



Shure Incorporated
222 Hartrey Avenue
Evanston IL 60202-3696 U.S.A.

UC UHF Wireless System

SERVICE MANUAL CHANGE NOTICE

UC4 DIVERSITY RECEIVER

Changes or corrections have been made to this service manual. Update your service manual by replacing the pages listed in the table below with the ones attached to this change notice.

CHANGES EFFECTIVE [DATE]

REMOVE these pages from your current manual	INSERT the following revised pages attached to this notice
Revision 1 pages: ALL	Revision 2 pages: ALL
Revision 2 pages: 14,15,19,20,21,22,26,27 and 30	Revision 3 pages:14,15,19,20,21,22,26,27 and 30

SERVICE MANUAL REVISION HISTORY

Release	Part Number	Date Code
Original	25A1045	RI
Revision 1	25B1045	SB
Revision 2	25C1045	TB
Revision 3	25C1045	TK

SHURE®

Service Manual

UC4 Diversity UHF Receiver

25C1045 (TK)

Characteristics

General

The Shure UC4 Diversity UHF Receiver is a microprocessor-controlled single diversity receiver operating in the 692 to 716 MHz and 774 to 862 MHz frequency range. The UC4 is used in mid-level installed sound, rental, and concert sound applications.

Controls and Connectors

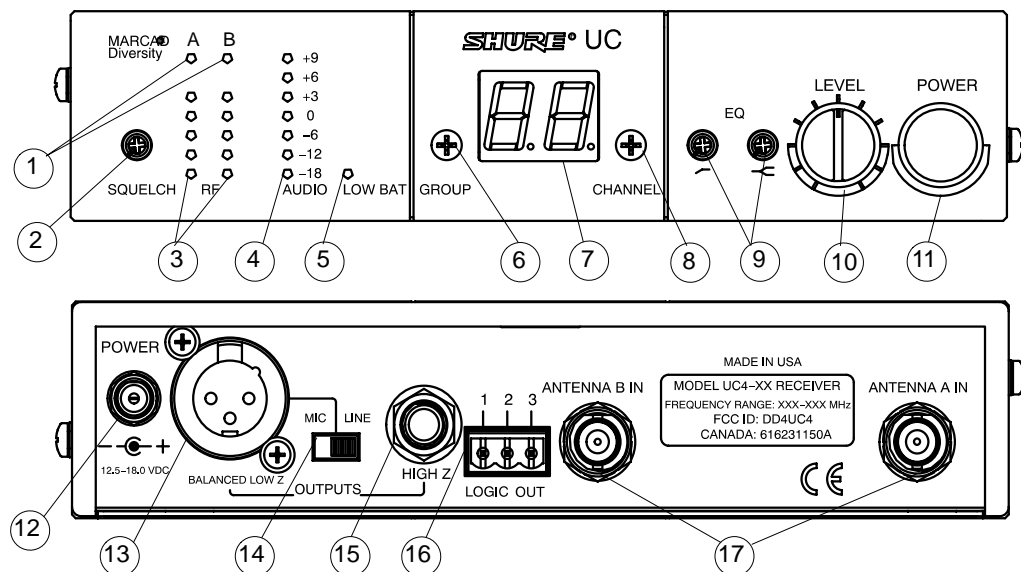

- | | |
|--|--|
| 1. Diversity Indicators | 10. Level (Volume) Control |
| 2. Squelch Control | 11. Power On/Off Switch |
| 3. Rf Level Indicators | 12. Power Input Connector |
| 4. Audio Level Indicators | 13. Balanced (LOW Z) Output Connector |
| 5. Low Transmitter Battery Indicator | 14. MIC/LINE Side Switch |
| 6. Group Rotary Switch | 15. Unbalanced (HIGH Z) Output Connector |
| 7. LED Display | 16. LOGIC OUT Connector |
| 8. Channel Rotary Switch | 17. Antenna Input Connectors |
| 9. Equalization (EQ) Adjustment Controls | |

Figure 1. UC4 Controls and Connectors

Service Note: Shure recommends that all service procedures be performed by a Factory-Authorized Service Center or that the product be returned directly to Shure Incorporated.

Licensing: Operation may require a user license. Frequency or power-output modifications may violate this product's approvals. Contact your country's communications authorities.

Circuit Description

The audio circuit and rf circuit description will describe only one channel because the other channel is identical for both. The local oscillator (LO) section is common for both channels and will be described separately.

Audio Section

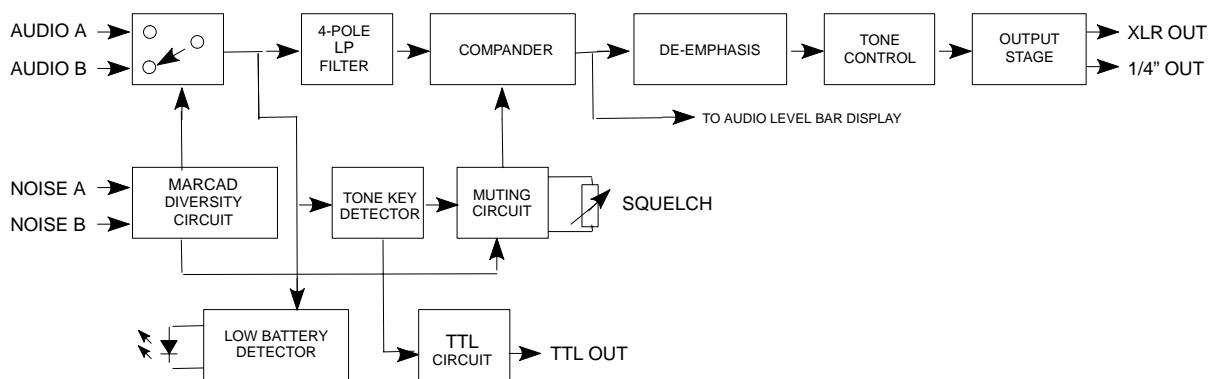

Figure 2. UC4 Audio Section Block Diagram

The audio for each channel comes from the appropriate channel detector output of the rf section. Each channel's audio then enters its own adjustable gain stage.

This adjustable gain stage is used to match the audio levels coming from each rf channel, as well as to set the correct level necessary for the compander.

From the gain stages, each channel enters an analog switch. Noise outputs also come from each channel detector outputs. Each noise output enters a bandpass noise filter that measures the 50 kHz noise present in the audio signal. The noise level is proportional to the signal-to-noise ratio of the channel.

In the MARCAD diversity system, a rectified version of the noise is sent to a bank of comparators. A version of the channel noise that is 6 dB less also enters the comparators.

The noise from one channel is compared to the noise from the other to make sure they are within 6 dB of each other. If the noise levels are within 6 dB of each other, the comparators send a logic high signal to the control of each channel's analog switch, allowing the audio to pass through.

If the noise levels are not within 6 dB of each other, the channel with a noise voltage 6 dB greater than the other channel is not allowed to pass through the analog switch; that is, the comparator puts a logic low signal on the control line for the analog switch.

Each channel's noise is also compared to an adjustable squelch level; a dc level. If either noise voltage is greater than the squelch threshold, it is shut off.

The outputs from the analog switches are connected together at the audio combining stage, a unity gain buffer stage where the audio from Channel A is combined with the audio from Channel B.

The output from this stage splits into three paths. The first path goes to a high Q tone key detection circuit. This is a crystal filter in which the level of tone key is converted to dc and compared against a fixed dc voltage.

The second path enters a low Q bandpass filter centered around 32 kHz. This filter is for low battery detection in the receiver. The lower Q allows for small frequency variation of tone key from various transmitters, without the large amplitude variations that the crystal filter would have. The filtered signal is then rectified and averaged. The dc that is obtained from this is amplified, triggering a comparator for the low battery LED display.

The third path is into the compander via a 24 kHz low-pass filter with a 32 kHz notch. The audio is expanded and de-emphasized here. The compander output then goes off the board to a high and low frequency equalization circuit.

A user-adjustable gain stage follows. The signal is then brought back to the main audio board, where it enters a balanced and unbalanced output stage. The balanced output can be set for either mic or line level, where the mic level is 30 dB down from the line level.

For the audio level meter, audio is tapped off from the 24 kHz filter's output and goes through a full wave precision rectifier and averaging circuit. This dc signal then enters a dc amplifier stage used to adjust levels for the LEDs.

The output from this stage drives the audio level meter on the front panel board. For the rf level meters, a dc voltage from the detector chip for the received signal strength indicator (RSSI) drives the bargraph IC on the front board.

Rf Section

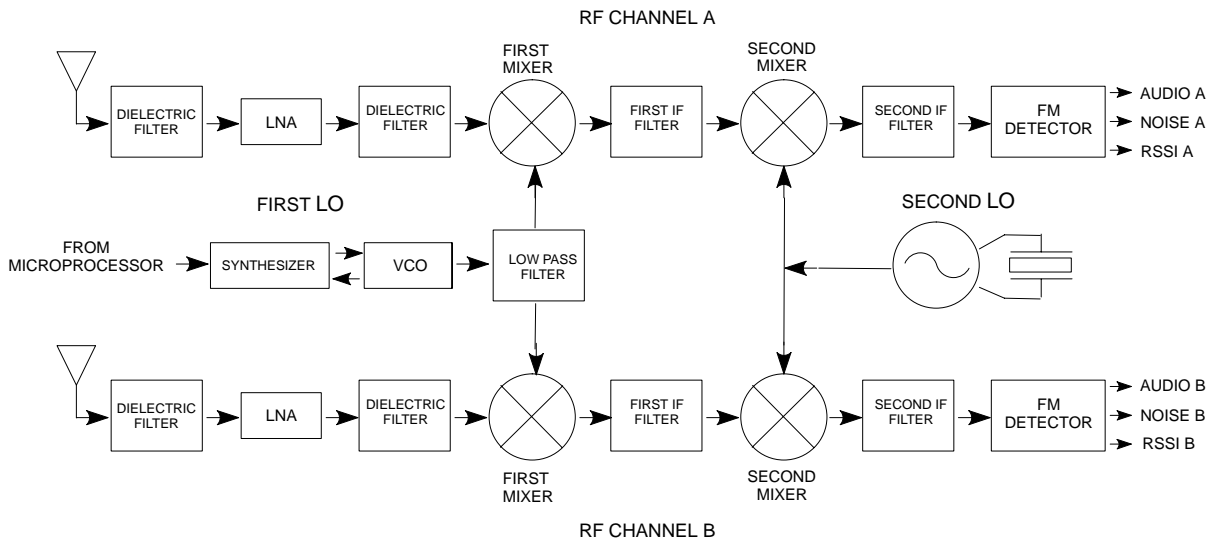

Figure 3. UC4 Rf Section Block Diagram

The rf input signal is provided from the antenna ports to the receiver by BNC connectors. Antenna port A is connected to J101 (channel A), and antenna port B is connected to J201 (channel B).

The rf circuit description will describe only one channel because the other rf channel is identical. The local oscillator (LO) section is common for both channels and will be described separately.

Rf Channel

The rf signal is pre-selected to the 782 – 806 MHz frequency range with two dielectric filters. The first dielectric filter is located between the antenna port and the low noise amplifier (LNA). The second filter is located between the LNA block and mixer input.

The LNA and the first mixer consist of a dual gate GaAs MOSFET. The first conversion gives the first intermediate frequency (IF) signal at 50 MHz.

The first IF signal is amplified with MMIC, band limited with a SAW filter, and then down-converted to the second intermediate frequency (IF) at 10.7 MHz with a second down-converter.

The second IF signal is filtered by 10.7 MHz ceramic filters and amplified by a 10.7 MHz pre-amp (Q105).

The 10.7 MHz signal goes to the second IF gain block with a detector. The audio output is buffered and then processed as stated in the audio section circuit description. The noise output is amplified to provide signal for the noise squelch circuitry. The Received Signal Strength Indication (RSSI) output of the detector drives the LEDs that are located on the receiver’s front panel.

Local Oscillator (LO)

The first local oscillator (LO) is common for channel A and channel B rf strips. The LO is a phase-locked loop (PLL) system.

The PLL consists of a prescaler/synthesizer, voltage-controlled oscillator (VCO), a loop filter, a VCO, an rf power divider, and a bandpass filter. The PLL limits the LO signal before injection to the first down converter, Q102 and Q202.

The prescaler receives the rf signal from the VCO via the coupling capacitor, C333. The output from the phase detector is connected to an external loop filter that controls the tuning voltage input to the VCO. The prescaler/synthesizer IC is a serial-programmable input IC. It receives the frequency programming data from the microprocessor, which is set by the user, as described in the digital circuit description.

Digital and Display Section

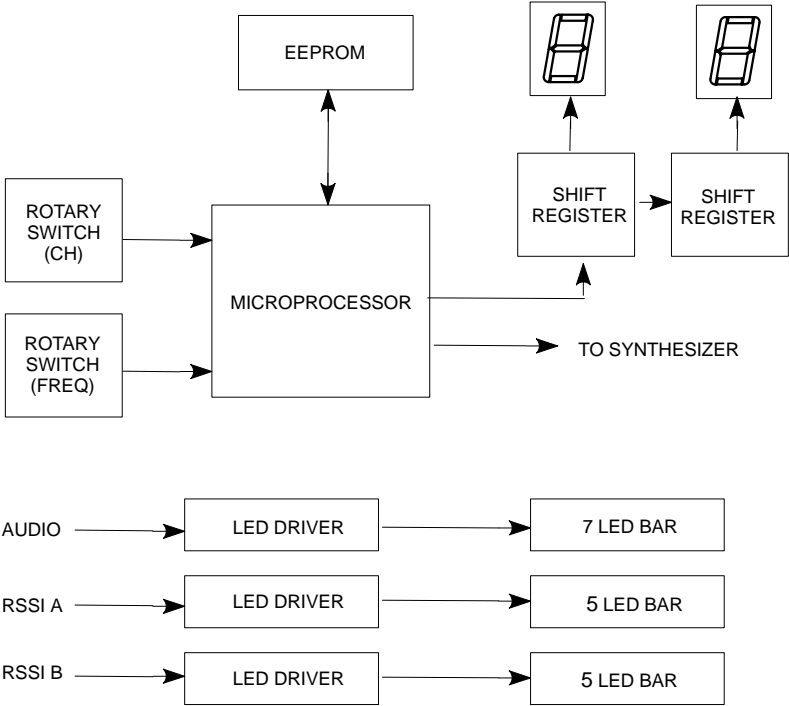

Figure 4. UC4 Digital and Display Section Block Diagram

Microcontroller

The microcontroller section consists of a U703 microcontroller and a two digit, seven segment, LED display.

The LED display indicates frequency in terms of compatible channels in a group. The LED display on the left indicates the current group. The LED display on the right indicates the channel. Each LED is capable of displaying digits 0 – 9. However, the channel LED also displays alpha letters A – F.

Serial shift registers, U705 and U705, latch the current LED display. A serial Load Enable (LE) signal of the display driver section is also shared with the rf interface section.

A 4.0 MHz oscillator, Y701, provides the operating frequency to the microcontroller. The oscillator circuit includes capacitors C702, C703, with the crystal oscillator, Y701.

Resistor R704, C704, and U702 make up the reset circuit. The microcontroller is reset if the supply voltage to it drops below 4.3 Vdc.

Memory

The memory section consists of U701, a non-volatile Electrically Erasable and Programmable Read Only Memory (EEPROM). The EEPROM stores the mapping of the compatible groups and channels with respect to rotary switch positions.

The microcontroller serially communicates with the memory via data and clock lines to read the frequency corresponding to the group and channel position. Write to the memory only occurs during factory programming. During normal usage, this memory is used as a look-up table only.

Resistors R702 and R703 allow in-circuit programming of the U701 EEPROM by letting data and clock lines be driven independently of the microcontroller port pin states. R701 is the pull-up resistor for the data line.

Audio / Rf Interface

The OUT ENAB signal gives the microcontroller the ability to mute the audio during turn on and off, and frequency changes.

The microcontroller sets the phase-lock loop (PLL) to the required signal using the DATA signal (U703, pin 12) to send the frequency initialization and set-up data. This data is clocked into the PLL by the microcontroller through the CLOCK signal (U703, pin 12) and the Load Enable (LE) signal (U703, pin 10). The LE signal loads the clocked data into a PLL's internal registers to initialize and set the frequency.

Rotary Switches for Frequency Selection

A 10-position group switch (S701) and a 16-position channel switch (S702) select the receiver frequency. The current position of these switches is displayed on the 7-segment LED display. Both rotary switches share the same U703 microcontroller port pins (3 through 6) for a multiplexed switch read operation.

The individual switches are selected by pins 7 and 8 of the U703 microcontroller. Resistors R705 through R708 are the pull-ups for switch position read. Dual diodes D701 through D704 isolate the switches during multiplexed read operation.

The multiplexed scheme to read switches does not allow switch change detection based on interrupts. Also, the switches cannot be constantly scanned to determine changes because the scanning frequency is in audio range, which makes it hard to filter out.

In a steady state, the switch common pins are inputs to pins 7 and 8 of the U703 microcontroller, while pins 3 through 6 of the microcontroller are outputs. In this state, pins 4, 5, and 6 are held low which pin 3 is held high. This forces the logic high level on switch common pins if the switches are set on odd positions. For even position settings, the contact on pin 1 is open from the switch common pin, and the internal pull-down resistors force logic low to the U703 microcontroller, pins 7 and 8.

Any switch change is done by state toggle from odd to even, or vice versa. Only this change is detected and followed by a multiplexed switch read. In this case, U703 microcontroller pins 7 and 8 selectively become grounded outputs to read the selected switch's state on pins 3 through 6.

A multiplexed switch read is preceded by an audio mute. The receiver audio is muted to allow a quiet change to another frequency.

Power Switch Interface

When a receiver is switched off, the MT signal goes to logic low on U703, pin 19. This interrupts the microcontroller to immediately mute the audio so that the receiver turns off without any audio pop.

Notes

This page intentionally left blank.

Functional Test

Verify operation and reported malfunction, referring to the product User's Guide for a description of the unit as well as information on its operation, troubleshooting, and technical data.

Disassembly and Assembly



Disassembly

Top Cover Removal

1. Remove two screws and washers each from the top, left, and right sides of the receiver (6 screws).
2. Slide the top cover off of the receiver to expose the circuit boards.

Front Panel Removal

1. Pull up on the top two tabs to partially release the front panel from the chassis.
2. With a thin tool and the unit upside down, pry the front panel away from the chassis at the two slots located on the bottom of the front panel.
3. With the front panel disengaged from the chassis, carefully pull the front panel away from the chassis.

Printed Circuit Board Removal

1. Pull the power knob off the power switch.
2. Disengage the front four standoffs from the chassis by pinching the standoff ends, which will free the front circuit board.
3. Except for the dc power receptacle, remove all screws, nuts, and washers from the back of the unit.
4. Unplug the connector between the dc power receptacle and the circuit board.
5. Remove the remaining five screws that secure the circuit board.
6. Raise the front of the circuit board to clear the chassis; then move the circuit board forward to free the rear components and lift the circuit board out.

Reassembly

1. Insert the rear circuit board components into their mating chassis holes, and lower the circuit board into its correct position.
2. Secure the circuit board with the previously removed screws.
3. Plug in the connector between the dc power receptacle and the circuit board.
4. Replace all previously removed screws, nuts, and washers to the back of the unit.
5. Snap the front circuit board with standoffs into the chassis front.
6. Push the power knob in to snap it back onto the power knob shaft.
7. Line up the front panel, and push the front panel toward the chassis. Make sure the ribbon cables are positioned to clear light pipes.
8. Latch both bottom and top tabs to the front of the chassis.
9. Slide the top cover onto the chassis until the cover is tight against the front panel.
10. Secure the top cover with the previously removed screws.

Service Procedures

Reference Material

Refer to the *Service Equipment Manual* for standard test equipment.

Optional Modification

“F” Version (Or Later) Printed Circuit Boards (pcbs)

The UC4 can be modified to match different gain structures required by different Shure UHF transmitters. There are two types of gain structure in the UC4 in which one has more gain in the output stage and in the audio LED circuitry. The UC4 can work with a U-series transmitter, although the battery meter circuitry is not compatible between systems. The modification in the table below alters the UC4 audio and LED gain.

To modify different UC receivers, check the label on the UC4 and add or remove parts according to the following table:

PCB Label	Reference Designator	Place for Use with UC Transmitter Group A	Place for Use with UC Transmitter Group B,C,D,E	Place for Use with U-series Transmitters
LED	R602	X		X
LED	R647		X	
GAIN	R651		X	
GAIN	R648		X	
GAIN	R649		X	
GAIN	D604		X	

These modifications can only be done on “F” version (or later) pcbs.

Measurement Reference

dBu is a measure of *voltage*, and dBm is a measure of *power*.

For example, the HP8903 should be labeled dBu instead of dBm because it is a voltage measurement. These two terms are often used interchangeably even though they have different meanings.

Audio levels in dBu are marked as dBm on the HP8903.

dB Conversion Chart	
0 dBV	= 2.2 dBu
0 dBu	= 0 dBm, assuming the load = 600 Ω

Test Equipment

Most test equipment needed is described in the Shure *Wireless Service Equipment Manual*. The following test equipment (or approved equivalent) is also needed.

Table 1
Test Equipment

Equipment Type	Model
Audio analyzer	*Hewlett-Packard 8903B
Digital multimeter	Fluke 87
Rf signal generator	Hewlett-Packard 8656B
Frequency counter	Hewlett-Packard 53181A
Spectrum analyzer	Hewlett-Packard 8591
Shure UC transmitter	Shure UC1 / UC2

*Audio levels in dBu are marked as dBm on the HP8903B.

Test Equipment Set-Up

The alignment procedure is sequential and does not change, unless specified.

1. Use RG58 or any low loss, 50 Ω cables for all rf connections.
2. Keep the test cables as short as possible.
3. Include the insertion loss of the cables and connectors for all rf measurements.
4. Dc voltages may be present at rf test points. As a precaution, use dc blocks to protect the test equipment

Test Set-Up

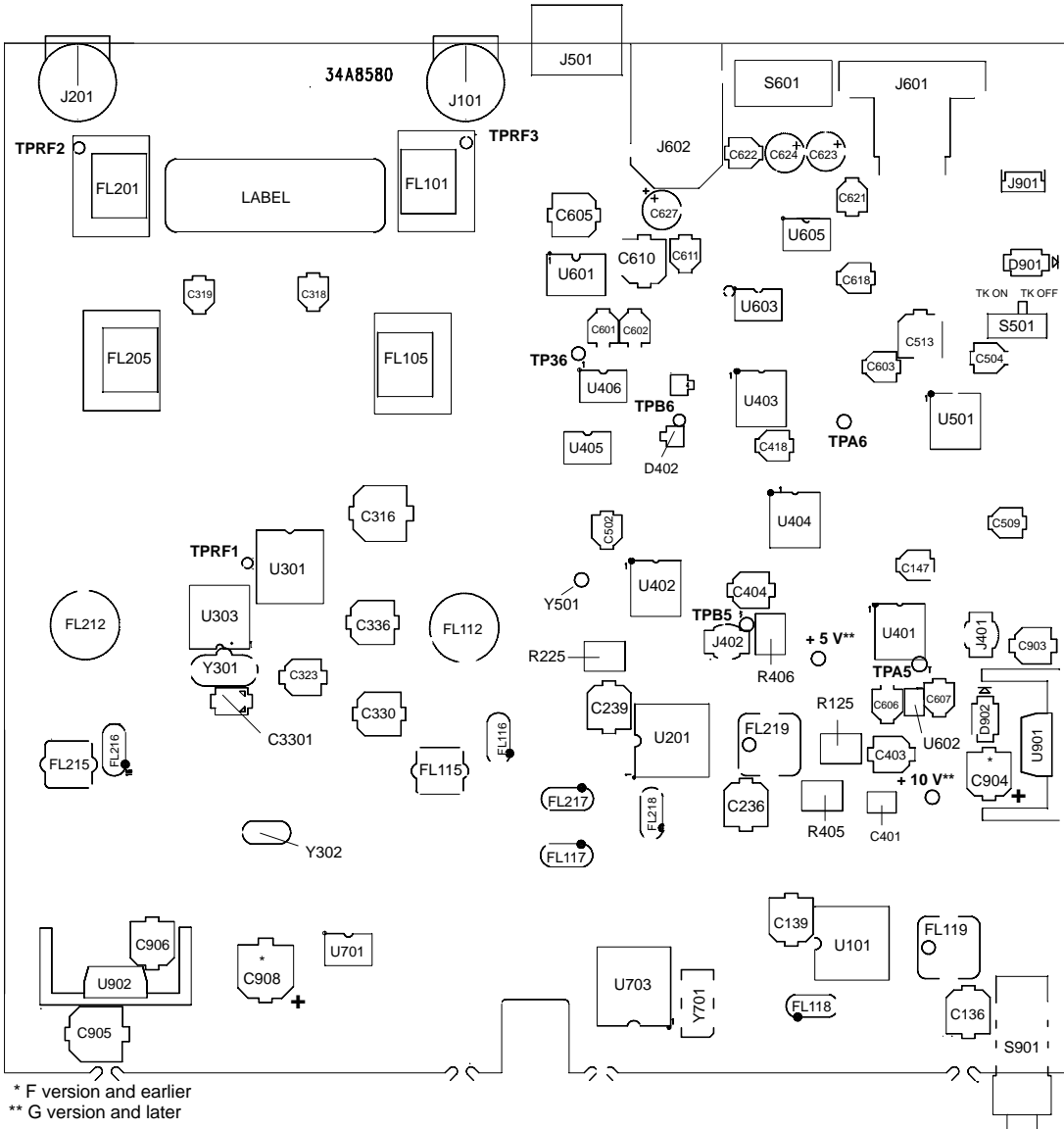

Figure 5. UC4 Major Test Component Locations

1. Install the receiver antennas.
2. Set the receiver to any unused frequency in the area. Select a television channel that is inactive in the area and then scan for a frequency at which the yellow LEDs are not lit. Note this as the operating frequency, "f 0".
3. Remove the top cover from the receiver.

Table 2 lists the group and channel switches, and the operating frequencies for all the tests that follow.

*Table 2
Group Carrier Frequencies
(in order by carrier frequency)*

Group	Group Code	Group Switch (S302)	Channel Switch (S301)	Operating Frequency "f 0" (MHz)
UA	A	8	8	798.125
UB	G	8	8	707.625
MB	B	8	8	808.375
MC	F	8	8	779.500
MD	B	8	8	808.500
JB	D	3	3	807.375
KK	E	8	8	847.500

Alignment

1. Connect the UC4 receiver as shown below in Figure 6.
2. Connect the rf signal generator EXT modulation input to the audio analyzer output.
3. Set the rf signal generator for external FM.
4. Set the audio analyzer's output impedance to 50 ohms and adjust audio signal amplitude in small increments until both the HI EXT and LO EXT lights on the rf signal generator turn off.
5. Engage the audio analyzer's 400 Hz high-pass and 30 kHz low-pass filters.
6. Set the rf signal generator deviation as given in table below.
7. Turn the volume potentiometer full clockwise (maximum).
8. Set the Group select switch (red knob) according to Table 2.
9. Set the Channel select switch (black knob) according to Table 2.
10. Set the low EQ full clockwise and set high EQ to mid-range.
11. Set the squelch to mid-range.
12. Set the MIC / LINE output switch to LINE.
13. Apply 15 Vdc to the power input of the receiver.
14. Turn the tone key switch to OFF.

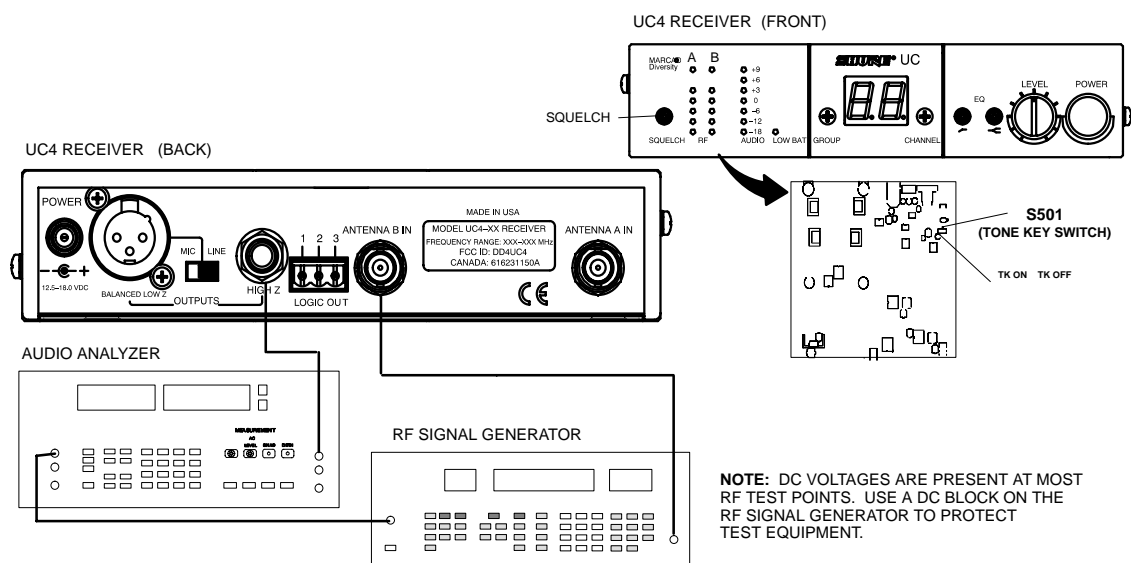

UC4 Receiver		Audio Analyzer		Rf Signal Generator	
Output:	Unbalanced	Measurement:	AC level	EXT:	FM
Gain:	Maximum	Output amplitude:	1.43 V	INT:	OFF
Squelch:	Mid	Frequency:	1 kHz	Output amplitude:	-108 dBm
Tone Key (S501):	OFF	Filters:		Frequency:	See Table 2
Group switch:	See Table 2	Low-Pass (30 kHz):	ON	Deviation:	
Channel switch:	See Table 2	High-Pass (400 Hz):	ON	UA,UB,MB,MC,MD:	45 kHz
				JB:	27.7 kHz
				KK:	15 kHz

Figure 6. Alignment Test Set-Up

Power Section

Checking the dc power will insure the correct dc biasing is applied to the operating circuits.

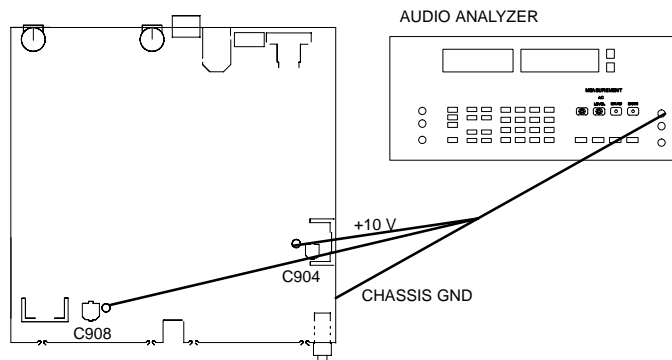

UC4 Receiver		Audio Analyzer	
Power:	ON (+15 Vdc)	Connect + :	F version and earlier: C904 (+ side) C908 (+ side) G version and later: +10 V +5 V
Operating freq:	See Table 2	Connect - :	GND (chassis)

Figure 7. UC4 Power Section Test Set-Up

1. For “F” and earlier pcb versions, measure +10.0 Vdc \pm 0.2 Vdc at the + side of C904 (10 V regulator out).

For “G” and later pcb versions, measure +10.0 Vdc \pm 0.2 Vdc at the test pad labeled + 10 V.

2. For “F” and earlier pcb versions, measure +5.0 Vdc \pm 0.2 Vdc at the + side of C908 (5 V regulator out).

For “G” and later pcb versions, measure +5.0 Vdc \pm 0.2 Vdc at the test pad labeled + 5 V.

3. Measure the dc current drain from +15 V supply with the amp meter. It should be less than 500 mV.

Local Oscillator

Performing the local oscillator alignment insures that the unit is fine-tuned to the operating frequency selected by the user. Adjusting C3301 controls the voltage-controlled oscillator (VCO) tuning voltage and the synthesizer reference frequency.

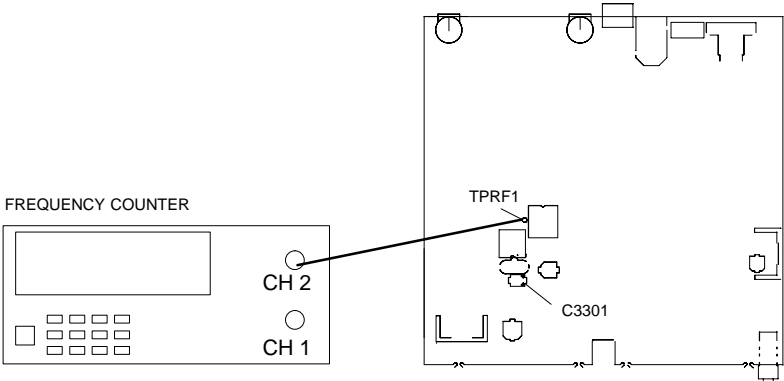

UC4 Receiver		Frequency Counter	
Power:	ON (+15 Vdc)	Operating freq:	See Table 2
Operating freq:	See Table 2	Connect CH 2:	TPRF1 and GND
Channel switch:	See Table 2		
Group switch:	See Table 2		

Figure 8. UC4 Local Oscillator Test Set-Up

1. Use a BNC to rocket cable or a shield test lead to attach a spectrum analyzer or frequency counter to TPRF1. (Remove sheild top cover to access test point TPRF1.)
2. Adjust C3301 for $(f_0 + 50 \text{ MHz}) \pm 5.0 \text{ kHz}$. If using a spectrum analyzer, adjust the span so the frequency accuracy measurement is better than 5 kHz. (Refer to the instrument manual.)

Rf Alignment

Channel A and B rf alignments are performed to increase the input signal strength of the receiver and filter out noise.

Tuning FL115 and FL215 maximizes the rf sensitivity (input signal strength). Tuning FL119 and FL219 minimizes the fm detector's total harmonic distortion (THD).

Rf Channel B

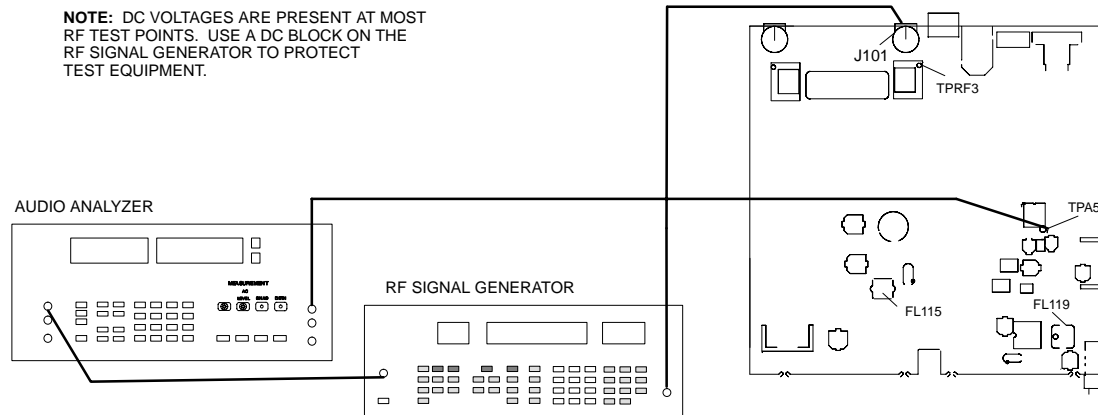

UC4 Receiver		Audio Analyzer		Rf Signal Generator	
Output:	Unbalanced	Measurement:	SINAD/LOG-LIN DISTN/RATIO	EXT:	FM
Gain:	Maximum	Output amplitude:	1.43 V	INT:	OFF
Squelch:	Mid	Frequency:	1 kHz	Output amplitude:	-106 dBm
Tone Key (S501):	OFF	Filters:		Frequency:	See Table 2
		Low-Pass (30 kHz):	OFF		
		High-Pass (400 Hz):	OFF		
		A weighting	ON		

Figure 9. UC4 Rf Alignment Channel B Test Set-Up

1. Connect the rf signal generator to J101 (TPRF3).
2. Set the rf signal generator amplitude output to -106 dBm.
3. Measure the audio at TPA5 and adjust FL115 for maximum signal-to-noise (SINAD). The typical level is 12.0 dB; the lower limit is 8.0 dB. Press the SINAD and LOG-LIN buttons for this measurement in dB.
4. Turn off the A weighting filter and turn on the 30KHz and 400Hz filters on the audio analyzer. Set the rf signal generator to -60 dBm and adjust FL119 for minimum total harmonic distortion (THD) at TPA5 ($\leq .7\%$). Press the DISTN button for this measurement in percentage.
5. Turn off the 30KHz and 400Hz filters and turn on the A weighting filter. Set the rf signal generator back to -106 dBm and make sure that the SINAD is still greater than 8.0 dB at TPA5. Press the SINAD and LOG-LIN buttons for this measurement in dB.

Rf Channel A

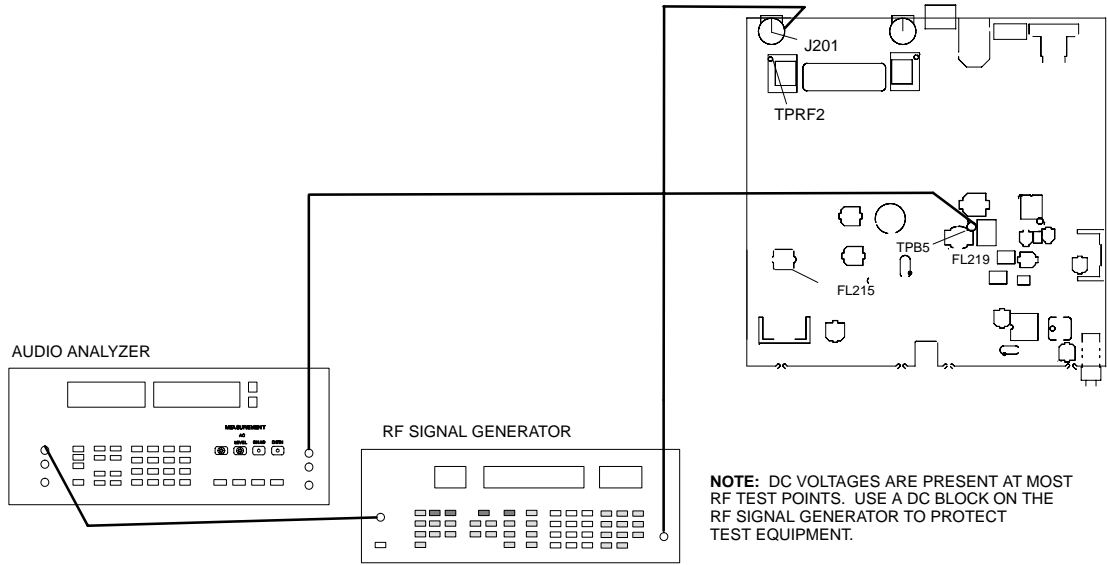

UC4 Receiver		Audio Analyzer		Rf Signal Generator	
Output:	Unbalanced	Measurement:	SINAD/LOG-LIN DISTN/RATIO	EXT:	FM
Gain:	Maximum	Output amplitude:	1.43 V	INT:	OFF
Squelch:	Mid	Frequency:	1 kHz	Output amplitude:	-106 dBm
Tone Key (S501):	OFF	Filters:		Frequency:	See Table 2
Group switch:	See Table 2	Low-Pass (30 kHz):	ON	Deviation:	
Channel switch:	See Table 2	High-Pass (400 Hz):	ON	UA,UB,MB,MC,MD:	45 kHz
		A weighting:	ON	JB:	27.7 kHz
				KK:	15 kHz

Figure 10. UC4 Rf Alignment Channel A Test Set-Up

1. Connect the rf signal generator to J201 (TPRF2).
2. Set the rf signal generator amplitude output to -106 dBm.
3. Measure the audio at TPB5 and adjust FL215 for maximum signal-to-noise (SINAD). The typical level is 12.0 dB; the lower limit is 8.0 dB. Press the SINAD and LOG-LIN buttons for this measurement in dB.
4. Turn off the A weighting filter and turn on the 30KHz and 400Hz filters on the audio analyzer. Set the rf signal generator to -60 dBm and adjust FL219 for minimum total harmonic distortion (THD) at TPB5 ($\leq .7\%$). Press the DISTN button for this measurement in percentage.
5. Turn off the 30KHz and 400Hz filters and turn on the A weighting filter. Set the rf signal generator back to -106 dBm and make sure that the SINAD is still greater than 8.0 dB at TPB5. Press the SINAD and LOG-LIN buttons for this measurement in dB.

Audio Alignment

Audio alignment insures that the compressor output in the transmitter exactly matches the expander input in the receiver. If these do not match, mistracking occurs and the audio signal between the transmitter output and the receiver input does not have the same characteristics.

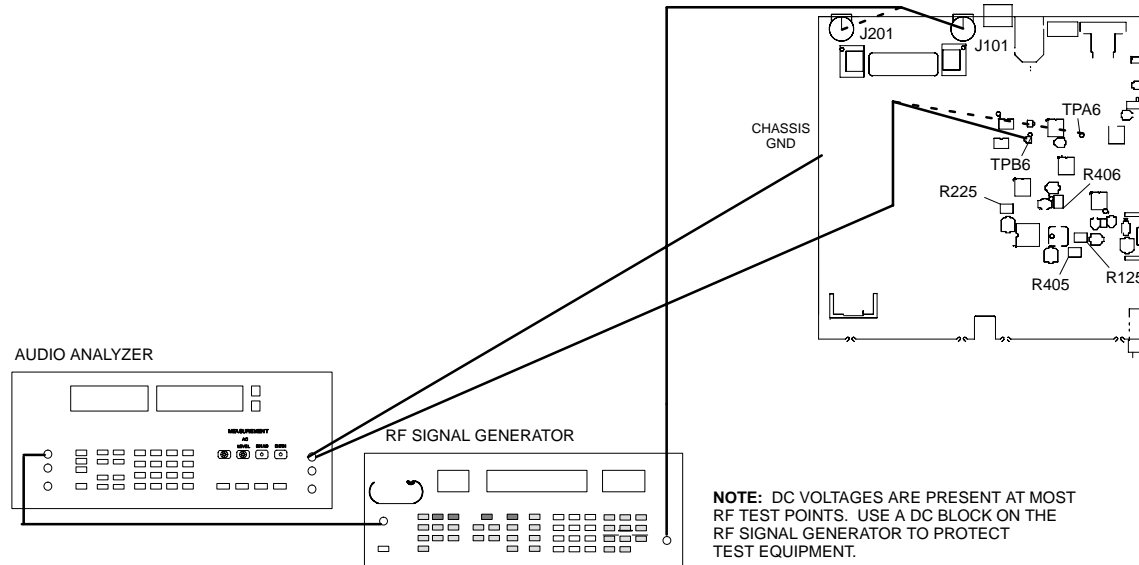

UC4 Receiver		Audio Analyzer		Rf Signal Generator	
Output:	Unbalanced	Measurement:	DC level, dB or mV	EXT:	FM
Gain:	Maximum	Output amplitude:	1.43 V	INT:	OFF
Squelch:	Mid	Frequency:	50 kHz	Output amplitude:	-60 dBm
Tone Key (S501):	OFF	Filters:		Frequency:	See Table 2
Group switch:	See Table 2	Low-Pass (30 kHz):	ON	Deviation:	
Channel switch:	See Table 2	High-Pass (400 Hz):	ON	UA,UB,MB,MC,MD:	45 kHz
				JB:	27.7 kHz
				KK:	15 kHz

Figure 11. UC4 Audio Alignment Test Set-Up, part 1

1. Connect the audio analyzer to the external modulation input of the rf signal generator.
2. Set the input measurement of the audio analyzer for AC level and turn on the 30KHz and 400Hz filters.
3. Set the rf signal generator to -60 dBm and 45 kHz deviation externally modulated with 50 kHz tone from the audio analyzer output.
4. Apply an rf signal to the channel A antenna port (J201).
5. Put the positive (+) terminal of the dc voltmeter on TPB6, and the negative (-) terminal to any rf chassis ground.
6. Adjust R225 for 6.00 Vdc \pm 0.03 V for raw PCB 34A8580G and earlier. Adjust R225 for 2.5 Vdc \pm 0.03 V for raw PCB 34A8580H and later. **Note** this raw PCB number is printed on the rear of the main PCB between the the antenna connectors.

7. Apply the rf signal to the antenna port of channel B (J101).
8. Put the positive (+) terminal of the dc voltmeter on TPA6, and the negative (-) terminal to any rf chassis ground.
9. Adjust R125 for 6.00 Vdc \pm 0.03 V for raw PCB 34A8580G and earlier. Adjust R125 for 2.5 Vdc \pm 0.03 V for raw PCB 34A8580H and later. **Note:** this raw PCB number is printed on the rear of the main PCB between the the antenna connectors.

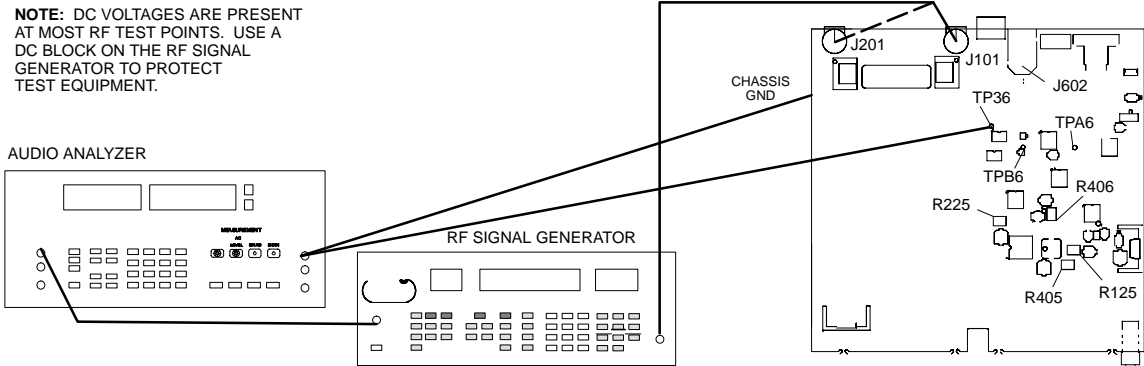

UC4 Receiver		Audio Analyzer		Rf Signal Generator	
Output:	Unbalanced	Measurement:	AC level, dB or mV	EXT:	FM
Gain:	Maximum	Output amplitude:	1.43 V	INT:	OFF
Squelch:	Mid	Frequency:	1 kHz	Output amplitude:	-60 dBm
Tone Key (S501):	OFF	Filters:		Frequency:	See Table 2
Group switch:	See Table 2	Low-Pass (30 kHz):	ON		
Channel switch:	See Table 2	High-Pass (400 Hz):	ON		

Group	Group Code	Tuning Deviation (kHz)	TP36 (dBu \pm 0.1 dB (mV))
UA	A	45	-6.8 (354)
UB	G	45	-6.8 (354)
MB / MD	B	45	-6.8 (354)
MC	F	45	-6.8 (354)
JB	D	27.7	-8.5 (292)
KK	E	15	-15.3 (133)

Figure 12. UC4 Audio Alignment Test Set-Up, part 2

1. Set the audio analyzer frequency to 1 kHz and readjust the amplitude to the reading given in the table above.
2. Put the positive (+) terminal of an RMS ac voltmeter in the audio analyzer on TP36, and the negative (-) terminal to any rf chassis ground.
3. Adjust R405 for the reading given in the table above.
4. Apply the rf signal back to channel A.
5. Adjust R406 until the ac voltmeter gives the reading in the table above.
6. Set the UC4 balanced output to line level using the Mic/Line switch.
7. Measure the audio level at the balanced line-level output using the following table:

Shure UC4 Diversity Receiver

Group	Group Code	Deviation (kHz)	1 kHz Audio Balanced Output	1 kHz Audio Unbalanced Output
UA	A	30	+6.7 dBu ± 2.0 dB	+0.2 dBu ± 2.0 dB
UB	G	30	+6.7 dBu ± 2.0 dB	+0.2 dBu ± 2.0 dB
MB, MD	B	10	-11.6 dBu ± 2.0 dB	-18.1 dBu ± 2.0 dB
MC	F	10	-11.6 dBu ± 2.0 dB	-18.1 dBu ± 2.0 dB
JB	D	10	+7.3 dBu ± 2.0 dB	+0.8 dBu ± 2.0 dB
KK	E	10	-9.7 dBu ± 2.0 dB	-16.2 dBu ± 2.0 dB

8. Turn the tone key switch back ON.

Product System Specifications

After tuning, the unit should meet the following specifications.

RF Carrier Frequency Range

774–862 MHz (782–806 MHz for U.S. models).

Working Range

152.4 m (500 ft), minimum, under typical conditions; 487.6 m (1600 ft) line of sight. Actual working range depends on rf signal absorption, reflection, and interference

Audio Frequency Response

The audio output level at 100 Hz should be + 8.5 dB \pm 2 dB relative to the 1 kHz level.

The audio output level at 10 kHz should be – 18.5 dB \pm 2 dB relative to the 1 kHz level.

Modulation

\pm 45 kHz deviation compressor-expander system with pre-and de-emphasis (domestic models only; international models may vary).

Dynamic Range

>100 dB, A-weighted

Receiver Audio Output Level (Maximum)

+5 dBu typical, unbalanced output
+14 dBu typical, balanced output

Rf Sensitivity

–108 dBm at 12 dB SINAD

Image Rejection

90 dB typical

Spurious Rejection

70 dB typical
Ultimate Quieting (ref. 45 kHz deviation)
>100 dB, A-weighted

Audio Polarity

Positive pressure on microphone diaphragm (or positive voltage applied to tip of WA302 phone plug) produces positive voltage on pin 2 with respect to pin 3 of low impedance output and the tip of the high impedance 1/4-inch output

System Distortion

(ref. \pm 45 kHz deviation, 1 kHz modulation)
0.4% Total Harmonic Distortion typical

Power Requirements

15 Vdc , 600 mA 50/60 Hz

Power consumption: 600 mA x 15 V, maximum

Transmitter battery life (typical): 8 hours
(with Duracell MN1604 9V alkaline battery)

Bench Checks

Set-Up

Dc voltages are present at most rf test points. Use dc blocks to protect the test equipment, if necessary.

Use RG58 or any other low loss 50 Ω cables for all rf connections. Keep the test cables as short as possible. Include insertion loss of cables and connectors when making rf measurements. The following is an example of a bench check procedure for the UC4–UA. For all other UC4 models substitute respective settings and measurement values found in the alignment procedures.

786.250 MHz will be used as the operating frequency (“f 0”) in the following procedures.

- ✔ Set the Group and Channel switches to 0.
- ✔ Use the following settings:

Squelch:	Center
Low Frequency Control:	Maximum
High Frequency Control:	Center
Volume:	Maximum
- ✔ Set the MIC / LINE switch to LINE position.
- ✔ Set the tone key switch (S501) to OFF.
- ✔ Apply an rf signal of 786.250 MHz to J201 (CHA antenna jack) at a level of –60 dBm. FM modulate the carrier 45 kHz with 1 kHz audio.

No Power

- ✔ With the power supply connected, verify +15 V \pm 1 V, as labeled on the pcb. If this voltage is incorrect, try another power supply.
- ✔ If +15 V is correct, verify regulated +10 V and +5 V. If these are incorrect, check the surrounding regulator circuitry for solder shorts, solder deficiencies, backward diodes and capacitors. If this is inconclusive, replace the corresponding regulator.

No Audio

- ✔ Check for audio at the detector output, U201, pin 15. If there is no audio there, the problem is in the rf section.
- ✔ If audio is detected and the audio LEDs are lit, the problem is occurring after the expander, U601. Follow the audio path from this point until the point of discontinuity is found and replace the corresponding part (s).

- ✓ If audio is detected and the audio LEDs are NOT lit, there are two possibilities. Either there is a break in the audio chain somewhere between the detector (U201) and the expander (U601), or the audio muting circuitry is engaged.

No Rf

- ✓ Check for the first intermediate frequency (IF) signal at the output of the SAW filter (FL112/FL212, pin 1). If there is no 50 MHz IF signal, check to see if the first LO frequency at TPRF1 is $f_0 \pm 50$ MHz.
- ✓ If the first LO frequency at TPRF1 is NOT correct, there are three possibilities: the voltage controlled oscillator (VCO) is bad; synthesizer failure; or a microprocessor problem.
- ✓ If the first LO frequency at TPRF1 is correct, trace the front-end amplifier (Q101/Q201), the first mixer (Q102/Q202), and the first IF amplifier (U103/U203).
- ✓ If the 50 MHz first IF signal is present, check the 10.7 MHz second IF at the input of the FM detector (U101/U201, pin 1).
- ✓ If there is no 10.7 MHz signal, check the second LO frequency at TPA9/TPB9.
- ✓ If the second LO frequency is NOT present, check the crystal, Y302, and the second LO circuitry.
- ✓ If the second LO frequency is correct, check the second mixer (Q104/Q204) and the second IF amplifier (Q105/Q205).
- ✓ If there is a 10.7 MHz signal at the input of the FM detector, check the FM detector IC (U101/U201) and the surrounding parts. Replace them, if necessary.

Replacement Parts and Drawings

Product Changes

Five variations of the Shure UC4 Diversity Receiver are available.

*Table 3
UC4 Model Variations
(in order by frequency)*

Country Code	Frequency Range	Country Designation	PCB #
UA	782–806 MHz	U.S.A. and Canada	90UA8793
UB	692–716 MHz	U.S.A.	90UB8793
MB	800–830 MHz	Europe	90MB8793
MC	774–782 MHz	Netherlands	90MC8793
MD	800–820 MHz	Scandinavia	90MD8793
JB	806–810 MHz	Japan	90JB8793
KK	838–862 MHz	United Kingdom	90KK8793

Parts Designations

The following comments apply to the parts list and the schematic:

Resistors: Unless otherwise noted, all resistors are surface-mount with $\frac{1}{10}$ W rating and 1% tolerance.

Capacitors: Unless otherwise noted, non-polarized capacitors are surface-mount NPO dielectric types with a 100 V capacity and a 5% tolerance, and polarized capacitors are tantalum types.

Table 4
Replacement Parts

Reference Designation	Description	Shure Part Number
A1	Cable/connector assembly, dc	90B8688
A2	Front panel assembly	90A8765
A3	Front panel and lens assembly	90A8810
MP1	Metal chassis	53A8506
MP3	Top Cover	53A8474
MP4	Front panel	65A8305
MP5	Gasket	36A8076
MP6	Knob, power	65A8302
MP7	Knob, volume	90A8764
MP8	Lens	65A8309
MP9	Light pipe	65A8306
MP10	RF cover shield	53A8467
MP11	Screws, hardware	RPW626
MP12	Long rack mounting bracket	53A8481
MP13	Short rack mounting bracket	53A8459
MP14	Link bar (for mounting two UC4's together)	31A8138

Table 5
PCB Assembly Parts

Reference Designation	Description	Shure Part Number
C333	Capacitor, 100 V, 8.2 pF	150DB828CA
C623,624,627	Capacitor, electrolytic, 47 x 63 V	86BE629
C3301	Capacitor, trim	152D02
D401,402,403,404,407, 408,409,410,501,502, 503,601,602,905	Diode, dual switching	184A08
D405,406,811,812, 813,814	LED, green	184E18
D504,817	LED, red	184A18
D603,701,702,703,704	Diode, dual switching, SMD, SOT-23, 1 V	184A07
D701,702,703,704	Diode, dual switching	184A07
D705	LED display	86A8442
D801,802,803,804, 805,806,807,808,809, 810,815,816	LED, yellow	184D18
D901,902	Diode, power, rectifier, silicon, 1.1 V	184A20
DZ999	Surge suppressor	184A34
FL101,105,201,205	Filter, dielectric (See table 6)	*140-07
FL102,107,202,302,303	Inductor, 15 nH SM	162N06
FL103,108,203,207,208	Inductor, 22 nH SM	162S06
FL104,204	Inductor, 8.2 nH SM	162W10
FL106,206	Inductor, 18 nH SM	162M06
FL109,209	Inductor, 470 nH SM	162V06
FL111,211	Inductor, 330 nH SM	162W06
FL112,212	Filter, saw	80A8195
FL113,213,305,306	Inductor, 220 nH SM	162C06
FL114,214	Inductor, 390 nH SM	162Y06
FL115,215	Coil, tunable	82A8005
FL116,117,118,216, 217,218	Filter, ceramic	86A8971
FL119,219	Coil, quadrature	82A8004
FL301	Filter, low pass (See table 7)	*162-17
FL304	Inductor, 150 nH SM	162E06
J101,201	BNC jack, pcb mount, 50 Ω	95A8631
J401,402	Pin jack	95A8278
J501	Header, block, 3 pin	95A8579
J601	Connector, XLR	95A8598
J602	1/4" Jack, phone	95A8104
J901	Header	95A8272

Reference Designation	Description	Shure Part Number
L101,102,103,104,105, 201,202,203,204,205,301, 302,303,304,305,306,307, 308,501,502,601,602,603, 604,903	Ferrite Bead	162A12
L152,252,352,353	Inductor	162N06
L153	Inductor	162L06
L154,254	Inductor	162W10
L156,256	Inductor	162M06
L157,253,257	Inductor	162S06
L159,259	Inductor	162V06
L163,263	Inductor	162W06
L164,264	Inductor	162Y06
LF901,902	Ferrite Bead	162A30
Q101,102,104, 201,202,204	Transistor, Dual Gate GaAs MESFET N	183A12
Q103,203	Microwave Isolator	183A37
Q105,205,301,302	Transistor, NPN	183A17
Q303,304,305	Transistor, NPN	183A14
Q306,502,503,504	Transistor, NPN	183A24
Q603,604,605,606	Transistor, SMD, SOT-34, FET, TMOS	183A30
R125,225,405,406	Potentiometer, trim, 5 k	146D02
R4401,6602	Potentiometer, 100 k	46D8048
R6601	Potentiometer, 10 k	46A8048
R6603	Potentiometer, 10 k	46A8069
S501	Tone key Switch, slide	55A168
S601	Mic/Line Switch, slide, DPST	55A8061
S701	Group Switch	55B8121
S702	Channel Switch	55A8121
S901	Power Switch	55A8062
U101,201	Quad Detector, SMT, FM, IF	188A190
U103,203	IC amp, monolithic microwave	183A37
U301	VCO (See table 6)	*187-04
U302,602	Regulator, 5 V 180 mA	188A115
U303	Serial Input PLL Freq Synthesizer	188A265
U401,402	IC Quad Op Amp	188A49
U403,501	IC Quad Comparator, ultra-low power	188A123
U404	IC quad switch / multiplexer	188A19
U405,406,603,604,605	IC amp, dual op	188A18
U601	IC Compandor, low voltage	188A126
U702	Under Voltage Reset	188C210

Shure UC4 Diversity Receiver

Reference Designation	Description	Shure Part Number
U704,705	8 Bit Serial in Parallel Out Shift Register	188A216
U801,802,803	Bargraph, Linear Display Driver	188A86
U804	Comparator, Dual Voltage SM	188A136
U901	Voltage Regulator, 10 V, 1 A	86A8918
U902	Voltage Regulator, IC	86B8930
Y301	Crystal, 24.0 MHz, XTAL	40A8016
Y302	Crystal, 60.7 MHz, XTAL	40A8013
Y501	Crystal, 32.768 kHz, XTAL	40A8010
Y701	Crystal, 4.0 MHz	140A005

*See Frequency Dependent Table, below.

*Table 6
Frequency Dependent Parts,
By Country Code*

Reference Designation	MC 774–782 MHz	UA 782–810 MHz	MB/MD 800–830 MHz	JB 806–810 MHz	KK 838–862 MHz	UB 692–716 MHz
FL101,105, 201,205	140E07	140A07	140D07	140C07	140F07	140G07
U301	187A04	187A04	187C04	187A04	187B04	187D04

*Table 7
Frequency Dependent Parts,
By Printed Circuit Board Code*

Reference Designation	F 774–782 MHz	A 782–810 MHz	B 800–830 MHz	D 806–810 MHz	E 838–862 MHz	G 692–716 MHz
FL301	162A26	162A26	162B26	162A26	162B26	162A06
R602	not placed	145BJ000	not placed	145BJ000	not placed	145BJ000
R647	145BJ000	not placed	145BJ000	not placed	145BJ000	not placed
R651	145BJ000	not placed	145BJ000	not placed	145BJ000	not placed

*Table 8
Programed Parts*

Country Code	U701 EEPROM	U703 Microprocessor
UA	188UCR131UA	188C238F
UB	188UCR131UB	
MB	188UCR131MB	
MC	188UCR131MC	
MD	188UCR131MD	
JB	188UCR131JB	
KK	188UCR131KK	

* Note: For replacement of U703 Microprocessor 188C238C you must replace the EEPROM U701 (188UCR131**)

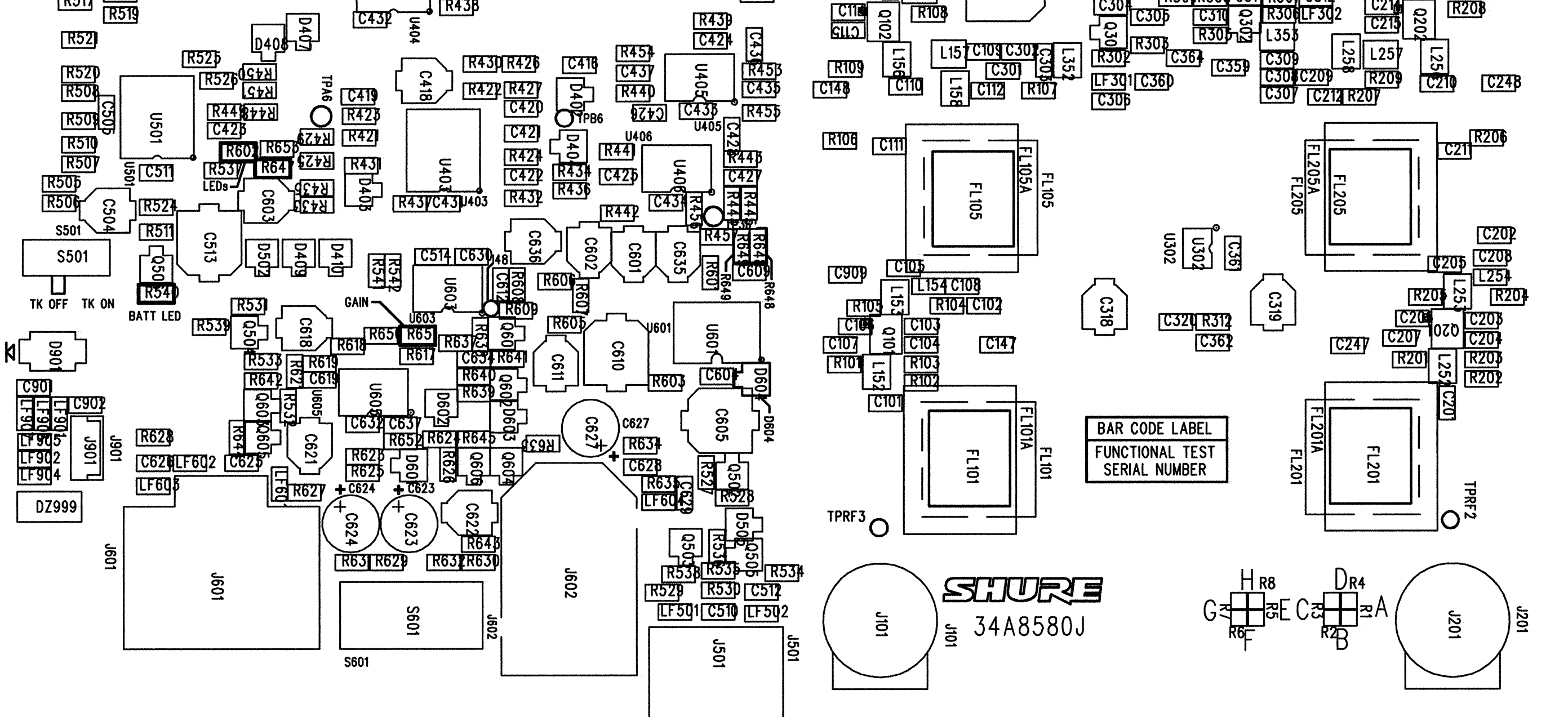
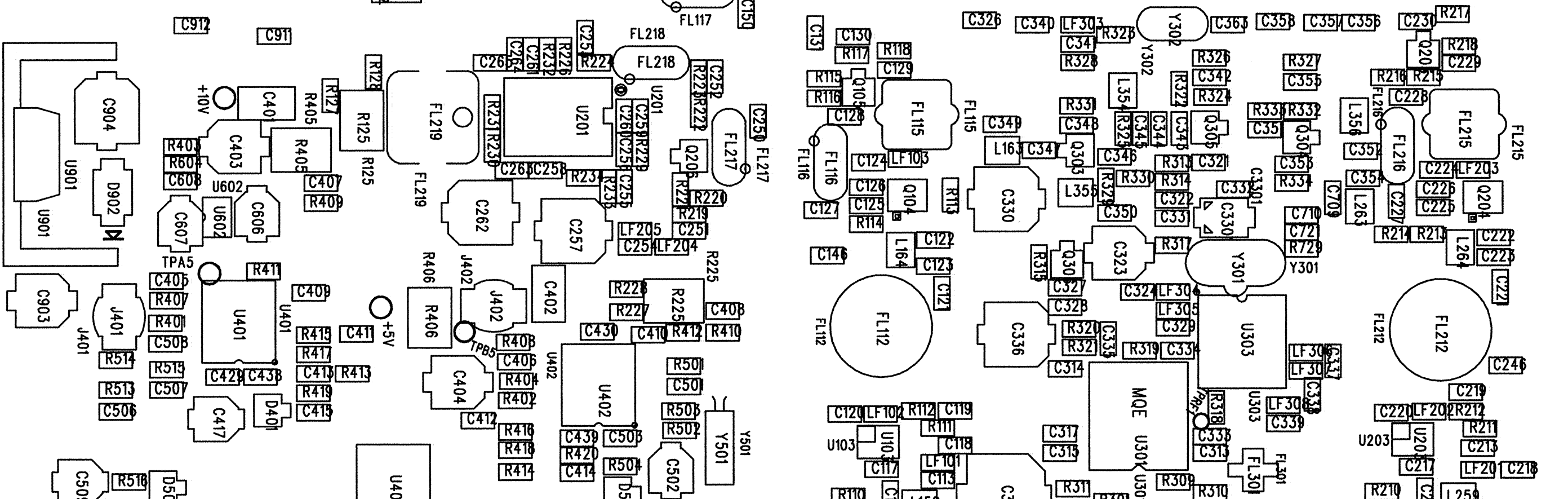
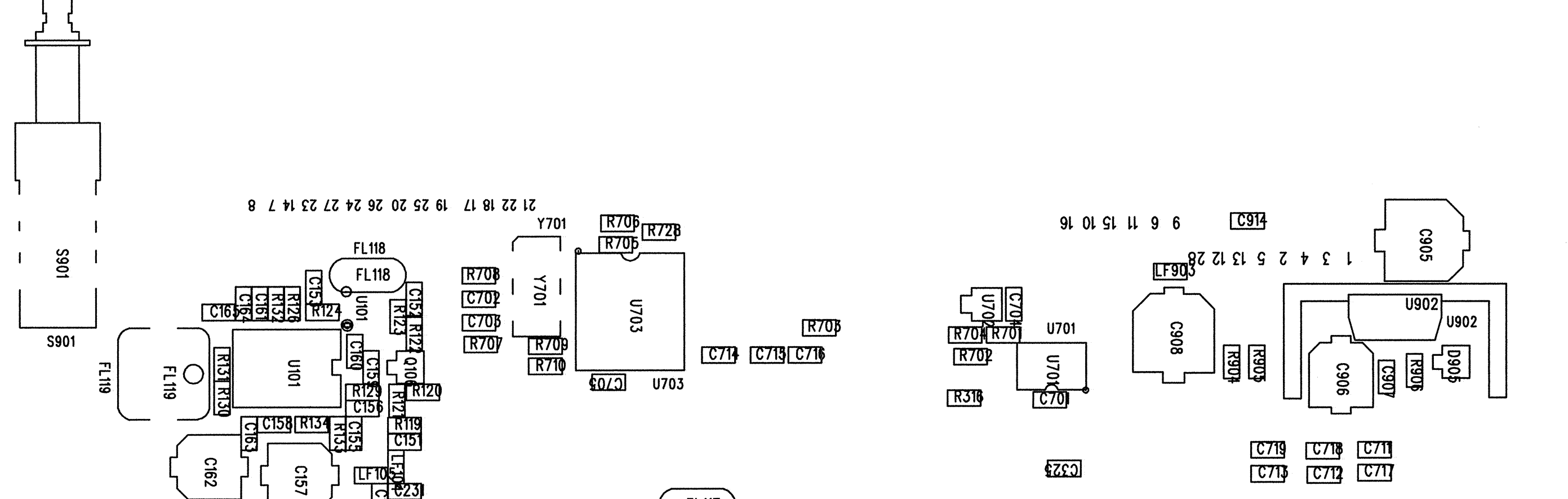
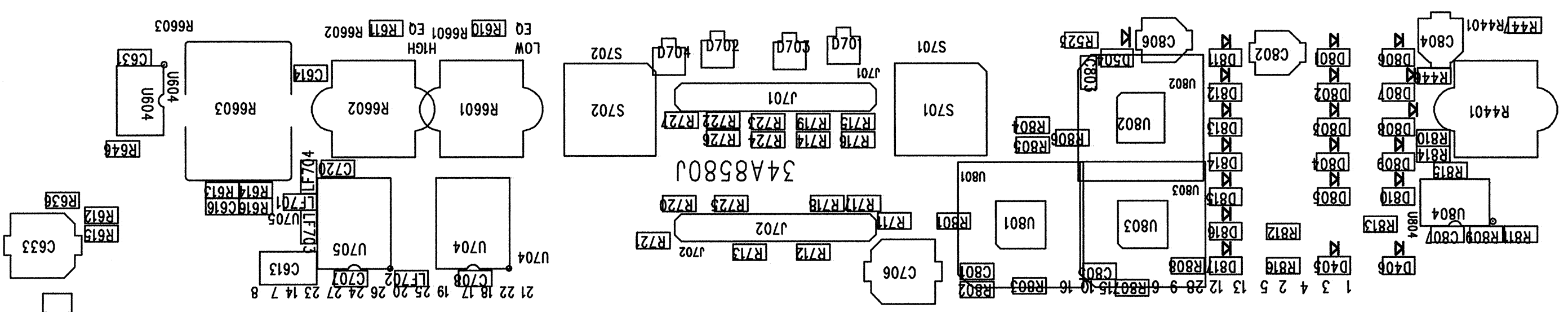

SHURE 34A8580J

BAR CODE LABEL
FUNCTIONAL TEST
SERIAL NUMBER

34A8580J

90_8766