

SWISS SOUND

VIEWES AND NEWS FROM SWITZERLAND

STUDER REVOX

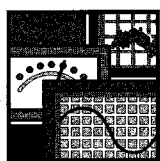

Dolby SR and the Studer A820

A Great Combination for Multitrack Recording

With 14,000 tracks already in use around the world, Dolby Spectral Recording (SR) has become a popular and indeed even 'fashionable' recording process, wherever highest quality audio is the overriding consideration.

In the multitrack studio, Dolby SR has already gained many friends who describe it as the 'purest' or 'best-sounding' recording system, having all the convenience and practicality of analogue tape. It will work with any recorder, at any speed, providing very significant improvements in sound quality and dynamic range. This is because Dolby SR does not stop at noise reduction (NR): it goes on to achieve very considerable reductions in distortion and improvements in transient response compared with conventional analogue recording.

The modulation noise and high-level saturation which have for many years

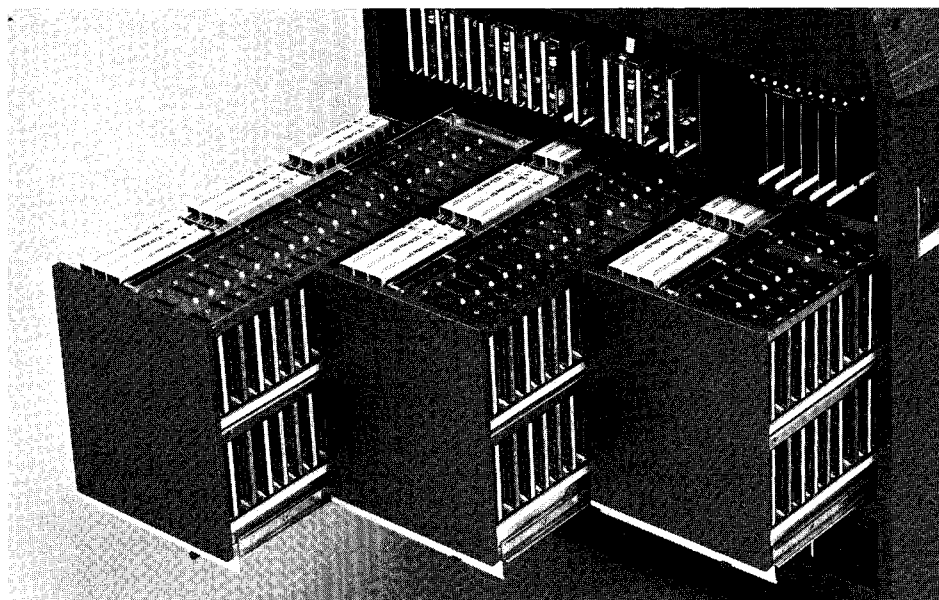

The Studer A820 was the first multichannel recorder in the world to have an integrated noise reduction system. The plug-in units are situated in the audio electronics drawers.

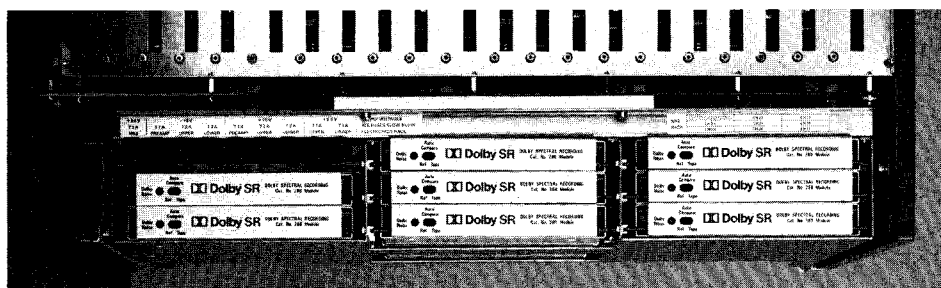

The Dolby SR units including interface are integrated in the drawer for eight audio channels.

been unavoidable byproducts of tape recording are also rendered inaudible.

Whilst SR will dramatically improve any recorder, the better the machine, the truer the sound. The result of incorporating SR into the Studer A820 is an integrated user-friendly system that is easy to use and quick in operation. It effectively makes the complete recording system a standalone process with central computer driven alignment and operational control as well as being physically transportable between control rooms. Already there are over 70 Studer A820 with built in Dolby SR in daily use.

The Signal Processing

Dolby SR takes extensive account of the way in which the ear hears. This is used

to help achieve a fundamental principle behind SR, namely that 'the least treatment of the signal is the best treatment'. If the ear won't hear the noise in a particular part of the spectrum, the signal isn't processed to achieve noise reduction. Moreover, the signal is always handled gently.

Dolby SR builds to some extent on techniques and features from earlier systems: the standard professional A-type circuit provides NR by low level compression in separate frequency bands; the Dolby B-type system provides NR by variable filtering techniques; and from C-type NR, multi level processing provides dramatic results from gentle compression ratios. The re-

sult is 24 dB of 'intelligent' noise reduction optimised to complement the psychoacoustic phenomenon of masking.

SR processing constantly adapts to the signal spectrum and is applied only where it is needed. The system noise floor is not only very low, but remains audibly unchanged whether a signal is present or not - a varying noise background is most disturbing on critical listening. The ability to discriminate between wanted signal and unwanted recording artifacts is such that SR will

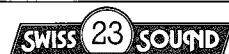

Read in this issue:

	page
● Studer A727	3
● Amorphous Sound Heads	5
● Sound Ideas Libraries	7
● TBS Live Studio	8
● Who is who	8
● Mosfilm Moscow	10
● Meltron Bombay	11
● Training Courses	12

render tape modulation noise inaudible and it will reduce distortion throughout the audible spectrum. (3rd harmonic distortion is typically reduced by 3 dB even at 'conservative' recording levels) Further, more dramatic reductions in distortion are achieved at higher levels, due to the anti-saturation circuits.

Anti-Saturation and 'Spectral Skewing'

Analogue tape is a non-linear storage medium at high levels: saturation begins at the frequency extremes and gets progressively worse as the level increases. Dolby SR overcomes this by applying a compensating Anti-Saturation characteristic. This is a simple shelving filter net-

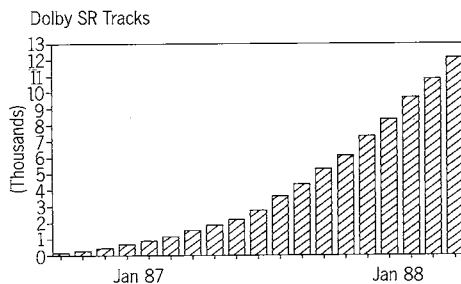

This diagram shows the steady increase in the use of SR units (as of March 1988); today there are already more than 14,000.

work that closely matches the high level imperfections of analogue tape, reducing the recording level of frequencies which the tape cannot handle. It is bypassed at low signal levels. Complementary shelving is applied on playback.

In addition, fixed high- and low-pass 'Spectral Skewing' filters are operative at all signal levels on record. These filters fulfill the joint functions of optimising the overall record characteristic for minimum distortion, and rendering the SR process less sensitive to mistracking from errors in the record/replay chain such as HF response errors and low-frequency head-bumps. On replay, similar complementary filters restore the frequency response.

The improvements in handling extremely low and high audio frequencies due to the Anti-Saturation and 'Spectral Skewing' techniques are compounded to provide extra headroom: 10 dB more at the frequency extremes, with a corresponding improvement in high-level transient performance resulting in the very clean 'line in' sound of Dolby SR.

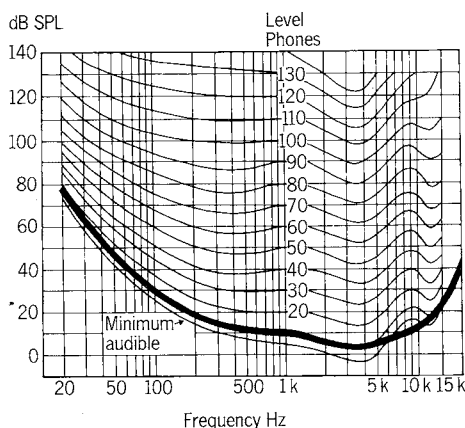

The noise floor of analogue tape with SR corresponds closely with the Fletcher-Munson curves for ear sensitivity at low levels.

System Alignment

In order to employ powerful processing that works only on the parts of the spectrum where it is really needed, the system must be level dependant - a reference level is needed to match signal levels in record and playback processors. This ensures 'transparent' processing and guards against noise modulation. Moreover, any system that is designed not to require level alignment inherently must suffer from noise modulation - pumping - with critical signals because it must treat all signals in the same manner irrespective of level.

With Dolby A-type NR, alignment is achieved by introducing a reference level ('Dolby Level') to relate programme levels and studio metering to internal Dolby processing levels. Dolby Level tone is read on a special indicator.

Dolby SR follows the same principles, although a new alignment signal - Dolby Noise - is used, to indicate Dolby Level. This is pink noise, with gaps every 2 seconds. The gaps are used to

Effect of Anti-Saturation Techniques.

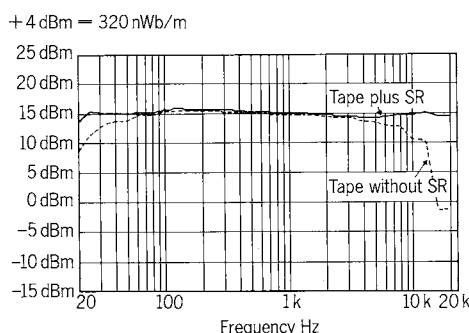

switch automatically between reference noise (generated in the processor) and off-tape noise, giving an immediate, audible line-in/line-out recorder alignment check.

This feature is called 'Auto Compare'. After aligning, it is always worth recording a section of Dolby Noise and replay it, checking

1. Dolby Level
2. Recorder alignment with 'Auto Compare'.

The incorporation of Dolby SR into the Studer A820 multitrack will allow the same operational facilities as with a stand alone Dolby unit, the only difference being that the machine's VU meters themselves will indicate Dolby level in the 'Set Up' (Dolby Calibration mode). The alignment procedures allow the user to set his own 'in-house' settings or to adjust these to match Dolby level on an incoming tape under software control, thus taking much of the tedium and all of the margin for error out of routine alignment.

Alignment Tolerances

Dolby SR is considerably more tolerant of errors in alignment and record/reproduce performance than Dolby A-type NR. The Least Treatment principle and the soft compression (with predominantly long time-constants), which is used only when necessary result in very gentle processing. The signal recorded on the tape sounds like a very smoothly compressed version of the original: it is very stable and 'easy' to decode.

An error in level of a few dB simply results in a change in overall level (rather than changes in frequency response) over most of the spectrum. Obviously errors in level will cause mistracking in the decoder, but they have to be large (>3 dB) for the mistracking to be audible. This insensitivity to errors does not mean that alignment procedures should be forgotten or relaxed - it does however allow a margin for error, after all everyone is human!

Dynamic range

The useable dynamic range obtainable from analogue tape with SR is 90 to 95 dB depending on the tape, tape speed and operating level. This wide dynamic range does not need to be fully utilised all the time. What it means is that normal recordings will be clean and quiet throughout the spectrum, allowing fur-

ther audio manipulation during mix-down or copying without significantly degrading the signal.

Different tape speeds

The published specifications and information on Dolby SR relate to its use with audio tape at 15ips. This does not mean that Dolby SR only works at 15ips! The SR processing is not affected by the use of other tape speeds where it gives similar dramatic reductions in noise and distortion.

At 30ips modulation noise and print-through being wavelength related are moved up in frequency into the more audible spectral areas – which is exactly where SR provides the most improvement. And because of the normally greater saturation at 7.5ips, the improvement in headroom and particularly in IM distortion will be very marked and the reduction in noise floor is extremely impressive.

Tape Copies, Editing etc.

There are two ways to copy an SR encoded tape:

1. Without SR decoding, a 1:1 copy: Copy the original line-up tones and Dolby Noise as well as the programme material.

2. With SR decoding, in order to change level or to add 'sweetening', etc: Copy the original recording, but replace the original tones and Dolby Noise.

Both of these methods give excellent results; to put things into a familiar context, a fourth-generation SR copy will have a dynamic range approximately equal to that of first generation 16-bit PCM.

Editing requires the same skills and tools as analogue editing with blade and block, and wide varispeeding is possible due to the gentle and continuous processing of SR.

"telcom" NR Systems

In the forthcoming edition of SWISS SOUND an article will appear on "telcom" NR systems in connection with the Studer A820 multichannel tape recording machine.

Conclusion

The very real improvements afforded by Dolby SR on 2" tape make it a logical and practical solution to the question of what to do about current multitrack recording formats. Incorporating such a process into the recorder – and after all the sophisticated analogue circuits in SR are meaningless without a tape recorder – make it an even more practical alternative. Two years of cooperation between Studer International and Dolby Laboratories on this project have resulted in the undeniable success of the A820/Dolby SR combination.

For further information please contact Tony Spath at Dolby Labs, or Louis Keller at Studer International.



Tony Spath (34)

was born at Hampton Court, England, in 1954. He graduated as a Tonmeister from Surrey University before working for 5 years at Strawberry Studios, as Recording Engineer at the Manchester studio and then as Engineer and Studio Manager for the group 10cc at the studios in Surrey. After 5 years as freelance producer and engineer working from London, he joined Dolby Laboratories in 1985 as Studio Projects Manager where he has since been working with Dolby SR principally in the areas of applications engineering and product promotion.

Tony Spath



Professional CD player Studer A727

Second generation

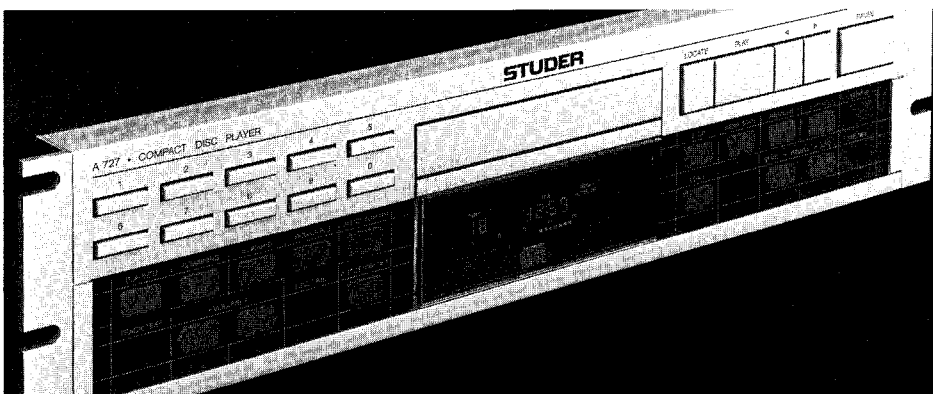

Fig. 1: Studer A727, a member of the CDS series, proven, stable, and suited for rack mounting.

The A727 CD player is the successor of the A725 and has been in production since 1987. More than 1000 units of this new professional CD player are in constant use by broadcasting services throughout the world.

The A727, like its predecessor, is designed as a rack module for broadcasting and program preparation. In contrast to the A725, the only function of the drawer is to slide the CD in and out. The drawer and its guides are made of zinc die cast and finished by high-precision NC milling machines.

The drawer is quiet, rigid, robust and extremely reliable even after years of continuous service.

Operation optimized for broadcasting applications

Although the operation of the A727 may at first sight appear to be virtually identical to its predecessor the A725, many new features have been implemented that will prove to be useful in broadcasting applications.

Particularly worth mentioning are:

● START REVIEW

A start sequence can be prelistened for as long as this button is pressed. The CD player subsequently returns to the start position (LOCATE).

● REVIEW END

When the REVIEW END key is touched, the last 8 seconds of the selected piece are played. The CD

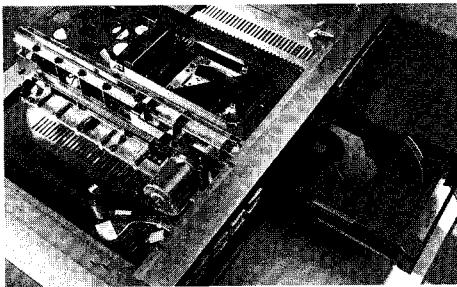

Fig. 2: Designed for a long service life, the player chassis, the supporting lateral guides and the drawer are die cast.

player then returns automatically to the start position. With this function the moderator can recall the end of a music selection without having to continually observe the display on the CD player or on the remote control.

● End-of-track warning signal

In auto stop mode the display of the CD player and the pause indicator on the parallel remote control flash during the last 15 seconds in order to alert the moderator to the fact that the end of the music selection is approaching.

● Start on modulation (autocue)

In autocue mode (indicated on the CD player display as 'A'), the CD player is automatically positioned at the start of the modulation of the corresponding track. To accomplish this, a threshold value is provided by the microprocessor (see Fig. 4). A digital circuit now compares each scanned value with the preset threshold and informs the microprocessor when the threshold is exceeded. To prevent clipping of the modulation start, the microprocessor backs up the starting point by 3 frames (40 ms).

The autocue mode can save a lot of time in broadcast preparations.

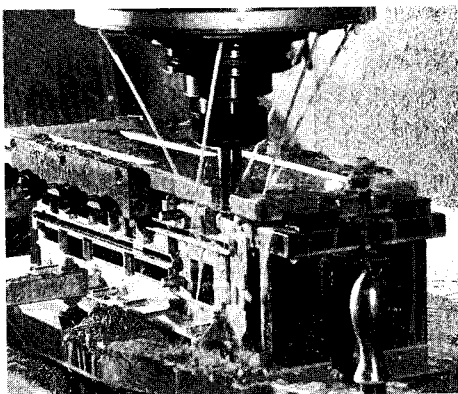

Fig. 3: Milling of the drawer guide on a modern NC machining center.

● Simple searching of a music title

A piece of music can be searched easily and quickly via the keyboard (numeric selection) or by means of the PREVIOUS and NEXT keys.

● Illuminated display

The display is now illuminated actively by means of a fluorescent film so that it can easily be read even in a dark room.

● Separate keys for direct access to four time indications:

- TRACK ELAPSED TIME
- TRACK REMAINING TIME
- DISC ELAPSED TIME
- DISC REMAINING TIME

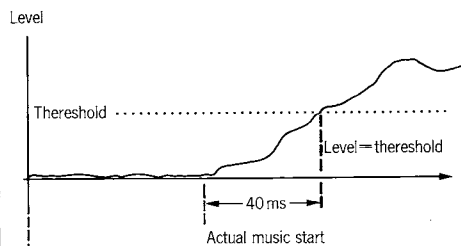

Track start according to subcode

Fig. 4: Threshold definition in the AUTOcue function.

The A727 is a system component with professional interface:

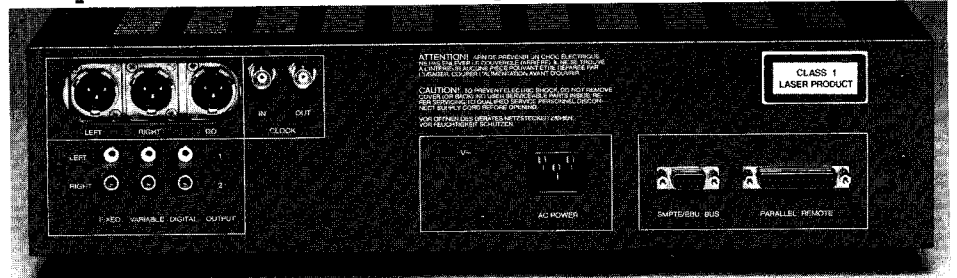

Fig. 5: Flexibility through analog and digital, balanced and unbalanced, fixed and variable outputs.

The parallel remote control units can be connected to the PARALLEL REMOTE socket. The low-cost version has no time, track, or index indication.

Both remote control units are designed for integration in a mixing console. All main operator functions of the CD player are accessible on both remote control units and are fully identical to those on the CD player. Like on the Studer tape recorders, the fader start signal is also available on the PARALLEL REMOTE socket and can be looped through the two remote control units.

Of course, the two remote control units can also be connected to the new CD player Studer A730.

Parallel Controller	Parallel Remote
Function of keys:	
PLAY	PLAY
PAUSE	PAUSE
LOCATE	LOCATE
>	>
<	<
NEXT	NEXT
PREVIOUS	PREVIOUS
START-REVIEW	
FADER (activate)	
Displays:	
AUTOSTOP (LED)	AUTOSTOP
FADER (LED)	FADER
READY (LED)	
TRACK (2x7 segment LED)	
INDEX (2x7 segment LED)	
MIN (2x7 segment LED)	
SEC (2x7 segment LED)	

The SMPTE/EBU BUS is the trend-setting serial interface for professional audio products. This interface is designed for comprehensive and fast control of several players. A corresponding peripheral control unit for multiple CD players is in development.

The A727 CD players can be synchronized with a master clock via the CLOCK IN. Because CLOCK IN (and CLOCK OUT) is in an accurately defined phase relation to the digital output (DO), several CD players can be connected synchronically via the digital inputs of a mixing console. No elaborate digital sampling frequency conversion is necessary.

The CLOCK IN is also of interest to broadcasting services who generally play their discs at slightly elevated speeds. The digital output (DO, DIGITAL OUTPUT 1/2) contains all information about the compact disc and corre-

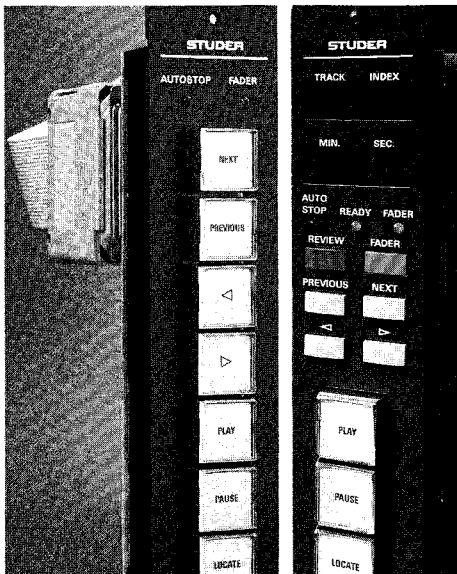

Fig. 6: PARALLEL REMOTE and the PARALLEL CONTROLLER, both with a module width of 40 mm for conveniently close installation.

sponds to the 'DIGITAL AUDIO INTERFACE FOR DOMESTIC USE' as described in the appendix of the 'Red book' (CD standards). Of course, analog outputs (XLR and RCA) are still needed at the moment. A high degree of flexibility is achieved, however, through the different outputs (digital, analog, balanced, and unbalanced).

Professional also means: Extensive quality tests of each individual CD player

Each A727 is checked for the guaranteed audio data after it has successfully passed an endurance test of at least 3 days at elevated temperature. The reproducibility of bad CDs is also tested. Every CD player is checked with the Philips test disc No. 5A to ensure that it can cope with the three largest defects (900 µm information interruption, 800 µm black spot, and fingerprint).

Future-safe software concept:

In contrast to the CD players for domestic use, the software is not masked in the microprocessor but in a 32 k EPROM. Only in this way is it possible to modify the software when, for example, the standards are extended. CD-ROM, CDI, CDV, graphics, and the SD single are examples of such extended standards.

And they will certainly not be the last ones!

David Roth



David Roth (30) Received his diploma of electric engineering at the Federal Institute of Technology, Zurich, in 1981. Since 1982, development engineer of Studer, engaged in the very first activities on the CD technology sector. 1983, he became project manager of the development group of the Revox CD players B225/B226 and Studer A725/A725QC/A727. As of 1986, manager for CD development, and within the framework of the Studer-Philips joint venture responsible for the work conducted at the Regensdorf laboratory.

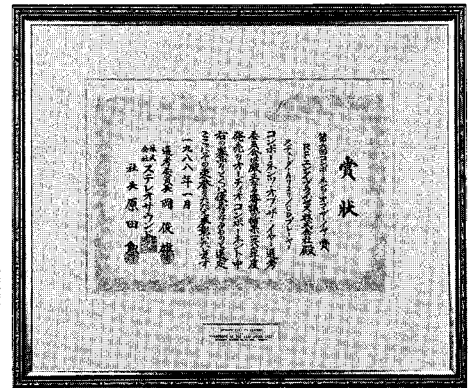

Latest news flash, just received: **Studer A727 receives "Stereo Sound" Award** The well-known Japanese audio magazine STEREO SOUND has awarded the professional CD Player Studer A727 for its superior sound quality.

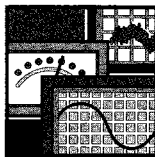

Amorphous core materials for Studer soundheads
Frozen Chaos

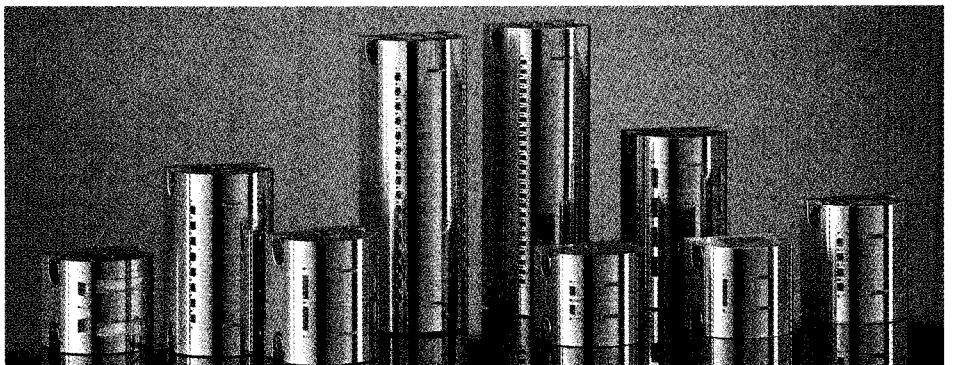

Fig. 1: Soundheads are high-quality components that must satisfy electrical as well as physical requirements.

Magnetic tapes and soundheads belong to the basic elements of the magnetic recording technique. Because they are fundamental to the principle, they are of utmost importance. That is why Studer has manufactured its own soundheads for 40 years. The following report discusses new aspects in the development of high-quality soundheads. The project manager answers the question: 'Why amorphous soundheads?'

The development of new magnetic tapes imposes more and more stringent demands on the soundheads. What is needed is a very high initial permeability, adequate saturation induction, high electrical resistance, low remagnetization losses, high mechanical strength as well as resistance to corrosion and abrasion.

The extreme hardness of the amorphous material alone does not ensure high wear and abrasion resistance because chemical processes are also involved.

Production of soundheads from amorphous material

Laminated 'ingots' are produced from the cleaned and tested material. These ingots are the starting material for the subsequent wire erosion process (spark erosion on an NC controlled precision machine). The erosion takes place in a water bath. The core geometry is traced several times on the ingot. This means that several blanks can be produced in one operation (Fig. 2). This process runs permanently, i. e. 24 hours per day and 7 days per week. Up to 72 hours of uninterrupted production are possible. Manual intervention is only required for unloading and loading of new material, for cleaning, and maintenance.

In the next step, cores are manufactured from these blanks. In a special machine they are cut exactly to the desired package height. After final inspection the core is ready for further processing. Since these steps follow a conventional pattern, they are not discussed here.

Advantages of amorphous heads

Heads with core packages made of amorphous materials have magnetic as well as certain mechanical advantages.

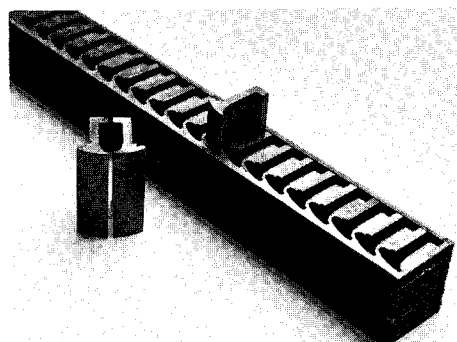

Fig. 2: From the laminated 'ingots' made of amorphous foils, the core shapes are 'cut' by means of spark erosion. During this process, no mechanical forces act on the core foil.

Because the packages are eroded as a monolithic block, the inaccuracies which are unavoidable with individual packaging of conventional heads, are eliminated.

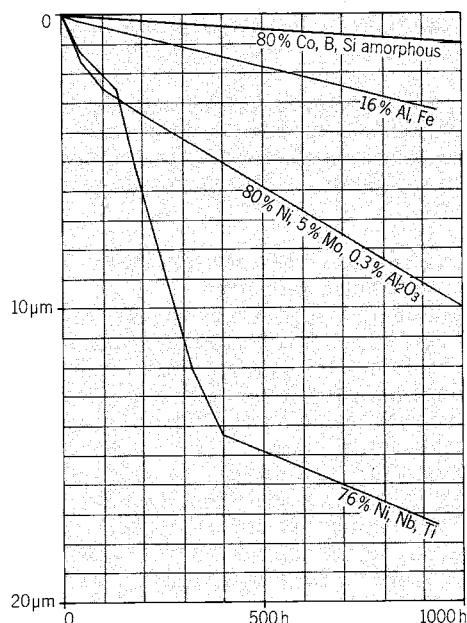

Fig. 3: This diagram shows the abrasion of different core materials. The amorphous material has excellent properties.

Due to the significantly lower head wear and the greater dimensional accuracy, the gap depth can be kept smaller.

This improves the efficiency of the soundhead.

The hardness of amorphous alloys plus other characteristics of the material guarantee an exceptionally long life span of the soundheads, several times longer than that of the ones we manufac-

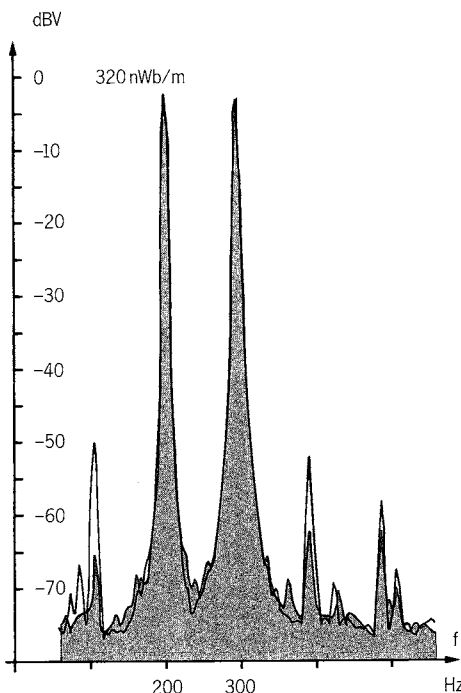

Fig. 4a: The intermodulation curves for 320 nWb/m show an improvement of 10...15 dB over traditional core material.

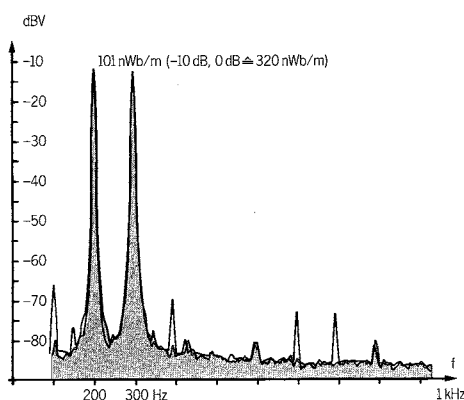

Fig. 4b: With a fluxivity of 101 nWb/m (-10 dB relative to 320 nWb/m), the intermodulation products are at -80 dB.

What are amorphous materials?

Amorphous materials are a group of alloys which do not have a crystal lattice like conventional metallic materials. Their atom arrangement has no order, i. e. it is amorphous, like in a frozen melt or glass (hence also the designation 'glass metal').

Due to their structure and composition, amorphous metals have some new properties and combinations of properties. The thin metal strip is produced directly from the melt. The liquid melt is sprayed through a nozzle directly on a fast rotating, cold roller. The metal chills very quickly (1 million °K/s) and solidifies into a strip. The draw-off speed is several kilometers per minute. Strip thicknesses of 20 to 50 µm and width from 1 to 100 mm are possible.

The principal component of the material we use is cobalt (70-80%) to which alloys (metalloids) such as B or Si are added (20-30%) in order to delay the crystallization. This alloy is almost free of magnetostriction and therefore has only a very low magnetic sensitivity to mechanical stress.

As is the case with conventional magnetic materials, the soft magnetic properties can further be improved through thermal treatment, possibly in a magnetic field. The thermal treatment takes place at relatively low temperatures of 300...400°C. The crystallization temperature of 400...500°C must not be exceeded, otherwise the amorphous condition changes to a crystalline condition which would change the material properties.

	u4	Bs	ρ _{Ohm} mm ² /m	Hc	Hv	λ
	-	T		A/m		10e-6
80% Co, B, Si amorphous	150000	0,55	0,9	<0,4	1000	<0,3
16% Al, Fe	8000	0,8	1,45	4,0	250	15
80% Ni, 5% Mo, 0,3% Al ₂ O ₃	60000	0,8	0,85	10	200	1
76% Ni, Nb, Ti	40000	0,5	0,9	1,5	220	1
88% Fe, 9% Si, 6% Al	10000	1,0	0,9	4,8	750	-

u4	Rel. permeability at 50 Hz
Bs	Saturation induction
ρ	Resistivity
Hc	Static coercivity
Hv	Vickers hardness
λ	Saturation magnetostriction

tured in the past (fig. 3). Another positive effect is that recalibration, made necessary by the change in the gap depth, can be performed at much longer intervals.

Because the shape of the core packages is defined by an erosion program and not by the cutting die, as has been the case in the past, the head geometry can easily be changed.

The relatively high resistance (0.9 ohm mm²/m) and the material thickness of only 0.03 mm minimize the losses from eddy currents. As a result, the recording currents can be decreased to approx. 60% of those required with conventional heads, while the reproduce level is approx. 3 dB higher at 1 kHz and 6 dB higher at 20 kHz. These higher reproduce levels yield an improved signal-to-noise ratio.

Through the low coercitivity, intermodulation and distortion have also been significantly decreased. Fig. 4a shows that when the two frequencies $f_1=200\text{Hz}$ and $f_2=300\text{Hz}$ are recorded, an intermodulation product with a frequency of 100Hz occurs. In the amorphous metal this signal level is down by -65dB rather than -50dB as in conventional material.

Rolf Hänggi



Rolf Hänggi (35) obtained his diploma in process engineering at the HTL in Muttenz in 1976. For five years after this he worked in the field of plastics blowmolding and extrusion.

He has been employed with Willi Studer AG since 1983 as a research engineer for magnetic soundheads.

mitted possibilities, the quality provides an optimal sound base.

The library is available with a detailed catalog (two parts: in alphabetical order according to CD track index).

The **Production Music** library currently comprises 25 CDs and will be extended with new releases yearly. It is ideally suited for audio visual, film, broadcast, and commercials. The music is new, original, and especially composed for this purpose. Each full-length original theme has a 60 and 30 second version which matches the duration of most TV commercials. The music is categorized by theme. All music has been digitally recorded.

All libraries sold through Studer International are on a buy-out basis as far as synchronizing and performance rights are concerned. Of course, copying of the library in whole or in part for resale and similar purposes is not allowed.

Studer International owns the worldwide distribution rights for Sound Ideas libraries on CD, with the exception of the USA, Canada and Australia, where the libraries are marketed directly by Sound Ideas Toronto.

Brief background on the history of the CD libraries

In the early days of the CD, when all CD producers were struggling to increase their repertory of CD titles, it was virtually impossible to find free mastering capacity.

In those days, Studer and Philips as competitors tried to boost the sale of their professional CD players. This was no easy task because the number of available CD titles and sound effects in CD libraries was too small to make the players attractive in broadcasting, TV, and postproduction studios.

Brian Nimens, president of Sound Ideas, who already owned the rights to large sound effects libraries and who had successfully marketed tape-based libraries, was convinced that a library on CD with its instant access and non-deteriorating sound quality would provide the ultimate solution. But Brian was unable to find any mastering capacity, so he finally approached Philips to discuss possible cooperation.

The mutual interest resulted in the launch of a first sound effects library comprising 28 CDs, known as the LHH7910. It quickly became popular and



«Sound Ideas» CD Library

Comprehensive sound effects production package

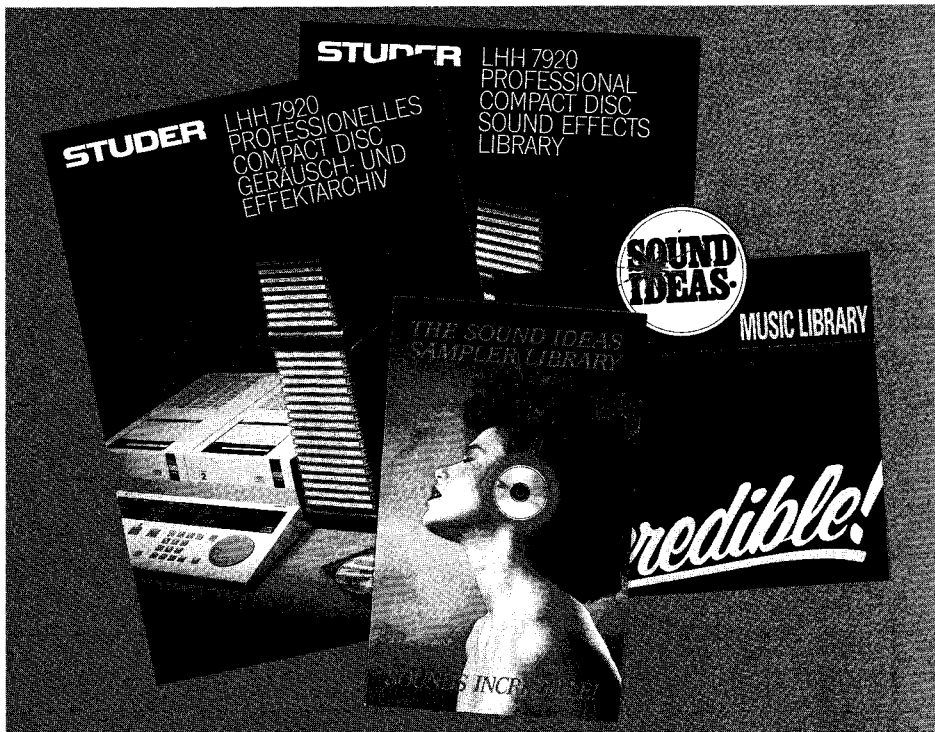

Studer has now enhanced its well-known CD software package with two new products from Sound Ideas: a sampler and a production music library. Both libraries were originally introduced at the spring AES in Paris, together with the professional Studer A730 CD player.

New: Sampler and production music libraries

The new CD software packages as additions to the popular LHH7910 libraries and the LHH7920 supplement which contains sounds and effects, greatly enhance the repertory.

The **SAMPLER** library is a package of 6 CDs. It is an important tool for composers of electronic music and for creative musicians. The library covers 135 different musical instruments with a total of 3300 top-quality, digitally recorded tones. Emphasis has been given to creating a large variety of tones (the library contains also music-like sounds) and musical resolution. With this comprehensive repertory, the composer obtains a library of pure sounds with which the sampler memory can be loaded as often as desired without deterioration of quality. The enormous variety offers unli-

elicited valuable response from professionals, this in turn had a considerable influence on the design of the new professional CD players. The users of sound effects libraries pushed the CD format to its limits. Frequently a disc has over 90 tracks, and these are often subdivided into many indices. Direct access to an index and frame-accurate cueing proved to be essential functions for professional CD players.

The success with the LHH7910 library encouraged Sound Ideas and Philips to market an extension (LHH7920) comprising 22 CDs. This library is better geared to the European sound perception. Three CDs were recorded by WDR in Cologne. Titles with atmosphere are

longer on the average. With a total of 50 CDs, the complete library now comprises more than 5000 sound effects which means that it is currently the world's largest commercially available collection.

The joint venture for professional CD products between Studer and Philips made these libraries available for marketing by Studer International. Although it may seem strange for a typical hardware company like Studer to sell CD libraries, it does create very interesting contacts with the end users and thus a lot of feedback for new, creative products in software and hardware.

Jan van Nes



The Studer Group
of Companies

«Who is who»

This column has been reserved for introduction of personalities of our companies and representatives in Europe and Overseas.

Intro-
ducing



Werner Hinn

Head of the Development Division of WILLI STUDER AG • member of the board • born 1946, grown up in Regensburg • schools in Regensburg and Zurich • 1965 Federal Mercantile Diploma • 1968-1973 studies of electrical engineering at the Federal Institute of Technology (ETH) with diploma as electrical engineer ETH • married, two children (5 and 9).

Before Werner Hinn took up studies at the Federal Institute of Technology in Zurich, he acquired commercial practice at Ford Motor Company and a private banking institute, both in Zurich. At the same time, he obtains the Swiss Federal certificate of matriculation in his spare time.

After successful graduation as electrical engineer at the Federal Institute of Technology, Werner Hinn worked in research and development, and also acted as licensee consultant for the American Laboratories RCA Ltd. of Zurich. He is the holder of twenty US patents with worldwide applications in the areas of TV studio engineering, home TV, IC development, analog and microprocessor based control systems, analog and digital signal processing, fast DA converters.

speakers fitted outside enable spectators to listen to the program.

The new studio is located in a city district that has been recently planned and constructed; shopping arcades, cinemas and office buildings have been centralized to form a sophisticated city area.

The picture shows Takeo Asano, Managing Director of Studer Revox Japan Ltd., training the 'Wild Duck' team on Studer equipment shortly before the opening of the studio.

Thomas Zeindler

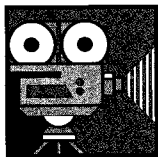

Japan

The 'Wild Duck' Team ready for action

TOKYO BROADCASTING SYSTEM, STUDIO HIBIYA CHANTER.
TBS 日比谷シャンテ
STUDIO

TELEVISION: CHANNEL 6 VHF 50KW RADIO: 95.4kHz 100KW

TBS, one of the largest broadcast companies in Japan, has opened a new live broadcast studio in Tokyo in October last year. It is equipped with Studer tape recorders and mixing consoles and has gained greatest popularity ever since it was established.

The modern and very lively facilities are situated in the heart of the city, in the grand neighbourhood of the Imperial Palace. Here, live programs are produced, transferred to the TBS main station by optical cable, and from there transmitted to the network throughout Japan.

A Studer 962/4-24+4S/8/2 serves as master console; additional consoles of the 962-16/2-VU and 962-14/4-VU type, two professional CD Players Studer A727, a telephone hybrid system and four A810-2/2 VU (B) tape recording machines ('B' stands for a special Japanese broadcast version, i. e. A810 without audio selectors, without monitor speakers) also belong to the studio set.

Three regular programs are produced per week. TV cameras, audio and video equipment are operated by 12 young ladies, the 'Wild Duck' team of which the youngest member is 19. Only on Saturdays, TBS takes over for round-



The 'Wild Duck' Team ready for action ...



the-clock service. The studio is surrounded by glass walls, inviting pedestrians to stop and watch the activities inside. A pair of powerful monitor loud-

1986, Werner Hinn joined Studer as head of the development sector that includes both Studer professional equipment and Revox hifi products. Shortly after his employment with the company, he was appointed member of the board of Willi Studer AG; the entire R&D activities were put under his responsibility. The whole development complex of Studer holds 15 departments where 150 employees handle a wide spectrum of products of different technologies. Not only analog technology is supported by a strong development group; there is at the same time a very large investment in digital audio with the objective to keep Studer on the forefront of technology and in close contact with the future market.

His spare time is spent with the family, on reading, listening to music and, depending on the season, on jogging and crosscountry skiing.

His reflections regarding the successful cooperation in the development area, Werner Hinn reveals as follows: "A specially critical factor for the success of a product today is the lapse of time a development project takes to evolve. It is consequently of special significance to choose the right dimensions, composition and management measures to successfully carry out a project. Well-organized cooperation is more and more of greatest importance for the best utilisation of available expertise. Software is a crucial component in most of our product developments. With new projects, we consequently base software development on newly established and modern methods which guarantee easier ways of maintaining a software product than ever before - thanks to a good definition, structure and documentary information."

Werner Hinn emphasizes that "one of the greatest challenges for the modern engineer is to guarantee the performance and reliability of a product, and at the same time realize efficient and economical designs; this requires the renouncement of luxurious, but first-thought solutions and demands great creativity from the engineer. Such creativity, an economical mind and reliable work belong to the essential characteristics of a successful development engineer who has the possibility to practice these issues in our company, from working out project specifications to designing technical details. If he succeeds, he will identify himself with the product. This I consider the most serious involvement."

Renate Ziemann



Studer Revox Japan - Headquarters at Tomigaya



In October last year, Studer Revox Japan Ltd. and their Studer product division moved to a new domicile at 1-45 Tomigaya, Shibuya-ku, Tokyo, with the purpose of increasing all Studer sales and service activities.

Tomigaya is part of Shibuya, one of the busiest commercial centres of Tokyo. The new SRJ office has been set up in a 4-storey building, next to Yoyogi Park, a big Shintoist shrine and - NHK headquarters. In addition, there is a good number of Japanese-style pubs that offer SRJ staff 'one for the road' after work is done. The front of the building faces the main street that conveniently leads to other central parts of the city. The basement serves as storage room and facilitates unloading of consignments at the back of the building.

Old Yoyogi office still exists; sales and service of a variety of brand-products are handled there, which complement the Studer line. 15 minutes ride on a bicycle from one office to the other make communication convenient, as it guarantees smooth operation at both places. There is also regular contact by telephone and telefax. The latter is successfully used for the urgent exchange

of picture material, thus eliminating any delay.

These organisational changes have brought considerable advantages. In fact, sales figures of Studer have in the last fiscal year increased by 50%. If one considers the extraordinary high price of Tokyo real estate, both Yoyogi and Tomigaya offices are relatively spacious in size by Japanese standards. Office equipment is neatly arranged, and the general design is pleasant if not generous. Visitors appear to be visibly relaxed.



After having seen the many new products at Paris AES this year, we realize that space will be scarce again: with the variety of released products to arrive at the basement of our new premises, we just vision our Chief Engineer, Ozawa-san, climbing his way over rows of machines...

Atsuko Nakayama, SRJ



New Patents

Variable speed replay of digital audio with constant output sampling rate

Digital audio systems work with a fixed sampling rate. If recordings are reproduced at speeds that are higher or lower than the original recording, the sampling frequency changes. This frequency cannot be processed by the subsequent equipment.

The process and the circuits developed by McNally show how a variable scanning rate can be transformed to a new scanning rate with preset frequency. The system is used, for example, when a certain location on tape or compact disc is read out of the editing memory. This procedure is also referred to as cueing.

A patent application for Guy W.W. McNally's invention was filed on December 29, 1987 with the US Patent Office under the number 4,716,472.

Signal transducer

Electromagnetic transducers, such as transformers, dynamic speakers, and motors are internally magnetized when a voltage is applied. This magnetization produces a voltage for example in an idle winding. This voltage can be compared with a reference value. Any deviations are thus detected and can be reactively decreased. This process is referred to as negative feedback.

Such idle windings require space and are not placed exactly in the right location. This results in leakage inductance which limits the corrective effect of the negative feedback.

This patent describes a process by which the effect achieved with this negative feedback can be significantly increased without requiring a separate winding.

A patent application for Paul Zwicky's invention was filed on January 19, 1988 with the US Patent Office under the number 4,720,665.

Method and apparatus for decoding

Not all digital audio recorded on tape can be read without error. For this reason the recording standard specifies that redundant information must be encoded. The arrangement of this supplementary information takes the nature of the expected reading errors into consideration.

The patent describes how the DASH signals can be processed in such a way that even very long tape segments with defective recording signals can be reconstructed. Up to 30 consecutive data blocks containing errors can be reconstructed.

A patent application for Claudia Brandes' invention was filed on February 23, 1988 with the US Patent Office under the number 4,727,547.

Paul Zwicky

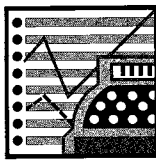

USSR

Mosfilm Studios Moscow

The Mosfilm Studios in Moscow are the largest and most important film studios in the Soviet Union. Because their audio dubbing facilities no longer satisfied today's requirements, it was decided to build a new studio. The generously planned new building complex accommodates studios for dialog and music recordings, audio dubbing of video recordings, and final mixdown in Dolby stereo.

In a first phase, the four dialog recording studios were handed over to the customer in March 1988 by Studer, who acted as the general contractor.

It was not as easy as it may sound. The size of the studios required professional film projectors which had been purchased previously from the Kinoton company. The problem was to set up the synchronization systems around these machines. For each studio the following equipment was required:

One Studer 902 mixing console, one Studer A812 tape recorder with TLS, two sprocket tape machines, one projector and one BVU 800, one system controller, one Sennheiser infra-red system, two Klark Teknik equalizers, and one AVTC time code generator with 12 VITC readers.

Because the FP30MC film projector made it impossible to use a straight

Studer synchronization system, we sought cooperation with another qualified manufacturer. SONDOR Ltd. of Switzerland was the ideal partner. From their product line we eventually selected the OMA S sprocket tape recorder (35 mm) and the EPS8000 synchronization system with loop program 8030. This system is used by each of the four Mosfilm studios as the master control, switch-selectable for projector or video recorder. The two sprocket tape machines are synchronized directly via the bi-phase signal. By contrast, the Studer A812 is synchronized with the master time code output and the TLS 4000.

The right-hand side of the 902A-8/4 mixing console contains all remote control key fields as well as other peripheral equipment. Four Studer limiter/compressor/noise gates can be looped to the inputs and outputs via a patch panel.

For testing purposes, the systems were preassembled in Regensdorf as far as possible. But would the system also function optimally with the film projectors? This question was not finally answered until the equipment arrived in Moscow: it functioned perfectly, thanks to the effort of the responsible engineers of Mosfilm, SONDOR, and Studer.

Wolfgang Waldis

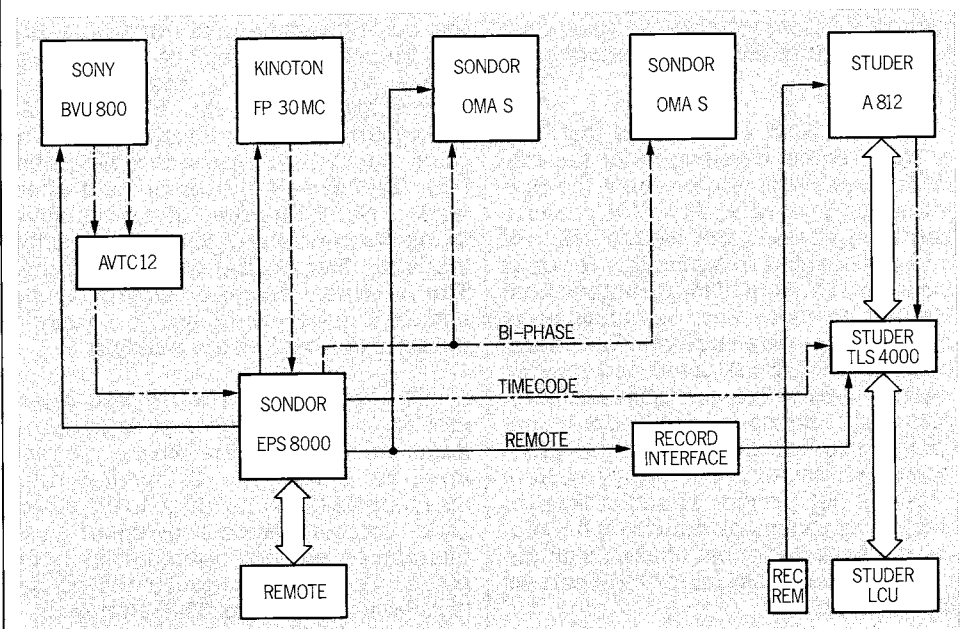

Configuration of the Mosfilm Studios.

Italy

900 Technology in TV Application

A typical example for the extremely flexible technology of the Series 900 mixing consoles is the audio mixer which we introduce below. It is the result of joint brainstorming and excellent cooperation with our Italian customer.

One unusual feature of this model is, for example, the **Stereo Multiplex System (MPX) for 8 different destinations**. When producing large live shows (quizzes, musical shows, coverage of sports events), the customer would like to transmit a stereo signal back to all production locations. This signal contains the program contributions of all other participants, except his own (n-1 technique). This signal is returned stereophonically to the auditorium; together with the image projected on a large screen, an authentic ambiance is thus created. The stereo MPX in this system has been cleverly integrated in such a way that it greatly facilitates the program execution and allows the Series 900 technique to be used for other applications.

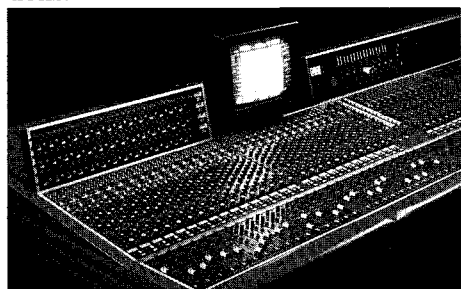

Other specialties are **8 auxiliary outputs** (plus 3 mono outputs and 1 stereo output). The customer would like to supply additional signals in mono or stereo to the various O.B. points; VCA fader on all mono inputs: here the customer would like flexible grouping and automation; a **video monitor** has been used as an output meter. The customer specified that all information had to be available via output levels with minimal space requirement. The solution of monitoring the desired output signals in this way is excellent in the dark control room.

The 904A mixing console has been configured with 28 mono inputs - equipped with VCA -, 12 stereo HL inputs for stereo sources, 8 groups with direct output, and 8 auxiliary outputs.

RAI Italy uses these models in all major TV production centers.

Paul Meisel

MELTRON - Gateway to India

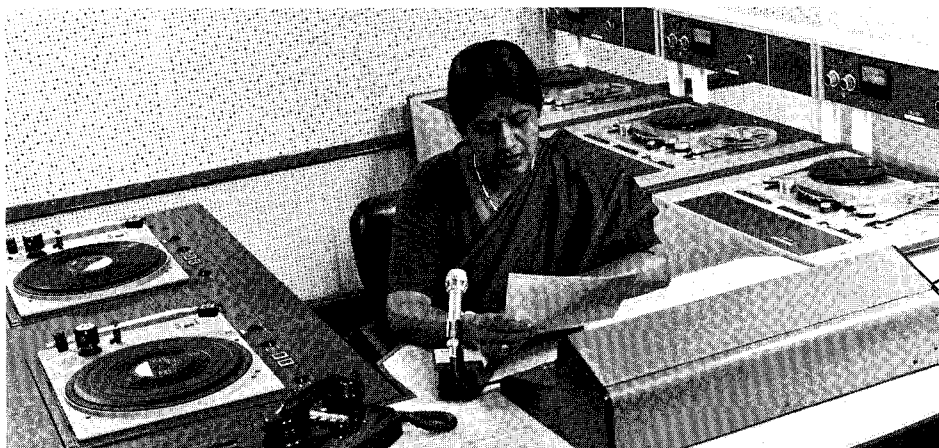

All India Radio, Continuity Studio

After lengthy negotiations, Studer signed a contract with Meltron Maharashtra Electronics Corp. Ltd. of Bombay in 1980 for the licence production of the Studer B67 tape recording machine in India. This agreement, being the first of its kind for Studer, confirmed the beginning of a new era in business.

It also initiated a series of unforeseen difficulties in the communication with Swiss and Indian authorities. Cumbersome bureaucracy created a great deal of extra work and strained the nerves of all employees involved with red tape.

Unfortunately, computer-aided administration work did not guarantee the desired smooth and logical work process.

But in spite of these hinderances, our decision for a licence production in India brought forth positive results: Since 1980, when the agreement was signed with Meltron, the remarkable quantity of a few thousand tape recorders had been assembled and sold in India, and made the Studer brand known in the market.

The good cooperation was consolidated two years ago when an additional agreement secured the supply of Studer mixing consoles 069 and 169 to Meltron. Regular visits to India by the responsible area manager, Rolf Breitschmid, underline the close relationship. Reactions from Bombay and New Delhi are positive throughout; the largest customer, All India Radio, plans the procurement of a few thousand assembly kits for the coming four years. The exchange for later models is not considered at present. Geographical distances (a trip from Bombay to Calcutta equals a flight Zurich-Istanbul) add to the difficulties for All India Radio who have to equip 200 larger and smaller

stations with suitable machines. Consequently, one adheres to the established - the Studer B67. The customer expects the supplier to produce the model of his choice for at least 12 to 15 years. The fulfillment of this request was of greatest importance at the time All India Radio decided for the B67 tape recording machine. Due to the important fact that product training of operation and maintenance staff takes a long time, the exchange for new generation equipment can only be considered after a decade of successful marketing of a machine.

All this makes us realize that our work for the Indian customer will neither stop at the production planning department, nor at the workshops, administration and export divisions.

With a Studer product that successfully meets the requirements of the Indian customer, good exporting business and the presence of the Studer brand is guaranteed in an interesting market, India.

Rolf Breitschmid

Editor:

Marcel Siegenthaler

Contributors of this issue:

Rolf Breitschmid, Rolf Hänggi, Paul Meisel, Atsuko Nakayama, Jan von Nes, David Roth, Tony Spath, Wolfgang Waldis, Thomas Zeindler, Renate Ziemann, Paul Zwicky.

Please mail your letters to:

SWISS SOUND, STUDER INTERNATIONAL AG
Althardstr. 10, CH-8105 Regensdorf
Telephone +41 840 29 60 · Telex 825 887 sti ch
Telefax +41 840 47 37 (CCITT 3/2)

Artwork: Lorenz Schneider

Publisher: Willi Studer AG, Althardstr. 30,
CH-8105 Regensdorf

Reprint permitted with reference to SWISS SOUND (please send a copy to the editor).

Dolby is a registered trademark of Dolby Laboratories Licensing Corporation.

Printed in Switzerland by WILLI STUDER AG
10.23.8210 (Ed.0788)

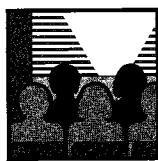

Studer Training courses

08.08. - 12.08.88 Mo 09.00 h - Fr 16.00 h A80/RC Tape Recorder Tape deck features, disassembling/assembly, alignment, explanation of various PCB's, trouble shooting	English	19.09. - 23.09.88 Mo 09.00 h - Fr 16.00 h A820 MCH Tape Recorder Tape deck features, ports, disassembling/assembly and alignment of tape deck, explanation of various circuits, trouble shooting	English	28.11. - 02.12.88 Mo 09.00 h - Fr 16.00 h A820 MCH Tape Recorder Tape deck features, ports, disassembling/assembly and alignment of tape deck, explanation of various circuits, trouble shooting	English
15.08. - 19.08.88 Mo 09.00 h - Fr 16.00 h 961/962/963 Mixing Consoles Features and operation, signal routing, explanation of various PCB's, console alignment, trouble shooting	English	10.10. - 12.10.88 Mo 09.00 h - We 12.30 h A807 Tape Recorder Tape deck features, ports, disassembling/assembly and alignment of tape deck, explanation of various circuits, trouble shooting	English	09.01.89 Lu 09.00 h - 16.45 h A727 Lecteur CD Fonctions, liaisons série/parallèle, explications des circuits, réglages du transport	French
05.09. - 06.09.88 Mo 09.00 h - Di 16.45 h TLS 4000 Synchronizer Funktionen und Bedienung, Anwendungen, Schaltungserklärungen, Interfaces, Fehlerbehebung	German	12.10. - 14.10.88 We 13.30 h - Fr 16.00 h A810 Tape Recorder Tape deck features, ports, disassembling/assembly and alignment of tape deck, explanation of various circuits, trouble shooting	English	09.01. - 12.01.89 Mo 09.00 h - Do 16.00 h A800 Mehrkanal-Tonbandmaschine Laufwerkfunktionen, Demontage/Montage des Laufwerkes, Geräteeinstellung, Schnittstellen, Erklärung der einzelnen Platinen, Fehlerbehebung	German
07.09.88 Mi 09.00 h - 16.45 h SC 4008 Controller Anwendung, Funktionen und Bedienung, Schaltungserklärungen	German	24.10. - 26.10.88 Mo 09.00 h - We 16.45 h A812 Tape Recorder Tape deck features, ports, disassembling/assembly and alignment of tape deck, explanation of various circuits, trouble shooting	English	10.01. - 11.01.89 Ma 08.30 h - Me 16.45 h A730 Lecteur CD Fonctions, liaisons série/parallèle, explications des circuits, réglages du transport	French
08.09.88 Do 09.00 h - 16.45 h SC 4016 Controller Funktion und Bedienung, Anwendung, Schaltungshinweise	German	26.10. - 28.10.88 We 08.30 h - Fr 16.00 h A820 1/4" Tape Recorder Tape deck features, ports, disassembling/assembly and alignment of tape deck, explanation of various circuits, trouble shooting	English	12.01.89 Je 08.30 h - 16.00 h A721 Magnétophone à cassette Conception, fonction du transport de bande, réglages mécaniques et électriques, explications des circuits, travaux pratiques	French
07.09. - 09.09.88 Mi 08.30 h - Fr 16.00 h A80/RC Magnetongerät Laufwerkfunktionen, Demontage/Montage des Laufwerkes, Geräteeinstellungen, Schnittstellen, Schaltungserklärungen, Fehlerbehebung	German	31.10. - 04.11.88 Mo 09.00 h - Fr 16.00 h D820X Tape Recorder / DE 4003 and PQ Editor D820X Application and features, signal flow, layout of circuits and trouble shooting on digital audio section DE 4003 Operation and features, layout PQ Editor Operation and application	English	16.01. - 18.01.89 Lu 09.00 h - Me 12.30 h A810 Magnétophone Fonctions du transport, portes, réglages mécaniques et électriques du transport, explications des circuits, travaux pratiques, dépannage	French
12.09. - 13.09.88 Mo 09.00 h - Tu 16.45 h TLS 4000 Synchronizer Application, operation, explanation of PCB's, interfaces, trouble shooting	English	07.11. - 09.11.88 Mo 09.00 h - We 16.45 h 900 Mixing Console Application, various modules, features, operation, circuit explanation, alignment, trouble shooting	English	18.01. - 19.01.89 Me 13.45 h - Ve 16.00 h A812 Magnétophone Fonctions du transport, portes, réglages mécaniques et électriques du transport, explications des circuits, travaux pratiques	French
14.09.88 We 09.00 h - 16.45 h SC 4008 Controller Applications, features and operation, circuit explanations	English	10.11. - 11.11.88 Th 08.30 h - Fr 16.00 h 961/962/963 Mixing Consoles Application, various modules, features, operation, circuit explanation, alignment, trouble shooting	English	23.01. - 27.01.89 Lu 09.00 h - Ve 16.00 h A820 Magnétophone multipistes Fonctions du transport, portes réglages mécaniques et électriques du transport, explications des circuits, travaux pratiques	French
13.09.88 Tu 09.00 h - 16.45 h A721 Cassette Recorder Tape deck features, ports, explanation of various PCB's, disassembling/assembly and alignment of tape deck, trouble shooting	English	21.11. - 23.11.88 Mo 09.00 h - Mi 16.45 h 900 Mischpult Anwendung, Bedienung der Module, Schaltungshinweise, Einmessvorgang, Pannenbehebung	German	30.01. - 31.01.89 Lu 09.00 h - Ma 16.45 h TLS 4000 Synchroniseur Applications, fonctions, conceptions du système, descriptions des circuits, schéma bloc	French
14.09.88 We 09.00 h - 16.45 h A727 CD Player Features, ports, explanation of circuits, transport alignment	English	24.11. - 25.11.88 Do 08.30 h - Fr 16.00 h 961/962/963 Mischpult Anwendung, Bedienung der Module, Schaltungshinweise, Einmessvorgang, Pannenbehebung	German	01.02.89 Me 08.30 h - 16.45 h SC 4008 Contrôleur Applications, fonctions, conceptions du système, descriptions des circuits, schéma bloc	French
15.09. - 16.09.88 Th 09.00 h - Fr 16.00 h A730 CD Player Features, ports, explanation of circuits, transport alignment	English			06.02. - 07.02.89 Lu 09.00 h - Ma 16.45 h 960/963/970 Consoles de mélange Conception, applications, explications des différentes unités, alignement, travaux pratiques, dépannage	French
14.09. - 15.09.88 We 08.30 h - Th 16.45 h B67 Tape Recorder Tape deck features, ports, explanation of various circuits, disassembling/assembly and alignment of tape deck, trouble shooting	English			08.02. - 09.02.89 Me 08.30 h - Ve 16.00 h 900 Console de mélange Conception, applications, explications des différentes unités, alignement, travaux pratiques, dépannage	French

