

Universal Audio SOLID STATE AMPLIFIER WITH ACCESSORY EQUALIZER

MODEL
1109
509

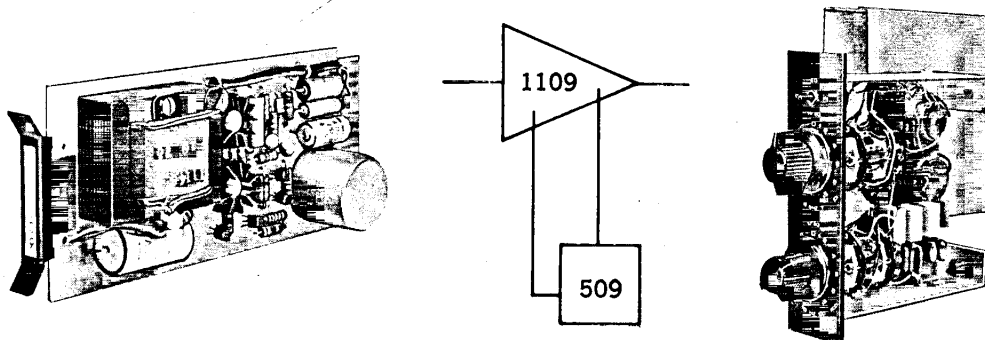

The 1109 Amplifier from U.R.E.I. is the latest of a very successful line of Universal Audio amplifiers, starting in 1957 with the Model 100, evolving through the well-known 1008 and 1016, the solid-state 1108, and now the all-new 1109. Preserving the ENVELOPMENTAL EQUALIZATION concept pioneered by Universal Audio, the 1109 combines newest state-of-the-art circuitry and packaging with the high reliability and performance always delivered by U.R.E.I. products.

Because the 1109 combines extreme low noise, (WITHIN 2 dB of the THEORETICAL LIMIT,) with high output capability (+30 dBm = A FULL WATT with 30 V supply) it can be used anywhere in the audio system, from microphone preamplifier through line amplifier. Input and output impedance matching, equalizer options, and gain adjustment are all accomplished on the mating edge connector. Therefore, all of the amplifiers in a system are completely interchangeable.

By changing one strap on the amplifier board, the 1109 may be powered optionally from dual polarity 15 VDC, or from single-polarity +24 to 30 VDC supply, without adding any components, and with no change in operating specifications.

ENVELOPMENTAL EQUALIZATION is achieved by electronically enclosing an external equalizer, the Universal Audio 509, within an active feedback loop of the amplifier, as shown in the block diagram above. The 1109/509 combination provides flexible equalization with no loss of gain. High frequency boost can be had at 2.5, 5, 7 or 10 kHz, and high frequency rolloff is at 10 kHz. Low frequency boosts are at 50, 70, 100 and 400 Hz, and low frequency rolloff is at 100 Hz.

Detented switches provide boost or rolloff steps of 2, 4, 6, 9 and 12 dB for both high and low frequencies. An EQ IN/OUT switch is furnished to remove equalization completely without disturbing the settings. The 1109 Amplifier and 509 Equalizer may be separated by as much as 25 feet of single-pair shielded cable.

The 1109 Amplifier is a printed circuit card 2 $\frac{3}{4}$ " X 6". An accessory 1109CC Card Cage holds eleven 1109's in 3 $\frac{1}{2}$ " of rack space. The 509 Equalizer will mount on 1 $\frac{1}{2}$ " centers, and occupies 5 $\frac{1}{2}$ " of vertical panel space. Depth behind panel is 5 $\frac{1}{2}$ ".

ACCESSORIES:

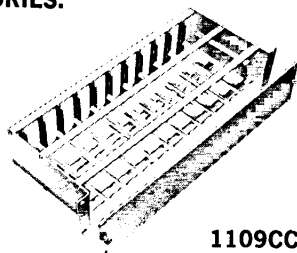

1109CC
CARD CAGE

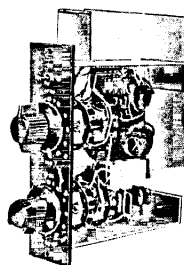

509
EQUALIZER



9C CONNECTOR

Urei

UNITED RECORDING ELECTRONICS INDUSTRIES

11922 VALERIO STREET, NO. HOLLYWOOD, CALIFORNIA 91605 TEL. (213) 764-1500

TELEX 65-1389

MODEL
1109
509

TECHNICAL SPECIFICATIONS

- VOLTAGE GAIN:**
- 600 ohms input strapping**—Adjustable 30 to 50 dB from terminated 600 ohm source; Adjustable 35 to 55 dB from unterminated 600 ohm source.
 - 150 ohms input strapping**—Adjustable 36 to 56 dB from terminated 150 ohm source; Adjustable 41 to 61 dB from unterminated 150 ohm source.
- POWER OUTPUT:** +30 dBm maximum, with 30 VDC supply. Nominally +27 dBm for single output, +24 dBm each for dual outputs, with less than 0.5% total harmonic distortion from 30 to 20,000 Hz. Typical midband distortion is less than 0.05%.
- FREQUENCY RESPONSE:** ± 0.5 dB from 30 to 20,000 Hz.
- SOURCE IMPEDANCE:** 150 to 600 ohms. Strappable at external connector.
- INPUT IMPEDANCE:** Nominally five times rated source impedance (secondary of input transformer virtually unloaded).
- LOAD IMPEDANCE:** Two separate output transformer secondary windings, each designed for 600 ohm load; or both may be paralleled for 3 dB higher power capability.
- NOISE:**
(15.7 kHz equivalent bandwidth)
- 132 dBv from 150 ohm source.
 - 126 dBv from 600 ohm source. (This is within approximately 2 dB of theoretical limits).
- THERMAL ENVIRONMENT:** Up to +150 degrees Fahrenheit without derating.
- POWER SUPPLY OPTIONS:** +24 to 30 VDC, or ± 15 VDC (strappable—no added components needed).
- POWER CONSUMPTION:** No Signal—typically less than 10 mA. At +12 dBm output—typically less than 17 mA. At +27 dBm output—typically less than 60 mA.
- EQUALIZATION OPTION:** May be used with Universal Audio Envelopmental Equalizer Model 509, with no change in operating parameters except voltage gain is fixed at:
 45 dB from terminated 600 ohm source.
 50 dB from unterminated 600 ohm source.
 51 dB from terminated 150 ohm source.
 56 dB from unterminated 150 ohm source.
- PHYSICAL:** 2 $\frac{3}{4}$ " X 6" glass epoxy printed circuit card. Gold plated contacts to mate with standard 15-pin edge connector. (See accessory list below)
- ACCESSORIES:**
- 1109CC CARD CAGE** is designed to hold up to eleven 1109 amplifier cards. Supplied complete with edge connectors and front cover. Requires 3 $\frac{1}{2}$ " vertical space in standard 19" USASI rack enclosures.
 - 509 EQUALIZER** for remote equalization of one 1109 amplifier. Requires only one two-conductor shielded pair for interconnection with amplifier. May be mounted on 1 $\frac{1}{2}$ " centers, to be compatible with contemporary vertical faders, etc. Panel size 1 $\frac{1}{2}$ " X 5 $\frac{1}{2}$ ". Depth behind panel 5 $\frac{1}{2}$ " inches.
 High Frequency Attenuation: -2, -4, -6, -9, -12 dB at 10 kHz.
 High Frequency Peaking: +2, +4, +6, +9, +12 dB at 2500, 5000, 7000 and 10,000 Hz.
 Low Frequency Attenuation: -2, -4, -6, -9, -12 dB at 100 Hz.
 Low Frequency Peaking: +2, +4, +6, +9, +12 dB at 50, 70, 100, 400 Hz.
 - 9C CONNECTOR.** Standard 15-pin edge connector to mate with 1109 Amplifier Card. (Not required when 1109CC card is used). Has gold bifurcated contacts.

MAXIMUM OBTAINABLE EQUALIZATION

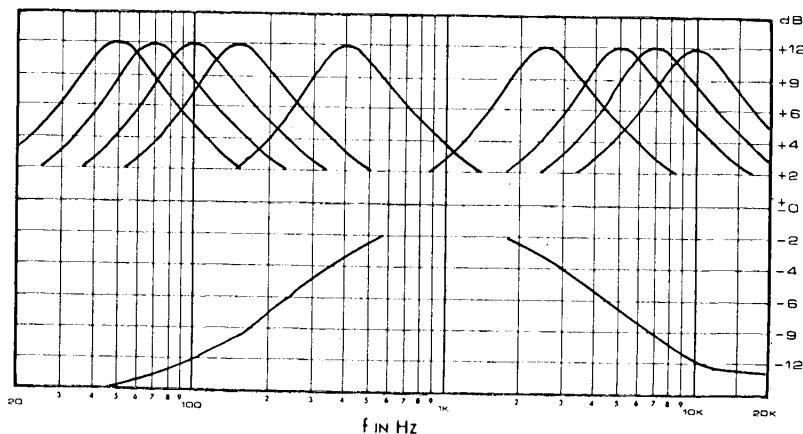

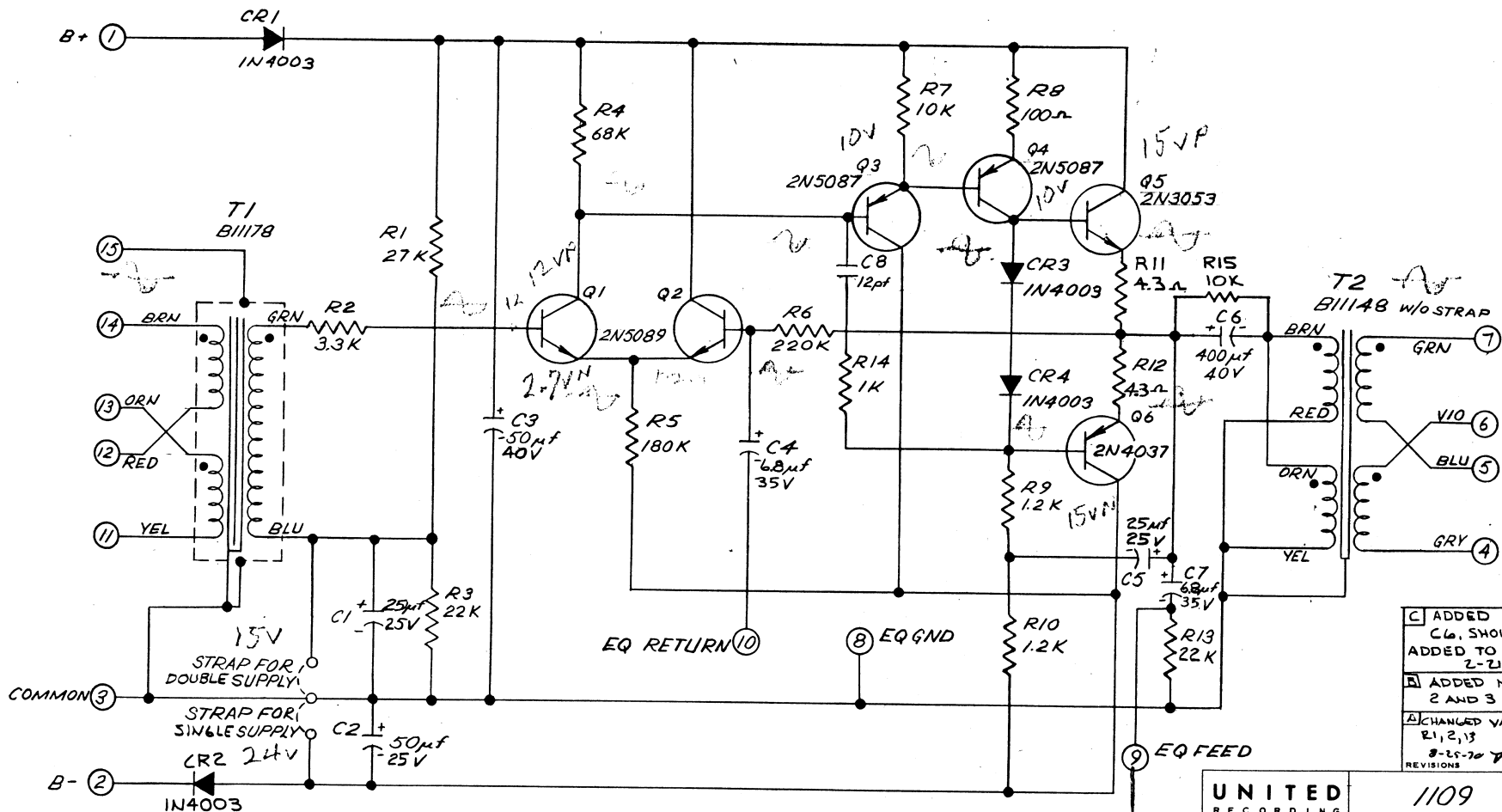

- C ADDED R15 ACROSS C6. SHOULD BE ADDED TO ALL UNITS 2-21-72 JE
- D ADDED NOTES 2 AND 3 9-9-70 JE
- E CHANGED VALUES OF R1, 2, 13 8-25-70 JE

- 3. * Q5 + Q6 ARE MATCHED PAIR
- 2. * Q1 + Q2 ARE SELECTED FOR LOW NOISE
- 1. NO'S IN BALLOONS INDICATE PIN NO'S ON CIRCUIT CARD CONNECTOR

NOTES:

UNITED RECORDING ELECTRONICS INDUSTRIES		1109 AMPLIFIER CARD	
		DATE 4-27-70	ISSUE MODEL 1109 2109
DEPARTMENT LOS ANGELES, CALIFORNIA	CHECKED <i>JE</i>	APPROVED B11195C	

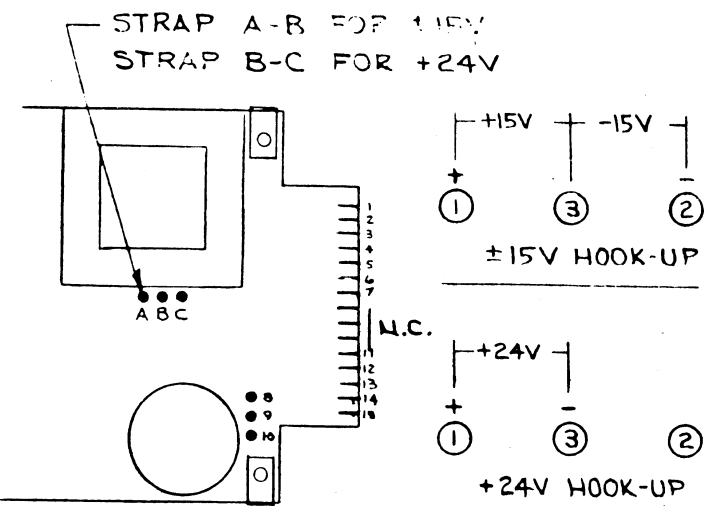

2109 AMPLIFIER

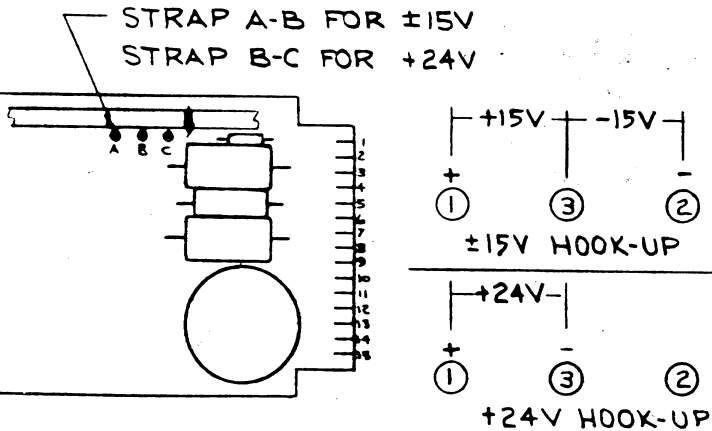
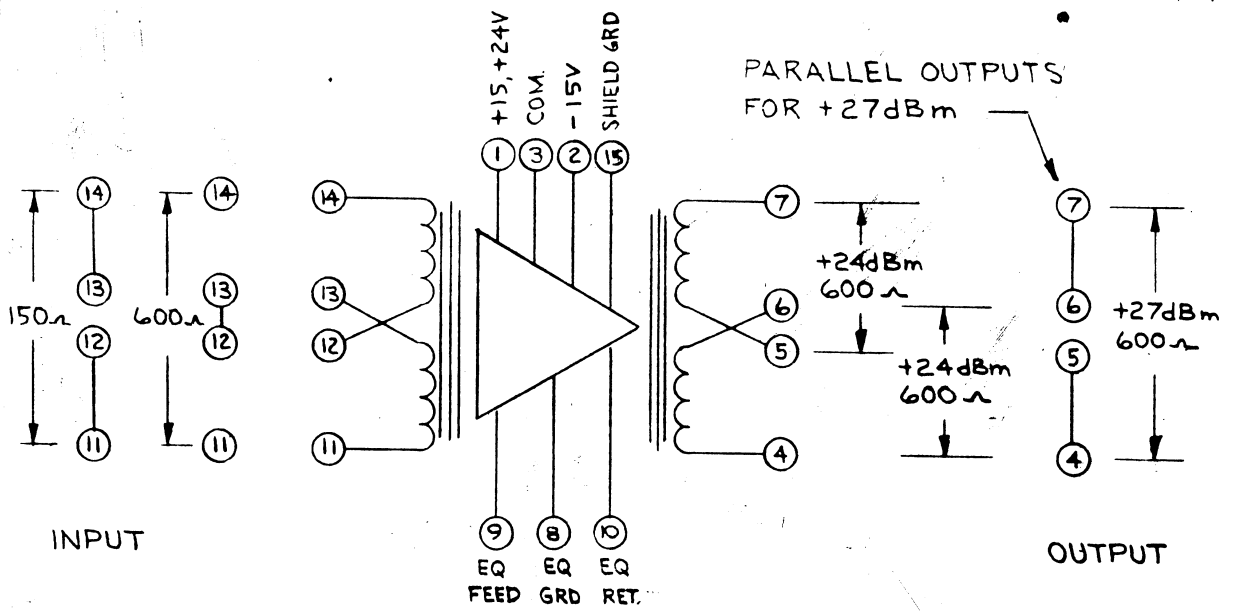

1109 AMPLIFIER

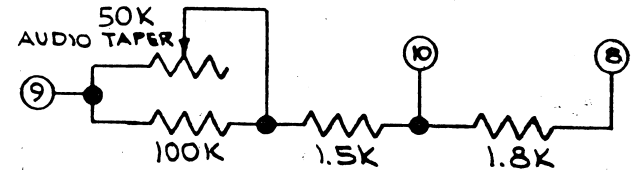
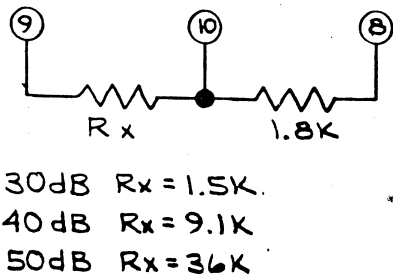

FOR 1109 ONLY

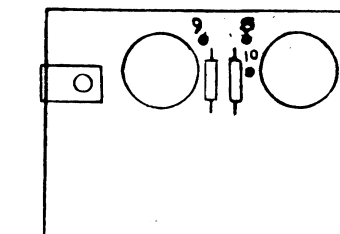

509/2109 EQUALIZER (RFF)



UNITED RECORDING ELECTRONICS INDUSTRIES

11922 VALERIO STREET, NO. HOLLYWOOD, CALIFORNIA 91605 TEL. (213) 764-1500