

**BEFORE PROCEEDING WITH COMPLETE UNPACKING AND SETUP,  
CONSULT UNPACKING AND INSPECTION INSTRUCTIONS ON PAGE 5**

**model 546**  
**DUAL PARAMETRIC EQUALIZER**



**United Recording Electronics Industries**

**8460 SAN FERNANDO ROAD, SUN VALLEY, CALIFORNIA 91352**

**(213) 767-1000**

## TABLE OF CONTENTS

<u>SECTION I. INTRODUCTION</u>	PAGE
1.1 DESCRIPTION	1
1.2 ELECTRICAL SPECIFICATIONS	2
1.3 PHYSICAL SPECIFICATIONS	3
1.4 CONTROLS	4
1.5 CONNECTIONS	4
<u>SECTION II. INSPECTION AND INSTALLATION</u>	
2.1 UNPACKING AND INSPECTION	5
2.2 ENVIRONMENTAL CONSIDERATIONS	5
2.3 POWERING	5
2.4 LINE VOLTAGE SWITCH	6
2.5 EXTERNAL CONNECTIONS	6
2.6 IMPEDANCE AND TERMINATION	8
2.7 SIGNAL LEVEL AND OVERLOAD DETECTOR	9
2.8 DUAL CHANNEL - EXPANDED SINGLE CHANNEL MODE	9
<u>SECTION III. OPERATING INSTRUCTIONS</u>	
3.1 GENERAL	10
3.2 SYSTEM CHECK	10
3.3 EXPERIMENTATION	10
3.4 DOCUMENTATION	10
3.5 APPLICATION	11
3.5.1 GENERAL CLASSIFICATION	11
3.5.2 CREATIVE EQ TECHNIQUES	11
3.5.3 USE OF "FREQUENCY RANGE OF VARIOUS SOUND SOURCES"	11
3.5.4 LOW CUT & HIGH CUT FILTERS FOR CREATIVE EQ	12
3.5.5 CORRECTIVE EQ TECHNIQUES	12
3.5.6 FREQUENCY RESPONSE MEASUREMENTS	13
3.5.7 EQUALIZATION TECHNIQUE	13
3.5.8 FEEDBACK SUPPRESSION	13
3.5.9 LOW CUT & HIGH CUT FILTERS AFTER CORRECTIVE EQUALIZATION	15
<u>SECTION IV. THEORY OF OPERATION</u>	
4.1 INPUT AMPLIFIER	16
4.2 END CUT FILTERS	16
4.3 PARAMETRIC FILTER	16
4.4 OUTPUT AMPLIFIER	17
4.5 OVERLOAD DETECTOR	17
4.6 POWER SUPPLY	17

## TABLE OF CONTENTS

(Continued)

	PAGE
<u>SECTION V. MAINTENANCE</u>	
5.1 GENERAL	18
5.2 REPAIRS AND WARRANTY	18
5.3 ADJUSTMENTS	19
5.3.1 COMMON MODE BALANCE	19
5.3.2 OFFSET ADJUSTMENT	19
 <u>SECTION VI. ILLUSTRATIONS</u>	
FIGURE 6-1	
to 6-4: SINGLE EQ SECTION FREQUENCY RESPONSE CURVES	20
FIGURE 6-5	
to 6-8: COMPLEX FREQUENCY RESPONSE CURVES	22
FIGURE 6-9	
to 6-11: FREQUENCY RANGE OF VARIOUS SOUND SOURCES	25
FIGURE 6-12: SCHEMATIC DIAGRAM OF UREI MODEL 546	28

## SECTION I INTRODUCTION

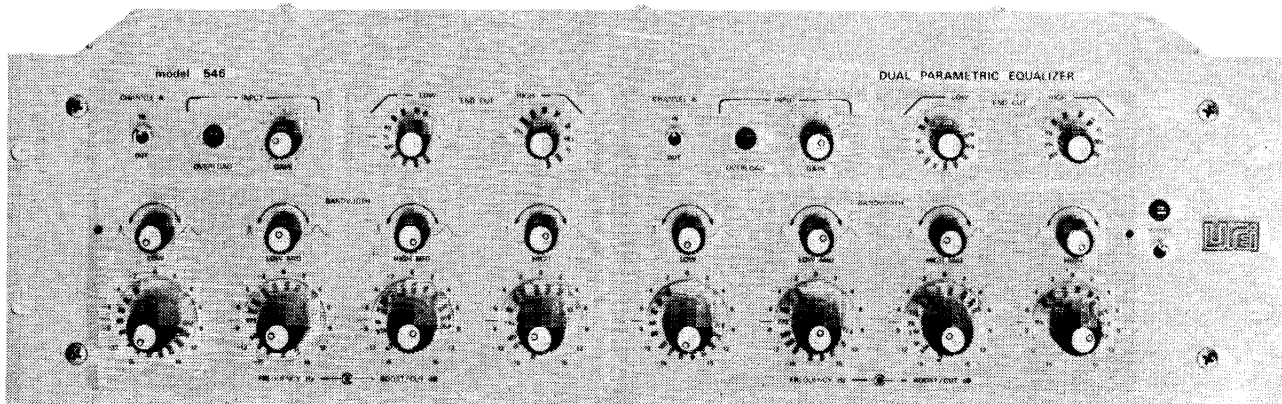

FIGURE 1-1. MODEL 546 FRONT PANEL.

### 1.1 DESCRIPTION.

The Model 546 is a true Dual Parametric Equalizer in which all important filter parameters--slope, bandwidth and frequency--are continuously variable. It is an ideal tool for creative and corrective equalization in professional sound recording, broadcast production, sound reinforcement systems, motion picture and TV recording, and live performances.

There are four parametric filter sections in each channel of the Model 546. The four filters cover overlapping ranges from 30 Hz to 15 kHz. All filters have perfectly reciprocal characteristics in boost and cut, and are continuously adjustable between plus and minus 15 dB. The bandwidth is variable from 1/4 to 4 octaves.

In addition, High Cut and Low Cut filter sections are included to adjust the overall bandwidth of the Model 546. The cutoff filters are of the Butterworth type with an attenuation of 12 dB per octave beyond their -3 dB points. (See Figures 6-1 through 6-4, Section VI.)

While all filter sections are independently adjustable, they combine smoothly when tuned to the same or nearly the same frequency. This is especially useful when extreme characteristics and settings are desired.

Overload detection circuits monitor the signal throughout the unit. If the signal level in any monitored circuit point approaches overload, a front panel LED flashes to warn the user. Individual EQ IN/OUT switches for both channels and each parametric filter section permit easy comparison.

Concentric controls, easy to read dials and markings, and accurate calibration aid in selecting and resetting any filter combination. The 546 has a rear panel switch to select an Expanded Single Channel mode of operation which combines all eight filter sections into one channel (with a single set of end-cut filters, too). Due to the front panel's uncluttered and logical arrangement, operation is simple and self-explanatory. However, a thorough understanding of the Model 546 Dual Parametric Equalizer can only benefit the user, so we recommend carefully reading this manual.

## 1.2 ELECTRICAL SPECIFICATIONS

INPUT: Balanced bridging, differential amplifier.

INPUT IMPEDANCE: 40 kohms, used as balanced input.  
20 kohms, used as unbalanced  
(single-ended) input.

MAXIMUM INPUT LEVEL: +26 dB (Ref. 0.775 V rms).\*

EQUIVALENT INPUT NOISE: Less than -85 dBm (15.7 kHz bandwidth)  
with all parametric controls at half  
rotation, and end cut filters set to  
maximum bandwidth.  
Less than -83 dBm in the Expanded Single  
Channel mode.

GAIN: Variable; -10 dB to +20 dB,  $\pm 1$ dB.  
controls set to zero.

FREQUENCY RESPONSE:  $\pm 1$  dB, EQ out, 20 Hz - 20 kHz;  
 $\pm 1$  dB, -3 dB, EQ in, 20 Hz - 20 kHz.

OUTPUT: Floating, transformer isolated.

OUTPUT LOAD: 150 ohms or greater.

POWER OUTPUT: +24 dBm into 600 ohm load. (12.28 V);  
+20 dB into 150 ohm load (Ref. 0.775 V rms).

DISTORTION: Less than 0.5% THD, 30 Hz to 15 kHz at  
maximum rated output.

---

\*In these specifications, where "dB" refers to a specific level, the 0 dB reference is 0.775 volts rms unless otherwise noted.

---

PARAMETRIC EQUALIZERS: Bandwidth continuously variable 1/4 to 4 octaves.

Boost - Cut continuously variable +15 to -15 dB.

Bypass switch on each section.

Frequency ranges:

Low Band	30	Hz	-	330	Hz
Low-Mid Band	110	Hz	-	1.2	kHz
High-Mid Band	390	Hz	-	4.2	kHz
High Band	1.4	kHz	-	15	kHz

CUTOFF FILTERS: Low cut: 16 Hz to 800 Hz, - 3dB point continuously tunable.  
High cut: 500 Hz to 25 kHz, -3dB point continuously tunable.

CUTOFF FILTER TYPE: Butterworth; attenuation 12 dB/octave beyond -3 dB points.

CHANNEL SEPARATION: Better than 70 dB, 20 Hz - 20 kHz.

POWER REQUIREMENTS: 100 - 125 VAC or 200 - 250 VAC, 50/60 Hz, switch selectable, less than 10 W.

ENVIRONMENT: Operating 0°C to +50°C (+32°F to +122°F); storage -20°C to +60°C (-4°F to +140°F).

### 1.3 PHYSICAL SPECIFICATIONS

DIMENSIONS: 483 x 133 mm rack panel; Depth behind panel 203 mm. (19" x 5-1/4" x 8")

FINISH: Panel is 3.18 mm (1/8") brushed clear anodized aluminum in two shades. Chassis is cadmium plated steel.

WEIGHT: 5.9 kg (13 pounds).

SHIPPING WEIGHT: 7.7 kg (17 pounds).

ACCESSORY: SC4 Security Cover

#### 1.4 CONTROLS (TYPICAL EACH CHANNEL)

- Frequency : Six knobs with transparent skirts show the selected frequency against a white background segment.
- Boost - Cut : Four controls, concentric with frequency knobs, set the desired amount of boost or cut for each individual parametric filter section.
- Width : Four continuously adjustable controls, one above each parametric filter section, set the bandwidth of each parametric section.
- IN/OUT Switch: Coupled with the Width control, this is a concentric push-pull switch with which the individual filter section may be bypassed for instant comparison. The filter is "in" when the switch is in.
- EQ Switch: 2-position toggle switch bypasses all filter sections.
- Gain: Adjusts the gain of the input amplifier from -10 dB to +20 dB.
- Overload : LED indicates when an overload condition occurs in any circuit section.
- Mode Switch: (on rear side of chassis) Selects "Dual Channel Mode" in which both channels of the Model 546 operate independently, or the "Expanded Channel A Mode" in which Channel A includes the four parametric filter sections of Channel B. (Only Channel A's input terminals are used, but the output is available simultaneously at the Channel A and B output terminals.
- Power : Toggle switch, with LED to indicate when the Model 546 is powered.

#### 1.5 CONNECTIONS

All connections for input and output are made on the rear panel through barrier strips and/or 3 pin XLR/QG connectors. Power is applied through a 3-wire IEC-style connector. (See Installation Instructions, Section 2.5., Figures 2-1 and 2-2.)

SECTION II  
INSPECTION AND INSTALLATION

2.1 UNPACKING AND INSPECTION

Your Model 546 was carefully packed at the factory, and the container was designed to protect the unit from rough handling. Nevertheless, we recommend careful examination of the shipping carton and its contents for any sign of physical damage which could have occurred in transit.

If damage is evident, do not destroy any of the packing material or the carton, and immediately notify the carrier of a possible claim for damage. Shipping claims must be made by the consignee.

The shipment should include:

Model 546 Dual Parametric Equalizer

UREI Instruction Manual (this book)

Two-part Warranty Card bearing the same serial number as the Model 546.

Rack mounting hardware.

2.2 ENVIRONMENTAL CONSIDERATIONS

The system will operate satisfactorily over a range of ambient temperatures from 0°C to +50°C (+32°F to 122°F), and up to 80% non-condensing relative humidity.

If the system is installed in an equipment rack with high heat producing equipment (such as power amplifiers), adequate ventilation should be provided in order to assure longest component life. Also, while circuitry susceptible to hum pick-up is sufficiently shielded from moderate electromagnetic fields, installation should be planned to avoid mounting the system immediately adjacent to large power transformers, motors, etc.

2.3 POWERING

The 546 may be operated from either 100 to 125 VAC or 200 to 250 VAC mains (50 Hz or 60 Hz, single phase.) As indicated in Section 2.4, the nominal line voltage may be selected with a rear panel switch. BE SURE TO VERIFY BOTH THE ACTUAL LINE VOLTAGE, AND THE SETTING OF THE VOLTAGE SELECTOR SWITCH BEFORE CONNECTING THE 546 TO THE MAINS.



To comply with most Electrical Codes, the 546 is supplied with a three-wire IEC style connector, the grounding pin of which is connected to the chassis. In some installations this may create ground-loop problems. Ground loops can result in hum and buzz if a significant potential difference exists between the AC conduit ground and the grounded metal enclosure in which the chassis is installed. If hum is experienced, one may check for the possibility of ground loops by using a 3-prong to 2-prong AC adapter between the power cord and the mains supply, ungrounding the AC plug temporarily. This ungrounds the Model 546, and may cure the hum or buzz, but is not a substitute for proper system grounding. Be aware that unless the Model 546 Dual Parametric Equalizer is AC grounded, a safety hazard can exist. UREI accepts no responsibility for legal actions or for direct, incidental or consequential damages that may result from violation of any electrical codes.

#### 2.4 LINE VOLTAGE SWITCH

Unless a tag on the line cord specifies otherwise, the Model 546 was shipped ready for operation with nominal 115 VAC power mains. In order to change this for nominal 230 V (50 Hz or 60 Hz), slide the VOLTAGE SELECTOR switch on the rear panel to the 230 position. The voltage is visible in a window next to the switch slot. Be sure to change the fuse to the correct value: 1/8-amp slo-blo when changing to 230 V operation or 1/4-amp slo-blo for 115 V operation. A small screwdriver should be used to move the recessed switch.

#### 2.5 EXTERNAL CONNECTIONS

Permanent input and output signal wires should be shielded cable, and connected in accordance with standard wiring practice to either the barrier strips or the XLR/QG connectors on the back of the chassis.

NOTE: The pins of the XLR's are wired as follows:

- #3 = "±" of input and output;
- #2 = "Common" of input and output;
- #1 = to chassis GROUND.

If the Model 546 output is connected to a high impedance circuit, we recommend shunting the "±" and "COM" output terminals with a 620 ohm, 1/2 watt resistor. This assures optimum loading.

(See Figures 2-1 and 2-2 on the following page for recommended connection procedures; and Section 2.6 regarding input termination.)

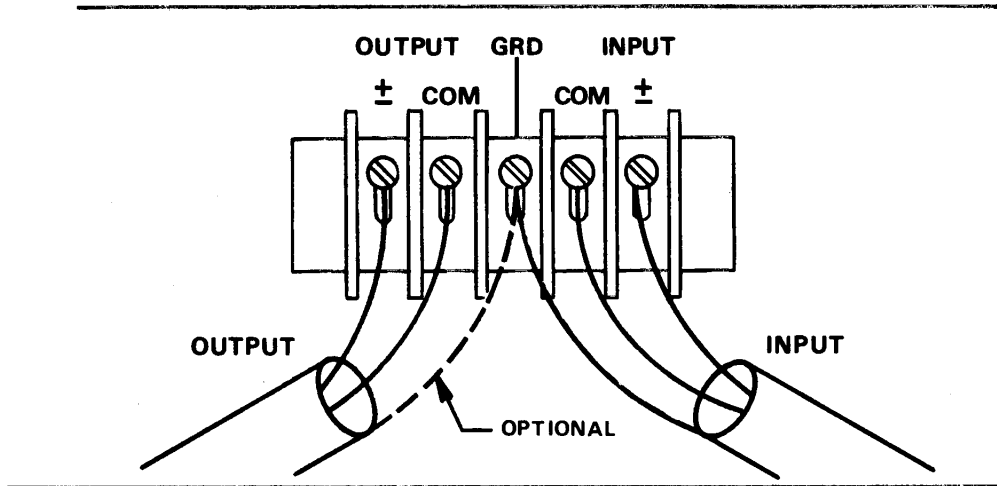

FIGURE 2-1. CONNECTING THE MODEL 546 WITH BALANCED INPUT AND BALANCED OUTPUT CIRCUITS.\*

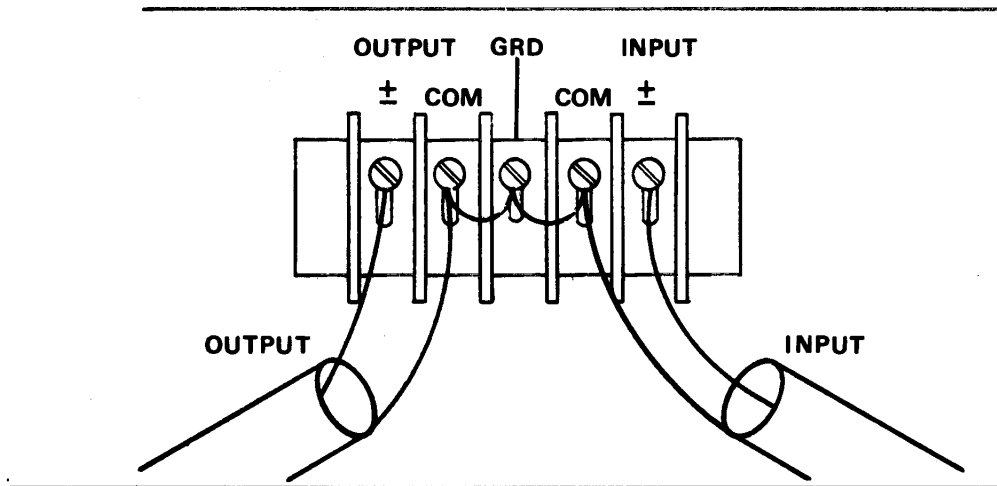

FIGURE 2-2. CONNECTING THE MODEL 546 WITH UNBALANCED INPUT AND UNBALANCED OUTPUT CIRCUITS.\*

\*With a balanced input and unbalanced output, or vice-versa, use the appropriate connections suggested by each of the above diagrams. No special switching or transformers are needed.

## 2.6 IMPEDANCE AND TERMINATION

Audio engineering had its roots in the telephone industry, and "600 ohm circuits" (together with their predecessors, "500 ohm circuits") are carry-overs from telephone transmission practices. Long audio transmission lines, like their video counterparts, must be properly sourced from and terminated in equipment which matches their characteristic impedance, if optimum frequency response and noise rejection are to be achieved.

However, transmission line theory and techniques are not only unnecessary but impractical within modern recording studios, broadcast studios and other local audio systems where transmission circuits are seldom more than several hundred feet in length. The advent of negative feedback circuitry and solid-state electronics has spawned modern audio amplifiers and other signal processing devices having source impedances of only a few ohms. They are essentially indifferent to load impedances and by varying their output current inversely to changes in load impedance, maintain the same output voltage into any load impedance above a rated minimum, with no change in frequency response.

Modern audio systems, therefore, utilize amplifiers and other active devices which have very low output impedances and high (10K to 50K) input impedances. These products may thus be cascaded (operated in series), or many inputs may be connected to a single output of a preceding device, without regard to impedance "matching". Switching, patching, etc. is simplified because "double loads" and "unterminated" bugaboos are essentially eliminated. "Floating" (ungrounded) transformer outputs minimize ground loop problems, and differential transformerless input circuitry (or input transformers) minimize common mode noise or interference which may be induced into the interconnecting wires or cables.

Where audio must be transmitted through cables or wire pairs of more than several hundred feet in length, however, transmission line termination practices should still be observed.

The Model 546 has input impedances of 40,000 ohms when used in a balanced, differential input configuration, and 20,000 ohms when used unbalanced (one side grounded). This makes the equalizer suitable for use with any nominal source impedance, low or high. Only when it is used from a source which requires a low impedance termination (such as a 600-ohm transmission line or older vacuum-tube equipment) is a source termination resistor required at the 546 input.

## 2.7 SIGNAL LEVEL AND OVERLOAD DETECTOR

The Model 546's differential input amplifiers are capable of being driven by signals up to a level of +26 dB, above which clipping and distortion occurs. The overload LED turns on when peak signals exceed the clipping level, and it will remain on long enough to be seen even if the excess signal is only a brief transient. To avoid audible distortion, when the LED indicator flashes more than occasionally, either lower the level of the source feeding the equalizer, or use an external attenuation pad.

Overload conditions are monitored at each individual parametric filter section output since it is possible, through boost-cut combinations, to overload these circuits even though the input signal level is below +26 dB.

The output amplifier is capable of delivering +24 dBm into a 600 ohm load (12.3 volts) or +20 dB into a 150 ohm load.

## 2.8 DUAL CHANNEL - EXPANDED CHANNEL A MODE

A slide switch at the rear of the chassis selects either of the two operational modes of the Model 546:

### 1) Dual Channel.

Both channels of the parametric equalizer are used independently. All controls are active and function as indicated on the front panel.

### 2) Expanded Channel A.

This mode is intended for applications where more than four parametric filter sections are needed. All eight filters may be adjusted according to the front panel markings. The Channel B Gain control, EQ IN/OUT switch and End Cut filters are not used in this mode. Connections are made to the input/output terminals of Channel A. A simultaneous output is also available at the Channel B output terminals. Both overload LED's remain active, indicating in which section of the equalizer the overload occurs.

## SECTION III OPERATING INSTRUCTIONS

### 3.1 GENERAL

After the Parametric Equalizer has been installed and is connected to both the signal source and the succeeding equipment according to SECTION II, power may be switched ON. Set all controls to minimum, i.e.:

BOOST-CUT control to midpoint ("0").  
FREQUENCY control in any position.  
Individual concentric push-pull EQ switches pushed IN.  
LOW CUT control fully counterclockwise.  
HIGH CUT control fully clockwise.  
EQ IN/OUT switch to OUT.  
MODE switch (rear panel) in "Dual Channel" position.

### 3.2 SYSTEM CHECK

Apply program material, and monitor the output signal while the EQ switch is in the OUT position. The signal should be passed through the Model 546 with no frequency alteration but with a loss or gain in amplitude, as adjusted with the Gain control. Half rotation is approximately unity gain. Since all controls are adjusted for minimum effect, no change should be noticeable when the EQ switch is set to the IN position.

### 3.3 EXPERIMENTATION

To become familiar with the range and effects of the various filters, it is helpful to "play" with the controls and listen to a combination of settings.

It will be helpful to study the graphs included in this manual in Section VI although they show only a small selection of the possible representations.

The individual EQ switches (concentric) are very useful to monitor the effect of a single filter while altering adjustments. The overall EQ switch (toggle) allows the user to bypass all filters and/or evaluate the total effect of the adjustments.

### 3.4 DOCUMENTATION

The very nature of a parametric equalizer permits an almost infinite number of control settings. For later duplication of a certain sound or a corrective filter shape it is necessary to document the position of the controls (Frequency, Bandwidth or "Q"), and the amount of Boost and/or Cut. This is made convenient by the Model 546's calibrated markings.

In addition, a frequency response curve may be drawn with a suitable sweep generator and X-Y Recorder system, such as the UREI Model 200/2000.

### 3.5.0 APPLICATION

#### 3.5.1 GENERAL CLASSIFICATION

A parametric equalizer is used differently, depending on the job it has to do. Two main application categories are now popular.

1. The creative modification of program material during a live performance, a recording session, a mix-down, or similar occasions.
2. The corrective modification of frequency response of equipment in studio monitoring, commercial sound, and entertainment sound reinforcement systems.

#### 3.5.2 CREATIVE EQ TECHNIQUES

It is acceptable to use extreme filter settings for creative work, especially to produce special effects. A single instrument, voice, or even a chord may be emphasized or de-emphasized by careful EQ adjustment. A feeling of motion or a "phasing" sound can be achieved by rotating the dials through their range as the signal passes through the filter. However, equalization is least obtrusive when a smooth filter characteristic is selected.

It should be remembered that excessive boost reduces the system headroom, makes additional power demands on amplifiers and speakers, and can cause clipping.

If "ringing" is experienced, it is usually due to high-Q (narrow bandwidth) settings. Although this may be an interesting effect for some work, ringing is not desirable in corrective equalization.

#### 3.5.3. USE OF "FREQUENCY RANGE OF VARIOUS SOUND SOURCES"

The frequency range charts in Section VI have been compiled from various publications (Ref. 1, 2). These charts may be helpful for finding the frequency setting on the Model 546 which affects a particular instrument. If a wide notch or peak is selected, it could eliminate or accentuate part of an entire musical passage.

The fundamental frequencies are shown in heavy lines; the upper harmonics are indicated by thin lines. Mechanical noise that extends beyond the upper harmonics is indicated with dots.

It should be recognized that the upper harmonics of most instruments extend to almost the top end of the audio spectrum. This implies that any EQ in the mid and upper frequency bands will affect the tonal character of other instruments, even though these instruments may not be played in the range the filter is tuned to.

Ref. 1 Olson, H.F., "Elements of Acoustical Engineering,"  
Van Nostrand, New York, 1947.

Ref. 2 Snow, W.B., Journal of the Acoustic Society of America,  
1931, Vol. 2, p. 33.

#### 3.5.4 LOW CUT & HIGH CUT FILTERS FOR CREATIVE EQ

The cutoff filters are used to restrict bandwidth. The Low cut eliminates problems such as hum and rumble from turntables, stage noises transmitted through mic stands, and low frequency vibration of electric instruments having pickups. The High cut reduces H.F. noise and scratches, and it aids in getting excessive treble out of the audio signal. If the signal loses "presence" due to high frequency attenuation, it may be partially restored by tuning a parametric filter section close to the roll-off point of the High cut and adding some boost, as shown in Fig. 6-5, Section VI. The same technique may be used at the low frequency end to improve the apparent "bass response" after bandwidth restriction is adjusted.

#### 3.5.5 CORRECTIVE EQ TECHNIQUES

This and the following sections are directed to the application of the parametric equalizer in acoustic sound systems. Proper equalization improves the reproduction of audio signals in several ways.

Since peaks in frequency response cause coloration of audio signals and also mask adjacent frequencies, the reduction of such peaks can positively affect the tonal balance of the program material and improve speech intelligibility.

The maximum available acoustic level is limited by those frequencies whose amplitude exceed the average level of the rest of the spectrum. These frequencies will cause ringing and feedback when their gains approach or exceed unity. Therefore, the aim of equalization in a room is to adjust the frequency response of the sound system for the smoothest overall electronic-acoustic curve. In practice, however, it is not always desirable to attempt to equalize to the last dB; minor anomalies in the response are not as objectionable as the artificial or "processed" sound that sometimes results from extensive equalization. More extreme filter settings

will inherently introduce more phase shift, which may cause more problems than the EQ solves.

### 3.5.6 FREQUENCY RESPONSE MEASUREMENTS

Before any equalization of a sound system in its environment is attempted, there are a few prerequisites:

- A) The entire system should be free of hum, noise, oscillation and RF interference. These are problems that benefit from source treatment more than from equalization.
- B) The frequency response characteristic of the system should first be measured; once the existing performance is known, effective equalization is then possible.

Several methods are available and, if applied judiciously, yield congruent results. Real-time analysis using pink noise, and periodic test signals such as Sonipulse™ or tone bursts, provide reliable and repeatable information about the frequency response characteristic.

The system's frequency response may also be measured using a warbled sine wave. This method is part of the previously mentioned (Section 3.4) UREI 200/2000 Automatic Frequency Response Plotting System. The advantages are: simultaneous hard copy plot and an analysis bandwidth continuously variable by adjusting the amount of warble from less than 1/10 octave to 1/2 octave.

### 3.5.7 EQUALIZATION TECHNIQUE

Examination of the measured curve will show the deficiencies of the sound system in its environment. (Fig. 6-6, Section VI) Using a low level point in the response curve as a reference, the simplest way to set the equalizer is to adjust its controls to an inverse of that curve. Remember that it is better to use mainly cut and to avoid adjustments which would require boost (Fig. 6-7).

### 3.5.8 FEEDBACK SUPPRESSION

Sounds reflected by walls and ceiling add to and subtract from the direct sound from a loudspeaker as it arrives at a listener's ear. Various frequencies reflect in different amounts, and resonant peaks and dips will occur. Peaks in the frequency response cause coloration of the original sound. They will mask adjacent frequen-



cies of program material. Aside from adversely influencing the quality of music and the intelligibility of speech reproduction, these peaks in the frequency response also reduce the maximum obtainable average sound level throughout the audio spectrum. The average sound level is limited by those frequencies whose amplitude approach or exceed a system gain of unity.

This condition is marked by ringing and feedback. Ringing is a prolongation of the reverberation time for those frequencies which are approaching unity gain. Feedback is a spontaneous oscillation at the frequency where loop gain (including the acoustic environment) exceeds unity.

Experience with narrow band notch filters has demonstrated that, in a typical sound reinforcement system, gain before feedback can be significantly improved by centering a narrow band reject filter on four or five of the most prominent system resonant frequencies. It has also been found that rolling off the low and high frequency ends of the spectrum, to pass only a program's required bandwidth, increases gain before feedback at the band edges.

When adjusted to the minimum bandwidth of 1/4 octave, the parametric filter sections of the Model 546 can be used to reduce feedback without affecting adversely the frequency balance of the program material. Although the range of the filters allow the user to tune to any frequency of the audio spectrum, more flexibility is given in the "Expanded Single Channel Mode". Of course, for feedback suppression the filters are only used in the range of attenuation.

CAUTION: Feedback is not only annoying to the ear but is also dangerous to unprotected amplifiers and loudspeakers!

SLOWLY increase the gain of the acoustic system until the first feedback frequency becomes detectable and has been stabilized. Use the parametric filter in whose frequency range the feedback occurs. Turn its Boost/Cut Control CCW to the -15 dB position and tune the Frequency control until the feedback disappears. With maximum cut the feedback frequency may be at the skirt of the filter; for a more accurate tuning, reduce the Boost/Cut depth setting and retune the Frequency control to eliminate the feedback.

Increase the system gain so the next feedback frequency will appear and repeat the procedure until no further improvement is possible. Use the End Cut filtersto restrict the bandwidth of the processed program material as necessary.

The result will be a higher amplifier gain setting than was possible before inserting the filter. Remember: an improvement of 3 dB is equal to twice the previously available power. To avoid ringing, it is best to adjust the gain at least 3 dB below the threshold of feedback.

### 3.5.9 LOW CUT & HIGH CUT FILTERS AFTER CORRECTIVE EQUALIZATION

Examination of the filter's frequency response characteristic, after equalization adjustments have been made, may show that the band ends (low frequency and high frequency extremes) could overdrive the amplifier or speakers if program material contains energy at these frequencies (e.g., microphone pops, etc.). Adjust the tunable Low cut and High cut filters until the resulting system response curve loses its "bathtub" shape and the house curve rolls off smoothly at each end, Fig. 6-8, Section VI.

## SECTION IV THEORY OF OPERATION

NOTE: In the following descriptions, the component designation for Channel A is used. Additional information regarding Channel B is contained in the schematic diagram in Section VI.

### 4.1 INPUT AMPLIFIER

The signal is applied to a differential input amplifier (IC50, sections C and D). The input accepts either balanced or unbalanced sources (see Installation, Section 2.6). Common mode rejection is factory adjusted with R50 and is typically better than 60 dB.

The gain of the input amplifier is -6 dB. This provides additional headroom in the following parametric filter sections when they are used with boost equalization. Potentiometer R53 adjusts the gain of amplifier IC50-A over a range of 30 dB. This front panel control changes the overall gain of the equalizer from -10 dB to +20 dB; at half rotation gain is approximately unity.

The factory set offset adjustment of R56 assures that no DC voltage is at the output of this amplifier stage, thus preventing audible clicks when operating the EQ switch.

### 4.2 END CUT FILTERS

From the input amplifier stage the signal is coupled into the END-CUT FILTER, IC50-B. The filter circuit has a Butterworth response for both Low Cut and High Cut. The -3 dB points can be adjusted continuously within their active frequency range, and the slopes are 12 dB/octave. Resistors R62 and R63 provide enough gain to restore unity with respect to the input signal level.

### 4.3 PARAMETRIC FILTER

The Model 546 contains two groups of 4 parametric equalizer sections. The only difference between the various sections is their respective tuning ranges; their function is otherwise identical. Therefore, this portion of the manual describes only the operation of the first (Low Band) filter.

All four sections of the Quad OP-Amp IC10 are used in this state variable filter circuit. The main signal path is through the inverting amplifier section B. Potentiometer R10-C is connected between the input and output of amplifier IC10-B. Depending on the position of the wiper, any portion of the audio signal may be selected between the in-phase input and the inverted (180° out-of-phase) output. This signal feeds into the actual filter circuit, which is tuned with the dual-potentiometer R10 (A and B). The bandpass output from IC10-C is then coupled back through capacitor C10 to be differentially summed with the original input signal in IC10-B. The effect is that the bandpass output is added or subtracted (BOOST or CUT) from the composite audio signal.

The bandwidth of the filter is adjusted with potentiometer R15, which changes the feedback parameters of IC2-A. The values are selected for a range from 1/4 octave (CCW) to 4 octaves (CW).

All parametric filter sections are cascaded and each output is separately monitored for any possible overload condition.

#### 4.4 OUTPUT AMPLIFIER

Depending on the position of the EQ switch, the signal is either coupled through C70 and R70 from the series of filter sections, or directly from the very low impedance output of the input stage IC50-A (effectively overriding the signal from the filters).

The output-amp consists of op-amp IC70-B, which drives the complementary pair of power output transistors. The gain of the output stage is set by the ratio of resistors R72 and R71. Resistors R70 and R73 balance the signal levels when the EQ section is switched IN or OUT. The output transformer provides 3 dB of gain (when terminated with 600 ohms).

#### 4.5 OVERLOAD DETECTOR

The overload detector will react to signal levels approaching the maximum signal amplitude at any of 5 different points throughout each channel of the Model 546.

Under normal conditions, the output of IC70-C is positive due to a negative bias voltage at its inverting input, and the LED is turned OFF. If a signal level, conducted through any of the 5 input diodes, is high enough to exceed the threshold set by R81 and R82, the amplifier output changes state. The output goes negative and the LED turns ON. To insure that the LED lights up long enough to be observed even though the overload may be caused by very short duration signals, a pulse-stretching network is included in the positive feedback loop of the amplifier IC70-C.

#### 4.6 POWER SUPPLY

The power supply is bipolar employing two integrated circuit voltage regulators VR1 and VR2 to provide low-ripple,  $\pm 18$  volt DC. Additional filter capacitors assure power supply stability and low noise.

The pilot LED is connected to the positive and negative sides of the power supply to indicate power ON condition.

SECTION V  
MAINTENANCE

5.1 GENERAL

The Model 546 is an all solid-state unit, ruggedly constructed with only the highest quality components. As such, it should provide years of trouble free use with normal care. All parts used are conservatively rated for their application, and workmanship meets the rigid standards you have learned to expect in UREI products.

NO SPECIAL PREVENTIVE MAINTENANCE IS REQUIRED.

5.2 REPAIRS AND WARRANTY

This product is factory warranted to the original purchaser against defects in material and workmanship for one year after initial purchase. This limited warranty must be activated at the time of purchase by returning the registry portion of the Warranty Card to the factory. Should a malfunction ever occur, the dealer from whom the unit was purchased will be glad to handle return for factory repair. Please call or write to the factory for a Return Authorization Number which must accompany all repairs. For prompt service, ship the unit prepaid directly to the factory with the RA Number visible on the shipping label. Be sure it is well packed in a sturdy carton, with shock-absorbing material such as foam rubber, styrofoam pellets, or "bubble-pack" completely filling the remaining space. Particular attention should be paid to protecting the controls, switches, etc. Tape a note to the top of the unit describing the malfunction, and instructions for return. We will pay one-way return shipping costs on any in-warranty repair.

Because of specially selected components in this product, field repairs are not authorized during the warranty period, and attempts to perform repairs may invalidate the warranty.

Even if your unit is out of warranty, we recommend that you return it to the factory for repairs. Our experienced personnel, supported by special test equipment, will be able to find and eliminate any problem in the most efficient way.

WARNING: The full AC Line voltage is present at several points inside the chassis. Be careful to avoid personal shock when you work on the unit with the covers removed.

### 5.3. SERVICE ADJUSTMENTS

These controls have been carefully set at the factory and should not require adjustments except after service work. (Channel B component designations, where given, are in parentheses.)

#### 5.3.1 COMMON MODE BALANCE

The internal trimpots R50 (R150) affect the COMMON MODE BALANCE. If a check or an adjustment is necessary the following procedure should be followed (each channel):

Connect the  $\pm$  and COM input terminals together and apply an input signal between this connection and the GND terminal (100 Hz, 3 V RMS).

Switch the EQ OUT and measure the signal with an AC VTVM or DVM across the output terminals of the Model 546. Adjust the trimpot for a minimum reading, switching the voltmeter gradually to more sensitive ranges.

#### 5.3.2 OFFSET ADJUSTMENT

The internal trimpots R56 (R156) affect this adjustment. It should only be necessary to change the factory setting if IC50 and/or IC70 are replaced. The adjustment is correct when the DC output of IC50-A is 0 VDC. Since there is no offset voltage at the input of IC70, no "click" will be generated when the EQ switch is operated.

##### PREFERRED METHOD

Adjust R56 for 0 VDC at the output of IC50-A (green wire at the EQ switch).

##### ALTERNATE METHOD

Connect the output terminals of the Model 546 to a high gain amplifier and loudspeaker. With no input signal applied switch the EQ IN and OUT.

Listen to the loudspeakers and adjust R56 for minimum audible "click" while operating the EQ switch.

SECTION VI

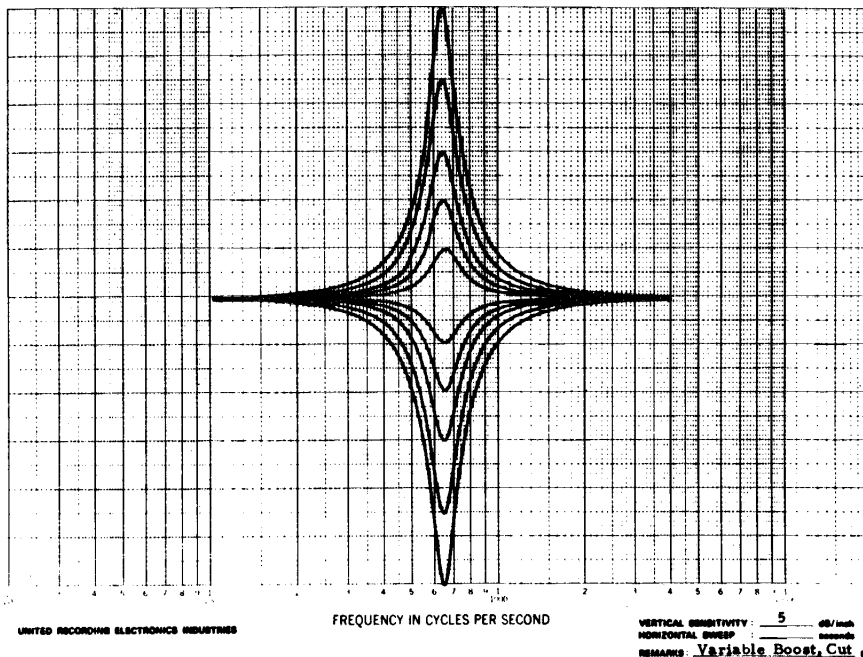

FIGURE 6-1. SINGLE PARAMETRIC FILTER SECTION ADJUSTED TO VARIOUS AMOUNTS OF BOOST OR CUT, WHILE THE BANDWIDTH (Q) REMAINS AT A CONSTANT NARROW (1/4-OCTAVE) SETTING. VERTICAL SENSITIVITY = 5 dB/in.

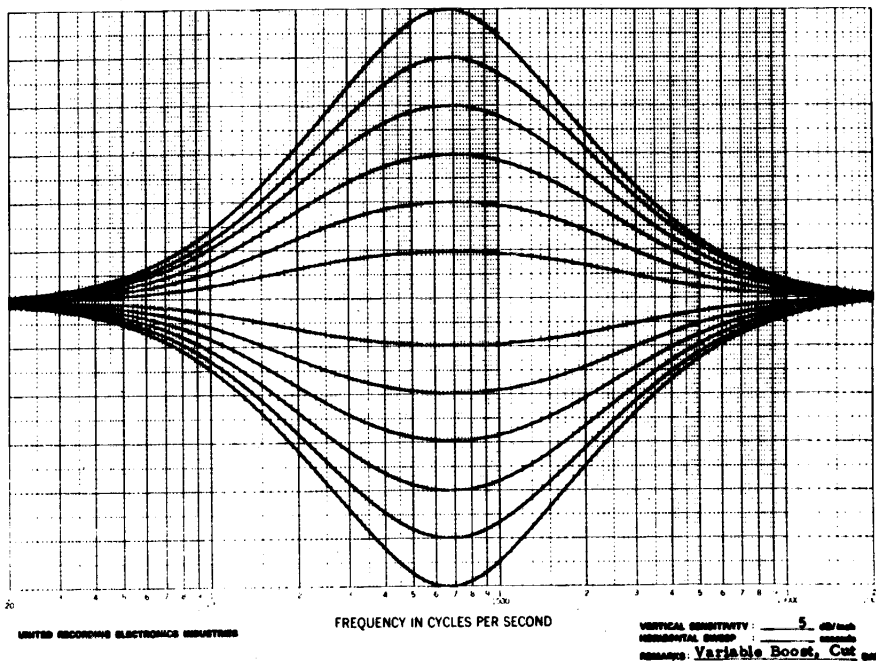

FIGURE 6-2. SINGLE PARAMETRIC FILTER SECTION ADJUSTED TO VARIOUS AMOUNTS OF BOOST OR CUT, WHILE THE BANDWIDTH (Q) REMAINS AT A CONSTANT WIDE (2 OCTAVE) SETTING. VERTICAL SENSITIVITY = 5 dB/in.

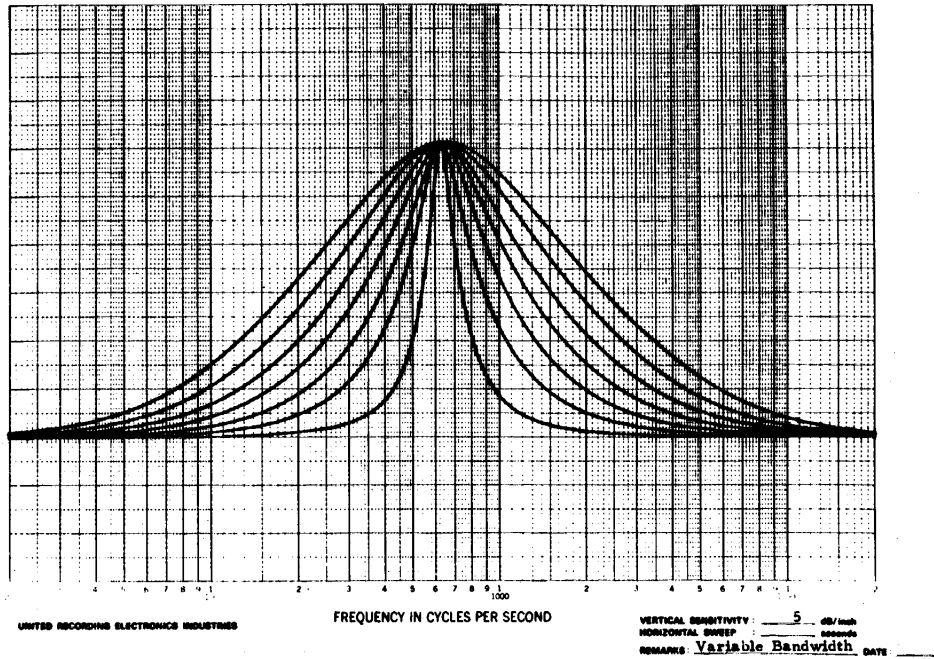

FIGURE 6-3. SINGLE PARAMETRIC FILTER SECTION ADJUSTED TO VARIOUS BANDWIDTHS (1/4 OCTAVE TO 2 OCTAVES). BOOST REMAINS CONSTANT AT +15 dB. VERTICAL SENSITIVITY = 5 dB/in.

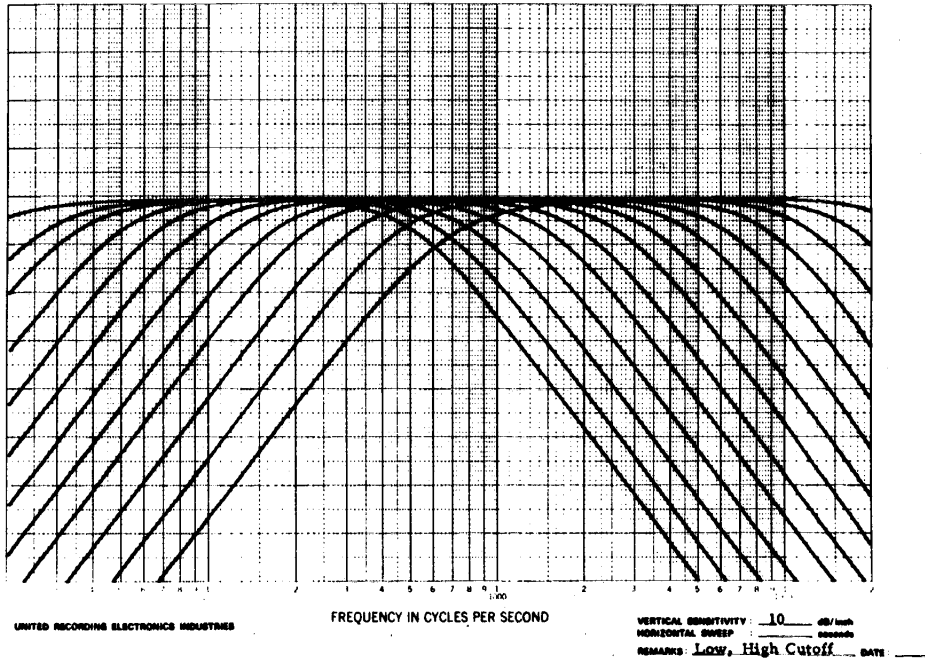

FIGURE 6-4. RANGE OF END CUT FILTERS. VERTICAL SENSITIVITY = 10 dB/in.



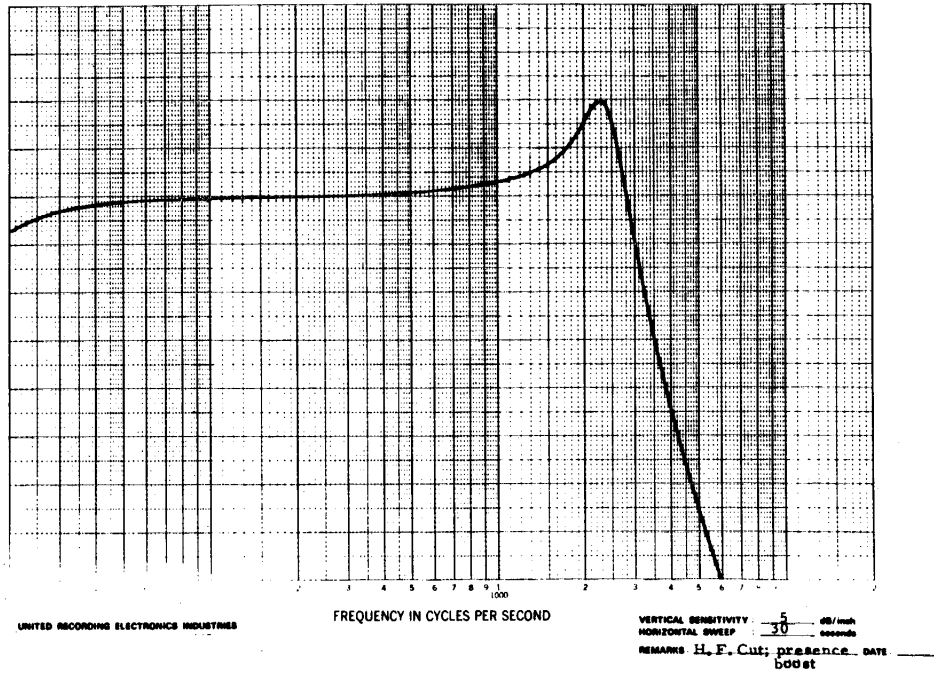

FIGURE 6-5. HIGH CUT FILTER ADJUSTED TO ROLL OFF HIGH FREQUENCY NOISE. SINGLE PARAMETRIC FILTER SECTION ADJUSTED +5 dB BOOST TO ACCENTUATE PRESENCE OF AUDIO SIGNAL (PARAGRAPH 3.5.4). VERTICAL SENSITIVITY = 5 dB/in.

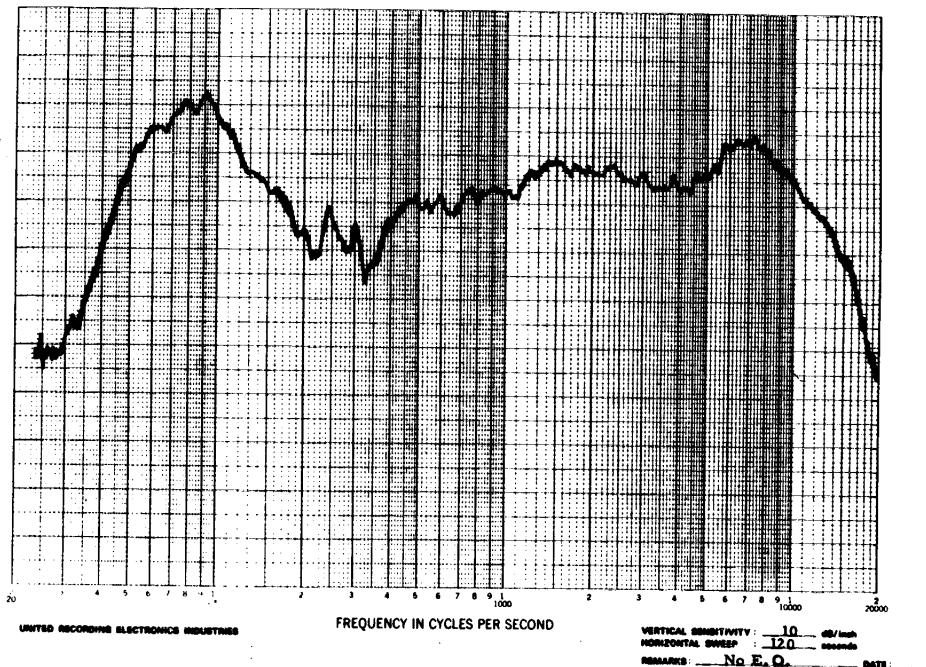

FIGURE 6-6. ACOUSTIC ANALYSIS OF A STUDIO MONITOR SPEAKER, MEASURED WITH A SWEEPED SINE WAVE WHICH WAS WARBLED WITH 1/3-OCTAVE BANDWIDTH. VERTICAL SENSITIVITY = 10 dB/in.

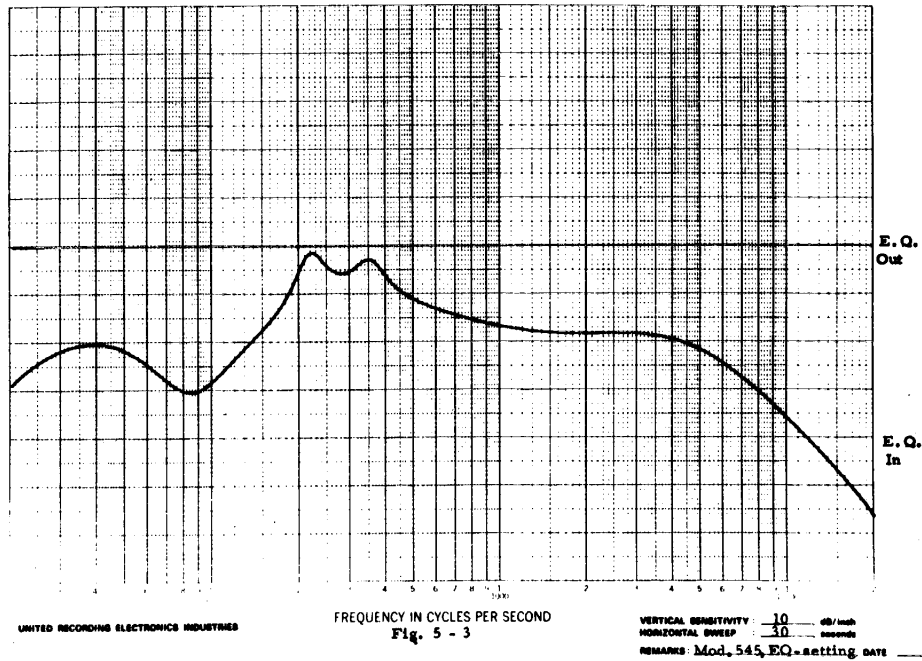

FIGURE 6-7. FILTER CHARACTERISTICS OF THE PARAMETRIC EQUALIZER AFTER THE NECESSARY ADJUSTMENTS WERE MADE TO COMPENSATE FOR THE RESPONSE INDICATED IN FIGURE 6-6. VERTICAL SENSITIVITY = 10 dB/in.

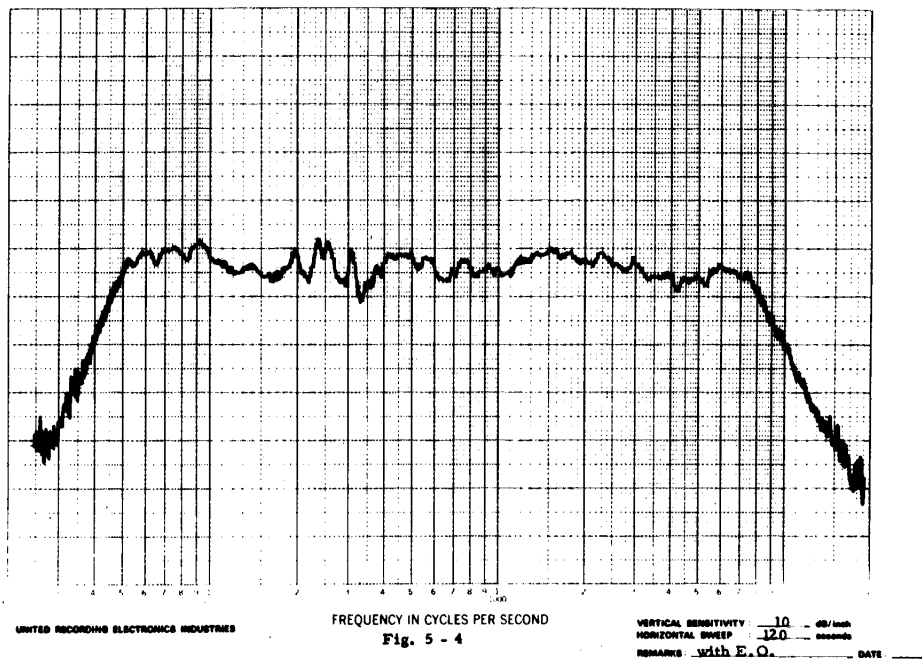
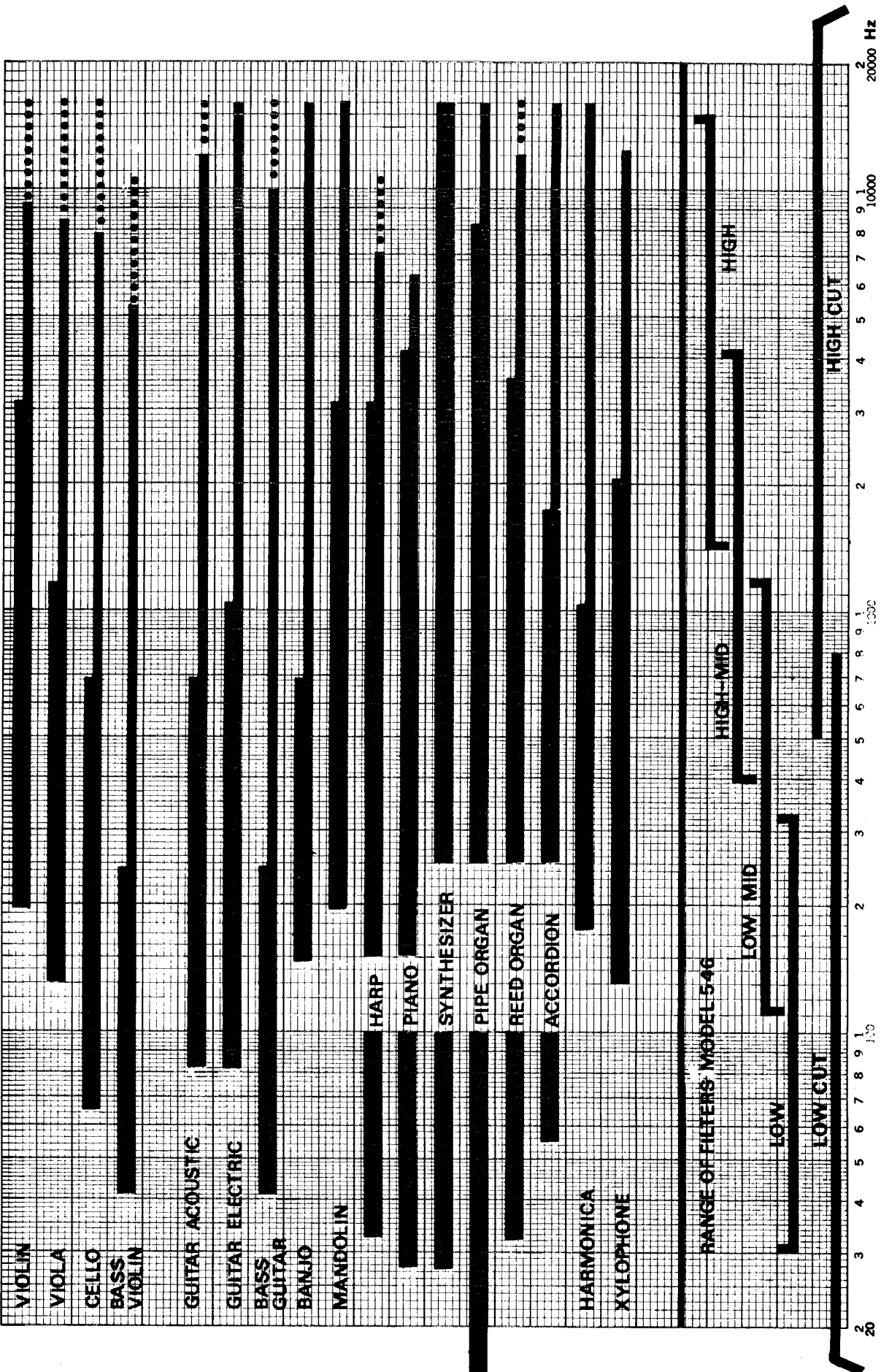

FIGURE 6-8. RESULTING "NEW" HOUSE CURVE OF THE MONITOR SYSTEM IN ITS ENVIRONMENT AFTER THE EQUALIZATION SHOWN IN FIGURE 6-7 WAS INSERTED IN THE SYSTEM. VERTICAL SENSITIVITY = 10 dB/in.

NOTE: All the frequency response graphs shown in this manual were made with the UREI Automatic Response Plotting System, Model 200/2000. The original size, before photographic reduction, displays 6 inches of vertical range.

#### FREQUENCY RANGE CHARTS OF VARIOUS SOUND SOURCES.

Figure 6-9 through 6-11, appearing on the three following pages, represent good approximations of the frequency response of various sound sources. Fundamental frequencies are indicated by heavy lines, harmonics by lighter lines, and any mechanical noise which extends beyond the upper harmonics is shown by dotted lines. The information used to create these illustrations was obtained from several widely published charts, as cited in Paragraph 3.5.3 of this manual.



STRING INSTRUMENTS  
KEYBOARD INSTRUMENTS

FREQUENCY RANGE OF  
VARIOUS SOUND SOURCES

FIG. 6-9

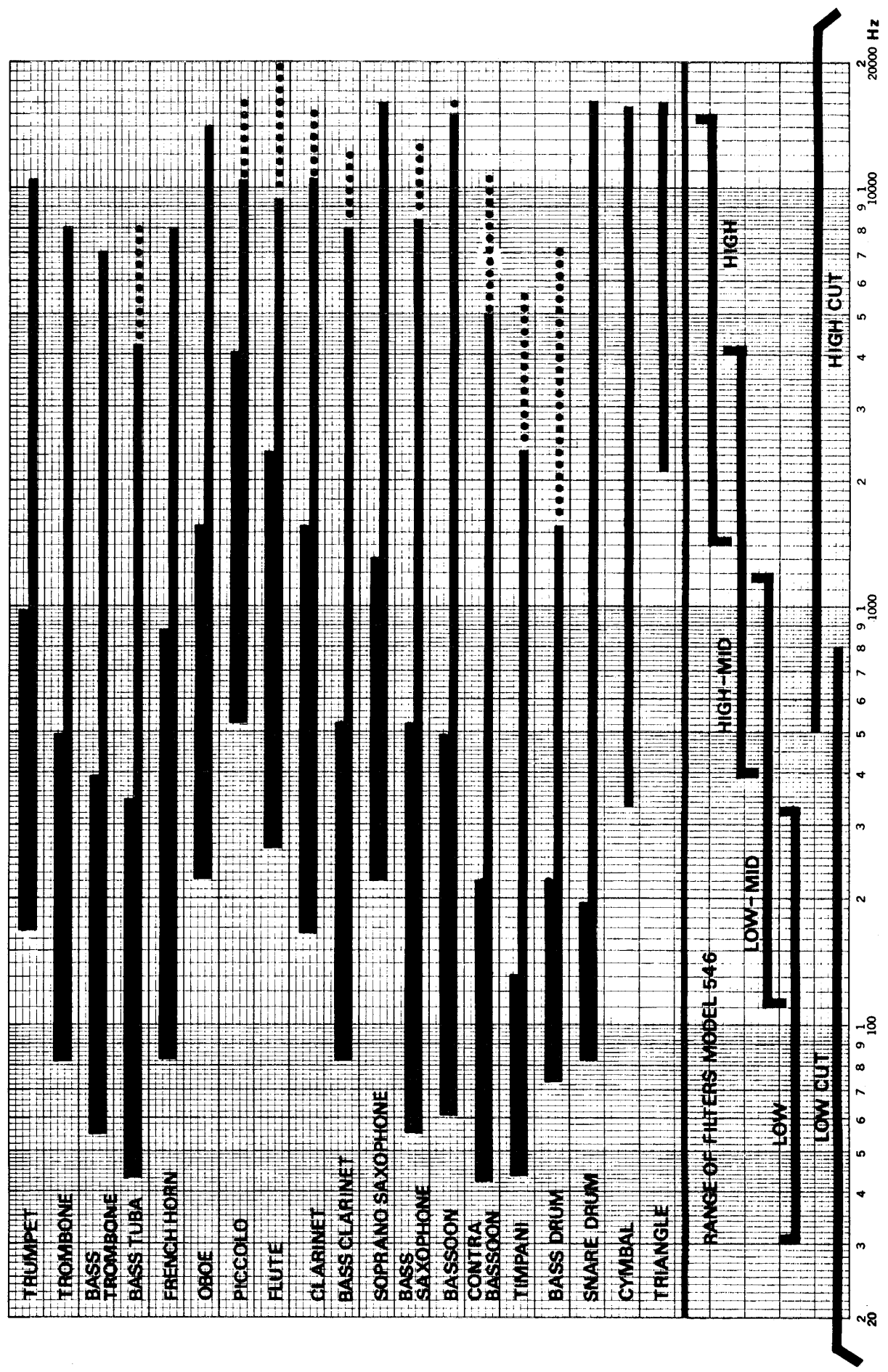
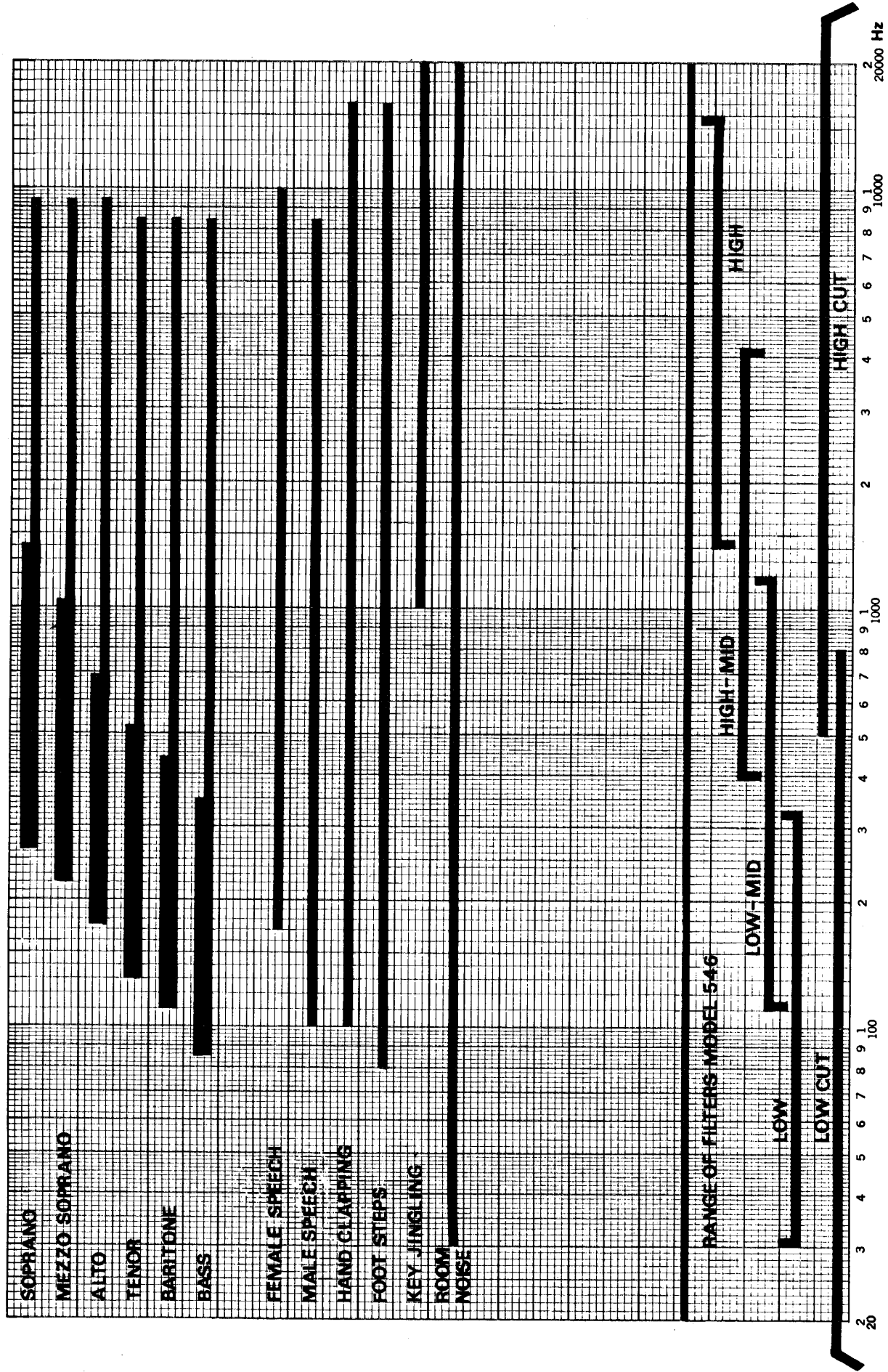

FIG. 6-10 FREQUENCY RANGE OF VARIOUS SOUND SOURCES/ BRASS, WOODWIND INSTRUMENTS. PERCUSSION INSTRUMENTS



HUMAN VOICE AND TYPICAL NOISE SOURCES

FREQUENCY RANGE OF VARIOUS SOUND SOURCES

FIG 6-11

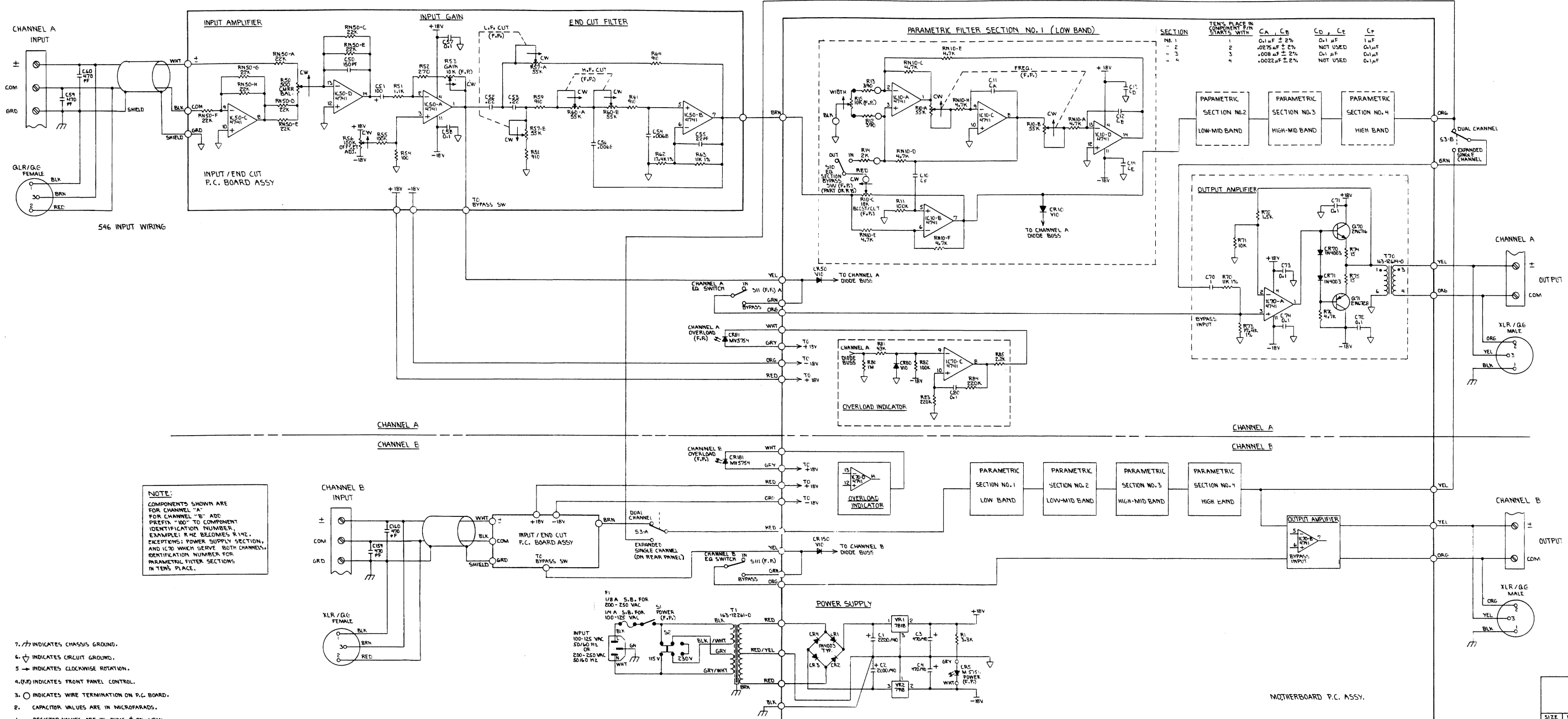

**NOTE:**  
 COMPONENTS SHOWN ARE FOR CHANNEL "A".  
 FOR CHANNEL "B" ADD PREFIX "100" TO COMPONENT IDENTIFICATION NUMBER.  
 EXAMPLE: R42 BECOMES R142.  
 EXCEPTIONS: POWER SUPPLY SECTION, AND IC70 WHICH SERVE BOTH CHANNELS.  
 IDENTIFICATION NUMBER FOR PARAMETRIC FILTER SECTIONS IN TENS PLACE.

- 7. INDICATES CHASSIS GROUND.
  - 6. INDICATES CIRCUIT GROUND.
  - 5. INDICATES CLOCKWISE ROTATION.
  - 4. (F.P.) INDICATES FRONT PANEL CONTROL.
  - 3. INDICATES WIRE TERMINATION ON P.C. BOARD.
  - 2. CAPACITOR VALUES ARE IN MICROFARADS.
  - 1. RESISTOR VALUES ARE IN OHMS ± 5% 1/2W.
- NOTES: UNLESS OTHERWISE SPECIFIED.

SCHEMATIC		
SIZE	MODEL	DRAWING NO.
R	546	R13328
DATE	DR. BY	SMT
1-21-80	R.P. MARR	1 OF 1