

**BEFORE PROCEEDING WITH COMPLETE UNPACKING AND SETUP,  
READ THE SECTION ON UNPACKING AND INSPECTION**

**JBL** UREI  
ELECTRONIC  
PRODUCTS  
**model 7922**  
**AUDIO DELAY**

**JBL Incorporated**  
8500 BALBOA BOULEVARD  
P.O. BOX 2200  
NORTHRIDGE, CA. 91329, U.S.A.  
PHONE: (818) 893-8411  
TELEX: 4720424

**SERVICE ADDRESS:**

**UREI Incorporated**  
8460 SAN FERNANDO ROAD  
SUN VALLEY, CA. 91352, U.S.A.  
PHONE: (818) 767-1000

## Preface

Thank you for purchasing this JBL/UREI product. We have prepared this instruction manual to enable you to achieve optimum utility and performance from your new Audio Delay. We encourage you to read and to make use of the material contained in this manual. We welcome your suggestions and comments on our products and on this manual.

This manual is dedicated to all the people who are interested in learning about the capabilities and limitations of our products in order to best use them. Learn, Enjoy and Share.

## Unpacking and Inspection

Your new JBL/UREI Audio Delay was carefully packed at the factory, and the container was designed to protect the unit during shipment. Nevertheless, we recommend careful examination of the shipping carton and its contents for any sign of physical damage which may have occurred in transit.

If damage is evident, do not destroy any of the packing material or the carton, and immediately notify the carrier of a possible claim for damage. Damage claims must be made by you.

The shipping carton should contain:

The JBL/UREI Model 7922 Digital Audio Delay

This Instruction Manual

JBL Tech Note Volume 3 Number 2

An envelope containing Rack Mounting Hardware

## Introduction to the Model 7922

The diagrams and information on the following two pages provide an overview of the operation of the Model 7922 Audio Delay. Additional information follows in the Installation, Operating Instructions, and Theory of Operation sections.

We are including with this manual a copy of JBL Tech Note Volume 2 No. 3, "Applications for the JBL/UREI 7922 Digital Audio Delay" which contains application information on the Model 7922 as it is used both for traditional signal delay and for Time Correction of cluster loudspeakers.

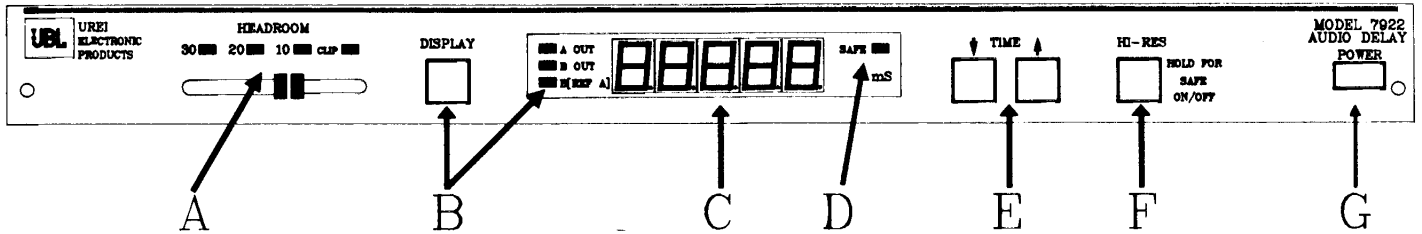

**Figure 1 - The Front Panel**

**A. Headroom Control and Display**

Adjusting the headroom control knob sets the internal signal-to-noise ratio of the 7922 while maintaining unity input/output gain. The LED headroom display indicates the amount of headroom available before the signal clips.

**B. Display Button and Display Mode Indicators**

The front panel DISPLAY button toggles through the 3 display modes - which are indicated by the red LEDs marked A OUT, B OUT, and B[REF A].

**C. Alphanumeric Display**

The LED display indicates delay time - in milliseconds - according to the current display and resolution mode. The display will be either three digits (LO RES mode), or five digits (HI RES) mode), depending on the resolution mode selected. The display will read "7922" during the turn-on delay, and "LO-AC" when a line fault is detected. The display will turn off if the SAFE mode is activated and if no buttons have been depressed for 5 minutes. The display turns on again when any front panel button (except POWER) is depressed.

**D. Safe Indicator**

The green SAFE light is on when the safe mode is active, and the delay times cannot be tampered with. Although the DISPLAY and HI-RES buttons will still be active - so the delay times can be examined - the TIME buttons will not cause the delay time to change until the safe mode is deactivated (see F).

**E. Time Buttons**

The time buttons are used to step the delay times for channels A or B over a range of 000.39 milliseconds to 328.06 milliseconds. The steps are either high resolution (10 microseconds), or low resolution (1 millisecond), depending on the current resolution mode (see F).

**F. Hi-Res Button and Safe On/Off**

The HI-RES (High Resolution) button toggles between the 5-digit high resolution mode - which displays delay times out to the 10 microsecond digit - and the 3-digit low resolution mode - which displays delay times to the nearest millisecond. The HI-RES button has the secondary function of safe on/off toggle. When the button is held down for 5 seconds, the safe condition changes, and the SAFE LED is updated to reflect the new condition.

**G. Power Switch**

Pushing this button will produce a mechanical "click" when the switch is thrown and the unit is powered up. A similar "click" is produced when the button is pushed again and released to the out position, shutting the power off.

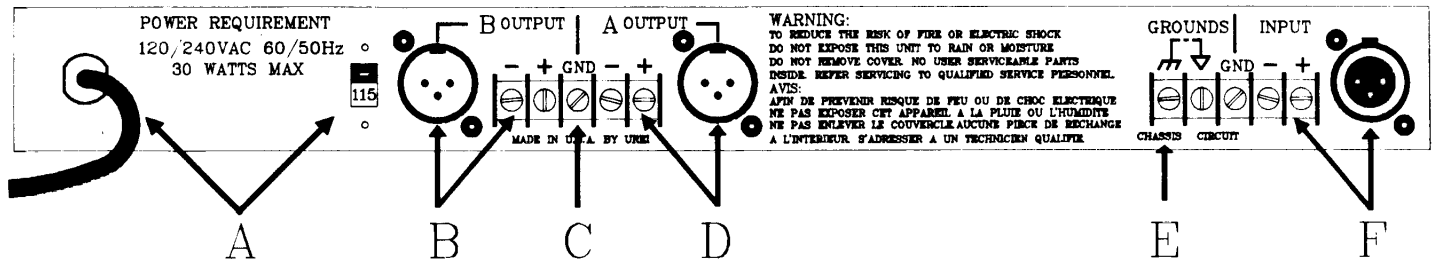

Figure 2 - The Rear Panel

### A. AC Line Cord

You can choose the "115" position of the AC switch, and connect the cord to a 120 V AC, 60 Hz, grounded power source, or you may choose the "230" position of the AC switch, and connect the cord to a 240 V AC, grounded power source.

### B. B Output

The B channel delayed output is available at the male XL-type connector (pin 3 "+", pin 2 "-") or at the "+" and "-" terminals of the barrier strip. The output signal is transformer- isolated, floating, and balanced.

### C. Signal Ground

The signal ground is available at the output terminal strip (GND), at the input terminal strip (GND and CIRCUIT) and pin 1 of the XL connectors. This is the ground common to all the internal analog circuitry.

### D. A Output

The A channel delayed output is available at the male XL- type connector (pin 3 "+", pin 2 "-") or at the "+" and "-" terminals of the barrier strip. The output signal is transformer- isolated, floating, and balanced.

### E. Chassis Ground

The chassis ground is connected to the "ground fault" pin of the AC line plug and is connected to signal ground (GND) via a 1000 ohm resistor, a 0.1 microfarad capacitor, and a removable barrier strip jumper, all in parallel. The jumper may be removed if it is necessary to isolate signal ground from chassis ground.

### F. Input Signal

The input signal can be applied at the female XL-type connector (pin 3 "+", pin 2 "-"), or at the "+" and "-" terminals of the barrier strip. Either balanced or unbalanced inputs are acceptable.

## Installation

### Input Connections

The 7922 will not unbalance floating or balanced output sources since the input circuits consist of balanced differential amplifiers. Balanced wiring is the preferred style, especially when running long lines, due to the ability of a balanced input to reject signals (such as hum fields) which are induced equally into both of the signal carrying conductors. Even if the previous piece of equipment has an unbalanced output it may be advantageous to wire it to the input of the 7922 as though it were balanced. This takes advantage of the ability of the input to reject common-mode noise.

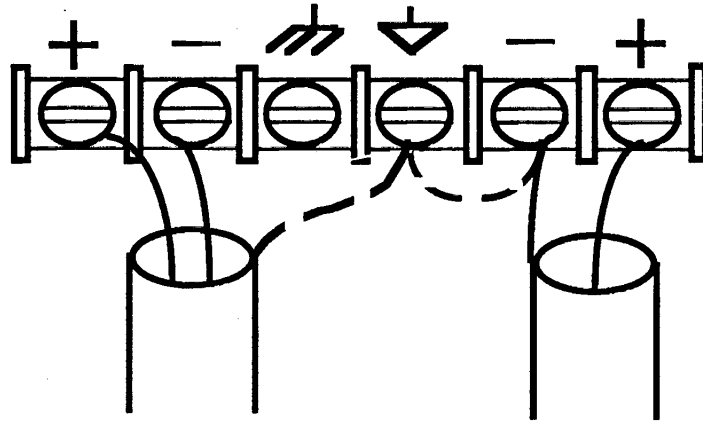

**FIGURE 3**  
 BALANCED AND UNBALANCED  
 BARRIER STRIP CONNECTIONS  
 {GROUND CONNECTIONS DEPEND ON YOUR INSTALLATION}

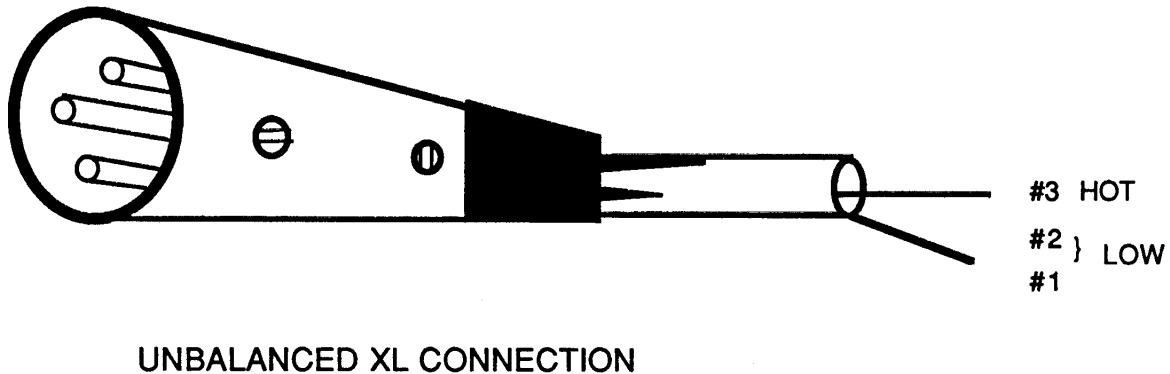
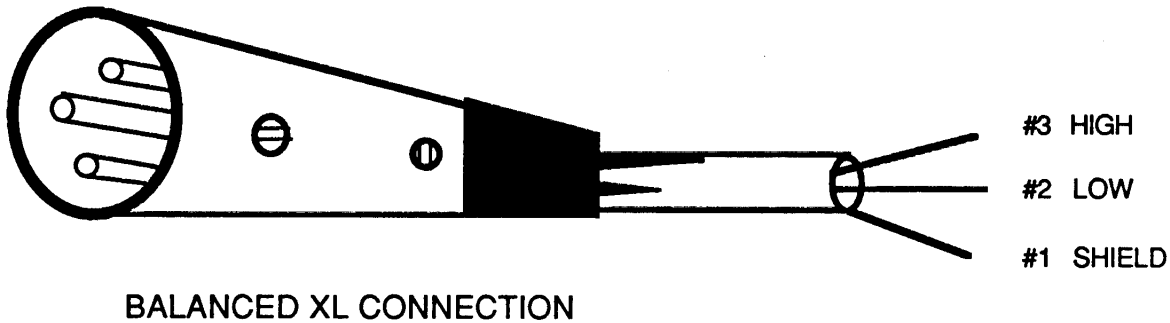

**FIGURE 4**

To use an unbalanced source, wire the signal carrying conductor of the cable from that source to the "+" terminal of the barrier strip (XL-type pin 3), and wire the shield to the "-" terminal of the barrier strip (XL-type pin 2). The unused connector terminal, pin 1 (sleeve), may also be connected to shield ground if that is compatible with your system grounding. (See the section on Grounding and Figure 3, for illustration of barrier strip connections.)

We recommend that two-conductor shielded cable be used even in an installation using unbalanced wiring. Do not depend on the shield wire itself to complete the signal connection. Stranded shield wires

are more subject to breakage, especially in portable installations, than the more protected internal insulated wires. Using this wiring system, the worst that would happen with a broken shield would be a rise in noise or hum due to the lack of shielding. If the ground connection were completely lost this would result either in loss of audio or a terrible loud hum.

## Output Connections

Output wiring is similar to input wiring. Because the output stage incorporates a transformer, it is important to remember that connection must be made to both (+) and (-) terminals of the output. The output will drive any load of 600 ohms or greater and does not require a termination. If the 7922 is driving a long line (in excess of 30 meters [100 feet]) a 620 ohm termination resistor at the other end of the line from the 7922, in combination with the use of balanced lines, will reduce the possibility of noise pickup in those lines.

## Impedance and Termination for 600 Ohm Lines

In the USA the early history of the audio industry is very closely tied to the history and technology of the telephone industry. Much of the early equipment used for public address systems, recording, broadcast and reproduction of sound was either designed by or heavily influenced by the scientists and engineers at Bell Telephone Laboratories. The technology that they and others developed has had a lasting influence on the design and specification of all types of audio products. Among their contributions was the 600 ohm transmission line.

The 600 ohm line was developed because of a need for a standardized impedance for long distance transmission lines. Transmission and reception equipment using vacuum tubes, transformers, and passive equalization and mixing networks require known source and load impedances to achieve predictable results. Because much of the early professional audio equipment was designed by telephone company people or used similar types of equipment, it is not surprising that the 600 ohm line became a standard in the professional audio industry.

Correct use of the 600 ohm transmission line requires a signal source with an exact 600 ohm source impedance, and a receiving device which also has a 600 ohm input impedance. If a device does not have the correct impedance, it must be modified until it does. In the case of a device with a lower than required source impedance this would require addition of a series buildout resistor (or two in the case of a balanced line). In the case of a higher impedance input a resistor across the input will suffice. Other variations require either a resistive network or transformer to match impedances.

The input impedance of the 7922 is very high, and the actual output source impedance is approximately 40 ohms. Therefore, if the 7922 is to be used in a 600 ohm system, attach a 620 ohm resistor across the input terminals of the delay to terminate the source, and build out the output impedance with a 560 ohm resistor in series with the output (or one 270 ohm resistor in each leg of a balanced system.)

However, most modern audio systems do not require the use of 600 ohm transmission line practices. This is for two reasons. First most audio systems are relatively small (especially as compared to a telephone network) and the cabling between parts of the system is under more careful control, and second, modern audio electronic products are no longer designed to require the use of 600 ohm line. Matching of input and output impedances is no longer necessary because the output impedance of a device may be made very low and the input impedance very high. Multiple inputs may thus be connected in parallel to the same source with ease and no loss of signal level.

## AC Power Connection & Line Voltage Conversion

The 7922 can be powered from either 100 to 120 VAC or 200 to 240 VAC, 50 or 60 Hz mains. The Supply Voltage Select Switch on the rear panel converts the unit from one operating range to the other.

As shipped, the unit is set for 100 to 120 VAC operation, and the line cord provided is suitable for use in the U.S. or Canada. To convert the unit for operation with other mains voltages or outlet types, use the following procedure.

1. Be sure the 7922 is not connected to any power source.
2. Slide the Supply Voltage Select Switch to the appropriate range.
3. Install a suitable plug or adaptor to mate the existing line cord with the power receptacle. The 7922 line cord uses IEC Standard color code in which Blue is Line, Brown is Neutral, and Green/Yellow is Mechanical Ground.

**Note:** Any line cord or adapter used for 200-240 V operation in the U.S. or Canada must be U.L. Listed or C.S.A. Certified. For 240 V AC, 50/60 Hz operation in other countries, select a line cord or adaptor based on governing local regulations.

**Caution:** This unit may be damaged if operated with the Supply Voltage Select Switch set incorrectly for the line voltage applied. Also, verify the mains are AC since, in some countries as well as certain areas within the U.S., DC mains exist.

## Grounding

For safe operation the 7922 must be connected to a good mechanical ground. This provides a current path for any voltage which might appear on the chassis due to a severe electrical fault in the delay. Without this path the unit might be a shock hazard. In addition, a good quality ground on the chassis provides shielding from external fields and minimizes radiation of internal fields to the outside world. To comply with safety regulations in many localities, and to protect our customers, we provide this product with a ground connection through a three-wire power cord.

In many situations this will present no problem. But there are instances where a hum or buzz will be introduced due to a phenomenon known as a ground loop. This results when there is a significant potential between the audio ground of the previous piece of equipment and the mechanical ground to which the 7922 has been connected.

If this is the case, the first attempt at a solution should be to remove the strap on the rear panel barrier strip which connects audio ground and chassis. Removal of this strap may have a significant effect on reducing the hum. Audio ground will then be referenced from the signal source and the chassis ground will be separate but still connected to mechanical ground for shock protection.

In some instances the voltage difference between the grounds will be so great that a direct connection to mechanical ground is not possible without hum in the output. Use of an isolation transformer in the input signal line may allow the signal to be connected while maintaining ground isolation. Check for this using a 3 prong to 2 prong AC adaptor between the power cord and the power outlet, temporarily ungrounding the unit. Try the 7922 both with and without the ground strap on the barrier strip. Determine which connection works best. Remember that for safety you must still have a connection to chassis ground. This is normally made through a properly grounded third pin connection.

## Mounting

Rack mount your Audio Delay with the enclosed rack mounting hardware. The 7922 is equipped with rack ears which may be moved forward to allow the controls to be recessed and/or the optional security cover mounted flush with the front of the rack ears.

The Model 7922 will operate satisfactorily over a range of ambient temperatures from 0° C to +50° C ( +32° F to +122° F ), and up to 80% non-condensing relative humidity.

If the unit is installed in an equipment rack, console or other area along with high heat producing equipment (such as power amplifiers), adequate ventilation should be provided to assure longest component life. Also, while internal circuitry susceptible to hum pickup is sufficiently shielded from moderate electromagnetic fields, avoid mounting the unit immediately adjacent to large power transformers, motors etc.

## Security Cover

In some installations it may be necessary to safeguard the 7922 control settings from deliberate or accidental mis-adjustment. In some environments the controls may benefit from additional protection against entry of dirt and dust.

The Model SC6 Security Cover offers protection for all operating controls of 1-3/4 in (44 mm) panel height JBL-UREI Electronic Products. The Security Cover is a five-sided box of smoked-gray plexiglass. It attaches to the front panel of the unit with two 6-32 x 2 in. Phillips head machine screws. Control positions and display status may be viewed through the cover after installation.

As noted earlier, the 7922 may be rack mounted in two different ways: flush mounted with the panel and rack ears in the same plane, or recess mounted with the rack ears extending forward so that the controls do not extend beyond the front panel of the rack ears. With the unit flush mounted the Security Cover will extend approximately 1-1/4 in. (32 mm) in front of the front surface of the rack ears. With the unit recess mounted the Security Cover is flush with the rack ears.

Actual installation of the Security Cover is simply a matter of placing it against the front panel of the unit, pushing the screws through the holes in the cover and screwing them into the two holes provided on the front panel. Note that the screws in the Security Cover match up with the holes in the front panel in only one orientation. Take care not to scratch the front panel of the unit with the screws. The Security Cover may be cleaned with any mild, non-abrasive cleaner and a clean cloth.

## Operating Instructions

### Turn On Procedure

After the power is switched on, there is a 3 second delay before any processed signal is passed through the unit. During this time, the input signal is passed directly to both outputs, and the front panel displays "7922". Afterwards, the delay times and SAFE condition are loaded from memory (duplicating the settings when the unit was shut off), Channel A is displayed (low resolution), the output relays close, and the unit passes processed (delayed) signal.

### Headroom

The headroom control operates three voltage controlled amplifiers (VCA's) - one at the input and one at each output. The input VCA provides up to 20 dB of gain in order to amplify a low level input signal up above the noise floor of the 7922. After the signal has been processed and delayed, an equal amount of attenuation is applied at the output VCA's, so that the output level always matches the input level regardless of the headroom setting. This gives the unit an input/output gain of unity in any situation, and the headroom can be adjusted for the best signal-to-noise ratio without concern for the system gain.

### Display

The front panel DISPLAY button toggles through the 3 display modes: A Out, B Out, and B[ref A]. The display can be either to the nearest millisecond (LO RES mode), or to the nearest 10 microsecond (HI RES mode), depending on the current resolution mode (see HI-RES). The A OUT and B OUT modes display the delay time between the input signal, and the output signal, of channels A and B respectively, while the B[REF A] mode displays the absolute time difference between the A and B outputs.



## Hi-Res

The HI-RES (High Resolution) button toggles between the 5-digit high resolution display mode - which displays delay times out to the 10 microsecond digit - and the 3-digit low resolution display mode - which displays delay times rounded off to the nearest millisecond. While in the low resolution display mode, the unit retains the 5-digit high resolution delay time - unless the delay time is changed. In this case, the high resolution digits of the current channel are cleared to .00, and the low resolution display reflects the exact, non-rounded, delay time.

## Safe On/Off

The HI-RES button has the secondary function of SAFE ON/OFF toggle. This safety feature protects the 7922 from tampering by deactivating the TIME buttons. When the SAFE light is on, the safety feature is active, and the delay times cannot be changed. The SAFE condition is retained, along with the delay times, after the unit is shut off and will return automatically when the power is switched back on. Pressing the HI-RES button will always toggle the resolution of the display and, if held down for 5 seconds, will also toggle the SAFE condition. Remember that this initial changing of the display resolution will not affect the delay times, and the 7922 always stores the high resolution delay times regardless of the low resolution display. Feel free to inspect the delay times after activating the safety feature. There is no danger of altering the delay times when the SAFE light is on.

## Time

The TIME buttons are used to change the delay times for channels A and B over a range of 390 microseconds to 328.06 milliseconds. Pushing in either button and holding it down will increment (or decrement) the delay times in single steps at an increasingly faster rate. The steps are either high resolution (10 microseconds), or low resolution (1 millisecond). When stepping in low resolution, the two non-displayed digits are automatically cleared to .00 so that the unit steps in exact 1 millisecond steps. The B[REF A] mode will always operate on the channel B delay time, and displays the absolute time difference between channel A and B. In this case, a 0.00 display means that channels A and B have the same delay time. A 1.00 display could mean one of two things; channel B either leads, or lags, channel A by 1.00 milliseconds. The situation can be checked out by looking at the individual delay times, or by noting if the steps are incrementing or decrementing the display. For example, if channel B is lagging channel A, a step "up" will decrement the display towards 0.00, and additional steps "up" past 0.00 will increment the display, and channel B will be leading channel A by the amount shown. The range of the B[REF A] delay time is limited by the channel A delay time, so keep this in mind when using the B(REF A) display mode. The maximum signal delay for either channel is 328.06 milliseconds.

## Sleep Mode

When the SAFE feature has been activated (see Safe On/Off), and the front panel buttons have not been pressed for 5 minutes, the sleep mode will automatically activate and shut off the front panel numeric display. This feature was implemented in order to avoid the distraction and power loss of a continuous display in permanent installations. The display will return immediately when any front panel button (except POWER) is pushed.

## Brownout Mode

A low line voltage or a momentary loss of line voltage may cause noise bursts in an audio system if no protection is provided. The 7922 will detect low line voltages (brownouts), or line voltage dropouts, before any distorted audio reaches the outputs, display a "LO-AC" message, and immediately bypass the input signal directly to the output connectors via relays in the non-powered state. The 7922 will automatically reset and resume passing processed signal after the line voltage has stabilized for 8 continuous seconds.

## Theory of Operation

### Input Amplifier

The input signal is applied to a differential amplifier, which accepts either balanced or unbalanced sources. Common mode rejection is typically better than 40 dB. The "+" and "-" inputs have 470pF capacitors shunted to the input ground (GND) for RF input immunity.

### Headroom Control

The input amplifier is followed by a voltage controlled amplifier (VCA) which provides 0 to 20 dB of input gain corresponding respectively to the far left and far right position of the headroom control. Both channels will receive an equivalent amount of output attenuation at the VCA circuit immediately preceding the output amplifier. This complimentary gain structure results in a constant input/output gain of unity regardless of the headroom control setting. The headroom control affects only the internal signal level; it does not affect the output level.

### Anti-Aliasing Filter

The anti-aliasing filter is the equivalent of an eight pole elliptical LC ladder filter with a flat passband. It has attenuations of .25 dB at 20 kHz and 3 dB at 22 kHz. A maximum of  $\pm 1$  degree deviation from linear phase within the 20 Hz to 20 kHz bandwidth is achieved with the filter.

### Headroom Display

After the anti-aliasing filter has rejected all of the out-of-bandwidth material from the input signal, a peak reading LED display indicates the headroom available to the signal before it "clips". The headroom display is calibrated in 10 dB steps from 30 dB to CLIP (i.e. 0 dB Headroom) and provides a simple visual indication of headroom and signal-to-noise ratio.

### Analog/Digital Conversion

A discrete sample and hold amplifier samples the filtered audio signal for 10 us, then discharges the hold capacitor into a 16-bit A/D converter - which employs a very fast coarse/fine integration conversion technique.

### Muting Circuit

Although the A/D converter exhibits excellent audio performance under normal conditions, "dither" noise can occur when the signal level falls below the quantization range. Some manufacturers choose to allow this noise in their units. The 7922 contains additional circuitry which will eliminate "dither" noise when the input to the A/D drops 90 dB below clipping for longer than 300ms, and will make a silent recovery when an input signal exists for at least 200 us. Under normal (non-mute) conditions, the maximum dynamic range of the A/D converter is typically better than 90 dB. The muting circuit can be deactivated by removing resistor R35 and jumper wire JW3.

### Digital Filter

The digital filter receives digital samples from memory at the sample rate of 50 kHz. For every sample it receives, the digital filter calculates 3 more samples to "fill in the gaps", which produces an effective sample rate of 200 kHz. This combination of digital interpolation and additional "noise shaping" allows the 14-bit D/A converter to produce the same quantizing signal-to-noise ratio as unprocessed 16-bit samples.

## Digital/Analog Conversion

The D/A converters operate at 200 kHz and are followed by third order Bessel filters with the -3 dB point at 34 kHz. The 200 kHz data rate is well above the audio spectrum and allows the use of low-order "reconstruction" filters - avoiding the phase distortion problems associated with higher-order filters.

## Microprocessor

Many of the features of the 7922 depend on the microprocessor for control. The microprocessor interfaces with the user via the control buttons, runs the front panel display, stores all pertinent information in non-volatile memory, monitors the AC line voltage, and operates the output relays.

## Maintenance

The Model 7922 is all solid state, ruggedly constructed and uses the finest components. As such it will provide years of trouble free use with normal care. All parts are conservatively rated for their application.

**NO SPECIAL PREVENTIVE MAINTENANCE IS REQUIRED, AND THERE ARE NO INTERNAL SERVICE ADJUSTMENTS.**

The metal and plastic surfaces of the Audio Delay may be cleaned with a damp cloth. In case of heavy dirt, a non-abrasive household cleaner such as Formula 409 or Fantastik may be used. **DO NOT SPRAY THE CLEANER DIRECTLY ONTO THE FRONT OF THE UNIT AS IT MAY DESTROY THE LUBRICANTS USED IN THE SWITCHES AND CONTROLS!** Spray onto a cloth and then use the cloth to clean the unit.

## Repairs and Warranty

This product is warranted by the manufacturer to the original purchaser against defects in material and workmanship for a period of one year from the date of purchase. We suggest that you retain a copy of your dated sales receipt for proof of warranty status should that be necessary.

If you wish to return the unit directly to the factory, please call or write to the Customer Service Department at the Service address listed on the title page of this manual for a Return Authorization Number. All products returned to the factory must be accompanied by a Return Authorization Number, and must be shipped prepaid. COD shipments will not be accepted.

For prompt service, ship the unit to the factory with the RA number marked on the shipping label. Be sure that it is well packed in a sturdy carton, with shock absorbing material such as styrofoam pellets or "bubble-pack" surrounding the unit. Pay particular attention to protecting the controls and switches and make sure that the unit cannot drift around in the shipping box. Shipping damage caused by inadequate packing is not covered by the JBL/UREI warranty. Tape a note to the top of the unit describing the problem, include your name and a phone number where we may contact you if necessary, and give us instructions for returning the product. We will pay return shipping costs on any repair covered under the terms of this warranty.

Field repairs are not normally authorized during the warranty period, and repair attempts by unqualified personnel may invalidate the warranty.

## SPECIFICATIONS

### ELECTRICAL:

Input:	Differential amplifier. May be used balanced or unbalanced, bridging.
Input Impedance:	40 kohm balanced, 20 kohm unbalanced.
Maximum Input Level:	+22 dBu.*
Output (Both Channels):	Floating, transformer-isolated.
Output Level:	+22 dBm with less than 0.4% THD max. into 600 ohm load (20Hz - 20 kHz).
Frequency Response:	±1 dB, 20 Hz to 20 kHz.
Gain:	Unity, ±1 dB.
Dynamic Range:	Greater than 90 dB. (15.7 kHz noise bandwidth with 600 ohm load.)
Phase:	Deviation from Linear Phase is less than ±5 degrees, 20 Hz to 20 kHz.
Delay Range:	390 microseconds to 328.06 milliseconds.
Delay Resolution:	10 microseconds per step (High resolution mode). 1 millisecond per step (Low resolution mode).
Digital Conversion:	16 bit, linear.
Sampling Rate:	50 kHz.
Power Requirements:	105 to 125 VAC or 200-250 VAC, 50-60 Hz, 30 W max.
Environment:	Operating, 0°C to +50°C. Storage, -20°C to +60°C.

### PHYSICAL:

Front Panel:	22.3 x 483 mm (1-3/4 x 19 in) EIA rack mount.
Depth Behind Panel:	375 mm (14-3/4 in) with rack ears flush, 400 mm (15-3/4 in) with rack ears forward.
Finish:	Aluminum extruded rack ears, Polycarbonate overlaid front panel, Chassis is black painted steel.
Net Weight:	5.9 kg (12.9 lb).

\* 0 dBu = 0.775 V RMS 0 dBm = 1 mW.



## **Field modification and calibration of the UREI type 7922 Audio Delay**

This bulletin describes modification and field calibration procedures for the UREI type 7922 audio delay line. It has been noted that occasionally units in the field have developed excessive noise and thumps during the action of the internal gate. In some instances excessive noise can be traced to improper gain structure of the system. Any digital device should be run at as high an input level as possible, keeping adequate headroom requirements in mind. The 7922 has internal input and output gain matching so that the net gain through the unit is unity, however the input level control of the 7922 should be set so that the internal LED meter peaks at near maximum (the red LED) during peaks in program material. If any gain compensation is needed, this should be done after the 7922, at the power amplifier or other signal processor. If the 7922 is run at too low a level, excessive noise will become evident. If the red LED constantly flashes, clipping of the digital converters is likely.

It is also very important to properly load the transformer output of the 7922. If the output of the 7922 is connected to any equipment which does not have a 600 ohm input impedance, the outputs of the 7922 must be terminated by a 620 ohm resistor. Most modern equipment has input impedance higher than 600 ohms, so it is important to check the owner's manual of the equipment connected to the output of the 7922.

### **Offset Adjustment**

Proper adjustment of offset is necessary to eliminate thumps whenever the internal gating circuit of the 7922 activates. A high quality digital DC voltmeter is required for this adjustment. Disconnect all external equipment from the 7922 and allow the unit to warm up for at least 1/2 hour before making the offset adjustment. Remove the top lid of the unit and set the input level control all the way to the left. Connect the negative meter lead to the ground wire connected to the metal can of the anti-aliasing filter. CAREFULLY touch the positive test lead to pin #6 of IC 15, which is located directly in front of the anti-aliasing filter. The DC voltage at this point should be zero volts; if it is not, adjust VR 7 SLOWLY until zero volts DC is measured. This is a very sensitive adjustment which must be done with care. Allow a few minutes and measure the voltage again, correcting for any drift. The final adjustment should be able to stabilize the voltage at plus or minus 10 millivolts DC of the ideal value of zero volts DC. No attempt should be made to adjust any other control within the 7922. It is a good idea to check this adjustment periodically, especially after transporting the 7922.

REVISIONS			
ZONE	LTR	DESCRIPTION	DATE
SEE BOTTOM LEFT HAND CORNER			

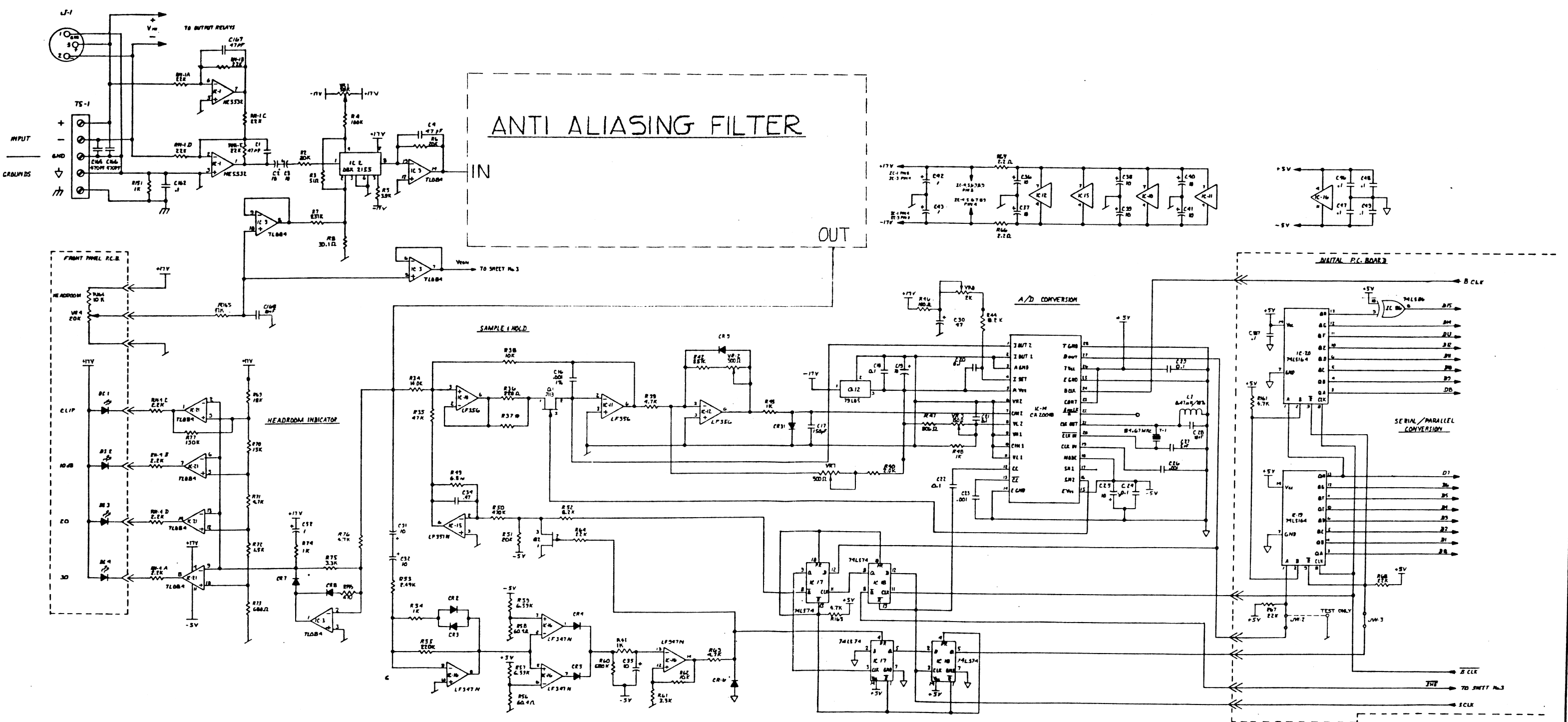

NO.	LTR.	DESCRIPTION	DATE	APPVD.
306706	B	REVISED & RESIZED WAS R'SIZE	12-11-87	
	A	REVISED TO LATEST STD'S	6-4-87	

UNLESS OTHERWISE SPECIFIED DIMENSIONS ARE IN INCHES TOLERANCES ARE: FRACTIONS DECIMALS ANGLES ± .005 ± .001 ± .005		CONTRACT NO. <b>DD-208</b>		
MATERIAL		APPROVALS DRAWN <b>M.R. MARTIN</b> CHECKED <b>M. ALBERS</b>	DATE <b>8-26-87</b> <b>6-4-87</b>	<b>SCHEMATIC-DIGITAL DELAY</b>  <b>ANALOG TO DIGITAL CONVERSION</b>
NEXT ASSY	USED ON	SIZE <b>D</b> MODEL NO <b>7922</b> DRAWING NO. <b>15008</b> REV <b>B</b>		
APPLICATION		SCALE SHEET 1 OF 3		

REVISIONS				
ZONE	LTR	DESCRIPTION	DATE	APPROVED

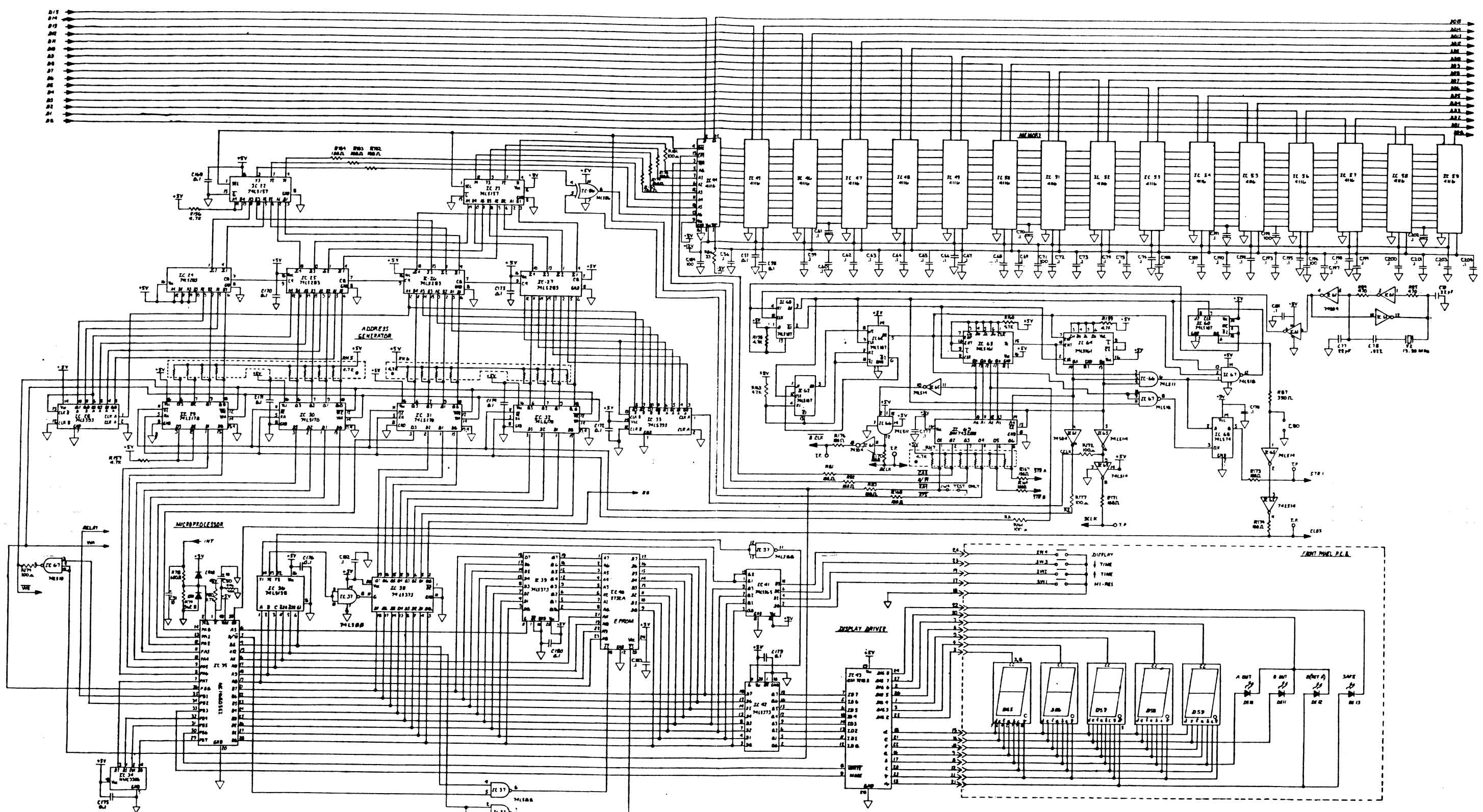

UNLESS OTHERWISE SPECIFIED DIMENSIONS ARE IN INCHES TOLERANCES ARE: FRACTIONS DECIMALS ANGLES ± .010 ± .005 ± .010	CONTRACT NO. <b>DD-208</b>		UNITED RECORDING ELECTRONICS INDUSTRIES 8450 SAN FERNANDO RD., SUN VALLEY, CALIFORNIA 91352	
	APPROVALS	DATE	SCHEMATIC - DIGITAL DELAY	
MATERIAL	DRAWN <b>M. MARTIN</b>	<b>8-26-86</b>	MEMORY AND CONTROL	
FINISH	CHECKED <b>M. ALBERS</b>	<b>6-8-87</b>	SIZE <b>D</b>	MODEL NO. <b>7922</b>
NEXT ASSY	USED ON	APPLICATION	DRAWING NO. <b>15008</b>	REV <b>B</b>
DO NOT SCALE DRAWING	SCALE	SHEET <b>2</b> OF <b>3</b>		

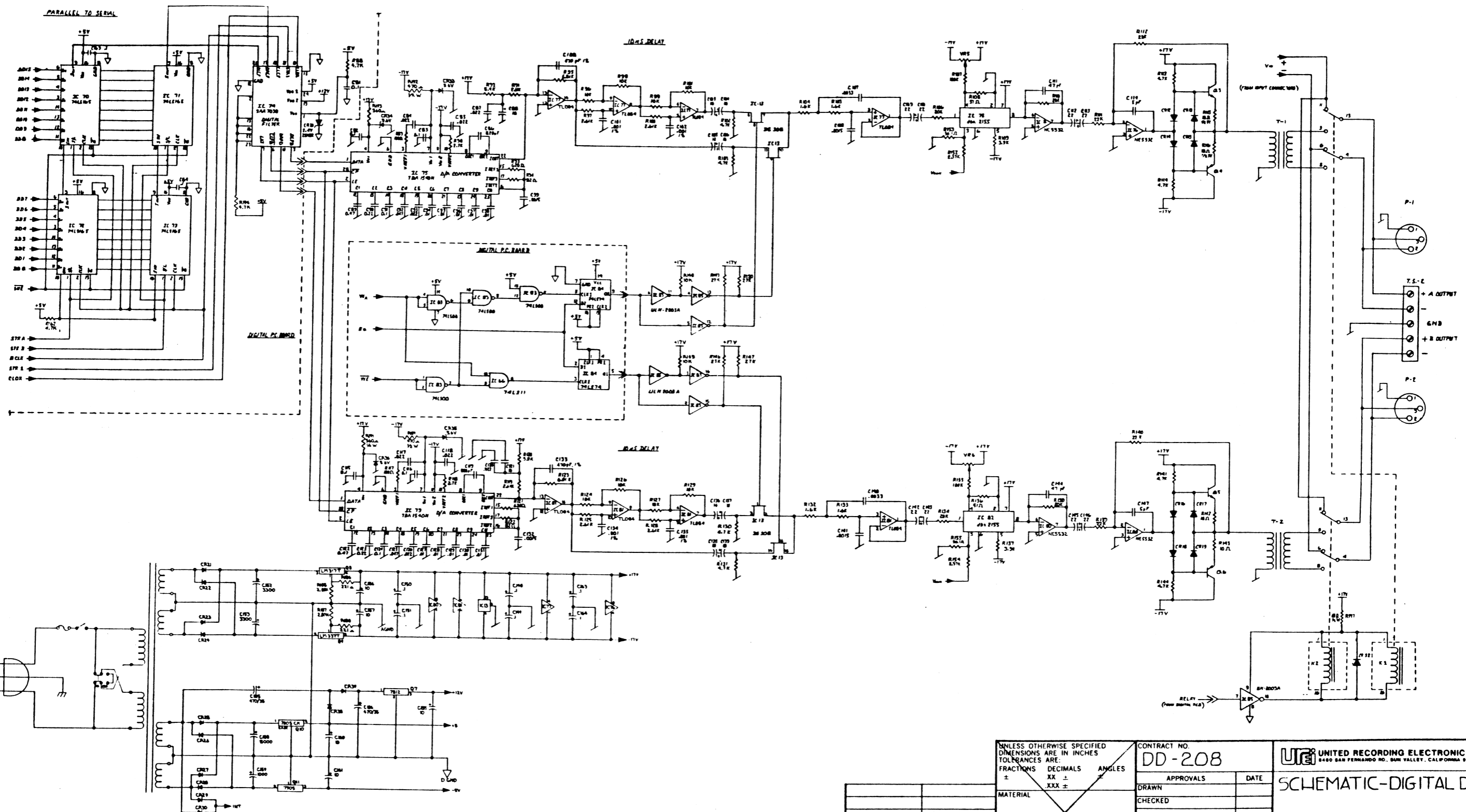

UNLESS OTHERWISE SPECIFIED DIMENSIONS ARE IN INCHES TOLERANCES ARE: FRACTIONS DECIMALS ANGLES ± .010 ± .005 ± .010		CONTRACT NO. <b>DD-208</b>		DATE	
DRAWN		APPROVALS		DATE	
CHECKED					
MATERIAL					
FINISH					
NEXT ASSY		USED ON		APPLICATION	
				DO NOT SCALE DRAWING	
UNITED RECORDING ELECTRONICS INDUSTRIES 8480 SAN FERNANDO RD., SUN VALLEY, CALIFORNIA 91352		SCHEMATIC-DIGITAL DELAY			
DIGITAL TO ANALOG CONVERSION				REV	
SIZE	MODEL NO	DRAWING NO			
D	7922	15008	B		
SCALE				SHEET 3 OF 3	