

# TEAC

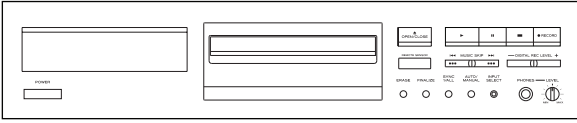

## SERVICE MANUAL

# CD-RW880

## CD-RW PLAYER/RECORDER



### NOTES

- PC board shown are viewed from parts side.
- The parts with no reference number or no parts number in the exploded views are not supplied.
- As regards the resistors and capacitors, refer to the circuit diagrams contained in this manual.
- ⚠ Parts marked with this sign are safety critical components. they must be replaced with identical components - refer to the appropriate parts list and ensure exact replacement.
- Parts of [ ] mark can be used only with the version designated.  
[EUR] - Europe; [USA] -U.S.A ; [JPN] - Japan

### CONTENTS

<b>1 SAFETY INFORMATION</b> .....	2
<b>2 SPECIFICATIONS</b> .....	3
<b>3 EXPLODED VIEW AND PARTS LIST</b> .....	4
<b>4 PC BOARDS AND PARTS LISTS</b> .....	7
<b>5 WIRING DIAGRAM</b> .....	13
<b>6 INCLUDED ACCESSORIES</b> .....	15

# CD-RW880

## 1 SAFETY INFORMATION

### SAFETY INFORMATION

This product has been designed and manufactured according to FDA regulations " title 21, CFR, chapter 1, subchapter J, based on The Radiation Control for Health and Safety Act of 1968" and is classified as class 1 laser product. There is not hazardous invisible laser radiation during operation because invisible laser radiation emitted inside of this product is completely confined in the protective housings. The label required in this regulation is shown ①.

• **CAUTION**

USE OF CONTROLS OR ADJUSTMENT OR PERFORMANCE OF PROCEDURES OTHER THAN THOSE SPECIFIED HEREIN MAY RESULT IN HAZARDOUS RADIATION EXPOSURE.

DO NOT REMOVE THE PROTECTIVE HOUSING USING SCREWDRIVER.

IF THIS PRODUCT DEVELOPS TROUBLE, MAKE A CONTACT WITH OUR SERVICEMAN, AND DO NOT USE THE PRODUCT A TROUBLED STATE.

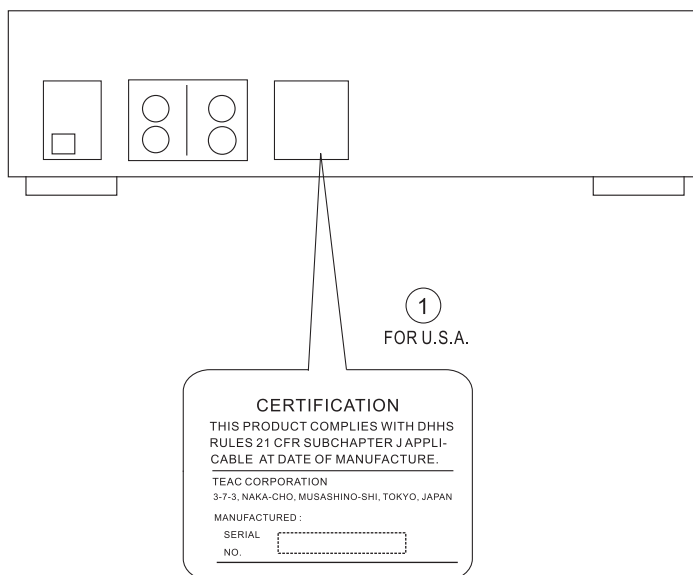

Optical pickup:
Type : SF-W37SGT
Manufacturer : SANYO ELECTRIC CO.,LTD.
Laser output : Less than 1 mW (Play) on the objective lens
Less than 5 mW (Record) on the objective lens
Less than 10 mW (Erase) on the objective lens
Wavelength : 783 nm

## 2 SPECIFICATIONS

<b>Media type</b>	CD-RW and CD-R for Digital audio (record and playback) CD (playback only)
<b>Frequency converter input sampling frequency</b>	32 kHz, 48 kHz
<b>Recording sampling frequency</b>	44.1 kHz
<b>Frequency response</b>	20 Hz to 20 kHz (playback: +/- 1.5dB, recording: +/- 1.5dB)
<b>Signal to noise ratio</b>	90 dB (playback) 90 dB (digital recording) 82 dB (analog recording)
<b>Dynamic range</b>	86 dB (playback) 84 dB (recording)
<b>Total Harmonic Distortion</b>	Less than 0.05% (playback) Less than 0.05% (recording)
<b>Wow &amp; flutter</b>	Unmeasurable
<b>Audio Input Sensitivity/Impedance</b>	LINE: -6 dB (0.5V)/20 kohm
<b>Output Level/Impedance</b>	LINE: -6 dB (0.5V)/1 kohm
<b>Maximum output level</b>	LINE: +6 dBV (2.0V)

<b>Power requirements:</b>	120V, 60Hz [USA] 100V, 50~60Hz [JPN] 230V, 50Hz [EUR]
<b>Power consumption:</b>	16 W
<b>Standby Power Consumption:</b>	12 W
<b>Dimension (W x H x D):</b>	435 x 100 x 295 mm
<b>Weight: (net)</b>	4.5 kg

<b>Standard Accessories:</b>	RCA cable x 2 Optical digital cable x 1 Remote control unit (RC-1037) x 1 Battery (AA, R6, SUM-3) x 2 Owner's manual x 1 Warranty card x 1
------------------------------	---

- Design and specifications are subject to change without notice.
- Illustrations may differ slightly from production models.
- Weight and dimensions are approximate.

# CD-RW880

## 3 EXPLODED VIEWS AND PARTSLIST

### EXPLODED VIEW

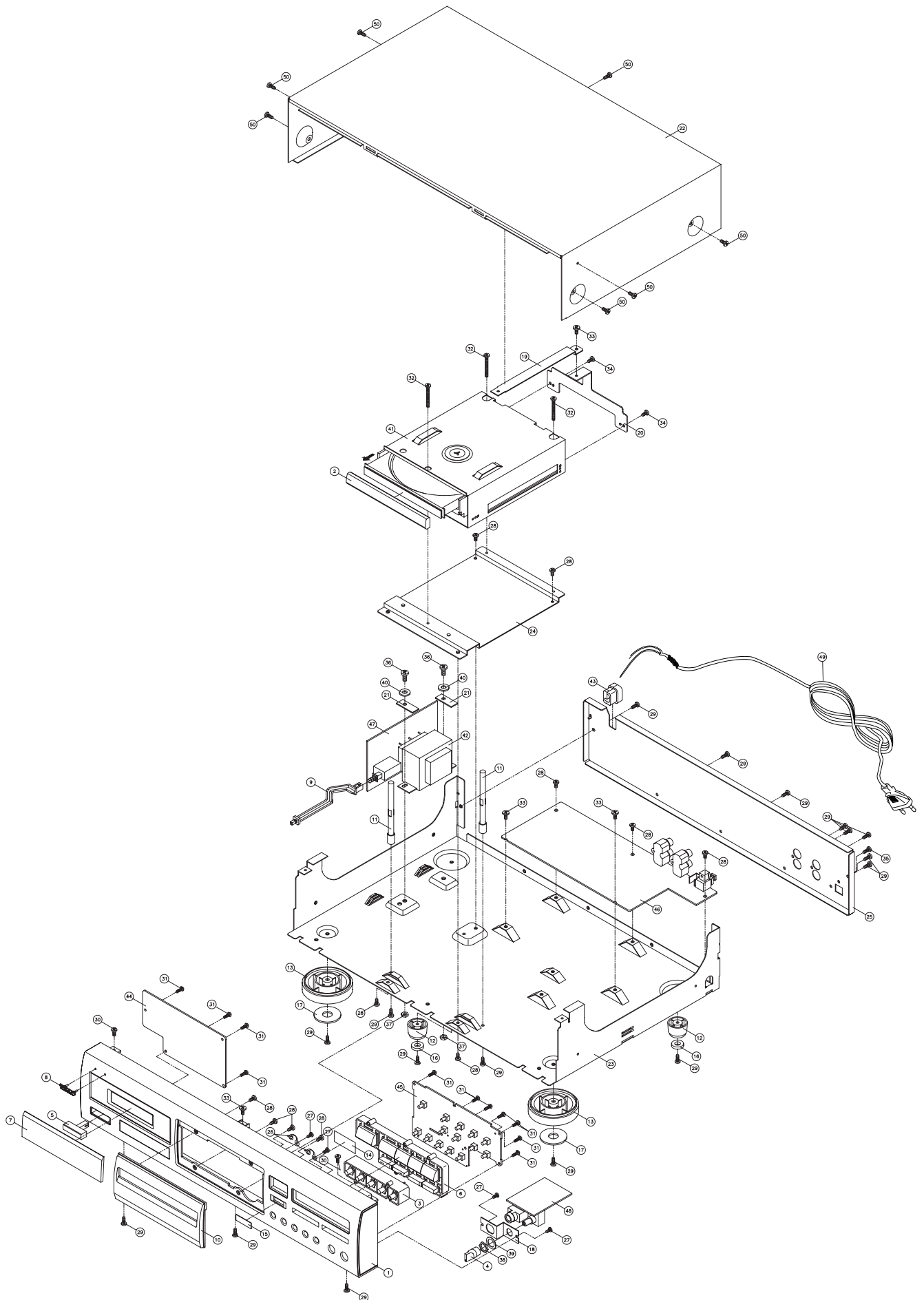





## EXPLODED VIEW

REF. NO	PARTS NO.	DESCRIPTION	REMARKS
1	56-12C11200B060	ESCUTCHEON(HIPS)(BLACK) [EUR]	
	56-12C11203A010	ESCUTCHEON (ABS)(DM) SLV [JPN]	
	56-12C11203B010	ESCUTCHEON (94V2/AF-308) [USA]	
2	56-14RW8800B010	DECORATION TRAY (ABS) [EUR] / [USA]	
	56-14RW8800A010	DECORATION TRAY (ABS) SLV [JPN]	
3	56-54C11200B000	CD KNOB REPEAT.5KEYS(ABS)(BLACK) [EUR] / [USA]	
	56-54C11200A000	CD KNOB REPEAT.5KEYS (ABS) [JPN]	
4	56-54C11202B000	KNOB-LEVEL(ABS)(BLACK)(CEC2171001800) [EUR] / [USA]	
	56-54C11202A000	KNOB PUSH (ABS) (CEC2174005203) SLV [JPN]	
5	56-54C11203B000	KNOB-POWER(ABS)(CEC2174005200) [EUR] / [USA]	
	56-54C11203A000	KNOB-POWER (ABS)(CEC2171001803) SLV [JPN]	
6	56-54RW8800B010	PLAY KNOB [EUR] / [USA]	
	56-54RW8800A010	PLAY KNOB-8KEYS (DM) SLV [JPN]	
7	56-57C112002010	WINDOW	
8	56-58EX0M118020	LOGO BADGE TEAC(3M0051640A) [EUR] / [USA]	
	56-58EX0M118010	LOGO BADGE TEAC(3M0051650A) [JPN]	
9	56-60C11200B000	POWER KNOB JOINT	
10	56-66C11200B020	PANEL TRAY (ABS) [EUR] / [USA]	
	56-66C11200A020	PANEL TRAY (ABS) (DM) SLV [JPN]	
11	56-79C11200B000	POST	
12	56-88C11200B000	LEG - REAR	
13	56-88RW2800A000	LEG - FRONT	
14	56-08C144000020	SHEET - IR	
15	56-33C112000020	REMOTE LENS	
16	56-193132650020	FELT DIA 13.5x6.5x3MM	
17	56-263303110020	RUBBER FOOT (2)	
18	61-11C112000020	MOUNTING BRACKET	
19	61-11C112010023	ESCUTCHEON FIT METAL PLATE	
20	61-11RW88000020	BRACKET MECHANISM	
21	61-11RW88000121	POWER PLATE 25 x10x1.2MM	
22	61-30C112000020	COVER /CEC2121003900 [EUR] / [USA]	
	61-30C185000120	COVER TOP (SPRAY:SIL.)(CEC2121003902) [JPN]	
23	61-31C112000022	CHASSIS	
24	61-31RW88000020	SUB CHASSIS	
25	61-33RW88000220	REAR PANEL "230V TEAC" [EUR]	
	61-33RW88000120	REAR PANEL "100V TEAC" [JPN]	
	61-33RW88000020	REAR PANEL "120V TEAC" [USA]	
26	61-87C145000020	LUG	
27	66-150226160223	HARDEN SCREW BTTB 2.6x6MM	
28	66-150230160223	HARDEN SCREW BTTB 3x6MM	
29	66-150230180183	HARDEN SCREW BTTB 3x8MM (BLK)	
30	66-150230180223	HARDEN SCREW BTTB 3x8MM	
31	66-151226180223	HARDEN SCREW BTTV 2.6x8MM	
32	66-151230230223	HARDEN SCREW PTTV 3x30MM	
33	66-151430160223	HARDEN SCREW BTTN 3x6MM	
34	66-170230160383	HARDEN SCREW TT/BH 3x6MM NI [EUR]	
	66-170230160321	HARDEN SCREW TT/BH 3x6MM [USA] / [JPN]	
35	66-170230180123	HARDEN SCREW BIN+SW STTB 3x8MM (BLK)	
36	66-170240210123	HARDEN SCREW STTB 4x10MM AB	
37	67-021400000020	NUT M4MM	

# CD-RW880





## EXPLODED VIEW

REF. NO	PARTS NO.	DESCRIPTION	REMARKS
38	67-021900000020	NUT M9MM	
39	68-112923140400	METAL WASHER 9.2x14x0.4mm	
40	68-113122551500	METAL WASHER 12x5.5x1.54mm	
41	06-200GF3501001	CD MECH ASSY, CRD-RA2A (205010)	
42	 18-405RW8800120	TRANSFORMER EI57 230V TG52467F0 [EUR]	
	 18-401RW8800120	TRANSFORMER EI57 TJ52457F0 100V [JPN]	
	 18-408RW8800120	TRANSFORMER EI57 TD52466F1 120/230V [USA]	
43	43-500000003020	AC CORD BUSHING	
44	05-RW8800400000	PCBA-DIS	
45	05-RW8800500000	PCBA-KEY	
46	05-RW8800700000	PCBA-IN OUT	
47	05-RW8800700030	PCBA-POWER -EUR [EUR]	
	05-RW8800700020	PCBA-POWER (100V) JAPAN [JPN]	
	05-RW8800700010	PCBA-POWER "UL"[USA]	
48	05-RW8800900000	PCBA-H.P.	
49	45-114200500061	AC CORD VDE APP 2M (M.T) (BLK) RoHS [EUR]	
	45-114183100060	AC CORD JIS/PSE APP 1.83M (M.T) (BLK) [JPN]	
	45-114180300061	AC CORD CUL APP 6FT(M.T)(BLK) [USA]	
50	66-150230180183	HARDEN SCREW BTTB 3x8mm (BLK) [EUR]/[UAS]	
	66-150230180383	HARDEN SCREW BTTB 3x8mm NI [JPN]	



# CD-RW880

## PCBA-IN OUT

REF. NO	PARTS NO.	DESCRIPTION	REMARKS
	05-RW8800700000	PCBA-IN OUT	
	48-07RW88000121	IN/OUT PCB 246x100mm 94V0 R1	
C71	 26-017470750121	E.CAP 4700UF/16V	
C75	 26-017470850121	E.CAP 4700UF/25V	
CN1	43-012100217120	F.F.C. WAFER 1MM 17P	
CN2	43-0122001430120	WAFER 2MM 4P	
CN3	43-012200130120	WAFER 2MM 3P	
CN4	43-012200150120	WAFER 2MM 5P	
CN5	43-012250170120	WAFER 2.5MM 7P	
CN6	43-012200160120	WAFER 2MM 6P	
CN7	43-012200214120	WAFER 2MM 14P	
CN10	43-012100190120	F.F.C. WAFER 1MM9P	
D1-8	 12-RL2020000021	RECTIFIER DIODE RL-202	
D9	12-1N4001000021	RECTIFIER DIODE 1N4001	
D10	12-012300330121	ZENER DIODE 30V 1W	
D11	12-011560320125	ZENER DIODE 5.6V 1/2W	
D12	12-012100320125	ZENER DIODE 10V 1/2W	
F1,2	 46-034900400000	PTC RESETTABLE FUSE 0.9A/90V	
F3,4	 46-034200400000	PTC RESETTABLE FUSE 0.2A/90V	
JK1	17-07GP1F000110	CONVERTOR #GP1FA550RZ/3RZ	
JK2,3	43-451200004020	V/RCA JACK 2P #PJB-21V05	
L2,3,4,5	38-013100050020	AXIAL INDUCTOR 10UH	
Q1	11-9015C0000021	TR - 9015C	
Q2,3,4	11-2SD1936T0125	TR - 2SD1936T	
Q10	11-8050C0000025	TR - 8050C	
U2	16-NJM2068D0021	IC - NJM2068D	
U5	16-KA7805000121	IC - KA7805E	
U6	16-KA7808000221	IC - LA7808E	

## PCBA-H.P.

REF. NO	PARTS NO.	DESCRIPTION	REMARKS
	05-RW8800900000	PCBA-H.P.	
	48-09RW88000120	H.P PCB 43x60mm 94V0(CEC4B10037200)	
CN9	43-012200150120	WAFER 2MM 5P	
JK4	43-431640000020	PH JACK 6.4MM	
L6,7	38-013330050020	AXIAL INDUCTOR 33UH	
U3	16-NJM2068D0021	IC - NJM2068D	
VOL1	22-051415500020	ROTARY VOLUME XVB14111GPD22.5F15A50K	

## PCBA-POWER

REF. NO	PARTS NO.	DESCRIPTION	REMARKS
	05-RW8800700030	PCBA-POWER -EUR [EUR]	
	05-RW8800700020	PCBA-POWER (100V) JAPAN [JPN]	
	05-RW8800700010	PCBA-POWER "UL"[USA]	
	48-07RW88001120	POWER PCB 94V0 (CEC4B10037100)	
CN101	43-012250170120	WAFER 2.5MM 7P	
SW101	41-191120020010	POWER SWITCH #SY16-12-1	

## DISPLAY PCB

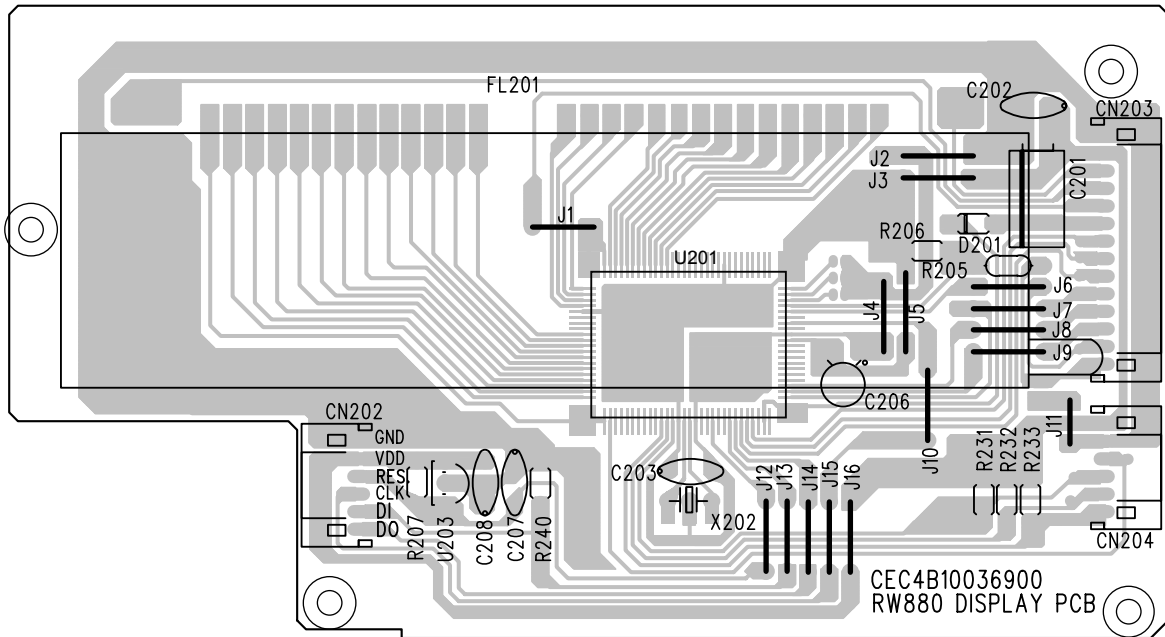

## KEY PCB

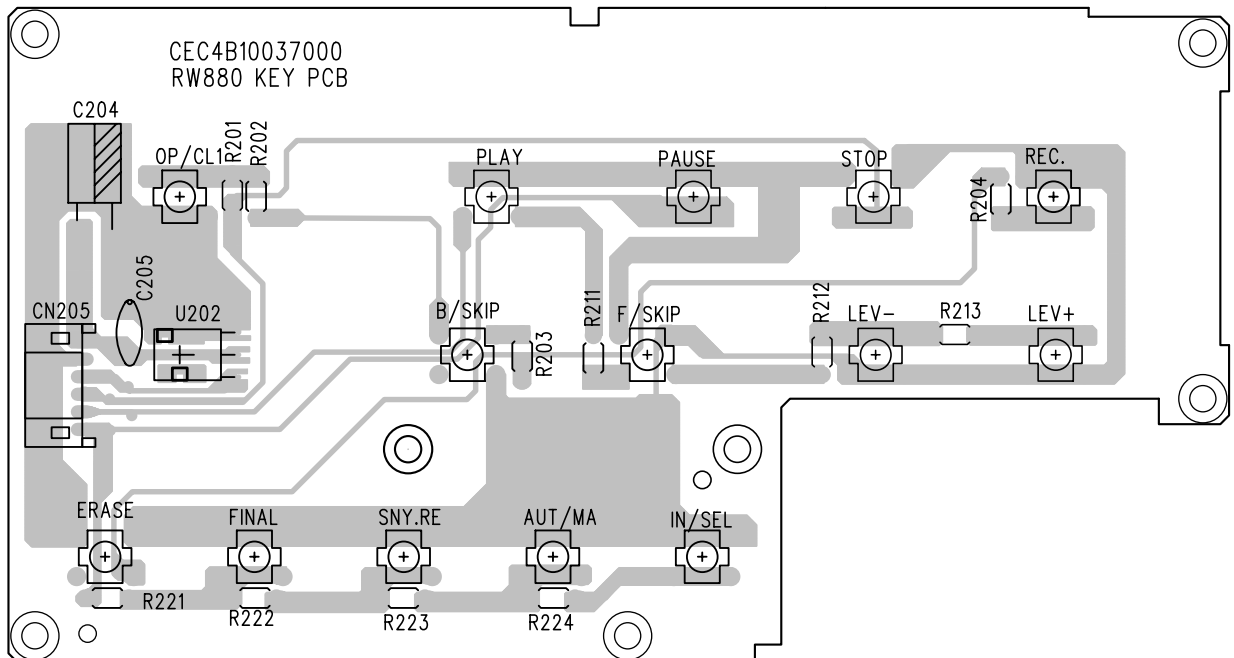

# CD-RW880

## PCBA-DIS

REF. NO	PARTS NO.	DESCRIPTION	REMARKS
	05-RW8800400000	PCBA-DIS	
	48-04RW88000220	DISPLAY PCB 132x72x1.6mm 94HB	
CN202	43-022200160120	WAFER 2MM 6P	
D201	12-1SS133T77021	SWITCHING DIODE 1SS133-T-77	
FL201	13-06RW88000020	VFD DISPLAY	
U201	16-LC876A48C021	IC - LC876A48C-57G5	
U203	16-PST600D00021	IC - PST600D	
X202	31-048100000220	RESONATOR 10MHZ	

## PCBA-KEY

REF. NO	PARTS NO.	DESCRIPTION	REMARKS
	05-RW8800500000	PCBA-KEY	
	48-05RW88000220	KEY PCB 139x74.5x1.6mm 94HB	
CN205	43-022200160120	WAFER 2MM 6P	
SW201-205,211, SW212-214,221-225	41-150010020020	TACT SWITCH 6x6MM	
U202	17-05HM33800020	IR RECEIVER MODULE HM338RS T-12M2	

## POWER MAIN PCB (CD MECHANISM ASSY) - TOP

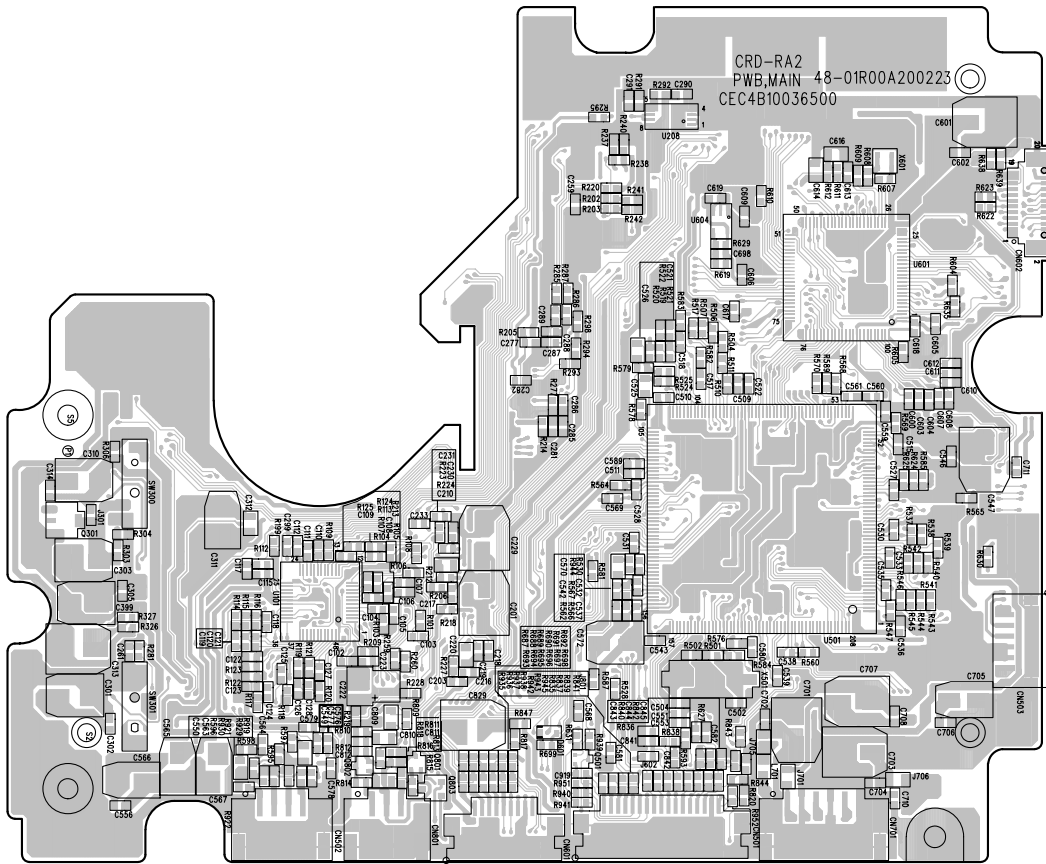

## POWER MAIN PCB (CD MECHANISM ASSY) - BOTTOM

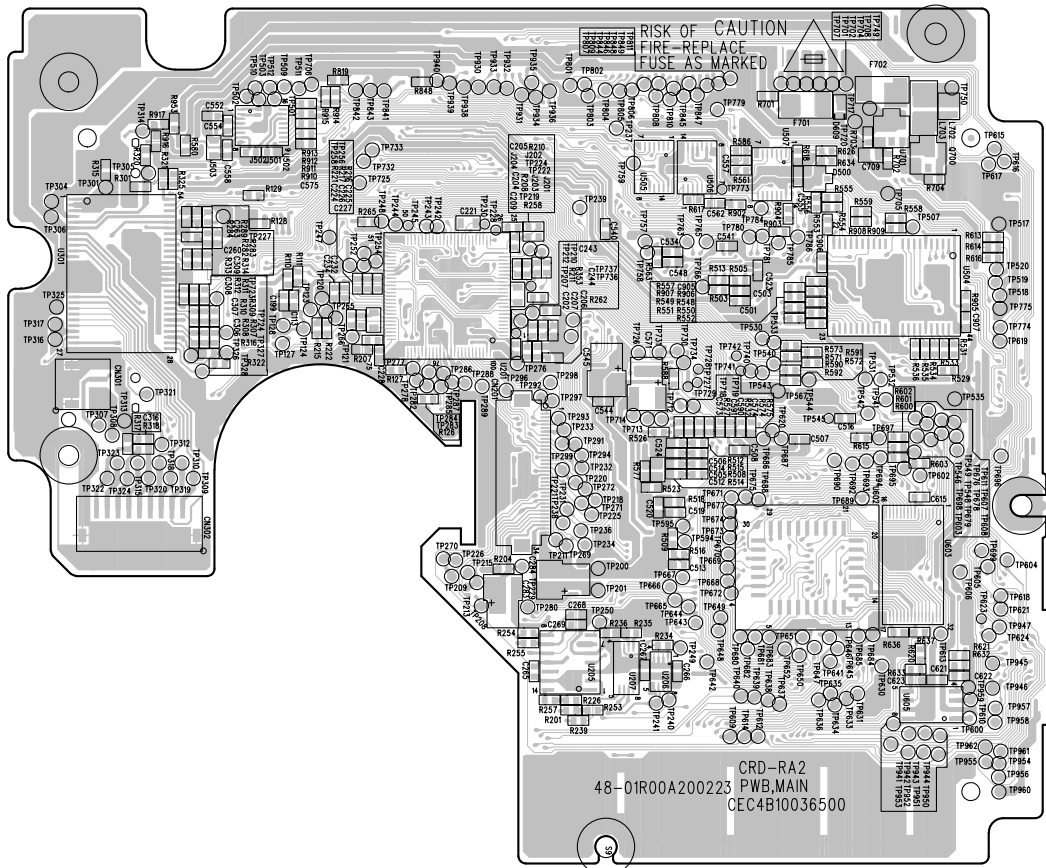

# CD-RW880

## PCB-MAIN (CD MECH ASSY)

REF. NO	PARTS NO.	DESCRIPTION	REMARKS
	05-RA0020100011	PCBA-MAIN SF-W37SGT (FCC APP)	
	48-01R00A200225	MAIN PCB FR4 (CEC4B10036500) R5	
CN201	43-011500234120	SMD WAFER 0.5MM 34P	
CN301	43-022150120520	SMD WAFER 1.5MM 2P	
CN302	43-022150190520	SMD WAFER 1.5MM 9P	
CN501	43-012100217530	SMD FFC.WAFER 1MM 17P	
CN502	43-022200140520	SMD WAFER 2MM 4P	
CN503	43-022150160520	SMD WAFER 1.5MM 6P	
CN601	43-012100190530	SMD FFC.WAFER 1MM 9P	
CN602	43-021800220520	SMD WAFER 0.8MM 20P	
CN701	73-022200160520	SMD WAFER 2MM 6P	
CN801	43-022200130520	SMD WAFER 2MM 3P	
D500	12-DAN217000021	DIODE - DAN217	
D601	12-011510320521	SMD ZENER DIODE - 5.1V	
D609	12-011560320511	SMD ZENER DIODE - 5.6V	
F701,702	 46-125200200010	SMT FUSE 6125T-2A 125V	
Q301,700	11-2SB113200021	SMD TR - 2SB1132	
Q801,802	11-2SC455570021	SMD TR - 2SC4555-7	
Q803	11-DTA124EK0021	SMD TR - DTA124EKA	
U101	16-BH3802KV0021	IC - BH3802KV	
U201	16-AK8567000021	IC - AK8567	
U205	16-AD8402AR0021	IC - AD8402AR10	
U206	16-TC4W53FU0021	IC - TC4W53FU	
U207,208	16-NJM3404A0021	IC - NJM3404AV	
U301	16-BA5960FS0021	IC - BA5960FS	
U501	16-LC8958700021	IC - LC89587	
U502	16-AK5353VT0021	IC - AK5353VT	
U504	16-M54160000021	IC - MSM5416258B	
U505	16-TC74VHC00021	IC - TC74VHC08FT	
U506	16-TC74VHC30021	IC - TC74VHC32FT	
U507	16-TC74VHC10021	IC - TC74VHV14FT	
U601	16-TMP95C260021	IC - TMP95C265F	
U602	16-EN29F0020021	IC -EN29F002ANT	
U604	16-PST597EN0021	IC - PST597ENR	
U605	16-BR9080AF0021	IC - BR9080AF	
U701	16-M5237ML00021	IC - M5237ML	
SW300,301	41-061120100020	LEAF SWITCH	
X501	31-018338600115	CRYSTAL 33.8688MHZ	
X601	31-048225701415	CRYSTAL 22.57MHZ	



# 5 WIRING DIAGRAM

IN OUT PCB

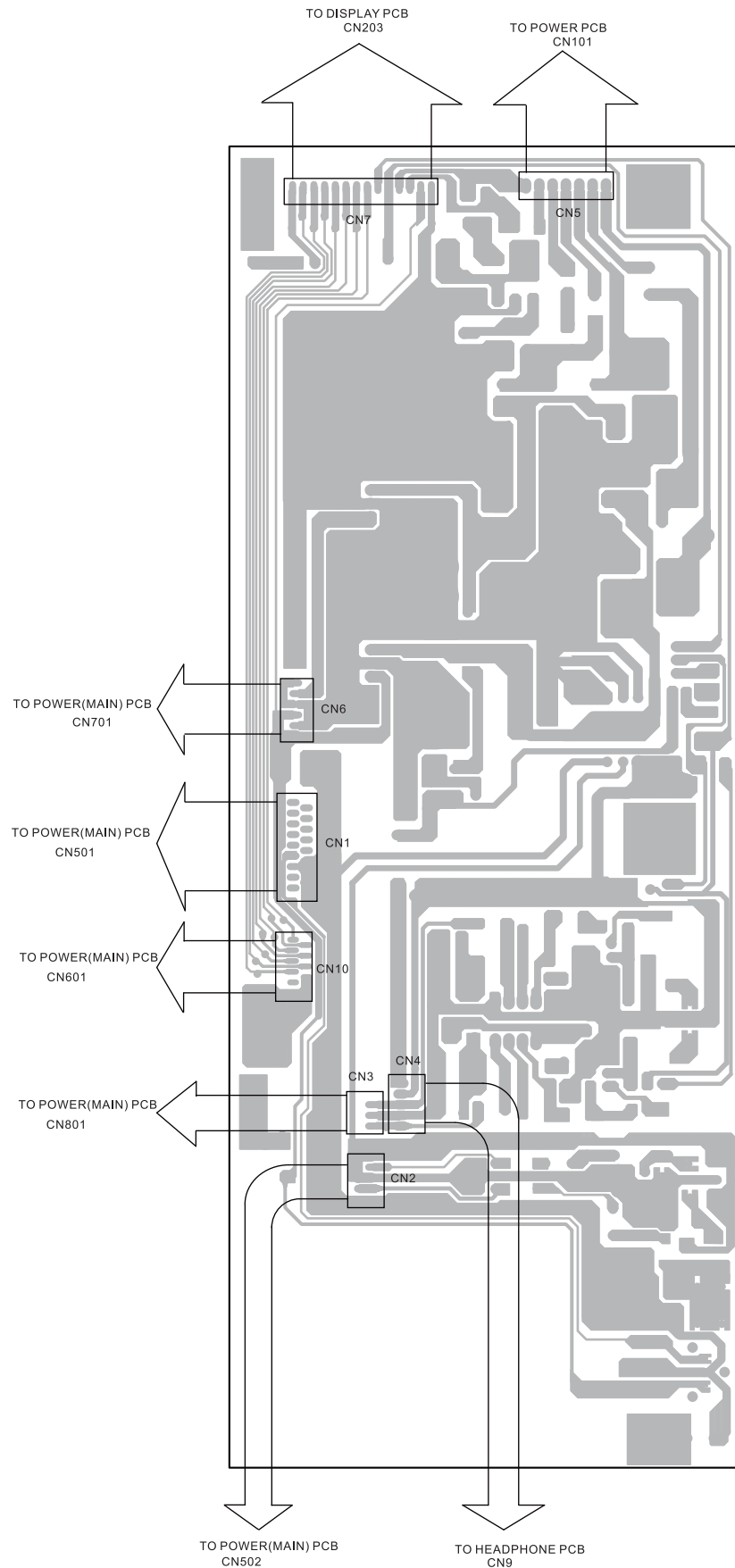

# CD-RW880

POWER MAIN PCB (CD MECHANISM ASSY)

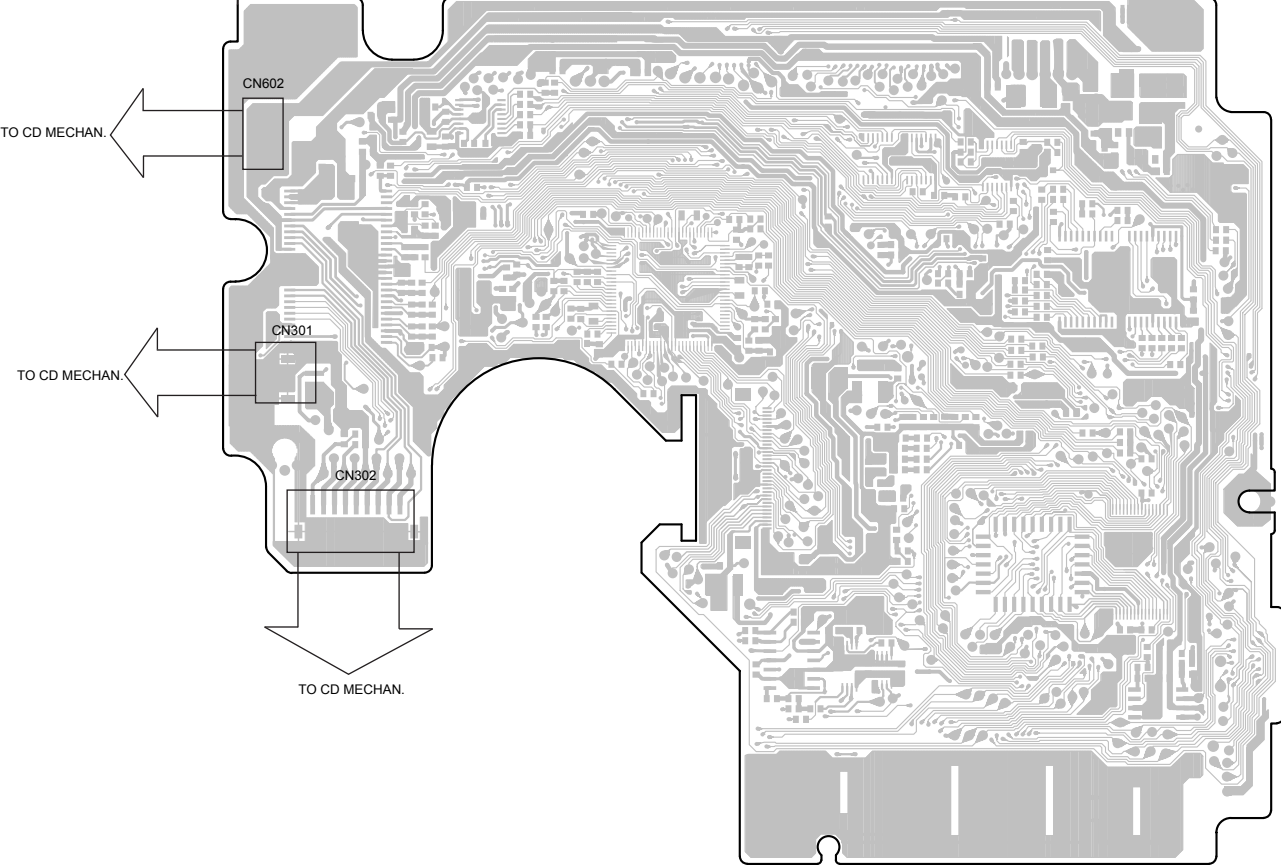

DISPLAY PCB

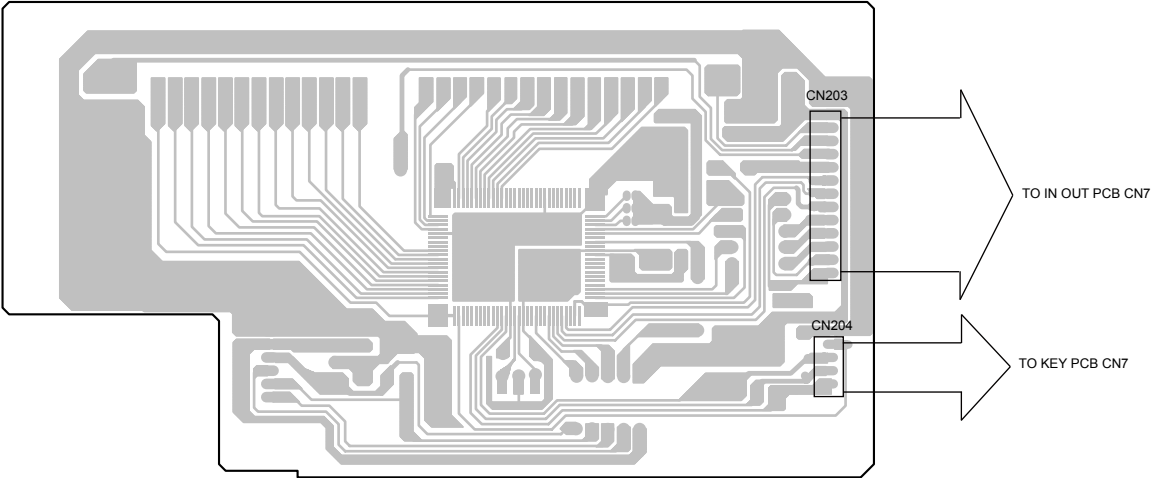

## 6 INCLUDED ACCESSORIES

### INCLUDED ACCESSORIES

REF. NO	PARTS NO.	DESCRIPTION	REMARKS
	77-20RW88000320	INSTRUCTION MANUAL(E/F) CEC6P12013620 [EUR]	
	77-20RW88000120	INSTRUCTION MANUAL(DM) CEC6P10081000 [JPN]	
	77-20RW88000020	INSTRUCTION MANUAL(E/F) CEC6P10081030 [USA]	
	45-203840005220	RCA PLUG CORD 2P	
	45-234100000020	OPTICAL CABLE	
	02-170RW8801700	REMOTE CONTROL RC-1037	
	51-011150300010	BATTERY 1.5V(SANYO) AA/UM-3	
	77-21RW88000220	INSTRUCTION SHEET(S/G/I/N) CEC6P12013630 [EUR]	
	77-21RW88000320	INSTRUCTION SHEET (E/F) CEC6P10081040 [EUR]	
	77-21RW88000120	INSTRUCTION SHEET CEC6P12013610 [JPN]	
	77-21RW88000020	INSTRUCTION SHEET CEC6P12013600 [USA]	

# CD-RW880

---

# TEAC

---

SKTE-SM0809005

---

<b>TEAC CORPORATION</b>	1-47, Ochiai, Tama-shi, Tokyo 206-8530, Japan Phone: (042) 356-9155
TEAC AMERICA, INC.	7733 Telegraph Road, Montebello, California 90640 Phone: (323) 726-0303
TEAC CANADA LTD.	5939 Wallace Street, Mississauga, Ontario L4Z 1Z8, Canada Phone: (905) 890-8008
TEAC MEXICO, S.A. De C.V	Río Churubusco 364, Colonia Del Carmen, Delegación Coyoacán, CP 04100, México DF, México Phone:(5255)5010-6000
TEAC UK LIMITED	Unit 19 & 20, The Courtyards, Hatters Lane, Watford, Hertfordshire, WD18 8TE, U.K. Phone: (0845) 130-2511
TEAC EUROPE GmbH	Bahnstrasse 12, 65205 Wiesbaden-Erbenheim, Germany Phone: 0611-71580

---

OCT 2008

PREPARED IN CHINA

IN OUT PCB

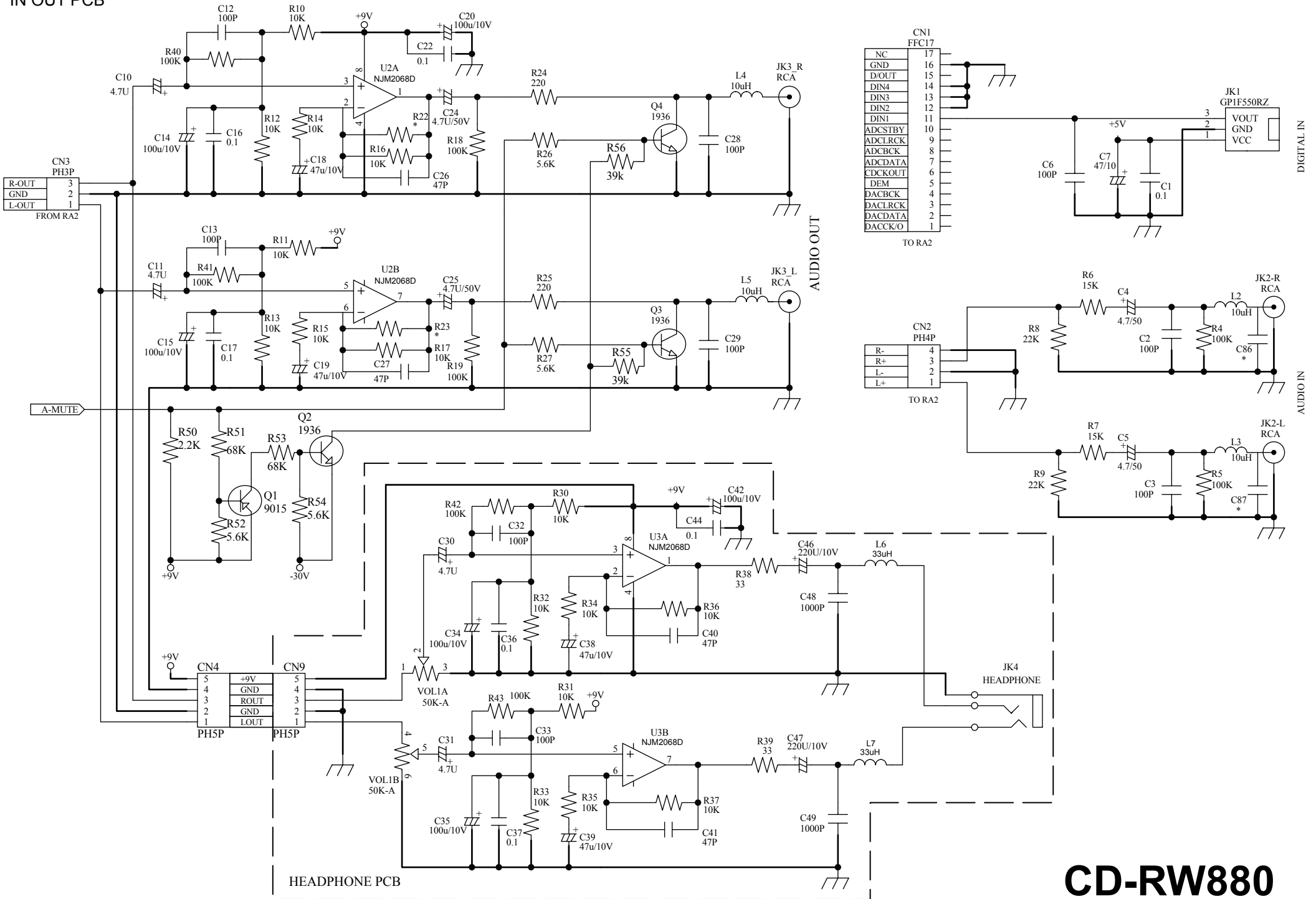

CN1 FFC17

NC	17
GND	16
D/OUT	15
DIN4	14
DIN3	13
DIN2	12
DIN1	11
ADCSTBY	10
ADCLRCK	9
ADCBCK	8
ADCDATA	7
CDCKOUT	6
DEM	5
DACBCK	4
DACLCK	3
DACDATA	2
DACCK/O	1

TO RA2

CN2 PH4P

R-	4
R+	3
L-	2
L+	1

TO RA2

**CD-RW880**  
CD-RW Player/Recorder

IN OUT / POWER PCB

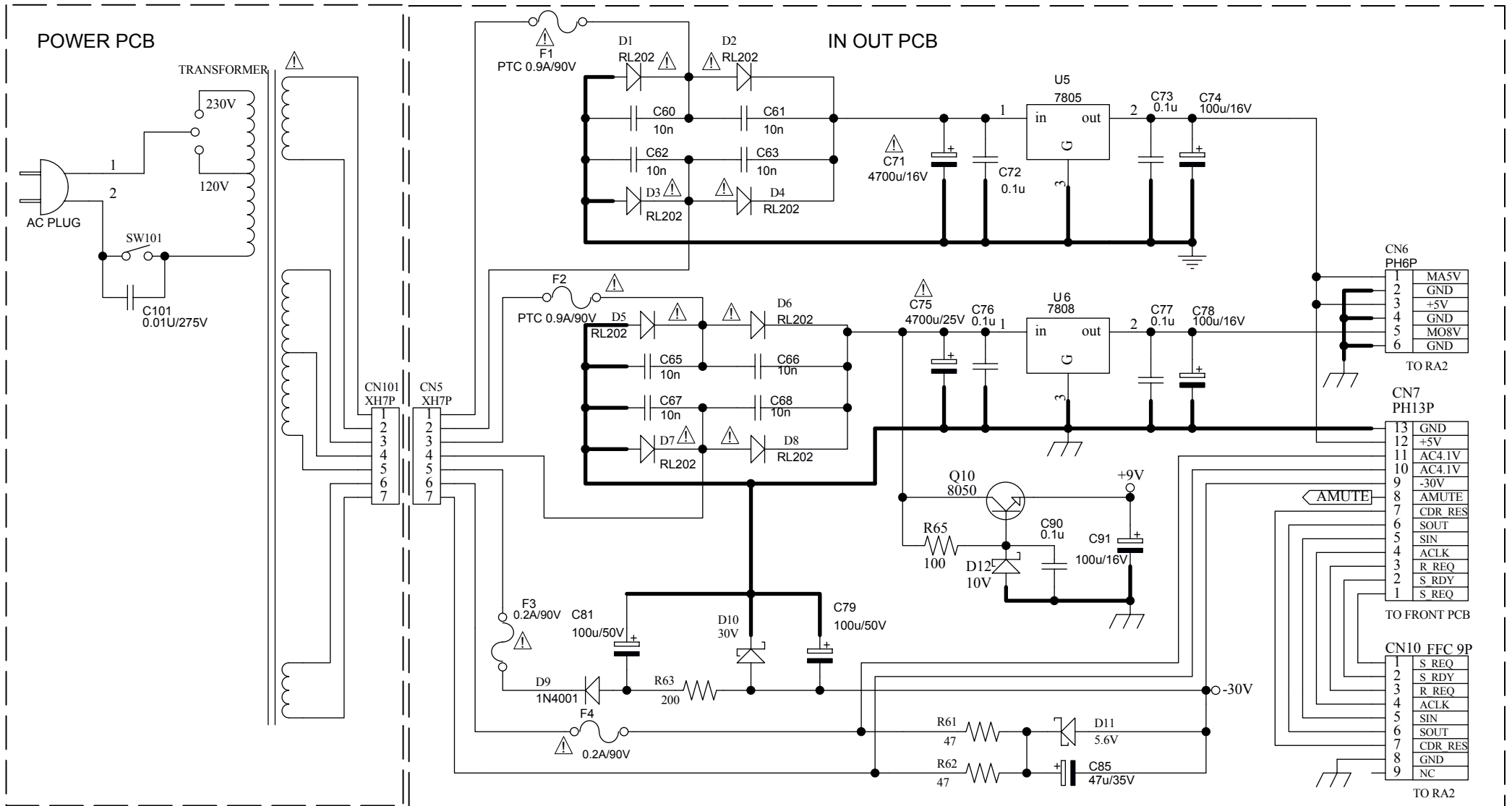

**CD-RW880**  
CD-RW Player/Recorder



POWER MAIN PCB (CD MECHANISM ASSY)

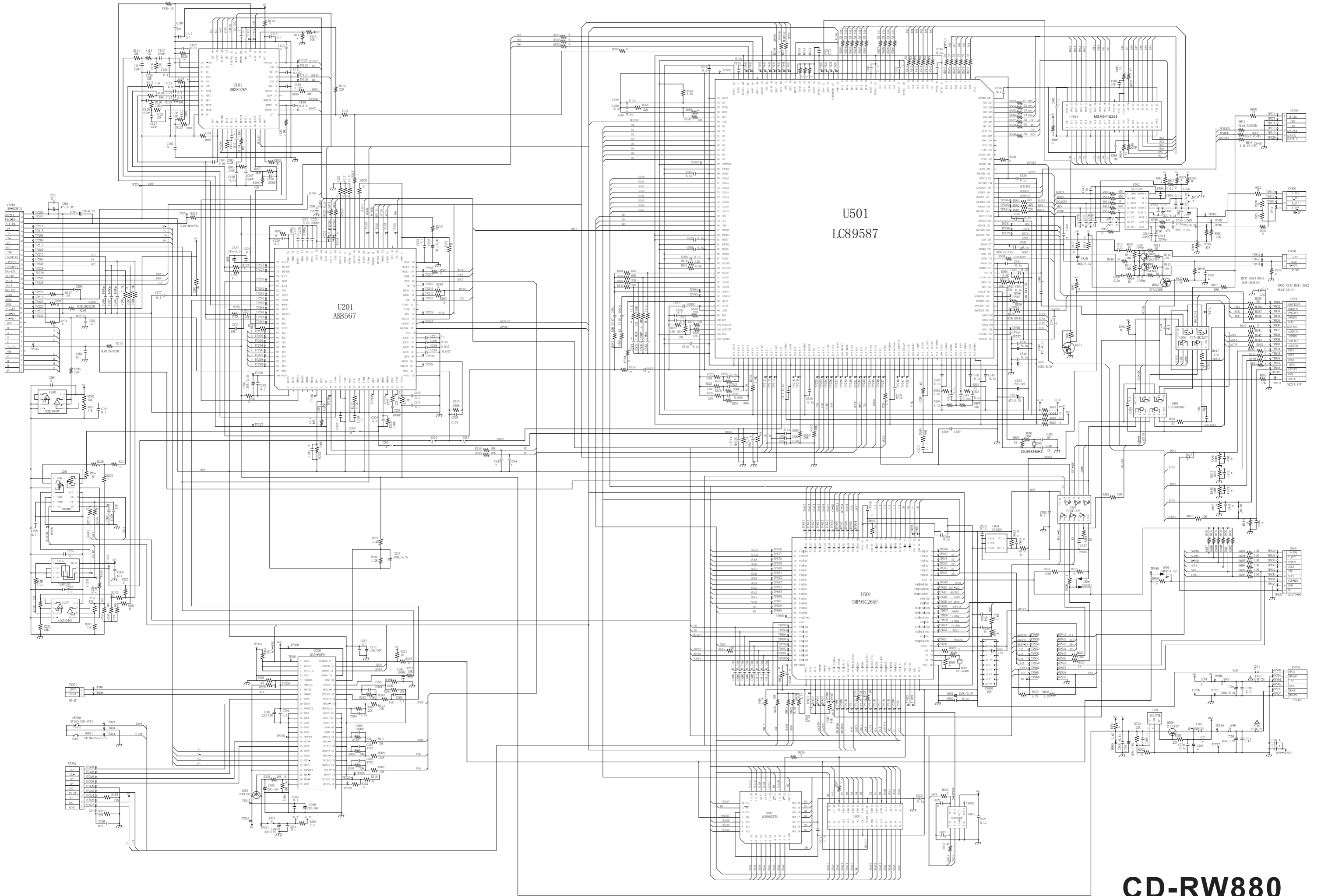

**CD-RW880**  
CD-RW Player/Recorder