

PROFESSIONAL AUDIO MIXING CONSOLE

PM1800A

OPERATING MANUAL

YAMAHA

How to use this manual

If you are an engineer or technician who is familiar with sound system design, much of this manual will serve as a review for you. The basic features are presented in the "BRIEF OPERATING INSTRUCTIONS" section. Check this and the "SPECIFICATIONS" section, and you will see most of what you need to know. The balance of this manual provides background information for better utilization of the console and auxiliary equipment.

If you would like to know more about AC power distribution and safety, grounding, balanced versus unbalanced cables, direct boxes, and so forth, this information is also presented. Check the TABLE OF CONTENTS.

There are internal jumpers within the console which can be configured to change the functions and/or signal paths in certain circuits. Refer to the OPTIONAL FUNCTIONS section for details.

TERMINOLOGY AND TYPOGRAPHIC CONVENTIONS

Generally, where we refer to a particular control or function as it is actually labeled on the console, we will use all upper case type. That is, if we refer to an input channel's gain control, we may print "the input GAIN control." On the other hand, if the feature is not labeled, we will use upper case type only on the first letter; for example, "observe there is no identification of the input Fader." If the front panel label is incomplete or ambiguous, we may augment it. For example, the input channel assign switches labeled "1, 2, 3, 4, 5, 6, 7, 8" may be accompanied by the parenthetic reference "(group bus assign)".

There are eight groups (or subgroups, depending on your linguistic preference). The group faders are known as "Group Master Faders". Their function is to control the level on the eight "Group Mixing Busses." The eight group busses are different and distinct from the six "Auxiliary Mixing Busses." The Stereo Fader has a single control that simultaneously adjusts the left and right stereo bus output level, so it is a single fader (it

does have an adjacent balance control for altering the relative output level on the left and right sides of the stereo bus).

We have used the terms "XLR" and "XLR-type" throughout this manual. The connectors actually used in this console are XLBs, which are compatible with and equivalent to the XLRs.

Particularly important information is distinguished in this manual by the following notations:

NOTE:

A NOTE provides key information to make procedures or functions clearer or easier.

CAUTION:

A CAUTION indicates special procedures or guidelines that must be observed to avoid damage to the console or related equipment, or to avoid an undesirable result while using the console.

WARNING:

A WARNING indicates special procedures or guidelines that must be observed to avoid injury to the operator or others using or exposed to the console or related equipment.

In the BRIEF OPERATING INSTRUCTIONS section of this manual, each feature is provided with a numerical reference. Elsewhere, if we are referring to that feature, we may cite the reference number in square brackets for clarity. For example, on the input module, the fourth control to be described is the PAN pot. In other places on the console there are other PAN pots. For clarity, then, if we are discussing this particular input PAN pot, we will describe it like this: "the PAN pot [6]".

WARNING: TO PREVENT FIRE OR SHOCK HAZARD, DO NOT EXPOSE THIS APPLIANCE TO RAIN OR MOISTURE.

IMPORTANT NOTICE FOR THE UNITED KINGDOM

Connecting the Plug and Cord

WARNING : THIS APPARATUS MUST BE EARTHED

IMPORTANT. The wires in this mains lead are coloured in accordance with the following code:

GREEN-AND-YELLOW	:	EARTH
BLUE	:	NEUTRAL
BROWN	:	LIVE

As the colours of the wires in the mains lead of this apparatus may not correspond with the coloured markings identifying the terminals in your plug proceed as follows:

The wire which is coloured GREEN-AND-YELLOW must be connected to the terminal in the plug which is marked by the letter E or by the safety earth symbol  or coloured GREEN or GREEN-AND-YELLOW.

The wire which is coloured BLUE must be connected to the terminal which is marked with the letter N or coloured BLACK.

The wire which is coloured BROWN must be connected to the terminal which is marked with the letter L or coloured RED.

Table of contents

PAGE	SECTION	TOPIC
A	A	HOW TO USE THIS MANUAL
A	A	TERMINOLOGY AND TYPOGRAPHIC CONVENTIONS
1-1	1	INTRODUCTION
2-1	2	BRIEF OPERATING INSTRUCTIONS
2-1	2.1	PM1800A FRONT PANEL FEATURES
2-2	2.1.1	Input Module
2-6	2.1.2	Group 1 - 4 Modules
2-10	2.1.3	Group 5 - 8 Modules
2-12	2.1.4	Stereo Module
2-15	2.1.5	COMM Module
2-18	2.1.6	The Meter Bridge
2-20	2.2	PM1800A REAR PANEL FEATURES
2-23	2.3	PW1800 POWER SUPPLY
3-1	3	PM1800A SPECIFICATIONS
3-1	3.1	GENERAL SPECIFICATIONS (PM1800A)
3-4	3.2	POWER SUPPLY SPECIFICATIONS (PW1800)
3-5	3.3	INPUT CHARACTERISTICS
3-5	3.4	OUTPUT CHARACTERISTICS
3-6	3.5	PERFORMANCE GRAPHS
3-10	3.6	BLOCK DIAGRAM AND GAIN STRUCTURE DIAGRAMS
4-1	4	INSTALLATION NOTES
4-1	4.1	PLANNING AN INSTALLATION
4-1	4.2	POWER MAINS
4-1	4.2.1	Verify The Correct Mains Voltage
4-1	4.2.2	Ensure There Is A Good Earth Ground
4-1	4.2.3	How To Obtain A Safety Ground When Using A 2-Wire Outlet
4-2	4.2.4	Improperly Wired AC Outlets: Lifted Grounds
4-2	4.2.5	Improperly Wired AC Outlets: Lifted Neutral
4-3	4.2.6	AC Safety Tips
4-3	4.3	THEORY OF GROUNDING
4-4	4.3.1	What Is A Ground Loop, When Is It Bad, And What to Do About It
4-5	4.3.2	Balanced Lines, Unbalanced Lines, And Ground Lift Switches
4-5	4.4	AUDIO CONNECTORS AND CABLES
4-6	4.4.1	Types Of Cable To Use
4-6	4.4.2	Cable Layout
4-7	4.4.3	Balanced Versus Unbalanced Wiring
4-9	4.4.4	The Pro's And Con's Of Input Transformers
4-9	4.4.5	Noise And Losses In Low And High Impedance Lines
4-10	4.5	DIRECT BOXES
4-10	4.5.1	Passive Guitar Direct Box
4-11	4.5.2	Active Guitar Direct Box
5-1	5	GAIN STRUCTURE AND LEVELS
5-1	5.1	STANDARD OPERATING LEVELS
5-1	5.2	DYNAMIC RANGE AND HEADROOM
5-1	5.2.1	What Is Dynamic Range?
5-1	5.2.2	The Relationship Between Sound Levels And Signal Levels
5-2	5.2.3	A Discussion Of Headroom
5-2	5.2.4	What Happens When The Program Source Has Wider Dynamics Than The Equipment?
5-3	5.2.5	A General Approach To Setting Levels In A Sound System
5-3	5.2.6	How To Select A Headroom Value And Adjust Levels Accordingly
5-4	5.3	GAIN OVERLAP AND HEADROOM

PAGE	SECTION	TOPIC
6-1	6	OPTIONAL FUNCTIONS
6-1	6.1	REMOVING AND INSTALLING A MODULE
6-2	6.2	INPUT CHANNEL AUX 3 THROUGH 6 SENDS: PRE OR POST FADER
6-3	6.3	INPUT CHANNEL AUX SEND PRE POSITION: PRE FADER & EQ OR PRE FADER/POST EQ
6-4	6.4	GROUP-TO-MATRIX: ASSIGNED PRE- OR POST- GROUP MASTER FADER
6-6	6.5	METER FUNCTION IN "GROUP" POSITION: PRE- OR POST- GROUP ON/OFF SWITCH
6-8	6.6	INSTALLATION OF OPTIONAL INPUT TRANSFORMERS
6-9	6.7	HINTS ON CIRCUITRY FOR REMOTE CONTROL OF THE MUTE GROUPS
7-1	7	OPERATING HINTS AND NOTES
7-1	7.1	CONSOLE GAIN STRUCTURE
7-1	7.1.1	What is the Proper Gain Structure?
7-1	7.1.2	What Affects Gain Structure?
7-1	7.1.3	Establishing the Correct Input Channel Settings
7-2	7.1.4	Establishing the Correct Group Master Settings
7-2	7.1.5	Establishing the Correct Aux Send Master Settings
7-2	7.1.6	Establishing the Correct Mix Matrix Settings
7-2	7.1.7	Establishing the Correct Aux Return Settings
7-2	7.1.8	Channel Muting and Gain Structure
7-3	7.2	FURTHER HINTS & CONCEPTUAL NOTES
7-3	7.2.1	Understanding and Using the Mix Matrix
7-4	7.2.2	Understanding and Use of the Master Mute Function
7-5	7.2.3	Stereo Panning to the Eight Group Mixing Busses
7-6	7.3	INTERFACE WITH POPULAR INTERCOM SYSTEMS
7-6	7.3.1	RTS Intercom Systems
7-7	7.3.2	CLEAR-COM Intercom Systems
8-1	8	APPLICATIONS
8-1	8.1	GENERAL
8-1	8.1.1	Sound Reinforcement
8-1	8.1.2	Theater
8-1	8.1.3	Production
8-2	8.1.4	Post Production
8-2	8.1.5	Video
8-2	8.2	SETUP CONCEPTS
8-2	8.2.1	Deriving a Stereo Mix From Groups 1-8
8-3	8.2.2	How to Get 4 Independent Stereo Mixes or 8 Mono Mixes (With Submasters) by Using the Stereo Bus, The Mix Matrix and The Input "Pan 7-8" Switches
9-1	9	MAINTENANCE
9-1	9.1	CLEANING THE CONSOLE
9-1	9.1.1	The Console and Power Supply Exterior
9-1	9.1.2	Power Supply Air Filter
9-1	9.1.3	Pots and Faders
9-1	9.1.4	The Console Interior
9-2	9.2	METER LAMP REPLACEMENT
9-3	9.3	WHERE TO CHECK IF THERE IS NO OUTPUT
9-4	9.4	WHAT TO DO IN CASE OF TROUBLE

List of illustrations

PAGE#	FIG#	TITLE (& SECTION, WHERE NECESSARY TO DISTINGUISH ONE DRAWING FROM ANOTHER)
2-1	2-1.	PM1800A INPUT MODULE
2-6	2-2.	PM1800A GROUP 1 - 4 MODULES
2-10	2-3.	PM1800A GROUP 5 - 8 MODULES
2-12	2-4.	PM1800A STEREO MODULE
2-15	2-5.	PM1800A COMM MODULE
2-19	2-6.	PM1800A-16 METER BRIDGE
2-19	2-7.	PM1800A-24 METER BRIDGE
2-20	2-8.	PM1800A REAR PANEL
2-22	2-9.	MUTE CONNECTOR PIN ASSIGNMENTS
2-23	2-10.	PW1800 POWER SUPPLY
2-23	2-11.	PW1800 UMBILICAL CONNECTOR PIN ASSIGNMENTS
3-3	3-1.	PM1800A DIMENSIONS
3-4	3-2.	PW1800 DIMENSIONS
3-6	3-3.	HIGH AND LOW FREQUENCY BAND EQUALIZER CHARACTERISTICS (SHELVING)
3-6	3-4.	HI-MID (A) AND LO-MID (B) BAND EQUALIZER CHARACTERISTICS (PEAKING)
3-6	3-5.	HIGH PASS FILTER CHARACTERISTICS
	3.5.1	Input Channel 1 to Group Output 1 With Input Gain control @ MAX)
3-7	3-6.	FREQUENCY RESPONSE
3-7	3-7.	FREQUENCY vs. T.H.D.
3-7	3-8.	OUTPUT LEVEL vs T.H.D. A) PAD at 0dB B) PAD at 20dB C) PAD at 40 dB
	3.5.2	Input Channel 1 to Group Output 1 With Input Gain Control @ MIN)
3-8	3-9.	FREQUENCY RESPONSE
3-8	3-10.	FREQUENCY vs. T.H.D.
3-8	3-11.	OUTPUT LEVEL vs T.H.D.
	3.5.3	Aux Return 4 (L) to Group Output 1)
3-8	3-12.	FREQUENCY RESPONSE
3-8	3-13.	OUTPUT LEVEL vs T.H.D.
3-8	3-14.	FREQUENCY vs. T.H.D.
	3.5.4	Channel 1 Input to Phones Output, With Input Pad @ 40 dB, Gain @ MIN.)
3-9	3-15.	FREQUENCY RESPONSE
3-9	3-16.	OUTPUT LEVEL vs T.H.D.
3-9	3-17.	FREQUENCY vs. T.H.D.
3-9	3-18.	CROSSTALK OF GROUP 1 INTO 3 OR 3 INTO 1 WITH INPUT PAN CONTROL AT FULL CW & FULL CCW POSITIONS
3-9	3-19.	CROSSTALK OF STEREO L INTO R OR R INTO L WITH INPUT PAN CONTROL AT FULL CW & FULL CCW POSITIONS
3-9	3-20.	CROSSTALK OF GROUP BUS 1 INTO GROUP BUSES 2 THROUGH 8
3-10	3-21.	PM1800A SIGNAL FLOW (BLOCK DIAGRAM)
3-12	3-22.	PM1800A GAIN STRUCTURE
4-2	4-1.	TESTING A 2-WIRE AC OUTLET
4-2	4-2.	SCHEMATIC OF AN OUTLET WITH A LIFTED NEUTRAL
4-3	4-3.	TESTING A 3-WIRE AC OUTLET
4-4	4-4.	TYPICAL GROUND LOOPS IN SOUND SYSTEMS
4-5	4-5.	AVOID USE OF AC POWER CORD GROUND ADAPTOR TO "BREAK GROUND"
4-6	4-6.	CONNECTOR WIRING FOR PM1800A A) XLR-3 input or output B) T/R/S phone plug input or output
4-7	4-7.	CABLES FOR UNBALANCED AND BALANCED LINES
4-8	4-8.	NOISE REJECTION IN A BALANCED LINE
4-10	4-9.	PASSIVE DIRECT BOX SCHEMATIC DIAGRAM
4-11	4-10.	ACTIVE DIRECT BOX SCHEMATIC DIAGRAM

PAGE#	FIG#	TITLE (& SECTION, WHERE NECESSARY TO DISTINGUISH ONE DRAWING FROM ANOTHER)
5-2	5-1.	DYNAMIC RANGE AND HEADROOM IN SOUND SYSTEMS
5-3	5-2.	HEADROOM IN DIFFERENT APPLICATIONS
6-1	6-1.	REMOVAL OF MODULE FROM PM1800A
6-2	6-2.	INTERNAL JUMPER WIRING FOR PRE OR POST FADER (& EQ) SENDS ON AUX 3 THROUGH AUX 6
6-3	6-3.	INTERNAL JUMPER WIRING FOR PRE-EQ AND POST-EQ AUX SENDS (WHEN AUX 1 OR AUX 2 PRE/OFF/POST SWITCH IS SET TO "PRE," OR AUX 3 THROUGH 6 JUMPERS ARE IN FACTORY-WIRED "PRE" POSITION).
6-4	6-4.	INTERNAL JUMPER WIRING FOR PRE- AND POST- GROUP MASTER FADER FEEDS TO MIX MATRIX
6-6	6-5.	INTERNAL JUMPER WIRING FOR GROUP METERING BEFORE AND AFTER THE GROUP ON/OFF SWITCH
6-8	6-6.	OPTIONAL INPUT TRANSFORMER INSTALLATION
7-3	7-1.	BLOCK DIAGRAM OF PM1800A MIX MATRIX
7-5	7-2.	BLOCK DIAGRAM OF PM1800A MASTER MUTE SYSTEM
7-6	7-3.	INTERFACE OF RTS INTERCOM TO PM1800A "COMM IN"
7-7	7-4.	INTERFACE OF PM1800A "TB OUT" TO RTS INTERCOM "AUDIO COUPLING" INPUT A) For Larger, PS-30 or PS-31 Power Supply B) For Smaller, PS-8 Power Supply
7-8	7-5.	ADAPTOR CABLE FOR SPLITTING XLR-4 INPUT/OUTPUT CONNECTOR ON CLEAR-COM IF4-4 INTERCOM INTERFACE
8-2	8-1.	SYSTEM DIAGRAM WITH GROUPS 1 - 8 AS SUBMASTERS, AND MAIN FEED FROM STEREO MASTER
8-3	8-2.	SYSTEM DIAGRAM FOR 4 INDEPENDENT STEREO OUTPUT MIXES VIA THE STEREO BUS, MIX MATRIX AND GROUP #7 AND #8 OUTPUTS
9-2	9-1.	REPLACEMENT OF VU METER LAMPS

SECTION 1

Introduction

The PM1800A is a professional audio mixing console with the kind of flexibility, performance and reliability for which Yamaha has earned a worldwide reputation. It picks up where the popular M1500 series left off, with still more functions, a higher level of performance, and a greater degree of versatility than ever before.

The console is available with 16, 24, 32, or 40 input channels. There are eight group mixing busses to which any of the input channels can be assigned. There are also six auxiliary mixing busses to which each input channel may be assigned by means of PRE/OFF/POST switches (Aux 1 & 2) or jumpers (Aux 3-6) and Send Level controls. These six busses may therefore be used to augment the eight groups for a total of 14 audio mixing busses, or they may be used for a combination of foldback send (stage monitor), effects send and remote mixes.

In addition to the aux and group busses, there is a discrete stereo bus to which signal can be assigned from any of the Group Masters. Thus, the console can function in a sub-grouped mode with a stereo "grand master" fader.

The PM1800A inputs are differentially balanced, and are equipped with a three-position attenuation PAD plus a continuously variable GAIN trim control so that literally any mic or line level signal can be accommodated with channel faders set at nominal level. Optional input transformers may be installed internally on a channel-by-channel basis when extra grounding isolation is required. While the console has ample headroom throughout, it is always possible to incorrectly set controls. For this reason, the PM1800A is equipped with level detection at several stages. "CLIP" LEDs are provided at the input preamp. Given that the signal is correct there, overboost in the EQ could still lead to clipping, so another LED, "EQ CLIP," is included after the EQ section. Finally, if the mixed level on the stereo bus adds up to be too high, a "PEAK" LED in the output meters will flash on to warn of the impending danger of clipping.

Naturally, the PM1800A is equipped with a Mix Matrix, the feature Yamaha pioneered in professional audio consoles. The PM1800A Mix Matrix is an 8x4 configuration. That is, there are 8 possible sources that can be mixed together into one output. Those 8 sources can be mixed together four different ways on four different modules. Each matrix channel accepts signals from the eight subgroups (pre or post master fader, depending on internal jumpers). These 8 sources all go through a MATRIX MASTER control and an ON/OFF switch to a discrete rear panel output. The matrix can save a tremendous amount of time and effort when you want to set up stage monitor mixes from the subgroups, when you want to create different speaker mixes for different zones of the house, to feed local and remote programs simultaneously, to make mono and stereo mixes from the same subgroups, and so on.

The PM1800A has a MASTER MUTE function just like that introduced with the PM3000. Each input channel has eight MUTE assign switches. These permit the channel's ON/OFF function to be remotely controlled by the eight MASTER MUTE switches. Once a channel is switched on locally, it can be muted (turned off) or unmuted (turned on) if it is assigned to one or more of the mute groups. This permits multiple channels to be silenced or activated all at once, which expedites live

sound mixing, band personnel or instrument changes, theatrical scene changes, and so forth. If, however, it is imperative that a certain channel never be inadvertently muted, or that muting temporarily be overridden, the input channel's MUTE SAFE switch can be engaged. Muting can also be controlled remotely, via a rear panel connector so automation is possible.

The PM1800A is equipped with four AUXiliary RETURN channels. Each of these is a stereo return, and can apply a stereo signal to any of the group mixing busses, with a BAL/PAN control for relative left/right level adjustments. Switches also allow aux return assignment to any of the six auxiliary send busses (for "looping" of one effect to the next, or for adding effects to an aux bus which is used for other than effects purposes). A switch in each return also permits it to accept a mono signal and to apply that signal to any of the busses; in this case, the BAL/PAN control becomes a PAN control for odd/even or L/R bus assignment. Of course, if panning is not desired, the pot may be bypassed. The returns also include CUE and ON/OFF functions. In fact, they may be used as mono or stereo line inputs to the console if not needed for effects returns.

An excellent feature of the PM1800A is its extensive cue and solo capability. There is a CUE/SOLO switch on every input channel and on the aux returns, and a CUE switch on every auxiliary send, the group outputs, the matrix outputs and the stereo master output. Cue replaces the signal in the headphones and the stereo cue XLR outputs with only those sources whose CUE switches are engaged. Furthermore, there is input cue priority, so that the operator may normally monitor the cue signal from the stereo bus or the group busses, and can instantly check one or more channel or aux return inputs without having to first release the bus CUE switches. This capability is great for troubleshooting, previewing a channel before applying it to the mix, or "touching up" the EQ on a channel during a performance. For use ahead of a live show, the console may be placed in solo mode. In this mode, only the input channel(s) whose CUE/SOLO switch is engaged will feed the console's outputs, and all other input channels will be muted; returns will not be muted so that any effects applicable to the input will be heard. Similarly, if an aux return Cue/solo switch (labeled CUE) is engaged, only the aux returns will be heard, and all input channels will be muted (unless their CUE/SOLO switches are engaged). The SOLO switch and LED flash to signal the operator that the console is in solo mode; in addition, the SOLO annunciator flashes or the CUE annunciator lights up (depending on whether the SOLO mode is selected) whenever any CUE or CUE/SOLO switch is engaged.

There is extensive talkback and communications capability in the PM1800A, plus a useful test oscillator. An XLR input can be set to accept any microphone or line level input, and is activated with the TALKBACK switch. That signal can be slated to any of the eight group mixing busses, the six aux send mixing busses, the stereo mixing bus, and to a rear panel XLR TB output. The test oscillator can be set to 100 Hz, 1 kHz or 10 kHz, and its output level is adjustable. Pink noise may be selected, too. The oscillator can be slated to the same busses as the talkback, and also has its own rear panel output connector so the signal can be routed to

other equipment or other console inputs for testing. Accompanying the talkback and oscillator functions is a communications input. That input will accept any mic or line level audio signal, typically from a professional intercom system, another console's talkback output, or a stage manager's mic. When a signal is present, a front panel COMM IN light flashes to signal the operator, who can then turn on the communications input (if desired), so the signal appears on the console headphone and cue outputs. Thus, with COMM IN and TALKBACK, the console operator can establish 2- way communications without having to wear an intercom headset as well as cue headphones.

Comprehensive metering is provided with a total of 10 VU meters on the 16-channel mainframe, or 13 VU meters on the larger mainframes (Stereo meters include peak LEDs). The meters on all consoles include switching to monitor 23 different circuits.

PM1800A electronic performance tracks that of its larger brother, the highly advanced PM3000. Its stable input preamplifiers, low noise integrated circuits, and sophisticated design make your job easier. In fact, low noise, wide headroom throughout, exceptionally low distortion, and quiet controls are the hallmark of this top quality mixing console. The specifications tell part of the story... your ears will tell you the most important part.

Physically, the PM1800A is as appealing as it is electronically. A special chassis and the widespread use of structural aluminum has enabled us to significantly reduce the console weight compared to older designs without sacrificing any strength. A modern-looking gray finish and subtly color coded controls set the backdrop for the PM1800A's hundreds of illuminated switches and indicators that give it the look of a NASA control console. All illumination (except VU meters and detachable hooded lamps) is by means of light emitting diodes, so maintenance is greatly reduced.

The highly advanced PM1800A, with its many internally jumpered functions, provides many of the features of custom consoles while retaining all the value and reliability of a Yamaha professional console. While its numerous internal and front panel functions may at first intimidate the casual console operator, the PM1800A is actually a very straightforward console to use. Anyone who has used the PM3000 will instantly know how this board works. In fact, if you've ever used a Yamaha M916, M1516A, M1524 or M1532 console, you will immediately feel comfortable with the PM1800A. Take a while to study the panel, read the descriptions in this manual, and you'll find operating this console comes as naturally as any you've encountered. And it's far more flexible than most.

SECTION 2

Brief operating instructions

NOTE: In the caption of each module illustration, we have included the Yamaha module part number in parentheses.

2.1 PM1800A FRONT PANEL FEATURES:

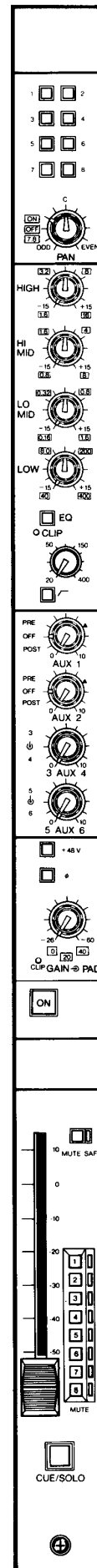
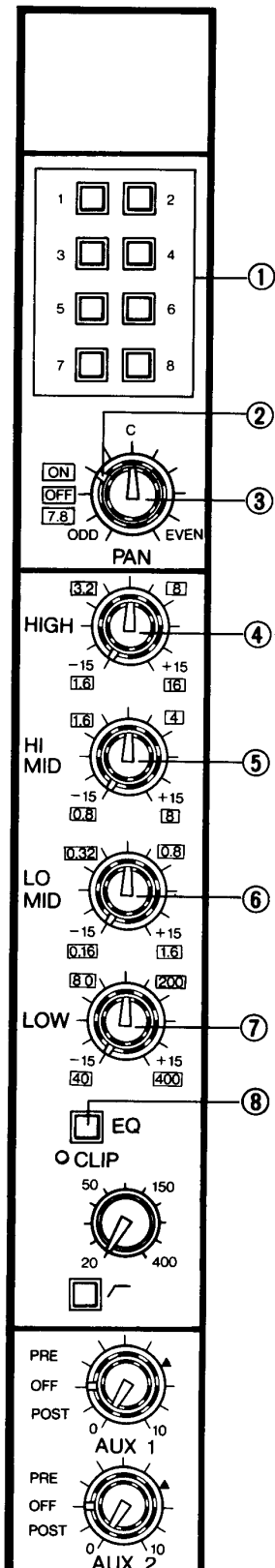

FIGURE 2-1. PM1800A INPUT MODULE (IP1800A).

2.1.1 The Input Module



1. 1 2 3 4 5 6 7 8 (Assign)

These locking gray switches assign the channel output to group mixing busses 1 through 8.

2. ON/OFF/7-8 (Switch)

A 3-position rotary switch is mounted concentrically with and determines the function of the PAN pot. When the switch is ON, the PAN pot (inner knob) affects signal which is assigned to odd-numbered (counterclockwise rotation) and even-numbered (clockwise rotation) group busses.

When the switch is OFF, no signal flows through the PAN pot, but instead can be assigned directly to any of the 8 group busses from the channel.

When the switch is set to 7-8 position, the PAN pot only applies signal to group busses 7 and 8 (assuming their bus assign switches are engaged). This permits the group 7 and 8 busses to serve as a convenient stereo pair. At the same time, the other six group busses can be assigned directly from the input channel, with the full level going to any of these assigned busses regardless of PAN pot position.

3. PAN (Pot)

This rotary control enables the channel output to be assigned between odd-numbered (counterclockwise rotation) and even-numbered (clockwise rotation) group busses. A center detent is provided for equal signal assignment to odd/even or left/right busses. Center position does apply 3 dB less signal to each bus than the level obtained with full left or right assignment so that the combined stereo signal adds up to constant power at all PAN pot positions.

(EQUALIZER)

The input channel equalizer is divided into four bands, each with sweepable filter frequencies. The high and low bands have shelving EQ curves, whereas the high-mid and low-mid bands have peaking curves. The level (gain) is adjustable over a range of 15 dB boost and 15 dB cut in each band.

4. HIGH

1.6 ~ 16 kHz

The outer concentric knob sweeps the EQ Frequency between 1,600 and 16,000 Hz.

+15 ~ -15 dB

The inner concentric knob adjusts the Gain of the set frequency band by plus or minus 15 dB. A center detent is provided for unity gain.

5. HIGH-MID

0.8 ~ 8 kHz

The outer concentric knob sweeps the EQ Frequency between 800 and 8,000 Hz.

+15 ~ -15 dB

The inner concentric knob adjusts the Gain of the set frequency band by plus or minus 15 dB. A center detent is provided for unity gain.

6. LOW-MID

0.16 ~ 1.6 kHz

The outer concentric knob sweeps the EQ Frequency between 160 and 1,600 Hz.

+15 ~ -15 dB

The inner concentric knob adjusts the GAIN of the set frequency band by plus or minus 15 dB. A center detent is provided for unity gain.

7. LOW

40 ~ 400 kHz

The outer concentric knob sweeps the EQ Frequency between 40 and 400 Hz.

+15 ~ -15 dB

The inner concentric knob adjusts the GAIN of the set frequency band by plus or minus 15 dB. A center detent is provided for unity gain.

8. EQ (In/Out switch)

This locking switch activates the channel EQ (switch in) or bypasses it completely. Bypass allows for A-B comparison, and absolutely minimum signal degradation when EQ is not needed.

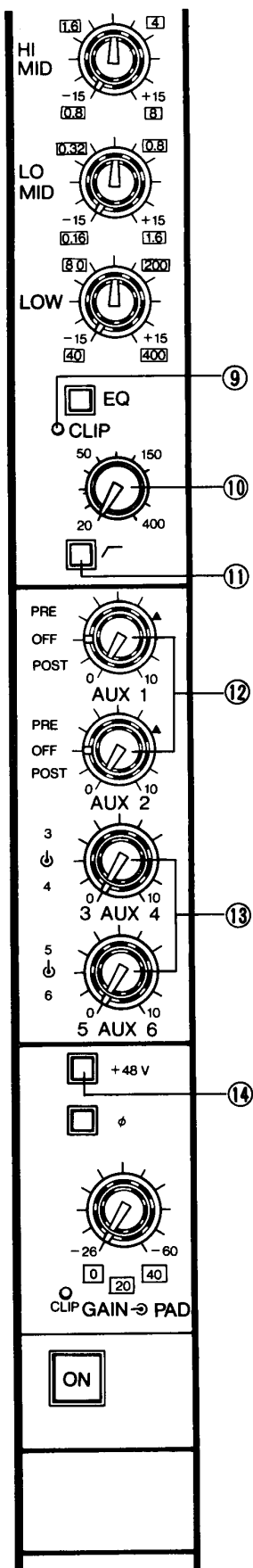

9. EQ CLIP

This red LED turns on when the post-EQ signal level is 3 dB below clipping, warning to decrease the EQ boost and/or to turn down the signal level at the channel input gain stage. Clipping at this stage can occur even though the input signal is not clipping, due to boost (gain) applied with the EQ circuitry.

10. 20 ~ 400 Hz (H.P. filter)

This rotary control sweeps the cutoff frequency of a high pass filter (low cut) from 20 Hz to 400 Hz. The filter slope is 12 dB/octave.

Typical applications include cutting wind noise, vocal "P" pops, stage rumble, and low frequency leakage from adjacent instruments. Higher frequency settings can be used to reduce leakage into mics that are primarily handling high-frequency sources. In general, it is a good practice to use the filter to protect woofers from unnecessary over-excursion due to the presence of unneeded low frequency or sub-sonic components, especially if a microphone is dropped or kicked; the filter should be bypassed (switch up) only when low frequencies are intentionally sought, as with a synthesizer, drum, bass guitar, and so forth.

11. (H.P. filter In/Out switch)

This locking switch activates the input channel HIGH PASS FILTER (switch in) or bypasses it. This filter bypass function is independent of the EQ section, which has its own bypass switch.

12. AUX 1, AUX 2 (Send Level & Pre/Off/Post Switches)

There are 2 rotary AUX send level controls with concentric PRE/OFF/POST switches. The switch mutes (turns off) the send, or derives signal before (PRE) or after (POST) the channel Fader and EQ. The associated rotary control determines how much of the selected signal source is applied to the correspondingly numbered auxiliary mixing bus. When the switch is in the center (OFF) position, no signal is applied to the auxiliary bus. (See Note below the AUX 3/4, AUX 5/6 description.)

13. AUX 3/4, AUX 5/6 (Send Level)

In order to provide the maximum number of auxiliary busses in the available space, these four send level controls are arranged in two concentric pairs: AUX 3/AUX 4, and AUX 5/AUX 6. These sends are factory wired to be pre EQ and Fader, and thus operate identically to the AUX 1 or AUX 2 sends when they are set to PRE mode. However, internal jumpers are provided for each of these four sends (Aux 3 to 6) which enable them to be individually changed so they are POST EQ and Fader.

NOTE:

In some applications, it is preferable to have the PRE mode be Pre-Fader & Post-EQ rather than Pre-Fader & Pre-EQ as these consoles are shipped. The PM1800A is equipped with an internal jumper on each channel that makes it easy to change the "Pre" of all six of the channel's AUX sends in this manner. This functional modification can be performed on a channel-by-channel basis. Refer to the OPTIONAL FUNCTIONS section of this manual for additional information.

14. +48V

This switch turns phantom power on and off at the channel's XLR input connector. Power can be turned on, however, only if the MASTER PHANTOM POWER switch is on.

When both the Master and this switch are on, +48 volts is applied to both pins 2 & 3 of the channel input XLR connector, via 6.8 kohms isolation/current limiting resistors, for remote powering of condenser microphones. Although phantom power will not harm most dynamic and other non-phantom powered microphones or line-level devices, connection of an unbalanced source to the channel input could partially short the console's phantom supply, cause undue loading, and induce hum. Therefore, it is a good practice to turn off the channel's phantom power unless it is actually in use.

NOTE:

The console's microphone power supply is not intended for A-B powered microphones. External supplies may be used with these devices, in which case the console's phantom power should be turned OFF on the appropriate channels. The optional input transformers, if installed, do not affect phantom power operation.

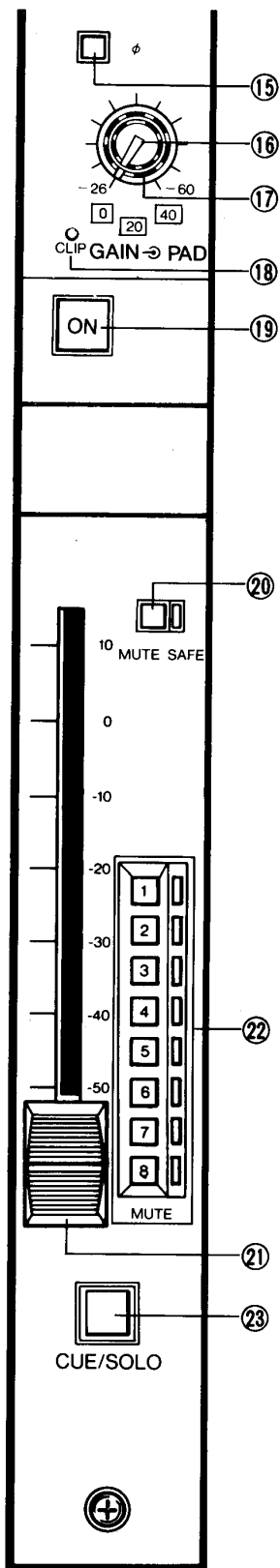

15. ϕ (Phase)

This switch reverses the polarity of pins 2 and 3 of the channel's XLR input connector. When this switch is up, pin 2 is the signal high conductor, and when the switch is engaged, pin 3 is high. This eliminates the need to rewire connectors or use adapters for out-of-phase (reversed polarity) audio sources. Sometimes intentional polarity reversal can be helpful in canceling leakage from adjacent microphones, or in creating electro-acoustic special effects by mixing together out-of-phase signals from mics picking up the same sound source.

16. GAIN

The inner concentric knob provides 34 dB of continuously variable adjustment for the input preamplifier gain.

17. PAD (0, 20, 40)

The outer concentric knob is a 3-position rotary switch that attenuates the signal from the channel's XLR input by 0, 20, or 40 dB. A setting of "40" is therefore least sensitive. The PAD should be used in conjunction with the GAIN control to obtain the precise channel sensitivity necessary for a given source. It is always a good idea to begin with the PAD set to 40 dB position, and to back off from there to avoid any chance of input overdrive.

18. CLIP

This red LED is provided to indicate when the signal present after the channel preamp (either from the XLR or from the INSERT IN jack) is too high in level. The CLIP LED turns on when that signal is 3 dB below clipping, and should therefore flash on only occasionally. If necessary, use a higher PAD value or decrease the GAIN setting to prevent the LED from remaining on any longer than momentarily; otherwise excessive distortion and insufficient range for fader motion will result.

19. ON (Channel On)

This locking, yellow, illuminated switch turns on when the input channel is ON, indicating the channel output is available to the 8 group mixing busses, and the 6 auxiliary mixing busses. Engaging the switch does not necessarily mean the switch will be illuminated or that the channel will turn on; muting logic may be dictating that the channel remain off. When the channel is OFF, its signal may still be previewed with the CUE/SOLO switch [23].

20. MUTE SAFE

When this locking switch is engaged, and adjacent yellow LED is illuminated, it overrides any combination of MASTER MUTE and channel MUTE switch settings, and prevents the channel from being muted. Engaging this switch ensures the channel will always be on so long as the channel ON switch is also engaged.

21. FADER

This smooth, long-throw fader sets the level applied to the 8 group mixing busses. It also affects any auxiliary feeds which are set to post-fader position.

22. MUTE (Assign 1 - 8)

Engaging any of these 8 locking switches enables the corresponding Group MUTE MASTER switch(es) to "kill" this channel. An exception exists when the channel MUTE SAFE switch [20] is engaged, in which case these MUTE switches can have no effect. When a MUTE switch is engaged, the adjacent yellow LED turns on.

23. CUE/SOLO

The function of this switch on each input channel will depend on the setting of the console's Master SOLO MODE switch [61].

If the console is set to the SOLO MODE, then pressing this switch mutes all other input channels, and only the input channel(s) whose CUE/SOLO switch is engaged will feed the console outputs. (This is also known as "solo in place.") Any AUX RETURN signals will not be muted so that effects can be heard in conjunction with the input signal. To silence the AUX RETURNS, turn them off manually.

If the console is set to the CUE MODE, the console then has a dual-priority cue system, designed to give the engineer maximum control and speed when it is most important. In this mode, pressing the input channel CUE/SOLO switch causes the channel signal to replace any master signal in the Cue output and the Phones output.

The engineer can readily select any of 20 output mixes (Group 1-8, Matrix 1-4, Aux Send 1-6, or Stereo L & R) by pressing the corresponding CUE switches. In most cases,

once the individual output mixes have been established, the engineer will want to listen to the "most important output mix" during the performance, possibly the main house feed or the vocal group. However, should feedback occur, or should any other condition require attention, the PM1800A enables the engineer to instantly check any input channel or channels by pressing their CUE/SOLO switch(es). The input whose CUE switch is engaged then automatically replaces the selected output mix in the headphone and cue outputs. The engineer can make the necessary adjustment, and then return to monitoring the original output mix simply by releasing the input CUE/SOLO switch.

Pressing the yellow illuminated CUE/SOLO switch part-way down causes momentary contact; pressing it further locks it down. Although the cue signal is not affected by the Fader or ON/OFF switch, it is affected by the Input PAD, GAIN control, Filter, channel EQ, and anything connected between the channel's INSERT IN and OUT jacks.

NOTE:

Since the console operator may normally be listening to the stereo bus or one or more group busses by means of engaging their cue switches, the PM1800A is set up for input cue priority. As soon as one or more input channel cue switches are engaged, any bus cue signal will be replaced by the input cue signal(s). Input priority is also given to other PM1800A inputs (Aux Return cue), not just to the input channel cue signals.

2.1.2 The Group 1 To Group 4 Modules

The upper halves of the GROUP 1 through GROUP 4 modules include the circuitry for the AUX SEND Master 1 through 4 and AUX RETURN inputs 1 through 4. These modules are similar, differing only in the actual group bus, aux send and aux return numbers.

The following descriptions of one of these modules is typical of all four (GROUP 1 through GROUP 4). Bear in mind that each rear-panel Auxiliary Return input actually consists of two input connectors, L/MONO and R. When a mono signal is applied to an Aux Return, the "L/MONO" input should be used.

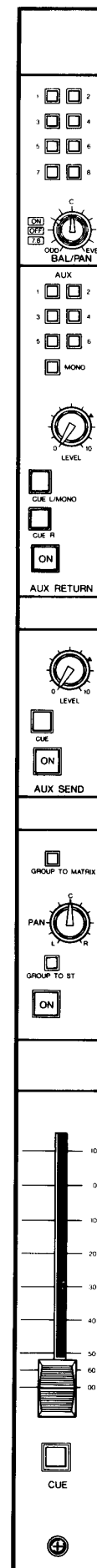
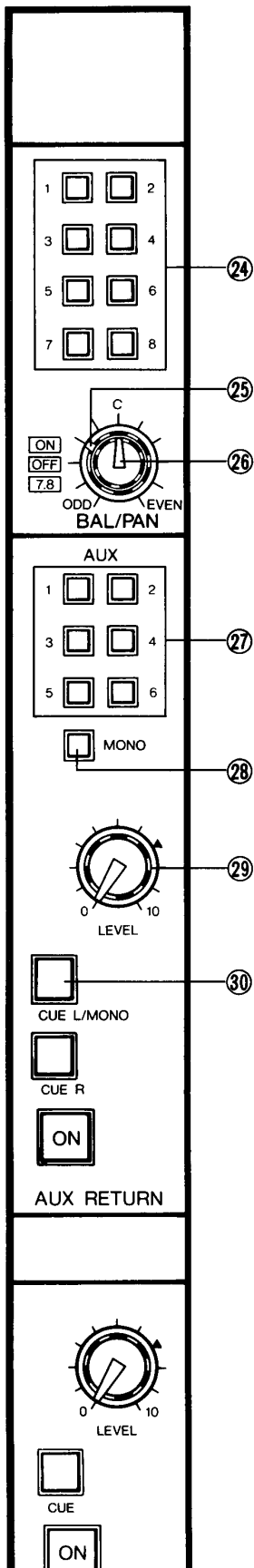

FIGURE 2-2. PM1800A GROUP 1 MODULE (RT1800A), TYPICAL OF 1 - 4



(AUX SECTION)

24. 1 2 3 4 5 6 7 8 (Group Assign)

These locking switches assign the AUX RTN signal to group mixing busses 1 through 8.

25. ON/OFF/7-8 (Switch)

A 3-position rotary switch is mounted concentrically with and determines the function of the BAL/PAN pot. When the switch is ON, the BAL/PAN pot (inner knob) affects signal which is assigned to odd-numbered (counterclockwise rotation) and even-numbered (clockwise rotation) group busses.

When the switch is OFF, no signal flows through the BAL/PAN pot, but instead can be assigned to directly to any of the 8 group busses from the Aux Return.

When the switch is set to 7-8 position, the BAL/PAN pot only affects signal to group busses 7 and 8 (assuming their bus assign switches are engaged. This permits the group 7 and 8 busses to serve as a convenient stereo pair. At the same time, the other six group busses can be assigned directly from the Aux Return, with the full level going to any of these assigned busses regardless of BAL/PAN pot position.

26. BAL/PAN

This rotary control enables a mono auxiliary return to be panned, or a stereo return to be balanced in level. Given a mono auxiliary return (using the L/MONO AUX RTN input), BAL/PAN acts as a PAN pot and can position the return signal between any odd-numbered and even-numbered group mixing busses (concentric switch set to ON) or only between group busses 7 and 8 (switch in 7-8 position).

Given a stereo auxiliary return signal, the BAL/PAN control instead functions as a BALANCE control. In this instance, the L input is routed entirely to the odd-numbered group busses, and the R input goes to the even-numbered group busses, per any engaged group assign switches. The BAL/PAN control then raises the level to one side while lowering it to the other, and vice versa.

A center detent is provided for equal signal assignment to odd/even; when panning a mono input, center position does apply 3 dB less signal to each bus than the level obtained with full left or right assignment so that the combined stereo signal adds up to constant power at all pot positions.

NOTE:

An aux return signal applied to an aux send bus is always mono, whether derived from a mono or stereo return.

27. AUX 1 - 6 (Assign)

These 6 locking switches assign the aux return signal directly to the correspondingly numbered auxiliary mixing busses. If the return is stereo, it will be combined to mono so that both sides of the return are applied to any of the assigned aux busses.

CAUTION:

DO NOT assign a return to the same auxiliary bus whose output is feeding a signal processor which is providing the return signal. This will almost certainly cause feedback which can damage circuits and/or loudspeakers.

28. MONO

Pressing this locking switch activates L/MONO aux input as the sole signal input to this AUX section. For stereo aux returns, do not engage this switch.

29. LEVEL

This rotary control sets incoming AUX level applied to any of the assigned group, or auxiliary mixing busses. It is a 2-ganged control, simultaneously adjusting the L/MONO and R aux returns.

30. CUE L/MONO

Pressing this switch part-way down causes momentary contact; pressing it further locks it down. The Cue signal from these modules is always MONO, but this switch and the CUE R switch below determine the source(s) of that cue signal. Engaging this switch derives signal from the AUX L/MONO INPUT (See [31]).

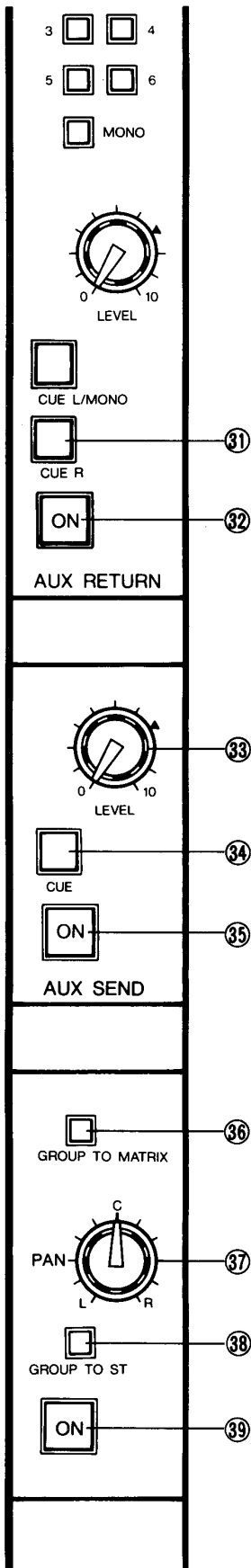

31. CUE R

With a stereo AUX input, pressing this switch applies signal from the AUX R IN to the cue bus, where it is mixed to mono with any AUX L cue signal (ref. [30]). This signal is fed to the Cue and Phones outputs. When the console is in cue mode (refer to SOLO switch [61]), and this CUE R switch (and/or the CUE L/MONO switch) is engaged, the aux return signal replaces any master signal in the corresponding side of the Cue output and the Phones output.

NOTE:

As noted under the input channel cue switch description, the PM1800A exhibits input cue priority logic. Since AUX IN is an input, it too receives priority. This means that either aux return cue (L/MONO or R), when selected, will replace any other group or stereo bus cue signals.

When the console is in solo mode (again, refer to SOLO switch [61]), the aux CUE switches function similarly, but not the same as, the input channel CUE/SOLO switches. Engaging either aux CUE switch will mute all input channels (unless their CUE/SOLO switches are engaged), but will not mute the other aux returns; to mute other returns, disengage their ON/OFF switches.

32. ON (Aux Return On)

This locking, yellow, illuminated switch turns ON when the aux return is ON, indicating the aux return signal is available to the 8 group mixing busses and the 6 auxiliary-mixing busses. When the return is OFF, its signal may still be previewed with the adjacent CUE switches [30 or 31].

33. LEVEL

This rotary control adjusts the overall level from the correspondingly numbered auxiliary mixing bus to the AUX OUT XLR connector.

34. CUE (Aux Send Cue)

Pressing this yellow illuminated switch part-way down causes momentary contact; pressing it further locks it down. When the CUE switch is illuminated, the correspondingly numbered auxiliary send is applied to the Cue output and the Phones output, along with any other AUX SEND or master Cue signals, unless an input CUE switch is engaged. (Bus cue signals are overridden by input cue.) The aux cue signal is mono, regardless of how many aux sends are cued.

35. ON (Auxiliary On)

This locking, yellow, illuminated switch turns on when the AUX OUT is ON. When the AUX OUT is turned off, its signal may still be previewed with the adjacent CUE switch [34].

(GROUP SECTION)

36. GROUP-TO- MATRIX

Engaging this locking switch assigns signal from the module's GROUP OUT (ahead of the Group ON switch) to the correspondingly numbered matrix rotary control.

NOTE:

The signal is assigned to the matrix by a jumper within each of the master modules. As shipped, the group feed to the matrix comes after the Group Fader; a jumper may be moved within each master module to obtain a pre-Group Fader feed to the matrix. Refer to Section 6.4 for more information on this optional jumper function.

37. PAN

This pan control is operational only when the adjacent ST (stereo) switch is engaged. It then pans the group signal (post- Group fader) between the left and right sides of the stereo mixing bus.

38. GROUP-TO-ST

Engaging this locking switch assigns the group bus output to the stereo bus via the adjacent PAN control. When the switch is not engaged, the group signal is not applied to the stereo bus.

39. ON (Group On)

This locking, yellow, illuminated switch turns on when the GROUP OUT XLR is ON. When the GROUP OUT is turned off, its signal may still be previewed with the group CUE switch [41]. This switch does not affect the group output to the matrix or the stereo

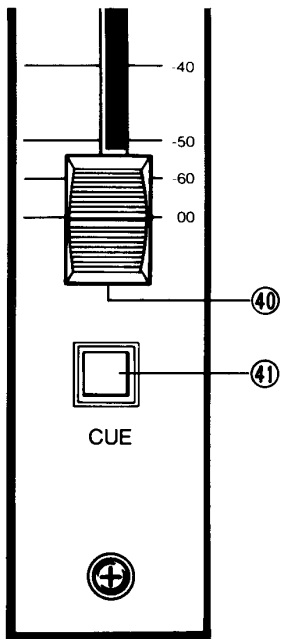

bus. It does normally affect the Group VU meter display, unless an internal jumper has been moved so the meter is driven from a point ahead of this switch.

40. (Group Out Fader)

This fader controls the audio signal level from the group mixing bus which is applied to the GROUP OUT.

41. CUE (Group Cue)

Pressing this yellow illuminated switch part-way down causes momentary contact; pressing it further locks it down. When the CUE switch is illuminated, the module's GROUP OUT signal (pre Group Fader) adds to any master signal in the Cue output and the Phones output unless an input CUE switch is engaged. (Bus cue signals are overridden by input cue.) The Group cue signal is mono, regardless of how many groups are cued.

2.1.3 The Group 5 To Group 8 Modules

The upper halves of the GROUP 5 through GROUP 8 modules include the circuitry for the MIX MATRIX. Group 5 and GROUP 6 modules also include AUX SEND 5 & 6 Master circuits, respectively (their function is identical to the AUX SEND 1 - 4 features covered in the GROUP 1 - 4 module description).

The following description of one of these modules covers only the MATRIX controls since the group and aux controls function identically to those in Group Modules 1 through 4. (to heading, next page, above 42).

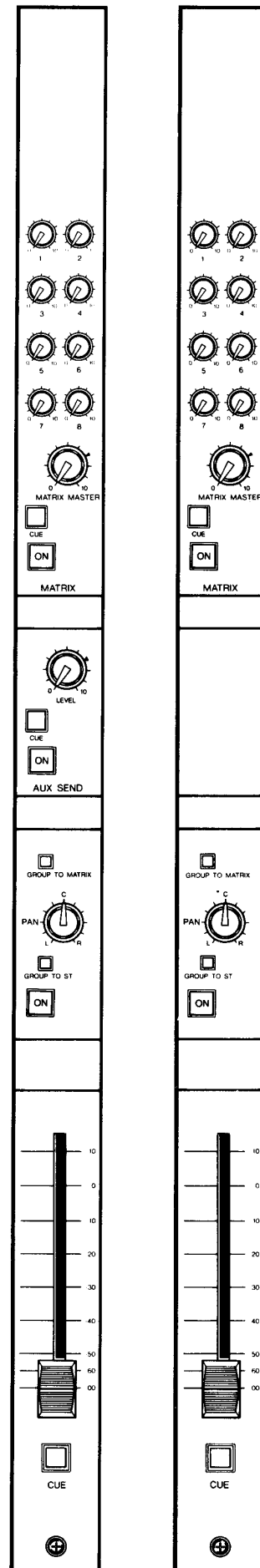
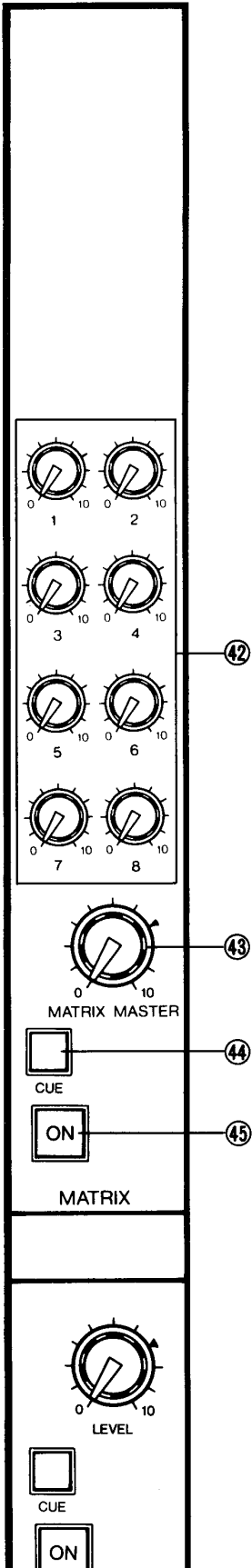

FIGURE 2-3. PM1800A GROUP 5 MODULE (MT1800AA), TYPICAL OF 5 & 6; PM1800A GROUP 7 MODULE (MT1800AB), TYPICAL OF 7 & 8



42. 1 2 3 4 5 6 7 8 (Matrix Mix Level Controls)

These 8 rotary controls adjust the level of signal from the correspondingly numbered group busses applied to the module's MATRIX OUT.

43. MATRIX MASTER

The Matrix Mix level controls (1, 2, 3, 4, 5, 6, 7, 8) permit a mono mix to be derived from the eight group busses. The MATRIX MASTER control then sets the overall level of this 8:1 mix just before it is routed to the MATRIX OUTPUT XLR connector.

44. CUE (Matrix Cue)

Pressing this yellow illuminated switch part-way down causes momentary contact; pressing it further locks it down. When the CUE switch is illuminated, the module's matrix mix signal (pre MATRIX MASTER) is applied to the Cue output and the Phones output, along with any other MATRIX CUE or Master cue signals, unless an input CUE switch is engaged. (Bus cue signals are overridden by input cue.) The MATRIX CUE signal is Mono, regardless of how many matrix channels are cued.

45. ON (Matrix On)

This locking, yellow, illuminated switch turns on when the MATRIX OUT XLR is ON. When the MATRIX OUT is turned OFF, its signal may still be previewed with the adjacent CUE switch [44].

2.1.4 The Stereo Module

This module contains the Talkback and Oscillator circuitry as well as the Stereo Master Fader and associated controls.

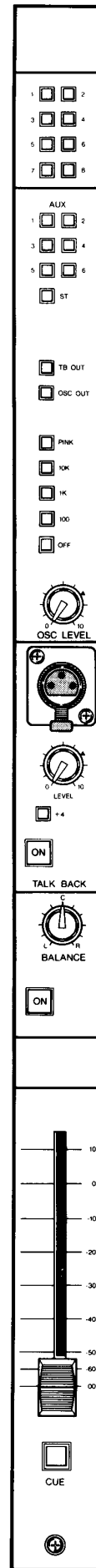
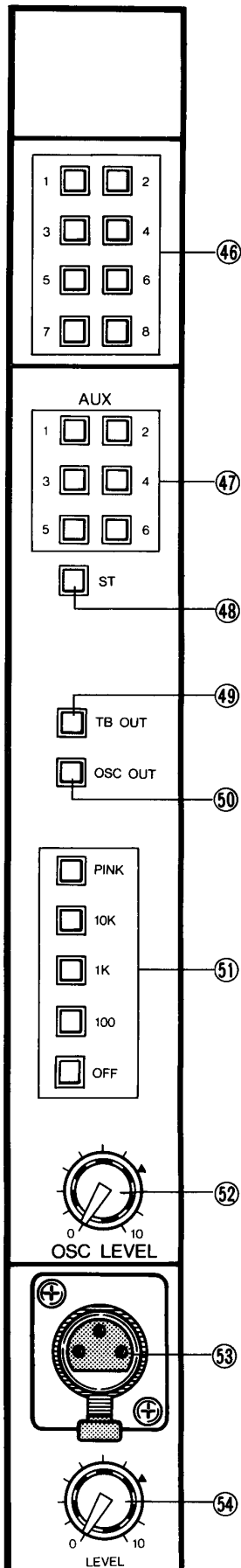

FIGURE 2-4. PM1800A STEREO MODULE (ST1800A).



46. 1 2 3 4 5 6 7 8 (Group Mixing Bus Assign)

These locking switches assign the Talkback or oscillator signal to group mixing busses 1 through 8.

47. AUX 1 - 6 (Assign)

These six locking switches assign the TB/OSC signal directly to the correspondingly numbered auxiliary mixing busses.

48. ST (Stereo)

This locking switch assigns the TB/OSC output directly to stereo mixing buss.

49. TB OUT

This locking switch turns the TB OUT XLR connector on and off. It affects only the output of the talkback system which appears at the TB OUT connector (the output being derived from the TB input when the TALKBACK ON switch is pressed, or otherwise from the oscillator). This switch does not affect any TB/OSC signal which may be switch-assigned to group mixing busses 1-8, the stereo bus or the six aux mixing busses.

50. OSC OUT

This locking switch turns the OSC OUT XLR connector on and off. It affects only the output of the oscillator that appears at this connector, and does not affect any oscillator signal which may be switch-assigned to group mixing busses 1-8, the stereo bus or the six aux mixing busses.

51. PINK 10K 1K 100 OFF

These 5 interlocking switches set the oscillator to 100 Hz, 1 kHz or 10 kHz operation. They also permit selection of a pink noise source, or turn off the oscillator/noise source altogether.

NOTE:

To prevent any possible leakage into mixing busses, the oscillator should be shut OFF when not actually in use.

52. OSC LEVEL

This rotary control adjusts the oscillator output level applied to the OSC OUT connector as well as any mixing busses to which the signal may be assigned. This control does not affect the Talkback level.

53. (TB INPUT)

This XLR-3 connector accepts a low-Z microphone or a line level signal, depending on the settings of the controls below it. This input is NOT phantom powered. Signal from this input is assigned to the TB OUT connector and to the various mixing busses by means of the assignment switches in the upper portion of this module [46], [48], [47], [49].

54. LEVEL (TB Input)

This rotary control adjusts the signal level after the talkback preamplifier, thereby affecting the sensitivity of the TB input whether it is set for a mic or line source. This control affects the TB level applied to any busses and to the TB OUT connector; it does not affect the oscillator level in any way.

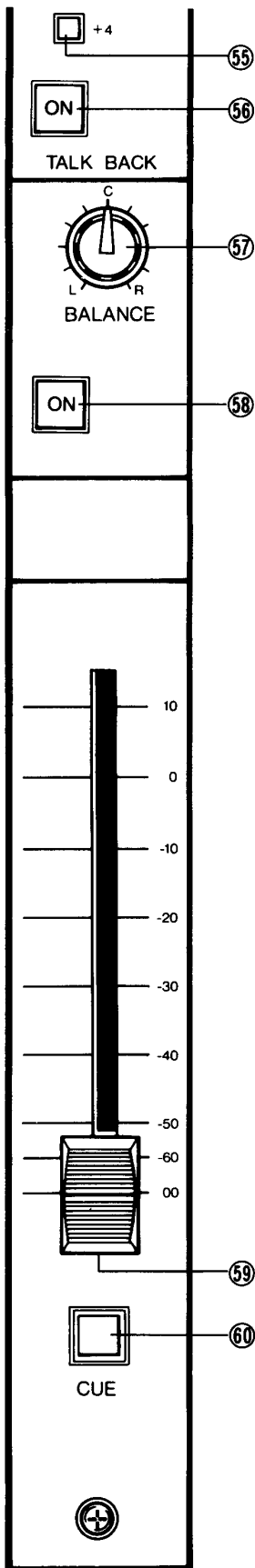

55. +4 (Line Pad)

This locking switch inserts a 54 dB pad after the XLR talkback input. The pad decreases the sensitivity of that input from nominal -50 dBu (for a microphone) to +4 dBu (for a line level input).

56. TALKBACK ON

Pressing this yellow illuminated switch part-way down causes momentary contact; pressing it further locks it down. The switch activates the XLR talkback input and applies signal from that input to any assigned busses (and to the TB OUT connector if the TB OUT switch is also on). When the TALKBACK ON switch is off (not illuminated), the oscillator output is instead routed to those busses (and to the TB OUT connector). This switch does not, however, affect the OSC OUT connector.

57. BALANCE

This pot acts as a balance control for the stereo output. Normally, the pot should be in the center detent so that whatever level is set with the Stereo Master Fader will go to the Left and Right outputs. However, if the L-R balance needs to be adjusted, simply turn this control. It then raises the level to one side while lowering it to the other.

58. ON (Stereo Out ON)

This locking, yellow, illuminated switch turns on when the stereo output is ON, indicating the post-fader signal is applied to the L and R stereo outputs. The STEREO VU meters will not operate if this switch is OFF, but the stereo signal may still be previewed with the CUE switch [60].

59. (Stereo Fader)

This single fader control operates a 2-gang linear fader which adjusts the level applied from the stereo mixing bus to the stereo output connectors.

60. CUE (Stereo Cue)

Pressing this yellow illuminated switch part-way down causes momentary contact; pressing it further locks it down. When the CUE switch is illuminated, this stereo signal is applied to the Cue output and the Phones output unless an input CUE switch is engaged. (Bus cue signals are overridden by input cue.) This switch provides the headphones with a stereo cue signal.

2.1.5 The Comm Module

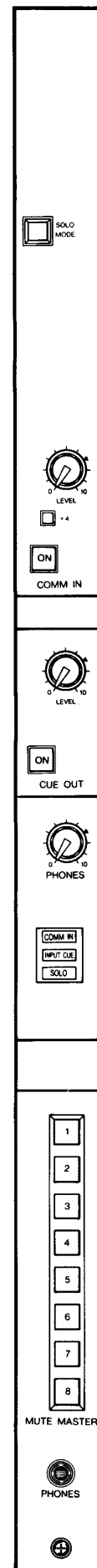
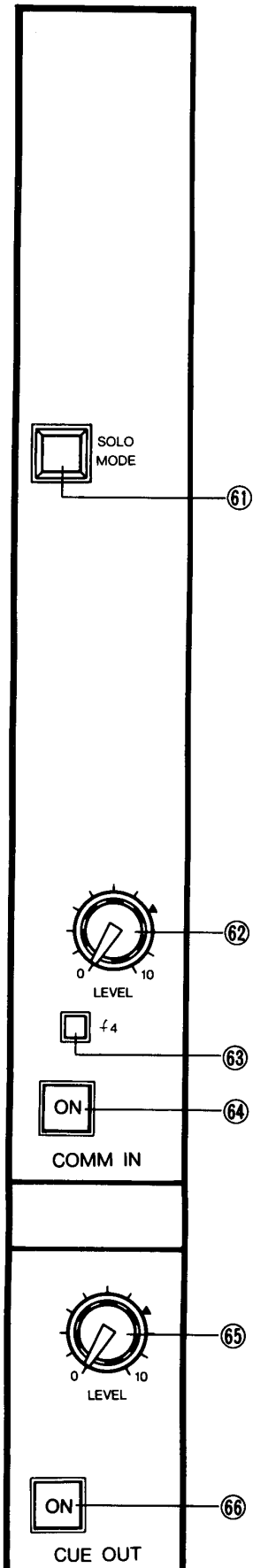

FIGURE 2-5. PM1800A COMM MODULE (COM1800A).



61. SOLO MODE

This locking, red, illuminated switch flashes when engaged, indicating the console monitor system is set to the SOLO mode. (A red LED below the Phones Level control also flashes to warn of the selected SOLO mode.) The switch is recessed to prevent accidental engagement. In this mode, input channel CUE/SOLO switches mute all other channels, much like a recording console SOLO function. This mode is useful during setup and sound check for a live show.

When the console is in SOLO mode, the aux return CUE switches have a solo function, but it is not quite like the input channel solo function. Pressing an aux return CUE switch in SOLO mode will mute all input channels (except those whose CUE/SOLO switch is engaged), and the soloed aux return will be heard, but so, too, will all other aux returns. (To silence the other returns, turn them off by disengaging their ON/off switches.)

The normal mode of operation during a show, CUE mode, is entered by releasing this switch; in this mode, input CUE/SOLO switches do not mute other channels, but merely replace the signal which appears in the Phones output.

CAUTION:

Be sure to disengage the solo mode, and confirm the console is in the cue mode, prior to the beginning of a performance. Otherwise pressing any input channel CUE/SOLO switch will mute all other channels.

(COMM IN SECTION)

A rear-panel COMM IN (Communications Input) [97] connector enables almost any intercom system to be used to communicate with the PM1800A console operator; or the stage manager's mic can be plugged in. When an audio signal is applied to this input, and the controls on this module (described below) are appropriately set, then the COMM IN light will turn on. Pressing the COMM IN ON switch then replaces any signal in the PHONES and CUE OUT with the COMM IN signal.

The COMM IN may also be used in conjunction with the TB out from a stage monitor mixing console, another PM1800A or PM3000 console, or with a signal from a stage manager's mic (+4 switch [83] not engaged so that COMM IN is set for mic level sensitivity). In any of these instances, someone talking at a remote location can visually signal the PM1800A operator merely by speaking, and can then be heard if the PM1800A operator engages the COMM IN ON switch [64].

62. LEVEL (COMM IN Level)

This rotary control adjusts the signal level after the COMM IN preamplifier, thereby affecting the sensitivity of the COMM input whether it is set for a mic or line source. This control affects the COMM level applied to the Phones output and to the Cue output, which are the only points to which COMM IN signal may be applied.

63. +4 (Line Pad)

This locking switch inserts a 54 dB pad after COMM IN XLR input. The pad decreases the sensitivity of that input from nominal -50 dBu (for mic level) to +4 dBu (for line level).

64. ON (COMM IN ON)

Pressing this yellow illuminated switch replaces any CUE signal in the CUE OUTPUT with the COMM IN signal. It also interrupts the PHONES output and replaces it with the COMM IN signal.

(CUE OUT MASTER SECTION)

65. LEVEL (Cue Out)

This rotary, 2-gang (stereo) control adjusts the output level applied to the CUE OUT L & R connectors. It does not affect any cue signal which may be applied to the PHONE outputs.

66. ON (CUE ON)

Engaging this yellow, illuminated switch turns on the CUE OUT L & R connectors. This switch does not affect the PHONES outputs.

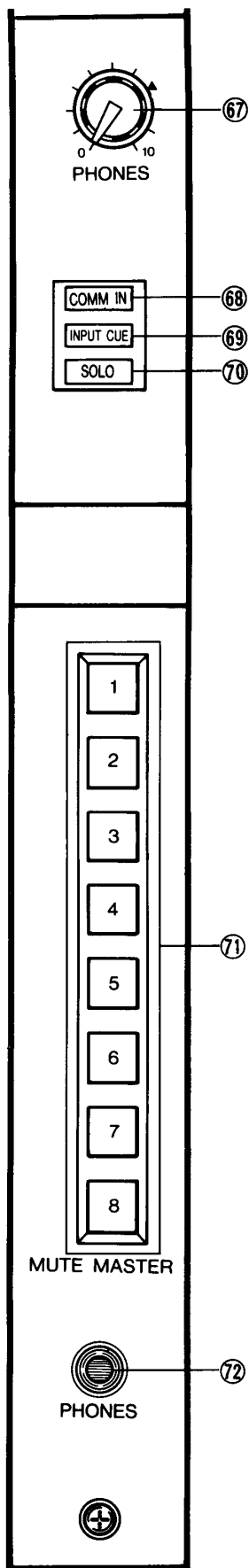

67. PHONES (Level control)

This 2-gang rotary control adjust the output level at the stereo PHONES output jack. It affects any signals which may be fed to this output.

(LED ANNUNCIATORS)

68. COMM IN

This LED flashes green in response to almost any level signal appearing at the COMM input. (It will not respond to a low microphone level signal if the "+4" COMM input pad is engaged.) This signals the console operator that someone is attempting to communicate so that the COMM IN ON switch can be engaged.

69. INPUT CUE

This yellow LED turns on when any input channel's CUE/SOLO switch or any AUX RETURN CUE switch is engaged, indicating the console is subject to input cue priority. This is an indication that the signal in the headphones output is being derived from one or more inputs via the cue system. The indicator operates the same whether the console is in cue or solo mode.

70. SOLO

This LED flashes red if the console is in the SOLO mode. This serves as an urgent warning that if any input CUE/SOLO switch (or aux return CUE switch) is depressed, that all input channels will be muted except the soloed channel(s).

CAUTION:

If this LED is flashing during a performance, DO NOT press any Input CUE/SOLO or aux return CUE switch. Instead, disengage the SOLO MODE switch [61]. This will prevent program interruption when attempting to cue an input.

71. MUTE MASTER 1 - 8

Engaging any of these locking, yellow illuminated switches mutes (turns off) any input channel(s) whose correspondingly numbered MUTE switch is engaged. An input channel will not be muted, however, if its MUTE SAFE switch is engaged.

72. PHONES

This 1/4" (6.33mm) stereo phone jack can accommodate a pair of standard 8-ohm or higher impedance stereo headphones.

2.1.6 The Meter Bridge

The 24, 32 and 40 channel versions of the PM1800A each are equipped with a total of 13 VU meters. Due to its compact size, the 16 channel version has just 10 meters, though it still is capable of displaying the level of the same 20 circuits as the larger console mainframes, thanks to selector switches. The Stereo L & R meters on all models are extra large, and always display the stereo output, whereas the other meters are standard size and most can be switched to multiple sources. Each meter is illuminated, has true VU ballistics to indicate approximate loudness. In addition, the Stereo L & R meters each include a red "PEAK" LED which responds to instantaneous levels that are beyond the scale of the meter. The PEAK LED turns on 10 dB below the clipping point. Assuming the meter is monitoring an output with +24 dBm maximum output capability, the PEAK LED will turn on when the instantaneous level reaches +14 dBm. Since the standard VU meter scale goes only to +3 VU (which is +7 dBm), the PEAK LED turns on when the level is 7 dB above maximum meter scale. Bear in mind, however, that a brief transient that may cause the PEAK LED to flash on may be too fast for the meter needle to respond. It is not unusual with plucked or percussive instruments, for example, for the peak level to be 20 to 30 dB above the average level.

Since there are 3 fewer meters on the 16-channel version, it utilizes 3-position switch banks over six of its meters, as contrasted to the 2-position switch banks on the larger consoles. Rather than duplicate the discussion of what each switch does on each console model, we are simply providing a discussion of each different type of meter switch. The accompanying illustrations (Figures 2-6 and 2-7) show where the switches are physically located.

NOTE:

The nomenclature at the bottom edge of the meter bridge refers not to meter functions, but instead serves to label the console's modules.

73. GROUP 1 - 8

The eight meters with this function monitor correspondingly numbered GROUP OUTputs. (The GROUP 8 meter on the 16-channel mainframe has no other functions associated with it.) As shipped, the signal is derived after the GROUP MASTER Fader and GROUP OUT ON/off switch. The meter feed can be internally jumpered to be derived from a point just before the GROUP OUT ON/off switch. Refer to the OPTIONAL FUNCTIONS section of this manual.

74. AUX 1 - 6

The six meters with this function monitor correspondingly numbered AUX SEND outputs after the Aux Send Master LEVEL control and ON/OFF switch.

75. MATRIX 1 - 4

The four meters with this function monitor correspondingly numbered MATRIX outputs after the MATRIX MASTER level control and ON/OFF switch.

76. CUE L & R

The pair of meters with this function monitor the left and right Cue outputs.

77. OSC OUT

This meter displays the signal at the Oscillator output connector. It DOES NOT necessarily show when the oscillator is turned on and applying signal to the console busses; it only enables you to monitor a signal if the oscillator is on AND the OSC OUT is switched on [50].

78. STEREO (L & R)

These two larger meters monitor the left and right sides of the STEREO OUTputs.

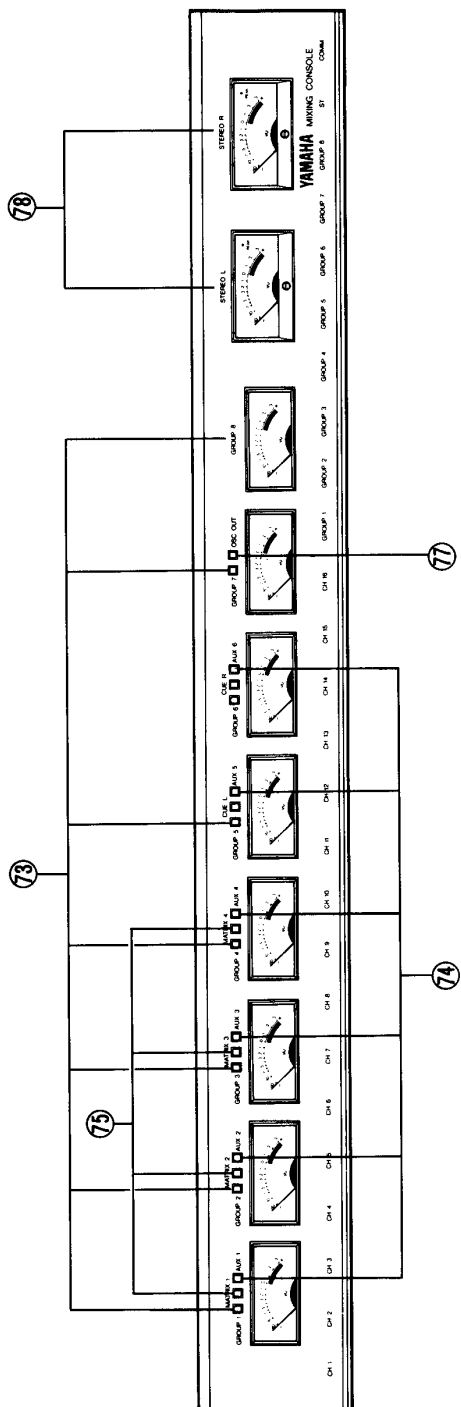

FIGURE 2-6. PM1800A-16 METER BRIDGE.

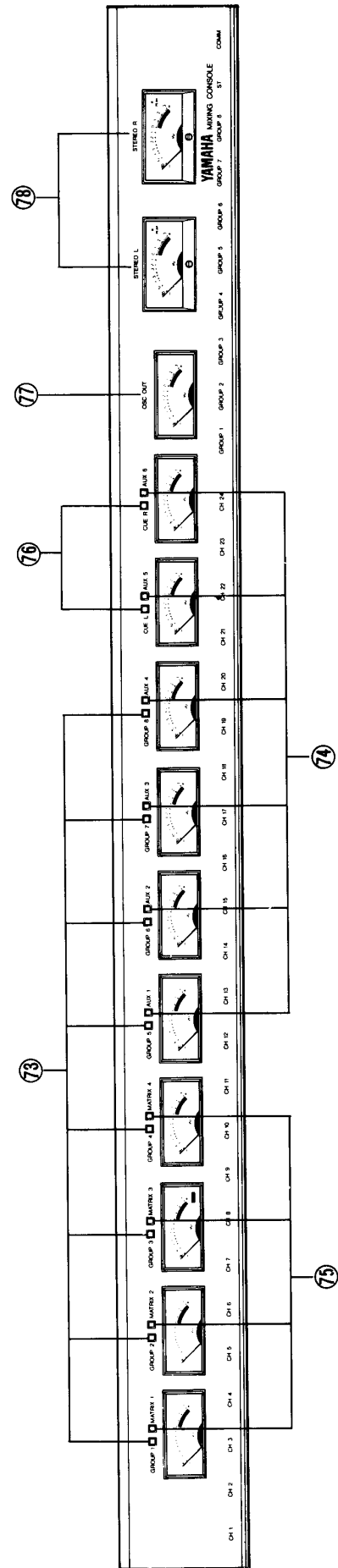

FIGURE 2-7. PM1800A-24 METER BRIDGE. (TYPICAL OF 24, 32 AND 40 CHANNEL CONSOLES)

2.2 PM1800A REAR PANEL FEATURES

All output XLR connectors are balanced, XLR-3 type, nominal +4 dBu level unless otherwise noted. INSERT IN/OUT jacks are wired in a "normalised" configuration such that as long as the IN jack is not used, the OUT jack is internally wired to it for signal continuity. The OUT jack may be used as a direct output without interrupting signal flow through the console. INSERT INs and OUTs are unbalanced.

Input channel XLRs are electronically balanced, as supplied. Optional input isolation transformers may

be installed on a module-by-module basis; refer to Section 6.6. Output XLRs are also electronically balanced. Optional output isolation transformers are available in an external package housing four transformers. In this way, inputs and outputs can be provided with extra grounding isolation and common mode rejection where required, but one need not pay the price in direct costs, weight or signal quality where the transformers are not needed.

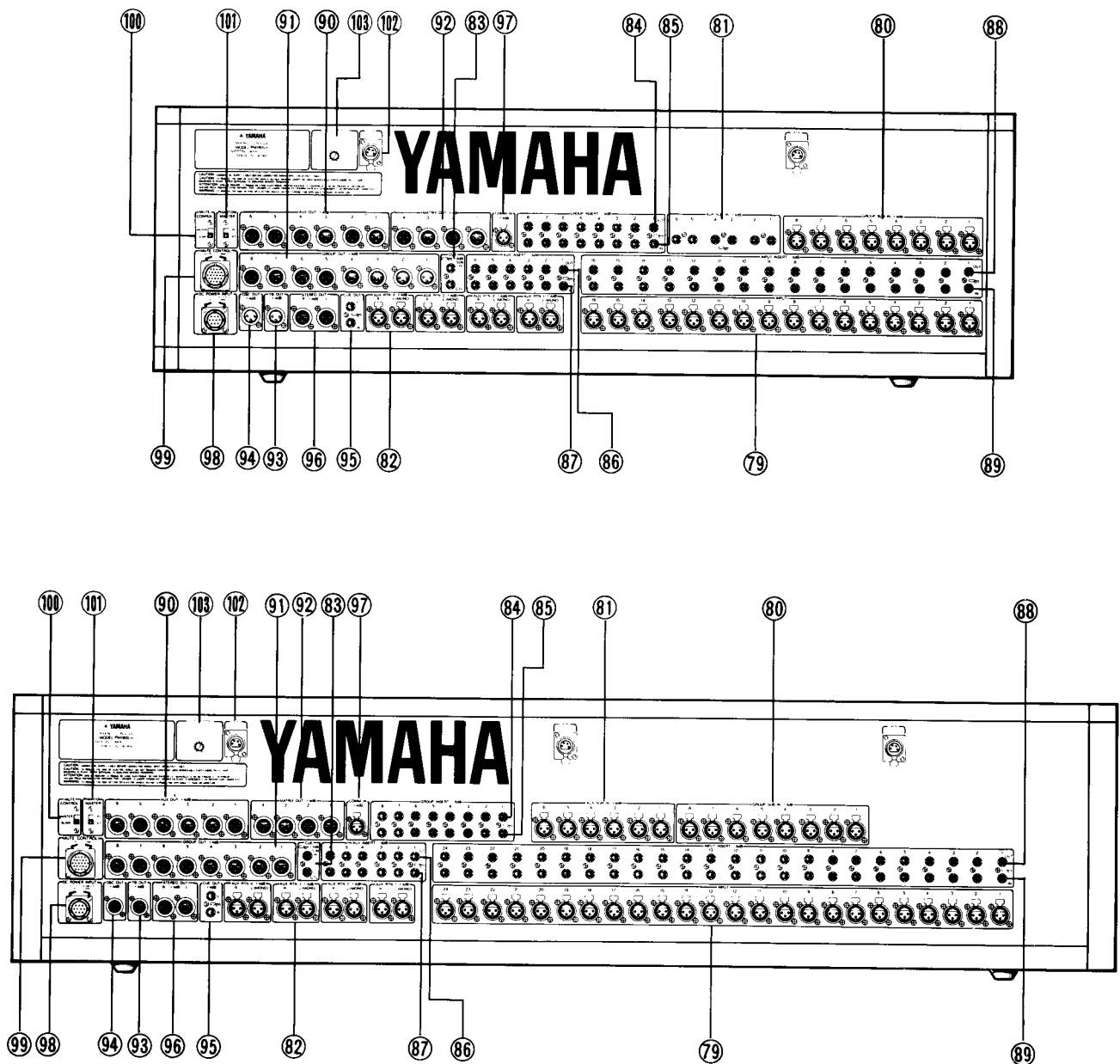

FIGURE 2-8. PM1800A REAR PANEL

79. INPUT (1 - 16, 1 - 24, 1 - 32, or 1 - 40)

These 16, 24, 32 or 40 female XLRs apply signal to the correspondingly numbered input modules. The nominal input level may vary from -60 dBu to +14 dBu depending on the settings of the individual input GAIN controls and PAD switches.

80. GROUP SUB IN (1 - 8)

These eight female XLR connectors apply signal directly to the group mixing busses (ahead of the Group Master Faders). They are used for "chaining" another mixing console's group outputs into this console, with this console serving as the master for both consoles.

81. AUX SUB IN (1 - 6)

These six female XLR connectors* apply signal directly to the auxiliary mixing busses (ahead of the rotary Aux Master controls). They are used for "chaining" another mixing console's aux send outputs into this console, with this console serving as the master for both consoles.

***NOTE:**

AUX SUB IN connectors in the PM1800A-16 are 1/4-inch T/R/S balanced phone jacks.

82. AUX RETURN (1 through 4, L/MONO and R)

These eight female XLR connectors accept auxiliary return signals. Each pair of L/MONO and R connectors can be used for a stereo return, or the L/MONO connector may be used for a monaural return (provided the corresponding front-panel MONO switch is engaged [28]). They may be used as auxiliary line inputs if they are not being used for effects returns.

83. CUE CONTROL (CUE IN, CUE CONTROL)

CUE IN and CUE CONTROL are 1/4" (6.33 mm) Tip/Ring/Sleeve phone jacks designed to link the cue systems of two PM1800A consoles (or a PM1800A with a PM3000). CUE IN applies audio (which should come from CUE OUT of another console) directly to the cue mixing bus. CUE CONTROL provides direct access to the console's cue/solo control bus. It serves as either an input or an output. When the CUE CONTROL jacks of two consoles are interconnected, pressing an input CUE/SOLO switch or any CUE switch on one console causes both consoles to enter the cue (or solo) mode. Provided that CUE IN is linked to the other console's CUE OUT, all cued or soloed signals can be monitored by the "master" console.

84. GROUP INSERT OUT (1 - 8)

These eight unbalanced 1/4" (6.33mm) Tip/Sleeve phone jacks output the signal from the group mixing busses just ahead of the Group Master faders. These jacks may be used as auxiliary group outputs to a multitrack tape recorder or another console. They are intended, however, for sending the group signals to auxiliary signal processors (compressors, graphic EQs, etc).

85. GROUP INSERT IN (1 - 8)

These eight unbalanced 1/4" (6.33mm) Tip/Ring/Sleeve phone jacks apply signal to the Group Master faders. These jacks accept the return from any auxiliary signal processor used on the overall group mixing bus signal.

86. AUX INSERT OUT (1 - 6)

These six unbalanced 1/4" (6.33mm) Tip/Sleeve phone jacks are nearly identical to the GROUP INSERT OUT jacks, except they output signal from just ahead of the AUX SEND rotary master level controls.

87. AUX INSERT IN (1 - 6)

These six unbalanced 1/4" (6.33mm) Tip/Ring/Sleeve phone jacks are nearly identical to the GROUP INSERT IN jacks, except they return signal to a point just ahead of the AUX SEND master rotary level controls. (The circuit is unbalanced even though these are T/R/S jacks.)

88. INPUT CHANNEL INSERT OUT (1 - 16, 1 - 24, 1 - 32, or 1 - 40)

These 16, 24, 32 or 40 unbalanced 1/4" (6.33 m) Tip/Sleeve phone jacks output the signal from the input channel (just after the GAIN control, PAD and polarity switch but before the EQ or fader*). Nominal output level is 0 dB (775 mV). These jacks may be used as auxiliary outputs to another console or as direct outs to a multitrack tape machine. They are intended, however, for sending the input channel signal to an auxiliary signal processor (compressor, graphic EQ, noise gate, etc). INSERT OUT is always "live" whether or not the channel is on.

89. INPUT CHANNEL INSERT IN (1 - 16, 1 - 24, 1 - 32, or 1 - 40)

These 16, 24, 32 or 40 unbalanced 1/4" Tip/Ring/Sleeve phone jacks apply signal to the input channel just ahead of the EQ and fader. Nominal input level is 0 dB (775 mV). These jacks are "normalled" so that inserting a plug interrupts the internal signal flow through the channel, instead bringing in the return from an auxiliary signal processor.

90. AUX SEND (1 - 6)

These six male XLR connectors output signal from the six auxiliary mixing busses, just after the Aux Master LEVEL controls. They may be used for echo/effects sends, for stage foldback (stage monitors), for auxiliary mono or stereo program feeds to remote locations and/or tape recorders, and so forth.

91. GROUP OUT (1 - 8)

These eight male XLR connectors output signal from the eight group mixing busses, just after the Group Master Faders. They may be used for submixed feeds to a remote console (i.e., to a stage monitor console or a broadcast remote), for feeds to a multitrack tape recorder, or for feeds to a multi-zone sound system, depending upon the application.

92. MATRIX OUT (1 - 4)

These four male connectors output signal from the four 8:1 matrix mixes, after the MATRIX MASTER controls and ON/off switches. They may be used for feeding mono or stereo tape recorders, multiple zones of a sound system, multiple sound systems, or remotes, depending upon the application. In some instances, these outputs can be used for effects sends or for monitors.

93. TB OUT

This male XLR connector outputs signal from the talkback circuit when the TB OUT switch [49] is on. If that switch is OFF, this output is muted. Assuming the TB OUT switch is on, this output is derived from the talkback input XLR when the TALKBACK switch [56] is engaged. Otherwise the TB OUT is derived from the console's oscillator/noise generator.

The TB OUT may be fed to the IFB (Interruptible Foldback) program input of an intercom system in order that the console operator can talk into the intercom system. In some cases, it can be applied to an auxiliary program audio input or some other input on a standard intercom system (see Section 7.3). It also may be fed to a monitor console's COMM input, or to a console's input channel (which is monitored via CUE) to enable the PM1800A operator to communicate with the other console's operator.

94. OSC OUT

This male XLR connector outputs signal from the console's oscillator/noise generator when the OSC OUT switch [50] is on. In order to actually obtain any output signal, however, the oscillator must be switched on [51], and the OSC LEVEL control [52] must be turned up.

95. CUE OUT (L, R)

This pair of 1/4" (6.3mm) Tip/Ring/Sleeve phone jacks output the same signal which appears at the PHONES output jacks. Unlike the PHONES output, however, these are separate, unbalanced left and right outputs. Moreover, the CUE OUT jacks may be muted with the front panel CUE OUT ON/off switch [66]. These connectors are useful for driving control room monitor amps and speakers for the console operator, or a headphone distribution system (with external power amp).

96. STEREO OUT (L, R)

This pair of XLR connectors output the stereo mix after the STEREO MASTER fader. They may be used to feed a stereo sound system, master tape recorder, remote source, or a monitor system.

97. COMM IN

This female XLR connector accepts mic or line level signals from another console (i.e., from TB OUT on another console), or from most professional intercom systems, although an adaptor will be required to accommodate certain types of intercoms. This is a "1-way" connection in that it accepts the audio from the intercom line, but does not apply audio back onto the line. Refer to Section 7.3 for instructions on interface to popular intercom systems.

98. DC POWER IN

This multi-pin, locking connector accepts a special umbilical cable from the console's external power supply (Model PW1800). Be sure the locking ring is securely hand tightened to avoid inadvertent disconnection.

NOTE:

The same PW1800 power supply and cable are used for all four mainframes, 16 through 40 channel. However, different power supplies will be necessary for dif-

ferent voltages in various parts of the world; be sure you verify you have the correct supply for your power mains.

99. MUTE CONTROL

This multi-pin locking connector is an input/output point for control voltages in the PM1800A. It enables two PM1800As to be interlinked so that the muting logic from one console also affect the other. The adjacent MUTE CONTROL MASTER/SLAVE Switch [100] affects the function of this connector. This connector also may be used for interface to a remote control system which may be developed for "automation" of master muting.

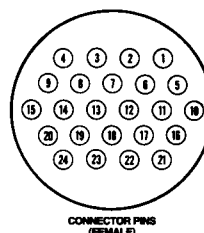

CONNECTOR PINS (FEMALE)

PIN#	FUNCTION	PIN#	FUNCTION
1	NC	13	MUTE BUS 3
2	NC	14	MUTE BUS 4
3	NC	15	MUTE BUS 5
4	NC	16	MUTE BUS 6
5	NC	17	MUTE BUS 7
6	NC	18	MUTE BUS 8
7	NC	19	GND
8	NC	20	GND
9	NC	21	GND
10	NC	22	NC
11	MUTE BUS 1	23	NC
12	MUTE BUS 1	24	NC

FIGURE 2-9. MUTE CONNECTOR PIN ASSIGNMENTS.

100. MUTE SLAVE/MASTER

Setting this recessed slide switch to MASTER position configures the console for local control of input channel muting via the MASTER MUTE switches [71]. SLAVE position disables this console's MASTER MUTE switches and, instead, allows a second PM1800A (or appropriately wired remote switch closures) to control this console's master muting via the MUTE CONTROL connector [99].

101. PHANTOM POWER MASTER

This recessed slide switch turns the console's 48-volt phantom power supply on and off. When this is OFF, no power will be supplied to any mic, regardless of the channel's +48 V on/off switch setting [14].

102. (Lamp Sockets)

These four-pin female XLR connectors provide dimmer-controlled DC power for miniature lamps on flexible stalks (the lamps are an optional accessory). There are two light sockets on the 16 channel mainframe, three on the 24 channel and 32 channel mainframes, and four on the 40 channel mainframe. Maximum output is 12 volts. (Pins 1 and 2 of the XLR are not used, pin 3 is the 12 volt supply, and pin 4 is DC ground.)

103. LAMP DIMMER

This rotary, screwdriver-adjustable dimmer turns the lamp socket power off, or on to a variable intensity from low to high brightness.

2.3 THE PW1800 POWER SUPPLY

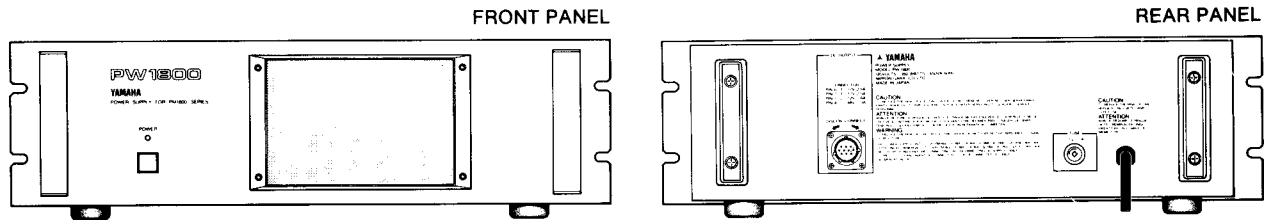

FIGURE 2-10. PW1800 POWER SUPPLY.

104. POWER (On/Off)

This locking switch turns on the AC power to the supply, and thereby provides the necessary voltages to the console via the umbilical power cables. An adjacent LED is on when power is on.

105. (Grille)

The power supply is cooled by a quiet running fan that pulls air through this front-panel grille and exhausts it through vents along the edge of the top and side panels. A reticulated foam element behind the grille filters the air entering the power supply.

NOTE:

The filter element is cleanable. Refer to Section 9.1.2

106. (Umbilical Connector)

This locking, multi-pin connector provides the necessary DC voltages from the PW1800 power supply to the PM1800A console. The cable must be connected before attempting to operate the console.

CAUTION:

Always make certain that the PW1800 power is turned OFF prior to connecting or disconnecting the umbilical cable at the console or at the power supply.

107. FUSES

Fuses protect the primary and secondary portions of the PW1800 power supply. They should be replaced only with fuses of the same current rating and type. The primary fuse is accessible on the rear panel, and is a 7A, 125V Slo-Blow type fuse. The internal secondary fuses normally will not blow, but are as follows:

- + 17 VDC Supply 6 A Slo-Blow
- 17 VDC Supply 6 A Slo-Blow
- + 12 VDC Supply 10 A Slo-Blow
- + 48 VDC Supply 2 A Slo-Blow

108. (Power Cord)

This power cable connects the PW1800 to the AC power mains. A grounded (3-wire) outlet of at least 15 amperes capacity should be used.

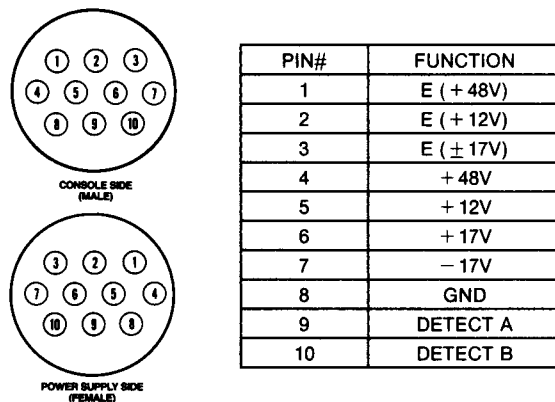

FIGURE 2-11. PW1800 UMBILICAL CONNECTOR PIN ASSIGNMENTS.

SECTION 3

PM1800A Specifications

3.1 GENERAL SPECIFICATIONS

Total Harmonic Distortion

Less than 0.1%, 20 Hz - 20 kHz, at +14 dBm output into 600 ohms.

Frequency Response

+1, -3 dB, 20 Hz - 20 kHz, at +4 dBm output into 600 ohms.

Hum & Noise

(20 Hz - 20 kHz, *Rs = 150 ohms, Input Pad @0 dB, Input Sensitivity @-60 dB, except as noted)

-128 dBm equivalent input noise

-93 dBu residual output noise (balanced outputs)

-80 dBu at GROUP OUT with Master fader at nominal level and all channel assign switches off

-64 dBu (68 dB S/N) at GROUP OUT with Master fader and one channel fader at nominal level, and channel assigned to the group bus

-90 dBu at STEREO OUT with Stereo Master fader at nominal level and all channel assign switches off

-80 dBu (84 dB S/N) at STEREO OUT with Stereo Master fader and Group Master fader at nominal level, and one GROUP-TO-STEREO switch on

-90 dBu at MATRIX OUT with MATRIX MASTER at nominal level and all matrix mix controls at maximum level, all GROUP-TO-MATRIX switches off

-82 dBu (86 dB S/N) at MATRIX OUT with MATRIX MASTER at nominal level, one Matrix Mix control at maximum level, one channel fader at nominal level, and the corresponding assigned group fader at nominal level and GROUP-TO-MATRIX switch on

-73 dBu at AUX OUT with Aux Master level control at nominal, all channel AUX mix controls at minimum level (Pre/Off/Post switches Off)

-64 dBu (68 dB S/N) at AUX OUT with Aux Master level and one channel AUX mix control at nominal level (PRE/OFF/POST switch in PRE position)

Maximum Voltage Gain

84 dB CH IN to GROUP OUT

94 dB CH IN to STEREO OUT

94 dB CH IN to MATRIX OUT

94 dB CH IN to AUX OUT

74 dB CH IN to CUE OUT

20 dB AUX RTN to GROUP OUT

10 dB SUB IN to GROUP OUT

10 dB SUB IN to AUX OUT

Input Channel Gain Control

34 dB variation in gain stop-to-stop.

Input Channel Pad Switch

0, 20, 40 dB of attenuation.

Input Channel Equalization

15 dB maximum boost or cut in the each of four bands

HIGH: 1.6 kHz ~ 16 kHz (shelving)

HI-MID: 800 Hz ~ 8 kHz (peaking)

LO-MID: 160 Hz ~ 1.6 kHz (peaking)

LOW: 40 Hz ~ 400 Hz (shelving)

Input Channel High Pass Filter

12 dB/octave roll off below 20 Hz ~ 400 Hz (adjustable -3 dB point)

Crosstalk

-60 dB at 1 kHz

Oscillator/Noise Generator

Switchable sine wave at 100 Hz, 1 kHz, or 10 kHz (less than 1% T.H.D. at +4 dBu output level), or pink noise.

VU Meters

STEREO L & R: 2 large, illuminated meters with Peak LEDs. Other meters are smaller size without Peak LEDs. All meters calibrated for 0 VU = +4 dBu = 1.23 Vrms output; Peak LEDs turn on 10 dB before clipping

16 channel console:

Meters 1 - 4	GROUP/MATRIX/AUX
Meter 5	GROUP 5/CUE L/AUX 5
Meter 6	GROUP 6/CUE R/AUX 6
Meter 7	GROUP 7/OSC
Meter 8	GROUP 8
Meter 9	STEREO L
Meter 10	STEREO R

24, 32 or 40 channel consoles

Meters 1 - 4	GROUP/MATRIX
Meter 5	GROUP 5/AUX 1
Meter 6	GROUP 6/AUX 2
Meter 7	GROUP 7/AUX 3
Meter 8	GROUP 8/AUX 4
Meter 9	CUE L/AUX 5
Meter 10	CUE R/AUX 6
Meter 11	OSC
Meter 12	STEREO L
Meter 13	STEREO R

Signal/Clip indicators

2 LEDs built into each input module monitor levels in the module: CLIP (red) turns on when pre-EQ signal is 3 dB below clipping. EQ CLIP (red) turns on when post-EQ level is 3 dB below clipping.

Phantom Power

48 V DC is applied to electronically balanced inputs or optional transformer-isolated inputs (via 6.8 kohm current limiting/isolation resistors) for powering condenser microphones. May be turned on or off via rear-panel phantom master switch; when on, individual channels may be turned off via +48 V switch on each input module.

Options

IT1800A Input Transformers; may be installed in individual input modules. Changes actual input impedance from 3K ohms to 1K ohm.

OT1800 Set of 4 output transformers, or OT3000 Set of 8 output transformers in rack-mountable external

chassis with male and female XLR connectors on the front panel. Occupies 2 rack spaces (3-1/2" or 88 mm) in a 19" (480 mm) wide rack; 3-1/2" (88 mm) depth. May be used to isolate any PM1800A XLR outputs.

Miniature lamps on flexible supports to mate with 4-pin XLR sockets in console; 2 sockets for 16 CH, 3 sockets for 24 or 32 CH, 4 sockets for 40 CH console.

Dust cover

Power Requirements

Requires Yamaha PW1800 power supply; see specifications for that unit.

Console Dimensions

HEIGHT 12-7/8 inches (307 mm)
DEPTH 34 inches (865 mm)
WIDTH: 16 channel, 39-1/2 inches (1003 mm)
24 channel, 50-3/4 inches (1290 mm)
32 channel, 62-1/8 inches (1578 mm)
40 channel, 73 inches (1854 mm)

Net Weight (excl. power supply)

<u>16 CH</u>	<u>24 CH</u>	<u>32 CH</u>	<u>40 CH</u>
125.7 lbs	161 lbs	194 lbs	224.9 lbs
57 kg	73 kg	88 kg	102 kg

NOTE:

0 dBu is referenced to 0.775 Vrms. 0 dBm is referenced to 1 milliwatt. Specifications are subject to change without notice or obligation.

* "Brick wall" 20 kHz bandwidth equivalent filter obtained by using 6 dB/octave low pass filter at 12.7 kHz.

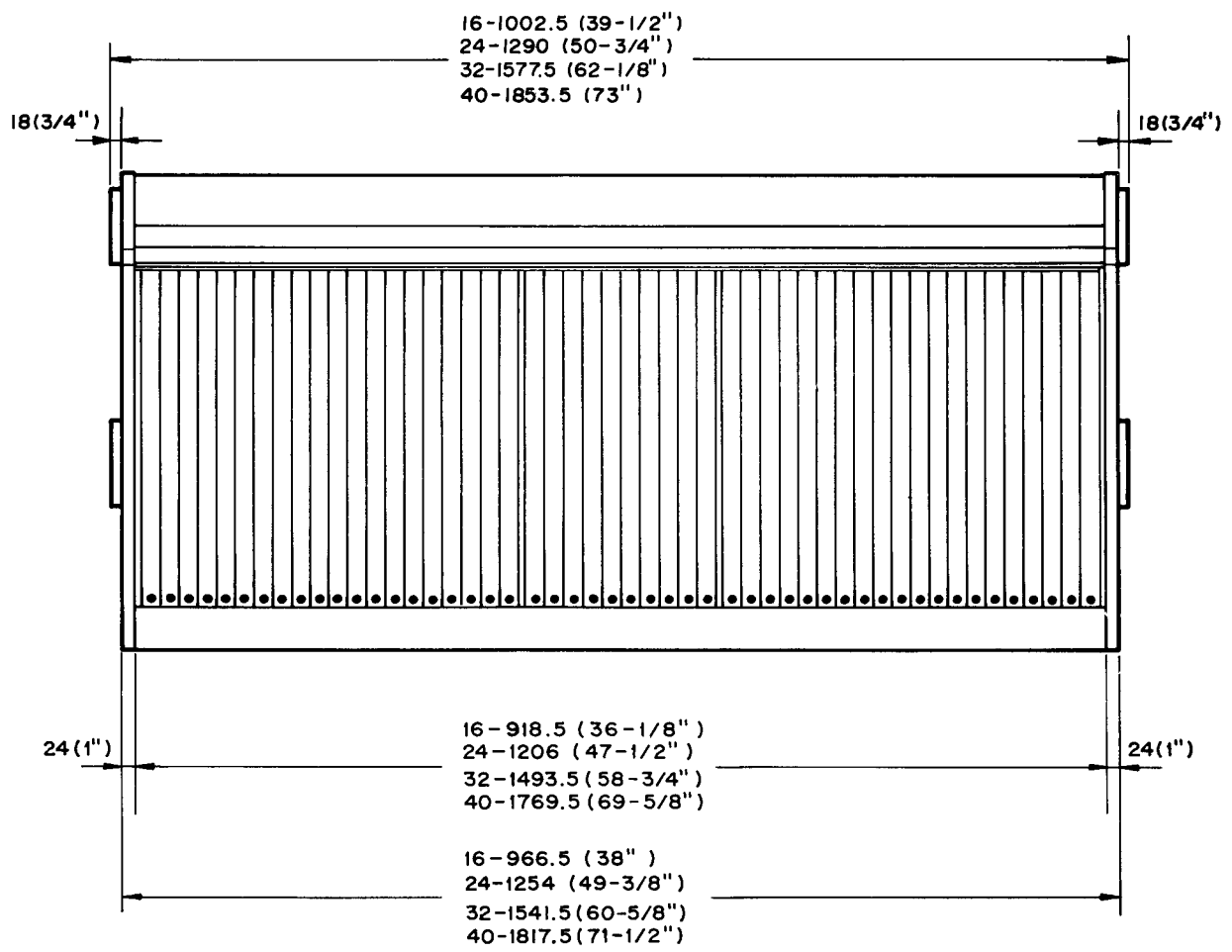
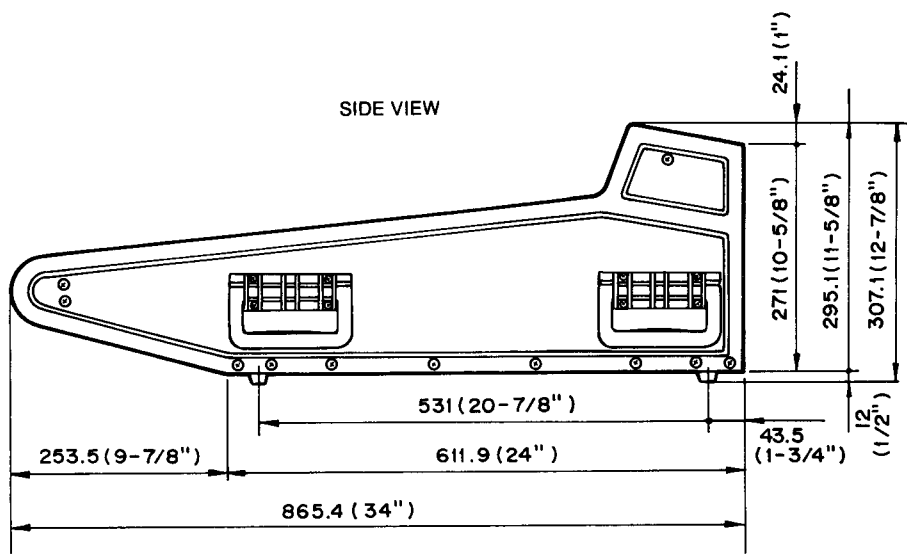

FIGURE 3-1. PM1800A DIMENSIONS

3.2 POWER SUPPLY (PW1800) SPECIFICATIONS

Dimensions

- HEIGHT 5-1/4 inches (132 mm) (excluding rubber feet; add 7/16" (10.5 mm) for feet).
- DEPTH Overall, 16-7/8 inches (429.2 mm); Behind panel, 15- 1/2 inches (394 mm).
- WIDTH 18-7/8 inches (480 mm); for standard rack mounting.

Net Weight

35.3 pounds (16 kg).

Fuse

Primary fuse 7 amp, slo-blow.

AC Requirements

U.S.A./Canada models: 105 to 130 V, 50/60 Hz. General Export models: 220 or 240 V, ± 10%, 50/60 Hz.

Umbilical Cable

Multi-conductor cable with locking, multi-pin connector conveys power to the PM1800A console. Cable is approximately 10 feet (3.6 meters) long.

Cooling

Internal fan, pulls air through foam grille on front panel, exhausts via top and side vents.

NOTE:

Specifications are subject to change without notice or obligation.

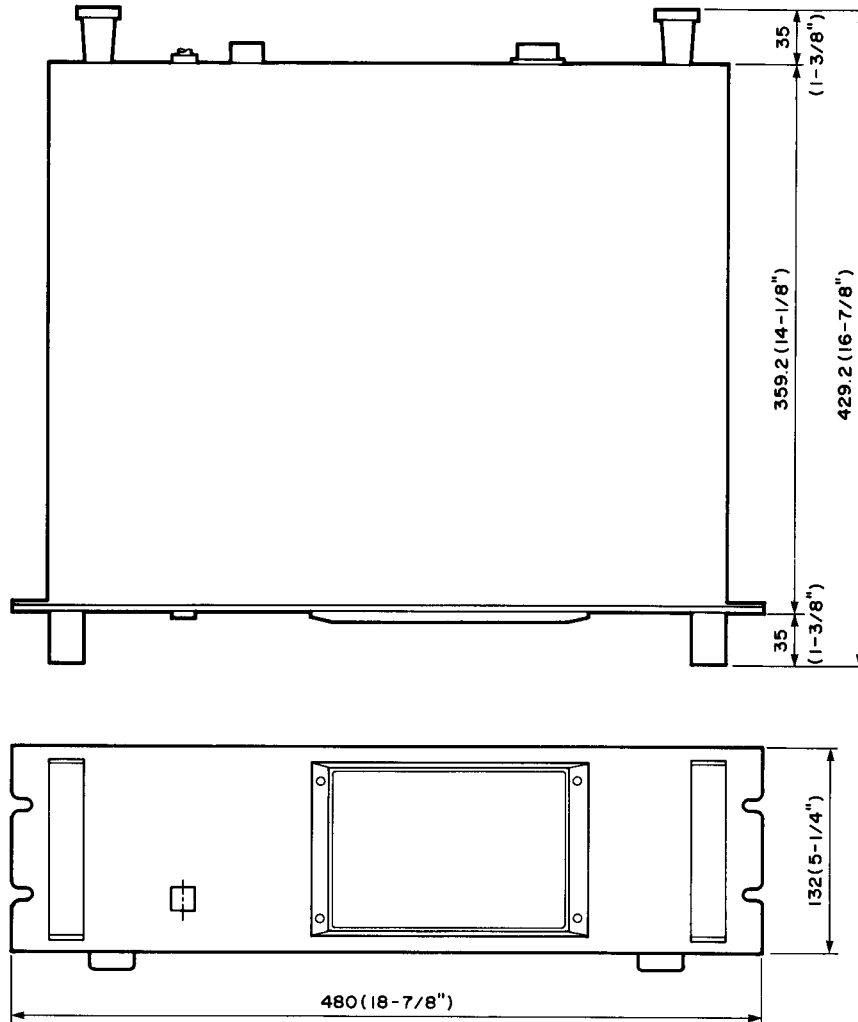

FIGURE 3-2. PW1800 DIMENSIONS

3.3 INPUT CHARACTERISTICS

CONNECTION	PAD	GAIN TRIM	ACTUAL LOAD IMPEDANCE	FOR USE WITH NOMINAL	INPUT LEVEL			CONNECTOR IN CONSOLE
					SENSITIVITY	NOMINAL	MAX. BEFORE CLIP	
CH INPUT, 1-16, 1-24, 1-32, or 1-40	0	-60	3K ohms if electronic balanced; 1K ohms if transformer balanced	50 ohm to 600 ohm mics and 600 ohm lines	-80 dB (0.075 mV)	-60 dB (0.75 mV)	-34 dB (1.75 mV)	XLR-3-31 type
	0	-26			-46 dB (3.88 mV)	-26 dB (38.8 mV)	0 dB (775 mV)	
	20	-26			-26 dB (38.8 mV)	-6 dB (388 mV)	+20 dB (7.75 V)	
	40	-26			-6 dB (388 mV)	+14 dB (3.88 V)	+24 dB (12.3 V)	
AUX RETURN, 1-4 (stereo)			10Kohms	600 ohm lines	-16 dB (123 mV)	+4 dB (1.23 V)	+24 dB (12.3 V)	XLR-3-31 type
SUB IN: GROUP 1-8 AUX 1-6 CUE			10K ohms	600 ohm lines	-6 dB (388 mV)	+4 dB (1.23 V)	+24 dB (12.3 V)	XLR-3-31
			10K ohms	600 ohm lines	-6 dB (388 mV)	+4 dB (1.23 V)	+24 dB (12.3 V)	**
			47K ohms	600 ohm lines	-6 dB (388 mV)	+4 dB (1.23 V)	+24 dB (12.3 V)	Phone jack (TRS)
TALKBACK IN	-50		3K ohms	50-600 ohm mics	-70 dB (0.25 mV)	-50 dB (2.45 mV)	-24 dB (48.9 mV)	XLR-3-31 type
	+4		3K ohms	600 ohm lines	-16 dB (123 mV)	+4 dB (1.23 V)	+24 dB (12.3 V)	
COMM IN	-50		3K ohms	50-600 ohm mics	-70 dB (0.25 mV)	-50 dB (2.45 mV)	-24 dB (48.9 mV)	XLR-3-31 type
	+4		3K ohms	600 ohm lines	-16 dB (123 mV)	+4 dB (1.23 V)	+24 dB (12.3 V)	
INSERT IN: CH 1-16 thru 40 GROUP 1-8 AUX 1-6			10K ohms	600 ohm lines	-10 dB (245 mV)	0 dB (775 mV)	+20 dB (7.75 V)	Phone Jack (TRS)

NOTES: 1) Sensitivity is the lowest level that will produce an output of +4 dB (1.23V), or the nominal output level, when the circuit is set to maximum gain.

2) All XLR connectors are electronically balanced, phone jacks are unbalanced (except as noted).

** Balanced TRS Phone Jack in 16 channel console, XLR-3-31 type in 24, 32 or 40 channel consoles.

3.4 OUTPUT CHARACTERISTICS

CONNECTION	ACTUAL SOURCE IMPEDANCE	FOR USE WITH NOMINAL	OUTPUT LEVEL		CONNECTOR IN CONSOLE
			NOMINAL	MAX. BEFORE CLIP	
GROUP OUT, 1-8	150 ohms	600 ohm lines	+4 dB (1.23 V)	+24 dB (12.3 V)	XLR-3-32 type
STEREO OUT, L-R	150 ohms	600 ohm lines	+4 dB (1.23 V)	+24 dB (12.3 V)	XLR-3-32 type
MATRIX OUT, 1-4	150 ohms	600 ohm lines	+4 dB (1.23 V)	+24 dB (12.3 V)	XLR-3-32 type
AUX OUT, 1-6	150 ohms	600 ohm lines	+4 dB (1.23 V)	+24 dB (12.3 V)	XLR-3-32 type
CUE OUT, L-R	150 ohms	600 ohm lines	+4 dB (1.23 V)	+20 dB (7.75 V)	Phone Jack (TRS)
OSC OUT	150 ohms	600 ohm lines	+4 dB (1.23 V)	+24 dB (12.3 V)	XLR-3-32 type
TALKBACK OUT	150 ohms	600 ohm lines	+4 dB (1.23 V)	+24 dB (12.3 V)	XLR-3-32 type
INSERT OUT: CH 1-16, 1-24, 1-32 or 1-40 GROUP 1-8 AUX 1-6	600 ohms	10K ohm lines	0 dB (775 mV)	+20 dB (7.75 V)	Phone Jack
PHONES OUT	15 ohms	8 ohm phones	75 mW	150 mW	Phone Jack (TRS)
		40 ohm phones	65 mW	130 mW	(Stereo Wired)

NOTES: 1) All XLR connectors are electronically balanced. Phones jacks outputs are unbalanced.

3.5 PERFORMANCE GRAPHS

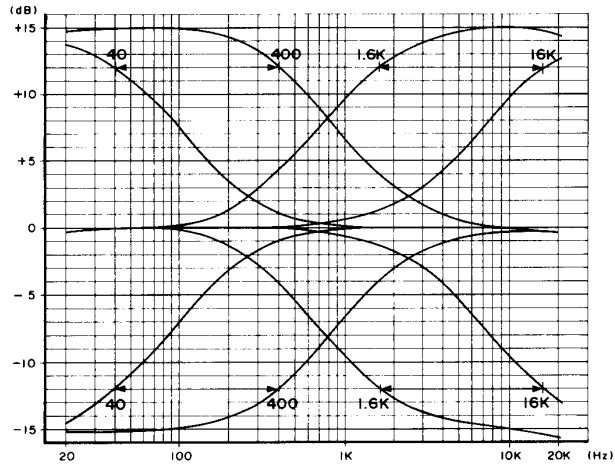
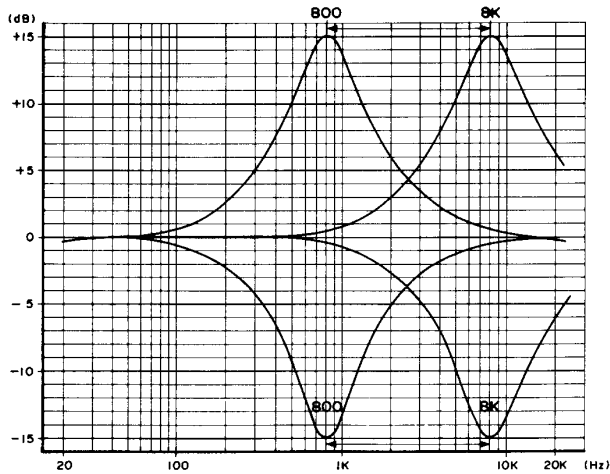

FIGURE 3-3. HIGH AND LOW FREQUENCY BAND EQUALIZER CHARACTERISTICS (SHELVING)

(A)



(B)

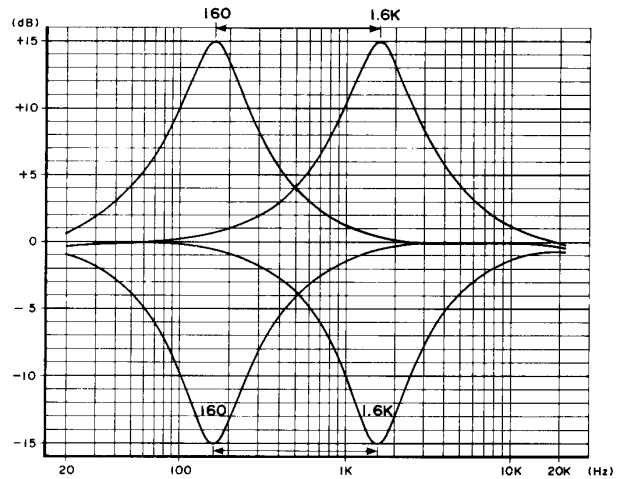

FIGURE 3-4. HI-MID (A) AND LO-MID (B) BAND EQUALIZER CHARACTERISTICS (PEAKING)

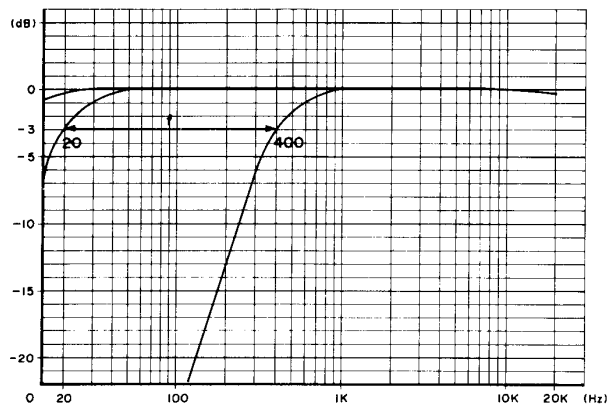

FIGURE 3-5. HIGH PASS FILTER CHARACTERISTICS

3.5.1 Input Channel 1 To Group Output 1 Performance Graphs With Input Gain Control @ Max

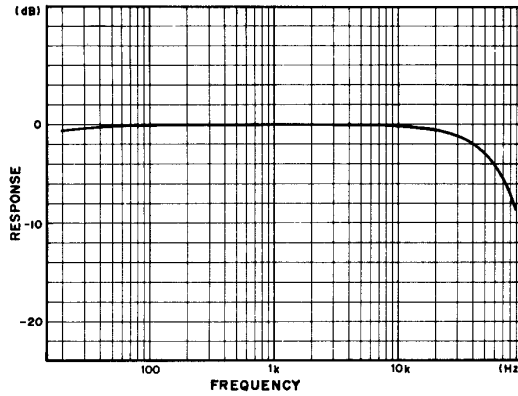

FIGURE 3-6. FREQUENCY RESPONSE
 AT +4 DBU & +14 DBU OUTPUT LEVELS, PAD AT 0 DB. (CURVES WOULD BE IDENTICAL WITH PAD AT 20, OR 40 DB.)

(A) PAD AT 0 DB

(B) PAD AT 20 DB

(C) PAD AT 40 DB

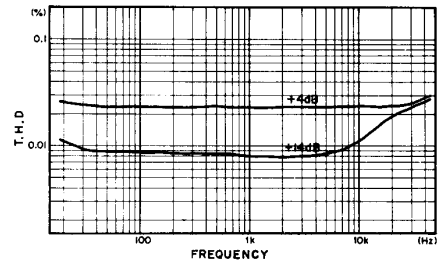
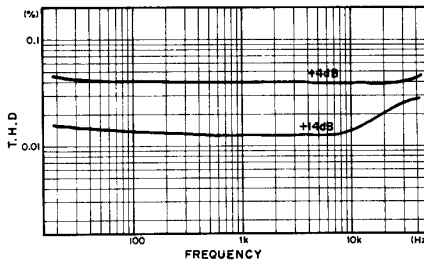
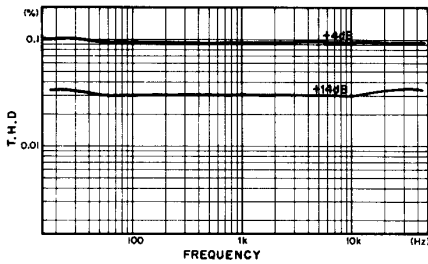

FIGURE 3-7. FREQUENCY VS. T.H.D. CURVES
 At +4 dBu & +14 dBu output levels

(A) PAD at 0 dB

(B) PAD at 20 dB

(C) PAD at 40 dB

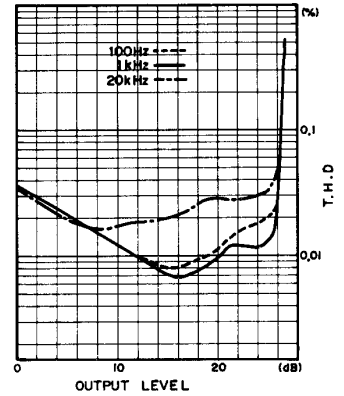
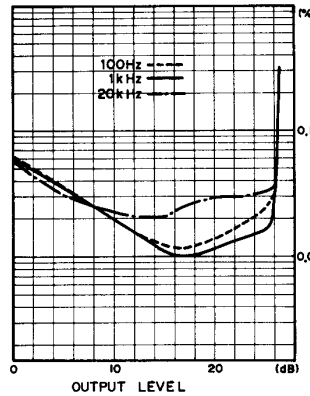
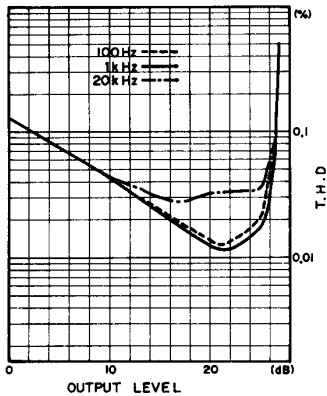

FIGURE 3-8. OUTPUT LEVEL VS T.H.D.
 At 100 Hz, 1 kHz & 20 kHz

3.5.2 Input Channel 1 To Group Output 1 Performance Graphs With Input Gain Control @ Min

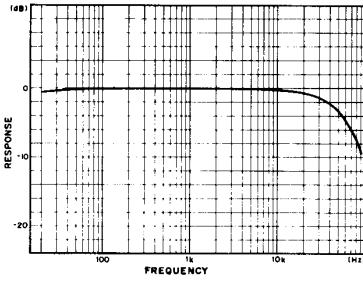

FIGURE 3-9. FREQUENCY RESPONSE
At +4 dB & +14 dB output levels,
PAD at 0 dB. (Curves would be identical
with PAD at 20 or 40 dB.)

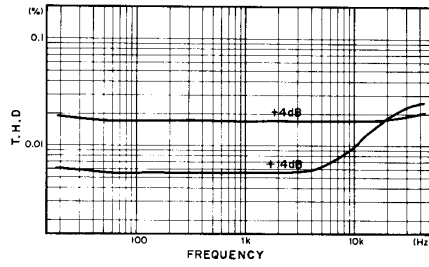

FIGURE 3-10. FREQUENCY vs. T.H.D. CURVES
At +4 dB & +14 dB output levels, PAD at 0 dB.

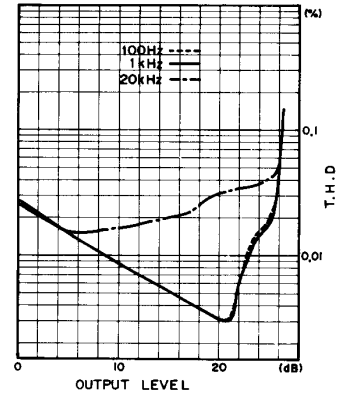

FIGURE 3-11. OUTPUT LEVEL vs T.H.D.
At 100 Hz, 1 kHz & 20 kHz, PAD at 0 dB.

3.5.3 Aux Return 4 (L) To Group Output 1 Performance Graphs

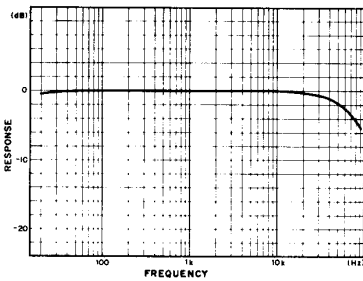

FIGURE 3-12. FREQUENCY RESPONSE
(At +4 dB output level.)

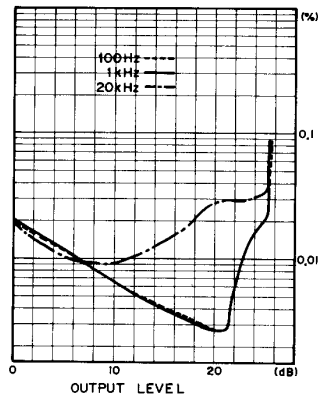

FIGURE 3-13. OUTPUT LEVEL vs T.H.D.
(At 100 Hz, 1 kHz & 20 kHz.)

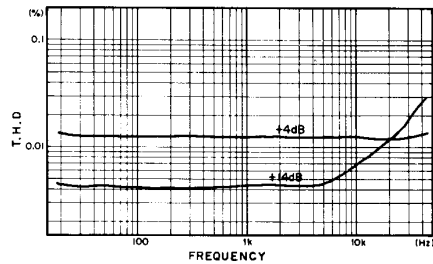

FIGURE 3-14. FREQUENCY vs. T.H.D. CURVES
(At +4 dB & +14 dB output levels.)

3.5.4 Channel 1 Input To Phones Output Performance Graphs With Input Pad @ 40 dB, Gain @ Min.

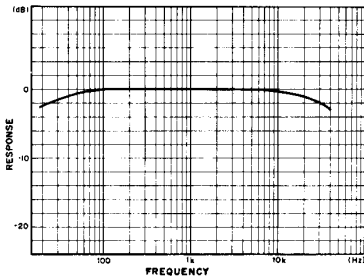

FIGURE 3-15. FREQUENCY RESPONSE

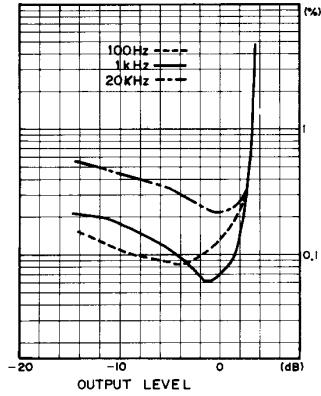

FIGURE 3-16. OUTPUT LEVEL vs T.H.D. At 100 Hz, 1 kHz & 20 kHz.

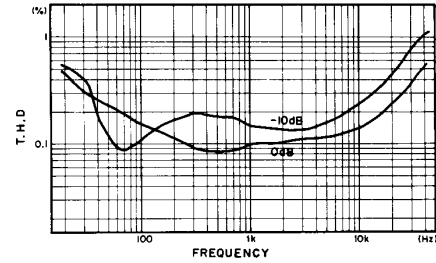

FIGURE 3-17. FREQUENCY vs. T.H.D. CURVES

3.5.5 Crosstalk Performance Graphs

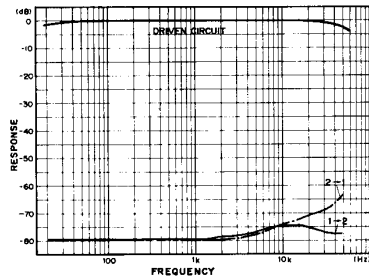

FIGURE 3-18. CROSSTALK OF GROUP 1 INTO 2 OR 2 INTO 1 WITH INPUT PAN CONTROL AT FULL CW & FULL CCW POSITIONS

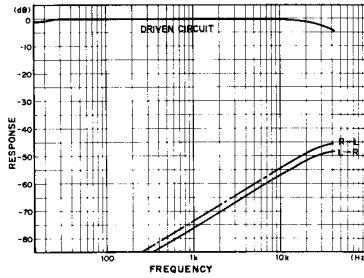

FIGURE 3-19. CROSSTALK OF STEREO L INTO R OR R INTO L WITH GROUP-TO-STEREO PAN CONTROL AT FULL SW & FULL CCW POSITIONS

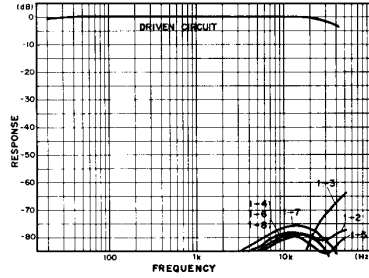

FIGURE 3-20. CROSSTALK OF GROUP BUS 1 INTO GROUP BUSES 2 THROUGH 8

3.6 BLOCK & GAIN STRUCTURE DIAGRAMS

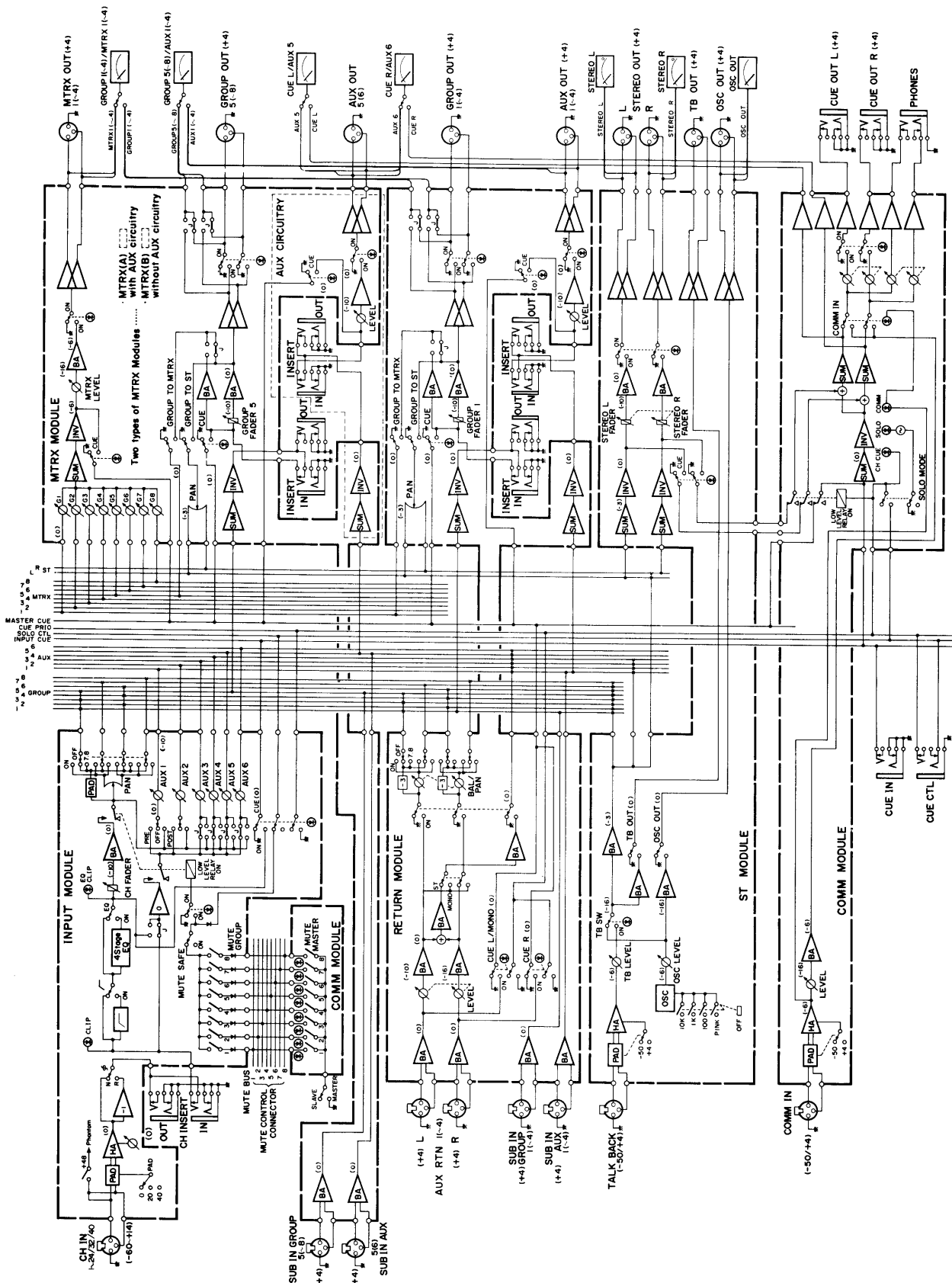

FIGURE 3-21A. SIGNAL FLOW for PM1800A 24, 32, 40C

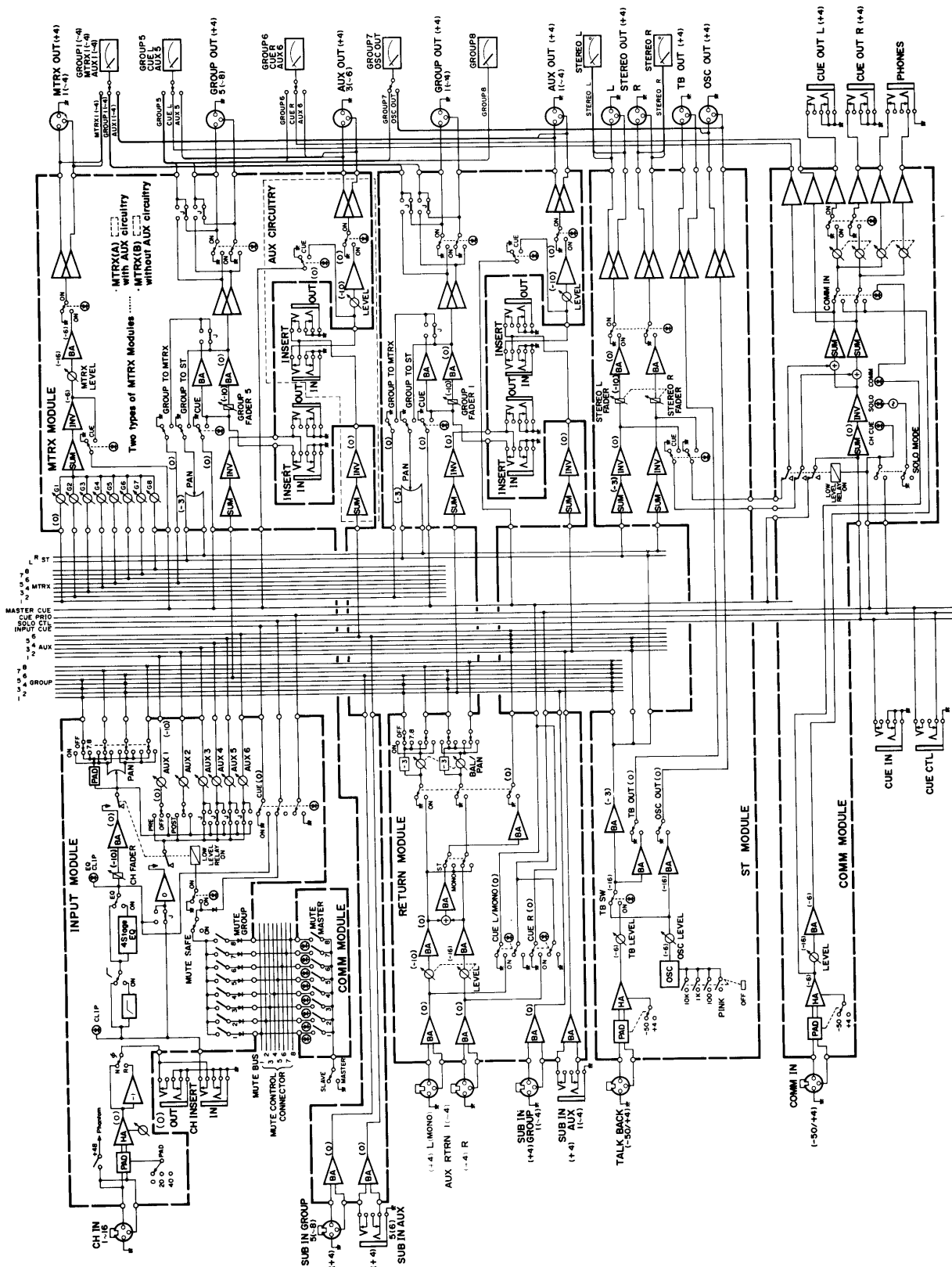

FIGURE 3-21B. SIGNAL FLOW for PM1800A-16 (BLOCK DIAGRAM)

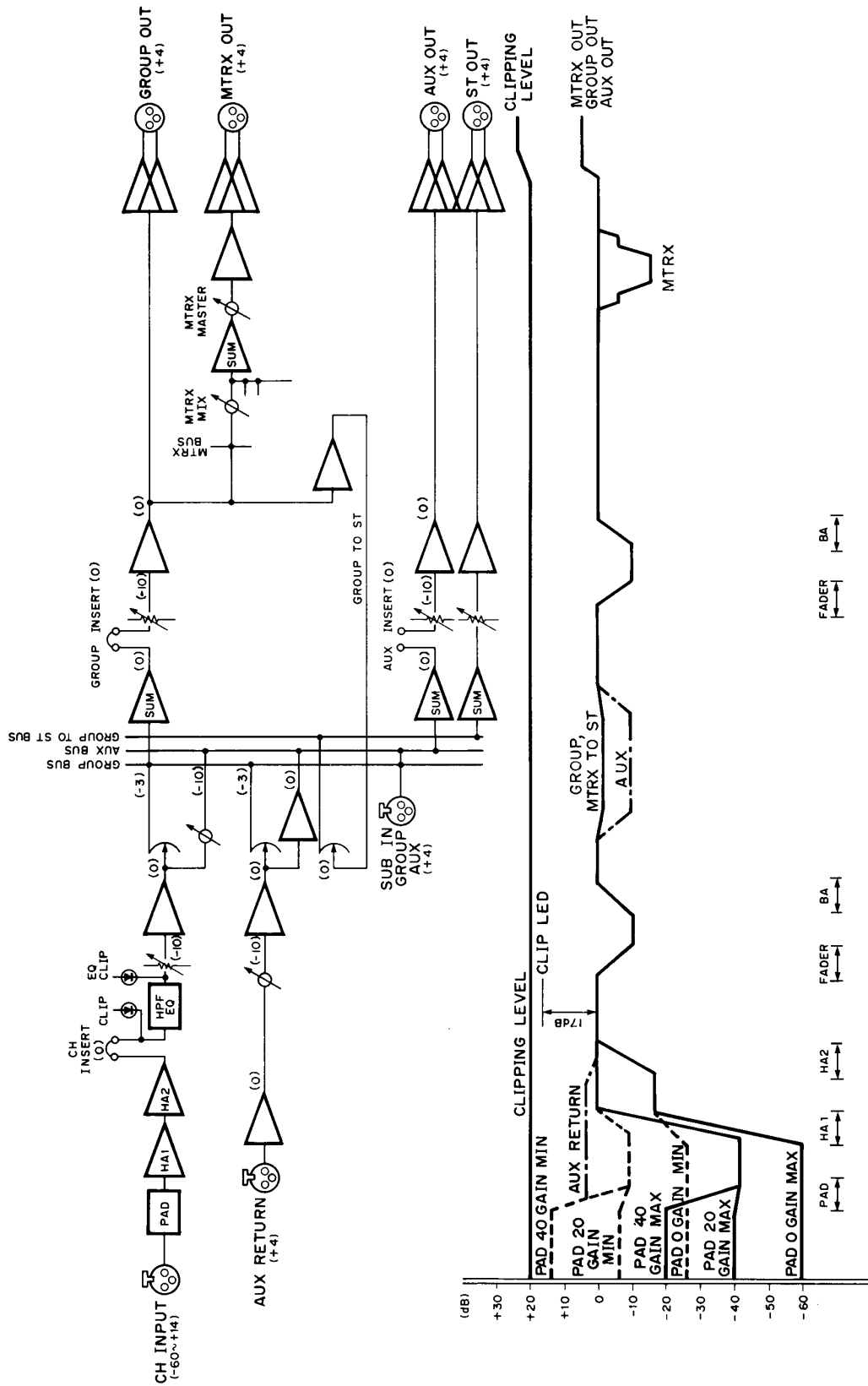

FIGURE 3-22. PM1800A GAIN STRUCTURE