

PM-3000

OPERATING MANUAL

How to use this manual

If you are an engineer or technician who is familiar with sound system design, much of this manual will serve as a review for you. The basic features are presented in the "BRIEF OPERATING INSTRUCTIONS" section. Check this and the "SPECIFICATIONS" section, and you will see most of what you need to know. The balance of this manual provides background information for better utilization of the console and auxiliary equipment.

If you would like to know more about AC power distribution and safety, grounding, balanced versus unbalanced cables, direct boxes, and so forth, this information is also presented. Check the TABLE OF CONTENTS.

There are internal preset switches within the console which can be configured to change the functions and/or signal paths in certain circuits. Refer to the OPTIONAL FUNCTIONS section for details.

TERMINOLOGY AND TYPOGRAPHIC CONVENTIONS

Generally, where we refer to a particular control or function as it is actually labeled on the console, we will use all upper case type. That is, if we refer to an input channel's gain control, we may print "the input GAIN control." On the other hand, if the feature is not labeled, we will use upper case type only on the first letter; for example, "observe there is no identification of the input Fader." If the front panel label is incomplete or ambiguous, we may augment it. For example, the input channel assign switches labeled "1, 2, 3, 4, 5, 6, 7, 8" may be accompanied by the parenthetical reference "(group bus assign)".

There are eight groups (or subgroups, depending on your linguistic preference). The group faders are known as "Group Master Faders". Their function is to control the level on the eight "Group Mixing Busses." The eight group busses are different and distinct from the eight "Auxiliary Mixing Busses." The Stereo Fader is actually a pair of closely spaced faders (L and R); when we refer to the general function, we use the term "Stereo Fader," but if the availability of separate left and right control is important, we may use the plural "Stereo Faders."

Particularly important information is distinguished in this manual by the following notations:

NOTE:

A NOTE provides key information to make procedures or functions clearer or easier.

CAUTION:

A CAUTION indicates special procedures or guidelines that must be observed to avoid damage to the console or related equipment, or to avoid an undesirable result while using the console.

WARNING:

A WARNING indicates special procedures or guidelines that must be observed to avoid injury to the operator or others using or exposed to the console or related equipment.

In the BRIEF OPERATING INSTRUCTIONS section of this manual, each feature is provided with a numerical reference. Elsewhere, if we are referring to that feature, we may cite the reference number in square brackets for clarity. For example, on the input module, the fourth control to be described is the PAN pot. In other places on the console there are other PAN pots. For clarity, then, if we are discussing this particular input PAN pot, we will describe it like this: "the PAN pot [6]."

WARNING: TO PREVENT FIRE OR SHOCK HAZARD, DO NOT EXPOSE THIS APPLIANCE TO RAIN OR MOISTURE.

Table of contents

PAGE	SECTION	
1-1	1	INTRODUCTION
2-1	2	BRIEF OPERATING INSTRUCTIONS
2-1	2.1	PM3000 FRONT PANEL FEATURES
2-1	2.1.1	The Input Module
2-6	2.1.2	The Aux Rtn A & Aux Rtn B Modules
2-9	2.1.3	The Master Modules (1-8)
2-13	2.1.4	The Aux/ST Module & The Aux Module
2-15	2.1.5	The TB/COMM Module
2-19	2.1.6	The Meter Bridge
2-21	2.2	PM3000 REAR PANEL FEATURES
2-25	2.3	THE PW3000A POWER SUPPLY
3-1	3	PM3000 SPECIFICATIONS
3-1	3.1	GENERAL SPECIFICATIONS (PM3000)
3-3	3.2	POWER SUPPLY SPECIFICATIONS (PW3000A)
3-4	3.3	INPUT CHARACTERISTICS
3-4	3.4	OUTPUT CHARACTERISTICS
3-5	3.5	PERFORMANCE GRAPHS
3-11	3.6	BLOCK DIAGRAM & GAIN STRUCTURE
4-1	4	INSTALLATION NOTES
4-1	4.1	PLANNING AN INSTALLATION
4-1	4.2	POWER MAINS
4-1	4.2.1	Verify The Correct Mains Voltage
4-1	4.2.2	Ensure There Is A Good Earth Ground
4-1	4.2.3	How To Obtain A Safety Ground When Using a 2-Wire Outlet
4-2	4.2.4	Improperly Wired AC Outlets: Lifted Grounds
4-2	4.2.5	Improperly Wired AC Outlets, Lifted Neutral
4-3	4.2.6	AC Safety Tips
4-3	4.3	THEORY OF GROUNDING
4-3	4.3.1	What Is A Ground Loop, Why Is It Bad, And How Is It Avoided?
4-4	4.3.2	Balanced Lines and Ground Lift Switches
4-5	4.4	AUDIO CONNECTORS AND CABLES
4-5	4.4.1	Types of Cable To Use
4-6	4.4.2	Cable Layout
4-6	4.4.3	Balanced Versus Unbalanced Wiring
4-8	4.4.4	The Pro's And Con's Of Input Transformers
4-8	4.4.5	Noise And Losses In Low And High Impedance Lines
4-8	4.5	DIRECT BOXES
4-9	4.5.1	Passive Guitar Direct Box
4-10	4.5.2	Active Guitar Direct Box
5-1	5	GAIN STRUCTURE AND LEVELS
5-1	5.1	STANDARD OPERATING LEVELS
5-1	5.2	DYNAMIC RANGE AND HEADROOM
5-1	5.2.1	What Is Dynamic Range?
5-1	5.2.2	The Relationship Between Sound Levels And Signal Levels
5-1	5.2.3	A Discussion Of Headroom
5-2	5.2.4	What Happens When The Program Source Has Wider Dynamics Than The Equipment?
5-3	5.2.5	A General Approach To Setting Levels In A Sound System
5-3	5.2.6	How To Select A Headroom Value And Adjust Levels Accordingly
5-4	5.3	GAIN OVERLAP AND HEADROOM

PAGE	SECTION	
6-1	6	OPTIONAL FUNCTIONS
6-1	6.1	REMOVING AND INSTALLING A MODULE
6-2	6.2	INPUT CHANNEL INSERT IN/OUT JACKS: PRE-EQ OR POST-EQ
6-2	6.3	INPUT CHANNEL AUX SENDS: PRE-FADER & EQ OR PRE-FADER/POST-EQ
6-4	6.4	STEREO MASTER TO MATRIX ST BUS: PRE- OR POST-ST ON/OFF SWITCH
6-5	6.5	GROUP-TO-MATRIX: ASSIGNED PRE- OR POST-GROUP MASTER FADER
6-6	6.6	METER FUNCTION IN "GROUP" POSITION: ONE OF THREE SOURCES
6-7	6.7	INSTALLATION OF OPTIONAL INPUT TRANSFORMERS
6-8	6.8	HINTS ON CIRCUITRY FOR REMOTE CONTROL OF THE VCA MASTERS AND MUTE GROUPS
7-1	7	OPERATING HINTS AND NOTES
7-1	7.1	CONSOLE GAIN STRUCTURE
7-1	7.1.1	What is the Proper Gain Structure?
7-1	7.1.2	What Affects Gain Structure?
7-1	7.1.3	Establishing the Correct Input Channel Settings
7-2	7.1.4	Establishing the Correct Group Master Settings
7-2	7.1.5	Establishing the Correct Aux Send Master Settings
7-2	7.1.6	Establishing the Correct Mix Matrix Settings
7-2	7.1.7	Establishing the Correct Aux Return Settings
7-2	7.1.8	How VCA Control Affects Gain Structure
7-3	7.1.9	Channel Muting and Gain Structure
7-3	7.2	FURTHER HINTS & CONCEPTUAL NOTES
7-3	7.2.1	What is a VCA, and Why is it Used?
7-4	7.2.2	The Distinction Between the Group Busses and the VCA Master "Groups"
7-6	7.2.3	Using the Channel Insert In Jack as a Line Input
7-6	7.2.4	Understanding and Using the Mix Matrix
7-7	7.2.4.1	The Mix Matrix in General Sound Reinforcement
7-7	7.2.4.2	Using the Matrix Sub Inputs For Effects
7-8	7.2.4.3	Other Uses for the Matrix Sub Inputs
7-8	7.2.4.4	Use of the Matrix to Pre-Mix Scenes
7-8	7.2.5	Understanding and Use of the Master Mute Function
7-9	7.2.6	Stereo Panning to the Eight Group Mixing Busses
7-10	7.3	INTERFACE WITH POPULAR INTERCOM SYSTEMS
7-10	7.3.1	RTS Intercom Systems
7-11	7.3.2	CLEAR-COM Intercom Systems
8-1	8	APPLICATIONS
8-1	8.1	GENERAL
8-1	8.1.1	Theatre
8-1	8.1.2	Production
8-1	8.1.3	Post Production
8-2	8.1.4	Video
8-2	8.1.5	Sound Reinforcement
8-3	8.2	SETUP CONCEPTS
8-3	8.2.1	Deriving a Stereo Mix From Groups 1-8
8-3	8.2.2	The Mix Matrix Allows the 8 Groups Plus the Stereo Bus to Function as 10 Subgroups
8-4	8.2.3	How to Get 5 Independent Stereo Mixes or 10 Mono Mixes By Using the Stereo Bus Plus the Mix Matrix
8-5	8.2.4	How to Use the VCA Masters Plus the Group Faders to Obtain the Functional Equivalent of 16 Subgroups
8-6	8.2.5	Using More Than One VCA Master to Control the Same Input Channels in Order to Handle Overlapping Scenes
9-1	9	MAINTENANCE
9-1	9.1	CLEANING THE CONSOLE
9-1	9.1.1	The Console and Power Supply Exterior
9-1	9.1.2	Power Supply Air Filter
9-1	9.1.3	Pots and Faders
9-1	9.1.4	The Console Interior
9-2	9.2	METER LAMP REPLACEMENT
9-3	9.3	VCA CALIBRATION
9-3	9.3.1	Standard Voltage Calibration: Input and Master Modules
9-3	9.3.2	VCA Calibration: Input Modules
9-4	9.4	WHERE TO CHECK IF THERE IS NO OUTPUT
9-5	9.5	WHAT TO DO IN CASE OF TROUBLE

List of illustrations

PAGE #	FIG #	TITLE (& SECTION, WHERE NECESSARY TO DISTINGUISH ONE DRAWING FROM ANOTHER)
2-1	2-1.	PM3000 INPUT MODULE.
2-6	2-2.	PM3000 AUX RTN A and AUX RTN B MODULES.
2-9	2-3.	PM3000 MASTER MODULE.
2-13	2-4.	PM3000 AUX/STAND AUX MODULES.
2-15	2-5.	PM3000 TB/COMM MODULE.
2-19	2-6.	PM3000 METER BRIDGE.
2-20	2-7.	SIGNAL PICK-OFF POINTS FOR THOSE VU METERS THAT DISPLAY GROUP, GROUP-TO-MATRIX, OR MATRIX LEVELS.
2-21	2-8.	PM3000 REAR PANEL.
2-24	2-9.	VCA/MUTE CONNECTOR PIN ASSIGNMENTS.
2-25	2-10.	PW3000A POWER SUPPLY.
2-25	2-11.	PW3000A UMBILICAL CONNECTOR PIN ASSIGNMENTS.
3-2	3-1.	PM3000 DIMENSIONS.
3-3	3-2.	PW3000A DIMENSIONS.
3-5	3-3.	INPUT CHANNEL EQUALIZER CHARACTERISTICS.
3-6	3-4.	INPUT CHANNEL HIGH PASS FILTER CHARACTERISTICS.
3-6	3-5.	AUX RETURN EQUALIZER CHARACTERISTICS.
	(3.5.1)	(Input Channel 1 to Group Output 1 With Input Gain control @ MAX)
3-7	3-6.	FREQUENCY RESPONSE.
3-7	3-7.	FREQUENCY vs. T.H.D.
3-8	3-8.	OUTPUT LEVEL vs. T.H.D.
	(3.5.2)	(Input Channel 1 to Group Output 1 With Input Gain Control @ MIN)
3-9	3-9.	FREQUENCY RESPONSE.
3-9	3-10.	FREQUENCY vs. T.H.D.
3-9	3-11.	OUTPUT LEVEL vs. T.H.D.
	(3.5.3)	(Aux Return 4 (L) to Group Output 1)
3-9	3-12.	FREQUENCY RESPONSE.
3-9	3-13.	OUTPUT LEVEL vs. T.H.D.
3-9	3-14.	FREQUENCY vs. T.H.D.
	(3.5.4)	(Channel 1 Input to Phones Output, With Input Pad @ 40 dB, Gain @ MIN.)
3-10	3-15.	FREQUENCY RESPONSE.
3-10	3-16.	OUTPUT LEVEL vs. T.H.D.
3-10	3-17.	FREQUENCY vs. T.H.D.
3-10	3-18.	CROSSTALK OF GROUP 1 INTO 3 OR 3 INTO 1 WITH INPUT PAN CONTROL AT FULL CW & FULL CCW POSITIONS.
3-10	3-19.	CROSSTALK OF STEREO L INTO R OR R INTO L WITH INPUT PAN CONTROL AT FULL CW & FULL CCW POSITIONS.
3-10	3-20.	CROSSTALK OF GROUP BUS 1 INTO GROUP BUSES 2 THROUGH 8.
3-11	3-21.	PM3000 SIGNAL FLOW (BLOCK DIAGRAM).
3-12	3-22.	PM3000 GAIN STRUCTURE.
4-2	4-1.	TESTING A 2-WIRE AC OUTLET.
4-2	4-2.	SCHEMATIC OF AN OUTLET WITH A LIFTED NEUTRAL.
4-3	4-3.	TESTING A 3-WIRE AC OUTLET.
4-4	4-4.	TYPICAL GROUND LOOPS IN SOUND SYSTEMS.
4-4	4-5.	AVOID USE OF AC POWER CORD GROUND ADAPTOR TO "BREAK GROUND".
4-5	4-6.	CONNECTOR WIRING FOR PM3000.
		A) XLR-3 input or output
		B) T/R/S phone plug for balanced INSERT input
		C) T/S phone plug for unbalanced INSERT input
		D) T/S phone plug for INSERT output
4-6	4-7.	CABLES FOR UNBALANCED AND BALANCED LINES.
4-7	4-8.	NOISE REJECTION IN A BALANCED LINE.
4-9	4-9.	PASSIVE DIRECT BOX SCHEMATIC DIAGRAM.
4-10	4-10.	ACTIVE DIRECT BOX SCHEMATIC DIAGRAM.

PAGE #	FIG #	TITLE
5-2	5-1.	DYNAMIC RANGE AND HEADROOM IN SOUND SYSTEMS.
5-3	5-2.	HEADROOM IN DIFFERENT APPLICATIONS.
6-1	6-1.	REMOVAL OF MODULE FROM PM3000.
6-2	6-2.	INTERNAL SWITCH POSITIONS FOR MAKING THE INSERT IN/OUT JACKS: PRE-EQ OR POST-EQ
6-3	6-3.	INTERNAL SWITCH POSITIONS FOR PRE-EQ AND POST-EQ AUX SENDS (WHEN PRE/OFF/POST SWITCH IS SET TO PRE).
6-4	6-4.	INTERNAL SWITCH POSITIONS FOR PRE- AND POST- STEREO MASTER FADER FEEDS TO MIX MATRIX.
6-5	6-5.	INTERNAL SWITCH POSITIONS FOR PRE- AND POST- GROUP MASTER FADER FEEDS TO MIX MATRIX.
6-6	6-6.	INTERNAL SWITCH POSITIONS FOR VARIOUS METER FEED POINTS IN THE "GROUP" METER MODE.
6-7	6-7.	OPTIONAL INPUT TRANSFORMER INSTALLATION.
6-8	6-8.	SUGGESTED CIRCUIT FOR REMOTE CONTROL OF A VCA MASTER GROUP.
6-9	6-9.	VCA CONTROL VOLTAGE VERSUS FADER POSITION.
7-3	7-1.	CONTROL VOLTAGES FROM UP TO 9 DIFFERENT POINTS (THE CHANNEL FADER PLUS 8 VCA MASTER FADERS) CAN AFFECT ANY CHANNEL'S VCA GAIN.
7-5	7-2.	SIGNAL PROCESSING OF THE MIXED PROGRAM IS A MAJOR DIFFERENCE BETWEEN THE VCA-CONTROLLED "GROUPS" AND THE CONVENTIONAL GROUP MASTERS. A) VCA Master Controlled Groups B) Group or Aux Master Controlled Groups
7-6	7-3.	BLOCK DIAGRAM OF PM3000 MIX MATRIX.
7-9	7-4.	BLOCK DIAGRAM OF PM3000 MASTER MUTE SYSTEM.
7-10	7-5.	INTERFACE OF RTS INTERCOM TO PM3000 "COMM IN."
7-11	7-6.	INTERFACE OF PM3000 "TB OUT" TO RTS INTERCOM "AUDIO COUPLING" INPUT. A) For Larger, PS-30 or PS-31 Power Supply B) For Smaller, PS-8 Power Supply
7-11	7-7.	ADAPTOR CABLE FOR SPLITTING XLR-4 INPUT/OUTPUT CONNECTOR ON CLEAR-COM IF4-4 INTERCOM INTERFACE
8-3	8-1.	SYSTEM DIAGRAM WITH GROUPS 1-8 AS SUBMASTERS, AND MAIN FEED FROM STEREO MASTER.
8-3	8-2.	SYSTEM DIAGRAM WITH MIX MATRIX PROVIDING 8 MONO OR 4 STEREO OUTPUTS FROM 10 SUBGROUPS.
8-4	8-3.	SYSTEM DIAGRAM FOR 5 INDEPENDENT STEREO OUTPUT MIXES VIA THE STEREO BUS AND THE MIX MATRIX.
8-5	8-4.	SYSTEM DIAGRAM WITH VCA-CONTROLLED INPUTS PLUS GROUP BUSES USED TO CREATE 16 SUBGROUPS, WHICH ALL MIX INTO THE STEREO OUTPUT.
8-6	8-5.	SYSTEM DIAGRAM WITH MULTIPLE VCAS CONTROLLING A GIVEN INPUT SO THAT DIFFERENT SCENES CAN BE SET UP AND THE LEVELS PREADJUSTED DURING REHEARSAL.
9-2	9-1.	REPLACEMENT OF VU METER LAMPS.
9-3	9-2.	LOCATION OF VOLTAGE CALIBRATION TRIMMERS ON INPUT AND MASTER MODULES.
9-3	9-3.	LOCATION OF VCA CALIBRATION TRIMMERS ON INPUT MODULE.

SECTION 1

Introduction

The PM3000 is a professional audio mixing console with the kind of flexibility, performance and reliability for which Yamaha has earned a worldwide reputation. It picks up where the famous PM2000 left off, with still more functions, a higher level of performance, and a greater degree of versatility than ever before.

The console is available with 24, 32, or 40 input channels. There are eight VCA (Voltage Controlled Amplifier) Master Faders which can be assigned to control any combination of input channels (see Section 7.2.1 for a discussion of VCAs). In addition, there are eight group mixing busses, as well as a stereo mixing bus, to which any of the input channels can be assigned. There are also eight auxiliary mixing busses to which each input channel may be assigned by means of PRE/OFF/POST switches and Send Level controls. These eight busses may therefore be used to augment the eight groups plus the stereo bus for a total of 18 audio mixing busses, or they may be used for a combination of foldback send (stage monitor), effects send and remote mixes.

In addition to the aux and group busses, there is a discrete stereo bus. Input channels and auxiliary returns may be assigned directly to the stereo bus, or assignment can be made via the Group Masters. Thus, the console can function in a sub-grouped mode with a stereo "grand master" fader, or it can function with independent stereo and multi-channel output mixes.

The PM3000 inputs are differentially balanced, and are equipped with a five-position attenuation PAD plus a continuously variable GAIN trim control so that literally any mic or line level signal can be accommodated with channel faders set at nominal level. Optional input transformers may be installed internally on a channel-by-channel basis when extra grounding isolation is required. While the console has ample headroom throughout, it is always possible to incorrectly set controls. For this reason, the PM3000 is equipped with level detection at several stages. At the input preamp, both "SIGNAL present" and "CLIP" LEDs are provided. Given that the signal is correct there, overboost in the EQ could still lead to clipping, so another LED, "EQ CLIP," is included after the EQ section. If multiple VCA master faders attempt to push the gain too high on a given input, a "VCA MAX" LED turns on to indicate there is no more gain available. Finally, if the mixed levels on the group, auxiliary, stereo, matrix or cue busses adds up to be too high, a "PEAK" LED in the output meters will flash on to warn of the impending danger of clipping.

Naturally, the PM3000 is equipped with a Mix Matrix, the feature Yamaha pioneered in professional audio consoles. The PM3000 Mix Matrix is an 11x8 configuration. That is, there are 11 possible sources that can be mixed together into one output. Those 11 sources can be mixed together eight different ways on eight different modules. Each matrix channel accepts a direct sub input from a rear panel connector, plus signals from the stereo bus (L&R) and the eight subgroups (pre or post master fader, depending on internal preset switches). These 11 sources all go through a MATRIX MASTER control and an ON/off switch to a discrete rear panel output. The matrix can save a tremendous amount of time and effort when you want to set up stage monitor mixes from the subgroups, when you want to create different speaker mixes for different zones of the house, to feed local and remote programs simultaneously, to make mono and stereo mixes from the same subgroups, and so on. In fact, if

the matrix is set to pick up the subgroups ahead of the Group Master Faders, then the subgroups can be mixed onto the stereo bus with one mix, and completely independent mono or stereo mixes can be achieved from the same subgroups via the matrix.

New in the PM3000 is a VCA grouping system which is separate from the audio grouping. Eight "VCA" switches next to each channel fader enable that channel to be assigned so it is controlled by one or more of the VCA MASTER FADERS. When multiple input channels are assigned to a given VCA bus, those channels output levels can be raised or lowered by the single VCA MASTER FADER. Consider how this differs from the conventional groups. When multiple input channels are assigned to one of the eight group (audio) mixing busses, those channels' combined signals can be raised or lowered in level with the Group Master Fader. The audio result is the same as though the VCA MASTERS were used... with one exception; if signal processing of multiple inputs is required, it is necessary to run that combined signal through a single bus, which is why conventional Group Master Faders are provided on the PM3000. However, when the VCA MASTER FADERS are used, more than one VCA MASTER can combine to alter the level of a single input channel. What's more, the VCA MASTER FADER, because it affects the input channel directly, can also alter that channel's post-Fader output to any of the eight auxiliary mixing busses, something not possible with the conventional Group Master Faders. Moreover, because the VCA MASTER levels are voltage controlled, the PM3000 can be automated, at least to the extent of controlling group levels. A rear panel multi-pin connector can be used for this purpose.

Also new with the PM3000 is a MASTER MUTE function. Each input channel has eight MUTE assign switches. These permit the channel's ON/off function to be remotely controlled by the eight MASTER MUTE switches. Once a channel is switched on locally, it can be muted (turned off) or unmuted (turned on) if it is assigned to one or more of the mute groups. This permits multiple channels to be silenced or activated all at once, which expedites live sound mixing, band personnel or instrument changes, theatrical scene changes, and so forth. If, however, it is imperative that a certain channel never be inadvertently muted, or that muting temporarily be overridden, the input channel's MUTE SAFE switch can be engaged. Muting can also be controlled remotely, via a rear panel connector, so automation here, too, is possible.

The PM3000 is equipped with four AUXiliary RETURN channels. Each of these is a stereo return, and can apply a stereo signal to any of the group mixing busses, with a BALance control for relative left/right level adjustments. A switch in each return also permits it to accept a mono signal and to apply that signal to any of the busses; in this case, the BALance control becomes a PAN control for odd/even or L/R bus assignment. Of course, if panning is not desired, the pot may be bypassed. Each AUX RETURN also includes two-band, shelving, sweep-type EQ (with in/out switch) for touch-up of the return signal. The returns also include CUE and ON/off functions. In fact, they may be used as mono or stereo line inputs to the console if not needed for effects returns.

An excellent feature of the PM3000 is its extensive cue and solo capability. There is a CUE/SOLO switch on every input channel and on the aux returns, and a CUE

switch on every auxiliary send, the group outputs, the matrix outputs and the stereo master output. Cue replaces the signal in the headphones and the stereo cue XLR outputs with only those sources whose CUE switches are engaged. Furthermore, there is input priority, so that the operator may normally monitor the cue signal from the stereo bus or the group busses, and can instantly check one or more channel or aux return inputs without having to first release the bus CUE switches. This capability is great for troubleshooting, previewing a channel before applying it to the mix, or "touching up" the EQ on a channel during a performance. For use ahead of a live show, the console may be placed in solo mode. In this mode, only the input channel(s) whose CUE/SOLO switch is engaged will feed the console's outputs, and all other input channels will be muted; returns will not be muted so that any effects applicable to the input will be heard. Similarly, if an aux return Cue/solo switch (labeled CUE) is engaged, only the aux returns will be heard, and all input channels will be muted (unless their CUE/SOLO switches are engaged). Annunciator lights signal the operator whether the console is in solo or cue mode, and whether any CUE or CUE/SOLO switch is engaged.

There is extensive talkback and communications capability in the PM3000, plus a useful test oscillator. An XLR input can be set to accept any microphone or line level input, and is activated with the TALKBACK switch. That signal can be slaved to any of the eight group mixing busses, the eight aux send mixing busses, the stereo mixing bus, and to a rear panel XLR TB output. The test oscillator can be set to 100 Hz, 1 kHz or 10 kHz fixed frequencies, or can be swept from 0.2 to 2x the set frequency, and its output level is adjustable. Pink noise may be selected, too. The oscillator can be slaved to the same busses as the talkback, and also has its own rear panel output connector so the signal can be routed to other equipment or other console inputs for testing. Accompanying the talkback and oscillator functions is a communications input. That input will accept any mic or line level audio signal, typically from a professional intercom system, another console's talkback output, or a stage manager's mic. When a signal is present, a front panel COMM IN light flashes to signal the operator, who can then turn on the communications input (if desired), so the signal appears on the console headphone and cue outputs. Thus, with COMM IN and TALKBACK, the console operator can establish 2-way communications without having to wear an intercom headset as well as cue headphones.

Extensive metering is provided with a total of 14 VU meters (each with a peak LED) that can be switched to monitor 37 different circuits: two large meters monitor the left and right stereo outputs full time; eight meters are each switchable to monitor the group output to the XLR connector, the group output applied to the mix matrix, or the correspondingly numbered mix matrix output; and the remaining four meters are switchable to monitor the eight auxiliary outputs, the stereo cue outputs, plus the oscillator output.

PM3000 electronic performance is everything you'd expect from the people who developed the PM2000. It is that much more advanced, with hybrid input preamplifiers, low noise integrated circuits, and a sophisticated design that makes your job easier. Low noise, wide headroom throughout, exceptionally low distortion, and quiet controls are the hallmark of this top quality mixing console. The specifications tell part of the story... your

ears will tell you the most important part.

Physically, the PM3000 is as appealing as it is electronically. An all new chassis with full aluminum exterior enabled us to reduce the weight (by some 30% compared to the PM2000), without sacrificing any strength. A modern-looking gray finish and subtly color coded controls set the backdrop for the PM3000's more than 1000 illuminated switches and indicators that give it the look of a NASA control console. All illumination (except VU meters and detachable hooded lamps) is by means of light emitting diodes, so maintenance is greatly reduced.

The highly advanced PM3000, with its many internally switchable functions, is as close to a custom console as you can get... while retaining all the value and reliability of an off-the-shelf Yamaha console. While its numerous internal and front panel functions may at first intimidate the casual console operator, the PM3000 is actually a very straightforward console to use. Anyone who has used the PM2000 should immediately feel comfortable with the PM3000. Take a while to study the panel, read the descriptions in this manual, and you'll find operating this console comes as naturally as any you've encountered. And it's far more flexible than most.

SECTION 2.

Brief operating instructions

2.1 PM3000 FRONT PANEL FEATURES

2.1.1 THE INPUT MODULE

Each input module processes the incoming mic or line level signal from the correspondingly numbered XLR input. Pre-amplification and/or attenuation are available to get optimum channel sensitivity, polarity may be reversed, and phantom power turned on or off. High pass filtering and parametric equalization can be applied, and the signal assigned to the 8 group busses, the stereo bus, the 8 auxiliary busses and the cue bus. VCA Master control of the channel level may be assigned, as well as master muting (remote on/off function). Internal slide switches in the module also permit the aux send "Pre" position to derive signal from two different points in the circuit, and alter the channel insert point to be pre or post equalizer.

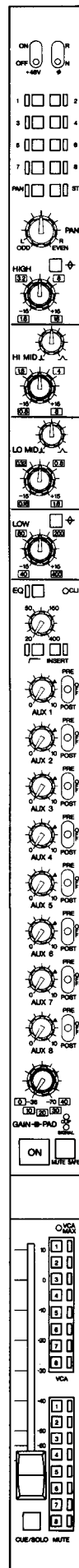
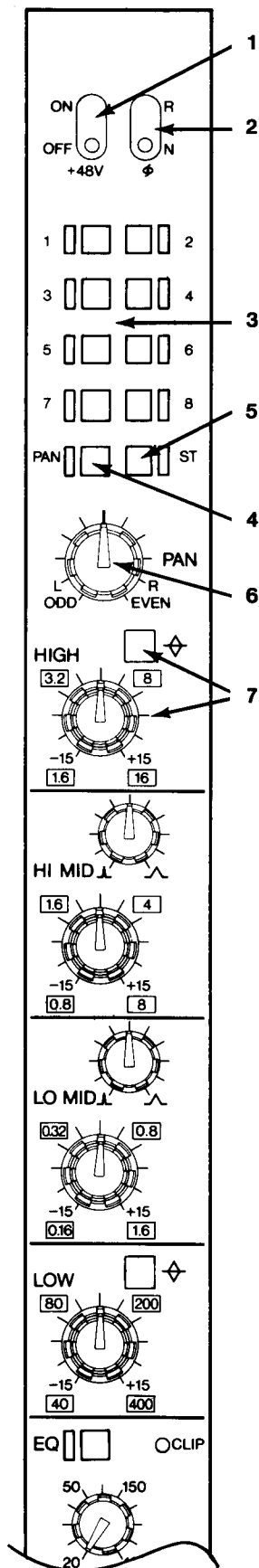

FIGURE 2-1. PM3000 INPUT MODULE.



1. + 48V

This switch turns phantom power on and off at the channel's XLR input connector. Power can be turned on, however, only if the MASTER PHANTOM POWER switch is on.

When both the Master and this switch are on, + 48 volts is applied to both pins 2 & 3 of the channel input XLR connector, via 6.8 kohm isolation/current limiting resistors, for remote powering of condenser microphones. Although phantom power will not harm most dynamic and other non-phantom powered microphones or line-level devices, connection of an unbalanced source to the channel input could partially short the console's phantom supply, cause undue loading, and induce hum. Therefore, it is a good practice to turn off the channel's phantom power unless it is actually in use.

NOTE: The console's microphone power supply is not intended for A-B powered microphones. External supplies may be used with these devices, in which case the console's phantom power should be turned OFF on the appropriate channels. The optional input transformers, if installed, do not affect phantom power operation.

2. ϕ (Phase)

This switch reverses the polarity of pins 2 and 3 of the channel's XLR input connector. In "N" (Normal) position, pin 2 is the signal high conductor, and in "R" (Reverse) position, pin 3 is high. This eliminates the need to rewire connectors or use adapters for out-of-phase (reversed polarity) audio sources. Sometimes intentional polarity reversal can be helpful in canceling leakage from adjacent microphones, or in creating electro-acoustic special effects by mixing together out-of-phase signals from mics picking up the same sound source.

3. 1.2.3.4.5.6.7.8. (Assign)

These locking gray switches assign the channel output to group mixing busses 1 through 8. A green LED adjacent to each switch turns on when the signal is assigned to the bus.

4. PAN (Switch)

This locking white switch activates the PAN pot, which then may be used to position signal between any odd-numbered and even-numbered group mixing busses (provided the corresponding ASSIGN switches are engaged), allowing up to four additional stereo mixes to be created. This switch does not affect panning to the stereo bus, which is under the full-time control of the PAN pot when the ST assign switch is engaged. A yellow LED adjacent to the switch turns on when the PAN switch is engaged.

5. ST (Stereo)

This locking switch assigns the channel output directly to the stereo bus. A green LED adjacent to the switch turns on when the signal is assigned to the stereo bus.

6. PAN L/ODD-R/EVEN (Pot)

This rotary control enables the channel output to be assigned between odd-numbered (counterclockwise rotation) and even-numbered (clockwise rotation) group busses when the nearby PAN switch is engaged. This same control also assigns the channel output between the left (L) and right (R) sides of the stereo mixing bus when the ST assign switch is engaged. A center detent is provided for equal signal assignment to odd/even or left/right busses. Center position does apply 3 dB less signal to each bus than the level obtained with full left or right assignment so that the combined stereo signal adds up to constant power at all PAN pot positions.

(EQUALIZER)

The input channel equalizer is divided into four bands, each with sweepable filter frequencies. The high and low bands may be switched for a peaking or shelving type curve, whereas the high-mid and low-mid bands are of the peaking type with adjustable Q, providing fully parametric type EQ. The level (gain) is adjustable over a range of 15 dB boost and 15 dB cut in each band.

7. HIGH (Peak/Shelf)

This locking switch selects Peaking type EQ (switch engaged) or Shelving type EQ.

1.6 ~ 16 kHz

The outer concentric knob sweeps the EQ Frequency between 1,600 and 16,000 Hz.

+ 15 ~ -15 dB

The inner concentric knob adjusts the Gain of the set frequency band by plus or minus 15 dB. A center detent is provided for unity gain.

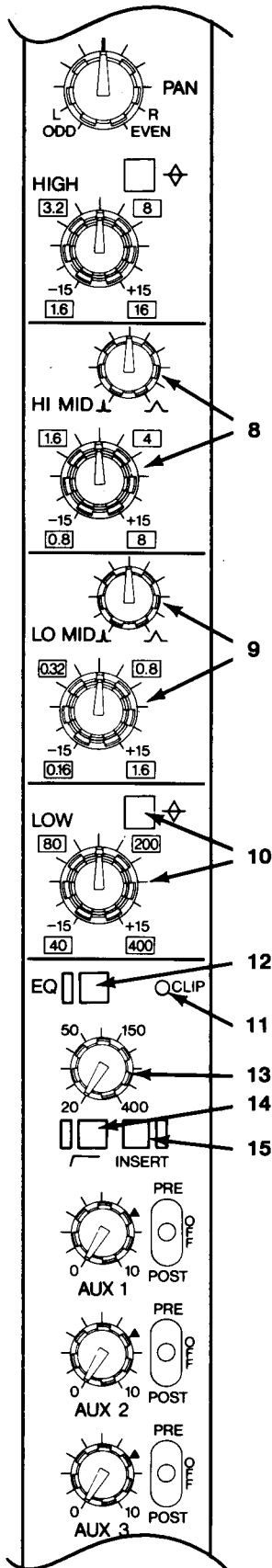

8. HIGH-MID

0.8 ~ 8 kHz

The outer concentric knob sweeps the EQ Frequency between 800 and 8,000 Hz.

+15 ~ -15 dB

The inner concentric knob adjusts the Gain of the set frequency band by plus or minus 15 dB. A center detent is provided for unity gain.

(Peak Curves)

This rotary control adjusts the Q (the bandwidth) of this section of the equalizer from 0.5 (a broad band) to 3 (a narrow band), with a center detent at 1.

9. LOW-MID

0.2 ~ 2 kHz

The outer concentric knob sweeps the EQ Frequency between 200 and 2,000 Hz.

+15 ~ -15 dB

The inner concentric knob adjusts the GAIN of the set frequency band by plus or minus 15 dB. A center detent is provided for unity gain.

(Peak Curves)

This rotary control adjusts the Q (the bandwidth) of this section of the equalizer from 0.5 to 3, with a center detent at 1.

10. LOW

(Peak/Shelf)

This locking switch selects Peaking type EQ (switch engaged) or Shelving type EQ.

40 ~ 400 kHz

The outer concentric knob sweeps the EQ Frequency between 40 and 400 Hz.

+15 ~ -15 dB

The inner concentric knob adjusts the GAIN of the set frequency band by plus or minus 15 dB. A center detent is provided for unity gain.

11. EQ CLIP

This red LED turns on when the post-EQ signal is 3 dB below clipping, warning to decrease the EQ boost and/or to turn down the signal level at the channel input gain stage. Clipping at this stage can occur even though the input signal is not clipping, due to boost (gain) applied with the EQ circuitry.

12. EQ (In/Out switch)

This locking switch activates the channel EQ (switch in, adjacent green LED on) or bypasses it completely. Bypass allows for A-B comparison, and absolutely minimum signal degradation when EQ is not needed.

13. 20 - 400 Hz (H.P. filter)

This rotary control sweeps the cutoff frequency of a high pass filter (low cut) from 20 Hz to 400 Hz. The filter slope is 12 dB/octave. Typical applications including cutting wind noise, vocal "P" pops, stage rumble, and low frequency leakage from adjacent instruments. Higher frequency settings can be used to reduce leakage into mics that are primarily handling high-frequency sources. In general, it is a good practice to use the filter to protect woofers from unnecessary over-excursion due to the presence of unneeded low frequency or sub-sonic components, especially if a microphone is dropped or kicked; the filter should be bypassed (switch up) only when low frequencies are intentionally sought, as with an organ, drum, bass guitar, and so forth.

14. (H.P. filter In/Out switch)

This locking switch activates the input channel HIGH PASS FILTER (switch in, adjacent green LED on) or bypasses it. This filter bypass is independent of the EQ section, which has its own bypass switch.

15. INSERT

This locking switch activates the channel's INSERT IN jack, from which it applies signal to a point just ahead of the filter and EQ.* The INSERT OUT jack is always "live," and this switch does not affect it. The primary use of this switch is to select or de-select any signal processor or independent line input source which may be plugged into INSERT IN. When

* NOTE: An internal preset switch may be altered in each input module so the INSERT IN/OUT point is post-EQ rather than preEQ.

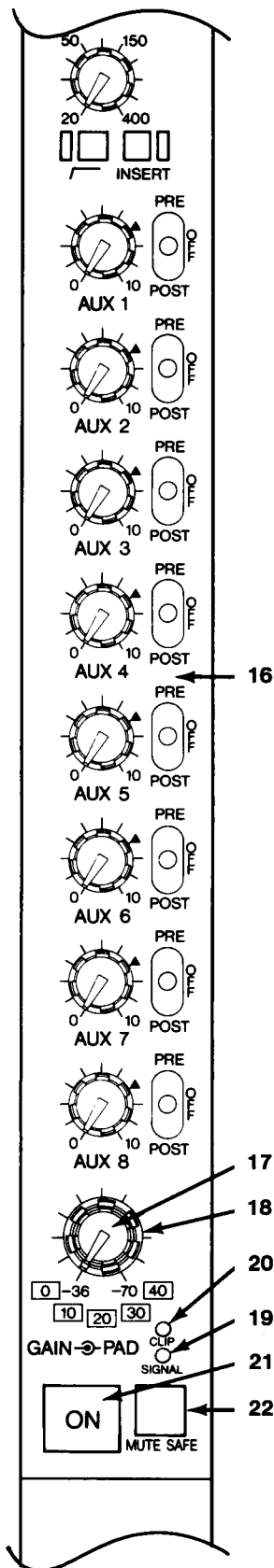

the switch is engaged, an adjacent yellow LED is illuminated.

If there is nothing plugged into the INSERT IN jack, this switch has no effect.

An effects device can be set up before it is needed, its levels adjusted using the always active INSERT OUT signal, and then the device can be inserted on cue in the channel's signal path by pressing this switch.

16. AUX 1 - 8 (Send Level & Pre/Off/Post Switches)

There are 8 rotary AUX send level controls with adjacent PRE/OFF/POST switches. The switch mutes (turns off) the send, or derives signal before (PRE) or after (POST) the channel Fader. The associated rotary control determines how much of the selected signal source is applied to the correspondingly numbered auxiliary mixing bus. When the switch is in the center (OFF) position, no signal is applied to the auxiliary bus.

NOTE: In some applications, it is preferable to have the PRE position be Pre-Fader & Pre-EQ rather than Pre-Fader & Post EQ. The PM3000 is equipped with internal switches that make it easy to change the "Pre" of each AUX send in this manner. This functional modification can be performed on a channel-by-channel basis, and for any or all AUX sends within each channel; Refer to the OPTIONAL FUNCTIONS section of this manual for additional information.

NOTE: All eight aux controls are colored blue, but controls #1-4 have gray pointers whereas controls #5-8 have black pointers. The Aux Master LEVEL controls [53] have similarly color-coded pointers. This is merely to help locate a particular aux send bus, and does not indicate any electronic or functional difference between the eight busses.

17. GAIN

The inner concentric knob provides 34 dB of continuously variable adjustment for the input preamplifier gain.

18. PAD (0, 10, 20, 30, 40)

The outer concentric knob is a 5-position rotary switch that attenuates the signal from the channel's XLR input by 0, 10, 20, 30, or 40 dB. A setting of "40" is therefore least sensitive. The PAD should be used in conjunction with the GAIN control to obtain the precise channel sensitivity necessary for a given source. It is always a good idea to begin with the PAD set to 40 dB position, and to back off from there to avoid any chance of input overdrive.

19. SIGNAL

This green LED is provided to indicate when there is signal present after the channel preamp (either from the XLR or from the INSERT IN jack). The SIGNAL LED turns on when that signal is 10 dB below the nominal level, and should therefore be on most of the time when the channel is in use. If necessary, use a lower PAD value or increase the GAIN setting to ensure the LED is ON; otherwise excess noise or a very small useable range of fader travel will become a problem.

20. CLIP

This red LED is provided to indicate when the signal present after the channel preamp (either from the XLR or from the INSERT IN jack) is too high in level. The SIGNAL LED turns on when that signal is 3 dB below clipping, and should therefore flash on only occasionally. If necessary, use a higher PAD value or decrease the GAIN setting to prevent the LED from remaining on any longer than momentarily; otherwise excessive distortion and insufficient fader travel will result.

21. ON (Channel On)

This locking, yellow, illuminated switch turns on when the input channel is ON, indicating the channel output is available to the stereo bus, the 8 group mixing busses, and the 8 auxiliary mixing busses. Engaging the switch does not necessarily mean the switch will be illuminated or that the channel will turn on; muting logic may be dictating that the channel remain off. When the channel is OFF, its signal may still be previewed with the CUE/SOLO switch [27].

22. MUTE SAFE

This locking switch is illuminated a red color when engaged. When MUTE SAFE is on, it overrides any combination of MASTER MUTE and channel MUTE switch settings, and prevents the channel from being muted. Engaging this switch ensures the channel will always be on so long as the channel ON switch is also engaged.

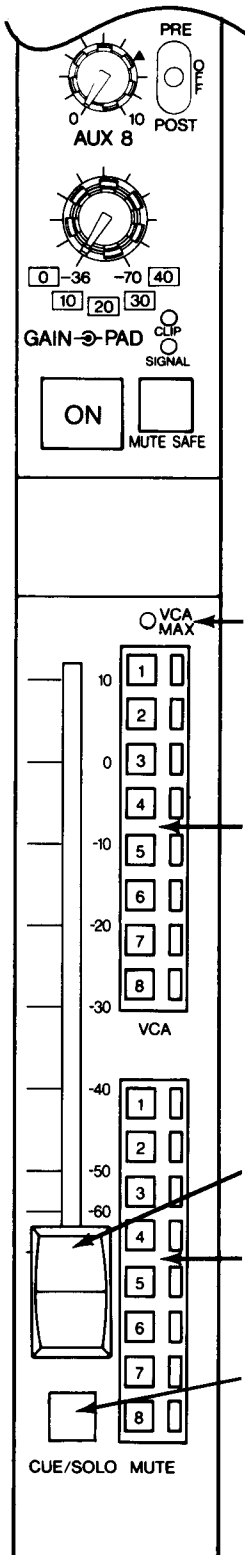

23. FADER

This smooth, long-throw fader sets the level applied to the 8 group mixing busses, and the stereo bus. It also affects any auxiliary feeds which are set to post-fader position. The Fader does not pass audio, but instead controls a VCA through which the audio signal flows. The channel level may, therefore, also be controlled remotely from the 8 VCA MASTER FADERS [52] or the VCA/MUTE CONTROL connector [110] if one or more of the VCA Assign switches [25] is engaged.

24. VCA MAX

This red LED turns on whenever the channel's VCA is commanded to reach its maximum output level. A "+10 dB" setting of the channel Fader, alone, will not trigger the MAX LED. The LED will only turn on if more than one assigned VCA MASTER FADER [52] is at maximum so that the total control voltage affecting the channel's VCA add up to the maximum permissible value. If the LED is on, further increases in Fader setting will produce no further increase in level. (This electronic equivalent of the maximum upward fader travel occurs when the control voltage is 1.2 VDC, corresponding to 24 dB of gain.) For additional VCA information, see the notes accompanying the description of the VCA MASTER FADER [52], and Section 7.2.1.

25. VCA (Assign 1 - 8)

Engaging any of these 8 locking switches enable the corresponding Group VCA MASTER FADER(s) to also control the output level of this channel. When a VCA switch is engaged, the adjacent yellow LED turns on.

CAUTION: If you assign or un-assign an input channel to a VCA MASTER group during a performance, the channel gain will jump up or down unless the corresponding VCA MASTER Fader [52] is set precisely to the nominal position (green LED "NOMINAL" pointer illuminated).

26. MUTE (Assign 1 - 8)

Engaging any of these 8 locking switches enables the corresponding Group MUTE MASTER switch(es) to "kill" this channel. An exception exists when the channel MUTE SAFE switch [22] is engaged, in which case these MUTE switches can have no effect. When a MUTE switch is engaged, the adjacent yellow LED turns on.

27. CUE/SOLO

The function of this switch on each input channel will depend on the setting of the console's Master SOLO MODE switch [59].

If the console is set to the SOLO MODE, then pressing this switch mutes all other input channels, and only the input channel(s) whose CUE/SOLO switch is engaged will feed the console outputs. (This is also known as "solo in place.") Any AUX RETURN signals will not be muted so that effects can be heard in conjunction with the input signal. To silence the AUX RETURNS, turn them off manually.

If the console is set to the CUE MODE, the console then has a dual-priority cue system, designed to give the engineer maximum control and speed when it is most important. In this mode, pressing the channel CUE/SOLO switch causes the channel signal to replace any master signal in the Cue output and the Phones output.

The engineer can readily select any of 26 output mixes (Group 1-8, Matrix 1-8, Aux Send 1-8, or Stereo L & R) by pressing the corresponding CUE switches. In most cases, once the individual output mixes have been established, the engineer will want to listen to the "most important output mix" during the performance, possibly the main house feed or the vocal group. However, should feedback occur, or should any other condition require attention, the PM3000 enables the engineer to instantly check any input channel or channels by pressing their CUE/SOLO switch(es). The input whose CUE switch is engaged then automatically replaces the selected output mix in the headphone and cue outputs. The engineer can make the necessary adjustment, and then return to monitoring the original output mix simply by releasing the input CUE/SOLO switch.

Pressing the yellow illuminated CUE/SOLO switch part-way down causes momentary contact; pressing it further locks it down. Although the cue signal is not affected by the Fader or ON/off switch, it is affected by the Input PAD, GAIN control, Filter, channel EQ, and anything connected between the channel's INSERT IN and OUT jacks (if the INSERT switch is engaged).

NOTE: Since the console operator may normally be listening to the stereo bus or one or more group busses by means of engaging their cue switches, the PM3000 is set up for input cue priority. As soon as one or more input channel cue switches are engaged, any bus cue signal will be replaced by the input cue signal(s). Input priority is also given to other PM3000 inputs (Aux Return cue), not just to the input channel cue signals.

2.1.2 THE AUX RTN A & AUX RTN B MODULES

The upper halves of the AUX RTN A and the AUX RTN B modules are similar, differing only in the actual return numbers; the AUX A module handles the AUX 1 and AUX 3 returns, while the AUX B module handles the AUX 2 and AUX 4 returns. The lower half of the AUX RTN A module has the MASTER MUTE switches which do not appear on the AUX RTN B module.

The following descriptions of one set of Auxiliary Return controls is typical of all four (AUX 1 through AUX 4). Bear in mind that each rear-panel Auxiliary Return input actually consists of two input connectors, L/MONO and R. When a mono signal is applied to an AUX Return, the "L/MONO" input should be used.

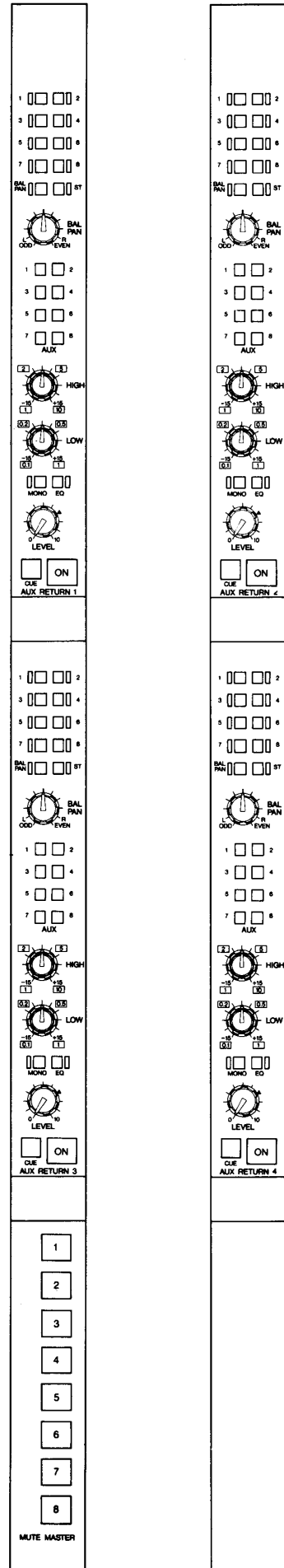
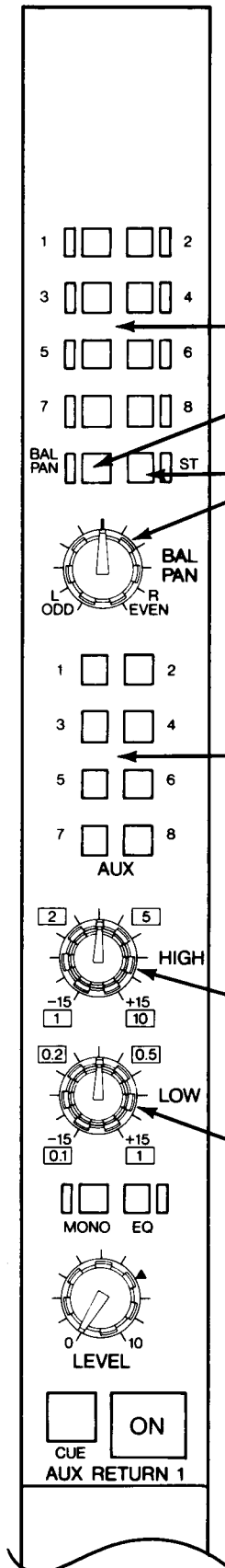

FIGURE 2-2. PM3000 AUX RTN A and AUX RTN B MODULES



28. 1.2.3.4.5.6.7.8. (Group Assign)

These locking switches assign the AUX RTN signal to group mixing busses 1 through 8. A green LED adjacent to each switch turns on when the signal is assigned to the bus.

29. BAL/PAN

This locking switch activates the BAL/PAN control. When the switch is up (not engaged), signal may be assigned fully to the 8 group mixing busses. When it is engaged (adjacent yellow LED on), the BAL/PAN control then affects the level applied to these busses. This switch does not affect panning to the stereo bus, which is under the full-time control of the PAN pot when the ST switch is engaged.

Given a mono auxiliary return (using the L/MONO AUX RTN input), BAL/PAN acts as a PAN pot and can position the return signal between any odd-numbered and even-numbered group mixing busses or between the left and right sides of the stereo bus.

Given a stereo auxiliary return signal, the BAL/PAN control instead functions as a BALANCE control. In this instance, the L input is routed entirely to the left stereo bus and/or the odd-numbered group busses, and the R input goes to the right stereo bus and/or the even-numbered group busses, per any engaged group assign switches. The BAL/PAN control then raises the level to one side while lowering it to the other, and vice versa.

NOTE: An aux return signal applied to an aux send bus is always mono, whether derived from a mono or stereo return.

30. ST (Stereo)

This locking switch assigns the aux return input directly to the stereo bus. A green LED adjacent to the switch turns on when the signal is assigned to the stereo bus.

31. BAL/PAN

This rotary control enables a mono auxiliary return to be panned, or a stereo return to be balanced in level. See the description of the BAL/PAN switch [29].

32. AUX 1 - 8 (Assign)

These 8 locking switches assign the aux return signal directly to the correspondingly numbered auxiliary mixing busses. If the return is stereo, it will be combined to mono so that both sides of the return are applied to any of the assigned aux busses.

CAUTION: DO NOT assign a return to the same auxiliary bus whose output is feeding a signal processor which is providing the return signal. This will almost certainly cause feedback which can damage circuits and/or loudspeakers.

(AUX RETURN EQ)

Each of the four auxiliary returns has an equalizer, divided into two bands. The equalization is of the shelving type, and each of the two bands has a sweepable "knee" frequency. This equalizer is actually a stereo EQ, with both channels "gang" controlled so that the same processing is applied to both sides of a stereo return. A gain control in each band provides 15 dB of boost or cut.

**33. HIGH
1.0 ~ 10 kHz**

The outer concentric knob sweeps the EQ FREQUENCY between 1,000 and 10,000 Hz. Shelving type EQ occurs above this 3 dB point.

+ 15 ~ -15 dB
The inner concentric knob adjusts the GAIN of the set frequency band by plus or minus 15 dB. A center detent is provided for unity gain.

**34. LOW
0.1 ~ 1 kHz**

The outer concentric knob sweeps the EQ FREQUENCY between 100 and 1,000 Hz. Shelving type EQ occurs below this 3 dB point.

+ 15 ~ -15 dB
The inner concentric knob adjusts the GAIN of the set frequency band by plus or minus 15 dB. A center detent is provided for unity gain.

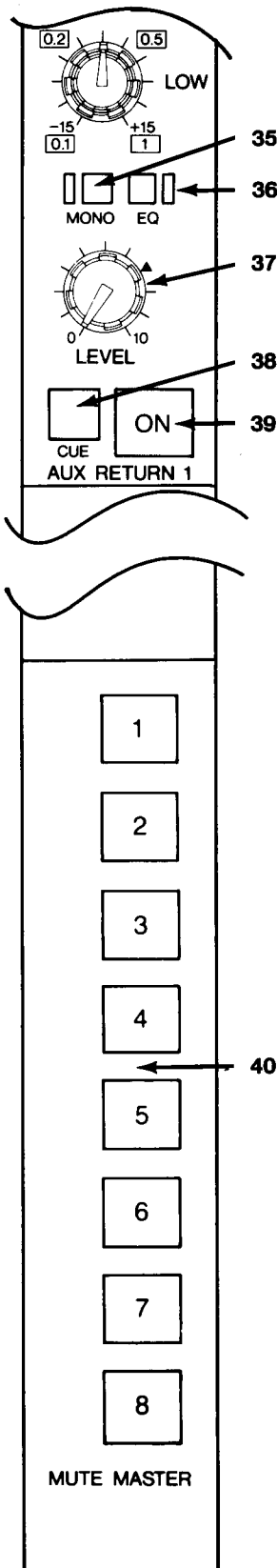

35. MONO

Pressing this locking switch activates L/MONO aux input as the sole signal input to this AUX section. When the MONO mode is engaged, an adjacent yellow LED turns on. For stereo aux returns, do not engage this switch.

36. EQ (In/Out switch)

This locking switch activates the aux return EQ (switch in, adjacent green LED on) or bypasses it completely. Bypass allows for A-B comparison, and absolutely minimum signal degradation when EQ is not needed. It also permits EQ to be selected (cue'd) instantaneously.

37. LEVEL

This rotary control sets incoming AUX level applied to any of the assigned group, stereo, or auxiliary mixing busses. It is a 2-ganged control, simultaneously adjusting the L/MONO and R aux returns.

38. CUE

Pressing this yellow illuminated switch part-way down causes momentary contact; pressing it further locks it down.

When the console is in cue mode (refer to SOLO switch [59]), and this CUE switch is engaged (illuminated), the aux return signal replaces any master signal in the Cue output and the Phones output. The Cue signal is stereo if a stereo return is used; when the MONO switch [35] is engaged, then a mono cue signal is derived from the L/MONO aux input.

NOTE: As noted under the input channel cue switch description, the PM3000 exhibits input priority cue logic. Since AUX IN is an input, it too receives priority. This means that the aux return cue, when selected, will replace any other group or stereo bus cue signals.

When the console is in solo mode (again, refer to SOLO switch [59]), this CUE switch functions similarly, but not the same as, the input channel CUE/SOLO switches. Engaging it will mute all input channels (unless their CUE/SOLO switches are engaged), but will not mute the other aux returns; to mute other returns, disengage their ON/off switches.

39. ON (Aux Return On)

This locking, yellow, illuminated switch turns ON when the aux return is ON, indicating the aux return signal is available to the stereo bus, the 8 group mixing busses, and the 8 auxiliary mixing busses. When the return is OFF, its signal may still be previewed with the adjacent CUE switch [38].

(MUTE MASTER SECTION, AUX RTN A MODULE ONLY)

40. MUTE MASTER 1 - 8

Engaging any of these locking, yellow illuminated switches mutes (turns off) any input channel(s) whose correspondingly numbered MUTE switch is engaged. An input channel will not be muted, however, if its MUTE SAFE switch is engaged.

2.1.3 THE MASTER MODULES (1 - 8)

These eight modules are identical, except that each controls a differently-numbered set of Group Master, VCA Master and Matrix Output channels.

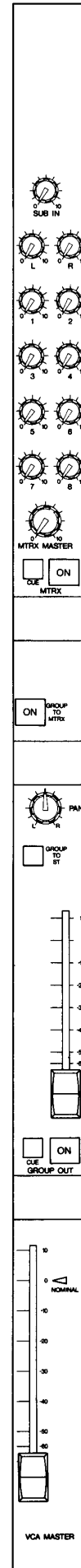
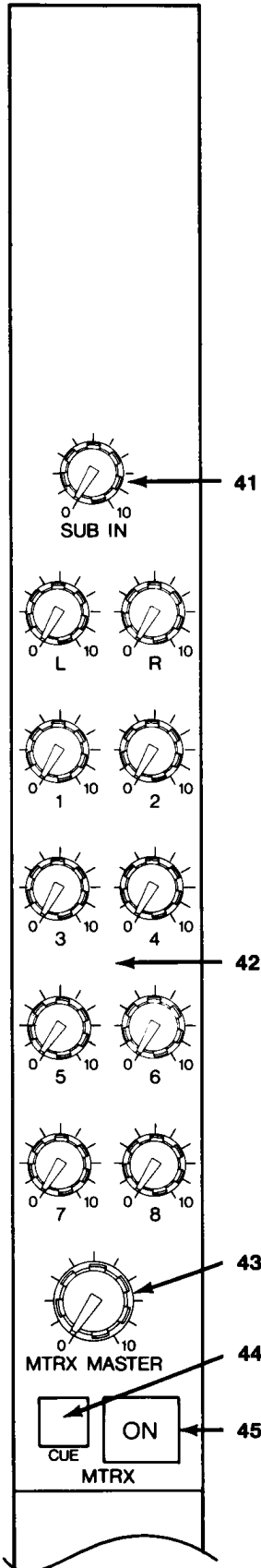

FIGURE 2-3. PM3000 MASTER MODULE.



(MATRIX SECTION)

41. SUB IN

This rotary control adjusts the level of the signal from the MTRX SUB IN connector applied to the module's MTRX OUT. MTRX SUB IN 1 is applied only to MTRX OUT 1, MTRX SUB IN 2 to MTRX OUT 2, and so forth.

42. L.R. 1.2.3.4.5.6.7.8. (Matrix Mix Level Controls)

These 10 rotary controls adjust the level of signal from the correspondingly numbered group or stereo busses applied to the module's MTRX OUT.

43. MTRX MASTER

The Matrix Mix level controls (L,R, 1, 2, 3, 4, 5, 6, 7, 8) permit a mono mix to be derived from the eight group busses and the stereo bus, while the SUB IN control adds an additional signal to the mix. The MTRX MASTER control then sets the overall level of this 11:1 mix just before it is routed to the matrix output connector.

44. CUE (Matrix Cue)

Pressing this yellow illuminated switch part-way down causes momentary contact; pressing it further locks it down. When the CUE switch is illuminated, the module's matrix mix signal (pre MTRX MASTER) replaces any other signal in the Cue output and the Phones output unless an input CUE switch is engaged. (Bus cue signals are overridden by input cue.) The MTRX CUE signal is Mono, regardless of how many matrix channels are cue'd.

45. ON (Matrix On)

This locking, yellow, illuminated switch turns on when the MTRX OUT is ON. When the MTRX OUT is turned OFF, its signal may still be previewed with the adjacent CUE switch [44].

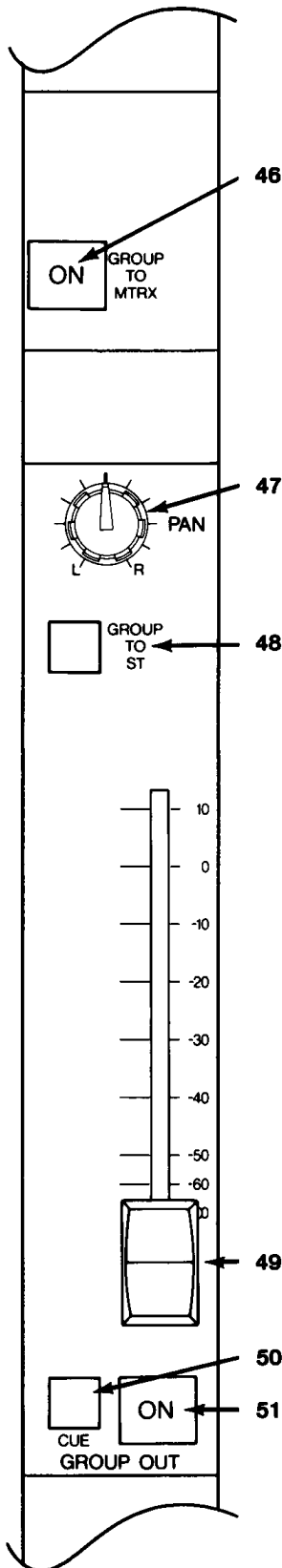

(GROUP SECTION)

46. GROUP-TO-MTRX

Engaging this locking switch assigns signal from the module's GROUP OUT (ahead of the Group ON switch) to the correspondingly numbered matrix rotary control. The switch is illuminated yellow when the group signal is assigned to the matrix.

NOTE: The signal is assigned to the matrix by a preset switch within each of the master modules. As shipped, the group feed to the matrix comes after the Group Fader; a switch may be moved within each master module to obtain a pre-Group Fader feed to the matrix. Refer to Section 6.5 for more information on this optional preset switch function.

47. PAN

This pan control is operational only when the adjacent ST (stereo) switch is engaged. It then pans the group signal (pre-group fader) between the left and right sides of the stereo mixing bus.

48. GROUP-TO-ST

Engaging this locking, yellow illuminated switch assigns the group bus output to the stereo bus via the adjacent PAN control. When the switch is not engaged (not illuminated), the group signal is not applied to the stereo bus.

49. (Group Out Fader)

This fader controls the audio signal level from the group mixing bus which is applied to the GROUP OUT. This is an audio fader which controls the actual mixed audio signal, not a VCA controller.

50. CUE (Group Cue)

Pressing this yellow illuminated switch part-way down causes momentary contact; pressing it further locks it down. When the CUE switch is illuminated, the module's GROUP OUT signal (pre Group Fader) replaces any master signal in the Cue output and the Phones output unless an input CUE switch is engaged. (Bus cue signals are overridden by input cue.) The Group cue signal is mono, regardless of how many groups are cue'd.

51. ON (Group On)

This locking, yellow, illuminated switch turns on when the GROUP OUT is ON. When the GROUP OUT is turned off, its signal may still be previewed with the adjacent CUE switch [50]. This switch does not affect the group output to the matrix or the stereo bus.

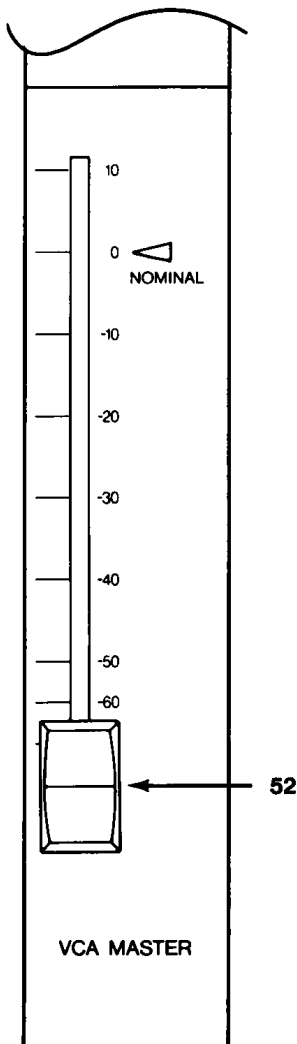

52. VCA MASTER

This fader applies a DC control voltage to any input channels whose correspondingly-numbered VCA assign switch is engaged. Raising or lowering this fader will raise or lower the output level from those assigned input modules. The end result can be similar to using a group fader, except that audio is not going through this fader. Because the VCA MASTER is controlling the output level of each assigned input channel, it affects any post-fader auxiliary sends from that channel, as well as the channel's output to the eight group mixing buses and to the stereo mixing bus.

NOTE: VCA MASTER faders apply DC voltage to one or more assigned input channels. The voltage applied to the VCA (voltage controlled amplifier) in a given input module will be the sum of the voltages from that module's channel fader, plus any assigned VCA MASTER faders. The higher the voltage, the greater the gain through the channel. VCA gain structure is calculated so that when a VCA MASTER Fader is set so its NOMINAL LED is on, then that Fader has no affect on any input channel levels. The VCA MASTER faders should be set to NOMINAL position when not in use so that if an input is subsequently assigned to a VCA, there will be no sudden change in channel level due to an added (or subtracted) control voltage.

Here are some additional VCA details:

If a channel Fader is set at 0 dB, and it is assigned to a VCA Master that is set at -10 dB, then the channel level will be -10 dB ($0 + (-10) = -10$).

If the channel Fader is set at -10 dB, and is assigned to two VCA Masters, each set at -10 dB, then the channel level will be -30 dB ($-10 + (-10) + (-10) = -30$).

If the channel Fader is set at +10 dB, and is assigned to two VCA Masters, one of which is set at +10 dB, and the other at -20 dB, then the channel level will be 0 dB ($+10 + (+10) + (-20) = 0$).

When an input Fader or an assigned VCA MASTER Fader is pulled all the way down to "infinite" attenuation position, the voltage is sensed in the input module. The channel ON lamp will remain active, however, indicating that any pre-fader channel outputs are still "live."

If the console is set to the "SLAVE" rather than the "MASTER" mode with the rear-panel VCA SLAVE/MASTER switch [111], then the console's VCA MASTER Faders will have no effect. Instead, any DC control signals applied to the VCA/MUTE CONTROL connector [110] will affect correspondingly assigned input channels.

2.1.4 THE AUX/ST MODULE & THE AUX MODULE

These two modules contain master send sections for all eight auxiliary busses, arranged in four sections per module. We have described just one of the eight clusters of auxiliary LEVEL, CUE and ON functions, since all are identical. The AUX/ST module also contains the STEREO MASTER Fader.

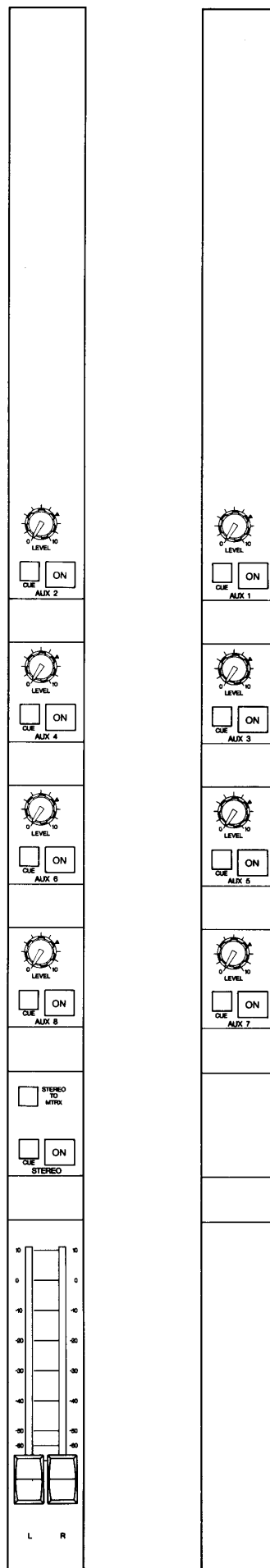
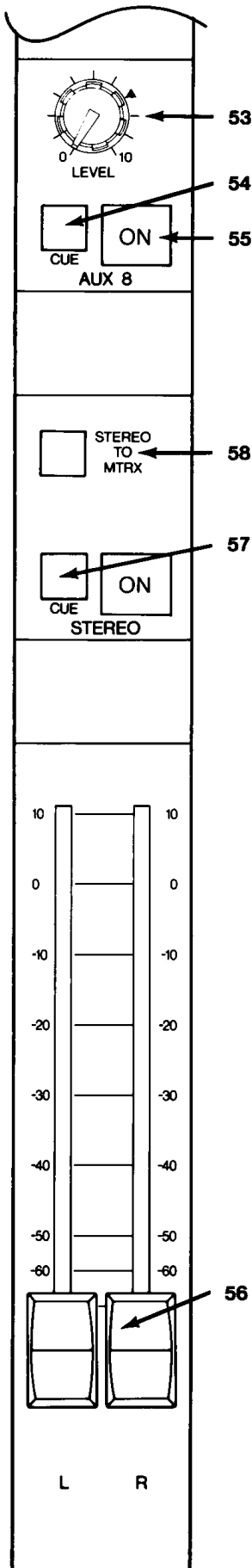

FIGURE 2-4. PM3000 AUX/ST AND AUX MODULES.



(AUX 1 MASTER CONTROLS, TYPICAL OF AUX 1 - AUX 8)

53. LEVEL

This rotary control adjusts the overall level from the correspondingly numbered auxiliary mixing bus to the AUX OUT connector.

54. CUE (Aux Send Cue)

Pressing this yellow illuminated switch part-way down causes momentary contact; pressing it further locks it down. When the CUE switch is illuminated, the correspondingly numbered auxiliary send replaces any master cue signal in the Cue output and the Phones output unless an input CUE switch is engaged. (Bus cue signals are overridden by input cue.) The aux cue signal is mono, regardless of how many aux sends are cue'd.

55. ON (Auxiliary On)

This locking, yellow, illuminated switch turns on when the AUX OUT is ON. When the AUX OUT is turned off, its signal may still be previewed with the adjacent CUE switch [54].



(STEREO MASTER SECTION)

56. (Dual Fader)

This pair of closely-spaced faders adjusts the level applied from the stereo mixing bus to the stereo output connectors. The Fader knobs are located immediately next to each other so both can be operated in unison with a single finger. At the same time, the two (Left and Right) knobs may be offset somewhat and still operated together, or they can be operated completely independently if, for example, the stereo bus is used for two discrete mono mixes.

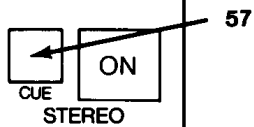

57. CUE (Stereo Cue)

Pressing this yellow illuminated switch part-way down causes momentary contact; pressing it further locks it down. When the CUE switch is illuminated, the correspondingly numbered auxiliary send replaces any other signal in the Cue output and the Phones output unless an input CUE switch is engaged. (Bus cue signals are overridden by input cue.) This switch provides the headphones with a stereo cue signal.

58. STEREO-TO-MTRX

Engaging this locking switch assigns signal from the Stereo Output (ahead of the Stereo ON switch) to the L and R rotary mix controls in the matrix. The switch is illuminated in yellow when the stereo signal is assigned to the matrix.

NOTE: The signal is routed to the matrix via an internal switch in the AUX/ST module. The switch is preset so the feed to the matrix comes after the Stereo Master Fader; the switch may be moved to obtain a pre-Stereo Master Fader feed. Refer to Section 6.4 for more information on this optional function.

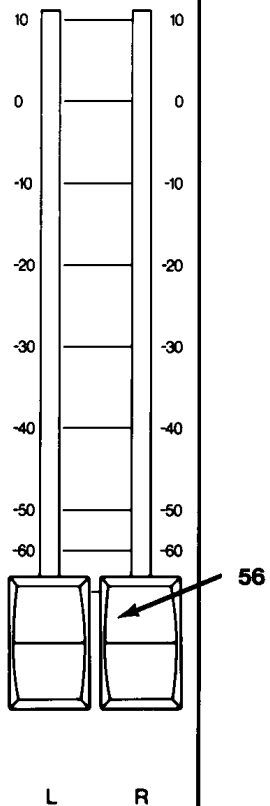

2.1.5 THE TB/COMM MODULE

This module contains an oscillator for testing and calibration, a talkback section for slating and communication, and a unique communications feature. It also contains the master SOLO mode switch, CUE/SOLO/COMM annunciator LEDs, and headphone jacks.

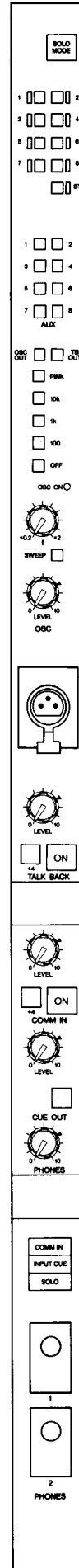
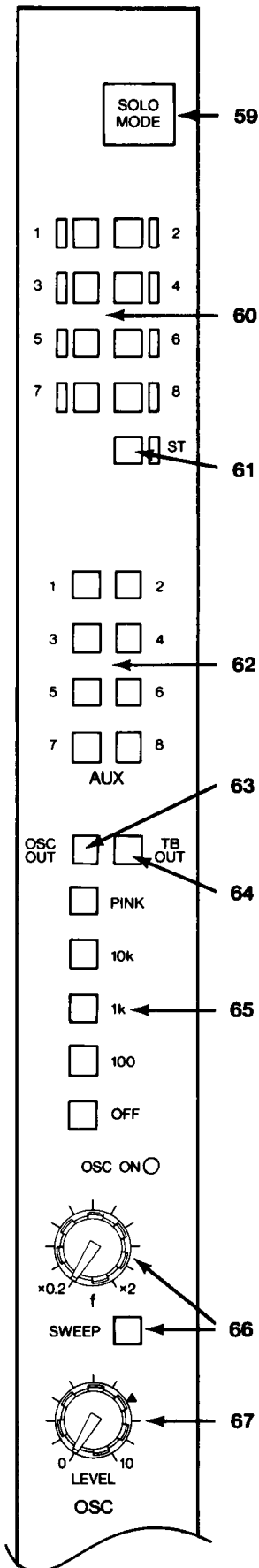

FIGURE 2-5. PM3000 TB/COMM MODULE.



59. SOLO MODE

This locking, red, illuminated switch flashes when engaged, indicating the console monitor system is set to the SOLO mode. In this mode, input channel CUE/SOLO switches mute all other channels, much like a recording console SOLO function. This mode is useful during setup and sound check for a live show.

When the console is in SOLO mode, the aux return CUE switches have a solo function, but it is not quite like the input channel solo function. Pressing an aux return CUE switch in SOLO mode will mute all input channels (except those whose CUE/SOLO switch is engaged), and the soloed aux return will be heard, but so, too, will all other aux returns. (To silence the other returns, turn them off by disengaging their ON/off switches.)

The normal mode of operation during a show, CUE mode, is entered by releasing this switch; in this mode, input CUE/SOLO switches do not mute other channels, but merely replace the signal which appears in the Phones output.

CAUTION: Be sure to disengage the solo mode, and confirm the console is in the cue mode, prior to the beginning of a performance. Otherwise pressing any input channel CUE/SOLO switch will mute all other channels.

60. 1.2.3.4.5.6.7.8. (Group Mixing Bus Assign)

These locking switches assign the Talkback or oscillator signal to group mixing busses 1 through 8. A green LED adjacent to each switch turns on when the signal is assigned to the bus.

61. ST (Stereo)

This locking switch assigns the TB/OSC output directly to stereo mixing buss. A green LED adjacent to the switch turns on when the signal is assigned to the stereo bus.

62. AUX 1 - 8 (Assign)

These eight locking switches assign the TB/OSC signal directly to the correspondingly numbered auxiliary mixing busses.

63. OSC OUT

This locking switch turns the OSC OUT connector on and off. It affects only the output of the oscillator that appears at this connector, and does not affect any oscillator signal which may be switch-assigned to group mixing busses 1-8, the stereo bus or the eight busses.

64. TB OUT

This locking switch turns the TB OUT connector on and off. It affects only the output of the talkback system which appears at the TB OUT connector (the output being derived from the TB input when the TALKBACK ON switch is pressed, or otherwise from the oscillator). This switch does not affect any TB/OSC signal which may be switch-assigned to group mixing busses 1-8, the stereo bus or the eight aux mixing busses.

65. PINK.10K.1K.100.OFF

These 5 interlocking switches set the oscillator to 100 Hz, 1 kHz or 10 kHz operation when the nearby SWEEP switch is in fixed frequency position (disengaged). They also permit selection of a pink noise source, or turn off the oscillator/noise source altogether.

NOTE: To prevent any possible leakage into mixing busses, the oscillator should be shut OFF when not actually in use. A red LED warns when the oscillator is on.

66. SWEEP (Uncal)

Engaging this switch removes the oscillator from its fixed frequency mode (i.e., generating exactly 100 Hz, 1 kHz or 10 kHz). The nearby rotary control then may be used to adjust the oscillator output from approximately 0.2 to 2 times the set "fixed" frequency.

67. OSC LEVEL

This rotary control adjusts the oscillator output level applied to the OSC OUT connector as well as any mixing busses to which the signal may be assigned. This control does not affect the Talkback level.

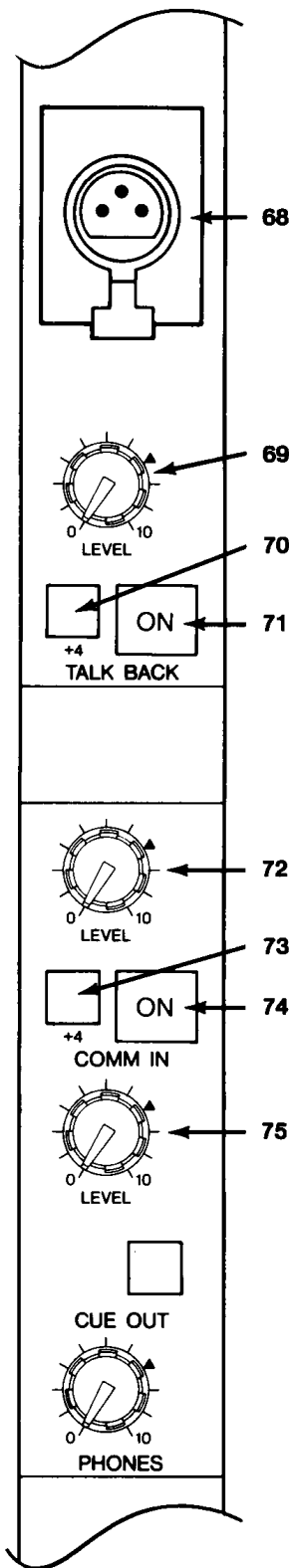

68. (TB INPUT)

This XLR-3 connector accepts a low-Z microphone or a line level signal, depending on the settings of the controls below it. This input is NOT phantom powered. Signal from this input is assigned to the TB OUT connector and to the various mixing busses by means of the assignment switches in the upper portion of this module [60], [61], [62], [64].

69. LEVEL (TB Input)

This rotary control adjusts the signal level after the talkback preamplifier, thereby affecting the sensitivity of the TB input whether it is set for a mic or line source. This control affects the TB level applied to any busses and to the TB OUT connector; it does not affect the oscillator level in any way.

70. +4 (Pad)

This locking, red illuminated switch inserts a 54 dB pad after XLR talkback input (switch illuminated = pad inserted). The pad decreases the sensitivity of that input from nominal -50 dBu (for a microphone) to +4 dBu (for a line level input).

71. TALKBACK ON

Pressing this yellow illuminated switch part-way down causes momentary contact; pressing it further locks it down. The switch activates the XLR talkback input and applies signal from that input to any assigned busses (and to the TB OUT connector if the TB OUT switch is also on). When the TALKBACK ON switch is off (not illuminated), the oscillator output is instead routed to those busses (and to the TB OUT connector). This switch does not, however, affect the OSC OUT connector.

(COMM IN)

A rear-panel COMM IN (Communications Input) [108] connector enables almost any intercom system to be used to communicate with the PM3000 console operator; or the stage manager's mic can be plugged in. When an audio signal is applied to this input, and the controls on this module (described below) are appropriately set, then the COMM IN light will turn on. Pressing the COMM IN ON switch then replaces any signal in the PHONES and CUE OUT with the COMM IN signal.

The COMM IN may also be used in conjunction with the TB out from a stage monitor mixing console, another audio mixing console, or with a signal from a stage manager's mic (+4 switch [73] not engaged so that COMM IN is set for mic level sensitivity). In any of these instances, someone talking at a remote location can visually signal the PM3000 operator merely by speaking, and can then be heard if the PM3000 operator engages the COMM IN ON switch [74].

72. LEVEL (COMM IN Level)

This rotary control adjusts the signal level after the COMM IN preamplifier, thereby affecting the sensitivity of the COMM input, whether it is set for a mic or line source. This control affects the COMM level applied to the Phones output and to the Cue output, which are the only points to which COMM IN signal may be applied.

73. +4 (Pad)

This locking, red illuminated switch inserts a 54 dB pad after COMM IN XLR input (switch illuminated = pad inserted). The pad decreases the sensitivity of that input from nominal -50 dBu (for mic level) to +4 dBu (for line level).

74. COMM IN ON

Pressing this yellow illuminated switch replaces any CUE signal in the CUE OUTPUT with the COMM IN signal. It also interrupts the PHONES output and replaces it with the COMM IN signal.

75. LEVEL (Cue Out)

This rotary, 2-gang (stereo) control adjusts the output level applied to the CUE OUT L & R connectors. It does not affect any cue signal which may be applied to the PHONE outputs.

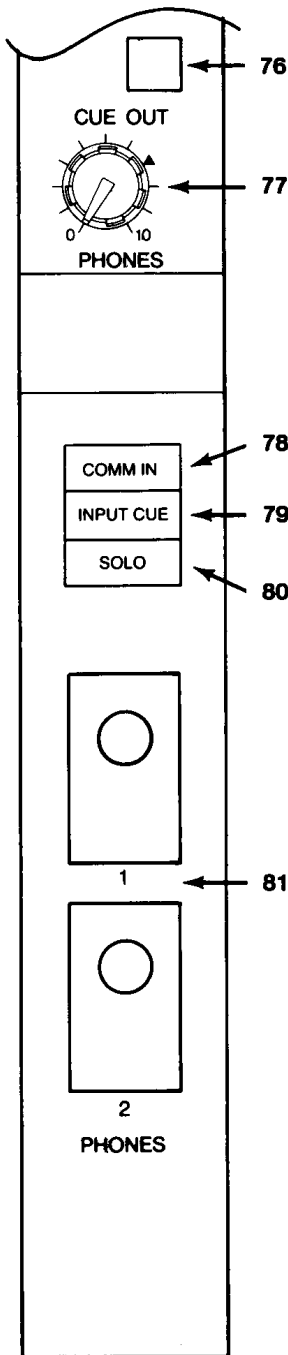

76. CUE OUT (ON/off switch)

Engaging this yellow, illuminated switch turns on the CUE OUT L & R connectors. This switch does not affect the PHONES outputs.

77. PHONES (Level control)

This 2-gang rotary control adjust the output level at both stereo PHONES output jacks. It affects any signals which may be fed to these outputs.

(LED ANNUNCIATORS)

78. COMM IN

This LED flashes green in response to almost any level signal appearing at the COMM input. (It will not respond to a low microphone level signal if the "+ 4" comm input pad is engaged.) This signals the console operator that someone may be attempting to communicate so that the COMM IN ON switch can be engaged.

79. INPUT CUE

This yellow LED turns on when any input channel's CUE/SOLO switch or any AUX RETURN CUE switch is engaged, indicating the console is subject to input cue priority. This is an indication that the signal in the headphones output is being derived from one or more inputs via the cue system. The indicator operates the same whether the console is in cue or solo mode.

80. SOLO

This LED flashes red if the console is in the SOLO mode. This serves as an urgent warning that if any input CUE/SOLO switch (or aux return CUE switch) is depressed, that all input channels will be muted except the soloed channel(s).

CAUTION: If this LED is flashing during a performance, **DO NOT** press any input CUE/SOLO or aux return CUE switch. Instead, disengage the SOLO MODE switch [59]. This will prevent program interruption when attempting to cue an input.

81. PHONES (1, 2)

This pair of 1/4" (6.33mm) stereo phone jacks can accommodate two pair of standard 8-ohm or higher impedance stereo headphones. The jacks are recessed behind a spring-loaded cover panel which excludes dust when the jacks are not in use. The jacks are also angled to minimize strain on the cable and connector.

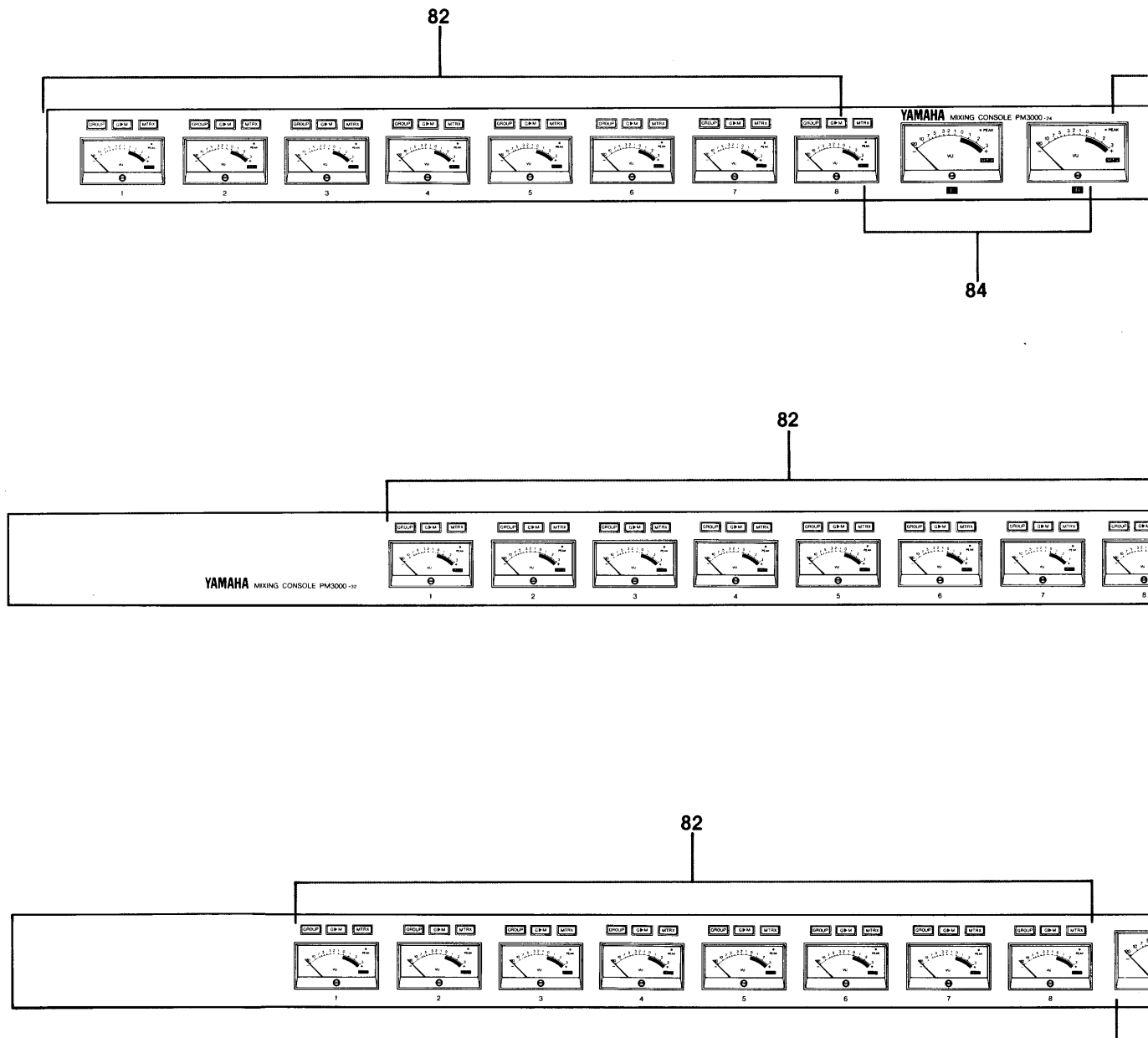
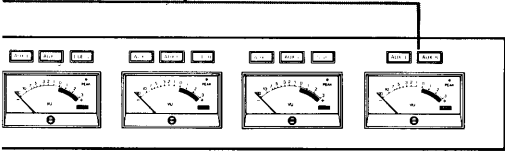

FIGURE 2-6. PM3000 METER BRIDGE.

83



PM3000-24

83

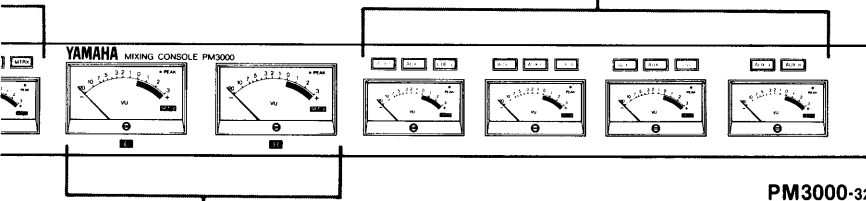

PM3000-32

84

83

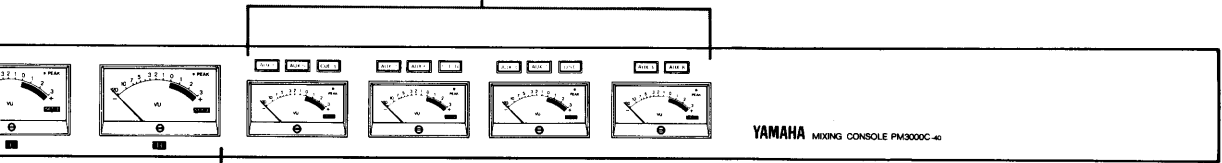

PM3000C-40

84

2.1.6 THE METER BRIDGE

The PM3000 is equipped with 14 large, illuminated VU meters. Each meter has true VU ballistics to indicate approximate loudness, plus a red "PEAK" LED which responds to instantaneous levels that are beyond the scale of the meter. The PEAK LED turns on 10 dB below the clipping point. Assuming the meter is monitoring an output with +24 dBm maximum output capability, the PEAK LED will turn on when the instantaneous level reaches +14 dBm. Since the standard VU meter scale goes only to +3 VU (which is +7 dBm), the PEAK LED turns on when the level is 7 dB above maximum meter scale. Bear in mind, however, that a brief transient that may cause the PEAK LED to flash on may be too fast for the meter needle to respond. It is not unusual with plucked or percussive instruments, for example, for the peak level to be 20 to 30 dB above the average level.

Most of the meters are switchable so they can monitor two or three possible signal sources. When one of the interlocking switches is engaged, an LED in the switch turns on to visually confirm the signal being monitored.

82. GROUP* G▷M* MTRX* (* numbered 1 through 8)

These eight meters monitor the correspondingly numbered GROUP OUT (after the GROUP ON/off switch**), or, in G▷M mode the feed to the matrix after the GROUP-TO-MTRX switch, or the output from the correspondingly numbered MTRX ON switch.

***NOTE: The actual signal monitored with these meters set to GROUP mode can be changed by means of internal preset slide switches. As shipped, the signal is derived after the GROUP MASTER Fader and GROUP OUT ON/off switch. The meter feed can be internally switched to be derived from a point just before the GROUP OUT ON/off switch, or from a point just after the GROUP-TO-STEREO switch (both post GROUP MASTER Fader). Refer to the OPTIONAL FUNCTIONS section of this manual.*

83. AUX 1/AUX 5/CUE L AUX 2/AUX 6/CUE R AUX 3/AUX 7/OSC AUX 4/AUX 8

These four meters monitor the correspondingly numbered AUX SEND outputs. In addition, the first two meters can be switched to monitor the CUE Left and Right output levels, and the third meter the OSCILLATOR output level.

84. STEREO (L & R)

These two larger meters monitor the left and right sides of the STEREO OUTPUTS.

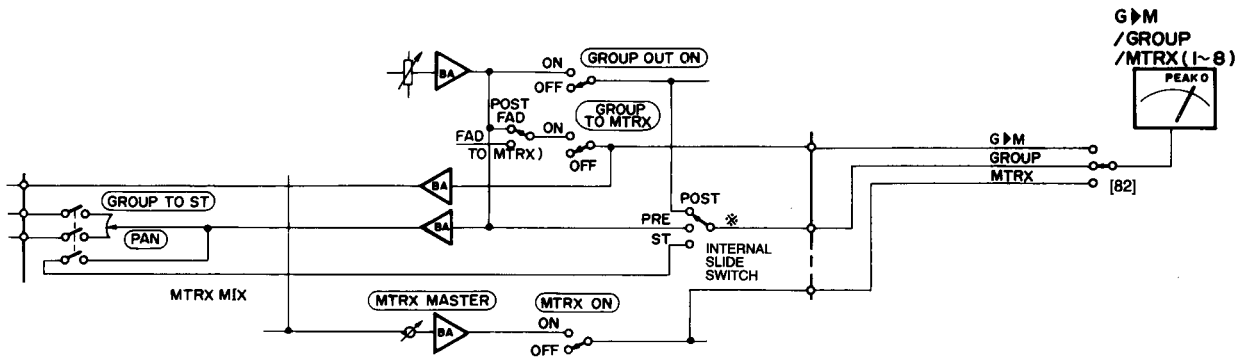

FIGURE 2-7. Signal pick-off points for those VU meters that display Group, Group-to-matrix, or Matrix Levels.

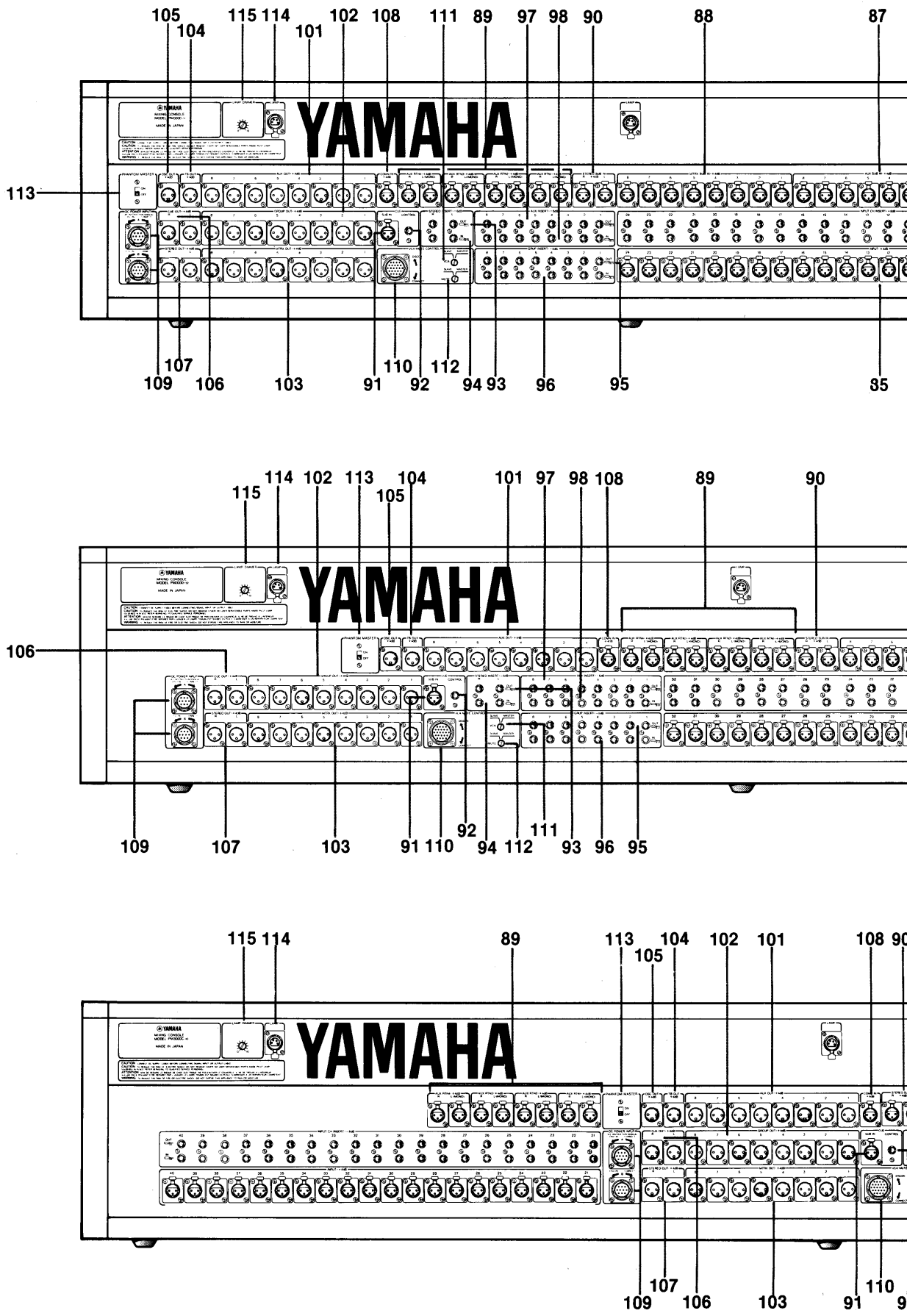
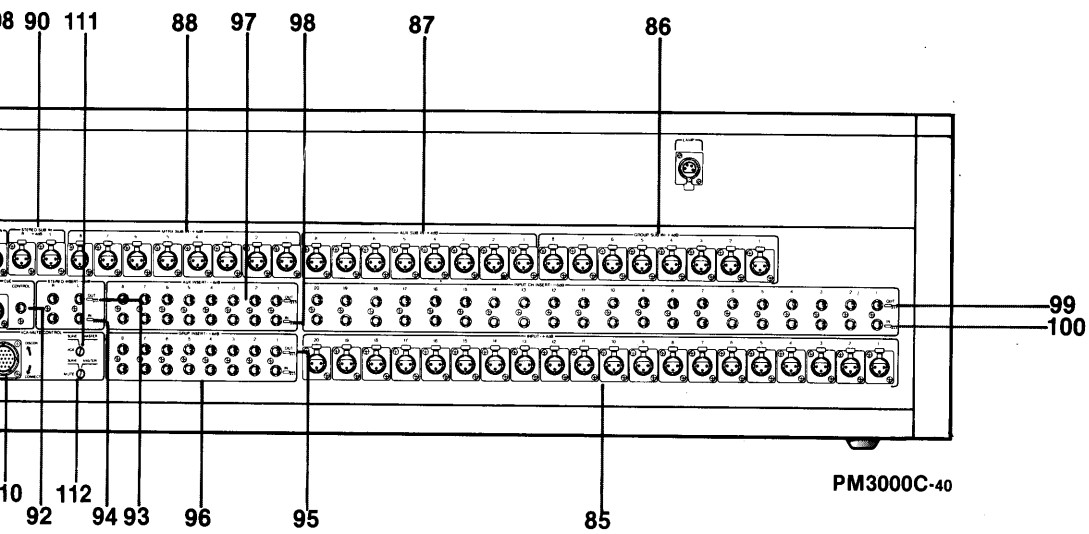
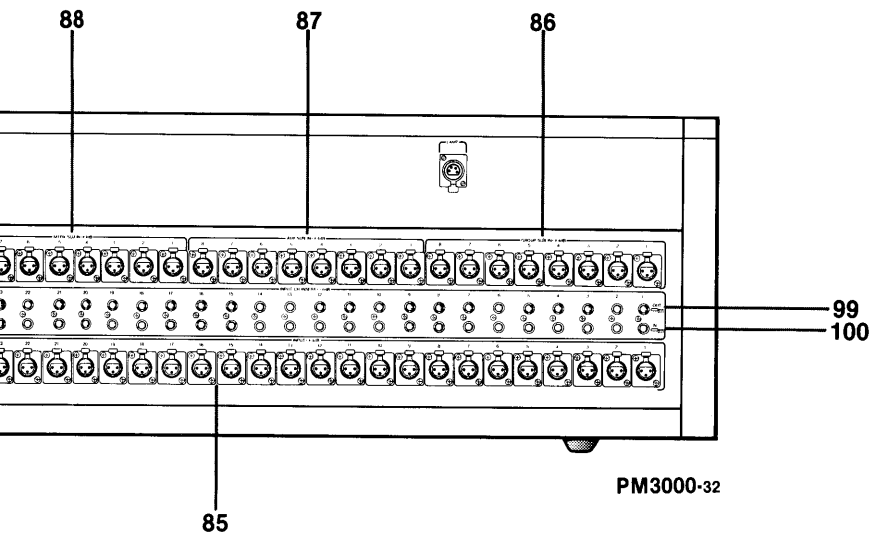
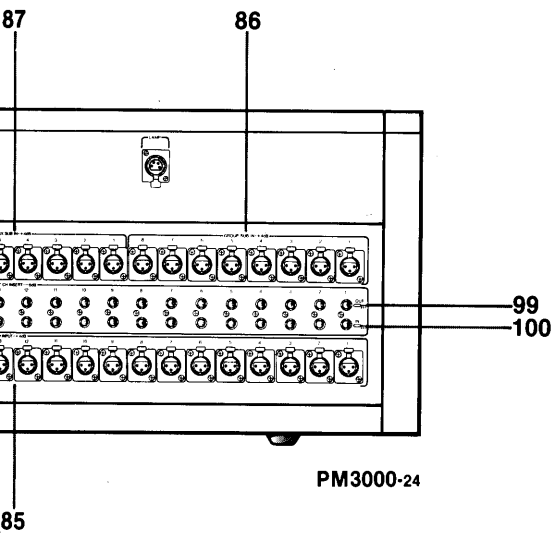

FIGURE 2-8. PM3000 REAR PANEL



2.2 PM3000 REAR PANEL FEATURES

All output XLR connectors are balanced, XLR-3 type, nominal +4 dBu level unless otherwise noted. INSERT IN/OUT jacks are wired in a "normalised" configuration such that as long as the IN jack is not used, the OUT jack is internally wired to it for signal continuity. The OUT jack may be used as a direct output without interrupting signal flow through the console. INSERT OUTs are unbalanced, whereas INSERT INs accept balanced or unbalanced sources.

Input channel XLRs are electronically balanced, as supplied. Optional input isolation transformers may be installed on a module-by-module basis; refer to Section 6.7. Output XLRs are also electronically balanced. Optional output isolation transformers are available in an external 19-inch rack mount package housing eight transformers. In this way, inputs and outputs can be provided with extra grounding isolation and common mode rejection where required, but one need not pay the price in direct costs, weight or signal quality where the transformers are not needed.

85. INPUT (1 - 24, 1 - 32, or 1 - 40)

These 24, 32 or 40 female XLR connectors apply signal to the correspondingly numbered input modules. The nominal input level may vary from -70 dBu to +4 dBu depending on the settings of the individual input GAIN controls and PAD switches.

86. GROUP SUB IN (1 - 8)

These eight female XLR connectors apply signal directly to the group mixing busses (ahead of the Group Master Faders). They are used for "chaining" another mixing console's group outputs into this console, with this console serving as the master for both consoles.

87. AUX SUB IN (1 - 8)

These eight female XLR connectors apply signal directly to the auxiliary mixing busses (ahead of the rotary Aux Master controls). They are used for "chaining" another mixing console's aux send outputs into this console, with this console serving as the master for both consoles.

88. MTRX SUB IN (1 - 8)

These eight female XLR connectors apply signal directly to the correspondingly numbered MTRX SUB IN controls [41]. These inputs can be used to apply effects return signals to individual matrix channels, to apply remote signals to the matrix, or to "Y" connect one or more aux send busses to the matrix for in order to create additional groups. MTRX SUB IN also may be used for "chaining" another mixing console's matrix outputs into this console, with this console's MTRX MASTERS serving as the masters for both consoles.

89. AUX RETURN (1 through 4, L/MONO and R)

These eight female XLR connectors accept auxiliary return signals. Each pair of L/MONO and R connectors can be used for a stereo return, or the L/MONO connector may be used for a monaural return (provided the corresponding front-panel MONO switch is engaged [35]. They may be used as auxiliary line inputs if they are not being used for effects returns.

90. STEREO SUB IN (L, R)

These two female XLR connectors apply signal directly to the stereo mixing bus (ahead of the Stereo Master Fader). They are used for "chaining" another mixing console's stereo outputs into this console, with this console serving as the master for both consoles.

91. CUE SUB IN

This female XLR connector applies signal directly to the cue mixing bus. It is used for "chaining" another mixing console's cue or solo output into this console, with this console serving as the master for both consoles.

92. CUE CONTROL

This 1/4" (6.33 mm) Tip/Ring/Sleeve phone jack provides direct access to the console's cue/solo control bus. It serves as either an input or an output. When the CUE CONTROL jacks of two PM3000 consoles are interconnected, pressing an input CUE/SOLO switch or any CUE switch on one console causes both consoles to enter the cue (or solo) mode. Provided that CUE SUB IN is linked, all cued or soloed signals can be monitored by the "master" console.

93. STEREO INSERT OUT (L, R)

These two unbalanced 1/4" (6.33mm) Tip/Sleeve phone jacks output the signal from the stereo mixing bus just ahead of the STEREO MASTER fader. Nominal level is -6 dBu (388 mV). These jacks may be used as auxiliary stereo outputs to a tape recorder. They are intended, however for sending the mixed stereo signal to an auxiliary signal processor (compressor, graphic EQ, etc).

94. STEREO INSERT IN (L, R)

These two balanced 1/4" (6.33mm) Tip/Ring/Sleeve phone jacks apply signal to the STEREO MASTER fader. Nominal level is -6 dBu (388 mV). Inserting a plug in these jacks interrupts the internal signal flow through the console, instead bringing in the return from an auxiliary signal processor.

95. GROUP INSERT OUT

These eight unbalanced 1/4" (6.33mm) Tip/Sleeve phone jacks output the signal from the group mixing busses just ahead of the Group Master faders. Similar to the STEREO INSERT OUT jacks [93], these jacks may be used as auxiliary group outputs to a multitrack tape recorder or another console. They are intended, however for sending the group signals to auxiliary signal processors (compressors, graphic EQs, etc).

96. GROUP INSERT IN (1 - 8)

These eight balanced 1/4" (6.33mm) Tip/Ring/Sleeve phone jacks apply signal to the Group Master faders. Similar to the STEREO INSERT IN jacks, these jacks accept the return from any auxiliary signal processor used on the overall group mixing bus signal.

97. AUX INSERT OUT (1 - 8)

These eight unbalanced 1/4" (6.33mm) Tip/Sleeve phone jacks are nearly identical to the GROUP INSERT OUT jacks, except they output signal from just ahead of the AUX SEND rotary master level controls.

98. AUX INSERT IN (1 - 8)

These eight balanced 1/4" (6.33mm) Tip/Ring/Sleeve phone jacks are nearly identical to the GROUP INSERT IN jacks, except they return signal to a point just ahead of the AUX SEND master rotary level controls.

99. INPUT CHANNEL INSERT OUT (1 - 24, 1 - 32, or 1 - 40)

These 24, 32 or 40 unbalanced 1/4" (6.33mm) Tip/Sleeve phone jacks output the signal from the input channel (just after the GAIN control, PAD and polarity switch, but before the EQ or fader*). Nominal output level is +4 dBu (1.23 V). These jacks may be used as auxiliary outputs to another console or as direct outs to a multitrack tape machine. They are intended, however for sending the input channel signal to an auxiliary signal processor (compressor, graphic EQ, noise gate, etc). INSERT OUT is always "live" whether or not the channel is on.

**NOTE: An internal preset switch in each module permits the insert point to be moved to a post-EQ, pre-Fader location in the circuit. Refer to Section 6.2 for more information.*

100. INPUT CHANNEL INSERT IN (1 - 32)

These 24, 32 or 40 balanced 1/4" (6.33mm) Tip/Ring/Sleeve phone jacks apply signal to the input channel just ahead of the EQ and fader.** Nominal input level is +4 dBu (1.23 V). These jacks are "normalised" so that inserting a plug interrupts the internal signal flow through the channel, instead bringing in the return from an auxiliary signal processor. However, there is an INSERT on/off switch in each channel which can bypass the INSERT IN jack, regardless of whether an external source is plugged in or not.

*** Refer to the note for item [99] above.*

101. AUX SEND (1 - 8)

These eight male XLR connectors output signal from the eight auxiliary mixing busses, just after the Aux Master LEVEL controls. They may be used for echo/effects sends, for stage foldback (stage monitors), for auxiliary mono or stereo program feeds to remote locations and/or tape recorders, and so forth.

102. GROUP OUT (1 - 8)

These eight male XLR connectors output signal from the eight group mixing busses, just after the Group Master Faders. They may be used for submixed feeds to a remote console (i.e., to a stage monitor console or a broadcast remote), for feeds to a multitrack tape recorder, or for feeds to a multi-zone sound system, depending upon the application.

103. MTRX OUT (1 - 8)

These eight male XLR connectors output signal from the eight 11:1 matrix mixes, after the MTRX MASTER controls and ON/off switches. They may be used for feeding mono or stereo tape recorders, multiple zones of a sound system, multiple sound systems, or remotes, depending upon the application. In some instances, these outputs can be used for effects sends or for monitors.

104. TB OUT

This male XLR connector outputs signal from the talkback circuit when the TB OUT switch [64] is on. If that switch is OFF, this output is muted. Assuming the TB

OUT switch is on, this output is derived from the talkback input XLR when the TALKBACK switch [71] is engaged. Otherwise the TB OUT is derived from the console's oscillator/noise generator.

The TB OUT may be fed to the IFB (Interruptible Foldback) program input of an intercom system in order that the console operator can talk into the intercom system. In some cases, it can be applied to an auxiliary program audio input or some other input on a standard intercom system (see Section 7.3). It also may be fed to a monitor console's COMM input, or to a console's input channel (which is monitored via CUE) to enable the PM3000 operator to communicate with the other console's operator.

105. OSC OUT

This male XLR connector outputs signal from the console's oscillator/noise generator when the OSC OUT switch [63] is on. In order to actually obtain any output signal, however, the oscillator must be switched on [65], and the OSC LEVEL control [67] must be turned up.

106. CUE OUT (L, R)

This pair of XLR connectors output the same signal which appears at the PHONES output jacks. However, the CUE OUT may be muted with the front panel CUE OUT ON/off switch [76]. These connectors are useful for driving control room monitor amps and speakers for the console operator, or a headphone distribution system (with external power amp).

107. STEREO OUT (L, R)

This pair of XLR connectors output the stereo mix after the STEREO MASTER fader. They may be used to feed a stereo sound system, master tape recorder, remote source, or a monitor system.

108. COMM IN

This female XLR connector accepts mic or line level signals from another console (i.e., from TB OUT on another console), or from most professional intercom systems, although an adaptor will be required to accommodate certain types of intercoms. This is a "1-way" connection in that it accepts the audio from the intercom line, but does not apply audio back onto the line. Refer to Section 7.3 for instructions on interface to popular intercom systems.

109. DC POWER IN (A, B)

This pair of multi-pin, locking connectors accept special umbilical cables from the console's external power supply (Model PW3000A). Cables should be properly mated, "A" output from the supply to "A" input on the console, and "B" out to "B" in. Be sure the locking rings are securely hand tightened to avoid inadvertent disconnection.

NOTE: If the two DC power cables are accidentally crossed, A for B, no damage will occur. However, the console will not turn on. (If the power supply does turn on, and the console does not, check these cables.)

110. VCA/MUTE CONTROL

This multi-pin locking connector is an input/output point for control voltages in the PM3000. It enables two PM3000s to be interlinked so that the muting logic and VCA MASTERS from one console also affect the other. The adjacent VCA and MUTE SLAVE/MASTER switches

[111], [112] affect the function of this connector. This connector also may be used for interface to a remote control system which may be developed for "automation" of master muting and group levels.

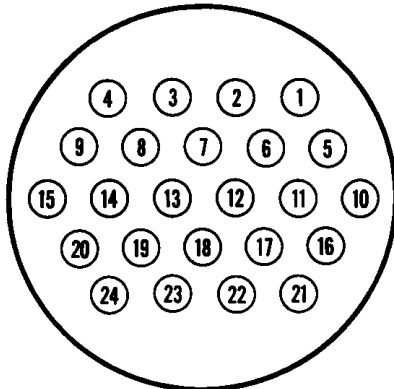

CONNECTOR PINS
(FEMALE)

PIN #	FUNCTION
1	VCA BUS 1
2	VCA BUS 2
3	VCA BUS 3
4	VCA BUS 4
5	VCA BUS 5
6	VCA BUS 6
7	VCA BUS 7
8	VCA BUS 8
9	GND
10	NC
11	MUTE BUS 1
12	MUTE BUS 2

PIN #	FUNCTION
13	MUTE BUS 3
14	MUTE BUS 4
15	MUTE BUS 5
16	MUTE BUS 6
17	MUTE BUS 7
18	MUTE BUS 8
19	GND
20	GND
21	GND
22	NC
23	NC
24	NC

FIGURE 2-9. VCA/MUTE CONNECTOR PIN ASSIGNMENTS.

111. VCA SLAVE/MASTER

Setting this rotary, screwdriver-operated switch to MASTER position configures the console for local control of the input channel VCAs via the VCA MASTER FADERS [52]. SLAVE position disables this console's VCA MASTER FADERS and, instead, allows a second PM3000 (or a specially designed remote automation system) to control this console's master VCAs via the VCA/MUTE CONTROL connector [110].

112. MUTE SLAVE/MASTER

Setting this rotary, screwdriver-operated switch to MASTER position configures the console for local control of input channel muting via the MASTER MUTE switches [40]. SLAVE position disables this console's MASTER MUTE switches and, instead, allows a second PM3000 (or appropriately wired remote switch closures) to control this console's master muting via the VCA/MUTE CONTROL connector [110].

113. PHANTOM POWER MASTER

This recessed slide switch turns the console's 48-volt phantom power supply on and off. When this is OFF, no power will be supplied to any mic, regardless of the channel's +48 V on/off switch setting [11].

114. (Light Sockets)

These four-pin female XLR connectors provide dimmer-controlled DC power for "LittLites" that are supplied with the console. There are three lights on the 24 channel and 32 channel mainframes, and four on the 40 channel mainframe. Maximum output is 12 volts. (Pins 1 and 2 of the XLR are not used, pin 3 is the 12 volt supply, and pin 4 is DC ground.)

115. (Light Dimmer/on switch)

This rotary, screwdriver-adjustable dimmer turns the light socket a variable intensity from low to high brightness. The console is shipped with standard incandescent lamps in the LittLites, but the hoods and power supply are designed so they can accommodate the higher intensity quartz lamps.

2.3 THE PW3000A POWER SUPPLY

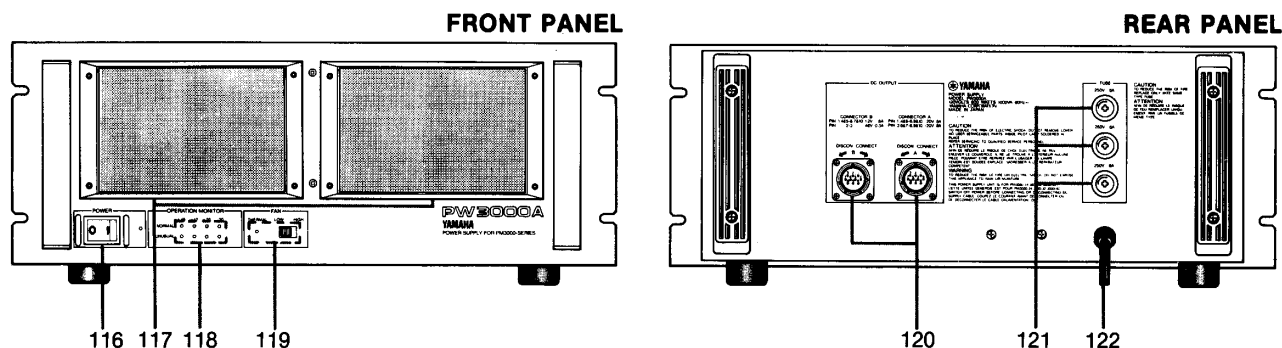

FIGURE 2-10. PW3000A POWER SUPPLY.

116. POWER (On/Off)

This switch turns on the AC power to the supply, and thereby provides the necessary AC and DC voltages to the console via the umbilical power cables. An adjacent LED is on when power is on.

117. (Grille)

The power supply is cooled by a quiet running fan that pulls air through this front-panel grille and exhausts it through vents along the edge of the top and side panels. A reticulated foam element behind the grille filters the air entering the power supply.

NOTE: The filter element is cleanable. Refer to Section 9.1.2

118. (OPERATION MONITOR)

These LEDs indicate the condition of the four types of power supply lines to the PM3000. The green LED (NORMAL) lights in normal operation and, in case of abnormality, one of the red LEDs (UNUSUAL) corresponding to the defective power line lights.

When a red LED lamp lights up, please contact your nearest YAMAHA PM3000 dealer. (Refer to Section 9.5).

119. (Fan Switch & Indicator)

The switch allows to select the speed of the forced cooling fan. Normally set the switch to LOW. If the internal temperature rises above 75°C (167°F), the LED (THERMAL) lights up. In this case, set the switch to HIGH.

120. (Umbilical Connectors)

This pair of locking, multi-pin connectors provides the necessary DC voltages from the PW3000A power supply to the PM3000 console. Both cables must be connected correctly before attempting to operate the console. No damage will occur if the cables are crossed, A for B, but the console will not turn on. The power supply light will turn on, however. If you observe this condition, look for crossed or disconnected umbilical cables.

CAUTION: Always make certain that the PW3000A power is turned OFF prior to connecting or disconnecting either of the umbilical cables at the console or at the power supply.

121. FUSES

These 3 fuses protect the primary and secondary portions of the PW3000A power supply. They should be replaced only with fuses of the same current rating and type:

Primary Fuses (x3): 6 A Slo-Blow

NOTE: Internal fuses in the PW3000A are also present, as follows:

+ 20 VDC Supply: 10 A Slo-Blow

-20 VDC Supply: 10 A Slo-Blow

+ 12 VDC Supply: 10 A Slo-Blow

+ 48 VDC Supply: 2 A Slo-Blow

122. (Power Cord)

This power cable connects the PW3000A to the AC power mains. A grounded (3-wire) outlet of at least 15 amperes capacity should be used.

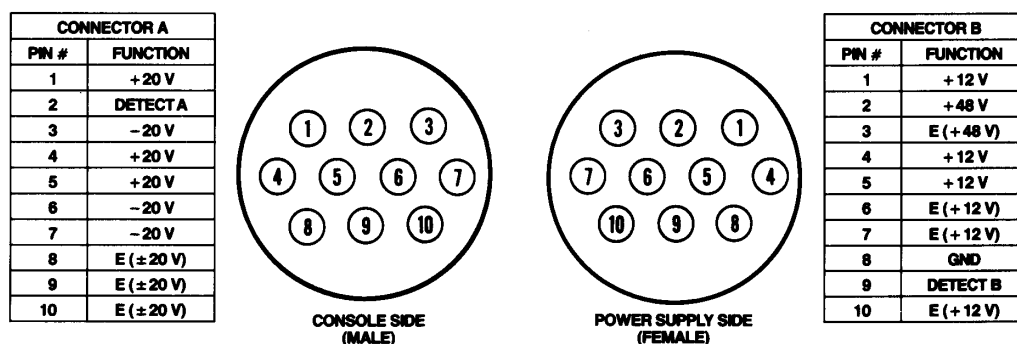

FIGURE 2-11. PW3000A UMBILICAL CONNECTOR PIN ASSIGNMENTS.

SECTION 3 Specifications

3.1 GENERAL SPECIFICATIONS

Total Harmonic Distortion

Less than 0.1%, 20 Hz–20 kHz, at +14 dBm output into 600 ohms.

Frequency Response

+1, -3 dB, 20 Hz–20 kHz, at +4 dBm output into 600 ohms.

Hum & Noise

(20 Hz–20 kHz, $R_g = 150$ ohms, Input Gain @ maximum, Input Pad @ 20 dB, except as noted)

-128 dBm equivalent input noise.

-95 dBu residual output noise (balanced outputs).

-81 dBu (85 dB S/N) at GROUP OUT with Master fader at nominal level and all channel assign switches off.

-74 dBu (78 dB S/N) at GROUP OUT with Master fader and one channel fader at nominal level, and channel assigned to the group bus.

-54 dBu (48 dB S/N) at GROUP OUT with Master fader and one channel fader at nominal level, and channel assigned to the group bus, WITH INPUT SENSITIVITY AT MAXIMUM AND PAD AT 0 dB.

-77 dBu (81 dB S/N) at STEREO OUT with Stereo Master fader at nominal level and all channel assign switches off.

-73 dBu (77 dB S/N) at STEREO OUT with Stereo Master fader and one channel fader at nominal level.

-90 dBu (94 dB S/N) at MTRX OUT with MTRX Master and all matrix mix controls at maximum level, all GROUP-TO-MTRX switches off.

-74 dBu (78 dB S/N) at MTRX OUT with MTRX Master and one Matrix Mix control at maximum level, one channel fader at nominal level (assigned to a group that is assigned to that matrix control).

-75 dBu (79 dB S/N) at AUX OUT with Aux Master level control at nominal, all channel AUX mix controls at minimum level.

-73 dBu (77 dB S/N) at AUX OUT with Aux Master level and one channel AUX mix control at nominal level.

Maximum Voltage Gain

94 dB CH IN to GROUP OUT
 94 dB CH IN to STEREO OUT
 94 dB CH IN to MTRX OUT
 104 dB CH IN to AUX OUT
 94 dB CH IN to CUE OUT
 20 dB AUX RTN to GROUP OUT
 10 dB SUB IN to GROUP OUT
 10 dB SUB IN to STEREO OUT
 10 dB SUB IN to AUX OUT
 0 dB SUB IN to MTRX OUT

Input Channel Gain Control

34 dB variation in gain stop-to-stop.

Input Channel Pad Switch

0, 10, 20, 30 or 40 dB of attenuation.

Input Channel Equalization

15 dB maximum boost or cut in the each of four bands.

HIGH: 1.6 kHz ~ 16 kHz (peaking or shelving).

HI-MID: 800 Hz ~ 8 kHz (peaking, variable Q from about 0.5 to 3.0).

LO-MID: 160 Hz ~ 1.6 kHz (peaking, variable Q from about 0.5 to 3.0).

LOW: 40 Hz ~ 400 Hz (peaking or shelving)

Input Channel High Pass Filter

12 dB/octave roll off below 20 Hz to 400 Hz (adjustable -3 dB point).

AUX RTN Equalization

15 dB maximum boost or cut, shelving curve, in two bands.

HIGH: 1 kHz ~ 10 kHz.

LOW: 100 Hz ~ 1 kHz.

Crosstalk

-80 dB at 1 kHz, adjacent input channels.

-70 dB at 10 kHz, adjacent input channels.

-80 dB at 1 kHz, input to output.

-70 dB at 10 kHz, input to output.

Oscillator/Noise Generator

Switchable sine wave at 100 Hz, 1 kHz, or 10 kHz (less than 1% T.H.D. at +4 dBu output level), or pink noise.

VU Meters (0 VU = +4 dBu, or 1.23 V RMS output level)

STEREO L & R: 2 large, illuminated meters. 12 smaller, illuminated meters, each switchable to monitor multiple circuits:

Meters 1-8	GROUP OUT/GROUP>MTRX/MTRX
Meter 9	AUX1/AUX5/CUE L
Meter 10	AUX2/AUX6/CUE R
Meter 11	AUX3/AUX7/OSC
Meter 12	AUX4/AUX8

Peak Indicators

LED (red) built into each VU meter turns on when post-Master fader level reaches 10 dB below clipping.

Signal/Clip Indicators

3 LEDs built into each input module monitor levels in the module: SIGNAL (green) turns on when pre-EQ signal is 10 dB below nominal level. CLIP (red) turns on when pre-EQ signal is 3 dB below clipping. EQ CLIP (red) turns on when post-EQ level is 3 dB below clipping.

Phantom Power

+48 V DC is applied to electronically balanced inputs or optional transformer-isolated inputs (via 6.8 kohm current limiting/isolation resistors) for powering condenser microphones. May be turned on or off via rear-panel phantom master switch; when on, individual channels may be turned off via +48 V switch on each input module.

Power Requirements

Requires Yamaha PW3000A power supply; see specifications for that unit.

Console Dimensions

HEIGHT 12-1/8 inches (309 mm)
 DEPTH 37-3/4 inches (960 mm)
 WIDTH: 24 channel, 53-3/4 inches (1367 mm)
 32 channel, 64-5/8 inches (1643 mm)
 40 channel, 75-1/2 inches (1919 mm)

Net Weight (excluding power supply)

<u>24 CH</u>	<u>32 CH</u>	<u>40 CH</u>
201 lbs	247 lbs	302 lbs
91 kg	112 kg	137 kg

Options

IT3000 Input Transformers; may be installed in individual input modules. Changes actual input impedance from 3K ohms to 1k ohm.

OT3000 Output Transformer Set; a rack-mountable, external chassis containing 8 output transformers, with male and female XLR connectors on the front panel. Occupies 2 rack spaces (3½" or 88 mm) in a 19 inch (480 mm) wide rack; 3½" (88 mm) depth. May be used to isolate any PM3000 XLR outputs.

Supplied Accessories

- PW3000A power supply
- Miniature gooseneck lamps
- 24 CH, 32 CH: ×3
- 40 CH : ×4
- VCA/MUTE control connector (SRCN6A25-24P)
- Umbilical cables ×2
- Vinyl cover

NOTE: Specifications are subject to change without notice or obligation.

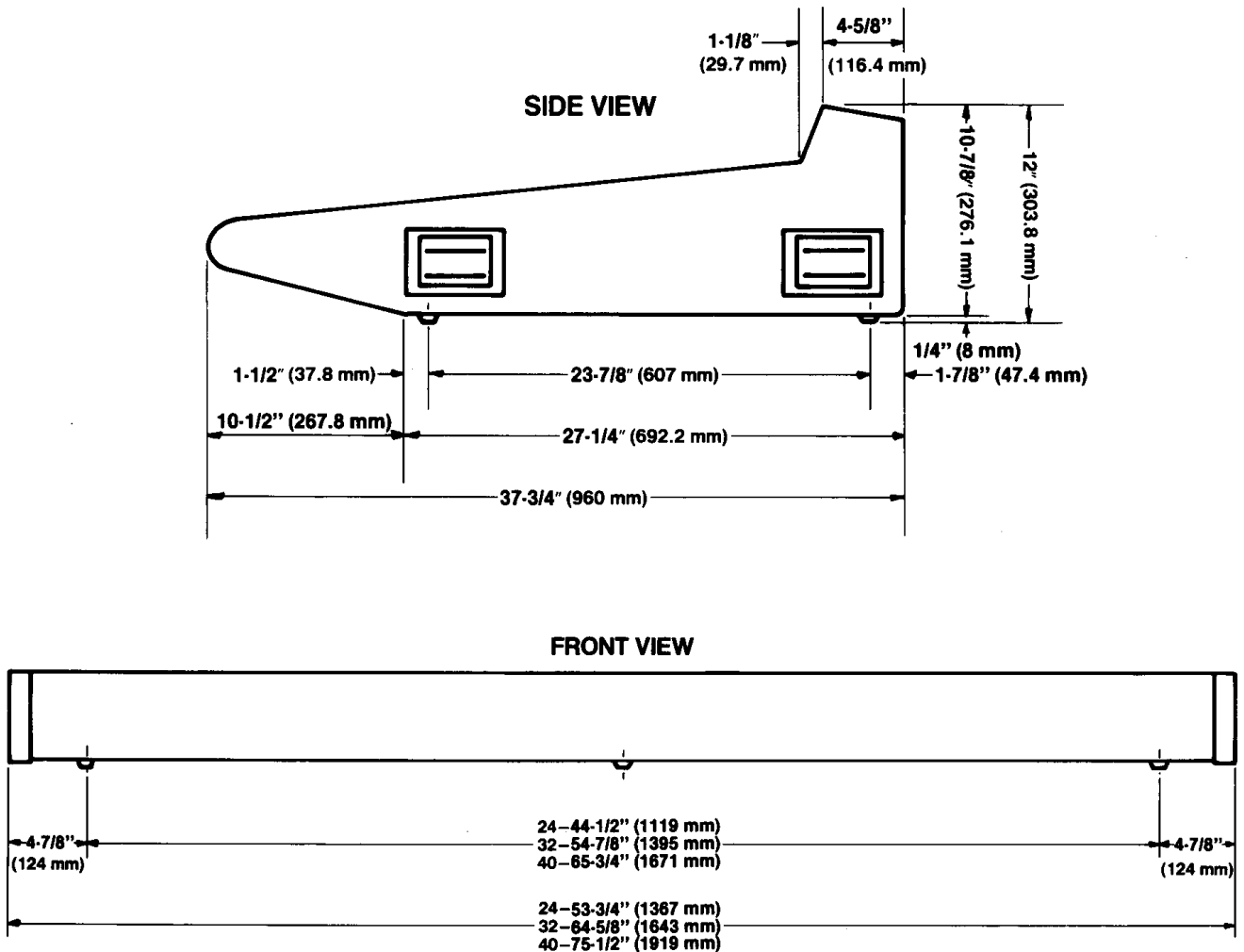

FIGURE 3-1. PM3000 DIMENSIONS

3.2 POWER SUPPLY (PW3000A) SPECIFICATIONS

Dimensions:

- HEIGHT 6-7/8 inches (176 mm) (excluding rubber feet; add 3/8" for feet).
 DEPTH Overall, 18 inches (457 mm); Behind panel, 16-1/2 inches (418 mm).
 WIDTH 18-7/8 inches (480 mm); for standard rack mounting.

Fuses

Primary fuses for each of 3 transformers, 250 V, 6 amperes, slo-blow.

Additionally, the DC supplies each have secondary fuses as follows:

- + 20 volt supply: 10 A, 250 V slo-blow
- 20 volt supply: 10 A, 250 V slo-blow
- + 12 volt supply: 10 A, 250 V slo-blow
- + 48 volt supply: 2 A, 250 V slo-blow

Outputs

- + 20 VDC @ 8 Amps
- 20 VDC @ 8 Amps
- Ground (common) for 20 V
- + 12 VDC @ 6.1 Amps
- + 48 VDC @ 0.3 Amps
- Ground (common) for 12 V
- Chassis ground
- Detector A & B

AC Requirements

- US & Canadian models: 105 to 130 V, 50/60 Hz.
- General model : 220 or 240 V, ± 10%, 50/60 Hz.

Umbilical Cables

Two multi-conductor cables with locking, multi-pin connectors convey power to the PM3000 console. Each cable is approximately 10 feet (3.6 meters) long. Protected against inadvertent A/B misconnection.

Cooling

Internal fan, pulls air through foam grille on front panel, exhausts via top and side vents.

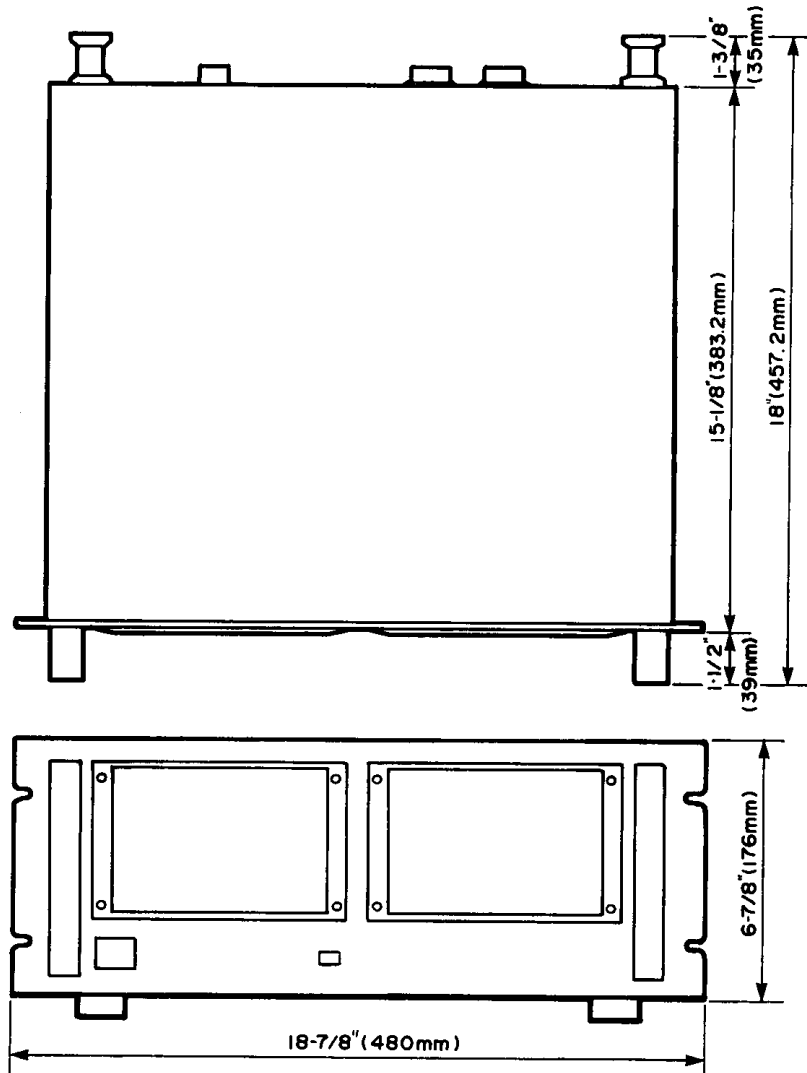

FIGURE 3-2. PW3000A DIMENSIONS

3.3 INPUT CHARACTERISTICS

CONNECTION	PAD	GAIN TRIM	ACTUAL LOAD IMPEDANCE	FOR USE WITH NOMINAL	INPUT LEVEL			CONNECTOR IN CONSOLE
					SENSITIVITY	NOMINAL	MAX BEFORE CLIP	
CH INPUT, 1-24; 1-32 or 1-40	0	-70	3K ohms if electronic balanced; 1K ohms if transformer balanced	50 ohm to 200 ohm mics and 600 ohm lines	-90 dBu (0.025 mV)	-70 dBu (0.25 mV)	-40 dBu (7.75 mV)	XLR-3-31
	0	-36			-56 dBu (1.23 mV)	-36 dBu (12.3 mV)	-16 dBu (123 mV)	
	10	-36			-46 dBu (3.88 mV)	-26 dBu (38.8 mV)	-6 dBu (388 mV)	
	20	-36			-36 dBu (12.3 mV)	-16 dBu (123 mV)	+4 dBu (1.23 V)	
	30	-36			-26 dBu (38.8 mV)	-6 dBu (388 mV)	+14 dBu (3.88 V)	
	40	-36			-16 dBu (123 mV)	+4 dBu (1.23 V)	+24 dBu (12.3 V)	
AUX RETURN, 1-4 (stereo)			10K ohms	600 ohm lines	-16 dBu (123 mV)	+4 dBu (1.23 V)	+24 dBu (12.3 V)	XLR-3-31
PGM SUB IN, 1-8			10K ohms	600 ohm lines	-6 dBu (388 mV)	+4 dBu (1.23 V)	+24 dBu (12.3 V)	XLR-3-31
STEREO SUB IN, L-R			10K ohms	600 ohm lines	-6 dBu (388 mV)	+4 dBu (1.23 V)	+24 dBu (12.3 V)	XLR-3-31
AUX SUB IN, 1-8			10K ohms	600 ohm lines	-6 dBu (388 mV)	+4 dBu (1.23 V)	+24 dBu (12.3 V)	XLR-3-31
MTRX SUB IN, 1-8			10K ohms	600 ohm lines	+4 dBu (1.23 V)	+4 dBu (1.23 V)	+24 dBu (12.3 V)	XLR-3-31
TALKBACK IN	-50		3K ohms	50-250 ohm mics	-70 dBu (0.25 mV)	-50 dBu (2.45 mV)	-30 dBu (24.5 mV)	XLR-3-31
	+4		3K ohms	600 ohm lines	-16 dBu (123 mV)	+4 dBu (1.23 V)	+24 dBu (12.3 V)	XLR-3-31
COMM IN	-50		3K ohms	50-250 ohm mics	-70 dBu (0.25 mV)	-50 dBu (2.45 mV)	-30 dBu (24.5 mV)	XLR-3-31
	+4		3K ohms	600 ohm lines	-16 dBu (123 mV)	+4 dBu (1.23 V)	+24 dBu (12.3 V)	XLR-3-31
CH INSERT IN, 1-24, 1-32, or 1-40			10K ohms	600 ohm lines	-16 dBu (123 mV)	+4 dBu (1.23 V)	+24 dBu (12.3 V)	Phone Jack (1/4" TRS)
INSERT IN: PGM, 1-8 STEREO, L-R AUX, 1-8			10K ohms	600 ohm lines	-16 dBu (123 mV)	-6 dBu (388 mV)	+24 dBu (12.3 V)	Phone Jack (1/4" TRS)

NOTES: (1) Sensitivity is the lowest level that will produce an output of +4 dBu (1.23V), or the nominal output level, when the circuit is set to maximum gain.
(2) All XLR connectors are electronically balanced. Phone jacks are balanced with Tip = signal high (+), Ring = signal low (-), and Sleeve = ground.
(3) 0 dBu is referenced to 0.775 V RMS. Where the circuit is capable of 600 ohm termination, this would be equivalent to 0 dBm.

3.4 OUTPUT CHARACTERISTICS

CONNECTION	ACTUAL SOURCE IMPEDANCE	FOR USE WITH NOMINAL	OUTPUT LEVEL		CONNECTOR IN CONSOLE
			NOMINAL	MAX. BEFORE CLIP	
GROUP OUT, 1-8	150 ohms	600 ohm lines	+4 dBu (1.23 V)	+24 dBu (12.3 V)	XLR-3-32
STEREO OUT, L-R	150 ohms	600 ohm lines	+4 dBu (1.23 V)	+24 dBu (12.3 V)	XLR-3-32
MATRIX OUT, 1-8	150 ohms	600 ohm lines	+4 dBu (1.23 V)	+24 dBu (12.3 V)	XLR-3-32
AUX OUT, 1-8	150 ohms	600 ohm lines	+4 dBu (1.23 V)	+24 dBu (12.3 V)	XLR-3-32
CUE OUT, L-R	150 ohms	600 ohm lines	+4 dBu (1.23 V)	+24 dBu (12.3 V)	XLR-3-32
TALKBACK OUT,	150 ohms	600 ohm lines	+4 dBu (1.23 V)	+24 dBu (12.3 V)	XLR-3-32
CH INSERT OUT (1-24, 1-32 or 1-40)	600 ohms	10K ohm lines	+4 dBu (1.23 V)	+24 dBu (12.3 V)	Phone Jack (1/4" TRS)
OSCILLATOR OUT			+4 dBu (1.23 V)		XLR-3-32
AUX. INSERT OUT, 1-8	600 ohms	10K ohm lines	-6 dBu (388 mV)	+24 dBu (12.3 V)	Phone Jack (1/4" TRS)
GROUP INSERT OUT, 1-8	600 ohms	10K ohm lines	-6 dBu (388 mV)	+24 dBu (12.3 V)	
STEREO INSERT OUT, L-R	600 ohms	10K ohm lines	-6 dBu (388 mV)	+24 dBu (12.3 V)	
PHONES OUT, 1-2	15 ohms	8 ohm phones	75 mW	150 mW	Phone Jack (1/4" TRS)
		40 ohm phones	65 mW	130 mW	

NOTES: (1) All XLR connectors are electronically balanced. Phone jacks are unbalanced, with Tip = signal, Ring = common, Sleeve = ground. PHONES out phone jacks are wired standard stereo with Tip = Left, Ring = Right, Sleeve = ground.
(2) 0 dBu is referenced to 0.775 V RMS. Where the circuit is capable of 600 ohm termination, this would be equivalent to 0 dBm.

3.5 PERFORMANCE GRAPHS

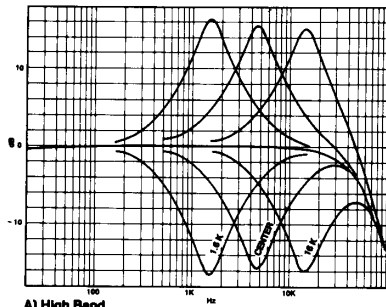

A) High Band
 Peaking/Shelving: peaking
 Gain: maximum boost & maximum cut curves
 Frequency: swept from minimum (1.6 kHz), through center (approx. 4.6 kHz), to maximum (16 kHz)
 Q: Non-Adjustable (fixed at 1.5)
 Note: This is similar to illustration (D) which depicts Low Band Equalization.

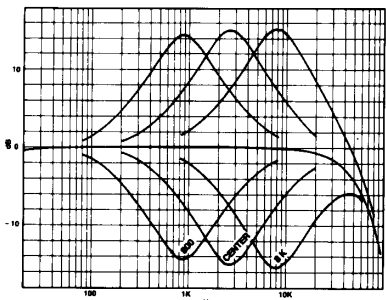

B) Hi-Mid Band
 Gain: maximum boost & maximum cut curves
 Frequency: swept from minimum (800 Hz), through center (approx. 2.6 kHz), to maximum (8 kHz)
 Q: centered (approx. 1.2)
 Note: This is similar to illustration (C) which depicts Lo-Mid Band Equalization.

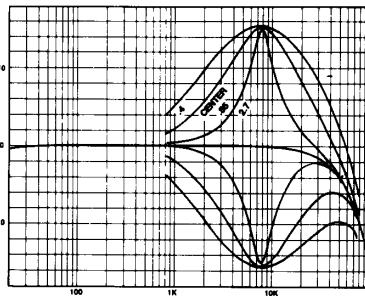

E) Hi-Mid Band
 Gain: maximum boost & maximum cut curves
 Frequency: set at 8 kHz
 Q: swept from minimum (approx. 0.5), through center (approx. 1.2), to maximum (approx. 3)
 Note: The middle curves here (Q = 0.85) are the same as the right-most curves in illustration (B).

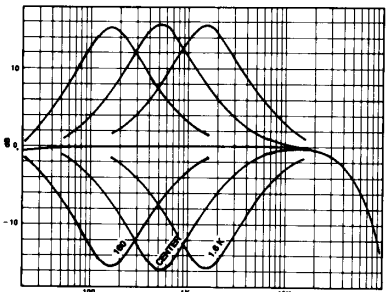

C) Lo-Mid Band
 Gain: maximum boost & maximum cut curves
 Frequency: swept from minimum (160 Hz), through center (approx. 500 Hz), to maximum (1.6 kHz)
 Q: centered (approx. 1.2)

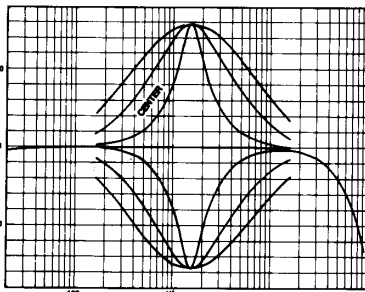

F) Lo-Mid Band
 Gain: maximum boost & maximum cut curves
 Frequency: set at 1.6 kHz
 Q: swept from minimum (approx. 0.5), through center (approx. 1.2), to maximum (approx. 3)
 Note: The middle curves here (Q = 1.2) are the same as the right-most curves in illustration (C).

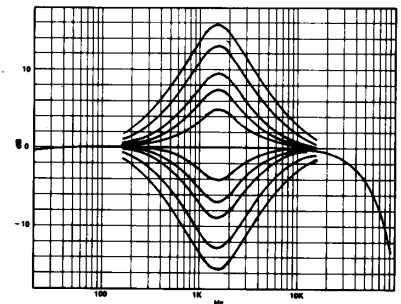

G) Lo-Mid Band
 Gain: varied from maximum boost to maximum cut
 Frequency: set at 1.6 kHz
 Q: centered (approx. 1.2)
 Note: The outer curves here (maximum boost and cut) are the same as the middle curves (Q centered) in illustration (F).

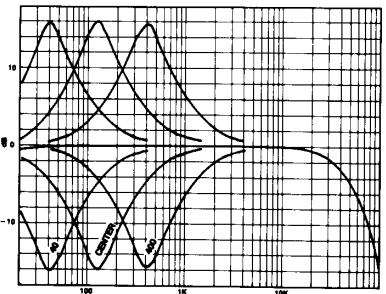

D) Low Band
 Peaking/Shelving: peaking
 Gain: maximum boost & maximum cut curves
 Frequency: swept from minimum (40 Hz), through center (approx. 125 Hz), to maximum (400 Hz)
 Q: Non-Adjustable (fixed at 1.5)

FIGURE 3-3. INPUT CHANNEL EQUALIZER CHARACTERISTICS

FIGURE 3-3. INPUT CHANNEL EQUALIZER CHARACTERISTICS (continued)

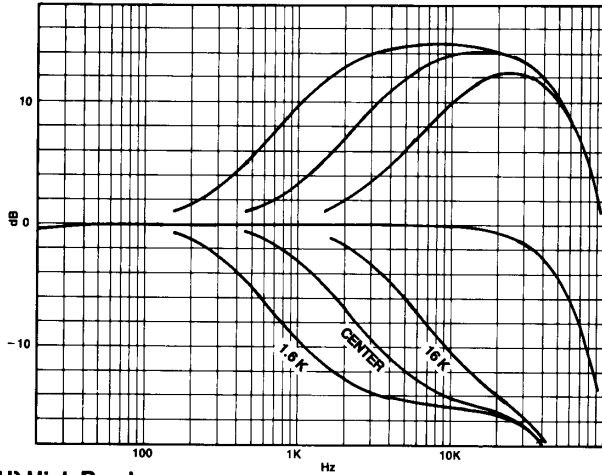

H) High Band

Peaking/Shelving: shelving
 Gain: maximum boost & maximum cut curves
 Frequency: swept from minimum (1.6 kHz), through center (approx. 4.6 kHz), to maximum (16 kHz)
 Q: Non-Adjustable (fixed at 1.5)
 Note: This is similar to illustration (I) which depicts Low Band equalization.

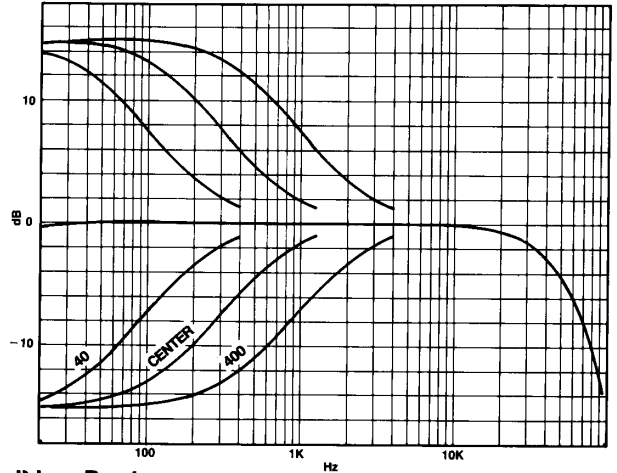

I) Low Band

Peaking/Shelving: shelving
 Gain: maximum boost & maximum cut curves
 Frequency: swept from minimum (40 Hz), through center approx. 125 Hz, to maximum (400 Hz)
 Q: Non-Adjustable (fixed at 1.5)

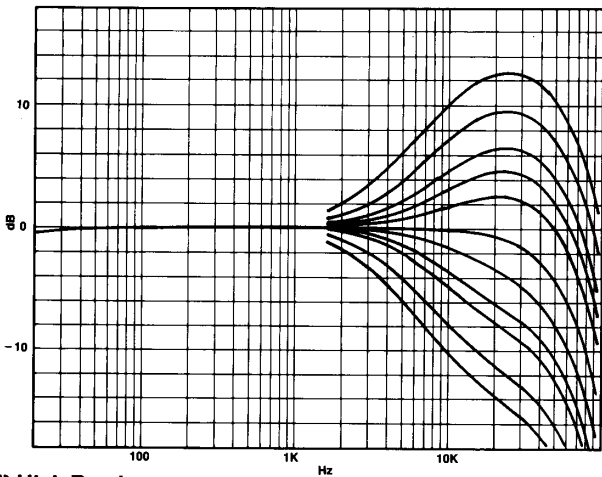

J) High Band

Peaking/Shelving: shelving
 Gain: varied from maximum boost to maximum cut
 Frequency: set at 1.6 kHz
 Q: Non-Adjustable (fixed at 1.5)
 Note: The outer curves here (maximum boost and cut) are the same as the right-most curves (1.6 kHz) in illustration (H).

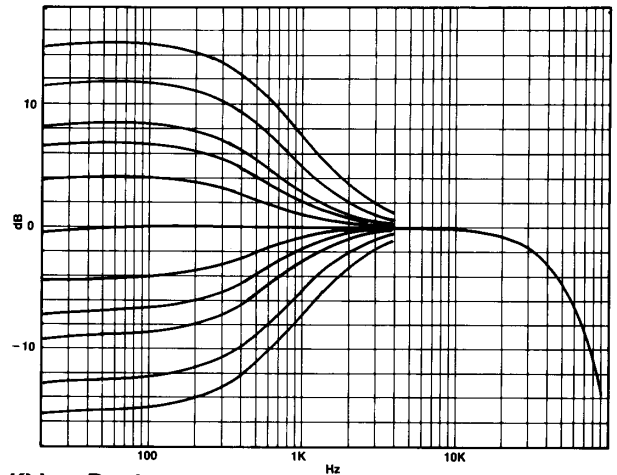

K) Low Band

Peaking/Shelving: shelving
 Gain: varied from maximum boost to maximum cut
 Frequency: set at 400 Hz
 Q: Non-Adjustable (fixed at 1.5)
 Note: The outer curves here (maximum boost and cut) are the same as the right-most curves (400 Hz) in illustration (I).

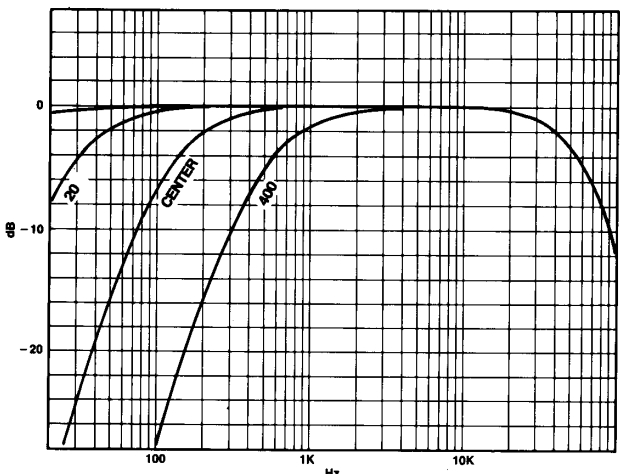

FIGURE 3-4. INPUT CHANNEL HIGH PASS FILTER CHARACTERISTICS

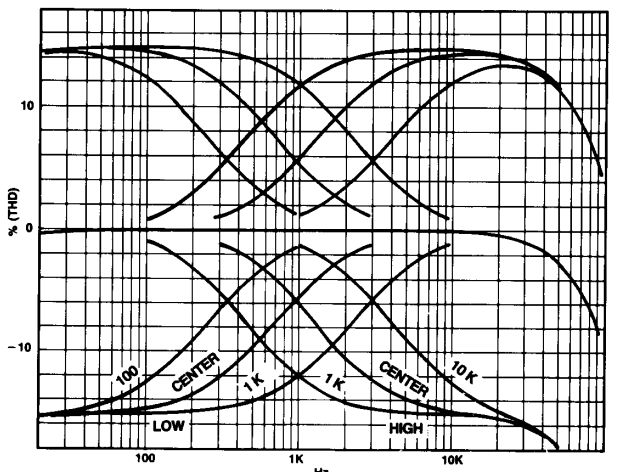

FIGURE 3-5. AUX RETURN EQUALIZER CHARACTERISTICS

3.5.1. Input Channel 1 to Group Output 1 Performance Graphs with Input Gain Control @ Max

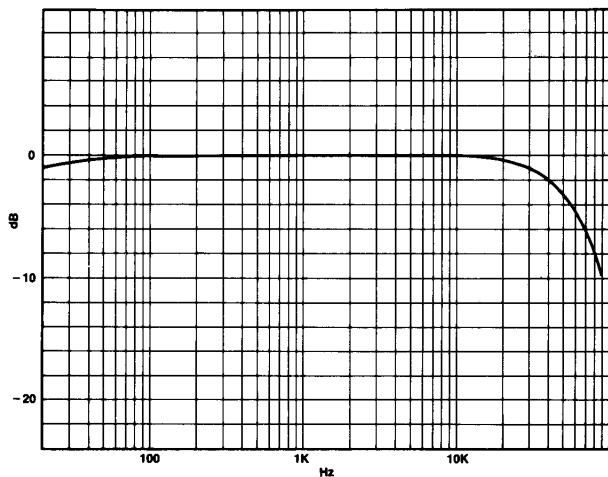

FIGURE 3-6. FREQUENCY RESPONSE
At +4 dBu output level, PAD at 0 dB.
(Curves would be identical with PAD at 10, 20, 30 or 40 dB).

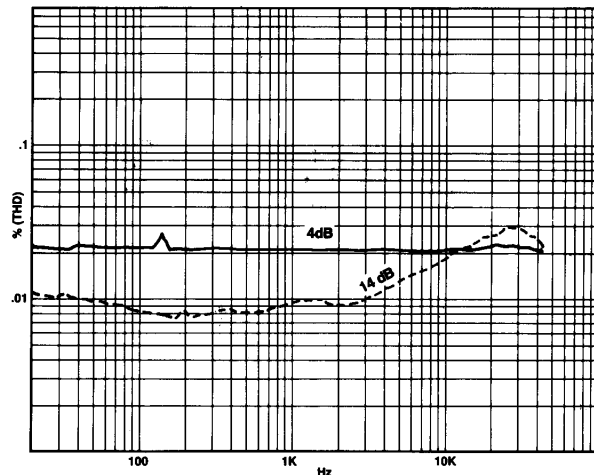
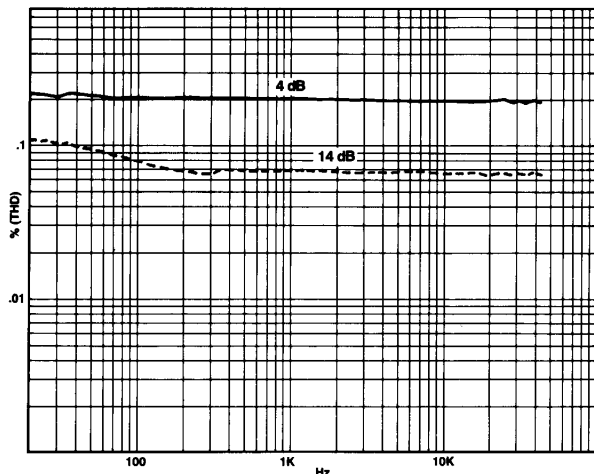
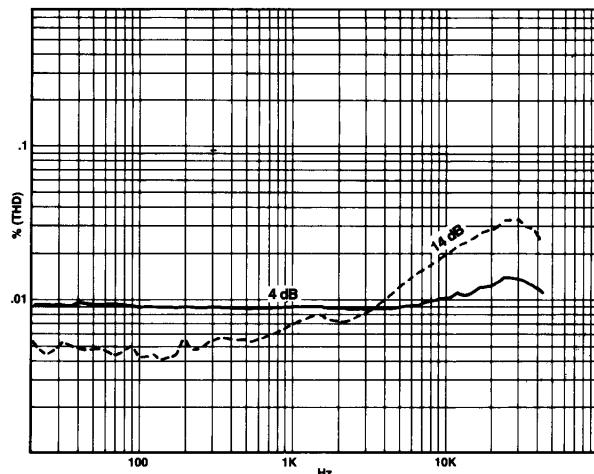

FIGURE 3-7. FREQUENCY vs. T.H.D. CURVES
At +4 dBu & +14 dBu output levels.

C) PAD at 20 dB



A) PAD at 0 dB



D) PAD at 30 dB

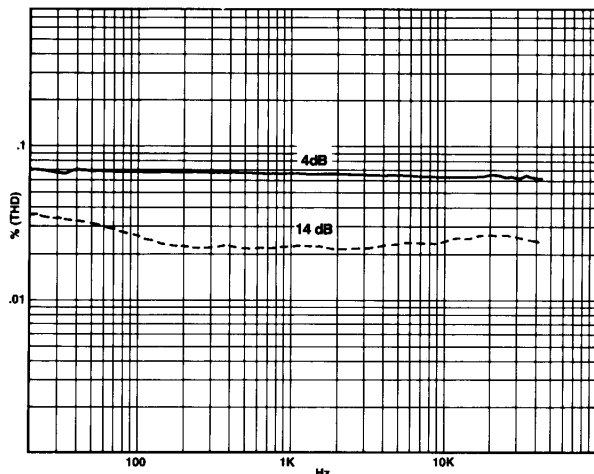

B) PAD at 10 dB

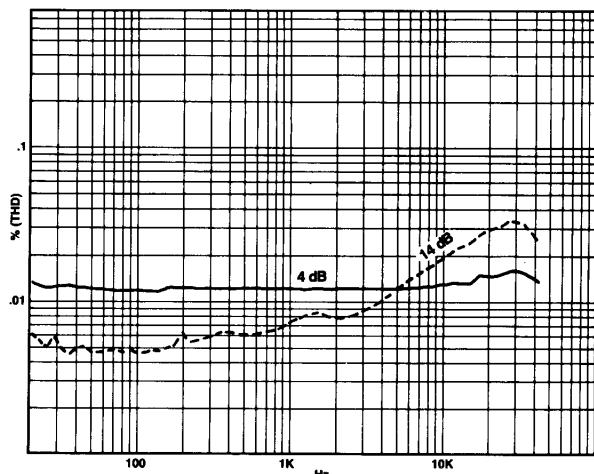

E) PAD at 40 dB

FIGURE 3-8. OUTPUT LEVEL vs T.H.D.
At 100 Hz, 1 kHz & 20 kHz.

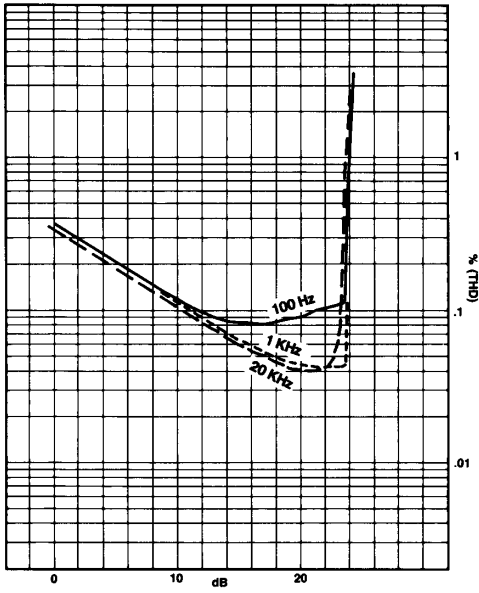

A) PAD at 0 dB

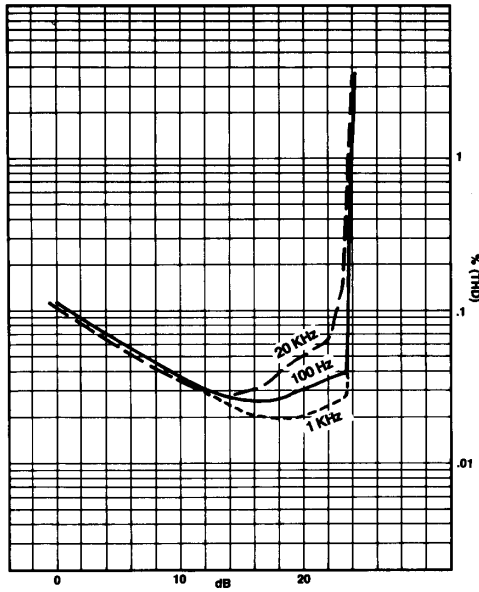

B) PAD at 10 dB

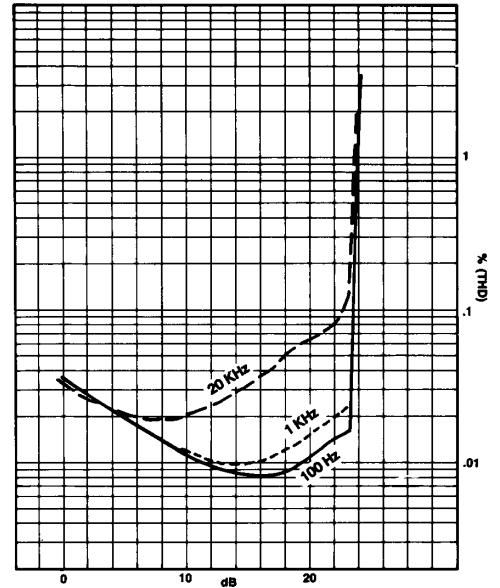

C) PAD at 20 dB

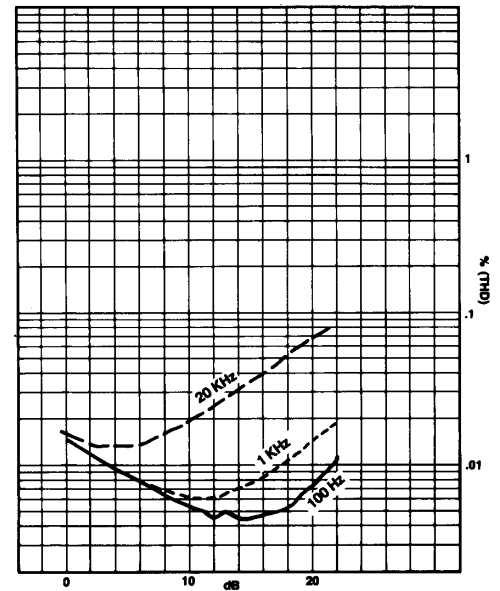

D) PAD at 30 dB

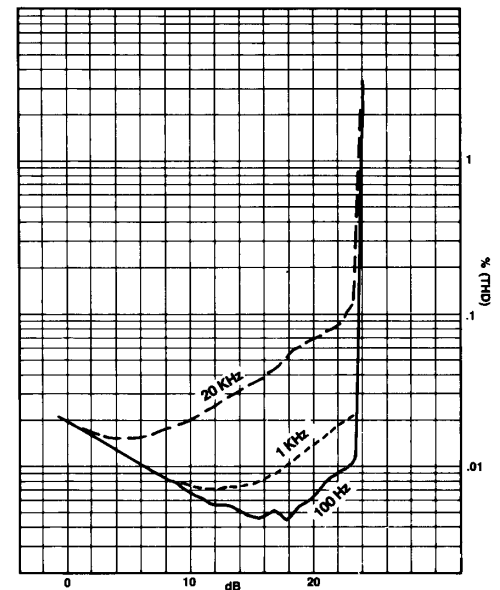

E) PAD at 40 dB

3.5.2. Input Channel 1 to Group Output 1 Performance Graphs with Input Gain Control @ Min

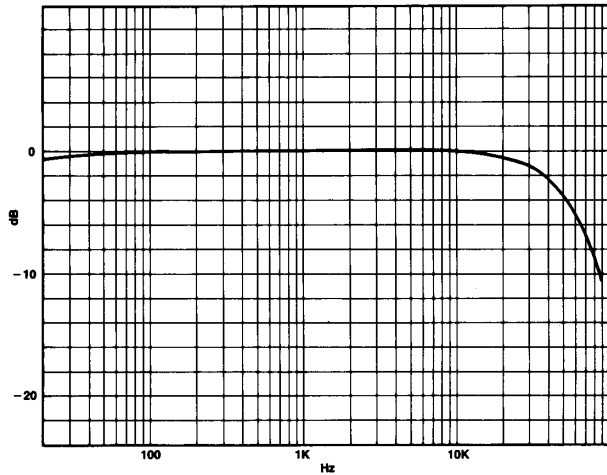

FIGURE 3-9. FREQUENCY RESPONSE
At +4 dBu output level. PAD at 40 dB.
(Curves would be identical with PAD at 0, 10, 20, or 30 dB.)

3.5.3. Aux Return 4 (L) to Group Output 1 Performance Graphs

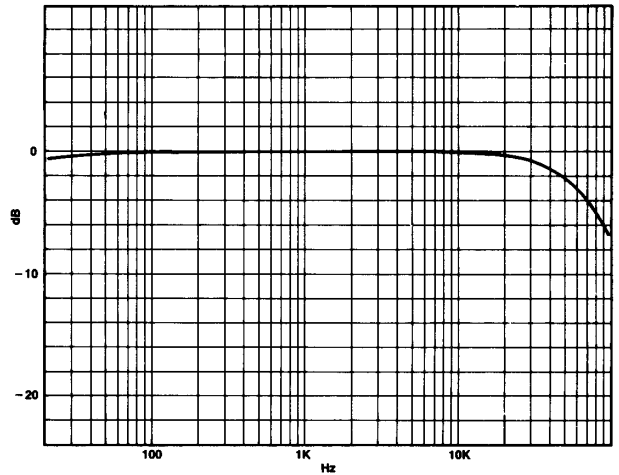

FIGURE 3-12. FREQUENCY RESPONSE
(At +4 dBu output level.)

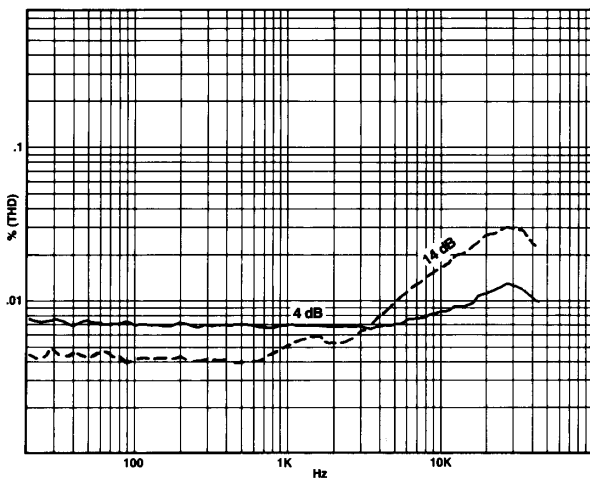

FIGURE 3-10. FREQUENCY vs. T.H.D. CURVES
At +4 dBu & +14 dBu output levels, PAD at 40 dB.
(Curves would be identical with PAD at 0, 10, 20, or 30 dB.)

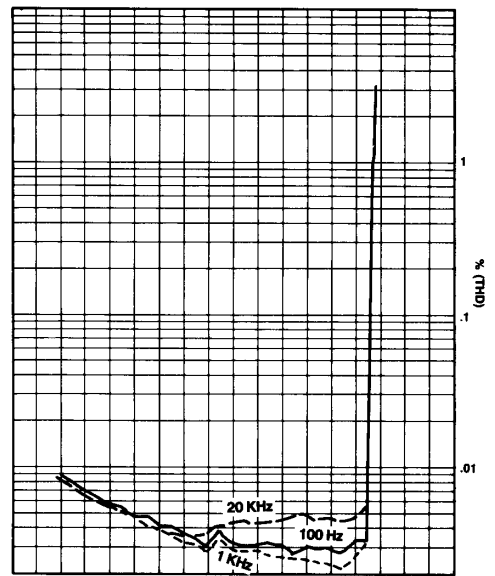

FIGURE 3-13. OUTPUT LEVEL vs T.H.D.
(At 100 Hz, 1 kHz & 20 kHz.)

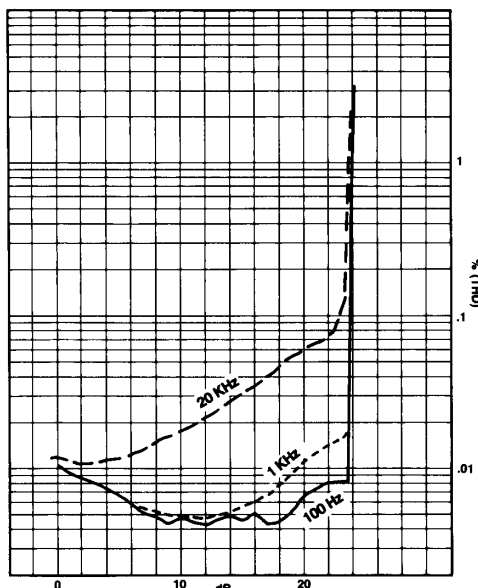

FIGURE 3-11. OUTPUT LEVEL vs T.H.D.
At 100 Hz, 1 kHz & 20 kHz, PAD at 40 dB.

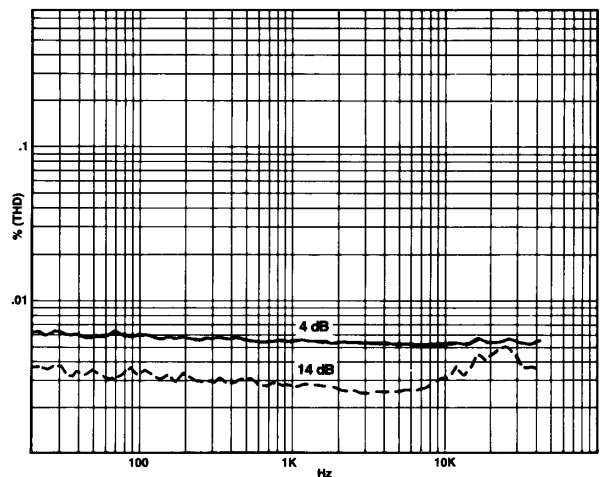

FIGURE 3-14. FREQUENCY vs. T.H.D. CURVES
(At +4 dBu & +14 dBu output levels.)

3.5.4. Channel 1 Input to Phones Output Performance
Graphs with Input Pad @ 40 dB, Gain @ Min.

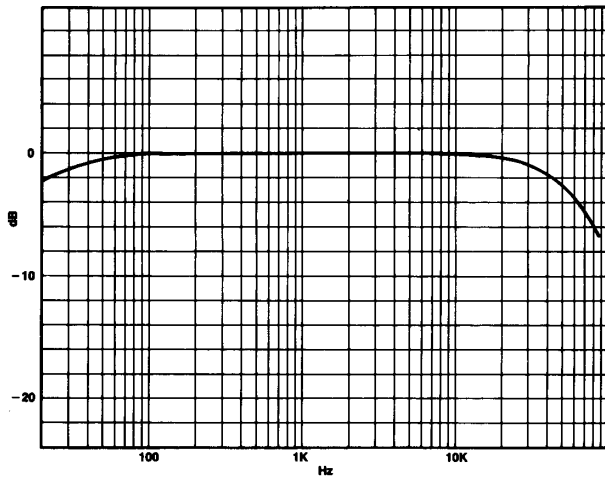

FIGURE 3-15. FREQUENCY RESPONSE

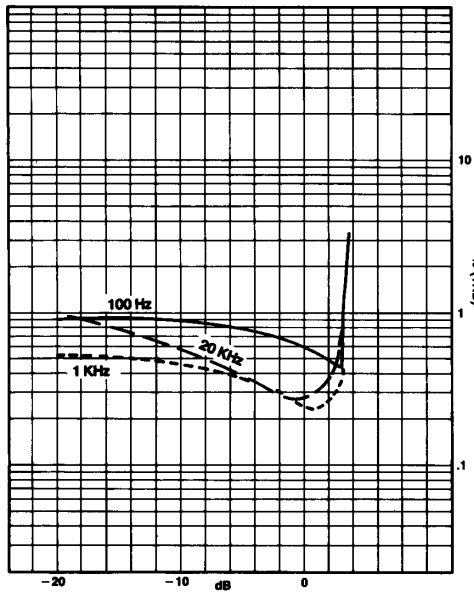

FIGURE 3-16. OUTPUT LEVEL vs T.H.D.
At 100 Hz, 1 kHz & 20 kHz.

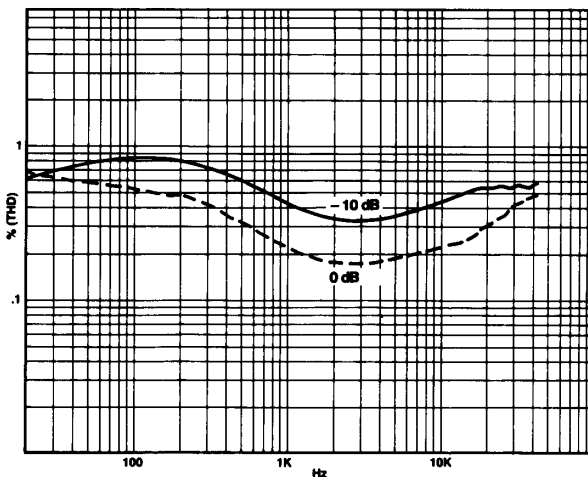

FIGURE 3-17. FREQUENCY vs. T.H.D. CURVES

3.5.5. Crosstalk Performance Graphs

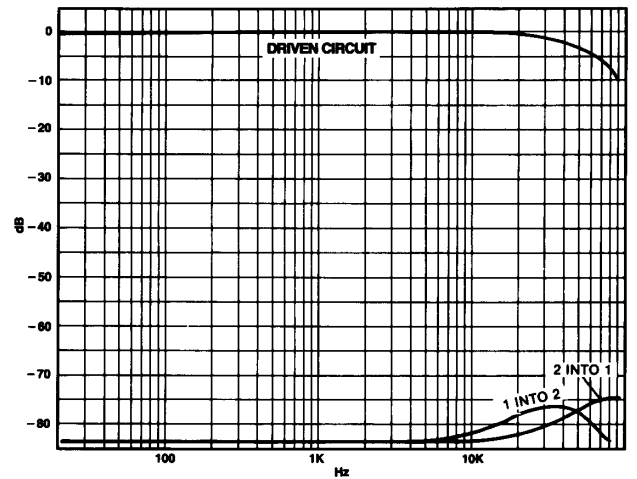

FIGURE 3-18. CROSSTALK OF GROUP 1 INTO 2 OR 2 INTO 1 WITH INPUT PAN CONTROL AT FULL CW & FULL CCW POSITIONS

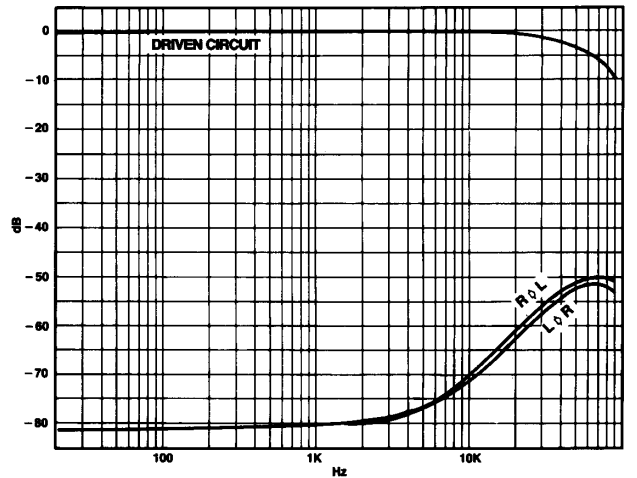

FIGURE 3-19. CROSSTALK OF STEREO L INTO R OR R INTO L WITH INPUT PAN CONTROL AT FULL CW & FULL CCW POSITIONS

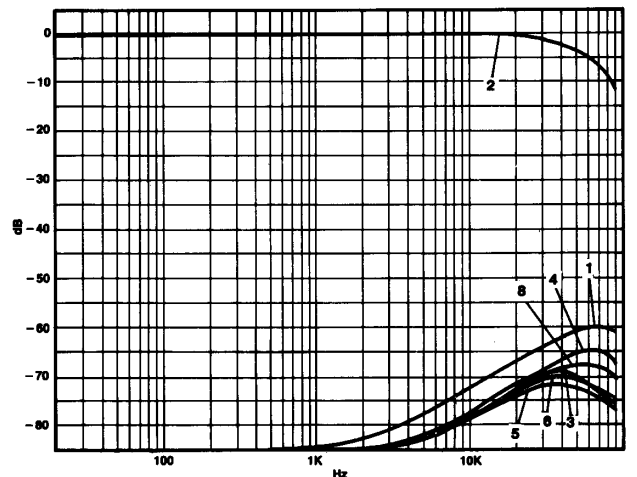

FIGURE 3-20. CROSSTALK OF GROUP BUS 2 INTO GROUP BUSES 1 AND 3 THROUGH 8

3.6 BLOCK & GAIN STRUCTURE DIAGRAMS

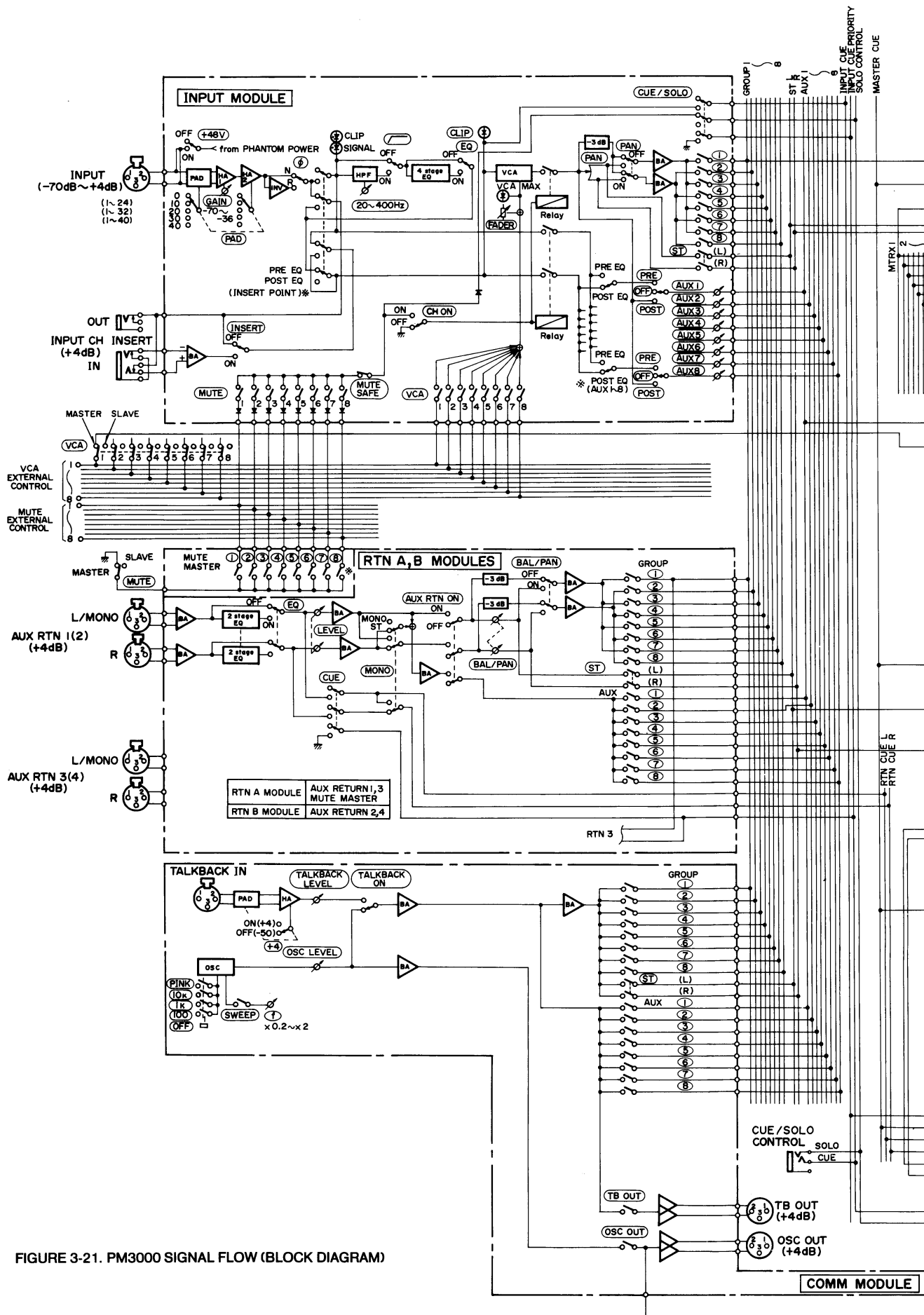
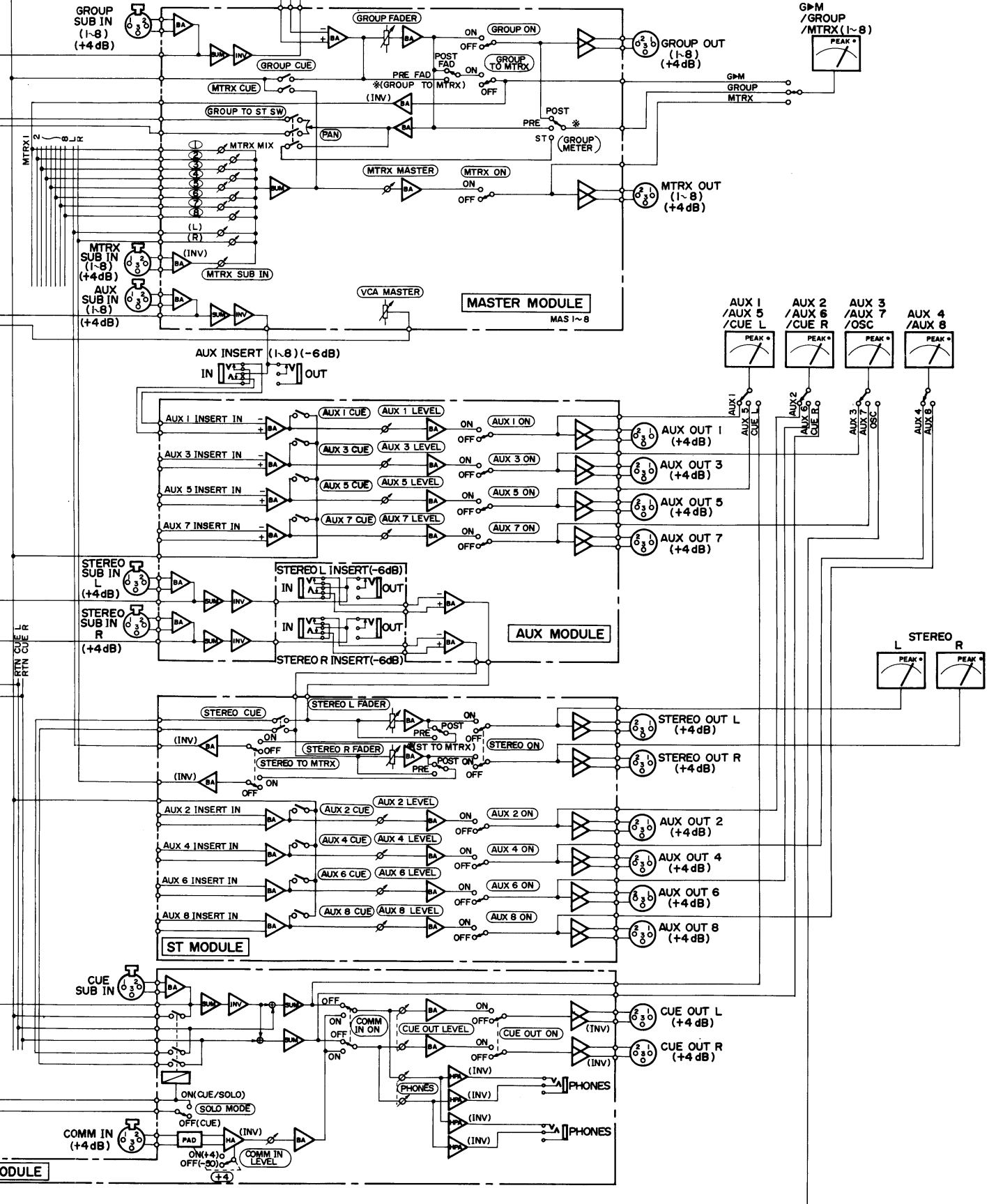

FIGURE 3-21. PM3000 SIGNAL FLOW (BLOCK DIAGRAM)

MASTER CUE



MODULE

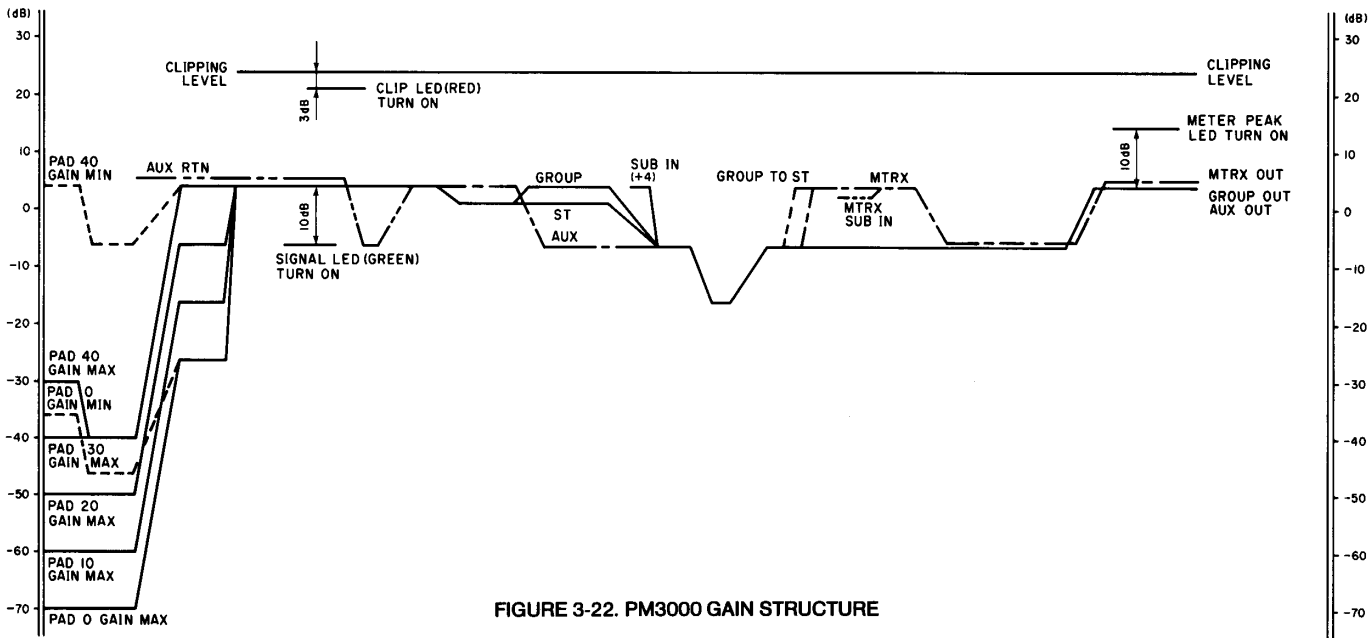
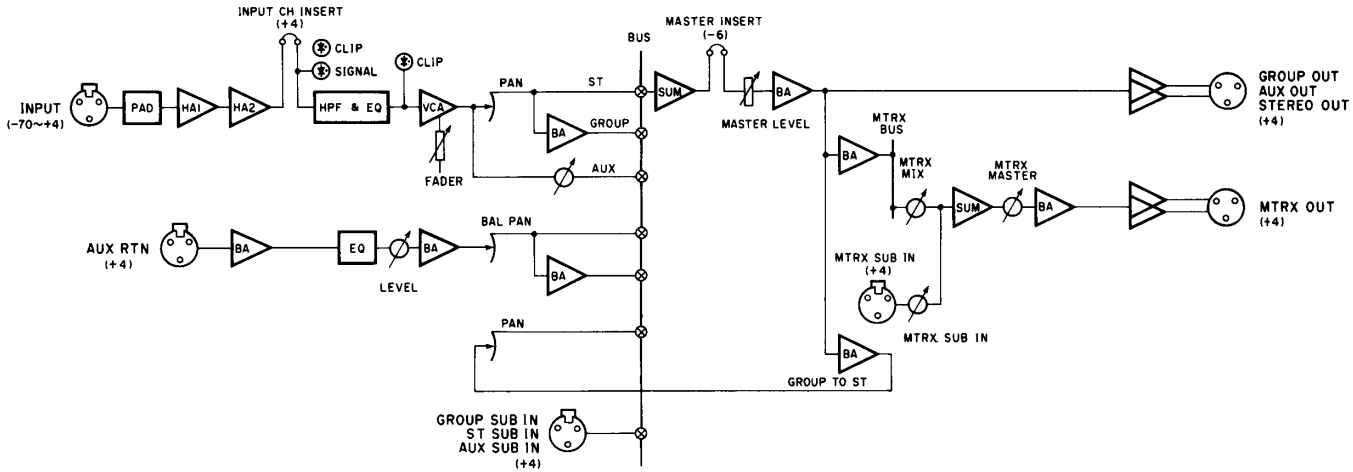

FIGURE 3-22. PM3000 GAIN STRUCTURE