

# SERVICE MANUAL

## P-2200

PA POWER AMPLIFIER

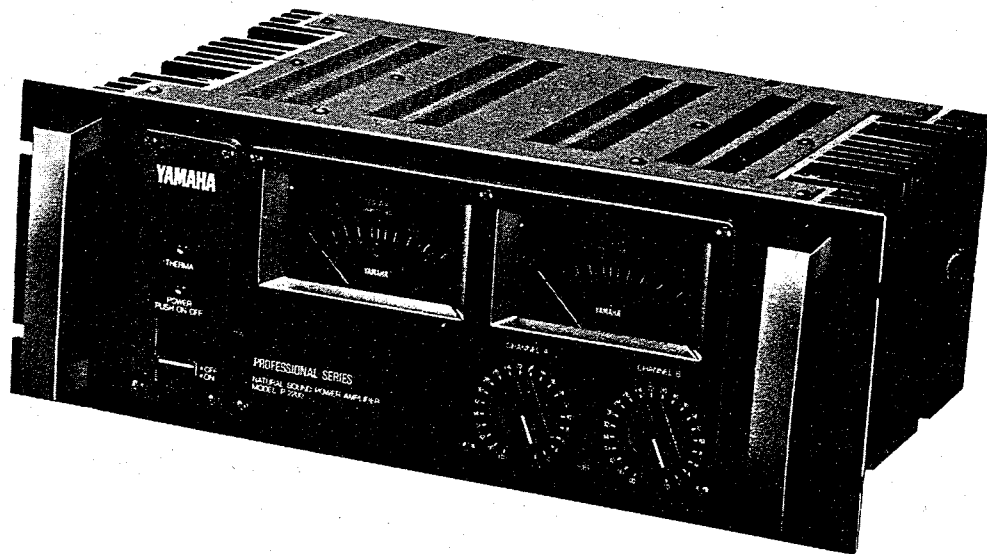

SINCE 1887



# YAMAHA

NIPPON GAKKI CO., LTD. HAMAMATSU, JAPAN

006346



Printed in Japan 9.7

# CONTENTS

PANEL OPERATION .....	1
SPECIFICATIONS .....	3
CHARACTERISTIC DIAGRAM .....	4
BLOCK DIAGRAM .....	5
OUTLINE OF CIRCUIT .....	6
DISASSEMBLY PROCEDURE .....	9
ADJUSTMENT .....	14
PRINTED CIRCUIT BOARD .....	15
WIRING .....	16
SCHEMATIC DIAGRAM .....	17
PACKAGE (SCHEMATIC DIAGRAM)	
EXPLODED VIEW .....	18
PARTS LIST .....	19

---

# PANEL OPERATION

## FRONT PANEL

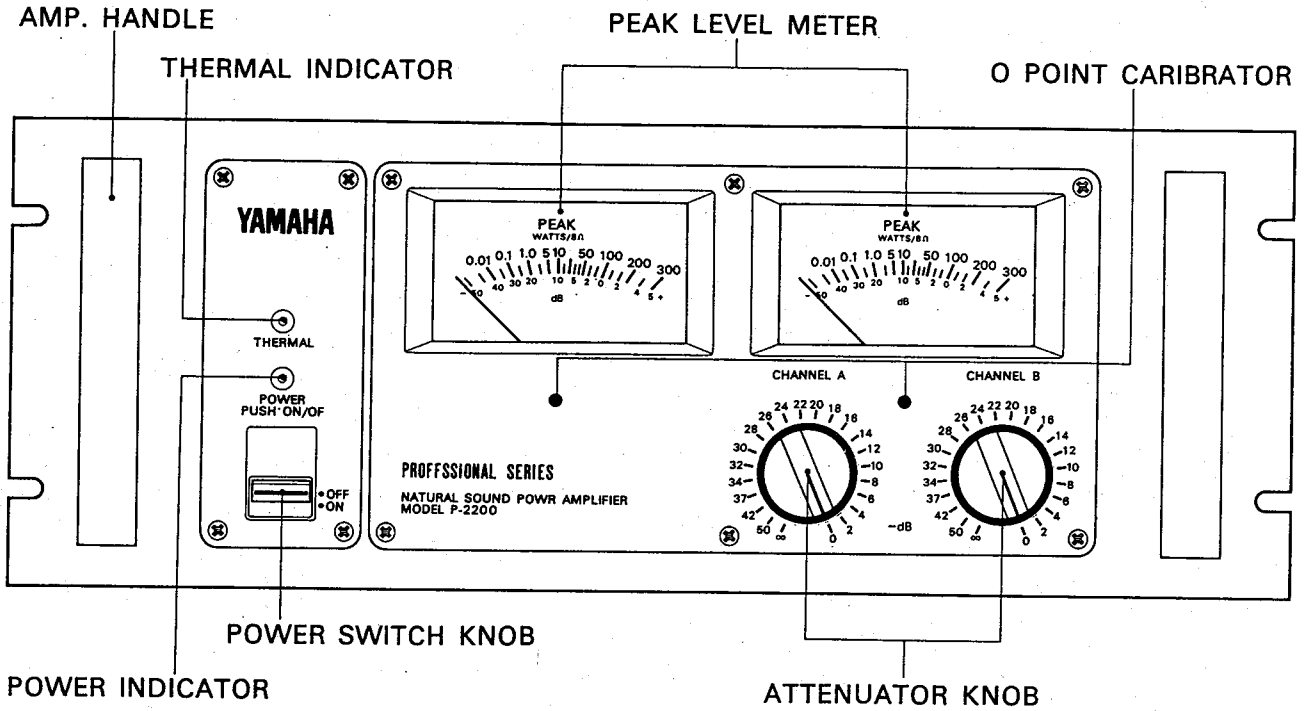

## REAR PANEL

GENERAL, U.K. & AUSTRIAN MODEL

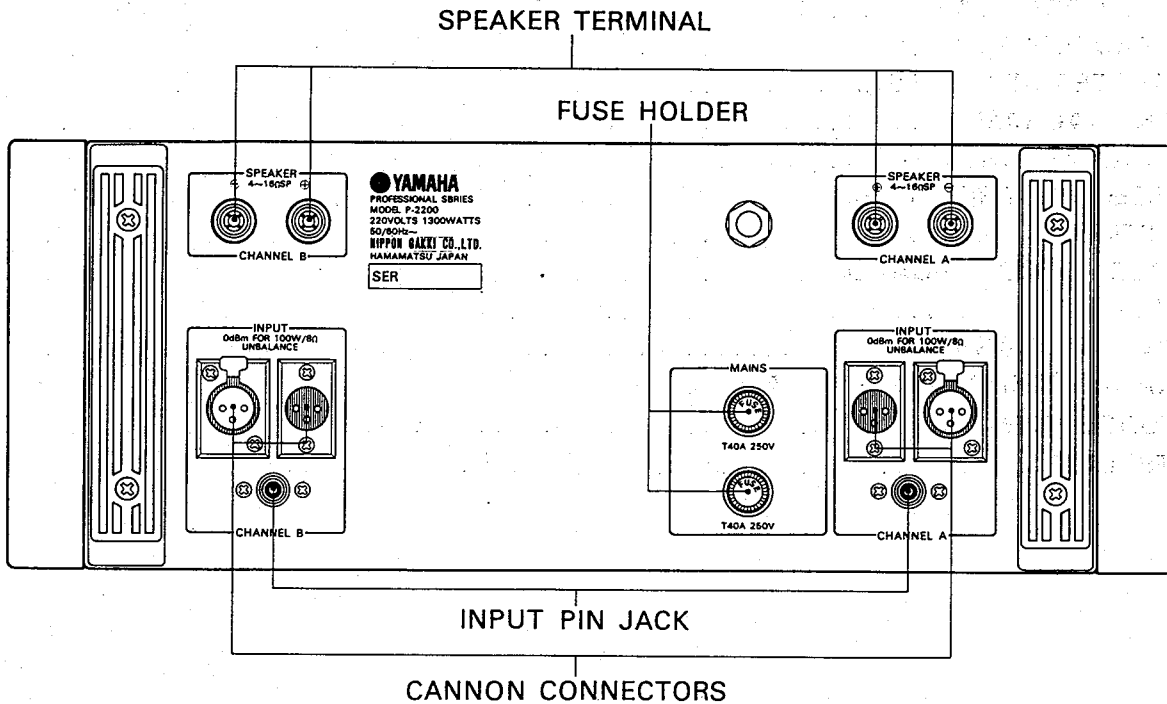

# PANEL OPERATION

## REAR PANEL U.S. MODEL

### AC OUTLET FAN USE ONLY

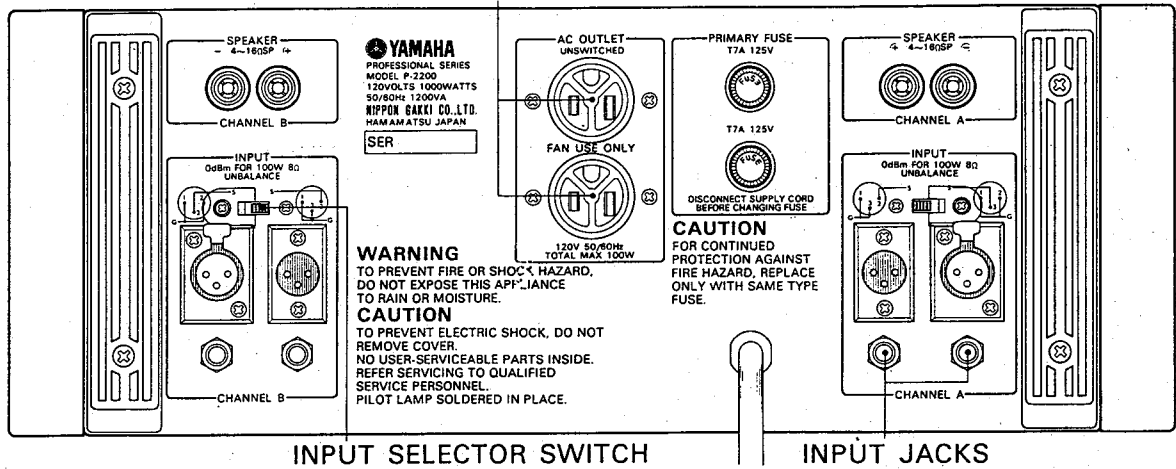

## CANADIAN MODEL

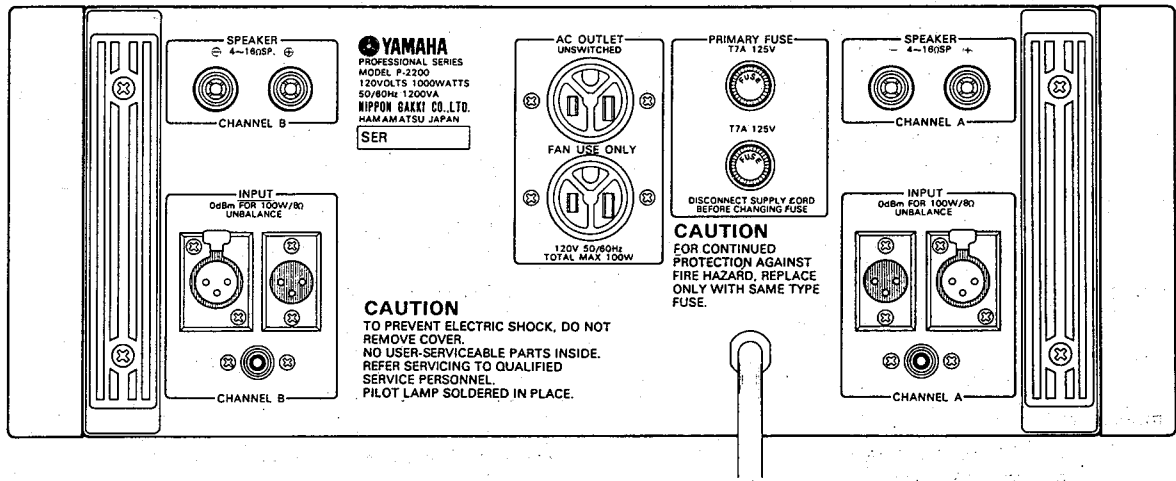

## EUROPEAN MODEL

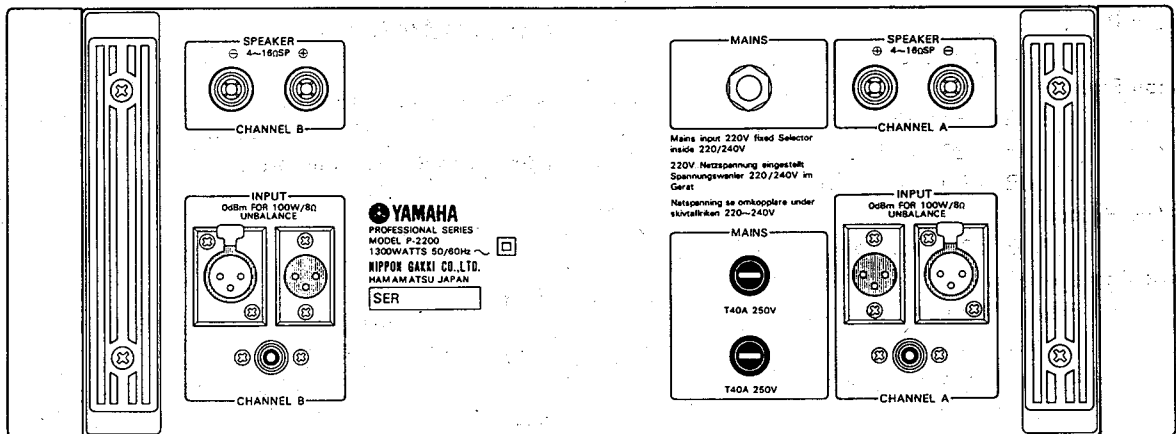

# SPECIFICATIONS

## AMPLIFIER SECTION

<b>Circuit System</b>	All-stage direct-coupled complementary OCL triple push-pull circuit.
<b>Dynamic Power</b>	340W + 340W (8Ω 1KHz THD 0.1%)
<b>Continuous Output</b>	240W + 240W (8Ω 20Hz – 20KHz THD 0.05%) (both channels driven)
<b>Frequency Characteristics</b>	5Hz – 100KHz (+0 –1dB at 8Ω 1W)
<b>Power Band Width</b>	10Hz or less, 100KHz or more (4Ω 175W THD 0.5%)
<b>Total Harmonic Distortion</b>	0.01% or less (8Ω 1W – 200W, 20Hz – 20KHz)
<b>Crosstalk</b>	75dB (20KHz)
<b>Cross Modulation Distortion</b>	0.01% or less (8Ω 100W 70Hz: 7KHz = 4 : 1) 0.1% or less (16Ω 100W)
<b>Damping Factor</b>	350 or more (8Ω 1KHz) 150 or more (8Ω 20KHz)
<b>Signal-to-Noise Ratio</b>	105dB (input 4.7K short-circuited) 115dB (input 4.7K short-circuited IHFA)
<b>Input Sensitivity</b>	0dBm + 0.5dBm (8Ω 100W)
<b>Voltage Gain</b>	31.2dB (volume max.)
<b>Input Impedance</b>	25KΩ (volume max.) 25 – 33KΩ (volume max. to min.)

## Peak METER SECTION

<b>Indication Range</b>	-50 to +5dB (0dB = 100W/8Ω)
<b>Indication Error</b>	±0.5dB (-5 to +5dB) ±1.0dB (-20 to -5dB) ±2.0dB (-50 to -20dB)
<b>Frequency Response</b>	±1.0dB (40Hz to 20KHz)
<b>Response Characteristics</b>	Rising 10msec (1KHz 0dB) 10msec – 1 ± 0.5dB indicated) Dropping 0.8sec (0dB – -20dB returning time)

## POWER SUPPLY

### GENERAL MODEL

<b>Rated Voltage</b>	220V 50/60Hz
<b>Rated Power Consumption</b>	1300W
<b>Primary Current at Rated Operation</b>	6.0A
<b>Primary Fuse</b>	T4.0A 125V x 2

### U.S. & CANADIAN MODEL

<b>Rated Voltage</b>	120V 50/60Hz
<b>Rated Power Consumption</b>	1000W, 1200VA
<b>Primary Current at Rated Operation</b>	11.5A
<b>Primary Fuse</b>	T7.0A 125V x 2

### U.K. & AUSTRIAN MODEL

<b>Rated Voltage</b>	240V 50/60Hz
<b>Rated Power Consumption</b>	1300W
<b>Primary Current at Rated Operation</b>	6.0A
<b>Primary Fuse</b>	T4.0A 250V x 2

### EUROPEAN MODEL

<b>Rated Voltage</b>	220/240V 50/60Hz
<b>Rated Power Consumption</b>	1300W
<b>Primary Current at Rated Operation</b>	6.0A
<b>Primary Fuse</b>	T4.0A 250V x 2

## MISCELLANEOUS

<b>Ambient Temperature</b>	-20°C to +50°C
<b>Number of Semiconductors Used</b>	42 (transistors) 41 (diodes) 1 (IC)
<b>Dimensions</b>	480(W) x 376(D) x 183(H)mm
<b>Panel Size</b>	480(W) x 176(H)mm
<b>Rack Mount</b>	19" standard rack mount attachable
<b>Weight</b>	19.5kg

# CHARACTERISTIC DIAGRAM

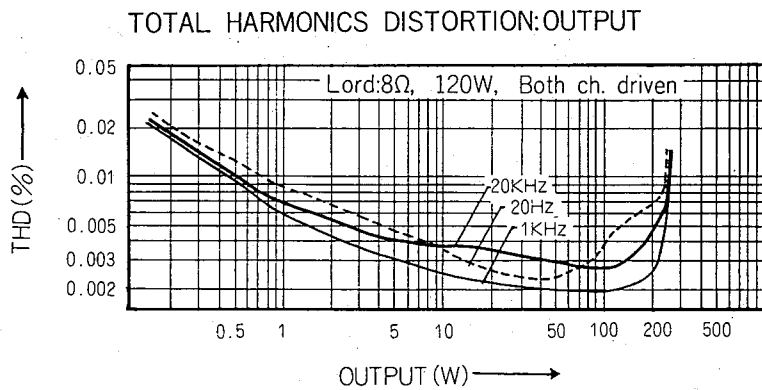
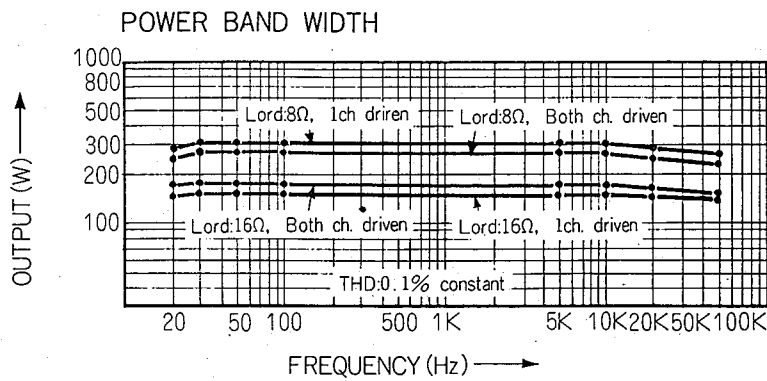
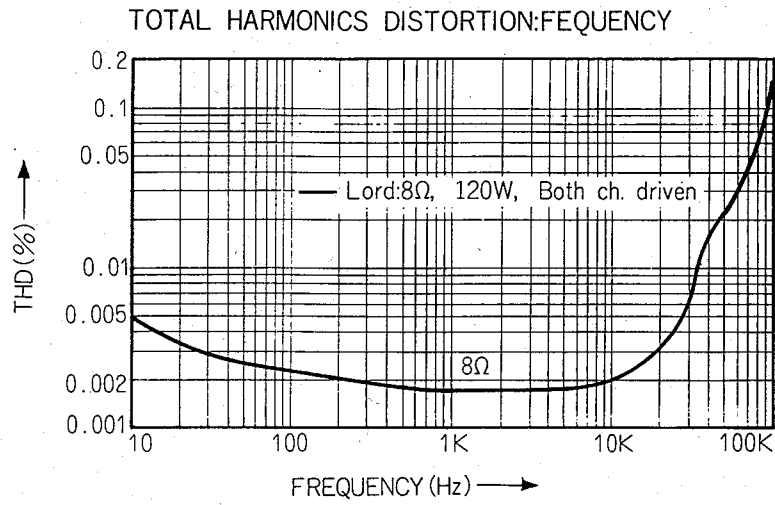
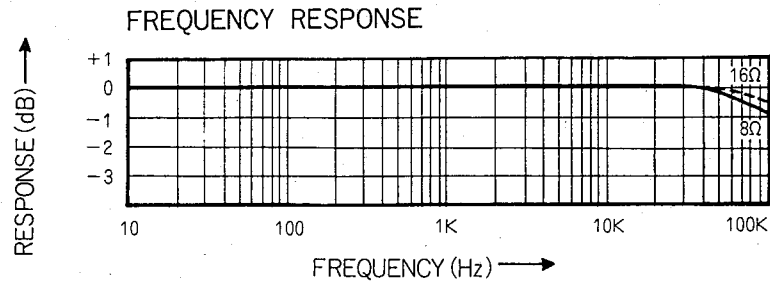

# BLOCK DIAGRAM

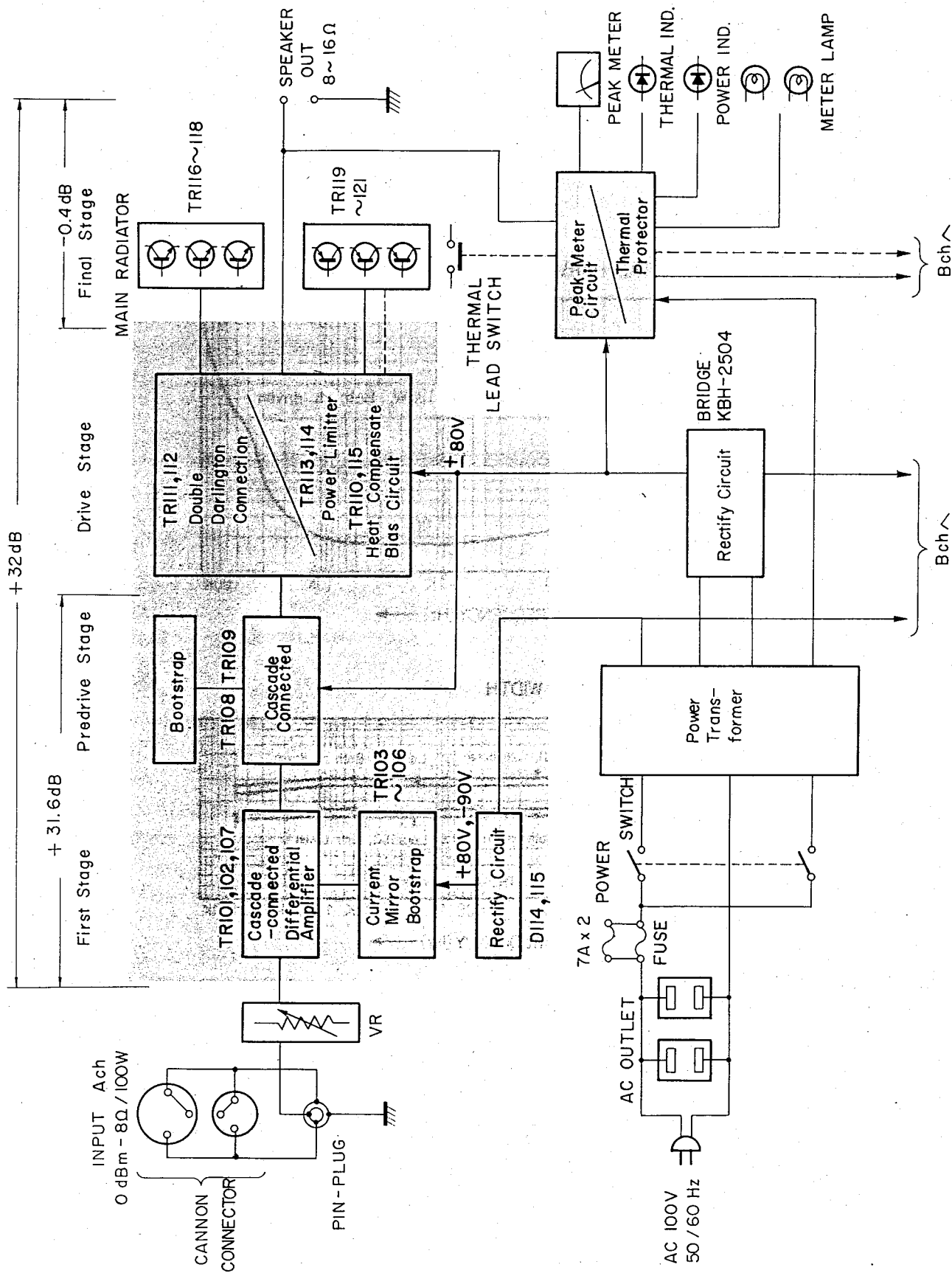

# OUTLINE OF CIRCUITS

## OUTLINE OF CIRCUITS

PA POWER AMPLIFIER P-2000 is designed and engineered for wider band and higher fidelity along with high reliability and high stability, backed by Yamaha's own advanced audio engineering and long-time experience in PA equipment.

For that purpose, every part is strictly engineered, and simplified circuits are employed, avoiding unnecessary complicated circuit system. More specifically, voltage amplifying stages (first stage and predrive stage) are all connected to the cascade for obtaining wider band, and Pc is distributed for improving reality — that is, improving of bare characteristics and achieving of high reliability. In addition, NFB at the final stage enables low distortion and high stability at relatively low level of 40dB.

### 1. Input Circuit/First Stage Differential Amplifier

The input level control employs the metal-grazed volume having attenuation characteristics according to PC-50C of the BTS Code. The input impedance is designed in such manner as to obtain 25KΩ at its maximum value, and the required attenuation characteristics and impedance characteristics at ATT load resistance of 100KΩ.

Values of capacitors C101(A) and C201(B) located at the inlet of the driver circuit board are determined with ultra-bass range and shock noise protection when the power switch is turned on. When the values are small, the peak occurs at low frequency, while when

the values are relatively large, rise of TR101 is delayed due to charging time constant when the power switch is turned on.

The first stage differential amplifier is cascode connected due to constant current operation of TR107, and delivers output due to current mirror load. In general, the basic voltage being cascode-connected is set at a constant value. In case of the cascade bootstrapped circuit consisting of TR103, TR104(A), TR203 and TR204(B), the basic function is set on the emitter side through R112, R113(A), R212 and R213(B) in order to reduce fluctuation of VCE at the operating differential stage, thus driving TR101, TR102(A), TR201 and TR202(B) at ideal conditions. And it also serves as a normal cascode circuit in treble range, as the base is ac grounded through C103(A) and C203(B). In addition, the current mirror circuit being as load reduces distortion factor. R109, R115(A), R209 and R215(B) ensure safety operations by working as fuse resistances.

Diodes D103, D104(A), D203 and D204(B), which are connected between B and B among differential amplifier transistors TR101, TR102(A), TR201 and TR202(B), serve as a diode limiter to regulate voltage between B and B at 0.6V, protecting the transistors from damage when input that largely exceeds the allowable input of the amplifier is applied. Parallel connected capacitors C104 and C204 serve for eliminating external r.f. noise.

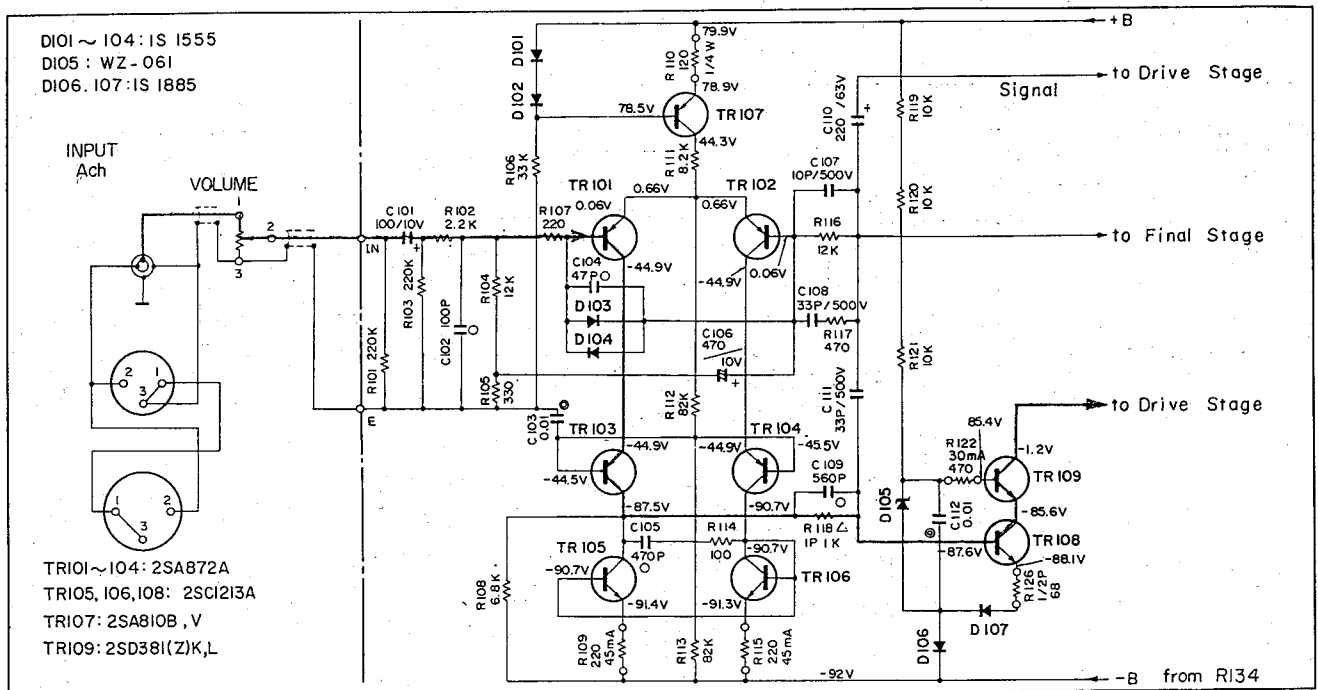



# OUT LINE OF CIRCUITS

## 2. Predrive Stage

The predrive stage consists of transistors TR108, TR109(A), TR208 and TR209(B), all being cascade connected. As a result, a transistor having small  $P_c$  and excellent voltage withstand characteristics is applicable to TR108, which largely contributes to reduction of distortion factor. Diodes D106, D107(A), D206 and D207(B) are connected to emitters of TR108(A) and TR208(B) for improving the slew rate and stability. For example, the slew rate is sufficiently reduced to mere  $20V/\mu\text{sec}$  in case of pure resistance compared with  $40$  to  $50V/\mu\text{sec}$  under the above conditions. To improve safety factor, fuse resistance is used for the emitter resistance that determines gain and input impedance in the predrive stage.

## 3. Drive Stage

For driving the transistors TR111, TR112(A), TR211 and TR212(B), transistors having 180V or more which are selected among having  $V_{CE0}$  of 140V transistors are used, giving sufficient margin in heat design.

The bias circuit is composed of transistors TR110, TR115(A), TR210 and TR215(B), and diodes D108(A) and D288(B). TR115 and TR215 are heat connected to the main transistor radiator, and D108 is placed on the circuit board, each of which compensates temperature. The bias voltage is regulated by the potentiometer VR101.

The bootstrap circuits each consist of C110, R125, C124 and C114(A), C210, R225, R224 and C214(B) which are connected to the bases of the driving

transistors TR111(A) and TR211(B). R132, R133, D109(A), R232, R233 and D209(B), which are series connected between E and E, determine idling current at the driver, and become discharging impedance at the power transistor whose high value leads to deterioration of the characteristics at high frequency.

TR113, TR114(A), TR213 and TR214(B) constitute the  $P_c$  limiter circuit that detects the loss of the power transistor to control the drive signal for protecting the power transistor from breakage. At start of operation, setting is  $R_L=2.5\Omega$ ,  $P_O=630W$ ,  $2\Omega 600W$  and  $1\Omega 40W$ . As for the loss of the power transistor, voltage at each emitter resistance of  $0.47\Omega$  is taken out through a resistance of  $10\Omega$ , mixed by R139, R140(A), R239 and R240(B), and finally led to the base of the limiter transistor.

## 4. Output Stage

The output stage, which is darlington-connected to the driver, is triple push-pull complementary OCL system, using the high power transistor of  $V_{CE0}=200V$  and  $P_c \text{ max}=150W$ . The output signal picked up at midpoint between the plus and minus terminals is delivered to the speaker through L101(A) and L201(B). L101, R158(A), L201 and R258(B) constitute the CR network used for stabilizing purpose when subject to capacitive load, and R157, C125(A), R257 and C225(B) constitute the CR network for correcting the load impedance.

This output is divided by R105, C106, R116(A), R205, C206 and R216(B), and returned to the first stage differential amplifier as NFB.

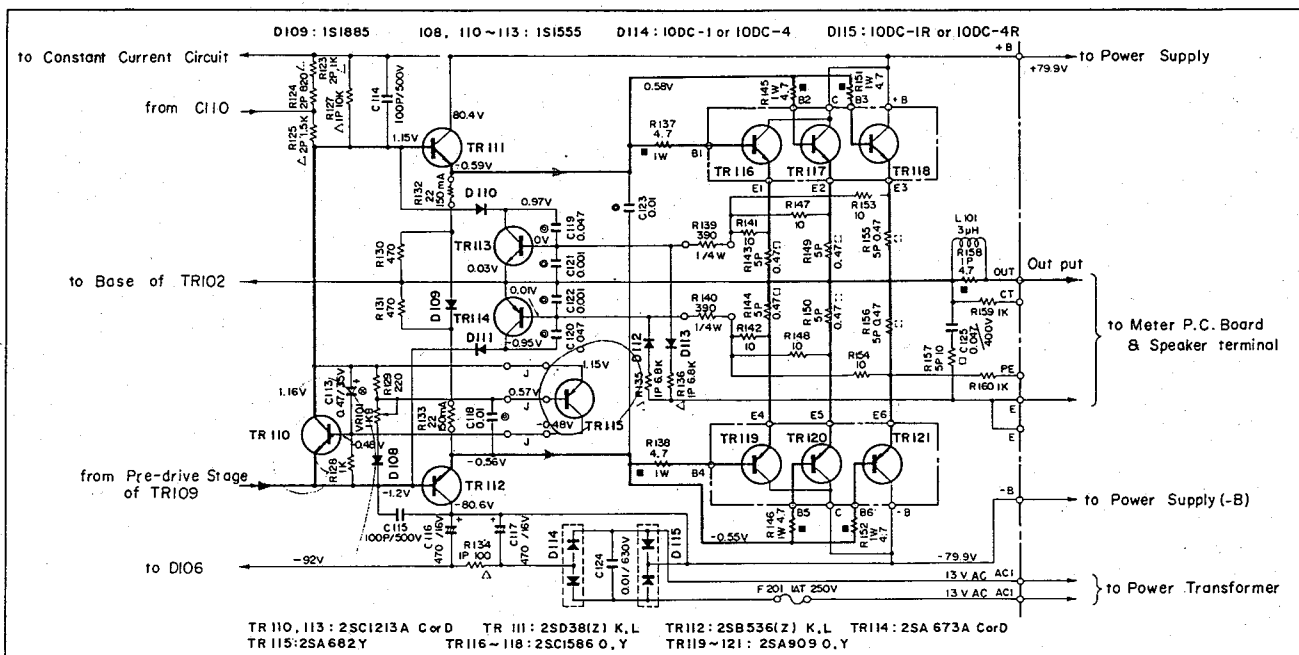

# OUTLINE OF CIRCUITS

## 5. Power Supply Circuit

The power supply transformer uses a toroidal iron core which is half the size and weight of the EI type core with the same capacity, thus significantly reducing in dimension and weight. Moreover, the capacity used is twice that of the conventional transformer. For other features, the primary winding is parallel wound, with a power switch provided on either side. Thus rush current, when the power switch is turned on, may be reduced to 73% of that of the ordinary transformer,

The power supply section employs a large capacity 22,000 $\mu$ F electrolytic condenser on each of the plus and minus sides, providing generous capacity power supply.

To the power stage, high voltage of +80V is supplied. To the first stage differential amplifier, predrive stage and driver stage, +80V and -32V are supplied, which are previously rectified and smoothed by the separate winding on the driver circuit board, and combined at the power stage.

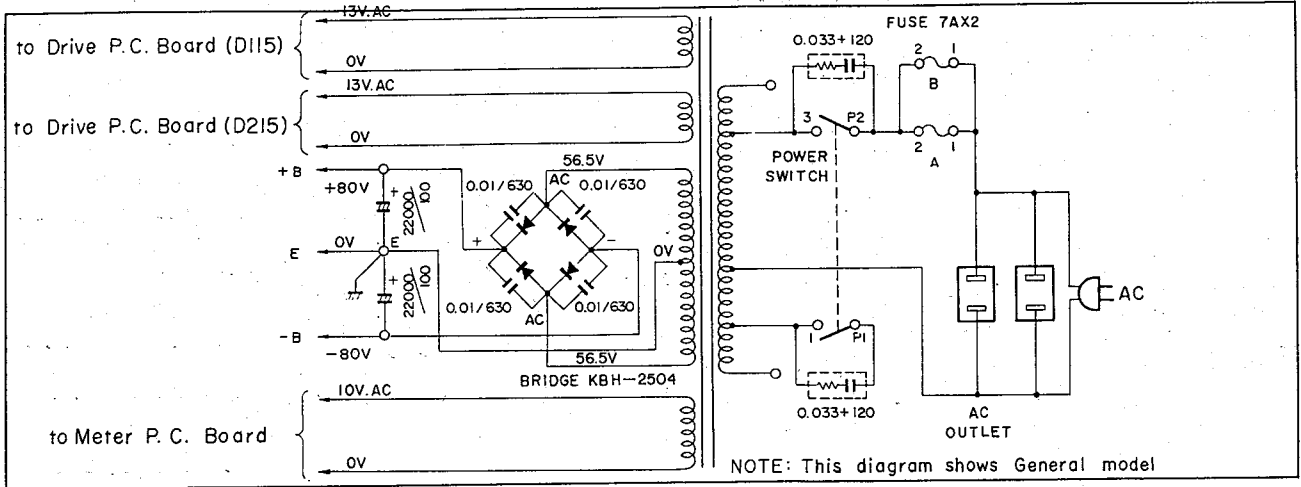

## 6. Peak Meter Circuit

The use of high brid IC incorporating logarithmic compression, full-wave rectifying and peak detecting functions offer high stability and reliability of the peak meter. The response characteristics conform to DIN Standard; rise by the sue of the meter is -0.5dB at 1kHz for .10msec, and -1dB for 5msec. Necessary adjustment is a mere sensitivity adjustment of the meter that is adjusted to 0dB.  $\pm 15V$  of the IC power

source is achieved by dropping +B by temporary constant voltage, since the allowable voltage range is wide from  $\pm 12$  to  $\pm 18V$ .

The thermal lead switch, which is wired to the meter circuit board, is heat connected to the main radiator for the power transistor. When the radiator reaches 100°C, the LED at the front panel lights to tell overheat.

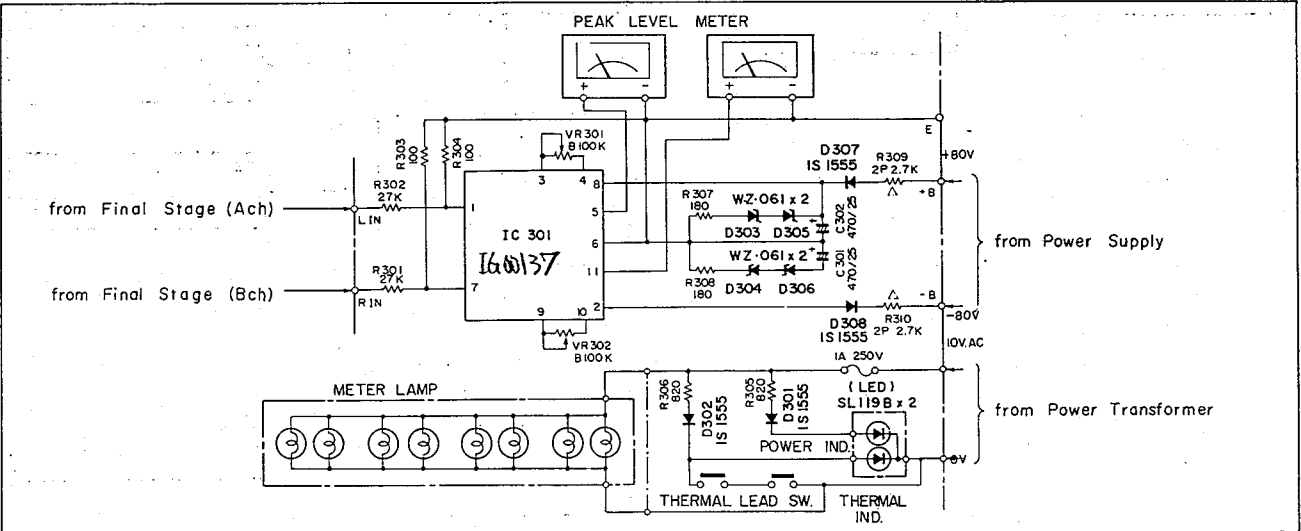

## DISASSEMBLY PROCEDURE

- Disassembly is performed in accordance with the Flow chart.
- When thermal lead switch is removed, follow the red-arrowed flow.

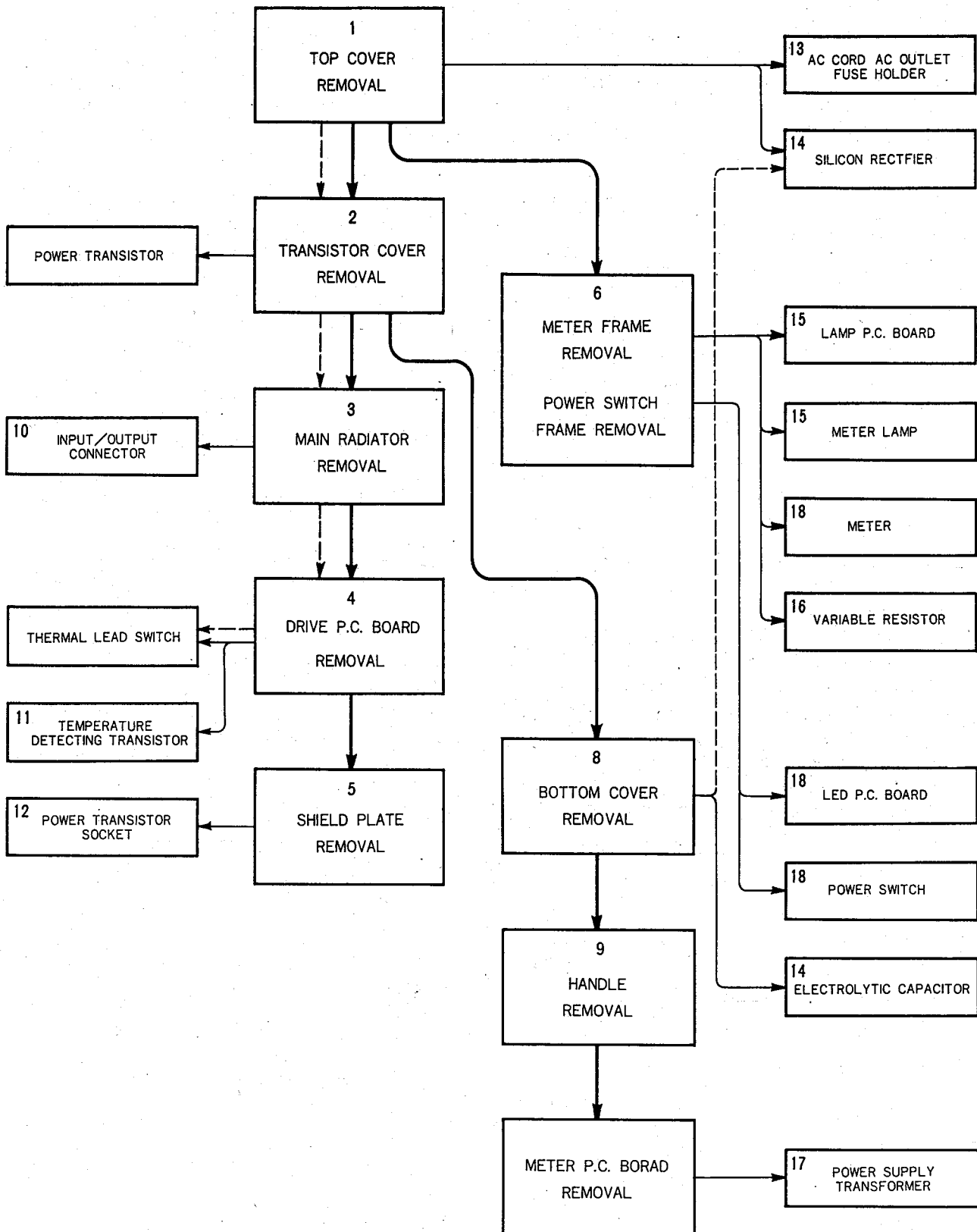

## DISASSEMBLY PROCEDURE

### 1. TOP COVER REMOVAL

13 screws

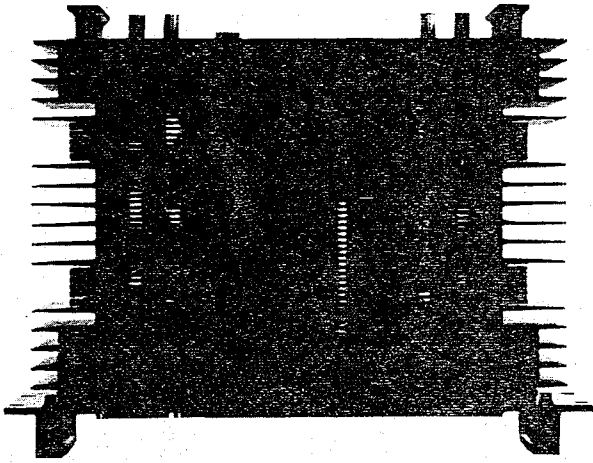

### 2. TRANSISTOR COVER REMOVAL

2 screws x 2

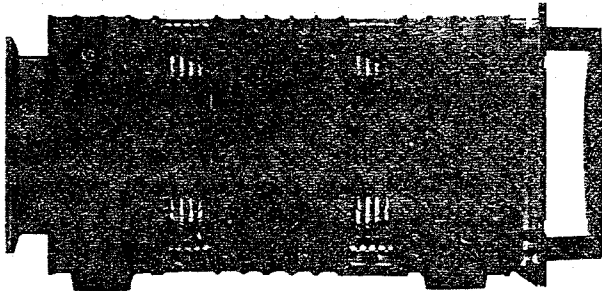

### 3. MAIN RADIATOR REMOVAL

Remove 4 plus screws between fins, and 4 plus screws fixing transistor cover. All those screws are threaded to bottom cover.

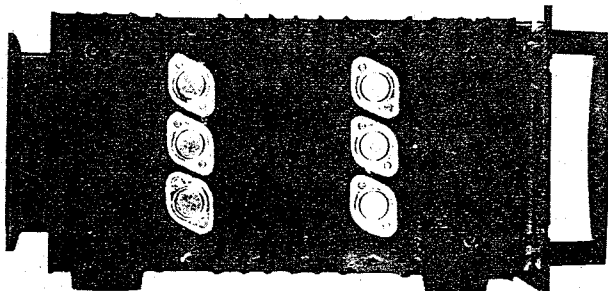

### 4. DRIVE P.C. BOARD REMOVAL

4 screws

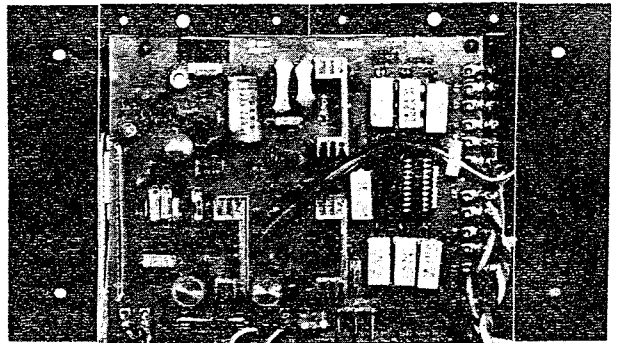

### 5. SHIELD PLATE REMOVAL

Remove drive P.C. board, then remove 4 plus binding screws. By removing input cord of drive P.C. board, the drive board may be opened on one side.

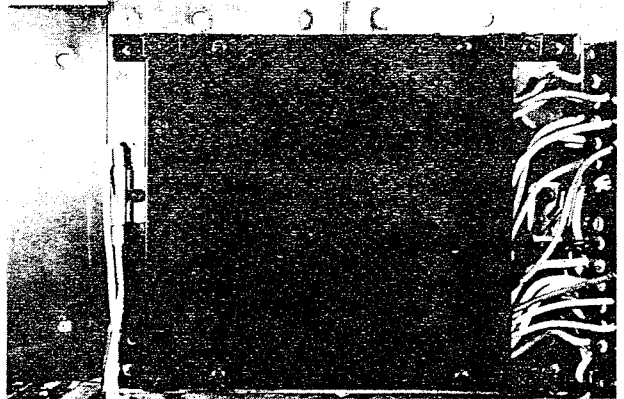

### 6. POWER SWITCH & METER FRAME REMOVAL

4 screws in Power switch frame.  
6 screws in Meter frame.

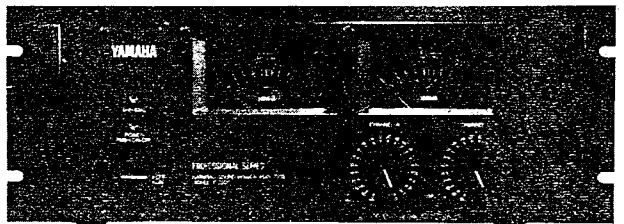

## DISASSEMBLY PROCEDURE

### 7. BOTTOM COVER REMOVAL

Remove 12 plus screws and 4 screws fixing power transistor cover.

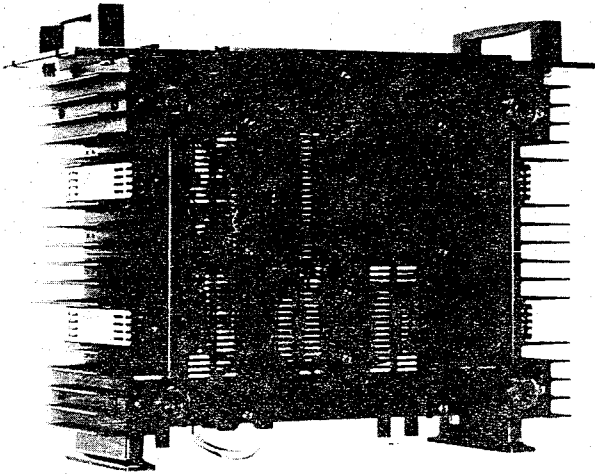

### 8. HANDLE REMOVAL

2 bolts x 2

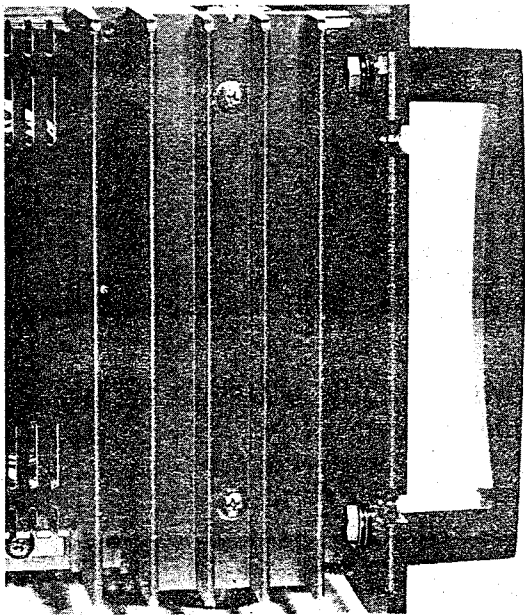

### 9. METER P.C. BOARD REMOVAL

4 binding screws.

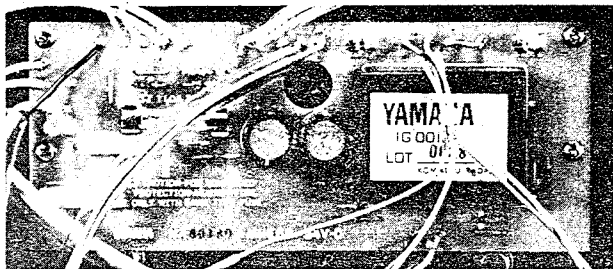

### 10. INPUT/OUTPUT CONNECTOR REMOVAL

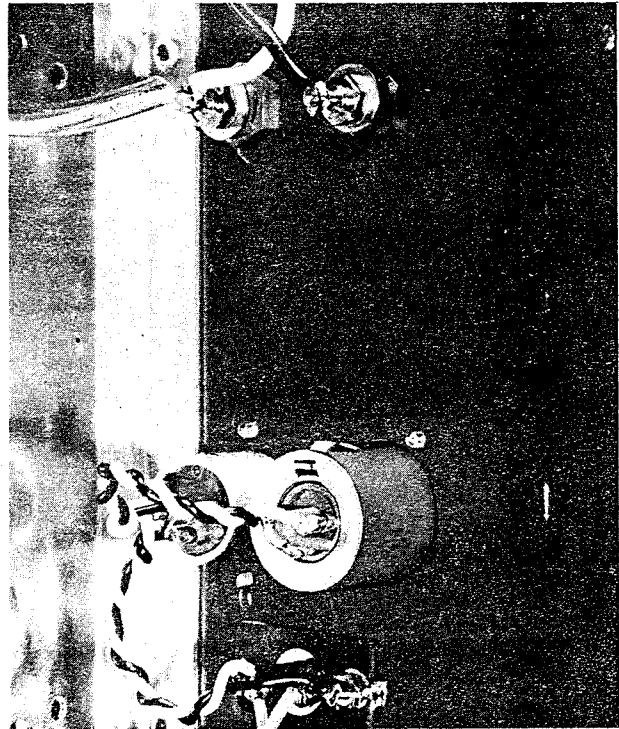

### 11. TEMPERATURE DETECTING TRANSISTOR REMOVAL

In case of renewal, make sure that new transistor is insulated from radiator, avoiding heat-coupling between them.

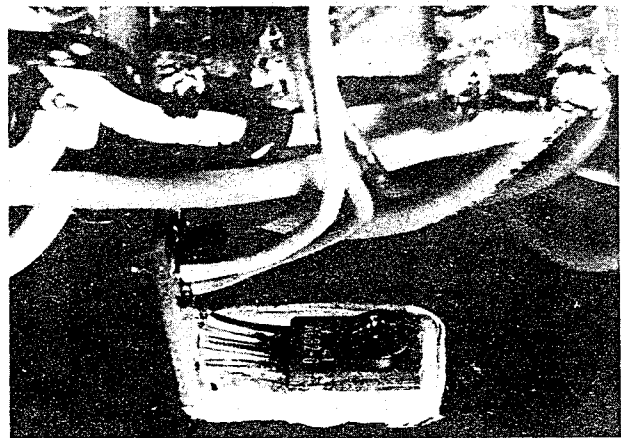

## DISASSEMBLY PROCEDURE

### 12. POWER TRANSISTOR SOCKET

Remove drive P.C. board first, then remove power transistor. Lead wire is wired to meter P.C. board.

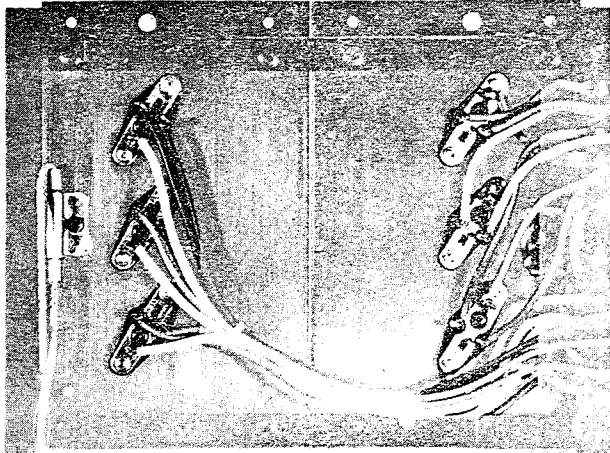

### 14. SILICON RECTIFIER

- \* Discharge electric capacitor by resistor about  $8\Omega$  100W.
- \* 2 electric capacitors are fixed by metal band.
- \* In case of renewal electric capacitors, confirm its pole of + -

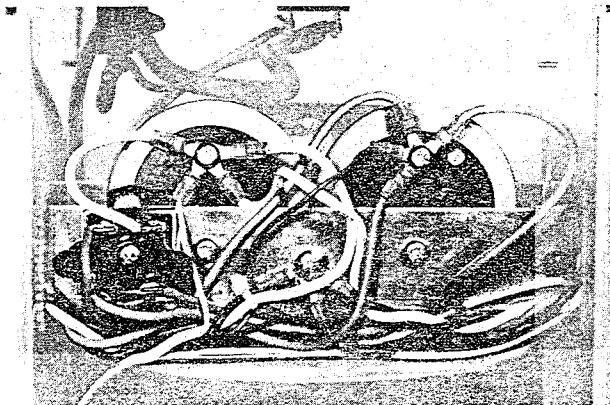

### 13. AC. CORD, AC. OUTLET, FUSE HOLDER

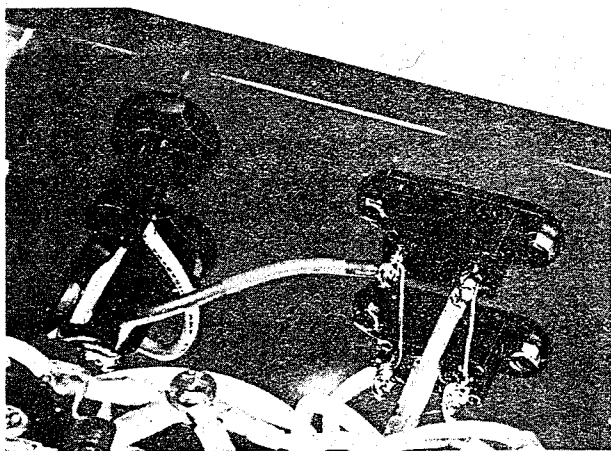

### 15. METER LAMP P.C. BOARD & LAMP

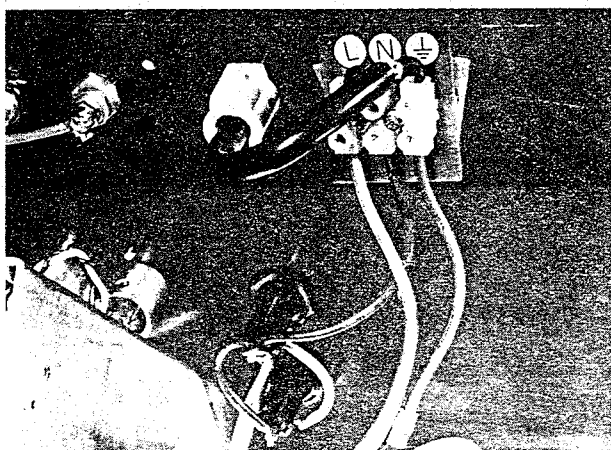
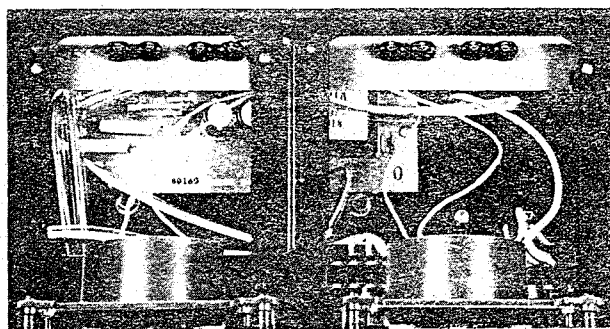

### 16. VARIABLE RESISTOR (ATTENUATOR)

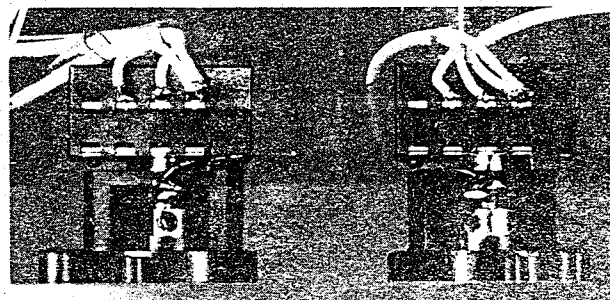

## DISASSEMBLY PROCEDURE

### 17. POWER TRANSFORMER

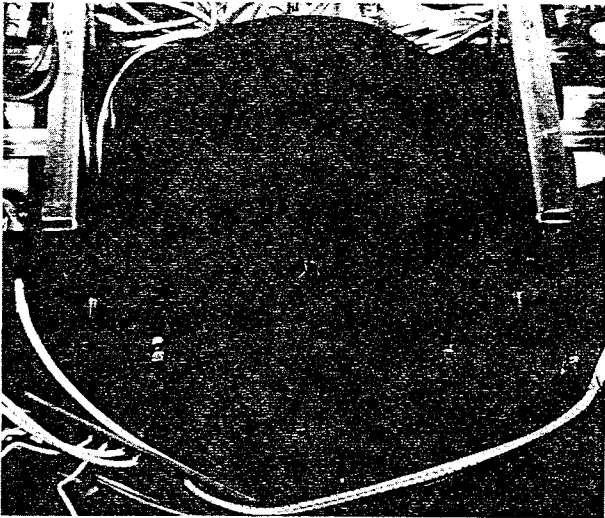

### 18. METER, POWER SWITCH, LED P.C. BOARD

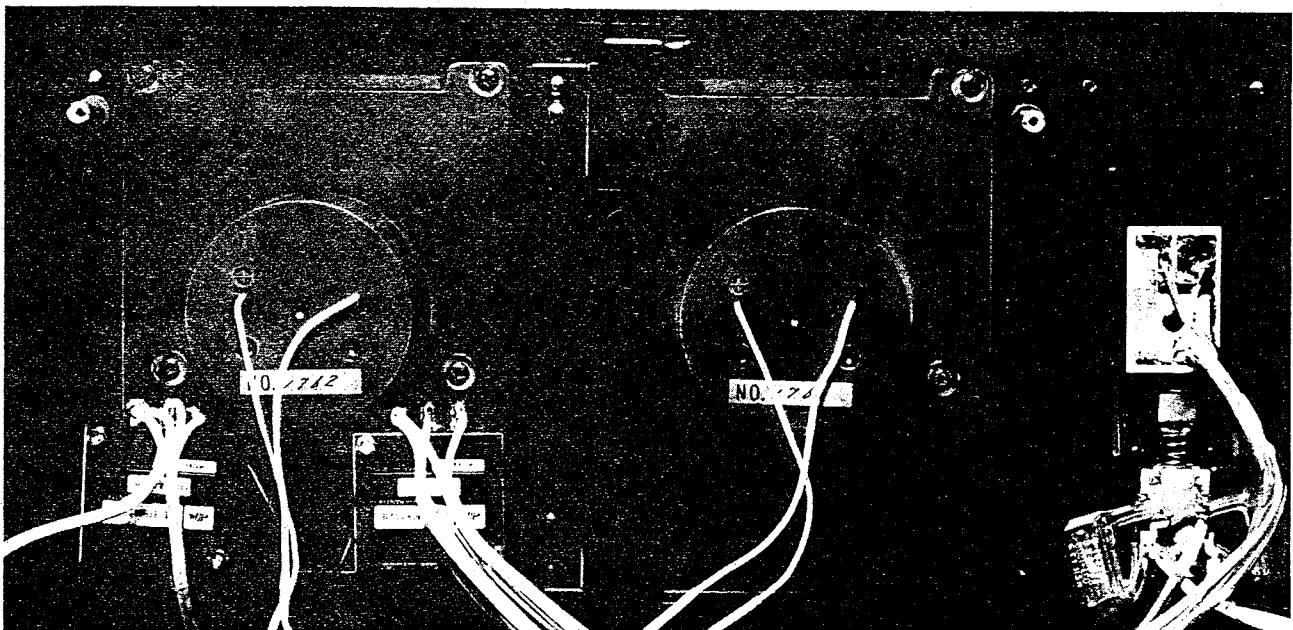

## ADJUSTMENT

### Before adjusting

- Before adjusting, wait a few minutes after turning-on of the power switch.
- In case of exchanging parts, make discharging by short-circuiting between terminals of the electrolytic condenser by means of a resistance of about  $8\Omega$  100W, since electric charge often remains at the electrolytic condenser in the power supply section.

### Adjusting Driver Circuit Board

The driver circuit board is adjusted with respect to only idling current at the output stage of VR101. V101(A) and VR201(B) are adjusted so that voltage between test terminals CT and PE becomes 10mV when no signal is present. The idling current is 21.2mA per power transistor. At this time, confirm that voltage between E and CT is 0V (confirmation of midpoint voltage).

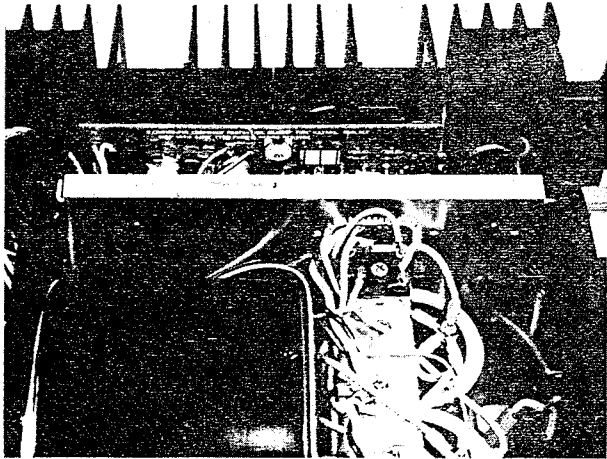

In case of exchanging parts in the driver circuit board, or in case of measuring voltage, remove the main radiator, and mount it on the body after turning it 180°.

### Adjusting Meter P.C. Board

#### Zero Adjusting

The zero-adjusting screws, each in a hole positioned below the respective meter on the front panel, are adjusted so that the meter reads zero when no signal is present.

#### 0dB Adjusting

VR301 and VR302 are adjusted so that the meter reads 0dB when operating at  $8\Omega$  100W by connecting a dummy resistance of  $8\Omega$  100W or more to the speaker terminal.

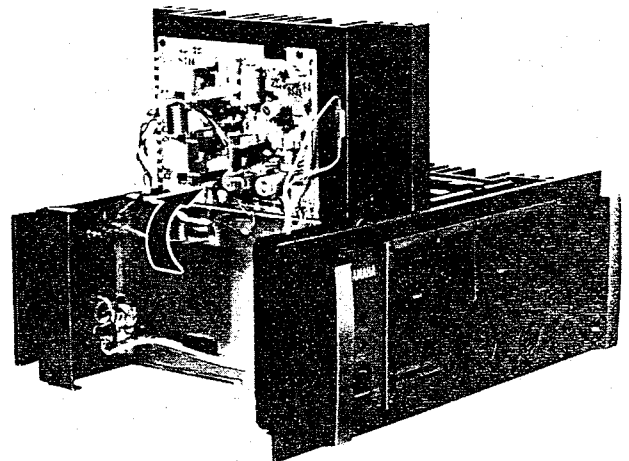
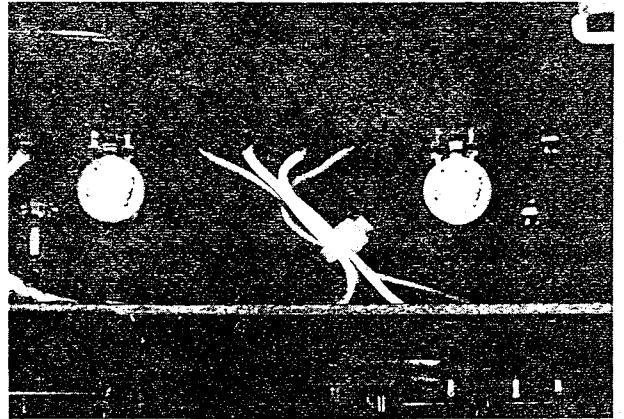



# PRINTED CIRCUIT BOARD

## DRIVE STAGE P.C. BOARD

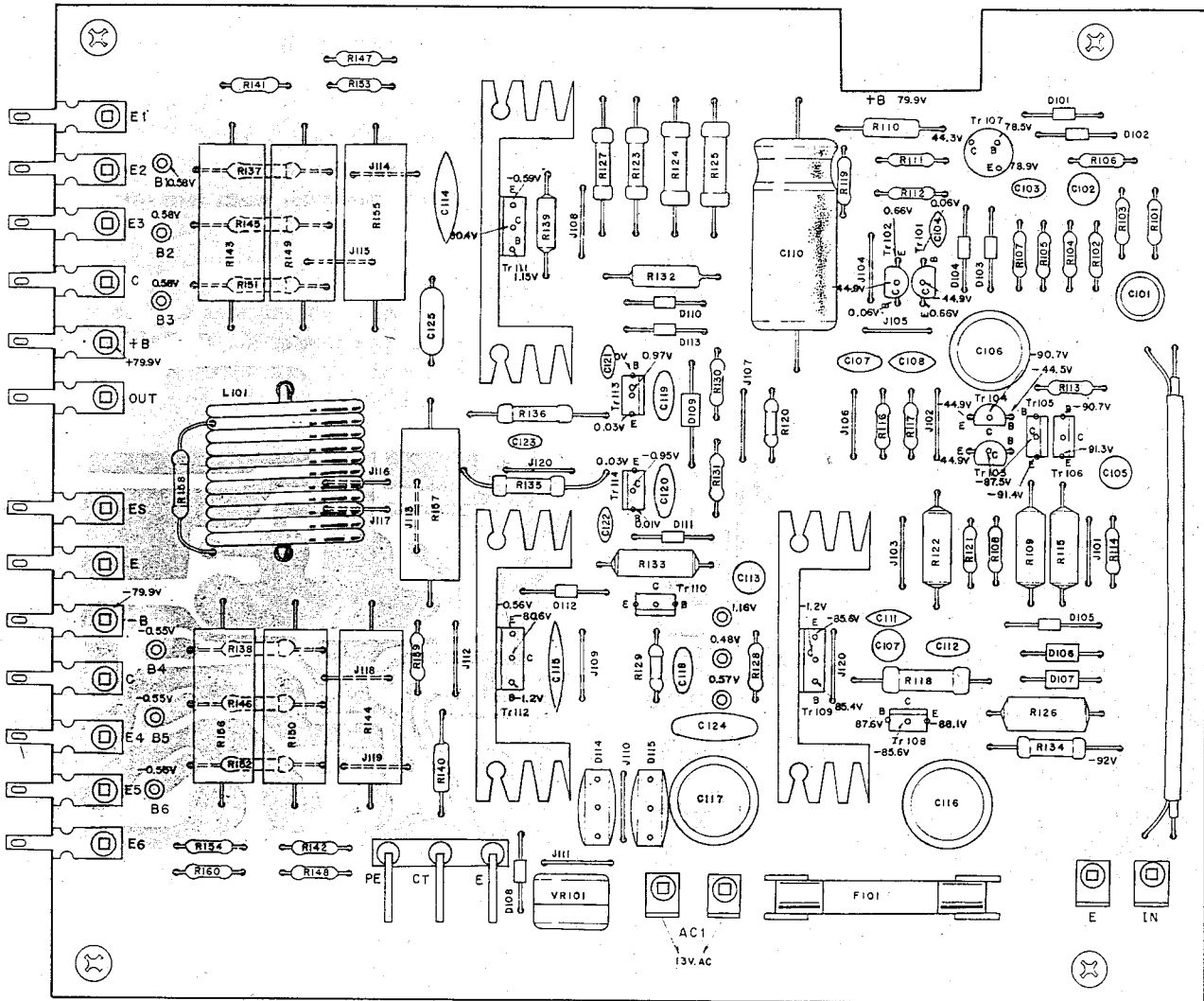

# WIRING

## WIRING COLOR CODE

- BL .... BLACK
- BR .... BROWN
- RE .... RED
- OR .... ORANGE
- YE .... YELLOW
- GR .... GREEN
- BE .... BLUE
- VI .... VIOLET
- GY .... GRAY
- WH .... WHITE
- PK .... PINK

Note: This wiring diagram is shown accordant with general export model. Refer to the schematic diagram each variation by export zone.

### US MODEL

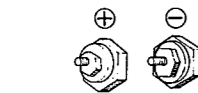

SPEAKER Rch

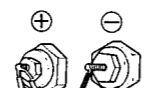

SPEAKER Bch.

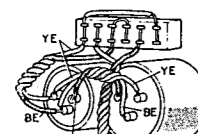

INPUT CONNECTOR



INPUT CONNECTOR

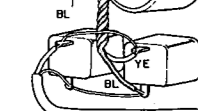

PHONE JACK

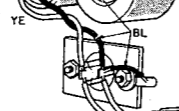

PIN JACK

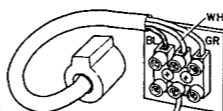

FUSE HOLDER

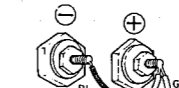

SPEAKER Ach.

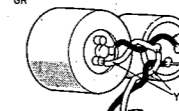

INPUT CONNECTOR

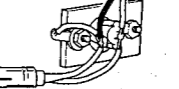

PIN JACK

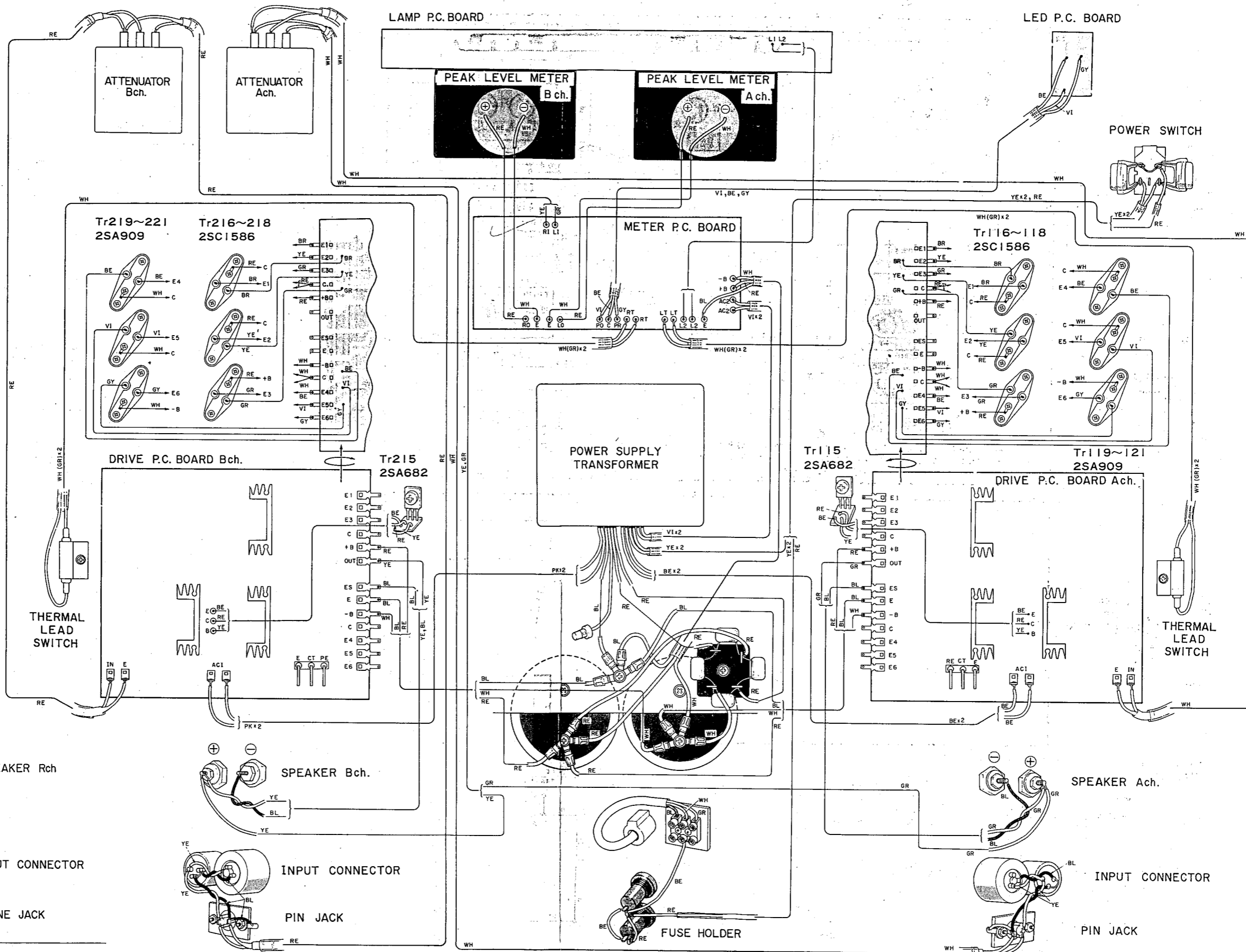

# SCHEMATIC DIAGRAM

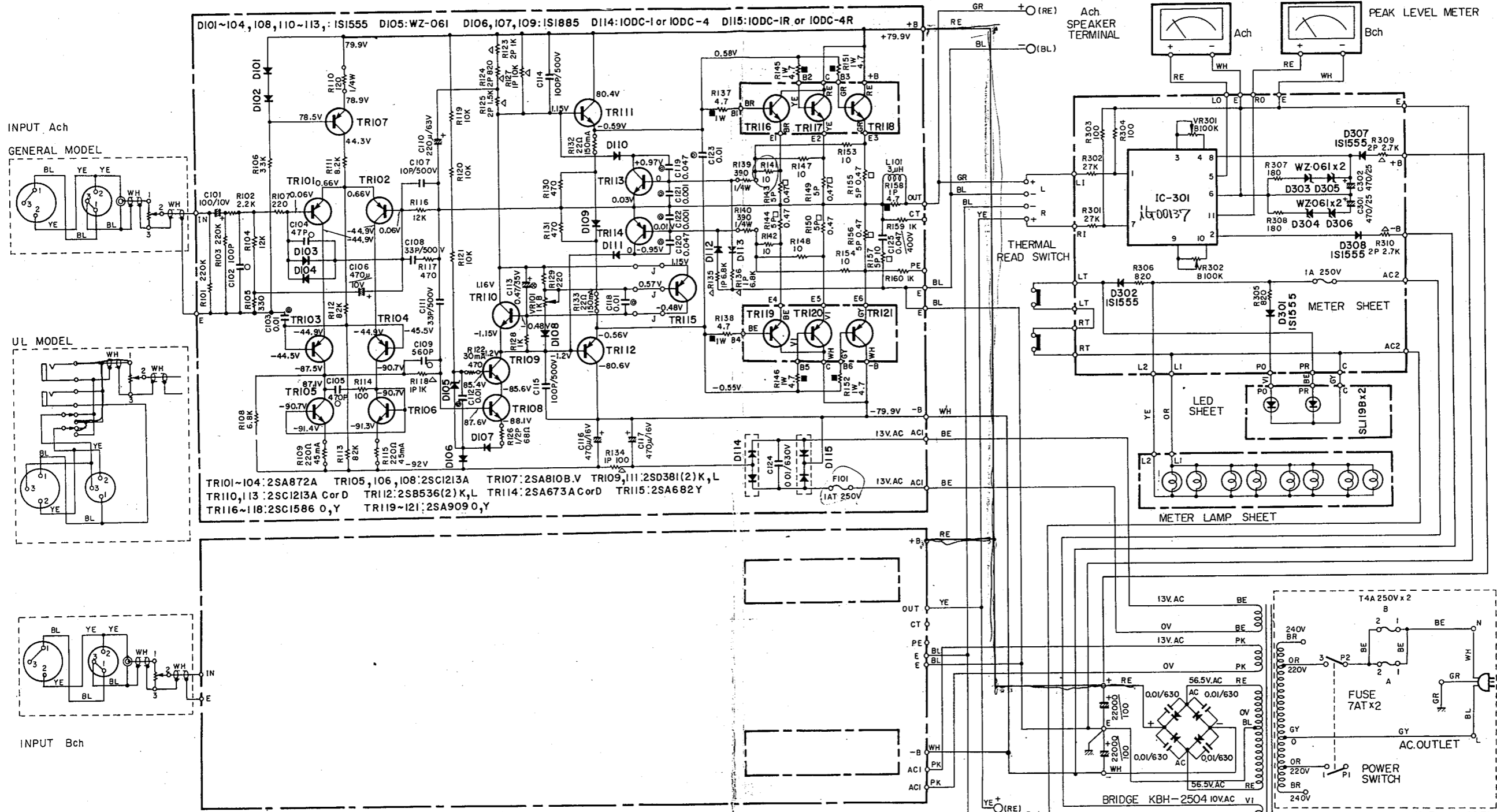

TR101-104: 2SA872A TR105, 106, 108: 2SC1213A TR107: 2SA810B.V TR109, 111: 2SD381(2)K, L  
 TR110, 113: 2SC1213A Cor D TR112: 2SB536(2)K, L TR114: 2SA673A Cor D TR115: 2SA682Y  
 TR116-118: 2SC1586 0, Y TR119-121: 2SA909 0, Y

## POWER SUPPLY CIRCUIT BY EXPORT ZONE

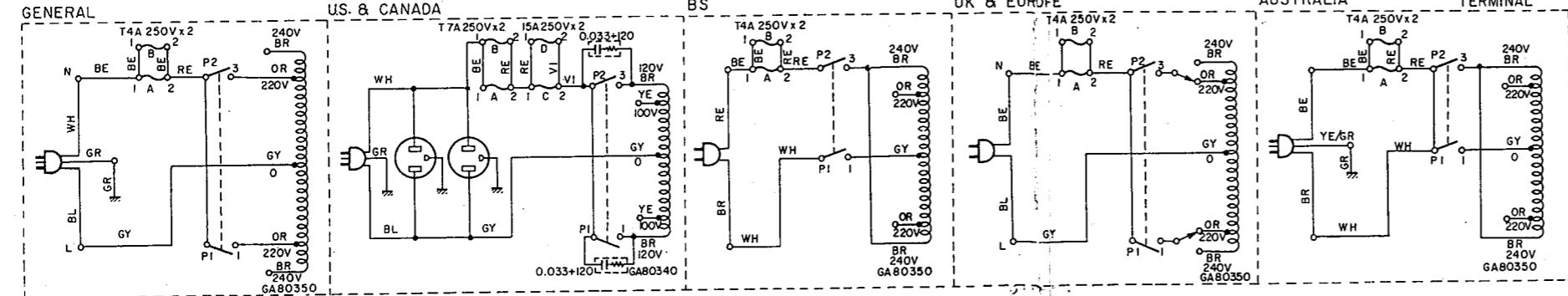

RESISTOR		CAPACITOR		REMARKS
SYMBOL	PART NAME	SYMBOL	PART NAME	
	FUSE RESISTOR		MYLAR CAPACITOR	— —
	METALIZED OXIDATION RESISTOR		CERAMIC CAPACITOR	
	CEMENT RESISTOR		POLYSTYRENE CAPACITOR	— —
	CARBON RESISTOR		(BI-POLAR) ELECTROLYTIC CAPACITOR	
	CEMENT MOLDED RESISTOR		LOW-NOISE ELECTROLYTIC CAPACITOR	— —
	METALIZED FILM RESISTOR		TANTALUM CAPACITOR	