

MIXING CONSOLE PM3000/PW3000

SERVICE MANUAL

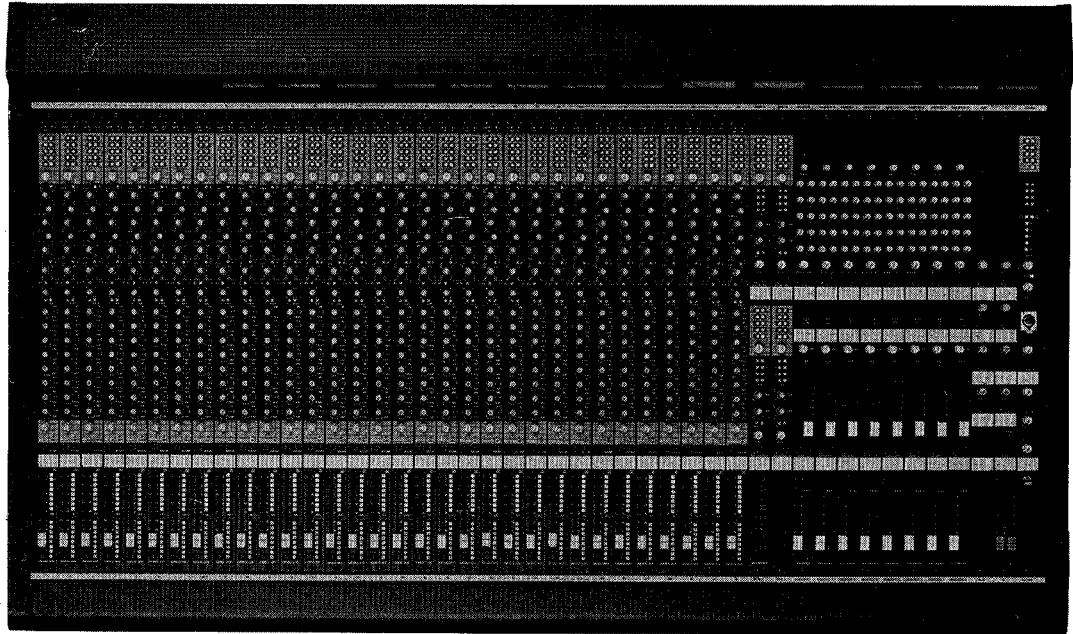

PM3000-32



006700

SINCE 1887



YAMAHA

NIPPON GAKKI CO., LTD. HAMAMATSU, JAPAN

1.4K-1241   Printed in Japan '86.3

IMPORTANT NOTICE

This manual has been provided for the use of authorized Yamaha Retailers and their service personnel. It has been assumed that basic service procedures inherent to the industry, and more specifically Yamaha Products, are already known and understood by the users, and have therefore not been restated.

WARNING: Failure to follow appropriate service and safety procedures when servicing this product may result in personal injury, destruction of expensive components and failure of the product to perform as specified. For these reasons, we advise all Yamaha product owners that all service required should be performed by an authorized Yamaha Retailer or the appointed service representative.

IMPORTANT: The presentation or sale of this manual to any individual or firm does not constitute authorization, certification, recognition of any applicable technical capabilities, or establish a principle-agent relationship of any form.

The data provided is believed to be accurate and applicable to the unit(s) indicated on the cover. The research, engineering, and service departments of Yamaha are continually striving to improve Yamaha products. Modifications are, therefore, inevitable and changes in specification are subject to change without notice or obligation to retrofit. Should any discrepancy appear to exist, please contact the distributor's Service Division.

WARNING: Static discharges can destroy expensive components. Discharge any static electricity your body may have accumulated by grounding yourself to the ground buss in the unit (heavy gauge black wires connect to this buss).

IMPORTANT: Turn the unit OFF during disassembly and parts replacement. Recheck all work before you apply power to the unit.

■ CONTENTS

SECTION 1	Specifications	2
	Input/Output Characteristics	5
	Performance Graphs	6
	Gain Structure	12
	Block Diagram	13
SECTION 2	Brief Operating Instructions	15
SECTION 3	Adjustment	42
SECTION 4	Optional Functions	44
SECTION 5	Maintenance	53
SECTION 6	Circuit Boards	56
PARTS LIST		

SECTION 1

Specifications

1.1 GENERAL SPECIFICATIONS

Total Harmonic Distortion

Less than 0.1%, 20 Hz–20 kHz, at +14 dBm output into 600 ohms.

Frequency Response

+1, -3 dB, 20 Hz–20 kHz, at +4 dBm output into 600 ohms.

Hum & Noise

(20 Hz–20 kHz, $R_s = 150$ ohms, Input Gain @ maximum, Input Pad @ 20 dB, except as noted)

-128 dBm equivalent input noise.

-95 dBu residual output noise (balanced outputs).

-88 dBu (92 dB S/N) at GROUP OUT with Master fader at nominal level and all channel assign switches off.

-74 dBu (78 dB S/N) at GROUP OUT with Master fader and one channel fader at nominal level, and channel assigned to the group bus.

-54 dBu (48 dB S/N) at GROUP OUT with Master fader and one channel fader at nominal level, and channel assigned to the group bus, WITH INPUT SENSITIVITY AT MAXIMUM AND PAD AT 0 dB.

-88 dBu (92 dB S/N) at STEREO OUT with Stereo Master fader at nominal level and all channel assign switches off.

-74 dBu (78 dB S/N) at STEREO OUT with Stereo Master fader and one channel fader at nominal level.

-90 dBu (94 dB S/N) at MTRX OUT with MTRX Master and all matrix mix controls at maximum level, all GROUP-TO-MTRX switches off.

-74 dBu (78 dB S/N) at MTRX OUT with MTRX Master and one Matrix Mix control at maximum level, one channel fader at nominal level (assigned to a group that is assigned to that matrix control).

-75 dBu (79 dB S/N) at AUX OUT with Aux Master level control at nominal, all channel AUX mix controls at minimum level.

-73 dBu (77 dB S/N) at AUX OUT with Aux Master level and one channel AUX mix control at nominal level.

Maximum Voltage Gain

- 94 dB CH IN to GROUP OUT
- 94 dB CH IN to STEREO OUT
- 94 dB CH IN to MTRX OUT
- 104 dB CH IN to AUX OUT
- 94 dB CH IN to CUE OUT
- 20 dB AUX RTN to GROUP OUT
- 10 dB SUB IN to GROUP OUT
- 10 dB SUB IN to STEREO OUT
- 10 dB SUB IN to AUX OUT
- 0 dB SUB IN to MTRX OUT

Input Channel Gain Control

34 dB variation in gain stop-to-stop.

Input Channel Pad Switch

0, 10, 20, 30 or 40 dB of attenuation.

Input Channel Equalization

15 dB maximum boost or cut in the each of four bands.

HIGH: 1.6 kHz ~ 16 kHz (peaking or shelving).

HI-MID: 800 Hz ~ 8 kHz (peaking, variable Q from about 0.5 to 3.0).

LO-MID: 160 Hz ~ 1.6 kHz (peaking, variable Q from about 0.5 to 3.0).

LOW: 40 Hz ~ 400 Hz (peaking or shelving)

Input Channel High Pass Filter

12 dB/octave roll off below 20 Hz to 400 Hz (adjustable -3 dB point).

AUX RTN Equalization

15 dB maximum boost or cut, shelving curve, in two bands.

HIGH: 1 kHz ~ 10 kHz.

LOW: 100 Hz ~ 1 kHz.

Crosstalk

-60 dB at 1 kHz, adjacent input channels.

-60 dB at 1 kHz, input to output.

Oscillator/Noise Generator

Switchable sine wave at 100 Hz, 1 kHz, or 10 kHz (less than 0.1% T.H.D. at +4 dBu output level), or pink noise.

VU Meters (0 VU = +4 dBu, or 1.23 V RMS output level)

STEREO L & R: 2 large, illuminated meters. 12 smaller, illuminated meters, each switchable to monitor multiple circuits:

Meters 1-8	GROUP OUT/GROUP>MTRX/MTRX
Meter 9	AUX1/AUX5/CUE L
Meter 10	AUX2/AUX6/CUE R
Meter 11	AUX3/AUX7/OSC
Meter 12	AUX4/AUX8

Peak Indicators

LED (red) built into each VU meter turns on when post-Master fader level reaches 10 dB below clipping.

Signal/Clip Indicators

3 LEDs built into each input module monitor levels in the module: SIGNAL (green) turns on when pre-EQ signal is 10 dB below nominal level. CLIP (red) turns on when pre-EQ signal is 3 dB below clipping. EQ CLIP (red) turns on when post-EQ level is 3 dB below clipping.

Phantom Power

48 V DC is applied to electronically balanced inputs or optional transformer-isolated inputs (via 6.8 kohm current limiting/isolation resistors) for powering condenser microphones. May be turned on or off via rear-panel phantom master switch; when on, individual channels may be turned off via +48 V switch on each input module.

Options

IT3000 Input Transformers; may be installed in individual input modules. Changes actual input impedance from 3K ohms to 1k ohm.

OT3000 Output Transformer Set; a rack-mountable, external chassis containing 8 output transformers, with male and female XLR connectors on the front panel. Occupies 2 rack spaces (3 1/2" or 88 mm) in a 19 inch (480 mm) wide rack; 3 1/2" (88 mm) depth. May be used to isolate any PM3000 XLR outputs.

Power Requirements

Requires Yamaha PW3000 power supply; see specifications for that unit.

Console Dimensions

HEIGHT	12-1/8 inches (309 mm)
DEPTH	37-3/4 inches (960 mm)
WIDTH:	24 channel, 53-3/4 inches (1367 mm)
	32 channel, 64-5/8 inches (1643 mm)
	40 channel, 75-1/2 inches (1919 mm)

Net Weight (excluding power supply)

<u>24 CH</u>	<u>32 CH</u>	<u>40 CH</u>
201 lbs	247 lbs	302 lbs
91 kg	112 kg	137 kg

NOTE: Specifications are subject to change without notice or obligation.

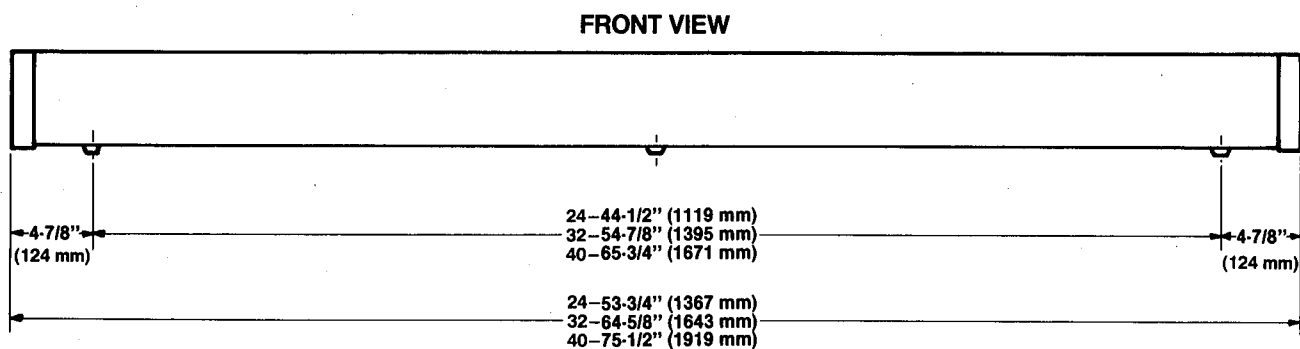
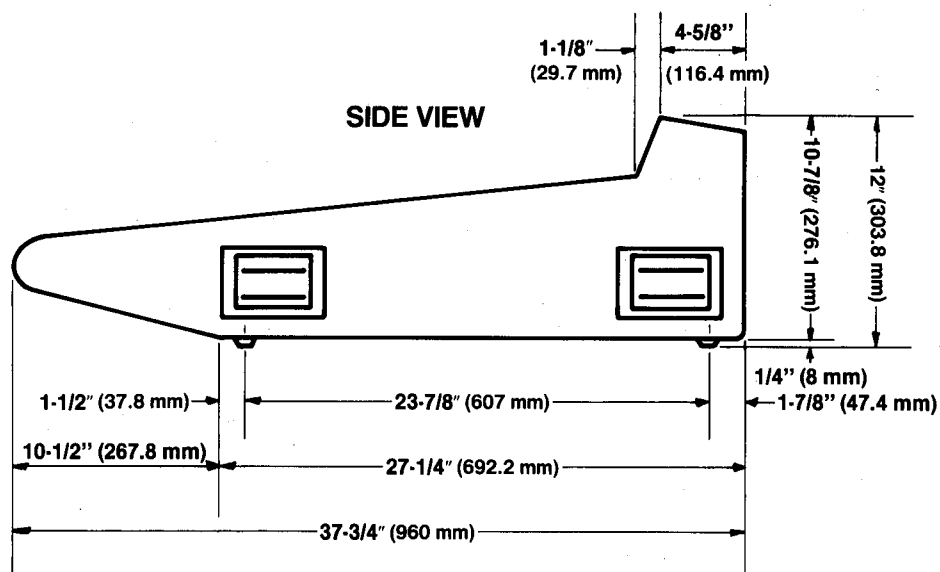

FIGURE 1-1 PM3000 DIMENSIONS

1.2 POWER SUPPLY (PW3000) SPECIFICATIONS

Dimensions:

- HEIGHT 6-7/8 inches (176 mm) (excluding rubber feet; add 3/8" for feet).
- DEPTH Overall, 18 inches (457 mm); Behind panel, 16-1/2 inches (418 mm).
- WIDTH 18-7/8 inches (480 mm); for standard rack mounting.

Fuses

Primary fuses for each of 3 transformers, 250 Watts, 6 amperes, slo-blow.

Additionally, the DC supplies each have secondary fuses as follows:

- + 20 volt supply: 10 A, 250 V slo-blow
- 20 volt supply: 10 A, 250 V slo-blow
- + 12 volt supply: 10 A, 250 V slo-blow
- + 48 volt supply: 2 A, 250 V slo-blow

Outputs

- +20 VDC @ 8 Amps
- 20 VDC @ 8 Amps
- Ground (common) for 20 V
- + 12 VDC @ 6.1 Amps
- + 48 VDC @ 0.3 Amps
- Ground (common) for 12 V
- Chassis ground
- Detector A & B

AC Requirements

U.S.A./Canada models: 105 to 130 V, 50/60 Hz.
 General Export models: 220 or 240 V, ± 10%, 50/60 Hz.

Umbilical Cables

Two multi-conductor cables with locking, multi-pin connectors convey power to the PM3000 console. Each cable is approximately 10 feet (3.6 meters) long. Protected against inadvertent A/B misconnection.

Cooling

Internal fan, pulls air through foam grille on front panel, exhausts via top and side vents.

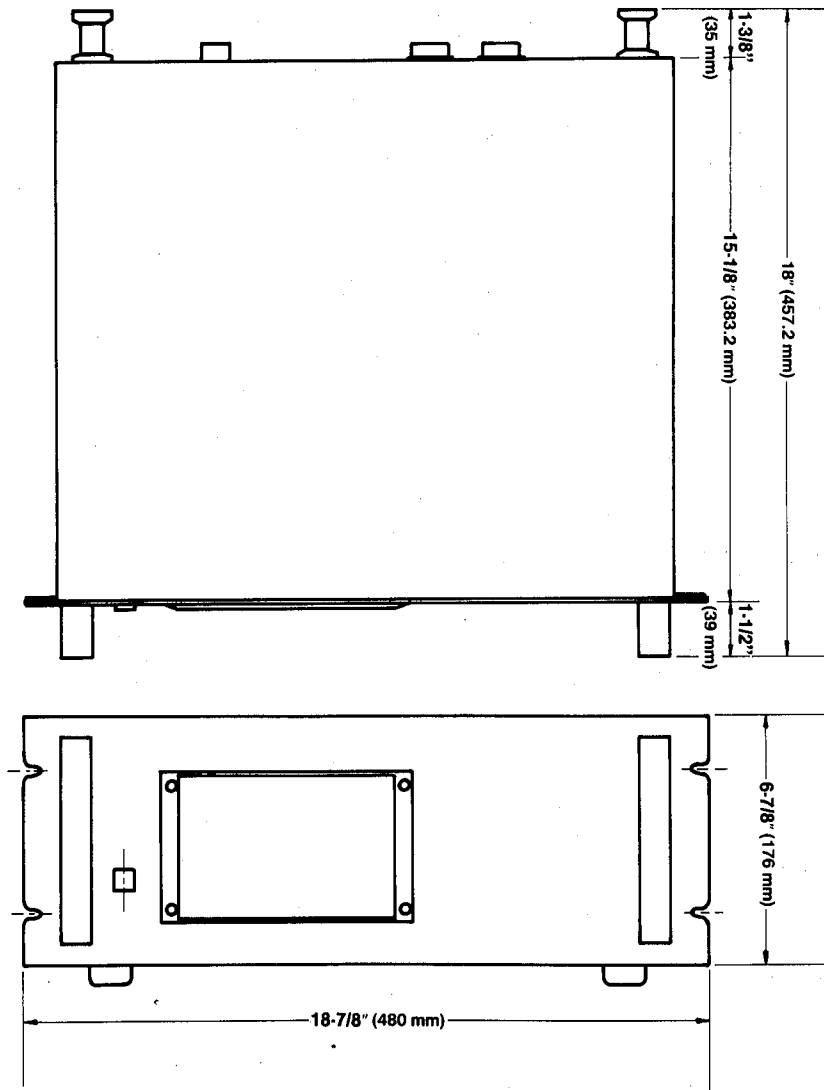

FIGURE 1-2 PW3000 DIMENSIONS

1.3 INPUT CHARACTERISTICS

CONNECTION	PAD	GAIN TRIM	ACTUAL LOAD IMPEDANCE	FOR USE WITH NOMINAL	INPUT LEVEL			CONNECTOR IN CONSOLE
					SENSITIVITY	NOMINAL	MAX BEFORE CLIP	
CH INPUT, 1-24; 1-32 or 1-40	0	-70	3K ohms if electronic balanced; 1K ohms if transformer balanced	50 ohm to 200 ohm mics and 600 ohm lines	-90 dBu (0.025 mV)	-70 dBu (0.25 mV)	-40 dBu (7.75 mV)	XLR-3-31
	0	-36			-56 dBu (1.23 mV)	-36 dBu (12.3 mV)	-16 dBu (123 mV)	
	10	-36			-46 dBu (3.88 mV)	-26 dBu (38.8 mV)	-6 dBu (388 mV)	
	20	-36			-36 dBu (12.3 mV)	-16 dBu (123 mV)	+4 dBu (1.23 V)	
	30	-36			-26 dBu (38.8 mV)	-6 dBu (388 mV)	+14 dBu (3.88 V)	
	40	-36			-16 dBu (123 mV)	+4 dBu (1.23 V)	+24 dBu (12.3 V)	
AUX RETURN, 1-4 (stereo)			10K ohms	600 ohm lines	-16 dBu (123 mV)	+4 dBu (1.23 V)	+24 dBu (12.3 V)	XLR-3-31
PGM SUB IN, 1-8			10K ohms	600 ohm lines	-6 dBu (388 mV)	+4 dBu (1.23 V)	+24 dBu (12.3 V)	XLR-3-31
STEREO SUB IN, L-R			10K ohms	600 ohm lines	-6 dBu (388 mV)	+4 dBu (1.23 V)	+24 dBu (12.3 V)	XLR-3-31
AUX SUB IN, 1-8			10K ohms	600 ohm lines	-6 dBu (388 mV)	+4 dBu (1.23 V)	+24 dBu (12.3 V)	XLR-3-31
MTRX SUB IN, 1-8			10K ohms	600 ohm lines	+4 dBu (1.23 V)	+4 dBu (1.23 V)	+24 dBu (12.3 V)	XLR-3-31
TALKBACK IN	-50		3K ohms	50-250 ohm mics	-70 dBu (0.25 mV)	-50 dBu (2.45 mV)	-30 dBu (24.5 mV)	XLR-3-31
	+4		3K ohms	600 ohm lines	-16 dBu (123 mV)	+4 dBu (1.23 V)	+24 dBu (12.3 V)	XLR-3-31
COMM IN	-50		3K ohms	50-250 ohm mics	-70 dBu (0.25 mV)	-50 dBu (2.45 mV)	-30 dBu (24.5 mV)	XLR-3-31
	+4		3K ohms	600 ohm lines	-16 dBu (123 mV)	+4 dBu (1.23 V)	+24 dBu (12.3 V)	XLR-3-31
CH INSERT IN, 1-24, 1-32, or 1-40			10K ohms	600 ohm lines	-16 dBu (123 mV)	+4 dBu (1.23 V)	+24 dBu (12.3 V)	Phone Jack (1/4" TRS)
INSERT IN: PGM, 1-8 STEREO, L-R AUX, 1-8			10K ohms	600 ohm lines	-16 dBu (123 mV)	-6 dBu (388 mV)	+24 dBu (12.3 V)	Phone Jack (1/4" TRS)

NOTES: (1) Sensitivity is the lowest level that will produce an output of +4 dBu (1.23V), or the nominal output level, when the circuit is set to maximum gain.
(2) All XLR connectors are electronically balanced. Phone jacks are balanced with Tip = signal high (+), Ring = signal low (-), and Sleeve = ground.
(3) 0 dBu is referenced to 0.775 V RMS. Where the circuit is capable of 600 ohm termination, this would be equivalent to 0 dBm.

1.4 OUTPUT CHARACTERISTICS

CONNECTION	ACTUAL SOURCE IMPEDANCE	FOR USE WITH NOMINAL	OUTPUT LEVEL		CONNECTOR IN CONSOLE
			NOMINAL	MAX. BEFORE CLIP	
GROUP OUT, 1-8	150 ohms	600 ohm lines	+4 dBu (1.23 V)	+24 dBu (12.3 V)	XLR-3-32
STEREO OUT, L-R	150 ohms	600 ohm lines	+4 dBu (1.23 V)	+24 dBu (12.3 V)	XLR-3-32
MATRIX OUT, 1-8	150 ohms	600 ohm lines	+4 dBu (1.23 V)	+24 dBu (12.3 V)	XLR-3-32
AUX OUT, 1-8	150 ohms	600 ohm lines	+4 dBu (1.23 V)	+24 dBu (12.3 V)	XLR-3-32
CUE OUT, L-R	150 ohms	600 ohm lines	+4 dBu (1.23 V)	+24 dBu (12.3 V)	XLR-3-32
TALKBACK OUT,	150 ohms	600 ohm lines	+4 dBu (1.23 V)	+24 dBu (12.3 V)	XLR-3-32
CH INSERT OUT (1-24, 1-32 or 1-40)	600 ohms	10K ohm lines	+4 dBu (1.23 V)	+24 dBu (12.3 V)	Phone Jack (1/4" TRS)
OSCILLATOR OUT			+4 dBu (1.23 V)		XLR-3-32
AUX. INSERT OUT, 1-8	600 ohms	10K ohm lines	-6 dBu (388 mV)	+24 dBu (12.3 V)	Phone Jack (1/4" TRS)
GROUP INSERT OUT, 1-8	600 ohms	10K ohm lines	-6 dBu (388 mV)	+24 dBu (12.3 V)	
STEREO INSERT OUT, L-R	600 ohms	10K ohm lines	-6 dBu (388 mV)	+24 dBu (12.3 V)	
PHONES OUT, 1-2	15 ohms	8 ohm phones	75 mW	150 mW	Phone Jack (1/4" TRS)
		40 ohm phones	65 mW	130 mW	

NOTES: (1) All XLR connectors are electronically balanced. Phone jacks are unbalanced, with Tip = signal, Ring = common, Sleeve = ground. PHONES out phone jacks are wired standard stereo with Tip = Left, Ring = Right, Sleeve = ground.
(2) 0 dBu is referenced to 0.775 V RMS. Where the circuit is capable of 600 ohm termination, this would be equivalent to 0 dBm.

1.5 PERFORMANCE GRAPHS

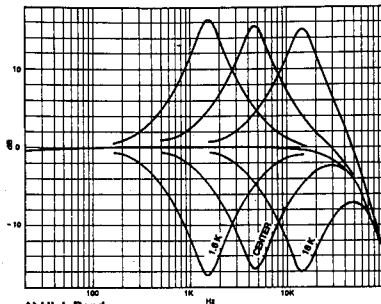

A) High Band
 Peaking/Shelving: peaking
 Gain: maximum boost & maximum cut curves
 Frequency: swept from minimum (1.6 kHz), through center (approx. 4.5 kHz), to maximum (16 kHz)
 Q: Non-Adjustable (fixed at 1.5)
 Note: This is similar to illustration (D) which depicts Low Band Equalization.

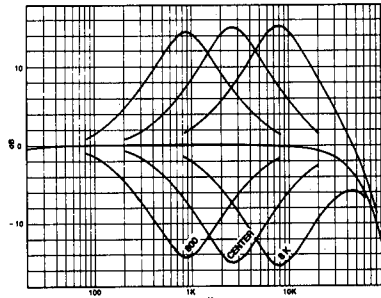

B) Hi-Mid Band
 Gain: maximum boost & maximum cut curves
 Frequency: swept from minimum (800 Hz), through center (approx. 2.6 kHz), to maximum (8 kHz)
 Q: centered (approx. 1.2)
 Note: This is similar to illustration (C) which depicts Lo-Mid Band Equalization.

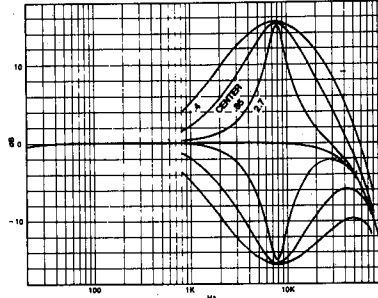

E) Hi-Mid Band
 Gain: maximum boost & maximum cut curves
 Frequency: set at 18 kHz
 Q: swept from minimum (approx. 0.5), through center (approx. 1.2), to maximum (approx. 3)
 Note: The middle curves here (Q=0.85) are the same as the right-most curves in illustration (B).

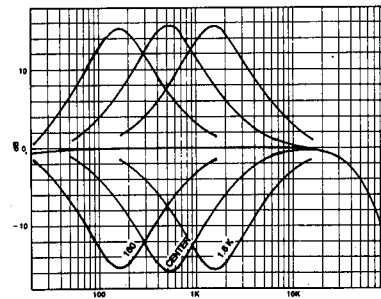

C) Lo-Mid Band
 Gain: maximum boost & maximum cut curves
 Frequency: swept from minimum (160 Hz), through center (approx. 500 Hz), to maximum (1.6 kHz)
 Q: centered (approx. 1.2)

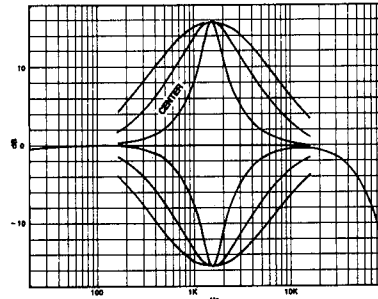

F) Lo-Mid Band
 Gain: maximum boost & maximum cut curves
 Frequency: set at 1.6 kHz
 Q: swept from minimum (approx. 0.5), through center (approx. 1.2), to maximum (approx. 3)
 Note: The middle curves here (Q 1.2) are the same as the right-most curves in illustration (C).

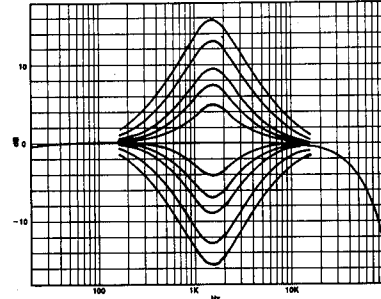

G) Lo-Mid Band
 Gain: varied from maximum boost to maximum cut
 Frequency: set at 1.6 kHz
 Q: centered (approx. 1.2)
 Note: The outer curves here (maximum boost and cut) are the same as the middle curves (Q centered) in illustration (F).

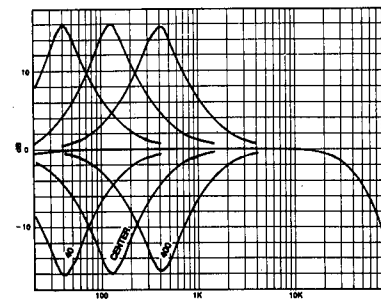

D) Low Band
 Peaking/Shelving: peaking
 Gain: maximum boost & maximum cut curves
 Frequency: swept from minimum (40 Hz), through center (approx. 125 Hz), to maximum (400 Hz)
 Q: Non-Adjustable (fixed at 1.5)

FIGURE 1-3 INPUT CHANNEL EQUALIZER CHARACTERISTICS

FIGURE 1-3 INPUT CHANNEL EQUALIZER CHARACTERISTICS (continued)

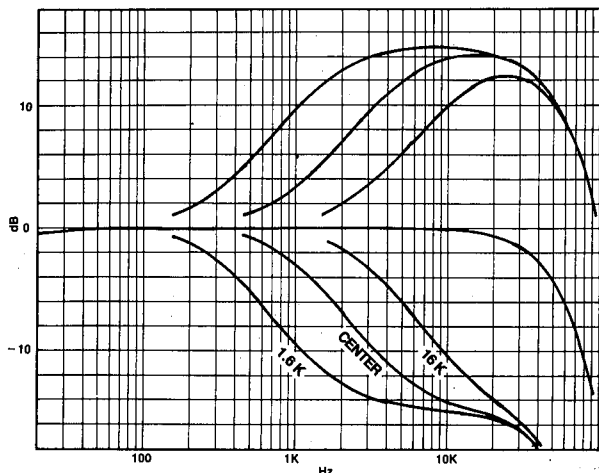

H) High Band

Peaking/Shelving: shelving
 Gain: maximum boost & maximum cut curves
 Frequency: swept from minimum (1.6 kHz), through center (approx. 4.6 kHz), to maximum (16 kHz)
 Q: Non-Adjustable (fixed at 1.5)
 Note: This is similar to illustration (I) which depicts Low Band equalization.

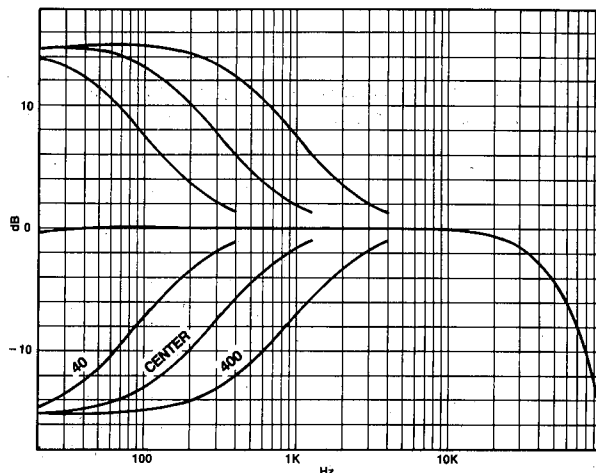

D) Low Band

Peaking/Shelving: shelving
 Gain: maximum boost & maximum cut curves
 Frequency: swept from minimum (40 Hz), through center (approx. 125 Hz), to maximum (400 Hz)
 Q: Non-Adjustable (fixed at 1.50)

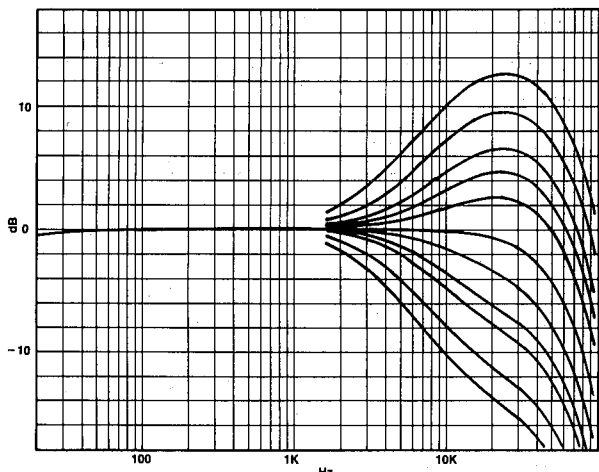

J) High Band

Peaking/Shelving: shelving
 Gain: varied from maximum boost to maximum cut
 Frequency: set at 1.6 kHz
 Q: Non-Adjustable (fixed at 1.5)
 Note: The outer curves here (maximum boost and cut) are the same as the right-most curves (1.6 kHz) in illustration (H).

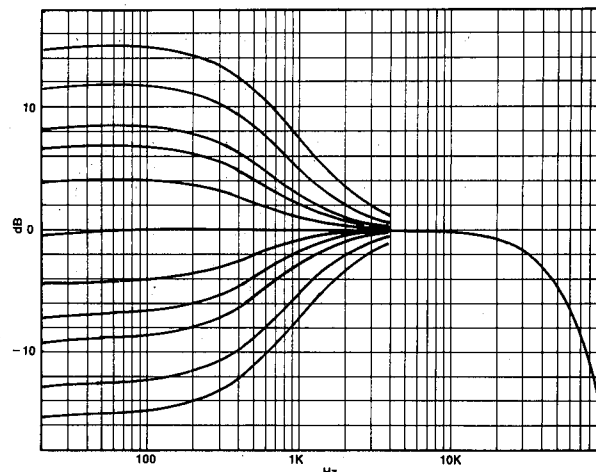

K) Low Band

Peaking/Shelving: shelving
 Gain: varied from maximum boost to maximum cut
 Frequency: set at 400 Hz
 Q: Non-Adjustable (fixed at 1.5)
 Note: The outer curves here (maximum boost and cut) are the same as the right-most curves (400 Hz) in illustration (I).

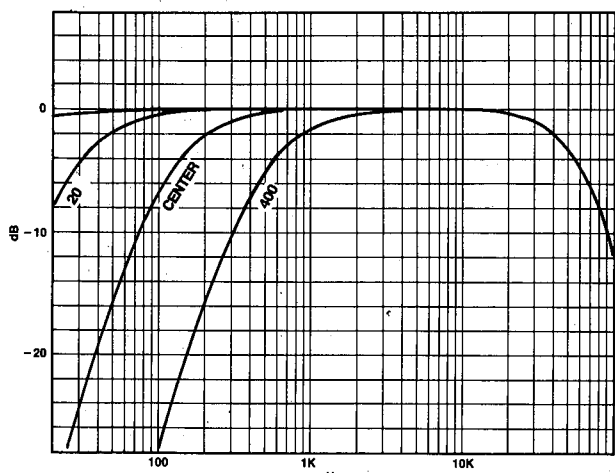

FIGURE 1-4 INPUT CHANNEL HIGH PASS FILTER CHARACTERISTICS

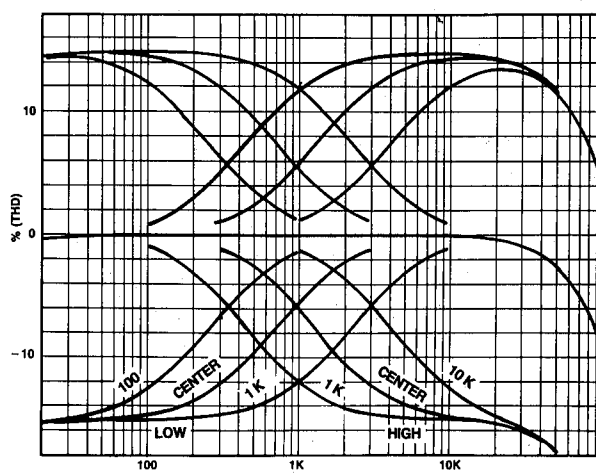

FIGURE 1-5 AUX RETURN EQUALIZER CHARACTERISTICS

1.5.1 Input Channel 1 to Group Output 1 Performance
 Graphs with Input Gain Control @ Max

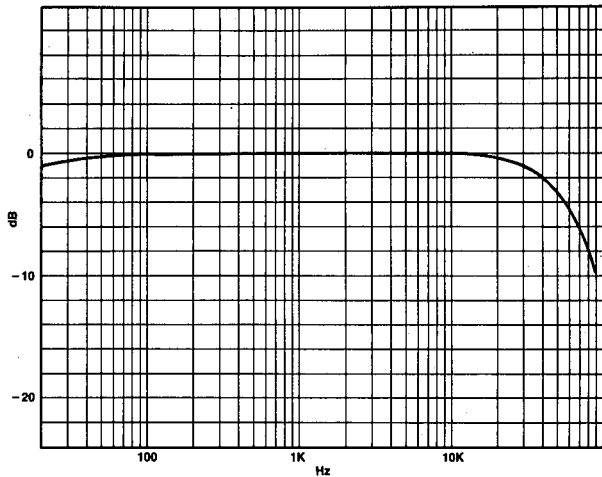
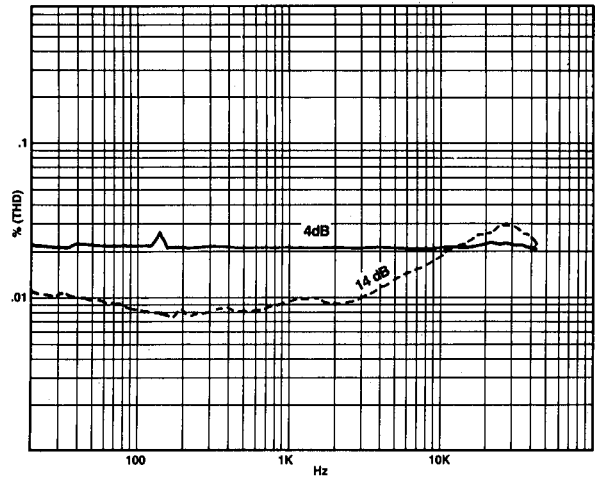
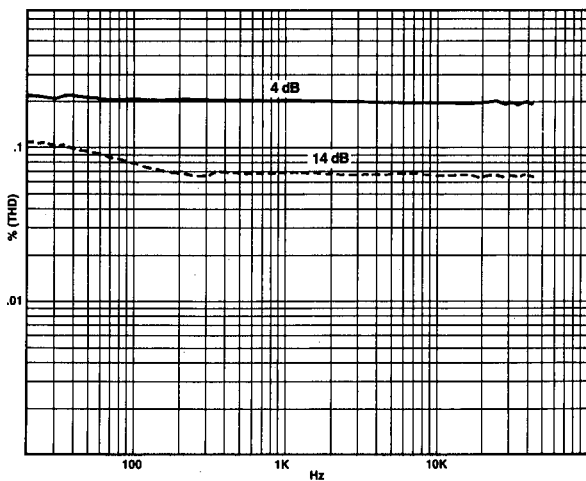

FIGURE 1-6 FREQUENCY RESPONSE
 At +4 dBu output level, PAD at 0 dB.
 (Curves would be identical with PAD at 10, 20, 30 or 40 dB).



C) PAD at 20 dB

FIGURE 1-7 FREQUENCY vs. T.H.D. CURVES
 At +4 dBu & +14 dBu output levels.



A) PAD at 0 dB

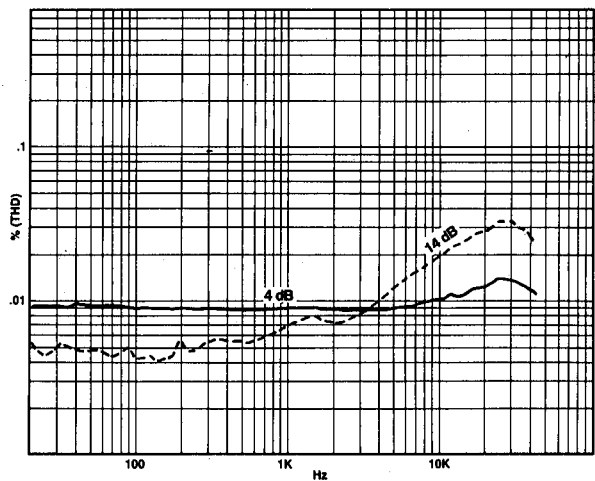

D) PAD at 30 dB

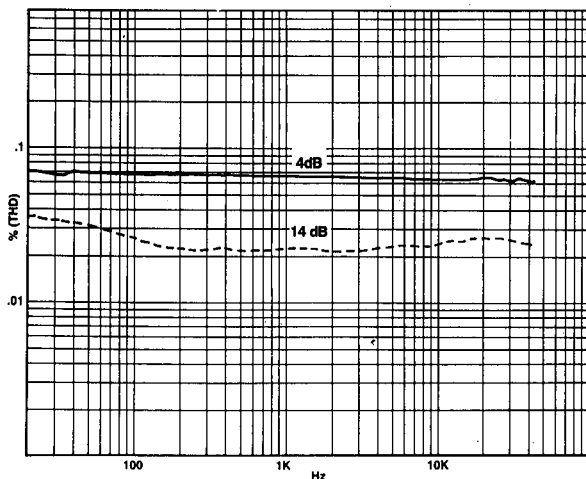

B) PAD at 10 dB

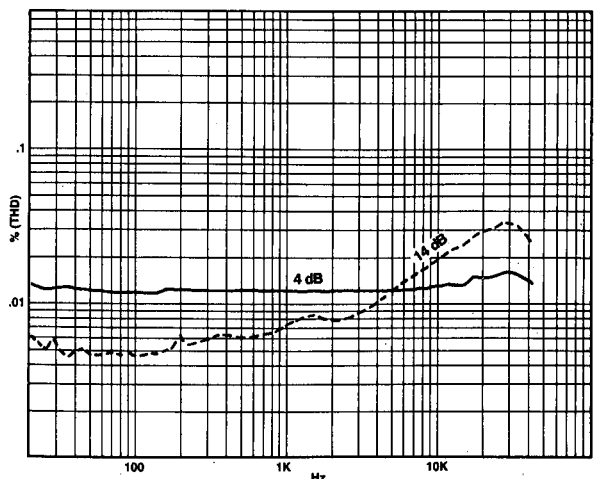

E) PAD at 40 dB

FIGURE 1-8 OUTPUT LEVEL vs T.H.D.
At 100 Hz, 1 kHz & 20 kHz.

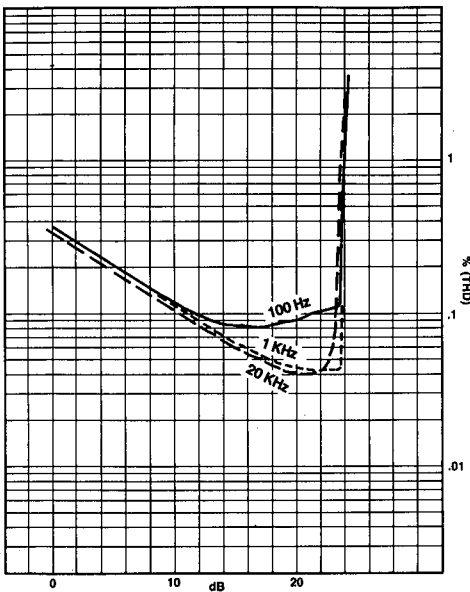

A) PAD at 0 dB

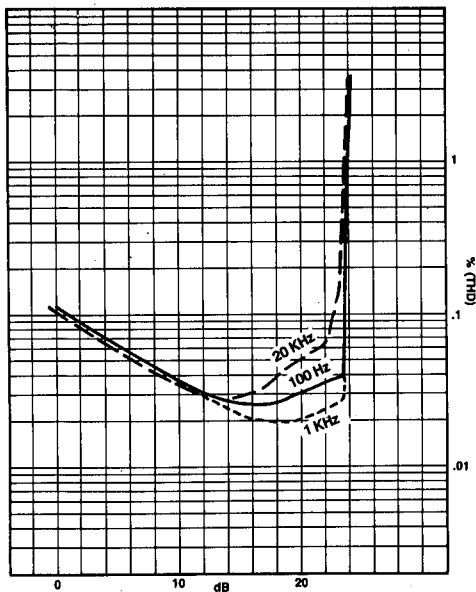

B) PAD at 10 dB

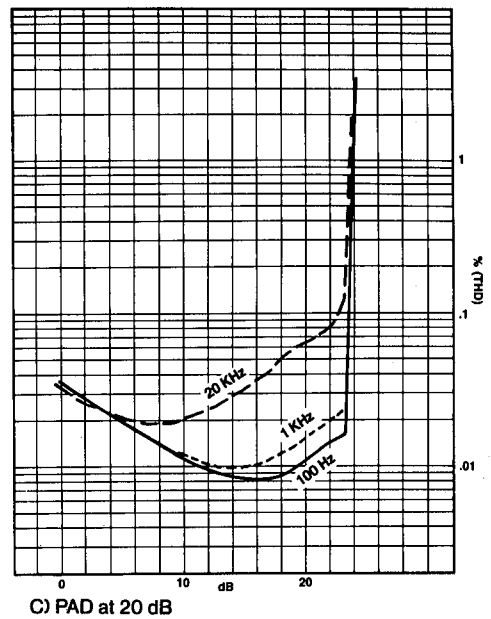

C) PAD at 20 dB

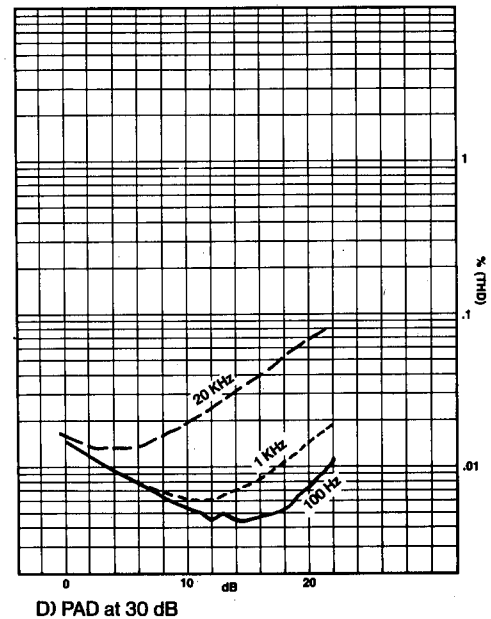

D) PAD at 30 dB

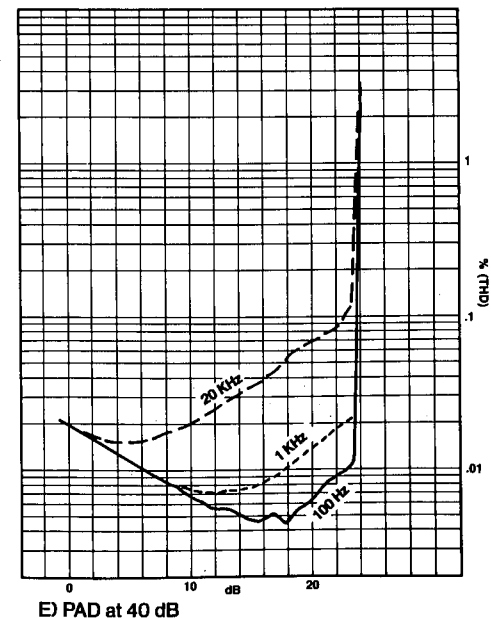

E) PAD at 40 dB

1.5.2 Input Channel 1 to Group Output 1 Performance Graphs with Input Gain Control @ Min

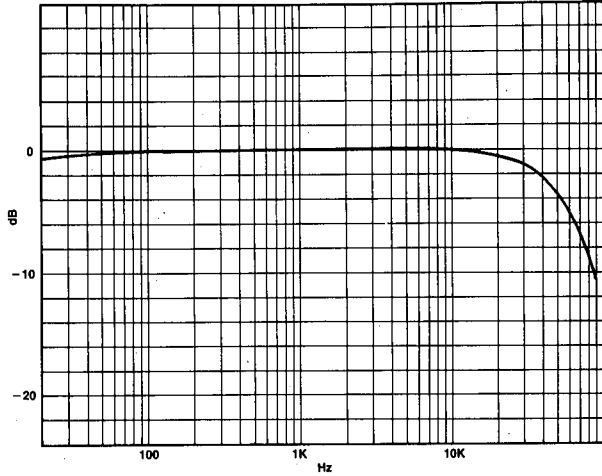

FIGURE 1-9 FREQUENCY RESPONSE
At +4 dBu output level. PAD at 40 dB.
(Curves would be identical with PAD at 0, 10, 20, or 30 dB.)

1.5.3 Aux Return 4 (L) to Group Output 1 Performance Graphs

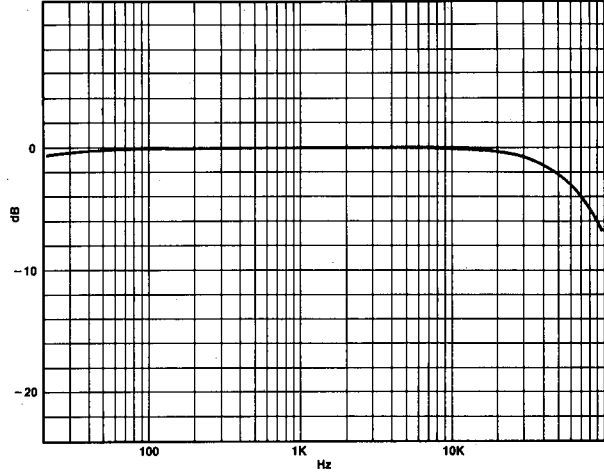

FIGURE 1-12 FREQUENCY RESPONSE
(At +4 dBu output level.)

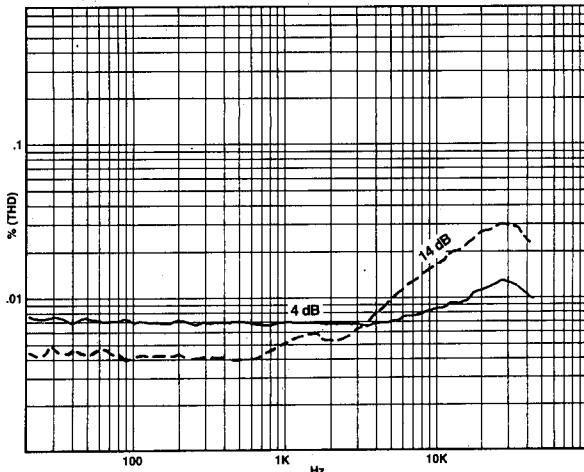

FIGURE 1-10 FREQUENCY vs. T.H.D. CURVES
At +4 dBu & +14 dBu output levels, PAD at 40 dB.
(Curves would be identical with PAD at 0, 10, 20, or 30 dB.)

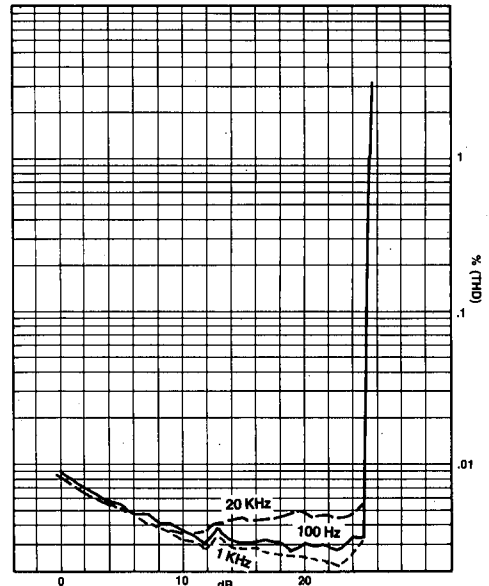

FIGURE 1-13 OUTPUT LEVEL vs T.H.D.
(At 100 Hz, 1 kHz & 20 kHz.)

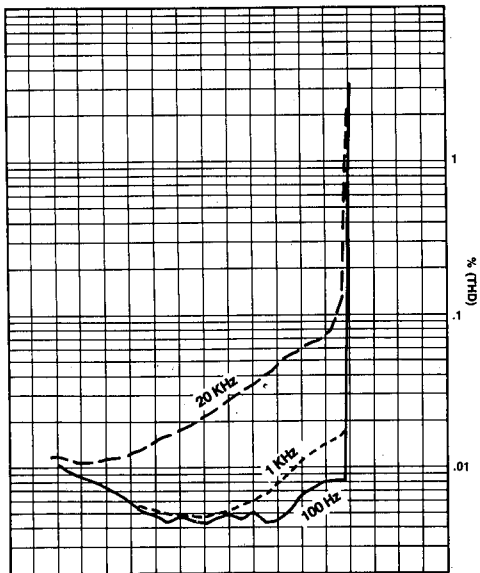

FIGURE 1-11 OUTPUT LEVEL vs T.H.D.
At 100 Hz, 1 kHz & 20 kHz, PAD at 40 dB.

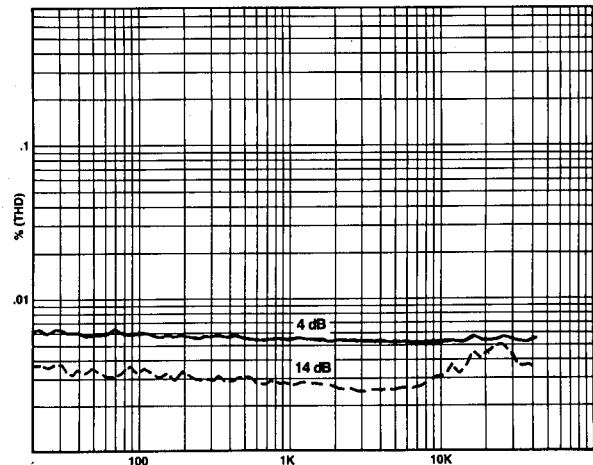

FIGURE 1-14 FREQUENCY vs. T.H.D. CURVES
(At +4 dBu & +14 dBu output levels.)

1.5.4 Channel 1 Input to Phones Output Performance Graphs with Input Pad @ 40 dB, Gain @ Min.

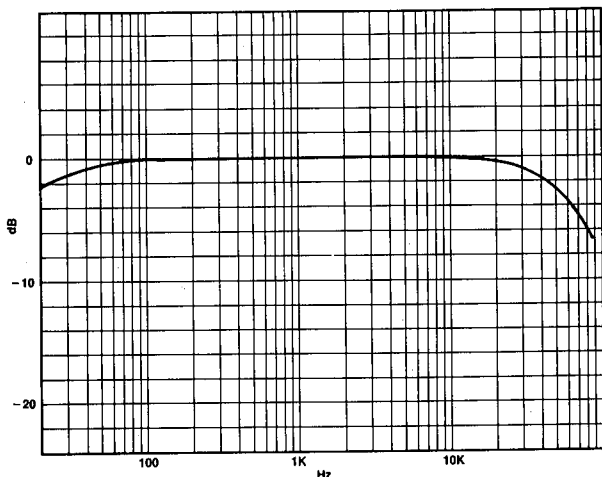

FIGURE 1-15 FREQUENCY RESPONSE

1.5.5 Crosstalk Performance Graphs

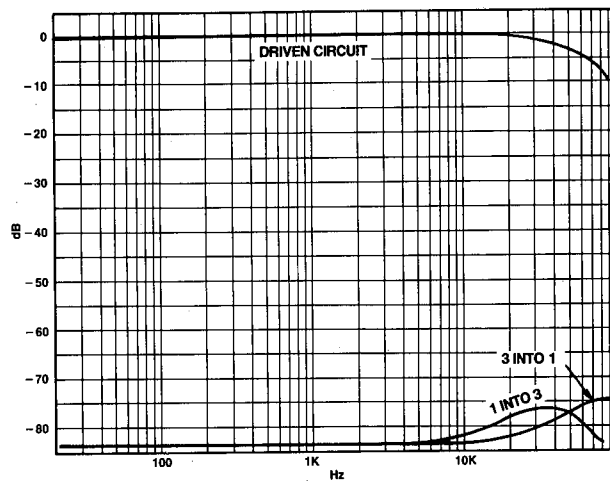

FIGURE 1-18 CROSSTALK OF GROUP 1 INTO 3 OR 3 INTO 1 WITH INPUT PAN CONTROL AT FULL CW & FULL CCW POSITIONS

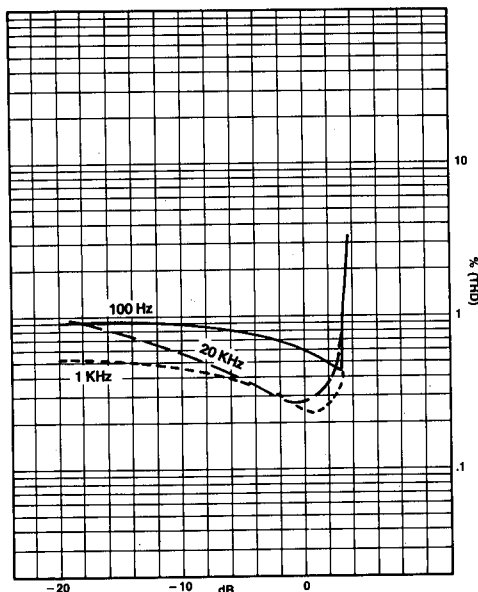

FIGURE 1-16 OUTPUT LEVEL vs T.H.D. At 100 Hz, 1 kHz & 20 kHz.

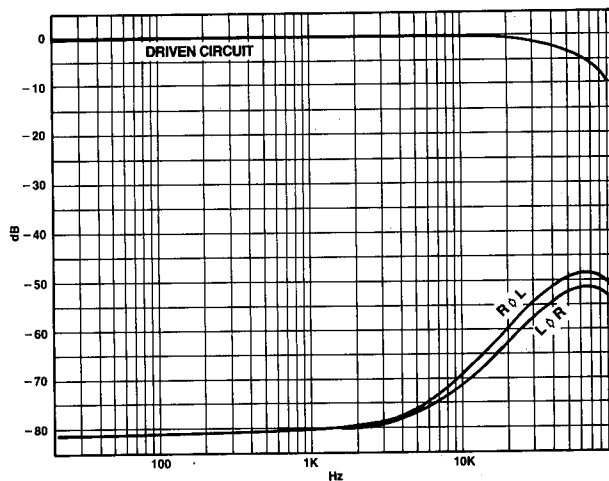

FIGURE 1-19 CROSSTALK OF STEREO L INTO R OR R INTO L WITH INPUT PAN CONTROL AT FULL CW & FULL CCW POSITIONS

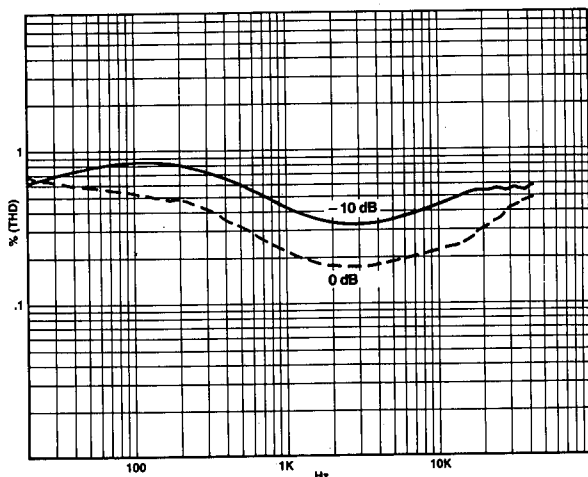

FIGURE 1-17 FREQUENCY vs. T.H.D. CURVES

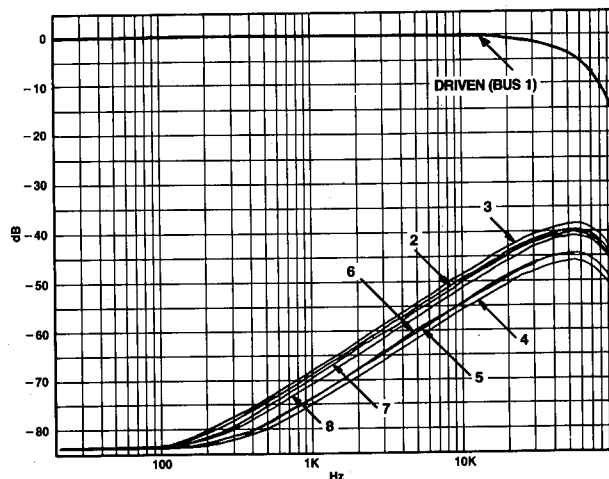

FIGURE 1-20 CROSSTALK OF GROUP BUS 1 INTO GROUP BUSES 2 THROUGH 8

1.6 GAIN STRUCTURE & BLOCK DIAGRAM

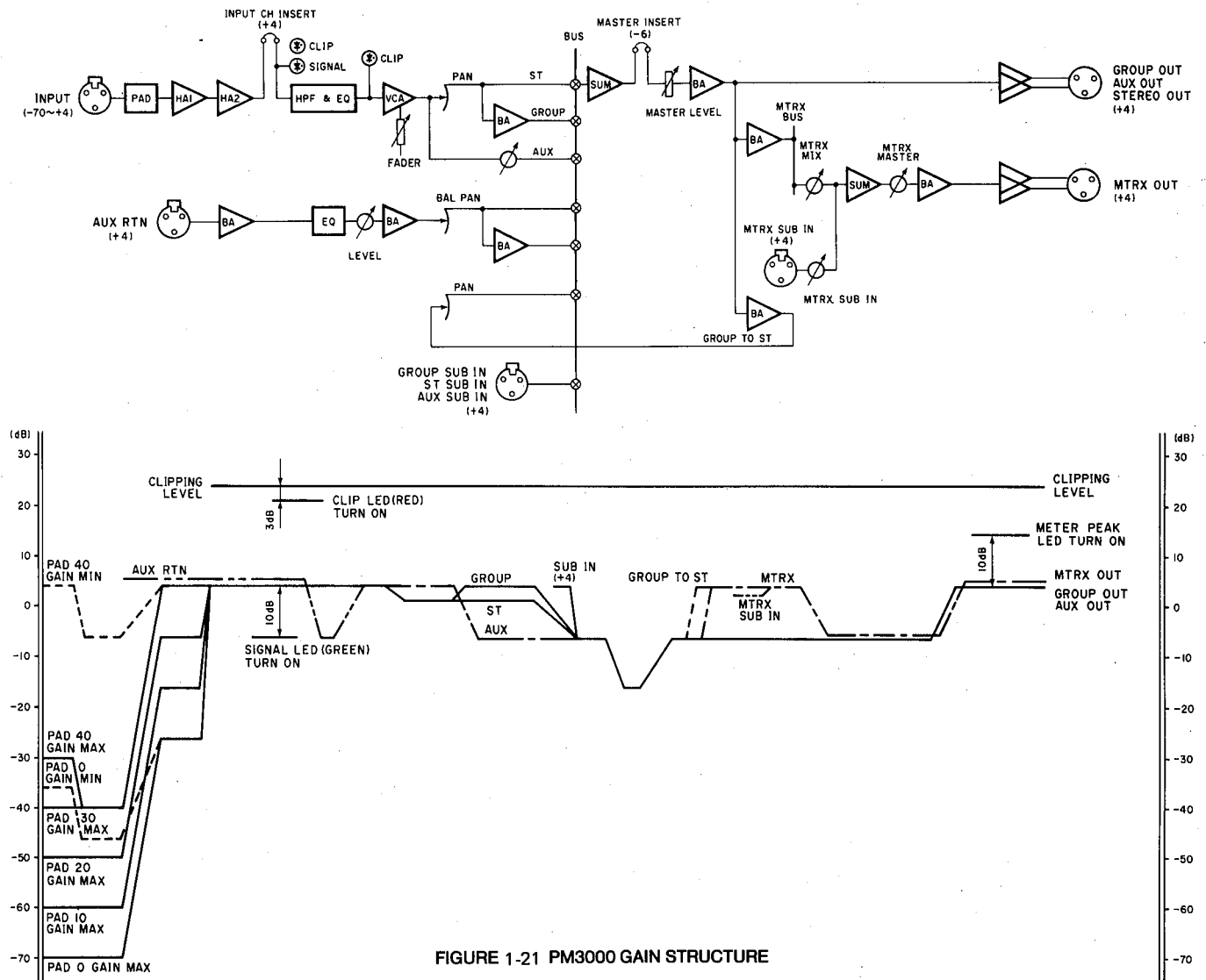

FIGURE 1-21 PM3000 GAIN STRUCTURE

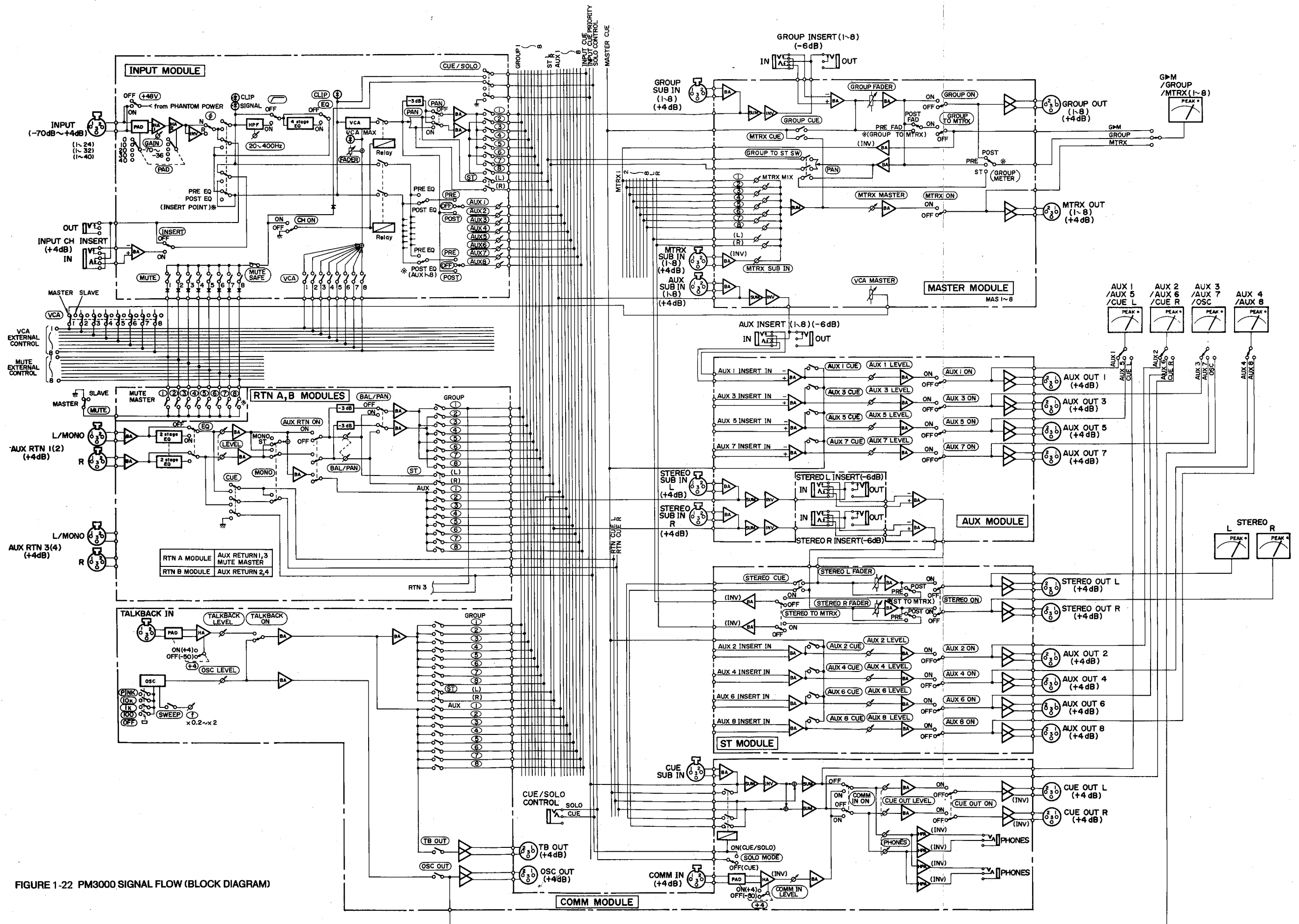

FIGURE 1-22 PM3000 SIGNAL FLOW (BLOCK DIAGRAM)

SECTION 2

Brief Operating Instructions

2.1 PM3000 FRONT PANEL FEATURES

2.1.1 THE INPUT MODULE

Each input module processes the incoming mic or line level signal from the correspondingly numbered XLR input. Preamplification and/or attenuation are available to get optimum channel sensitivity, polarity may be reversed, and phantom power turned on or off. High pass filtering and parametric equalization can be applied, and the signal assigned to the 8 group busses, the stereo bus, the 8 auxiliary busses and the cue bus. VCA Master control of the channel level may be assigned, as well as master muting (remote on/off function). Internal slide switches in the module also permit the aux send "Pre" position to derive signal from two different points in the circuit, and alter the channel insert point to be pre or post equalizer.

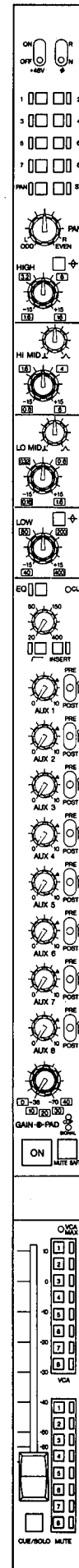
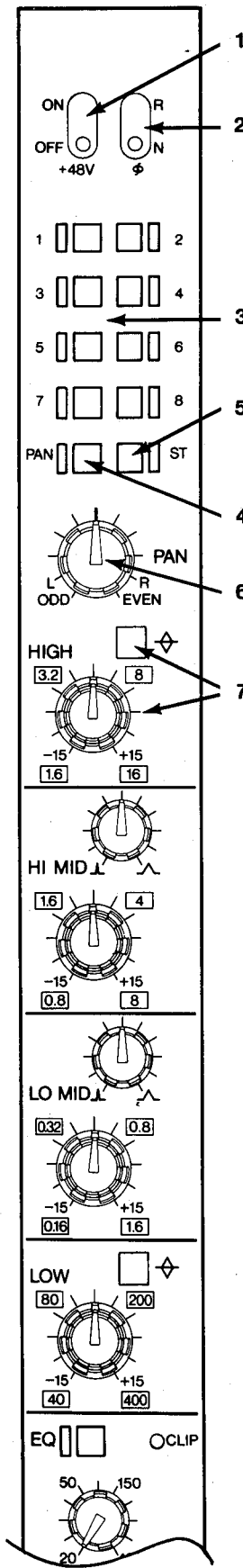

FIGURE 2-1. PM3000 INPUT MODULE.



1. +48V

This switch turns phantom power on and off at the channel's XLR input connector. Power can be turned on, however, only if the MASTER PHANTOM POWER switch is on.

When both the Master and this switch are on, +48 volts is applied to both pins 2 & 3 of the channel input XLR connector, via 6.8 kohm isolation/current limiting resistors, for remote powering of condenser microphones. Although phantom power will not harm most dynamic and other non-phantom powered microphones or line-level devices, connection of an unbalanced source to the channel input could partially short the console's phantom supply, cause undue loading, and induce hum. Therefore, it is a good practice to turn off the channel's phantom power unless it is actually in use.

NOTE: The console's microphone power supply is not intended for A-B powered microphones. External supplies may be used with these devices, in which case the console's phantom power should be turned OFF on the appropriate channels. The optional input transformers, if installed, do not affect phantom power operation.

2. \emptyset (Phase)

This switch reverses the polarity of pins 2 and 3 of the channel's XLR input connector. In "N" (Normal) position, pin 2 is the signal high conductor, and in "R" (Reverse) position, pin 3 is high. This eliminates the need to rewire connectors or use adapters for out-of-phase (reversed polarity) audio sources. Sometimes intentional polarity reversal can be helpful in canceling leakage from adjacent microphones, or in creating electro-acoustic special effects by mixing together out-of-phase signals from mics picking up the same sound source.

3. 1.2.3.4.5.6.7.8. (Assign)

These locking gray switches assign the channel output to group mixing busses 1 through 8. A green LED adjacent to each switch turns on when the signal is assigned to the bus.

4. PAN (Switch)

This locking white switch activates the PAN pot, which then may be used to position signal between any odd-numbered and even-numbered group mixing busses (provided the corresponding ASSIGN switches are engaged), allowing up to four additional stereo mixes to be created. This switch does not affect panning to the stereo bus, which is under the full-time control of the PAN pot when the ST assign switch is engaged. A yellow LED adjacent to the switch turns on when the PAN switch is engaged.

5. ST (Stereo)

This locking switch assigns the channel output directly to the stereo bus. A green LED adjacent to the switch turns on when the signal is assigned to the stereo bus.

6. PAN L/ODD-R/EVEN (Pot)

This rotary control enables the channel output to be assigned between odd-numbered (counterclockwise rotation) and even-numbered (clockwise rotation) group busses when the nearby PAN switch is engaged. This same control also assigns the channel output between the left (L) and right (R) sides of the stereo mixing bus when the ST assign switch is engaged. A center detent is provided for equal signal assignment to odd/even or left/right busses. Center position does apply 3 dB less signal to each bus than the level obtained with full left or right assignment so that the combined stereo signal adds up to constant power at all PAN pot positions.

(EQUALIZER)

The input channel equalizer is divided into four bands, each with sweepable filter frequencies. The high and low bands may be switched for a peaking or shelving type curve, whereas the high-mid and low-mid bands are of the peaking type with adjustable Q, providing fully parametric type EQ. The level (gain) is adjustable over a range of 15 dB boost and 15 dB cut in each band.

7. HIGH (Peak/Shelf)

This locking switch selects Peaking type EQ (switch engaged) or Shelving type EQ.

1.6 ~ 16 kHz

The outer concentric knob sweeps the EQ Frequency between 1,600 and 16,000 Hz.

+15 ~ -15 dB

The inner concentric knob adjusts the Gain of the set frequency band by plus or minus 15 dB. A center detent is provided for unity gain.

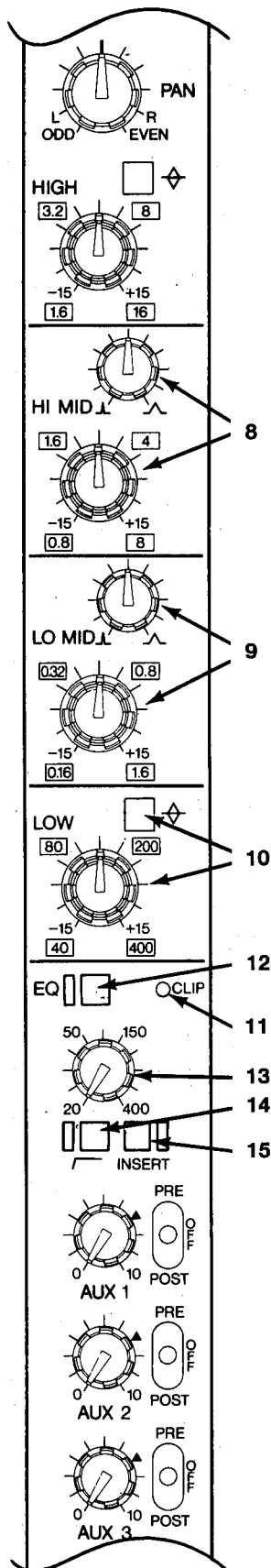

8. HIGH-MID
0.8 ~ 8 kHz

The outer concentric knob sweeps the EQ Frequency between 800 and 8,000 Hz.

+15 ~ -15 dB

The inner concentric knob adjusts the Gain of the set frequency band by plus or minus 15 dB. A center detent is provided for unity gain.

(Peak Curves)

This rotary control adjusts the Q (the bandwidth) of this section of the equalizer from 0.5 (a broad band) to 3 (a narrow band), with a center detent at 1.

9. LOW-MID
0.2 ~ 2 kHz

The outer concentric knob sweeps the EQ Frequency between 200 and 2,000 Hz.

+15 ~ -15 dB

The inner concentric knob adjusts the GAIN of the set frequency band by plus or minus 15 dB. A center detent is provided for unity gain.

(Peak Curves)

This rotary control adjusts the Q (the bandwidth) of this section of the equalizer from 0.5 to 3, with a center detent at 1.

10. LOW
(Peak/Shelf)

This locking switch selects Peaking type EQ (switch engaged) or Shelving type EQ.

40 ~ 400 kHz

The outer concentric knob sweeps the EQ Frequency between 40 and 400 Hz.

+15 ~ -15 dB

The inner concentric knob adjusts the GAIN of the set frequency band by plus or minus 15 dB. A center detent is provided for unity gain.

11. EQ CLIP

This red LED turns on when the post-EQ signal is 3 dB below clipping, warning to decrease the EQ boost and/or to turn down the input level at the channel input gain stage. Clipping at this stage can occur even though the input signal is not clipping, due to boost (gain) applied with the EQ circuitry.

12. EQ (In/Out switch)

This locking switch activates the channel EQ (switch in, adjacent green LED on) or bypasses it completely. Bypass allows for A-B comparison, and absolutely minimum signal degradation when EQ is not needed.

13. 20 - 400 Hz (H.P. filter)

This rotary control sweeps the cutoff frequency of a high pass filter (low cut) from 20 Hz to 400 Hz. The filter slope is 12 dB/octave. Typical applications including cutting wind noise, vocal "P" pops, stage rumble, and low frequency leakage from adjacent instruments. Higher frequency settings can be used to reduce leakage into mics that are primarily handling high-frequency sources. In general, it is a good practice to use the filter to protect woofers from unnecessary over-excursion due to the presence of unneeded low frequency or sub-sonic components, especially if a microphone is dropped or kicked; the filter should be bypassed (switch up) only when low frequencies are intentionally sought, as with an organ, drum, bass guitar, and so forth.

14. (H.P. filter In/Out switch)

This locking switch activates the input channel HIGH PASS FILTER (switch in, adjacent green LED on) or bypasses it. This filter bypass is independent of the EQ section, which has its own bypass switch.

15. INSERT

This locking switch activates the channel's INSERT IN jack, from which it applies signal to a point just ahead of the filter and EQ.* The INSERT OUT jack is always "live," and this switch does not affect it. The primary use of this switch is to select or de-select any signal processor or independent line input source which may be plugged into INSERT IN. When

* NOTE: An internal preset switch may be altered in each input module so the INSERT IN/OUT point is post-EQ rather than preEQ.

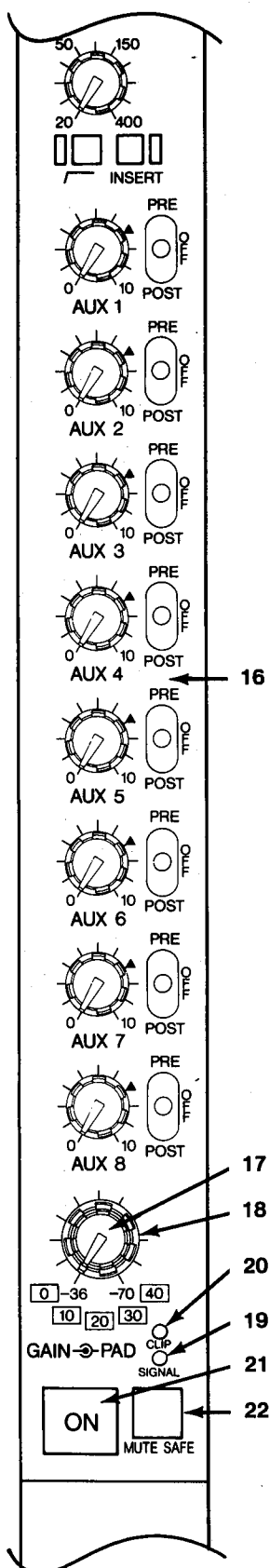

the switch is engaged, an adjacent yellow LED is illuminated.

If there is nothing plugged into the INSERT IN jack, this switch has no effect.

An effects device can be set up before it is needed, its levels adjusted using the always active INSERT OUT signal, and then the device can be inserted on cue in the channel's signal path by pressing this switch.

16. AUX 1 - 8 (Send Level & Pre/Off/Post Switches)

There are 8 rotary AUX send level controls with adjacent PRE/OFF/POST switches. The switch mutes (turns off) the send, or derives signal before (PRE) or after (POST) the channel Fader. The associated rotary control determines how much of the selected signal source is applied to the correspondingly numbered auxiliary mixing bus. When the switch is in the center (OFF) position, no signal is applied to the auxiliary bus.

NOTE: In some applications, it is preferable to have the PRE position be Pre-Fader & Pre-EQ rather than Pre-Fader & Post EQ. The PM3000 is equipped with internal switches that make it easy to change the "Pre" of each AUX send in this manner. This functional modification can be performed on a channel-by-channel basis, and for any or all AUX sends within each channel; Refer to the OPTIONAL FUNCTIONS section of this manual for additional information.

NOTE: All eight aux controls are colored blue, but controls #1-4 have gray pointers whereas controls #5-8 have black pointers. The Aux Master LEVEL controls [53] have similarly color-coded pointers. This is merely to help locate a particular aux send bus, and does not indicate any electronic or functional difference between the eight busses.

17. GAIN

The inner concentric knob provides 34 dB of continuously variable adjustment for the input preamplifier gain.

18. PAD (0, 10, 20, 30, 40)

The outer concentric knob is a 5-position rotary switch that attenuates the signal from the channel's XLR input by 0, 10, 20, 30, or 40 dB. A setting of "40" is therefore least sensitive. The PAD should be used in conjunction with the GAIN control to obtain the precise channel sensitivity necessary for a given source. It is always a good idea to begin with the PAD set to 40 dB position, and to back off from there to avoid any chance of input overdrive.

19. SIGNAL

This green LED is provided to indicate when there is signal present after the channel preamp (either from the XLR or from the INSERT IN jack). The SIGNAL LED turns on when that signal is 10 dB below the nominal level, and should therefore be on most of the time when the channel is in use. If necessary, use a lower PAD value or increase the GAIN setting to ensure the LED is ON; otherwise excess noise or a very small useable range of fader travel will become a problem.

20. CLIP

This red LED is provided to indicate when the signal present after the channel preamp (either from the XLR or from the INSERT IN jack) is too high in level. The SIGNAL LED turns on when that signal is 3 dB below clipping, and should therefore flash on only occasionally. If necessary, use a higher PAD value or decrease the GAIN setting to prevent the LED from remaining on any longer than momentarily; otherwise excessive distortion and insufficient fader travel will result.

21. ON (Channel On)

This locking, yellow, illuminated switch turns on when the input channel is ON, indicating the channel output is available to the stereo bus, the 8 group mixing busses, and the 8 auxiliary mixing busses. Engaging the switch does not necessarily mean the switch will be illuminated or that the channel will turn on; muting logic may be dictating that the channel remain off. When the channel is OFF, its signal may still be previewed with the CUE/SOLO switch [27].

22. MUTE SAFE

This locking switch is illuminated a red color when engaged. When MUTE SAFE is on, it overrides any combination of MASTER MUTE and channel MUTE switch settings, and prevents the channel from being muted. Engaging this switch ensures the channel will always be on so long as the channel ON switch is also engaged.

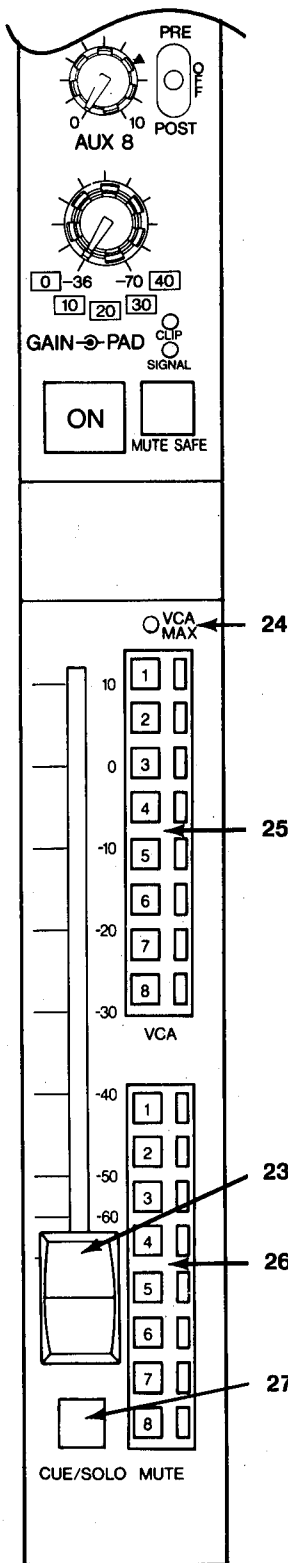

23. FADER

This smooth, long-throw fader sets the level applied to the 8 group mixing busses, and the stereo bus. It also affects any auxiliary feeds which are set to post-fader position. The Fader does not pass audio, but instead controls a VCA through which the audio signal flows. The channel level may, therefore, also be controlled remotely from the 8 VCA MASTER FADERS [52] or the VCA/MUTE CONTROL connector [110] if one or more of the VCA Assign switches [25] is engaged.

24. VCA MAX

This red LED turns on whenever the channel's VCA is commanded to reach its maximum output level. A "+ 10 dB" setting of the channel Fader, alone, will not trigger the MAX LED. The LED will only turn on if more than one assigned VCA MASTER FADER [52] is at maximum so that the total control voltage affecting the channel's VCA add up to the maximum permissible value. If the LED is on, further increases in Fader setting will produce no further increase in level. (This electronic equivalent of the maximum upward fader travel occurs when the control voltage is 1.2 VDC, corresponding to 24 dB of gain.) For additional VCA information, see the notes accompanying the description of the VCA MASTER FADER [52].

25. VCA (Assign 1 - 8)

Engaging any of these 8 locking switches enable the corresponding Group VCA MASTER FADER(s) to also control the output level of this channel. When a VCA switch is engaged, the adjacent yellow LED turns on.

CAUTION: If you assign or un-assign an input channel to a VCA MASTER group during a performance, the channel gain will jump up or down unless the corresponding VCA MASTER Fader [52] is set precisely to the nominal position (green LED "NOMINAL" pointer illuminated).

26. MUTE (Assign 1 - 8)

Engaging any of these 8 locking switches enables the corresponding Group MUTE MASTER switch(es) to "kill" this channel. An exception exists when the channel MUTE SAFE switch [22] is engaged, in which case these MUTE switches can have no effect. When a MUTE switch is engaged, the adjacent yellow LED turns on.

27. CUE/SOLO

The function of this switch on each input channel will depend on the setting of the console's Master SOLO MODE switch [59].

If the console is set to the SOLO MODE, then pressing this switch mutes all other input channels, and only the input channel(s) whose CUE/SOLO switch is engaged will feed the console outputs. (This is also known as "solo in place.") Any AUX RETURN signals will not be muted so that effects can be heard in conjunction with the input signal. To silence the AUX RETURNS, turn them off manually.

If the console is set to the CUE MODE, the console then has a dual-priority cue system, designed to give the engineer maximum control and speed when it is most important. In this mode, pressing the channel CUE/SOLO switch causes the channel signal to replace any master signal in the Cue output and the Phones output.

The engineer can readily select any of 26 output mixes (Group 1-8, Matrix 1-8, Aux Send 1-8, or Stereo L & R) by pressing the corresponding CUE switches. In most cases, once the individual output mixes have been established, the engineer will want to listen to the "most important output mix" during the performance, possibly the main house feed or the vocal group. However, should feedback occur, or should any other condition require attention, the PM3000 enables the engineer to instantly check any input channel or channels by pressing their CUE/SOLO switch(es). The input whose CUE switch is engaged then automatically replaces the selected output mix in the headphone and cue outputs. The engineer can make the necessary adjustment, and then return to monitoring the original output mix simply by releasing the input CUE/SOLO switch.

Pressing the yellow illuminated CUE/SOLO switch part-way down causes momentary contact; pressing it further locks it down. Although the cue signal is not affected by the Fader or ON/off switch, it is affected by the Input PAD, GAIN control, Filter, channel EQ, and anything connected between the channel's INSERT IN and OUT jacks (if the INSERT switch is engaged).

NOTE: Since the console operator may normally be listening to the stereo bus or one or more group busses by means of engaging their cue switches, the PM3000 is set up for input cue priority. As soon as one or more input channel cue switches are engaged, any bus cue signal will be replaced by the input cue signal(s). Input priority is also given to other PM3000 inputs (Aux Return cue), not just to the input channel cue signals.

2.1.2 THE AUX RTN A & AUX RTN B MODULES

The upper halves of the AUX RTN A and the AUX RTN B modules are similar, differing only in the actual return numbers; the AUX A module handles the AUX 1 and AUX 3 returns, while the AUX B module handles the AUX 2 and AUX 4 returns. The lower half of the AUX RTN A module has the MASTER MUTE switches which do not appear on the AUX RTN B module.

The following descriptions of one set of Auxiliary Return controls is typical of all four (AUX 1 through AUX 4). Bear in mind that each rear-panel Auxiliary Return input actually consists of two input connectors, L/MONO and R. When a mono signal is applied to an AUX Return, the "L/MONO" input should be used.

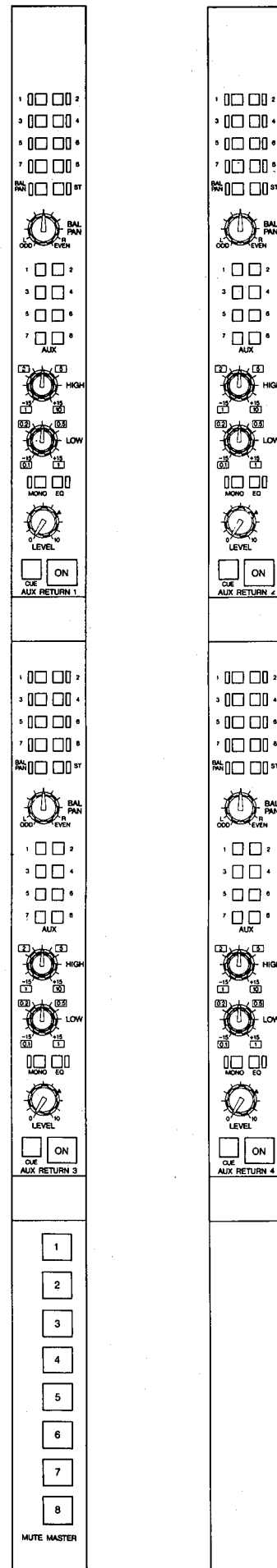
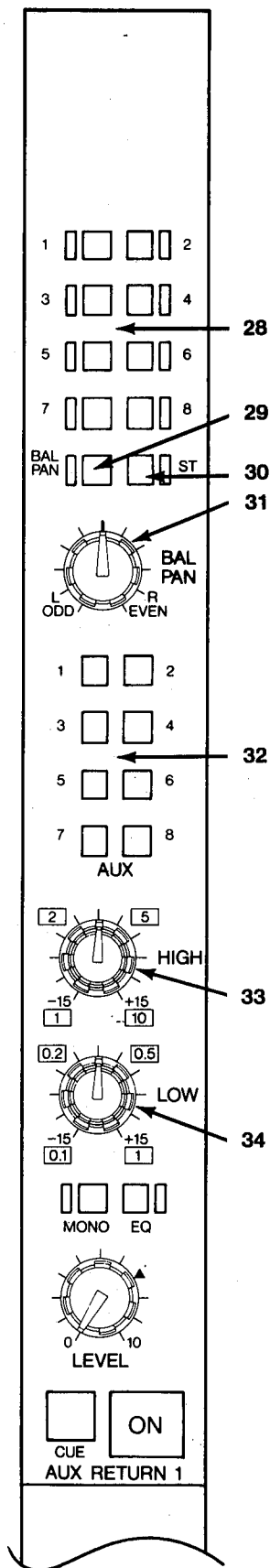

FIGURE 2-2. PM3000 AUX RTN A and AUX RTN B MODULES



28. 1.2.3.4.5.6.7.8. (Group Assign)

These locking switches assign the AUX RTN signal to group mixing busses 1 through 8. A green LED adjacent to each switch turns on when the signal is assigned to the bus.

29. BAL/PAN

This locking switch activates the BAL/PAN control. When the switch is up (not engaged), signal may be assigned fully to the 8 group mixing busses. When it is engaged (adjacent yellow LED on), the BAL/PAN control then affects the level applied to these busses. This switch does not affect panning to the stereo bus, which is under the full-time control of the PAN pot when the ST switch is engaged.

Given a mono auxiliary return (using the LMONO AUX RTN input), BAL/PAN acts as a PAN pot and can position the return signal between any odd-numbered and even-numbered group mixing busses or between the left and right sides of the stereo bus.

Given a stereo auxiliary return signal, the BAL/PAN control instead functions as a BALANCE control. In this instance, the L input is routed entirely to the left stereo bus and/or the odd-numbered group busses, and the R input goes to the right stereo bus and/or the even-numbered group busses, per any engaged group assign switches. The BAL/PAN control then raises the level to one side while lowering it to the other, and vice versa.

NOTE: An aux return signal applied to an aux send bus is always mono, whether derived from a mono or stereo return.

30. ST (Stereo)

This locking switch assigns the aux return input directly to the stereo bus. A green LED adjacent to the switch turns on when the signal is assigned to the stereo bus.

31. BAL/PAN

This rotary control enables a mono auxiliary return to be panned, or a stereo return to be balanced in level. See the description of the BAL/PAN switch [29].

32. AUX 1 - 8 (Assign)

These 8 locking switches assign the aux return signal directly to the correspondingly numbered auxiliary mixing busses. If the return is stereo, it will be combined to mono so that both sides of the return are applied to any of the assigned aux busses.

CAUTION: DO NOT assign a return to the same auxiliary bus whose output is feeding a signal processor which is providing the return signal. This will almost certainly cause feedback which can damage circuits and/or loudspeakers.

(AUX RETURN EQ)

Each of the four auxiliary returns has an equalizer, divided into two bands. The equalization is of the shelving type, and each of the two bands has a sweepable "knee" frequency. This equalizer is actually a stereo EQ, with both channels "gang" controlled so that the same processing is applied to both sides of a stereo return. A gain control in each band provides 15 dB of boost or cut.

33. HIGH
1.0 ~ 10 kHz

The outer concentric knob sweeps the EQ FREQUENCY between 1,000 and 10,000 Hz. Shelving type EQ occurs above this 3 dB point.

+ 15 ~ -15 dB

The inner concentric knob adjusts the GAIN of the set frequency band by plus or minus 15 dB. A center detent is provided for unity gain.

34. LOW
0.1 ~ 1 kHz

The outer concentric knob sweeps the EQ FREQUENCY between 100 and 1,000 Hz. Shelving type EQ occurs below this 3 dB point.

+ 15 ~ -15 dB

The inner concentric knob adjusts the GAIN of the set frequency band by plus or minus 15 dB. A center detent is provided for unity gain.

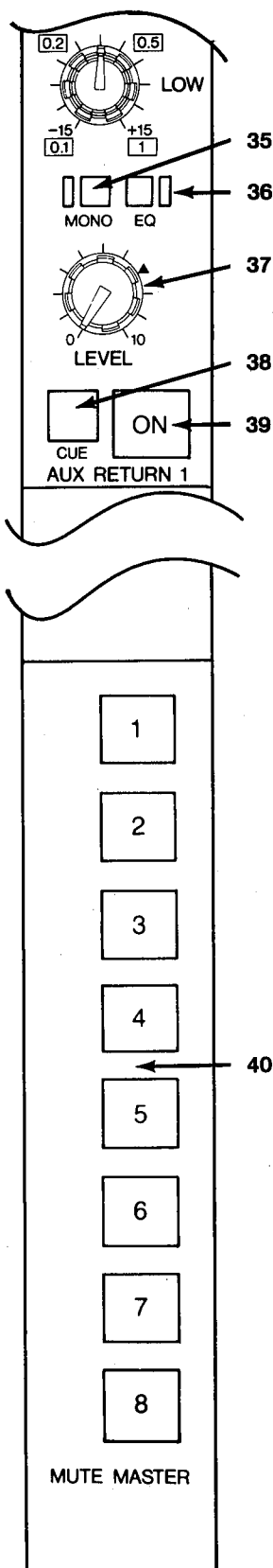

35. MONO

Pressing this locking switch activates L/MONO aux input as the sole signal input to this AUX section. When the MONO mode is engaged, an adjacent yellow LED turns on. For stereo aux returns, do not engage this switch.

36. EQ (In/Out switch)

This locking switch activates the aux return EQ (switch in, adjacent green LED on) or bypasses it completely. Bypass allows for A-B comparison, and absolutely minimum signal degradation when EQ is not needed. It also permits EQ to be selected (cue'd) instantaneously.

37. LEVEL

This rotary control sets incoming AUX level applied to any of the assigned group, stereo, or auxiliary mixing busses. It is a 2-ganged control, simultaneously adjusting the L/MONO and R aux returns.

38. CUE

Pressing this yellow illuminated switch part-way down causes momentary contact; pressing it further locks it down.

When the console is in cue mode (refer to SOLO switch [59]), and this CUE switch is engaged (illuminated), the aux return signal replaces any master signal in the Cue output and the Phones output. The Cue signal is stereo if a stereo return is used; when the MONO switch [35] is engaged, then a mono cue signal is derived from the L/MONO aux input.

NOTE: As noted under the input channel cue switch description, the PM3000 exhibits input priority cue logic. Since AUX IN is an input, it too receives priority. This means that the aux return cue, when selected, will replace any other group or stereo bus cue signals.

When the console is in solo mode (again, refer to SOLO switch [59]), this CUE switch functions similarly, but not the same as, the input channel CUE/SOLO switches. Engaging it will mute all input channels (unless their CUE/SOLO switches are engaged), but will not mute the other aux returns; to mute other returns, disengage their ON/off switches.

39. ON (Aux Return On)

This locking, yellow, illuminated switch turns ON when the aux return is ON, indicating the aux return signal is available to the stereo bus, the 8 group mixing busses, and the 8 auxiliary mixing busses. When the return is OFF, its signal may still be previewed with the adjacent CUE switch [38].

(MUTE MASTER SECTION, AUX RTN A MODULE ONLY)

40. MUTE MASTER 1 - 8

Engaging any of these locking, yellow illuminated switches mutes (turns off) any input channel(s) whose correspondingly numbered MUTE switch is engaged. An input channel will not be muted, however, if its MUTE SAFE switch is engaged.

2.1.3 THE MASTER MODULES (1 - 8)

These eight modules are identical, except that each controls a differently-numbered set of Group Master, VCA Master and Matrix Output channels.

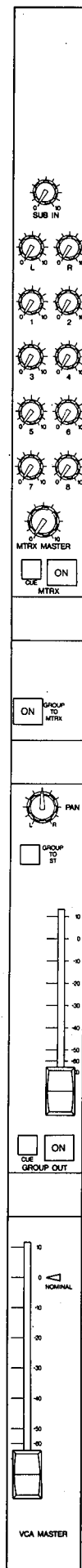

FIGURE 2-3. PM3000 MASTER MODULE.

(MATRIX SECTION)

41. SUB IN

This rotary control adjusts the level of the signal from the MTRX SUB IN connector applied to the module's MTRX OUT. MTRX SUB IN 1 is applied only to MTRX OUT 1, MTRX SUB IN 2 to MTRX OUT 2, and so forth.

42. L.R.1.2.3.4.5.6.7.8. (Matrix Mix Level Controls)

These 10 rotary controls adjust the level of signal from the correspondingly numbered group or stereo busses applied to the module's MTRX OUT.

43. MTRX MASTER

The Matrix Mix level controls (L,R, 1, 2, 3, 4, 5, 6, 7, 8) permit a mono mix to be derived from the eight group busses and the stereo bus, while the SUB IN control adds an additional signal to the mix. The MTRX MASTER control then sets the overall level of this 11:1 mix just before it is routed to the matrix output connector.

44. CUE (Matrix Cue)

Pressing this yellow illuminated switch part-way down causes momentary contact; pressing it further locks it down. When the CUE switch is illuminated, the module's matrix mix signal (pre MTRX MASTER) replaces any other signal in the Cue output and the Phones output unless an input CUE switch is engaged. (Bus cue signals are overridden by input cue.) The MTRX CUE signal is Mono, regardless of how many matrix channels are cue'd.

45. ON (Matrix On)

This locking, yellow, illuminated switch turns on when the MTRX OUT is ON. When the MTRX OUT is turned OFF, its signal may still be previewed with the adjacent CUE switch [44].

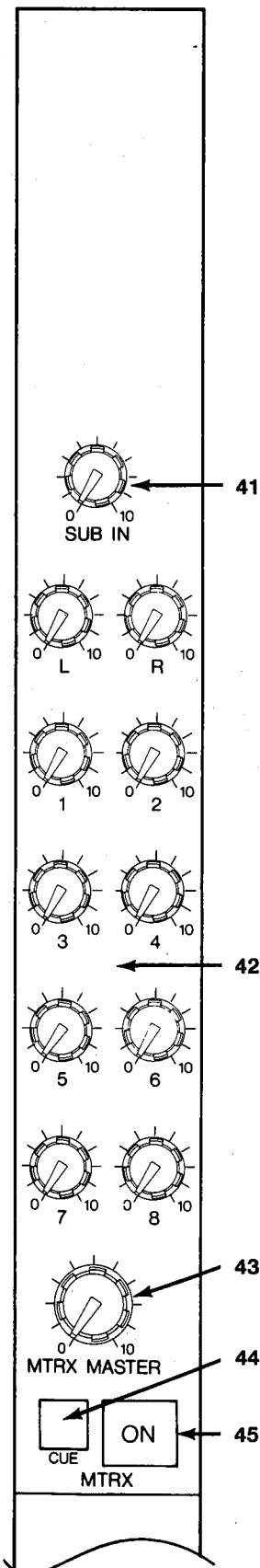

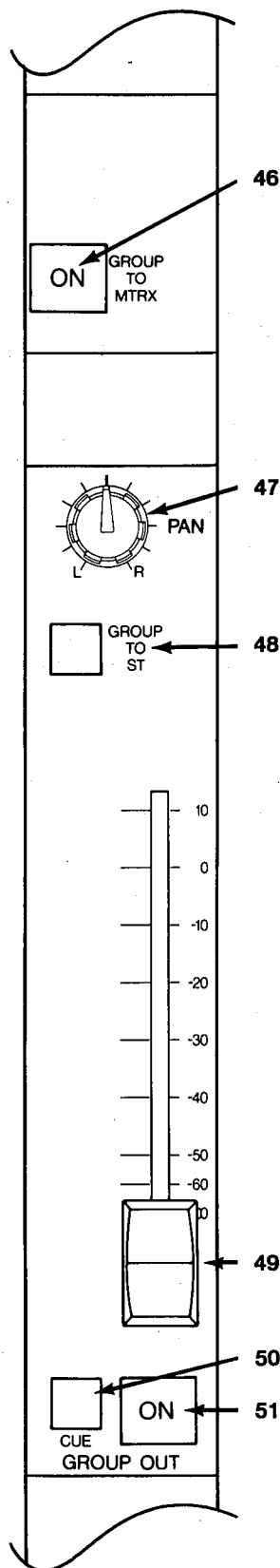

(GROUP SECTION)

46. GROUP-TO-MTRX

Engaging this locking switch assigns signal from the module's GROUP OUT (ahead of the Group ON switch) to the correspondingly numbered matrix rotary control. The switch is illuminated yellow when the group signal is assigned to the matrix.

NOTE: The signal is assigned to the matrix by a preset switch within each of the master modules. As shipped, the group feed to the matrix comes after the Group Fader; a switch may be moved within each master module to obtain a pre-Group Fader feed to the matrix. Refer to Section 4.5 for more information on this optional preset switch function.

47. PAN

This pan control is operational only when the adjacent ST (stereo) switch is engaged. It then pans the group signal (pre-group fader) between the left and right sides of the stereo mixing bus.

48. GROUP-TO-ST

Engaging this locking, yellow illuminated switch assigns the group bus output to the stereo bus via the adjacent PAN control. When the switch is not engaged (not illuminated), the group signal is not applied to the stereo bus.

49. (Group Out Fader)

This fader controls the audio signal level from the group mixing bus which is applied to the GROUP OUT. This is an audio fader which controls the actual mixed audio signal, not a VCA controller.

50. CUE (Group Cue)

Pressing this yellow illuminated switch part-way down causes momentary contact; pressing it further locks it down. When the CUE switch is illuminated, the module's GROUP OUT signal (pre Group Fader) replaces any master signal in the Cue output and the Phones output unless an input CUE switch is engaged. (Bus cue signals are overridden by input cue.) The Group cue signal is mono, regardless of how many groups are cue'd.

51. ON (Group On)

This locking, yellow, illuminated switch turns on when the GROUP OUT is ON. When the GROUP OUT is turned off, its signal may still be previewed with the adjacent CUE switch [50]. This switch does not affect the group output to the matrix or the stereo bus.

52. VCA MASTER

This fader applies a DC control voltage to any input channels whose correspondingly-numbered VCA assign switch is engaged. Raising or lowering this fader will raise or lower the output level from those assigned input modules. The end result can be similar to using a group fader, except that audio is not going through this fader. Because the VCA MASTER is controlling the output level of each assigned input channel, it affects any post-fader auxiliary sends from that channel, as well as the channel's output to the eight group mixing buses and to the stereo mixing bus.

NOTE: VCA MASTER faders apply DC voltage to one or more assigned input channels. The voltage applied to the VCA (voltage controlled amplifier) in a given input module will be the sum of the voltages from that module's channel fader, plus any assigned VCA MASTER faders. The higher the voltage, the greater the gain through the channel. VCA gain structure is calculated so that when a VCA MASTER Fader is set so its NOMINAL LED is on, then that Fader has no affect on any input channel levels. The VCA MASTER faders should be set to NOMINAL position when not in use so that if an input is subsequently assigned to a VCA, there will be no sudden change in channel level due to an added (or subtracted) control voltage.

Here are some additional VCA details:

If a channel Fader is set at 0 dB, and it is assigned to a VCA Master that is set at -10 dB, then the channel level will be -10 dB ($0 + (-10) = -10$).

If the channel Fader is set at -10 dB, and is assigned to two VCA Masters, each set at -10 dB, then the channel level will be -30 dB ($-10 + (-10) + (-10) = -30$).

If the channel Fader is set at +10 dB, and is assigned to two VCA Masters, one of which is set at +10 dB, and the other at -20 dB, then the channel level will be 0 dB ($+10 + (+10) + (-20) = 0$).

When an input Fader or an assigned VCA MASTER Fader is pulled all the way down to "infinite" attenuation position, the voltage is sensed in the input module. The channel ON lamp will remain active, however, indicating that any pre-fader channel outputs are still "live."

If the console is set to the "SLAVE" rather than the "MASTER" mode with the rear-panel VCA SLAVE/MASTER switch [111], then the console's VCA MASTER Faders will have no effect. Instead, any DC control signals applied to the VCA/MUTE CONTROL connector [110] will affect correspondingly assigned input channels.

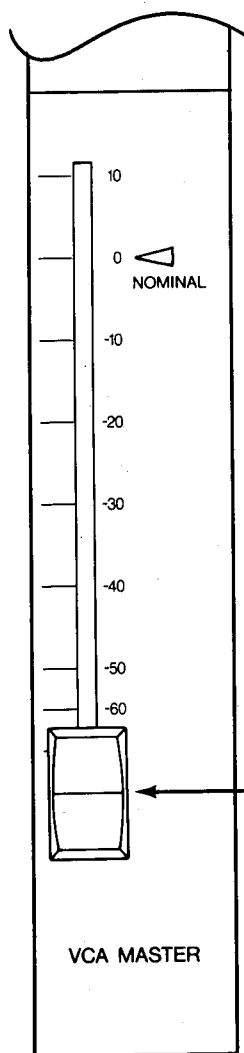

2.1.4 THE AUX/ST MODULE & THE AUX MODULE

These two modules contain master send sections for all eight auxiliary busses, arranged in four sections per module. We have described just one of the eight clusters of auxiliary LEVEL, CUE and ON functions, since all are identical. The AUX/ST module also contains the STEREO MASTER Fader.

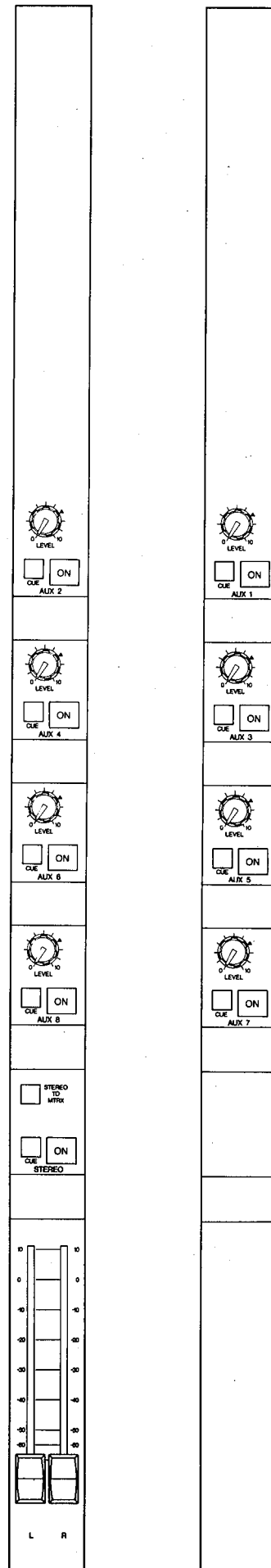
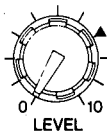

FIGURE 2-4. PM3000 AUX/ST AND AUX MODULES.

(AUX 1 MASTER CONTROLS, TYPICAL OF AUX 1 - AUX 8)

53. LEVEL

This rotary control adjusts the overall level from the correspondingly numbered auxiliary mixing bus to the AUX OUT connector.



53

54. CUE (Aux Send Cue)

Pressing this yellow illuminated switch part-way down causes momentary contact; pressing it further locks it down. When the CUE switch is illuminated, the correspondingly numbered auxiliary send replaces any master cue signal in the Cue output and the Phones output unless an input CUE switch is engaged. (Bus cue signals are overridden by input cue.) The aux cue signal is mono, regardless of how many aux sends are cue'd.



AUX 8

54

55

55. ON (Auxiliary On)

This locking, yellow, illuminated switch turns on when the AUX OUT is ON. When the AUX OUT is turned off, its signal may still be previewed with the adjacent CUE switch [54].



STEREO TO MTRX

58

(STEREO MASTER SECTION)

56. (Dual Fader)

This pair of closely-spaced faders adjusts the level applied from the stereo mixing bus to the stereo output connectors. The Fader knobs are located immediately next to each other so both can be operated in unison with a single finger. At the same time, the two (Left and Right) knobs may be offset somewhat and still operated together, or they can be operated completely independently if, for example, the stereo bus is used for two discrete mono mixes.



STEREO

57

57. CUE (Stereo Cue)

Pressing this yellow illuminated switch part-way down causes momentary contact; pressing it further locks it down. When the CUE switch is illuminated, the correspondingly numbered auxiliary send replaces any other signal in the Cue output and the Phones output unless an input CUE switch is engaged. (Bus cue signals are overridden by input cue.) This switch provides the headphones with a stereo cue signal.

58. STEREO-TO-MTRX

Engaging this locking switch assigns signal from the Stereo Output (ahead of the Stereo ON switch) to the L and R rotary mix controls in the matrix. The switch is illuminated in yellow when the stereo signal is assigned to the matrix.

NOTE: The signal is routed to the matrix via an internal switch in the AUX/ST module. The switch is preset so the feed to the matrix comes after the Stereo Master Fader; the switch may be moved to obtain a pre-Stereo Master Fader feed. Refer to Section 4.4 for more information on this optional function.

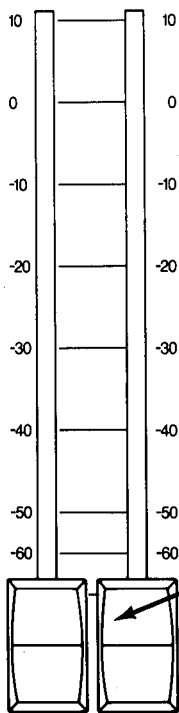

56

L

R

2.1.5 THE TB/COMM MODULE

This module contains an oscillator for testing and calibration, a talkback section for slating and communication, and a unique communications feature. It also contains the master SOLO mode switch, CUE/SOLO/COMM annunciator LEDs, and headphone jacks.

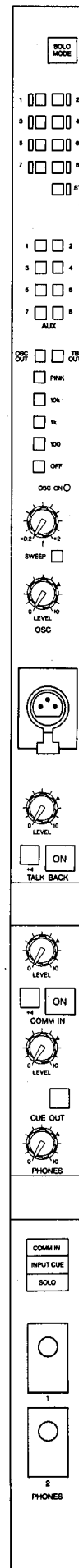
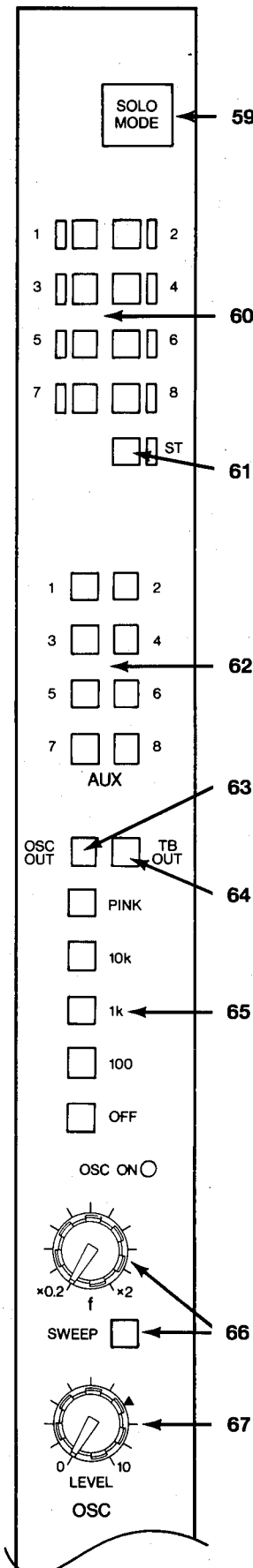

FIGURE 2-5. PM3000 TB/COMM MODULE.



59. SOLO MODE

This locking, red, illuminated switch flashes when engaged, indicating the console monitor system is set to the SOLO mode. In this mode, input channel CUE/SOLO switches mute all other channels, much like a recording console SOLO function. This mode is useful during setup and sound check for a live show.

When the console is in SOLO mode, the aux return CUE switches have a solo function, but it is not quite like the input channel solo function. Pressing an aux return CUE switch in SOLO mode will mute all input channels (except those whose CUE/SOLO switch is engaged), and the soloed aux return will be heard, but so, too, will all other aux returns. (To silence the other returns, turn them off by disengaging their ON/off switches.)

The normal mode of operation during a show, CUE mode, is entered by releasing this switch; in this mode, input CUE/SOLO switches do not mute other channels, but merely replace the signal which appears in the Phones output.

CAUTION: Be sure to disengage the solo mode, and confirm the console is in the cue mode, prior to the beginning of a performance. Otherwise pressing any input channel CUE/SOLO switch will mute all other channels.

60. 1.2.3.4.5.6.7.8. (Group Mixing Bus Assign)

These locking switches assign the Talkback or oscillator signal to group mixing busses 1 through 8. A green LED adjacent to each switch turns on when the signal is assigned to the bus.

61. ST (Stereo)

This locking switch assigns the TB/OSC output directly to stereo mixing buss. A green LED adjacent to the switch turns on when the signal is assigned to the stereo bus.

62. AUX 1 - 8 (Assign)

These eight locking switches assign the TB/OSC signal directly to the correspondingly numbered auxiliary mixing busses.

63. OSC OUT

This locking switch turns the OSC OUT connector on and off. It affects only the output of the oscillator that appears at this connector, and does not affect any oscillator signal which may be switch-assigned to group mixing busses 1-8, the stereo bus or the eight busses.

64. TB OUT

This locking switch turns the TB OUT connector on and off. It affects only the output of the talkback system which appears at the TB OUT connector (the output being derived from the TB input when the TALKBACK ON switch is pressed, or otherwise from the oscillator). This switch does not affect any TB/OSC signal which may be switch-assigned to group mixing busses 1-8, the stereo bus or the eight aux mixing busses.

65. PINK. 10K. 1K. 100. OFF

These 5 interlocking switches set the oscillator to 100 Hz, 1 kHz or 10 kHz operation when the nearby SWEEP switch is in fixed frequency position (disengaged). They also permit selection of a pink noise source, or turn off the oscillator/noise source altogether.

NOTE: To prevent any possible leakage into mixing busses, the oscillator should be shut OFF when not actually in use. A red LED warns when the oscillator is on.

66. SWEEP (Uncal)

Engaging this switch removes the oscillator from its fixed frequency mode (i.e., generating exactly 100 Hz, 1 kHz or 10 kHz). The nearby rotary control then may be used to adjust the oscillator output from approximately 0.2 to 2 times the set "fixed" frequency.

67. OSC LEVEL

This rotary control adjusts the oscillator output level applied to the OSC OUT connector as well as any mixing busses to which the signal may be assigned. This control does not affect the Talkback level.

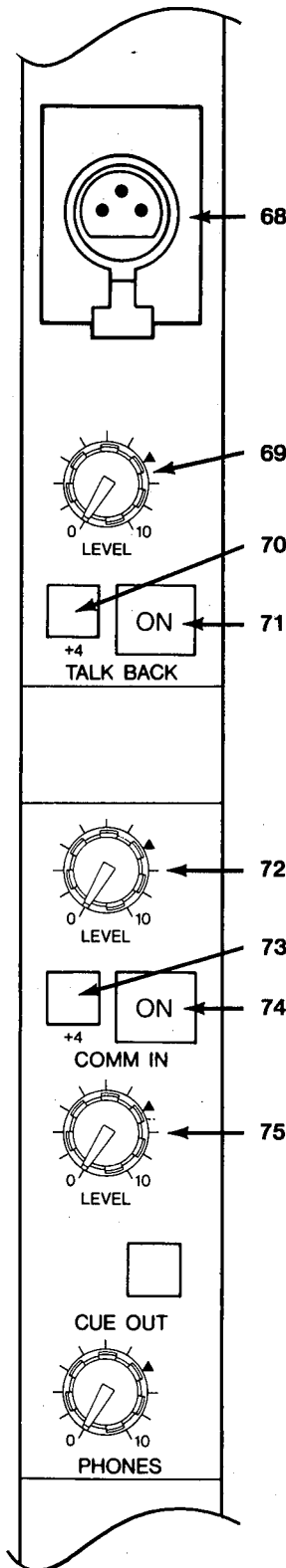

68. (TB INPUT)

This XLR-3 connector accepts a low-Z microphone or a line level signal, depending on the settings of the controls below it. This input is NOT phantom powered. Signal from this input is assigned to the TB OUT connector and to the various mixing busses by means of the assignment switches in the upper portion of this module [60], [61], [62], [64].

69. LEVEL (TB Input)

This rotary control adjusts the signal level after the talkback preamplifier, thereby affecting the sensitivity of the TB input whether it is set for a mic or line source. This control affects the TB level applied to any busses and to the TB OUT connector; it does not affect the oscillator level in any way.

70. +4 (Pad)

This locking, red illuminated switch inserts a 54 dB pad after XLR talkback input (switch illuminated = pad inserted). The pad decreases the sensitivity of that input from nominal -50 dBu (for a microphone) to +4 dBu (for a line level input).

71. TALKBACK ON

Pressing this yellow illuminated switch part-way down causes momentary contact; pressing it further locks it down. The switch activates the XLR talkback input and applies signal from that input to any assigned busses (and to the TB OUT connector if the TB OUT switch is also on). When the TALKBACK ON switch is off (not illuminated), the oscillator output is instead routed to those busses (and to the TB OUT connector). This switch does not, however, affect the OSC OUT connector.

(COMM IN)

A rear-panel COMM IN (Communications Input) [108] connector enables almost any intercom system to be used to communicate with the PM3000 console operator; or the stage manager's mic can be plugged in. When an audio signal is applied to this input, and the controls on this module (described below) are appropriately set, then the COMM IN light will turn on. Pressing the COMM IN ON switch then replaces any signal in the PHONES and CUE OUT with the COMM IN signal.

The COMM IN may also be used in conjunction with the TB out from a stage monitor mixing console, another audio mixing console, or with a signal from a stage manager's mic (+4 switch [73] not engaged so that COMM IN is set for mic level sensitivity). In any of these instances, someone talking at a remote location can visually signal the PM3000 operator merely by speaking, and can then be heard if the PM3000 operator engages the COMM IN ON switch [74].

72. LEVEL (COMM IN Level)

This rotary control adjusts the signal level after the COMM IN preamplifier, thereby affecting the sensitivity of the COMM input whether it is set for a mic or line source. This control affects the COMM level applied to the Phones output and to the Cue output, which are the only points to which COMM IN signal may be applied.

73. +4 (Pad)

This locking, red illuminated switch inserts a 54 dB pad after COMM IN XLR input (switch illuminated = pad inserted). The pad decreases the sensitivity of that input from nominal -50 dBu (for mic level) to +4 dBu (for line level).

74. COMM IN ON

Pressing this yellow illuminated switch replaces any CUE signal in the CUE OUTPUT with the COMM IN signal. It also interrupts the PHONES output and replaces it with the COMM IN signal.

75. LEVEL (Cue Out)

This rotary, 2-gang (stereo) control adjusts the output level applied to the CUE OUT L & R connectors. It does not affect any cue signal which may be applied to the PHONE outputs.

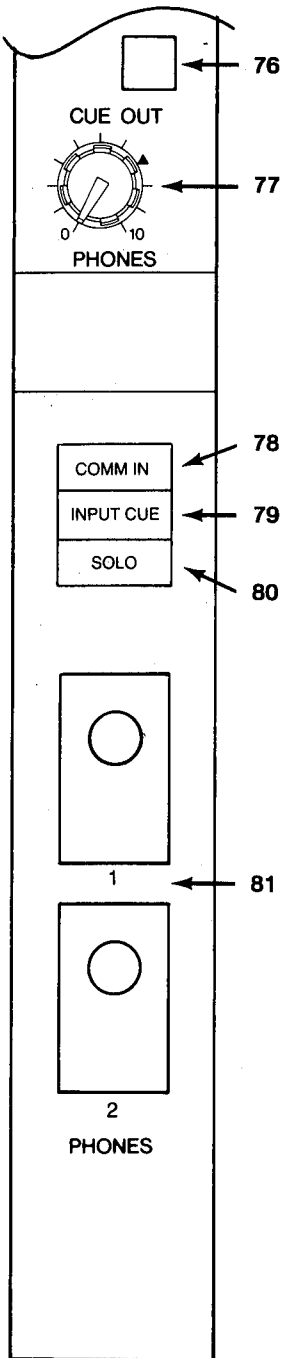

76. CUE OUT (ON/off switch)

Engaging this yellow, illuminated switch turns on the CUE OUT L & R connectors. This switch does not affect the PHONES outputs.

77. PHONES (Level control)

This 2-gang rotary control adjust the output level at both stereo PHONES output jacks. It affects any signals which may be fed to these outputs.

(LED ANNUNCIATORS)

78. COMM IN

This LED flashes green in response to almost any level signal appearing at the COMM input. (It will not respond to a low microphone level signal if the "+ 4" input pad is engaged.) This signals the console operator that someone may be attempting to communicate so that the COMM IN ON switch can be engaged.

79. INPUT CUE

This yellow LED turns on when any input channel's CUE/SOLO switch or any AUX RETURN CUE switch is engaged, indicating the console is subject to input cue priority. This is an indication that the signal in the headphones output is being derived from one or more inputs via the cue system. The indicator operates the same whether the console is in cue or solo mode.

80. SOLO

This LED flashes red if the console is in the SOLO mode. This serves as an urgent warning that if any input CUE/SOLO switch (or aux return CUE switch) is depressed, that all input channels will be muted except the soloed channel(s).

CAUTION: If this LED is flashing during a performance, **DO NOT** press any input CUE/SOLO or aux return CUE switch. Instead, disengage the SOLO MODE switch [59]. This will prevent program interruption when attempting to cue an input.

81. PHONES (1, 2)

This pair of 1/4" (6.33mm) stereo phone jacks can accommodate two pair of standard 8-ohm or higher impedance stereo headphones. The jacks are recessed behind a spring-loaded cover panel which excludes dust when the jacks are not in use. The jacks are also angled to minimize strain on the cable and connector:

2.1.6 THE METER BRIDGE

The PM3000 is equipped with 14 large, illuminated VU meters. Each meter has true VU ballistics to indicate approximate loudness, plus a red "PEAK" LED which responds to instantaneous levels that are beyond the scale of the meter. The PEAK LED turns on 10 dB below the clipping point. Assuming the meter is monitoring an output with +24 dBm maximum output capability, the PEAK LED will turn on when the instantaneous level reaches +14 dBm. Since the standard VU meter scale goes only to +3 VU (which is +7 dBm), the PEAK LED turns on when the level is 7 dB above maximum meter scale. Bear in mind, however, that a brief transient that may cause the PEAK LED to flash on may be too fast for the meter needle to respond. It is not unusual with plucked or percussive instruments, for example, for the peak level to be 20 to 30 dB above the average level.

Most of the meters are switchable so they can monitor two or three possible signal sources. When one of the interlocking switches is engaged, an LED in the switch turns on to visually confirm the signal being monitored.

82. GROUP* G>M* MTRX* (* numbered 1 through 8)

These eight meters monitor the correspondingly numbered GROUP OUT (after the GROUP ON/off switch**), or, in G>M mode the feed to the matrix after the GROUP-TO-MTRX switch, or the output from the correspondingly numbered MTRX ON switch.

***NOTE: The actual signal monitored with these meters set to GROUP mode can be changed by means of internal preset slide switches. As shipped, the signal is derived after the GROUP MASTER Fader and GROUP OUT ON/off switch. The meter feed can be internally switched to be derived from a point just before the GROUP OUT ON/off switch, or from a point just after the GROUP-TO-STEREO switch (both post GROUP MASTER Fader). Refer to the OPTIONAL FUNCTIONS section of this manual.*

**83. AUX 1/AUX 5/CUE L
AUX 2/AUX 6/CUE R
AUX 3/AUX 7/OSC
AUX 4/AUX 8**

These four meters monitor the correspondingly numbered AUX SEND outputs. In addition, the first two meters can be switched to monitor the CUE Left and Right output levels, and the third meter the OSCILLATOR output level.

84. STEREO (L & R)

These two larger meters monitor the left and right sides of the STEREO OUTPUTS.

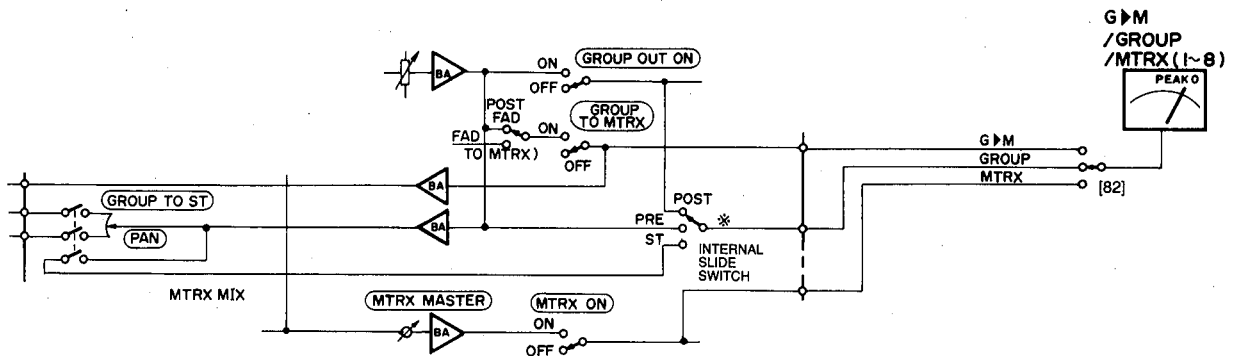

FIGURE 2-6 Signal pick-off points for those VU meters that display Group, Group-to-matrix, or Matrix Levels.

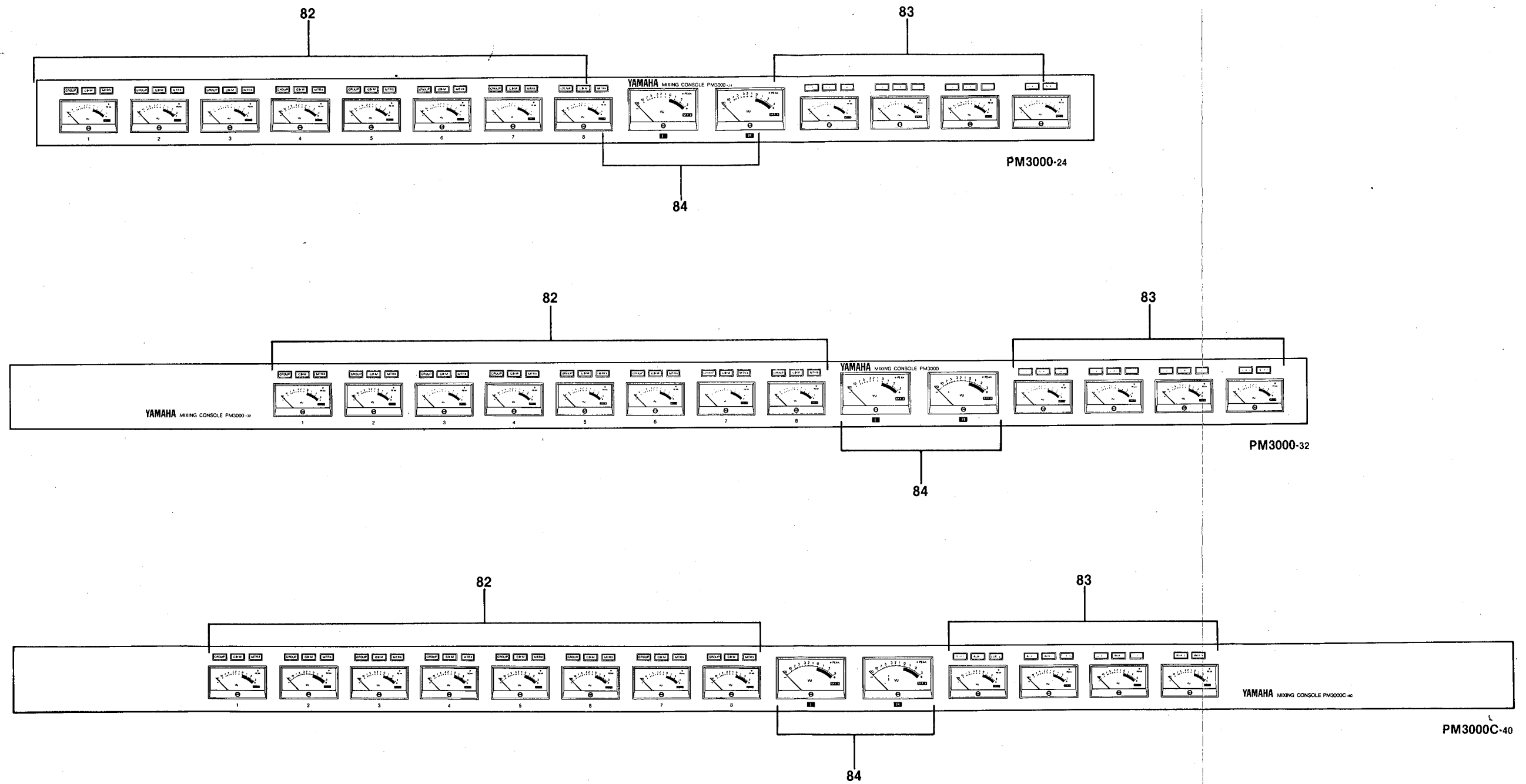

FIGURE 2-7 PM3000 METER BRIDGE.

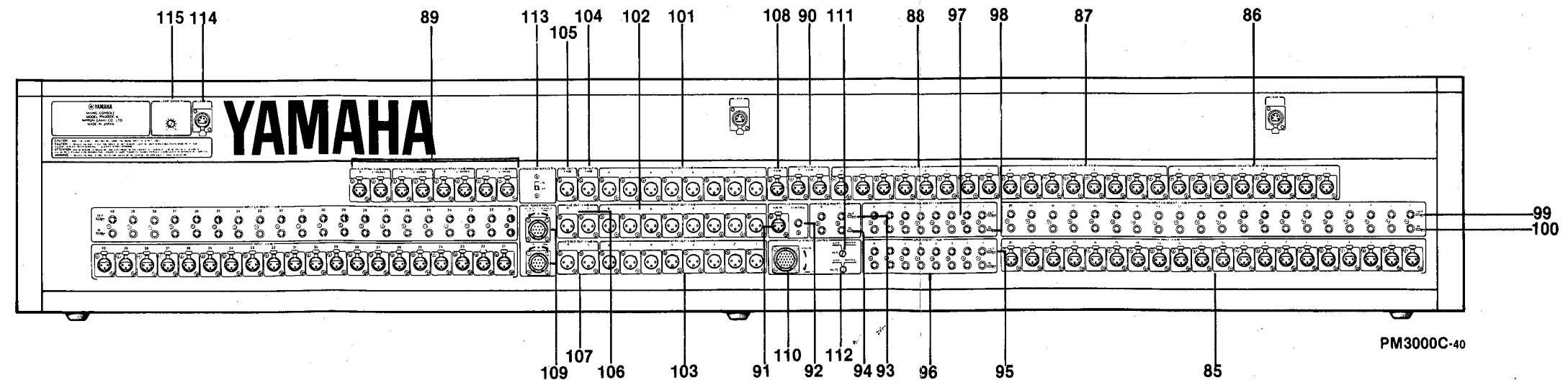
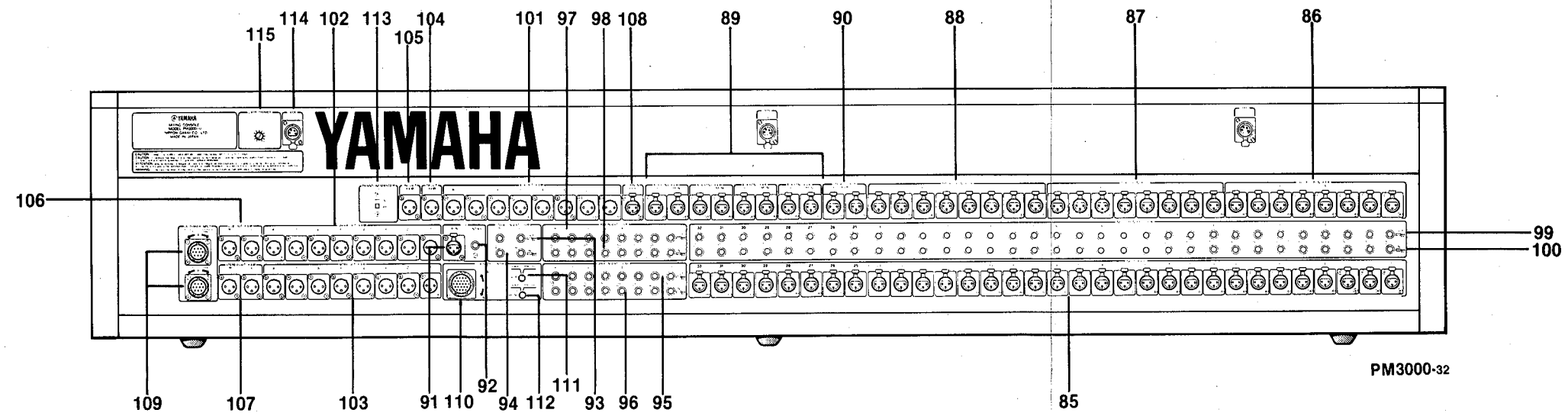
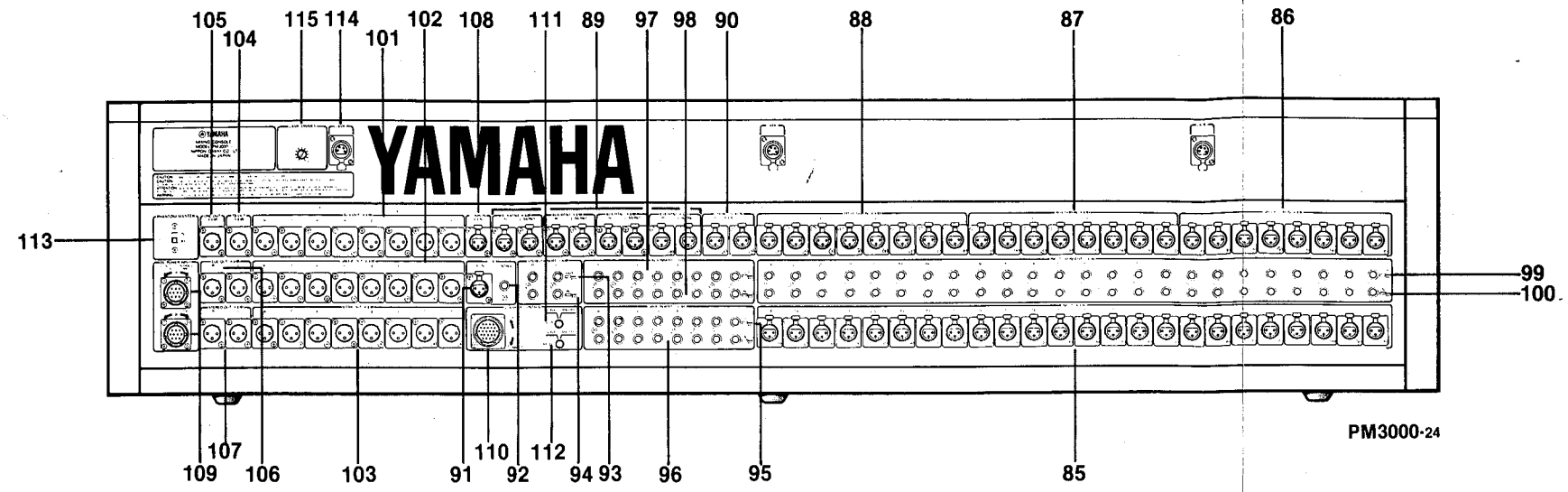

FIGURE 2-8. PM3000 REAR PANEL

2.2 PM3000 REAR PANEL FEATURES

All output XLR connectors are balanced, XLR-3 type, nominal +4 dBu level unless otherwise noted. INSERT IN/OUT jacks are wired in a "normalised" configuration such that as long as the IN jack is not used, the OUT jack is internally wired to it for signal continuity. The OUT jack may be used as a direct output without interrupting signal flow through the console. INSERT OUTs are unbalanced, whereas INSERT INs accept balanced or unbalanced sources.

Input channel XLRs are electronically balanced, as supplied. Optional input isolation transformers may be installed on a module-by-module basis; refer to Section 6.7. Output XLRs are also electronically balanced. Optional output isolation transformers are available in an external 19-inch rack mount package housing eight transformers. In this way, inputs and outputs can be provided with extra grounding isolation and common mode rejection where required, but one need not pay the price in direct costs, weight or signal quality where the transformers are not needed.

85. INPUT (1 - 24, 1 - 32, or 1 - 40)

These 24, 32 or 40 female XLR connectors apply signal to the correspondingly numbered input modules. The nominal input level may vary from -70 dBu to +4 dBu depending on the settings of the individual input GAIN controls and PAD switches.

86. GROUP SUB IN (1 - 8)

These eight female XLR connectors apply signal directly to the group mixing busses (ahead of the Group Master Faders). They are used for "chaining" another mixing console's group outputs into this console, with this console serving as the master for both consoles.

87. AUX SUB IN (1 - 8)

These eight female XLR connectors apply signal directly to the auxiliary mixing busses (ahead of the rotary Aux Master controls). They are used for "chaining" another mixing console's aux send outputs into this console, with this console serving as the master for both consoles.

88. MTRX SUB IN (1 - 8)

These eight female XLR connectors apply signal directly to the correspondingly numbered MTRX SUB IN controls [41]. These inputs can be used to apply effects return signals to individual matrix channels, to apply remote signals to the matrix, or to "Y" connect one or more aux send busses to the matrix for in order to create additional groups. MTRX SUB IN also may be used for "chaining" another mixing console's matrix outputs into this console, with this console's MTRX MASTERS serving as the masters for both consoles.

89. AUX RETURN (1 through 4, L/MONO and R)

These eight female XLR connectors accept auxiliary return signals. Each pair of L/MONO and R connectors can be used for a stereo return, or the L/MONO connector may be used for a monaural return (provided the corresponding front-panel MONO switch is engaged [35]). They may be used as auxiliary line inputs if they are not being used for effects returns.

90. STEREO SUB IN (L, R)

These two female XLR connectors apply signal directly to the stereo mixing bus (ahead of the Stereo Master Fader). They are used for "chaining" another mixing console's stereo outputs into this console, with this console serving as the master for both consoles.

91. CUE SUB IN

This female XLR connector applies signal directly to the cue mixing bus. It is used for "chaining" another mixing console's cue or solo output into this console, with this console serving as the master for both consoles.

92. CUE CONTROL

This 1/4" (6.33 mm) Tip/Ring/Sleeve phone jack provides direct access to the console's cue/solo control bus. It serves as either an input or an output. When the CUE CONTROL jacks of two PM3000 consoles are interconnected, pressing an input CUE/SOLO switch or any CUE switch on one console causes both consoles to enter the cue (or solo) mode. Provided that CUE SUB IN is linked, all cued or soloed signals can be monitored by the "master" console.

93. STEREO INSERT OUT (L, R)

These two unbalanced 1/4" (6.33mm) Tip/Sleeve phone jacks output the signal from the stereo mixing bus just ahead of the STEREO MASTER fader. Nominal level is -6 dBu (388 mV). These jacks may be used as auxiliary stereo outputs to a tape recorder. They are intended, however for sending the mixed stereo signal to an auxiliary signal processor (compressor, graphic EQ, etc).

94. STEREO INSERT IN (L, R)

These two balanced 1/4" (6.33mm) Tip/Ring/Sleeve phone jacks apply signal to the STEREO MASTER fader. Nominal level is -6 dBu (388 mV). Inserting a plug in these jacks interrupts the internal signal flow through the console, instead bringing in the return from an auxiliary signal processor.

95. GROUP INSERT OUT

These eight unbalanced 1/4" (6.33mm) Tip/Sleeve phone jacks output the signal from the group mixing busses just ahead of the Group Master faders. Similar to the STEREO INSERT OUT jacks [93], these jacks may be used as auxiliary group outputs to a multitrack tape recorder or another console. They are intended, however for sending the group signals to auxiliary signal processors (compressors, graphic EQs, etc).

96. GROUP INSERT IN (1 - 8)

These eight balanced 1/4" (6.33mm) Tip/Ring/Sleeve phone jacks apply signal to the Group Master faders. Similar to the STEREO INSERT IN jacks, these jacks accept the return from any auxiliary signal processor used on the overall group mixing bus signal.

97. AUX INSERT OUT (1 - 8)

These eight unbalanced 1/4" (6.33mm) Tip/Sleeve phone jacks are nearly identical to the GROUP INSERT OUT jacks, except they output signal from just ahead of the AUX SEND rotary master level controls.

98. AUX INSERT IN (1 - 8)

These eight balanced 1/4" (6.33mm) Tip/Ring/Sleeve phone jacks are nearly identical to the GROUP INSERT IN jacks, except they return signal to a point just ahead of the AUX SEND master rotary level controls.

99. INPUT CHANNEL INSERT OUT (1 - 24, 1 - 32, or 1 - 40)

These 24, 32 or 40 unbalanced 1/4" (6.33mm) Tip/Sleeve phone jacks output the signal from the input channel (just after the GAIN control, PAD and polarity switch, but before the EQ or fader*). Nominal output level is +4 dBu (1.23 V). These jacks may be used as auxiliary outputs to another console or as direct outs to a multitrack tape machine. They are intended, however for sending the input channel signal to an auxiliary signal processor (compressor, graphic EQ, noise gate, etc). INSERT OUT is always "live" whether or not the channel is on.

**NOTE: An internal preset switch in each module permits the insert point to be moved to a post-EQ, pre-Fader location in the circuit. Refer to Section 4.2 for more information.*

100. INPUT CHANNEL INSERT IN (1 - 32)

These 24, 32 or 40 balanced 1/4" (6.33mm) Tip/Ring/Sleeve phone jacks apply signal to the input channel just ahead of the EQ and fader.** Nominal input level is +4 dBu (1.23 V). These jacks are "normalised" so that inserting a plug interrupts the internal signal flow through the channel, instead bringing in the return from an auxiliary signal processor. However, there is an INSERT on/off switch in each channel which can bypass the INSERT IN jack, regardless of whether an external source is plugged in or not.

*** Refer to the note for item [99] above.*

101. AUX SEND (1 - 8)

These eight male XLR connectors output signal from the eight auxiliary mixing busses, just after the Aux Master LEVEL controls. They may be used for echo/effects sends, for stage foldback (stage monitors), for auxiliary mono or stereo program feeds to remote locations and/or tape recorders, and so forth.

102. GROUP OUT (1 - 8)

These eight male XLR connectors output signal from the eight group mixing busses, just after the Group Master Faders. They may be used for submixed feeds to a remote console (i.e., to a stage monitor console or a broadcast remote), for feeds to a multitrack tape recorder, or for feeds to a multi-zone sound system, depending upon the application.

103. MTRX OUT (1 - 8)

These eight male XLR connectors output signal from the eight 11:1 matrix mixes, after the MTRX MASTER controls and ON/off switches. They may be used for feeding mono or stereo tape recorders, multiple zones of a sound system, multiple sound systems, or remotes, depending upon the application. In some instances, these outputs can be used for effects sends or for monitors.

104. TB OUT

This male XLR connector outputs signal from the talkback circuit when the TB OUT switch [64] is on. If that switch is OFF, this output is muted. Assuming the TB

OUT switch is on, this output is derived from the talkback input XLR when the TALKBACK switch [71] is engaged. Otherwise the TB OUT is derived from the console's oscillator/noise generator.

The TB OUT may be fed to the IFB (Interruptible Foldback) program input of an intercom system in order that the console operator can talk into the intercom system. In some cases, it can be applied to an auxiliary program audio input or some other input on a standard intercom system. It also may be fed to a monitor console's COMM input, or to a console's input channel (which is monitored via CUE) to enable the PM3000 operator to communicate with the other console's operator.

105. OSC OUT

This male XLR connector outputs signal from the console's oscillator/noise generator when the OSC OUT switch [63] is on. In order to actually obtain any output signal, however, the oscillator must be switched on [65], and the OSC LEVEL control [67] must be turned up.

106. CUE OUT (L, R)

This pair of XLR connectors output the same signal which appears at the PHONES output jacks. However, the CUE OUT may be muted with the front panel CUE OUT ON/off switch [76]. These connectors are useful for driving control room monitor amps and speakers for the console operator, or a headphone distribution system (with external power amp).

107. STEREO OUT (L, R)

This pair of XLR connectors output the stereo mix after the STEREO MASTER fader. They may be used to feed a stereo sound system, master tape recorder, remote source, or a monitor system.

108. COMM IN

This female XLR connector accepts mic or line level signals from another console (i.e., from TB OUT on another console), or from most professional intercom systems, although an adaptor will be required to accommodate certain types of intercoms. This is a "1-way" connection in that it accepts the audio from the intercom line, but does not apply audio back onto the line.

109. DC POWER IN (A, B)

This pair of multi-pin, locking connectors accept special umbilical cables from the console's external power supply (Model PW3000). Cables should be properly mated, "A" output from the supply to "A" input on the console, and "B" out to "B" in. Be sure the locking rings are securely hand tightened to avoid inadvertent disconnection.

NOTE: If the two DC power cables are accidentally crossed, A for B, no damage will occur. However, the console will not turn on. (If the power supply does turn on, and the console does not, check these cables.)

110. VCA/MUTE CONTROL

This multi-pin locking connector is an input/output point for control voltages in the PM3000. It enables two PM3000s to be interlinked so that the muting logic and VCA MASTERS from one console also affect the other. The adjacent VCA and MUTE SLAVE/MASTER switches

[111], [112] affect the function of this connector. This connector also may be used for interface to a remote control system which may be developed for "automation" of master muting and group levels.

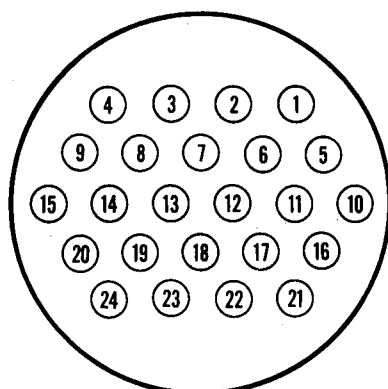

CONNECTOR PINS
(FEMALE)

PIN #	FUNCTION	PIN #	FUNCTION
1	VCA BUS 1	13	MUTE BUS 3
2	VCA BUS 2	14	MUTE BUS 4
3	VCA BUS 3	15	MUTE BUS 5
4	VCA BUS 4	16	MUTE BUS 6
5	VCA BUS 5	17	MUTE BUS 7
6	VCA BUS 6	18	MUTE BUS 8
7	VCA BUS 7	19	GND
8	VCA BUS 8	20	GND
9	GND	21	GND
10	NC	22	NC
11	MUTE BUS 1	23	NC
12	MUTE BUS 2	24	NC

FIGURE 2-9. VCA/MUTE CONNECTOR PIN ASSIGNMENTS.

111. VCA SLAVE/MASTER

Setting this rotary, screwdriver-operated switch to MASTER position configures the console for local control of the input channel VCAs via the VCA MASTER FADERS [52]. SLAVE position disables this console's VCA MASTER FADERS and, instead, allows a second PM3000 (or a specially designed remote automation system) to control this console's master VCAs via the VCA/MUTE CONTROL connector [110].

112. MUTE SLAVE/MASTER

Setting this rotary, screwdriver-operated switch to MASTER position configures the console for local control of input channel muting via the MASTER MUTE switches [40]. SLAVE position disables this console's MASTER MUTE switches and, instead, allows a second PM3000 (or appropriately wired remote switch closures) to control this console's master muting via the VCA/MUTE CONTROL connector [110].

113. PHANTOM POWER MASTER

This recessed slide switch turns the console's 48-volt phantom power supply on and off. When this is OFF, no power will be supplied to any mic, regardless of the channel's +48 V on/off switch setting [1].

114. (Light Sockets)

These four-pin female XLR connectors provide dimmer-controlled DC power for "LittLites" that are supplied with the console. There are three lights on the 24 channel and 32 channel mainframes, and four on the 40 channel mainframe. Maximum output is 12 volts. (Pins 1 and 2 of the XLR are not used, pin 3 is the 12 volt supply, and pin 4 is DC ground.)

115. (Light Dimmer/on switch)

This rotary, screwdriver-adjustable dimmer turns the light socket a variable intensity from low to high brightness. The console is shipped with standard incandescent lamps in the LittLites, but the hoods and power supply are designed so they can accommodate the higher intensity quartz lamps.

2.3 THE PW3000 POWER SUPPLY

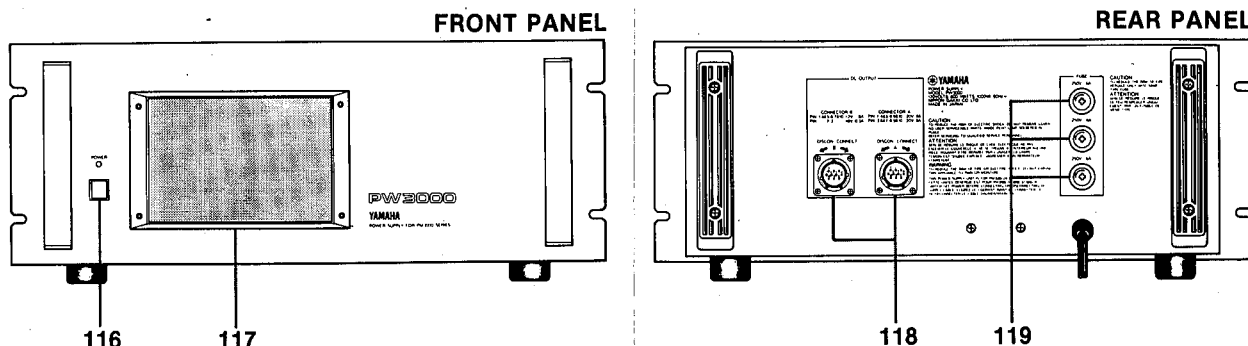

FIGURE 2-10. PW3000 POWER SUPPLY.

116. POWER (On/Off)

This locking switch turns on the AC power to the supply, and thereby provides the necessary AC and DC voltages to the console via the umbilical power cables. An adjacent LED is on when power is on.

117. (Grille)

The power supply is cooled by a quiet running fan that pulls air through this front-panel grille and exhausts it through vents along the edge of the top and side panels. A reticulated foam element behind the grille filters the air entering the power supply.

NOTE: The filter element is cleanable. Refer to Section 5.1.2

118. (Umbilical Connectors)

This pair of locking, multi-pin connectors provides the necessary DC voltages from the PW3000 power supply to the PM3000 console. Both cables must be connected correctly before attempting to operate the console. No damage will occur if the cables are crossed, A for B, but the console will not turn on. The power supply light will turn on, however. If you observe this condition, look for crossed or disconnected umbilical cables.

CAUTION: Always make certain that the PW3000 power is turned OFF prior to connecting or disconnecting either of the umbilical cables at the console or at the power supply.

119. FUSES

These 3 fuses protect the primary and secondary portions of the PW3000 power supply. They should be replaced only with fuses of the same current rating and type:

Primary Fuses (x3): 6 A Slo-Blow

NOTE: Internal fuses in the PW3000 are also present, as follows:

+20 VDC Supply: 10 A Slo-Blow

-20 VDC Supply: 10 A Slo-Blow

+12 VDC Supply: 10 A Slo-Blow

+48 VDC Supply: 2 A Slo-Blow

120. (Power Cord)

This power cable connects the PW3000 to the AC power mains. A grounded (3-wire) outlet of at least 15 amperes capacity should be used.

CONNECTOR A	
PIN #	FUNCTION
1	+20 V
2	DETECT A
3	-20 V
4	+20 V
5	+20 V
6	-20 V
7	-20 V
8	E (±20 V)
9	E (±20 V)
10	E (±20 V)

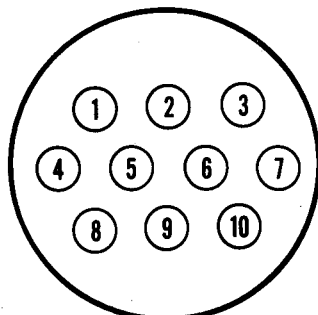

CONSOLE SIDE (MALE)

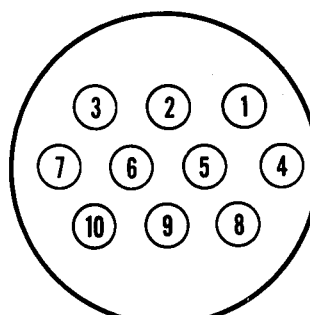

POWER SUPPLY SIDE (FEMALE)

CONNECTOR B	
PIN #	FUNCTION
1	+12 V
2	+48 V
3	E (+48 V)
4	+12 V
5	+12 V
6	E (+12 V)
7	E (+12 V)
8	GND
9	DETECT B
10	E (+12 V)

FIGURE 2-11. PW3000 UMBILICAL CONNECTOR PIN ASSIGNMENTS.

Adjustments

All adjustments have been made at factory. Normally, an adjustment would be required after a repair has been made to the circuit where the adjustment potentiometer is located.

NOTE: Unless specified, all switches are off and controls at minimum. In order to carry out the following adjustments, module extension cables are required. Allow the console to warm up several minutes for VCA adjustments. Refer to the corresponding circuit board for adjustment locations.

Module	Adjustment	Control/Switch Settings	Equipment Required	Measure at	Procedure
Input	VCA reference voltage		DC voltmeter	IN3 board "I" terminal of the fader	Adjust VR101 for a voltage of $3.5V \pm 0.01V$.
	VCA offset A	Fader: Nominal (0 dB)	DC voltmeter	IN1 board "TP101" terminal	Adjust VR116 for a voltage of $0V \pm 50mV$. <i>NOTE: This adjustment should be performed only after the reference voltage adjustment has been checked.</i>
	VCA offset B	Fader: Max. (+10 dB)	DC voltmeter	IN1 board "TP101" terminal	Assign an input channel to a VCA MASTER and set the corresponding VCA MASTER fader to the maximum position (+10 dB). Adjust VR118 for a voltage of $0V \pm 50mV$. <i>NOTE: The offset A and offset B pots interact, so it is necessary to perform both steps several times.</i>
	Distortion at 0 dB VCA gain	EQ section: Centered PAD: 40 GAIN: Min. (-36) Fader: Nominal (0 dB)	AF oscillator Distortion meter	IN1 board "T101" terminal	Apply a 0 dBu, 1kHz signal to the channel input. Adjust VR119 for a minimum THD.
	Distortion at +20 dB VCA gain	EQ section: Centered PAD: 40 GAIN: Min. (-36) Fader: Max. (+10 dB)	AF oscillator Distortion meter	IN1 board "TP101" terminal	Assign an input channel to a VCA MASTER and set the corresponding VCA MASTER fader to the maximum position (+10 dB). Adjust VR117 for a minimum THD.
Master	VCA reference voltage		DC voltmeter	MAS3 board pin #1 of connector CN101	Adjust VR101 for a voltage of $3.5V \pm 0.01V$.
Talkback/ Communi- cation	Pink noise generator output level	PINK: ON OSC OUT: ON OSC LEVEL: Max.	AC voltmeter	OSC OUT connector	Adjust VR107 for a voltage of $+14 \text{ dBu (3.88V)} \pm 0.5 \text{ dB}$ into 600-ohm load resistor.
	Oscillator output level	SWEEP: OFF 1K: ON OSC OUT: ON OSC LEVEL: Max.	AC voltmeter	OSC OUT connector	Adjust VR108 for a voltage of $+14 \text{ dBu (3.88V)} \pm 0.5 \text{ dB}$ into 600-ohm load resistor.
	VU meter calibration				Adjust VR101's on the MT1/2/3 boards for $0 \pm 0.1VU$.
PW3000 Power Supply	+20V power supply		DC voltmeter	Connector CNA pin #1	Adjust VR101 on the DC1 board for a voltage of $+20V \pm 0.1V$.
	-20V power supply		DC voltmeter	Connector CNA pin #3	Adjust VR201 on the DC1 board for a voltage of $-20V \pm 0.1V$.
	+12V power supply		DC voltmeter	Connector CNB pin #1	Adjust VR301 on the DC2 board for a voltage of $+12V \pm 0.1V$. <i>NOTE: These adjustments should be performed with the PM3000 connected to the PW3000.</i>

NOTE: 0 dBu is referenced to 0.775 VRMS. Where the circuit is capable of 600-ohm termination, this would be equivalent to 0 dBm.

Module extension cables

TX800080 : 50pin
TX800090 : 24pin
TX800100 : 14pin
TX800110 : Alligator clip

SECTION 4 Optional Functions

The PM3000 is factory wired to suit what Yamaha engineers believe to be the greatest number of applications. Yamaha recognizes, however, that there are certain functions which must be altered for certain specific applications. In designing the PM3000, a number of optional functions have been built in, and can be selected by moving factory preset switches within certain modules.

WARNING: Underwriter's Laboratories (UL) requires that we inform you there are no user-serviceable parts inside the PM3000. Only qualified service personnel should attempt to open the meter bridge, to remove a module, or to gain access to the inside of the console or power supply for any purpose. Lethal voltages are present inside the power supply, and the AC line cord and console umbilical cords should be disconnected prior to opening the console.

WARNING: We at Yamaha additionally caution you never to open the console and remove or install a module for the purpose of inspection, replacement or changing the preset switches unless the power has first been turned off. If a module is removed or installed with power on, the circuitry may be damaged. Unless you are a qualified service technician, do not plug in the AC cord while the interior of the power supply is exposed; dangerous voltages may exist within the chassis, and lethal shock is possible. Yamaha neither authorizes nor encourages unqualified personnel to service modules or console internal wiring. Damage to the console, the individual, and other equipment in the sound system can result from improper service or alterations, and any such work may void the warranty.

4.1 REMOVING AND INSTALLING A MODULE

The modules in the PM3000 are designed for easy removal. It is not necessary to open the meter bridge or to remove the arm rest.

1. Turn the Power OFF first, before removing or installing a module.
2. Loosen the Philips head screws at the top and bottom of the module. These screws are retained by threaded, cylindrical fittings so they will not pull all the way out of the module.
3. Lift up on the screws (or you may also want to pull up gently on a control knob), and as you feel the module connectors release, slide the module forward toward the front of the console slightly.
4. Now lift the module the rest of the way out of the console.
5. Installation of a module should be done by reversing the order of this procedure. Work slowly to make sure that edge connectors mate properly.

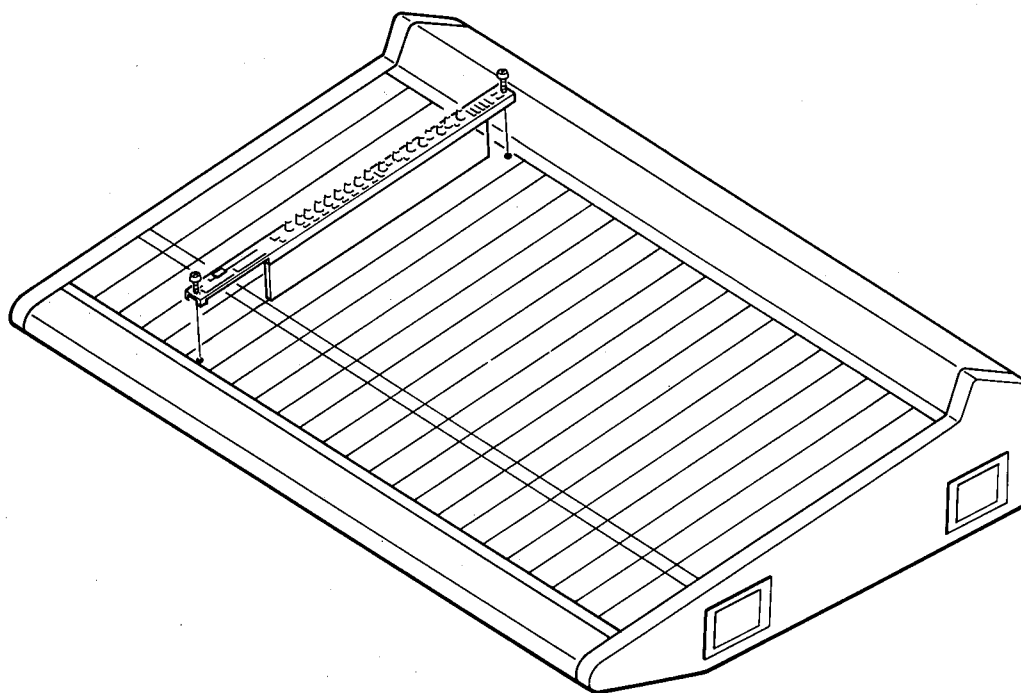

FIGURE 4-1 Removal of Module from PM3000.

4.2 INPUT CHANNEL INSERT IN/OUT JACKS: PRE-EQ OR POST-EQ

A slide switch in each input module permits the Insert In/Out point to be altered. As shipped, the console is set so that the Insert In/Out point comes ahead of the channel equalizer. This is useful, for example, when one

wishes to equalize the return from a signal processor. However, sometimes one wishes to equalize the send to the signal processor...for example, to apply the boost prior to compression. In this case, the In/Out point can be switched to come after the channel equalizer. Move the switch to the appropriate position, as illustrated.

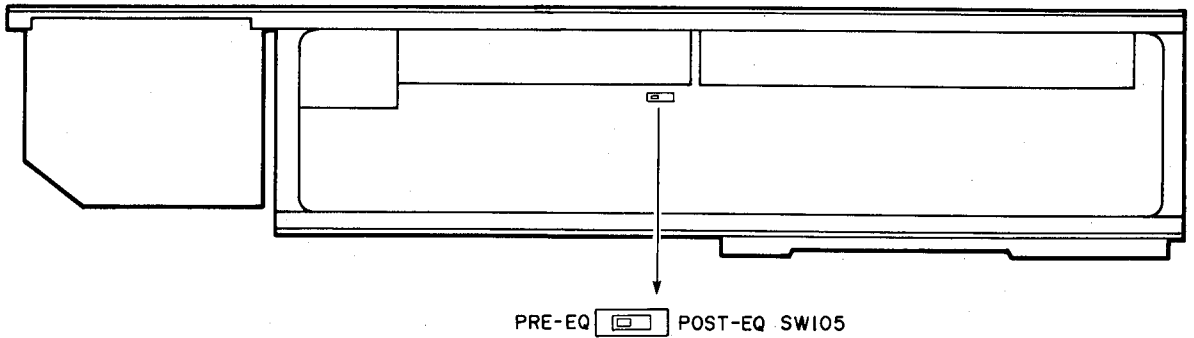
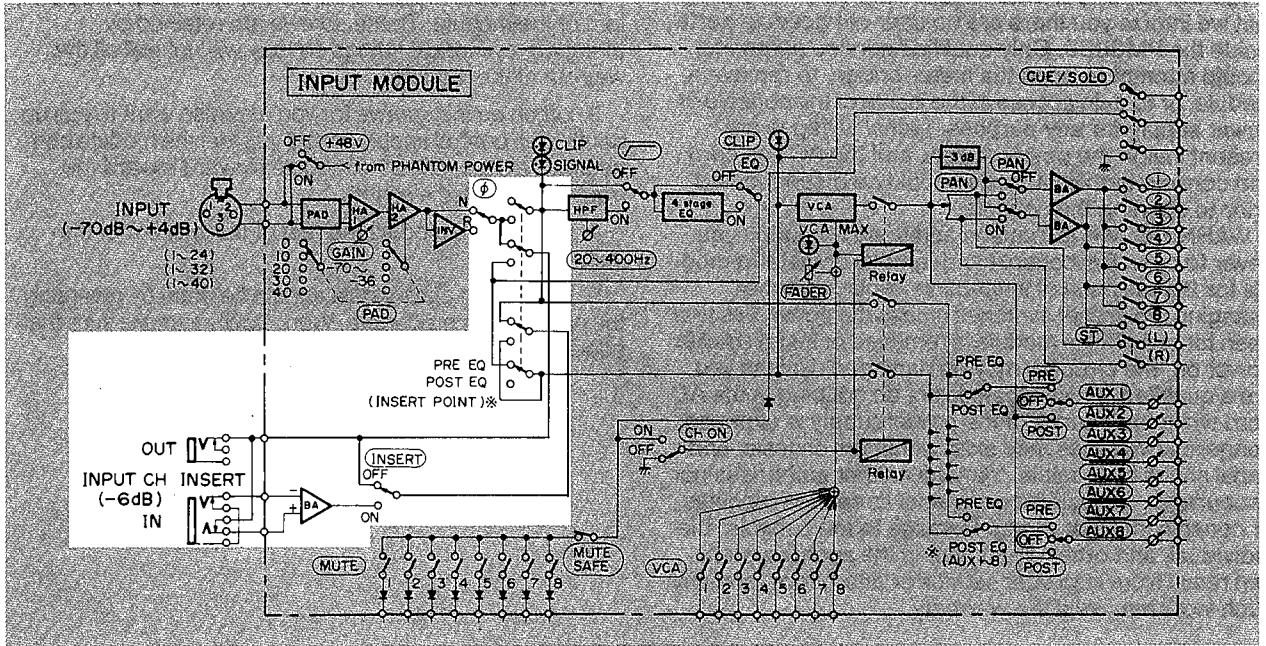
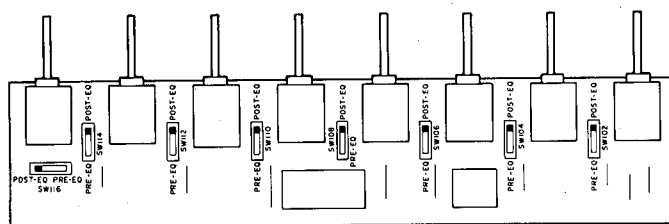
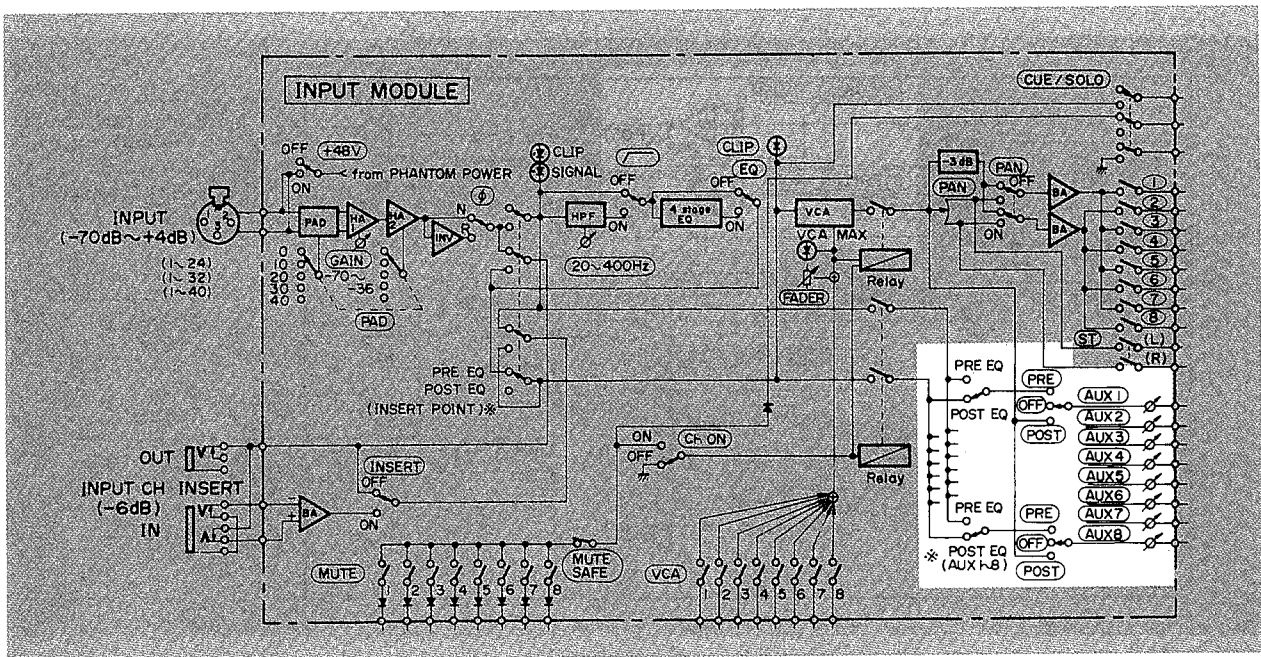

FIGURE 4-2 Internal Switch Positions for PRE-EQ and POST-EQ Insert IN/OUT Point.

4.3 INPUT CHANNEL AUX SENDS: PRE FADER & EQ OR PRE FADER/POST EQ

Eight slide switches in each input module permit each of the auxiliary sends to be altered. As shipped, the console is wired so that if front-panel aux PRE/OFF/POST switch is set to PRE position, the aux send is derived ahead of the the fader, equalizer and high pass filter. This is useful for stage monitor work, for example, where the channel EQ for the house may not be desired for the

monitors. On the other hand, suppose that one aux mix is used for a pre-fader effects send. In this case, it may be desirable to apply channel EQ and HP filter effects to the send, yet the POST position would also cause the channel fader to affect the send. To solve the problem, the switch for that aux send can be reset so that the PRE position remains pre-fader, but is taken after the EQ and HP filter.



AUX 1	= SW 102
AUX 2	= SW 104
AUX 3	= SW 106
AUX 4	= SW 108
AUX 5	= SW 110
AUX 6	= SW 112
AUX 7	= SW 114
AUX 8	= SW 116

"PRE-EQ/POST-EQ" switches when AUX Switch is in "PRE" position.

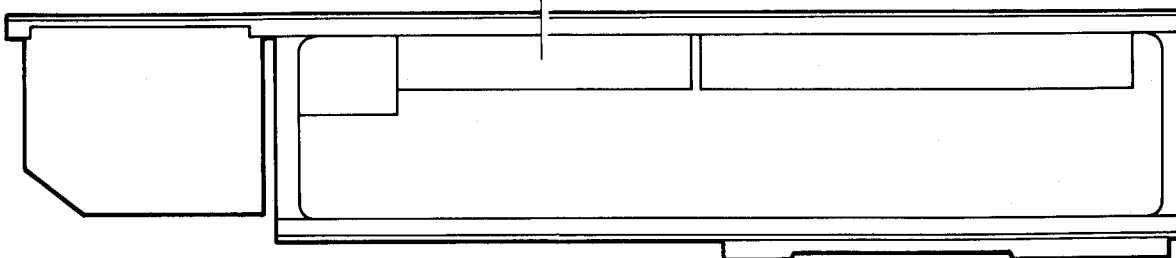

FIGURE 4-3 Internal Switch Positions for PRE-EQ and POST-EQ AUX SENDS (when pre/off/post switch is set to pre).

4.4 STEREO MASTER TO MATRIX ST BUS: PRE OR POST ST MASTER FADER

A pair of slide switches in AUX/ST module enable the signal applied to the matrix stereo bus from the AUX/ST module to be derived from two different points. As shipped, the switch is preset so the matrix is fed its signal after the STEREO MASTER fader so that adjustments in the stereo output also affect the feed to the matrix. The internal switches can be repositioned so that the matrix is

fed pre STEREO MASTER fader. In this way, the stereo output can be used for one feed, and it can be remixed in the matrix to create other stereo feeds. Since the stereo bus can actually be used as though the L and R sides of the bus were two discrete mono mix busses, this optional function is accomplished with separate L and R switches. In this way, the feed can be split, with one pre- and one post-STEREO MASTER fader; normally, however, both switches would be set the same way.

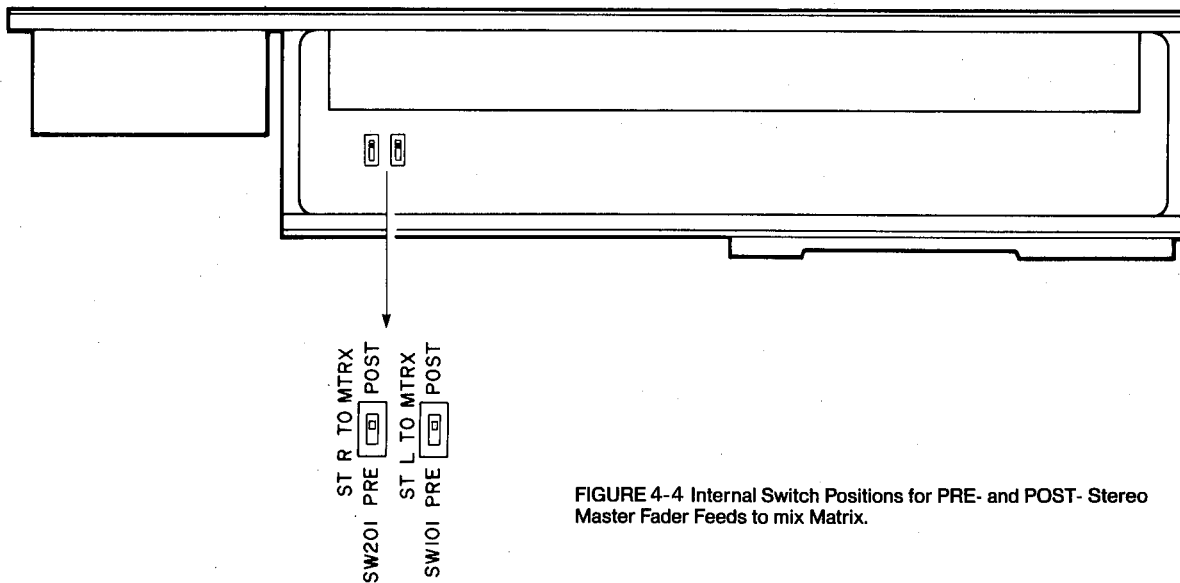
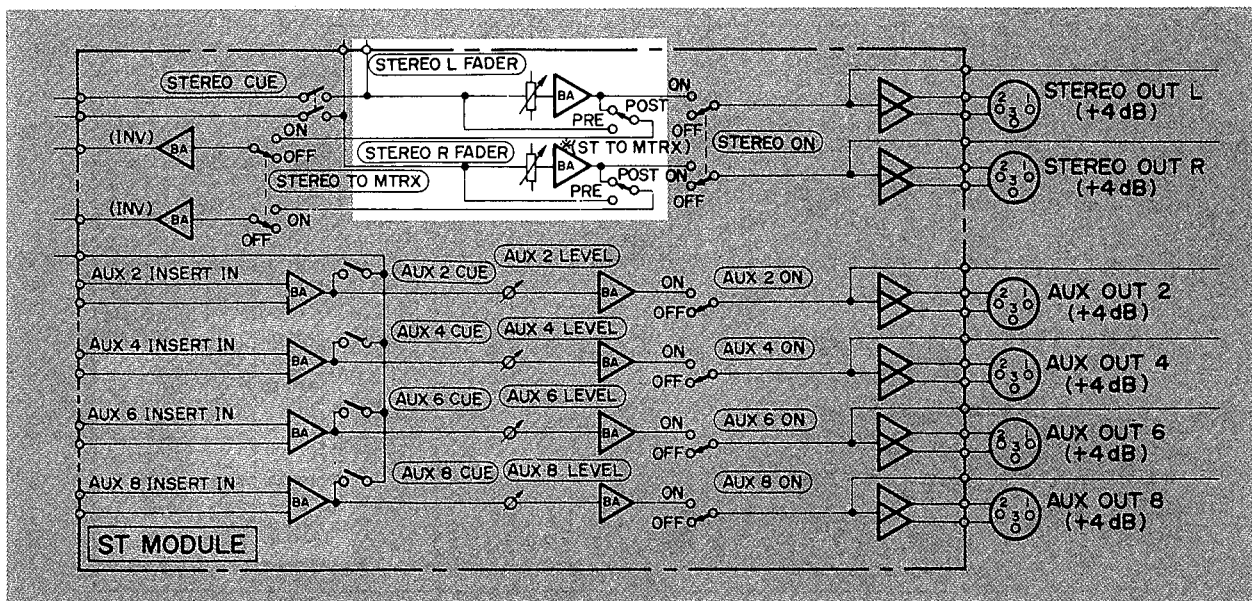

FIGURE 4-4 Internal Switch Positions for PRE- and POST- Stereo Master Fader Feeds to mix Matrix.

4. 5 GROUP-TO-MATRIX: ASSIGNED PRE OR POST GROUP MASTER-FADER

A slide switch in each master module permits the eight group sends to the mix matrix to be altered. As shipped, the console is preset so that when the GROUP-TO-MTRX switch is on, the matrix is fed signal after the Group Master Fader (but before the GROUP ON/off switch). The internal switch in each of these modules can be repositioned so that the matrix is fed before the Group Master Fader.

In the factory preset configuration, the matrix follows the group mix. If one group, for example, is used for vocals, another for keyboards, etc., then all vocals going to all matrix outputs can be adjusted with one Group Master Fader... all Keyboards going to all matrix outputs can be adjusted with another Group Master Fader, etc. Suppose, however, that you plan to feed a stereo house mix from the eight subgroups, yet you need as many as eight

additional mono or five stereo mixes.

The mix matrix alone allows for only one stereo and six mono mixes, or a total of four stereo mixes. A greater number of mixes can be obtained by selecting the alternate (pre-Group Master Fader) switch positions. In that case, you can assign the Group Outputs to the stereo bus via the ST switch [48] and the adjacent PAN pot [47]; the Group Master Faders will serve as submasters for this stereo mix, and the Stereo Master Fader will control the mixed output. At the same time, the matrix controls on each master module will provide an 8:1 mix of the same groups; that matrix channel's #1 - #8 mix controls will serve as submasters, and the MTRX MASTER will control the mixed output. (Do not turn up the L and R controls in the matrix, since these would be redundant here). In this way, you can obtain one stereo and eight mono mixes, five stereo mixes, or some combination thereof all with independent submaster and master controls.

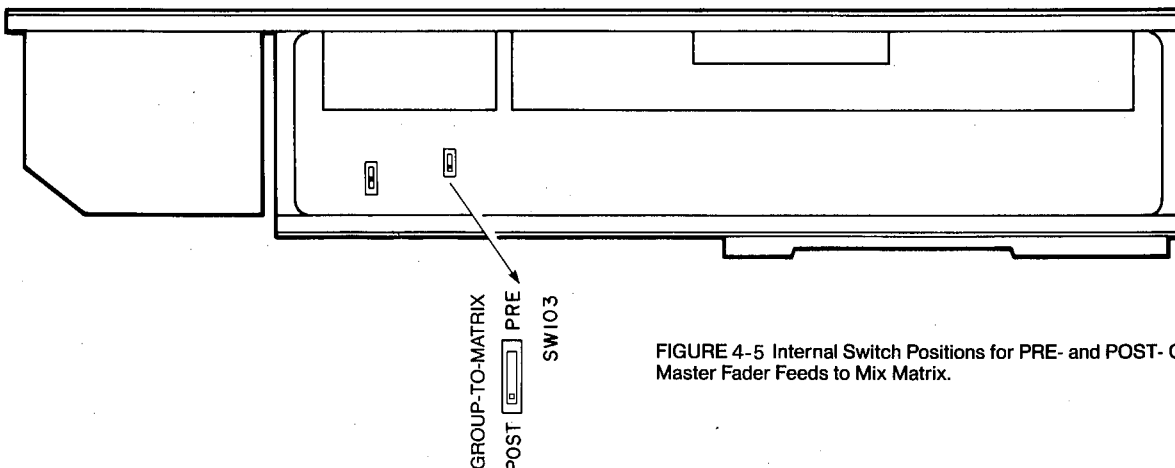
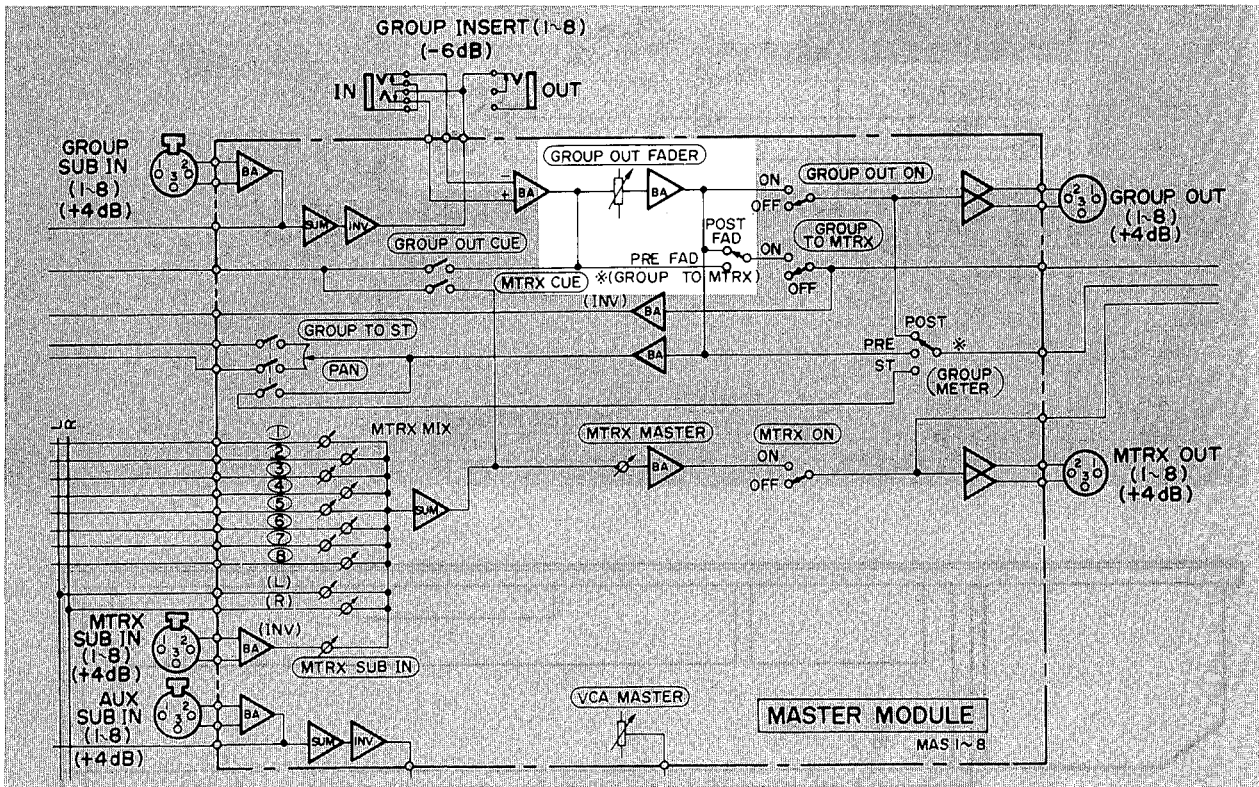

FIGURE 4-5 Internal Switch Positions for PRE- and POST- Group Master Fader Feeds to Mix Matrix.

**4.6 METER FUNCTION IN "GROUP" POSITION:
ONE OF 3 SOURCES**

There are eight VU meters which are factory wired so they can be switched to monitor the GROUP output, the GROUP-TO-MATRIX feed, or the MATRIX output. Actually, though, there are internal slide switches in each MASTER module that permit the GROUP meter switch position to derive signal from two points other than the factory preset (post GROUP OUT ON/off switch feed to the GROUP OUT XLR):

- (A) ahead of the GROUP OUT ON/off switch (pre-GROUP ON/off switch) but still post- GROUP MASTER fader,
- (B) post GROUP-TO-STEREO switch.

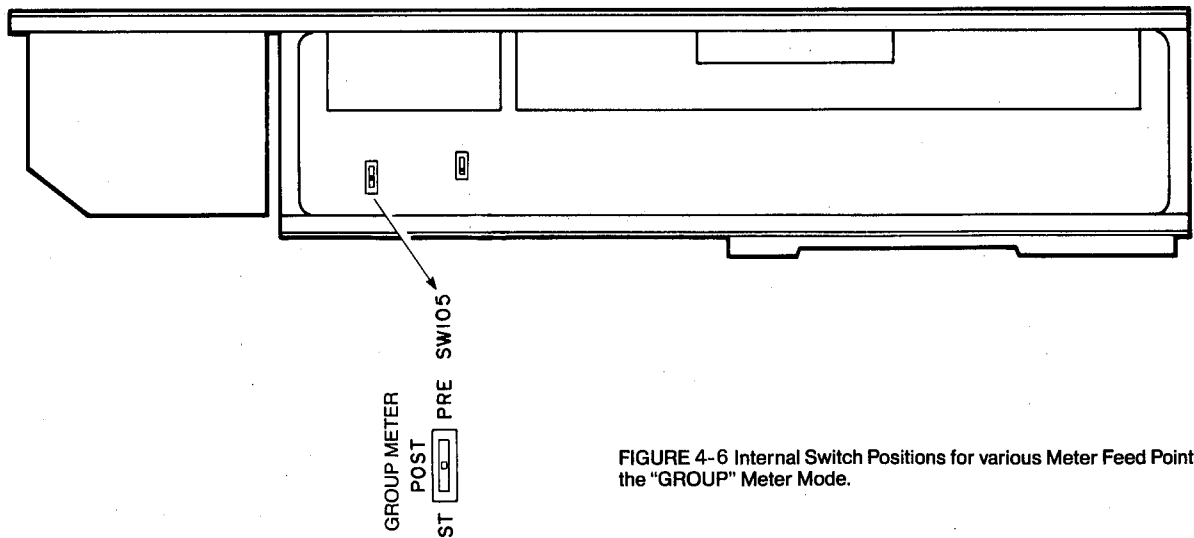
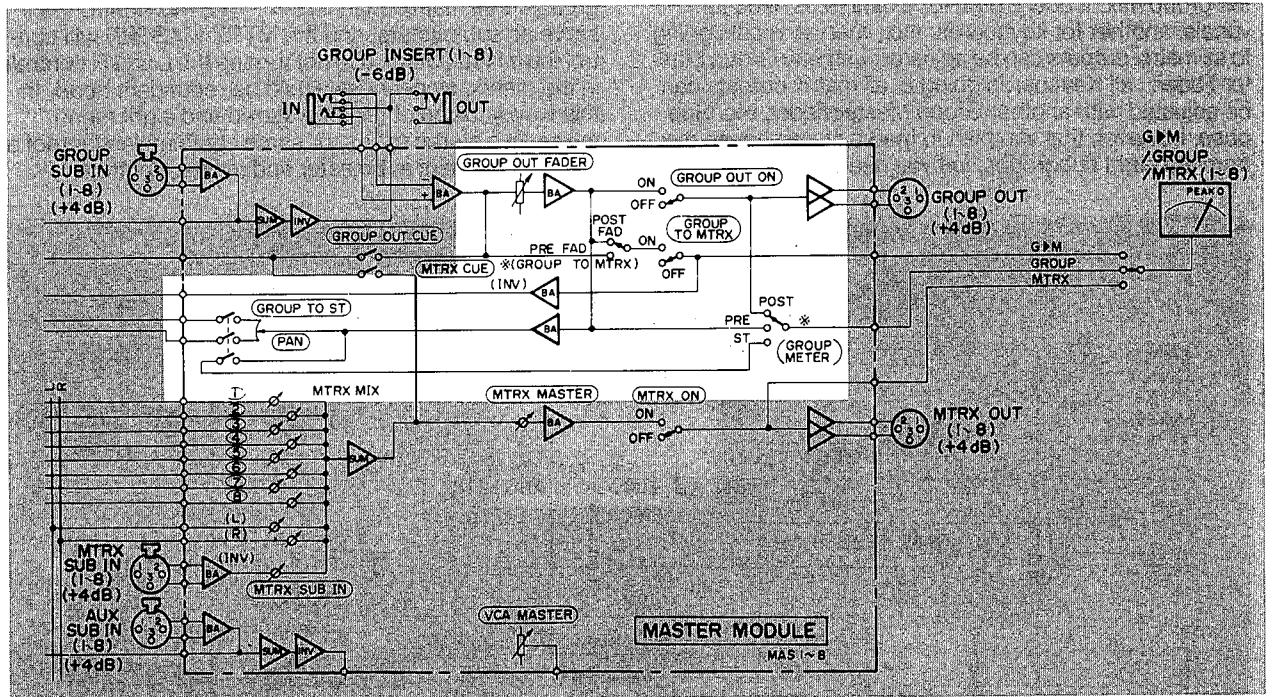

FIGURE 4-6 Internal Switch Positions for various Meter Feed Points in the "GROUP" Meter Mode.

4.7 INSTALLATION OF OPTIONAL INPUT TRANSFORMERS

The PM3000 standard input module is equipped with a balanced, differential input preamplifier for the XLR connector. That preamp, along with some circuitry for the resistive attenuation pads, is located on a small printed circuit board that "piggy back" mounts to the module's main circuit board.

An optional transformer balancing option may be installed by a Yamaha PM3000 dealer or a qualified electronic service technician. The modification kit contains a replacement circuit board for the original differential preamplifier, and a separate input transformer. In order to install the kit, the following steps must be performed.

1. Shut off the power to the console.
2. Remove any input module(s) to be converted from the console mainframe.
3. Hold the module with the fader to the left, and lay the module on its side, controls facing away from you.
4. In the upper left corner (just to the right of the fader), locate the "IN 2 3/3" board. Refer to Figure 6-7B. Remove the 2 screws that secure this board, and set it aside.
5. Locate the "IN 4" board now exposed by the "IN 2 3/3" board just removed. Remove the "IN 4" board.

6. Install the new board (that comes wired to the transformer) in place of the "IN 4" board.

7. Install the transformer by securing its bracket to the lower right edge of the module frame with the screw provided. Dress the cable that joins the transformer and its circuit board neatly. You may wish to tie it to the board so that after the module is reinstalled, the cable does not become pinched between modules or the module and mainframe.

8. Replace the "IN 2 3/3" board.

9. Reinstall the input module into the mainframe.

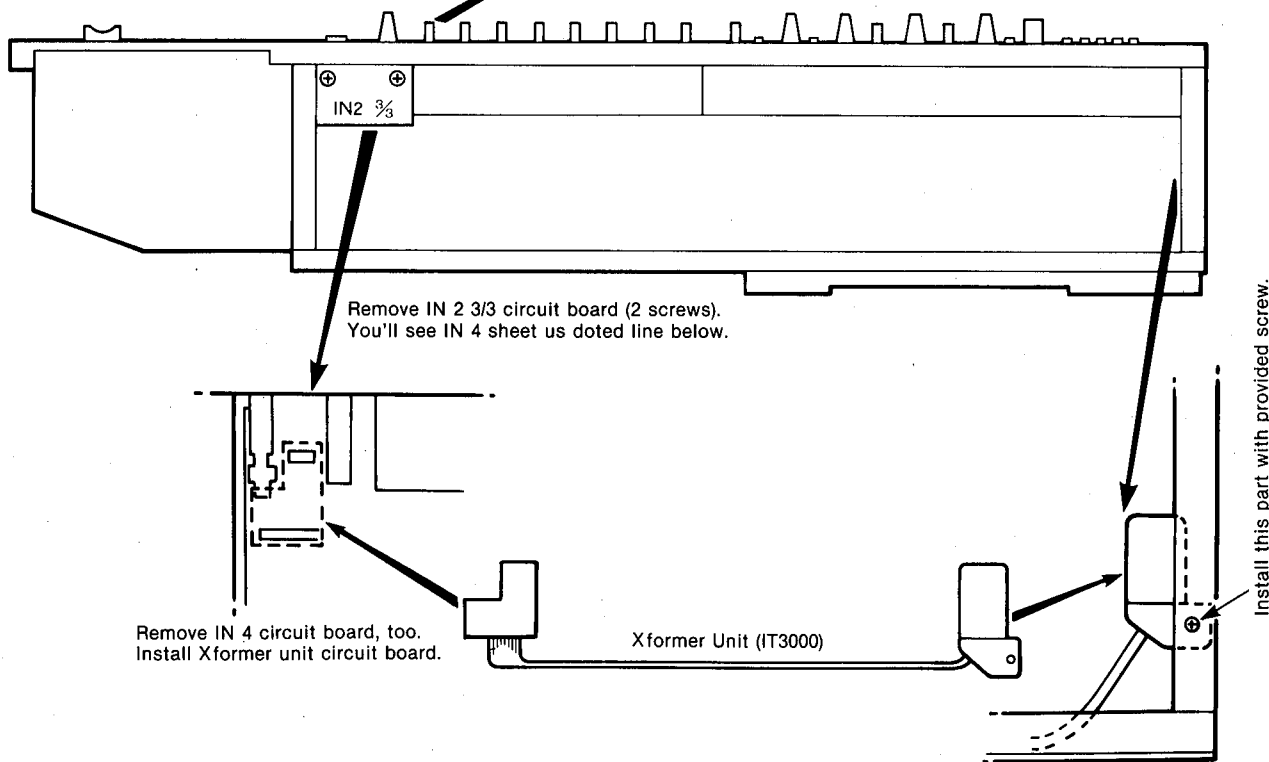
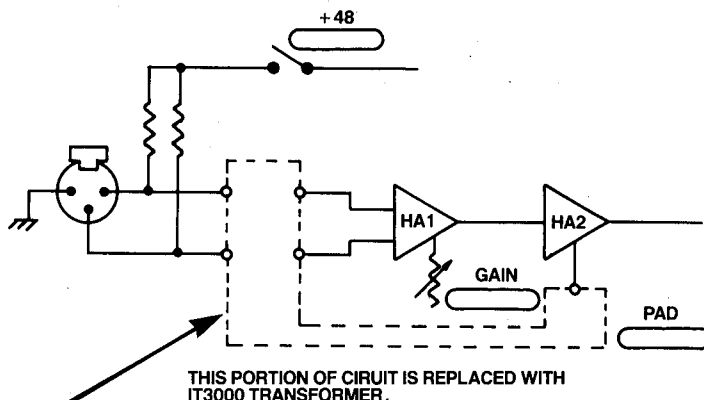

FIGURE 4-7 Optional Input Transformer Installation.

4. 8 HINTS ON CIRCUITRY FOR REMOTE CONTROL OF THE VCA MASTERS AND MUTE GROUPS

The VCA/MUTE CONTROL connector on the PM3000 rear panel is provided primarily so that two consoles may be linked, and just one console's VCA MASTER FADERS and/or MUTE MASTER switches will affect both consoles input channels. However, it is possible to create an independent controller so that these functions can be remotely controlled. One possible application would be to remotely adjust mix levels in the middle of a venue even though the console is located in a booth. Another possible application would be the creation of a limited automation system. Yamaha does not offer detailed instructions for this type of remote control. However, we do present here a schematic diagram of the VCA control fader circuit which, if constructed externally by a competent technician and interfaced via the VCA/MUTE CONTROL connector, can do the job. A graph of control voltage versus channel VCA gain is also provided.

Note that the nominal fader position delivers 0 VDC to the VCA, and the VCA operates at unity gain with that input. The control voltage scaling is approximately -20 dB per volt DC in the linear range of fader travel (above -50 dB on the fader scale). Thus, at maximum upward fader travel, a single fader will deliver about 1/2 volt negative, which drives the VCA to +10 dB of gain. If several VCA faders are set above nominal and assigned to a channel, the maximum negative voltage that will be applied to the VCA is -1.2 VDC (a DC limiter circuit prevents any more negative voltage from being passed and turns on the VCA MAX LED). This corresponds to +24 dB of gain. At minimum VCA fader setting, the output is +10 VDC, corresponding to over 100 dB of attenuation.

The VCA and MUTE connections are illustrated in Figure 2-9. In order to mute a group, simply ground the conductor corresponding to that group. Naturally, the console's VCA MASTER/SLAVE and/or MUTE MASTER/SLAVE switch(es) must be set to the SLAVE position in order for the corresponding remote control to take effect.

WARNING: Only qualified service technicians should attempt to construct and connect any circuit to interface with the PM3000 VCA/MUTE CONTROL connector. A circuit or wiring error could severely damage the console, and such damage is not covered under the terms of the PM3000 Warranty. Improper grounding could also create noise and/or safety hazards. This information is provided only to illustrate the extent of such a modification; the PM3000 Service Manual should be consulted before actually building any remote control device.

YAMAHA PART #	QUAN	SUFFIX LETTER	ITEM	VALUE OR TYPE
UA21410	2	K	MYLAR CAPACITOR	0.01 uF, 50 V
HU07543	1	F	METALIZED FILM RESISTOR	430 ohm, 1/4 W
HU07610	4	F	METALIZED FILM RESISTOR	1 kohm, 1/4 W
HU07620	1	F	METALIZED FILM RESISTOR	2 kohm, 1/4 W
HU07710	4	F	METALIZED FILM RESISTOR	10 kohm, 1/4 W
HU07712	1	F	METALIZED FILM RESISTOR	12 kohm, 1/4 W
HU07713	2	F	METALIZED FILM RESISTOR	13 kohm, 1/4 W
HK05715	1	J	CARBON RESISTOR	15 kohm, 1/4 W
HK05733	1	J	CARBON RESISTOR	33 kohm, 1/4 W
IG06920	3		IC AMP	MJM2041DD
HT56009	1	B	SEMI-FIXED VR (TRIMMER)	50 kohm
IF00004	2		DIODE	1S1555
IF00214	1		ZENER DIODE	RD5.6ED2
VA25610	1	B	SLIDER VR (FADER)	10 kohm

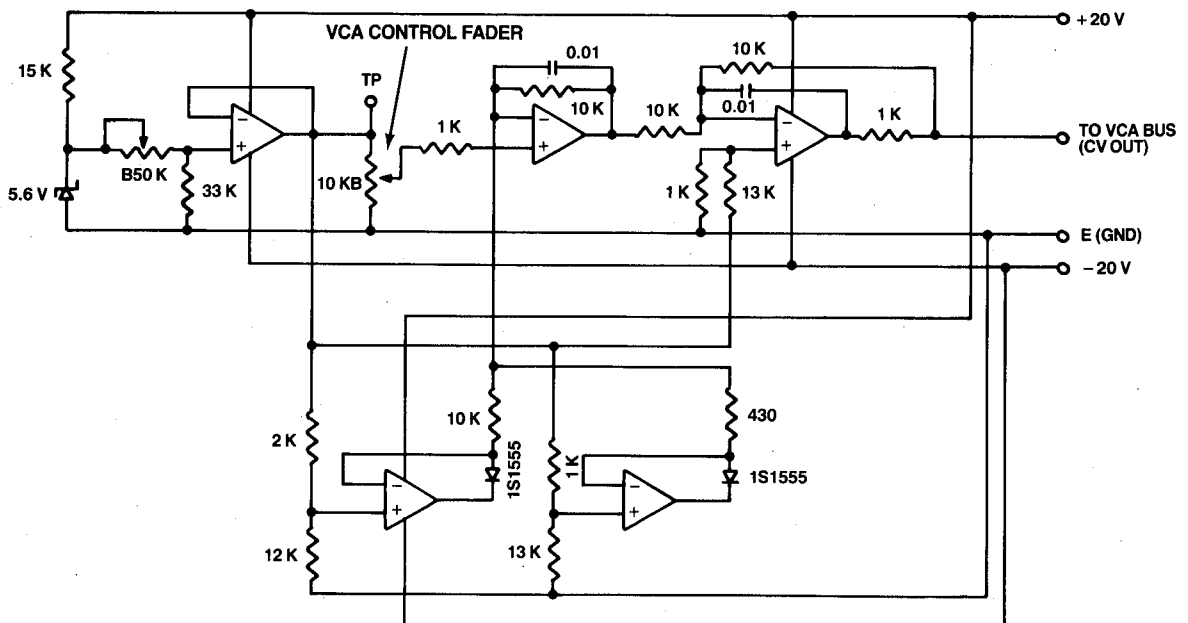
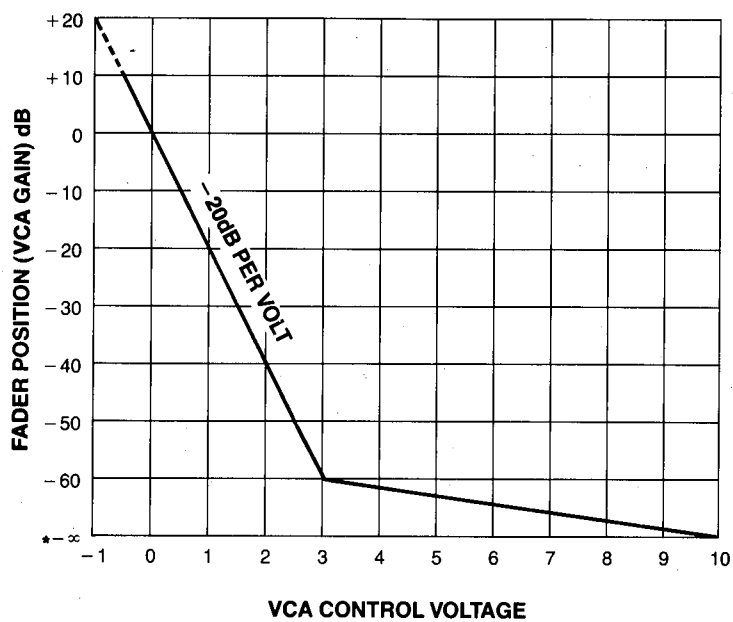

FIGURE 4-8 Suggested Circuit for Remote Control of a VCA Master Group.



*CHANNEL ON relay opens when fader is at $-\infty$ position.

FIGURE 4-9 VCA Control Voltage versus Fader Position.

SECTION 5

Maintenance**5. 1 CLEANING THE CONSOLE****5. 1. 1 The Console and Power Supply Exterior**

The console and power supply are painted with a durable finish. To avoid damage to the paint, control knobs, switch caps and other parts, **DO NOT USE SOLVENTS**. Instead, keep the console as free of dust as practical. Cover it when not in use, and brush or vacuum it periodically. The surface may be cleaned with a soft rag moistened with a dilute solution of non-abrasive detergent and water. If sticky gum is left on the panel (from masking tape or other tape used for channel labeling), it may be necessary to use a specialized solvent. In general, rubber cement solvent will remove tape residue without harming the console; however, it is your responsibility to test any such solvent in an inconspicuous location to ensure it does not attack the console finish or mar any plastic part.

Avoid getting the inside of the console wet from excessively wet rags. **DO NOT USE AEROSOL OR SPRAY CLEANERS.**

5. 1. 2 Power Supply Air Filter

The reticulated foam air filter on the front of the PW3000 power supply screens cooling air as it is drawn through the unit. When the foam becomes clogged or dirty, it should be cleaned; check it periodically. Using a 3 mm allen wrench, remove the four cap screws that secure the front grille. The foam element may now be removed and rinsed in cool water. For greasy or stubborn dirt, dip the element in a mild solution of detergent and water, then rinse with clear water. Blot and/or air dry the element thoroughly before returning it to the amplifier. **DO NOT USE SOLVENTS TO CLEAN THE FOAM ELEMENT.**

5. 1. 3 Pots and Faders

Yamaha **DOES NOT** recommend the routine use of any contact cleaners or solvents for cleaning pots or faders. Such "preventive maintenance" can actually do more harm than good by removing the lubricating film on certain pots or faders. While treatment with such solvents or cleaners may temporarily "clean up" a noisy control, it can also quickly result in a worn element (due to lack of lubrication) and even greater, incurable noise.

When a component is to be cleaned, use a very small amount of an appropriate cleaner, solvent, or pure isopropyl alcohol. Try to get it on the element, and immediately work the pot or fader several times all the way between stops.

In general, cleaning pots and faders is not a trivial task. Some have carbon elements, some have conductive plastic elements, and others have cermet elements. What cleans one part reliably may not work on another. When in doubt, consult your authorized Yamaha PM3000 dealer or service center.

5. 1. 4 The Console Interior

Dust and dirt are the enemy of electronic and mechanical systems. Switches and controls may wear prematurely due to the abrasive nature of dirt. A coating of dust may, in some cases, be conductive and change the electrical properties of the circuit. Similarly, dirt accumulations can reduce the thermal dissipation from heat sinks and transistors, leading to premature failure. It is advisable to use a soft brush or a vacuum cleaner with a soft brush attachment to clean the console periodically. Depending on the environment, this may be as often as once a month, or as infrequently as once a year. Use care not to bend or dislodge any components. Always do this work with the console power OFF.

If a beverage is spilled into the console, try to blot up as much excess moisture as possible immediately. If practical, immediately turn off the power and remove any affected modules. If not, wait until it is practical, and then turn off the power and proceed. Rinse contaminated parts on the module with distilled water, shake off the excess water, blot dry with a soft cloth, and air dry or use a warm (not hot) stream of air from a hair dryer to facilitate drying. If the console interior is contaminated, wipe it clean with a water-moistened cloth.

It is best to clean a spill as soon as possible. Unsweetened black coffee is probably the least harmful. The sugar in sweetened coffee can leave a sticky film on parts, and cream or milk will leave a residue that can be very troublesome. Similarly, sweetened soft drinks and fruit juices can leave sticky residues that degrade the performance of switches, faders and pots.

5.2 METER LAMP REPLACEMENT

Two lamps illuminate the face of each VU meter. To change a meter lamp, first open the meter bridge. This is done by removing 2 screws from the rear of the meter bridge, and several screws from the top of the meter bridge (4 on the 24-channel, 5 on the 32-channel, or 6 on the 40-channel mainframe). The meter bridge is hinged, and can be swung open for access to the meters.

Each replacement lamp (Yamaha part number VA75570) comes with a connector affixed to pigtail leads from the lamp. Withdraw the old lamp from the rear, pulling it out of its retaining grommet in the meter face, and unplug the connector from the rear of the meter assembly. Insert the new lamp in its place, and secure the connector.

NOTE: The meter assign select switches are illuminated by LEDs, which should not normally require replacement.

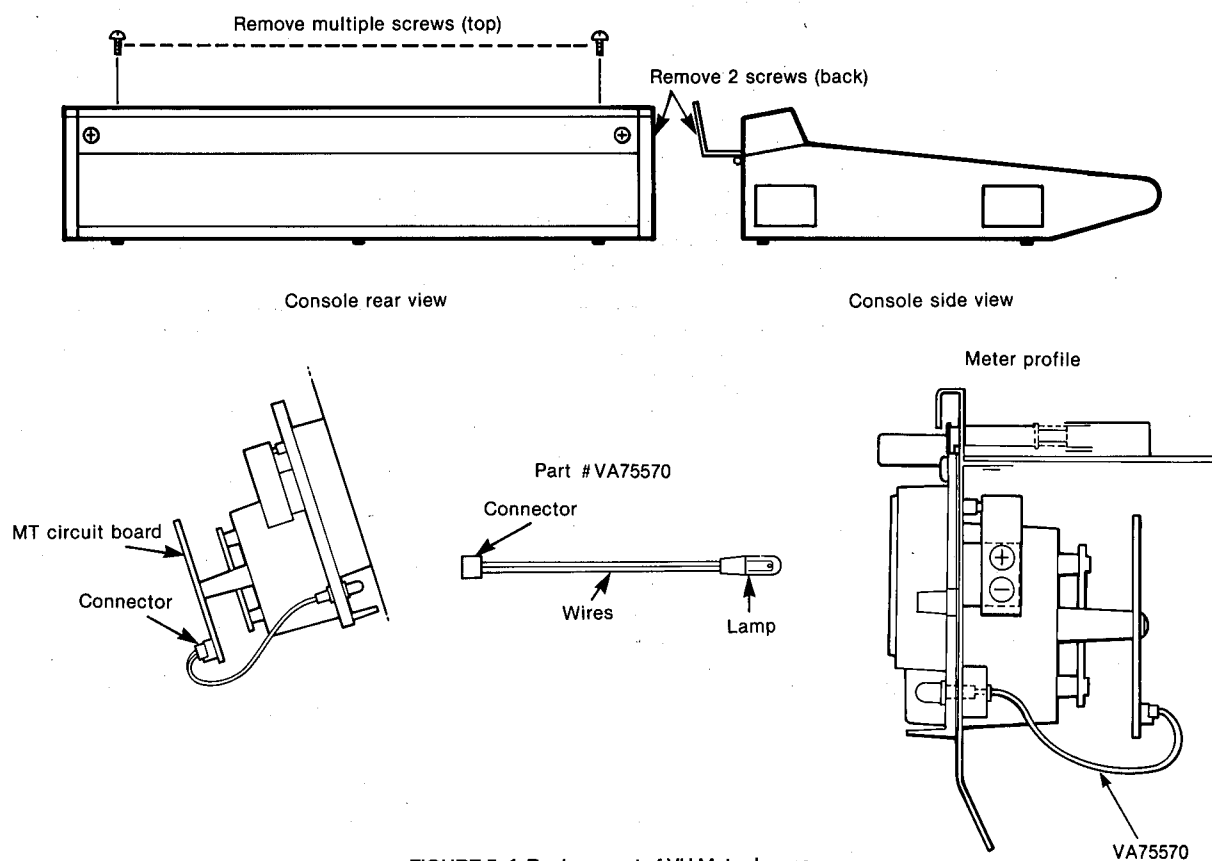

FIGURE 5-1 Replacement of VU Meter Lamps.

5.3 WHERE TO CHECK IF THERE IS NO OUTPUT

In general, when something appears not to be working properly in a sound system, it is necessary to have a clear understanding of the system block diagram. One should look for a "good" signal by patching around suspect equipment, modules or circuits. Suspected "bad" cables can be replaced or swapped to see if the problem follows the cable. These techniques should be known to most

experienced sound system operators. In the case of the PM3000 console, however, there are a number of apparent fault conditions, which the operator may inadvertently create simply by setting controls in a particular configuration, whereby no signal reaches the output. The following chart depicts the most likely errors you may encounter, and points out how to correct the problem.

"FAULT" CONDITION	POSSIBLE CAUSE	CORRECTION
Input channel signals do not appear at the Group, Stereo, Aux or Matrix outputs	Console is in SOLO mode, and an input channel to which no signal is applied has its CUE/SOLO switch engaged.	Release master SOLO MODE switch to activate all channels which should be on.
	The affected input channel(s) have MUTE assign switches engaged, and the MASTER MUTE group to which the channel(s) is assigned is set to mute mode.	Disengage the MASTER MUTE switch, or the affected input channel MUTE switch(es).
	The affected input channel(s) have MUTE assign switches engaged, and the remote VCA/MUTE connection is causing the MASTER MUTE group to be engaged.	Disconnect the VCA/MUTE connector to check theory; if output is restored, check remote circuitry.
Certain input channels or groups of channels, cannot be heard at Group, Stereo, Post-Fader Aux sends, or Matrix outputs.	The affected input channel(s) have VCA assign switches engaged, and the VCA Master Fader to which the channel(s) is assigned is set to minimum level (down).	Disengage VCA assign switch on the channel affected or raise the VCA Master Fader to a higher setting.
	The affected input channel(s) have VCA assign switches engaged, and the remote VCA/MUTE connection is causing the VCA Master level to go to minimum.	Disconnect the VCA/MUTE connector to check theory; if output is restored, check remote circuitry.
Certain input channels or groups of channels cannot be heard at Group outputs, Group-to-Stereo outputs or Group-to-Mtrx outputs.	The affected input channels are assigned to a Group Fader which is set to minimum level (down), and the G·ST and G·MTRX feeds are post Group Fader.	Raise the Group Fader setting to a higher level.
Individual input channel cannot be heard at the Group, Stereo, Aux or Matrix outputs.	Channel ON/off switch is off, or its PAD and GAIN controls are set so input sensitivity is too low.	Turn On the channel. Set the PAD for a lower value and/or GAIN at a higher value.
	Channel INSERT switch is engaged, and a plug is connected to the channel's INSERT IN jack, but no signal is applied to that plug.	Disengage INSERT switch or check the signal at the INSERT IN jack.
	A phantom powered condenser microphone or direct box is connected to the channel and is not receiving phantom power.	Check to be sure channel and master 48V switches are on.
There is no output, and no console functions work at all.	Power is not reaching the PM3000.	Verify that PW3000 is On and that its umbilical cables both are properly connected. Check fuses and AC mains voltage.
Fuses are OK and power supply turns on, but console does not turn on.	Power supply cables are misconnected (A to B and vice-versa) or not connected.	Check cables and correct as required.

● IN 1

● VCA Adjustments

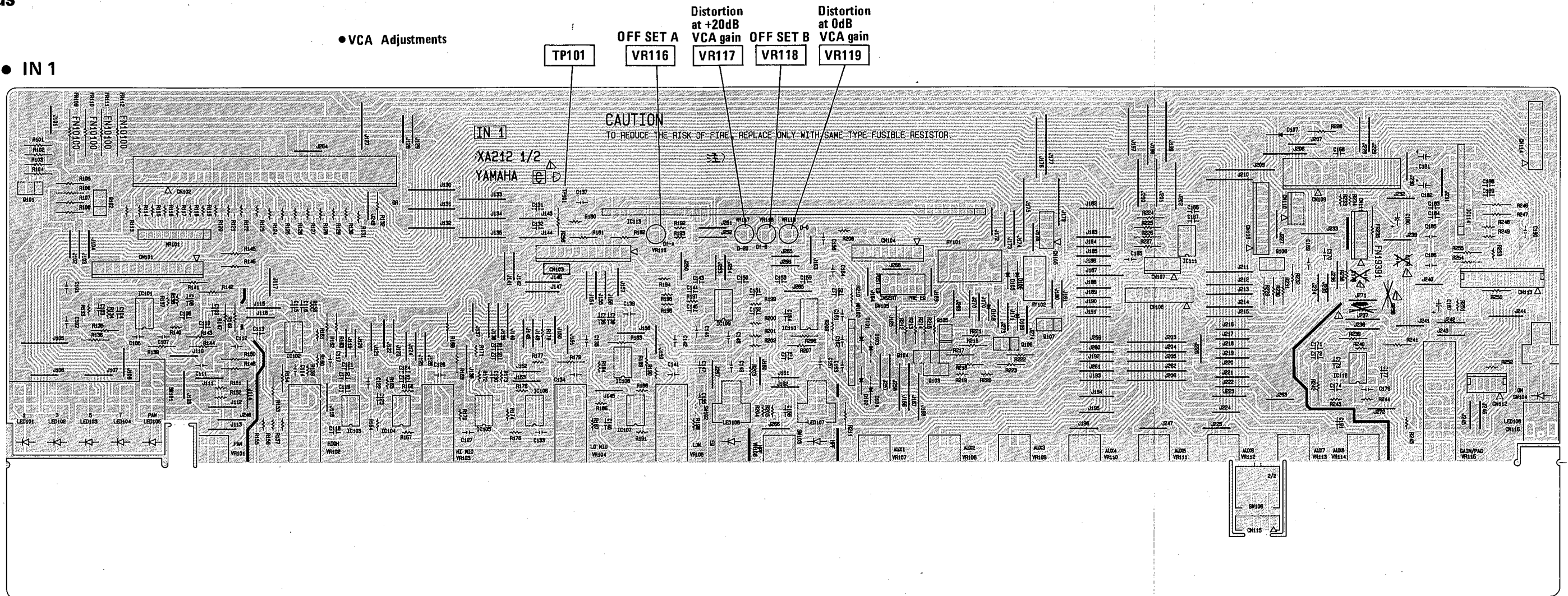

● IMB

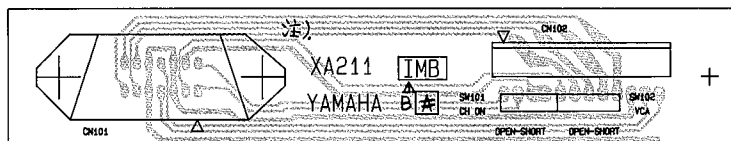

- | | | | |
|-------------------------|-----------------------------|--------------------------------------|----------------------|
| 1. Circuit Board | : XA212 | 9. Trimmer Potentiometer | |
| 2. IC | | VR116, 117 | : B20 kΩ (HT560080) |
| 102 ~ 108, 111 | : NJM2041DD | VR118, 119 | : B100 kΩ (HT560100) |
| 101, 109, 110, 112 | : NE5532P | 10. Rotary Potentiometer with switch | |
| 114 | : BX7097 | VR115 | : (VA256800) |
| 113 | : BX7183 | 11. Toggle Switch | |
| 3. Tr | | SW106 | : FTD61 (VA298200) |
| 106, 107 | : 2SA937 | 12. Slide Switch | |
| 101, 102, 104, 108 | : 2SC2021 | SW105 | : SSS342 (VA247700) |
| 4. DI | | 13. Push Switch | |
| 105 ~ 107, 109 | : 1S1555 | SW104 | : (VA257900) |
| 101 ~ 104 | : 1SS82 | 102, 103 | : (VA258000) |
| 5. LED | | 101 | : (VA258700) |
| 101 ~ 104, 106, 107 | : LN342GP (VA247500) | 14. Relay | |
| 105 | : LN442YP (VA247600) | RY101 | : RY12W (KC001900) |
| 6. Resistor Array | | 102 | : SY-12 (VA248100) |
| MR101 | : RKL8S-474J (VA259200) | | |
| 102 | : RKL4A-103F (VA249500) | | |
| 7. Fuse Resistor | | | |
| FR109 ~ 112 | : 10Ω 1/2W (HW904100) | | |
| 235 | : 390Ω 25 mA (HW995390) | | |
| 8. Rotary Potentiometer | | | |
| VR107 ~ 114 | : A20K (VA255100) | | |
| 106 | : C100K - C50 kΩ (VA255300) | | |
| 101 | : A20K - C20 kΩ (VA255400) | | |
| 102 ~ 105 | : (VA255500) | | |

● IN 2

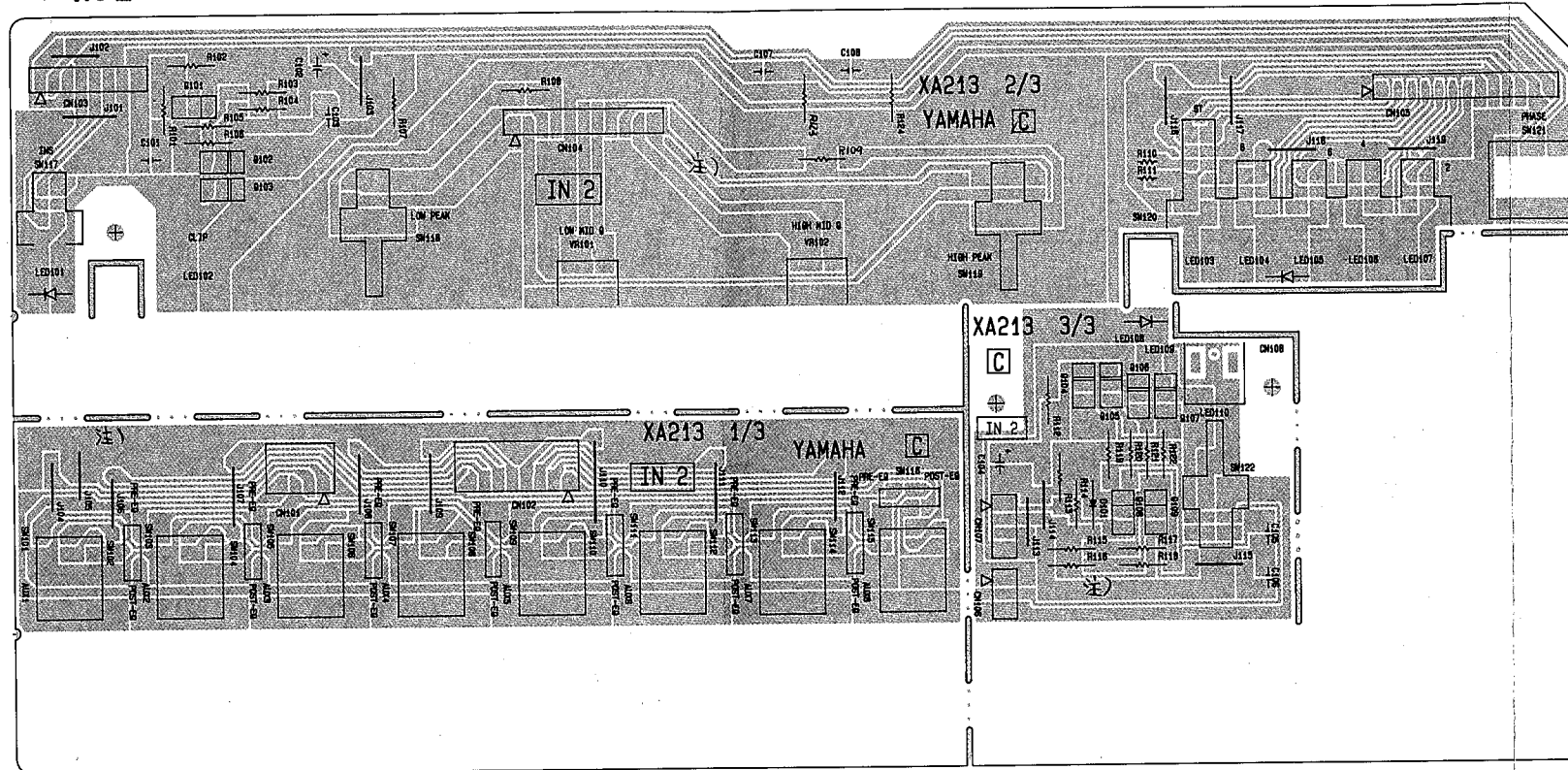

● IN 3

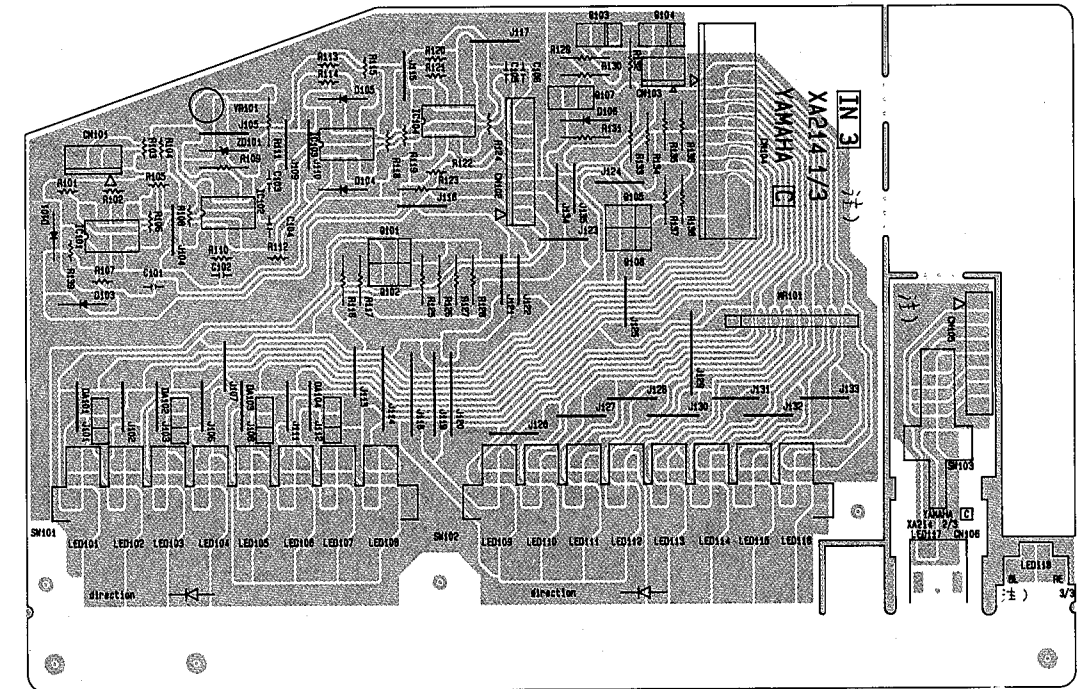

● IN 4

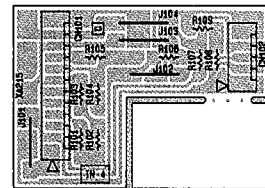

- | | | |
|-------------------------|---|--------------------|
| 1. Circuit Board | : | XA213 |
| 2. Tr | | |
| 102 ~ 107 | : | 2SA937 |
| 101, 108, 109 | : | 2SC2021 |
| 3. DI | | |
| 101 | : | 1S1555 |
| 4. LED | | |
| 102, 108 | : | LN222RP (IF001720) |
| 109 | : | LN322GP (IF002180) |
| 103 ~ 107 | : | LN342GP (VA247500) |
| 101 | : | LN442YP (VA247600) |
| 5. Rotary Potentiometer | | |
| VR101, 102 | : | C50 kΩ (VA255200) |
| 6. Toggle Switch | | |
| SW121 | : | FFD61 (VA298200) |
| 101, 103, 105, 107, | | |
| 109, 111, 113, 115 | : | FTPA64 (VA298300) |
| 7. Slide Switch | | |
| SW102, 104, 106, 108, | | |
| 110, 112, 114, 116 | : | SSS212 (KA401270) |
| 8. Push Switch | | |
| SW117 ~ 119, 122 | : | (VA258000) |
| 120 | : | (VA258800) |

- | | | |
|--------------------------|---|-----------------------|
| 1. Circuit Board | : | XA214 |
| 2. IC | | |
| 101 ~ 104 | : | NJM2041DD |
| 3. Tr | | |
| 103, 104 | : | 2SA937 |
| 101, 102, 105 ~ 107 | : | 2SC2021 |
| 4. DI | | |
| 101, 103, 104, 105, 106 | : | 1S1555 |
| ZD101 | : | RD5.6EB3 |
| DA101 ~ 104 | : | DAP201 |
| 5. LED | | |
| 118 | : | LN222RP (IF001720) |
| 101 ~ 116 | : | LN442YP (VA247600) |
| 6. Resistor Array | | |
| MR101 | : | RKL8S-104F (VA249400) |
| 7. Trimmer Potentiometer | | |
| VR101 | : | B50K (HT560090) |
| 8. Push Switch | | |
| SW103 | : | (VA258300) |
| 101, 102 | : | (VA258400) |

● RTN 1

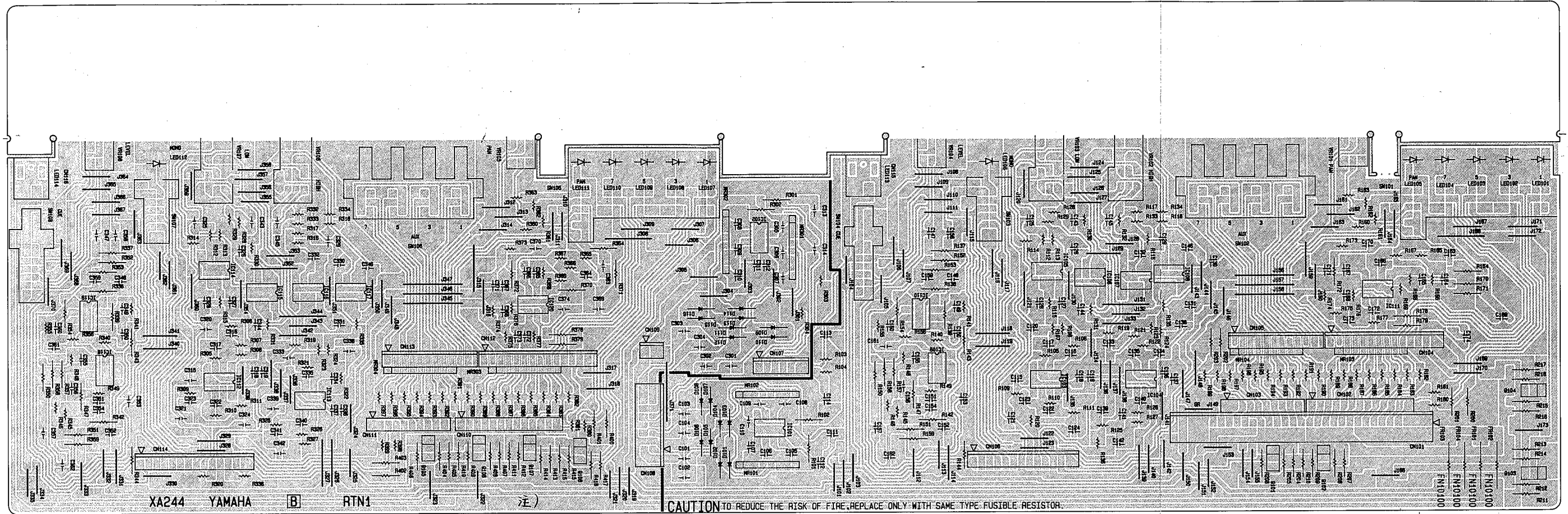

- | | | | |
|------------------|---|--|--|
| 1. Circuit Board | : XA244 | 6. Resistor Array | MR101, 102, 301, 302 : RKL4A-103F (VA249500) |
| 2. IC | 105 ~ 108, 114 ~ 117 : NJM2041DD | MR103, 104, 303, 304 : RKL8S-474J (VA259200) | |
| | 101 ~ 104, 119 ~ 113, 118 ~ 120 : NE5532P | 7. Fuse Resistor | FR101 ~ 104 : 10Ω 1/2W (HW904100) |
| 3. Tr | 101 ~ 108 : 2SC2021 | 8. Rotary Potentiometer | VR104, 108 : A10K x 2 (VA255700) |
| 4. DI | 101 ~ 116 : 1SS82 | | 101, 105 : A20K - C20K (VA255400) |
| | | | 102, 103, 106, 107 : (VA255600) |
| 5. LED | 101 ~ 104, 107 ~ 110 : LN342GP (VA247500) | 9. Push Switch | SW103, 104, 107, 108 : (VA258100) |
| | 105, 106, 111, 112 : LN442YP (VA247600) | | 101, 105 : (VA258700) |
| | | | 102, 106 : (VA258900) |

● RTN 2

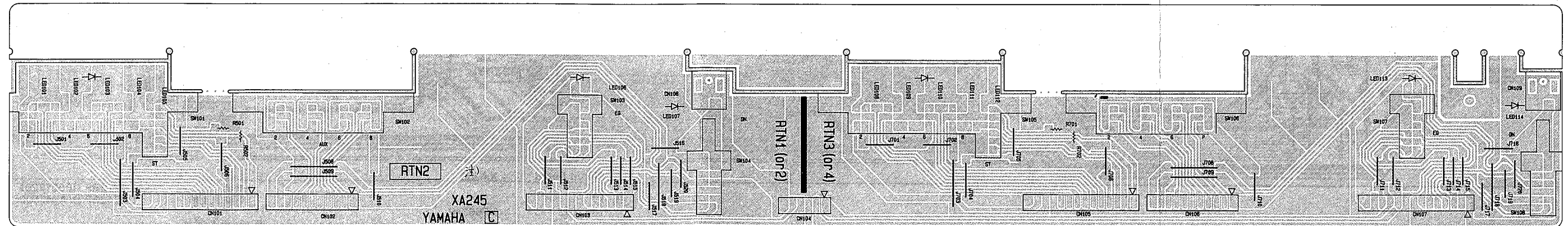

- | | | | |
|------------------|---|----------------|-----------------------------------|
| 1. Circuit Board | : XA245 | 3. Push Switch | SW103, 104, 107, 108 : (VA258100) |
| 2. LED | 101 ~ 106, 108 ~ 113 : LN342GP (VA247500) | | 101, 105 : (VA258800) |
| | | | 102, 106 : (VA258900) |

● COM 1

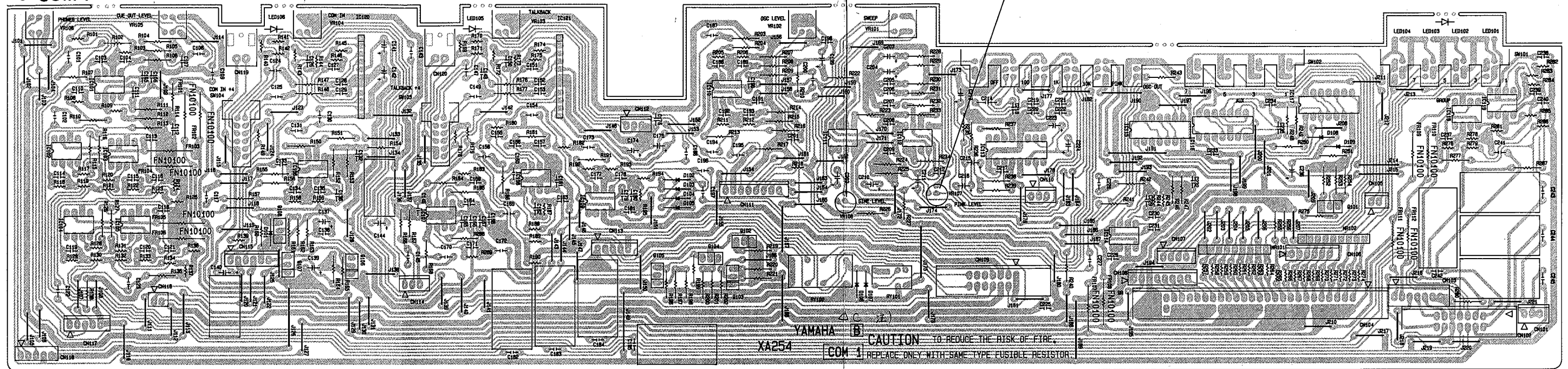

- | | | | | | |
|------------------|---|-------------------------|---|--------------------------|--|
| 1. Circuit Board | : XA254 | 6. Resistor Array | MR102 | : RKL8S-474J (VA259200) | |
| 2. IC | 111, 112 : NJM2041DD
102 ~ 105, 118, 119 : NE5534P
101, 106 ~ 110, 114 : NE5532P
120, 121 : BX7097
113 : XR-2206CP
115, 117 : TC4006BP
116 : TC4030BP | 7. Fuse Resistor | FR101 ~ 112 | : 10Ω 1/2W (HW904100) | |
| 3. Tr | 102, 103, 106, 107 : 2SA937
101, 104, 105, 108 : 2SC2021 | 8. Rotary Potentiometer | VR102 ~ 104 : A10K (VA255900)
105, 106 : A10K x 2 (VA255700)
101 : C100K x 2 (VA255800) | 9. Trimmer Potentiometer | VR107, 108 : B100K (HT560100) |
| 4. D1 | 101, 106 ~ 109 : 1S1555
102 ~ 105 | 10. Push Switch | SW103, 104 : (VA258100)
101 : (VA258900)
102 : (VA259000) | 11. Relay | RY102 : RY12W (KC001900)
RY101 : SY-12 (VA248100) |
| 5. LED | 101 ~ 104 : LN342GP (VA247500) | | | | |

● COM 2

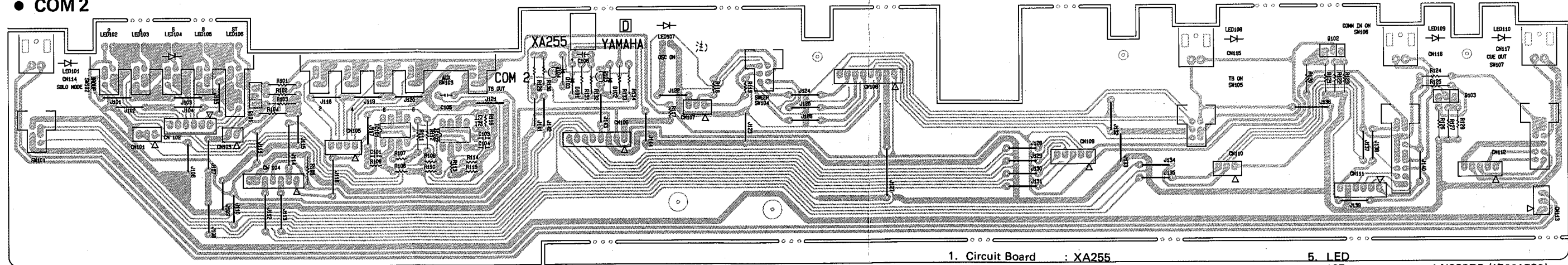

- | | | | |
|------------------|---|----------------|--|
| 1. Circuit Board | : XA255 | 5. LED | 107 : LN222RP (IF001720)
102 ~ 106 : LN342GP (VA247500) |
| 2. IC | 101, 102 : NE5534P | 6. Push Switch | SW101, 104, 105 : (VA258000)
107 : (VA258100)
106 : (VA258200)
102 : (VA258800)
103 : (VA259100) |
| 3. Tr | 101 ~ 103 : 2SC2021
105 : 2SC2320
104 : 2SA999(F) | | |
| 4. DI | 101, 102 : 1S1555 | | |

● MAS 1

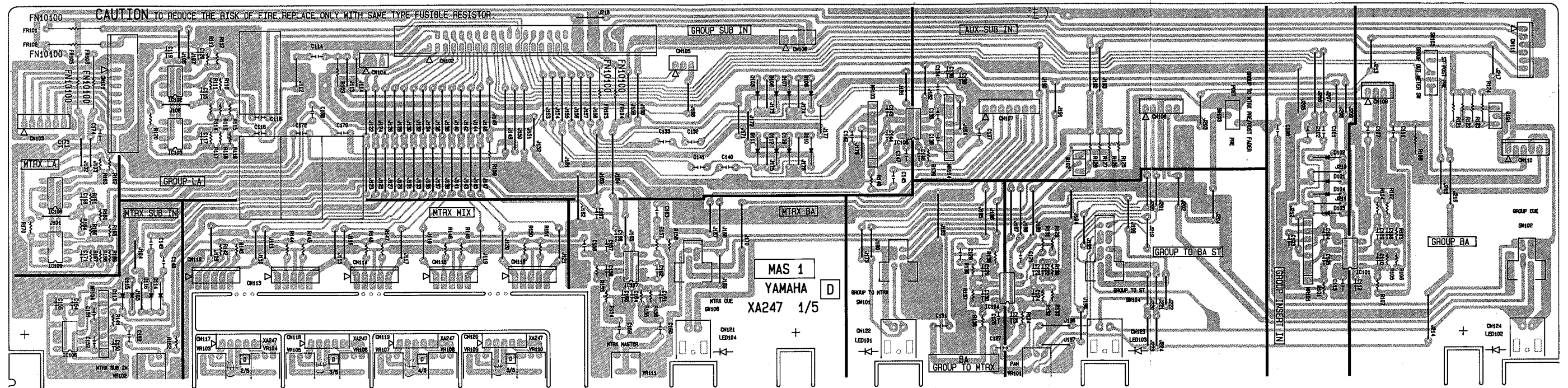

1. Circuit Board : XA247
2. IC
102, 103, 108, 109 : NE5534
101, 104 ~ 107 : NE5532P
3. Tr
101, 102 : 2SC2021
4. DI
101 ~ 116 : 1SS82
5. Resistor Array
MR101 ~ 104 : RKL4A-103F (VA249500)
6. Fuse Resistor
FR101 ~ 106 : (HW904100)
7. Rotary Resistor
VR102 : A20K (VA255100)
111 : A10K (VA255900)
103 ~ 110 : A20K (VA256000)
101 : A20K-C20K (VA255400)
8. Slide Switch
SW103 : SSS212 (KA401270)
105 : SSS313 (KA401360)
9. Push Switch
SW101, 102, 106 : (VA258000)
104 : (VA258100)

● MAS 2

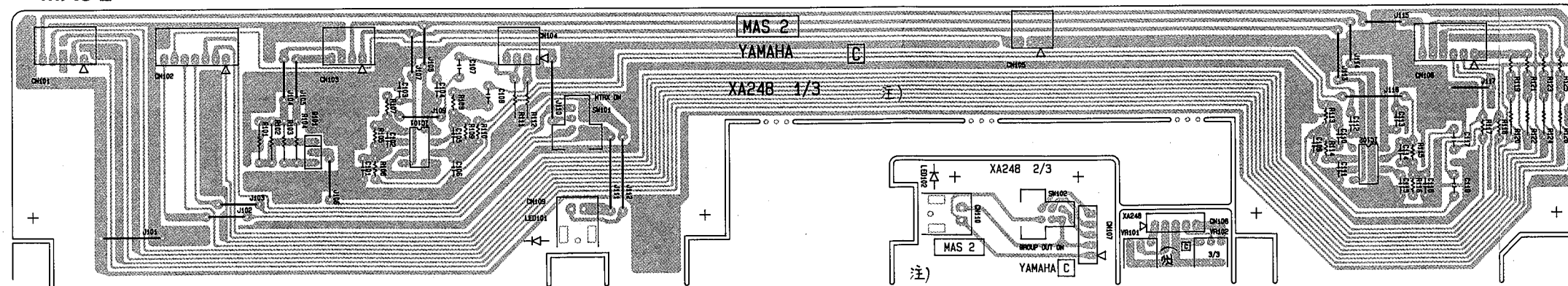

1. Circuit Board : XA248
2. IC
101, 102 : NE5532P
3. Tr
101 : 2SC2021
4. Rotary Potentiometer
VR101, 102 : A20K (VA256000)
5. Push Switch
SW101, 102 : (VA258000)

● AUX 1

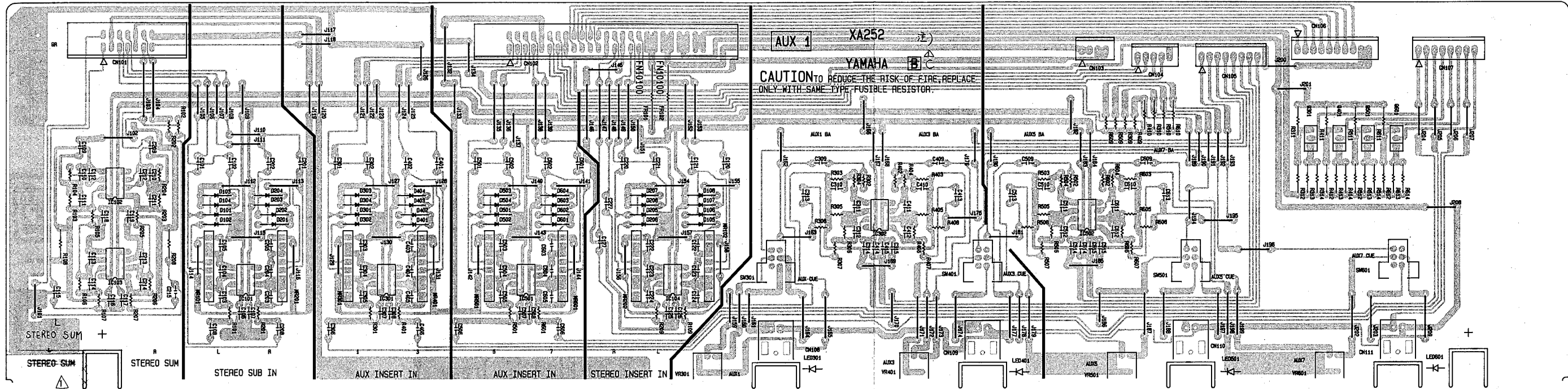

- 1. Circuit Board : XA252
- 2. IC : NE5532P
101 ~ 104, 301, 302, 501, 502
- 3. Tr : 2SC2021
301, 401, 501, 601
- 4. DI : 1SS82
101 ~ 108, 201 ~ 208, 301 ~ 304, 401 ~ 404, 501 ~ 504, 601 ~ 604
- 5. Resistor Array : RKL4A-103F (VA249500)
MR101, 102, 201, 202, 301, 401, 501, 601
- 6. Fuse Resistor : (HW904100)
FR101, 102
- 7. Rotary Potentiometer : A10K (VA255900)
VR301, 401, 501, 601
- 8. Push Switch : (VA258000)
SW301, 401, 501, 601

● AUX 2

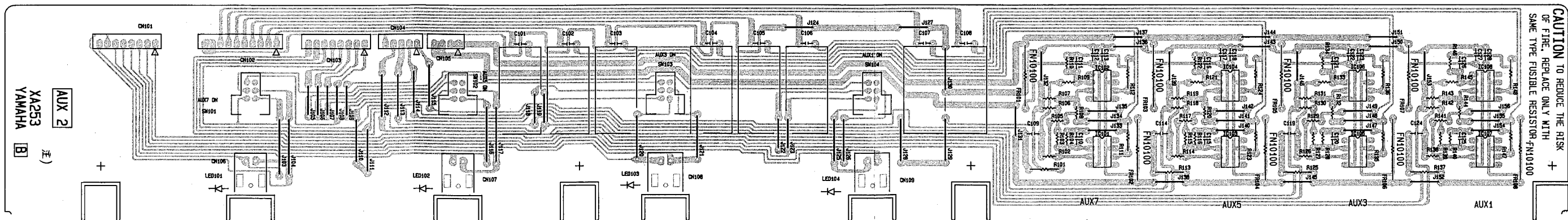

- 1. Circuit Board : XA253
- 2. IC : NE5534P
101 ~ 108
- 3. Fuse Resistor : (HW904100)
FR101 ~ 108
- 4. Push Switch : (VA258000)
SW101 ~ 104

● ST 1

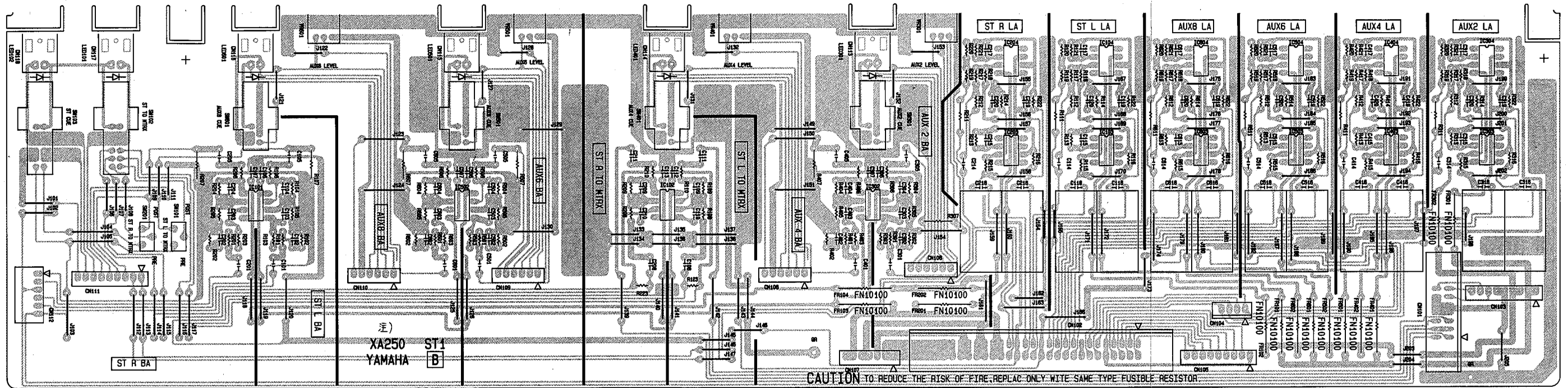

- 1. Circuit Board : XA250
- 2. IC
103, 104, 203, 204, 303, 304,
403, 404, 503, 504, 603, 604 : NE5534P
101, 102, 302, 502 : NE5532P
- 3. Rotary Potentiometer
VR301, 401, 501, 601 : A10K (VA256000)
- 4. Fuse Resistor
FR101 ~ 104, 201, 202, 301, 302,
401, 402, 501, 502, 601, 602 : (HW904100)
- 5. Slide Switch : SSS212 (KA401270)
- 6. Push Switch
SW301, 401, 501, 601 : (VA258000)
102, 103 : (VA258100)

● ST 2

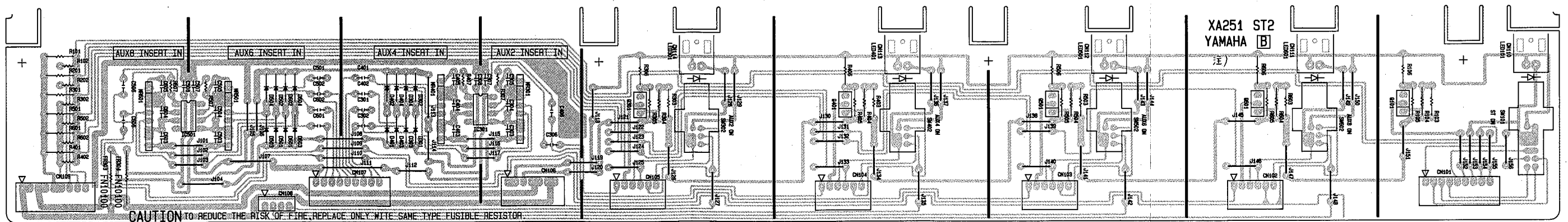

- 1. Circuit Board : XA251
- 2. IC
301, 501 : NE5532P
- 3. Tr
101, 301, 401, 501, 601 : 2SC2021
- 4. DI
301 ~ 304, 401 ~ 404,
501 ~ 504, 601 ~ 604 : 1SS82
- 5. Resistor Array
MR301, 401, 501, 601 : 10KA
- 6. Fuse Resistor
FR303, 304 : (HW904100)
- 7. Push Switch
SW301, 401, 501, 601 : (VA258000)
101 : (VA258100)

● COM 3

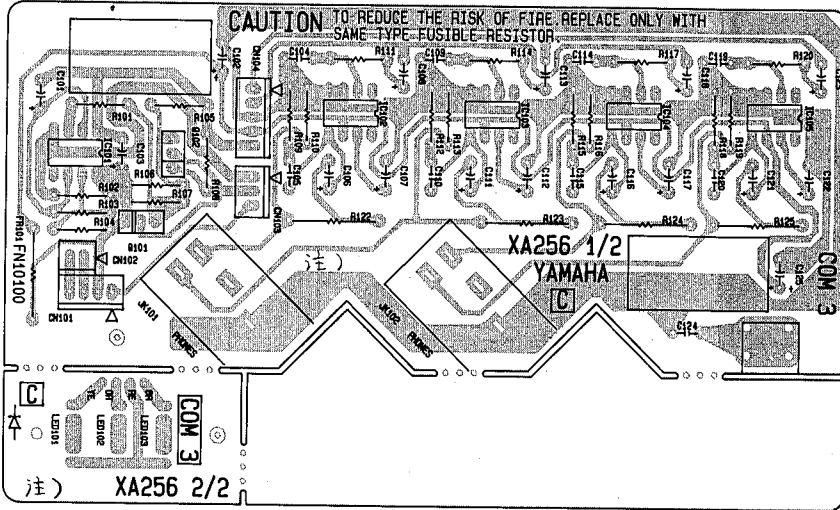

1. Circuit Board: XA256
2. IC
 - 101 : NJM555
 - 102 ~ 105 : NJM386D
3. Tr
 - 101 : 2SA937
 - 102 : 2SC2021
4. LED
 - 103 : LN0202RP2 (VA273400)
 - 101 : LN0202GP3 (VA273500)
 - 102 : LN0202YP4 (VA273600)
5. Fuse Resistor
 - FR101 : (HW904100)
6. Phone Jack
 - JK101, 102 : (LB205220)

● RTN 3

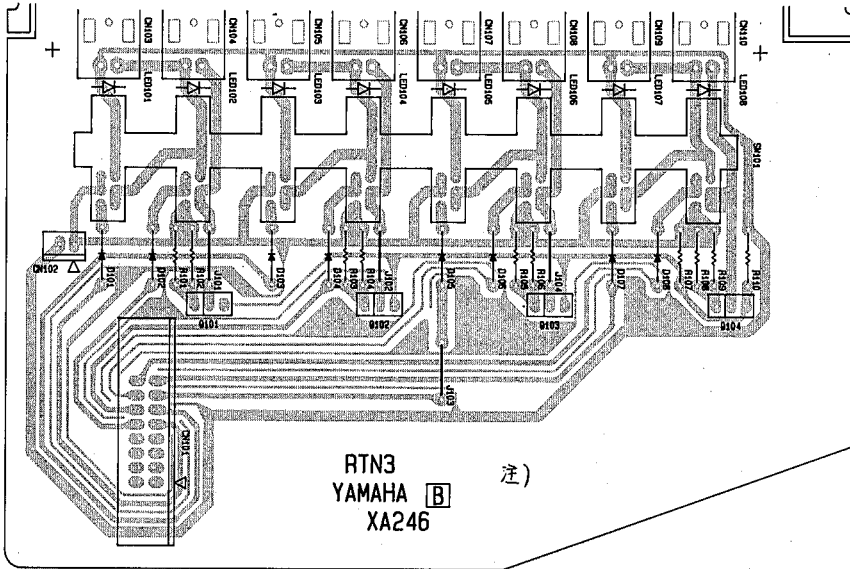

1. Circuit Board : XA246
2. Tr
101 ~ 104 : 2SC2021
3. D1
101 ~ 108 : 1SS82
4. Push Switch
SW101 : (VA273300)

● MAS 3

CN101-①

● VCA MASTER Voltage Adjustments

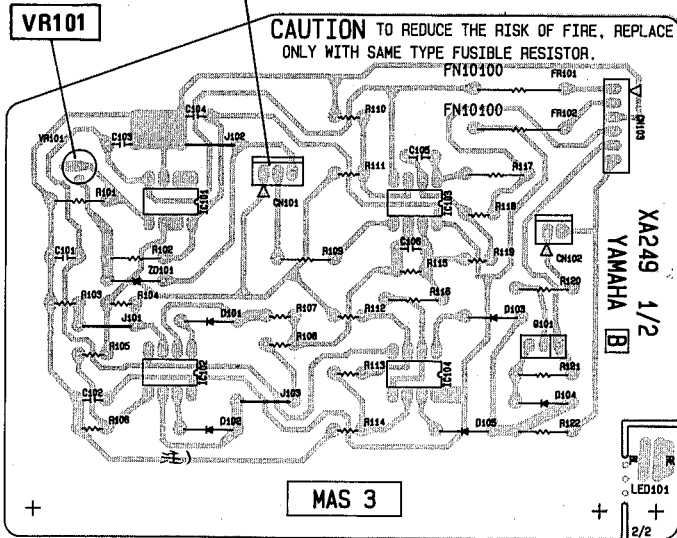

1. Circuit Board : XA249
2. IC
101 ~ 104 : NJM2041DD
3. Tr
101 : 2SC2021
4. DI
101 ~ 105 : 1S1555
ZD101 : RD5.6EB2
5. LED
101 : LN328GP (VA264700)
6. Fuse Resistor
FR101, 102 : (HW904100)
7. Trimmer Potentiometer
VR101 : B50K (HT560090)

● MB

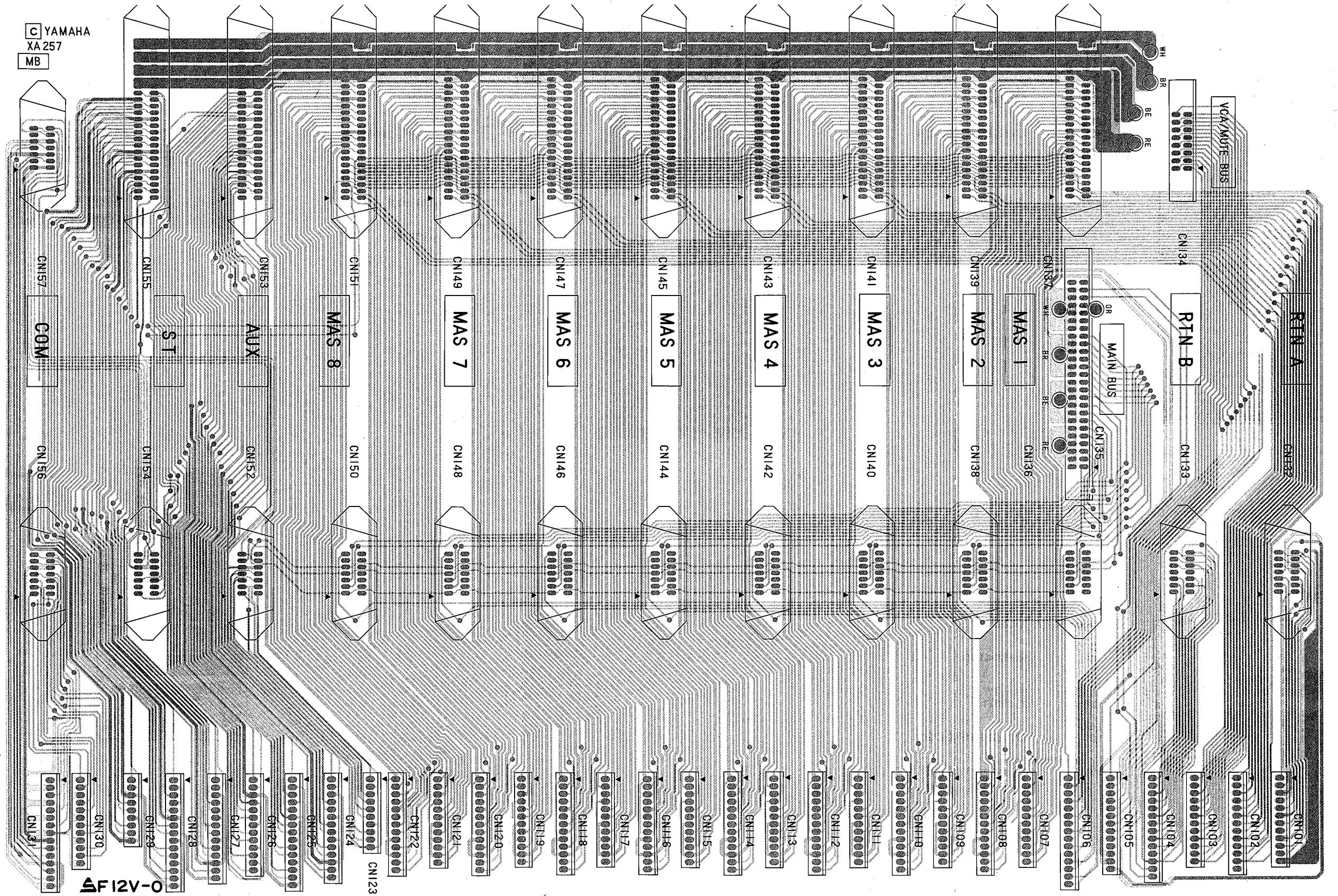

● MT 1

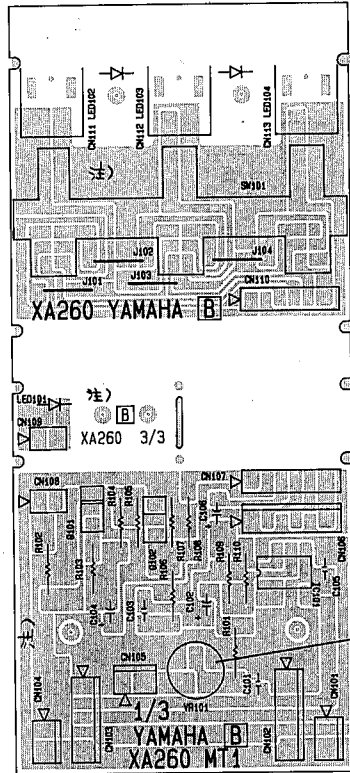

1. Circuit Board : XA260
2. IC
101 : NJM2041DD
3. Tr
101 : 2SA937
102 : 2SC2021
4. LED
101 : LN222RP (IF001720)
5. Trimmer Potentiometer
VR101 : B1.0K (HT410020)
6. Push Switch
SW101 : (VA258600)

● VU Meter

VR101

● MT 3

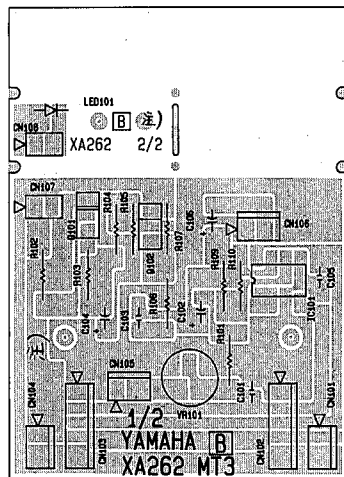

1. Circuit Board : XA262
2. IC
101 : NJM2041DD
3. Tr
101 : 2SA937
102 : 2SC2021
4. LED
101 : LN222RP (IF001720)
5. Trimmer Potentiometer
VR101 : B1.0K (HT410020)

● MT 2

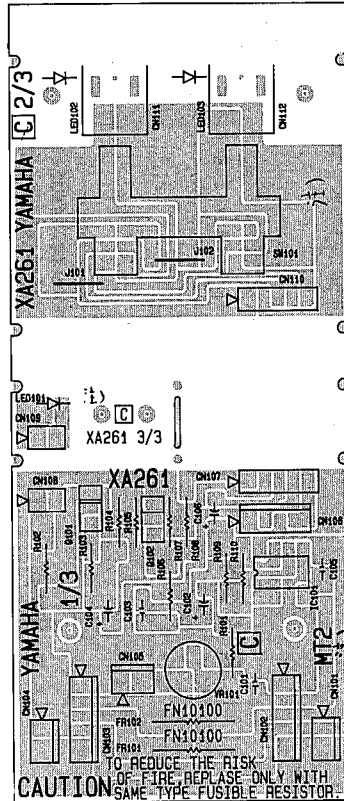

1. Circuit Board : XA261
2. IC
101 : NJM2041DD
3. Tr
101 : 2SA937
102 : 2SC2021
4. LED
101 : LN222RD (IF001720)
5. Trimmer Potentiometer
VR101 : B1.0K (HT410020)
6. Push Switch
SW101 : (VA258600)
7. Fuse Resistor
FR101, 102 : (HW904100)

CAUTION
TO REDUCE THE RISK
OF FIRE, REPLACE ONLY WITH
SAME TYPE FUSIBLE RESISTOR.

● EXT

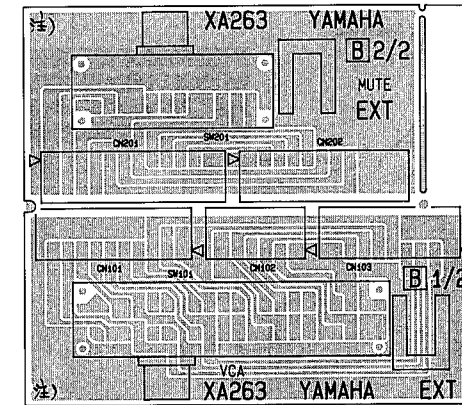

1. Circuit Board : XA263
2. Rotary Switch
SW101 : SRRZL8 (VA313200)
201 : SRRZR4 (VA313300)

● CO

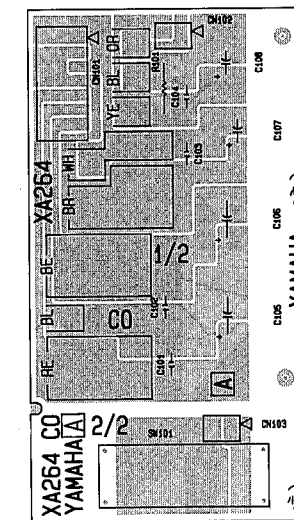

1. Circuit Board : XA264
2. Slide Switch
SW101 : SSB042E8 (KA400760)

● DC1

● PW 3000 Adjustments

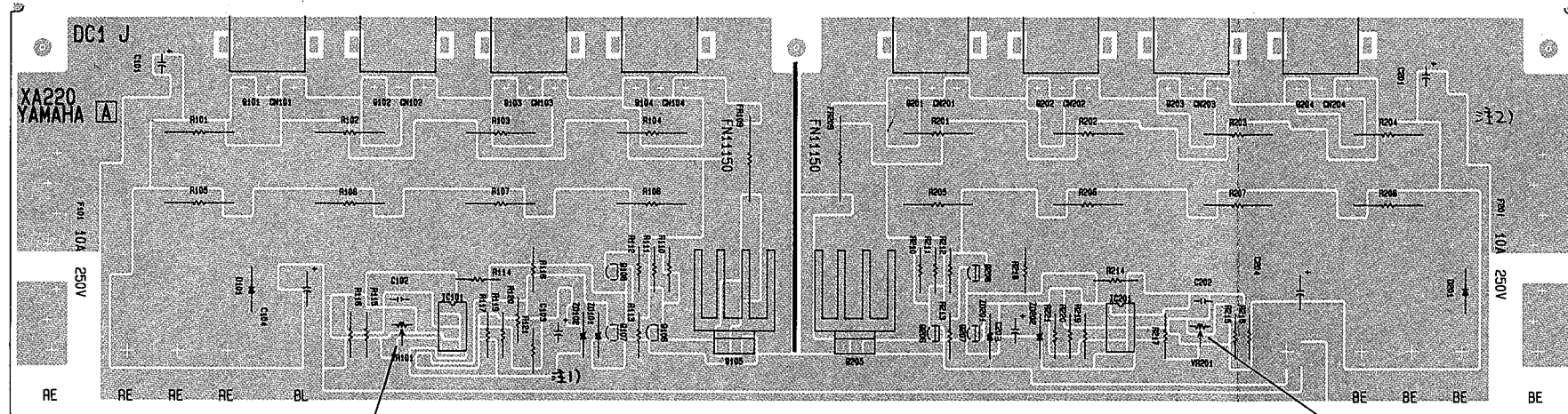

VR101
+20V

1. Circuit Board : XA220
2. IC
101, 201 : NJM4558DV
3. Tr
206, 207, 208 : 2SA999
205 : 2SB596
106, 107, 108 : 2SC2320
105 : 2SD526

4. DI
D101, 201 : 10DI
ZD101, 102, 201, 202 : RD5.6E
5. FR
109, 209 : 15Ω-1P

VR201
-20V

● DC2

● PW 3000 Adjustments

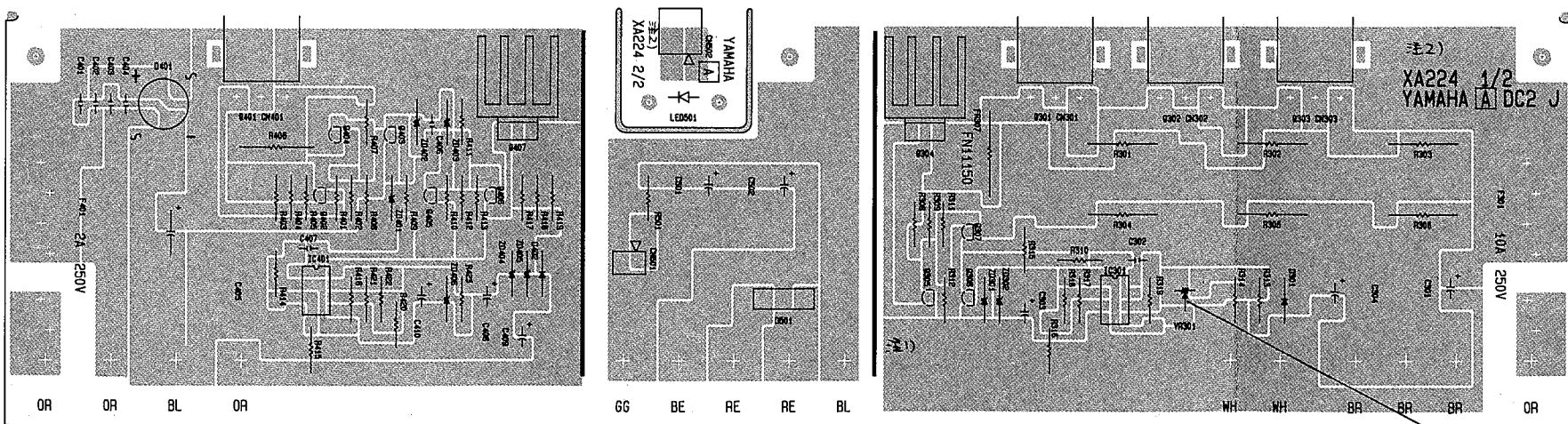

1. Circuit Board : XA224
2. IC
301, 401 : NJM4558DV
3. Tr
402 ~ 406 : 2SC2240
305 ~ 307 : 2SC2320
304, 407 : 2SD526

5. LED
501 : LN222RP
6. Fuse
F401 : 250V-2A
F301 : 250V-10A
7. VR
301 : B2.2K

VR301
+12V

● DC 3

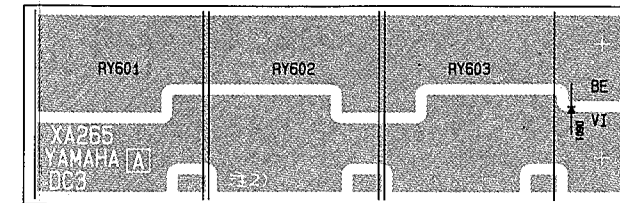

● LP

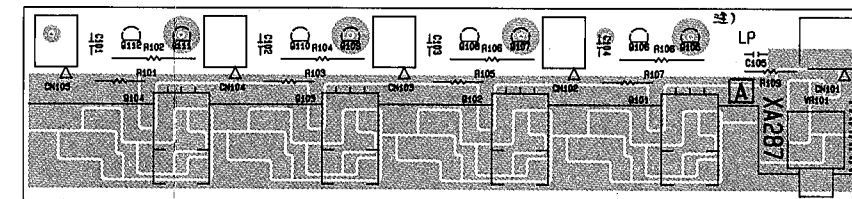

1. Circuit Board: XA287
2. Tr
101 ~ 104 : 2SB596
105 ~ 112 : 2SC2320
3. Rotary Potentiometer
VR101 : B5.0K (VA313400)

MIXING CONSOLE

PM3000

PARTS LIST (パーツリスト)

■CONTENTS (目次)

ELECTRICAL PARTS (電気部品)	1
MAIN FRAME (外装組立)	13
INPUT MODULE (INPUTモジュール)	16
RETURN MODULE (RETURNモジュール)	19
MASTER MODULE (MASTERモジュール)	21
AUX MODULE (AUXモジュール)	23
STEREO MODULE (STEREOモジュール)	25
COMMUNICATION MODULE (COMMモジュール)	27
TOP BOARD ASSEMBLY (天板Ass'y)	29
REAR PANEL (リアパネル)	31
POWER SUPPLY UNIT PW3000	33
(電源ユニットPW3000)	

Notes DESTINATION ABBREVIATIONS

J : Japanese model	A : Australian model
U : U.S.A. model	E : European model
C : Canadian model	D : West German model
X : General model	B : British model
M : South African model	I : Indonesian model
H : North European model	

■ ELECTRICAL PARTS (電気部品)

Ref. No.	Part No.	Description	部 品 名	Remarks	Common Model	Markets	ランク
※	VA 30:19:00	IN 1 Circuit Board		I N 1 シ ー ト			53
	IG 06:92:00	IC	NJM2041DD	I C	Operational Amp.		05
	IG 10:25:00	"	NE5532P	"	Dual Operational Amp.		06
※	XA 21:70:01	"	BX7097	"	HA		10
※	XA 21:80:01	"	BX7183	"	VCA		18
	IA 09:37:00	Transistor	2SA937 (Q,R,S)	ト ラ ン ジ ス タ			03
	IC 20:21:80	"	2SC2021(Q,R,S)	"			03
	IF 00:00:40	Diode	1S1555	ダ イ オ ー ド			01
	IF 00:14:00	"	1SS82	"			
	VA 24:75:00	LED	LN342GP	フ ッ ク 付 L E D	Green		01
	VA 24:76:00	"	LN442YP	"	Yellow		01
	HU 07:41:00	Metal Film Resistor	10Ω 1/4W	金 属 皮 膜 抵 抗			02
	HU 07:42:70	"	27Ω 1/4W	"			02
	HU 07:61:00	"	1kΩ 1/4W	"			02
	HU 07:62:00	"	2kΩ 1/4W	"			02
	HU 07:62:20	"	2.2kΩ 1/4W	"			02
	HU 07:62:40	"	2.4kΩ 1/4W	"			02
	HU 07:63:00	"	3kΩ 1/4W	"			02
	HU 07:63:30	"	3.3kΩ 1/4W	"			02
	HU 07:64:30	"	4.3kΩ 1/4W	"			02
	HU 07:64:70	"	4.7kΩ 1/4W	"			02
	HU 07:66:80	"	6.8kΩ 1/4W	"			02
	HU 07:69:10	"	9.1kΩ 1/4W	"			02
	HU 07:71:00	"	10kΩ 1/4W	"			02
	HU 07:71:50	"	15kΩ 1/4W	"			02
	HU 07:71:80	"	18kΩ 1/4W	"			02
	HU 07:72:20	"	22kΩ 1/4W	"			02
	HU 07:72:40	"	24kΩ 1/4W	"			02
	HU 07:72:70	"	27kΩ 1/4W	"			02
	HU 07:73:30	"	33kΩ 1/4W	"			02
	HU 07:74:70	"	47kΩ 1/4W	"			02
※	VA 24:95:00	Resistor Array	RKL4A-103F	抵 抗 ア レ イ			01
※	VA 25:92:00	"	RKL8S-474J	"			01
	HW 90:41:00	Fuse Resistor	10Ω 1/2W	ヒ ュ ー ズ 抵 抗			02
	HW 99:53:90	"	390Ω 25mA	"			02
※	VA 25:51:00	Rotary Potentiometer	A20kΩ	ロ ー タ リ ー V R			04
※	VA 25:53:00	"	C100k-C50kΩ	2 連 ロ ー タ リ ー V R			04
※	VA 25:54:00	"	A20k-C20kΩ	"			04
※	VA 25:55:00	"	RK9BD00081	"			07
※	VA 25:68:00	Rotary Potentiometer with SW	ZY2kΩ	S W 付 ロ ー タ リ ー V R			07
	HT 56:00:80	Trimmer Potentiometer	B20kΩ	半 固 定 V R			05
	HT 56:01:00	"	B100kΩ	"			05
	FZ 00:74:70	Electrolytic Cap.	1000μF 6.3V	ケ ミ コ ン			
※	VA 29:82:00	Toggle Switch	FTD61	ト グ ル S W			08
※	VA 24:77:00	Slide Switch	SSS342	ス ラ イ ド S W			03

※New Parts (新規部品) NR

ランク: Japan only

Ref. No.	Part No.	Description	部 品 名	Remarks	Common Model	Markets	ランク
※	VA 25 79 00	Push Switch	SPUJ12	プ ッ シ ュ S W			02
※	VA 25 80 00	"	SPUJ12	"			02
※	VA 25 87 00	"	SPUJ50 5	"			06
	KC 00 19 00	Relay	RY-12W	リ レ -			07
※	VA 24 81 00	"	SY-12	"			06
	VA 03 03 00	Connector Base Pin	5483-03A	コネクタベースピン	TE		01
	VA 03 04 00	"	5483-04A	"	TE		01
	VA 03 05 00	"	5483-05A	"	TE		01
	VA 03 08 00	"	5483-08A	"	TE		01
	VA 03 11 00	"	5483-11A	"	TE		01
	VA 03 13 00	"	5483-13A	"	TE		01
※	VA 25 16 00	Connector Header	14P FRC2	コネクタヘッダー	TE		05
※	VA 25 18 00	"	50P FRC2	"	TE		07
※	VA 25 23 00	Connector, MQ	5P	M Q コ ネ ク タ	TE		07
※	VA 25 24 00	"	12P	"	TE		03
※	VA 29 90 00	LED Connector	(L) 2P	L E D コ ネ ク タ	SE		01
※	CB 10 15 50	Connector Housing	5480-04	コネクタハウジング			01
※	CB 10 15 60	"	5480-05	"			01
	CB 10 15 90	"	5480-08	"			01
	BB 00 58 20	Contact Pin	5479PBT	コ ン タ ク ト ピ ン			01
	LA 00 36 90	Lug Terminal	4φ	歯 付 ア - ス ラ グ			01
※	VA 30 20 00	IN 2 Circuit Board		I N 2 シ ー ト			27
	IA 09 37 00	Transistor	2SA937(Q,R,S)	ト ラ ン ジ ス タ			03
	IC 20 21 80	"	2SC2021 (Q,R,S)	"			03
	IF 00 00 40	Diode	1S1555	ダ イ オ ー ド			01
	IF 00 17 20	LED	LN222RP	フ ッ ク 付 L E D	Red		03
	IF 00 21 80	"	LN322GP	"	Green		02
※	VA 24 75 00	"	LN342GP	"	Green		01
※	VA 24 76 00	"	LN442YP	"	Yellow		01
	HU 07 71 80	Metal Film Resistor	18kΩ 1/4W	金 属 被 膜 抵 抗			02
※	VA 25 52 00	Rotary Potentiometer	C50kΩ	ロ ー タ リ ー V R			04
※	VA 29 82 00	Toggle Switch	FTD61	ト グ ル S W			08
※	VA 29 83 00	"	FTPA64	"			07
	KA 40 12 70	Slide Switch	SSS212	ス ラ イ ド S W			03
※	VA 25 80 00	Push Switch	SPUJ12	プ ッ シ ュ S W			02
※	VA 25 88 00	"	SPUJ50 5	"			06
※	VA 29 91 00	LED Connector	(S)	L E D コ ネ ク タ			01
	CB 10 15 40	Connector Housing	5480-03	コネクタハウジング			01
※	CB 10 15 50	"	5480-04	"			01
	CB 10 15 90	"	5480-08	"			01
	CB 10 16 20	"	5480-11	"			01
※	CB 10 16 40	"	5480-13	"			01
※	BB 00 58 20	Contact Pin	5479PBT	コ ン タ ク ト ピ ン			01

※New Parts (新規部品) NR

ランク : Japan only

Ref. No.	Part No.	Description	部 品 名	Remarks	Common Model	Markets	ランク
※	VA 30:21:00	IN 3 Circuit Board		I N 3 シ ー ト			19
	IG 06:92:00	IC	NJM2041DD	I C	Operational Amp.		05
	IA 09:37:00	Transistor	2SA937(Q,R,S)	ト ラ ン ジ ス タ			03
	IC 20:21:80	"	2SC2021(Q,R,S)	"			03
	IF 00:00:40	Diode	1S1555	ダ イ オ ー ド			01
	IF 00:77:40	Diode Array	DAP201	ダ イ オ ー ド ア レ イ			01
	IF 00:16:90	Zener Diode	RD5.6EB3	ツ ェ ナ ー ダ イ オ ー ド			03
	IF 00:17:20	LED	LN222RP	フ ッ ク 付 L E D	Red		03
※	VA 24:76:00	"	LN442YP	"	Yellow		01
	HU 07:54:30	Metal Film Resistor	430Ω 1/4W	金 属 皮 膜 抵 抗			02
	HU 07:61:00	"	1kΩ 1/4W	"			02
	HU 07:62:00	"	2kΩ 1/4W	"			02
	HU 07:71:00	"	10kΩ 1/4W	"			02
	HU 07:71:20	"	12kΩ 1/4W	"			02
	HU 07:71:30	"	13kΩ 1/4W	"			02
	HU 07:71:80	"	18kΩ 1/4W	"			02
	HU 07:75:60	"	56kΩ 1/4W	"			02
	HU 07:81:00	"	100kΩ 1/4W	"			02
※	VA 24:94:00	Resistor Array	RKL83-104F	抵 抗 ア レ イ			01
	HT 56:00:90	Trimmer Potentiometer	B50kΩ	半 固 定 V R			05
※	VA 25:83:00	Push Switch	SPUY12	プ ッ シ ュ S W			03
※	VA 25:84:00	"	SPUY85 8	"			07
※	VA 03:02:00	Connector Base Pin	5483-02A	コ ネ ク タ ベ ー ス ピ ン	TE		01
	VA 03:03:00	"	5483-03A	"	TE		01
	VA 03:08:00	"	5483-08A	"	TE		01
※	VA 25:17:00	Receptacle	16P	F R C 2 ソ ケ ッ ト	TE		05
※	VA 29:91:00	LED Connector	(S)	L E D コ ネ ク タ			01
※	CB 10:15:30	Connector Housing	5480-02	コ ネ ク タ ハ ウ ジ ン グ			01
	CB 10:15:90	"	5480-08	"			01
	BB 00:58:20	Contact Pin	5479PBT	コ ン タ ク ト ピ ン			01
※	VA 33:78:00	MT 1 Circuit Board		M T 1 シ ー ト			10
※	VA 33:79:00	MT 2 Circuit Board		M T 2 シ ー ト			11
※	VA 33:80:00	MT 3 Circuit Board		M T 3 シ ー ト			09
	IG 06:92:00	IC	NJM2041DD	I C	Operational Amp.		05
	IA 09:37:00	Transistor	2SA937 (Q,R,S)	ト ラ ン ジ ス タ			03
	IC 20:21:80	"	2SC2021(Q,R,S)	"			03
	IF 00:17:20	LED	LN222RP	フ ッ ク 付 L E D	Red		03
	HT 41:00:20	Trimmer Potentiometer	B1kΩ SR19R	半 固 定 V R			02
※	VA 25:86:00	Push Switch	SPUY35 3	プ ッ シ ュ S W	MT 1		04
※	VA 25:85:00	"	SPUY25 2	"	MT 2		03

※New Parts (新規部品) NR

ランク : Japan only

Ref. No.	Part No.	Description	部品名		Remarks	Common Model	Markets	ランク
※	VA 03:02:00	Connector Base Pin	5483-02A	コネクタベースピン				01
	VA 03:04:00	"	5483-04A	"	MT 2			01
	VA 03:05:00	"	5483-05A	"				01
	VA 03:06:00	"	5483-06A	"	MT 1			01
※	VA 29:91:00	LED Connector	(S)	L E D コネクタ	MT 1,MT 2			01
※	VA 33:82:00	DC 1 Circuit Board		D C 1 シート			J	19
※	VA 33:83:00	"		"			U,C	
※	VA 33:84:00	"		"			H	
	IG 00:13:90	IC	NJM4558DV	I C	Operational Amp.			03
	IA 09:99:10	Transistor	2SA999 (E,F)	トランジスタ				03
	IB 05:96:30	"	2SB596 (O,Y)	"				04
	IC 23:20:10	"	2SC2320 (E,F)	"				03
	ID 05:26:30	"	2SD526 (O,Y)	"				04
	IH 00:00:30	Diode	10D1	ダイオード				01
	IF 00:21:40	Zener Diode	RD5.6EB2	ツェナーダイオード				01
	HM 55:22:20	Wire Wound Resistor	0.22Ω 5W	セメント抵抗				02
※	HW 91:41:50	Fuse Resistor	15Ω 1W	ヒューズ抵抗				02
※	HT 41:04:00	Trimmer Potentiometer	B2.2kΩ	半固定 V R				01
	KB 00:14:90	Fuse	10A 250V	ヒューズ			J	01
	KB 00:13:90	"	10A 250V	"			U,C	
	LA 00:05:30	Lug Terminal		ラグ端子				01
	LB 20:05:70	Fuse Holder Pin		ヒューズホルダーピン				01
	LB 60:77:70	Socket, Transistor		トランジスタソケット				02
	ED 33:00:66	Bind Head Screw	3×6 FCM3-BL	バインド小ネジ				01
※	VA 33:85:00	DC 2 Circuit Board		D C 2 シート			J	20
※	VA 33:86:00	"		"			U,C	
※	VA 33:87:00	"		"			H	
	IG 00:13:90	IC	NJM4558DV	I C	Operational Amp.			03
	IC 22:40:00	Transistor	2SC2240 (GR,BL)	トランジスタ				03
	IC 23:20:10	"	2SC2320 (E,F)	"				03
	ID 05:26:30	"	2SD526 (O,Y)	"				04
	IH 00:00:30	Diode	10D1	ダイオード				01
	IH 00:02:80	"	1D2C1	"				03
	IH 00:14:00	"	1G4B1	"				03
	IF 00:21:40	Zener Diode	RD5.6EB2	ツェナーダイオード				01
	IF 00:56:50	"	RD33EB2	"				01
	IF 00:56:60	"	RD27EB3	"				01
	IF 00:56:70	"	RD24EB2	"				01
	IF 00:17:20	LED	LN222RP	フック付 L E D	Red			03
	HL 31:32:20	Metal Oxide Film Resistor	2.2Ω 1W	酸化金抵抗				01
	HM 75:22:20	Wire Wound Resistor	0.22Ω 5W	セメント抵抗				02

※New Parts (新規部品) NR

ランク: Japan only

Ref. No.	Part No.	Description	部 品 名	Remarks	Common Model	Markets	ランク
※	HW 91:41:50	Fuse Resistor	15Ω 1W	ヒューズ抵抗			02
※	HT 41:04:00	Trimmer Potentiometer	B2.2kΩ	半固定VR			01
	FL 18:92:20						
※	VA 27:41:00	Electrolytic Cap.	2200μF 80V	ケミコン			06
	UJ 29:64:70	"	4.7Ω 100V	"			01
	UW 63:91:00	"	1000μF 16V	"			03
	FH 22:34:70	Ceramic Cap.	0.0047μF 500V	セラコン			01
	KB 00:03:50	Fuse	2A 250V	ヒューズ		J	01
	KB 00:14:90	"	10A 250V	"		J	01
	KB 00:27:60	"	2A 250V	"		U,C	
	KB 00:13:90	"	10A 250V	"		U,C	
	KB 00:07:50	"	2A 250V	"		H	
※	CB 10:15:30	Connector Housing	5480-02	コネクタハウジング			01
	CB 04:83:60	"	5395-02	"			01
	BB 00:58:20	Contact Pin	5379PBT	コンタクトピン			01
	BB 00:55:40	"	5494T	"			01
	CB 06:92:50	Binding Tie		インシュロックタイ			01
	LA 00:05:30	Lug Terminal		ラグ端子			01
	LB 20:05:70	Fuse Holder Pin		ヒューズホルダーピン			01
	LB 60:77:70	Socket, Transistor		トランジスタソケット			02
	ED 33:00:66	Bind Head Screw	3×6 FCM3-BI	バインド小ネジ			01
※	VA 33:88:00	DC 3 Circuit Board		DC 3 シート			16
	IH 00:00:30	Diode	10D1	ダイオード			01
※	VA 91:27:00	Relay	DC12V	リレー			08
	LA 00:05:30	Lug Terminal		ラグ端子			01
※	VA 33:89:00	EXT Circuit Board		EXT シート			11
※	VA 31:32:00	Rotary Switch	8RZL	ロータリーSW			06
※	VA 31:33:00	"	8RZR	"			05
※	VA 33:90:00	LP Circuit Board		LP シート			17
	IB 05:96:00	Transistor	2SB596LBB (O,Y)	トランジスタ			04
	IC 23:20:10	"	2SC2320 (E,F)	"			03
	HL 31:31:50	Metal Oxide Film Resistor	1.5Ω 1W	酸化金抵抗			01
※	VA 31:34:00	Rotary Potentiometer	B5kΩ	ロータリーVR			04
	IL 00:06:90	Insulator		放熱シート			01
	CB 07:28:80	Insulation Bush		絶縁ブッシュ			01
	ED 32:60:56	Bind Head Screw	2.6×5 FCM3-BI	バインド小ネジ			01
	EA 32:60:86	Pan Head Screw	2.6×8 FCM3-BI	ナベ小ネジ			01
※	VA 71:04:00	JK 1 Circuit Board		JK 1 シート			07
	LB 60:69:40	Phone Jack	Stereo	ホーンジャック			03

※New Parts (新規部品) NR

ランク: Japan only

Ref. No.	Part No.	Description	部 品 名	Remarks	Common Model	Markets	ランク
※	VA 71 05 00	JK 2 Circuit Board		J K 2 シ ー ト			11
	LB 20 27 00	Phone Jack	Stereo	ホ ー ン ジ ャ ッ ク			03
※	VA 71 30 00	AUX 1 Circuit Board		A U X 1 シ ー ト			36
	IG 10 25 00	IC	NE5532P	I C	Dual Operational Amp.		06
	IC 20 21 80	Transistor	2SC2021(O,R,S)	ト ラ ン ジ ス タ			03
	IF 00 14 00	Diode	1SS82	ダ イ オ ー ド			02
	HU 07 44 70	Metal Film Resistor	47Ω 1/4W	金 属 被 膜 抵 抗			02
	HU 07 52 20	"	220Ω 1/4W	"			02
	HU 07 61 00	"	1kΩ 1/4W	"			02
	HU 07 63 30	"	3.3kΩ 1/4W	"			02
	HU 07 66 20	"	6.2kΩ 1/4W	"			02
	HU 07 67 50	"	7.5kΩ 1/4W	"			02
	HU 07 68 20	"	8.2kΩ 1/4W	"			02
	HU 07 71 00	"	10kΩ 1/4W	"			02
	HU 07 72 40	"	24kΩ 1/4W	"			02
	HU 07 74 70	"	47kΩ 1/4W	"			02
	HU 07 81 00	"	100kΩ 1/4W	"			02
※	VA 24 95 00	Resistor Array	RKL4A-103F	抵 抗 ア レ イ			01
	HW 90 41 00	Fuse Resistor	10Ω 1/2W	ヒ ュ ー ズ 抵 抗			02
※	VA 25 59 00	Rotary Potentiometer	A10kΩ	ロ ー タ リ ー V R			04
※	VA 25 80 00	Push Switch	SPUJ12	プ ッ シ ュ S W			02
	VA 03 04 00	Connector Base Pin	5483-04A	コ ネ ク タ ベ ー ス ピ ン	TE		01
	VA 03 05 00	"	5483-05A	"	TE		01
	VA 03 08 00	"	5483-08A	"	TE		01
	VA 03 10 00	"	5483-10A	"	TE		01
※	VA 25 16 00	Connector Header	14P FRC2	コ ネ ク タ ヘ ッ ダ ー			05
※	VA 25 18 00	"	50P FRC2	"			07
※	VA 29 91 00	LED Connector	(S)	L E D コ ネ ク タ			01
	LA 00 36 90	Lug Terminal	4φ	ラ グ 端 子			01
※	VA 71 31 00	AUX 2 Circuit Board		A U X 2 シ ー ト			25
	IG 07 67 00	IC	NE5534P	I C	Operational Amp.		05
	IG 10 25 00	"	NE5532P	"	Dual Operational Amp.		06
	HU 07 54 30	Metal Film Resistor	430Ω 1/4W	金 属 被 膜 抵 抗			02
	HU 07 71 00	"	10kΩ 1/4W	"			02
	HU 07 73 60	"	36kΩ 1/4W	"			02
	HU 07 73 90	"	39kΩ 1/4W	"			02
	HW 90 41 00	Fuse Resistor	10Ω 1/2W	ヒ ュ ー ズ 抵 抗			02
※	VA 25 80 00	Push Switch	SPUJ12	プ ッ シ ュ S W			02
※	VA 29 90 00	LED Connector	(L) 2P	L E D コ ネ ク タ	SE		01
※	CB 10 15 50	Connector Housing	5480-04	コ ネ ク タ ハ ウ ジ ン グ			01
※	CB 10 15 60	"	5480-05	"			01

※New Parts (新規部品) NR

ランク : Japan only

Ref. No.	Part No.	Description	部 品 名	Remarks	Common Model	Markets	ランク
※	CB 10 15 90	Connector Housing	5480-08	コネクタハウジング			01
	CB 10 16 10	"	5480-10	"			01
	BB 00 58 20	Contact Pin	5479PBT	コンタクトピン			01
※	VA 71 32 00	CO Circuit Board		C O シ ー ト			10
	UJ 13 91 00	Electrolytic Cap.	1000 μ F 16V	ケ ミ コ ン			02
	UJ 14 91 00	"	1000 μ F 25V	"			03
	KA 40 07 60	Slide Switch	SSB042E8	ス ラ イ ド S W			04
※	CB 10 15 30	Connector Housing	5480-02	コネクタハウジング			04
	BB 00 58 20	Contact Pin	5479PBT	コンタクトピン			01
	LA 00 04 40	Lug Terminal	2 ϕ	歯付アースラグ端子			01
※	VA 71 33 00	MB Circuit Board		M B シ ー ト			40
	VA 03 09 00	Connector Base Pin	5483-09A	コネクタベースピン	TE		01
	VA 03 10 00	"	5483-10A	"	TE		01
	VA 03 12 00	"	5483-12A	"	TE		01
	VA 03 13 00	"	5483-13A	"	TE		01
	VA 03 14 00	"	5483-14A	"	TE		01
	VA 03 15 00	"	5483-15A	"	TE		01
※	VA 25 49 00	Receptacle	50P	F R C 2 コネクタ	TE		07
※	VA 25 50 00	"	16P	"	TE		05
	LB 40 07 30	Connector Housing	4P Red	コネクタハウジング	LB		01
	LB 30 11 30	"	3P Red	"	2B		01
	LB 20 19 30	"	2P	"	LB		01
	LB 10 18 30	Contact Pin	LLF-61T-2.0	コンタクトピン			01
※	VA 71 34 00	IMB Circuit Board		I M B シ ー ト			08
	KA 40 12 70	Slide Switch	SSS212	ス ラ イ ド S W			03
	VA 03 12 00	Connector Base Pin	5483-12A	コネクタベースピン	TE		01
※	VA 25 19 00	Connector	14P	コ ネ ク タ	TE		06
※	VA 71 95 00	COM 1 Circuit Board		C O M 1 シ ー ト			55
	IG 06 92 00	IC	NJM2041DD	I C	Operational Amp.		05
	IG 07 67 00	"	NE5534P	"	"		05
	IG 10 25 00	"	NE5532P	"	"		06
※	XA 21 70 01	"	BX7097	"	HA		10
※	XA 24 30 01	"	XR-2206CP	"	Function Generator		12
	IG 00 16 80	"	TC4006BP	"	18-Stage Static Shift Register		06
	IG 00 17 90	"	TC4030BP	"	Quad Exclusive-or Gate		03
	IA 09 37 00	Transistor	2SA937 (Q,R,S)	ト ラ ン ジ ス タ			03
	IC 20 21 80	"	2SC2021 (Q,R,S)	"			03
	IF 00 00 40	Diode	1S1555	ダ イ オ ード			01
	IF 00 14 00	"	1SS82	"			02
	IF 00 14 70	Zener Diode	RD6.2EB2	ツェナーダイオード			01
	VA 24 75 00	LED	LN342GP	フック付LED	Green		01

※New Parts (新規部品) NR

ランク : Japan only

Ref. No.	Part No.	Description	部 品 名	Remarks	Common Model	Markets	ランク
	HU:07:42:70	Metal Film Resistor	27Ω 1/4W	金属被膜抵抗			02
	HU:07:54:30	"	430Ω 1/4W	"			02
	HU:07:54:70	"	470Ω 1/4W	"			02
	HU:07:57:50	"	750Ω 1/4W	"			02
	HU:07:62:00	"	2kΩ 1/4W	"			02
	HU:07:62:20	"	2.2kΩ 1/4W	"			02
	HU:07:63:30	"	3.3kΩ 1/4W	"			02
	HU:07:66:20	"	6.2kΩ 1/4W	"			02
	HU:07:67:50	"	7.5kΩ 1/4W	"			02
	HU:07:71:00	"	10kΩ 1/4W	"			02
	HU:07:71:20	"	12kΩ 1/4W	"			02
	HU:07:71:80	"	18kΩ 1/4W	"			02
	HU:07:72:40	"	24kΩ 1/4W	"			02
	HU:07:73:60	"	36kΩ 1/4W	"			02
	HU:07:73:90	"	39kΩ 1/4W	"			02
※	VA:25:92:00	Resistor Array	RKL8S-474J	抵抗アレイ			01
	HW:90:41:00	Fuse Resistor	10Ω 1/2W	ヒューズ抵抗			02
※	VA:25:59:00	Rotary Potentiometer	A10kΩ	ロータリーVR			04
※	VA:25:57:00	"	A10kΩ×2	二連ロータリーVR			04
※	VA:25:58:00	"	C100kΩ×2	"			04
	HT:56:01:00	Trimmer Potentiometer	B100kΩ	半固定VR			05
※	VA:25:81:00	Push Switch	SPUJ12	プッシュSW			03
※	VA:25:89:00	"	SPUJ40 4	"			05
※	VA:25:90:00	"	SPUJA0 10	"			07
	KC:00:19:00	Relay	RY-12W	リレ-			07
※	VA:24:81:00	"	SY-12	"			06
※	VA:03:02:00	Connector Base Pin	5483-02A	コネクタベースピン	TE		01
	VA:03:03:00	"	5483-03A	"	TE		01
	VA:03:04:00	"	5483-04A	"	TE		01
	VA:03:05:00	"	5483-05A	"	TE		01
	VA:03:06:00	"	5483-06A	"	TE		01
	VA:03:07:00	"	5483-07A	"	TE		01
	VA:03:08:00	"	5483-08A	"	TE		01
※	VA:25:16:00	Connector Header	14P FRC2	コネクタヘッダー	TE		05
※	VA:25:18:00	"	50P FRC2	"			07
※	CB:10:15:30	Connector Housing	5480-02	コネクタハウジング			01
※	CB:10:15:60	"	5480-05	"			01
	BB:00:58:20	Contact Pin	5479PBT	コンタクトピン			01
	LA:00:36:90	Lug Terminal		ラグ端子			01
※	VA:71:96:00	COM 2 Circuit Board		COM 2 シート			23
	IG:07:67:00	IC	NE5534P	I C	Operational Amp.		05
	IC:20:21:80	Transistor	2SC2021(O,R,S)	トランジスタ			03
	IF:00:17:20	LED	LN222RP	フック付LED	Red		03
※	VA:24:75:00	"	LN342GP	"	Green		01

※ New Parts (新規部品) NR

ランク : Japan only

Ref. No.	Part No.	Description	部品名		Remarks	Common Model	Markets	ランク
	HU 07:54:30	Metal Film Resistor	430Ω	1/4W	金属被膜抵抗			02
	HU 07:69:10	"	9.1kΩ	1/4W	"			02
	HU 07:71:00	"	10kΩ	1/4W	"			02
	HU 07:71:20	"	12kΩ	1/4W	"			02
	HU 07:73:60	"	36kΩ	1/4W	"			02
	HU 07:73:90	"	39kΩ	1/4W	"			02
※	VA 25:80:00	Push Switch	SPUJ12		プッシュSW			02
※	VA 25:81:00	"	SPUJ12		"			02
※	VA 25:82:00	"	SPUJ12		"			03
※	VA 25:88:00	"	SPUJ50 5		"			06
※	VA 25:91:00	"	SPUJ50 5		"			05
※	CB 10:15:30	Connector Housing	5480-02		コネクタハウジング			01
	CB 10:15:40	"	5480-03		"			01
※	CB 10:15:50	"	5480-04		"			01
※	CB 10:15:60	"	5480-05		"			01
	CB 10:15:70	"	5480-06		"			01
	CB 10:15:80	"	5480-07		"			01
	CB 10:15:90	"	5480-08		"			01
	BB 00:58:20	Contact Pin	5479PBT		コンタクトピン			01
※	VA 71:97:00	COM 3 Circuit Board			COM 3 シート			16
	IG 05:66:00	IC	NJM386D		I C	Power Amp.		04
	IG 06:35:00	"	NJM555		"	Timer		03
	IA 09:37:00	Transistor	2SA937 (Q,R,S)		トランジスタ			03
	IC 20:21:80	"	2SC2021 (Q,R,S)		"			03
※	VA 27:34:00	LED Display	LN0202RP2		LEDディスプレイ			03
※	VA 27:35:00	"	LN0202GP3		"			03
※	VA 27:36:00	"	LN0202YP4		"			04
	HL 31:41:50	Metal Oxide Film Resistor	15Ω	1W	酸化金抵抗			01
	HW 90:41:00	Fuse Resistor	10Ω	1/2W	ヒューズ抵抗			02
	LB 20:25:20	Phone Jack	Stereo		ホンジャック			03
※	VA 03:02:00	Connector Base Pin	5483-02A		コネクタベースピン	TE		01
	VA 03:03:00	"	5483-03A		"	TE		01
	VA 03:04:00	"	5483-04A		"	TE		01
	VA 03:05:00	"	5483-05A		"	TE		01
※	CB 10:15:50	Connector Housing	5480-04		コネクタハウジング			01
	BB 00:58:20	Contact Pin	5479PBT		コンタクトピン			01
※	VA 73:36:00	MAS 3 Circuit Board			M A S 3 シート			12
	IG 06:92:00	IC	NJM2041DD		I C	Operational Amp.		05
	IC 20:21:80	Transistor	2SC2021 (Q,R,S)		トランジスタ			03
	IF 00:00:40	Diode	1S1555		ダイオード			01
	IF 00:21:40	Zener Diode	RD5.6EB2		ツェナーダイオード			01

※New Parts (新規部品) NR

ランク: Japan only

Ref. No.	Part No.	Description	部 品 名	Remarks	Common Model	Markets	ランク
※	VA 26:47:00	LED	LN328GP	フック付LED	Green		02
	HU 07:48:20	Metal Film Resistor	82Ω 1/4W	金属被膜抵抗			02
	HU 07:54:30	"	430Ω 1/4W	"			02
	HU 07:61:00	"	1kΩ 1/4W	"			02
	HU 07:61:80	"	1.8kΩ 1/4W	"			02
	HU 07:62:00	"	2kΩ 1/4W	"			02
	HU 07:71:00	"	10kΩ 1/4W	"			02
	HU 07:71:20	"	12kΩ 1/4W	"			02
	HU 07:71:30	"	13kΩ 1/4W	"			02
	HW 90:41:00	Fuse Resistor	10Ω 1/2W	ヒューズ抵抗			02
	HT 56:00:90	Trimmer Potentiometer	B50kΩ	半固定VR			05
※	VA 03:02:00	Connector Base Pin	5483-02A	コネクタベースピン	TE		01
	VA 03:03:00	"	5483-03A	"	TE		01
	CB 10:15:70	Connector Housing	5480-06	コネクタハウジング			01
※	CB 10:15:30	"	5480-02	"			01
	BB 00:58:20	Contact Pin	5479PBT	コンタクトピン			01
※	VA 75:58:00	RTN 1 Circuit Board		RTN1シート			52
※	VA 24:75:00	LED	LN342GP	フック付LED	Green		01
※	VA 24:76:00	"	LN442YP	"	Yellow		01
※	VA 25:57:00	Rotary Potentiometer	A10kΩ×2	2連ロータリーVR			04
※	VA 25:54:00	"	A20k-C20kΩ	"			04
※	VA 25:56:00	"	RK9BD0	"			07
※	VA 25:81:00	Push Switch	SPUJ12	プッシュSW			03
※	VA 25:87:00	"	SPUJ50 5	"			06
※	VA 25:89:00	"	SPUJ40 4	"			05
※	VA 25:16:00	Connector Header	14P FRC2	コネクタヘッダー	TE		05
※	VA 25:18:00	"	50P FRC2	"	TE		07
※	VA 29:91:00	LED Connector	(S)	LEDコネクタ			01
	LA 00:36:90	Lug Terminal	4φ	ラグ端子			01
※	VA 75:59:00	RTN 2 Circuit Board		RTN2シート			21
※	VA 24:75:00	LED	LN342GP	フック付LED	Green		01
※	VA 25:81:00	Push Switch	SPUJ12	プッシュSW			06
※	VA 25:88:00	"	SPUJ50 5	"			06
※	VA 25:89:00	"	SPUJ40 4	"			05
※	VA 29:90:00	LED Connector	(L) 2P	LEDコネクタ	SE		01
※	VA 75:60:00	RTN 3 Circuit Board		RTN3シート			15
※	VA 27:33:00	Push Switch	SPUY82 8	プッシュSW			07
※	VA 25:17:00	Receptacle	16P	FRC2コネクタ	TE		05
※	VA 29:90:00	LED Connector	(L) 2P	LEDコネクタ	SE		01

※New Parts (新規部品) NR

ランク: Japan only

Ref. No.	Part No.	Description	部 品 名	Remarks	Common Model	Markets	ランク
※	VA 75 61 00	MAS 1 Circuit Board		M A S 1 シート			33
	IG 07 67 00	IC	NE5534P	I C	Operational Amp.		05
	IG 10 25 00	"	NE5532P	"	"		06
	IC 20 21 80	Transistor	2SC2021(Q,R,S)	ト ラ ン ジ ス タ			03
	IF 00 14 00	Diode	1SS82	ダ イ オード			02
	HU 07 44 70	Metal Film Resistor	47Ω 1/4W	金 属 被 膜 抵 抗			02
	HU 07 47 50	"	75Ω 1/4W	"			02
	HU 07 52 20	"	220Ω 1/4W	"			02
	HU 07 54 30	"	430Ω 1/4W	"			02
	HU 07 63 30	"	3.3kΩ 1/4W	"			02
	HU 07 66 20	"	6.2kΩ 1/4W	"			02
	HU 07 67 50	"	7.5kΩ 1/4W	"			02
	HU 07 71 00	"	10kΩ 1/4W	"			02
	HU 07 71 80	"	18kΩ 1/4W	"			02
	HU 07 73 30	"	33kΩ 1/4W	"			02
	HU 07 73 60	"	36kΩ 1/4W	"			02
	HU 07 73 90	"	39kΩ 1/4W	"			02
	HU 07 74 70	"	47kΩ 1/4W	"			02
	HU 07 81 00	"	100kΩ 1/4W	"			02
※	VA 24 95 00	Resistor Array	RKL4A-103F	抵 抗 ア レ イ			01
	HW 90 41 00	Fuse Resistor	10Ω 1/2W	ヒ ュ ー ズ 抵 抗			02
※	VA 25 51 00	Rotary Potentiometer	A20kΩ	ロ ー タ リ ー V R			04
※	VA 25 59 00	"	A10kΩ	"			04
※	VA 25 60 00	"	A20kΩ	"			04
※	VA 25 54 00	"	A20k-C20kΩ	2 連 ロータリー V R			04
	KA 40 12 70	Slide Switch	SSS212	ス ラ イ ド S W			03
	KA 40 13 60	"	SSS313	"			02
※	VA 25 80 00	Push Switch	SPUJ12	プ ッ シ ュ S W			02
※	VA 25 81 00	"	SPUJ12	"			03
	VA 03 03 00	Connector Base Pin	5483-03A	コネクタベースピン	TE		01
	VA 03 05 00	"	5483-05A	"	TE		01
	VA 03 06 00	"	5483-06A	"	TE		01
※	VA 25 16 00	Connector Header	14P FRC2	コネクタヘッダー	TE		05
※	VA 25 18 00	"	50P FRC2	"	TE		07
	CB 10 15 40	Connector Housing	5480-03	コネクタハウジング			01
※	CB 10 15 50	"	5480-04	"			01
※	CB 10 15 60	"	5480-05	"			01
	CB 10 15 70	"	5480-06	"			01
	CB 10 15 80	"	5480-07	"			01
	BB 00 58 20	Contact Pin	5479PBT	コ ン タ ク ト ピ ン			01
	LA 00 36 90	Lug Terminal	4φ	ラ グ 端 子			01
※	VA 75 62 00	MAS 2 Circuit Board		M A S 2 シート			15
	IG 10 25 00	IC	NE5532P	I C	Operational Amp.		06
	IC 20 21 80	Transistor	2SC2021(Q,R,S)	ト ラ ン ジ ス タ			03

※ New Parts (新規部品) NR

ランク: Japan only

Ref. No.	Part No.	Description	部品名	Remarks	Common Model	Markets	ランク
	HU:07:44:70	Metal Film Resistor	47Ω 1/4W 金属被膜抵抗				02
	HU:07:61:00	"	1kΩ 1/4W "				02
	HU:07:66:20	"	6.2kΩ 1/4W "				02
	HU:07:71:00	"	10kΩ 1/4W "				02
	HU:07:71:80	"	18kΩ 1/4W "				02
	HU:07:72:00	"	20kΩ 1/4W "				02
	HU:07:75:60	"	56kΩ 1/4W "				02
*	VA:25:60:00	Rotary Potentiometer	A20kΩ	ロータリーVR			04
*	VA:25:80:00	Push Switch	SPUJ12	プッシュSW			02
*	CB:10:15:60	Connector Housing	5480-05	コネクタハウジング			01
	BB:00:58:20	Contact Pin	5479PBT	コンタクトピン			01
*	VA:75:63:00	ST 1 Circuit Board		ST 1 シート			42
*	VA:25:59:00	Rotary Potentiometer	A10kΩ	ロータリーVR			04
*	VA:25:80:00	Push Switch	SPUJ12	プッシュSW			02
*	VA:25:81:00	"	SPUJ12	"			03
*	VA:25:16:00	Connector Header	14P FRC2	コネクタヘッダー	TE		05
*	VA:25:18:00	"	50P FRC2	"	TE		07
*	VA:29:91:00	LED Connector	(S)	LEDコネクタ			01
	LA:00:36:90	Lug Terminal	4φ	歯付アースラグ端子			01
*	VA:75:64:00	ST 2 Circuit Board		ST 2 シート			22
*	VA:25:80:00	Push Switch	SPUJ12	プッシュSW			02
*	VA:25:81:00	"	SPUJ12	"			03
*	VA:29:90:00	LED Connector	(L) 2P	LEDコネクタ	SE		01
*	VA:77:02:00	DC 4 Circuit Board		DC 4 シート			11
	IH:00:03:90	Bridge Rectifier	KBH-2504	ブリッジダイオード			09
	FZ:00:06:50	Mylar Cap.	0.01μF 630V	マイラーコン			02
*	VB:09:86:00	DC 5 Circuit Board		DC 5 シート		J	08
*	VB:09:87:00	"		"		U,C	
*	VB:09:88:00	"		"		H	
	HM:55:51:50	Wire Wound Resistor	150Ω 5W	セメント抵抗			02
	LA:00:05:30	Lug Terminal		ラグ端子			01

*New Parts (新規部品) NR

ランク: Japan only

A

B

C

D

E

PM3000/PW3000

MAIN FRAME (外装組立)

1

2

3

4

5

6

7

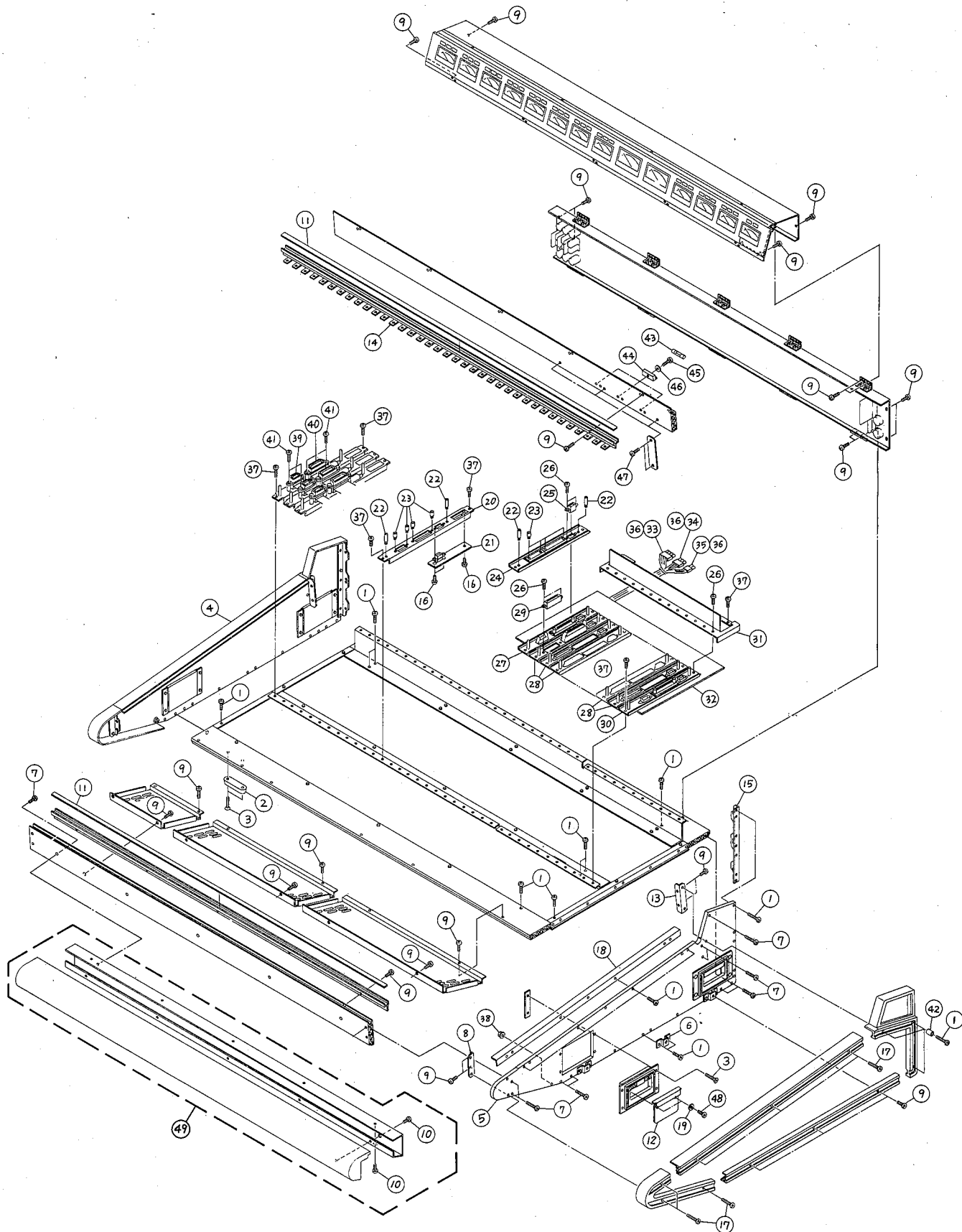

Ref. No.	Part No.	Description	部 品 名	Remarks	Common Model	Markets	ランク
1	ED 34 01 66	Bind Head Screw	4x16 FCM3-BI	バインド小ネジ			01
2	VA 30 30 00	Foot		脚			09
3	EO 34 02 52	Flat Head Tapping Screw	4x25 FCM3-BI	皿タッピングネジ			01
4	VB 04 67 00	Side Board	Left (Front)	側板			10
4	VB 04 69 00	"	Left (Rear)	"			10
5	VB 04 68 00	"	Right (Front)	"			10
5	VB 04 70 00	"	Right (Rear)	"			10
6	VA 30 32 00	Angle Bracket	Left	モ-ルアングル			07
7	ED 34 02 06	Bind Head Screw	4x20 FCM3-BI	バインド小ネジ			01
8	VA 30 29 00	Angle Bracket	Front	モ-ルアングル			09
9	ED 34 00 86	Bind Head Screw	4x8 FCM3-BI	バインド小ネジ			01
10	Ei 34 01 26	Bind Head Tapping Screw	4x12 FCM3-BI	バインドタッピングネジ			01
11	VA 70 54 00	Module Indicator		表示チップ	PM3000-24		11
"	VA 70 53 00	"		"	PM3000-32		12
"	VA 70 55 00	"		"	PM3000-40		12
"	VB 21 86 00	"		"	PM3000C-32		12
"	VB 21 87 00	"		"	PM3000C-40		12
12	VA 78 14 00	Handle Bracket		取手金具			08
13	VA 32 02 00	Angle Bracket	Right	モ-ルアングル			09
14	VA 32 33 00	Trim	Rear	表示サッシ	PM3000-24		38
"	VA 32 34 00	"	"	"	PM3000-32, PM3000C-32		42
"	VA 32 35 00	"	"	"	PM3000-40, PM3000C-40		47
15	VA 30 46 00	Rear Panel Bracket		リアパネル金具			13
16	ED 33 00 66	Bind Head Screw	3x6 FCM3-BI	バインド小ネジ			01
17	ED 34 02 56	"	4x25 FCM3-BI	"			01
18	VA 30 52 00	Trim		飾りサッシ			14
19	EV 20 30 46	Flat Washer	4S FCM3-BI	平座金			01
20	VA 30 91 00	Connector Bracket	(IN)	コネクタモジュール			08
21	VA 71 34 00	IMB Circuit Board		I M B シ-ト			08
22	VA 32 43 00	Guide Pin		ガイドピン			03
23	VA 32 44 00	Connector Post		コネクタ-ポスト			04
24	VA 71 19 00	Connector Bracket	(RTN A)	コネクタモジュール			16
25	VA 25 19 00	Connector	14P TE	コネクタプラグ			06
26	ED 33 00 56	Bind Head Screw	3x5 FCM3-BI	バインド小ネジ			01
27	VA 71 20 00	Connector Bracket	(RTN B)	コネクタモジュール			16
28	VA 71 21 00	"	(MAS)	"			09
29	VA 25 20 00	Connector	50P TE	コネクタプラグ			08
30	VA 71 22 00	Connector Bracket	(COMM)	コネクタモジュール			14
31	VA 73 47 00	Holder		ボード取付金具	PM3000-24, PM3000-32, PM3000-40		17
"	VB 21 85 00	"		"	PM3000C-32, PM3000C-40		19
32	VA 71 33 00	MB Circuit Board		M B シ-ト			40
33	LB 40 07 30	Connector Housing	LP-04V-R	コネクタハウジング	Red		01
34	LB 30 11 30	"	LP-03V-R	"	Red		01
35	LB 20 19 30	"	2P	"			01
36	LB 10 18 30	Contact Pin		コンタクトピン			01
37	ED 33 01 06	Bind Head Screw	3x10 FCM3-BI	バインド小ネジ			01
38	ES 10 00 50	Flange Nut	4S FCM3-BI	フランジ付六角ナット			
39	VA 75 17 00	Flat Cable	24CH 24C	フラットケーブル	PM3000-24		50
"	VA 75 19 40	"	32CH 24C	"	PM3000-32		56
"	VA 75 21 40	"	40CH 24C	"	PM3000-40		63
"	VB 18 03 40	"	32CM 24C	"	PM3000C-32		57
"	VB 18 07 40	"	40CM 24C	"	PM3000C-40		63
40	VA 75 16 40	"	24CH 50C	"	PM3000-24		57

*New Parts (新規部品) NR

ランク : Japan only

Ref. No.	Part No.	Description			部 品 名	Remarks	Common Model	Markets	ランク
※ 40	VA 75 18 40	Flat Cable	32CH	50C	フラットケーブル	PM3000-32			65
※ "	VA 75 20 40	"	40CH	50C	"	PM3000-40			72
※ "	VB 18 01 00	"	32CM	50C	"	PM3000C-32			65
※ "	VB 18 05 40	"	40CM	50C	"	PM3000C-40			72
41	ED 33 00 86	Bind Head Screw	3×8	FCM3-BI	バインド小ネジ				01
※ 42	VB 24 66 00	Spacer			スペーサー				01
※ 43	VB 24 52 00	Fuse	3.15A	250V	ヒューズ				01
44	LB 20 12 10	Fuse Holder			ヒューズホルダー				02
45	Ei 33 01 06	Bind Head Tapping Screw	3×10	FCM3-BI	バインドタッピングネジ				01
46	EV 20 30 36	Flat Washer	3S	FCM3-BI	平 座 釜				01
47	Ei 33 00 86	Bind Head Tapping Screw	3×8	FCM3-BI	バインドタッピングネジ				01
48	EF 34 02 06	Oval Head Screw	4×20	FCM3-BI	丸 皿 小 ネ ジ				01
※ 49	VA 72 70 00	Arm Rest Assembly			パ ッ ド Ass'y	PM3000-24			44
※ "	VA 75 81 00	"			"	PM3000-32 PM3000C-32			47
※ "	VA 75 82 00	"			"	PM3000-40 PM3000C-40			50
	MZ 81 67 70	DC Power Supply Cable			D C ケ ー ブ ル				17
	LB 60 57 70	Connector	SRCN 6A21-10P		丸 型 コ ネ ク タ	PW3000 side			09
	LB 60 57 80	"	SRCN 6A21-10S		"	PM3000 side			09
※	VA 71 59 00	Cover			ビ ニ ール カ バ ー	PM3000-24			27
※	VA 71 60 00	"			"	PM3000-32 PM3000C-32			28
※	VA 71 61 00	"			"	PM3000-40 PM3000C-40			30
※	VA 75 44 00	Gooseneck Lamp	12V	5W	ラ ン プ				
※	VB 17 52 00	Connector	SRCN 6A25-24P		丸 型 コ ネ ク タ				11
※	TX 80 00 80	Module Extension Cable	50Pin		延 長 ケ ー ブ ル				20
※	TX 80 00 90	"	24Pin		"				18
※	TX 80 01 00	"	14Pin		"				18
※	TX 80 01 10	"	Alligator Clip		"	ワニロクリップ			

※New Parts (新規部品) NR

ランク : Japan only

A

B

C

D

E

PM3000/PW3000

INPUT MODULE (INPUTモジュール)

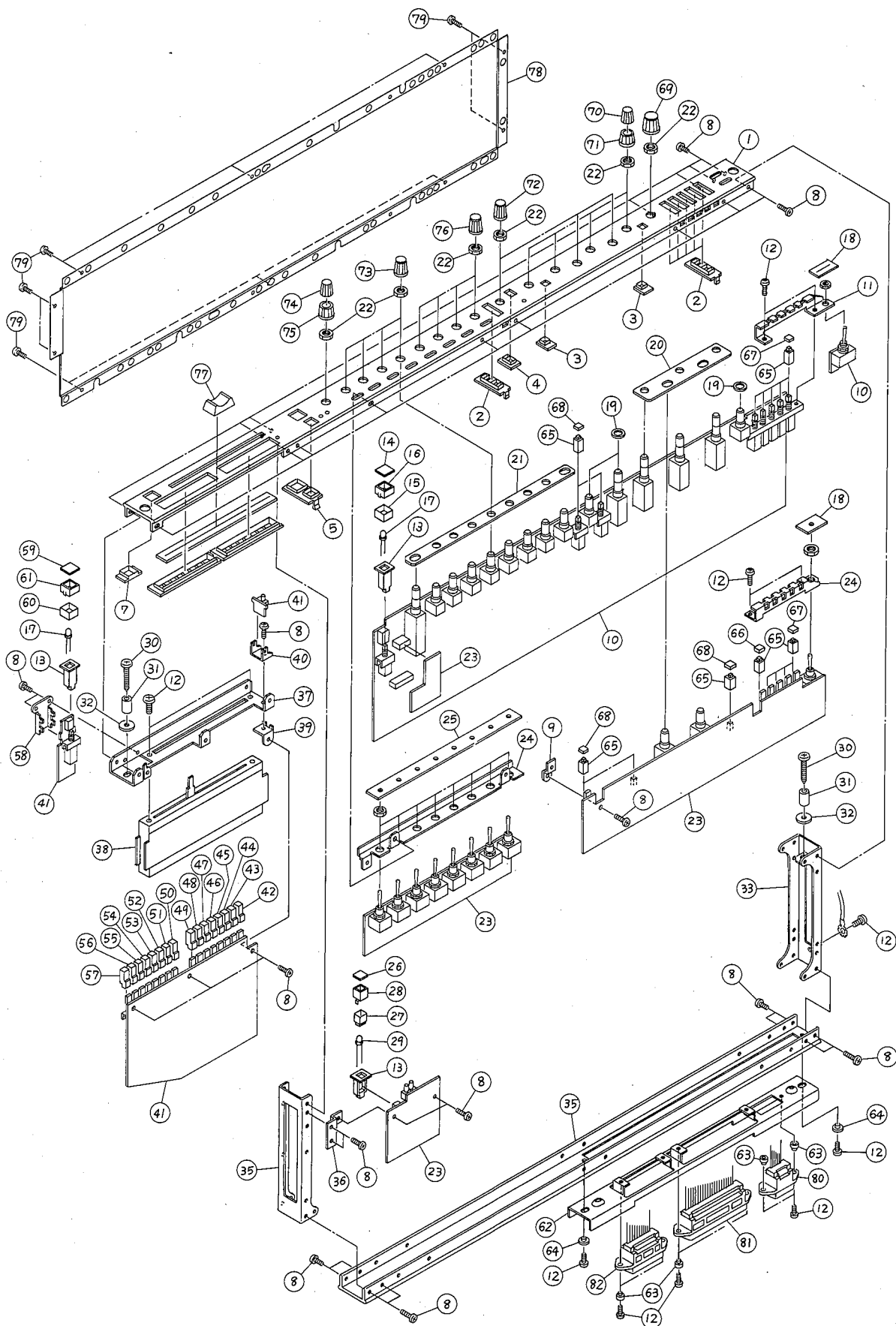

Ref. No.	Part No.	Description	部品名	Remarks	Common Model	Markets	ランク
※	VA: 71: 52: 00	INPUT Module		INPUTモジュール			86
※	1 VA: 26: 61: 00	Module Panel	INPUT	I N パネル			15
※	2 VA: 24: 63: 00	Escutcheon		A S S エスカッション			01
※	3 VA: 24: 64: 00	"		E エスカッション			02
※	4 VA: 24: 65: 00	"		e s エスカッション			02
※	5 VA: 24: 66: 00	"	(IN)	C H エスカッション			02
※	6 VA: 24: 78: 00	"		V M エスカッション			03
※	7 VA: 24: 79: 00	"	(IN)	C U E エスカッション			02
※	8 ED: 32: 60: 56	Bind Head Screw	2.6x5 FCM3-BI	バインド小ネジ			01
※	9 VA: 26: 50: 00	Holder	S	シートホルダー			02
※	10 VA: 30: 19: 00	IN 1 Circuit Board		I N 1 シート			53
※	11 VA: 24: 56: 00	Angle Bracket	Left	A S S アングル			02
※	12 ED: 33: 00: 66	Bind Head Screw	3x6 FCM3-BI	バインド小ネジ			01
※	13 VA: 28: 10: 00	Holder		ノブホルダー			01
※	14 VA: 28: 12: 00	Knob Plate	Large	ノブプレート			03
※	15 VA: 28: 14: 00	Reflector	"	反射板			01
※	16 VA: 28: 07: 00	Knob	"	ノブワク			02
※	17 VA: 73: 48: 00	LED	Yellow	L E D			01
※	18 VA: 25: 71: 00	Switch Cover	(PH)	スイッチカバー			01
※	19 VA: 24: 58: 00	Spacer		V O L スペースサー			01
※	20 VA: 24: 49: 00	"		E Q スペースサー			01*
※	21 VA: 24: 59: 00	"		A U X スペースサー			01
※	22 ES: 20: 01: 80	Hexagonal Nut	7S ZMC2-BI	特殊六角ナット			01
※	23 VA: 30: 20: 00	IN 2 Circuit Board		I N 2 シート			27
※	24 VA: 24: 57: 00	Angle Bracket	Right	A S S アングル			02
※	25 VA: 25: 72: 00	Switch Cover	(AUX)	スイッチカバー			01
※	26 VA: 29: 66: 00	Knob Plate	Small	ノブプレート			01
※	27 VA: 29: 65: 00	Reflector	"	反射板			01
※	28 VA: 29: 68: 00	Knob	"	ノブワク			01
※	29 VA: 73: 17: 00	LED	Red	L E D			01
※	30 VB: 31: 04: 00	Screw, Module		モジュールネジ			01
※	31 VA: 24: 48: 00	Spacer		ネジスペースサー			01
※	32 VA: 24: 62: 00	Module Retainer		モジュール押え			01
※	33 VA: 24: 47: 00	Angle Bracket	Rear	モジュールアングル			03
※	34 VA: 24: 55: 00	"	Front	"			03
※	35 VA: 30: 34: 00	Stay		C H ステータ			07
※	36 VA: 24: 61: 00	Angle Bracket		M U T E アングル			01
※	37 VA: 27: 97: 00	Fader Angle	(IN)	フェーダーアングル			08
※	38 VA: 25: 61: 00	Slide Potentiometer	B10kΩ	スライド V R			11
※	39 VA: 27: 73: 00	Holder	(VM)	シートホルダー			02
※	40 VA: 27: 74: 00	"	(LED)	"			01
※	41 VA: 30: 21: 00	IN 3 Circuit Board		I N 3 シート			19
※	42 VA: 25: 94: 00	Knob	VM	ノブ	VCA 1		02
※	43 VA: 25: 95: 00	"	"	"	VCA 2		02
※	44 VA: 25: 96: 00	"	"	"	VCA 3		02
※	45 VA: 25: 97: 00	"	"	"	VCA 4		02
※	46 VA: 25: 98: 00	"	"	"	VCA 5		02
※	47 VA: 25: 99: 00	"	"	"	VCA 6		02
※	48 VA: 26: 00: 00	"	"	"	VCA 7		02
※	49 VA: 26: 01: 00	"	"	"	VCA 8		02
※	50 VA: 26: 02: 00	"	"	"	MUTE 1		02
※	51 VA: 26: 03: 00	"	"	"	MUTE 2		02
※	52 VA: 26: 04: 00	"	"	"	MUTE 3		02

※New Parts (新規部品) NR

ランク: Japan only

RETURN MODULE (RETURNモジュール)

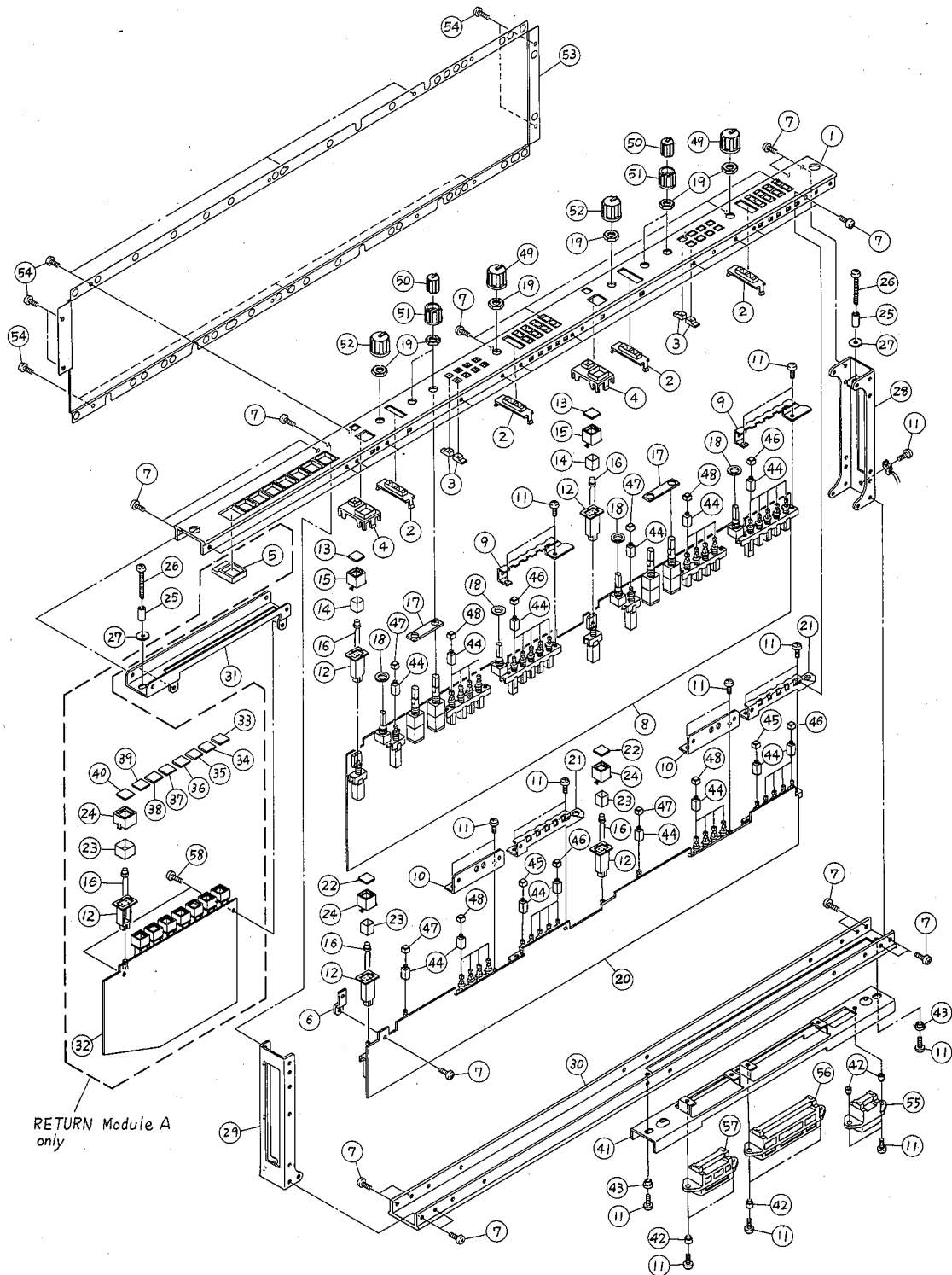

Ref. No.	Part No.	Description	部品名	Remarks	Common Model	Markets	ランク
		RETURN Module A	RETURNモジュールA				
		" B	" B				
※ 1	VA 26 62 00	Module Panel	RETURN A	R T N パネル A			46
※ "	VA 26 63 00	"	" B	" B			46
※ 2	VA 24 63 00	Escutcheon		A S エスカッション			01
※ 3	VA 24 64 00	"		E エスカッション			02
※ 4	VA 25 74 00	"	(MA)	C H エスカッション			02

Ref. No.	Part No.	Description	部 品 名	Remarks	Common Model	Markets	ランク
※	5	VA 29 45 00	Escutcheon	(MUTE MAS)	エスカッション		03
※	6	VA 26 50 00	Holder	S	シートホルダー		02
※	7	ED 32 60 56	Bind Head Screw	2.6x5 FCM3-BI	バインド小ネジ		01
※	8	VA 75 58 00	RTN 1 Circuit Board		RTN 1 シート		52
※	9	VA 24 56 00	Angle Bracket	Left	A S S アングル		02
※	10	VA 26 52 00	"		AUX SW アングル		02
※	11	ED 33 00 66	Bind Head Screw	3x6 FCM3-BI	バインド小ネジ		01
※	12	VA 28 10 00	Holder		ノブホルダー		01
※	13	VA 29 66 00	Knob	Small	ノブ		01
※	14	VA 29 65 00	Reflector	"	反射板		01
※	15	VA 29 68 00	Knob	"	ノブワク		01
※	16	VA 73 48 00	LED	Yellow	LED		01
※	17	VA 27 72 00	Spacer	(RTN)	E Q スペーサー		05
※	18	VA 24 58 00	"		V O L スペーサー		01
※	19	ES 20 01 80	Hexagonal Nut	7S ZMC2-BI	特殊六角ナット		01
※	20	VA 75 59 00	RTN 2 Circuit Board		RTN 2 シート		21
※	21	VA 24 57 00	Angle Bracket	Right	A S S アングル		02
※	22	VA 28 12 00	Knob	Large	ノブプレート		03
※	23	VA 28 14 00	Reflector	"	反射板		01
※	24	VA 28 07 00	Knob	"	ノブワク		02
※	25	VA 24 48 00	Spacer		ネジスペーサー		01
※	26	VB 31 04 00	Screw, Module		モジュールネジ		01
※	27	VA 24 62 00	Module Retainer		モジュール押え		01
※	28	VA 24 47 00	Angle Bracket	Rear	モジュールアングル		03
※	29	VA 24 55 00	"	Front	"		03
※	30	VA 30 34 00	Stay Bracket		C H ステー		07
※	31	VA 28 39 00	Mute Bracket	(MAS)	M U T E アングル		18
※	32	VA 75 60 00	RTN 3 Circuit Board		RTN 3 シート		15
※	33	VA 73 69 00	Knob	Large	ノブ		03
※	34	VA 73 70 00	"	"	"		03
※	35	VA 73 72 00	"	"	"		03
※	36	VA 73 73 00	"	"	"		03
※	37	VA 73 74 00	"	"	"		03
※	38	VA 73 75 00	"	"	"		03
※	39	VA 73 76 00	"	"	"		03
※	40	VA 73 77 00	"	"	"		03
※	41	VA 30 94 00	Stay	(IN)	コネクタステー		11
※	42	VA 30 88 00	Bushing		ブッシュ		01
※	43	VA 30 87 00	Stay Guide		ステーガイド		01
※	44	VA 25 66 00	Knob		ノブ		01
※	45	VA 25 67 00	Cap.	Ivory	ノブキャップ		01
※	46	VA 25 69 00	"	Gray	"		01
※	47	VA 25 70 00	"	Green	"		01
※	48	VA 73 91 00	"	Blue	"		01
※	49	VA 73 51 00	Knob	Orange	ツマミ		01
※	50	VA 73 52 00	"	Upper	"	Green	02
※	51	VA 73 53 00	Knob	Lower	ツマミ	Green	02
※	52	VA 73 80 00	"	Orange	"	Brown	01
※	53	VA 30 35 00	Shield Plate		シールド板		09
※	54	ED 32 60 46	Bind Head Screw	2.6x4 ZMC2-BI	バインド小ネジ		01
※	55	LB 60 17 00	Socket	14P	F R C 2 ソケット		03
※	56	VA 25 15 00	"	50P	"		07
※	57	VA 25 14 00	"	16P	"		05
※		VA 24 97 00	Receptacle	14P	レセプタクル		08
※		VA 25 01 00	"	50P	"		09
※		VA 24 99 00	"	24P	"		08

※New Parts (新規部品) NR

ランク : Japan only

A

B

C

D

E

PM3000/PW3000

1

MASTER MODULE (MASTERモジュール)

2

3

4

5

6

7

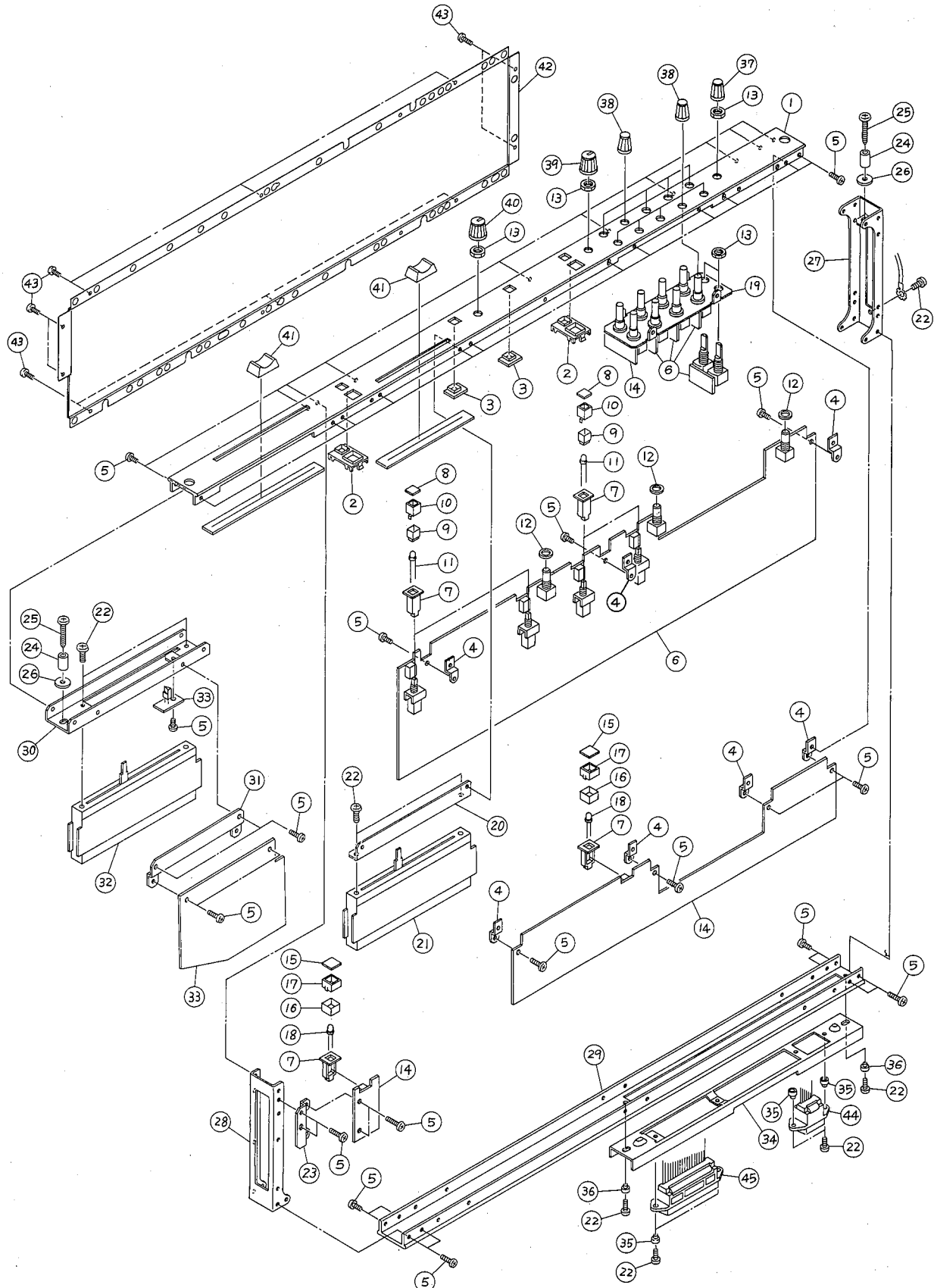

Ref. No.	Part No.	Description	部 品 名	Remarks	Common Model	Markets	ランク
		MASTER Module		MASTERモジュール			
※ 1	VA 26:64:00	Module Panel	MASTER	M A S パネル			33
※ 2	VA 25:74:00	Escutcheon	(MA)	C H エスカッション			02
※ 3	VA 30:90:00	"	(S)	"			03
※ 4	VA 26:50:00	Holder	S	シートホルダー			02
5	ED 32:60:56	Bind Head Screw	2.6x5 FCM3-BI	バインド小ネジ			01
※ 6	VA 75:61:00	MAS 1 Circuit Board		M A S シート			33
※ 7	VA 28:10:00	Holder		ノブホルダー			01
※ 8	VA 29:66:00	Knob	Small	ノブプレート	Red		01
※ 9	VA 29:65:00	Reflector	"	反 射 板			01
※ 10	VA 29:68:00	Knob	"	ノブワク			01
※ 11	VA 73:48:00	LED	Yellow	L E D			01
※ 12	VA 24:58:00	Spacer		V O L スペース			01
13	ES 20:01:80	Hexagonal Nut	7S ZMC2-BI	特殊六角ナット			01
※ 14	VA 75:62:00	MAS 2 Circuit Board		M A S 2 シート			15
※ 15	VA 28:12:00	Knob	Large	ノブ			03
※ 16	VA 28:14:00	Reflector	"	反 射 板			01
※ 17	VA 28:07:00	Knob	"	ノブワク			02
※ 18	VA 73:48:00	LED	Yellow	L E D			01
※ 19	VA 26:54:00	Angle Bracket		M T R X アングル			02
※ 20	VA 26:60:00	Fader Angle	G	フェーダーアングル			07
※ 21	VA 25:63:00	Slide Potentiometer	10kΩ	スライド V R	特殊		10
22	ED 33:00:66	Bind Head Screw	3x6 FCM3-BI	バインド小ネジ			01
※ 23	VA 26:57:00	Angle Bracket		C H S W アングル			06
※ 24	VA 24:48:00	Spacer		ネジスペース			01
※ 25	VB 31:04:00	Screw, Module		モジュールネジ			01
※ 26	VA 24:62:00	Module Retainer		モジュール押え			01
※ 27	VA 24:47:00	Angle Bracket	Rear	モジュールアングル			03
※ 28	VA 24:55:00	"	Front	"			03
※ 29	VA 30:34:00	Stay		C H ステ			07
※ 30	VA 26:59:00	Fader Angle	MAS	フェーダーアングル			08
※ 31	VA 27:42:00	Holder	VCA	シートホルダー			07
※ 32	VA 25:61:00	Slide Potentiometer	B10kΩ	スライド V R			11
※ 33	VA 73:36:00	MAS 3 Circuit Board		M A S 3 シート			12
※ 34	VA 30:92:00	Stay	(MAS)	コネクタステー			10
※ 35	VA 30:88:00	Bushing		ブ ッ シ ュ			01
※ 36	VA 30:87:00	Stay Guide		ステーガイド			01
※ 37	VA 73:83:00	Knob	Small	ツ マ ミ	Brown		01
※ 38	VA 73:85:00	"	"	"	Gray		01
※ 39	VA 73:80:00	"	Large	"	Orange		01
※ 40	VA 73:51:00	"	"	"	Red		01
※ 41	VA 73:87:00	"	Fader	"	Gray		02
※ 42	VA 30:35:00	Shield Plate		シールド板			09
43	ED 32:60:46	Bind Head Screw	2.6x4 ZMC2-BI	バインド小ネジ			01
44	LB 60:17:00	Socket	14P	F R C 2 ソケット			03
※ 45	VA 25:15:00	"	50P	"			07
※	VA 24:97:00	Receptacle	14P	レセプタクル			08
※	VA 25:01:00	"	50P	"			09
※	CB 10:15:40	Connector Housing	3P	コネクタハウジング			01
※	BB 00:58:20	Contact Pin	5479PBT	コンタクトピン			01

※ New Parts (新規部品) NR

ランク : Japan only

AUX MODULE (AUXモジュール)

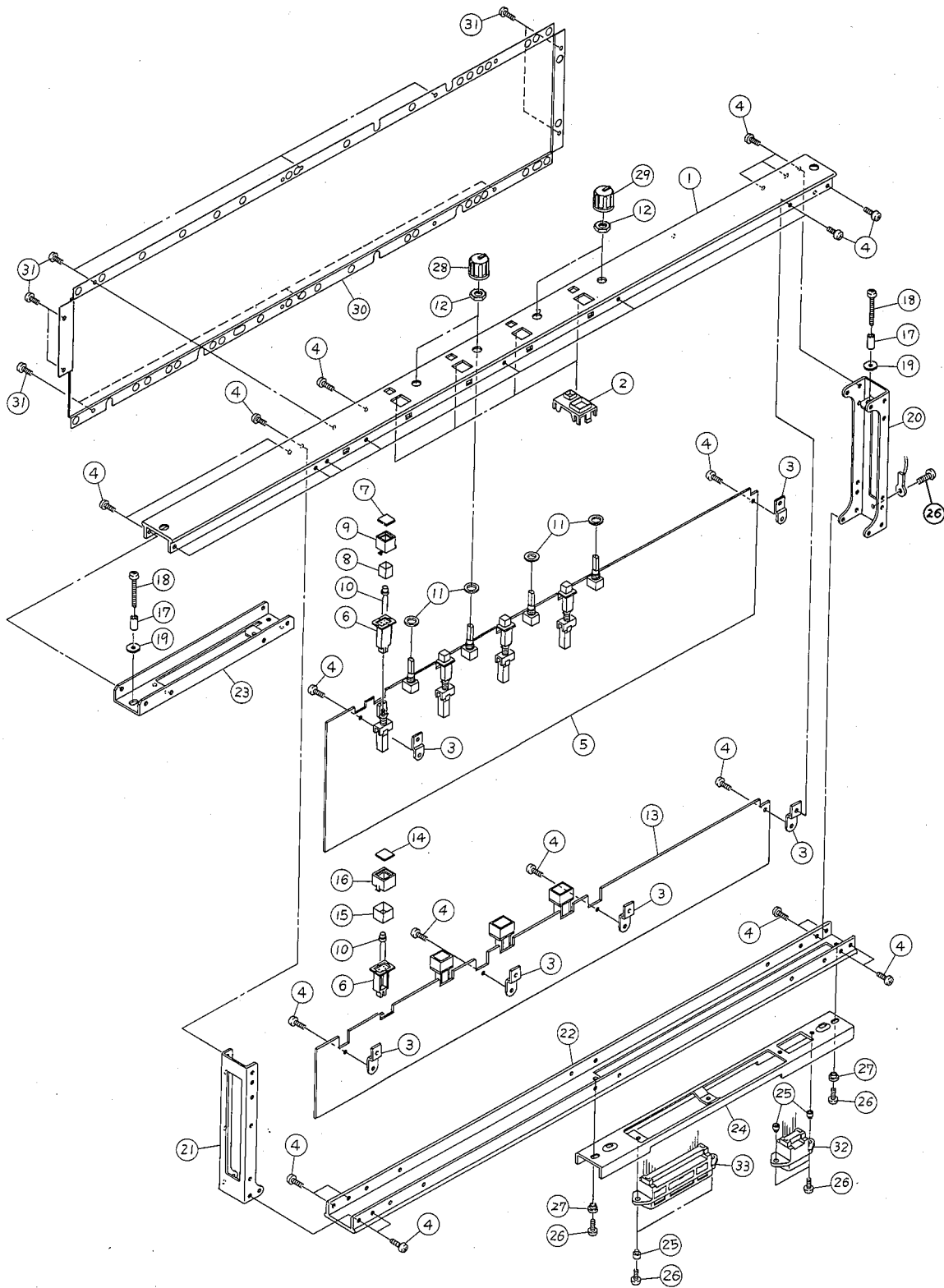

Ref. No.	Part No.	Description	部 品 名	Remarks	Common Model	Markets	ランク
		AUX Module		A U X モジュール			
※ 1	VA 26:65:00	Module Panel	AUX	A U X パネル			31
※ 2	VA 25:74:00	Escutcheon	(MA)	C H エスカッション			02
※ 3	VA 26:50:00	Holder	S	シートホルダー			02
※ 4	ED 32:60:56	Bind Head Screw	2.6x5 FCM3-BI	バインド小ネジ			01
※ 5	VA 71:30:00	AUX 1 Circuit Board		A U X 1 シート			36
※ 6	VA 28:10:00	Holder		ノブホルダー			01
※ 7	VA 29:66:00	Knob	Small	ノブ			01
※ 8	VA 29:65:00	Reflector	"	反 射 板			01
※ 9	VA 29:68:00	Knob	"	ノブワク			01
※ 10	VA 73:48:00	LED	Yellow	L E D			01
※ 11	VA 24:58:00	Spacer		V O L スペース			01
※ 12	ES 20:01:80	Hexagonal Nut	7S ZMC2-BI	特殊六角ナット			01
※ 13	VA 71:31:00	AUX 2 Circuit Board		A U X 2 シート			25
※ 14	VA 28:12:00	Knob	Large	ノブ			03
※ 15	VA 28:14:00	Reflector	"	反 射 板			01
※ 16	VA 28:07:00	Knob	"	ノブワク			02
※ 17	VA 24:48:00	Spacer		ネジスペース			01
※ 18	VB 31:04:00	Screw, Module		モジュールネジ			01
※ 19	VA 24:62:00	Module Retainer		モジュール押え			01
※ 20	VA 24:47:00	Angle Bracket	Rear	モジュールアングル			03
※ 21	VA 24:55:00	"	Front	"			03
※ 22	VA 30:34:00	Stay		C H ステ			07
※ 23	VA 26:59:00	Fader Angle	MAS	フェーダーアングル			08
※ 24	VA 30:92:00	Stay	(MAS)	コネクターステ			10
※ 25	VA 30:88:00	Bushing		ブッシュ			01
※ 26	ED 33:00:66	Bind Head Screw	3x6 FCM3-BI	バインド小ネジ			01
※ 27	VA 30:87:00	Stay Guide		ステーガイド			01
※ 28	VA 73:88:00	Knob	Orange	ツマミ			01
※ 29	VB 05:95:00	"	"	"			01
※ 30	VA 30:35:00	Shield Plate		シールド板			09
※ 31	ED 32:60:46	Bind Head Screw	2.6x4 ZMC2-BI	バインド小ネジ			01
※ 32	LB 60:17:00	Socket	14P	F R C 2 ソケット			03
※ 33	VA 25:15:00	"	50P	"			07
※	VA 24:97:00	Receptacle	14P	レセプタクル			08
※	VA 25:01:00	"	50P	"			07

※New Parts (新規部品) NR

ランク : Japan only

A

B

C

D

E

PM3000/PW3000

STEREO MODULE (STEREOモジュール)

1

2

3

4

5

6

7

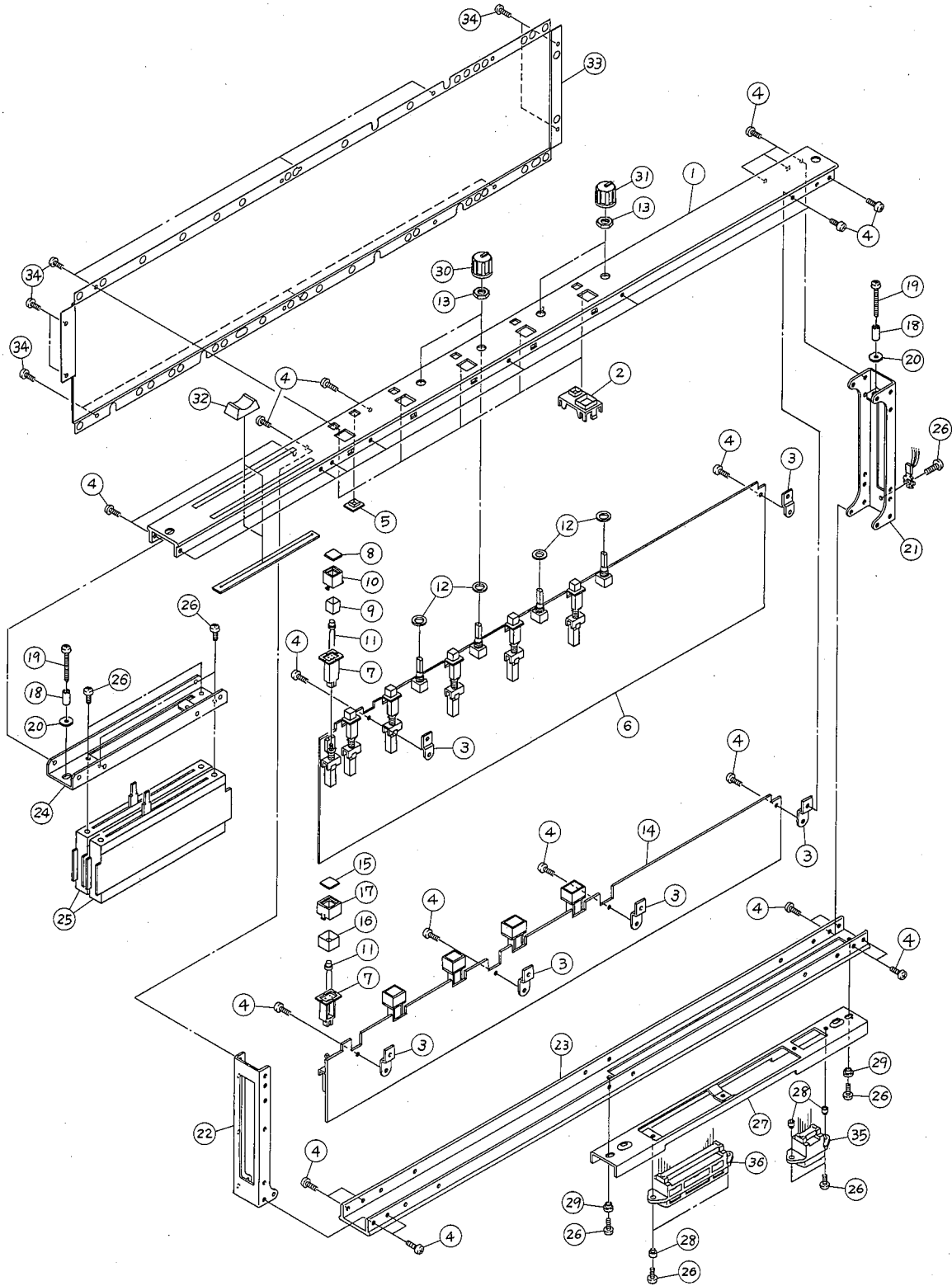

COMMUNICATION MODULE (COMMモジュール)

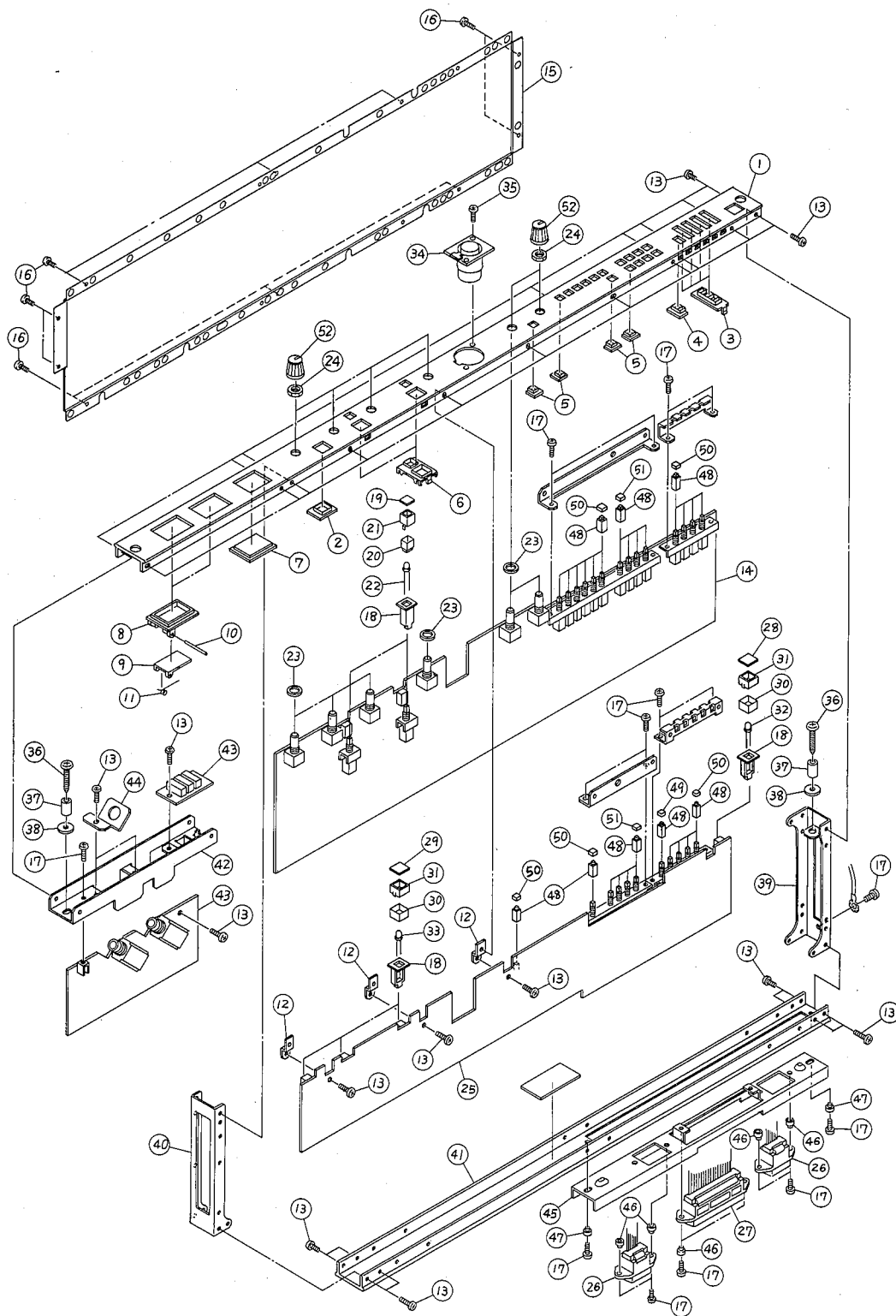

Ref. No.	Part No.	Description	部品名	Remarks	Common Model	Markets	ランク
		COMMUNICATION Module	COMMモジュール				
※ 1	VA 26 67 00	Module Panel	COMMUNICATION	COMM パネル			42
※ 2	VA 30 89 00	Escutcheon	L	エスカッション			03
※ 3	VA 24 63 00	"		ASSエスカッション			01
※ 4	VA 24 65 00	"		ESエスカッション			02

※New Parts (新規部品) NR

ランク : Japan only

Ref. No.	Part No.	Description	部 品 名	Remarks	Common Model	Markets	ランク
※ 5	VA 24 64 00	Escutcheon	E エスカッション				02
※ 6	VA 25 74 00	"	MA C H エスカッション				02
※ 7	VA 27 98 00	Plate	表 示 プ レ ー ト				07
※ 8	VA 29 46 00	Escutcheon	PHONES エスカッション				03
※ 9	VA 29 47 00	Cover	蓋				03
※ 10	VA 29 43 00	Spring	ス プ リ ン グ				03
※ 11	VA 29 44 00	Shaft	軸				03
※ 12	VA 26 50 00	Holder	S シ ー ト ホ ル ダ ー				02
※ 13	ED 32 60 56	Bind Head Screw	2.6x5 FCM3-BI バ イ ン ド 小 ネ ジ				01
※ 14	VA 71 95 00	COM 1 Circuit Board	C O M 1 シ ー ト				55
※ 15	VA 30 35 00	Shield Plate	シ ー ル ド 板				09
※ 16	ED 32 60 46	Bind Head Screw	2.6x4 ZMC2-BI バ イ ン ド 小 ネ ジ				01
※ 17	ED 33 00 66	"	3x6 FCM3-BI "				01
※ 18	VA 28 10 00	Holder	ノ ブ ホ ル ダ ー				01
※ 19	VA 29 66 00	Knob	Small ノ ブ	Red			01
※ 20	VA 29 65 00	Reflector	" 反 射 板				01
※ 21	VA 29 68 00	Knob	" ノ ブ ワ ク				01
※ 22	VA 73 17 00	LED	Red L E D				01
※ 23	VA 24 58 00	Spacer	V O L ス ペ ー サ ー				01
※ 24	ES 20 01 80	Hexagonal Nut	7S ZMC2-BI 特 殊 六 角 ナ ッ ト				01
※ 25	VA 71 96 00	COM 2 Circuit Board	C O M 2 シ ー ト				23
※ 26	LB 60 17 00	Socket	14P F R C 2 ソ ケ ッ ト				03
※ 27	VA 25 15 00	"	50P "				07
※ 28	VA 73 90 00	Knob	Large ノ ブ				03
※ 29	VA 28 12 00	"	" "				03
※ 30	VA 28 14 00	Reflector	" 反 射 板				01
※ 31	VA 28 07 00	Knob	" ノ ブ ワ ク				02
※ 32	VA 73 17 00	LED	Red L E D				01
※ 33	VA 73 48 00	"	Yellow "				01
※ 34	VA 72 82 00	XLR Connector	XLR-3-31-F77 キ ャ ノ ン ソ ケ ッ ト				09
※ 35	VA 72 95 00	Pan Head Screw	2.6x6 FCM3-3G ナ ベ 小 ネ ジ				01
※ 36	VB 31 04 00	Screw, Module	モ ジ ュ ー ル ネ ジ				01
※ 37	VA 24 48 00	Spacer	ネ ジ ス ペ ー サ ー				01
※ 38	VA 24 62 00	Module Retainer	モ ジ ュ ー ル 押 え				01
※ 39	VA 24 47 00	Angle Bracket	Rear モ ジ ュ ー ル ア ン グ ル				03
※ 40	VA 24 55 00	"	Front "				03
※ 41	VA 30 34 00	Stay	C H ス テ ー				07
※ 42	VA 28 35 00	Phones Bracket	PHONESアングル				17
※ 43	VA 71 97 00	COM 3 Circuit Board	C O M 3 シ ー ト				16
※ 44	VA 28 37 00	Jack Bracket	J A C K 板				08
※ 45	VA 30 93 00	Stay	COM コ ネ ク タ ー ス テ ー				18
※ 46	VA 30 88 00	Bushing	ブ ッ シ ュ				01
※ 47	VA 30 87 00	Stay Guide	ス テ ー ガ イ ド				01
※ 48	VA 25 66 00	Knob	ノ ブ				01
※ 49	VA 25 67 00	Cap	Ivory ノ ブ キ ャ ッ プ				01
※ 50	VA 25 69 00	"	Gray "				01
※ 51	VA 73 91 00	"	Blue "				01
※ 52	VA 73 80 00	Knob	Orange ツ マ ミ				01
※	VA 24 97 00	Receptacle	14P レ セ ブ タ ク ル				08
※	VA 25 01 00	"	50P "				09
※	CB 10 15 40	Connector Housing	3P コ ネ ク タ ハ ウ ジ ン グ				01
※	BB 00 58 20	Contact Pin	コ ン タ ク ト ピ ン				01
※	CB 06 92 50	Binding Tie	イ ン シ ュ ロ ッ ク タイ				01

※New Parts (新規部品) NR

ランク : Japan only

TOP BOARD ASSEMBLY (天板Ass,y)

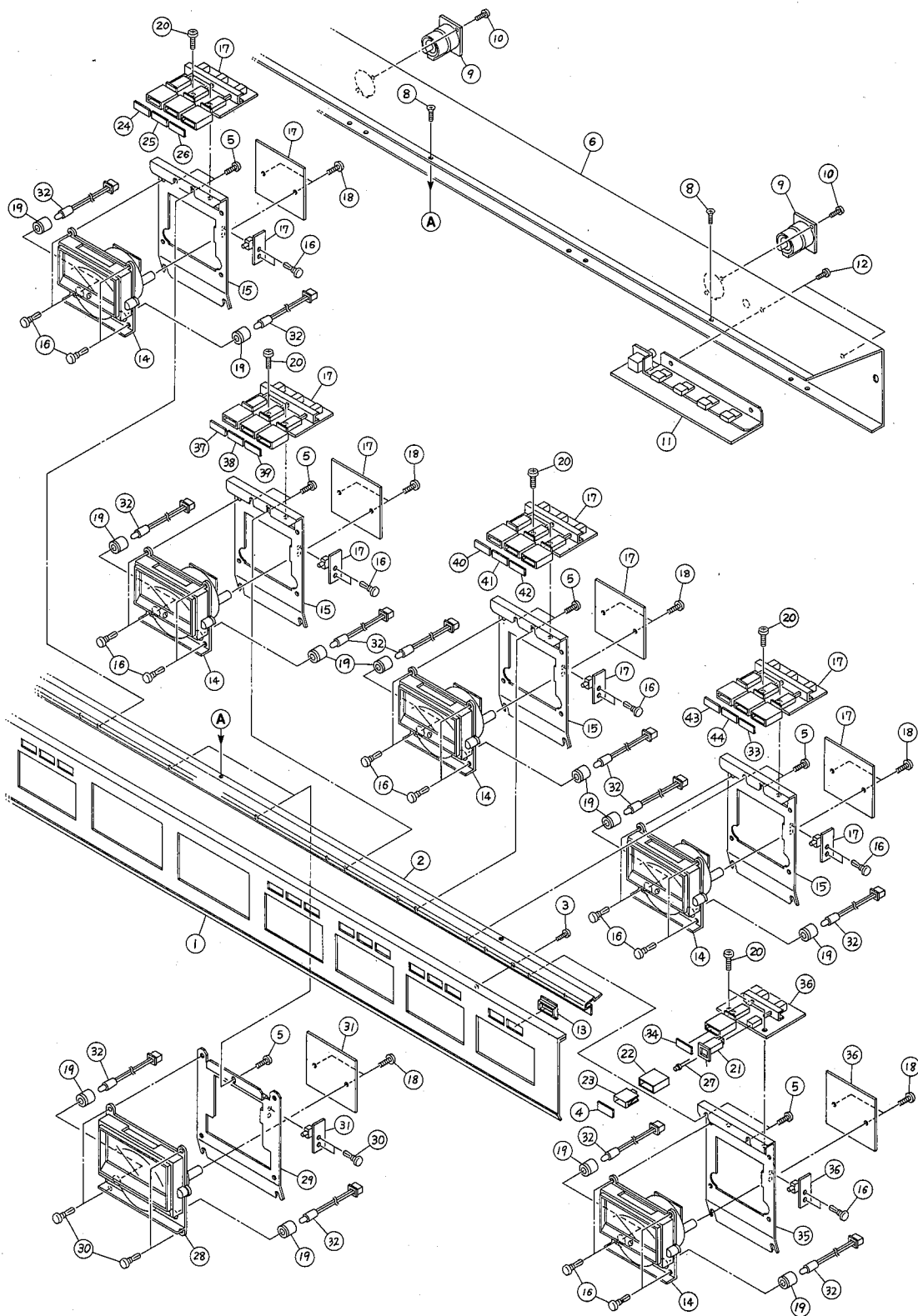

Ref. No.	Part No.	Description	部 品 名	Remarks	Common Model	Markets	ランク
* 1	VA;32;36;00	Meter Panel	メーターパネル	PM3000-24			38
* "	VA;32;37;00	"	"	PM3000-32			40
* "	VA;32;38;00	"	"	PM3000-40			42
* "	VB;21;71;00	"	"	PM3000C-32			42
* "	VB;21;73;00	"	"	PM3000C-40			44

Ref. No.	Part No.	Description	部 品 名	Remarks	Common Model	Markets	ランク	
※	2	VA:32:29:00	Trim		天 板 サ ッ シ	PM3000-24		24
※	"	VA:32:30:00	"		"	PM3000-32,PM3000-40		38
※	"	VB:21:69:00	"		"	PM3000C-32		25
※	"	VB:21:70:00	"		"	PM3000C-40		27
※	3	Ei:33:00:86	Bind Head Tapping Screw	3×8 FCM3-BI	バインドタッピングネジ			01
※	4	VA:73:34:00	Knob	(M) AUX 8	ノ ブ	AUX 4/8		03
※	5	ED:33:01:06	Bind Head Screw	3×10 FCM3-BI	バインド小ネジ			01
※	6	VA:30:75:00	Rear Panel, Top Board		天 板 リ ア パ ネ ル	PM3000-24		43
※	"	VA:30:85:00	"		"	PM3000-32		46
※	"	VA:30:86:00	"		"	PM3000-40		54
※	"	VB:21:67:00	"		"	PM3000C-32		46
※	"	VB:21:68:00	"		"	PM3000C-40		54
※	7	ED:33:00:66	Bind Head Screw	3×6 FCM3-BI	バインド小ネジ			01
※	8	EF:33:00:66	Oval Head Screw	3×6 FCM3-BI	丸 皿 小 ネ ジ			01
※	9	VA:72:81:00	XLR Connector	XLR-4-31-F77	キャノンソケット			10
※	10	EA:22:60:86	Pan Head Screw	2.6×8 FCM3-3G	ナベ小ネジ			01
※	11	VA:33:90:00	LP Circuit Board		L P シ ー ト			17
※	12	ED:32:60:86	Bind Head Screw	2.6×8 FCM3-BI	バインド小ネジ			01
※	13	VA:29:87:00	Escutcheon	(M)	エスカッション			02
※	14	VA:72:99:00	VU Meter		V U メ ー タ ー	GROUP/MTRX,AUX		21
※	15	VA:29:98:00	Bracket, Meter	(GM)	メ ー タ ー 金 具	"		08
※	16	CB:06:88:80	Plastic Rivet		プラスチックリベット	"		01
※	17	VA:33:78:00	MT 1 Circuit Board		M T 1 シ ー ト	"		10
※	18	Ei:33:00:66	Bind Head Tapping Screw	3×6 FCM3-BI	バインドタッピングネジ	GROUP/MTRX, STEREO,AUX		01
※	19	CB:06:86:20	Lamp Holder		ランプホルダー	"		01
※	20	ED:33:00:66	Bind Head Screw	3×6 FCM3-BI	バインド小ネジ	GROUP/MTRX,AUX		01
※	21	VA:28:10:00	Holder		ノブホルダー	"		01
※	22	VA:29:89:00	Knob	(M)	ノブワク	"		01
※	23	VA:29:86:00	Reflector	"	反 射 板	"		01
※	24	VA:29:88:00	Knob	" GROUP	ノ ブ	GROUP/MTRX		03
※	25	VA:73:05:00	"	" G▶M	"	"		03
※	26	VA:73:07:00	"	" MTRX	"	"		03
※	27	VA:73:17:00	LED	Red	L E D	GROUP/MTRX,AUX		01
※	28	VA:73:02:00	VU Meter		V U メ ー タ ー	STEREO		24
※	29	VA:29:97:00	Bracket, Meter	(ST)	メ ー タ ー 金 具	"		11
※	30	CB:81:68:90	Plastic Rivet		プラスチックリベット	"		01
※	31	VA:33:80:00	MT 3 Circuit Board		M T 3 シ ー ト	"		09
※	32	VA:75:57:00	Pilot Lamp	12V 0.7W	パイロットランプ	GROUP/MTRX, STEREO,AUX		04
※	33	VA:73:32:00	Knob	(M) OSC	ノ ブ	AUX 3/7/OSC		03
※	34	VA:73:33:00	"	" AUX 4	"	AUX 4/8		03
※	35	VA:29:96:00	Bracket, Meter	(AUX)	メ ー タ ー 金 具	"		16
※	36	VA:33:79:00	MT 2 Circuit Board		M T 2 シ ー ト	"		11
※	37	VA:73:20:00	Knob	(M) AUX 1	ノ ブ	AUX 1/5/CUE L		03
※	38	VA:73:21:00	"	" AUX 5	"	"		03
※	39	VA:73:23:00	"	" CUE L	"	"		03
※	40	VA:73:24:00	"	" AUX 2	"	AUX 2/6/CUE R		03
※	41	VA:73:26:00	"	" AUX 6	"	"		03
※	42	VA:73:27:00	"	" CUE R	"	"		03
※	43	VA:73:30:00	"	" AUX 3	"	AUX 3/7/OSC		03
※	44	VA:73:31:00	"	" AUX 7	"	"		03

※New Parts (新規部品) NR

ランク: Japan only

A

B

C

D

E

PM3000/PW3000

1 ■ REAR PANEL (リアパネル)

2

3

4

5

6

7

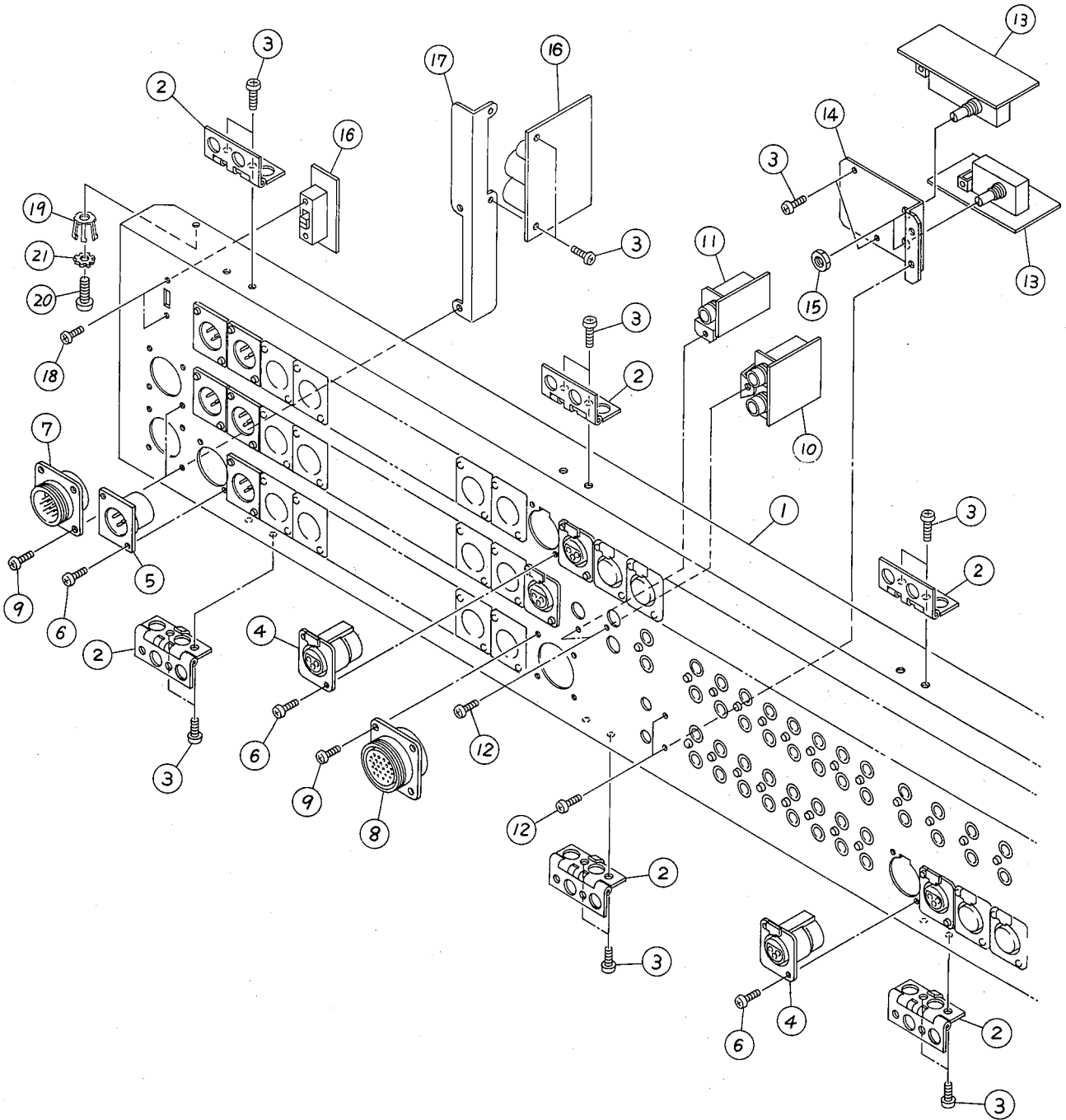

Ref. No.	Part No.	Description	部 品 名	Remarks	Common Model	Markets	ランク
※ 1	VA 30:47:00	Rear Panel	リ ア パ ネ ル	PM3000-24			63
※ "	VA 30:48:00	"	"	PM3000-32			65
※ "	VA 30:49:00	"	"	PM3000-40			67
※ "	VB 21:78:00	"	"	PM3000C-32			65
※ "	VB 21:79:00	"	"	PM3000C-40			67
2	AA 82:99:40	Hinge	蝶 番				04
3	ED 33:00:66	Bind Head Screw	3×6 FCM3-BI	バ イ ン ド 小 ネ ジ			01
※ 4	VA 72:82:00	XLR Connector	XLR-3-31-F77	キャ ノ ン ソ ケ ッ ト	INPUT		09
※ 5	VA 72:83:00	"	XLR-3-32-F77	"	OUTPUT		08
6	VA 72:95:00	Pan Head Screw	2.6×6 FCM3-3G	ナ ベ 小 ネ ジ			01
7	LB 60:57:50	Multi Connector	SRCN2A-21-10P	マ ル チ コ ネ ク タ	DC POWER INPUT		08
8	VA 72:96:00	"	SRCN2A-25-24S	"	VCA/MUTE CONTROL		08
9	ED 33:01:06	Bind Head Screw	3×10 FCM3-BI	バ イ ン ド 小 ネ ジ			01
※ 10	VA 71:04:00	JK 1 Circuit Board		J K 1 シ ー ト			07
※ 11	VA 71:05:00	JK 2 Circuit Board		J K 2 シ ー ト			11
12	ED 32:60:56	Bind Head Screw	2.6×5 FCM3-BI	バ イ ン ド 小 ネ ジ			01
※ 13	VA 33:89:00	EXT Circuit Board		E X T シ ー ト			11
※ 14	VA 32:45:00	Bracket		E X T シ ー ト 金 具			11
15	ES 20:01:80	Hexagonal Nut	7S ZMC2-BI	特 殊 六 角 ナ ッ ト			01
※ 16	VA 71:32:00	CO Circuit Board		C O シ ー ト			10
※ 17	VA 72:97:00	Capacitor Bracket		C O シ ー ト 金 具			11
18	ED 32:60:46	Bind Head Screw	2.6×4 FCM3-BI	バ イ ン ド 小 ネ ジ			01
19	BB 06:85:40	Lug Terminal		ラ グ 端 子			02
20	ED 34:00:86	Bind Head Screw	4×8 FCM3-BI	バ イ ン ド 小 ネ ジ			01
21	EV 42:30:46	Toothed Lock Washer	B4S ZMC2-BI	歯 付 座 金			01
	LA 00:36:90	Ground Lug		歯 付 ア ー ス ラ グ			01
	LB 40:07:50	Connector Housing	LR-04V-R	コ ネ ク タ ハ ウ ジ ン グ	Red		01
	LB 30:11:50	"	LR-03V-R	"	Red		01
※	LB 20:24:80	"	LR-02V-R	"			01
	LB 10:18:20	Contact Pin	LLM-61T-2.0	コ ン タ ク ト ピ ン			01
	BB 00:58:20	"	5479PBT	"			01
※	CB 10:15:30	Connector Housing	5480 2P	コ ネ ク タ ハ ウ ジ ン グ	PM3000C-32, PM3000C-40		01
	CB 10:15:40	"	" 3P	"	"		01
	CB 10:15:50	"	" 4P	"	"		01
※	CB 10:15:60	"	" 5P	"	"		01
	CB 10:15:70	"	" 6P	"	"		01
	CB 10:15:80	"	" 7P	"	"		01
	CB 10:16:00	"	" 9P	"	"		01
※	CB 10:16:10	"	" 10P	"	"		01
※	CB 10:16:20	"	" 11P	"	"		01
	CB 10:16:30	"	" 12P	"	PM3000C-32 PM3000C-40		01
	CB 10:16:40	"	" 13P	"	"		01
	CB 10:16:50	"	" 14P	"	"		01
	CB 10:16:60	"	" 15P	"	"		01

※ New Parts (新規部品) NR

ランク : Japan only

POWER SUPPLY UNIT PW3000 (電源ユニットPW3000)

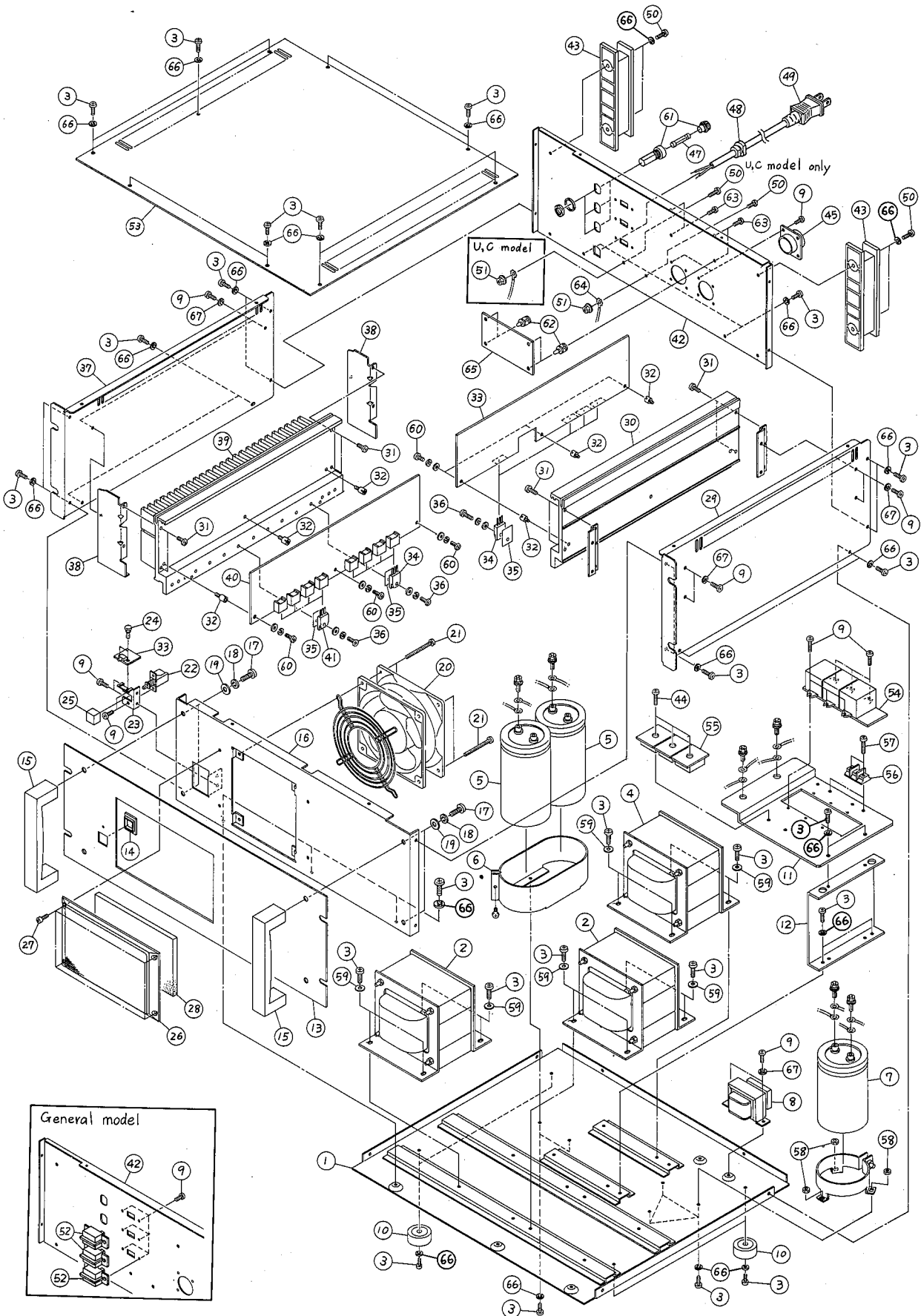

Ref. No.	Part No.	Description	部 品 名	Remarks	Common Model	Markets	ランク
※ 1	VA 31:82:00	Bottom Cover	ボトムカバー				26
※ 2	XA 23:10:01	Power Transformer	電源トランス			J	23
※ "	XA 23:20:01	"	"			U,C	
※ "	XA 23:30:01	"	"			H	
※ 3	ED 34:00:86	Bind Head Screw	4×8 FCM3-BI	バインド小ネジ			01
※ 4	XA 23:40:01	Power Transformer	電源トランス			J	21
※ "	XA 23:50:01	"	"			U,C	
※ "	XA 23:60:01	"	"			H	
※ 5	VA 27:39:00	Electrolytic Cap.	68000 μ F 50V	ケミコン			18
※ 6	AA 80:32:10	Holder	65	ケミコンホルダー			04
※ 7	VA 27:40:00	Electrolytic Cap.	100000 μ F 25V	ケミコン			17
※ 8	XA 23:70:01	Power Transformer	電源トランス			J	09
※ "	XA 23:80:01	"	"			U,C	
※ "	XA 23:90:01	"	"			H	
※ 9	ED 33:00:66	Bind Head Screw	3×6 FCM3-BI	バインド小ネジ			01
※ 10	CB 80:65:90	Foot		脚			01
※ 11	VA 32:62:00	Bracket		ケミコンプレート			16
※ 12	VA 32:63:00	"		ケミコン金具			11
※ 13	VA 27:44:00	Front Panel		フロントパネル			17
※ 14	VA 02:96:00	Escutcheon	(L)	SWエスカッション			02
※ 15	BA 80:12:00	Handle		アンプハンドル			08
※ 16	VA 27:53:00	Sub Panel		サブパネル			21
※ 17	EA 36:01:56	Pan Head Screw	6×15 FCM3-BI	ナベ小ネジ			01
※ 18	EV 30:30:66	Spring Washer	6S ZMC2-BI	バネ座金			01
※ 19	EV 20:30:66	Flat Washer	6S ZMC2-BI	平座金			01
※ 20	VA 77:69:00	Cooling Fan		放熱ファン		J	16
※ "	VA 77:70:00	"		"		U,C	
※ "	VA 77:71:00	"		"		H	
※ 21	ED 34:04:52	Bind Head Screw	4×45 FCM3-BI	バインド小ネジ			01
※ 22	KA 80:36:10	Push Switch	ESB-8213A	プッシュSW			03
※ 23	VA 32:60:00	Bracket, Switch		スイッチ金具			10
※ 24	CB 06:88:80	Plastic Rivet		プラスチックリベット			01
※ 25	CB 81:23:80	Push Button		プッシュボタン			01
※ 26	NB 83:15:70	Front Grill		フロントグリル			08
※ 27	EX 80:01:80	Cap Screw	4×8 FCM3-BI	六角穴付ボルト			01
※ 28	CB 83:57:10	Filter		フィルター			02
※ 29	VA 27:51:00	Side Cover	Right	サイドカバー			16
※ 30	VA 78:01:00	Heat Sink		放熱板			11
※ 31	ED 33:01:06	Bind Head Screw	3×10 FCM3-BI	バインド小ネジ			01
※ 32	AA 07:75:90	Spacer		スペーサー			02
※ 33	VA 33:85:00	DC 2 Circuit Board		DC 2シート		J	20
※ "	VA 33:86:00	"		"		U,C	
※ "	VA 33:87:00	"		"		H	
※ 34	VA 27:37:00	Transistor	2SD1148 (O)	トランジスタ			05
※ 35	iL 00:06:80	Insulator		マイカベース			01
※ 36	ES 03:01:20	Pan Head Screw	3×12 ZMC2-Y	ナベ小ネジ			01
※ 37	VA 27:52:00	Side Cover	Left	サイドカバー			16
※ 38	AA 83:29:30	Angle Bracket		ラジエターアングル			02
※ 39	BA 81:01:70	Heat Sink		放熱板			14
※ 40	VA 33:82:00	DC 1 Circuit Board		DC 1シート		J	19
※ "	VA 33:83:00	"		"		U,C	
※ "	VA 33:84:00	"		"		H	

*New Parts (新規部品) NR

ランク : Japan only

PM3000/PW3000 OVERALL CIRCUIT DIAGRAM

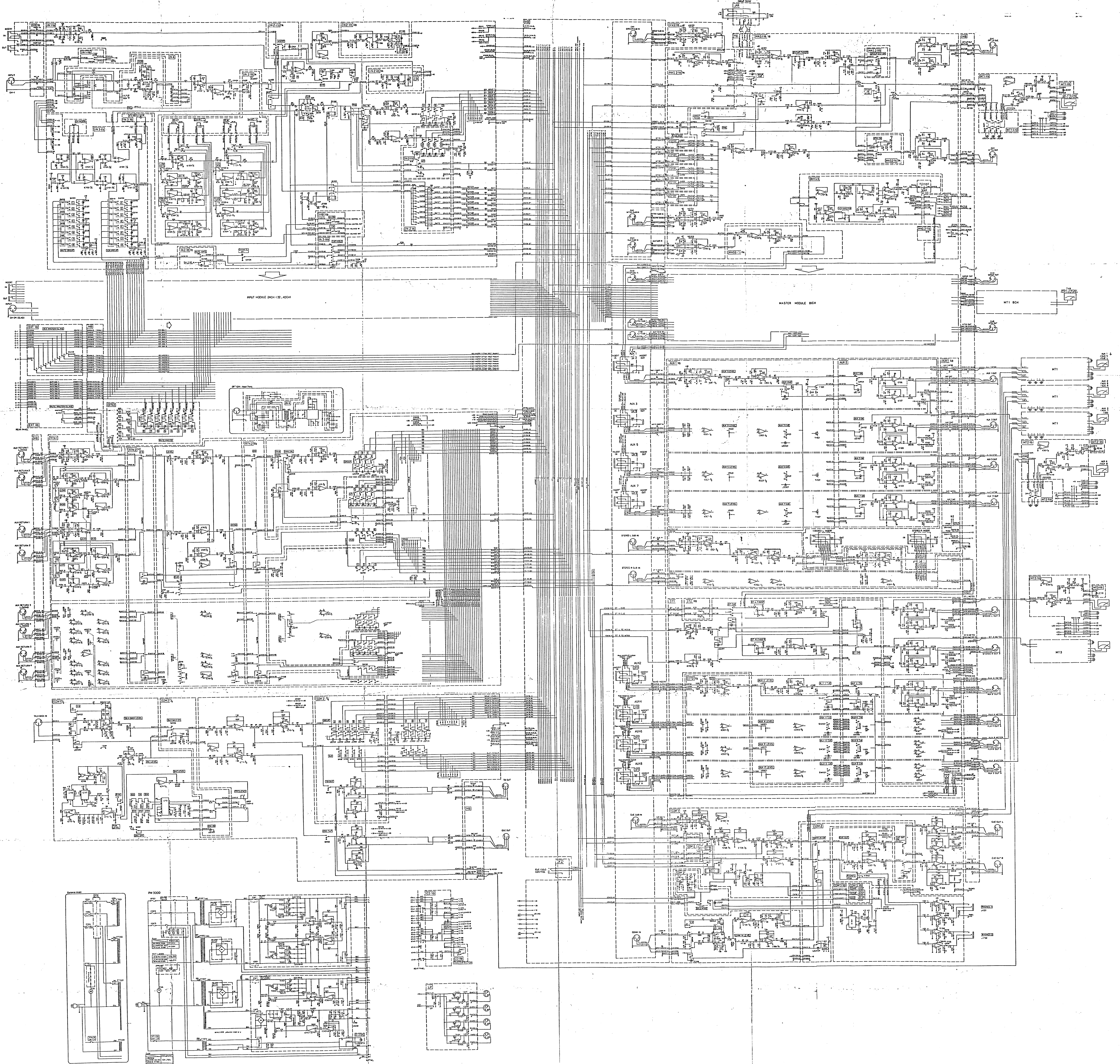

MIXING CONSOLE PM3500/PM3500M SERVICE MANUAL

~~~~~

Addition of Connector Circuit Diagram for PM3500/PM3500M.

This circuit diagram is a supplement to PM3500 service manual  
011260 issued in March 1995.

~~~~~

~~~~~

PM3500/PM3500Mコネクタ回路図追加、

本回路図は95年3月発行のPM3500のサービスマニュアル 011260 に追  
加して使用するものです。

~~~~~

APPENDIX

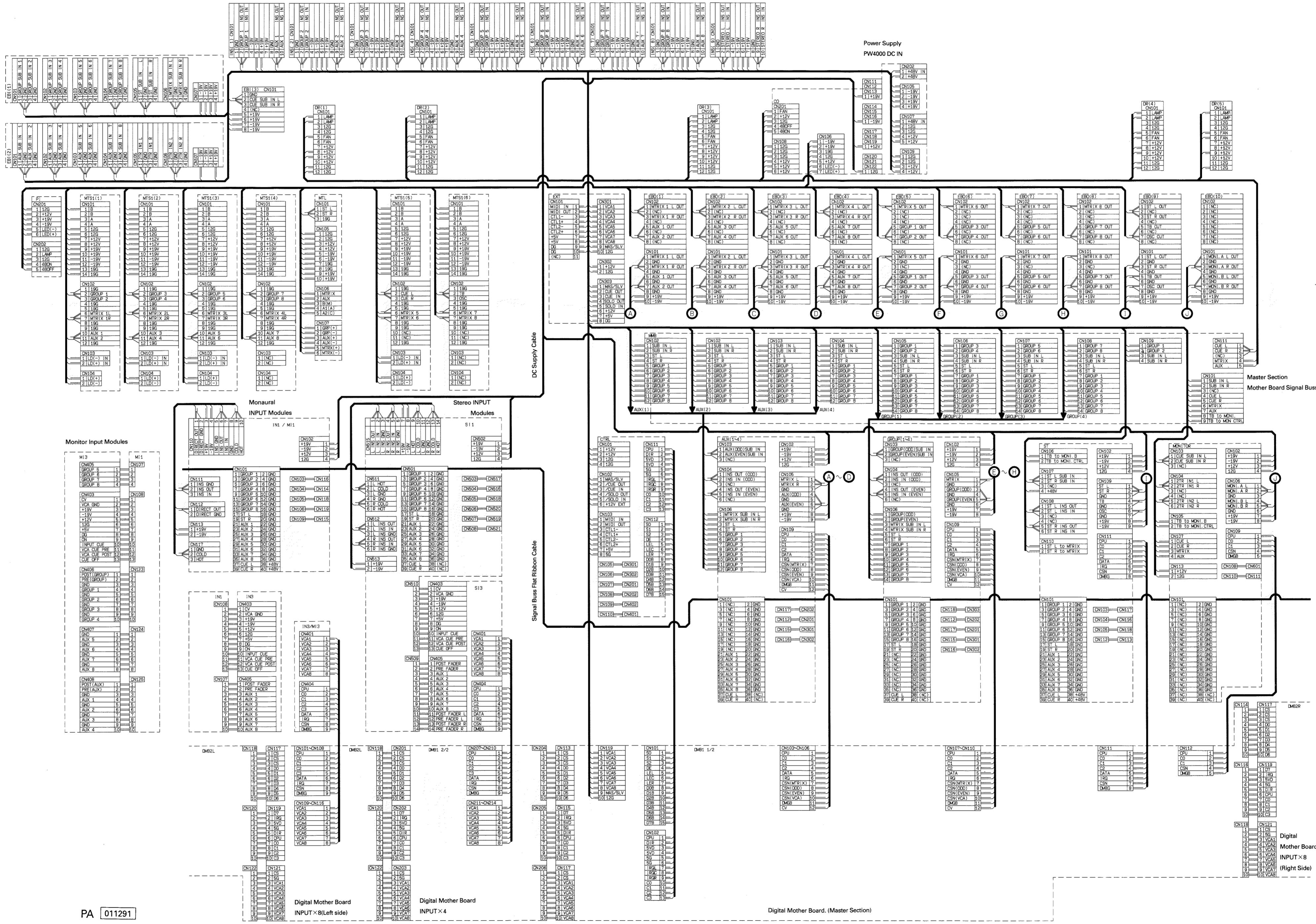

PA 011291