

CS-400
'B' SERIES

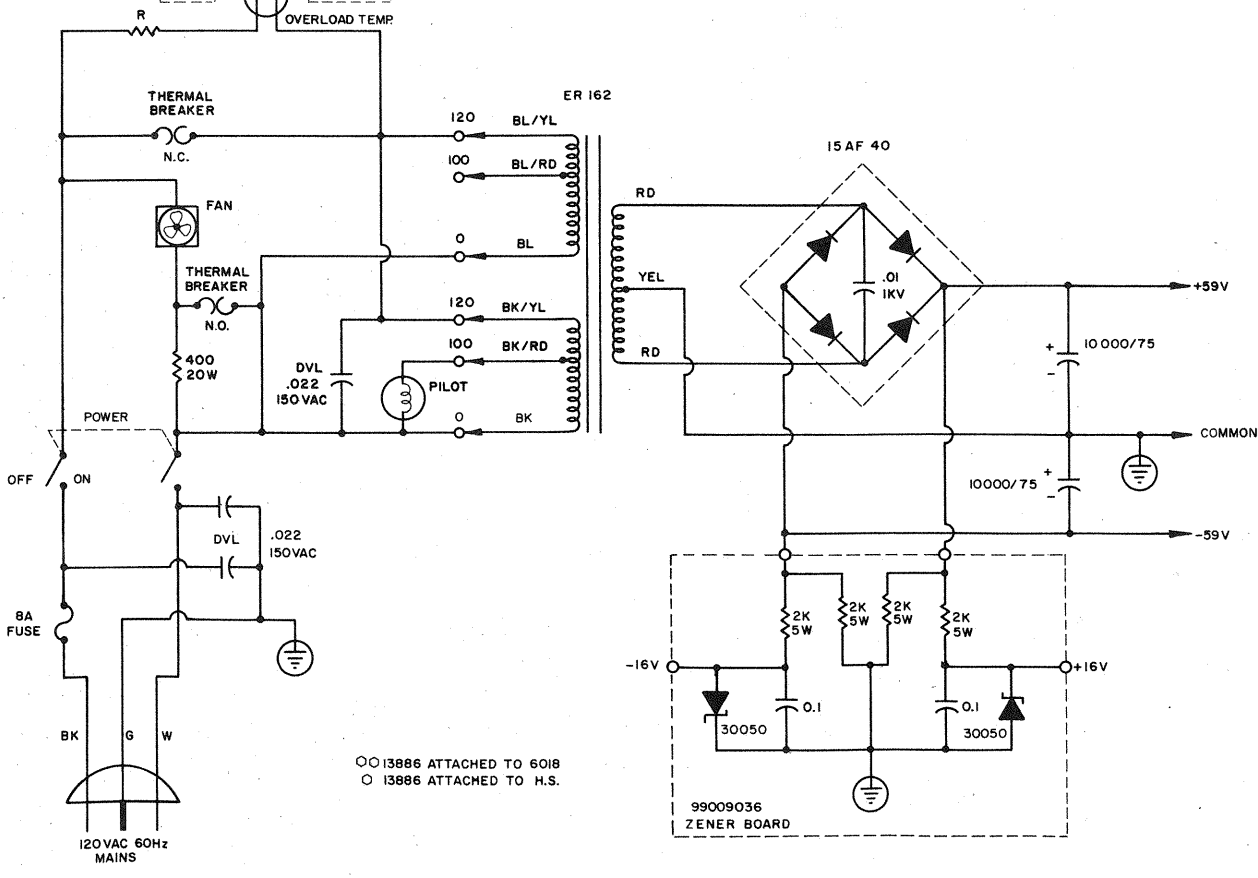

NOTE
ALL RESISTORS 1/4W UNLESS NOTED
ALL CAPACITORS IN MFD UNLESS NOTED
ALL DIODES IN 4148 UNLESS NOTED
ALL VOLTAGE MEASUREMENTS ARE REF TO GND.

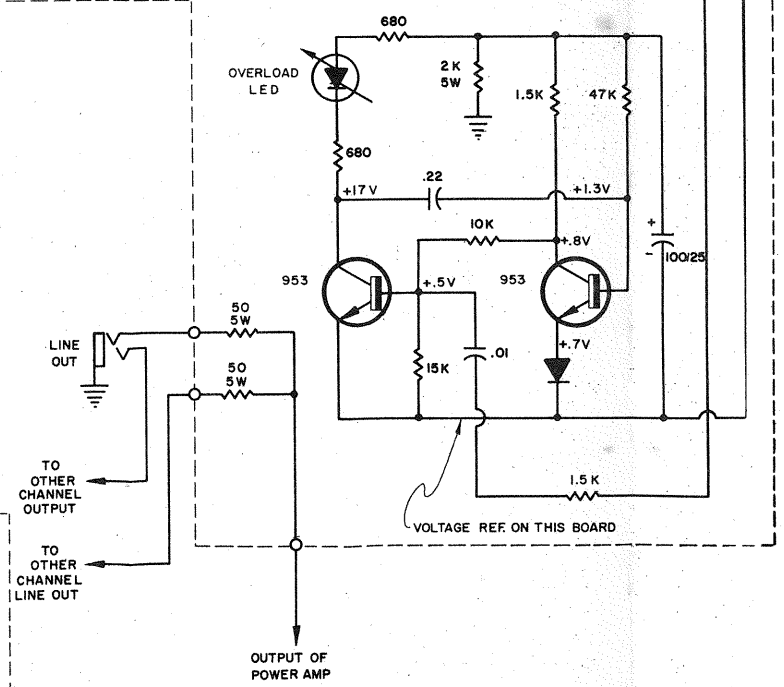
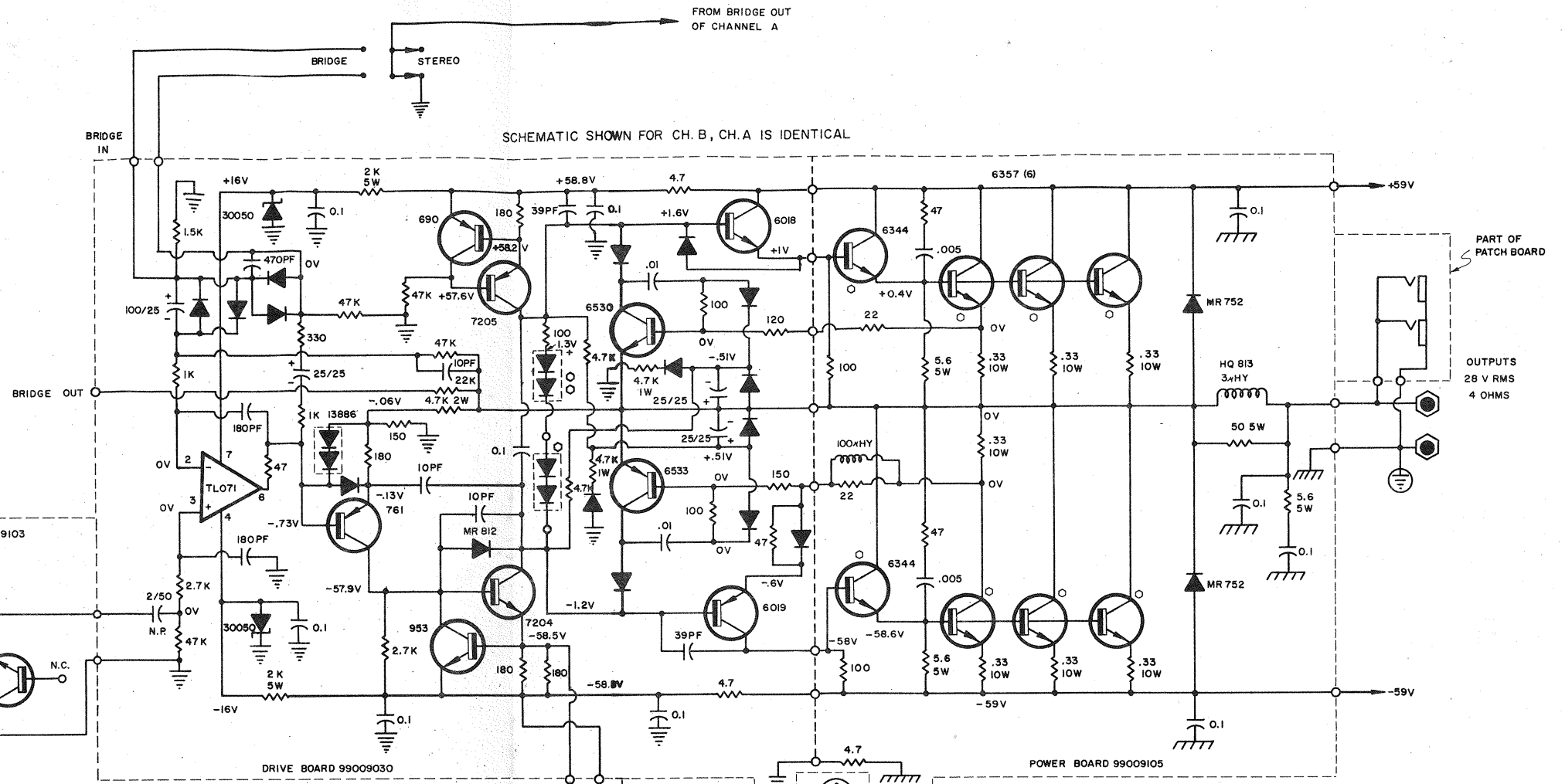
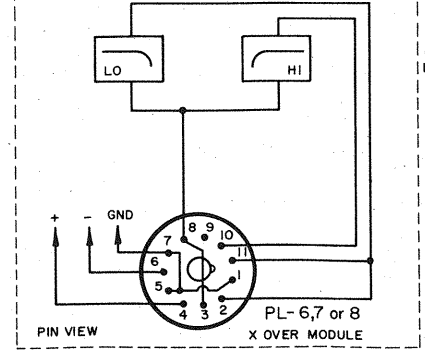
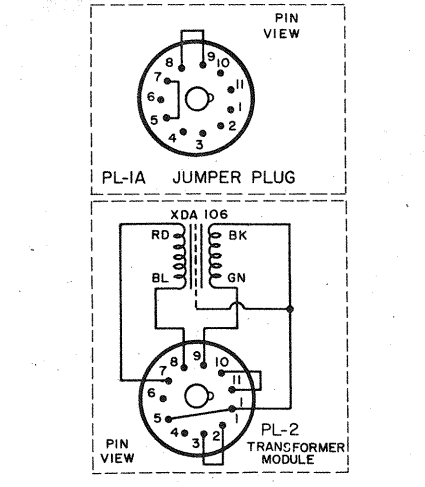
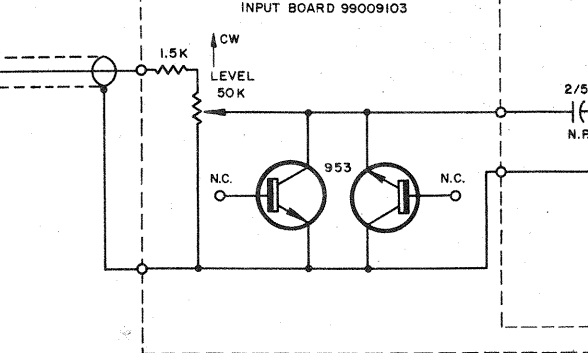
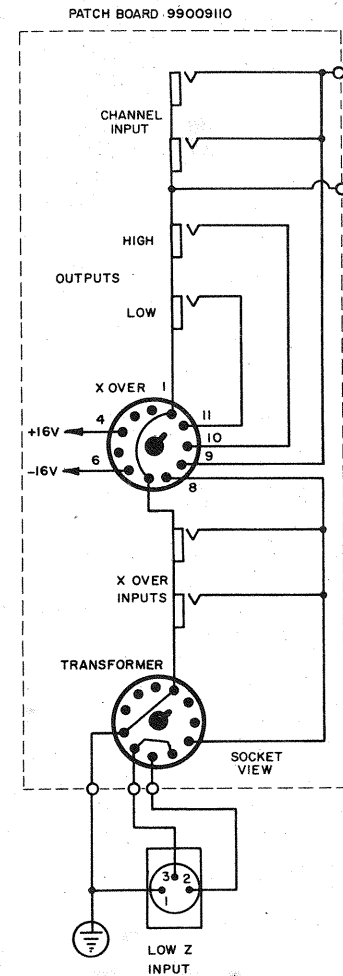
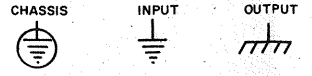

○ 13886 ATTACHED TO 6018
○ 13886 ATTACHED TO H.S.

99009036
ZENER BOARD

PEAVEY ELECTRONICS CORP
MERIDIAN MS
DRAWN BY *LAK* DATE 9-12-78
CK. BY *LAK* 9-72-78
APPR. BY *jet*