

Rane Corp. (425)355-6000  
 106698 DES MAIN PE 17  
 ACTION: NEW LAYOUT, SKH 18JAN03

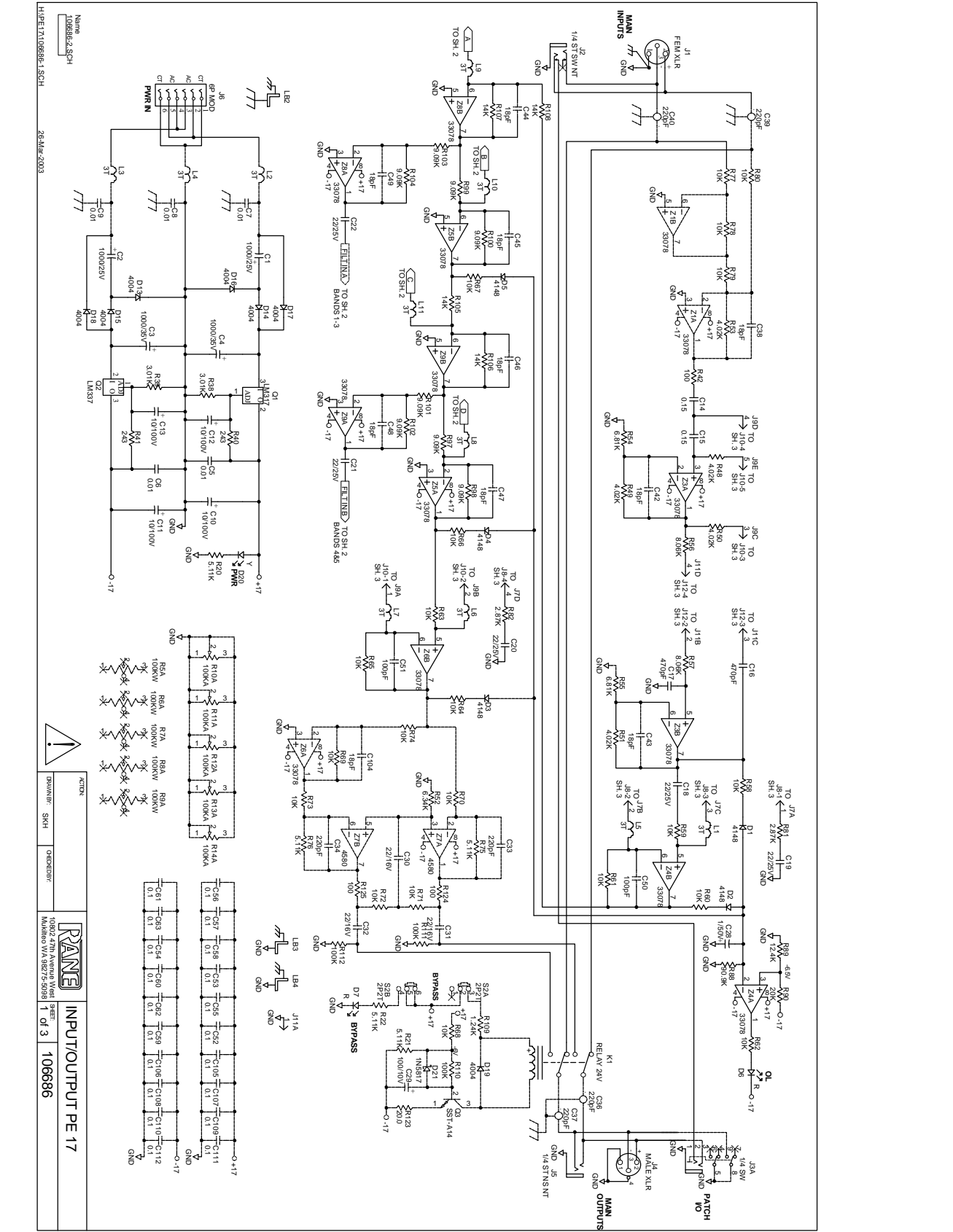

REF	VALUE	UNIT
C1	1000	25V
C2	1000	25V
C3	1000	35V
C4	1000	35V
C5	1000	35V
C6	1000	35V
C7	1000	25V
C8	1000	25V
C9	1000	25V
C10	1000	25V
C11	1000	25V
C12	1000	25V
C13	1000	25V
C14	1000	25V
C15	1000	25V
C16	1000	25V
C17	1000	25V
C18	1000	25V
C19	1000	25V
C20	1000	25V
C21	1000	25V
C22	1000	25V
C23	1000	25V
C24	1000	25V
C25	1000	25V
C26	1000	25V
C27	1000	25V
C28	1000	25V
C29	1000	25V
C30	1000	25V
C31	1000	25V
C32	1000	25V
C33	1000	25V
C34	1000	25V
C35	1000	25V
C36	1000	25V
C37	1000	25V
C38	1000	25V
C39	1000	25V
C40	1000	25V
C41	1000	25V
C42	1000	25V
C43	1000	25V
C44	1000	25V
C45	1000	25V
C46	1000	25V
C47	1000	25V
C48	1000	25V
C49	1000	25V
C50	1000	25V
C51	1000	25V
C52	1000	25V
C53	1000	25V
C54	1000	25V
C55	1000	25V
C56	1000	25V
C57	1000	25V
C58	1000	25V
C59	1000	25V
C60	1000	25V
C61	1000	25V
C62	1000	25V
C63	1000	25V
C64	1000	25V
C65	1000	25V
C66	1000	25V
C67	1000	25V
C68	1000	25V
C69	1000	25V
C70	1000	25V
C71	1000	25V
C72	1000	25V
C73	1000	25V
C74	1000	25V
C75	1000	25V
C76	1000	25V
C77	1000	25V
C78	1000	25V
C79	1000	25V
C80	1000	25V
C81	1000	25V
C82	1000	25V
C83	1000	25V
C84	1000	25V
C85	1000	25V
C86	1000	25V
C87	1000	25V
C88	1000	25V
C89	1000	25V
C90	1000	25V
C91	1000	25V
C92	1000	25V
C93	1000	25V
C94	1000	25V
C95	1000	25V
C96	1000	25V
C97	1000	25V
C98	1000	25V
C99	1000	25V
C100	1000	25V
C101	1000	25V
C102	1000	25V
C103	1000	25V
C104	1000	25V
C105	1000	25V
C106	1000	25V
C107	1000	25V
C108	1000	25V
C109	1000	25V
C110	1000	25V
C111	1000	25V
C112	1000	25V

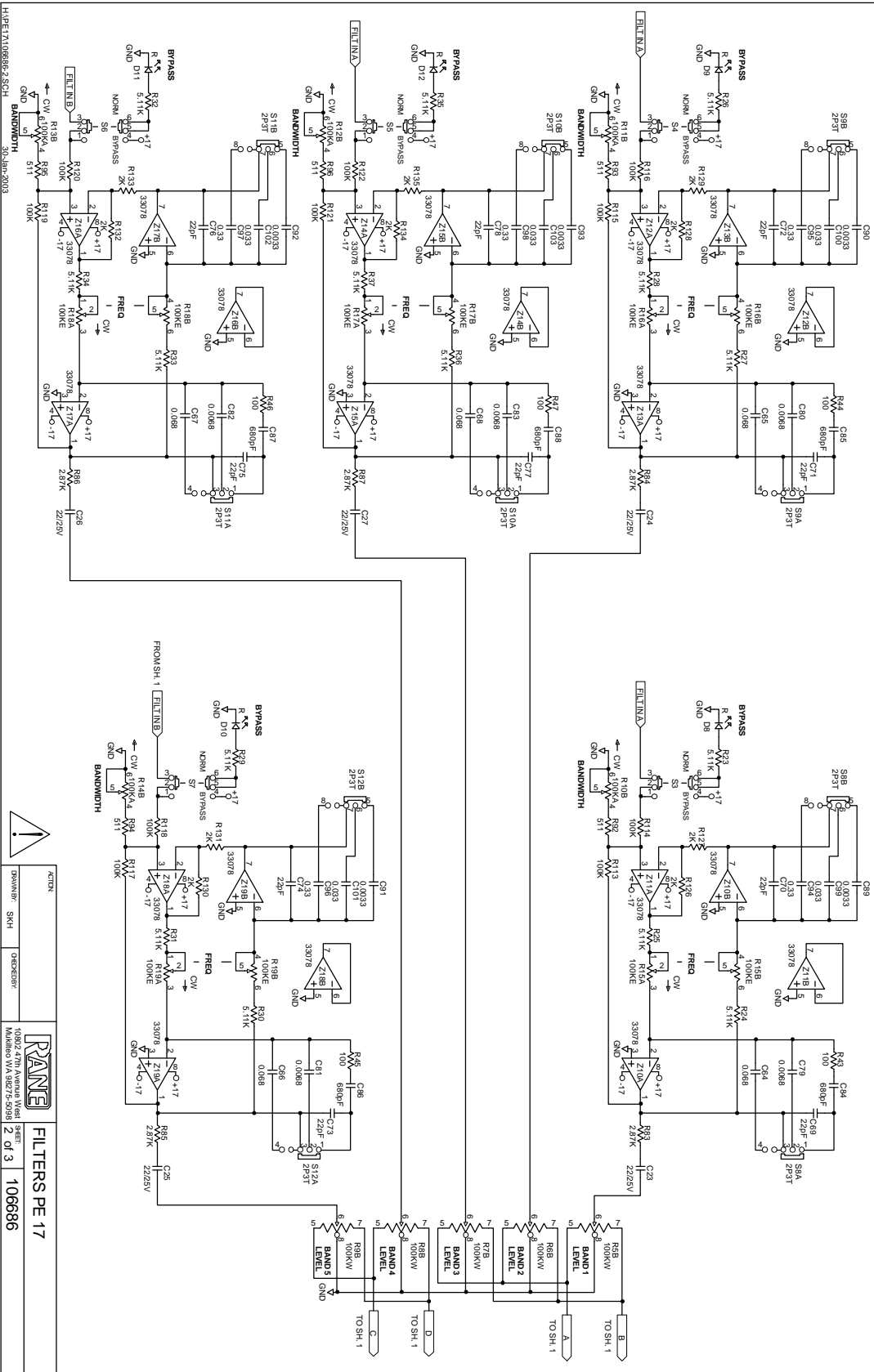

HPE17A08686ZSCH 30.Jan.2003

ACION	REVISION	10862 27th Avenida Wsari	SHEET	106686
DIAGRAMA	SKM	MAKERS VIA S0725-5881	2	3
CREADOR				
<b>PANÉ</b>		<b>FILTERS PE 17</b>		

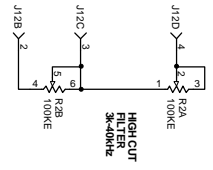
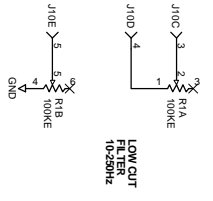
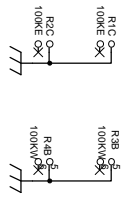
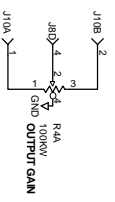
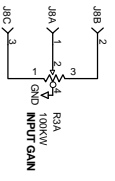
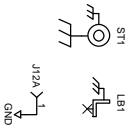

ACTION			SLIDER PE 17
DRAWN BY	CHKD BY		
SKW	CPB/CEC/STW	10802 47th Avenue West Hudsonville, MI 49427-3898	SHEET 3 of 3
			106686