

**CIRCUIT OPERATION**

The engine is controlled by the Fuel Injection ECU (Z132). The ECU is a microprocessor-controlled device that uses the following electrical components to control engine operation:

Fuel Injectors (K141)  
 Fuel Injection Coolant Temperature Sensor (X126)  
 Fuel Temperature Sensor (X128)  
 Idle Speed Stepper Motor (M112)  
 Left and Right Lambda Sensors (X139, X160)  
 Fuel Pump (M109)  
 Air Flow Sensor (X105)  
 Throttle Potentiometer (X171)  
 Vehicle Speed Sensor Buffer (Z160)  
 A/C Thermostat Unit (Z102)  
 Ignition Amplifier Module (Z139)  
 Purge Control Valve (K132)  
 Starter Inhibit Reverse Switch (X167)  
 Tune Select Resistor (K140)  
 Fuel Injection Fault Display Unit (Z133)

**Fuel Injectors (K141)**

With the engine running, the ECU applies earth to the Fuel Injection Load Relay (K116), energizing the relay and applying battery voltage to the Fuel Injectors (K141). The Fuel Injectors are connected to the ECU in groups of 4. The ECU earths each group of Fuel Injectors alternately.

**Fuel Injection Coolant Temperature Sensor (X126)**

The Fuel Injection Coolant Temperature Sensor (X126) decreases its resistance as engine coolant temperature increases. The ECU applies a voltage signal to the Coolant Temperature Sensor. The ECU detects a small current when the engine coolant is at a low temperature; it detects a larger current with a high temperature.

**Fuel Temperature Sensor (X128)**

The Fuel Temperature Sensor (X128) decreases its resistance with an increase in temperature. The ECU applies a voltage signal to the Fuel Temperature Sensor (X128). The ECU detects a small current when the fuel is at a low

temperature; it detects a larger current with a high temperature.

**Idle Speed Stepper Motor (M112)**

The ECU controls engine idle speed by adjusting the Idle Speed Stepper Motor (M112) to compensate for increased electrical and mechanical loads. The ECU controls the stepper motor by sending voltage signals to a pair of motor control windings inside the stepper motor. This allows the ECU to reverse the voltage signals to the stepper motor, moving the bypass valve in or out to vary air flow to the plenum chamber.

**Left and Right Lambda Sensors (X139, X160)**

A heating element and an oxygen sensor are inside each Lambda Sensors (X139, X160). When the engine is running, battery voltage is applied to both Lambda Sensors via the Fuel Pump Relay. A small voltage is generated as exhaust gas passes the sensors. The ECU senses this voltage and adjusts fuel supply to the engine.

**Fuel Pump (M109)**

With the engine running, the ECU provides an earth for the Fuel Pump Relay (K119), which applies battery voltage to the Fuel Pump (M109) via the Inertia Switch (X135). The Inertia Switch opens to turn off the Fuel Pump when the vehicle experiences a sudden impact.

**Air Flow Sensor (X105)**

With the Ignition Switch (X134) in position II, the ECU applies earth to the Fuel Injection Load Relay (K116), energizing the relay and applying battery voltage to the Air Flow Sensor (X105). The ECU applies 5 volts to the Air Flow Sensor terminal 6 and the sensor sends a voltage signal to the ECU terminal 35. The greater the volume of air passing through the Air Flow Sensor, the greater the voltage signal to the ECU.

**Throttle Potentiometer (X171)**

With the Ignition Switch (X134) in position II, the ECU provides an earth via terminal 25 and supplies 5 volts to the Throttle Potentiometer (X171) terminal 3. When the throttle is moved, the potentiometer sends a voltage signal to ECU terminal 20. This signal varies between less than 1 volt at closed throttle to more than 4 volts at full open throttle.

**Vehicle Speed Sensor Buffer (Z160)**

The Vehicle Speed Sensor Buffer (Z160) sends signals to the ECU in the form of voltage pulses. The voltage varies between battery voltage and 0 volts 6 times per wheel revolution.

**A/C Thermostat Unit (Z102)**

When Compressor Clutch (K107) operation is requested, a voltage signal is sent to the ECU from the A/C Thermostat Unit (Z102) via the A/C High and Low Pressure Switches (X102, X103). The ECU uses this signal both to engage the Compressor Clutch and to compensate for the added load placed on the engine by the Compressor Clutch. If the refrigerant pressure is too high or too low, the High or Low Pressure Switch opens, interrupting the voltage signal from the Thermostat Unit to the ECU.

**Purge Control Valve (K132)**

With the engine running, the ECU provides an earth for the Fuel Pump Relay (K119). The relay applies battery voltage to the Purge Control Valve (K132). Earth is applied to operate the Purge Control Valve by the ECU when the following conditions prevail: (1) Engine is running at speeds above 1700 rev/min and temperatures above 54°C (ECU will open the valve as necessary) or (2) Engine speed is below 1700 rev/min (ECU will pulse valve open for short periods).

**Starter Inhibit Reverse Switch (X167)**

The Starter Inhibit Reverse Switch (X167) applies earth to the ECU with the transmission in P or N.

**Tune Select Resistor (K140) (Not Fitted To U.S.A. Vehicles)**

The Tune Select Resistor (K140) receives a 5 volt signal from the ECU. The opposite terminal of the Tune Select Resistor (K140) is earthed at all times. The Tune Select Resistor (K140) causes the 5 volt signal read at the ECU terminal 5 to decrease. The ECU determines how the engine should perform based on the amount of voltage at terminal 5. This resistor is not present on USA vehicles.

**Ignition Amplifier Module (Z139)**

The ignition system consists of the Ignition Amplifier Module (Z139) and Distributor (Z125).

The ECU receives a pulsing earth signal from the Ignition Amplifier Module via a 6.8K ohm resistor. The rate of these pulses corresponds to the engine speed.

**Fuel Injection Fault Display Unit (Z133) (U.S.A. Vehicles Only)**

The Fuel Injection Fault Display Unit (Z133) receives battery voltage when the Ignition Switch (X134) is in position II. It is earthed at all times. Behind the dark exterior of this unit there is a 2-digit 7-segment digital display that is visible only when a fault code is set. The unit receives data from the ECU via the 2 wires that link them together.

**THIS PAGE HAS BEEN INTENTIONALLY LEFT BLANK**

THIS PAGE HAS BEEN INTENTIONALLY LEFT BLANK

**THIS PAGE HAS BEEN INTENTIONALLY LEFT BLANK**

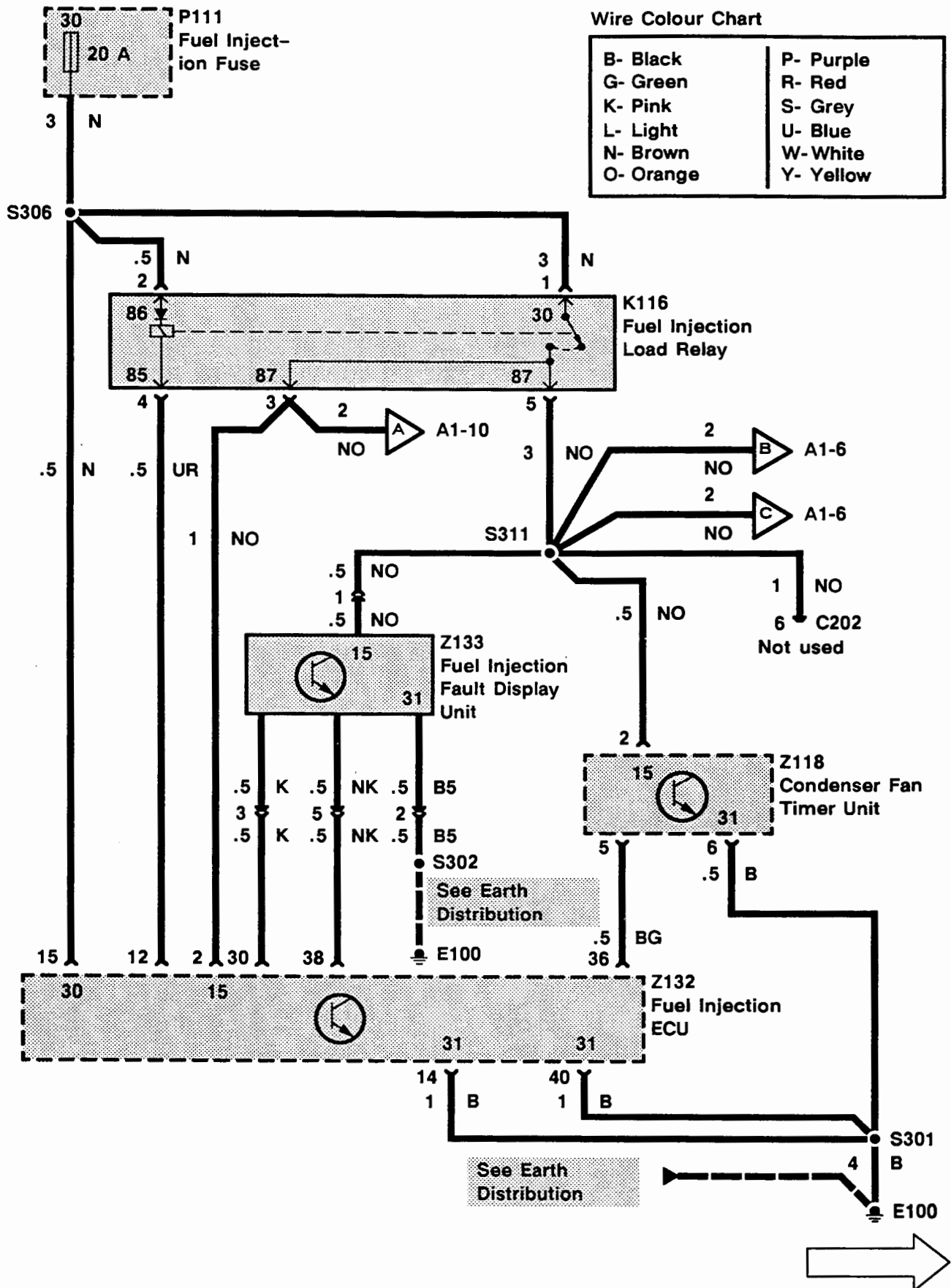

**A1 ETM**

**1992 RANGE ROVER**

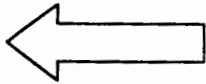

Wire Colour Chart

B- Black	P- Purple
G- Green	R- Red
K- Pink	S- Grey
L- Light	U- Blue
N- Brown	W- White
O- Orange	Y- Yellow

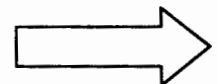
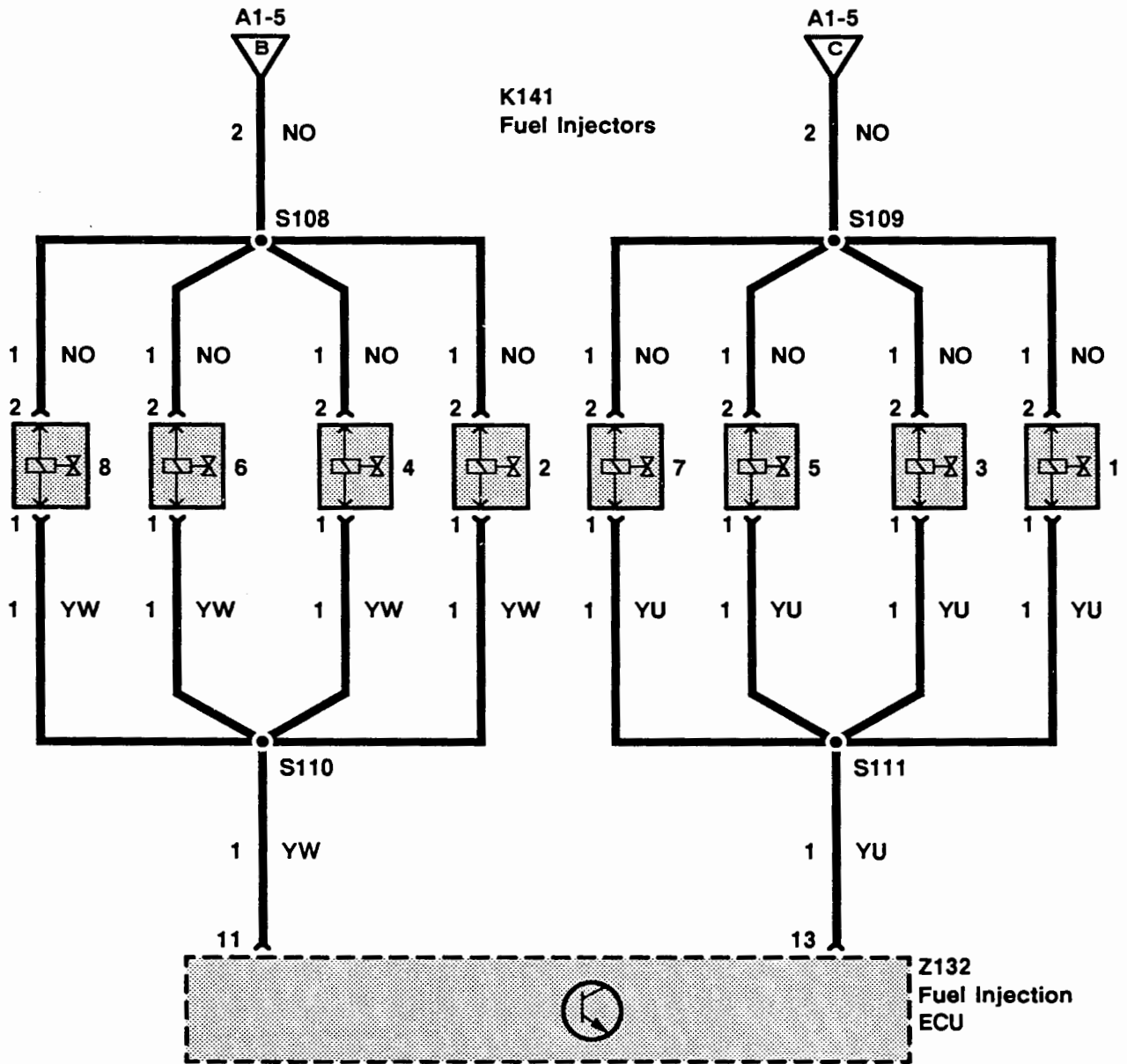

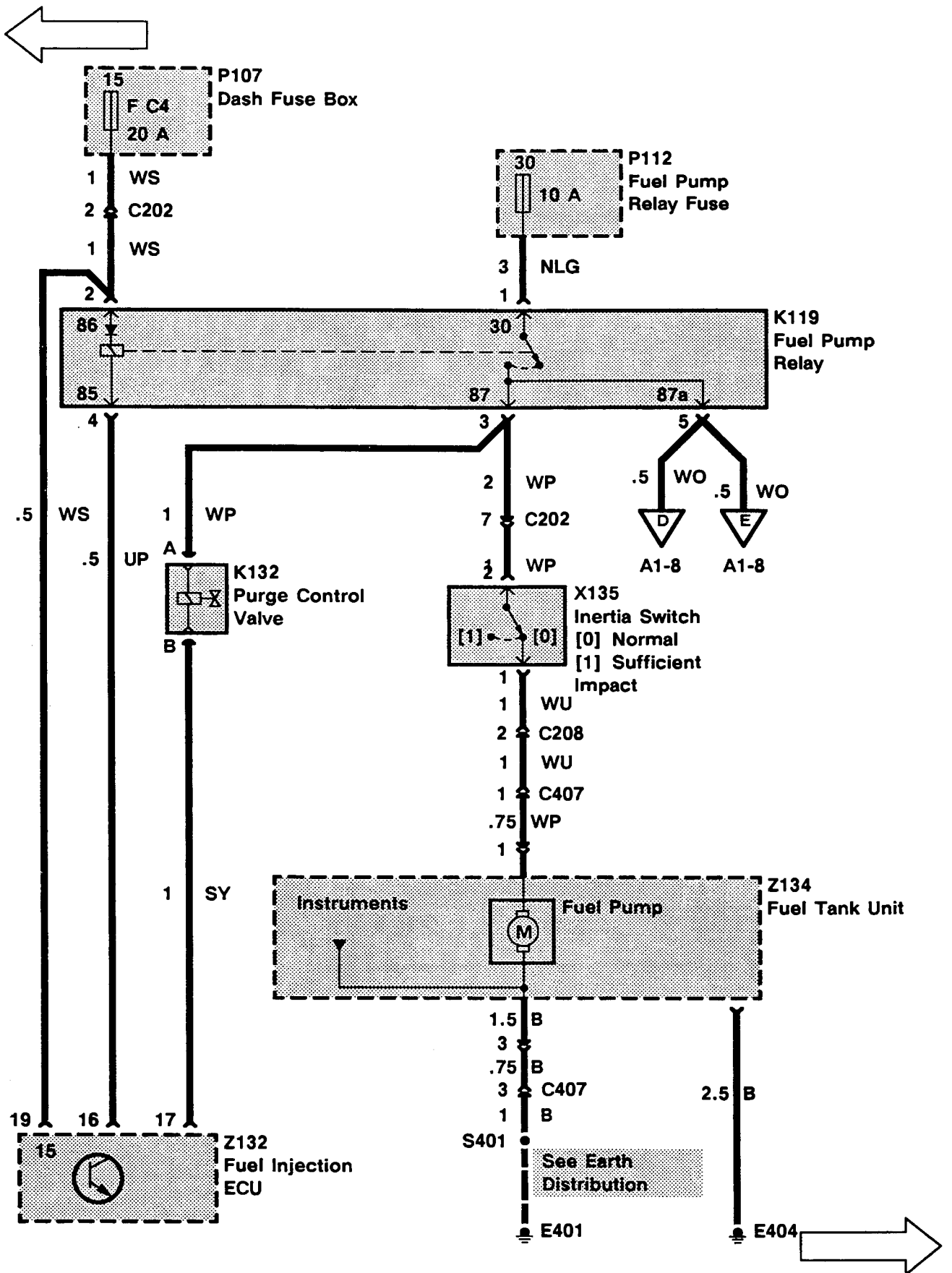



**A1 ETM**

**1992 RANGE ROVER**

Wire Colour Chart

B- Black	P- Purple
G- Green	R- Red
K- Pink	S- Grey
L- Light	U- Blue
N- Brown	W- White
O- Orange	Y- Yellow

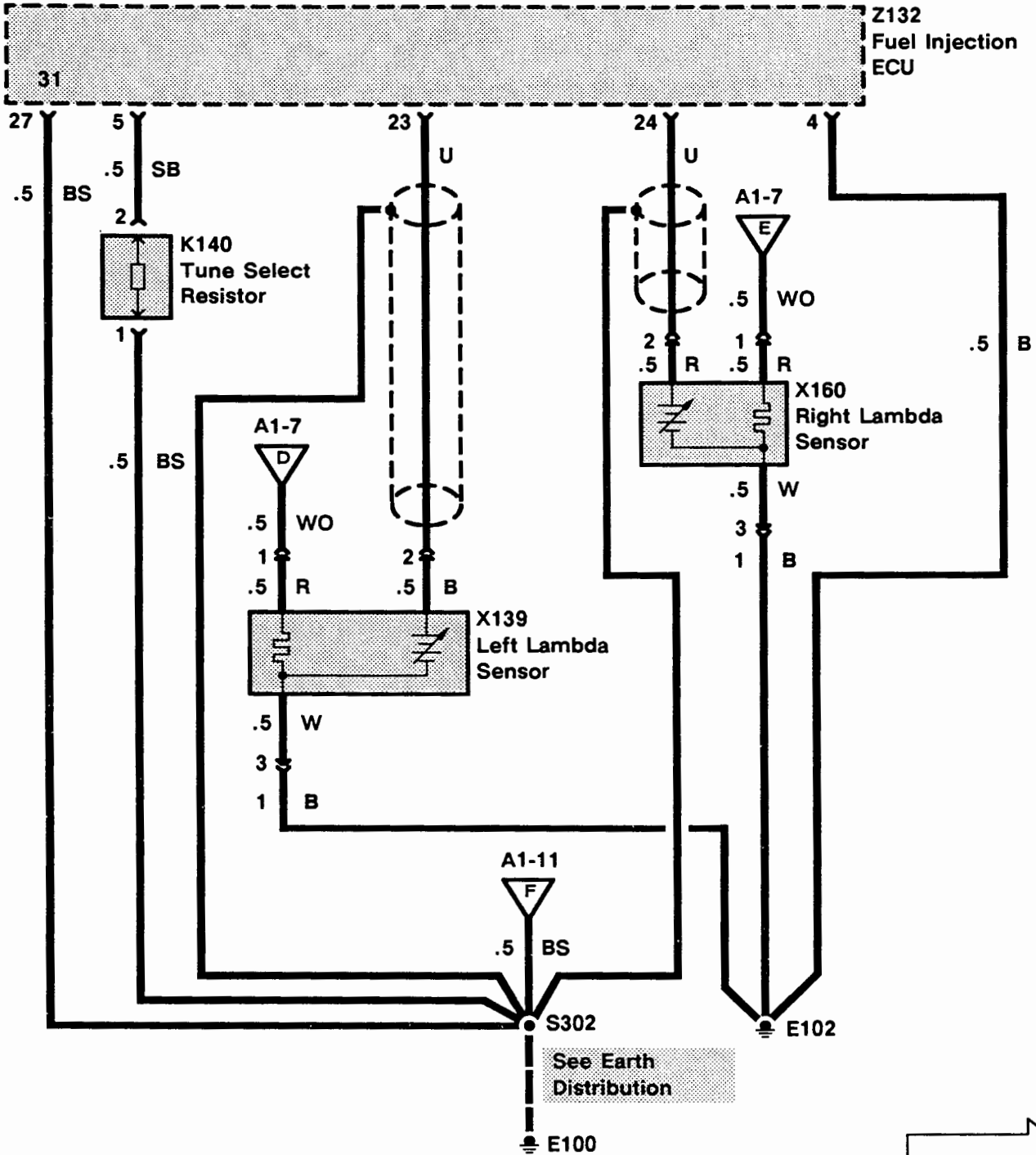

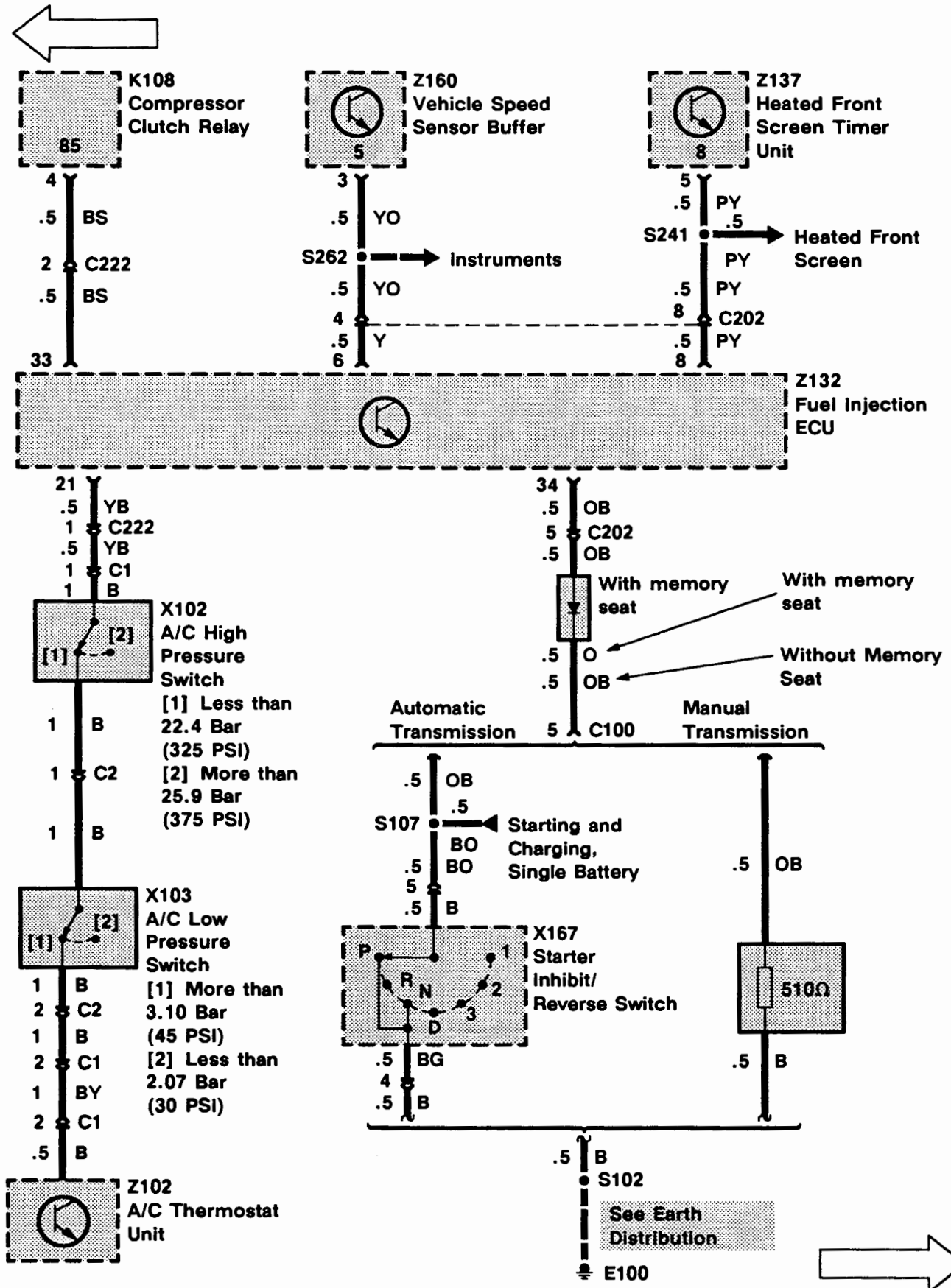

**A1 ETM**

**1992 RANGE ROVER**

**Wire Colour Chart**

B- Black	P- Purple
G- Green	R- Red
K- Pink	S- Grey
L- Light	U- Blue
N- Brown	W- White
O- Orange	Y- Yellow

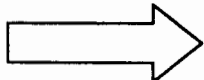
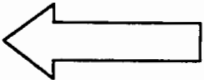
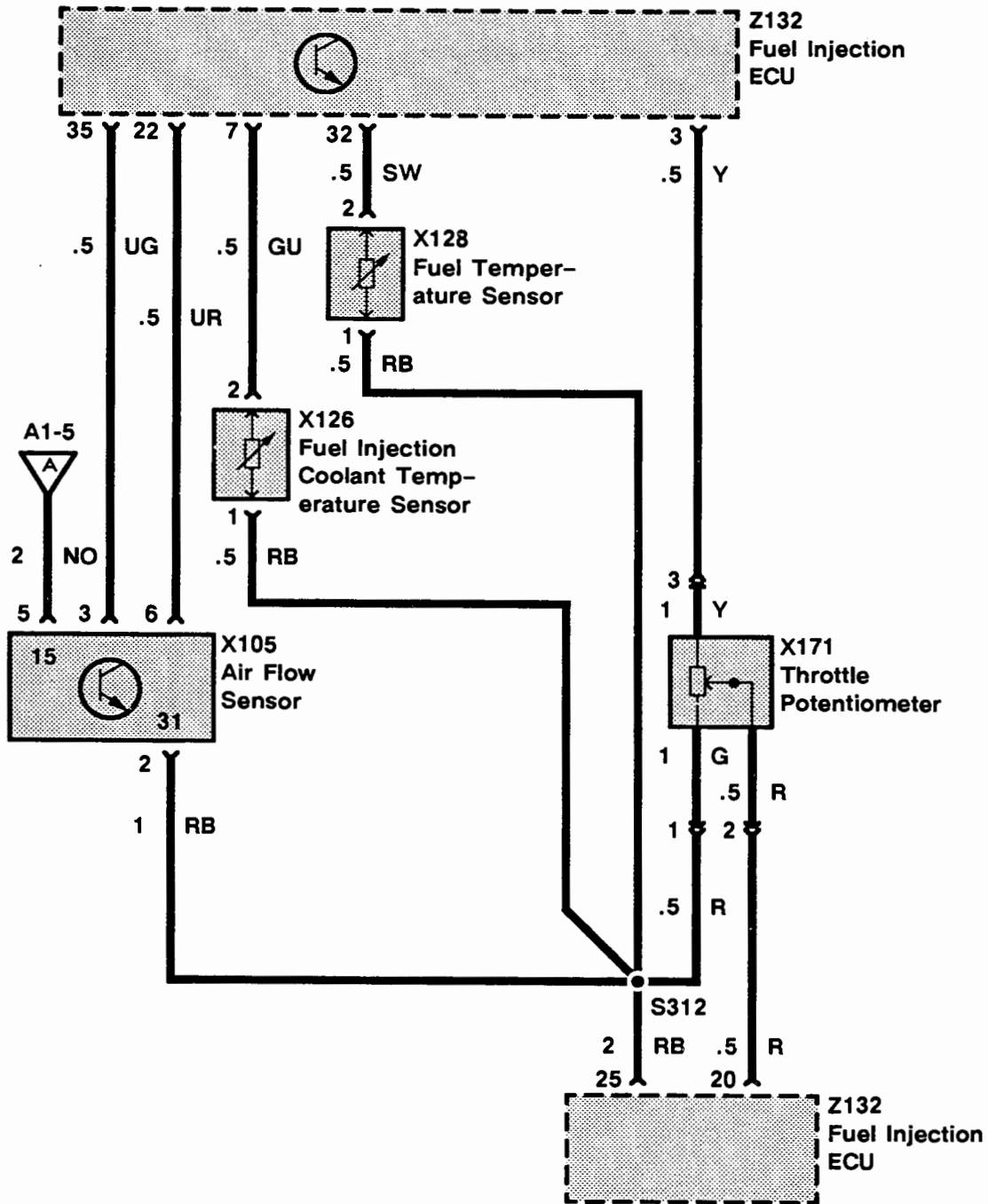

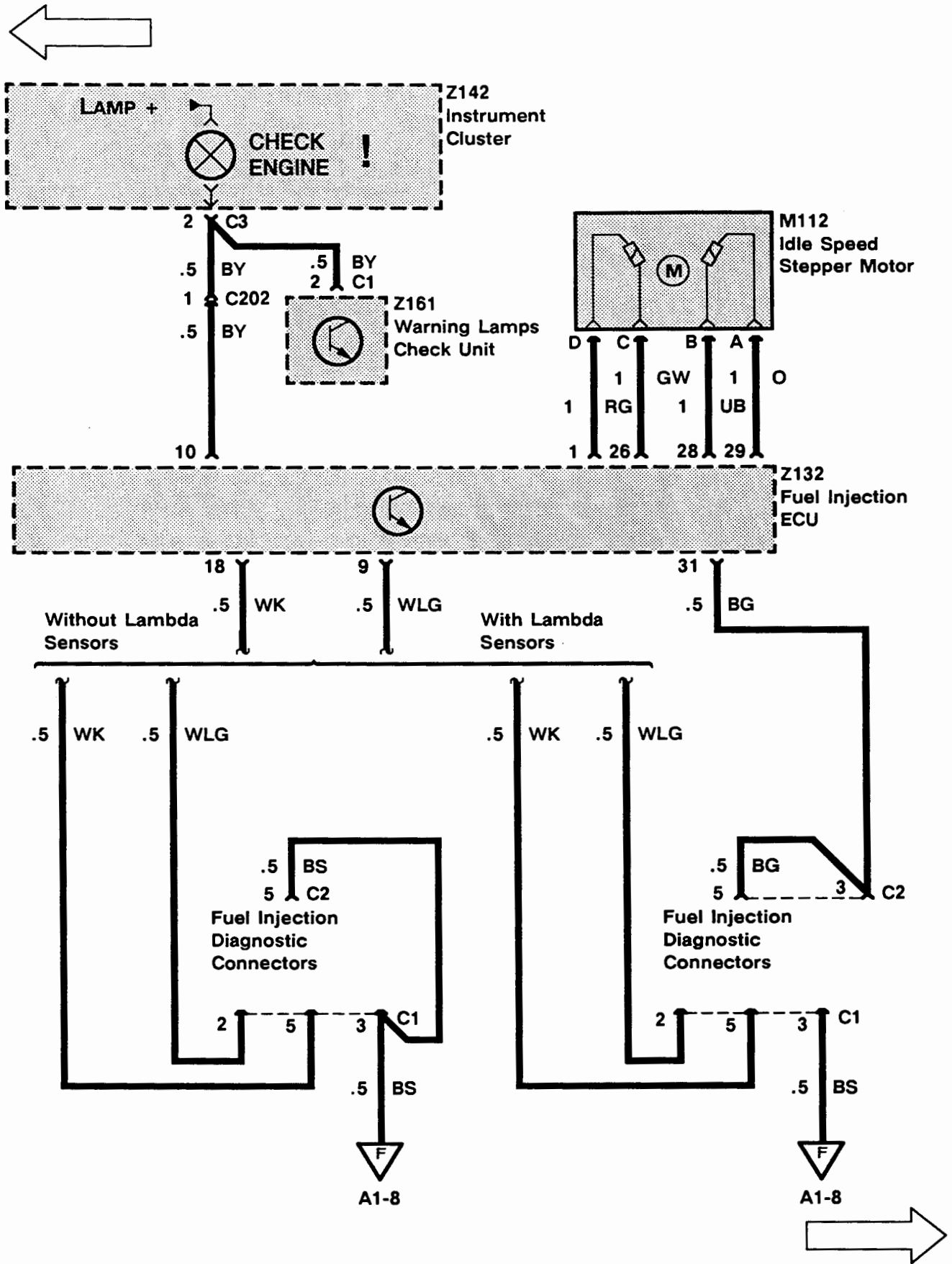

# A1 ETM

## 1992 RANGE ROVER

### Wire Colour Chart

B- Black	P- Purple
G- Green	R- Red
K- Pink	S- Grey
L- Light	U- Blue
N- Brown	W- White
O- Orange	Y- Yellow

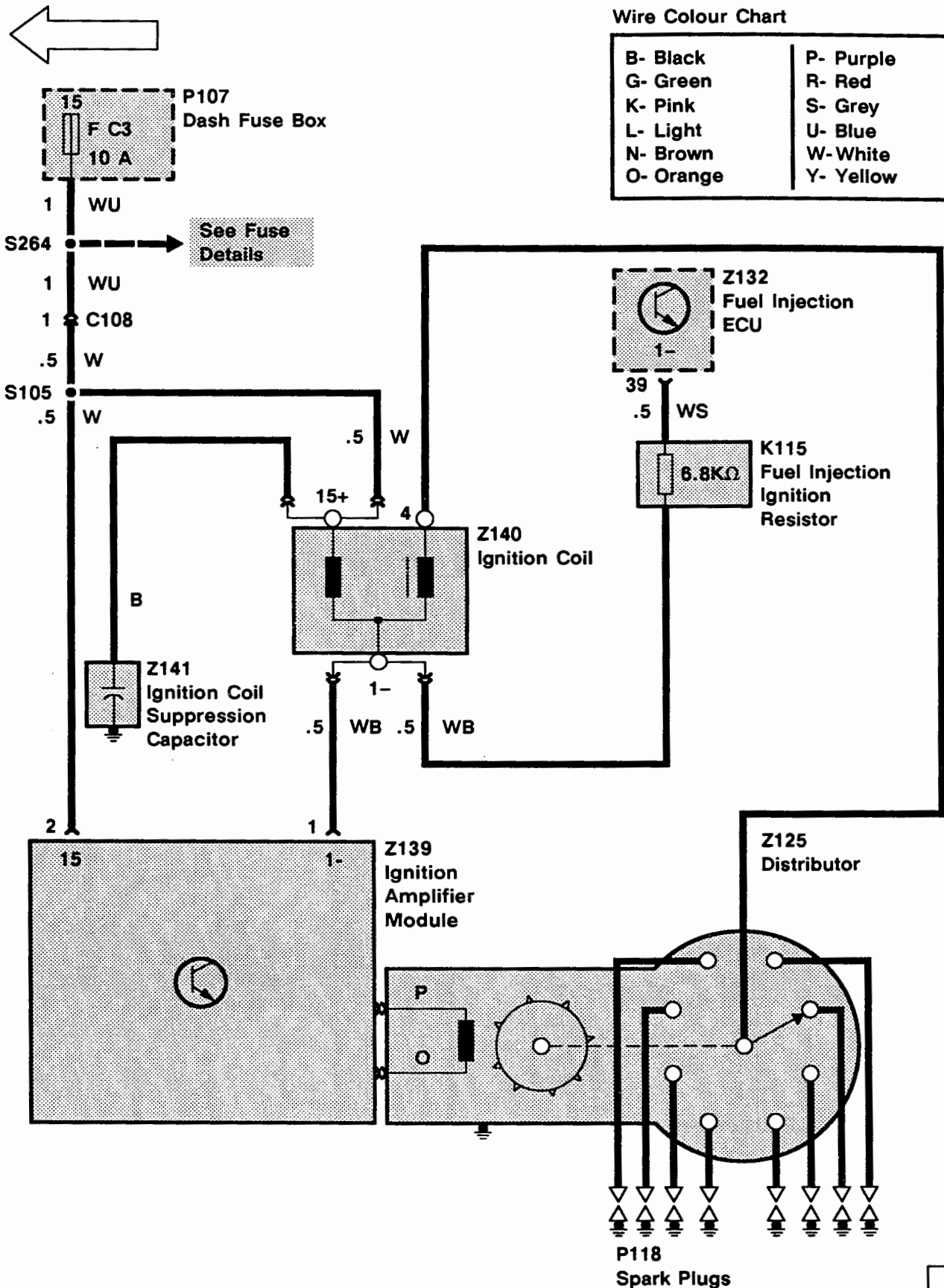

**TROUBLESHOOTING HINTS**

1. If the engine starts but the check engine warning light does not light momentarily, check the bulb and BY wire.

**Reading Fault Codes**

The ECU is capable of storing fault codes. For U.S. vehicles, these fault codes may be read by switching the Ignition Switch (X134) to position II and observing the Fuel Injection Fault Display Unit (Z133). If no codes are present, the display will appear blank. A lit service engine warning light indicates that a fault is present. For non-U.S. vehicles (not equipped with a Fuel Injection Fault Display), the Lucas diagnostic equipment, part number 60600965, is recommended for reading fault codes.

**Clearing Fault Codes**

When a fault has been corrected, the fault code must be cleared. This is done by performing the following procedure:

1. Put the Ignition Switch (X134) in position II.
2. Disconnect the Fuel Injection Diagnostic Connectors (X127) and wait 5 seconds. Reconnect Fuel Injection Diagnostic Connectors.
3. Put the Ignition Switch (X134) in position 0 and wait till the load relay drops out.
4. Put the Ignition Switch (X134) in position II. The display will be blank if no other faults exist. If other codes exist, the next fault code will be displayed.
5. If multiple faults exist, repeat steps 1 through 4 until all faults are cleared.

Code 02 indicates that the ECU has just been reconnected. Switch the Ignition Switch (X134) to position II to clear code 02.

**CAUTION:** All ECU connector measurements must be made at the back of the ECU connector. Probing the connector face cavities will result in damage to the connector terminals, resulting in poor terminal contact.

**SYSTEM DIAGNOSIS**

1. If the engine cranks but does not start and the check engine warning light does not light

with the Ignition Switch (X134) in position II, do Test B.

2. If the engine cranks but does not start and the check engine warning light does light with Ignition Switch (X134) in position II, do Test C.

**Code Diagnosis**

1. Code 12 indicates an Air Flow Sensor (X105) fault. Do Test D.
2. Code 14 indicates a Fuel Injection Coolant Temperature Sensor (X126) fault. Do Test E.
3. Code 15 indicates a Fuel Temperature Sensor (X128) fault. Do Test F.
4. Code 17 indicates a Throttle Potentiometer (X171) fault. Do Test G.
5. Code 18 indicates a high Throttle Potentiometer (X171) output versus a low Air Flow Sensor (X105) output. Do Test H.
6. Code 19 indicates a low Throttle Potentiometer (X171) output versus a high Air Flow Sensor (X105) output. Do Test H.
7. Code 21 indicates a Tune Select Resistor (K140) fault. Do Test A.
8. Code 23 indicates a fuel supply fault. Go to Workshop Manual Section 19 for fuel regulation tests.
8. Code 28 indicates an engine air leak. Go to Workshop Manual Section 19.
10. Code 29 indicates an ECU memory fault. Do Test I.  
NOTE: If code 29 is present, all other fault codes stored are unreliable and must be ignored.
11. Code 34 indicates a left bank injector fault. Do Test J.
12. Code 36 indicates a right bank injector fault. Do Test J.
13. Code 40 indicates a left bank misfire. Go to Workshop Manual Section 19.
14. Code 44 Indicates a left bank Lambda Sensor (X139, X160) fault. Do Test K.
15. Code 45 Indicates a right bank Lambda Sensor (X139, X160) fault. Do Test K.
16. Code 48 indicates an Idle Speed Stepper Motor (M112) fault. Check engine base idle speed. If OK, do Test M.

Test A

1A

**CONDITIONS**

- Ignition Switch  
Position: 0

**RESULTS**

3700 - 4100  $\Omega$  (Euro, catalyst)  
 446 - 494  $\Omega$  (Euro, non-catalyst)  
 171 - 189  $\Omega$  (Australia)  
 864 - 956  $\Omega$  (Saudi)

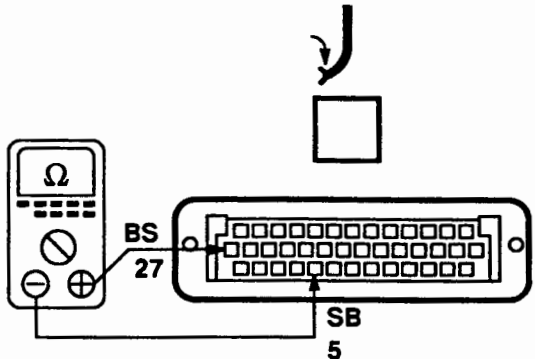

Z132  
Fuel Injection  
ECU

- OK** PROBLEM CAUSE
- SB Wire
  - BS Wire
  - Tune Select Resistor

- OK** PROBLEM CAUSE
- Connector
  - Fuel Injection ECU

Test B

1B

**CONDITIONS**

- Ignition Switch  
Position: 0

**RESULTS**

BAT VOLT

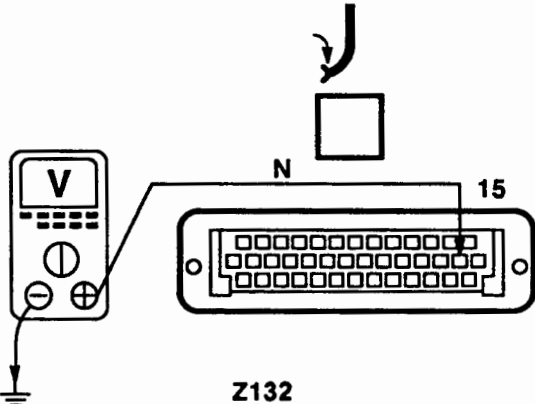

Z132  
Fuel Injection  
ECU

- OK** PROBLEM CAUSE
- N Wire
  - Fuel Injection Fuse

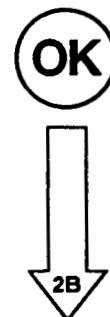

# A1 ETM

## 1992 RANGE ROVER

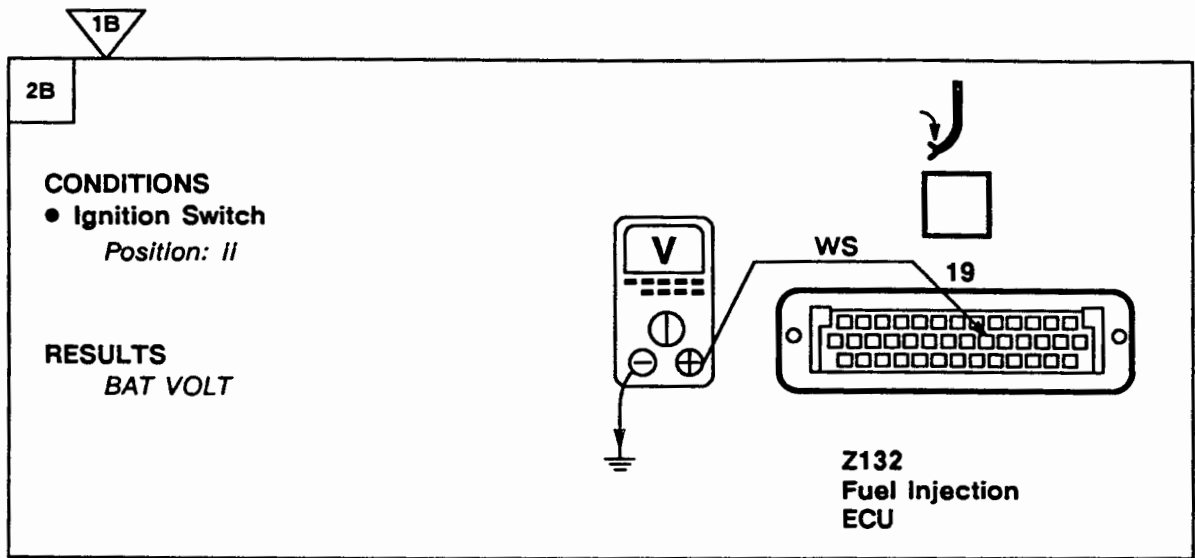

~~OK~~ PROBLEM CAUSE  
- WS Wire

OK

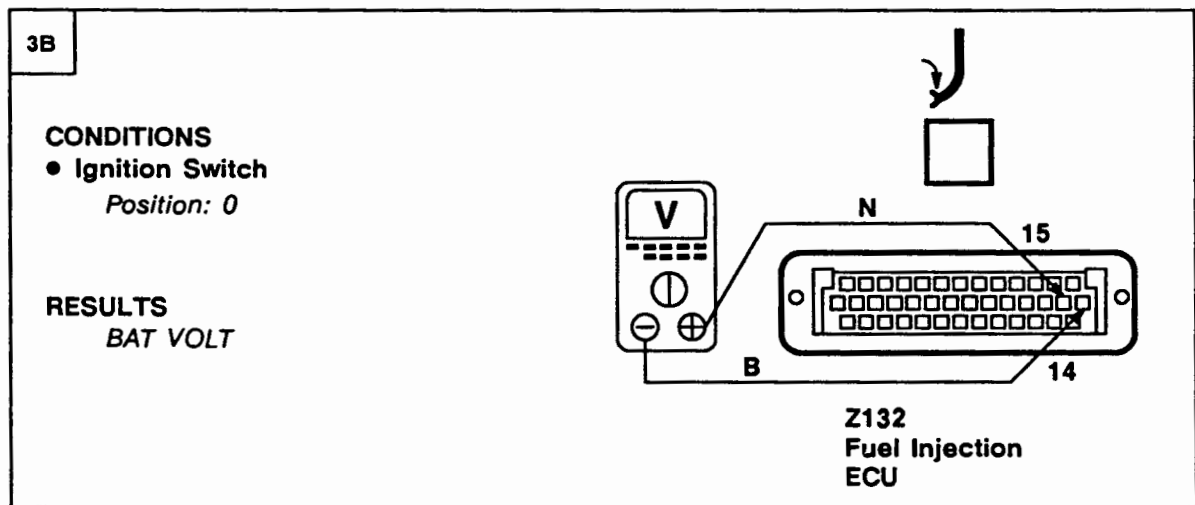

~~OK~~ PROBLEM CAUSE  
- B Wire

OK





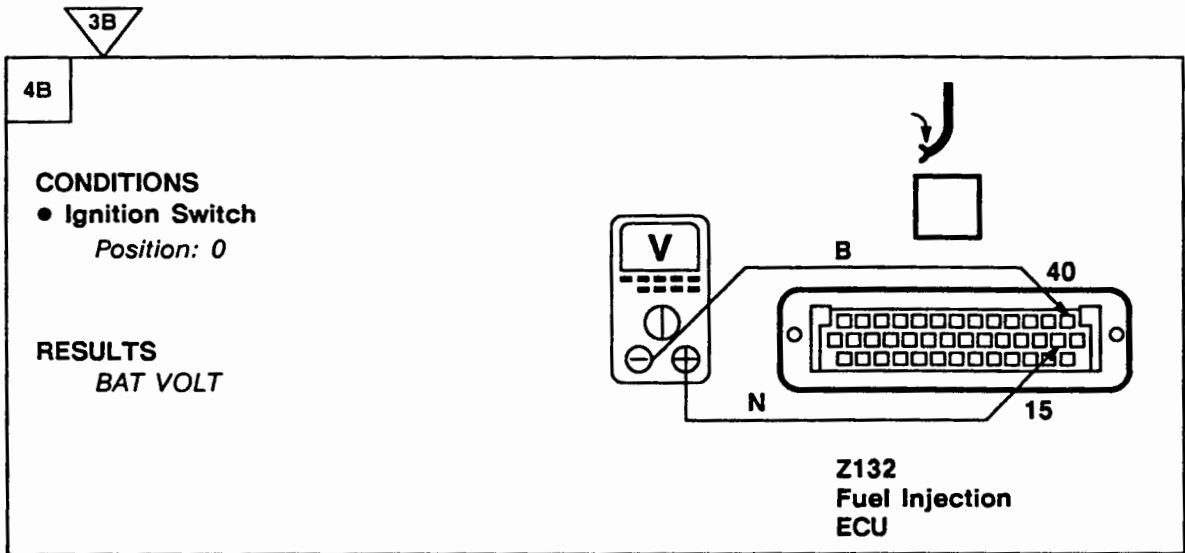

**OK** PROBLEM CAUSE  
- B Wire

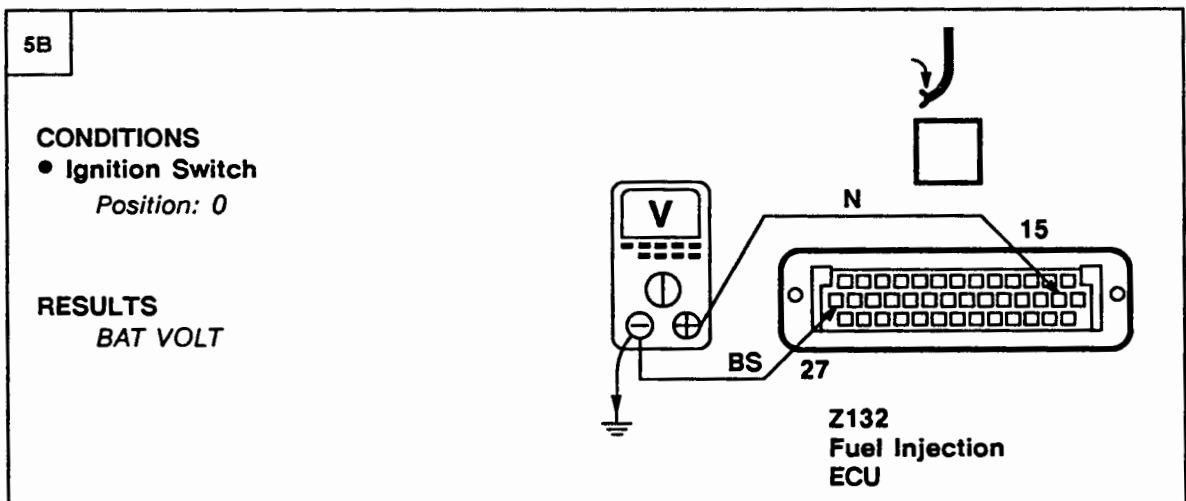
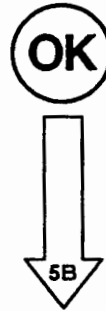

**OK** PROBLEM CAUSE  
- BS Wire

**OK** PROBLEM CAUSE  
- Fuel Injection ECU

# A1 ETM

## 1992 RANGE ROVER

### Test C

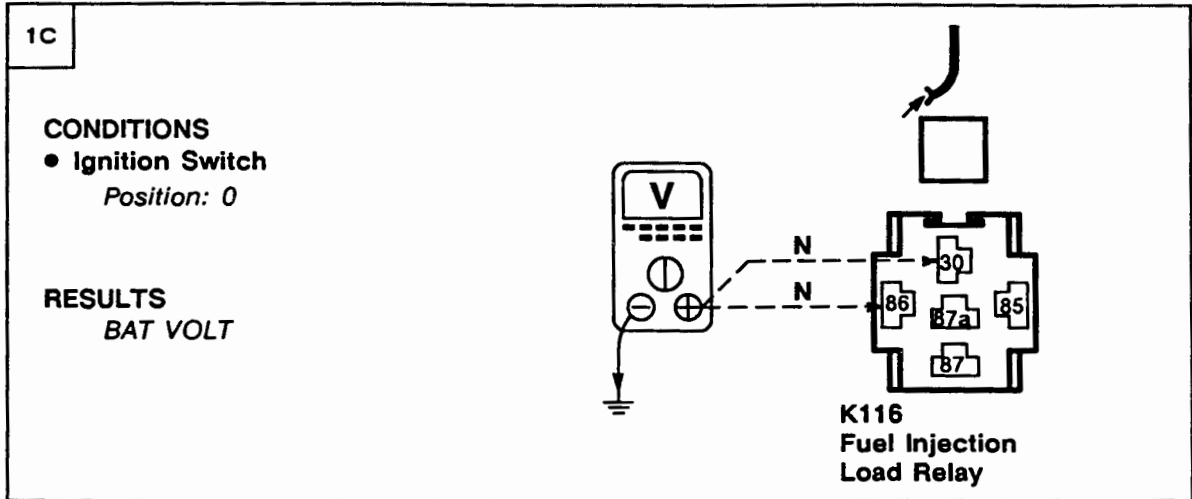

**PROBLEM CAUSE**  
- N Wire

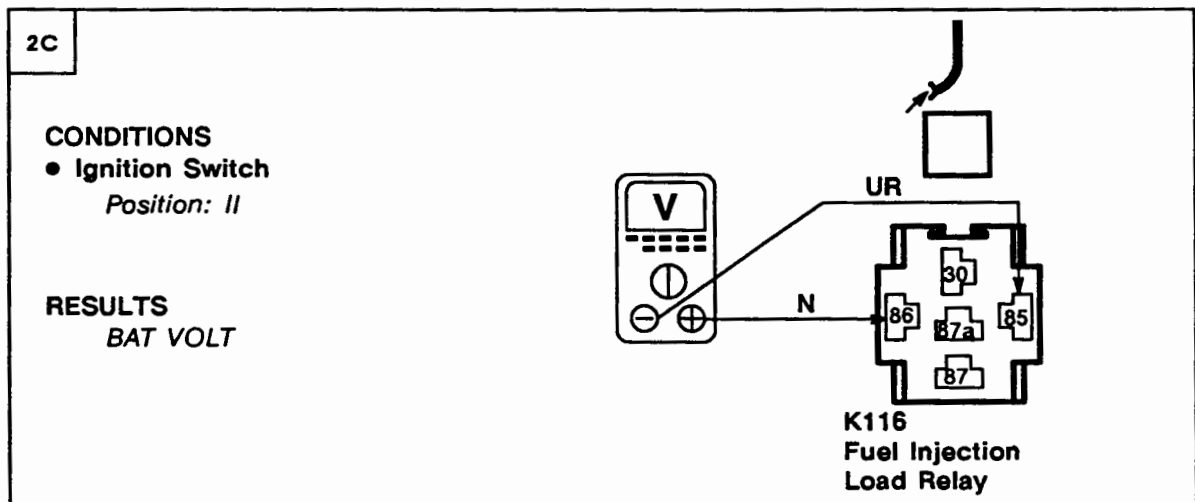

**PROBLEM CAUSE**  
- UR Wire  
- Fuel Injection ECU



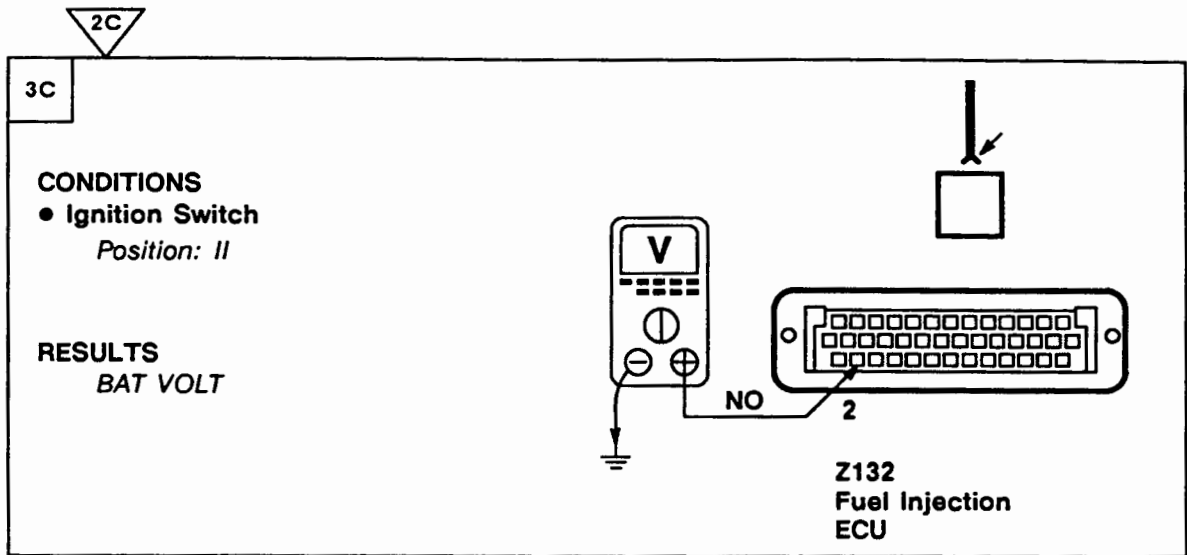

~~OK~~ **PROBLEM CAUSE**

- NO Wire
- Fuel Injection Load Relay

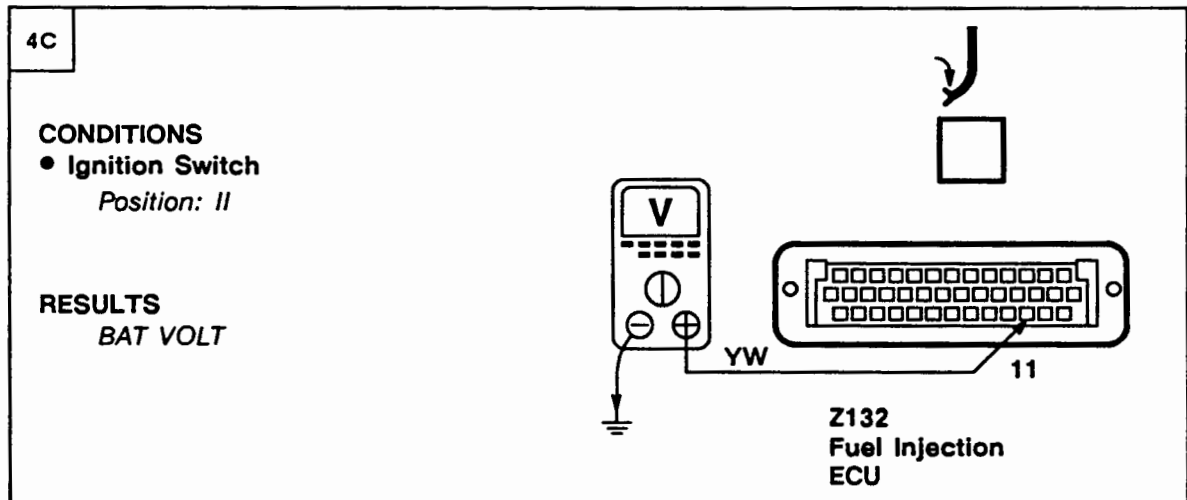

~~OK~~ **PROBLEM CAUSE**

- NO Wire
- YW Wire

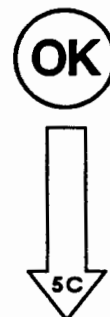

# A1 ETM

## 1992 RANGE ROVER

4C

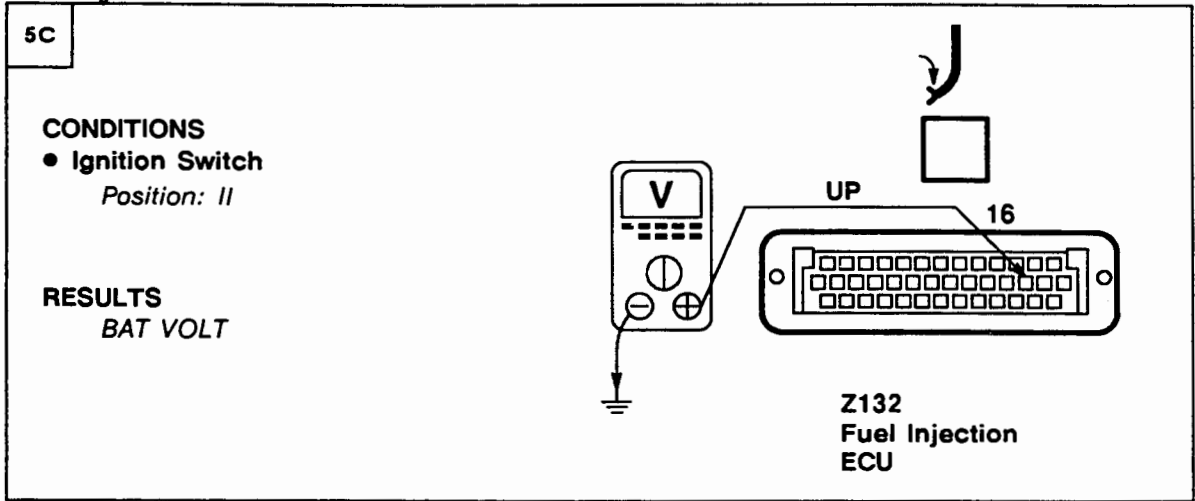

**PROBLEM CAUSE**

- UP Wire
- Fuel Pump Relay

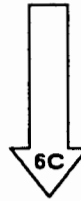

6C

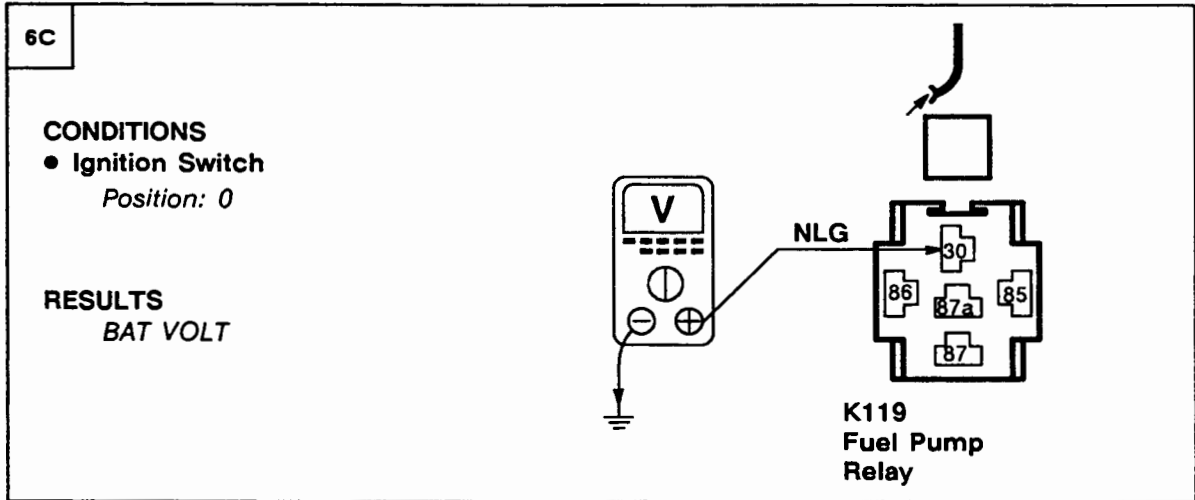

**PROBLEM CAUSE**

- NLG Wire
- Fuel Pump Relay Fuse

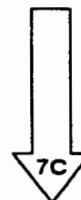

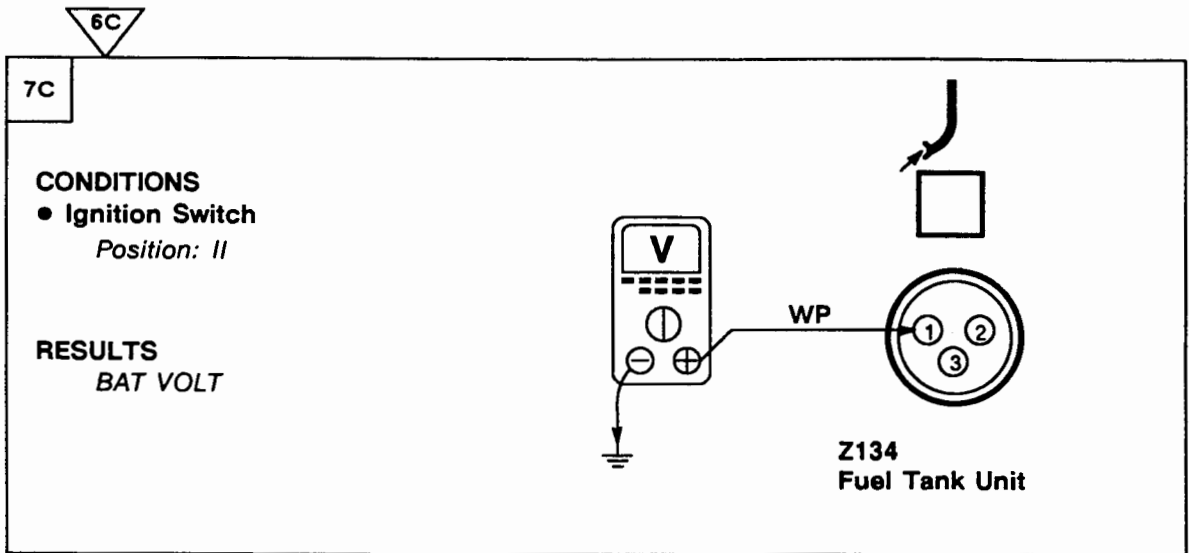

~~OK~~ PROBLEM CAUSE

- WP Wire
- WU Wire
- Inertia Switch
- Fuel Pump Relay

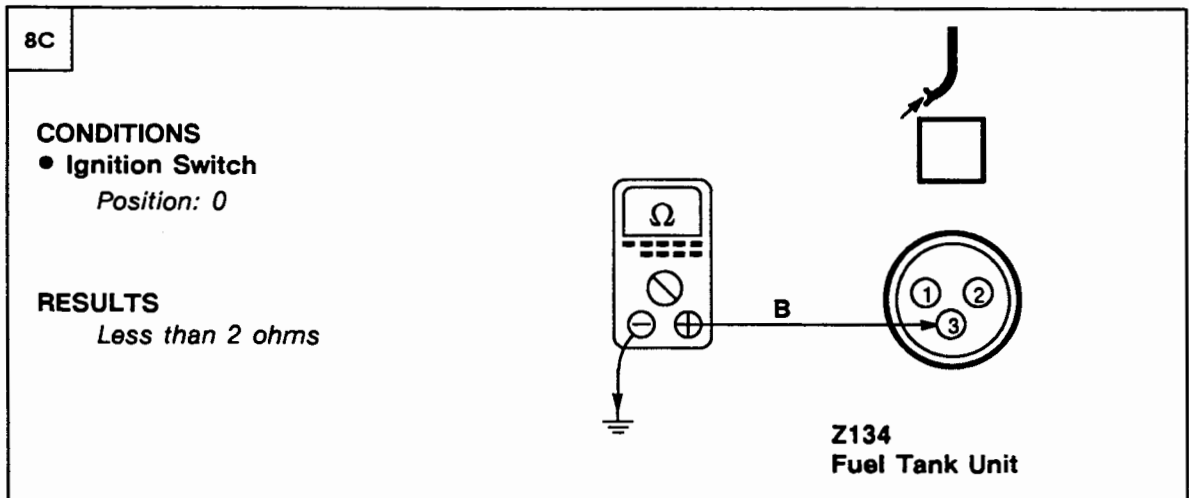
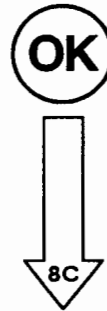

~~OK~~ PROBLEM CAUSE

- B Wire

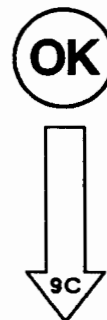

# A1 ETM

## 1992 RANGE ROVER

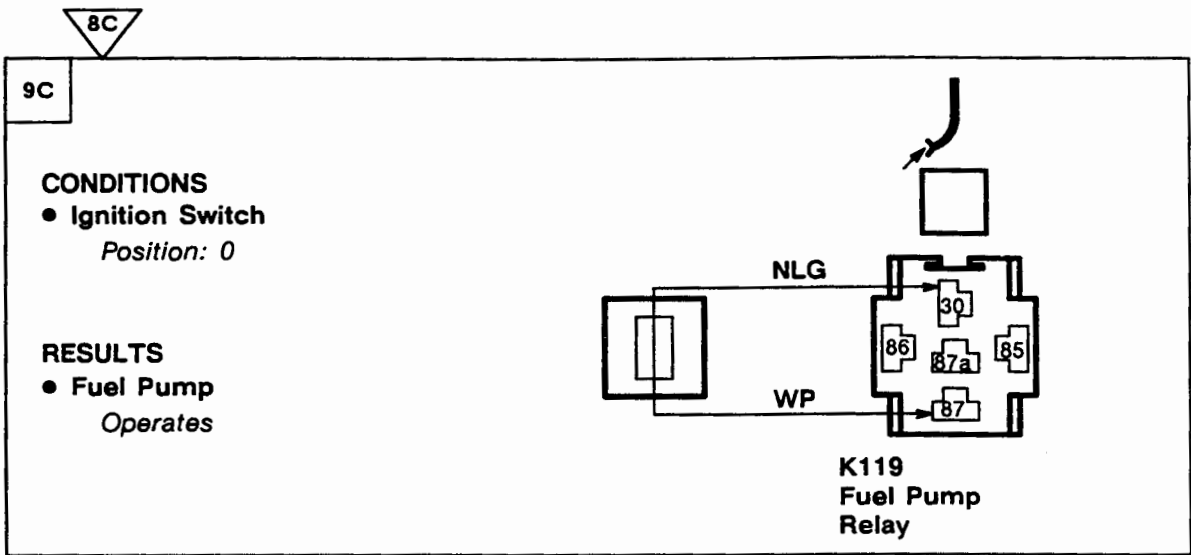

~~OK~~ **PROBLEM CAUSE**  
- Fuel Pump

OK

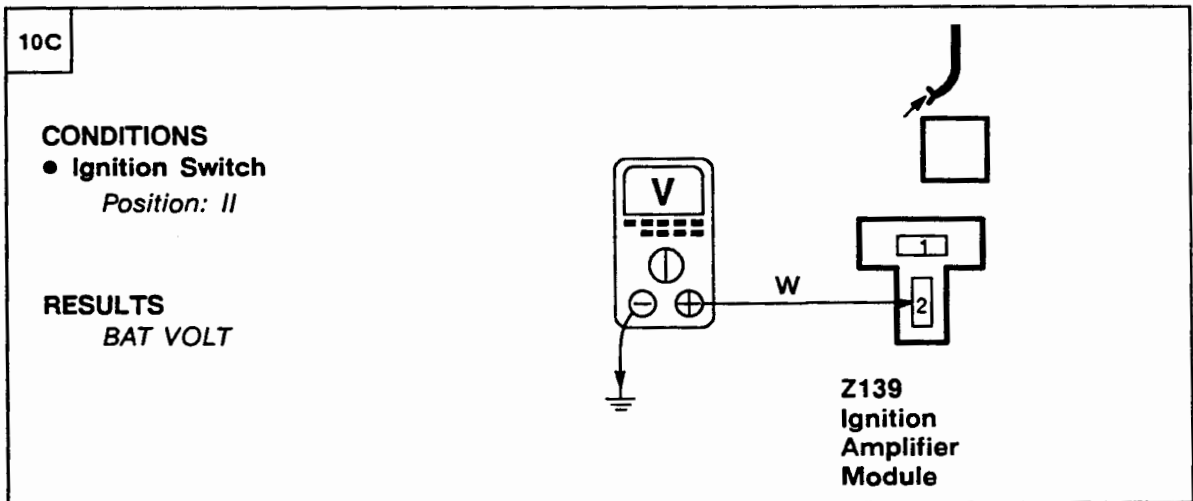
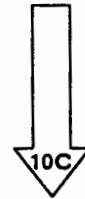

~~OK~~ **PROBLEM CAUSE**  
- F C3 Fuse  
- W Wire  
- WU Wire

OK

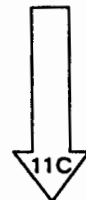

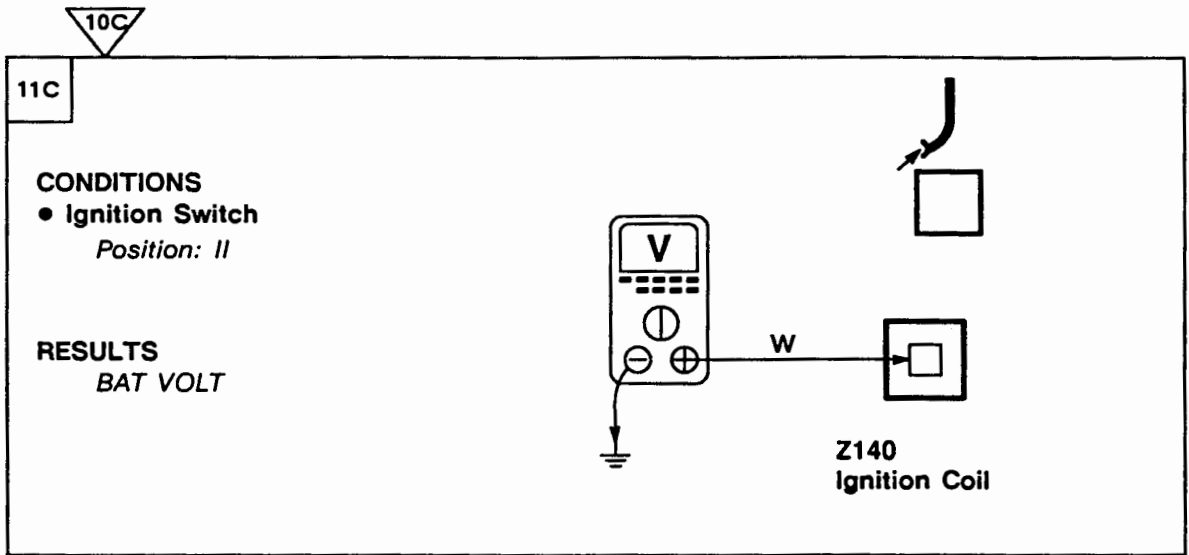

~~OK~~ PROBLEM CAUSE  
 - W Wire

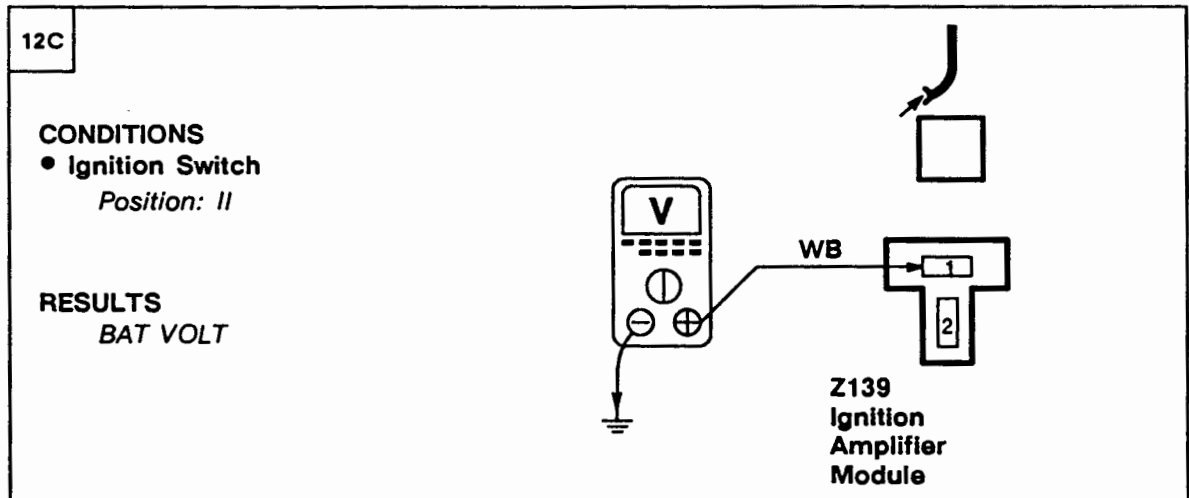
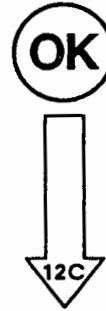

~~OK~~ PROBLEM CAUSE  
 - WB Wire  
 - Ignition Coil

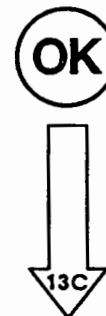

**A1 ETM**

**1992 RANGE ROVER**

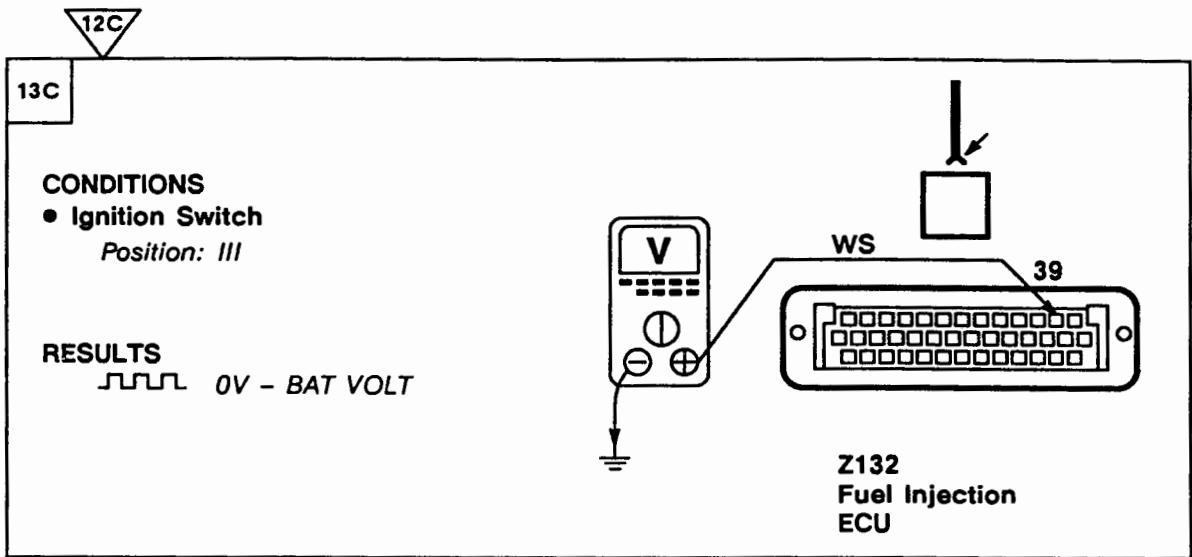

**PROBLEM CAUSE**

- WB Wire
- Distributor
- Fuel Injection Ignition Resistor
- Ignition Amplifier Module



**GO TO WORKSHOP  
MANUAL SECTION 12**

**Test D**

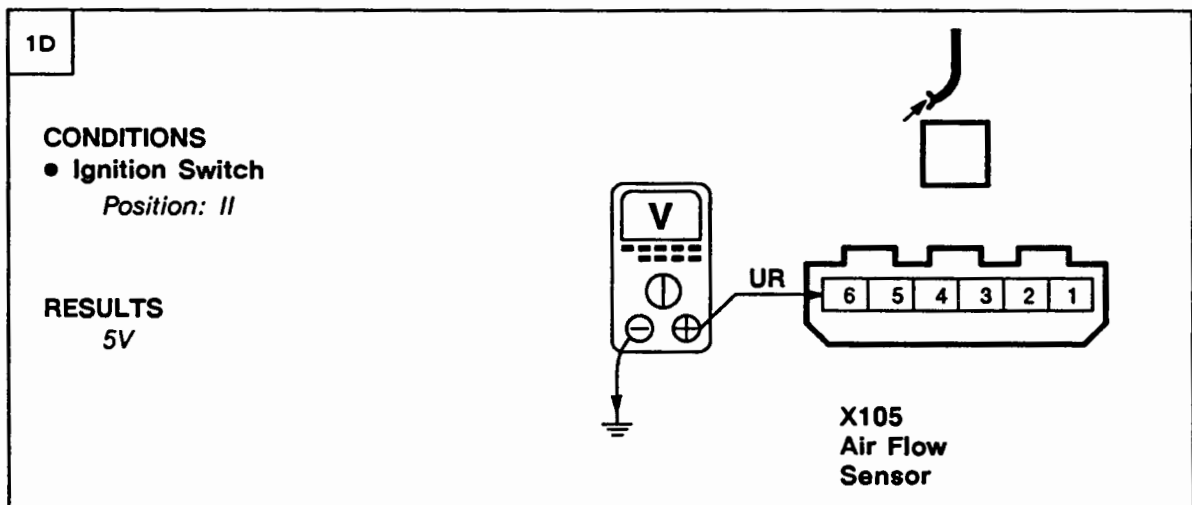

**PROBLEM CAUSE**

- UR Wire
- Fuel Injection ECU





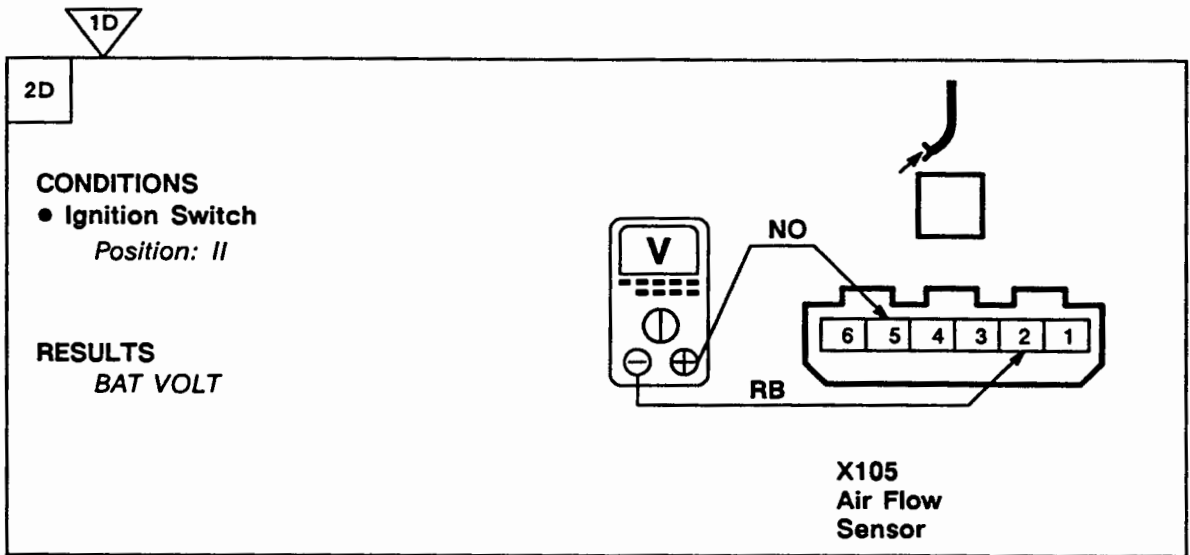

~~OK~~ PROBLEM CAUSE  
- NO Wire  
- RB Wire

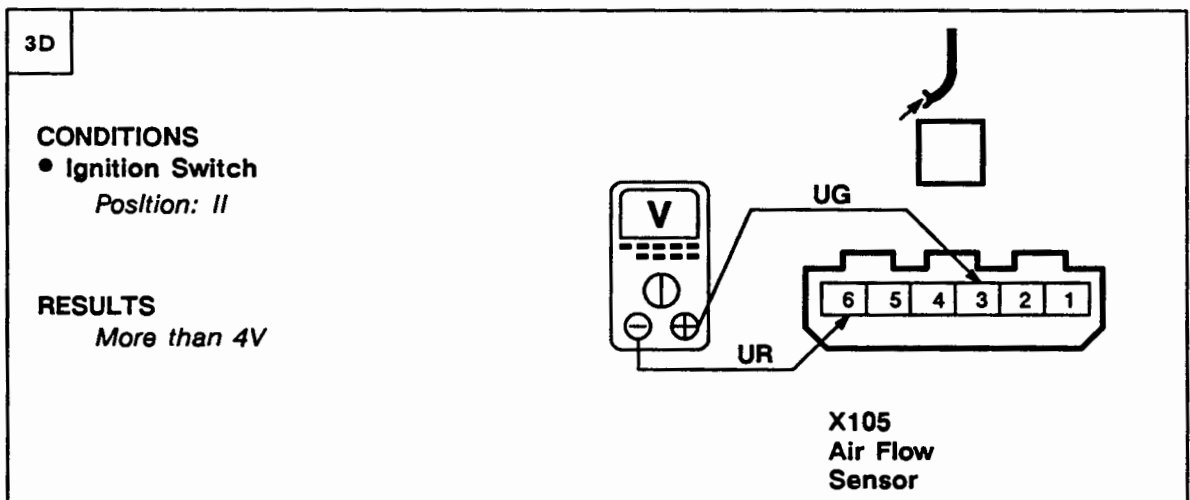

~~OK~~ PROBLEM CAUSE  
- UG Wire  
- Fuel Injection ECU



# A1 ETM

## 1992 RANGE ROVER

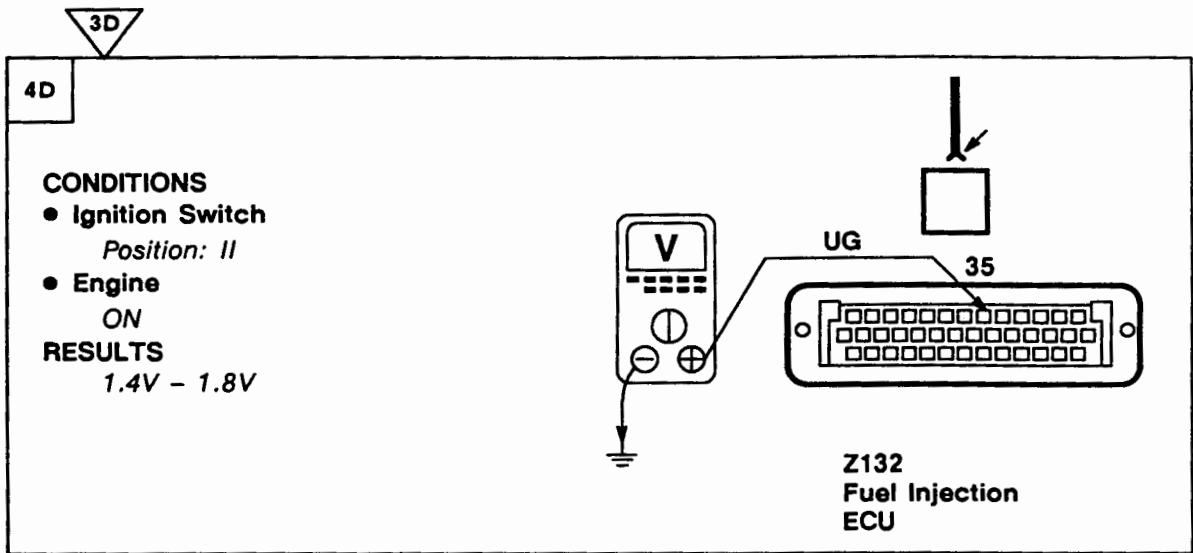

**PROBLEM CAUSE**  
- Air Flow Sensor



**PROBLEM CAUSE**  
- Fuel Injection ECU

### Test E

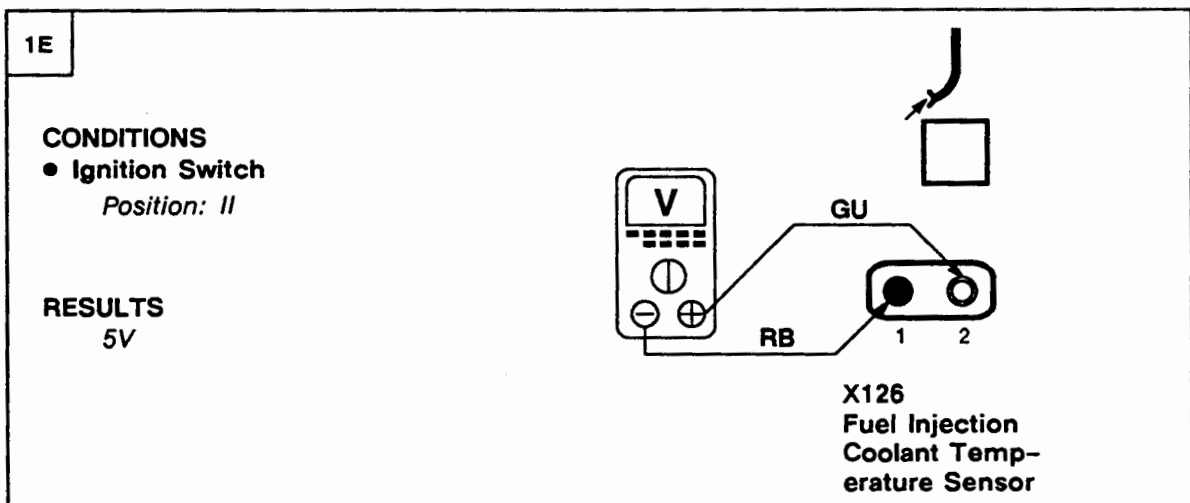

**PROBLEM CAUSE**  
- GU Wire  
- RB Wire  
- Fuel Injection ECU



**PROBLEM CAUSE**  
- Fuel Injection  
Coolant Temperature  
Sensor

**Test F**

1F

**CONDITIONS**

- Ignition Switch  
*Position: II*

**RESULTS**  
5V

X128  
Fuel Temperature Sensor



**PROBLEM CAUSE**

- SW Wire
- RB Wire
- Fuel Injection ECU



**PROBLEM CAUSE**

- Fuel Temperature Sensor

**Test G**

1G

**CONDITIONS**

- Ignition Switch  
*Position: II*

**RESULTS**  
5V

X171  
Throttle Potentiometer



**PROBLEM CAUSE**

- RB Wire
- Y Wire
- Fuel Injection ECU



# A1 ETM

## 1992 RANGE ROVER

1G

2G

**CONDITIONS**

- Ignition Switch  
*Position: II*

**RESULTS**

- Throttle closed  
*.085V - .545V*
- Throttle fully open  
*4.2V - 4.9V*

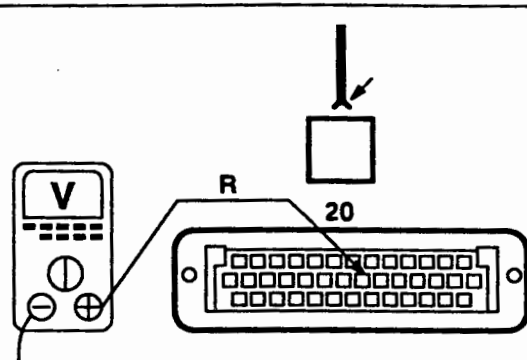

**Z132  
Fuel Injection  
ECU**



**PROBLEM CAUSE**

- R Wire
- Throttle Potentiometer



**PROBLEM CAUSE**

- Fuel Injection ECU

### Test H

1H

**CONDITIONS**

- Ignition Switch  
*Position: II*
- Engine  
*ON (1.4V - 1.8V)*

**RESULTS**

*RPM*

1000	= 1.9V
2000	= 2.1V
3000	= 2.5V
4000	= 3.0V

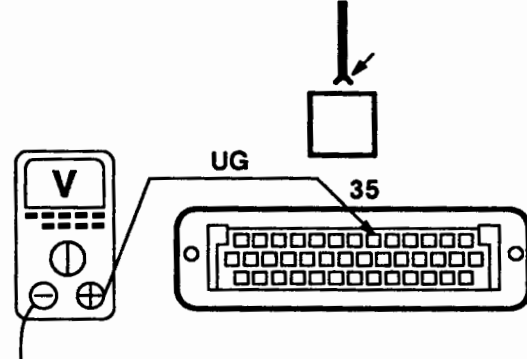

**Z132  
Fuel Injection  
ECU**



**PROBLEM CAUSE**

- Air filter
- Engine air leak
- Air Flow Sensor



1H

2H

**CONDITIONS**

- Ignition Switch  
*Position: II*

**RESULTS**

- Throttle closed  
0.85V - 5.45V
- Throttle fully open  
4.2V - 4.9V

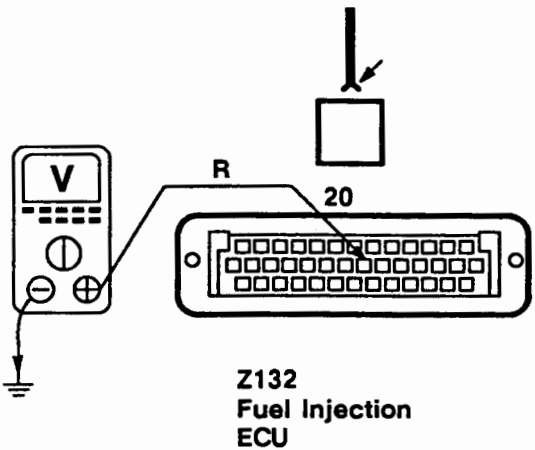

Z132  
Fuel Injection  
ECU



**PROBLEM CAUSE**  
- Throttle Potentiometer



**GO TO WORKSHOP MANUAL**  
**SECTION 19 FOR**  
**FUEL REGULATOR TESTS**

**Test I**

1I

**CONDITIONS**

1. Ignition Switch  
*Position: 0*
2. Wait 5 seconds
3. Disconnect and then reconnect Fuel Injection ECU (Z312)
4. Ignition Switch  
*Position: II*

**RESULTS**

*Code 29 is not displayed*



**PROBLEM CAUSE**  
- Fuel Injection ECU



**PROBLEM CAUSE**  
- Electrical noise

# A1 ETM

## 1992 RANGE ROVER

### Test J

1J

**CONDITIONS**

- Ignition Switch  
Position: 0

**RESULTS**  
4 - 4.5  $\Omega$

Z132  
Fuel Injection  
ECU

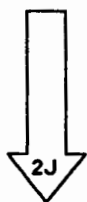

GO TO WORKSHOP  
MANUAL SECTION 19 FOR  
FUEL REGULATOR TESTS

2J

**CONDITIONS**

- Ignition Switch  
Position: 0

**RESULTS**  
1 - 1.2  $\Omega$

K118  
Fuel Injector



**PROBLEM CAUSE**  
- Fuel Injector



**PROBLEM CAUSE**  
- NO Wire  
- YU/YW Wire

Test K

1K

**CONDITIONS**  
• Ignition Switch  
*Position: 0*

**RESULTS**  
*2.5 - 6.0 Ω*

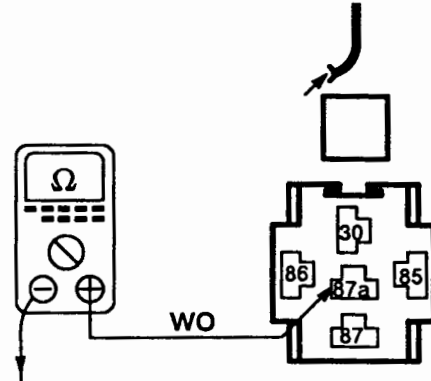

WO

K119  
Fuel Pump  
Relay

Detailed description: A schematic diagram of a K119 Fuel Pump Relay. The relay has several terminals labeled: 30, 86, 87a, 85, and 87. A terminal labeled 'WO' is also shown. An ohmmeter is connected between the 'WO' terminal and a ground symbol. A checkmark is present above the relay diagram.

~~OK~~ GO TO TEST L



2K

**CONDITIONS**  
• Ignition Switch  
*Position: 0*

**RESULTS**  
*Less than 2 ohms*

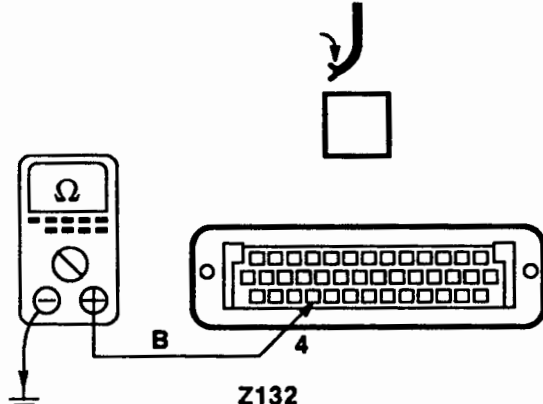

B

Z132  
Fuel Injection  
ECU

Detailed description: A schematic diagram of a Z132 Fuel Injection ECU. It shows a multi-pin connector with terminal 'B' and terminal '4' labeled. An ohmmeter is connected between terminal 'B' and a ground symbol. A checkmark is present above the ECU diagram.

~~OK~~ PROBLEM CAUSE  
- B Wire

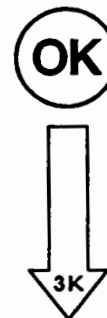

# A1 ETM

## 1992 RANGE ROVER

3K
2K

**CONDITIONS**

- Ignition Switch  
*Position: II*
- Engine at normal operating temperature

**RESULTS**

RPM

1000 = 0.5V - 1.0V

**Z132  
Fuel Injection  
ECU**



**PROBLEM CAUSE**

- U Wire
- X139, X160 Lambda Sensor



**PROBLEM CAUSE**

- Connector
- Fuel Injection ECU

### Test L

1L

**CONDITIONS**

- Ignition Switch  
*Position: II*

**RESULTS**

BAT VOLT

**X139, X160  
Lambda Sensor**



**PROBLEM CAUSE**

- WO Wire
- B Wire





1L

2L

**CONDITIONS**  
 • Ignition Switch  
 Position: 0

**RESULTS**  
 1.2 - 3.0 Ω

X139, X160  
 Lambda Sensor

**OK** PROBLEM CAUSE  
 - X139, X160 Lambda Sensor

**OK** PROBLEM CAUSE  
 - WO Wire  
 - B Wire

**Test M**

1M

**CONDITIONS**  
 • Ignition Switch  
 Position: 0

**RESULTS**  
 40 - 60 Ω

Z132  
 Fuel Injection  
 ECU

**OK** PROBLEM CAUSE  
 - RG Wire  
 - GW Wire  
 - Idle Speed Stepper Motor

**OK**

↓

2M

# A1 ETM

## 1992 RANGE ROVER

1M

2M

**CONDITIONS**

- Ignition Switch  
*Position: 0*

**RESULTS**  
40 - 60 Ω

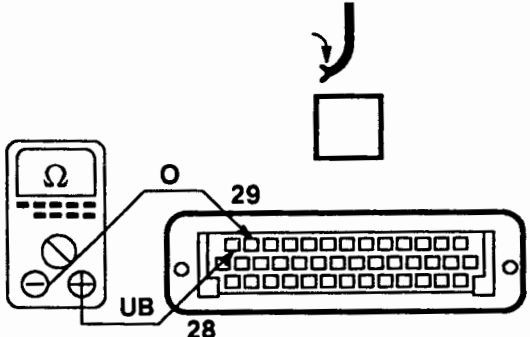

Z132  
Fuel Injection  
ECU



**PROBLEM CAUSE**

- O Wire
- UB Wire
- Idle Speed Stepper Motor

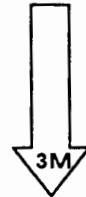

3M

3M

**CONDITIONS**

- Ignition Switch  
*Position: II*

**RESULTS**

- Throttle closed  
*.085V - 0.545V*
- Throttle fully open  
*4.2V - 4.9V*

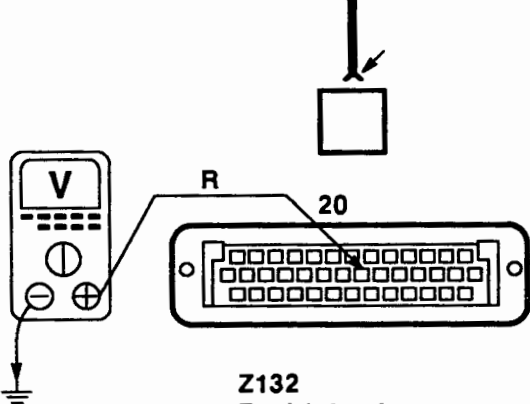

Z132  
Fuel Injection  
ECU



**PROBLEM CAUSE**

- R Wire
- RB Wire
- Y Wire
- Throttle Potentiometer



**GO TO TEST N**

**Test N**

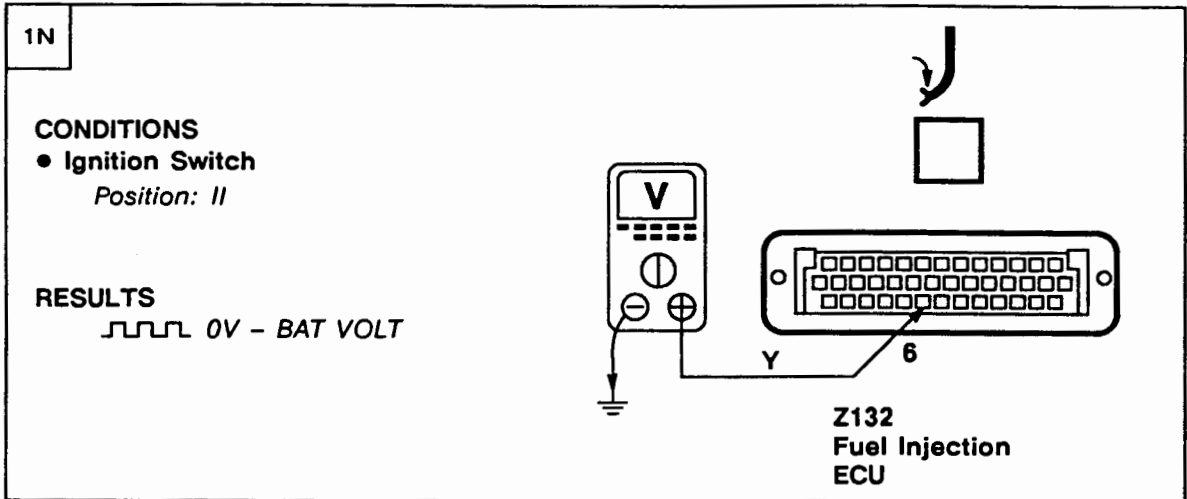

**PROBLEM CAUSE**

- Y Wire
- YO Wire
- Vehicle Speed Sensor Buffer



**PROBLEM CAUSE**

- Connector
- Fuel Injection ECU

**Test O**

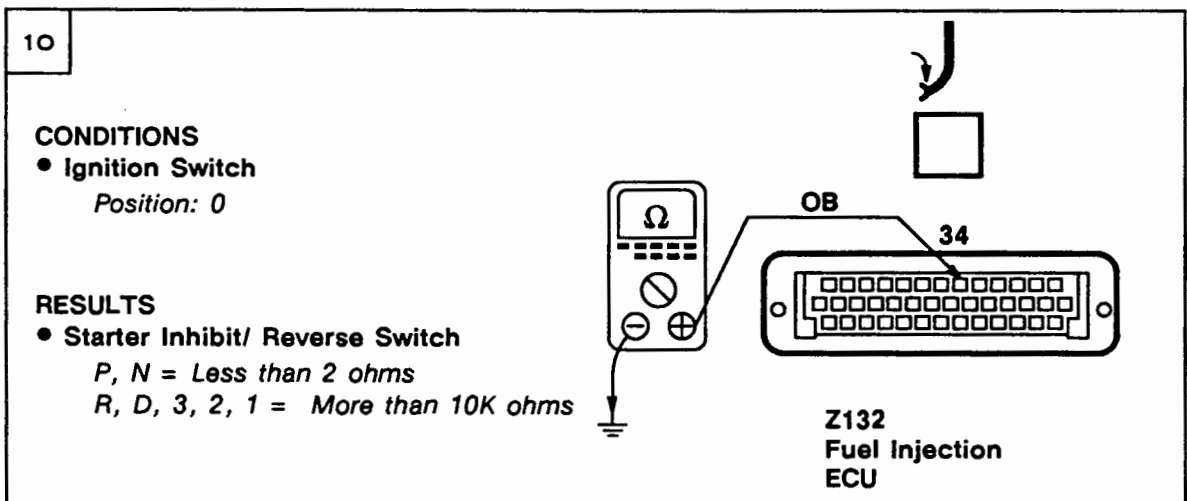

**PROBLEM CAUSE**

- OB Wire
- B Wire
- Starter Inhibit/ Reverse Switch



**PROBLEM CAUSE**

- Connector
- Fuel Injection ECU

# A1 ETM

## 1992 RANGE ROVER

### Test P

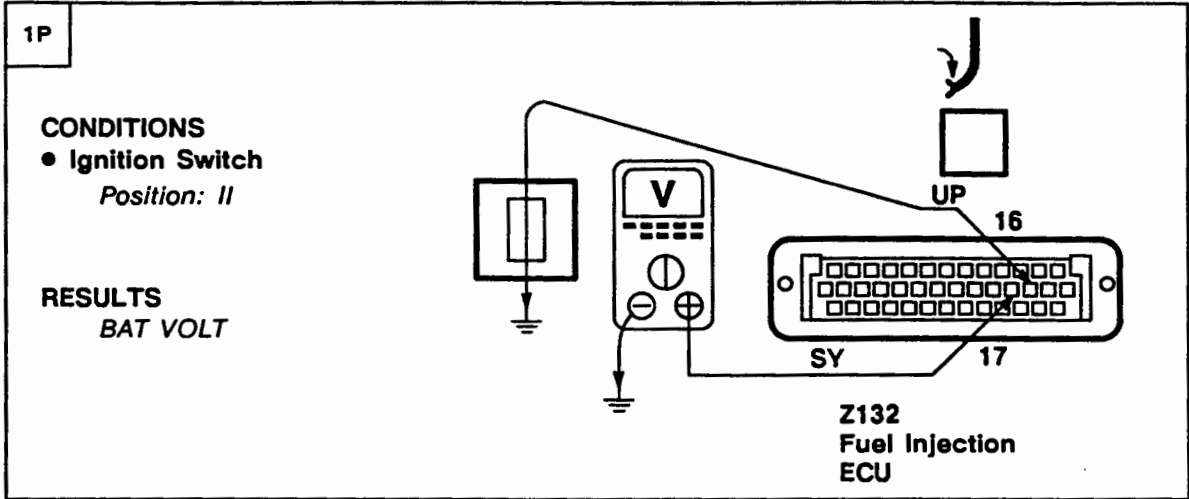

**PROBLEM CAUSE**

- UP Wire
- SY Wire
- Purge Control Valve

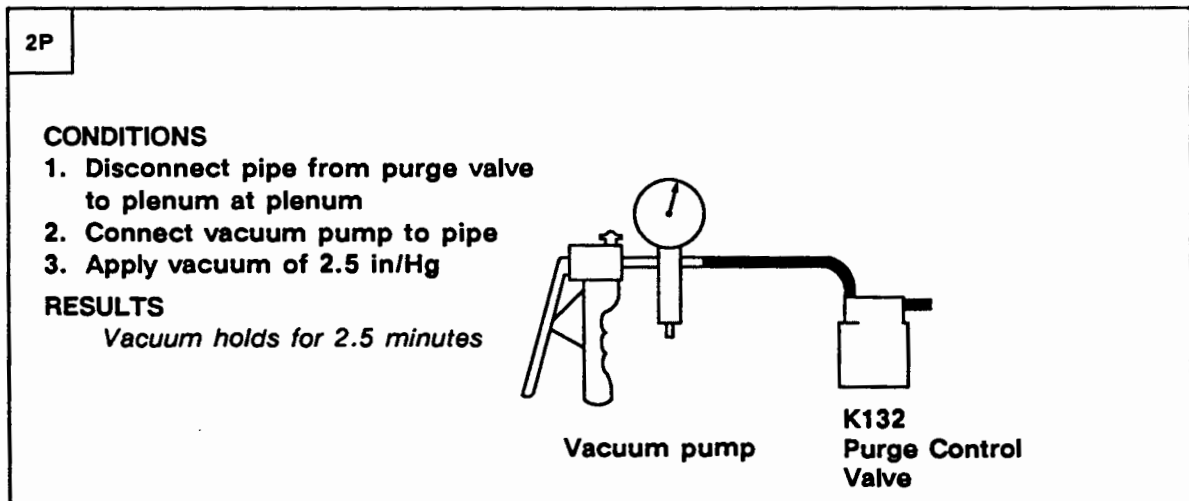

**PROBLEM CAUSE**

- Vacuum pipe
- Purge Control Valve



2P

3P

**CONDITIONS**

- Ignition Switch  
*Position: 0*
- Vacuum pump connected from previous step
- Vacuum pump holding 2.5 in/Hg
- Ignition Switch  
*Position: II*

**RESULTS**

*Vacuum drops to 0 in/Hg*

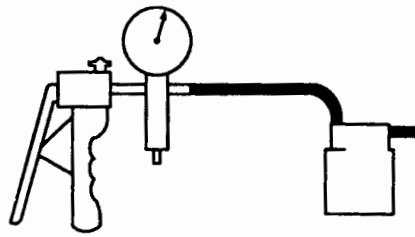

Vacuum pump
K132 Purge Control Valve



**PROBLEM CAUSE**

- Purge Control Valve
- Fuel Injection ECU



System OK

# 1992 RANGE ROVER

## KEY INFORMATION

### CIRCUIT DIAGRAMS

- Circuit diagrams are arranged so that current flow is from the top of the diagram (current source) to the bottom of the diagram (earth).
- Only those components that work together in the circuit are shown. If only part of a component is used in the circuit, then only that part of the component is shown.
- Remember:

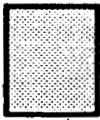

Entire component

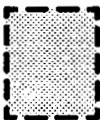

Part of a component

### TERMINAL NUMBER

50

### DESIGNATION

Battery voltage: Ignition Switch in position III

30

Battery voltage: supplied constantly

15

Battery voltage: Ignition Switch in position II or III

R

Battery voltage: Ignition Switch in positions I, II

31

Earth

See Introduction (i) for additional circuit diagram symbols.

### DIAGNOSIS

- If the diagram is accompanied by text:
  - Read the Circuit Operation before proceeding with the electrical diagnosis.
  - Read the Troubleshooting Hints before performing the System Diagnosis.
  - Tests follow the System Diagnosis.
  - When performing the System Diagnosis, be certain that all components disconnected in previous steps are reconnected unless otherwise directed.

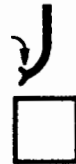

Component is disconnected.  
Backprobe harness connector

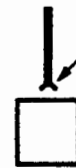

Component is connected.  
Backprobe harness connector



Component is disconnected.  
Probe component



Component is disconnected.  
Probe harness connector



Probe in-line connector

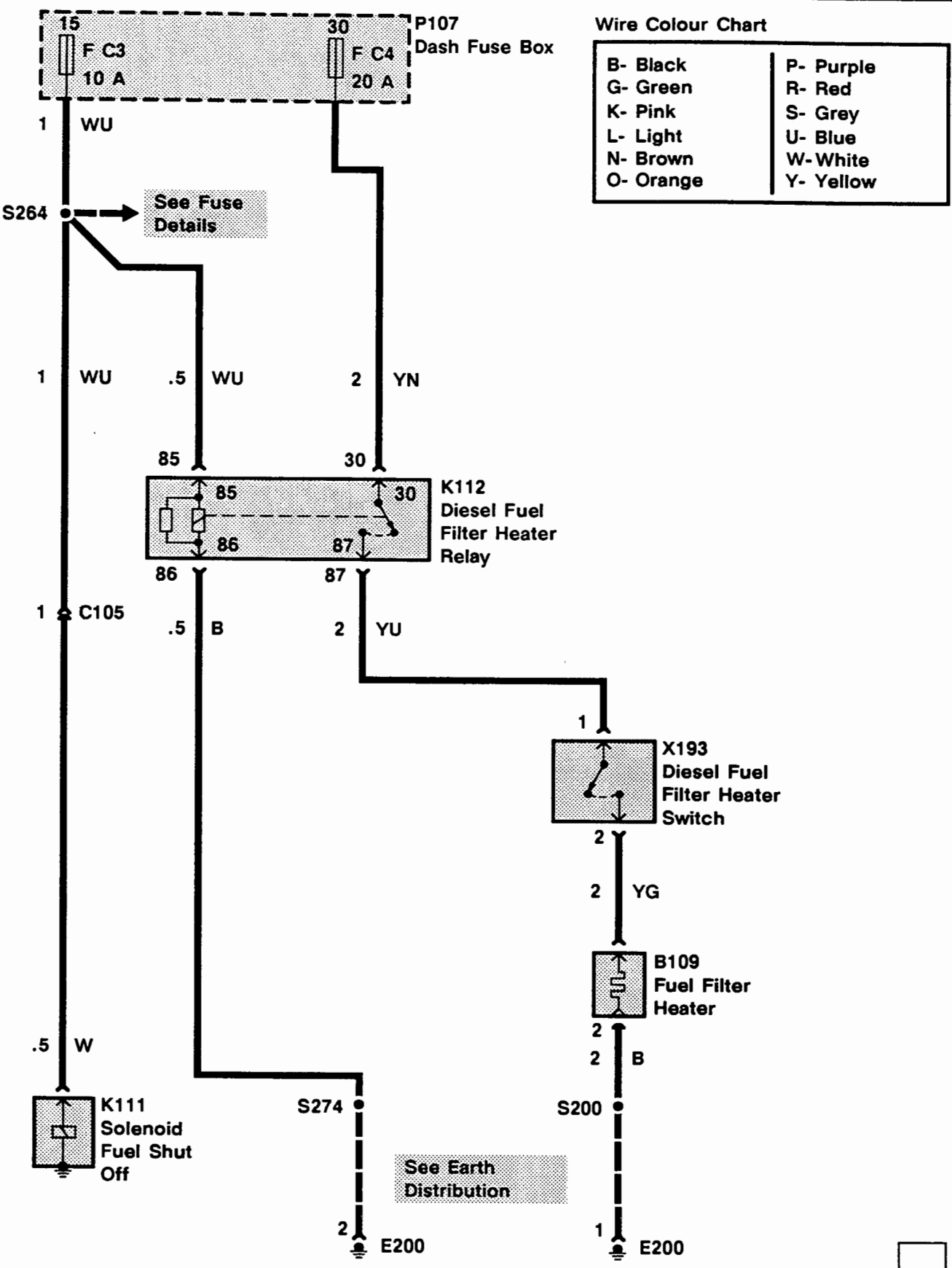

**Wire Colour Chart**

B- Black	P- Purple
G- Green	R- Red
K- Pink	S- Grey
L- Light	U- Blue
N- Brown	W- White
O- Orange	Y- Yellow

# 1992 RANGE ROVER

## KEY INFORMATION

### CIRCUIT DIAGRAMS

- Circuit diagrams are arranged so that current flow is from the top of the diagram (current source) to the bottom of the diagram (earth).
- Only those components that work together in the circuit are shown. If only part of a component is used in the circuit, then only that part of the component is shown.
- Remember:

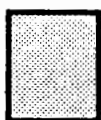

Entire component

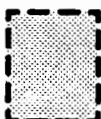

Part of a component

### TERMINAL NUMBER

50

### DESIGNATION

Battery voltage: Ignition Switch in position III

30

Battery voltage: supplied constantly

15

Battery voltage: Ignition Switch in position II or III

R

Battery voltage: Ignition Switch in positions I, II

31

Earth

See Introduction (i) for additional circuit diagram symbols.

### DIAGNOSIS

- If the diagram is accompanied by text:
  - Read the Circuit Operation before proceeding with the electrical diagnosis.
  - Read the Troubleshooting Hints before performing the System Diagnosis.
  - Tests follow the System Diagnosis.
  - When performing the System Diagnosis, be certain that all components disconnected in previous steps are reconnected unless otherwise directed.



Component is disconnected.  
Backprobe harness connector



Component is connected.  
Backprobe harness connector



Component is disconnected.  
Probe component



Component is disconnected.  
Probe harness connector



Probe in-line connector



Wire Colour Chart

B- Black	P- Purple
G- Green	R- Red
K- Pink	S- Grey
L- Light	U- Blue
N- Brown	W- White
O- Orange	Y- Yellow

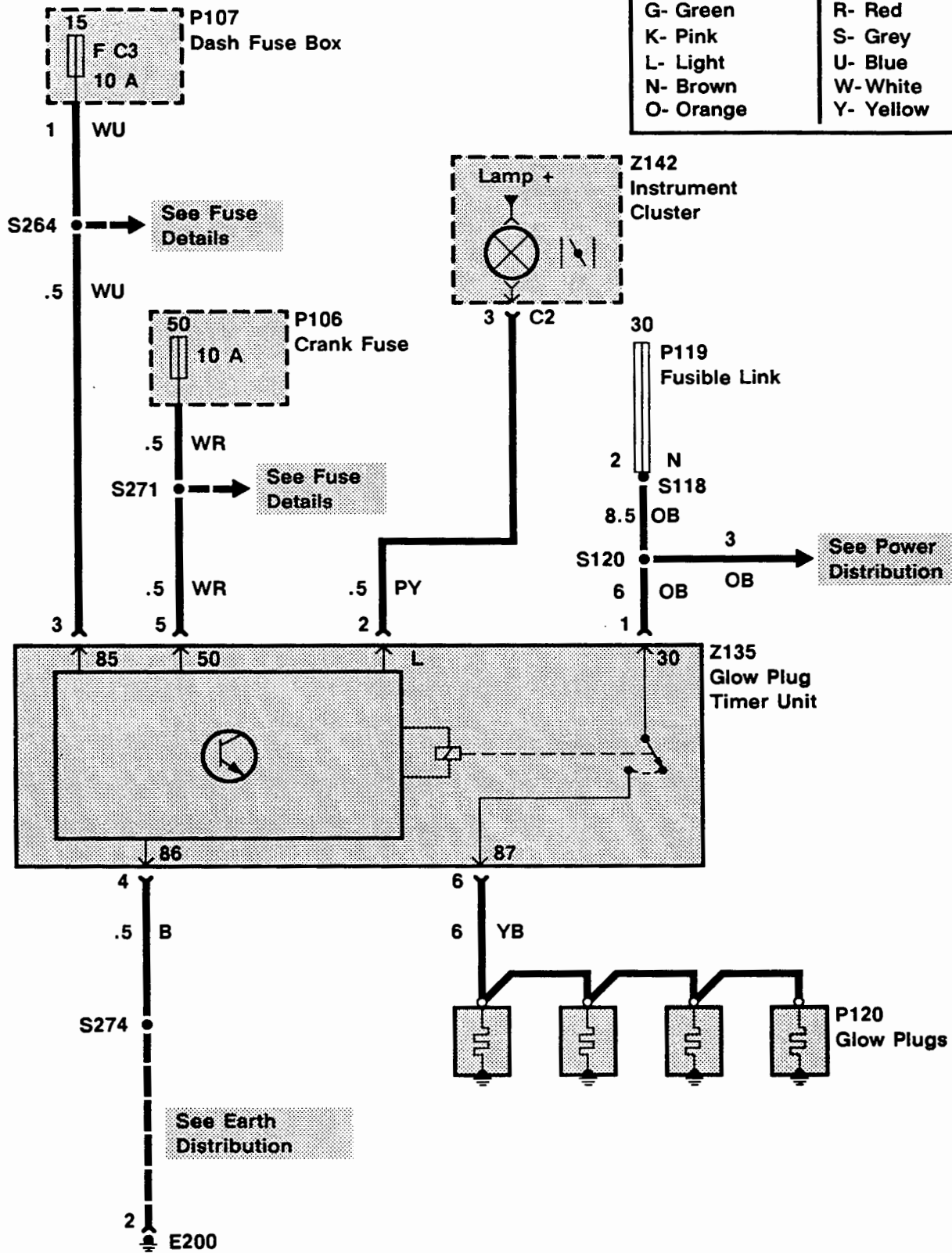

# 1992 RANGE ROVER

## KEY INFORMATION

### CIRCUIT DIAGRAMS

- Circuit diagrams are arranged so that current flow is from the top of the diagram (current source) to the bottom of the diagram (earth).
- Only those components that work together in the circuit are shown. If only part of a component is used in the circuit, then only that part of the component is shown.
- Remember:

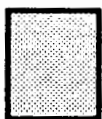

Entire component

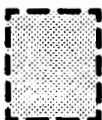

Part of a component

### TERMINAL NUMBER

50

### DESIGNATION

Battery voltage: Ignition Switch in position III

30

Battery voltage: supplied constantly

15

Battery voltage: Ignition Switch in position II or III

R

Battery voltage: Ignition Switch in positions I, II

31

Earth

See Introduction (i) for additional circuit diagram symbols.

### DIAGNOSIS

- If the diagram is accompanied by text:
  - Read the Circuit Operation before proceeding with the electrical diagnosis.
  - Read the Troubleshooting Hints before performing the System Diagnosis.
  - Tests follow the System Diagnosis.
  - When performing the System Diagnosis, be certain that all components disconnected in previous steps are reconnected unless otherwise directed.



Component is disconnected.  
Backprobe harness connector



Component is connected.  
Backprobe harness connector

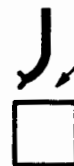

Component is disconnected.  
Probe component



Component is disconnected.  
Probe harness connector



Probe in-line connector