

CIRCUIT OPERATION

The Anti-Lock Brake System prevents wheel lockup during braking operations. This enables the driver to maintain vehicle stability and 'steerability' while braking.

The Electronic Traction Control System aids traction when a rear wheel spins or loses traction. The system works by applying the brake to the spinning rear wheel. The braking action allows more torque to be transferred and applied to the non-spinning rear wheel.

Anti-Lock Brake System ECU (Z108)

The Anti-Lock Brake System ECU (Z108) is a computer that controls ABS system operation by constantly monitoring the vehicle's 4 wheel speeds when the ignition is in position II. If an impending wheel lock up is detected during this monitoring, the Anti-Lock Brake ECU will apply voltage to the various inlet and outlet valve solenoids contained in the ABS Booster Unit (Z103). Operation of the solenoid valves regulates the pressure applied to the each wheel brake calliper and therefore prevents wheel lock-up.

Electronic Traction Control (ETC) is another function of the Anti-Lock Brake System ECU. In addition to monitoring the rear wheel speeds for lockup, the Anti-Lock Brake System ECU also monitors wheel speed for traction control. When rear wheel slip is detected (one wheel spinning faster than the other), the Anti-lock Brake System ECU will apply the brake to the spinning wheel causing additional torque to be applied to the non-spinning wheel. The Anti-lock Brake System ECU applies the brake by operating various inlet and outlet solenoid valves in the ABS Booster. The ETC warning light will be on for up to 60 seconds while the system is active. After 60 seconds of ETC operation, the ETC warning light will begin to flash to inform the driver that the system has been shut down to allow the brakes to cool. If the ETC warning light stays on continuously for more than 60 seconds, a fault in the system is indicated.

The Anti-Lock Brake System ECU (Z108) also has diagnostic capabilities that allow it to detect faults that may impair the system's efficiency. If a fault occurs, the ECU informs the operator of a problem by illuminating the ABS or the ETC warning light. The ECU also illuminates the

warning light when the ignition is first placed in position II. The ABS warning light will remain illuminated until the ECU completes a self check of the system. When the ECU sees all wheels reach a speed of 7 km/h (5 mph), the self check is completed and the ABS warning light turns off. If a fault is detected during the self check, the ABS or the ETC warning light will remain on and a fault code will be stored in memory to aid in servicing the system. The fault code can be retrieved using a diagnostic tester or by flashing the ABS warning light.

ABS Booster Unit (Z103)

The ABS Booster Unit (Z103) contains 2 isolation solenoid valves and 4 pairs of solenoid control valves which are grounded through the ground strap. The pairs of solenoid control valves each include a fluid pressure inlet and outlet valves that control ABS braking to 1 wheel. The Anti-Lock Brake System ECU (Z108) operates these valves by applying battery voltage to them. The valves are designed to decrease, hold or increase pressure to retain wheel rotation and optimum braking.

The 2 isolation valves consist of 2 solenoid valves that control fluid inlet and outlet. Their function is to disconnect or isolate the master cylinder from the servo cylinder and to connect the servo cylinder to the reservoir return during ABS functions.

Wheel Speed Sensors (X137, X140, X158, X161)

A wheel speed sensor is located at each wheel. The speed sensors generate an AC voltage signal as a magnetic toothed ring rotates past the stationary sensor pick-up. The Anti-Lock Brake System ECU (Z108) calculates the wheel speed by measuring the frequency of the AC voltage signal generated by the sensors.

ABS Hydraulic Pump (M102)

The hydraulic boost for the system is provided by the ABS Hydraulic Pump (M102), which is controlled by the ABS Pump Relay (K102) and the ABS Pressure Switch Unit (Z104). The Pressure Switch unit incorporates 3 electro-mechanical switches. The first operates the pump; the second illuminates the low pressure condition and that ABS functions should be curtailed. The Hydraulic Pump also

contains a non-return valve, a low pressure inlet filter, and a pressure relief valve to protect the system.

When low pressure occurs in the brake system, a switch in the Pressure Switch Unit closes to ground the coil of the Pump Relay through the WO wire. The Pump Relay now energizes and applies battery voltage from fuse F 4 to the Hydraulic Pump through the closed relay contacts and the NR wire. The Hydraulic Pump runs to increase pressure because it is grounded through the B wire. When sufficient pressure is developed in the system, the Pressure Switch opens to de-energize the Pump Relay and to turn off the Hydraulic Pump.

ABS Warning Relay (K103)

The ABS Warning Relay (K103) circuit ensures that the ABS warning light illuminates if the Anti-Lock Brake System ECU (Z108) loses power. If the Warning Relay is not energized, the warning light illuminates because it is grounded at E300 through the BS wire and the relay's closed contacts. When the Warning Relay is energized, the relay's contacts open to interrupt the ABS warning light's ground path. The Warning Relay is energized whenever the ABS Load Relay (K101) is energized.

The Load Relay is energized when the ignition is in position II. Voltage from fuse F 2 is now applied to terminal 9 of the ECU. This signals the ECU to energize the Load Relay by applying voltage from terminal 8 to the coil of the Load Relay. With the Load Relay now energized, fuse F 1 applies voltage to the Warning Relay to energize through the NK wire.

ETC Valve Block

The ETC Valve Block contains two solenoid valves that are operated by the Anti-lock Brake ECU. The Anti-lock Brake ECU applies voltage to the ETC Valve Block solenoids when the ETC system is active. The solenoid valves are grounded through the valve block.

D1 ETM

1993 RANGE ROVER

Wire Colour Chart

B- Black	P- Purple
G- Green	R- Red
K- Pink	S- Grey
L- Light	U- Blue
N- Brown	W- White
O- Orange	Y- Yellow

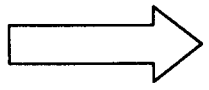
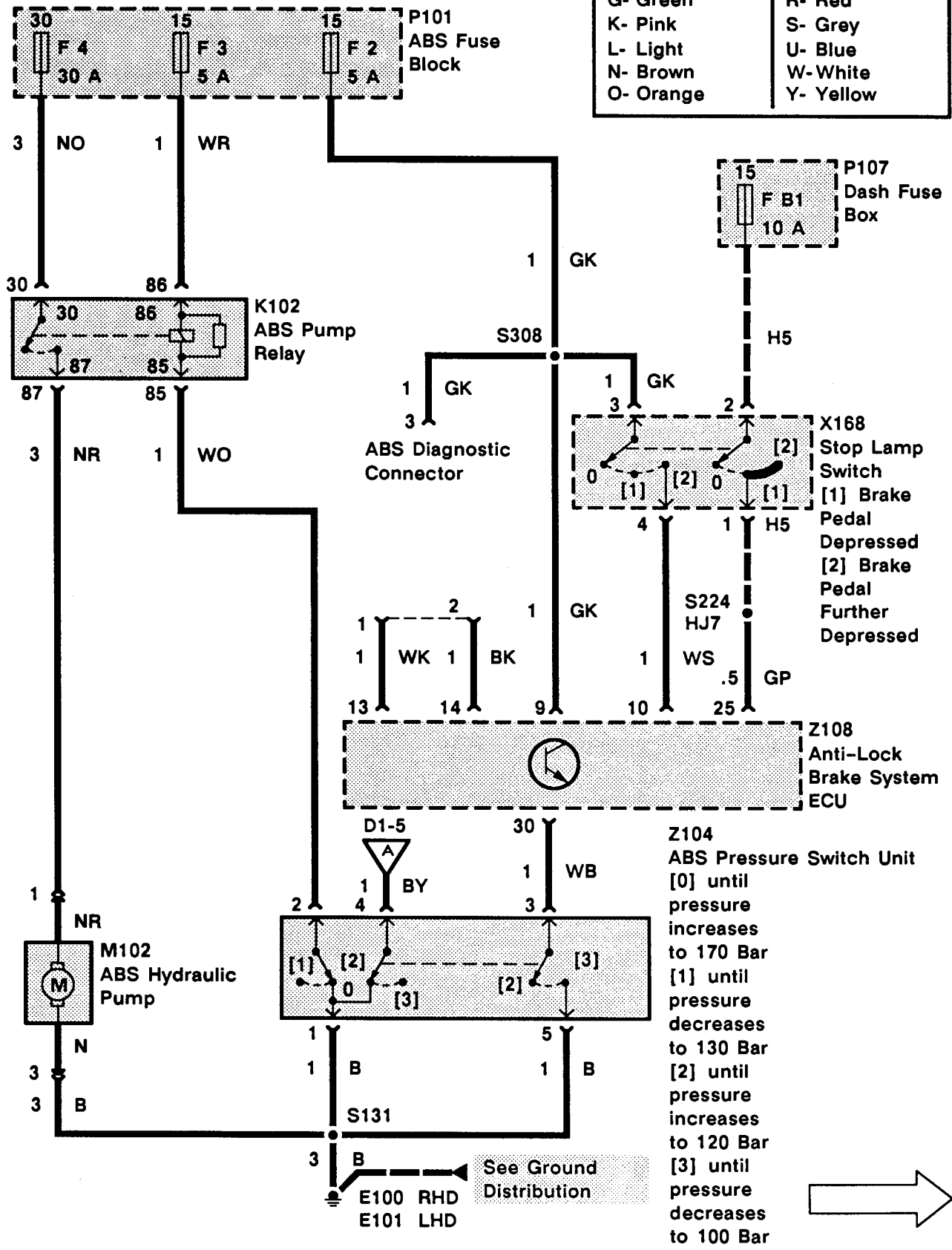

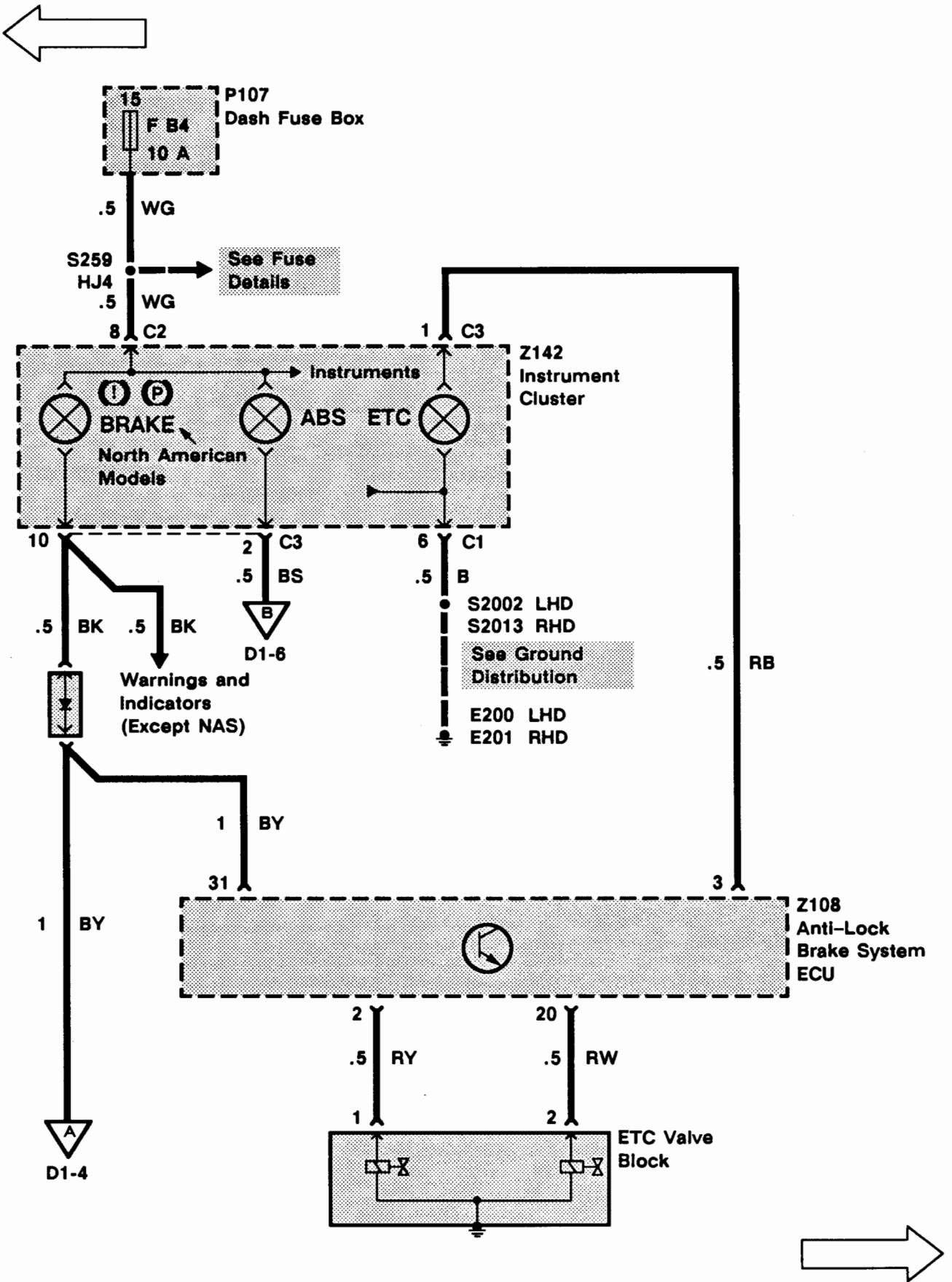

D1 ETM

1993 RANGE ROVER

Wire Colour Chart

B- Black	P- Purple
G- Green	R- Red
K- Pink	S- Grey
L- Light	U- Blue
N- Brown	W- White
O- Orange	Y- Yellow

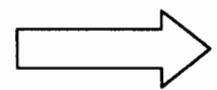
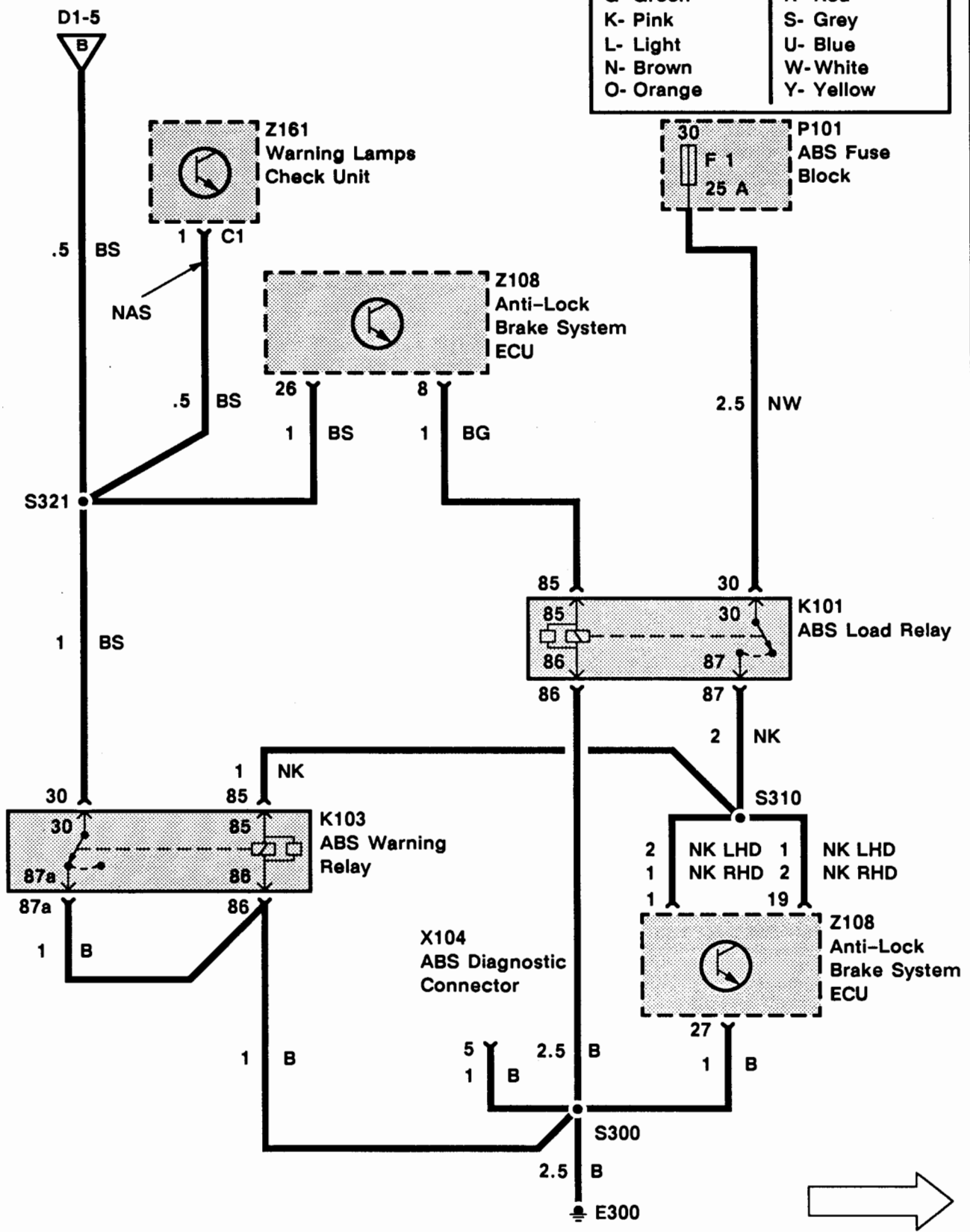

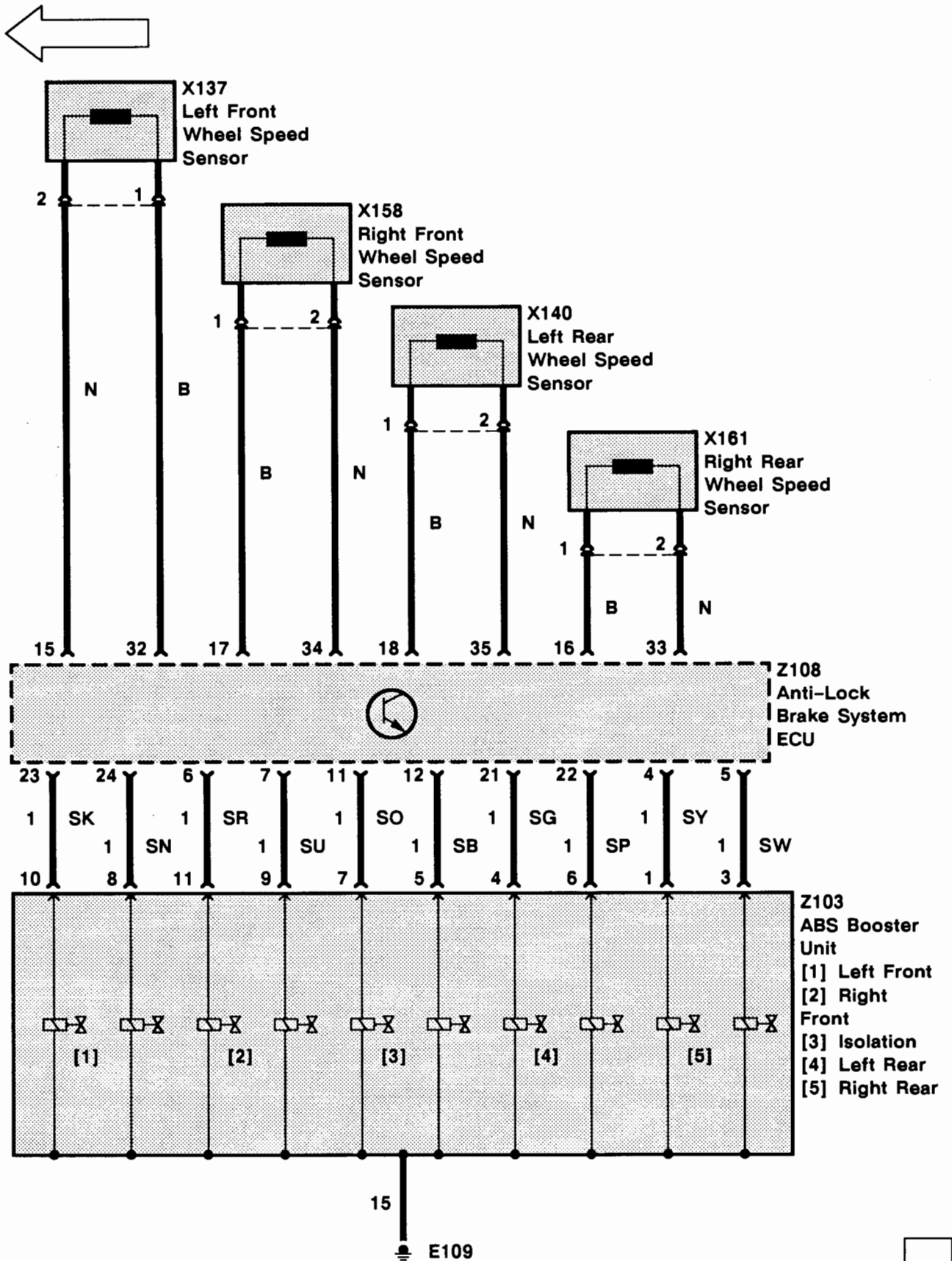

ABS AND ETC DIAGNOSIS

Diagnosis of the Anti-Lock Brake system or the Electronic Traction Control should begin with a visual check of the components for leaks, loose connectors or damage. After the visual inspection, check for fault codes stored in the Anti-Lock Brake System ECU (Z108). If a fault code or codes are stored, record the codes and then proceed to Code Diagnosis. If no codes are stored, proceed to the System Diagnosis.

**Fault Code Diagnosis Procedure**

The Anti-Lock Brake System ECU (Z108) is capable of storing fault codes. These codes can be read using the Wabco Diagnostic Controller, part number 446 300 300 0, or by following the blink code procedure. Use of the Wabco Diagnostic Controller (STC 2) is recommended and comprises the following:

- Tester Unit
- Carrying Case
- Power Lead (part # STC 781)
- Multimeter lead
- Adaptor Plug (part # STC 644)

Memory cards and Instruction Manual

- English STC 3
- French STC 4
- German STC 5
- Dutch STC 6
- Spanish STC 7

**Blink Code Procedure**

If the Wabco Diagnostic Controller is not available, the blink code procedure can be used to retrieve the fault codes stored in memory. The fault code is read by counting a series of ABS warning light flashes and pauses. Reading of the blink code aids in determining the location of the fault and can reduce diagnostic time. In order to initiate the blink code mode, use a female plug designed to fit the ABS Diagnostic Connector (X104). The plug should be pre-wired to connect the Diagnostic Connector's BK and B terminals.

To initiate the blink code, carry out the following procedure:

1. Locate the Diagnostic Connector and ABS Warning Relay (K103) under the left front seat. Disconnect the relay.
2. Place the ignition in position II.
3. Connect the plug to the Diagnostic Connector.
4. Approximately 5 seconds after connecting the plug, the warning light should go out, indicating the start of the blink code cycle.
5. Observe the warning light. The start phase consists of the following:

Pause for 2.5 seconds

Flash for 2.5 seconds

Pause for 2.5 seconds

Flash for 0.5 seconds

The following figure illustrates the start phase.

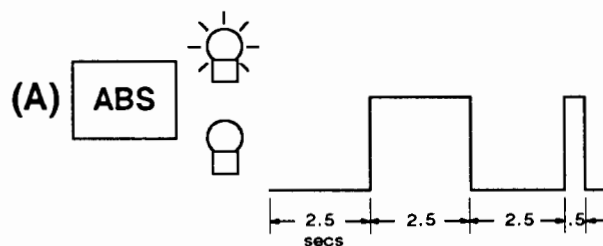

6. First part of code number:

A pause of 2.5 seconds is followed by a series of short flashes. Count the flashes until the next long pause occurs. The number of flashes counted is the first part of the code number.

7. Second part of code number:

A pause of 2.5 seconds occurs between the first and second part of the code number. Count the number of short flashes that occur after the 2.5 second pause. The number of flashes counted forms the second part of the code number.

The following figure illustrates the start phase.

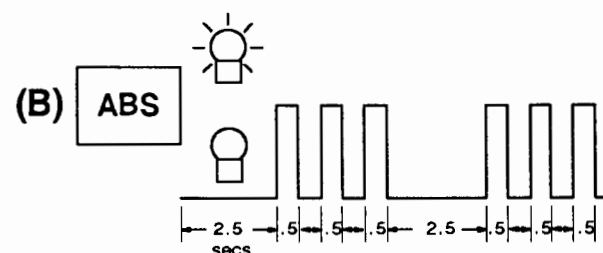

8. The whole cycle will continue to repeat itself until the operator terminates the process. This allows the operator to re-check the code number.
9. To terminate the process, disconnect the plug from the Diagnostic Connector. Termination of the process will clear the code recorded from the ECU memory.
10. The ECU is capable of storing more than 1 code. To search the memory, reconnect the diagnostic plug and wait for the next start phase. The ECU memory is clear of all codes when a pause of 7.5 seconds occurs after the start phase.
11. Reconnect the Warning Relay.
9. Code 3-0 indicates an open circuit in the right front inlet solenoid valve circuit. Start diagnosis at Test A, Step 18A.
10. Code 3-1 indicates an open circuit in the right front outlet solenoid valve circuit. Start diagnosis at Test A, Step 17A.
11. Code 3-2 indicates an open circuit in the left front inlet solenoid valve circuit. Start diagnosis at Test A, Step 16A.
12. Code 3-3 indicates an open circuit in the left front outlet solenoid valve circuit. Start diagnosis at Test A, Step 15A.
13. Code 3-4 indicates an open circuit in the right rear inlet solenoid valve circuit. Start diagnosis at Test A, Step 22A.
14. Code 3-5 indicates an open circuit in the right rear outlet solenoid valve circuit. Start diagnosis at Test A, Step 21A.
15. Code 3-6 indicates an open circuit in the left rear inlet solenoid valve circuit. Start diagnosis at Test A, Step 20A.
16. Code 3-7 indicates an open circuit in the left rear outlet solenoid valve circuit. Start diagnosis at Test A, Step 19A.
17. Code 3-8 indicates an open circuit in the isolation inlet solenoid valve circuit. Start diagnosis at Test A, Step 14A.
18. Code 3-9 indicates an open circuit in the isolation inlet solenoid valve circuit. Start diagnosis at Test A, Step 13A.
19. Code 3-10 indicates an open in the ETC NC Solenoid valve circuit. Start diagnosis at Test R.
20. Code 3-11 indicates an open in the ETC NO valve circuit. Start diagnosis at Test S.
21. Code 4-0 indicates a short to ground in the right front inlet solenoid valve circuit. Start diagnosis at Test A, Step 18A.
22. Code 4-1 indicates a short to ground in the right front outlet solenoid valve circuit. Start diagnosis at Test A, Step 17A.
23. Code 4-2 indicates a short to ground in the left front inlet solenoid valve circuit. Start diagnosis at Test A, Step 15A.
24. Code 4-3 indicates a short to ground in the left front outlet solenoid valve circuit. Start diagnosis at Test A, Step 16A.

CODE DIAGNOSIS

1. Code 2-3 indicates an ABS Pressure Switch, (Z104), start diagnosis at Test T.
2. Code 2-6 indicates a Stop Lamp Switch (X168) failure. Start diagnosis at Test A Step 23A.
3. Code 2-7 is set when a continuous battery supply to the ECU is detected to a shorted Load Relay. Start diagnosis at Step 1A.
4. Code 2-8 is set when no voltage is applied from the Load Relay to the ECU. Start diagnosis at Step 1A.
5. Code 2-12 indicates that a Right Front Wheel Speed Sensor (X158) air gap is too large. Check sensor ring runout and bearing freeplay. Fit a new sensor bushing and refit sensor.
6. Code 2-13 indicates that a Left Rear Wheel Speed Sensor (X140) air gap is too large. Check sensor ring runout and bearing freeplay. Fit a new sensor bushing and refit sensor.
7. Code 2-14 indicates that a Left Front Wheel Speed Sensor (X137) air gap is too large. Check sensor ring runout and bearing freeplay. Fit a new sensor bushing and refit sensor.
8. Code 2-15 indicates that a Right Rear Wheel Speed Sensor (X161) air gap is too large. Check sensor ring runout and bearing freeplay. Fit a new sensor bushing and refit sensor.

25. Code 4-4 indicates a short to ground in the right rear inlet solenoid valve circuit. Start diagnosis at Test A, Step 22A.
26. Code 4-5 indicates a short to ground in the right rear outlet solenoid valve circuit. Start diagnosis at Test A, Step 21A.
27. Code 4-6 indicates a short to ground in the left rear inlet solenoid valve circuit. Start diagnosis at Test A, Step 20A.
28. Code 4-7 indicates a short to ground in the left rear outlet solenoid valve circuit. Start diagnosis at Test A, Step 19A.
29. Code 4-8 indicates a short to ground in the isolation inlet solenoid valve circuit. Start diagnosis at Test A, Step 14A.
30. Code 4-9 indicates a short to ground in the isolation outlet solenoid valve circuit. Start diagnosis at Test A, Step 13A.
31. Code 4-10 indicates a short to ground in the ETC NC solenoid valve circuit. Start diagnosis at Test R.
32. Code 4-11 indicates a short to ground in the ETC NO solenoid valve circuit. Start diagnosis at Test S.
33. Code 4-12 indicates an open in the Right Front Wheel Speed Sensor (X158) wiring. Start diagnosis at Test A, Step 7A.
34. Code 4-13 indicates an open in the Left Rear Wheel Speed Sensor (X140) wiring. Start diagnosis at Test A, Step 9A.
35. Code 4-14 indicates an open in the Left Front Wheel Speed Sensor (X137) wiring. Start diagnosis at Test A, Step 5A.
36. Code 4-15 indicates an open in the Right Rear Wheel Speed Sensor (X161) wiring. Start diagnosis at Test A, Step 11A.
37. Codes 5-0 through 5-9 indicate a short to battery voltage in a solenoid valve circuit between the ABS Booster Unit (Z103) or ETC Valve Block and the Anti-Lock Brake System ECU (Z108). This fault could be intermittent. Check the booster unit's or ETC Valve Block earth strap, the wiring harness and the connectors at the booster unit and the ECU. If all components check OK, replace the ECU. The specific solenoid valve circuit affected is as listed:
- | | |
|------|--------------------|
| 5-0 | Right Front Inlet |
| 5-1 | Right Front Outlet |
| 5-2 | Left Front Inlet |
| 5-3 | Left Front Outlet |
| 5-4 | Right Rear Inlet |
| 5-5 | Right Rear Outlet |
| 5-6 | Left Rear Inlet |
| 5-7 | Left Rear Outlet |
| 5-8 | Isolation Inlet |
| 5-9 | Isolation Outlet |
| 5-10 | ETC NC Valve |
| 5-11 | ETC NO Valve |
38. Codes 5-12 through 5-15 indicate an intermittent signal from a wheel speed sensor. Before proceeding with the electrical diagnosis, check the sensor, the related CV joint bearing or wheel bearing for damage.
39. Code 5-12 indicates an intermittent open circuit in the Right Front Wheel Speed Sensor (X158). Start diagnosis at Test A, Step 7A. Perform the test while wiggling harness to induce the fault.
40. Code 5-13 indicates an intermittent open circuit in the Left Rear Wheel Speed Sensor (X140). Start diagnosis at Test A, Step 9A. Perform the test while wiggling harness to induce the fault.
41. Code 5-14 indicates an intermittent open circuit in the Left Front Wheel Speed Sensor (X137). Start diagnosis at Test A, Step 5A. Perform the test while wiggling harness to induce the fault.
42. Code 5-15 indicates an intermittent open circuit in the Right Rear Wheel Speed Sensor (X161). Start diagnosis at Test A, Step 10A. Perform the test while wiggling harness to induce the fault.
43. Codes 6-0 through 6-9 indicate a short circuit between 2 solenoid valves. Failure codes for both affected valves will be stored. Check to see if the short is located in the wiring harness by measuring for continuity between the circuits with the ABS Booster Unit (Z103) and Anti-Lock Brake System ECU (Z108) disconnected. If OK, check the booster unit and ECU.
- | | |
|-----|--------------------|
| 6-0 | Right Front Inlet |
| 6-1 | Right Front Outlet |
| 6-2 | Left Front Inlet |
| 6-3 | Left Front Outlet |
| 6-4 | Right Rear Inlet |
| 6-5 | Right Rear Outlet |
| 6-6 | Left Rear Inlet |
| 6-7 | Left Rear Outlet |

- 6-8 Isolation Inlet
- 6-9 Isolation Outlet

44. Codes 6-12 through 6-15 indicate that the wheel speed sensor has no output signal. This code sets due to a extremely large air gap. Check the affected sensor's mounting and bushing. Replace the sensor if mounting and installation are OK. The specific code and the related wheel speed sensor are:

- 6-12 Right Front Wheel
- 6-13 Left Rear Wheel
- 6-14 Left Front Wheel
- 6-15 Right Rear Wheel

SYSTEM DIAGNOSIS

1. If the ABS warning light is on and no fault codes are set or if fault codes can not be accessed, do Test Q (warning relay test).
2. If both the brake and ABS warning lights are on, pedal travel has increased, and no pump operation is noted, check for low brake fluid and then do Test N (hydraulic pump test).
3. If both the brake and ABS warning lights are on, the ABS Hydraulic Pump (M102) operates normally, and no other symptoms are noted, do Test O (pressure switch test).
4. If only the brake warning light is on, check the brake fluid level and the park brake switch for a short or low fluid condition. If OK, do Test N (hydraulic pump test).
5. If the ABS Hydraulic Pump (M102) runs constantly, the brake and ABS warning lights are off, and pedal travel seems to be normal, do Test P (pump short test).
6. If the ABS Hydraulic Pump (M102) runs constantly and the brake warning light is on, check brake fluid level and inspect system for leaks.
7. If the ETC warning light is on for more than 60 seconds and no fault codes are set, do Test U.
8. If the ETC warning light does not light for 3 seconds when the ignition is turned on, do Test V.
9. If a hydraulic fault is suspected, refer to section 70 of the Workshop Manual.

D1 ETM

1993 RANGE ROVER

Test A

1A ABS ECU Pinout

CONDITIONS
 • Ignition Switch
 Position: 0

RESULTS
 Less than 1 ohm

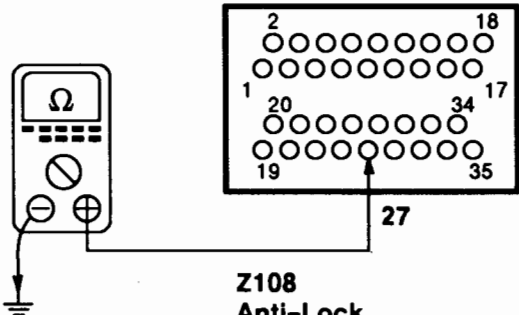

Z108
 Anti-Lock
 Brake System ECU
 Connector adaptor

~~OK~~ **PROBLEM CAUSE**
 - B Wire
 - E300

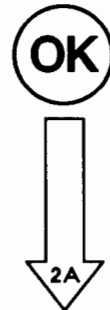

2A

CONDITIONS
 • Ignition Switch
 Position: II

RESULTS
 BAT VOLT

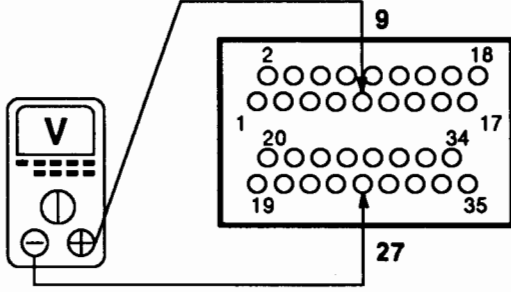

Z108
 Anti-Lock
 Brake System ECU
 Connector adaptor

~~OK~~ **PROBLEM CAUSE**
 - F 2 Fuse
 - GK Wire

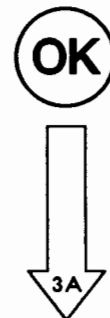

D1 ETM

1993 RANGE ROVER

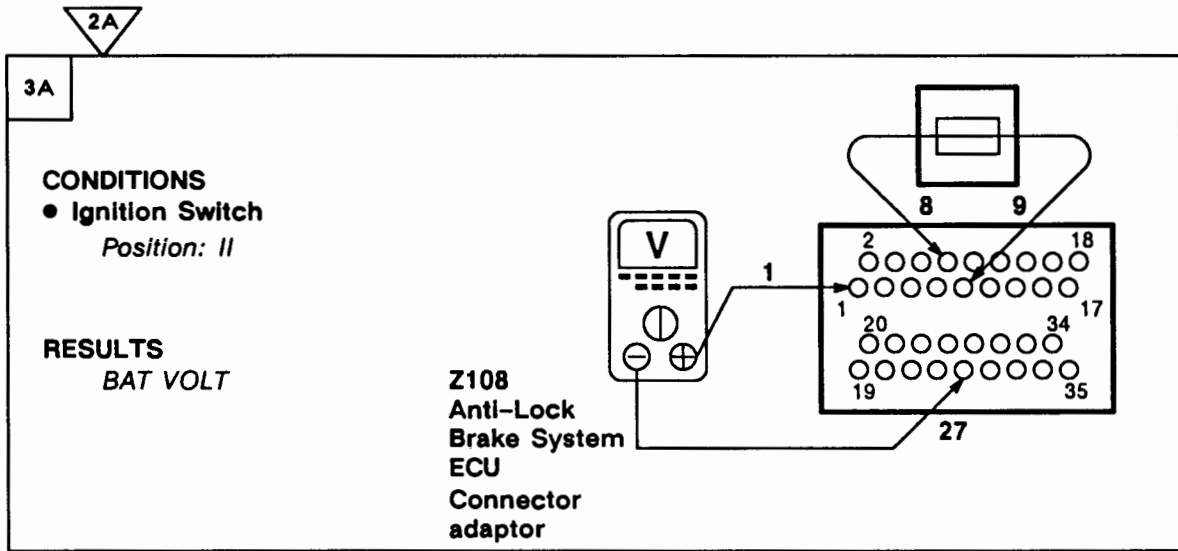

~~OK~~ GO TO TEST B

OK

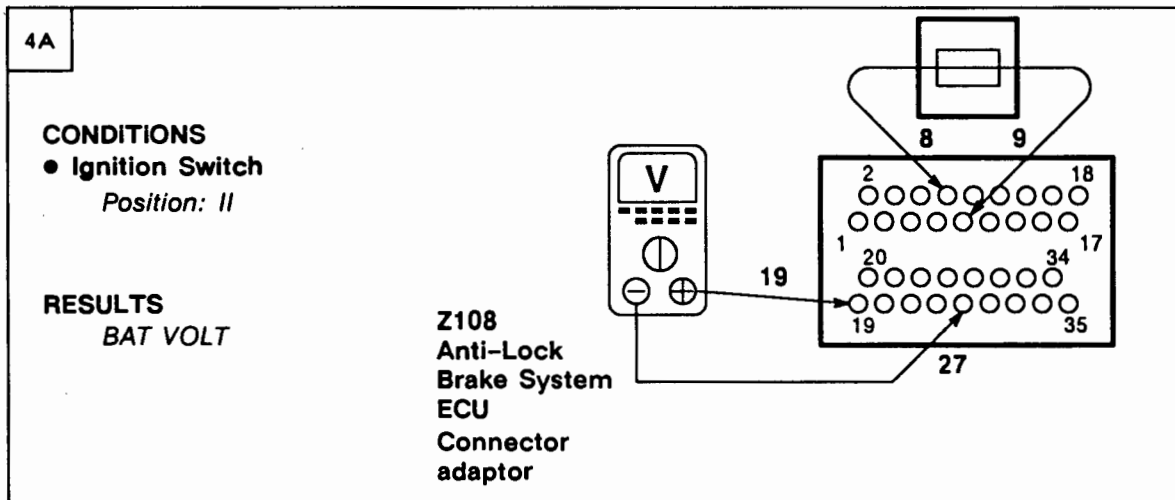

~~OK~~ PROBLEM CAUSE
- NK Wire

OK

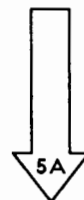

4A

5A

CONDITIONS
• Ignition Switch
Position: 0

RESULTS
1.5K - 2.0K Ω

Z108
Anti-Lock
Brake System
ECU
Connector
adaptor

~~OK~~ GO TO TEST C

OK

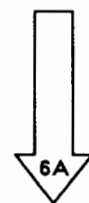

6A

CONDITIONS
• Ignition Switch
Position: 0

RESULTS
More than 100K ohms

Z108
Anti-Lock
Brake System
ECU
Connector
adaptor

~~OK~~ GO TO TEST C

OK

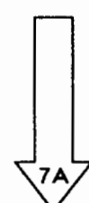

D1 ETM

1993 RANGE ROVER

6A

7A

CONDITIONS

- Ignition Switch
Position: 0

RESULTS
1.5K - 2.0K Ω

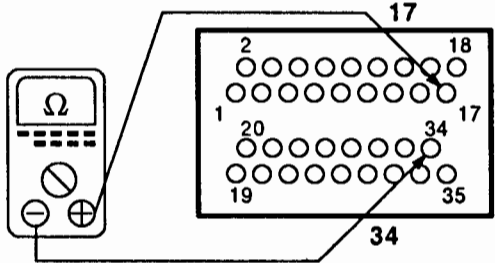

Z108
Anti-Lock
Brake System
ECU
Connector
adaptor

~~OK~~ GO TO TEST C

OK

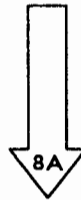

8A

8A

CONDITIONS

- Ignition Switch
Position: 0

RESULTS
More than 100K ohms

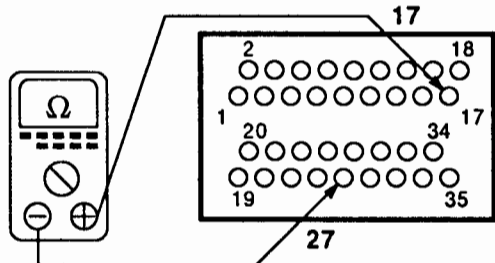

Z108
Anti-Lock
Brake System
ECU
Connector
adaptor

~~OK~~ GO TO TEST C

OK

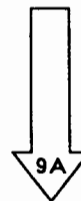

8A

9A

CONDITIONS
● Ignition Switch
Position: 0

RESULTS
1.5K - 2.0K Ω

Z108
Anti-Lock
Brake System
ECU
Connector
adaptor

~~OK~~ GO TO TEST C

OK

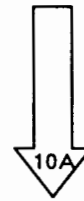

10A

CONDITIONS
● Ignition Switch
Position: 0

RESULTS
More than 100K ohms

Z108
Anti-Lock
Brake System
ECU
Connector
adaptor

~~OK~~ GO TO TEST C

OK



D1 ETM

1993 RANGE ROVER

10A

11A

CONDITIONS

- Ignition Switch
Position: 0

RESULTS
1.5K - 2.0K Ω

Z108
Anti-Lock
Brake System
ECU
Connector
adaptor

~~OK~~ GO TO TEST C

OK

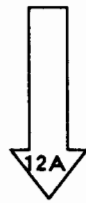

12A

CONDITIONS

- Ignition Switch
Position: 0

RESULTS
More than 100K ohms

Z108
Anti-Lock
Brake System
ECU
Connector
adaptor

~~OK~~ GO TO TEST C

OK

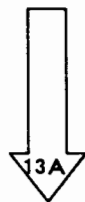

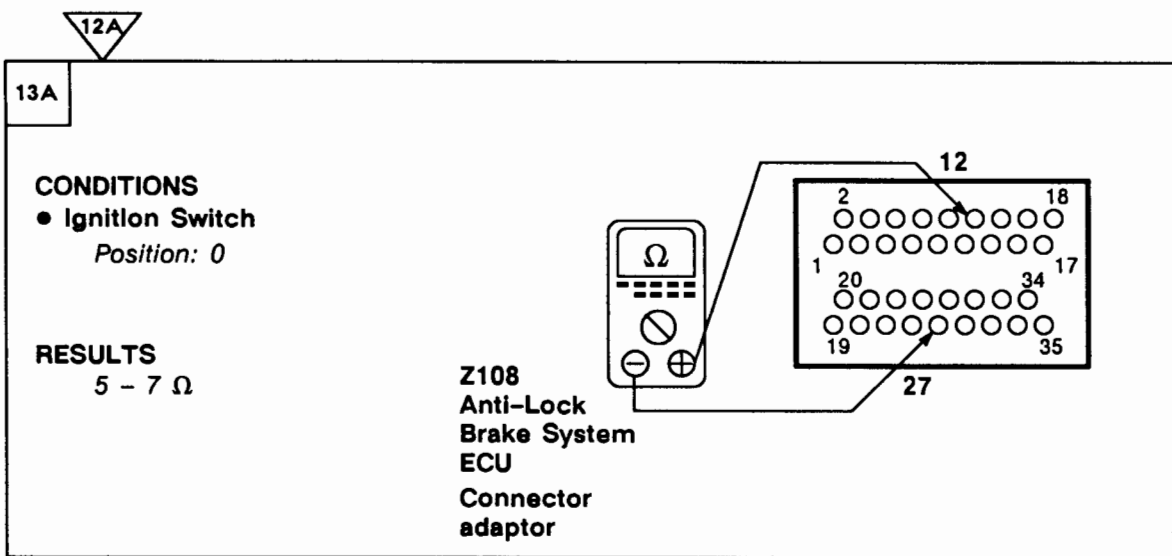

~~OK~~ GO TO TEST D

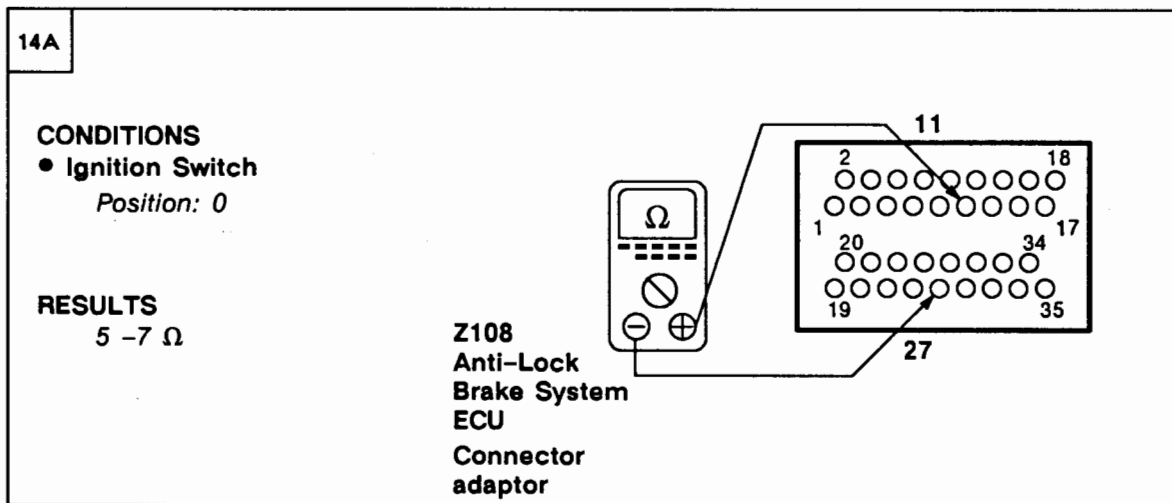
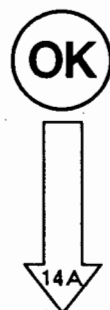

~~OK~~ GO TO TEST E

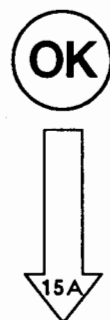

D1 ETM

1993 RANGE ROVER

14A

15A

CONDITIONS

- Ignition Switch
Position: 0

RESULTS
2.5 - 4.5 Ω

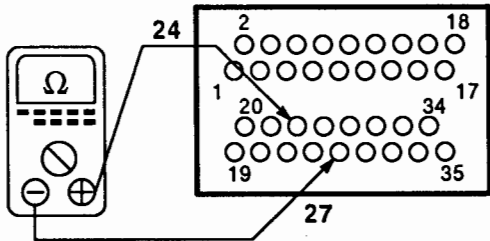

Z108
Anti-Lock
Brake System
ECU
Connector
adaptor



GO TO TEST F

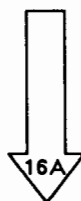

16A

16A

CONDITIONS

- Ignition Switch
Position: 0

RESULTS
5 - 7 Ω

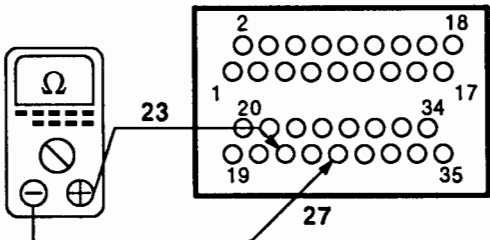

Z108
Anti-Lock
Brake System
ECU
Connector
adaptor



GO TO TEST G

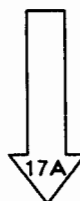

16A

17A

CONDITIONS

- Ignition Switch
Position: 0

RESULTS
2.5 - 4.5 Ω

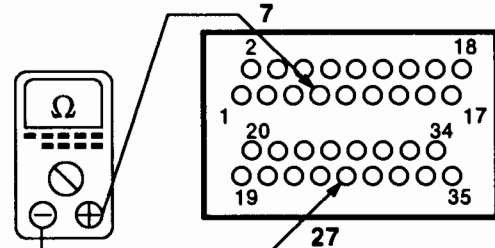

Z108
Anti-Lock
Brake System
ECU

Connector
adaptor

~~OK~~ GO TO TEST H

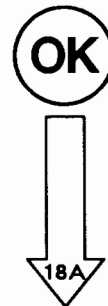

18A

CONDITIONS

- Ignition Switch
Position: 0

RESULTS
5 - 7 Ω

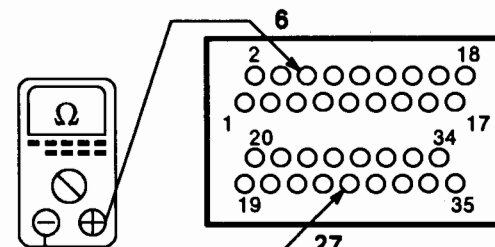

Z108
Anti-Lock
Brake System
ECU

Connector
adaptor

~~OK~~ GO TO TEST I

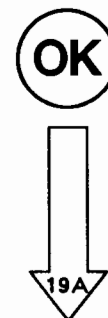

D1 ETM

1993 RANGE ROVER

18A

19A

CONDITIONS

- Ignition Switch
Position: 0

RESULTS
2.5 - 4.5 Ω

Z108
Anti-Lock
Brake System
ECU
Connector
adaptor



GO TO TEST J

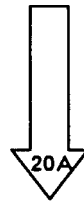

20A

CONDITIONS

- Ignition Switch
Position: 0

RESULTS
5 - 7 Ω

Z108
Anti-Lock
Brake System
ECU
Connector
adaptor



GO TO TEST K

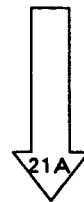

16A

17A

CONDITIONS
● Ignition Switch
Position: 0

RESULTS
2.5 - 4.5 Ω

Z108
Anti-Lock
Brake System
ECU

Connector
adaptor

~~OK~~ GO TO TEST H

OK

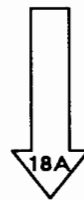

18A

CONDITIONS
● Ignition Switch
Position: 0

RESULTS
5 - 7 Ω

Z108
Anti-Lock
Brake System
ECU

Connector
adaptor

~~OK~~ GO TO TEST I

OK



D1 ETM

1993 RANGE ROVER

18A

19A

CONDITIONS

- Ignition Switch
Position: 0

RESULTS
2.5 - 4.5 Ω

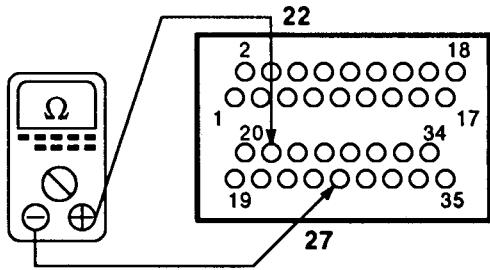

Z108
Anti-Lock
Brake System
ECU
Connector
adaptor

~~OK~~ GO TO TEST J

OK



20A

20A

CONDITIONS

- Ignition Switch
Position: 0

RESULTS
5 - 7 Ω

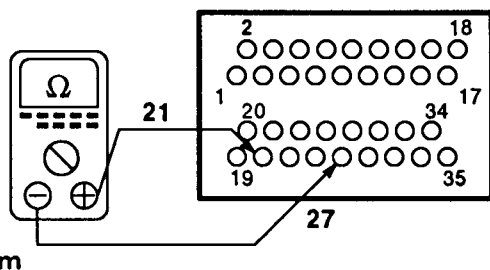

Z108
Anti-Lock
Brake System
ECU
Connector
adaptor

~~OK~~ GO TO TEST K

OK



20A

21A

CONDITIONS
• Ignition Switch
Position: 0

RESULTS
2.5 - 4.5 Ω

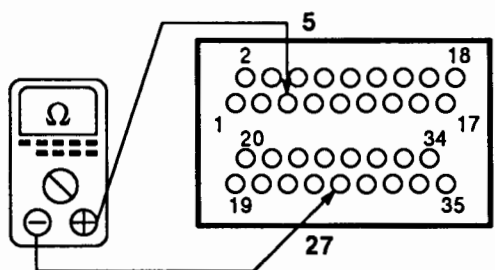

Z108
Anti-Lock
Brake System
ECU
Connector
adaptor

~~OK~~ GO TO TEST L

OK

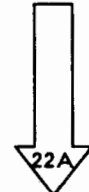

22A

CONDITIONS
• Ignition Switch
Position: 0

RESULTS
5 - 7 Ω

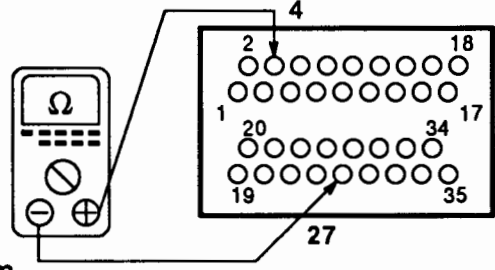

Z108
Anti-Lock
Brake System
ECU
Connector
adaptor

~~OK~~ GO TO TEST M

OK

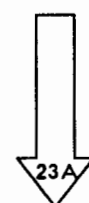

D1 ETM

1993 RANGE ROVER

22A

23A

CONDITIONS

- Ignition Switch
Position: 0
- Brake Pedal
Depressed

RESULTS
BAT VOLT

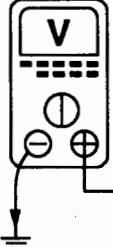

Z108
Anti-Lock
Brake System
ECU
Connector
adaptor

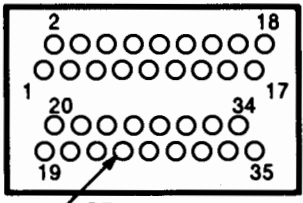



PROBLEM CAUSE

- GP Wire
- Stop Lamp Switch

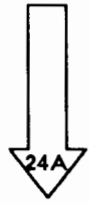

24A

24A

CONDITIONS

- Ignition Switch
Position: 0
- Brake Pedal
Depressed

RESULTS
BAT VOLT



Z108
Anti-Lock
Brake System
ECU
Connector
adaptor

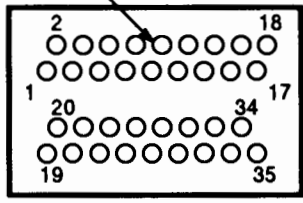



PROBLEM CAUSE

- WS Wire
- Stop Lamp Switch



PROBLEM CAUSE

- Anti-Lock Brake System ECU

Test B

1B ABS Power Test

CONDITIONS

- Ignition Switch
Position: II
- Jumper in place from Test 3A

RESULTS
BAT VOLT

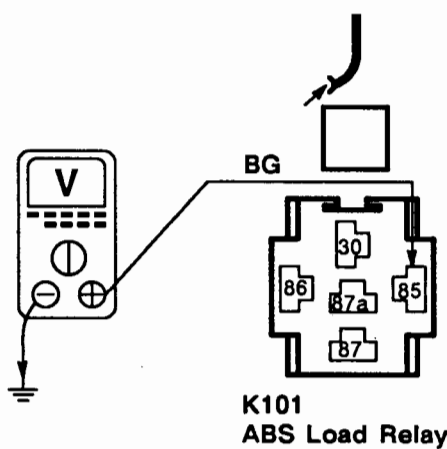

**K101
ABS Load Relay**

~~OK~~ **PROBLEM CAUSE**
- BG Wire

OK



2B

CONDITIONS

- Ignition Switch
Position: II

RESULTS
BAT VOLT

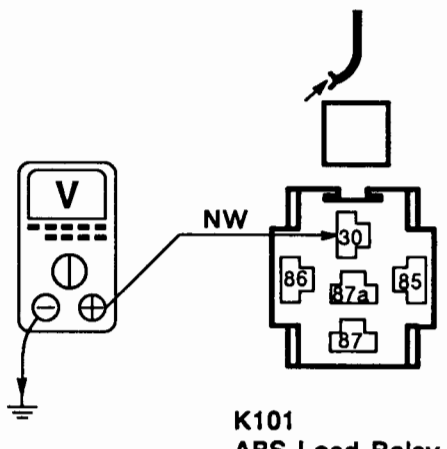

**K101
ABS Load Relay**

~~OK~~ **PROBLEM CAUSE**
- F 1 Fuse
- NW Wire

OK



D1 ETM

1993 RANGE ROVER

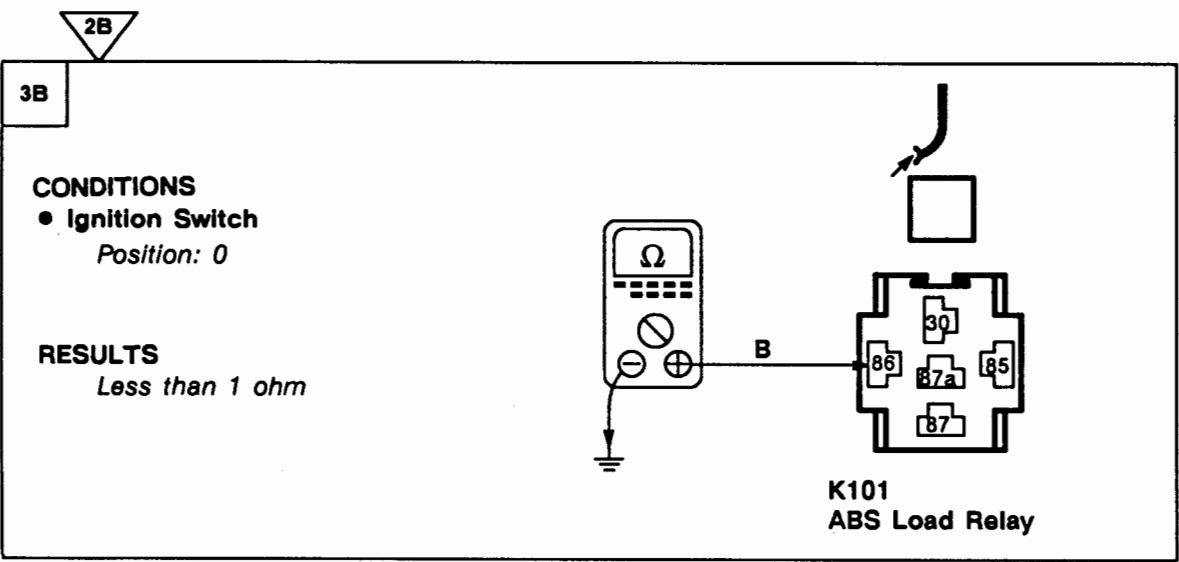

OK PROBLEM CAUSE
- B Wire

OK PROBLEM CAUSE
- NK Wire
- ABS Load Relay

Test C

1C Wheel Speed Sensors Test

CONDITIONS
 • Ignition Switch
Position: 0

RESULTS
 1.5K - 2.0K Ω

Wheel speed sensor



PROBLEM CAUSE
- Wheel speed sensor



2C

CONDITIONS
 • Ignition Switch
Position: 0

RESULTS
 More than 100K ohms

Wheel speed sensor



PROBLEM CAUSE
- Wheel speed sensor



PROBLEM CAUSE
- B Wire
- N Wire

D1 ETM

1993 RANGE ROVER

Test D

1D Isolation Outlet Valve

CONDITIONS
 • Ignition Switch
 Position: 0

RESULTS
 5 - 7 Ω

Z103
 ABS Booster
 Unit

~~OK~~ PROBLEM CAUSE
 - ABS Booster Unit

OK PROBLEM CAUSE
 - SB Wire

Test E

1E Isolation Inlet Valve

CONDITIONS
 • Ignition Switch
 Position: 0

RESULTS
 5 - 7 Ω

Z103
 ABS Booster
 Unit

~~OK~~ PROBLEM CAUSE
 - ABS Booster Unit

OK PROBLEM CAUSE
 - SO Wire

Test F

1F Left Front Outlet Valve

CONDITIONS
 • Ignition Switch
Position: 0

RESULTS
 2.5 - 4.5 Ω

**Z103
ABS Booster Unit**



PROBLEM CAUSE
 - ABS Booster Unit



PROBLEM CAUSE
 - SN Wire

Test G

1G Left Front Inlet Valve

CONDITIONS
 • Ignition Switch
Position: 0

RESULTS
 5 - 7 Ω

**Z103
ABS Booster Unit**



PROBLEM CAUSE
 - ABS Booster Unit



PROBLEM CAUSE
 - SK Wire

Test H

1H Right Front Outlet Valve

CONDITIONS

- Ignition Switch
Position: 0

RESULTS
2.5 - 4.5 Ω

**Z103
ABS Booster
Unit**



PROBLEM CAUSE
- ABS Booster Unit



PROBLEM CAUSE
- SU Wire

Test I

1I Right Front Inlet Valve

CONDITIONS

- Ignition Switch
Position: 0

RESULTS
5 - 7 Ω

**Z103
ABS Booster
Unit**



PROBLEM CAUSE
- ABS Booster Unit



PROBLEM CAUSE
- SU Wire

Test J

1J Left Rear Outlet Valve

CONDITIONS
 • Ignition Switch
 Position: 0

RESULTS
 2.5 - 4.5 Ω

Z103
ABS Booster
Unit



PROBLEM CAUSE
 - ABS Booster Unit



PROBLEM CAUSE
 - SP Wire

Test K

1K Left Rear Inlet Valve

CONDITIONS
 • Ignition Switch
 Position: 0

RESULTS
 5 - 7 Ω

Z103
ABS Booster
Unit



PROBLEM CAUSE
 - ABS Booster Unit



PROBLEM CAUSE
 - SG Wire

Test L

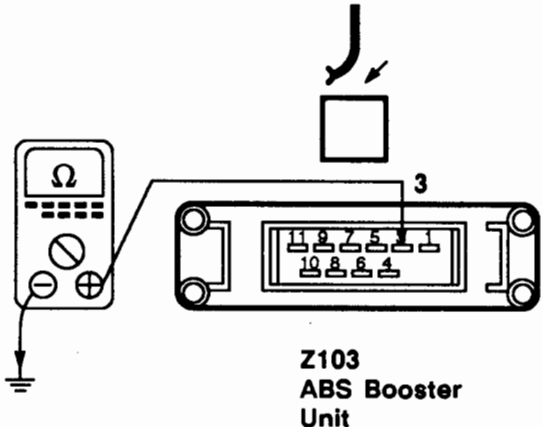
1L	Right Rear Outlet Valve
<p>CONDITIONS</p> <ul style="list-style-type: none"> • Ignition Switch Position: 0 	
<p>RESULTS</p> <p>2.5 - 4.5 Ω</p>	
 <p style="text-align: center;">Z103 ABS Booster Unit</p>	



PROBLEM CAUSE
- ABS Booster Unit



PROBLEM CAUSE
- SW Wire

Test M

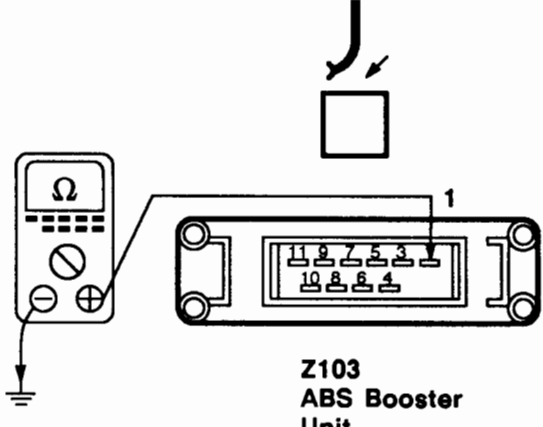
1M	Right Rear Inlet Valve
<p>CONDITIONS</p> <ul style="list-style-type: none"> • Ignition Switch Position: 0 	
<p>RESULTS</p> <p>5 - 7 Ω</p>	
 <p style="text-align: center;">Z103 ABS Booster Unit</p>	



PROBLEM CAUSE
- ABS Booster Unit



PROBLEM CAUSE
- SY Wire

Test N

1N Pump Test

CONDITIONS
 • Ignition Switch
 Position: 0

RESULTS
 Less than 1 ohm

Z104
 ABS Pressure
 Switch Unit



PROBLEM CAUSE

- ABS Pressure Switch Unit
- low brake fluid
- hydraulic fault or leak



2N

CONDITIONS
 • Ignition Switch
 Position: 0

RESULTS
 Less than 1 ohm

Z104
 ABS Pressure
 Switch Unit



PROBLEM CAUSE

- B Wire

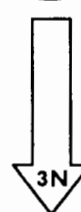

D1 ETM

1993 RANGE ROVER

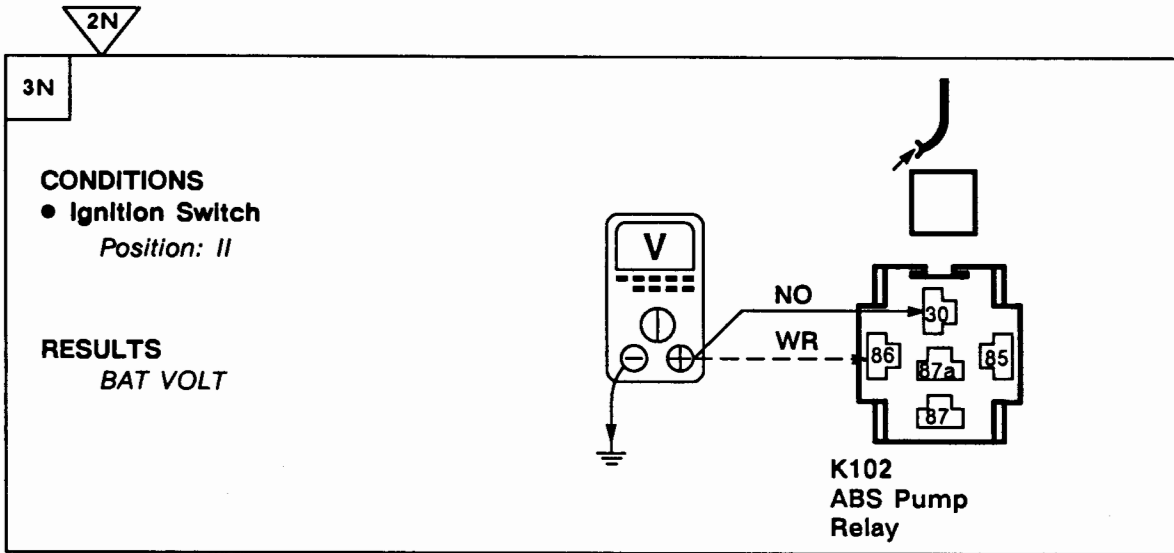

PROBLEM CAUSE

- F 4 Fuse
- NO Wire
- F 3 Fuse
- WR Wire

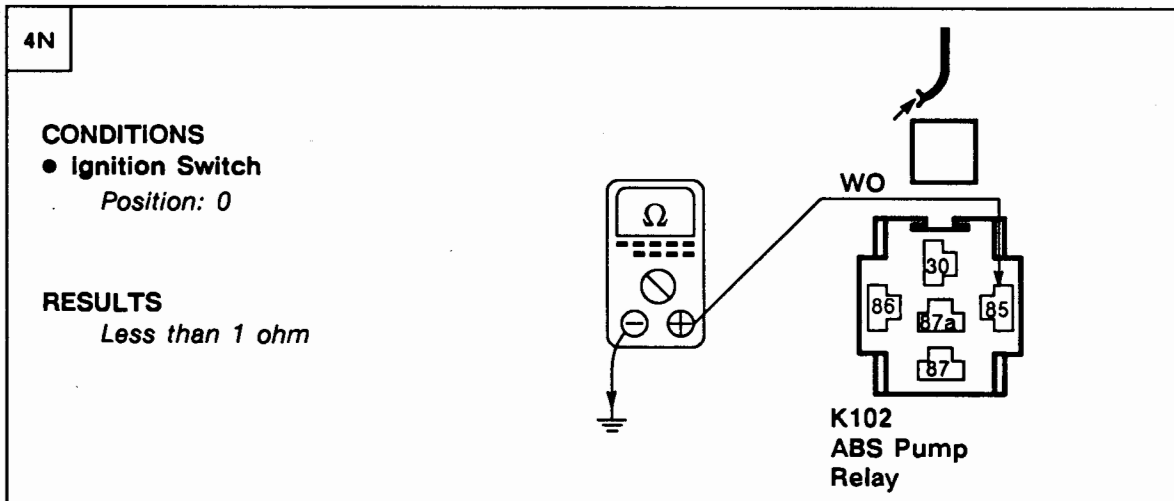
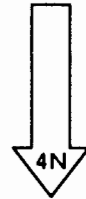

PROBLEM CAUSE

- WO Wire

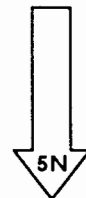

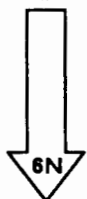
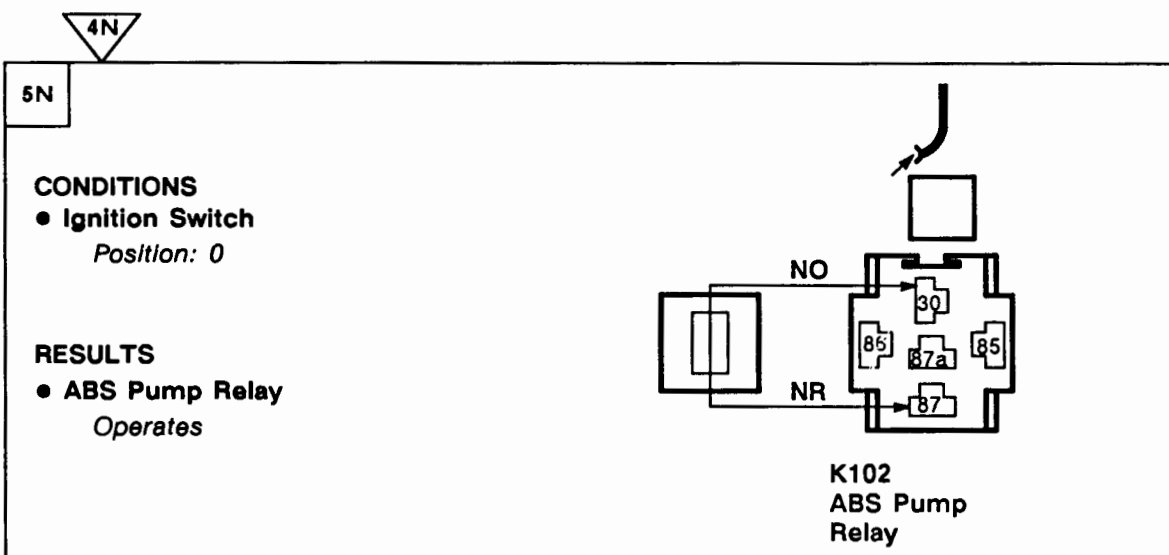

PROBLEM CAUSE
- ABS Pump Relay

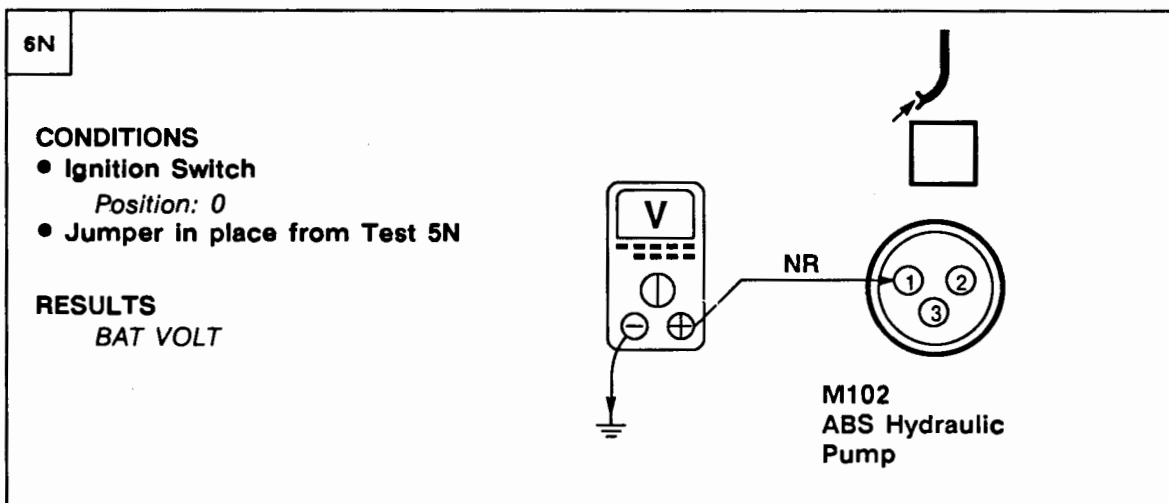

PROBLEM CAUSE
- NR Wire

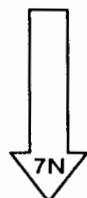

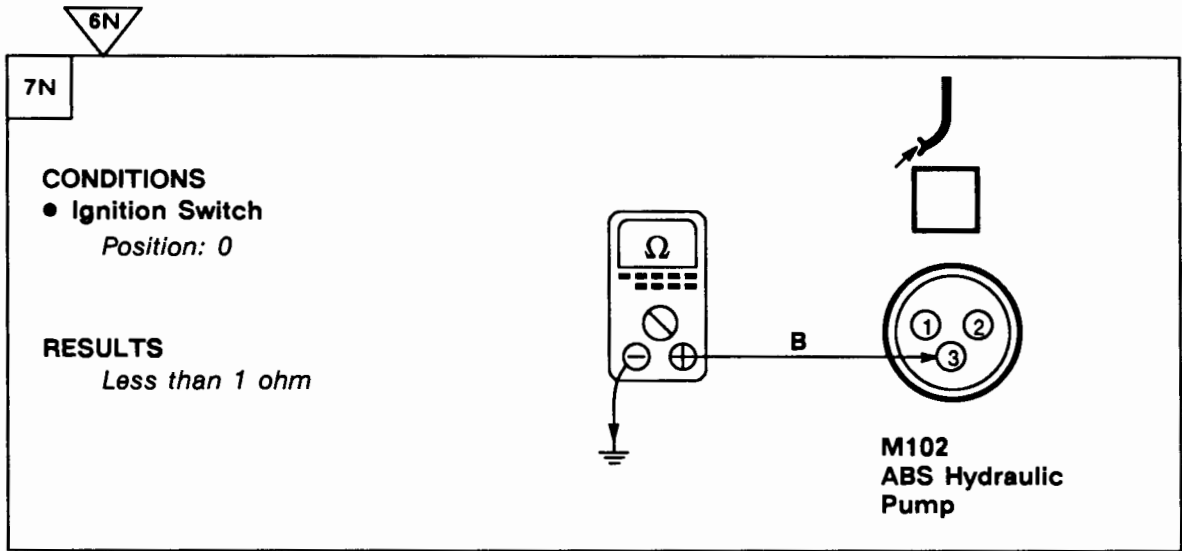

PROBLEM CAUSE
- B Wire



PROBLEM CAUSE
- ABS Hydraulic Pump

Test O

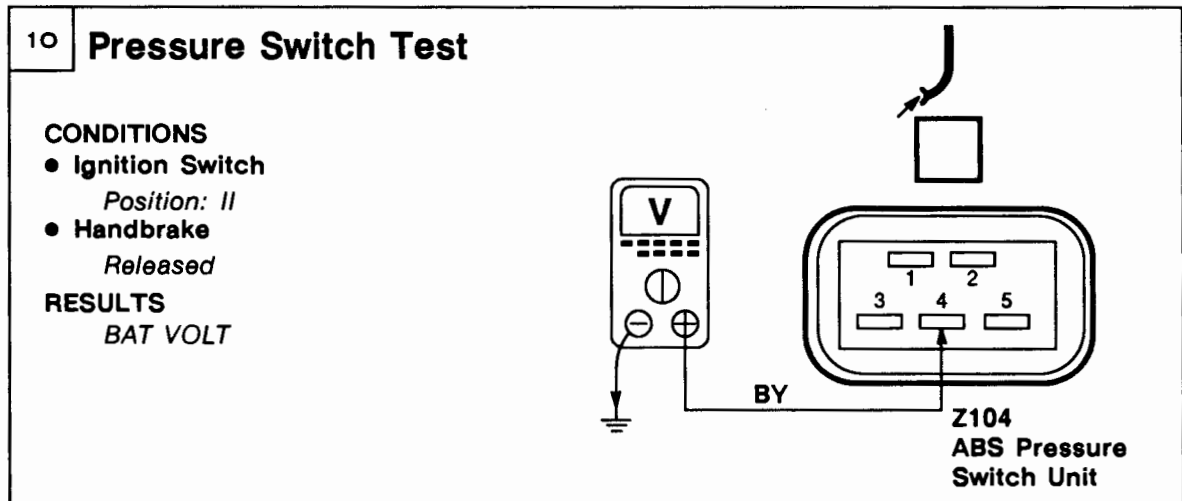

PROBLEM CAUSE
- BY Wire
- Low brake fluid
- Anti-Lock Brake System ECU



PROBLEM CAUSE
- ABS Pressure Switch Unit
- Brake fluid leak
- ABS Hydraulic Pump
(M102) output

Test P

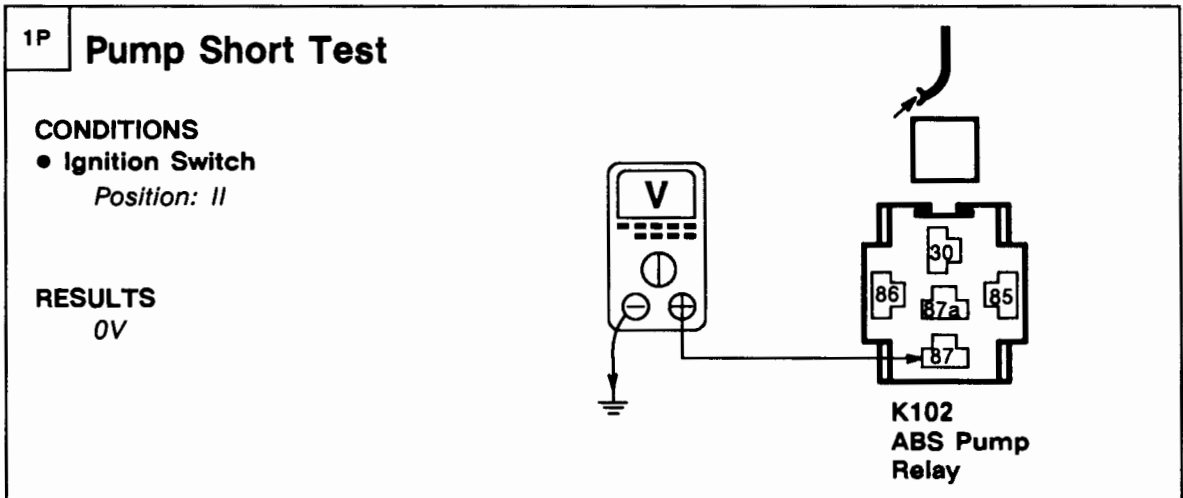

~~OK~~ PROBLEM CAUSE
- NR Wire

OK

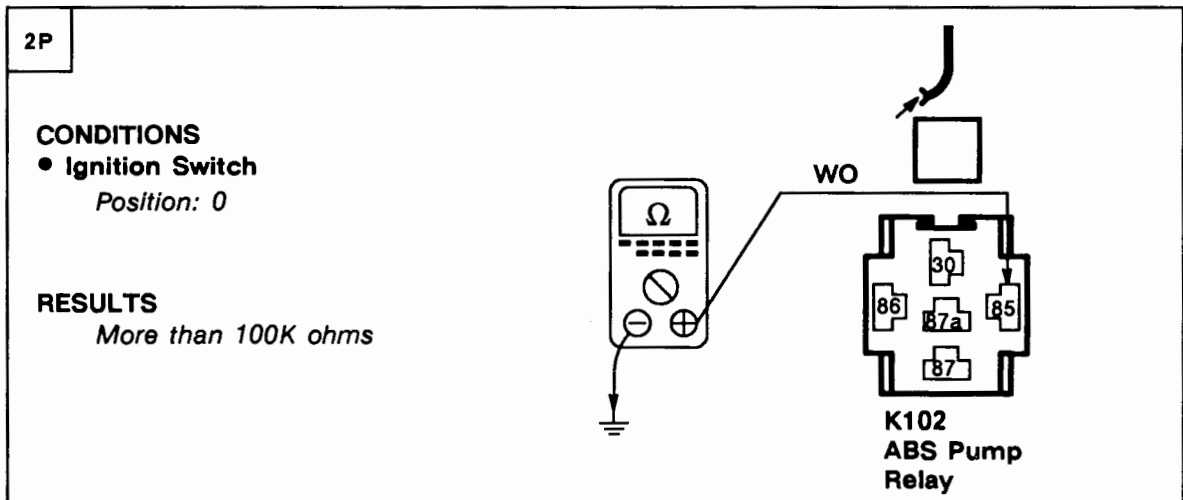
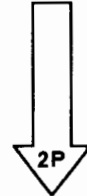

~~OK~~

OK PROBLEM CAUSE
- ABS Pump Relay

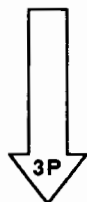

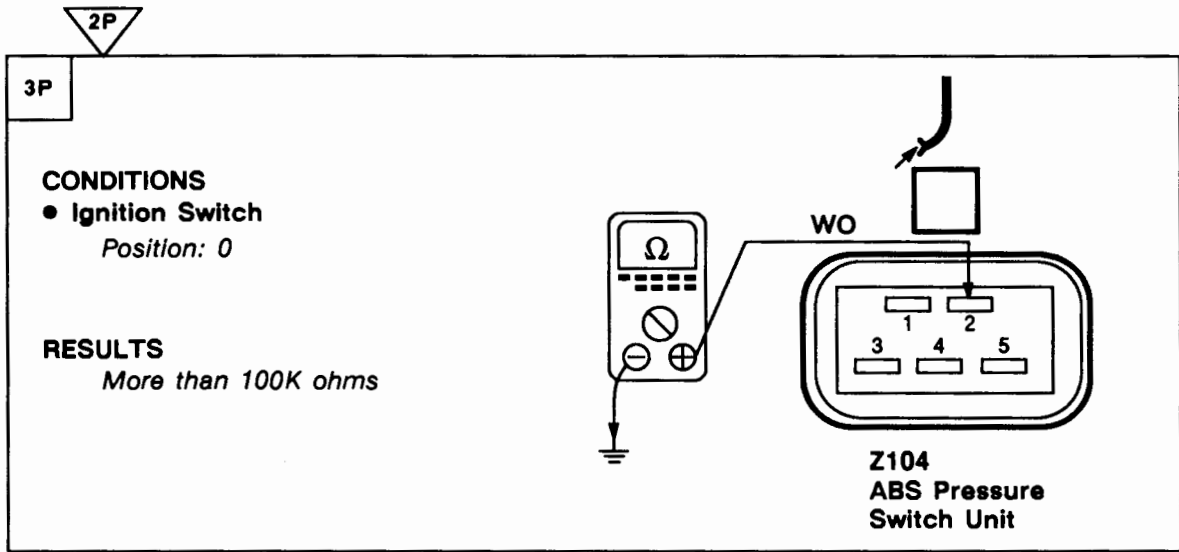

PROBLEM CAUSE
- WO Wire



PROBLEM CAUSE
- ABS Pressure Switch Unit

Test Q

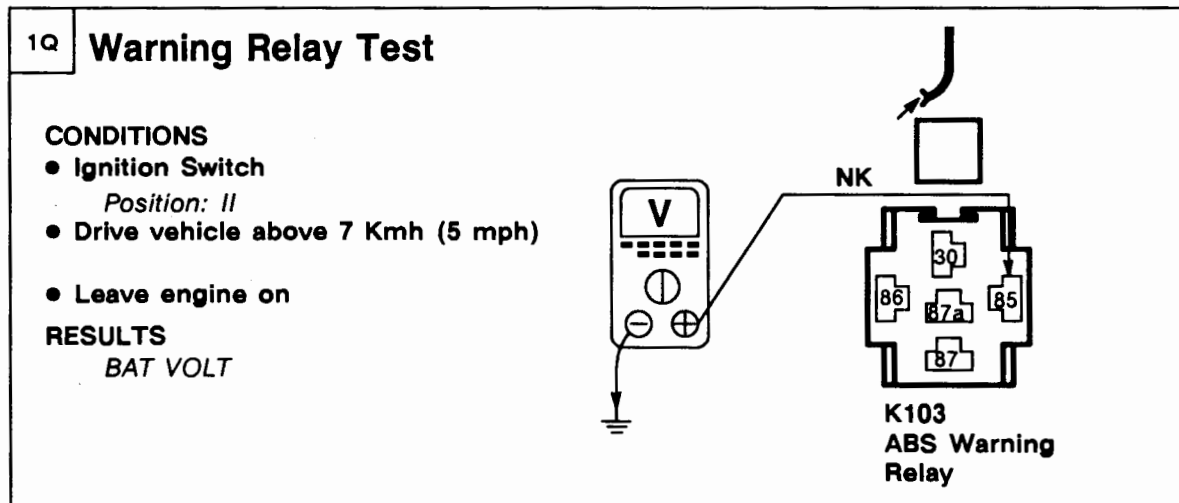

GO TO TEST A



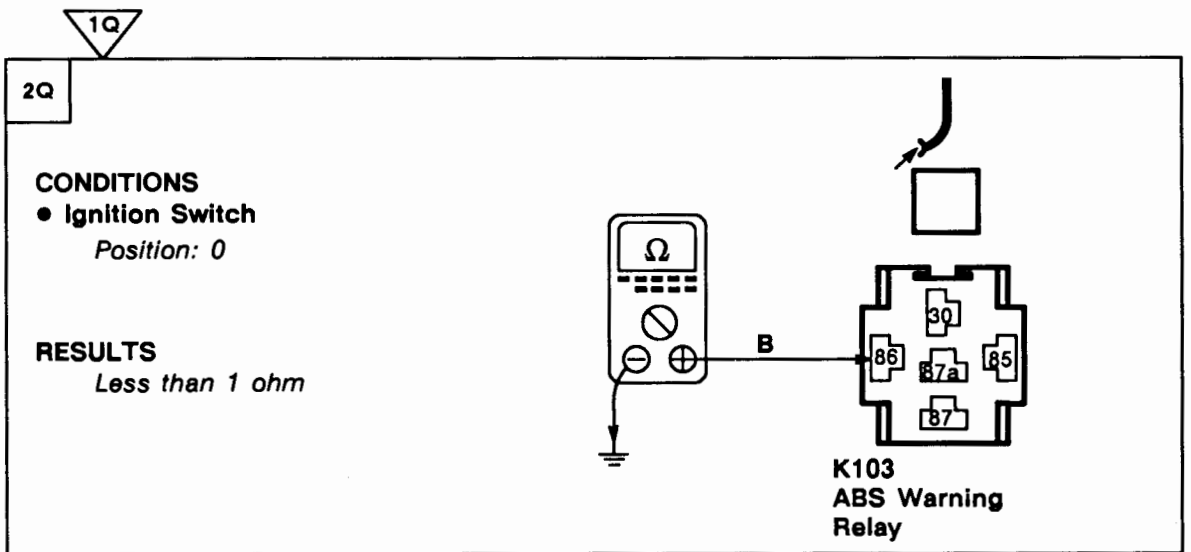

PROBLEM CAUSE
- B Wire

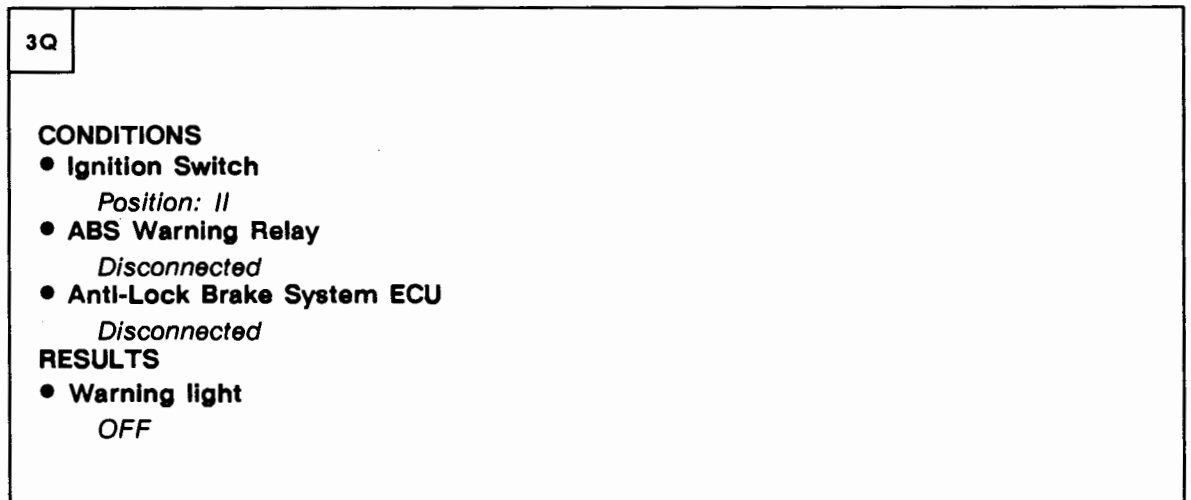

PROBLEM CAUSE
- BS Wire
- Instrument Cluster
- Warning Lamps Check Unit



3Q

4Q

CONDITIONS

- Ignition Switch
Position: II
- Anti-Lock Brake System ECU
Connected
- ABS Warning Relay
Disconnected
- Drive vehicle above 7 Km/h (5 mph)

RESULTS

- Warning light
OFF

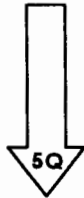

PROBLEM CAUSE
- ABS Warning Relay

5Q

CONDITIONS

- Ignition Switch
Position: I
- Pump brake pedal more than 15 times

RESULTS

More than 100K ohms

Z104
ABS Pressure
Switch Unit



PROBLEM CAUSE
- WB Wire



D1 ETM

1993 RANGE ROVER

3Q

4Q

CONDITIONS

- Ignition Switch
Position: II
- Anti-Lock Brake System ECU
Connected
- ABS Warning Relay
Disconnected
- Drive vehicle above 7 Km/h (5 mph)

RESULTS

- Warning light
OFF

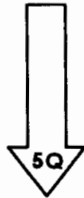

PROBLEM CAUSE
- ABS Warning Relay

5Q

CONDITIONS

- Ignition Switch
Position: I
- Pump brake pedal more than 15 times

RESULTS

More than 100K ohms

Z104
ABS Pressure
Switch Unit



PROBLEM CAUSE
- WB Wire



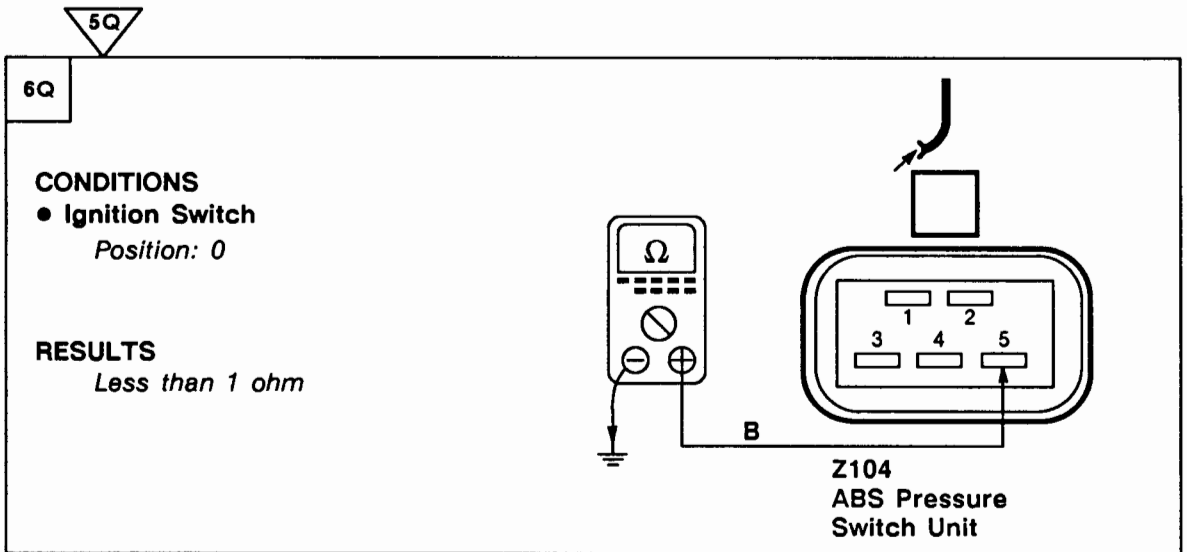

~~OK~~ PROBLEM CAUSE
- B Wire

OK

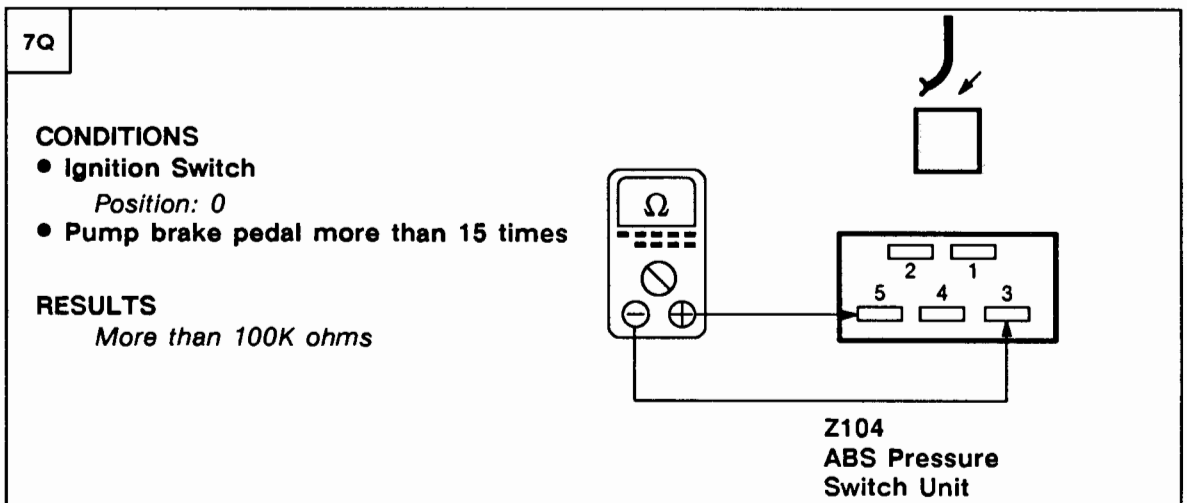

~~OK~~ PROBLEM CAUSE
- ABS Pressure Switch Unit

OK



D1 ETM

1993 RANGE ROVER

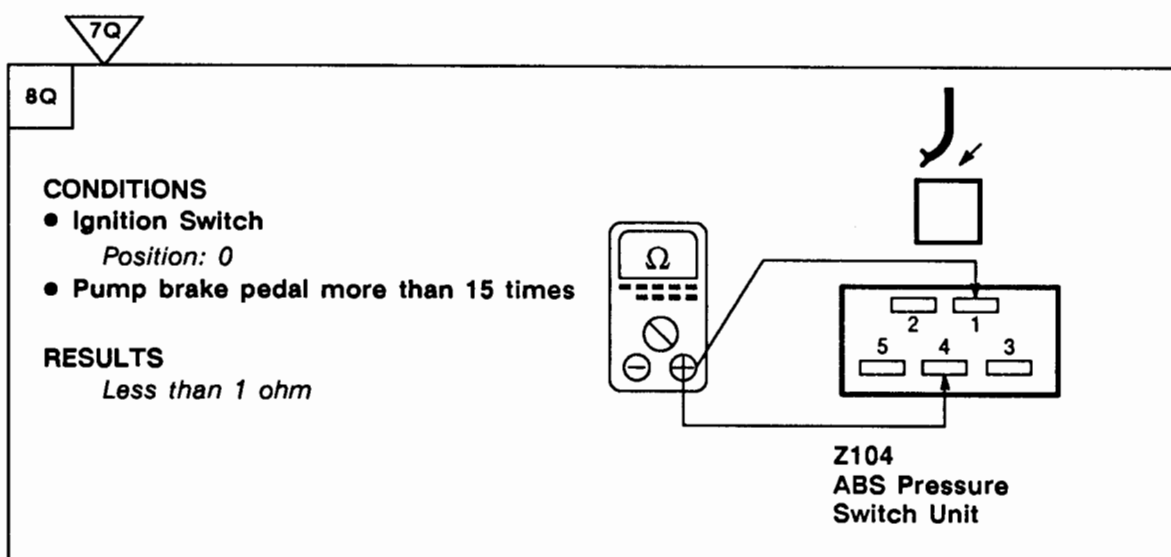

PROBLEM CAUSE
- ABS Pressure Switch Unit



PROBLEM CAUSE
- Anti-Lock Brake System ECU

Test R

1R ETC NC Valve

CONDITIONS
 • Ignition Switch
 Position: 0

RESULTS
 5 - 7 Ω

**Z108
 Anti-Lock
 Brake System ECU
 Connector
 adaptor**

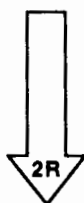

PROBLEM CAUSE
 - Anti-Lock Brake System ECU

2R

CONDITIONS
 • Ignition Switch
 Position: 0

RESULTS
 5 - 7 Ω

ETC Valve Block



PROBLEM CAUSE
 - ETC Valve Block



PROBLEM CAUSE
 - RY Wire

Test S

S1 ETC NO Valve

CONDITIONS
 • Ignition Switch
 Position: 0

RESULTS
 2.5 - 4.5 Ω

Z108 Anti-Lock Brake System ECU

Connector adaptor

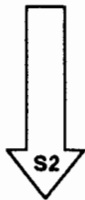

PROBLEM CAUSE
 - Anti-Lock Brake System ECU

S2

CONDITIONS
 • Ignition Switch
 Position: 0

RESULTS
 2.5 - 4.5 Ω

ETC Valve Block



PROBLEM CAUSE
 - ETC Valve Block



PROBLEM CAUSE
 - RW Wire

Test T

1T code 2-3

CONDITIONS

- Ignition Switch
Position: 0

RESULTS
Less than 1 ohm

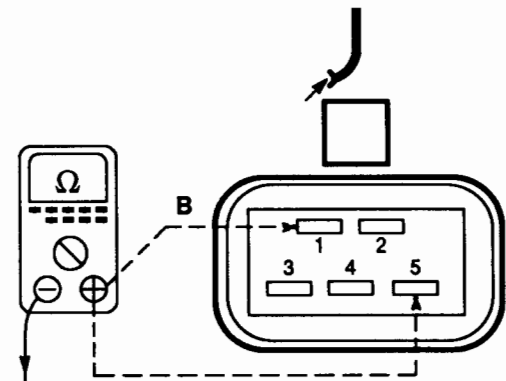

Z104
ABS Pressure
Switch Unit

~~OK~~ PROBLEM CAUSE
- B Wire

OK

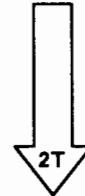

2T

CONDITIONS

- Ignition Switch
Position: II
- Handbrake
Released

RESULTS
*Test lamp
illuminates*

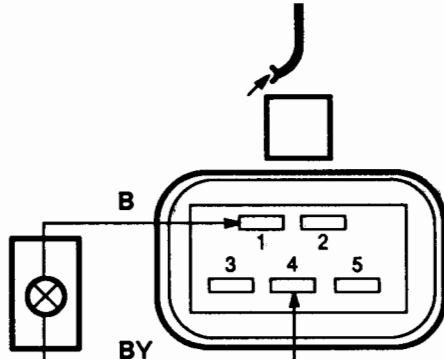

Z104
ABS Pressure
Switch Unit

~~OK~~ PROBLEM CAUSE
- BY Wire
- Low brake fluid
- Anti-Lock Brake System ECU

OK



2T

3T

CONDITIONS

- Ignition Switch
Position: 0
- Pump brake pedal more than 15 times

RESULTS
Less than 1 ohm

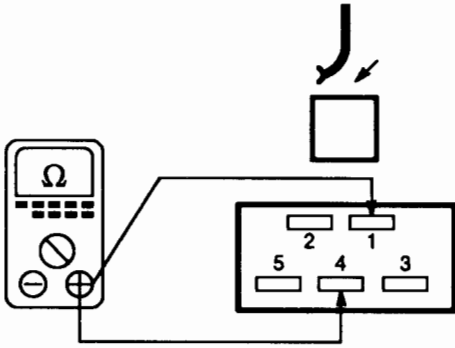

**Z104
ABS Pressure
Switch Unit**



PROBLEM CAUSE
- ABS Pressure Switch Unit

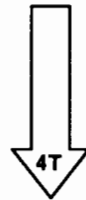

4T

CONDITIONS

- Ignition Switch
Position: 0
- Pump brake pedal more than 15 times

RESULTS
More than 100K ohms

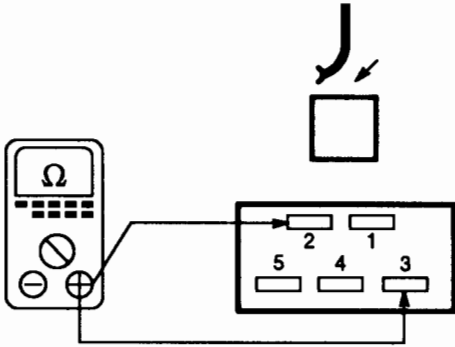

**Z104
ABS Pressure
Switch Unit**



PROBLEM CAUSE
- ABS Pressure Switch Unit



PROBLEM CAUSE
- WB Wire
- Anti-Lock Brake System ECU

Test U

1U

ETC Lamp Shorted

CONDITIONS

- Ignition Switch
Position: II

RESULTS

0 VOLTS

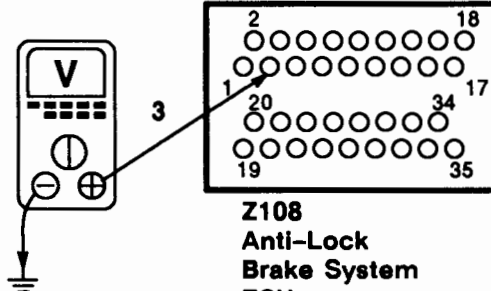

Z108
Anti-Lock
Brake System
ECU
Connector
adaptor



PROBLEM CAUSE

- RB Wire
- Instrument Cluster



PROBLEM CAUSE

- Anti-Lock Brake System ECU

Test V

1V

ETC Lamp Open

CONDITIONS

- Ignition Switch
Position: II

RESULTS

ETC light is on

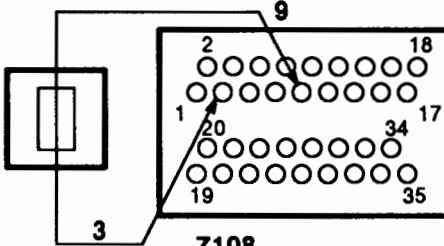

Z108
Anti-Lock
Brake System
ECU
Connector
adaptor



PROBLEM CAUSE

- RB Wire
- Bulb
- Instrument Cluster



PROBLEM CAUSE

- Anti-Lock Brake System ECU

1993 RANGE ROVER

KEY INFORMATION

CIRCUIT DIAGRAMS

- Circuit diagrams are arranged so that current flow is from the top of the diagram (current source) to the bottom of the diagram (ground).
- Only those components that work together in the circuit are shown. If only part of a component is used in the circuit, then only that part of the component is shown.

● Remember:

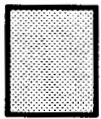

Entire component

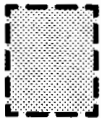

Part of a component

TERMINAL NUMBER

DESIGNATION

50	Battery voltage: Ignition Switch in position III
30	Battery voltage: supplied constantly
15	Battery voltage: Ignition Switch in position II or III
R	Battery voltage: Ignition Switch in positions I, II
31	Ground

See Introduction (i) for additional circuit diagram symbols.

DIAGNOSIS

- If the diagram is accompanied by text:
 - Read the Circuit Operation before proceeding with the electrical diagnosis.
 - Read the Troubleshooting Hints before performing the System Diagnosis.
 - Tests follow the System Diagnosis.
 - When performing the System Diagnosis, be certain that all components disconnected in previous steps are reconnected unless otherwise directed.



Component is disconnected.
Backprobe harness connector



Component is connected.
Backprobe harness connector

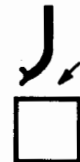

Component is disconnected.
Probe component



Component is disconnected.
Probe harness connector



Probe in-line connector