

# 07 - GENERAL FITTING REMINDERS

## CONTENTS

Page

### INFORMATION

GENERAL FITTING REMINDERS .....	1
PRECAUTIONS AGAINST DAMAGE .....	1
SAFETY PRECAUTIONS .....	1
PREPARATION .....	2
DISMANTLING .....	2
INSPECTION - GENERAL .....	2
BALL AND ROLLER BEARINGS .....	3
OIL SEALS .....	4
JOINTS AND JOINT FACES .....	5
FLEXIBLE HYDRAULIC PIPES, HOSES .....	5
FUEL SYSTEM HOSES .....	6
METRIC BOLT IDENTIFICATION .....	6
METRIC NUT IDENTIFICATION .....	6
KEYS AND KEYWAYS .....	6
TAB WASHERS .....	6
COTTER PINS .....	7
NUTS .....	7
LOCKING WIRE .....	7
SCREW THREADS .....	7
UNIFIED THREAD IDENTIFICATION .....	7





---

**GENERAL FITTING REMINDERS**

---

**WORKSHOP SAFETY IS YOUR RESPONSIBILITY!**

The suggestions, cautions and warnings in the section are intended to serve as reminders for trained and experienced mechanics. This manual is not a course in automotive mechanics or workshop safety.

Shop equipment, shop environment, and the use and disposal of solvents, fluids, and chemicals are subject to government regulations which are intended to provide a level of safety. It is your responsibility to know and comply with such regulations.

---

**PRECAUTIONS AGAINST DAMAGE**

---

1. Always fit covers to protect fenders before commencing work in engine compartment.
2. Cover seats and carpets, wear clean overalls and wash hands or wear gloves before working inside vehicle.
3. Avoid spilling hydraulic fluid or battery acid on paint work. Wash off with water immediately if this occurs. Use Polythene sheets to protect carpets and seats.
4. Always use a recommended Service Tool, or a satisfactory equivalent, where specified.
5. Protect temporarily exposed screw threads by replacing nuts or fitting plastic caps.

---

**SAFETY PRECAUTIONS**

---

1. Whenever possible use a lift or pit when working beneath vehicle, in preference to jacking. Chock wheels as well as applying parking brake.



**WARNING: Do not use a pit when removing fuel system components.**

2. Never rely on a jack alone to support vehicle. Use axle stands carefully placed at jacking points to provide rigid support.
3. Ensure that a suitable form of fire extinguisher is conveniently located.
4. Check that any lifting equipment used has adequate capacity and is fully serviceable.
5. Disconnect the battery negative lead.



**WARNING: Do not disconnect any pipes in air conditioning refrigeration system, unless trained and instructed to do so. A refrigerant is used which can cause blindness if allowed to contact eyes.**

6. Ensure that adequate ventilation is provided when volatile degreasing agents are being used.
7. Do not apply heat in an attempt to free stiff nuts or fittings; as well as causing damage to protective coatings, there is a risk of damage to electronic equipment and brake linings from stray heat.

---

**PREPARATION**

---

1. Before removing a component, clean it and its surrounding areas as thoroughly as possible.
2. Blank off any openings exposed by component removal, using greaseproof paper and masking tape.
3. Immediately seal fuel, oil or hydraulic lines when separated, using plastic caps or plugs, to prevent loss of fluid and entry of dirt.
4. Close open ends of oilways, exposed by component removal, with tapered hardwood plugs or readily visible plastic plugs.
5. Immediately a component is removed, place it in a suitable container; use a separate container for each component and its associated parts.
6. Before dismantling a component, clean it thoroughly with a recommended cleaning agent; check that agent is suitable for all materials of component.
7. Clean bench and provide marking materials, labels, containers and locking wire before dismantling a component.

---

**INSPECTION - GENERAL**

---

1. Never inspect a component for wear or dimensional check unless it is absolutely clean; a slight smear of grease can conceal an incipient failure.
2. When a component is to be checked dimensionally against figures quoted for it, use correct equipment (surface plates, micrometers, dial gauges, etc.) in serviceable condition. Makeshift checking equipment can be dangerous.
3. Reject a component if its dimensions are outside limits quoted, or if damage is apparent. A part may, however, be refitted if its critical dimension is exactly limit size, and is otherwise satisfactory.
4. Use 'Plastigauge' 12 Type PG-1 for checking bearing surface clearances. Directions for its use, and a scale giving bearing clearances in 0,0025 mm steps are provided with it.

---

**DISMANTLING**

---

1. Observe scrupulous cleanliness when dismantling components, particularly when brake, fuel or hydraulic system parts are being worked on. A particle of dirt or a cloth fragment could cause a dangerous malfunction if trapped in these systems.
2. Blow out all tapped holes, crevices, oilways and fluid passages with an air line. Ensure that any O-rings used for sealing are correctly replaced or renewed, if disturbed.
3. Use marking ink to identify mating parts, to ensure correct reassembly. If a centre punch or scribe is used they may initiate cracks or distortion of components.
4. Wire together mating parts where necessary to prevent accidental interchange (e.g. roller bearing components).
5. Wire labels on to all parts which are to be renewed, and to parts requiring further inspection before being passed for reassembly; place these parts in separate containers from those containing parts for rebuild.
6. Do not discard a part due for renewal until after comparing it with a new part, to ensure that its correct replacement has been obtained.

---

**BALL AND ROLLER BEARINGS**



---



**CAUTION: Never refit a ball or roller bearing without first ensuring that it is in a fully serviceable condition.**

1. Remove all traces of lubricant from bearing under inspection by washing in a suitable degreaser; maintain absolute cleanliness throughout operations.
2. Inspect visually for markings of any form on rolling elements, raceways, outer surface of outer rings or inner surface of inner rings. Reject any bearings found to be marked, since any marking in these areas indicates onset of wear.
3. Holding inner race between finger and thumb of one hand, spin outer race and check that it revolves absolutely smoothly. Repeat, holding outer race and spinning inner race.
4. Rotate outer ring gently with a reciprocating motion, while holding inner ring; feel for any check or obstruction to rotation, and reject bearing if action is not perfectly smooth.
5. Lubricate bearing generously with lubricant appropriate to installation.
6. Inspect shaft and bearing housing for discoloration or other marking suggesting that movement has taken place between bearing and seatings. (This is particularly to be expected if related markings were found in operation 2).
7. Ensure that shaft and housing are clean and free from burrs before fitting bearing.

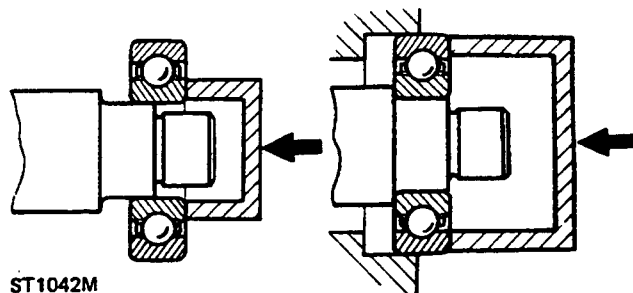
8. If one bearing assembly of a pair shows an imperfection it is generally advisable to replace both with new bearings; an exception could be made if the faulty bearing had covered a low mileage, and it could be established that damage was confined to it only.
9. When fitting bearing to shaft, apply force only to inner ring of bearing, and only to outer ring when fitting into housing. (Refer to ST1042M).



ST1042M

10. In the case of grease lubricated bearings (e.g. hub bearings) fill space between bearing and outer seal with recommended grade of grease before fitting seal.
11. Always mark components of separable bearings (e.g. taper roller bearings) in dismantling, to ensure correct reassembly. Never fit new rollers in a used outer ring, always fit a complete new bearing assembly.

## OIL SEALS



**NOTE:** Ensure that the seal running track is free from pits, scores, corrosion and general damage prior to fitting replacement seal.

1. Always fit new oil seals when rebuilding an assembly.
2. Carefully examine seal before fitting to ensure that it is clean and undamaged.
3. Coat the sealing lips with clean grease; pack dust excluder seals with grease, and heavily grease duplex seals in cavity between sealing lips.
4. Ensure that seal spring, if provided, is correctly fitted.
5. Place lip of seal towards fluid to be sealed and slide into position on shaft, using fitting sleeve when possible to protect sealing lip from damage by sharp corners, threads or splines. If fitting sleeve is not available, use plastic tube or tape to prevent damage to sealing lip.

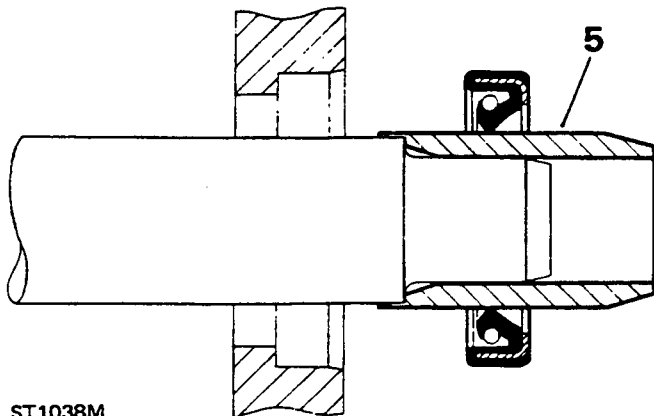

ST1038M

6. Grease outside diameter of seal, place square to housing recess and press into position, using great care and if possible a 'bell piece' to ensure that seal is not tilted. (In some cases it may be preferable to fit seal to housing before fitting to shaft). Never let weight of unsupported shaft rest in seal.

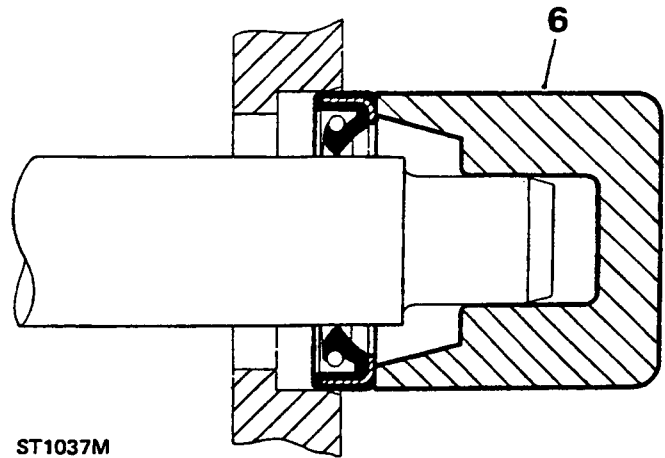

ST1037M

7. If correct service tool is not available, use a suitable drift approximately 0.4mm (0.015 in) smaller than outside diameter of seal. Use a hammer **VERY GENTLY** on drift if a press is not suitable.
8. Press or drift seal in to depth of housing if housing is shouldered, or flush with face of housing where no shoulder is provided. Ensure that the seal does not enter the housing in a tilted position.



**NOTE:** Most cases of failure or leakage of oil seals are due to careless fitting, and resulting damage to both seals and sealing surfaces. Care in fitting is essential if good results are to be obtained. **NEVER** use a seal which has been improperly stored or handled, such as hung on a hook or nail.



---

**JOINTS AND JOINT FACES**

---

1. Always use correct gaskets where they are specified.
2. Use jointing compound only when recommended. Otherwise fit joints dry.
3. When jointing compound is used, apply in a thin uniform film to metal surfaces; take great care to prevent it from entering oilways, pipes or blind tapped holes.
4. Remove all traces of old jointing materials prior to reassembly. Do not use a tool which could damage joint faces.
5. Inspect joint faces for scratches or burrs and remove with a fine file or oil stone; do not allow removed material or dirt to enter tapped holes or enclosed parts.
6. Blow out any pipes, channels or crevices with compressed air, fit new 'O' rings or seals displaced by air blast.

---

**FLEXIBLE HYDRAULIC PIPES, HOSES**

---

1. Before removing any brake or power steering hose, clean end fittings and area surrounding them as thoroughly as possible.
2. Obtain appropriate plugs or caps before detaching hose end fittings, so that ports can be immediately covered to exclude dirt.
3. Clean hose externally and blow through with airline. Examine carefully for cracks, separation of plies, security of end fittings and external damage. Reject any hose found faulty.
4. When refitting hose, ensure that no unnecessary bends are introduced, and that hose is not twisted before or during tightening of union nuts.
5. Containers for hydraulic fluid must be kept absolutely clean.
6. Do not store brake fluid in an unsealed container. It will absorb water, and fluid in this condition would be dangerous to use due to a lowering of its boiling point.
7. Do not allow brake fluid to be contaminated with mineral oil, or use a container which has previously contained mineral oil.
8. Do not re-use brake fluid bled from system.
9. Always use clean brake fluid to clean hydraulic components.
10. Fit a cap to seal a hydraulic union and a plug to its socket after removal to prevent ingress of dirt.
11. Absolute cleanliness must be observed with hydraulic components at all times.
12. After any work on hydraulic systems, inspect carefully for leaks underneath the vehicle while a second operator applies maximum pressure to the brakes (engine running) and operates the steering.

## FUEL SYSTEM HOSES

**CAUTION:** All fuel hoses are made up of two laminations, an armoured rubber outer sleeve and an inner viton core. If any of the fuel system hoses have been disconnected, it is imperative that the internal bore is inspected to ensure that the viton lining has not become separated from the armoured outer sleeve. A new hose must be fitted if separation is evident.

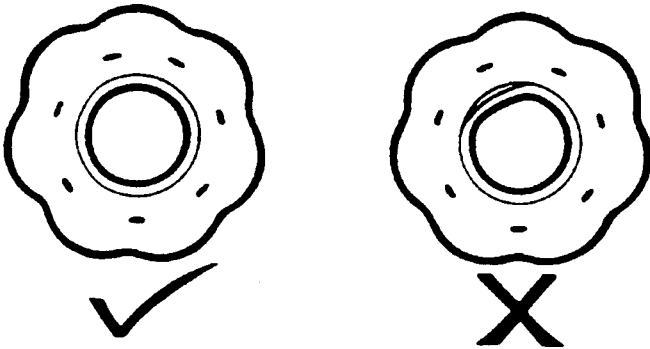

RR2302M

## METRIC NUT IDENTIFICATION

1. A nut with an ISO metric thread is marked on one face or on one of the flats of the hexagon with the strength grade symbol 8, 12 or 14. Some nuts with a strength 4, 5 or 6 are also marked and some have the metric symbol M on the flat opposite the strength grade marking.
2. A clock face system is used as an alternative method of indicating the strength grade. The external chamfers or a face of the nut is marked in a position relative to the appropriate hour mark on a clock face to indicate the strength grade.
3. A dot is used to locate the 12 o'clock position and a dash to indicate the strength grade. If the grade is above 12, two dots identify the 12 o'clock position.

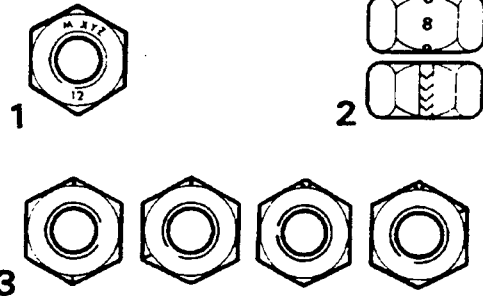

ST1036M

## METRIC BOLT IDENTIFICATION

1. An ISO metric bolt or screw, made of steel and larger than 6 mm in diameter can be identified by either of the symbols ISO M or M embossed or indented on top of the head.
2. In addition to marks to identify the manufacture, the head is also marked with symbols to indicate the strength grade, e.g. 8.8, 12.9 or 14.9, where the first figure gives the minimum tensile strength of the bolt material in tens of kgf/mm<sup>2</sup>.
3. Zinc plated ISO metric bolts and nuts are chromate passivated, a gold-bronze colour.

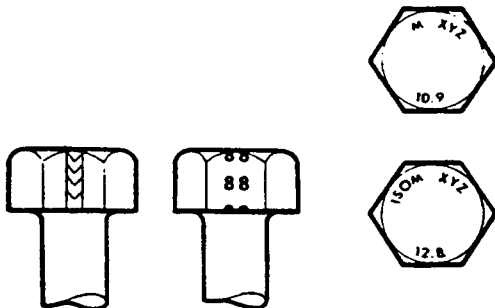

ST1035M

## KEYS AND KEYWAYS

1. Remove burrs from edges of keyways with a fine file and clean thoroughly before attempting to refit key.
2. Clean and inspect key closely; keys are suitable for refitting only if indistinguishable from new, as any indentation may indicate the onset of wear.

## TAB WASHERS

1. Fit new washers in all places where they are used. Always fit a new tab washer.
2. Ensure that the new tab washer is of the same design as that replaced.



**COTTER PINS**

1. Fit new cotter pins throughout when replacing any unit.
2. Always fit cotter pins where cotter pins were originally used. Do not substitute spring washers: there is always a good reason for the use of a cotter pin.
3. All cotter pins should be fitted as shown unless otherwise stated.

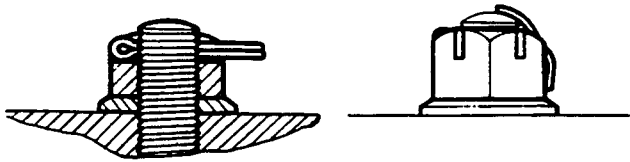

ST1030M

**NUTS**

1. When tightening a slotted or castellated nut never loosen it back to insert cotter pin or locking wire except in those recommended cases where this forms part of an adjustment. If difficulty is experienced, alternative washers or nuts should be selected, or washer thickness reduced.
2. Where self-locking nuts have been removed it is advisable to replace them with new ones of the same type.



**NOTE: Where bearing pre-load is involved, nuts should be tightened in accordance with special instructions.**

**LOCKING WIRE**

1. Fit new locking wire of the correct type for all assemblies incorporating it.
2. Arrange wire so that its tension tends to tighten the bolt heads, or nuts, to which it is fitted.

**SCREW THREADS**

1. Both UNF and Metric threads to ISO standards are used. See below for thread identification.
2. Damaged threads must always be discarded. Cleaning up threads with a die or tap impairs the strength and closeness of fit of the threads and is not recommended.
3. Always ensure that replacement bolts are at least equal in strength to those replaced.
4. Do not allow oil, grease or jointing compound to enter blind threaded holes. The hydraulic action on screwing in the bolt or stud could split the housing.
5. Always tighten a nut or bolt to the recommended torque value. Damaged or corroded threads can affect the torque reading.
6. To check or re-tighten a bolt or screw to a specified torque value first loosen a quarter of a turn, then re-tighten to the correct value.
7. Oil thread lightly before tightening to ensure a free running thread, except in the case of threads treated with sealant/lubricant (see section 06 - Torque Values), and self-locking nuts.

**UNIFIED THREAD IDENTIFICATION**

1. **Bolts**  
A circular recess is stamped in the upper surface of the bolt head.
2. **Nuts**  
A continuous line of circles is indented on one of the flats of the hexagon, parallel to the axis of the nut.
3. **Studs, Brake rods, etc.**  
The component is reduced to the core diameter for a short length at its extremity.

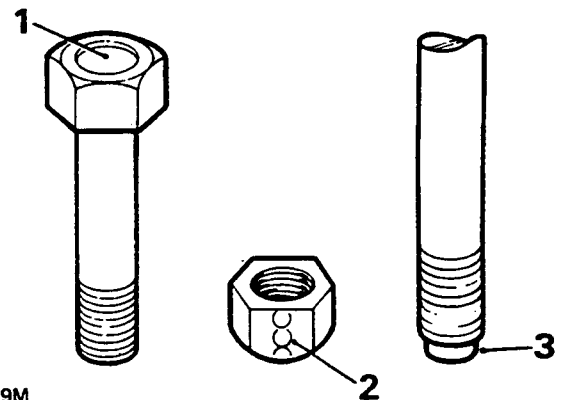

ST1039M