

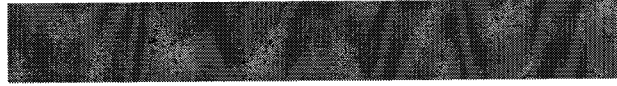















# Workshop Manual Supplement

## RANGE ROVER



This supplement contains information applicable to the 200 TDi engine fitted to vehicles from 1990 to 1994 and should be used in conjunction with Range Rover workshop manual part no. LHA WM A01.

01	INTRODUCTION
04	GENERAL SPECIFICATION DATA
05	ENGINE TUNING DATA
09	LUBRICANTS, FLUIDS AND CAPACITIES
10	MAINTENANCE
12	ENGINE
19	FUEL SYSTEM
26	COOLING SYSTEM
30	MANIFOLD AND EXHAUST SYSTEM
86	ELECTRICAL

	01 04 05 07 09
	10
	12
	17 19
	26
	30
	33
	37 41 44
	47 51 54
	57
	60 64 68 74
	70
	76
	80 82
	84 86

Published by the  
Technical Communication Department of  
Rover Group  
Cowley  
Oxford  
OX4 5NL  
England

Publication number LRL 0009ENG  
©Copyright Rover Group Limited 1995



# 01 - INTRODUCTION

## CONTENTS

Page

### INFORMATION

LOCATION OF IDENTIFICATION NUMBER ..... 1



---

**LOCATION OF IDENTIFICATION NUMBER**

---

**Engine serial number - 200 Tdi Diesel engine**

Stamped on the RH side of cylinder block adjacent to the fuel injection pump.

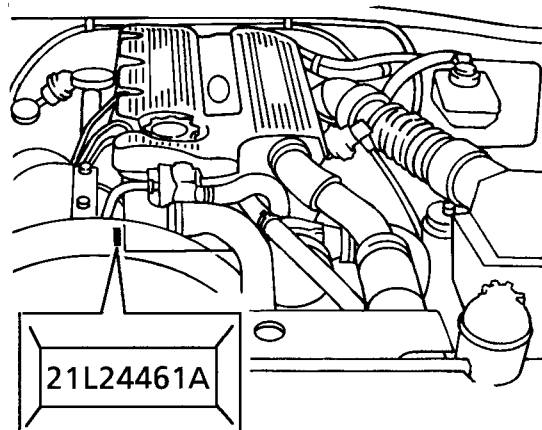

1M0063