

TYRES

inspection

Inspect tyres at weekly intervals to obtain maximum tyre life and performance and to ensure compliance with legal requirements. Check for signs of incorrect inflation and uneven wear, which may indicate a need for balancing or front wheel alignment. Refer to the **Tyre Wear Diagnosis Chart** if the tyres have abnormal or uneven wear patterns.

Check tyres at least weekly for cuts, abrasions, bulges and for objects embedded in the tread. More **frequent** inspections are recommended when the vehicle is regularly used in off road conditions.

To assist tyre inspection, tread wear indicators are moulded into the bottom of the tread grooves, as shown in the illustration below.

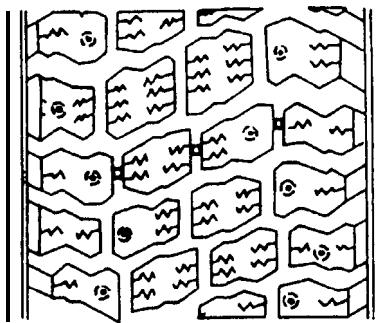

When the tread has worn to a remaining depth of 1.6 mm (1/16 in) the indicators appear at the surface as bars which connect the tread pattern across the width of the tread as shown in the illustration below.

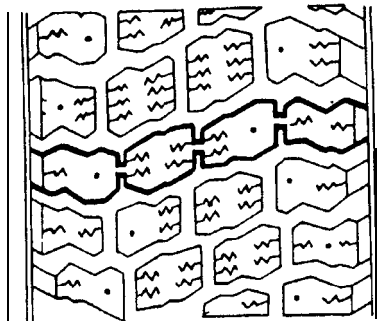

When the indicators appear in two or more adjacent grooves, at three locations around the tyre, a new tyre must be fitted.

NOTE: Do not attempt to interchange tyres, e.g. from front to rear, as tyre wear produces characteristic patterns depending on their position. If such position is changed after wear has occurred, the performance of the tyre will be adversely affected.

NOTE: Territorial vehicle regulations governing tyre wear MUST be adhered to.

Tyre pressures

Maximum tyre life and performance will be obtained only if tyres are maintained at the correct pressures.

Tyre pressures must be checked at least once a month and at least once a week, preferably daily, if the vehicle is used off road.

The tyre inflation pressure is calculated to give the vehicle satisfactory ride and steering characteristics without compromising tyre tread life. The recommended tyre pressures for all conditions are given in the General Specification Data Section and the Owner's Manual. A label attached to the inside edge of the driver's door also provides tyre pressure information.

Always check tyre inflation pressures using an accurate gauge and inflate tyres to the recommended pressures only.

Check and adjust tyre pressures **ONLY** when the tyres are cold, vehicle parked for three hours or more, or driven for less than 3.2 km (2 miles) at speeds below 64 km/h (40 mph). Do not reduce inflation pressures if the tyres are hot or the vehicle has been driven for more than 3.2 km (2 miles) at speeds over 64 km/h (40 mph), as pressures can increase by 0.41 bars (6 p.s.i.) over cold inflation pressures.

Check **ALL** tyre pressures including the spare. Refit the valve caps as they form a positive seal and keep dust out of the valve.

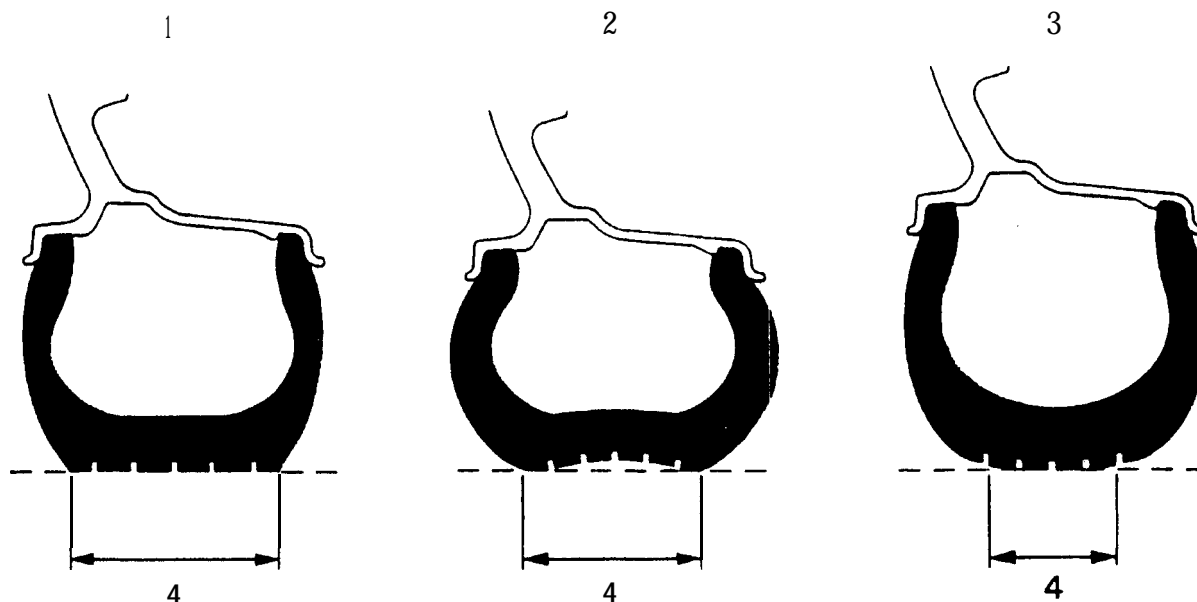

RR2133E

NOTE: Radial ply tyres have a flexible sidewall, which produces a sidewall bulge making the tyre appear under-inflated. This is a normal condition for radial ply tyres. Do not attempt to reduce this bulge by over-inflating the tyre.

1. Correct inflation.
2. Under-inflation.
3. Over-inflation.
4. Tread contact with road.

WHEELS

Regularly check the condition of the wheels. Replace any wheel that is bent, cracked, dented or has excessive runout.

VALVES

Check the condition of the inflation valve. Replace any valve that is worn, cracked, loose, or leaking air.

TYRE WEAR DIAGNOSIS .

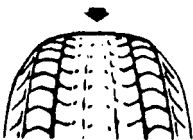
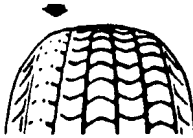
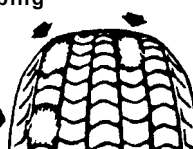
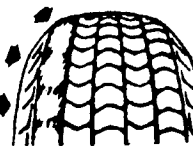
CONDITION	POSSIBLE CAUSE	CURE
<p>Rapid wear at the shoulders</p> 	<p>Tyres under-inflated Worn suspension components i.e. ball joints, panhard rod bushes, steering damper Excessive cornering speeds</p>	<p>Inflate to correct pressure Replace worn components</p>
<p>Rapid wear at centre of tread</p> 	<p>Tyres over-inflated</p>	<p>Inflate to correct pressure</p>
<p>Wear at one shoulder</p> 	<p>Toe out of adjustment Bent panhard rod Bent shock absorber</p>	<p>Adjust toe to correct figure Check and replace worn or damaged components</p>
<p>Bald spots or tyre cupping</p> 	<p>Wheel out of balance Excessive radial runout Shock absorber worn Excessive braking</p>	<p>Balance wheel and tyre assembly Check runout and replace tyre if necessary Replace shock</p>
<p>Tyre scalloped</p> 	<p>Toe out of adjustment Worn suspension components Excessive cornering speeds</p>	<p>Adjust toe to correct figure Replace as necessary</p>

IR2138E

CAUTION: This diagnosis chart is for general guidance only and does not necessarily include every cause of abnormal tyre wear.

WHEELS AND TYRES

Balance

NOTE: Before attempting to balance a wheel and tyre assembly clean all mud and dirt deposits from both inside and outside rims and remove existing balance weights.

Remove stones from the tyre tread in order to avoid operator injury during dynamic balancing and to obtain the correct balance.

Inspect tyres for damage and correct tyre pressures and balance according to the equipment manufacturer's instructions.

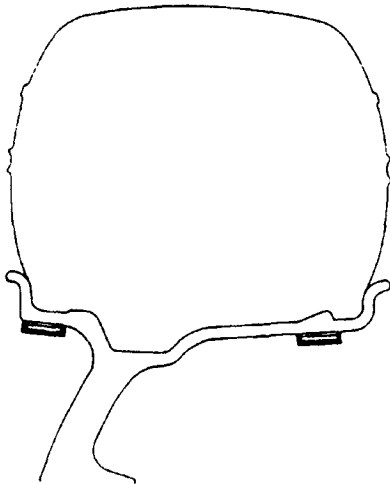

RR2138E

Clean area of wheel rim and attach adhesive balance weights in position shown. Cut through rear face of weight strip to detach required weights.

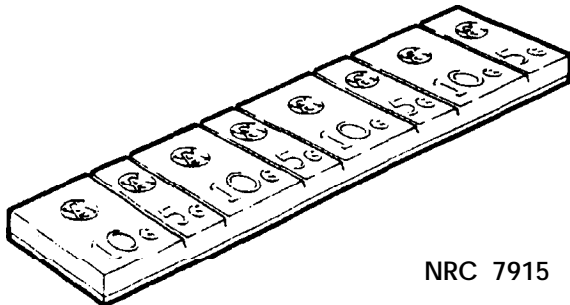

NRC 7915

RR2137E

CAUTION: Use only the correct adhesive balance weights to avoid damage to the aluminium wheel rim. DO NOT attempt to use a steel wheel weight on an aluminium wheel.

Static balance

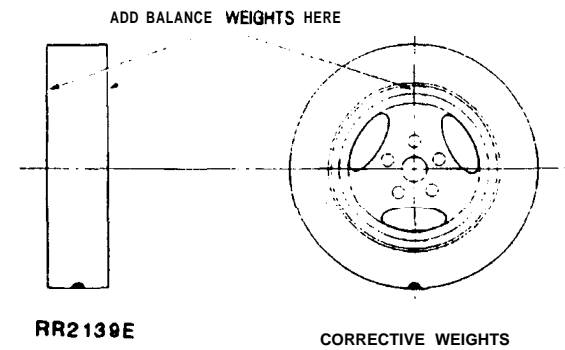
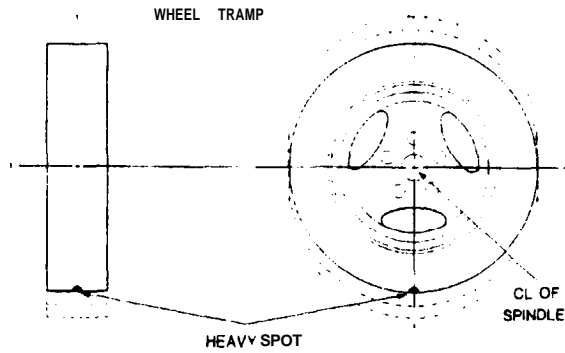

RR2139E

CORRECTIVE WEIGHTS

Static balance is the equal distribution of weight around the wheel. A statically unbalanced wheel will cause a bouncing action called wheel tramp. This condition will eventually cause uneven tyre wear.

Dynamic balance

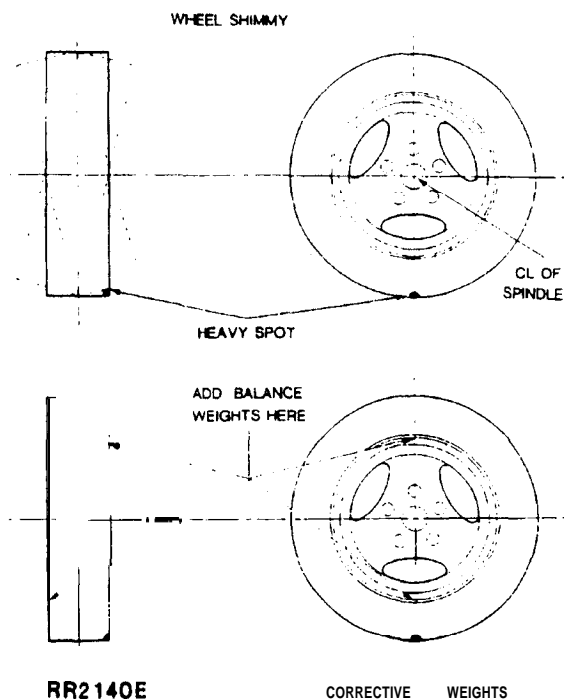

Dynamic balance is the equal distribution of weight on each side of the centre line so that when the wheel spins there is no tendency for side to side movement. A dynamically unbalanced wheel will cause wheel shimmy.

Off vehicle balancing

Balance the wheel assembly referring to the equipment manufacturer's instructions.

It is essential that the wheel is located by the centre hole NOT the stud holes. To ensure positive wheel location the diameter of the locating collar on the machine shaft must be 112.80 to 112.85 mm (4.441 to 4.443 in). This diameter will ensure that the collar fits correctly within the centre hole of the wheel.

Where possible always use the vehicle wheel retaining nuts to locate the wheel on the balancer, to avoid damaging the wheel. If this is not possible, the locating nuts must be of a similar pattern to the original wheel nuts. The use of conical type wheel nuts for this purpose may damage the aluminium alloy.

CAUTION: It is essential that all wheel balancing is carried out off the vehicle. The use of on the vehicle balancing could cause component damage or personal injury and **MUST NOT** be attempted.

GENERAL INFORMATION

WARNING: THE RANGE ROVER IS A MULTI-PURPOSE VEHICLE AND AS SUCH THE WHEELS AND TYRES ARE DESIGNED FOR BOTH ON AND OFF ROAD USAGE. ONLY THE WHEELS AND TYRES SPECIFIED FOR USE ON THE VEHICLE MUST BE USED.

The Range Rover is equipped with tubeless 'S' rated radial tyres as standard equipment. The tyres are of European metric size and must not be confused with the "P" size metric tyres available in North America.

When tyre replacement is required the correct type of radial-ply tyre must be used. Under no circumstances must cross-ply or bias-belted tyres be used.

Always use the same make and type of radial-ply tyre throughout the vehicle.

See Data section for tyre specification and pressures.

The tyres are mounted on 7.0 inch wide by 16 inch diameter cast aluminium alloy wheels. The wheel rim is of the asymmetric hump type incorporating a safety hump to improve location of the tyre bead in its seat. The surface has a paint finish covered with a clear polyurethane lacquer. Care must be taken when handling the wheel to avoid scratching or chipping the finish.

Cleaning

Wash the aluminium wheels using a suitable wash and wax concentrate correctly diluted and rinse with cold clear water. **DO NOT** use abrasives or aluminium wheel cleaners containing acid, as they will destroy the lacquer finish.

Tyre changing

Use only tyre changing equipment to mount or demount tyres, following the equipment manufacturer's instructions. **DO NOT** use hand tools or tyre levers, as they may damage tyre beads or the aluminium wheel rim.

Puncture repair

Remove the punctured tyre from the wheel and repair using a combination service plug and vulcanising patch. Always follow the manufacturer's instructions when using a puncture repair kit.

Only punctures in the tread area are repairable, **DO NOT** attempt to repair punctures in the tyre shoulders or sidewalls.

Do not attempt to repair a tyre that has sustained the following damage: bulges or blisters, ply separation, broken or cracked beads, wear indicators visible and punctures larger than 1/4 inch diameter.

CAUTION: Do not use tyre sealants that are injected through the valve stem to repair punctured tyres as they may produce wheel corrosion and tyre imbalance.

Aluminium wheel rim bead seats should be cleaned using a non-abrasive cleaner to remove the mounting lubricants and old rubber. Before mounting or demounting a tyre, the bead area should be well lubricated with a suitable tyre lubricant.

Tyre fitting

1. Install a new valve assembly.
2. Ensure the wheel and tyre is adequately lubricated.
3. Mount the tyre in the normal manner. Inflate the tyre and at the same time apply hand pressure to the area around the valve to aid seating over the valve first.

NOTE: Stop inflation immediately if the tyre seats opposite the valve, as this will result in the valve being blocked by the tyre beading, making further inflation impossible, and carry out the following procedure.

4. Deflate the tyre, unseat and rotate it around the rim until the valve is in line with that part of the tyre which seated initially. This part of the beading having seated over the hump previously will automatically seat first when the tyre is re-inflated.
5. Inflate the tyre to seat the beads correctly, finally inflate to the correct pressure.

Wheels

Remove and refit

WARNING: The parking brake acts on the transmission, not the rear wheels, and may not hold the vehicle when jacking unless the following procedure is used. If one front wheel and one rear wheel is raised no vehicle holding or braking effect is possible. Wheels **MUST** be chocked in all circumstances.

Always engage the differential lock. Note that the differential lock is only engaged if the warning light is illuminated with the ignition switched on.

Apply the parking brake, select 'P' in the main gearbox and engage low gear in the transfer box.

Removing

1. Loosen the five wheel nuts.
2. Using a suitable floor jack raise the vehicle and place on axle stands, see jacking procedure in Maintenance- Section 10.
3. Remove the wheel nuts and carefully withdraw the wheel over the studs.

Refitting

4. Ensure that the retaining studs and nuts are clean.
5. Lightly coat the wheel mounting spigot face with a suitable anti-seize compound to minimise the possibility of adhesion between wheel and spigot face.
6. Apply a drop of oil to the wheel studs.
7. Refit the wheel taking care not to damage the stud threads.
8. Fit the wheel nuts and turn by hand for at least three full threads before using any form of wheel wrench.
9. Tighten the nuts as much as possible using a suitable wrench.

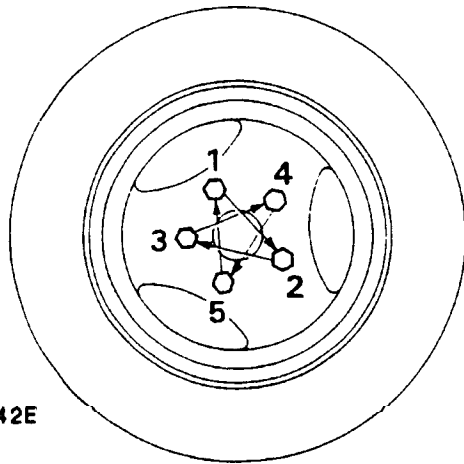

RR2142E

10. Lower the vehicle and finally tighten the nuts to the correct torque (see section 06-Torque values) in the sequence shown.

Wheel stud

Remove and refit

Removing

1. Remove the wheel.
2. Drive the stud out of the driveshaft flange.

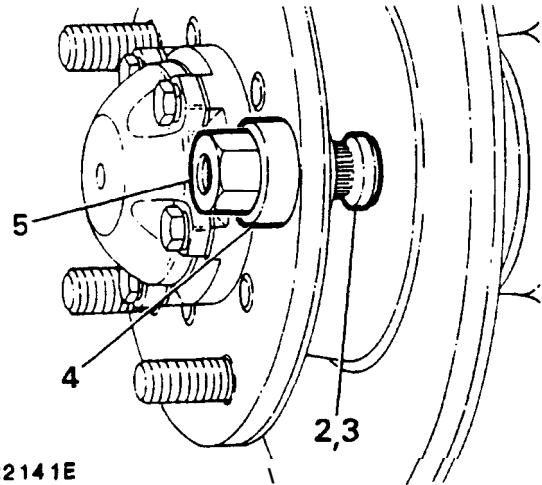

RR2141E

Refitting

3. Position the stud in the flange.
4. Install a suitable spacer over the stud.
5. Using a M16 x 1.5P nut, a slave Range Rover wheel nut is suitable, pull the stud into the flange until the shoulder of the stud abuts the flange.
6. Refit the wheel, tighten the wheel nuts to the correct torque (see section 06-Torque values).

100

100

100

100

100

100