

## Electrical Library





# **DISCOVERY 99MY to 03MY ELECTRICAL LIBRARY**

LRL0529ENG(3)

Published by Land Rover

© Land Rover 2003

All rights reserved. No part of this publication may be reproduced, stored in a retrieval system or transmitted in any form, electronic, mechanical, recording or other means without prior written permission from Land Rover.



|   |            |
|---|------------|
| <b>INTRODUCTION .....</b>                                 | <b>1.1</b> |
| ABOUT THIS DOCUMENT .....                                 | 1.1        |
| ELECTRICAL PRECAUTIONS .....                              | 1.3        |
| HARNESSES REPAIRS .....                                   | 1.6        |
| ABBREVIATIONS .....                                       | 1.9        |
| HOW TO USE THIS DOCUMENT .....                            | 1.11       |
| FAULT DIAGNOSIS .....                                     | 1.14       |
| WIRE COLOUR CODES .....                                   | 1.15       |
| <br>  |            |
| <b>FUSE DETAILS .....</b>                                 | <b>2.1</b> |
| ENGINE COMPARTMENT FUSE BOX .....                         | 2.2        |
| PASSENGER COMPARTMENT FUSE BOX .....                      | 2.5        |
| LH/RH SATELLITE FUSE BLOCKS (SEATS) .....                 | 2.8        |
| <br>  |            |
| <b>EARTH POINTS AND HEADER JOINTS .....</b>               | <b>3.1</b> |
| <br>  |            |
| <b>DESCRIPTION AND OPERATION .....</b>                    | <b>4.1</b> |
| ANTI-THEFT ALARM .....                                    | 4.1        |
| CENTRAL DOOR LOCKING (CDL) .....                          | 4.7        |
| WINDOWS - FRONT .....                                     | 4.11       |
| WINDOWS - REAR .....                                      | 4.14       |
| SUNROOF .....   | 4.19       |
| MIRRORS .....   | 4.24       |
| FOLDING MIRRORS (JAPAN ONLY) .....                        | 4.29       |
| ELECTRIC SEATS .....                                      | 4.31       |
| MANUAL SEATS .....  | 4.35       |
| DIAGNOSTIC SOCKET .....                                   | 4.37       |
| BODY CONTROL UNIT (BCU) .....                             | 4.39       |
| STARTING AND CHARGING - Td5 .....                         | 4.40       |
| STARTING AND CHARGING - V8 .....                          | 4.44       |
| ENGINE MANAGEMENT - Td5 .....                             | 4.47       |
| ENGINE MANAGEMENT - V8 .....                              | 4.48       |
| IGNITION AND SHIFT INTERLOCK (NAS/JAPAN ONLY) .....       | 4.49       |
| CRUISE CONTROL - V8 ENGINES .....                         | 4.53       |
| CRUISE CONTROL - Td5 ENGINES .....                        | 4.58       |
| ELECTRONIC AUTOMATIC TRANSMISSION (EAT) .....             | 4.59       |
| ACTIVE CORNERING ENHANCEMENT (ACE) .....                  | 4.63       |
| SELF LEVELLING AND ANTI-LOCK BRAKING SYSTEM (SLABS) ..... | 4.66       |
| ANTI-LOCK BRAKING SYSTEM (ABS) .....                      | 4.70       |

# CONTENTS

---

|  |            |
|--|------------|
| SUPPLEMENTARY RESTRAINT SYSTEM (SRS) .....                               | 4.75       |
| AIR CONDITIONING (A/C) .....   | 4.77       |
| HEATER BLOWER - FRESH/RECIRCULATED AIR MOTOR<br>(NON A/C VEHICLES) ..... | 4.84       |
| FUEL BURNING HEATER (FBH) - Td5 ONLY .....                               | 4.87       |
| COOLING FAN .....  | 4.89       |
| HEATED REAR WINDOW (HRW) .....   | 4.92       |
| HEATED FRONT SCREEN (HFS) .....  | 4.95       |
| FRONT WIPERS AND WASHERS .....   | 4.98       |
| REAR WIPERS AND WASHERS .....  | 4.103      |
| BRAKE/REVERSE LAMPS .....  | 4.107      |
| HEADLAMP LEVELLING .....   | 4.110      |
| LIGHTS ON ALARM .....  | 4.112      |
| HEAD/SIDE AND NUMBER PLATE LAMPS .....                                   | 4.114      |
| FRONT FOG LAMPS .....  | 4.118      |
| REAR FOG GUARD LAMPS .....   | 4.121      |
| INDICATORS AND HAZARDS .....   | 4.124      |
| INTERIOR LAMPS .....   | 4.129      |
| INTERIOR ILLUMINATION .....  | 4.133      |
| INSTRUMENTS .....  | 4.135      |
| HORNS .....  | 4.143      |
| CLOCK .....  | 4.144      |
| CIGAR LIGHTER .....  | 4.145      |
| ACCESSORY SOCKET .....   | 4.147      |
| IN-CAR ENTERTAINMENT (ICE) .....   | 4.148      |
| TRAILER SOCKET .....   | 4.162      |
| PARK DISTANCE CONTROL (PDC) .....  | 4.163      |
| <br>   |            |
| <b>CONNECTOR .....</b>   | <b>5.1</b> |
| CIRCUIT REFERENCE NUMBERS .....  | 5.1        |

## ABOUT THIS DOCUMENT

### GENERAL

This document is intended to assist in diagnosing electrical faults, and should be used in conjunction with the Electrical Circuit Diagrams. The document is divided into the following sections:

1. **INTRODUCTION** – includes Electrical Precautions, a list of Abbreviations and general information on how to use the document.
2. **FUSE DETAILS** – provides details of location, rating in Amperes and circuit(s) protected.
3. **EARTH POINTS AND HEADERS** – provides details of earth points, earth and power headers, including a plan view of the vehicle to aid location.
4. **DESCRIPTION AND OPERATION** – provides an explanation of how each of the systems operates.
5. **CONNECTOR DETAILS** – details of connectors including a location photograph, face view and pin-out table.

*NOTE: Before starting electrical checks on the vehicle, ensure that the relevant mechanical functions operate satisfactorily.*

### References

References to the LH or RH side given in this document are made when viewing the vehicle from the rear.

Operations covered in this document do not include reference to testing the vehicle after repair. It is essential that work is inspected and tested after completion and, if necessary, a road test of the vehicle undertaken, particularly where safety related items are concerned.

**CAUTION: Before undertaking any electrical work on a vehicle ALWAYS read the ELECTRICAL PRECAUTIONS.**

# INTRODUCTION

---

## **Battery voltage**

### ***Open Circuit Voltage Test***

Before commencing diagnosis of electrical problems, verify the condition of the battery is acceptable by using the open circuit voltage test.

1. Switch off all electrical loads on the vehicle.
2. Adjust digital multimeter to read dc volts on the appropriate scale.
3. Connect test probes across battery terminals ensuring that polarity is correct and record the voltage displayed.

**A reading of 12.3V or more is acceptable; any battery which reads less than this will need charging.**

*NOTE: If the vehicle has been used within a period of 8 hours prior to the test, surface charge must be removed from the battery by switching the headlamps on for approximately 30 seconds. Wait a further 60 seconds before checking the open circuit voltage.*

Battery voltage is used as a known reference for ascertaining whether or not circuits are receiving sufficiently high voltage for components to function correctly. This reference is only a guide since most electronic circuits are designed to function over a wide range of voltages. In addition, consideration must be given to readings affected by voltage drop across certain components and fluctuations due to cable lengths.

## ELECTRICAL PRECAUTIONS

### General

The following guidelines are intended to ensure the safety of the operator whilst preventing damage to the electrical and electronic components fitted to the vehicle. Where necessary, specific precautions are detailed in the relevant sections of this document, reference to which should be made prior to commencing repair operations.

Equipment – Prior to commencing any test procedure on the vehicle, ensure that the relevant test equipment is working correctly and any harness or connectors are in good condition. This particularly applies to mains lead and connections.

***WARNING: Before commencing work on an ignition system, all high tension terminals, adapters and diagnostic equipment for testing should be inspected to ensure that they are adequately insulated and shielded to prevent accidental personal contact and to minimise the risk of shock. Wearers of surgically implanted pacemaker devices should not work in close proximity to ignition circuits or diagnostic equipment.***

Polarity – Never reverse connect the vehicle battery and always observe the correct polarity when connecting test equipment.

High Voltage Circuits – Whenever disconnecting live ht circuits, always use insulated pliers and never allow the open end of the ht lead to come into contact with other components, particularly ECU's. Since high voltage spikes can occur on the terminals of the coil while the engine is running, exercise caution when measuring the voltage at these points.

Connectors and Harnesses – The engine compartment of a vehicle is a particularly hostile environment for electrical components and connectors. Always ensure these items are dry and oil free before disconnecting and connecting test equipment. Never force connectors apart either by using tools or by pulling on the wiring harness. Always ensure locking tabs are disengaged before removal and note orientation to enable correct reconnection. Ensure that any protective covers and substances are replaced if disturbed.

Before removing a faulty component, refer to the Workshop Manual for removal procedures. Ensure the ignition switch is turned to the 'OFF' position, the battery is disconnected (***see Battery Disconnecting***) and any disconnected harnesses are supported to avoid any undue strain at the terminals. When replacing the component keep oily hands away from electrical connection areas and push connectors home until any locking tabs fully engage.



# INTRODUCTION

---

## **Battery disconnecting**

Before disconnecting the battery, switch off all electrical equipment. If the radio is to be serviced, ensure the security code has been deactivated. When the battery is disconnected, certain data such as radio code, clock time, °C/°F on ATC panel and adaptive setups will be lost. On vehicles with battery backed-up sounder (BBUS) fitted, if the battery is disconnected with the alarm armed, the BBUS will sound.

**CAUTION: To prevent damage to electrical components, ALWAYS disconnect the battery when working on the vehicle electrical system. The earth lead must be disconnected first and reconnected last. Always ensure that battery leads are routed correctly and are not close to any potential chafing points.**

## **Battery charging**

Recharge the battery out of the vehicle and keep the top well ventilated. While being charged or discharged, and for approximately fifteen minutes afterwards, batteries emit hydrogen gas. This gas is inflammable.

Always ensure any battery charging area is well ventilated and that every precaution is taken to avoid naked flames and sparks.

## **Disciplines**

Switch off ignition prior to making any connection or disconnection in the system as electrical surge caused by disconnecting 'live' connections can damage electronic components.

Ensure hands and work surfaces are clean and free of grease, swarf, etc. as grease collects dirt which can cause tracking or high-resistance contacts.

When handling printed circuit boards, treat them as you would a disc – hold by the edges only; note that some electronic components are susceptible to body static.

Connectors should never be subjected to forced removal or refit, especially inter-board connectors, damaged contacts will cause short-circuit and open-circuit conditions.

Prior to commencing test, and periodically during test, touch a good earth, i.e. cigar lighter socket, to discharge body static as some electronic components are vulnerable to static electricity.

## **Grease for electrical connectors**

Some under bonnet and under body connectors are protected against corrosion by the application of a special grease during production. Should connectors of this type be disturbed, repaired, or replaced, a grease of this type, available under part number BAU 5811, should again be applied. Do not apply grease to any connectors that do not have grease applied as standard.

*NOTE: The use of other greases must be avoided as they can migrate into relays, switches etc. contaminating the contacts and leading to intermittent operation or failure.*

# INTRODUCTION

---

## HARNESS REPAIRS

### Introduction

Two Land Rover harness repair kits are available. Range Rover (LM) harness repairs can be carried out using repair kit LRT-86-010. Range Rover (LP), Discovery Series II, and Freelander (01MY onwards) are covered by Harness Repair Kit LRT-86-010/1.

The Harness Repair Kits contain the following components to enable the technician to carry out 'Right First Time' repairs:

- Crimping pliers.
- Wire cutter/stripping tool.
- Heat shrink tubing.
- Wire colour identification rings.
- Splice connectors.
- Pre-terminated leads (connector pins with 90mm wire 'pig tails').
- Connector housings.
- Connector pin extractor tools.

*NOTE: Replacement connector housings and pre-terminated leads can be ordered from: SPX UK Ltd, Genoa House, Everdon Park, Daventry, Northants, NN11 5YJ. Tel: +44 (0)1327 303400*

In order to carry out a repair, a suitable hot air gun and heat resistant blanket will also be required. These can be sourced locally.

The kits can be used to make repairs to all except the following:

- Any Media Orientated System Transport (MOST) network harnesses.
- Supplementary Restraint System (SRS) firing circuits.
- ABS wheel speed sensors with moulded connectors (Defender, Discovery Series II, and pre-02MY Freelanders only).
- Any wires with a Cross Sectional Area (CSA) of greater than 4.0mm.

If damage occurs in any of these areas, an overlay harness must be used.

***WARNING: Repairs should only be carried out on wires that have been mechanically damaged, not electrically damaged (overheated/burned)***

## **Repair Guidelines**

The Harness Repair Kit includes an illustrated instruction booklet. However, there are additional repair guidelines that should be adhered to.

### ***Twisted Pairs***

Twisted pairs of wires (CAN bus, ABS wiring, etc.) can be repaired as required. When repairing a twisted pair of wires do not unwind the existing wires any more than necessary. Before completing the repair, replicate as closely as possible the original twisting pattern on any new wiring.

### ***Splice Connectors***

Whenever a repair is required, the position of the splice connectors must be staggered as follows:

- Small (red) and medium (blue) splice connectors = 40mm stagger.
- Large (yellow) splice connectors = 50mm stagger.

This keeps the bulk of the repaired area to a minimum, ensuring all trim etc. can be refitted correctly after the repair has been effected.

*NOTE: Do not make more than 5 repairs per connector. If more than 5 wires are damaged, a part harness must be used to carry out the repair.*

### ***Replacement Connectors***

If a connector is damaged and needs replacing, use the tools contained in the Harness Repair Kit to relocate the wires into the replacement connector. Only relocate one wire at a time, ensuring it is fitted to the correct cavity in the new connector.

### ***Gold Connector Pins***

A number of connector pins on the vehicle are gold plated. When a repair is required, these must be replaced by gold connector pins. Do not replace gold connector pins with tin connector pins as this will lead to early failure of the electrical contact.

### ***Sealed Terminals***

A number of terminals on the vehicle are sealed. When a repair is required, these must be replaced by a sealed terminal. An unsealed terminal fitted in place of a sealed terminal will result in early failure of the electrical contact.

# INTRODUCTION

---

## Repair Methods

The following process should be used when carrying out a repair:

**CAUTION: Before starting any work, ensure the vehicle battery has been disconnected. Work must not start on the vehicle for a further ten minutes. This allows the SRS and Satellite Navigation systems time to de-energise.**

1. Using the cutter/stripping tool, cut the wire to be repaired and strip the required amount of insulation from the wire.
2. Slide an appropriately sized heat shrink sleeve over the bare end wire for later fitment.
3. Remove the damaged connector pin from the connector housing using the appropriate extraction tools.
4. Select the correct connector pin pre-terminated lead and fit the appropriate wire colour identification rings.
5. Select the correct size of splice connector from the kit.
6. Using the crimping tool, crimp the splice connector to the harness bare end wire. The crimping tool contains three sets of jaws for crimping the splices. The jaw colours correspond to the splice connector colour.

**CAUTION: The crimping tool jaws perform two different crimps simultaneously. One crimps the wire insulation, one crimps the bare wire. Ensure the splice connector is placed correctly in the crimping tool or the wire will be insufficiently crimped and a poor electrical contact may result.**

7. Using the crimping tool, crimp the pre-terminated lead to the splice connector.
8. Slide the previously fitted heat shrink sleeve into position over the splice connector. Using the hot air gun to the manufacturers guidelines, apply heat evenly to the heat shrink tubing until it is tightly shrunk around the splice connector.

**CAUTION: Place the asbestos blanket in a suitable position to avoid heat damage to adjacent components and trim.**

**CAUTION: Do not overheat the repair as degradation and subsequent failure of the connection may result.**

9. Connect the repaired wire to the connector housing.
10. Repeat steps 1 to 9 for any further damaged wires.

**ABBREVIATIONS****General**

|      |                                   |
|------|-----------------------------------|
| A    | Ampere                            |
| AAT  | Ambient Air Temperature           |
| ac   | Alternating current               |
| ABS  | Anti-lock Braking System          |
| A/C  | Air Conditioning                  |
| ACE  | Active Cornering Enhancement      |
| ATC  | Automatic Temperature Control     |
| BBUS | Battery Backed-Up Sounder         |
| BCU  | Body Control Unit                 |
| Cav  | Cavity                            |
| Cct  | Circuit                           |
| CDL  | Central Door Locking              |
| CKP  | Crankshaft Position               |
| CMP  | Camshaft Position                 |
| Col  | Colour                            |
| db   | Decibels                          |
| dc   | Direct Current                    |
| DCU  | Diagnostic Control Unit           |
| EAT  | Electronic Automatic Transmission |
| ECM  | Engine Control Module             |
| ECT  | Engine Coolant Temperature        |
| ECU  | Electronic Control Unit           |
| EGR  | Exhaust Gas Recirculation         |
| EKA  | Emergency Key Access              |
| F    | Fuse                              |
| FBH  | Fuel Burning Heater               |
| FL   | Fusible Link                      |
| HCT  | Heater Coolant Temperature        |
| HDC  | Hill Descent Control              |
| HFS  | Heated Front Screen               |
| HO2S | Heated Oxygen Sensor              |
| HRW  | Heated Rear Window                |
| ht   | High Tension                      |
| IACV | Inlet Air Control Valve           |
| ICE  | In-Car Entertainment              |
| IDM  | Intelligent Driver Module         |

# INTRODUCTION

---

|       |  |
|-------|--|
| ISO   | International Organisation for Standardization |
| LEV's | Low Emission Vehicles                          |
| LH    | Left Hand                                      |
| LHD   | Left Hand Drive                                |
| NAS   | North American Specification                   |
| PDC   | Park Distance Control                          |
| RH    | Right Hand                                     |
| RHD   | Right Hand Drive                               |
| ROW   | Rest of World                                  |
| SAI   | Secondary Air Injection                        |
| SLABS | Self Levelling/Anti-Lock Braking System        |
| SPE   | Single Point Entry                             |
| SRS   | Supplementary Restraint System                 |
| V     | Volt   |
| VIN   | Vehicle Identification Number                  |
| W     | Watts  |

## **HOW TO USE THIS DOCUMENT**

### **Fuse details**

Contains information on fuse functions and values and should be used together with the power distribution circuit diagrams to establish which systems share a common power supply and to ensure that correct value fuses are fitted.

### **Earth points and headers**

Shows a plan view of the vehicle with location of all earth points. Supporting photographs and connector detail information appear in the Connector section.

### **Description and Operation**

Presented in the same order as the circuit diagrams in the Electrical Circuit Diagram folder, each of the descriptions contains a brief overview of the main system functions and includes reference to the appropriate wire colours. Always read this section before starting work on a system so that a good understanding of system functionality is obtained.

Each electrical item uses a description common on the circuit diagrams and the connector details.



# INTRODUCTION

---

## Connector Details

This section is effectively an index of every electrical connector on the vehicle, including headers and eyelets. A page is dedicated to each connector, with the information presented in a standard format. The connector number is displayed on each page header to ease reference. Connector information comprises:

- **Connector Number** – The assigned number, prefixed 'C'
- **Connector Name** – Usually derived from the component to which the connection is made.
- **Male/Female** – If applicable, identifies the gender of the connector pins (NOT the housing) as Male or Female. Generally, connectors mating directly to a component have Female pins.
- **Colour** – If applicable, the colour of the connector housing is shown. NATURAL is used to describe connectors with a clear/translucent plastic finish.
- **Location Statement** – Used in conjunction with the photograph to determine the location of the connector.
- **Photograph** – Shows the location of the subject connector. In most cases, the photograph will indicate the amount of trim removal necessary to reveal the connector. For convenience some photographs identify more than one connector.
- **Face View** – An outline of the connector housing, viewed from the front, showing pin numbers (if applicable).
- **Pin-out Table** – A three column table, detailing the colour and position of each wire in the connector:

| Cav | Col | Cct |
|-----|-----|-----|
| 1   | GR  | ALL |
| 2   | B   | ALL |

1. **Cav:** The connector pin (cavity) number.
2. **Col:** The colour of wire populating the connector pin.
3. **Cct:** Identifies the model or feature which uses the wire. 'ALL' means applicable to all models in the range fitted with the feature or system in question. In instances where different models, features or systems require different colour wires to be fitted in a cavity, each instance of the cavity is included in the pin-out table.

*NOTE: Wires may not be fitted to all cavities.*

**Example – 9 pin connector**

| <b>Cav</b> | <b>Col</b> | <b>Cct</b> |
|------------|------------|------------|
| 2          | G          | ALL        |
| 4          | GW         | 7          |
| 4          | GB         | 79         |
| 4          | GW         | 90         |
| 5          | LGB        | ALL        |
| 6          | GB         | 7          |
| 6          | GW         | 79         |
| 6          | GB         | 80         |
| 8          | B          | ALL        |

Where necessary a table listing the circuit reference numbers against a description of the model or features which may or may not be fitted, can be found at the beginning of the Connector section. A sample of a typical table is shown below:

| <b>Cct</b> | <b>Model or Feature</b> |
|------------|-------------------------|
| 1          | Premium ICE             |
| 2          | Non Premium ICE         |
| 3          | Diesel                  |
| 4          | Diesel Auto             |
| 5          | V8                      |
| 6          | V8 Auto                 |
| 7          | Power Seats             |

# INTRODUCTION

---

## FAULT DIAGNOSIS

### General

When diagnosing an electrical fault follow the steps below:

1. Read the circuit description appropriate to the reported fault to ensure a good understanding of circuit operation.
2. Study the power distribution, fuse details and earth distribution diagrams and identify other circuits which share fuses and/or earth points. Check whether these circuits operate correctly.
3. Using the photographs contained in the Connector section, locate a point on the circuit (approximately half way between supply and earth) which is easily accessible.
4. Check that the pin out details of the connector are correct and that the correct signals exist at the correct terminals.
5. Continue to the next point on the circuit which is easiest to access and repeat the above.
6. Continue this approach until a fault is found, rectify the fault and then verify that the circuit operates correctly.

**CAUTION: Never probe directly into the front face of a connector. This can damage the terminal and cause a failure. Always probe the back of a terminal, taking care not to damage the terminal or any seals.**

**Never probe wire insulation. On small diameter cables this can cut the conductors. It may also allow moisture into the cable, causing corrosion.**

**WIRE COLOUR CODES****General**

The following list contains the wire colour codes used on the vehicle harnesses.

| <b>Code</b> | <b>Colour</b> |
|-------------|---------------|
| B           | Black         |
| G           | Green         |
| K           | Pink          |
| LG          | Light green   |
| N           | Brown         |
| O           | Orange        |
| P           | Purple        |
| R           | Red           |
| S           | Slate (Grey)  |
| T           | Transparent   |
| U           | Blue          |
| W           | White         |
| Y           | Yellow        |



## INTRODUCTION

The fuses are mounted in four fuse boxes; one in the right hand side of the engine compartment, one in the passenger compartment, under the fascia below the steering wheel, and a satellite fuse box is located under each front seat.

The engine compartment fuse box contains high current screw-in fuses, which feed multiple circuits, smaller pull-out type fuses, and relays. A 150 Amp fusible link is included to protect the alternator.

The passenger compartment fuse box contains the smaller pull-out type fuses and relays.

The two satellite fuse boxes each contain three pull-out type fuses and protect the seat motors.

On vehicles with rear air conditioning fitted, a 40 Amp in-line fuse is located behind the LH rear quarter trim panel, taped to the harness. The in-line fuse protects the resistor pack used for rear blower motor speed operation. Failure of the fuse will prevent blower operation in speeds 1, 2 and 3. The fastest speed 4 will still operate when the fuse has failed.

# FUSE DETAILS

## ENGINE COMPARTMENT FUSE BOX

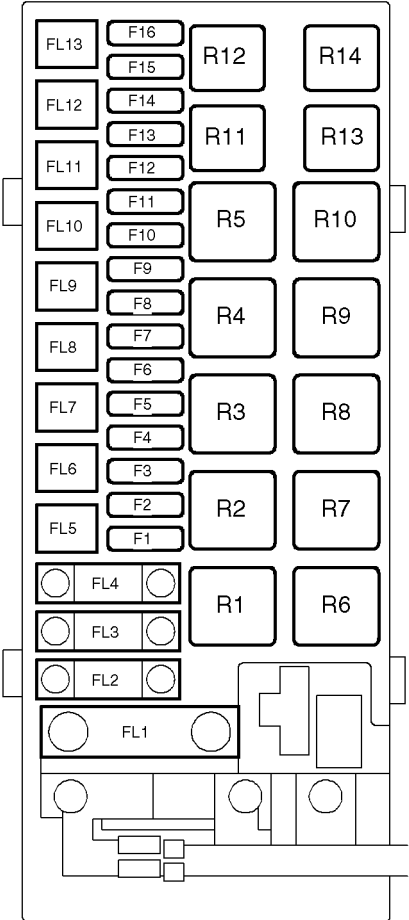

M86 4472

## Relays (R)

1. Fuel pump
2. Starter
3. Headlamp powerwash
4. Cooling fan
5. Self Levelling/ABS (SLABS)
6. Glowplugs - Diesel only
7. Auxiliary circuits
8. Heated Front Screen (HFS)
9. Main relay
10. Anti-lock Braking System (ABS)
11. Compressor clutch (A/C only)
12. Front fog lamps
13. Horns
14. Active Cornering Enhancement (ACE)

| Link | Rating | Vehicle | Function   |
|------|--------|---------|--|
| FL1  | 150 A  | ALL     | Fusible links 4, 5, 6 and 7, fuses 3, 4, 5, and 6 of the engine compartment fuse box, and the HFS relay. |
| FL2  | 100 A  | Td5     | Glow plug relay.   |
| FL3  | 50 A   | ALL     | Fuses 1, 2, 20 and 21 of the passenger compartment fuse box.   |
| FL4  | 100 A  | ALL     | Fuses 6 and 7 of the passenger compartment fuse box.   |
| FL5  | 50 A   | ALL     | RH seat relay, LH seat relay, and fuse 34 of the passenger compartment fuse box.                         |
| FL6  | 50 A   | ALL     | Fuses 8, 12 and 13 of the passenger compartment fuse box.  |
| FL7  | 30 A   | ALL     | Auxiliary relay and fuse 17 of the passenger compartment fuse box.                                       |
| FL8  | 50 A   | ALL     | Ignition switch and the ignition relay.  |
| FL9  | 30 A   | ALL     | SLABS relay.   |
| FL10 | 40 A   | ALL     | Lighting switch, fuses 4 and 5 of the passenger compartment fuse box.                                    |
| FL11 | 30 A   | ALL     | ABS return pump relay.   |
| FL12 | 30 A   | ALL     | Starter relay.   |
| FL13 | 30 A   | ALL     | Lighting switch.   |



## FUSE DETAILS

---

| Fuse | Rating | Vehicle | Function   |
|------|--------|---------|--|
| F1   | 30 A   | Td5     | ECM  |
| F1   | 30 A   | V8      | ECM, fuel injectors, IACV, idle suppressor solenoid.   |
| F2   | 15 A   | Td5     | EGR modulator, EGR throttle, MAF sensor, RH front HO2S, RH rear HO2S, LH front HO2S, LH rear HO2S.     |
| F2   | 15 A   | V8      | Purge control valve, CMP sensor, MAF sensor, RH front HO2S, RH rear HO2S, LH front HO2S, LH rear HO2S. |
| F3   | 15 A   | All     | Front fog lamp relay.  |
| F4   | 20 A   | All     | Headlamp power wash relay.   |
| F5   | 40 A   | All     | Cooling fan relay.   |
| F6   | 10 A   | All     | A/C compressor clutch relay.   |
| F7   | 40 A   | All     | LH HFS element.  |
| F8   | 40 A   | All     | RH HFS element.  |
| F9   | 30 A   | Td5     | FBH  |
| F10  | 30 A   | All     | Fuel pump relay.   |
| F11  | 30 A   | All     | SLABS ECU  |
| F12  | 20 A   | Td5     | EAT ECU.   |
| F12  | 20 A   | V8      | EAT ECU, ECM.  |
| F13  | 10 A   | All     | Inertia switch, BCU, IDM, instrument pack.   |
| F14  | 15 A   | All     | IDM  |
| F15  | 15 A   | All     | ACE relay.   |
| F16  | 10 A   | All     | Horn relay.  |

## PASSENGER COMPARTMENT FUSE BOX

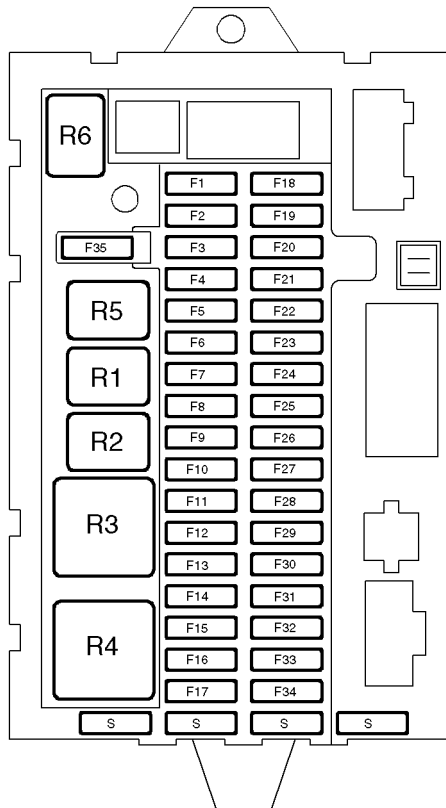

M86 4473A

### Relays (R)

1. LH indicators
2. RH indicators
3. Rear window lift
4. Ignition coils - V8 only
5. Daylight running lamps - if fitted
6. Daylight running lamps - if fitted

# FUSE DETAILS

| Fuse | Rating | Vehicle | Function  |
|------|--------|---------|---|
| F1   | 25 A   | All     | RH front door lock motor, LH front door lock motor, RH rear door lock motor, LH rear door lock motor, tail door lock motor. |
| F2   | 10 A   | All     | Fuel flap release switch.   |
| F3   | 10 A   | All     | LH headlamp main beam bulb.   |
| F4   | 10 A   | All     | Rear fog lamp switch, trailer socket, header 295.   |
| F5   | 15 A   | All     | Daylight running lamp relay.  |
| F6   | 25 A   | All     | Rear blower motor relay.  |
| F7   | 30 A   | All     | Blower motor relay.   |
| F8   | 30 A   | All     | HRW element, drivers door mirror, passenger door mirror.  |
| F9   | 10 A   | All     | LH headlamp dipped beam bulb.   |
| F10  | 10 A   | All     | RH headlamp dipped beam bulb.   |
| F11  | 10 A   | All     | Header 286.   |
| F12  | 30 A   | All     | Sunroof ECU.  |
| F13  | 30 A   | All     | Rear window lift relay.   |
| F14  | 20 A   | V8      | Ignition coils  |
| F15  | 20 A   | All     | IDM, header 291, header 761.  |
| F16  | 15 A   | All     | Radio/cassette player, aerial, PDC ECU.   |
| F17  | 15 A   | All     | Audio system power amplifier.   |
| F18  | 15 A   | All     | Rear screen wiper motor.  |
| F19  | 15 A   | All     | Header 292, windscreen wash/wipe switch.  |
| F20  | 15 A   | All     | Transponder coil, header 294, header 725.   |
| F21  | 15 A   | All     | Header 292, header 293.   |
| F22  | 10 A   | All     | RH headlamp main beam bulb.   |
| F23  | 10 A   | All     | BCU, starter relay.   |
| F24  | 10 A   | Td5     | EAT ECU, header 287.  |
| F24  | 10 A   | V8      | Ignition relay, EAT ECU, ECM.   |
| F25  | 15 A   | All     | Brake pedal switch.   |
| F26  | 10 A   | All     | Auxiliary relay.  |
| F27  | 10 A   | All     | Header 760.   |
| F28  | 10 A   | All     | SLABS ECU.  |
| F29  | 10 A   | All     | BCU, ACE ECU, IDM.  |
| F30  | 20 A   | Td5     | Mirror switch.  |
| F30  | 20 A   | V8      | Cruise control switch, mirror switch.   |
| F31  | 10 A   | All     | Header 289, ATC ECU, fresh/recirculated air switch.   |
| F32  | 25 A   | All     | Accessory socket.   |

---

| Fuse | Rating | Vehicle | Function                  |
|------|--------|---------|---------------------------|
| F33  | 10 A   | All     | Header 290, header 759.   |
| F34  | 30 A   | All     | BCU                       |
| F35  | 10 A   | All     | Instrument pack, SRS DCU. |

# FUSE DETAILS

---

## LH/RH SATELLITE FUSE BLOCKS (SEATS)

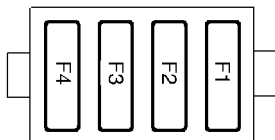

M86 6058

| Fuse | Rating | Vehicle | Function                   |
|------|--------|---------|----------------------------|
| F1   | n/a    | All     | Not used.                  |
| F2   | 40 A   | All     | Seat electrical supply.    |
| F3   | 3 A    | All     | Lumber pump (inflate).     |
| F4   | 3 A    | All     | Lumbar solenoid (deflate). |





## **ANTI-THEFT ALARM**

### **DESCRIPTION**

#### **Anti-Theft Alarm Description**

The anti-theft alarm system is controlled by the Body Control Unit (BCU). The system alarms and disables the vehicle and monitors the vehicle status using door switches and ultrasonic sensors. The BCU also operates in conjunction with the Engine Control Module to disable the engine operation. Refer to the Workshop Manual for detailed Description and Operation of the anti-theft system.

When an alarm is triggered, the BCU operates the vehicle horns, an alarm sounder unit and/or a Battery Back Up Sounder (BBUS), depending on market, to produce an audible warning. In some markets, the BCU also operates the direction indicators to produce a visual warning when the system is armed and disarmed and/or an alarm is triggered.

On Korean vehicles only, the RF remote handset and receiver are replaced by an infra-red handset and receiver. The infra-red signal is received by the infra-red receiver located in the front interior lamp. An additional link harness is used as shown on the circuit diagrams and described in the following circuit operation. The feed for the receiver is taken from the rear interior lamp circuit - refer to interior illumination description in this manual for details.

### **OPERATION**

#### **Anti-Theft Alarm Supply**

##### ***Circuit supply***

A feed from the battery positive terminal is connected on an R wire to the engine compartment fusebox. The feed passes through fusible links 3 and 8 and fuses 13 and 16.

The feed from fusible link 3 is connected on an NR wire to fuses 2, 20 and 21 in the passenger compartment fusebox. Fuse 21 supplies a feed to the contacts of the alarm sounder relay in the passenger compartment fusebox.

Fuse 21 also supplies a feed to the BBUS (where fitted), on a PB wire via header C0292, to keep the BBUS battery charged. If this feed is disrupted while the alarm system is armed, the BBUS is automatically activated. The BBUS is connected to earth header C0706 on a B wire.

The feed from fusible link 8 is connected on an NW wire to the passenger compartment fusebox and from the fusebox to the ignition switch on an N wire. The feed from fuse 16 is connected to the coil and contacts of the horn relay located in the engine compartment fusebox.



# DESCRIPTION AND OPERATION

---

Where an alarm sounder unit is installed, a feed from fuse 13 is connected on a PN wire from the engine compartment fusebox to the passenger compartment fusebox. The feed passes through a diode and is connected to the coil of a relay integrated into the fusebox. The relay controls a power feed to the alarm sounder unit. Activation of the relay is controlled by the BCU via the IDM. The BCU communicates with the IDM using serial data messages on a SK wire via header C0292.

## ***Ignition switch supply***

When the ignition switch is in position II, the feed from fusible link 8 passes through the ignition switch to the passenger compartment fusebox on a Y wire where it passes through fuse 29. From fuse 29, the feed is connected on a GU wire to provide an ignition on supply to the BCU.

When the ignition switch is in the crank position III, the feed from fusible link 8 passes through the ignition switch to the passenger compartment fusebox on a WR wire and passes through fuse 23.

From fuse 23 the feed is connected on a WR wire to the coil of the starter relay in the engine compartment fusebox. The coil of the starter relay is connected on a BO wire from the engine compartment fusebox to pin C0662-5 on the BCU.

A second feed from fuse 23 is also connected on a WR wire to pin C0663-1 on the BCU. When the ignition switch is in crank position III, this feed signals the BCU to provide an earth path for the starter relay coil. This energises the coil closing the relay contacts and supplying power to the starter motor. Refer to Starting and Charging Description and Operation for circuit description.

## **Anti-Theft Alarm Operation**

### ***Fuel flap release switch***

A feed from fuse 2 in the passenger compartment fusebox is connected on a PS wire to the fuel flap release switch. When the switch is operated and the alarm is not armed, the feed passes from the switch and is connected on a PR wire to the fuel flap release solenoid.

The feed energises the solenoid, retracting the plunger and opening the fuel flap. The fuel flap release solenoid is connected on an RU wire to pin C0664-3 on the BCU. The BCU completes the earth path from the solenoid only if the alarm is not armed.

## ***Vehicle horns***

The contacts of the horn relay, in the engine compartment fusebox, are connected to the LH and RH horns by PG wires. The LH horn is earthed by a B wire connected to earth point C0564. The RH horn is earthed by a B wire connected to earth header C0018. Where the vehicle horns are used by the anti-theft alarm system, the horn relay coil is connected to the BCU, via header C0286, by a PO wire. To operate the horns the BCU earths the PO wire, which energises the relay and connects the feed from fuse 16 in the engine compartment fusebox to the horns.

## ***Battery Backed-Up Sounder (BBUS)***

Where fitted, operation of the BBUS is controlled by the BCU.

The BBUS is armed and disarmed on a PG wire between BCU pin C0661-14 and the BBUS. In the armed condition the BBUS monitors the power feed from the passenger compartment fusebox and automatically sounds if it is interrupted. To disarm the BBUS the BCU supplies a 12 volts power feed on the PG wire. To arm the BBUS, the BCU disconnects the power feed.

The BCU sounds the BBUS using a PO wire between BCU pin C0661-3 and the BBUS. In addition to sounding the BBUS when the alarm system has been triggered, armed and disarmed, the BCU can also sound the BBUS to produce mislock and EKA warnings. The BCU normally maintains a 12 volts power feed to the BBUS on the PO wire. To sound the BBUS the BCU disconnects the power feed.

## ***Alarm sounder unit***

When fitted, and the IDM and the BCU determine that alarm sounder unit operation is required, the IDM provides an earth for the applicable relay coil in the passenger compartment fusebox. This energises the coil closing the relay contacts.

With the relay contacts closed, a feed from fuse 21 in the passenger compartment fusebox passes through the relay contacts and from the fusebox on a PB LHD/RU RHD wire, via header C0293 (RHD only), to the alarm sounder unit.

On LHD vehicles, the alarm sounder unit is connected to earth header C0552 on a B wire.

On RHD vehicles, the alarm sounder unit is connected, via header C0288, to earth header C0018 on a B wire.

# DESCRIPTION AND OPERATION

---

## ***Key in sensor***

A feed from fuse 20 in the passenger compartment fusebox is connected on a P wire to header C0289 LHD/C0294 RHD. From the header the feed is connected on a P wire to the key in sensor.

When the ignition key is inserted into the lock barrel the key in sensor contacts close. The feed passes through the sensor and is connected on a WP wire, via header C0293 LHD/C0289 RHD, to pin C0662-2 on the BCU.

A second connection from the key in sensor is connected on a PU wire, via header C0285 LHD/C0294 RHD, to pin C0663-9 on the BCU. This connection is used for the BCU to activate the switch illumination.

## ***Body Control Unit (BCU)***

A feed from fuse 13 in the engine compartment fusebox is connected on a PN wire to provide a permanent power supply to the BCU.

A feed from fuse 20 in the passenger compartment fusebox is connected on a P wire, via header C0289 LHD/C0294 RHD to pin C0661-19 on the BCU.

A B wire connects BCU pin C0660-11 to earth header C0551.

## ***Transponder coil***

A feed from fuse 20 in the passenger compartment fusebox is connected on a GU wire to the transponder coil. The transponder coil is connected on an SR wire to pin C0661-18 on the BCU.

The transponder coil is connected on a B wire, via header C0286 LHD/C0288 RHD to earth header C0018 LHD/C0017 RHD.

## ***Radio Frequency (RF) receiver***

The RF receiver is connected on a PS wire to pin C0661-5 on the BCU and on a BN wire to pin C0661-6 on the BCU.

## ***Infra-red receiver (Korean vehicles only)***

The infra-red receiver is located in the front interior lamp. A feed from fuse 20 in the passenger compartment fusebox is connected on a P wire from header C0289, via header C0723, to the front interior lamp. The lamp is connected on a B wire, via splice joint A4, to earth header C0706.

The front interior lamp is connected on an RP wire to connector interface C1461-2/C0674-2. From the connector interface the connection continues on a BN wire to pin C0661-6 on the BCU.

## ***LH front door lock motor (LHD vehicles only)***

The LH front door lock motor switch is connected on a UG wire to pin C0660-5 on the BCU and on a US wire to pin C0661-22 on the BCU.

The LH door switch is connected on a PW wire, via header C0287, to pin C0660-17 on the BCU.

The LH front door lock motor is connected on a B wire, via header C0288, to earth header C0017.

## ***RH front door lock motor (RHD vehicles only)***

The RH front door lock motor switch is connected on a UG wire to pin C0660-5 on the BCU and on a US wire to pin C0661-22 on the BCU.

The RH door switch is connected on a PW wire, via header C0285, to pin C0660-17 on the BCU.

The RH front door lock motor is connected on a B wire to earth header C0018.

## ***RH front door lock motor (LHD vehicles only)***

The RH door switch is connected on a PW wire to connector C0733-1/C0464-1 interface. From the connector interface, the wire changes to a PLG wire to header C0291 and from header C0291 on a PLG wire to pin C0660-4 on the BCU.

The RH door switch is connected on a B wire to earth header C0018.

## ***LH front door lock motor (RHD vehicles only)***

The LH door switch is connected on a PW wire to connector C0733-1/C0464-1 interface. From the connector interface, the wire changes to a PLG wire to header C0285 and from header C0285 on a PLG wire to pin C0660-4 on the BCU.

The LH Door switch is connected on a B wire to earth header C0017.

## ***Tail door lock motor (LHD/RHD Vehicles)***

The tail door open switch is connected on a PLG wire to pin C0660-4 on the BCU via header C0285. The boot/tail door switch is also connected on a B wire to earth header C0706.

## ***RH rear door lock motor (LHD vehicles only)***

The RH rear door switch is connected on a PLG wire to connector C0805-3/C0756-3 interface. From the connector interface the wire continues on a PLG wire to header C0291 and from the header to pin C0660-4 on the BCU. The RH rear door switch is connected on a B wire to earth header C0552.

# DESCRIPTION AND OPERATION

---

## ***RH rear door lock motor (RHD vehicles only)***

The RH rear door switch is connected on a PLG wire to pin C0660-4 on the BCU via header C0285. The RH rear door switch is also connected on a B wire to earth header C0552.

## ***LH rear door lock motor (LHD vehicles only)***

The LH rear door switch is connected on a PLG wire to connector C0805-3/C0753-3 interface. From the connector interface the wire continues on a PLG wire to header C0291 and from the header to pin C0660-4 on the BCU. The LH rear door switch is connected on a B wire to earth header C0552.

## ***LH rear door lock motor (RHD vehicles only)***

The LH rear door switch is connected on a PLG wire to pin C0660-4 on the BCU via header C0285. The LH rear door switch is also connected on a B wire to earth header C0552.

## ***Bonnet switch***

The bonnet switch is connected on a PO wire from pin C0660-15 to the switch. The bonnet switch is connected on a B wire to earth header C0017, via header C0288.

## ***Instrument pack***

The instrument pack is connected on a BS wire to BCU pin C0661-20. This connection is used for the alarm LED operation.

## ***Diagnostic socket***

The BCU provides outputs to and receives inputs from the diagnostic socket on a K wire, via header C0285 LHD/C0286 RHD, to BCU pin C0661-4.

## ***Engine Control Module (ECM)***

The ECM is connected to BCU pin C0661-10 on a LGS wire.

## ***Ultrasonic modules***

The BCU is connected to the front and rear ultrasonic modules from pin C0663-6 on a WB wire. The WB wire passes through splice joint A46 and is connected to the front ultrasonic module.

A second connection from the BCU, on an SP wire from BCU pin C0663-8, passes through splice joint A44/A105 and is connected to the front ultrasonic module. A second SP wire is taken from splice joint A44/A105 and is also connected to the front ultrasonic module.

From splice joint A46 a WB wire is connected to the rear ultrasonic module. From splice joint A44/A105 two SP wires are connected to the rear ultrasonic module.

A B wire connects the front ultrasonic module to earth header C0707. A B wire connects the rear ultrasonic module to earth header C0706.

## **CENTRAL DOOR LOCKING (CDL)**

### **DESCRIPTION**

#### **General**

Four methods are available for locking the doors; locking using vehicle key, remote handset locking, locking using the CDL switch on the fascia or speed related locking. The anti-theft alarm operates in conjunction with the CDL system. Refer to Anti-Theft Alarm - Description and Operation in this manual for alarm details.

Two levels of door locking are available; Central Door Locking (CDL) and Superlocking.

#### ***CDL***

CDL allows the doors to be locked from inside and outside of the vehicle. In the CDL state, the doors can be opened from inside the vehicle or unlocked using the vehicle key or the remote handset. CDL can be initiated using the vehicle key in the driver's door lock, the remote handset or the CDL switch on the fascia.

CDL locking is also used for the optional speed related locking. This feature automatically locks all the doors when the vehicle speed exceeds 4 mph (7 km/h). Refer to the Workshop Manual Body Control Unit Description and Operation.

#### ***Superlocking***

Superlocking only allows the doors to be locked from outside the vehicle. When superlocked, the doors cannot be opened from inside the vehicle. Superlocking can be initiated with two turns of the vehicle key in the driver's door lock or the remote handset. In the superlocked state the remote handset is used to unlock the doors. In the event of the remote handset not being available, the vehicle key can be used in the driver's door lock to enter an Emergency Key Access (EKA) code which will unlock the doors and disarm the anti-theft alarm. Refer to the Workshop Manual Alarm System for EKA and door locking Description and Operation.

An inertia switch is located in the engine compartment. In the event of a collision, the inertia switch will trip. When the inertia switch is tripped with the ignition on and the alarm disarmed, all doors will automatically unlock and locking of the doors will be prevented until the inertia switch is reset.

The locking system can be interrogated using TestBook/T4 for diagnostic information.

# DESCRIPTION AND OPERATION

---

## OPERATION

### **CDL Supply**

#### ***Circuit supply***

A feed from the battery positive terminal is connected by an R wire to the engine compartment fusebox, where it passes to fusible link 3 and fuse 13.

The feed from fusible link 3 is connected on an NR wire to the passenger compartment fusebox where it passes through fuses 1, 20 and 21.

From fuse 1 in the passenger compartment fusebox the feed is connected to the contacts of the four electronic CDL relays in the passenger compartment fusebox. When the relay contacts are open they are connected on a B wire from the passenger compartment fusebox to earth header C0017 LHD/ C0018 RHD.

From fuse 20 in the passenger compartment fusebox the feed is connected on a GU wire to the passive coil which surrounds the ignition switch.

From fuse 21 in the passenger compartment fusebox the feed is connected on a P wire via header C0289 LHD, and a PB wire, header C0292 and a P wire RHD, to Body Control Unit (BCU) pin C0661-19.

The feed from fuse 13 is connected on a PN wire to BCU pin C0660-13 and provides a permanent battery supply to the BCU. A second feed from fuse 13 is connected on a PN wire to the passenger compartment fusebox and supplies power to the electronic CDL relays in the fusebox. A third feed from fuse 13 is connected on an NB wire to the inertia switch.

## CDL OPERATION

### ***Inertia switch***

When the inertia switch contact is closed (switch not tripped) the feed from fuse 13 in the engine compartment fusebox passes through the switch and is connected on a WG wire to the engine compartment fusebox. The feed passes through the fusebox and is connected on an NS wire to the Intelligent Driver Module (IDM) in the passenger compartment fusebox.

### ***Body Control Unit (BCU)***

The BCU is connected from pin C0661-1 on an SK wire (serial data bus), via header C0293/ C0292 RHD to the passenger compartment fusebox. The BCU uses the serial data bus to the IDM in the passenger compartment fusebox to energise each electronic relay. When each relay is energised power is supplied to each door lock motor as applicable. When each relay is de-energised it is connected to earth.

The BCU is connected using the serial data bus from pin C0661-1 on an SK wire, via header C0293 LHD/C0292 RHD, to the instrument pack pin C0233-16. The instrument pack pin C0230-16 is connected on a KG wire via header C0290 (and splice joint A87 on automatic vehicles) to the SLABS ECU pin C0504-3. The SLABS ECU supplies a road speed signal to the instrument pack.

The BCU receives the road speed signal from the instrument pack via the serial data bus to BCU pin C0661-1. The BCU uses the speed signal to enable the speed related locking when the road speed exceeds 4 mph (7 km/h).

The BCU is connected on a B wire from pin C0660-11 to earth header C0551.

The BCU is connected on a US wire from pin C0660-22 to the driver's door lock motor switch. This connection provides an earth signal which informs the BCU that CDL lock using the vehicle key has been requested.

The BCU is connected on a UG wire from pin C0660-5 to the driver's door lock motor switch. This connection provides an earth signal which informs the BCU that superlock using the vehicle key has been requested. The door lock motor switch is connected on a B wire, via header C0288 (LHD only), to earth header C0017 LHD/C0018 RHD.

### ***Transponder coil***

The transponder coil receives a supply from fuse 20 in the passenger compartment fusebox on a GU wire. The transponder coil is connected on an SR wire to BCU pin C0661-18. When applicable the BCU supplies an earth on this wire to energise the passive coil.

The transponder coil is connected on a B wire, via header C0286 LHD/C0288 RHD, to earth header C0018 LHD/C0017 RHD.

### ***Radio frequency (RF) receiver***

The RF receiver is connected on a PS wire to pin C0661-5 on the BCU. This connection provides the power supply to the RF receiver.

A BN wire is connected from BCU pin C0661-6 to the RF receiver. This connection provides an RF signal to the BCU when the remote handset is operated.

The RF receiver is connected on a B wire to earth header C0707.

### ***CDL switch***

The CDL switch is connected on a KR wire to BCU pin C0660-16. This connection provides an earth input to the BCU to signal that the lock has been requested from the CDL switch.

A second connection from the CDL switch on a YK wire to BCU pin C0662-7 provides an earth input to the BCU to signal that unlock has been requested from the CDL switch.

The CDL switch is connected on a B wire, via headers C0725 and C0760, to earth header C0017 LHD/C0018 RHD.

### ***Diagnostic socket***

The BCU is connected on a K wire, via header 0286, from pin C0661-4 to the diagnostic socket pin C0040-7.



# DESCRIPTION AND OPERATION

---

## ***CDL motor operation***

The electronic relays in the passenger compartment fusebox supply power feeds or earth paths for each door lock motor as necessary. Each door lock motor is connected to the passenger compartment fusebox as follows:

Front LH/RH (driver's) door lock motor:

- A KR wire is connected from the fusebox to the LH/RH front CDL motor.
- A KP wire is connected from the fusebox, via header C0292 LHD/C0291 RHD, to the LH/RH front superlock motor and the LH/RH front CDL motor.
- A KS wire is connected from the fusebox, via header C0292 LHD/C0285 RHD, to the LH/RH front superlock motor.

Front LH/RH (Passenger) door lock motor:

- A KR wire is connected from the fusebox, via header C0292 LHD/C0290 RHD, to the LH/RH front CDL motor.
- A KP wire is connected from the fusebox, via header C0292 LHD/C0291 RHD, to the LH/RH front superlock motor and the LH/RH front CDL motor.
- A KS wire is connected from the fusebox, via header C0292 LHD/C0285 RHD, to the LH/RH front superlock motor.

LH rear passenger door lock motor:

- A KR wire is connected from the fusebox, via header C0292 LHD/C0290 RHD, and header C0761, to the LH rear CDL motor.
- A KP wire is connected from the fusebox, via header C0292 LHD/C0291 RHD, to the LH rear superlock motor and the LH rear CDL motor.
- A KS wire is connected from the fusebox, via header C0292 LHD/C0285 RHD, to the LH rear superlock motor.

RH rear passenger door lock motor:

- A KR wire is connected from the fusebox, via header C0292 LHD/C0290 RHD and header C0761, to the RH rear CDL motor.
- A KP wire is connected from the fusebox, via header C0292 LHD/C0291 RHD to the RH rear CDL motor and the RH rear superlock motor.
- A KS wire is connected from the fusebox, via header C0292 LHD/C0285 RHD, to the RH rear superlock motor.

Tail door lock motor:

- A KR wire is connected from the fusebox, via header C0292 LHD/C0290 RHD, to the tail door CDL motor.
- A KP wire is connected from the fusebox, via header C0292 LHD/C0291 RHD, to the tail door CDL motor and the tail door superlock motor.
- A KS wire is connected from the fusebox, via header C0292 LHD/C0285 RHD, to the tail door superlock motor.

## **WINDOWS - FRONT**

### **DESCRIPTION**

#### **Windows - Front Description**

The front windows are electrically operated from two rocker switches located in the centre console. The front windows are controlled by the Body Control Unit (BCU) which limits the operation of the windows to when the ignition is in position II and for a period of 44 seconds after the ignition is switched off or after the driver's door is opened. The front window operation is suspended when the ignition switch is in the crank position III.

The front windows are powered by electric motors located in each front door. The window up/down functions are controlled by reversing the polarity to the motors. The BCU logic circuits have a stall detect function that monitors the current drawn by the window motor. When the window contacts the top of the door frame or an obstruction the current drawn by the electric motor rises. If the BCU detects a sudden current rise the internal logic will remove the power supply to the front window motor.

The front windows have a one shot down function which operates if the switch is pressed for less than 0.4 seconds. Operation of the switch for more than 0.4 seconds operates the windows in inch down mode. The windows stop when the switch is released.

The front windows only operate in the inch up mode for as long as the switch is pressed. The windows stop when the switch is released.

Fault conditions related to the front windows can be retrieved from the BCU via the diagnostic socket using TestBook/T4.

### **OPERATION**

#### **Windows - Front Supply**

##### ***Circuit supply***

A feed from the battery positive terminal is connected on an R wire to the engine compartment fusebox where it passes through fusible links 1, 5 and 8 and fuse 13. Fusible links 1 and 5 are connected in series.

A feed from fusible links 1 and 5 is connected from the fusebox on an NW wire to the passenger compartment fusebox, where it passes through fuse 34. From fuse 34, the feed is connected to pin C0664-7 of the BCU on an NG wire. This feed provides the power for the window lift motors.

A feed from fuse 13 is connected from the fusebox on a PN wire to pin C0660-13 of the BCU. This feed is the permanent battery supply to the BCU.

A feed from fusible link 8 is connected on an NW wire to the passenger compartment fusebox and from the fusebox to the ignition switch on an N wire.

# DESCRIPTION AND OPERATION

---

## ***Ignition switch supply***

With the ignition switch in position II, the feed from fusible link 8 passes through the ignition switch to fuse 29 in the passenger compartment fusebox on a Y wire. From fuse 29 the feed is connected to pin C0660-1 of the BCU on a GU wire.

## **Windows - Front Operation**

### ***BCU earth connection***

The BCU is earthed from pin C0660-11 on a B wire to earth header C0551.

### ***Front left window up***

The left window switch up contact is connected to pin C0660-18 on the BCU by a BS wire. When the switch is set to the up position an internal supply from the BCU flows along the BS wire through the contacts of the switch and to earth via earth header C0552 on a B wire.

The BCU internal logic monitors the current flow from pin C0660-18 and uses this input as an up signal. The BCU routes power from the permanent feed from pin C0664-7 to pin C0664-4. From pin C0664-4, the power flows to connector interface C0463-6/C0744-6 on an SB wire, and from the connector interface to the LH front window motor on a SU wire. The motor is energised and drives the window mechanism towards the up position.

The front left window motor is earthed via an SK wire to connector interface C0744-7/C0463-7, and an SR wire from the connector interface to pin C0664-1 on the BCU. The BCU completes the earth via pin C0664-5 on a B wire to earth header C0018 LHD/C0017 RHD.

### ***Front left window down***

The left window switch down contact is connected to pin C0662-1 on the BCU by a BR wire. When the switch is set to the down position an internal supply from the BCU flows along the BR wire through the contacts of the switch and to earth via earth header C0552 on a B wire.

The BCU internal logic monitors the current flow from pin C0662-1 and uses this input as a down signal. The BCU routes power from the permanent feed from pin C0664-7 to pin C0664-1. From pin C0664-1, the power flows to connector interface C0463-7/C0744-7 on an SR wire, and from the connector interface to the LH front window motor on a SK wire. The motor is energised and drives the window mechanism towards the down position.

The front left window motor is earthed via an SU wire to connector interface C0744-6/C0463-6, and an SB wire from the connector interface to pin C0664-4 on the BCU. The BCU completes the earth via pin C0664-5 on a B wire to earth header C0018 LHD/C0017 RHD.

## ***Front right window up***

The right window switch up contact is connected to pin C0660-19 on the BCU by a BU wire. When the switch is set to the up position an internal supply from the BCU flows along the BU wire through the contacts of the switch and to earth via earth header C0552 on a B wire.

The BCU internal logic monitors the current flow from pin C0660-19 and uses this input as an up signal. The BCU routes power from the permanent feed from pin C0664-7 to pin C0664-6, from pin C0664-6 on an SK wire to connector C0326-2 on the RH front window motor. The motor is energised and drives the window mechanism towards the up position.

The front right window lift motor is earthed via an SK wire to connector C0664-2 on the BCU. The BCU completes the earth via pin C0664-5 on a B wire to earth header C0018 LHD/C0017 RHD.

## ***Front right window down***

The right window switch down contact is connected to pin C0660-2 on the BCU by a BK wire. When the switch is set to the down position an internal supply from the BCU flows along the BK wire through the contacts of the switch and to earth via earth header C0552 on a B wire.

The BCU internal logic monitors the current flow from pin C0660-2 and uses this input as a down signal. The BCU routes power from the permanent feed from pin C0664-7 to pin C0664-2. From pin C0664-2, the power flows to the RH front window motor on an SU wire. The motor is energised and drives the window mechanism towards the down position.

The front right window motor is earthed via an SK wire to connector C0664-6 on the BCU. The BCU completes the earth via pin C0664-5 on a B wire to earth header C0018 LHD/C0017 RHD.

## ***Ignition key modes***

Depending on the vehicle specification:

The BCU controls operation of the front windows and will allow operation for a period of 44 seconds after the ignition switch is moved to the off position.

On some models if the time is less than 44 seconds and the drivers door (or any door on some models) is opened the BCU will disable the function of the windows.

On some models the BCU disables the windows as soon as the ignition is turned off.

On all models the windows will not operate while the ignition key is turned to the cranking position III.

# DESCRIPTION AND OPERATION

---

## **WINDOWS - REAR**

### **DESCRIPTION**

#### **Windows - Rear**

The rear windows are electrically operated from two rockers switches located in the centre console. A rocker switch located in each rear door trim panel also operates the corresponding rear window.

A window lift isolation switch is located in the centre console. The isolation switch prevents rear window operation using the rear window switches in the rear door trims, but allows operation from the rear window switches in the centre console.

Power to the rear window motors is enabled by the Intelligent Driver's Module (IDM) which energises the rear window lift relay located in the passenger compartment fusebox.

The rear window enable is operative when the ignition switch is in position II and for a period of 44 seconds after the ignition is switched off or after the driver's door is opened. The rear window operation is suspended when the ignition switch is in the crank position III.

The rear windows are operated by electric motors located in each rear door. The window up/down functions are controlled by reversing the polarity to the motors.

### **OPERATION**

#### **Windows - Rear Supply**

##### ***Circuit supply***

A feed from the battery positive terminal is connected on an R wire to the engine compartment fusebox, where it passes through fusible links 1, 6 and 8. Fusible links 1 and 6 are connected in series.

A feed from fusible links 1 and 6 is connected from the engine compartment fusebox, on an NU wire, to the passenger compartment fusebox, where it passes through fuse 13. From fuse 13, the feed is connected to the contacts and the coil of the rear window lift relay located in the passenger compartment fusebox.

A feed from fusible link 8 is connected from the engine compartment fusebox, on an NW wire, to the passenger compartment fusebox. From the passenger compartment fusebox the feed is connected to the ignition switch on an N wire.

## ***Ignition switch supply***

With the ignition switch in position II, the feed from fusible link 8 passes through the ignition switch to fuse 29 in the passenger compartment fusebox on a Y wire.

When the ignition switch is in position II, the feed from fuse 29 is connected to the IDM. The IDM logic connects the feed from fuse 13 in the passenger compartment fusebox through the coil of the rear window lift relay, to earth header C0551 on a B wire. This supply energises the coil of the rear window lift relay.

The contacts of the rear window lift relay close when the coil is energised and allow the feed from fuse 13 to pass through the rear window lift relay contacts. The feed is connected from the passenger compartment fusebox to splice joint A183 by a WK wire. The feed is then connected on four WK wires to the LH and RH window console switches.

## **Windows - Rear Operation**

### ***LH rear window console switch - down***

Operation of the LH window console switch in the down position, allows the feed from the rear window lift relay to pass through the up switch contacts to the LH rear window switch on an SW wire. The feed passes through the up switch contacts and is connected to the LH rear window motor on an SO wire.

When the LH window console switch is set in the down position, the contacts complete the earth path for the LH rear window motor. The LH rear window motor is earthed via an SR wire to the LH rear window switch. From the down contacts of LH rear window switch the earth continues on an SY wire to the closed contacts of LH window console switch. From the contacts of the LH rear console switch the earth continues on a B wire to earth header C0552.

### ***LH rear window console switch - up***

Operation of the LH window console switch in the up position, allows the feed from the rear window lift relay to pass through the down switch contacts to the LH rear window switch on an SY wire. The feed passes through the down switch contacts and is connected to the LH rear window motor on an SR wire.

When the LH window console switch is set in the up position, the contacts complete the earth path for the LH rear window motor. The earth path from the LH rear window motor is connected to the LH rear window switch on an SO wire. The earth continues through the up switch contacts and is connected to the LH window console switch on an SW wire. The earth passes through the down switch contacts and is connected to earth header C0552 on a B wire.

# DESCRIPTION AND OPERATION

---

## ***RH rear window console switch - down***

Operation of the RH window console switch in the down position, allows the feed from the rear window lift relay to pass through the up switch contacts to the RH rear window switch on an SY wire. The feed passes through the up switch contacts and is connected to the RH rear window motor on an SO wire.

When the RH window console switch is set in the down position, the contacts complete the earth path for the RH rear window motor. The RH rear window motor is earthed via an SR wire to the down contacts of the RH rear window switch, then on a SW wire to connector interface C0650-3/C0804-3. From this interface the feed continues on a SN wire to the RH window console switch. From the RH window console switch the earth continues via the closed down contacts, via a B wire to earth header C0552.

## ***RH rear window console switch - up***

Operation of the RH window console switch in the up position, allows the feed from the rear window lift relay to pass through the down switch contacts on an SN wire to connector interface C0650-3/C0804-3. From this interface the feed continues on a SW wire to the RH rear window switch. The feed passes through the down switch contacts and is connected to the RH rear window motor on an SR wire.

When the RH window console switch is set in the up position, the contacts complete the earth path for the RH rear window motor. The earth path from the RH rear window motor is connected to the RH rear window switch on an SO wire. The earth continues on an SY wire to the up contacts of the RH rear window console switch. From the RH rear window console switch the earth continues on a B wire to earth header C0552.

## ***LH rear window switch - down***

Operation of the LH rear window switch in the down position, allows the feed from the rear window lift relay to pass through the up contacts of the LH window console switch on an SW wire. The feed passes through the up switch contacts and is connected to the LH rear window motor on an SO wire.

When the LH rear window switch is set in the down position, the contacts complete the earth path for the LH rear window motor. The earth path from the LH rear window motor is connected to the LH rear window switch on an SR wire. The earth continues through the down switch contacts and is connected via splice joint A358 to the window lift isolation switch on an SG wire. The earth is connected from the closed contacts of the window lift isolation switch on a B wire to earth header C0552.

## ***LH rear window switch - up***

Operation of the LH rear window switch in the up position, allows the feed from the rear window lift relay to pass through the down contacts of the LH window console switch to the rear window switch on an SY wire. The feed passes through the down switch contacts to the LH rear window motor on an SR wire.

When the LH rear window switch is set in the up position, the contacts complete the earth path for the LH rear window motor. The earth path from the LH rear window motor is connected to the LH rear window switch on an SO wire. The earth continues through the up switch contacts and is connected via splice joint A358 to the window lift isolation switch on an SG wire. The earth is connected from the closed contacts of the window lift isolation switch on a B wire to earth header C0552.

## ***RH rear window switch - down***

Operation of the RH rear window switch in the down position, allows the feed from the rear window lift relay to pass through the up contacts of the RH window console switch on an SY wire to the RH rear window switch. The feed passes through the up switch contacts and is connected to the RH rear window motor on an SO wire.

When the RH rear window switch is set in the down position, the contacts complete the earth path for the LH rear window motor. The earth path from the RH rear window motor is connected to the RH rear window switch on an SR wire. The earth continues through the switch down contacts and is connected via splice joint A358 to the window lift isolation switch on an SG wire. The earth is connected from the closed contacts of the window lift isolation switch on a B wire to earth header C0552.

## ***RH rear window switch - up***

Operation of the RH rear window switch in the up position, allows the feed from the rear window lift relay to pass through the down contacts of the RH window console switch on an SN wire to connector interface C0650-3/C0804-3. From this interface the feed continues on an SW wire to the rear window switch. The feed passes through the down switch contacts to the RH rear window motor on an SR wire.

When the RH rear window switch is set in the up position, the contacts complete the earth path for the RH rear window motor. The earth path from the RH rear window motor is connected to the RH rear window switch on an SO wire. The earth continues through the up switch contacts and is connected via splice joint A358 to the window lift isolation switch on an SG wire. The earth is connected from the closed contacts of the window lift isolation switch on a B wire to earth header C0552.



# DESCRIPTION AND OPERATION

---

## ***Window lift isolation switch***

If the window lift isolation switch is latched out, the earth path from the LH and RH rear window switches is broken, preventing operation of the LH and RH rear window switches. Rear window operation using the console switches is not affected by the isolation switch.

When the window lift isolation switch is latched out, the removal of the earth path also breaks the earth path for the LH and RH rear window switch illumination. Refer to interior illumination - Description and Operation in this manual for switch illumination circuit description.

## **SUNROOF**

### **DESCRIPTION**

#### **Sunroof Description**

Electric sunroofs are fitted at the front and rear of the vehicle. Both sunroofs are electrically operated. Switches on the front overhead console control operation of the front and rear sunroofs.

The rear sunroof can be operated by a switch located in the rear overhead console. The switch is only operative when not disabled by the rear sunroof isolation switch located in the front overhead console.

### **OPERATION**

#### **Sunroof Supply**

##### ***Circuit supply***

A feed from the battery positive terminal is connected on an R wire to the engine compartment fusebox where it passes through fusible links 1, 6 and 8. Fusible links 1 and 6 are connected in series.

The feed from fusible links 1 and 6 is connected on an NU wire to the passenger compartment fusebox where it passes through fuse 12. The feed is connected from fuse 12 to supply a continuous battery feed on an NR wire to the sunroof ECU pin C0785-3.

The feed from fusible link 8 is connected on an NW wire to the passenger compartment fusebox and from the fusebox to the ignition switch on an N wire.

##### ***Ignition switch supply***

With the ignition switch in position II, the feed from fusible link 8 passes through the ignition switch to the passenger compartment fusebox on a Y wire, where it passes through fuse 29. The feed is connected from fuse 29 to the Body Control Unit (BCU) pin C0660-1 on a GU wire.

#### **Sunroof Operation**

##### ***Front sunroof operation***

When the ignition switch is in position II, an enable input is sent from the BCU pin C0661-9 on a WG wire to pin C0785-10 on the sunroof ECU. When the enable input is present the power feed from pin C0785-3 is made available by the logic circuits in the sunroof ECU.

The sunroof ECU is earthed from pin C0785-2 on a B wire via splice joints A14 and A15 to earth header C0018.

# DESCRIPTION AND OPERATION

---

## ***Front sunroof tilt detection***

The front sunroof motor is connected to pin C0784-8 on the sunroof ECU by an OU wire. An input to the sunroof ECU via this connection forms a sunroof tilt input to the sunroof ECU.

## ***Front sunroof - open function***

When the front sunroof switch is set to the open position, an earth path from pin C0784-2 to the front sunroof switch on a GK wire is completed. From the front sunroof switch the earth continues to earth header C0018 via splice joints A14 and A15. The sunroof ECU logic circuit monitors a current flow from pin C0784-2. This current flow forms the 'open' input to the sunroof ECU, and the ECU logic supplies a power feed to pin C0785-5.

The feed flows from pin C0785-5 on the sunroof ECU to the sunroof motor on a P wire. The front sunroof motor is earthed on a B wire via splice joints A14 and A15 to earth header C0018.

The sunroof motor drives the sunroof mechanism towards the open position. When the sunroof switch is released, the earth path via the sunroof switch is interrupted and the 'open' input to the sunroof ECU is lost. The sunroof ECU logic circuits remove the power supply to pin C0785-5, this removes the power supply from the sunroof motor.

## ***Front sunroof - close function***

When the front sunroof switch is set to the close position, an earth path from pin C0785-7 of the sunroof ECU to the front sunroof switch is completed on a GR wire. The front sunroof switch is earthed via splice joints A14 and A15 to earth header C0018 on a B wire. The sunroof ECU logic circuit monitors a current flow from pin C0785-7. With this current flow forming a 'close' input the sunroof ECU logic supplies a power feed to pin C0785-1.

The feed flows from pin C0785-1 of the sunroof ECU to the sunroof motor on a W wire. The front sunroof motor is earthed on a B wire via splice joints A14 and A15 to earth header C0018. The sunroof motor drives the sunroof mechanism towards the close position.

When the sunroof switch is released, the earth path via the sunroof switch is interrupted and the close input to the sunroof ECU will be lost. The sunroof ECU logic circuits remove the power supply to pin C0785-1, this removes the power supply from the sunroof motor.

## **Rear sunroof operation**

### ***Rear sunroof tilt detection***

The rear sunroof motor is connected to pin C0784-1 on the sunroof ECU by a OG wire. An input to the sunroof ECU via this connection forms a sunroof tilt input to the sunroof ECU.

## **Rear sunroof operation - via front switch 1**

### ***Rear sunroof - open function - via front switch 1***

When the rear 1 sunroof switch is set to the open position, an earth path from pin C0784-7 of the sunroof ECU to the sunroof switch is completed on a GU wire. From sunroof switch 1 the earth continues via splice joints A14 and A15 to earth header C0018 on a B wire. The sunroof ECU logic circuit monitors the current flow from pin C0784-7. With this current flow forming an 'open' input the sunroof ECU logic supplies a power feed to pin C0785-4.

The feed flows from pin C0785-4 of the sunroof ECU to the rear sunroof motor on an U wire. The rear sunroof motor is earthed on two B wires via splice joints A14 and A15 to earth header C0018. The sunroof motor drives the sunroof mechanism towards the open position.

When the sunroof switch is released, the earth path via the sunroof switch is interrupted and the open input to the sunroof ECU will be lost. The sunroof ECU logic circuits remove the power supply to pin C0785-4, this removes the power supply from the sunroof motor.

### ***Rear sunroof - close function - via front switch 1***

When the rear sunroof switch 1 is set to the close position, an earth path from pin C0785-8 on the sunroof ECU to the rear sunroof switch 1 is connected on a GO wire. The rear sunroof switch 1 is earthed via splice joints A14 and A15 to earth header C0018 on a B wire. The sunroof ECU logic circuit monitors a current flow from pin C0785-8. With a current flow forming an 'close' input the sunroof ECU logic supplies a power feed to pin C0785-6.

The feed flows from pin C0785-6 on a O wire to the rear sunroof motor. The rear sunroof motors are earthed on a B wire via splice joints A14 and A15 to earth header C0018. The sunroof motor drives the sunroof mechanism towards the close position.

When the sunroof switch is released, the earth path via the sunroof switch is interrupted and the close input to the sunroof ECU will be lost. The sunroof ECU logic circuits remove the power supply to pin C0785-6, this removes the power supply from the sunroof motor.

## **Rear sunroof operation - via rear switch 2**

### ***Rear sunroof switch 2 - isolation***

An isolation switch is connected by an BS wire to the rear sunroof switch 2. From the isolation switch a B wire is connected to earth via splice joints A14 and A15 to earth header C0018. When the isolation switch is pressed the earth line from the rear sunroof switch 2 is interrupted. This function allows the driver or front seat passenger to disable the rear sunroof switch 2.

# DESCRIPTION AND OPERATION

---

## **Rear sunroof switch 2 - normal operation**

### ***Rear sunroof - open function - via switch 2***

When the rear 2 sunroof switch is set to the open position, an earth path from pin C0784-6 on a GW wire is completed via the closed contacts of the isolation switch, and on a B wire via splice joints A14 and A15 to earth header C0018. The sunroof ECU logic circuit monitors the current flow from pin C0784-6. With this current flow forming an 'open' input the sunroof ECU logic supplies a power feed to pin C0785-4.

The feed flows from pin C0785-4 on an OU wire to the rear sunroof motor. The rear sunroof motor is earthed on a B wire via splice joints A14 and A15 to earth header C0018. The sunroof motor drives the sunroof mechanism towards the open position.

When the sunroof switch is released, the earth path via the sunroof and isolation switches is interrupted. The open input to the sunroof ECU will be lost and the sunroof ECU logic circuits remove the power feed to pin C0785-4, this removes the power supply from the sunroof motor.

### ***Rear sunroof - close function - via switch 2***

When the rear sunroof switch 2 is set to the close position, an earth path from pin C0785-9 on a GB wire is completed via the closed contacts of the isolation switch, and on a B wire via splice joints A14 and A15 to earth header C0018. The sunroof ECU logic circuit monitors the current flow from pin C0785-9, this current flow forms a 'close' input and the sunroof ECU logic supplies a power feed to pin C0785-6.

The feed flows from pin C0785-6 on a O wire to the rear sunroof motor. The sunroof motor drives the sunroof mechanism towards the close position. When the sunroof switch 2 is released, the earth path via the sunroof switch is interrupted. The close input to the sunroof ECU is lost and the sunroof ECU logic circuits remove the power supply to pin C0785-6. This removes the power supply from the rear sunroof motor.

## ***Sunroof motor protection***

Control functions of the sunroof ECU prevent damage to the sunroof motors at full travel positions when the operating switch is still pressed:

- Current (step) sensing
- A backup seven second time delay after movement has stopped.

*NOTE: Either of these control functions will stop the operation of the sunroof motors at the end of travel positions.*

## ***Ignition key modes***

Depending on the vehicles specification:

The sunroof ECU controls operation of both sunroofs and will allow sunroof operation for a period of 44 seconds after the ignition switch is moved to the off position.

On some models if the time is less than 44 seconds and the drivers door (or any door on some models) is opened the sunroof ECU will disable the function of the sunroofs.

On some models the sunroof ECU will disable the sunroofs as soon as the ignition is turned off.

On all models the sunroofs will not operate while the ignition key is turned to the cranking position III.

# DESCRIPTION AND OPERATION

---

## **MIRRORS**

### **DESCRIPTION**

#### **General**

The door mirrors are electrically adjustable using a joystick operated mirror switch located on the fascia. The mirrors only operate with the ignition switch in position II.

The mirror switch can be rotated to select the left or right hand door mirror. A central position on the switch isolates the mirror operation. Movement of the switch in the vertical or horizontal positions moves the selected mirror glass accordingly. The mirror glass is attached to a swash plate operated vertically and horizontally by two motors.

Each mirror glass has heater elements bonded to the rear of the glass for demisting. The mirror heater elements operate when the heated rear window is switched on.

### **OPERATION**

#### **Mirrors Supply**

##### ***Circuit supply***

A feed from the battery positive terminal is connected on an R wire to the engine compartment fusebox where it passes through fusible links 1, 6 and 8, and fuse 13.

A feed from fusible link 6 is connected to the passenger compartment fusebox on an OS wire. The feed passes through fuse 8 in the passenger compartment fusebox and is connected to the contacts of the heated rear screen relay.

A feed from fusible link 8 is connected on an NW wire to the passenger compartment fusebox and from the fusebox to the ignition switch on an N wire.

A feed from fuse 13 is connected to the passenger compartment fusebox on a PN wire and is connected to the coil of the heated rear screen relay.

##### ***Ignition switch supply***

With the ignition switch in position II, the feed from fusible link 8 passes through the ignition switch to the passenger compartment fusebox on a W wire. The feed continues through fuse 30 in the passenger compartment fusebox and is connected on a GLG wire to the electric mirror switch.

#### **Mirrors Operation**

##### ***Driver mirror adjustment***

The mirror switch is connected on a B wire, via header C0760, to earth header C0017 LHD/C0018 RHD.

## ***Vertical - Up***

When the electric mirror switch is operated in the up position the feed from fuse 30 passes through the switch contacts and is connected to the mirror vertical adjustment motor. The wire connections are as follows:

- On LHD vehicles, the connection from the switch is on a BK wire to the motor.
- On RHD vehicles, the connection from the switch is on a BN wire to connector interface C0460-7/C0733-7. From the connector interface the connection continues to the motor on a BK wire.

The earth path for the motor is connected on an SW wire, via splice joint A9 and earth header C0285 LHD/C0292 RHD, to the mirror switch.

## ***Vertical down***

When the electric mirror switch is operated in the down position the feed from fuse 30 passes through the switch contacts and is connected to the mirror vertical adjustment motor on an SW wire, via splice joint A9 and header joint C0285 LHD/C0292 RHD.

The earth path for the motor is connected as follows:

- On LHD vehicles, the earth path is on a BK wire to the mirror switch.
- On RHD vehicles, the earth path is on a BK wire to connector interface C0733-7/C0460-7. From the connector interface the earth is connected to the mirror switch on a BN wire.

## ***Horizontal - left***

When the electric mirror switch is operated in the left position the feed from fuse 30 passes through the switch contacts and is connected to the mirror horizontal adjustment motor on an SW wire, via splice joint A9 and header joint C0285 LHD/C0292 RHD.

The earth path for the motor is connected as follows:

- On LHD vehicles, the earth path is on a BU wire to the mirror switch.
- On RHD vehicles, the earth path is on a BU wire to connector interface C0733-8/C0460-8. From the connector interface the earth is connected to the mirror switch on a BP wire.



# DESCRIPTION AND OPERATION

---

## ***Horizontal - right***

When the electric mirror switch is operated in the right position the feed from fuse 30 passes through the switch contacts and is connected to the mirror horizontal adjustment motor. The wire connections are as follows:

- On LHD vehicles, the connection from the switch is on a BU wire to the motor.
- On RHD vehicles, the connection from the switch is on a BP wire to connector interface C0460-8/C0733-8. From the connector interface the connection continues to the motor on a BU wire.

The earth path for the motor is connected on an SW wire, via splice joint A9 and earth header C0285 LHD/C0292 RHD, to the mirror switch.

## ***Passenger mirror adjustment***

The mirror switch is connected on a B wire, via header C0760, to earth header C0017 LHD/C0018 RHD.

## ***Vertical - Up***

When the electric mirror switch is operated in the up position the feed from fuse 30 passes through the switch contacts and is connected to the mirror vertical adjustment motor. The wire connections are as follows:

- On LHD vehicles, the connection from the switch is on a BN wire to connector interface C0464-7/C0733-7. From the connector interface the connection continues to the motor on a BK wire.
- On RHD vehicles, the connection from the switch is on a BK wire to the motor.

The earth path for the motor is connected on an SW wire, via splice joint A9 and earth header C0285 LHD/C0292 RHD, to the mirror switch.

## ***Vertical down***

When the electric mirror switch is operated in the down position the feed from fuse 30 passes through the switch contacts and is connected to the mirror vertical adjustment motor on an SW wire, via splice joint A9 and header joint C0285 LHD/C0282 RHD.

The earth path for the motor is connected as follows:

- On LHD vehicles, the earth path is on a BK wire to connector interface C0733-7/C0464-7. From the connector interface the earth is connected to the mirror switch on a BN wire.
- On RHD vehicles, the earth path is on a BK wire to the mirror switch.

## ***Horizontal - left***

When the electric mirror switch is operated in the left position the feed from fuse 30 passes through the switch contacts and is connected to the mirror horizontal adjustment motor on an SW wire, via splice joint A9 and header joint C0285 LHD/C0292 RHD.

The earth path for the motor is as follows:

- On LHD vehicles, the earth path is on a BU wire to connector interface C0733-8/C0464-8. From the connector interface the earth is connected to the mirror switch on a BP wire.
- On RHD vehicles, the earth path is on a BU wire to the mirror switch.

## ***Horizontal - right***

When the electric mirror switch is operated in the right position the feed from fuse 30 passes through the switch contacts and is connected to the mirror horizontal adjustment motor. The wire connections are as follows:

- On LHD vehicles, the connection from the switch is on a BP wire to connector interface C0464-8/C0733-8. From the connector interface the connection continues to the motor on a BU wire.
- On RHD vehicles, the connection from the switch is on a BU wire to the motor.

## ***Mirror heater***

The LH and RH door mirror heaters are connected from the heated rear screen relay in the passenger compartment fusebox on an NP wire via splice joints A19/A167.

When the heated rear window switch is operated an earth path is completed from the switch on a B wire, via header C0760, to earth header C0017 LHD/C0018 RHD. The switch is connected on an NB wire to pin C0663-5 on the BCU.

On vehicles with Air Temperature Control (ATC), when the demist function is selected the ATC ECU provides an earth path on an NB wire through splice joint A249, to pin C0663-5 on the BCU.

The completed earth path is interpreted by the BCU as a signal for heated rear screen operation. The BCU is connected from pin C0661-1 on an SK wire to the the IDM in the passenger compartment fusebox. The SK wire is the serial data bus between the BCU and the IDM. The BCU passes a signal to the IDM which in turn provides an earth path, on a B wire to earth header C0551, for the coil of the heated rear screen relay in the passenger compartment fusebox.

## DESCRIPTION AND OPERATION

---

The heated rear screen relay coil is energised by the feed from fuse 13 in the engine compartment fusebox causing the relay contacts to close. With the contacts closed, a feed from fuse 8 in the passenger compartment fusebox passes through the relay and is connected from the fusebox on an NP wire to splice joints A19/A167. From the splice joints the feed is connected on NP wires to the driver and passenger door mirror heaters.

On LHD vehicles, the driver's door mirror heater is connected on a B wire, via splice joint A34 and header C0288, to earth header C0017. The passenger door mirror heater is connected on a B wire, via splice joint A34, to earth header C0018.

On RHD vehicles, the driver's door mirror heater is connected on a B wire, via splice joint A34, to earth header C0018. The passenger door mirror is connected on a B wire, via splice joint A34, to earth header C0017.

The door mirror heaters will operate for as long as the heated rear screen relay is energised.

## **FOLDING MIRRORS (JAPAN ONLY)**

### **DESCRIPTION**

#### **Folding Mirrors (Japan only)**

The door mirrors can be folded electrically to prevent damage using the joystick operated mirror switch located on the fascia. The mirrors only operate with the ignition switch in position II.

The central position on the switch is used for the folding mirrors function. The switch is moved vertically down to fold the mirrors in or out. A dedicated folding mirrors ECU is located behind the fascia adjacent to the 'A' post. All feeds to and from the folding mirror motors are controlled by the ECU.

Folding mirror operation is controlled by an earth signal received by the ECU from the mirror switch. The ECU supplies a feed to each motor to drive it in the required direction. The feed is supplied for a maximum of 30 seconds. The motors detect a stall condition when they are fully folded in or out which is sensed by the ECU which then removes the power feed.

### **OPERATION**

#### **Folding Mirrors Supply**

##### ***Circuit supply***

A feed from the battery positive terminal is connected on an R wire to the engine compartment fusebox, where it passes through fusible links 3 and 8.

A feed from fusible link 3 is connected on an NR wire to the passenger compartment fusebox where it passes through fuse 21. The feed is connected from fuse 21 on a PB wire to header C0292. From the header the feed is connected on an NS wire to pin C0907-8 on the folding mirror ECU.

A feed from fusible link 8 is connected from the engine compartment fusebox on an NW wire to the passenger compartment fuse box. The passenger compartment fusebox is connected to the ignition switch on an N wire.

##### ***Ignition switch supply***

With the ignition switch in position II, the feed from fusible link 8 flows through the ignition switch to the passenger compartment fusebox on a W wire where it passes through fuse 31. From fuse 31 the feed is connected on a GR wire from the fusebox, via header C0289, to pin C0907-6 on the folding mirror ECU. The ECU is connected on a B wire to earth header C0017.

# DESCRIPTION AND OPERATION

---

## **Folding Mirrors Operation**

When the switch is moved to the fold position, an earth path is completed on a UB wire from the ECU pin C0907-5 to the mirror switch. The earth continues through the switch contact and is connected on a B wire to earth header C0018.

The ECU supplies a feed to the RH folding mirror motor from pins C0907-1 or C0907-3 on O or OR wires to the motor. Depending on motor direction required to fold mirrors in or out, the earth from each motor is on either the O or the OR wire back to the ECU.

The ECU supplies a feed to the LH folding mirror motor from pins C0907-7 or C0907-9 on YR or Y wires to the motor. Depending on motor direction required to fold mirrors in or out, the earth from each motor is on either the YR or the Y wire back to the ECU.

## **ELECTRIC SEATS**

### **DESCRIPTION**

#### **Adjustment**

The electrically powered front seats are operated by four electric motors which control the seat base rear up/down, seat base front up/down, seat base forward/rearward and seat squab recline. The seats are operated by switches and controlled by the Body Control Unit (BCU). The seats operate when the ignition switch is in position I or II or for a predetermined period when the driver's door is open.

A electrically powered lumbar adjustment in each seat is operated by a single motorised pump and a solenoid located on the seat squab frame. The pump inflates a cushion in the seat squab and the solenoid operates a valve to deflate the cushion. The seat cushion and seat squab also contain heater elements.

A seat switch pack is located on each side of the centre console. Each switch pack comprises two non-latching switch levers. The horizontal lever has three, two position switches which control the seat cushion forward and rearward movement and also the seat cushion front and rear height adjustment. The vertical switch has two, two position switches which control the seat squab recline function and also the lumbar adjustment.

The power supply to each seat switch pack is supplied from a power seat relay located on the underside of each seat frame. The feed from the relay is protected by a fuse located in a satellite fuse block adjacent to the power seat relay. The fuse block also contains two additional fuses which protect the feeds to the lumbar pump and solenoid.

#### **Heating**

The heated seat elements for each seat are supplied power from a seat heat module located on the underside of the seat frame. The seat heat module provides consistent temperature control of the seat heater elements. A negative temperature coefficient variable resistor is located in the seat cushion heater element. The resistor changes its resistance as the seat cushion temperature increases or decreases. The resistance is monitored by electronics within the seat heat module, which raises or lowers the power supplied to the elements and controls the element temperature between 26 and 36 degrees C (79 and 97 degrees F).

The heated seat elements are operated by a latching seat heater switch for each seat located in the centre console between the two rear window switches. The heated seats only operate when the ignition switch is in position II.

# DESCRIPTION AND OPERATION

---

## OPERATION

### Circuit Supply

A feed from the battery positive terminal is connected on an R wire to the engine compartment fusebox where it passes through fusible links 1, 5, 7 and 8. Fusible links 1 and 5 and 1 and 7 are connected in series.

A feed from fusible links 1 and 7 is connected to the contacts of the auxiliary circuits relay.

A feed from fusible links 1 and 5 is connected on an NG wire to connector C0255-5/C0751-1 interface. From connector C0751-1, the feed continues on an NP wire to the coil and contacts of the LH power seat relay. The earth path from the relay coil is connected on an OP wire to the BCU pin C0663-3, via header C0724.

A second feed from fusible links 1 and 5 is connected on an NP wire to the coil and contacts of the RH power seat relay. The earth path from the relay coil is connected on an OP wire to the BCU pin C0663-3, via header C0724.

The BCU completes the earth path when ignition I or II or driver's door open is sensed.

A feed from fusible link 8 is connected on an NW wire to the passenger compartment fusebox and from the fusebox to the ignition switch on an N wire.

### Ignition Switch Supply

With the ignition switch in position I or II, the feed from fusible link 8 passes through the ignition switch to the passenger compartment fusebox on an LGW wire.

The feed continues through fuse 26 in the passenger compartment fusebox and is connected from the fusebox on an LG wire to the coil of the auxiliary circuits relay in the engine compartment fusebox. This feed energises the relay coil, closing the relay contacts. The relay coil is earthed on a B wire, via header C0286 LHD/C0288 RHD, to earth header C0018.

### Seat Heating Operation

With the auxiliary circuits relay energised, the feed from fusible links 1 and 7 passes through the relay contacts and is connected to the passenger compartment fusebox on a WG wire where it passes through fuse 15.

From the passenger compartment fusebox, the feed is connected to header C0761 on an LGW wire. From the header C0761, the feed separates into two LGW wires which are connected to the LH and RH seat heater switches.

From the LH seat heater switch the feed is connected on a US wire to connector C0225-1/C0751-1 interface. From connector C0751-1 the feed continues on an OW wire to the LH seat heat module.

From the RH seat heater switch the feed is connected on a UK wire to connector C0253-1/ C0751-1 interface. From connector C0751-1 the feed continues on an OW wire to the RH seat heat module.

Power is supplied to the electronics within the LH or RH seat heat module by the feed from the LH or RH seat heater switch. This allows the feed to pass through the module and is connected to the LH or RH seat cushion heater on a K wire. The LH or RH seat squab heater is connected in series from the LH or RH seat cushion heater on a KW wire. The LH and RH seat squab heaters are connected to earth header C0708 on B wires via splice joint 1.

The earth from the LH or RH seat heat module is connected on an LG wire to a temperature variable resistor contained within each of the LH and RH seat cushion heaters. As the temperature of the seat cushion heater increases, the resistance of the resistor changes. This is sensed by the seat heat module which varies the power supplied to the LH and RH seat cushion heaters, raising or lowering their temperature accordingly.

The resistors are connected to the LH and RH seat heat module on B wires and from the LH and RH seat heat modules to earth header C0708 on B wires via splice joint 1.

## **Seat Adjustment Operation**

With the ignition switch in position I or II or the driver's door open, the BCU provides an earth path for the coils of the LH and RH power seat relays, energising the relays and closing the contacts.

The feeds from fusible links 1 and 7 pass through the relay contacts and connect on WN wires to the LH and RH satellite fuse blocks. The feed passes through fuse 2 in each satellite fuse block and is connected to the LH and RH seat switch packs on WR wires.

Each of the four seat motors are connected to the LH or RH seat switch pack by two wires. The operation of the switches can supply the feed from fuse 2 into either of the wires to operate the motors in either direction. The wire connections to each motor from the LH or RH switch pack is as follows:

- The LH and RH rear up/down seat motors are connected on U and NY wires respectively.
- The LH and RH seat motor forward/rearward motors are connected on R and GY wires respectively.
- The LH and RH front up/down seat motors are connected on Y and W wires respectively.
- The LH and RH back recline forward/rearward seat motors are connected on O and S wires respectively.



# DESCRIPTION AND OPERATION

---

## **Lumbar Operation**

When the lumbar inflate switch is operated, the feed from fuse 2 in the LH or RH satellite fuse block is connected from the LH or RH seat switch pack and connected to fuse 3 in the LH or RH satellite fuse block on a P wire. From fuse 3, the feed is connected to the LH or RH lumbar pump on a P wire.

When the lumbar deflate switch is operated, the feed from fuse 2 in the LH or RH satellite fuse block is connected from the LH or RH seat switch pack to fuse 4 in the LH or RH satellite fuse block on a PS wire. From each fuse 4 the feed is connected to the LH or RH lumbar pump solenoid on a PS wire.

The earth from the LH and RH lumbar pumps is on B wires to earth header C0708 via splice joint 1.

## **MANUAL SEATS**

### **DESCRIPTION**

#### **General**

On vehicles with manual seats and seat heaters, the temperature is controlled by a thermostatic switch located in the seat cushion. The thermostat disconnects the power supply when the thermostat reaches 36 degrees C (97 degrees F) and restores the power supply when the temperature is below 26 degrees C (79 degrees F).

### **OPERATION**

#### **Circuit Supply**

A feed from the battery positive terminal is connected on an R wire to the engine compartment fusebox where it passes through fusible links 1, 7 and 8. Fusible links 1 and 7 are connected in series.

A feed from fusible links 1 and 7 is connected to the contacts of the auxiliary circuits relay.

A feed from fusible link 8 is connected on an NW wire to the passenger compartment fusebox and from the fusebox to the ignition switch on an N wire.

#### ***Ignition switch supply***

With the ignition switch in position I or II, the feed from fusible link 8 passes through the ignition switch to the passenger compartment fusebox on an LGW wire.

The feed continues through fuse 26 in the passenger compartment fusebox and is connected from the fusebox on an LG wire to the coil of the auxiliary circuits relay in the engine compartment fusebox. The feed energises the relay coil, closing the relay contacts. The relay coil is earthed on a B wire, via header C0286 LHD/C0288 RHD, to earth header C0018.

#### **Seat Heating Operation**

with the auxiliary circuits relay energised, the feed from fusible links 1 and 7 passes through the relay contacts and is connected to the passenger compartment fusebox on a WG wire where it passes through fuse 15.

From the passenger compartment fusebox, the feed is connected to header C0761 on an LGW wire. From the header C0761, the feed separates into two LGW wires which are connected to the LH and RH seat heater switches.

# DESCRIPTION AND OPERATION

---

## ***LH seat***

From the LH seat heater switch the feed is connected on a US wire to connector interface C0255-1/C0751-1. From the interface the feed continues on an R wire to the LH seat cushion heater. The feed passes through the thermostatic switch and the cushion heater and is connected in series on a B wire to the LH seat squab heater. The seat squab heater is connected on a B wire to earth header C0708.

## ***RH seat***

From the RH seat heater switch the feed is connected on a UK wire to connector interface C0253-1/C0751-1. From the interface the feed continues on an R wire to the RH seat cushion heater. The feed passes through the thermostatic switch and the cushion heater and is connected in series on a B wire to the RH seat squab heater. The seat squab heater is connected on a B wire to earth header C0708.

## **DIAGNOSTIC SOCKET**

### **DESCRIPTION**

#### **General**

The diagnostic socket is located below the fascia on the drivers side. The connector is constructed to ISO standard and allows the attachment of TestBook/T4 or any other ISO standard scantool.

The diagnostic socket allows diagnostic information stored in any of the ECU's listed below to be retrieved. It also allows engine tuning and fault diagnosis to be carried out.

### **OPERATION**

#### **Diagnostic Socket Supply**

##### ***Circuit supply***

A feed from the battery positive terminal is connected by an R wire to the engine compartment fusebox, where it passes through fusible link 3.

The feed from fusible link 3 is connected by an NR wire to the passenger compartment fusebox where it passes through fuse 20.

The feed from fuse 20 is connected to the diagnostic socket, via header C0294 by a P wire.

##### ***Diagnostic socket earth connection - LHD vehicles***

The diagnostic socket is connected to two earth headers C0551 and C0017 by B wires.

##### ***Diagnostic socket earth connection - RHD vehicles***

The diagnostic socket is connected to earth header C0551 by a B wire. The diagnostic socket is also connected with a B wire through header C0291 to earth header C0017.

#### **Diagnostic Socket Connections**

##### ***Engine Control Module (ECM)***

The ECM for V8 and Td5 variants is connected to header C0286 on a K wire. The connection continues from the header C0286 to the diagnostic socket on a K wire.

##### ***Body Control Unit (BCU)***

The BCU is connected to header C0286 on a K wire. The connection continues from header C0286 to the diagnostic socket on a K wire.

##### ***Electronic Automatic Transmission (EAT) ECU***

The EAT ECU is connected to header C0286 on a K wire. The connection continues from the header C0286 to the diagnostic socket on a K wire.

## DESCRIPTION AND OPERATION

---

### ***Self Levelling/Anti-Lock Brake System (SLABS) ECU***

The SLABS ECU is connected to header C0286 on a K wire. The connection continues from the header C0286 to the diagnostic socket on a K wire.

### ***Active Cornering Enhancement (ACE) ECU***

The ACE ECU is connected to header C0286 on a K wire. The connection continues from the header C0286 to the diagnostic socket on a K wire.

### ***Cruise control ECU - V8 engines only***

The cruise control ECU is connected to header C0286 on a K wire. The connection continues from the header to the diagnostic socket on a K wire.

### ***Airbag DCU***

The airbag DCU is connected to header C0286 on a K wire. The connection continues from the header C0286 to the diagnostic socket on a K wire.

### ***Fuel Burning Heater (FBH) - Td5 vehicles (if fitted)***

The fuel burning heater is connected to the diagnostic socket on a R wire.

## **BODY CONTROL UNIT (BCU)**

### **DESCRIPTION**

#### **General**

The BCU communicates with and controls a large number of functions on the vehicle. Refer to BCU circuit diagram for BCU connection details.

For BCU power supplies refer to Power Distribution circuits.

# DESCRIPTION AND OPERATION

---

## **STARTING AND CHARGING - Td5**

### **DESCRIPTION**

#### **General**

The starting system comprises a starter motor and solenoid located at the rear right hand side of the engine. A starter relay, controlled by the Body Control Unit (BCU), supplies battery power for starter solenoid operation. The starter motor receives its feed directly from the battery.

The charging system comprises an alternator containing a rectifier pack and a regulator to maintain a constant direct current (dc) in the system. The alternator is located at the front right of the engine and is belt driven from the crankshaft pulley.

A warning lamp in the instrument pack illuminates if the charging system is not generating a voltage equal to or more than the battery voltage.

### **OPERATION**

#### **Starting and Charging Supply**

##### ***Circuit supply***

A feed from the battery positive terminal is connected on an R wire to the engine compartment fusebox where it passes through fusible links 1, 2, 8 and 12 and fuses 10 and 13. A feed from the battery is also connected directly to the contacts of the main relay located in the engine compartment fusebox.

A second feed from the battery positive terminal is connected on an R wire to the contacts of the starter motor solenoid located on the starter motor.

The feed from fusible link 1 is connected from the fusebox on an N wire to the alternator/generator.

A feed from fusible link 2 is connected to the contacts of the glow plug relay located in the engine compartment fusebox.

A feed from fusible link 8 is connected on an NW wire to the passenger compartment fusebox and from the fusebox to the ignition switch on an N wire.

A feed from fuse 10 is connected to the contacts of the fuel pump relay located in the engine compartment fusebox. The Engine Control Module (ECM) provides an earth path for the fuel pump relay coil, which energises and closes the relay contacts.

A feed from fuse 13 is connected from the fusebox to the inertia switch (S206) on an NB wire. When the inertia switch contacts are closed, the feed passes through the switch and is connected to the coil of the main relay on a WG wire. The ECM provides an earth path for the main relay coil, which energises and closes the relay contacts.

## ***Ignition switch supply***

With the ignition switch in position II, the feed from fusible link 8 passes through the ignition switch to the passenger compartment fusebox on a Y wire, where it passes through fuses 24 and 27 in the fusebox.

With the ignition switch in the crank position III, the feed from fusible link 8 passes through the ignition switch to the passenger compartment fusebox on a WR wire, where it passes through fuse 23 in the fusebox.

## **Starting Operation**

### ***Main relay operation***

With the ignition switch in position II and the ECM is satisfied that all conditions are correct, the ECM grants an earth path on a UR wire from the engine compartment fusebox to the ECM pin C0658-21, energising the relay coil and closing the contacts.

The direct feed from the battery passes through the relay contacts and connects with the coils of the glow plug and fuel pump relays.

### ***Fuel pump relay operation***

The ECM grants an earth path for the fuel pump relay coil on a UP wire from the engine compartment fusebox to ECM pin C0658-5. This allows the feed from fuse 10 to pass through the relay contacts and connect from the fusebox on a WP wire to the fuel tank unit.

The fuel tank unit is connected on a B wire to earth eyelet connector C0810-1. The fuel pump operates and the fuel gauge sender unit energises to operate the fuel gauge in the instrument pack.

### ***Glow plug relay operation***

The ECM grants an earth path for the glow plug relay coil on a GU wire from the engine compartment fusebox to ECM pin C0158-29. This allows the feed from fusible link 2 to pass through the relay contacts and connect from the fusebox on a YB wire to splice joint 5.

From splice joint 5, the feed splits into four B wires which are each connected to one of the four glow plugs fitted to cylinder No's. 1,2, 3 and 4. Cylinder No. 5 does not have a glow plug.

The ECM will operate the glow plugs for a predetermined period, dependant on engine coolant temperature.



# DESCRIPTION AND OPERATION

---

## ***Starter relay operation***

When the ignition switch is moved to the crank position III, a feed passes from the switch, through fuse 23 in the passenger compartment fusebox to the coil of the starter relay in the engine compartment fusebox on a WR wire.

The coil is earthed to the BCU on a BO wire. When the BCU determines that starter operation is allowed, the earth path is completed and the starter relay energises, closing the relay contacts.

The feed from fusible link 12 passes through the starter relay contacts and is connected from the engine compartment fusebox to the coil of the starter motor solenoid on an NR wire. The coil energises, closing the starter motor solenoid contacts. The coil is earthed via the starter motor body.

The feed from the battery positive terminal passes through the closed contacts of the starter motor solenoid and operates the starter motor. The starter motor is earthed through the motor body attachment.

When the ignition switch is released, it returns to position II. This terminates the feed from the ignition switch to the starter relay coil, de-energising the coil and opening the relay contacts. This in turn removes the feed from fusible link 12 to the starter motor solenoid coil, opening the solenoid contacts and removing the battery feed to the starter motor.

## **Charging Operation**

With the ignition switch in position II, the feed from fuse 24 is connected from the passenger compartment fusebox, through header C0294 LHD/ C0287 RHD, to connector interface C0448-4/C0162-4 on a W wire. From the connector interface the feed is connected on a WG wire to the alternator/generator. This feed protects the alternator/generator from short circuit damage should a wiring fault occur.

The feed from fuse 27 is connected from the passenger compartment fusebox on an LG wire to the ignition/no charge warning lamp in the instrument pack, via header C0760. From the instrument pack, the feed is connected on an NY wire to the alternator/generator, via header C0294 LHD/C0287 RHD.

The feed passes to earth via the brushes and regulator within the alternator, completing the warning lamp circuit which allows the warning lamp to illuminate.

When the engine is started, the magnetized rotor turns within the stator windings, generating 3 phase alternating current (ac) and a voltage that rises rapidly with rotor speed. The field diodes in the rectifier pack convert the ac current into dc current flowing through the field windings. This causes an increase in the magnetic influence of the rotor, resulting in self-excitation of the alternator. The field current increases with rotor speed and thus increases the generated current and voltage until the alternator/generator is fully excited.

# DESCRIPTION AND OPERATION

---

When the voltage applied to the alternator/generator side of the ignition/no charge warning lamp exceeds the battery voltage applied to the warning lamp, the lamp is extinguished. This shows that the alternator/generator is producing battery charging current.

When the battery is at a low state of charge or the current draw from the electrical functions of the vehicle causes a voltage drop, the alternator/ generator automatically charges at its maximum rate (dependant on rotor speed) until 14 Volts is reached. When demand on the alternator/generator falls, the current output is reduced.

Battery charging is accomplished on an N wire from the alternator/generator through fusible link 1 in the engine compartment fusebox, and from fusible link 1 to the battery positive terminal on an R wire.

# DESCRIPTION AND OPERATION

---

## **STARTING AND CHARGING - V8**

### **DESCRIPTION**

#### **General**

The starting system comprises a starter motor and solenoid located at the rear right side of the engine. A starter relay, controlled by the Body Control Unit (BCU), supplies battery power for starter solenoid operation. The starter motor receives its feed directly from the battery.

The charging system comprises an alternator containing a rectifier pack and a regulator to maintain a constant direct current (dc) in the system. The alternator is located at the top right of the engine and is belt driven from the crankshaft pulley.

A warning lamp in the instrument pack illuminates if the charging system is not generating a voltage equal to or more than the battery voltage.

### **OPERATION**

#### **Starting and Charging Supply**

##### ***Circuit supply***

A feed from the battery positive terminal is connected on an R wire to the engine compartment fusebox where it passes through fusible links 1, 8 and 12 and fuses 10 and 13. A feed from the battery is connected directly to the contacts of the main relay located in the engine compartment fusebox.

A second feed from the battery positive terminal is connected on an R wire to the contacts of the starter motor solenoid, located on the starter motor.

A feed from fusible link 1 is connected from the fusebox on an N wire to the alternator/generator.

A feed from fusible link 8 is connected on an NW wire to the passenger compartment fusebox and from the fusebox to the ignition switch on an N wire.

A feed from fuse 10 is connected to the contacts of the fuel pump relay located in the engine compartment fusebox. The Engine Control Module (ECM) provides an earth path for the fuel pump relay coil, which energises and closes the relay contacts.

A feed from fuse 13 is connected from the fusebox to the inertia switch on an NB wire. When the inertia switch contacts are closed, the feed passes through the switch and is connected to the coil of the main relay on a WG wire. An earth connection from the main relay coil is connected on a UR wire to the ECM. When the ECM completes the earth path, the coil energises and closes the main relay contacts.

## ***Ignition switch supply***

With the ignition switch in position II, the feed from fusible link 8 passes through the ignition switch to the passenger compartment fusebox on a Y wire, where it passes through fuse 27 in the fusebox.

With the ignition switch in the crank position III, the feed from fusible link 8 passes through the ignition switch to the passenger compartment fusebox on a WR wire, where it passes through fuse 23 in the fusebox.

## **Starting Operation**

### ***Main relay operation***

With the ignition switch in position II and the ECM is satisfied that all conditions are correct, the ECM grants an earth path on a UR wire from the engine compartment fusebox to the ECM pin C0635-23, energising the relay coil and closing the contacts.

### ***Fuel pump relay operation***

When the main relay contacts are closed, the feed direct from the battery passes through the relay contacts and is connected to the coil of the fuel pump relay. An earth path from the fuel pump coil is connected to the ECM pin C0635-18 on a UP wire. When the ECM completes the earth path, the coil energises and closes the fuel pump relay contacts.

The feed from fuse 10 passes through the contacts of the fuel pump relay and is connected on a WP wire from the engine compartment fusebox to the fuel pump, which operates. The fuel pump is connected to earth eyelet connector C0810-1 on a B wire.

### ***Starter relay operation***

When the ignition switch is moved to the crank position III, a feed passes from fuse 23 to the coil of the starter relay in the engine compartment fusebox on a WR wire.

The coil is earthed to the BCU on a BO wire. When the BCU determines that starter operation is allowed, the earth path is completed and the starter relay energises, closing the relay contacts.

The feed from fusible link 12 passes through the starter relay contacts and is connected from the engine compartment fusebox to the coil of the starter motor solenoid on an NR wire. The coil energises, closing the starter motor solenoid contacts. The coil is earthed via the starter motor body.

# DESCRIPTION AND OPERATION

---

The feed from the battery positive terminal passes through the closed contacts of the starter motor solenoid and operates the starter motor. The starter motor is earthed through the motor body attachment.

When the ignition switch is released, it returns to position II. This terminates the feed from the ignition switch to the starter relay coil, de-energising the coil and opening the relay contacts. This, in turn removes the feed from fusible link 12 to the starter motor solenoid coil, opening the contacts and removing the battery feed to the starter motor.

## **Charging Operation**

With the ignition switch in position II, the feed from fuse 27 is connected from the passenger compartment fusebox on an LG wire, through header C0760, to the ignition/no charge warning lamp in the instrument pack. From the instrument pack, the feed is connected on an NY wire to the alternator/ generator. The feed passes to earth via the brushes and regulator within the alternator, completing the warning lamp circuit which allows the warning lamp to illuminate.

When the engine is started, the magnetized rotor turns within the stator windings, generating 3 phase alternating current (ac) and a voltage that rises rapidly with rotor speed. The field diode in the rectifier pack converts the ac current into dc current flowing through the field windings. This causes an increase in the magnetic influence of the rotor, resulting in self-excitation of the alternator. The field current increases with rotor speed and thus increases the generated current and voltage until the alternator/generator is fully excited.

When the voltage applied to the alternator/generator side of the ignition/no charge warning lamp exceeds the battery voltage applied to the warning lamp, the lamp is extinguished. This shows that the alternator/generator is producing battery charging current.

When the battery is at a low state of charge or the current draw from the electrical functions of the vehicle causes a voltage drop, the alternator/ generator automatically charges at its maximum rate (dependant on rotor speed) until 14 volts is reached. When demand on the alternator/generator falls, the current output is reduced.

Battery charging is accomplished on an N wire from the alternator/generator through fusible link 1 in the engine compartment fusebox, and from fusible link 1 to the battery positive terminal on an R wire.

## **ENGINE MANAGEMENT - Td5**

### **DESCRIPTION**

#### **General**

Refer to Workshop Manual for description and operation.

# DESCRIPTION AND OPERATION

---

## **ENGINE MANAGEMENT - V8**

### **DESCRIPTION**

#### **General**

Refer to Workshop Manual for description and operation.

## **IGNITION AND SHIFT INTERLOCK (NAS/JAPAN ONLY)**

### **DESCRIPTION**

#### **General**

#### ***Shift interlock***

When the transmission gear selector is in the PARK position and the ignition is in the OFF position '0', a shift interlock solenoid is de-energised, locking the transmission gear selector in the PARK position.

The transmission gear selector can only be moved from the PARK position when the ignition is on and the brake pedal is depressed. The brake pedal switch signals the BCU, which in turn signals the Intelligent Driver Module (IDM) to energise the shift interlock relay in the passenger compartment fusebox. This energises the shift interlock solenoid allowing the transmission gear selector to be moved from the PARK position.

#### ***Ignition key interlock***

The key interlock solenoid prevents removal of the key when the transmission gear selector is not in the Park position.

#### ***Transfer box interlock***

The transfer box interlock prevents the transfer box being shifted from 'H' or 'L' with the key removed from the ignition switch. A transfer gearbox interlock solenoid is controlled by the IDM which energises the solenoid and prevents transfer box lever operation.

### **OPERATION**

#### **Ignition and Shift Interlock Supply**

#### ***Circuit supply***

A feed from the battery positive terminal is connected by an R wire to the engine compartment fusebox where it passes through fusible links 3 and 8 and fuse 13.

A feed from fusible link 3 is connected from the engine compartment fusebox on an NR wire to the passenger compartment fusebox. The feed passes to fuses 20 and 21 in the passenger compartment fusebox.

A feed from fuse 13 is connected from the engine compartment fusebox on a PN wire to the passenger compartment fusebox. The feed is connected to the IDM and the coils of the interlock and transfer box relays.

A feed from fusible link 8 is connected on an NW wire to the passenger compartment fusebox and from the fusebox to the ignition switch on an N wire.



# DESCRIPTION AND OPERATION

---

## ***Ignition switch supply***

With the ignition switch in position II, the feed from fusible link 8 flows through the ignition switch to the passenger compartment fusebox on a Y wire.

The feed continues through fuse 25 in the passenger compartment fusebox and is connected on a GO wire to the brake pedal switch.

## **Ignition and Shift Interlock Operation**

### ***Ignition interlock***

A feed from fuse 20 in the passenger compartment fusebox is connected on a P wire to header C0289 LHD/C0294 RHD. From the the header the feed is connected on P wires to the key interlock unit. The feed is connected within the key interlock unit to the ignition switch illumination and the 'ignition key' inserted switch.

When a door is opened or the vehicle is unlocked using the remote handset, the BCU provides an earth path for the ignition switch illumination. The earth path is from the interlock unit on a PU wire to pin C0663-9 on the BCU, via header C0285 LHD/C0294 RHD. The completed earth path allows the feed from fuse 20 in the passenger compartment fusebox to illuminate the bulb.

When the ignition key is inserted in the ignition switch, the 'ignition key inserted' switch is tripped and allows the feed from fuse 20 in the passenger compartment fusebox to flow through the switch contacts. The feed is connected from the key interlock unit on a WP wire to pin C0662-2 on the BCU, via header C0293 LHD/C0289 RHD. This provides a signal to the BCU that the key is inserted.

A feed from fuse 21 in the passenger compartment fusebox is connected on a PB wire to the key interlock unit. The feed is connected within the interlock unit to the 'ignition key in position' switch.

When the key is inserted in the ignition switch, the switch contacts close, allowing the feed from fuse 21 to pass on an OW wire to the interlock solenoid. If the transmission is in a position, other than PARK, the BCU will supply an earth path for the key interlock solenoid on a BLG wire. The solenoid will energise and removal of key from the ignition switch is prevented.

## ***Shift interlock***

The shift interlock solenoid is normally in a de-energised state. When the transmission is to be moved from the PARK position, the ignition must be on and the brake pedal depressed. This energises the solenoid and allows movement of the transmission selector.

When the brake pedal is depressed, the feed from fuse 25 in the passenger compartment fusebox flows through the brake pedal switch contacts and is connected to BCU pin C0661-7 on a GP wire via header C0287 LHD/C0290 RHD.

This feed signals the BCU that the ignition is on and the brake pedal is depressed. The BCU sends a signal, on an SK wire, via header C0293 LHD/C0292 RHD, to the IDM. The IDM in turn provides an earth path for the interlock relay in the passenger compartment fusebox, energising the relay coil and closing the relay contacts.

With the relay contacts closed, a feed from fuse 21 in the passenger compartment fusebox flows through the relay contacts and from the fusebox to the shift interlock solenoid on a LGP wire, energising the solenoid. The shift interlock solenoid is connected to earth header C0552 LHD/C0708 RHD on a B wire.

With the shift interlock solenoid energised, the transmission selector can be moved from the PARK position. When the brake pedal is released, the feed to the BCU is removed and the shift interlock solenoid is de-energised. The locking mechanism controlled by the solenoid will lock the transmission selector once it is returned to the park position.

## ***Automatic transmission selector***

A starter/ inhibitor/ reverse lights switch is located on the gearbox and is used to inform related components of the gear selector position. The connection used on this circuit is on an NP wire from the switch to pin C0663-10 on the BCU and signals the BCU of PARK and NEUTRAL selector positions.

## ***Transmission neutral sensor***

The transmission neutral sensor provides an earth signal to the BCU when the transfer box is in neutral. The earth signal causes the BCU to operate an audible warning to warn of the transfer box in neutral when the ignition is on.

The sensor is connected on a BK wire from pin C0662-15 on the BCU. The sensor is connected on a B wire, via header C1002 to earth header C0552.

# DESCRIPTION AND OPERATION

---

## ***Transfer gearbox interlock solenoid***

When the BCU senses that the ignition key is removed from the ignition switch, it signals the IDM via the serial data bus. The IDM then grants an earth path for the coil of the transfer box relay in the passenger compartment fusebox, energising the relay coil and closing the relay contacts.

With the contacts closed, a feed from fuse 21 in the passenger compartment fusebox passes through the relay and is connected from the fusebox on an RU wire, via header C0293, to the transfer gearbox interlock solenoid. The solenoid energises and is connected by a B wire to earth header C0552. This prevents neutral being selected locking the transfer gearbox in high or low. A diode is located in the feed to the solenoid from splice joint A77 on an RU wire and from the diode to splice SJ2 on a B wire. The diode prevents residual current causing the solenoid to 'stick' in the energised position.

## **CRUISE CONTROL - V8 ENGINES**

### **DESCRIPTION**

#### **General**

The cruise control is selected from a switch located on the fascia. The cruise control operation is governed by a cruise control ECU located on the RH 'A' post behind the trim panel. Operation is controlled from two switches located on the steering wheel, a set/accelerate switch (SET+) and a resume/suspend switch (RES.).

A speed signal is supplied from the SLABS ECU to the cruise control ECU, the cruise control ECU monitors the signal for use in its control logic circuits. The cruise control system ECU supplies outputs to operate a vacuum pump and its internal control/dump valves.

The vacuum acting within a pneumatic throttle actuator moves the actuator to the required position.

#### ***Cruise suspend/resume - manual gearbox***

Inputs to the cruise control ECU from a switch on the brake pedal mechanism or the clutch pedal mechanism can disengage the cruise control by interrupting a feed into the cruise control ECU. The feed is used by the ECU to power the cruise control pump. When the feed is interrupted the ECU logic circuits stop the operation of the cruise control pump, open an internal dump valve, and close an internal control valve. This action stops the actuator and suspends the cruise control function.

In addition to the feed removal to the ECU when the brake pedal is pressed, a low voltage 'brakelight' signal is also sent via the Body Control Unit (BCU) to the cruise control ECU. The 'brakelight' signal is also used by the logic circuits in the cruise control ECU, to control the operation of the throttle actuator and control valves when the brake pedal has been pressed.

Operation of the resume/suspend switch after a braking event, can restore the operation of the cruise control system if the vehicles speed is acceptable to the cruise control ECU.

#### ***Cruise suspend/resume - automatic gearbox***

A gearbox selector lever position sensor sends an input via the BCU to the cruise control ECU if the selector lever is in park, neutral or reverse. An input to the cruise control ECU from a switch on the brake pedal mechanism will also disengage the cruise control by interrupting a feed to the cruise control ECU. The feed is used by the ECU to power the cruise control pump. When the feed is interrupted the ECU logic circuits stop the operation of the cruise control pump, open an internal dump valve, and close an internal control valve. This action stops the throttle actuator and suspends the cruise control function.

# DESCRIPTION AND OPERATION

---

In addition to the feed removal to the ECU when the brake pedal is pressed, a low voltage 'brakelight' signal is also sent via the BCU to the cruise control ECU. The 'brakelight' signal is also used by the logic circuits in the cruise control ECU, to control the operation of the throttle actuator and control/dump valves when the brake pedal has been pressed.

Operation of the resume/suspend switch after a braking event, can restore the operation of the cruise control system if the vehicles speed and gearbox selector position is acceptable to the cruise control ECU.

## **OPERATION**

### **Cruise Control Supply**

#### ***Circuit supply***

A feed from the battery positive terminal is connected by a R wire to the engine compartment fusebox, where it passes through fuse 16 and fusible link 8.

A feed from fuse 16 passes to the coil of the horn relay. From the coil of the horn relay, the feed is connected to the set/accel and res/suspend switches on a PO wire, via header C0291 LHD/C0286 RHD and the rotary coupler.

A feed from fusible link 8 is connected to the passenger compartment fusebox on a NW wire and from the fusebox to the ignition switch on a N wire.

#### ***Ignition switch supply***

With the ignition switch in position II, the feed from fusible link 8 flows from the ignition switch to the passenger compartment fusebox on a W wire. The feed continues through fuse 30 in the passenger compartment fusebox and is connected by a GLG wire to the cruise control switch.

With the ignition switch in position II, a second feed from fusible link 8 flows from the ignition switch to the passenger compartment fusebox on a Y wire. The feed continues through fuse 25 in the passenger compartment fusebox and is connected to the brake pedal switch by a GO wire.

## **Cruise Control Operation**

When the cruise control switch is on, the feed from fuse 30 in the passenger compartment fusebox, passes through the cruise control switch contacts to provide power input to the cruise control ECU pin C0239-8 on a WY wire.

Simultaneously, the feed also passes through the cruise control switch indicator lamp which illuminates. The indicator lamp is connected to earth on a black wire via header C0760 to earth header C0017 LHD/C0018 RHD. The cruise control ECU is earthed on a B wire from pin C0239-18, via header C0286 LHD/C0291 RHD to earth header C0018 LHD/C0017 RHD.

When the brake or clutch pedal or is not depressed, the feed from fuse 25 in the passenger compartment fusebox flows to a pair of contacts in the brake pedal switch on a GO wire.

## **Manual transmission**

The feed passes from the contacts of the brake pedal switch and is connected to the clutch pedal switch by an OG wire. The feed passes through the closed contacts of the clutch pedal switch to a PG wire that is connected to pin C0239-1 on the cruise control ECU. This feed provides the power source to the cruise control pump via the cruise control ECU.

If either the clutch pedal or the brake pedal is depressed, the respective switch contacts will be opened, removing power from the cruise control ECU and disengaging cruise control. If the cruise control switch remains on, the previous speed will be retained in the cruise control ECU memory.

The previous speed can be resumed by operation of the resume/suspend switch. The cruise control ECU will engage the cruise control if:

- The vehicle is travelling at over 28 mph (45 km/h)
- The cruise control switch is still on and has not been turned off
- The brake pedal is not depressed.
- The clutch pedal is not depressed.

## **Automatic transmission**

The feed from the contacts of the brake pedal switch is connected by an OG wire to connector interface C0712-2/C0667-1. From the connector interface the feed continues on a PG wire to the cruise control ECU. The feed from the brake pedal switch provides the power source to the cruise control pump via the cruise control ECU.

The cruise control ECU will engage the cruise control if:

- The vehicle is travelling at over 28 mph (45 km/h)
- The gearbox selector position is acceptable to the cruise control ECU
- The cruise control switch is still on and has not been turned off
- The brake pedal is not depressed.

# DESCRIPTION AND OPERATION

---

## ***Speed signal***

The cruise control ECU receives a speed signal input on a KG wire via header C0290 to pin C0239-15, from pin C0504-3 on the SLABS ECU.

## ***Cruise set/accelerate***

When the set/accel switch is operated, the switch contacts close and connect the feed from the horn relay to cruise control ECU pin C0239-4, via the rotary coupler and an RW wire. This signal initiates the cruise control ECU to activate the cruise control pump functions, providing all other parameters are correct.

## ***Cruise resume/suspend***

When the res/suspend switch is operated, the switch contacts close and connect the feed from the horn relay to cruise control ECU pin C0239-2, via the rotary coupler and a UW wire. If cruise control is engaged, this signal suspends cruise control operation. If cruise control is suspended, the signal will initiate the cruise control ECU to engage cruise control at the speed retained in the ECU's memory.

## ***Cruise control pump***

The cruise control pump has three connections to the cruise control ECU. One connection on a WU wire from pin C0239-11 supplies power directly to the pump. The control valve solenoid and dump valve solenoid are connected to pin C0239-17 of the cruise control ECU on a BY wire. The pump is earthed via pin C0239-7 of the cruise control ECU on a BR wire.

The dump valve solenoid is connected via header C0287 LHD/C0290 RHD on a GP wire to the contacts of the brake pedal switch. In normal operation the coil of the dump valve is earthed by the brake light circuit, via the contacts of the the brake pedal switch. When the brake pedal is pressed power is supplied on the earth path of the dump valve solenoid. When the voltage on each side of the coil of the dump valve solenoid is equalised, there is no voltage drop across the solenoid. With no current flowing through the coil of the dump valve solenoid, the solenoid is de-energised and the dump valve opens.

When the cruise control switch is on and vehicle speed is more than 28 mph (45km/h) and less than 125 mph (201 km/h), the cruise control ECU supplies power to the pump and valve solenoids. The earth paths for the pump and the control valve solenoid are switched as required by the cruise control ECU to set and maintain vehicle speed.

## **Other Body Control Unit (BCU) inputs/outputs**

### ***'Brakelight' Signal***

If the brake pedal is depressed a pair of contacts in the brake pedal switch allow a feed to flow on a GP wire via header C0287 LHD/C0290 RHD to pin C0661-7 on the BCU. The BCU sends a 'brakelight' signal output from pin C0661-16 on a GS wire, to pin C0239-5 on the cruise control ECU.

The logic circuits in the cruise control ECU use this 'brakelight' signal to lock out the cruise control. The internal logic of the ECU uses the 'brakelight' signal to cancel cruise control by interrupting the earth path to the pump, and activating the dump valve solenoid. The dump valve opens the vacuum chamber to ambient air pressure, the vacuum is dissipated and the throttle actuator no longer has an effect on the throttle position.

### ***Gearbox inputs - automatic transmission***

An Input for Park, Neutral and Reverse positions are passed from the gearbox position selector on a BG wire via splice joint A31 and connectors C0668-5, C0681-5 to pin C0663-11 of the BCU.

If an input from the gearbox position selector or the brake pedal switch is received by the BCU, a 'brakelight' signal is sent from the BCU to the cruise control ECU, This signal will cancel or inhibit cruise control operation.

### ***Gearbox inputs - manual transmission***

There are no signals from the manual gearbox to the BCU. The BCU is permanently connected to earth header C0552, via a BG wire from pin C0663-11 through connectors C0668-5 and C0661-5 to splice joint A33. From splice joint A33 the earth continues on a B wire through connectors C0681-8 and C0668-8 to earth header C0552.

## **Diagnostic socket - all models**

Diagnostic information can be retrieved on a K wire from cruise control ECU pin C0239-16, through header C0286, to the diagnostic socket. The information can be retrieved using TestBook/T4 or other suitable scantool.



# DESCRIPTION AND OPERATION

---

## **CRUISE CONTROL - Td5 ENGINES**

### **DESCRIPTION**

#### **General**

Cruise control is integral with the engine management system. Refer to Workshop Manual - Engine Management System Td5 - Diesel for description and operation.

## **ELECTRONIC AUTOMATIC TRANSMISSION (EAT)**

### **DESCRIPTION**

#### **General**

The automatic gearbox is a four speed unit with electronic control of gear selection, shift quality and torque converter lock-up. A starter/ inhibitor/ reverse light switch on the gearbox transmits gear selector position to the EAT ECU, which outputs appropriate signals to an electro-hydraulic valve block in the gearbox. The signals from the starter/ inhibitor/ reverse light switch are also transmitted to the BCU, which uses them to operate the gear selected indicator in the instrument pack.

The EAT ECU is located under the LH front seat below the radio/cassette player power amplifier (if fitted). A mode switch on the gear selector panel allows the driver to change the mode of the ECU operation between manual and sport modes. Warning lamps in the instrument pack are operated by the ECU to indicate control mode and system status.

Refer to Workshop Manual Automatic Gearbox for Description and Operation of the EAT.

### **OPERATION**

#### **EAT Supply**

##### ***Circuit supply***

A feed from the battery positive terminal is connected on an R wire to the engine compartment fusebox where it passes through fusible link 8 and fuse 12.

The feed from fuse 12 is connected from the fusebox on a PY wire to the EAT ECU pin C0193-26 and supplies a continuous battery feed to the ECU.

The feed from fusible link 8 is connected on an NW wire to the passenger compartment fusebox and from the fusebox to the ignition switch on an N wire.

##### ***Ignition switch supply***

With the ignition switch in position II, the feed from fusible link 8 passes through the ignition switch to the passenger compartment fusebox on a Y wire, where it passes through fuses 24 and 25.

The feed from fuse 24 is connected from the fusebox to the EAT ECU pin C0193-54 on an LGO wire to inform the ECU that the ignition is on. The feed from fuse 25 is connected from the fusebox to the starter/ inhibitor/ reverse light switch pin C0675-2 on a GY wire.

# DESCRIPTION AND OPERATION

---

## EAT Operation

### ***Gearbox solenoid valve block***

The gearbox solenoid valve block is connected to the EAT ECU as follows:

- ECU pin C0193-5 on an OG wire to gearbox solenoid pin C0543-H. This provides an output to the pressure regulator solenoid valve.
- ECU pin C0193-43 on an R wire to connector interface C0728-2/C0678-2 and from the interface to the gearbox solenoid pin C0243-E on an OK wire. This receives a positive input from the gearbox output shaft speed sensor.
- ECU pin C0193-14 on a B wire to connector interface C0728-1/C0678-1 and from the interface to gearbox solenoid pin C0243-F on an OB wire. This receives a negative input from the gearbox output shaft speed sensor.
- ECU pin C0193-30 on an OP wire to gearbox solenoid pin C0243-B. This provides an output for the shift control solenoid valve (MV1).
- ECU pin C0193-33 on an OW wire to gearbox solenoid pin C0243-K. This provides an output for the shift control solenoid valve (MV2).
- ECU pin C0193-32 on an SO wire to gearbox solenoid pin C0243-M. This provides an output to the converter lock-up solenoid valve (MV3).
- ECU pin C0193-53 on an OLG wire to gearbox solenoid pin C0243-L. This provides an output for power supply to the solenoid valves.

### ***Starter/ inhibitor/ reverse light switch***

The starter/ inhibitor/ reverse light switch is connected to the EAT ECU as follows:

- ECU pin C0193-7 on a UG wire, via header C0724, to starter/ inhibitor/ reverse light switch pin C0675-37. This receives an input from the switch Y contacts. The input is also supplied via header C0724 to the BCU pin C0662-6.
- ECU pin C0193-36 on a UP wire, via header C0724, to starter/ inhibitor/ reverse light switch pin C0675-9. This receives an input from the switch W contacts. The input is also supplied via header C0724 to the BCU pin C0662-9.
- ECU pin C0193-8 on a UB wire, via header C0724, to starter/ inhibitor/ reverse light switch pin C0675-10. This receives an input from the switch X contacts. The input is also supplied via header C0724 to the BCU pin C0662-13.
- ECU pin C0193-9 on a UW wire, via header C0724, to starter/ inhibitor/ reverse light switch pin C0675-6. This receives an input from the switch Z contacts. The input is also supplied via header C0724 to the BCU pin C0663-7.

The starter/ inhibitor/ reverse light switch pin C0675-4 is connected on a B wire, via splice SJ2, to earth header C0552.

The starter/ inhibitor/ reverse light switch pin C0675-1 is connected on a GN wire, via header C0287 LHD/C0294 RHD, to the BCU pin C0661-8.

The starter/ inhibitor/ reverse light switch pin C0675-8 is connected on an NP wire to BCU pin C0663-10.

The starter/ inhibitor/ reverse light switch pin C0675-5 is connected on a BG wire, via splice joint A31 (and header C0294 LHD/C0287 RHD Td5 only), to BCU pin C0663-11.

On Td5 engine vehicles only, the starter/ inhibitor/ reverse light switch is connected from pin C0675-5, through splice joint A31, to connector interface C0681-10/C0668-10 on a BG wire. From the interface the connection continues on a BW wire, via header C0294 LHD/C0287 RHD, to the ECM pin C0658-35.

### ***Automatic transmission selector lamp***

The automatic transmission selector lamp is connected to the BCU as follows:

- BCU pin C0662-22 on an RG wire to automatic transmission selector lamp pin C0245-6.
- BCU pin C0662-23 on an RS wire to automatic transmission selector lamp pin C0245-5.
- BCU pin C0662-24 on an RK wire to automatic transmission selector lamp pin C0245-4.
- BCU pin C0662-25 on an RP wire to automatic transmission selector lamp pin C0245-3.
- BCU pin C0662-26 on an RY wire to automatic transmission selector lamp pin C0245-12.
- BCU pin C0662-8 on an RU wire to automatic transmission selector lamp pin C0245-11.
- BCU pin C0662-9 on an RW wire to automatic transmission selector lamp pin C0245-10.

The automatic transmission selector lamp pin C0245-9 is connected on a GLG wire to the IDM in the passenger compartment fusebox.

The automatic transmission selector lamp pin C0245-7 is connected on a UO wire to the EAT ECU pin C0193-45.

The automatic transmission selector lamp pin C0245-1 is connected on a B wire to earth header C0708.

# DESCRIPTION AND OPERATION

---

## ***Instrument pack***

The instrument pack pin C0230-5 is connected on a YG wire to the EAT ECU pin C0193-51. This connection operates the manual mode lamp in the instrument pack.

The instrument pack pin C0230-4 is connected on a YR wire to the EAT ECU pin C0193-25. This connection operates the sport mode lamp in the instrument pack.

The instrument pack pin C0233-16 is connected on an SK wire, via header C0293 LHD/ C0292 RHD to the IDM in the passenger compartment fusebox. This connection is the serial data bus and supplies gear position data from the selector indicator, via the IDM, to the instrument pack.

## ***Diagnostic socket***

The diagnostic socket pin C0040-7 is connected on a K wire, via header C0286, to the EAT ECU pin C0193-31.

## ***Engine Control Module (ECM)***

The EAT ECU pin C0193-16 is connected on a W wire to ECM pin C0637-36 V8/C0158-35 Td5.

The EAT ECU pin C0193-44 is connected on a Y wire to ECM pin C0637-37 V8/C0158-32 Td5.

## ***EAT ECU***

EAT ECU pin C0193-13 is connected to the transmission high/low switch by an RK wire. When the transfer box is in low range the switch is closed and connects the RK wire to earth on a B wire through splice SJ2 and earth header C0552.

The EAT ECU is connected on B wires from pins C0193-6 and C0193-28 to earth header C0708.

## **ACTIVE CORNERING ENHANCEMENT (ACE)**

### **DESCRIPTION**

#### **General**

The ACE system is an optional fitment to control vehicle roll angles. The system is electrically and hydraulically operated with all operations controlled by an ACE ECU. The ACE system provides improved vehicle handling and suspension characteristics and is active for both on and off-road driving. Refer to the Workshop Manual for detailed description and operation of the ACE system.

### **OPERATION**

#### **ACE Supply**

##### ***Circuit supply***

A feed from the battery positive terminal is connected on an R wire to the engine compartment fusebox. The feed passes through fusible link 8 and fuse 15.

The feed from fusible link 8 is connected on a NW wire to the passenger compartment fusebox and from the fusebox to the ignition switch on an N wire.

The feed from fuse 15 is connected to the contacts and coil of the ACE relay.

##### ***Ignition switch supply***

When the ignition switch is in position II, the feed from fusible link 8 flows through the ignition switch to the passenger compartment fusebox on a Y wire and passes through fuses 25 and 29.

##### ***Ignition signal***

When the ignition is in position II, the feed from fuse 29 in the passenger compartment fusebox passes on a GO wire to the ACE ECU pin C0647-11.

#### **ACE Operation**

##### ***Mains supply***

The coil of the ACE relay is connected to pin C0647-6 on a BR wire to the ACE ECU. When conditions are correct, the ACE ECU provides an earth path for the relay coil, which allows the feed from fuse 15 to energise the coil and close the relay contacts.

When the ACE relay contacts close, the feed from fuse 15 passes through the contacts and passes on a PO wire to pin C0647-28 on the ACE ECU.

# DESCRIPTION AND OPERATION

---

## ***Road speed signal***

The ACE ECU receives a road speed signal from pin C0504-3, via header C0290, to ACE ECU pin C0647-5 on a KG wire.

## ***ACE ECU***

The ACE ECU receives two earth connections on B wires from pins C0647-20 and C0647-32 to earth header C0018 LHD/C0017 RHD.

## ***ACE upper accelerometer***

The ACE ECU provides a power supply output on a YR wire from ECU pin C0647-18 to the upper accelerometer pin C0657-3.

The ACE ECU receives an earth input from the upper accelerometer pin C0657-2 to ECU pin C0647-34 on a YG wire.

The ACE ECU receives a signal input from the upper accelerometer pin C0657-1 to ECU pin C0647-17 on an OU wire.

## ***ACE lower accelerometer***

The ACE ECU provides a power supply output on a YB wire from ECU pin C0647-12 to the lower accelerometer pin C0656-3.

The ACE ECU receives an earth input from the lower accelerometer pin C0656-2 to ECU pin C0647-33 on a YK wire.

The ACE ECU receives a signal input from the lower accelerometer pin C0656-1 to ECU pin C0647-15 on an OS wire.

## ***ACE valve block***

The ACE valve block houses the pressure transducer, pressure control valve and two directional control valves. The ACE ECU sends and receives inputs and outputs to the valve block components as follows:

### ***Pressure transducer***

The ACE ECU provides a power supply output on a KY wire from ECU pin C0647-13 to the pressure transducer pin C0770-3.

The ACE ECU receives an earth input from the pressure transducer pin C0770-1 to ECU pin C0647-21 on a UG wire.

The ACE ECU receives a signal input from the pressure transducer pin C0729-2 to ECU pin C0647-16 on a KW wire.

## ***Pressure control valve***

The ACE ECU provides a power output on a P wire from ECU pin C0647-27 to pressure control valve pin C0728-2.

The ACE ECU receives an earth input on a BG wire from ECU pin C0647-25 to the pressure control valve pin C0728-1

## ***Directional control valves***

The ACE ECU provides a power supply output on a GR wire from pin C0647-24 to the directional control valve 1 pin C0770-2 and directional control valve 2 pin C0771-2.

The ACE ECU receives an earth input from directional control valve 1 pin C0729-1 to ECU pin C0647-23 on an OG wire.

The ACE ECU receives an earth input from directional control valve 2 pin C0771-1 to ECU pin C0647-22 on a YB wire.

## ***Instrument pack***

The ACE ECU provides a warning lamp output to the instrument pack from ECU pin C0647-36 to the instrument pack pin C0233-1 on a BO wire.

## ***Engine speed signal***

The ACE ECU receives an engine speed input signal from the ECM.

On V8 engine vehicles the signal is passed from ECM pin C0637-17 on a WS wire, via header C0291, to ACE ECU pin C0647-19.

On Td5 engine vehicles the signal is passed from ECM pin C0658-19 on a WS wire, via header C0291, to ACE ECU pin C0647-19.

## ***Reverse gear signal***

The feed from fuse 25 in the passenger compartment fusebox is connected to the reverse lamp switch (manual gearbox), or starter inhibitor/reverse light switch (automatic transmission), by a GY wire. When reverse gear is selected, the switch closes and the feed is connected to the ACE ECU, by a GN wire via header C0287 LHD/C0294 RHD, to provide a reverse gear selected signal. The reverse gear selected signal is used by the ACE ECU to set the system in a 'locked bars' condition when reversing.

## ***Diagnostic socket***

The ACE ECU provides outputs and receives inputs from the diagnostic socket pin C0040-7 on a K wire, via header C0286, to ACE ECU pin C0647-10.



# DESCRIPTION AND OPERATION

---

## **SELF LEVELLING AND ANTI-LOCK BRAKING SYSTEM (SLABS)**

### **DESCRIPTION**

#### **General**

SLS and ABS is controlled by the Self Levelling and Anti-Lock Braking System (SLABS) ECU. The two systems are housed in the one ECU, but operate independently of each other.

The SLS system comprises an air supply unit comprising a compressor and air valves, two height sensors and the SLS part of the SLABS ECU. The SLS system controls the height of the rear suspension for off-road driving and passenger/load compensation. Refer to Workshop Manual - Description and Operation for further details.

The ABS system comprises ABS wheel sensors, an ABS modulator and the ABS part of the SLABS ECU. The ABS system also controls electronic brake distribution, hill descent control, centre differential lock control and electronic traction control. Refer to Workshop Manual - Description and Operation for further details.

*NOTE: This Description and Operation applies to vehicles with Self Levelling Suspension (SLS). For vehicles without SLS refer to the ABS Description and Operation in this manual.*

### **OPERATION**

#### **SLABS Supply**

##### ***Circuit supply***

A feed from the battery positive terminal is connected by an R wire to the engine compartment fusebox, where it passes through fusible links 8, 9 and 11 and fuse 11.

The feed from fusible link 11 is connected to the contacts of the ABS return pump relay in the engine compartment fusebox.

The feed from fusible link 9 is connected to the contacts of the SLS relay in the engine compartment fusebox.

The feed from fuse 11 is connected to the SLABS ECU pin C0504-1 on an NK wire.

The feed from fusible link 8 is connected to the passenger compartment fusebox on an NW wire and from the fusebox to the ignition switch on an N wire.

## ***Ignition switch supply***

When the ignition switch is in position II, the feed from fusible link 8 flows through the ignition switch to the passenger compartment fusebox on a Y wire and passes through fuses 25, 27 and 28.

From fuse 25 is connected to the contacts of the hill descent relay in the passenger compartment fusebox. The feed from fuse 25 is also connected on a GY wire to the reverse lamp switch (manual gearbox vehicles) or the starter inhibitor/reverse lamp switch (automatic gearbox vehicles). When the switch is operated, the feed is connected on a GN wire, through header joint C0287 LHD/C0294 RHD, to the SLABS ECU pin C0504-7.

From fuse 27 the feed is connected, via header C0760, on an LG wire to the hill descent switch. When the hill descent switch is operated, the feed continues from the switch on a PS wire to the SLABS ECU pin C0504-14.

From fuse 28 the feed is connected on an LG wire to the SLABS ECU pin C0504-2.

## **SLS Operation**

### ***Air supply unit***

Compressor:

When compressor operation is required, the SLABS ECU supplies an output feed from pin C0655-6 on an NP wire to the engine compartment fusebox. The feed is connected to the coil of the SLS relay closing the relay contacts. The coil is connected from the fusebox on a B wire, via header C0286 LHD/ C0288 RHD to earth header C0018.

The feed from fusible link 9 passes through the relay contacts and is connected from the engine compartment fusebox on a WB wire to the SLS compressor. The compressor is connected on a B wire, via splice joint A47, to earth eyelet connector C0811-1.

SLS exhaust valve:

When exhaust valve operation is required, the SLABS ECU outputs a feed on pin C0655-5 on a BW wire to the exhaust valve. The valve is connected on a B wire, via splice joint A47 to earth eyelet connector C0811-1.

SLS LH rear valve:

When LH rear valve operation is required, the SLABS ECU outputs a feed on pin C0655-3 on a WY wire to the valve. The valve is connected on a B wire, via splice joint A47 to earth eyelet connector C0811-1.

# DESCRIPTION AND OPERATION

---

## SLS RH rear valve:

When RH rear valve operation is required, the SLABS ECU outputs a feed on pin C0655-4 on a UO wire to the valve. The valve is connected on a B wire, via splice joint A47 to earth eyelet connector C0811-1.

### ***Off-road mode switch***

When the non-latching off-road mode switch is pressed, an earth path is completed from SLABS ECU pin C0655-11 on a PK wire, via splice joint A186, to the off-road mode switch. The switch is connected on a B wire, via headers C0725 and C0760 to earth header C0017 LHD/C0018 RHD.

The momentary completion of the earth path is sensed by the ECU which then operates the air supply unit accordingly. The ECU then connects pin C0655-11 to earth. The earth is also connected to the off-road mode warning lamp in the instrument pack on a PK wire from splice joint A186, causing the warning lamp to illuminate. The ECU quickly removes and re-instates the earth path continuously to check if a second off-road mode switch request has been made.

### ***Door switches***

The SLABS ECU receives earth input signals from the door switches to inform the ECU that a door is open. The ECU can only differentiate between the driver's door on ECU pin C0655-1 and the remaining doors on pin C0655-2.

### ***Driver's door***

The earth input for ECU pin C0655-1 is connected on a PW wire, via headers C0287 LHD/C0285 RHD, to the front (driver's) door lock motor. The motor is connected on a B wire to earth header C0017 LHD/C0018 RHD.

### ***Passenger door***

The earth input for ECU pin C0655-2 is connected on a PLG wire to header C0291 LHD/C0285 RHD. From the header a PLG wire is connected to connector interface C0464-1/C0733-1. A PW wire connects the front (passenger) door lock motor to the connector interface. The motor is connected on a B wire to earth header C0018 LHD/C0017 RHD.

### ***LH and RH rear doors***

The earth input for ECU pin C0655-2 is connected on a PLG wire to header C0291 LHD/C0285 RHD. From the header PLG wires connect to the LH and RH rear door lock motors. Each motor is connected on a B wire to earth header C0552.

## ***Tail door***

The earth input for ECU pin C0655-2 is connected on a PLG wire to header C0291 LHD/ C0285 RHD. From the header a PLG wire connects to the tail door motor switch. The motor is connected on a B wire to earth header C0706.

## ***Body Control Unit (BCU)***

The SLABS ECU provides outputs and receives inputs to/from the BCU on connectors C0655 and C0504 as follows:

- An output is passed from SLABS ECU pin C0655-7 to BCU pin C0660-10 on a WK wire. This output enables the SLS audible warning.
- An input is received from BCU pin C0660-12 to SLABS ECU C0655-12 on a WU wire. This input is the SLS raise/lower command from the remote handset.

## ***Instrument pack***

The SLABS ECU provides an output from pin C0655-8 on a WO wire to the instrument pack pin C0233-2 for SLS warning lamp operation.

## ***Height sensors***

The SLABS ECU provides outputs and receives inputs from the left and right hand height sensors as follows:

### ***LH height sensor***

- Power supply output from SLABS ECU pin C0654-1 on an SY wire to LH height sensor pin C0764-5.
- Earth output from SLABS ECU pin C0654-2 on an SU wire to LH height sensor pin C0764-1.
- Signal input from LH height sensor pin C0764-4 on an SR wire to SLABS ECU pin C0654-3.

### ***RH Height sensor***

- Power supply output from SLABS ECU pin C0654-4 on an SG wire to RH height sensor pin C0763-5.
- Earth output from SLABS ECU pin C0654-5 on an SO wire to RH height sensor pin C0763-1.
- Signal input from RH height sensor pin C0763-4 on an SB wire to SLABS ECU pin C0654-6.

## ***Engine Control Module (ECM)***

The ECM provides an engine speed signal on a WS wire to header C0291. From the header the signal is passed on a WS wire to the instrument pack for tachometer operation. A second WS wire is connected from the header to the SLABS ECU pin C0655-10.

## ***ABS Operation***

Refer to Anti-lock Braking System (ABS) - Operation in this manual for description of the ABS circuit.

# DESCRIPTION AND OPERATION

---

## **ANTI-LOCK BRAKING SYSTEM (ABS)**

### **DESCRIPTION**

#### **General**

ABS is controlled by the Self Levelling and Anti-lock Braking System (SLABS) ECU. The ABS system comprises the ECU, ABS wheel sensors and an ABS modulator. The ABS system also controls electronic brake distribution, hill descent control, centre differential lock control and electronic traction control. Refer to Workshop Manual - Description and Operation for further details.

*NOTE: This Description and Operation applies to vehicles without Self Levelling Suspension (SLS). For vehicles with SLS refer to the SLABS Description and Operation in this manual.*

### **OPERATION**

#### **ABS Supply**

##### ***Circuit supply***

A feed from the battery positive terminal is connected by an R wire to the engine compartment fusebox, where it passes through fusible links 8 and 11 and fuse 11.

The feed from fusible link 8 is connected to the passenger compartment fusebox on an NW wire and from the fusebox to the ignition switch on an N wire.

The feed from fusible link 11 is connected to the contacts of the ABS return pump relay in the engine compartment fusebox.

The feed from fuse 11 is connected to the SLABS ECU pin C0504-1 on an NK wire.

##### ***Ignition switch supply***

When the ignition switch is in position II, the feed from fusible link 8 flows through the ignition switch to the passenger compartment fusebox on a Y wire and passes through fuses 25, 27 and 28.

From fuse 25 the feed is connected to the contacts of the hill descent relay. The feed from fuse 25 is also connected on a GY wire to the reverse lamp switch (manual gearbox vehicles) or the starter inhibitor/reverse lamp switch (automatic gearbox vehicles). When the switch is operated, the feed is connected on a GN wire, through header joint C0287 LHD/C0294 RHD, to the SLABS ECU pin C0504-7.

From fuse 27 the feed is connected, via header joint C0760, on an LG wire to the hill descent switch. When the hill descent switch is operated the feed continues from the switch on a PS wire to the SLABS ECU pin C0504-14.

From fuse 28 the feed is connected on an LG wire to the SLABS ECU pin C0504-2.

## **ABS Operation**

### ***HDC Brake lamp operation***

When the hill descent control operates, the SLABS ECU pin C0506-12 provides a power supply on a BG wire to the coil of the hill descent relay in the passenger compartment fusebox. The relay coil energises and the contacts close. The earth path from the coil is from the passenger compartment fusebox on a B wire to earth header C0017 LHD/C0018 RHD.

The feed from fuse 25 in the passenger compartment fusebox passes through the closed relay contacts and is connected from the fusebox on a GP wire, through header C0287 LHD/C0290 RHD to header C0295.

The feed is then connected to the LH tail lamp on a GP wire and illuminates the brake lamp bulb. The feed is also connected from the header C0295 to header C0723 on a GP wire. From the header C0723, the feed is connected on GP wires to the RH tail lamp, the high mounted brake lamp and the trailer socket, illuminating the brake lamp bulbs.

### ***ABS return pump operation***

When the ABS or other ABS related functions operate, the SLABS ECU pin C0506-15 provides a power supply on a WO wire to the coil of the ABS return pump relay in the engine compartment fusebox. The relay coil energises and the relay contacts close. The earth path from the coil is from the engine compartment fusebox on a B wire, via header C0286 LHD/C0288 RHD to earth header C0018.

The feed from fusible link 11 in the engine compartment fusebox passes through the closed contacts and is connected from the fusebox on an NR wire to splice joint A306. The feed continues from splice joint A306 on an NR wire to the SLABS ECU pin C0504-8. The feed is also connected from the splice joint A306 on an NR wire to the ABS return pump. The earth path from the ABS return pump is on a B wire to earth eyelet connector C0562-1.

### ***Differential lock unit switch operation***

When the differential lock unit switch is operated, an earth path is completed from the SLABS ECU pin C0506-9, via header C0761, to the differential lock unit switch on a BU wire.

On vehicles with automatic transmission the earth path is completed from the switch on a B wire to splice joint SJ2. From the splice joint the earth is connected on a B wire to earth header C0552.

On vehicles with manual transmission, the earth path is completed from the switch on a B wire to splice joint A33. From the splice joint the earth is connected on a B wire to earth header C0552.

When the differential lock unit switch completes the earth path, the SLABS ECU interprets the earth as a signal. Simultaneously, the closure of the switch also completes an earth path from the instrument pack on a BU wire to header C0761, through the differential lock unit switch to the earth header C0552. This earth is used by the instrument pack to illuminate the differential lock warning lamp.

# DESCRIPTION AND OPERATION

---

## ***Transmission high/low switch operation***

When the transmission high/low switch is operated, an earth path is completed from the SLABS ECU pin C0504-11, via header C0290 LHD/C0288 RHD to the transmission high/low switch on an RK wire.

On vehicles with automatic transmission, the earth path is completed from the switch on a B wire to splice joint SJ2. From the splice joint the earth is connected on a B wire to earth header C0552.

On vehicles with manual transmission, the earth path is completed from the switch on a B wire to splice joint A33. From the splice joint the earth is connected on a B wire to earth header C0552.

When the transmission high/low switch completes the earth path, the SLABS ECU interprets the earth as a signal to confirm that the transfer box is in low range.

## ***ABS sensors***

The SLABS ECU receives inputs from each wheel speed sensor through connector C0505. The inputs are as follows:

- From Front LH ABS sensor pins C0516-1/2 to SLABS ECU pins C0505-1/2 on G wires
- From Front RH ABS sensor pins C0517-1/2 to SLABS ECU pins C0505-4/5 on G wires
- From Rear LH ABS sensor pins C0502-1/2 to SLABS ECU pins C0505-7/8 on W wires
- From Rear RH ABS sensor pins C0503-1/2 to SLABS ECU pins C0505-3/6 on W wires.

## ***ABS modulator***

The SLABS ECU provides outputs to and receives inputs from the ABS modulator through connector C0506. The inputs and outputs are as follows:

- Output from SLABS ECU pin C0506-1 to ABS modulator pin C0501-1 on an SW wire
- Output from SLABS ECU pin C0506-2 to ABS modulator pin C0501-2 on an SR wire
- Input from ABS modulator pin C0501-8 to SLABS ECU pin C0506-3 on a BS wire
- Output from SLABS ECU pin C0506-4 to ABS modulator pin C0501-13 on an SG wire
- Output from SLABS ECU pin C0506-5 to ABS modulator pin C0501-12 on an SU wire
- Input from ABS modulator pin C0501-9 to SLABS ECU pin C0506-6 on a YG wire
- Output from SLABS ECU pin C0506-7 to ABS modulator pin C0501-5 on an SY wire
- Output from SLABS ECU pin C0506-8 to ABS modulator pin C0501-4 on an SN wire
- Output from SLABS ECU pin C0506-10 to ABS modulator pin C0501-10 on an SP wire
- Output from SLABS ECU pin C0506-11 to ABS modulator pin C0501-11 on an SK wire.

The ABS modulator (D124) is connected on a B wire to earth eyelet connector C0561-1.

## ***Instrument pack***

The SLABS ECU provides outputs to the instrument pack through connector C0504. The outputs are as follows:

- From SLABS ECU pin C0504-16 to instrument pack pin C0233-5 on a WY wire (HDC warning lamp)
- From SLABS ECU pin C0504-17 to instrument pack pin C0233-10 on a WK wire (HDC info warning lamp)
- From SLABS ECU pin C0504-18 to instrument pack pin C0233-3 on a WR wire (ABS warning lamp)
- From SLABS ECU pin C0504-13 to instrument pack pin C0233-4 on a WU wire ( TC warning lamp)
- From SLABS ECU pin C0504-9, via header joint C0293 LHD/C0285 RHD on a KO wire (brake warning lamp).

The instrument pack is also connected from the instrument pack pin C0233-16 on an SK wire, via header C0292 LHD/C0290 RHD to the IDM in the passenger compartment fusebox. The SK wire is the serial data bus between the IDM and the instrument pack.

## ***Diagnostic socket***

The SLABS ECU provides outputs and receives inputs from the diagnostic socket through connector C0504. Connector pin C0504-5 is connected on a K wire, via header C0286 to the diagnostic socket pin C0040-7.

## ***Body Control Unit (BCU)***

The SLABS ECU pin C0504-15 receives an input from the BCU pin C0662-10 on a GB wire. This signal is used by the ABS system for automatic transmission in neutral for HDC control.

## ***Engine Control Module (ECM)***

On V8 engine vehicles the SLABS ECU outputs a rough road signal to the ECM from SLABS ECU pin C0504-4 on an RG wire to ECM pin C0637-34. The rough road signal inhibits misfire detection on NAS vehicles. The SLABS ECU receives engine data from the ECM from ECM pin C0636-29 on an SP wire to SLABS ECU pin C0504-10.

On Td5 engine vehicles the SLABS ECU receives engine data from ECM pin C0658-32 on an SP wire to SLABS ECU pin C0504-10.



# DESCRIPTION AND OPERATION

---

## ***Road speed signal***

The SLABS ECU outputs a road speed signal from pin C0504-3 on a KG wire to header C0290. From header C0290 the road speed signal is passed on KG wires to the following ECU pins:

- Cruise control ECU pin C0239-15
- Engine Control Module (ECM pin C0637-22 on V8 engine vehicles and pin C0658-13 on Td5 engine vehicles
- Active Cornering Enhancement (ACE) ECU pin C0647-5
- ICE Tuner/Amplifier pin C0491-20
- Instrument pack pin C0230-16
- Air Temperature Control (ATC) ECU pin C0792-2 via splice joint A87.

## **SUPPLEMENTARY RESTRAINT SYSTEM (SRS)**

### **DESCRIPTION**

#### **General**

The Supplementary Restraint System (SRS) provides additional protection for front seat occupants during a frontal collision above a preset severity.

The system is operational only with the ignition switch in position II. With the ignition on, any frontal collision is detected by an accelerometer and a mechanical safing sensor within the airbag DCU. If the impact is above the preset severity, the airbag DCU transmits simultaneous signals to fire the airbag modules and seat belt pretensioners. The airbag modules deploy protective airbags in front of the driver and front seat passenger and the seat belt pretensioners retract to tighten the front seat belts.

The airbag DCU can store fault codes for the DCU, the driver and passenger airbag modules and the pretensioners. These fault codes can be accessed using TestBook/T4 via the diagnostic socket.

The airbag DCU is located below the centre console near the handbrake mounting. The driver airbag is located in the centre of the steering wheel and the passenger airbag is located in the fascia, above the glovebox. The seat belt pretensioners are located with the seat belt anchorages.

An SRS warning LED is located in the instrument pack. When the ignition switch is turned to position II, the LED will be illuminated for 3 to 5 seconds to confirm LED operation. If a fault in the SRS system occurs, the LED will be illuminated for the duration of the fault or for a period of between 8 to 16 seconds.

The airbag DCU can supply a low voltage test current to the airbags and pretensioners to check circuit continuity. The DCU can also detect shorts, shorts to ground or battery and open circuits. These conditions can be retrieved using TestBook/T4.

***WARNING: Never use multimeters or other general purpose test equipment on SRS system components or connectors. System faults should be diagnosed through the use of recommended test equipment only.***

# DESCRIPTION AND OPERATION

---

## **OPERATION**

### **SRS Supply**

#### ***Circuit supply***

A feed from the battery positive terminal is connected on an R wire to the engine compartment fusebox where it passes through fusible link 8.

A feed from fusible link 8 is connected on an NW wire to the passenger compartment fusebox and from the fusebox to the ignition switch (S176) on an N wire.

#### ***Ignition switch supply***

With the ignition switch in position II, the feed from fusible link 8 passes through the ignition switch to fuse 35 in the passenger compartment fusebox on a Y wire. G wires connect fuse 35 in the passenger compartment fusebox to the instrument pack and the airbag DCU.

The SRS warning lamp is connected from the instrument pack to the airbag DCU on a YR wire. If a failure of the LED or connecting wiring occurs, the airbag DCU detects a 0V condition on the YR wire and stores a fault code in the DCU memory.

The airbag DCU is connected to earth eyelet connector C0360-1 on a B wire.

### **SRS Connections**

#### ***Diagnostic socket***

The diagnostic socket is connected to the airbag DCU on a K wire via header C0286. The airbag DCU can send/receive digital outputs and inputs to/from TestBook/T4 for diagnostic interrogation.

#### ***LH pretensioner***

The LH pretensioner is connected to the airbag DCU on an OR wire and an O wire. The OR wire supplies a negative digital output and the O wire supplies a positive digital output for pretensioner operation.

#### ***RH pretensioner***

The RH pretensioner is connected to the airbag DCU on an N wire and an NR wire. The N wire supplies a positive digital output and the NR wire supplies a negative digital output for pretensioner operation.

#### ***Passenger airbag***

The passenger airbag is connected to the airbag DCU on a WY wire and a W wire. The WY wire supplies a positive digital output and the W wire supplies a negative digital output for airbag operation.

#### ***Driver airbag***

The driver airbag is connected, via the rotary coupler, to the airbag DCU on an RY wire and an R wire. The RY wire supplies a negative digital output and the R wire supplies a positive digital output for airbag operation.

## **AIR CONDITIONING (A/C)**

### **DESCRIPTION**

#### **General**

The air conditioning (A/C) can only be operated with the engine running. The A/C is selected using the Air Temperature Control (ATC) panel on the fascia. The A/C system controls the temperature, distribution and volume of air supplied to the vehicle interior. The system is electronically controlled with automatic and manual modes of operation. The system also features separate temperature control of the LH and RH air outlets.

Rear A/C is an optional fitment and provides additional cooling by recirculating air through a second evaporator.

The cooling fan is used by the ATC ECU for A/C condensor cooling and also by the ECM for engine cooling. Refer to cooling fan Description and Operation in this manual for ECM operation.

Operation of the A/C system is dependant on various conditions being correct, i.e. engine coolant temperature, engine speed, vehicle speed, A/C dual cut-off switch etc. For further details of A/C operating parameters refer to the Workshop Manual Air Conditioning Description and Operation.

### **OPERATION**

#### **Air Conditioning Supply**

##### ***Circuit supply***

A feed from the battery positive terminal is connected on an R wire to the engine compartment fusebox. The feed passes through fusible links 1, 3, 4 and 8 and fuses 5, 6 and 13. Fusible links 1 and 4 are connected in series. Fuses 5 and 6 are also connected in series with fusible link 1.

The feed from the battery is also connected directly to the contacts of the main relay in the engine compartment fusebox.

From fusible link 3 is connected on an NR wire to the passenger compartment fusebox where it passes through fuse 20.

The feed from fusible link 4 is connected on an NK wire to the passenger compartment fusebox where it passes through fuses 6 and 7.

The feed from fusible link 8 is connected on an NW wire to the passenger compartment fusebox and from the fusebox to the ignition switch on an N wire.

# DESCRIPTION AND OPERATION

---

## ***Ignition switch supply***

When the ignition switch is in position II, the feed from fusible link 8 flows through the ignition switch to the passenger compartment fusebox on a W wire and passes through fuse 31.

From fuse 31 the feed passes on a GK wire to splice joint A9/A144. From the splice joint the feed is divided into three separate feeds as follows:

- A GK wire supplies power to the Air Temperature Control (ATC) ECU.
- A GR wire supplies power to the in-car temperature sensor.
- A GR wire to connector interface C0765-1/C0778-1 changes to a LGW wire to splice joint A1. From splice joint A1 the feed is connected on a LGW wire to the fresh/recirculated air mode motor. A tapping from splice joint A1 passes on a LGW wire, via splice joint B1, to the coil of the blower relay. From splice joint B1 a second LGW wire is connected to the coil of the power relay.

## **Front Air Conditioning Operation**

### ***Air temperature control ECU supply***

A feed from fusible link 3 in the engine compartment fusebox is connected on an NR wire to the passenger compartment fusebox. The feed passes through fuse 20 and is connected, via header C0725, to the Air Temperature Control ECU on a P wire.

### ***Main relay/inertia switch supply***

A feed from fuse 13 in the engine compartment fusebox is connected to the inertia switch by a NB wire. When the inertia switch is closed (not tripped), the feed continues on a WG wire to the coil of the main relay in the engine compartment fusebox. The main relay coil is then connected from the relay to the Engine Control Module (ECM) on a UR wire. When conditions are correct, the ECM provides the earth path which in turn energises the main relay, closing the contacts.

### ***Cooling fan relay supply***

A feed from fuse 5 in the engine compartment fusebox, is connected to the contacts of the cooling fan relay.

### ***Cooling fan motor operation***

When the main relay is energised, a feed passes from the relay contacts to the coil of the cooling fan relay. The cooling fan relay coil is earthed on a BP wire (Td5 engines) or a GW wire (V8 engines) to the ECM.

When conditions are correct, the ECM provides the earth path which energises the cooling fan relay coil closing the contacts. The feed from fuse 5 in the engine compartment fusebox passes through the cooling fan relay contacts and from the fusebox to the cooling fan motor on a BN wire. The feed operates the cooling fan motor which is connected to earth header C0018 on a B wire.

## ***Air conditioning compressor clutch relay supply***

A feed from fuse 6 in the engine compartment fusebox, is connected to the contacts of the air conditioning compressor clutch relay.

## ***Air conditioning compressor clutch operation***

When the main relay is energised, a feed passes from the relay contacts to the coil of the air conditioning compressor clutch relay. The compressor clutch relay coil is earthed on a BS wire to the ECM.

When conditions are correct, the ECM provides the earth path which in turn energises the compressor clutch relay coil closing the contacts. The feed from fuse 6 in the engine compartment fusebox passes through the relay contacts and from the fusebox is connected on a BG wire to the air conditioning compressor clutch. The feed operates the air conditioning compressor clutch which is connected to earth header C0018 (Td5 engines) or earth eyelet connector C0807-1 (V8 engines).

## ***Fresh/recirculated air mode motor***

The feed from fuse 31 in the passenger compartment fusebox passes on a GK wire to splice joint A9/A144. From the splice joint the feed passes on a GR wire to connector interface C0765-1/C0778-1. From the connector interface the feed passes, via splice joint A1, to the fresh/recirculated air mode motor on a LGW wire.

The fresh/recirculated air mode motor is connected to the Air Temperature Control (ATC) ECU on an RG wire to ECU pin C0793-8 and on a UB wire to ECU pin C0793-16.

## ***Blower relay***

The feed from fuse 31 in the passenger compartment fusebox passes on a GK wire to splice joint A9/A144. From the splice joint the feed passes on a GR wire to connector interface C0765-1/C0778-1. From the connector interface the feed passes, via splice joint A1, to the coil of the blower relay. The coil is connected on an N wire to pin C0793-2 of the ATC ECU.

When blower relay (R176) operation is required, the ATC ECU completes an earth path for the relay coil, energising the relay and closing the contacts. A feed from fuse 7 in the passenger compartment fusebox is connected on an NR wire to contacts of the blower relay. The feed passes through the relay contacts and is connected on a WR wire to the front blower motor. The front blower motor is connected on a B wire to the power relay and the power transistor via splice joint A10.

The contact of the blower relay is also connected on a B wire, via splice joint B9, to earth eyelet connector C0910-1. When the relay is connected to the earth, the front blower motor power feed will be removed preventing motor operation.

# DESCRIPTION AND OPERATION

---

## ***Power relay***

The coil of the power relay receives a feed from fuse 31 in the passenger compartment fusebox. The feed passes on a GK wire to splice joint A9/A144. From the splice joint the feed passes on a GR wire to connector interface C0765-1/C0778-1. From the connector interface the feed passes, via splice joint A1, to the coil of the power relay. The coil is connected to pin C0793-10 on the ATC ECU.

The power relay operates speed 31 of the blower motor. This fastest motor speed is operated by the ATC ECU granting the earth path for the power relay coil. The energised coil closes the relay contacts and allows the earth for the front blower motor to pass, via splice joint A10, through the contacts. The earth path is completed on a B wire, via splice joints A9 and B9, to earth eyelet connector C0910-1.

## ***Power transistor***

The power transistor controls speeds 1 to 30 of the front blower motor. The power transistor is controlled by the ATC ECU on a PG wire to ECU pin C0792-8 and on a G wire to ECU pin C0793-1.

Speeds 1 to 30 are controlled by the power transistor varying the resistance to the earth flow from the front blower motor. The earth path from the front blower motor is connected on a B wire, via splice joint A10, to the power transistor. The power transistor is connected on a B wire, via splice joints A9 and B9, to earth eyelet connector C0910-1.

## ***Air Temperature Control (ATC) ECU***

The ATC ECU is connected from ECU pin C0792-2 to the SLABS ECU pin C0504-3 on a KG wire via header C0290. The SLABS ECU provides a speed signal to the ATC ECU for blower speed control.

On V8 engine vehicles, the ECM is connected on a PW wire to ATC ECU pin C0793-12.

On Td5 engine vehicles, the ECM is connected on a GO wire to ATC ECU pin C0793-9.

On all vehicles, the ATC ECU is connected from pin C0791-4 on a B wire, via header C0725, to earth header C0017 LHD/C0018 RHD.

## ***Air conditioning (A/C) dual cut-off switch***

The A/C dual cut-off switch is a high/low pressure switch fitted into the A/C system. When the switch is operated, the ECM signals the ATC ECU to request the air conditioning compressor clutch relay to be de-energised.

The ATC ECU is connected from ECU pin C0793-11 on a YB wire to the A/C dual cut-off switch. The A/C dual cut-off switch is connected on a YS wire, via header C0290 (LHD only), to the ECM.

## ***In-car temperature sensor***

The in-car temperature sensor receives a feed from fuse 31 in the passenger compartment fusebox. The feed passes on a GK wire to splice joint A9/A144. From the splice joint the feed passes on a GR wire to the in-car temperature sensor and is connected to a motor which draws air over the sensor. The motor is connected on a B wire from the in-car temperature sensor, via header C0760, to earth header C0017 LHD/C0018 RHD.

A reference voltage from the ATC ECU pin C0791-8 is connected on a BW wire, via splice joint A145/A146 to the in-car temperature sensor. An input from the sensor is connected on a WB wire to the ATC ECU pin C0792-7.

## ***Ambient Air Temperature (AAT) Sensor***

A reference voltage from the ATC ECU pin C0791-8 is connected on a BW wire, via splice joint A145/A146 to the AAT sensor. An input from the sensor is connected on a YG wire to the ATC ECU pin C0792-6.

## ***Heater Coolant Temperature (HCT) Sensor***

A reference voltage from the ATC ECU pin C0791-8 is connected on a BW wire, via splice joints A145/A146, A26, B26, C26 and D26 to the HCT sensor. An input from the sensor is connected on an RB wire to the ATC ECU pin C0792-5.

## ***Evaporator sensor***

A reference voltage from the ATC ECU pin C0791-8 is connected on a BW wire, via splice joints A145/A146, A26, B26, C26 and D26 to the evaporator sensor. An input from the sensor is connected on a PB wire to the ATC ECU pin C0792-18.

## ***Sunlight sensor***

A reference voltage from the ATC ECU pin C0791-3 is connected on a GW wire, via splice joint A278, to the sunlight sensor. Two inputs from the sunlight sensor are connected on WU and WR wires to ATC ECU pins C0792-16 and C0792-17 respectively.

## ***Air Temperature mode motor – LH***

A reference voltage from the ATC ECU pin C0791-8 is connected on a BW wire, via splice joints A146/A146, A26 and B26 to the LH air temperature mode motor.

A reference voltage from the ATC ECU pin C0791-3 is connected on a GW wire to splice joint A278. From the splice joint the reference voltage continues on a GR wire, through splice joint A22 to the LH air temperature mode motor.

An input from the LH air temperature mode motor is passed to pin C0792-14 on the ATC ECU on an SU wire.

Two outputs from ATC ECU pins C0793-14 and C0793-6 are connected to the LH air temperature mode servo motor on GU and UO wires respectively. Each output drives the servo motor to blend hot or cold air.



# DESCRIPTION AND OPERATION

---

## ***Air temperature mode motor – RH***

A reference voltage from the ATC ECU pin C0791-8 is connected on a BW wire, via splice joints A145/A145, A26, B26 and C26 to the RH air temperature mode motor.

A reference voltage from the ATC ECU pin C0791-3 is connected on a GW wire to splice joint A278. From the splice joint the reference voltage continues on a GR wire, through splice joint A22 and B22 to the RH air temperature mode motor.

An input from the RH air temperature mode motor is passed to pin C0792-15 on the ATC ECU on a YG wire.

Two outputs from ATC ECU pins C0793-13 and C0793-5 are connected to the RH air temperature mode servo motor on Y and PY wires respectively. Each output drives the servo motor to blend hot or cold air.

## ***Air distribution mode motor***

A reference voltage from the ATC ECU pin C0791-8 is connected on a BW wire, via splice joints A145/A146, and A26 to the air distribution mode motor.

A reference voltage from the ATC ECU pin C0791-3 is connected on a GW wire to splice joint A278. From the splice joint the reference voltage continues on a GR wire, through splice joint A22 and B22 to the air distribution mode motor.

An input from the air distribution mode motor is passed to pin C0792-4 on a UY wire.

Two outputs from ATC ECU pins C0793-15 and C0793-7 are connected to the air distribution servo motor on US and UW wires respectively. Each output drives the servo motor to the windscreen demist or footwells position.

## **Rear Air Conditioning Operation**

### ***Rear Blower relay***

A feed from fusible link 4 in the engine compartment fusebox is connected by an NK wire to the passenger compartment fusebox. The feed passes through fuse 6 in the the passenger compartment fusebox and is connected by a YG wire to the contacts of the rear blower relay.

A feed from fuse 31 in the passenger compartment fusebox is connected on a GK wire, via header C0289 (RHD only), to connector interface C0692-4/C0856-4. From the connector interface the feed continues on a WG wire to diode (G126). From the diode the feed is connected on a U wire, through splice joint A48, to the coil of the rear blower relay.

The coil of the rear blower relay is connected on a PG wire to the rear air conditioning switch. The contacts of the rear blower relay are connected on a B wire to earth header C0707, via splice joint A52 when the relay coil is de-energised.

When the rear air conditioning switch is operated, the rear blower relay coil is energised, closing the relay contacts. This allows the feed from fusible link 4 in the engine compartment fusebox to pass through the relay to operate the rear blower motor on an NR wire.

### ***Rear air conditioning switch***

When the rear A/C switch is operated, an earth path is completed from the switch on a BR wire to the rear blower switch. The completion of the earth path energises the coil of the rear blower relay and illuminates the switch ON illumination.

The completion of the earth path is also used by the ATC ECU to sense when rear A/C has been selected on. A PG wire is connected from the rear A/C switch, via splice joint A58, to ATC ECU pin C0792-13.

From splice joint A48, the feed from fuse 31 is also connected on a U wire to connector interface C0856-3/C0692-3. From the connector interface the feed is connected to the on/off illumination of the rear air conditioning switch on a WG wire.

### ***Rear blower motor***

The rear blower motor is connected on a G wire to splice joint A44. From splice joint A44 the motor is connected on G wires to the rear blower switch and the resistor pack.

### ***Rear blower switch***

The rear blower switch is a four position switch which controls the speed of the rear blower motor through a resistor pack.

With the switch in position 1, the earth path for the rear blower motor cannot pass through the rear blower switch. The earth path is through a fusible link and three resistors in the resistor pack to earth header C0707 on a B wire. This causes the rear blower motor to operate at the slowest speed.

With the switch in position 2, the earth path for the rear blower motor is through the fusible link and two resistors in the resistor pack to the switch on an N wire. The switch is connected to earth header C0707 on a TB wire. This causes the rear blower motor to operate at the second slowest speed.

With the switch in position 3, the earth path for the rear blower motor is through the fusible link and one resistor in the resistor pack to the switch on a Y wire. The switch is connected to earth header C0707 on a B wire. This causes the rear blower motor to operate at the second fastest speed.

With the switch in position 4, the earth path for the rear blower motor is direct to the rear blower switch on a G wire, by-passing the resistor pack. This allows full power to flow through the motor which operates at its fastest speed.

# DESCRIPTION AND OPERATION

---

## **HEATER BLOWER - FRESH/RECIRCULATED AIR MOTOR (NON A/C VEHICLES)**

### **DESCRIPTION**

#### **General**

The heater blower is operated from a four position linear switch located in the centre of the fascia on the heater control panel. The blower motor only operates with the ignition switch in position II. The blower motor control switch is illuminated when the side lights are turned on.

The blower motor is located in the air inlet duct. A resistor pack is located on the air inlet duct and controls the voltage through the blower motor for fan speeds one, two and three. Fan speed four drives the blower motor at full speed with a 12 V direct supply through the motor. Position zero is the off position.

#### **Fresh/Recirculated Air Description**

The heater blower circuit also incorporates a fresh/recirculated air switch and motor. The latching fresh/recirculated air switch is located in the centre of the fascia and has an indicator light to show when the switch is in the recirculation position. The switch is illuminated when the side lights are turned on. The fresh/recirculated air motor only operates with the ignition switch in position II.

The switch is connected to the fresh/recirculated air mode motor which, when selected, moves a flap in the heater air distribution unit to prevent the intake of air from outside the vehicle. A warning lamp on the switch illuminates to show that recirculated air has been selected.

### **OPERATION**

#### **Heater Blower - Fresh/Recirculated Air Supply**

##### ***Circuit supply***

A feed from the battery positive terminal is connected by an R wire to the engine compartment fusebox, where it passes through fusible links 1, 4 and 8. Fusible links 1 and 4 are connected in series.

The feed from fusible links 1 and 4 is connected from the engine compartment fusebox to the passenger compartment fusebox on an NK wire, where it passes through fuse 7. The feed is connected from the passenger compartment fusebox to the contacts of the blower relay on an NR wire.

A feed from fusible link 8 in the engine compartment fusebox is connected on an NW wire to the passenger compartment fusebox and from the fusebox to the ignition switch on an N wire.

## ***Ignition switch supply***

When the ignition switch is in position II, the feed from fusible link 8 flows through the ignition switch to the passenger compartment fusebox on a W wire where it passes through fuse 31. From fuse 31 the feed is connected on a GK wire to splice joint A240.

From the splice joint A240 the feed is connected on a GK wire to the fresh recirculated air switch.

From the splice joint A240, the feed is also connected on a GR to splice joint A5. From the splice joint A5 the feed is connected on GR wires to the coil of the blower relay and the fresh/recirculated air mode motor.

## **Heater Blower Operation**

The speed of the front blower motor is controlled by the blower motor switch position and three resistors located in the resistor pack. The blower motor will only operate with the ignition switch in position II.

With the ignition switch in position II and the blower motor switch in position 0 (off), the earth path for the blower relay coil is not complete and the relay coil cannot energise.

When the blower motor switch is moved to position 1, 2, 3 or 4 the blower relay coil is connected to earth on an N wire to the blower motor switch. The blower motor switch is connected on a B wire, via splice joint A7, to earth eyelet connector C0910-1. This causes the blower relay coil to energise closing the relay contacts.

With the relay contacts closed, the feed from fuse 7 in the passenger compartment fusebox passes through the relay contacts to the front blower motor.

With the blower motor switch in position 1, the earth path for the motor is via the resistor pack, through the 40 Amp in-line fuse and the three resistors (0.32/0.85/1.71 ohms) which limit the power flow to earth and operate the blower motor at slow speed. The resistor pack is connected on a B wire, via splice joint A7, to earth eyelet connector C0910-1.

With the blower motor in position 2, the earth path for the motor is via the resistor pack, through the in-line fuse and two resistors (0.32 and 0.85 ohms) which limit the power flow to earth and operate the blower motor at slow/medium speed. The resistor pack is connected on a PU wire to the blower motor switch. The blower motor switch is connected on a B wire, via splice joint A7, to earth eyelet connector C0910-1.

With the blower motor switch in position 3, the earth path for the blower motor is via the resistor pack, through the in-line fuse and through one resistor (0.32 ohm) which limits the power flow to earth and operates the blower motor at medium/fast speed. The resistor pack is connected on a G wire to the blower motor switch. The blower motor switch is connected on a B wire, via splice joint A7, to earth eyelet connector C0910-1.

# DESCRIPTION AND OPERATION

---

With the blower motor switch in position 4, the earth path for the blower motor is direct to the blower motor switch on a BO wire via splice joint A1 and operates the blower motor at fast speed. The blower motor switch is connected on a B wire, via splice joint A7, to earth eyelet connector C0910-1.

## **Fresh/Recirculated Air Operation**

The fresh/recirculated air mode motor can only operate when the ignition switch is in position II. The feed from fuse 31 in the passenger compartment fusebox is connected to the fresh/recirculated air switch and the fresh/recirculated air mode motor.

### ***Fresh air position***

When the switch is in the fresh air position (latched out, indicator lamp off), the feed from fuse 31 on a GK wire cannot pass through the indicator bulb to earth due to the switch position.

The air mode motor is connected on an UB wire to the switch. When the motor reaches the end of its operation to move the fresh/recirculation air flap, an internal switch in the motor moves ready to accept a feed to move to the recirculate air position. While the motor is operating it is connected through the switch on a B wire, via headers C0725 and C0760 to earth header C0017 LHD/C0018 RHD.

### ***Recirculated air position***

When the switch is in the recirculate position (latched in, indicator lamp on) the feed from fuse 31 can pass through the indicator bulb which illuminates and flows through the switch contacts. The switch is connected on a B wire, via headers C0725 and C0760 to earth header C0017 LHD/C0018 RHD.

The air mode motor is connected on an RG wire to a diode and from the diode to the switch on an RU wire. When the motor reaches the end of its operation to move the fresh/recirculation air flap, an internal switch in the motor moves ready to accept a feed to move to the fresh air position. While the motor is operating it is connected through the switch on a B wire, via headers C0725 and C0760 to earth header C0017 LHD/C0018 RHD.

## **FUEL BURNING HEATER (FBH) - Td5 ONLY**

### **DESCRIPTION**

#### **General**

The FBH system is an optional auxiliary heating system that compensates for relatively low coolant temperatures inherent in Diesel engines. At low ambient temperatures, the FBH system heats the coolant supply to the heater matrix and maintains it at a temperature for good in-car heating performance. FBH operation is fully automatic with no driver intervention required.

The system comprises an air temperature sensor, FBH pump and the FBH unit. The FBH unit has diagnostic capabilities and can be interrogated by TestBook/T4.

### **OPERATION**

#### **FBH Supply**

##### ***Circuit supply***

A feed from the battery positive terminal is connected by an R wire to the engine compartment fusebox where it passes through fusible link 8 and fuse 9.

The feed from fusible link 8 is connected to the passenger compartment fusebox on an NW wire and from the fusebox to the ignition switch on an N wire.

##### ***Ignition switch supply***

When the ignition switch is in position II, the feed from fusible link 8 flows through the ignition switch to the passenger compartment fusebox on a Y wire and passes through fuse 27.

#### **FBH Operation**

From fuse 27, the feed passes through header C0760 to the instrument pack on an LG wire. The feed passes through the ignition/no charge warning lamp and is connected, via header C0294 LHD/C0287 RHD to the alternator by a NY wire. With the engine not running, the feed from the ignition switch passes to earth through the alternator windings and illuminates the ignition/no charge warning lamp.

When the engine is running, the voltage produced by the alternator, passes on the NY wire to header C0294 LHD/C0287 RHD extinguishing the ignition/no charge warning lamp. Simultaneously, the feed from the alternator passes on a third NY wire from the header C0294 LHD/C0287 RHD to the FBH air temperature sensor.

At temperatures below 5 degrees C (41 degrees F), the sensor contacts are closed and connect the feed from the alternator to FBH unit, on an N wire from the sensor to header C0294 and an NY wire from header C0294 to the FBH unit.

## DESCRIPTION AND OPERATION

---

A feed from fuse 9 in the engine compartment fusebox is connected on a PN wire to the FBH unit. When the FBH unit senses the voltage from the air temperature sensor, internal circuitry in the FBH unit allows the feed from fuse 9 to activate the FBH. The FBH unit is connected on a B wire to earth header C0018 LHD/C0017 RHD.

The FBH unit supplies a feed on a WU wire to the FBH pump. The feed operates the FBH pump which is connected on a B wire to earth eyelet connector C0810-1.

The FBH unit is connected on a R wire to the diagnostic socket. This allows the FBH to be interrogated by TestBook/T4 to retrieve FBH diagnostic information.

## **COOLING FAN**

### **DESCRIPTION**

#### **General**

The cooling fan is located on brackets forward of the radiator. The fan motor is operated by a cooling fan relay controlled by the Engine Control Module (ECM). The main relay supplies a feed to the coil of the cooling fan relay. A permanent feed is supplied to the coils of the main and cooling fan relays located in the engine compartment fusebox. On V8 models a coolant temperature sensor is located in the inlet manifold, on Td5 models the sensor is located in the outlet housing.

The ECM controls the operation of the main and cooling fan relays. At a preset temperature the ECM receives an input from a coolant temperature sensor above the values stored in the ECM. The ECM logic enables the earth path for the coil of the cooling fan relay. The fan motor then gets a feed from the closed contacts of the cooling fan relay.

When the engine temperature falls, the sensor gives an input below the values stored in the ECM. When the input from the coolant temperature sensor is low, the ECM interrupts the earth path to the coil of the cooling fan relay. The contacts of the cooling fan relay open, this action breaks the feed to the cooling fan motor, and the motor stops. The cycle will start again when the engine coolant temperature rises and the sensor sends a high input to the ECM.

The ECM has an engine off function, when the ignition is turned off the ECM logic goes into a watchdog routine and monitors the coolant temperature for approximately seven to ten seconds. If the coolant temperature is still high, over 100 degrees C (212 degrees F) V8, 110 degrees C (230 degrees F) Td5, the ECM logic can control the operation of the fan motor.

On V8 engines the ECM will only enable the fan if the inlet air temperature is over 60 degrees C (140 degrees F). The ECM will allow the fan to run for a maximum of ten minutes, however the ECM continues to monitor the coolant temperature. The ECM logic will stop the fan if the coolant temperature is below the acceptable values stored in the ECM. To prevent a flat battery, the fan will be stopped (regardless of coolant temperature) if the battery voltage falls to 12 V.



# DESCRIPTION AND OPERATION

---

## OPERATION

### Cooling Fan Supply

#### *Circuit supply*

A permanent feed from the battery positive terminal is connected by an R wire to the engine compartment fusebox. A feed from this wire is connected to the contacts of the main relay and also to fuse 13. The feed passes through fuse 13 and to the inertia switch on a NB wire. The feed from the inertia switch flows on a WG wire to the engine compartment fusebox and is connected to the coils of the main relay. In this condition the coil and contacts of the main relay receive a permanent supply.

The permanent feed from the battery on a R wire to the engine compartment fusebox is also connected via fusible link 1 to fuse 5. From fuse 5 the permanent feed is connected to the contacts on the cooling fan relay. In this condition the contacts of the fan relay receives a permanent feed from the battery via fuse 5.

#### *Main relay - ignition supply*

When the ignition switch is a position II, the ECM switches on the earth path for coil of the main relay. Current flows through the coil of the main relay and flows on a UR wire to pin C0635-23 V8/C0658-21 Td5 on the ECM. With the coil of the main relay energised the main relay contacts close, power is now available to the coil of the cooling fan relay, via the closed contacts of the main relay.

### Cooling Fan Operation

#### *V8 engine*

The engine coolant temperature sensor sends an input on a G wire to pin C0636-22 on the ECM. The engine coolant temperature sensor is earthed on a RB wire to pin C0636-21 on the ECM.

When the coolant temperature is high, the value of input from the coolant temperature sensor causes the ECM logic to switch on the earth path for the coil of the cooling relay, on a GW wire to pin C0636-31 on the ECM. With the coil of the cooling relay earthed the coil is now energised. The cooling relay contacts close and current flows on a BN wire to the cooling fan motor.

## ***Td5 engine***

The engine coolant temperature sensor sends an input on a KG wire to pin C0158-7 on the ECM. The engine coolant temperature sensor is earthed on a KB wire to pin C0158-18 on the ECM.

When the coolant temperature is high, the value of input from the coolant temperature sensor causes the ECM logic to switch on the earth path for the coil of the cooling relay, on a BP wire to pin C0658-4 on the ECM. With the coil of the cooling relay earthed the coil is now energised. The cooling relay contacts close and current flows on a BN wire to the cooling fan motor.

## ***All models***

The current flows through the cooling fan motor to earth header C0018 on a B wire. The cooling fan motor will operate as long as the ECM receives a high signal input from the coolant temperature sensor. When the coolant temperature is low, the ECM logic interrupts the earth path to the coil of the cooling relay. The contacts of the cooling fan relay open, the fan motor power supply is now broken and the motor stops. The cooling fan will cycle on and off as the coolant temperature rises and falls.

# DESCRIPTION AND OPERATION

---

## **HEATED REAR WINDOW (HRW)**

### **DESCRIPTION**

#### **General**

The HRW is operated from a non-latching switch located to the left of the instrument pack. The switch has an indicator light to show when the HRW is operating. The HRW element comprises fourteen metallic strips bonded to the inside surface of the rear window. The HRW will only function when the engine is running due to the high current draw and subsequent load on the battery.

The HRW can also be operated by the air temperature control ECU on vehicles fitted with air conditioning.

When the HRW is selected on, heater elements in the door mirror glass also operate. Refer to Mirrors - Description and Operation in this manual for details.

### **OPERATION**

#### **Heated Rear Window Supply**

##### ***Circuit supply***

A feed from the battery positive terminal is connected by an R wire to the engine compartment fusebox, where it passes through fusible links 1, 6, 8 and fuse 13. Fusible links 1 and 6 are connected in series.

A feed from fusible links 1 and 6 is connected from the engine compartment fusebox to the passenger compartment fusebox on an S wire, where it passes through fuse 8 and is connected to the contacts of the heated rear screen relay.

A feed from fuse 13 in the engine compartment fusebox is connected on a PN wire to the Body Control Unit (BCU).

A second feed from fuse 13 is connected on a PN wire to the passenger compartment fusebox and is connected to the coil of the heated rear screen relay.

A feed from fusible link 8 in the engine compartment fusebox is connected on an NW wire to the passenger compartment fusebox and from the fusebox to the ignition switch on an N wire.

##### ***Ignition switch supply***

When the ignition switch is in position II, the feed from fusible link 8 flows through the ignition switch to the passenger compartment fusebox on a Y wire. The feed continues through fuse 29 in the passenger compartment fusebox and is connected to the BCU on a GU wire.

## **Heated Rear Window Switch Operation**

When the HRW switch is operated, an earth path is completed from the HRW switch to earth header C0017 LHD/C0018 RHD on a B wire, via header C0760.

The completion of the earth path from the HRW switch, completes an earth path from the BCU to the switch on an NB wire. The earth path completes a circuit within the BCU for an internal electronic switch which receives its feed from fuse 29 in the passenger compartment fusebox.

The internal switch closes, completing a circuit which allows the feed from fuse 13 to flow through the internal switch, then to the HRW switch on an NP wire. The feed illuminates the HRW switch indicator light and is earthed from the switch to earth header C0017 LHD/C0018 RHD on a B wire, via header C0760.

The feed from fuse 29 is connected to a second internal switch within the BCU. When the HRW switch is operated, the completed earth path closes the internal switch. This completes an earth path from the coil of the heated rear screen relay, through the Intelligent Driver's Module (IDM) and from the passenger compartment fusebox to the BCU on an SK wire, via header C0293 LHD/C0292 RHD. This connection is the serial data bus between the IDM and the BCU.

The BCU earth is connected from the BCU to earth header C0551 on a B wire. The IDM is also connected to earth header C0551 on a B wire from the passenger compartment fusebox.

The completed earth path energises the heated rear screen relay, closing the contacts and allowing the feed from fuse 8 in the passenger compartment fusebox to flow through the contacts.

The feed flows from the passenger compartment fusebox to the rear screen heater element on an NP wire.

The rear screen heater element is connected to earth header C0706 on a B wire.< /PARA>

The momentary operation of the non-latching HRW switch, signals internal electronic switches within the BCU to close. Internal circuitry within the BCU holds the switches closed for a pre-determined period or until the HRW switch is pushed a second time.

# DESCRIPTION AND OPERATION

---

## **Air Temperature Control (ATC) ECU Operation**

On vehicles fitted with air conditioning, the HRW can be operated when 'DEF', 'feet/screen' or 'screen' is selected on the ATC control panel.

When one of the above selections is made, the ATC ECU provides a feed to the HRW switch into the NP wire from the BCU to the HRW switch. This illuminates the switch indicator light.

Simultaneously, the ATC ECU also provides an earth path into the NB wire from the BCU to the HRW switch. This earth path allows the internal electronic switches within the BCU to close, powering the rear screen heater element as described previously.

## **HEATED FRONT SCREEN (HFS)**

### **DESCRIPTION**

#### **General**

The heated front screen (HFS) is operated from a non-latching switch located to the left of the instrument pack. The switch has an indicator light to show when the HFS is operating. The HFS comprises two elements laminated in the screen, each element being controlled by a separate fuse. The HFS will only function with the engine running, due to the high current draw and subsequent load on the battery.

The HFS can also be operated by the air temperature control ECU on vehicles fitted with air conditioning.

### **OPERATION**

#### **Heated Front Screen Supply**

##### ***Circuit supply***

A feed from the battery positive terminal is connected by an R wire to the engine compartment fusebox, where it passes through fusible links 1, 7, 8 and fuse 13. Fusible links 1 and 7 are connected in series.

A feed from fusible link 1 is connected to the contacts of the heated front screen relay in the engine compartment fusebox.

A feed from fusible links 1 and 7 is connected to the contacts of the auxiliary circuits relay in the engine compartment fusebox.

A feed from fuse 13 is connected from the engine compartment fusebox to the Body Control Unit (BCU) on a PN wire.

A feed from fusible link 8 in the engine compartment fusebox is connected on an NW wire to the passenger compartment fusebox and from the fusebox to the ignition switch on an N wire.

##### ***Ignition switch supply***

When the ignition switch is in position I or II, the feed from fusible link 8 flows through the ignition switch to the passenger compartment fusebox on an LGW wire. The feed continues through fuse 26 in the passenger compartment fusebox and is connected on an LG wire to the coil of the auxiliary circuits relay in the engine compartment fusebox.

# DESCRIPTION AND OPERATION

---

In this condition, the auxiliary circuits relay coil is energised and the contacts close. The relay coil is earthed to earth header C0018 on a B wire from the engine compartment fusebox, via header C0286 LHD/C0288 RHD.

When the ignition switch is in position II, the feed from fusible link 8 flows through the ignition switch to the passenger compartment fusebox on a Y wire. The feed continues through fuse 29 in the passenger compartment fusebox and is connected to the BCU on a GU wire.

## **Heated Front Screen Operation**

When the HFS switch is operated, an earth path is completed from the HFS switch to earth header C0017 LHD/C0018 RHD on a B wire, via header C0760.

The completion of the earth path from the HFS switch, completes an earth path from the BCU to the switch on a KO wire. The earth path completes a circuit within the BCU for an internal electronic switch which receives its feed from fuse 29.

The internal switch closes, completing a circuit which allows the feed from fuse 13 to flow through the internal switch, then to the HFS switch on a PS wire. The feed illuminates the HFS switch indicator light and is earthed from the switch to earth header C0017 LHD/C0018 RHD on a B wire, via header C0760.

The feed from fuse 29 is connected to a second internal switch within the BCU. When the HFS switch is operated, the completed earth path closes the internal switch. This completes the connection from the heated screen relay coil to the BCU on a KN wire. The earth path from the BCU is on a B wire to earth header C0551.

The completed earth path energises the heated screen relay, closing the relay contacts, allowing the feed from fusible link 1 to flow through the relay contacts to fuses 7 and 8.

The feed from fuse 7 is connected to the LH front screen element on a PS wire. The LH front screen element is connected to earth header C0018 LHD/C0017 RHD on a B wire.

The feed from fuse 8 is connected to the RH front screen element on a PK wire. The RH front screen element is connected to earth header C0017 LHD/C0018 RHD on a B wire.

The momentary operation of the non-latching HFS switch, signals internal switches in the BCU to close. Electronics within the BCU holds the switches closed for a pre-determined period or until the HFS switch is pushed a second time.

## ***Air Temperature Control (ATC) ECU operation***

On vehicles fitted with air conditioning, the HFS can be operated when 'DEF', 'feet/screen' or 'screen' is selected on the ATC control panel.

When one of the above selections is made, the ATC ECU provides a feed to the HFS switch into the PS wire from the BCU to the switch. This illuminates the HFS switch indicator light.

Simultaneously, the ATC ECU also provides an earth path into the KO wire from the BCU to the HFS switch. This earth path allows the internal electronic switches within the BCU to close, powering the front screen elements as described previously.



# DESCRIPTION AND OPERATION

---

## **FRONT WIPERS AND WASHERS**

### **DESCRIPTION**

#### **General**

The front wipers and washers are operated from a switch stalk located on the right hand side of the steering column and operate with the ignition switch in positions I or II. The wipers are operated by a wiper motor located below the windscreen plenum. The washers and optional headlamp power washers are operated from electric pumps attached to the washer reservoir located in the left hand wheel arch.

The electrical wiper and washer functions are controlled by the Body Control Unit (BCU) and the Intelligent Driver's Module (IDM).

The stalk switch selects all operations of the front wipers and washers. A rotary switch on the end of the stalk selects the wipers in the off, intermittent slow and fast speeds. A rotary wiper delay switch on the stalk has five positions to select the frequency of the intermittent function. The BCU determines the resistance through the delay switch and functions the wipers at the required interval, depending on switch position.

The stalk can be pulled towards the steering wheel to select the washer function. When the washers are operated, the wipers will also operate for three full cycles. The stalk can also be pushed down to operate the flick wipe function.

On vehicles fitted with headlamp powerwash, if the headlights are on when the washer function is selected, the headlamp powerwash will also operate. The BCU will supply an earth path for the coil of the power wash relay, located in the engine compartment fusebox, for a period of 0.5 seconds from when the washer function is selected. The powerwash function only operates on alternate washer function requests.

The stalk can be moved downwards to operate the wipers. A single push downwards will operate the wiper for one full cycle at slow speed. If the switch is pushed and held, the wipers operate at fast speed until the switch is released. When the switch is released, the wipers will finish their cycle at slow speed.

## OPERATION

### Front Wipers and Washers Supply

#### *Circuit supply*

A feed from the battery positive terminal is connected on an R wire to the engine compartment fusebox, where it passes through fusible links 1, 7, 8, 10 and fuse 4. Fusible link 1 and fuse 4 and fusible links 1 and 7 are connected in series.

A feed from fusible link 1 and fuse 4 is connected to the contacts of the power wash relay located in the engine compartment fusebox (P108).

A feed from fusible links 1 and 7 is connected to the contacts of the auxiliary circuits relay located in the engine compartment fusebox.

A feed from fusible link 8 is connected from the fusebox, on an NW wire, to the passenger compartment fusebox and from the fusebox to the ignition switch on an N wire.

A feed from fusible link 10 is connected from the fusebox, on an NP wire to the lighting switch.

#### *Ignition switch supply*

With the ignition switch in position I or II, the feed from fusible link 8 passes through the ignition switch to the passenger compartment fusebox on an LGW wire, where it passes through fuse 26.

From fuse 26, the feed is connected on an LG wire to the engine compartment fusebox where it is connected to the coil of the auxiliary circuits relay.

The coil of the auxiliary circuits relay is connected from the engine compartment fusebox via header C0286 LHD/C0288 RHD, to earth header C0018 on a B wire. The feed from the ignition switch energises the auxiliary circuits relay coil, closing the relay contacts.

The closed contacts of the auxiliary circuits relay allow the feed from fusible link 7 to pass through the auxiliary circuits relay and connect from the engine compartment fusebox to the passenger compartment fusebox on a WG wire, where it passes through fuse 19. The feed is also connected to the coil of the powerwash relay in the engine compartment fusebox.

### Front Wipers and Washers Operation

The IDM is connected to pin C0661-1 of the BCU via header C0293 LHD/C0292 RHD on an SK wire. This connection is the serial data bus between the IDM and BCU.

# DESCRIPTION AND OPERATION

---

## ***Slow speed operation***

Operation of the front screen wash/wipe switch to the slow wipe position, connects the feed from fuse 19 in the passenger compartment fusebox to the front screen wash/wipe switch on a GS wire, via header C0292.

The feed passes through the slow wipe switch contacts and is connected to the windscreen wiper motor on an RLG wire. The windscreen wiper motor is connected to earth header C0017, via header C0288 on a B wire. The feed is connected to the slow speed brushes within the motor and operates the motor at slow speed.

## ***Fast speed operation***

Operation of the front screen wash/wipe switch to the fast wipe position, connects the feed from fuse 19 in the passenger compartment fusebox to the front screen wash/wipe switch on a GS wire, via header C0292.

The feed passes through the fast wipe switch contacts and is connected to the windscreen wiper motor on a ULG wire. The windscreen wiper motor is connected to earth header C0017, via header C0288 on a B wire. The feed is connected to the fast speed brushes within the motor and operates the motor at fast speed.

## ***Intermittent operation***

Operation of the front screen wash/wipe switch to the intermittent position allows a feed from fuse 19 to pass on a GS wire, through header C0292, to the wash/wipe switch. The feed passes through the switch contacts and is connected on an LGG wire to pin C0660-21 on the BCU. The BCU interprets the signal as an intermittent wiper request and signals the IDM via the serial data bus.

The feed from fuse 19 is also connected from the header C0292 on a GS wire to the wiper motor, where it passes through the park switch. The feed is connected from the wiper motor on a WLG wire to the passenger compartment fusebox.

The feed passes through the front wiper relay contacts and is connected from the fusebox on an LGP wire to the wash/wipe switch. The feed passes through the switch contacts and is connected from the switch on an RLG wire to the wiper motor. This operates the wiper motor moving it from the park position.

Simultaneously, the feed from fuse 19, via header C0292 and the wiper motor park switch, is also connected to the coil of the front wiper relay. The IDM grants an earth for the relay coil moving the contacts. This allows a direct feed from fuse 19 to pass through the relay and is connected from the fusebox on an LGP wire to the wash/wipe switch.

The feed passes through the switch contacts and is connected from the switch on an RLG wire to the wiper motor. When the wiper motor reaches the park position, the park switch moves to power the wipers to their park position. The IDM removes the earth for the relay coil preventing further wiper operation.

The BCU pin C0660-21 is connected on a WLG wire to the wiper delay switch, which is connected on a B wire to earth header C0551. The BCU provides an output voltage which it uses to measure the resistance through the delay switch.

The resistance determines the delay required and the BCU transmits a signal, via the serial data bus to the IDM, for the front wiper relay to be operated.

### ***Flick wipe operation***

When the switch stalk is momentarily pushed downwards and released, a feed from fuse 19 is connected on a GS wire to header C0292. From the header the feed is connected on a GS wire to the wash/wipe switch. From the switch the feed is connected on a ULG wire to fast speed brushes in the motor.

This momentary feed to the motor is enough to move the motor, moving the park switch from the park position. When the stalk switch is released, the feed from the wash/wipe switch is removed.

The motor is now powered by a feed from fuse 19, via header C0292, on a GS wire to the motor. The feed passes through the park switch and is connected from the motor on a WLG wire to the front wiper relay.

The feed passes through the wiper relay and is connected from the fusebox on an LGP wire to the wash/wipe switch, through the switch contacts and is connected from the switch on an RLG wire to the wiper motor slow speed brushes. The motor operates at slow speed. When the wiper motor reaches the park position the park switch moves, removing the feed from fuse 19 and the motor stops.

If the switch stalk is pushed downwards and held, the feed from fuse 19 is passed directly from the switch to the motor fast speed brushes causing the motor to operate at fast speed for as long as the switch is held. When the switch is released, the motor completes its cycle to the park position powered through the park switch to the motor slow speed brushes causing the motor to operate at slow speed.

# DESCRIPTION AND OPERATION

---

## ***Washer operation***

When the switch stalk is pulled, a feed from fuse 19 is connected on a GS wire, via header C0292, to the wash/wipe switch. The feed passes through the washer switch contacts and is connected from the switch on an LGO wire, through header C0289, to the washer pump and the BCU pin C0661-11. The feed operates the washer pump motor which is connected on a B wire to earth eyelet connector C0564-1.

The feed to the BCU is interpreted by the BCU as a wash/wipe request. If the washer switch is held for longer than 0.4 seconds the BCU signals the IDM through the serial data bus to energise the front wiper relay. A feed from fuse 19 passes through the relay and is connected from the fusebox on a LGP wire to the wash/wipe switch.

The feed passes through the switch and is connected on an RLG wire to the motor slow speed brushes. The IDM energises the front wiper relay for 4 seconds allowing the screen to be cleared. After 4 seconds the IDM removes the earth path for the relay coil, causing the wipers to return to the park position.

## ***Powerwash operation***

When the headlamps are turned on, a feed from fusible link 10 passes from the engine compartment fusebox on an NP wire to the lighting switch. The feed passes through the switch and is connected on a UR wire to the IDM. The IDM senses that the headlamps are on and signals the BCU via the serial data bus.

When washer operation is requested, the BCU grants an earth path for the powerwash relay in the engine compartment fusebox. The earth path is on an LG wire from the fusebox to pin C0662-12 on the BCU. The relay coil is energised by the feed from the auxiliary circuits relay allowing the feed from fuse 4 to pass through the relay contacts.

The feed is connected from the fusebox on an LGR wire to the powerwash pump. The powerwash pump is connected on a B wire to earth eyelet connector C0564-1. The BCU only energises the powerwash relay coil for 0.5 seconds on every alternate washer request.

## **REAR WIPERS AND WASHERS**

### **DESCRIPTION**

#### **General**

The rear wiper is operated from a latching push button switch located on the right hand side of the instrument pack. The rear wash/wipe is operated from a non-latching push button switch also located on the right hand side of the instrument pack. The rear wiper park facility operates with the ignition switch in positions I or II. The rear wiper and washer only operates with the ignition switch in position II.

The rear wiper and washer functions are controlled by the Body Control Unit (BCU) and the Intelligent Driver's Module (IDM).

The rear wiper is operated by an electric motor located in the tail door. The rear washer is operated by an electric pump located on the reservoir in the left hand front wheel arch.

Operation of the rear wiper switch causes the wiper to complete two full cycles. The wiper then operates intermittently until selected off. The frequency of the intermittent operation is controlled by the front wiper delay switch on the column stalk. The intermittent delay is twice that of the front delay selected. The BCU determines the resistance through the delay switch and functions the rear wiper at the required interval, depending on the front wiper delay switch position.

Operation of the rear washer switch causes the washer motor to operate for as long as the switch is operated. The wiper will also operate while the switch is depressed and will operate for a further 4 seconds after the switch is released.

If the front wipers are selected on and reverse gear is engaged, the rear wiper will operate continuously until reverse gear is disengaged.

If the front wipers are selected on intermittent and reverse gear is engaged, the rear wiper will wipe continuously for 4 seconds. It will then change to intermittent operation but the delay will be the same as that for front wipers. When reverse gear is disengaged, the rear wiper will stop at the park position.

# DESCRIPTION AND OPERATION

---

## OPERATION

### **Rear Wiper and Washers Supply**

#### ***Circuit supply***

A feed from the battery positive terminal is connected on an R wire to the engine compartment fusebox, where it passes through fusible links 1, 7 and 8. Fusible links 1 and 7 are connected in series.

A feed from fusible links 1 and 7 is connected to the contacts of the auxiliary circuits relay located in the engine compartment fusebox.

A feed from fusible link 8 is connected from the fusebox, on an NW wire, to the passenger compartment fusebox and from the fusebox to the ignition switch on an N wire.

#### ***Ignition switch supply***

With the ignition switch in position I, the feed from fusible link 8 passes through the ignition switch to the passenger compartment fusebox (P101) on an LGW wire, where it passes through fuse 26. From fuse 26, the feed passes to the engine compartment fusebox on an LG wire where it connects to the coil of the auxiliary circuits relay.

The coil of the auxiliary circuits relay is connected from the engine compartment fusebox on a B wire to earth header C0018, via header C0286 LHD/C0288 RHD. The feed from the ignition switch energises the auxiliary circuits relay coil, closing the relay contacts.

The feed from fusible links 1 and 7 passes through the closed contacts of the auxiliary circuits relay. The feed is connected from the relay on a WG wire from the engine compartment fusebox to the passenger compartment fusebox, where it passes through fuse 18.

From fuse 18 the feed is connected to the contacts of the rear wiper relay and to the rear screen wiper motor on a GLG wire. The feed to the motor supplies power through the park switch to allow the wiper to move to the park position. The rear screen wiper motor is connected on a B wire to earth header C0706, via splice joints A39/A109.

With the ignition switch in position II, the feed from fusible link 8 passes through the ignition switch to the passenger compartment fusebox on an W wire, where it passes through fuse 30. From fuse 30 the feed is connected on a GLG wire, via splice joint A128, to the rear screen washer switch.

A second feed from the ignition switch is connected on a Y wire to the passenger compartment fusebox where it passes through fuse 25. From fuse 25 the feed is connected on a GY wire to the reverse lamp switch (manual transmission) or the starter inhibitor/reverse lamp switch (automatic transmission).

The reverse lamp switch is connected is connected on a GN wire, via header C0287 LHD/ C0294 RHD, to pin C0661-8 on the BCU. When the reverse lamp switch is operated, the feed from fuse 25 passes through the switch to the BCU which uses the signal to function the rear wiper accordingly.

## **Rear Wipers and Washers Operation**

The IDM is connected to pin C0661-1 of the BCU via header C0293 LHD/ C0292 RHD on an SK wire. This connection is the serial data bus between the IDM and the BCU.

### ***Wiper operation***

When the rear wiper switch is operated an earth path is completed on an OB wire from pin C0662-3 of the BCU to the switch, and a B wire from the switch to earth header C0018 via header C0760. The completed earth path provides a signal to the BCU that rear wiper operation has been requested.

The BCU sends a signal through the serial data bus to the IDM to commence wiper operation. The IDM provides a power supply and earth for the coil of the rear wiper relay in the passenger compartment fusebox, which energises closing the relay contacts.

With the relay contacts closed, a feed from fuse 18 passes through the relay and is connected on an NG wire to the park switch in the wiper motor. This feed initially operates the motor until the park switch contact is broken. On each revolution, the motor is moved from the park position by the feed from the park switch. When the park switch contact moves the feed from the relay is disconnected and the motor completes the cycle on a feed from fuse 18 on a GLG wire to the motor.

When the rear wiper switch is moved to the off position, the earth path to the BCU is removed. The BCU sends a signal through the serial data bus to the IDM which removes the power and earth for the rear wiper relay coil. The feed through the relay to the park switch is removed causing the motor to stop when it reaches the end of its cycle.

### ***Intermittent operation***

The BCU operates the rear wiper continuously for 4 seconds, after which the wiper operates at a delay interval set by the position of the wiper delay switch on the column stalk.

The delay switch is connected on a WLG wire to pin C0661-21 on the BCU and on a B wire to earth header C0551. The BCU provides an output voltage which it uses to measure the resistance through the delay switch. The resistance determines the delay required and the BCU transmits a signal, via the serial data bus to the IDM, for the rear wiper relay to be operated.



# DESCRIPTION AND OPERATION

---

## ***Washer operation***

When the rear screen washer switch is operated, a feed from fuse 30 in the passenger compartment fusebox is connected on a GLG wire to the switch. The feed passes through the switch contacts and is connected on an LGS wire, via header C0293, to the rear screen washer pump. The pump is connected on a B wire to earth eyelet connector C0564-1. The feed is also connected from the header C0293 on an LGS wire to pin C0660-20 on the BCU.

The pump operates for as long as the switch is pushed. The connection to the BCU signals that rear washer operation has been requested. The BCU signals the IDM to energise the rear wiper relay to operate the rear wiper 0.5 seconds after the request has been made.

## ***Reverse wipe operation***

When reverse gear is selected, a feed from fuse 25 in the passenger compartment fusebox is connected on a GY wire to the reverse lamp switch (manual transmission) or the starter/inhibitor/ reverse lamp switch (automatic transmission).

The feed passes through the switch contacts and is connected on a GN wire, via header C0287 LHD/C0294 RHD, to pin C0661-8 on the BCU. The BCU interprets the signal and signals the IDM via the serial data bus to energise the rear wiper relay. The operation of the rear wiper is dependant on front wiper selection as described in Description.

## **BRAKE/REVERSE LAMPS**

### **DESCRIPTION**

#### **Brake Lamp Description**

The brake lamps are operated by a switch mounted on the pedal box. The switch, when operated, supplies power to two brake lights located in the tail lamp units and a high mounted brake light. All brake light bulbs are rated at 21 Watts. A feed is provided to the trailer pick-up (if fitted) when the brake switch is operated. When the brake light switch is in the open position feeds are routed through the switch contacts to give:

Automatic V8 vehicles: A feed to the cruise control ECU for cruise control operation.

Manual V8 vehicles: A feed to the clutch pedal switch for cruise control operation.

Td5 vehicles: A feed to the Engine Control Module (ECM) for cruise control operation.

#### **Reverse Lamp Description**

The reverse lamps are operated by a switch located in the vehicle gearbox. The switch, when operated, supplies power to two reverse lamps located in the tail lamp units. The reverse lamp bulbs are rated at 21 Watts. When the reverse lamp switch is operated an input is also provided to:

- The Body Control Unit (BCU) for rear wiper operation.
- The interior mirror for selection of normal mirror position.
- The trailer pick-up (if fitted).

Automatic vehicles have a dual function starter inhibitor and reverse light switch. The inhibitor function prevents the engine from cranking if reverse gear is selected.

### **OPERATION**

#### **Brake/Reverse Lamp Supply**

##### ***Circuit supply***

A feed from the battery positive terminal is connected by an R wire to the engine compartment fusebox where it passes through fusible link 8.

##### ***Ignition switch supply***

In the engine compartment fusebox, a feed from fusible link 8 is connected to the passenger compartment fusebox by an NW wire. The feed passes through the fusebox and is connected to the ignition switch by an N wire.

When the ignition is switched on to position II, a feed from the ignition switch is connected to the passenger compartment fusebox by a Y wire and passes through fuse 25.

# DESCRIPTION AND OPERATION

---

## **Brake Lamp Operation**

A feed from fuse 25 in the passenger compartment fusebox is connected by a GO wire to the brake pedal switch.

When the brake pedal switch is operated, the switch contact closes and allows current to flow on a GP wire, from the switch, through header joints C0287 LHD/C0290 RHD and C0295. From header C0295 a connection on a GP wire allows current flow to the LH brake lamp. Another connection from header C0295 on a GP wire, goes through header C0723 and allows current flow to the RH tail lamp. A second connection from header C0723 on a GP wire, allows current flow to the high mounted brake lamp.

A third connection from earth header C0723 is connected to the trailer pick-up (if fitted) on a GP wire. The trailer pick-up is earthed on a B wire to earth point C0808.

The LH brake lamp is earthed on a B wire to an earth header C0707. The RH brake lamp is earthed on a B wire to an earth header C0706. The high mounted brake lamp is earthed on a B wire to earth header C0706.

When the contacts of the brake pedal switch are open the connection from fuse 25 in the passenger compartment fuse box supplies:

Automatic V8 vehicles: A feed on a PG wire to the cruise control ECU.

Manual V8 vehicles: A feed on a OG wire to the clutch pedal switch.

Td5 vehicles: A feed on an OG wire to the ECM for cruise control operation.

## **Reverse Lamp Operation**

### ***Manual transmission***

A feed from fuse 25 is connected by a GY wire to the reverse lamp switch.

### ***Automatic transmission***

A feed from fuse 25 is connected by a GY wire to the automatic transmission starter inhibitor/reverse light switch.

### ***All models***

When the reverse lamp switch is operated, the switch contact closes and allows current flow on a GN wire, from the switch, through two headers C0287 LHD/C0294 RHD and C0295, to the RH reverse lamp and the LH reverse lamp. The LH reverse lamp is earthed on a B wire to earth header C0707. The RH reverse lamp is earthed on a B wire to earth header C0706.

# DESCRIPTION AND OPERATION

---

When the reverse lamps are on, a splice joint A13 between headers C0287 LHD/C0294 RHD and C0295, gives a feed on a GN wire to the interior mirror.

The feed supplied to the interior mirror will change the interior mirror to the undipped condition, if the interior mirror is dipped. The interior mirror will remain in the undipped condition as long as a feed is supplied. This feature ensures that the interior mirror is in the undipped condition when reverse gear is selected.

A GN wire from header C0287 LHD/C0294 RHD is connected to the BCU. When the reverse lamp switch is operated, this feed is used by the BCU logic circuits to enable rear wiper operation.

# DESCRIPTION AND OPERATION

---

## **HEADLAMP LEVELLING**

### **DESCRIPTION**

#### **General**

The headlamp levelling is operated from a four position switch located on the fascia. The switch operates a motor located in each headlamp unit which moves the headlamp position to allow for changes in vehicle attitude due to load or passenger distribution.

The headlamp levelling operates when the side lamps or headlamps are on and is independent of the ignition switch position.

### **OPERATION**

#### **Headlamp Levelling Supply**

##### ***Circuit supply***

A feed from the battery positive terminal is connected by an R wire to the engine compartment fusebox, where it passes through fusible link 13.

When the lighting switch is in the side lamp or headlamp position, the feed from fusible link 13 flows to the lighting switch on an NG wire. The feed flows through the lighting switch contacts and is connected to the passenger compartment fusebox on an R wire, where it passes through fuses 11 and 33.

##### ***Headlamp levelling motor supply***

Fuse 11 supplies a feed to header C0288 LHD/C0286 RHD on an RB wire. Fuse 33 supplies a feed to the headlamp levelling switch on an RO wire, via header C0759.

From the header C0288 LHD/C0286 RHD, the feed is connected to the LH headlamp levelling motor on an RB wire. The earth path from the LH headlamp levelling motor is on a B wire to earth point C0564.

A second feed is connected to the RH headlamp levelling motor on a RB wire from the header C0288 LHD/C0286 RHD. The earth path from the RH headlamp levelling motor is on a B wire to earth header C0018.

## Headlamp Levelling Operation

At each of the four headlamp levelling switch positions, the contacts in the switch connect through resistors with differing values, which in turn provide four differing output voltages.

The output from the headlamp levelling switch is on a UY wire to header C0293 LHD/C0289 RHD. The output is connected from header C0293 LHD/C0289 RHD on UY wires to both headlamp levelling motors. The headlamp levelling switch is connected on a B wire, via header C0760, to earth header C0018.

The difference in the voltage output from the headlamp levelling switch and the battery voltage is compared by a potentiometer in the LH/RH headlamp levelling motors. When the headlamp levelling switch is moved, the differing voltage causes the motor to operate until the potentiometer output equals the switch output. The motors stop and set the headlamps to a position which corresponds to the headlamp levelling switch position.

The input voltage to the headlamp levelling switch passes through the following resistors depending on switch position as follows:

Position 0 = 120 Ohm (R5) and 390 Ohm (R6)

Position 1 = 120 Ohm (R5), 20 Ohm (R4) and 390 Ohm (R6)

Position 2 = 120 Ohm (R5), 20 Ohm (R4), 100 Ohm (R3) and 390 Ohm (R6)

Position 3 = 120 Ohm (R5), 20 Ohm (R4), 100 Ohm (R3), 75 Ohm (R2) and 390 Ohm (R6).

# DESCRIPTION AND OPERATION

---

## **LIGHTS ON ALARM**

### **DESCRIPTION**

#### **General**

The lights on alarm in the instrument pack operates when the driver's door is open and the side lamps are on. The system uses inputs from:

- The driver's door switch
- The lighting switch

A serial data bus allows communication between the the Body Control Unit (BCU), the Intelligent Driver's Module (IDM) and the instrument pack.

### **OPERATION**

#### **Lights On Alarm Supply**

##### ***Circuit supply***

A feed from the battery positive terminal is connected on an R wire to the engine compartment fusebox where it is connected to fusible links 8 and 12 and fuse 13.

A feed from fusible link 12 is connected on an NG wire to the lighting switch.

A feed from fuse 13 is connected on a PN wire to pin C0660-13 on the BCU. A BCU system earth is provided by a B wire connected to earth header C0551.

A feed from fusible link 8 is connected on an NW wire to the passenger compartment fusebox and from the fusebox to the ignition switch on an N wire.

##### ***Ignition switch supply***

With the ignition switch in position II, the feed from fusible link 8 flows through the ignition switch to the passenger compartment fusebox on a Y wire. The feed continues through fuse 29 in the passenger compartment fusebox and is connected to pin C0660-1 on the BCU by a GU wire.

#### **Lights On Alarm Operation**

When the lighting switch is moved to the side lamp or the headlamp position, the feed from fusible link 12 passes through the lighting switch contacts and is connected to the passenger compartment fusebox on an R wire.

The feed passes to the Intelligent Driver's Module (IDM), which is integral with the passenger compartment fusebox. This feed is used as a 'side lights on' signal by the logic circuits in the IDM and BCU.

## DESCRIPTION AND OPERATION

---

The IDM is connected on the serial data bus link to pin C0661-1 on the BCU, and to the instrument pack via header C0293 LHD/C0292 RHD by an SK wire. When the driver's door is opened, the door switch contacts close, current flows from fuse 13 on a PN wire to pin C0660-13 on the BCU. From pin C0660-17 on the BCU the current flows on a PW wire via header C0287 LHD/C0285 RHD to the closed contacts of the drivers door switch. From the closed contacts of the drivers door switch the current flows on a B wire through splice joint A34 to earth header C0017 LHD/C0018 RHD (also via header C0288 on LH drive vehicles).

The current flow from fuse 13 is used by the logic signals of the BCU to generate a door open output. The BCU communicates along the serial data bus with the IDM and the Instrument pack.

The two 'door open' and 'lights on' signals generate the appropriate 'lights on' alarm output to the instrument pack. The sounder in the instrument pack emits the lights on signal, and is earthed via the instrument pack.

For the system logic to generate a lights on alarm signal both the 'door open' and 'lights on' inputs must be present. If the light switch is turned off, the 'sidelights on' signal is removed. With the loss of the input to the system the lights on alarm signal is cancelled by the logic circuits. If the door is closed when the side lights are on, the logic circuits will also cancel the lights on alarm signal.



# DESCRIPTION AND OPERATION

---

## **HEAD/SIDE AND NUMBER PLATE LAMPS**

### **DESCRIPTION**

#### **General**

The side lamps, headlamps and number plate lamp are all controlled from a rotary lighting switch located on the column indicator lever. The side lamps and headlamps receive a permanent supply from the battery and operate independently of the ignition switch.

Two front headlamps contain the side lamp, dip and main beam bulbs. The side lamp bulbs are rated at 5 Watts. The dip beam bulbs are rated at 55 Watts and the main beam bulbs are rated at 60 Watts. A front side marker lamp is located in the outer part of each front indicator lense. Each side marker lamp is operated by one 2.2 Watt bulb.

A tail lamp and rear side marker lamp are located in a cluster on the outer panel of each 'E' post. Each lamp cluster contains a tail lamp bulb and a side marker lamp bulb, both rated at 5 Watts.

A number plate lamp is located in the tail door handle and contains one bulb rated at 5 Watts.

### **OPERATION**

#### **Head/Side and Number Plate Lamps Supply**

##### ***Circuit supply***

A feed from the battery positive terminal is connected by an R wire to the engine compartment fusebox, where it passes through fusible links 10, 12 and fuse 13.

A feed from fusible link 12 is connected from the engine compartment fusebox to the side lamp feed pin of the lighting switch on an NG wire.

A feed from fusible link 10 is connected from the engine compartment fusebox to the headlamp feed pin of the lighting switch on an NP wire.

A second feed from fusible link 10 in the engine compartment fusebox is connected to the passenger compartment fusebox on an U wire. The feed passes through fuse 5 in the passenger compartment fusebox and is connected to the contacts of the daylight running relay (if fitted).

A feed from fuse 13 in the engine compartment fusebox is connected to the passenger compartment fusebox on a PN wire. This feed supplies power to the coil of the daylight running relay (if fitted) and the Intelligent Driver's Module (IDM) which is integral with the passenger compartment fusebox.

## **Side and Number Plate Lamps Operation**

When the lighting switch is moved to the side lamps position, the feed from fusible link 12 in the engine compartment fusebox, passes through the switch contacts. The feed is connected on an R wire to the passenger compartment fusebox, where it passes through fuses 11 and 33.

When the lighting switch is moved to the headlamp position, the feed from fusible link 12 to the front and rear side lamps is maintained.

### ***LH side, tail, side marker and number plate lamps***

The feed from fuse 11 is connected from the passenger compartment fusebox to header C0288 LHD/C0286 RHD on an RB wire.

### ***LH front side lamp***

From the header C0288 LHD/C0286 RHD, a feed is connected on an RB wire to the LH front side lamp. The earth path from the LH front side lamp is on a B wire, via splice joint SJ2 to earth eyelet connector C0564-1.

### ***LH tail and rear side marker lamps***

A feed is taken from header C0288 LHD/C0286 RHD on an RB wire to header C0295. The feed continues from header C0295 on an RB wire to the LH tail lamp and the LH rear side marker lamp. The earth path from the LH tail lamp and the LH side marker lamp is on a B wire to earth header C0707.

### ***LH front side marker lamp***

A feed from header C0288 LHD/C0286 RHD is connected on an RB wire to the LH front side marker lamp. The earth path from the LH front side marker lamp is on a B wire, via header C0288 LHD/C1001 RHD, to earth header C0017 LHD or earth eyelet connector C0564-1 RHD.

### ***Number plate lamp***

A feed from header C0295 is connected on an RB wire to the number plate lamp. The earth path from the number plate lamp is on a B wire to earth header C0706.

### ***Trailer pick-up LH***

A LH tail lamp feed from header C0295 is connected on an RB wire to connector interface C1481/C1482, and from the connector interface to the trailer pick-up on a B wire. The earth path for the trailer pick-up is on B wire to earth eyelet connector C0808-1.

### ***RH side, tail and side marker lamps***

The feed from fuse 33 is connected from the passenger compartment fusebox to header C0289 LHD/C0290 RHD on an RO wire.

# DESCRIPTION AND OPERATION

---

## ***RH front side lamp***

From the header C0289 LHD/C0290 RHD, a feed is connected on an RO wire to the RH front side lamp. The earth path from the RH front side lamp is on a B wire, via splice joint SJ3 to earth eyelet connector C0559-1.

## ***RH tail and rear side marker lamps***

A feed is taken from header C0289 LHD/C0290 RHD on an RO wire to header C0723. The feed continues from header C0723 on a RO wire to the RH tail lamp and the RH rear side marker lamp. The earth path from the RH tail lamp and the RH rear side marker lamp is on a B wire to earth header C0706.

## ***RH front side marker lamp***

A feed from header C0289 LHD/C0290 RHD is connected on an RO wire to the RH front side marker lamp. The earth path from the RH front side marker lamp is on a B wire, via header C1001, to earth eyelet connector C0558-1.

## ***Trailer pick-up RH***

A RH tail lamp feed is taken from header C0289 LHD/C0290 RHD on an RO wire to header C0723. The feed continues from header C0723 on an RO wire to connector interface C1481/C1482, and from the connector interface to the trailer pick-up on an N wire. The earth path for the trailer pick-up is on B wire to earth eyelet connector C0808-1.

## **Headlamps - Dip Beam Operation**

When the lighting switch is moved to the headlamp position, the feed from fusible link 10 in the engine compartment fusebox passes through the switch contacts. The feed is connected on a UR wire to the passenger compartment fusebox, where it passes through fuses 9 and 10.

## ***LH headlamp***

The feed from fuse 9 is connected on a UK wire from the passenger compartment fusebox to the LH headlamp and illuminates the LH dip beam bulb. The earth path from the LH headlamp is connected on a B wire to earth eyelet connector C0564-1.

## ***RH headlamp***

The feed from fuse 10 is connected on a UB wire from the passenger compartment fusebox to the RH headlamp and illuminates the RH dip beam bulb. The earth path from the RH headlamp is connected on a B wire to earth eyelet connector C0559-1.

## **Headlamps - Main Beam Operation**

When the lighting switch is moved to the flash or main position, the feed from fusible link 10 in the engine compartment fusebox, passes through the switch contacts. The feed is connected on a UW wire to the passenger compartment fusebox, where it passes through fuses 3 and 22.

The IDM senses the headlamp main beam request and through internal circuitry, provides a feed, on a US wire, to the main beam warning lamp in the instrument pack. The main beam warning lamp is connected from the instrument pack to earth on a B wire to earth header C0551.

### ***LH headlamp***

The feed from fuse 3 is connected on a US wire from the passenger compartment fusebox to the LH headlamp and illuminates the LH main beam bulb. The earth path from the LH headlamp is connected on a B wire to earth eyelet connector C0564-1.

### ***RH headlamp***

The feed from fuse 22 is connected on a UO wire from the passenger compartment fusebox to the RH headlamp and illuminates the RH main beam bulb. The earth path from the RH headlamp is connected on a B wire to earth eyelet connector C0559-1.

## **Daylight Running Lamps Supply**

The feed from fuse 13 in the engine compartment fusebox is connected to the coil of the daylight running relay and the IDM integral with the passenger compartment fusebox.

When the engine is started, the IDM senses, through internal circuitry, that the engine is running and provides an earth for the daylight running relay coil. The energised coil closes the contacts of the daylight running relay allowing the feed from fuse 5 in the passenger compartment fusebox to pass through the relay contacts.

## **Daylight Running Lamps Operation**

### ***Canadian vehicles***

The feed from the daylight running relay contacts flows from the passenger compartment fusebox and is connected to a 0.75 Ohm in-line resistor on an RU wire. The feed from the in-line resistor is reduced to 6.7 V and reconnected to the passenger compartment fusebox on a UY wire. The feed is connected to fuses 3 and 22 in the passenger compartment fusebox, where it operates both headlamp main beam bulbs at reduced power.

### ***Scandinavian vehicles***

The feed from the daylight running relay contacts flows from and back to the passenger compartment fusebox on a UY wire. The feed is connected to fuses 9 and 10 in the passenger compartment fusebox, where it operates both headlamp dip beam bulbs.

# DESCRIPTION AND OPERATION

---

## **FRONT FOG LAMPS**

### **DESCRIPTION**

#### **General**

The front fog lamps are controlled by a non-latching switch located on the left hand side of the instrument pack. Two front fog lamps are located below the front bumper. Front fog lamp operation is monitored by the Body Control Unit (BCU) which only allows the front fog lamps to operate when the side lamps or headlamps are on.

When the side lamps, headlamps or ignition is turned off, the front fog lamps are extinguished. When the side or headlamps are switched on again, the front fog lamps will not operate until reselected using the switch. If the rear fog guard lamps are switched on, switching off the front fog lamps will also switch off the rear fog guard lamps.

The front fog lamp switch is illuminated when the side lights are switched on. Each front fog lamp bulb is rated at 21 Watts.

### **OPERATION**

#### **Front Fog Lamps Supply**

##### ***Circuit supply***

A feed from the battery positive terminal is connected by an R wire to the engine compartment fusebox, where it passes through fusible links 1, 7, 8 and 13 and fuses 3 and 13. Fusible links 1 and 7 and fusible link 1 and fuse 3 are connected in series.

A feed from fusible link 13 is connected by an NG wire to the lighting switch.

A feed from fuse 3 is connected to the front fog lamp relay in the engine compartment fusebox. A feed from fusible link 7 is connected to the auxiliary circuits relay in the engine compartment fusebox.

A feed from fuse 13 is connected by a PN wire to the passenger compartment fusebox. This feed is connected to the Intelligent Driver Module (IDM) which is integral with the passenger compartment fusebox.

A feed from fusible link 8 is connected on an NW wire to the passenger compartment fusebox and from the fusebox to the ignition switch on an N wire.

## ***Ignition switch supply***

With the ignition switch in position I, the feed from fusible link 8 flows through the ignition switch to the passenger compartment fusebox on a LGW wire. The feed continues through fuse 26 in the passenger compartment fusebox and is connected by an LG wire to the engine compartment fusebox and the coil of the auxiliary circuits relay. The auxiliary circuits relay coil is connected to earth header C0018, via header C0286 LHD/C0288 RHD on a B wire.

In this condition, the auxiliary circuits relay is energised and the contacts close, allowing the feed from fusible link 7 to pass through the closed contacts to the coil of the front fog lamp relay.

With the ignition switch in position II, a second feed from fusible link 8 flows from the ignition switch to the passenger compartment fusebox on a Y wire. The feed continues through fuse 29 in the passenger compartment fusebox and is connected to the IDM.

In this condition, one of two electronic switches in the IDM closes. The earth path from the IDM is connected from the passenger compartment fusebox to earth header C0551 on a B wire.

## **Lighting Switch Operation**

When the lighting switch is moved to the side lamp or headlamp position, the feed from fusible link 13 passes through the switch contacts, and is connected from the lighting switch to the passenger compartment fusebox on an R wire. The feed is connected to the IDM, causing the second of the two electronic switches to close.

## **Body Control Unit Operation**

The feed from fuse 13 passes through the two closed IDM switches and is connected by an SK wire to BCU pin C0661-1, via header C0293 LHD/ C0292 RHD. This connection is the serial data bus between the BCU and the IDM.

The BCU is connected to earth header C0551 from pin C0660-11 on a B wire and from pin C0664-5 on a B wire to earth header C0018 LHD/C0017 RHD.

# DESCRIPTION AND OPERATION

---

## **Front Fog Lamps Operation**

When the front fog lamp switch is operated, an earth path is completed from the BCU pin C0660-7 to the switch on a KB wire. The earth path continues through the switch contacts and is connected to earth header C0017 LHD/C0018 RHD on a B wire, via header C0760.

The completion of the earth path signals the BCU to provide an earth path from the coil of the front fog lamp relay in the engine compartment fusebox to the BCU pin C0663-4 on a UY wire.

The energised coil closes the contacts in the front fog lamp relay. This allows the feed from fuse 3 to pass through the relay contacts and from the engine compartment fusebox to header C0293 on a UP wire.

From the header C0293, the feed is connected on a UP wire to the RH front fog lamp, which is connected to earth header C0018 by a B wire.

A second feed from the header C0293 is connected on a UP wire to the LH front fog lamp, which is connected to earth point C0564 by a B wire.

## **Switch indicator lamp operation**

A third feed from header C0293 is connected to the front fog lamp switch on a UP wire. The feed passes through the front fog lamp switch indicator lamp which illuminates. The indicator lamp is earthed from the front fog lamp switch to earth header C0017 LHD/C0018 RHD, via header C0760 on a B wire.

## **REAR FOG GUARD LAMPS**

### **DESCRIPTION**

#### **General**

The rear fog guard lamps are controlled by a non-latching switch located on the left side of the instrument pack. The lamps are located in the rear bumper, adjacent to the indicator lamps. Rear fog guard lamp operation is monitored by the Body Control Unit (BCU) which only allows the lamps to operate when the side lamps or headlamps are on and the front fog lamps are switched on.

When the side lamps, headlamps or ignition is turned off, the rear fog guard lamps are extinguished. When the side or headlamps are switched on again, the rear fog guard lamps will not operate until reselected using the switch. If the front fog lamps are switched off, the rear fog guard lamps will also switch off.

The rear fog guard lamp switch is illuminated when the side lights are switched on. Each rear fog guard lamp bulb is rated at 21 Watts.

### **OPERATION**

#### **Rear Fog Guard Lamps Supply**

##### ***Circuit supply***

A feed from the battery positive terminal is connected by an R wire to the engine compartment fusebox, where it passes through fusible links 8, 10 and 13 and fuse 13.

A feed from fusible link 13 is connected by an NG wire to the lighting switch.

A feed from fusible link 10 is connected by an U wire to the passenger compartment fusebox. The feed passes through fuse 4 in the passenger compartment fusebox and connects to the contacts of the rear fog guard lamp relay.

A feed from fusible link 8 is connected on an NW wire to the passenger compartment fusebox and from the fusebox to the ignition switch on an N wire.

A feed from fuse 13 is connected by a PN wire to the passenger compartment fusebox. The feed connects to the coil of the rear fog guard lamp relay. The relay coil is connected inside the passenger compartment fusebox to two electronic switches in the Intelligent Driver Module (IDM) which is integral with the fusebox.



# DESCRIPTION AND OPERATION

---

## ***Ignition switch supply***

With the ignition switch in position II, the feed from fusible link 8 flows through the ignition switch to the passenger compartment fusebox on a Y wire. The feed continues through fuse 29 in the passenger compartment fusebox and is connected to one of the two electronic switches in the IDM.

In this condition, one of two switches in the IDM closes. The earth path from the IDM is connected from the passenger compartment fusebox to earth header C0551 on a B wire.

## **Lighting Switch Operation**

When the lighting switch is moved to the side lamp or headlamp position, the feed from fusible link 13 passes through the switch contacts and is connected from the lighting switch to the passenger compartment fusebox on an R wire. The feed is connected to the IDM, causing the second of the two electronic switches to close.

## **Body Control Unit**

With the lighting switch in the side lamp or headlamp position an earth path from the coil of the rear fog guard lamp relay is completed through the two electronic switches in the IDM. The earth is connected by an SK wire to BCU pin C0661-1, via header C0293 LHD/C0292 RHD. This connection is the serial data bus between the BCU and the IDM.

The BCU is connected to earth header C0551 from pin C0660-11 on a B wire and from pin C0664-5 on a B wire to earth header C0018 LHD/C0017 RHD.

## **Rear Fog Guard Lamp Switch Operation**

When the rear fog guard lamp switch is operated, an earth path is completed from the BCU pin 662-8 to the switch on a UP wire. The earth path continues through the switch contacts and is connected to earth header C0017 LHD/C0018 RHD on a B wire, via header C0760.

The completion of the earth path signals the BCU to provide an earth path from the coil of the rear fog guard lamp relay, through the two IDM electronic switches to the BCU on the SK wire.

The energised coil closes the contacts of the rear fog guard lamp relay. This allows the feed from fuse 4 in the passenger compartment fusebox to flow through the relay contacts.

From the fusebox the feed is connected on a RY wire, to connector interface C0020-1/C0905-1. From this interface the feed continues on a R wire to connector interface C0905-2/C0020-2. From this interface the feed continues on a RY wire to the trailer pick-up socket.

From the connector interface C0905-2/C0020-2, the feed is connected on a Y wire to connector interface C0905-3/C0020-3. From this interface the feed is connected on an RY wire to header C0295.

A feed from header C0295 is connected on an RY wire to the RH rear fog guard lamp which in turn is connected to earth header C0706 on a B wire.

A second feed from header C0295 is connected on a RY wire to the LH rear fog guard lamp which in turn is connected to earth header C0707 on a B wire.

## **Switch Indicator Lamp Operation**

A second feed from the rear fog guard relay is connected from the passenger compartment fusebox to the rear fog guard lamp switch on an RY wire. The feed passes through the rear fog guard lamp switch indicator lamp which illuminates. The indicator lamp is earthed from the rear fog guard lamp switch to earth header C0017 LHD/C0018 RHD, via header C0760 on a B wire.

# DESCRIPTION AND OPERATION

---

## **INDICATORS AND HAZARDS**

### **DESCRIPTION**

#### **General**

The direction indicator lamps are operated from a three position direction indicator switch located on the left hand side of the steering column and only operate with the ignition switch in position II. Left and right indicator lights in the instrument pack flash accordingly to show correct flasher operation. If a failure of an indicator bulb occurs, the appropriate flasher symbol on the instrument pack will flash quickly.

The hazard warning lamps are operated from a latching pushbutton switch located in the group of six switches on the fascia. When the switch is pushed, both left and right indicator lights in the instrument pack flash to show hazard warning lamps are operating and all hazard warning lamps flash simultaneously. The hazard warning flashers operate independently of the ignition switch position.

If a trailer is fitted and connected to the trailer pick-up socket, a trailer symbol in the instrument pack also flashes to show correct operation of the trailer direction indicator/hazard warning lamps.

Two direction indicator/hazard warning lamps are located outboard of the headlamps. Two side repeater lamps are located on the left and right hand front wings, forward of the A posts. Two rear direction indicator/hazard warning lamps are located in the rear bumper. All direction indicator/hazard warning lamp bulbs are rated at 5 Watts.

The direction indicators and hazard warning lamp operation is controlled by the Body Control Unit (BCU), Intelligent Driver Module (IDM) and two electronic relays in the passenger compartment fusebox. The IDM and the relays are an integral part of the passenger compartment fusebox and cannot be serviced individually.

The direction indicator circuit uses the serial data bus between the BCU, IDM and the instrument pack for flasher and hazard request and operation.

## **OPERATION**

### **Direction Indicators and Hazard Warning Lamps Supply**

#### ***Circuit supply***

A feed from the battery positive terminal is connected by an R wire to the engine compartment fusebox, where it passes through fusible link 8 and fuse 14.

A feed from fuse 14 is connected to the passenger compartment fusebox on a PN wire where it is connected to the contacts and coils of the RH and LH indicator relays in the fusebox.

A feed from fusible link 8 is connected on an NW wire to the passenger compartment fusebox and from the fusebox to the ignition switch on an N wire.

#### ***Ignition switch supply***

With the ignition switch in position II, the feed from fusible link 8 flows through the ignition switch to the passenger compartment fusebox on a Y wire. The feed continues through fuse 29 in the passenger compartment fusebox and is connected on a GU wire to the BCU pin C0660-1.

### **Direction Indicator Lamps Operation**

The BCU supplies a reference voltage from pin C0663-2 on a GR wire for the LH flasher and from pin C0660-6 on a GW wire for the RH flasher. When the flasher switch is moved to the LH or RH hand flasher position an earth path is completed from the switch on a B wire, via header C0286 LHD/C0291 RHD to earth header C0018 LHD/C0017 RHD. The completion of the earth, signals the BCU that a request for LH or RH flasher operation has been made.

The BCU then sends a signal on an SK wire from pin C0661-1, via header C0293 LHD/C0292 RHD, to the IDM in the passenger compartment fusebox. The SK wire is the serial data bus between the BCU, IDM and the instrument pack.

The signal is received by the IDM and interpreted as a request for LH or RH flasher operation. The IDM grants an earth path for the coil of the LH or RH direction indicator relay. The coil is energised by the feed from fuse 14 in the engine compartment fusebox, closing the relay contacts.

With the contacts closed, the feed from fuse 14 also passes through the relay and is connected, via a resistor, from the passenger compartment fusebox to the applicable direction indicator. The IDM controls the flasher operation by momentarily removing and restoring the earth for the relay coil, which opens and closes the contacts causing the indicator bulbs to flash on and off.

# DESCRIPTION AND OPERATION

---

The resistor is used by the IDM to monitor the current drawn through the resistor by the direction indicator bulbs. If an indicator bulb fails, the IDM detects the drop in current draw across the resistor and operates the flasher relay at a faster speed. The faster flash is also transmitted to the instrument pack to inform the driver of the bulb failure.

The IDM operates the direction indicator lamps in the instrument pack on the serial data bus on the SK wire from the passenger compartment fusebox, via header C0293 LHD/C0292 RHD, to the instrument pack.

The direction indicators are connected from the passenger compartment fusebox as follows:

## ***LH front, rear and side direction indicator/hazard warning lamps***

The feed from the LH direction indicator relay is connected on a GR wire from the passenger compartment fusebox to header C0289.

### ***LH front***

The feed is connected from header C0289 on a GR wire to the LH front direction indicator/hazard warning lamp. The lamp is connected on a B wire, via header C1001 LHD/C0288 RHD, to earth eyelet connector C0564-1 LHD or earth header C0017 RHD.

### ***LH rear***

The feed is connected from header C0289, via header C0295, on a GR wire to the LH rear direction indicator/hazard warning lamp. The lamp is connected on a B wire to earth header C0707.

### ***LH Side repeater***

The feed is connected from header C0289 on a GR wire to the LH front side repeater lamp. The lamp is connected on a B wire, via header C0288, to earth header C0017.

### ***Trailer connection***

The feed for the trailer connection is taken from header C0289, via header C0295, on a GR wire to the trailer pick-up. The trailer pick-up is connected on a B wire to earth eyelet connector C0808-1.

## ***RH front, rear and side direction indicator/hazard warning lamps***

The feed from the RH direction indicator relay is connected on a GW wire from the passenger compartment fusebox to header C0289.

### ***RH front***

The feed is connected from the header C0289 on a GW wire to the front RH direction indicator/hazard warning lamp. The lamp is connected on a B wire, via header C1000 to earth eyelet connector C0558-1.

## ***RH rear***

The feed is connected from header C0289, via header C0723, on a GW wire to the RH rear direction indicator/hazard warning lamp. The lamp is connected on a B wire to earth header C0706.

## ***RH Side repeater***

The feed is connected from header C0289 on a GW wire to the RH RH front side repeater lamp. The lamp is connected on a B wire, via header C1000, to earth eyelet connector C0558-1.

## ***Trailer connection***

The feed for the trailer connection is taken from header C0289, via header C0723, on a GW wire to the trailer pick-up. The trailer pick-up is connected on a B wire to earth eyelet connector C0808-1.

## **Hazard Warning Lamps Operation**

The BCU supplies a reference voltage from pin C0663-12 on a GR wire to the hazard warning switch. When the hazard warning switch is operated an earth path is completed from the switch on a B wire, via header C0760, to earth header C0018 LHD/C0017 RHD. The completion of the earth signals the BCU that a request for hazard warning lamp operation has been made.

The BCU then sends a signal on an SK wire from pin C0661-1, via header C0293 LHD/C0292 RHD, to the IDM in the passenger compartment fusebox. The SK wire is the serial data bus between the BCU, IDM and the instrument pack.

The signal is received by the IDM and interpreted as a request for hazard warning lamp operation. The IDM grants an earth path for the coils of the LH and RH direction indicator relays. The coils are energised by the feed from fuse 14 in the engine compartment fusebox, closing the relay contacts.

With the contacts closed, the feed from fuse 14 also passes through the relays and is connected, via resistors, from the passenger compartment fusebox to the direction indicators. The IDM controls the flasher operation by momentarily removing and restoring the earth for the relay coils, which opens and closes the contacts causing the indicator bulbs to flash on and off.

The resistor is used by the IDM to monitor the current drawn through the resistor by the direction indicator bulbs. If an indicator bulb fails, the IDM detects the drop in current draw across the resistor and operates the flasher relay at a faster speed. The faster flash is also transmitted to the instrument pack to inform the driver of the bulb failure.

## DESCRIPTION AND OPERATION

---

The IDM operates both direction indicator lamps in the instrument pack on the serial data bus on the SK wire from the passenger compartment fusebox, via header C0293 LHD/ C0292 RHD, to the instrument pack.

The hazard warning lamp operation is the same as that described for the direction indicator lamps operation.

## **INTERIOR LAMPS**

### **DESCRIPTION**

#### **General**

Interior illumination is provided by front, rear and load space lamps, ignition switch illumination, vanity mirror illumination and also includes an electrically operated interior rear view mirror (if fitted).

The front, rear and load space lamps and the ignition illumination operate from a direct feed from the battery, independent of the ignition switch position. The vanity mirrors and the interior rear view mirror operate with the ignition switch in position I or II.

The Body Control Unit (BCU) is programmed to operate the interior lamps and the ignition illumination for a predetermined period after a door has been opened or an unlock request is made with the handset.

Power is supplied to the interior rear view mirror when reverse gear is selected. This changes the mirror from its dipped to normal state for clarity of vision.

On Korean vehicles only, an additional link harness is used to provide a power supply from the rear interior lamp to the front interior lamp and infra-red sensor.

### **OPERATION**

#### **Interior Lamps Supply**

##### ***Circuit supply***

A feed from the battery positive terminal is connected on an R wire to the engine compartment fusebox where it passes through fusible links 1, 3, 7 and 8. Fusible links 1 and 7 are connected in series.

A feed through fusible links 1 and 7 is connected to the contacts of the auxiliary circuits relay.

A feed from fusible link 3 is connected from the engine compartment fusebox to the passenger compartment fusebox on an NR wire. The feed passes through fuse 20 in the passenger compartment fusebox and is connected on a P wire to header C0289 LHD/C0294 RHD.

A feed from fusible link 8 in the engine compartment fusebox is connected on an NW wire to the passenger compartment fusebox and from the fusebox to the ignition switch on an N wire.



# DESCRIPTION AND OPERATION

---

## ***Ignition switch supply***

With the ignition switch in position I or II, a feed is connected from the ignition switch to the passenger compartment fusebox on an LGW wire.

The feed passes through fuse 26 in the passenger compartment fusebox and is connected on an LG wire to the coil of the auxiliary circuits relay in the engine compartment fusebox. This energises the coil and closes the relay contacts. The coil is earthed on a B wire from the engine compartment fusebox to earth header C0018, via header C0286 LHD/C0288 RHD.

With the ignition switch in position II, a feed is connected from the ignition switch to the passenger compartment fusebox on a Y wire. The feed passes through fuse 25 in the passenger compartment fusebox, through splices A37, A58 and is connected on a GY wire to the reverse lamp switch on vehicles with manual transmission or the automatic transmission starter inhibitor/reverse lamp switch on vehicles with automatic transmission.

## **Interior Lamps Operation**

### ***Vanity and rear view mirror***

With the ignition switch in position I or II, the feed from fusible link 7 passes through the auxiliary circuits relay contacts and is connected on a WG wire to the passenger compartment fusebox where it passes through fuse 15. From fuse 15 the feed is connected on an LGW wire, via header C0286 LHD/C0291 RHD to the interior mirror.

The power supply from fuse 15 in the passenger compartment fusebox supplies power to the interior rear view mirror. The automatic dip function of the mirror can be selected on or off on the mirror. The mirror is connected on a B wire to earth header C0706.

When reverse is selected, the feed from fuse 25 in the passenger compartment fusebox passes through the reverse switch contacts and is connected, via header C0287 LHD/C0294 RHD to the interior mirror on a GN wire. This supplies power to the interior mirror and changes it from its dipped to normal condition when applicable.

The interior lamps operate independent of the ignition switch position and can be operated manually or automatically when a door is opened.

## ***Interior lamps - Manual operation***

The feed from fuse 20 in the passenger compartment fusebox is connected to the header C0289 LHD/C0294 RHD. From the header the feed is connected on a P wire to header C0723. Three feeds on P wires are connected from header C0723 to the front interior lamp, the rear interior lamp and the load space lamp.

On Korean vehicles only, two feeds on P wires are connected from header C0723 to the rear interior lamp and the loadspace lamp. The front interior lamp/infra-red sensor is also connected on a P wire from splice joint A2.

The earth path from the load space lamp is on a PU wire, through headers C0723 and C0285 LHD/C0294 RHD to the BCU pin C0663-9.

When the front interior lamp is in the manual (continuous) operation position, the earth path from the lamp is on a B wire to earth header C0706.

When the rear interior lamp is in the manual (continuous) operation position, the earth path from the lamp is on a B wire to earth header C0707.

## ***Interior lamps - Automatic operation***

The feed from fuse 20 in the passenger compartment fusebox is connected to the header C0289 LHD/C0294 RHD. From the header the feed is connected on a P wire to the ignition switch illumination bulb. The earth connection from the ignition switch illumination is connected on a PU wire to the BCU pin C0663-9, via header C0285 LHD/C0294 RHD.

On Korean vehicles only, two feeds on P wires are connected from header C0723 to the rear interior lamp and the load space lamp. The front interior lamp/infra-red sensor is also connected on a P wire from splice joint A2.

With the interior lamps set for automatic operation, switches located in the front and rear door lock motors, complete an earth path from the BCU. The interior lamps receive a feed from fuse 20 in the passenger compartment fusebox, via headers C0289 LHD/C0294 RHD and C0723 on P wires.

The earth path for the LH or RH (driver's) door switch is from the BCU pin C0660-17 to the LH or RH front door lock motor on a PW wire, via header C0285. The earth is connected on a B wire from the LH or RH door switch to earth header C0017 LHD/C0018 RHD.

## DESCRIPTION AND OPERATION

---

The earth paths for the LH or RH (passenger) door switch, tail door switch and LH and RH rear door switches is from the BCU pin C0660-4 to header C0291 LHD/C0285 RHD on a PLG wire.

From the header C0291 LHD/C0285 RHD a PLG wire is connected to connector interface C0464-1/C0733-1. From the connector interface the earth continues on a PW wire to the LH or RH (passenger) door switch. The earth is connected from the switch on a B wire to earth header C0018 LHD/C0017 RHD.

From the header C0291 LHD/C0285 RHD a PLG wire is connected to the tail door switch and the LH and RH rear door switches. The earth from the tail door switch is connected on a B wire to earth header C0706. The earth from the LH and RH rear door switches are connected on B wires to earth header C0552.

When a door is opened the BCU provides earth paths from the interior lamps, the load space lamp and the ignition switch illumination through the BCU. The earth path(s) from the lamp(s) is on PU wires, through header C0723 and C0285 LHD/C0294 RHD to the BCU pin C0663-9.

## **INTERIOR ILLUMINATION**

### **DESCRIPTION**

#### **General**

The interior illumination provides background lighting for the instrument pack and control switch graphics. The interior illumination operates with the side lamps or headlamps, independent of the ignition switch position.

The radio, air temperature control (if fitted) and digital clock displays are illuminated permanently. When the side lamps are switched on the displays are dimmed.

The LH and RH rear window switches will not illuminate if the rear window lift isolation switch is operated to isolate the rear windows.

On NAS/JAPAN vehicles, an instrument illumination dimmer rheostat is provided to dim the instrument pack and switch graphic illuminations. The rotary dimmer control is located on the lower left corner of the instrument pack.

### **OPERATION**

#### **Interior Illumination Supply**

A feed from the battery positive terminal is connected on an R wire to the engine compartment fusebox where it passes through fusible link 13.

The feed from fusible link 13 is connected on an NG wire to the lighting switch.

#### **Interior Illumination Operation**

When the lighting switch is moved to the side lamps or headlamps position, the feed passes through the switch contacts and is connected to the passenger compartment fusebox on an R wire. The feed passes through fuses 11 and 33 in the fusebox.

A feed from fuse 33 is connected on an RO wire to header C0759.

A feed from fuse 11 is connected on an RB wire to header C0288 LHD/C0286 RHD.

From header C0759, RN wires supply power to the interior illumination bulbs, with the exception of the glove box switch. The glove box switch is supplied on an RB wire to the switch and an R wire from the switch to the glove box lamp.

## DESCRIPTION AND OPERATION

---

From header C0286, RB wires pass through headers C0295 and C0724 and supply power to the remaining interior illumination bulbs.

All of the bulbs are earthed by B wires, with the exception of the rear window LH and RH switches. These switches are connected to the window lift isolation switch on SG wires which is then connected to earth on a B wire.

### ***NAS/Japan vehicles only***

The instrument illumination dimmer rheostat receives a supply on an RO wire from header C0759. The rheostat supplies a reduced power feed on an RN wire to the header C0759. The rheostat is earthed on a B wire to earth header C0018, via header C0760.

## **INSTRUMENTS**

### **DESCRIPTION**

#### **General**

Indications of vehicle and system status are relayed to the driver by the instruments and warning lamps contained within the instrument pack. The warning lamps fitted in the instrument pack are dependant on model/market variants and the engine/gearbox fitted.

*NOTE: Some of the warning lamps are LED indicators that are powered at low voltages from the instrument pack internal circuits.*

### **OPERATION**

#### **Instruments Supply**

##### ***Circuit supply***

A feed from the battery positive terminal is connected on an R wire to the engine compartment fusebox where it passes through fusible link 8 and fuses 10 and 13.

A permanent feed from fuse 13 is connected to the passenger compartment fusebox on a PN wire. The feed is connected from the passenger compartment fusebox to the instrument pack on a PO wire.

A feed from fusible link 8 is connected on an NW wire to the passenger compartment fusebox and from the fusebox to the ignition switch on an N wire.

##### ***Ignition switch supply***

With the ignition switch in position II, the feed from fusible link 8 flows through the ignition switch to the passenger compartment fusebox on a Y wire, where it passes through fuses 25, 27, and 35. Fuse 27 is connected on an LG wire to the instrument pack.

Fuse 35 is connected to the instrument pack on a G wire. Fuse 25 is connected to connector interface C1837/C1838 on a GY wire. The connector interface supplies a feed to the differential lock resistor on a KG wire.

##### ***Internal voltage supplies***

Some of the warning lamps operate at very low voltages, the reduced voltages are controlled by the instrument pack. The instrument pack is earthed from pin C0230-17 and pin C0230-18 to earth header C0551 on B wires.

# DESCRIPTION AND OPERATION

---

## **Instruments Operation**

### ***Handbrake and low brake fluid level warning lamp***

The handbrake and low brake fluid level warning lamps are connected to the instrument pack from pin C0230-10 on a KO wire to Header C0293 LHD/C0285 RHD. From header C0293 LHD/C0285 RHD a KO wire is connected to the handbrake switch, the handbrake switch is locally earthed.

A second connection from header C0293 LHD/C0285 RHD is connected to the brake fluid level switch on a KO wire. The brake fluid level switch is earthed on a B wire.

If either of the switches closes, an earth circuit via the closed switch contacts is completed and the handbrake/low fluid level warning lamp will be illuminated. Power for the warning lamp is internally connected to a supply from pin C0230-19. Pin C0239-19 is supplied power from the ignition feed from fuse 27 in the passenger compartment fusebox.

### ***Oil pressure warning lamp***

The oil pressure warning lamp is connected to the instrument pack from pin C0230-6 on a WN wire to the oil pressure warning switch, the oil pressure warning switch is locally earthed.

If the oil pressure switch closes, an earth circuit via the closed switch contacts is completed and the oil pressure warning lamp will be illuminated. Power for the warning lamp is internally connected to a power supply from pin C0230-19. Pin C0239-19 is supplied power from the ignition feed from fuse 27 in the passenger compartment fusebox.

Refer to the Workshop Manual engine for detailed description and operation of the oil pressure warning lamp.

### ***Ignition and no charge warning lamp - V8***

The ignition and no charge warning lamp in the instrument pack is connected from pin C0230-11 to the alternator on an NY wire.

Refer to the starting and charging section of this manual for a detailed description and operation of the ignition and no charge warning lamp.

### ***Ignition and no charge warning lamp - Td5***

The ignition and no charge warning lamp is connected from pin C0230-11 of the instrument pack via header C0294 LHD/C0287 RHD to the alternator on an NY wire.

Refer to the starting and charging section - Td5 of this manual for a detailed description and operation of the ignition and no charge warning lamp.

## ***SRS warning lamp***

The SRS warning lamp is connected from pin C0233-7 to pin C0256-13 on the SRS DCU on a YR wire.

Refer to Supplementary Restraint System (SRS) section of this manual for a description and operation of the SRS warning lamp circuit.

## ***Fuel filter water warning lamp (Td5 models only)***

A water sensor is installed in the fuel system, the power supply for the sensor is from fuse 10 in the engine compartment fusebox and the closed contacts of the fuel pump relay on a WP wire. The operation of the fuel pump relay coil is controlled by the Engine Control Module (ECM). The coil of the fuel pump relay is connected to pin C0658-5 of the ECM on a UP wire. The water sensor is grounded on a B wire via splice joint A3 to earth eyelet C0810-1.

The water sensor measures the resistance of the liquid between two electrodes. The sensor outputs a voltage to the instrument pack pin C0233-11. The instrument pack monitors the voltage. When the water in the filter becomes too great, the instrument pack illuminates the warning lamp when the voltage reaches a predetermined level.

## ***Engine management warning lamp - V8***

The engine management warning lamp is connected from pin C0233-13 on the instrument pack to pin C0237-20 on the ECM on an RS wire.

Refer to the Workshop Manual - Engine Management System V8 for Description and Operation of the engine management warning lamp.

## ***Engine management warning lamp - Td5***

The engine management warning lamp is connected from pin C0233-13 on the instrument pack to pin C0658-6 on the ECM on an RS wire.

Refer to the Workshop Manual - Engine Management System Td5 for Description and Operation of the engine management warning lamp.

## ***Glow plug warning lamp (Td5 vehicles only)***

The glow plug warning lamp is connected from pin C0233-12 on the instrument pack to pin C0658-30 of the ECM on an BY wire.

Refer to the Workshop Manual Engine Management System Td5 for Description and Operation of the glow plug warning lamp.



# DESCRIPTION AND OPERATION

---

## ***Off road warning lamp***

The off road warning lamp is connected from pin C0230-9 on the instrument pack to the off road mode switch.

Refer to the Self Levelling and Anti-Lock Braking System (SLABS) section in this manual for a description of the operation of the off road warning lamp.

## ***SLS warning lamp***

The SLS warning lamp is connected from pin C0233-2 on the instrument pack to the SLABS ECU pin C0655-8 on a WO wire.

Refer to the Self Levelling and Anti-Lock Braking System (SLABS) section of this manual for a description of the operation of the warning lamp circuit.

## ***ABS warning lamp***

The ABS warning lamp is connected from pin C0233-3 on the instrument pack to the SLABS ECU pin C0504-18 on a WR wire.

Refer to the Self Levelling and Anti-Lock Braking System (SLABS) section of this manual for a description of the operation of the warning lamp circuit.

## ***Traction control warning lamp***

The traction control warning lamp is connected from pin C0233-4 on the instrument pack to the SLABS ECU pin C0504-13 on a WU wire.

Refer to the Self Levelling and Anti-Lock Braking System (SLABS) section of this manual for a description of the operation of the warning lamp circuit.

## ***Hill descent control 'active' warning lamp (green)***

The HDC active warning lamp is connected from pin C0233-5 on the instrument pack to the SLABS ECU pin C0504-16 on a WY wire.

Refer to the Self Levelling and Anti-Lock Braking System (SLABS) section of this manual for a description of the operation of the warning lamp circuit.

## ***Hill descent 'fail' warning lamp (amber)***

The hill descent 'fail' warning lamp is connected from pin C0233-10 on the instrument pack to the SLABS ECU pin C0504-17 on a WK wire.

Refer to the Self Levelling and Anti-Lock Braking System (SLABS) section of this manual for a description of the operation of the warning lamp circuit.

## ***Direction indicator warning lamps***

The direction indicator left and right warning lamps are connected from the instrument pack pin C0233-16 via header C0293 LHD/ C0292 RHD to pin C0661-1 on the BCU. This connection is part of the serial data bus between the instrument pack and the BCU.

The BCU and the Intelligent Driver Module (IDM) control the operation of the direction indicators warning lamps.

Refer to the direction indicators and hazard warning lamps section of this manual for details of operation.

## ***Trailer warning lamp***

The trailer warning lamp is connected from the instrument pack pin C0233-16 via header C0293 LHD/ C0292 RHD to pin C0661-1 on the BCU on an SK wire. This connection is part of the serial data bus between the instrument pack and the BCU.

The BCU and the Intelligent Driver Module (IDM) control the operation of the trailer warning lamp.

Refer to the direction indicators and hazard warning lamps section of this manual for details of operation.

## ***Seat belt warning lamp (if fitted)***

The seat belt warning lamp is connected on an SK wire from the instrument pack pin C0233-16 via header C0293 LHD/ C0292 RHD to pin C0661-1 on the BCU. This connection is the serial data bus between the instrument pack and the BCU. The seat belt switch is connected to pin C0662-16 of the BCU on a RW wire. The seat belt switch is earthed on a B wire to earth header C0708 LHD/C0552 RHD.

The BCU controls the operation of the seat belt on warning lamp and an audible warning. The warning operates for a maximum of 6 seconds, after this time the BCU logic stops the warning output to the serial data bus.

The seat belt warning lamp is connected to the ignition supply from fuse 13 in the engine compartment fusebox. When the seat belt is fastened the seat belt switch is closed, and an earth path is completed from pin C0662-16 of the BCU on a RW wire to the closed contacts of the seat belt switch, to earth header C0708 LHD/C0552 RHD on a B wire.

When the earth path is completed the BCU logic circuits cancel the 'seat belt light on' and seat belt audible warning signals sent via the serial data bus.

# DESCRIPTION AND OPERATION

---

## ***Transfer box in neutral warning lamp (if fitted)***

The transfer box in neutral warning lamp is connected on an SK wire from the instrument pack pin C0233-16 via header C0293 LHD/ C0292 RHD to pin C0661-1 on the BCU. This connection is the serial data bus between the instrument pack and the BCU.

Refer to the Workshop Manual Transfer Box - LT 2305E for detailed Description and Operation of the transfer box in neutral warning lamp.

## ***Main beam warning lamp***

The main beam warning lamp is connected from the instrument pack pin C0230-3 on a US wire to the IDM in the passenger compartment fusebox.

Refer to the head/side and number plate lamps section of this manual for details of operation.

## ***Anti theft alarm LED***

The anti theft alarm LED is connected from the instrument pack pin C0233-8 on a BS wire to pin C0661-20 on the BCU.

Refer to the Workshop Manual Alarm System for Description and Operation of the anti-theft system.

## ***Active Cornering Enhancement (ACE) warning lamp***

The ACE warning lamp is connected from the instrument pack pin C0233-1 on a BO wire to pin C0647-36 on the ACE ECU.

Refer to the Workshop Manual Front Suspension for Description and Operation of the ACE system.

## ***Differential lock warning lamp***

The differential lock warning lamp is connected from the instrument pack pin C0230-8 on a BU wire via header C0761 to the differential lock unit. A feed from fuse 25 is sent by a GY wire through a resistor unit on pin C0038-1 and to the differential lock unit on a WN wire from pin C0037-2

If an earth path is completed on pin C0230-8 the instrument pack logic circuit monitors this as an input and provides power from the ignition supply to illuminate the warning lamp.

The ABS system controls the operation of the centre differential lock, refer to Workshop Manual Brakes Description and Operation for further details.

## ***Transmission oil warning lamp***

The transmission oil warning lamp is connected from the instrument pack pin C0230-7 on a BLG wire to header C0293. BLG wires from header C0293 are connected to the transmission oil temperature sensors. The sensors are located in the gearbox oil cooler and the rear of the transfer gearbox.

If an earth path is completed on pin C0230-7 the instrument pack logic circuit monitors this as an input and provides power from the ignition supply to illuminate the warning lamp.

## ***Fuel warning lamp***

The instrument pack internal logic circuits monitors the resistance value of the fuel gauge circuit. The warning lamp will be illuminated via an internal supply from the ignition circuit if the value stored in the instrument pack memory is reached.

## ***Sport and manual warning lamps (automatic vehicles only)***

The sport warning lamp is connected from pin C0230-4 of the instrument pack on a YR wire to pin C0193-25 on the Electronic Automatic Transmission (EAT) ECU. The manual warning lamp is connected from pin C0230-5 of the instrument pack on a YG wire to the pin C0193-51 of the EAT ECU.

Both lamps are illuminated by the input from the EAT ECU and are earthed via the instrument pack. The EAT ECU sends an input to the lamps to indicate the EAT operating mode.

Refer to the Electronic Automatic Transmission (EAT) section of this manual for details of operation.

## ***Speedometer - vehicles with ATC***

The instrument pack is connected from pin C0230-16 on a KG wire via splice joint A87 and header C0290 to pin C0504-3 on the SLABS ECU. The SLABS ECU sends a speed signal to the instrument pack via this connection.

## ***Speedometer - vehicles without ATC***

The instrument pack is connected from pin C0230-16 on a KG wire via header C0290 to pin C0504-3 on the SLABS ECU. The SLABS ECU sends a speed signal to the instrument pack via this connection.

## ***Overspeed warning***

The overspeed warning lamp is connected from the SLABS ECU as described for the speedometer. The instrument pack software monitors the road speed signal supplied to the instrument pack on pin C0230-16. The warning lamp is illuminated at speeds of 78 mph (125.5 km/h) or above and extinguished at 74 mph (118.5 km/h).

# DESCRIPTION AND OPERATION

---

## ***Coolant temperature gauge***

The coolant temperature gauge is connected from pin C0233-15 on a GU wire to the ECM pin C0636-44 V8/C0658-7 Td5.

Refer to the engine management section in the workshop manual for details of operation.

## ***Tachometer***

The tachometer gets an engine speed signal via pin C0230-15 of the instrument pack. Pin C0235-15 is connected on a WS wire via header C0291 to pin C0637-17 V8/C0658-19 Td5 on the ECM.

Refer to the engine management section in the workshop manual for details of operation.

## ***Fuel gauge***

The fuel gauge is connected from pin C230-14 of the instrument pack to the fuel tank unit on a GB wire. The fuel tank unit sends an earth input on a KB wire to pin C0230-13 on the instrument pack. The fuel tank unit sender is of the variable resistance type and the fuel gauge displays a value according to the input sent from the fuel tank unit sender.

## **HORNS**

### **DESCRIPTION**

#### **General**

Two horns are located in the left and right hand sides of the front panel, forward of the radiator. The horns are operated by pushing either of two buttons located on the upper spokes of the steering wheel. One horn emits a low tone, the other a high tone. Each horn produces a sound of between 93 and 112 db at a distance of 7 m (23ft).

Each horn switch is connected to the horn circuit via a rotary coupler in the steering column. The horn circuit is on a permanent feed from the battery and operates independently of the ignition circuits.

### **OPERATION**

#### **Horns Supply**

##### ***Circuit supply***

A feed from the battery positive terminal is connected by an R wire to the engine compartment fusebox. The feed passes through fuse 16 and is connected to the contacts and coil of the horn relay. In this condition the horn relay receives a permanent feed from the battery.

#### **Horns Operation**

When one of the horn switches is pushed, an earth path is completed from the horn relay coil on a PO wire from the engine compartment fusebox, via header C0291 LHD/C0286 RHD, the rotary coupler and horn switches, to earth via fixings E110.

The completed earth path energises the horn relay coil, closing the relay contacts. The feed from fuse 16 passes through the relay contacts to the LH and RH horns on PG wires causing the horns to sound.

The LH horn is connected to earth point C0564-1 on a B wire. The RH horn is connected to earth header C0018 on a B wire.

# DESCRIPTION AND OPERATION

---

## **CLOCK**

### **DESCRIPTION**

#### **General**

The digital clock is located on the fascia. The clock receives a permanent feed from the battery and is illuminated when the ignition switch is in position I or II.

### **OPERATION**

#### **Clock Supply**

##### ***Circuit supply***

A feed from the battery positive terminal is connected by an R wire to the engine compartment fusebox, where it passes to fusible links 3 and 8 and to fusible links 1 and 7, which are connected in series. The feed from fusible link 7 is connected to the contacts of the auxiliary circuits relay located in the engine compartment fusebox.

A permanent feed from fusible link 3 is connected to the passenger compartment fusebox by an NR wire, where it passes through fuse 20. From fuse 20 the feed is connected by a P wire, through header C0725 to the digital clock.

##### ***Ignition switch supply***

When the ignition switch is in position I or II, the feed from fusible link 8 flows to the passenger compartment fusebox on an NW wire. From the fusebox the feed flows on an N wire to the ignition switch.

From the ignition switch the feed continues on an LGW wire to fuse 26 in the passenger compartment fusebox. From fuse 26 the feed is connected by an LG wire to the coil of the auxiliary circuits relay. The coil of the auxiliary circuits relay is now energised, and is connected by a B wire to earth header C0018, via header C0286 LHD/C0288 RHD.

#### **Clock Operation**

With the coil of the auxiliary circuits relay energised, the relay contacts close. This allows the feed from fusible links 1 and 7 to pass through the relay contacts to the passenger compartment fusebox on a WG wire.

The feed then passes through fuse 16 and is connected to the digital clock on an LGP wire. This feed provides the illumination when the ignition switch is in position I or II. The digital clock is connected, via headers C0725 and C0760 to earth header C0017 LHD/C0018 RHD on a B wire.

The permanent feed to the digital clock, via fusible link 3 in the engine compartment fusebox and fuse 20 in the passenger compartment fusebox ensure that the time settings are retained in the digital clock memory.

## **CIGAR LIGHTER**

### **DESCRIPTION**

#### **General**

The cigar lighter is located in the centre console. The socket accepts a standardized plug type. The lighter is operated by depressing the centre of the lighter which latches the heated element into the holder.

### **OPERATION**

#### **Cigar Lighter Supply**

##### ***Circuit supply***

A feed from the battery positive terminal is connected by a R wire to the engine compartment fusebox, where it passes to fusible link 8 and fusible links 1 and 7 which are connected in series. The feed from fusible link 7 is connected to the auxiliary circuits relay mounted in the engine compartment fusebox.

The feed from fusible link 8 is connected to the passenger compartment fusebox on an NW wire and from the fusebox to the ignition switch on an N wire.

##### ***Ignition switch supply***

When the ignition switch is in position I or II, the feed from fusible link 8 flows through the ignition switch) to the passenger compartment fusebox on an LGW wire. The feed continues through fuse 26 and is connected by an LG wire to the auxiliary circuits relay. The feed passes through the auxiliary relay coil and is connected to earth header C0018, via header C0285 LHD/C0288 RHD on a B wire.

The auxiliary circuits relay is energised which closes the relay contacts. This allows the feed from fusible link 7 to pass through the relay contacts to the passenger compartment fusebox on a WG wire. The feed then passes through fuse 15 and is connected, through header C0286 LHD/C0291 RHD to the cigar lighter on an LGW wire. The cigar lighter is connected through header C0286 LHD/C0288 RHD to earth header C0018 on a B wire.



# DESCRIPTION AND OPERATION

---

## **Cigar Lighter Operation**

With the ignition switch in position I or II the supply circuit is completed as the auxiliary relay is closed. Current is available at the cigar lighter.

When the cigar lighter is pushed into its holder, a central contact on the element completes the circuit and current flows through the element to earth on a B wire via header C0286 LHD/C0288 RHD and earth header C0018.

Locking clips in the holder hold the cigar lighter in position in the housing. As the temperature of the element rises, heat is transmitted to the locking clips. The heat causes the locking clips to expand and release the cigar lighter from the housing at a predetermined temperature.

When the cigar lighter is released, the central contact on the element is disconnected, the power supply circuit is now broken and the lighter element starts to cool.

## **ACCESSORY SOCKET**

### **DESCRIPTION**

#### **General**

The accessory socket is located behind the rear seats in the LH trim panel and is of similar construction to the cigar lighter socket. The socket has a maximum power rating of 180 Watts and accepts a standardised plug type. The location of the accessory socket is illuminated when the side lights are switched on.

### **OPERATION**

#### **Accessory Socket Supply**

##### ***Circuit supply***

A feed from the battery positive terminal is connected by an R wire to the engine compartment fusebox, where it passes to fusible link 8 and to fusible link 7 via fusible link 1. The feed from fusible link 7 is connected to the auxiliary circuits relay mounted in the engine compartment fusebox.

The feed from fusible link 8 is connected to the passenger compartment fusebox on an NW wire and from the fusebox to the ignition switch on an N wire.

##### ***Ignition switch supply***

When the ignition switch is in position I or II, the feed from fusible link 8 flows through the ignition switch to the passenger compartment fusebox on an LGW wire. The feed continues through fuse 26 in the passenger compartment fusebox and is connected by an LG wire to the auxiliary circuits relay. The feed passes through the relay coil and is connected to earth header C0018 on a B wire, via header C0286 LHD/C0288 RHD.

The auxiliary relay is energised which closes the relay contacts. This allows the feed from fusible link 7 to pass through the relay contacts and to the passenger compartment fusebox on a WG wire. The feed then passes through fuse 32 and is connected to the accessory socket on a PG wire. The accessory socket is connected to earth eyelet connector C0707 by a B wire.

# DESCRIPTION AND OPERATION

---

## **IN-CAR ENTERTAINMENT (ICE)**

### **DESCRIPTION**

#### **General**

The base and mid-line systems are contained within the same wiring diagram, the high-line system and the combined ICE/navigation system each have separate wiring diagrams. This section covers all three wiring diagrams.

#### **Base and Mid-Line In-Car Entertainment Description**

##### ***Base ICE description***

The base in-car entertainment system consists of a head unit, located in the centre of the fascia, four 30 Watt speakers located in the doors and a single AM/FM aerial mounted on the RH rear side window.

##### ***Mid-line ICE description***

The mid-line in-car entertainment system consists of a head unit, located in the centre of the fascia, four 30 Watt speakers located in the doors, a high range speaker located in each 'A' post trim and a single AM/FM aerial mounted on the RH rear side window.

*NOTE: A CD autochanger may be located under the RH front seat and is a dealer fit option.*

The system can be controlled from the head unit or remote controls located on the LH side of the steering wheel.

#### **In-Car Entertainment (ICE) Base and Mid line Supply**

##### ***Circuit supply***

A permanent feed from the battery positive terminal is connected by an R wire to the engine compartment fusebox, where it passes through fusible link 3. From fusible link 3 the feed passes on an NR to fuse 20 in the passenger compartment fusebox. From fuse 20 the feed flows on a P wire via header C0725 to the head unit. This feed supplies power to the internal memory and the power switch on the head unit.

A feed for illumination passes through fusible link 13 in the engine compartment fusebox and on an NG wire to the lighting switch. From the lighting switch the feed passes on an R wire to fuse 33 in the passenger compartment fusebox. The feed from fuse 33 is connected to header C0759 by an RO wire. From header C0759 the feed is connected on a RN wire to the head unit.

The permanent feed to the engine compartment fusebox also passes in series through fusible links 1 and 7. From fusible link 7 the feed is connected to the contacts of the auxiliary circuits relay.

## ***Ignition switch supply***

When the ignition switch is in position II, the feed from fusible link 8 in the engine compartment fusebox flows to the passenger compartment fusebox on a NW wire.

From the passenger compartment fusebox the feed is connected to the ignition switch on an N wire. The feed from the ignition switch is connected to fuse 26 in the passenger compartment fusebox on an LGW wire.

From fuse 26 the feed is connected on an LG wire to the coil of the auxiliary circuits relay. The relay coil is earthed via header C0286 LHD/C0288 RHD to earth header C0018 on a B wire.

## **In-Car Entertainment Base and Mid-Line Operation**

When the ignition switch is in position II the coil of the auxiliary relay is energised, with the coil energised the contacts of the auxiliary relay close.

The feed from the contacts of the auxiliary relay flows on a WG wire to fuse 16 in the passenger compartment fusebox. From fuse 16 a feed on an LGO wire flows to the aerial amplifier. The aerial amplifier is locally earthed to the vehicle. Another feed from fuse 16 is connected through splice joint A7 on a LGP wire to the head unit.

When the power switch on the head unit is turned on, the internal amplification and power supply circuits are energised from the fuse 16 supply. The head unit is earthed on a B wire to earth point C0361-1.

## ***RH rear door speaker***

The positive output from the head unit is connected on a BG wire to connector interface C0436-1/C0803-1. From the interface the positive output continues on a BU wire to the RH rear door speaker. The RH rear door speaker negative output is connected on a BG wire to connector interface C0436-2/C0803-2. From this interface the negative output is connected on a BU wire to the head unit.

## ***RH front door speaker***

The positive output from the head unit is connected on a BK wire to the RH front door speaker. The RH front door speaker negative output is connected on a BR wire to the head unit.

## ***RH high range 'A' post speaker (Mid-line model only)***

From connector interface C0459-3/C0744-3 the positive output continues on a BK wire to connector interface C0485-14/C0480-14, and from the connector interface on a BK wire to the RH high range 'A' post speaker. The RH high range 'A' post speaker negative output is connected on a RB wire to connector interface C0485-13/C0480-13, then on a BR wire to connector interface C0459-4/C0744-4.

# DESCRIPTION AND OPERATION

---

## ***LH front door speaker***

The positive output from the head unit is connected on a BW wire to connector interface C0463-3/C0744-3. From the interface the positive output continues on a BK wire to the LH front door speaker. The LH front door speaker negative output is connected on a BR wire to connector interface C0463-4/C0744-4. From this interface the negative output is connected on a BN wire to the head unit.

## ***LH high range 'A' post speaker (Mid-line model only)***

From connector interface C0463-3/C0744-3 the positive output continues on a BW wire to connector interface C0483-16/C0101-16, then from the interface on a YK wire to the LH high range 'A' post speaker. The LH high range 'A' post speaker negative output is connected on a YB wire to connector interface C0101-15/C0483-15, then from the connector interface on a BN wire to connector interface C0463-4/C0744-4.

## ***LH rear door speaker***

The positive output from the head unit is connected on a BY wire to connector interface C0435-1/C0803-1. From this interface the positive output continues on a BU wire to the LH rear door speaker. The LH rear door speaker negative output is connected on a BG wire to connector interface C0435-2/C0803-2. From this interface the negative output is connected on a BO wire to the head unit.

## ***Remote controls (Mid-line model only)***

The remote control inputs are connected to the head unit via the rotary coupler with an SB wire. The remote control output is connected to the head unit by an SR wire via the rotary coupler.

## **High-Line In-Car Entertainment Description**

The high-line in-car entertainment system consists of a head unit, located in the centre of the fascia, a power amplifier located under the LH front seat and a CD autochanger located under the RH front seat. Radio headphone amplifiers are located in the lower rear quarter trim casing. Remote controls are located on the LH side of the steering wheel. The high line system has:

- A high range speaker located in each 'A' post trim
- A low and mid range speaker located in the front doors
- A low and a high range speaker located in the rear doors
- Low range speakers located in a housing on the tail door
- An AM/FM aerial mounted on the RH rear side window and an FM aerial mounted on the LH side window. The LH aerial is used for improved FM reception in urban areas.

The system can be controlled from the head unit, the remote controls on the steering wheel, or the radio headphone amplifiers. The driver's selection via the head unit or remote controls has priority over the radio headphone amplifier's control selections.

## **In-Car Entertainment (ICE) High-Line System Supply**

### ***Circuit supply***

A permanent feed from the battery positive terminal is connected by an R wire to the engine compartment fusebox, where it passes through fusible link 3. From fusible link 3 the feed passes on an NR wire to fuse 20 in the passenger compartment fusebox. From fuse 20 the feed flows on a P wire via header C0725 to the head unit. This feed supplies power to the internal memory and the power switch on the head unit.

A feed for illumination passes through fusible link 13 in the engine compartment fusebox and on an NG wire to the lighting switch. From the lighting switch the feed passes on an R wire to fuse 33 in the passenger compartment fusebox. The feed from fuse 33 is connected to header C0759 by an RO wire. After passing through two links on header C0759, one on an RO wire and one on an RN wire, the feed is connected to the head unit on an RN wire.

The permanent feed to the engine compartment fusebox is also connected in series through fusible links 1 and 7. From fusible link 7 the feed is connected to the contacts of the auxiliary circuits relay.

A permanent feed from fusible link 7 in the engine compartment fusebox is connected to fuse 17 in the passenger compartment fusebox on a PG wire. From fuse 17 the feed is connected to the power amplifier by a LGP wire.

*NOTE: This feed is operational when enabled by a signal from the head unit.*

Another connection inside the engine compartment fusebox connects fusible link 8 to the permanent supply. From fusible link 8 the feed is connected to the passenger compartment fusebox on an NW wire. From the passenger compartment fusebox the feed flows to the ignition switch on an N wire.

### ***Ignition switch supply***

When the ignition switch is in position II, the feed from fusible link 8 in the engine compartment fusebox flows on an LGW wire to fuse 26 in the passenger compartment fusebox.

From fuse 26 the feed is connected on an LG wire to the coil of the auxiliary circuits relay. The coil of the auxiliary circuits relay is earthed via header C0286 LHD/C0288 RHD to earth header C0018 on a B wire.

When the ignition switch is in position II the coil of the auxiliary relay is energised closing the relay contacts.

# DESCRIPTION AND OPERATION

---

The feed from the contacts of the auxiliary relay flows on a WG wire to fuse 16 in the passenger compartment fusebox. From fuse 16 a feed on an LGO wire flows to header C0296. From header C0296 the feed flows on a LGO wire to the LH and RH radio headphone amplifiers.

*NOTE: This feed is operational when enabled by a signal from the head unit.*

Another feed from fuse 16 in the passenger compartment fusebox is connected via splice joint A7 to the head unit on an LGP wire. This feed supplies the power to the head unit on/off switch and glowing illumination.

A feed from the head unit is connected via header C0285 LHD/C0761 RHD to the power amplifier and header C0296 on RU wires. From header C0296 RU wires connect the feed to the LH and RH aerial amplifiers, and the LH and RH radio headphone amplifiers.

*NOTE: This feed is the power supply to the aerial amplifiers and forms the system 'enable' output from the head unit to the radio headphone amplifiers and the power amplifier. This feed is on as long as the head unit is switched on.*

## **In-Car Entertainment High-Line System Operation**

### ***Head unit***

When the power switch on the head unit is turned on, the internal power supply circuits are energised. Enable signals are sent from the head unit to the radio headphone amplifiers and the power amplifier. The CD autochanger also receives an enable signal. The head unit is connected by a B wire to earth point C0361-1.

### ***Spatial imaging enable***

The head unit spatial imaging enable output is connected from the head unit to the power amplifier on an SG wire.

### ***RH low range rear door speaker***

The positive output from the head unit is connected on a BG wire to connector interface C0229-18/C0067-18. From the interface the positive output continues on a R wire to the power amplifier. From the power amplifier the positive output continues on a SR wire to connector interface C0436-1/C0803-1. From this interface the feed continues on a BU wire to the low range RH rear door speaker.

The RH low range rear door speaker negative output is connected on a BG wire to connector interface C0436-2/C0803-2. From this interface the negative output is connected on a SP wire to the power amplifier. From the power amplifier the negative output is connected on a W wire to connector interface C0229-19/C0067-19. From this interface the feed continues on a BU wire to the head unit.

## ***RH rear door high range speaker (upper door trim)***

The positive output from the RH rear door speaker continues on to the RH rear door high range speaker on a BU wire. The negative output from the RH rear door high range speaker is connected on a BG wire to the negative output connector on the RH rear door speaker.

## ***RH mid range front door speaker***

The positive output from the head unit is connected on a BK wire to connector interface C0229-20/C0067-20. From the interface the positive output continues on a G wire to the power amplifier. From the power amplifier the positive output continues on a KB wire to connector interface C0463-2/C0744-2 LHD or C0459-2/C0744-2 RHD. From this interface the output continues on a KB wire to the RH front mid range door speaker.

The RH front mid range door speaker negative output is connected on a RB wire to connector interface C0463-1/C0744-1 LHD or C0459-1/C0744-1 RHD. From this interface the negative output is connected on a RB wire to the power amplifier. From the power amplifier the negative output is connected on a S wire to connector interface C0229-21/C0067-21 LHD or C0229-21/C0067-21 RHD. From this interface the feed continues on a BR wire to the head unit.

## ***RH high range 'A' post speaker***

From connector interface C0463-2/C0744-2 LHD or C0459-2/C0744-2 RHD the positive output continues on a KB wire to the RH high range 'A' post speaker. The RH high range 'A' post speaker negative output is connected on a RB wire to connector interface C0463-1/C0744-1 LHD or C0459-1/C0744-1 RHD.

## ***LH mid range front door speaker***

The positive output from the head unit is connected on a BW wire to connector interface C0229-22/C0067-22. From the interface the positive output continues on a Y wire to the power amplifier. From the power amplifier the positive output continues on a YB wire to connector interface C0459-1/C0744-1 LHD or C0463-1/C0744-1 RHD. From this interface the feed continues on a RB wire to the LH front door mid range speaker.

The LH front door mid range speaker negative output is connected on a KB wire to connector interface C0459-2/C0744-2 LHD or C0463-2/C0744-2 RHD. From this interface the negative output is connected on a YK wire to the power amplifier. From the power amplifier the negative output is connected on an O wire to connector interface C0229-23/C0067-23. From this interface the feed continues on a BN wire to the head unit.

## ***LH high range 'A' post speaker***

From connector interface C0459-1/C0744-1 LHD or C0463-1/C0744-1 RHD, the positive output continues on a YB wire to the LH high range A-post speaker. The LH high range 'A' post speaker negative output is connected on a YK wire to connector interface C0459-2/C0744-2 LHD or C0463-2/C0744-2 RHD.



# DESCRIPTION AND OPERATION

---

## ***LH low range rear door speaker***

The positive output from the head unit is connected on a BY wire to connector interface C0229-24/C0067-24, from the interface the positive output continues on a U wire to the power amplifier. From the power amplifier the positive output continues on a SK wire to connector interface C0435-1/C0803-1. From this interface the feed continues on a BU wire to the LH low range rear door speaker.

The LH low range rear door speaker negative output is connected on a BG wire to connector interface C0435-2/C0803-2. From this interface the negative output is connected on a SO wire to the power amplifier. From the power amplifier the negative output is connected on a P wire to connector interface C0229-25/C0067-25. From this interface the feed continues on a BO wire to the head unit.

## ***LH rear door high range speaker (upper door trim)***

The positive output from the LH rear door speaker continues on to the LH rear door high range speaker on a BU wire. The negative output from the LH rear door high range speaker is connected on a BG wire to the negative output connector on the LH rear door speaker.

## ***Low range tail door speakers***

The power amplifier is connected to the low range tail door speaker 1 on a KB wire. From the low range tail door speaker 1 the connection returns on a RB wire to the power amplifier.

The power amplifier is connected to the low range tail door speaker 2 on a NB wire. From the low range tail door speaker 2 the connection returns on a WB wire to the power amplifier.

## ***LH low range front door speaker***

The power amplifier is connected on a KG wire to connector interface C0459-3/C0744-3. From this interface the connection continues on a BK wire to the low range LH front door speaker. The connection from the low range LH front door speaker returns on a BR wire to connector interface C0459-4/C0744-4. From this interface the connection continues on an OK LHD/KR RHD wire to the power amplifier.

## ***RH low range front door speaker***

The power amplifier is connected on a OB wire to connector interface C0463-3/C0744-3. From this interface the connection continues on a BK wire to the low range RH front door speaker. The connection from the low range RH front door speaker returns on a BR wire to connector interface C0463-4/C0744-4. From this interface the connection continues on a KR LHD/OK RHD wire to the power amplifier.

## ***Remote controls (steering wheel)***

The remote control output is connected to the head unit by an SR wire via the rotary coupler. The remote control inputs are connected to the head unit via the rotary coupler with an SB wire.

## ***Radio headphone amplifiers***

Radio headphone earth: The radio headphone amplifiers are connected via header C0296 to earth header C0707 on a B wire.

Left channel input/output: The positive left channel output from the head unit is connected on a R wire to the LH and RH radio headphone amplifiers. The negative output from the left channel of the LH and RH radio headphone amplifiers is connected on a W wire to the head unit.

Right channel input/output: The positive right channel output from the head unit is connected on a U wire to the LH and RH radio headphone amplifiers. The negative output from the right channel of the LH and RH radio headphone amplifiers is connected on a P wire to the head unit.

Radio headphone remote control input/output: The radio headphones remote control feed from the head unit is connected to header C0296 on a Y wire. From header C0296 the feed continues on Y wires to the LH and RH radio headphone amplifiers. The remote control input from the LH radio headphone amplifier is connected on an G wire to the head unit. The remote control input from the RH radio headphone amplifier is connected on an S wire to the head unit.

Radio headphone active input: Both of the radio headphone amplifiers are connected to header C0296 on O wires. From header C0296 the input continues on a O wire to the head unit.

## ***Power amplifier - road speed connection***

The power amplifier receives a road speed signal, for automatic volume control, on a KG wire connected to the Self Levelling and Anti-lock Braking System (SLABS) ECU via header C0290.

## ***Power amplifier - earth connection***

The power amplifier is connected to earth header C0708 by a B wire.

# DESCRIPTION AND OPERATION

---

## ***CD autochanger connections***

The CD autochanger is earthed, via the head unit, on an N wire from the CD autochanger to connector interface C0912-8/C0911-8, and a B wire from the interface to the head unit.

An I bus communications link is connected from the CD autochanger to connector interface C0912-5/C0911-5 on a G wire, and from the interface to the head unit on a K wire.

The CD auto changer permanent feed is connected from the head unit on a P wire.

The CD autochanger left channel positive input is connected to the head unit by a R wire. The left channel negative input is connected to the head unit on a S wire.

The CD autochanger right channel positive input is connected to the head unit by a W wire. The right channel negative input is connected to the head unit on a B wire from the CD autochanger to connector interface C0912-2/C0911-2, and a U wire from the interface to the head unit.

## **In-Car Entertainment/Satellite Navigation Description**

The In-Car Entertainment (ICE)/satellite navigation system consists of the an ICE system with a navigation computer, integrated into the audio system head unit, and an additional aerial. The additional aerial is installed on the roof centreline above the tail door and receives Global Positioning System (GPS) satellite radio signals, which are relayed to the head unit on a dedicated co-axial cable. The satellite navigation function provides audio and visual route guidance to help the driver reach a selected destination. In addition to satellite navigation, the head unit incorporates a Compact Disc (CD) player and an AM/FM radio.

The head unit is located in the centre of the fascia. A power amplifier is located under the LH front seat and a CD autochanger is located under the RH front seat. Remote controls are located on the LH side of the steering wheel and connected to the head unit via an interface module. The system also has:

- A high range speaker located in each 'A' post trim
- A low and mid range speaker located in the front doors
- A low and a high range speaker located in the rear doors
- Low range speakers located in a housing on the tail door
- An AM/FM radio aerial, mounted on the RH rear side window, and an aerial amplifier to boost signal strength

The satellite navigation functions are controlled from the head unit. The radio and CD functions can be controlled from the head unit or the remote controls.

## **ICE/Satellite Navigation Supply**

### ***Circuit supply***

A permanent feed from the battery positive terminal is connected by an R wire to the engine compartment fusebox, where it passes through fusible link 3. From fusible link 3 the feed passes on an NR wire to fuse 20 in the passenger compartment fusebox. From fuse 20 the feed flows on a P wire via header C0725 to the head unit and the CD autochanger. The permanent feed to the head unit powers the internal memory. The permanent feed to the CD autochanger allows the CD magazine to be changed with the ignition off.

The head unit is earthed by two B wires from the head unit to splice A22/A190, and a B wire from the splice to earth point C0361-1. The CD autochanger is earthed by an N wire to connector interface C0912-8/C0911-8, then a B wire to earth point C0361-1 via splice A22/A190.

A feed for illumination passes through fusible link 13 in the engine compartment fusebox and on an NG wire to the lighting switch. When the side lamps or head lamps are selected on, the feed passes from the lighting switch to fuse 33 in the passenger compartment fusebox on an R wire. Fuse 33 is connected to header C0759 by an RO wire. After passing through two links on header C0759, one on an RO wire and one on an RN wire, the feed is connected to the head unit on an RN wire.

The permanent feed to the engine compartment fusebox is also connected in series through fusible links 1 and 7. From fusible link 7 the feed is connected to the contacts of the auxiliary circuits relay.

A feed from fusible link 7 in the engine compartment fusebox is also connected to fuse 17 in the passenger compartment fusebox on a PG wire. From fuse 17 the feed is connected to the power amplifier by a LGP wire. The power amplifier is connected to earth header C0708 by a B wire.

Fusible link 8 in the engine compartment fusebox is also connected to the permanent supply. From fusible link 8 a feed is connected to the passenger compartment fusebox on an NW wire. From the passenger compartment fusebox the feed flows to the ignition switch on an N wire.

# DESCRIPTION AND OPERATION

---

## ***Ignition switch supply***

When the ignition switch is in position I or II, the feed from fusible link 8 in the engine compartment fusebox flows from the ignition switch to fuse 26 in the passenger compartment fusebox on an LGW wire. From fuse 26 the feed is connected on an LG wire to the coil of the auxiliary circuits relay, which is connected via header C0286 LHD/C0288 RHD to earth header C0018 on a B wire. The auxiliary circuits relay is energised, closing the relay contacts.

From the closed contacts of the auxiliary circuits relay, a feed flows on a WG wire to fuse 16 in the passenger compartment fusebox. From fuse 16, a feed is connected to the aerial amplifier by an LGO wire. A second feed from fuse 16 supplies power to the on/off switch of the head unit and to the interface module, via splice A47/A194, on an LGP wire. The interface module is earthed on a B wire to earth point C0361-1 via splice A22/A190.

## **ICE/Satellite Navigation Operation**

### ***Head unit***

When the power switch on the head unit is turned on, an enable signal is sent from the head unit to the power amplifier. The enable signal consists of a power feed on an RU wire via header C0285 LHD/C0761 RHD.

A road speed signal, for the automatic volume control and satellite navigation functions, is input to the head unit on an O wire from the instrument pack.

A reverse signal, for the satellite navigation function, is input to the head unit on a GN wire from the reverse lamp switch (manual gearbox) or the starter inhibitor/reverse light switch (automatic gearbox), via header C0287 LHD/C0294 RHD.

Where a telephone is installed, signals are input to the head unit from the accessory power connector. When the telephone is active, a mute signal is input on a PO wire. The telephone circuit positive is input on an SO wire and the telephone circuit negative is input on a YG wire.

### ***Serial communications link***

K wires connected between the head unit, interface module and CD autochanger, via splice A217, provide a serial communications link for operation of the CD autochanger and head unit, using either the remote switches or the switches on the head unit.

### ***Remote control switches***

The remote control switches are connected to the interface module by an SR wire and an SB wire via the rotary coupler. The switches form a resistance ladder between the two wires, with the resistance dependent on which switch is pressed. The interface module monitors the two wires and converts their input into Instrument (I) bus protocol messages, which it outputs on the serial communications link.

## ***CD autochanger connections***

The right channel positive input of the CD autochanger is connected to the head unit by a W wire. The left channel positive input of the CD autochanger is connected to the head unit by an R wire.

The left and right channel negative inputs of the CD autochanger are both connected to splice SJ1, which is connected to a common connection on the head unit by an S wire. The left channel negative input is connected from the CD autochanger to splice SJ1 by an S wire. The right channel negative input is connected from the CD autochanger to splice SJ1 by a B wire to connector interface C0912-2/C0911-2, then from the interface to the splice by a U wire.

## ***RH rear speakers***

The positive output from the head unit is connected by a BG wire to connector interface C0229-18/C0067-18, then by an R wire from the interface to the power amplifier. From the power amplifier the positive output continues on a SR wire to connector interface C0436-1/C0803-1, then on a BU wire from the interface to the RH rear door low range speaker. A second BU wire connects the positive output connection of the RH rear door low range speaker to the RH rear door high range speaker.

The negative output of the RH rear door high range speaker is connected by a BG wire to the RH rear door low range speaker. A second BG wire connects the negative output connection of the RH rear door low range speaker to connector interface C0436-2/C0803-2. From the interface the negative output is connected by an SP wire to the power amplifier. From the power amplifier the negative output is connected by a W wire to connector interface C0229-19/C0067-19, then by a BU wire to the head unit.

## ***RH front speakers***

The positive output from the head unit is connected by a BK wire to connector interface C0229-20/C0067-20, then by a G wire from the interface to the power amplifier. From the power amplifier the positive output continues on a KB wire to the RH front door mid range speaker, via connector interface C0463-2/C0744-2 LHD or C0459-2/C0744-2 RHD. From the interface (C0463-2 LHD or C0459-2 RHD), a KB wire also supplies the positive output to the RH A post high range speaker.

The negative output of the RH front door mid range speaker is connected by an RB wire to the power amplifier via connector interface C0463-1/C0744-1 LHD or C0459-1/C0744-1 RHD. An RB wire also connects the negative output from the RH A post high range speaker to the connector interface (C0463-1 LHD or C0459-1 RHD). From the power amplifier the negative output is connected by an S wire to connector interface C0229-21/C0067-21, then by a BR wire to the head unit.

# DESCRIPTION AND OPERATION

---

For the RH front door low range speaker the power amplifier supplies a positive output on a KG wire to connector interface C0459-3/C0744-3, then on a BK wire from the interface to the speaker. The negative output from the RH front door low range speaker returns on a BR wire to connector interface C0459-4/C0744-4, then on a KR wire to the power amplifier.

## ***LH front speakers***

The positive output from the head unit is connected by a BW wire to connector interface C0229-22/C0067-22, then by a Y wire from the interface to the power amplifier. From the power amplifier the positive output continues on a YB wire to connector interface C0459-1/C0744-1 LHD or C0463-1/C0744-1 RHD, then on an RB wire from the interface to the LH front door mid range speaker. From the interface (C0459-1 LHD or C0463-1 RHD), a YB wire also supplies the positive output to the LH A post high range speaker.

The negative output of the LH front door mid range speaker is connected by a KB wire to connector interface C0459-2/C0744-2 LHD or C0463-2/C0744-2 RHD, then by a YK wire to the power amplifier. A YK wire also connects the negative output from the LH A post high range speaker to the connector interface (C0459-2 LHD or C0463-2 RHD). From the power amplifier, the negative output is connected by an O wire to connector interface C0229-23/C0067-23, then by a BN wire to the head unit.

For the LH front door low range speaker the power amplifier supplies a positive output on an OB wire to connector interface C0463-3/C0744-3, then on a BK wire from the interface to the speaker. The negative output from the RH front door low range speaker returns on a BR wire to connector interface C0463-4/C0744-4, then on an OK wire to the power amplifier.

## ***LH rear speakers***

The positive output from the head unit is connected by a BY wire to connector interface C0229-24/C0067-24, then by a U wire from the interface to the power amplifier. From the power amplifier the positive output continues on a SK wire to connector interface C0435-1/C0803-1, then on a BU wire from the interface to the LH rear door low range speaker. A second BU wire connects the positive output connection of the LH rear door low range speaker to the LH rear door high range speaker.

The negative output of the LH rear door high range speaker is connected by a BG wire to the LH rear door low range speaker. A second BG wire connects the negative output connection of the LH rear door low range speaker to connector interface C0435-2/C0803-2. From the interface the negative output is connected by an SO wire to the power amplifier. From the power amplifier the negative output is connected by a P wire to connector interface C0229-25/C0067-25, then by a BO wire to the head unit.

## ***Tail door speakers***

The power amplifier is connected to tail door low range speaker 1 on a KB wire. From tail door low range speaker 1 the connection returns on an RB wire to the power amplifier.

The power amplifier is connected to tail door low range speaker 2 on an NB wire. From tail door low range speaker 2 the connection returns on a WB wire to the power amplifier.



# DESCRIPTION AND OPERATION

---

## **TRAILER SOCKET**

### **DESCRIPTION**

#### **General**

The 7 pin trailer socket is mounted on the rear bumper to provide power feeds for the exterior lighting of a trailer or caravan. Refer to Description and Operation of individual exterior lighting circuits for trailer socket details.

## **PARK DISTANCE CONTROL (PDC)**

### **DESCRIPTION**

#### **General**

Park Distance Control (PDC) provides an audible warning to the driver when any obstacles are in the path of the vehicle during reverse parking manoeuvres. The system consists of four ultrasonic sensors mounted in the rear bumper, an ECU a PDC switch, and a sounder.

For detailed information on PDC, refer to the Driving Aids section of the Workshop manual.

### **OPERATION**

#### **PDC Operation**

##### ***Circuit supply***

A feed from the battery positive terminal is connected by a R wire to the engine compartment fusebox, where it passes through fusible link 1 and fusible links 8. Fusible link 1 is connected in series with fusible link 7. Fusible link 7 provides a battery feed to the auxiliary circuits relay contacts.

Fusible link 8 is connected to the passenger compartment fusebox by an NW wire. From the passenger compartment fusebox, current flows to the ignition switch on an N wire.

##### ***Ignition switch supply***

When the ignition switch is in position I, current flows from the ignition switch on an LGW wire to fuse 26 of the passenger compartment fusebox. Fuse 26 provides a feed to the auxiliary circuits relay coil on an LG wire. The relay coil is earthed on a B wire via earth header C0018.

When the ignition switch is in position II, current flows from the ignition switch on a Y wire to fuse 25 of the passenger compartment fusebox. Fuse 25 provides a feed to the reverse lamp switch (manual vehicles only) or the automatic transmission starter inhibitor/reverse lamp switch (automatic vehicles only) on a GY wire.

##### ***PDC ECU***

When energised, the auxiliary circuits relay provides a feed to fuse 16 of the passenger compartment fuse box on a WG wire. Current flows through fuse 16 to the PDC ECU on an LGO wire. The PDC ECU is earthed on a B wire via earth header C0707.

# DESCRIPTION AND OPERATION

---

## ***PDC Switch***

The PDC switch is used to switch off PDC if a trailer is attached.

The PDC ECU provides a feed to the PDC switch on an RS wire. When the switch is pressed, the contacts close momentarily and a signal is returned to the PDC ECU on an S wire. When the PDC ECU registers this signal, it will deactivate PDC.

## ***Reverse Gear***

When reverse gear is selected, current from fuse 25 flows across the reverse lamp switch (manual vehicles only) or the automatic transmission starter inhibitor/reverse lamp switch (automatic vehicles only) to the PDC ECU on a GN wire. When the PDC ECU receives this feed it registers that reverse gear has been selected and activates PDC.

## ***PDC Sensors***

The PDC ECU provides a feed to connector interface C2403/C2404 on a WG wire, and from the connector interface to all four PDC sensors on W wires. The sensors are earthed on B wires to connector interface C2404/C2403, and from the connector interface to the PDC ECU on a BG wire.

The PDC sensors provide distance signals to the PDC ECU as follows:

- The RH outer PDC sensor provides a signal to the ECU on an O wire.
- The RH inner PDC sensor provides a signal to the ECU on a Y wire.
- The LH inner PDC sensor provides a signal to the ECU on a U wire.
- The LH outer PDC sensor provides a signal to the ECU on a G wire.

## ***PDC Speaker***

The PDC ECU powers the PDC speaker to give the driver an audible indication of the distance to an obstacle. The PDC ECU provides the speaker a positive signal on a K wire and a negative signal on an N wire.

**CIRCUIT REFERENCE NUMBERS****CONNECTOR APPLICABILITY****General**

The following table lists the circuit reference numbers against a description of the model or feature to which they apply.

This information should be used in conjunction with the connector pin-out tables on the following pages to determine the wire configuration of the vehicle being worked on.

| <b>Cct</b> | <b>Model or Feature</b>                   |
|------------|---|
| 1          | All vehicles                              |
| 2          | Td5                                       |
| 3          | V8  |
| 4          | Td5 with EAT                              |
| 5          | V8 with EAT                               |
| 6          | V8 with EAT and cruise control            |
| 7          | V8 manual transmission and cruise control |
| 8          | Cruise control                            |
| 9          | EAT                                       |
| 10         | ACE                                       |
| 11         | ACE - Td5 only                            |
| 12         | ACE - V8 only                             |
| 13         | SLS                                       |
| 14         | FBH                                       |
| 15         | ATC                                       |
| 16         | Non ATC                                   |
| 17         | Rear A/C                                  |
| 18         | SAI                                       |
| 19         | LEVS 2                                    |
| 20         | NAS, LEVS1 and non LEVS only              |
| 21         | Non LEVS                                  |
| 22         | V8 with 2 HO2S                            |
| 23         | V8 with 4 HO2S                            |
| 24         | High line audio                           |
| 25         | High line audio - Phillips                |
| 26         | High line audio - Harman Kardon           |
| 27         | High line audio plus telephone            |
| 28         | All except high line audio                |
| 29         | Mid-line audio                            |

# CONNECTOR

---

|    |  |
|----|--|
| 30 | All except mid-line audio                    |
| 31 | Satellite navigation                         |
| 32 | Non satellite navigation                     |
| 33 | CD autochanger                               |
| 34 | NAS  |
| 35 | Japanese specification vehicles only         |
| 36 | NAS and Japanese specification vehicles only |
| 37 | All except NAS                               |
| 38 | German border police vehicles only           |
| 39 | German border police with HFS                |
| 40 | Folding door mirrors                         |
| 41 | HFS  |
| 42 | Heated seats                                 |
| 43 | Electric seats                               |
| 44 | RH window lift                               |
| 45 | LH window lift                               |
| 46 | Headlamp levelling                           |
| 47 | Diff lock                                    |
| 48 | Non diff lock                                |
| 49 | Ignition/shift interlock                     |
| 50 | Ignition/shift interlock and diff lock       |
| 51 | No Ignition/shift interlock or diff lock     |

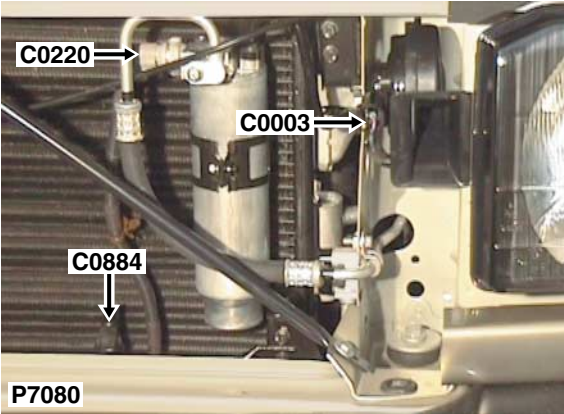

| Cav | Col | Cct |
|-----|-----|-----|
| 1   | B   | ALL |
| 2   | PG  | ALL |

Description: *Horn-LH*

Location: *Behind the front grille*

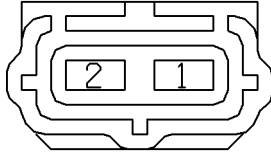

YPC10070

Colour: *BLACK*

Gender: *Female*

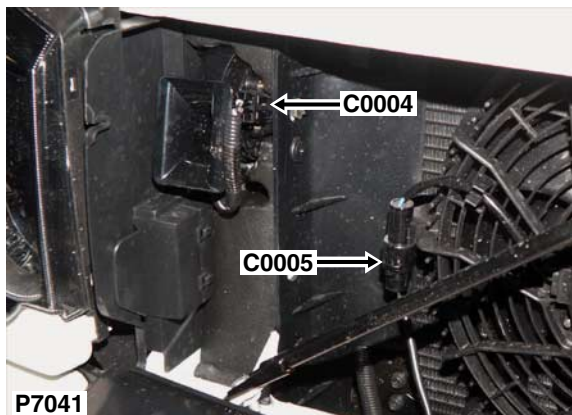

| Cav | Col | Cct |
|-----|-----|-----|
| 1   | B   | ALL |
| 2   | PG  | ALL |

Description: *Horn-RH*

Location: *Front of vehicle - RH side*

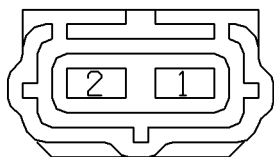

YPC10070

Colour: *BLACK*

Gender: *Female*

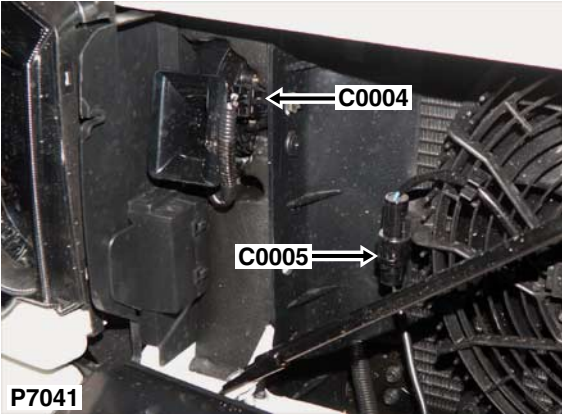

| Cav | Col | Cct |
|-----|-----|-----|
| 1   | BN  | 15  |
| 2   | B   | 15  |

Description: *Motor-Cooling fan-1*  
 Location: *Front of vehicle - RH side*

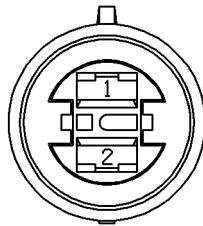

YPC107260

Colour: *BLACK*  
 Gender: *Female*





| Cav | Col | Cct |
|-----|-----|-----|
| 1   | PO  | ALL |
| 2   | B   | ALL |

Description: *Switch-Bonnet*

Location: *Front LH side of engine compartment*

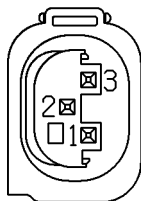

YPC116850

Colour: *BLACK*

Gender: *Female*

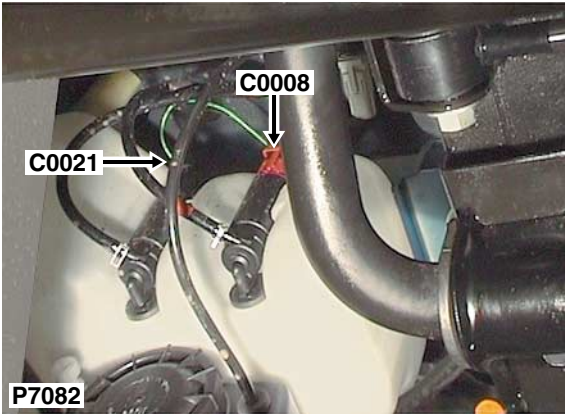

| Cav | Col | Cct |
|-----|-----|-----|
| 1   | LGO | ALL |
| 2   | B   | ALL |

Description: *Pump-Washer-Windscreen*  
 Location: *Behind LH side of front bumper*

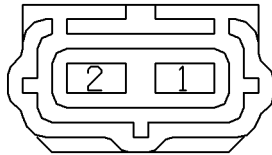

YPC10070

Colour: *BLACK*  
 Gender: *Female*

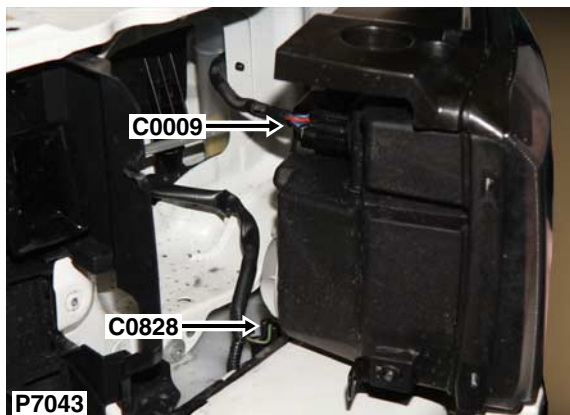

Description: *Headlamp-LH*

Location: *Front of vehicle - LH side*

| Cav | Col | Cct |
|-----|-----|-----|
| 1   | B   | ALL |
| 2   | RB  | ALL |
| 3   | GR  | ALL |
| 4   | RB  | ALL |
| 5   | UY  | ALL |
| 6   | B   | ALL |
| 7   | US  | ALL |
| 8   | UK  | ALL |
| 9   | B   | ALL |

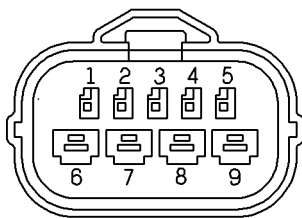

YPC115380

Colour: *BLACK*

Gender: *Female*

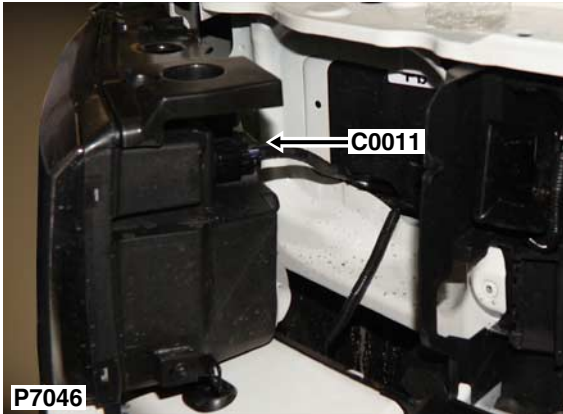

Description: *Headlamp-RH*

Location: *Front of vehicle - RH side*

| Cav | Col | Cct |
|-----|-----|-----|
| 1   | B   | ALL |
| 2   | RO  | ALL |
| 3   | GW  | ALL |
| 4   | RB  | ALL |
| 5   | UY  | ALL |
| 6   | B   | ALL |
| 7   | UO  | ALL |
| 8   | UB  | ALL |
| 9   | B   | ALL |

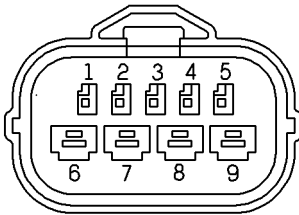

YPC115380

Colour: *BLACK*

Gender: *Female*



| Cav | Col | Cct |
|-----|-----|-----|
| 1   | GW  | ALL |
| 2   | B   | ALL |

Description: *Lamp-Side repeater-Front-RH*  
 Location: *Behind RH side repeater lamp*

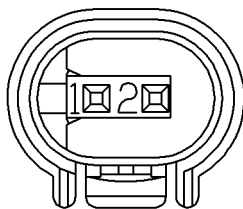

YPC110580

Colour: *GREY*  
 Gender: *Female*

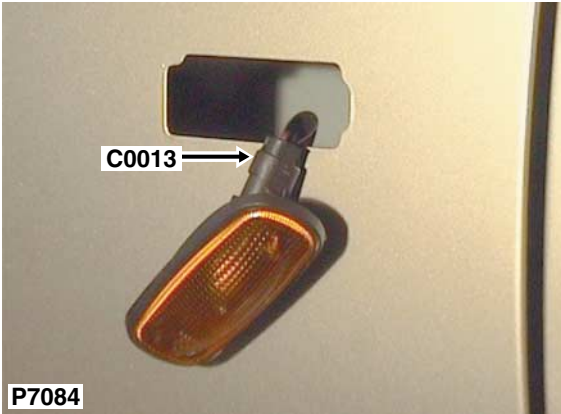

| Cav | Col | Cct |
|-----|-----|-----|
| 1   | GR  | ALL |
| 2   | B   | ALL |

Description: *Lamp-Side repeater-Front-LH*

Location: *Behind LH side repeater lamp*

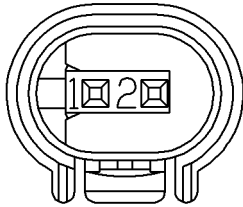

YPC110580

Colour: *GREY*  
Gender: *Female*

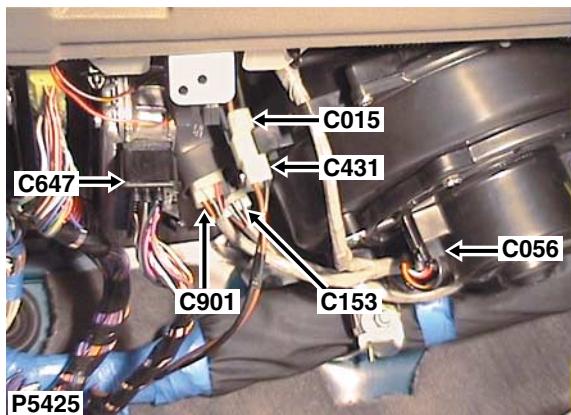

Description: *Heater harness to main harness - RHD*

Location: *Under LH side of fascia*

| Cav | Col | Cct |
|-----|-----|-----|
| 1   | NR  | ALL |
| 2   | B   | ALL |

NO CONNECTOR FACE

Colour:

Gender: *Male*

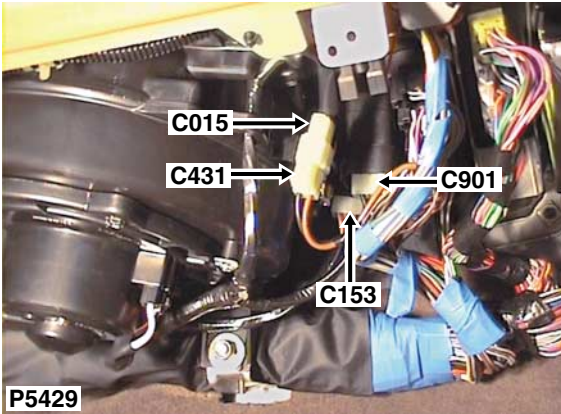

Description: *Heater harness to main harness - LHD*

Location: *Under RH side of fascia*

| Cav | Col | Cct |
|-----|-----|-----|
| 1   | NR  | ALL |
| 2   | B   | ALL |

NO CONNECTOR FACE

Colour:

Gender: *Male*



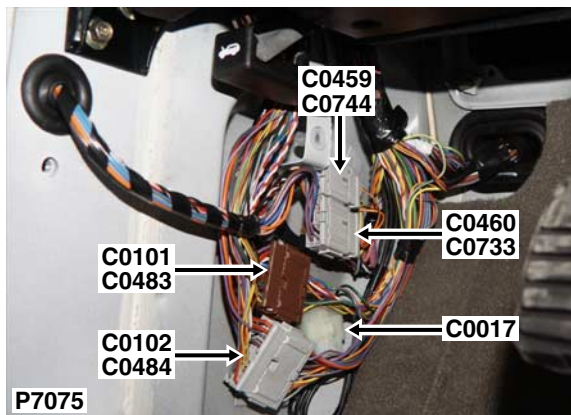

Description: *Header -Earth*

Location: *Under LH side of fascia*

| Cav | Col | Cct |
|-----|-----|-----|
| 1   | B   | ALL |
| 2   | B   | ALL |
| 3   | B   | ALL |
| 4   | B   | ALL |
| 5   | B   | ALL |
| 6   | B   | ALL |
| 7   | B   | ALL |
| 9   | B   | ALL |
| 10  | B   | 40  |

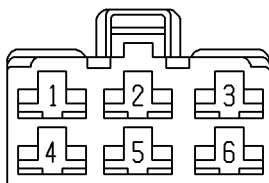

YPC10004

Colour: *NATURAL*

Gender: *Female*

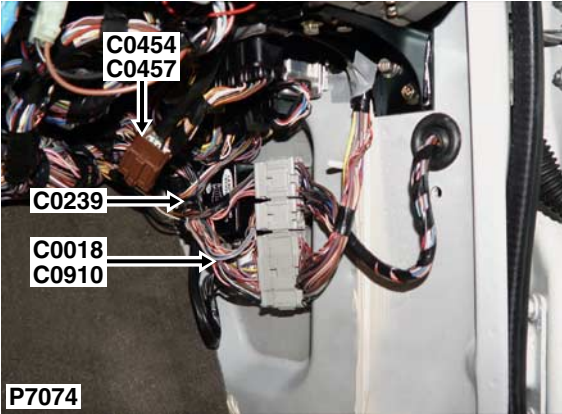

| Cav | Col | Cct |
|-----|-----|-----|
| 1   | B   | ALL |
| 2   | B   | 2   |
| 3   | B   | 13  |
| 4   | B   | ALL |
| 5   | B   | ALL |
| 6   | B   | ALL |
| 7   | B   | ALL |
| 8   | B   | ALL |
| 9   | B   | ALL |
| 10  | B   | ALL |

Description: *Header -Earth*  
 Location: *RH 'A' post*

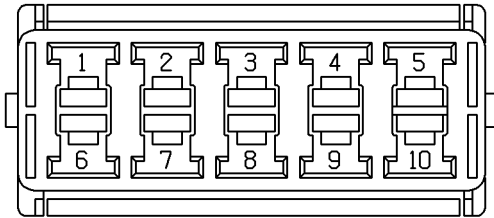

YPC10611

Colour: *LIGHT GREY*  
 Gender: *Female*

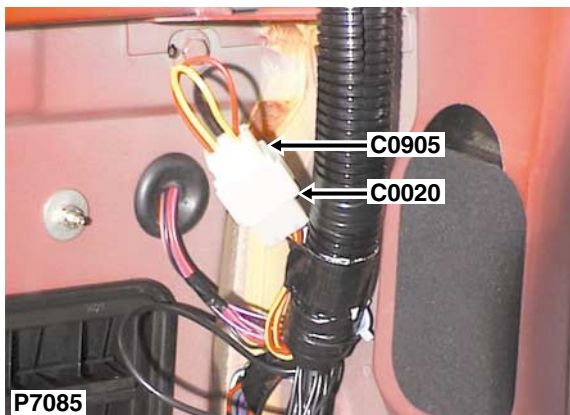

| Cav | Col | Cct |
|-----|-----|-----|
| 1   | RY  | 1   |
| 2   | RY  | 1   |
| 3   | RY  | 1   |

Description: *Body harness to link harness*

Location: *Behind RH rear trim panel*

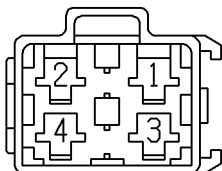

AFU3856

Colour: *NATURAL*

Gender: *Male*

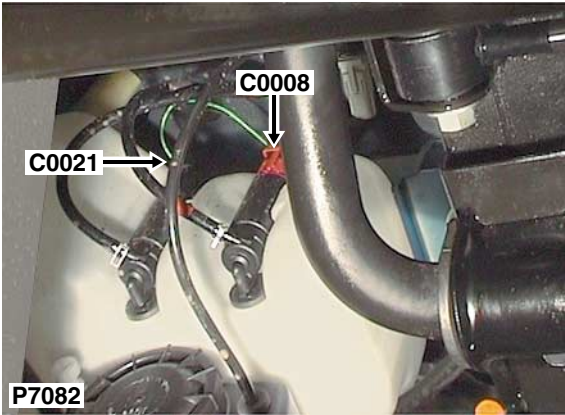

| Cav | Col | Cct |
|-----|-----|-----|
| 1   | LGS | ALL |
| 2   | B   | ALL |

Description: *Pump-Washer-Rear screen*  
 Location: *Behind LH side of front bumper*

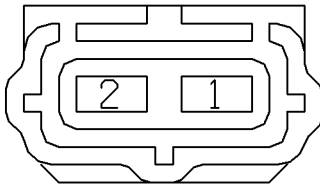

YPC10131

Colour: *RED*  
 Gender: *Female*

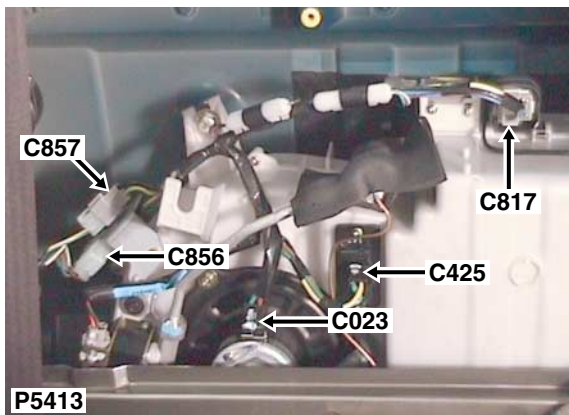

Description: *Motor-Blower-Rear*

Location: *Behind LH rear trim panel*

| Cav | Col | Cct |
|-----|-----|-----|
| 1   | NR  | 17  |
| 2   | G   | 17  |

NO CONNECTOR FACE

Colour: *BLACK*

Gender: *Female*

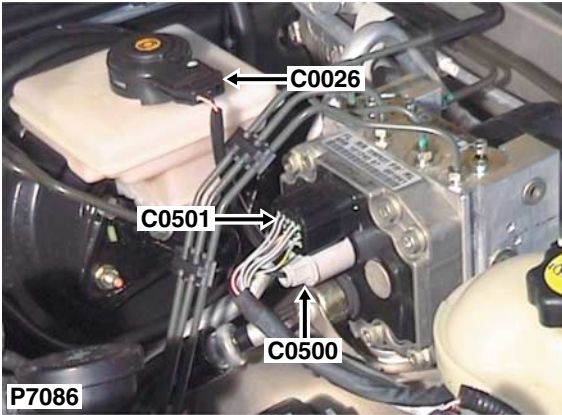

| Cav | Col | Cct |
|-----|-----|-----|
| 1   | KO  | ALL |
| 2   | B   | ALL |

Description: *Switch-Brake fluid level - LHD*  
 Location: *Rear LH side of engine compartment*

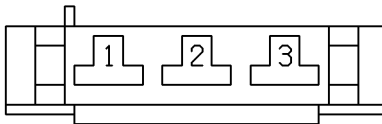

ADU6599

Colour: *BLACK*  
 Gender: *Female*

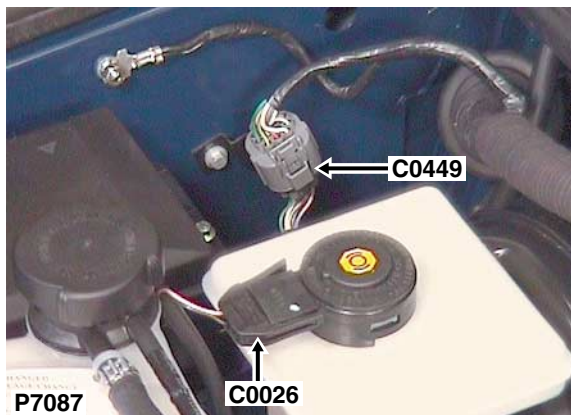

Description: *Switch-Brake fluid level - RHD*

Location: *Rear RH side of engine compartment*

| Cav | Col | Cct |
|-----|-----|-----|
| 1   | KO  | ALL |
| 2   | B   | ALL |

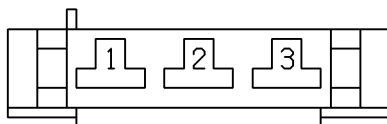

ADU6599

Colour: *BLACK*

Gender: *Female*

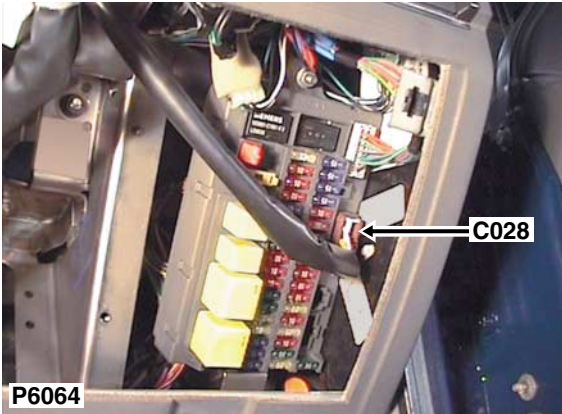

| Cav | Col | Cct |
|-----|-----|-----|
| 1   | N   | ALL |
| 3   | LGW | ALL |
| 4   | W   | ALL |
| 5   | Y   | ALL |
| 6   | WR  | ALL |

Description: *Switch-Ignition - RHD*  
Location: *Behind RH side of fascia*

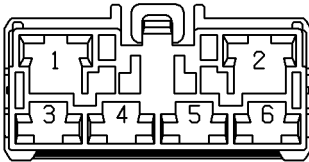

YPC109090

Colour: *BROWN*  
Gender: *Female*



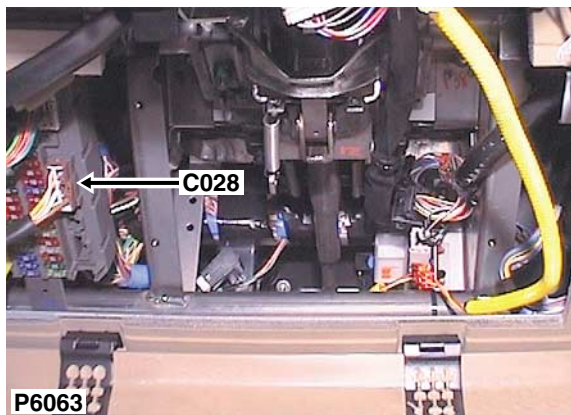

Description: *Switch-Ignition - LHD*

Location: *Behind LH side of fascia*

| Cav | Col | Cct |
|-----|-----|-----|
| 1   | N   | ALL |
| 3   | LGW | ALL |
| 4   | W   | ALL |
| 5   | Y   | ALL |
| 6   | WR  | ALL |

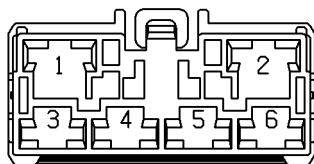

YPC109090

Colour: *BROWN*

Gender: *Female*

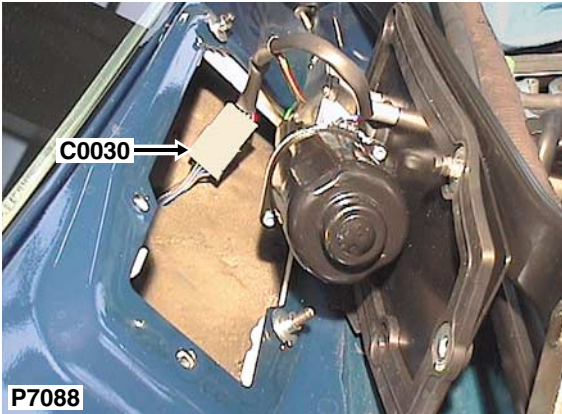

| Cav | Col | Cct |
|-----|-----|-----|
| 1   | B   | ALL |
| 2   | WLG | ALL |
| 3   | ULG | ALL |
| 4   | GS  | ALL |
| 5   | U   | 38  |
| 5   | RLG | ALL |

Description: *Motor-Wiper-Windscreen*

Location: *Top of bulkhead - centre*

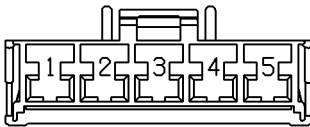

YPC108290

Colour: *LIGHT GREY*

Gender: *Female*

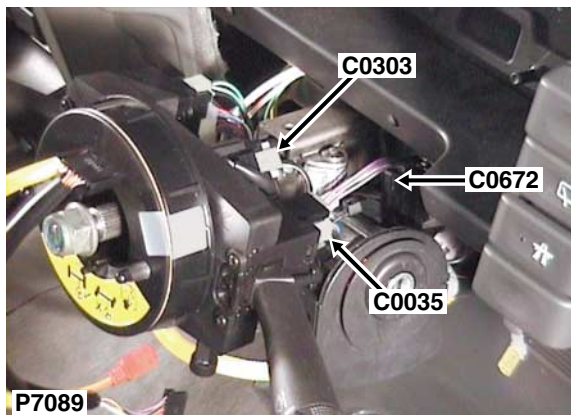

Description: *Switch-Wash/wipe-Windscreen*

Location: *RH side of steering column*

| Cav | Col | Cct |
|-----|-----|-----|
| 1   | GS  | ALL |
| 2   | LGG | ALL |
| 3   | ULG | ALL |
| 4   | N   | 38  |
| 4   | RLG | ALL |
| 5   | GS  | ALL |
| 7   | LGP | ALL |
| 8   | LGO | ALL |

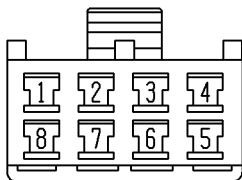

YPC10006

Colour: *NATURAL*

Gender: *Female*

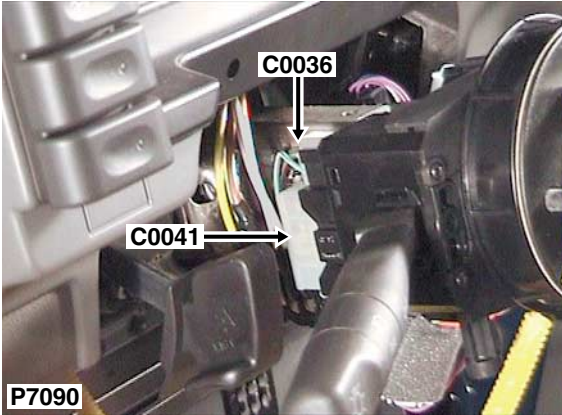

Description: *Switch-Direction indicator*

Location: *LH side of steering column*

| Cav | Col | Cct |
|-----|-----|-----|
| 1   | GR  | ALL |
| 2   | B   | ALL |
| 4   | GW  | ALL |

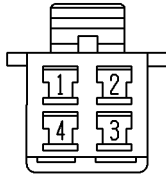

YPC10002

Colour: *NATURAL*

Gender: *Female*

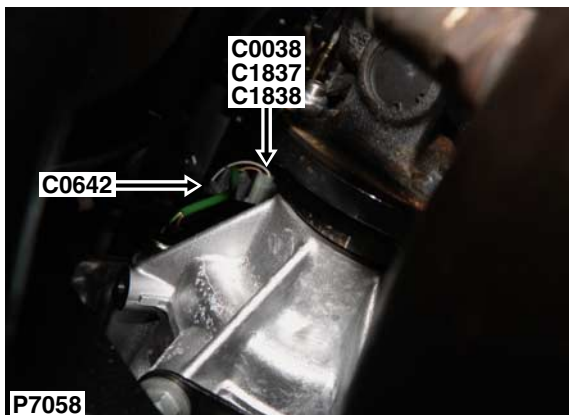

Description: *Resistor*

Location: *Top of transfer box*

| Cav | Col | Cct |
|-----|-----|-----|
| 2   | WN  | 47  |

■  
Colour:  
Gender:

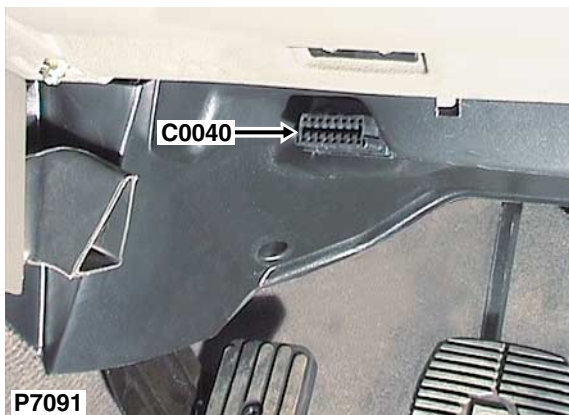

| Cav | Col | Cct |
|-----|-----|-----|
| 4   | B   | ALL |
| 5   | B   | ALL |
| 7   | K   | ALL |
| 13  | R   | ALL |
| 16  | P   | ALL |

**P7091**

Description: *Diagnostic socket - LHD*

Location: *Under RH side of fascia*

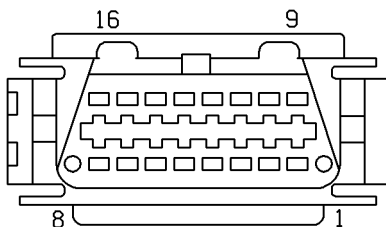

YPC107920

Colour: *BLACK*

Gender: *Female*

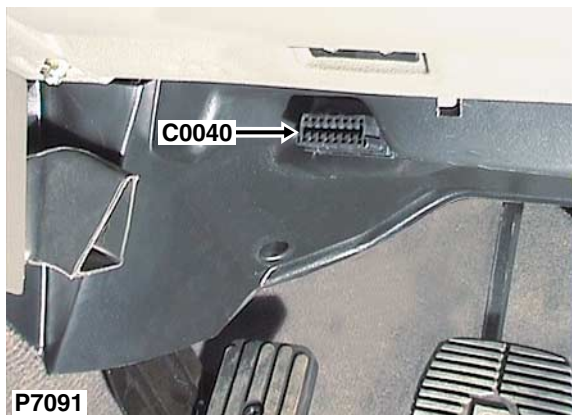

Description: *Diagnostic socket - RHD*

Location: *Under LH side of fascia*

| Cav | Col | Cct |
|-----|-----|-----|
| 4   | B   | ALL |
| 5   | B   | ALL |
| 7   | K   | ALL |
| 13  | R   | 14  |
| 16  | P   | ALL |

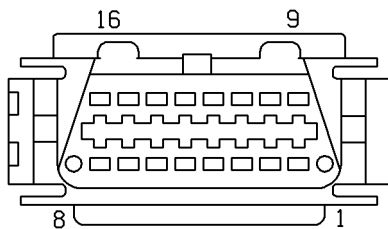

YPC107920

Colour: *BLACK*

Gender: *Female*

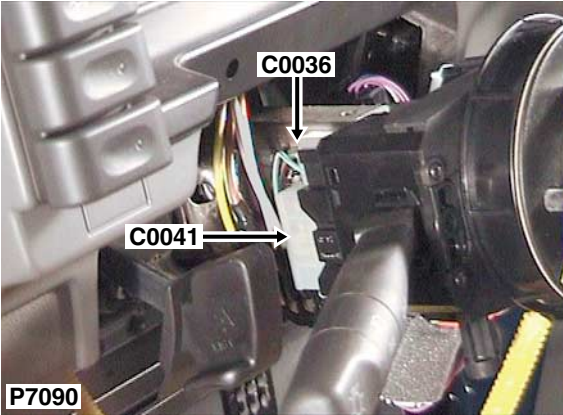

Description: *Switch-Lighting*  
 Location: *LH side of steering column*

| Cav | Col | Cct |
|-----|-----|-----|
| 2   | UR  | ALL |
| 3   | NG  | ALL |
| 4   | R   | ALL |
| 5   | UW  | ALL |
| 6   | NP  | ALL |

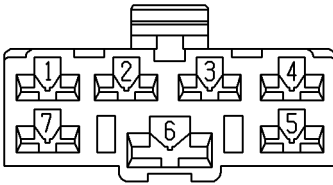

YPC10008

Colour: *NATURAL*  
 Gender: *Female*



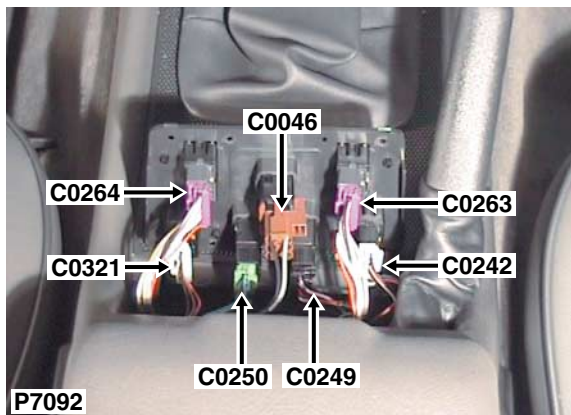

| Cav | Col | Cct |
|-----|-----|-----|
| 1   | SG  | ALL |
| 4   | B   | ALL |

Description: *Switch-Isolation-Window lift*

Location: *Behind centre console*

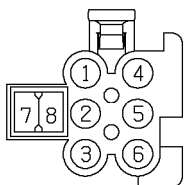

ADU6630

Colour: *BROWN*

Gender: *Female*

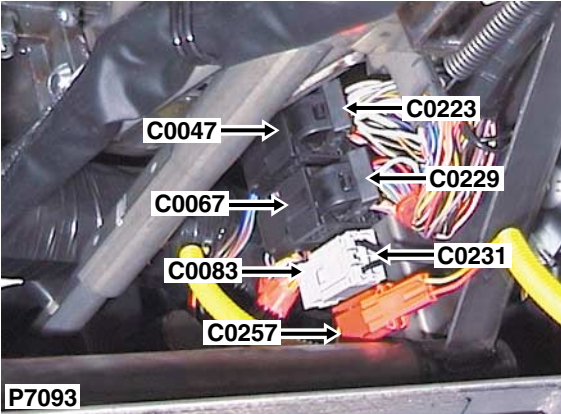

Description: *Main harness to fascia harness - LHD*  
 Location: *LH side of steering column*

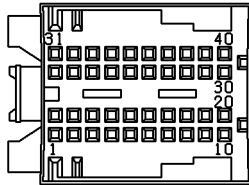

YPC113480

Colour: *BLACK*  
 Gender: *Male*

| Cav | Col | Cct |
|-----|-----|-----|
| 1   | BLG | ALL |
| 2   | KO  | ALL |
| 3   | WN  | ALL |
| 4   | RS  | ALL |
| 5   | BO  | 10  |
| 6   | GS  | 3   |
| 7   | NY  | ALL |
| 8   | YR  | ALL |
| 9   | SK  | ALL |
| 10  | KB  | ALL |
| 11  | B   | ALL |
| 12  | BS  | ALL |
| 13  | B   | ALL |
| 14  | OG  | 2   |
| 15  | YG  | 9   |
| 16  | YR  | 9   |
| 17  | WU  | ALL |
| 18  | GU  | ALL |
| 19  | BY  | 2   |
| 20  | WS  | ALL |
| 21  | GB  | ALL |
| 22  | WO  | 13  |
| 23  | WK  | ALL |
| 24  | WR  | ALL |
| 25  | WY  | ALL |
| 26  | SW  | ALL |
| 27  | BU  | ALL |
| 28  | BK  | ALL |
| 29  | BN  | ALL |
| 30  | BP  | ALL |
| 31  | RN  | ALL |
| 32  | KB  | ALL |
| 33  | UP  | ALL |
| 34  | PR  | ALL |
| 35  | KR  | ALL |
| 36  | YK  | ALL |
| 37  | UY  | 37  |

| Cav | Col | Cct |
|-----|-----|-----|
| 38  | PK  | 13  |
| 39  | BU  | ALL |
| 40  | PW  | ALL |

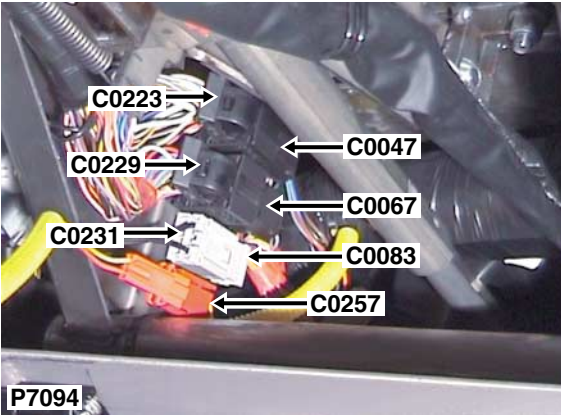

Description: *Main harness to fascia harness - RHD*  
 Location: *RH side of steering column*

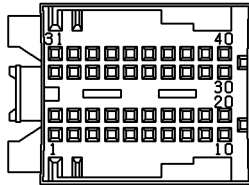

YPC113480

Colour: *BLACK*  
 Gender: *Male*

| Cav | Col | Cct |
|-----|-----|-----|
| 1   | BLG | ALL |
| 2   | KO  | ALL |
| 3   | WN  | ALL |
| 4   | RS  | ALL |
| 5   | BO  | 10  |
| 6   | GS  | 3   |
| 7   | NY  | ALL |
| 8   | YR  | ALL |
| 9   | SK  | ALL |
| 10  | KB  | ALL |
| 11  | B   | ALL |
| 12  | BS  | ALL |
| 13  | B   | ALL |
| 14  | OG  | 2   |
| 15  | YG  | 9   |
| 16  | YR  | 9   |
| 17  | WU  | ALL |
| 18  | GU  | ALL |
| 19  | BY  | 2   |
| 20  | WS  | ALL |
| 21  | GB  | ALL |
| 22  | WO  | 13  |
| 23  | WK  | ALL |
| 24  | WR  | ALL |
| 25  | WY  | ALL |
| 26  | SW  | ALL |
| 27  | BU  | ALL |
| 28  | BK  | ALL |
| 29  | BN  | ALL |
| 30  | BP  | ALL |
| 31  | RN  | ALL |
| 32  | KB  | ALL |
| 33  | UP  | ALL |
| 34  | PR  | ALL |
| 35  | KR  | ALL |
| 36  | YK  | ALL |
| 37  | UY  | ALL |

| Cav | Col | Cct |
|-----|-----|-----|
| 38  | PK  | 13  |
| 39  | BU  | ALL |
| 40  | PW  | ALL |

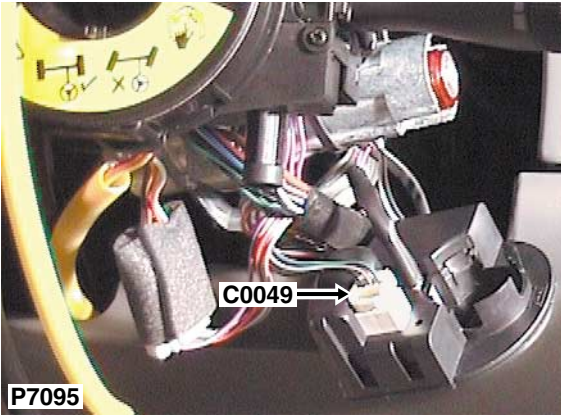

| Cav | Col | Cct |
|-----|-----|-----|
| 1   | B   | ALL |
| 2   | SR  | ALL |
| 3   | GU  | ALL |

Description: *Coil-Transponder*  
 Location: *RH side of steering column*

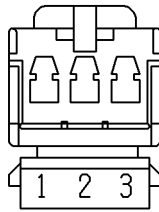

YPC10227

Colour: *WHITE*  
 Gender: *Female*

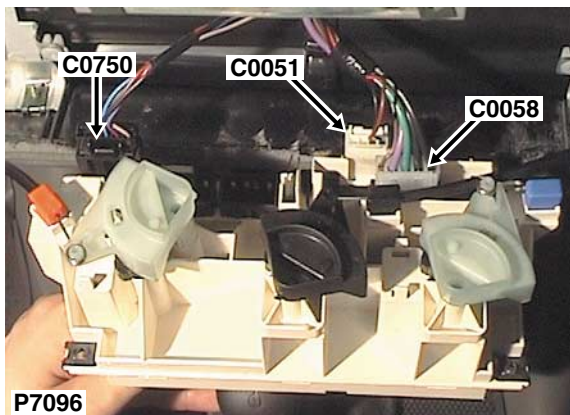

| Cav | Col | Cct |
|-----|-----|-----|
| 3   | RN  | 16  |
| 4   | B   | 16  |

Description: *Heater control illumination*  
 Location: *Behind heater control panel*

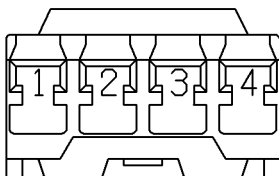

YPC107290

Colour: *NATURAL*  
 Gender: *Female*

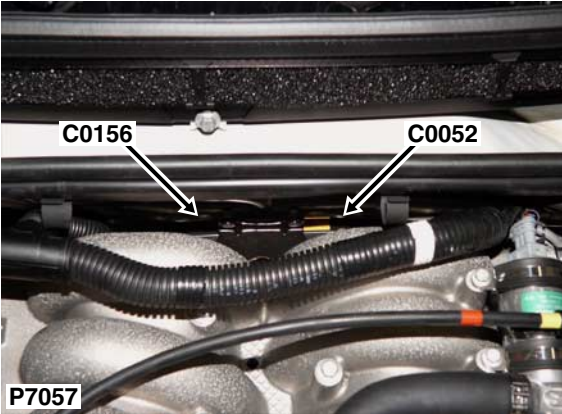

| Cav | Col | Cct |
|-----|-----|-----|
| 1   | WU  | ALL |
| 2   | GN  | ALL |
| 3   | KB  | ALL |

Description: *Ignition coil*  
 Location: *Centre rear of engine*

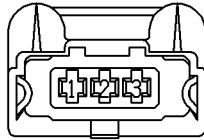

YPC107900

Colour: *BLACK*  
 Gender: *Female*



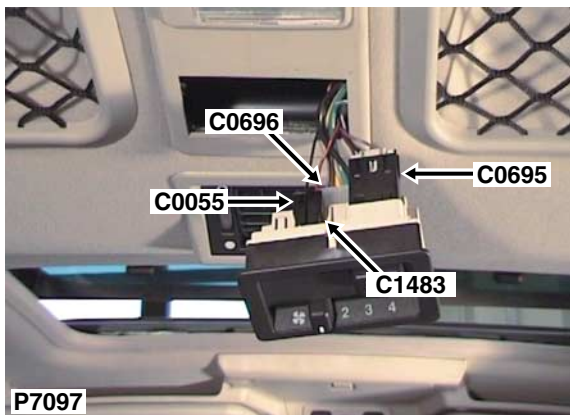

| Cav | Col | Cct |
|-----|-----|-----|
| 1   | B   | 17  |

Description: *Rear A/C switch illumination*

Location: *Behind centre headlining*

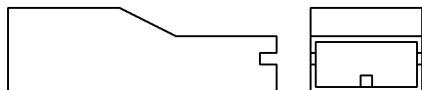

AAU1010

Colour: *BLACK*

Gender: *Female*

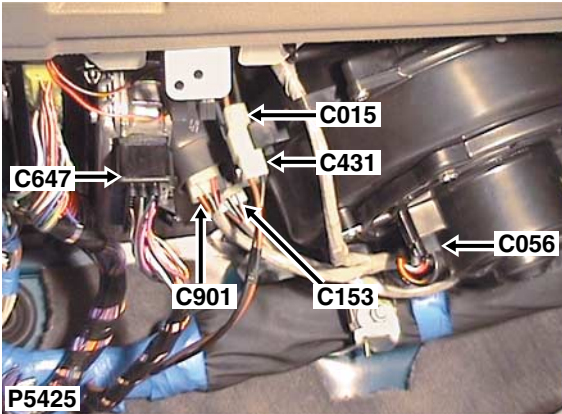

| Cav | Col | Cct |
|-----|-----|-----|
| 1   | WR  | 15  |
| 2   | BO  | 15  |

Description: *Motor-Blower-Front - RHD*

Location: *Under LH side of fascia*

NO CONNECTOR FACE

Colour: *BLACK*

Gender: *Female*

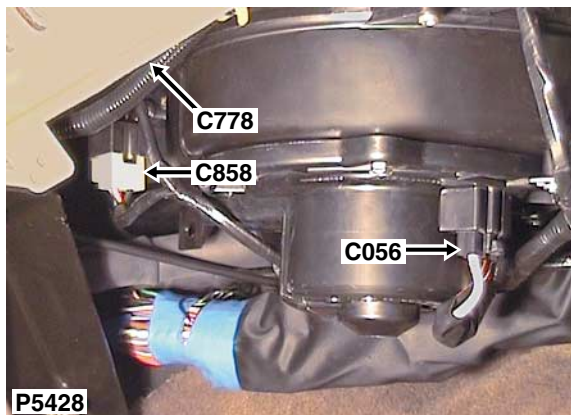

| Cav | Col | Cct |
|-----|-----|-----|
| 1   | WR  | ALL |
| 2   | BO  | ALL |

Description: *Motor-Blower-Front - LHD*

Location: *Under RH side of fascia*

NO CONNECTOR FACE

Colour: *BLACK*

Gender: *Female*

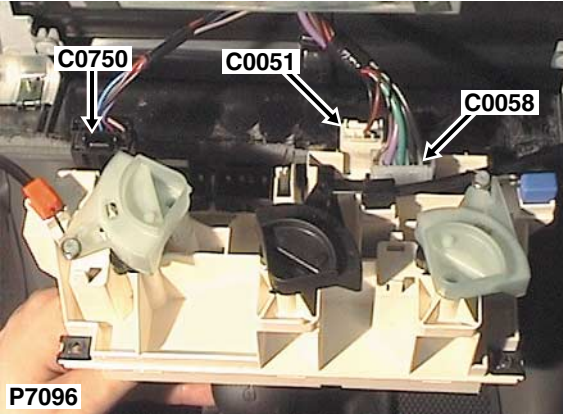

Description: *Switch-Blower motor*  
 Location: *Behind heater control panel*

| Cav | Col | Cct |
|-----|-----|-----|
| 1   | N   | 16  |
| 2   | PU  | 16  |
| 3   | G   | 16  |
| 4   | BO  | 16  |
| 5   | B   | 16  |

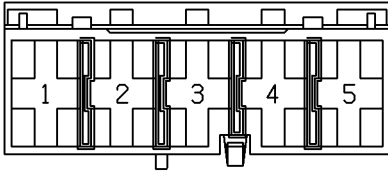

YPC108000

Colour: *NATURAL*  
 Gender: *Female*



| Cav | Col | Cct |
|-----|-----|-----|
| 1   | UP  | ALL |
| 2   | RN  | ALL |
| 4   | B   | ALL |
| 5   | RY  | ALL |

Description: *Switch-Fog guard lamp-Rear*

Location: *Adjacent instrument pack*

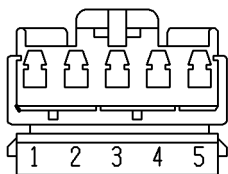

YPC10525

Colour: *BLUE*

Gender: *Female*



| Cav | Col | Cct |
|-----|-----|-----|
| 1   | KB  | ALL |
| 2   | RN  | ALL |
| 4   | B   | ALL |
| 5   | UP  | ALL |

Description: *Switch-Fog lamp-Front*

Location: *Adjacent instrument pack*

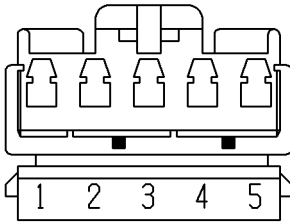

YPC10526

Colour: *GREEN*

Gender: *Female*

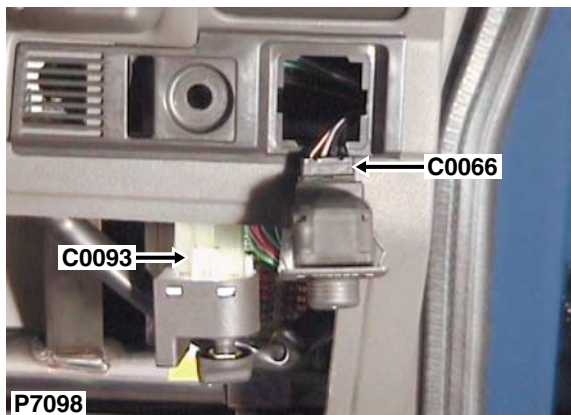

| Cav | Col | Cct |
|-----|-----|-----|
| 1   | BK  | ALL |
| 2   | BN  | ALL |
| 3   | SW  | ALL |
| 4   | B   | ALL |
| 5   | BP  | ALL |
| 6   | GLG | ALL |
| 7   | BU  | ALL |
| 8   | UB  | ALL |

Description: *Switch-Mirror*

Location: *Behind driver side of fascia*

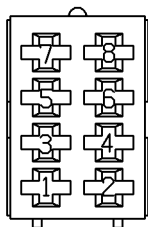

ADU9122

Colour: *BLACK*

Gender: *Female*

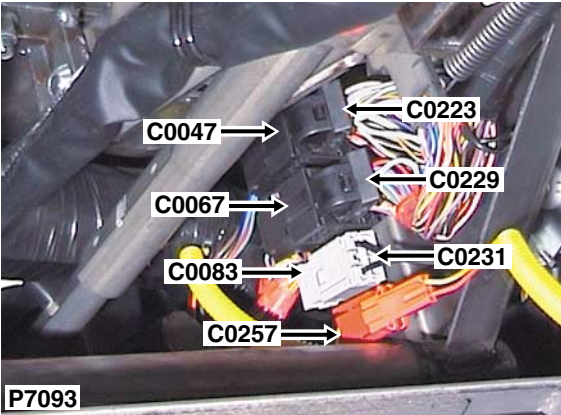

Description: *Main harness to fascia harness - LHD*  
 Location: *LH side of steering column*

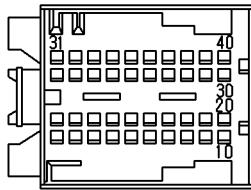

YPC116360

Colour: *GREEN*  
 Gender: *Male*

| Cav | Col | Cct |
|-----|-----|-----|
| 1   | NP  | ALL |
| 2   | KO  | 41  |
| 3   | PS  | 41  |
| 4   | NB  | ALL |
| 5   | KG  | ALL |
| 6   | YG  | 15  |
| 7   | BW  | 15  |
| 9   | YB  | 15  |
| 10  | PG  | 15  |
| 11  | W   | 24  |
| 12  | G   | 24  |
| 13  | S   | 24  |
| 14  | Y   | 24  |
| 15  | O   | 24  |
| 16  | KG  | 25  |
| 16  | SG  | 26  |
| 17  | RU  | 24  |
| 18  | R   | 24  |
| 18  | BG  | 28  |
| 19  | W   | 24  |
| 19  | BU  | 28  |
| 20  | G   | 24  |
| 20  | BK  | 28  |
| 21  | S   | 24  |
| 21  | BR  | 28  |
| 22  | Y   | 24  |
| 22  | BW  | 28  |
| 23  | O   | 24  |
| 23  | BN  | 28  |
| 24  | U   | 24  |
| 24  | BY  | 28  |
| 25  | P   | 24  |
| 25  | BO  | 28  |
| 26  | U   | 24  |
| 27  | P   | 24  |
| 28  | GO  | ALL |
| 30  | R   | 24  |



| <b>Cav</b> | <b>Col</b> | <b>Cct</b> |
|------------|------------|------------|
| 31         | PW         | 3          |
| 32         | LGS        | ALL        |
| 33         | UP         | ALL        |
| 34         | OB         | ALL        |
| 35         | LGR        | ALL        |
| 36         | WY         | ALL        |
| 37         | SB         | ALL        |
| 38         | SR         | ALL        |
| 39         | PS         | ALL        |
| 40         | UB         | 40         |

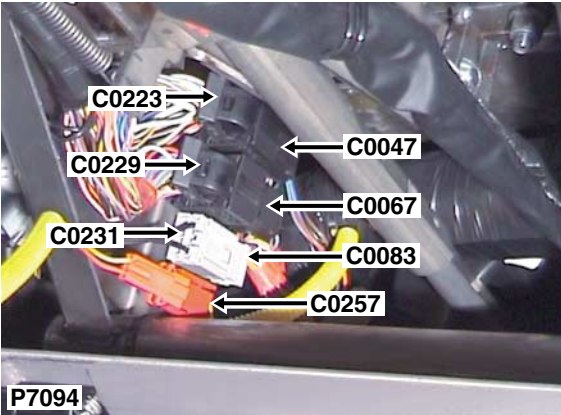

Description: *Main harness to fascia harness - RHD*  
 Location: *RH side of steering column*

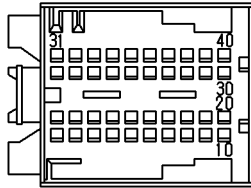

YPC116360

Colour: *GREEN*  
 Gender: *Male*

| Cav | Col | Cct |
|-----|-----|-----|
| 1   | NP  | ALL |
| 2   | KO  | 41  |
| 3   | PS  | 41  |
| 4   | NB  | ALL |
| 5   | KG  | ALL |
| 6   | YG  | 15  |
| 7   | BW  | 15  |
| 8   | B   | 15  |
| 9   | YB  | 15  |
| 10  | PG  | 15  |
| 11  | W   | 24  |
| 12  | G   | 24  |
| 13  | S   | 24  |
| 14  | Y   | 24  |
| 15  | O   | 24  |
| 16  | KG  | 25  |
| 16  | SG  | 26  |
| 17  | RU  | 24  |
| 18  | R   | 24  |
| 18  | BG  | 28  |
| 19  | W   | 24  |
| 19  | BU  | 28  |
| 20  | G   | ALL |
| 20  | BK  | 28  |
| 21  | S   | ALL |
| 21  | BR  | 28  |
| 22  | Y   | ALL |
| 22  | BW  | 28  |
| 23  | O   | ALL |
| 23  | BN  | 28  |
| 24  | U   | 24  |
| 24  | BY  | 28  |
| 25  | P   | 24  |
| 25  | BO  | 28  |
| 26  | U   | 24  |
| 27  | P   | 24  |
| 28  | GO  | ALL |

| <b>Cav</b> | <b>Col</b> | <b>Cct</b> |
|------------|------------|------------|
| 30         | R          | 24         |
| 31         | PW         | 3          |
| 32         | LGS        | ALL        |
| 33         | UP         | ALL        |
| 34         | OB         | ALL        |
| 35         | LGR        | ALL        |
| 36         | WY         | ALL        |
| 37         | SB         | ALL        |
| 38         | SR         | ALL        |
| 39         | PS         | ALL        |
| 40         | UB         | 40         |

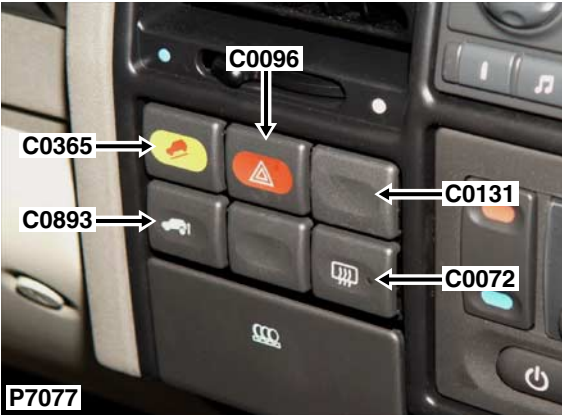

| Cav | Col | Cct |
|-----|-----|-----|
| 1   | NB  | ALL |
| 2   | RN  | ALL |
| 4   | B   | ALL |
| 5   | NP  | ALL |

Description: *Switch-Heated rear screen*  
 Location: *Behind centre of fascia*

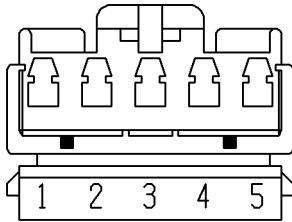

YPC10523

Colour: *BLACK*  
 Gender: *Female*



| Cav | Col | Cct |
|-----|-----|-----|
| 1   | GLG | ALL |
| 2   | B   | ALL |
| 4   | LGS | ALL |
| 5   | RN  | ALL |

Description: *Switch-Washer-Rear screen*

Location: *Behind instrument pack surround RH side*

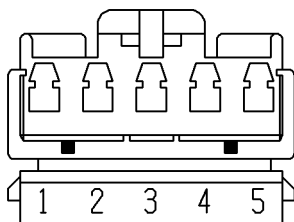

YPC10523

Colour: *BLACK*

Gender: *Female*

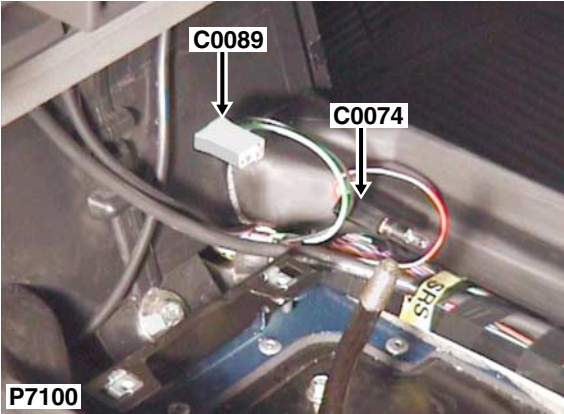

| Cav | Col | Cct |
|-----|-----|-----|
| 1   | RN  | ALL |

Description: *Cigar lighter illumination*  
 Location: *Behind centre console*

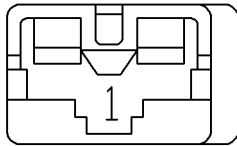

AFU4521

Colour: *NATURAL*  
 Gender: *Female*

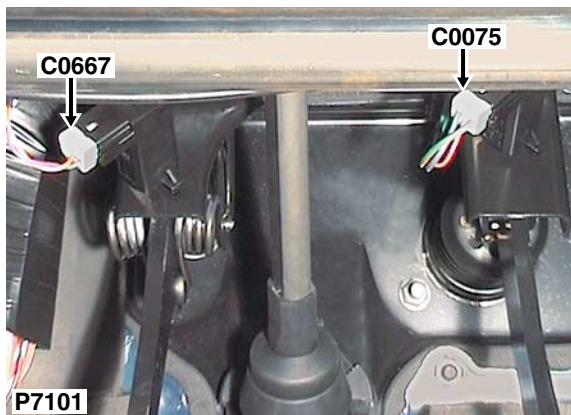

| Cav | Col | Cct |
|-----|-----|-----|
| 1   | GO  | ALL |
| 2   | OG  | ALL |
| 2   | PG  | ALL |
| 3   | GP  | ALL |

Description: *Switch-Brake pedal - LHD*

Location: *Under LH side of fascia*

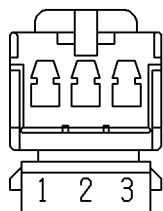

YPC10227

Colour: *WHITE*

Gender: *Female*

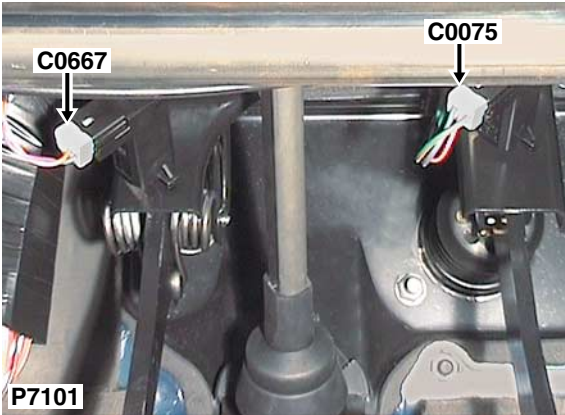

| Cav | Col | Cct |
|-----|-----|-----|
| 1   | GO  | ALL |
| 2   | OG  | ALL |
| 2   | PG  | 6   |
| 3   | GP  | ALL |

Description: *Switch-Brake pedal - RHD*  
 Location: *Under RH side of fascia*

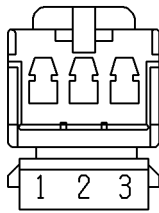

YPC10227

Colour: *WHITE*  
 Gender: *Female*





| Cav | Col | Cct |
|-----|-----|-----|
| 1   | OB  | ALL |
| 2   | RN  | ALL |
| 4   | B   | ALL |

Description: *Switch-Wiper-Rear*

Location: *Behind instrument pack surround RH side*

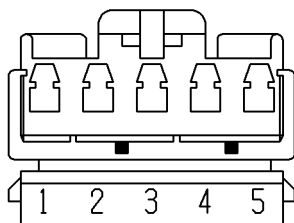

YPC10526

Colour: *GREEN*

Gender: *Female*

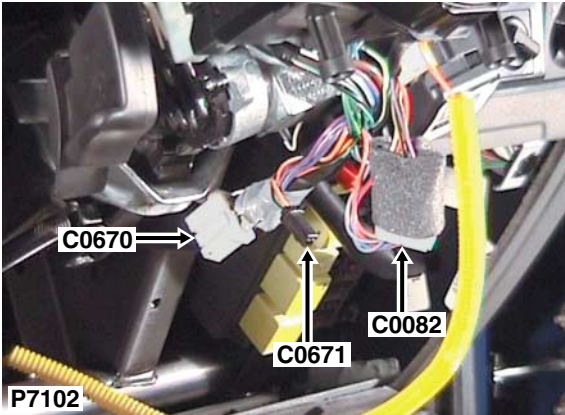

| Cav | Col | Cct |
|-----|-----|-----|
| 1   | SR  | ALL |
| 2   | SB  | ALL |
| 3   | UW  | ALL |
| 4   | RW  | ALL |
| 5   | PO  | ALL |

Description: *Rotary coupler*

Location: *Underside of steering column*

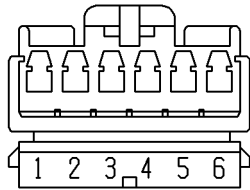

YPC10270

Colour: *WHITE*

Gender: *Female*

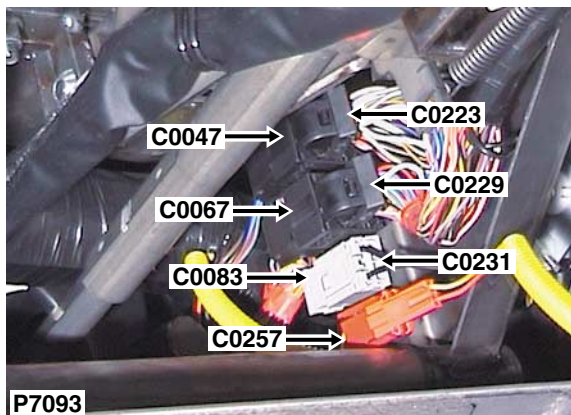

Description: *Main harness to fascia harness - LHD*  
 Location: *LH side of steering column*

| Cav | Col | Cct |
|-----|-----|-----|
| 1   | S   | ALL |
| 2   | B   | ALL |
| 3   | SO  | 38  |
| 4   | GN  | ALL |
| 5   | RS  | ALL |
| 6   | GK  | 38  |

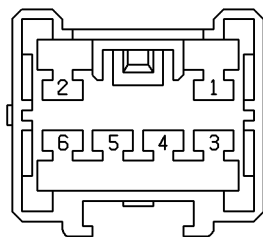

YPC10500

Colour: *LIGHT GREY*  
 Gender: *Male*

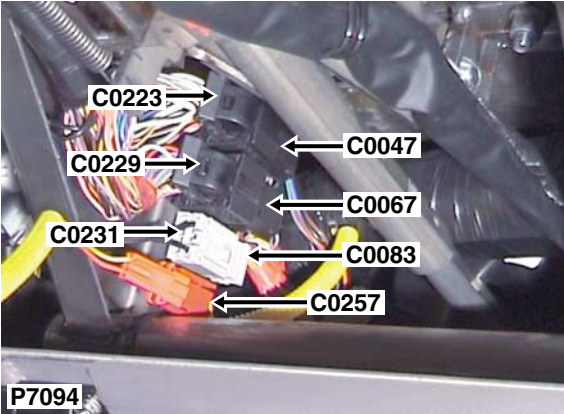

| Cav | Col | Cct |
|-----|-----|-----|
| 1   | S   | ALL |
| 2   | B   | ALL |
| 4   | GN  | ALL |
| 5   | RS  | ALL |

Description: *Main harness to fascia harness - RHD*  
 Location: *RH side of steering column*

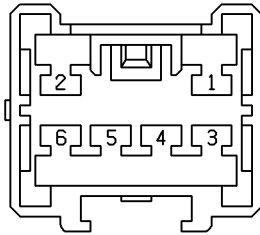

YPC10500

Colour: *LIGHT GREY*  
 Gender: *Male*

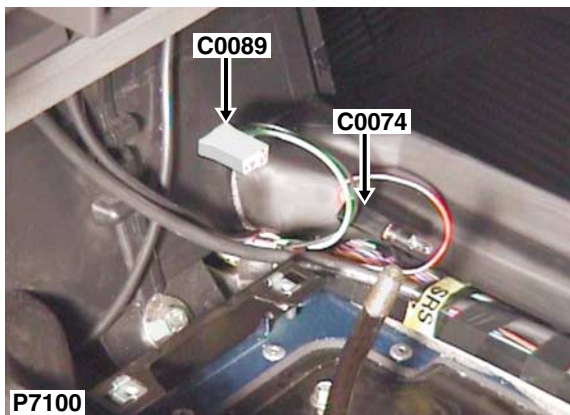

Description: *Cigar lighter*

Location: *Behind centre console*

| Cav | Col | Cct |
|-----|-----|-----|
| 1   | B   | ALL |
| 2   | LGW | ALL |

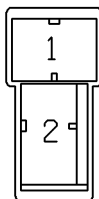

ADU9448

Colour: *NATURAL*

Gender: *Female*

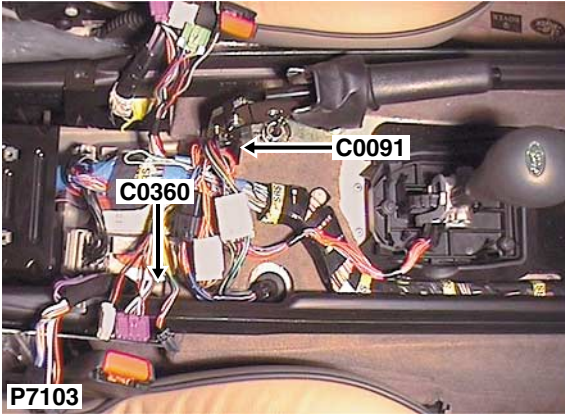

| Cav | Col | Cct |
|-----|-----|-----|
| 1   | KO  | ALL |

Description: *Switch-Handbrake - LHD*  
 Location: *Behind centre console*

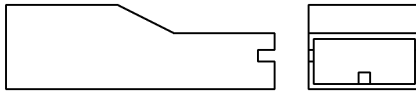

AAU1010

Colour: *BLACK*  
 Gender: *Female*

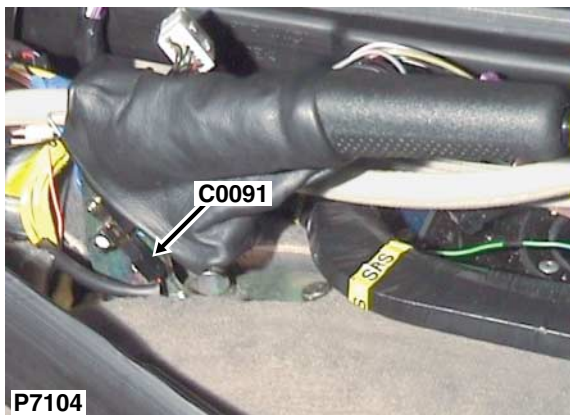

| Cav | Col | Cct |
|-----|-----|-----|
| 1   | KO  | ALL |

Description: *Switch-Handbrake - RHD*

Location: *Behind centre console*

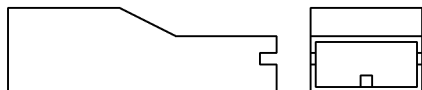

AAU1010

Colour: *BLACK*

Gender: *Female*

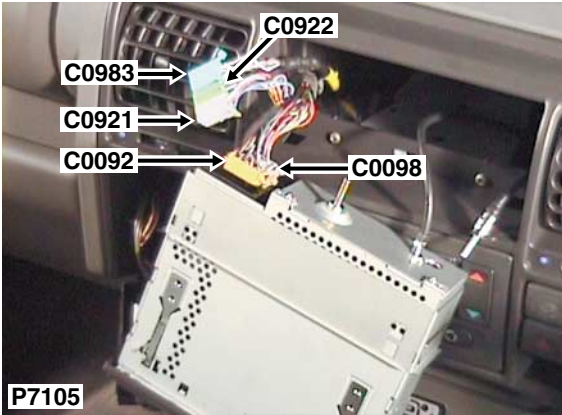

Description: *Head Unit-Audio System*  
 Location: *Behind radio*

| Cav | Col | Cct |
|-----|-----|-----|
| 1   | BG  | 30  |
| 2   | BU  | 30  |
| 3   | BK  | 30  |
| 4   | BR  | 30  |
| 5   | BW  | 30  |
| 6   | BN  | 30  |
| 7   | BY  | 30  |
| 8   | BO  | 30  |

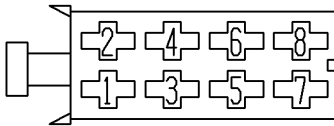

YPC10191

Colour: *BROWN*  
 Gender: *Female*



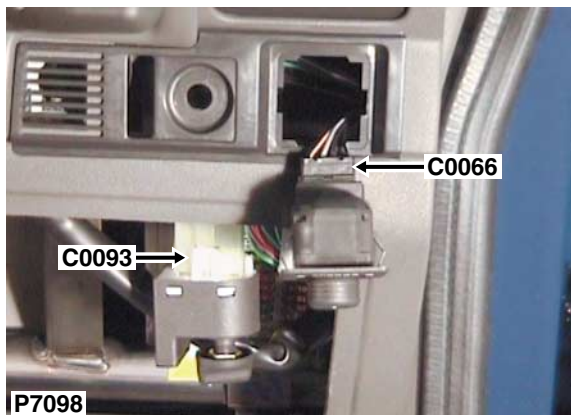

| Cav | Col | Cct |
|-----|-----|-----|
| 1   | B   | 35  |
| 2   | UY  | 35  |
| 4   | RN  | 35  |
| 5   | RO  | ALL |

Description: *Switch-Headlamp levelling*

Location: *Behind driver side of fascia*

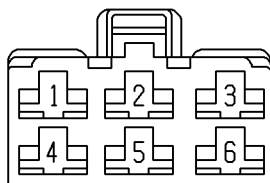

YPC10004

Colour: *NATURAL*

Gender: *Female*

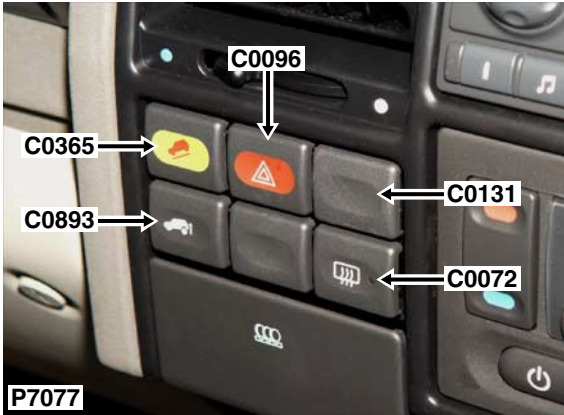

| Cav | Col | Cct |
|-----|-----|-----|
| 1   | LGR | ALL |
| 2   | RN  | ALL |
| 4   | B   | ALL |

Description: *Switch-Hazard warning*  
 Location: *Behind centre of fascia*

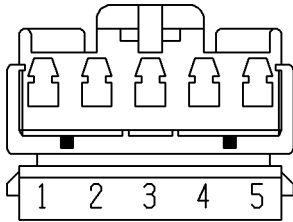

YPC10523

Colour: *BLACK*  
 Gender: *Female*

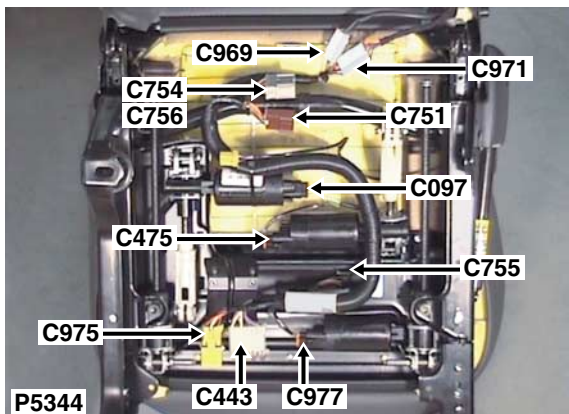

| Cav | Col | Cct |
|-----|-----|-----|
| 1   | W   | 42  |
| 2   | Y   | 42  |

Description: *Motor-Seat-Front up/down-LH*

Location: *Underside of front passenger's seat*

NO CONNECTOR FACE

Colour: *BLACK*

Gender: *Female*

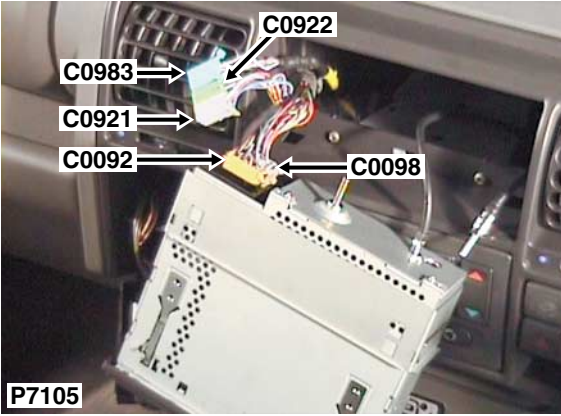

Description: *Head Unit-Audio System*  
 Location: *Behind radio*

| Cav | Col | Cct |
|-----|-----|-----|
| 1   | K   | 31  |
| 1   | PO  | 32  |
| 2   | GN  | 31  |
| 2   | SB  | 32  |
| 3   | PO  | 31  |
| 3   | SR  | 32  |
| 4   | P   | 30  |
| 5   | RU  | 30  |
| 6   | RN  | 30  |
| 7   | LGP | ALL |
| 8   | B   | ALL |

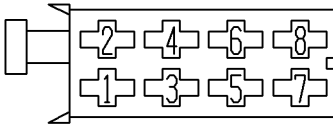

YPC10190

Colour: *GREY*  
 Gender: *Female*

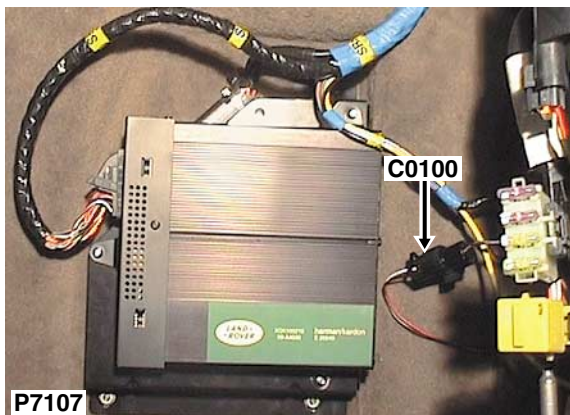

| Cav | Col | Cct |
|-----|-----|-----|
| 1   | RW  | ALL |
| 2   | B   | ALL |

Description: *Switch-Seat belt - LHD*

Location: *Beneath LH seat*

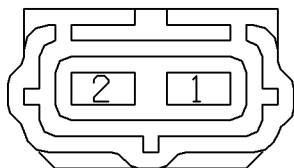

YPC10069

Colour: *BLACK*

Gender: *Female*

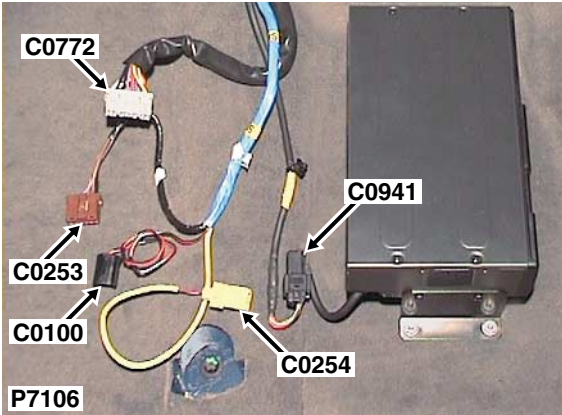

| Cav | Col | Cct |
|-----|-----|-----|
| 1   | RW  | ALL |
| 2   | B   | ALL |

Description: *Switch-Seat belt - RHD*

Location: *Beneath RH seat*

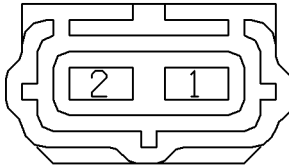

YPC10069

Colour: *BLACK*

Gender: *Female*

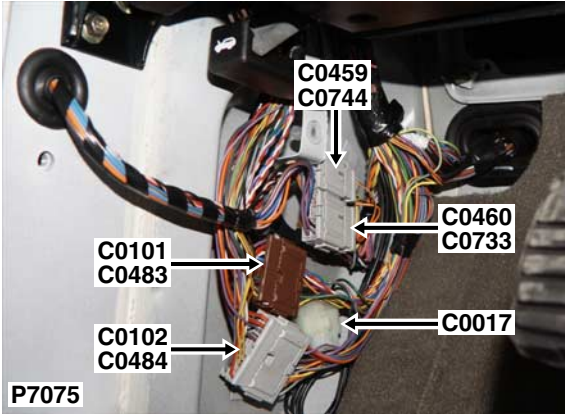

Description: *Body harness to main harness*

Location: *Under LH side of fascia*

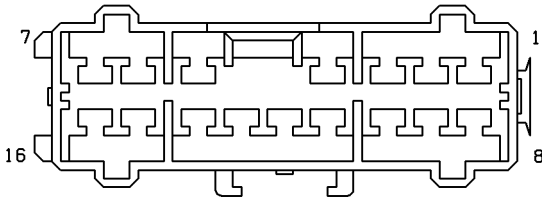

YPC107930

Colour: *BROWN*

Gender: *Male*

| Cav | Col | Cct |
|-----|-----|-----|
| 1   | P   | 24  |
| 1   | BN  | 39  |
| 2   | R   | 24  |
| 2   | WP  | 39  |
| 3   | W   | 24  |
| 3   | SO  | 39  |
| 4   | U   | 24  |
| 4   | PO  | 39  |
| 5   | GLG | ALL |
| 6   | G   | 24  |
| 6   | W   | 39  |
| 7   | Y   | 24  |
| 8   | RU  | 24  |
| 8   | PW  | 39  |
| 9   | O   | 24  |
| 9   | GK  | 39  |
| 10  | LGO | ALL |
| 11  | GK  | 17  |
| 12  | PG  | 17  |
| 13  | BG  | 17  |
| 15  | YB  | ALL |
| 15  | BN  | 28  |
| 16  | YK  | ALL |
| 16  | BW  | 28  |

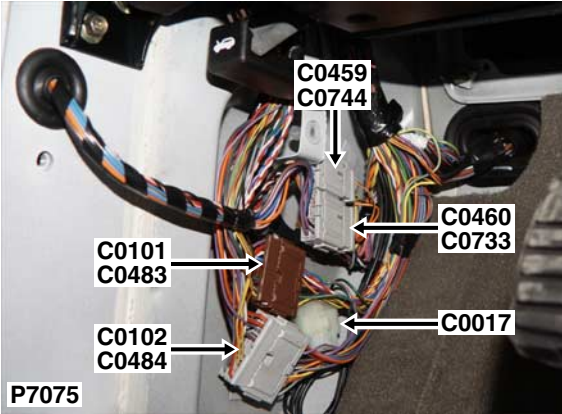

Description: *Body harness to main harness*  
 Location: *Under LH side of fascia*

| Cav | Col | Cct |
|-----|-----|-----|
| 1   | RO  | ALL |
| 2   | RB  | ALL |
| 3   | PS  | ALL |
| 4   | GR  | ALL |
| 5   | YG  | ALL |
| 6   | YR  | ALL |
| 7   | SP  | ALL |
| 8   | RY  | 1   |
| 9   | GP  | ALL |
| 10  | OU  | ALL |
| 11  | GN  | ALL |
| 12  | BN  | ALL |
| 13  | P   | ALL |
| 14  | LGW | ALL |
| 15  | WB  | ALL |
| 16  | PU  | ALL |
| 17  | RS  | ALL |
| 18  | S   | ALL |

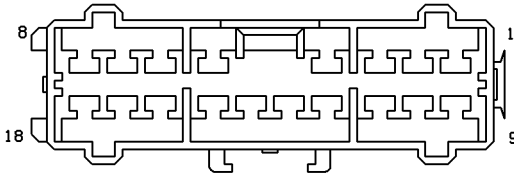

YPC10547

Colour: *LIGHT GREY*  
 Gender: *Male*



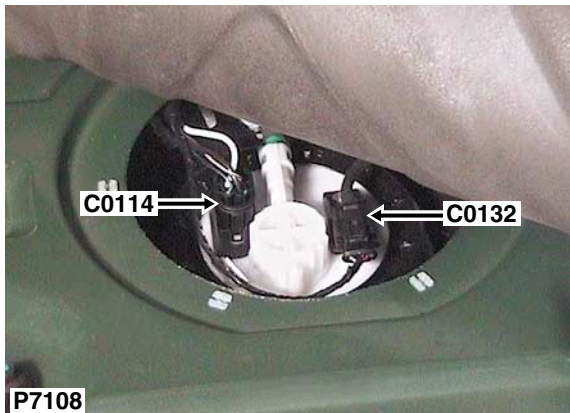

Description: *Unit-Fuel Tank*

Location: *Beneath fuel tank cover*

| Cav | Col | Cct |
|-----|-----|-----|
| 1   | WP  | ALL |
| 2   | GB  | ALL |
| 3   | KB  | ALL |
| 4   | B   | ALL |

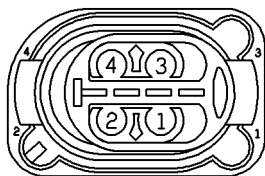

YPC110200

Colour: *BLACK*

Gender: *Female*

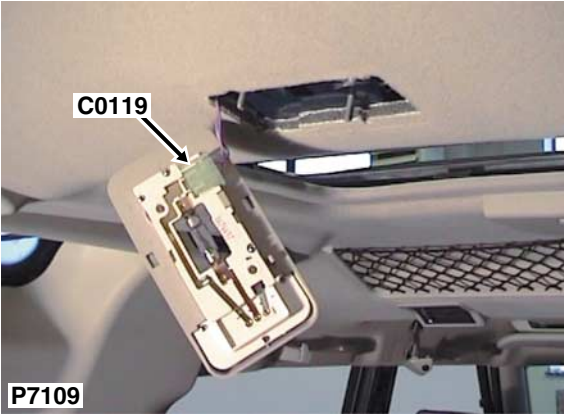

| Cav | Col | Cct |
|-----|-----|-----|
| 1   | PU  | ALL |
| 3   | P   | ALL |

Description: *Lamp-Load space*  
 Location: *Rear of headlining*



YPC10026

Colour: *NATURAL*  
 Gender: *Female*

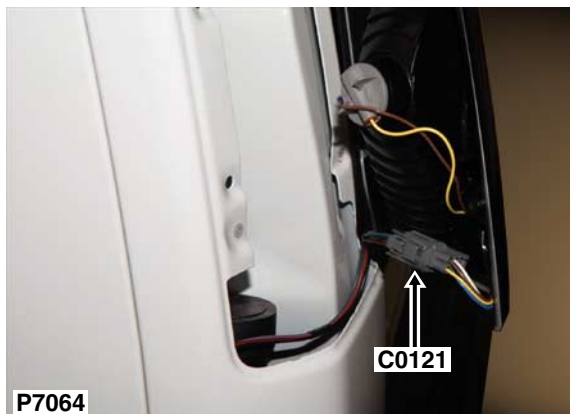

| Cav | Col | Cct |
|-----|-----|-----|
| 1   | GR  | ALL |
| 2   | B   | ALL |
| 3   | RB  | ALL |
| 4   | GP  | ALL |

Description: *Lamp-Tail-LH*

Location: *LH rear of vehicle*

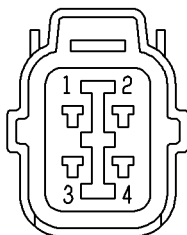

YPC10470

Colour: *GREY*

Gender: *Female*

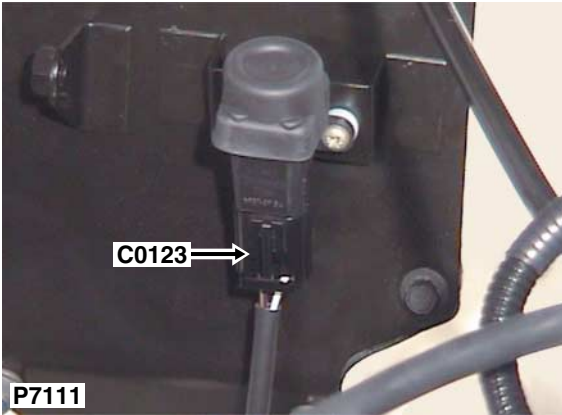

| Cav | Col | Cct |
|-----|-----|-----|
| 1   | NB  | ALL |
| 3   | WG  | ALL |

Description: *Switch-Inertia - LHD*

Location: *Rear LH side of engine compartment*

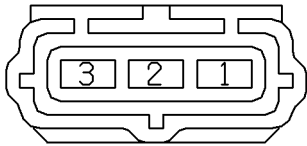

YPC10068

Colour: *BLACK*

Gender: *Female*

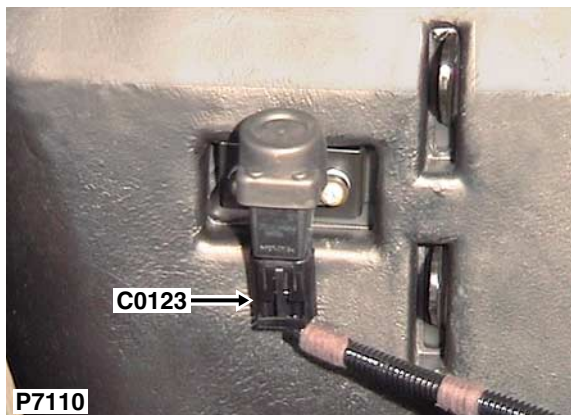

| Cav | Col | Cct |
|-----|-----|-----|
| 1   | NB  | ALL |
| 3   | WG  | ALL |

Description: *Switch-Inertia - RHD*

Location: *Rear LH side of engine compartment*

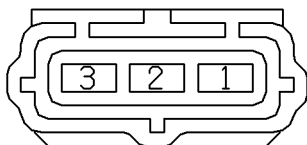

YPC10068

Colour: *BLACK*

Gender: *Female*

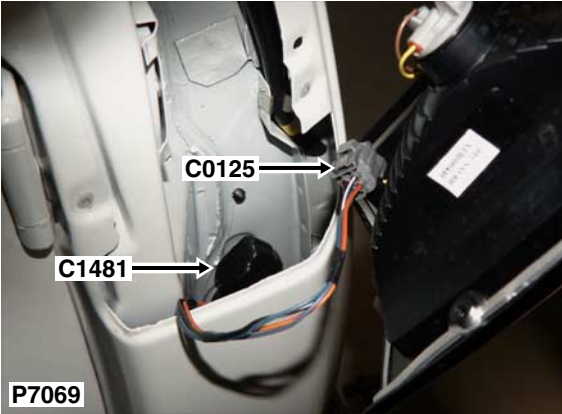

| Cav | Col | Cct |
|-----|-----|-----|
| 1   | GW  | ALL |
| 2   | B   | ALL |
| 3   | RO  | ALL |
| 4   | GP  | ALL |

Description: *Lamp-Tail-RH*  
 Location: *RH rear of vehicle*

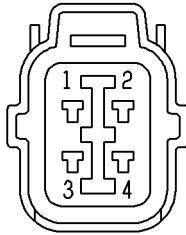

YPC10470

Colour: *GREY*  
 Gender: *Female*

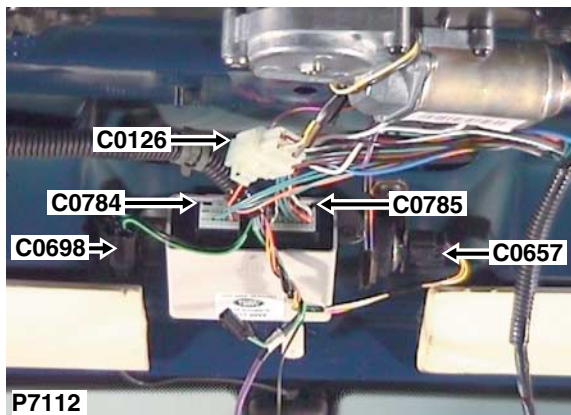

| Cav | Col | Cct |
|-----|-----|-----|
| 1   | W   | ALL |
| 2   | OU  | ALL |
| 3   | B   | ALL |
| 4   | P   | ALL |

Description: *Motor-Sunroof-Front*

Location: *Front of headlining in the centre*

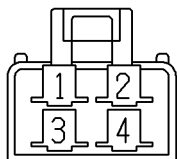

AFU3855

Colour: *NATURAL*

Gender: *Female*

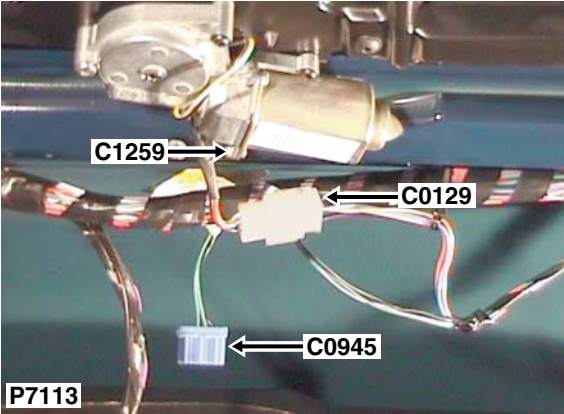

| Cav | Col | Cct |
|-----|-----|-----|
| 1   | O   | ALL |
| 2   | OG  | ALL |
| 3   | B   | ALL |
| 4   | U   | ALL |

Description: *Motor-Sunroof-Rear*  
 Location: *Behind centre headlining*

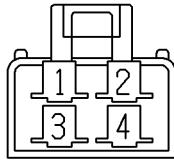

AFU3855

Colour: *NATURAL*  
 Gender: *Female*



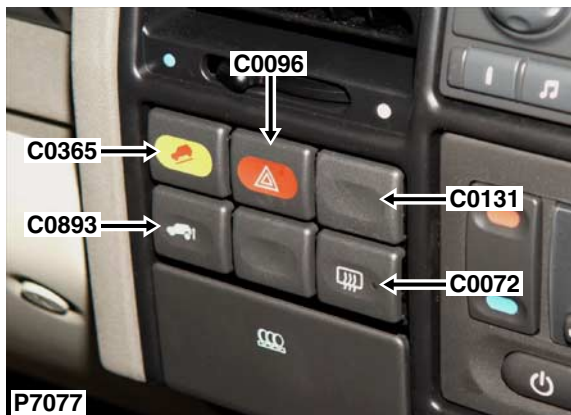

| Cav | Col | Cct |
|-----|-----|-----|
| 1   | KO  | ALL |
| 2   | RN  | ALL |
| 4   | B   | ALL |
| 5   | PS  | ALL |

Description: *Switch-Heated front screen*

Location: *Behind centre of fascia*

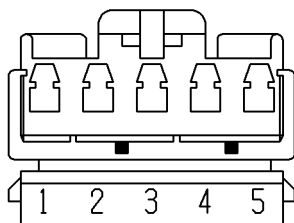

YPC10526

Colour: *GREEN*

Gender: *Female*

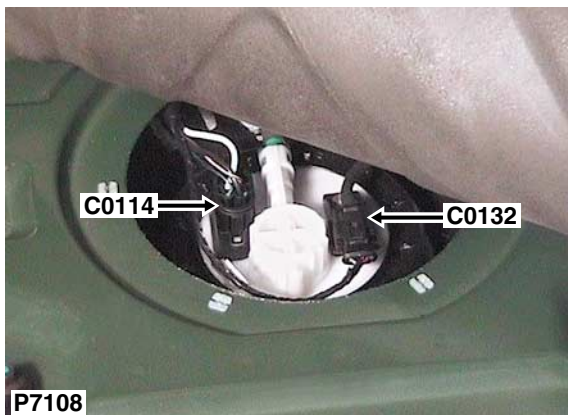

| Cav | Col | Cct |
|-----|-----|-----|
| 1   | R   | 21  |
| 2   | RB  | 21  |
| 3   | GK  | 21  |

Description: *Sensor-Fuel tank pressure*

Location: *Beneath fuel tank cover*

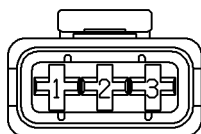

YPC110140

Colour: *BLACK*

Gender: *Female*

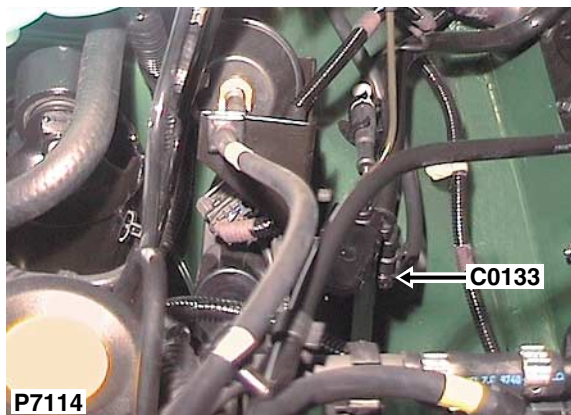

| Cav | Col | Cct |
|-----|-----|-----|
| 1   | NK  | 20  |
| 2   | SY  | 20  |

Description: *Vent-EVAP canister*

Location: *Rear RH side of engine compartment*

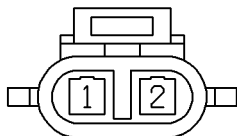

YPC10568

Colour: *BLACK*

Gender: *Female*

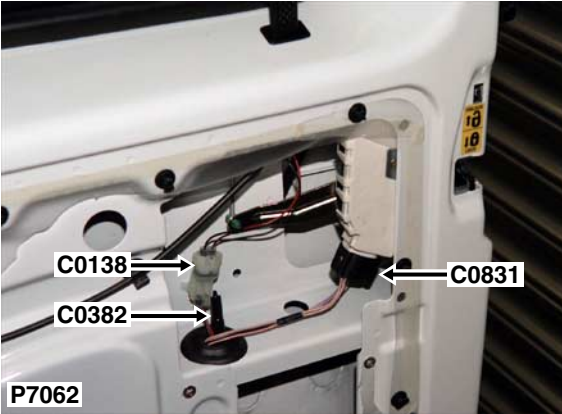

| Cav | Col | Cct |
|-----|-----|-----|
| 1   | RB  | ALL |
| 2   | B   | ALL |

Description: *Lamp-Rear number plate-RH*  
 Location: *Centre of taildoor, behind trim panel*

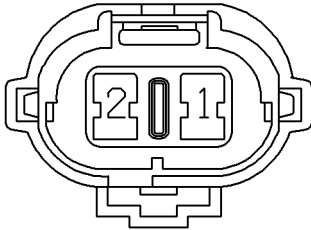

AFU3584

Colour: *NATURAL*  
 Gender: *Male*

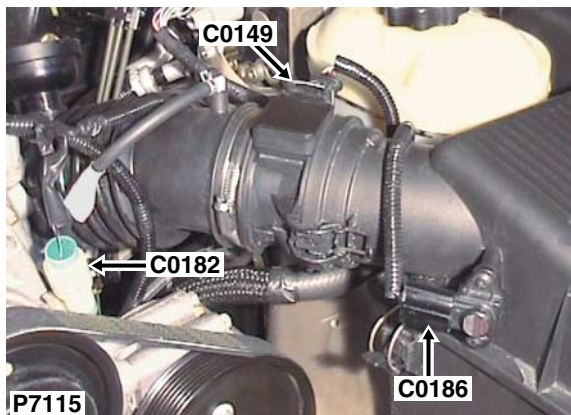

| Cav | Col | Cct |
|-----|-----|-----|
| 1   | KB  | ALL |
| 2   | NO  | ALL |
| 3   | NK  | ALL |

Description: *Sensor-Mass air flow (MAF) - Td5*

Location: *Front LH side of engine*

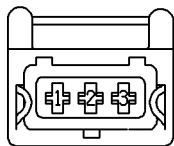

YPC114930

Colour: *BLACK*

Gender: *Female*



| Cav | Col | Cct |
|-----|-----|-----|
| 1   | SLG | ALL |
| 2   | NK  | ALL |
| 3   | RB  | ALL |
| 4   | R   | ALL |
| 5   | UG  | ALL |

Description: *Sensor-Mass air flow (MAF) - V8*  
 Location: *Front LH side of engine*

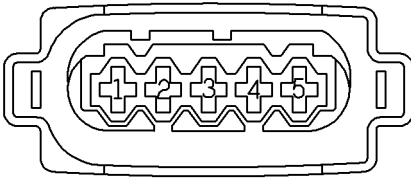

YPC113350

Colour: *BLACK*  
 Gender: *Female*

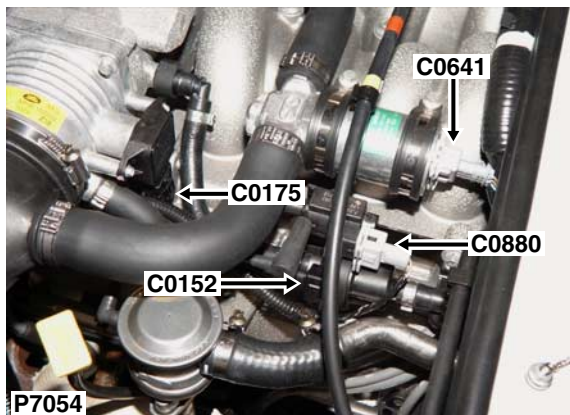

| Cav | Col | Cct |
|-----|-----|-----|
| 1   | NR  | ALL |
| 2   | NK  | ALL |

Description: *Purge control valve*

Location: *LH side of engine compartment*

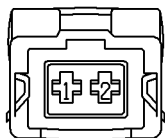

YPC107790

Colour: *BLACK*

Gender: *Female*

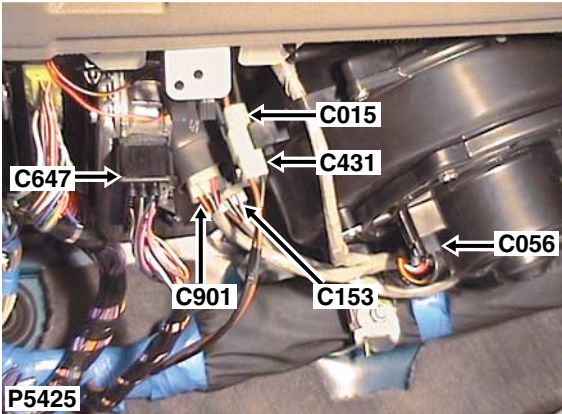

Description: *Relay-Blower - RHD*

Location: *Under LH side of fascia*

| Cav | Col | Cct |
|-----|-----|-----|
| 1   | LGW | ALL |
| 2   | N   | ALL |
| 3   | NR  | ALL |
| 4   | WR  | ALL |
| 5   | B   | ALL |

NO CONNECTOR FACE

Colour:

Gender: *Female*



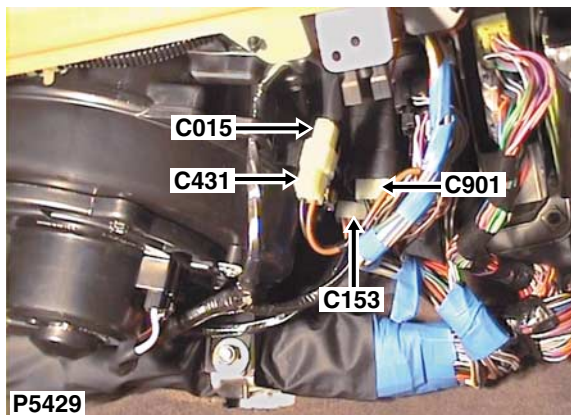

Description: *Relay-Blower - LHD*

Location: *Under RH side of fascia*

| Cav | Col | Cct |
|-----|-----|-----|
| 1   | LGW | ALL |
| 2   | N   | ALL |
| 3   | NR  | ALL |
| 4   | WR  | ALL |
| 5   | B   | ALL |

NO CONNECTOR FACE

Colour:

Gender: *Female*

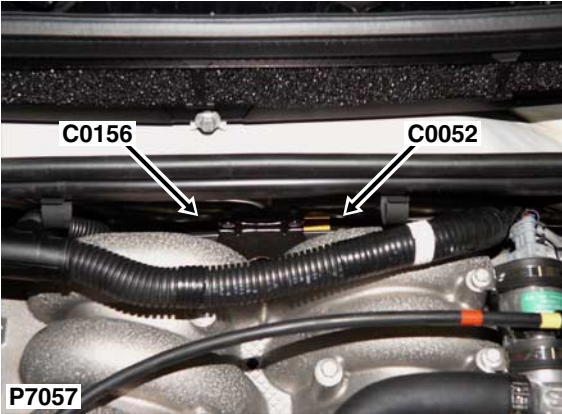

| Cav | Col | Cct |
|-----|-----|-----|
| 1   | R   | ALL |
| 2   | GY  | ALL |
| 3   | U   | ALL |

Description: *Ignition coil*  
 Location: *Centre rear of engine*

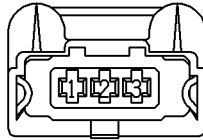

YPC107900

Colour: *BLACK*  
 Gender: *Female*

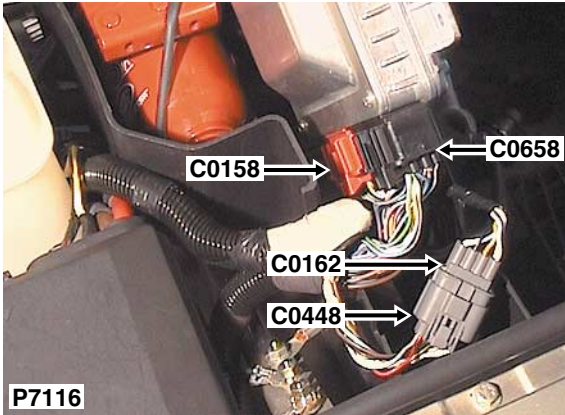

Description: *Engine control module (ECM)*

Location: *RH side of engine compartment*

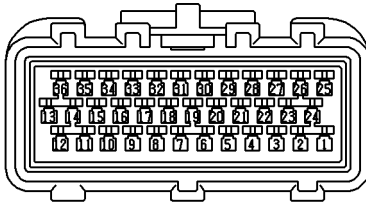

YPC10530

Colour: *RED*  
Gender: *Female*

| Cav | Col | Cct |
|-----|-----|-----|
| 1   | YP  | ALL |
| 3   | U   | 35  |
| 4   | O   | 35  |
| 5   | KB  | ALL |
| 6   | WY  | ALL |
| 7   | KG  | ALL |
| 8   | KP  | ALL |
| 10  | WY  | ALL |
| 11  | NO  | ALL |
| 13  | KB  | ALL |
| 17  | KB  | ALL |
| 18  | KB  | ALL |
| 19  | YW  | ALL |
| 20  | KB  | ALL |
| 21  | SW  | ALL |
| 22  | NK  | ALL |
| 23  | NO  | ALL |
| 24  | YR  | ALL |
| 25  | Y   | ALL |
| 26  | YN  | ALL |
| 27  | YU  | ALL |
| 29  | GU  | ALL |
| 30  | KB  | ALL |
| 31  | GU  | ALL |
| 32  | Y   | ALL |
| 33  | WB  | ALL |
| 34  | GB  | ALL |
| 35  | W   | ALL |
| 36  | WU  | ALL |

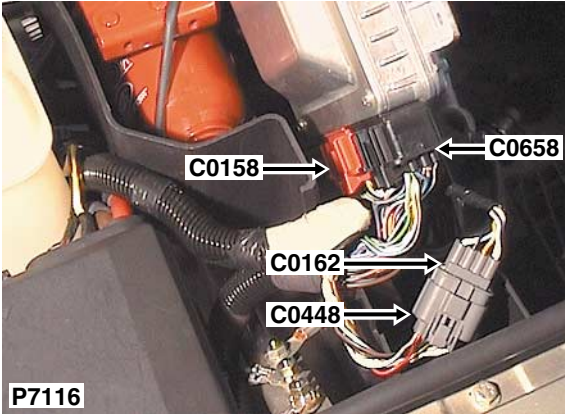

| Cav | Col | Cct |
|-----|-----|-----|
| 1   | WN  | ALL |
| 2   | NY  | ALL |
| 3   | NK  | ALL |
| 4   | WG  | ALL |
| 5   | W   | ALL |
| 6   | Y   | ALL |
| 7   | B   | ALL |
| 8   | WB  | ALL |

Description: *Engine harness to main harness*  
 Location: *RH side of engine compartment*

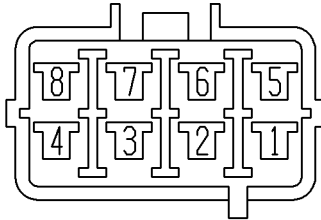

YPC10467

Colour: *GREY*  
 Gender: *Male*

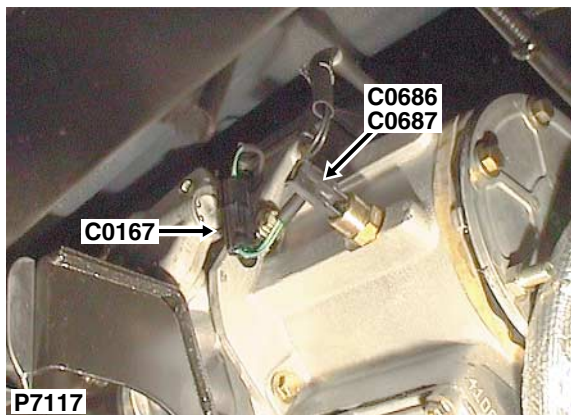

Description: *Switch-Reverse lamp*

Location: *LH side of transfer box*

| Cav | Col | Cct |
|-----|-----|-----|
| 1   | GN  | ALL |
| 2   | GY  | ALL |

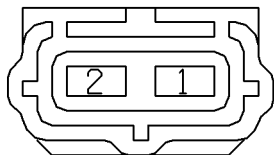

YPC10070

Colour: *BLACK*

Gender: *Female*

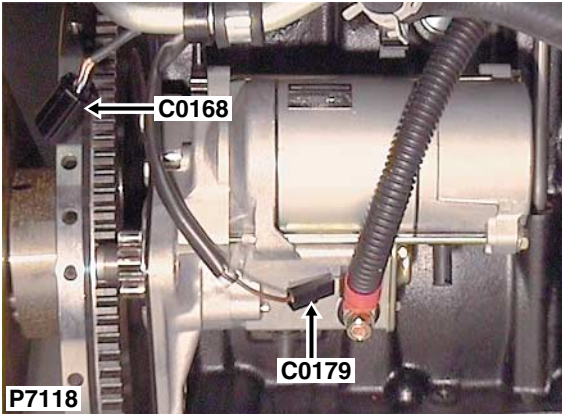

| Cav | Col | Cct |
|-----|-----|-----|
| 1   | KB  | ALL |
| 2   | WU  | ALL |

Description: *Sensor-Crankshaft position (CKP) - Td5*  
 Location: *Lower rear of engine - RH side*

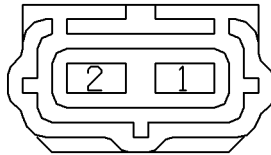

YPC10070

Colour: *BLACK*  
 Gender: *Female*

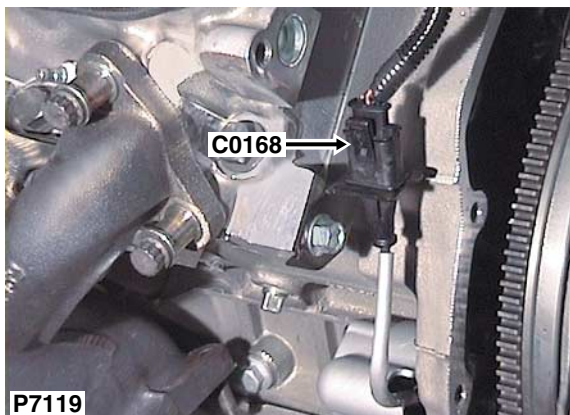

Description: *Sensor-Crankshaft position (CKP) - V8*  
 Location: *Rear LH side of engine*

| Cav | Col | Cct |
|-----|-----|-----|
| 1   | BY  | ALL |
| 2   | KB  | ALL |
| 3   | B   | ALL |

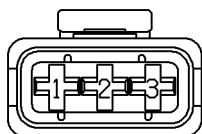

YPC110140

Colour: *BLACK*  
 Gender: *Female*

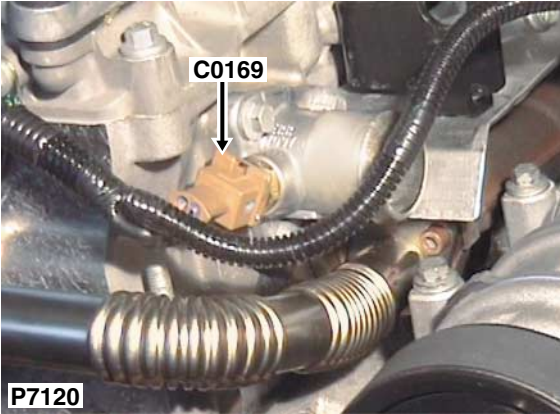

Description: *Sensor-Engine coolant temperature (ECT)*  
Location: *Front LH side of engine*

| Cav | Col | Cct |
|-----|-----|-----|
| 1   | KB  | ALL |
| 2   | KG  | ALL |

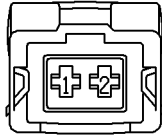

YPC107780

Colour: *BROWN*  
Gender: *Female*



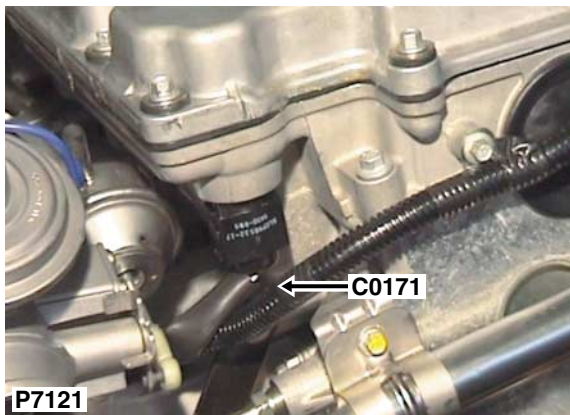

Description: *Engine harness to injector harness*

Location: *Front RH side of engine*

| Cav | Col | Cct |
|-----|-----|-----|
| 1   | Y   | ALL |
| 2   | YN  | ALL |
| 4   | YR  | ALL |
| 5   | YP  | ALL |
| 6   | YU  | ALL |
| 7   | NO  | ALL |
| 8   | NK  | ALL |

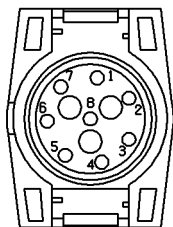

YYC10324

Colour: *BLACK*

Gender: *Female*

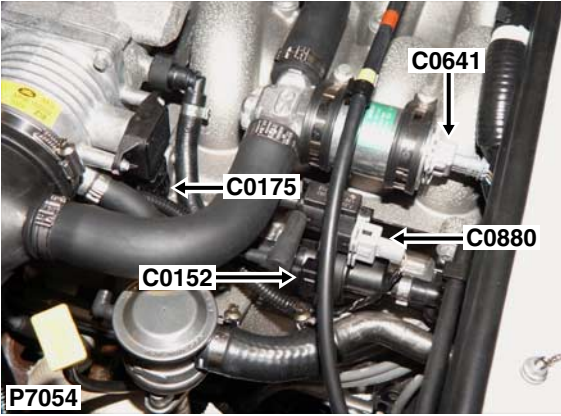

| Cav | Col | Cct |
|-----|-----|-----|
| 1   | R   | ALL |
| 2   | RB  | ALL |
| 3   | YLG | ALL |

Description: *Sensor-Throttle position (TP)*  
 Location: *LH side of engine compartment*

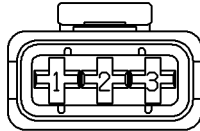

YPC110140

Colour: *BLACK*  
 Gender: *Female*

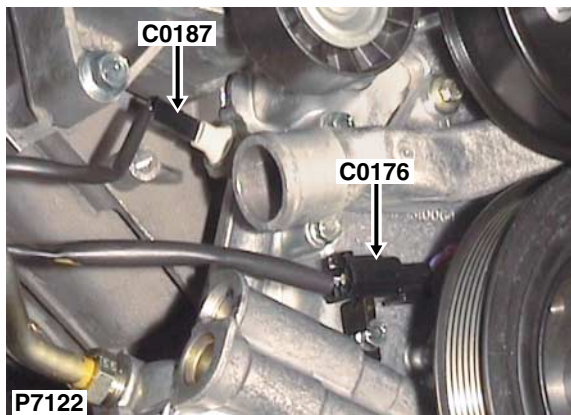

| Cav | Col | Cct |
|-----|-----|-----|
| 1   | B   | ALL |
| 2   | SU  | ALL |
| 3   | NK  | ALL |

Description: *Sensor-Camshaft position (CMP)*

Location: *Lower front of engine - RH side*

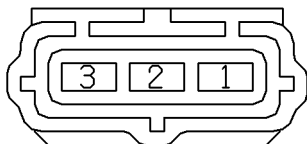

YPC10068

Colour: *BLACK*

Gender: *Female*

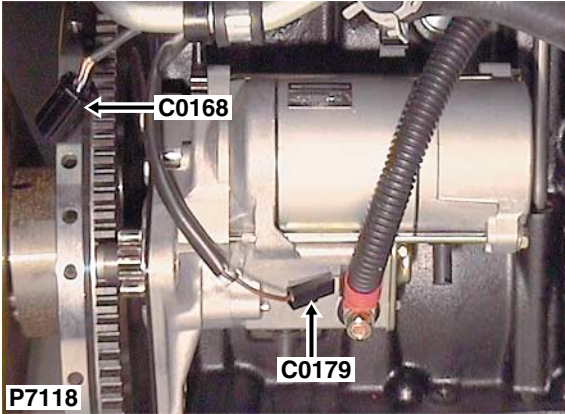

| Cav | Col | Cct |
|-----|-----|-----|
| 1   | NR  | ALL |

Description: *Starter motor - Td5*  
 Location: *Lower rear of engine - RH side*

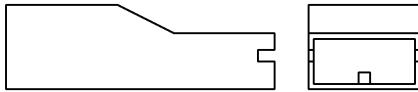

AAU1010

Colour: *BLACK*  
 Gender: *Female*

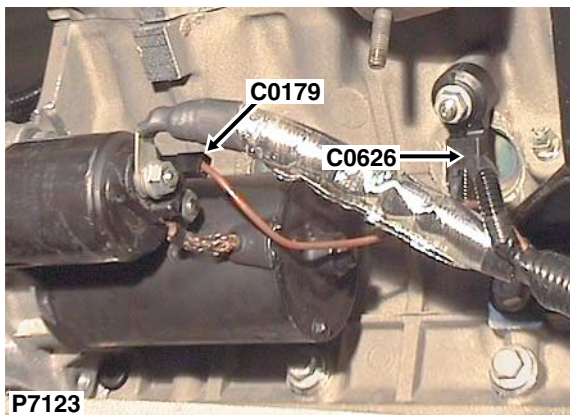

| Cav | Col | Cct |
|-----|-----|-----|
| 1   | NR  | ALL |

Description: *Starter motor - V8*  
 Location: *Lower rear of engine - RH side*

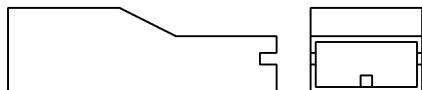

AAU1010

Colour: *BLACK*  
 Gender: *Female*

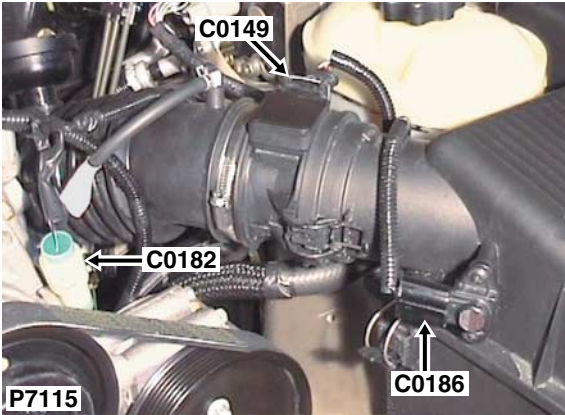

| Cav | Col | Cct |
|-----|-----|-----|
| 1   | BG  | ALL |
| 2   | B   | ALL |

Description: *Clutch-Compressor-Air conditioning (A/C) - Td5*  
 Location: *Front LH side of engine*

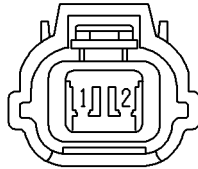

YPC10180

Colour: *GREY*  
 Gender: *Female*

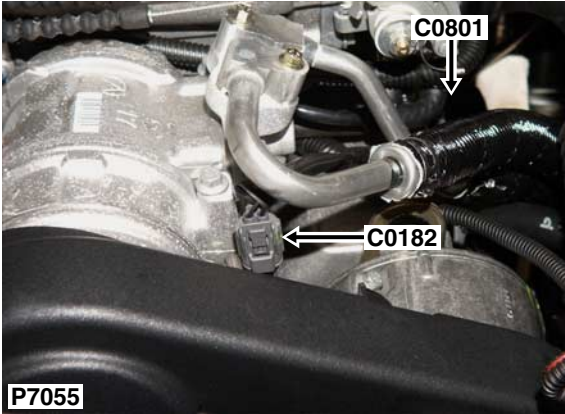

| Cav | Col | Cct |
|-----|-----|-----|
| 1   | BG  | ALL |
| 2   | B   | ALL |

Description: *Clutch-Compressor-Air conditioning (A/C) - V8*

Location: *Top of engine*

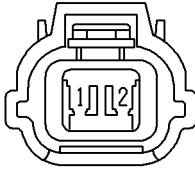

YPC10180

Colour: *GREY*  
Gender: *Female*

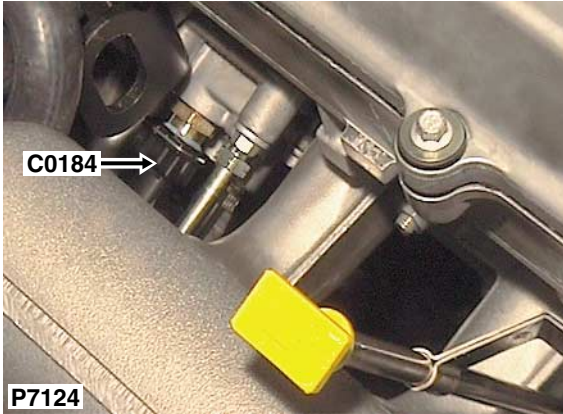

| Cav | Col | Cct |
|-----|-----|-----|
| 1   | KB  | ALL |
| 2   | YW  | ALL |

Description: *Sensor-Temperature-Fuel rail*

Location: *Rear RH side of engine*

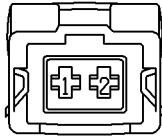

YPC107790

Colour: *BLACK*

Gender: *Female*



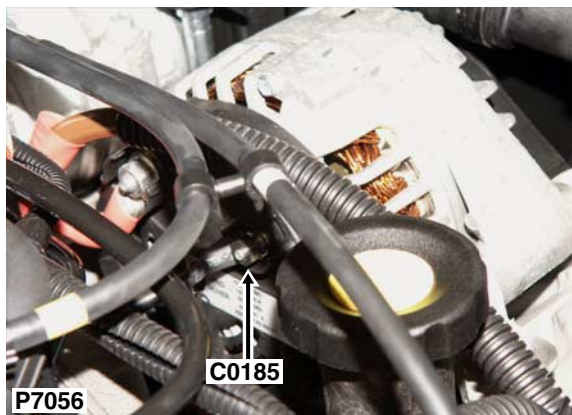

| Cav | Col | Cct |
|-----|-----|-----|
| 1   | NY  | ALL |

Description: *Alternator/generator*

Location: *Top of engine*

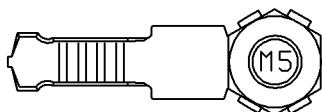

YPG100730

Colour: *BRASS*

Gender: *Female*

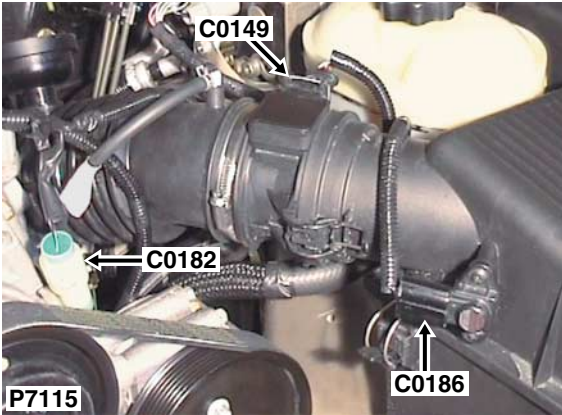

| Cav | Col | Cct |
|-----|-----|-----|
| A   | KB  | ALL |
| B   | GU  | ALL |
| C   | KP  | ALL |
| D   | WY  | ALL |

Description: *Sensor-Mass air flow (MAF)*  
 Location: *Front LH side of engine*

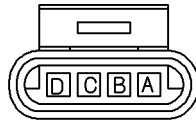

YPC117460

Colour: *BLACK*  
 Gender: *Female*

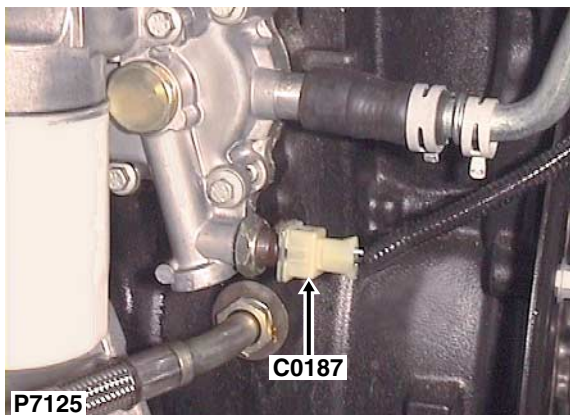

| Cav | Col | Cct |
|-----|-----|-----|
| 1   | WN  | ALL |
| 2   | B   | ALL |

Description: *Switch-Oil pressure - Td5*

Location: *Rear LH side of engine*

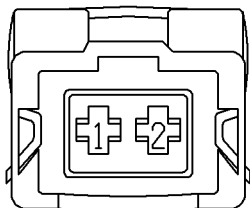

YPC107830

Colour: *NATURAL*

Gender: *Female*

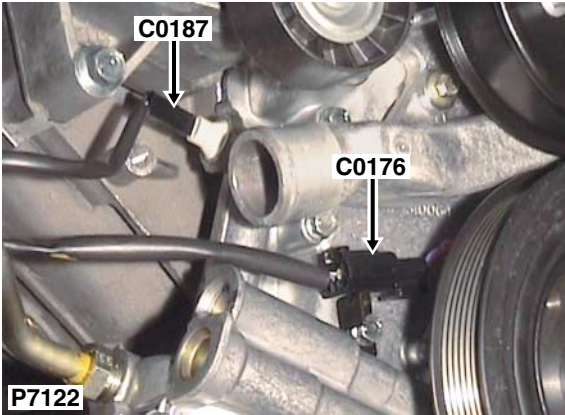

| Cav | Col | Cct |
|-----|-----|-----|
| 1   | WN  | ALL |

Description: *Switch-Oil pressure - V8*  
 Location: *Lower front of engine - RH side*

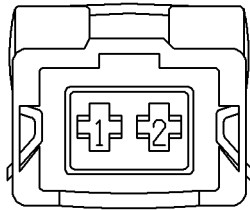

YPC107830

Colour: *NATURAL*  
 Gender: *Female*

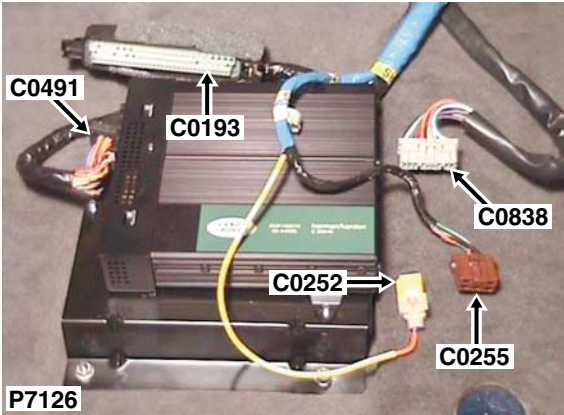

Description: *ECU-Electronic automatic transmission*  
 Location: *Beneath LH seat*

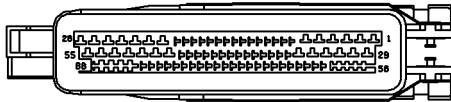

YPC114580

Colour: *NATURAL*  
 Gender: *Female*

| Cav | Col | Cct |
|-----|-----|-----|
| 5   | OG  | 9   |
| 6   | B   | 9   |
| 8   | UB  | 9   |
| 9   | UW  | 9   |
| 13  | RK  | 9   |
| 14  | B   | 9   |
| 15  | W   | 9   |
| 16  | W   | ALL |
| 25  | YR  | 9   |
| 26  | PY  | 9   |
| 28  | B   | 9   |
| 30  | OP  | 9   |
| 31  | K   | 9   |
| 32  | SO  | 9   |
| 33  | OW  | 9   |
| 36  | UP  | 9   |
| 37  | UG  | 9   |
| 42  | R   | 9   |
| 44  | Y   | ALL |
| 45  | UO  | 9   |
| 51  | YG  | 9   |
| 53  | OLG | 9   |
| 54  | LGO | 9   |

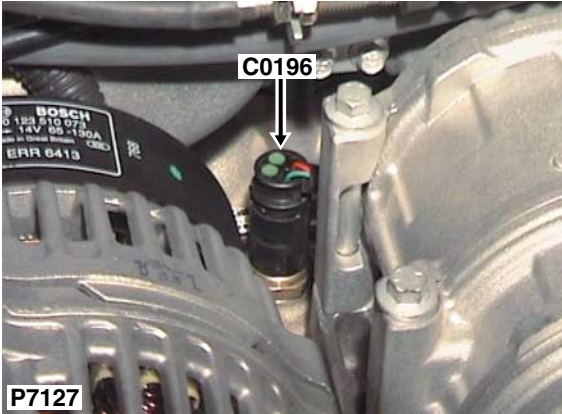

| Cav | Col | Cct |
|-----|-----|-----|
| 3   | RB  | ALL |
| 4   | G   | ALL |

Description: *Sensor-Engine coolant temperature (ECT)*  
 Location: *Front of engine - centre*

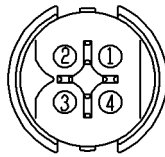

YPC113850

Colour: *BLACK*  
 Gender: *Female*

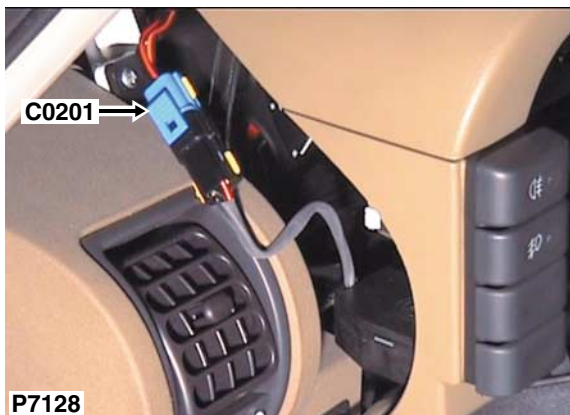

| Cav | Col | Cct |
|-----|-----|-----|
| 1   | RN  | 36  |
| 2   | RO  | 36  |
| 3   | B   | 36  |

Description: *Dimmer-Instrument illumination*

Location: *Behind driver side of fascia*

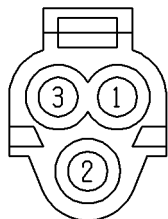

AFU1457

Colour: *BLUE*

Gender: *Female*

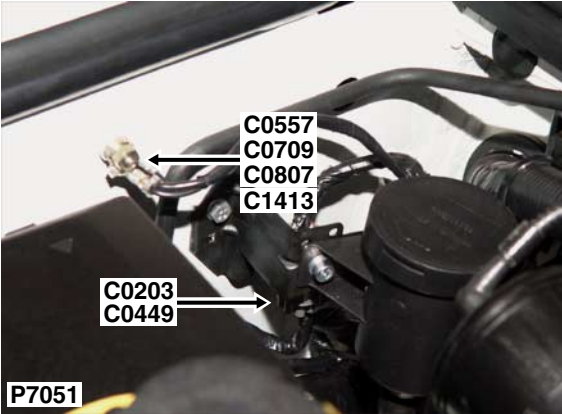

Description: *Engine harness to main harness*  
 Location: *Rear RH side of engine compartment*

| Cav | Col | Cct |
|-----|-----|-----|
| 1   | SY  | 34  |
| 2   | RB  | 34  |
| 3   | W   | ALL |
| 4   | GN  | ALL |
| 5   | GY  | ALL |
| 6   | SP  | ALL |
| 7   | WN  | ALL |
| 8   | GU  | ALL |
| 9   | NY  | ALL |
| 10  | UP  | ALL |
| 11  | RK  | ALL |
| 12  | KO  | 18  |
| 13  | BY  | 18  |
| 14  | NK  | ALL |

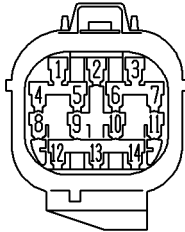

YPC10549

Colour: *GREY*  
 Gender: *Female*





| Cav | Col | Cct |
|-----|-----|-----|
| 1   | B   | 9   |
| 2   | BLG | 9   |

Description: *Switch-Oil temperature*

Location: *Behind radiator RH side*

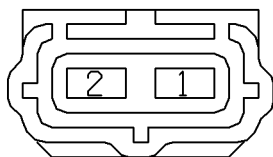

YPC10070

Colour: *BLACK*

Gender: *Female*

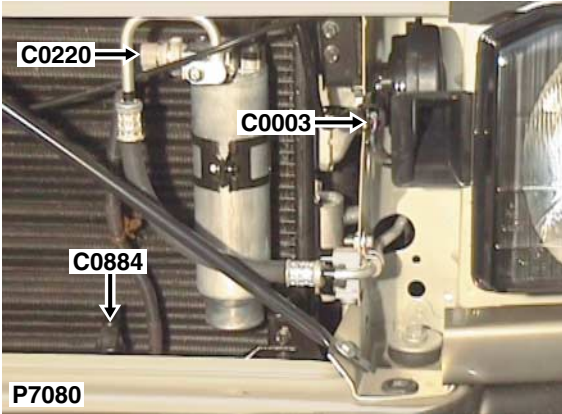

| Cav | Col | Cct |
|-----|-----|-----|
| 1   | YB  | 15  |
| 2   | YS  | ALL |

Description: *Switch-Dual pressure*  
 Location: *Behind the front grille*



YPC10617

Colour: *LIGHT GREY*  
 Gender: *Female*

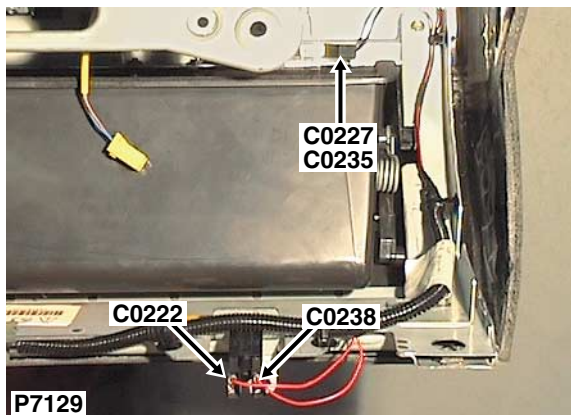

| Cav | Col | Cct |
|-----|-----|-----|
| 1   | RB  | ALL |

Description: *Switch-Glove box*  
 Location: *Behind glovebox*

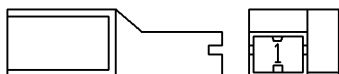

YPC10165

Colour: *BLACK*  
 Gender: *Female*

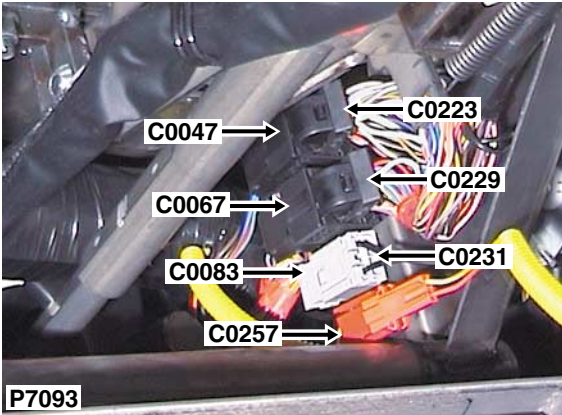

Description: *Fascia harness to main harness*  
 Location: *LH side of steering column*

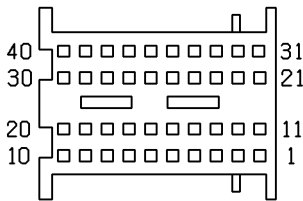

YPH100430

Colour: *BLACK*  
 Gender: *Female*

| Cav | Col | Cct |
|-----|-----|-----|
| 1   | BLG | ALL |
| 2   | KO  | ALL |
| 3   | WN  | ALL |
| 4   | RS  | ALL |
| 5   | BO  | ALL |
| 6   | GS  | ALL |
| 7   | NY  | ALL |
| 8   | YR  | ALL |
| 9   | SK  | ALL |
| 10  | KB  | ALL |
| 11  | B   | ALL |
| 12  | BS  | ALL |
| 13  | B   | ALL |
| 14  | OG  | ALL |
| 15  | YG  | ALL |
| 16  | YR  | ALL |
| 17  | WU  | ALL |
| 18  | GU  | ALL |
| 19  | BY  | ALL |
| 20  | WS  | ALL |
| 21  | GB  | ALL |
| 22  | WO  | ALL |
| 23  | WK  | ALL |
| 24  | WR  | ALL |
| 25  | WY  | ALL |
| 26  | SW  | ALL |
| 27  | BU  | ALL |
| 28  | BK  | ALL |
| 29  | BN  | ALL |
| 30  | BP  | ALL |
| 31  | RN  | ALL |
| 32  | KB  | ALL |
| 33  | UP  | ALL |
| 34  | PR  | ALL |
| 35  | KR  | ALL |
| 36  | YK  | ALL |
| 37  | UY  | 35  |

| <b>Cav</b> | <b>Col</b> | <b>Cct</b> |
|------------|------------|------------|
| 38         | PK         | ALL        |
| 39         | BU         | ALL        |
| 40         | PW         | ALL        |

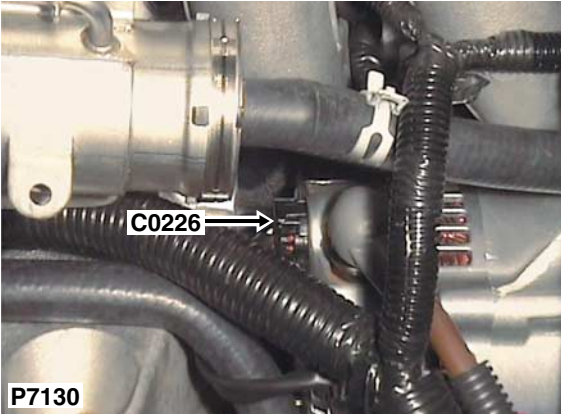

| Cav | Col | Cct |
|-----|-----|-----|
| 1   | NY  | ALL |
| 2   | WG  | ALL |

Description: *Alternator/generator*  
 Location: *RH side of engine*

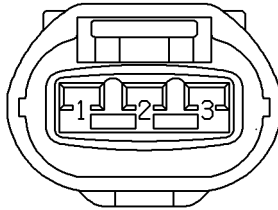

YPC10604

Colour: *BLACK*  
 Gender: *Female*

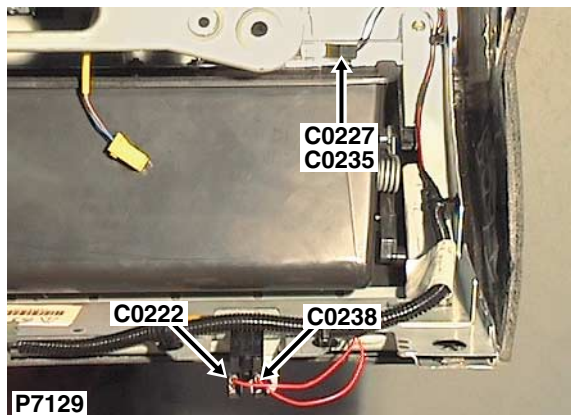

Description: *Lamp-Glove box*

Location: *Behind glovebox*

| Cav | Col | Cct |
|-----|-----|-----|
| 1   | B   | ALL |

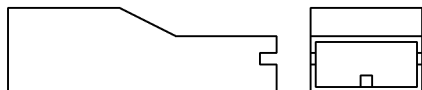

AAU1010

Colour: *BLACK*

Gender: *Female*



| Cav | Col | Cct |
|-----|-----|-----|
| 2   | GP  | 3   |
| 3   | BY  | 3   |
| 4   | BR  | 3   |
| 5   | WU  | 3   |

Description: *Pump-Cruise control - LHD*  
 Location: *Rear RH side of engine compartment*

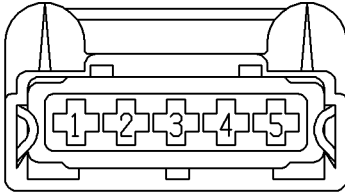

YPC107840

Colour: *BLACK*  
 Gender: *Female*



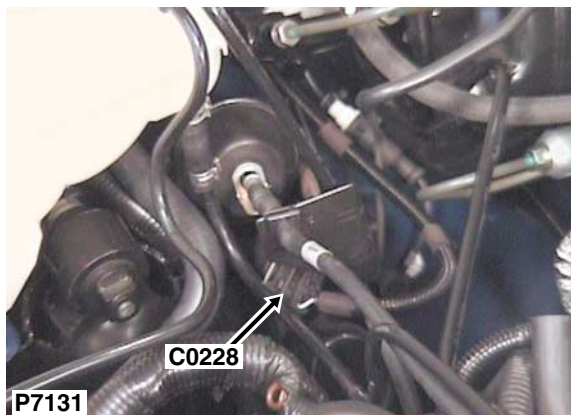

Description: *Pump-Cruise control - RHD*

Location: *Lower RH rear of engine compartment*

| Cav | Col | Cct |
|-----|-----|-----|
| 2   | GP  | 3   |
| 3   | BY  | 3   |
| 4   | BR  | 3   |
| 5   | WU  | 3   |

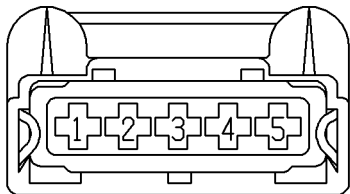

YPC107840

Colour: *BLACK*

Gender: *Female*

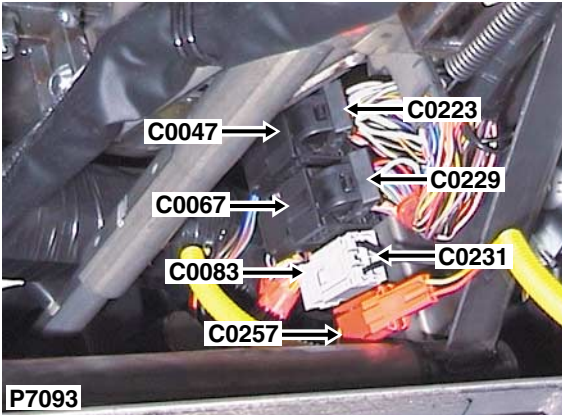

Description: *Fascia harness to main harness*  
 Location: *Underside of steering column*

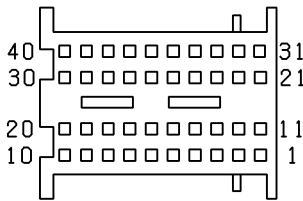

YPH101400

Colour: *GREEN*  
 Gender: *Female*

| Cav | Col | Cct |
|-----|-----|-----|
| 1   | NP  | ALL |
| 2   | KO  | ALL |
| 3   | PS  | ALL |
| 4   | NB  | ALL |
| 5   | KG  | ALL |
| 6   | YG  | 15  |
| 7   | BW  | 15  |
| 8   | B   | 15  |
| 9   | YB  | 15  |
| 10  | PG  | 15  |
| 11  | W   | 24  |
| 12  | G   | 24  |
| 13  | S   | 24  |
| 14  | Y   | 24  |
| 15  | O   | 24  |
| 16  | SG  | 24  |
| 17  | RU  | ALL |
| 18  | BG  | ALL |
| 19  | BU  | ALL |
| 20  | BK  | ALL |
| 21  | BR  | ALL |
| 22  | BW  | ALL |
| 23  | BN  | ALL |
| 24  | BY  | ALL |
| 25  | BO  | ALL |
| 26  | U   | 24  |
| 27  | P   | 24  |
| 28  | GO  | 15  |
| 30  | R   | 24  |
| 31  | PW  | 15  |
| 32  | LGS | ALL |
| 33  | UP  | ALL |
| 34  | OB  | ALL |
| 35  | LGR | ALL |
| 36  | WY  | ALL |
| 37  | SB  | ALL |
| 38  | SR  | ALL |

| <b>Cav</b> | <b>Col</b> | <b>Cct</b> |
|------------|------------|------------|
| 39         | PS         | ALL        |
| 40         | UB         | ALL        |

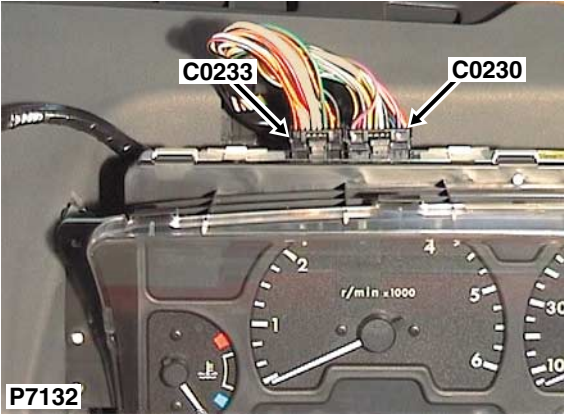

Description: *Instrument Pack*  
 Location: *Behind instrument pack*

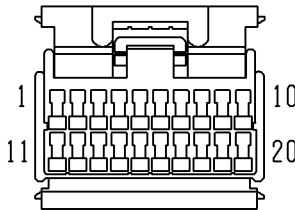

YPC10175

Colour: *BLACK*  
 Gender: *Female*

| Cav | Col | Cct |
|-----|-----|-----|
| 1   | PW  | ALL |
| 3   | US  | ALL |
| 4   | YR  | ALL |
| 5   | YG  | ALL |
| 6   | WN  | ALL |
| 7   | BLG | ALL |
| 8   | BU  | ALL |
| 9   | PK  | ALL |
| 10  | KO  | ALL |
| 11  | NY  | ALL |
| 12  | RN  | ALL |
| 13  | KB  | ALL |
| 14  | GB  | ALL |
| 15  | WS  | ALL |
| 16  | KG  | ALL |
| 17  | B   | ALL |
| 18  | B   | ALL |
| 19  | LG  | ALL |
| 20  | PO  | ALL |

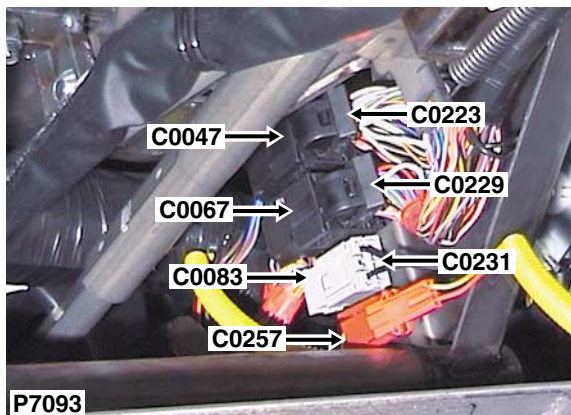

Description: *Fascia harness to main harness*

Location: *Underside of steering column*

| Cav | Col | Cct |
|-----|-----|-----|
| 1   | S   | ALL |
| 2   | B   | ALL |
| 3   | PO  | 32  |
| 4   | GN  | ALL |
| 5   | RS  | ALL |
| 6   | GK  | 38  |

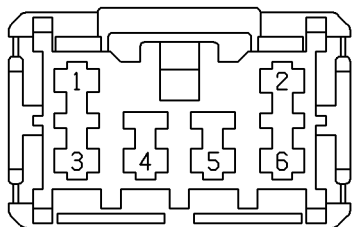

YPC10634

Colour: *LIGHT GREY*

Gender: *Female*

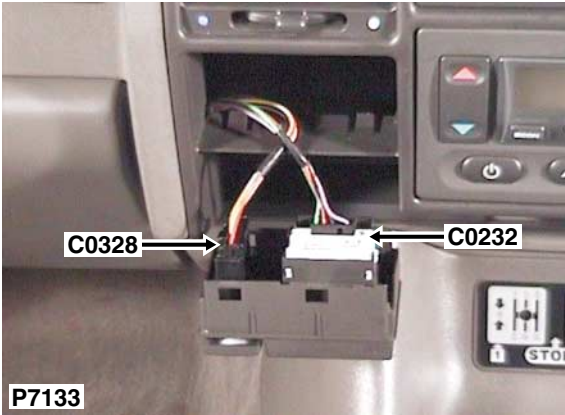

| Cav | Col | Cct |
|-----|-----|-----|
| 1   | P   | ALL |
| 2   | B   | ALL |
| 3   | RN  | ALL |
| 4   | LGP | ALL |

Description: *Clock-Digital*  
 Location: *Behind clock*

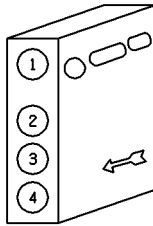

AFU4583

Colour: *BLACK*  
 Gender: *Female*

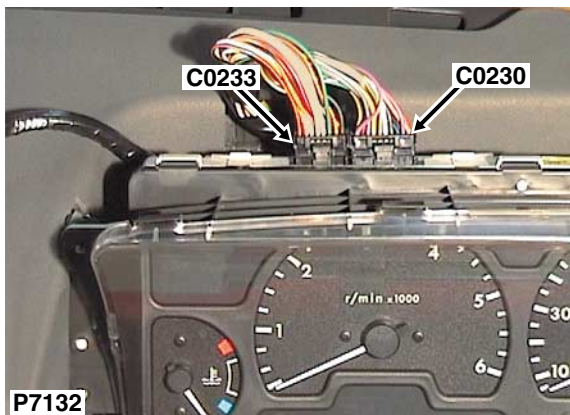

Description: *Instrument Pack*

Location: *Behind instrument pack*

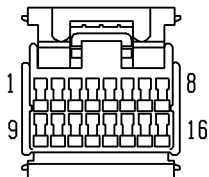

YPC10174

Colour: *BLACK*

Gender: *Female*

| Cav | Col | Cct |
|-----|-----|-----|
| 1   | BO  | ALL |
| 2   | WO  | ALL |
| 3   | WR  | ALL |
| 4   | WU  | ALL |
| 5   | WY  | ALL |
| 6   | G   | ALL |
| 7   | YR  | ALL |
| 8   | BS  | ALL |
| 9   | K   | ALL |
| 10  | WK  | ALL |
| 11  | OG  | ALL |
| 12  | BY  | ALL |
| 13  | RS  | ALL |
| 14  | GS  | ALL |
| 15  | GU  | ALL |
| 16  | SK  | ALL |

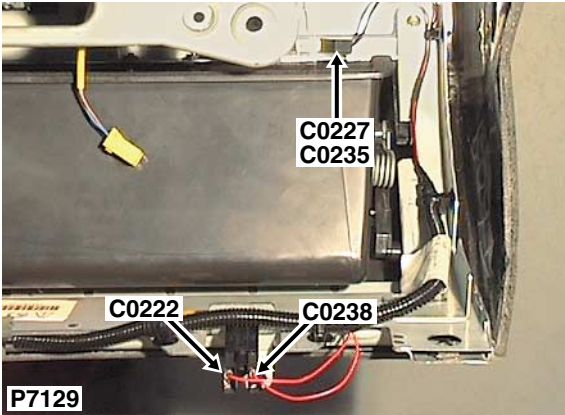

| Cav | Col | Cct |
|-----|-----|-----|
| 1   | R   | ALL |

Description: *Lamp-Glove box*  
 Location: *Behind glovebox*

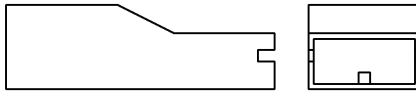

AAU1010

Colour: *BLACK*  
 Gender: *Female*



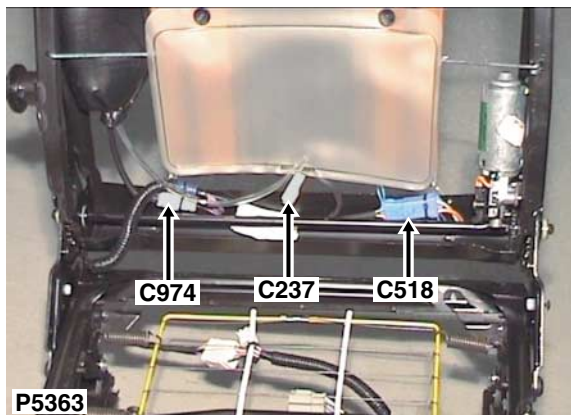

| Cav | Col | Cct |
|-----|-----|-----|
| 1   | KW  | 42  |
| 2   | B   | 42  |

Description: *Seat cushion harness to seat squab harness*

Location: *Passenger seat - below*

NO CONNECTOR FACE

Colour: *WHITE*

Gender: *Male*

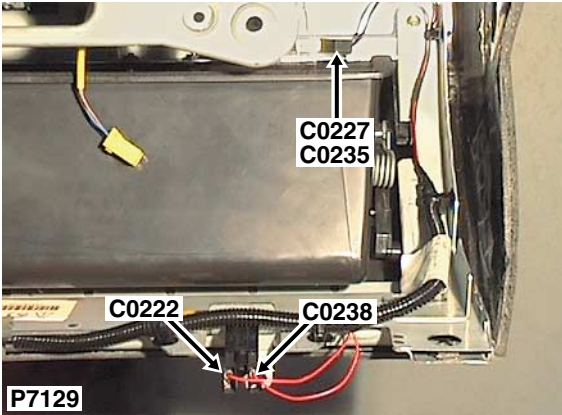

| Cav | Col | Cct |
|-----|-----|-----|
| 1   | R   | ALL |

Description: *Switch-Glove box*  
 Location: *Behind glovebox*

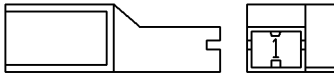

YPC10165

Colour: *BLACK*  
 Gender: *Female*

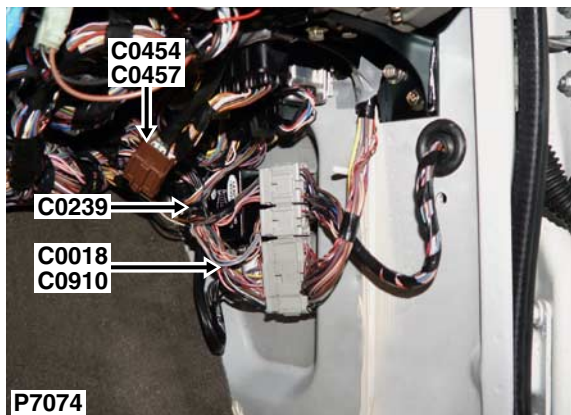

Description: *ECU-Cruise control*

Location: *RH 'A' post*

| Cav | Col | Cct |
|-----|-----|-----|
| 1   | PG  | ALL |
| 2   | UW  | 3   |
| 4   | RW  | 3   |
| 5   | GS  | 3   |
| 7   | BR  | 3   |
| 8   | WY  | 3   |
| 11  | WU  | 3   |
| 15  | KG  | 3   |
| 16  | K   | 3   |
| 17  | BY  | 3   |
| 18  | B   | 3   |

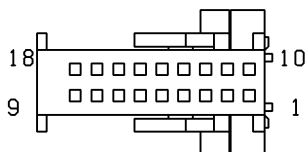

YPC111800

Colour: *BLACK*

Gender: *Female*

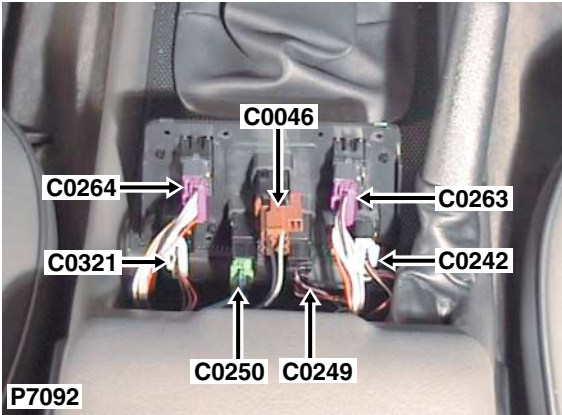

| Cav | Col | Cct |
|-----|-----|-----|
| 1   | B   | ALL |
| 3   | BK  | ALL |
| 4   | BU  | ALL |
| 6   | RN  | ALL |

Description: *Switch-Window-Front-RH*  
 Location: *Behind centre console*

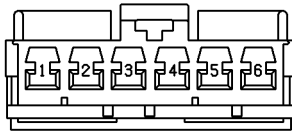

YPC113220

Colour: *WHITE*  
 Gender: *Female*

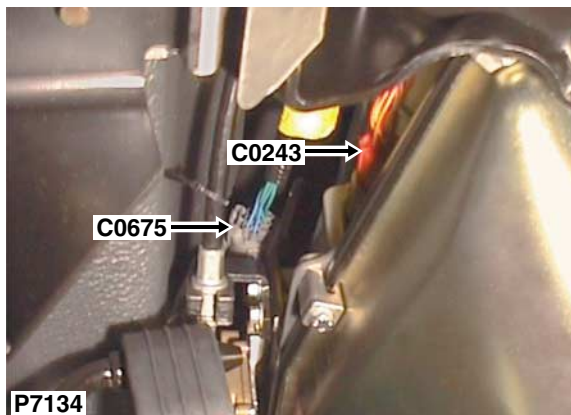

Description: *Solenoid-Gearbox*

Location: *Lower rear of engine - LH side*

| Cav | Col | Cct |
|-----|-----|-----|
| B   | OP  | ALL |
| E   | OK  | ALL |
| F   | OB  | ALL |
| H   | OG  | ALL |
| K   | OW  | ALL |
| L   | OLG | ALL |
| M   | SO  | ALL |

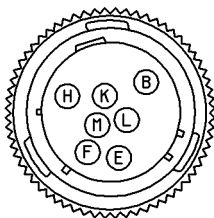

YPC115800

Colour: *BLACK*

Gender: *Female*



Description: *Lamp-Automatic gearbox selector indicator*  
 Location: *Beneath centre console*

| Cav | Col | Cct |
|-----|-----|-----|
| 1   | B   | 9   |
| 2   | RN  | ALL |
| 3   | RP  | 9   |
| 4   | RK  | 9   |
| 5   | RS  | 9   |
| 6   | RG  | 9   |
| 7   | UO  | 9   |
| 8   | RB  | 9   |
| 9   | GLG | 9   |
| 10  | RW  | 9   |
| 11  | RU  | 9   |
| 12  | RY  | 9   |

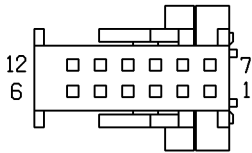

YPC111790

Colour: *BLACK*  
 Gender: *Female*

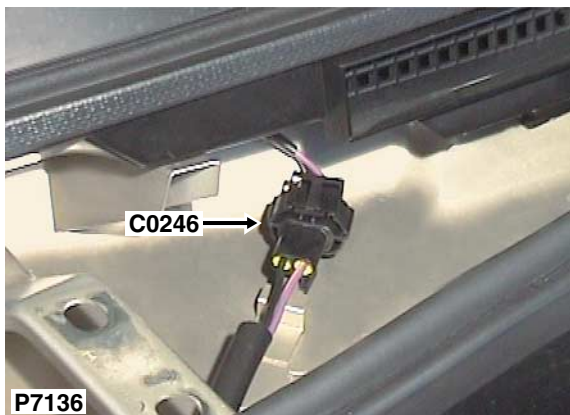

| Cav | Col | Cct |
|-----|-----|-----|
| 1   | B   | 41  |
| 2   | PK  | 41  |

Description: *Element-Front screen-RH*

Location: *Under bonnet, RH side*

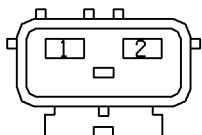

AFU3814

Colour: *BLACK*

Gender: *Male*

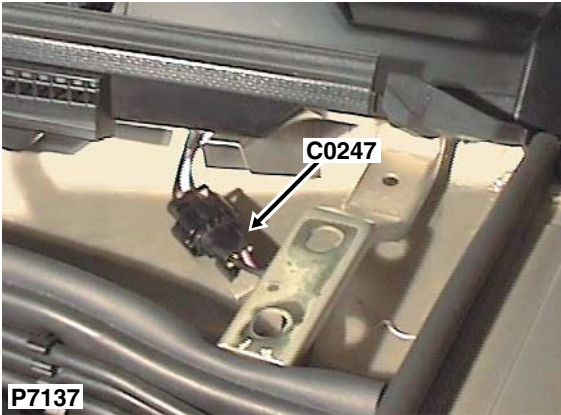

| Cav | Col | Cct |
|-----|-----|-----|
| 1   | PS  | 41  |
| 2   | B   | 41  |

Description: *Element-Front screen-LH*

Location: *Under bonnet, LH side*

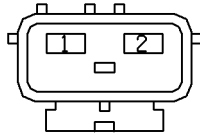

AFU3814

Colour: *BLACK*

Gender: *Male*



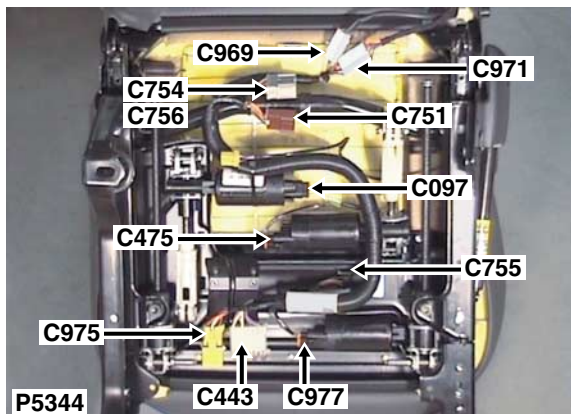

Description: *Seat cushion harness to seat squab harness*

Location: *Underside of front passenger's seat*

| Cav | Col | Cct |
|-----|-----|-----|
| 2   | KW  | 42  |
| 3   | B   | 42  |
| 4   | P   | 42  |
| 5   | PS  | 42  |
| 6   | S   | 42  |
| 7   | PB  | 42  |

NO CONNECTOR FACE

Colour: *WHITE*

Gender: *Male*

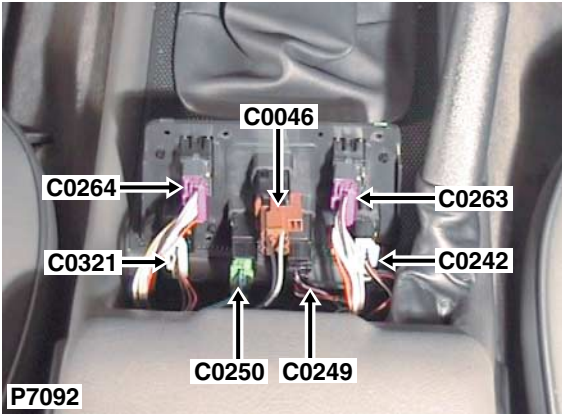

| Cav | Col | Cct |
|-----|-----|-----|
| 1   | LGW | 42  |
| 2   | RN  | 42  |
| 4   | UK  | 42  |
| 5   | B   | 42  |

Description: *Switch pack-Seat-LH*  
 Location: *Beneath centre console*

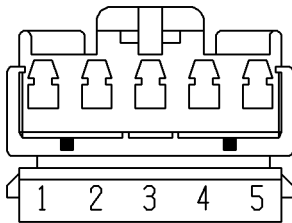

YPC10523

Colour: *BLACK*  
 Gender: *Female*

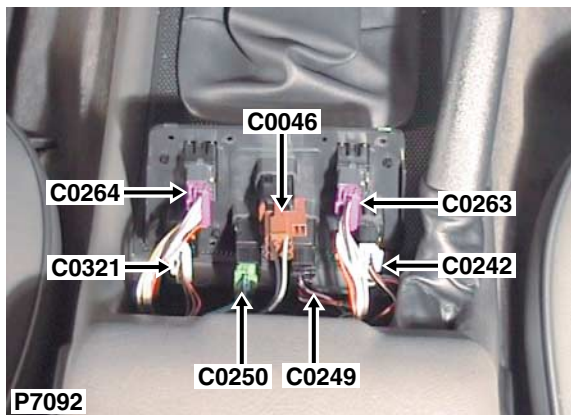

Description: *Switch pack-Seat-RH*

Location: *Beneath centre console*

| Cav | Col | Cct |
|-----|-----|-----|
| 1   | LGW | 42  |
| 2   | RN  | 42  |
| 4   | US  | 42  |
| 5   | B   | 42  |

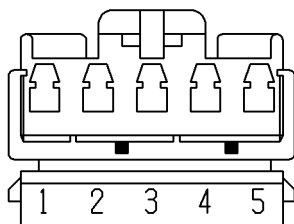

YPC10526

Colour: *GREEN*

Gender: *Female*

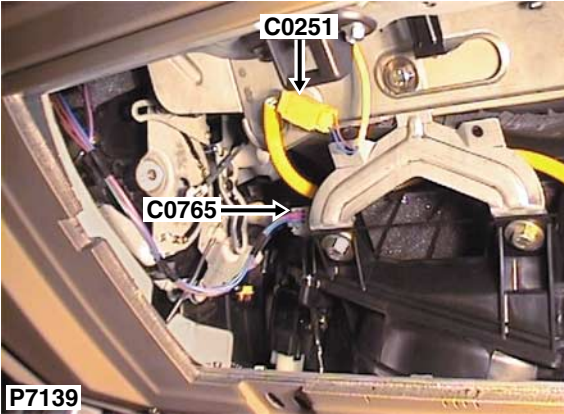

| Cav | Col | Cct |
|-----|-----|-----|
| 1   | WY  | ALL |
| 2   | W   | ALL |

Description: *Air bag-Passenger - LHD*  
 Location: *Behind glovebox*

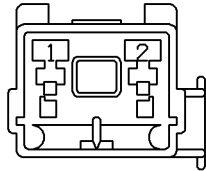

YPC108810

Colour: *YELLOW*  
 Gender: *Male*



Description: *Air bag-Passenger - RHD*

Location: *Behind glovebox*

| Cav | Col | Cct |
|-----|-----|-----|
| 1   | WY  | ALL |
| 2   | W   | ALL |

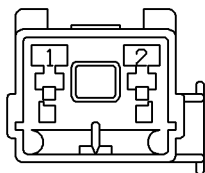

YPC108810

Colour: *YELLOW*

Gender: *Male*

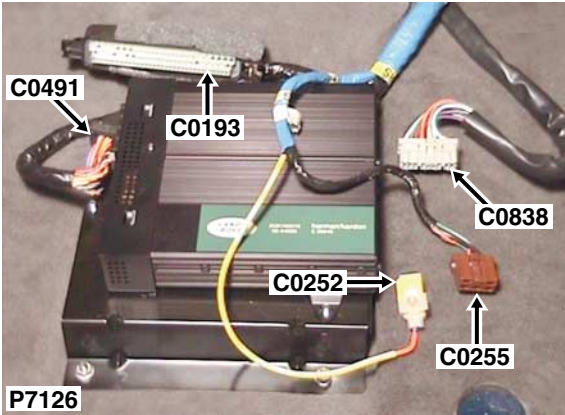

| Cav | Col | Cct |
|-----|-----|-----|
| 1   | OR  | ALL |
| 2   | O   | ALL |

Description: *Pre-tensioner-LH*  
 Location: *Beneath LH seat*

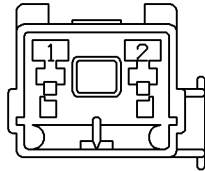

YPC108810

Colour: *YELLOW*  
 Gender: *Male*

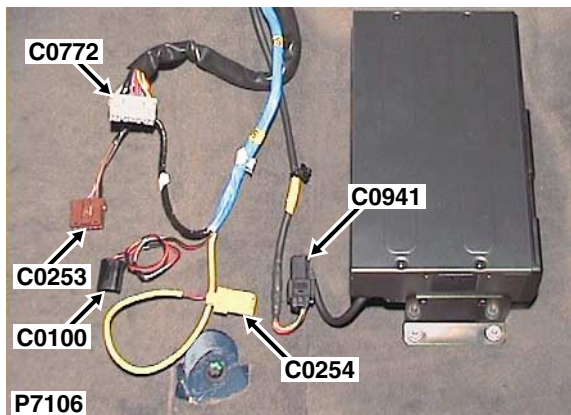

| Cav | Col | Cct |
|-----|-----|-----|
| 1   | UK  | 42  |
| 2   | B   | 42  |
| 4   | OP  | 43  |
| 5   | NP  | 43  |

Description: *Main harness to seat harness*

Location: *Beneath RH seat*

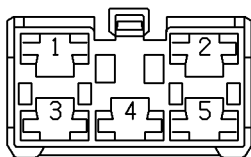

YPC10462

Colour: *BROWN*

Gender: *Female*

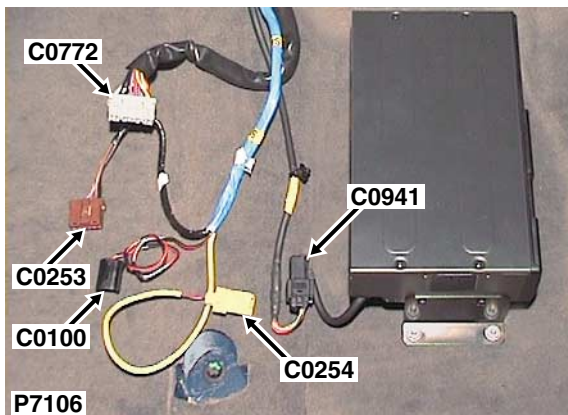

| Cav | Col | Cct |
|-----|-----|-----|
| 1   | NR  | ALL |
| 2   | N   | ALL |

Description: *Pre-tensioner-RH*

Location: *Beneath RH seat*

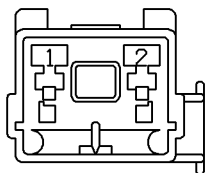

YPC108810

Colour: *YELLOW*

Gender: *Male*



# C0255

## CONNECTOR DETAILS

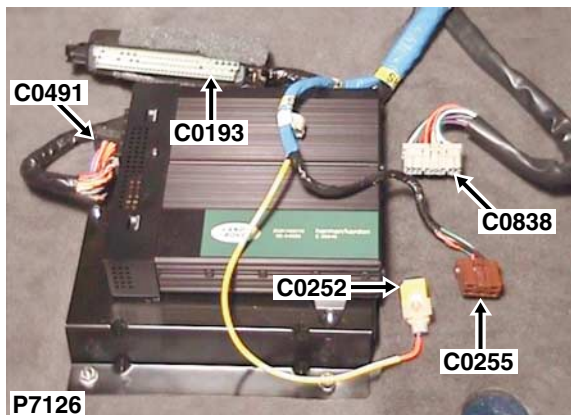

Description: *Main harness to seat harness*

Location: *Beneath LH seat*

| Cav | Col | Cct |
|-----|-----|-----|
| 1   | US  | 42  |
| 2   | B   | 42  |
| 4   | OP  | 43  |
| 5   | NG  | 43  |

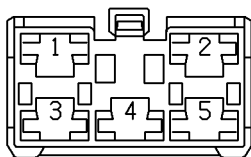

YPC10462

Colour: *BROWN*

Gender: *Female*

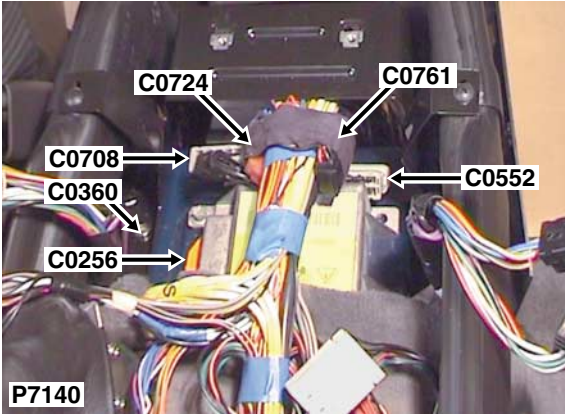

Description: DCU-Airbag  
 Location: Behind centre console

| Cav | Col | Cct |
|-----|-----|-----|
| 1   | RY  | ALL |
| 2   | R   | ALL |
| 3   | WY  | ALL |
| 4   | W   | ALL |
| 6   | N   | ALL |
| 7   | NR  | ALL |
| 9   | K   | ALL |
| 10  | O   | ALL |
| 11  | OR  | ALL |
| 13  | YR  | ALL |
| 14  | B   | ALL |
| 15  | G   | ALL |

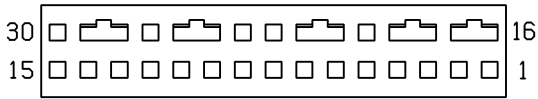

YPC109860

Colour: *YELLOW*  
 Gender: *Female*

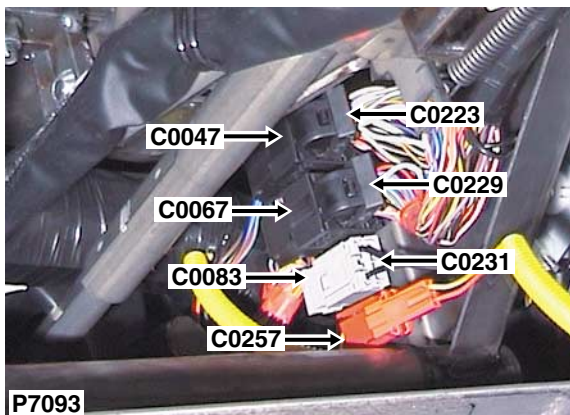

Description: *Air bag-Driver - LHD*  
 Location: *Underside of steering column*

| Cav | Col | Cct |
|-----|-----|-----|
| 1   | RY  | ALL |
| 2   | R   | ALL |

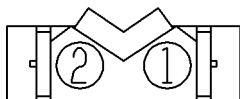

YPC10274

Colour: *RED*  
 Gender: *Female*

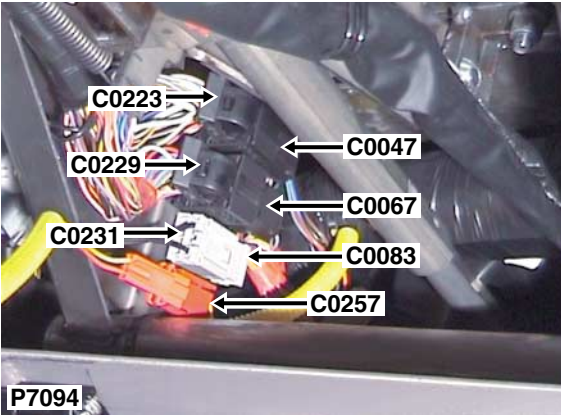

| Cav | Col | Cct |
|-----|-----|-----|
| 1   | RY  | ALL |
| 2   | R   | ALL |

Description: *Air bag-Driver - RHD*  
 Location: *Underside of steering column*



YPC10274

Colour: *RED*  
 Gender: *Female*

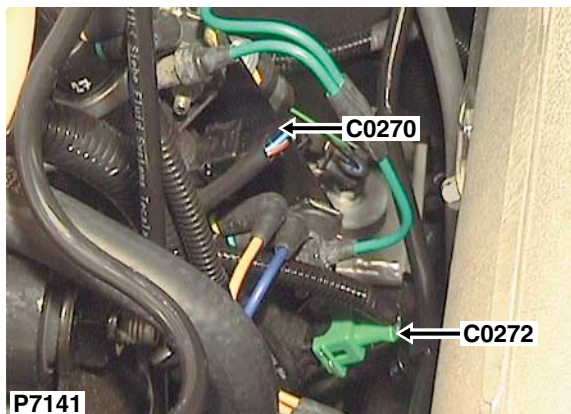

Description: *Modulator-EGR*

Location: *RH side of engine compartment*

| Cav | Col | Cct |
|-----|-----|-----|
| 1   | NK  | 35  |
| 2   | U   | 35  |

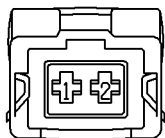

YPC107790

Colour: *BLACK*

Gender: *Female*

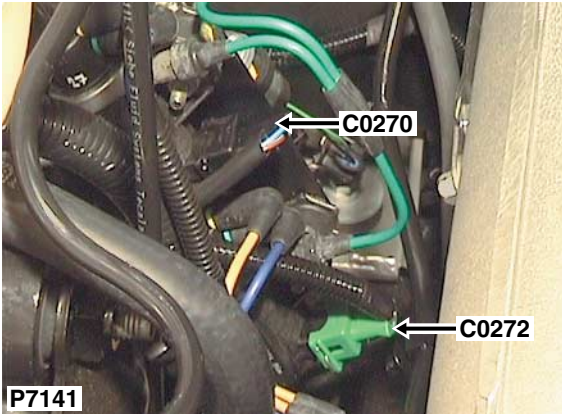

| Cav | Col | Cct |
|-----|-----|-----|
| 1   | NK  | 35  |
| 2   | O   | 35  |

Description: *Throttle-EGR-Inlet*

Location: *RH side of engine compartment*

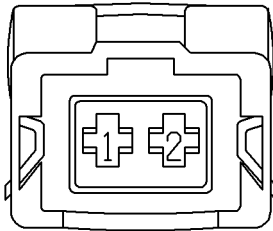

YPC107810

Colour: *GREEN*

Gender: *Female*

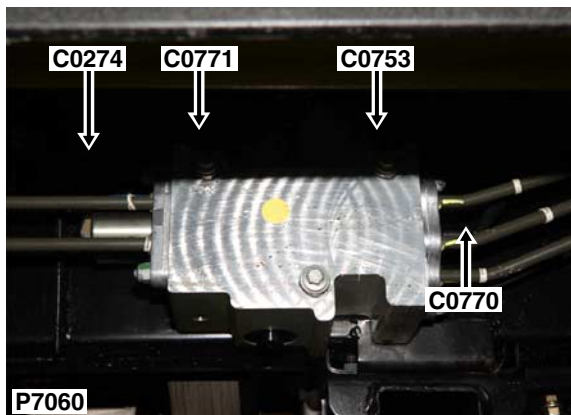

Description: *Main harness to gearbox harness*

Location: *Beneath vehicle - RH side*

| Cav | Col | Cct |
|-----|-----|-----|
| 1   | BG  | 10  |
| 2   | P   | 10  |

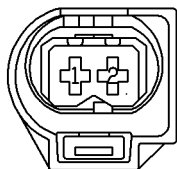

YPC113410

Colour: *BLACK*

Gender: *Female*

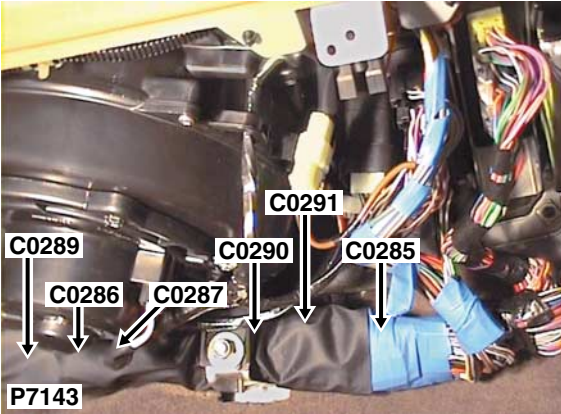

Description: *Header - LHD*  
 Location: *Under RH side of fascia*

| Cav | Col | Cct |
|-----|-----|-----|
| 1   | PU  | ALL |
| 2   | PU  | ALL |
| 3   | PU  | 37  |
| 4   | PU  | 34  |
| 5   | LGO | ALL |
| 6   | LGO | ALL |
| 7   | LGO | ALL |
| 11  | RU  | 24  |
| 12  | RU  | 24  |
| 13  | RU  | 24  |
| 14  | SW  | ALL |
| 15  | SW  | ALL |
| 16  | SW  | ALL |
| 17  | UP  | ALL |
| 18  | UP  | ALL |
| 19  | UP  | ALL |
| 20  | UP  | ALL |

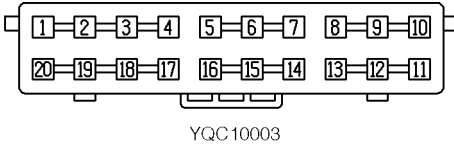

Colour: *ORANGE*  
 Gender: *Female*



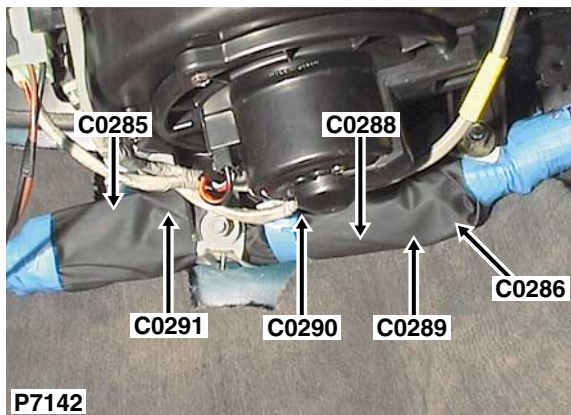

Description: *Header - RHD*

Location: *Under LH side of fascia*

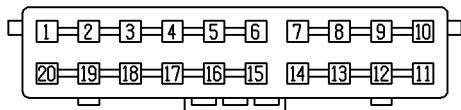

YQC10005

Colour: *BLUE*  
 Gender: *Female*

| Cav | Col | Cct |
|-----|-----|-----|
| 1   | PLG | ALL |
| 2   | PLG | 13  |
| 3   | PLG | ALL |
| 4   | PLG | ALL |
| 5   | PLG | ALL |
| 6   | PLG | ALL |
| 7   | PW  | ALL |
| 8   | PW  | ALL |
| 9   | PW  | 13  |
| 10  | PW  | ALL |
| 11  | KO  | ALL |
| 12  | KO  | ALL |
| 13  | KO  | ALL |
| 14  | KO  | ALL |
| 15  | KS  | ALL |
| 16  | KS  | ALL |
| 17  | KS  | ALL |
| 18  | KS  | ALL |
| 19  | KS  | ALL |
| 20  | KS  | ALL |

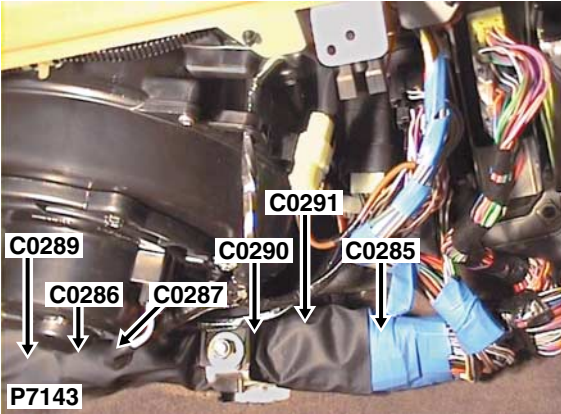

Description: *Header - LHD*  
 Location: *Under RH side of fascia*

| Cav | Col | Cct |
|-----|-----|-----|
| 1   | B   | ALL |
| 2   | B   | ALL |
| 3   | B   | 40  |
| 4   | B   | ALL |
| 5   | B   | 3   |
| 7   | B   | ALL |
| 8   | B   | 37  |
| 9   | LGW | ALL |
| 10  | LGW | ALL |
| 11  | LGW | ALL |
| 12  | LGW | ALL |
| 13  | K   | 3   |
| 14  | K   | ALL |
| 15  | K   | 10  |
| 16  | K   | ALL |
| 17  | K   | ALL |
| 18  | K   | 9   |
| 19  | K   | ALL |
| 20  | K   | ALL |

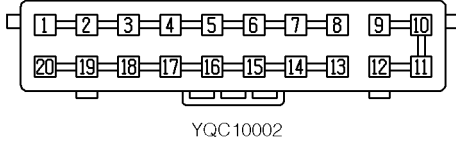

Colour: *GREY*  
 Gender: *Female*

# C0286

# CONNECTOR DETAILS

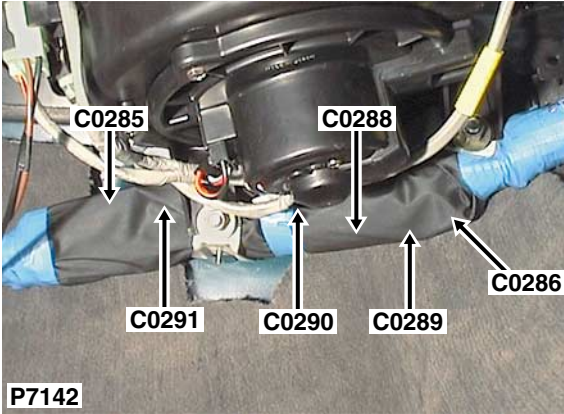

Description: *Header - RHD*

Location: *Under LH side of fascia*

| Cav | Col | Cct |
|-----|-----|-----|
| 1   | RB  | ALL |
| 3   | RB  | ALL |
| 4   | RB  | ALL |
| 5   | RB  | ALL |
| 6   | RB  | ALL |
| 7   | RB  | ALL |
| 9   | PO  | ALL |
| 10  | PO  | ALL |
| 11  | PO  | ALL |
| 13  | K   | 3   |
| 14  | K   | 10  |
| 15  | K   | ALL |
| 16  | K   | ALL |
| 17  | K   | 9   |
| 18  | K   | ALL |
| 19  | K   | ALL |
| 20  | K   | ALL |

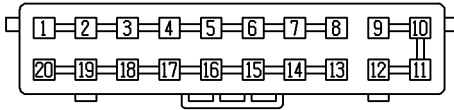

YQC10002

Colour: *GREY*  
 Gender: *Female*

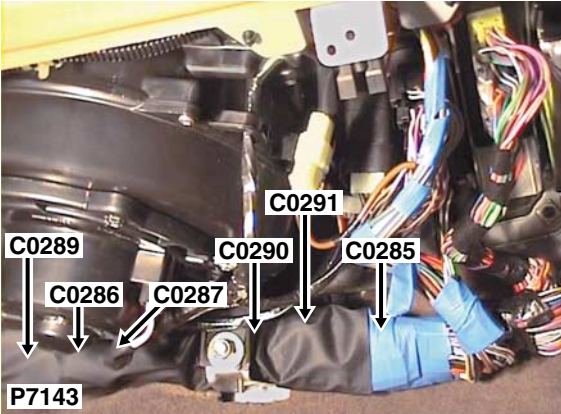

Description: *Header - LHD*  
 Location: *Behind RH side of fascia*

| Cav | Col | Cct |
|-----|-----|-----|
| 1   | GP  | ALL |
| 2   | GP  | ALL |
| 3   | GP  | 2   |
| 4   | GP  | ALL |
| 5   | GP  | ALL |
| 6   | GP  | 3   |
| 7   | PW  | ALL |
| 8   | PW  | 13  |
| 9   | PW  | ALL |
| 10  | PW  | ALL |
| 11  | PN  | ALL |
| 12  | PN  | 34  |
| 12  | PB  | 37  |
| 13  | P   | 37  |
| 14  | NS  | 40  |
| 16  | GN  | ALL |
| 17  | GN  | 10  |
| 18  | GN  | ALL |
| 19  | GN  | ALL |
| 20  | GN  | 1   |

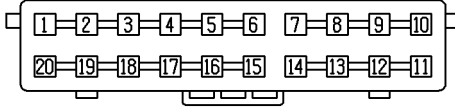

YQC10005

Colour: *BLUE*  
 Gender: *Female*

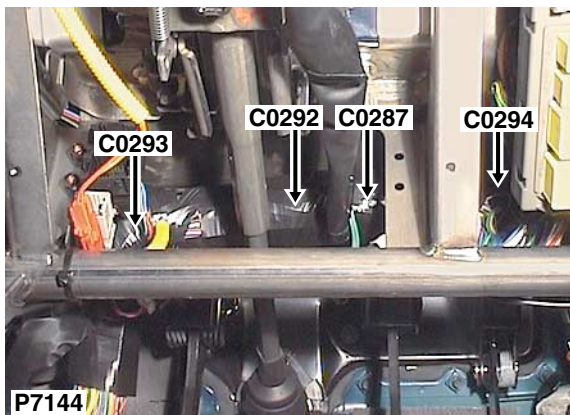

Description: *Header - RHD*

Location: *Behind RH side of fascia*

| Cav | Col | Cct |
|-----|-----|-----|
| 1   | NY  | 2   |
| 2   | NY  | 2   |
| 3   | NY  | 14  |
| 5   | WP  | 2   |
| 6   | WP  | 2   |
| 7   | WP  | 2   |
| 8   | BY  | 2   |
| 9   | BY  | 2   |
| 10  | BY  | 2   |
| 11  | BG  | 2   |
| 12  | BG  | 2   |
| 13  | BG  | 2   |
| 14  | BW  | 2   |
| 15  | BW  | 2   |
| 16  | BW  | 2   |
| 18  | W   | 2   |
| 19  | W   | 2   |
| 20  | W   | 2   |

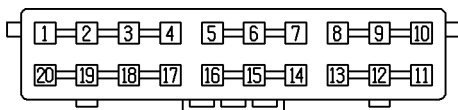

YQC10003

Colour: *ORANGE*

Gender: *Female*

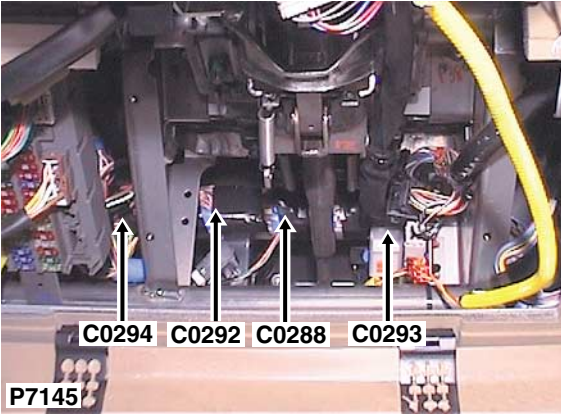

Description: *Header - LHD*  
 Location: *Behind LH side of fascia*

| Cav | Col | Cct |
|-----|-----|-----|
| 1   | RB  | ALL |
| 3   | RB  | ALL |
| 4   | RB  | ALL |
| 5   | RB  | ALL |
| 6   | RB  | ALL |
| 8   | RB  | ALL |
| 9   | B   | ALL |
| 11  | B   | 9   |
| 12  | B   | ALL |
| 13  | B   | ALL |
| 14  | B   | ALL |
| 15  | B   | ALL |
| 16  | B   | ALL |
| 17  | B   | ALL |
| 19  | B   | 38  |
| 20  | B   | ALL |

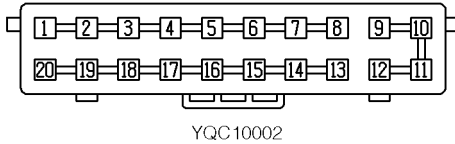

Colour: *GREY*  
 Gender: *Female*

# C0288

# CONNECTOR DETAILS

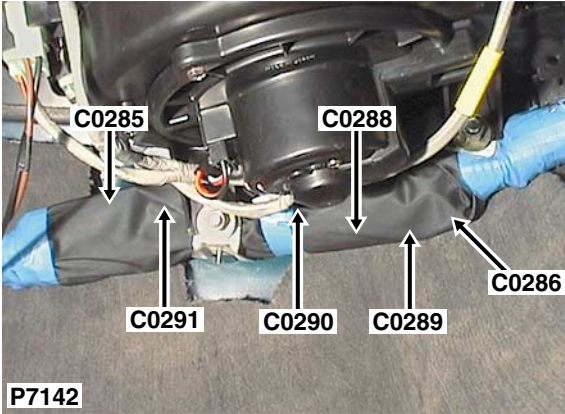

Description: *Header - RHD*

Location: *Behind LH side of fascia*

| Cav | Col | Cct |
|-----|-----|-----|
| 2   | B   | ALL |
| 5   | B   | ALL |
| 6   | B   | ALL |
| 8   | B   | ALL |
| 9   | RK  | ALL |
| 10  | RK  | ALL |
| 11  | RK  | 2   |
| 12  | RK  | 3   |
| 13  | B   | ALL |
| 15  | B   | 9   |
| 16  | B   | ALL |
| 17  | B   | ALL |
| 19  | B   | ALL |
| 20  | B   | ALL |

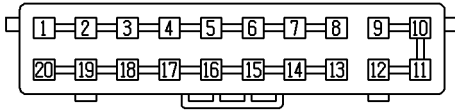

YQC10002

Colour: *GREY*  
Gender: *Female*

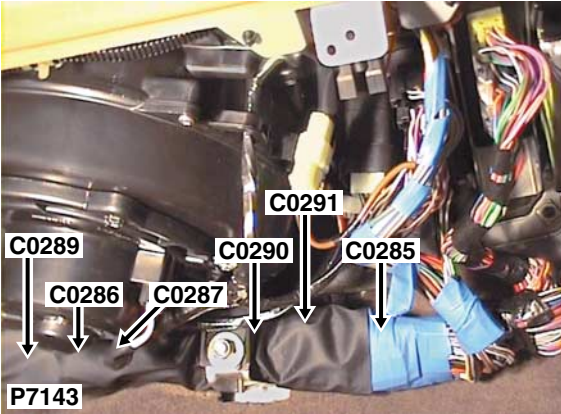

Description: *Header - LHD*  
 Location: *Behind RH side of fascia*

| Cav | Col | Cct |
|-----|-----|-----|
| 1   | GW  | ALL |
| 2   | GW  | ALL |
| 3   | GW  | ALL |
| 4   | GW  | ALL |
| 5   | GR  | ALL |
| 6   | GR  | ALL |
| 7   | GR  | ALL |
| 8   | GR  | ALL |
| 9   | RO  | ALL |
| 10  | RO  | ALL |
| 12  | RO  | ALL |
| 13  | P   | 34  |
| 14  | P   | ALL |
| 15  | P   | 34  |
| 16  | P   | ALL |
| 17  | P   | 37  |
| 18  | P   | ALL |
| 19  | P   | 34  |
| 20  | P   | 37  |

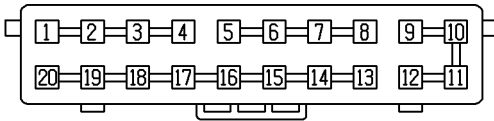

YQC10006

Colour: *GREEN*  
 Gender: *Female*



# C0289

# CONNECTOR DETAILS

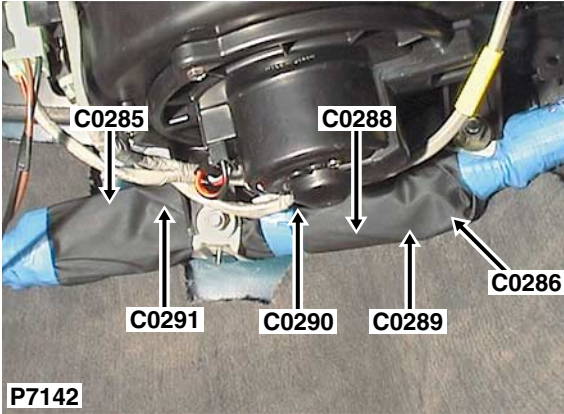

Description: *Header - RHD*

Location: *Behind LH side of fascia*

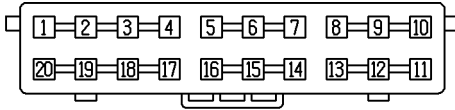

YQC10003

Colour: *ORANGE*

Gender: *Female*

| Cav | Col | Cct |
|-----|-----|-----|
| 1   | GW  | ALL |
| 2   | GW  | ALL |
| 3   | GW  | ALL |
| 4   | GW  | ALL |
| 5   | GK  | 40  |
| 6   | GK  | ALL |
| 7   | GK  | 15  |
| 8   | WP  | ALL |
| 9   | WP  | ALL |
| 10  | WP  | 9   |
| 11  | LGO | ALL |
| 12  | LGO | ALL |
| 13  | LGO | ALL |
| 14  | UY  | ALL |
| 15  | UY  | ALL |
| 16  | UY  | ALL |
| 17  | GR  | ALL |
| 18  | GR  | ALL |
| 19  | GR  | ALL |
| 20  | GR  | ALL |

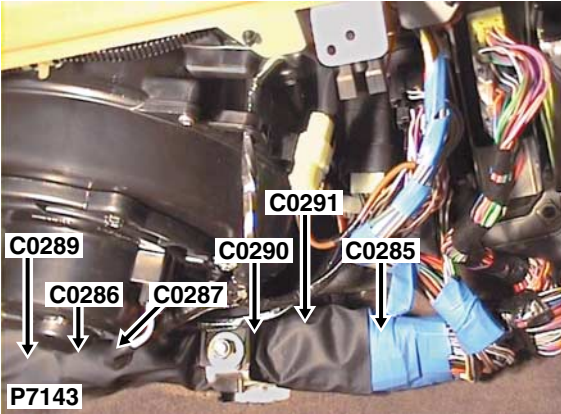

Description: *Header - LHD*  
 Location: *Behind RH side of fascia*

| Cav | Col | Cct |
|-----|-----|-----|
| 1   | RK  | ALL |
| 2   | RK  | ALL |
| 3   | RK  | 2   |
| 4   | RK  | 3   |
| 5   | GK  | 40  |
| 6   | GK  | 15  |
| 7   | GK  | ALL |
| 9   | YS  | 2   |
| 10  | YS  | 3   |
| 11  | YS  | 15  |
| 13  | KG  | ALL |
| 14  | KG  | ALL |
| 15  | KG  | 10  |
| 16  | KG  | 3   |
| 17  | KG  | 3   |
| 18  | KG  | 2   |
| 19  | KG  | ALL |

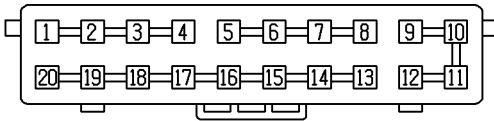

YQC10006

Colour: *GREEN*  
 Gender: *Female*

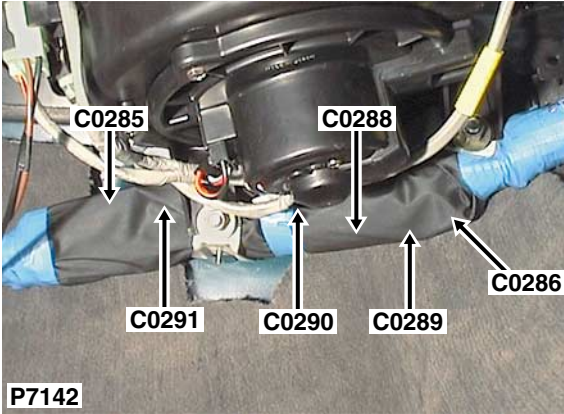

Description: *Header - RHD*

Location: *Behind LH side of fascia*

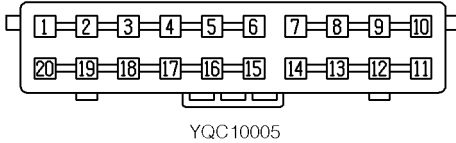

Colour: *BLUE*  
 Gender: *Female*

| Cav | Col | Cct |
|-----|-----|-----|
| 1   | GP  | ALL |
| 2   | GP  | 3   |
| 3   | GP  | ALL |
| 4   | GP  | ALL |
| 5   | GP  | ALL |
| 6   | GP  | 2   |
| 7   | RO  | ALL |
| 8   | RO  | ALL |
| 10  | RO  | ALL |
| 11  | KR  | ALL |
| 12  | KR  | ALL |
| 13  | KR  | ALL |
| 14  | KR  | ALL |
| 15  | KG  | ALL |
| 16  | KG  | ALL |
| 17  | KG  | ALL |
| 18  | KG  | ALL |
| 19  | KG  | 10  |

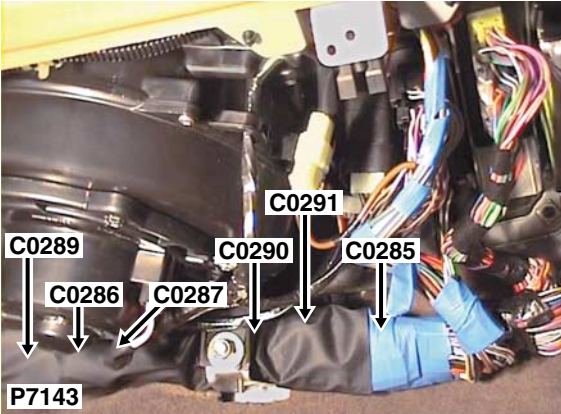

Description: *Header - LHD*  
 Location: *Behind RH side of fascia*

| Cav | Col | Cct |
|-----|-----|-----|
| 1   | PLG | 13  |
| 2   | PLG | ALL |
| 3   | PLG | ALL |
| 4   | PLG | ALL |
| 5   | PLG | ALL |
| 6   | PLG | ALL |
| 7   | WS  | ALL |
| 8   | WS  | ALL |
| 9   | WS  | 10  |
| 10  | WS  | ALL |
| 11  | PO  | ALL |
| 12  | PO  | ALL |
| 13  | PO  | ALL |
| 14  | PO  | 38  |
| 15  | RN  | ALL |
| 17  | RN  | ALL |
| 18  | RN  | ALL |
| 19  | RN  | ALL |
| 20  | RN  | ALL |

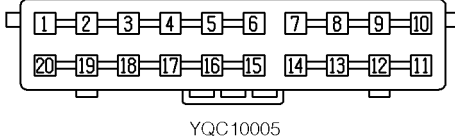

Colour: *BLUE*  
 Gender: *Female*

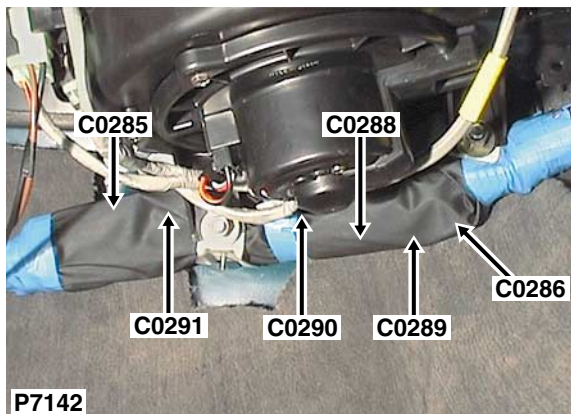

Description: *Header - RHD*

Location: *Behind LH side of fascia*

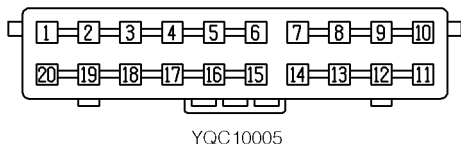

Colour: *BLUE*

Gender: *Female*

| Cav | Col | Cct |
|-----|-----|-----|
| 1   | B   | 15  |
| 2   | B   | ALL |
| 3   | B   | ALL |
| 4   | B   | 3   |
| 5   | B   | ALL |
| 7   | WS  | ALL |
| 8   | WS  | ALL |
| 9   | WS  | 10  |
| 10  | WS  | ALL |
| 11  | LGW | ALL |
| 12  | LGW | ALL |
| 13  | LGW | ALL |
| 14  | LGW | ALL |
| 15  | KP  | ALL |
| 16  | KP  | ALL |
| 17  | KP  | ALL |
| 18  | KP  | ALL |
| 19  | KP  | ALL |
| 20  | KP  | ALL |

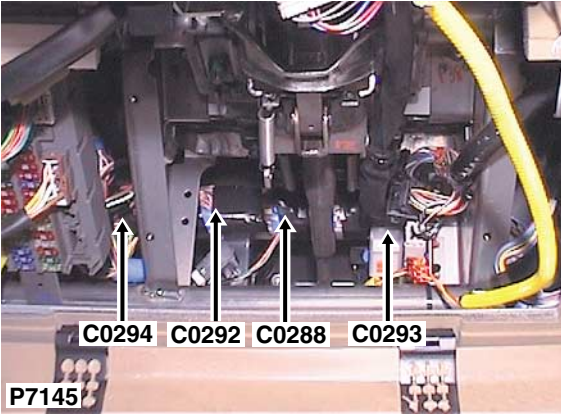

Description: *Header - LHD*  
 Location: *Behind LH side of fascia*

| Cav | Col | Cct |
|-----|-----|-----|
| 1   | KS  | ALL |
| 2   | KS  | ALL |
| 3   | KS  | ALL |
| 4   | KS  | ALL |
| 5   | KS  | ALL |
| 6   | KS  | ALL |
| 7   | KR  | ALL |
| 8   | KR  | ALL |
| 9   | KR  | ALL |
| 10  | KR  | ALL |
| 11  | GS  | ALL |
| 12  | GS  | ALL |
| 13  | GS  | ALL |
| 14  | GS  | ALL |
| 15  | KP  | ALL |
| 16  | KP  | ALL |
| 17  | KP  | ALL |
| 18  | KP  | ALL |
| 19  | KP  | ALL |
| 20  | KP  | ALL |

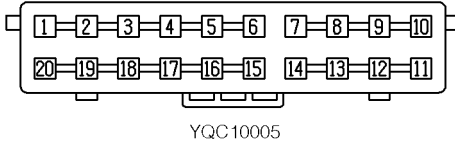

Colour: *BLUE*  
 Gender: *Female*

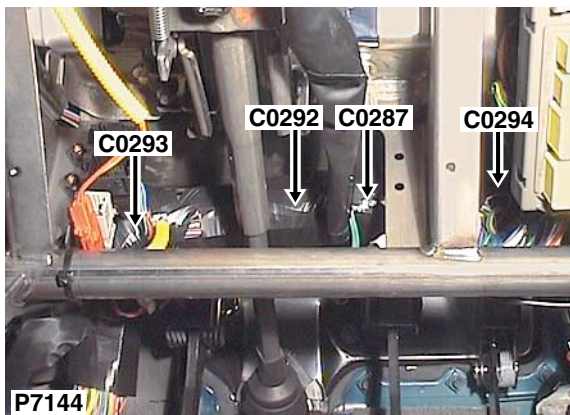

Description: *Header - RHD*

Location: *Behind RH side of fascia*

| Cav | Col | Cct |
|-----|-----|-----|
| 1   | GS  | ALL |
| 2   | GS  | ALL |
| 3   | GS  | ALL |
| 4   | GS  | ALL |
| 5   | PB  | ALL |
| 6   | PB  | 9   |
| 7   | NS  | 40  |
| 8   | NS  | ALL |
| 9   | NS  | ALL |
| 10  | PB  | ALL |
| 11  | P   | ALL |
| 14  | SW  | ALL |
| 15  | SW  | ALL |
| 16  | SW  | ALL |
| 18  | SK  | ALL |
| 19  | SK  | ALL |
| 20  | SK  | ALL |

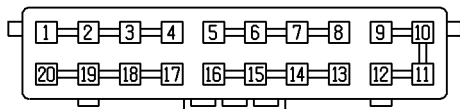

YQC10004

Colour: *YELLOW*

Gender: *Female*

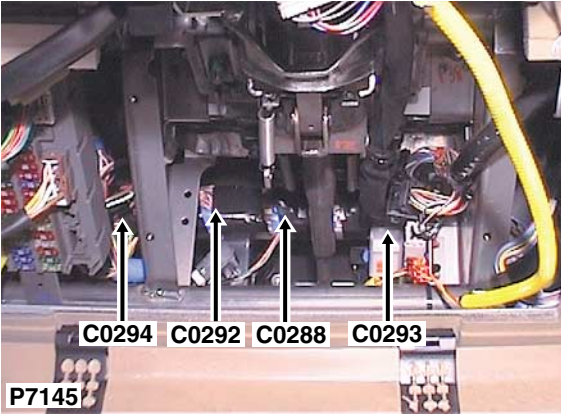

Description: *Header - LHD*  
 Location: *Behind LH side of fascia*

| Cav | Col | Cct |
|-----|-----|-----|
| 1   | BLG | ALL |
| 2   | BLG | ALL |
| 3   | BLG | 9   |
| 4   | UY  | ALL |
| 5   | UY  | 37  |
| 6   | UY  | ALL |
| 7   | SK  | ALL |
| 8   | SK  | ALL |
| 9   | SK  | ALL |
| 11  | LGS | ALL |
| 12  | LGS | ALL |
| 13  | LGS | ALL |
| 15  | KO  | ALL |
| 16  | KO  | ALL |
| 17  | KO  | ALL |
| 18  | KO  | ALL |

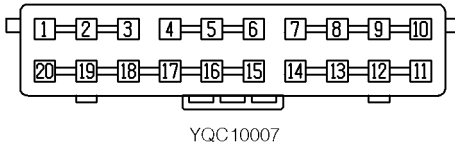

Colour: *BLACK*  
 Gender: *Female*



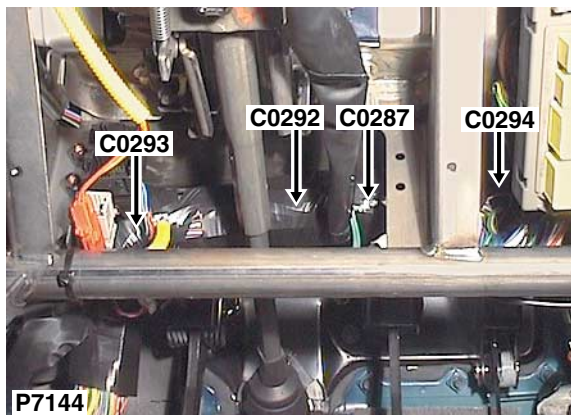

Description: *Header - RHD*

Location: *Behind RH side of fascia*

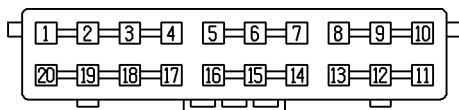

YQC10003

Colour: *ORANGE*

Gender: *Female*

| Cav | Col | Cct |
|-----|-----|-----|
| 1   | UP  | ALL |
| 2   | UP  | ALL |
| 3   | UP  | ALL |
| 4   | UP  | ALL |
| 5   | RU  | 9   |
| 6   | RU  | ALL |
| 7   | RU  | ALL |
| 8   | RN  | ALL |
| 9   | RN  | ALL |
| 10  | RN  | ALL |
| 11  | LGS | ALL |
| 12  | LGS | ALL |
| 13  | LGS | ALL |
| 14  | BLG | ALL |
| 15  | BLG | ALL |
| 16  | BLG | 9   |
| 17  | RN  | ALL |
| 18  | RN  | ALL |
| 19  | RN  | ALL |
| 20  | RN  | ALL |

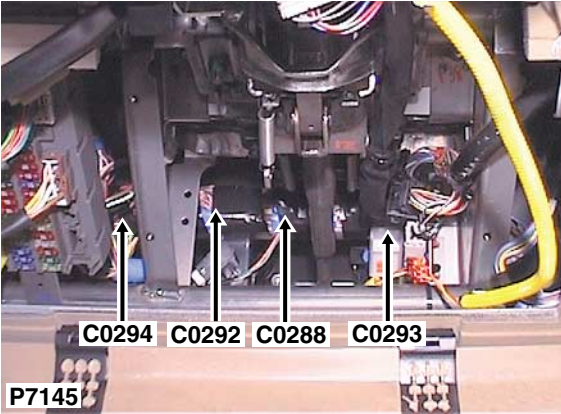

Description: *Header - LHD*  
 Location: *Behind LH side of fascia*

| Cav | Col | Cct |
|-----|-----|-----|
| 1   | WP  | 2   |
| 2   | WP  | 2   |
| 3   | WP  | 2   |
| 5   | BY  | 2   |
| 6   | BY  | 2   |
| 7   | BY  | 2   |
| 8   | W   | 2   |
| 9   | W   | 2   |
| 10  | W   | 2   |
| 11  | BG  | 2   |
| 12  | BG  | 2   |
| 13  | BG  | 2   |
| 14  | BW  | 2   |
| 15  | BW  | 2   |
| 16  | BW  | 2   |
| 17  | NY  | 38  |
| 18  | NY  | 2   |
| 19  | NY  | ALL |
| 20  | NY  | 2   |

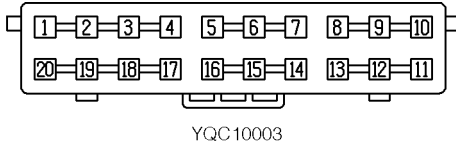

Colour: *ORANGE*  
 Gender: *Female*

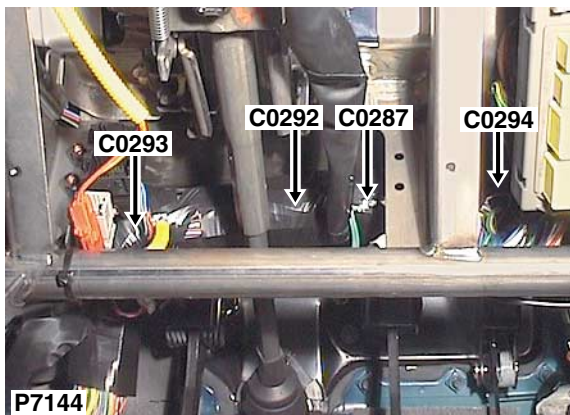

Description: *Header - RHD*

Location: *Behind RH side of fascia*

| Cav | Col | Cct |
|-----|-----|-----|
| 1   | GN  | ALL |
| 2   | GN  | 10  |
| 3   | GN  | ALL |
| 4   | GN  | ALL |
| 5   | N   | 14  |
| 6   | NY  | 14  |
| 9   | PU  | ALL |
| 10  | PU  | ALL |
| 11  | PU  | 9   |
| 12  | PU  | ALL |
| 13  | P   | ALL |
| 14  | P   | 9   |
| 15  | P   | ALL |
| 16  | P   | ALL |
| 17  | P   | ALL |
| 19  | P   | ALL |
| 20  | P   | 9   |

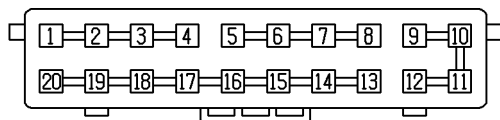

YQC10006

Colour: *GREEN*

Gender: *Female*

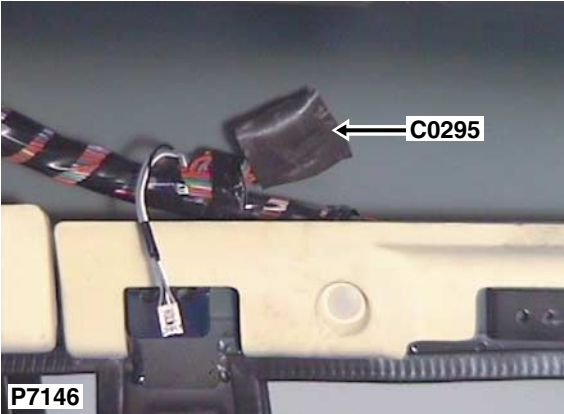

Description: *Header*

Location: *Top of LH 'B' post, behind headlining*

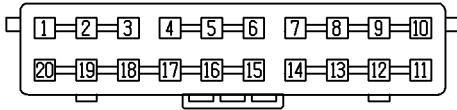

YQC10007

Colour: *BLACK*

Gender: *Female*

| Cav | Col | Cct |
|-----|-----|-----|
| 1   | GR  | ALL |
| 2   | GR  | ALL |
| 3   | GR  | ALL |
| 4   | GP  | ALL |
| 5   | GP  | ALL |
| 6   | GP  | ALL |
| 7   | RY  | 1   |
| 8   | RY  | 1   |
| 9   | RY  | 1   |
| 10  | RY  | 1   |
| 11  | GN  | ALL |
| 12  | GN  | ALL |
| 13  | GN  | ALL |
| 14  | GN  | ALL |
| 15  | RB  | ALL |
| 16  | RB  | ALL |
| 17  | RB  | ALL |
| 18  | RB  | ALL |
| 19  | RB  | ALL |
| 20  | RB  | ALL |

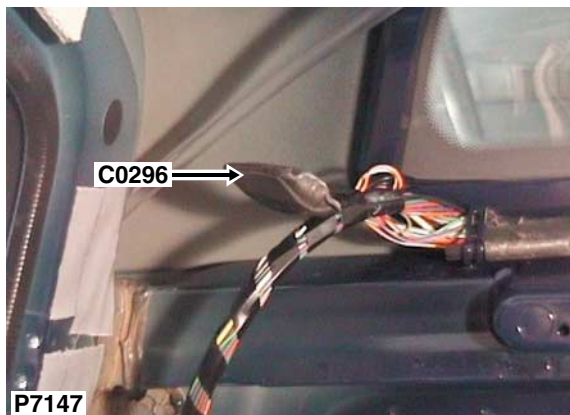

Description: *Header*

Location: *Behind LH rear trim panel*

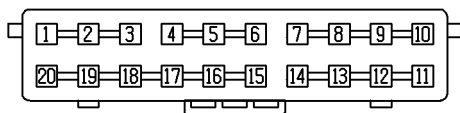

YQC10007

Colour: *BLACK*

Gender: *Female*

| Cav | Col | Cct |
|-----|-----|-----|
| 1   | B   | 24  |
| 2   | B   | 24  |
| 3   | B   | 24  |
| 4   | Y   | 24  |
| 5   | Y   | 24  |
| 6   | Y   | 24  |
| 7   | LGO | 24  |
| 8   | LGO | 24  |
| 9   | LGO | 24  |
| 10  | LGO | 24  |
| 11  | O   | 24  |
| 12  | O   | 24  |
| 13  | O   | 24  |
| 15  | RU  | 24  |
| 16  | RU  | 24  |
| 17  | RU  | 24  |
| 18  | RU  | 24  |
| 19  | RU  | 24  |

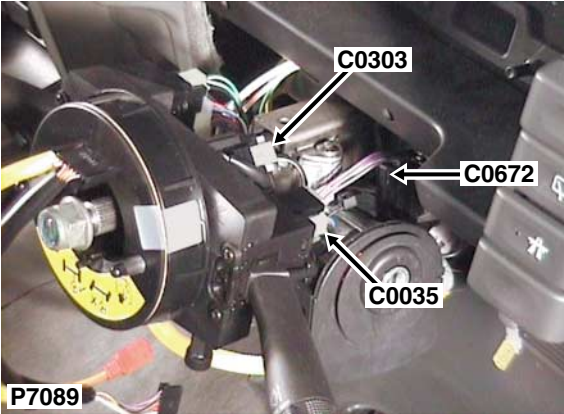

| Cav | Col | Cct |
|-----|-----|-----|
| 4   | B   | ALL |
| 6   | WLG | ALL |

Description: *ECU-Delay-Windscreen wiper*  
 Location: *RH side of steering column*

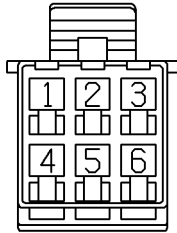

YPC10038

Colour: *NATURAL*  
 Gender: *Female*

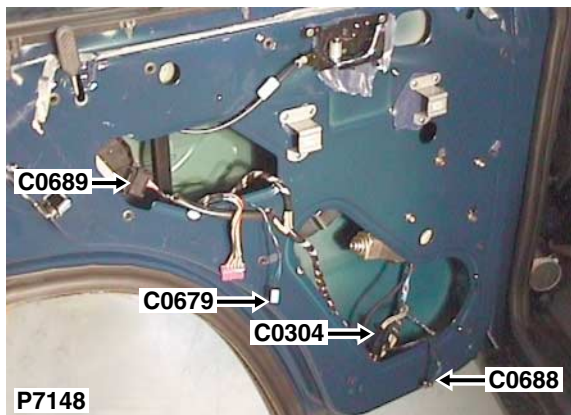

| Cav | Col | Cct |
|-----|-----|-----|
| 1   | SO  | 45  |
| 2   | SR  | 45  |

Description: *Motor-Window-Rear*

Location: *Behind rear door trim panel*

■  
Colour: *BLACK*  
Gender: *Female*

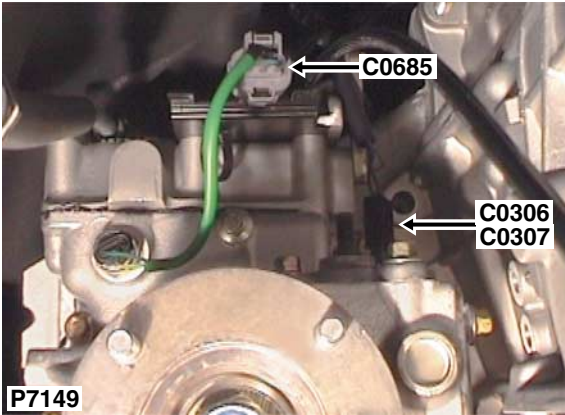

| Cav | Col | Cct |
|-----|-----|-----|
| 1   | BU  | 47  |

Description: *Differential lock unit*  
 Location: *RH side of transfer box*

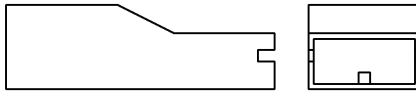

AAU1010

Colour: *BLACK*  
 Gender: *Female*



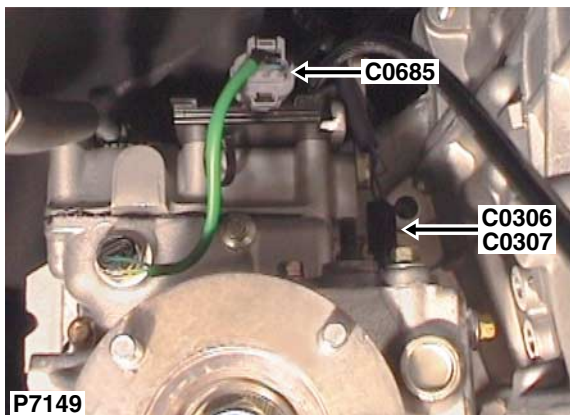

| Cav | Col | Cct |
|-----|-----|-----|
| 1   | B   | ALL |

Description: *Differential lock unit*

Location: *RH side of transfer box*

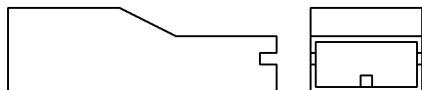

AAU1010

Colour: *BLACK*

Gender: *Female*

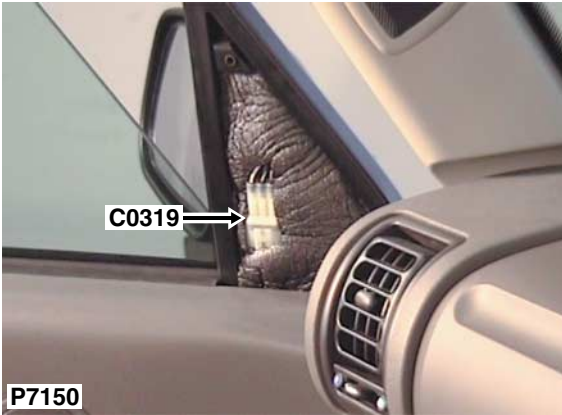

| Cav | Col | Cct |
|-----|-----|-----|
| 1   | B   | ALL |
| 2   | NP  | ALL |
| 3   | BU  | ALL |
| 4   | SW  | ALL |
| 5   | SW  | ALL |
| 6   | BK  | ALL |

Description: *Mirror-Door-Driver side*

Location: *Behind front door trim panel*



AFU3563

Colour: *NATURAL*

Gender: *Female*

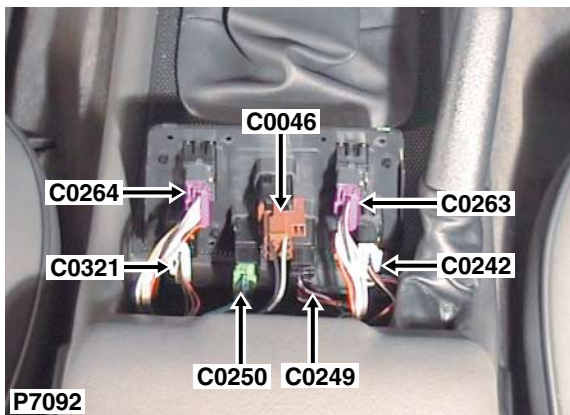

Description: *Switch-Window-Front-LH*

Location: *Beneath centre console*

| Cav | Col | Cct |
|-----|-----|-----|
| 1   | B   | ALL |
| 3   | BR  | ALL |
| 4   | BS  | ALL |
| 6   | RN  | ALL |

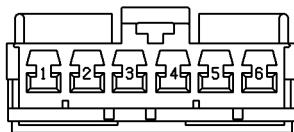

YPC113220

Colour: *WHITE*

Gender: *Female*

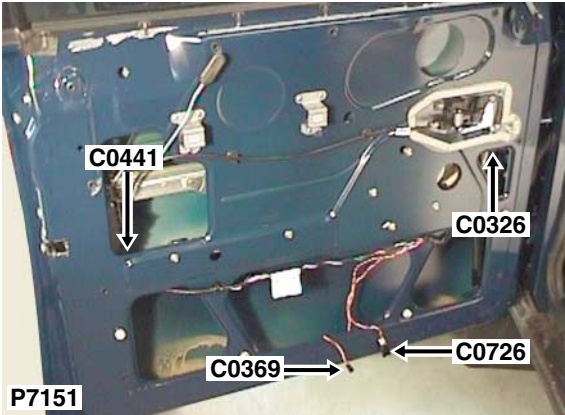

| Cav | Col | Cct |
|-----|-----|-----|
| 1   | SU  | ALL |
| 2   | SK  | ALL |

Description: *Motor-Window-Front-LH*  
 Location: *Behind front door trim panel*

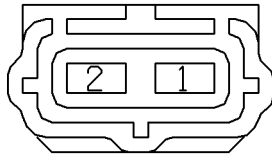

YPC10070

Colour: *BLACK*  
 Gender: *Female*

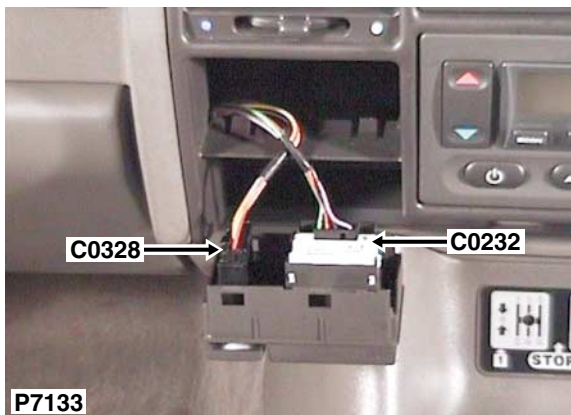

| Cav | Col | Cct |
|-----|-----|-----|
| 1   | B   | ALL |
| 3   | YK  | ALL |
| 4   | KR  | ALL |
| 6   | RN  | ALL |

Description: *Switch-Central door locking*

Location: *Behind clock*

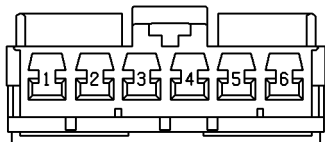

YPC113230

Colour: *BLACK*

Gender: *Female*

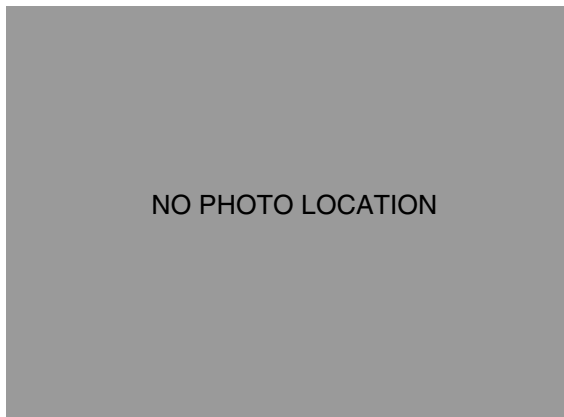

| Cav | Col | Cct |
|-----|-----|-----|
| 1   | BW  | 2   |
| 2   | BG  | 2   |

Description: *Switch-Clutch pedal*

Location: *Rear of engine compartment - driver's side*

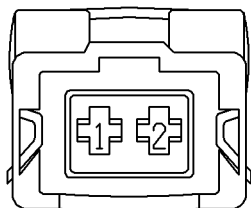

YPC107830

Colour: *NATURAL*

Gender: *Female*

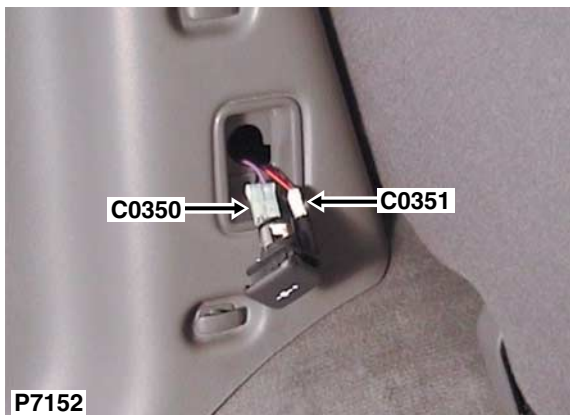

| Cav | Col | Cct |
|-----|-----|-----|
| 1   | B   | ALL |
| 2   | W   | 38  |
| 2   | PG  | ALL |

Description: *Socket-Accessory*

Location: *Behind LH rear trim panel*

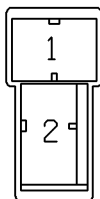

ADU9448

Colour: *NATURAL*

Gender: *Female*



| Cav | Col | Cct |
|-----|-----|-----|
| 1   | RB  | ALL |

Description: *Illumination-Accessory socket*  
 Location: *Behind LH rear trim panel*

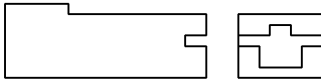

YPC10395

Colour: *WHITE*  
 Gender: *Female*



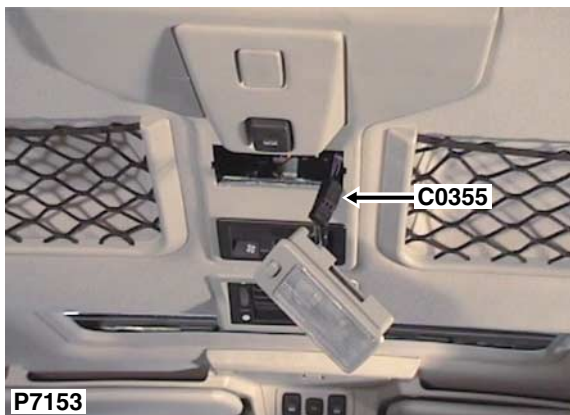

| Cav | Col | Cct |
|-----|-----|-----|
| 1   | P   | ALL |
| 2   | PU  | ALL |
| 3   | B   | ALL |

Description: *Unit-Lamp-Interior*

Location: *Behind centre headlining*

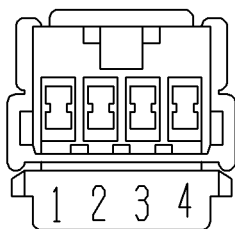

YPC10247

Colour: *BLACK*

Gender: *Female*

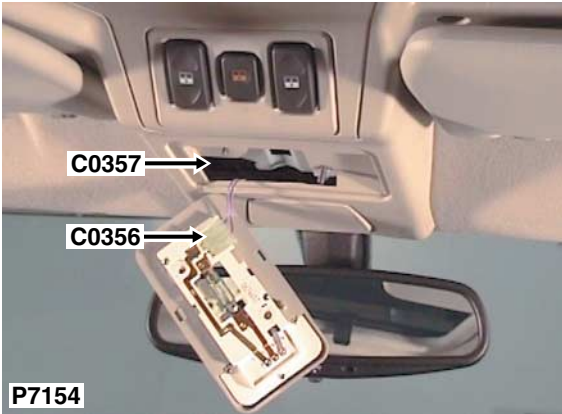

| Cav | Col | Cct |
|-----|-----|-----|
| 1   | PU  | ALL |
| 3   | P   | ALL |

Description: *Unit-Lamp-Interior*  
 Location: *Front of headlining in the centre*



YPC10026

Colour: *NATURAL*  
 Gender: *Female*



| Cav | Col | Cct |
|-----|-----|-----|
| 1   | B   | ALL |

Description: *Unit-Lamp-Interior*

Location: *Front of headlining in the centre*

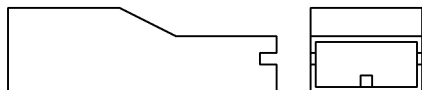

AAU1010

Colour: *BLACK*

Gender: *Female*



| Cav | Col | Cct |
|-----|-----|-----|
| 1   | SP  | ALL |
| 2   | B   | ALL |
| 3   | WB  | ALL |
| 4   | SP  | ALL |

Description: *Sensor-Volumetric*  
 Location: *Top of LH 'B' post, behind headlining*

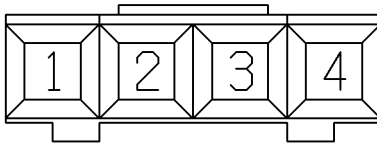

YPC10199

Colour: *BLACK*  
 Gender: *Female*

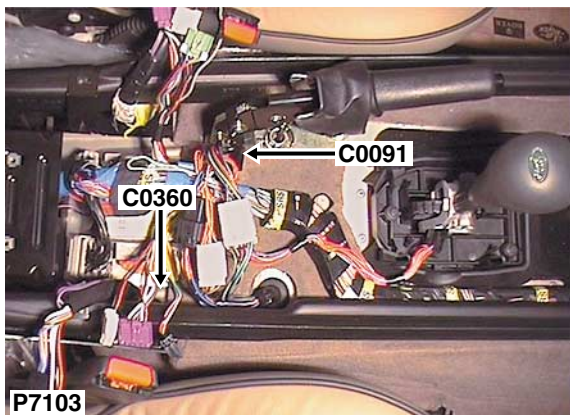

| Cav | Col | Cct |
|-----|-----|-----|
| 1   | B   | ALL |

Description: *Earth-SRS - LHD*

Location: *Behind centre console*

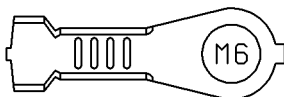

YPG10003

Colour: *TIN-PLATE*

Gender: *Eyelet*

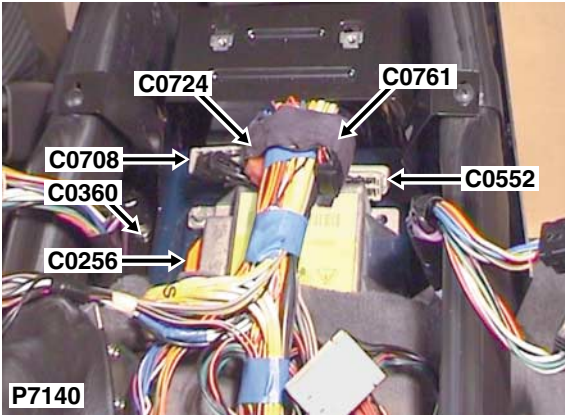

| Cav | Col | Cct |
|-----|-----|-----|
| 1   | B   | ALL |

Description: *Earth-SRS - RHD*  
 Location: *Behind centre console*

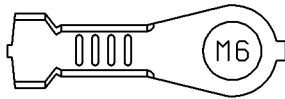

YPG10003

Colour: *TIN-PLATE*  
 Gender: *Eyelet*

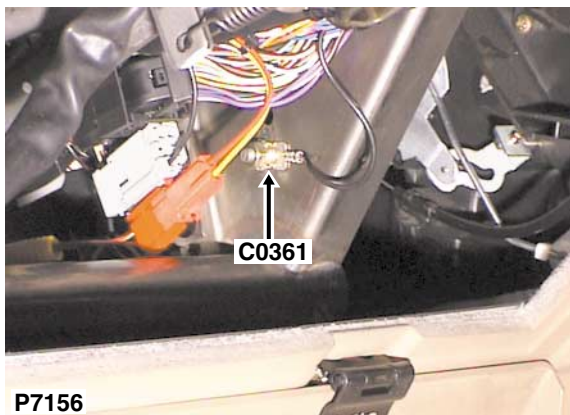

| Cav | Col | Cct |
|-----|-----|-----|
| 1   | B   | ALL |

Description: *Earth-In-Car Entertainment (ICE)*  
 Location: *Behind passenger side of fascia*

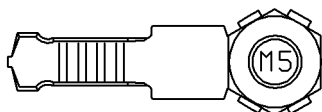

YPG100730

Colour: *BRASS*  
 Gender: *Female*

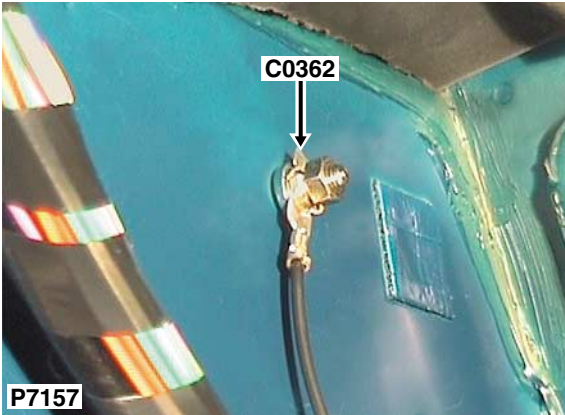

| Cav | Col | Cct |
|-----|-----|-----|
| 1   | B   | ALL |

Description: *Earth-ABS*  
 Location: *Under LH side of fascia*

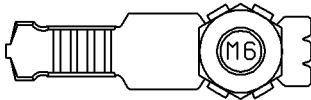

YPG10049

Colour: *TIN-PLATE*  
 Gender: *Female*



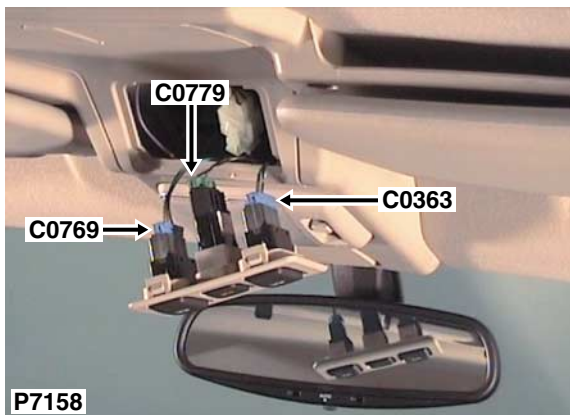

| Cav | Col | Cct |
|-----|-----|-----|
| 1   | B   | ALL |
| 3   | GK  | ALL |
| 4   | GR  | ALL |

Description: *Switch-Sunroof-Front*

Location: *Front of headlining in the centre*

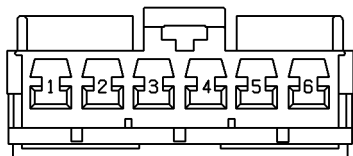

YPC113210

Colour: *BLUE*

Gender: *Female*

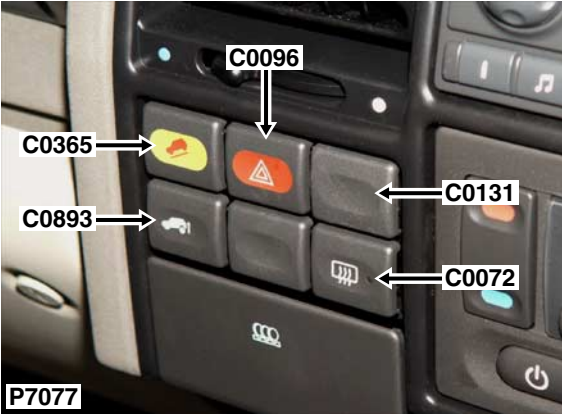

| Cav | Col | Cct |
|-----|-----|-----|
| 1   | LG  | ALL |
| 2   | B   | ALL |
| 4   | PS  | ALL |
| 5   | RN  | ALL |

Description: *Switch-Hill descent*  
 Location: *Behind centre of fascia*

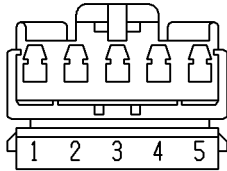

YPC10524

Colour: *WHITE*  
 Gender: *Female*

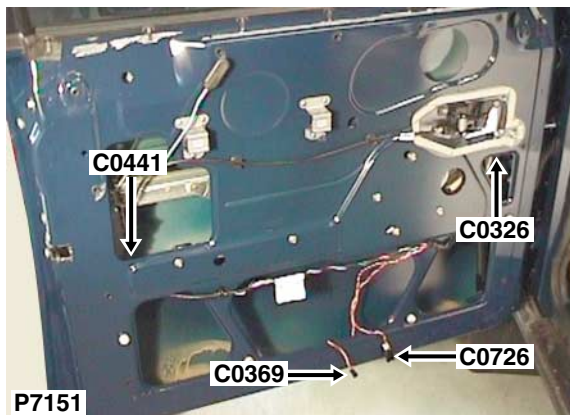

| Cav | Col | Cct |
|-----|-----|-----|
| 1   | RB  | ALL |
| 2   | KB  | 26  |
| 3   | KB  | 25  |

Description: *Speaker-Mid range-Front door-RH*

Location: *Behind front door trim panel*

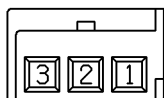

YPC117810

Colour: *WHITE*

Gender: *Female*

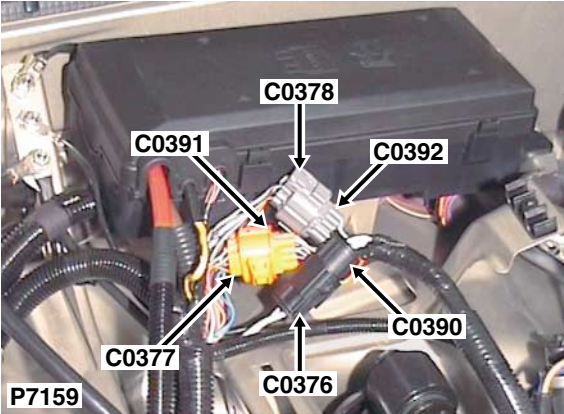

| Cav | Col | Cct |
|-----|-----|-----|
| 1   | WB  | 13  |
| 2   | WP  | ALL |

Description: *Main harness to chassis harness*  
 Location: *Beneath engine compartment fusebox*

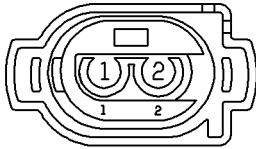

YPC110340

Colour: *BLACK*  
 Gender: *Female*

# C0377

## CONNECTOR DETAILS

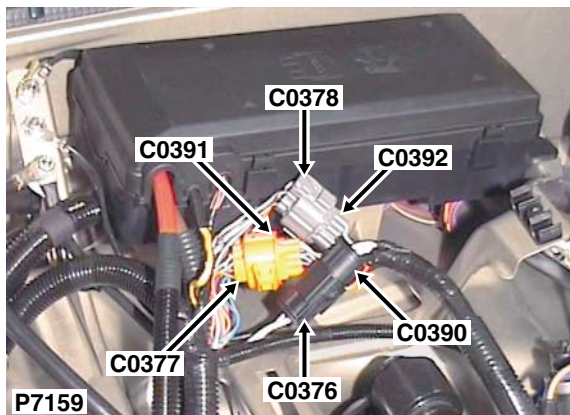

Description: *Main harness to chassis harness*

Location: *Beneath engine compartment fusebox*

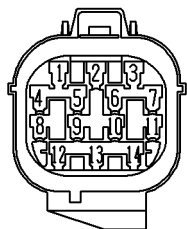

YPC108280

Colour: *ORANGE*

Gender: *Female*

| Cav | Col | Cct |
|-----|-----|-----|
| 1   | BW  | 13  |
| 2   | GR  | 10  |
| 3   | SR  | 13  |
| 4   | KY  | 10  |
| 5   | WY  | 13  |
| 6   | SU  | 13  |
| 7   | BG  | 10  |
| 8   | YB  | 10  |
| 9   | SY  | 13  |
| 10  | UO  | 13  |
| 11  | UG  | 10  |
| 12  | KW  | 10  |
| 13  | P   | 10  |
| 14  | OG  | 10  |

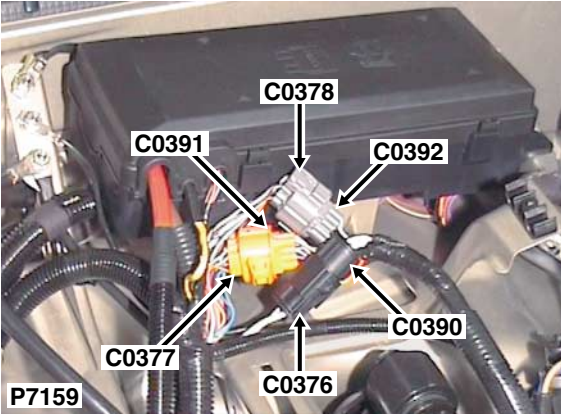

Description: *Main harness to chassis harness*  
 Location: *Beneath engine compartment fusebox*

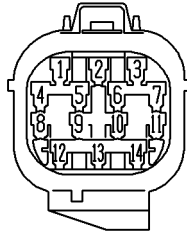

YPC10549

Colour: *GREY*  
 Gender: *Female*

| Cav | Col | Cct |
|-----|-----|-----|
| 1   | WB  | ALL |
| 2   | NB  | ALL |
| 3   | W   | ALL |
| 4   | N   | ALL |
| 5   | BY  | 19  |
| 5   | R   | 20  |
| 6   | KO  | 19  |
| 6   | RB  | 20  |
| 7   | NK  | 19  |
| 7   | GK  | 20  |
| 8   | SG  | 13  |
| 9   | SO  | 13  |
| 10  | SB  | 13  |
| 11  | OG  | ALL |
| 12  | KB  | ALL |
| 13  | GB  | ALL |
| 14  | WU  | ALL |

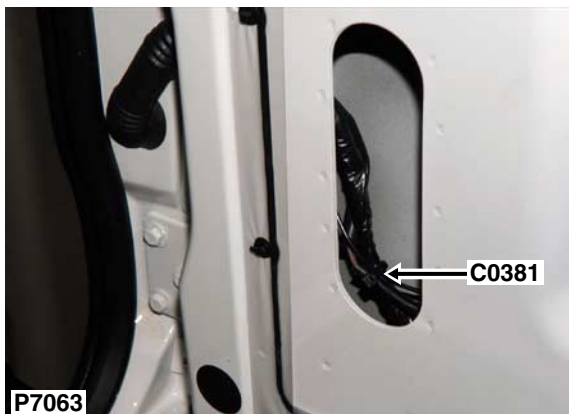

| Cav | Col | Cct |
|-----|-----|-----|
| 1   | NP  | ALL |

Description: *Heater element-Rear screen*

Location: *Centre of taildoor, behind trim panel*



YPC10450

Colour: *BLACK*

Gender: *Female*

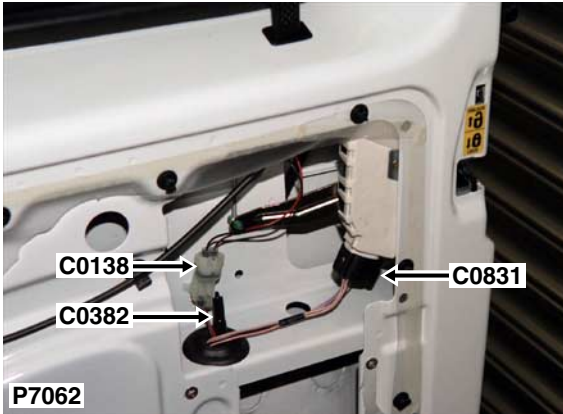

| Cav | Col | Cct |
|-----|-----|-----|
| 1   | B   | ALL |

Description: *Heater element-Rear screen*

Location: *Centre of taildoor, behind trim panel*



YPC10450

Colour: *BLACK*

Gender: *Female*



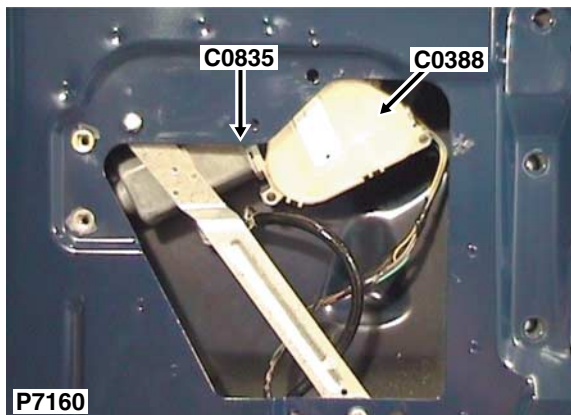

| Cav | Col | Cct |
|-----|-----|-----|
| 1   | NY  | ALL |
| 2   | GLG | ALL |
| 3   | NG  | ALL |

Description: *Motor-Wiper-Rear screen*

Location: *Behind rear door trim panel*

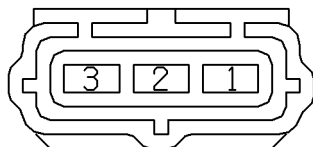

YPC10067

Colour: *BLACK*

Gender: *Female*

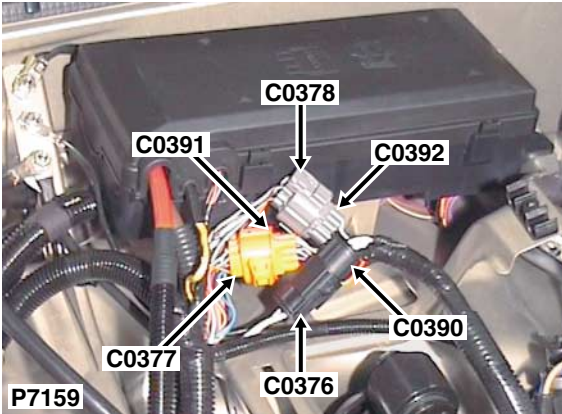

| Cav | Col | Cct |
|-----|-----|-----|
| 1   | WB  | 13  |
| 2   | WP  | ALL |

Description: *Chassis harness to main harness*

Location: *Beneath engine compartment fusebox*

NO CONNECTOR FACE

Colour: *BLACK*

Gender: *Male*

# C0391

## CONNECTOR DETAILS

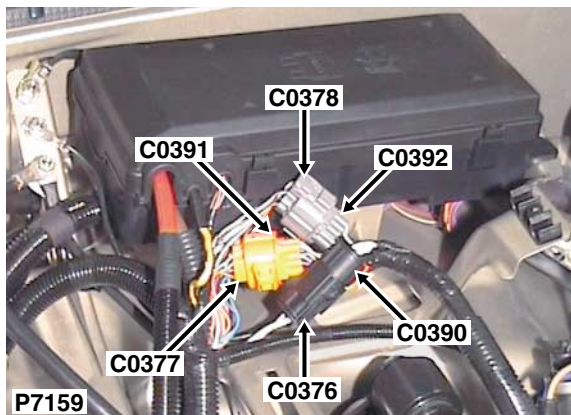

Description: *Chassis harness to main harness*

Location: *Beneath engine compartment fusebox*

| Cav | Col | Cct |
|-----|-----|-----|
| 1   | BW  | 13  |
| 2   | GR  | 10  |
| 3   | SR  | 13  |
| 4   | KY  | 10  |
| 5   | WY  | 13  |
| 6   | SU  | 13  |
| 7   | BG  | 10  |
| 8   | YB  | 10  |
| 9   | SY  | 13  |
| 10  | UO  | 13  |
| 11  | UG  | 10  |
| 12  | KW  | 10  |
| 13  | P   | 10  |
| 14  | OG  | 10  |

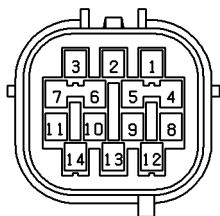

YPC10561

Colour: *ORANGE*

Gender: *Male*

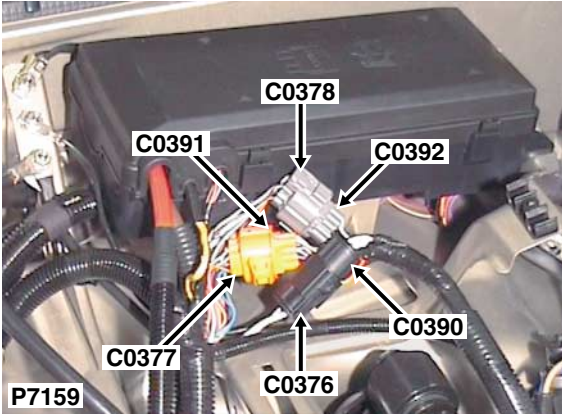

Description: *Chassis harness to main harness*  
 Location: *Beneath engine compartment fusebox*

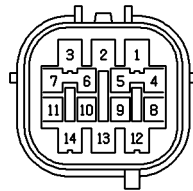

YPC10469

Colour: *GREY*  
 Gender: *Male*

| Cav | Col | Cct |
|-----|-----|-----|
| 1   | W   | ALL |
| 2   | W   | ALL |
| 3   | W   | ALL |
| 4   | W   | ALL |
| 5   | BY  | 18  |
| 5   | R   | 21  |
| 6   | KO  | 18  |
| 6   | RB  | 21  |
| 7   | NK  | 18  |
| 7   | GK  | 21  |
| 8   | SG  | 13  |
| 9   | SO  | 13  |
| 10  | SB  | 13  |
| 11  | OG  | 2   |
| 12  | KB  | ALL |
| 13  | GB  | ALL |
| 14  | WU  | 2   |



| Cav | Col | Cct |
|-----|-----|-----|
| 1   | S   | ALL |
| 2   | RN  | ALL |
| 4   | B   | ALL |
| 5   | RS  | ALL |

Description: *Switch-PDC*

Location: *Adjacent instrument pack*

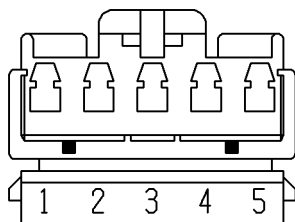

YPC10523

Colour: *BLACK*

Gender: *Female*

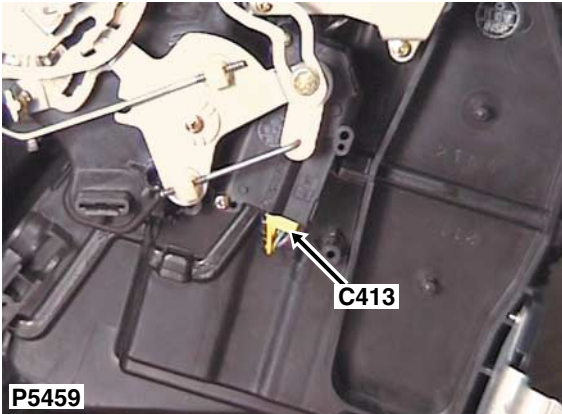

| Cav | Col | Cct |
|-----|-----|-----|
| 1   | UR  | 15  |
| 2   | BW  | 15  |
| 3   | GR  | 15  |
| 4   | UY  | 15  |
| 5   | UW  | 15  |

Description: *Motor-Mode-Air distribution*

Location: *Behind centre of fascia*

NO CONNECTOR FACE

Colour:

Gender: *Female*

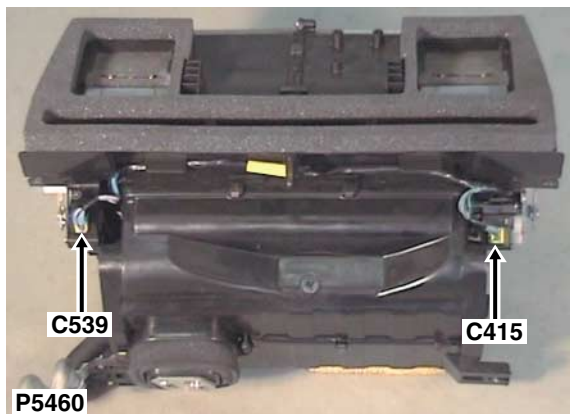

| Cav | Col | Cct |
|-----|-----|-----|
| 1   | GU  | 15  |
| 2   | GU  | 15  |
| 3   | GR  | 15  |
| 4   | SU  | 15  |
| 5   | UO  | 15  |

Description: *Motor-Mode-Air temperature*

Location: *Behind centre of fascia*

NO CONNECTOR FACE

Colour: *GREEN*

Gender: *Female*

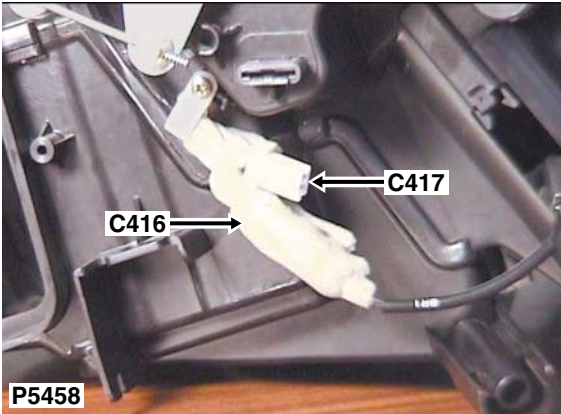

| Cav | Col | Cct |
|-----|-----|-----|
| 1   | BW  | 15  |
| 2   | RB  | 15  |

Description: *Sensor-Temperature-Heater coolant*

Location: *Behind centre of fascia*

NO CONNECTOR FACE

Colour:

Gender: *Female*



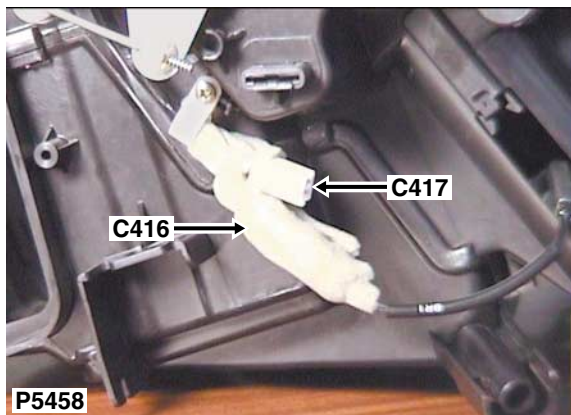

Description: *Sensor-Evaporator*

Location: *Behind centre of fascia*

| Cav | Col | Cct |
|-----|-----|-----|
| 1   | BW  | 15  |
| 2   | KB  | 15  |

NO CONNECTOR FACE

Colour:

Gender: *Female*



Description: *Motor-Mode-Fresh/recirculated air - RHD*

Location: *Behind glovebox*

| Cav | Col | Cct |
|-----|-----|-----|
| 1   | LGW | 15  |
| 2   | UB  | 15  |
| 4   | RG  | 15  |

NO CONNECTOR FACE

Colour: *YELLOW*

Gender: *Female*

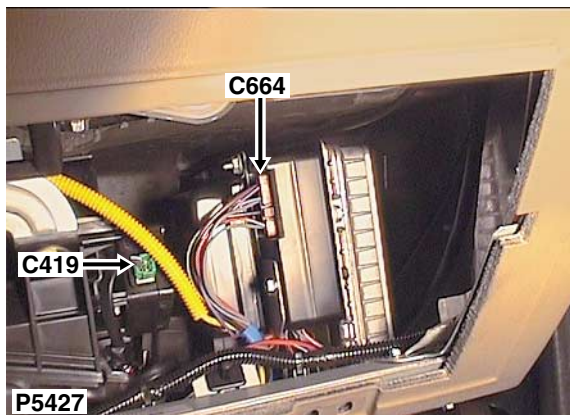

Description: *Motor-Mode-Fresh/recirculated air - LHD*

Location: *Behind glovebox*

| Cav | Col | Cct |
|-----|-----|-----|
| 1   | LGW | ALL |
| 2   | UB  | ALL |
| 4   | RG  | ALL |

NO CONNECTOR FACE

Colour: *YELLOW*

Gender: *Female*

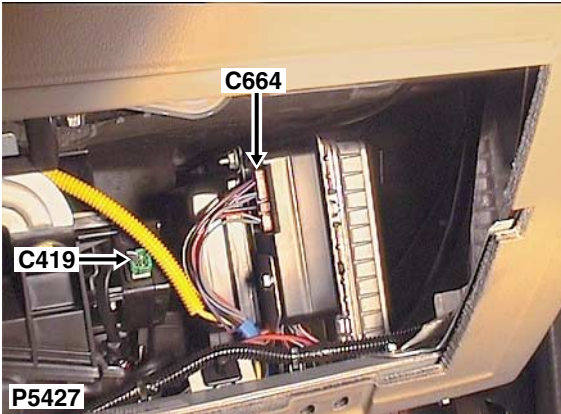

| Cav | Col | Cct |
|-----|-----|-----|
| 1   | LGW | 15  |
| 2   | UB  | 15  |
| 4   | RG  | 15  |

Description: *Motor-Mode-Fresh/recirculated air*

Location: *Behind glovebox*

NO CONNECTOR FACE

Colour: *YELLOW*

Gender: *Female*

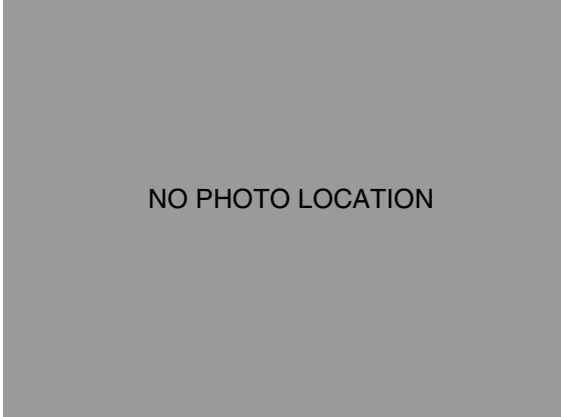

| Cav | Col | Cct |
|-----|-----|-----|
| 1   | SG  | 18  |
| 2   | BG  | 18  |

Description: *Sensor-Thermostat monitoring*

Location: *Behind radiator RH side*

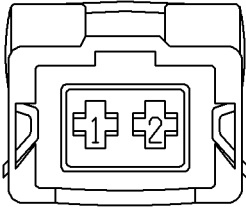

YPC107830

Colour: *NATURAL*

Gender: *Female*

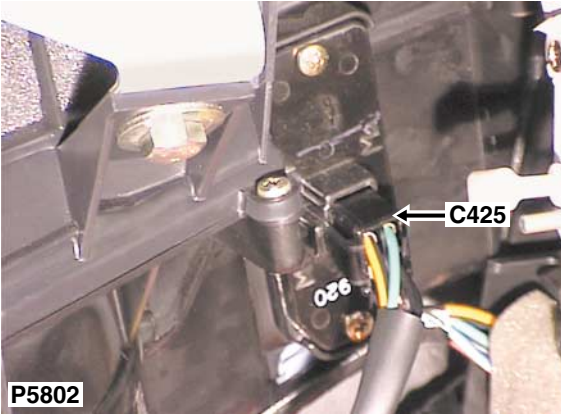

Description: *Resistor pack - LHD*  
Location: *Under LH side of fascia*

| Cav | Col | Cct |
|-----|-----|-----|
| 1   | B   | ALL |
| 2   | N   | ALL |
| 3   | Y   | ALL |
| 4   | G   | ALL |

NO CONNECTOR FACE

Colour: *BLACK*  
Gender: *Female*

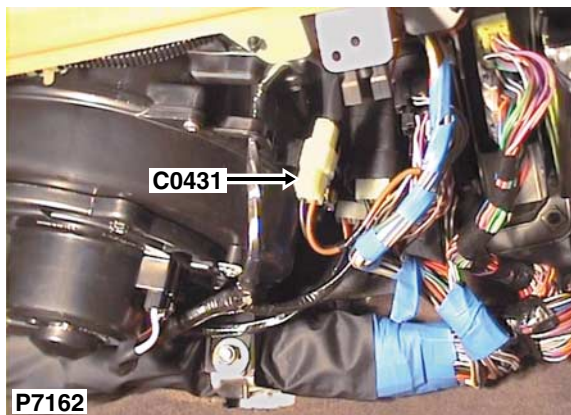

| Cav | Col | Cct |
|-----|-----|-----|
| 2   | NR  | ALL |
| 3   | B   | ALL |

Description: *Main harness to heater harness - LHD*

Location: *Behind RH side of fascia*

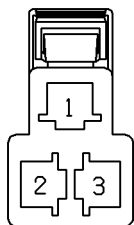

AFU3554

Colour: *NATURAL*

Gender: *Female*

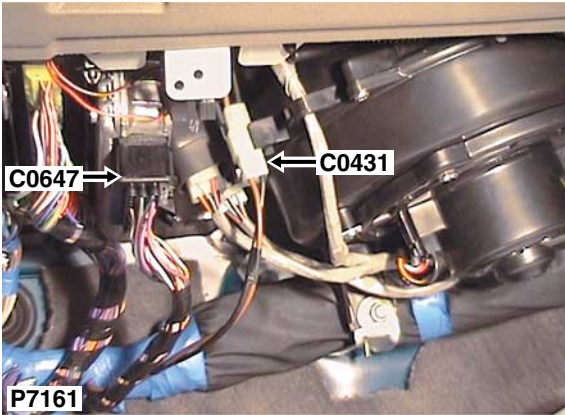

| Cav | Col | Cct |
|-----|-----|-----|
| 2   | NR  | ALL |
| 3   | B   | ALL |

Description: *Main harness to heater harness - RHD*  
 Location: *Behind LH side of fascia*

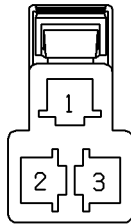

AFU3554

Colour: *NATURAL*  
 Gender: *Female*



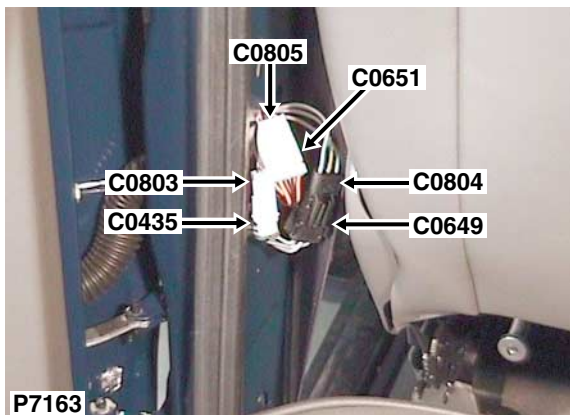

| Cav | Col | Cct |
|-----|-----|-----|
| 1   | SK  | 24  |
| 1   | BY  | 28  |
| 2   | SO  | 24  |
| 2   | BO  | 28  |

Description: *Main harness to door harness*

Location: *Base of 'B' post LH side*

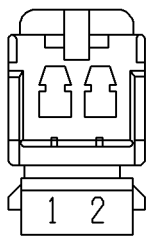

YPC10246

Colour: *WHITE*

Gender: *Female*

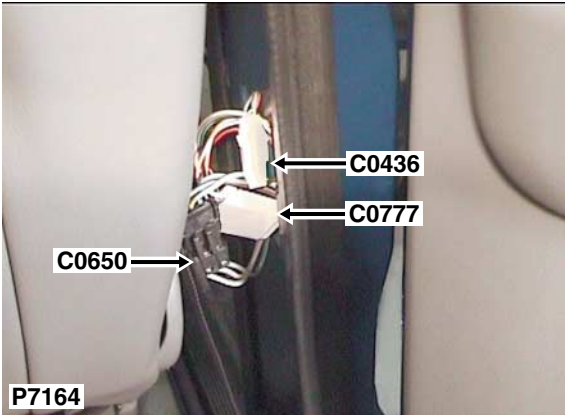

| Cav | Col | Cct |
|-----|-----|-----|
| 1   | SR  | 24  |
| 1   | BG  | 28  |
| 2   | SP  | 24  |
| 2   | BU  | 28  |

Description: *Main harness to door harness*  
 Location: *Base of 'B' post RH side*

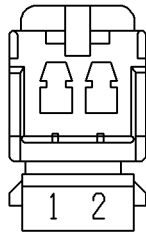

YPC10246

Colour: *WHITE*  
 Gender: *Female*

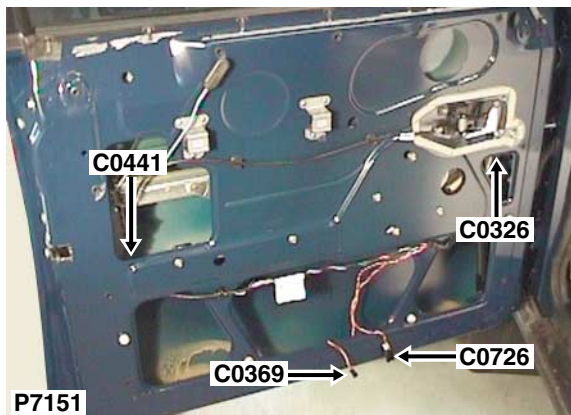

| Cav | Col | Cct |
|-----|-----|-----|
| 1   | UG  | ALL |
| 3   | US  | ALL |
| 4   | KR  | ALL |
| 5   | B   | ALL |
| 6   | PW  | ALL |
| 7   | KP  | ALL |
| 8   | KS  | ALL |

Description: *Motor-Central door locking-Passenger*

Location: *Behind front door trim panel*

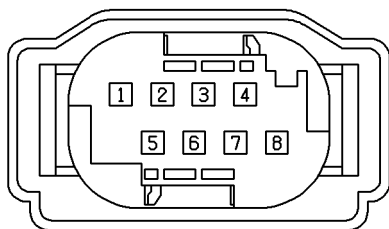

YPC108040

Colour: *BLACK*

Gender: *Female*

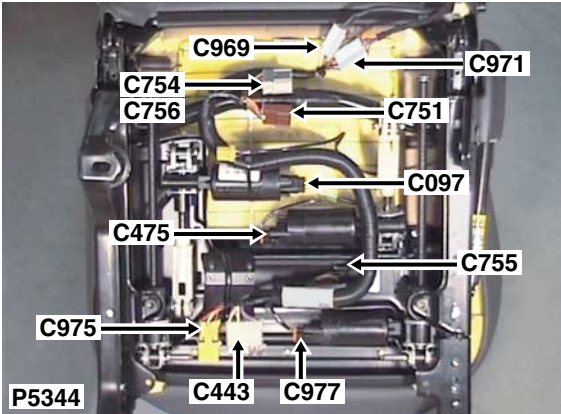

Description: *Fuse-Seat motor*

Location: *Underside of front passenger's seat*

| Cav | Col | Cct |
|-----|-----|-----|
| 3   | WN  | 22  |
| 4   | WR  | 22  |
| 5   | P   | 22  |
| 6   | P   | 22  |
| 7   | PS  | 22  |
| 8   | PS  | 22  |

NO CONNECTOR FACE

Colour: *WHITE*

Gender:

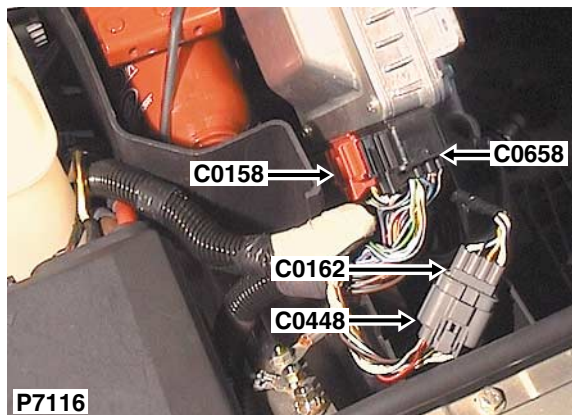

Description: *Main harness to engine harness*

Location: *RH side of engine compartment*

| Cav | Col | Cct |
|-----|-----|-----|
| 1   | WN  | 2   |
| 2   | NY  | 2   |
| 3   | NK  | 2   |
| 4   | W   | 2   |
| 5   | W   | 4   |
| 6   | Y   | 4   |
| 7   | B   | 2   |
| 8   | RK  | 2   |

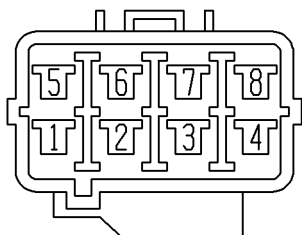

YPC10466

Colour: *GREY*

Gender: *Female*

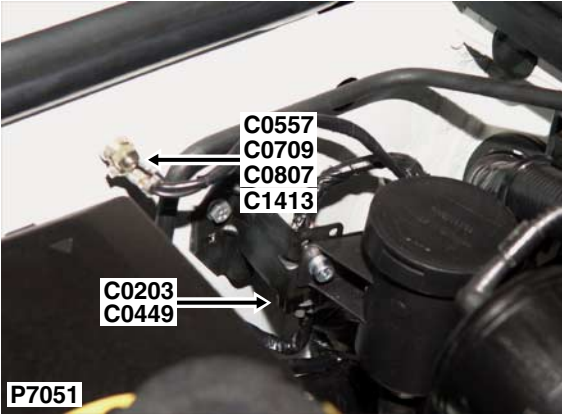

Description: *Main harness to engine harness - LHD*  
 Location: *Rear RH side of engine compartment*

| Cav | Col | Cct |
|-----|-----|-----|
| 1   | SY  | 20  |
| 2   | RB  | 20  |
| 3   | W   | 3   |
| 4   | GN  | 3   |
| 5   | GY  | 3   |
| 6   | SP  | 3   |
| 7   | WN  | 3   |
| 8   | GU  | 3   |
| 9   | NY  | 3   |
| 10  | UP  | 3   |
| 11  | RK  | 3   |
| 12  | KO  | 19  |
| 13  | BY  | 19  |
| 14  | NK  | ALL |

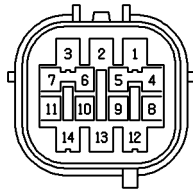

YPC10469

Colour: *GREY*  
 Gender: *Male*

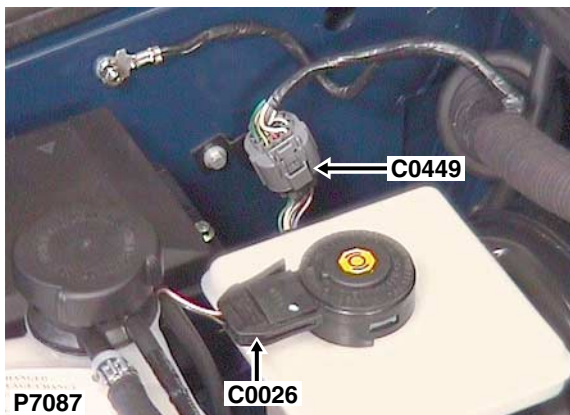

| Cav | Col | Cct |
|-----|-----|-----|
| 3   | W   | 3   |
| 4   | GN  | 3   |
| 5   | GY  | 3   |
| 6   | SP  | 3   |
| 7   | WN  | 3   |
| 8   | GU  | 3   |
| 9   | NY  | 3   |
| 10  | UP  | 3   |
| 11  | RK  | 3   |
| 14  | NK  | 3   |

Description: *Main harness to engine harness - RHD*

Location: *Rear RH side of engine compartment*

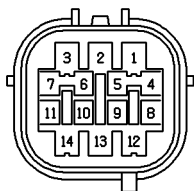

YPC10469

Colour: *GREY*

Gender: *Male*

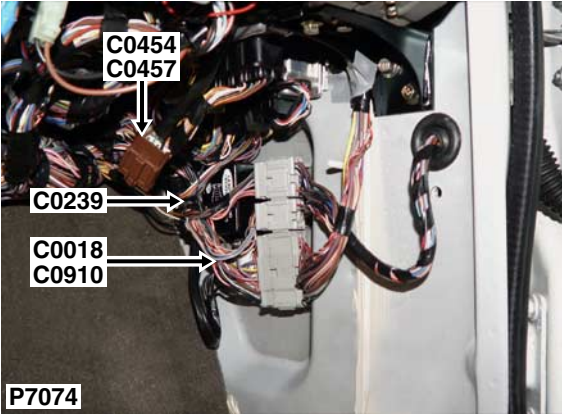

| Cav | Col | Cct |
|-----|-----|-----|
| 1   | B   | 13  |
| 2   | WG  | 13  |
| 3   | NR  | 13  |

Description: *Main harness to sunroof harness*  
 Location: *RH 'A' post*

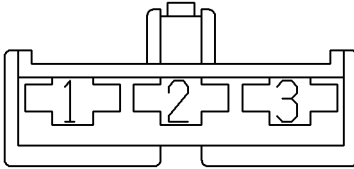

YPC10579

Colour: *BROWN*  
 Gender: *Female*



# C0457

## CONNECTOR DETAILS

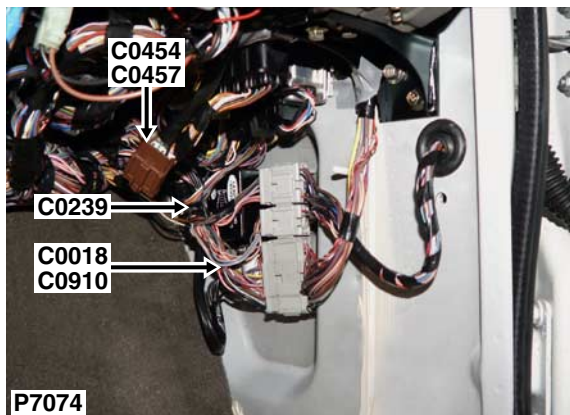

| Cav | Col | Cct |
|-----|-----|-----|
| 1   | B   | ALL |
| 2   | WG  | ALL |
| 3   | NR  | ALL |

Description: *Sunroof harness to main harness*

Location: *RH 'A' post*

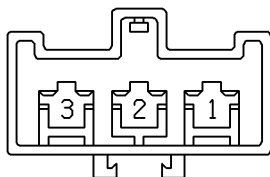

YPC10590

Colour: *BROWN*

Gender: *Male*

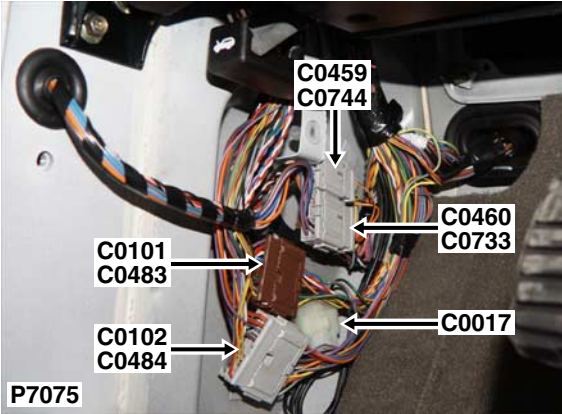

Description: *Main harness to door harness - LHD*  
 Location: *Under LH side of fascia*

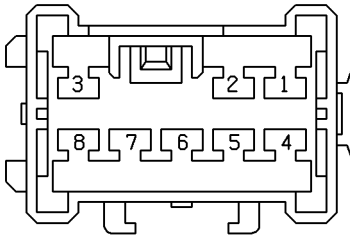

YPC10591

Colour: *LIGHT GREY*  
 Gender: *Male*

| Cav | Col | Cct |
|-----|-----|-----|
| 1   | RB  | ALL |
| 1   | YB  | ALL |
| 2   | KB  | ALL |
| 2   | YK  | ALL |
| 3   | KG  | ALL |
| 3   | OB  | ALL |
| 3   | BK  | 28  |
| 3   | BW  | 28  |
| 4   | OK  | ALL |
| 4   | KR  | ALL |
| 4   | BN  | 28  |
| 4   | BR  | 28  |
| 5   | UG  | ALL |
| 6   | SB  | ALL |
| 6   | SU  | ALL |
| 7   | SK  | ALL |
| 7   | SR  | ALL |

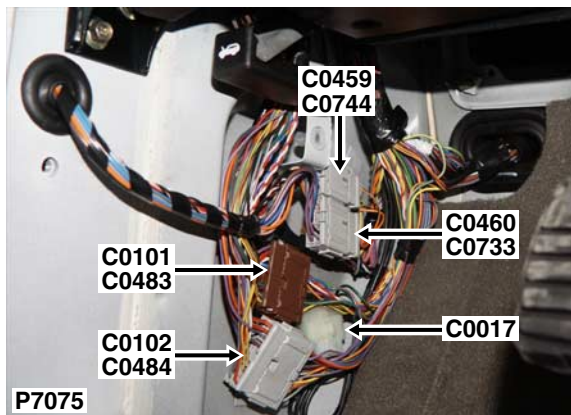

Description: *Main harness to door harness - LHD*

Location: *Under LH side of fascia*

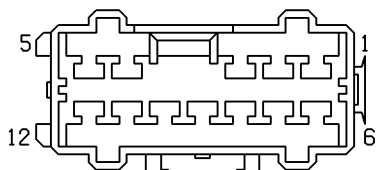

YPC10545

Colour: *LIGHT GREY*

Gender: *Male*

| Cav | Col | Cct |
|-----|-----|-----|
| 1   | PW  | ALL |
| 2   | B   | ALL |
| 3   | SW  | ALL |
| 4   | KP  | ALL |
| 5   | KR  | ALL |
| 6   | NP  | ALL |
| 7   | BK  | ALL |
| 7   | BN  | ALL |
| 8   | BP  | ALL |
| 8   | BU  | ALL |
| 9   | KS  | ALL |
| 10  | US  | ALL |
| 11  | O   | 40  |
| 11  | YR  | 40  |
| 12  | OR  | 40  |
| 12  | Y   | 40  |

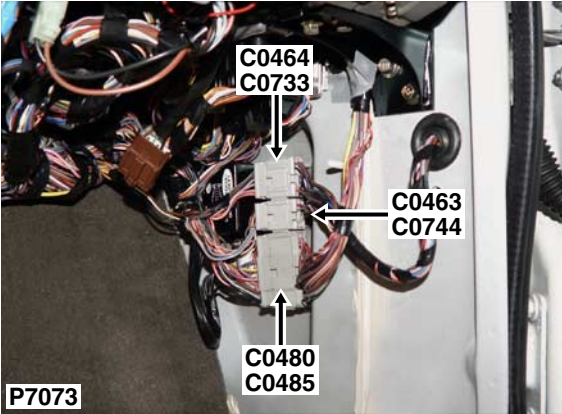

| Cav | Col | Cct |
|-----|-----|-----|
| 1   | RB  | ALL |
| 2   | KB  | ALL |
| 3   | KG  | ALL |
| 3   | BK  | ALL |
| 4   | KR  | ALL |
| 4   | BR  | ALL |
| 6   | SU  | ALL |
| 7   | SK  | ALL |

Description: *Main harness to door harness - LHD*  
 Location: *RH 'A' post*

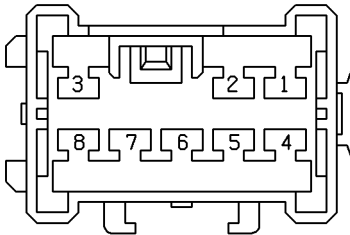

YPC10591

Colour: *LIGHT GREY*  
 Gender: *Male*

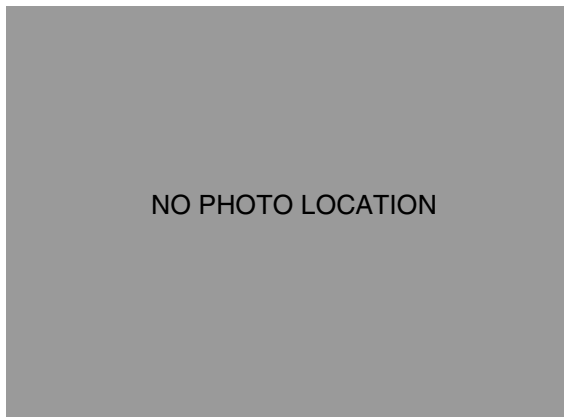

| Cav | Col | Cct |
|-----|-----|-----|
| 1   | YB  | ALL |
| 2   | YK  | ALL |
| 3   | OB  | ALL |
| 3   | BW  | ALL |
| 4   | OK  | ALL |
| 4   | BN  | ALL |
| 6   | SB  | ALL |
| 7   | SR  | ALL |

Description: *Main harness to door harness - RHD*

Location: *LH 'A' post*

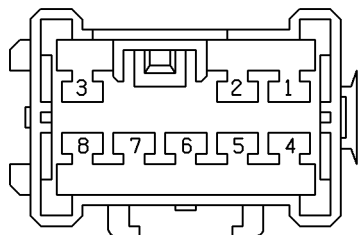

YPC10591

Colour: *LIGHT GREY*

Gender: *Male*

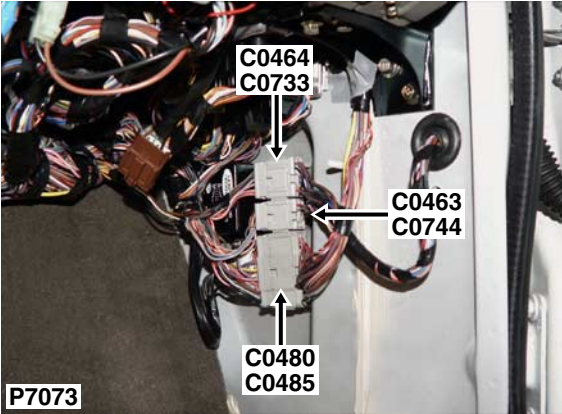

Description: *Main harness to door harness - LHD*  
 Location: *RH 'A' post*

| Cav | Col | Cct |
|-----|-----|-----|
| 1   | PLG | ALL |
| 2   | B   | ALL |
| 3   | SW  | ALL |
| 4   | KP  | ALL |
| 5   | KR  | ALL |
| 6   | NP  | ALL |
| 7   | BN  | ALL |
| 8   | BP  | ALL |
| 9   | KS  | ALL |
| 11  | O   | 40  |
| 12  | OR  | 40  |

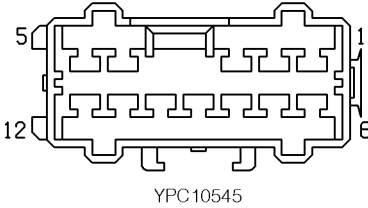

Colour: *LIGHT GREY*  
 Gender: *Male*

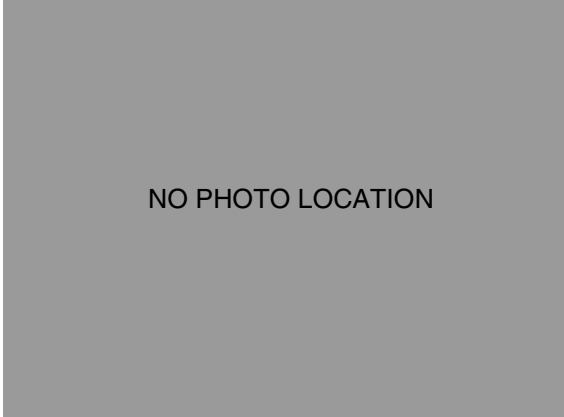

| Cav | Col | Cct |
|-----|-----|-----|
| 1   | PLG | ALL |
| 2   | B   | ALL |
| 3   | SW  | ALL |
| 4   | KP  | ALL |
| 5   | KR  | ALL |
| 6   | NP  | ALL |
| 7   | BK  | ALL |
| 8   | BU  | ALL |
| 9   | KS  | ALL |
| 11  | YR  | 40  |
| 12  | Y   | 40  |

Description: *Main harness to door harness - RHD*

Location: *LH 'A' post*

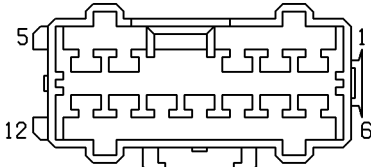

YPC10545

Colour: *LIGHT GREY*

Gender: *Male*

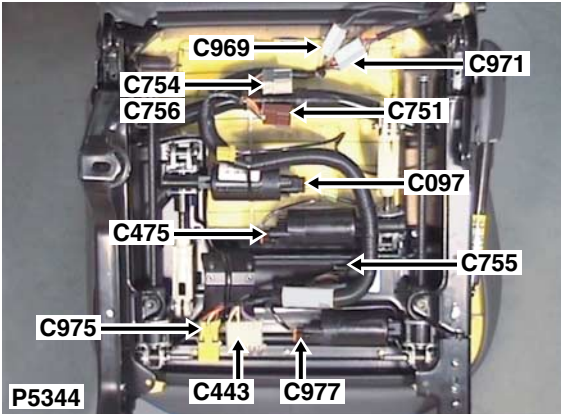

Description: *Motor-Seat-Rear up/down-LH*

Location: *Underside of front passenger's seat*

| Cav | Col | Cct |
|-----|-----|-----|
| 1   | NY  | 43  |
| 2   | U   | 43  |

NO CONNECTOR FACE

Colour: *BLACK*

Gender: *Female*



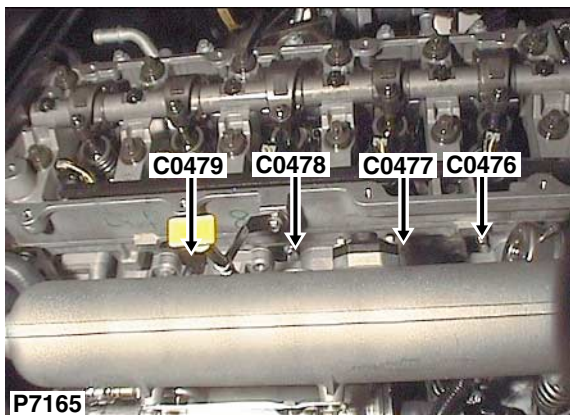

| Cav | Col | Cct |
|-----|-----|-----|
| 1   | B   | ALL |

Description: *Glow plug*  
Location: *RH side of engine*

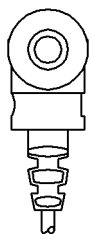

YPC107890

Colour: *BLACK*  
Gender: *Female*

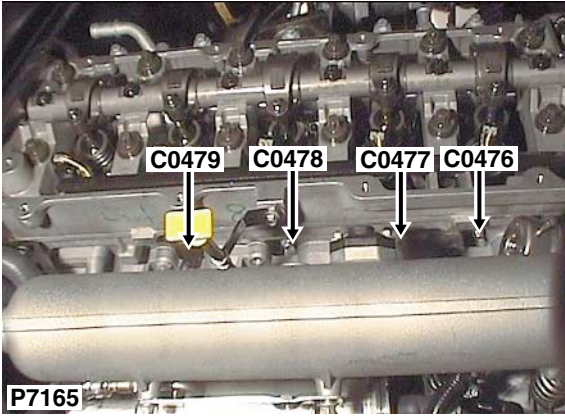

| Cav | Col | Cct |
|-----|-----|-----|
| 1   | B   | ALL |

Description: *Glow plug*

Location: *RH side of engine*

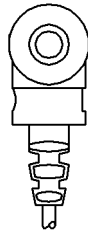

YPC107890

Colour: *BLACK*

Gender: *Female*

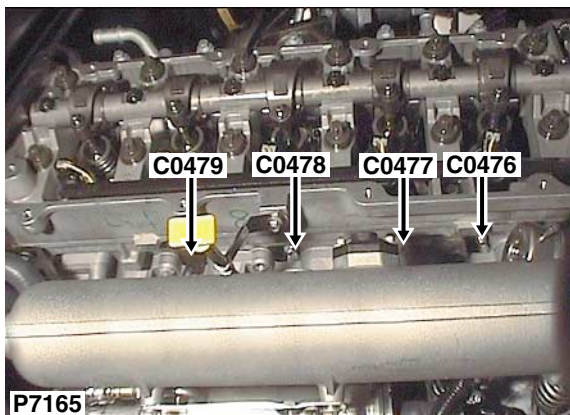

| Cav | Col | Cct |
|-----|-----|-----|
| 1   | B   | ALL |

Description: *Glow plug*  
 Location: *RH side of engine*

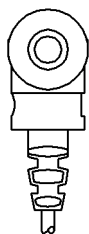

YPC107890

Colour: *BLACK*  
 Gender: *Female*

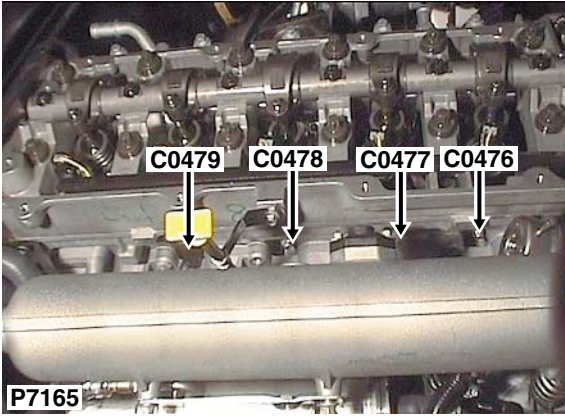

| Cav | Col | Cct |
|-----|-----|-----|
| 1   | B   | ALL |

Description: *Glow plug*

Location: *RH side of engine*

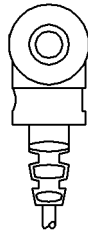

YPC107890

Colour: *BLACK*

Gender: *Female*

# C0480

# CONNECTOR DETAILS

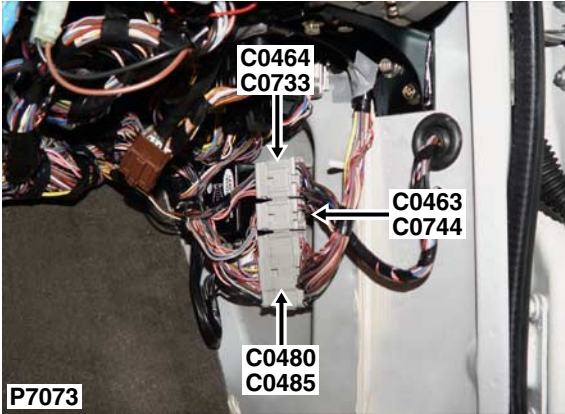

Description: *Body harness to main harness*

Location: *RH 'A' post*

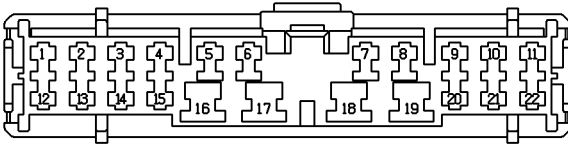

YPC109620

Colour: *LIGHT GREY*

Gender: *Female*

| Cav | Col | Cct |
|-----|-----|-----|
| 1   | WB  | 25  |
| 1   | KB  | 26  |
| 2   | RB  | ALL |
| 3   | NB  | ALL |
| 4   | PB  | 25  |
| 4   | WB  | 26  |
| 5   | PG  | ALL |
| 6   | PB  | ALL |
| 7   | PO  | ALL |
| 8   | KP  | ALL |
| 9   | NG  | ALL |
| 10  | KS  | ALL |
| 11  | S   | 24  |
| 12  | PLG | ALL |
| 13  | RB  | ALL |
| 13  | BR  | 28  |
| 14  | KB  | ALL |
| 14  | BK  | 28  |
| 15  | PR  | ALL |
| 16  | PG  | ALL |
| 17  | YG  | 17  |
| 17  | NY  | 39  |
| 18  | NP  | ALL |
| 19  | PN  | ALL |
| 20  | RU  | ALL |
| 21  | KR  | ALL |
| 22  | GW  | ALL |

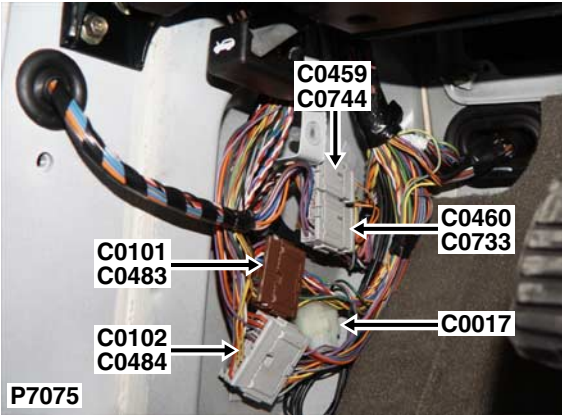

Description: *Main harness to body harness*  
 Location: *Under LH side of fascia*

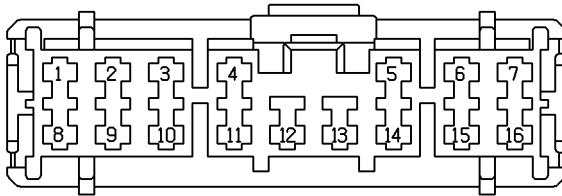

YPC109930

Colour: *BROWN*  
 Gender: *Female*

| Cav | Col | Cct |
|-----|-----|-----|
| 1   | P   | 24  |
| 1   | BN  | 38  |
| 2   | R   | 24  |
| 2   | WP  | 38  |
| 3   | W   | 24  |
| 3   | SO  | 38  |
| 4   | U   | 24  |
| 4   | PO  | 38  |
| 5   | GLG | ALL |
| 6   | G   | 24  |
| 6   | W   | 38  |
| 7   | Y   | 24  |
| 8   | RU  | 24  |
| 8   | PW  | 38  |
| 9   | O   | 24  |
| 9   | GK  | 38  |
| 10  | LGO | ALL |
| 11  | GK  | 15  |
| 12  | PG  | 15  |
| 13  | BG  | 15  |
| 15  | YB  | ALL |
| 15  | BN  | 28  |
| 16  | YK  | ALL |
| 16  | BW  | 28  |

# C0484

# CONNECTOR DETAILS

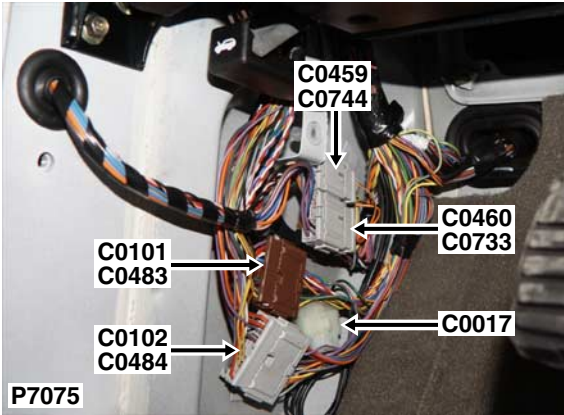

Description: *Main harness to body harness*

Location: *Under LH side of fascia*

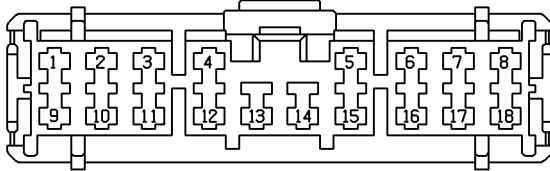

YPC10539

Colour: *LIGHT GREY*

Gender: *Female*

| Cav | Col | Cct |
|-----|-----|-----|
| 1   | RO  | ALL |
| 2   | RB  | ALL |
| 3   | PS  | ALL |
| 4   | GR  | ALL |
| 5   | YG  | 10  |
| 6   | YR  | 10  |
| 7   | SP  | ALL |
| 8   | RY  | ALL |
| 9   | GP  | ALL |
| 10  | OU  | 10  |
| 11  | GN  | ALL |
| 12  | BN  | ALL |
| 13  | P   | ALL |
| 14  | LGW | ALL |
| 15  | WB  | ALL |
| 16  | PU  | ALL |
| 17  | RS  | ALL |
| 18  | S   | ALL |

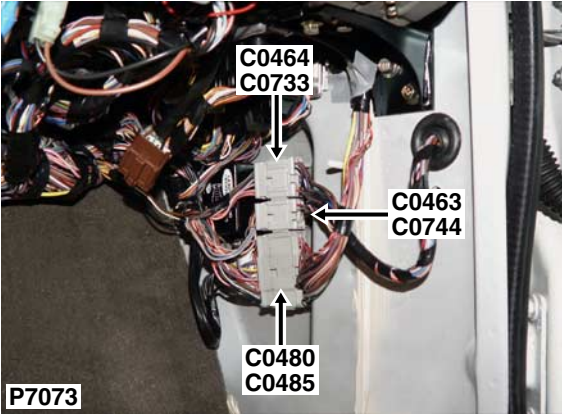

Description: *Main harness to body harness*  
 Location: *RH 'A' post*

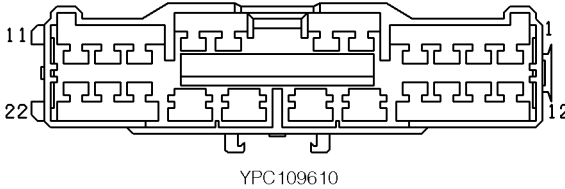

Colour: *LIGHT GREY*  
 Gender: *Male*

| Cav | Col | Cct |
|-----|-----|-----|
| 1   | WB  | 25  |
| 1   | KB  | 26  |
| 2   | RB  | ALL |
| 3   | NB  | ALL |
| 4   | PB  | 25  |
| 4   | WB  | 26  |
| 5   | PG  | ALL |
| 6   | PB  | ALL |
| 7   | PO  | ALL |
| 8   | KP  | ALL |
| 9   | NG  | ALL |
| 10  | KS  | ALL |
| 11  | S   | 24  |
| 11  | NY  | 38  |
| 12  | PLG | ALL |
| 13  | RB  | ALL |
| 13  | BR  | 28  |
| 14  | KB  | ALL |
| 14  | BK  | 28  |
| 15  | PR  | ALL |
| 16  | PG  | ALL |
| 17  | YG  | 15  |
| 18  | NP  | ALL |
| 19  | PN  | ALL |
| 20  | RU  | ALL |
| 21  | KR  | ALL |
| 22  | GW  | ALL |



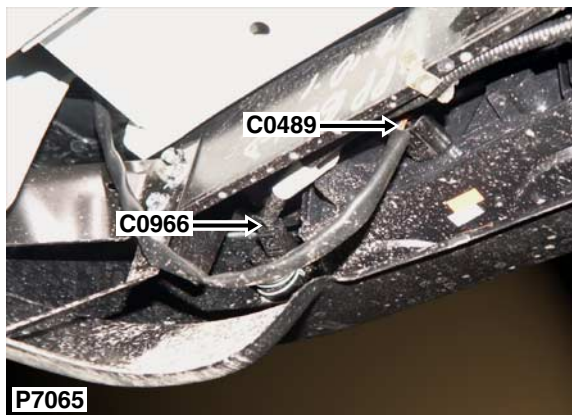

| Cav | Col | Cct |
|-----|-----|-----|
| 1   | GN  | ALL |
| 2   | B   | ALL |
| 3   | RY  | 1   |

Description: *Lamp-Tail-RH*  
 Location: *RH rear of vehicle*

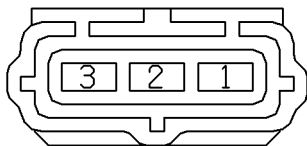

YPC10068

Colour: *BLACK*  
 Gender: *Female*

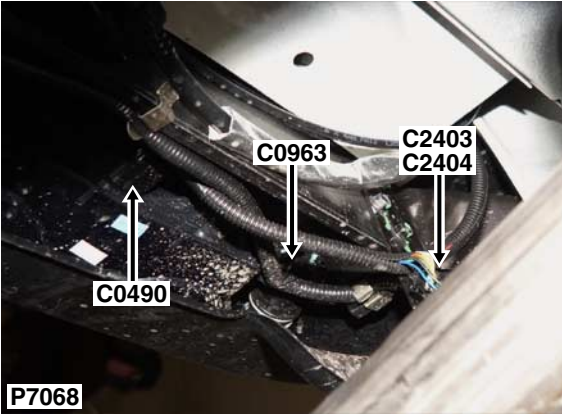

| Cav | Col | Cct |
|-----|-----|-----|
| 1   | RY  | 1   |
| 2   | B   | ALL |
| 3   | GN  | ALL |

Description: *Lamp-Tail-LH*  
 Location: *LH rear of vehicle*

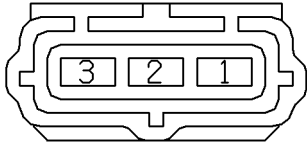

YPC10068

Colour: *BLACK*  
 Gender: *Female*

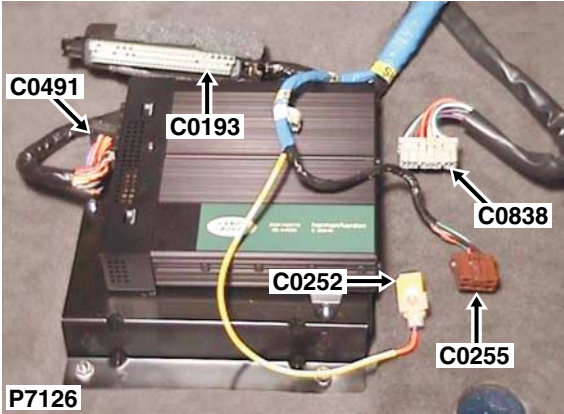

Description: *Amplifier-Power-ICE*

Location: *Beneath LH seat*

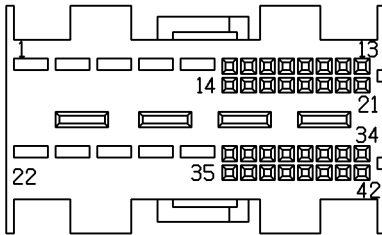

YPH101650

Colour: *BLACK*

Gender: *Female*

| Cav | Col | Cct |
|-----|-----|-----|
| 1   | NB  | ALL |
| 2   | PB  | 25  |
| 2   | WB  | 26  |
| 3   | OB  | ALL |
| 4   | OK  | ALL |
| 5   | LGP | 24  |
| 7   | B   | 25  |
| 8   | R   | 24  |
| 9   | G   | ALL |
| 9   | Y   | 26  |
| 10  | RU  | 24  |
| 11  | KB  | 25  |
| 12  | RB  | 25  |
| 13  | SP  | 24  |
| 15  | SG  | 26  |
| 16  | W   | 24  |
| 17  | S   | ALL |
| 17  | O   | 26  |
| 20  | KG  | 26  |
| 21  | SR  | 24  |
| 22  | KG  | ALL |
| 23  | KR  | ALL |
| 24  | WB  | 25  |
| 24  | KB  | 26  |
| 25  | RB  | ALL |
| 26  | B   | 24  |
| 29  | P   | 24  |
| 30  | O   | ALL |
| 30  | S   | 26  |
| 31  | SO  | 24  |
| 32  | SK  | 24  |
| 33  | YK  | 25  |
| 34  | YB  | 25  |
| 37  | U   | 24  |
| 38  | Y   | ALL |
| 38  | G   | 26  |
| 39  | YK  | ALL |

| <b>Cav</b> | <b>Col</b> | <b>Cct</b> |
|------------|------------|------------|
| 40         | YB         | ALL        |
| 41         | KB         | ALL        |
| 42         | RB         | ALL        |

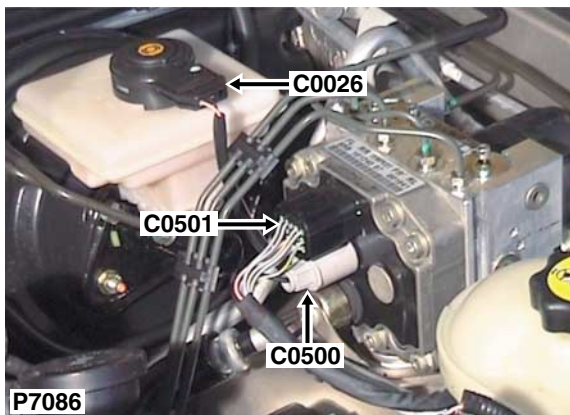

| Cav | Col | Cct |
|-----|-----|-----|
| 1   | B   | ALL |

Description: *Modulator-ABS - LHD*

Location: *Rear LH side of engine compartment*

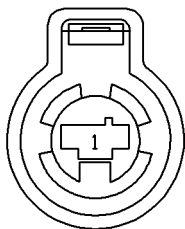

YPC109840

Colour: *LIGHT GREY*

Gender: *Female*

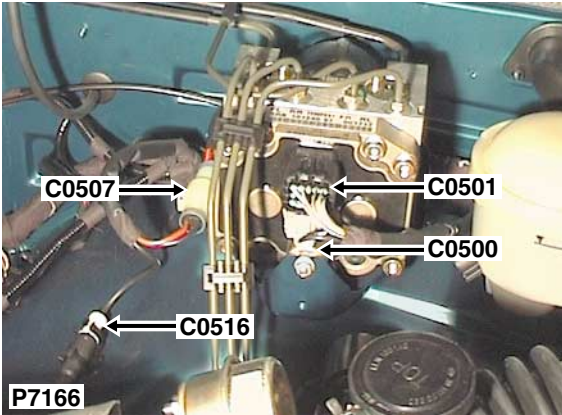

| Cav | Col | Cct |
|-----|-----|-----|
| 1   | B   | ALL |

Description: *Modulator-ABS - RHD*  
 Location: *Rear LH side of engine compartment*

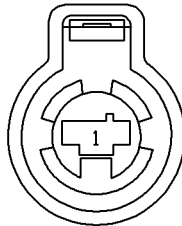

YPC109840

Colour: *LIGHT GREY*  
 Gender: *Female*

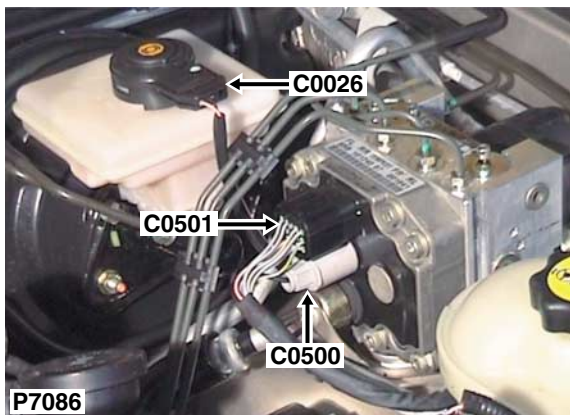

Description: *Modulator-ABS - LHD*

Location: *Rear LH side of engine compartment*

| Cav | Col | Cct |
|-----|-----|-----|
| 1   | SW  | ALL |
| 2   | SR  | ALL |
| 4   | SN  | ALL |
| 5   | SY  | ALL |
| 8   | BS  | ALL |
| 9   | YG  | ALL |
| 10  | SP  | ALL |
| 11  | SK  | ALL |
| 12  | SU  | ALL |
| 13  | SG  | ALL |

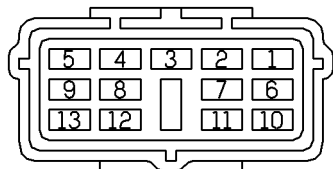

YPC10062

Colour: *BLACK*

Gender: *Female*

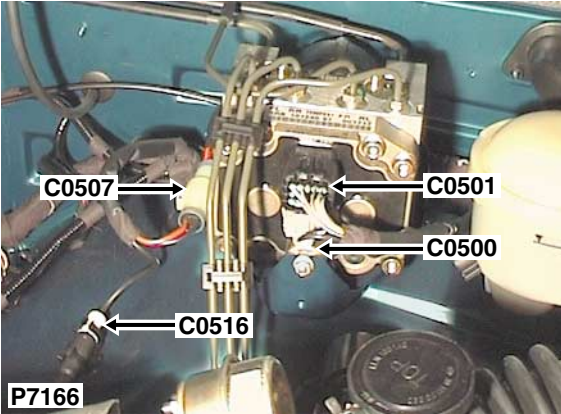

| Cav | Col | Cct |
|-----|-----|-----|
| 1   | SW  | ALL |
| 2   | SR  | ALL |
| 4   | SN  | ALL |
| 5   | SY  | ALL |
| 8   | BS  | ALL |
| 9   | YG  | ALL |
| 10  | SP  | ALL |
| 11  | SK  | ALL |
| 12  | SU  | ALL |
| 13  | SG  | ALL |

Description: *Modulator-ABS - RHD*

Location: *Rear LH side of engine compartment*

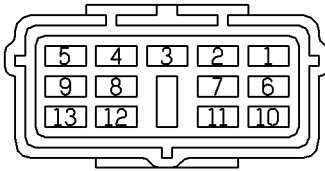

YPC10062

Colour: *BLACK*

Gender: *Female*





| Cav | Col | Cct |
|-----|-----|-----|
| 1   | W   | ALL |
| 2   | W   | ALL |

Description: *Sensor-ABS-Rear-LH*

Location: *Beneath rear of vehicle LH side*

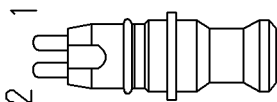

YPC108380

Colour: *NATURAL*

Gender: *Female*



| Cav | Col | Cct |
|-----|-----|-----|
| 1   | W   | ALL |
| 2   | W   | ALL |

Description: *Sensor-ABS-Rear-RH*  
 Location: *Beneath rear of vehicle RH side*

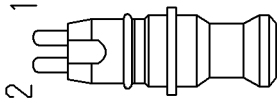

YPC108380

Colour: *NATURAL*  
 Gender: *Female*

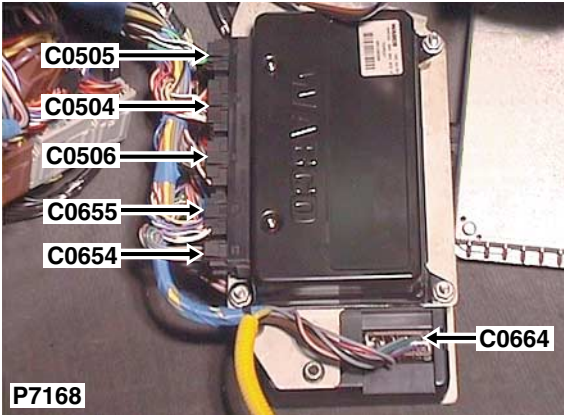

Description: *ECU-Self-levelling/ABS (SLABS)*

Location: *Behind passenger side of fascia*

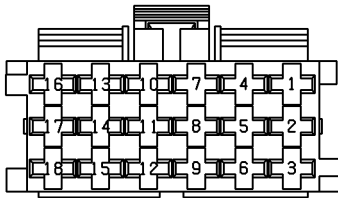

YPC110370

Colour: *BLACK*

Gender: *Female*

| Cav | Col | Cct |
|-----|-----|-----|
| 1   | NK  | ALL |
| 2   | LG  | ALL |
| 3   | KG  | ALL |
| 4   | RG  | 3   |
| 5   | K   | ALL |
| 7   | GN  | ALL |
| 8   | NR  | ALL |
| 9   | KO  | ALL |
| 10  | SP  | ALL |
| 11  | RK  | ALL |
| 12  | B   | ALL |
| 13  | WU  | ALL |
| 14  | PS  | ALL |
| 15  | GB  | 9   |
| 16  | WY  | ALL |
| 17  | WK  | ALL |
| 18  | WR  | ALL |

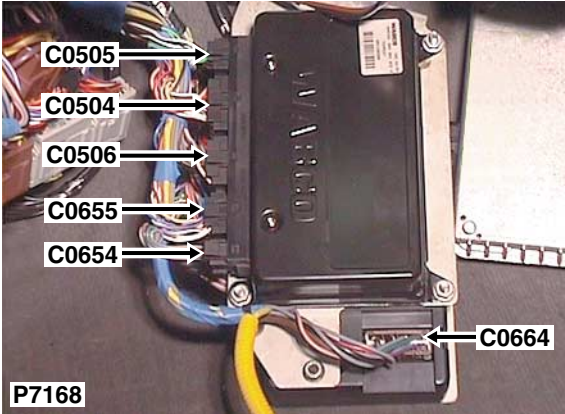

| Cav | Col | Cct |
|-----|-----|-----|
| 1   | G   | ALL |
| 2   | G   | ALL |
| 3   | W   | ALL |
| 4   | G   | ALL |
| 5   | G   | ALL |
| 6   | N   | ALL |
| 7   | WB  | ALL |
| 8   | NB  | ALL |

Description: *ECU-Self-levelling/ABS (SLABS)*  
 Location: *Behind passenger side of fascia*

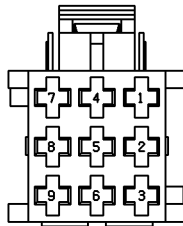

YPC108770

Colour: *BLACK*  
 Gender: *Female*

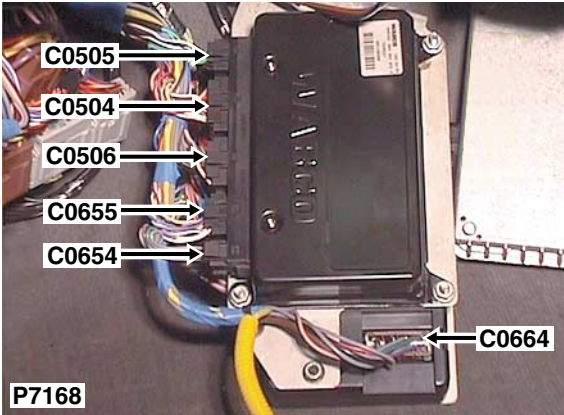

Description: *ECU-Self-levelling/ABS (SLABS)*

Location: *Behind passenger side of fascia*

| Cav | Col | Cct      |
|-----|-----|----------|
| 1   | SW  | ALL      |
| 2   | SR  | ALL      |
| 3   | BS  | ALL      |
| 4   | SG  | ALL      |
| 5   | SU  | ALL      |
| 6   | YG  | ALL      |
| 7   | SY  | ALL </td |
| 8   | SN  | ALL      |
| 9   | BU  | ALL      |
| 10  | SP  | ALL      |
| 11  | SK  | ALL      |
| 12  | BG  | ALL      |
| 15  | WO  | ALL      |

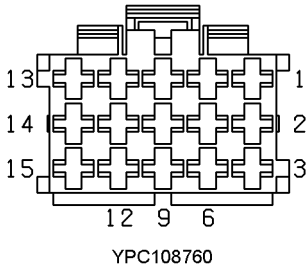

Colour: *BLACK*

Gender: *Female*

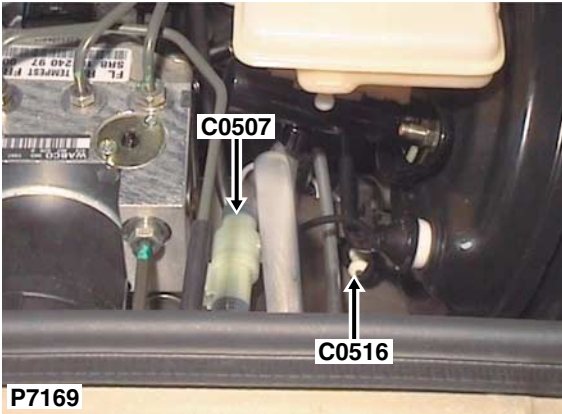

| Cav | Col | Cct |
|-----|-----|-----|
| 1   | NR  | ALL |
| 2   | B   | ALL |

Description: *Pump-Return-ABS - LHD*  
 Location: *Rear LH side of engine compartment*

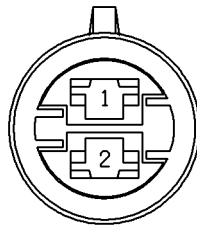

AFU3727

Colour: *NATURAL*  
 Gender: *Female*

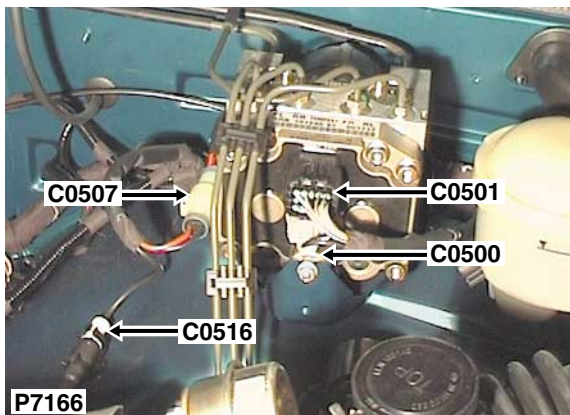

| Cav | Col | Cct |
|-----|-----|-----|
| 1   | NR  | ALL |
| 2   | B   | ALL |

Description: *Pump-Return-ABS - RHD*

Location: *Rear LH side of engine compartment*

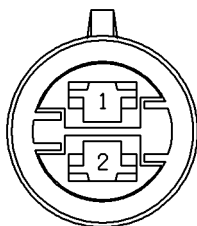

AFU3727

Colour: *NATURAL*

Gender: *Female*

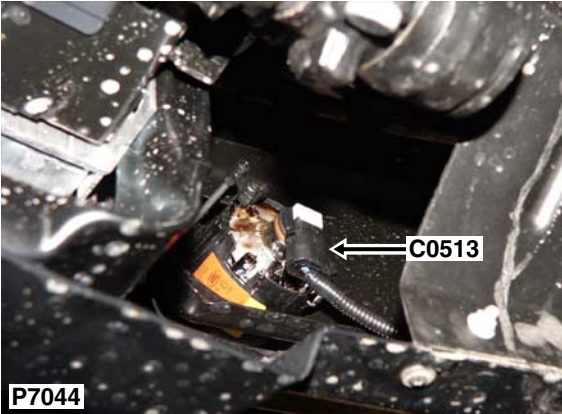

| Cav | Col | Cct |
|-----|-----|-----|
| 1   | UP  | ALL |
| 2   | B   | ALL |

Description: *Lamp-Fog-Front-RH*  
 Location: *Behind RH side of front bumper*

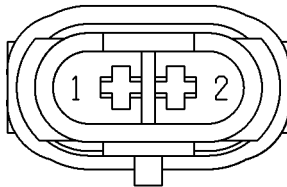

YPC000340

Colour: *BLACK*  
 Gender: *Female*



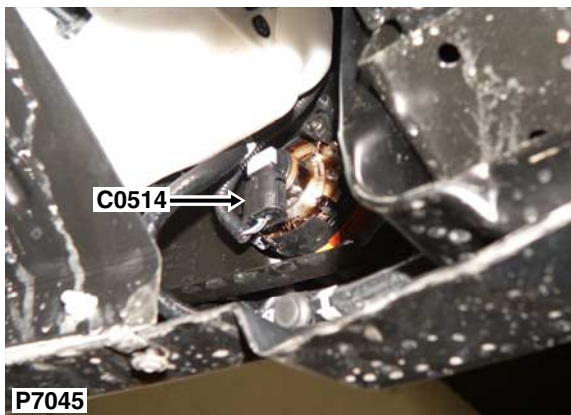

| Cav | Col | Cct |
|-----|-----|-----|
| 1   | UP  | ALL |
| 2   | B   | ALL |

Description: *Lamp-Fog-Front-LH*

Location: *Behind LH side of front bumper*

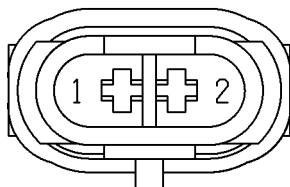

YPC000340

Colour: *BLACK*

Gender: *Female*

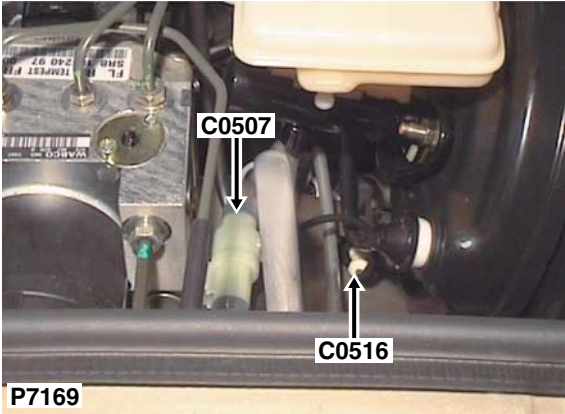

| Cav | Col | Cct |
|-----|-----|-----|
| 1   | G   | ALL |
| 2   | G   | ALL |

Description: *Sensor-ABS-Front-LH - LHD*  
 Location: *Rear LH side of engine compartment*

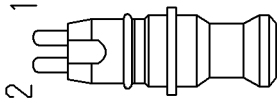

YPC108380

Colour: *NATURAL*  
 Gender: *Female*

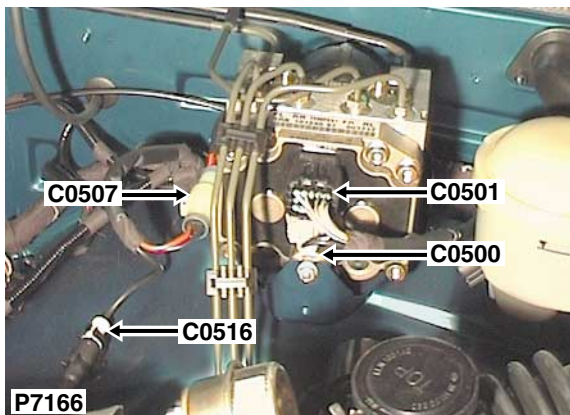

| Cav | Col | Cct |
|-----|-----|-----|
| 1   | G   | ALL |
| 2   | G   | ALL |

Description: *Sensor-ABS-Front-LH - RHD*  
 Location: *Rear LH side of engine compartment*

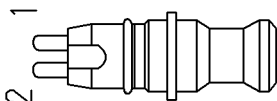

YPC108380

Colour: *NATURAL*  
 Gender: *Female*



| Cav | Col | Cct |
|-----|-----|-----|
| 1   | G   | ALL |
| 2   | G   | ALL |

Description: *Sensor-ABS-Front-RH*  
 Location: *Rear RH side of engine compartment*

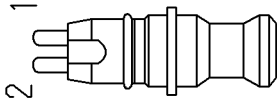

YPC108380

Colour: *NATURAL*  
 Gender: *Female*

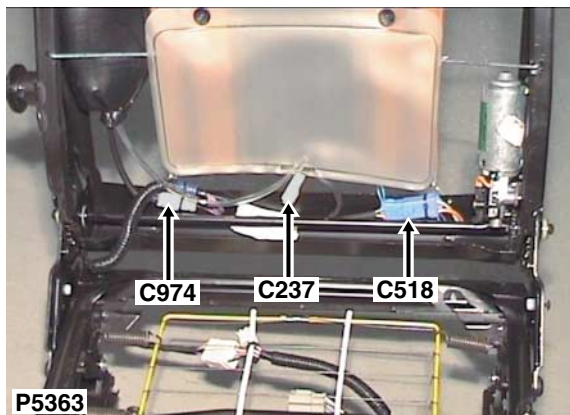

| Cav | Col | Cct |
|-----|-----|-----|
| 1   | O   | 43  |
| 2   | S   | 43  |

Description: *Motor-Seat-Back recline*

Location: *Passenger seat - below*

NO CONNECTOR FACE

Colour: *BLUE*

Gender: *Female*

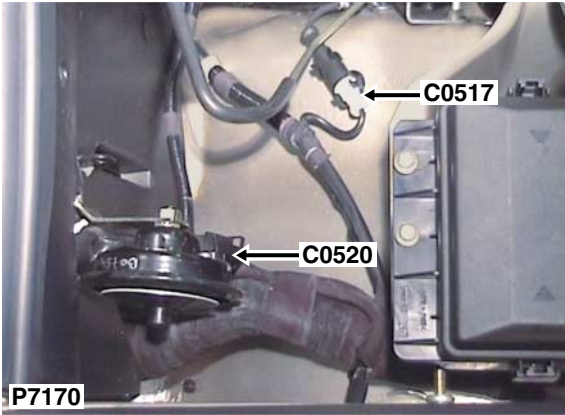

| Cav | Col | Cct |
|-----|-----|-----|
| 1   | PB  | 37  |
| 1   | RU  | ALL |
| 2   | B   | ALL |

Description: *Unit-Sounder-Alarm*  
 Location: *Rear RH side of engine compartment*

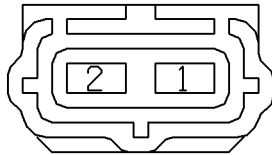

YPC10070

Colour: *BLACK*  
 Gender: *Female*

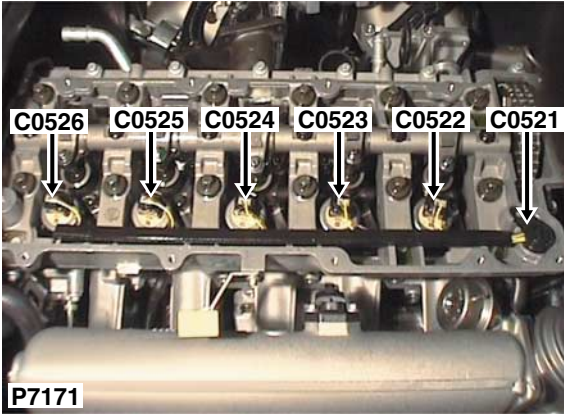

| Cav | Col | Cct |
|-----|-----|-----|
| 1   | Y   | ALL |
| 2   | YN  | ALL |
| 4   | YR  | ALL |
| 5   | YP  | ALL |
| 6   | YU  | ALL |
| 7   | NO  | ALL |
| 8   | NB  | ALL |

Description: *Injector harness to engine harness*

Location: *Top of engine - RH side*

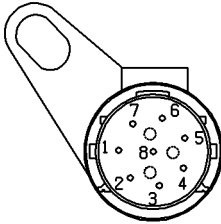

YYC103220

Colour: *BLACK*

Gender: *Male*

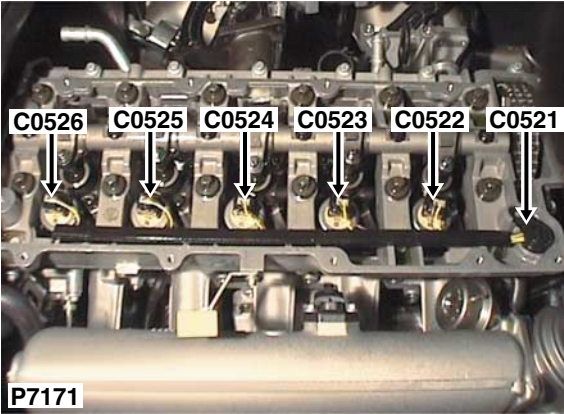

| Cav | Col | Cct |
|-----|-----|-----|
| 1   | Y   | ALL |
| 2   | NB  | ALL |

Description: *Fuel injector-No.1 - Td5*  
 Location: *Top of engine - RH side*

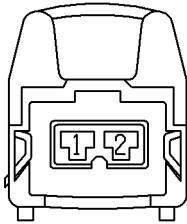

YPC115190

Colour: *BLACK*  
 Gender: *Female*



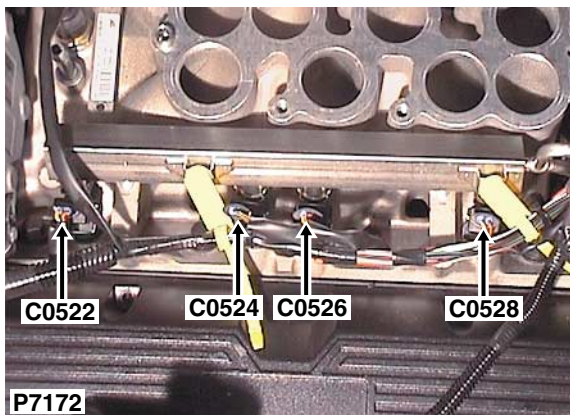

| Cav | Col | Cct |
|-----|-----|-----|
| 1   | YU  | ALL |
| 2   | NO  | ALL |

Description: *Fuel injector-No.1 - V8*

Location: *LH side of engine*

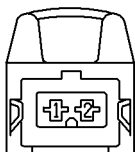

YPC114900

Colour: *BLACK*

Gender: *Female*

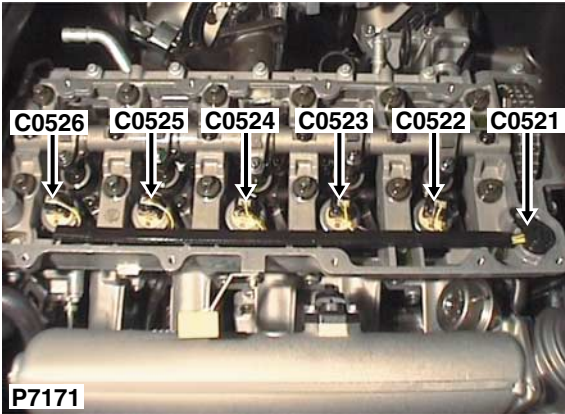

| Cav | Col | Cct |
|-----|-----|-----|
| 1   | YN  | ALL |
| 2   | NO  | ALL |

Description: *Fuel injector-No.2 - Td5*  
 Location: *Top of engine - RH side*

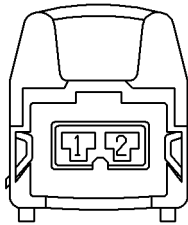

YPC115190

Colour: *BLACK*  
 Gender: *Female*

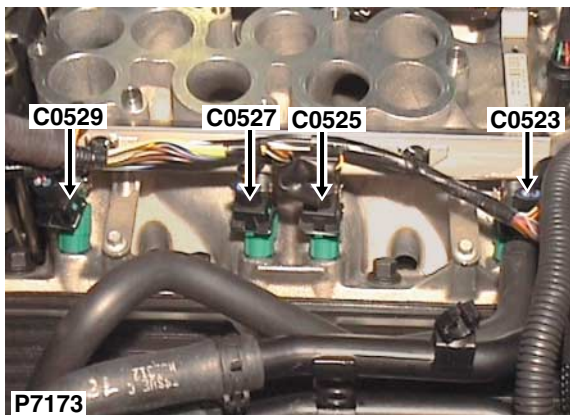

| Cav | Col | Cct |
|-----|-----|-----|
| 1   | YW  | ALL |
| 2   | NO  | ALL |

Description: *Fuel injector-No.2 - V8*

Location: *RH side of engine*

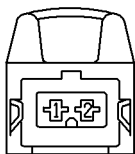

YPC114900

Colour: *BLACK*

Gender: *Female*

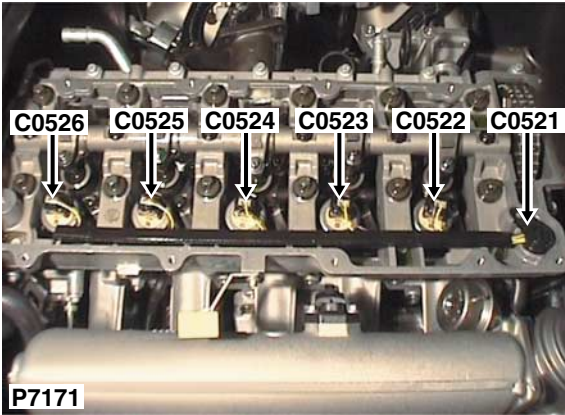

| Cav | Col | Cct |
|-----|-----|-----|
| 1   | YU  | ALL |
| 2   | NB  | ALL |

Description: *Fuel injector-No.3 - Td5*  
 Location: *Top of engine - RH side*

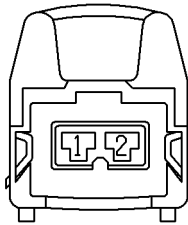

YPC115190

Colour: *BLACK*  
 Gender: *Female*

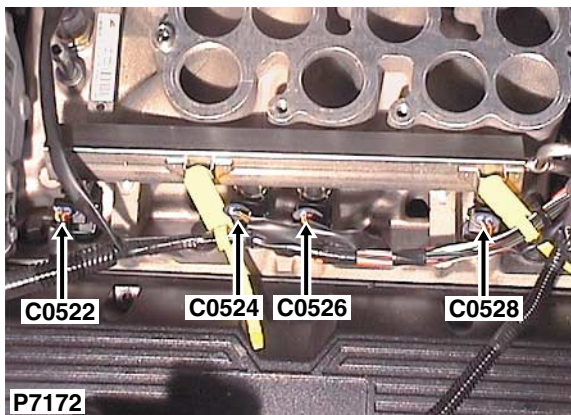

Description: *Fuel injector-No.3 - V8*

Location: *LH side of engine*

| Cav | Col | Cct |
|-----|-----|-----|
| 1   | YB  | ALL |
| 2   | NO  | 22  |
| 2   | NO  | 23  |

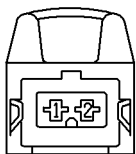

YPC114900

Colour: *BLACK*

Gender: *Female*

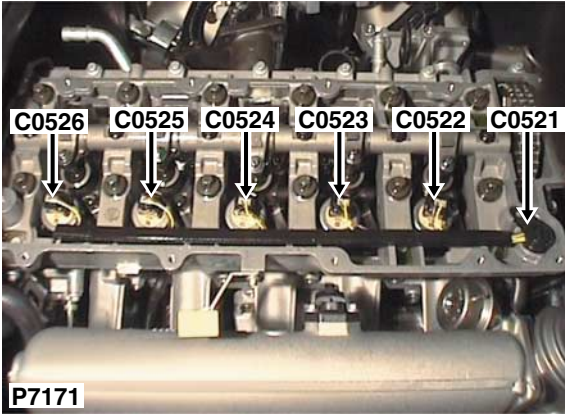

| Cav | Col | Cct |
|-----|-----|-----|
| 1   | YR  | ALL |
| 2   | NB  | ALL |

Description: *Fuel injector-No.4 - Td5*  
 Location: *Top of engine - RH side*

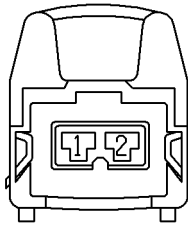

YPC115190

Colour: *BLACK*  
 Gender: *Female*

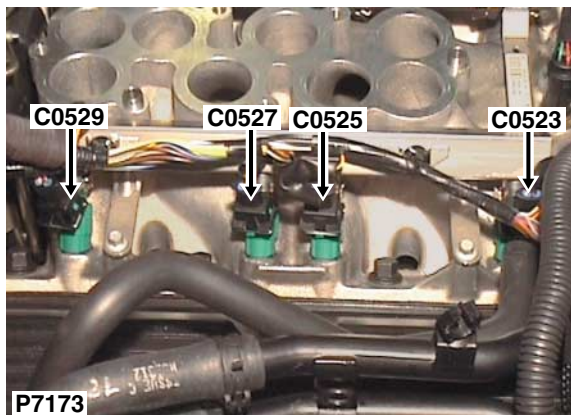

Description: *Fuel injector-No.4 - V8*

Location: *RH side of engine*

| Cav | Col | Cct |
|-----|-----|-----|
| 1   | YN  | ALL |
| 2   | NO  | 22  |
| 2   | NO  | 23  |

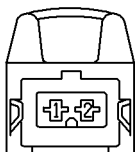

YPC114900

Colour: *BLACK*

Gender: *Female*

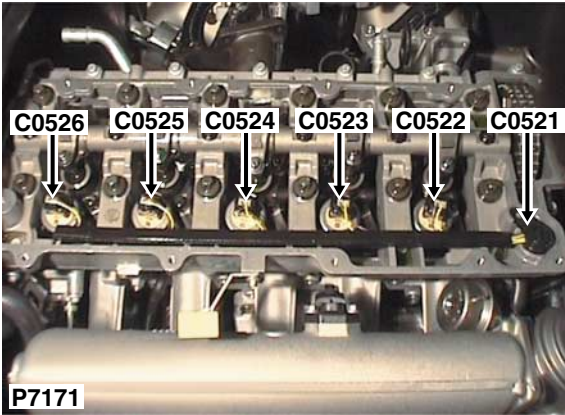

| Cav | Col | Cct |
|-----|-----|-----|
| 1   | YP  | ALL |
| 2   | NO  | ALL |

Description: *Fuel injector-No.5 - Td5*  
 Location: *Top of engine - RH side*

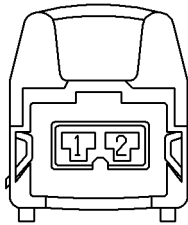

YPC115190

Colour: *BLACK*  
 Gender: *Female*



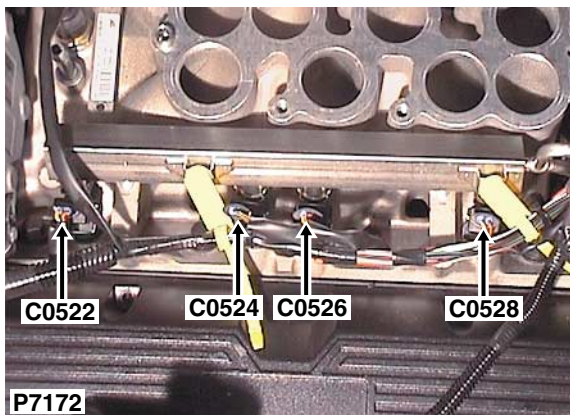

| Cav | Col | Cct |
|-----|-----|-----|
| 1   | YG  | ALL |
| 2   | NO  | ALL |

Description: *Fuel injector-No.5 - V8*

Location: *LH side of engine*

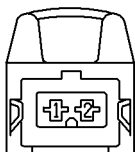

YPC114900

Colour: *BLACK*

Gender: *Female*

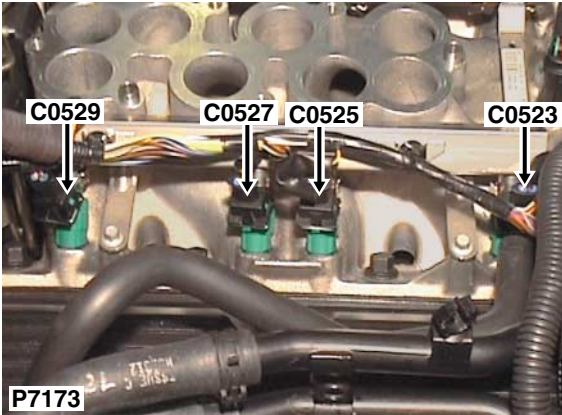

| Cav | Col | Cct |
|-----|-----|-----|
| 1   | YS  | ALL |
| 2   | NO  | ALL |

Description: *Fuel injector-No.6*  
 Location: *RH side of engine*

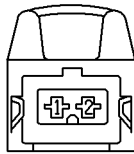

YPC114900

Colour: *BLACK*  
 Gender: *Female*

# C0528

## CONNECTOR DETAILS

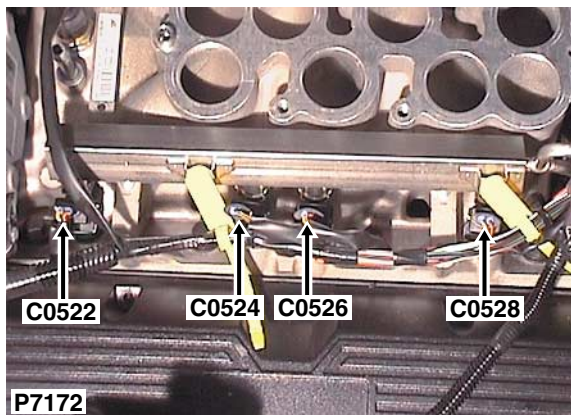

| Cav | Col | Cct |
|-----|-----|-----|
| 1   | YR  | ALL |
| 2   | NO  | ALL |

Description: *Fuel injector-No.7*

Location: *LH side of engine*

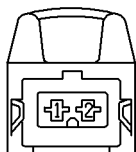

YPC114900

Colour: *BLACK*

Gender: *Female*

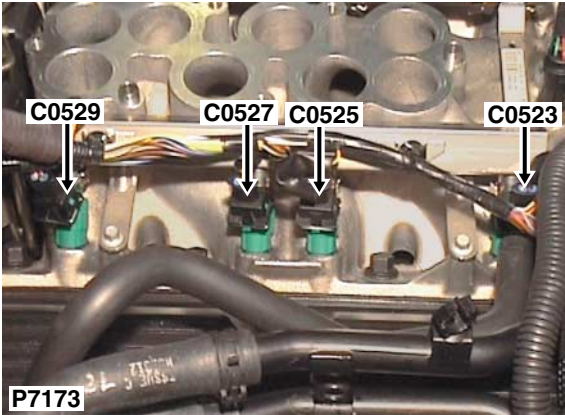

| Cav | Col | Cct |
|-----|-----|-----|
| 1   | YK  | ALL |
| 2   | NO  | ALL |

Description: *Fuel injector-No.8*  
 Location: *RH side of engine*



YPC114900

Colour: *BLACK*  
 Gender: *Female*



Description: *Speaker-High range-'A' post-RH*

Location: *RH 'A' post*

| Cav | Col | Cct |
|-----|-----|-----|
| 1   | RB  | 26  |
| 1   | BR  | 28  |
| 2   | KB  | 26  |
| 2   | BK  | 28  |

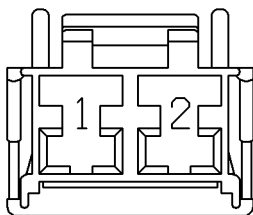

YPC10427

Colour: *LIGHT GREY*

Gender: *Female*



| Cav | Col | Cct |
|-----|-----|-----|
| 1   | YB  | 26  |
| 1   | BN  | 28  |
| 2   | YK  | 26  |
| 2   | BW  | 28  |

Description: *Speaker-High range-'A' post-LH*  
 Location: *LH 'A' post*

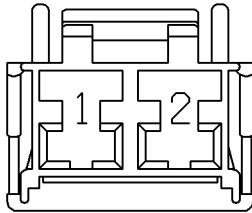

YPC10427

Colour: *LIGHT GREY*  
 Gender: *Female*

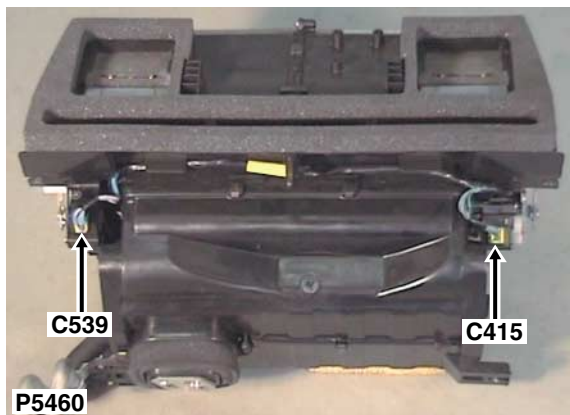

| Cav | Col | Cct |
|-----|-----|-----|
| 1   | PY  | 15  |
| 2   | GR  | 15  |
| 3   | BW  | 15  |
| 4   | YG  | 15  |
| 5   | Y   | 15  |

Description: *Motor-Mode-Air temperature*

Location: *Behind centre of fascia*

NO CONNECTOR FACE

Colour: *GREEN*

Gender: *Female*

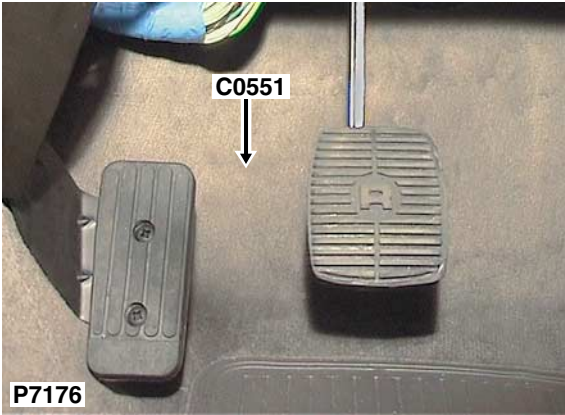

| Cav | Col | Cct |
|-----|-----|-----|
| 1   | B   | ALL |
| 2   | B   | ALL |
| 3   | B   | ALL |
| 4   | B   | ALL |
| 5   | B   | ALL |
| 6   | B   | ALL |

Description: *Header -Earth*  
 Location: *Under RH side of fascia*

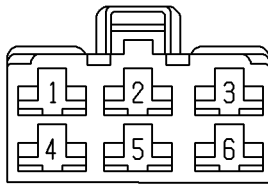

YPC10004

Colour: *NATURAL*  
 Gender: *Female*



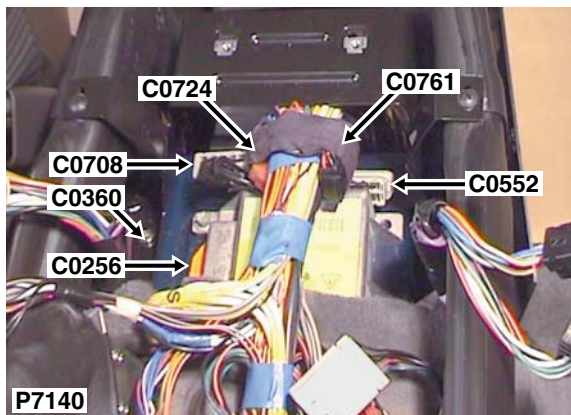

| Cav | Col | Cct |
|-----|-----|-----|
| 1   | B   | ALL |
| 2   | B   | ALL |
| 3   | B   | ALL |
| 4   | B   | ALL |
| 5   | B   | 37  |
| 6   | B   | ALL |
| 7   | B   | ALL |
| 8   | B   | ALL |
| 9   | B   | ALL |
| 10  | B   | ALL |

Description: *Header -Earth*

Location: *Behind centre console*

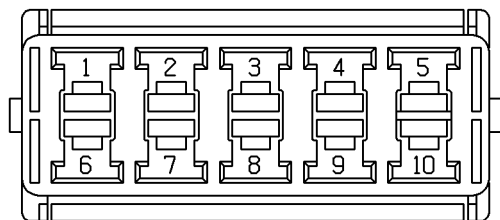

YPC10611

Colour: *LIGHT GREY*

Gender: *Female*

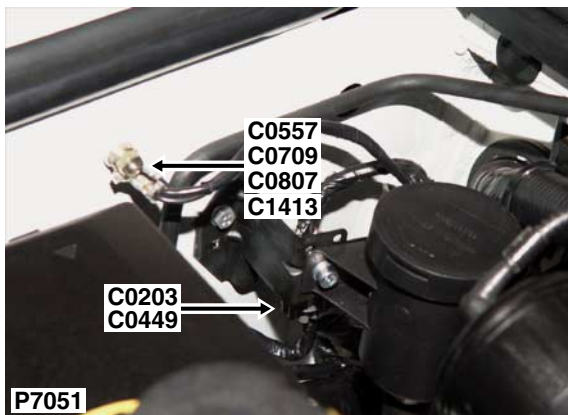

| Cav | Col | Cct |
|-----|-----|-----|
| 1   | B   | 38  |

Description: *Earth*

Location: *Rear RH side of engine compartment*

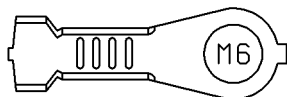

YPG10003

Colour: *TIN-PLATE*

Gender: *Eyelet*

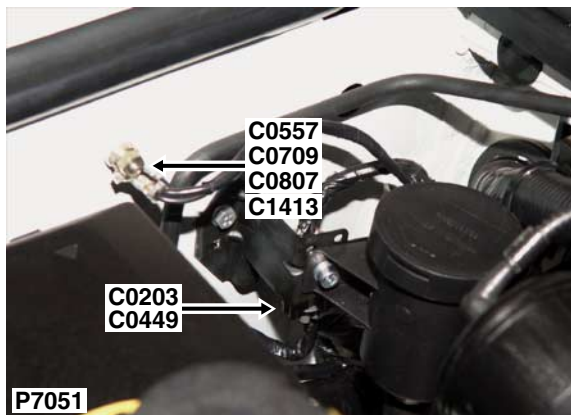

| Cav | Col | Cct |
|-----|-----|-----|
| 1   | B   | 22  |

Description: *Earth*

Location: *Rear RH side of engine compartment*

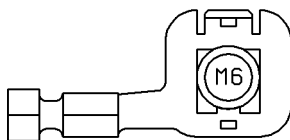

YPG10053

Colour: *TIN-PLATE*

Gender: *Eyelet*

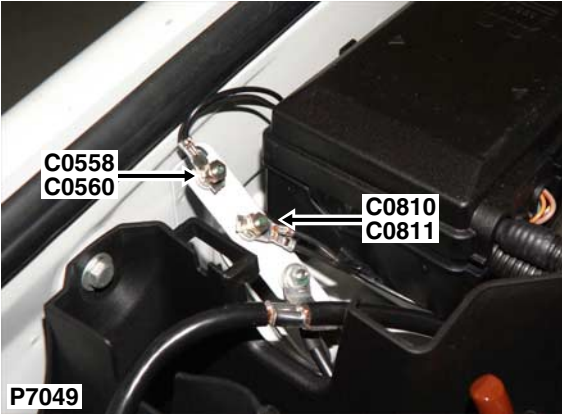

| Cav | Col | Cct |
|-----|-----|-----|
| 1   | B   | ALL |

Description: *Earth*

Location: *RH side of engine compartment*

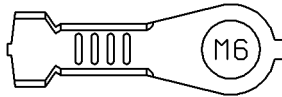

YPG10014

Colour: *TIN-PLATE*

Gender: *Female*

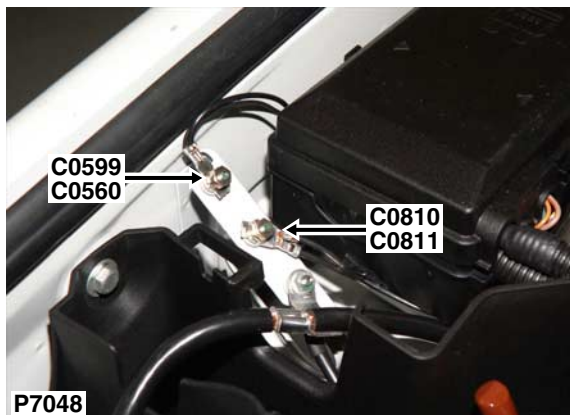

| Cav | Col | Cct |
|-----|-----|-----|
| 1   | B   | ALL |

Description: *Earth*

Location: *RH side of engine compartment*

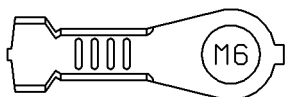

YPG10014

Colour: *TIN-PLATE*

Gender: *Female*

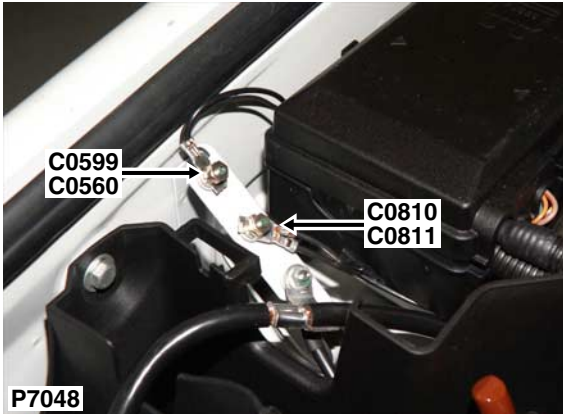

| Cav | Col | Cct |
|-----|-----|-----|
| 1   | B   | ALL |

Description: *Earth*

Location: *RH side of engine compartment*

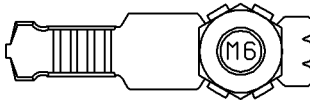

YPG10049

Colour: *TIN-PLATE*

Gender: *Female*

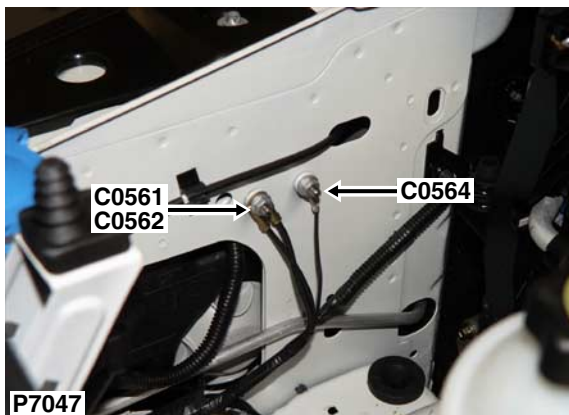

| Cav | Col | Cct |
|-----|-----|-----|
| 1   | B   | ALL |

Description: *Earth*

Location: *Front LH side of engine compartment*

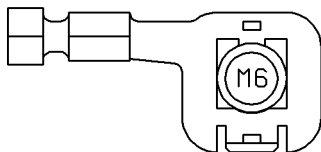

YPG10050

Colour: *TIN-PLATE*

Gender: *Eyelet*

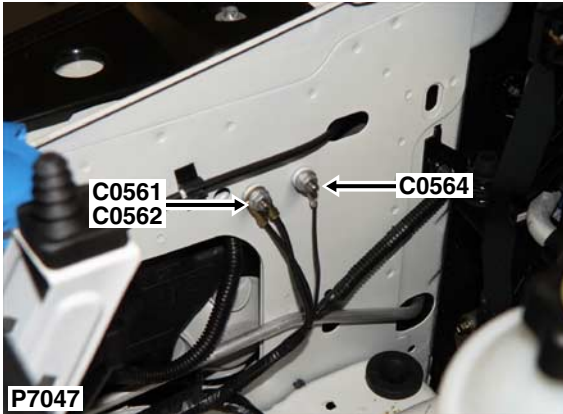

| Cav | Col | Cct |
|-----|-----|-----|
| 1   | B   | ALL |

Description: *Earth*

Location: *Front LH side of engine compartment*

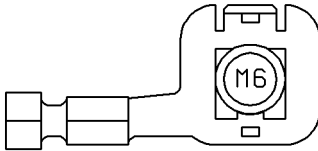

YPG10051

Colour: *TIN-PLATE*

Gender: *Eyelet*



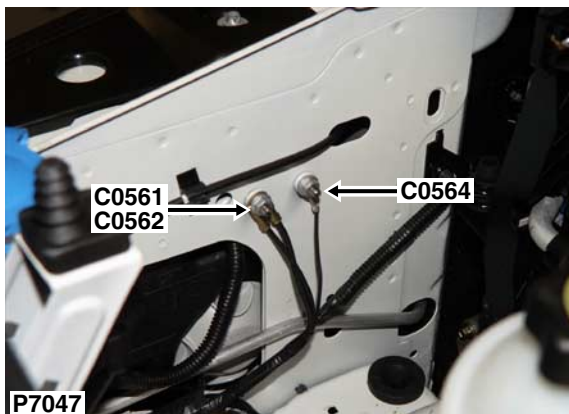

| Cav | Col | Cct |
|-----|-----|-----|
| 1   | B   | ALL |

Description: *Earth*

Location: *Front LH side of engine compartment*

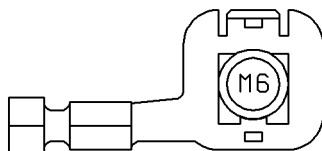

YPG10051

Colour: *TIN-PLATE*

Gender: *Eyelet*

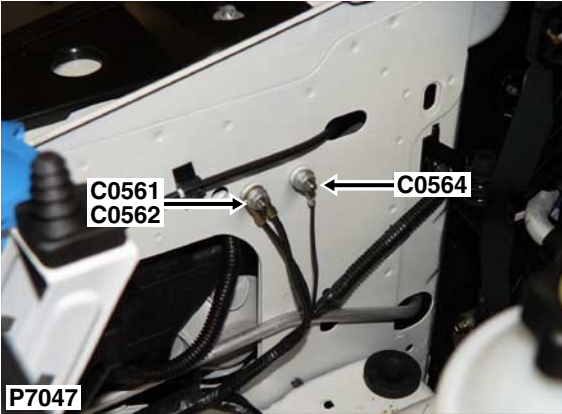

| Cav | Col | Cct |
|-----|-----|-----|
| 1   | B   | ALL |

Description: *Earth*

Location: *Front LH side of engine compartment*

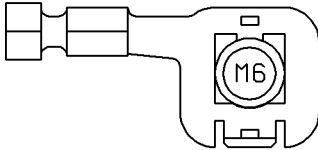

YPG10050

Colour: *TIN-PLATE*

Gender: *Eyelet*

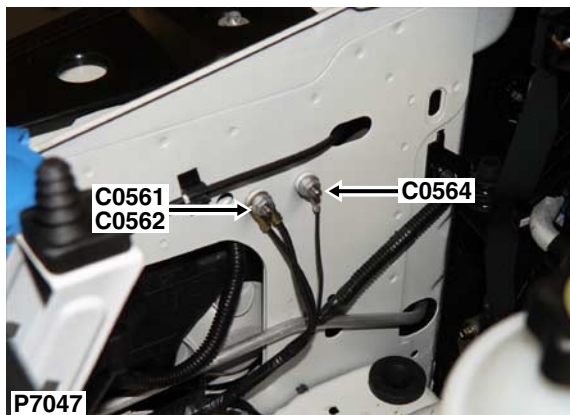

| Cav | Col | Cct |
|-----|-----|-----|
| 1   | B   | ALL |

Description: *Earth*

Location: *Front LH side of engine compartment*

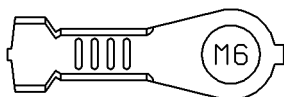

YPG10014

Colour: *TIN-PLATE*

Gender: *Female*

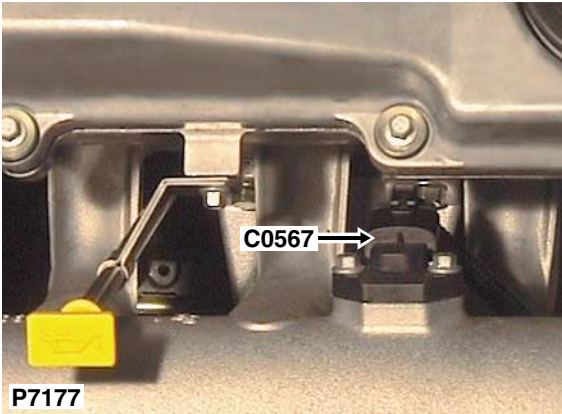

Description: *Sensor-Inlet air temperature (IAT)*

Location: *RH side of engine*

| Cav | Col | Cct |
|-----|-----|-----|
| 1   | KB  | ALL |
| 2   | GB  | ALL |
| 3   | KP  | ALL |
| 4   | WY  | ALL |

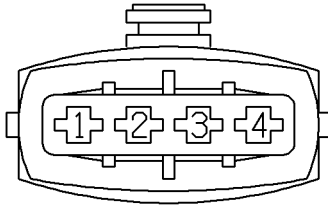

Colour: *BLACK*

Gender: *Female*

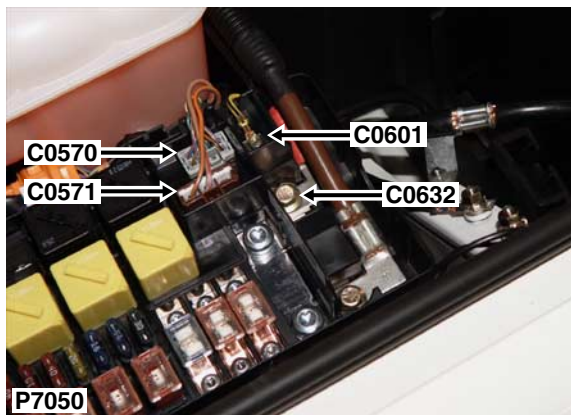

Description: *Fuse box-Engine compartment*

Location: *Front RH side of engine compartment*

| Cav | Col | Cct |
|-----|-----|-----|
| 1   | NK  | ALL |
| 2   | GW  | ALL |
| 3   | BO  | 18  |
| 3   | GU  | ALL |
| 4   | UR  | ALL |
| 5   | NK  | ALL |
| 7   | BG  | ALL |
| 8   | PY  | ALL |

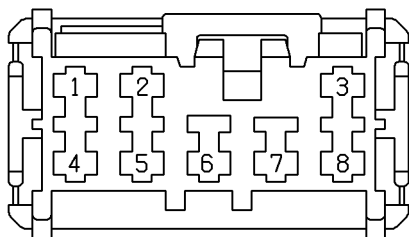

YPC10492

Colour: *LIGHT GREY*

Gender: *Female*

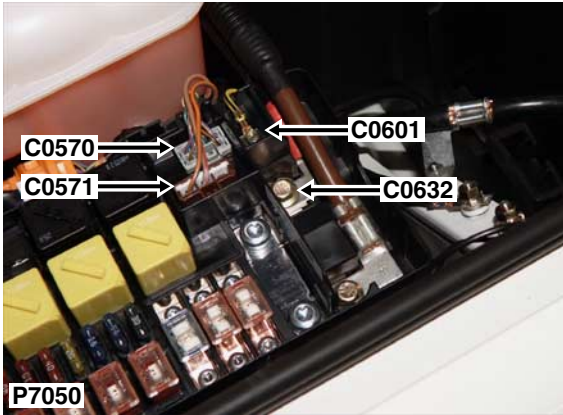

| Cav | Col | Cct |
|-----|-----|-----|
| 1   | NO  | ALL |
| 2   | NR  | ALL |

Description: *Fuse box-Engine compartment*

Location: *Front RH side of engine compartment*

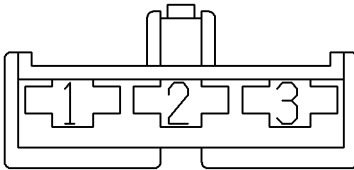

YPC10579

Colour: *BROWN*

Gender: *Female*

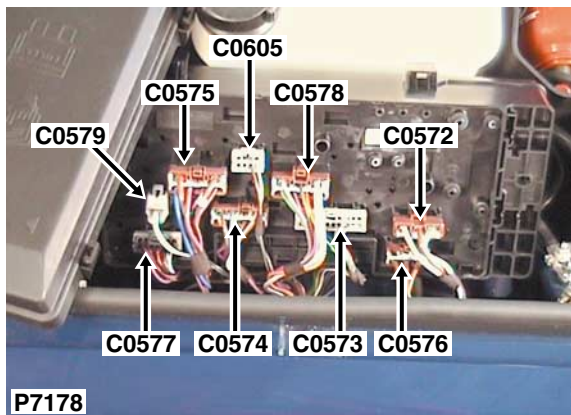

Description: *Fuse box-Engine compartment*

Location: *Beneath engine compartment fusebox*

| Cav | Col | Cct |
|-----|-----|-----|
| 1   | WG  | ALL |
| 2   | NR  | ALL |
| 3   | NK  | ALL |

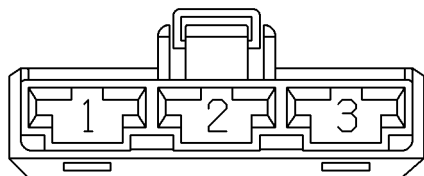

YPC10428

Colour: *BROWN*

Gender: *Female*

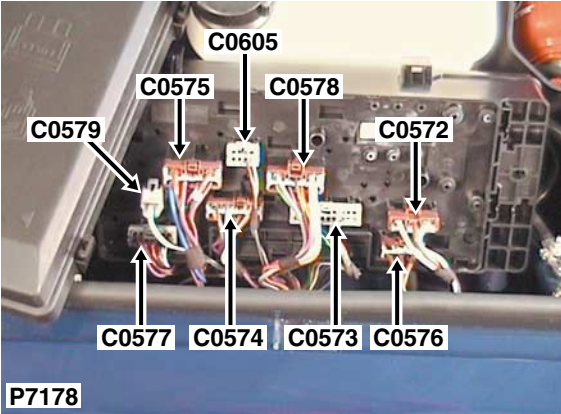

Description: Fuse box-Engine compartment  
 Location: Beneath engine compartment fusebox

| Cav | Col | Cct |
|-----|-----|-----|
| 2   | NK  | 20  |
| 3   | NK  | ALL |
| 5   | WR  | ALL |
| 7   | BO  | ALL |
| 8   | KN  | 41  |
| 9   | UP  | ALL |
| 11  | BP  | 2   |
| 11  | GO  | 3   |
| 12  | UR  | 2   |
| 15  | LG  | ALL |
| 16  | B   | ALL |
| 17  | LG  | ALL |
| 18  | UY  | ALL |

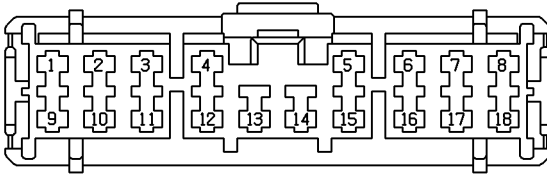

YPC10539

Colour: LIGHT GREY  
 Gender: Female



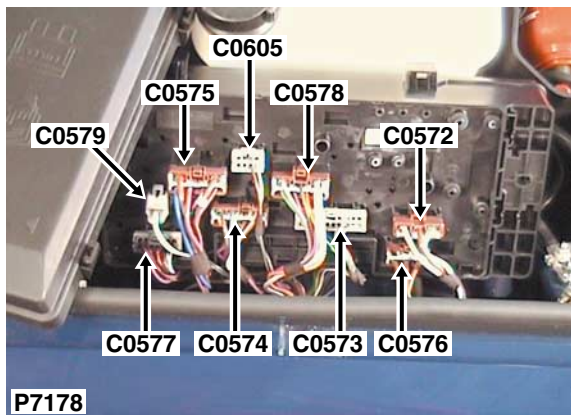

Description: *Fuse box-Engine compartment*

Location: *Beneath engine compartment fusebox*

| Cav | Col | Cct |
|-----|-----|-----|
| 1   | NK  | ALL |
| 2   | UP  | ALL |
| 3   | NG  | ALL |
| 4   | BN  | 15  |
| 5   | PN  | ALL |
| 6   | WG  | ALL |
| 7   | PO  | 10  |

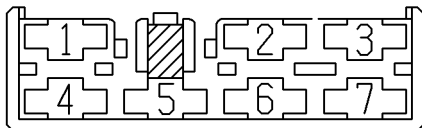

YPC10473

Colour: *BROWN*

Gender: *Female*

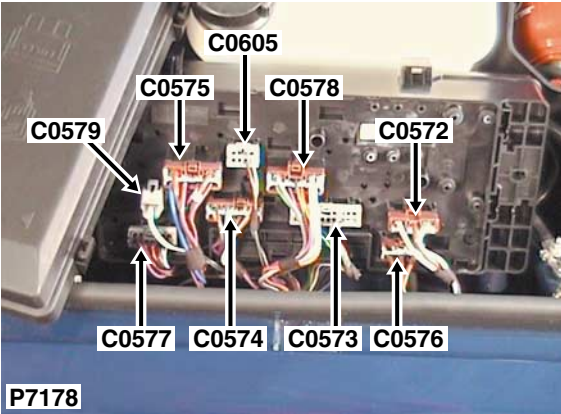

| Cav | Col | Cct |
|-----|-----|-----|
| 1   | NW  | ALL |
| 2   | NR  | ALL |
| 3   | PY  | 9   |
| 4   | PN  | ALL |
| 5   | NP  | ALL |
| 6   | U   | ALL |

Description: *Fuse box-Engine compartment*  
 Location: *Beneath engine compartment fusebox*

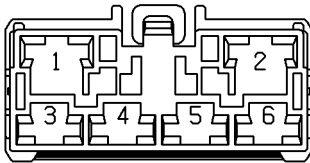

YPC109090

Colour: *BROWN*  
 Gender: *Female*

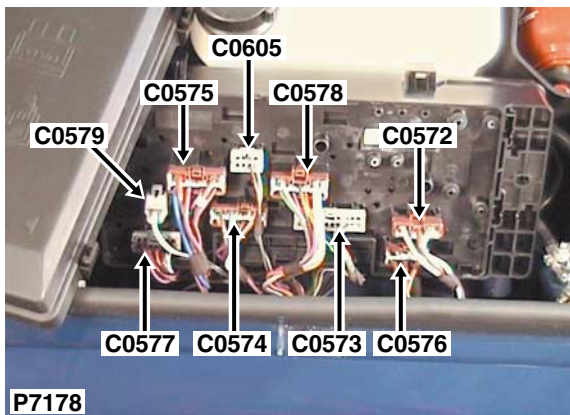

Description: *Fuse box-Engine compartment*  
 Location: *Beneath engine compartment fusebox*

| Cav | Col | Cct |
|-----|-----|-----|
| 2   | NO  | 2   |
| 3   | NW  | ALL |
| 4   | NP  | 43  |
| 5   | NG  | 43  |

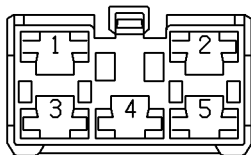

YPC10462

Colour: *BROWN*  
 Gender: *Female*

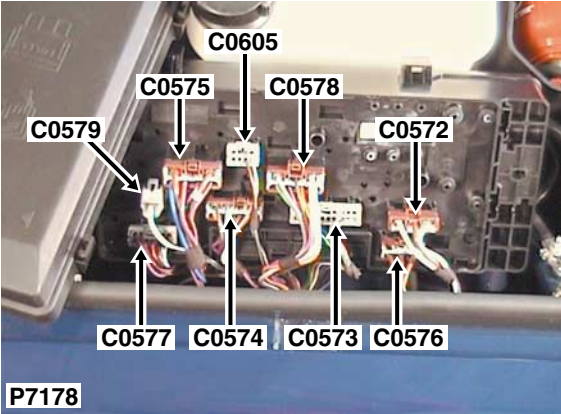

Description: *Fuse box-Engine compartment*  
 Location: *Beneath engine compartment fusebox*

| Cav | Col | Cct |
|-----|-----|-----|
| 1   | BG  | 15  |
| 2   | BS  | ALL |
| 3   | NB  | ALL |
| 4   | PN  | ALL |
| 5   | PN  | ALL |
| 6   | WO  | ALL |
| 7   | NP  | 13  |
| 8   | PG  | ALL |
| 9   | BR  | 10  |
| 11  | PG  | ALL |
| 12  | PO  | ALL |

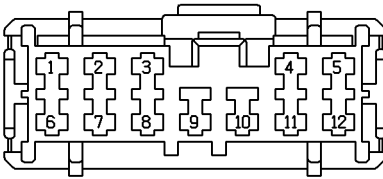

YPC10494

Colour: *LIGHT GREY*  
 Gender: *Female*

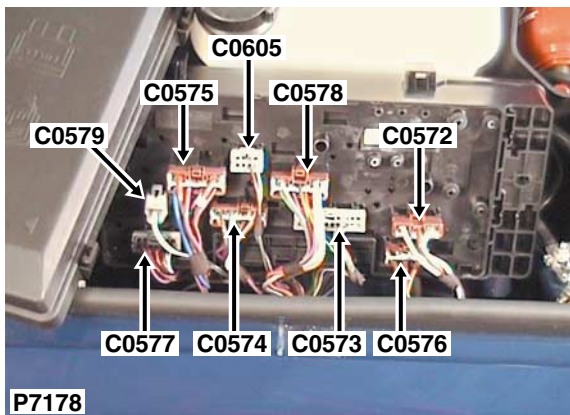

Description: *Fuse box-Engine compartment*

Location: *Beneath engine compartment fusebox*

| Cav | Col | Cct |
|-----|-----|-----|
| 1   | PK  | 41  |
| 2   | NU  | ALL |
| 3   | PS  | 41  |
| 4   | WP  | ALL |
| 5   | OS  | ALL |
| 6   | PG  | 24  |
| 7   | LGR | ALL |

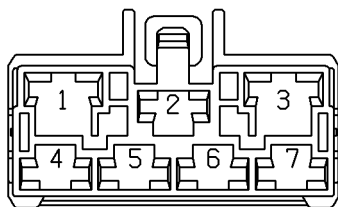

YPC10480

Colour: *BROWN*

Gender: *Female*

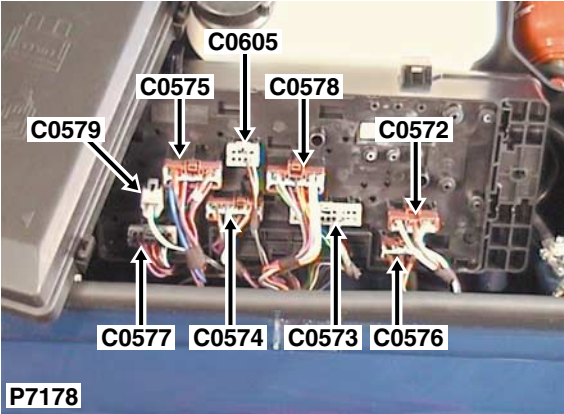

| Cav | Col | Cct |
|-----|-----|-----|
| 1   | WB  | 13  |

Description: *Fuse box-Engine compartment*  
 Location: *Beneath engine compartment fusebox*

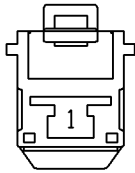

YPC109810

Colour: *WHITE*  
 Gender: *Female*

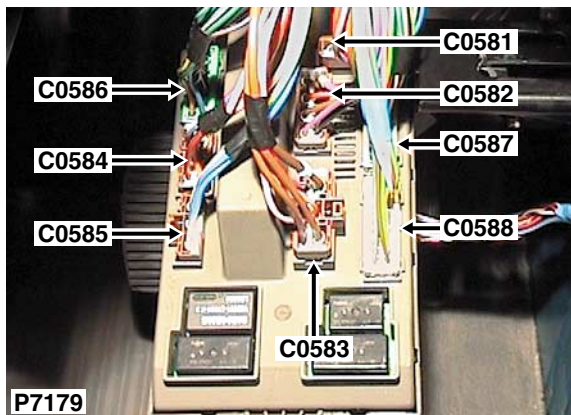

| Cav | Col | Cct |
|-----|-----|-----|
| 1   | NU  | ALL |
| 2   | NK  | ALL |
| 3   | WG  | ALL |

Description: *Fuse box-Passenger compartment*  
 Location: *Behind passenger compartment fusebox*

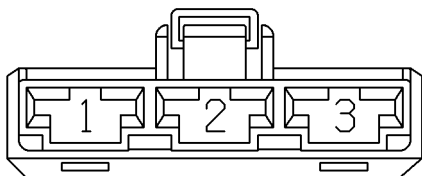

YPC10428

Colour: *BROWN*  
 Gender: *Female*

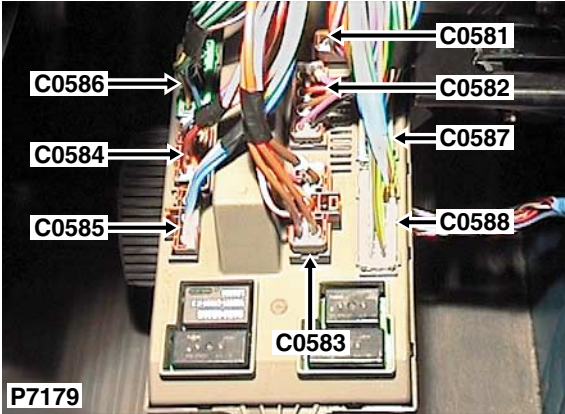

| Cav | Col | Cct |
|-----|-----|-----|
| 1   | NR  | ALL |
| 2   | KR  | ALL |
| 3   | NW  | ALL |
| 4   | NP  | ALL |
| 5   | KR  | ALL |
| 6   | KP  | ALL |
| 7   | PN  | ALL |

Description: *Fuse box-Passenger compartment*  
 Location: *Behind passenger compartment fusebox*

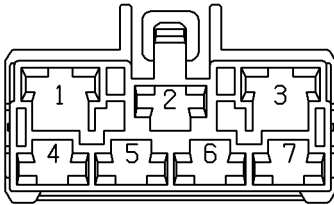

YPC10480

Colour: *BROWN*  
 Gender: *Female*



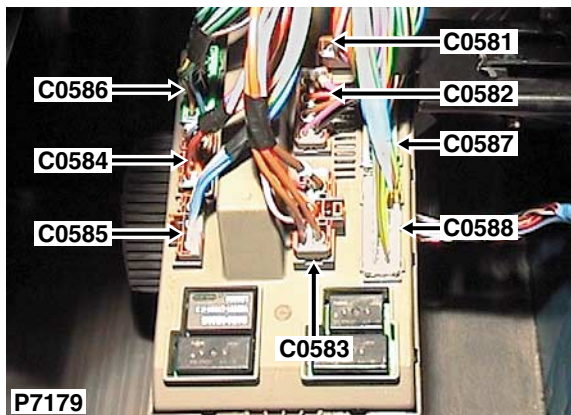

Description: *Fuse box-Passenger compartment*  
 Location: *Behind passenger compartment fusebox*

| Cav | Col | Cct |
|-----|-----|-----|
| 1   | B   | ALL |
| 2   | NG  | ALL |
| 3   | PG  | ALL |
| 4   | PG  | 24  |
| 5   | NW  | ALL |
| 6   | R   | ALL |
| 7   | NR  | 13  |

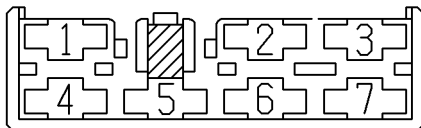

YPC10473

Colour: *BROWN*  
 Gender: *Female*

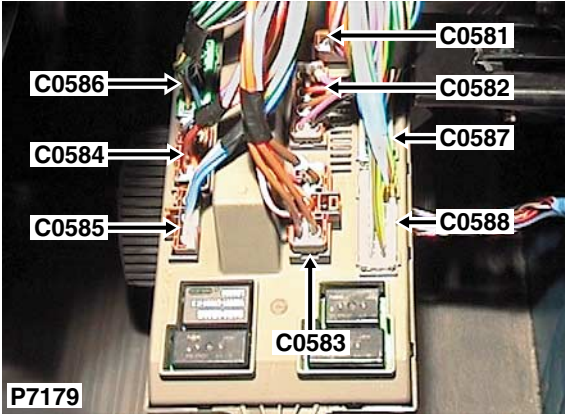

| Cav | Col | Cct |
|-----|-----|-----|
| 1   | WK  | ALL |
| 2   | NR  | ALL |
| 3   | WG  | ALL |
| 4   | UR  | ALL |
| 5   | OS  | ALL |

Description: *Fuse box-Passenger compartment*  
 Location: *Behind passenger compartment fusebox*

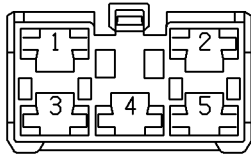

YPC10462

Colour: *BROWN*  
 Gender: *Female*

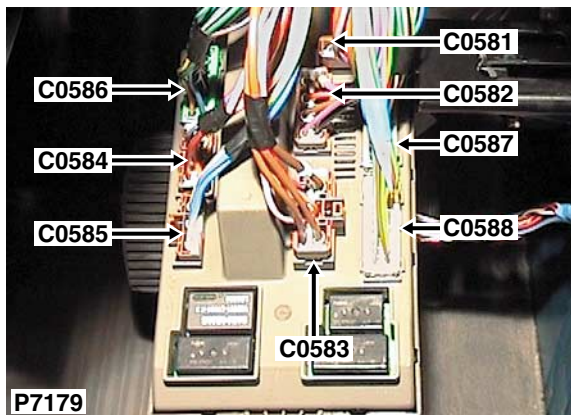

| Cav | Col | Cct |
|-----|-----|-----|
| 1   | YG  | 15  |
| 2   | U   | ALL |
| 3   | UW  | ALL |

Description: *Fuse box-Passenger compartment*  
 Location: *Behind passenger compartment fusebox*

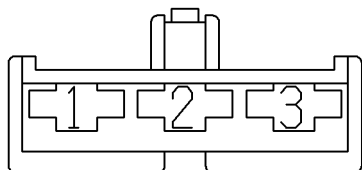

YPC10579

Colour: *BROWN*  
 Gender: *Female*

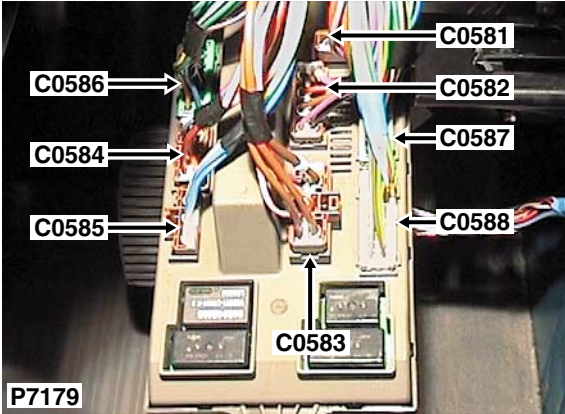

Description: Fuse box-Passenger compartment  
 Location: Behind passenger compartment fusebox

| Cav | Col | Cct |
|-----|-----|-----|
| 1   | RO  | ALL |
| 2   | LGO | ALL |
| 3   | LGW | 42  |
| 4   | RU  | 37  |
| 4   | UY  | ALL |
| 5   | GY  | ALL |
| 6   | GO  | ALL |
| 7   | LGP | 24  |
| 8   | GLG | 9   |
| 9   | PN  | ALL |
| 10  | GU  | ALL |
| 11  | WLG | ALL |
| 12  | NS  | ALL |
| 13  | BG  | ALL |
| 14  | US  | ALL |

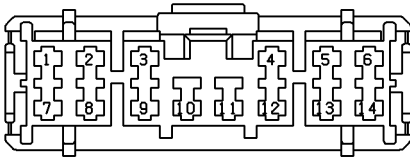

YPC10537

Colour: GREEN  
 Gender: Female

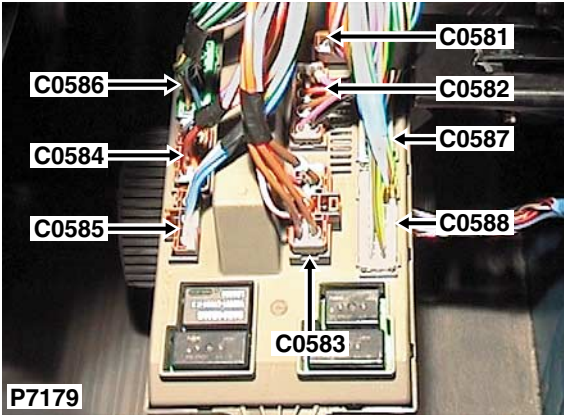

Description: *Fuse box-Passenger compartment*  
 Location: *Behind passenger compartment fusebox*

| Cav | Col | Cct |
|-----|-----|-----|
| 1   | UB  | ALL |
| 2   | LG  | ALL |
| 3   | RB  | ALL |
| 4   | GY  | 3   |
| 5   | GU  | ALL |
| 6   | P   | ALL |
| 7   | LGW | ALL |
| 8   | GK  | ALL |
| 9   | UK  | ALL |
| 10  | WR  | ALL |
| 11  | KS  | ALL |
| 12  | GR  | ALL |
| 13  | GW  | ALL |
| 14  | GN  | 3   |
| 15  | GO  | 10  |
| 16  | RU  | 37  |
| 16  | UY  | ALL |
| 17  | SK  | ALL |
| 18  | B   | ALL |

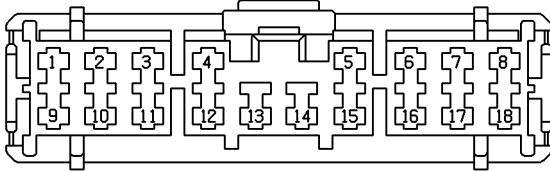

YPC10539

Colour: *LIGHT GREY*  
 Gender: *Female*

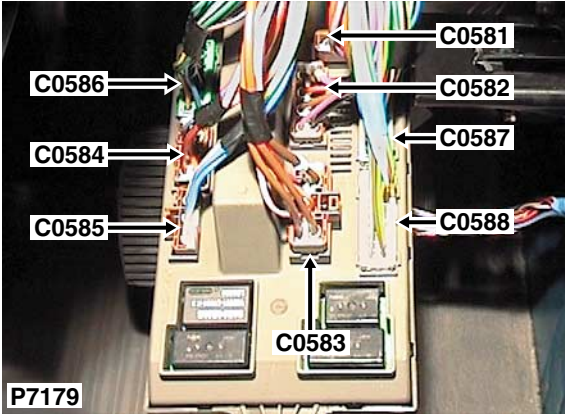

Description: Fuse box-Passenger compartment  
 Location: Behind passenger compartment fusebox

| Cav | Col | Cct |
|-----|-----|-----|
| 1   | NG  | ALL |
| 2   | LGP | ALL |
| 3   | RY  | ALL |
| 5   | WR  | ALL |
| 6   | W   | ALL |
| 7   | LG  | ALL |
| 8   | GS  | ALL |
| 9   | GLG | ALL |
| 10  | G   | ALL |
| 11  | PB  | ALL |
| 11  | PN  | ALL |
| 12  | LGP | ALL |
| 13  | UO  | ALL |
| 14  | LGO | 9   |
| 15  | PB  | 37  |
| 15  | RU  | ALL |
| 16  | GP  | ALL |

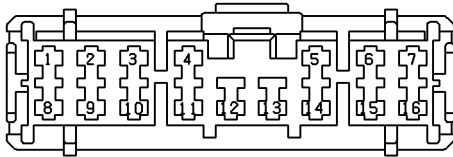

YPC113560

Colour: YELLOW  
 Gender: Female

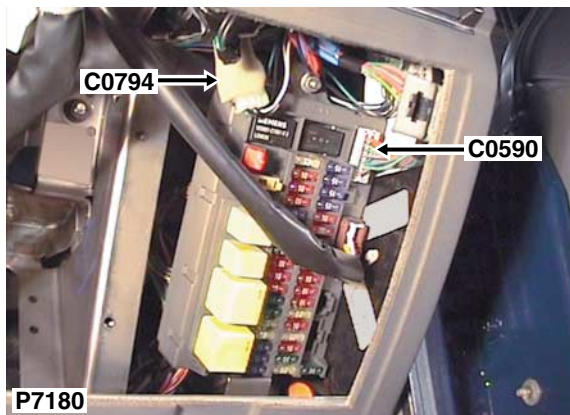

Description: *Fuse box-Passenger compartment*

Location: *Behind passenger compartment fusebox cover*

| Cav | Col | Cct |
|-----|-----|-----|
| 1   | PO  | ALL |
| 2   | GK  | ALL |
| 3   | GLG | ALL |
| 4   | RO  | ALL |
| 5   | US  | ALL |
| 6   | P   | ALL |
| 7   | LG  | ALL |
| 8   | GLG | ALL |
| 9   | PS  | ALL |
| 10  | G   | ALL |
| 11  | LGP | ALL |
| 12  | RY  | ALL |

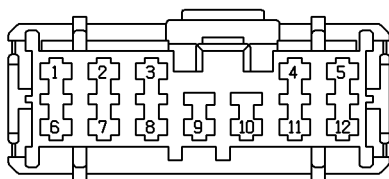

YPC10494

Colour: *LIGHT GREY*

Gender: *Female*

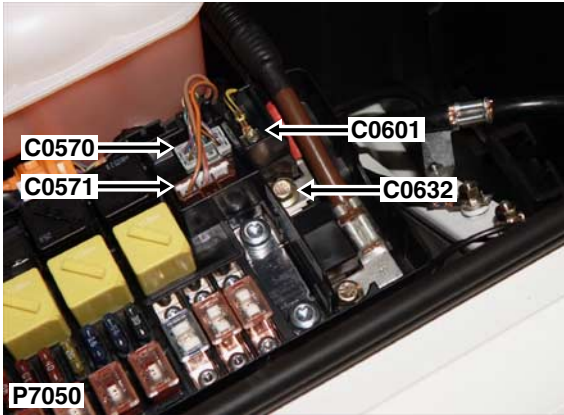

| Cav | Col | Cct |
|-----|-----|-----|
| 1   | YB  | 18  |

Description: *Holder-Fuse*

Location: *Front RH side of engine compartment*

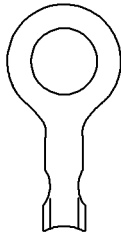

YPG100610

Colour: *BRASS*

Gender: *Eyelet*



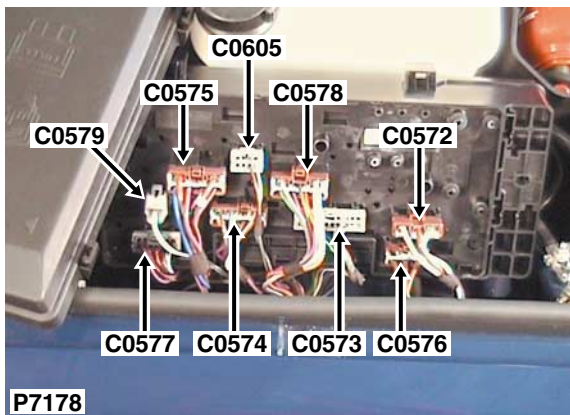

Description: *Fuse box-Engine compartment*

Location: *Beneath engine compartment fusebox*

| Cav | Col | Cct |
|-----|-----|-----|
| 3   | WG  | ALL |
| 4   | NS  | ALL |
| 6   | PN  | ALL |

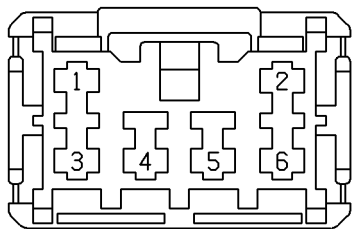

YPC10634

Colour: *LIGHT GREY*

Gender: *Female*



| Cav | Col | Cct |
|-----|-----|-----|
| 1   | YB  | ALL |

Description: *Fuse box-Engine compartment*  
Location: *RH side of engine compartment*

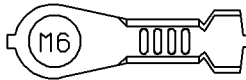

51109165

Colour:  
Gender:

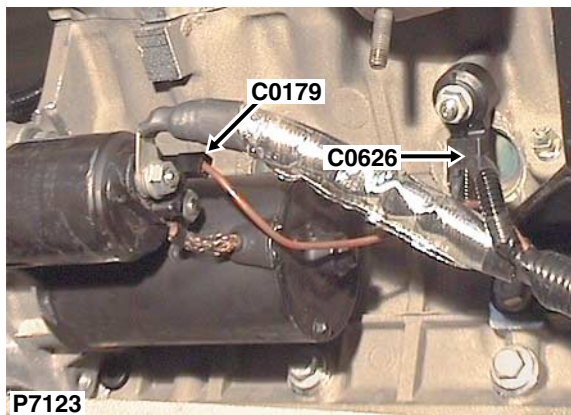

Description: *Sensor-Knock-RH bank*  
Location: *Lower rear of engine - RH side*

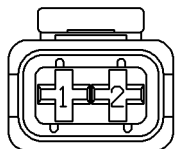

YPC110130

Colour: *BLACK*  
Gender: *Female*

| Cav | Col | Cct |
|-----|-----|-----|
| 1   | KB  | ALL |
| 2   | B   | ALL |

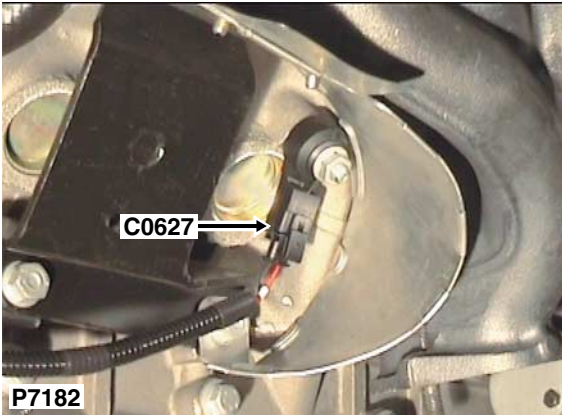

| Cav | Col | Cct |
|-----|-----|-----|
| 1   | KW  | ALL |
| 2   | B   | ALL |

Description: *Sensor-Knock-LH bank*  
Location: *Lower rear of engine - LH side*

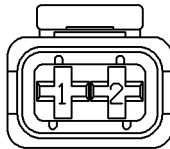

YPC110130

Colour: *BLACK*  
Gender: *Female*

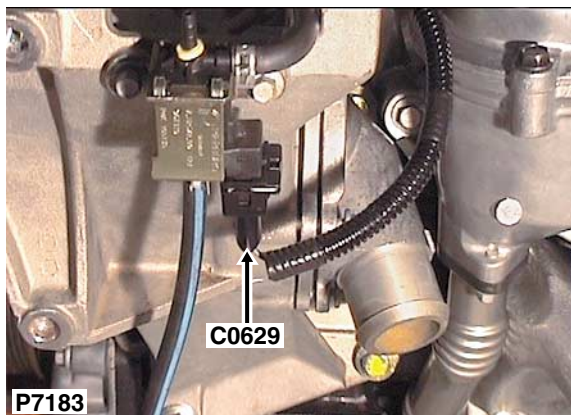

Description: *Solenoid-Wastegate control*

Location: *Front LH side of engine*

| Cav | Col | Cct |
|-----|-----|-----|
| 1   | NK  | ALL |
| 2   | SW  | ALL |

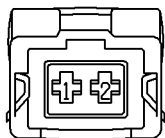

YPC107790

Colour: *BLACK*

Gender: *Female*

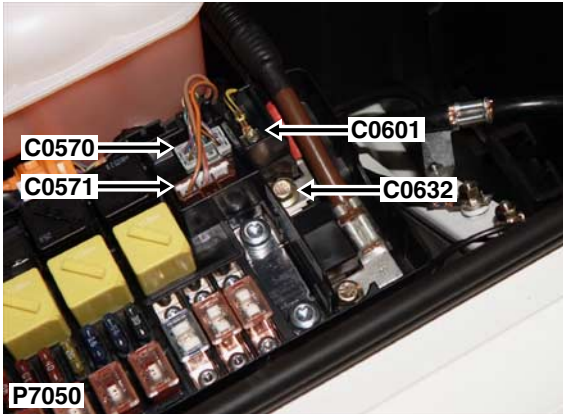

| Cav | Col | Cct |
|-----|-----|-----|
| 1   | R   | 38  |

Description: *Fuse box-Engine compartment*

Location: *Front RH side of engine compartment*

NO CONNECTOR FACE

Colour:

Gender:

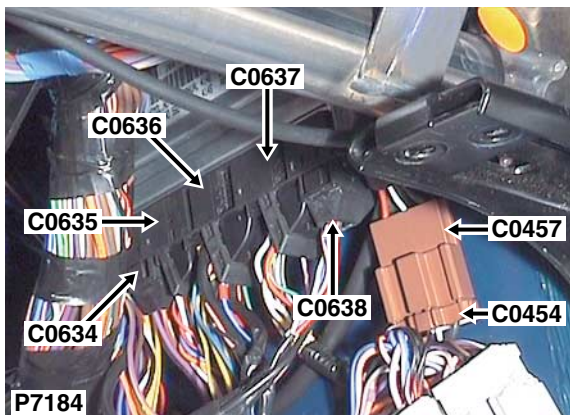

Description: *Engine control module (ECM)*

Location: *Behind RH side of fascia*

| Cav | Col | Cct |
|-----|-----|-----|
| 1   | W   | ALL |
| 4   | B   | ALL |
| 5   | B   | ALL |
| 6   | B   | ALL |
| 7   | PY  | ALL |
| 8   | NO  | ALL |

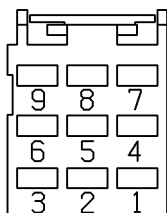

YPC108920

Colour: *BLACK*

Gender: *Female*

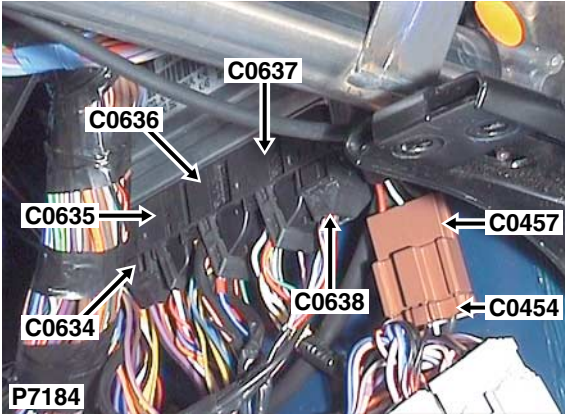

Description: *Engine control module (ECM)*  
 Location: *Behind RH side of fascia*

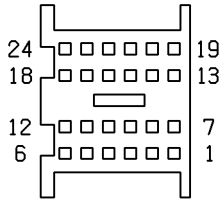

YPH100440

Colour: *BLACK*  
 Gender: *Female*

| Cav | Col | Cct |
|-----|-----|-----|
| 1   | WU  | 23  |
| 5   | BG  | 18  |
| 7   | WU  | 23  |
| 8   | RB  | 23  |
| 9   | RB  | ALL |
| 10  | RB  | ALL |
| 11  | RB  | 23  |
| 13  | WO  | ALL |
| 14  | G   | 23  |
| 15  | O   | ALL |
| 16  | U   | ALL |
| 17  | Y   | 23  |
| 18  | UP  | ALL |
| 19  | WO  | ALL |
| 21  | SG  | 18  |
| 23  | UR  | ALL |
| 24  | KO  | 18  |



# C0636

# CONNECTOR DETAILS

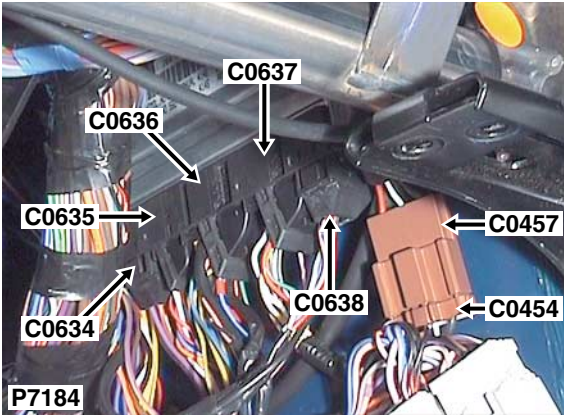

Description: *Engine control module (ECM)*

Location: *Behind RH side of fascia*

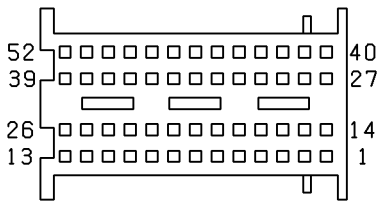

YPH100450

Colour: *BLACK*

Gender: *Female*

| Cav | Col | Cct |
|-----|-----|-----|
| 1   | YW  | ALL |
| 2   | YG  | ALL |
| 3   | NR  | ALL |
| 4   | BU  | 18  |
| 6   | RB  | 34  |
| 7   | R   | ALL |
| 9   | RB  | ALL |
| 10  | R   | ALL |
| 14  | YR  | ALL |
| 15  | YS  | ALL |
| 16  | BO  | 18  |
| 17  | B   | ALL |
| 18  | RK  | ALL |
| 20  | SU  | ALL |
| 21  | RB  | ALL |
| 22  | G   | ALL |
| 23  | UG  | ALL |
| 24  | YLG | ALL |
| 25  | RB  | ALL |
| 27  | YB  | ALL |
| 28  | YK  | ALL |
| 29  | SP  | ALL |
| 30  | BY  | 18  |
| 30  | SY  | 34  |
| 31  | GW  | ALL |
| 32  | BY  | ALL |
| 34  | SLG | ALL |
| 35  | W   | ALL |
| 36  | KB  | ALL |
| 40  | YN  | ALL |
| 41  | YU  | ALL |
| 42  | US  | ALL |
| 43  | RG  | ALL |
| 44  | GU  | ALL |
| 45  | SCR | ALL |
| 46  | KB  | ALL |
| 48  | B   | ALL |

---

| Cav | Col | Cct |
|-----|-----|-----|
| 49  | KW  | ALL |

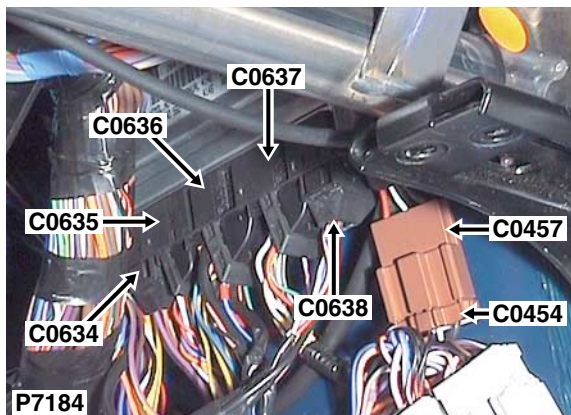

Description: *Engine control module (ECM)*

Location: *Behind RH side of fascia*

NO CONNECTOR FACE

Colour:

Gender:

| Cav | Col | Cct |
|-----|-----|-----|
| 1   | YW  | ALL |
| 2   | YG  | ALL |
| 3   | NR  | ALL |
| 4   | BU  | 18  |
| 6   | RB  | 34  |
| 7   | R   | ALL |
| 9   | RB  | ALL |
| 10  | R   | ALL |
| 14  | YR  | ALL |
| 15  | YS  | ALL |
| 16  | BO  | 18  |
| 17  | B   | ALL |
| 18  | RK  | ALL |
| 20  | SU  | ALL |
| 21  | RB  | ALL |
| 22  | G   | ALL |
| 23  | UG  | ALL |
| 24  | YLG | ALL |
| 25  | RB  | ALL |
| 27  | YB  | ALL |
| 28  | YK  | ALL |
| 29  | SP  | ALL |
| 30  | BY  | 18  |
| 30  | SY  | 34  |
| 31  | GW  | ALL |
| 32  | BY  | ALL |
| 34  | SLG | ALL |
| 35  | W   | ALL |
| 36  | KB  | ALL |
| 40  | YN  | ALL |
| 41  | YU  | ALL |
| 42  | US  | ALL |
| 43  | RG  | ALL |
| 44  | GU  | ALL |
| 45  | SCR | ALL |
| 46  | KB  | ALL |
| 48  | B   | ALL |

---

| Cav | Col | Cct |
|-----|-----|-----|
| 49  | KW  | ALL |

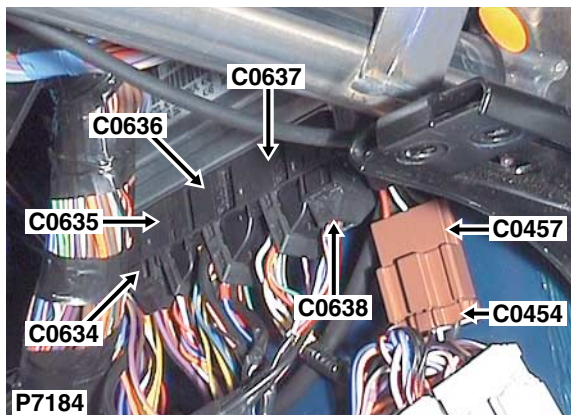

Description: *Engine control module (ECM)*

Location: *Behind RH side of fascia*

| Cav | Col | Cct |
|-----|-----|-----|
| 8   | GS  | 3   |
| 9   | R   | 20  |
| 12  | GB  | 18  |
| 14  | GK  | 20  |
| 16  | YS  | ALL |
| 17  | WS  | 3   |
| 20  | RS  | 3   |
| 22  | KG  | 3   |
| 29  | BS  | 3   |
| 31  | OG  | 19  |
| 32  | K   | 3   |
| 33  | LGS | 3   |
| 34  | RG  | 3   |
| 36  | W   | 5   |
| 37  | Y   | 5   |
| 38  | PW  | 3   |

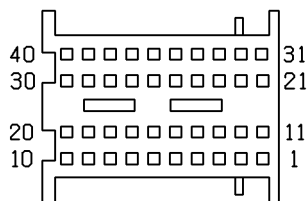

YPH100430

Colour: *BLACK*

Gender: *Female*

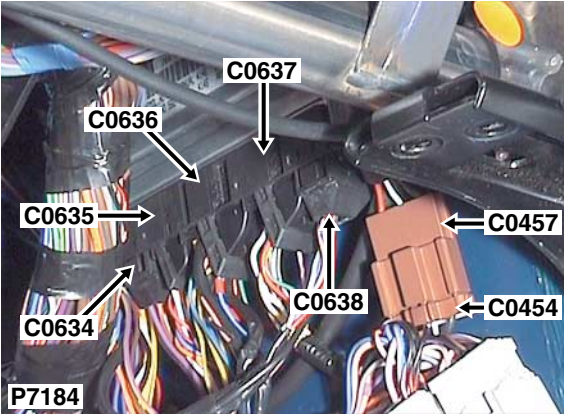

Description: *Engine control module (ECM)*  
 Location: *Behind RH side of fascia*

| Cav | Col | Cct |
|-----|-----|-----|
| 2   | U   | ALL |
| 5   | B   | ALL |
| 6   | KB  | ALL |
| 7   | WU  | ALL |
| 8   | R   | ALL |

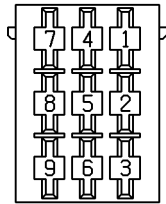

YPC112950

Colour: *GREY*  
 Gender: *Female*

# C0641

## CONNECTOR DETAILS

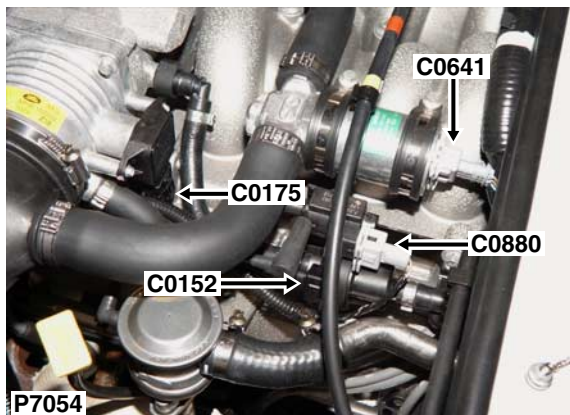

| Cav | Col | Cct |
|-----|-----|-----|
| 1   | RG  | ALL |
| 2   | NO  | ALL |
| 3   | US  | ALL |

Description: *Idle air control valve (IACV)*

Location: *LH side of engine compartment*

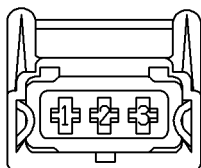

YPC108850

Colour: *GREY*  
Gender: *Female*

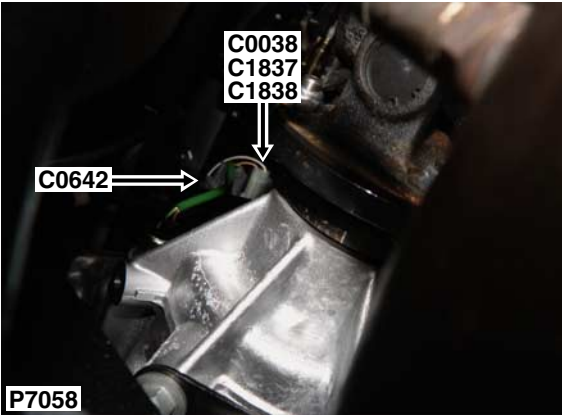

| Cav | Col | Cct |
|-----|-----|-----|
| 1   | RB  | 23  |
| 2   | G   | 23  |
| 3   | NK  | 23  |
| 4   | WU  | 23  |

Description: *Sensor-Heated oxygen (HO2S)-Rear-RH*  
 Location: *Top of transfer box*

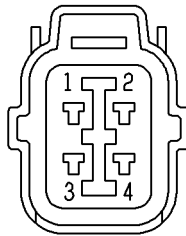

YPC10470

Colour: *GREY*  
 Gender: *Female*



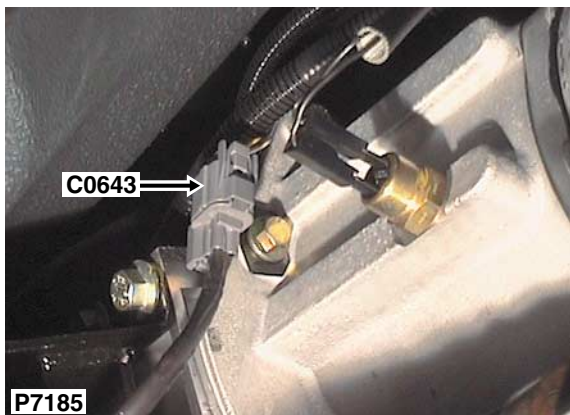

| Cav | Col | Cct |
|-----|-----|-----|
| 1   | RB  | 23  |
| 2   | Y   | 23  |
| 3   | NK  | 23  |
| 4   | WU  | 23  |

Description: *Sensor-Heated oxygen (HO2S)-Rear-LH*

Location: *LH side of transfer box*

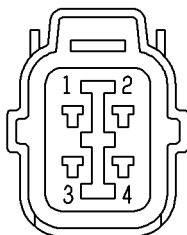

YPC10470

Colour: *GREY*  
 Gender: *Female*

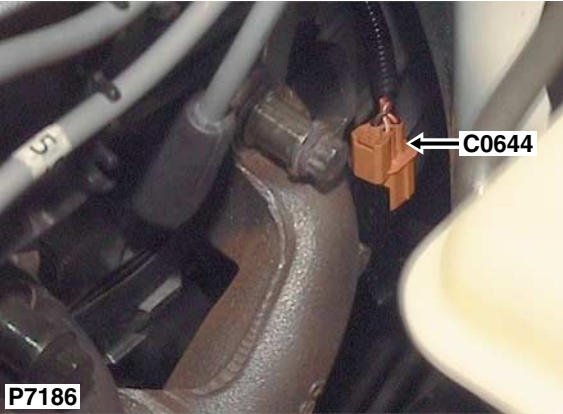

| Cav | Col | Cct |
|-----|-----|-----|
| 1   | RB  | ALL |
| 2   | O   | ALL |
| 3   | NK  | ALL |
| 4   | WO  | ALL |

Description: *Sensor-Heated oxygen (HO2S)-Front-LH*  
 Location: *Rear LH side of engine*

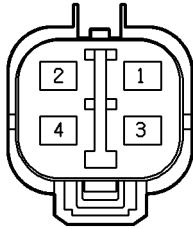

YPC113730

Colour: *ORANGE*  
 Gender: *Male*

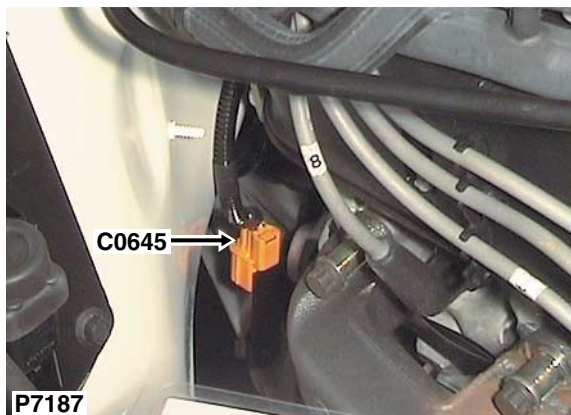

| Cav | Col | Cct |
|-----|-----|-----|
| 1   | RB  | ALL |
| 2   | U   | ALL |
| 3   | NK  | ALL |
| 4   | WO  | ALL |

Description: *Sensor-Heated oxygen (HO2S)-Front-RH*

Location: *Rear RH side of engine*

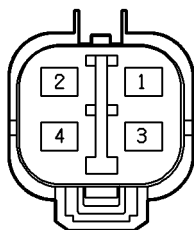

YPC113730

Colour: *ORANGE*

Gender: *Male*

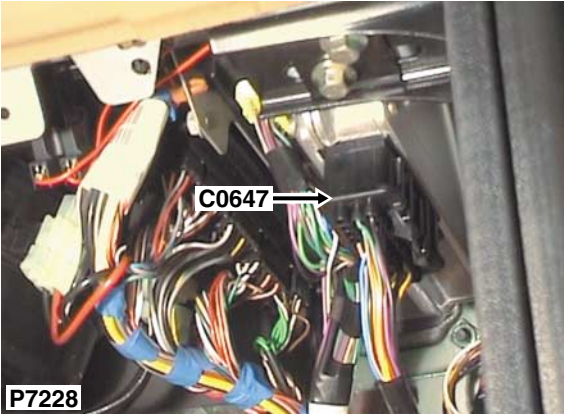

Description: *ECU-Active Cornering Enhancement (ACE) - LHD*  
 Location: *Behind RH side of fascia*

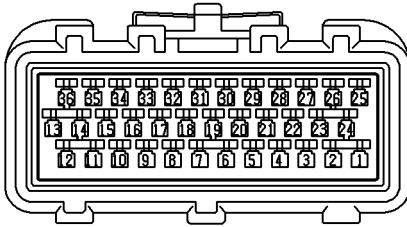

YPC106770

Colour: *BLACK*  
 Gender: *Female*

| Cav | Col | Cct |
|-----|-----|-----|
| 5   | KG  | 10  |
| 6   | BR  | 10  |
| 10  | K   | 10  |
| 11  | GO  | 10  |
| 12  | YB  | 10  |
| 13  | KY  | 10  |
| 14  | GN  | 10  |
| 15  | OS  | 10  |
| 16  | KW  | 10  |
| 17  | OU  | 10  |
| 18  | YR  | 10  |
| 19  | WS  | 10  |
| 20  | B   | 10  |
| 21  | UG  | 10  |
| 22  | YB  | 10  |
| 23  | OG  | 10  |
| 24  | GR  | 10  |
| 25  | BG  | 10  |
| 27  | P   | 10  |
| 28  | PO  | 10  |
| 32  | B   | 10  |
| 33  | YK  | 10  |
| 34  | YG  | 10  |
| 36  | BO  | 10  |

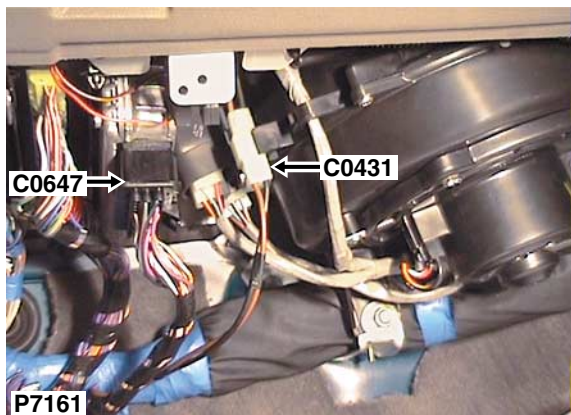

Description: *ECU-Active Cornering Enhancement (ACE) - RHD*

Location: *Behind LH side of fascia*

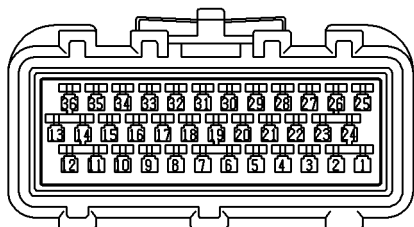

YPC106770

Colour: *BLACK*

Gender: *Female*

| Cav | Col | Cct |
|-----|-----|-----|
| 5   | KG  | 10  |
| 6   | BR  | 10  |
| 10  | K   | 10  |
| 11  | GO  | 10  |
| 12  | YB  | 10  |
| 13  | KY  | 10  |
| 14  | GN  | 10  |
| 15  | OS  | 10  |
| 16  | KW  | 10  |
| 17  | OU  | 10  |
| 18  | YR  | 10  |
| 19  | WS  | 10  |
| 20  | B   | 10  |
| 21  | UG  | 10  |
| 22  | YB  | 10  |
| 23  | OG  | 10  |
| 24  | GR  | 10  |
| 25  | BG  | 10  |
| 27  | P   | 10  |
| 28  | PO  | 10  |
| 32  | B   | 10  |
| 33  | YK  | 10  |
| 34  | YG  | 10  |
| 36  | BO  | 10  |

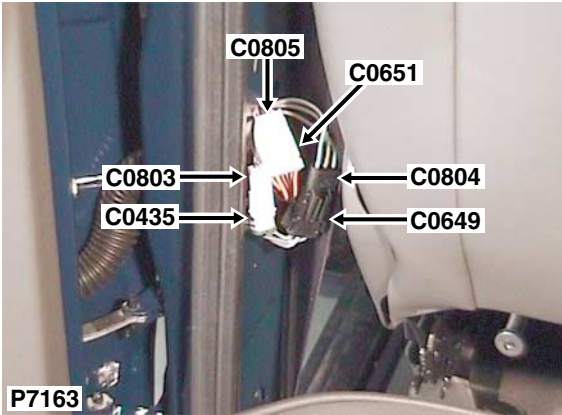

| Cav | Col | Cct |
|-----|-----|-----|
| 1   | SG  | ALL |
| 2   | SY  | ALL |
| 3   | SW  | ALL |

Description: *Main harness to door harness*  
 Location: *In LH 'B' post*

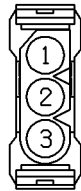

YPC112530

Colour: *BLACK*  
 Gender: *Female*

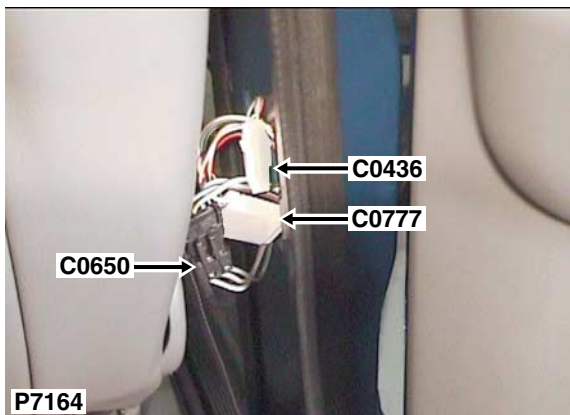

| Cav | Col | Cct |
|-----|-----|-----|
| 1   | SG  | ALL |
| 2   | SY  | ALL |
| 3   | SN  | ALL |

Description: *Main harness to door harness*

Location: *In RH 'B' post*

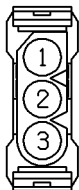

YPC112530

Colour: *BLACK*

Gender: *Female*

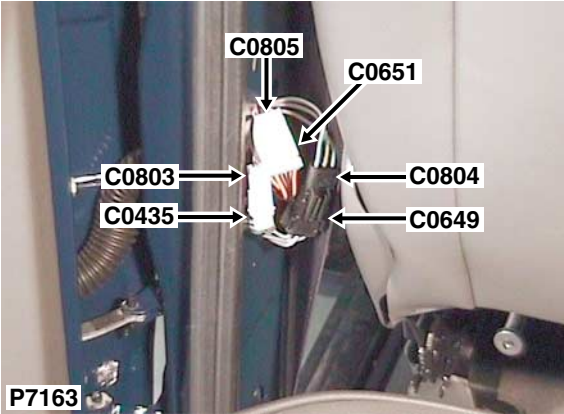

Description: *Main harness to door harness*  
 Location: *In LH 'B' post*

| Cav | Col | Cct |
|-----|-----|-----|
| 1   | KP  | ALL |
| 2   | KR  | ALL |
| 3   | PLG | ALL |
| 4   | B   | ALL |
| 5   | RB  | ALL |
| 6   | KS  | ALL |

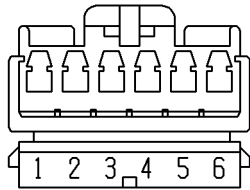

YPC10270

Colour: *WHITE*  
 Gender: *Female*



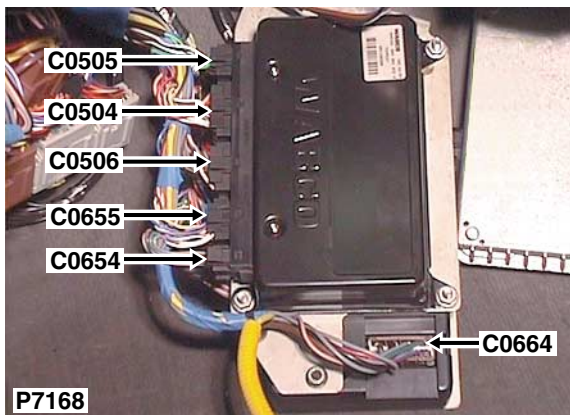

| Cav | Col | Cct |
|-----|-----|-----|
| 1   | SY  | 13  |
| 2   | SU  | 13  |
| 3   | SR  | 13  |
| 4   | SG  | 13  |
| 5   | SO  | 13  |
| 6   | SB  | 13  |

Description: *ECU-Self-levelling/ABS (SLABS)*

Location: *Behind passenger side of fascia*

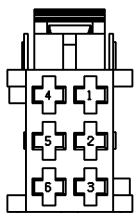

YPC110350

Colour: *BLACK*

Gender: *Female*

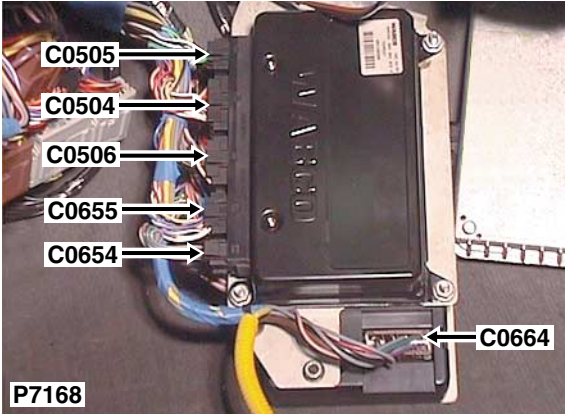

Description: *ECU-Self-levelling/ABS (SLABS)*  
 Location: *Behind passenger side of fascia*

| Cav | Col | Cct |
|-----|-----|-----|
| 1   | PW  | 13  |
| 2   | PLG | 13  |
| 3   | WY  | 13  |
| 4   | UO  | 13  |
| 5   | BW  | 13  |
| 6   | NP  | 13  |
| 7   | WK  | ALL |
| 8   | WO  | 13  |
| 10  | WS  | ALL |
| 11  | PK  | 13  |
| 12  | WU  | 13  |

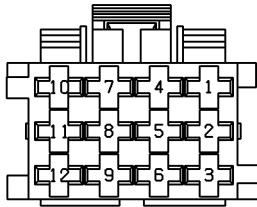

YPC110360

Colour: *BLACK*  
 Gender: *Female*

# C0656

## CONNECTOR DETAILS



| Cav | Col | Cct |
|-----|-----|-----|
| 1   | OS  | 10  |
| 2   | YK  | 10  |
| 3   | YB  | 10  |

Description: *Accelerometer-Lower*  
Location: *Beneath vehicle - RH side*

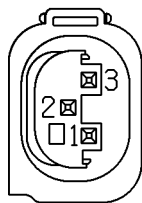

YPC116860

Colour: *GREY*  
Gender: *Female*

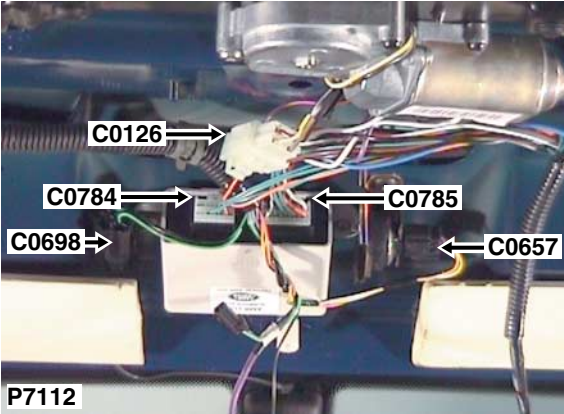

| Cav | Col | Cct |
|-----|-----|-----|
| 1   | OU  | ALL |
| 2   | YG  | ALL |
| 3   | YR  | ALL |

Description: *Accelerometer-Upper*  
 Location: *Front of headlining in the centre*



YPC110630

Colour: *BLUE*  
 Gender: *Female*

# C0658

# CONNECTOR DETAILS

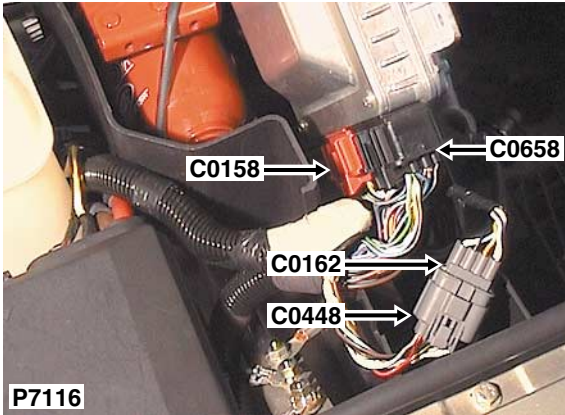

Description: *Engine control module (ECM)*

Location: *RH side of engine compartment*

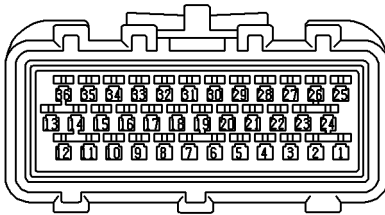

YPC10073

Colour: *BLACK*

Gender: *Female*

| Cav | Col | Cct |
|-----|-----|-----|
| 1   | B   | 2   |
| 2   | B   | 2   |
| 3   | NO  | 2   |
| 4   | BP  | 2   |
| 5   | UP  | 2   |
| 6   | RS  | 2   |
| 7   | GU  | 2   |
| 9   | YS  | ALL |
| 10  | OG  | 2   |
| 11  | RW  | 2   |
| 12  | WG  | 2   |
| 13  | KG  | 2   |
| 14  | WP  | 2   |
| 15  | WY  | 2   |
| 16  | GP  | 2   |
| 17  | UW  | 2   |
| 18  | K   | 2   |
| 19  | WS  | 2   |
| 20  | RG  | 2   |
| 21  | UR  | 2   |
| 22  | NO  | 2   |
| 23  | GO  | 2   |
| 24  | B   | 2   |
| 25  | B   | 2   |
| 26  | BY  | 2   |
| 27  | NO  | 2   |
| 29  | BS  | 2   |
| 30  | BY  | 2   |
| 32  | SP  | 2   |
| 33  | W   | 2   |
| 34  | LGS | 2   |
| 35  | BW  | 2   |
| 36  | UG  | 2   |
| 36  | WS  | 2   |

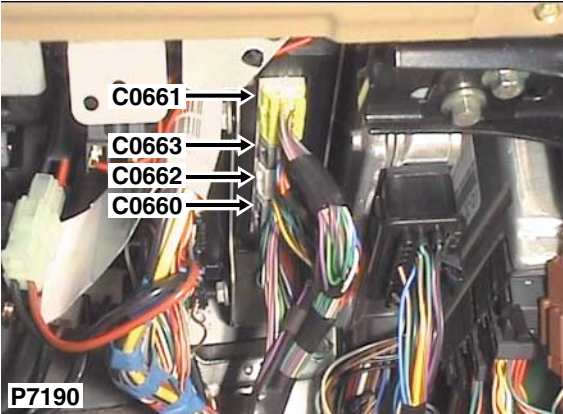

Description: *Body control unit (BCU) - LHD*  
 Location: *Behind RH side of fascia*

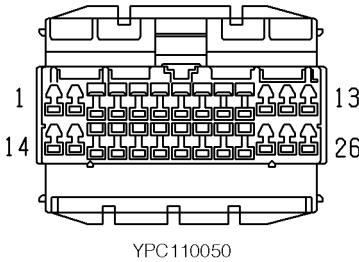

Colour: *GREY*  
 Gender: *Female*

| Cav | Col | Cct |
|-----|-----|-----|
| 1   | GU  | ALL |
| 2   | BK  | ALL |
| 3   | LGW | ALL |
| 4   | PLG | ALL |
| 5   | UG  | ALL |
| 6   | GW  | ALL |
| 7   | KB  | ALL |
| 8   | RU  | 9   |
| 9   | RW  | 9   |
| 10  | WK  | ALL |
| 11  | B   | ALL |
| 12  | WU  | 13  |
| 13  | PN  | ALL |
| 14  | KO  | 41  |
| 15  | PO  | ALL |
| 16  | KR  | ALL |
| 17  | PW  | ALL |
| 18  | BS  | ALL |
| 19  | BU  | ALL |
| 20  | LGS | ALL |
| 21  | LGG | ALL |
| 22  | RG  | 9   |
| 23  | RS  | 9   |
| 24  | RK  | 9   |
| 25  | RP  | 9   |
| 26  | RY  | 9   |

# C0660

# CONNECTOR DETAILS

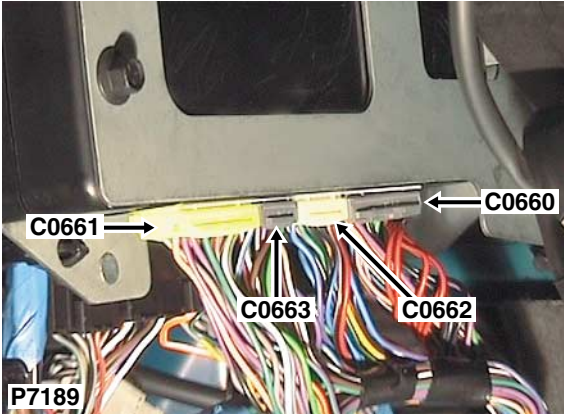

Description: *Body control unit (BCU) - RHD*

Location: *Behind LH side of fascia*

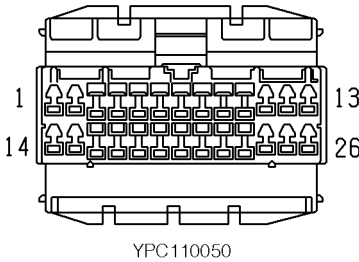

Colour: *GREY*  
 Gender: *Female*

| Cav | Col | Cct |
|-----|-----|-----|
| 1   | GU  | ALL |
| 2   | BK  | ALL |
| 3   | LGW | ALL |
| 4   | PLG | ALL |
| 5   | UG  | ALL |
| 6   | GW  | ALL |
| 7   | KB  | ALL |
| 8   | RU  | 9   |
| 9   | RW  | 9   |
| 10  | WK  | ALL |
| 11  | B   | ALL |
| 12  | WU  | 13  |
| 13  | PN  | ALL |
| 14  | KO  | 41  |
| 15  | PO  | ALL |
| 16  | KR  | ALL |
| 17  | PW  | ALL |
| 18  | BS  | ALL |
| 19  | BU  | ALL |
| 20  | LGS | ALL |
| 21  | LGG | ALL |
| 22  | RG  | 9   |
| 23  | RS  | 9   |
| 24  | RK  | 9   |
| 25  | RP  | 9   |
| 26  | RY  | 9   |

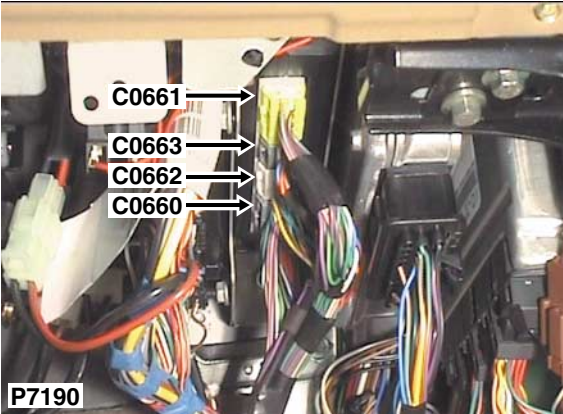

Description: *Body control unit (BCU) - LHD*  
 Location: *Behind RH side of fascia*

| Cav | Col | Cct |
|-----|-----|-----|
| 1   | SK  | ALL |
| 3   | PO  | 37  |
| 4   | K   | ALL |
| 5   | PS  | ALL |
| 6   | BN  | ALL |
| 7   | GP  | ALL |
| 8   | GN  | 1   |
| 9   | WG  | 13  |
| 10  | LGS | ALL |
| 11  | LGO | ALL |
| 12  | KN  | 41  |
| 13  | PS  | 41  |
| 14  | PG  | 37  |
| 15  | NP  | ALL |
| 16  | GS  | 3   |
| 18  | SR  | 37  |
| 19  | P   | ALL |
| 20  | BS  | ALL |
| 21  | WLG | ALL |
| 22  | US  | ALL |

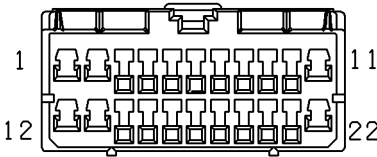

YPC108940

Colour: *YELLOW*  
 Gender: *Female*



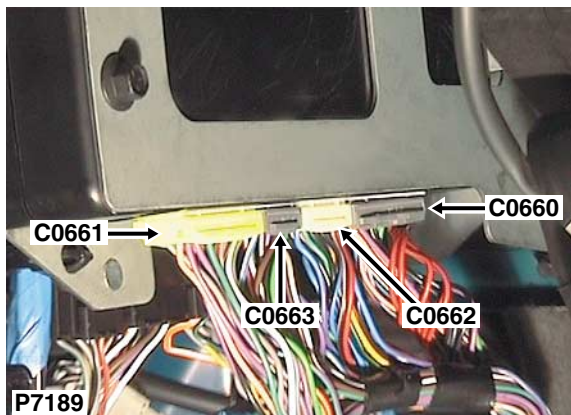

Description: *Body control unit (BCU) - RHD*

Location: *Behind LH side of fascia*

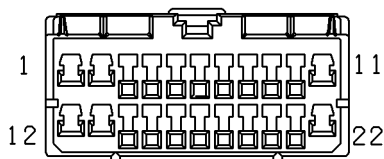

YPC108940

Colour: *YELLOW*

Gender: *Female*

| Cav | Col | Cct |
|-----|-----|-----|
| 1   | SK  | ALL |
| 3   | PO  | ALL |
| 4   | K   | ALL |
| 5   | PS  | ALL |
| 6   | BN  | ALL |
| 7   | GP  | ALL |
| 8   | GN  | ALL |
| 9   | WG  | 13  |
| 10  | LGS | ALL |
| 11  | LGO | ALL |
| 12  | KN  | 41  |
| 13  | PS  | 41  |
| 14  | PG  | ALL |
| 15  | NP  | ALL |
| 16  | GS  | 3   |
| 18  | SR  | ALL |
| 19  | P   | ALL |
| 20  | BS  | ALL |
| 21  | WLG | ALL |
| 22  | US  | ALL |

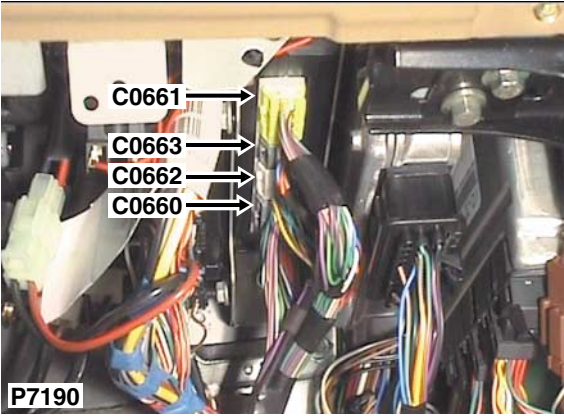

Description: *Body control unit (BCU) - LHD*  
 Location: *Behind RH side of fascia*

| Cav | Col | Cct |
|-----|-----|-----|
| 1   | BR  | ALL |
| 2   | WP  | ALL |
| 3   | OB  | ALL |
| 4   | PO  | ALL |
| 5   | BO  | ALL |
| 6   | UG  | 9   |
| 7   | YK  | ALL |
| 8   | UP  | ALL |
| 9   | UP  | 9   |
| 10  | GB  | 9   |
| 11  | BLG | 34  |
| 12  | LG  | ALL |
| 13  | UB  | 9   |
| 15  | BK  | 34  |
| 16  | RW  | ALL |

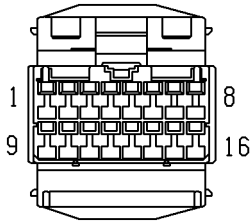

YPC108950

Colour: *WHITE*  
 Gender: *Female*

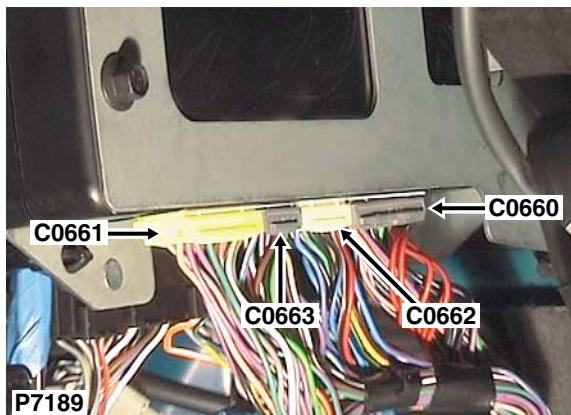

Description: *Body control unit (BCU) - RHD*

Location: *Behind LH side of fascia*

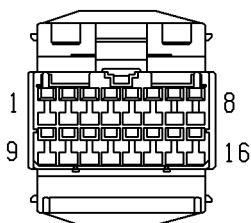

YPC108950

Colour: *WHITE*

Gender: *Female*

| Cav | Col | Cct |
|-----|-----|-----|
| 1   | BR  | ALL |
| 2   | WP  | ALL |
| 3   | OB  | ALL |
| 4   | PO  | ALL |
| 5   | BO  | ALL |
| 6   | UG  | 9   |
| 7   | YK  | ALL |
| 8   | UP  | ALL |
| 9   | UP  | 9   |
| 10  | GB  | 9   |
| 11  | BLG | 9   |
| 12  | LG  | ALL |
| 13  | UB  | 9   |
| 15  | BK  | 9   |
| 16  | RW  | ALL |

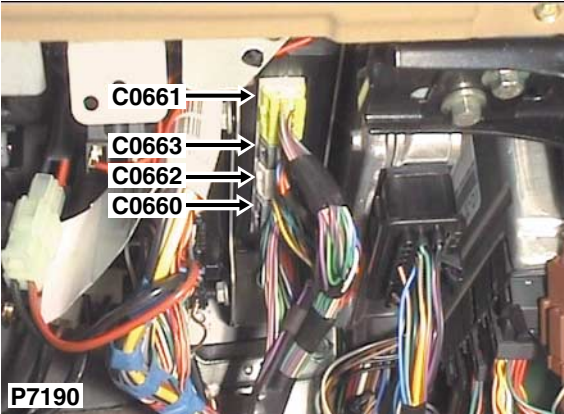

Description: *Body control unit (BCU) - LHD*  
 Location: *Behind RH side of fascia*

| Cav | Col | Cct |
|-----|-----|-----|
| 1   | WR  | ALL |
| 2   | GR  | ALL |
| 3   | OP  | 43  |
| 4   | UY  | ALL |
| 5   | NB  | ALL |
| 6   | WB  | ALL |
| 7   | UW  | 9   |
| 8   | SP  | ALL |
| 9   | PU  | ALL |
| 10  | NP  | 9   |
| 11  | BG  | ALL |
| 12  | LGR | ALL |

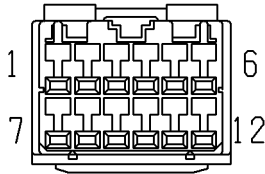

YPC109040

Colour: *DARK GREY*  
 Gender: *Female*

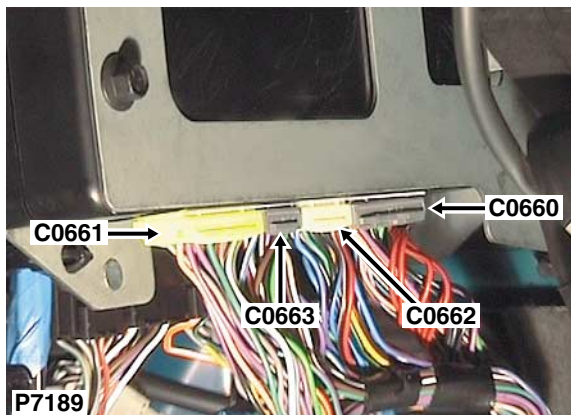

Description: *Body control unit (BCU) - RHD*

Location: *Behind LH side of fascia*

| Cav | Col | Cct |
|-----|-----|-----|
| 1   | WR  | ALL |
| 2   | GR  | ALL |
| 3   | OP  | 43  |
| 4   | UY  | ALL |
| 5   | NB  | ALL |
| 6   | WB  | ALL |
| 7   | UW  | 9   |
| 8   | SP  | ALL |
| 9   | PU  | ALL |
| 10  | NP  | 9   |
| 11  | BG  | ALL |
| 12  | LGR | ALL |

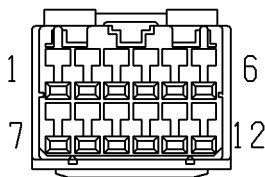

YPC109040

Colour: *DARK GREY*

Gender: *Female*

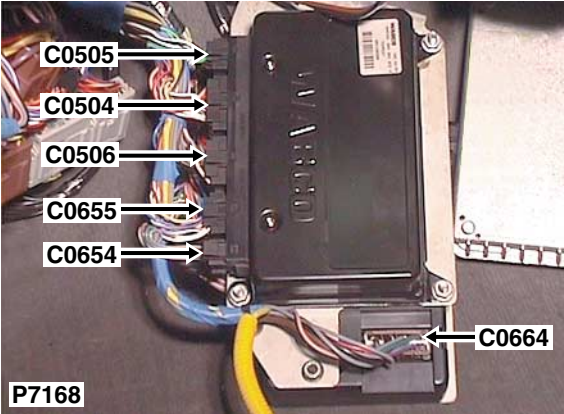

| Cav | Col | Cct |
|-----|-----|-----|
| 1   | SR  | ALL |
| 2   | SU  | ALL |
| 3   | RU  | ALL |
| 4   | SB  | ALL |
| 5   | B   | ALL |
| 6   | SK  | ALL |
| 7   | NG  | ALL |

Description: *Body control unit (BCU)*  
 Location: *Behind passenger side of fascia*

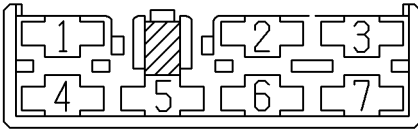

YPC10473

Colour: *BROWN*  
 Gender: *Female*

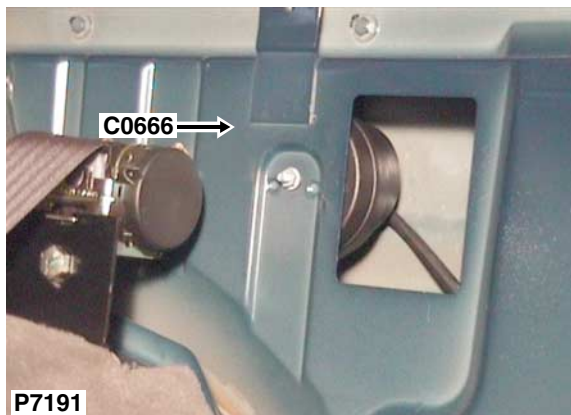

Description: *Sounder-Alarm-Battery backed up*

Location: *Behind RH rear trim panel*

| Cav | Col | Cct |
|-----|-----|-----|
| 1   | B   | ALL |
| 2   | PG  | ALL |
| 3   | PB  | ALL |
| 4   | PO  | ALL |

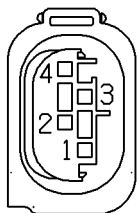

YPC117060

Colour: *NATURAL*

Gender: *Female*

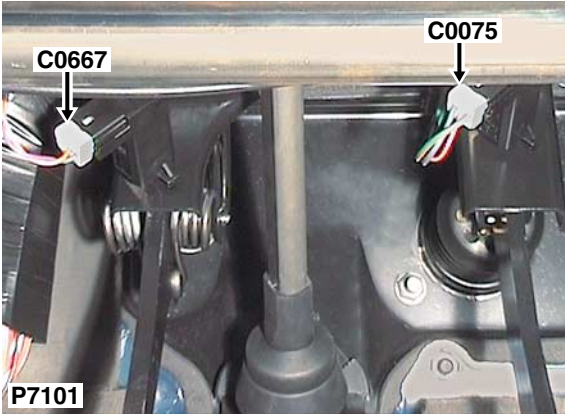

| Cav | Col | Cct |
|-----|-----|-----|
| 1   | PG  | 7   |
| 2   | OG  | 7   |

Description: *Switch-Clutch pedal*  
 Location: *Behind driver side of fascia*

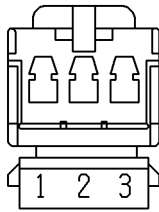

YPC10227

Colour: *WHITE*  
 Gender: *Female*



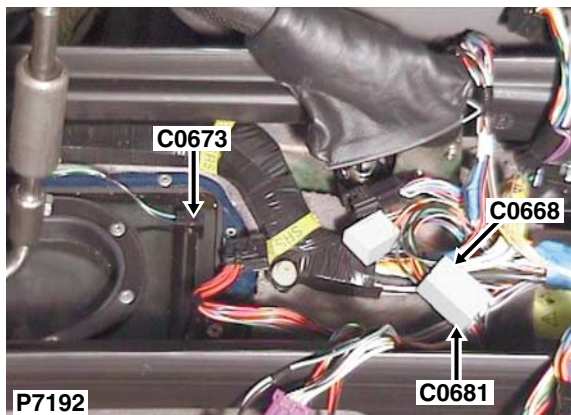

| Cav | Col | Cct |
|-----|-----|-----|
| 1   | GN  | ALL |
| 2   | GY  | ALL |
| 3   | NP  | 9   |
| 4   | BLG | ALL |
| 5   | BG  | ALL |
| 6   | RK  | ALL |
| 7   | BU  | ALL |
| 8   | B   | ALL |
| 10  | BW  | 2   |

Description: *Main harness to gearbox harness*

Location: *Beneath centre console*

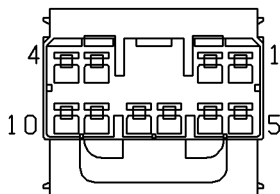

YPC10177

Colour: *WHITE*

Gender: *Male*

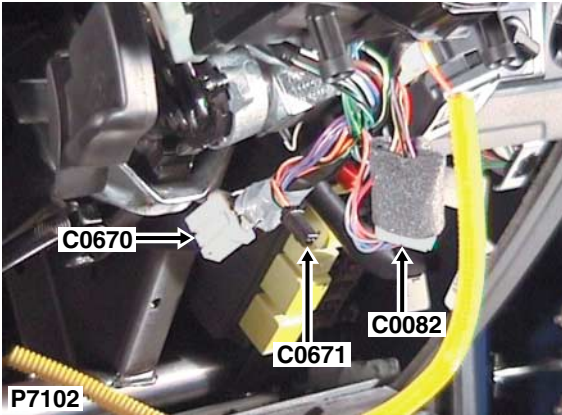

| Cav | Col | Cct |
|-----|-----|-----|
| 3   | OW  | ALL |
| 4   | P   | ALL |
| 5   | PB  | 9   |
| 5   | PN  | 34  |
| 6   | WP  | ALL |
| 7   | P   | ALL |
| 8   | PU  | ALL |

Description: *Unit-Interlock*  
 Location: *Underside of steering column*

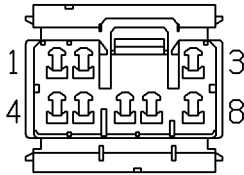

YPC10186

Colour: *WHITE*  
 Gender: *Female*

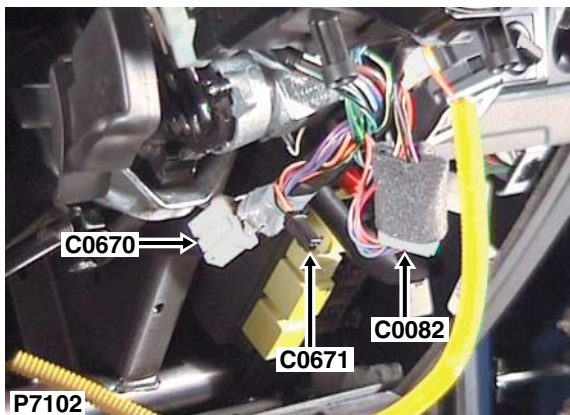

| Cav | Col | Cct |
|-----|-----|-----|
| 1   | OW  | ALL |
| 2   | BLG | ALL |

Description: *Unit-Interlock*

Location: *Underside of steering column*

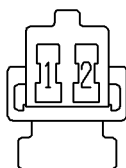

YPC10225

Colour: *BLACK*

Gender: *Female*

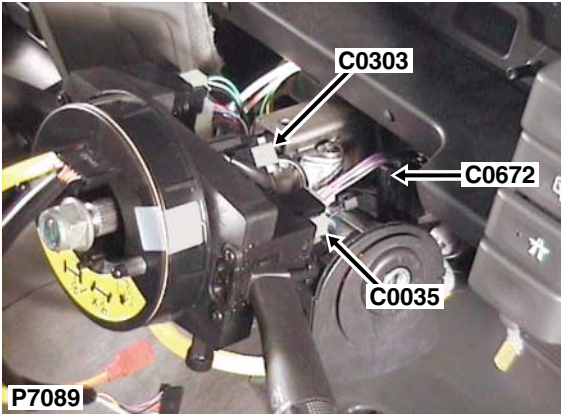

Description: *Sensor-Key in*

Location: *RH side of steering column*

| Cav | Col | Cct |
|-----|-----|-----|
| 1   | P   | ALL |
| 2   | PU  | ALL |
| 3   | P   | ALL |
| 4   | WP  | ALL |

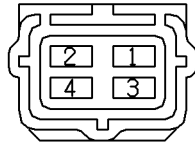

YPC10065

Colour: *BLACK*

Gender: *Female*

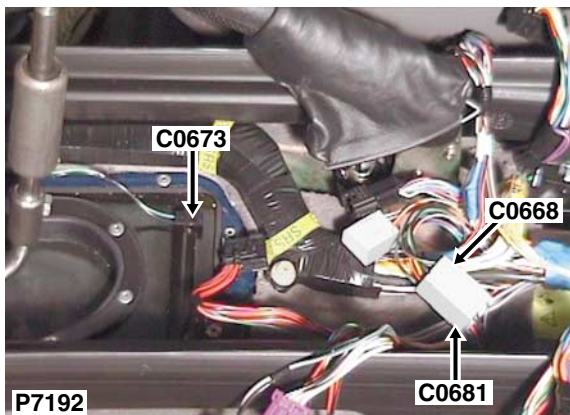

| Cav | Col | Cct |
|-----|-----|-----|
| 1   | LGP | ALL |
| 3   | B   | ALL |

Description: *Solenoid-Shift-Interlock*  
 Location: *Beneath centre console*

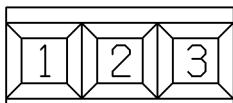

YPC117800

Colour: *BLACK*  
 Gender: *Female*

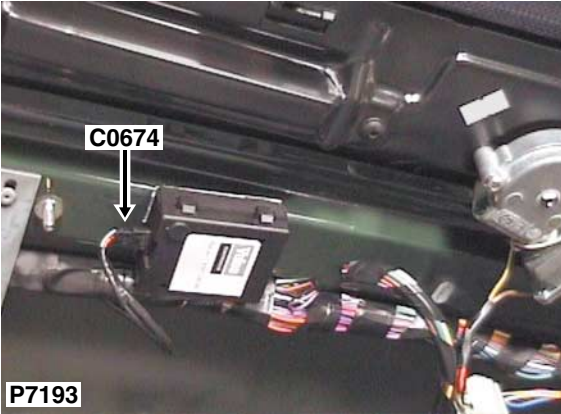

| Cav | Col | Cct |
|-----|-----|-----|
| 1   | PS  | ALL |
| 2   | BN  | ALL |

Description: *Receiver-Radio frequency (RF)*  
 Location: *Behind centre headlining*

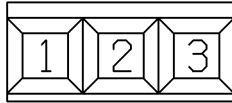

YPC117800

Colour: *BLACK*  
 Gender: *Female*

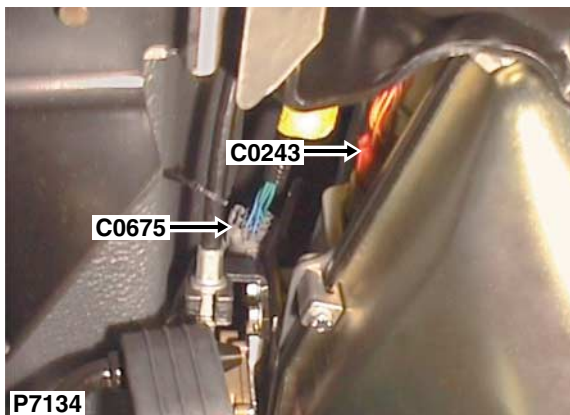

| Cav | Col | Cct |
|-----|-----|-----|
| 1   | GN  | ALL |
| 2   | GY  | ALL |
| 4   | B   | ALL |
| 5   | BG  | ALL |
| 6   | UW  | ALL |
| 7   | UG  | ALL |
| 8   | NP  | ALL |
| 9   | UP  | ALL |
| 10  | UB  | ALL |

Description: *Selector-Automatic transmission*

Location: *Lower rear of engine - LH side*

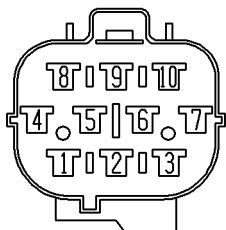

YPC10633

Colour: *GREY*

Gender: *Female*

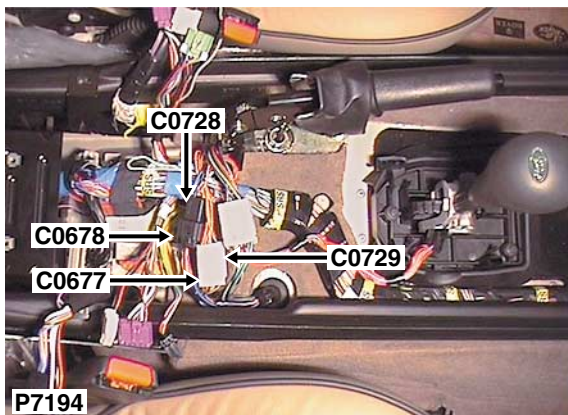

Description: Gearbox harness to main harness

Location: Beneath centre console

| Cav | Col | Cct |
|-----|-----|-----|
| 1   | OP  | ALL |
| 2   | OG  | ALL |
| 3   | OLG | ALL |
| 4   | OW  | ALL |
| 6   | SO  | ALL |

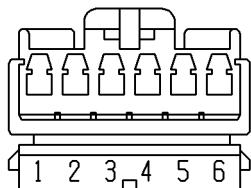

YPC10270

Colour: *WHITE*

Gender: *Female*



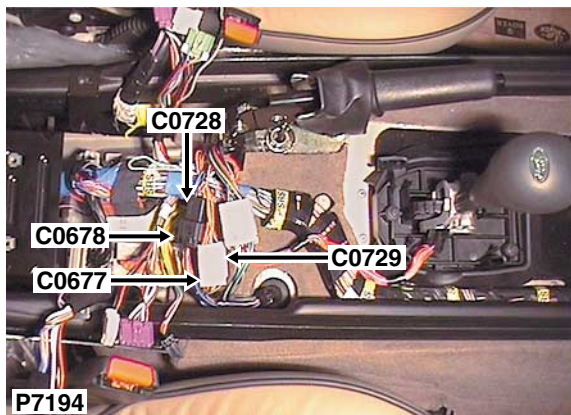

| Cav | Col | Cct |
|-----|-----|-----|
| 1   | OB  | ALL |
| 2   | OK  | ALL |
| 3   | W   | ALL |
| 4   | UG  | ALL |
| 5   | UW  | ALL |
| 6   | UB  | ALL |
| 7   | UP  | ALL |
| 8   | BK  | ALL |
| 9   | RK  | ALL |
| 10  | RU  | ALL |

Description: *Gearbox harness to main harness*

Location: *Beneath centre console*

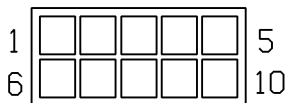

YPC111780

Colour: *BLACK*

Gender: *Female*

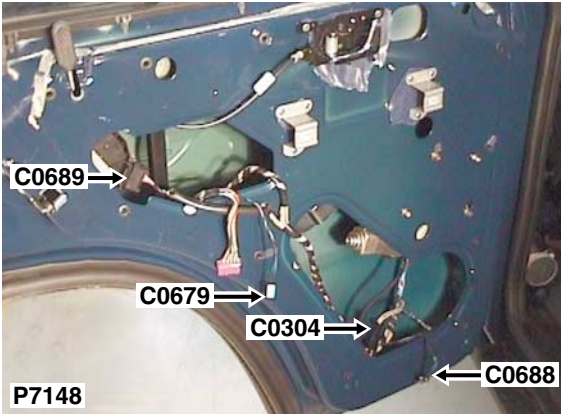

| Cav | Col | Cct |
|-----|-----|-----|
| 1   | BG  | 25  |
| 2   | BU  | 24  |
| 3   | BG  | 24  |
| 3   | BU  | 25  |

Description: *Speaker-High range-Rear door-RH*

Location: *Behind rear door trim panel*

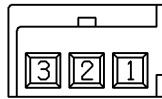

YPC117810

Colour: *WHITE*

Gender: *Female*

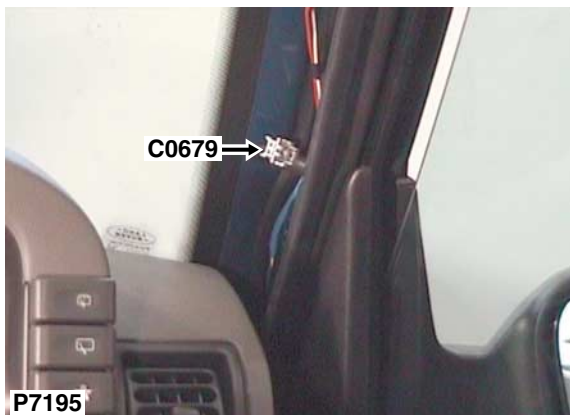

| Cav | Col | Cct |
|-----|-----|-----|
| 1   | RB  | 25  |
| 3   | KB  | 25  |

Description: *Speaker-High range-'A' post-RH*

Location: *RH 'A' post*

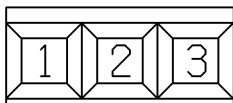

YPC117800

Colour: *BLACK*

Gender: *Female*



| Cav | Col | Cct |
|-----|-----|-----|
| 1   | YB  | 25  |
| 3   | YK  | 25  |

Description: *Speaker-High range-'A' post-LH*  
 Location: *LH 'A' post*

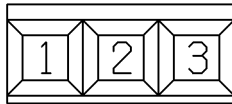

YPC117800

Colour: *BLACK*  
 Gender: *Female*

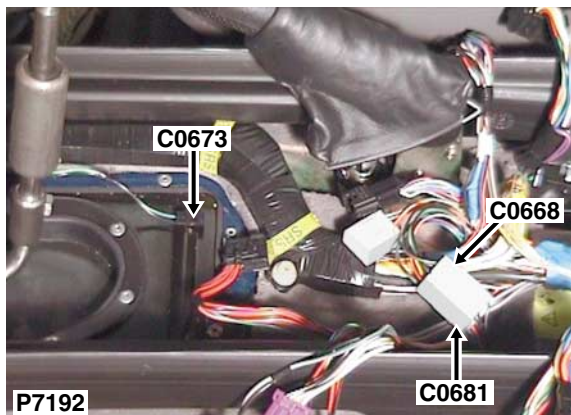

Description: *Gearbox harness to main harness*

Location: *Beneath centre console*

| Cav | Col | Cct |
|-----|-----|-----|
| 1   | GN  | ALL |
| 2   | GY  | ALL |
| 3   | NP  | ALL |
| 4   | BLG | ALL |
| 5   | BG  | ALL |
| 6   | RK  | ALL |
| 7   | BU  | 47  |
| 8   | B   | ALL |
| 10  | BG  | ALL |

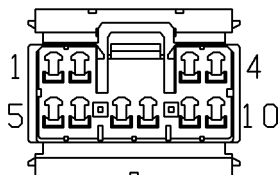

YPC10170

Colour: *WHITE*

Gender: *Female*

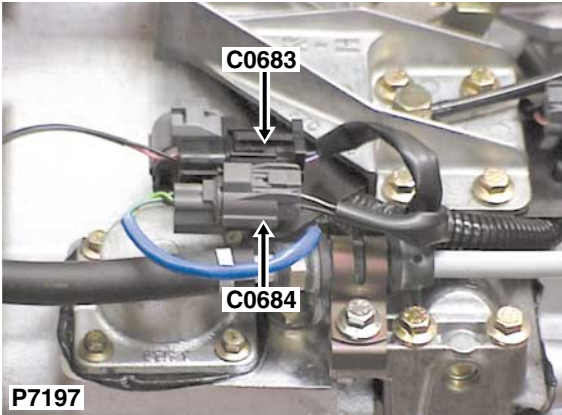

| Cav | Col | Cct |
|-----|-----|-----|
| 1   | RU  | ALL |
| 2   | B   | ALL |

Description: *Solenoid-Gearbox*  
 Location: *RH side of transfer box*

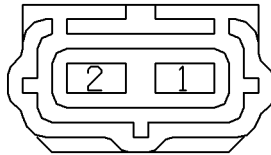

YPC10070

Colour: *BLACK*  
 Gender: *Female*

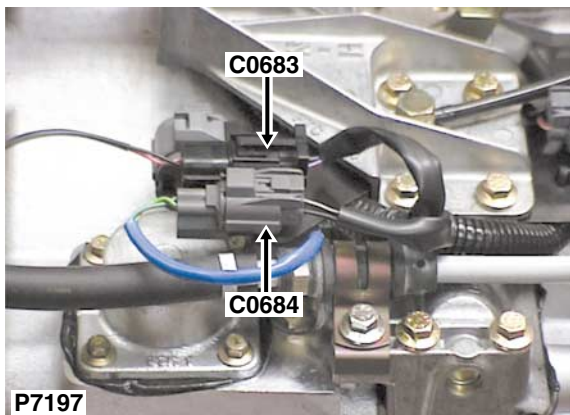

| Cav | Col | Cct |
|-----|-----|-----|
| 1   | BK  | ALL |
| 2   | B   | ALL |

Description: *Sensor-Neutral-Transmission*  
 Location: *RH side of transfer box*

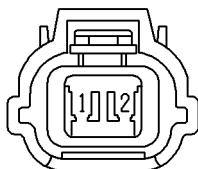

YPC10180

Colour: *GREY*  
 Gender: *Female*

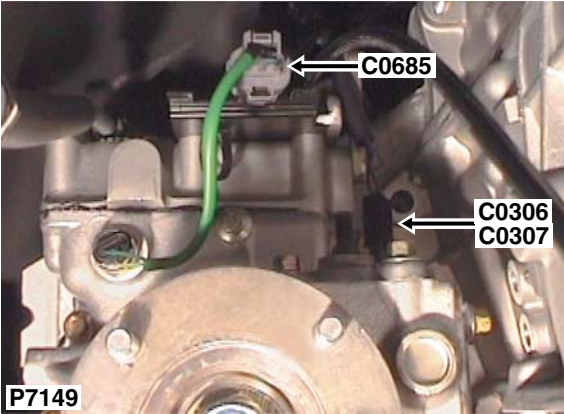

| Cav | Col | Cct |
|-----|-----|-----|
| 1   | RK  | ALL |
| 3   | B   | ALL |
| 3   | BG  | ALL |

Description: *Switch-Transmission-High-Low*  
 Location: *Top of transfer box*

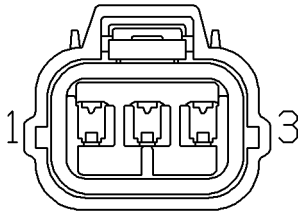

YPC10181

Colour: *LIGHT GREY*  
 Gender: *Female*



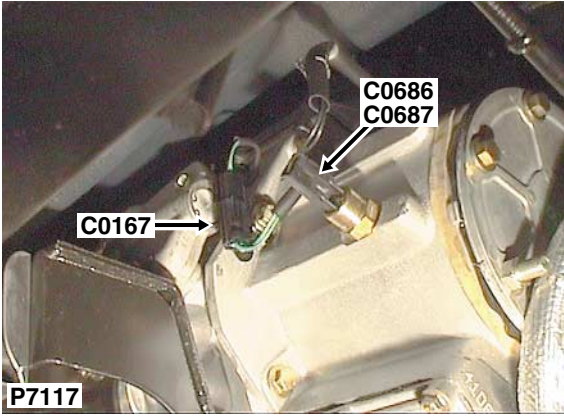

| Cav | Col | Cct |
|-----|-----|-----|
| 1   | BLG | ALL |

Description: *Switch-Temperature-Transfer box oil*

Location: *LH side of transfer box*

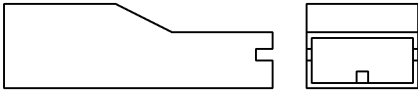

AAU1010

Colour: *BLACK*

Gender: *Female*

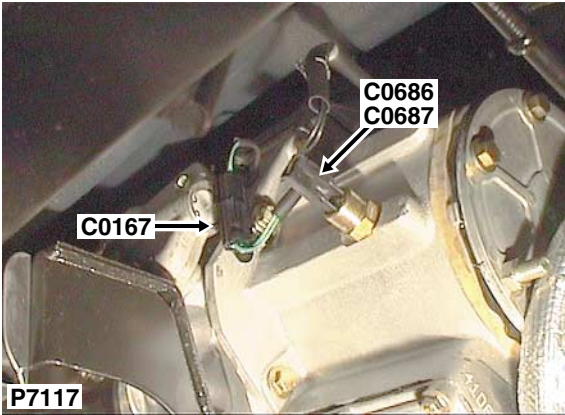

| Cav | Col | Cct |
|-----|-----|-----|
| 1   | B   | ALL |

Description: *Switch-Temperature-Transfer box oil*  
 Location: *LH side of transfer box*

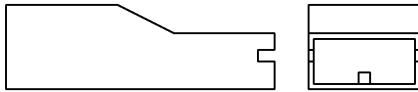

AAU1010

Colour: *BLACK*  
 Gender: *Female*

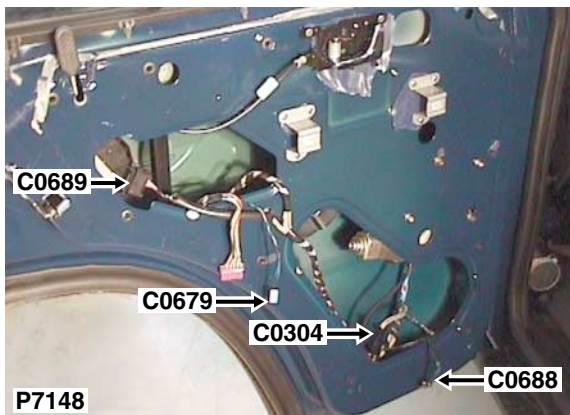

| Cav | Col | Cct |
|-----|-----|-----|
| 1   | BG  | ALL |
| 2   | BU  | ALL |

Description: *Speakers-Low range*

Location: *Behind rear door trim panel*

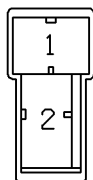

AFU3199

Colour: *BLACK*

Gender: *Female*

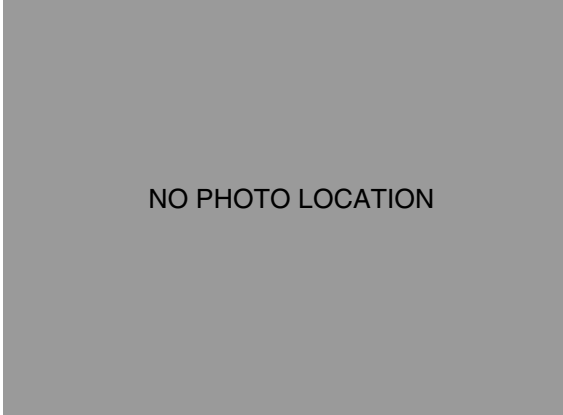

| Cav | Col | Cct |
|-----|-----|-----|
| 1   | BK  | 25  |
| 2   | BR  | 25  |

Description: *Speakers-Low range*  
Location: *Behind front door trim panel*

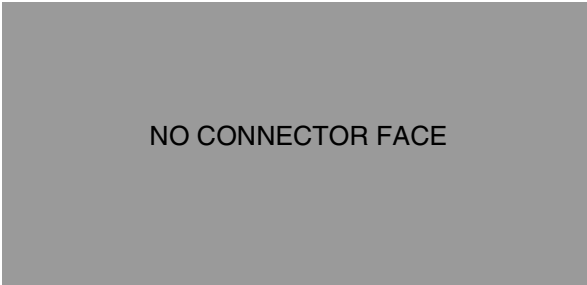

Colour:  
Gender:

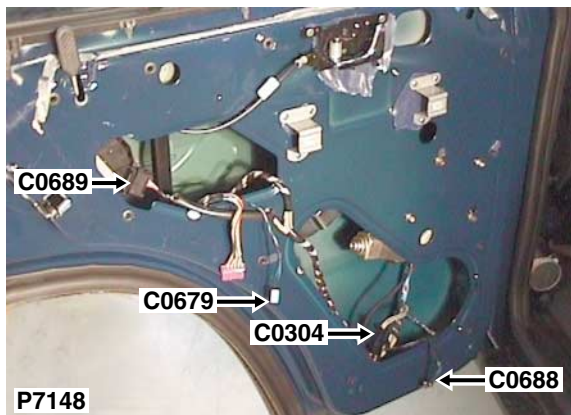

| Cav | Col | Cct |
|-----|-----|-----|
| 4   | KR  | ALL |
| 5   | B   | ALL |
| 6   | PLG | ALL |
| 7   | KP  | ALL |
| 8   | KS  | ALL |

Description: *Motor-Door lock-Rear-LH*  
 Location: *Behind rear door trim panel*

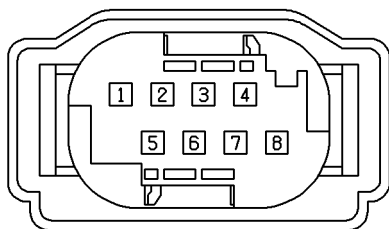

YPC108040

Colour: *BLACK*  
 Gender: *Female*

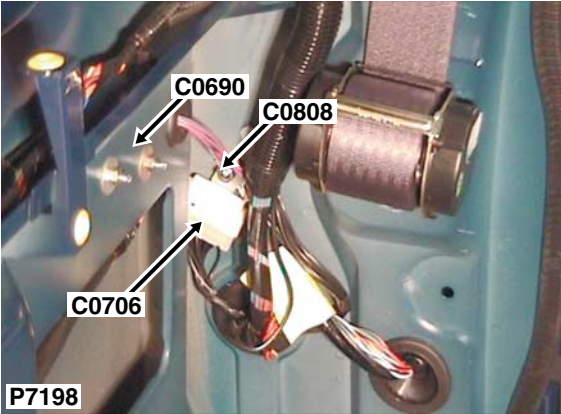

| Cav | Col | Cct |
|-----|-----|-----|
| 1   | RU  | ALL |
| 2   | PR  | ALL |

Description: *Solenoid-Fuel flap release*  
 Location: *Behind RH rear trim panel*

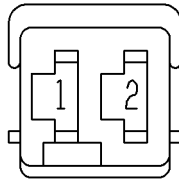

YPC10159

Colour: *NATURAL*  
 Gender: *Female*

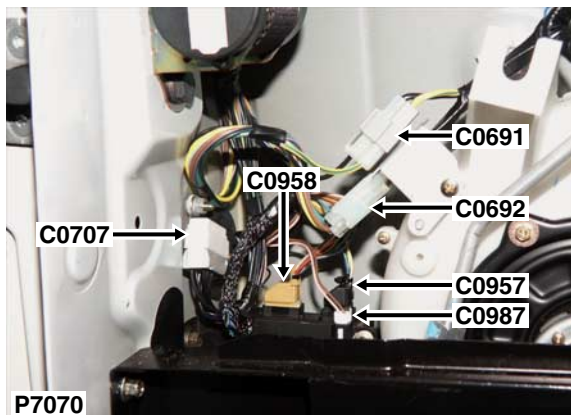

| Cav | Col | Cct |
|-----|-----|-----|
| 1   | B   | 17  |
| 2   | YG  | 17  |

Description: *Rear A/C harness to body harness*

Location: *Luggage compartment - LH side*



YPC107600

Colour: *NATURAL*

Gender: *Female*

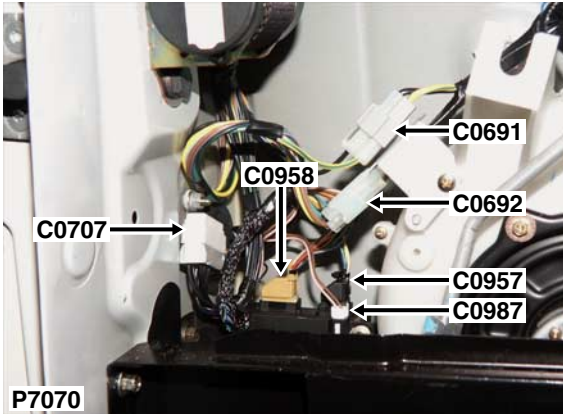

Description: *Rear A/C harness to body harness*

Location: *Luggage compartment - LH side*

| Cav | Col | Cct |
|-----|-----|-----|
| 2   | PG  | 17  |
| 3   | WG  | 17  |
| 4   | GK  | 17  |
| 5   | BG  | 17  |
| 6   | N   | 17  |
| 7   | Y   | 17  |
| 8   | G   | 17  |

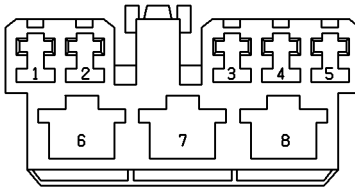

YPC111830

Colour: *NATURAL*

Gender: *Female*



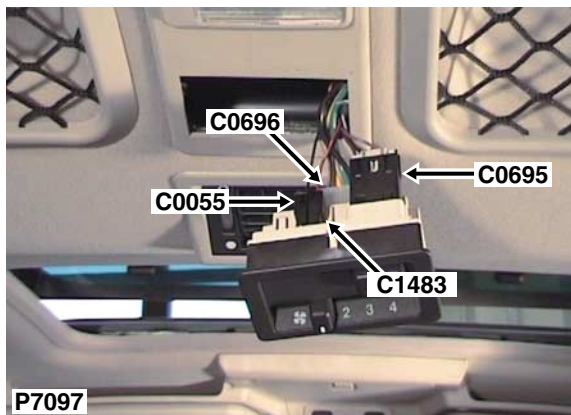

Description: *Switch-Air Conditioning (A/C)-Rear*

Location: *Behind centre headlining*

| Cav | Col | Cct |
|-----|-----|-----|
| 1   | BR  | 17  |
| 2   | B   | 17  |
| 3   | RB  | 17  |
| 4   | PG  | 17  |
| 5   | WG  | 17  |

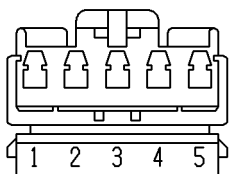

YPC10524

Colour: *WHITE*

Gender: *Female*

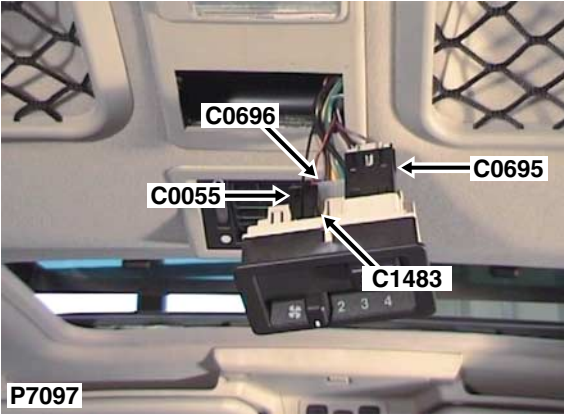

| Cav | Col | Cct |
|-----|-----|-----|
| 1   | BR  | 17  |
| 2   | N   | 17  |
| 3   | Y   | 17  |
| 4   | G   | 17  |
| 5   | B   | 17  |

Description: *Switch-Blower-Rear*  
 Location: *Behind centre headlining*

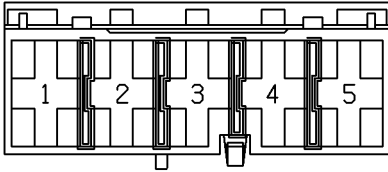

YPC108000

Colour: *NATURAL*  
 Gender: *Female*

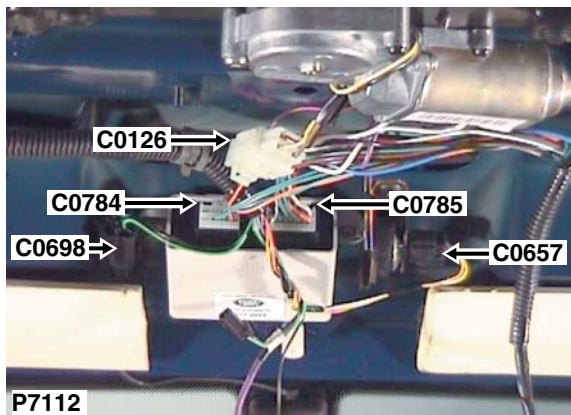

Description: *Mirror-interior*

Location: *Front of headlining in the centre*

| Cav | Col | Cct |
|-----|-----|-----|
| 1   | GN  | ALL |
| 3   | LGW | ALL |
| 10  | B   | ALL |

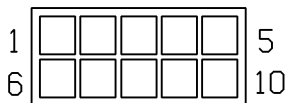

YPC111780

Colour: *BLACK*

Gender: *Female*

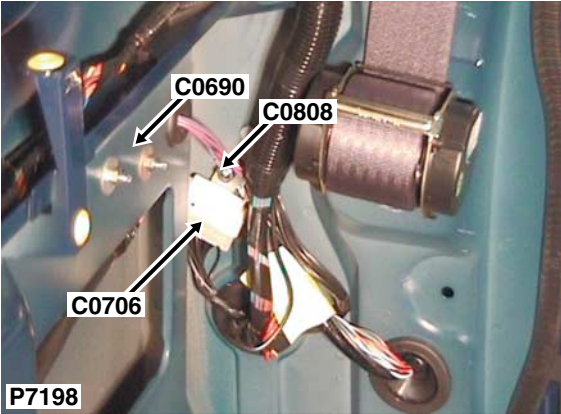

| Cav | Col | Cct |
|-----|-----|-----|
| 1   | B   | ALL |
| 2   | B   | ALL |
| 3   | B   | ALL |
| 4   | B   | ALL |
| 5   | B   | ALL |
| 6   | B   | ALL |
| 7   | B   | ALL |
| 8   | B   | ALL |
| 9   | B   | 34  |

Description: *Header -Earth*  
 Location: *Behind RH rear trim panel*

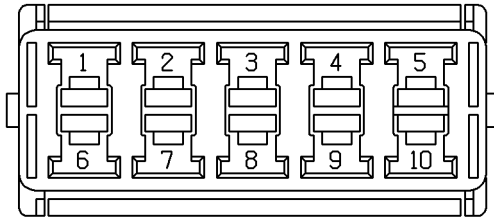

YPC10611

Colour: *LIGHT GREY*  
 Gender: *Female*

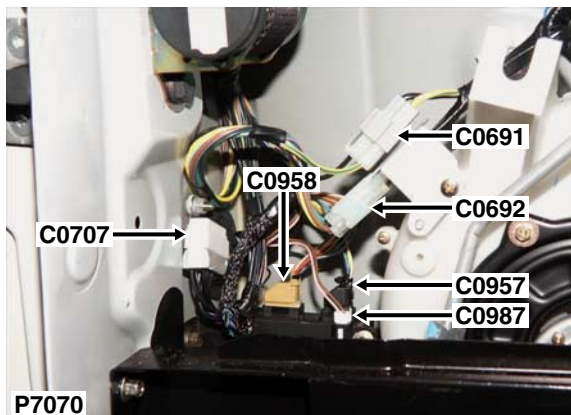

Description: *Header -Earth*

Location: *Luggage compartment - LH side*

| Cav | Col | Cct |
|-----|-----|-----|
| 1   | B   | 17  |
| 2   | B   | ALL |
| 3   | B   | 17  |
| 4   | B   | ALL |
| 5   | B   | ALL |
| 6   | B   | ALL |
| 7   | B   | ALL |
| 8   | B   | 34  |
| 9   | B   | ALL |
| 10  | B   | 24  |

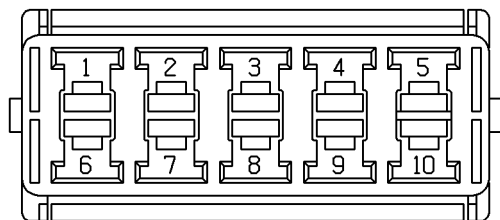

YPC10611

Colour: *LIGHT GREY*

Gender: *Female*

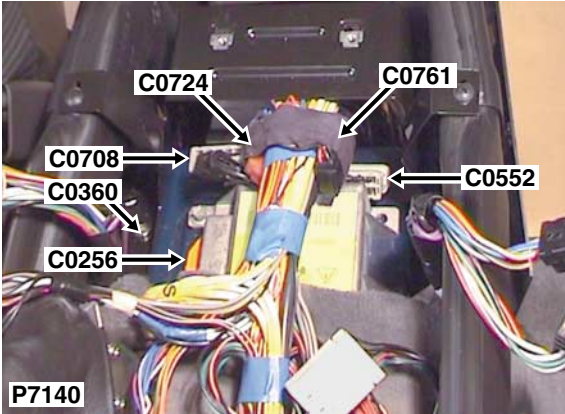

| Cav | Col | Cct |
|-----|-----|-----|
| 1   | B   | 24  |
| 2   | B   | 9   |
| 3   | B   | 9   |
| 4   | B   | 42  |
| 5   | B   | 42  |
| 6   | B   | 42  |
| 7   | B   | 42  |
| 8   | B   | ALL |
| 9   | B   | ALL |
| 10  | B   | 9   |

Description: *Header -Earth*  
 Location: *Beneath centre console*

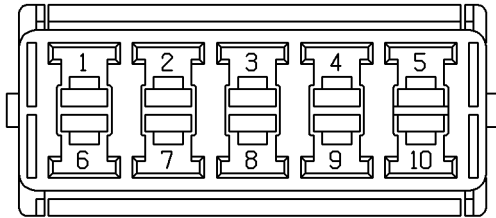

YPC10611

Colour: *LIGHT GREY*  
 Gender: *Female*

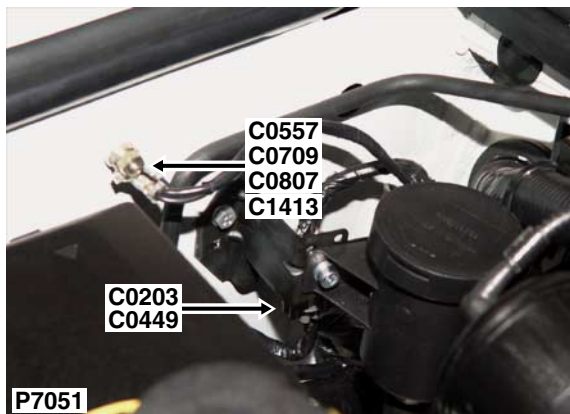

Description: *Header -Earth*

Location: *Rear RH side of engine compartment*

NO CONNECTOR FACE

Colour:

Gender:

| Cav | Col | Cct |
|-----|-----|-----|
| 1   | N   | 22  |



| Cav | Col | Cct |
|-----|-----|-----|
| 1   | NY  | ALL |
| 2   | N   | ALL |

Description: *Sensor-Air temperature-Fuel burning heater*

Location: *Behind the front grille*

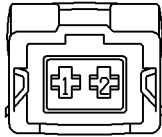

YPC107790

Colour: *BLACK*

Gender: *Female*





| Cav | Col | Cct |
|-----|-----|-----|
| 1   | NY  | ALL |
| 2   | NY  | ALL |

Description: *Sensor-Air temperature-Fuel burning heater*

Location: *Behind the front grille*

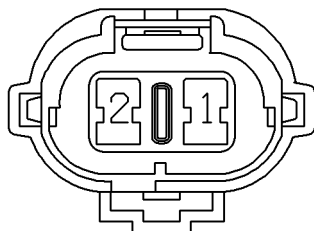

AFU3584

Colour: *NATURAL*

Gender: *Male*



| Cav | Col | Cct |
|-----|-----|-----|
| 1   | SP  | ALL |
| 2   | B   | ALL |
| 3   | WB  | ALL |
| 4   | SP  | ALL |

Description: *Module-Ultrasonic-Rear*  
 Location: *Behind RH rear trim panel*

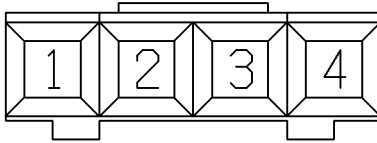

YPC10199

Colour: *BLACK*  
 Gender: *Female*

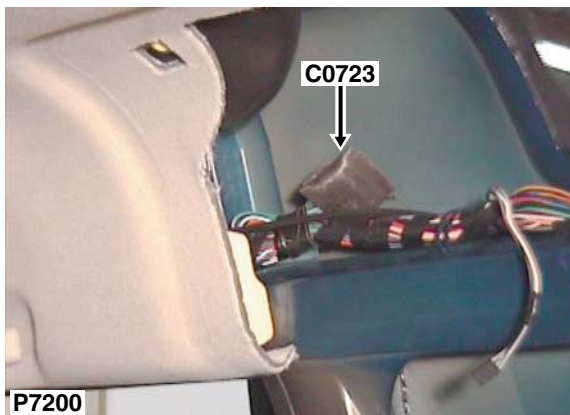

Description: *Header*

Location: *Behind RH rear trim panel*

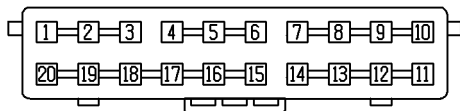

YQC10007

Colour: *BLACK*

Gender: *Female*

| Cav | Col | Cct |
|-----|-----|-----|
| 1   | RO  | ALL |
| 2   | RO  | ALL |
| 3   | RO  | ALL |
| 4   | GW  | ALL |
| 5   | GW  | ALL |
| 6   | GW  | ALL |
| 7   | PU  | ALL |
| 8   | PU  | ALL |
| 9   | PU  | ALL |
| 10  | PU  | ALL |
| 11  | GP  | ALL |
| 12  | GP  | ALL |
| 13  | GP  | ALL |
| 14  | GP  | ALL |
| 15  | P   | ALL |
| 16  | P   | ALL |
| 18  | P   | ALL |
| 20  | P   | ALL |

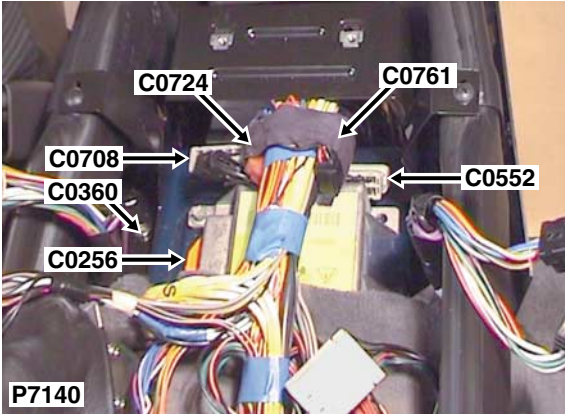

Description: *Header*

Location: *Beneath centre console*

| Cav | Col | Cct |
|-----|-----|-----|
| 1   | RB  | ALL |
| 2   | RB  | ALL |
| 3   | RB  | ALL |
| 4   | RB  | 9   |
| 5   | OP  | 43  |
| 6   | OP  | 43  |
| 7   | OP  | 43  |
| 8   | UP  | 9   |
| 9   | UP  | 9   |
| 10  | UP  | 9   |
| 11  | UB  | 9   |
| 12  | UB  | 9   |
| 13  | UB  | 9   |
| 14  | UW  | 9   |
| 15  | UW  | 9   |
| 16  | UW  | 9   |
| 18  | UG  | 9   |
| 19  | UG  | 9   |
| 20  | UG  | 9   |

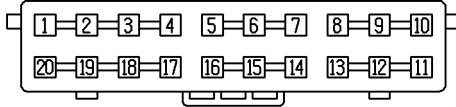

YQC10003

Colour: *ORANGE*

Gender: *Female*

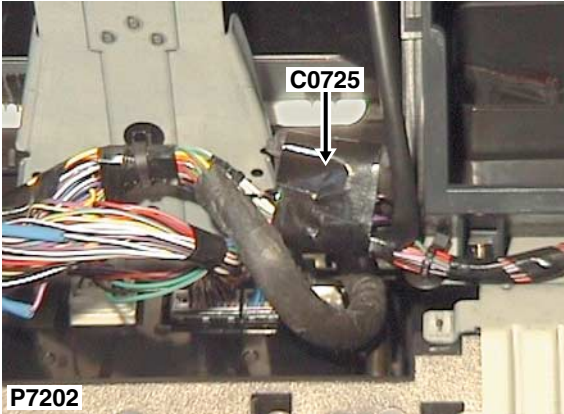

Description: *Header*

Location: *Behind RH side of fascia*

| Cav | Col | Cct |
|-----|-----|-----|
| 1   | P   | ALL |
| 2   | P   | ALL |
| 6   | P   | ALL |
| 7   | P   | 15  |
| 8   | P   | 31  |
| 9   | B   | ALL |
| 10  | B   | ALL |
| 11  | B   | 16  |
| 12  | B   | ALL |
| 13  | B   | ALL |
| 14  | B   | ALL |
| 15  | B   | ALL |
| 16  | B   | ALL |
| 17  | B   | ALL |
| 18  | B   | ALL |
| 19  | B   | ALL |
| 20  | B   | ALL |

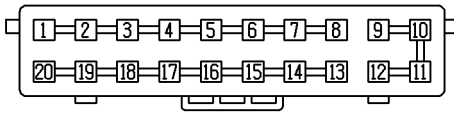

YQC10002

Colour: *GREY*

Gender: *Female*

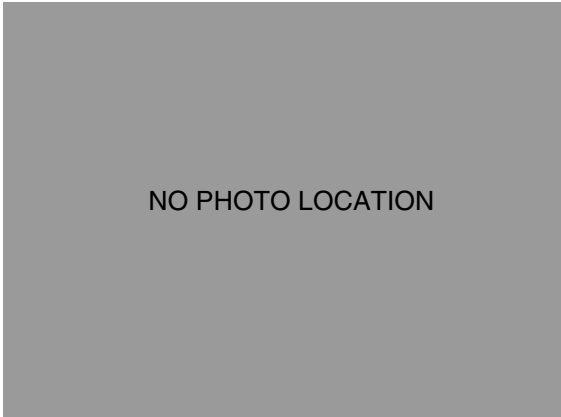

| Cav | Col | Cct |
|-----|-----|-----|
| 1   | BG  | ALL |
| 2   | BU  | ALL |

Description: *Speakers-Low range*  
Location: *Behind rear door trim panel*

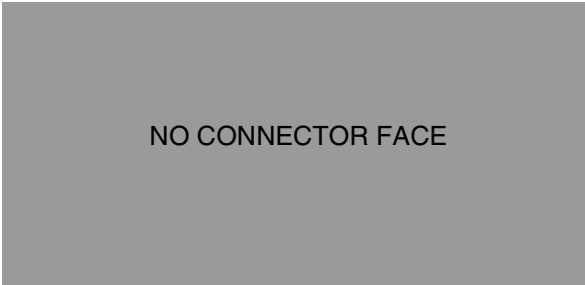

Colour:  
Gender:

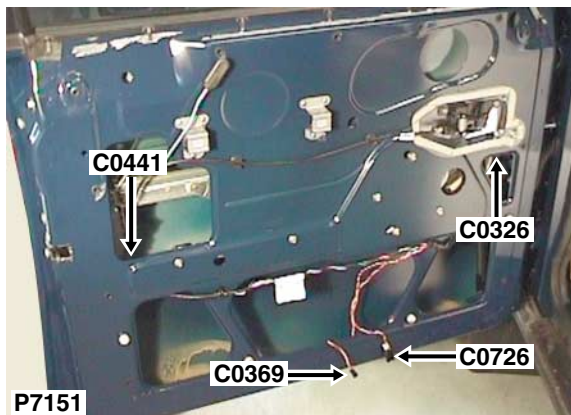

| Cav | Col | Cct |
|-----|-----|-----|
| 1   | BK  | ALL |
| 2   | BR  | ALL |

Description: *Speakers-Low range*

Location: *Behind front door trim panel*

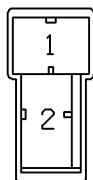

AFU3199

Colour: *BLACK*

Gender: *Female*

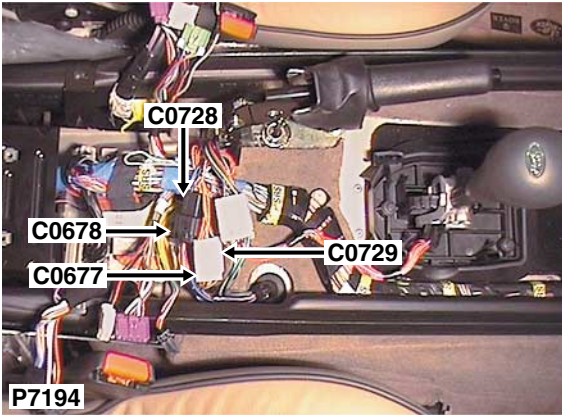

| Cav | Col | Cct |
|-----|-----|-----|
| 1   | B   | 9   |
| 2   | R   | 9   |
| 3   | W   | 9   |
| 4   | UG  | 9   |
| 5   | UW  | 9   |
| 6   | UB  | 9   |
| 7   | UP  | 9   |
| 8   | BK  | ALL |
| 9   | RK  | 9   |
| 10  | RU  | ALL |

Description: *Main harness to gearbox harness*  
 Location: *Beneath centre console*

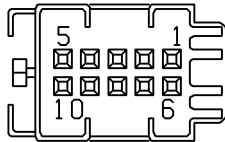

YPC114560

Colour: *BLACK*  
 Gender: *Male*



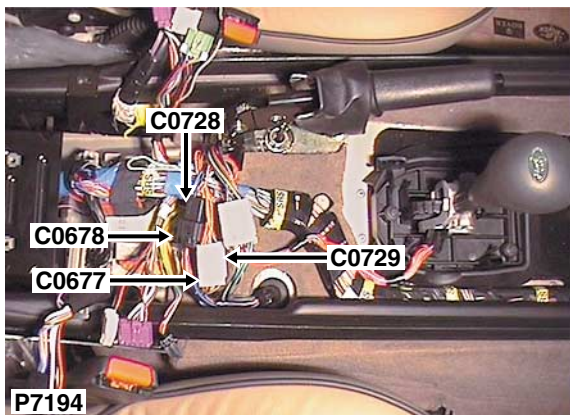

| Cav | Col | Cct |
|-----|-----|-----|
| 1   | OP  | 9   |
| 2   | OG  | 9   |
| 3   | OLG | 9   |
| 4   | OW  | 9   |
| 6   | SO  | 9   |

Description: *Main harness to gearbox harness*

Location: *Beneath centre console*

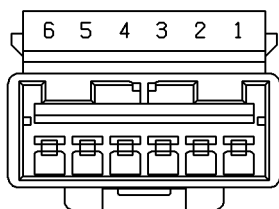

YPC10315

Colour: *WHITE*

Gender: *Male*

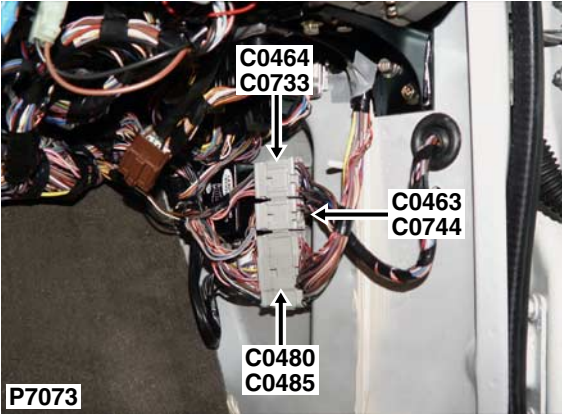

Description: *Door harness to main harness*  
 Location: *RH 'A' post*

| Cav | Col | Cct |
|-----|-----|-----|
| 1   | PW  | ALL |
| 2   | B   | ALL |
| 3   | SW  | ALL |
| 4   | KP  | ALL |
| 5   | KR  | ALL |
| 6   | NP  | ALL |
| 7   | BK  | ALL |
| 8   | BU  | ALL |
| 9   | KS  | ALL |
| 10  | US  | ALL |
| 11  | O   | 40  |
| 12  | OR  | 40  |

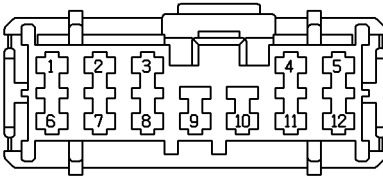

YPC10494

Colour: *LIGHT GREY*  
 Gender: *Female*

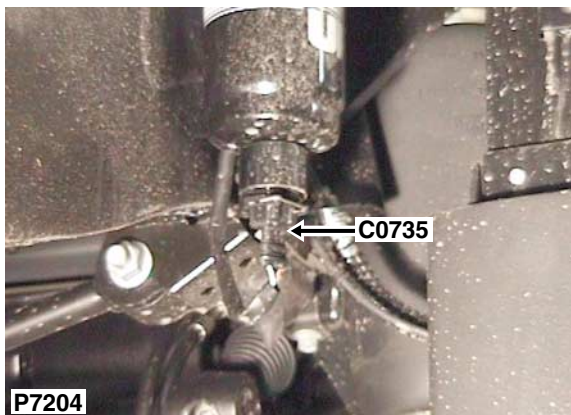

| Cav | Col | Cct |
|-----|-----|-----|
| 1   | OG  | 2   |
| 2   | B   | 2   |
| 3   | WP  | 2   |

Description: *Sensor-Water filter*

Location: *Below RH rear wheelarch*

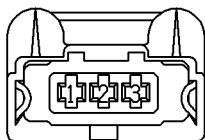

YPC107900

Colour: *BLACK*

Gender: *Female*

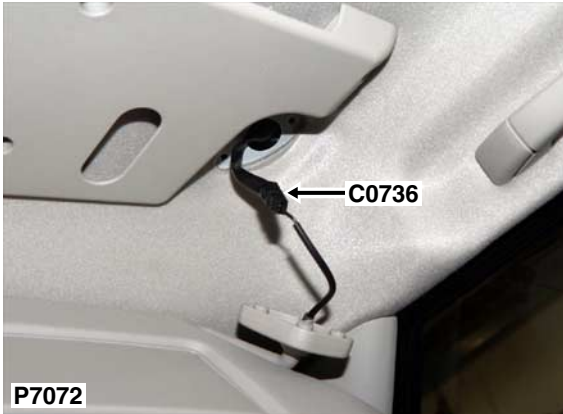

| Cav | Col | Cct |
|-----|-----|-----|
| 1   | LGW | 34  |
| 2   | B   | 34  |

Description: *Mirror-Vanity-RH*

Location: *Headlining - front RH side*

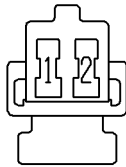

YPC10225

Colour: *BLACK*

Gender: *Female*

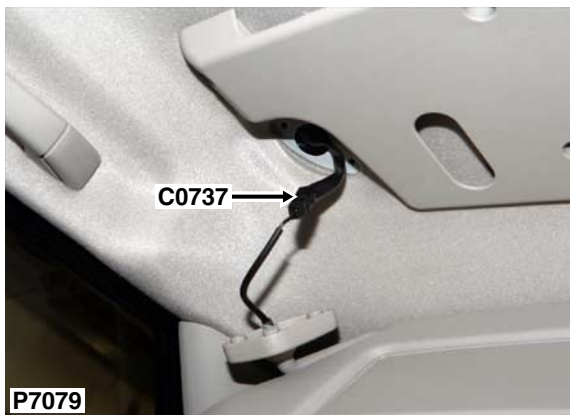

| Cav | Col | Cct |
|-----|-----|-----|
| 1   | LGW | 34  |
| 2   | B   | 34  |

Description: *Mirror-Vanity-LH*

Location: *Headlining - front LH side*

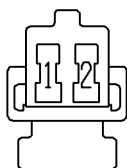

YPC10225

Colour: *BLACK*

Gender: *Female*

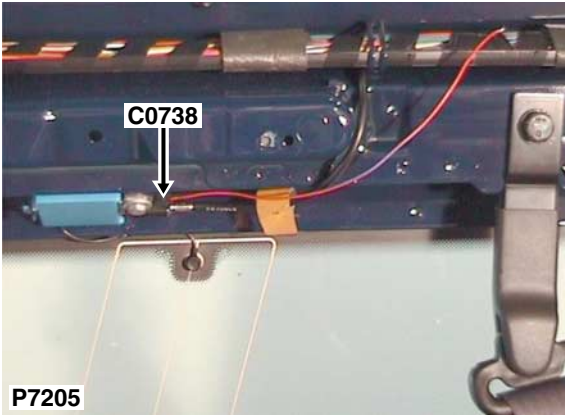

| Cav | Col | Cct |
|-----|-----|-----|
| 1   | RU  | 24  |

Description: *Amplifier-Aerial*  
 Location: *Behind LH rear trim panel*

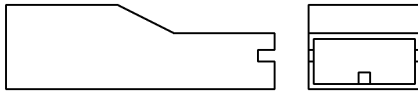

AAU1010

Colour: *BLACK*  
 Gender: *Female*

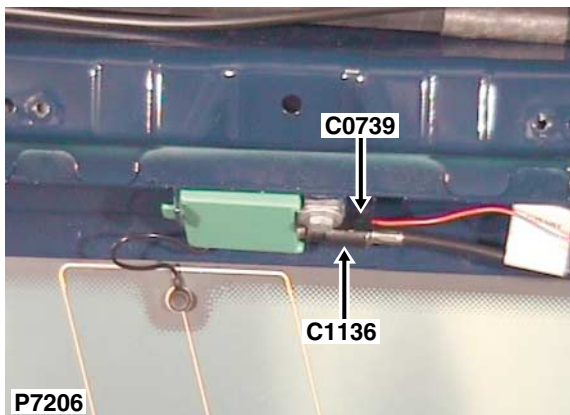

| Cav | Col | Cct |
|-----|-----|-----|
| 1   | RU  | 24  |
| 1   | LGO | ALL |

Description: *Amplifier-Aerial*

Location: *Behind RH rear trim panel*

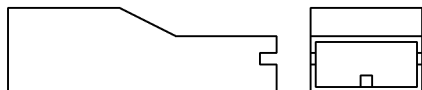

AAU1010

Colour: *BLACK*

Gender: *Female*

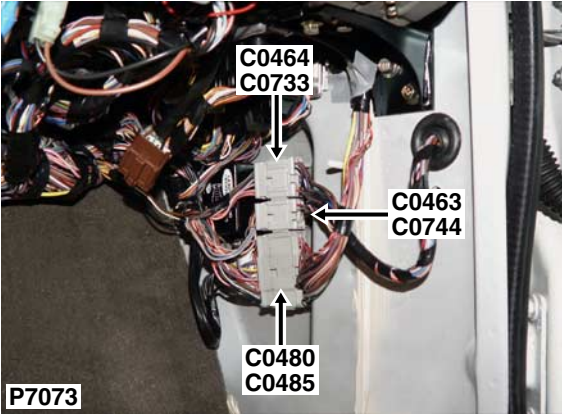

Description: Door harness to main harness  
 Location: RH 'A' post

| Cav | Col | Cct |
|-----|-----|-----|
| 1   | KB  | 25  |
| 1   | RB  | 26  |
| 2   | RB  | 25  |
| 2   | KB  | 26  |
| 3   | BR  | 25  |
| 3   | BK  | ALL |
| 4   | BK  | 25  |
| 4   | BR  | ALL |
| 5   | UG  | ALL |
| 6   | SU  | ALL |
| 7   | SK  | ALL |

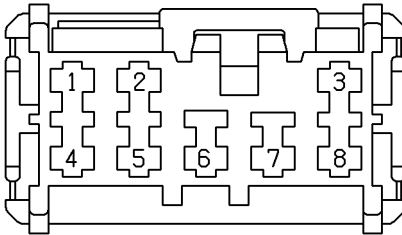

YPC10492

Colour: LIGHT GREY  
 Gender: Female





| Cav | Col | Cct |
|-----|-----|-----|
| 1   | PS  | ALL |
| 2   | B   | ALL |
| 4   | PR  | ALL |
| 5   | RN  | ALL |

Description: *Switch-Fuel flap release*

Location: *Adjacent instrument pack*

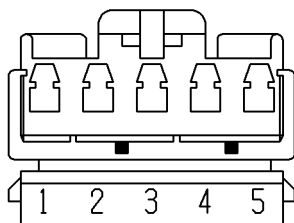

YPC10526

Colour: *GREEN*

Gender: *Female*



| Cav | Col | Cct |
|-----|-----|-----|
| 1   | GLG | ALL |
| 2   | RN  | ALL |
| 4   | WY  | ALL |
| 5   | B   | ALL |

**P7099**

Description: *Switch-Cruise control*  
 Location: *Behind instrument pack surround RH side*

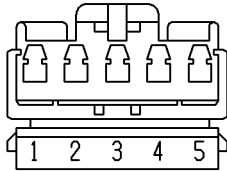

YPC10524

Colour: *WHITE*  
 Gender: *Female*

# C0750

## CONNECTOR DETAILS

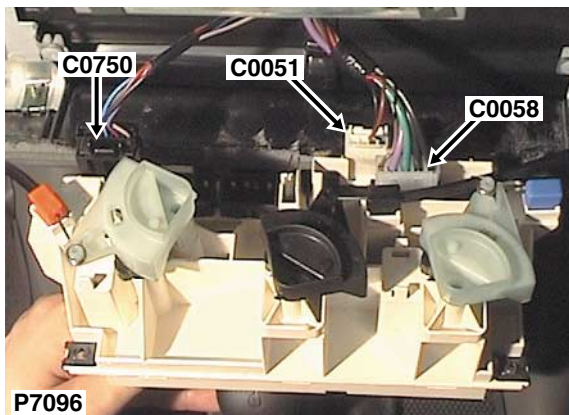

| Cav | Col | Cct |
|-----|-----|-----|
| 1   | B   | 16  |
| 2   | RN  | 16  |
| 3   | UB  | 16  |
| 4   | RU  | 16  |
| 5   | GK  | 16  |

Description: *Switch-Fresh/recirculated air*

Location: *Behind heater control panel*

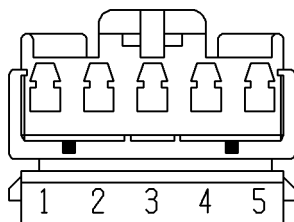

YPC10523

Colour: *BLACK*

Gender: *Female*

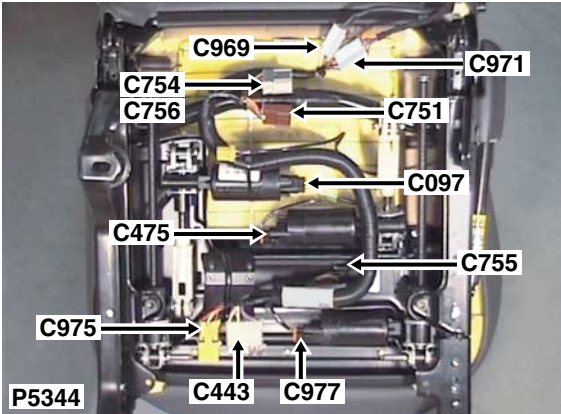

Description: *Seat link harness to main harness*

Location: *Underside of front passenger's seat*

| Cav | Col | Cct |
|-----|-----|-----|
| 1   | OW  | 43  |
| 2   | B   | 43  |
| 4   | OP  | 43  |
| 5   | NP  | 43  |

NO CONNECTOR FACE

Colour: *BROWN*

Gender: *Male*

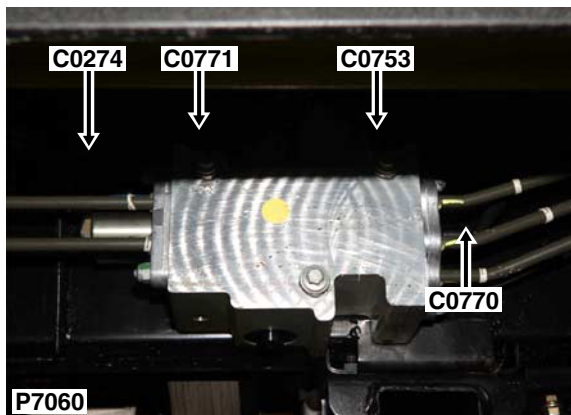

| Cav | Col | Cct |
|-----|-----|-----|
| 1   | OG  | 10  |
| 2   | GR  | 10  |

Description: *Main harness to gearbox harness*

Location: *Beneath vehicle - RH side*

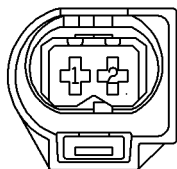

YPC113410

Colour: *BLACK*

Gender: *Female*

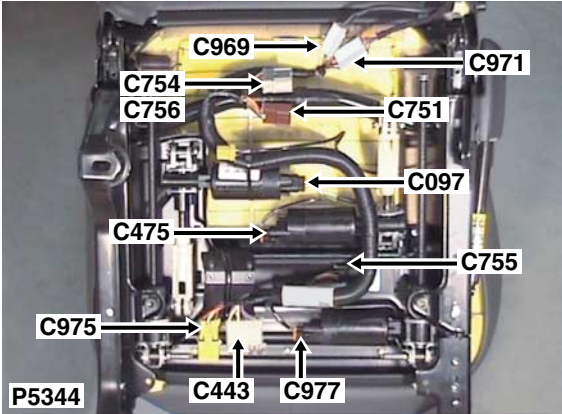

Description: *Seat cushion harness to seat link harness*  
 Location: *Underside of front passenger's seat*

| Cav | Col | Cct |
|-----|-----|-----|
| 1   | WR  | 43  |
| 2   | GY  | 43  |
| 3   | R   | 43  |
| 4   | O   | 43  |
| 5   | S   | 43  |
| 6   | W   | 43  |
| 7   | Y   | 43  |
| 9   | U   | 43  |
| 10  | P   | 43  |
| 11  | PS  | 43  |
| 12  | B   | 43  |



Colour: *LIGHT GREY*  
 Gender: *Male*

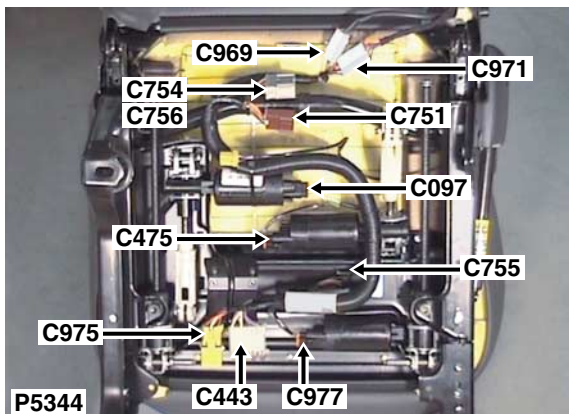

| Cav | Col | Cct |
|-----|-----|-----|
| 2   | W   | 43  |
| 3   | 0   | 43  |
| 4   | K   | 43  |
| 5   | LG  | 43  |
| 6   | B   | 43  |

Description: *Module-seat heater*

Location: *Underside of front passenger's seat*

NO CONNECTOR FACE

Colour: *BLACK*

Gender:

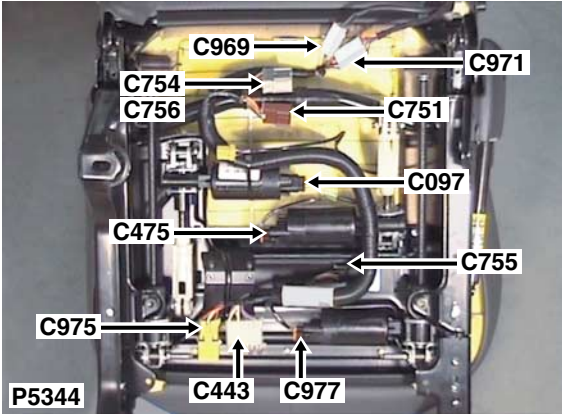

Description: *Seat cushion harness to seat link harness*  
 Location: *Underside of front passenger's seat*

| Cav | Col | Cct |
|-----|-----|-----|
| 1   | WR  | 43  |
| 2   | GY  | 43  |
| 3   | R   | 43  |
| 4   | O   | 43  |
| 5   | S   | 43  |
| 6   | W   | 43  |
| 7   | Y   | 43  |
| 8   | NY  | 43  |
| 9   | U   | 43  |
| 10  | P   | 43  |
| 11  | PS  | 43  |
| 12  | B   | 43  |

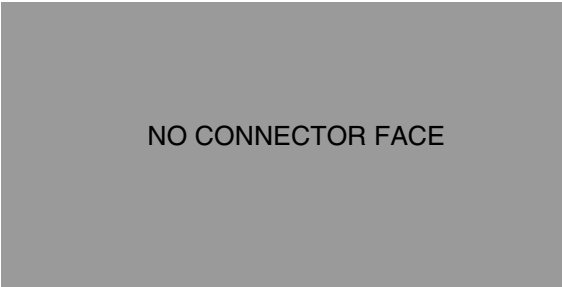

Colour: *LIGHT GREY*  
 Gender: *Male*



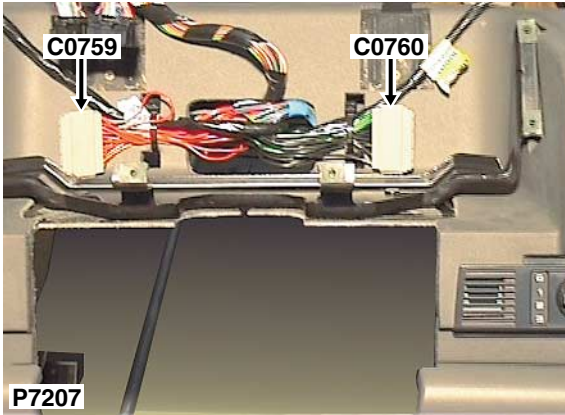

Description: *Header*

Location: *Behind instrument pack*

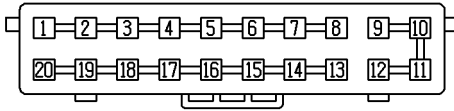

YQC10002

Colour: *GREY*  
 Gender: *Female*

| Cav | Col | Cct |
|-----|-----|-----|
| 1   | RN  | ALL |
| 2   | RN  | ALL |
| 3   | RN  | ALL |
| 4   | RN  | ALL |
| 5   | RN  | ALL |
| 6   | RN  | 16  |
| 7   | RN  | 35  |
| 8   | RN  | ALL |
| 9   | RO  | ALL |
| 10  | RB  | ALL |
| 11  | RO  | 36  |
| 12  | RO  | ALL |
| 13  | RN  | 36  |
| 13  | RO  | 46  |
| 14  | RN  | ALL |
| 15  | RN  | ALL |
| 16  | RN  | ALL |
| 17  | RN  | ALL |
| 18  | RN  | ALL |
| 19  | RN  | ALL |
| 20  | RN  | ALL |

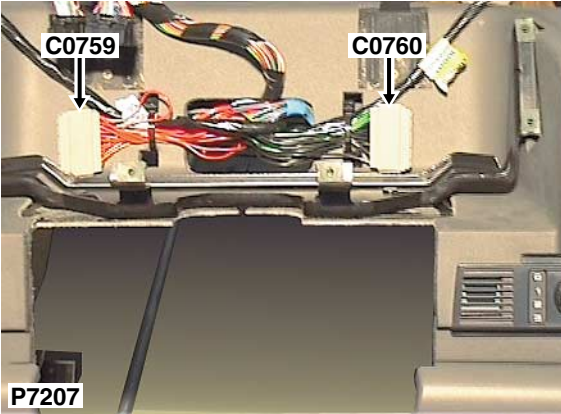

Description: *Header*

Location: *Behind instrument pack*

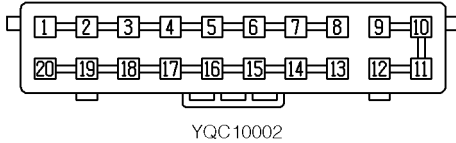

Colour: *GREY*  
 Gender: *Female*

| Cav | Col | Cct |
|-----|-----|-----|
| 1   | B   | ALL |
| 2   | B   | ALL |
| 3   | B   | 36  |
| 4   | B   | ALL |
| 5   | B   | ALL |
| 6   | B   | ALL |
| 7   | B   | ALL |
| 8   | B   | ALL |
| 9   | LG  | ALL |
| 10  | LG  | ALL |
| 11  | LG  | ALL |
| 13  | B   | ALL |
| 14  | B   | ALL |
| 15  | B   | ALL |
| 16  | B   | ALL |
| 17  | B   | 15  |
| 18  | B   | 35  |
| 19  | B   | ALL |
| 20  | B   | ALL |

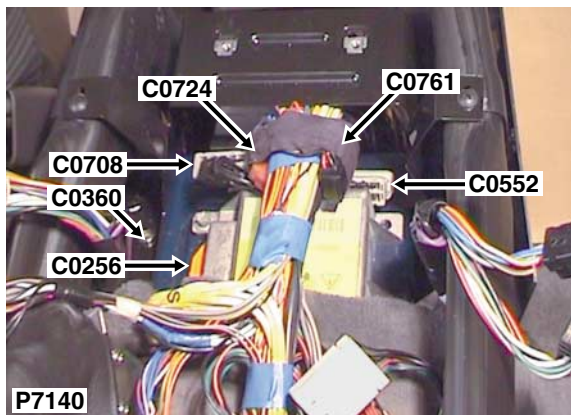

Description: *Header*

Location: *Beneath centre console*

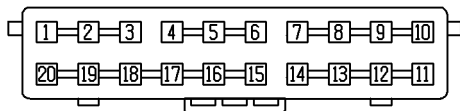

YQC10007

Colour: *BLACK*

Gender: *Female*

| Cav | Col | Cct |
|-----|-----|-----|
| 1   | BU  | ALL |
| 2   | BU  | ALL |
| 3   | BU  | ALL |
| 4   | UG  | 9   |
| 4   | RU  | 24  |
| 5   | UG  | 9   |
| 5   | RU  | 24  |
| 6   | UG  | 9   |
| 6   | RU  | 24  |
| 7   | KR  | ALL |
| 8   | KR  | ALL |
| 9   | KR  | ALL |
| 11  | LGW | 42  |
| 12  | LGW | 42  |
| 13  | LGW | 42  |
| 15  | RN  | 42  |
| 16  | RN  | 42  |
| 17  | RN  | ALL |
| 18  | RN  | ALL |
| 19  | RN  | ALL |
| 20  | RN  | ALL |

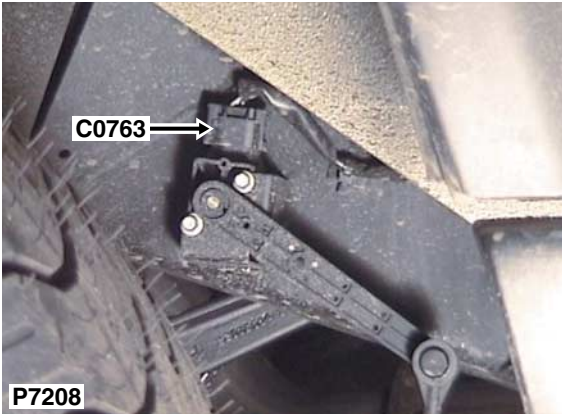

| Cav | Col | Cct |
|-----|-----|-----|
| 1   | SO  | 13  |
| 4   | SB  | 13  |
| 5   | SG  | 13  |

Description: *Sensor-Height-RH*

Location: *Below RH rear wheelarch*

NO CONNECTOR FACE

Colour: *BLACK*

Gender: *Female*

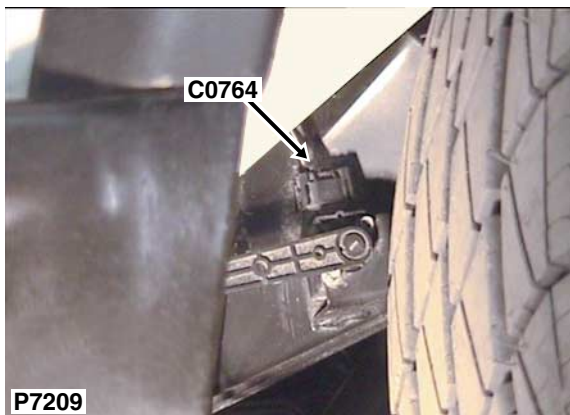

| Cav | Col | Cct |
|-----|-----|-----|
| 1   | SU  | 13  |
| 4   | SR  | 13  |
| 5   | SY  | 13  |

Description: *Sensor-Height-LH*

Location: *Below LH rear wheelarch*

NO CONNECTOR FACE

Colour: *BLACK*

Gender: *Female*

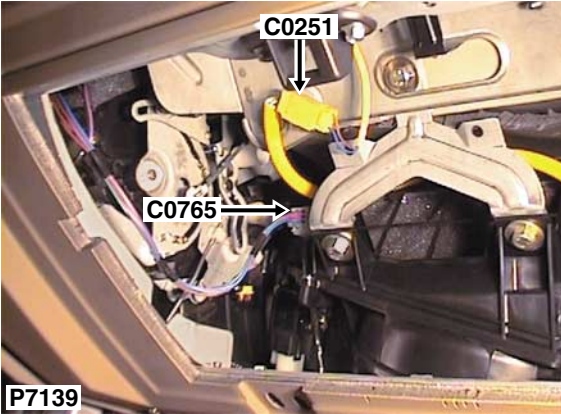

| Cav | Col | Cct |
|-----|-----|-----|
| 1   | GR  | ALL |
| 2   | N   | 15  |
| 3   | PG  | 15  |
| 4   | G   | 15  |
| 5   | UR  | 15  |
| 6   | RG  | 15  |
| 7   | UB  | 15  |

Description: *Fascia harness to heater harness*  
 Location: *Behind glovebox*

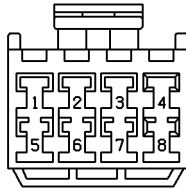

AFU3574

Colour: *NATURAL*  
 Gender: *Female*



| Cav | Col | Cct |
|-----|-----|-----|
| 1   | BO  | 16  |
| 2   | G   | 16  |
| 3   | PU  | 16  |
| 4   | N   | 16  |
| 5   | GR  | 16  |
| 6   | UB  | 16  |
| 7   | B   | 16  |
| 8   | RG  | 16  |

Description: *Fascia harness to heater harness*

Location: *Behind LH side of fascia*

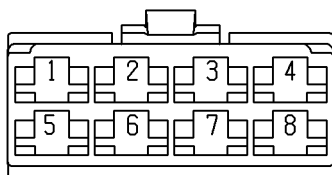

YPC111880

Colour: *NATURAL*

Gender: *Female*



Description: *Fascia harness to heater harness*  
 Location: *Behind glovebox*

| Cav | Col | Cct |
|-----|-----|-----|
| 1   | RU  | 15  |
| 2   | PB  | 15  |
| 3   | GR  | 15  |
| 4   | YG  | 15  |
| 5   | SU  | 15  |
| 6   | UY  | 15  |
| 7   | BW  | 15  |
| 8   | UW  | 15  |
| 9   | US  | 15  |
| 10  | UO  | 15  |
| 11  | GU  | 15  |
| 12  | PY  | 15  |
| 13  | Y   | 15  |

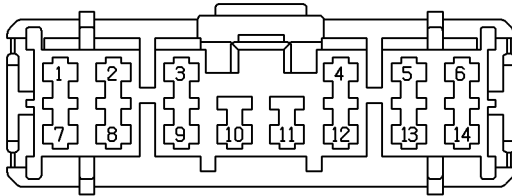

YPC10495

Colour: *LIGHT GREY*  
 Gender: *Female*



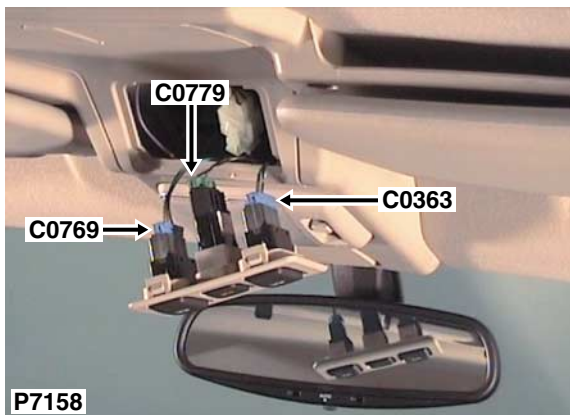

| Cav | Col | Cct |
|-----|-----|-----|
| 1   | B   | ALL |
| 3   | GU  | ALL |
| 4   | GO  | ALL |

Description: *Switch-Sunroof-Rear*

Location: *Front of headlining in the centre*

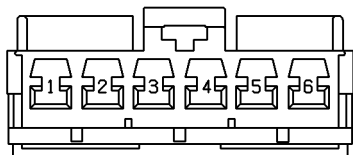

YPC113210

Colour: *BLUE*

Gender: *Female*

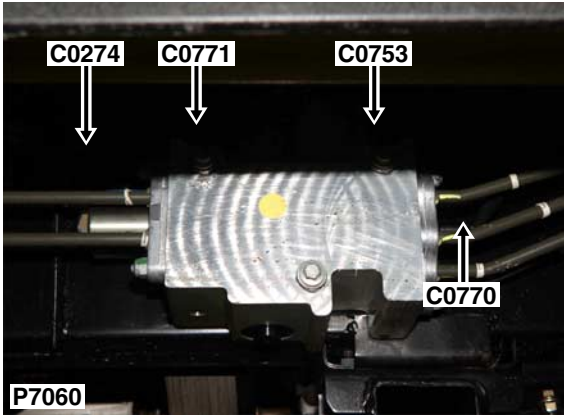

| Cav | Col | Cct |
|-----|-----|-----|
| 1   | UG  | 10  |
| 2   | KW  | 10  |
| 3   | KY  | 10  |

Description: *Block-Valve (ACE)*

Location: *Beneath vehicle - RH side*

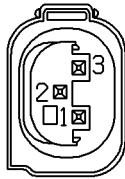

YPC110630

Colour: *BLUE*

Gender: *Female*

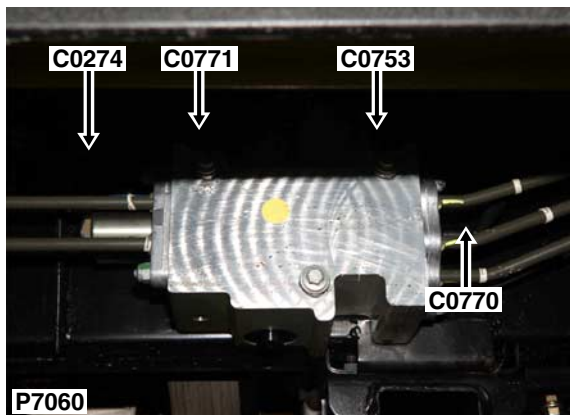

| Cav | Col | Cct |
|-----|-----|-----|
| 1   | YB  | 10  |
| 2   | GR  | 10  |

Description: *Block-Valve (ACE)*

Location: *Beneath vehicle - RH side*

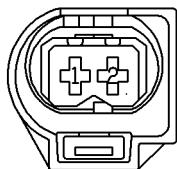

YPC113410

Colour: *BLACK*

Gender: *Female*

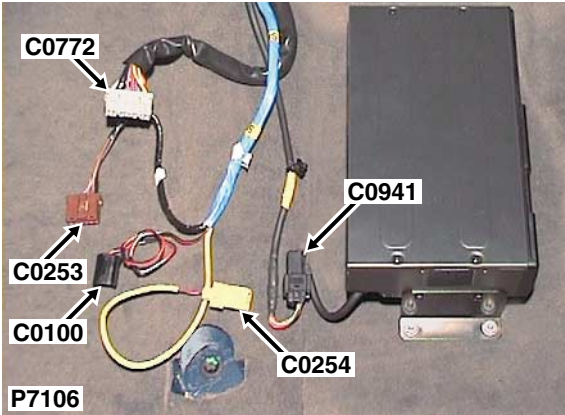

Description: *Seat cushion harness to seat link harness*  
 Location: *Beneath RH seat*

| Cav | Col | Cct |
|-----|-----|-----|
| 1   | WR  | 43  |
| 2   | GY  | 43  |
| 3   | R   | 43  |
| 4   | O   | 43  |
| 5   | S   | 43  |
| 6   | W   | 43  |
| 7   | Y   | 43  |
| 8   | NY  | 43  |
| 9   | U   | 43  |
| 10  | P   | 43  |
| 11  | PS  | 43  |
| 12  | B   | 43  |

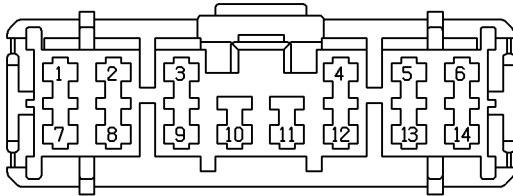

YPC10495

Colour: *LIGHT GREY*  
 Gender: *Female*



Description: *Switch pack-Seat*

Location: *Beneath centre console LH side*

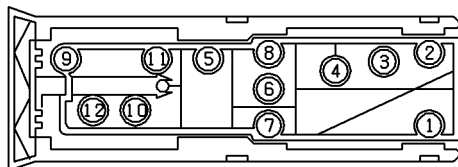

YPC119330

Colour: *BLACK*

Gender: *Female*

| Cav | Col | Cct |
|-----|-----|-----|
| 1   | W   | 43  |
| 1   | Y   | 43  |
| 2   | W   | 43  |
| 2   | Y   | 43  |
| 3   | GY  | 43  |
| 4   | R   | 43  |
| 5   | WR  | 43  |
| 6   | B   | 43  |
| 7   | NY  | 43  |
| 7   | U   | 43  |
| 8   | NY  | 43  |
| 8   | U   | 43  |
| 9   | PS  | 43  |
| 10  | O   | 43  |
| 11  | P   | 43  |
| 12  | S   | 43  |

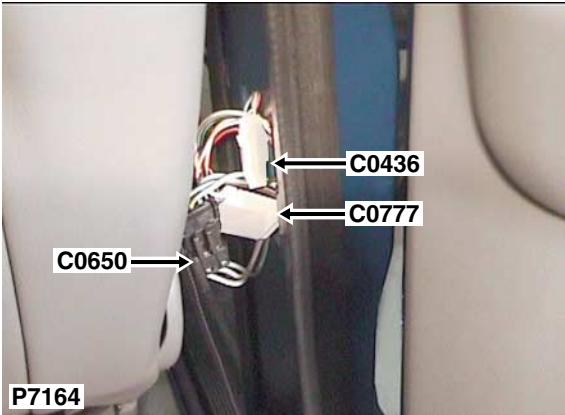

| Cav | Col | Cct |
|-----|-----|-----|
| 1   | KP  | ALL |
| 2   | KR  | ALL |
| 3   | PLG | ALL |
| 4   | B   | ALL |
| 5   | RB  | ALL |
| 6   | KS  | ALL |

Description: *Main harness to door harness*  
 Location: *In RH 'B' post*

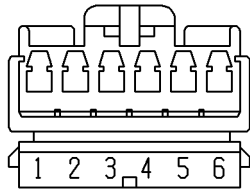

YPC10270

Colour: *WHITE*  
 Gender: *Female*

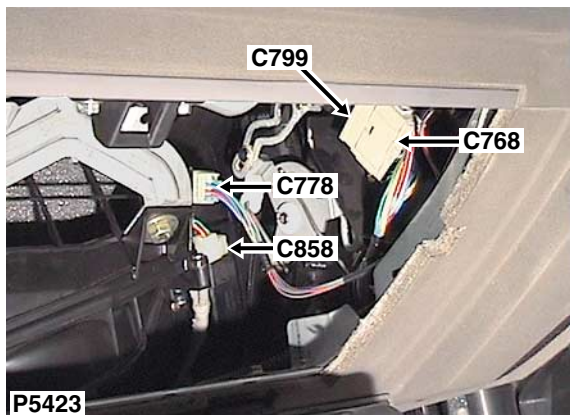

Description: *Air conditioning (A/C) harness to fascia harness - RHD*

Location: *Behind glovebox*

| Cav | Col | Cct |
|-----|-----|-----|
| 1   | LGW | 15  |
| 2   | N   | 15  |
| 3   | PG  | 15  |
| 4   | G   | 15  |
| 5   | UR  | 15  |
| 6   | RG  | 15  |
| 7   | UB  | 15  |

NO CONNECTOR FACE

Colour:

Gender: *Male*

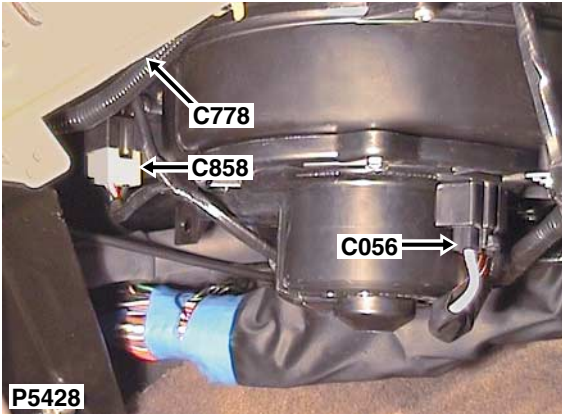

Description: Air conditioning (A/C) harness to fascia harness - LHD

Location: Under RH side of fascia

| Cav | Col | Cct |
|-----|-----|-----|
| 1   | LGW | 15  |
| 2   | N   | 15  |
| 3   | PG  | 15  |
| 4   | G   | 15  |
| 5   | UR  | 15  |
| 6   | RG  | 15  |
| 7   | UB  | 15  |

NO CONNECTOR FACE

Colour:

Gender: *Male*



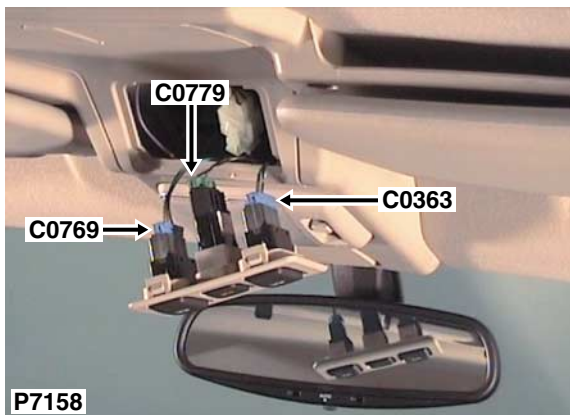

| Cav | Col | Cct |
|-----|-----|-----|
| 1   | B   | ALL |
| 4   | BS  | ALL |

Description: *Switch-Sunroof-Isolate*

Location: *Front of headlining in the centre*

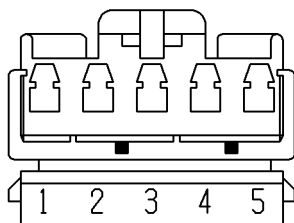

YPC10526

Colour: *GREEN*

Gender: *Female*

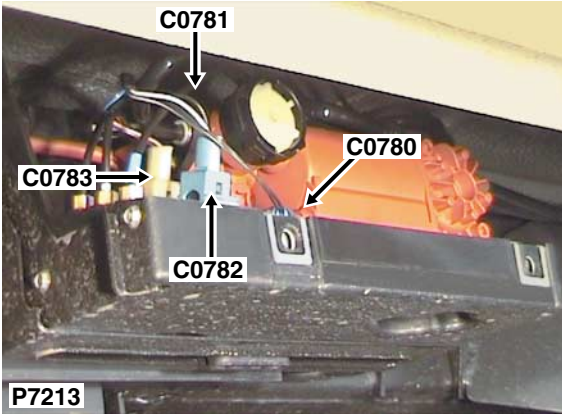

| Cav | Col | Cct |
|-----|-----|-----|
| 1   | WB  | 13  |
| 2   | B   | 13  |

Description: *Compressor-Self levelling suspension (SLS)*  
 Location: *Behind LH sill*

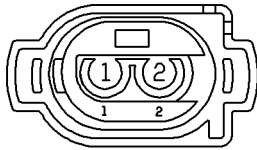

YPC110340

Colour: *BLACK*  
 Gender: *Female*

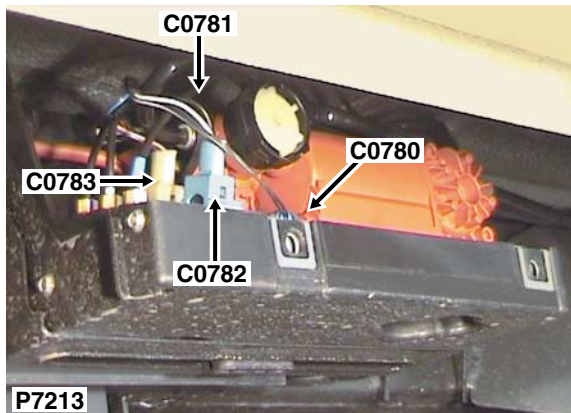

| Cav | Col | Cct |
|-----|-----|-----|
| 1   | BW  | 13  |
| 2   | B   | 13  |

Description: *Valve-Exhaust-Self levelling suspension (SLS)*

Location: *Behind LH sill*

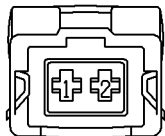

YPC107790

Colour: *BLACK*

Gender: *Female*

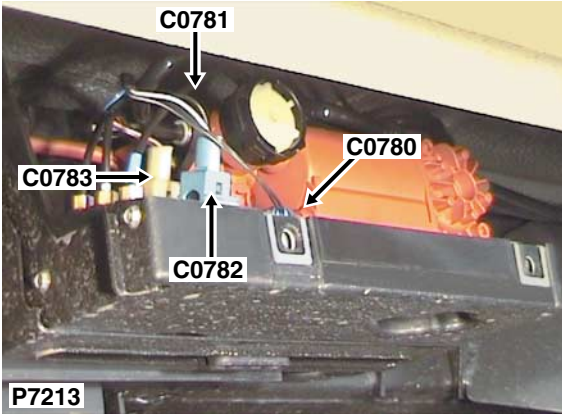

| Cav | Col | Cct |
|-----|-----|-----|
| 1   | WY  | 13  |
| 2   | B   | 13  |

Description: *Valve-Self levelling suspension (SLS)-Rear-LH*  
 Location: *Behind LH sill*

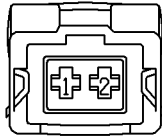

YPC107800

Colour: *BLUE*  
 Gender: *Female*

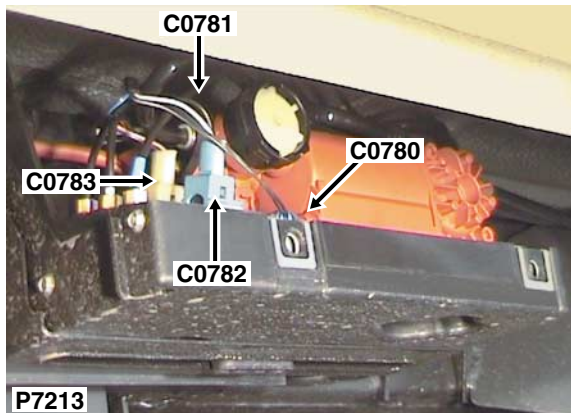

| Cav | Col | Cct |
|-----|-----|-----|
| 1   | UO  | 13  |
| 2   | B   | 13  |

Description: *Valve-Self levelling suspension (SLS)-Rear-RH*

Location: *Behind LH sill*

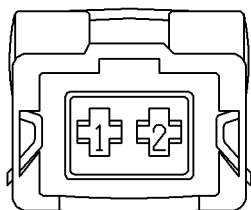

YPC107830

Colour: *NATURAL*

Gender: *Female*

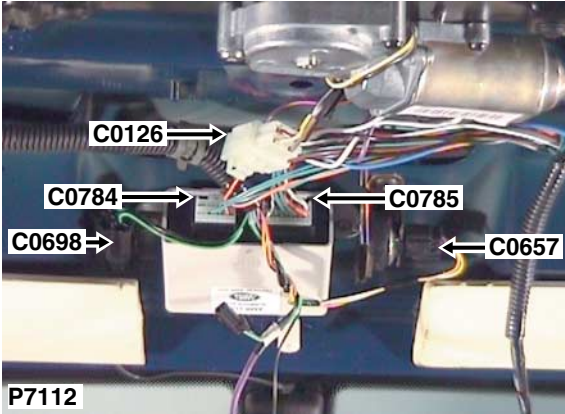

| Cav | Col | Cct |
|-----|-----|-----|
| 1   | OG  | ALL |
| 2   | GK  | ALL |
| 6   | GW  | ALL |
| 7   | GU  | ALL |
| 8   | OU  | ALL |

Description: *ECU-Sunroof*

Location: *Front of headlining in the centre*

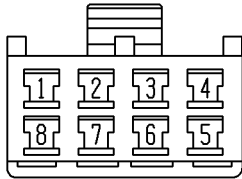

YPC10006

Colour: *NATURAL*

Gender: *Female*

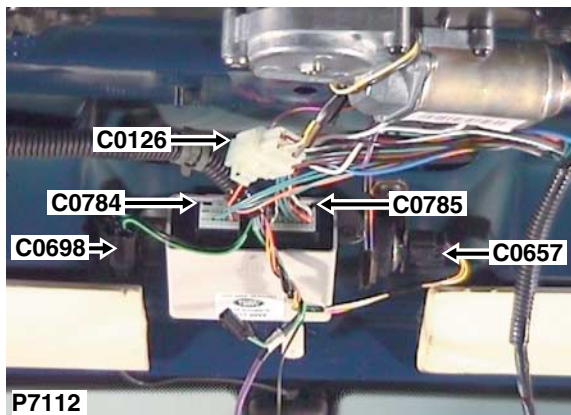

| Cav | Col | Cct |
|-----|-----|-----|
| 1   | W   | ALL |
| 2   | B   | ALL |
| 3   | NR  | ALL |
| 4   | U   | ALL |
| 5   | P   | ALL |
| 6   | O   | ALL |
| 7   | GR  | ALL |
| 8   | GO  | ALL |
| 9   | GB  | ALL |
| 10  | WG  | ALL |

Description: *ECU-Sunroof*

Location: *Front of headlining in the centre*

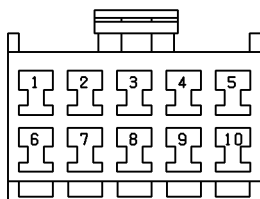

YPC107630

Colour: *NATURAL*

Gender: *Female*



| Cav | Col | Cct |
|-----|-----|-----|
| B   | WP  | 2   |
| C   | RG  | 2   |
| D   | BY  | 2   |
| F   | WG  | 2   |
| G   | BY  | 2   |
| J   | WP  | 2   |
| K   | UG  | 2   |

Description: *Switch-Throttle pedal - LHD*

Location: *Behind driver side of fascia*

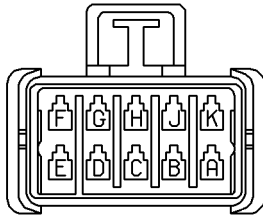

YPC111870

Colour: *BLACK*

Gender: *Female*



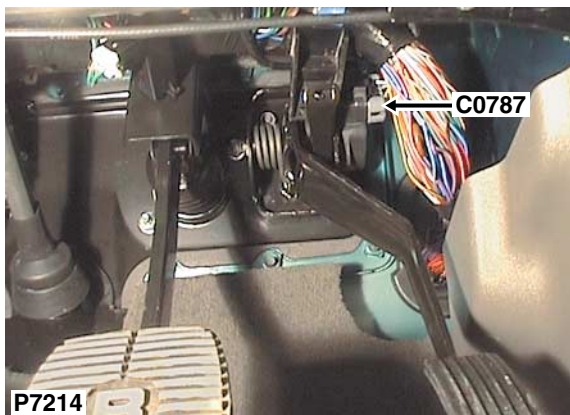

| Cav | Col | Cct |
|-----|-----|-----|
| B   | WP  | 2   |
| C   | RG  | 2   |
| D   | BY  | 2   |
| F   | WG  | 2   |
| G   | BY  | 2   |
| J   | WP  | 2   |
| K   | WS  | 2   |

Description: *Switch-Throttle pedal - RHD*

Location: *Behind driver side of fascia*

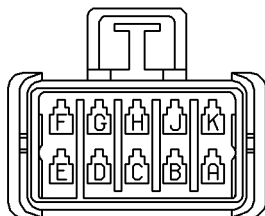

YPC111870

Colour: *BLACK*

Gender: *Female*



| Cav | Col | Cct |
|-----|-----|-----|
| 1   | GW  | 15  |
| 2   | WR  | 15  |
| 3   | WU  | 15  |

Description: *Sensor-Sunlight*  
 Location: *Behind centre of fascia*

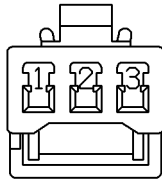

YPC113300

Colour: *WHITE*  
 Gender: *Female*

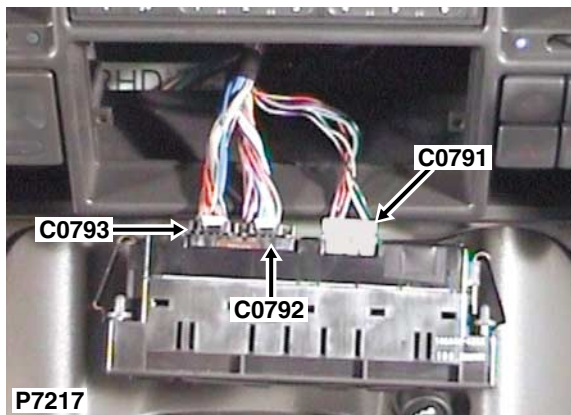

Description: *ECU-Air temperature control (ATC)*

Location: *Behind heater control panel*

| Cav | Col | Cct |
|-----|-----|-----|
| 1   | P   | 15  |
| 2   | GK  | ALL |
| 3   | GW  | 15  |
| 4   | B   | 15  |
| 5   | RN  | 15  |
| 8   | BW  | 15  |

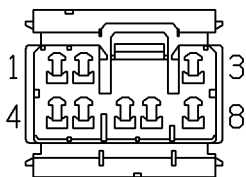

YPC10186

Colour: *WHITE*

Gender: *Female*

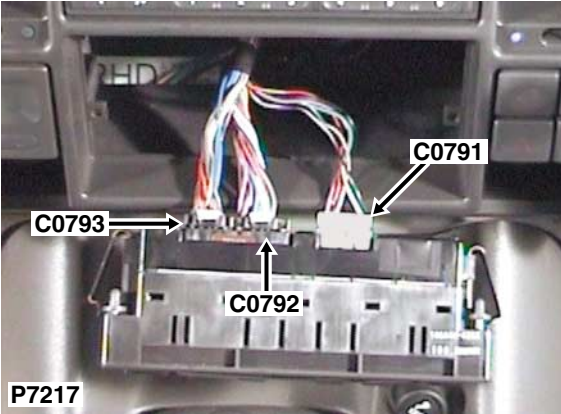

Description: *ECU-Air temperature control (ATC)*  
 Location: *Behind heater control panel*

| Cav | Col | Cct |
|-----|-----|-----|
| 1   | RB  | 15  |
| 2   | KG  | 15  |
| 3   | B   | 15  |
| 4   | UY  | 15  |
| 5   | RU  | 15  |
| 6   | YG  | 15  |
| 7   | WB  | 15  |
| 8   | PG  | 15  |
| 11  | PS  | 15  |
| 12  | NP  | 15  |
| 13  | PG  | 15  |
| 14  | SU  | 15  |
| 15  | YG  | 15  |
| 16  | WU  | 15  |
| 17  | WR  | 15  |
| 18  | PB  | 15  |

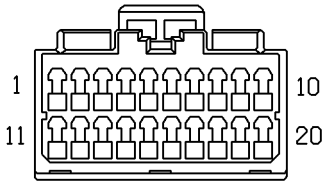

YPC111850

Colour: *BLACK*  
 Gender: *Female*

# C0793

# CONNECTOR DETAILS

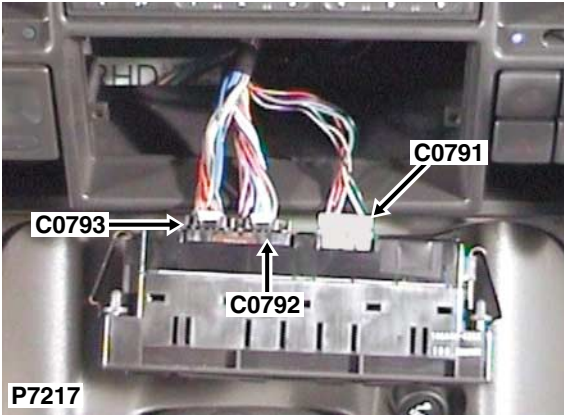

Description: *ECU-Air temperature control (ATC)*

Location: *Behind heater control panel*

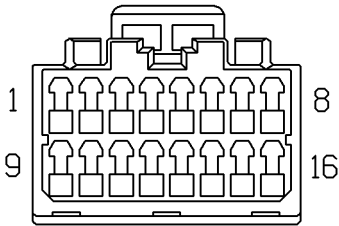

YPC111840

Colour: *BLACK*

Gender: *Female*

| Cav | Col | Cct |
|-----|-----|-----|
| 1   | G   | 15  |
| 2   | N   | 15  |
| 3   | KO  | ALL |
| 4   | NB  | ALL |
| 5   | PY  | 15  |
| 6   | UO  | 15  |
| 7   | UW  | 15  |
| 8   | RG  | 15  |
| 9   | GO  | 15  |
| 10  | UR  | 15  |
| 11  | YB  | 15  |
| 12  | PW  | 15  |
| 13  | Y   | 15  |
| 14  | GU  | 15  |
| 15  | US  | 15  |
| 16  | UB  | 15  |

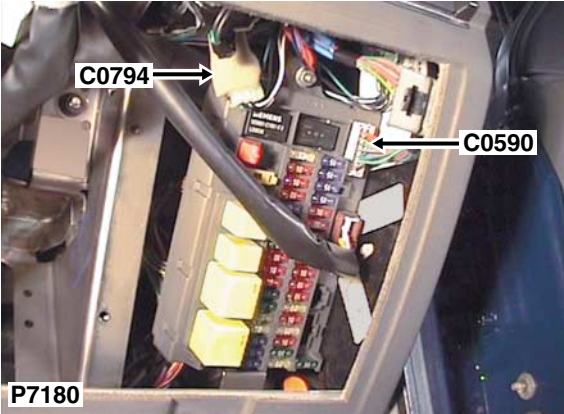

| Cav | Col | Cct |
|-----|-----|-----|
| 1   | BW  | 15  |
| 2   | WB  | 15  |
| 3   | GR  | ALL |
| 4   | B   | 15  |

Description: *Sensor-Temperature-In-car*  
 Location: *Behind RH side of fascia*

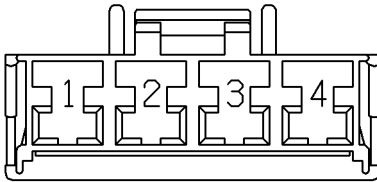

YPC10490

Colour: *LIGHT GREY*  
 Gender: *Female*

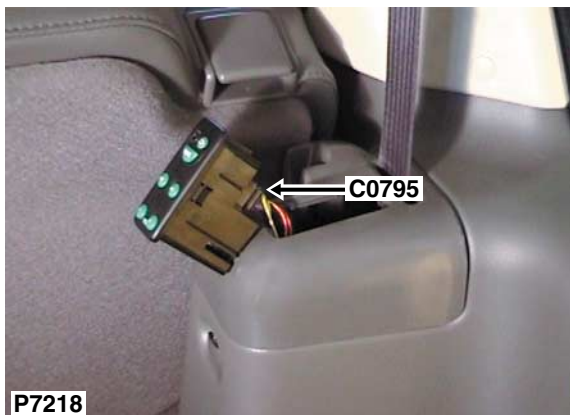

**P7218**

Description: *Amplifier-Radio headphone-RH*

Location: *Behind RH rear trim panel*

| Cav | Col | Cct |
|-----|-----|-----|
| 3   | RU  | 24  |
| 4   | O   | 24  |
| 5   | B   | 24  |
| 6   | LGO | 24  |
| 7   | R   | 24  |
| 8   | W   | 24  |
| 9   | U   | 24  |
| 10  | P   | 24  |
| 11  | S   | 24  |
| 12  | Y   | 24  |

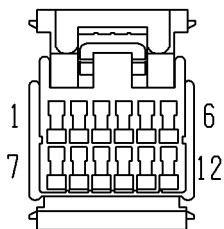

YPC10173

Colour: *BLACK*

Gender: *Female*



| Cav | Col | Cct |
|-----|-----|-----|
| 3   | RU  | 24  |
| 4   | O   | 24  |
| 5   | B   | 24  |
| 6   | LGO | 24  |
| 7   | R   | 24  |
| 8   | W   | 24  |
| 9   | U   | 24  |
| 10  | P   | 24  |
| 11  | G   | 24  |
| 12  | Y   | 24  |

Description: *Amplifier-Radio headphone-LH*  
 Location: *Behind LH rear trim panel*

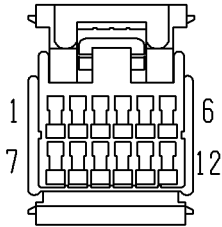

YPC10173

Colour: *BLACK*  
 Gender: *Female*





Description: *Fascia harness to heater harness - RHD*

Location: *Behind glovebox*

| Cav | Col | Cct |
|-----|-----|-----|
| 1   | BO  | ALL |
| 2   | G   | ALL |
| 3   | KU  | ALL |
| 4   | N   | ALL |
| 5   | GR  | ALL |
| 6   | UB  | ALL |
| 7   | B   | ALL |
| 8   | RG  | ALL |

NO CONNECTOR FACE

Colour: *NATURAL*

Gender: *Male*

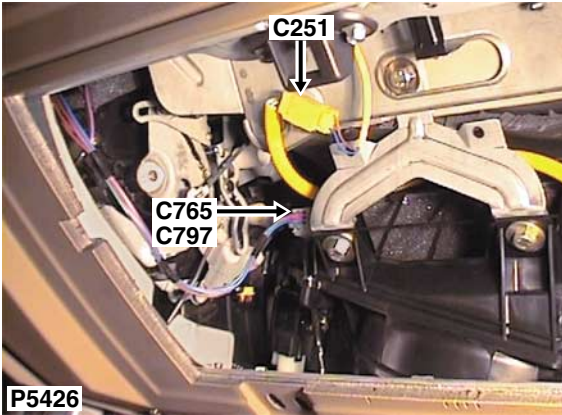

Description: *Heater harness to fascia harness - LHD*

Location: *Behind glovebox*

| Cav | Col | Cct |
|-----|-----|-----|
| 1   | BO  | ALL |
| 2   | G   | ALL |
| 3   | KU  | ALL |
| 4   | N   | ALL |
| 5   | GR  | ALL |
| 6   | UB  | ALL |
| 7   | B   | ALL |
| 8   | RG  | ALL |

NO CONNECTOR FACE

Colour: *NATURAL*

Gender: *Male*

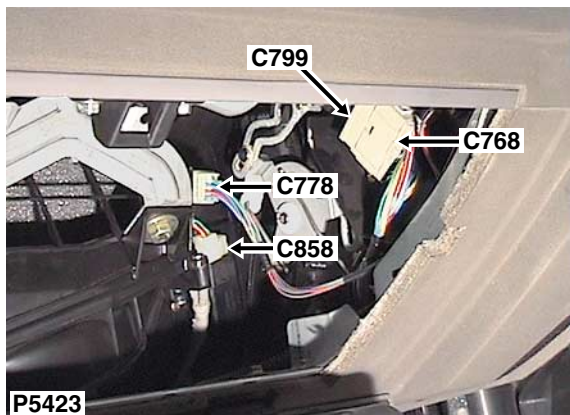

Description: *Heater harness to fascia harness*

Location: *Behind glovebox*

| Cav | Col | Cct |
|-----|-----|-----|
| 1   | RB  | 15  |
| 3   | GR  | 15  |
| 4   | YG  | 15  |
| 5   | SU  | 15  |
| 6   | UY  | 15  |
| 8   | UW  | 15  |
| 9   | UR  | 15  |
| 10  | UO  | 15  |
| 11  | GU  | 15  |
| 12  | PY  | 15  |
| 13  | Y   | 15  |

NO CONNECTOR FACE

Colour:

Gender: *Male*

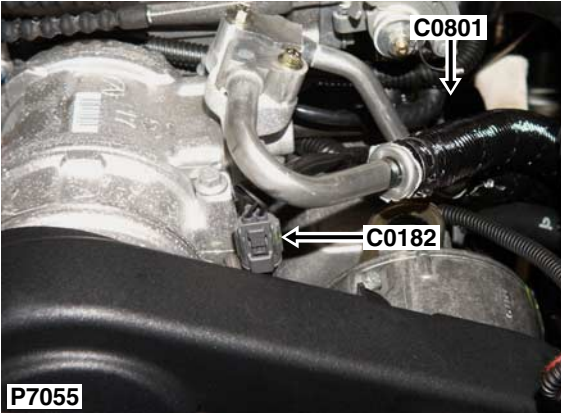

| Cav | Col | Cct |
|-----|-----|-----|
| 1   | B   | ALL |
| 2   | BG  | ALL |

Description: *Diode*

Location: *Top of engine*

NO CONNECTOR FACE

Colour:

Gender:

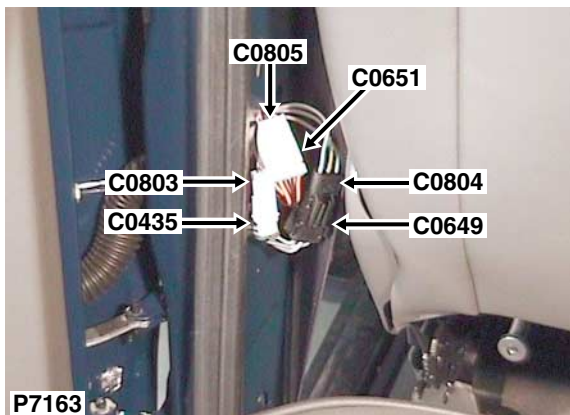

| Cav | Col | Cct |
|-----|-----|-----|
| 1   | BU  | ALL |
| 2   | BG  | ALL |

Description: *Door harness to main harness*

Location: *In LH 'B' post*

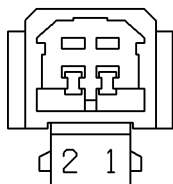

YPC10269

Colour: *WHITE*

Gender: *Male*

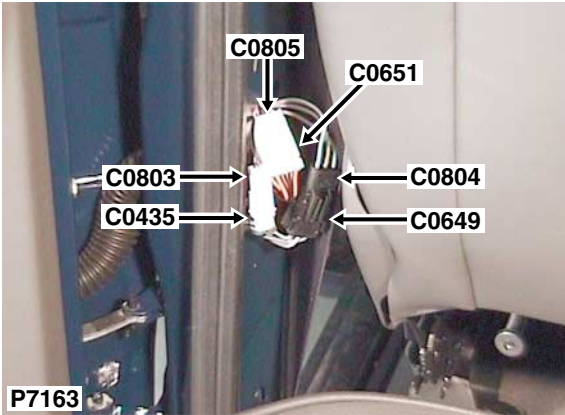

| Cav | Col | Cct |
|-----|-----|-----|
| 1   | SG  | ALL |
| 2   | SY  | ALL |
| 3   | SW  | ALL |

Description: *Door harness to main harness*  
 Location: *In LH 'B' post*

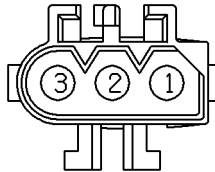

YPC112000

Colour: *BLACK*  
 Gender: *Male*

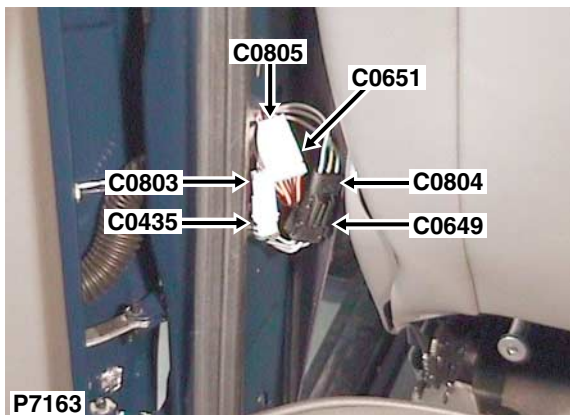

| Cav | Col | Cct |
|-----|-----|-----|
| 1   | KP  | ALL |
| 2   | KR  | ALL |
| 3   | PLG | ALL |
| 4   | B   | ALL |
| 5   | RB  | ALL |
| 6   | KS  | ALL |

Description: *Door harness to main harness*

Location: *In LH 'B' post*

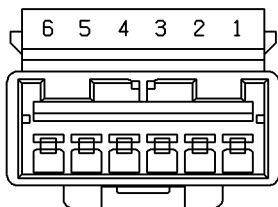

YPC10315

Colour: *WHITE*

Gender: *Male*

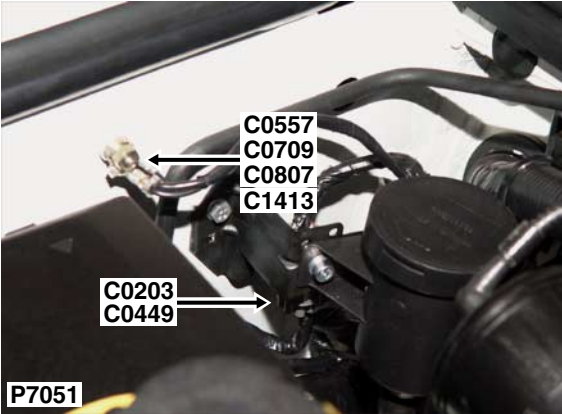

| Cav | Col | Cct |
|-----|-----|-----|
| 1   | B   | ALL |

Description: *Earth*

Location: *Rear RH side of engine compartment*

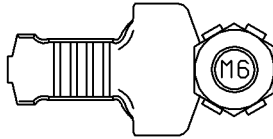

YPG10042

Colour: *BRASS*

Gender: *Female*



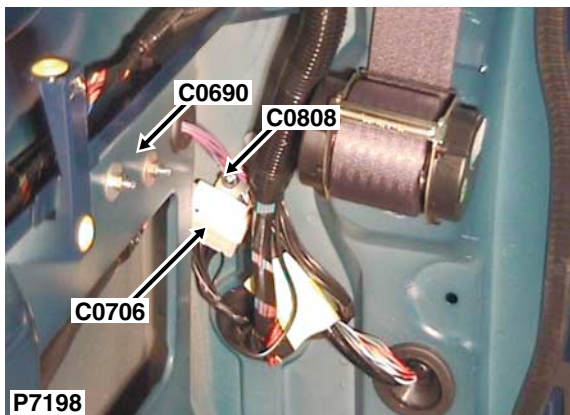

| Cav | Col | Cct |
|-----|-----|-----|
| 1   | B   | ALL |

Description: *Earth*

Location: *Behind RH rear trim panel*

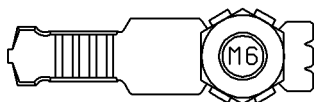

YPG10049

Colour: *TIN-PLATE*

Gender: *Female*

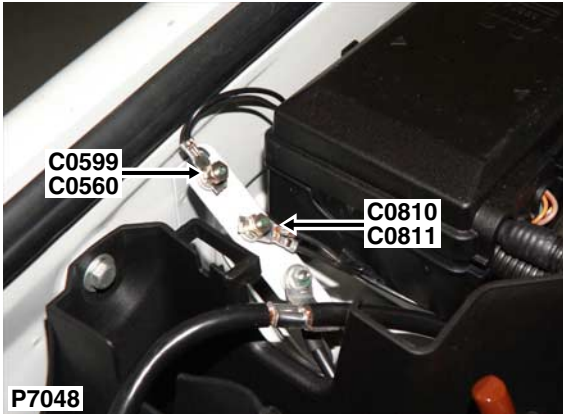

| Cav | Col | Cct |
|-----|-----|-----|
| 1   | B   | ALL |

Description: *Earth*

Location: *RH side of engine compartment*

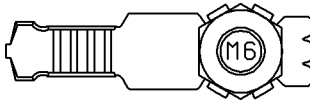

YPG10049

Colour: *TIN-PLATE*

Gender: *Female*

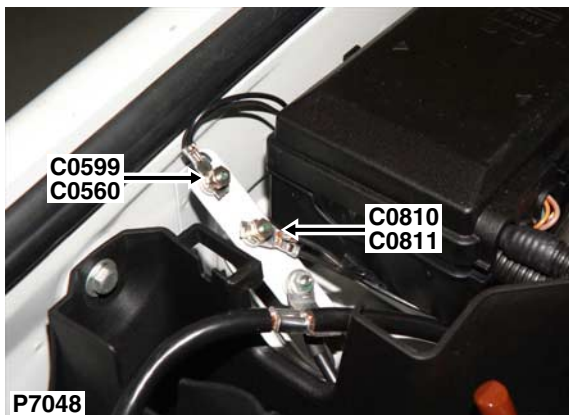

| Cav | Col | Cct |
|-----|-----|-----|
| 1   | B   | 13  |

Description: *Earth*

Location: *RH side of engine compartment*

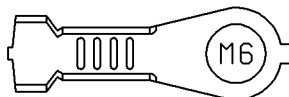

YPG10013

Colour: *TIN-PLATE*

Gender: *Female*

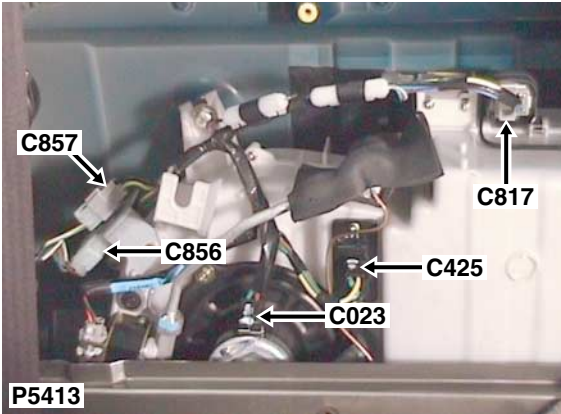

Description: *Relay-Blower*

Location: *Behind LH rear trim panel*

| Cav | Col | Cct |
|-----|-----|-----|
| 1   | PG  | 17  |
| 2   | U   | 17  |
| 3   | YG  | 17  |
| 4   | NR  | 17  |
| 5   | B   | 17  |

NO CONNECTOR FACE

Colour:

Gender: *Female*

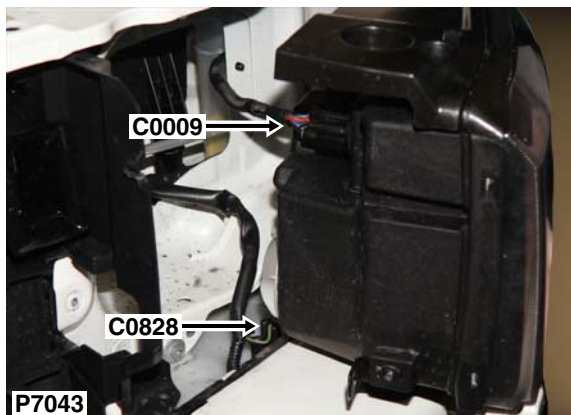

| Cav | Col | Cct |
|-----|-----|-----|
| 1   | LGR | ALL |
| 2   | B   | ALL |

Description: *Pump-Power wash*

Location: *Behind LH side of front bumper*

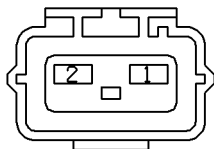

AFU3820

Colour: *BLACK*

Gender: *Female*

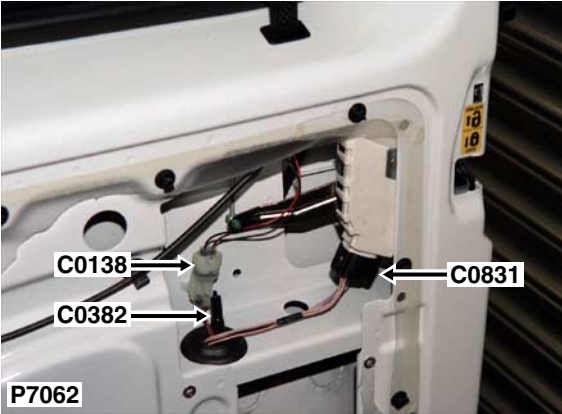

| Cav | Col | Cct |
|-----|-----|-----|
| 4   | KR  | ALL |
| 5   | B   | ALL |
| 6   | PLG | ALL |
| 7   | KP  | ALL |
| 8   | KS  | ALL |

Description: *Motor-Lock-Tail door*

Location: *Centre of taildoor, behind trim panel*

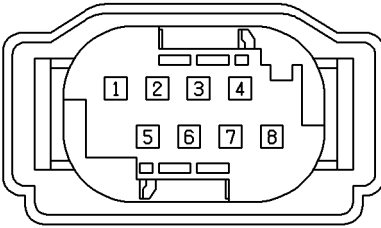

YPC108040

Colour: *BLACK*

Gender: *Female*

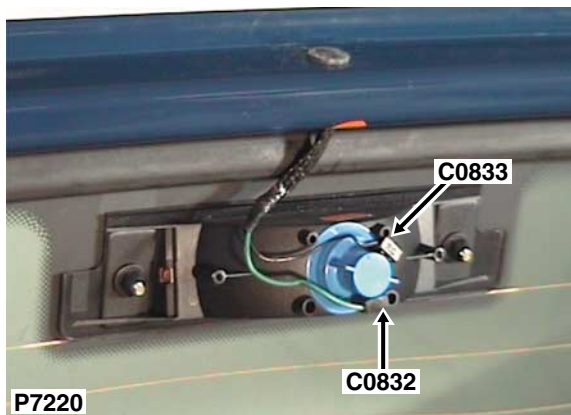

| Cav | Col | Cct |
|-----|-----|-----|
| 1   | GP  | ALL |

Description: *Lamp-brake-high mounted*

Location: *Top of rear screen*



YPQ10011

Colour: *NATURAL*

Gender: *Female*

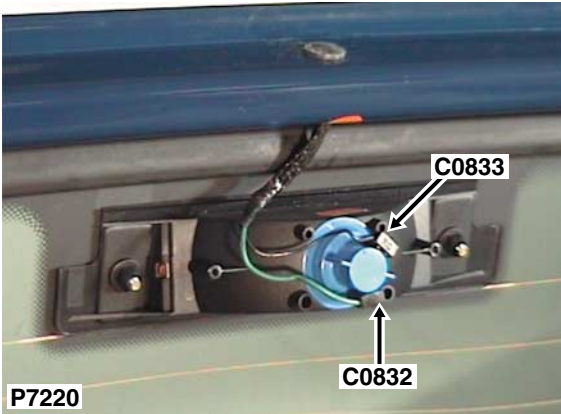

| Cav | Col | Cct |
|-----|-----|-----|
| 1   | B   | ALL |

Description: *Lamp-brake-high mounted*

Location: *Top of rear screen*

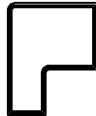

YPQ10011

Colour: *NATURAL*

Gender: *Female*





**P7221**

Description: *Speakers-Low range-Tail door*

Location: *Behind rear door trim panel*

| Cav | Col | Cct |
|-----|-----|-----|
| 1   | WB  | 25  |
| 1   | RB  | 26  |
| 2   | NB  | 25  |
| 2   | KB  | 26  |
| 3   | RB  | 25  |
| 3   | WB  | 26  |
| 4   | PB  | 25  |
| 4   | NB  | 26  |

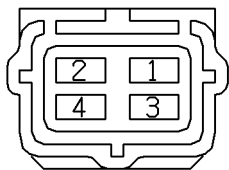

YPC10066

Colour: *BLACK*

Gender: *Female*

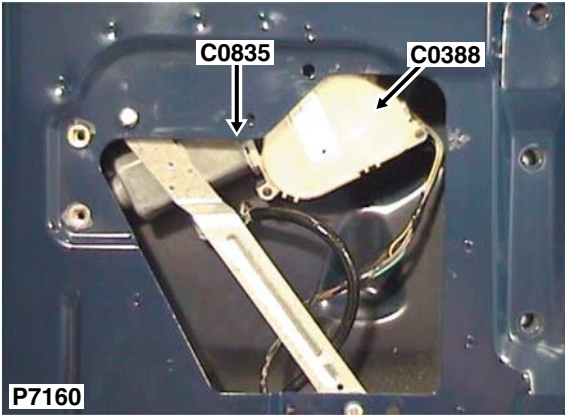

| Cav | Col | Cct |
|-----|-----|-----|
| 1   | B   | ALL |
| 2   | NY  | ALL |

Description: *Motor-Wiper-Rear screen*  
 Location: *Behind rear door trim panel*

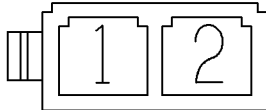

YPC106820

Colour: *BLACK*  
 Gender: *Female*

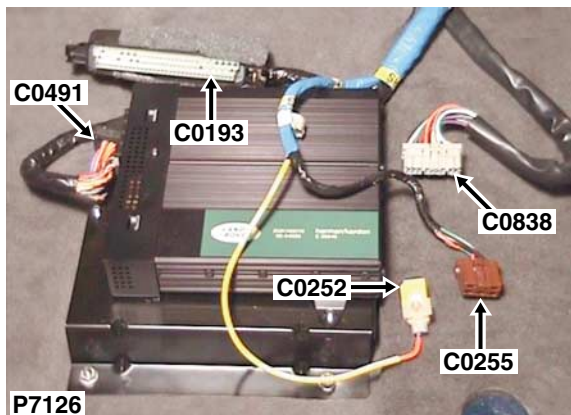

Description: *Seat link harness to main harness*

Location: *Beneath LH seat*

| Cav | Col | Cct |
|-----|-----|-----|
| 1   | WR  | 43  |
| 2   | GY  | 43  |
| 3   | R   | 43  |
| 4   | O   | 43  |
| 5   | S   | 43  |
| 6   | W   | 43  |
| 7   | Y   | 43  |
| 8   | NY  | 43  |
| 9   | U   | 43  |
| 10  | P   | 43  |
| 11  | PS  | 43  |
| 12  | B   | 43  |

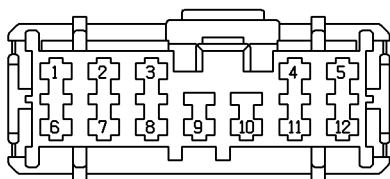

YPC10494

Colour: *LIGHT GREY*

Gender: *Female*

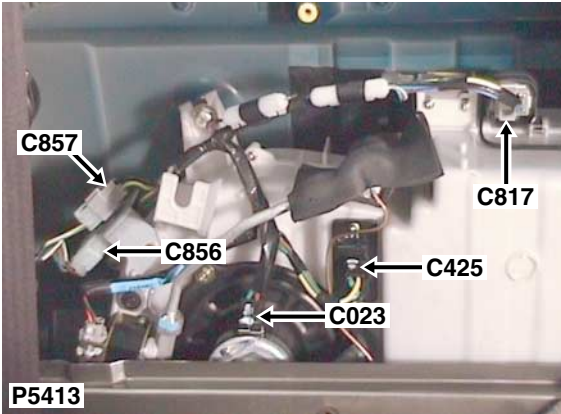

Description: *Rear A/C harness to body harness*

Location: *Behind LH rear trim panel*

| Cav | Col | Cct |
|-----|-----|-----|
| 2   | PG  | 17  |
| 3   | BU  | 17  |
| 4   | WG  | 17  |
| 6   | N   | 17  |
| 7   | Y   | 17  |
| 8   | G   | 17  |

NO CONNECTOR FACE

Colour:

Gender: *Male*

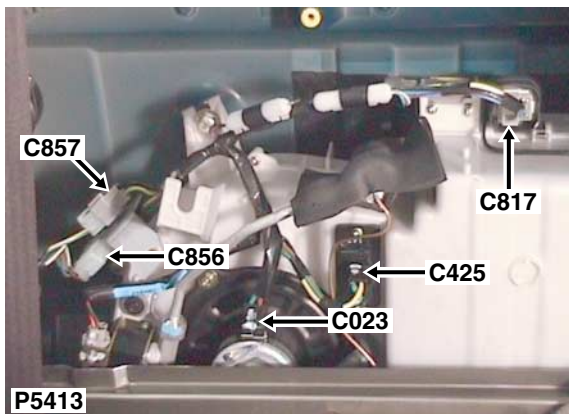

Description: *Rear A/C harness to body harness*

Location: *Behind LH rear trim panel*

| Cav | Col | Cct |
|-----|-----|-----|
| 1   | B   | 17  |

NO CONNECTOR FACE

Colour:

Gender: *Male*

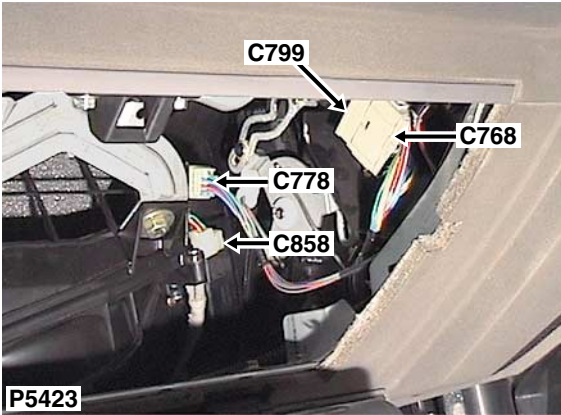

Description: *Transistor-Power - RHD*

Location: *Behind glovebox*

| Cav | Col | Cct |
|-----|-----|-----|
| 1   | BO  | 15  |
| 2   | B   | 15  |
| 3   | G   | 15  |
| 4   | KG  | 15  |

NO CONNECTOR FACE

Colour: *BLACK*

Gender: *Female*

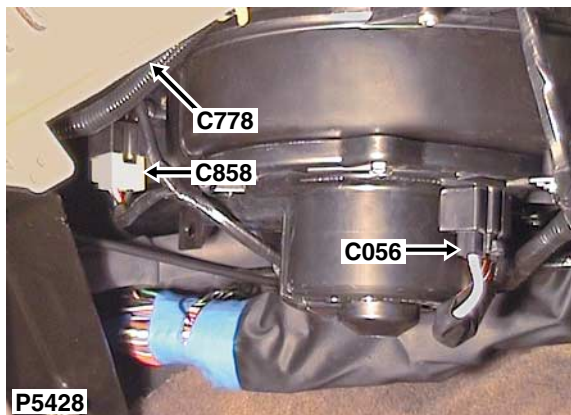

Description: *Transistor-Power - LHD*

Location: *Under RH side of fascia*

| Cav | Col | Cct |
|-----|-----|-----|
| 1   | BO  | 15  |
| 2   | B   | 15  |
| 3   | G   | 15  |
| 4   | PG  | 15  |

NO CONNECTOR FACE

Colour: *BLACK*

Gender: *Female*

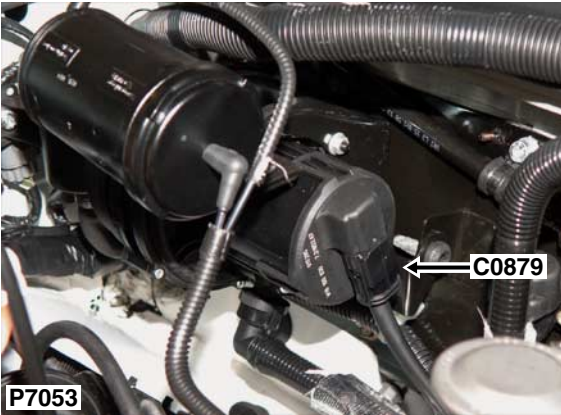

| Cav | Col | Cct |
|-----|-----|-----|
| 1   | B   | 18  |
| 2   | YB  | 18  |

Description: *Pump-Air injection*

Location: *Rear RH side of engine compartment*

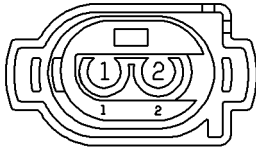

YPC110340

Colour: *BLACK*

Gender: *Female*



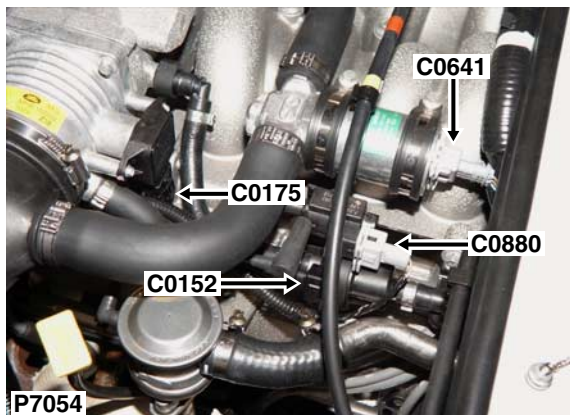

| Cav | Col | Cct |
|-----|-----|-----|
| 1   | NK  | 18  |
| 2   | BU  | 18  |

Description: *Valve-Air injection*

Location: *LH side of engine compartment*

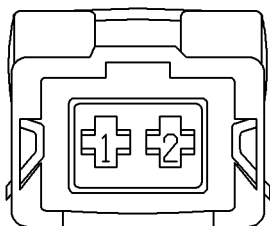

YPC107820

Colour: *GREY*

Gender: *Female*

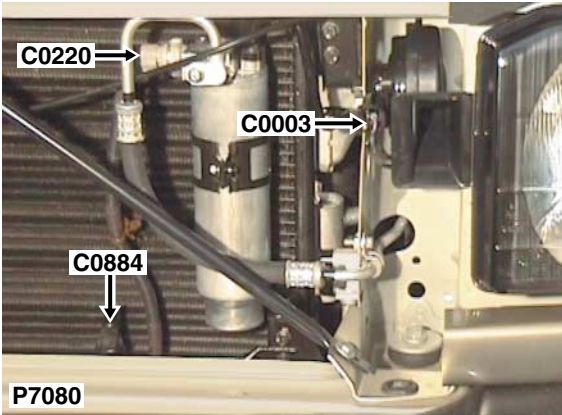

| Cav | Col | Cct |
|-----|-----|-----|
| 1   | YG  | 15  |
| 2   | BW  | 15  |

Description: *Sensor-Ambient air temperature*  
 Location: *Behind the front grille*

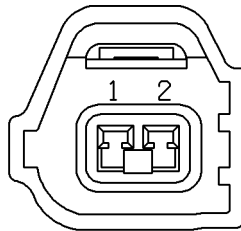

YPC108190

Colour: *BLACK*  
 Gender: *Female*

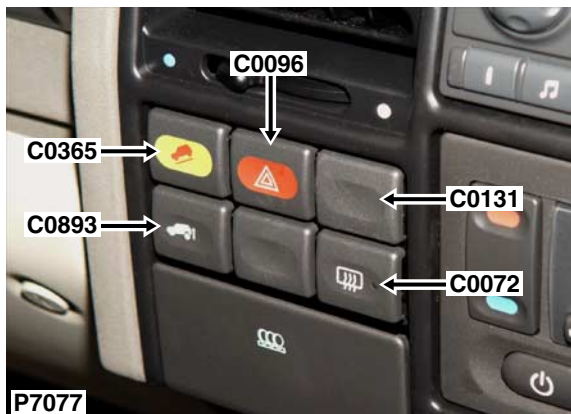

| Cav | Col | Cct |
|-----|-----|-----|
| 1   | PK  | ALL |
| 2   | RN  | ALL |
| 4   | B   | ALL |

Description: *Switch-Off road mode*

Location: *Behind centre of fascia*

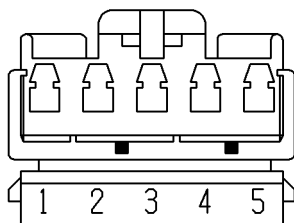

YPC10526

Colour: *GREEN*

Gender: *Female*

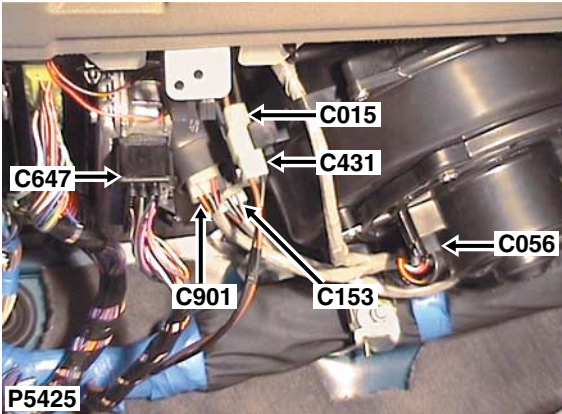

Description: *Relay-Power - RHD*

Location: *Under LH side of fascia*

| Cav | Col | Cct |
|-----|-----|-----|
| 1   | GW  | 15  |
| 2   | UR  | 15  |
| 3   | BO  | 15  |
| 4   | B   | 15  |

NO CONNECTOR FACE

Colour:

Gender: *Female*

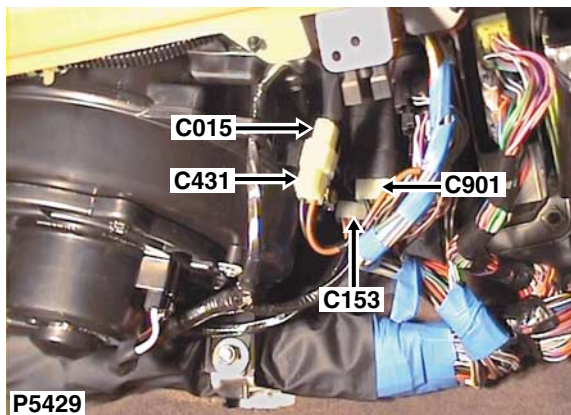

Description: *Relay-Power - LHD*

Location: *Under RH side of fascia*

| Cav | Col | Cct |
|-----|-----|-----|
| 1   | GW  | 15  |
| 2   | UR  | 15  |
| 3   | BO  | 15  |
| 4   | B   | 15  |

NO CONNECTOR FACE

Colour:

Gender: *Female*

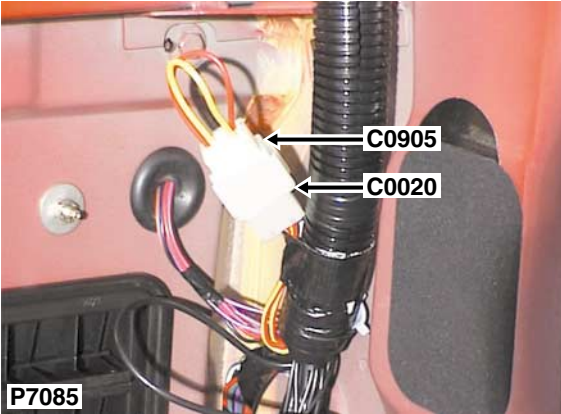

| Cav | Col | Cct |
|-----|-----|-----|
| 1   | R   | 1   |
| 2   | R   | 1   |
| 2   | Y   | 1   |
| 3   | Y   | 1   |

Description: *Link harness to body harness*  
 Location: *Behind RH rear trim panel*

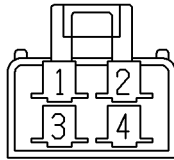

AFU3855

Colour: *NATURAL*  
 Gender: *Female*

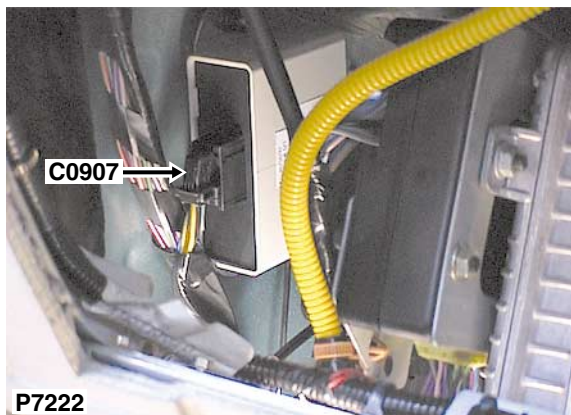

Description: *ECU-Mirror-Folding*  
 Location: *Behind glovebox*

| Cav | Col | Cct |
|-----|-----|-----|
| 1   | O   | 40  |
| 3   | OR  | 40  |
| 5   | UB  | 40  |
| 6   | GK  | 40  |
| 7   | YR  | 40  |
| 8   | NS  | 40  |
| 9   | Y   | 40  |
| 12  | B   | 40  |

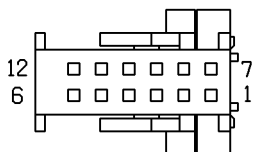

YPC111790

Colour: *BLACK*  
 Gender: *Female*

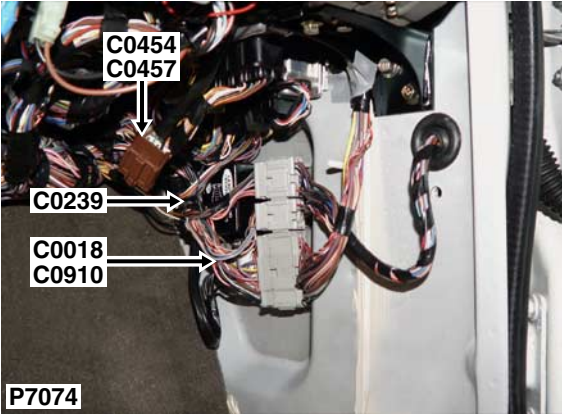

| Cav | Col | Cct |
|-----|-----|-----|
| 1   | B   | ALL |

Description: *Earth*  
Location: *RH 'A' post*

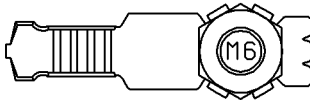

YPG10049

Colour: *TIN-PLATE*  
Gender: *Female*



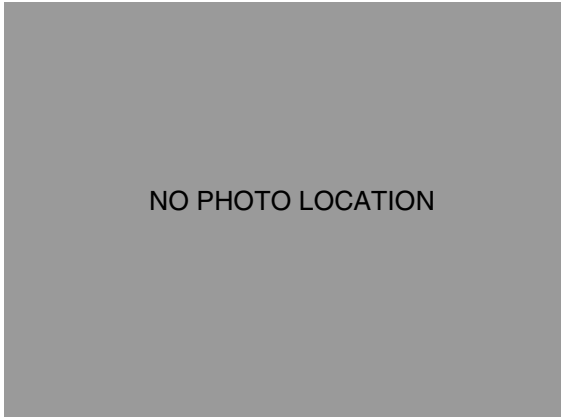

| Cav | Col | Cct |
|-----|-----|-----|
| 1   | W   | ALL |
| 2   | U   | ALL |
| 5   | K   | ALL |
| 6   | R   | ALL |
| 7   | S   | ALL |
| 8   | B   | ALL |
| 10  | P   | ALL |

Description: *CD player*

Location: *Behind centre of fascia*

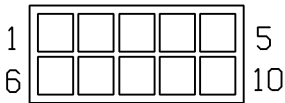

YPC111780

Colour: *BLACK*

Gender: *Female*

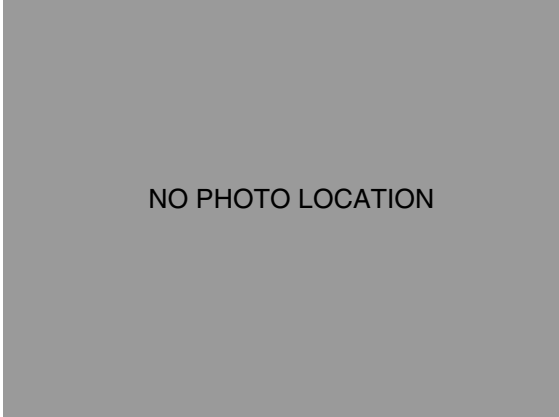

| Cav | Col | Cct |
|-----|-----|-----|
| 1   | W   | 24  |
| 2   | B   | 24  |
| 5   | G   | 24  |
| 6   | R   | 24  |
| 7   | S   | 24  |
| 8   | N   | 24  |
| 10  | P   | 24  |

Description: *CD player*

Location: *Beneath driver's seat*

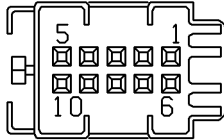

YPC114560

Colour: *BLACK*

Gender: *Male*

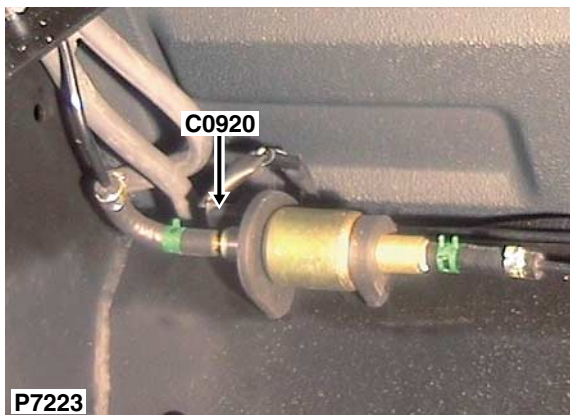

| Cav | Col | Cct |
|-----|-----|-----|
| 1   | WU  | 2   |
| 2   | B   | 2   |

Description: *Pump-Fuel burning heater (FBH)*

Location: *Above fuel tank*

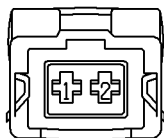

YPC107790

Colour: *BLACK*

Gender: *Female*

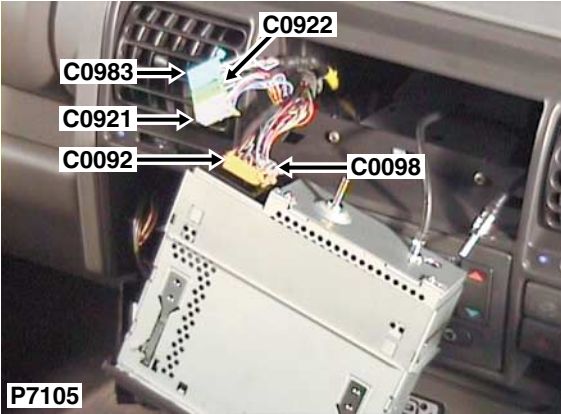

Description: *Head Unit-Audio System*  
 Location: *Behind radio*

| Cav | Col | Cct |
|-----|-----|-----|
| 1   | R   | 24  |
| 2   | U   | 24  |
| 3   | SO  | 27  |
| 4   | W   | 24  |
| 5   | P   | 24  |
| 6   | YG  | 27  |

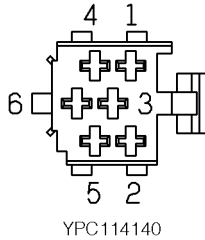

Colour: *YELLOW*  
 Gender: *Female*

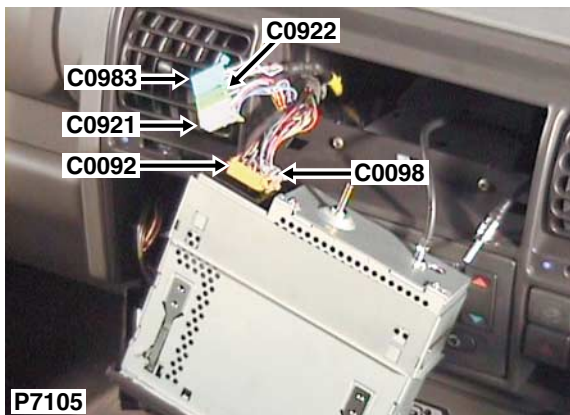

Description: *Head Unit-Audio System*  
 Location: *Behind radio*

| Cav | Col | Cct |
|-----|-----|-----|
| 7   | O   | 24  |
| 9   | SG  | 24  |
| 10  | G   | 24  |
| 11  | S   | 24  |
| 11  | B   | 31  |
| 12  | Y   | 24  |
| 12  | K   | 31  |

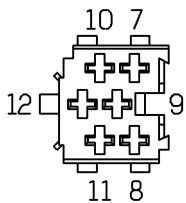

YPC114130

Colour: *GREEN*  
 Gender: *Female*



Description: *Head Unit-Audio System*  
 Location: *Behind radio*

| Cav | Col | Cct |
|-----|-----|-----|
| 1   | BW  | 29  |
| 2   | BK  | 29  |
| 3   | BY  | 29  |
| 4   | PO  | 29  |
| 5   | LGP | 29  |
| 6   | BG  | 29  |
| 8   | BN  | 29  |
| 9   | P   | 29  |
| 10  | SR  | 29  |
| 11  | BR  | 29  |
| 12  | BO  | 29  |
| 13  | RN  | 29  |
| 14  | BU  | 29  |
| 15  | B   | 29  |
| 16  | RU  | 29  |
| 17  | SB  | 29  |

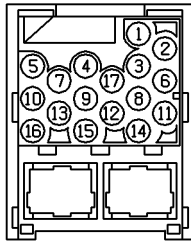

YPC115120

Colour: *BLACK*  
 Gender: *Female*

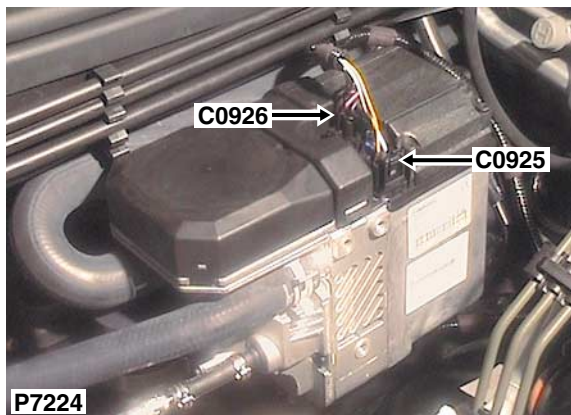

| Cav | Col | Cct |
|-----|-----|-----|
| 2   | R   | ALL |
| 3   | NY  | ALL |
| 6   | WU  | ALL |

Description: *Heater-Fuel burning - RHD*

Location: *Rear LH side of engine compartment*

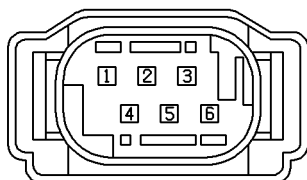

YPC110680

Colour: *BLACK*

Gender: *Female*

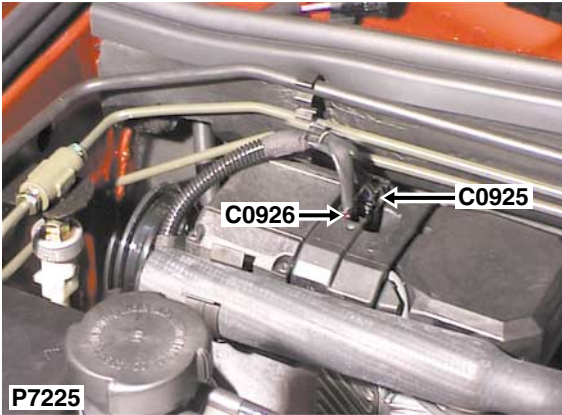

| Cav | Col | Cct |
|-----|-----|-----|
| 1   | YB  | 38  |
| 2   | R   | 38  |
| 3   | NY  | 38  |
| 4   | BN  | 38  |
| 6   | WU  | 38  |

Description: *Heater-Fuel burning - LHD*  
 Location: *Rear RH side of engine compartment*

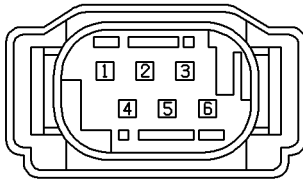

YPC110680

Colour: *BLACK*  
 Gender: *Female*



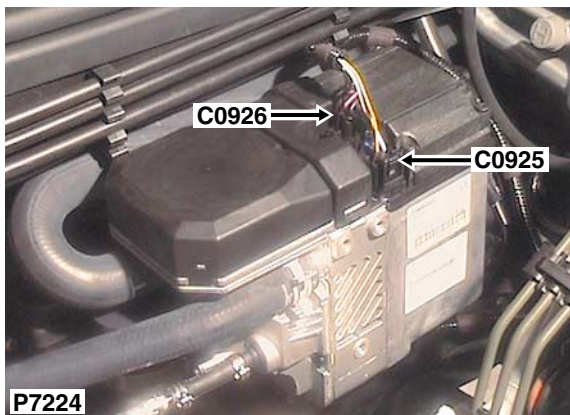

| Cav | Col | Cct |
|-----|-----|-----|
|     |     |     |

Description: *Heater-Fuel burning - RHD*

Location: *Rear LH side of engine compartment*



YPC10542

Colour: *GREY*

Gender: *Female*

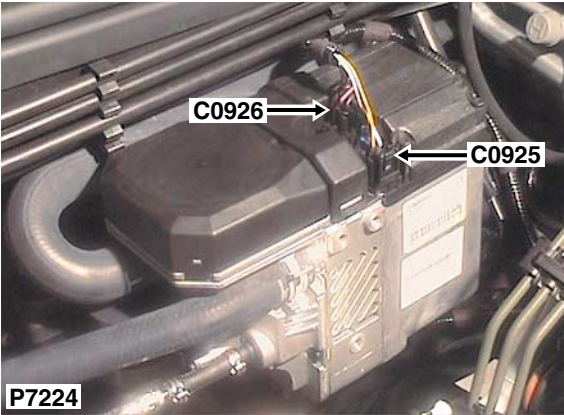

| Cav | Col | Cct |
|-----|-----|-----|
| 1   | PN  | ALL |
| 2   | B   | ALL |

Description: *Heater-Fuel burning - RHD*  
 Location: *Rear LH side of engine compartment*

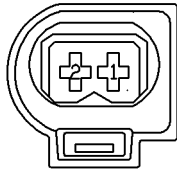

YPC115080

Colour: *BLACK*  
 Gender: *Female*

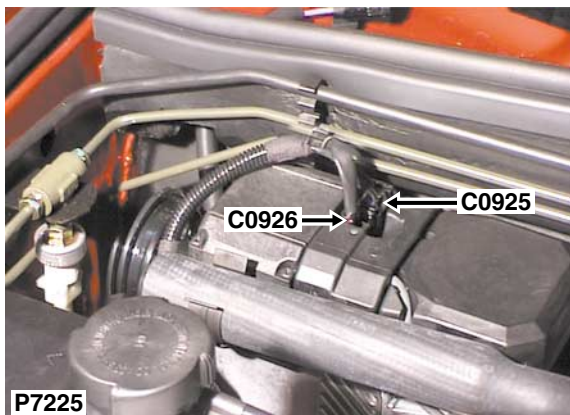

| Cav | Col | Cct |
|-----|-----|-----|
| 1   | PN  | 38  |
| 2   | B   | 38  |

Description: *Heater-Fuel burning - LHD*  
 Location: *Rear RH side of engine compartment*

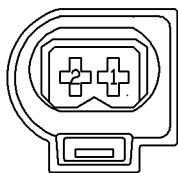

YPC115080

Colour: *BLACK*  
 Gender: *Female*

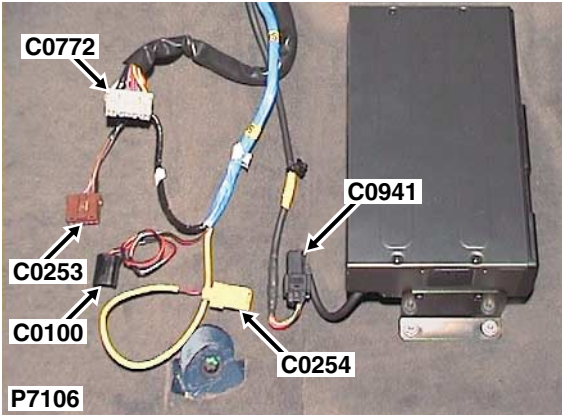

Description: *CD auto changer*  
 Location: *Beneath RH seat*

| Cav | Col | Cct |
|-----|-----|-----|
| 1   | W   | 24  |
| 2   | B   | 24  |
| 5   | G   | 24  |
| 6   | R   | 24  |
| 7   | S   | 24  |
| 8   | N   | 24  |
| 10  | P   | 24  |

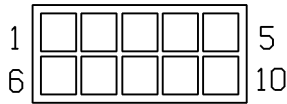

YPC111780

Colour: *BLACK*  
 Gender: *Female*

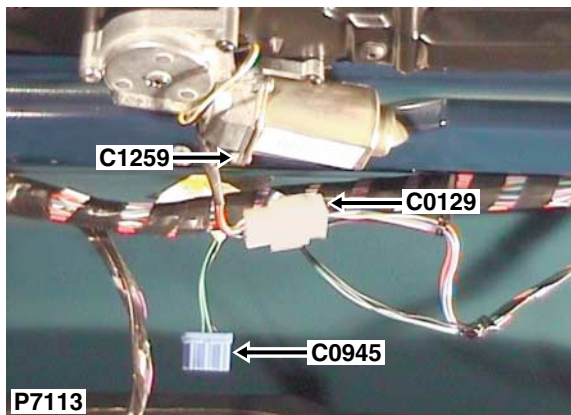

| Cav | Col | Cct |
|-----|-----|-----|
| 1   | BS  | ALL |
| 3   | GW  | ALL |
| 4   | GB  | ALL |

Description: *Switch-Sunroof-Rear*  
 Location: *Behind centre headlining*

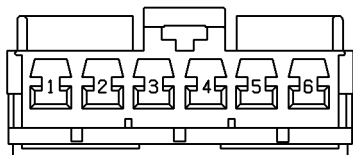

YPC113210

Colour: *BLUE*  
 Gender: *Female*

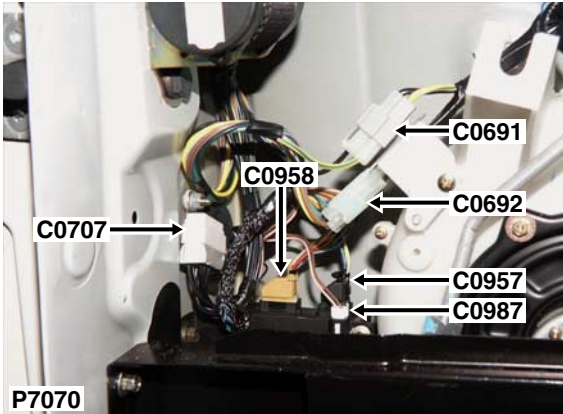

Description: *ECU-PDC*

Location: *Luggage compartment - LH side*

| Cav | Col | Cct |
|-----|-----|-----|
| 2   | Y   | ALL |
| 3   | U   | ALL |
| 4   | O   | ALL |
| 5   | G   | ALL |
| 8   | BG  | ALL |
| 10  | WG  | ALL |

NO CONNECTOR FACE

Colour:

Gender:

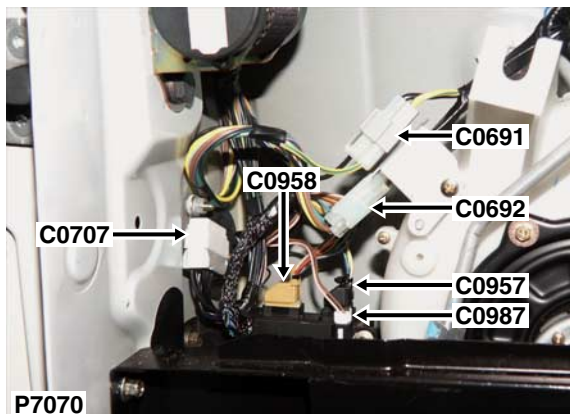

Description: *ECU-PDC*

Location: *Luggage compartment - LH side*

| Cav | Col | Cct |
|-----|-----|-----|
| 1   | LGO | ALL |
| 2   | N   | ALL |
| 4   | S   | ALL |
| 6   | GN  | ALL |
| 8   | B   | ALL |
| 10  | K   | ALL |
| 13  | RS  | ALL |

NO CONNECTOR FACE

Colour:

Gender:

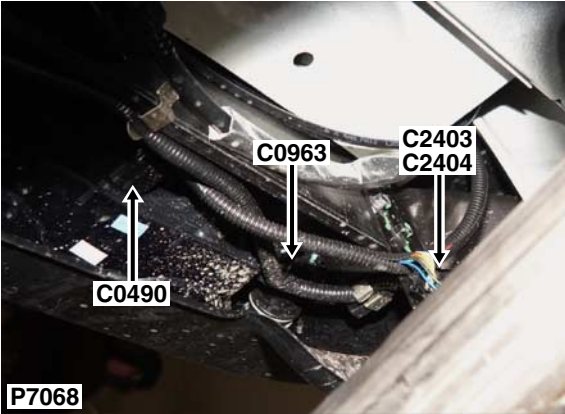

| Cav | Col | Cct |
|-----|-----|-----|
| 1   | W   | ALL |
| 2   | G   | ALL |
| 3   | B   | ALL |

Description: *Sensor-PDC-Outer-Rear-LH*  
 Location: *LH rear of vehicle*

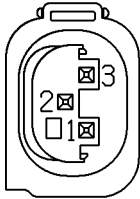

YPC116850

Colour: *BLACK*  
 Gender: *Female*



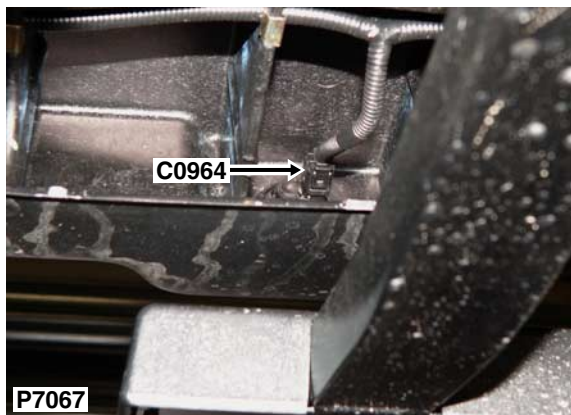

| Cav | Col | Cct |
|-----|-----|-----|
| 1   | W   | ALL |
| 2   | U   | ALL |
| 3   | B   | ALL |

Description: *Sensor-PDC-Inner-Rear-LH*

Location: *LH rear of vehicle*

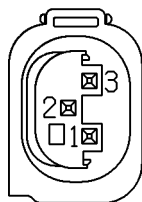

YPC116850

Colour: *BLACK*

Gender: *Female*

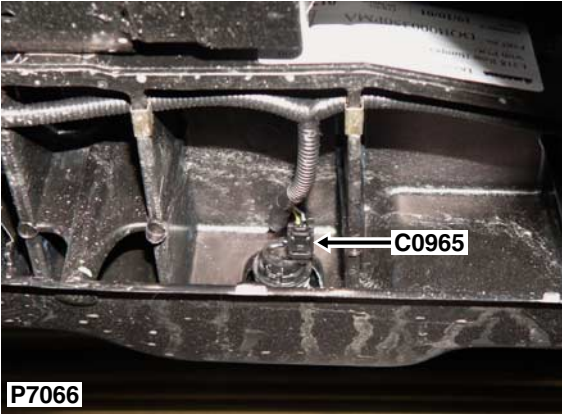

| Cav | Col | Cct |
|-----|-----|-----|
| 1   | W   | ALL |
| 2   | Y   | ALL |
| 3   | B   | ALL |

Description: *Sensor-PDC-Inner-Rear-RH*  
 Location: *RH rear of vehicle*

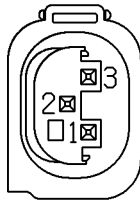

YPC116850

Colour: *BLACK*  
 Gender: *Female*

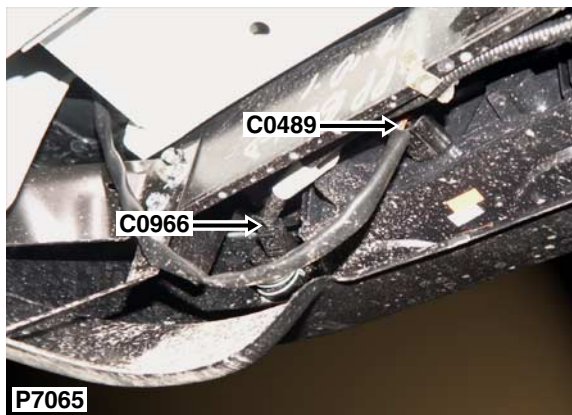

| Cav | Col | Cct |
|-----|-----|-----|
| 1   | W   | ALL |
| 2   | O   | ALL |
| 3   | B   | ALL |

Description: *Sensor-PDC-Outer-Rear-RH*

Location: *RH rear of vehicle*

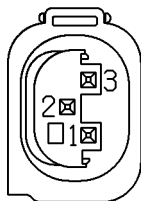

YPC116850

Colour: *BLACK*

Gender: *Female*

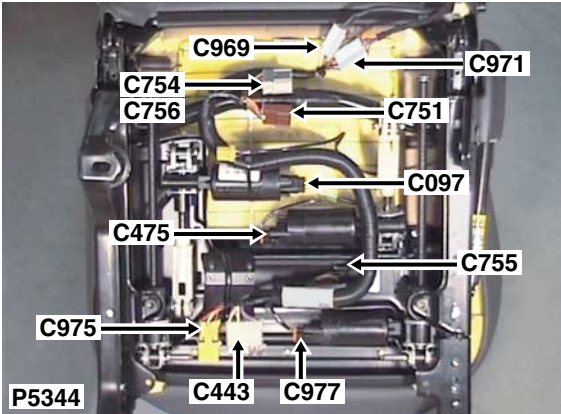

Description: *Heater-Seat cushion-RH*

Location: *Underside of front passenger's seat*

| Cav | Col | Cct |
|-----|-----|-----|
| 1   | K   | 42  |
| 2   | B   | 42  |
| 3   | LG  | 42  |
| 4   | KW  | 42  |

NO CONNECTOR FACE

Colour: *WHITE*

Gender: *Female*

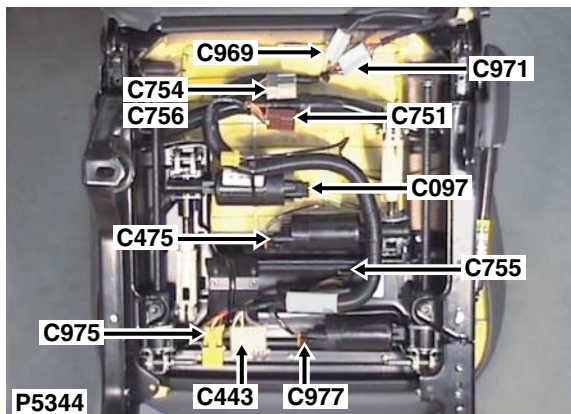

| Cav | Col | Cct |
|-----|-----|-----|
| 1   | O   | 42  |
| 2   | KW  | 42  |
| 3   | B   | 42  |
| 4   | P   | 42  |
| 5   | PS  | 42  |
| 6   | S   | 42  |
| 7   | B   | 42  |

Description: *Seat cushion harness to seat squab harness*

Location: *Underside of front passenger's seat*

NO CONNECTOR FACE

Colour: *WHITE*

Gender: *Female*

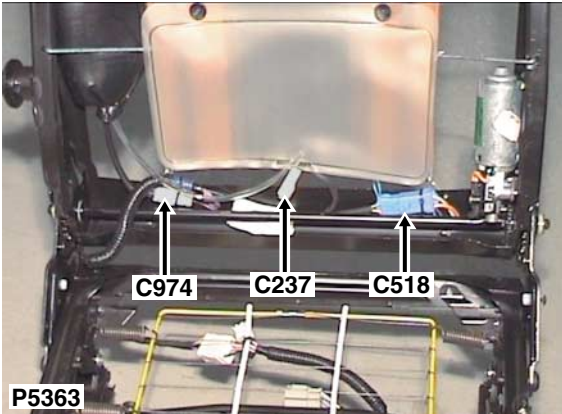

Description: *Pump-Lumbar-LH*  
Location: *Passenger seat - below*

| Cav | Col | Cct |
|-----|-----|-----|
| 1   | PB  | 43  |
| 2   | P   | 43  |
| 3   | PS  | 43  |

NO CONNECTOR FACE

Colour: *WHITE*  
Gender: *Female*

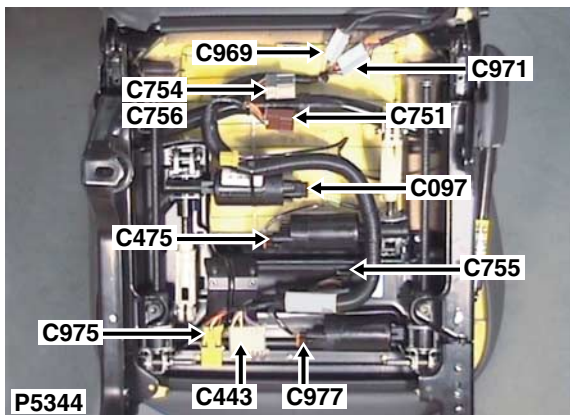

| Cav | Col | Cct |
|-----|-----|-----|
| 30  | NP  | 43  |
| 85  | NP  | 43  |
| 86  | NP  | 43  |
| 87  | WN  | 43  |

Description: *Relay-Power Seat-LH*

Location: *Underside of front passenger's seat*

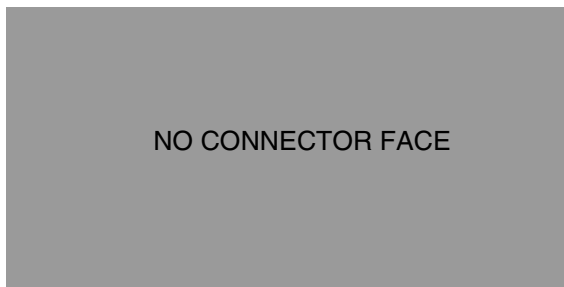

Colour: *YELLOW*

Gender: *Female*

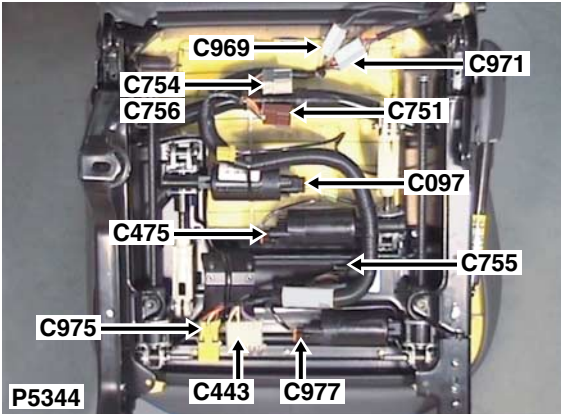

| Cav | Col | Cct |
|-----|-----|-----|
| 1   | R   | 43  |
| 2   | GY  | 43  |

Description: *Motor-Seat-Forward/rearward-LH*  
 Location: *Underside of front passenger's seat*

NO CONNECTOR FACE

Colour: *BLACK*  
 Gender: *Female*



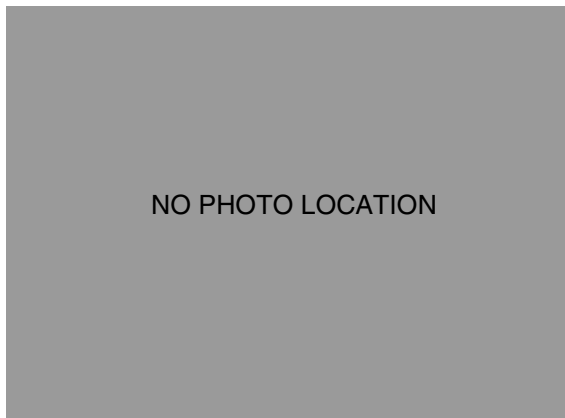

| Cav | Col | Cct |
|-----|-----|-----|
| CUT | P   | 38  |
| CUT | YB  | 38  |
| CUT | B   | 38  |

Description: *Main harness to radio harness*

Location: *Behind radio*

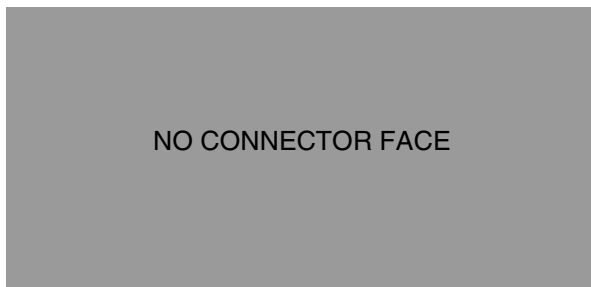

Colour:

Gender:

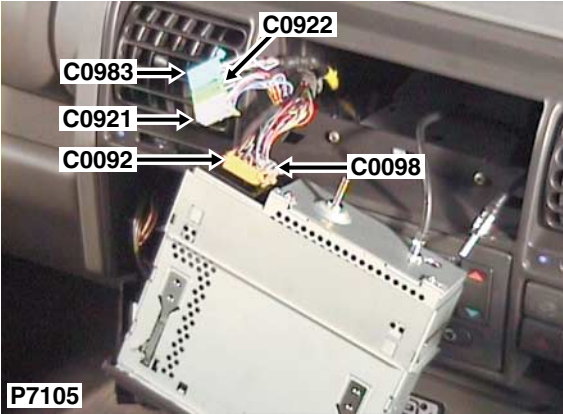

Description: *Head Unit-Audio System*  
 Location: *Behind radio*

| Cav | Col | Cct |
|-----|-----|-----|
| 13  | SO  | 31  |
| 13  | R   | 33  |
| 14  | YG  | 31  |
| 14  | W   | 33  |
| 15  | B   | 33  |
| 16  | S   | 33  |
| 17  | U   | 33  |
| 18  | S   | 31  |
| 19  | R   | 31  |
| 19  | K   | 33  |
| 20  | W   | 31  |
| 20  | P   | 33  |

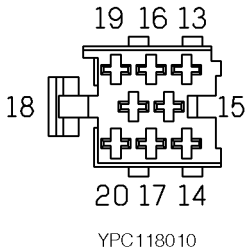

Colour: *BLACK*  
 Gender: *Female*

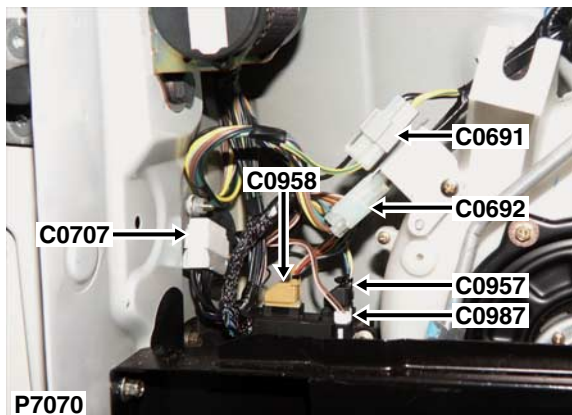

| Cav | Col | Cct |
|-----|-----|-----|
| 1   | K   | ALL |
| 2   | N   | ALL |

Description: *Speaker-PDC*

Location: *Luggage compartment - LH side*

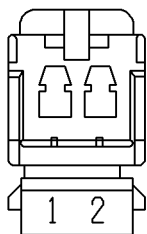

YPC10246

Colour: *WHITE*

Gender: *Female*

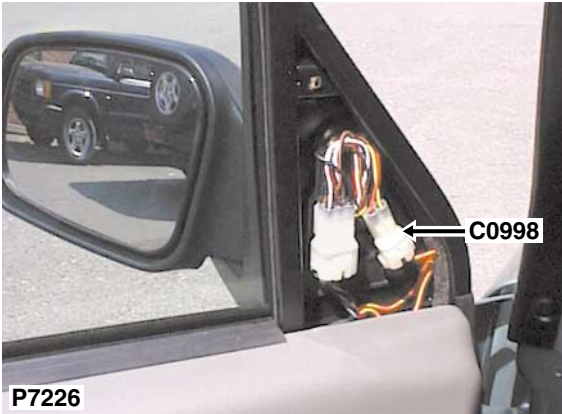

| Cav | Col | Cct |
|-----|-----|-----|
| 1   | O   | 40  |
| 2   | OR  | 40  |

Description: *Motor-Folding mirror*

Location: *Behind front door trim panel*

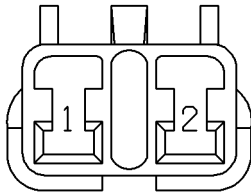

AFU3635

Colour: *NATURAL*

Gender: *Female*

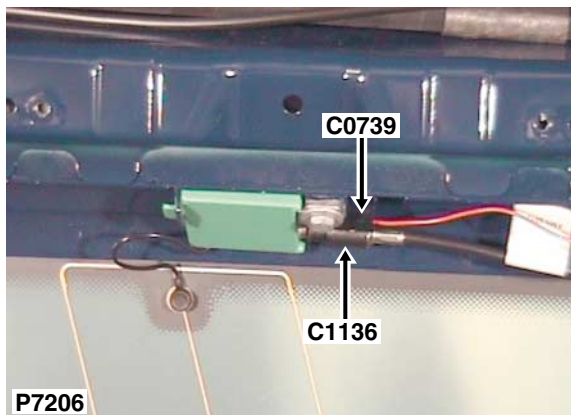

| Cav | Col | Cct |
|-----|-----|-----|
| 1   | B   | ALL |

Description: *Aerial*

Location: *Behind RH rear trim panel*

NO CONNECTOR FACE

Colour:

Gender:

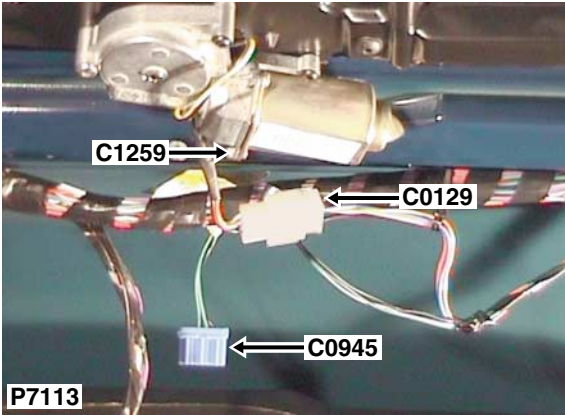

| Cav | Col | Cct |
|-----|-----|-----|
| 1   | B   | ALL |

Description: *Earth*

Location: *Behind centre headlining*

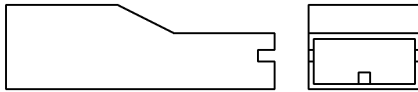

AAU1010

Colour: *BLACK*

Gender: *Female*

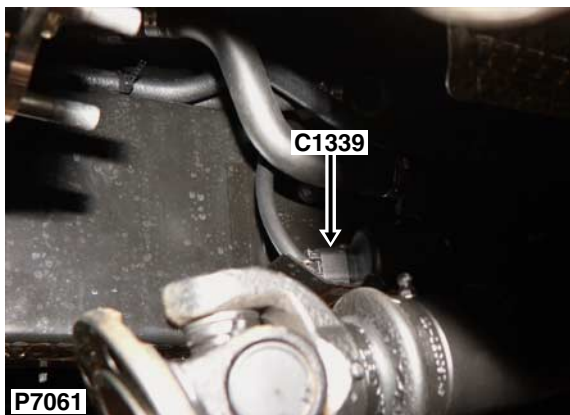

| Cav | Col | Cct |
|-----|-----|-----|
| 1   | KO  | 18  |
| 2   | BY  | 18  |
| 3   | NK  | 18  |

Description: *Pump-Leak detection*

Location: *Beneath vehicle - RH side*

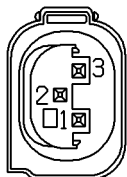

YPC110630

Colour: *BLUE*

Gender: *Female*

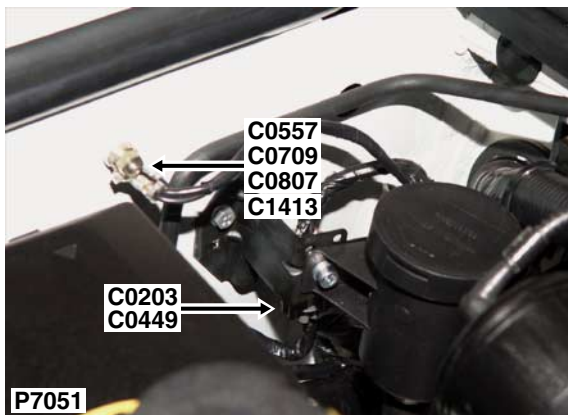

| Cav | Col | Cct |
|-----|-----|-----|
| 1   | B   | 23  |

Description: *Earth*

Location: *Rear RH side of engine compartment*

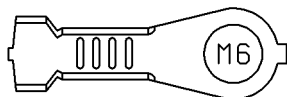

YPG10003

Colour: *TIN-PLATE*

Gender: *Eyelet*



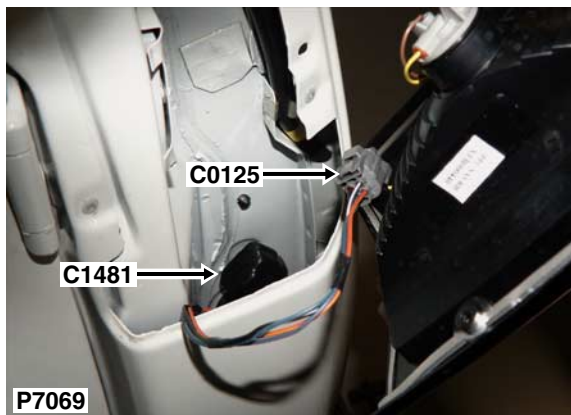

| Cav | Col | Cct |
|-----|-----|-----|
| 1   | GR  | ALL |
| 2   | RB  | ALL |
| 3   | GW  | ALL |
| 4   | RO  | ALL |
| 5   | GP  | ALL |
| 6   | PN  | ALL |
| 7   | GN  | ALL |
| 8   | RY  | 1   |
| 9   | B   | ALL |

Description: *Body harness to trailer harness*

Location: *RH rear of vehicle*

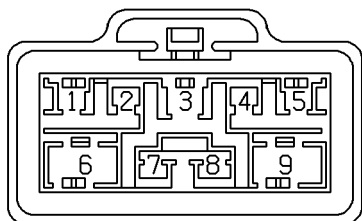

YPC114850

Colour: *GREY*

Gender: *Female*

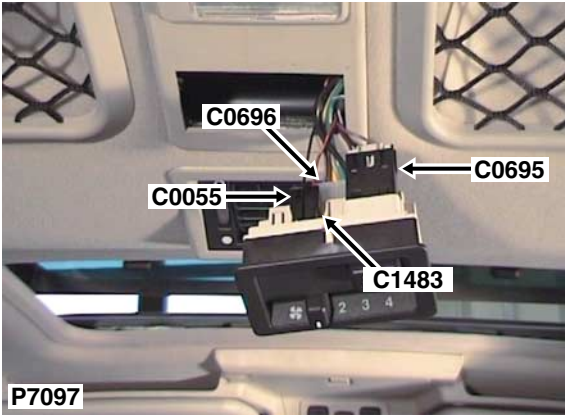

| Cav | Col | Cct |
|-----|-----|-----|
| 1   | RB  | 17  |

Description: *Switch-Blower-Rear*  
 Location: *Behind centre headlining*

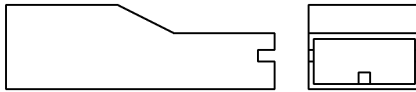

AAU1010

Colour: *BLACK*  
 Gender: *Female*

# C1564

## CONNECTOR DETAILS

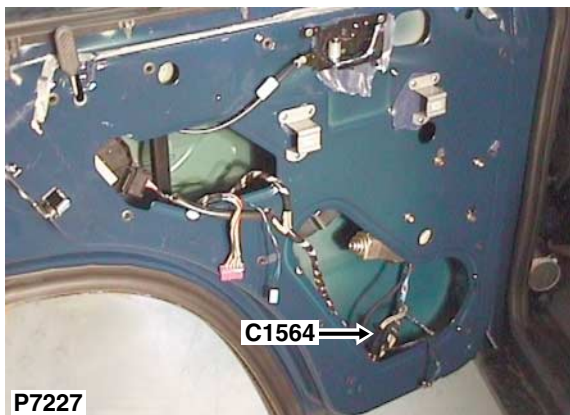

| Cav | Col | Cct |
|-----|-----|-----|
| 1   | SR  | 44  |
| 2   | SO  | 44  |

Description: *Motor-Window-Rear*

Location: *Behind rear door trim panel*

NO CONNECTOR FACE

Colour:

Gender:

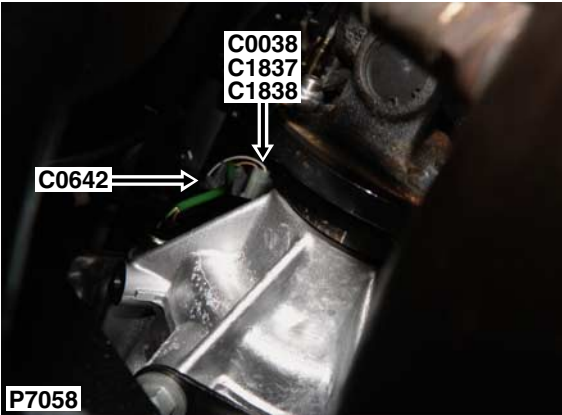

| Cav | Col | Cct |
|-----|-----|-----|
| 1   | GY  | 47  |
| 2   | BU  | 47  |

Description: *Resistor*

Location: *Top of transfer box*

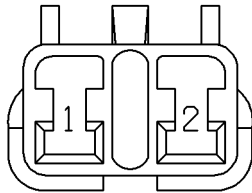

AFU3635

Colour: *NATURAL*

Gender: *Female*

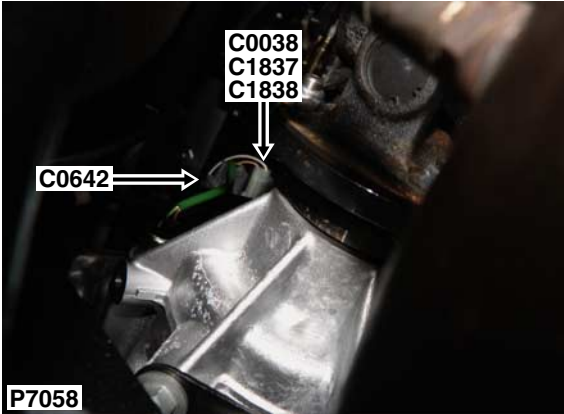

| Cav | Col | Cct |
|-----|-----|-----|
| 1   | KG  | ALL |
| 2   | WN  | ALL |

Description: *Resistor*

Location: *Top of transfer box*

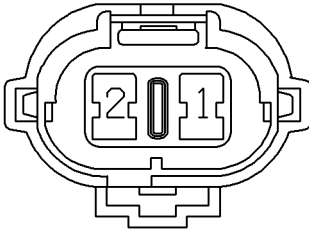

AFU3584

Colour: *NATURAL*

Gender: *Male*

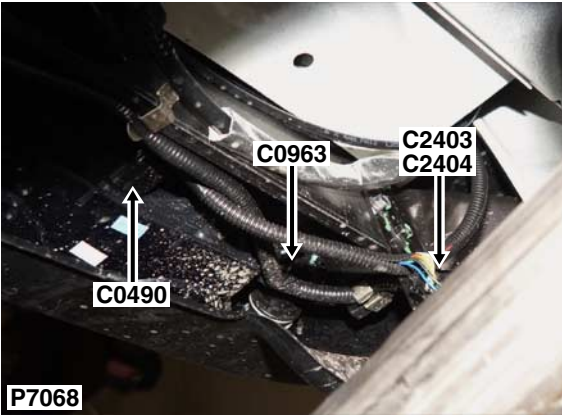

| Cav | Col | Cct |
|-----|-----|-----|
| 1   | WG  | ALL |
| 2   | G   | ALL |
| 3   | U   | ALL |
| 4   | Y   | ALL |
| 5   | O   | ALL |
| 6   | BG  | ALL |

Description: *Body harness to PDC harness*  
 Location: *LH rear of vehicle*

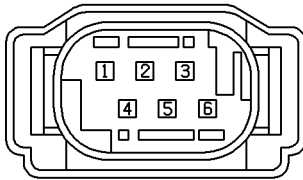

YPC110680

Colour: *BLACK*  
 Gender: *Female*

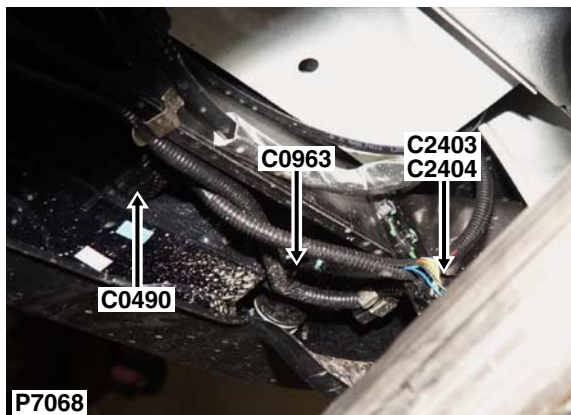

Description: *PDC harness to body harness*

Location: *LH rear of vehicle*

| Cav | Col | Cct |
|-----|-----|-----|
| 1   | W   | ALL |
| 2   | G   | ALL |
| 3   | U   | ALL |
| 4   | Y   | ALL |
| 5   | O   | ALL |
| 6   | B   | ALL |

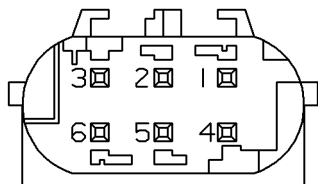

YPC110770

Colour: *BLACK*

Gender: *Male*





