



RANGE ROVER

Electrical Library



RANGE ROVER

ELECTRICAL LIBRARY

LRL 0453ENG(2)

Published by Land Rover

© Land Rover 2002

All rights reserved. No part of this publication may be reproduced, stored in a retrieval system or transmitted in any form, electronic, mechanical, recording or other means without prior written permission from Land Rover.

| | |
|---|----------|
| INTRODUCTION | 1 |
| ABOUT THIS DOCUMENT | 1.1 |
| ELECTRICAL PRECAUTIONS | 1.3 |
| ABBREVIATIONS | 1.6 |
| HOW TO USE THIS DOCUMENT | 1.8 |
| FAULT DIAGNOSIS | 1.10 |
| WIRE COLOUR CODES | 1.11 |
| | |
| FUSE DETAILS | 2 |
| ENGINE COMPARTMENT FUSE BOX | 2.2 |
| PASSENGER COMPARTMENT FUSE BOX | 2.3 |
| REAR FUSE BOX | 2.6 |
| | |
| EARTH POINTS AND HEADERS | 3 |
| | |
| DESCRIPTION AND OPERATION | 4 |
| ANTI-THEFT ALARM AND CENTRAL DOOR LOCKING (CDL) | 4.1 |
| ENGINE IMMOBILISATION | 4.9 |
| WINDOWS | 4.13 |
| SUNROOF | 4.17 |
| DOOR MIRRORS | 4.19 |
| INTERIOR MIRROR | 4.23 |
| FRONT SEATS | 4.25 |
| FRONT HEATED SEATS | 4.28 |
| REAR HEATED SEATS | 4.29 |
| DIAGNOSTIC SOCKET | 4.30 |
| STARTING AND CHARGING – Td6 | 4.31 |
| STARTING AND CHARGING – V8 | 4.35 |
| CRUISE CONTROL | 4.38 |
| ELECTRONIC AUTOMATIC TRANSMISSION (EAT) – GM5 | 4.40 |
| ELECTRONIC AUTOMATIC TRANSMISSION (EAT) – ZF | 4.43 |
| ANTI-LOCK BRAKING SYSTEM (ABS) | 4.46 |
| SUPPLEMENTARY RESTRAINT SYSTEM (SRS) | 4.49 |
| AUTOMATIC TEMPERATURE CONTROL (ATC) | 4.53 |
| AUTOMATIC TEMPERATURE CONTROL (ATC) – COMFORT | 4.56 |
| FUEL BURNING HEATER – Td6 | 4.61 |
| FUEL BURNING HEATER – V8 | 4.62 |
| COOLING FAN | 4.64 |
| HEATED REAR WINDOW (HRW) | 4.66 |

CONTENTS

| | |
|--|-------|
| HEATED FRONT SCREEN (HFS) | 4.67 |
| WIPERS AND WASHERS | 4.68 |
| HEADLAMP WASH/WIPE | 4.71 |
| BRAKE AND REVERSE LAMPS | 4.72 |
| HEAD, SIDE AND TAIL LAMPS | 4.74 |
| AUTOMATIC HEADLAMP LEVELLING | 4.78 |
| FOG LAMPS | 4.80 |
| DIRECTION INDICATOR/HAZARD WARNING LAMPS | 4.82 |
| INTERIOR LAMPS | 4.84 |
| INTERIOR ILLUMINATION | 4.87 |
| INSTRUMENTS | 4.90 |
| HORNS | 4.92 |
| CLOCK | 4.93 |
| CIGAR LIGHTERS | 4.94 |
| ACCESSORY SOCKETS | 4.95 |
| TRAILER SOCKET | 4.96 |
| AUDIO SYSTEM – LOW LINE | 4.98 |
| AUDIO SYSTEM – MID-LINE | 4.99 |
| AUDIO SYSTEM – HIGH LINE | 4.100 |
| SATELLITE NAVIGATION SYSTEM | 4.101 |
| SATELLITE NAVIGATION SYSTEM – NAS | 4.102 |
| TELEPHONE | 4.103 |
| TELEPHONE – HANDS FREE | 4.104 |
| TELEPHONE – NAS | 4.105 |
| FUEL PUMP | 4.106 |
| ROTARY COUPLER | 4.108 |
| PARK DISTANCE CONTROL (PDC) | 4.110 |
| TYRE PRESSURE MONITORING (TPM) | 4.113 |
| STEERING COLUMN | 4.114 |
| AIR SUSPENSION | 4.117 |

CONNECTOR 5

| | |
|---------------------------------|-----|
| CIRCUIT REFERENCE NUMBERS | 5.1 |
|---------------------------------|-----|

ABOUT THIS DOCUMENT

General

This document is intended to assist in diagnosing electrical faults, and should be used in conjunction with the Electrical Circuit Diagrams. The document is divided into the following sections.

1. **INTRODUCTION** – Includes Electrical Precautions, a list of Abbreviations and general information on how to use this document.
2. **FUSE DETAILS** – Provides details of location, rating in Amperes, and circuit(s) protected.
3. **EARTH POINTS AND HEADERS** – Provides details of earth points and earth headers, including a plan view of the vehicle to aid location.
4. **DESCRIPTION AND OPERATION** – Provides an explanation of how each of the systems operate.
5. **CIRCUIT REFERENCE NUMBERS** – Provides a list of circuit reference numbers against a model or feature to which they apply.
6. **CONNECTOR DETAIL** – Details of connectors including a location photograph, face view and pin-out table.

NOTE: Before starting electrical checks on the vehicle, ensure that relevant mechanical functions operate satisfactorily.

References

References to the LH or RH side given in this document are made when viewing the vehicle from the rear.

Operations covered in this document do not include reference to testing the vehicle after repair. It is essential that work is inspected and tested after completion and, if necessary, a road test of the vehicle is undertaken, particularly where safety related items are concerned.

CAUTION: Before undertaking any electrical work on a vehicle ALWAYS read the ELECTRICAL PRECAUTIONS.

INTRODUCTION

Battery Voltage

Open Circuit Voltage Test

Before commencing diagnosis of electrical problems, verify the condition of the battery is acceptable by using the open circuit voltage test.

1. Switch off all electrical loads on the vehicle.
2. Adjust digital multimeter to read dc volts on the appropriate scale.
3. Connect test probes across battery terminals ensuring that polarity is correct and record the voltage displayed.

A reading of 12.5 V or more is acceptable; any battery which reads less than this will need charging.

NOTE: If the vehicle has been used within a period of 8 hours prior to the test, surface charge must be removed from the battery by switching the headlamps on for approximately 30 seconds. Wait a further 60 seconds before checking the open circuit voltage.

Battery voltage is used as a known reference for ascertaining whether or not circuits are receiving sufficiently high voltage for components to function correctly. This reference is only a guide since most electronic circuits are designed to function over a wide range of voltages. In addition, consideration must be given to readings affected by voltage drop across certain components and fluctuations due to cable lengths.

ELECTRICAL PRECAUTIONS

General

The following guidelines are intended to ensure the safety of the operator whilst preventing damage to the electrical and electronic components fitted to the vehicle. Where necessary, specific precautions are detailed in the relevant sections of this document, reference to these precautions should be made prior to commencing repair operations.

Equipment – Prior to commencing any test procedure on the vehicle, ensure that the relevant test equipment is working correctly and any harnesses or connections are in good condition. This particularly applies to mains lead or connections.

WARNING: Before commencing work on an ignition system, all high tension terminals, adaptors and diagnostic equipment for testing should be inspected to ensure that they are adequately insulated and shielded to prevent accidental personal contact and to minimise the risk of shock. Wearers of surgically implanted pacemaker devices should not work in close proximity to ignition circuits or diagnostic equipment.

Polarity – Never reverse connect the vehicle battery and always observe correct polarity when connecting test equipment.

High Voltage Circuits – Whenever disconnecting live ht circuits, always use insulated pliers and never allow the open end of the ht lead to come into contact with other components, particularly ECU's. Since high voltage spikes can occur on the terminals of the coil while the engine is running, exercise caution when measuring the voltage at these points.

WARNING: The Xenon headlamp system generates up to 28,000 V and contact with this voltage could lead to fatality. Make sure that the headlamps are switched off before working on the system. Refer to the guidelines given in the 'General Information' section of the Service Repair Procedures Workshop Manual before any work is carried out.

Connectors and Harnesses – The engine compartment of a vehicle is a particularly hostile environment for electrical components and connectors. Always ensure these items are dry and oil free before disconnecting and connecting test equipment. Never force connectors apart either by using tools or by pulling on the wiring harness. Always ensure locking tabs are disengaged before removal and note orientation to enable correct reconnection. Ensure that any protective covers and substances are replaced if disturbed.

INTRODUCTION

Before removing a faulty component, refer to the Workshop Manual for removal procedures. Ensure the ignition switch is turned to the 'OFF' position, the battery is disconnected (**see *Battery Disconnecting***) and any disconnected harnesses are supported to avoid any undue strain at the terminals. When replacing the component keep oily hands away from electrical connection areas and push connectors home until any locking tabs fully engage.

Battery Disconnecting

It is imperative that the key is removed from the ignition switch before disconnecting the battery. A time of 2 minutes must also elapse (after the ignition has been switched off) before the battery should be disconnected. Failure to do so could result in:

- Navigation computer software damage
- Incorrect fuel gauge reading.

Before disconnecting the battery, disable the alarm system and switch off all electrical equipment. If the radio is to be serviced, ensure the security code has been deactivated.

CAUTION: Never disconnect the battery with the ignition switched on.

CAUTION: To prevent damage to the navigation computer software, a waiting period of two minutes must elapse after the ignition is switched off before the battery leads are disconnected.

CAUTION: To prevent damage to electrical components, always disconnect the battery when working on the vehicle's electrical system. The earth lead must be disconnected first and reconnected last.

CAUTION: Always ensure that battery leads are routed correctly and are not close to any potential chafing points.

After reconnecting the battery, the steering wheel must be turned to full LH and RH lock (with the engine running). This allows the Dynamic Stability Control (DSC) system to relearn the steering wheel position. Failure to do so will result in a variety of instrument pack warning lamps being illuminated.

Battery Charging

Only recharge the battery with it removed from the vehicle. Always ensure any battery charging area is well ventilated and that every precaution is taken to avoid naked flames and sparks.

The New Range Rover is fitted with a lead calcium battery, and can only be charged using equipment specifically designed to operate on this type of battery. Refer to the **Land Rover Equipment** bulletin for a list of recommended battery charging equipment.

Disciplines

Switch off ignition prior to making any connection or disconnection in the system as electrical surge caused by disconnecting 'live' connections can damage electrical components.

Ensure hands and work surfaces are clean and free of grease, swarf, etc. as grease collects dirt which can cause tracking or high-resistance contacts.

When handling printed circuit boards, treat them as you would a disc – hold by the edges only; note that some electrical components are susceptible to body static.

Connectors should never be subjected to forced removal or refit, especially inter-board connectors. Damaged contacts will cause short-circuit and open-circuit conditions.

Prior to commencing testing, and periodically during testing, touch a good earth, i.e. cigar lighter socket, to discharge body static as some electrical components are vulnerable to static electricity.

Grease for Electrical Connectors

Some under bonnet and under body connectors are protected against corrosion by the application of a special grease during production. Should connectors of this type be disturbed, repaired, or replaced, a grease of this type, available under part number BAU 5811, should again be applied. Do not apply grease to any connectors that do not have grease applied as standard.

NOTE: The use of other greases must be avoided as they can migrate into relays, switches, etc. contaminating the contacts and leading to intermittent operation or failure.

INTRODUCTION

ABBREVIATIONS

General

| | |
|-------|--|
| A | Ampere |
| ABS | Anti-lock Braking System |
| ac | Alternating current |
| A/C | Air Conditioning |
| ATC | Automatic Temperature Control |
| ATF | Automatic Transmission Fluid |
| BBUS | Battery Backed-Up Sounder |
| BCU | Body Control Unit |
| Bus | Databus |
| CAN | Controller Area Network |
| Cav | Cavity |
| CBC | Corner Braking Control |
| Cct | Circuit |
| CDL | Central Door Locking |
| CHMSL | Centre High Mounted Stop Lamp |
| CKP | Crankshaft Position |
| CMP | Camshaft Position |
| Col | Colour |
| dc | Direct current |
| DCU | Diagnostic Control Unit |
| DOT | Department of Transport |
| DSC | Dynamic Stability Control |
| DSP | Digital Signal Processor |
| EAT | Electronic Automatic Transmission |
| EBA | Emergency Brake Assist |
| EBD | Electronic Brake force Distribution |
| E-box | Environmental box |
| ECM | Engine Control Module |
| ECT | Engine Coolant Temperature |
| ECU | Electronic Control Unit |
| EPRS | Electronic Pressure Regulator Solenoid |
| ETC | Electronic Traction Control |
| F | Fuse |
| FBH | Fuel Burning Heater |
| FIP | Fuel Injection Pump |
| FL | Fusible Link |

| | |
|--------|--|
| HeVAC | Heating, Ventilation and Air Conditioning |
| HO2S | Heated Oxygen Sensor |
| HDC | Hill Descent Control |
| HFS | Heated Front Screen |
| HRW | Heated Rear Window |
| LCM | Light Check Module |
| LED | Light Emitting Diode |
| LH | Left Hand |
| MF | Maxi-fuse |
| MOSFET | Metal Oxide Semi-conductor Field Effect Transistor |
| MFD | Multi-Function Display |
| NAS | North American Specification |
| NTC | Negative Temperature Coefficient |
| PDC | Park Distance Control |
| PWM | Pulse Width Modulated |
| RF | Radio Frequency |
| RH | Right Hand |
| rpm | Revs per minute |
| SAI | Secondary Air Injection |
| SRS | Supplementary Restraint System |
| TCC | Torque Converter Clutch |
| TPM | Tyre Pressure Monitoring |
| TV | Television |
| V | Volts |

INTRODUCTION

HOW TO USE THIS DOCUMENT

Fuse Details

Contains information on fuse functions and values and should be used together with the power distribution circuit diagrams to establish which systems share a common power supply and to ensure that correct value fuses are fitted.

Earth Points and Headers

Shows a plan view of the vehicle with location of all earth points. Supporting photographs and connector detail information appear in the Connector section.

Description and Operation

Presented in the same order as the circuit diagrams in the Electrical Circuit Diagrams publication, each of the descriptions contains a brief overview of the main system functions and includes reference to the appropriate wire colours. Always read this section before starting work on a system so that a good understanding of system functionality is obtained.

Connector Details

This section is effectively an index of every electrical connector on the vehicle, including headers and eyelets. A page is dedicated to each connector, with the information presented in a standard format. The connector number is displayed on each page header to ease reference. Connector information comprises:

- **Connector Number** – The assigned number, prefixed 'C'.
- **Connector Name** – Usually derived from the component to which the connection is made.
- **Male/Female** – If applicable, identifies the gender of the connector pins (NOT the housing) as Male or Female. Generally, connectors mating directly into a component have Female pins.
- **Colour** – If applicable, the colour of the connector housing is shown. NATURAL is used to describe connectors with a clear/translucent plastic finish.
- **Location Statement** – Used in conjunction with the photograph to determine the location of the connector.
- **Photograph** – Shows the location of the subject connector. In most cases the photograph will indicate the amount of trim removal necessary to reveal the connector. For convenience some photographs identify more than one connector.
- **Face View** – An outline of the connector housing, viewed from the front, showing pin numbers (if applicable).
- **Pin-out Table** – A three column table, detailing the colour and position of each wire in the connector:

| Cav | Col | Cct |
|------------|------------|------------|
| 1 | GR | ALL |
| 2 | B | ALL |

1. **Cav:** The connector pin (cavity) number.
2. **Col:** The colour of wire populating the connector pin.
3. **Cct:** Identifies the model or feature which uses the wire. 'ALL' means applicable to all models in the range fitted with the feature or system in question. In instances where different models, features or systems require different colour wires to be fitted in a cavity, each instance of the cavity is included in the pin-out table.

NOTE: Wires may not be fitted to all cavities.

Example – 12 Pin Connector

| Cav | Col | Cct |
|------------|------------|------------|
| 2 | G | 58 |
| 4 | GW | 499 |
| 4 | GB | 573 |
| 4 | GR | 574 |
| 5 | LGB | 58 |
| 6 | GB | 499 |
| 6 | GW | 573 |
| 6 | GR | 574 |
| 8 | B | 499 |

Where necessary, a table listing the circuit reference numbers against a description of the model or features which may or may not be fitted can be found at the beginning of the connector section. A sample of a typical table is shown below.

| Cct | Model or Feature |
|------------|-------------------------|
| 1 | LHD |
| 2 | RHD |
| 3 | Td6 |
| 4 | V8 |
| 5 | Heated rear seats |
| 6 | NAS vehicles only |

INTRODUCTION

FAULT DIAGNOSIS

General

When diagnosing an electrical fault, follow the steps below:

1. Read the circuit description appropriate to the reported fault to ensure a good understanding of circuit operation.
2. Study the power distribution, fuse details and earth distribution diagrams and identify other circuits which share fuses and/or earth points. Check whether these circuits operate correctly.
3. Using the photographs contained in the Connector section, locate a point on the circuit (approximately half way between supply and earth) which is easily accessible.
4. Check that the pin-out details of the connector are correct and that the correct signals exist at the correct terminals.
5. Using a suitable non-permanent marker, mark the parts of the circuit you have verified.
6. Continue to the next point on the circuit which is easiest to access and repeat the above.
7. Continue with this approach until a fault is found, rectify the fault and then verify that the circuit operates correctly.

CAUTION: Never probe directly into the front face of a connector. This can damage the terminal and cause a failure. Always probe the back of a terminal, taking care not to damage the terminal or any seals.

Never probe wire insulation. On small diameter cables this can cut the conductors. It may also allow moisture into the cable, causing corrosion.

WIRE COLOUR CODES

General

The following list contains wire colour codes used on the vehicle harness's.

| Code | Colour |
|-------------|---------------------|
| B | Black |
| G | Green |
| K | Pink |
| LG | Light green |
| N | Brown |
| O | Orange |
| P | Purple |
| R | Red |
| S | Slate (Grey) |
| T | Transparent (White) |
| U | Blue |
| W | White |
| Y | Yellow |

Introduction

Fuses are mounted in one of three fuse boxes. The engine compartment fuse box is located in the environmental box (E-box). The passenger compartment fuse box is located behind the glove box, while the rear fuse box is located behind the luggage compartment RH trim casing.

The passenger compartment fuse box contains three different types of fuse:

1. **Blade type fuse** – Small, pull out, male fuse, used to protect circuits from 5 A to 30 A.
2. **Maxi-fuse** – A larger version of the blade type fuse. Used to protect circuits at 50 A. These are shown on the circuits using the same symbol as a fusible link. Each Maxi-fuse is shown with an MF prefix.
3. **Bolt down fuse** – Also known as a fusible link, used to protect circuits from 50 A to 100 A.

The engine compartment fuse box contains blade type fuses only. The rear fuse box contains blade and maxi-fuses.

NOTE: The lighting circuits are not protected by conventional fuses. Metal Oxide Semiconductor Field Effect Transistors (MOSFETS) within the Light Check Module (LCM) protect the lighting circuits. For more information, refer to the Lighting section of the System Description and Operation Workshop Manual.

FUSE DETAILS

ENGINE COMPARTMENT FUSE BOX

| Fuse | Rating | Vehicle | Function |
|------|--------|---------|---|
| F1 | 30 A | V8 | ECM, EAT ECU. |
| F1 | 30 A | Td6 | ECM. |
| F2 | 30 A | V8 | Variable camshaft control solenoids. |
| F2 | 30 A | Td6 | CMP sensor, MAF/IAT sensor. |
| F3 | 30 A | V8 | LH front HO2S, RH front HO2S, LH rear HO2S, RH rear HO2S. |
| F3 | 30 A | Td6 | EAT ECU. |
| F4 | 30 A | V8 | ECM. |
| F5 | 30 A | V8 | Ignition |

PASSENGER COMPARTMENT FUSE BOX

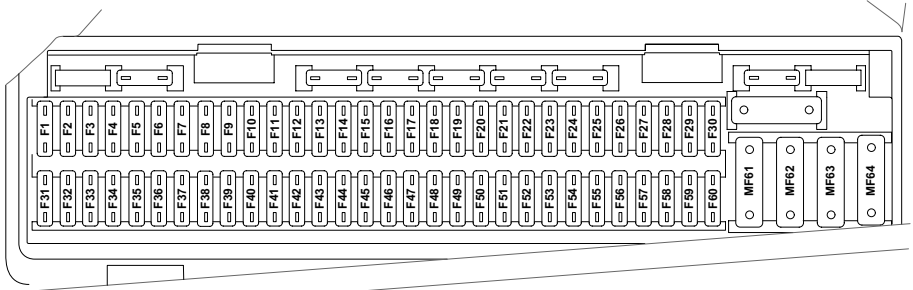

M86 5908

| Link | Rating | Vehicle | Function |
|------|--------|---------|--|
| FL1 | 80 A | All | Heated front screen relay. |
| FL2 | 60 A | Td6 | Ignition switch. |
| FL2 | 60 A | V8 | Engine immobilisation ECU, header 499. |
| FL3 | 50 A | All | Light Check Module. |
| FL4 | 50 A | All | Light Check Module. |
| FL5 | 100 A | All | MF17, MF18, MF19, F1, F2, F3, F4, F6, F7, F9, F10, F11, F12, F13, F14, F15 and F16 of the rear fuse box. |

FUSE DETAILS

| Fuse | Rating | Vehicle | Function |
|------|--------|---------|--|
| F1 | 5 A | All | Instrument pack |
| F2 | 5 A | All | Heated rear screen relay, rear blower motor relay, seat heat relay, relay 2, F5 and F8 of the rear fuse box. |
| F3 | 7.5 A | All | Fuel cooling fan motor. |
| F4 | 5 A | All | Light Check Module, Door lamp module. |
| F5 | 7.5 A | All | Diagnostic socket, EAT ECU. |
| F6 | 5 A | All | Tyre Pressure Monitoring ECU, Interior mirror, Park Distance Control ECU. |
| F7 | 5 A | All | Not used. |
| F8 | 5 A | All | Radio/cassette player. |
| F9 | 5 A | All | Light Check Module, Brake pedal switch, Rotary coupler. |
| F10 | 15 A | All | Horn relay. |
| F11 | 30 A | All | Drivers door module. |
| F12 | 10 A | All | HeVAC control unit. |
| F13 | 5 A | All | Transmission selector indicator lamp, Steering angle sensor, Clock. |
| F14 | 5 A | All | Not used. |
| F15 | 5 A | All | Diagnostic socket, BCU. |
| F16 | 5 A | All | Tyre Pressure Monitoring ECU. |
| F17 | 5 A | All | Door lamp module. |
| F18 | 10 A | All | Engine immobilisation ECU, Steering column interlock ECU. |
| F20 | 30 A | All | LH seat switch pack. |
| F21 | 30 A | All | RH seat switch pack. |
| F22 | 7.5 A | All | Telephone module. |
| F23 | 15 A | All | Steering wheel relay. |
| F24 | 30 A | All | Passenger door module. |
| F25 | 5 A | V8 | Ignition switch. |
| F26 | 30 A | All | Windscreen wiper delay ECU. |
| F27 | 20 A | All | BCU. |
| F28 | 30 A | All | Headlamp wash/wipe relay. |
| F29 | 10 A | All | Steering wheel heater ECU. |
| F30 | 15 A | All | Not used. |
| F31 | 5 A | All | ECM, Steering column interlock ECU. |
| F32 | 5 A | All | LH Xenon headlamp, RH Xenon headlamp. |
| F33 | 5 A | All | Transfer box ECU. |

FUSE DETAILS

| | | | |
|-----|-------|-----|--|
| F34 | 7.5 A | All | HeVAC control module. |
| F35 | 5 A | All | Centre console switch pack, Hill Descent Control switch. |
| F36 | 5 A | All | Not used. |
| F37 | 5 A | All | Transfer box ECU – Only fitted for towing purposes. |
| F38 | 5 A | All | Not used. |
| F39 | 5 A | All | Steering column lighting switch. |
| F40 | 5 A | All | CD autochanger. |
| F41 | 5 A | All | BCU, Rain sensor, Rear screen wiper ECU. |
| F42 | 5 A | All | LH vanity mirror, RH vanity mirror. |
| F43 | 5 A | All | Tilt sensor, Interior mirror, BBUS, Volumetric sensor. |
| F44 | 5 A | All | SRS DCU, occupancy detector, LH seat belt buckle, RH seat belt buckle. |
| F45 | 5 A | All | Instrument pack. |
| F46 | 5 A | All | Instrument pack. |
| F47 | 30 A | All | Heated washer jet relay. |
| F48 | 15 A | All | Not used. |
| F49 | 30 A | All | Radio/cassette player. |
| F51 | 10 A | Td6 | Steering angle sensor, ABS ECU, fuel pump relay. |
| F51 | 10 A | V8 | Steering angle sensor, Secondary Air Injection pump relay, Secondary Air Injection pump, ABS ECU, fuel pump relay. |
| F52 | 25 A | All | HeVAC control module. |
| F53 | 30 A | All | Ignition switch. |
| F54 | 15 A | All | EAT ECU. |
| F55 | 30 A | All | ABS ECU. |
| F56 | 7.5 A | All | Relay 6. |
| F57 | 15 A | All | Air suspension ECU. |
| F58 | 20 A | All | Sunroof ECU. |
| F59 | 20 A | All | Fuel burning heater, Fuel burning heater receiver. |
| F60 | 30 A | All | BCU. |

| Maxi-fuse | Rating | Vehicle | Function |
|-----------|--------|---------|-------------------------------------|
| MF61 | 50 A | All | Cooling fan control unit. |
| MF62 | 50 A | V8 | Secondary Air Injection pump relay. |
| MF63 | 50 A | All | ABS ECU. |
| MF64 | 50 A | All | Front blower motor control unit. |

FUSE DETAILS

REAR FUSE BOX

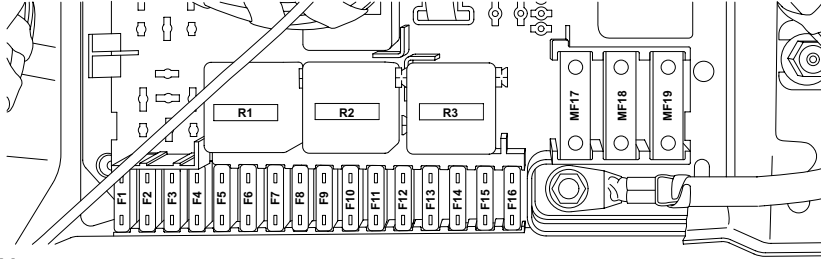

M86 5909

| Fuse | Rating | Vehicle | Function |
|------|--------|---------|--|
| F1 | 20 A | All | Front cigar lighter, Rear cigar lighter, Front accessory socket. |
| F2 | 25 A | All | Relay 4. |
| F3 | 25 A | All | Relay 2. |
| F4 | 15 A | All | Trailer pick-up. |
| F6 | 20 A | All | Trailer pick-up. |
| F7 | 20 A | All | Rear accessory socket. |
| F9 | 30 A | All | Heated rear window relay. |
| F10 | 20 A | All | Rear screen wiper motor. |
| F11 | 20 A | All | Seat heat relay. |
| F12 | 15 A | All | Rear blower motor relay. |
| F14 | 5 A | All | RF receiver. |
| F15 | 25 A | All | Fuel pump relay. |
| F16 | 10 A | All | Tail door relay. |

| Maxi-fuse | Rating | Vehicle | Function |
|-----------|--------|---------|-----------------------|
| MF17 | 50 A | All | Trailer ECU. |
| MF18 | 50 A | All | Air suspension relay. |
| MF19 | 50 A | All | Not used. |

EARTH POINTS AND HEADERS

General

The following illustration indicates the general position of each earth point and header on the vehicle. Refer to the **Connector** section for more information.

Refer to the **Circuit Diagrams** for details of electrical components and their associated earth points.

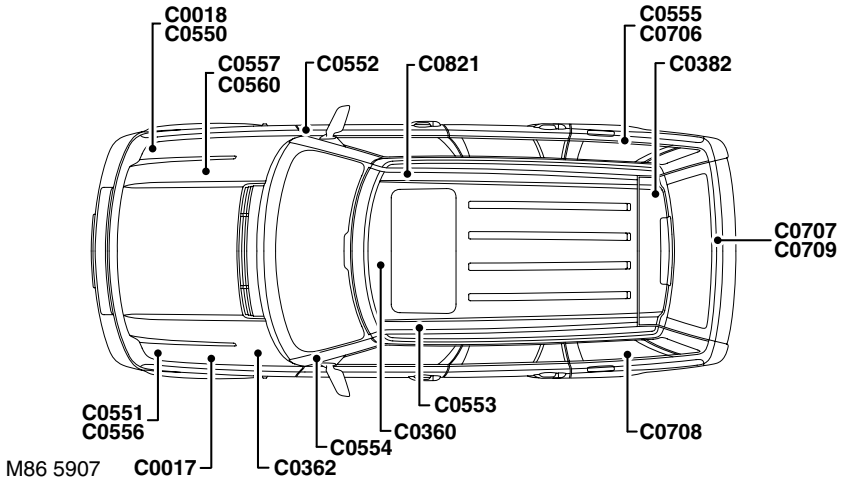

ANTI-THEFT ALARM AND CENTRAL DOOR LOCKING (CDL)

DESCRIPTION

Anti-Theft Alarm

The anti-theft alarm system fitted to New Range Rover consists three main areas:

- Perimetric protection.
- Volumetric protection.
- Vehicle angle monitoring.

Perimetric Protection

The Body Control Unit (BCU) protects the outside of the vehicle by monitoring the condition of all four door switches, the bonnet switch, and the upper tail door switch and sounds the alarm if any are triggered.

Volumetric Protection

The BCU protects the inside of the vehicle via an volumetric sensor mounted in the centre of the headlining. If the volumetric sensor detects movement within the passenger compartment, it informs the BCU to sound the alarm. When the alarm is first armed, the BCU allows 15 seconds for the air within the passenger compartment to stabilise. The alarm will then become fully armed after a further 15 seconds.

Vehicle Angle Monitoring

The BCU protects against the vehicle being illegally towed away, or any of the wheels being stolen by measuring the longitudinal and transverse angle of the vehicle. The angle of the vehicle is monitored by the tilt sensor, which is located beneath the front passenger seat. When the vehicle is first armed, the tilt sensor stores the angle of the vehicle in its memory. If the angle changes more than 1.2° (longitudinal) or 1.4° (transverse), the tilt sensor informs the BCU to sound the alarm. After the alarm has been triggered once, the threshold is lowered to 1.1 ° and 1.3 ° to make the alarm even more sensitive to vehicle angle movement.

NOTE: If the upper tail door is unlocked using the RF transmitter, the tail door switch, volumetric sensor, and tilt sensor will be disabled. These will be reactivated 30 seconds after the tail door is closed and locked.

An anti-theft alarm LED is mounted in the rear view mirror to act as a visual deterrent. The flashing sequence of the LED is dependent upon the status of the anti-theft alarm system. For detailed information on the anti-theft alarm system, refer to the ***Anti-theft Alarm and Central Door Locking*** section of the Description and Operation Workshop Manual.

DESCRIPTION AND OPERATION

Central Door Locking (CDL) and Superlocking

Two levels of locking are available; Central Door Locking (CDL) and Superlocking. CDL locks all doors, the tail door and the fuel filler flap. Superlocking carries out the same function as CDL but also inhibits operation of the interior door handles and sill buttons.

Superlocking is activated when either the Radio Frequency (RF) handset or the key is used to lock the vehicle. CDL is activated if the CDL master switch mounted on the fascia is pressed.

The RF handset, which is incorporated into the head of the ignition key, has three buttons. Pressing the large 'Land Rover' button once locks all doors and the tail door. This is followed by a single confirmation flash of the hazard warning lamps to inform that the vehicle has been locked successfully.

Pressing and holding the 'Land Rover' button for longer than 2 seconds locks all the doors and tail door and also closes any open windows (including the sunroof). Completion of this is again followed by a single confirmation flash of the hazard warning lamps to inform that the vehicle has been locked successfully.

Pressing the unlock 'Arrow' button once unlocks the drivers door. Pressing the unlock 'Arrow' button a second time unlocks the remaining three doors and the tail door. Pressing and holding the 'Arrow' button for longer than 2 seconds opens all the windows and the sunroof.

NOTE: Automatic opening and closing of the windows and sunroof is suspended if the lock or unlock button is released before the operation has been completed.

A third button on the handset operates the upper tail door lock. A single press of this button will unlock the upper tail door and temporarily suspend operation of the anti-theft alarm system. Once the tail door has been closed the tail door is automatically locked and the anti-theft alarm system reinstated. This is confirmed by a single flash of the hazard warning lamps.

For a detailed description of the CDL system, refer to the **Anti-theft Alarm and Central Door Locking** section of the Description and Operation Workshop Manual.

OPERATION

Anti-Theft Alarm

Power Distribution

Feed from the positive battery terminal (C0192) is supplied to fusible link 1, fuse 15, fuse 43, and fuse 53 (C0632) on an R wire. All are located in the passenger compartment fuse box. Fuse 15 (C0586) provides a constant battery feed to the Body Control Unit (BCU) (C0660) on an RS wire. The BCU (C0660) is earthed on an NB wire.

Fusible link 1 (C0588) provides a constant battery feed to fuse 14 of the rear fuse box (C2024) on an R wire. Fuse 14 (C2022) provides a constant battery feed to the radio frequency (RF) receiver (C0674) on an RB wire.

Fuse 43 of the passenger compartment fuse box (C0586) provides a constant battery feed to the following:

- The Battery Backed-Up Sounder (BBUS) (C0666) on an RN wire.
- The volumetric sensor (C0359) on an RW wire.
- The tilt sensor (C0960) on an RB wire.

Fuse 53 of the passenger compartment fuse box (C0583) provides a constant battery feed to the ignition switch (C0099 on Td6 vehicles, C0028 on V8 vehicles) on an R wire. When the ignition switch is turned to the 'ignition' position, current flows across the switch (C0099 on Td6 vehicles, C0028 on V8 vehicles) to fuse 6 of the passenger compartment fuse box (C0585) on a G wire. Fuse 6 (C0587) provides an ignition feed to the interior mirror (C0698) on a GW wire.

RF Receiver

The RF receiver (C0674) is located at the top of the upper tail door, and is provided a constant battery feed from fuse 14 of the rear fuse box (C2022) on an RB wire. The RF receiver is connected to an element in the rear screen via a pair of B wires. The RF receiver uses the rear screen element as an aerial.

NOTE: The B wires connecting the RF receiver to the rear screen element are not shown on the system circuit diagrams as they are fly leads incorporated into the manufacture of the rear screen.

The RF receiver converts high frequency wave forms transmitted by the remote handset into bi-phase, pulsed signals that can be understood by the BCU. The RF receiver (C0674) is connected to the BCU (C0660) by a WY wire.

DESCRIPTION AND OPERATION

Volumetric Sensor

The volumetric sensor monitors the inside of the vehicle by emitting a series of ultrasound pulses, and measuring the profile of the returned echo. The sensor (C0359) is located the centre of the headlining, and is provided a constant battery feed from fuse 43 of the passenger compartment fuse box (C0586) on an RW wire.

When the anti-theft alarm is armed, the BCU (C0661) 'switches on' the volumetric sensor by providing a pulsed voltage signal to the tilt sensor (C0960) on a BS wire. This signal is relayed to the volumetric sensor (C0359) on a BW wire. If the volumetric sensor detects movement within the passenger compartment, it provides a feed to the BCU (C0661) on a BY wire. The volumetric sensor (C0359) is earthed on an N wire.

Tilt Sensor

The tilt sensor monitors the angle of the vehicle. If the angle of the vehicle moves more than the thresholds outlined in the ***Description*** section, the alarm will be triggered. The sensor (C0960) is located beneath the front passenger seat, and is provided a constant battery feed from fuse 43 of the passenger compartment fuse box (C0586) on an RW wire. When the anti-theft alarm is armed, the BCU (C0661) 'switches on' the tilt sensor (C0960) by providing a pulsed voltage signal on a BS wire.

When the anti-theft alarm system is activated, the tilt sensor (C0960) provides a voltage pulse to the BCU (C0661) on a BU wire. If this isn't received within a set time, the BCU determines that the unit is defective.

If the tilt sensor is triggered, it provides a voltage pulse to the BCU (C0661) on a BU wire. Recognising this signal, the BCU (C0661) returns a pulsed voltage signal to the tilt sensor (C0960) on a BS wire.

Battery Backed-Up Sounder (BBUS)

The BBUS (C0666) is mounted adjacent the brake servo, and is provided a constant battery feed by fuse 43 of the passenger compartment fuse box (C0586) on an RN wire. Dependant upon market configuration, the BBUS can emit one of three tones:

- Continuous.
- Pulsed.
- Modulated.

When the anti-theft alarm is armed, the BCU (C0661) 'switches on' the BBUS by providing a pulsed voltage signal to the tilt sensor (C0960) on a BS wire. This signal is relayed to the BBUS (C0666) on a BG wire.

When the alarm is triggered, the BBUS (C0662) provides a feed to the BBUS (C0666) on a BU wire. The BBUS (C0666) is earthed on an N wire.

Perimetric Protection

The BCU (C0660) is located beneath the front passenger seat, and is provided a constant battery feed from fuse 15 of the passenger compartment fuse box (C0586) on an RS wire. The door, bonnet, and tail door switches are all normally open switches. When any of these panels are opened, the switch contacts close and an earth path is created. The BCU (C0660) monitors the condition of door bonnet and tail door switches as follows:

- The BCU monitors the condition of the drivers door switch (C1449) via the drivers door module (C2058) on a UR then NW wire. The drivers door switch (C1449) is earthed on an N wire.
- The BCU monitors the condition of the front passenger door switch (C1451) via the passenger door module (C2057) on a UR then NW wire. The passenger door switch (C1451) is earthed on an N wire.
- The BCU monitors the condition of the LH rear passenger door (C0442) on an NS then NG wire. The LH rear passenger door switch (C0442) is earthed on an N wire.
- The BCU monitors the condition of the RH rear passenger door (C0442) on an NW then NG wire. The RH rear passenger door switch (C0442) is earthed on an N wire.
- The BCU monitors the condition of the bonnet switch (C0007) on a PG wire. The bonnet switch (C0007) is earthed on an N wire.
- The BCU monitors the condition of the upper tail door switch (C0383) on an SW wire. The upper tail door switch (C0383) is earthed on an N wire.

NOTE: The LH rear and RH rear passenger door switches have the same connector number as they utilise the same harness.

Anti-theft Alarm LED

The anti-theft alarm LED is located in the rear view mirror. The flashing sequence of the LED (C0698) is controlled by the BCU (C0661) on an SBY wire.

DESCRIPTION AND OPERATION

Central Door Locking (CDL)

Power Distribution

Feed from the positive battery terminal (C0192) is supplied to the following on an R wire:

- Fusible link 1.
- Fuse 11.
- Fuse 15.
- Fuse 24.
- Fuse 60.

All are located in the passenger compartment fuse box (C0632). Fuse 15 (C0586) provides a constant battery feed to the BCU (C0660) on an RS wire. Fuse 60 (C0582) also provides a feed to the BCU (C0662) on an RW wire. The BCU (C0660) is earthed on an NB wire.

Fuse 24 (C0583) provides a constant battery feed to the passenger door module (C2016) on an RW wire. Fuse 11 (C0585) provides a constant battery feed to the drivers door module (C2017) on an RP wire.

Fusible link 1 (C0588) is connected to fuse 14 and fuse 16 of the rear fuse box (C2024) on an R wire. Fuse 14 (C2022) provides a constant battery feed to the RF receiver (C0674) on an RB wire. Fuse 16 provides a constant battery feed to relay 8, which is also located in the rear fuse box.

RF Receiver

The RF receiver (C0674) is located at the top of the upper tail door and is provided a constant battery feed from fuse 14 of the rear fuse box (C2022) on an RB wire. The RF receiver converts the radio frequency signals from the remote handset and converts them into a digital signals. The RF receiver (C0674) provides the digital signal to the BCU (C0660) on a WY wire. The BCU processes the signal from the RF receiver and carries out the appropriate function.

CDL Master Switch

The non-latching CDL master switch is mounted on the fascia, below the hazard warning switch. The BCU (C0661) monitors the condition of the switch (C0700) by providing a feed on an SN wire. When the switch is pressed, the switch contacts close and a momentary earth is created on an N wire. When the BCU registers this earth, it will lock all four doors, the tail door, and the fuel filler flap. Pressing the button a second time unlocks all four doors, the tail door and the fuel filler flap.

NOTE: Superlocking is not initiated when the CDL master switch is pressed.

Drivers Door

The BCU controls operation of the drivers door lock via the drivers door module. The drivers door module (C2017) is provided a constant battery feed from fuse 11 of the passenger compartment fuse box (C0585) on an RP wire. The module (C2017) is earthed on an N wire.

The BCU (C0660) communicates with the drivers door module (C2058) via the P-bus on a UR wire. If the drivers door module (C2058) receives an unlock signal from the BCU, it provides a feed to the door lock motor (C1449) on a U wire. Current flows across the motor (C1449) and is provided an earth path via the drivers door module (C2058) on a B wire.

The drivers door can also be unlocked using the key. The drivers door module (C2058) monitors the condition of the door lock barrel switch (C1449) on a WB wire. When the door lock is moved to the unlock position, the switch contacts close and an earth path is created on an N wire. Sensing this, the drivers door module unlocks the drivers door.

If the drivers door module (C2058) receives a lock signal from the BCU, it provides a feed to the door lock motor (C1449) on a B wire. Current flows across the motor (C1449) and is provided an earth path via the drivers door module (C2058) on a U wire.

If the drivers door module (C2058) receives a superlock signal from the BCU, it provides a feed to the superlock motor (C1449) on a W wire. Current flows across the superlock motor (C1449) and is provided an earth path via the drivers door module (C2058) on a U wire.

The drivers door can also be locked using the key. The drivers door module (C2058) monitors the condition of the door lock barrel switch (C1449) on a UR wire. When the door lock is moved to the lock position, the switch contacts close and an earth path is created on an N wire. Sensing this, the drivers door module locks the drivers door.

Front Passenger Door

The BCU controls operation of the front passenger door lock via the passenger door module. The passenger door module (C2016) is provided a constant battery feed from fuse 24 of the passenger compartment fuse box (C0583) on an RW wire. The module (C2016) is earthed on an N wire.

The BCU (C0660) communicates with the passenger door module (C2057) via the P-bus on a UR wire. If the passenger door module (C2057) receives an unlock signal from the BCU, it provides a feed to the door lock motor (C1451) on a U wire. Current flows across the motor (C1451) and is provided an earth path via the drivers door module (C2057) on a B wire.

If the passenger door module (C2057) receives a lock signal from the BCU, it provides a feed to the door lock motor (C1451) on a B wire. Current flows across the motor (C1451) and is provided an earth path via the passenger door module (C2057) on a U wire.

If the passenger door module (C2057) receives a superlock signal from the BCU, it provides a feed to the superlock motor (C1451) on a W wire. Current flows across the superlock motor (C1451) and is provided an earth path via the drivers door module (C2057) on a U wire.

DESCRIPTION AND OPERATION

Rear Passenger Doors

When the BCU (C0662) receives an unlock signal from the RF receiver, it provides a feed to the RH and LH rear (C0442) door lock motors on a pair of U wires. Current flows across the motors (C0442) to earth path via the BCU (C0662) on a pair of B wires.

When the BCU (C0662) receives a lock signal from the RF receiver, it provides a feed to the RH and LH rear door lock motors (C0442) on a pair of B wires. Current flows across the motors (C0442) to earth via the BCU (C0662) on a pair of U wires.

When the BCU (C0662) receives a superlock signal from the RF receiver, it provides a feed to the RH and LH rear (C0442) superlock motors on a pair of W wires. Current flows across the superlock motors (C0442) to earth via the BCU (C0662) on a pair of U wires.

Tail Door

The non-latching tail door switch is located on the centre console, adjacent to the clock. When the switch is pressed a momentary earth path is created. Sensing this, the BCU (C0662) provides a feed to the upper tail door motor (C0383) on a YN wire. The motor (C0383) is earthed on an N wire.

Once the upper tail door has been opened, the lower tail door can be opened. This can be carried out by pressing the non-latching switch located on the upper edge of the lower tail door.

The BCU (C0660) monitors the condition of the switch (C0615) by providing a feed on a YB wire. When pressed, the switch contacts close and a momentary earth path is created via the rear fuse box. Sensing this, the BCU (C0661) provides a feed to relay 8 of the rear fuse box (C2022) on an NY wire. This feed energises relay 8.

The energised relay 8 (C2022) allows a feed from fuse 16 of the rear fuse box to power the RH lower (C2052) and LH lower (C0617) tail door motors on UW wires. Both motors are earthed on N wires.

Fuel Filler Flap

When the BCU (C0662) receives an unlock signal from the RF receiver, it provides a feed to the fuel filler flap release motor (C0690) on a U wire. On European vehicles, current flows across the motor (C0690) and is provided an earth path via the BCU (C0662) on a W wire. On NAS vehicles, current flows across the motor (C0690) and is provided an earth path via the BCU (C0662) on a B wire.

When the BCU (C0662) receives a lock signal from the RF receiver, it provides a feed to the fuel filler flap release motor (C0690) on a W wire (B wire on NAS vehicles). Current flows across the motor (C0690) and is provided an earth path via the BCU (C0662) on a U wire.

ENGINE IMMOBILISATION

DESCRIPTION

General

The function of the engine immobilisation system is to prevent unauthorised starting of the vehicle. The system is controlled by an immobilisation ECU which is located beneath the centre console, adjacent to the handbrake. Re-mobilisation is achieved via a transponder in the vehicle key, which is read by a transponder coil when the ignition switch is turned to the 'auxiliary' position. The transponder coil is mounted around the ignition switch.

For a detailed description of the engine immobilisation system, refer to the **Security** section of the Description and Operation Workshop Manual.

OPERATION

Td6

Power Distribution

Feed from the positive battery terminal (C0192) is supplied to fusible link 2, fuse 18, and fuse 53 of the passenger compartment fuse box (C0632) on an R wire. Fuse 18 (C0584) provides a constant battery feed to the immobilisation ECU (C0059) and the steering column interlock ECU (C2055) on a pair of RY wires.

Fuse 53 (C0583) provides a constant battery feed to the ignition switch (C0099) on an R wire. When the ignition switch is turned to the 'auxiliary' position, current flows across the switch (C0099) to fuse 39 of the passenger compartment fuse box (C0585) on a PB wire. Fuse 39 (C0587) provides an auxiliary ignition feed to the immobilisation ECU (C0059) and the steering column interlock ECU (C2055) on a pair of PB wires.

When the ignition switch is turned to the 'ignition' position, current flows across the switch (C0099) to fuse 31 of the passenger compartment fuse box (C0585) on a G wire. Fuse 31 (C0587) provides an ignition feed to the steering column interlock ECU (C2055) on a GB wire.

Fusible link 2 of the passenger compartment fuse box (C0591) provides a constant battery feed to the ignition switch (C0099) on an R wire. When the ignition switch is turned to the 'crank' position, current flows across the switch (C0099) to the immobilisation ECU (C0059) on a BY wire.

DESCRIPTION AND OPERATION

Steering Column Interlock ECU

The steering column interlock ECU (C2055) receives the following power supplies:

- A constant battery feed from fuse 18 of the passenger compartment fuse box (C0584) on an RY wire.
- An auxiliary ignition feed from fuse 39 of the passenger compartment fuse box (C0587) on a PB wire.
- An 'ignition on' feed from fuse 31 of the passenger compartment fuse box (C0587) on a GB wire.

The ECU is earthed on an NB wire.

Transponder Coil

The transponder coil (C0049) is connected to the immobilisation ECU (C0059) by YU and YN wires. Both connections between the immobilisation ECU and the transponder coil switch between being both inputs and outputs. The transponder coil reads the vehicle identification information contained within the key transponder and relays it to the immobilisation ECU.

Immobilisation ECU

The immobilisation ECU (C0059) is located beneath the centre console, adjacent to the handbrake. It receives a constant battery feed from fuse 18 of the passenger compartment fuse box (C0584) on an RY wire, and an auxiliary ignition feed from fuse 39 of the passenger compartment fuse box (C0587) on a PB wire.

If the immobilisation ECU (C0059) has received a valid signal from both the transponder coil (C0049) and the steering column interlock ECU (C2055) when the ignition switch is turned to the 'crank' position, it transmits a rolling code to the Engine Control Module (ECM) (C0331) on a BP wire. The immobilisation ECU (C0059) also provides a feed to the starter motor relay (C0179) on a B wire.

For more information on operation of the starter motor, refer to the ***Starting and Charging – Td6*** section of this manual.

 **STARTING AND CHARGING – Td6.**

V8

Power Distribution

Feed from the positive battery terminal (C0192) is supplied to the following on an R wire:

- Fusible link 2.
- Fuse 18.
- Fuse 25.
- Fuse 53.

All are located in the passenger compartment fuse box (C0632).

Fusible link 2 (C0591) provides a constant battery feed to the immobilisation ECU (C0059) on an R wire. Fuse 18 (C0584) provides a constant battery feed to the immobilisation ECU (C0059) and the steering column interlock ECU (C2055) on a pair of RY wires.

Fuse 53 (C0583) provides a constant battery feed to the ignition switch (C0028) on an R wire. When the ignition switch is turned to the 'auxiliary' position, current flows across the switch (C0028) to fuse 39 of the passenger compartment fuse box (C0585) on a PB wire. Fuse 39 (C0587) provides an auxiliary ignition feed to the immobilisation ECU (C0059) and the steering column interlock ECU (C2055) on a pair of PB wires.

When the ignition switch is turned to the 'ignition' position, current flows across the switch (C0028) to fuse 31 of the passenger compartment fuse box (C0585) on a G wire. Fuse 31 (C0587) provides an ignition feed to the steering column interlock ECU (C2055) on a GB wire.

Fuse 25 of the passenger compartment fuse box (C0583) provides a constant battery feed to the ignition switch (C0028) on an RU wire. When the ignition switch is turned to the 'crank' position, current flows across the switch (C0028) to the Engine Control Module (ECM) (C0331) on a BY wire.

Steering Column Interlock ECU

The steering column interlock ECU (C2055) receives the following power supplies:

- A constant battery feed from fuse 18 of the passenger compartment fuse box (C0584) on an RY wire.
- An auxiliary ignition feed from fuse 39 of the passenger compartment fuse box (C0587) on a PB wire.
- An 'ignition on' feed from fuse 31 of the passenger compartment fuse box (C0587) on a GB wire.

The ECU is earthed on an NB wire.

DESCRIPTION AND OPERATION

Transponder Coil

The transponder coil (C0049) is connected to the immobilisation ECU (C0059) by YU and YN wires. Both connections between the immobilisation ECU and the transponder coil switch between being both inputs and outputs. The transponder coil reads the vehicle identification information contained within the key transponder and relays it to the immobilisation ECU.

Immobilisation ECU

The immobilisation ECU (C0059) is located beneath the centre console, adjacent to the handbrake. It receives a constant battery feed from fuse 18 of the passenger compartment fuse box (C0584) on an RY wire, and an auxiliary ignition feed from fuse 39 of the passenger compartment fuse box (C0587) on a PB wire.

If the immobilisation ECU (C0059) has received a valid signal from both the transponder coil (C0049) and the steering column interlock ECU (C2055) when the ignition switch is turned to the crank position, it transmits a rolling code to the Engine Control Module (ECM) (C0331) on a BP wire.

The immobilisation ECU (C0059) also provides a feed to the interlock relay (C1455) on a B wire. The energised interlock relay (C1455) provides a feed to the starter motor relay (C0179) on a B then BY wire.

For more information on operation of the starter motor, refer to the ***Starting and Charging*** – ***V8*** section of this manual.

 **STARTING AND CHARGING – V8.**

WINDOWS

DESCRIPTION

General

Operation of all four windows is controlled by the Body Control Unit (BCU) via the P-bus. The P-bus allows communication between the BCU and the drivers and passenger door modules. The door modules are mounted in the relevant front door. The drivers door module features four rocker switches, and a non-latching switch to inhibit operation of the rear windows. A rocker switch is also located on the front passenger door, and both rear passenger doors for operation of the relevant window.

Both front and rear windows feature an anti-trap function. If an obstacle is detected while the window is being closed, it will return to the fully open position.

For a detailed description of window lift operation, refer to the ***Windows*** section of the Description and Operation Workshop Manual.

For a detailed description of the P-bus, refer to the ***Communication Databases*** section of the Description and Operation Workshop Manual.

OPERATION

Front

Power Distribution

Feed from the positive battery terminal (C0192) is supplied to fuse 11, fuse 24, and fuse 53 of the passenger compartment fuse box (C0632) on an R wire. Fuse 11 (C0585) provides a constant battery feed to the drivers door module (C2017) on an RP wire. Fuse 24 (C0583) provides a constant battery feed to the passenger door module (C2016) on an RW wire.

Fuse 53 (C0583) provides a constant battery feed to the ignition switch (C0099 on Td6 vehicles, C0028 on V8 vehicles) on an R wire. When the ignition switch is turned to the 'auxiliary' position, current flows across the switch (C0099 on Td6 vehicles, C0028 on V8 vehicles) to fuse 41 of the passenger compartment fuse box (C0585) on a PB wire. Fuse 41 (C0586) provides an auxiliary ignition feed to the Body Control Unit (BCU) (C0660) on a PW wire. The BCU (C0662) is earthed on an N wire.

Drivers Window

When the drivers door switch is moved to the 'Up' position, the feed from fuse 11 of the passenger compartment fuse box (C0585) flows through the drivers door module (C2017) to earth on an N wire. The drivers door module (C2017) will now provide a feed to the window lift motor (C0740) on a BS wire. Current flows across the motor and back to the drivers door module (C2017) on a BG wire. The drivers door module provides an earth path for the motor on an N wire. When the current draw of the window lift motor increases, the BCU (via the P-bus) determines the window has reached the limit of its travel and cuts the supply from the drivers door module.

DESCRIPTION AND OPERATION

When the drivers door switch is moved to the 'Down' position, the feed from fuse 11 of the front passenger compartment fuse box (C0585) flows through the drivers door module (C2017) to earth on an N wire. The drivers door module (C2017) will now provide a feed to the window lift motor (C0740) on a BG wire. Current flows across the motor and back to the drivers door module (C2017) on a BS wire. The drivers door module provides an earth path for the motor on an N wire. When the current draw of the window lift motor increases, the BCU (via the P-bus) determines the window has reached the limit of its travel and cuts the supply from the drivers door module.

Front Passenger Window

When the passenger door switch is moved to the 'Up' position, the feed from fuse 24 of the passenger compartment fuse box (C0583) flows through the passenger door module (C2016) to earth on an N wire. The passenger door module (C2016) will now provide a feed to the window lift motor (C0741) on a BS wire. Current flows across the motor and back to the passenger door module (C2016) on a BG wire. The passenger door module provides an earth path for the motor on an N wire. When the current draw of the window lift motor increases, the BCU (via the P-bus) determines the window has reached the limit of its travel and cuts the supply from the passenger door module.

When the passenger door switch is moved to the 'Down' position, the feed from fuse 24 of the front passenger compartment fuse box (C0583) flows through the passenger door module (C2016) to earth on an N wire. The passenger door module (C2016) will now provide a feed to the window lift motor (C0741) on a BG wire. Current flows across the motor and back to the passenger door module (C2016) on a BS wire. The passenger door module provides an earth path for the motor on an N wire. When the current draw of the window lift motor increases, the BCU (via the P-bus) determines the window has reached the limit of its travel and cuts the supply from the passenger door module.

Anti-Trap

The anti-trap system consists of an anti-trap seal, which runs along the door glass frame. The seal contains two elements, with a combined resistance of 1.2 k Ω . This resistance is constantly monitored by the BCU via the P-bus. If the window meets an obstacle, it pushes it against the anti-trap seal. This 'shorts' the two elements together, reducing the seals resistance to approximately 500 Ω . When the BCU detects this drop in resistance, it reverses the feed to the window lift motor. Both the drivers door module (C2058) and the passenger door module (C2057) are connected to the anti-trap seals (C0599 & C0600 respectively) by NR wires. The anti-trap seals are both earthed on N wires.

Rear

Power Distribution

Feed from the positive battery terminal (C0192) is supplied to fuse 53 and fuse 60 of the passenger compartment fuse box (C0632) on an R wire. Fuse 60 (C0582) provides a constant battery feed to the BCU (C0662) on an RW wire.

Fuse 53 (C0583) provides a constant battery feed to the ignition switch (C0099 on Td6 vehicles, C0028 on V8 vehicles) on an R wire. When the ignition switch is turned to the 'auxiliary' position, current flows across the switch (C0099 on Td6 vehicles, C0028 on V8 vehicles) to fuse 41 of the passenger compartment fuse box (C0585) on a PB wire. Fuse 41 (C0586) provides an auxiliary ignition feed to the BCU (C0660) on a PW wire.

RH Rear Window

The BCU (C0660) provides a feed to the RH rear window switch (C0732) on SY then N and SU then SB wires. If the switch is moved to the 'Up' position, the switch contacts close momentarily, allowing the feed on the SY then N wire to flow to earth on an N wire. Sensing this earth path, the BCU (C0662) provides a feed to the RH rear window lift motor (C0304) on a BN then BG wire. Current flows across the motor (C0304) and back to the BCU (C0662) on a US then UP wire. When the current draw of the window lift motor increases, the BCU determines the window has reached the limit of its travel and cuts the supply to the motor.

If the switch is moved to the 'Down' position, the switch contacts close momentarily, allowing the feed on the SU then SB wire to flow to earth on an N wire. Sensing this earth path, the BCU (C0662) provides a feed to the RH rear window lift motor (C0304) on a UP then US wire. Current flows across the motor (C0304) and back to the BCU (C0662) on a BG then BN wire. When the current draw of the window lift motor increases, the BCU determines the window has reached the limit of its travel and cuts the supply to the motor.

LH Rear Window

The BCU (C0660) provides a feed to the LH rear window switch (C0732) on SN and SB wires. If the switch is moved to the 'Up' position, the switch contacts close momentarily, allowing the feed on the SN wire to flow to earth on an N wire. Sensing this earth path, the BCU (C0662) provides a feed to the LH rear window lift motor (C0304) on a BG wire. Current flows across the motor (C0304) and back to the BCU (C0662) on a US wire. When the current draw of the window lift motor increases, the BCU determines the window has reached the limit of its travel and cuts the supply to the motor.

If the switch is moved to the 'Down' position, the switch contacts close momentarily, allowing the feed on the SB wire to flow to earth on an N wire. Sensing this earth path, the BCU (C0662) provides a feed to the LH rear window lift motor (C0304) on a US wire. Current flows across the motor (C0304) and back to the BCU (C0662) on a BG wire. When the current draw of the window lift motor increases, the BCU determines the window has reached the limit of its travel and cuts the supply to the motor.

DESCRIPTION AND OPERATION

Anti-Trap

The anti-trap system consists of an anti-trap seal, which runs along the door glass frame. The seal contains two elements, with a combined resistance of 1.2 k. This resistance is constantly monitored by the BCU. If the window meets an obstacle, it pushes it against the anti-trap seal. This 'shorts' the two elements together, reducing the seals resistance to approximately 500 . When the BCU detects this drop in resistance, it reverses the feed to the window lift motor.

The BCU (C0661) is connected to the RH rear anti-trap seal (C2015) by an NR then NY wire, and to the LH rear anti-trap seal (C2015) by an NY wire. Both anti-trap seals (C2015) are earthed on N wires.

NOTE: Both rear anti-trap seals have the same connector number as they utilise the same harness.

SUNROOF

DESCRIPTION

General

Operation of the sunroof is controlled via the three position switch located on the front of the headlining. Moving the switch rearwards opens the sunroof. Similarly, moving the switch forward closes the sunroof. A single press in the centre of the switch opens or closes the sunroof from the tilt position.

All switch inputs are registered by the sunroof ECU, which is located behind the front of the headlining, adjacent the sunroof motor. The sunroof ECU also receives messages from the Body Control Unit (BCU) via the P-Bus to enable it to carry out its automatic closing and opening routine. Automatic closing is carried out when the 'Land Rover' button on the remote handset is pressed and held for longer than 2 seconds. Similarly, pressing and holding the 'Arrow' key on the remote handset for longer than 2 seconds opens both the sunroof and all windows.

For more information on P-Bus messages, refer to the **Communication Databases** section of the System Description and Operation Workshop Manual.

For more information on Sunroof operation, refer to the **Sunroof** section of the System Description and Operation Workshop Manual.

For more information on automatic opening and closing, refer to the **Anti-theft Alarm and Central Door Locking** section of this manual.

 **ANTI-THEFT ALARM AND CENTRAL DOOR LOCKING (CDL).**

OPERATION

Power Distribution

Feed from the positive battery terminal (C0192) is supplied to fuse 53, and fuse 58 of the passenger compartment fuse box (C0632) on an R wire. Fuse 58 (C0582) provides a constant battery feed to the sunroof ECU (C0784) on an RS wire. Fuse 53 (C0583) provides a constant battery feed to the ignition switch (C0099 on Td6 vehicles, C0028 on V8 vehicles) on an R wire. When the ignition switch is turned to the 'auxiliary' position, current flows across the switch (C0099 on Td6 vehicles, C0028 on V8 vehicles) to fuse 41 of the passenger compartment fuse box (C0585) on a PB wire. Fuse 41 (C0586) provides an auxiliary ignition feed to the Body Control Unit (BCU) (C0660) on a PW wire.

DESCRIPTION AND OPERATION

Sunroof ECU

The sunroof ECU (C0784) provides a feed to the sunroof switch (C0363) on a YS wire. If the switch is moved to the 'Open' position, a feed is returned to the ECU (C0784) on a YG wire. The ECU will now power the sunroof motor to open the sunroof. By measuring the voltage pulses returned from two Hall effect sensors located within the sunroof mechanism, the ECU can determine when the sunroof has reached the end of its travel and cut the voltage supply to the motor.

If the switch is moved to the 'Close' position, a feed is returned to the sunroof ECU (C0784) on an SB wire. The ECU will now power the sunroof motor to close the sunroof. By measuring the voltage pulses returned from the two Hall effect sensors, the ECU determines when the sunroof has reached the end of its travel and cuts the voltage supply to the motor.

If the centre of the switch is pressed, a feed is returned to the sunroof ECU (C0784) on a YW wire. The ECU will now power the sunroof motor in the 'Close' direction to raise the rear of the sunroof. By measuring the voltage pulses returned from the two Hall effect sensors, the ECU determines when the sunroof has reached the end of its travel and cuts the voltage supply to the motor.

If the centre of the switch is pressed a second time, a feed is returned to the sunroof ECU (C0784) on a YW wire. The ECU will now power the sunroof motor in the 'Open' direction to lower the sunroof. By measuring the voltage pulses returned from the two Hall effect sensors, the ECU determines when the sunroof has reached the end of its travel and cuts the voltage supply to the motor.

The sunroof ECU (C0784) is earthed on an N wire.

Body Control Unit (BCU)

The Body Control Unit (BCU) (C0660) communicates with the sunroof ECU (C0784) via the P-Bus. In addition to enabling automatic opening and closing to be carried out, the BCU also triggers the sunroof ECU into an energy saving 'sleep' mode.

For a detailed description of P-Bus operation and messages, refer to the **Communication Databuses** section of the System Description Operation Workshop Manual.

DOOR MIRRORS

DESCRIPTION

General

The door mirrors operate when the ignition switch is turned to the 'auxiliary' position. Operation of the door mirrors is carried out by door modules located in each front door, in conjunction with the Body Control Unit (BCU).

The BCU can store up to three mirror positions in its memory, which it transmits to the door modules via the peripheral (P) bus. The BCU also initiates mirror heating if the outside temperature is between -10 °C and 35 °C.

If reverse gear is selected, the passenger door mirror will automatically lower to enable the driver to gain a better view of the kerb. When reverse gear is deselected, the mirror returns to its original position.

For a detailed description of door mirror operation, refer to the ***Exterior Fittings – Door Mirrors*** section of the Description and Operation Workshop Manual.

OPERATION

Power Distribution

Feed from the positive battery terminal (C0192) is supplied to fuse 11, fuse 24, and fuse 53 of the passenger compartment fuse box (C0632) on an R wire. Fuse 11 (C0585) provides a constant battery feed to the drivers door module (C2017) on an RP wire. Fuse 24 (C0583) provides a constant battery feed to the passenger door module (C2016) on an RW wire. The drivers (C2017) and passenger (C2016) door modules are both earthed on N wires.

Fuse 53 (C0583) provides a constant battery feed to the ignition switch (C0099 on Td6 vehicles, C0028 on V8 vehicles) on an R wire. When the ignition switch is turned to the 'auxiliary' position, current flows across the switch (C0099 on Td6 vehicles, C0028 on V8 vehicles) to fuse 41 of the passenger compartment fuse box (C0585) on a PB wire. Fuse 41 (C0586) provides an auxiliary ignition feed to the Body Control Unit (BCU) (C0660) on a PW wire. The BCU (C0662) is earthed on an N wire.

DESCRIPTION AND OPERATION

Drivers Door Mirror

Horizontal Adjustment

When RH adjustment of the drivers door mirror is required, the drivers door module (C2271) provides a feed to the horizontal motor on a G wire. Current flows across the motor and back to the drivers door module (C2271) on an R wire. If LH adjustment of the drivers door mirror is required, the feed to the horizontal motor is reversed. The motor is provided a feed on an R wire, with an earth path provided by the drivers door module (C2271) via a G wire.

To prevent the vertical motor from operating, the drivers door module (C2271) also provides a feed to the vertical motor on an S wire. As the potential difference across the motor is 0V, the motor does not operate.

Vertical Adjustment

When upwards adjustment of the drivers door mirror is required, the drivers door module (C2271) provides a feed to the vertical motor on an S wire. Current flows across the motor and back to the drivers door module (C2271) on an R wire. If downwards adjustment of the drivers door mirror is required, the feed to the vertical motor is reversed. The motor is provided a feed on an R wire, with an earth path provided by the drivers door module (C2271) via an S wire.

To prevent the horizontal motor from operating, the drivers door module (C2271) also provides a feed to the horizontal motor on a G wire. As the potential difference across the motor is 0V, the motor does not operate.

Mirror Memory

The door mirror memory function works in conjunction with the seat and steering wheel memory functions. The BCU (C0660) receives a memory request from the seat memory ECU (C0862) via the K-bus on a WRY wire. The BCU (C0660) relays this message to the drivers door module (C2058) via the P-bus on a UR wire.

When the drivers door module receives a memory request it moves the mirrors as described above. Two potentiometers are fitted within the mirror assembly to determine its position. The drivers door module (C2271) provides a feed to both potentiometers on an O wire. The horizontal potentiometer is provided an earth path by the drivers door module (C2271) on a B wire. By measuring the current returned on a W wire, the drivers door module can determine the mirror's horizontal position.

The vertical potentiometer is also provided an earth path by the drivers door module (C2271) on a B wire. By measuring the current returned on a K wire, the drivers door module can determine the mirror's vertical position.

Mirror Fold

A non-latching mirror folding switch is located on the drivers door module. When the switch is pressed a first time, the drivers door module (C2271) provides a feed to the mirror fold motor on an RU wire. Current flows across the motor and back to the drivers door module (C2271) on a GN wire. The drivers door mirror now moves to the folded position. If the switch is pressed a second time, the feed to the fold motor is reversed. The motor is provided a feed on a GN wire, with an earth path provided by the drivers door module (C2271) via an RU wire.

NOTE: Mirror fold is disabled if vehicle speed is greater than 10 km/h (6 mph).

The drivers door module (C2058) communicates the mirror fold request to the passenger door module (C2057) via the P-bus on a UR wire.

Mirror Heater

If the BCU (C0660) receives an outside temperature reading of between -10 °C and 35 °C, it informs the drivers door module (C2058) to initiate mirror heating via the P-bus on a UR wire. Pin 7 of the drivers door module (C2271) provides a feed to the door mirror heater on a B wire. An earth path is provided via pin 6 of the drivers door module (C2271), also on a B wire.

Passenger Door Mirror

Horizontal Adjustment

When RH adjustment of the passenger door mirror is required, the passenger door module (C2271) provides a feed to the horizontal motor on a G wire. Current flows across the motor and back to the passenger door module (C2271) on an R wire. If LH adjustment of the passenger door mirror is required, the feed to the horizontal motor is reversed. The motor is provided a feed on an R wire, with an earth path provided by the passenger door module (C2271) via a G wire.

To prevent the vertical motor from operating, the passenger door module (C2271) also provides a feed to the vertical motor on an S wire. As the potential difference across the motor is 0V, the motor does not operate.

Vertical Adjustment

When upwards adjustment of the passenger door mirror is required, the passenger door module (C2271) provides a feed to the vertical motor on an S wire. Current flows across the motor and back to the passenger door module (C2271) on an R wire. If downwards adjustment of the passenger door mirror is required, the feed to the vertical motor is reversed. The motor is provided a feed on an R wire, with an earth path provided by the passenger door module (C2271) via an S wire.

To prevent the horizontal motor from operating, the passenger door module (C2271) also provides a feed to the horizontal motor on a G wire. As the potential difference across the motor is 0V, the motor does not operate.

DESCRIPTION AND OPERATION

Mirror Memory

The door mirror memory function works in conjunction with the seat and steering wheel memory functions. The BCU (C0660) receives a memory request from the seat memory ECU (C0862) via the K-bus on a WRY wire. The BCU (C0660) relays this message to the passenger door module (C2057) via the P-bus on a UR wire.

When the passenger door module receives a memory request it moves the mirrors as described above. Two potentiometers are fitted within the mirror assembly to determine its position. The passenger door module (C2271) provides a feed to both potentiometers on an O wire. The horizontal potentiometer is provided an earth path by the passenger door module (C2271) on a B wire. By measuring the current returned on a W wire, the passenger door module can determine the mirror's horizontal position.

The vertical potentiometer is also provided an earth path by the passenger door module (C2271) on a B wire. By measuring the current returned on a K wire, the passenger door module can determine the mirror's vertical position.

Mirror Fold

When the passenger door module (C2057) receives a folding request from the drivers door module (C2058) via the P-bus, it provides a feed to the folding mirror motor on an RU wire. Current flows across the motor and back to the passenger door module (C2271) on a GN wire. The passenger door mirror now moves to the folded position. If the passenger door module receives a second fold request, the feed to the folding mirror is reversed. The motor is provided a feed on a GN wire, with an earth path provided by the passenger door module (C2271) via an RU wire.

NOTE: Mirror fold is disabled if vehicle speed is greater than 10 km/h (6 mph).

Mirror Heater

If the BCU (C0660) receives an outside temperature reading of between -10 °C and 35 °C, it informs the passenger door module (C2057) to initiate mirror heating via the P-bus on a UR wire. Pin 7 of the drivers door module (C2271) provides a feed to the door mirror heater on a B wire. An earth path is provided via pin 6 of the drivers door module (C2271), also on a B wire.

NOTE: The driver and passenger door modules have the same connector numbers as they utilise the same harness.

Door Mirror Memory

Door mirror memory information is stored in the driver and passenger door modules. When the memory function is selected, the BCU (C0660) informs the driver (C2058) and passenger (C2057) door modules to move the mirrors to the required position via the P-bus on a UR wire.

INTERIOR MIRROR

DESCRIPTION

General

New Range Rover is fitted with an automatically dimming 'electrochromic' interior mirror. A light sensor, incorporated into the interior mirror, dims the mirror if it detects a light source behind the vehicle. The interior mirror also provides an output to both door mirrors, allowing dimming of all three rear view mirrors.

OPERATION

Power Distribution

Feed from the positive battery terminal (C0192) is supplied to fuse 43 and fuse 53 of the passenger compartment fuse box (C0632) on an R wire. Fuse 43 (C0586) provides a constant battery feed to the interior mirror (C0698) on an RY wire.

Fuse 53 (C0583) provides a constant battery feed to the ignition switch (C0099 on Td6 vehicles, C0028 on V8 vehicles) on an R wire. When the ignition switch is turned to the 'ignition' position, current flows across the switch (C0099 on Td6 vehicles, C0028 on V8 vehicles) to fuse 6 of the passenger compartment fuse box (C0585) on a G wire. Fuse 6 (C0587) provides an auxiliary ignition feed to the interior mirror (C0698) on a GW wire. The interior mirror (C0698) is earthed on an NB wire.

Automatic Dimming

When the light sensor incorporated in the interior mirror detects a light source from behind the vehicle, it automatically dims the interior mirror. When this happens, the interior mirror will also dim both the drivers and passenger door mirrors.

Drivers Door Mirror

The interior mirror (C0698) provides an output to the drivers door mirror (C2292) on WR then P and WU then B wires. When the drivers door mirror receives these feeds, it automatically dims. When the light source is removed from behind the vehicle, the feeds are removed and the drivers door mirror returns to normal brightness.

Passenger Door Mirror

The interior mirror (C0698) provides an output to the passenger door mirror (C2292) on WG then P and WY then B wires. When the passenger door mirror receives these feeds, it automatically dims. When the light source is removed from behind the vehicle, the feeds are removed and the passenger door mirror returns to normal brightness.

NOTE: The drivers and passenger door mirrors have the same connector number as they utilise the same harness.

DESCRIPTION AND OPERATION

Reverse Gear Inhibit

The automatic dimming function of the electrochromic interior mirror is inhibited if reverse gear is selected. The Light Check Module (LCM) (C2040) provides a 'reverse gear selected' signal to the interior mirror (C0698) on a UY wire.

Anti-theft Alarm LED

The anti-theft alarm LED is located on the interior mirror (C0698) and receives a signal from the BCU (C0661) on an SBY wire. For more information on anti-theft alarm operation, refer to the ***Anti-theft Alarm and Central Door Locking (CDL)*** section of this manual.

 **ANTI-THEFT ALARM AND CENTRAL DOOR LOCKING (CDL).**

FRONT SEATS

DESCRIPTION

General

Two levels of electric front seats are fitted to Range Rover, with a memory function available as an option. The memory function is capable of storing up to three seat positions. The standard electric front seats have four motors to control the following:

- Horizontal movement
- Seat height
- Seat angle
- Seat backrest recline.

The higher specification 'Contour' seat has two additional motors which control the following:

- Headrest movement
- Additional upper backrest adjustment.

For a detailed description of front seat operation, refer to the **Body – Seats** section of the System Description and Operation Workshop manual.

OPERATION

Power Distribution

Feed from the positive battery terminal (C0192) is provided to the seat relay and fuse 53. Both are located in the passenger compartment fuse box (C0632). Fuse 53 (C0583) provides a constant battery feed to the ignition switch (C0099 on Td6 vehicles, C0028 on V8 vehicles) on an R wire.

When the ignition switch is turned to the 'ignition' position, current flows across the switch (C0099 on Td6 vehicles, C0028 on V8 vehicles) to the seat relay coil (C0585) on a G wire. Current flows through the seat relay coil (C0583) to earth on an N wire. This energises the seat relay. The energised seat relay provides a feed to fuse 20 and fuse 21, which are also located in the passenger compartment fuse box.

Non-Memory Drivers Seat

Fuse 20 (C0584) provides a feed to the LH seat switch pack (C0773) on an RN wire. Fuse 21 (C0584) provides a feed to the RH seat switch pack (C0774) on an RN wire. Both the LH (C0773) and the RH (C0774) seat switch packs are earthed on N wires.

Memory Drivers Seat

Fuse 20 (C0584) provides a feed to the seat memory ECU (C0722) on an RN wire, and the upper backrest motor (C2308) on an RN then R wire. The seat memory ECU (C0722) is earthed on an N and an NB wire. The upper backrest motor (C2308) is earthed on an N wire.

NOTE: The upper backrest motor is only fitted on the 'Comfort' seat.

DESCRIPTION AND OPERATION

RH Front Seat

Horizontal Movement

A single seat motor controls horizontal movement of the RH front seat. To move the seat forwards and backwards, the RH seat switch pack (C0774) provides feeds to the forward/backward seat motor (C0721) on GY and BY wires.

Vertical Movement

Two seat motors are used to control vertical movement of the RH front seat; one for the front of the seat, and one for the rear. To move the front of the seat up and down, the RH seat switch pack (C0774) provides feeds to the front up/down motor (C0097) on PR and UR wires. To move the rear of the seat up and down, the RH seat switch pack (C0774) provides feeds to the rear up/down motor (C0475) on UG and PG wires.

Recline

A single seat motor controls RH front seat backrest recline. To recline the backrest, the RH seat switch pack (C0774) provides feeds to the recline motor (C0718) on GP and BP wires.

Upper Backrest

A single seat motor controls movement of the RH front seat upper backrest. To move the upper backrest, the RH seat switch pack (C0774) provides feeds to the motor (C1418) on GR and GU wires.

LH Front Seat

Horizontal Movement

A single seat motor controls horizontal movement of the LH front seat. To move the seat forwards and backwards, the LH seat switch pack (C0773) provides feeds to the forward/backward seat motor (C0720) on GY and BY wires.

Vertical Movement

Two seat motors are used to control vertical movement of the LH front seat; one for the front of the seat, and one for the rear. To move the front of the seat up and down, the LH seat switch pack (C0773) provides feeds to the front up/down motor (C1637) on PR and UR wires. To move the rear of the seat up and down, the LH seat switch pack (C0773) provides feeds to the rear up/down motor (C1636) on UG and PG wires.

Recline

A single seat motor controls LH front seat backrest recline. To recline the backrest, the LH seat switch pack (C0773) provides feeds to the recline motor (C0518) on GP and BP wires.

Upper Backrest

A single seat motor controls movement of the LH front seat upper backrest. To move the upper backrest the LH seat switch pack (C0773) provides feeds to the motor (C1419) on GR and GU wires.

Memory Drivers Seat

When the memory function is selected, the seat memory ECU (C0722) transmits the relevant data along the K-bus to the Body Control Unit (BCU) (C0660) on a WRY wire. The BCU then moves both the steering column and the door mirrors to the required position. For more information on door mirror operation, refer to the ***Door Mirrors*** section of this manual.

 **DOOR MIRRORS.**

For more information on steering column operation, refer to the ***Steering Column*** section of this manual.

 **STEERING COLUMN.**

Horizontal Movement

When the memory function is selected, the seat memory ECU (C0772) provides feeds to the forward/backward seat motor (C0720) on a pair of R wires. The seat memory ECU (C0772) monitors the position of the seat by measuring the voltage pulses returned from the hall effect sensor (C0720) on an R wire.

Vertical Movement

When the memory function is selected, the seat memory ECU (C0772) provides feeds to the front (C1637) and rear (C1636) up/down motors on R wires. The seat memory ECU (C0772) monitors the position of the seat by measuring the voltage pulses returned from the hall effect sensors (C1637 & C1636) on R wires.

Recline

When the memory function is selected, the seat memory ECU (C0772) provides feeds to the backrest recline seat motor (C0518) on a pair of R wires. The seat memory ECU (C0772) monitors the position of the seat by measuring the voltage pulses returned from the hall effect sensor (C0518) on an R wire.

Headrest

When the memory function is selected, the seat memory ECU (C0772) provides feeds to the headrest seat motor (C1419) on a pair of R wires. The seat memory ECU (C0772) monitors the position of the headrest by measuring the voltage pulses returned from the hall effect sensor (C1419) on an R wire.

DESCRIPTION AND OPERATION

FRONT HEATED SEATS

DESCRIPTION

General

Operation of the front electric seats is controlled by the Automatic Temperature Control (ATC) ECU via the two centre console mounted switches. Pressing the relevant seat heat switch once will heat the seat to a temperature of 44 °C (111 °F) and illuminate two LED's on the switch face. Pressing the seat heat switch a second time will lower the temperature to 39 °C (102 °F) and illuminate one LED on the switch face. Pressing the switch a third time switches off the seat heat function and extinguishes the remaining LED.

OPERATION

Power Distribution

Feed from the positive battery terminal (C0192) is supplied to fuse 12 and fuse 52 of the passenger compartment fuse box (C0632) on an N wire. Fuse 12 (C0586) provides a constant battery feed to the ATC ECU (C1629) on an RP wire. Fuse 52 (C0582) provides a constant battery feed to the ATC ECU (C0249) on a PU wire. The ATC ECU (C1630) is earthed on an N wire.

RH Seat

When the non-latching RH seat heat switch is pressed, the ATC ECU (C0249) provides a feed to the cushion heater matrix (C0969) and the backrest heater matrix (C0971) on GY wires. Both matrices are earthed on N wires.

The ATC ECU (C1629) monitors the temperature of the cushion heater matrix (C0969) by providing a feed to a Negative Temperature Coefficient (NTC) sensor on a WU wire. The sensor is earthed on an N wire. By calculating the resistance of the NTC sensor, the ATC ECU can determine the temperature of the seat and regulate the supply voltage to the heater matrices accordingly.

LH Seat

When the non-latching LH seat heat switch is pressed, the ATC ECU (C0249) provides a feed to the cushion heater matrix (C2090) and the backrest heater matrix (C2091) on GP wires. Both matrices are earthed on N wires.

The ATC ECU (C1629) monitors the temperature of the cushion heater matrix (C2090) by providing a feed to a Negative Temperature Coefficient (NTC) sensor on a WG wire. The sensor is earthed on an N wire. By calculating the resistance of the NTC sensor, the ATC ECU can determine the temperature of the seat and regulate the supply voltage to the heater matrices accordingly.

REAR HEATED SEATS

DESCRIPTION

General

Operation of the rear electric seats is controlled by the two seat heat switches located on the rear face of the centre console. Pressing the relevant seat heat switch once will heat the seat to a temperature of 44 °C (111 °F) and illuminate two LED's on the switch face. Pressing the seat heat switch a second time will lower the temperature to 39 °C (102 °F) and illuminate one LED on the switch face. Pressing the switch a third time switches off the seat heat function and extinguishes the remaining LED.

OPERATION

Power Distribution

Feed from the positive battery terminal (C0192) is supplied to fusible link 1 and fuse 53 of the passenger compartment fuse box (C0632) on an R wire. Fusible link 1 (C0588) is connected to fuse 11 of the rear fuse box (C2024) by an R wire. Fuse 11 provides a constant battery feed to the rear heated seat relay, which is also located in the rear fuse box.

Fuse 53 of the passenger compartment fuse box (C0583) is connected to the ignition switch (C0099) by a G wire. When the ignition switch is turned to the 'ignition' position, current flows across the switch (C0099 on Td6 vehicles, C0028 on V8 vehicles) to fuse 2 of the passenger compartment fuse box (C0585) on a G wire. Fuse 2 (C0587) provides an ignition feed to the rear heated seat relay coil (C2022) on a GY wire. The relay coil (C2021) is earthed on an N wire. The energised rear heated seat relay (C2021) provides a feed to the LH rear seat heat switch (C1401) on a GW wire, and the RH rear seat heat switch (C1403) on a GN wire. Both switches are earthed on NB wires.

RH Rear Seat

When the RH rear seat heat switch (C1401) is pressed it provides a feed to the cushion heater matrix (C2085) on a WY wire. The heater matrix (C2085) is earthed on an N wire. The seat heat switch (C1401) monitors the temperature of the cushion heater matrix (C2085) by providing a feed to a Negative Temperature Coefficient (NTC) sensor on a YN wire. The sensor is earthed on an N wire. By calculating the resistance of the NTC sensor, the switch can determine the temperature of the seat and regulate the supply voltage to the RH rear heater matrix accordingly.

LH Rear Seat

When the LH rear seat heat switch (C1403) is pressed it provides a feed to the cushion heater matrix (C2084) on a BY wire. The heater matrix (C2084) is earthed on an N wire. The seat heat switch (C1403) monitors the temperature of the cushion heater matrix (C2084) by providing a feed to a Negative Temperature Coefficient (NTC) sensor on a WN wire. The sensor is earthed on an N wire. By calculating the resistance of the NTC sensor, the switch can determine the temperature of the seat and regulate the supply voltage to the LH rear heater matrix accordingly.

DESCRIPTION AND OPERATION

DIAGNOSTIC SOCKET

DESCRIPTION

General

The diagnostic socket is located behind an access panel on the drivers side of the fascia. The socket is constructed to SAE directive J1962 standard and allows attachment of TestBook or T4. The diagnostic socket allows detailed fault diagnosis checks to be carried out on the vehicle via an ISO 9141 K Line Bus and the Diagnostic DS2 Bus.

OPERATION

Power Distribution

Feed from the positive battery terminal (C0192) is supplied to fuse 15 and fuse 53 of the passenger compartment fuse box (C0632) on an R wire. Fuse 15 (C0586) provides a constant battery feed to the diagnostic socket (C0040) on an RUY wire.

Fuse 53 (C0583) provides a constant battery feed to the ignition switch (C0099 on Td6 vehicles, C0028 on V8 vehicles) on an R wire. When the ignition switch is turned to the 'ignition' position, current flows across the switch (C0099 on Td6 vehicles, C0028 on V8 vehicles) to fuse 5 of the passenger compartment fuse box (C0585) on a G wire. Fuse 5 (C0587) provides an ignition feed to the diagnostic socket (C0040) on a GW wire. The diagnostic socket (C0040) is earthed on a pair of NB wires.

K Line Bus

The following are connected to the diagnostic socket (C0040) via the K Line Bus on WP wires:

- Transfer box ECU (C1319).
- ABS ECU (C0506).
- LH Xenon Lamp ECU (C0009).
- RH Xenon Lamp ECU (C0011).
- Steering angle sensor (C0862).
- Instrument pack (C0233).

Diagnostic DS2 Bus

The following are connected to the diagnostic socket (C0040) via the Diagnostic DS2 Bus:

- The V8 ECM (C0331) on WPY and B wires.
- The Td6 ECM (C0331) on WPY and B wires.
- The ZF automatic transmission ECU (C0932) on a WPY then WP wire.

STARTING AND CHARGING – Td6

DESCRIPTION

Starting

The starting system on the vehicle comprises a 12 V starter motor which drives the engine to start the combustion process. The starter converts electrical energy into mechanical power. The vehicle electrical system must be capable of supplying sufficient power to enable the engine to be cranked.

Range Rover features 'lazy starting'. This entails the driver not having to hold the ignition key in the 'crank position'. Starting of the engine is controlled automatically by the Engine Control Module (ECM), which provides power to the starter motor until engine speed is greater than 400 rpm.

Charging

The charging system comprises a battery and an alternator. The battery must be of a sufficient capacity to operate the starter motor and operate the various electrical systems in the vehicle. The alternator charges the battery when the engine is running and increases its output as demand on the battery increases.

CAUTION: The battery positive terminal uses a pyrotechnic attachment which detaches the battery cable in the event of a crash severe enough to trigger the airbags. Refer to the Supplementary Restraint System section of the System Description and Operation Workshop manual for further details.

The alternator is located at the front LH side of the engine, below the steering pump. The alternator has an output of 90/150 Amps and is manufactured by Valeo. A polyvee belt drives the alternator pulley, which in turn is driven from the engine crankshaft pulley.

The instrument pack incorporates a charge warning lamp which illuminates when there is no output or a low output from the alternator. For a detailed description of the starting and charging system, refer to the ***Engine Management System – Td6*** section of the System Description and Operation Workshop manual.

DESCRIPTION AND OPERATION

OPERATION

Power Distribution

Feed from the positive battery terminal (C0192) is supplied to the fuse holder (C1875) on an R wire. A constant battery feed is also supplied to fusible link 2 and fuse 53 of the passenger compartment fuse box (C0632) on an R wire.

The 100A fuse located in the fuse holder (C1875) provides a constant battery feed to the glow plug timer (C0189) on an R wire. A second 100A fuse in the fuse holder (C1875) provides a constant battery feed to the Engine Control Module (ECM) relay (C1895) on an R wire.

Fuse 53 of the passenger compartment fuse box (C0583) provides a constant battery feed to the ignition switch (C0099) on an R wire. When the ignition switch is turned to the 'ignition' position, current flows across the switch (C0099) to fuse 5 of the passenger compartment fuse box (C0585) on an G wire. Fuse 5 (C0587) provides an ignition feed to the alternator (C0053) on a GW wire.

Fusible link 2 of the passenger compartment fuse box (C0591) is connected to the ignition switch (C0099) by an R wire. When the ignition switch is turned to the 'crank' position, current flows across the switch (C0099) to the immobilisation ECU (C0059) on a BY wire.

Starting

ECM Relay

The ECM relay coil (C1895) is provided a constant battery feed from the 100A fuse located in the fuse holder (C1875) on an R wire. The earth path for the relay coil (C1895) is controlled by the ECM (C0603) on an N wire. If the ECM has received a valid 'remobilisation' signal from the immobilisation ECU, it will energise the ECM relay. The energised ECM relay (C1895) provides a feed to fuse 2 of the engine compartment fuse box (C0570) on an RW wire. Fuse 2 (C0570) is connected to the glow plug timer (C0190) by an R then RW wire.

Glow Plug Timer

The glow plug timer receives a constant battery feed from the 100A fuse located in the fuse holder (C1875) on an R wire, and a second feed from the energised ECM relay (C1895) via fuse 2 of the engine compartment fuse box (C0570) on an R then RW wire.

When all starting parameters have been met, the ECM (C0606) provides a control feed to the glow plug timer (C0190) on a BR wire. The glow plug timer (C0190) will now power the glow plugs as follows:

- Glow plug number 1 (C0476) on a BG wire.
- Glow plug number 2 (C0477) on a BP wire.
- Glow plug number 3 (C0478) on a BY wire.
- Glow plug number 4 (C0479) on a BR wire.
- Glow plug number 5 (C1500) on a BW wire.
- Glow plug number 6 (C1501) on a BN wire.

All six glow plugs are earthed via their fixings. The glow plug timer (C0190) is earthed on an NO wire.

The ECM (C0606) monitors the fault status of the glow plug timer (C0190) via a BY wire.

Starter Motor

The battery (C1641) provides a constant battery feed to the starter motor solenoid (C0178) on an R wire. Operation of the starter solenoid is controlled by the immobilisation ECU. When the immobilisation ECU (C0059) receives an ignition crank feed from the ignition switch (and all other starting parameters have been met) it provides a feed to the starter motor solenoid (C0179) on a B then BY wire. The energised starter solenoid allows the battery feed to power the starter motor.

The starter motor (C0823) also provides an 'engine start' signal back to the ECM (C0606) on a BG wire.

Fuel Pump

When the engine is started, the ECM (C0331) provides an earth path for the fuel pump relay coil (C2022) on a BP wire. The energised fuel pump relay (C2022) provides a feed to the fuel pump (C0114) on a WU wire. The fuel pump (C0114) is earthed on an N wire.

DESCRIPTION AND OPERATION

Charging

The battery (C1641) provides a permanent feed to the alternator (C0183) via the starter motor (C0178) on an R wire. Fuse 5 of the passenger compartment fuse box (C0587) provides an ignition feed to the alternator (C0053) on a GW wire.

When the engine is cranked, the alternator (C0053) supplies the ECM (C0606) a Pulse Width Modulated (PWM) signal on a U wire. The ECM uses this PWM signal to calculate the electrical load on the alternator, and controls engine idle speed accordingly.

When the engine is started, the magnetised rotor within the stator windings generate 3 phase alternating current (ac) and voltage that rises rapidly with rotor speed. The field diodes in the rectifier pack convert the ac current into direct current (dc). Output current from the field diodes supplements the initial current flowing through the field windings. This causes an increase in the magnetic influence of the rotor, resulting in self-excitation of the alternator. The field current increases with rotor speed and thus increases the generated current and voltage until the alternator is fully excited. The alternator (C0178) charges the battery (C1641) by providing current on an R wire.

STARTING AND CHARGING – V8

DESCRIPTION

Starting

The starting system on the vehicle comprises a 12 V starter motor which drives the engine to start the combustion process. The starter converts electrical energy into mechanical power. The vehicle electrical system must be capable of supplying sufficient power to enable the engine to be cranked.

Range Rover features 'lazy starting'. This entails the driver not having to hold the ignition key in the 'crank position'. Starting of the engine is controlled automatically by the Engine Control Module (ECM), which provides power to the starter motor until engine speed is greater than 920 rpm (engine cold) or 680 rpm (engine warm).

Charging

The charging system comprises a battery and an alternator. The battery must be of a sufficient capacity to operate the starter motor and operate the various electrical systems in the vehicle. The alternator charges the battery when the engine is running and increases its output as demand on the battery increases.

CAUTION: The battery positive terminal uses a pyrotechnic attachment which detaches the battery cable in the event of a crash severe enough to trigger the airbags. Refer to the Supplementary Restraint System section of the System Description and Operation Workshop manual for further details.

The alternator is located at the front LH side of the engine. The alternator has an output of 90/150 Amps and is manufactured by Bosch. A polyvee belt drives the alternator pulley, which in turn is driven from the engine crankshaft pulley.

The instrument pack incorporates a charge warning lamp which illuminates when there is no output or a low output from the alternator. For a detailed description of the starting and charging system, refer to the ***Engine Management System – V8*** section of the System Description and Operation Workshop manual.

DESCRIPTION AND OPERATION

OPERATION

Power Distribution

Feed from the positive battery terminal (C0192) is supplied to fuse 25 and fuse 53 of the passenger compartment fuse box (C0632) on an R wire. Fuse 53 (C0583) is connected to the ignition switch (C0028) by an RU wire. When the ignition switch is turned to the 'ignition' position, current flows across the switch (C0028) to fuse 5 of the passenger compartment fuse box (C0585) on a G wire. Fuse 5 (C0587) provides an ignition feed to the alternator (C0053) on a GW wire.

Fuse 25 of the passenger compartment fuse box (C0583) is connected to the ignition switch (C0028) by an R wire. When the ignition switch is turned to the 'crank' position, current flows across the switch (C0028) to the Engine Control Module (ECM) (C0331) on a BY wire, and the ignition coil relay (C2089) on a G then GN wire.

Starting

Starter Motor

The starter motor solenoid (C0178) is provided a constant battery feed from the battery (C0192) on an R wire. If all parameters for starting have been met, the ECM (C0331) provides a feed to the automatic transmission interlock relay (C1455) on a YN wire. If the gear selector lever is in 'Park' or 'Neutral', the interlock relay (C1455) provides a feed to the starter solenoid (C0179) on a B then BY wire. The energised starter solenoid allows the battery feed to power the starter motor.

The starter motor (C0179) also provides an 'engine start' signal back to the ECM (C0606) on a BG wire.

Ignition Coils

The ignition coil relay (C2089) receives an 'engine crank' feed from the ignition switch (C0028) on a GN wire. The relay coil (C2089) is earthed on an N wire. The energised ignition coil relay (C2089) provides a feed to the following on G wires:

- Ignition coil 1 (C0156).
- Ignition coil 2 (C0052).
- Ignition coil 3 (C0276).
- Ignition coil 4 (C1770).
- Ignition coil 5 (C1771).
- Ignition coil 6 (C1772).
- Ignition coil 7 (C2087).
- Ignition coil 8 (C2088).

Fuel Pump

When the engine is started, the ECM (C0331) provides an earth path for the fuel pump relay coil (C2022) on a BP wire. The energised fuel pump relay (C2020) provides a feed to the fuel pump (C0114) on a WU wire. The fuel pump (C0114) is earthed on an N wire.

Charging

The battery (C0192) provides a permanent feed to the alternator (C0183) on an R wire. Fuse 5 of the passenger compartment fuse box (C0587) provides an ignition feed to the alternator (C0053) on a GW wire.

When the engine is cranked, the alternator (C0053) supplies the ECM (C0606) a Pulse Width Modulated (PWM) signal on a U wire. The ECM uses this PWM signal to calculate the electrical load on the alternator, and controls engine idle speed accordingly.

When the engine is started, the magnetised rotor within the stator windings generate 3 phase alternating current (ac) and voltage that rises rapidly with rotor speed. The field diodes in the rectifier pack convert the ac current into direct current (dc). Output current from the field diodes supplements the initial current flowing through the field windings. This causes an increase in the magnetic influence of the rotor, resulting in self-excitation of the alternator. The field current increases with rotor speed and thus increases the generated current and voltage until the alternator is fully excited. The alternator (C0183) charges the battery (C0192) by providing current on an R wire.

DESCRIPTION AND OPERATION

CRUISE CONTROL

DESCRIPTION

General

The cruise control system is enabled by pressing the non-latching master switch located on the LH steering wheel switch pack. The system is controlled by the Engine Control Module (ECM), which receives commands from the 'SET+' and 'RES' switches, which are also located on the LH steering wheel switch pack. The ECM interprets the messages sent from the steering wheel switches and then controls the speed of the vehicle using electric throttle intervention.

For a detailed description of cruise control operation, refer to the **Engine Management – Td6** or **Engine Management – V8** section of the Description and Operation Workshop Manual.

OPERATION

Power Distribution

Feed from the positive battery terminal (C0192) is supplied to fuse 53 of the passenger compartment fuse box (C0632) on an R wire. Fuse 53 (C0583) is connected to the ignition switch (C0099 on Td6 vehicles, C0028 on V8 vehicles) by an R wire. When the ignition switch is turned to the 'auxiliary' position, current flows across the switch (C0099 on Td6 vehicles, C0028 on V8 vehicles) to fuse 9 of the passenger compartment fuse box (C0585) on a PB wire. Fuse 9 (C0587) provides an auxiliary ignition feed to the rotary coupler (C0082) on a PY wire.

When the ignition switch is turned to the 'ignition' position, current flows across the switch (C0099 on Td6 vehicles, C0028 on V8 vehicles) to fuse 31 of the passenger compartment fuse box (C0585) on a G wire. Fuse 31 (C0587) provides an ignition feed to the Engine Control Module (ECM) (C0331) on a GB wire.

Throttle Position (TP) Sensor

The TP sensor (C0787) comprises two potentiometer tracks. Track 1 is provided a 5V reference feed by the ECM (C0331) on a Y wire. Track 2 is provided a 5V reference feed by the ECM (C0331) on a YG wire. Track 1 provides a throttle position signal back to the ECM on a W wire. This signal will be approximately 0.5V with the pedal at rest, and 2V at full throttle. Track 2 provides a throttle position signal back to the ECM on a WG wire. This signal will be approximately 0.5V with the throttle at rest, and 4.5V at full throttle. The ECM also provides an earth path for track 1 and track 2 on NG and UG wires respectively.

For more information of TP sensor operation, refer to the **Engine Management – Td6** or **Engine Management – V8** section of the System Description and Operation Workshop Manual.

Brake Pedal Switch

Fuse 9 of the passenger compartment fuse box (C0586) provides an auxiliary ignition feed to the brake pedal switch (C0075) on a PY wire. When the brake pedal is pressed, the switch (C0075) provides the ECM (C0331) a voltage of between 6 V and battery voltage on an NS wire. When the pedal is released, the switch provides the ECM a voltage of between approximately 0 and 2 V. Once the ECM registers the brake pedal has been pressed, it will suspend cruise control operation.

The brake pedal switch (C0075) also provides a test signal to the ECM (C0331) on a UR wire. The switch (C0075) is earthed on an NB wire.

CAN Bus

When cruise control is activated, the ECM (C0331) informs the automatic transmission ECU via the CAN Bus on YN (low) and YB (high) wires. The automatic transmission ECU will change its shift patterns accordingly. For more information on automatic transmission operation, refer to the **Automatic Transmission – ZF 5HP24** or **Automatic Transmission – GM5L40–E** section of the System Description and Operation Workshop Manual, and the **Electronic Automatic Transmission – ZF** or **Electronic Automatic Transmission – GM5** section of this manual.

 **ELECTRONIC AUTOMATIC TRANSMISSION (EAT) – ZF.**

 **ELECTRONIC AUTOMATIC TRANSMISSION (EAT) – GM5.**

Rotary Coupler

The rotary coupler (C0082) receives an ignition feed from fuse 9 of the passenger compartment fuse box (C0587) on a PY wire, and is earthed on an NB wire. The rotary coupler (C2287) receives voltage pulse messages from the LH steering wheel module (C2283) as follows:

- A cruise control on/off signal on a W wire.
- A set/accelerate signal on a U wire.
- A decelerate signal on an R wire.
- A resume signal on a B wire.

The messages from the LH steering wheel module are relayed from the rotary coupler (C0082) to the ECM (C0331) on a YB wire. The ECM interprets this message and controls the throttle pedal accordingly.

DESCRIPTION AND OPERATION

ELECTRONIC AUTOMATIC TRANSMISSION (EAT) – GM5

DESCRIPTION

General

The GM 5L40-E transmission is an electrically controlled, five speed unit and is mated with the Td6 diesel engine. The transmission is controlled by an Electronic Automatic Transmission (EAT) ECU which contains software to provide operation as a semi-automatic 'Steptronic' transmission. This allows the transmission to be operated as a conventional automatic unit by selecting P, R, N, or D on the selector lever. Movement of the selector lever across the gate to the 'M/S' position puts the transmission into electronic sport mode. Movement of the selector lever in a lateral position to the + or – positions puts the transmission into electronic manual 'Steptronic' mode.

For a detailed description of GM5 automatic transmission operation, refer to the ***Automatic Transmission – GM 5L40–E*** section of the System Description and Operation Workshop Manual.

OPERATION

Power Distribution

Feed from the positive battery terminal (C0192) is supplied to fuse 53 and fuse 54 of the passenger compartment fuse box (C0632) and the fuse holder (C1875) on R wires. The 100A fuse located in the fuse holder (C1878) provides a constant battery feed to the Engine Control Module (ECM) relay (C1895) on an R wire. The 50A fuse located in the fuse holder (C1876) provides a constant battery feed to the transfer box ECU (C1855) on a pair of R wires.

Fuse 54 of the passenger compartment fuse box (C0583) provides a constant battery feed to the EAT ECU (C0932) on a RY wire. Fuse 53 of the passenger compartment fuse box (C0583) provides a constant battery feed to the ignition switch (C0099) on an R wire. When the ignition switch is turned to the 'auxiliary' position, current flows across the switch (C0099) to fuse 37 of the passenger compartment fuse box (C0585) on a PB wire. Fuse 37 (C0587) provides an ignition feed to the transfer box ECU (C1319) on a PU wire.

When the ignition switch is turned to the 'ignition' position, current flows across the switch (C0099) to fuse 5, fuse 33, and fuse 35 of the passenger compartment fuse box (C0585) on a G wire. Fuse 5 (C0587) provides an ignition feed to the EAT ECU (C0932) on a GW wire. Fuse 33 (C0587) provides an ignition feed to the transfer box ECU (C1319) on a GP wire. Fuse 35 (C0587) provides an ignition feed to the Hill Descent Control (HDC) switch (C0365) on a GBY wire.

ECM Relay

The ECM (C0604) provides an earth path for the ECM relay coil (C1895) on an N wire. The energised relay (C1895) provides a feed to fuse 2 of the engine compartment fuse box (C0570) on an RW wire. Fuse 2 (C0570) is connected to the EAT ECU (C0932) by a pair of RU wires.

For more details on ECM relay operation, refer to the **Engine Management System – Td6** section of the System Description and Operation Workshop Manual.

EAT ECU

The EAT ECU controls operation of the transmission via the following:

Pressure Regulator Solenoid

The EAT ECU (C1835) provides a Pulse Width Modulated (PWM) signal to the pressure regulator solenoid (C0244) on a P wire. This enables the pressure regulator solenoid (in conjunction with the pressure regulator valve) to control line pressure supplied to the clutches and shift control valves. The EAT ECU (C1835) provides an earth path for the pressure regulator solenoid (C0244) on an R wire.

Torque Converter Clutch (TCC) Solenoid

The EAT ECU (C1835) provides a PWM signal to the TCC solenoid (C0244) on a G wire. The TCC solenoid is a normally closed solenoid, and controls the output fluid pressure to the torque converter clutch. The EAT ECU (C1835) provides an earth path for the TCC solenoid (C0244) on a BY wire.

Shift Control Solenoids

The EAT ECU (C1835) provides a PWM signal to the three identical shift control solenoids (C0244) on a G wire. The EAT ECU (C1835) provides an earth path for solenoid A (C0244) on an OB wire, solenoid B (C0244) on a GR wire, and solenoid C (C0244) on a Y wire. For details of solenoid opening and closing, refer to the **Automatic Transmission – GM 5L40–E** section of the System Description and Operation Workshop manual.

Input Shaft Speed Sensor

The EAT ECU (C1835) provides a feed to the input shaft speed sensor (C0244) on a U wire. The input shaft speed sensor (C0244) returns an ac voltage pulse back to the EAT ECU (C1835) on an O wire. By measuring the peak to peak voltage of the voltage wave form, the EAT ECU can determine the speed of the input shaft.

Output Shaft Speed Sensor

The EAT ECU (C1835) provides a feed to the output shaft speed sensor (C0244) on a W wire. The output shaft speed sensor (C0244) returns an ac voltage pulse back to the EAT ECU (C1835) on an N wire. By measuring the peak to peak voltage of the voltage wave form, the EAT ECU can determine the speed of the output shaft.

DESCRIPTION AND OPERATION

Transmission Temperature Sensor

The temperature of the Automatic Transmission Fluid (ATF) is measured by the Negative Temperature Coefficient (NTC) transmission temperature sensor. The EAT ECU (C1835) provides a feed to the temperature sensor (C0244) on a BR wire. By measuring the voltage returned on a WR wire, the EAT ECU can determine ATF temperature.

Inhibitor Switch

The inhibitor switch is mounted on the LH side of the transmission, and enables the EAT ECU to monitor the position of the manual selector spool valve and the selected drive program. The EAT ECU (C1835) provides an ignition feed to the inhibitor switch (C0244) on a YB wire. When Park or Neutral is selected, the inhibitor switch (C0244) returns a feed back to the EAT ECU (C1835) on an O wire. When Drive is selected, the inhibitor switch (C0244) returns a feed back to the EAT ECU (C1835) on a B wire.

When shift solenoid A is energised, the inhibitor switch (C0244) returns a feed back to the EAT ECU (C1835) on a PW wire. When shift solenoid B is energised, the inhibitor switch (C0244) returns a feed back to the EAT ECU (C1835) on a YB wire. When shift solenoid C is energised, the inhibitor switch (C0244) returns a feed back to the EAT ECU (C1835) on a TB wire.

NOTE: Wire colour TB is transparent with a black tracer.

Shift Interlock Solenoid

To lock the selector lever assembly, the EAT ECU (C0193) provides a feed to the shift interlock solenoid (C0673) on a BP wire. An earth path is provided by the EAT ECU (C0193) on an NP wire.

Steptronic

When manual (Steptronic) mode is selected, the EAT ECU selects gears according to inputs received from the Steptronic switch. The EAT ECU (C0193) provides two feeds to the Steptronic switch (C1664); one on a UY wire, one on a US wire. If a downshift is requested via the selector lever, a momentary earth is created. Current on the UY wire is allowed to flow across the switch to earth on an NB wire. Sensing this, the EAT ECU downshifts 1 gear.

If an upshift is requested via the selector lever, a momentary earth is created. Current on the US wire is now allowed to flow across the switch to earth on an NB wire. Sensing this, the EAT ECU upshifts 1 gear.

ELECTRONIC AUTOMATIC TRANSMISSION (EAT) – ZF

DESCRIPTION

General

The ZF 5HP24 transmission is an electronically controlled, five speed unit and is mated with the V8 petrol engine. The transmission is controlled by an Electronic Automatic Transmission (EAT) ECU, which contains software to provide operation as a semi-automatic 'Steptronic' transmission. This allows the transmission to be operated as a conventional automatic unit by selecting P, R, N, or D on the selector lever. Movement of the selector lever across the gate to the 'M/S' position puts the transmission into electronic 'Sport' mode. Movement of the selector lever in a lateral position to the + or – positions puts the transmission into electronic manual 'Steptronic' mode.

For a detailed description of ZF automatic transmission operation, refer to the **Automatic Transmission – ZF 5HP24** section of the System Description and Operation Workshop Manual.

OPERATION

Power Distribution

Feed from the positive battery terminal (C0192) is supplied to fusible link 2 and fuse 53 of the passenger compartment fuse box (C0632) on an R wire. A permanent battery feed is also supplied to the 50A fuse contained within the fuse holder (C1875) on an R wire. This fuse (C1876) provides a constant battery feed to the transfer box ECU (C1855) on a pair of R wires.

Fusible link 2 of the passenger compartment fuse box (C0591) provides a constant battery feed to the ECM relay (C1895) and fuse 4 of the engine compartment fuse box (C0570) on a pair of R wires. Operation of the ECM relay (C1895) is controlled by the ECM (C0604) on an N wire. The energised ECM relay (C1895) provides a feed to fuse 1 of the engine compartment fuse box (C0570) on an RW wire. Fuse 1 (C0570) is connected to the EAT ECU (C0932) by a pair of RU wires. The EAT ECU (C0932) is earthed on N wires.

Fuse 4 of the engine compartment fuse box (C0570) is connected to the EAT ECU (C0932) by an R wire.

Fuse 53 of the passenger compartment fuse box (C0583) is connected to the ignition switch (C0099) by an R wire. When the ignition switch is turned to the 'auxiliary' position, current flows across the switch (C0099) to fuse 37 of the passenger compartment fuse box (C0587) on a PB wire. Fuse 37 (C0587) provides an auxiliary ignition feed to the transfer box ECU (C1319) on a PU wire.

DESCRIPTION AND OPERATION

When the ignition switch is turned to the 'ignition' position, current flows across the switch (C0099) to fuse 5, fuse 33, and fuse 35 of the passenger compartment fuse box (C0585) on a G wire. Fuse 5 (C0587) provides an ignition feed to the EAT ECU (C1835) on a GW wire. Fuse 33 (C0587) provides an ignition feed to the transfer box ECU (C1319) on a GP wire. Fuse 35 (C0587) provides an ignition feed to the Hill Descent Control (HDC) switch (C0365) on a GBY wire.

EAT ECU

The EAT ECU controls operation of the transmission via the following:

Electronic Pressure Regulator Solenoids (EPRS)

The five EPRS located in the automatic transmission (C0244) are provided a Pulse Width Modulated (PWM) by the EAT ECU (C1835) on a P wire. The EAT ECU controls operation of the EPRS by providing earth paths on TB, R, B, K and YR wires.

NOTE: Wire colour TB is transparent with a black tracer.

Shift Control Solenoids

The three shift control solenoids located in the automatic transmission (C0244) are provided a feed by the EAT ECU (C1835) on a YU wire. The EAT ECU (C1835) energises the solenoids by providing earth paths on O, G, and Y wires.

Turbine Speed Sensor

The turbine speed sensor acts as an input speed sensor. The EAT ECU (C1835) provides a feed to the turbine speed sensor (C0244) on a U wire. The turbine speed sensor (C0244) returns an ac voltage pulse back to the EAT ECU (C1835) on an S wire. By measuring the peak to peak voltage of the voltage wave form, the EAT ECU can determine the speed of the turbine.

Output Shaft Speed Sensor

The EAT ECU (C1835) provides a feed to the output shaft speed sensor (C0244) on a W wire. The output shaft speed sensor (C0244) returns an ac voltage pulse back to the EAT ECU (C1835) on an N wire. By measuring the peak to peak voltage of the voltage wave form, the EAT ECU can determine the speed of the output shaft.

Transmission Temperature Sensor

The temperature of Automatic Transmission Fluid (ATF) is measured by the Negative Temperature Coefficient (NTC) transmission temperature sensor. The EAT ECU (C1835) provides a feed to the temperature sensor (C0244) on a BR wire. By measuring the voltage returned on a WR wire, the EAT ECU can determine ATF temperature.

Shift Interlock Solenoid

To lock the selector lever assembly, the EAT ECU (C0193) provides a feed to the shift interlock solenoid (C0673) on a BP wire. An earth path is provided by the EAT ECU (C0193) on an NP wire.

Steptronic

When manual (Steptronic) mode is selected, the EAT ECU selects gears according to inputs received from the Steptronic switch. The EAT ECU (C0193) provides two feeds to the Steptronic switch (C1664); one on a UY wire, one on a US wire. If a downshift is requested via the selector lever, a momentary earth is created. Current on the UY wire is allowed to flow across the switch to earth on an NB wire. Sensing this, the EAT ECU downshifts 1 gear.

If an upshift is requested via the selector lever, a momentary earth is created. Current on the US wire is now allowed to flow across the switch to earth on an NB wire. Sensing this, the EAT ECU upshifts 1 gear.

DESCRIPTION AND OPERATION

ANTI-LOCK BRAKING SYSTEM (ABS)

DESCRIPTION

General

New Range Rover is equipped with Dynamic Stability Control (DSC) for enhanced braking and stability control. Functions of the DSC include:

- Hill Decent Control (HDC).
- Electronic traction control (ETC).
- Anti-lock Braking System (ABS).

The DSC system for New Range Rover provides all of the following functions and features:

- Optimised traction under all driving conditions.
- Optimised directional control (Longitudinal Stability).
- Lateral stability (Correction for over steer/under steer).
- Corner Braking Control (CBC).
- Emergency Brake Assist (EBA).
- Electronic Brake Force Distribution (EBD).

For a detailed description of the ABS, HDC, and ETC systems, refer to the **Brakes** section of the System Description and Operation Workshop Manual.

OPERATION

Power Distribution

Feed from the positive battery terminal (C0192) is supplied to the following on R wires:

- Fusible link 2 (C0632) – V8 vehicles only.
- Maxi fuse 63 (C0632).
- Fuse 13 (C0632).
- Fuse 53 (C0632).
- Fuse 55 (C0632).
- Fuse holder (C1875) – Td6 vehicles only.

Maxi fuse 63 (C0580) and fuse 55 (C0583) provide constant battery feeds to the ABS ECU (C0506) on R and RB wires respectively. The ABS ECU is earthed on a pair of N wires. Fuse 13 (C0586) provides a constant battery feed to the steering angle sensor (C0862) on an RG wire.

Fuse 53 (C0583) provides a constant battery feed to the ignition switch (C0099 on Td6 vehicles, C0028 on V8 vehicles) on an R wire. When the ignition switch is turned to the 'auxiliary' position, current flows across the switch (C0099 on Td6 vehicles, C0028 on V8 vehicles) to fuse 37 of the passenger compartment fuse box (C0585) on a PB wire. Fuse 37 (C0587) provides an auxiliary ignition feed to the Dynamic Stability Control (DSC) switch (C0700), located on the centre console, on a GBY wire.

V8

Fusible link 2 (C0632) provides a constant battery feed to the ECM relay (C1895) on an R wire. Operation of the ECM relay (C1895) is controlled by the ECM (C0604) on an N wire. The energised ECM relay (C1895) provides a feed to fuse 51 of the passenger compartment fuse box (C0584) on an RW wire. Fuse 51 (C0584) is connected to the ABS ECU (C0506) and the steering angle sensor (C0862) by a pair of RW wires.

Td6

The 100A fuse within the fuse holder (C1878) provides a constant battery feed to the ECM relay (C1895) on an R wire. Operation of the ECM relay (C1895) is controlled by the ECM (C0604) on an N wire. The energised ECM relay (C1895) provides a feed to fuse 51 of the passenger compartment fuse box (C0584) on an RW wire. Fuse 51 (C0584) is connected to the ABS ECU (C0506) and the steering angle sensor (C0862) by a pair of RW wires.

ABS

Wheel Speed Sensors

The ABS ECU (C0506) provides a feed to all four wheel speed sensors as follows:

- To the LH front wheel speed sensor (C0516) on an R wire.
- To the RH front wheel speed sensor (C0517) on a Y wire.
- The LH rear wheel speed sensor (C0502) on a W wire.
- To the RH rear wheel speed sensor (C0503) on a G wire.

The wheel speed sensors are hall effect sensors, and provide the ABS ECU with a square wave form signal. This signal rises and falls between approximately 2.5V and 0.75V. By measuring the frequency of the waveform, the ABS ECU can calculate the speed of the road wheel. The sensors provide the ABS ECU (C0506) with a wheel speed signal as follows:

- From the LH front wheel speed sensor (C0516) on a UR wire.
- From the RH front wheel speed sensor (C0517) on a UY wire.
- From the LH rear wheel speed sensor (C0502) on a UW wire.
- From the RH rear wheel speed sensor (C0503) on a UG wire.

DSC

DSC Switch

DSC is active as soon as the ignition switch is turned to the 'ignition' position. DSC can be switched off by pressing the non-latching master switch located on the centre console. When the ABS ECU (C0506) receives a momentary feed from the DSC switch (C0700) on a BY wire, it suspends DSC operation. Pressing the switch a second time reinstates DSC.

DESCRIPTION AND OPERATION

Steering Angle Sensor

The steering angle sensor (C0862) receives a constant battery feed from fuse 13 of the passenger compartment fuse box (C0586) on an RG wire, and a feed from the energised ECM relay (C1895) via fuse 51 of the passenger compartment fuse box (C0584) on an RW wire. The sensor (C0862) is earthed on an NB wire.

The steering angle sensor (C0862) transmits steering angle and rate of steering messages via the Can bus on YN (low) and YB (high) wires. These signals are created by two potentiometers located within the sensor. The ABS ECU uses these messages to enable the DSC system control lateral stability.

Brake Fluid Level Warning Switch

If the brake fluid level is below the minimum level, DSC operation is suspended. The ABS ECU (C0506) monitors the condition of the brake fluid level switch (C0026) via an NGY wire.

HDC

The HDC switch (C0365) is mounted on the side of the gear selector lever, and is provided an auxiliary ignition feed from fuse 35 of the passenger compartment fuse box (C0587) on a GBY wire. The ABS ECU (C0506) monitors the condition of the HDC switch (C0365) via a BG wire.

EBA

Brake Pedal Switch

The brake pedal switch (C0075) is provided an auxiliary ignition feed from fuse 9 of the passenger compartment fuse box (C0587) on a PY wire. The ABS ECU (C0506) monitors the condition of the brake pedal switch (C0075) on a UR wire to enable it to operate its Emergency Brake Assist (EBA) function.

Diagnostic Socket

The diagnostic socket is located behind an access panel on the drivers side of the fascia. The ABS ECU (C0506) and the steering angle sensor (C0862) can be interrogated by T4 via the K line bus on WP wires.

SUPPLEMENTARY RESTRAINT SYSTEM (SRS)

DESCRIPTION

General

The Supplementary Restraint System (SRS) is controlled by the SRS Diagnostic Control Unit (DCU) which is mounted on the transmission tunnel, to the rear of the gear selector lever. The SRS DCU registers front and rear impacts via an integral accelerometer. Side impacts are registered via two side impact sensors; one mounted on the base of the RH B/C post, one mounted on the base of the LH B/C post.

The drivers and passenger airbags can be deployed in one of two stages. A lesser impact will result in stage 1 deployment. Both the drivers airbag and the passenger airbag contain two squibs. Stage 1 entails the SRS DCU delaying deployment of the second squib for a split second. This results in a less severe deployment of the airbags. A larger impact will result in stage 2 deployment. This entails both squibs within the drivers and passenger airbags being deployed simultaneously.

Front head airbags are also mounted in the 'A' post. These work in conjunction with the door mounted airbags. Rear head airbags, mounted in the 'D' post are available as an option.

OPERATION

Power Distribution

Feed from the positive battery terminal (C0192) is supplied to fuse 53 of the passenger compartment fuse box (C0632) on an R wire. Fuse 53 (C0583) is connected to the ignition switch (C0099 on Td6 vehicles, C0028 on V8 vehicles) by an R wire. When the ignition switch is turned to the 'auxiliary' position, current flows across the switch (C0099 on Td6 vehicles, C0028 on V8 vehicles) to fuse 44 of the passenger compartment fuse box (C0585) on a PB wire. Fuse 44 (C0586) provides an auxiliary ignition feed to the following:

- The SRS DCU (C0256) on a PU wire.
- The LH seat belt buckle switch (C0100) on a PG wire.
- The RH seat belt buckle switch (C0260) on a PG wire.
- The occupancy detector sensor (C0962) on a PG wire.

DESCRIPTION AND OPERATION

Drivers Airbag

The drivers airbag can deploy in one of two stages, depending upon the severity of impact. If a less severe impact is detected, stage 1 deployment is carried out. The SRS DCU (C0256) provides a firing signal to the drivers airbag (C1254) via the rotary coupler (C0082) on a YB then S wire. The SRS DCU (C0256) provides an earth path for the drivers airbag (C1254) via the rotary coupler (C0082) on an LG then YN wire.

A split second later, the SRS DCU (C0256) provides a second firing signal to the drivers airbag (C1254) via the rotary coupler (C0082) on an SN then U wire. The SRS DCU (C0256) provides a second earth path for the drivers airbag (C1254) via the rotary coupler (C0082) on a US then SB wire.

When stage two deployment is required, the SRS DCU provides simultaneous firing signals to both squibs as described previously.

Passenger Airbag

The passenger airbag can deploy in one of two stages, depending upon the severity of impact. If a less severe impact is detected, stage 1 deployment is carried out. The SRS DCU (C0256) provides a firing signal to the passenger airbag (C0251) on a UN wire. The SRS DCU (C0256) provides an earth path for the passenger airbag (C0251) on a UB wire.

A split second later, the SRS DCU (C0256) provides a second firing signal to the passenger airbag (C0251) on a WB wire. The SRS DCU (C0256) provides an earth path for the passenger airbag (C0251) on a WN wire.

When stage two deployment is required, the SRS DCU provides simultaneous firing signals to both squibs as described previously.

Door Airbags

The SRS DCU registers a side impact via the side impact sensors, which are mounted at the base of the LH and RH B/C posts. The SRS DCU monitors the condition of the RH sensor (C0951) and the LH sensor (C0950) on YR and YG wires respectively. Both sensors are earthed on NB wires. When the SRS DCU registers a side impact above its threshold level, it will fire the relevant door airbag.

The SRS DCU (C0256) provides a firing signal to the RH door airbag (C1499) on a U wire. An earth path is provided by the SRS DCU (C0256) on an N wire.

The SRS DCU (C0256) provides a firing signal to the LH door airbag (C1499) on an N wire. An earth path is provided by the SRS DCU (C0256) on a Y wire.

Head Airbags

The SRS DCU registers a side impact via the side impact sensors, which are mounted at the base of the LH and RH B/C posts. The SRS DCU monitors the condition of the RH sensor (C0951) and the LH sensor (C0950) on YR and YG wires respectively. Both sensors are earthed on NB wires. When the SRS DCU registers a side impact above its threshold level, it will fire the relevant head airbag.

LH Front

The SRS DCU (C0256) provides a firing signal to the LH front head airbag (C1477) on a UY wire. An earth path is provided by the SRS DCU (C0256) on a Y wire.

RH Front

The SRS DCU (C0256) provides a firing signal to the RH front head airbag (C1478) on a W wire. An earth path is provided by the SRS DCU (C0256) on a UW wire.

LH Rear

The SRS DCU (C0256) provides a firing signal to the LH rear head airbag (C1474) on a B wire. An earth path is provided by the SRS DCU (C0256) on a Y wire.

RH Rear

The SRS DCU (C0256) provides a firing signal to the RH rear head airbag (C0948) on a UG then UR wire. An earth path is provided by the SRS DCU (C0256) on an R then G wire.

Occupancy Detector

The occupancy detector determines if there is a passenger occupying the front seat. If the front seat passenger is not detected, the front passenger airbag, and front passenger head airbag deployment is suspended in the event of an impact. All other SRS components will operate as normal.

The occupancy detector (C0962) is provided an auxiliary ignition feed from fuse 44 of the passenger compartment fuse box (C0586) on a PG wire, and is earthed on an NB wire. The occupancy detector (C0962) provides a pulsed voltage signal to the SRS DCU (C0256) on a WR wire. The signal consists of 7 bits. A signal of '0 00 00 01' informs the SRS DCU the front passenger seat is unoccupied. A signal of '0 11 11 01' informs the SRS DCU the front passenger seat is occupied.

Seat Belt Switches

The SRS DCU determines if the front seat belts are being used by monitoring the status of the seat belt switches. If the seat belt tongue is inserted into the buckle, the switch contacts close and battery voltage is supplied to the SRS DCU (C0256) on UW (LH) and UP (RH) wires. If the SRS DCU detects a seat belt is not being used, it will not fire the relevant seat belt pre-tensioner.

DESCRIPTION AND OPERATION

Seat Belt Pre-tensioners

If the SRS DCU detects a front or rear impact, it will deploy the front seat belt pre-tensioners. The SRS DCU (C0256) provides a firing signal to the RH seat belt pre-tensioner (C0252) on a UN wire. An earth path is provided by the SRS DCU (C0256) on a UR wire. The SRS DCU (C0256) provides a firing signal to the LH seat belt pre-tensioner (C0254) on a YR wire. An earth path is provided by the SRS DCU (C0256) on a YN wire.

Battery Disconnection

In the event of an impact severe enough to implement stage 2 airbag deployment, a pyrotechnic charge on the positive battery terminal will disconnect the battery. The SRS DCU (C0256) provides a firing signal to the battery (C2250) on an NR then B wire. An earth path is provided by the SRS DCU (C0256) on a B then N wire.

Body Control Unit (BCU)

In the event of an impact severe enough to trigger the SRS system, the SRS DCU (C0256) provides a pulsed voltage signal to the BCU (C0661) on an SU wire. The BCU then enters its 'crash' mode, unlocking all the doors, illuminating the interior lamps, and powering the hazard warning lamps.

SRS Warning Lamp

The SRS DCU (C0256) controls operation of the SRS warning lamp (C0230) by providing a pulsed voltage feed on an NP wire.

AUTOMATIC TEMPERATURE CONTROL (ATC)

DESCRIPTION

General

The Automatic Temperature Control (ATC) system is controlled by the ATC ECU, which is located behind the centre console. ATC features automatic control of a common temperature setting for both sides of the passenger compartment, with manual control of the blower speed, air recirculation, and air distribution.

A Fuel Burning Heater (FBH) is fitted as standard on Td6 vehicles, and as an option on V8 vehicles. For more information on FBH operation, refer to the relevant **Fuel Burning Heater (FBH)** section of this manual.

 **FUEL BURNING HEATER – Td6.**

 **FUEL BURNING HEATER – V8.**

For more details on ATC operation, refer to the **Air Conditioning** section of the System Description and Operation Workshop manual.

OPERATION

Power Distribution

Feed from the positive battery terminal (C0192) is supplied to the following on an R wire:

- Maxi fuse 61.
- Maxi fuse 64.
- Fuse 12.
- Fuse 53.

All are located in the passenger compartment fuse box (C0632). Maxi fuse 61 (C0581) provides a constant battery feed to the cooling fan control unit (C0005) on an RU then U wire. Maxi fuse 64 (C0580) provides a constant battery feed to the blower motor control unit (C2281) on an RU then YG wire.

Fuse 12 (C0586) provides a constant battery feed to the ATC ECU (C1630) on an RP wire. The ATC ECU (C1630) is earthed on an N wire.

Fuse 53 (C0583) provides a constant battery feed to the ignition switch (C0099 on Td6 vehicles, C0028 on V8 vehicles) on an R wire. When the ignition switch is turned to the 'ignition' position, current flows across the switch (C0099 on Td6 vehicles, C0028 on V8 vehicles) to fuse 34 of the passenger compartment fuse box (C0585) on a G wire. Fuse 34 (C0587) provides an ignition feed to the ATC ECU (C1629) on a GY wire.

DESCRIPTION AND OPERATION

Compressor

When compressor operation is required, the ATC ECU (C1629) sends a message to the Engine Control Module (ECM) via the K bus on a WRY wire. Provided there are no engine management constraints, the ECM (C0331) responds by increasing throttle angle and fuelling and returns a signal granting operation of the compressor to the ATC ECU (C1629) on a BG wire. The ATC ECU (C1630) then provides a feed to the compressor clutch (C0182) on a BS wire.

For more details of compressor operation, refer to the **Air Conditioning** section of the System Description and Operation Workshop manual.

Refrigerant Pressure Sensor

The refrigerant pressure sensor is located in the refrigerant line between the condenser and the thermostatic expansion valve. It provides the ATC ECU with a pressure input from the high pressure side of the refrigerant system. The ATC ECU (C1629) provides a 5 V reference feed to the pressure sensor (C1610) on a GY wire. The pressure sensor (C1610) returns a signal voltage of between 0 V and 5 V, depending upon system pressure, to the ATC ECU (C1629) on a BS wire. The ATC ECU (C1629) provides an earth path for the pressure sensor (C1610) on an NB wire.

Evaporator Temperature Sensor

The evaporator temperature sensor is a Negative Temperature Coefficient (NTC) sensor. The ATC ECU (C0923) provides a feed to the evaporator temperature sensor (C0417) on an NB wire. By measuring the voltage returned on a YB wire, the ATC ECU (C0923) can determine evaporator temperature.

Blower Motor

Operation of the blower motor is controlled by the ATC ECU via the blower motor control unit. To control blower motor speed, the ATC ECU (C0923) provides a stepped voltage of between 0 V and 8 V to the control unit (C2281) on a UR wire. This is used by the control unit to regulate the supply voltage from maxi fuse 64 of the passenger compartment fuse box to the blower motor (C0056) on BG and RG wires.

The blower motor control unit (C2281) is earthed on an N wire.

Heater Coolant Temperature Sensor

The heater coolant temperature sensor is a Negative Temperature Coefficient (NTC) sensor. The ATC ECU (C0923) provides a feed to the temperature sensor (C0416) on an NB wire. By measuring the voltage returned on the YR wire, the ATC ECU (C0923) can determine the temperature of the air exiting the heater matrix.

Coolant Valve

A single coolant valve is fitted on the ATC system to control coolant flow to the heater matrix. The coolant valve (C2034) is controlled by a Pulse Width Modulated (PWM) signal from the ATC ECU (C1629) on a YN wire.

Auxiliary Coolant Pump

The auxiliary coolant pump is used to ensure a satisfactory flow rate through the heater matrix at low engine speeds. The ATC ECU (C1629) provides a feed to the pump (C2035) on a UG wire. The pump (C2035) is earthed on an N wire.

Cooling Fan

Operation of the cooling fan is controlled by the ECM. When the compressor is engaged, the ATC ECU (C1629) informs the ECM (C0331) via the K bus on a WRY wire that cooling fan operation is required. The ATC ECU also informs the ECM of the speed at which the fan should be driven.

The ECM also monitors Engine Coolant Temperature (ECT) to determine fan speed. The ECM (C0606) provides a feed to the ECT sensor (C0169) on an SU (Td6) or YG (V8) wire. The ECT sensor is a Negative Temperature Coefficient (NTC) sensor. By measuring the voltage returned on an NG (Td6) or NO (V8) wire, the ECM can determine engine coolant temperature.

The ECM (C0331) now provides a feed to the cooling fan control unit (C0005) on a BG wire. This is used by the control unit to regulate the supply voltage from maxi fuse 61 of the passenger compartment fuse box (C0581) on an RU wire.

DESCRIPTION AND OPERATION

AUTOMATIC TEMPERATURE CONTROL (ATC) – COMFORT

DESCRIPTION

General

The 'Comfort' Automatic Temperature Control (ATC) system is controlled by the ATC ECU, which is located behind the centre console. In addition to the features included on the low line system, the 'Comfort' ATC system also features a second coolant valve, a pollution sensor, and a rear blower unit.

The 'Comfort' ATC system is fully automatic, with separate temperature settings for the LH and RH sides of the passenger compartment. Manual override is available for blower speed, air recirculation, and air distribution.

A Fuel Burning Heater (FBH) is fitted as standard on Td6 vehicles, and as an option on V8 vehicles. For more information on FBH operation, refer to the relevant ***Fuel Burning Heater (FBH)*** section of this manual.

 **FUEL BURNING HEATER – Td6.**

 **FUEL BURNING HEATER – V8.**

For more details on ATC operation, refer to the ***Air Conditioning*** section of the System Description and Operation Workshop manual.

OPERATION

Power Distribution

Feed from the positive battery terminal (C0192) is supplied to the following on an R wire:

- Fusible link 5.
- Maxi fuse 61.
- Maxi fuse 64.
- Fuse 12.
- Fuse 53.

All are located in the passenger compartment fuse box (C0632). Maxi fuse 61 (C0581) provides a constant battery feed to the cooling fan control unit (C0005) on an RU wire. Maxi fuse 64 (C0580) provides a constant battery feed to the front blower motor control unit (C2281) on an RU then YG wire.

Fuse 12 (C0586) provides a constant battery feed to the ATC ECU (C1630) on an RP wire. The ATC ECU (C1630) is earthed on an N wire.

Fuse 53 (C0583) is connected to the ignition switch (C0099 on Td6 vehicles, C0028 on V8 vehicles) by an R wire. When the ignition switch is turned to the 'ignition' position, current flows across the switch (C0099 on Td6 vehicles, C0028 on V8 vehicles) to fuse 34 and fuse 2 of the passenger compartment fuse box (C0585) on a G wire. Fuse 34 (C0587) provides an ignition feed to the ATC ECU (C1629) on a GY wire.

Fuse 2 (C0587) provides an ignition feed to the rear blower relay coil (C2022) on a GY wire. The rear blower relay is located in the rear fuse box (C2021) and is earthed on an N wire.

Fusible link 5 of the passenger compartment fuse box (C0588) provides a constant battery feed to fuse 12R in the rear fuse box (C2024) on an R wire. Fuse 12R is connected to the rear blower relay switch. When the relay is energised, current flows across the closed switch contacts (C2021) to the rear blower motor control unit (C2282) on a GU then SUY then UG wire.

Compressor

When compressor operation is required, the ATC ECU (C1629) sends a message to the Engine Control Module (ECM) via the K bus on a WRY wire. Provided there are no engine management constraints, the ECM (C0331) responds by increasing throttle angle and fuelling and returns a signal granting operation of the compressor to the ATC ECU (C1629) on a BG wire. The ATC ECU (C1630) then provides a feed to the compressor clutch (C0182) on a BS wire.

For more details of compressor operation, refer to the ***Air Conditioning*** section of the System Description and Operation Workshop manual.

Refrigerant Pressure Sensor

The refrigerant pressure sensor provides the ATC ECU with a pressure input from the high pressure side of the refrigerant system. The ATC ECU (C1629) provides a 5 V reference feed to the pressure sensor (C1610) on a GY wire. The pressure sensor (C1610) returns a signal voltage of between 0 V and 5 V, depending upon system pressure, to the ATC ECU (C1629) on a BS wire. The ATC ECU (C1629) provides an earth path for the pressure sensor (C1610) on an NB wire.

Evaporator Temperature Sensor

The evaporator temperature sensor is a Negative Temperature Coefficient (NTC) sensor. The ATC ECU (C0923) provides a feed to the evaporator temperature sensor (C0417) on an NB wire. By measuring the voltage returned on a YB wire, the ATC ECU (C0923) can determine evaporator temperature.

DESCRIPTION AND OPERATION

Sunlight Sensor

The sunlight sensor consists of a LH and a RH photoelectric cell that provide the ATC ECU with inputs of light intensity. These are used by the ATC to adjust blower speed, temperature, and air distribution. The ATC ECU (C1629) provides a feed to the sunlight sensor (C0790) on a YB wire. The LH photoelectric cell (C0790) returns a signal back to the ATC ECU (C1629) on a YR wire. The RH photoelectric cell (C0790) returns a signal back to the ATC ECU (C1629) on a YG wire. The ATC ECU (C1629) provides an earth path for the sensor (C0790) on a YN wire.

Pollution Sensor

The pollution sensor allows the ATC ECU to monitor the ambient air for the level of hydrocarbons and oxidized gases. The ATC (C1629) provides two feeds to the sensor (C1548). The first is on a U wire, and is used to heat the sensor. A second feed is provided on a Y wire. This is a 5 V reference voltage to the sensor itself. A signal voltage of between 0 V and 5 V is returned from pin 3 of the sensor (C1548) to the ATC ECU (C1629) on an N wire. The ATC ECU (C1629) provides an earth path for the sensor (C1548) on a second N wire (pin 1 of the sensor connector).

Front Blower Motor

Operation of the front blower motor is controlled by the ATC ECU via the front blower motor control unit. To control front blower motor speed, the ATC ECU (C0923) provides a stepped voltage of between 0 V and 8 V to the control unit (C2281) on a UR wire. This is used by the control unit to regulate the supply voltage from maxi fuse 64 of the passenger compartment fuse box to the front blower motor (C0056) on BG and RG wires.

The front blower motor control unit (C2281) is earthed on an N wire.

Rear Blower Motor

Operation of the rear blower motor is controlled by the ATC ECU via the rear blower motor control unit. The ATC ECU (C0923) receives an input voltage of between 1.25 V (blower off) and 5 V (maximum blower speed) from the rear blower motor thumbwheel (C0846) on an RB wire. The thumbwheel is a potentiometer located in the rear ATC control unit. The ATC ECU (C0923) determines the blower speed requested from the voltage received from the thumbwheel and provides a stepped voltage of between 0 V and 5 V to the control unit (C2282) on a B then R wire. This is used by the control unit to regulate the supply voltage from the rear blower relay (C2021) to the rear blower motor (C2279) on GY and N wires.

The rear blower motor control unit (C2282) is earthed on an N wire.

Air Distribution Motors

Unless manually overridden, operation of the air distribution motor is controlled automatically by the ATC ECU. The ATC ECU (C2295) provides a feed to the following on BW wires:

- The face level air distribution motor (C2133).
- The screen air distribution motor (C2134).
- The footwell air distribution motor (C2135).

The ATC ECU (C2295) provides an earth path for all three motors on B wires.

Air Recirculation Motor

Unless manually overridden, operation of the recirculation motor is controlled automatically by the ATC ECU, using inputs from the pollution sensor and/or if rapid passenger compartment cooling is required. The ATC ECU (C2295) provides a feed to the recirculated air motor (C0006) on a BW wire. The ATC ECU (C2295) provides an earth path for the motor (C0006) on a B wire.

Heater Coolant Temperature Sensors

Two heater coolant temperature sensors are fitted on 'Comfort' ATC systems; on RH one LH. Both sensors are Negative Temperature Coefficient (NTC) sensors. The ATC ECU (C0923) provides a feed to the RH (C2296) and LH (C0416) temperature sensors on a pair of NB wires. By measuring the voltage returned on a YU (RH) and YR (LH) wire, the ATC ECU (C0923) can determine the temperature of the air exiting both sides of the heater matrix.

Coolant Valves

Two coolant valves are fitted to 'Comfort' ATC systems to control coolant flow to each side of the heater matrix. Both are controlled by Pulse Width Modulated (PWM) signals from the ATC ECU (C1629) on YN (LH) and YP (RH) wires.

Auxiliary Coolant Pump

The auxiliary coolant pump is used to ensure a satisfactory flow rate through the heater matrix at low engine speeds. The ATC ECU (C1629) provides a feed to the pump (C2035) on a UG wire. The pump (C2035) is earthed on an N wire.

DESCRIPTION AND OPERATION

Cooling Fan

Operation of the cooling fan is controlled by the ECM. When the compressor is engaged, the ATC ECU (C1629) informs the ECM (C0331) via the K bus on a WRY wire that cooling fan operation is required. The ATC ECU also informs the ECM of the speed at which the fan should be driven.

The ECM also monitors Engine Coolant Temperature (ECT) to determine fan speed. The ECM (C0606) provides a feed to the ECT sensor (C0169) on an SU (Td6) or YG (V8) wire. The ECT sensor is a Negative Temperature Coefficient (NTC) sensor. By measuring the voltage returned on an NG (Td6) or NO (V8) wire, the ECM can determine engine coolant temperature.

The ECM (C0331) now provides a feed to the cooling fan control unit (C0005) on a BG wire. This is used by the control unit to regulate the supply voltage from maxi fuse 61 of the passenger compartment fuse box (C0581) on an RU wire.

FUEL BURNING HEATER – Td6

DESCRIPTION

General

The Fuel Burning Heater (FBH) is mounted in the rear of the engine compartment on the passengers side, and is fitted as standard on Td6 vehicles. The FBH is an additional heater installed in the heater coolant circuit. The FBH can be operated without the engine running to pre-heat the passenger compartment and after the engine starts to reduce heater coolant warm-up time. The FBH also boosts the heater coolant temperature while the engine is running at low ambient air and engine coolant temperatures to maintain heater performance at an acceptable level.

For a detailed description of FBH operation, refer to the ***Air Conditioning*** section of the System Description and Operation Workshop Manual.

OPERATION

Power Distribution

Feed from the positive battery terminal (C0192) is supplied to fuse 59 of the passenger compartment fuse box (C0632) on an R wire. Fuse 59 (C0582) provides a constant battery feed to the FBH (C0925) on an RY wire. The FBH (C0925) is earthed on an N wire.

FBH Receiver

A remote request for park heating is received by the TV antenna located in the RH rear window. This is relayed to the FBH receiver (C2229) by the antenna amplifier (C2228) on an R wire. The FBH receiver (C2046) then provides a feed to the FBH (C0926) on a WG wire informing the FBH to operate the park heating function.

FBH Pump

The FBH pump is mounted below the RH side of the fuel tank. The FBH (C0926) provides a Pulse Width Modulated (PWM) signal to the pump (C0920) on a BR wire. The pump is earthed on an N wire.

K Bus

The instrument pack (C0233) communicates with the Air Temperature Control (ATC) ECU (C1629) and the FBH (C0926) via the K-bus on a WRY wire to initiate FBH operation. For a detailed description of the parameters for operation, and the messages sent via the K bus, refer to the ***Air Conditioning*** section of the System Description and Operation Workshop manual.

DESCRIPTION AND OPERATION

FUEL BURNING HEATER – V8

DESCRIPTION

General

The Fuel Burning Heater (FBH) is mounted in the rear of the engine compartment on the passengers side, and is fitted as an option on V8 vehicles. The FBH is an additional heater installed in the heater coolant circuit. The FBH can be operated without the engine running to pre-heat the passenger compartment and after the engine starts to reduce heater coolant warm-up time. The FBH also boosts the heater coolant temperature while the engine is running at low ambient air and engine coolant temperatures to maintain heater performance at an acceptable level.

For a detailed description of FBH operation, refer to the **Air Conditioning** section of the System Description and Operation Workshop Manual.

OPERATION

Power Distribution

Feed from the positive battery terminal (C0192) is supplied to fuse 59 of the passenger compartment fuse box (C0632) on an R wire. Fuse 59 (C0582) provides a constant battery feed to the FBH (C0925) and the FBH receiver (C2046) on a pair of RY wires. The FBH (C0925) is earthed on an N wire, FBH receiver (C2046) on an NB wire.

FBH Receiver

A remote request for park heating is received by the TV antenna located in the RH rear window. This is relayed to the FBH receiver (C2229) by the antenna amplifier (C2228) on an R wire. The FBH receiver (C2046) then provides a feed to the FBH (C0926) on a WG wire informing the FBH to operate the park heating function.

FBH Pump

The FBH pump is mounted below the RH side of the fuel tank. The FBH (C0926) provides a Pulse Width Modulated (PWM) signal to the pump (C0920) on a BR wire. The pump is earthed on an N wire.

Changeover Valve

The changeover valve isolates the heater coolant circuit from the engine coolant circuit. The changeover valve is a normally open solenoid. To close the valve, the ATC ECU (C1629) provides a feed to the valve (C2037) on an SB wire. The valve is earthed (C2037) on an NB wire.

K Bus

The instrument pack (C0233) communicates with the Air Temperature Control (ATC) ECU (C1629) and the FBH (C0926) via the K-bus on a WRY wire to initiate FBH operation. For a detailed description of the parameters for operation, and the messages sent via the K bus, refer to the ***Air Conditioning*** section of the System Description and Operation Workshop manual.

DESCRIPTION AND OPERATION

COOLING FAN

DESCRIPTION

General

The electrically powered cooling fan is mounted on the front of the radiator and works in conjunction with the cooling fan mounted on the front of the engine. Operation of the cooling fan is controlled by the Engine Control Module (ECM). The ECM determines cooling fan operating strategy after receiving inputs of Engine Coolant Temperature (ECT) from the ECT sensor, and requests for extra engine cooling from the Automatic Temperature Control (ATC) ECU via the K bus.

For more information on ATC operation, refer to the ***Automatic Temperature Control (ATC)*** or ***Automatic Temperature Control – Comfort*** section of this manual.

 **AUTOMATIC TEMPERATURE CONTROL (ATC).**

 **AUTOMATIC TEMPERATURE CONTROL (ATC) – COMFORT.**

OPERATION

Power Distribution

Feed from the positive battery terminal (C0192) is supplied to maxi fuse 61, fuse 12, and fuse 53 of the passenger compartment fuse box (C0632) on an R wire. Fuse 12 (C0586) provides a constant battery feed to the ATC ECU (C1630) on an RP wire. Maxi fuse 61 (C0581) provides a constant battery feed to the cooling fan control unit (C0005) on an RU wire.

Fuse 53 (C0583) provides a constant battery feed to the ignition switch (C0099 on Td6 vehicles, C0028 on V8 vehicles) by an R wire. When the ignition switch is turned to the 'ignition' position, current flows across the switch (C0099 on Td6 vehicles, C0028 on V8 vehicles) to fuse 34 of the passenger compartment fuse box (C0585) on a G wire. Fuse 34 (C0587) provides an ignition feed to the ATC ECU (C1629) on a GY wire.

Cooling Fan – Td6

Operation of the cooling fan is controlled by the ECM. The ECM monitors Engine Coolant Temperature (ECT) to determine fan speed. The ECM (C0606) provides a feed to the ECT sensor (C0169) on an SU wire. The ECT sensor is a Negative Temperature Coefficient (NTC) sensor. By measuring the voltage returned on an NG wire, the ECM can determine engine coolant temperature.

When the ATC ECU engages the A/C compressor clutch, the ATC ECU (C1629) informs the ECM (C0331) via the K bus on a WRY wire that cooling fan operation is required. The ATC ECU also informs the ECM of the speed to drive the motor. For more information on A/C operation, refer to the ***Automatic Temperature Control (ATC)*** or ***Automatic Temperature Control (ATC) – Comfort*** section of this manual.

 **AUTOMATIC TEMPERATURE CONTROL (ATC).**

 **AUTOMATIC TEMPERATURE CONTROL (ATC) – COMFORT.**

The ECM (C0331) now provides a feed to the cooling fan control unit (C0005) on a BG wire. This is used by the control unit to regulate the supply voltage from maxi fuse 61 of the passenger compartment fuse box (C0581) on an RU wire.

Cooling Fan – V8

Operation of the cooling fan is controlled by the ECM. The ECM also monitors Engine Coolant Temperature (ECT) to determine fan speed. The ECM (C0606) provides a feed to the ECT sensor (C0169) on a YG wire. The ECT sensor is a Negative Temperature Coefficient (NTC) sensor. By measuring the voltage returned on an NO wire, the ECM can determine engine coolant temperature.

When the ATC ECU engages the Air Conditioning (A/C) compressor clutch, the ATC ECU (C1629) informs the ECM (C0331) via the K bus on a WRY wire that cooling fan operation is required. The ATC ECU also informs the ECM of the speed to drive the motor. For more information on A/C operation, refer to the ***Automatic Temperature Control (ATC)*** or ***Automatic Temperature Control (ATC) – Comfort*** section of this manual.

 **AUTOMATIC TEMPERATURE CONTROL (ATC).**

 **AUTOMATIC TEMPERATURE CONTROL (ATC) – COMFORT.**

The ECM (C0331) now provides a feed to the cooling fan control unit (C0005) on a BG wire. This is used by the control unit to regulate the supply voltage from maxi fuse 61 of the passenger compartment fuse box (C0581) on an RU wire.

DESCRIPTION AND OPERATION

HEATED REAR WINDOW (HRW)

DESCRIPTION

General

Operation of the Heated Rear Window (HRW) is controlled by the Automatic Temperature Control (ATC) ECU via the non latching HRW switch. After 10 minutes of operation, (when ambient temperature is -15°C (5°F) or above) or 17 minutes (when ambient temperature is less than -15°C (5°F)), the ATC ECU operates the HRW at low power for 60 minutes. During the 60 minutes, the ATC ECU cycles the HRW relay off for 80 seconds and on for 40 seconds. If the HRW switch is pressed again during the low power phase, the ATC ECU returns the HRW to full power by keeping the HRW relay energised for 5 minutes. At the end of the 5 minutes the low power phase is repeated.

The ATC ECU outputs a K bus message when the HRW is active. The message allows the navigation computer to compensate for the effect of the magnetic field generated when the HRW is active. The BCU transfers the message onto the P bus for the door modules, which activate the door mirror heaters together with the HRW.

OPERATION

Power Distribution

Feed from the positive battery terminal (C0192) is supplied to fusible link 5 and fuse 53 of the passenger compartment fuse box (C0632) on an R wire. Fusible link 5 (C0588) is connected to fuse 9 of the rear fuse box (C2024) by an R wire. Fuse 9 provides a constant battery feed to the HRW relay, which is also located in the rear fuse box.

Fuse 53 of the passenger compartment fuse box (C0583) provides a constant battery feed to the ignition switch (C0099 on Td6 vehicles, C0028 on V8 vehicles) on an R wire. When the ignition switch is turned to the 'ignition' position, current flows across the switch (C0099 on Td6 vehicles, C0028 on V8 vehicles) to fuse 2 of the passenger compartment fuse box (C0585) on a G wire. Fuse 2 (C0587) provides an ignition feed to the HRW relay coil (C2022) on a GY wire. The earth path for the relay coil (C2022) is controlled by the ATC ECU (C1629) on a UN wire.

HRW

When the HRW switch is pressed, a momentary earth path (C1630) is created on an N wire. If all operational conditions are met (*see 'Description' above*), the ATC ECU energises the HRW relay. The energised HRW relay (C2021) provides a feed to the HRW (C0381) on a B wire. The HRW (C0382) is earthed on an N wire.

HEATED FRONT SCREEN (HFS)

DESCRIPTION

General

Operation of the Heated Front Screen (HFS) is controlled by the Automatic Temperature Control (ATC) ECU via the non latching HFS switch.

When the engine is running and the HFS is selected, the ATC ECU illuminates the LED above the switch and energises the HFS relay attached to the passenger end of the fascia cross tube. If not already active, the ATC ECU also activates the A/C compressor and the blower, and sets air distribution to windscreen. After 10 minutes (when ambient temperature is $-15\text{ }^{\circ}\text{C}$ ($5\text{ }^{\circ}\text{F}$) or above) or 17 minutes (when ambient temperature is less than $-15\text{ }^{\circ}\text{C}$ ($5\text{ }^{\circ}\text{F}$)), the ATC ECU extinguishes the LED and de-energises the heated front screen relay. After the heater times out or is switched off, the timer in the ATC ECU is reset to zero.

OPERATION

Power Distribution

Feed from the positive battery terminal (C0192) is supplied to fusible link 1 and fuse 53 of the passenger compartment fuse box (C0632) on an R wire. Fusible link 1 (C0592) provides a constant battery feed to the HFS relay (C0994) on an R wire.

Fuse 53 (C0583) provides a constant battery feed to the ignition switch (C0099 on Td6 vehicles, C0028 on V8 vehicles) on an R wire. When the ignition switch is turned to the 'ignition' position, current flows across the switch (C0099 on Td6 vehicles, C0028 on V8 vehicles) to fuse 34 of the passenger compartment fuse box (C0585) on a G wire. Fuse 34 (C0587) provides an ignition feed to the HFS relay coil (C0994) on a GY wire. The earth path for the relay coil (C0994) is controlled by the ATC ECU (C1629) on a UN wire.

HFS

When the HFS switch is pressed, a momentary earth path (C1630) is created on an N wire. If all operational conditions are met (*see 'Description' above*), the ATC ECU energises the HFS relay. The energised HFS relay (C0994) provides a feed to the LH (C0247) and RH (C0246) heater elements on a pair of B wires. Both elements are earthed on N wires.

DESCRIPTION AND OPERATION

WIPERS AND WASHERS

DESCRIPTION

General

The wipers and washers system is controlled by the Body Control Unit (BCU) on receipt of requests made by the driver or the rain sensor unit (if fitted). All wiper functions for the front and rear wipers are controlled from a multifunction wash/wipe switch assembly located on the right hand side of the steering column.

Optional equipment on Range Rover includes a rain sensor. The sensor, located below the interior rear view mirror, detects rain drops on the windscreen and automatically operates the wipers in the intermittent mode.

NOTE: The column stalk switch must be in the intermittent position for rain sensor controlled wiper operation.

The front wiper system has four stages of wiper operation with four different delay periods for intermittent wipe. The four stages are as follows:

- Flick wipe
- Intermittent
- Normal (slow) speed continuous
- Fast speed continuous.

The intermittent wiper delay periods change with the road speed, with the delay decreasing as the road speed increases. Normal continuous operation changes to intermittent operation when the vehicle is stationary. Fast speed operation changes to normal operation when the vehicle is stationary.

For a detailed description of the wipers and washers, refer to the **Wipers and Washers** section of the System Description and Operation Workshop manual.

OPERATION

Front

Power Distribution

Feed from the positive battery terminal (C0192) is supplied to fuse 26 and fuse 53 of the passenger compartment fuse box (C0632) on an R wire. Fuse 26 (C0583) provides a constant battery feed to the wiper delay ECU (C0546) on an RW wire.

Fuse 53 (C0583) provides a constant battery feed to the ignition switch (C0099 on Td6 vehicles, C0028 on V8 vehicles) on an R wire. When the ignition switch is turned to the 'auxiliary' position, current flows across the switch (C0099 on Td6 vehicles, C0028 on V8 vehicles) to fuse 41 of the passenger compartment fuse box (C0585) on a PB wire. Fuse 41 (C0586) provides an auxiliary ignition feed to the Body Control Unit (BCU) (C0660) on a PW wire, and the rain sensor (C0961) on a PR wire.

Rain Sensor

The rain sensor (C0961) is mounted on the upper edge of the windscreen. It is provided an auxiliary ignition feed from fuse 41 of the passenger compartment fuse box (C0586) on a PR wire, and is earthed on an NB wire. The rain sensor (C0961) provides information to the BCU (C0660) via the K bus on a WRY wire. This information is used by the BCU to determine optimum wiper operation for the prevailing conditions.

Steering Wheel Switch

The BCU (C0660) provides feeds to the steering wheel switches (C0278) on BW and BU wires. The steering wheel switch (C0278) is earthed on an NB wire. The BCU determines which function has been selected by the earth paths that are created by the switch. If slow wipe is selected, current on the BW wire flows across the switch to earth. If fast wipe is selected, current on both the BW and BU wires flows across the switch to earth. If intermittent wipe is selected, current on the BU wire flows across the switch to earth.

The steering wheel switch also contains a rotary potentiometer to control the intermittent wipe function. The intermittent wipe setting is interpreted by the BCU (C0661) from the feed returned from the switch (C0278) on a BG wire.

When the BCU (C0661) senses that wiper operation is required, it provides a feed to the wiper delay ECU (C0546) on an NU wire. The wiper delay ECU (C0546) is earthed on an N wire and provides two feeds to the wiper motor (C0546) on BG and BN wires.

Washer

If the steering wheel switch is pulled towards the driver, current flows from the BCU (C0660) to the steering wheel switch (C0278) on an NP wire, and then to earth on an NB wire.

Sensing this earth, the BCU (C0662) provides a feed to the washer pump motor (C0008) on a B wire. Current flows across the washer pump motor (C0008) to earth on an N wire. The BCU powers the washer pump motor for as long as the switch is held in position, and also powers the wipers at slow speed.

DESCRIPTION AND OPERATION

Rear

Power Distribution

Feed from the positive battery terminal (C0192) is supplied to fuse 27, fuse 53, and fusible link 5 of the passenger compartment fuse box (C0632) on an R wire. Fuse 27 (C0585) provides a constant battery feed to the BCU (C0662) on an RU wire. Fusible link 5 (C0588) is connected to fuse 10 of the rear fuse box (C2024) on an R wire. Fuse 10 (C2021) provides a constant battery feed to the rear screen wiper ECU (C0388) on an RW wire.

Fuse 53 of the passenger compartment fuse box (C0583) is connected to the ignition switch (C0099 on Td6 vehicles, C0028 on V8 vehicles) by an R wire. When the ignition switch is turned to the 'auxiliary' position, current flows across the switch (C0099 on Td6 vehicles, C0028 on V8 vehicles) to fuse 41 of the passenger compartment fuse box (C0585) on a PB wire. Fuse 41 (C0586) provides an auxiliary ignition feed to the rear screen wiper ECU (C0835) on a PR wire. The ECU is earthed on an N (C0388) and an NB (C0835) wire.

Rear Wiper ECU

Operation of the rear wiper and washer system is controlled by the rear wiper ECU, which is integral with the motor assembly. The ECU (C0835) monitors the condition of the steering wheel switch (C0278) by providing feeds on BW and BU wires. If a request is made for rear wiper or washer operation, an earth path is created on an NB wire.

The rear wiper ECU (C0835) receives a 'reverse gear selected' signal from the Light Check Module (LCM) (C2040) on a UY wire. When the rear wiper ECU receives this feed it powers the rear wiper motor.

Washer

When the rear wiper ECU receives a washer request from the steering wheel switch, it provides a feed to the rear washer pump (C0021) on a BR wire. Current flows across the pump motor (C0021) to earth on an N wire.

HEADLAMP WASH/WIPE

DESCRIPTION

General

Operation of the headlamp wash/wipe system is controlled by the Body Control Unit (BCU) via the headlamp wash/wipe relay. Headlamp wash/wipe is activated automatically when the ignition and the headlamps are switched on, and windscreen wash/wipe is selected via the column switch. The headlamp wipers will operate through four cycles, with the washer jets spraying twice. This operation is only carried out on the first windscreen wash/wipe request, and then every fifth request from then on. This sequence is reset when the ignition is switched off.

For more information on headlamp wash/wipe, refer to the *Wipers and Washers* section of the System Description and Operation Workshop Manual.

OPERATION

Power Distribution

Feed from the positive battery terminal (C0192) is supplied to fuse 28 and fuse 53 of the passenger compartment fuse box (C0632) on an R wire. Fuse 28 (C0582) provides a constant battery feed to the following on RS wires:

- The headlamp wash/wipe relay (C2031)
- The RH headlamp wiper motor (C1341)
- The LH headlamp wiper motor (C1340).

Fuse 53 (C0583) provides a constant battery feed to the ignition switch (C0099 on Td6 vehicles, C0028 on V8 vehicles) on an R wire. When the ignition switch is turned to the 'auxiliary' position, current flows across the switch (C0099 on Td6 vehicles, C0028 on V8 vehicles) to fuse 41 of the passenger compartment fuse box (C0585) on a PB wire. Fuse 41 (C0586) provides an auxiliary ignition feed to the BCU (C0660) on a PW wire. The BCU (C0662) is earthed on an N wire.

Headlamp Wash/Wipe Relay

When the BCU (C0661) determines a wash/wipe selection has been made, it provides a pulsed voltage feed to the headlamp wash/wipe relay (C2031) on a UB wire. The headlamp wash/wipe relay (C2031) is earthed on an NB wire. When this feed is received, circuitry contained within the relay converts this signal into a headlamp wash/wipe request and closes the relay switch contacts. This allows a feed to be provided to the RH headlamp motor (C1341) and the LH headlamp motor (C1340) on a pair of BN wires. Current flows across the motors to earth on N wires.

DESCRIPTION AND OPERATION

BRAKE AND REVERSE LAMPS

DESCRIPTION

Brake Lamps

The brake lamps are active with the ignition switch in the 'auxiliary' or 'ignition' positions. The Light Check Module (LCM) receives an input from the brake switch, which is used as a signal to activate the brake lamps. When Hill Descent Control (HDC) is active, the ABS ECU outputs a signal on a separate hardwired connection to the LCM to activate the brake lamps when the HDC function is operating.

For more information on brake lamp operation, refer to the **Exterior Lamps** section of the System Description and Operation Workshop Manual.

Reverse Lamps

The reverse lamps will operate when the ignition switch is in the 'ignition' position. The LCM activates the reverse lamps on receipt of a message on the I Bus that reverse gear has been selected.

For more information on reverse lamp operation, refer to the **Exterior Lamps** section of the System Description and Operation Workshop Manual.

OPERATION

Power Distribution

Feed from the positive battery terminal (C0192) is supplied to fusible link 3 and fuse 53 of the passenger compartment fuse box (C0632) on an R wire. Fusible link 3 (C0589) provides a constant battery feed to the Light Check Module (LCM) (C0937) on an R wire.

Fuse 53 (C0583) provides a constant battery feed to the ignition switch (C0099 on Td6 vehicles, C0028 on V8 vehicles) on an R wire. When the ignition switch is turned to the 'auxiliary' position, current flows across the switch (C0099 on Td6 vehicles, C0028 on V8 vehicles) to fuse 9 of the passenger compartment fuse box (C0585) on a PB wire. Fuse 9 (C0587) provides an auxiliary ignition feed to the LCM (C2040) and the brake pedal switch (C0075) on a pair of PY wires.

Brake Lamps

The LCM (C2040) monitors the condition of the brake pedal via the brake pedal switch (C0075) on a UR wire. When the brake pedal is pressed, the switch contacts close and an earth path is created on an NB wire. Sensing this, the LCM (C0937) provides a feed to the following on BU wires:

- The RH brake lamp (C0125)
- The LH brake lamp (C0121)
- The Centre High Mounted Stop Lamp (CHMSL) (C0613).

All are earthed on N wires.

When HDC is functioning, the ABS ECU (C0506) outputs a signal to the LCM (C2040) on a YN wire. When the LCM receives this signal, it operates the brake lamps as described above. For more information on ABS operation, refer to the **Anti-Lock Braking System (ABS)** section of this manual, and the **Brakes** section of the System Description and Operation Workshop manual.

 **ANTI-LOCK BRAKING SYSTEM (ABS).**

Reverse Lamps

When reverse gear is selected, a message is sent from the Electronic Automatic Transmission (EAT) ECU (C1835) to the Engine Control Module (ECM) (C0604) via the CAN Bus on YN (low) and YB (high) wires. This message is relayed from the ECM (C0331) to the instrument pack (C0234) via the CAN Bus on YN (low) and YB (high) wires

When the instrument pack receives this message, it outputs a signal to the LCM (C2040) via the I Bus on a WSY wire. When the LCM (C2039) receives a reverse gear selected signal, it provides a feed to the following on WY wires:

- The RH reverse lamp (C0455)
- The LH reverse lamp (C0472).

Both lamps are earthed on N wires.

DESCRIPTION AND OPERATION

HEAD, SIDE AND TAIL LAMPS

DESCRIPTION

General

Operation of the head, side, tail, and side marker (NAS vehicles only) is controlled by the Light Check Module (LCM). The LCM receives inputs from other systems via the I Bus.

Two headlamp systems are available; Halogen or bi-xenon. The two types of headlamps share a common lens.

NOTE: NAS vehicles are fitted with headlamp lenses marked with a Department of Transport (DOT) rating.

The bi-xenon headlamps illuminate when an arc of electrical current is established between two electrodes within the bulb. The xenon gas sealed in the bulb reacts to the electrical excitation and the heat generated by the current flow. This causes the gas to produce a blue/white light.

WARNING: The bi-xenon system generates up to 28000 volts and contact with this voltage could lead to fatality. Ensure the headlamps are switched off before working on the system.

For more details of headlamp operation, refer to the **Lighting** section of the System Description and Operation Workshop Manual.

OPERATION

Halogen System

Power Distribution

Feed from the positive battery terminal (C0192) is supplied to fuse 53, fusible link 3, and fusible link 4 on an R wire. All are located in the passenger compartment fuse box. Fusible link 3 (C0589) and fusible link 4 (C0590) provide constant battery feeds to the Light Check Module (LCM) (C0937 & C2039 respectively) on a pair of R wires. The LCM (C2039) is earthed on an N wire.

Fuse 53 (C0583) provides a constant battery feed to the ignition switch (C0099 on Td6 vehicles, C0028 on V8 vehicles) on an R wire. When the ignition switch is turned to the 'auxiliary' position, current flows across the switch (C0099 on Td6 vehicles, C0028 on V8 vehicles) to fuse 9 of the passenger compartment fuse box (C0585) on a PB wire. Fuse 9 (C0587) provides an auxiliary ignition feed to the LCM (C2040) on a PY wire.

When the ignition switch is turned to the 'ignition' position, current flows across the switch (C0099 on Td6 vehicles, C0028 on V8 vehicles) to fuse 4 of the passenger compartment fuse box (C0585) on a G wire. Fuse 4 (C0587) provides an ignition feed to the LCM (C2040) on a GS wire.

Light Check Module

The LCM (C2040) is located at the base of the RH 'A' post, and monitors the condition of the fascia mounted rotary lighting switch (C0041) by providing a feed on an NB wire. The LCM can determine the position of the switch by sensing if a feed is returned on a Y (side lamps) or a B (headlamps) wire. The LCM also monitors the condition of the column mounted main/dipped beam switch (C1832) via a U wire.

Side Lamps

If the LCM detects that side lamps have been selected, it provides a feed to the following:

- To the RH side lamp (C0537) on an SU wire
- To the LH side lamp (C0538) on an SG wire
- To the RH tail lamp (C0125) on an SW wire
- To the LH tail lamp (C0121) on an SP wire
- The rear number plate lamp (C1495) on an SN and an SB wire
- To the RH front side marker lamp (C0916) on an SU wire (NAS vehicles only)
- To the RH rear side marker lamp (C0918) on an SU wire (NAS vehicles only)
- To the LH front side marker lamp (C0917) on an SG wire (NAS vehicles only)
- To the LH rear side marker lamp (C0919) on an SG wire (NAS vehicles only).

All are earthed on N wires.

Headlamp Dipped Beam

In addition to the lamps outlined in the side lamps section, the LCM will provide feeds to the following lamps if it detects that headlamp dipped beam has been selected:

- To the RH headlamp dipped beam bulb (C0011) on a YU wire
- To the LH headlamp dipped beam bulb (C0009) on a WG wire.

Both are earthed on N wires.

Headlamp Main Beam

In addition to the lamps outlined in the side lamps and headlamp dipped beam sections, the LCM will provide feeds to the following lamps if it detects that headlamp main beam has been selected:

- To the RH headlamp main beam bulb (C0011) on a WU wire
- To the LH headlamp main beam bulb (C0009) on a YG wire.

Both are earthed on N wires.

DESCRIPTION AND OPERATION

Bi-Xenon System

Power Distribution

Feed from the positive battery terminal (C0192) is supplied to fuse 53, fusible link 3, and fusible link 4 on an R wire. All are located in the passenger compartment fuse box. Fusible link 3 (C0589) and fusible link 4 (C0590) provide constant battery feeds to the Light Check Module (LCM) (C0937 & C2039 respectively) on a pair of R wires. The LCM (C2039) is earthed on an N wire.

Fuse 53 (C0583) provides a constant battery feed to the ignition switch (C0099 on Td6 vehicles, C0028 on V8 vehicles) on an R wire. When the ignition switch is turned to the 'auxiliary' position, current flows across the switch (C0099 on Td6 vehicles, C0028 on V8 vehicles) to fuse 9 of the passenger compartment fuse box (C0585) on a PB wire. Fuse 9 (C0587) provides an auxiliary ignition feed to the LCM (C2040) on a PY wire.

When the ignition switch is turned to the 'ignition' position, current flows across the switch (C0099 on Td6 vehicles, C0028 on V8 vehicles) to fuse 4 and fuse 32 of the passenger compartment fuse box (C0585) on a G wire. Fuse 4 (C0587) provides an ignition feed to the LCM (C2040) on a GS wire.

Fuse 32 of the passenger compartment fuse box (C0585) provides an ignition feed to LH bi-xenon headlamp (C0009) on a GR wire. Fuse 32 (C0587) also provides an ignition feed to the RH bi-xenon headlamp (C0011) on a GR wire.

Light Check Module

The LCM (C2040) is located at the base of the RH 'A' post, and monitors the condition of the fascia mounted rotary lighting switch (C0041) by providing a feed on an NB wire. The LCM can determine the position of the switch by sensing if a feed is returned on a Y (side lamps) or a B (headlamps) wire. The LCM also monitors the condition of the column mounted main/dipped beam switch (C1832) via a U wire.

Side Lamps

If the LCM detects that side lamps have been selected, it provides a feed to the following:

- To the RH side lamp (C0537) on an SU wire
- To the LH side lamp (C0538) on an SG wire
- To the RH tail lamp (C0125) on an SW wire
- To the LH tail lamp (C0121) on an SP wire
- The rear number plate lamp (C1495) on an SN and an SB wire
- To the RH front side marker lamp (C0916) on an SU wire (NAS vehicles only)
- To the RH rear side marker lamp (C0918) on an SU wire (NAS vehicles only)
- To the LH front side marker lamp (C0917) on an SG wire (NAS vehicles only)
- To the LH rear side marker lamp (C0919) on an SG wire (NAS vehicles only).

All are earthed on N wires.

Headlamp Dipped Beam

In addition to the lamps outlined in the side lamps section, the LCM will provide feeds to the following lamps if it detects that headlamp dipped beam has been selected:

- To the RH headlamp dipped beam bulb (C0011) on a YU wire
- To the LH headlamp dipped beam bulb (C0009) on a WG wire.

Both are earthed on N wires.

Headlamp Main Beam

In addition to the lamps outlined in the side lamps and headlamp dipped beam sections, the LCM will provide feeds to the following lamps if it detects that headlamp main beam has been selected:

- To the RH headlamp bi-xenon unit (C0011) on a WU and a WB wire
- To the LH headlamp bi-xenon unit (C0009) on a YG and a WB wire.

Both are earthed on N wires.

Diagnostic Socket

The bi-xenon headlamp system can be interrogated using TestBook or T4 via the diagnostic socket. The diagnostic socket (C0040) is connected to the RH (C0011) and LH (C0009) bi-xenon units via a pair of WP wires.

DESCRIPTION AND OPERATION

AUTOMATIC HEADLAMP LEVELLING

DESCRIPTION

General

Automatic headlamp levelling is only fitted to vehicles with bi-xenon headlamps. The system adjusts the vertical positioning of the headlamps to provide optimum headlamp beam position for maximum driving visibility and preventing glare to oncoming drivers.

WARNING: The bi-xenon headlamp system generates up to 28000 volts and contact with this voltage could lead to fatality. Ensure the headlamps are switched off before working on the system.

The system is controlled by the headlamp levelling ECU, which is located at the base of the LH 'A' post. The ECU receives information from the front and rear height sensors and the ABS ECU to maintain the headlamps in the optimum vertical position.

For more information on automatic headlamp levelling, refer to the **Lighting** section of the System Description and Operation Workshop Manual.

OPERATION

Power Distribution

Feed from the positive battery terminal (C0192) is supplied to fusible link 4 and fuse 53 of the passenger compartment fuse box (C0632) on an R wire. Fusible link 4 (C0590) provides a constant battery feed to the Light Check Module (LCM) (C2039) on an R wire.

Fuse 53 (C0583) provides a constant battery feed to the ignition switch (C0099 on Td6 vehicles, C0028 on V8 vehicles) on an R wire. When the ignition switch is turned to the 'auxiliary' position, current flows across the switch (C0099 on Td6 vehicles, C0028 on V8 vehicles) to fuse 9 of the passenger compartment fuse box (C0585) on a PB wire. Fuse 9 (C0587) provides an auxiliary ignition feed to the LCM (C2040) on a PY wire.

Light Check Module

When the engine is running, the Light Check Module (LCM) (C2040) provides a feed to the headlamp levelling ECU (C1543) on a YR wire to initiate the automatic headlamp levelling function.

The LCM (C2040) also monitors the condition of the brake pedal switch (C0075) by providing a feed on a UR wire. This feed allows the headlamp levelling ECU to register when the vehicle is about to decelerate and adjust the vertical position of the headlamps accordingly.

For more information on the brake pedal switch, refer to the **Brake and Reverse Lamps** section of this manual.

 **BRAKE AND REVERSE LAMPS.**

ABS ECU

The ABS ECU (C0506) provides a vehicle speed signal to the headlamp levelling ECU (C1543) on a YW wire. This allows the headlamp levelling ECU to monitor the acceleration of the vehicle and adjust the vertical position of the headlamps accordingly.

RH Front Height Sensor

The headlamp levelling ECU (C1543) provides a 5V reference feed to the RH front height sensor (C1697) on a WB wire, and provides an earth path on a WN wire. The height sensor (C1697) returns a signal feed back to the headlamp levelling ECU (C1543) on a WS wire. By measuring this signal feed the headlamp ECU can determine the height of the front of the vehicle, compare this to the signal supplied by the RH rear height sensor and adjust the vertical position of the headlamps accordingly.

RH Rear Height Sensor

The headlamp levelling ECU (C1543) provides a 5V reference feed to the RH rear height sensor (C1698) on an SB wire, and provides an earth path on an SN wire. The height sensor (C1698) returns a signal feed back to the headlamp levelling ECU (C1543) on an SW wire. By measuring this signal feed the headlamp ECU can determine the height of the rear of the vehicle, compare this to the signal supplied by the RH front height sensor and adjust the vertical position of the headlamps accordingly.

DESCRIPTION AND OPERATION

FOG LAMPS

DESCRIPTION

General

Operation of both the front and rear fog lamps is controlled by the Light Check Module (LCM). The front fog lamps are only active when the ignition switch is in the 'ignition' position and the fascia mounted rotary lighting switch is in the side or headlamp position.

When the lighting switch is in the side lamp position, the rear fog lamps will only operate if the front fog lamps are operational. If the lighting switch is in the headlamp position, the rear fog lamps can be switched on separately from the front fog lamps.

For more information on fog lamp operation, refer to the **Lighting** section of the System Description and Operation Workshop Manual.

OPERATION

Front Fog Lamps

Power Distribution

Feed from the positive battery terminal (C0192) is supplied to fusible link 3 and fuse 53 of the passenger compartment fuse box (C0632) on an R wire. Fusible link 3 (C0589) provides a constant battery feed to the LCM (C0937) on an R wire.

Fuse 53 (C0583) provides a constant battery feed to the ignition switch (C0099 on Td6 vehicles, C0028 on V8 vehicles) on an R wire. When the ignition switch is turned to the 'auxiliary' position, current flows across the switch (C0099 on Td6 vehicles, C0028 on V8 vehicles) to fuse 9 of the passenger compartment fuse box (C0585) on a PB wire. Fuse 9 (C0587) provides an auxiliary ignition feed to the LCM (C2040) on a PY wire. The LCM (C2039) is earthed on an N wire.

Light Check Module

The Light Check Module (LCM) (C2040) provides a feed to the lighting switch (C0041) on a YW wire. When front fog lamps are selected, the switch contacts close momentarily. Current flows across the switch to the LCM on an NB wire. Sensing this, the LCM powers the front fog lamps.

The LCM (C0937) provides a feed to the RH front fog lamp (C0513) on a YN wire. The lamp is earthed on an N wire. The LCM (C2039) also provides a feed to the LH front fog lamp (C0514) on a YR wire. The lamp is earthed on an N wire.

Rear Fog Lamps

Power Distribution

Feed from the positive battery terminal (C0192) is supplied to fusible link 3 and fuse 53 of the passenger compartment fuse box (C0632) on an R wire. Fusible link 3 (C0589) provides a constant battery feed to the LCM (C0937) on an R wire.

Fuse 53 (C0583) provides a constant battery feed to the ignition switch (C0099 on Td6 vehicles, C0028 on V8 vehicles) on an R wire. When the ignition switch is turned to the 'auxiliary' position, current flows across the switch (C0099 on Td6 vehicles, C0028 on V8 vehicles) to fuse 9 of the passenger compartment fuse box (C0585) on a PB wire. Fuse 9 (C0587) provides an auxiliary ignition feed to the LCM (C2040) on a PY wire. The LCM (C2039) is earthed on an N wire.

Light Check Module

The Light Check Module (LCM) (C2040) provides a feed to the lighting switch (C0041) on a YB wire. When rear fog lamps are selected, the switch contacts close momentarily. Current flows across the switch to the LCM on an NB wire. Sensing this, the LCM powers the rear fog lamps.

The LCM (C0937) provides a feed to the RH rear fog lamp (C0125) on a YB wire. The lamp is earthed on an N wire. The LCM (C2039) also provides a feed to the LH rear fog lamp (C0121) on a YB wire. The lamp is earthed on an N wire.

DESCRIPTION AND OPERATION

DIRECTION INDICATOR/HAZARD WARNING LAMPS

DESCRIPTION

General

Operation of the direction indicator lamps is controlled by the column mounted switch via the Light Check Module (LCM). The direction indicator lamps operate when the ignition switch is in either the 'auxiliary' or 'ignition' positions.

The front direction indicator lamps are located within the side lamp assemblies, outboard of the headlamps. The rear direction indicator lamps are located within the tail lamp assemblies. The rear direction indicators are mounted behind the brake lamp LED assemblies. When the direction indicators are selected, a lens within the tail lamp directs the light around the outer diameter of the brake lamp LED assembly.

The hazard warning switch is mounted on the centre of the fascia. When pressed, both sets of direction indicator lamps operate simultaneously.

For more details on direction indicator and hazard warning lamp operation, refer to the **Lighting** section of the System Description and Operation Workshop manual.

OPERATION

Power Distribution

Feed from the positive battery terminal (C0192) is supplied to fusible link 3, fusible link 4, and fuse 53 of the passenger compartment fuse box (C0632) on an R wire. Fusible link 3 (C0589) and fusible link 4 (C0590) provide constant battery feeds to the Light Check Module (LCM) (C0937 & C2039 respectively) on a pair of R wires.

Fuse 53 of the passenger compartment fuse box (C0583) provides a constant battery feed to the ignition switch (C0099 on Td6 vehicles, C0028 on V8 vehicles) on an R wire. When the ignition switch is turned to the 'auxiliary' position, current flows across the switch (C0099 on Td6 vehicles, C0028 on V8 vehicles) to fuse 9 of the passenger compartment fuse box (C0585) on a PB wire. Fuse 9 (C0587) provides an auxiliary ignition feed to the Light Check Module (LCM) (C2040) on a PY wire.

When the ignition switch is turned to the 'ignition' position, current flows across the switch (C0099 on Td6 vehicles, C0028 on V8 vehicles) to fuse 4 of the passenger compartment fuse box (C0585) on a G wire. Fuse 4 (C0587) provides an ignition feed to the LCM (C2040) on a GS wire.

The LCM (C2039) is earthed on an N wire.

RH Turn

The LCM (C2040) monitors the condition of the column mounted direction indicator switch (C1832) by providing a feed on an NB wire. If a RH turn is selected, the LCM provides the following outputs:

- From the LCM (C0937) to the RH front direction indicator lamp (C0002) on a UN wire.
- From the LCM (C2039) to the RH rear direction indicator lamp (C0125) on a UN wire.
- From the LCM (C0937) to the RH rear side repeater lamp (C0012) on a UY wire.

All are earthed on N wires.

LH Turn

The LCM (C2040) monitors the condition of the column mounted direction indicator switch (C1832) by providing a feed on an NB wire. If a LH turn is selected, the LCM provides the following outputs:

- From the LCM (C2039) to the LH front direction indicator lamp (C0001) on a UG wire.
- From the LCM (C0937) to the LH rear direction indicator lamp (C0121) on a UG wire.
- From the LCM (C2039) to the LH rear side repeater lamp (C0013) on a UY wire.

All are earthed on N wires.

Hazard Warning Lamps

If an impact severe enough to trigger the airbags is detected, the SRS DCU sends a K bus message to the instrument pack requesting the hazard warning lamps be initiated. This is relayed to the LCM (C2040) via the I bus on a WSY wire.

DESCRIPTION AND OPERATION

INTERIOR LAMPS

DESCRIPTION

General

Operation of the interior lamps is controlled by the Body Control Unit (BCU) which is located beneath the front passenger seat.

The interior lamps have two modes of operation; automatic or manual. In the automatic mode the interior lamp functionality is controlled by the BCU on receipt of various input signals. In manual mode, the lamps can be switched on and off using the non-latching switch adjacent to the front interior lamp, or can be disabled completely using the same switch.

For more information on interior lamp functionality, refer to the **Lighting** section of the System Description and Operation Workshop manual.

OPERATION

Power Distribution

Feed from the positive battery terminal (C0192) is supplied to fuse 17, fuse 27 and fuse 53 of the passenger compartment fuse box (C0632) on an R wire. Fuse 17 is connected to the door lamp module, which is also located in the passenger compartment fuse box.

Fuse 27 (C0582) provides a constant battery feed to the Body Control Unit (BCU) (C0662) on an RP wire.

Fuse 53 (C0583) provides a constant battery feed to the ignition switch (C0099 on Td6 vehicles, C0028 on V8 vehicles) on an R wire. When the ignition switch is turned to the 'auxiliary' position, current flows across the switch (C0099 on Td6 vehicles, C0028 on V8 vehicles) to fuse 42 of the passenger compartment fuse box (C0585) on a PB wire. Fuse 42 (C0586) provides an auxiliary ignition feed to the RH (C0736) and LH (C0737) vanity mirrors on a pair of PS wires.

When the ignition switch is turned to the 'ignition' position, current flows across the switch (C0099 on Td6 vehicles, C0028 on V8 vehicles) to fuse 4 of the passenger compartment fuse box (C0585) on a G wire. Fuse 4 provides an ignition feed to the door lamp module, which is also located in the passenger compartment fuse box.

Body Control Unit (BCU)

The BCU (C0662) monitors the condition of all four doors and provides feeds to the following lamps via the passenger compartment fuse box on RU wires if any are opened:

- The RH front footwell lamp (C0076)
- The LH front footwell lamp (C0077)
- The RH front sill lamp (C1794)
- The LH front sill lamp (C1795)
- The LH rear puddle lamp (C2212)
- The RH front puddle lamp (C2211)
- The RH rear puddle lamp (C2212)
- The LH front puddle lamp (C2210)
- The front interior lamp (C0355)
- The rear interior lamp (C0357).

All are earthed on N wires.

NOTE: The LH rear and RH rear puddle lamps have the same connector number as they utilise the same harness.

Approach Lamps

When the BCU receives a valid unlocking signal from the remote handset, it will illuminate the approach lamps via the door lamp module. The door lamp module (C0587) is located in the passenger compartment fuse box and provides a feed to the LH (C2291) and RH (C2291) approach lamps on a pair of RG then K wires. Both lamps are earthed on Y then N wires.

NOTE: The LH and RH approach lamps have the same connector number as they utilise the same harness.

Luggage Compartment Lamps

The BCU (C0662) provides a feed to the LH (C0120) and RH (C0119) upper tail door lamps, and the luggage compartment lamp (C2047) on RY wires. The earth path for the lamps is controlled by the tail door tail door motor (C0383).

Map Reading Lamps

The front and rear interior lamps both contain 2 map reading lamps. The BCU (C0662) provides a feed to the front (C0355) and rear (C0357) map reading lamps on a pair of RY wires. When any of the map reading lamp switches are pressed, the switch contacts close allowing current to flow to earth on an N wire to illuminate the lamp.

DESCRIPTION AND OPERATION

Glove Box Lamp

The BCU (C0662) monitors the condition of the glove box switch (C0227) by providing a feed on a RY wire. When the glove box is opened, the switch contacts close creating a path to earth on an N wire.

Automatic Mode

When the interior lamps are in automatic mode and any of the doors are opened, the BCU (C0662) provides a feed to all the interior lamps listed in the **Body Control Unit (BCU)** section previously. Current flows across the lamps to earth on N wires. When all the doors are closed, the BCU withdraws the feed to the interior lamps.

Manual Mode

When the switch located on the front interior lamp is pressed to enter the manual 'continuously on' mode, current flows across the front interior lamp to the BCU (C0660) on a WN wire. Sensing this, the BCU illuminates all the interior lamps listed in the **Body Control Unit (BCU)** section irrespective of door status.

INTERIOR ILLUMINATION

DESCRIPTION

General

Operation of the interior illumination LED's and lamps is controlled by the Light Check Module (LCM). The LCM is located at the base of the RH 'A' post, and powers the LED's and lamps when the ignition switch is in either the auxiliary or ignition position, and the lighting switch is in either the side or headlamp position.

OPERATION

Power Distribution

Feed from the positive battery terminal (C0192) is supplied to fusible link 3, fusible link 4, and fuse 53 of the passenger compartment fuse box (C0632) on an R wire. Fusible link 3 (C0589) and fusible link 4 (C0590) provide constant battery feeds to the LCM on R wires.

Fuse (C0583) provides a constant battery feed to the ignition switch (C0099 on Td6 vehicles, C0028 on V8 vehicles) on an R wire. When the ignition switch is turned to the 'auxiliary' position, current flows across the switch (C0099 on Td6 vehicles, C0028 on V8 vehicles) to fuse 9 of the passenger compartment fuse box (C0585) on a PB wire. Fuse 9 (C0587) provides an auxiliary ignition feed to the LCM (C2040) on a PY wire.

When the ignition switch is turned to the 'ignition' position, current flows across the switch (C0099 on Td6 vehicles, C0028 on V8 vehicles) to fuse 4 of the passenger compartment fuse box (C0585) on a G wire. Fuse 4 (C0587) provides an ignition feed to the LCM (C2040) on a GS wire.

Lighting Switch

The LCM (C2040) monitors the condition of the fascia mounted rotary lighting switch (C0041) by providing a feed on an NB wire. When the lighting switch is turned to the side lamp position, it returns a feed to the LCM (C2040) on a Y wire. When the lighting switch is turned to the headlamp position, it returns a feed to the LCM (C2040) on a B wire.

DESCRIPTION AND OPERATION

Light Check Module (LCM)

When the LCM (C2039) senses that the ignition switch is in either the auxiliary or ignition position, and the lighting switch is in either the side or headlamp position, it provides a feed to the following lamps on SR wires:

- RH inner face level air vent illumination (C1295)
- RH outer face level air vent illumination (C1200)
- LH inner face level air vent illumination (C1294)
- LH outer face level air vent illumination (C1199)
- Clock illumination (C0232)
- Rear heater illumination (C0846)
- Sunroof switch illumination (C0363)
- Automatic Temperature Control (ATC) control panel (C1629)
- Emergency switch illumination (C2082)
- Instrument pack illumination (C0230)
- Hazard warning switch illumination (C0096)
- Centre console switch pack illumination (C0700)
- Radio remote display illumination (C0241)
- Multi Function Display (MFD) illumination (C0816)
- Radio/cassette player illumination (C0098)
- Rear radio illumination (C0818)
- LH rear window switch illumination (C0732)
- RH rear window switch illumination (C0732)

NOTE: The LH and RH rear window switches have the same connector number as they utilise the same harness.

- Air suspension ride height switch illumination (C2186)
- Drivers door module illumination (C2058)
- Passenger door module illumination (C2057)
- Front cigar lighter (C0074)
- Rear cigar lighter (C1596)
- Ashtray illumination (C2322)
- RH seat heat switch (C1401)
- LH seat heat switch (C1403)
- Automatic transmission selector indicator illumination (C0245)
- Telephone eject box illumination (C1252).

All the above are earthed on N wires. The LCM also provides a feed to the following LED's on SR wires:

- Front interior lamp LED's (C0355)
- Rear interior lamp LED (C0357)
- RH rear door handle LED (C2335)
- LH rear door handle LED (C2335)

NOTE: The LH and RH rear door handle LED's have the same connector number as they utilise the same harness.

All the above are earthed on N wires.

Drivers Door Module

When the drivers door module (C2058) receives an illumination feed from the LCM, it illuminates the following LED's by providing a feed on SR then SU wires:

- Drivers door interior handle LED
- Door pocket front LED
- Door pocket rear LED.

Passenger Door Module

When the passenger door module (C2057) receives an illumination feed from the LCM, it illuminates the following LED's by providing a feed on SR then SU wires:

- Passenger door interior handle LED
- Door pocket front LED
- Door pocket rear LED.

DESCRIPTION AND OPERATION

INSTRUMENTS

DESCRIPTION

General

The instrument pack is a totally electronic device which receives analogue or digital signals via hardwired or bus systems for instrumentation operation. The instrument pack has two main functions:

- To provide the driver information on vehicle status
- To process and relay digital signals to and from other system controlling ECU's.

The signals are processed by two microprocessors which transpose the data into analogue gauge indications or warning lamp illumination. For more details on instrument pack operation, refer to the ***Instruments*** section of the System Description and Operation Workshop Manual.

OPERATION

Power Distribution

Feed from the positive battery terminal (C0192) is supplied to fuse 27, fuse 46, and fuse 53 of the passenger compartment fuse box (C0632) on an R wire. Fuse 27 (C0582) provides a constant battery feed to the Body Control Unit (BCU) (C0662) on an RP wire. Fuse 46 (C0586) provides two constant battery feeds to the instrument pack (C0230 & C0233) on a pair of RY wires.

Fuse 53 (C0583) provides a constant battery feed to the ignition switch (C0099 on Td6 vehicles, C0028 on V8 vehicles) on an R wire. When the ignition switch is turned to the 'auxiliary' position, current flows across the switch (C0099 on Td6 vehicles, C0028 on V8 vehicles) to fuse 45 of the passenger compartment fuse box (C0585) on a PB wire. Fuse 45 (C0586) provides an auxiliary ignition feed to the instrument pack (C0233) on a PG wire.

When the ignition switch is turned to the 'ignition' position, current flows across the switch (C0099 on Td6 vehicles, C0028 on V8 vehicles) to fuse 1 of the passenger compartment fuse box (C0585) on a G wire. Fuse 1 (C0587) provides two ignition feeds to the instrument pack (C0230 & C0233) on a pair of GU wires.

The instrument pack (C0230 & C0233) is earthed on NB wires.

Analogue Instruments

Speedometer

The ABS ECU (C0506) provides the instrument pack (C0230) a pulsed signal on an SB wire. The instrument pack calculates the vehicle speed from this signal and broadcasts it to other systems via the CAN, I, and K buses.

Tachometer

The instrument pack (C0234) receives an engine speed signal from the Engine Control Module (ECM) via the CAN bus on YN (low) and YB (high) wires.

Fuel Level Gauge

The instrument pack (C0234) provides a feed to the LH fuel tank level sensor (C0114) and the RH fuel tank level sensor (C0114) on BRW and BRY wires respectively. Each level sensor is a float operated potentiometer. By measuring the current returned on an NBW (LH) and an NBY (RH) wire, the instrument pack can determine how much fuel is in the tank.

Engine Coolant Temperature (ECT) Gauge

The instrument pack (C0234) provides a feed to the ECT sensor (C0169) on an NP wire. The ECT sensor is a Negative Temperature Coefficient (NTC) sensor. As ECT rises, the resistance of the sensor falls. By measuring the signal returned on an NY wire, the instrument pack can determine the ECT.

Warning Lamps

For details on warning lamp operation, refer to the ***Instruments*** section of the Service Description and Operation Workshop manual.

DESCRIPTION AND OPERATION

HORNS

DESCRIPTION

General

Two horns are located behind the RH side of the front bumper. Operation of the horns is controlled by the two steering wheel mounted switches when the ignition switch is in either the 'auxiliary' or 'ignition' position.

OPERATION

Power Distribution

Feed from the positive battery terminal (C0192) is supplied to fuse 10 and fuse 53 of the passenger compartment fuse box (C0632) on an R wire. Fuse 10 is connected to the switch contacts of the horn relay, which is also located in the passenger compartment fuse box.

Fuse 53 (C0583) is connected to the ignition switch (C0099 on Td6 vehicles, C0028 on V8 vehicles) by an R wire. When the ignition switch is turned to the 'auxiliary' position, current flows across the switch (C0099 on Td6 vehicles, C0028 on V8 vehicles) to the horn relay coil (C0585) on a PB wire.

Horn Relay

The earth path for the horn relay coil (C0587) is controlled by the steering wheel modules (C2285) via the rotary coupler (C0082) on an NR wire. When either of the horn switches are pressed, an earth path is created via the rotary coupler (C0082) on an NB wire. This energises the horn relay (C0585) allowing fuse 10 of the passenger compartment fuse box to supply a battery feed to the LH (C0003) and RH (C0004) horns on a pair of PS wires. Both horns are earthed on N wires.

CLOCK

DESCRIPTION

General

The analogue clock is mounted on the passenger side of the centre console, and is illuminated when the fascia mounted rotary lighting switch is turned to either the side or headlamp position.

OPERATION

Power Distribution

Feed from the positive battery terminal (C0192) is supplied to fuse 13 of the passenger compartment fuse box (C0632) on an R wire. Fuse 13 (C0586) provides a constant battery feed to the clock (C0232) on an RG wire. The clock (C0232) is earthed on an NB wire.

Illumination

When the Light Check Module (LCM) (C2039) senses that the ignition switch is in either the auxiliary or ignition position, and the lighting switch is in either the side or headlamp position, it provides a feed to the lamp contained within the clock assembly (C0232) on an SR wire. The lamp is earthed on an NB wire.

DESCRIPTION AND OPERATION

CIGAR LIGHTERS

DESCRIPTION

General

Two cigar lighters are fitted to Range Rover. The front cigar lighter is located in the front of the centre console for use by the driver and front passenger. The rear cigar lighter is located in the rear of the centre console for use by the rear seat passengers.

When the cigar lighter element is pushed into the cigar lighter, power is automatically switched through its locking clips to the heater coil. As current passes through the heater coil, the element will heat up to the point where the locking clips expand and release the cigar lighter element.

CAUTION: The cigar lighter should NOT be used for accessory power or damage may result.

OPERATION

Power Distribution

Feed from the positive battery terminal (C0192) is supplied to fusible link 1 of the passenger compartment fuse box (C0632) on an R wire. Fusible link 1 (C0588) is connected to fuse 1 of the rear fuse box (C2024) on an R wire.

Front Cigar Lighter

Fuse 1 of the rear fuse box (C2020) provides a constant battery feed to the front cigar lighter (C0089) on an RBY wire. When the cigar lighter element is pushed into the cigar lighter, an earth path is created (C0086) on an N wire. When the element reaches the correct temperature and is ejected, the circuit is broken.

Rear Cigar Lighter

Fuse 1 of the rear fuse box (C2020) provides a constant battery feed to the rear cigar lighter (C1594) on an RG wire. When the cigar lighter element is pushed into the cigar lighter, an earth path is created (C1595) on an N wire. When the element reaches the correct temperature and is ejected, the circuit is broken.

ACCESSORY SOCKETS

DESCRIPTION

General

Two accessory sockets are fitted to Range Rover. The front accessory socket is located in the storage compartment at the rear of the centre console. The rear accessory socket is located on the RH side of the luggage compartment, behind a protective cover.

Both accessory sockets provide battery voltage to any approved Land Rover accessory.

CAUTION: The cigar lighter should NOT be used for accessory power or damage may result.

OPERATION

Power Distribution

Feed from the positive battery terminal (C0192) is supplied to fusible link 1 (C0632) of the passenger compartment fuse box on an R wire. Fusible link 1 (C0588) is connected to fuse 1 and fuse 7 of the rear fuse box (C2024) by an R wire.

Front Accessory Socket

Fuse 1 of the rear fuse box (C2020) provides a constant battery feed to the front accessory socket (C0350) on an RG wire. The front accessory socket (C0942) is earthed on an N wire.

Rear Accessory Socket

Fuse 7 of the rear fuse box (C2020) provides a constant battery feed to the rear accessory socket (C1632) on an RB wire. The rear accessory socket (C1632) is earthed on an N wire.

DESCRIPTION AND OPERATION

TRAILER SOCKET

DESCRIPTION

General

The trailer socket is mounted at the rear of the vehicle, and receives inputs from the trailer ECU. The trailer ECU is mounted behind the rear fuse box, on the RH side of the luggage compartment. The trailer ECU receives inputs from the Light Check Module (LCM), which is located at the base of the RH 'A' post.

For more information on the LCM, refer to the **Lighting** section of the System Description and Operation Workshop Manual.

OPERATION

Power Distribution

Feed from the positive battery terminal (C0192) is supplied to fusible link 5 and fuse 53 of the passenger compartment fuse box (C0632) on an R wire. Fusible link 5 (C0588) is connected to fuse 4, fuse 6, and fuse 17 of the rear fuse box (C2024) by an R wire. Fuse 4 and fuse 6 (C2020) supply constant battery feeds to the trailer socket (C0499) on RY and RU wires respectively. Fuse 17 (C2022) provides a constant battery feed to the trailer ECU (C0380) on an RW wire.

Fuse 53 of the passenger compartment fuse box (C0583) provides a constant battery feed to the ignition switch (C0099 on Td6 vehicles, C0028 on V8 vehicles) on an R wire. When the ignition switch is turned to the 'auxiliary' position, current flows across the switch (C0099 on Td6 vehicles, C0028 on V8 vehicles) to fuse 2 of the passenger compartment fuse box (C0585) on a G wire. Fuse 2 (C0587) provides an auxiliary ignition feed to the trailer socket (C0499) via the rear fuse box (C2022) on a GY wire.

Light Check Module (LCM)

The LCM provides signal inputs to the trailer ECU as follows:

Rear Fog Lamp

The rear fog lamp function of the trailer ECU is controlled via a bi-directional data line between the LCM (C2040) and the trailer ECU (C0380) on a UNY wire. When the trailer ECU receives a rear fog lamp signal, it provides a feed to the trailer socket (C0499) on a YR wire.

Reverse Lamp

The reverse lamp function of the trailer ECU is controlled via a bi-directional data line between the LCM (C2040) and the trailer ECU (C0380) on a UNY wire. When the trailer ECU receives a reverse lamp signal, it provides a feed to the trailer socket (C0499) on a YU wire.

RH Tail Lamp

When the LCM (C0937) detects that side or headlamps have been selected, it provides a feed to the trailer ECU (C0380) on an SP wire. The trailer ECU (C0380) will now provide a feed to the trailer socket (C0499) on an SR wire.

LH Tail Lamp

When the LCM (C2040) detects that side or headlamps have been selected, it provides a feed to the trailer ECU (C0380) on an SW wire. The trailer ECU (C0380) will now provide a feed to the trailer socket (C0499) on an SB wire.

RH Direction Indicator Lamp

When the LCM (C2039) detects that a right turn has been selected, it provides a feed to the trailer ECU (C0380) on a UN wire. The trailer ECU (C0380) will now provide a feed to the trailer socket (C0499) on a UY wire.

LH Direction Indicator Lamp

When the LCM (C0937) detects that a left turn has been selected, it provides a feed to the trailer ECU (C0380) on a UG wire. The trailer ECU (C0380) will now provide a feed to the trailer socket (C0499) on a UR wire.

Brake Lamps

When the LCM (C0937) detects that the brake pedal has been pressed, it provides a feed to the trailer ECU (C0380) on a BU wire. The trailer ECU (C0380) will now provide a feed to the trailer socket (C0499) on a BW wire.

DESCRIPTION AND OPERATION

AUDIO SYSTEM – LOW LINE

DESCRIPTION

General

For a detailed description of the audio systems fitted to New Range Rover, refer to the ***Entertainment and Information Systems*** section of the System Description and Operation Workshop Manual.

OPERATION

General

For a detailed description of audio system operation, refer to the ***Entertainment and Information Systems*** section of the System Description and Operation Workshop Manual.

AUDIO SYSTEM – MID-LINE

DESCRIPTION

General

For a detailed description of the audio systems fitted to New Range Rover, refer to the ***Entertainment and Information Systems*** section of the System Description and Operation Workshop Manual.

OPERATION

General

For a detailed description of audio system operation, refer to the ***Entertainment and Information Systems*** section of the System Description and Operation Workshop Manual.

DESCRIPTION AND OPERATION

AUDIO SYSTEM – HIGH LINE

DESCRIPTION

General

For a detailed description of the audio systems fitted to New Range Rover, refer to the ***Entertainment and Information Systems*** section of the System Description and Operation Workshop Manual.

OPERATION

General

For a detailed description of audio system operation, refer to the ***Entertainment and Information Systems*** section of the System Description and Operation Workshop Manual.

SATELLITE NAVIGATION SYSTEM

DESCRIPTION

General

For a detailed description of the satellite navigation system fitted to New Range Rover, refer to the ***Entertainment and Information Systems*** section of the System Description and Operation Workshop Manual.

OPERATION

General

For a detailed description of satellite navigation operation, refer to the ***Entertainment and Information Systems*** section of the System Description and Operation Workshop Manual.

DESCRIPTION AND OPERATION

SATELLITE NAVIGATION SYSTEM – NAS

DESCRIPTION

General

For a detailed description of the satellite navigation systems fitted to New Range Rover, refer to the ***Entertainment and Information Systems*** section of the System Description and Operation Workshop Manual.

OPERATION

General

For a detailed description of satellite navigation system operation, refer to the ***Entertainment and Information Systems*** section of the System Description and Operation Workshop Manual.

TELEPHONE

DESCRIPTION

General

For a detailed description of the telephone systems fitted to New Range Rover, refer to the ***Entertainment and Information Systems*** section of the System Description and Operation Workshop Manual.

OPERATION

General

For a detailed description of telephone system operation, refer to the ***Entertainment and Information Systems*** section of the System Description and Operation Workshop Manual.

DESCRIPTION AND OPERATION

TELEPHONE – HANDS FREE

DESCRIPTION

General

For a detailed description of the telephone systems fitted to New Range Rover, refer to the ***Entertainment and Information Systems*** section of the System Description and Operation Workshop Manual.

OPERATION

General

For a detailed description of telephone system operation, refer to the ***Entertainment and Information Systems*** section of the System Description and Operation Workshop Manual.

TELEPHONE – NAS

DESCRIPTION

General

For a detailed description of the telephone systems fitted to New Range Rover, refer to the ***Entertainment and Information Systems*** section of the System Description and Operation Workshop Manual.

OPERATION

General

For a detailed description of telephone system operation, refer to the ***Entertainment and Information Systems*** section of the System Description and Operation Workshop Manual.

DESCRIPTION AND OPERATION

FUEL PUMP

DESCRIPTION

Td6

The fuel system on Td6 vehicles features three fuel pumps. A primary fuel pump is mounted in the plastic fuel tank. This pump supplies fuel to the secondary pump mounted externally to the tank. The secondary pump supplies fuel to the high pressure Fuel Injection Pump (FIP) mounted on the engine. For more information on the Td6 fuel system, refer to the ***Fuel Delivery – Td6*** section of the System Description and Operation Workshop manual.

V8

The fuel pump fitted on V8 vehicles is mounted in the plastic fuel tank, and supplies fuel at a constant 3.5 bar pressure to the fuel rail. The fuel rail distributes fuel evenly to each of the eight injectors. For more information on the V8 fuel system, refer to the ***Fuel Delivery – V8*** section of the System Description and Operation Workshop manual.

OPERATION

Td6

Power Distribution

Feed from the positive battery terminal (C0192) is supplied to fusible link 5 of the passenger compartment fuse box (C0632) on an R wire. A constant battery feed is also supplied to the 100A fuse located within the fuse holder (C1875) on an R wire. The 100A fuse (C1878) provides a constant battery feed to the Engine Control Module (ECM) relay (C1895) on an R wire.

Fusible link 5 of the passenger compartment fuse box (C0588) is connected to fuse 15 of the rear passenger compartment fuse box (C2024) by an R wire. Fuse 15 provides a constant battery feed to the fuel pump relay, which is also located in the rear fuse box.

ECM Relay

The 100A fuse located in the fuse holder (C1878) provides a constant battery feed to the ECM relay coil (C1895) on an R wire. The earth path for the relay coil (C1895) is controlled by the ECM (C0603) on an N wire. The energised ECM relay (C1895) provides a feed to fuse 51 of the passenger compartment fuse box (C0584) on an RW wire. Fuse 51 (C0585) supplies a feed to the fuel pump relay coil (C2022) on an RW wire.

Fuel Pump Relay

The fuel pump relay coil (C2022) receives a feed from fuse 51 of the passenger compartment fuse box (C0585) on an RW wire. The earth path for the relay coil (C2022) is controlled by the ECM (C0331) on a BP wire. The energised fuel pump relay provides a battery feed from fuse 15 of the rear fuse box to the primary (C0114) and secondary (C0205) fuel pumps on a pair of WU wires. Both pumps are earthed on N wires.

V8

Power Distribution

Feed from the positive battery terminal (C0192) is supplied to fusible link 2 and fusible link 5 of the passenger compartment fuse box (C0632) on an R wire. Fusible link 2 (C0591) provides a constant battery feed to the Engine Control Module (ECM) relay (C1895) on an R wire.

Fusible link 5 of the passenger compartment fuse box (C0588) is connected to fuse 15 of the rear passenger compartment fuse box (C2024) by an R wire. Fuse 15 provides a constant battery feed to the fuel pump relay, which is also located in the rear fuse box.

ECM Relay

Fusible link 2 of the passenger compartment fuse box (C0591) provides a constant battery feed to the ECM relay coil (C1895) on an R wire. The earth path for the relay coil (C1895) is controlled by the ECM (C0604) on an N wire. The energised ECM relay (C1895) provides a feed to fuse 51 of the passenger compartment fuse box (C0584) on an RW wire. Fuse 51 (C0585) supplies a feed to the fuel pump relay coil (C2022) on an RW wire.

Fuel Pump Relay

The fuel pump relay coil (C2022) receives a feed from fuse 51 of the passenger compartment fuse box (C0585) on an RW wire. The earth path for the relay coil (C2022) is controlled by the ECM (C0331) on a BP wire. The energised fuel pump relay provides a battery feed from fuse 15 of the rear fuse box to the fuel pump (C0114) on a WU wire. The fuel pump is earthed on an N wire.

DESCRIPTION AND OPERATION

ROTARY COUPLER

DESCRIPTION

General

The rotary coupler is a rotating link harness, acting as a bridge between the electrical circuits contained within the steering wheel and the steering column. It relays signals for the following systems:

- Horns
- Audio system
- Telephone
- Cruise Control
- Heated steering wheel
- Driver airbag.

WARNING: Before carrying out any work on the rotary coupler, refer to the warning information contained within the Service Procedures Workshop Manual.

OPERATION

Horns

For detailed information on horn operation, refer to the ***Horns*** section of this manual.

 **HORNS.**

Audio System

For detailed information on audio system operation, refer to the ***Entertainment and Information Systems*** section of the System Description and Operation Workshop manual.

Telephone

For detailed information on telephone operation, refer to the ***Entertainment and Information Systems*** section of the System Description and Operation Workshop manual.

Cruise Control

For detailed information on cruise control operation, refer to the ***Cruise Control*** section of this manual.

 **CRUISE CONTROL.**

Heated Steering Wheel

For detailed information on heated steering wheel operation, refer to the ***Steering Column*** section of this manual.

 **STEERING COLUMN.**

Driver Airbag

For detailed information on driver airbag operation, refer to the ***Supplementary Restraint System (SRS)*** section of this manual.

 **SUPPLEMENTARY RESTRAINT SYSTEM (SRS).**

DESCRIPTION AND OPERATION

PARK DISTANCE CONTROL (PDC)

DESCRIPTION

General

Park Distance Control (PDC) provides an audible warning to the driver when any obstacles are in the path of the vehicle during forward and reverse parking manoeuvres. The system consists of four ultrasonic sensors in each bumper, an ECU, a sounder and a parking switch.

For detailed information on PDC, refer to the ***Driving Aids*** section of the System Description and Operation Workshop Manual.

OPERATION

Power Distribution

Feed from the positive battery terminal (C0192) is supplied to fuse 27 and fuse 53 of the passenger compartment fuse box (C0632) on an R wire. Fuse 27 (C0582) provides a constant battery feed to the Body Control Unit (BCU) (C0662) on an RP wire.

Fuse 53 (C0583) provides a constant battery feed to the ignition switch (C0099 on Td6 vehicles, C0028 on V8 vehicles) on an R wire. When the ignition switch is turned to the 'ignition' position, current flows across the switch (C0099 on Td6 vehicles, C0028 on V8 vehicles) to fuse 6 of the passenger compartment fuse box (C0585) on a G wire. Fuse 6 (C0587) provides an ignition feed to the PDC ECU (C0957) on a GN wire. The PDC ECU (C0957) is earthed on an NB wire.

PDC Switch

The PDC ECU (C0957) monitors the condition of the PDC switch (C0700) by providing a feed on an NUY wire. When the switch is pressed, an earth path is created on an N wire. Sensing this, the PDC initiates the PDC system, and provides a feed to the switch tell-tale LED (C0700) on an NXY wire.

Rear PDC

RH Outer Sensor

The PDC ECU (C0958) provides a feed to the RH outer PDC sensor (C0966) on a GP wire. An earth path is provided for the sensor by the PDC ECU on an NY wire. The PDC sensor outputs a pulsed signal to the PDC ECU on a YN wire, which the PDC ECU translates into a distance reading.

RH Inner Sensor

The PDC ECU (C0958) provides a feed to the RH inner PDC sensor (C0965) on a GS wire. An earth path is provided for the sensor by the PDC ECU on an NU wire. The PDC sensor outputs a pulsed signal to the PDC ECU on a YB wire, which the PDC ECU translates into a distance reading.

LH Inner Sensor

The PDC ECU (C0958) provides a feed to the LH inner PDC sensor (C0964) on a GN wire. An earth path is provided for the sensor by the PDC ECU on an NB wire. The PDC sensor outputs a pulsed signal to the PDC ECU on a YG wire, which the PDC ECU translates into a distance reading.

LH Outer Sensor

The PDC ECU (C0958) provides a feed to the LH outer PDC sensor (C0963) on a GB wire. An earth path is provided for the sensor by the PDC ECU on an NW wire. The PDC sensor outputs a pulsed signal to the PDC ECU on a YS wire, which the PDC ECU translates into a distance reading.

PDC Sounder

The PDC ECU covers the signals received from the rear PDC sensors and outputs a pulsed signal to the PDC sounder. The PDC sounder (C0987) is located on the RH side of the luggage and is provided a positive signal on a UR wire, and a negative signal on a US wire.

Front PDC

RH Outer Sensor

The PDC ECU (C1457) provides a feed to the RH outer PDC sensor (C0403) on a GP wire. An earth path is provided for the sensor by the PDC ECU on an NY wire. The PDC sensor outputs a pulsed signal to the PDC ECU on a YN wire, which the PDC ECU translates into a distance reading.

RH Inner Sensor

The PDC ECU (C1457) provides a feed to the RH inner PDC sensor (C0401) on a GS wire. An earth path is provided for the sensor by the PDC ECU on an NU wire. The PDC sensor outputs a pulsed signal to the PDC ECU on a YB wire, which the PDC ECU translates into a distance reading.

LH Inner Sensor

The PDC ECU (C1457) provides a feed to the LH inner PDC sensor (C0400) on a GN wire. An earth path is provided for the sensor by the PDC ECU on an NB wire. The PDC sensor outputs a pulsed signal to the PDC ECU on a YG wire, which the PDC ECU translates into a distance reading.

DESCRIPTION AND OPERATION

LH Outer Sensor

The PDC ECU (C1457) provides a feed to the LH outer PDC sensor (C0402) on a GB wire. An earth path is provided for the sensor by the PDC ECU on an NW wire. The PDC sensor outputs a pulsed signal to the PDC ECU on a YS wire, which the PDC ECU translates into a distance reading.

PDC Sounder

The PDC ECU converts the signals received from the front PDC sensors a feed to the front sounder (C0405) on a US wire. The PDC sounder is located behind the lower edge of the fascia, above the drivers footwell and is earthed (C0369) on an NB wire.

I Bus

The PDC ECU (C0957) receives the following information on the I-bus via the instrument pack (C0233) on a WSY wire:

- Vehicle speed
- Reverse gear selected
- Trailer fitted.

TYRE PRESSURE MONITORING (TPM)

DESCRIPTION

General

The Tyre Pressure Monitoring (TPM) system continuously monitors tyre pressures so long as vehicle battery power is available. If a low tyre pressure is detected, the system alerts the driver via the message centre when the ignition is on. The system monitors the tyre pressure of each road wheel and the full size spare wheel.

NOTE: The tyre pressure of a space saver spare wheel is not monitored.

For a detailed description of the TPM system, refer to the **Driving Aids** section of the System Description and Operation Workshop Manual.

OPERATION

Power Distribution

Feed from the positive battery terminal (C0192) is supplied to fuse 16 and fuse 53 of the passenger compartment fuse box (C0632) on an R wire. Fuse 16 (C0586) provides a constant battery feed to the TPM ECU (C1537) on an RNY wire. The TPM ECU (C1537) is located under the front passenger seat and is earthed on an NB wire.

Fuse 53 (C0583) provides a constant battery feed to the ignition switch (C0099 on Td6 vehicles, C0028 on V8 vehicles) on an R wire. When the ignition switch is turned to the 'ignition' position, current flows across the switch (C0099 on Td6 vehicles, C0028 on V8 vehicles) to fuse 6 of the passenger compartment fuse box (C0585) on a G wire. Fuse 6 (C0587) provides an ignition feed to the TPM ECU (C1537) on a GN wire.

TPM Antennae

An air pressure and temperature sensor is fitted to the rim of each road wheel and the full size spare wheel. The sensors transmit radio signals to the relevant antenna at a frequency of 433 MHz. The TPM ECU (C1537) is connected to the antennae as follows:

- To the RH front TPM antenna (C2027) by a W and a U wire
- To the LH front TPM antenna (C2026) by a W and a G wire
- To the RH rear TPM antenna (C2029) by a W and a Y wire
- To the LH rear TPM antenna (C2028) by a W and an R wire.

TPM Reset Switch

The TPM ECU (C1537) provides a feed to the TPM reset switch (C0700) on a UR wire. When the switch is pressed, a feed is returned to the TPM ECU (C1537) on a UN wire. When the TPM registers that the reset switch has been pressed, it takes the current tyre pressure readings as the nominal pressures.

DESCRIPTION AND OPERATION

STEERING COLUMN

DESCRIPTION

General

The steering column fitted to New Range Rover features fully electrical adjustment for tilt and reach. On vehicles fitted with memory seats, the steering wheel position is incorporated into the memory of the seat ECU. On certain models, a heater is fitted around the rim of the steering wheel.

For a detailed description of the steering column, refer to the ***Steering*** section of the System Description and Operation Workshop Manual.

OPERATION

Non-Memory Steering Column

Power Distribution

Feed from the positive battery terminal (C0192) is supplied to fuse 23 of the passenger compartment fuse box (C0632) on an R wire. Fuse 23 (C0583) provides a constant battery feed to the steering column adjustment control unit (C1392) on an RN wire. The control unit (C1392) is earthed on an N wire.

Steering Column Switch

Movement of the steering column is controlled via the 4 way switch mounted on the LH side of the steering column. The control unit (C1392) is connected to the switch (C1393) as follows:

- If forward movement is selected, an earth path is created via the switch on an NU wire
- If backward movement is selected, an earth path is created via the switch on an NR wire
- If upwards movement is selected, an earth path is created via the switch on an NB wire
- If downwards movement is selected, an earth path is created via the switch on an NW wire.

The switch is earthed on an NB wire.

Tilt Movement

If tilt movement of the steering column is requested, the control unit (C1392) powers the height motor (C1397) via BU and UB wires.

Reach Movement

If reach movement of the steering column is requested, the control unit (C1392) powers the telescope motor (C1396) via B and U wires.

Memory Steering Column

Power Distribution

Feed from the positive battery terminal (C0192) is supplied to the seat relay and fuse 53 of the passenger compartment fuse box (C0632) on an R wire. Fuse 53 (C0583) provides a constant battery feed to the ignition switch (C0099 on Td6 vehicles, C0028 on V8 vehicles) on an R wire. When the ignition switch is turned to the 'ignition' position, current flows across the switch (C0099 on Td6 vehicles, C0028 on V8 vehicles) to the seat relay (C0585) on a G wire. The seat relay is located in the passenger compartment fuse box and is earthed (C0585) on an N wire.

Steering Column Switch

Movement of the steering column is controlled via the 4 way switch mounted on the LH side of the steering column. The seat memory ECU (C0773) is connected to the switch (C1393) as follows:

- If forward movement is selected, an earth path is created via the switch on an NU wire
- If backward movement is selected, an earth path is created via the switch on an NR wire
- If upwards movement is selected, an earth path is created via the switch on an NB wire
- If downwards movement is selected, an earth path is created via the switch on an NW wire.

The switch is earthed on an NB wire.

Seat Memory ECU

The seat memory ECU (C0773) interprets the signals received from the steering column switch (C0773) and adjusts the steering column as follows:

- If vertical adjustment is requested, the seat memory ECU provides a feed to the height motor (C1395) on a B wire
- If height adjustment is requested, the seat memory ECU provides a feed to the telescope motor (C1394) on a BU wire.

Both motors are earthed on N wires.

DESCRIPTION AND OPERATION

Steering Wheel Heater

Power Distribution

Feed from the positive battery terminal (C0192) is supplied to the steering wheel relay and fuse 53 of the passenger compartment fuse box (C0632) on an R wire. Fuse 53 (C0583) is connected to the ignition switch (C0099 on Td6 vehicles, C0028 on V8 vehicles) by an R wire. When the ignition switch is turned to the 'ignition' position, current flows across the switch (C0099 on Td6 vehicles, C0028 on V8 vehicles) to the steering wheel relay coil (C0585) on a G wire. The steering wheel relay coil (C0585) is earthed on an N wire.

Steering Wheel Heater

The energised steering wheel relay provides a feed to fuse 29. Fuse 29 (C0582) is connected to the rotary coupler (C0374) by a GB wire, allowing the rotary coupler to provide a feed to the heated steering wheel ECU (C1948) on an N wire. The steering wheel ECU is earthed via the rotary coupler on an R then N wire.

AIR SUSPENSION

DESCRIPTION

General

The main function of the four wheel air suspension system is to maintain the vehicle at the correct ride height, irrespective of load. Additionally, the system allows the driver to request ride height changes to improve off-road performance or ease of access or for loading. The system automatically adjusts the ride height to improve the vehicle handling and dynamics when speed increases or decreases.

The air suspension system fitted to Range Rover is controlled by an ECU located behind the passenger side of the fascia. The ECU monitors the height of each corner of the vehicle via four height sensors, which are mounted in-board of each road wheel. The ECU also performs an 'on-board diagnostic' function to perform 'health checks' on the system. If faults are detected, codes are stored in the ECU and can be retrieved using TestBook or T4.

For a detailed description of the air suspension system, refer to the ***Suspension*** section of the System Description and Operation Workshop Manual.

OPERATION

Power Distribution

Feed from the positive battery terminal (C0192) is supplied to fusible link 5 and fuse 57 of the passenger compartment fuse box (C0632) on an R wire. Fuse 57 (C0582) provides a constant battery feed to the air suspension ECU (C2030) on an RN wire. The air suspension ECU (C2030) is earthed on an N wire.

Fusible link 5 (C0588) is connected to fuse 18 of the rear fuse box (C2024) by an R wire. Fuse 18 provides a constant battery feed to the air suspension relay, which is also located in the rear fuse box.

DESCRIPTION AND OPERATION

Air Suspension ECU

The air suspension ECU (C0867) is located behind the LH side of the fascia, and is connected to the centre console rotary switch (C0700) as follows:

- If the rotary switch is turned to select a lower suspension setting, an earth path is created via the switch on a UP wire
- If the rotary switch is turned to select a higher suspension setting, an earth path is created via the switch on an SR wire
- If the 'Hold' switch has been selected, an earth path is created via the switch on a YW wire.

NOTE: The air suspension ECU will only allow the suspension settings to change if all the conditions described in the 'Suspension' section of the System Description and Operation Workshop manual have been met.

The air suspension ECU (C0867) also provides a feed to the LED's contained on the face of the centre console rotary switch (C0700) as follows:

- To the 'Motorway' LED on an SY wire
- To the 'Off Road' LED on an SG wire
- To the 'Access' LED on an SP wire
- To the 'Standard' LED on a WY wire
- To the 'Hold' LED on an SU wire.

Height Sensors

The Air Suspension ECU monitors the height of the vehicle via four height sensors. The air suspension ECU is connected to the height sensors as follows:

RH Front Height Sensor

The air suspension ECU (C0867) provides a feed to the RH front height sensor (C1697) on a BW wire. An earth path is provided for the sensor on a BN wire. By measuring the voltage returned on a BS wire, the air suspension ECU can determine the height of the RH front of the vehicle.

LH Front Height Sensor

The air suspension ECU (C0867) provides a feed to the LH front height sensor (C1696) on an SB wire. An earth path is provided for the sensor on an SN wire. By measuring the voltage returned on an SW wire, the air suspension ECU can determine the height of the LH front of the vehicle.

RH Rear Height Sensor

The air suspension ECU (C0867) provides a feed to the RH rear height sensor (C1698) on a YB wire. An earth path is provided for the sensor on a YN wire. By measuring the voltage returned on a YS wire, the air suspension ECU can determine the height of the RH rear of the vehicle.

LH Rear Height Sensor

The air suspension ECU (C0867) provides a feed to the LH rear height sensor (C1699) on a WB wire. An earth path is provided for the sensor on a WN wire. By measuring the voltage returned on a WS wire, the air suspension ECU can determine the height of the LH rear of the vehicle.

Cross Link Valves

The cross link valves connect the height sensors in pairs, front and rear. When air is required to flow between the two rear height sensors, the air suspension ECU (C2030) provides a feed to the rear cross link valve (C2033) on a UR wire. The air suspension ECU provides an earth path for the cross link valve on a UP wire.

When air is required to flow between the two front height sensors, the air suspension ECU (C2030) provides a feed to the front cross link valve (C2032) on a UN wire. The air suspension ECU provides an earth path for the cross link valve on a WU wire.

Air Supply Unit

The air supply unit is located in a sealed housing in the spare wheel well. Located within the unit is the compressor. To power the compressor, the air suspension ECU (C0867) provides a feed to the air suspension relay coil (C2022) on a B wire. The relay is located in the rear fuse box and is earthed (C2021) on an N wire. The energised relay (C2023) provides a battery feed from fuse 18 of the rear fuse box to the compressor (C0873) on an RY wire. The compressor (C0873) is earthed on an N wire.

The air suspension ECU (C0867) monitors the temperature within the air supply unit (C0873) by providing a feed to the temperature sensor on a BRY wire. The air suspension ECU determines the temperature within the air supply unit by measuring the voltage returned on an S wire.

DESCRIPTION AND OPERATION

Valve Block

The valve block contains five solenoid valves which control the air supply as follows:

RH Front

If air is required in the RH front air spring, the air suspension ECU (C0867) provides a feed to the valve block (C0770) on a UB wire. An earth path is provided by the ECU on a UY wire.

LH Front

If air is required in the LH front air spring, the air suspension ECU (C0867) provides a feed to the valve block (C0770) on a UB wire. An earth path is provided by the ECU on a US wire.

RH Rear

If air is required in the RH rear air spring, the air suspension ECU (C0867) provides a feed to the valve block (C0274) on a WP wire. An earth path is provided by the ECU on a WR wire.

LH Rear

If air is required in the LH rear air spring, the air suspension ECU (C0867) provides a feed to the valve block (C0274) on a WP wire. An earth path is provided by the ECU on a YP wire.

Reservoir Valve

The reservoir valve controls the air pressure supply from the reservoir to the air springs. The air suspension ECU (C0867) provides a feed to the valve block (C0771) on a UW wire, and an earth path on a UG wire.

Air Pressure Sensor

The air pressure sensor measures the pressure within the air reservoir. The air suspension ECU (C0867) provides a feed to the pressure sensor (C1611) on a Y wire. An earth path is provided for the sensor on a W wire. By measuring the voltage returned on a U wire, the air suspension ECU can determine the pressure within the air reservoir.

CIRCUIT REFERENCE NUMBERS**CONNECTOR APPLICABILITY****General**

The following table lists the circuit reference numbers against a description of the model or feature to which they apply.

This information should be used in conjunction with the connector pin-out tables on the following pages to determine the wire configuration of the vehicle being worked on.

| Cct | Model or Feature |
|------------|----------------------------------|
| 1 | Td6 |
| 2 | V8 |
| 3 | All |
| 4 | ATC |
| 5 | Comfort ATC |
| 6 | Park Distance Control |
| 7 | Cruise Control |
| 8 | Fuel Burning Heater |
| 9 | Heated Front Screen |
| 10 | Infra Red Remote Handset |
| 11 | RF Remote Handset |
| 12 | Low Line Interior Lamps |
| 13 | High Line Interior Lamps |
| 14 | Rain Sensor |
| 15 | Satellite Navigation |
| 16 | Seat Belt Warning |
| 17 | Electric Seats |
| 18 | Heated Front Seats |
| 19 | Heated Rear Seats |
| 20 | Rear Head Airbag |
| 21 | Headlamp Wash/Wipe |
| 22 | Xenon Lamps |
| 23 | Tyre Pressure Monitoring |
| 24 | Non-Memory Steering Column |
| 25 | Heated Steering Wheel |
| 26 | Electrochromic Rear View Mirrors |
| 27 | Low Line Audio System |
| 28 | High Line Audio System |
| 29 | Trailer Socket |

CONNECTOR

| | |
|----|---------------------------|
| 30 | Auxiliary Module (Europe) |
| 31 | Auxiliary Module (NAS) |

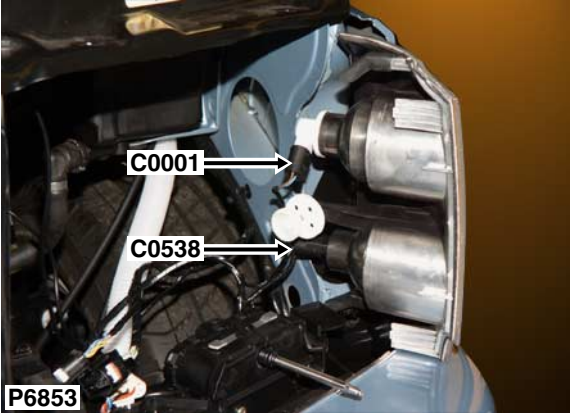

| Cav | Col | Cct |
|-----|-----|-----|
| 1 | UG | ALL |
| 2 | N | ALL |

Description: *Lamp-Direction indicator/hazard warning-Front-LH*
Location: *Front of vehicle - LH side*

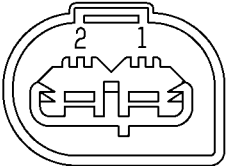

YPC115060

Colour: *BLACK*
Gender: *Female*

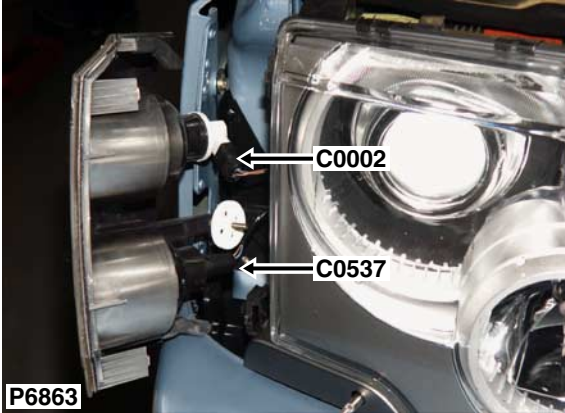

| Cav | Col | Cct |
|-----|-----|-----|
| 1 | UN | ALL |
| 2 | N | ALL |

Description: *Lamp-Direction indicator/hazard warning-Front-RH*
Location: *Front of vehicle - RH side*

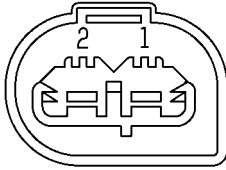

YPC115060

Colour: *BLACK*
Gender: *Female*

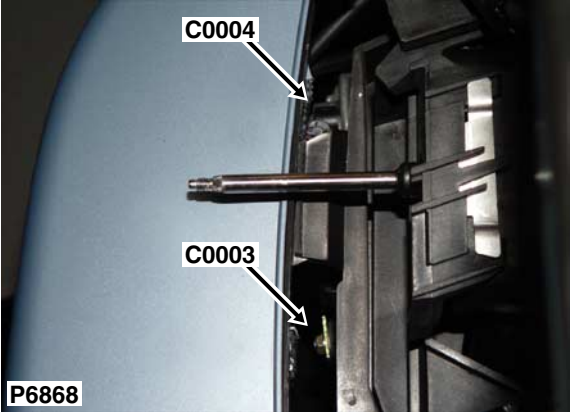

| Cav | Col | Cct |
|-----|-----|-----|
| 1 | N | ALL |
| 2 | PS | ALL |

Description: *Horn (s)*

Location: *Behind RH side of front bumper*

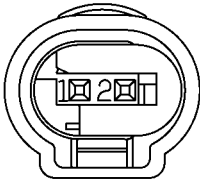

YPC116830

Colour: *GREY*
Gender: *Female*

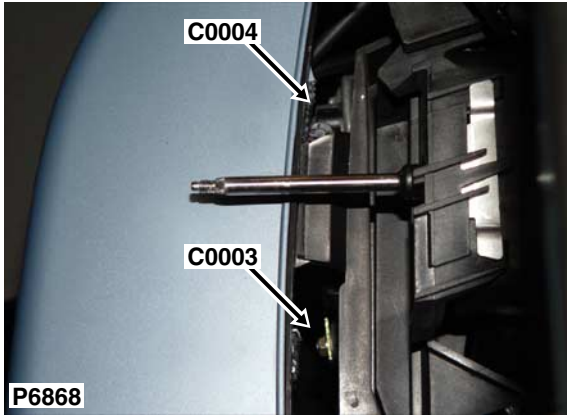

| Cav | Col | Cct |
|-----|-----|-----|
| 1 | N | ALL |
| 2 | PS | ALL |

Description: *Horn (s)*

Location: *Behind RH side of front bumper*

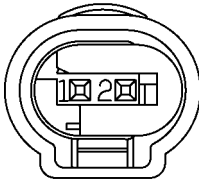

YPC116830

Colour: *GREY*
Gender: *Female*

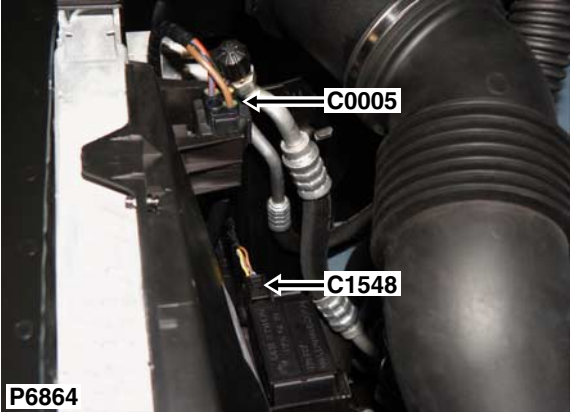

| Cav | Col | Cct |
|-----|-----|-----|
| 1 | N | ALL |
| 2 | BG | ALL |
| 4 | RU | ALL |

Description: *Cooling fan*
Location: *Front of engine compartment - centre*

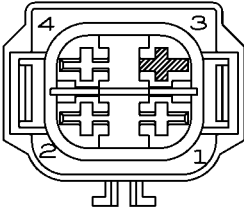

YPC116470

Colour: *BLACK*
Gender: *Female*

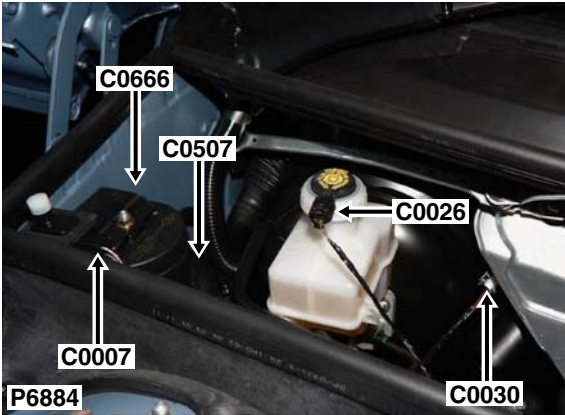

| Cav | Col | Cct |
|-----|-----|-----|
| 1 | N | ALL |
| 3 | PG | ALL |

Description: *Switch-Bonnet*

Location: *Rear RH side of engine compartment*

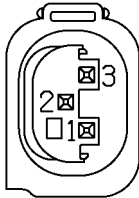

YPC116850

Colour: *BLACK*
 Gender: *Female*

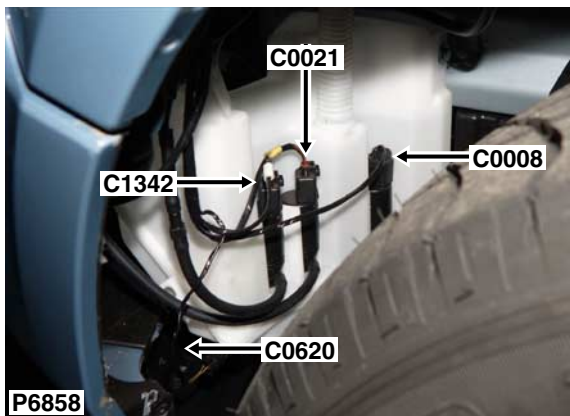

| Cav | Col | Cct |
|-----|-----|-----|
| 1 | B | ALL |
| 2 | N | ALL |

Description: *Pump-Washer-Windscreen*

Location: *Front LH side of engine compartment*

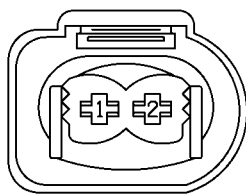

YPC116370

Colour: *BLACK*

Gender: *Female*

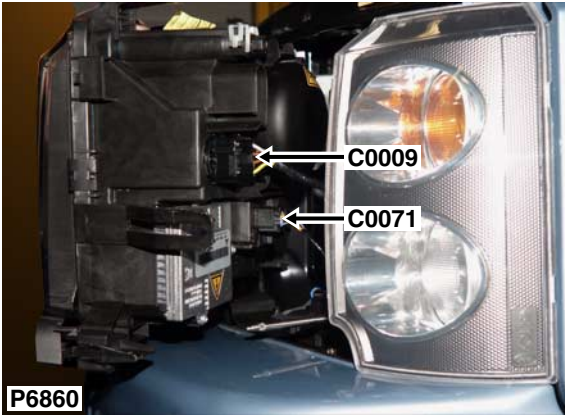

P6860

Description: *Headlamp-LH*

Location: *Front of vehicle - LH side*

| Cav | Col | Cct |
|-----|-----|-----|
| 3 | WP | 22 |
| 4 | GR | 22 |
| 5 | WB | 22 |
| 6 | YG | ALL |
| 7 | N | ALL |
| 8 | N | ALL |
| 9 | WG | ALL |

NO CONNECTOR FACE

Colour: *BLACK*

Gender: *Female*

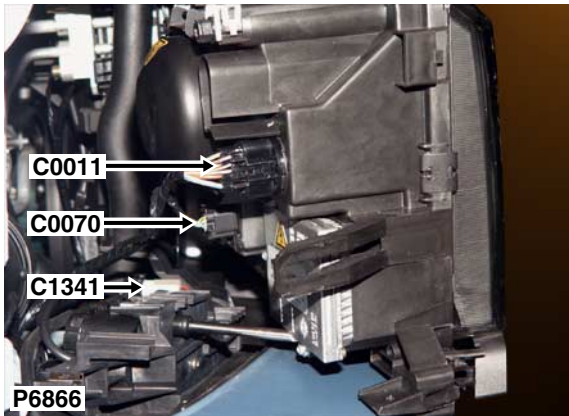

Description: *Headlamp-RH*

Location: *Front of vehicle - RH side*

| Cav | Col | Cct |
|-----|-----|-----|
| 3 | WP | 22 |
| 4 | GR | 22 |
| 5 | WB | 22 |
| 6 | WU | ALL |
| 7 | N | ALL |
| 8 | N | ALL |
| 9 | YU | ALL |

NO CONNECTOR FACE

Colour: *BLACK*

Gender: *Female*



| Cav | Col | Cct |
|-----|-----|-----|
| 1 | N | ALL |
| 2 | UY | ALL |

Description: *Lamp-Side repeater-Front-RH*
Location: *Front of vehicle - RH side*

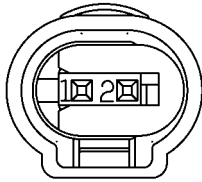

YPC116820

Colour: *BLACK*
Gender: *Female*



| Cav | Col | Cct |
|-----|-----|-----|
| 1 | N | ALL |
| 2 | UY | ALL |

P6873

Description: *Lamp-Side repeater-Front-LH*
Location: *Front of vehicle - LH side*

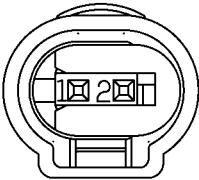

YPC116820

Colour: *BLACK*
Gender: *Female*

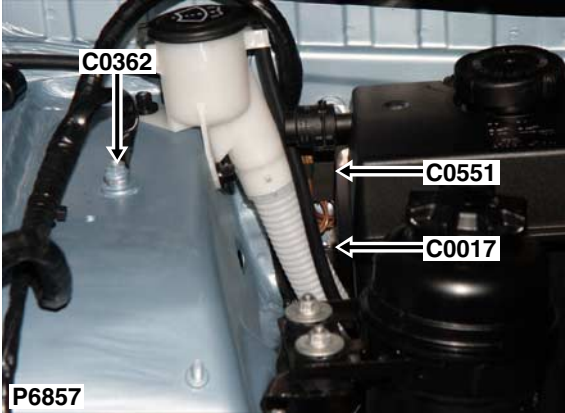

| Cav | Col | Cct |
|-----|-----|-----|
| 0 | N | ALL |

Description: *Header -Earth*

Location: *LH side of engine compartment*

NO CONNECTOR FACE

Colour: *TIN-PLATE*

Gender: *Male*



| Cav | Col | Cct |
|-----|-----|-----|
| 0 | N | ALL |

Description: *Header -Earth*
Location: *Front RH side of engine compartment*



Colour: *TIN-PLATE*
Gender: *Male*

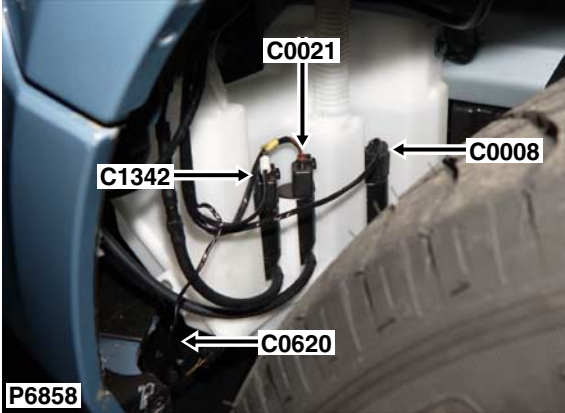

| Cav | Col | Cct |
|-----|-----|-----|
| 1 | BR | ALL |
| 2 | N | ALL |

Description: *Pump-Washer-Rear screen*
Location: *Front LH side of engine compartment*

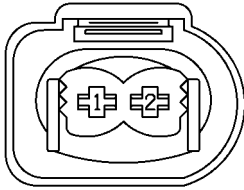

YPC116370

Colour: *BLACK*
Gender: *Female*

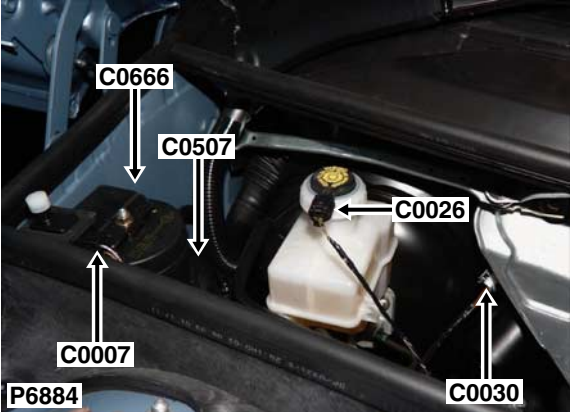

| Cav | Col | Cct |
|-----|-----|-----|
| 1 | NB | ALL |
| 2 | NGY | ALL |

Description: *Switch-Brake fluid level*
Location: *Rear of engine compartment*

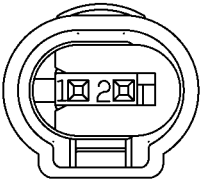

YPC116820

Colour: *BLACK*
Gender: *Female*

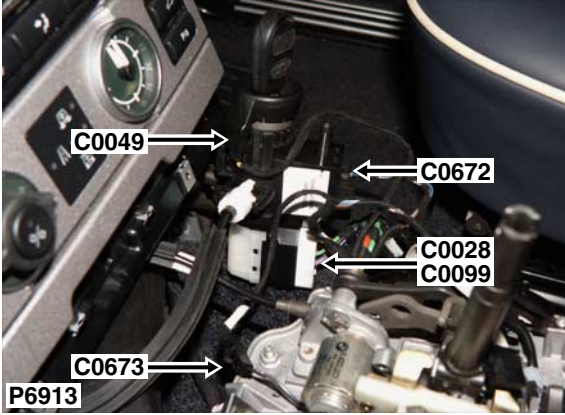

| Cav | Col | Cct |
|-----|-----|-----|
| 1 | G | 2 |
| 2 | PB | 2 |
| 5 | RU | 2 |
| 6 | R | 2 |
| 8 | BY | 2 |
| 9 | G | 2 |

Description: *Switch-Ignition - V8*
 Location: *Beneath centre console*

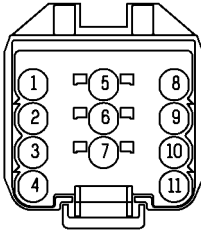

1393792

Colour: *WHITE*
 Gender: *Female*

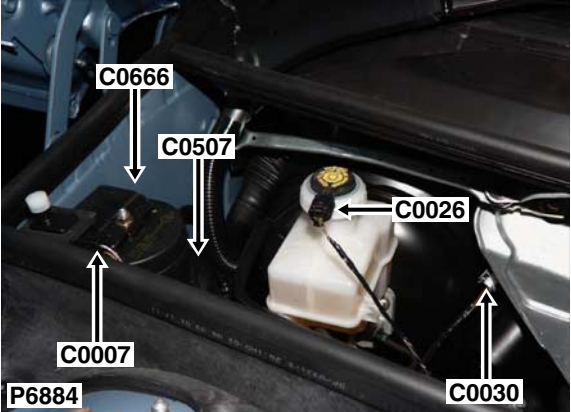

| Cav | Col | Cct |
|-----|-----|-----|
| 1 | N | ALL |
| 2 | BG | ALL |
| 3 | BN | ALL |
| 4 | NG | ALL |

Description: *Motor-Wiper-Windscreen*
Location: *Rear of engine compartment*

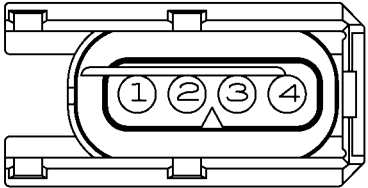

8352356

Colour: *BLACK*
Gender: *Female*

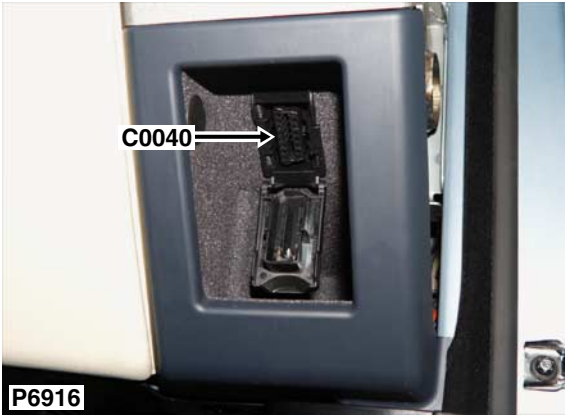

| Cav | Col | Cct |
|-----|-----|-----|
| 1 | GW | ALL |
| 4 | NB | ALL |
| 5 | NB | ALL |
| 7 | WPY | ALL |
| 8 | WP | ALL |
| 9 | B | ALL |
| 16 | RUY | ALL |

Description: *Diagnostic socket*

Location: *Behind driver side of fascia*

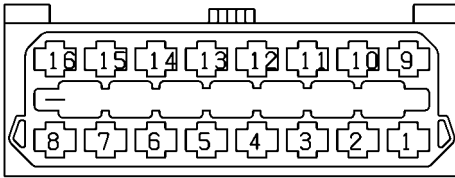

8380698

Colour: *BLACK*

Gender: *Female*

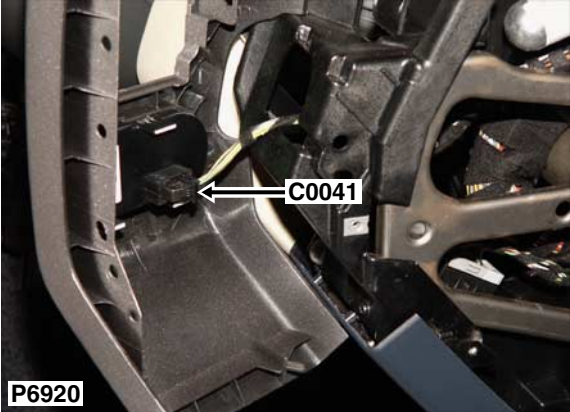

| Cav | Col | Cct |
|-----|-----|-----|
| 1 | YG | ALL |
| 2 | B | ALL |
| 3 | SB | ALL |
| 7 | NB | ALL |
| 8 | YB | ALL |
| 9 | YW | ALL |
| 10 | G | ALL |
| 11 | Y | ALL |

Description: *Switch-Lighting*

Location: *Behind driver side of fascia*

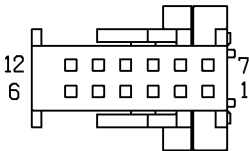

YPC111790

Colour: *BLACK*

Gender: *Female*

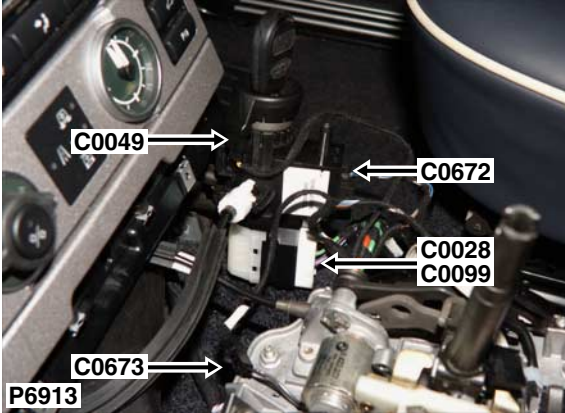

| Cav | Col | Cct |
|-----|-----|-----|
| 1 | YU | ALL |
| 3 | YN | ALL |

Description: *Coil-Transponder*

Location: *Beneath centre console*

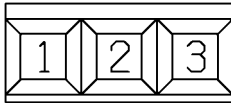

YPC117800

Colour: *BLACK*

Gender: *Female*

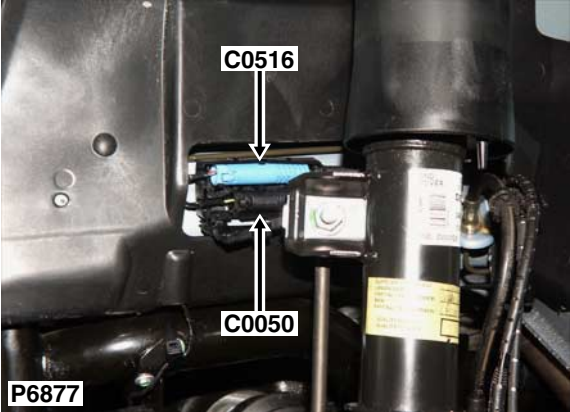

| Cav | Col | Cct |
|-----|-----|-----|
| 1 | Y | ALL |
| 2 | B | ALL |

Description: *Sensor-Pad wear*
Location: *Behind LH front wheel arch liner*

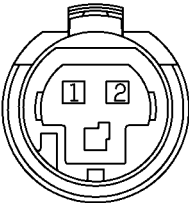

YPC110480

Colour: *BLACK*
Gender: *Female*

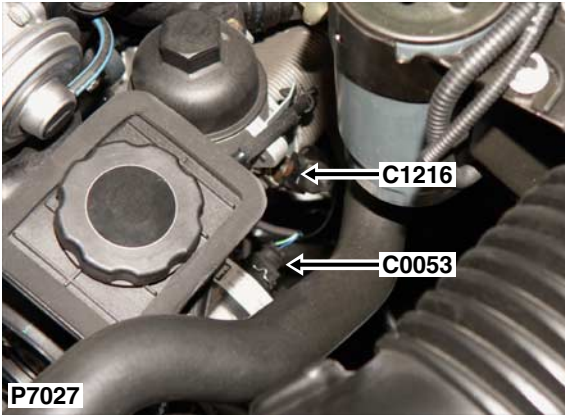

| Cav | Col | Cct |
|-----|-----|-----|
| 1 | G | 3 |
| 1 | GW | 3 |
| 2 | U | 3 |

Description: *Alternator/generator - Td6*

Location: *LH side of engine*

NO CONNECTOR FACE

Colour:

Gender:

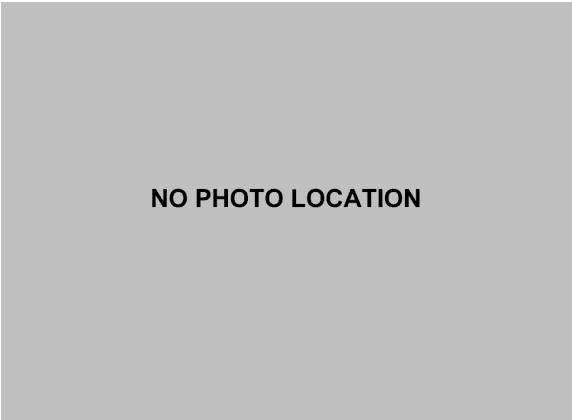

| Cav | Col | Cct |
|-----|-----|-----|
| 1 | BG | ALL |
| 2 | RG | ALL |

Description: *Motor-Blower-Front*
Location: *Behind centre of fascia*



Colour:
Gender:

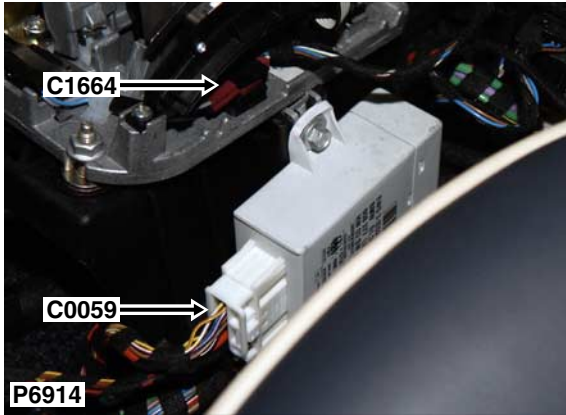

Description: *ECU-Engine Immobilisation*

Location: *Beneath centre console*

| Cav | Col | Cct |
|-----|-----|-----|
| 1 | B | ALL |
| 2 | BY | 1 |
| 2 | R | 2 |
| 4 | BP | ALL |
| 5 | YU | ALL |
| 6 | BU | 1 |
| 9 | NB | ALL |
| 10 | RY | ALL |
| 11 | PB | ALL |
| 12 | YN | ALL |
| 13 | WRY | ALL |

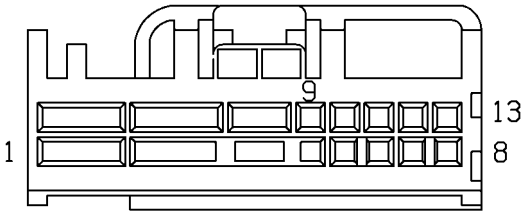

YPC114780

Colour: *BLACK*

Gender: *Female*

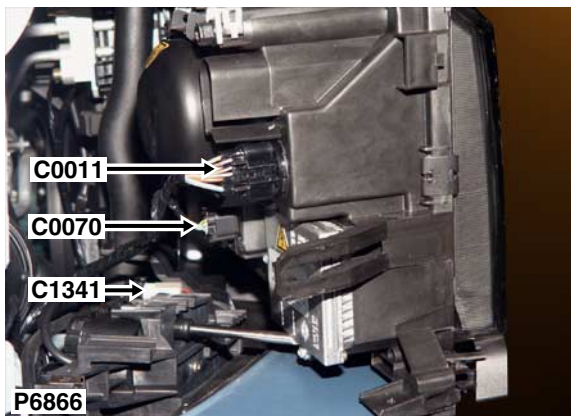

| Cav | Col | Cct |
|-----|-----|-----|
| 1 | YB | 22 |
| 2 | YN | 22 |
| 3 | UB | 22 |
| 4 | UN | 22 |

Description: *Motor-Headlamp levelling-RH*
 Location: *Front of vehicle - RH side*

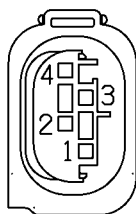

YPC117060

Colour: *NATURAL*
 Gender: *Female*

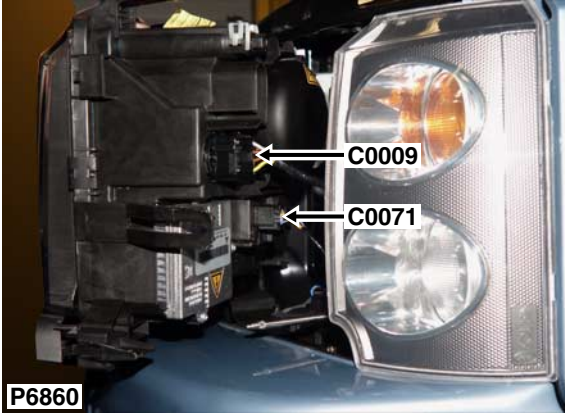

P6860

Description: *Motor-Headlamp levelling-LH*

Location: *Front of vehicle - LH side*

| Cav | Col | Cct |
|-----|-----|-----|
| 1 | YR | 22 |
| 2 | YN | 22 |
| 3 | UR | 22 |
| 4 | UN | 22 |

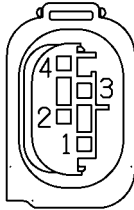

YPC117060

Colour: *NATURAL*

Gender: *Female*

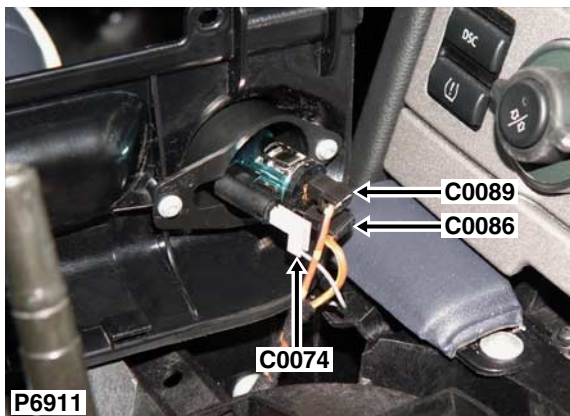

| Cav | Col | Cct |
|-----|-----|-----|
| 1 | SR | ALL |

Description: *Cigar lighter illumination*

Location: *Beneath centre console*

NO CONNECTOR FACE

Colour: *WHITE*

Gender: *Female*



Description: *Switch-Brake pedal*
Location: *Driver's footwell*

| Cav | Col | Cct |
|-----|-----|-----|
| 1 | PY | ALL |
| 2 | NB | ALL |
| 3 | NS | ALL |
| 4 | UR | ALL |

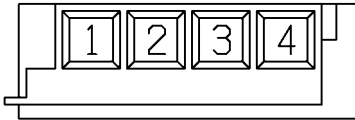

YPC117850

Colour: *NATURAL*
Gender: *Female*

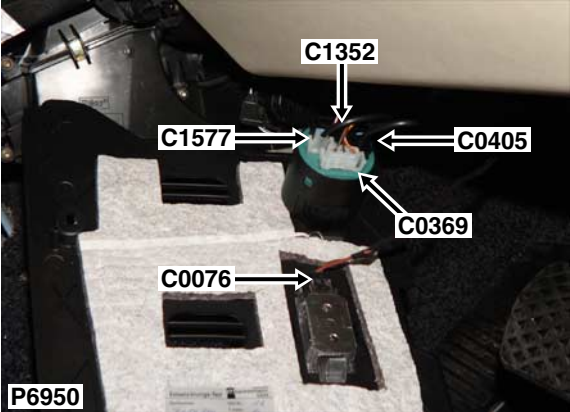

| Cav | Col | Cct |
|-----|-----|-----|
| 1 | N | ALL |
| 3 | RU | ALL |

Description: *Lamp-Footwell-Front-RH*
Location: *Behind footwell trim panel - RH side*

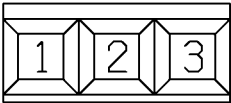

YPC117800

Colour: *BLACK*
Gender: *Female*

C0077

CONNECTOR DETAILS

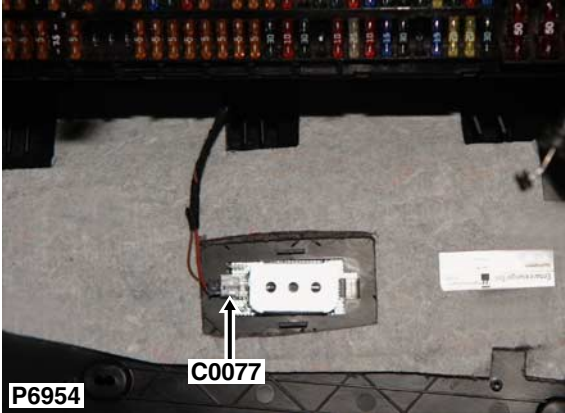

| Cav | Col | Cct |
|-----|-----|-----|
| 1 | N | ALL |
| 3 | RU | ALL |

Description: *Lamp-Footwell-Front-LH*

Location: *Behind footwell trim panel - LH side*

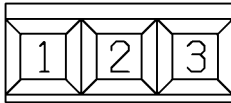

YPC117800

Colour: *BLACK*

Gender: *Female*

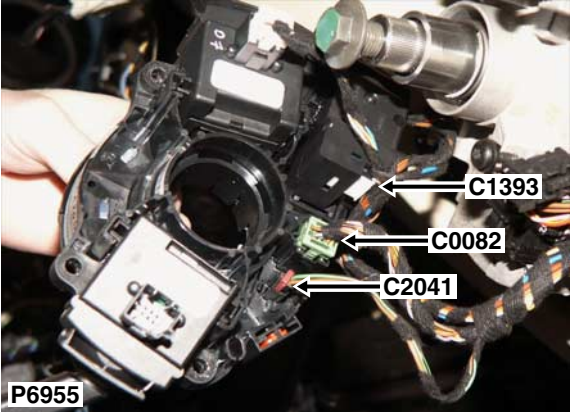

| Cav | Col | Cct |
|-----|-----|-----|
| 2 | SN | ALL |
| 3 | SB | ALL |
| 4 | YN | ALL |
| 5 | YB | ALL |
| 6 | NR | ALL |
| 7 | NB | ALL |
| 8 | YB | 7 |
| 9 | WSY | 7 |
| 10 | PY | 7 |

Description: *Rotary coupler*
Location: *Underside of steering column*

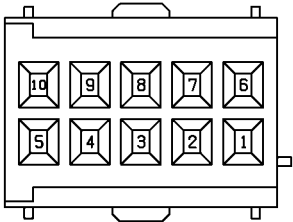

6909006

Colour: *GREEN*
Gender: *Female*

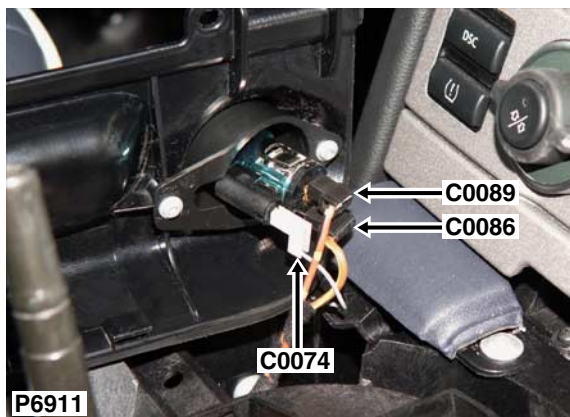

Description: *Cigar lighter*

Location: *Beneath centre console*

NO CONNECTOR FACE

Colour: *BLACK*

Gender: *Female*

| Cav | Col | Cct |
|-----|-----|-----|
| 1 | N | ALL |

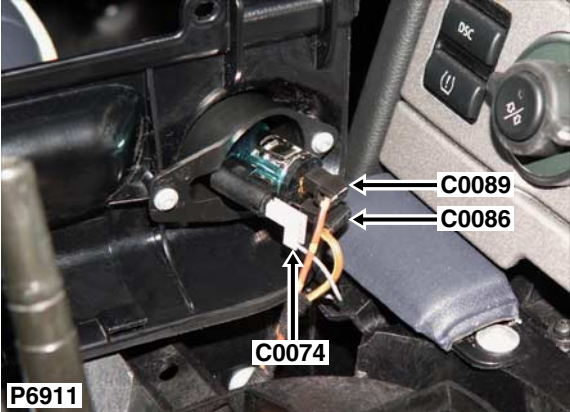

| Cav | Col | Cct |
|-----|-----|-----|
| 1 | RBY | ALL |

Description: *Cigar lighter*
Location: *Beneath centre console*



Colour: *BLACK*
Gender: *Female*

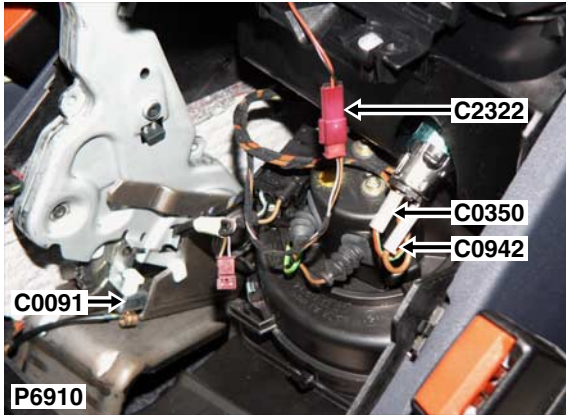

| Cav | Col | Cct |
|-----|-----|-----|
| 1 | UNY | ALL |

Description: *Switch-Handbrake*

Location: *Beneath centre console*

NO CONNECTOR FACE

Colour: *BRASS*

Gender: *Eyelet*

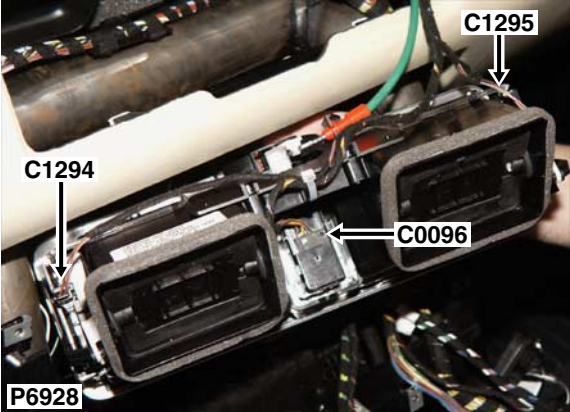

| Cav | Col | Cct |
|-----|-----|-----|
| 2 | NB | ALL |
| 3 | NU | ALL |
| 4 | UN | ALL |
| 5 | YR | ALL |
| 6 | SR | ALL |

Description: *Switch-Hazard Warning and CDL Master*
Location: *Behind centre console*

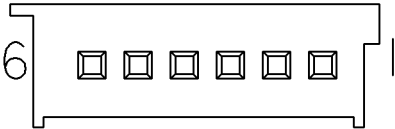

6909052

Colour: *BLACK*
Gender: *Female*

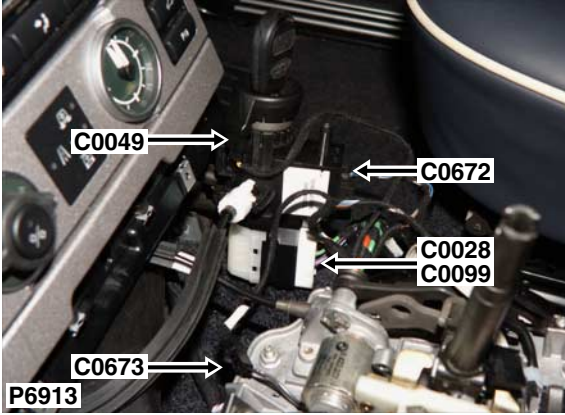

| Cav | Col | Cct |
|-----|-----|-----|
| 2 | PB | 1 |
| 5 | R | 1 |
| 6 | R | 1 |
| 8 | BY | 1 |
| 9 | G | 1 |

Description: *Switch-Ignition - Td6*
 Location: *Beneath centre console*

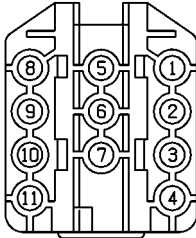

YPC115200

Colour: *BLACK*
 Gender: *Female*

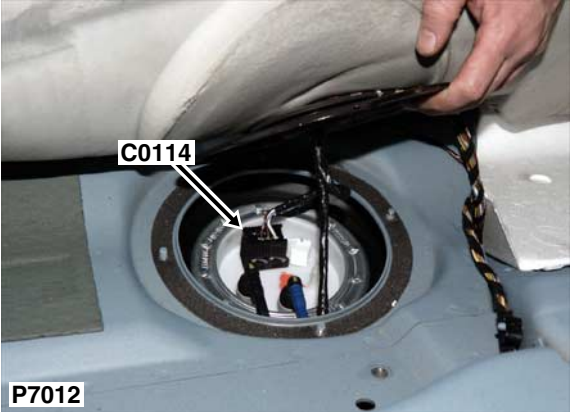

| Cav | Col | Cct |
|-----|-----|-----|
| 1 | WU | ALL |
| 2 | NBY | ALL |
| 3 | NBW | ALL |
| 4 | N | ALL |
| 5 | BRY | ALL |
| 6 | BRW | ALL |

Description: *Pump-Fuel*
Location: *Above fuel tank*

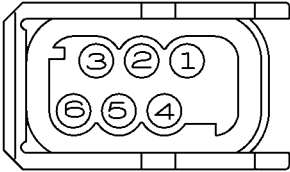

YPC114770

Colour: *BLACK*
Gender: *Female*



P6960

Description: *Main harness to tail door harness*

Location: *Rear of luggage compartment*

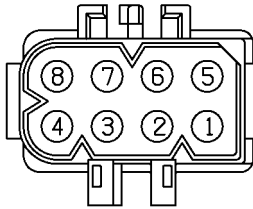

YPC112730

Colour: *BLACK*

Gender: *Male*

| Cav | Col | Cct |
|-----|-----|-----|
| 1 | UY | ALL |
| 2 | UW | ALL |
| 3 | RS | ALL |
| 4 | YB | ALL |
| 5 | N | ALL |
| 6 | WY | 30 |
| 7 | WY | 30 |

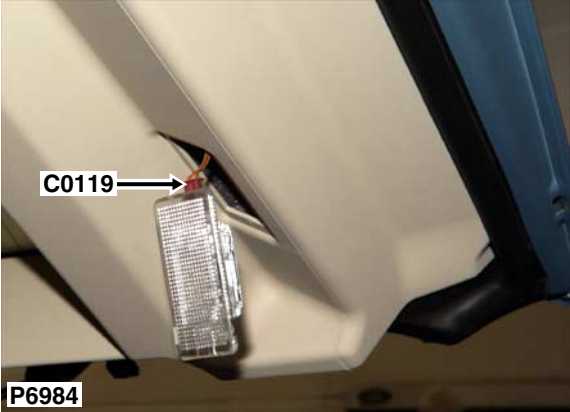

| Cav | Col | Cct |
|-----|-----|-----|
| 1 | NY | ALL |
| 3 | RY | ALL |

Description: *Lamp-Load space-RH*
Location: *RH side of tail door*



Colour: *BLACK*
Gender: *Female*

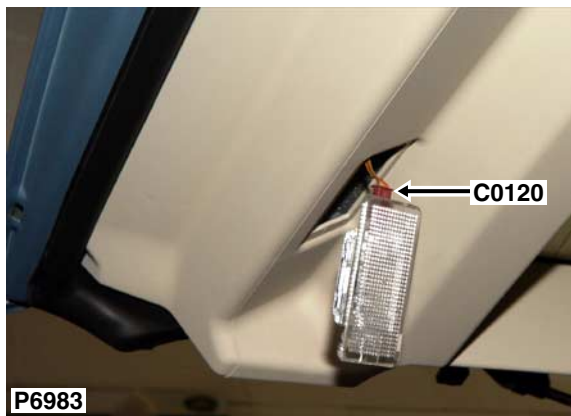

Description: *Lamp-Load space-LH*

Location: *LH side of taildoor*

| Cav | Col | Cct |
|-----|-----|-----|
| 1 | NY | ALL |
| 3 | RY | ALL |

NO CONNECTOR FACE

Colour: *BLACK*

Gender: *Female*

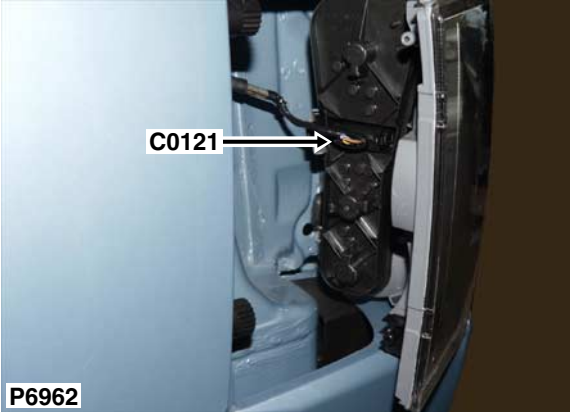

| Cav | Col | Cct |
|-----|-----|-----|
| 1 | UG | ALL |
| 2 | BU | ALL |
| 3 | YB | ALL |
| 4 | SP | ALL |
| 5 | N | ALL |

P6962

Description: *Lamp-Tail-LH*
Location: *LH rear of vehicle*

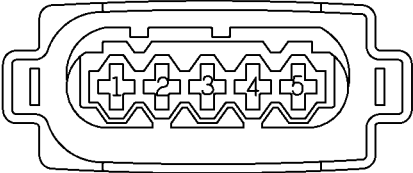

YPC113350

Colour: *BLACK*
Gender: *Female*



Description: *Lamp-Tail-RH*
Location: *RH rear of vehicle*

| Cav | Col | Cct |
|-----|-----|-----|
| 1 | UN | ALL |
| 2 | BU | ALL |
| 3 | YB | ALL |
| 4 | SW | ALL |
| 5 | N | ALL |

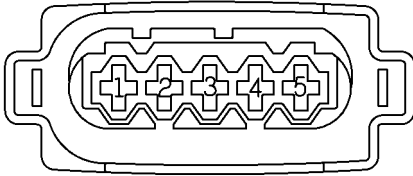

YPC113350

Colour: *BLACK*
Gender: *Female*

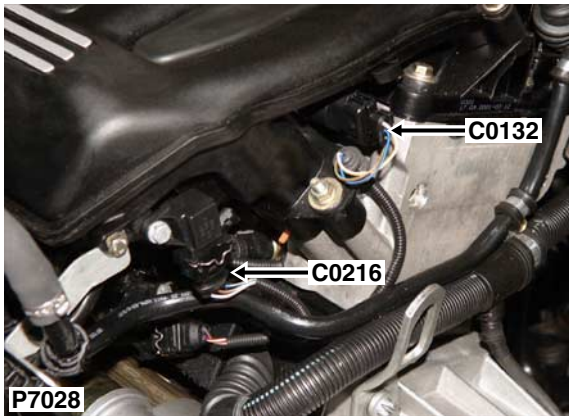

| Cav | Col | Cct |
|-----|-----|-----|
| 1 | NG | 3 |
| 2 | UB | 3 |
| 3 | WY | 8 |

Description: *Sensor-Fuel rail pressure - Td6*

Location: *Centre rear of engine*

NO CONNECTOR FACE

Colour:

Gender:

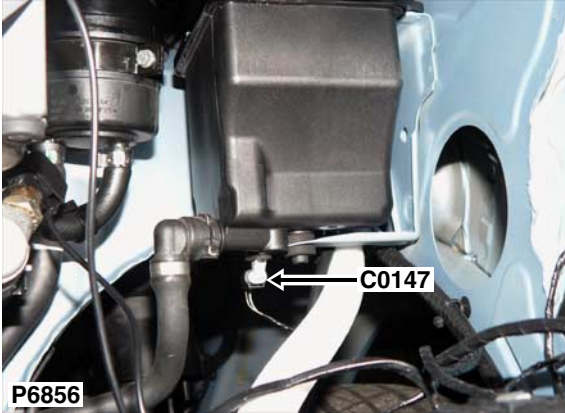

| Cav | Col | Cct |
|-----|-----|-----|
| 1 | NB | ALL |
| 2 | NW | ALL |

Description: *Sensor-Engine coolant level*
Location: *Front LH side of engine compartment*

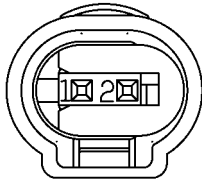

YPC116820

Colour: *BLACK*
Gender: *Female*



| Cav | Col | Cct |
|-----|-----|-----|
| 1 | UW | 3 |
| 2 | RW | 3 |
| 3 | B | 3 |
| 4 | RY | 3 |
| 5 | Y | 23 |

Description: *Sensor-Mass air flow (MAF) - V8*
Location: *Front RH side of engine*



Colour:
Gender:

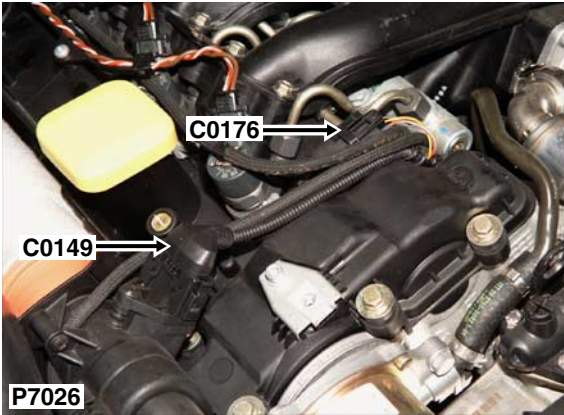

| Cav | Col | Cct |
|-----|-----|-----|
| 1 | YU | 3 |
| 2 | RU | 3 |
| 3 | B | 3 |
| 4 | RG | 3 |
| 5 | Y | 3 |

Description: *Sensor-Mass air flow (MAF) - Td6*

Location: *Top of engine*

NO CONNECTOR FACE

Colour:
Gender:

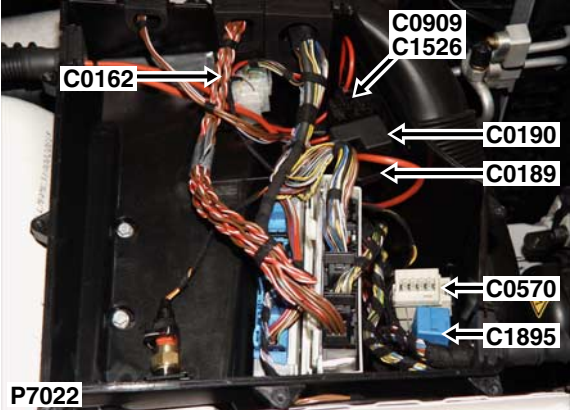

| Cav | Col | Cct |
|-----|-----|-----|
| 1 | B | 3 |
| 2 | RY | 3 |
| 6 | GW | 3 |
| 7 | RW | 3 |
| 10 | NP | 3 |
| 11 | NY | 3 |
| 12 | GR | 3 |

Description: *Engine harness to main harness - Td6*
Location: *Inside E-box*



Colour:
Gender:

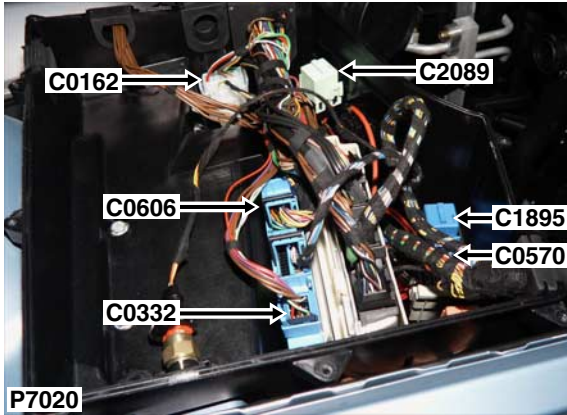

Description: *Engine harness to main harness - V8*
Location: *Inside E-box*

| Cav | Col | Cct |
|-----|-----|-----|
| 1 | BY | 3 |
| 3 | G | 3 |
| 4 | WP | 3 |
| 6 | GW | 24 |
| 7 | RW | 3 |
| 10 | NP | 3 |
| 11 | NY | 3 |

NO CONNECTOR FACE

Colour:
Gender:

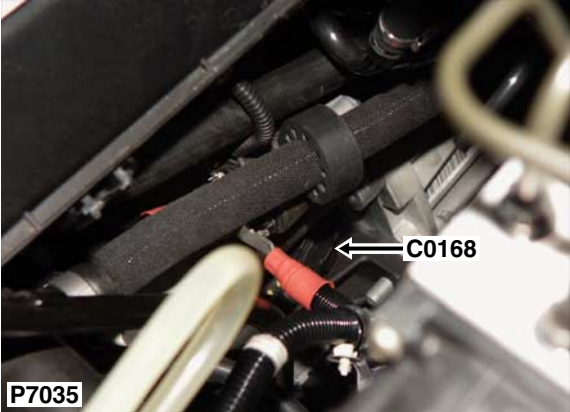

| Cav | Col | Cct |
|-----|-----|-----|
| 1 | B | 3 |
| 2 | Y | 3 |

Description: *Sensor-Crankshaft position (CKP) - Td6*
Location: *LH side of engine*



Colour:
Gender:

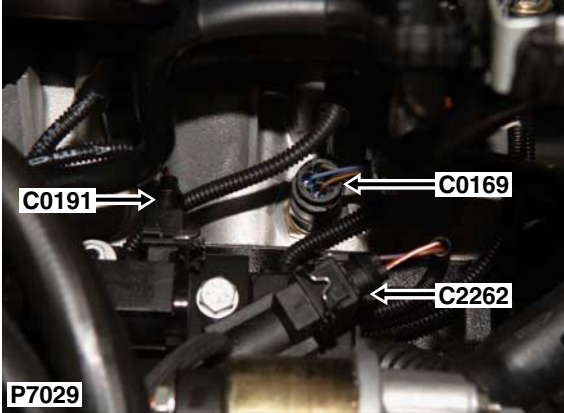

| Cav | Col | Cct |
|-----|-----|-----|
| 1 | NP | 3 |
| 2 | NY | 3 |
| 3 | SU | 3 |
| 3 | YG | 3 |
| 4 | NG | 3 |
| 4 | NO | 3 |

Description: *Sensor-Engine coolant temperature (ECT) - Td6*
Location: *Rear LH side of engine*



Colour:
Gender:

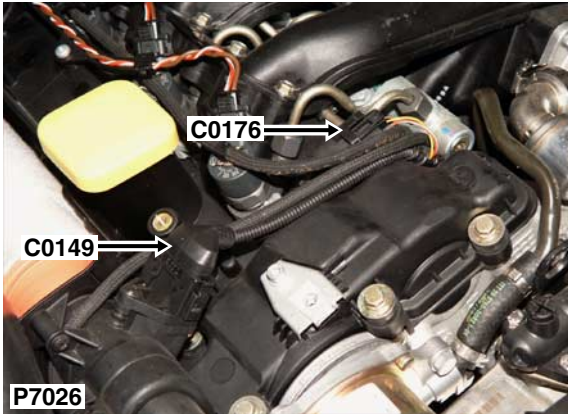

| Cav | Col | Cct |
|-----|-----|-----|
| 1 | RW | 3 |
| 2 | Y | ALL |
| 3 | N | 3 |

Description: *Sensor-Camshaft position (CMP) - Td6*

Location: *Top of engine*

NO CONNECTOR FACE

Colour:

Gender:

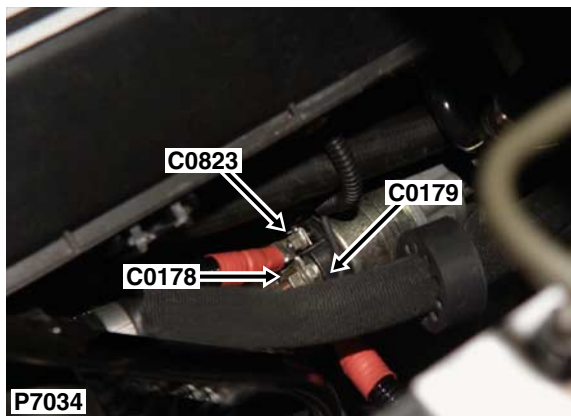

Description: *Solenoid-Starter motor - Td6*

Location: *LH side of engine*

| Cav | Col | Cct |
|-----|-----|-----|
| 1 | B | 3 |

NO CONNECTOR FACE

Colour:
Gender:

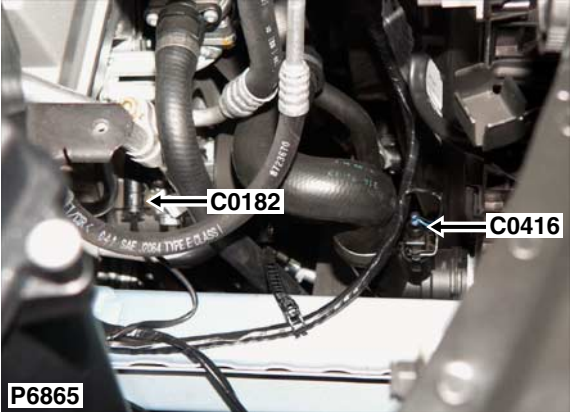

| Cav | Col | Cct |
|-----|-----|-----|
| 1 | BS | 2 |

Description: *Clutch-Compressor-Air conditioning (A/C) - V8*
Location: *Lower RH front of engine compartment*

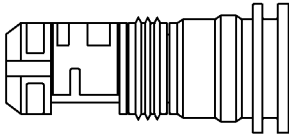
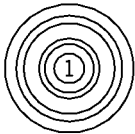

YPC110230

Colour: *BLACK*
Gender: *Female*

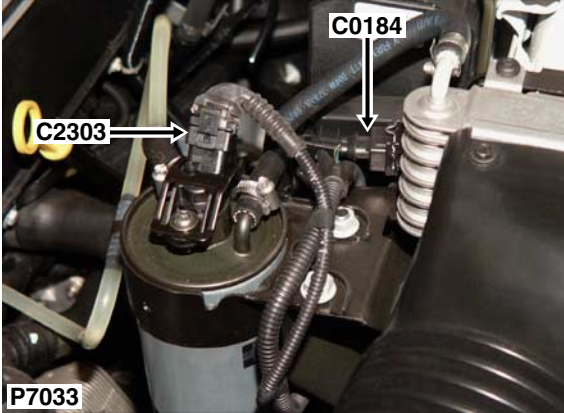

| Cav | Col | Cct |
|-----|-----|-----|
| 1 | UG | 3 |
| 2 | NG | 3 |

Description: *Sensor-Temperature-Fuel rail - Td6*

Location: *LH side of engine compartment*

NO CONNECTOR FACE

Colour:

Gender:



| Cav | Col | Cct |
|-----|-----|-----|
| 1 | NG | 2 |

Description: *Switch-Oil pressure*
Location: *Front LH side of engine compartment*

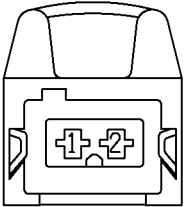

1732460

Colour: *BLACK*
Gender: *Female*

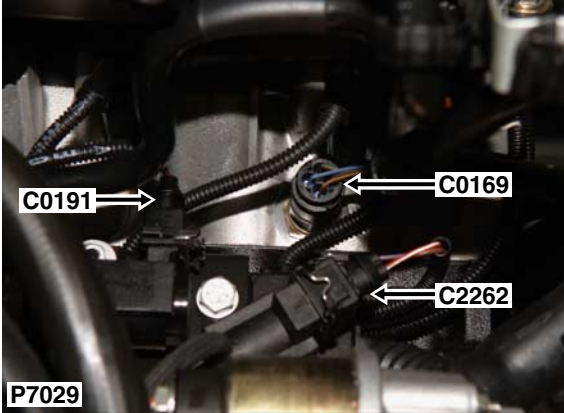

Description: *Solenoid-EGR - Td6*
Location: *LH side of engine*

| Cav | Col | Cct |
|-----|-----|-----|
| 1 | RW | 3 |
| 2 | NS | 3 |

NO CONNECTOR FACE

Colour:
Gender:

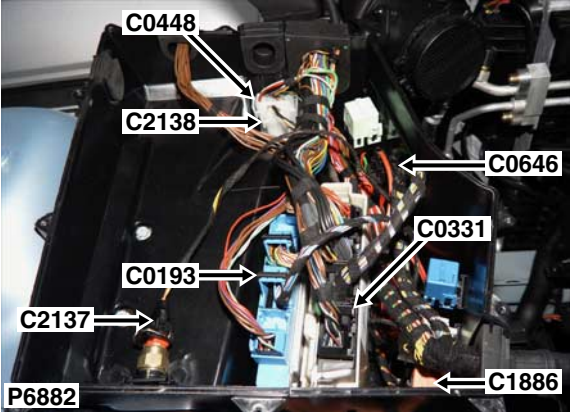

| Cav | Col | Cct |
|-----|-----|-----|
| 1 | NP | ALL |
| 2 | BP | ALL |
| 3 | UB | ALL |
| 9 | WR | ALL |
| 10 | WB | ALL |
| 18 | WU | ALL |
| 19 | US | ALL |
| 20 | UY | ALL |

Description: ECU-Electronic automatic transmission
Location: Inside E-box

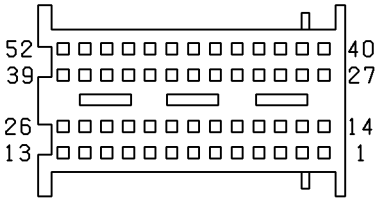

YPH100670

Colour: BLUE
Gender: Female



Description: *Accelerometer*

Location: *Beneath centre console*

| Cav | Col | Cct |
|-----|-----|-----|
| 1 | WUY | ALL |
| 2 | WRY | ALL |
| 3 | WSY | ALL |
| 4 | BRY | ALL |
| 5 | NBY | ALL |
| 6 | UWY | ALL |

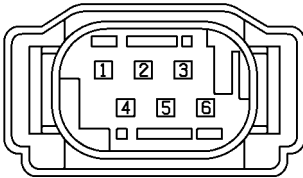

YPC110680

Colour: *BLACK*

Gender: *Female*



| Cav | Col | Cct |
|-----|-----|-----|
| 1 | UY | 3 |
| 2 | NG | 3 |
| 3 | W | 3 |

Description: *Sensor-Boost pressure - Td6*
Location: *Centre rear of engine*



Colour:
Gender:

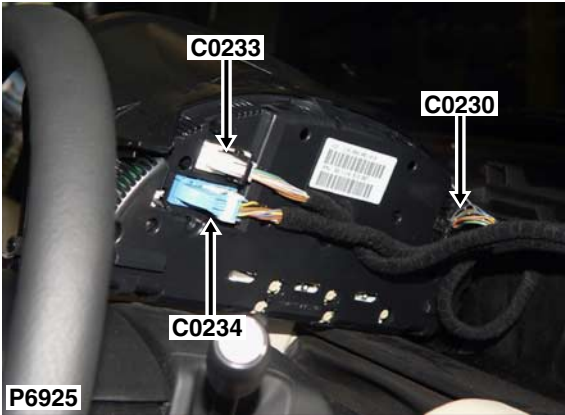

Description: *Instrument Pack*
 Location: *Behind instrument pack*

| Cav | Col | Cct |
|-----|-----|-----|
| 1 | NB | ALL |
| 3 | U | ALL |
| 4 | NG | ALL |
| 5 | UNY | ALL |
| 7 | RY | ALL |
| 8 | SR | ALL |
| 13 | NP | ALL |
| 15 | SB | ALL |
| 17 | GU | ALL |

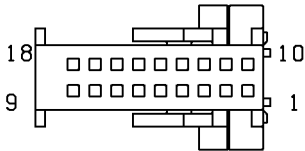

YPC111800

Colour: *BLACK*
 Gender: *Female*

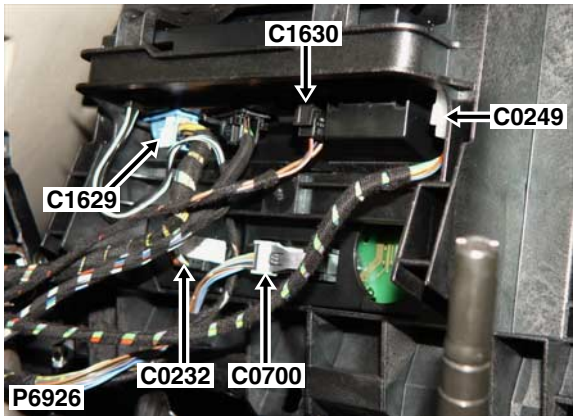

| Cav | Col | Cct |
|-----|-----|-----|
| 1 | RG | ALL |
| 2 | NB | ALL |
| 3 | SR | ALL |
| 4 | WSY | ALL |

Description: *Clock-Analogue*
Location: *Behind centre console*

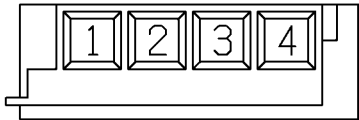

YPC117840

Colour: *BLACK*
Gender: *Female*

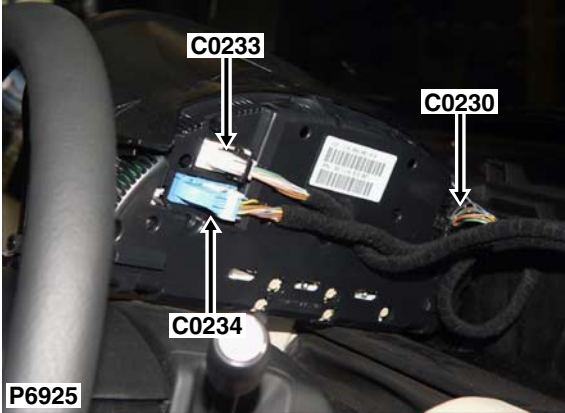

Description: *Instrument Pack*

Location: *Behind instrument pack*

| Cav | Col | Cct |
|-----|-----|-----|
| 1 | WP | ALL |
| 3 | BW | 15 |
| 7 | WRY | ALL |
| 8 | WSY | ALL |
| 9 | NB | ALL |
| 10 | NB | ALL |
| 11 | BR | ALL |
| 12 | PG | ALL |
| 14 | BG | ALL |
| 15 | RY | ALL |
| 16 | GU | ALL |
| 17 | WU | ALL |
| 18 | WR | ALL |

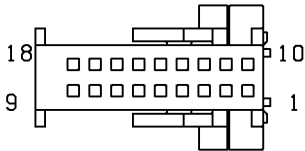

YPC111800

Colour: *BLACK*

Gender: *Female*

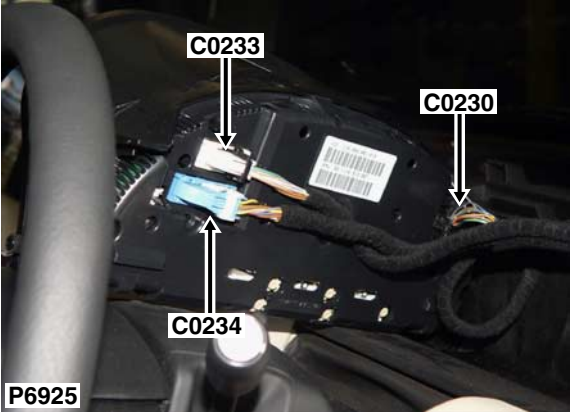

Description: *Instrument Pack*
 Location: *Behind instrument pack*

| Cav | Col | Cct |
|-----|-----|-----|
| 1 | NR | ALL |
| 4 | Y | ALL |
| 5 | YR | ALL |
| 7 | BRY | ALL |
| 8 | YB | 1 |
| 9 | YN | 1 |
| 12 | NBY | ALL |
| 14 | UR | ALL |
| 16 | NBW | ALL |
| 18 | NY | ALL |
| 19 | NP | ALL |
| 20 | YN | ALL |
| 22 | UN | ALL |
| 23 | BRW | ALL |
| 25 | SP | ALL |

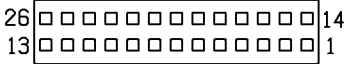

YPC114350

Colour: *GREY*
 Gender: *Female*

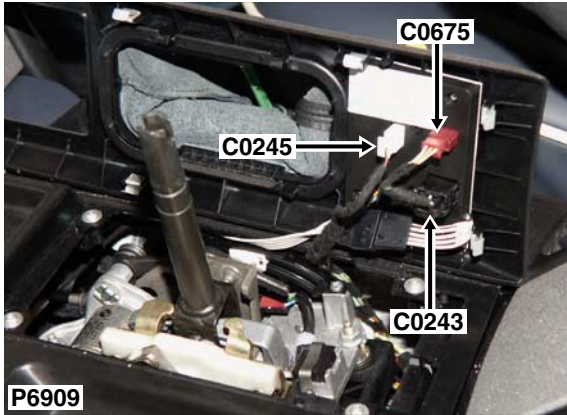

| Cav | Col | Cct |
|-----|-----|-----|
| 1 | WG | ALL |
| 3 | BG | ALL |
| 6 | GBY | ALL |

Description: *Selector-Automatic transmission*

Location: *Beneath centre console*

NO CONNECTOR FACE

Colour: *BLACK*

Gender: *Female*

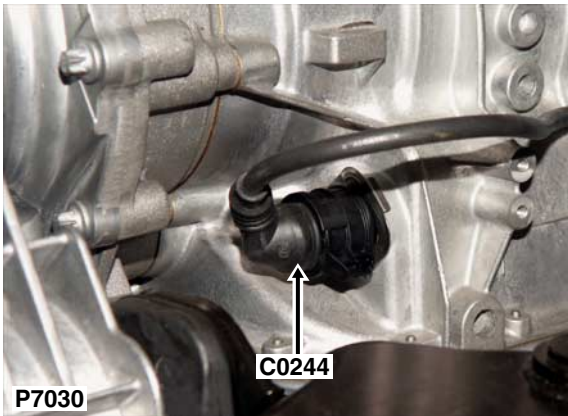

Description: *Gearbox - Td6*
 Location: *RH side of gearbox*

NO CONNECTOR FACE

Colour:
 Gender:

| Cav | Col | Cct |
|-----|-----|-----|
| 1 | W | 3 |
| 2 | O | 3 |
| 2 | R | 25 |
| 3 | N | 3 |
| 3 | B | 3 |
| 4 | YU | 3 |
| 4 | Y | 3 |
| 5 | U | 3 |
| 5 | Y | 26 |
| 6 | S | 3 |
| 6 | WR | 3 |
| 7 | YB | 3 |
| 7 | K | 3 |
| 8 | O | 3 |
| 8 | P | 3 |
| 9 | G | 3 |
| 9 | GR | 3 |
| 10 | N | 3 |
| 10 | BR | 24 |
| 11 | TB | 3 |
| 11 | B | 3 |
| 12 | P | 3 |
| 13 | BR | 3 |
| 13 | R | 3 |
| 14 | OB | 3 |
| 14 | WR | 3 |
| 15 | S | 3 |
| 15 | YR | 3 |
| 16 | PB | 3 |
| 16 | YU | 3 |
| 17 | G | 3 |
| 18 | U | 3 |
| 19 | TB | 3 |
| 20 | BY | 3 |

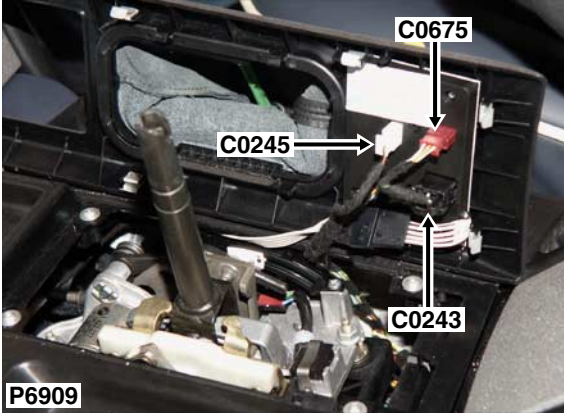

| Cav | Col | Cct |
|-----|-----|-----|
| 1 | SR | ALL |
| 2 | NB | ALL |
| 3 | RY | 27 |

Description: *Lamp-Automatic gearbox selector indicator*
Location: *Beneath centre console*



Colour: *WHITE*
Gender: *Female*

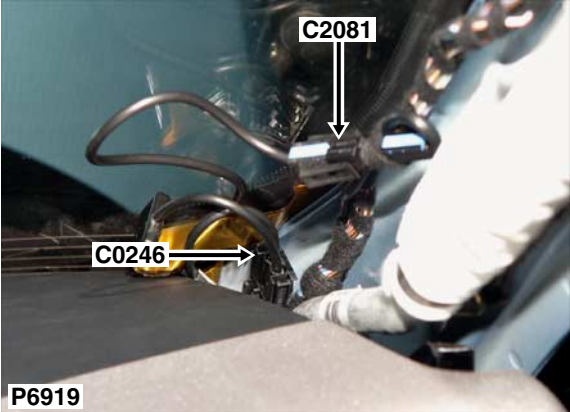

| Cav | Col | Cct |
|-----|-----|-----|
| 1 | N | 9 |
| 2 | B | 9 |

Description: *Heated screen-Front*
Location: *Behind RH side of fascia*

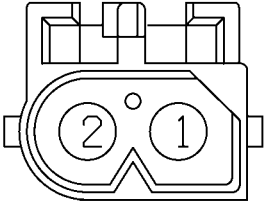

8380381

Colour: *BLACK*
Gender: *Male*

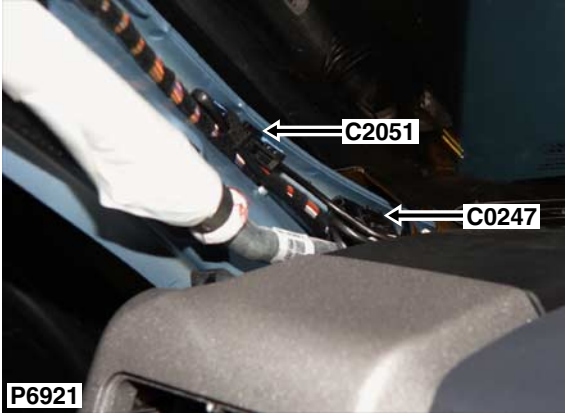

| Cav | Col | Cct |
|-----|-----|-----|
| 1 | N | 9 |
| 2 | B | 9 |

Description: *Heated screen-Front*
Location: *Behind LH side of fascia*

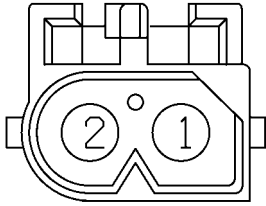

8380381

Colour: *BLACK*
Gender: *Male*

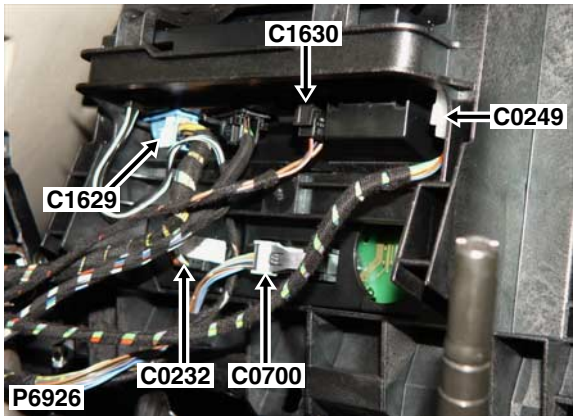

| Cav | Col | Cct |
|-----|-----|-----|
| 1 | RU | 18 |
| 2 | GP | 18 |
| 3 | GY | 18 |

Description: *Heater-Seat*
Location: *Behind centre console*

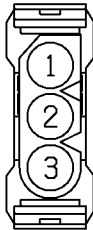

YPC112540

Colour: *NATURAL*
Gender: *Female*

C0251

CONNECTOR DETAILS

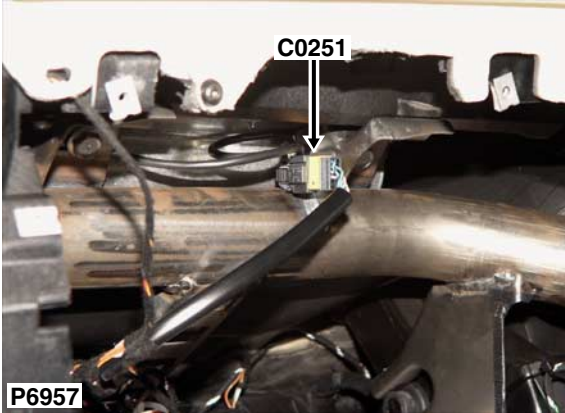

| Cav | Col | Cct |
|-----|-----|-----|
| 1 | UB | ALL |
| 2 | UN | ALL |
| 3 | WB | ALL |
| 4 | WN | ALL |

Description: *Air bag-Passenger*

Location: *Behind passenger side of fascia*

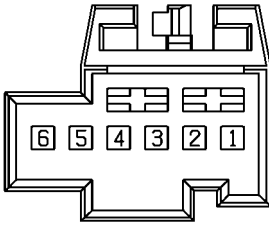

YPC118190

Colour: *BLACK*

Gender: *Male*

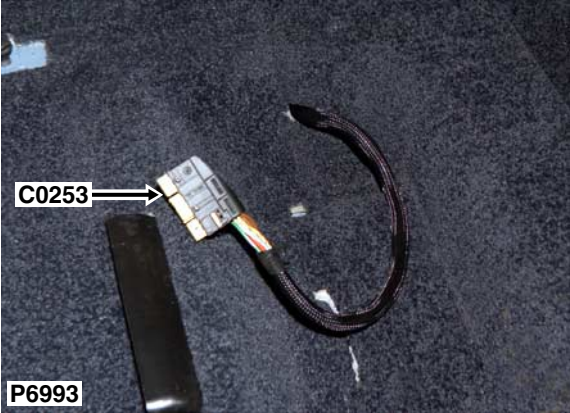

Description: *Main harness to seat harness*
Location: *Beneath RH seat*

| Cav | Col | Cct |
|-----|-----|-----|
| 5 | PG | 16 |
| 7 | UW | 16 |
| 9 | YR | ALL |
| 10 | YN | ALL |
| 13 | RN | 17 |
| 14 | N | 17 |
| 15 | WRY | 17 |
| 16 | NB | 17 |
| 17 | NU | 3 |
| 18 | NR | 3 |
| 19 | NB | 3 |
| 20 | NW | 3 |
| 21 | B | 3 |
| 22 | BU | 3 |
| 23 | WG | 18 |
| 24 | N | 18 |
| 25 | GP | 18 |

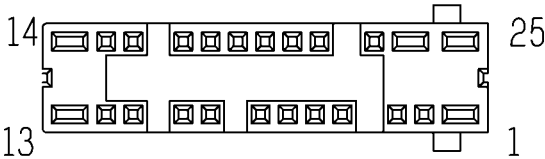

YPC119240

Colour: *YELLOW*
Gender: *Female*

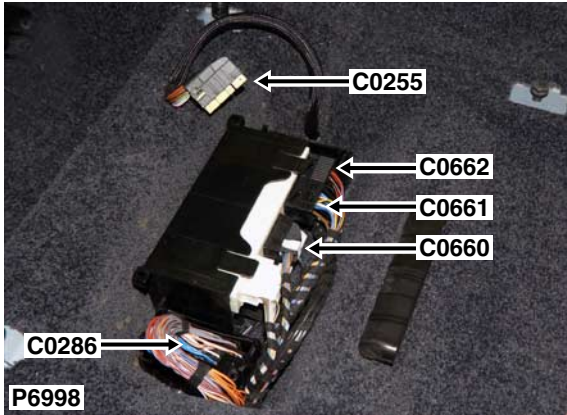

Description: *Main harness to seat harness*

Location: *Beneath LH seat*

| Cav | Col | Cct |
|-----|-----|-----|
| 5 | PG | 27 |
| 7 | UP | 27 |
| 9 | UR | ALL |
| 10 | UN | ALL |
| 13 | RN | 17 |
| 14 | N | 17 |
| 17 | PG | ALL |
| 18 | WR | ALL |
| 19 | NB | ALL |
| 23 | WU | 18 |
| 24 | N | 18 |
| 25 | GY | 18 |

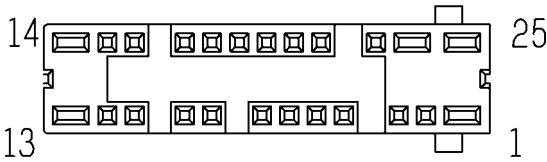

YPC119240

Colour: *YELLOW*

Gender: *Female*

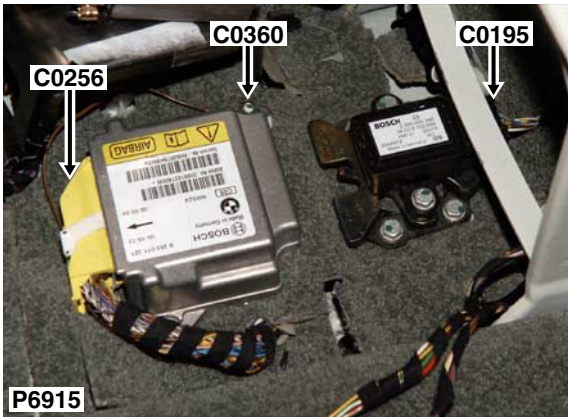

Description: *DCU-Airbag*

Location: *Beneath centre console*

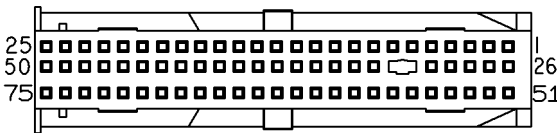

6906030

Colour: *NATURAL*

Gender: *Female*

| Cav | Col | Cct |
|-----|-----|-----|
| 1 | YR | ALL |
| 2 | YN | ALL |
| 3 | UR | ALL |
| 4 | UN | ALL |
| 5 | PU | ALL |
| 6 | NB | ALL |
| 7 | NP | ALL |
| 8 | UP | 27 |
| 9 | WRY | ALL |
| 10 | YB | ALL |
| 11 | YN | ALL |
| 12 | UW | 16 |
| 13 | UB | ALL |
| 14 | UN | ALL |
| 15 | WR | ALL |
| 16 | Y | ALL |
| 17 | N | ALL |
| 18 | U | ALL |
| 19 | N | ALL |
| 20 | YG | ALL |
| 21 | YR | ALL |
| 26 | SB | ALL |
| 27 | SN | ALL |
| 28 | Y | 20 |
| 29 | B | 20 |
| 33 | WB | ALL |
| 34 | SU | ALL |
| 40 | WN | ALL |
| 41 | G | 20 |
| 42 | B | 20 |
| 45 | Y | ALL |
| 46 | UY | ALL |
| 47 | W | ALL |
| 48 | UW | ALL |
| 49 | N | ALL |
| 50 | NR | ALL |

C0274

CONNECTOR DETAILS

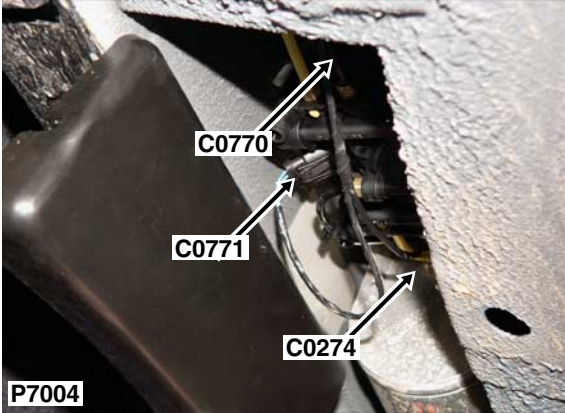

P7004

Description: *Valve block-Air Suspension*

Location: *Beneath vehicle - RH side*

| Cav | Col | Cct |
|-----|-----|-----|
| 1 | WR | 3 |
| 2 | YP | 3 |
| 3 | WP | 3 |

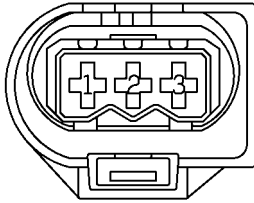

YPC113390

Colour: *BLACK*

Gender: *Female*

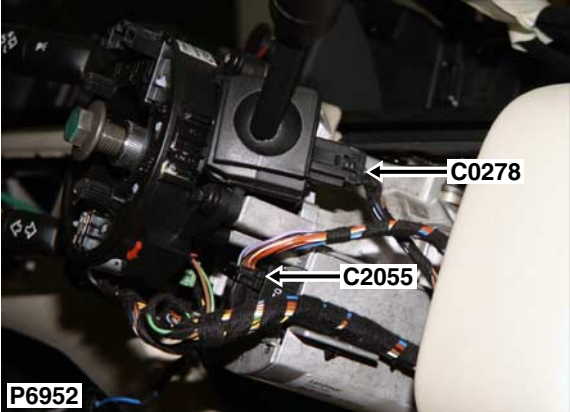

| Cav | Col | Cct |
|-----|-----|-----|
| 1 | BW | ALL |
| 3 | BW | ALL |
| 4 | NP | ALL |
| 5 | NW | ALL |
| 6 | NB | ALL |
| 7 | BU | ALL |
| 8 | BU | ALL |
| 9 | BG | ALL |
| 10 | NW | ALL |

Description: *Switch-Wash/wipe-Windscreen*
Location: *Top of steering column*

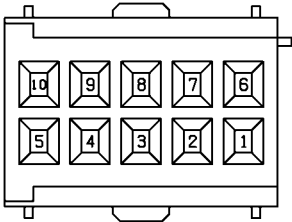

6909000

Colour: *BLACK*
Gender: *Female*

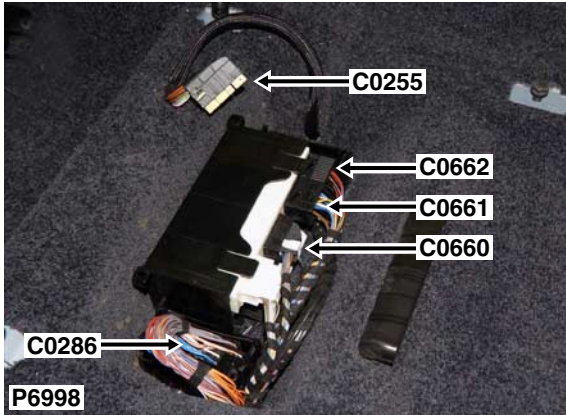

Description: *Header*

Location: *Beneath front passenger's seat*

NO CONNECTOR FACE

Colour:
Gender:

| Cav | Col | Cct |
|-----|-----|-----|
| 0 | UR | 3 |
| 0 | RU | 12 |
| 0 | RY | 17 |
| 0 | WRY | ALL |
| 0 | B | 27 |
| 0 | W | ALL |
| 0 | U | 30 |
| 1 | W | ALL |
| 1 | UR | ALL |
| 1 | U | ALL |
| 1 | WRY | ALL |
| 0 | SR | ALL |
| 1 | RY | ALL |
| 0 | RY | ALL |
| 1 | RY | ALL |
| 0 | RY | ALL |
| 1 | RY | ALL |
| 1 | B | ALL |
| 1 | RU | ALL |
| 1 | SR | ALL |

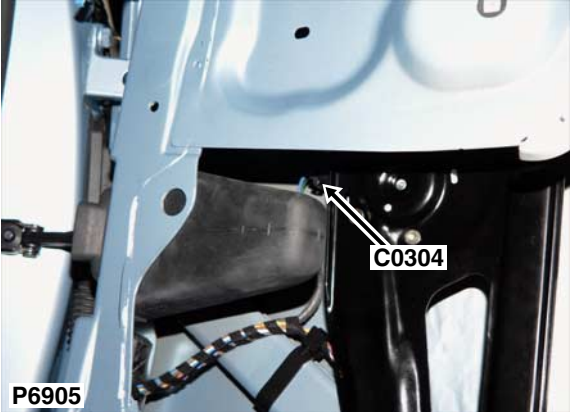

| Cav | Col | Cct |
|-----|-----|-----|
| 1 | BG | 3 |
| 2 | US | 3 |

Description: *Motor-Window-Rear*
Location: *Behind rear door trim panel*

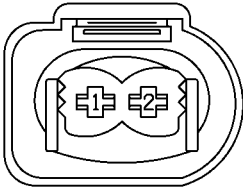

YPC116370

Colour: *BLACK*
Gender: *Female*

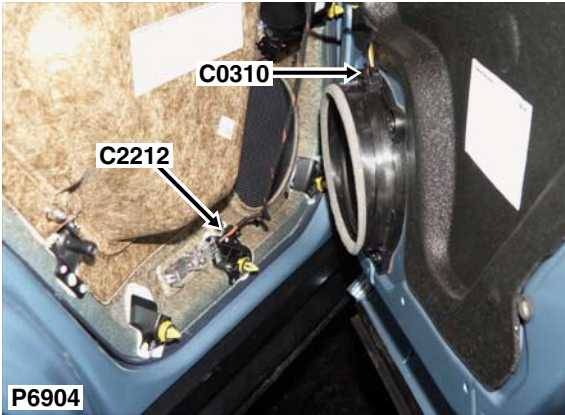

Description: *Speaker-Low range-Rear-RH*
Location: *Behind rear door trim panel*

| Cav | Col | Cct |
|-----|-----|-----|
| 1 | N | ALL |
| 2 | Y | ALL |

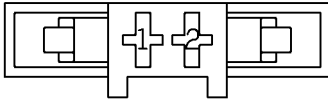

YPC113640

Colour: *BLACK*
Gender: *Female*

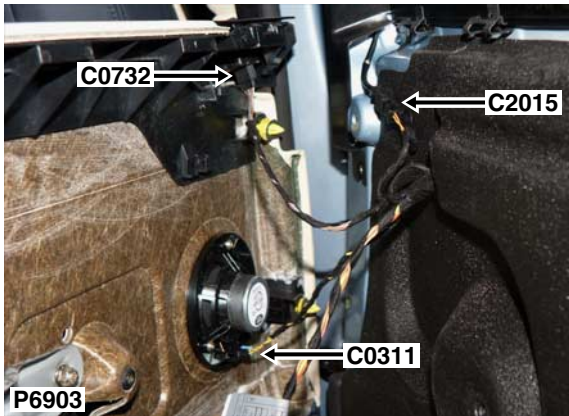

| Cav | Col | Cct |
|-----|-----|-----|
| 1 | YN | 28 |
| 2 | YB | 28 |

Description: *Speaker-Mid range-Rear-RH*

Location: *Behind rear door trim panel*

NO CONNECTOR FACE

Colour: *WHITE*

Gender: *Female*

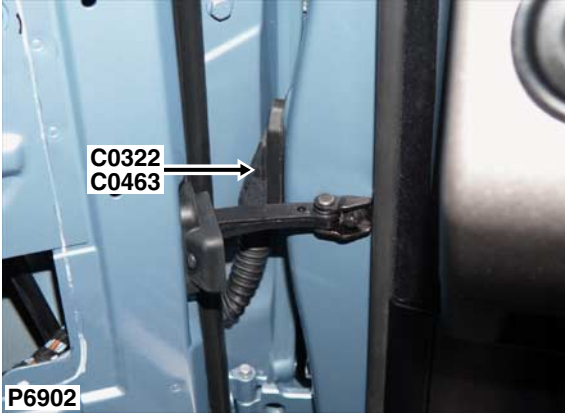

Description: *Passenger door harness to main harness*
 Location: *Base of passenger side 'A' post*

| Cav | Col | Cct |
|-----|-----|-----|
| 5 | SR | 3 |
| 9 | U | 3 |
| 10 | N | 3 |
| 11 | RU | 12 |
| 14 | UB | 28 |
| 15 | UN | 28 |
| 16 | UY | 28 |
| 17 | N | 28 |
| 19 | RG | 13 |
| 20 | WG | 26 |
| 21 | WY | 26 |
| 23 | UR | 3 |
| 26 | N | 3 |
| 27 | RW | 3 |
| 28 | UR | ALL |
| 29 | UN | ALL |

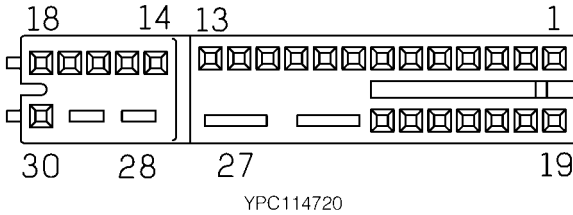

Colour: *BLACK*
 Gender: *Female*

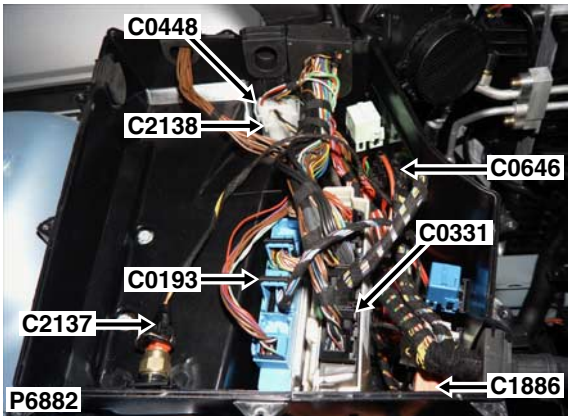

Description: *Engine control module (ECM)*

Location: *Inside E-box*

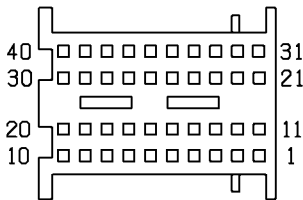

YPH100430

Colour: *BLACK*

Gender: *Female*

| Cav | Col | Cct |
|-----|-----|-----|
| 1 | U | ALL |
| 2 | BG | ALL |
| 3 | NU | 2 |
| 4 | BG | ALL |
| 6 | BY | 2 |
| 7 | NG | ALL |
| 8 | W | ALL |
| 9 | Y | ALL |
| 10 | BP | ALL |
| 11 | NG | 1 |
| 12 | UG | ALL |
| 13 | WG | ALL |
| 14 | YG | ALL |
| 17 | B | ALL |
| 18 | S | 27 |
| 19 | SP | ALL |
| 20 | BG | 27 |
| 21 | SN | ALL |
| 22 | YG | ALL |
| 24 | UR | ALL |
| 26 | GB | ALL |
| 27 | YB | 7 |
| 28 | NS | ALL |
| 29 | BG | ALL |
| 30 | NU | 27 |
| 32 | WPY | ALL |
| 33 | BP | ALL |
| 36 | YB | ALL |
| 37 | YN | ALL |
| 38 | US | 2 |
| 39 | BS | 2 |
| 40 | YN | 2 |

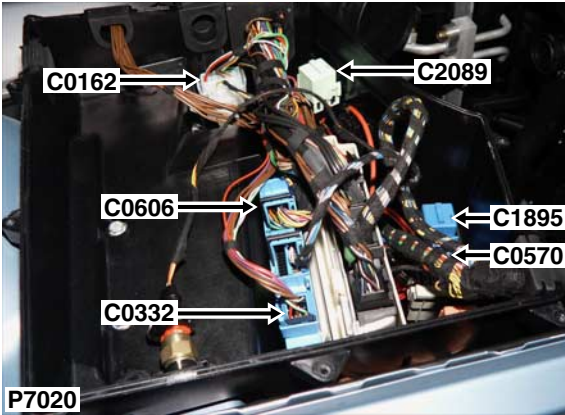

Description: *Engine control module (ECM) - V8*
Location: *Inside E-box*

| Cav | Col | Cct |
|-----|-----|-----|
| 1 | BY | 26 |
| 2 | BU | 3 |
| 3 | BR | 3 |
| 4 | BY | 3 |
| 5 | N | 3 |
| 6 | BW | 3 |
| 7 | BU | 3 |
| 8 | BW | 3 |
| 9 | BR | 3 |

NO CONNECTOR FACE

Colour:
Gender:

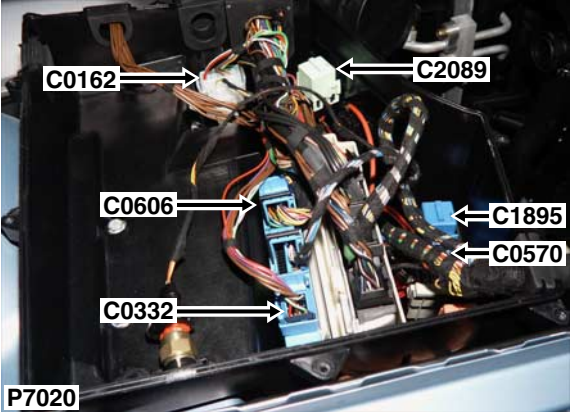

Description: *Engine control module (ECM) - Td6*
Location: *Inside E-box*

| Cav | Col | Cct |
|-----|-----|-----|
| 1 | RW | 3 |
| 3 | N | 3 |
| 4 | RW | 3 |
| 5 | N | 3 |
| 6 | N | 3 |
| 7 | N | 3 |
| 8 | N | 3 |
| 9 | N | 3 |



Colour: *BLUE*
Gender: *Male*

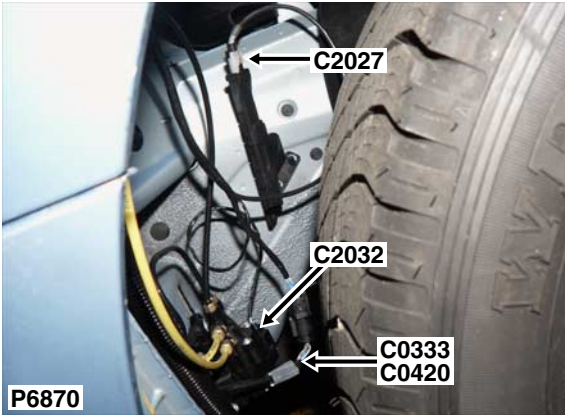

Description: *Main harness to air suspension harness*
 Location: *Behind RH front wheel arch liner*

| Cav | Col | Cct |
|-----|-----|-----|
| 1 | UW | ALL |
| 2 | WP | ALL |
| 3 | WR | ALL |
| 4 | YP | ALL |
| 5 | UG | ALL |
| 6 | UB | ALL |
| 7 | UY | ALL |
| 8 | US | ALL |

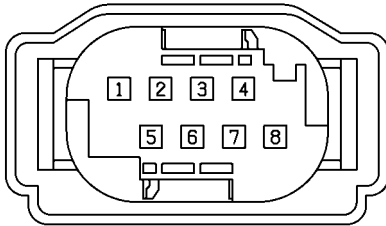

YPC108040

Colour: *BLACK*
 Gender: *Female*



Description: *Door harness to main harness*
 Location: *Base of driver side 'A' post*

| Cav | Col | Cct |
|-----|-----|-----|
| 1 | YG | 3 |
| 5 | SR | 3 |
| 9 | Y | 3 |
| 10 | N | 3 |
| 11 | RU | 12 |
| 14 | YR | 28 |
| 15 | YN | 28 |
| 16 | SB | 28 |
| 17 | SN | 28 |
| 19 | RG | 13 |
| 20 | WR | 26 |
| 21 | WU | 26 |
| 23 | UR | 3 |
| 26 | N | 3 |
| 27 | RV | 3 |
| 28 | UW | ALL |
| 29 | UN | ALL |

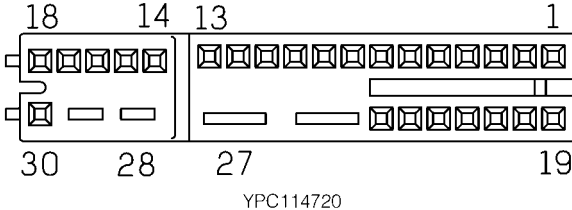

Colour: *BLACK*
 Gender: *Female*



| Cav | Col | Cct |
|-----|-----|-----|
| 1 | RB | ALL |
| 2 | N | ALL |

Description: *Socket-Accessory-Rear*
Location: *Luggage compartment - RH side*

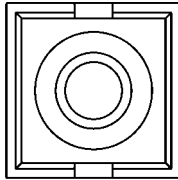

1351144

Colour:
Gender:

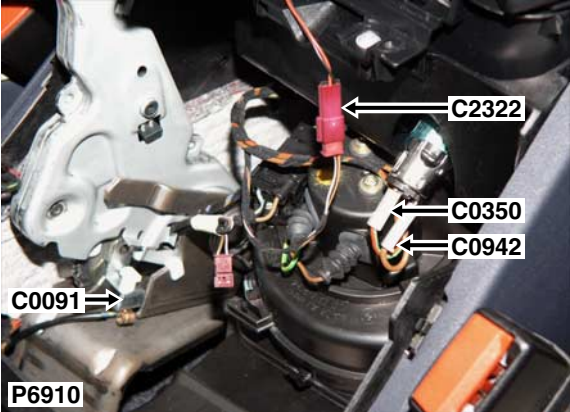

| Cav | Col | Cct |
|-----|-----|-----|
| 1 | RG | 3 |

Description: *Socket-Accessory-Front*
Location: *Beneath centre console*

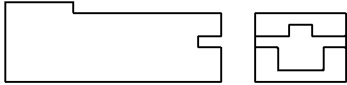

YPC10395

Colour: *WHITE*
Gender: *Female*

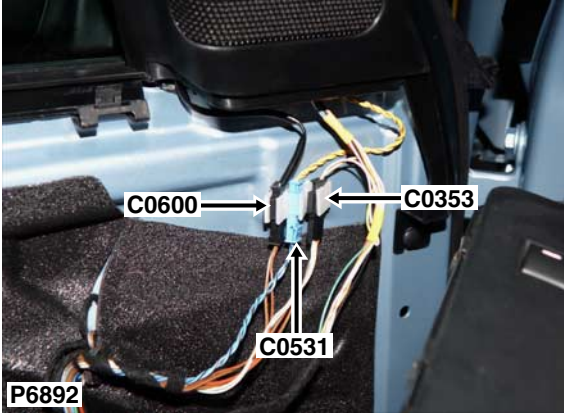

| Cav | Col | Cct |
|-----|-----|-----|
| 1 | WG | 26 |
| 2 | WY | 26 |
| 3 | N | 13 |
| 4 | RG | 13 |

Description: *Mirror-Door-Passenger side*

Location: *Behind passenger's door trim panel*

NO CONNECTOR FACE

Colour:

Gender:



| Cav | Col | Cct |
|-----|-----|-----|
| 1 | RY | ALL |
| 5 | SR | ALL |
| 6 | N | ALL |
| 7 | WN | ALL |
| 8 | RU | ALL |

Description: *Lamp-Interior-Front*
Location: *Front of headlining in the centre*

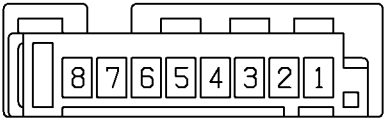

YPC117320

Colour: *BLACK*
Gender: *Female*

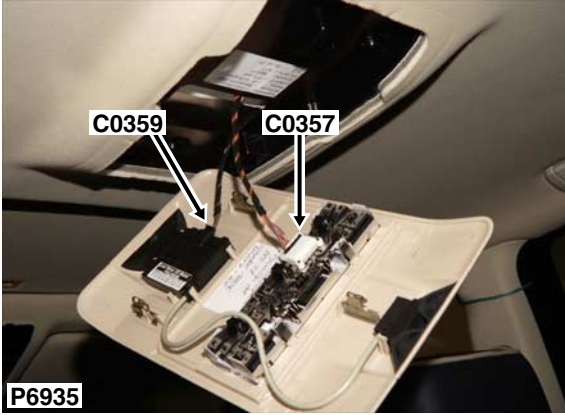

Description: *Lamp-Interior-Rear*
Location: *Behind centre headlining*

| Cav | Col | Cct |
|-----|-----|-----|
| 1 | RY | ALL |
| 5 | SR | ALL |
| 6 | N | ALL |
| 7 | RY | ALL |
| 8 | RU | ALL |

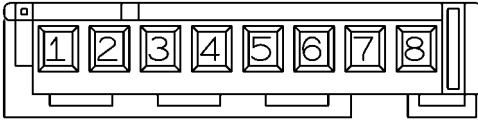

8383296

Colour: *NATURAL*
Gender: *Female*

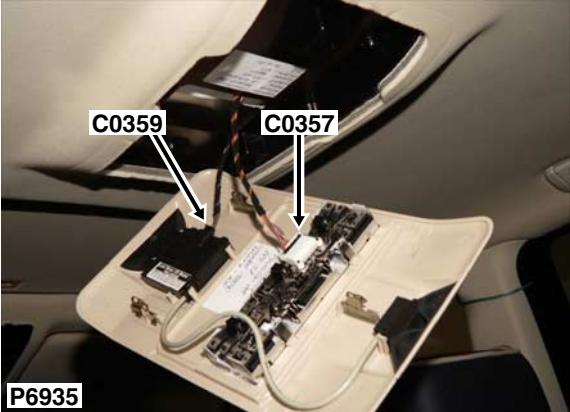

| Cav | Col | Cct |
|-----|-----|-----|
| 1 | NB | ALL |
| 2 | BW | ALL |
| 3 | BY | ALL |
| 4 | RW | ALL |

Description: *Sensor-Volumetric*
Location: *Behind centre headlining*

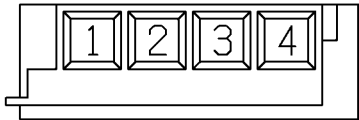

YPC117840

Colour: *BLACK*
Gender: *Female*

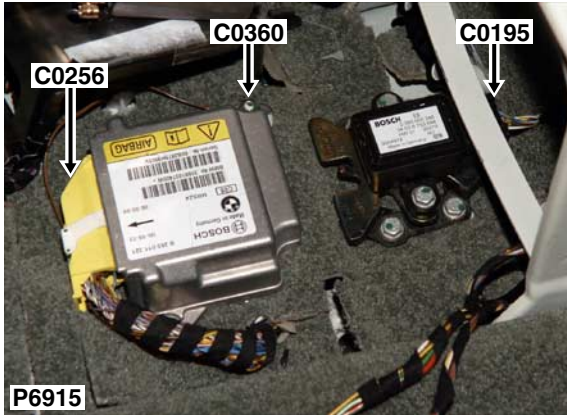

Description: *Earth-SRS*

Location: *Beneath centre console*

| Cav | Col | Cct |
|-----|-----|-----|
| 1 | NB | ALL |

NO CONNECTOR FACE

Colour: *TIN-PLATE*

Gender: *Eyelet*

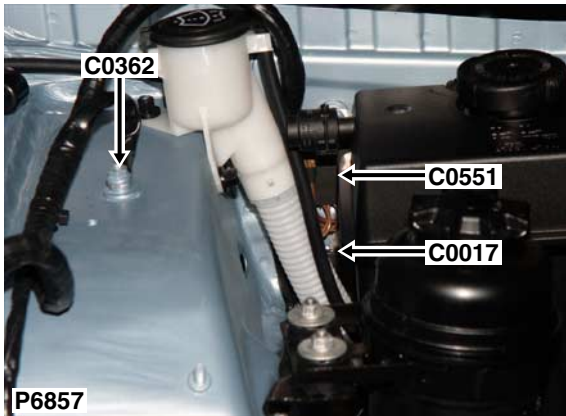

| Cav | Col | Cct |
|-----|-----|-----|
| 1 | N | ALL |
| 2 | N | ALL |

Description: *Earth-ABS*

Location: *Rear LH side of engine compartment*

NO CONNECTOR FACE

Colour: *TIN-PLATE*

Gender: *Eyelet*

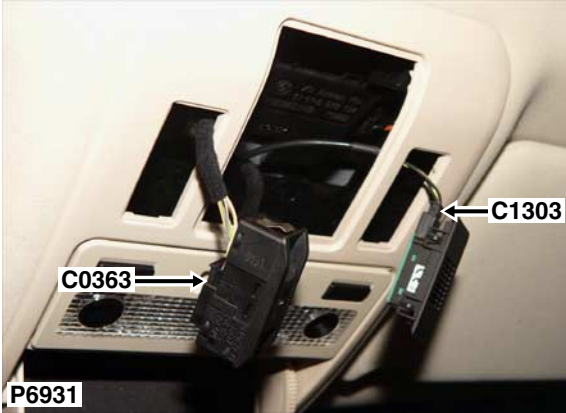

| Cav | Col | Cct |
|-----|-----|-----|
| 2 | SR | 3 |
| 3 | YW | 3 |
| 4 | YG | 3 |
| 5 | SB | 3 |
| 6 | YS | 3 |

Description: *Switch-Sunroof-Front*
Location: *Front of headlining in the centre*

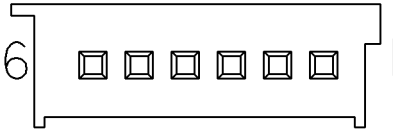

6909052

Colour: *BLACK*
Gender: *Female*

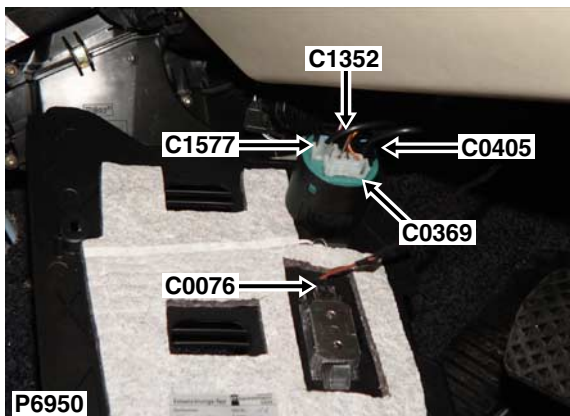

| Cav | Col | Cct |
|-----|-----|-----|
| 1 | NB | ALL |
| 2 | BR | ALL |
| 3 | RY | ALL |

Description: *Speaker-PDC*
 Location: *Driver's footwell*

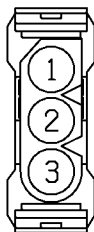

YPC112540

Colour: *NATURAL*
 Gender: *Female*

C0381

CONNECTOR DETAILS

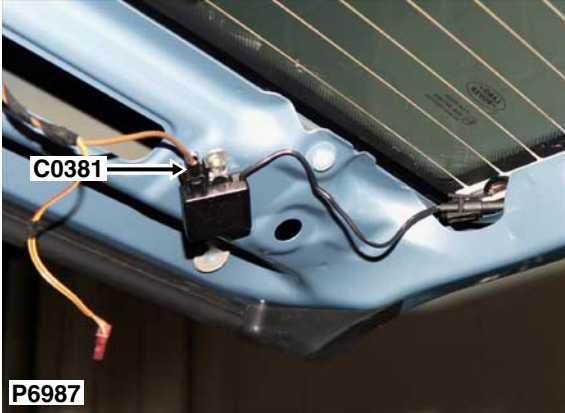

| Cav | Col | Cct |
|-----|-----|-----|
| 1 | B | ALL |

Description: *Heated rear window (HRW)*
Location: *LH side of taildoor*

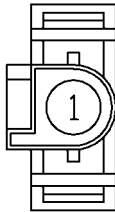

YPC113890

Colour: *BLACK*
Gender: *Female*

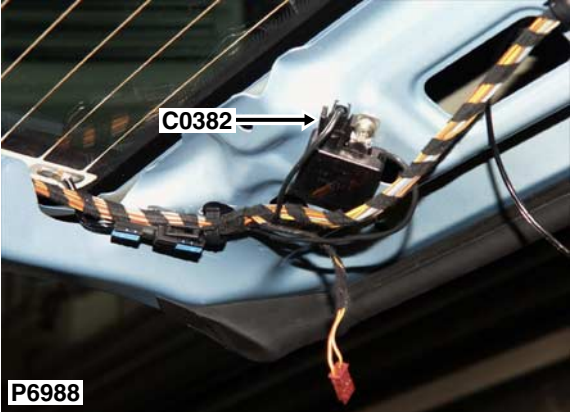

| Cav | Col | Cct |
|-----|-----|-----|
| 1 | N | ALL |

Description: *Heated rear window (HRW)*
Location: *RH side of tail door*

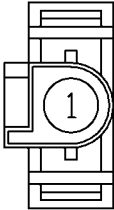

YPC113890

Colour: *BLACK*
Gender: *Female*

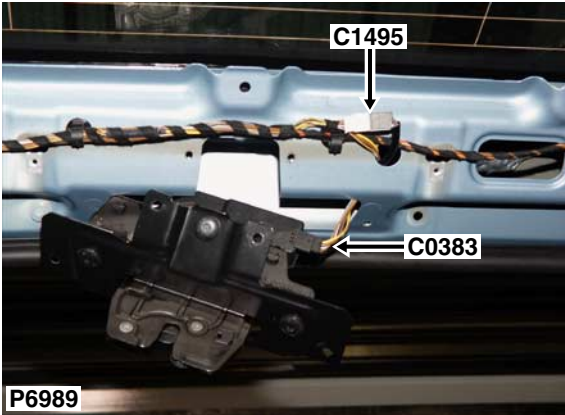

P6989

Description: *Motor-Lock-Tail door*

Location: *Centre of taildoor, behind trim panel*

| Cav | Col | Cct |
|-----|-----|-----|
| 1 | NY | ALL |
| 2 | SW | ALL |
| 3 | N | ALL |
| 4 | YN | ALL |

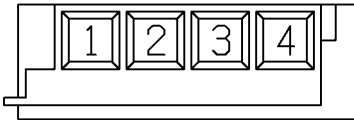

YPC117840

Colour: *BLACK*

Gender: *Female*



| Cav | Col | Cct |
|-----|-----|-----|
| 1 | UY | 3 |
| 2 | UW | 3 |
| 3 | RS | 3 |
| 4 | YB | 3 |
| 5 | N | 3 |
| 6 | WY | 3 |
| 7 | WY | 3 |

Description: Tail door harness to main harness
Location: Rear of luggage compartment

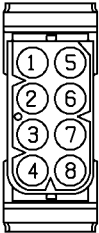

YPC112390

Colour: BLACK
Gender: Female

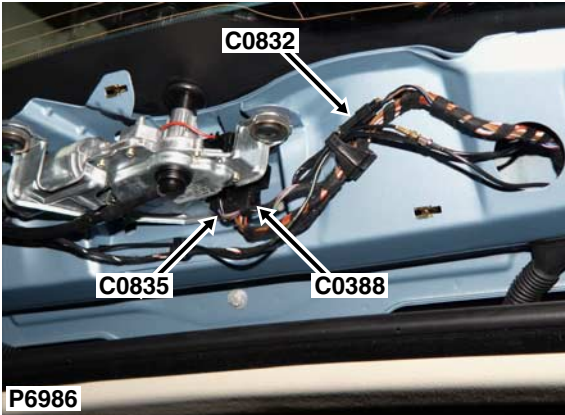

| Cav | Col | Cct |
|-----|-----|-----|
| 1 | N | ALL |
| 2 | RW | ALL |
| 3 | BR | ALL |

Description: *Motor-Wiper-Rear screen*
Location: *Centre of taildoor, behind trim panel*

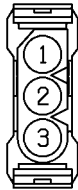

YPC112530

Colour: *BLACK*
Gender: *Female*

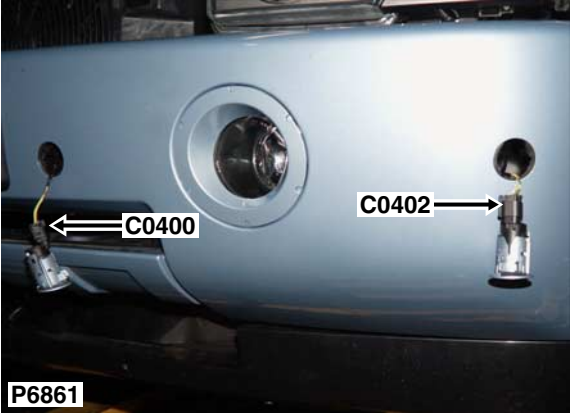

| Cav | Col | Cct |
|-----|-----|-----|
| 1 | GN | 6 |
| 2 | YG | 6 |
| 3 | NB | 6 |

Description: *Sensor-PDC-Inner-Front-LH*
Location: *Behind LH side of front bumper*

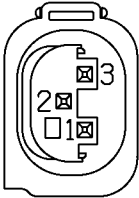

YPC116860

Colour: *GREY*
Gender: *Female*

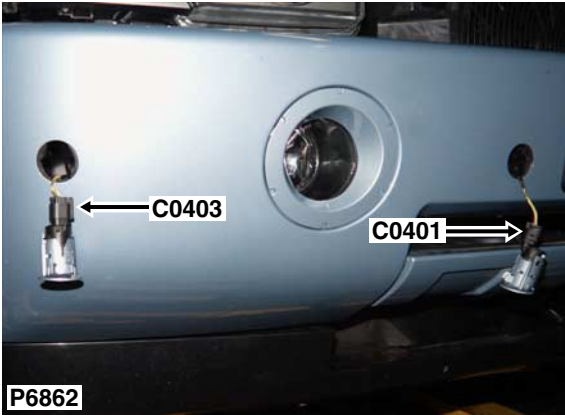

| Cav | Col | Cct |
|-----|-----|-----|
| 1 | GS | 6 |
| 2 | YB | 6 |
| 3 | NU | 6 |

Description: *Sensor-PDC-Inner-Front-RH*
Location: *Behind RH side of front bumper*

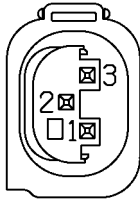

YPC116860

Colour: *GREY*
Gender: *Female*

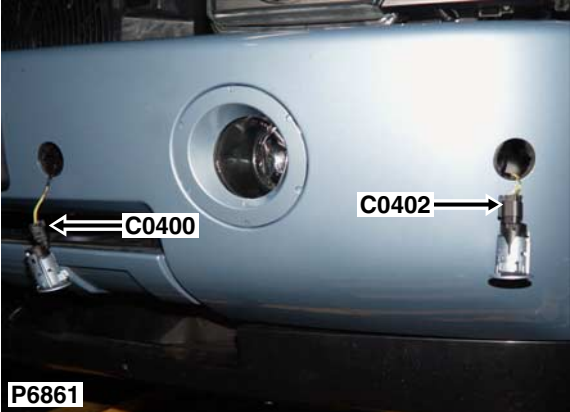

| Cav | Col | Cct |
|-----|-----|-----|
| 1 | GB | 6 |
| 2 | YS | 6 |
| 3 | NW | 6 |

Description: *Sensor-PDC-Outer-Front-LH*
Location: *Behind LH side of front bumper*

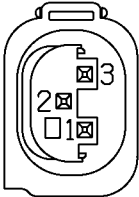

YPC116860

Colour: *GREY*
Gender: *Female*

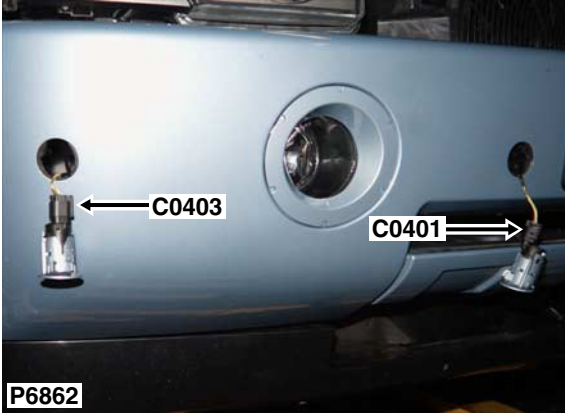

| Cav | Col | Cct |
|-----|-----|-----|
| 1 | GP | 6 |
| 2 | YN | 6 |
| 3 | NY | 6 |

Description: *Sensor-PDC-Outer-Front-RH*
Location: *Behind RH side of front bumper*

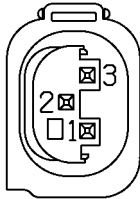

YPC116860

Colour: *GREY*
Gender: *Female*

| Cav | Col | Cct |
|-----|-----|-----|
| 1 | US | 6 |

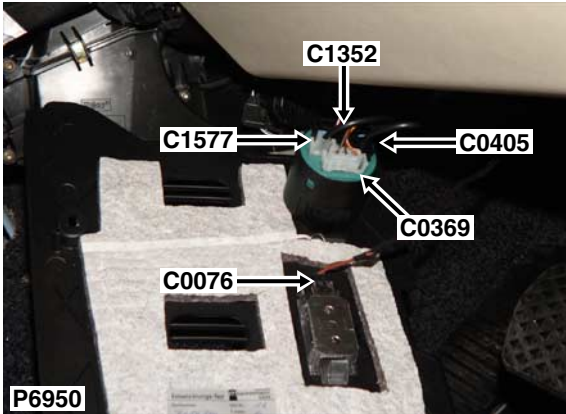

Description: *Speaker-PDC*
 Location: *Driver's footwell*

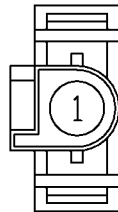

YPC113890

Colour: *BLACK*
 Gender: *Female*

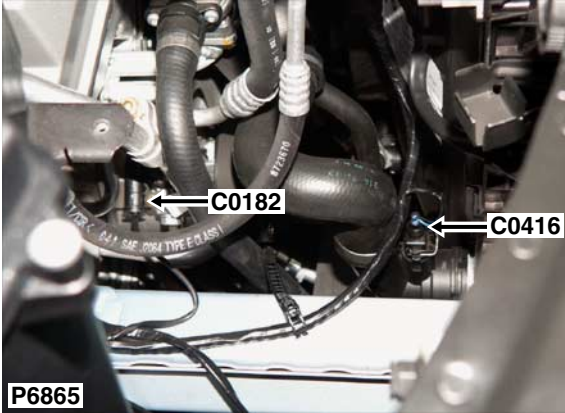

| Cav | Col | Cct |
|-----|-----|-----|
| 1 | US | 2 |
| 2 | NB | 2 |

Description: *Sensor-Temperature-Heater coolant*
Location: *Lower RH front of engine compartment*

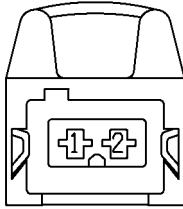

1732460

Colour:
Gender:

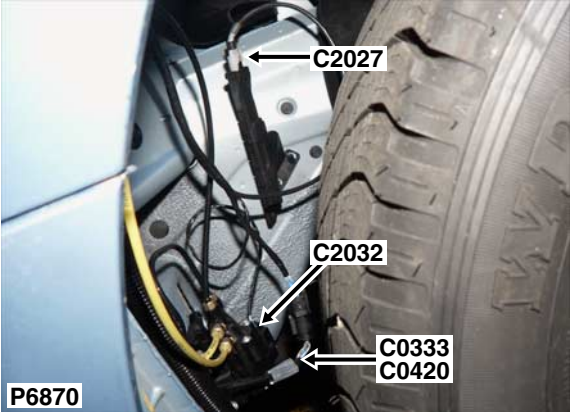

| Cav | Col | Cct |
|-----|-----|-----|
| 1 | UW | 3 |
| 2 | WP | 3 |
| 3 | WR | 3 |
| 4 | YP | 3 |
| 5 | UG | 3 |
| 6 | UB | 3 |
| 7 | UY | 3 |
| 8 | US | 3 |

Description: *Air suspension harness to main harness*
Location: *Behind RH front wheel arch liner*



Colour: *BLACK*
Gender: *Male*

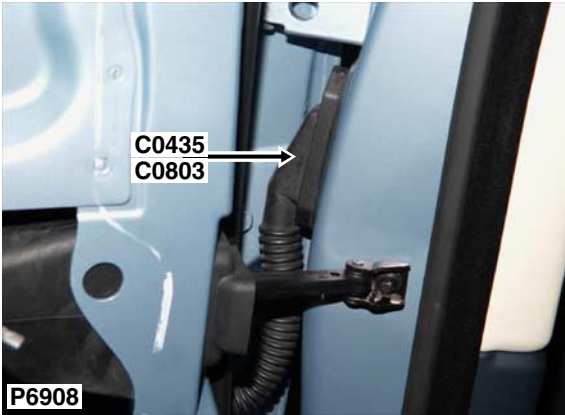

Description: *Main harness to door harness*
 Location: *LH 'C' post*

| Cav | Col | Cct |
|-----|-----|-----|
| 1 | W | ALL |
| 2 | U | ALL |
| 3 | B | ALL |
| 4 | N | ALL |
| 5 | SR | ALL |
| 6 | SN | ALL |
| 7 | SB | ALL |
| 8 | NY | ALL |
| 11 | RU | ALL |
| 12 | NS | ALL |
| 26 | BG | ALL |
| 27 | US | ALL |

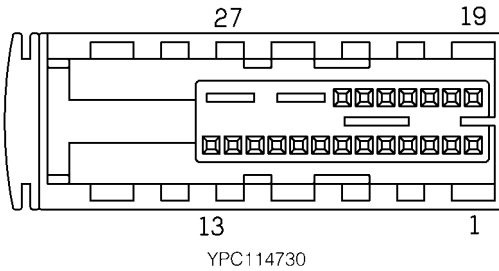

Colour: *BLACK*
 Gender: *Male*



Description: *Main harness to door harness*
 Location: *RH 'C' post*

| Cav | Col | Cct |
|-----|-----|-----|
| 1 | W | ALL |
| 2 | U | ALL |
| 3 | B | ALL |
| 4 | N | ALL |
| 5 | SR | ALL |
| 6 | SY | ALL |
| 7 | SU | ALL |
| 8 | NR | ALL |
| 11 | RU | ALL |
| 12 | NW | ALL |
| 26 | BN | ALL |
| 27 | UP | ALL |

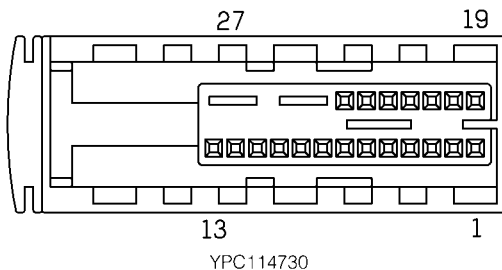

Colour: *BLACK*
 Gender: *Male*

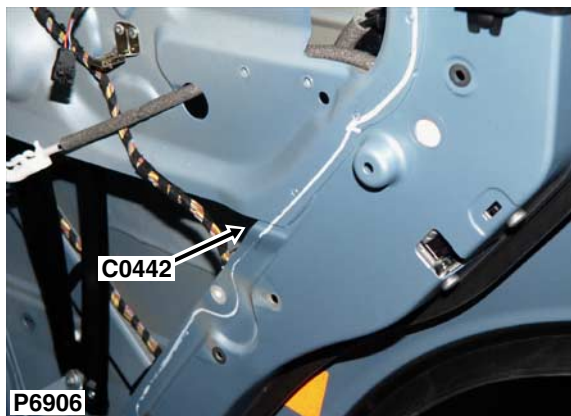

Description: *Motor-Door lock-Rear*

Location: *Behind rear door trim panel*

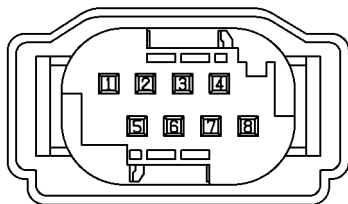

YPC110420

Colour: *BLUE*

Gender: *Female*

| Cav | Col | Cct |
|-----|-----|-----|
| 4 | W | 3 |
| 5 | N | 12 |
| 6 | NS | 12 |
| 7 | U | 3 |
| 8 | B | 3 |

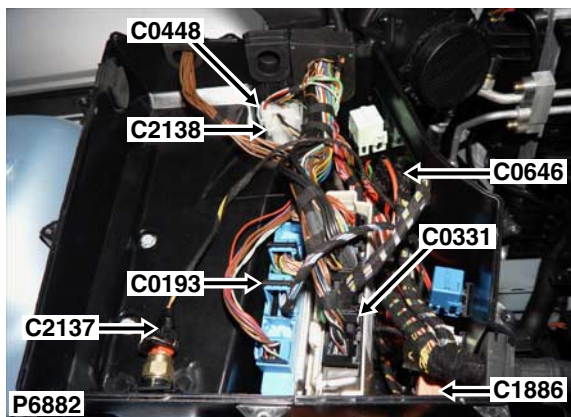

| Cav | Col | Cct |
|-----|-----|-----|
| 1 | B | ALL |
| 2 | RY | 1 |
| 3 | G | 2 |
| 4 | WPY | 2 |
| 6 | GW | ALL |
| 7 | RW | ALL |
| 10 | NP | ALL |
| 11 | NY | ALL |
| 12 | GR | 1 |

Description: *Main harness to engine harness - V8*

Location: *Inside E-box*

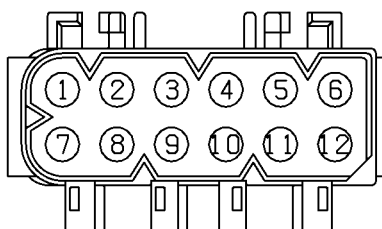

YPC112190

Colour: *NATURAL*

Gender: *Male*



| Cav | Col | Cct |
|-----|-----|-----|
| 1 | N | 3 |
| 2 | WY | 3 |

Description: *Lamp-Reverse-RH*
 Location: *RH rear of vehicle*

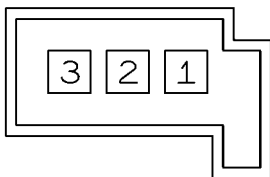

6905979

Colour:
 Gender:

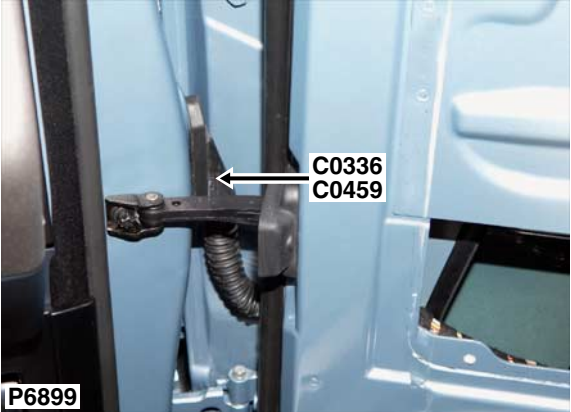

| Cav | Col | Cct |
|-----|-----|-----|
| 1 | YG | ALL |
| 5 | SR | ALL |
| 9 | Y | ALL |
| 10 | N | ALL |
| 11 | RU | ALL |
| 19 | RG | 12 |
| 20 | WR | 26 |
| 21 | WU | 26 |
| 23 | UR | ALL |
| 26 | N | ALL |
| 27 | RP | ALL |

Description: *Main harness to door harness*
Location: *Base of driver side 'A' post*

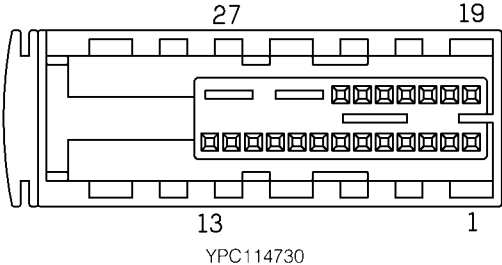

Colour: *BLACK*
Gender: *Male*

C0463

CONNECTOR DETAILS

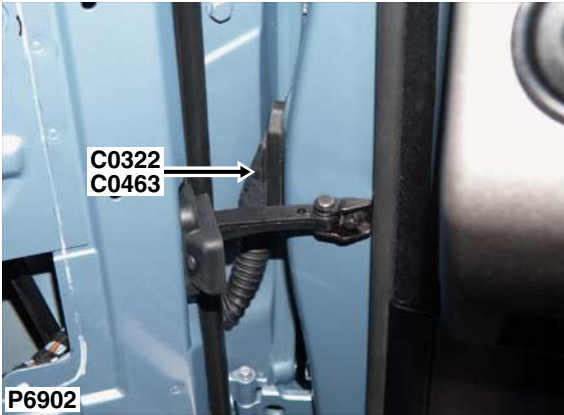

| Cav | Col | Cct |
|-----|-----|-----|
| 5 | SR | ALL |
| 9 | U | ALL |
| 10 | N | ALL |
| 11 | RU | ALL |
| 19 | RG | 12 |
| 20 | WG | 26 |
| 21 | WY | 26 |
| 23 | UR | ALL |
| 26 | N | ALL |
| 27 | RW | ALL |

Description: *Main harness to door harness*
 Location: *Base of passenger side 'A' post*

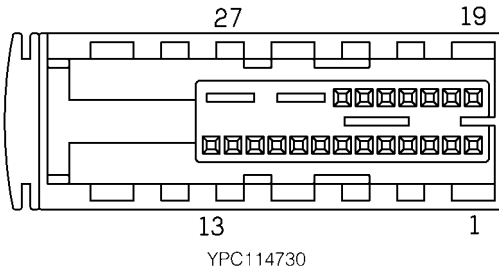

Colour: *BLACK*
 Gender: *Male*



| Cav | Col | Cct |
|-----|-----|-----|
| 1 | N | 3 |
| 2 | WY | 3 |

P6967

Description: *Lamp-Reverse-LH*

Location: *LH rear of vehicle*



Colour:

Gender:

C0473

CONNECTOR DETAILS

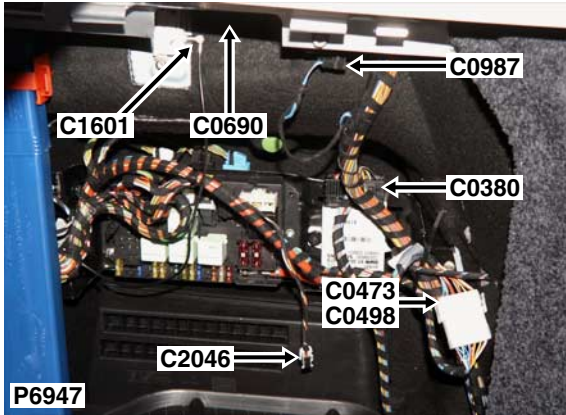

Description: *Main harness to trailer harness*

Location: *Rear of luggage compartment - RH side*

| Cav | Col | Cct |
|-----|-----|-----|
| 1 | RW | ALL |
| 2 | GY | ALL |
| 3 | RY | ALL |
| 4 | RU | ALL |
| 5 | UNY | ALL |
| 6 | UG | ALL |
| 8 | SB | 27 |
| 9 | UN | ALL |
| 10 | BU | 29 |
| 11 | SW | 29 |
| 12 | SP | 29 |

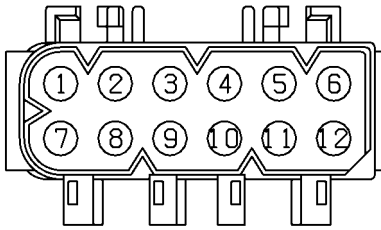

YPC112190

Colour: *NATURAL*

Gender: *Male*

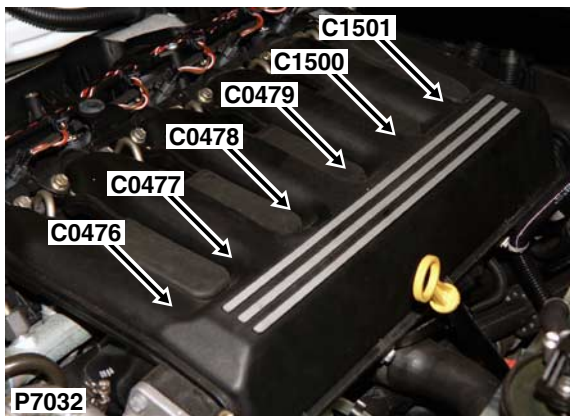

| Cav | Col | Cct |
|-----|-----|-----|
| 1 | BG | 3 |

Description: *Glow plug - Td6*

Location: *LH side of engine*

NO CONNECTOR FACE

Colour:

Gender:

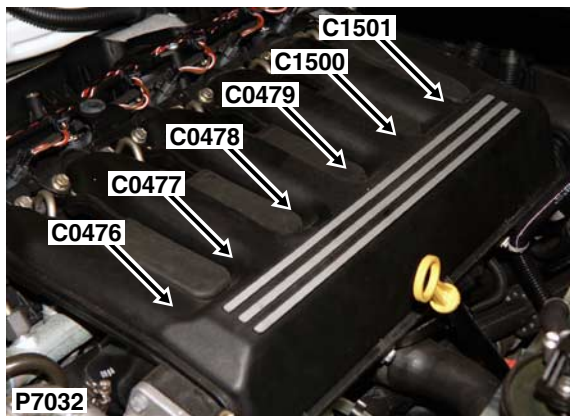

Description: *Glow plug - Td6*
Location: *LH side of engine*

| Cav | Col | Cct |
|-----|-----|-----|
| 1 | BP | 3 |

NO CONNECTOR FACE

Colour:
Gender:

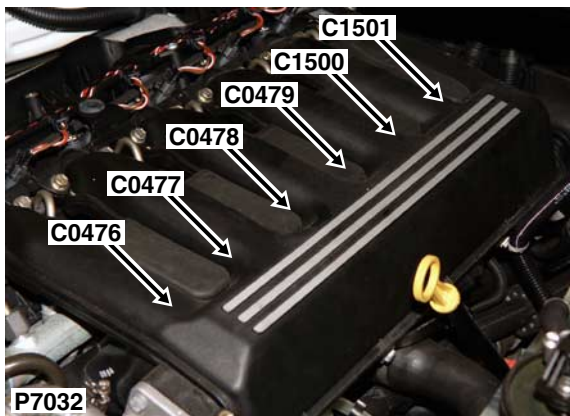

Description: *Glow plug - Td6*

Location: *LH side of engine*

| Cav | Col | Cct |
|-----|-----|-----|
| 1 | BY | 3 |

NO CONNECTOR FACE

Colour:

Gender:

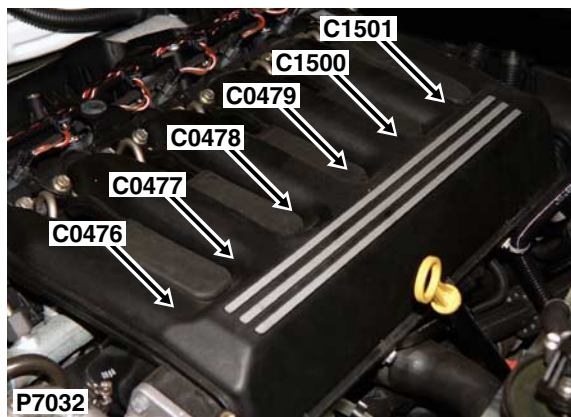

Description: *Glow plug - Td6*
Location: *LH side of engine*

| Cav | Col | Cct |
|-----|-----|-----|
| 1 | BR | 3 |

NO CONNECTOR FACE

Colour:
Gender:

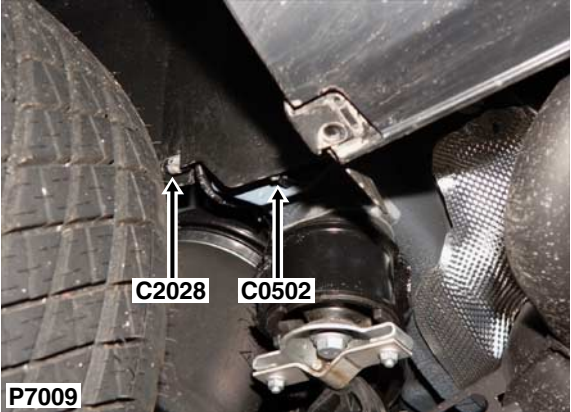

| Cav | Col | Cct |
|-----|-----|-----|
| 1 | W | ALL |
| 2 | UW | ALL |

Description: *Sensor-ABS-Rear-LH*
Location: *Below LH rear wheelarch*

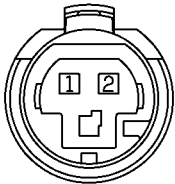

YPC110510

Colour: *BLUE*
Gender: *Female*

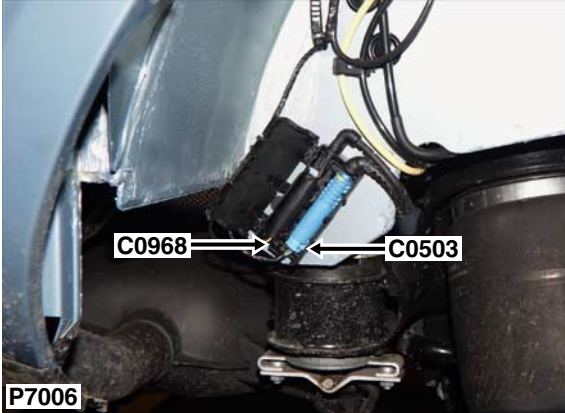

| Cav | Col | Cct |
|-----|-----|-----|
| 1 | G | ALL |
| 2 | UG | ALL |

Description: *Sensor-ABS-Rear-RH*
Location: *Below RH rear wheelarch*

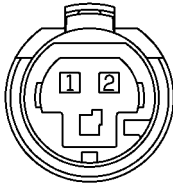

YPC110510

Colour: *BLUE*
Gender: *Female*

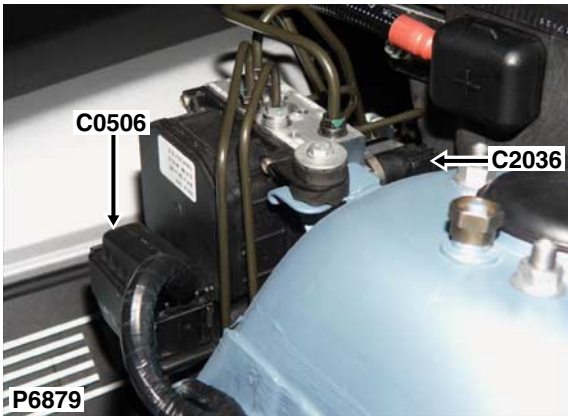

Description: *ECU-ABS*

Location: *Rear LH side of engine compartment*

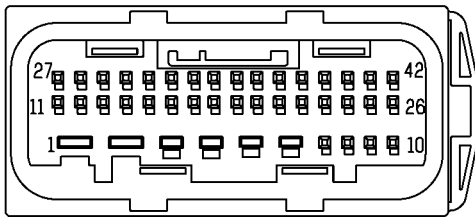

6908994

Colour:

Gender:

| Cav | Col | Cct |
|-----|-----|-----|
| 1 | N | ALL |
| 2 | R | ALL |
| 3 | BG | ALL |
| 4 | BN | ALL |
| 5 | N | ALL |
| 6 | RB | ALL |
| 7 | YN | ALL |
| 8 | NBY | ALL |
| 9 | WRY | ALL |
| 10 | WUY | ALL |
| 11 | WP | ALL |
| 12 | R | ALL |
| 13 | UW | ALL |
| 14 | UG | ALL |
| 15 | UY | ALL |
| 16 | Y | ALL |
| 17 | BG | ALL |
| 18 | YW | 22 |
| 19 | YG | ALL |
| 20 | SB | ALL |
| 21 | UWY | ALL |
| 23 | RW | ALL |
| 24 | YB | 1 |
| 25 | WU | ALL |
| 26 | UB | ALL |
| 27 | BY | ALL |
| 28 | UR | ALL |
| 29 | W | ALL |
| 31 | G | ALL |
| 32 | UR | ALL |
| 34 | NR | ALL |
| 35 | YR | 15 |
| 36 | NGY | ALL |
| 39 | WSY | ALL |
| 40 | YN | 1 |
| 41 | BRY | ALL |
| 42 | BP | ALL |

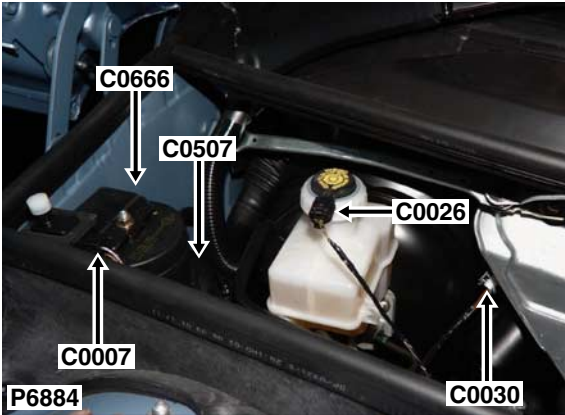

| Cav | Col | Cct |
|-----|-----|-----|
| 1 | BN | ALL |
| 2 | BG | ALL |

Description: *Pump-Return-ABS*

Location: *Rear of engine compartment*

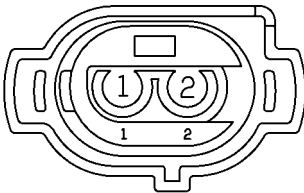

YPC110300

Colour: *BLACK*
 Gender: *Female*



| Cav | Col | Cct |
|-----|-----|-----|
| 1 | N | ALL |
| 2 | YN | ALL |

P6851

Description: *Lamp-Fog-Front-RH*
Location: *Front of vehicle - RH side*

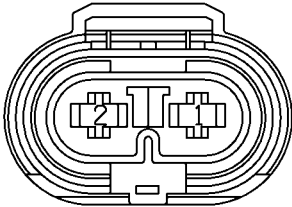

YPC118750

Colour: *GREY*
Gender: *Female*



| Cav | Col | Cct |
|-----|-----|-----|
| 1 | N | ALL |
| 2 | YR | ALL |

Description: *Lamp-Fog-Front-LH*

Location: *Front of vehicle - LH side*

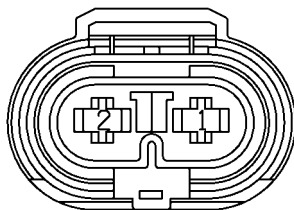

YPC118750

Colour: *GREY*

Gender: *Female*

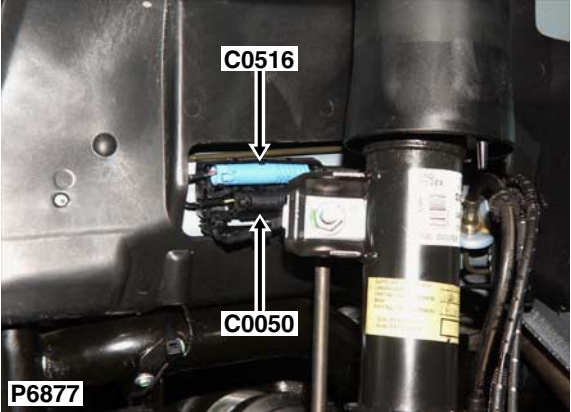

| Cav | Col | Cct |
|-----|-----|-----|
| 1 | R | ALL |
| 2 | UR | ALL |

Description: *Sensor-ABS-Front-LH*
Location: *Behind LH front wheel arch liner*

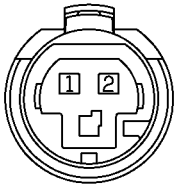

YPC110510

Colour: *BLUE*
Gender: *Female*

C0517

CONNECTOR DETAILS



Description: *Sensor-ABS-Front-RH*
Location: *Behind RH front wheel arch liner*

| Cav | Col | Cct |
|-----|-----|-----|
| 1 | Y | ALL |
| 2 | UY | ALL |

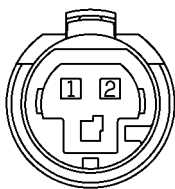

YPC110510

Colour: *BLUE*
Gender: *Female*

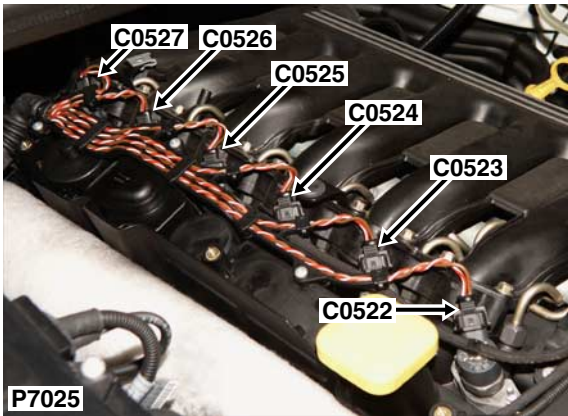

Description: *Fuel injector-No.1 - Td6*
 Location: *Top of engine*

| Cav | Col | Cct |
|-----|-----|-----|
| 1 | RW | 3 |
| 2 | N | 3 |
| 2 | NW | 3 |

NO CONNECTOR FACE

Colour: *BLACK*
 Gender: *Female*

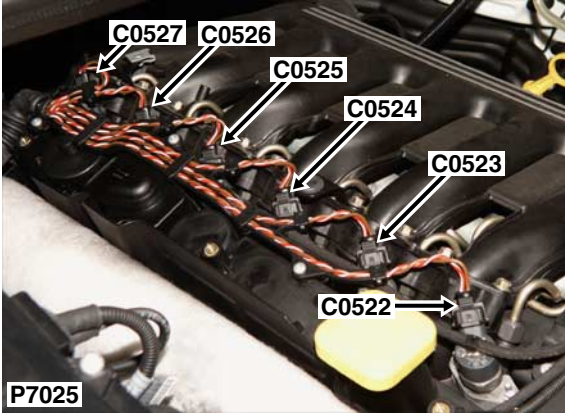

Description: *Fuel injector-No.2 - Td6*
Location: *Top of engine*

| Cav | Col | Cct |
|-----|-----|-----|
| 1 | RW | 3 |
| 2 | N | 3 |
| 2 | NY | 3 |

NO CONNECTOR FACE

Colour: *BLACK*
Gender: *Female*

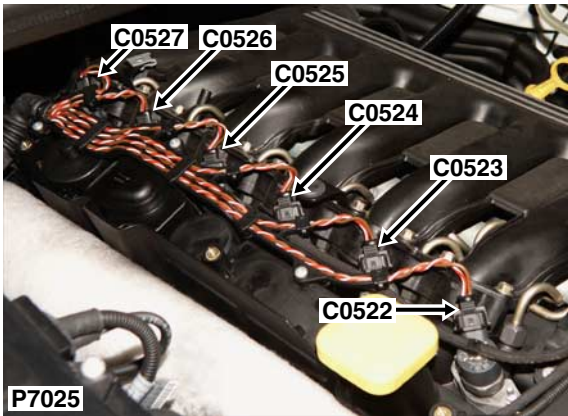

Description: *Fuel injector-No.3 - Td6*
Location: *Top of engine*

| Cav | Col | Cct |
|-----|-----|-----|
| 1 | RW | 3 |
| 2 | NG | 3 |
| 2 | N | 3 |

NO CONNECTOR FACE

Colour: *BLACK*
Gender: *Female*

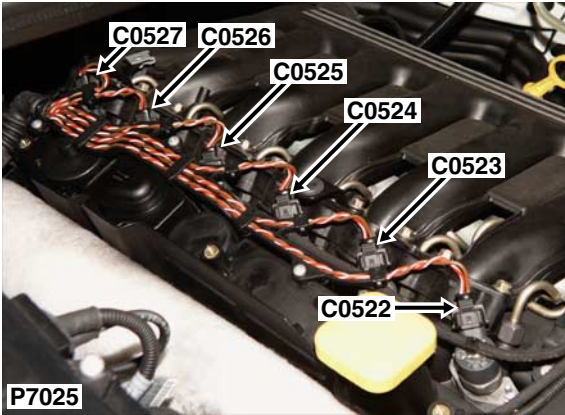

Description: *Fuel injector-No.4 - Td6*

Location: *Top of engine*

| Cav | Col | Cct |
|-----|-----|-----|
| 1 | RW | 3 |
| 2 | N | 3 |
| 2 | NU | 3 |

NO CONNECTOR FACE

Colour: *BLACK*
Gender: *Female*

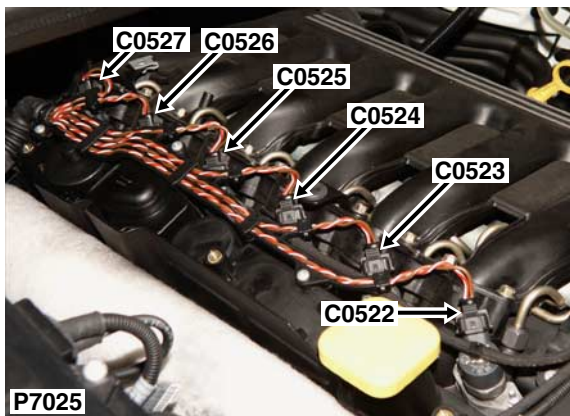

Description: *Fuel injector-No.5 - Td6*

Location: *Top of engine*

| Cav | Col | Cct |
|-----|-----|-----|
| 1 | RW | 3 |
| 2 | O | 3 |
| 2 | N | 3 |

NO CONNECTOR FACE

Colour: *BLACK*

Gender: *Female*

C0527

CONNECTOR DETAILS

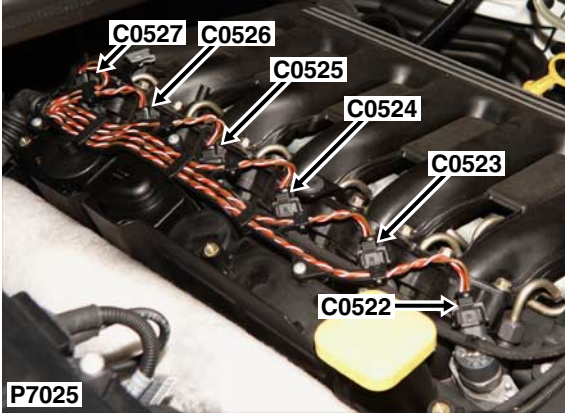

Description: *Fuel injector-No.6*

Location: *Top of engine*

| Cav | Col | Cct |
|-----|-----|-----|
| 1 | RW | 3 |
| 2 | N | 1 |
| 2 | NS | 2 |

NO CONNECTOR FACE

Colour: *BLACK*
Gender: *Female*

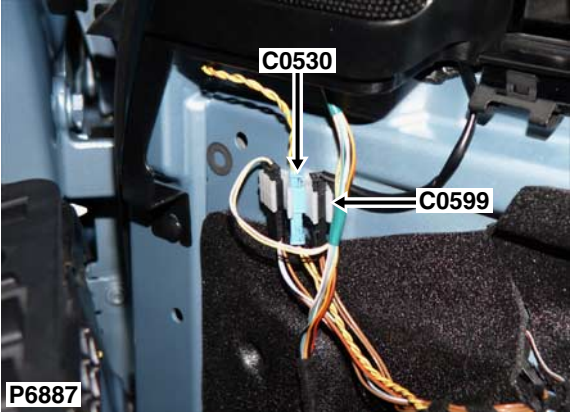

| Cav | Col | Cct |
|-----|-----|-----|
| 1 | YN | 28 |
| 2 | YR | 28 |

Description: *Speakers-High Range*
Location: *Behind driver's door trim panel*

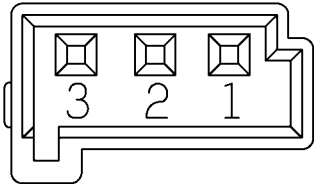

6905981

Colour:
Gender:

C0531

CONNECTOR DETAILS

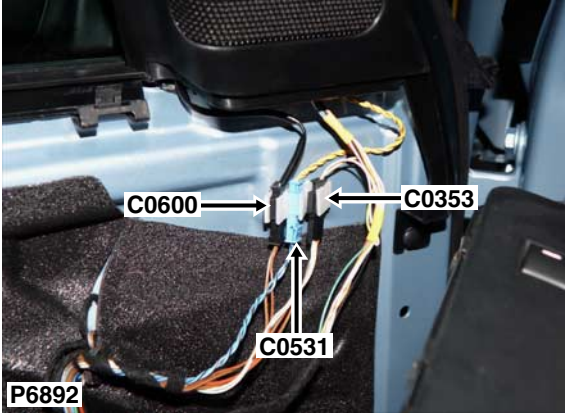

| Cav | Col | Cct |
|-----|-----|-----|
| 1 | UN | 28 |
| 2 | UB | 28 |

Description: *Speakers-High Range*

Location: *Behind passenger's door trim panel*

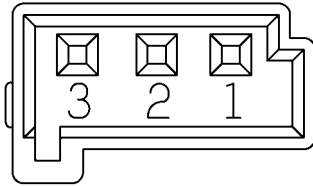

6905981

Colour:
Gender:

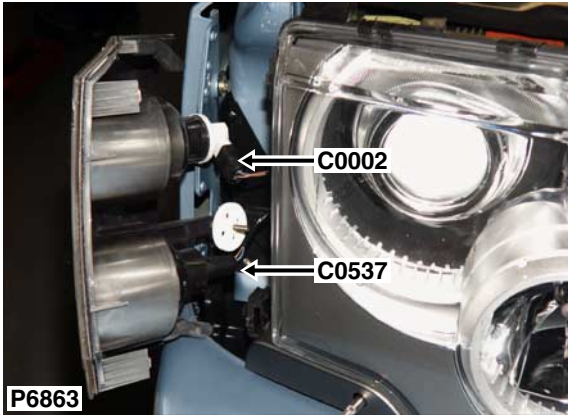

| Cav | Col | Cct |
|-----|-----|-----|
| 1 | N | ALL |
| 2 | SU | ALL |

Description: *Lamp-Side-Front-RH*

Location: *Behind RH side of front bumper*

NO CONNECTOR FACE

Colour:

Gender:

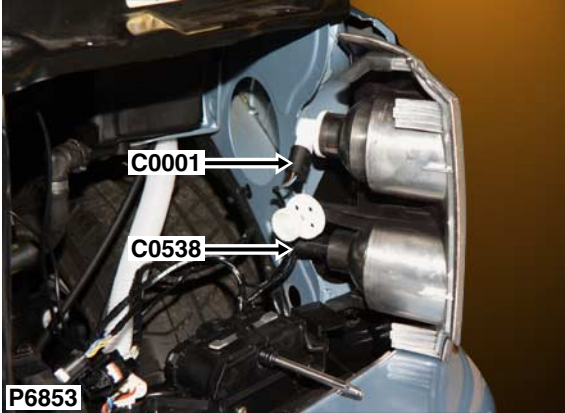

| Cav | Col | Cct |
|-----|-----|-----|
| 1 | N | ALL |
| 2 | SG | ALL |

Description: *Lamp-Side-Front-LH*

Location: *Behind LH side of front bumper*

NO CONNECTOR FACE

Colour:

Gender:

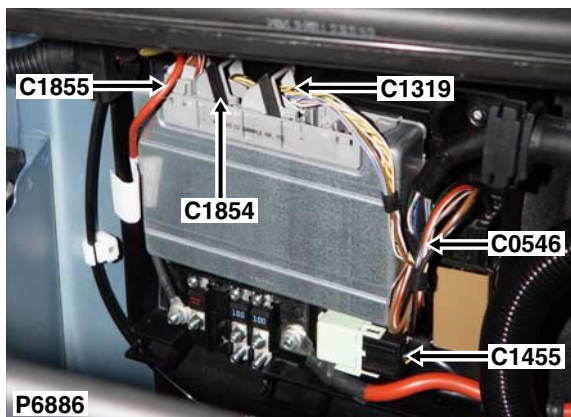

Description: *ECU-Delay-Windscreen wiper*
 Location: *Rear LH side of engine compartment*

| Cav | Col | Cct |
|-----|-----|-----|
| 1 | NU | ALL |
| 2 | RW | ALL |
| 3 | NW | ALL |
| 4 | BG | ALL |
| 5 | N | ALL |
| 6 | BN | ALL |

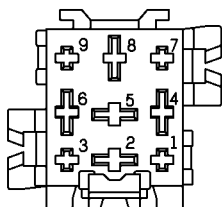

YPP100210

Colour: *BLACK*
 Gender: *Female*

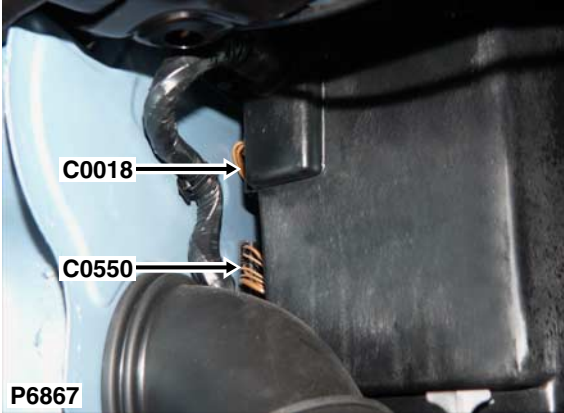

| Cav | Col | Cct |
|-----|-----|-----|
| 0 | N | ALL |

Description: *Earth*

Location: *Front RH side of engine compartment*

NO CONNECTOR FACE

Colour: *TIN-PLATE*

Gender: *Male*

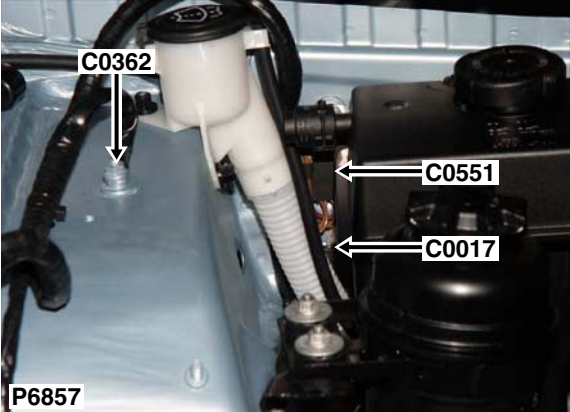

| Cav | Col | Cct |
|-----|-----|-----|
| 0 | N | ALL |

Description: *Header -Earth*
Location: *Front LH side of engine compartment*



Colour: *TIN-PLATE*
Gender: *Male*

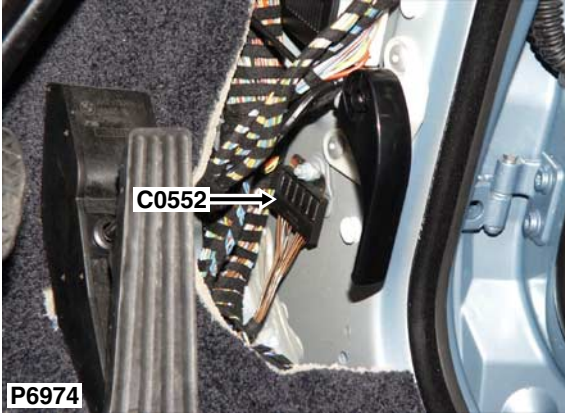

| Cav | Col | Cct |
|-----|-----|-----|
| 0 | NB | ALL |

Description: *Header -Earth*

Location: *Base of RH 'A' post*

NO CONNECTOR FACE

Colour: *TIN-PLATE*

Gender: *Male*



| Cav | Col | Cct |
|-----|-----|-----|
| 0 | N | ALL |

Description: *Header -Earth*
Location: *Beneath LH seat*



Colour: *TIN-PLATE*
Gender: *Male*

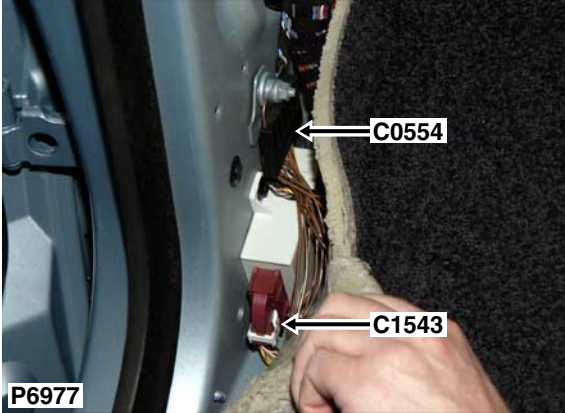

| Cav | Col | Cct |
|-----|-----|-----|
| 0 | NB | ALL |

Description: *Header -Earth*

Location: *Beneath footwell carpet - LH side*

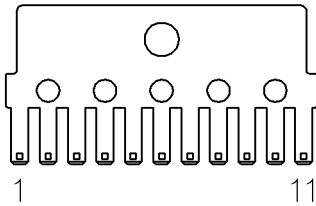

YQC100970

Colour: *TIN-PLATE*

Gender: *Male*

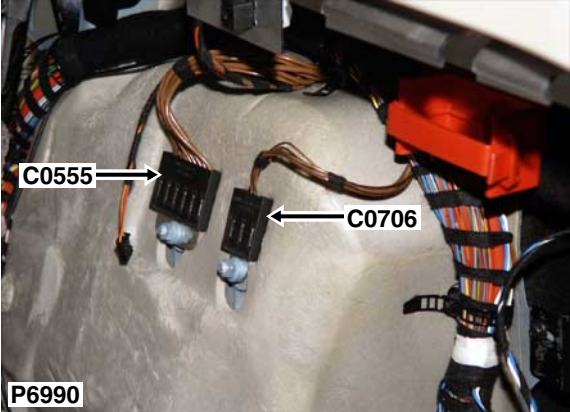

| Cav | Col | Cct |
|-----|-----|-----|
| 0 | N | ALL |

Description: *Header -Earth*
Location: *Luggage compartment - RH side*



Colour: *TIN-PLATE*
Gender: *Male*

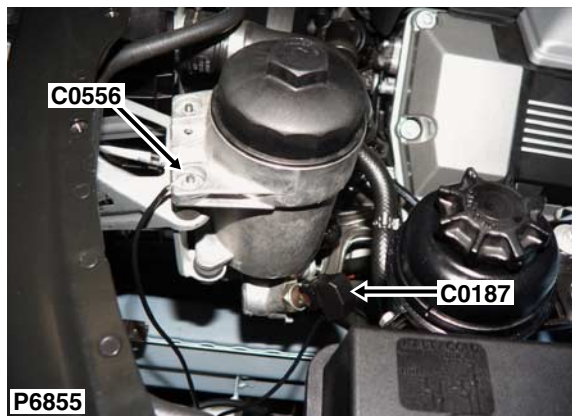

| Cav | Col | Cct |
|-----|-----|-----|
| 1 | NB | 2 |

Description: *Earth*

Location: *Front LH side of engine compartment*

NO CONNECTOR FACE

Colour: *TIN-PLATE*

Gender: *Eyelet*



| Cav | Col | Cct |
|-----|-----|-----|
| 1 | NO | 3 |

Description: *Earth*

Location: *RH side of engine compartment*

NO CONNECTOR FACE

Colour: *TIN-PLATE*

Gender: *Eyelet*

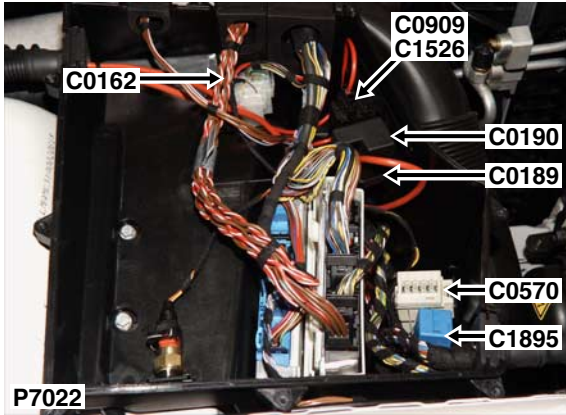

Description: *Holder-Fuse - Td6*

Location: *Inside E-box*

| Cav | Col | Cct |
|-----|-----|-----|
| 2 | RW | 3 |
| 4 | RW | 3 |
| 6 | RU | 3 |

NO CONNECTOR FACE

Colour:
Gender:

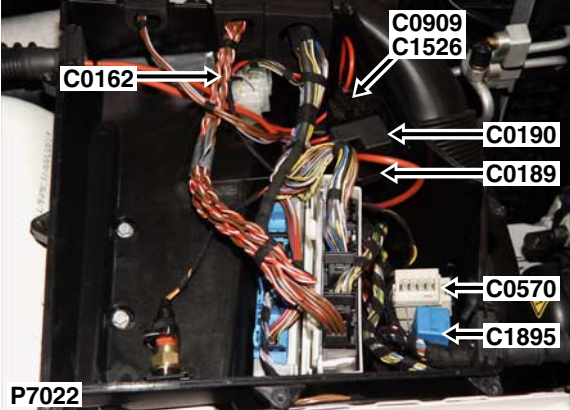

Description: *Holder-Fuse - V8*
Location: *Inside E-box*

| Cav | Col | Cct |
|-----|-----|-----|
| 2 | RU | 3 |
| 4 | RW | 3 |
| 6 | GW | 3 |
| 8 | R | 3 |
| 10 | R | 3 |

NO CONNECTOR FACE

Colour:
Gender:

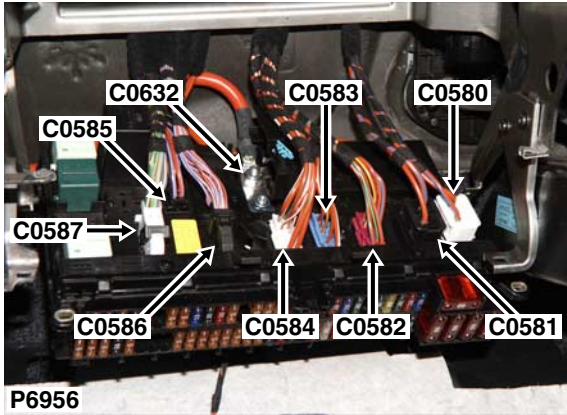

P6956

Description: *Fuse box-Passenger compartment*

Location: *Behind glovebox*

| Cav | Col | Cct |
|-----|-----|-----|
| 1 | R | ALL |
| 2 | RU | ALL |

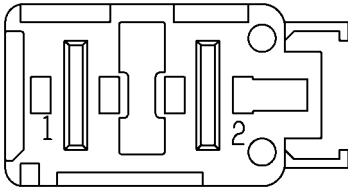

8380404

Colour:
Gender:

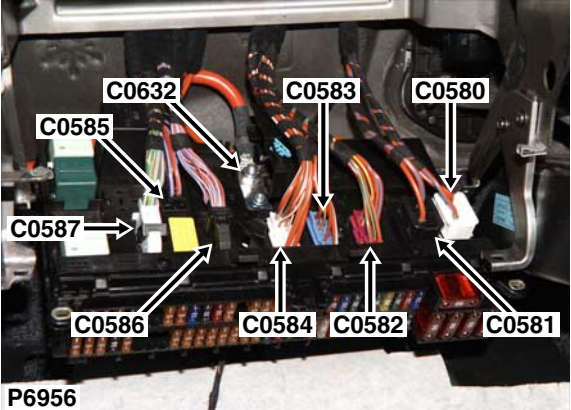

| Cav | Col | Cct |
|-----|-----|-----|
| 1 | RU | ALL |
| 2 | R | 2 |

Description: Fuse box-Passenger compartment
Location: Behind glovebox

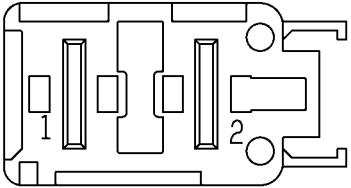

8380402

Colour: BLACK
Gender: Female

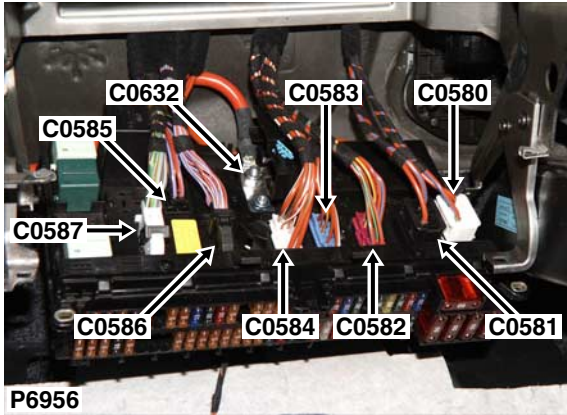

P6956

Description: *Fuse box-Passenger compartment*

Location: *Behind glovebox*

| Cav | Col | Cct |
|-----|-----|-----|
| 1 | RP | ALL |
| 2 | RY | ALL |
| 3 | RN | ALL |
| 4 | RS | 21 |
| 5 | RW | ALL |
| 7 | RY | 8 |
| 8 | RU | 18 |
| 9 | GB | 25 |
| 10 | RS | 3 |

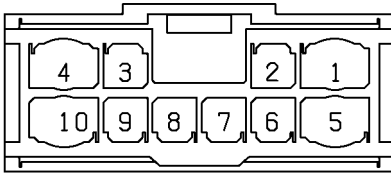

6901810

Colour:
Gender:

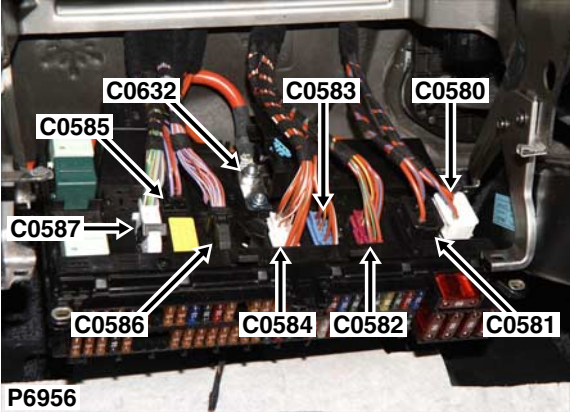

| Cav | Col | Cct |
|-----|-----|-----|
| 1 | RW | ALL |
| 2 | RY | 1 |
| 3 | RU | 2 |
| 4 | RB | ALL |
| 5 | R | ALL |
| 6 | RN | ALL |
| 8 | RY | ALL |
| 9 | RY | 17 |
| 10 | RW | ALL |

Description: Fuse box-Passenger compartment
Location: Behind glovebox

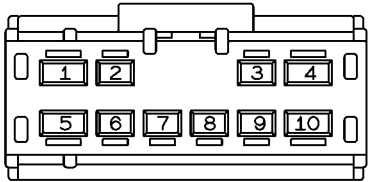

6901808

Colour: BLUE
Gender: Female

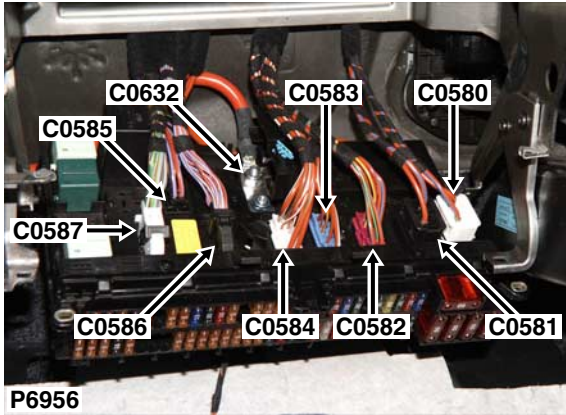

P6956
 Description: *Fuse box-Passenger compartment*
 Location: *Behind glovebox*

| Cav | Col | Cct |
|-----|-----|-----|
| 1 | RW | ALL |
| 2 | RW | ALL |
| 4 | RG | ALL |
| 5 | RN | 17 |
| 6 | RW | ALL |
| 7 | RW | 2 |
| 8 | RY | ALL |
| 10 | RN | 17 |

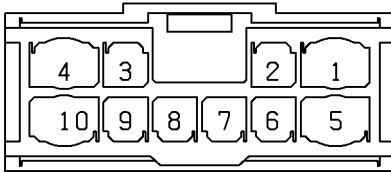

6901806

Colour: *NATURAL*
 Gender: *Female*

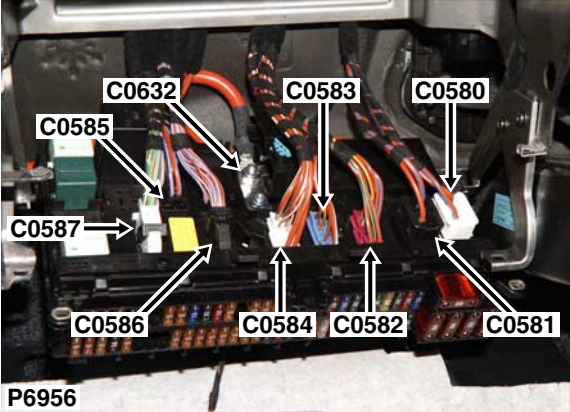

Description: Fuse box-Passenger compartment
Location: Behind glovebox

| Cav | Col | Cct |
|-----|-----|-----|
| 1 | RP | ALL |
| 2 | RW | ALL |
| 3 | PS | ALL |
| 4 | BG | ALL |
| 5 | PB | ALL |
| 6 | GR | 22 |
| 7 | RU | ALL |
| 8 | N | ALL |
| 9 | PS | ALL |
| 10 | G | ALL |

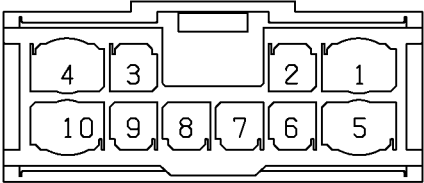

6901804

Colour: BLACK
Gender: Female

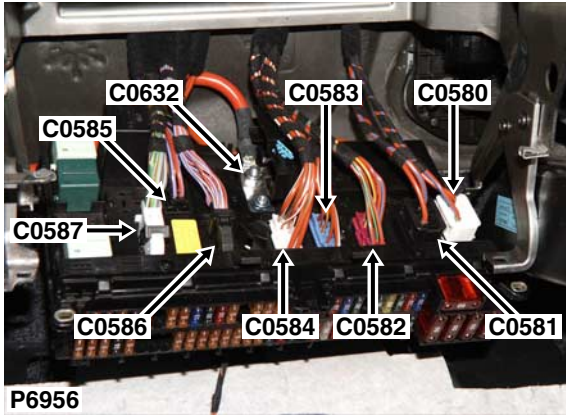

Description: *Fuse box-Passenger compartment*
 Location: *Behind glovebox*

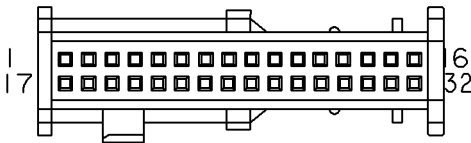

8373646

Colour: *BLACK*
 Gender: *Female*

| Cav | Col | Cct |
|-----|-----|-----|
| 1 | RU | ALL |
| 2 | RU | ALL |
| 3 | RU | ALL |
| 4 | RY | ALL |
| 5 | RG | ALL |
| 6 | PR | ALL |
| 7 | RP | ALL |
| 8 | PS | ALL |
| 9 | PS | ALL |
| 10 | RY | 27 |
| 11 | RG | ALL |
| 12 | RN | ALL |
| 13 | RY | ALL |
| 14 | PU | ALL |
| 15 | PG | ALL |
| 17 | SY | ALL |
| 18 | RU | ALL |
| 19 | RU | ALL |
| 20 | RY | ALL |
| 21 | PR | 14 |
| 22 | PW | ALL |
| 23 | RNY | 23 |
| 24 | PG | ALL |
| 25 | RS | ALL |
| 26 | RUY | ALL |
| 27 | RW | ALL |
| 28 | RB | ALL |
| 29 | PG | 16 |
| 32 | PG | 27 |

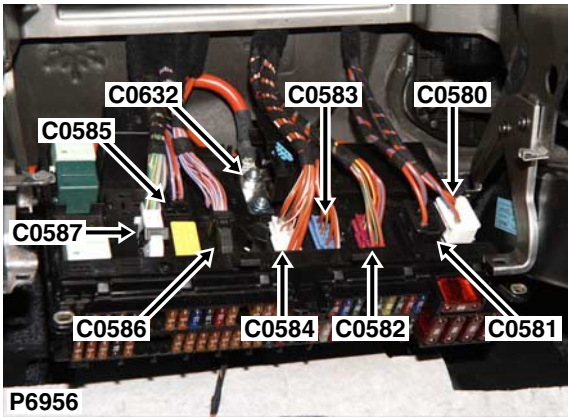

Description: *Fuse box-Passenger compartment*
 Location: *Behind glovebox*

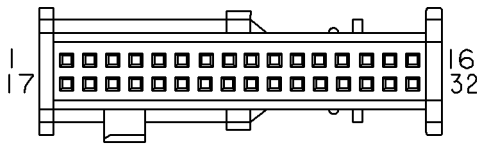

8383274

Colour: *NATURAL*
 Gender: *Female*

| Cav | Col | Cct |
|-----|-----|-----|
| 1 | RG | 12 |
| 2 | NR | ALL |
| 3 | GU | ALL |
| 4 | GB | 1 |
| 5 | GB | ALL |
| 6 | GY | ALL |
| 7 | GR | 22 |
| 8 | PY | ALL |
| 9 | GR | 1 |
| 10 | GP | ALL |
| 11 | GS | ALL |
| 12 | GY | ALL |
| 13 | GW | ALL |
| 14 | GW | ALL |
| 15 | GN | 23 |
| 16 | GBY | ALL |
| 17 | RG | 12 |
| 19 | GU | ALL |
| 20 | RU | ALL |
| 21 | PB | ALL |
| 23 | PY | ALL |
| 25 | PY | 7 |
| 27 | PW | ALL |
| 28 | PU | ALL |
| 31 | GW | 26 |
| 32 | GN | 6 |

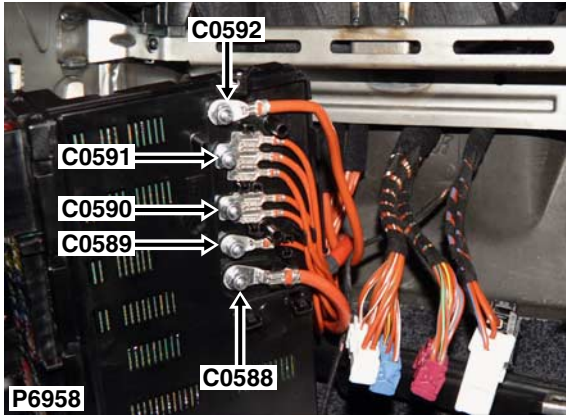

| Cav | Col | Cct |
|-----|-----|-----|
| 1 | R | ALL |

Description: *Fuse box-Passenger compartment*

Location: *Behind passenger compartment fusebox*

NO CONNECTOR FACE

Colour:

Gender:

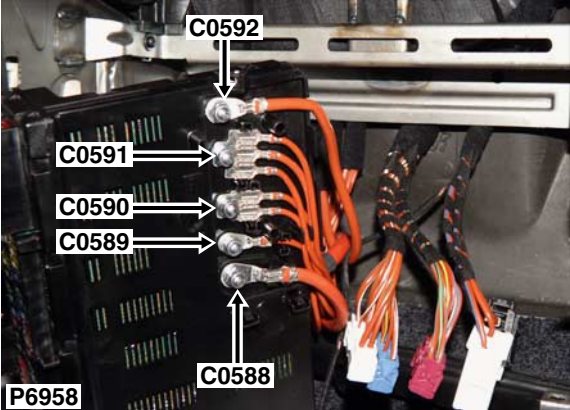

| Cav | Col | Cct |
|-----|-----|-----|
| 0 | R | ALL |

Description: Fuse box-Passenger compartment
Location: Behind passenger compartment fusebox

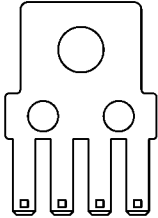

8380414

Colour:
Gender:

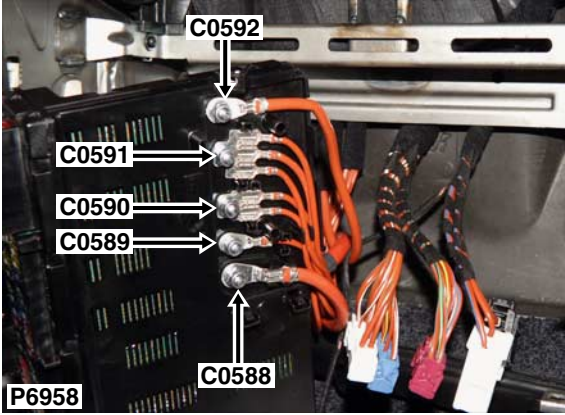

| Cav | Col | Cct |
|-----|-----|-----|
| 1 | R | ALL |

Description: *Fuse box-Passenger compartment*
Location: *Behind passenger compartment fusebox*



Colour:
Gender:

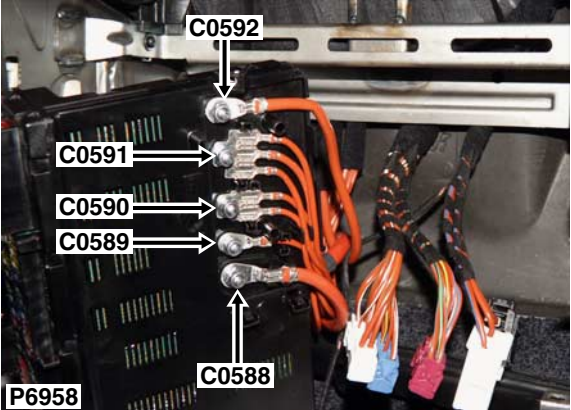

| Cav | Col | Cct |
|-----|-----|-----|
| 0 | R | 2 |
| 2 | R | 2 |
| 3 | R | 1 |

Description: Fuse box-Passenger compartment
Location: Behind passenger compartment fusebox

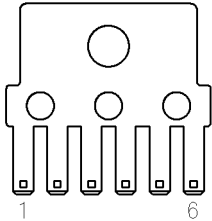

8380416

Colour: TIN-PLATE
Gender: Male

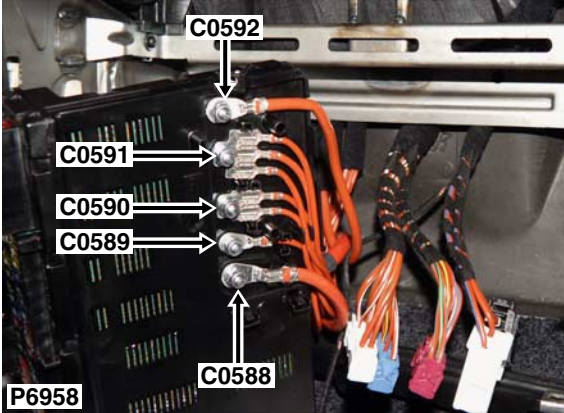

| Cav | Col | Cct |
|-----|-----|-----|
| 1 | R | 9 |

Description: *Fuse box-Passenger compartment*
Location: *Behind passenger compartment fusebox*



Colour:
Gender:

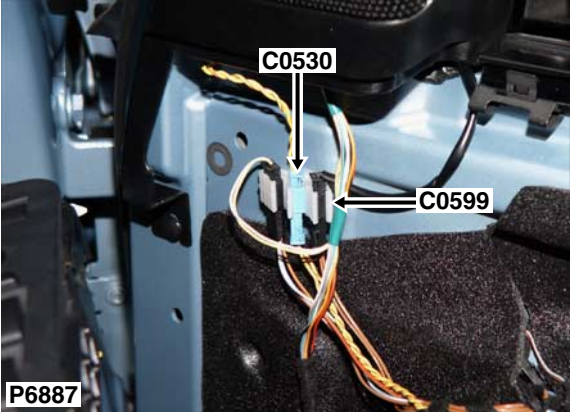

| Cav | Col | Cct |
|-----|-----|-----|
| 1 | N | 3 |
| 2 | NR | 3 |

Description: *Sensor-Anti-trap-Driver*
Location: *Behind driver's door trim panel*

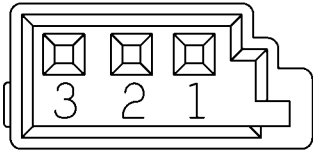

6905977

Colour:
Gender:

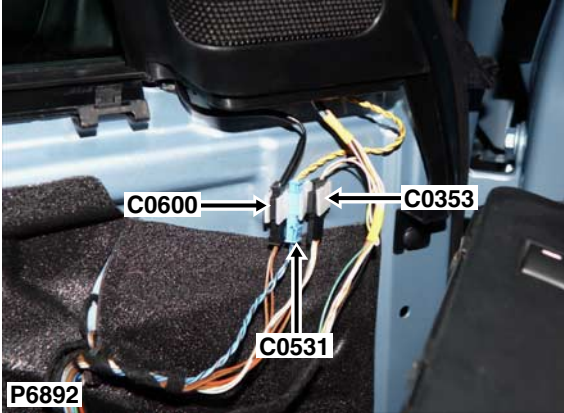

| Cav | Col | Cct |
|-----|-----|-----|
| 1 | N | 3 |
| 2 | NR | 3 |

Description: *Sensor-Anti-trap-Passenger*
Location: *Behind passenger's door trim panel*

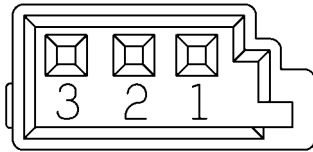

6905977

Colour:
Gender:

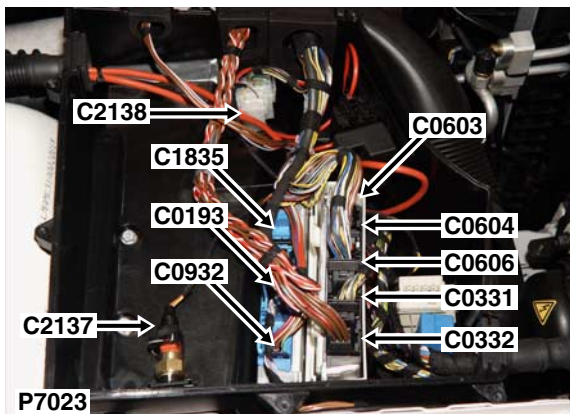

Description: *Engine control module (ECM) - Td6*

Location: *Inside E-box*

| Cav | Col | Cct |
|-----|-----|-----|
| 1 | RW | 3 |
| 4 | NO | 3 |
| 5 | NO | 1 |
| 6 | NO | 3 |
| 8 | RW | 3 |
| 9 | N | 3 |

NO CONNECTOR FACE

Colour:

Gender:

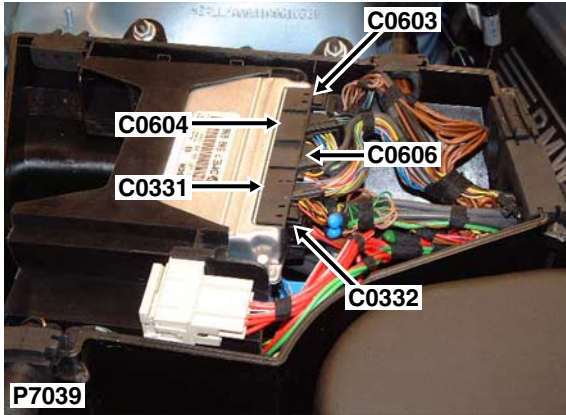

Description: *Engine control module (ECM) - V8*

Location: *Inside E-box*

| Cav | Col | Cct |
|-----|-----|-----|
| 4 | N | 3 |
| 5 | N | 3 |
| 6 | N | 3 |
| 7 | R | 3 |
| 8 | RU | 3 |

NO CONNECTOR FACE

Colour:
Gender:

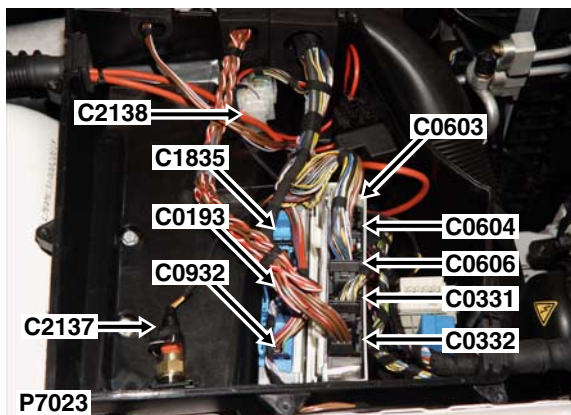

Description: *Engine control module (ECM) - Td6*

Location: *Inside E-box*

| Cav | Col | Cct |
|-----|-----|-----|
| 3 | YN | 3 |
| 4 | YB | 3 |
| 6 | WPY | 3 |
| 8 | NP | 3 |
| 9 | Y | 8 |
| 10 | WN | 3 |
| 17 | BW | 2 |

NO CONNECTOR FACE

Colour:

Gender:

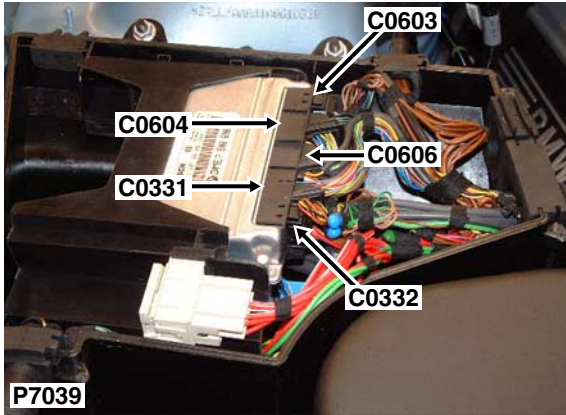

Description: *Engine control module (ECM) - V8*
 Location: *Inside E-box*

| Cav | Col | Cct |
|-----|-----|-----|
| 1 | NW | 3 |
| 3 | YN | 3 |
| 4 | YB | 3 |
| 7 | NU | 31 |
| 8 | YW | 3 |
| 9 | Y | 3 |
| 10 | YR | 3 |
| 11 | YU | 3 |
| 13 | NR | 3 |
| 14 | BW | 3 |
| 15 | B | 3 |
| 16 | BR | 2 |
| 17 | BU | 3 |
| 19 | N | 3 |
| 23 | N | 3 |

NO CONNECTOR FACE

Colour:
 Gender:

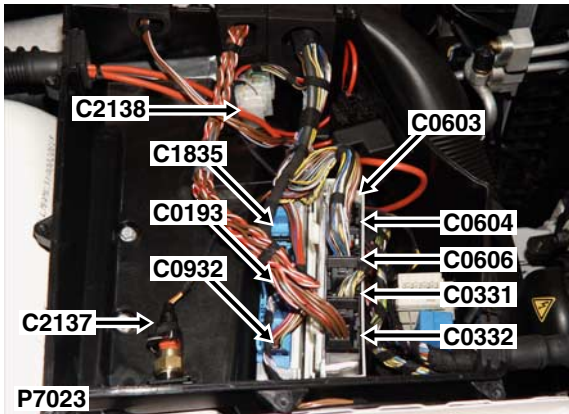

Description: *Engine control module (ECM) - Td6*

Location: *Inside E-box*

NO CONNECTOR FACE

Colour:

Gender:

| Cav | Col | Cct |
|-----|-----|-----|
| 1 | RY | 3 |
| 2 | Y | 23 |
| 3 | B | 3 |
| 4 | Y | 3 |
| 6 | B | 3 |
| 10 | NS | 3 |
| 11 | UG | 3 |
| 12 | BR | 3 |
| 14 | W | 3 |
| 15 | UY | 3 |
| 16 | NG | 3 |
| 17 | N | 3 |
| 18 | NG | 3 |
| 19 | SCR | 3 |
| 20 | NG | 3 |
| 23 | SP | 3 |
| 28 | SU | 3 |
| 29 | UW | 3 |
| 31 | Y | 3 |
| 32 | NG | 3 |
| 33 | UB | 3 |
| 35 | WY | 8 |
| 38 | NU | 3 |
| 41 | NG | 3 |
| 50 | U | 3 |
| 51 | BG | 3 |
| 52 | BY | 3 |

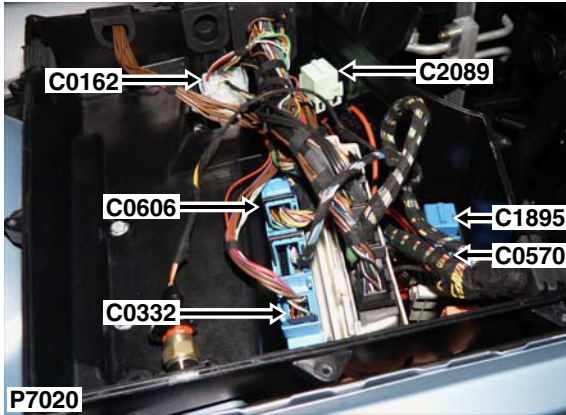

Description: *Engine control module (ECM) - V8*
 Location: *Inside E-box*

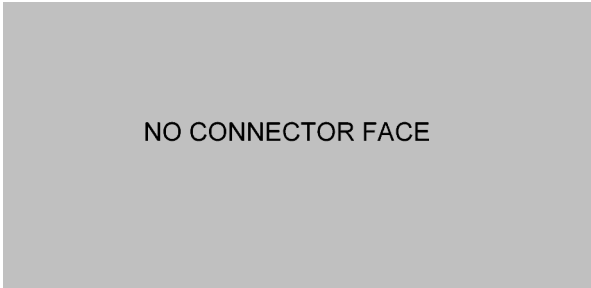

Colour:
 Gender:

| Cav | Col | Cct |
|-----|-----|-----|
| 1 | NY | 3 |
| 2 | NG | 3 |
| 3 | N | 3 |
| 6 | N | 3 |
| 7 | RG | 3 |
| 8 | NR | 8 |
| 9 | B | 3 |
| 10 | N | 3 |
| 12 | BG | 3 |
| 13 | U | 3 |
| 14 | NR | 3 |
| 15 | NS | 23 |
| 16 | GS | 3 |
| 19 | W | 3 |
| 20 | Y | 8 |
| 21 | NO | 3 |
| 22 | YG | 3 |
| 24 | P | 3 |
| 25 | U | 2 |
| 27 | NP | 3 |
| 28 | O | 3 |
| 29 | Y | 3 |
| 29 | GU | 3 |
| 31 | NW | 3 |
| 32 | Y | 3 |
| 34 | YU | 3 |
| 35 | SCR | 3 |
| 36 | B | 3 |
| 36 | SCR | 3 |
| 37 | B | 3 |
| 40 | NU | 3 |
| 41 | NW | 3 |
| 42 | w | 3 |
| 43 | R | 3 |
| 45 | SCR | 3 |
| 46 | B | 3 |
| 48 | SCR | 3 |

| Cav | Col | Cct |
|-----|-----|-----|
| 49 | B | 3 |
| 50 | B | 3 |
| 51 | SCR | 3 |
| 52 | UY | 3 |

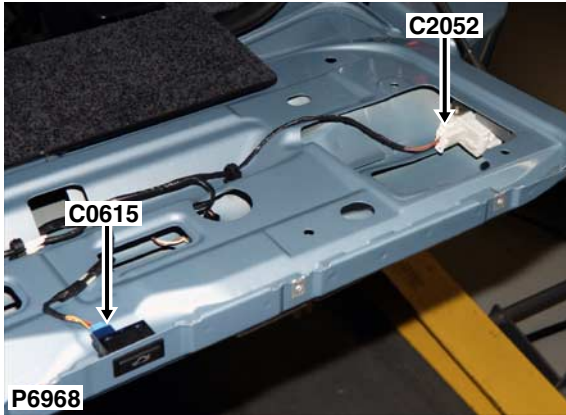

| Cav | Col | Cct |
|-----|-----|-----|
| 5 | YB | 3 |
| 6 | RS | 3 |

Description: *Switch-Tail door open*

Location: *Centre of taildoor, behind trim panel*

NO CONNECTOR FACE

Colour:
Gender:



| Cav | Col | Cct |
|-----|-----|-----|
| 1 | N | 3 |
| 2 | UW | 3 |

Description: *Motor-Lock-Tail door*
Location: *LH side of taildoor*



Colour:
Gender:

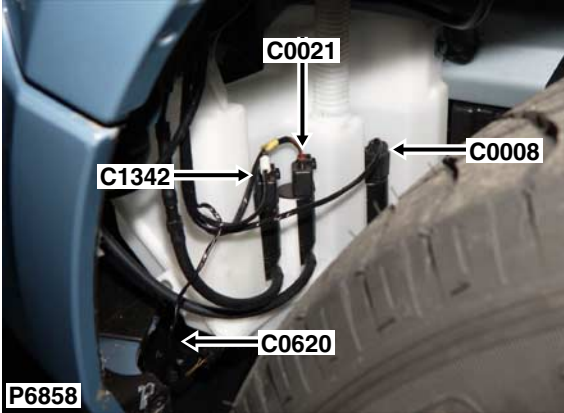

| Cav | Col | Cct |
|-----|-----|-----|
| 1 | NB | ALL |
| 2 | NG | ALL |

Description: *Sensor-Low washer fluid level*
Location: *Front LH side of engine compartment*

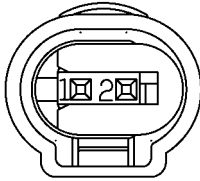

YPC116820

Colour: *BLACK*
Gender: *Female*



| Cav | Col | Cct |
|-----|-----|-----|
| 1 | RW | 3 |
| 2 | SP | 3 |

Description: *Solenoid valve-Boost Control - Td6*

Location: *RH side of engine compartment*

NO CONNECTOR FACE

Colour:

Gender:

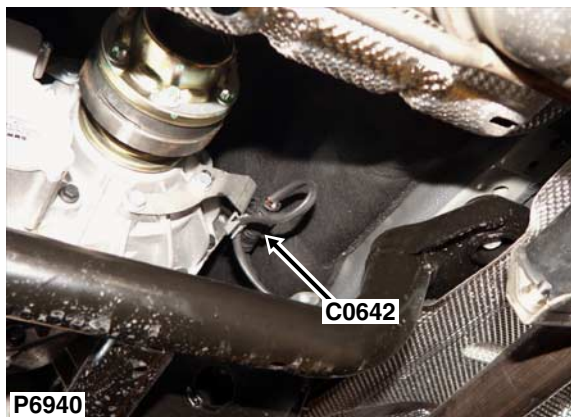

Description: *Sensor-Heated oxygen (HO2S)*

Location: *Beneath centre of vehicle*

| Cav | Col | Cct |
|-----|-----|-----|
| 1 | G | 3 |
| 2 | NW | 3 |
| 3 | YW | 3 |
| 4 | BW | 3 |

NO CONNECTOR FACE

Colour:
Gender:

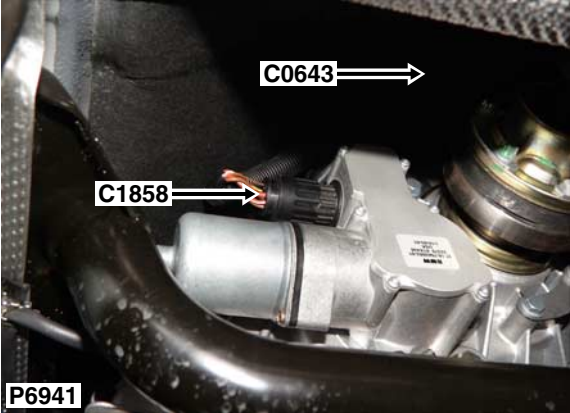

| Cav | Col | Cct |
|-----|-----|-----|
| 1 | G | 3 |
| 2 | NU | 31 |
| 3 | YU | 3 |
| 4 | BU | 3 |

Description: *Sensor-Heated oxygen (HO2S)*
Location: *Beneath centre of vehicle*



Colour:
Gender:

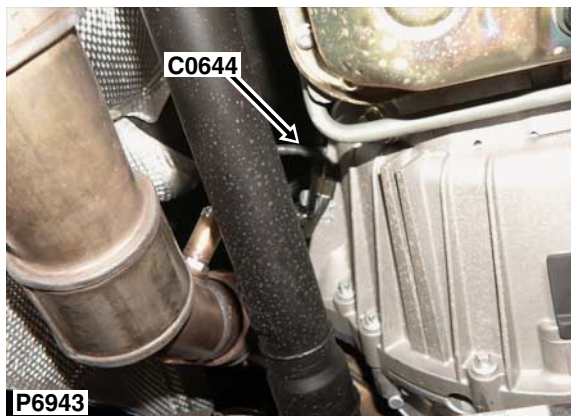

Description: *Sensor-Heated oxygen (HO2S)*

Location: *Beneath centre of vehicle*

| Cav | Col | Cct |
|-----|-----|-----|
| 1 | G | 3 |
| 2 | N | 3 |
| 3 | Y | 3 |
| 4 | B | 3 |

NO CONNECTOR FACE

Colour:
Gender:

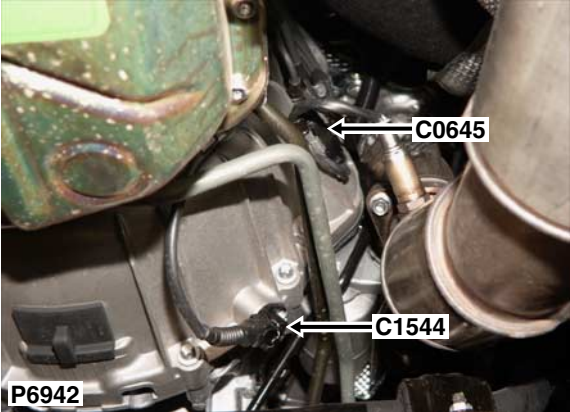

| Cav | Col | Cct |
|-----|-----|-----|
| 1 | G | 31 |
| 2 | NR | 3 |
| 3 | YR | 3 |
| 4 | BR | 2 |

Description: *Sensor-Heated oxygen (HO2S)*
Location: *Beneath centre of vehicle*



Colour:
Gender:

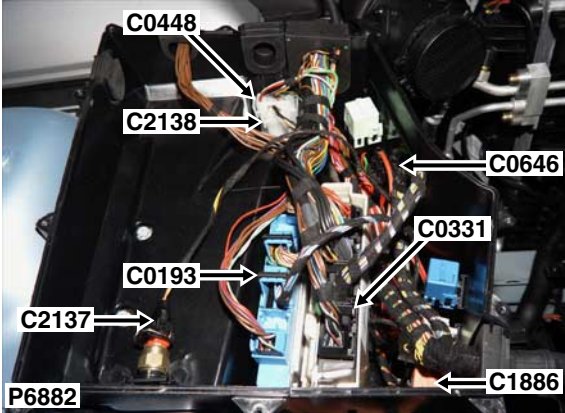

| Cav | Col | Cct |
|-----|-----|-----|
| 1 | R | 2 |

Description: *Fan-E-box*
Location: *Inside E-box*

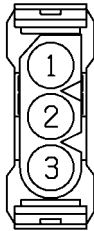

YPC112540

Colour: *NATURAL*
Gender: *Female*

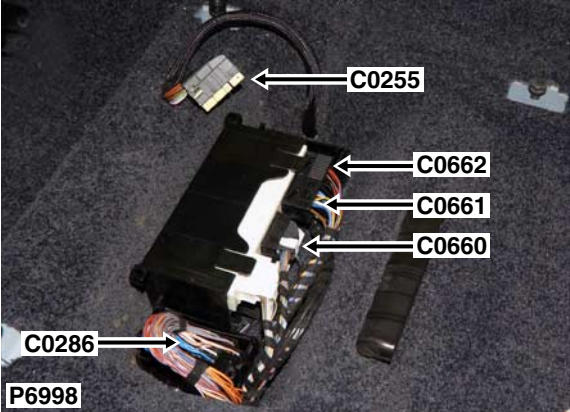

Description: *Body control unit (BCU)*
Location: *Beneath front passenger's seat*

| Cav | Col | Cct |
|-----|-----|-----|
| 1 | RS | ALL |
| 2 | WN | ALL |
| 3 | NP | ALL |
| 4 | BW | ALL |
| 5 | BU | ALL |
| 6 | NW | ALL |
| 7 | NS | ALL |
| 12 | WRY | ALL |
| 13 | WY | ALL |
| 14 | NB | ALL |
| 15 | SN | ALL |
| 17 | SU | ALL |
| 18 | SY | ALL |
| 19 | SW | ALL |
| 20 | NG | ALL |
| 22 | YB | ALL |
| 23 | PW | ALL |
| 24 | YR | ALL |
| 25 | UR | ALL |
| 26 | SB | ALL |

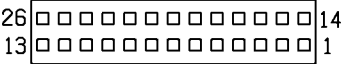

YPC114350

Colour: *GREY*
Gender: *Female*

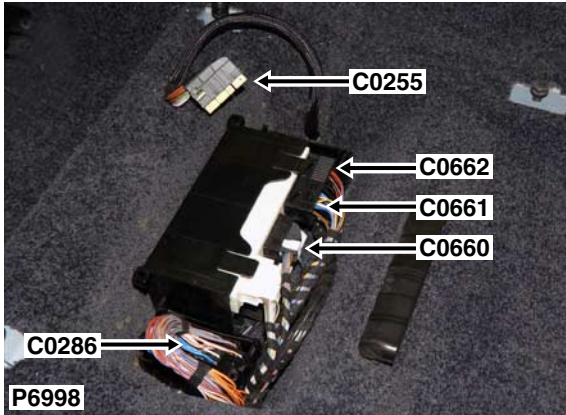

Description: *Body control unit (BCU)*
 Location: *Beneath front passenger's seat*

| Cav | Col | Cct |
|-----|-----|-----|
| 2 | PG | ALL |
| 4 | UY | 23 |
| 5 | BY | ALL |
| 8 | BU | ALL |
| 10 | SY | ALL |
| 11 | SN | ALL |
| 12 | NY | ALL |
| 13 | SU | ALL |
| 15 | NU | ALL |
| 16 | NW | ALL |
| 17 | UB | 21 |
| 19 | SBY | ALL |
| 20 | BS | ALL |
| 22 | NY | ALL |
| 23 | NR | ALL |
| 24 | NR | ALL |
| 25 | BG | ALL |
| 26 | NB | ALL |

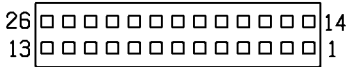

YPC114350

Colour: *GREY*
 Gender: *Female*

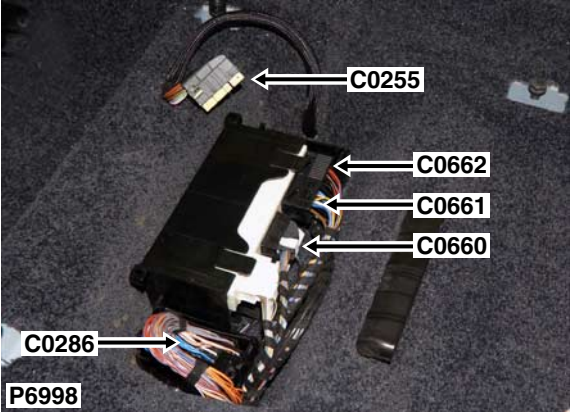

Description: *Body control unit (BCU)*
Location: *Beneath front passenger's seat*

| Cav | Col | Cct |
|-----|-----|-----|
| 1 | N | ALL |
| 2 | US | ALL |
| 3 | YN | ALL |
| 4 | RW | ALL |
| 5 | UP | ALL |
| 6 | B | ALL |
| 9 | BW | ALL |
| 10 | RP | ALL |
| 11 | BR | ALL |
| 12 | BG | ALL |
| 13 | W | ALL |
| 14 | U | ALL |
| 15 | BN | ALL |
| 17 | BU | ALL |
| 18 | B | ALL |
| 19 | RY | ALL |
| 20 | RU | ALL |

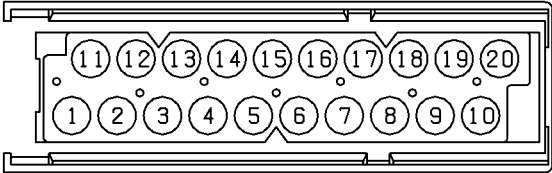

YPC113130

Colour: *BLACK*
Gender: *Female*

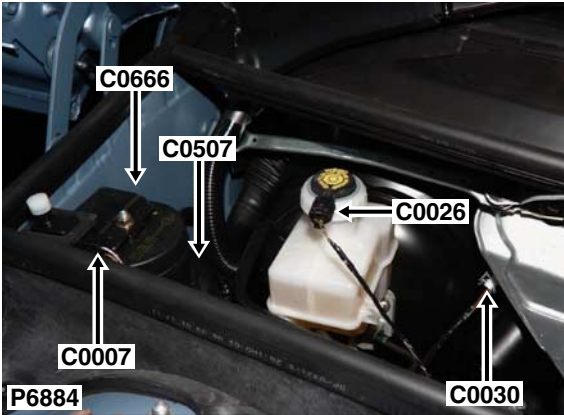

| Cav | Col | Cct |
|-----|-----|-----|
| 1 | N | ALL |
| 2 | BG | ALL |
| 3 | RN | ALL |
| 4 | BU | ALL |

Description: *Sounder-Alarm-Battery backed up*

Location: *Rear of engine compartment*

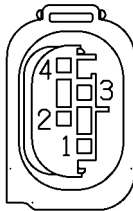

YPC117060

Colour: *NATURAL*

Gender: *Female*

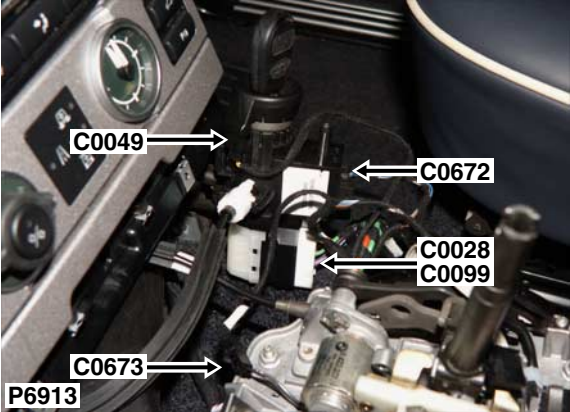

| Cav | Col | Cct |
|-----|-----|-----|
| 1 | B | 1 |
| 2 | S | 1 |
| 3 | U | 1 |
| 4 | NB | 1 |

Description: *Sensor-Key in*
Location: *Beneath centre console*

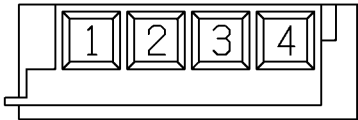

YPC117840

Colour: *BLACK*
Gender: *Female*

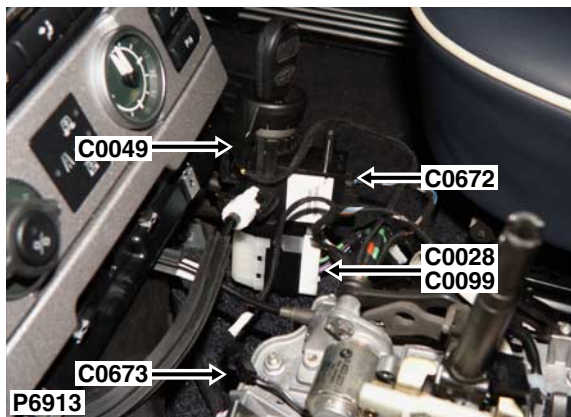

Description: *Solenoid-Interlock*

Location: *Beneath centre console*

| Cav | Col | Cct |
|-----|-----|-----|
| 1 | BP | ALL |
| 3 | NP | ALL |

NO CONNECTOR FACE

Colour:
Gender:

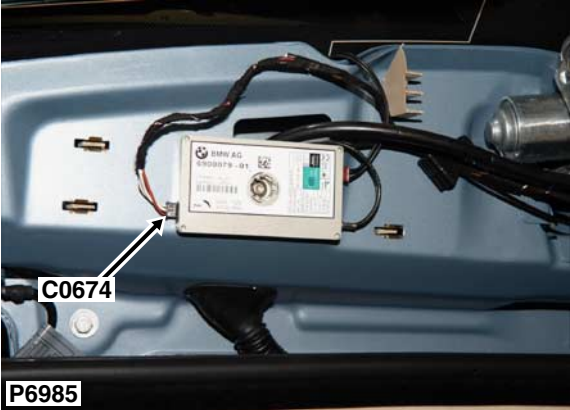

| Cav | Col | Cct |
|-----|-----|-----|
| 1 | RB | 11 |
| 2 | W | 11 |
| 3 | WY | ALL |

Description: Receiver-Radio frequency (RF)
Location: Centre of taildoor, behind trim panel

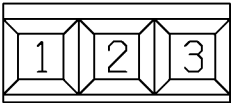

YPC117800

Colour: BLACK
Gender: Female

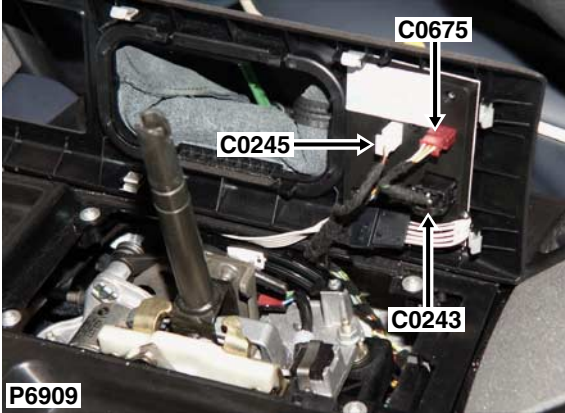

Description: *Switch-Transmission-High-Low*
Location: *Beneath centre console*

| Cav | Col | Cct |
|-----|-----|-----|
| 1 | WG | ALL |
| 2 | RY | ALL |
| 3 | WU | ALL |

NO CONNECTOR FACE

Colour:
Gender:

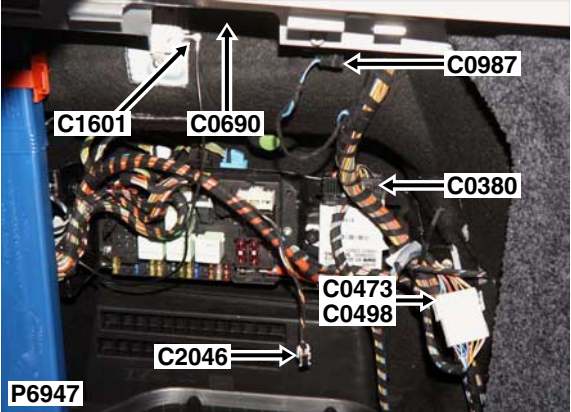

| Cav | Col | Cct |
|-----|-----|-----|
| 1 | U | 30 |
| 2 | B | 27 |
| 2 | W | 30 |

Description: Solenoid-Fuel flap release
Location: Rear of luggage compartment - RH side

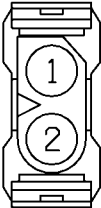

YPC112260

Colour: BLACK
Gender: Female

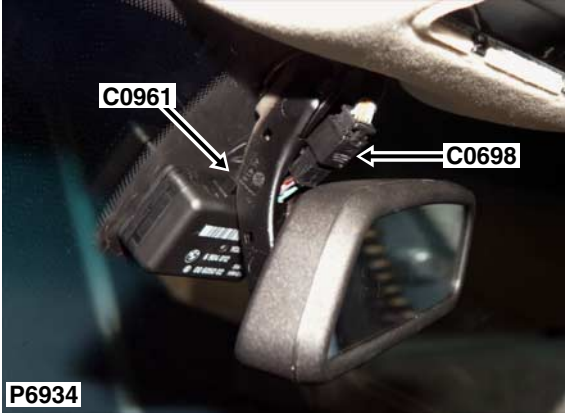

| Cav | Col | Cct |
|-----|-----|-----|
| 1 | UY | 26 |
| 2 | WY | 10 |
| 3 | GW | 26 |
| 4 | WU | 26 |
| 5 | WR | 26 |
| 6 | WY | 26 |
| 7 | WG | 26 |
| 8 | RY | ALL |
| 9 | SBY | ALL |
| 10 | NB | 26 |

Description: *Mirror-interior*

Location: *Top of windscreen*

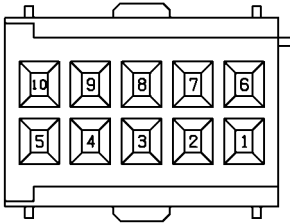

6909000

Colour:
Gender:

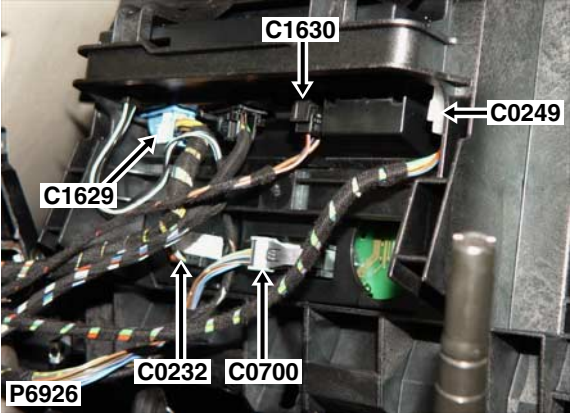

Description: *Switch pack-Centre console*
 Location: *Behind centre console*

| Cav | Col | Cct |
|-----|-----|-----|
| 2 | SN | ALL |
| 4 | YW | ALL |
| 5 | SR | ALL |
| 6 | UP | ALL |
| 7 | BY | ALL |
| 11 | SR | ALL |
| 12 | NUY | 6 |
| 14 | UR | 23 |
| 15 | GBY | ALL |
| 17 | SU | ALL |
| 18 | SP | ALL |
| 19 | SY | ALL |
| 20 | SG | ALL |
| 21 | WY | ALL |
| 22 | NWY | 6 |
| 25 | UN | 23 |
| 26 | N | ALL |

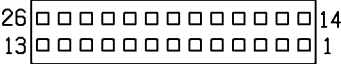

YPC114350

Colour: *GREY*
 Gender: *Female*

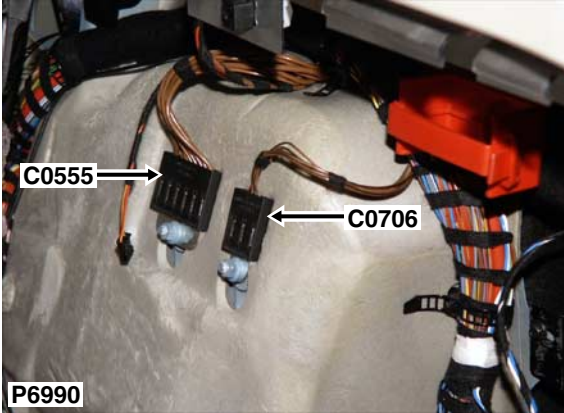

| Cav | Col | Cct |
|-----|-----|-----|
| 0 | NB | ALL |

Description: *Header -Earth*

Location: *Luggage compartment - RH side*

NO CONNECTOR FACE

Colour: *TIN-PLATE*

Gender: *Male*

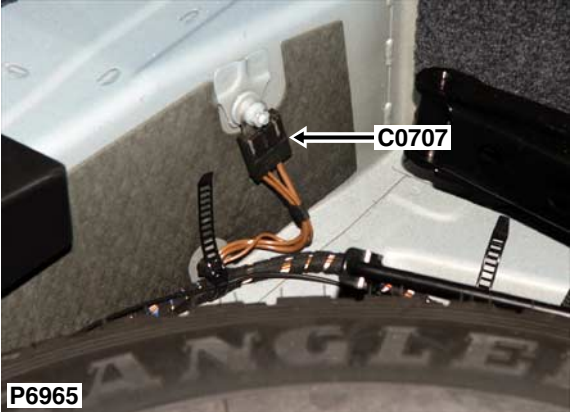

| Cav | Col | Cct |
|-----|-----|-----|
| 0 | N | ALL |

Description: *Header -Earth*
Location: *Rear of luggage compartment*



Colour: *TIN-PLATE*
Gender: *Male*



| Cav | Col | Cct |
|-----|-----|-----|
| 1 | UN | ALL |
| 2 | UR | ALL |

Description: *Speakers-Low range*

Location: *Behind passenger's door trim panel*

NO CONNECTOR FACE

Colour:

Gender:

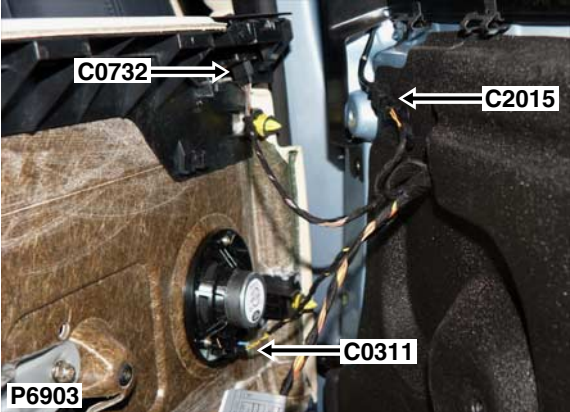

| Cav | Col | Cct |
|-----|-----|-----|
| 1 | SN | 3 |
| 2 | N | 3 |
| 3 | SR | 3 |
| 4 | SB | 3 |

Description: *Switch-Window-Rear*
Location: *Behind rear door trim panel*

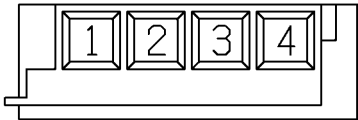

YPC117840

Colour: *BLACK*
Gender: *Female*



| Cav | Col | Cct |
|-----|-----|-----|
| 1 | NB | ALL |
| 3 | PS | ALL |

Description: *Mirror-Vanity-RH*
Location: *Headlining - front RH side*

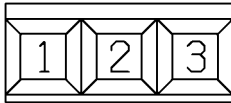

YPC117800

Colour: *BLACK*
Gender: *Female*



| Cav | Col | Cct |
|-----|-----|-----|
| 1 | NB | ALL |
| 3 | PS | ALL |

Description: *Mirror-Vanity-LH*
Location: *Headlining - front LH side*

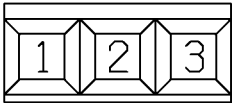

YPC117800

Colour: *BLACK*
Gender: *Female*

C0740

CONNECTOR DETAILS

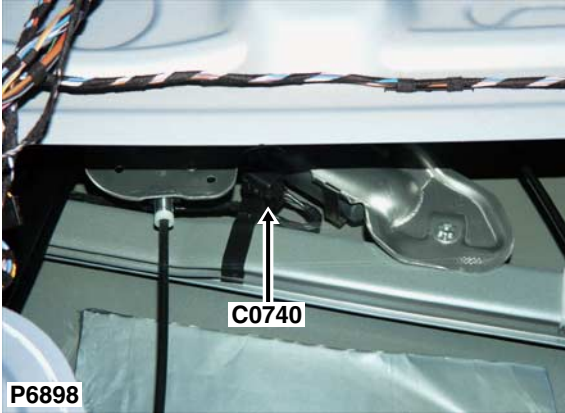

| Cav | Col | Cct |
|-----|-----|-----|
| 1 | BG | 3 |
| 2 | BS | 3 |

Description: *Motor-Window-Driver*

Location: *Behind driver's door trim panel*

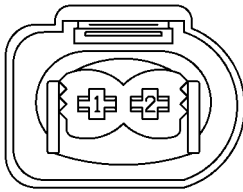

YPC116370

Colour: *BLACK*

Gender: *Female*



| Cav | Col | Cct |
|-----|-----|-----|
| 1 | BG | 3 |
| 2 | BS | 3 |

Description: *Motor-Window-Passenger*
Location: *Behind passenger's door trim panel*

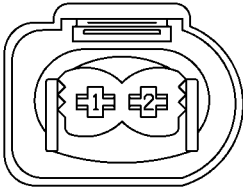

YPC116370

Colour: *BLACK*
Gender: *Female*

C0751

CONNECTOR DETAILS

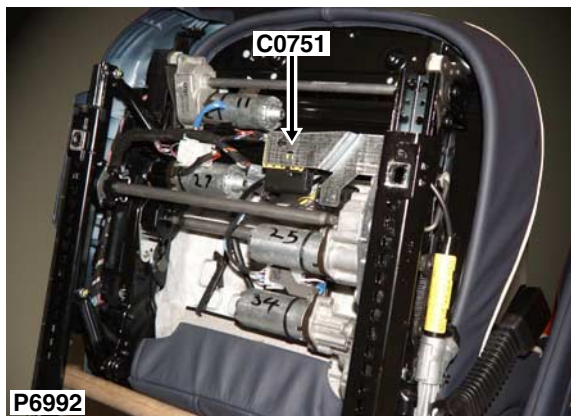

Description: *Seat link harness to main harness*

Location: *Beneath front seat*

| Cav | Col | Cct |
|-----|-----|-----|
| 13 | RN | 3 |
| 14 | N | 2 |
| 15 | WRY | 3 |

NO CONNECTOR FACE

Colour:

Gender:

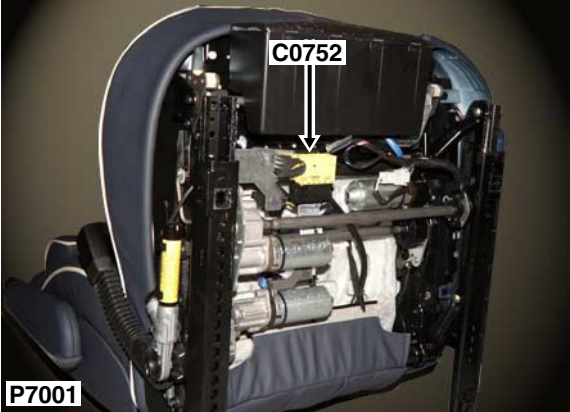

| Cav | Col | Cct |
|-----|-----|-----|
| 13 | RN | 5 |
| 14 | N | 3 |
| 15 | WRY | 3 |

Description: *Seat link harness to main harness*
Location: *Beneath front seat*



Colour:
Gender:

C0770

CONNECTOR DETAILS

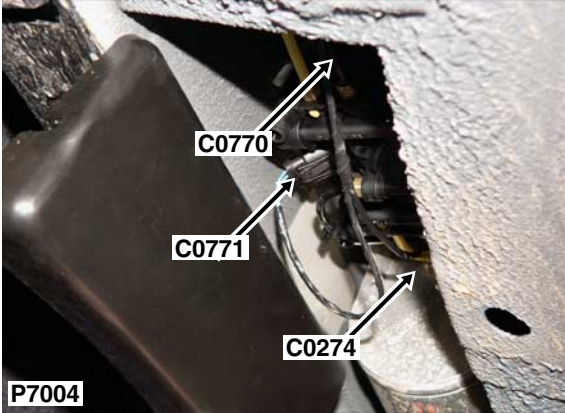

| Cav | Col | Cct |
|-----|-----|-----|
| 1 | US | 3 |
| 2 | UY | 3 |
| 3 | UB | 3 |

Description: *Valve block-Air Suspension*
Location: *Beneath vehicle - RH side*

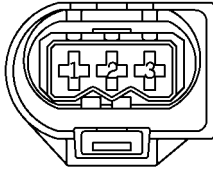

YPC113380

Colour: *BLACK*
Gender: *Female*

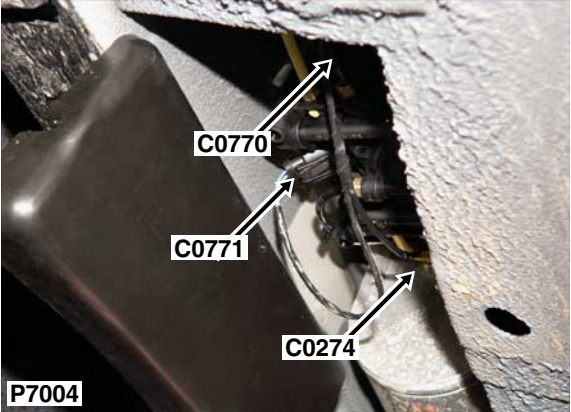

| Cav | Col | Cct |
|-----|-----|-----|
| 1 | UG | 3 |
| 2 | UW | 3 |

Description: *Valve block-Air Suspension*
Location: *Beneath vehicle - RH side*

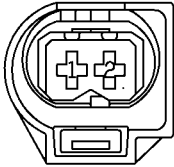

YPC113410

Colour: *BLACK*
Gender: *Female*

C0784

CONNECTOR DETAILS

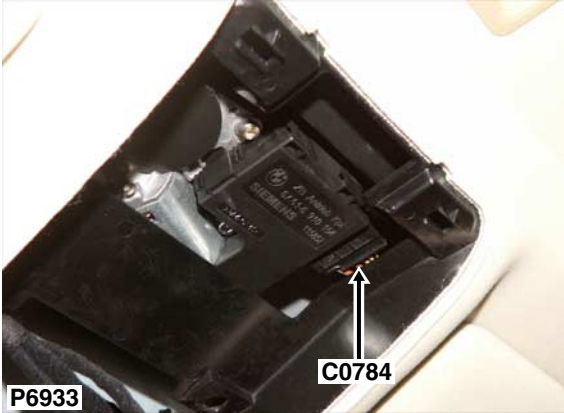

Description: *ECU-Sunroof-1*
Location: *Front of headlining in the centre*

| Cav | Col | Cct |
|-----|-----|-----|
| 1 | RS | 3 |
| 2 | N | 3 |
| 3 | YS | 3 |
| 9 | YG | 3 |
| 10 | UR | 3 |
| 11 | SB | 3 |
| 13 | YW | 3 |

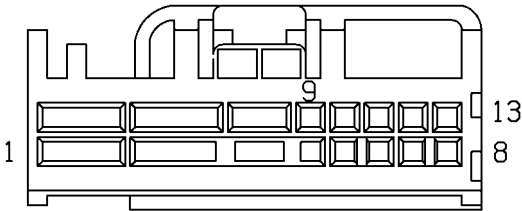

YPC114780

Colour: *BLACK*
Gender: *Female*

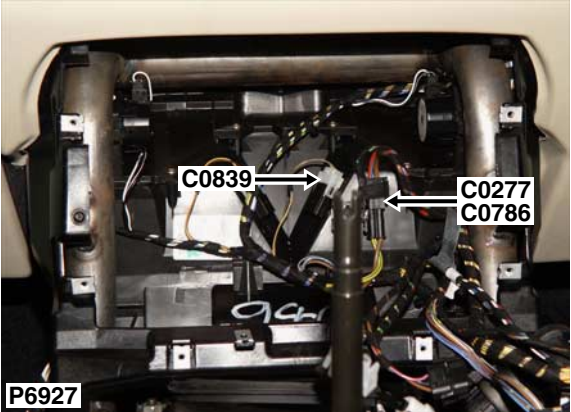

| Cav | Col | Cct |
|-----|-----|-----|
| 1 | N | ALL |
| 2 | RU | ALL |

Description: *Main harness to air conditioning (A/C) harness*
Location: *Behind centre console*

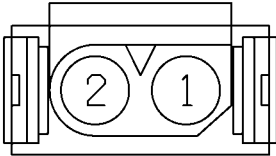

8378970

Colour: *BLACK*
Gender: *Female*



| Cav | Col | Cct |
|-----|-----|-----|
| 1 | NG | 3 |
| 2 | UG | 3 |
| 3 | YG | 3 |
| 4 | W | 3 |
| 5 | Y | 3 |
| 6 | WG | 3 |

Description: *Sensor-Throttle position (TP)*
Location: *Driver's footwell*

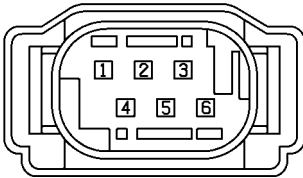

YPC110680

Colour: *BLACK*
Gender: *Female*



| Cav | Col | Cct |
|-----|-----|-----|
| 1 | YN | 5 |
| 2 | YG | 5 |
| 3 | YR | 5 |
| 4 | YB | 5 |

Description: *Sensor-Sunlight*
Location: *Fascia - top centre*

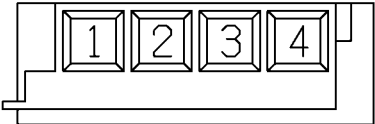

YPC117870

Colour: *PURPLE*
Gender: *Female*



Description: *Door harness to main harness*

Location: *Base of 'C' post RH side*

| Cav | Col | Cct |
|-----|-----|-----|
| 1 | W | 3 |
| 2 | U | 3 |
| 3 | B | 3 |
| 4 | N | 3 |
| 5 | SR | 3 |
| 6 | SN | 3 |
| 7 | SB | 3 |
| 8 | NY | 3 |
| 11 | RU | 12 |
| 12 | NS | 12 |
| 14 | YB | 28 |
| 15 | YN | 28 |
| 26 | BG | 3 |
| 27 | US | 3 |
| 28 | Y | ALL |
| 29 | N | ALL |

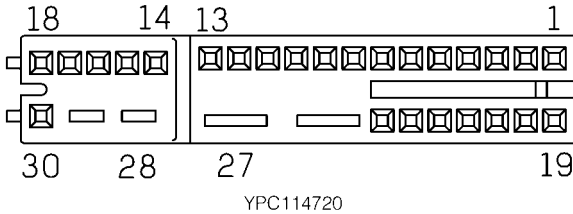

Colour: *BLACK*

Gender: *Female*

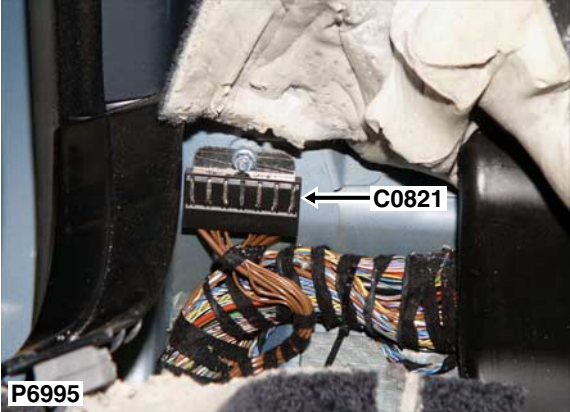

| Cav | Col | Cct |
|-----|-----|-----|
| 0 | N | ALL |

Description: *Header -Earth*
Location: *Beneath RH seat*

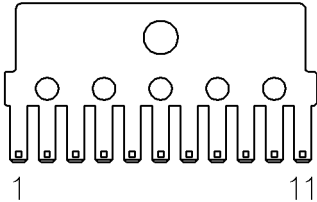

YQC100970

Colour: *TIN-PLATE*
Gender: *Male*

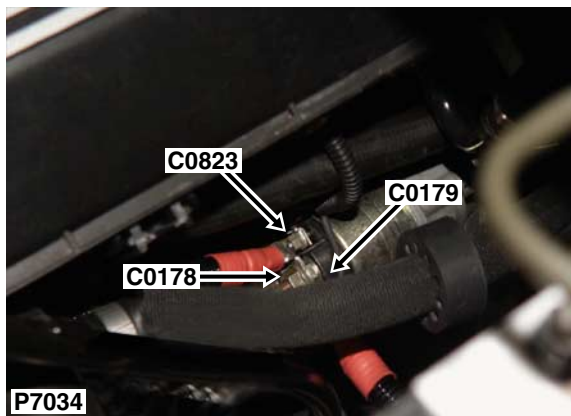

Description: *Starter motor - Td6*
Location: *LH side of engine*

| Cav | Col | Cct |
|-----|-----|-----|
| 1 | BG | 3 |

NO CONNECTOR FACE

Colour:
Gender:

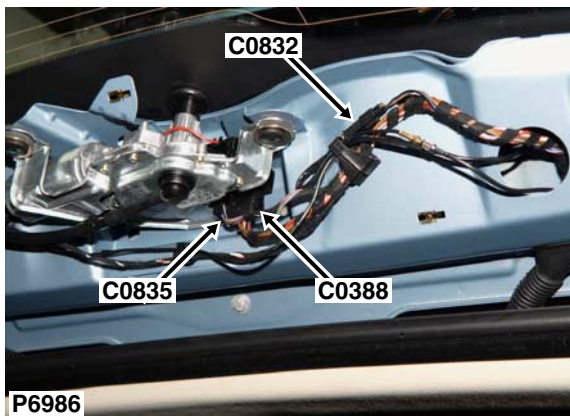

Description: *Lamp-brake-high mounted*

Location: *Centre of taildoor, behind trim panel*

| Cav | Col | Cct |
|-----|-----|-----|
| 1 | N | ALL |
| 2 | BU | ALL |

NO CONNECTOR FACE

Colour:

Gender:

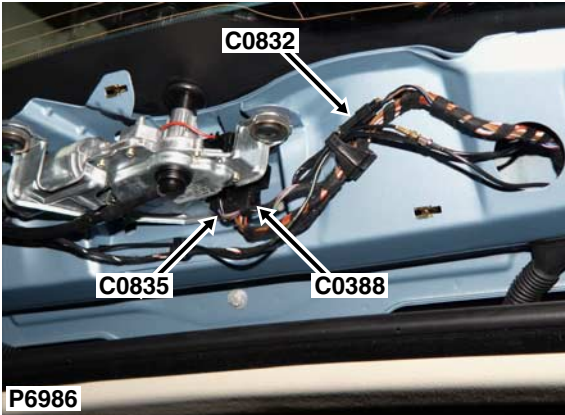

P6986

Description: *Motor-Wiper-Rear screen*

Location: *Centre of taildoor, behind trim panel*

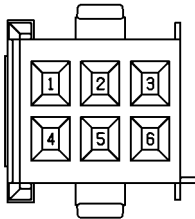

YPC115290

Colour: *BLACK*

Gender: *Female*

| Cav | Col | Cct |
|-----|-----|-----|
| 1 | BW | ALL |
| 2 | BU | ALL |
| 3 | PR | ALL |
| 4 | NB | ALL |
| 6 | UY | ALL |

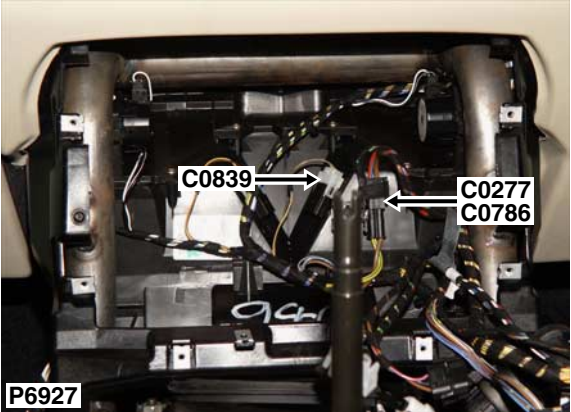

| Cav | Col | Cct |
|-----|-----|-----|
| 1 | N | 5 |
| 2 | GU | 5 |
| 3 | SR | 5 |

Description: *Main harness to air conditioning (A/C) harness*
Location: *Behind centre console*

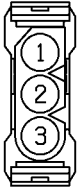

YPC112530

Colour: *BLACK*
Gender: *Female*

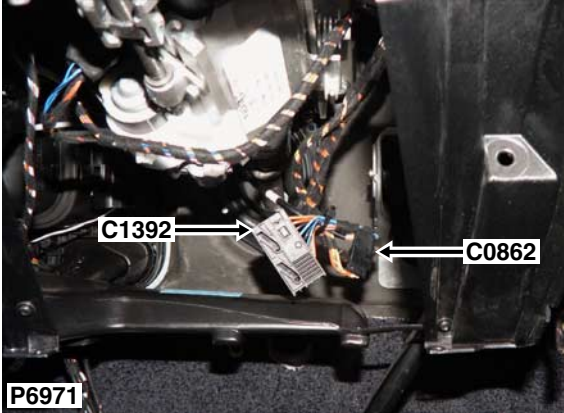

| Cav | Col | Cct |
|-----|-----|-----|
| 1 | RG | ALL |
| 2 | RW | ALL |
| 3 | YB | 1 |
| 4 | YN | 1 |
| 5 | NB | ALL |
| 6 | WP | ALL |

Description: *Sensor-Steering angle*
Location: *Underside of steering column*

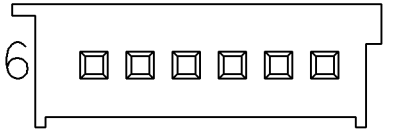

6909052

Colour: *BLACK*
Gender: *Male*

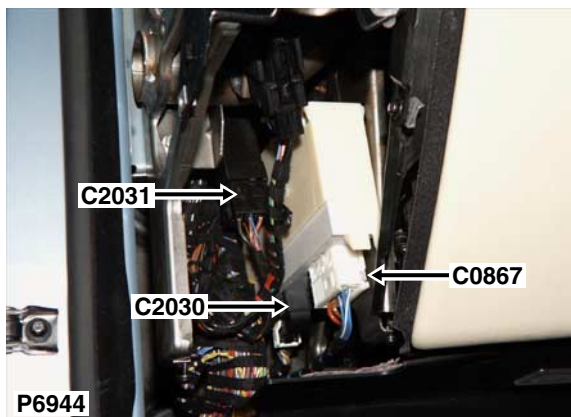

Description: *ECU-Air suspension*

Location: *Behind LH side of fascia*

NO CONNECTOR FACE

Colour:

Gender:

| Cav | Col | Cct |
|-----|-----|-----|
| 1 | YU | 2 |
| 2 | YB | ALL |
| 3 | SR | ALL |
| 4 | YW | ALL |
| 5 | SY | ALL |
| 6 | UY | ALL |
| 7 | UB | ALL |
| 8 | US | ALL |
| 9 | WR | ALL |
| 10 | WP | ALL |
| 11 | YP | ALL |
| 12 | UG | ALL |
| 13 | UW | ALL |
| 14 | WG | ALL |
| 15 | WU | ALL |
| 16 | B | ALL |
| 17 | BU | ALL |
| 19 | YU | 2 |
| 20 | YN | ALL |
| 21 | UP | ALL |
| 22 | SG | ALL |
| 23 | SP | ALL |
| 24 | BS | ALL |
| 25 | SW | ALL |
| 26 | YS | ALL |
| 27 | WS | ALL |
| 28 | U | ALL |
| 31 | BRY | ALL |
| 32 | SB | ALL |
| 33 | BW | ALL |
| 34 | Y | ALL |
| 35 | BY | ALL |
| 37 | WRY | ALL |
| 38 | RY | ALL |
| 39 | YG | ALL |
| 40 | WY | ALL |
| 41 | SU | ALL |

| Cav | Col | Cct |
|------------|------------|------------|
| 42 | BN | ALL |
| 43 | SN | ALL |
| 44 | YN | ALL |
| 45 | WN | ALL |
| 46 | W | ALL |
| 49 | S | ALL |
| 50 | YB | ALL |
| 51 | WB | ALL |



| Cav | Col | Cct |
|-----|-----|-----|
| 1 | RY | ALL |
| 2 | WG | ALL |
| 4 | S | ALL |
| 5 | BU | ALL |
| 6 | BRY | ALL |
| 7 | N | ALL |
| 11 | BY | ALL |
| 12 | WU | ALL |

Description: *Pump-Air suspension*
Location: *Rear of luggage compartment*



Colour: *NATURAL*
Gender: *Female*

C0876

CONNECTOR DETAILS

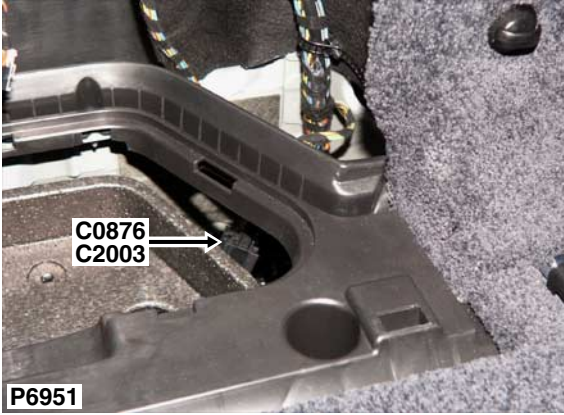

Description: *Main harness to PDC harness*
Location: *Rear of luggage compartment - RH side*

| Cav | Col | Cct |
|-----|-----|-----|
| 1 | NB | 6 |
| 2 | NY | 6 |
| 3 | NW | 6 |
| 4 | GS | 6 |
| 5 | GN | 6 |
| 6 | GP | 6 |
| 7 | NU | 6 |
| 8 | YB | 6 |
| 9 | YG | 6 |
| 10 | YN | 6 |
| 11 | YS | 6 |
| 12 | GB | 6 |

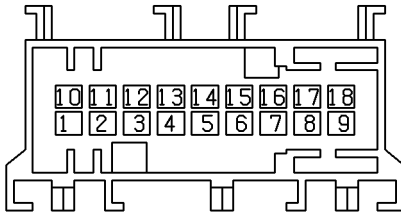

YPC113590

Colour: *BLACK*
Gender: *Male*



| Cav | Col | Cct |
|-----|-----|-----|
| 1 | N | 2 |
| 2 | BRY | 2 |

Description: *Pump-Air injection*
Location: *Behind RH front wheel arch liner*

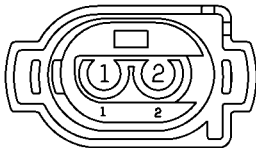

YPC110340

Colour: *BLACK*
Gender: *Female*

C0884

CONNECTOR DETAILS

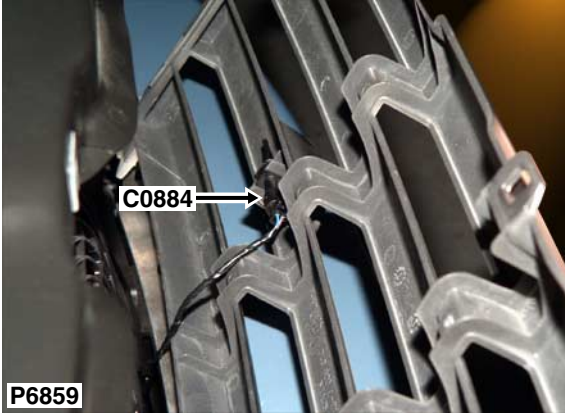

| Cav | Col | Cct |
|-----|-----|-----|
| 1 | UN | ALL |
| 2 | UR | ALL |

Description: *Sensor-Ambient air temperature*
Location: *Behind the front grille*

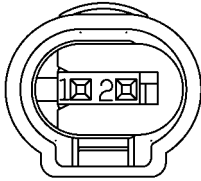

YPC116820

Colour: *BLACK*
Gender: *Female*

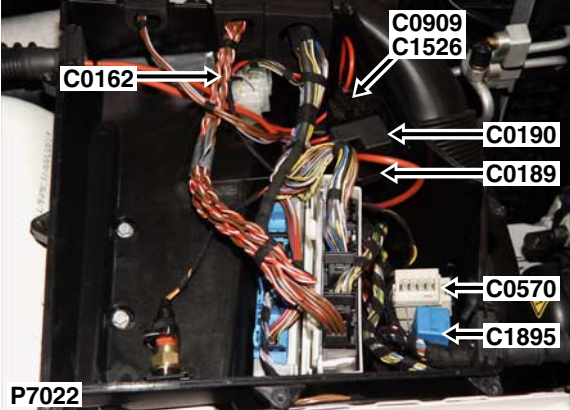

| Cav | Col | Cct |
|-----|-----|-----|
| 1 | R | 3 |
| 2 | R | 3 |

Description: *Engine harness to main harness - Td6*
Location: *Inside E-box*



Colour:
Gender:



| Cav | Col | Cct |
|-----|-----|-----|
| 1 | N | 27 |
| 2 | SU | 27 |

Description: *Lamp-Side marker-Front-RH*
 Location: *Front of vehicle - RH side*

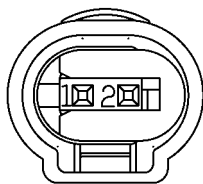

YPC116820

Colour: *BLACK*
 Gender: *Female*



| Cav | Col | Cct |
|-----|-----|-----|
| 1 | SG | 27 |
| 2 | N | 27 |

Description: *Lamp-Side marker-Front-LH*
Location: *Front of vehicle - LH side*

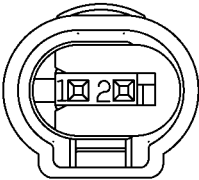

YPC116820

Colour: *BLACK*
Gender: *Female*



| Cav | Col | Cct |
|-----|-----|-----|
| 1 | SU | 27 |
| 2 | N | 27 |

Description: *Lamp-Side marker-Rear-RH*
 Location: *RH rear of vehicle*

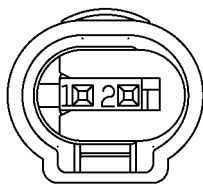

YPC116820

Colour: *BLACK*
 Gender: *Female*



| Cav | Col | Cct |
|-----|-----|-----|
| 1 | SG | 27 |
| 2 | N | 27 |

Description: *Lamp-Side marker-Rear-LH*
Location: *LH rear of vehicle*

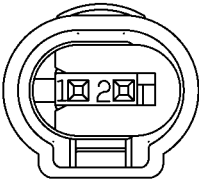

YPC116820

Colour: *BLACK*
Gender: *Female*

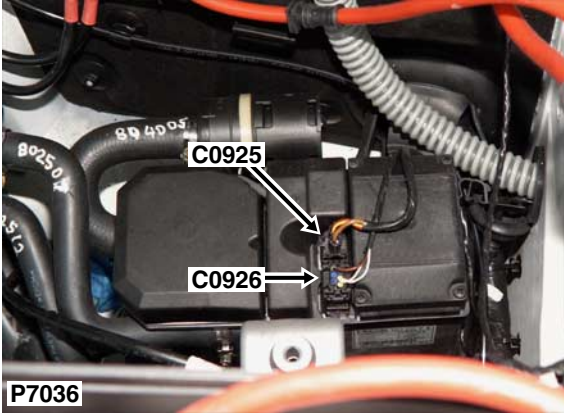

P7036

Description: *Heater-Fuel burning*

Location: *Rear of engine compartment*

| Cav | Col | Cct |
|-----|-----|-----|
| 1 | RY | ALL |
| 2 | N | ALL |

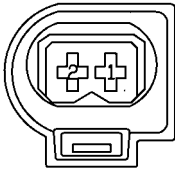

YPC115080

Colour: *BLACK*

Gender: *Female*

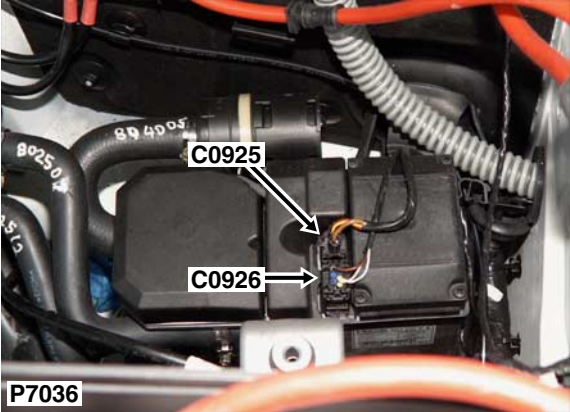

| Cav | Col | Cct |
|-----|-----|-----|
| 1 | WG | 8 |
| 2 | WRY | ALL |
| 6 | BR | ALL |

P7036

Description: *Heater-Fuel burning*
Location: *Rear of engine compartment*

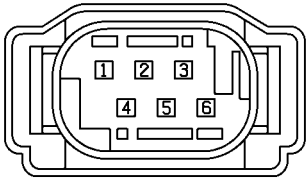

YPC110680

Colour: *BLACK*
Gender: *Female*

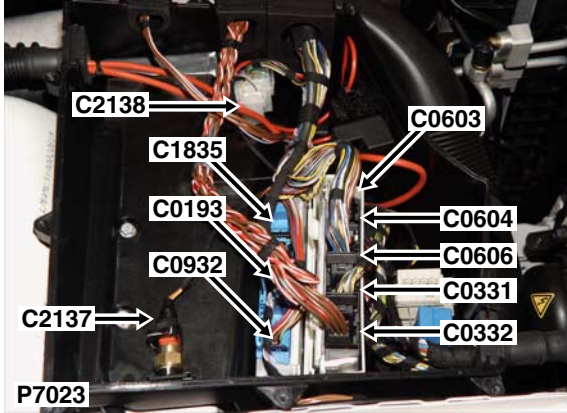

Description: *ECU-Electronic automatic transmission - Td6*
 Location: *Inside E-box*

| Cav | Col | Cct |
|-----|-----|-----|
| 1 | GW | ALL |
| 3 | WP | 3 |
| 4 | NO | 3 |
| 4 | N | 3 |
| 5 | N | 3 |
| 5 | NO | 3 |
| 6 | N | 3 |
| 6 | NO | 3 |
| 7 | R | 3 |
| 7 | RY | 3 |
| 8 | RU | 3 |
| 9 | RU | ALL |



Colour:
 Gender:

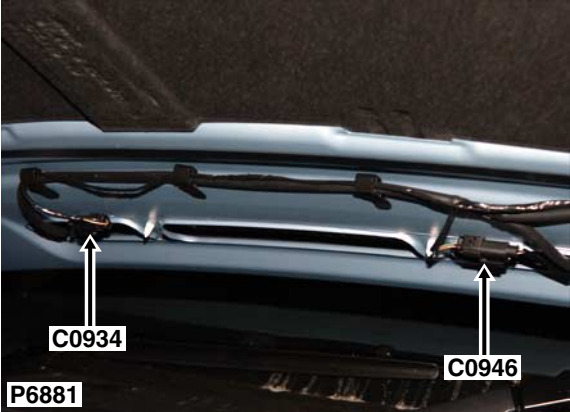

| Cav | Col | Cct |
|-----|-----|-----|
| 1 | BG | ALL |
| 2 | N | ALL |

Description: *Washer jet-Heated*
Location: *Under bonnet, RH side*

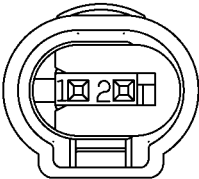

YPC116820

Colour: *BLACK*
Gender: *Female*

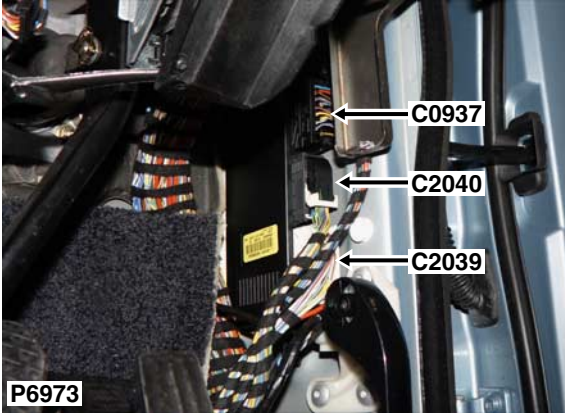

Description: *Module-Lighting switch*

Location: *Base of RH 'A' post*

| Cav | Col | Cct |
|-----|-----|-----|
| 1 | UN | 27 |
| 2 | SP | ALL |
| 3 | SU | ALL |
| 4 | YN | ALL |
| 5 | SN | ALL |
| 6 | UN | ALL |
| 7 | NB | ALL |
| 8 | UG | ALL |
| 9 | YB | ALL |
| 10 | BU | ALL |
| 11 | YG | ALL |
| 12 | SB | ALL |
| 13 | YU | ALL |
| 14 | UY | ALL |
| 15 | R | ALL |

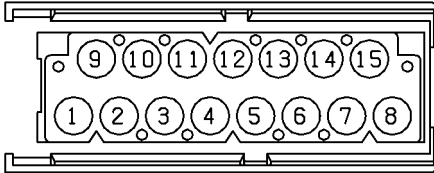

YPC112210

Colour: *BLACK*

Gender: *Female*

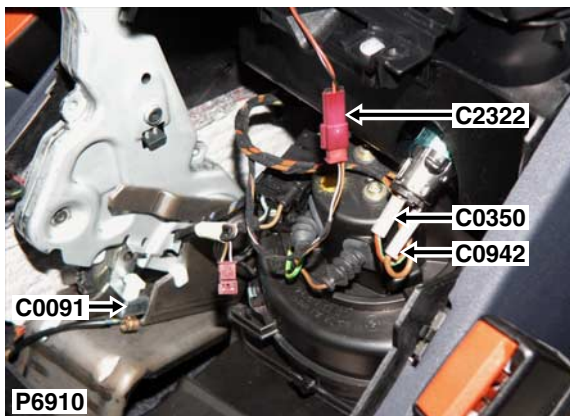

| Cav | Col | Cct |
|-----|-----|-----|
| 1 | N | 3 |

Description: *Socket-Accessory*

Location: *Beneath centre console*

NO CONNECTOR FACE

Colour:

Gender:

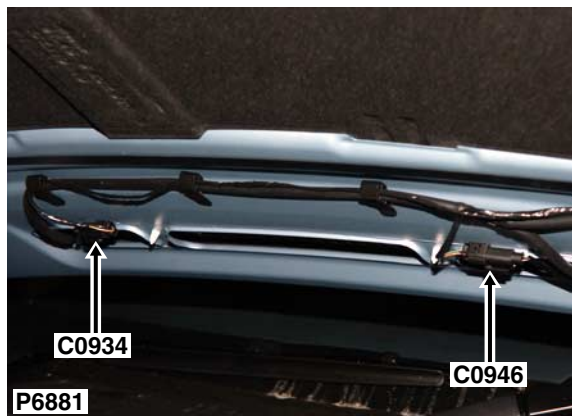

Description: *Heater-Washer jet-LH*
Location: *Under bonnet, LH side*

| Cav | Col | Cct |
|-----|-----|-----|
| 1 | BG | ALL |
| 2 | N | ALL |

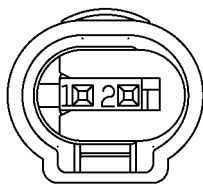

YPC116820

Colour: *BLACK*
Gender: *Female*

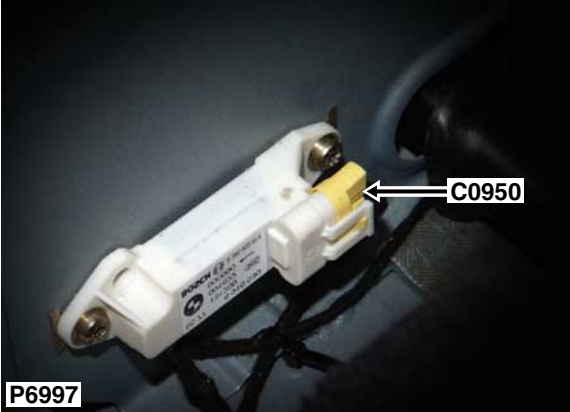

| Cav | Col | Cct |
|-----|-----|-----|
| 1 | NB | ALL |
| 3 | YG | ALL |

Description: *Sensor-Airbag-Side-LH*
Location: *Base of 'B' post LH side*



Colour:
Gender:



| Cav | Col | Cct |
|-----|-----|-----|
| 1 | NB | ALL |
| 3 | YR | ALL |

P6996

Description: *Sensor-Airbag-Side-RH*

Location: *Base of 'B' post RH side*

NO CONNECTOR FACE

Colour:

Gender:

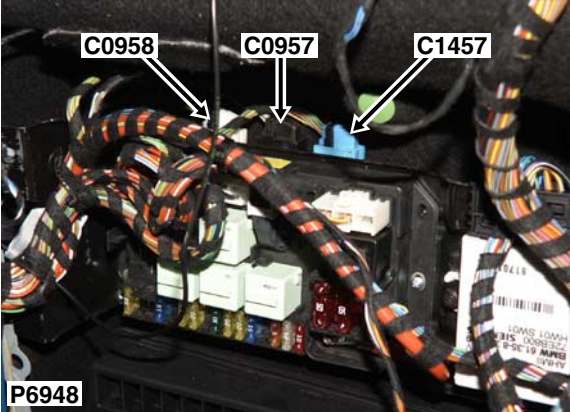

| Cav | Col | Cct |
|-----|-----|-----|
| 1 | GN | 6 |
| 2 | UR | 6 |
| 4 | WSY | 6 |
| 6 | NB | 6 |
| 7 | NWY | 6 |
| 8 | US | 6 |
| 9 | US | 6 |
| 10 | NUY | 6 |

Description: ECU-PDC

Location: Luggage compartment - RH side

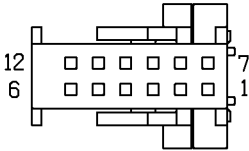

YPC111790

Colour: BLACK
Gender: Female

C0958

CONNECTOR DETAILS

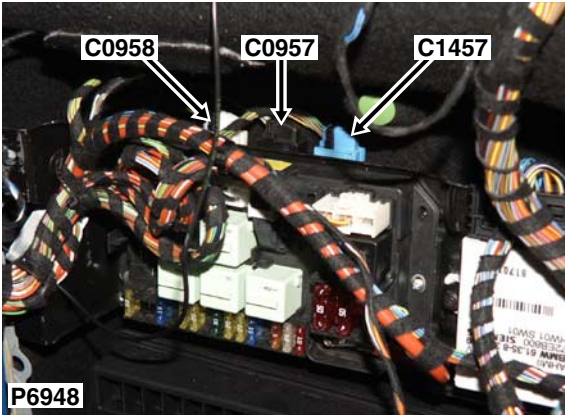

Description: *ECU-PDC*

Location: *Luggage compartment - RH side*

| Cav | Col | Cct |
|-----|-----|-----|
| 1 | NB | 6 |
| 2 | NY | 6 |
| 3 | NW | 6 |
| 4 | GS | 6 |
| 5 | GN | 6 |
| 6 | GP | 6 |
| 7 | NU | 6 |
| 8 | YB | 6 |
| 9 | YG | 6 |
| 10 | YN | 6 |
| 11 | YS | 6 |
| 12 | GB | 6 |

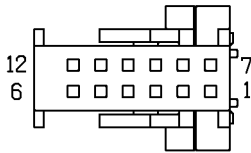

YPC111790

Colour: *BLACK*

Gender: *Female*

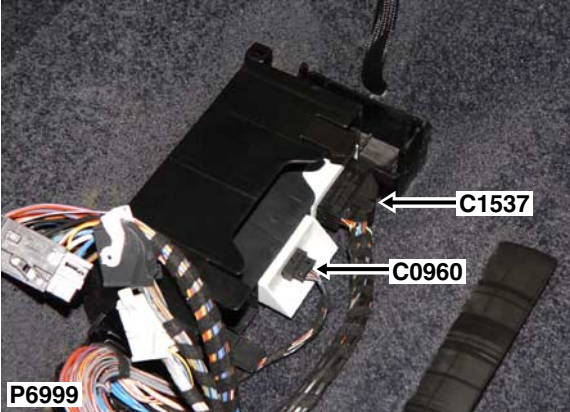

| Cav | Col | Cct |
|-----|-----|-----|
| 1 | BU | ALL |
| 2 | BW | ALL |
| 3 | RB | ALL |
| 4 | BS | ALL |
| 5 | BG | ALL |

Description: *Sensor-Tilt*
Location: *Beneath front passenger's seat*

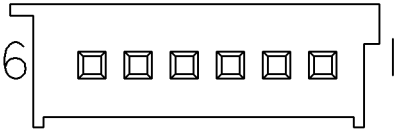

6909052

Colour: *BLACK*
Gender: *Male*

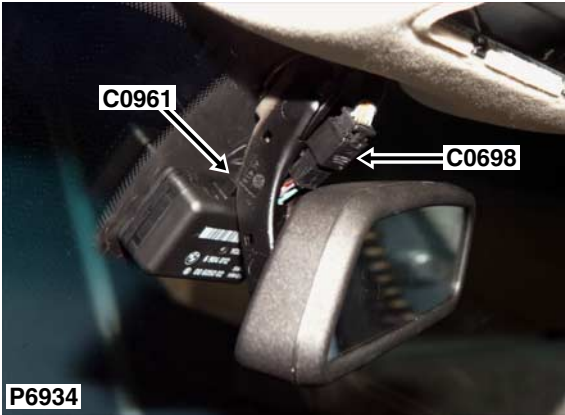

Description: *Sensor-Rain*
Location: *Top of windscreen*

| Cav | Col | Cct |
|-----|-----|-----|
| 1 | PR | 14 |
| 2 | NB | 14 |
| 3 | WRY | 14 |
| 4 | NG | 14 |

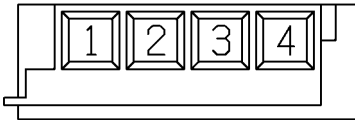

YPC117840

Colour: *BLACK*
Gender: *Female*



| Cav | Col | Cct |
|-----|-----|-----|
| 1 | GB | 6 |
| 2 | YS | 6 |
| 3 | NW | 6 |

Description: *Sensor-PDC-Outer-Rear-LH*
Location: *Behind LH side of rear bumper*

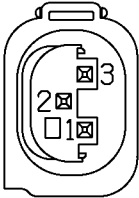

YPC116860

Colour: *GREY*
Gender: *Female*

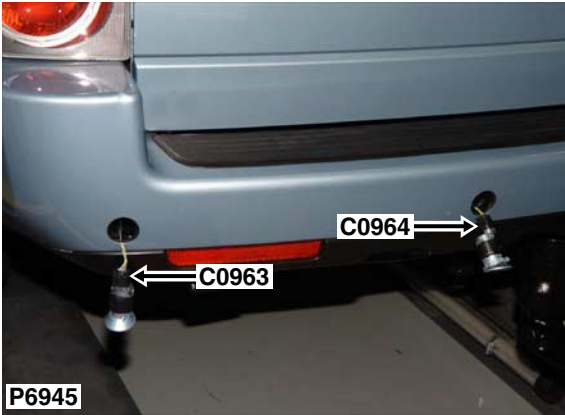

| Cav | Col | Cct |
|-----|-----|-----|
| 1 | GN | 6 |
| 2 | YG | 6 |
| 3 | NB | 6 |

Description: *Sensor-PDC-Inner-Rear-LH*
Location: *Behind LH side of rear bumper*

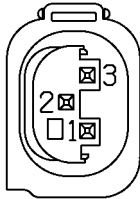

YPC116860

Colour: *GREY*
Gender: *Female*



| Cav | Col | Cct |
|-----|-----|-----|
| 1 | GS | 6 |
| 2 | YB | 6 |
| 3 | NU | 6 |

Description: *Sensor-PDC-Inner-Rear-RH*
Location: *Behind RH side of rear bumper*

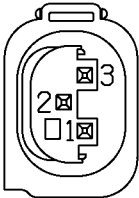

YPC116860

Colour: *GREY*
Gender: *Female*

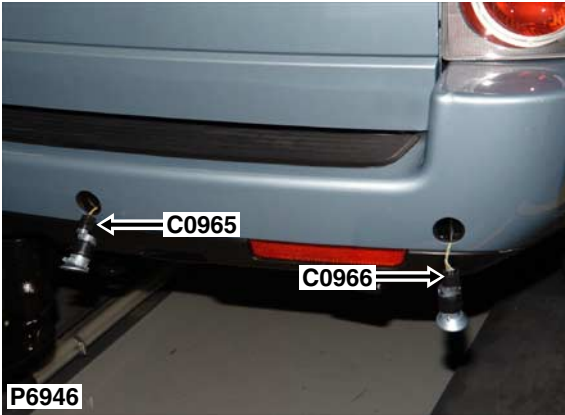

| Cav | Col | Cct |
|-----|-----|-----|
| 1 | GV | 6 |
| 2 | YN | 6 |
| 3 | NY | 6 |

Description: *Sensor-PDC-Outer-Rear-RH*
Location: *Behind RH side of rear bumper*

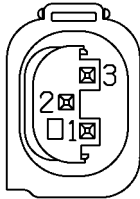

YPC116860

Colour: *GREY*
Gender: *Female*

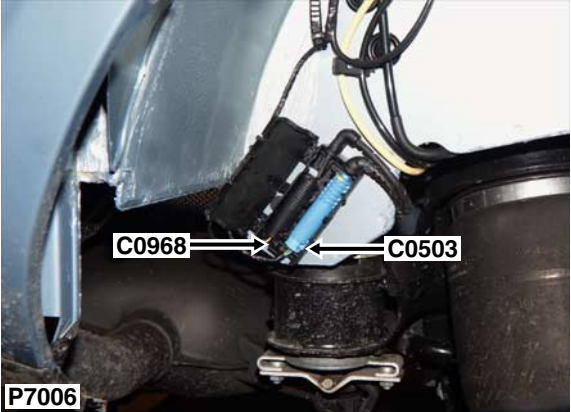

| Cav | Col | Cct |
|-----|-----|-----|
| 1 | YN | ALL |
| 2 | B | ALL |

Description: *Sensor-Pad wear*
Location: *Below RH rear wheelarch*

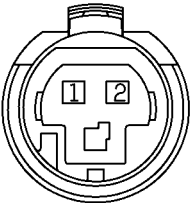

YPC110480

Colour: *BLACK*
Gender: *Female*

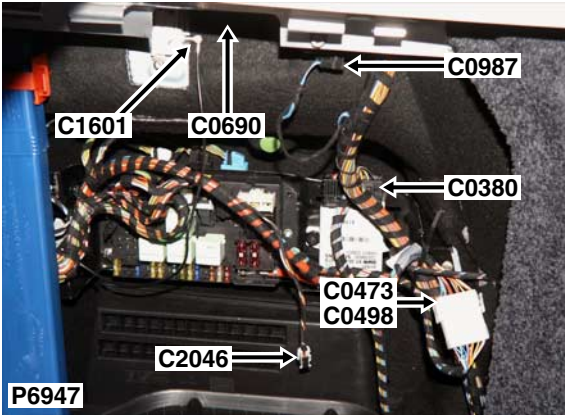

| Cav | Col | Cct |
|-----|-----|-----|
| 1 | US | 6 |
| 2 | UR | 6 |

Description: *Speaker-PDC*

Location: *Luggage compartment - RH side*

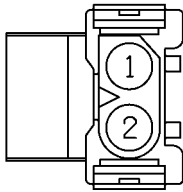

1378110

Colour: *BLACK*
 Gender: *Female*

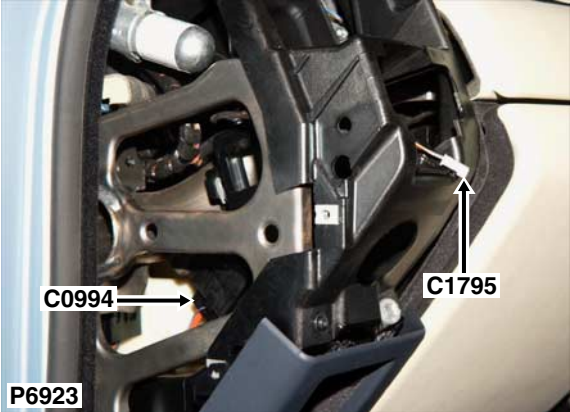

| Cav | Col | Cct |
|-----|-----|-----|
| 1 | UN | 9 |
| 2 | GY | 9 |
| 3 | R | 9 |
| 5 | B | 9 |

Description: *Relay-Heated front screen*
Location: *Behind driver side of fascia*

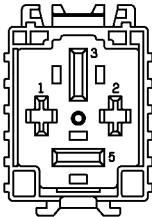

8380420

Colour: *BLACK*
Gender: *Female*

C1216

CONNECTOR DETAILS

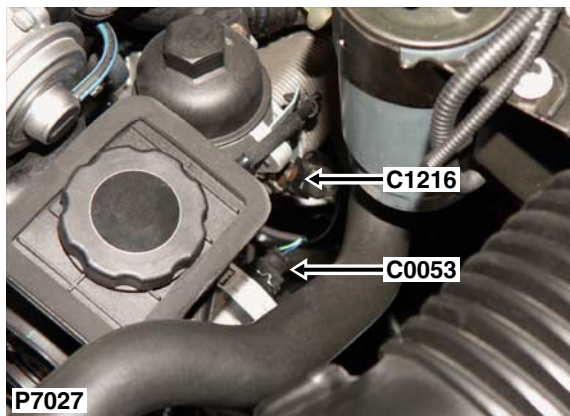

| Cav | Col | Cct |
|-----|-----|-----|
| 1 | NG | 3 |

Description: *Switch-Oil pressure - Td6*

Location: *LH side of engine*

NO CONNECTOR FACE

Colour:
Gender:

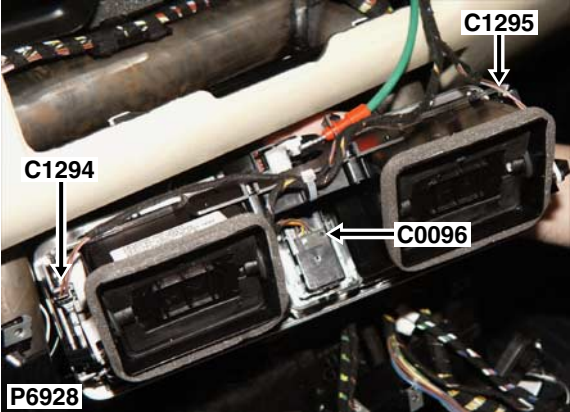

| Cav | Col | Cct |
|-----|-----|-----|
| 1 | NB | ALL |
| 2 | SR | ALL |

Description: *Illumination-Heater Control-LH*
Location: *Behind centre of fascia*

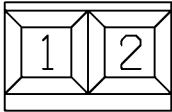

YPC111740

Colour: *BLACK*
Gender: *Female*

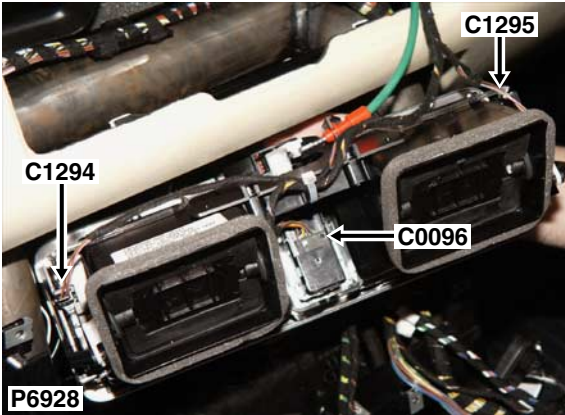

| Cav | Col | Cct |
|-----|-----|-----|
| 1 | NB | ALL |
| 2 | SR | ALL |

Description: *Illumination-Heater Control-RH*

Location: *Behind centre of fascia*

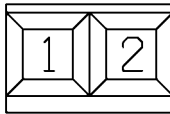

YPC111740

Colour: *BLACK*

Gender: *Female*

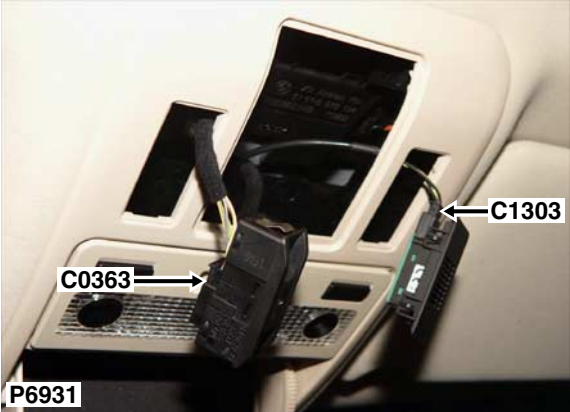

| Cav | Col | Cct |
|-----|-----|-----|
| 1 | B | ALL |
| 2 | Y | ALL |
| 3 | SCR | ALL |

Description: *Microphone-Telephone*
Location: *Front of headlining in the centre*

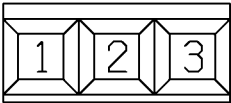

YPC117800

Colour: *BLACK*
Gender: *Female*

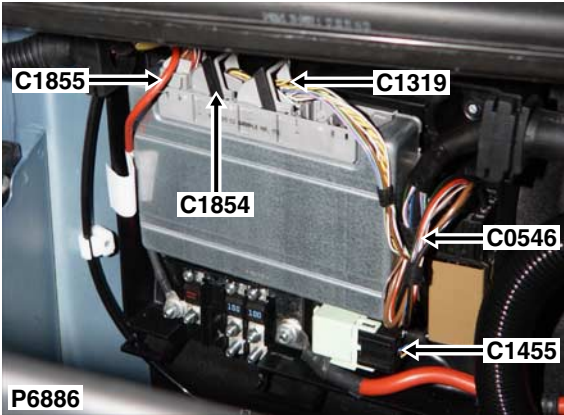

| Cav | Col | Cct |
|-----|-----|-----|
| 7 | PU | ALL |
| 8 | WG | ALL |
| 13 | YN | ALL |
| 15 | GP | ALL |
| 17 | WR | ALL |
| 18 | WB | ALL |
| 19 | WP | ALL |
| 26 | YB | ALL |

Description: *ECU-Transfer box*

Location: *Rear LH side of engine compartment*

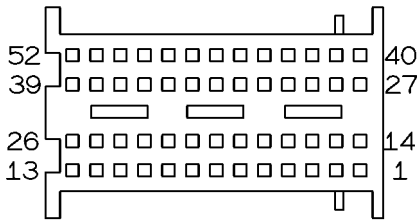

YPH100650

Colour: *GREY*
 Gender: *Female*

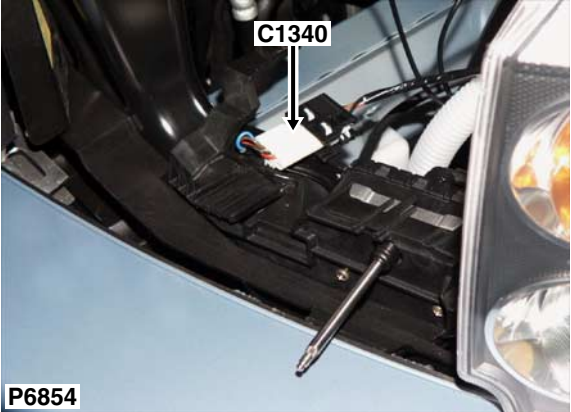

| Cav | Col | Cct |
|-----|-----|-----|
| 1 | BN | 21 |
| 2 | RS | 21 |
| 3 | N | 21 |
| 4 | BY | 21 |

P6854

Description: *Motor-Wiper-Headlamp-LH*
Location: *Front of vehicle - LH side*

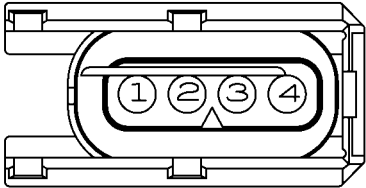

8352356

Colour: *BLACK*
Gender: *Female*

C1341

CONNECTOR DETAILS

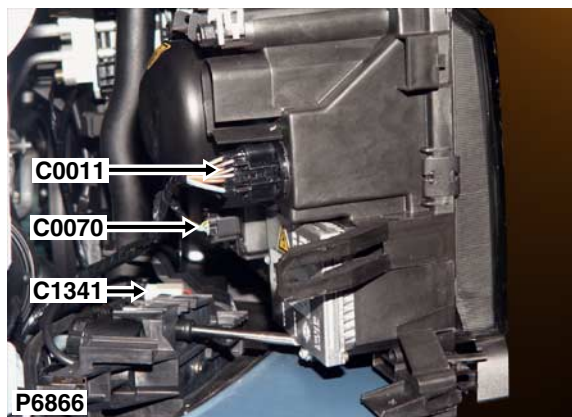

| Cav | Col | Cct |
|-----|-----|-----|
| 1 | BN | 21 |
| 2 | RS | 21 |
| 3 | N | 21 |

Description: *Motor-Wiper-Headlamp-RH*

Location: *Front of vehicle - RH side*

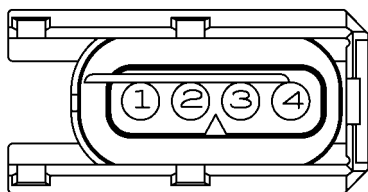

8352356

Colour: *BLACK*

Gender: *Female*

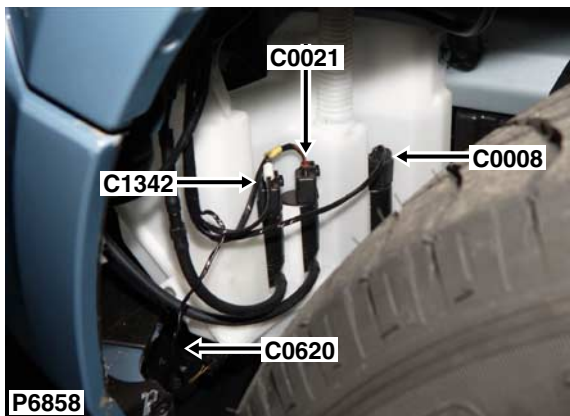

| Cav | Col | Cct |
|-----|-----|-----|
| 1 | N | 21 |
| 2 | BY | 21 |

Description: *Pump-Power wash*

Location: *Front LH side of engine compartment*

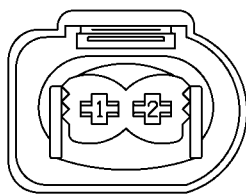

YPC116370

Colour: *BLACK*

Gender: *Female*

C1352

CONNECTOR DETAILS

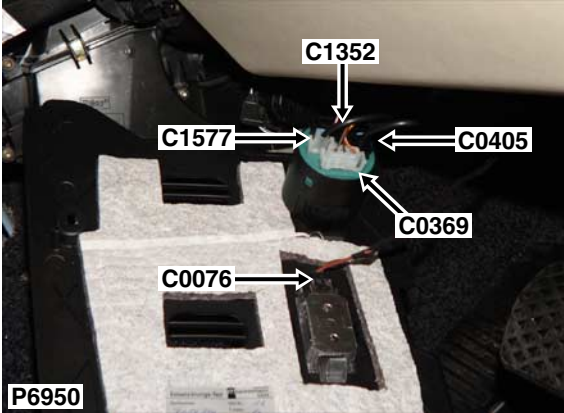

Description: *Speaker-PDC*
Location: *Driver's footwell*

| Cav | Col | Cct |
|-----|-----|-----|
| 2 | WR | ALL |
| 3 | WU | ALL |

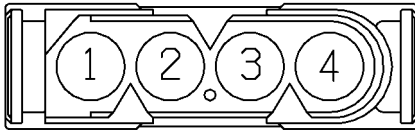

YPC10444

Colour: *BLACK*
Gender: *Female*

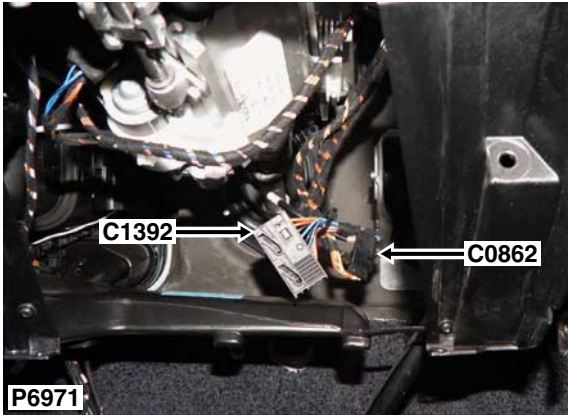

| Cav | Col | Cct |
|-----|-----|-----|
| 1 | N | ALL |
| 2 | RN | ALL |
| 3 | B | ALL |
| 4 | U | ALL |
| 5 | BU | ALL |
| 6 | UB | ALL |
| 7 | NU | ALL |
| 8 | NR | ALL |
| 14 | NB | ALL |
| 15 | NW | ALL |

Description: *Relay-Steering column*
 Location: *Underside of steering column*

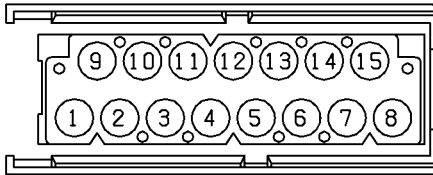

YPC112210

Colour: *BLACK*
 Gender: *Female*

C1393

CONNECTOR DETAILS

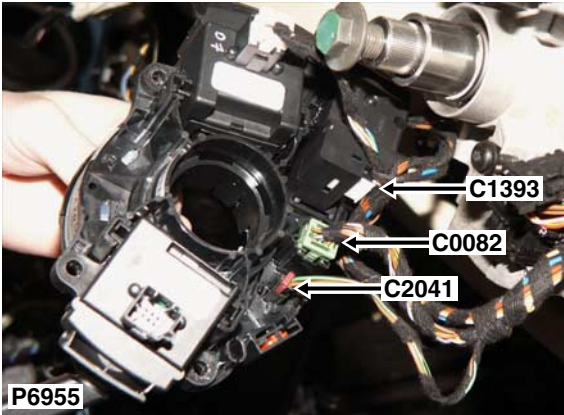

Description: *Switch-Steering column*
Location: *Underside of steering column*

| Cav | Col | Cct |
|-----|-----|-----|
| 1 | NU | ALL |
| 2 | NR | ALL |
| 3 | NB | ALL |
| 4 | NW | ALL |
| 5 | NB | ALL |

NO CONNECTOR FACE

Colour:
Gender:

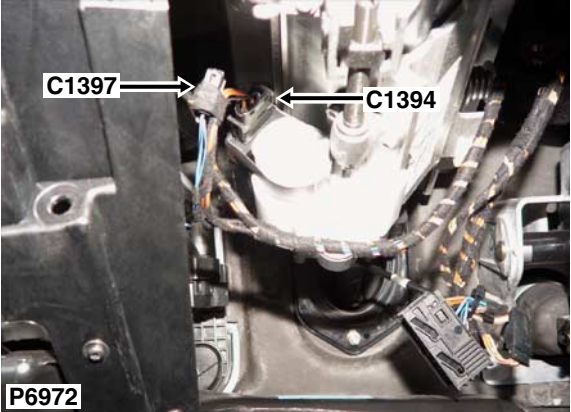

| Cav | Col | Cct |
|-----|-----|-----|
| 1 | BU | 3 |
| 2 | RN | 3 |
| 3 | N | 3 |

Description: *Motor-Column-Telescope*
Location: *Underside of steering column*

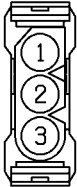

YPC112530

Colour: *BLACK*
Gender: *Female*

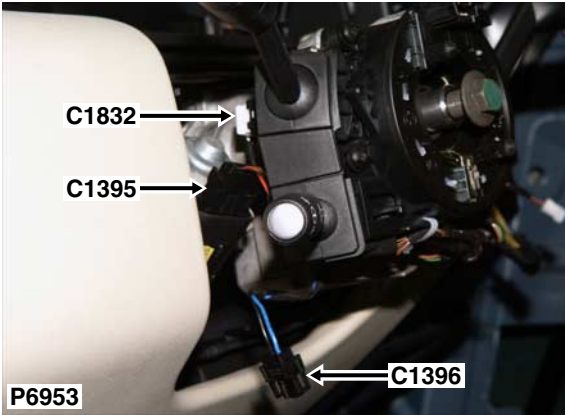

| Cav | Col | Cct |
|-----|-----|-----|
| 1 | B | 3 |
| 2 | RN | 3 |
| 3 | N | 3 |

Description: *Motor-Column-Height*
Location: *Top of steering column*

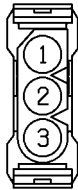

YPC112530

Colour: *BLACK*
Gender: *Female*

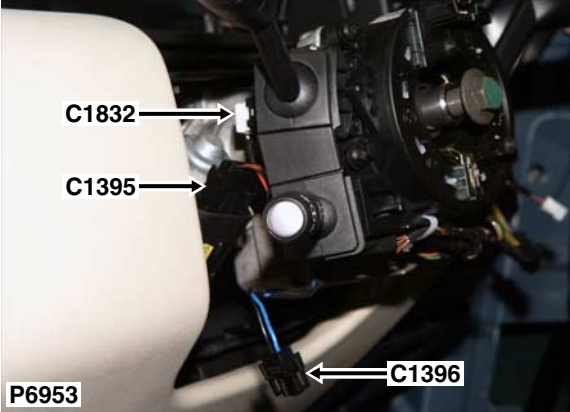

| Cav | Col | Cct |
|-----|-----|-----|
| 1 | U | ALL |
| 2 | B | ALL |

Description: *Motor-Column-Telescope*
Location: *Top of steering column*

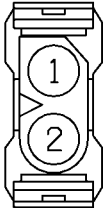

YPC112260

Colour: *BLACK*
Gender: *Female*

C1397

CONNECTOR DETAILS

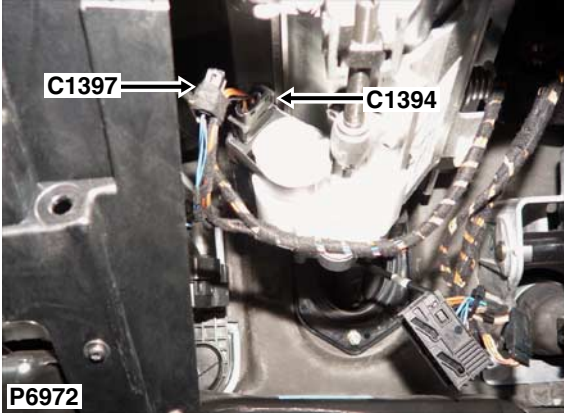

| Cav | Col | Cct |
|-----|-----|-----|
| 1 | UB | ALL |
| 2 | BU | ALL |

Description: *Motor-Column-Height*
Location: *Underside of steering column*

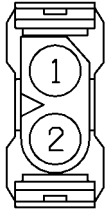

YPC112260

Colour: *BLACK*
Gender: *Female*



| Cav | Col | Cct |
|-----|-----|-----|
| 1 | UR | 3 |
| 3 | WB | 3 |
| 4 | W | 3 |
| 5 | N | 3 |
| 6 | NW | 3 |
| 7 | U | 3 |
| 8 | B | 3 |

Description: Motor-Central door locking-Driver
Location: Behind driver's door trim panel

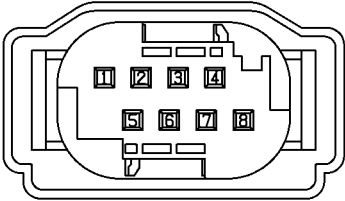

YPC110420

Colour: BLUE
Gender: Female

C1451

CONNECTOR DETAILS

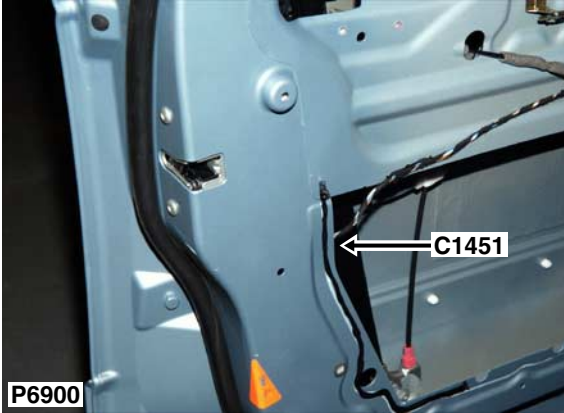

| Cav | Col | Cct |
|-----|-----|-----|
| 4 | W | 3 |
| 5 | N | 3 |
| 6 | NW | 3 |
| 7 | U | 3 |
| 8 | B | 3 |

Description: *Motor-Central door locking-Passenger*

Location: *Behind passenger's door trim panel*

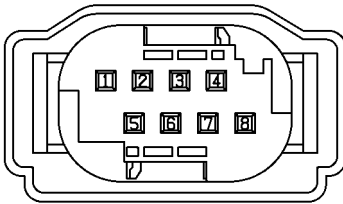

YPC110420

Colour: *BLUE*
Gender: *Female*

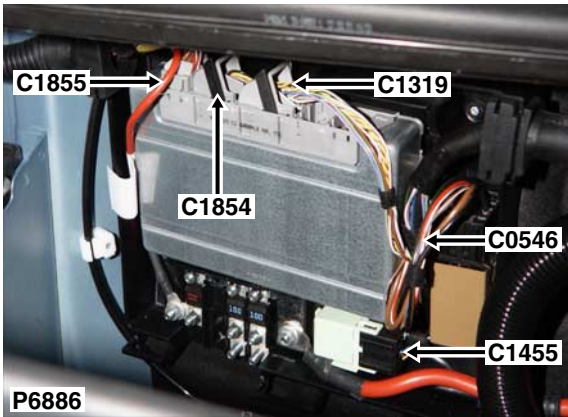

| Cav | Col | Cct |
|-----|-----|-----|
| 2 | B | 2 |
| 4 | YN | 2 |
| 6 | B | 2 |
| 8 | UB | 2 |

Description: *Relay-Interlock*

Location: *Rear LH side of engine compartment*

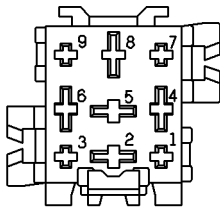

YPP100240

Colour: *BLACK*

Gender: *Female*

C1457

CONNECTOR DETAILS

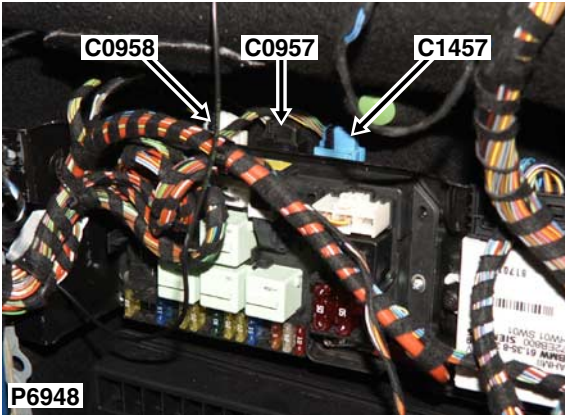

Description: *ECU-PDC*

Location: *Luggage compartment - RH side*

| Cav | Col | Cct |
|-----|-----|-----|
| 1 | NB | 6 |
| 2 | NY | 6 |
| 3 | NW | 6 |
| 4 | GS | 6 |
| 5 | GN | 6 |
| 6 | GP | 6 |
| 7 | NU | 6 |
| 8 | YB | 6 |
| 9 | YG | 6 |
| 10 | YN | 6 |
| 11 | YS | 6 |
| 12 | GB | 6 |

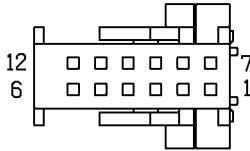

YPC111790

Colour: *BLACK*

Gender: *Female*



| Cav | Col | Cct |
|-----|-----|-----|
| 1 | Y | 20 |
| 2 | B | 20 |

Description: *Airbag-ITS-Rear-LH*
Location: *Rear of headlining*

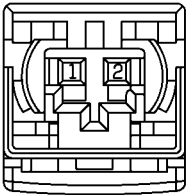

8380742

Colour: *BLACK*
Gender: *Female*

C1475

CONNECTOR DETAILS



| Cav | Col | Cct |
|-----|-----|-----|
| 1 | G | 20 |
| 2 | B | 20 |

Description: *Airbag-Side-Rear-RH*

Location: *Rear of headlining*

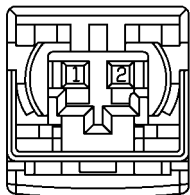

8380742

Colour: *BLACK*

Gender: *Female*

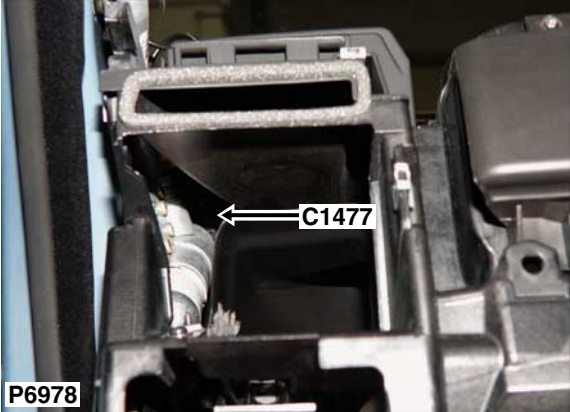

| Cav | Col | Cct |
|-----|-----|-----|
| 1 | Y | ALL |
| 2 | UY | ALL |

Description: *Airbag-ITS-Front-LH*
Location: *Behind LH side of fascia*



Colour: *BLACK*
Gender: *Female*

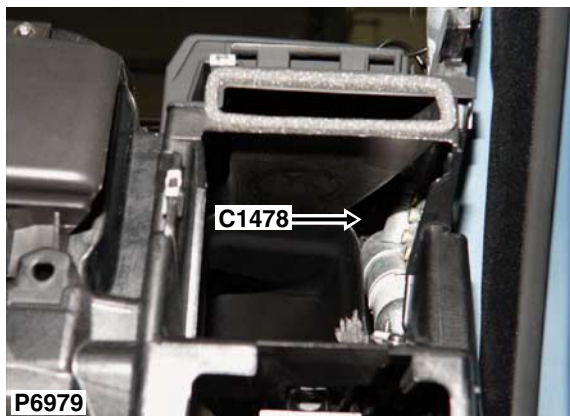

Description: *Airbag-ITS-Front-RH*
Location: *Behind RH side of fascia*

| Cav | Col | Cct |
|-----|-----|-----|
| 1 | W | ALL |
| 2 | UW | ALL |

NO CONNECTOR FACE

Colour: *BLACK*
Gender: *Female*

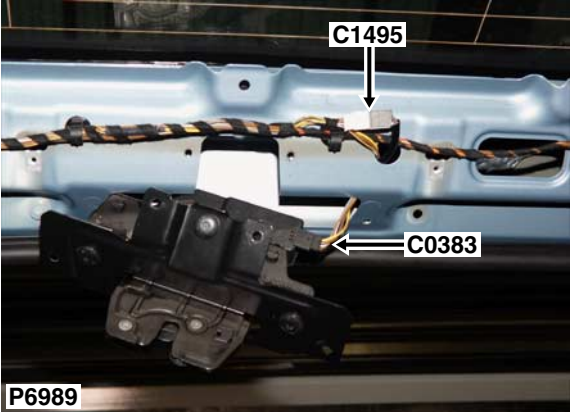

| Cav | Col | Cct |
|-----|-----|-----|
| 1 | SN | ALL |
| 2 | N | ALL |
| 3 | SY | ALL |
| 4 | SB | ALL |

Description: *Lamp-Number plate and tail door switch*
Location: *Centre of taildoor, behind trim panel*

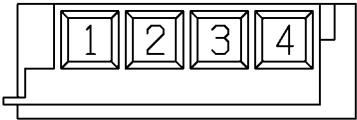

YPC117850

Colour: *NATURAL*
Gender: *Female*



Description: *Airbag-Side-Passenger*

Location: *Behind passenger's door trim panel*

| Cav | Col | Cct |
|-----|-----|-----|
| 1 | U | 3 |
| 2 | N | 3 |

NO CONNECTOR FACE

Colour:

Gender:



| Cav | Col | Cct |
|-----|-----|-----|
| 1 | Y | 3 |
| 2 | N | 3 |

Description: *Airbag-Side-Driver*
Location: *Behind driver's door trim panel*



Colour:
Gender:

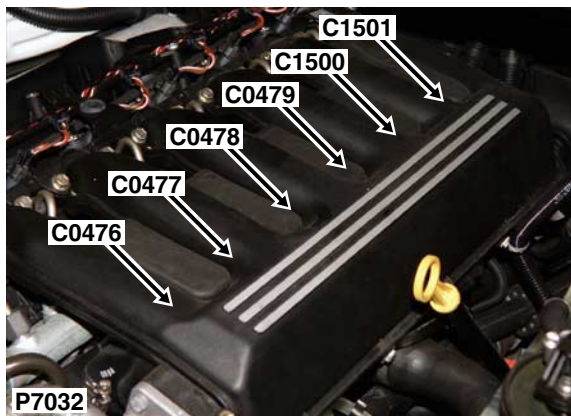

Description: *Glow plug - Td6*
Location: *LH side of engine*

| Cav | Col | Cct |
|-----|-----|-----|
| 1 | BW | 3 |

NO CONNECTOR FACE

Colour:
Gender:

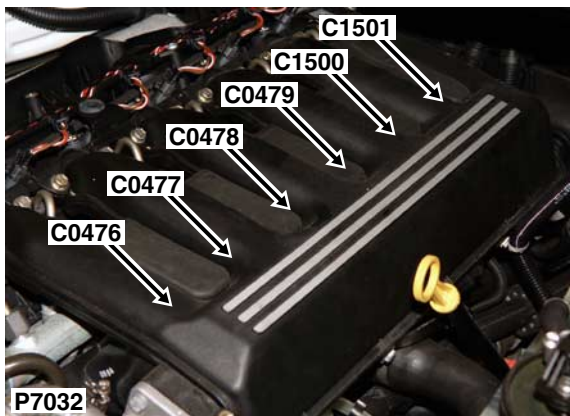

| Cav | Col | Cct |
|-----|-----|-----|
| 1 | BN | 3 |

Description: *Glow plug - Td6*

Location: *LH side of engine*

NO CONNECTOR FACE

Colour:

Gender:

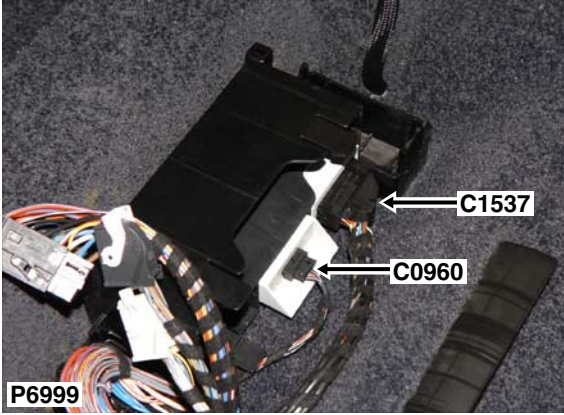

Description: *ECU-Tyre deflation*

Location: *Beneath front passenger's seat*

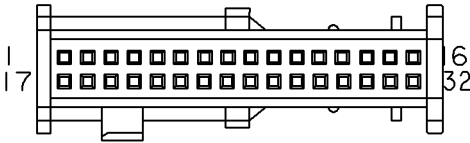

8373646

Colour: *BLACK*

Gender: *Female*

| Cav | Col | Cct |
|-----|-----|-----|
| 1 | WRY | 23 |
| 3 | UR | 23 |
| 5 | W | 23 |
| 6 | SCR | 23 |
| 7 | W | 23 |
| 8 | W | 23 |
| 9 | SCR | 23 |
| 10 | W | 23 |
| 14 | UN | 23 |
| 15 | RNY | 23 |
| 16 | NB | 23 |
| 17 | UY | 23 |
| 21 | G | 23 |
| 22 | SCR | 23 |
| 23 | U | 23 |
| 24 | R | 23 |
| 25 | SCR | 23 |
| 26 | Y | 23 |
| 31 | GN | 23 |

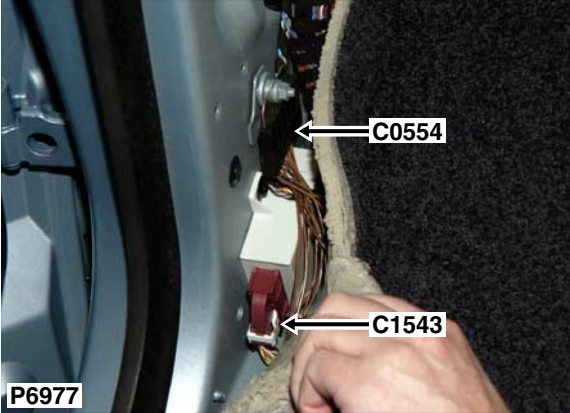

Description: ECU-Headlamp levelling
 Location: Passenger's footwell

| Cav | Col | Cct |
|-----|-----|-----|
| 1 | YR | 22 |
| 2 | YN | 22 |
| 3 | UR | 22 |
| 4 | UN | 22 |
| 5 | WN | 22 |
| 7 | SN | 22 |
| 8 | UN | 22 |
| 9 | UB | 22 |
| 10 | YB | 22 |
| 11 | YN | 22 |
| 13 | YR | 22 |
| 14 | WRY | 22 |
| 16 | WS | 22 |
| 18 | WB | 22 |
| 20 | SW | 22 |
| 21 | UR | 22 |
| 22 | SB | 22 |
| 24 | YW | 22 |
| 26 | NB | 22 |

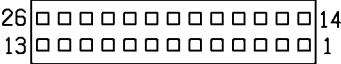

YPC114350

Colour: GREY
 Gender: Female

C1544

CONNECTOR DETAILS

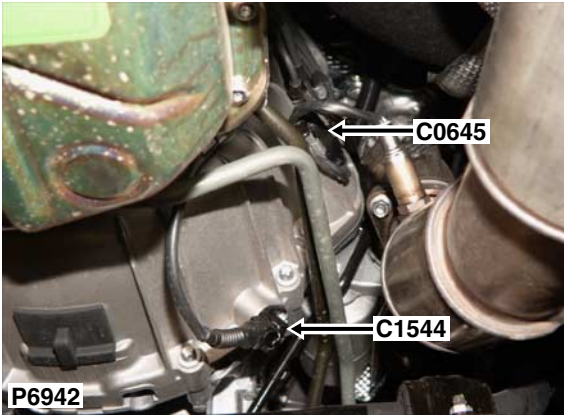

| Cav | Col | Cct |
|-----|-----|-----|
| 1 | Y | 3 |
| 2 | B | 3 |

Description: *Sensor-Crankshaft position (CKP)*

Location: *Rear RH side of engine*

NO CONNECTOR FACE

Colour:

Gender:

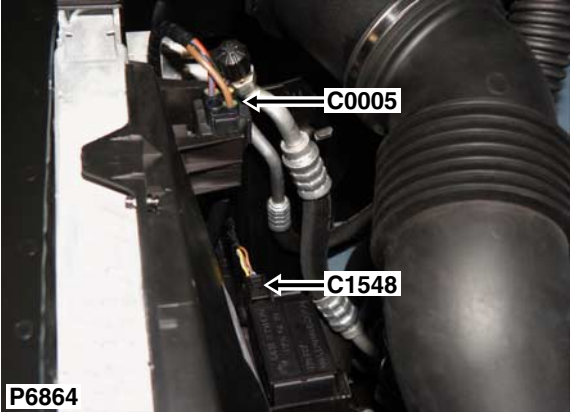

| Cav | Col | Cct |
|-----|-----|-----|
| 1 | N | 5 |
| 2 | Y | 5 |
| 3 | N | 5 |
| 4 | U | 5 |

Description: *Sensor-Air Temperature Control (ATC)*
Location: *Front of engine compartment - centre*

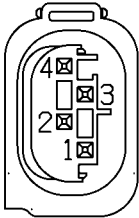

YPC117050

Colour: *BLACK*
Gender: *Female*

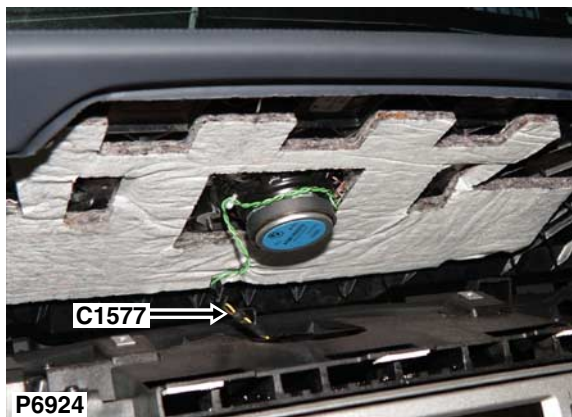

Description: *Speaker-PDC*
 Location: *Driver's footwell*

| Cav | Col | Cct |
|-----|-----|-----|
| 1 | N | 6 |
| 2 | Y | 6 |

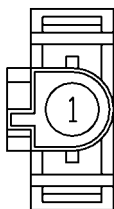

YPC113900

Colour: *NATURAL*
 Gender: *Female*

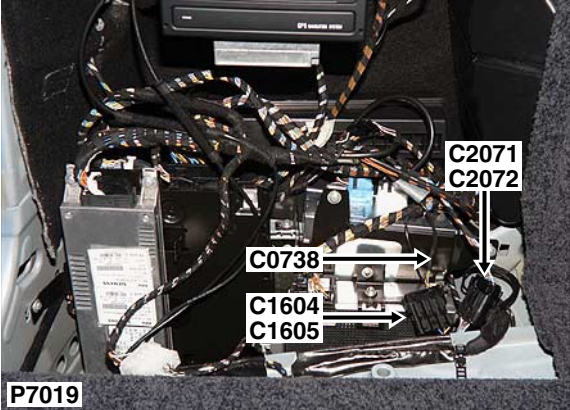

| Cav | Col | Cct |
|-----|-----|-----|
| 1 | YR | 15 |
| 2 | BW | 15 |
| 3 | UY | 15 |

Description: *Main harness to navigation harness*
Location: *Luggage compartment - LH side*

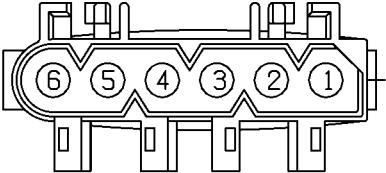

YPC112110

Colour: *BLACK*
Gender: *Male*

C1610

CONNECTOR DETAILS

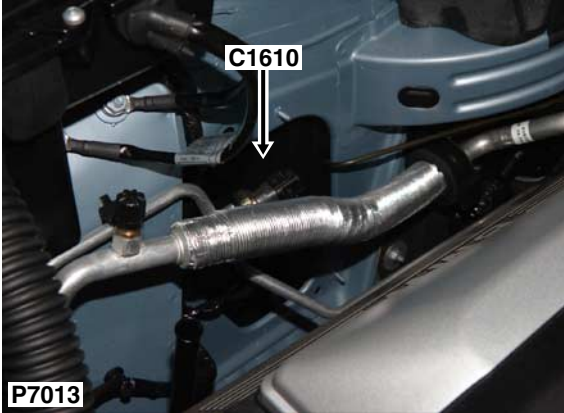

| Cav | Col | Cct |
|-----|-----|-----|
| 1 | NB | ALL |
| 2 | BS | ALL |
| 3 | GY | ALL |

Description: *Sensor-Pressure-Air*

Location: *RH side of engine compartment*

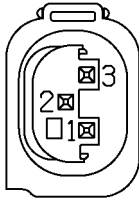

YPC116850

Colour: *BLACK*

Gender: *Female*

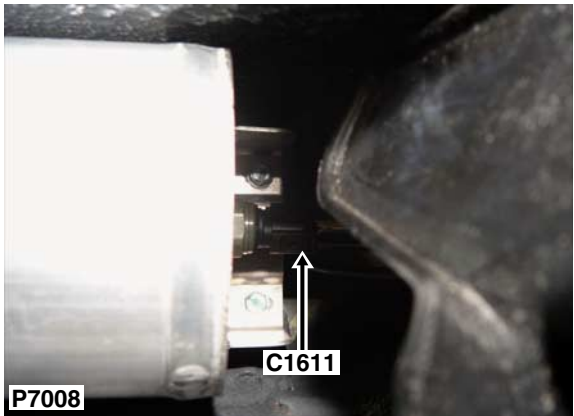

| Cav | Col | Cct |
|-----|-----|-----|
| 1 | W | ALL |
| 2 | U | ALL |
| 3 | Y | ALL |

Description: *Sensor-Pressure-Air*
Location: *Beneath vehicle - RH side*

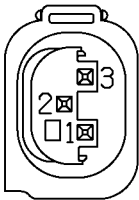

YPC116850

Colour: *BLACK*
Gender: *Female*

C1629

CONNECTOR DETAILS

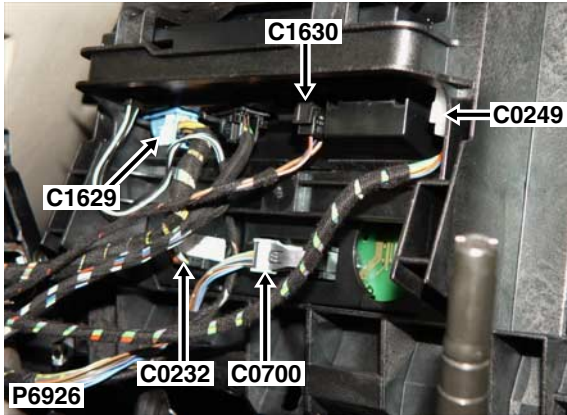

Description: *Module-HEVAC control*
 Location: *Behind centre console*

| Cav | Col | Cct |
|-----|-----|-----|
| 1 | GY | ALL |
| 2 | YN | 5 |
| 3 | WRY | ALL |
| 4 | RY | ALL |
| 5 | YN | ALL |
| 6 | YP | 5 |
| 7 | UN | ALL |
| 8 | SY | ALL |
| 9 | UG | ALL |
| 10 | BS | ALL |
| 12 | N | 5 |
| 13 | Y | 5 |
| 14 | UN | 9 |
| 15 | WG | 18 |
| 16 | WU | 18 |
| 17 | BG | ALL |
| 18 | YR | 5 |
| 19 | YG | 5 |
| 20 | NB | ALL |
| 21 | GY | ALL |
| 22 | SB | 8 |
| 23 | SR | ALL |
| 24 | YB | 5 |
| 25 | N | 5 |
| 26 | U | 5 |

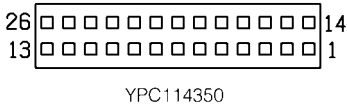

Colour: *GREY*
 Gender: *Female*

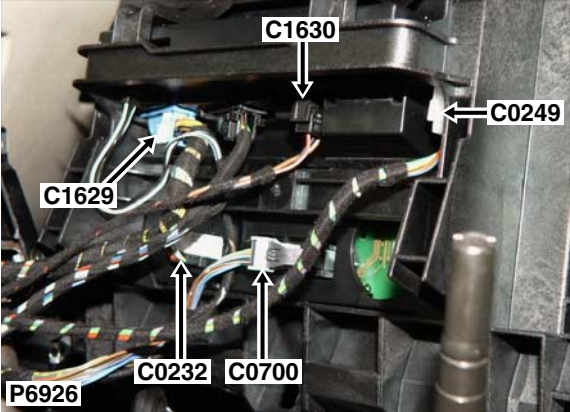

| Cav | Col | Cct |
|-----|-----|-----|
| 1 | RP | ALL |
| 2 | BS | ALL |
| 3 | N | ALL |

Description: *Module-HEVAC control*
Location: *Behind centre console*

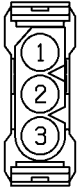

YPC112530

Colour: *BLACK*
Gender: *Female*

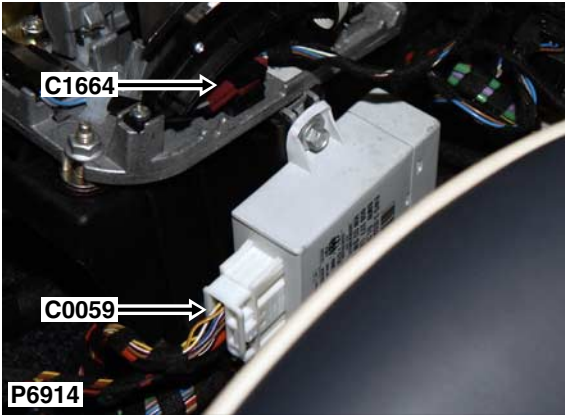

| Cav | Col | Cct |
|-----|-----|-----|
| 1 | NB | ALL |
| 2 | UY | ALL |
| 3 | US | ALL |
| 4 | WG | ALL |

Description: *Switch-Stepronic*

Location: *Beneath centre console*

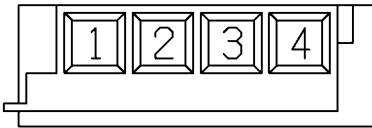

YPC117870

Colour: *PURPLE*

Gender: *Female*



| Cav | Col | Cct |
|-----|-----|-----|
| 1 | RW | 3 |
| 2 | NU | 3 |

Description: *Regulator-Fuel pressure - Td6*
Location: *LH side of engine*



Colour:
Gender:



| Cav | Col | Cct |
|-----|-----|-----|
| 1 | SN | ALL |
| 4 | SW | ALL |
| 5 | SB | ALL |

Description: *Sensor-Height-Front-LH*
Location: *Behind LH front wheel arch liner*

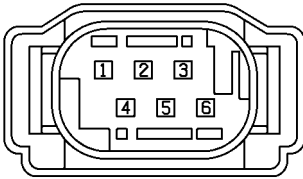

YPC110680

Colour: *BLACK*
Gender: *Female*



| Cav | Col | Cct |
|-----|-----|-----|
| 1 | BN | ALL |
| 2 | WN | 22 |
| 3 | WB | 22 |
| 4 | BS | ALL |
| 5 | BW | ALL |
| 6 | WS | 22 |

Description: *Sensor-Height-Front-RH*

Location: *Behind RH front wheel arch liner*

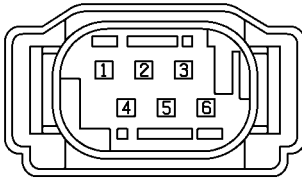

YPC110680

Colour: *BLACK*

Gender: *Female*

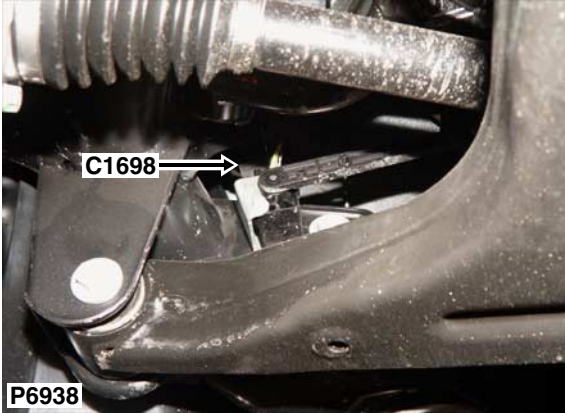

| Cav | Col | Cct |
|-----|-----|-----|
| 1 | YN | ALL |
| 2 | SN | 22 |
| 3 | SB | 22 |
| 4 | YS | ALL |
| 5 | YB | ALL |
| 6 | SW | 22 |

Description: *Sensor-Height-Rear-RH*

Location: *Below RH rear wheelarch*

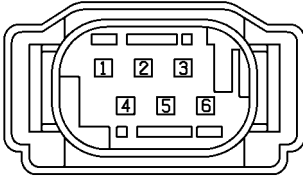

YPC110680

Colour: *BLACK*

Gender: *Female*

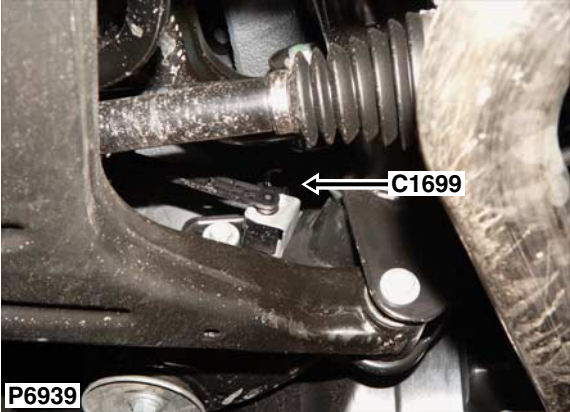

| Cav | Col | Cct |
|-----|-----|-----|
| 1 | WN | ALL |
| 4 | WS | ALL |
| 5 | WB | ALL |

P6939

Description: *Sensor-Height-Rear-LH*
Location: *Below LH rear wheelarch*

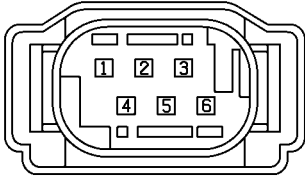

YPC110680

Colour: *BLACK*
Gender: *Female*

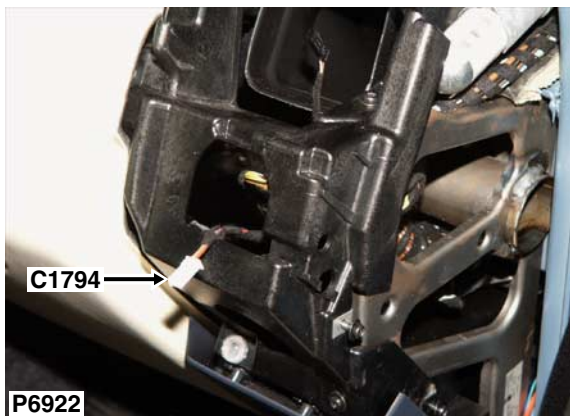

| Cav | Col | Cct |
|-----|-----|-----|
| 1 | N | 12 |
| 2 | RU | 12 |

Description: *Lamp-Door sill-Front-RH*
Location: *Behind RH side of fascia*

NO CONNECTOR FACE

Colour:
Gender:

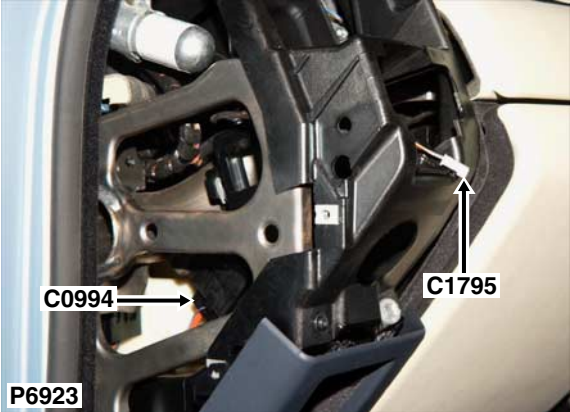

| Cav | Col | Cct |
|-----|-----|-----|
| 1 | N | 12 |
| 2 | RU | 12 |

Description: *Lamp-Door sill-Front-LH*
Location: *Behind LH side of fascia*



Colour:
Gender:

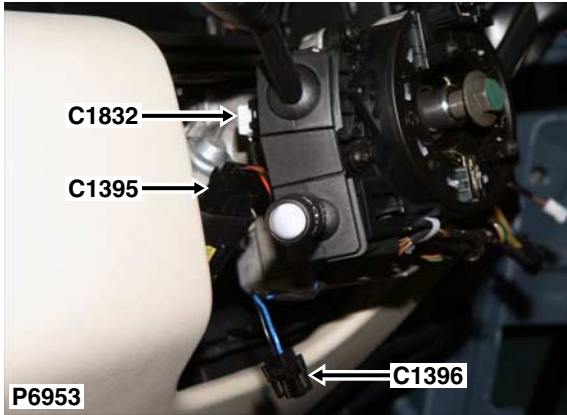

| Cav | Col | Cct |
|-----|-----|-----|
| 1 | YR | ALL |
| 7 | U | ALL |
| 9 | W | ALL |
| 10 | NB | ALL |

Description: *Switch-Steering column-Lighting*
Location: *Top of steering column*

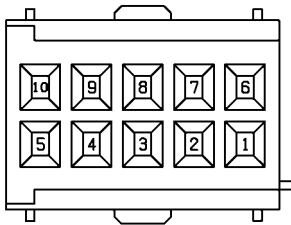

6909002

Colour:
Gender:

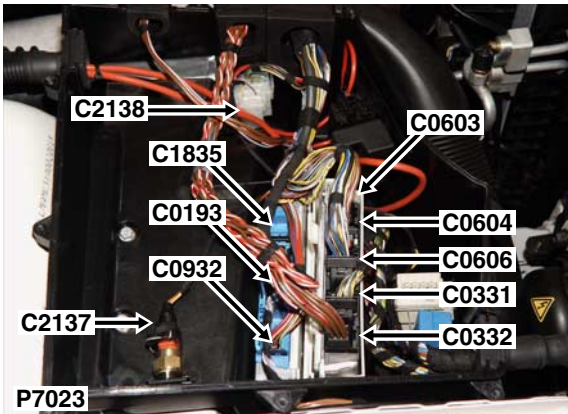

Description: ECU-Electronic automatic transmission - Td6

Location: Inside E-box

NO CONNECTOR FACE

Colour:

Gender:

| Cav | Col | Cct |
|-----|-----|-----|
| 1 | O | 3 |
| 2 | SCR | 3 |
| 2 | YU | 3 |
| 3 | G | 3 |
| 3 | N | 3 |
| 4 | Y | 3 |
| 5 | SCR | 3 |
| 6 | BY | 3 |
| 6 | YR | 3 |
| 7 | TB | 3 |
| 8 | R | 3 |
| 9 | Y | 26 |
| 10 | GR | 3 |
| 11 | P | 3 |
| 13 | W | 3 |
| 14 | P | 3 |
| 14 | PB | 3 |
| 15 | YB | 3 |
| 16 | TB | 3 |
| 16 | Y | 3 |
| 17 | B | 3 |
| 17 | K | 3 |
| 18 | BR | 24 |
| 19 | WR | 3 |
| 20 | OB | 3 |
| 21 | YU | 3 |
| 22 | BR | 3 |
| 23 | U | 3 |
| 24 | S | 3 |
| 24 | O | 9 |
| 25 | SCR | 2 |
| 26 | G | 3 |
| 26 | R | 25 |
| 27 | B | 3 |
| 31 | G | 3 |
| 32 | WPY | 3 |
| 33 | S | 3 |

| Cav | Col | Cct |
|------------|------------|------------|
| 34 | B | 3 |
| 36 | YB | 3 |
| 37 | YN | 3 |
| 38 | O | 3 |
| 38 | SCR | 3 |
| 39 | N | 3 |
| 40 | W | 3 |

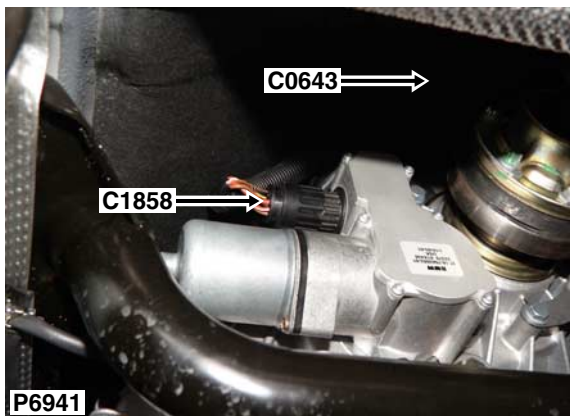

Description: *Transfer gearbox - V8*
Location: *LH side of transfer box*

| Cav | Col | Cct |
|-----|-----|-----|
| 1 | N | 3 |
| 2 | Y | 3 |
| 4 | B | 3 |
| 6 | RW | 3 |
| 7 | N | 5 |
| 9 | RW | 3 |
| 10 | N | 3 |

NO CONNECTOR FACE

Colour:
Gender:

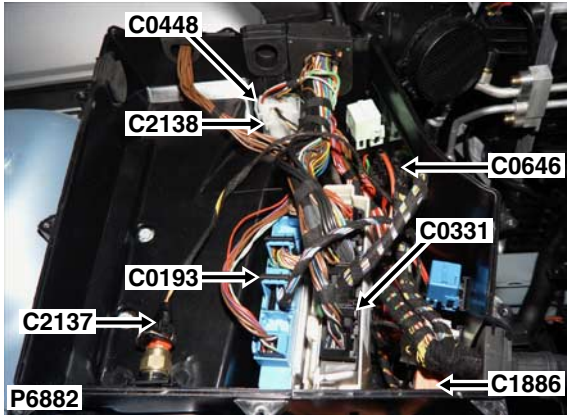

| Cav | Col | Cct |
|-----|-----|-----|
| 2 | R | 2 |
| 4 | NU | 2 |
| 5 | N | 2 |
| 6 | BRY | 2 |
| 8 | RW | 2 |

Description: *Relay-Air injection pump*

Location: *Inside E-box*

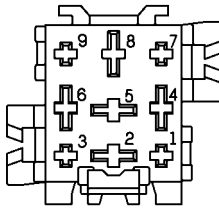

8378979

Colour:
Gender:



| Cav | Col | Cct |
|-----|-----|-----|
| 1 | N | ALL |
| 2 | NR | ALL |

Description: *Battery*
Location: *Rear of engine compartment*

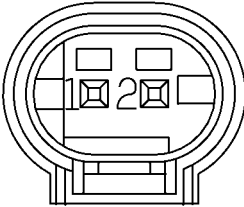

YPC115230

Colour: *YELLOW*
Gender: *Female*

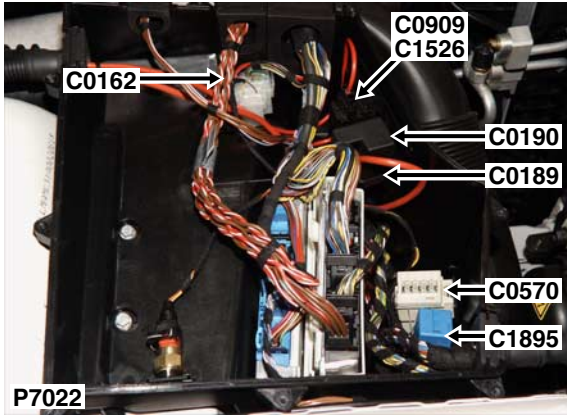

Description: *Relay-Engine control module (ECM) - Td6*
 Location: *Inside E-box*

| Cav | Col | Cct |
|-----|-----|-----|
| 2 | RW | 3 |
| 4 | N | 3 |
| 5 | RW | 3 |
| 6 | R | 3 |

NO CONNECTOR FACE

Colour:
 Gender:

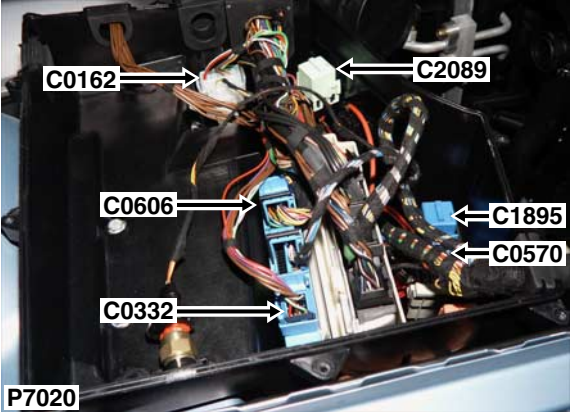

| Cav | Col | Cct |
|-----|-----|-----|
| 2 | RW | 3 |
| 4 | N | 3 |
| 5 | RW | 3 |
| 6 | R | 3 |

Description: *Relay-Engine control module (ECM) - V8*
Location: *Inside E-box*



Colour:
Gender:

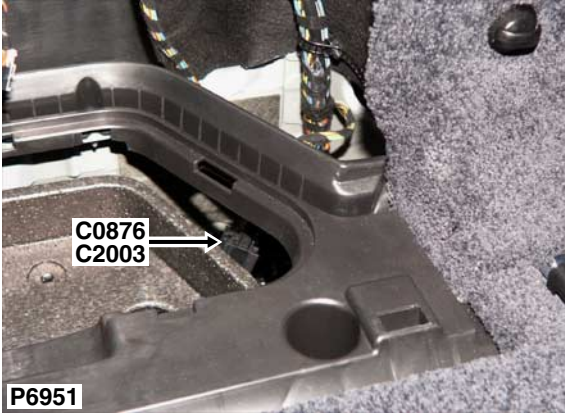

Description: *PDC harness to main harness*

Location: *Rear of luggage compartment*

| Cav | Col | Cct |
|-----|-----|-----|
| 1 | NB | 6 |
| 2 | NY | 6 |
| 3 | NW | 6 |
| 4 | GS | 6 |
| 5 | GN | 6 |
| 6 | GV | 6 |
| 7 | NU | 6 |
| 8 | YB | 6 |
| 9 | YG | 6 |
| 10 | YN | 6 |
| 11 | YS | 6 |
| 12 | GB | 6 |

NO CONNECTOR FACE

Colour:
Gender:

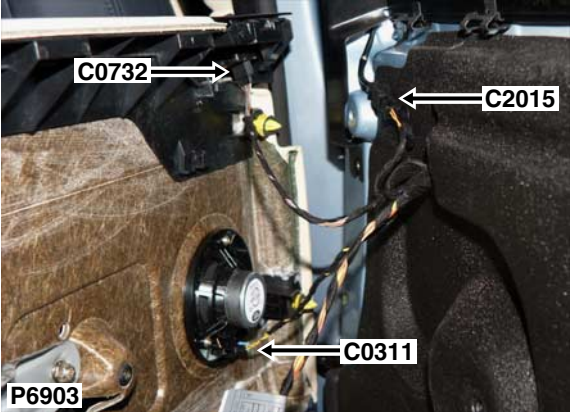

| Cav | Col | Cct |
|-----|-----|-----|
| 1 | N | 3 |
| 2 | NY | 3 |

Description: *Sensor-Anti-trap-Rear-RH*
Location: *Behind rear door trim panel*

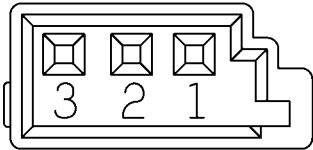

6905977

Colour:
Gender:

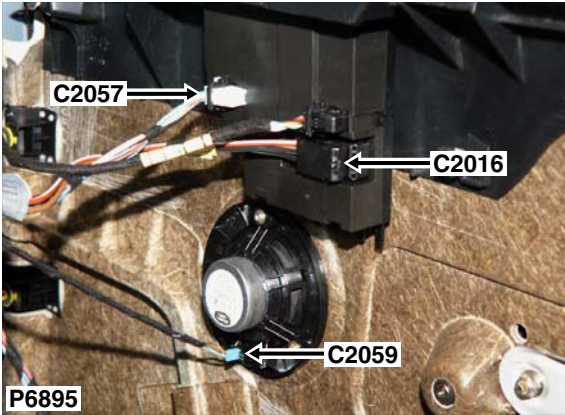

| Cav | Col | Cct |
|-----|-----|-----|
| 1 | RW | 3 |
| 2 | N | 3 |
| 4 | BG | 3 |
| 5 | BS | 3 |

Description: *Module-Passenger door*

Location: *Behind passenger's door trim panel*

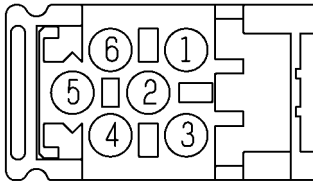

1387194

Colour:
Gender:

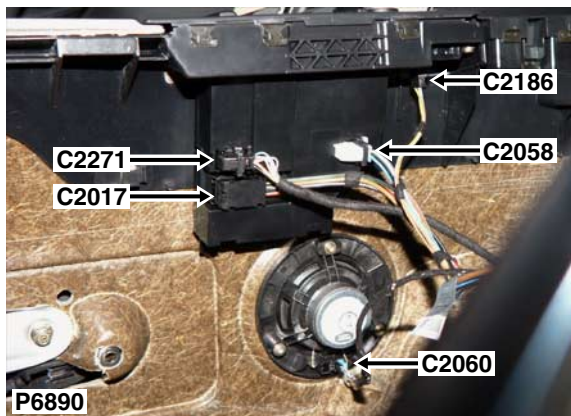

| Cav | Col | Cct |
|-----|-----|-----|
| 1 | RV | 3 |
| 2 | N | 3 |
| 4 | BG | 3 |
| 5 | BS | 3 |

Description: *Module-Drivers door*

Location: *Behind driver's door trim panel*

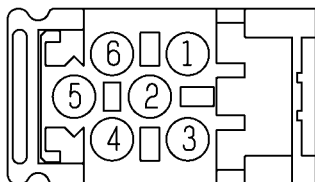

1387194

Colour:

Gender:

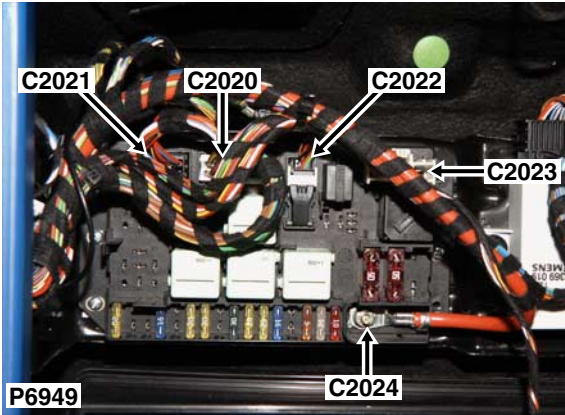

Description: *Fuse box-Rear*

Location: *Luggage compartment - RH side*

| Cav | Col | Cct |
|-----|-----|-----|
| 1 | RU | ALL |
| 2 | RB | ALL |
| 3 | WU | ALL |
| 4 | WU | 1 |
| 5 | RBY | ALL |
| 7 | RY | ALL |
| 12 | RG | ALL |

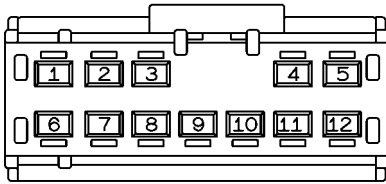

6906564

Colour:
Gender:

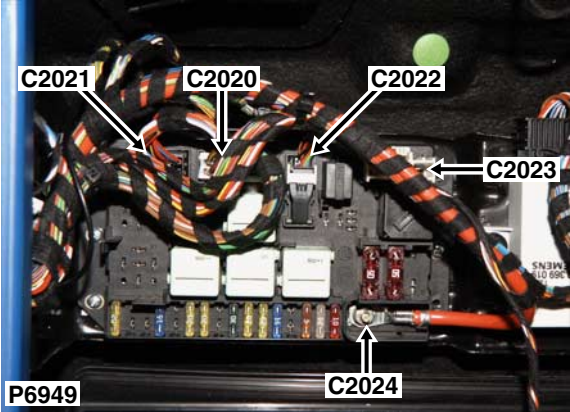

| Cav | Col | Cct |
|-----|-----|-----|
| 2 | GU | 5 |
| 5 | B | ALL |
| 6 | GW | 19 |
| 7 | GN | 19 |
| 9 | RW | ALL |
| 10 | N | ALL |

Description: Fuse box-Rear

Location: Luggage compartment - RH side

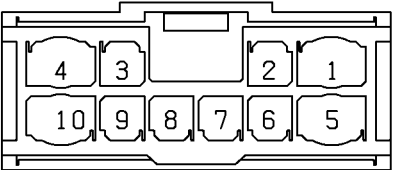

6901806

Colour: NATURAL

Gender: Female

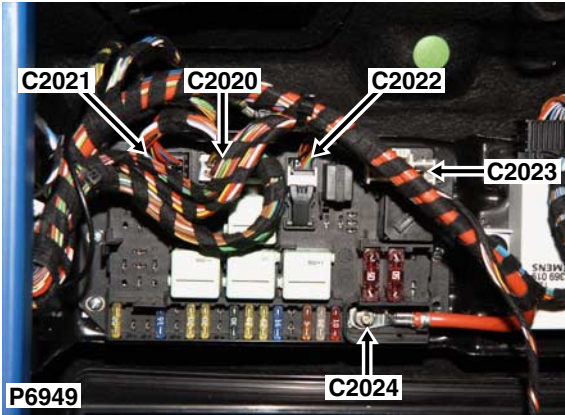

Description: *Fuse box-Rear*

Location: *Luggage compartment - RH side*

| Cav | Col | Cct |
|-----|-----|-----|
| 1 | B | ALL |
| 9 | GY | ALL |
| 10 | GY | ALL |
| 14 | NY | ALL |
| 15 | UY | ALL |
| 16 | UW | ALL |
| 17 | RS | ALL |
| 21 | RB | 11 |
| 22 | BP | ALL |
| 23 | RW | ALL |
| 26 | UN | ALL |

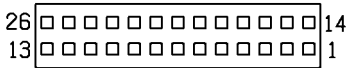

YPC114350

Colour: *GREY*
 Gender: *Female*

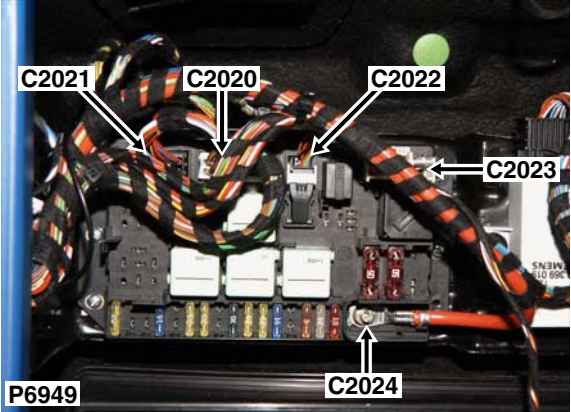

| Cav | Col | Cct |
|-----|-----|-----|
| 2 | RY | ALL |
| 3 | RW | ALL |

Description: Fuse box-Rear

Location: Luggage compartment - RH side

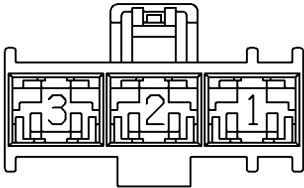

6900557

Colour: NATURAL

Gender: Female

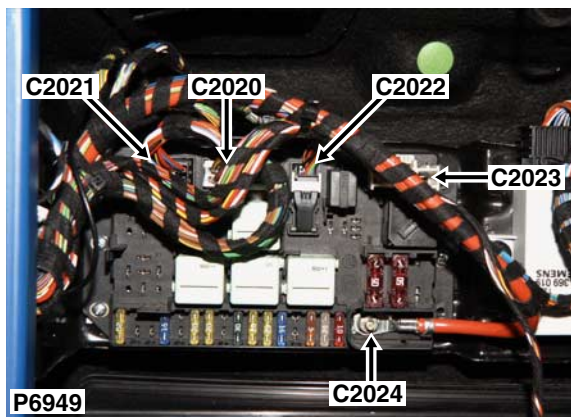

| Cav | Col | Cct |
|-----|-----|-----|
| 1 | R | ALL |

Description: *Fuse box-Rear*

Location: *Luggage compartment - RH side*

NO CONNECTOR FACE

Colour:

Gender:



| Cav | Col | Cct |
|-----|-----|-----|
| 1 | W | 23 |
| 2 | G | 23 |

Description: *Sensor-Tyre-Front-LH*
Location: *Behind LH front wheel arch liner*

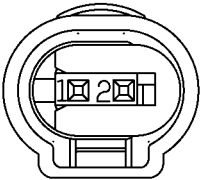

YPC116820

Colour: *BLACK*
Gender: *Female*

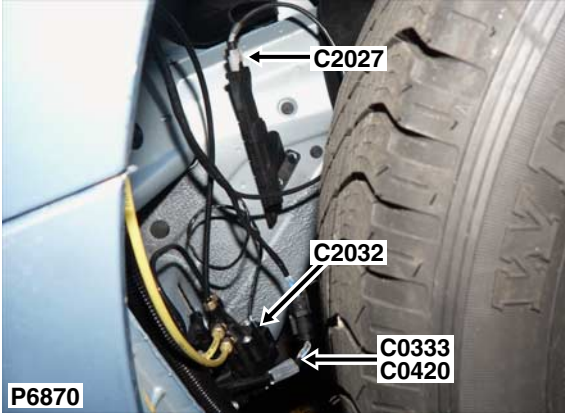

| Cav | Col | Cct |
|-----|-----|-----|
| 1 | W | 23 |
| 2 | U | 23 |

Description: *Sensor-Tyre-Front-RH*
Location: *Behind RH front wheel arch liner*

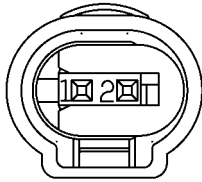

YPC116820

Colour: *BLACK*
Gender: *Female*



| Cav | Col | Cct |
|-----|-----|-----|
| 1 | W | 23 |
| 2 | R | 23 |

Description: *Sensor-Tyre-Rear-LH*
Location: *Below LH rear wheelarch*

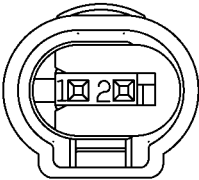

YPC116820

Colour: *BLACK*
Gender: *Female*



| Cav | Col | Cct |
|-----|-----|-----|
| 1 | W | 23 |
| 2 | Y | 23 |

Description: *Sensor-Tyre-Rear-RH*

Location: *Below RH rear wheelarch*

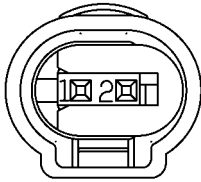

YPC116820

Colour: *BLACK*

Gender: *Female*

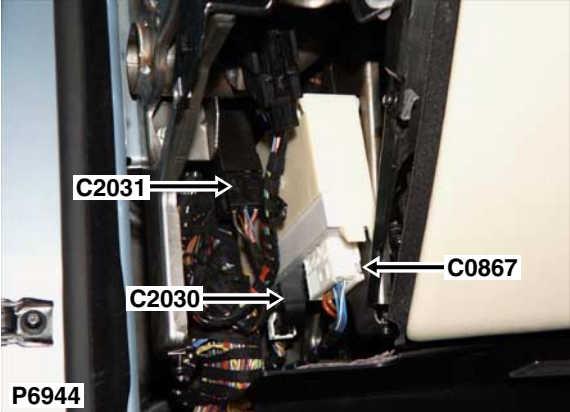

| Cav | Col | Cct |
|-----|-----|-----|
| 2 | WU | ALL |
| 3 | UP | ALL |
| 5 | N | ALL |
| 7 | UR | ALL |
| 8 | UN | ALL |
| 10 | RN | ALL |

Description: ECU-Air suspension
Location: Behind LH side of fascia

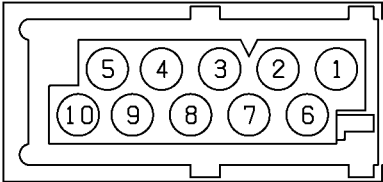

YPC112630

Colour: NATURAL
Gender: Female

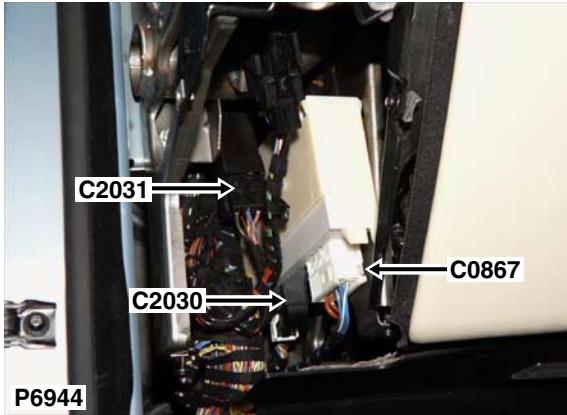

| Cav | Col | Cct |
|-----|-----|-----|
| 2 | RS | 21 |
| 4 | NB | 21 |
| 5 | N | 21 |
| 6 | UB | 21 |
| 8 | BN | 21 |

Description: *Relay-Headlamp wash/wipe*

Location: *Behind LH side of fascia*

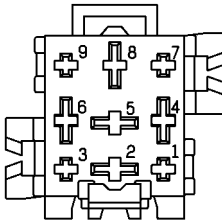

1389112

Colour:
Gender:

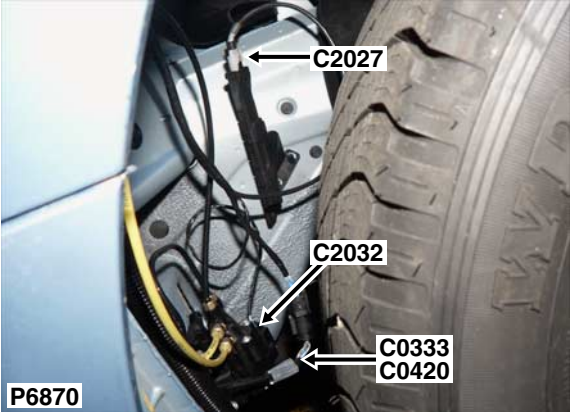

| Cav | Col | Cct |
|-----|-----|-----|
| 1 | UN | ALL |
| 2 | WU | ALL |

Description: *Valve-Off-road-Front*
Location: *Behind RH front wheel arch liner*

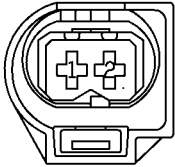

YPC113410

Colour: *BLACK*
Gender: *Female*

C2033

CONNECTOR DETAILS

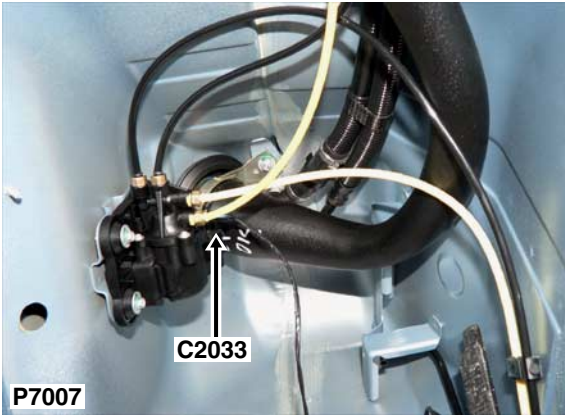

| Cav | Col | Cct |
|-----|-----|-----|
| 1 | UR | ALL |
| 2 | UP | ALL |

Description: *Valve-Off-road-Rear*

Location: *Below RH rear wheelarch*

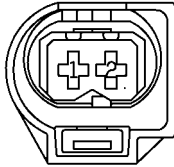

YPC113410

Colour: *BLACK*

Gender: *Female*

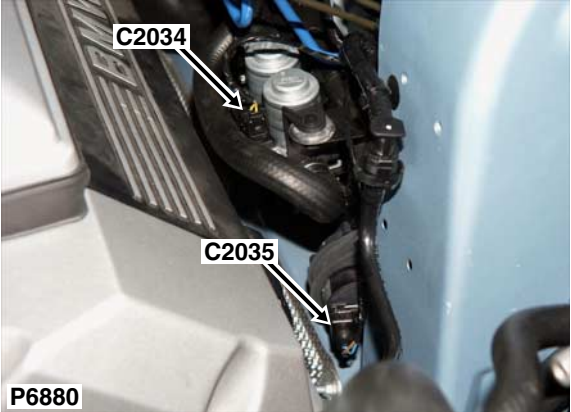

| Cav | Col | Cct |
|-----|-----|-----|
| 1 | NB | ALL |
| 2 | YN | ALL |
| 3 | YP | 5 |

Description: *Valve-Water*
Location: *LH side of engine compartment*

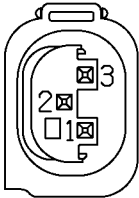

YPC116850

Colour: *BLACK*
Gender: *Female*

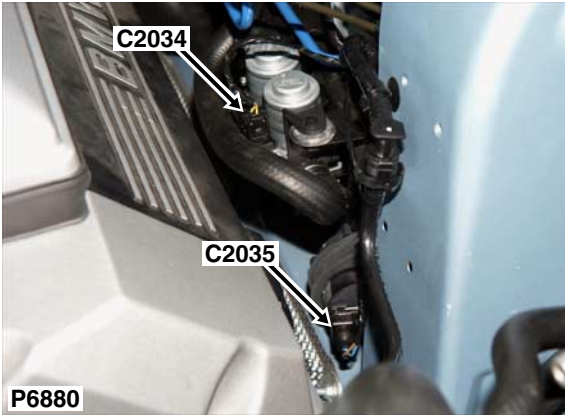

| Cav | Col | Cct |
|-----|-----|-----|
| 1 | N | ALL |
| 2 | UG | ALL |

Description: *Pump-Water*

Location: *LH side of engine compartment*

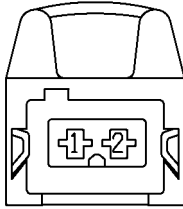

1732460

Colour:
Gender:

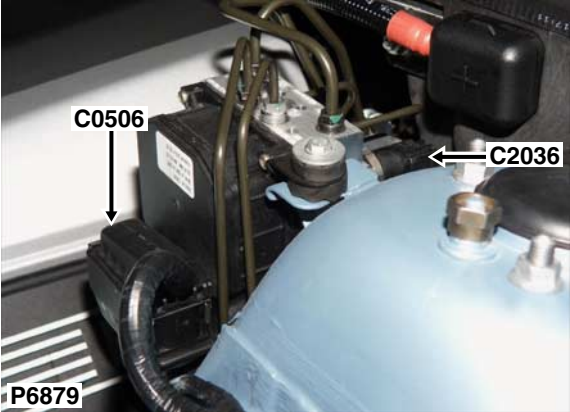

| Cav | Col | Cct |
|-----|-----|-----|
| 1 | WU | ALL |
| 2 | UB | ALL |
| 3 | BP | ALL |

Description: *Switch-Pressure-ABS*
Location: *Rear LH side of engine compartment*

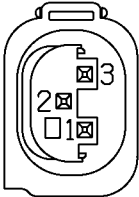

YPC116860

Colour: *GREY*
Gender: *Female*

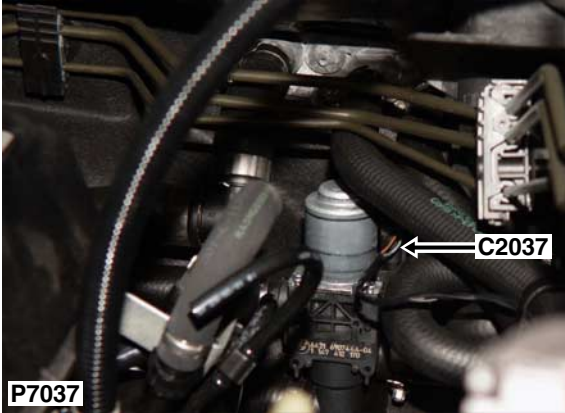

| Cav | Col | Cct |
|-----|-----|-----|
| 1 | NB | 8 |
| 2 | SB | 8 |

Description: *Valve-Non-return*

Location: *Rear of engine compartment*

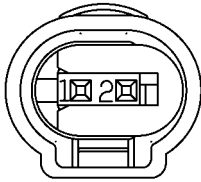

YPC116820

Colour: *BLACK*

Gender: *Female*

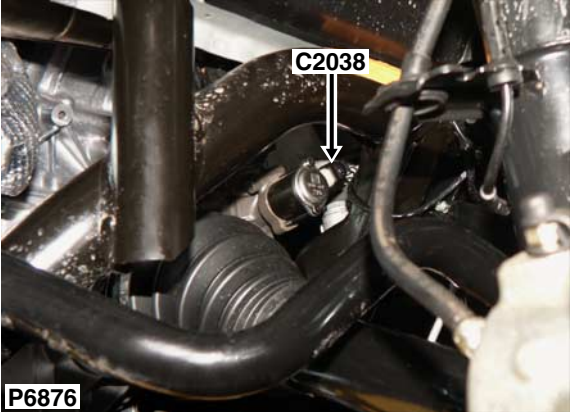

| Cav | Col | Cct |
|-----|-----|-----|
| 1 | BW | ALL |
| 2 | BR | ALL |

P6876

Description: *Valve-Servotronic*
Location: *Behind RH front wheel arch liner*

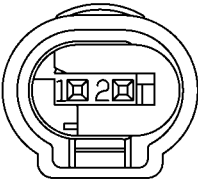

YPC116830

Colour: *GREY*
Gender: *Female*

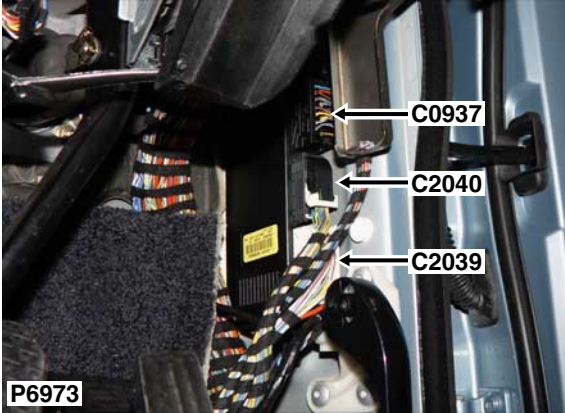

Description: *Module-Lighting switch*

Location: *Base of RH 'A' post*

| Cav | Col | Cct |
|-----|-----|-----|
| 1 | SR | ALL |
| 2 | N | ALL |
| 3 | WU | ALL |
| 4 | UY | ALL |
| 5 | SG | 27 |
| 6 | WG | ALL |
| 7 | YR | ALL |
| 8 | R | ALL |
| 9 | WY | 30 |
| 10 | WB | 22 |
| 11 | UG | ALL |
| 12 | UN | ALL |
| 13 | SU | 27 |
| 14 | YB | ALL |
| 15 | UG | 27 |

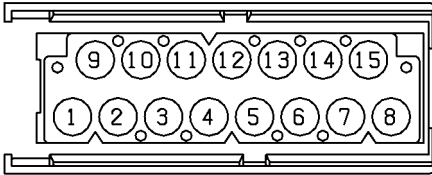

YPC112220

Colour: *NATURAL*

Gender: *Female*

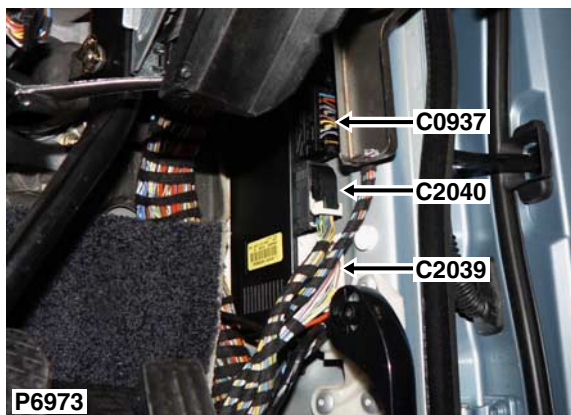

Description: *Module-Lighting switch*

Location: *Base of RH 'A' post*

NO CONNECTOR FACE

Colour:

Gender:

| Cav | Col | Cct |
|-----|-----|-----|
| 1 | YG | ALL |
| 7 | NU | ALL |
| 8 | YW | ALL |
| 10 | NG | ALL |
| 13 | PY | ALL |
| 15 | SN | ALL |
| 16 | SB | ALL |
| 17 | SW | ALL |
| 18 | SG | ALL |
| 19 | UN | ALL |
| 24 | NW | ALL |
| 25 | UR | ALL |
| 26 | UY | 15 |
| 27 | YR | 22 |
| 28 | UY | ALL |
| 29 | G | ALL |
| 30 | W | ALL |
| 31 | GS | ALL |
| 33 | Y | ALL |
| 35 | UNY | ALL |
| 36 | WSY | ALL |
| 39 | UY | 26 |
| 41 | NGY | ALL |
| 45 | YB | ALL |
| 47 | YN | ALL |
| 50 | U | ALL |
| 51 | B | ALL |
| 52 | NB | ALL |

C2041

CONNECTOR DETAILS

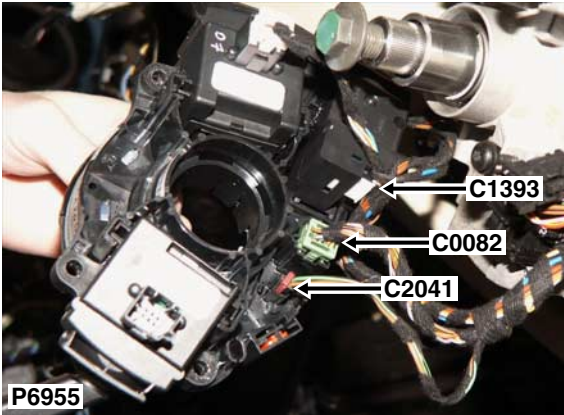

| Cav | Col | Cct |
|-----|-----|-----|
| 1 | N | 25 |
| 2 | GB | 25 |

Description: *Heater-Steering wheel*

Location: *Underside of steering column*

NO CONNECTOR FACE

Colour:

Gender:

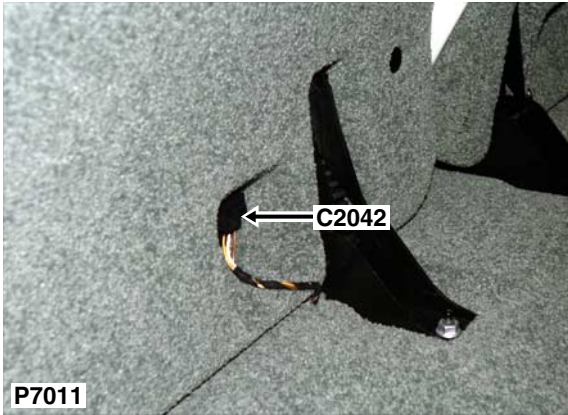

| Cav | Col | Cct |
|-----|-----|-----|
| 1 | YN | 19 |
| 2 | WY | 19 |
| 3 | N | 19 |

Description: *Heater-Cushion-Rear-LH*

Location: *Beneath rear seat*

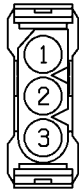

YPC112530

Colour: *BLACK*

Gender: *Female*

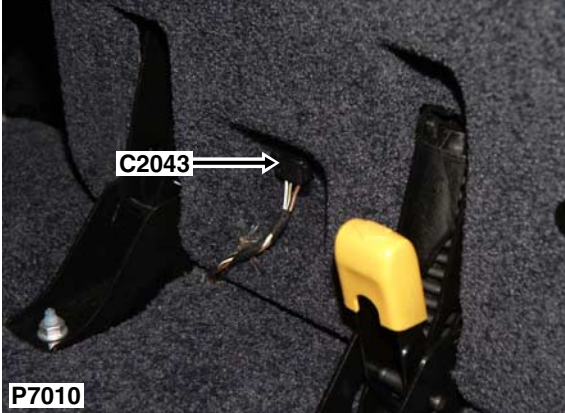

| Cav | Col | Cct |
|-----|-----|-----|
| 1 | WN | 19 |
| 2 | BY | 19 |
| 3 | N | 19 |

Description: *Heater-Cushion-Rear-RH*

Location: *Beneath rear seat*

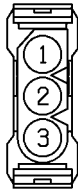

YPC112530

Colour: *BLACK*

Gender: *Female*

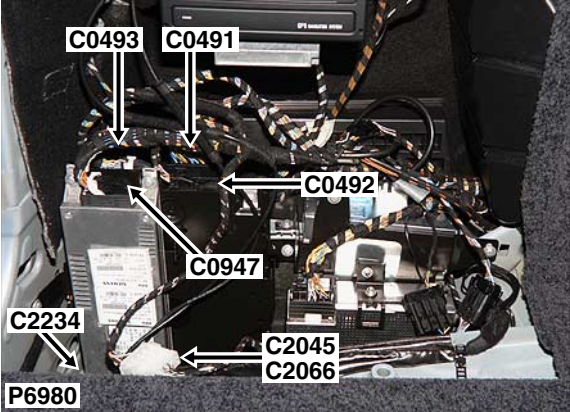

Description: Main harness to telephone harness
Location: Luggage compartment - LH side

| Cav | Col | Cct |
|-----|-----|-----|
| 1 | RY | ALL |
| 2 | PW | ALL |
| 3 | UY | 27 |
| 4 | WSY | ALL |
| 5 | SR | ALL |
| 6 | W | 27 |
| 7 | NB | ALL |
| 8 | WN | ALL |
| 9 | BW | ALL |
| 10 | BN | ALL |
| 11 | WG | ALL |
| 12 | YN | 27 |

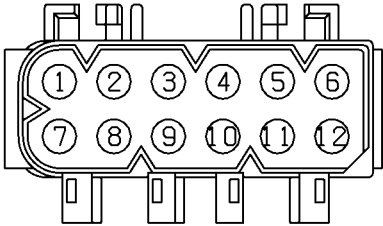

YPC112190

Colour: NATURAL
Gender: Male

C2046

CONNECTOR DETAILS

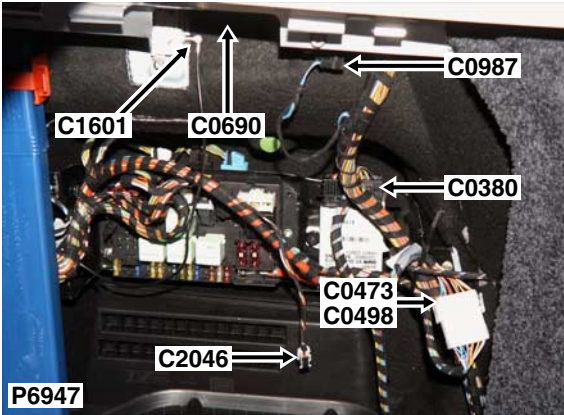

| Cav | Col | Cct |
|-----|-----|-----|
| 1 | WG | 8 |
| 4 | RY | 8 |
| 6 | NB | 8 |

Description: *Receiver-Fuel burning heater*
Location: *Luggage compartment - RH side*

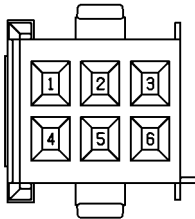

YPC115290

Colour: *BLACK*
Gender: *Female*



| Cav | Col | Cct |
|-----|-----|-----|
| 1 | NY | ALL |
| 3 | RY | ALL |

Description: *Lamp-Load space-RH*
Location: *Luggage compartment - RH side*

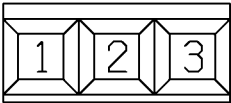

YPC117800

Colour: *BLACK*
Gender: *Female*

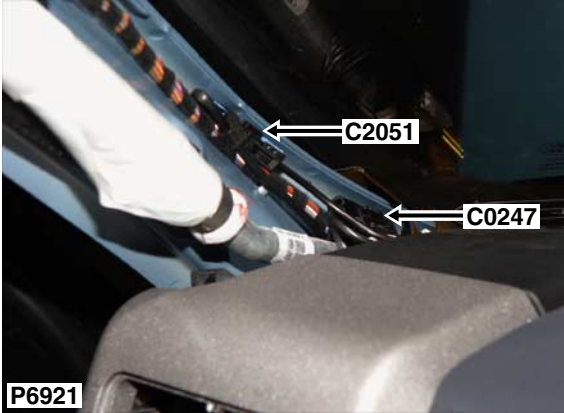

| Cav | Col | Cct |
|-----|-----|-----|
| 1 | BG | ALL |

Description: *Heater-Wiper blade*
Location: *Behind LH side of fascia*

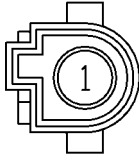

YPC113940

Colour: *BLACK*
Gender: *Male*

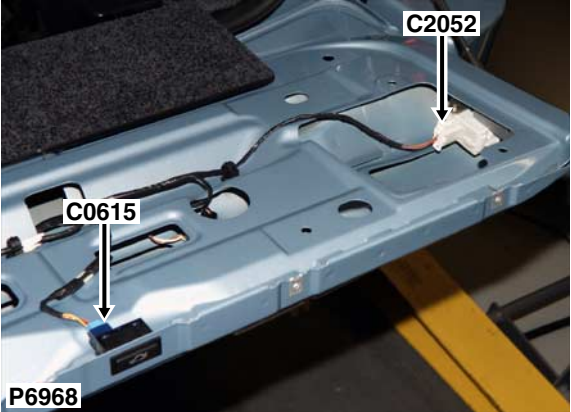

| Cav | Col | Cct |
|-----|-----|-----|
| 1 | N | 3 |
| 2 | UY | 3 |

Description: *Motor-CDL-Tailgate-Lower-RH*
Location: *RH side of taildoor, behind trim panel*



Colour:
Gender:

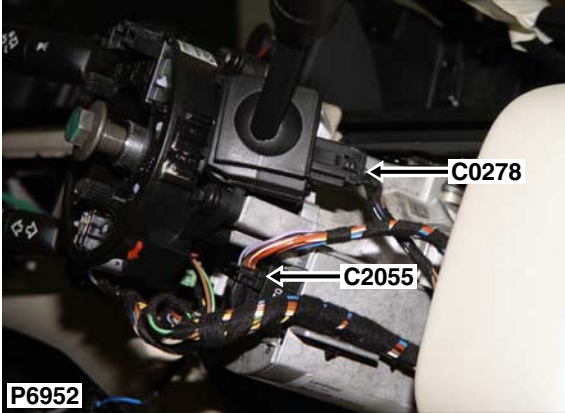

Description: *ECU-Interlock-Steering column*

Location: *Top of steering column*

| Cav | Col | Cct |
|-----|-----|-----|
| 1 | U | 1 |
| 2 | B | 1 |
| 3 | UB | 1 |
| 5 | BU | 1 |
| 6 | S | 1 |
| 7 | RY | 1 |
| 8 | WRY | 1 |
| 9 | NR | 1 |
| 10 | GB | 1 |
| 11 | PB | 1 |
| 12 | NB | 1 |

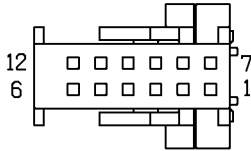

YPC111790

Colour: *BLACK*

Gender: *Female*

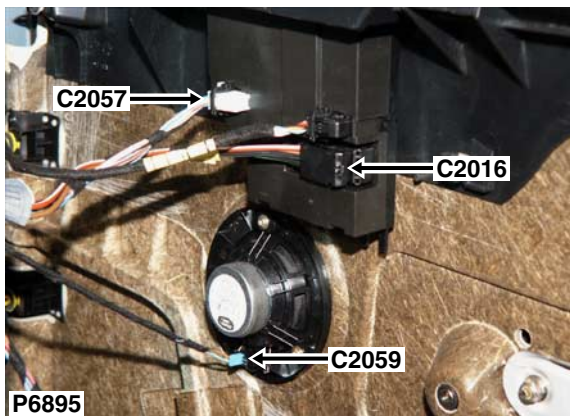

Description: *Module-Passenger door*

Location: *Behind passenger's door trim panel*

| Cav | Col | Cct |
|-----|-----|-----|
| 1 | UR | 3 |
| 2 | SR | 3 |
| 6 | W | 3 |
| 7 | B | 3 |
| 8 | SR | 13 |
| 9 | NR | 3 |
| 11 | NW | 3 |
| 12 | U | 3 |

NO CONNECTOR FACE

Colour:

Gender:

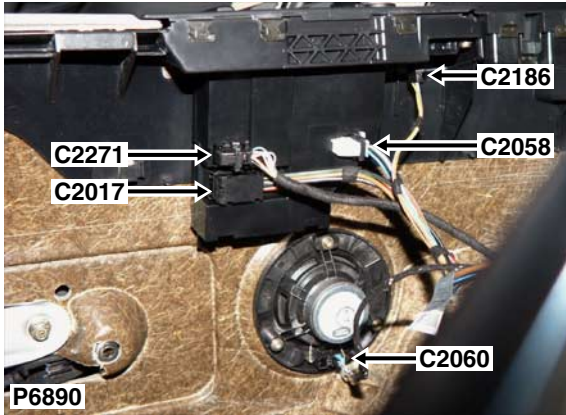

| Cav | Col | Cct |
|-----|-----|-----|
| 1 | UR | 3 |
| 2 | SR | 3 |
| 3 | WB | 3 |
| 4 | UR | 3 |
| 6 | W | 3 |
| 7 | B | 3 |
| 8 | SR | 13 |
| 9 | NR | 3 |
| 11 | NW | 3 |
| 12 | U | 3 |

Description: *Module-Drivers door*

Location: *Behind driver's door trim panel*

NO CONNECTOR FACE

Colour:

Gender:

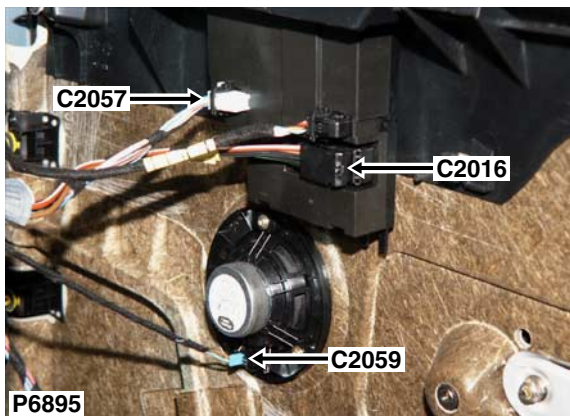

| Cav | Col | Cct |
|-----|-----|-----|
| 1 | N | 28 |
| 2 | UY | 28 |

Description: *Speaker-Mid range-Front door-LH*

Location: *Behind passenger's door trim panel*

NO CONNECTOR FACE

Colour:

Gender:

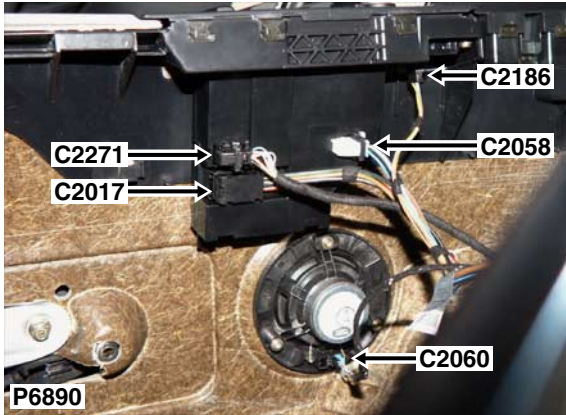

| Cav | Col | Cct |
|-----|-----|-----|
| 1 | SN | 28 |
| 2 | SB | 28 |

Description: *Speaker-Mid range-Front door-RH*

Location: *Behind driver's door trim panel*

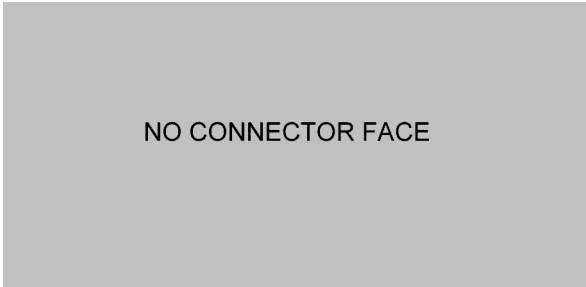

Colour:
Gender:

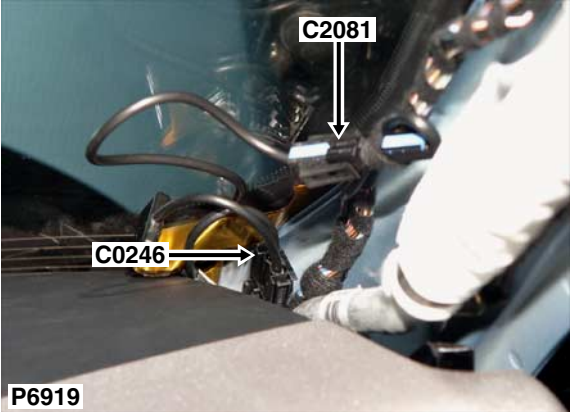

| Cav | Col | Cct |
|-----|-----|-----|
| 1 | N | ALL |

Description: *Heater-Wiper blade*
Location: *Behind RH side of fascia*

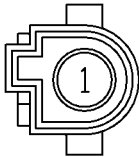

YPC113940

Colour: *BLACK*
Gender: *Male*

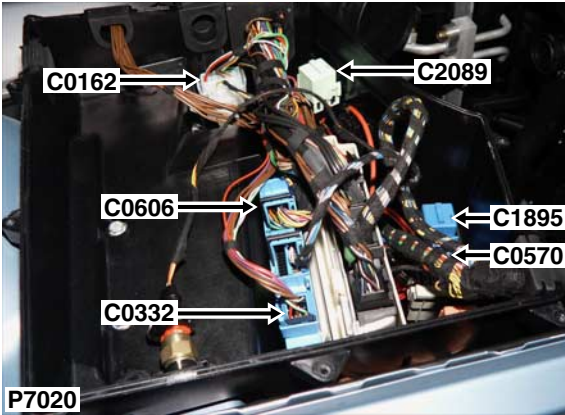

| Cav | Col | Cct |
|-----|-----|-----|
| 2 | G | 3 |
| 4 | N | 3 |
| 8 | R | 3 |
| 8 | G | 3 |

Description: *Relay-Ignition - V8*
Location: *Inside E-box*

NO CONNECTOR FACE

Colour:
Gender:

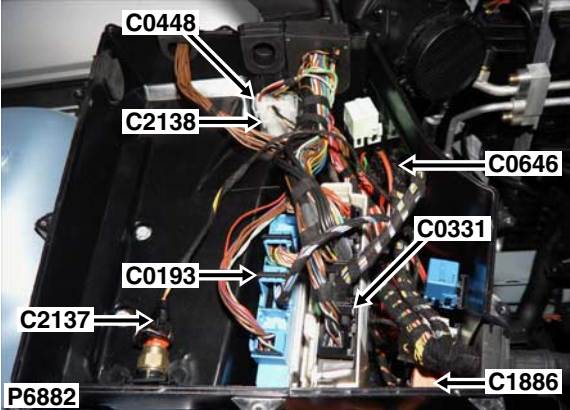

| Cav | Col | Cct |
|-----|-----|-----|
| 1 | YU | ALL |
| 2 | RY | ALL |

Description: *Sensor-Temperature-E-box*
Location: *Inside E-box*

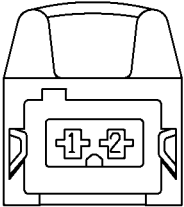

1732460

Colour:
Gender:

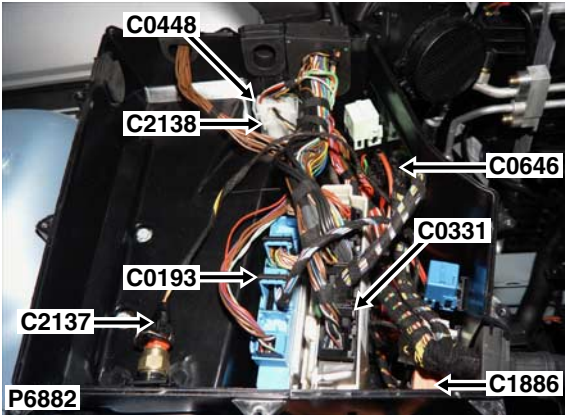

| Cav | Col | Cct |
|-----|-----|-----|
| 1 | N | ALL |
| 2 | YU | ALL |

Description: *Fan-E-box*
 Location: *Inside E-box*

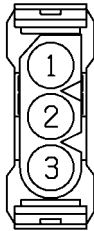

YPC112540

Colour: *NATURAL*
 Gender: *Female*

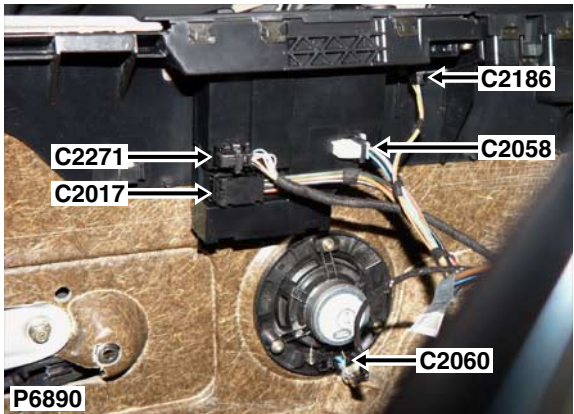

| Cav | Col | Cct |
|-----|-----|-----|
| 1 | SR | 3 |
| 2 | N | 3 |
| 4 | YG | 3 |

Description: *Switch-Ride height-air suspension*
Location: *Behind driver's door trim panel*

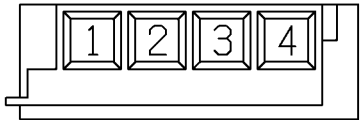

YPC117840

Colour: *BLACK*
Gender: *Female*

C2210

CONNECTOR DETAILS



| Cav | Col | Cct |
|-----|-----|-----|
| 1 | N | 12 |
| 2 | RU | 12 |

Description: *Lamp-Puddle-Front*

Location: *Behind driver's door trim panel*

NO CONNECTOR FACE

Colour:

Gender:

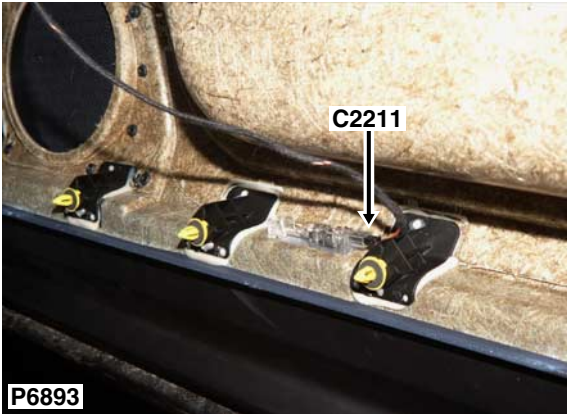

Description: *Lamp-Puddle-Front*

Location: *Behind passenger's door trim panel*

| Cav | Col | Cct |
|-----|-----|-----|
| 1 | N | 12 |
| 2 | RU | 12 |

NO CONNECTOR FACE

Colour:

Gender:

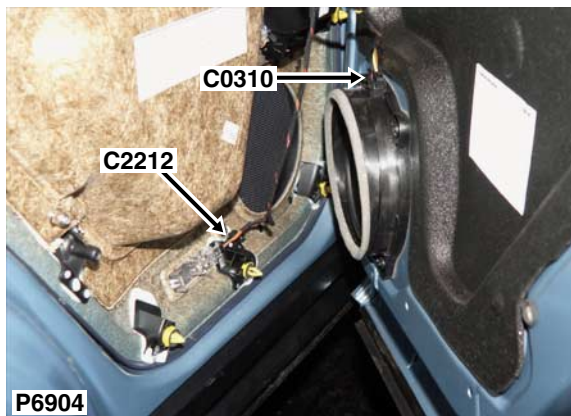

Description: *Lamp-Puddle-Rear*

Location: *Behind rear door trim panel*

| Cav | Col | Cct |
|-----|-----|-----|
| 1 | N | 12 |
| 2 | RU | 12 |

NO CONNECTOR FACE

Colour:
Gender:

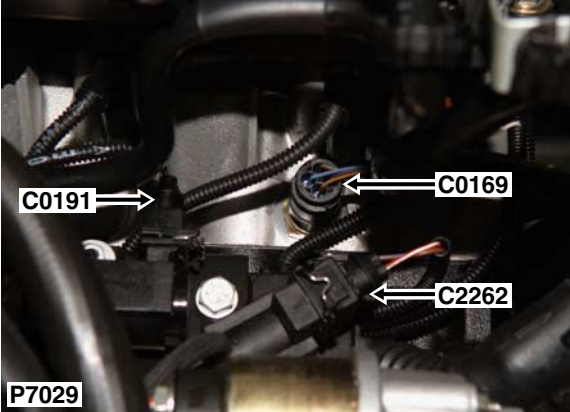

| Cav | Col | Cct |
|-----|-----|-----|
| 1 | NP | 3 |
| 2 | RW | 3 |

Description: *Actuator-Damping control - Td6*
Location: *Rear LH side of engine*



Colour:
Gender:

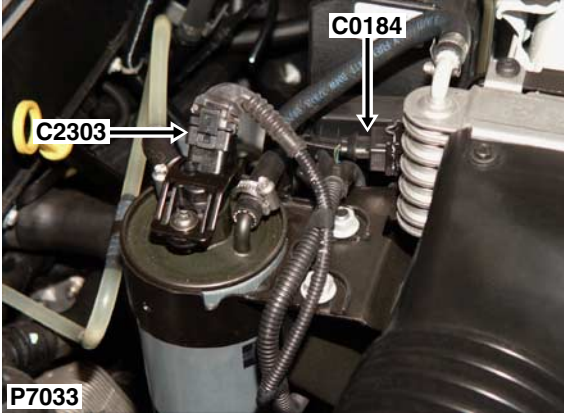

Description: *Sensor-Low fuel pressure - Td6*

Location: *LH side of engine compartment*

| Cav | Col | Cct |
|-----|-----|-----|
| 1 | Y | 8 |
| 2 | WN | 3 |
| 3 | BW | 2 |

NO CONNECTOR FACE

Colour:
Gender:

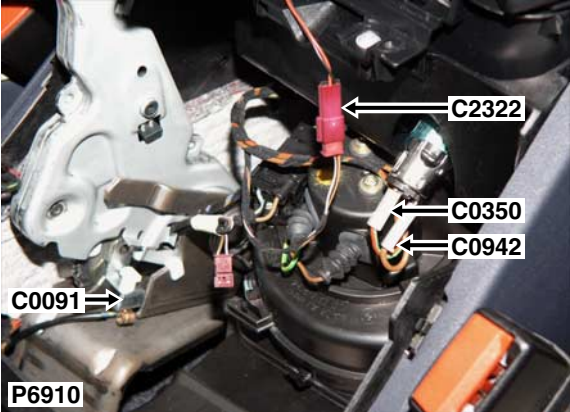

| Cav | Col | Cct |
|-----|-----|-----|
| 1 | NB | 3 |
| 2 | SR | 3 |

Description: *Lamp-Ashtray*
Location: *Beneath centre console*



Colour:
Gender: