

BRITPART

The quality parts for Land Rovers



ACCESSORY CATALOGUE

4th
edition

4

www.britpart.com



BRITPART

The quality parts for Land Rovers

Welcome to Version 4 of the Britpart Accessory Catalogue. In addition to adding many more quality parts and accessories for Land Rover owners we've also given this edition a bit of a facelift - we hope you like the result and would welcome any comments.

At Britpart we are always adding new and exciting products to our accessories range, so remember to look at www.britpart.com for all the latest additions. Also worth remembering is that if there is no picture in the catalogue of a product in the catalogue, go to our website as there are plenty more product pictures there.

Exterior Protection	5 - 18
Side & Rear Steps	19 - 24
Racks & Luggage Boxes	25 - 30
Wheels	31 - 36
Lighting Equipment	37 - 42
Towing Equipment	43 - 48
Interior Protection	49 - 60
Seats & Trim	61 - 68
Off-Road Equipment	69 - 80
Winching Equipment	81 - 92
Performance Equipment	93 - 102
Suspension Equipment	103 - 114
Exhausts	115 - 118
Engines & Transmission	119 - 122
Repair & Service Parts	123 - 140
Service Kits & Filters	141 - 144
Vehicle Enhancements	145 - 156
Miscellaneous	157 - 166

ABOUT BRITPART



*innovation, quality
& style on demand*

Picture courtesy of Pascal Perrier

The Marque

Britpart is the leading independent wholesaler of parts and accessories for Land Rover vehicles, supplying in excess of 800 customers worldwide from government agencies to trade outlets.

The name 'Britpart' is synonymous with quality parts for Land Rovers and the company has earned a truly enviable reputation around the globe. For nearly 30 years, Land Rover enthusiasts the world over have come to identify Britpart as a brand to be trusted.

The Britpart logo has become a widely recognised and highly respected marque; it embodies excellence in the field, both in quality and commitment to meeting the needs of the customer.

Products

Britpart has always reacted swiftly to the demands of the parts market for all Land Rover vehicles, aiming to provide customers with exactly what they want, when they want it. Parts have long been the mainstay of Britpart's business, with many parts simply being unavailable from other sources; however, accessories are now becoming a major part of the business as owners of Land Rovers, old and new, are customising their vehicles to suit their individual tastes and lifestyles; everything they need is now available from Britpart.

The vast array of Britpart accessories ensures that no two Land Rovers are ever identical!

Land Rover appointed Britpart as an 'Approved European Parts Distributor' for all Land Rover Genuine Parts; this, together with Britpart's own vast range of parts and accessories, along with their extensive inventory of O.E.M. product, has resulted in Britpart becoming the ultimate 'One-Stop-Shop' providing everything its customers could possibly require, all ordered and delivered from one dedicated source.

Quality

Britpart is approved by Lloyd's Register Quality Assurance to BS EN ISO 9001:2000.

Britpart is renowned for quality parts at very competitive prices and takes pride in its excellent customer service, maintaining high stock levels with the aim of fulfilling orders promptly.

Distribution

Parts and accessories for Land Rover vehicles continually flow in and out of the massive state-of-the-art warehouse. Britpart's fleet of vans and trucks all sport the undeniably eye-catching Britpart blue and white livery. Between them they cover the length and breadth of the United Kingdom, including Northern Ireland, delivering directly to Britpart customers on a regular basis, adding to the personal touch that customers have come to associate with Britpart.

Service

Britpart has an enthusiastic and highly knowledgeable team so that you deal with people who have in-depth knowledge of the business. In addition to major government contracts, we successfully support individual parts retailers, supplying spares for Land Rover models old and new including Series, Defender, Range Rover, Discovery and Freelander.

The lively Sales operation boasts three highly trained teams; one each for Home Sales, European Sales and Export Sales with technical experts and sales advisors in each, eager to answer the telephone and organise despatch of goods to their customers within the shortest possible time.

Handmade

The highly skilled team in the Trim Shop make a wide range of seats, seat covers, bases, backs and benches etc for Land Rover vehicles by hand.

Equally skilled is the team in the Lock Shop where a wide range of light engineering work is carried out.

In keeping with the Britpart philosophy, all products leaving the Trim Shop and the Lock Shop are produced to the highest standards and meet with the strictest safety regulations.

Global

When Land Rover finally severed its association with Santana Motor SA it was Britpart who bought up all the existing stock from the factory in Spain and shipped it to their UK headquarters in Shropshire. The shipment included everything from small components to body panels and new engines, along with all the original drawings and tooling. Some of the stock was found to be interchangeable with Land Rover parts and a proportion of the rest is gradually making the journey back home with the assistance of our partner in Spain, Britpart España, Estanfi Automoción.

Britpart's other partners around the globe include: Britpart France, Britpart Belgium, Britpart Brazil, Britpart USA and Britpart Poland.

Britpart is seeking to further expand its comprehensive customer base overseas and is continually looking for well established independent stockists of Land Rover parts to work closely with.



Picture courtesy of Darren Whiley

Quality Parts

Britpart hold in excess of 16,000 stock items from o-rings and oil seals to engines and exhaust systems. Customers can choose from Britpart quality parts, O.E.M. products and Land Rover Genuine Parts; all delivered promptly at competitive prices.

Everything required for servicing, repairing, restoring or even rebuilding any Land Rover can be supplied by Britpart, thus enabling customers to order all they need on just one order sheet making it easy to keep track of stock and take delivery.

Quality Accessories

Britpart have all the latest accessories you need to customise your Land Rover; whatever the model, to look great on the road and work better off it! From wheels to roof racks, Britpart have everything to ensure that no two Land Rovers need ever look identical.



Certification No. 910885



01

exterior protection

EXTERIOR PROTECTION

Going off-road?
Then here's where to find
all the protection
equipment your Land
Rover will need from front
to back and top to bottom.

Section contents -

A Bars	6
Bull/nudge bar	7
Bumper	7
Bumperettes	7
Chequer plate	8
Diff guards	9
Lamp guards	10 - 14
Mirrors & fittings	14
Mud flaps	15
Parking sensors	16
Radiator muffs	16
Rubbing strips	16
Steering/sump guards	17
Swivel housing gaiter kits	17
Transmission guard	17
Wheel arch kit - standard	18
Wheel arch kits - off-road	18

Through the jungle
Picture courtesy of Cyril Mischler

A BARS



LR005235



STC53037



STC50413



VUB501980

Add some front end protection to your vehicle with an A Bar - also a great addition if you'd like to add spot lights to your Land Rover!



LR005742



LR005237

IMPORTANT NOTICE
Please check local legislation before fitting a frontal protection device to a vehicle that is to be used on public roads.



STC53129



VUB501330



LR005239

Defender

LR005235	Defender - up to 2007	Black rubber	Includes spot lamp brackets
LR005742 NEW	Defender - 2007 onwards	Black rubber	Includes spot lamp brackets
STC53037	Defender - air con	Stainless steel	Includes spot lamp brackets

Discovery

LR005237	Discovery 3	Moulded black rubber	Includes spot lamp brackets
-----------------	-------------	----------------------	-----------------------------

Freelander

STC50413	Freelander	Preformed plastic & foam	No spot lamp brackets
STC53129	Freelander V6	Preformed plastic & foam	No spot lamp brackets
VUB501330	Freelander - from VIN4A00001	Moulded grey rubber	No spot lamp brackets

Range Rover

VUB501980	Range Rover Sport	Moulded grey plastic	Includes spot lamp brackets
LR005239 NEW	Range Rover L322	Moulded black plastic	Includes spot lamp brackets

BULL / NUDGE BAR

VUB501270

Discovery 3

Flat

Note - Can only be supplied to non-EU countries



Serious front end protection for your Discovery 3!



Picture courtesy of Daniel Taw

BUMPER

DPB000270

Defender military front bumper

RRC6681

Centre pin for bumper

RRC6682

'R' Clip for centre pin

DA5626

Bumper kit - contains all the above

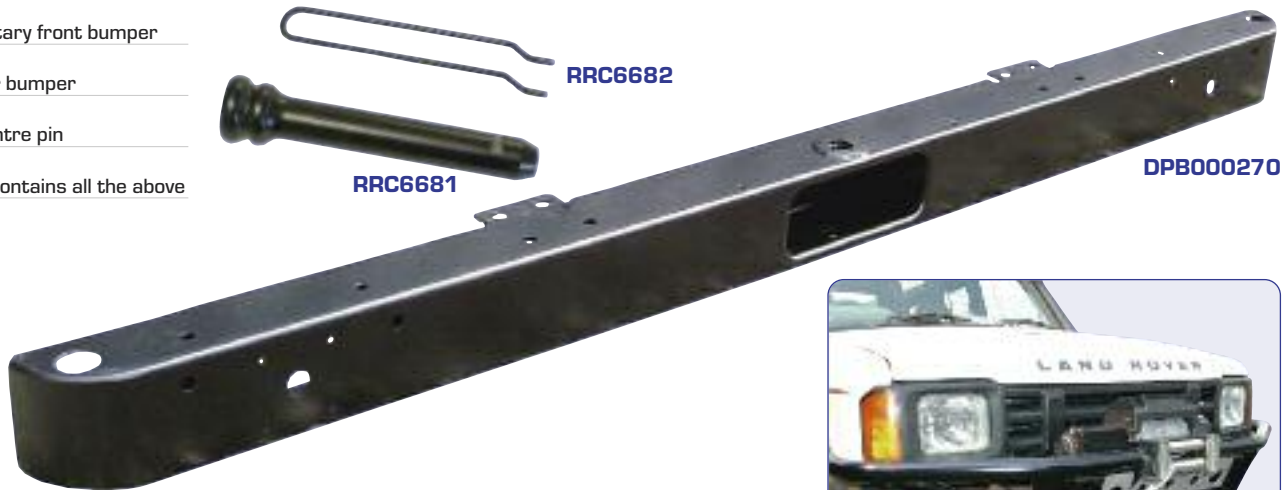

Winch Bumpers - see winching equipment section

BUMPERETTES



Added protection!

RTC4769



DA2071



RRC2970 / RRC2971

RTC4769 Series/Defender Front Single Galvanised

DA2071 Series/Defender Rear Pair Black

RRC2970 Series/Defender Rear Single - RHS Black
RRC2971 Series/Defender Rear Single - LHS Black

CHEQUER PLATE



DA2070



DA4073 / DA4072



DA3080 / DA3078



DA3079

Series

DA2004	Wing top		Pair
DA2050	Rear cross member		Single
DA2051	Load bay liner	Short wheel base	Kit
DA2052	Sills	Short wheel base	Pair
DA2053	Sills	Long wheel base	Pair
DA2054	Bumper plate		Single
DA2067	Rear door	Without wiper	Single
DA4074	Rear wing	Short wheel base	Pair

Defender

DA2054	Bumper plate		Single
DA2062	Bumper tops		Pair
DA2060	Mud flap brackets		Pair
DA2061	Rear cross member		Single
DA2063	Rear floor - 110 County Station Wagon		Single
DA2064	Rear sides - 110 County Station Wagon		Pair
DA2066	Bonnet protector		Single
DA2067	Rear door	Without wiper	Single
DA2068	Rear door	Wiper - late	Single
DA2069	Rear door	Wiper - early	Single
DA2070	Load bay liner		Kit
	90/Pickup/Hard top/County Station Wagon		
DA4049	Wing top		Pair
DA4072	Sills	90	Pair
DA4073	Rear wing	90	Pair
DA4100	Sills	110	Pair
DA4071	Rear wing	110	Pair

Miscellaneous

DA2065	1,200mm x 2,500mm Chequer plate steel	Single
---------------	---------------------------------------	--------

Britpart Chequer Plate - Defender

DA3078	Wing tops		Pair
	Natural aluminium finish		
DA3080	Bonnet protector	Defender 1983 - 2006	Single
	Natural aluminium finish		
DA4342	Bonnet protector	Defender 2007 - onwards	Kit
	Natural aluminium finish		
DA3079	Wing tops		Pair
	Satin black finish		
DA3081	Bonnet protector	Defender 1983 - 2006	Single
	Satin black finish		
DA4343	Bonnet protector	Defender 2007 - onwards	Kit
	Satin black finish		

Chequer Plate Kit - Defender

Kit contains - bonnet, wing, sill & rear corner protection

DA4296	90
DA4297	110



DA4296



DA2052

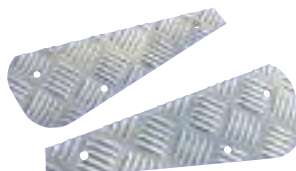

DA2060

Add some **heavy-duty** protection to your Land Rover!

DIFF GUARDS - BOLT ON

Give your vehicle some extra protection with a diff guard. These guards are simple to fit (no drilling) and have the added advantage of having the fill plugs accessible at all times.

DA2250

Defender/Discovery
Bright galvanised finish

DA2250B

Defender/Discovery
Electroplate finish

**DA2250****DA2250B**

Picture courtesy of Cyril Mischler

LAMP GUARDS

Defender

DA1079 NEW	Defender	Rear	Wolf style - rectangular & round	Pair
DA4077	Defender	Front	Wolf style	Pair
DA4133	Defender Td5	Rear	Rectangular	Single
DA4134	Defender Td5	Rear	Round	Single
DA4349 NEW	Defender	Rear	Round ABS plastic tail light	Single
DA4400	Defender Td5 - 2003 on	Front & rear	Wolf style	Kit
RTC8860AA	Defender - to VIN 2A	Rear	1 Square & 1 L-shape	Pair
RTC8969	Defender - up to 2A622423	Front	Rectangular	Pair
STC8056	Defender 110 Hi Capacity	Rear	Rectangular	Pair
STC53157	Defender - from VIN 2A	Rear	1 Square & 1 L-shape	Pair
STC53158	Defender	Rear	Square hinged	Pair
STC53161	Defender - from 2A622424	Front	Rectangular	Pair
VUB504110	Defender 90 & 110	Rear	Round	Pair



DA1079



DA4077

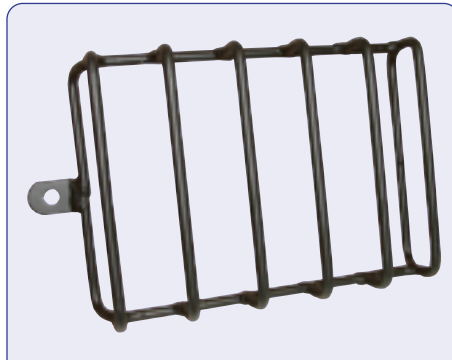

DA4133



DA4134



DA1079



DA4400

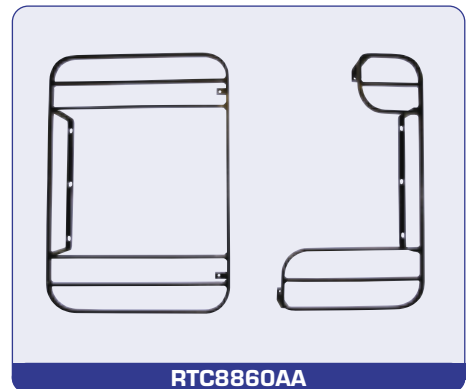

RTC8860AA

Protect those **valuable headlights** from accidental damage either on or off-road!



RTC8969



STC8056

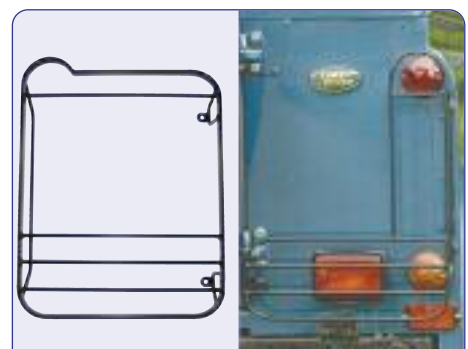

STC53157

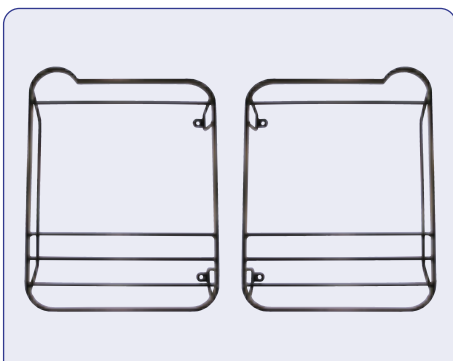

STC53158



STC53161

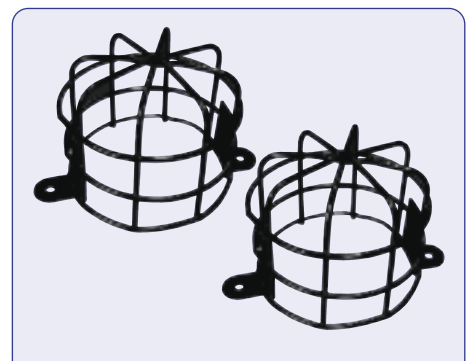

VUB504110

LAMP GUARDS - continued

Discovery

DA4130	Discovery 1 - to 1995	Front	Pair
DA4172	Discovery 1 300Tdi	Acrylic headlamp protectors	Pair
STC8452	Discovery 1 - 1995-1999	Front	Pair
STC8453	Discovery 1 - to 1999	Rear bumper - no drill	Pair
RTC9503AA	Discovery 1 - to 1999	Rear wing	Pair
STC50026	Discovery 2	Front - plastic	Pair
STC50027	Discovery 2	Rear bumper & rear upper set - plastic	Pair
STC50064	Discovery 2 - 1999 - 2002	Acrylic headlamp protectors	Pair
STC53181	Discovery 2 - from VIN 3A	Front	Pair
Note - For fitment with nudge bar (STC53176)			
STC53193	Discovery 2 - 2003	Front	Pair
STC53194	Discovery 2	Rear wing	Pair
VUB500520	Discovery 2	Rear low	Pair
VUB501200	Discovery 3	Front (picture on next page)	Pair
VUB501380	Discovery 3	Rear (picture on next page)	Pair



Need a dog guard?
See interior protection section!



LAMP GUARDS - continued



VUB501200



VUB501380

Freelander

STC7960	Freelander - to 2004	Rear kit - no drill	Set of 4
STC7962AA	Freelander - to 2004	Front	Pair
VUB501390	Freelander - 2004 on	Front	Pair
VUB501400	Freelander - 2004 on	Rear	Pair
LR002408	Freelander 2	Front	Pair
LR003685	Freelander 2	Rear	Pair



STC7960



STC7962AA



VUB501390



VUB501400



LR002408



LR003685



Picture courtesy of Pascal Perrier

LAMP GUARDS - continued

Range Rover

STC8026	Range Rover Classic	Front - hinged	Pair
STC8027	Range Rover Classic	Rear - hinged	Pair
STC8503AA	Range Rover P38	Front - drill fit	Pair
STC8504AB	Range Rover P38	Rear - drill fit	Pair
DA4173	Range Rover P38 - to 1999	Acrylic headlamp protectors	Pair
VUB001070	Range Rover L322 - pre 2006	Front	Pair
Note - Front lamp guards not compatible with wraparound protection bar			
VUB502610	Range Rover L322 - 2006	Front	Pair
VUB001080	Range Rover L322	Rear	Pair
VUB501930	Range Rover Sport	Front	Pair
VUB501920	Range Rover Sport	Rear	Pair



STC8026



STC8027



STC8503AA



STC8504AB



DA4173



VUB001070

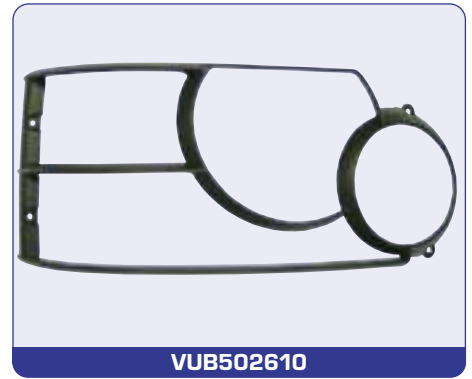

VUB502610



VUB001080



VUB501930



VUB501920



LAMP GUARDS - continued



345985



MRC316



345985P



MRC316

Series

345985	Series		Front
MRC316	Series		Rear
345985P	Series	Plastic coated	Front
MRC316P	Series	Plastic coated	Rear



MIRRORS & FITTINGS

Unbreakable Mirrors for Defenders

- > Optical quality polycarbonate lens - will not shatter like glass or discolour in sunlight
- > Strong, flexible polypropylene casing - will absorb hard blows without breaking
- > Universal - can be fitted to either left or right of vehicle
- > Lightweight - puts less strain on body fixings
- > Hard lacquer coating on lens - will repel condensation and surface water
- > Excellent reflectivity - superb daylight and night time vision



DA4405



DA4406

		Head Dimensions	Arm Length	
DA4404	Flat mirror	204 x 140mm (8 x 5 1/2")		Flat with fixing kit
DA4405	Flat mirror	204 x 140mm (8 x 5 1/2")	170mm	Flat with fixing kit and short arm
DA4406	Flat mirror	204 x 140mm (8 x 5 1/2")	290mm	Flat with fixing kit and long arm
DA4407	Convex mirror	204 x 140mm (8 x 5 1/2")		Convex with fixing kit
DA4408	Convex mirror	204 x 140mm (8 x 5 1/2")	170mm	Convex with fixing kit and short arm
DA4409	Convex mirror	204 x 140mm (8 x 5 1/2")	290mm	Convex with fixing kit and long arm

Mirrors & Fittings

DA2128	Series arm standard
DA2130	Series head 7 x 5"
DA2301	Series glass 7 x 5"
DA4034	Defender head 6 x 10 1/2"
MTC5083	Mirror arm - 90/110
MTC5084	Mirror head - 90/110
MTC5217	Assembly - 90/110
RRC8443	Arm 11 1/2" long

Good visibility is imperative on today's highways and byways so these new high impact resistant mirror heads are essential stock items.



MTC5217

MUD FLAPS



CAT500540PMA



DA4531

Britpart Branded Defender Rear Mudflaps

CAT500410PMA	RHS - universal fitment	Black logo	Single
CAT500450PMA	LHS - no exhaust cut-out	Black logo	Single
CAT500540PMA	LHS - exhaust cut-out	Black logo	Single
DA4531	90 - exhaust cut-out	Yellow logo	Pair
DA4532	90 - no exhaust cut-out	Yellow logo	Pair

Other Mudflaps

RTC9479	Defender 90 & 110 - from 2007	Front	Pair
RTC6820	Discovery 1 - kit	Front	Pair
RTC6821	Discovery 1 - kit	Rear	Pair
CAS500010PCL	Discovery 3	Front	Pair
CAT500010PCL	Discovery 3	Rear	Pair
LR003324	Freelander 2	Front	Pair
LR003322	Freelander 2	Rear	Pair
CAS000150PMA	Range Rover L322 - up to VIN 5A999999	Front	Pair
CAT000180PMA	Range Rover L322 - up to VIN 5A999999	Rear	Pair
CAS500060PMA	Range Rover L322 - from VIN 6A198416	Front	Pair
CAT500070PMA	Range Rover L322 - from VIN 6A198416	Rear	Pair
CAS500070PCL	Range Rover Sport	Front	Pair
CAT500120PCL	Range Rover Sport	Rear	Pair



DA4532

Reduce those muddy splashes from over your Land Rover



RTC6821



CAS500010PCL



CAT500010PCL



LR003324



CAT500070PMA



CAS500070PCL

PARKING SENSORS

These bumper* mounted sensors will detect the distance between your vehicle and any rear obstruction and warn the driver to any potential obstructions.

Add an extra set of 'eyes' when reversing...



DA4510

- DA4510**
Three stage alarm sound warning system
Kit contents include -
- > 4 x Bumper fit sensors
 - > 1 x Warning buzzer
 - > 1 x Control unit
 - > 1 x Wiring harness
 - > 1 x Cutting tool
 - > 1 x Fitting accessories
 - > 1 x Installation instructions



DA4511

- DA4511**
Three stage alarm sound warning system with LED display
Kit contents include -
- > 4 x Bumper fit sensors
 - > 1 x Warning buzzer and LED display
 - > 1 x Control unit
 - > 1 x Wiring harness
 - > 1 x Cutting tool
 - > 1 x Fitting accessories
 - > 1 x Installation instructions

*Note - sensors do not work with metal bumpers

RADIATOR MUFFS



DA4025BLACK



DA2160BLACK



DA2161BLACK

Series 2

DA4025BLACK	Black edging
DA4025BLUE	Blue edging
DA4025BROWN	Brown edging
DA4025GREEN	Green edging

Series 3

DA2160BLACK	Black edging
DA2160BLUE	Blue edging
DA2160BROWN	Brown edging
DA2160GREEN	Green edging

Defender

DA2161BLACK	Black edging
DA2161BLUE	Blue edging
DA2161BROWN	Brown edging
DA2161GREEN	Green edging

Note - The radiator muffs are black with either black, blue, brown or green coloured edging.

Control the flow of air into your radiator with a quality British made radiator muff!

RUBBING STRIPS

Protect your bodywork from dents and scrapes with a smart set of 4 solid and durable bodyside moulding strips.

DGJ500140PMA	Range Rover L322
DGJ500020PCL	Range Rover Sport

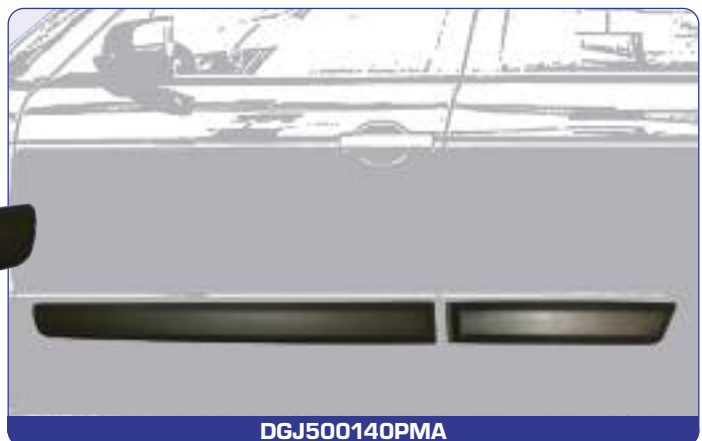
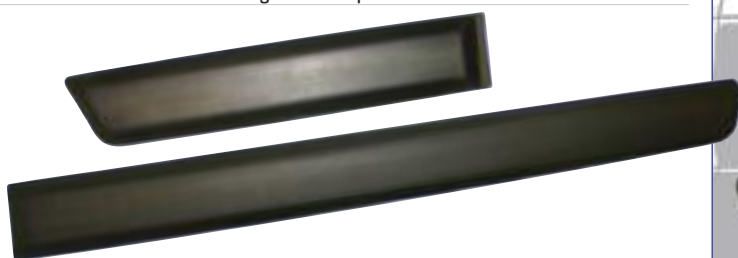

DGJ500140PMA

STEERING / SUMP GUARDS



DA2228



DA5507



DA5507LHD

DA2228	Defender - 1985 onwards	Galvanised steel	RHD & LHD
DA5507	Defender - 1985 onwards	Aluminium	RHD
DA5507LHD	Defender - 1985 onwards	Aluminium	LHD
DA5508	Discovery 1 / Range Rover Classic	Aluminium	RHD & LHD



DA5508

Added **protection** from those hidden dangers when off-roading!

SWIVEL HOUSING GAITER KITS

- > Bond in place under existing flange
- > Completely seals against dust, water and grit
- > Moulded in high performance neoprene rubber
- > Kit includes two gaiters, metal straps, bonding agent, gloves and full instructions
- > No special tools required
- > Proven tongue and groove for easy assembly
- > Two year guarantee

DA3056	Series
DA3057	Defender/Discovery/Range Rover Classic
DA3057GLUE NEW	Additional bonding agent for DA3057

- > For easier fitment of gaiter without dismantling the axle assembly

Permanent protection for swivels, spheres and joints!



DA3056 / DA3057

TRANSMISSION GUARD

DA5625
Reduce damage to your Defender 90. Made from galvanised steel, this transmission guard protects your 90's gear box and cross members from snagging and reduces damage to your vehicle. Bolts on and is easy to fit and importantly it is also easy to remove when your vehicle needs servicing. Fits pre-Td5 or can be fitted to Td5 with centre exhaust removed and pipe fitted.



DA5625



WHEEL ARCH KIT - STANDARD



DA1059

Defender eyebrow kit

> 4 eyebrows and rivets

WHEEL ARCH KITS - OFF-ROAD



DA2366



DA2364

DA2365

DA1960

DA2364	Discovery 1/Range Rover Classic	3-door
DA2365	Discovery 1/Range Rover Classic	5-door
DA2366	Defender	

Suitable for Defender 90 from 1984 to present and from 90 to 130 wheelbase and Hi-Cabs. 2" wider than standard enabling tyres up to 14" wide and/or wheel spacers to be fitted while being legal for MOT testing. Made from an unbreakable plastic - ideal for extreme off-road use.

DA1960	Discovery 2	50mm
DA1961	Discovery 2	75mm

These two Discovery 2 wheel arches enable larger tyres to be fitted while still being legal as these arches cover the tyres when wider tyres are fitted. The 50mm ones are required for large off set wheels while the 75mm arches will cover the tyres when wheel spacers are used. They are virtually indestructible and all fixings are supplied with the kit. Up to 35" diameter tyres are ok with a 2" lift and these arches as just over 40mm is cut out of the wings when fitting them.



Picture courtesy of Guy Stryckmans

02

side & rear steps

SIDE & REAR STEPS

Add some smart new steps to your Land Rover for assistance with getting in and out.

Section contents -

Defender	20
Discovery	21
Freelander	22
Range Rover	23



SIDE & REAR STEPS - DEFENDER



STOP PRESS... See page 174

These side steps are available in a stainless steel finish without chequer plate - **DA7012SS**

DA7012

DA7012
90 - all models Side steps - pair
Black with chequer plate

DA7012SS NEW
90 - all models Side steps - pair
Stainless steel

DA7011
110 - all models Side steps - pair
Black with chequer plate

DA7011SS NEW
110 - all models Side steps - pair
Stainless steel

DA4101
90 - all models Side steps - pair
Rubber top

DA4060
110 - all models Side steps - pair
Rubber top

DA4070
Rear tow ballstep - double
Zinc plated

DA4070B
Rear tow ballstep - double
Black

STC50269AA
90 from XA onwards Rear step - includes
regulation tow bracket

STC50301
110 from XA onwards Rear step - includes
regulation tow bracket

STC7631
Side step - folding

STC7632
Rear door step - folding



STOP PRESS... See page 174

These side steps are available in a stainless steel finish without chequer plate - **DA7011SS**

DA7011



DA4070

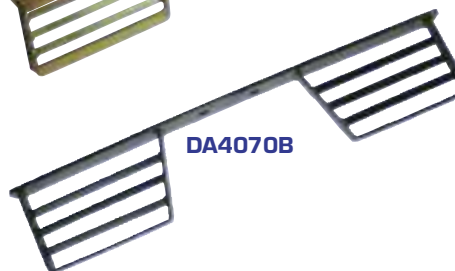

DA4070B



STC7631



DA4101

DA4060

STC50269AA



STC7632

SIDE & REAR STEPS - DISCOVERY



STC8130AB



DA4258



STC50030



STC50031



STC50032



VTD500010



VTD500020



VTK500010 / VPLAP0035

RTC9505AC	Discovery 1	Rear retractable step		
RTC9593AA	Discovery 1	Spare shock absorber for rear retractable step (RTC9505AC)		
STC8130AB	Discovery 1	Side steps	Chevron tread	Pair
DA4258	Discovery 2	Side steps - including mudflaps	Black rubber	Pair
KVL100040	Discovery 2	Spare shock absorber for rear retractable step		
STC50030	Discovery 2	Side steps - including mudflaps	Chevron tread	Pair
STC50031	Discovery 2	Side steps - including mudflaps	Oasis tread	Pair
STC50032	Discovery 2	Side steps - including mudflaps	Stainless steel	Pair
VTD500010	Discovery 3	Black steel side protection tubes		Pair
VTD500020	Discovery 3	Stainless steel side protection tubes		Pair
VTK500010	Discovery 3	Side steps		Pair
VPLAP0035		With polypropylene side step top and a brushed aluminium side trim		



RTC9505AC

Britpart have a wide range of steps to suit your vehicle

SIDE STEPS - FREELANDER

STC53077

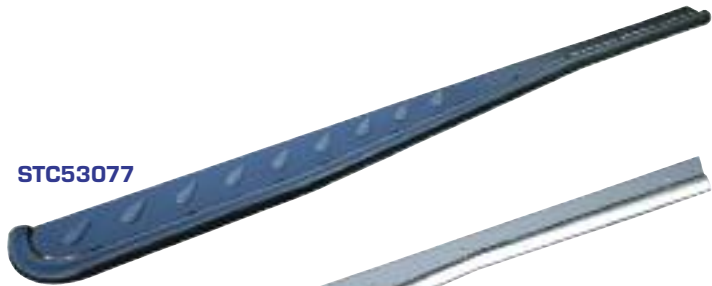

STC53078



LR002773



LR003318



LR003840

STC53077	Freelander - from 2002 onwards		
	Side steps	Black	Pair
STC53078	Freelander - from VIN2A000001		
	Side steps	Stainless steel	Pair
LR002773	Freelander 2		
	Side steps		Pair
	With thermo plastic elastomer side step top and a brushed aluminium side trim		
LR003318	Freelander 2		
	Side protection tubes	Stainless steel	Pair
LR003840	Freelander 2		
	Side protection tubes	Black	Pair



SIDE STEPS - RANGE ROVER

- STC8130AB**
Range Rover Classic Pair
Side steps - black rubber

- STC8505AA**
Range Rover P38 Pair
Side steps Oasis pattern
Not including mudflaps - front STC8535

- VUB001230**
Range Rover L322 Pair
Stainless steel side protection tubes

- VUB002510**
Range Rover L322 Pair
Black steel side protection tubes
Note - Both above tubes can be fitted with or without front mudflaps

- VUB503660**
Range Rover L322 Pair
Side steps including front mudflaps with EPDM (synthetic rubber) top and hard plastic trimming

- VUB001300**
Range Rover L322
Side step replacement insert moulding for VUB503660
Right hand side Single

- VUB001310**
Range Rover L322
Side step replacement insert moulding for VUB503660
Left hand side Single

- VTK500020**
Range Rover Sport Pair
Side steps
With thermo plastic elastomer side step top and a brushed aluminium side trim



STC8505AA



VUB001230



VUB002510



VUB503660



VTK500020



STC8130AB





Picture courtesy of John Stewart

03

racks & luggage boxes
RACKS & LUGGAGE BOXES

Got a load to carry?
We've got racks and
luggage boxes to suit all
Land Rovers and all loads.

Section contents -

Bike racks	26
Ladders	26
Roof racks - galvanised flat pack kits	27
Roof racks & bars	28
Roof racks & boxes - Mont Blanc	29
Roof racks & boxes - Thule	30

Haast Beach, New Zealand
Picture courtesy of John Brunsdon

BIKE RACKS



DA4118



DA4119



DA4121



STC7929



STC50063

These bike racks mount to the spare wheel carrier and are easy to fit.

DA4118	Discovery 1	4 Bike
DA4119	Discovery 2	4 Bike
DA4121	Freelander	3 Bike
STC7929	Freelander 1/Freelander 2	2 Bike
STC50063	Discovery 2/Discovery 3 & Range Rover Sport	2 Bike

LADDERS



DA3073



STC50417



DA3071



STC50134



DA3073B

NEW



AGP780020

DA1089	Defender - 90/110	Galvanised
(see picture in next section)		
DA3073	Defender - 90/110	Grey
DA3073B NEW	Defender - 90/110	Black
STC50417	Defender - 90/110	Black
DA3071	Discovery 1 & 2	Black
STC50134 NEW	Discovery 2	Black
AGP780020 NEW	Discovery 3	Black

NEW

ROOF RACKS - GALVANISED FLAT PACK KITS



DA1089



DA1091



DA1093

DA1090	LWB/110	Flat floor
DA1091	SWB/90	Contour floor
DA1092	LWB/110	Contour floor
DA1093	SWB/90	Flat floor
DA1089	For above kits	Ladder

Note - Contour racks must **NOT** be used on vehicles fitted with a sunroof.

Note -

SWB flat packed roof racks - length 1,990mm (78^{1/2}""); height 420mm (16^{1/2}""); width 120mm (5"); weight 25kgs
 LWB flat packed roof racks - length 2,800mm (110^{1/2}""); height 420mm (16^{1/2}""); width 120mm (5"); weight 30.5kgs



Picture courtesy of Darren Whiley

ROOF RACKS & BARS NEW



DA3072



DA3070



DA3075



DA3077

- > All aluminium construction, fully welded
- > Powder coated finish
- > Patented slat, with groves to accommodate 8mm bolt head
- > Modular design - allow accessories to be mounted and removed as need without drilling
- > Rail towards the rear, open in the front
- > Gutter mount stainless steel clamps

DA3072	Defender 90	Full rack	Black
DA3070	Defender 110	Full rack	Black
DA3075	Discovery 1 & 2	Short rack	Silver
DA3077	Freelander 1	Full rack	Silver
DA3086	Freelander 1	Full rack - original mountings	Silver

Defender NEW

LR004101	90	Roof rack	1,600mm
LR004100	110	Roof rack	2,400mm
LR004102	110/130 Crew cab	Roof rack	
STC7582		Roof bars	Sports

Discovery NEW

RTC9539AB	Discovery 1	Roof rack	Standard
STC8057AC	Discovery 2	Roof bars	Sports
LR006848	Discovery 3 & 4	Roof rack luggage carrier	Use in conjunction with roof cross bars
CAB500021PMA	Discovery 3 & 4	Roof rack assembly - luggage	
VPLAR0001	Discovery 3 & 4	Roof rack cross bars	
LR006849	Discovery 3 & 4	Roof ski carrier	Use in conjunction with roof cross bars

Freelander NEW

STC7932	Freelander 1 - 5-door	Roof rack cross bars	
STC50327AA	Freelander 1 - 3-door	Roof rack cross bars	
STC50433	Freelander 1	Roof rack	Expedition
LR006848	Freelander 2	Roof rack luggage carrier	Use in conjunction with roof cross bars
LR002417	Freelander 2	Roof rack cross bars	
LR006849	Freelander 2	Roof ski carrier	

Range Rover NEW

STC50176AA	Range Rover Classic	Luggage cross bars	
LR006848	Range Rover Classic	Roof rack luggage carrier	Use in conjunction with luggage cross bars
STC50252	Range Rover P38	Roof cross bars	Sports
STC8506	Range Rover P38	Roof rails	Side
LR006849	Range Rover P38	Roof ski carrier	
CAB500070PMA	Range Rover L322	Roof rack luggage carrier	Expedition
CAB000040PMA	Range Rover L322	Roof rack cross bars & rails	
LR006848	Range Rover L322	Roof rack luggage carrier	Use in conjunction with roof cross bars
VUB502790	Range Rover L322	Roof bars - fixed	Sports
LR006849	Range Rover L322	Roof ski carrier	Use in conjunction with roof cross bars
CAB500130PMA	Range Rover Sport	Roof rack luggage carrier	Expedition
LR006848	Range Rover Sport	Roof rack luggage carrier	Use in conjunction with roof cross bars and rails
VUB502130	Range Rover Sport	Roof rack cross bars and rails	
LR006849	Range Rover Sport	Roof ski carrier	

ROOF RACKS & BOXES - MONT BLANC

Roof Boxes

DA4331	Vista 380	Half width	
380 litres	2,000 x 650 x 450mm (LxWxH)		Weight: 15kg
DA4332	Vista 540	Full width	
540 litres	2,000 x 950 x 420mm (LxWxH)		Weight: 17kg

- > Secure-Assure - keys cannot be removed until locks securely engaged
- > 2 or 3 point central lock system
- > Lock up struts - new improved design with side opening for ease of loading
- > 80mm width fixings to suit most roof bar sizes
- > UV resistant, high impact ABS
- > Load securing straps included

DA4333	Triton 450	430 litres	2,240 x 940 x 430mm (LxWxH)
DA4334	Triton 650	620 litres	1,970 x 830 x 380mm (LxWxH)

- > Premium roof box range with modern design for all kind of activities
- > Made of UV-resistant ABS plastic with gas struts for soft opening and closing of box
- > Three point central locking
- > Load securing straps included
- > Flexible attachment to the load bar
- > Unique quick attachments - the box is attached from the inside
- > Fits both square bars and aluminium bars with C-slots



DA4332



DA4333

Roof Bars & Rails

DA2312	Discovery 1	System 400 - Standard
DA2310	Freelander 1	System 400 - Standard
DA4313	Range Rover P38	System 400 - Standard

- > Easy to fit, good value load carrier system with fully galvanised roof bars

MONT BLANC

DA4312	Discovery 3	System 3000 - Premium
DA4311	Freelander 1	System 3000 - Premium
DA2311	Defender	System 3000 - Premium
DA2315	Range Rover P38	System 3000 - Premium
DA4314	Range Rover Sport	System 3000 - Premium
DA4319	Range Rover L322	System 3000 - Premium

- > Premium roof bar system with quick fit and release feature and integrated lock system (excluding gutter fit) with max load range 75-100kg
- > Manufactured to DIN standard 75302/15011154



SYSTEM 400 - STANDARD



SYSTEM 3000 - PREMIUM



DA4315

DA4316

DA4317

Rails not included

DA4318

Carriers

- DA4315** Discovery - cycle carrier
- Roof mounted with stylish aluminium profile • Wheels fit into moulded profile which holds the cycle upright leaving both hands free to secure the frame and wheels • Locking the cycle into frame holder secures carrier to load carrier • Black-painted frame holder tube in special steel • Base unit made of aluminium and UV-resistant composite material • Takes frame diameters from 20 up to 80mm • Max. tyre width 2.2 inches • Manufactured in accordance with DIN75302 • Will fit to both standard and aluminium bars • Weight: 4.2 kg
- DA4316** Scott - cycle carrier
- Stable easy-to-use roof mounted cycle holder • Frame holder with quick attachment for easy fitting without tools • Takes frame diameters from 25 up to 80mm • Wheels rest in adjustable wheel holders and are fastened with strong securing straps • Lockable to roof rack as well as bicycle • Can be fitted on all standard load bars and aluminium profiles.
- DA4317** Barracuda - cycle carrier
- Wheels locate in a moulded profile, which holds the cycle in an upright position - you can use both hands when securing the wheels and the frame
 - When the cycle is attached to the frame holder, the cycle holder is secured to the load carrier • Cycle is secured in the frame holder • Chromium-plated frame holder tube in special steel • Base unit made of UV-resistant composite material • Takes frame diameters from 20 up to 80mm • Max tyre width 2.2 inches • Manufactured in accordance with DIN 75302 • Max weight capacity 17kg
- DA4318** Tahiti 6 - surfboard and canoe carrier
- Stable and gentle holder for surfboards, canoes, kayaks, etc. • Holder comes complete with cradles, straps and a holder for a mast or paddle
 - Rubber-covered cradles are kind to the hull and allow the boat/surfboard to lie steadily during transport

ROOF RACKS & BOXES - THULE

Roof Boxes

DA4321 X1 450 litres
1,900 x 900 x 380 (LxWxH) Load capacity 75kg Weight 23kg

- > Rugged design for those who want to stand out from the crowd
- > Quick-Snap mounting system, for easy fitting of the box
- > Dual-Side opening for convenient mounting, loading and unloading
- > Central safety locking system
- > Unique and spacious design in special tech silver colour



DA4321

DA4322 Atlantis 600 340 litres
1,900 x 630 x 410 (LxWxH) Load capacity 75kg Weight 16kg

- > Spacious roof boxes featuring exciting design and smart functions
- > Patented Power-Grip quick mount system, for fast and secure fitting using one hand
- > Aerodynamic design for great stability, reduced air resistance, wind noise and vibrations
- > Dual-Side opening for convenient mounting, loading and unloading
- > Central safety locking system with grip-friendly key



DA4326

THULE[®]
SWEDEN
CAR RACK SYSTEMS



DA4322

Roof Bars

DA2990	Discovery 1	Roof bars
DA2991	Discovery 2 (with modified trim)	Roof bars
DA4323	Discovery 2	Roof bars
DA4325	Discovery 3 - (T Profile)	Roof bars
DA4324	Discovery 3	Roof bars
DA4328	Freelander 1 1998-2003 3-door and 5-door	Roof bars
DA4329	Freelander 1	Roof bars
DA4326	Freelander 2 - mounts to gutter	Roof bars & rails
DA4327	Freelander 2	Roof bars
DA3002	Range Rover Classic	Roof bars
DA2993	Range Rover P38	Roof bars
DA2996	Range Rover Sport	Roof bars



DA4327



DA4329



DA4323



DA2996



Carrier

STC7969 Cycle carrier

- > The smartest, most elegant solution for loading and transporting a bike on the roof
- > The self-adjusting and upright frame holder into which the bike automatically slides, makes bike loading easy
- > Adjusting and securing is done comfortably and quickly, with a turning knob, at roof height
- > Quick-release straps, adjustable for different wheel sizes, hold the wheels securely in place
- > Light and convenient aluminium design
- > Can easily be fitted on either side of the car roof
- > Lockable - bike to bike carrier, bike carrier to load carrier
- > Best in test
- > Fits frame dimensions up to 100mm



STC7969

04

WHEELS

Freshen up your Land Rover with a new set of wheels, then secure them with a set of locking wheel nuts.

Section contents -

Inner tube	32
Locking wheel nuts, keys & caps	32
Spare wheel carriers	33
Spare wheel covers	33
Tyre pressure monitoring system	34
Tyre repair kit & air compressors	33
Wheel spacers & adaptor kits	34
Wheel wrenches	34
Wheels	35
Zu rims	36



INNER TUBE



DA3000

DA3000 750 x 16



LOCKING WHEEL NUTS, KEYS & CAPS



STC3420



KBM100450



STC3415



RRB100510



RRB500100



RTC9535



STC3582



STC3601



STC7623



STC8513



STC50080



STC8843AA

Locking wheel nut keys for

Defender/Discovery 1/Discovery 2/Range Rover P38

Code A	STC3420
Code B	STC3421
Code C	STC3422
Code D	STC3423
Code E	STC3424
Code F	STC3425
Code G	STC3426
Code H	STC3427
Code I	STC3428
Code J	STC3429

Protect your valuable wheels and tyres from theft!

Locking wheel nuts and keys for Freelander to 2006

	Locking wheel nut	Locking wheel nut key
Code A	RRD100520	KBM100450
Code B	RRD100530	KBM100460
Code C	RRD100540	KBM100470
Code D	RRD100550	KBM100480
Code E	RRD100560	KBM100490
Code F	RRD100570	KBM100500
Code G	RRD100580	KBM100510
Code H	RRD100590	KBM100520
Code I	RRD100600	KBM100530
Code J	RRD100610	KBM100540

Locking wheel nuts keys for Defender 1987-2006 & 2006 -/Discovery 1

Code F	STC3415
Code H	STC3417

ANR6094L	Freelander locking wheel nut cap
KBP10001	Universal nut cover removal tool
RRB100510	Discovery 2 with alloy wheels
Kit contains -	1 x nut; 1 x key; 1 x cover; 1 x removal tool
RRB500100	Discovery 3/Range Rover L322/Range Rover Sport
Kit contains -	4 x nuts; 1 x key
RRD000100	Range Rover L322 - Locking wheel nut - 35
RRD000110	Range Rover L322 - Locking wheel nut - 36
RRD000120	Range Rover L322 - Locking wheel nut - 37
RRD000130	Range Rover L322 - Locking wheel nut - 38
RRJ000030	Range Rover L322 - Wheel nut cap
RTC9535	Range Rover Classic 1989 to 1994/Defender/Discovery 1 with steel wheels
Kit contains -	5 x nuts; 1 x key (black finish)
STC3582	Discovery 2/Range Rover P38
Locking wheel nut key - code C	
STC3601	Defender/Discovery 1 with alloy wheels
Kit contains -	5 x nuts; 1 x key; 1 x black bag for key
STC7623	Defender with deep dish alloy wheels
Kit contains -	5 x nuts; 2 x keys
STC8513	Range Rover P38A with alloy wheels
Kit contains -	4 x nuts; 1 x key
STC50080	Discovery 2 - Full set of wheel nuts
Kit contains -	4 x locking nuts; 4 x spare caps; 18 x normal nuts (inc. caps); 1 x key; 1 x remover tool
STC8843AA	Range Rover Classic 1989 to 1994/Defender/Discovery 1 with alloy wheels (not deep dish wheels)
Kit contains -	5 x nuts; 1 x key

SPARE WHEEL CARRIERS



DA2232

DA2232 NEW
Defender/Series
Swing away rear door mount

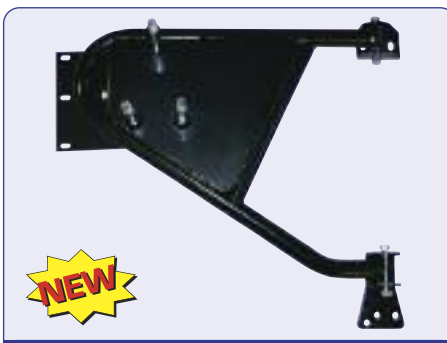

DA2259

DA2259 NEW
Defender 2002 - 2007
Swing away rear door mount

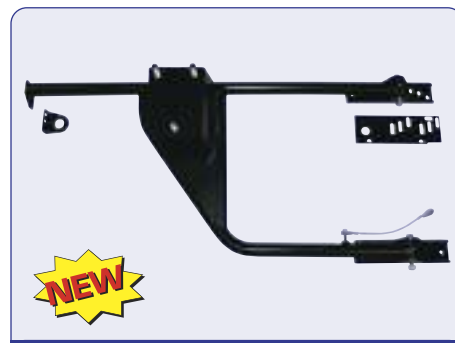

DA2274

DA2274 NEW
Defender with half door tailgate
Swing away rear door mount

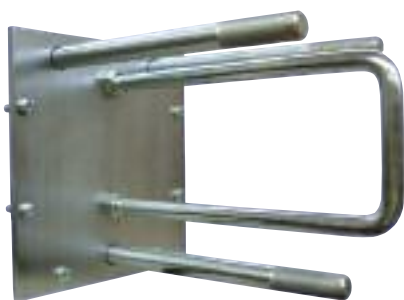

DA2215

DA2215
Defender/Series
Fixed rear door mount

SPARE WHEEL COVERS

DA2021	750 x 16	Plain black
DA2022	600 x 16	Plain black
DA2026	205 x 16	Plain black



DA2026

TYRE REPAIR KIT & AIR COMPRESSORS

Don't get caught out with a flat tyre or two!

*Pack and leave an easy to use Britpart tyre repair kit in your vehicle.**

DA2390 - Tyre repair kit in travel case

How It Works

1. Find and remove the item that caused the puncture.
2. Apply rubber solution to the reamer tool then push the reamer into the puncture and work up and down until the reamer moves easily in the hole.
3. Thread one rubber tyre plug in the hook tool.
4. Push the rubber tyre plug into the hole until 1/2" of the tyre plug remains outside the tyre then turn the hook tool a quarter turn and pull out slowly.
5. Cut off the excess tyre plug as close to the tyre as possible.
6. If the puncture is too big have the tyre fixed by a professional.

**Recommended for off-road use only.*



DA2390



It's no good being able to repair your tyre if you can't inflate it!

- DA2392** Double-pump air compressor
> Air flow - 150ltr/min
- DA2354** Single-pump air compressor
> Air flow - 72ltr/min



DA2392



DA2354

See the off-road section for more details on the portable air compressors from Britpart.

TYRE PRESSURE MONITORING SYSTEM



Are your tyres at the right pressure?

DA4512

This system is an advanced monitoring & alert system of tyre conditions. It monitors tyre pressure and temperature then relays the state of each tyre to a display unit. When any abnormalities are detected, the system will display the status of the affected tyre and sound an alarm to ensure you take action to remedy the problem. Keeping your tyres in good condition at the right pressure can extend the life of your tyres, reduce fuel consumption and improve handling.

Tyres that are at the right pressure will -

- > Improve fuel consumption
- > Increase the tyre life span
- > Help enhance vehicle handling & braking
- > Reduce susceptibility to hydroplaning

System contents -

- 1 x Display
- 1 x Receiver
- 4 x Tyre sensors
- 3 x Display brackets,
- 2 x 3M stickers
- 1 x Instruction manual

WHEEL SPACERS & ADAPTOR KITS



DA2075



DA5005



DA5006



DA5004

Wheel Adaptor Kit

DA2075

To fit Range Rover L322 wheels to Range Rover P38

To fit Range Rover Sport wheels to Discovery 2

DA5005

To fit Range Rover P38 wheels to Range Rover Classic

DA5006

To fit Discovery 2 wheels to Defender

Wheel Spacers

DA5004

Defender/Range Rover Classic/Discovery 1

30mm thick, steel machine finish complete with wheel nuts and OEM studs

WHEEL WRENCHES



Wrench size - 15/16"

537179



Wrench size - 27mm

DA4026



Wrench size - 27mm

NTC7829



Wrench size - 27mm
Heavy-duty

NTC7829HD

WHEELS



ANR4583PM



ANR4583SILVER



ANR5307MNH



ANR5593PM



RRC503400MNH



RRC503600PM



ANR3631MNH



ANR1534PM



ANR4636PM



ANR4635PM



NTC5193PM



RRC114560MUW



RRC501470MCM



RRC505360MNH



ANR3973



RRC505370MNH

ANR4583PM Defender - use longer studs (FRC7577)
Steel Wolf rim welded tubeless 16" x 6.5J black

ANR4583SILVER Defender - use longer studs (FRC7577)
Steel Wolf rim welded tubeless 16" x 6.5J silver

ANR5307MNH Defender - from TA/Discovery 1
16" x 7 Tornado alloy

ANR5593PM Defender
Steel Wolf rim welded tube type 16" x 6.5J primed

RRC503400MNH Defender - 1987 onwards Boost alloy - 16" x 7

RRC503600PM Defender - 1987 onwards Steel tubeless - 16" x 5.5

ANR3631MNH Defender/Discovery 1 16" x 7 Deepdish alloy

ANR1534PM Defender/Series
Steel 1 ton 569204 welded 16" x 6.5 primed

ANR4636PM Defender/Series
Steel standard welded tube type 16" x 5.5F primed

ANR4635PM Defender/Range Rover Classic
16" x 6 Steel Ro-Style NTC2165 primed

NTC5193PM Discovery 1 Steel 16" x 7 primed

RRC114560MUW Discovery 2 Steel silver 16" x 7J

RRC501470MCM Discovery 2/Range Rover P38
18" x 8 Hurricane alloy

RRC505360MNH Discovery 3/Range Rover Sport
18" x 8 10 spoke alloy wheel - silver sparkle finish

ANR3973 Freelander Steel 15" x 5.5J

RRC505370MNH Range Rover Sport
19" x 9 alloy wheel - silver sparkle finish

Smarten up your Land Rover with a smart new set of alloy wheels.

ZU RIMS



- > Super strong
- > Super light
- > TÜV approved and meets or exceeds UK - European - U.S. - Canadian - Australian - South African and Japanese wheel manufacturing specifications
 - > Uses standard Land Rover alloy wheel nuts
- > Easy to balance
- > Manufactured in the UK

Super strong

Discovery 2/Range Rover P38

- > 38mm offset
- > 1,400kg rating
- > 12kg each

DA2430	16 x 8	White
DA2431	16 x 8	Silver
DA2432	16 x 8	Black - gloss
DA2438	16 x 8	Black - matt
DA2433	16 x 8	Anthracite

Defender/Discovery 1/Range Rover Classic

- > 11mm offset
- > 1,400kg rating
- > 10.4kg each

DA2434	16 x 7	White
DA2435	16 x 7	Silver
DA2436	16 x 7	Black - gloss
DA2439	16 x 7	Black - matt
DA2437	16 x 7	Anthracite

RRJ500030MNH	Wheel cap
Discovery 2/Range Rover P38	
ANR2763MMM	Alloy wheel nut
Defender up to 2006/Discovery 1/Range Rover Classic	
ANR3679	Alloy wheel nut
Discovery 2	

Super light



DA2437



DA2434



DA2432



DA2435



DA2433



DA2431

05

LIGHTING EQUIPMENT

Be seen and light the way with a decent set of driving lamps.

Section contents -

Light bar	38
Light conversion kits	38
Light kits	38
Light mounting kits	40
Light upgrade kits	40
Lights - driving	39
Lights - fog	38
Lights - Roo-lites	40
Map reading lamp	41
NAS lights	41

Water splash
Picture courtesy of Simon Hodson

LIGHT BAR



DA5624

DA5624

Defender - non air-con models

Black finish

Note - Light bar exclude lights



DA5624

LIGHT CONVERSION KITS



RTC4615C

RTC4615C

Crystal halogen headlamp

Series/Defender/Range Rover Classic

- > Clear lenses and profiled back reflector offer brilliant lighting
- > Fully E-marked
- > Pair

Note - Bulb not included

PRC7994K

Sealed beam to halogen

Series/Defender/Range Rover Classic

Left hand drive

Pair

RTC4615K

Sealed beam to halogen

Series/Defender/Range Rover Classic

Right hand drive

Pair



RTC4615K

LIGHT KITS



DA1077



DA1080

DA1077

Defender/Series

DA1080

Defender 300Tdi

LIGHTS - FOG



RTC8922

STC7643



RTC8922

Defender/Range Rover Classic

Hella Comet 550 rectangular - pair

Black

Note - 195mm wide x 96mm high x 83mm deep. 12 vol

STC7643

Hella Rallye 1000

Black

LIGHTS - DRIVING

DA4088	8" Light	Black	Pair
DA4088C	8" Light	Chrome	Pair
DA4088W	Wipac 8" Light > High power, 100 watt 8", halogen lamp > Easy installation > Fitted plastic stone guards	Black	Pair > Black body, chrome rim > Armoured cable
DA4088BULB	Replacement bulb for DA4088C	100 watt	
DA4088COVER	Replacement 8" spot light cover for DA4088/DA4088C/DA4088W		
DA4099	Hella Rallye 3000	Black	Single
PRC8238	Spoiler lamps classic	Black	Pair
STC7644	Hella Rallye 1000 long range	Black	Single
STC8480	Land Rover Safari 5000 Defender 1987-2006/Discovery 1/Discovery 2/Range Rover Classic 1992-1994/Range Rover P38	Black	Single
STC8842	Lamp guard for Land Rover Safari 5000 driving & fog lamp		Pair
VUB001090	Range Rover L322 driving light kit - includes electrics & fittings	Black	Pair
XQB500080	Discovery 3 driving light kit - includes electrics & fittings	Black	Pair
VUB500870 NEW	Freelander 1 from 4A00001 long range driving lamp kit Kit includes lamps, brackets, switch, looms and full fitting instructions	Black	Pair



DA4088



DA4088C



DA4088W



DA4088COVER



DA4099



PRC8238



STC7644



STC8480



STC8842



VUB001090



XQB500080



VUB500870

LIGHTS - ROO-LITES



Exclusive to Britpart

ROO-LITE®

High performance lighting with super strength construction



DA1062



DA1062AMBER

DA1062BLUE



DA1062COVER



DA1064

DA1062

Roo-lite

- > High performance lighting with super strength construction
- > 7 1/4" round long range spot lamps with "stone-proof" clear polycarbonate lens
- > Super strength housing with an Osram 100 watt Xenophot long life technology bulb
- > Variable focus from spot to fog beam pattern
- > Lightweight for reduced vibration
- > Reflector unit is screw-on for easy bulb change
- > 12V - 100W - 8 amps

Note - Roolites sold individually

DA1062AMBER Amber coloured cover

DA1062BLUE Blue coloured cover

DA1062COVER Protective cover

Note - Roolites covers sold individually

DA1063 Spare bulb

DA1064 Harness

- > Harness is of a heavy gauge wire to ensure safe operation of high wattage lamps. It includes digital switch, in-line fuse, built-in relay and wiring harness.

LIGHT MOUNTING KITS



DA3010B

DA3010

Series/Defender
8" Headlamp
Chrome

DA3010B

Series/Defender
8" Headlamp
Black

LIGHT UPGRADE KITS



STC50383

STC50383

Range Rover P38
Right hand drive lamp upgrade kit

Note - Does not include headlamps

STC50408

Range Rover P38
Left hand drive lamp upgrade kit

Note - Does not include headlamps

Got something to tow?



Towing gear for all Land Rovers - see towing equipment section!

MAP READING LAMP



Flexible interior lamp!

AMR4910
Defender
24 volt

AMR4910

NAS LIGHTS



AMR6526



AMR6527



AMR6528

Defender lights with North American specification...

AMR6526	AMR6527	AMR6528
Round Red Stop or tail lamp	Round Amber Indicator lamp	Round Clear Reverse or side lamp
Note - Supplied without mounting plinth and screws		
AMR6528	XFD500010	XFE500010
Round Clear Reverse or side lamp	Round Clear Reverse or side lamp	Round Red Rear fog lamp
Note - Supplied with mounting plinth but without screws		

Sundry items

AMR3850	Mounting plinth
SE105161L	Screws
STC1188	Link leads 2 wire for indicator, side, reverse and fog lamp
STC4637	Link leads 3 wire for stop and tail lamp

“ The Britpart logo has become a widely recognised and highly respected marque; it *embodies excellence* in the field, both in quality and commitment to meeting the needs of the customer. ”



06

towing equipment

TOWING EQUIPMENT

Haul that load - towing equipment for all Land Rover models.

Section contents -

All models	44
Defender	45
Discovery	46
Freelander	47
Range Rover	48
Series	48



Farmyard Defender
Picture courtesy of Greg Mawson

ALL LAND ROVER MODELS



67187



201691



DA2123

67187	All	Pin universal coupling HD (201691)
201691	All	Ball and jaw + pin HD 4 bolt mounted (ball 3 1/2 ton/jaw 5 ton)
579408	All	7-Pin trailer plug
ANR3635	All	50mm Tow ball cover
DA2123	All	Ball, jaw & pin (RTC8159)
DA2123A	All	Replacement chain, tag, clip
DA2194	All	Replacement pin for DA2123
DA2195	All	Replacement slider bracket - 1-pin
DA2118	All	Replacement slider bracket - 2-pin
DA2196	All	Replacement slider pin
DA2197	All	Replacement slider pin 'R Clip'
DA5100	All	Tow hitch - to tow 3,500kgs gross
KNB100640	All	Towing jaw (3 1/2 ton)
NRC2051	NATO	Tow hitch
RTC8831	All	Saddle slider - fits all Dixon Bates kits



NRC2051



DA2118



DA5100



RTC8831



Picture courtesy of John Brunsten

DEFENDER



DA2123 / LR007221



DA2121



DA2136



YWJ101500



RTC8891AA

DA2121	Defender	Adjustable kit (RTC8828)
DA2136	Defender 90 - from WA	Towbar assembly (VUB105460) - no electrics
DA2137	Defender 110 - from WA	Towbar assembly (VUB105470) - no electrics
LR007221	Defender Td5 90	Adjustable tow kit
LR007222	Defender Td5 110	Adjustable tow kit
RTC8891AA	Defender	50mm Tow ball
YWJ101500	Defender Td5	'N' Type electrics plug
STC50269AA NEW	Defender 90 from XA onwards	Rear step - includes regulation tow bracket Note - does not include drop plate and tow ball
STC50301 NEW	Defender 110 from XA onwards	Rear step - includes regulation tow bracket Note - does not include drop plate and tow ball



STC50269AA

Britpart have the equipment to get you hitched up and towing!



DISCOVERY



DA2125



DA2134



RTC8891AA



DA2138



STC50289AB



KNB500070



LR007484



STC8919AA

DA2125	Discovery 1 - 1994 on	Adjustable coupling (RTC8830, STC8060)
DA2134	Discovery 1 - to 1994	Tow kit (STC8816) to 1994 - includes electrics but not plug-in electrics
RTC8891AA	Discovery 1	50mm Tow ball
DA2138	Discovery 2	Towing kit - includes electrics
STC50287AB	Discovery 2	Tow kit - coil suspension - no electrics
STC50289AB	Discovery 2	Tow kit - air suspension - no electrics
KNB500070	Discovery 3	Towing hook assembly - quick disconnect without height adjustment
LR007484	Discovery 3	Adjustable tow hook kit
STC8919AA	Discovery 3	Tow strap
YWJ500201	Discovery 3	Tow bar electrics kit 'N' & 'S' type



Picture courtesy of Victor Petrovsky

FREELANDER



VUB501500



LR002738



LR002742

KNK500070	Freelander 1	Towing kit - UK style 50mm ball fitted	Note - this has a plug connection to the vehicle loom - with electrics
STC50391	Freelander 1	Tow kit - includes electrics but not plug-in electrics or tow ball	
VUB501500	Freelander 1	Towing kit - swan neck detachable - with plug-in electrics	
LR002738	Freelander 2	Tow bracket kit	
LR002740	Freelander 2	Tow bracket kit - detachable ball tow bar	
LR002742	Freelander 2	Tow bracket kit - swan neck	
LR003106	Freelander 2	Electrics kit - 12N/12S 7 pin socket	
LR003107	Freelander 2	Electrics kit - 13 pin socket	



Picture courtesy of Jake Perks

RANGE ROVER



DA2134



RTC8829



KNB500070



LR007484



STC8919AA



VUB000720

DA2125	Range Rover Classic	Adjustable coupling (RTC8830, STC8060)
DA2134	Range Rover Classic	Tow kit (STC8816) to 1994 - includes electrics but not plug-in electrics
RTC8829	Range Rover Classic	Towing kit
DA4030	Range Rover P38	Tow kit
		Note - No tow ball included. It is not a Swan neck type, a standard 50mm tow ball is required (RTC8891AA). Electrics are included but not plug-in.
KNB500070	Range Rover Sport	Towing hook assembly - quick disconnect without height adjustment
LR007484	Range Rover Sport	Adjustable tow hook kit
STC8919AA	Range Rover Sport	Tow strap
STC8919AA	Range Rover L322	Tow strap
VUB000720	Range Rover L322	Multi-height tow bar - includes carry bag
VUB000730	Range Rover L322	Quick release tow bar
VUB000740	Range Rover L322	Tow bar armature - towing subframe - pre 2006 model years
		Note - The tow bar armature accepts quick release, multi-height tow bars and bike carrier
VUB503960	Range Rover L322	Tow bar armature - towing subframe - 2006 model year only
YWC000840	Range Rover L322	Towing electrics control unit
YWJ500450	Range Rover L322	Tow bar electrics kit 12'N' & 12'S' type



A full range of filters available from Britpart
See service kits & filter section

SERIES



DA2122



RTC8891AA



DA2129

DA2012	Series SWB	Plate and bracket (short)	RTC8891AA	Series	50mm Tow ball
DA2122	Series	Adjustable kit	DA2129	Lightweight	Adjustable tow hitch
DA2133	Series 88/109	Drop plate extension			

07

interior protection

INTERIOR PROTECTION

Loadspace liners, mats and of course, dog guards - all that you need to protect and keep your Land Rover looking great inside.

Section contents -

Dog guards	50 - 51
Gear box gaiters	51
Loadspace liners	52 - 53
Loadspace nets & retention kit	54
Mats	55 - 56
Waterproof seat covers	57 - 58
Wind deflectors	59



"I'm going to get very muddy in a minute - once you get me down from up here"
Picture of Kelo courtesy of Richard Reid

DOG GUARDS

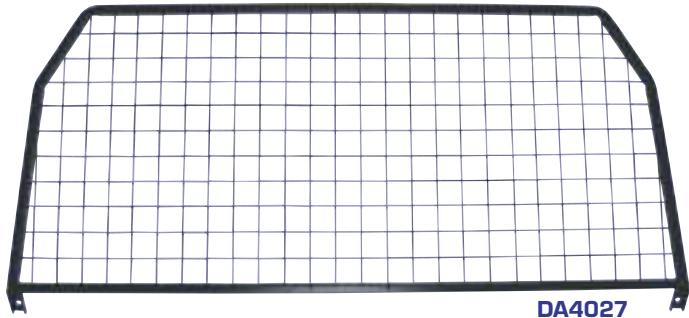

DA4027

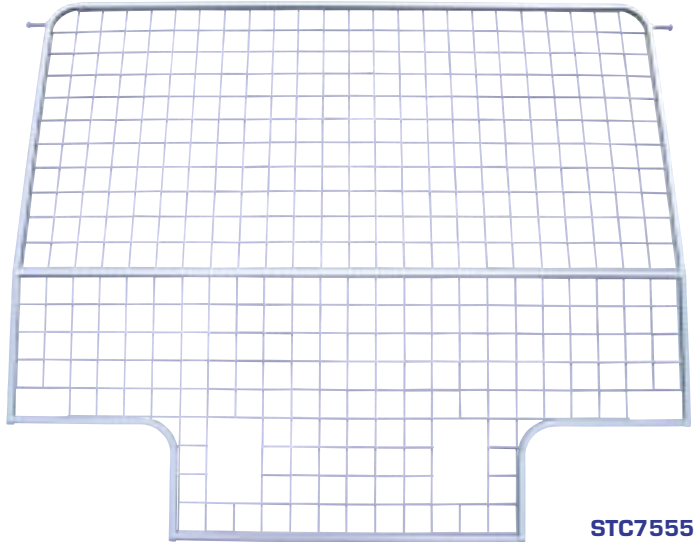

STC7555

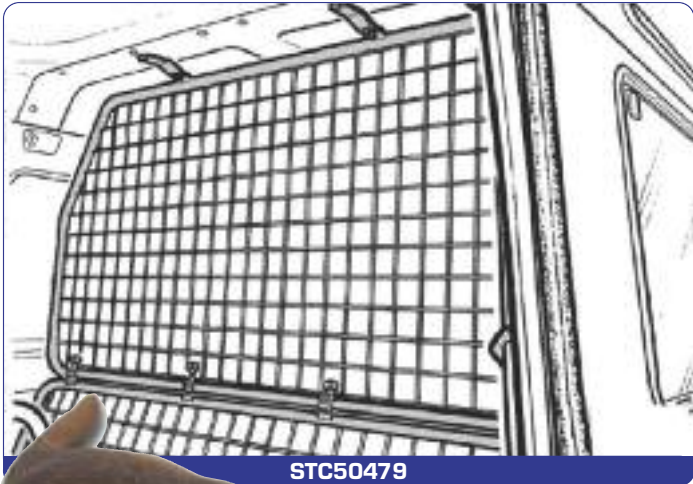

STC50479

Defender/Series

DA4027	Series/Defender to 2002	
	Mesh type	Black
STC7555	Defender 110 County Station Wagon	
	Mesh type	Grey
STC50479	Defender 90	
	Full height guard for vehicles without a bulkhead	
	Mesh type	Grey



Keep Rover in his place!

Discovery

STC7570	Discovery 1	Bar type	Half length	Grey
STC8414	Discovery 1	Mesh type	Half length	Grey
STC50323	Discovery 2 - 2003	Mesh type	Half length	Grey
STC50082AA	Discovery 2	Bar type	Half length	Grey
DA5511	Discovery 3	Mesh type	Half length	Grey
VUB501170	Discovery 3	Mesh type	Full length	Black



STC7570

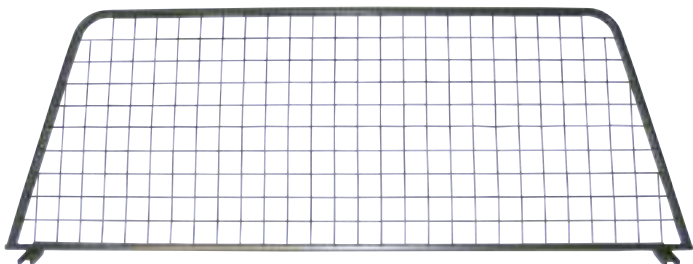

STC8414



STC50082AA



STC50323



DA5511



VUB501170

DOG GUARDS - continued



STC7939AB



DA5801

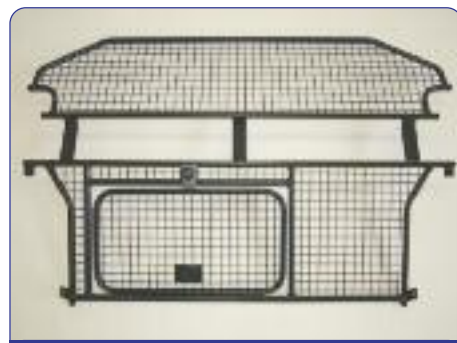

LR002521

Freelander

STC7939AB	Freelander 1	Bar type	Floor to roof	Grey
DA5801	Freelander 2	Half height	Full width	Grey
Easy to fit and remove. No vehicle modifications needed.				
LR002521	Freelander 2	Full height	Full width	Black
LR002522	Freelander 2	Full height	Half width	Black

Range Rover

DA4141	Range Rover - 1986 - 1994	Mesh type	Black
RTC8093	Range Rover Classic - to 1994	Bar type	Grey
STC8524	Range Rover P38	Tubular type	Grey
VUB002120	Range Rover L322	Mesh type	Black
DA1081	Range Rover Sport	Mesh type	Dark grey



LR002522

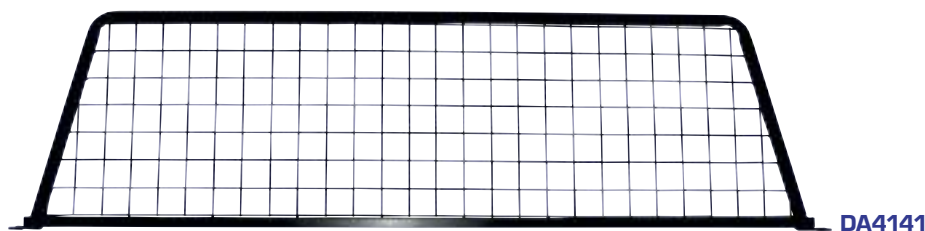

DA4141



VUB002120



RTC8093



DA1081

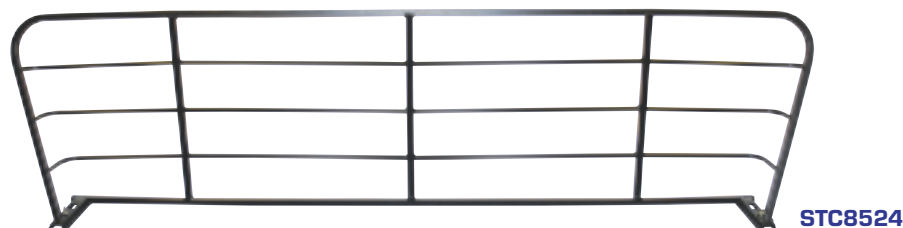

STC8524

GEAR BOX GAITERS

Got a Defender with a tatty gear box gaiter? Well replace it with a smart new hard wearing one from Britpart!

DA5498	Grey
DA5499	Black

For details of the alloy gear stick knobs (DA5500) see the Vehicle Enhancement section.



DA5498



DA5499 - FITTED

Smarten up your Defender's interior!

LOADSPACE LINERS



DA4470

Defender

DA4470 Defender 90 Rubber



And now she needs a lift home in the back of your nice clean Land Rover...

Keep your Land Rover's interior clean and tidy!



DA4183



DA4169



STC50050



STC50052AA



STC50053AA



DA5602



EBF500010



LR003895

Discovery

DA4183	Discovery 1	Loadspace liner	2" deep sides	Semi-rigid
DA4169	Discovery 2	Loadspace liner	3" deep sides	Semi-rigid
STC50050	Discovery 2	Loadspace liner	5" deep sides	Rigid
STC50052AA	Discovery 2	Loadspace mat	Half length	Rubber
STC50053AA	Discovery 2	Loadspace mat	Full length	Rubber
DA5602	Discovery 3	Loadspace liner	3" deep sides	Semi-rigid
EBF500010	Discovery 3	Loadspace liner	6" deep sides	Rigid
LR003895	Discovery 3	Loadspace mat	Full length	Rubber

LOADSPACE LINERS - continued



DA4171



STC50435



DA5554



LR002516



LR002424



Shown here fitted to a Range Rover Sport
VPLFS0014

Freelander

DA4171	Freelander 1	Loadspace liner	2" deep sides	Semi-rigid
STC50435	Freelander 1	Loadspace mat		Rubber
DA5554	Freelander 2	Loadspace liner	2" deep sides	Semi-rigid
LR002516	Freelander 2	Loadspace mat		Rubber
LR002424	Freelander 2	Loadspace liner	3" deep sides	Semi-rigid
VPLFS0014	Freelander 2	Luggage compartment protection		



DA4170



DA5555



VPLSS0016



DA5556



EBF000040

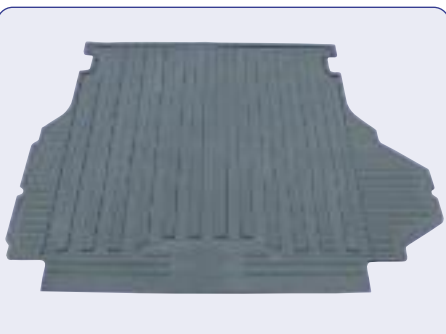

LR003894

Range Rover

DA4170	Range Rover P38	Loadspace liner	3" deep sides	Semi-rigid
DA5555	Range Rover Sport	Loadspace liner	2" deep sides	Semi-rigid
VPLSS0016	Range Rover Sport	Luggage compartment protection		
DA5556	Range Rover L322	Loadspace liner	2" deep sides	Semi-rigid
EBF000040	Range Rover L322	Loadspace liner	6" deep sides	Rigid
LR003894	Range Rover L322	Loadspace mat		Rubber

LOADSPACE NETS & RETENTION KIT**VUB000700****VUB000710**

VUB000700	Range Rover L322 Restricts the movement of goods in the rear of the vehicle.	Loadspace retention kit	Contents - 1 x floor net & 2 x ratchet straps
VUB000710	Range Rover L322 A convenient way of storing luggage to maximise load space.	Luggage nets	Contents - 2 x side nets



MATS



331401



DA4503



BTR7895



BTR7896



BTR7897



BTR7898

Defender Rubber Mats

Individual Mats

331401	SWB Series 88 & Defender 90	Floor only	
DA4503	110 Hard top & truck cab		Rear loadspace mat
	5mm rubber with 6mm foam backing - 93 x 198cm		
BTR7895	LT77 Gearbox	Front floor left hand	Heavy duty with foam backing
BTR7896	LT77 Gearbox	Front floor right hand	Heavy duty with foam backing
BTR7897	1993 on	Front floor left hand	Heavy duty with foam backing
BTR7898	1993 on	Front floor right hand	Heavy duty with foam backing

Mat Sets

DA4501	LT77 Gearbox	Front right & left hand	Contains - BTR7895 & BTR7896
DA4502	1993 on	Front right & left hand	Contains - BTR7897 & BTR7898
LR005039	2007 MY onwards	Front right & left hand	
STC50172	Pre-2007 MY	Front right & left hand	

Keep your Land Rover interior clean with a set of mats from Britpart

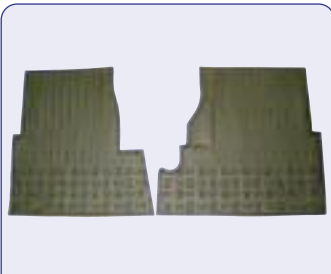

DA4422



DA4423



DA4426



DA4427



DA4424



DA4425



DA4428



DA4429



DA4430



DA4431

Quality Rubber Over Mats

DA4422	Series 2 & 3	Front	Black	Pair
DA4423	Defender	Front	Black	Pair
DA4426	Discovery 1	Front	Black	Pair
DA4427	Discovery 1	Rear	Black	Pair
DA4424	Discovery 2	Front	Black	Pair
DA4425	Discovery 2	Rear	Black	Pair
DA4428	Freelander 1	Front	Black	Pair
DA4429	Freelander 1	Rear	Black	Pair
DA4430	Range Rover P38	Front	Black	Pair
DA4431	Range Rover P38	Rear	Black	Pair

MATS - continued



DA4022BLACK



DA4023GREY



DA4024BLUE



LR002485



LR006435



EAH000300SUN



EAH500052PMA



EAH500054PMA

Carpet Mat Sets

DA4022BLACK	Defender	Black
DA4023BLACK	Discovery 1	Black
DA4023BLUE	Discovery 1	Blue
DA4023GREY	Discovery 1	Grey
DA4024BLUE	Range Rover Classic - 1986 on	Blue

Note - Front and rear carpet sets with rubber backing

Protect your
vehicle interior
with a set of
smart floor mats

Premium Mats - Carpet With Rubber Backing NEW

LR002484	Freelander 2	Front & rear contour set	RHD	Ebony black
LR002486	Freelander 2	Front & rear contour set	LHD	Ebony black
LR002485	Freelander 2	Front & rear contour set	RHD	Alpaca beige
LR002497	Freelander 2	Front & rear contour set	LHD	Alpaca beige
LR006431	Discovery 3	Front & rear contour set	RHD	Ebony black
LR006432	Discovery 3	Front & rear contour set	LHD	Ebony black
EAH500010PVJ	Discovery 3	Front & rear floor set	RHD	Ebony black
EAH500080PVJ	Discovery 3	Front & rear floor set	LHD	Ebony black
LR006433	Discovery 3	Front & rear contour set	LHD	Alpaca beige
VPLAS00022PVJ	Discovery 4	Front & rear contour set	RHD	Ebony black
VPLAS00023PVJ	Discovery 4	Front & rear contour set	LHD	Ebony black
LR006434	Range Rover Sport	Front & rear contour set	RHD	Aspen
LR006436	Range Rover Sport	Front & rear contour set	LHD	Aspen
EAH500012LUP	Range Rover Sport	Front & rear floor set	RHD	Aspen
EAH500011LUP	Range Rover Sport	Front & rear floor set	LHD	Aspen
LR006435	Range Rover Sport	Front & rear contour set	RHD	Ebony black
LR006437	Range Rover Sport	Front & rear contour set	LHD	Ebony black
EAH500012PVJ	Range Rover Sport	Front & rear floor set	RHD	Ebony black
EAH500011PVJ	Range Rover Sport	Front & rear floor set	LHD	Ebony black
LR006438	Range Rover Sport	Front & rear contour set	LHD	Alpaca beige
EAH500015SMS	Range Rover Sport	Front & rear floor set	LHD	Alpaca beige
EAH000300JMN	Range Rover L322 up to 6A	Front & rear contour set	RHD	Navy
EAH000310JMN	Range Rover L322 up to 6A	Front & rear contour set	LHD	Navy
EAH500280JMN	Range Rover L322 from 7A	Front & rear contour set	RHD	Navy
EAH500290JMN	Range Rover L322 from 7A	Front & rear contour set	LHD	Navy
EAH000300LUP	Range Rover L322 up to 6A	Front & rear contour set	RHD	Aspen
EAH000310LUP	Range Rover L322 up to 6A	Front & rear contour set	LHD	Aspen
EAH500280LUP	Range Rover L322 from 7A	Front & rear contour set	RHD	Aspen
EAH500290LUP	Range Rover L322 from 7A	Front & rear contour set	LHD	Aspen
EAH000300PVA	Range Rover L322 up to 6A	Front & rear contour set	RHD	Jet
EAH000310PVA	Range Rover L322 up to 6A	Front & rear contour set	LHD	Jet
EAH500280PVA	Range Rover L322 from 7A	Front & rear contour set	RHD	Jet
EAH500290PVA	Range Rover L322 from 7A	Front & rear contour set	LHD	Jet
EAH000300SUN	Range Rover L322 up to 6A	Front & rear contour set	RHD	Sand
EAH000310SUN	Range Rover L322 up to 6A	Front & rear contour set	LHD	Sand
EAH500280SUN	Range Rover L322 from 7A	Front & rear contour set	RHD	Sand
EAH500290SUN	Range Rover L322 from 7A	Front & rear contour set	LHD	Sand

Premium Mats - Rubber NEW

LR002481	Freelander 2	Front & rear contour set	RHD	Black
LR002483	Freelander 2	Front & rear contour set	LHD	Black
LR006237	Discovery 3 & 4	Front & rear contour set	RHD	Black
LR006238	Discovery 3 & 4	Front & rear contour set	LHD	Black
EAH500100PMA	Discovery 3 & 4	3rd Row floor mat	N/A	Black
EAH500052PMA	Discovery 3	Front & rear floor set	RHD	Black
EAH500050PMA	Discovery 3	Front & rear floor set	LHD	Black
EAH500058PMA	Discovery 3	Front contour set	RHD	Black
EAH500057PMA	Discovery 3	Front contour set	LHD	Black
LR006241	Range Rover Sport	Front & rear contour set	RHD	Black
LR006242	Range Rover Sport	Front & rear contour set	LHD	Black
EAH500054PMA	Range Rover Sport	Front & rear floor set	RHD	Black
EAH500051PMA	Range Rover Sport	Front & rear floor set	LHD	Black
EAH500320PMA	Range Rover L322	Front & rear contour set	RHD	Black
EAH500330PMA	Range Rover L322	Front & rear contour set	LHD	Black
EAH000261PMA	Range Rover L322	Front & rear floor set	RHD	Black
EAH000271PMA	Range Rover L322	Front & rear floor set	LHD	Black

WATERPROOF SEAT COVERS



DA2815GREY

**Defender - up to 2007
3 Seats - Front**

DA2815BLACK DA2815BLUE
DA2815GREEN DA2815GREY

Covers in kit -
3 x full seat (excludes headrest covers)



DA2816GREY

**Defender - up to 2007 - 2nd Row
110 Station Wagon - 60/40**

DA2816BLACK DA2816BLUE
DA2816GREEN DA2816GREY

Covers in kit -
1 x two-seat back & cushion
1 x one-seat back & cushion

Note - Will fit 110 Crew Cab with minor modification to seat covers.

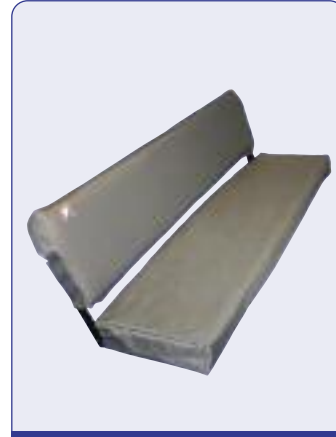

DA2817GREY

**Defender - up to 2007
110 Station Wagon**

**- Bench Rear Inward Facing
DA2817BLUE DA2817GREEN**
DA2817GREY

Covers in kit -
2 x bench-seat back & cushion

Note - For 1,200mm long seat



DA2818BLACK

**Defender 2007 - onwards
Front**

DA2818BLACK

Covers in kit -
2 x full seat 2 x headrest



DA2807GREY

Discovery 1 - Front

DA2807BLACK DA2807BLUE
DA2807GREEN DA2807GREY

Covers in kit -
2 x full seat



DA2808GREY

Discovery 1 - Rear

DA2808BLACK DA2808BLUE
DA2808GREEN DA2808GREY

Covers in kit -
1 x two-seat back & cushion
1 x one-seat back & cushion



DA2809GREY

Discovery 1 - Boot

DA2809BLUE DA2809GREEN
DA2809GREY

Covers in kit -
2 x full seat

What better way to protect your Land Rover seats than these waterproof covers from Britpart?



- > An extensive range of quality and stylish waterproof seat cover sets.
- > Front and rear sets available with headrests and armrests included in the Range Rover and Freelander range. Rear inward facing sets are also available for the 7-seater Discovery models.
- > The hard-wearing washable covers are made from waterproof woven polyester with a PVC backing.
- > Snug, tailor fit covers available in 3 stylish colours.
- > Easy to put on the seats and just as easy to remove again.



DA2800BLUE

Discovery 2 - Front

DA2800BLACK DA2800BLUE
DA2800GREEN DA2800GREY

Covers in kit -
2 x full seat 2 x headrest
2 x armrest



DA2801BLUE

Discovery 2 - Rear

DA2801BLACK DA2801BLUE
DA2801GREEN DA2801GREY

Covers in kit -
1 x two-seat back & cushion
1 x full seat 1 x armrest
3 x headrest



DA2802BLUE

Discovery 2 - Boot

DA2802BLUE
DA2802GREEN DA2802GREY

Covers in kit -
2 x full seat
2 x roof headrest (not shown)

**Discovery 3 - Front
DA2822BLACK**

Covers in kit -
2 x full seat 2 x headrest
2 x armrest

Note - suitable for vehicles with side air bags

WATERPROOF SEAT COVERS - continued



DA2810GREEN

Freeland 1
3 Door - Front
DA2810BLACK DA2810BLUE
DA2810GREEN DA2810GREY

Covers in kit -
 2 x back, cushion & headrest

Freeland 1
3 Door Sport - 2 Rear Seats
DA2812BLUE DA2812GREEN
DA2812GREY

Covers in kit -
 2 x back, cushion & headrest



DA2811BLUE

Freeland 1
5 Door - Front
DA2811BLACK DA2811BLUE
DA2811GREEN DA2811GREY

Covers in kit -
 2 x back, cushion & headrest

Freeland 2
Front
DA2821BLACK

Covers in kit -
 2 x full seat 2 x headrest
 2 x armrest



DA2813GREEN

Freeland 1
3 or 5 Door - Rear
60/40 split without armrest
DA2813BLUE DA2813GREEN
DA2813GREY

Covers in kit -
 1 x two-seat back & cushion
 1 x one-seat back & cushion
 3 x headrest



DA2814BLUE

Freeland 1
3 or 5 Door - Rear
60/40 split with armrest
DA2814BLUE DA2814GREEN
DA2814GREY

Covers in kit -
 1 x two-seat back & cushion
 1 x one-seat back & cushion
 3 x headrest* *pre-Td4 only



DA2803GREY

Range Rover Classic
4 Door - Front
DA2803BLACK DA2803BLUE
DA2803GREEN DA2803GREY

Covers in kit -
 2 x back, cushion, armrest & headrest



DA2804GREY

Range Rover Classic
4 Door - Rear
DA2804BLUE DA2804GREEN
DA2804GREY

Covers in kit -
 1 x two-seat back & cushion
 1 x one-seat back & cushion
 3 x armrest



DA2805BLUE

Range Rover P38 - Front
DA2805BLUE DA2805GREEN
DA2805GREY

Covers in kit -
 2 x full seat, headrest & armrest
Note - Not suitable for vehicles with rear air bags mounted in the front seats.



DA2806BLUE

Range Rover P38 - Rear
DA2806BLUE DA2806GREEN
DA2806GREY

Covers in kit -
 1 x two-seat back & cushion
 1 x one-seat back & cushion
 3 x headrest 1 x armrest

Range Rover Sport - Front
DA2819BLACK

Covers in kit -
 2 x full seat 2 x headrest
 2 x armrest

Range Rover L322 - Front
DA2820BLACK

Covers in kit -
 2 x full seat 2 x headrest
 2 x armrest



Helping you protect your Land Rover!

Waterproof Seat Covers - Other

LR005058	Freeland 2	Front	Aspen
LR005059	Freeland 2	Front	Sand
DA4083	Range Rover Classic	Front & rear	Grey/Navy
HBD000320JMN	Range Rover L322	Front set	Navy
	Standard seats including head and arm rest - pair		
HBD000320LUP	Range Rover L322	Front set	Aspen
	Standard seats including head and arm rest - pair		
HBD000320LYR	Range Rover L322	Front set	Charcoal
	Standard seats including head and arm rest - pair		
HBD000320SUN	Range Rover L322	Front set	Sand
	Standard seats including head and arm rest - pair		



WIND DEFLECTORS



DA6070



DA6071



DA4175



DA6072



DA6073



DA6077



DA6074



DA6075



DA6076

DA6070 NEW	Discovery 1/Range Rover Classic	Front & rear	4 piece kit
DA6071 NEW	Discovery 2	Front & rear	4 piece kit
DA4175	Discovery 2	Front	2 piece kit
DA6072 NEW	Discovery 3	Front & rear	4 piece kit
DA6073 NEW	Freelander 1 - 2 door	Front	2 piece kit
DA6077 NEW	Freelander 1	Front & rear	4 piece kit
DA6074 NEW	Freelander 2	Front & rear	4 piece kit
DA4176	Range Rover Classic	Front	2 piece kit
DA4177	Range Rover P38	Front	2 piece kit
DA6075 NEW	Range Rover L322	Front & rear	4 piece kit
DA6076 NEW	Range Rover Sport	Front & rear	4 piece kit
VUB502390	Discovery 3	Front & rear	4 piece kit
VUB000610	Range Rover L322	Front & rear	4 piece kit
VUB502520	Range Rover Sport	Front & rear	4 piece kit

Allows for fresh air to enter the vehicle by enabling the driver to have the windows open whilst being shielded from the wind and rain. Custom designed for each vehicle and easily attached using the fitting kit supplied - no drilling required for install.



Picture courtesy of Pascal Perrier



Picture courtesy of Guy Stryckmans

SEATS & TRIM

Saggy old seats? Get a set of smart new ones. We've plenty to choose from in a multitude of materials and colours. Also keep your vehicle clutter free with a cubby box.

Section contents -

Cubby boxes	62 - 63
Door trim	63
Extended slide seat rails & bulkhead bars	64
Fume curtain	64
Hoods	64
Re-trim kits - Defender	65
Seats - Defender & Series	66
Seats - Techno style	67
Seats - XS style	67
Trim	68



Inside view of the Britpart Trim Shop

CUBBY BOXES - DEFENDER & SERIES



DA2035T

RANGE IMPROVED
NOW WITH DOUBLE CUP HOLDER

Defender/Series 3 Cubby Boxes

With a Britpart cubby box in your Land Rover you can ensure your vehicle remains clutter free with these handy storage devices. Now with a double cup holder as standard, spilt drinks are a thing of the past. If security is a worry, then peace of mind can be achieved with our cubby box made from metal with a padded lid which is lockable.

	Top	Body
DA2035	Black	Black
DA2035LCS	Grey	Grey
DA2035RPI	Vinyl twill	Grey
DA2035T	Techno	Grey
DA2149	Grey	Black

Security box - 2 keys & 3 removable cup holders

Defender Cubby Box Cup Holder

FWJ500020PMA

Double cup holder for both old and new model Defenders - ideal for holding a Britpart travel mug or two!! **Note** - To fit to existing carpet lined cubby box the lining may have to be taken out. Fits XS Style cubby boxes too.

Excludes travel mug -

DA8015



FWJ500020PMA

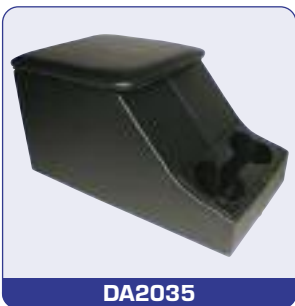

DA2035

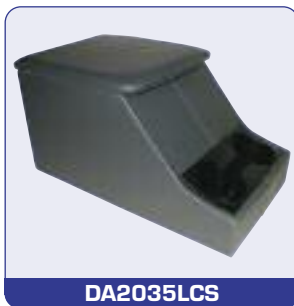

DA2035LCS



DA2035RPI



DA2149

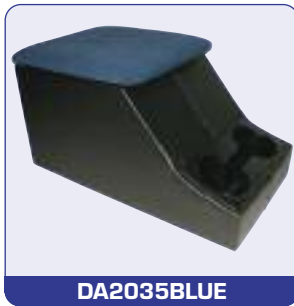

DA2035BLUE



DA2035BROWN



DA2035CHAR



DA2035GREEN



DA2035GREY

Keep your Defender & Series 3 clutter free!

XS Style Cubby Boxes

Hand-built in the UK, these quality XS style cubby boxes are suitable for Series 3 and Defenders. Well crafted with precision tools using a hard wearing leatherette outer and velour trim inner. Each box has locking stay brass hinges. These XS Style cubby boxes match our range of XS Style seats - see this section. Now with a double cup holder as standard, spilt drinks are a thing of the past.

	Top	Body
DA2035BLUE	Blue	Black
DA2035BROWN	Light brown	Dark brown
DA2035CHAR	Charcoal	Black
DA2035GREEN	Green	Black
DA2035GREY	Light grey	Dark grey



Picture courtesy of Kristjan Kristjansson

CUBBY BOXES - FREELANDER



DA5101



DA5103



DA5113

Add some extra storage space in a Freelander 2 with one of these stylish cubby boxes.

- > Innovative design
- > Strong ABS storage base
- > Large storage capacity
- > Easy do-it-yourself installation in only 5 minutes in the original point
- > Boxes for vehicles with no factory fitted armrests have adjustable sliding tops

Freelander 2 with no factory fitted armrests

DA5101	RHD	Black real leather
DA5102	RHD	Black eco leather
DA5103	RHD	Alpaca leather
DA5113 NEW	RHD	Almond leather
DA5104	LHD	Black real leather
DA5105	LHD	Black eco leather
DA5106	LHD	Alpaca leather
DA5114 NEW	LHD	Almond leather

Freelander 2 with factory fitted armrests

DA5115 NEW	Black real leather
DA5109 NEW	Black eco leather
DA5111 NEW	Alpaca leather
DA5112 NEW	Almond leather

Note - for both RHD & LHD vehicles



DA5111

Freelander 1 - 2001 - 2006

Add some support to your Freelander with one of these stylish adjustable armrests.

- > Innovative design
- > Easy do-it-yourself installation



DA5118

DA5116 NEW	Black eco leather
DA5117 NEW	Black real leather
DA5118 NEW	Smokestone real leather



DA5116



DOOR TRIM NEW



DA2124



DA2029



DA2441

DA2124	Defender/Series	Door trim safari	Rear		
DA2029	Series	Door trim lower	RH		
DA2030	Series	Door trim lower	LH		
DA2440	Defender	Door casing	Manual window	Black	RHS
DA2441	Defender	Door casing	Manual window	Black	LHS
DA2442	Defender	Door casing	Manual window	Grey	RHS
DA2443	Defender	Door casing	Manual window	Grey	LHS
DA2444	Defender	Door casing	Electric window	Black	RHS
DA2445	Defender	Door casing	Electric window	Black	LHS
DA2446	Defender	Door casing	Electric window	Grey	RHS
DA2447	Defender	Door casing	Electric window	Grey	LHS

Replace your Defender's old tatty door cards with one of these smart plastic replacements. Easy to fit they are also easy to keep clean with a wipe clean finish.

EXTENDED SLIDE SEAT RAILS & BULKHEAD BARS



DA2148

DA2148

Give your Defender seats 3" of extra slide with a pair of these seat rails. Ideal for the taller driver to give a more practical and comfortable driving position. One pair of rails is suitable for one seat.

- > Ideal for the taller driver
- > A more practical and comfortable driving position



DA2351

DA2351

Up until recently, Land Rover hasn't catered (in the Defender) for the people with stature. The bulk head removal bar alleviates the problem without compromising strength. The bulk head removal bar allows an extra 105mm of seat rake at the top and 50mm of travel on the seat base. The tubular bar creates a rigid bracing for the front of the Defender tub. As well as the added benefits of extra room in the vehicle due to the seats been more manoeuvrable, access to the rear of the Defender is now not compromised by a higher bulk head. Powder coated and supplied complete with all the necessary fixings.

FUME CURTAIN



MRC3519

MRC3519

Series & Defender

Note - Hood stick not included - 330553

HOODS

Got a Land Rover with a hood that has seen better days? Tears? Frayed fixings? Scratched windows? Well give your vehicle a quick facelift with a new canvass hood from Britpart.

- > Hoods are made from the original 18oz canvas and made to OEM specifications
- > All fittings are brass and made to OEM specifications
- > Webbing is made the same way as the original
- > Polypropylene rope is the same construction as the original rope
- > Ropes are all inserted into the hood to help customers
- > Care instruction are included

Other hoods available on request - please ask for details.

331110AG	Series	88"	Full hood	Khaki	Without windows
331113AG	Series	88"	Full hood	Khaki	With windows
331110SA	Series	88"	Full hood	Sand	Without windows
331113SA	Series	88"	Full hood	Sand	With windows
331371AG	Series	88"	Three quarters hood	Khaki	Without windows
331259AG	Series	109"	Full hood	Khaki	Without windows
331260AG	Series	109"	Full hood	Khaki	With windows
331259SA	Series	109"	Full hood	Sand	Without windows
331260SA	Series	109"	Full hood	Sand	With windows
331308AG	Series	109"	Three quarters hood	Khaki	Without windows
MUC2437	Series	109" - V8	High capacity pick-up		
			Three quarters hood	Khaki	Without windows
MUC4122ABE	Defender	90	Full hood	Sand	With windows



331110AG - SIDE VIEW



331110AG - REAR VIEW



331113AG



331371AG

RE-TRIM KITS - DEFENDER

Going off-road? Got a working Land Rover?

Well the chances are your seats won't be in showroom condition, luckily here at Britpart we have the answer - a Defender re-trim kit.

Outer Seats - up to 2007

An outer Britpart re-trim kit includes:

- | | |
|---|---------------------|
| 1 x Fitment guide CD - This 20 minute tutorial will give you a detailed step-by-step guide to disassembling and assembling your Defender seat and information on the correct use of the included parts. | |
| 1 x Can of contact adhesive spray | 1 x Cushion foam |
| 1 x Squab foam | 1 x Cushion cover |
| 1 x Squab cover | 1 x Headrest cover |
| 6 x Plastic nails | 2 x Metal rods |
| 3 x Cable ties | 1 x Rubber retainer |

DA5627	Vinyl twill
DA5628	Techno
DA5629	Black
DA5630	Grey



DA5628

Centre Seats - 1990 onwards

A centre Britpart re-trim kit includes:

- | | |
|-----------------------------------|---------------------|
| 1 x Can of contact adhesive spray | 1 x Cushion foam |
| 1 x Squab foam | 1 x Cushion cover |
| 1 x Squab cover | 6 x Plastic nails |
| 1 x Metal rods | 1 x Rubber retainer |

DA5632	Vinyl twill
DA5633	Techno
DA5634	Black
DA5635	Grey



DA5634

Breathe life back into your old saggy Defender seats with a Britpart re-trim kit.



Swatches

Material colours are an approximate match. Sample swatches of the actual material are available on request.



SEATS - DEFENDER & SERIES



Defender Seats

DA4028	Seat cover	Base outer	Black
DA4041	Seat cover	Back outer	Black
MWC3302	Seat	Back RH	Black
MWC3303	Seat	Back LH	Black
MWC4535	Seat	Base outer	Black
MWC1010	Headrest assembly		Black
DA4029	Seat cover	Base outer	Grey
DA4042	Seat cover	Back outer	Grey
MWC5670LCS	Seat	Base outer	Grey
MWC9843LCS	Seat	Back LH	Grey
MWC9844LCS	Seat	Back RH	Grey
MWC5628LCS	Headrest assembly		Grey
AWR5701RPI	Seat cover	Base outer	Vinyl twill
AWR5702RPI	Seat cover	Back outer	Vinyl twill
AWR5708RPI	Headrest assembly		Vinyl twill
AWR5700RPI	Seat	Base outer	Vinyl twill
BTR8140RPI	Right hand assembly	Less headrest	Vinyl twill
BTR8141RPI	Left hand assembly	Less headrest	Vinyl twill
DA4031	Seat foam	Base outer	
DA4055	Seat foam	Back outer	
DA4056	Seat foam	Centre to 07/95	

Defender & Series Seats

320737	Bench seat	Rear assembly SWB	Black
DA3059	Bench seat	Rear assembly LWB	Black
DA4067	Rear seat	Individual inward facing	Black
320737CB	Bench seat	Rear assembly SWB	County brown
320737CG	Bench seat	Rear assembly SWB	County grey
320737LCS	Bench seat	Rear assembly SWB	Grey
DA4075	Rear seat	Individual inward facing	Grey
320737T	Bench seat	Rear assembly SWB	Techno style
DA4075T	Rear seat	Individual inward facing	Techno style
320737RPI	Bench seat	Rear assembly SWB	Vinyl twill
DA4075RPI	Rear seat	Individual inward facing	Vinyl twill

Series Seats

320698	Seat back - pin fitment - adjustable	Standard outer	Black
320699	Seat base - adjustable	Standard outer	Black
320726	Seat base	Standard centre	Black
349967	Seat base	Standard outer	Black
MUC1488	Seat back	Standard centre	Black
MUC1520	Seat back - pin fitment	Standard outer	Black
MUC1520G	Seat back - bolt fitment	Standard outer	Black
DA4305	Standard seat kit		
Note - Kit contains - 2 x 349967; 2 x MUC1520; 1 x 320726 & 1 x MUC1488			
MRC6980	Seat base	Deluxe outer	Black
MRC6982	Seat back	Deluxe outer	Black
MRC6982H	Seat back with headrest	Deluxe outer	Black
MRC6985	Seat base	Deluxe centre	Black
MTC3181	Seat back	Deluxe centre	Black
DA4298	Deluxe seat kit		
Note - Kit contains - 2 x MRC6982; 2 x MRC6980; 1 x MTC3181 & 1 x MRC6985			

All products leaving the Trim Shop are produced to the highest standards!



A COMPLETE BRITPART SEAT

The skilled team in the Trim Shop make a wide range of seats and seat covers for Land Rover vehicles by hand. The material arrives in vast reams and has to be cut with great precision before being stitched together and then assembled into seat bases, seat backs, seat benches etc. In keeping with the Britpart philosophy, all products leaving the Trim Shop are produced to the highest standards and meet with the strictest safety regulations.



320737



DA4298



MRC6982H

SEATS - TECHNO STYLE

Hand-built in the UK, these quality seats with the ever popular 'Techno' pattern are suitable for Defenders. Well-crafted with precision tools using a hard wearing velour trim. Comfort is ensured with injection moulded foam.

HAG100970LOY	Base	
HCA106010LOY	Cover base	
HAJ101400LOY	Squab assembly - no pockets	Right hand side
HAJ101410LOY	Squab assembly - no pockets	Left hand side
HBA106190LOY	Squab cover - no pocket	
HBA106180LOY	Squab cover - with pocket	
HAH103510LOY	Headrest	
320737T	Rear seat assembly	
DA4075T	Rear seat individual inward facing	
HHD102280	Runner & sub-frame	Right hand side
HHD102290	Runner & sub-frame	Left hand side



320737T

Swatches
Material colours are an approximate match. Sample swatches of the actual material are available on request.



TECHNO



SEATS - XS STYLE

Hand-built in the UK, these quality XS style seats are suitable for Defenders. Well-crafted with precision tools using a hard wearing leatherette outer and velour trim inner. Comfort is ensured with injection moulded foam. Seats complete with base, back and headrest but the runners are not included.

	Outer	Inner	Side
DA5610	Dark grey	Light grey	Right
DA5611	Dark grey	Light grey	Left
DA5612	Black	Green	Right
DA5613	Black	Green	Left
DA5614	Black	Blue	Right
DA5615	Black	Blue	Left
DA5616	Dark brown	Light brown	Right
DA5617	Dark brown	Light brown	Left
DA5618	Black	Charcoal	Right
DA5619	Black	Charcoal	Left
HHD102280	Runner & sub-frame		Right hand side
HHD102290	Runner & sub-frame		Left hand side

DA5612 / DA5613



Re-trim Kit

A Britpart XS Style re-trim kit includes:

1 x Fitment guide CD - This 20 minute tutorial will give you a detailed step-by-step guide to disassembling and assembling your Defender seat and information on the correct use of the included parts.

- | | |
|-----------------------------------|---------------------|
| 1 x Can of contact adhesive spray | 1 x Cushion foam |
| 1 x Squab foam | 1 x Cushion cover |
| 1 x Squab cover | 1 x Headrest cover |
| 6 x Plastic nails | 2 x Metal rods |
| 3 x Cable ties | 1 x Rubber retainer |

DA5636 Outer - Black Inner - Charcoal



DA5610 / DA5611



DA5614 / DA5615



DA5616 / DA5617



DA5618 / DA5619

BLUE

LIGHT BROWN

CHARCOAL

LIGHT GREY

GREEN

TRIM

Discovery

DA2090		
Discovery 1	Dash trim kit	Black
DA2091		
Discovery 1	Dash trim kit	Blue
DA2096		
Discovery 1	Dash trim kit	Grey
DA2098		
Discovery 1	Dash trim kit	Brown

Put a stop to the dreaded dash peel!



Other

DA2002	Series	Window channel 2m length
DA2007	Series	Door rubber 30m roll



Be prepared for the unexpected when exploring the exotic far flung corners of the globe - or even down your local greenlane.

Section contents -

Air compressors & tyre repair kit	70
Diff lockers - uprated - ARB	71
Diff lockers - uprated - Detroit	72
Fire extinguishers	72
Fuel tanks - additional	72
Hammer - emergency	73
Jacking equipment	76
Jacks - Hi-Lift	75
Jacks - Jackall	74
Jerry cans	74
Ladders	76
Land meters	76
Raised air intake - Britpart	77
Raised air intake - Safari	78
Roof tents	79

In the middle of nowhere
Picture courtesy of Cyril Mischler

AIR COMPRESSORS & TYRE REPAIR KIT

Double pump

DA2392



DA2392 - double-pump
> Air flow - 150ltr/min

DA2354 - single-pump
> Air flow - 72ltr/min

Features for both air compressors

- > 12 volt / 30 amp
- > Max. pressure - 150psi
- > Automatic cut off to prevent overheating
- > 2 metre electric hose with heavy-duty clamps
- > 10 metre air hose with heavy-duty gauge and brass fittings
- > Integrated sand tray
- > Blow moulded carrying case
- > Also great for camping and outdoor use

DA2394 NEW

Replacement cap and filter for DA2392 & DA2354

Ideal for 4x4 use!

Great features...



Heavy-duty gauge



3 nozzles

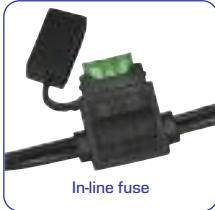

In-line fuse



Screw in air filter
DA2394



Built-in sand tray



Anti-vibration rubber feet



10m coiled hose



Heavy-duty battery clips



Blow moulded case



DA2354

Single pump

Don't get caught out with a flat tyre or two!

Pack and leave an easy to use Britpart tyre repair kit in your vehicle.*



DA2390

DA2390
Tyre repair kit in travel case

See the wheels section for more details on the tyre repair kit from Britpart.

* Recommended for off-road use only



Picture courtesy of Kristjan Kristjansson

DIFF LOCKERS - UPRATED - ARB

Air Locker locking differentials allow you to tackle the toughest terrain. As the world's premier traction aid, ARB Air Lockers keep you moving in all conditions.



ARB Diff Lockers

- > Provides 100% traction on demand without affecting on road driveability or driveline wear
- > Vastly improved traction means less reliance on momentum, thus reducing the likelihood of vehicle damage and environmental impact
- > Easy, convenient operation allows the driver to concentrate on the terrain without leaving the comfort and safety of their seat
- > Ultra durable and extremely strong - only the highest quality materials used in construction
- > Incredibly simple yet effective design that employs minimal moving parts, thereby ensuring maximum reliability
- > Thoroughly tested and proven design - trusted and used in over 80 countries around the world
- > Easy installation and maintenance - no special tools, skills or additives required
- > Two year warranty guarantees the Air Locker will be free of defects in materials



DA4191

Ultra durable and extremely strong - only the highest quality materials used in construction

Part Number	Vehicle/ Model	Axle Location	Year	Shaft Description	Shaft Diameter	Spline	Ratio
DA4191 ^{1,4}	Range Rover Classic	Front	To 1992	Rover type	28.2 (1.11")	10	3.54
DA4193 ^{1,5}	Range Rover Classic	Front	1993-1996	Rover type	31.5 (1.24")	24	3.54
DA4191 ^{1,4}	Range Rover Classic	Rear	To 1992	Rover type	28.2 (1.11")	10	3.54
DA4193 ^{1,5}	Range Rover Classic	Rear	1993-1996	Rover type	31.5 (1.24")	24	3.54
DA4344 ⁵	Range Rover P38	Front	1996-2002	Rover type, P38A	31.5 (1.24")	24	3.54
DA4344 ⁵	Range Rover P38	Rear	1996-2002	Rover type, P38A	31.5 (1.24")	24	3.54
DA4191 ¹	Discovery 1	Front	To 1993	Rover type	28.2 (1.11")	10	3.54
DA4193 ^{1,5}	Discovery 1	Front	1993-1998	Rover type	31.5 (1.24")	24	3.54
DA4191 ¹	Discovery 1	Rear	To 1993	Rover type	28.2 (1.11")	10	3.54
DA4193 ^{1,5}	Discovery 1	Rear	1993-1998	Rover type	31.5 (1.24")	24	3.54
DA4193 ^{1,5}	Discovery 2	Front	All	Rover type	31.5 (1.24")	24	3.54
DA4193 ⁶	Discovery 2	Rear	All	Rover type	31.5 (1.24")	24	3.54
DA4344 ⁶	Discovery 2	Rear	2002 on	Rover type, P38A	31.5 (1.24")	24	3.54
DA4191 ¹	Defender 110, 130	Front	1983-1993	Rover type	28.2 (1.11")	10	3.54
DA4193 ^{1,5}	Defender 110, 130	Front	1993 on	Rover type	31.5 (1.24")	24	3.54
DA4192	Defender 110, 130	Rear	1983-2002	Salisbury type	31.5 (1.24")	24	3.54
DA4193 ⁶	Defender 110, 130	Rear	2002 on	Rover type	31.5 (1.24")	24	3.54
DA4344 ⁶	Defender 110, 130	Rear	2002 on	Rover type, P38A	31.5 (1.24")	24	3.54
DA4191 ¹	Defender 90	Front	1984-1993	Rover type	28.2 (1.11")	10	3.54
DA4193 ^{1,5}	Defender 90	Front	1993 on	Rover type	31.5 (1.24")	24	3.54
DA4191 ¹	Defender 90	Rear ^c	1983-1993	Rover type, 4 cyl. petrol & diesel engines	28.2 (1.11")	10	3.54
DA4193 ^{1,6}	Defender 90	Rear	1993 on	Rover type	31.5 (1.24")	24	3.54
DA4344 ⁶	Defender 90	Rear	2002 on	Rover type, P38A	31.5 (1.24")	24	3.54
DA4191 ^{2,3}	Series 1, Series 2, Series 3	Front	1948-1985	Rover type	28.2 (1.11")	10	4.7
DA4191 ^{2,3}	Series 1, Series 2, Series 3	Rear	1948-1985	Rover type	28.2 (1.11")	10	4.7
DA4345	Series 1, Series 2, Series 3	Rear	1948-1985	Salisbury type	31.5 (1.24")	24	4.7

Notes: 1 If vehicle was manufactured during 1993, check spline count. 2 Air Locker not available for vehicles equipped with high load option. 3 Ring gear spacer required. Longer ring gear bolts (not supplied) are also necessary - (Land Rover part no. 576521). 4 When an DA4191 Air Locker is to be installed in Range Rovers manufactured prior to 1980 (approx.), special carrier bearings (No. K11300/K11162) may also be necessary - Land Rover part no. RTC3426. 5 Some vehicles have crown wheel bolts which cannot be reused and must be replaced. Consult service manual. 6 P38A is most commonly found in traction control equipped vehicles. Identify P38A type diff by large 205mm [8.07"] flange diameter. P38A was not used on North American delivered Discoverys - use DA4193.

ARB Compressor

- > Designed for Air Locker use
- > High flow, compact 12v compressor
- > Sealed for moisture and dust resistance
- > Hard anodised cylinder bore and Teflon impregnated carbon fibre piston seal for reduced friction and maximum trouble free life
- > Heavy-duty maxi-fuse equipped for professional in-line circuit protection
- > Quality components for quiet operation and extra long life
- > Anodised mounting brackets dissipates motor heat and allows compressor to be repositioned 180°
- > Constructed entirely of lightweight, high strength engineering grade materials
- > Over-pressure safety valve equipped
- > Motor is internally thermal protected against extreme temperature damage



DA4190



DA4194



SWITCH COVERS

DA4190 Compressor assembly 12 volt

DA4194 Dash switch for compressor and lockers

NEW Dash switch covers - DA4360 - Front locker; DA4361 - Rear locker; DA4362 - Compressor

DIFF LOCKERS - UPRATED - DETROIT

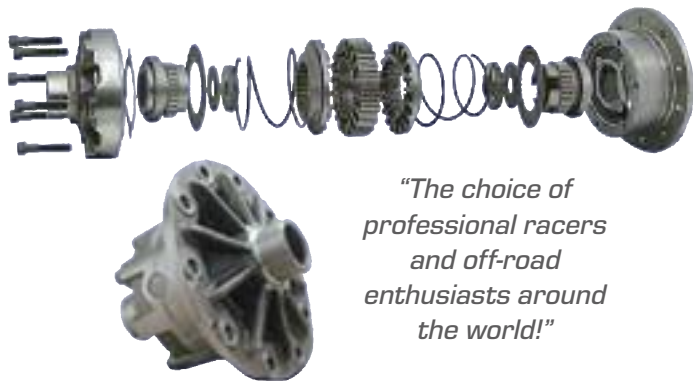

"The choice of professional racers and off-road enthusiasts around the world!"

Detroit Locker

- > 100% locking differential
- > Legendary traction
- > Ultimate performance

The legendary Detroit Locker began the revolution in performance differentials and still leads the industry today as an Eaton brand. The Detroit Locker is the most durable and dependable locking differential available. The Detroit Locker maximises traction by delivering 100% of the torque to both drive wheels. It is engineered to keep both wheels in a constant drive mode, and has the ability to automatically allow wheel speed differentiation when required. No other performance differential has the reputation for delivering traction in mud, snow, rocks and on the track. The choice of professional racers and off-road enthusiasts around the world! The durability of the Detroit Locker is unmatched!

DA5700	Series 3/Defender/Discovery 1/Range Rover Classic	Detroit Locker	24 spline	Rear
DA5701	Series 3/Defender/Discovery 1/Range Rover Classic	Detroit Locker	10 spline	Rear
DA5704	Defender - Salisbury axle	Detroit Locker	24 spline	Rear

Detroit Truetrac

- > Smooth operation
- > Performs open until needed
- > Fully automatic limited slip

Note - when fitting to non-metric diff casings 2 x RTC3095 bearings are required

The Detroit Truetrac was the first helical gear differential ever introduced into the automotive aftermarket as an Eaton brand. It remains the leading helical gear-type limited slip differential in the industry. Detroit Truetrac's proven helical gear design eliminates the need for wearable parts, resulting in maintenance free traction. Recognised not only for its toughness but also it's smooth and quiet operation. Engineered to work efficiently in front and rear axles, semi-floating (C-clip axles) and transfer cases. Power transfer is so smooth, it literally goes unnoticed by the driver - even in front wheel drive axles. Proven design, low cost and effective performance, all make the Detroit Truetrac limited slip differential the ideal choice for a wide variety of vehicle applications. No maintenance - just traction!

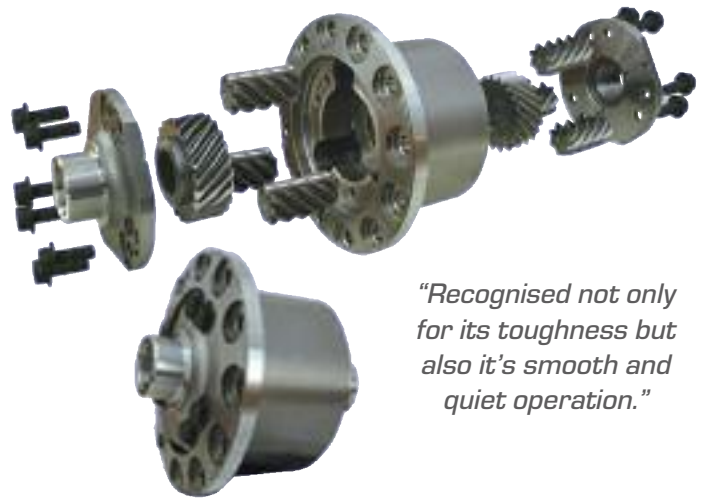

"Recognised not only for its toughness but also it's smooth and quiet operation."

DA5705	Series 3/Defender/Discovery 1/Range Rover Classic	Detroit Truetrac	10 spline	Rear
DA5706	Series 3/Defender/Discovery 1/Discovery 2/Range Rover Classic	Detroit Truetrac	10 spline	Front
DA5709	Series 3/Defender/Discovery 1/Discovery 2/Range Rover Classic	Detroit Truetrac	24 spline	Rear
DA5710	Series 3/Defender/Discovery 1/Discovery 2/Range Rover Classic	Detroit Truetrac	24 spline	Front
DA5711	Defender - Salisbury axle	Detroit Truetrac	24 spline	Rear

FIRE EXTINGUISHERS



STC8529AA

- > 1kg kit
- > One-handed operation fire extinguisher
- > High rating
- > Checkable & re-chargeable
- > With crash-tested bracket
- > Attractive design
- > Controlled discharge

STC8138AB

- > 2kg kit
- > Long-life - 100% polyester resin coated fire extinguisher
- > Safe handling & crash proof fastening
- > Readiness to operate displayed by manometer
- > Precision brass valve



FUEL TANKS - ADDITIONAL

DA4545



DA4545 NEW

Defender 110 up to 1999 (metal tank, pre Td5 models)
Rear arch spare fuel tank - right hand side - 45 litres
> Supplied with all the necessary fittings to install and use

DA4546

The best way of getting more fuel in to the vehicle without using valuable space or complex pumping systems

DA4546 NEW

Defender 110 after 1999 (plastic tank, Td5 and the new Td4 models)
Rear arch spare fuel tank - right hand side - 45 litres
> Supplied with all the necessary fittings as well as a replacement filler neck and specifically engineered bulkhead fitting for the balance pipe, having these makes the fitting of the tank quicker and easier as well as it working better too.

Note - Both tanks are not suitable for Defender 130

HAMMER - EMERGENCY**DA6500**

Life Hammer - The Original

- > Double-sided steel hammer for shattering windows quickly and easily for a safe and quick exit from any vehicle.
- > Razor sharp blade cuts through seatbelts to ease escape.
- > Fluorescent button allows hammer to be located in the dark.
- > Installation mounting bracket ensures hammer is accessible when you most need it.



DA6500



Picture courtesy of Daniel Taw

JERRY CANS

"Don't get caught short!"



DA2166

- DA2166**
Jerry can
20ltr

- DA2170**
Jerry can
20ltr stainless steel

- DA2171**
Jerry can
10ltr stainless steel

- DA2172**
Jerry can spout
stainless steel

- DA2182**
Jerry can holder for
20ltr cans



DA2170



DA2171



DA2172



DA2182

Jerry can not included

JACKS - JACKALL

8,000lbs capacity Jacks - Versatile! Rugged! Pow'R-ful!



Built with a patented 'Safety Link', the Maasdam Jackall is the 'Jack with More!' Larger base for greater stability. 'Safety Link' mechanism that prevents abuse, misuse and makes operations safer. Jacks come with a lifetime warranty and are built to current ANSI/ASME specifications. When safety and dependability matter most, continue to rely on Jackall.

Features

- > Patented "safety link" mechanism
- > Heavy ribbed, extra large base
- > Cast components
- > Hot roll-formed, alloy steel beam
- > Steel handle locks against beam
- > Powder coated through and through

Benefits

- > Prevents abuse and misuse
- > Provides strength and greater load stability
- > Assures long life, trouble free operation
- > Strong and reliable
- > For convenient storage
- > Reduces scratching, greater corrosive resistance

DA3121	48" Jack (4ft)	DA3122	60" Jack (5ft)
DA3130	Top clamp	DA4058	Maintenance kit
DA4059	Jacking point adaptor	DA4061	Mounting kit jack rack

DA3121

DA3122



DA3130



DA4058



DA4059



DA4061

Patented "Safety Link" pitman mechanism prevents abuse and misuse. "Safety Link" yields when capacity exceeded — load can no longer be lifted. Operational safety at its best.

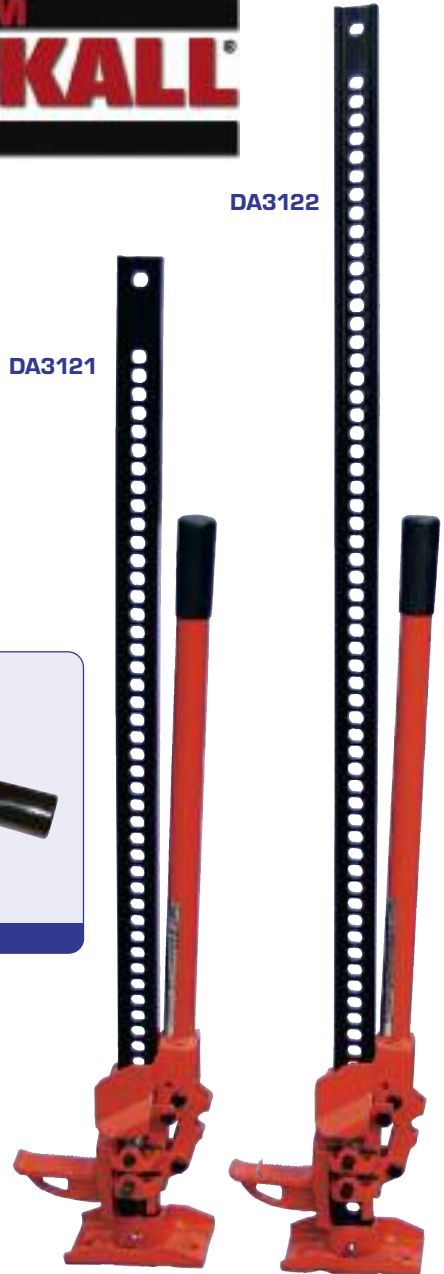

JACKS - HI-LIFT



rugged,
highly versatile jack

DA3120

- DA2243 48" Jack (4ft)
- DA3120 60" Jack (5ft)

The Hi-Lift jack is a rugged, highly versatile jack that puts you in command of situations requiring lifting, pushing, pulling, winching, and clamping. Although light in weight and easy to manoeuvre, the Hi-Lift jack offers a rated lifting capacity of 2¹/₃ tons (2,114kgs).

Specifications

- > Approximate weight: 30lbs (14 kg)
- > 4,660lbs (2,113kgs) rated capacity
- > Climbing pins of specially processed steel with 125,000psi tensile strength and 100,000psi yield
- > Steel bar is manufactured of specially rolled extra high carbon steel with 80,000lbs minimum tensile and carbon 0.69 to 0.82
- > Steel handle of 14-gauge high-yield structural tubing with minimum yield of 55,000psi 1⁵/₁₆" diameter x 30" long

Features

- > Every jack comes complete with an adjustable top clam clevis for use in clamping and winching
- > For speedy disengaging, lifting unity automatically drops away when load is removed
- > 4¹/₂" (11cm) long lifting nose for positive contact with load
- > Safety bolt is designed to shear at 7,000lbs. (3,175 kg)
- > Steel bar can be reversed for extra long life
- > Low pickup of 4¹/₂" (11cm)
- > 28" square base plate

DA2243

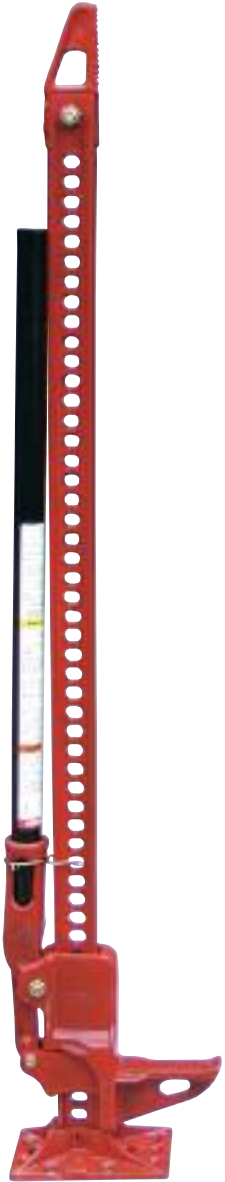

DA2174



DA2243EYE

DA2248

DA4350

DA4355

DA4351

DA4353

DA4352

DA4354



DA4356



DA4357 & DA4358

Accessories

DA2174	Off-road base	Alleviates jack sinkage on soft surfaces. Suits all models.
DA2243EYE	Jacking eye	Spare jacking eye.
DA2248	Fix-it-kit	The maintenance kit contains all the key components for servicing all Hi-Lift jacks.
DA4350	4XRAC	Heavy-duty mounting system for the serious off-roader.
DA4351	Loc-Rac	Conveniently mounts and locks your Hi-Lift jack. Includes lock and suits all models.
DA4352	Jack protector	The jack protector vinyl bag protects your jack from the elements. One size fits all.
DA4353	Lift mate	Designed to provide a lift point from most wheels for quick and easy lifting. The lifting capacity is 5,000lbs/2,273kgs.
DA4354	Off-road kit	The Hi-Lift winching kit includes a winch attachment, winch tensioner, tree strap, d-ring shackle, Hi-Lift gloves and gear bag. Winch time is reduced significantly using the winch attachment and tensioner together. Designed to fit curved steel bumpers. The rugged design of the bumper lift has a lifting capacity of 3,000lbs/1,361kgs.
DA4355	Bumper lift	
DA4356 NEW	Neoprene jack cover	This jack cover offers a level of mud and dirt protection for the main lifting mechanism of the jack when not in use. It zips on easily over the foot of the jack and provides a tight fit.
	Adjustable tube jack mount	Designed for mounting a Hi-Lift® jack to round and square tube bumpers, bull bars, roll cages and roof racks, this accessory allows for easy and adjustable mounting on tubes from 1" to 3" in diameter.
DA4357 NEW	Small set	Is for use on round tubes from 1 to 2" in diameter, which works on many roof racks. It can also be used on ATV/UTV bars, bumpers and roll cages
DA4358 NEW	Large set	Is intended for round tubes from 2 to 3" in diameter that will work on most vehicle bull bars and roll cages

JACKING EQUIPMENT



DA2244

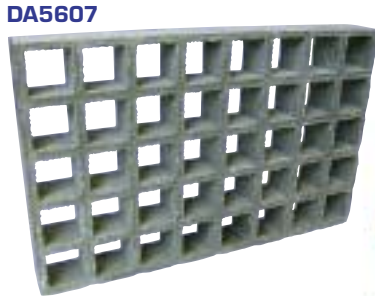

DA5607



ANR4489 (kit), KAJ100570 & KAH000050 (individual)

Anti-rattle jack clamps



DA3153 / DA3154 / DA3155

ANR4489	Jack and handle (KAJ100570 & KAH000050)	
KAJ100570	Standard bottle jack	
KAH000050	Handle for KAJ100570	Note - Defender only
DA2244	Jacking point adaptor	
DA3153	Anti-rattle jack clamp	Red
DA3154	Anti-rattle jack clamp	Black
DA3155	Anti-rattle jack clamp	Yellow
DA5607	Jack base - 310 x 195 x 38mm	Grey



LADDERS



DA2231



DA5601

DA2231	Sandtrack 4mm aluminium	1,500 long x 390mm wide - pair	
DA5600	Fibreglass bridging ladders	1,220 long x 260 wide x 50mm deep - pair	Grey with gritted surface for extra traction
DA5601	Fibreglass bridging ladders	1,220 long x 270 wide x 38mm deep - pair	Grey with gritted surface for extra traction

LAND METERS



DA1003

- DA1003 Double incline land meter Black finish
- DA1004 Double incline land meter Carbon effect finish

- > Independent twin meter
- > Convenient for seeing the pitching and rolling of the vehicle body or terrain
- > Transparent illumination for easy-to-see readings at night



DA1004

RAISED AIR INTAKES - BRITPART

If you're likely to be driving your Land Rover in circumstances which could mean wading deep water or driving in very dusty conditions then you should consider fitting a raised air intake to your vehicle. This version from Britpart is a classic mushroom-top snorkel for Defender. Featuring heavy-duty metal pipe work, cyclone pre-cleaner and a durable attractive matt black finish.

DA2225	Defender - 300Tdi/Td5
PHD500340	Defender - 2007 onwards
NRC6920	Raised air intake cleaner



NRC6920



DA2225



Be prepared for the **unexpected**
with off-road equipment from **Britpart!**

RAISED AIR INTAKES - SAFARI



Pioneered in Australia in the early 1980's, Safari Snorkels were born out of a need to protect 4WD engines from the hazards of dust and water commonly encountered in touring and off road applications. Safari snorkels are manufactured to the highest standards in durable, UV stable, cross linked polyethylene material, using stainless

steel hardware where appropriate. Each system includes quality fixtures and fittings, which offer superior sealing, presentation and long-term durability.

In arguably the best, if not toughest environment, Safari Snorkel Systems are thoroughly researched, tested and tooled for each model of Land Rover. The Safari Snorkel delivers a continuous and cooler supply of air for maximum engine performance. It is positively sealed as well to ensure the best protection against deep water crossings and dust.



DA3024



DA3069



DA3021

Defender

DA3024	200Tdi - 1990 - 1994	LHS
DA3025	V8 1984 - 1994	RHS
DA3026	300Tdi - 1994 - 1999	RHS
DA3027	Td5 - 1999 onwards - right hand drive	RHS
DA3027LH	Td5 - 1999 onwards - left hand drive	RHS
DA3069	2007 onwards	RHS
DA2374	Stainless steel air ram grille (shown attached to air ram - grille only) Note - Will not fit DA3069 snorkel	
DA3141	3" replacement air ram for DA3024	
DA3142	3 1/2" replacement air ram for DA3025, DA3026, DA3027, DA3027LH	
Note	- Fitment from seated internal view - RHS - right hand side and LHS - left hand side.	

Discovery

DA3015	Discovery 1 - 200Tdi - 1990-1994	LHS
DA3018	Discovery 1 - V8 1990 - 1994	LHS
DA3020	Discovery 1 - 300Tdi (none EGR)/V8 - 1994-1999 - Non ABS	LHS
DA3022	Discovery 1 - 300Tdi (none EGR)/V8 - 1994-1999 - ABS	LHS
DA3023	Discovery 2 - Td5/V8 - 1999 on	LHS
DA3021	Discovery 3 - TdV6 SE	RHS
DA2374	Stainless steel air ram grille (shown attached to air ram - grille only)	
DA3141	3" replacement air ram for DA3015, DA3018, DA3020, DA3022, DA3023	
DA3142	3 1/2" replacement air ram for DA3021	
Note	- Fitment from seated internal view - RHS - right hand side and LHS - left hand side	



DA2374



DA3141 / DA3142

For more Safari Snorkel pictures visit - www.britpart.com/safari

Safari snorkels are manufactured to the highest standards in durable, UV stable, cross linked polyethylene material

ROOF TENTS

Britpart are proud to be the sole European distributor for Echo roof top tents. They are the only heavy-duty tents available with convenient one-piece pitching and self-support.

Roof Top Tents

- > Manufactured from washable UV-varnished PVC canvas with welded seams.
- > 100% waterproof and they have been tested to withstand extreme weather conditions.
- > Ample ventilation is provided by having windows and doors on each side and each is covered with insect netting.
- > Maintenance-free floor - constructed from lightweight aluminium.
- > Comfort is ensured with a 60mm two-layer laminated foam mattress.
- > Removable two-section ladder provides easy access.
- > Quick and easy to store with the fold-up bungee system with dust cover.

'T' Top Tents

The same superior quality design as the above Roof Top Tents but with a unique designed versatile tent that allows access into the main rooftop from inside the tent. The bottom tent has 4 roll-up side panels which could be used as awnings and as doors to access your vehicle from inside the tent. Easy to open and close, no maintenance.



DA2501 - with add-on room not fitted

DA2500

Roof top tent

Including condensation sheet
Open - 1,300 x 2,400mm;
Closed - 1,300 x 1,200mm

DA2501

'T' Top tent

Including add-on room & condensation sheet
Open - 1,300 x 2,600mm;
Closed - 1,300 x 1,200mm



DA2501 - with add-on room fitted



DA2500

They are the only **heavy-duty** tents available with convenient one-piece pitching and self-support.



DA2501 - inside



DA2501 - alternative fitting option



DA2501 - alternative fitting option



Picture courtesy of Ian Hulme

10

winching equipment

WINCHING EQUIPMENT

Never get stuck again with a Britpart winch and winching accessories - we've all you need to get out of that sticky situation.

Section contents -

Batteries - Lucas	82
Batteries - Optima	82
Britpart winch - DB12000i	83
Britpart winch - DB9500i	83
Britpart winch - DB9000C	84
Britpart winch - DB8000	84
Britpart winch - DB6000	85
Britpart winch - DB2000	85
Winch bumper kits	86
Winch bumpers	87
Winch spare parts	88
Winching accessories	89 - 91
Winching accessory kits	91



BATTERIES - LUCAS NEW

Lucas batteries offer:

- > Original equipment (OE) quality standards, giving assurance that the batteries will not let the user down
- > Batteries are manufactured on the same equipment as OE batteries and use the same components to give a consistent quality and performance
- > The confidence of the Lucas brand
- > Lucas batteries are recyclable, helping to protect the environment
- > 3 Year warranty

	Voltage	Capacity	Cold Cranking Amps (CCA)
STC4757	12v	70Ah	500
STC8587	12v	110Ah	750
YGD000271	12v	110Ah	920
YGD100860	12v	115Ah	900
YGD500100	12v	70Ah	750
YGD500130	12v	95Ah	855
YGD500190	12v	80Ah	770



YGD500100

BATTERIES - OPTIMA



DB1018

With its patented Spiralcell® Technology, Optima batteries offer 15 times the vibration resistance and up to twice the life of ordinary batteries. The Optima is like no other battery found in today's market. Optima's unique patented Spiralcell® design offers the best technology by providing a strong and clean power source that far surpasses any of today's traditional lead acid batteries. With Optima as your choice, you can count on a longer lasting battery.



DB1020



> Twice the life of ordinary batteries

> 15 times the vibration resistance

Yellow Top

Demand more from your vehicle? Then get more from your battery. Optima Yellow Top batteries are made for the extremes. If your vehicle is designed to take the abuse of off-road driving, you need increased performance and reliability from your battery. Optima batteries combine patented Spiralcell® Technology to deliver that performance. The deep cycle characteristics of this technology coupled with its extreme resistance to vibration provides performance vehicles with the repetitive power they need, packaged in a spill-proof compact design.

If your vehicle is fitted with high drain accessories such as additional lighting, tracking devices, ICE systems, winches, hydraulics etc, then this ultimately demands more from your battery. Optima Yellow Top batteries provide the extra performance and deep cycling capability that your vehicle demands.

Voltage - 12v Capacity - 55Ah Cold Cranking Amps (CCA) - 765

DB1018	Yellow Top	Top terminals
DB1020	Yellow Top	Side terminals

Red Top

Optima Red Top batteries are built to withstand the abuse 4x4's experience on and off-road. Spiralcell® Technology immobilises the internal components of the battery, enabling Optima batteries to withstand incredible amounts of vibration.

Vehicles modified for improved engine performance demand more from a battery. Optima batteries withstand the high engine bay temperatures associated with these performance vehicles. The sealed construction makes the battery spill-proof, even if you install it on its side! This prevents external gassing and leaking which can damage engine components and reduce battery performance.

If your battery is used in applications that demand extra reliability endurance and performance, or if you just take pride in getting the best performance out of your vehicle, Optima Red Top batteries deliver the performance you demand.

Voltage - 12v Capacity - 50Ah Cold Cranking Amps (CCA) - 815

DB1019	Red Top	Top terminals
DB1021	Red Top	Side terminals



DB1019



DB1021

BRITPART WINCH - DB12000i - 12 & 24 VOLT

Features

- > 3.6Kw (4.8Hp) heavy duty series wound DC motor
- > Weather and dustproof contactor controls for longer life and improved amperage draw
- > Planetary gear system for fast line speed
- > Automatic load-holding brake
- > Free spooling
- > Power in and power out
- > Low electric current
- > Hardened drum
- > Thermal overload protection

Don't forget a DB1014!
When fitting a winch to a Defender don't forget to order the extended winch wiring kit with cut-off switch.

Specification

- > Rated line pull - single line 5,443kgs 12,000lbs
- > Gear reduction ratio 294:1
- > Motor (series wound) 3.6Kw 4.8Hp
- > Drum size (D x L) 63 x 228mm 2 1/2" x 9"
- > Cable supplied 9.53mm x 30.5m 3/8" x 100'
(Galvanised aircraft cable with minimum break force 14,400lbs)
- > Overall dimension (L x W x H) 548 x 160 x 254mm 21.57 x 6.3 x 10"
- > Net weight 41.7kgs 92.0lbs
- > Mounting bolt pattern 254 x 114.3mm 10 x 4 1/2"

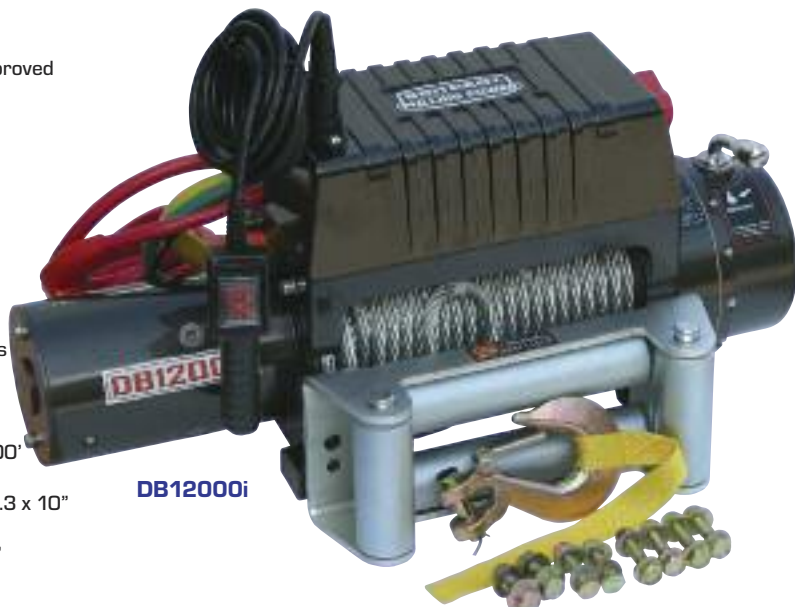

DB12000i

DB12000i Britpart Pulling Power 12,000lbs 12 volt winch
DB12000i24 Britpart Pulling Power 12,000lbs 24 volt winch

Performance of 1st Layer

Line Pull		Line Speed				Motor Current	
		12 volt		24 volt		12 volt	24 volt
Lbs	Kgs	Fpm	Mpm	Fpm	Mpm	Amp	Amp
0	0	14.60	4.45	16.40	5.00	90	58
2,000	907	12.81	3.90	14.43	4.40	145	95
4,000	1,814	9.68	2.95	12.46	3.80	185	120
6,000	2,722	7.90	2.41	10.83	3.30	230	160
8,000	3,629	7.07	2.15	9.50	2.90	270	190
10,000	4,536	5.06	1.54	7.87	2.40	315	230
12,000	5,443	4.45	1.36	5.90	1.80	375	280

Line Pull & Cable Capacity by Layer

Cable Layer	Rated Line Pull		Cable Capacity	
	Lbs	Kgs	Feet	Meters
1	12,000	5,443	15	5.0
2	10,200	4,627	38	11.5
3	8,400	3,810	64	19.5
4	7,300	3,310	95	29.0
5	6,500	2,948	100	30.5

BRITPART WINCH - DB9500i - 12 & 24 VOLT

Features

- > 3.6Kw (4.8Hp) heavy duty series wound DC motor
- > Weather and dustproof contactor controls for longer life and improved amperage draw
- > Hardened drum
- > Planetary gear system for fast line speed
- > Free spooling
- > Automatic load-holding brake
- > Low electric current
- > Power in and power out
- > Thermal overload protection

Don't forget a DB1014!
When fitting a winch to a Defender don't forget to order the extended winch wiring kit with cut-off switch.

Specification

- > Rated line pull - single line 4,309kgs 9,500lbs
- > Gear reduction ratio 212:1
- > Motor (series wound) 3.6Kw 4.8Hp
- > Drum size (D x L) 63 x 228mm 2 1/2" x 9"
- > Cable supplied 9.53mm x 30.5m 3/8" x 100'
(Galvanised aircraft cable with minimum break force 14,400lbs)
- > Overall dimension (L x W x H) 548 x 160 x 254mm 21.57 x 6.3 x 10"
- > Net weight 41.7kgs 92.0lbs
- > Mounting bolt pattern 254 x 114.3mm 10 x 4 1/2"



DB9500i

DB9500i Britpart Pulling Power 9,500lbs 12 volt winch
DB9500i24 Britpart Pulling Power 9,500lbs 24 volt winch

Performance of 1st Layer

Line Pull		Line Speed				Motor Current	
		12 volt		24 volt		12 volt	24 volt
Lbs	Kgs	Fpm	Mpm	Fpm	Mpm	Amp	Amp
0	0	18.70	5.70	21.30	6.50	85	58
2,000	907	13.12	4.00	16.70	5.10	150	110
4,000	1,814	10.50	3.20	13.12	4.00	210	135
6,000	2,722	7.90	2.41	10.17	3.10	270	185
8,000	3,629	5.91	1.80	7.71	2.35	320	220
9,500	4,309	4.32	1.32	5.90	1.80	365	240

Line Pull & Cable Capacity by Layer

Cable Layer	Rated Line Pull		Cable Capacity	
	Lbs	Kgs	Feet	Meters
1	9,500	4,309	15	5.0
2	7,500	3,402	38	11.5
3	6,200	2,812	64	19.5
4	5,300	2,404	95	29.0
5	4,630	2,100	100	30.5

BRITPART WINCH - DB9000C



DB9000C

DB9000C Britpart Pulling Power 9,000lbs 12 volt winch

Performance of 1st Layer

Line Pull		Line Speed		Motor Current
Lbs	Kgs	Fpm	Mpm	Amp
0	0	13.0	4.0	30
4,000	1,814	7.5	2.3	130
6,000	2,722	6.3	1.9	180
8,000	3,629	5.0	1.5	240
9,000	4,082	4.3	1.3	300

Features

- > 3.3Kw (4.5Hp) permanent magnet motor
- > Dustproof contactor controls for longer life and improved amperage draw
- > Low electric current
- > Planetary gear system for fast line speed
- > Free spooling
- > Automatic load-holding brake
- > Power in and power out
- > Hardened drum

Don't forget a DB1014!
When fitting a winch to a Defender don't forget to order the extended winch wiring kit with cut-off switch.

Specification

- > Rated line pull - single line 4,082kgs 9,000lbs
- > Gear reduction ratio 212:1
- > Motor (permanent magnet) 3.3Kw 4.5Hp
- > Drum size (D x L) 63 x 228mm 2 1/2" x 9"
- > Cable supplied 9.53mm x 30.5m 3/8" x 100'
(Aircraft cable with minimum break force 14,400lbs)
- > Overall dimension (L x W x H) 560 x 160 x 280mm 22 x 6.3 x 11"
- > Net weight 38.0kgs 84.0lbs
- > Mounting bolt pattern 254 x 114.3mm 10 x 4 1/2"

Line Pull & Cable Capacity by Layer

Cable Layer	Rated Line Pull		Cable Capacity	
	Lbs	Kgs	Feet	Meters
1	9,000	4,082	15	5.0
2	7,300	3,311	38	11.5
3	6,200	2,812	64	19.5
4	5,400	2,449	95	29.0
5	4,200	1,905	100	30.5

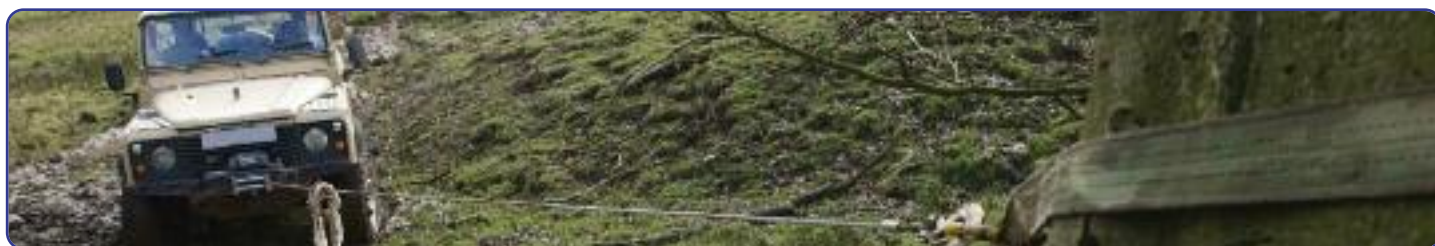

BRITPART WINCH - DB8000



DB8000

DB8000 Britpart Pulling Power 8,000lbs 12 volt winch

Performance of 1st Layer

Line Pull		Line Speed		Motor Current
Lbs	Kgs	Fpm	Mpm	Amp
0	0	8.2	2.5	35
2,000	900	7.8	2.4	100
4,000	1,810	7.2	2.2	180
6,000	2,710	6.5	2.0	230
8,000	3,620	5.0	1.5	300

Features

- > 3.0Kw (4.1Hp) heavy duty electric permanent magnetic DC motor
- > Weather and dustproof contactor controls for longer life and improved amperage draw
- > Hardened drum
- > Planetary gear system for fast line speed
- > Free spooling
- > Automatic load-holding brake
- > Low electric current
- > Power in and power out

Don't forget a DB1014!
When fitting a winch to a Defender don't forget to order the extended winch wiring kit with cut-off switch.

Specification

- > Rated line pull - single line 3,632kgs 8,000lbs
- > Gear reduction ratio 210:1
- > Motor (permanent magnet) 3.0Kw 4.1Hp
- > Drum size (D x L) 63 x 228mm 2 1/2" x 9"
- > Cable supplied 9.53mm x 30.5m 3/8" x 100'
(Galvanised aircraft cable with minimum break force 14,400lbs)
- > Overall dimension (L x W x H) 564 x 179 x 295mm 22.2 x 7.0 x 11.6"
- > Net weight 36kgs 80lbs
- > Mounting bolt pattern 254 x 114.3mm 10 x 4 1/2"

Line Pull & Cable Capacity by Layer

Cable Layer	Rated Line Pull		Cable Capacity	
	Lbs	Kgs	Feet	Meters
1	8,000	3,620	15	5.0
2	6,335	2,876	38	11.5
3	5,243	2,380	64	19.5
4	4,473	2,030	95	29.0
5	3,900	1,770	100	30.5

BRITPART WINCH - DB6000

Features

- > 2.7Kw (3.6Hp) permanent magnet motor
- > Dustproof contactor controls for longer life and improved amperage draw
- > Planetary gear system for fast line speed
- > Free spooling
- > Low electric current
- > Automatic load-holding brake
- > Power in and power out

Don't forget a DB1014!
When fitting a winch to a Defender don't forget to order the extended winch wiring kit with cut-off switch.

Specification

- > Rated line pull - single line 2,724kgs 6,000lbs
- > Gear reduction ratio 210:1
- > Motor (permanent magnet) 2.7Kw 3.6Hp
- > Drum size (D x L) 63 x 140mm 2 1/2" x 5.51"
- > Cable supplied 7.94mm x 26m 5/16" x 85'
(Aircraft cable with minimum break force 10,000lbs)
- > Dimensions (L x W x H) 438 x 158 x 185mm 17.24 x 6.22 x 7.28"
- > Net weight 31.8kgs 70.0lbs
- > Mounting bolt pattern 166 x 114.3mm 6.535 x 4 1/2"



DB6000

DB6000 Britpart Pulling Power 6,000lbs 12 volt winch

Performance of 1st Layer

Line Pull		Line Speed		Motor Current
Lbs	Kgs	Fpm	Mpm	Amp
0	0	15.0	4.6	30
1,000	454	11.5	3.5	80
3,000	1,361	9.0	2.7	120
5,000	2,268	7.0	2.0	170
6,000	2,722	4.9	1.5	210

Line Pull & Cable Capacity by Layer

Cable Layer	Rated Line Pull		Cable Capacity	
	Lbs	Kgs	Feet	Meters
1	6,000	2,722	12.7	3.87
2	5,000	2,268	27.5	8.38
3	4,250	1,928	44.0	13.41
4	3,720	1,687	64.0	19.51
5	3,330	1,497	85.0	25.91



Get to where you want to go!

BRITPART WINCH - DB2000

Features

- > 1.0Kw (1.5Hp) heavy duty electric permanent magnetic motor
- > Planetary gear system for fast line speed
- > Free spooling
- > Power in and power out
- > Low electric current
- > Tension plate to prevent rope entanglement

Specification

- > Rated line pull - single line 907kgs 2,000lbs
- > Gear reduction ratio 153:1
- > Motor (permanent magnet) 1.0Kw 1.5Hp
- > Drum size (D x L) 32 x 71mm 1.26 x 2.8"
- > Cable supplied - 4mm x 15.2m 5/32" x 50'
(minimum break force 4,000lbs)
- > Dimension (L x W x H) 320 x 105 x 110.5mm 12.6 x 4.13 x 4.35"
- > Net weight 6.6kgs 14.6lbs
- > Mounting bolt pattern 48 x 76mm 1.89 x 3"



DB2000

DB2000 Britpart Pulling Power 2,000lbs 12 volt winch

Performance of 1st Layer

Line Pull		Line Speed		Motor Current
Lbs	Kgs	Fpm	Mpm	Amp
0	0	14.0	4.3	14
1,000	454	9.0	2.7	60
1,500	680	7.5	2.3	90
2,000	907	5.9	1.8	115

Line Pull & Cable Capacity by Layer

Cable Layer	Rated Line Pull		Cable Capacity	
	Lbs	Kgs	Feet	Meters
1	2,000	907	6	1.8
2	1,636	742	13	4.0
3	1,385	628	22	6.7
4	1,200	544	33	10.0
5	1,059	480	44	13.4
6	947	430	50	15.2

WINCH BUMPER KITS



The only kits you need to get winching...

DB1310	Defender - non air-con	Standard bumper	DB9500i winch	Extended wiring kit including safety cut-off switch
DB1313	Defender - non air-con	Standard bumper	DB12000i winch	Extended wiring kit including safety cut-off switch
DB1319	Defender - non air-con	Tubular bumper	DB12000i winch	Extended wiring kit including safety cut-off switch
DB1321	Defender - air-con	Tubular bumper	DB12000i winch	Extended wiring kit including safety cut-off switch
DB1320	Discovery 1	Tubular bumper	DB12000i winch	
DB1324	Discovery 1/Range Rover Classic	Heavy-duty bumper	DB9500i winch	
DB1325	Discovery 1/Range Rover Classic	Heavy-duty bumper	DB12000i winch	



DB1320



DB1324 / DB1325



WINCH BUMPERS

DA5609

- > Stylish tubular steel space-frame construction for strength to fit Defender with air con
- > Suitable for DB12000i, DB9500i, DB9000C & DB8000 winches
- > Extremely close fitting for maximum approach angle
- > Compatible with many steering guards
- > Built in high-lift jacking points
- > Integral rock guard
- > Supplied with full fitting

DA5620

- > Heavy duty steel winch bumper for Defender
- > Suitable for DB12000i, DB9500i & DB9000C winches

DA5622

- > Stylish tubular steel space-frame construction for strength to fit Defender - no air con
- > Suitable for DB12000i, DB9500i, DB9000C & DB8000 winches
- > Extremely close fitting for maximum approach angle
- > Compatible with many steering guards
- > Built in high-lift jacking points
- > Integral rock guard
- > Supplied with full fitting

DA5623

- > Heavy duty steel winch bumper for Defender with air con
- > Suitable for DB12000i, DB9500i & DB9000C winches

DA5643

- > Heavy duty steel winch bumper for Defender with air-con
- > Suitable for Warn 9000 and 9.5 Series winches

DA5604

- > Stylish tubular steel space-frame construction for strength to fit Discovery 1
- > Suitable for DB12000i, DB9500i, DB9000C & DB8000 winches
- > Extremely close fitting for maximum approach angle
- > Compatible with many steering guards
- > Built in high-lift jacking points
- > Integral rock guard
- > Supplied with full fitting

DA5621

- > Heavy duty steel winch bumper for Discovery 1 & Range Rover Classic
- Note** - not suitable for V8 automatic vehicles
- > Suitable for DB12000i, DB9500i, DB9000C & DB8000 winches



Winch and A bar not included

DA5620

DA5609



DA5622



DA5623



DA5643



DA5604



DA5621



Winch not included

A range of winch bumpers to suit your vehicle!



WINCH SPARE PARTS



DB1301



DB1302



DB1303



DB1304



DB1307



DB1326



DB1328



DB1330

Part	Winch				
	DB12000i	DB9500i	DB9000C	DB8000	DB6000
Winch motor	DB1300	DB1300	DB1332	DB1301	DB1337
Solenoid assembly	DB1303	DB1303	DB1302	DB1302	DB1336
Brake service kit	DB1304	DB1304	DB1333		DB1338
Roller fairlead	DB1307	DB1307	DB1307	DB1307	DB1341
Remote control	DB1326 - 15mm socket DB1327 - 20mm socket	DB1326 - 15mm socket DB1327 - 20mm socket	DB1327	DB1326 - 15mm socket DB1327 - 20mm socket	DB1334
Winch cable	DB1328	DB1328	DB1328	DB1328	DB1339
Brush and holder set	DB1330	DB1330	DB1331	DB1331	DB1340

Note - Early models of DB1200i & DB9500i were fitted with an external thermal cut-off switch. Replacements are still available - **DB1305**



Britpart DB2000 fitted to a working model of a Land Rover

WINCHING ACCESSORIES



DB1003



DB1004



DB1005



DB1315

Fairleads

DB1003	Hawse fairlead - mounting holes 255mm, large aperture
DB1004	Hawse fairlead - mounting holes 255mm, medium aperture
DB1005	Hawse fairlead - mounting holes 125mm
DB1315	Hawse fairlead - aluminium
DB1316	Roller fairlead - stainless steel
DB1317	Hawse fairlead - stainless steel



DB1316



DB1317

More winching accessories over the page...



DB1006



DB1011



STC8919AA



DA3028



DA3030



DA3034



DB1007

Ropes & Straps

DA2246	Tow strap	2t WLL	5m x 60mm
DB1006	Tow strap - 60mm x 9 metre with a breaking strength of 8,000kgs and reinforced eyes		
DB1011	High elasticity tow sling - 9 metre with a 10 ton pulling capacity. Complete with reinforced eyes and overload warning tag.		
STC8919AA	Tow strap	Discovery 3/Range Rover L322/Range Rover Sport	
DA3028	Rope - polypropylene	2t WLL/8t MBL	5m x 24mm
DA3029	Rope - nylon	2t WLL/12t MBL	5m x 24mm
DA3030	Kinetic recovery rope - octoplait	2t WLL/12t MBL	5m x 24mm
DA3031	Kinetic recovery rope - octoplait	2t WLL/12t MBL	8m x 24mm
DA3032	Tree strap	2t WLL/14t MBL	3m x 90mm
DA3033	Tree strap	2t WLL/14t MBL	4m x 90mm
DA3034	Tree strap	2t WLL/14t MBL	6m x 90mm
DB1007	Tree protection belt - 1.6 metre 4 ton		

Note - WLL = working load limit (lifting), MBL = minimum breaking load



WINCHING ACCESSORIES - continued



DA3160



DB1002



DB1008



DB1009



DB1012



DB1322



DB1323



DB1329

Shackles & Pulleys

- DA3160** Swivel recovery eye - stainless steel **Note** - not suitable for standard Land Rover bumpers
- DB1002** Snatch block - high quality tempered steel suitable for winch ropes from 5mm to 10mm
Maximum head load - 16,000lbs
- DB1008** Pulley hook - SWL loads 1,500kgs for pulling, 750kgs for lifting
- DB1009** Shackle - 1.4 ton
- DB1012** Shackle - 4.7 ton
- DB1322** Swivel shackle
- DB1323** Non-forged jate ring
- DB1329** Forged jate ring



DA2037



DA3156



DB1000



DB1010



DB1016



DB1308

Safety Equipment

- DA2037** Battery isolator switch universal
- DA3156** Winch in safety book
- DB1000** Wheel chocks - pair
- DB1010** Gloves - for protection winch operation
- DB1016** Winch blanket - manufactured from heavy-duty vinyl, the blanket will absorb most of the recoil in the unlikely event of the cable breaking. It's also very useful to kneel on in the mud!
- DB1308** Winch remote control - operate your winch from a safe distance with this wireless remote control
 - > High frequency circuit using SMD design for reliability
 - > The transmitter uses FM technology for frequency stability and greater control distance
 - > Receiver output is protected against voltage spikes



WINCHING ACCESSORIES - continued



DB1001



DB1014



DB1309

Other Essential Winching Accessories

- DB1001** Winch bag - a heavy-duty black and green bag
- DB1013** 12 Strand plasma winch line - 9.5mm (3/8"), 17,500lbs NBS x 100ft (30.5m). Supplied fully finished with a galvanised tube thimble, large safety hook and 2m of heavy-duty black rock guard.
- DB1014** Extended winch wiring kit - 1 x red, 1 x black wire, each 1.8m in length with end connectors and cut-off switch for Defender vehicles
- DB1309** 'Dyneema Bowrope' - 12 strand synthetic fibre replacement winch rope - 11mm x 90ft
NEW
- > For use with DB9000C, DB9500i and DB12000i winches
 - > CE certified
 - > Easy to handle
 - > Floats
 - > Does not kink
 - > Very light
 - > Easily spliced
 - > Highly visible
 - > Less effort in use
 - > Very strong
 - > Does not curl
 - > Compact
 - > Safety in use
- DB1314** Ground anchor set
- DB1318** Ground anchor bag set - 2 x Pulling Power bags, ground anchor not included (DA1314)
- DB1328** Replacement winch cable with hook - 30.5m x 9.5mm



DB1318



DB1314



DB1013



DB1328

WINCHING ACCESSORY KITS



DB1017



DB1015

- DB1017** Contents -
- 1 x DB1001 Winch kit bag
 - 1 x DB1002 Snatch block - 16,000lbs
 - 1 x DB1006 Tow strap - 8 ton, 60mm x 9m
 - 1 x DB1007 Tree strap
 - 1 x DB1010 Winching gloves
 - 2 x DB1012 Alloy bow shackle - 4.75 ton
- DB1015** Contents - as per DB1017 plus
- 1 x DB1000 Wheel chocks (pair)
 - 1 x DB1011 Snatch tow sling - 10 ton
 - 1 x DB1016 Winching blanket

Britpart Pulling Power winching recovery kits come with all the basic items needed to ensure your winch can be used to the best effect. There is a choice of a starter or professional kit depending on your needs.





Ooops!

“Glad I’ve got that Britpart winch”

11

performance equipment
PERFORMANCE EQUIPMENT

Upgrade your Land Rover from its standard spec into something a bit more special.

Section contents -

Air filters - Britpart Performance	94
Air filters - K&N Consumables	95
Brake discs - Britpart Performance	96
Brake hose kits	95
Brake lubrication	95
EBC brake parts	97 - 98
EGR blanking kits	99
Handbrake conversion kits	99
Intercooler silicone hoses	100
Intercoolers - performance	100
PSI power tuning products	101
Weber carburettors	101



AIR FILTERS - BRITPART PERFORMANCE

DA3138 Series 3 - 4-cylinder - fits Zenith and Weber carbs



DA3139 Corresponds to PHE000112

Discovery 3 - 2.7 V6 diesel, 4.0 V6 petrol & 4.4 V8 petrol
Range Rover Sport - 2.7 V6 diesel, 4.0 V6 petrol & 4.4 V8 petrol



DA4259 Corresponds to PHE000040

Range Rover L322 - Td6



DA4260 Defender 90/110/130 - 2.5 Td5 1999 - 2007

Discovery 2 - Td5 1999 - 2004
Discovery 2 - 4.0i 1999 - 2004
Freelander 1 - V6 petrol
Range Rover P38 - 2.5DSE diesel (BMW engine) 1998 - 2002
Range Rover P38 - 4.0i V8 1994 - 2002
Range Rover P38 - 4.6i V8 1994 - 2002



DA4261 Corresponds to ESR1445

Discovery 1 - 2.0i Mpi petrol
Discovery 1 - 2.5 300Tdi 1994 - 1997
Discovery 1 - 3.9i V8 1994 - 1997
Range Rover Classic - 2.5 300Tdi 1992 - 1994
Range Rover Classic - 3.9i V8 Efi 1994



DA4262 Corresponds to NTC1435 & ESR2623

Defender 90/110/130 2.5 300Tdi 1994 - 1997
Discovery 1 - 2.5 200Tdi 1989 - 1992
Range Rover Classic - 2.4D VM Turbo 1986 - 1992
Range Rover Classic - 2.5D VM Turbo 1986 - 1992



DA4263 Corresponds to PHE100500L

Freelander 1 - 2.0 Td4 (BMW engine) 2001 - 2006



DA4264 Corresponds to ESR1049

Discovery 1 - 2.5 200Tdi 1992 - 1994
Range Rover Classic - 2.5 200Tdi - 1992 - 1994



DA4265 Corresponds to ESR341

Range Rover Classic - 4.0i V8 1990 - 1995
Range Rover Classic - 4.2i V8 1990 - 1995
Range Rover Classic - 4.6i V8 1990 - 1995
Range Rover P38 - 2.5DSE diesel (BMW engine) 1994 - 1997



DA4266 Range Rover Classic - 3.5 carb V8

Cone type - replaces 605191 - 2 filters required



DA4267 Corresponds to ESR4103

Freelander 1 - 1.8 16v 1997 - 2000
Freelander 1 - 2.0i Tdci diesel (Rover engine) 1997 - 2000



DA4268 Corresponds to RTC4683

Discovery 1 - 3.5i V8 Efi 1990 - 1993
Range Rover Classic - 3.5i V8 Efi 1985 - 1989
Range Rover Classic - 3.9i 1989 - 1994



DA4269 Corresponds to NRC9238

Defender 90/110/130 - 2.5 petrol 1983 - 1990
Defender 90/110/130 - 2.5 D & Td 1983 - 1990



DA4270 Corresponds to NTC6660

Defender 90/110/130 - 2.5 200Tdi 1990 - 1993



DA4271 Corresponds to ESR4238

Defender 90/110/130 - 2.5 Td5 1999 - 2007
Discovery 2 - Td5 1999 - 2004
Discovery 2 - 4.0i 1999 - 2004



DA4272 Range Rover Classic - 3.5 carb V8

Cone type off-road extreme power filter - 2 filters required



DA4274 Corresponds to 605191

Series 3 - 109 3.5 V8 1979 - 1982 - 2 filters required
Discovery 1 - 3.5 V8 carb 1989 - 1990 - 2 filters required
Range Rover Classic - 3.5 V8 carb 1972 - 1986 - 2 filters required



A breath of
fresh air
for your
Land Rover

> A range of performance filters tailored to fit your Land Rover

> Maximum breathing efficiency for your engine means more power or better fuel mileage

> No compromise on quality - the engine gets more air but the dirt particles are trapped by the quality filters

> No need to replace as easy cleaning means maximum performance guaranteed

> Easy fit, directly replaces standard air filter

> Ideal for use in hot dusty conditions to reduce engine wear

> Compatible with snorkels, ideal for use in conjunction with other performance modifications

> Filters don't need pre-oiling and if the filter gets dirty there is no need to use a cleaner to clear the dirt on the filter - just use air, water or detergent



"breathing efficiency for your engine means more power or better fuel mileage"

AIR FILTERS - K&N CONSUMABLES



DA4275 DA4276 DA3136 DA3137

K&N Dirt Retention Lubricating Oil

DA4275 K&N Oil - 200ml aerosol

DA4276 K&N Oil - 250ml bottle

K&N Cleaning Solution

DA3136 1ltr Bottle

DA3137 Cleaning kit - 200ml cleaning fluid & 200ml lubricating oil

BRAKE LUBRICATION **NEW**

Cera-Tec Advanced Lubricant

Mintex Cera TEC is an advanced non-metallic universal lubricant that provides many benefits over traditional copper-based grease.

DA2389

- > Non-metallic content - ABS and ESP friendly
- > Operates to a high temperature (1,000°C)
- > Non-conductive
- > Free of copper and acid
- > More effective at reducing any brake squeal
- > Protects against corrosion and dirt
- > Neutral colour prevents any visible residue or staining



DA2389

BRAKE HOSE KITS

	Standard		Plus 40mm	
	Goodridge	Britpart Stainless Steel	Goodridge	Britpart Stainless Steel
Defender 90				
1984 to 1998 WA159806		DA2400S		DA240040S
1999 to 2004 from XA159807 metric non abs		DA2401S		DA240140S
Defender 110				
1983 to 1998 WA159806		DA2402S		DA240240S
Discovery 1				
1989 to 1992 to JA034313	DA2410	DA2410S		DA241040S
1992 to 1995 KA034314 to LA081991	DA2411	DA2411S	DA241140	DA241140S
1995 to 1999 from MA018992 non-abs	DA2412	DA2412S		DA241240S
1995 to 1999 from MA018992 abs	DA2413	DA2413S	DA241340	DA241340S
Discovery 2				
ABS		DA2414S		DA241440S
Range Rover Classic				
Up to 1981 UNF non-abs			DA240340	DA240340S
1981 to 1990 metric non-abs				DA240440S
107 up to 1981 UNF non-abs			DA240540	
1990 to 1992 abs				DA240640S
1992 abs				DA240740S
1992 to 1995 non-abs			DA240840	
Range Rover P38				
1995 to 2001		DA2409S		
Series 2 & 3				
88 imperial 1960 to 1979	DA2418	DA2418S	DA241840	DA241840S
88 metric 1980 to 1984	DA2419	DA2419S	DA241940	DA241940S
109 imperial 1971 to 1979 approx	DA2420	DA2420S	DA242040	DA242040S
109 metric 1980 to 1984	DA2421	DA2421S	DA242140	DA242140S



BRITPART

The quality parts for Land Rovers

Increase your braking efficiency

These brakelines are constructed from the finest quality hose, consisting of a PTFE inner and stainless steel overbraid and both the Britpart and Goodridge brands offer -

- > Eliminates sponginess under heavy braking
- > Increases braking efficiency
- > Abrasion and corrosion resistant



GOODRIDGE



BRITPART PERFORMANCE BRAKE DISCS



- > Slotted design to increase braking efficiency by reducing dust, debris, water and gas on the disc.
- > To improve brake cooling, reduce weight and to offer an escape route for dirt and gasses these performance discs are drilled with rows of holes.
- > Excellent upgrade for your Land Rover to aid braking, especially under a heavy load.
- > Ideal for off-road use.
- > Manufactured to British Standard BS1452 Grade 220 and DIN1691 GG20.
- > Supplied in pairs.



DA4600

Quality manufactured slotted brake discs! BRITPART

DA4600	FRC7329	Front	Defender 1987-2006, 2007->/Discovery 1/Range Rover Classic 1986-1991
DA4601	FTC1381	Rear	Defender 1987-2006, 2007->/Discovery 1/Range Rover Classic 1986-1994
DA4602	FTC902	Front	Defender 1987-2006, 2007->/Discovery 1/Range Rover Classic 1986-1994
DA4603	NTC8780	Front	Range Rover P38 1995-2002
DA4604	SDB000470	Rear	Range Rover P38 1995-2002/Discovery 2
DA4605	SDB000330	Rear	Defender 1987-2006, 2007->
DA4606	SDB000380	Front	Discovery 2
DA4607	SDB100830	Front	Freelander 1 1996-> - up to YA999999
DA4608	SDB101070	Front	Freelander 1 1996-> - from 1A000001
DA4609 NEW	SDB000201	Front	Range Rover L322
DA4610 NEW	SDB000211	Rear	Range Rover L322

IMPORTANT BRAKE INFORMATION

For exact change over points with vehicle applications please contact your local Britpart distributor with the full chassis number for the correct application. These references are intended as a guide only.



Picture courtesy of Jake Perks

EBC BRAKE DISCS

EBC BRAKES

- > Wide aperture slots that draw cool air under the pad surface.
- > Slots that expel all dirt dust and debris from the braking area.
- > Blind drilled dimples that eliminate cracking common with through drilled sport rotors whilst helping maintain perfect pad contact.
- > Gold zinc corrosion resistant coating.



EBC Brake Discs - Pairs

DA4147	NTC8780	Front	Vented	Range Rover P38 1995-2002
DA4148	NTC8781 & SDB000470	Rear	Solid	Range Rover P38 1995-2002/Discovery 2
DA4151	FTC902	Front	Vented	Defender 1987-2006, 2007->/Discovery 1/Range Rover Classic 1986-1994
DA4152	FTC1381 & 571912	Rear	Solid	Defender 1987-2006, 2007->/Discovery 1/Range Rover Classic
DA4158	ANR4582 & SDB000380	Front	Vented	Discovery 2
DA4165	FRC7329	Front	Solid	Defender 1987-2006, 2007->/Discovery 1/Range Rover Classic
DA4166	571762	Front	Solid	Range Rover Classic to 1985
DA4475	SDB000604	Front	Vented	Discovery 3/Range Rover Sport - various applications
DA4473	SDB000636	Rear	Vented	Discovery 3/Range Rover Sport - various applications
DA4187	SDB000614	Front	Vented	Discovery 3/Range Rover Sport - various applications
DA4188	SDB000646	Rear	Vented	Discovery 3/Range Rover Sport - various applications
DA4472	SDB000211	Rear	Solid	Range Rover L322 - various applications
DA4474	SDB000201	Front	Vented	Range Rover L322 - various applications
DA4476	SDB500193	Front	Vented	Range Rover L322 - various applications
DA4477	SDB101070	Front	Vented	Freelander 1 1996-> - from 1A000001

IMPORTANT BRAKE INFORMATION

For exact change over points with vehicle applications please contact your local Britpart distributor with the full chassis number for the correct application. These references are intended as a guide only.

EBC BRAKE PADS

- > New AF42/66 friction material which completely eliminates brake judder and produces a high friction long lasting brake pad.
- > Unique powder coat finish to both pad and back plate gives lifetime resistance to corrosion and prevents moisture ingress.
- > Unique Brake-In surface coating provides instant brake efficiency on installation and conditions the brake rotor removing glaze, black spotting etc from disc surface.
- > All pads feature centre line slot which prevents heat expansion cracks and reduces brake noise.
- > All pads feature edge chamfers which have major technical benefits;
 - Significant reduction in brake noise
 - Prevents 'edge lifting' under left and right extremities of pad which can cause corrosion ingress and eventual pad de-bond
 - Can extend pad life by virtue of improved pad efficiency
- > Most pads in the Ultimax range features factory fitted noise reduction shims.

* pad sets excludes shims

Ultimax

EBC BRAKES



EBC Ultimax Heavy-duty Brake Pads - Sets

DA3300	SFP100460	Front	Range Rover P38 1995-2002/Discovery 2
DA3301	SFP500100	Front	Freelander 1 1996-> - from 1A000001
DA3302	SFP100360	Front	Freelander 1 1996-> - up to YA999999
DA3303	SFC500050	Front	Range Rover L322 - various applications
DA3304	SFP500010	Front	Range Rover L322/Range Rover Sport/Discovery 3 - various applications
DA3306	LR004936	Front	Freelander 2
DA3307	STC9186	Front	Range Rover Classic to 1986/Defender 90 to 1986
DA3308*	STC2950	Front	Defender 110 to 1986
DA3309*	STC9187	Front	Range Rover Classic 1986 to 1991/Discovery 1 to 1993
DA3310*	STC2952	Front	Defender 110 from 1986/Defender 90 from 1991
DA3311*	STC9191	Front	Defender 90 1986 to 1991/Discovery 1 from 1994
DA3312*	STC9190	Front	Discovery 1/Range Rover Classic 1986 to 1996 with sensor
DA3313*	STC1601	Rear	Defender 110 from 1994
DA3314	SFP100470	Rear	Range Rover P38 1995-2002/Discovery 2
DA3315	SFP000120	Rear	Range Rover L322 - various applications
DA3316	SFP500140	Rear	Range Rover L322/Range Rover Sport/Discovery 3 - various applications
DA3318	SFP000270	Rear	Range Rover Classic to 1985/Discovery 1 without sensor/Defender 90 from 1994
DA3319*	STC9189	Rear	Range Rover Classic from 1986/Discovery 1 with sensor

EBC BRAKE PADS - continued

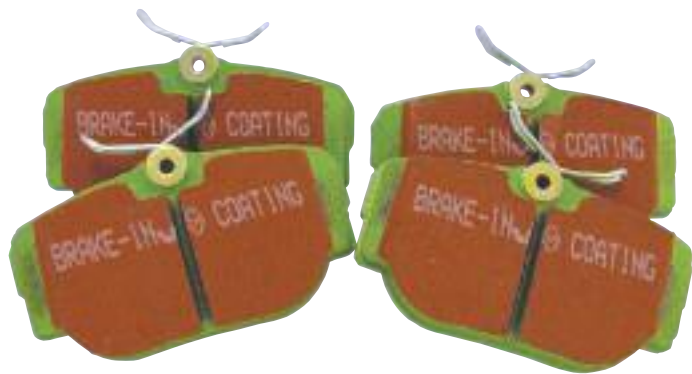

> Unique "Brake-In" surface coating to accelerate pad bed in

> 100% British design and manufacture

- > 100% British design and manufacture.
- > Superb gloss powder coat paint finish to reduce corrosion.
- > Unique engineering finish with noise reduction slots and edge chamfers.
- > Extra high friction compounds for better stops, these pads will improve your stopping power by up to three vehicle lengths.
- > Special compound ingredients that prevent "Outline Etching" eliminating brake stiction onto the rotor in damp conditions.
- > Unique "Brake-In" surface coating to accelerate pad bed in after installing new pads which also guarantees brake efficiency from install.
- > Super quiet braking with rubber-steel-rubber noise reduction shims on the reverse, this dampens all possible noise.
- > Extra heavy duty compound lasts longer than low cost standard pads
- > Fully ECE R 90 approved and legal for road and off road use.

EBC
BRAKES

GREEN
STUFF

EBC Green Stuff High Performance Brake Pads - Sets

DA4149	SFP100460 & SFP100480	Front	Range Rover P38 1995-2002/Discovery 2
DA4150	SFP100470 & SFP500130	Rear	Range Rover P38 1995-2002/Discovery 2
DA4153	STC9186 & STC9187	Front	Range Rover Classic to 1986/Defender 90 to 1986
DA4154	STC9189	Rear	Range Rover Classic to 1985/Discovery 1 with sensor/Defender 90 from 1994
DA4155	SFP500200	Rear	Range Rover Classic from 1986/Discovery 1 with sensor
DA4156	STC9190	Front	Discovery 1/Range Rover Classic 1986 to 1996 with sensor
DA4157	STC9191	Front	Defender 90 1986 to 1991/Discovery 1 from 1994
DA4159	STC2952 & SFP000260	Front	Defender 110 from 1986/Defender 90 from 1991
DA4185	STC1601 & SFP000280	Rear	Defender 110 from 1994
DA4478	SFP500100	Front	Freelander 1 1996-> - from 1A000001
DA4479	SFP100360	Front	Freelander 1 1996-> - up to YA999999
DA4480	SFC500050	Front	Range Rover L322 - various applications
DA4481	SFP500010	Front	Range Rover L322/Range Rover Sport/Discovery 3 - various applications
DA4482	SFP500070	Front	Range Rover L322/Range Rover Sport - various applications
DA4483	SFP000120	Rear	Range Rover L322 - various applications
DA4484	SFP500140	Rear	Range Rover L322/Range Rover Sport/Discovery 3 - various applications
DA4485	SFP000270	Rear	Range Rover Classic to 1985/Discovery 1 without sensor/Defender 90 from 1994

IMPORTANT BRAKE INFORMATION

For exact change over points with vehicle applications please contact your local Britpart distributor with the full chassis number for the correct application. These references are intended as a guide only.



> Effective brake upgrade for heavy duty braking

> High friction compound

EBC Yellowstuff brake pads are British made with Aramid fibres such as Kevlar and Twaron and are one of the highest friction brake pad compounds on today's market. Not only high in friction from first application when brakes are cold but extremely effective at higher brake temperatures as encountered in faster driving and towing/trailing. These pads are a favourite with the military and are used on armoured vehicles in several countries to handle the higher loads and heat and offer a good brake upgrade. Fitted with shims chamfers, centre slots and the unique EBC Brake in coating for fast bedding in of new brakes these pads are also long lasting and silent in operation.

- > High friction compound
- > Effective from cold up to high heat
- > Effective brake upgrade for heavy duty braking
- > Long lasting powerful brakes
- > Shims, edge chamfers and slots for silent braking

EBC
BRAKES

Yellow
STUFF

EBC Yellow Stuff Performance Race Brake Pads - Sets

DA4335	SFP500010	Front	Range Rover L322/Range Rover Sport/Discovery 3 - various applications
DA4336	SFP500150	Front	Range Rover P38 1995-2002/Discovery 2
DA4337	SFP500070	Front	Range Rover L322/Range Rover Sport - various applications
DA4338	SFC500050 & SFC500080	Front	Range Rover L322 - various applications
DA4339	SFP500130	Rear	Range Rover P38 1995-2002/Discovery 2
DA4340	SFP500140	Rear	Range Rover L322/Range Rover Sport/Discovery 3 - various applications
DA4341	SFP500210	Rear	Range Rover L322 - various applications

EGR BLANKING KITS **NEW**

A Britpart EGR (exhaust gas recirculation) blanking kit enables you to remove the original mechanical EGR from the vehicle resulting in better fuel economy and improved performance.



DA1108



DA1109



DA1112



- DA1108** 300Tdi EGR blanking kit
- DA1109** Td5 EGR blanking kit
- DA1112** TdV6 up to 7A (not EU4)



Picture courtesy of Paul Wade

HANDBRAKE CONVERSION KITS

Beef up your handbrake!



DA5526

- DA5513** Defender 1987 - 2006
- DA5526** Discovery 1/Discovery 2 & Range Rover Classic

Note - will not fit Range Rover Classics with a Borg Warner or LT95 transfer box.

The standard Land Rover hand brake can easily get bunged up with dirt if you drive off-road a lot and once the mechanism gets clogged up it doesn't work as efficiently as it should. Britpart now offer a solution to that problem - a drum to disc conversion kit.

This kit uses a powerful caliper whose mechanism is sealed to prevent the access of mud! The special pads provide greater friction than the standard ones and are resistant from abrasion from mud.



DA5513

INTERCOOLERS - PERFORMANCE

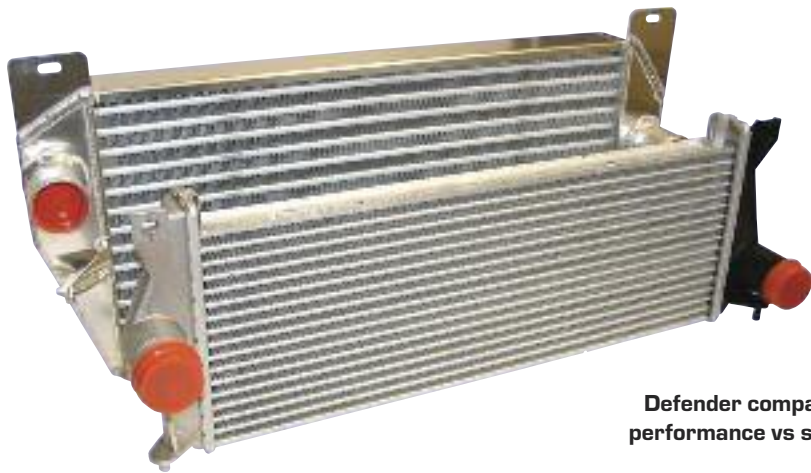

Defender comparison - performance vs standard

These high performance and robust units are constructed from polished aluminium and are 30% larger than the standard intercooler. As a result air has a chance to cool before entering the engine. This cooler air can increase engine power by up to 25bhp (subject to application). Other benefits include better throttle response and reduction in fuel consumption depending on driving conditions. Ideal for on or off road use. Fully pressure tested, capped and sealed. Manufactured in the UK.

DA4630	Defender 90/110 Td5 - 1998-2006 Inc. air-con vehicles	60mm deep x 300mm high
DA4631	Discovery 2 Td5 - Automatic - 1999-2004	60mm deep x 235mm high
DA4632	Discovery 2 Td5 - Manual - 1999-2004	60mm deep x 300mm high
DA4633	Range Rover P38 DSE	60mm deep x 280mm high

Notes - Dimensions for main intercooler body only. If you have a winch fitted please check clearance before fitment.



DA4630



DA4631

increase engine power & reduce fuel consumption



DA4633



DA4632

INTERCOOLER SILICONE HOSES NEW

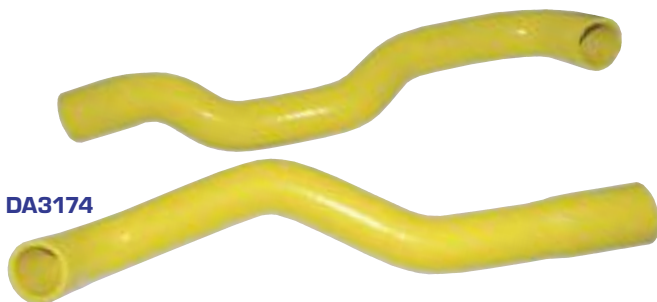

DA3174



DA3176

Britpart Yellow Silicone Hose Kits

Quality silicone intercooler hoses designed to operate at a higher temperature than the original hoses. Fits with both standard and performance intercoolers.

DA3170	Defender 200Tdi	4 piece kit
DA3171	Defender 300Tdi	3 piece kit
DA3173	Defender Td5	3 piece kit
DA3174	Defender 2007 onwards	2 piece kit
DA3175	Discovery 200Tdi	3 piece kit
DA3176	Discovery 300Tdi	3 piece kit
Note - remove EGR valve and pipe		
DA3177	Discovery Td5	3 piece kit
DA3182	Freelander Td4	2 piece kit



DA3170



DA3173

PSI POWER TUNING PRODUCTS

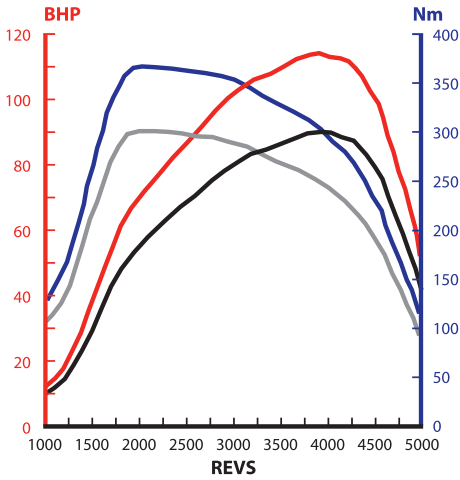

Performances for Defender Td5:
 Standard: 122 HP 90 kW 300 Nm
PSI: 155 HP 114 kW 365 Nm

The Power Box houses a digital microprocessor which intercepts the fuelling signals being transmitted from the ECU to the fuel pump; it then modifies them to ensure the exact amount of diesel required for enhanced performance. Such efficient use of the fuel optimises consumption, reduces smoke emissions and there is less engine stress, enhancing engine life in many cases.

The Power Box improves torque enabling the vehicle to change gears earlier and hold higher gears at lower speeds, making driving more pleasurable.

The unit fits using the original manufacturers plugs; these existing plugs are opened and the Power Box is secured in between. Full fitting instructions are included with every unit.



Features

- > Plug-in unit
- > No intervention with the original ECU
- > 1-year equipment warranty & 1-year engine warranty - subject to terms*
- > TUV approval
- > Compact size
- > Shock resistant & waterproof
- > Competitively priced

*vehicles up to 40,000km and up to 3 years old

Benefits

- > Can be removed prior to sale or used as a selling point
- > Traceless
- > Peace of mind
- > Quality product which is legal & safe
- > Unobtrusive in interior of vehicle
- > No worries off road
- > A good investment

Performance improvement - (before/after)

	Power - HP	Power - Kw	Torque - Nm
DA4418	112/ 129	82/ 95	260/ 300
DA4419	136/ 160	100/ 118	268/ 310
DA4420	136/ 160	100/ 118	268/ 310
DA4421	177/ 203	130/ 149	390/ 440
DA4433	122/ 155	90/ 114	300/ 365
DA4436	122/ 150	90/ 110	360/ 415

DA4418

Freelander - Td4 2000 - 2006

DA4419

Range Rover - 2.5Td 1995 - 1999

DA4420

Range Rover - 2.5Td 2000 - 2001

DA4421

Range Rover - Td6 2002 onwards

DA4433

Defender & Discovery - Td5 1995 - 2007

DA4436

Defender 2007 onwards

Improves torque

Improves m.p.g

WEBER CARBURETTORS

DA3049

V8 4-Barrel conversion kit including manifold

The Webcon 4 barrel replacement carburettor kit is a direct replacement for the twin Stromberg or SU carbs fitted to the Rover V8. Calibrated to work perfectly on the 3.5 and 3.9 engines, the Webcon kit is the most complete on the market and features a Webcon modified Weber 4 barrel 500cfm carburettor, intake manifold, air filter and every single nut, bolt, washer, gasket and hose that could possibly be needed. The kit adds up to 20bhp at the wheels and transforms the driveability and economy. Starting becomes instant either hot or cold and with no balance adjustment to worry about with twin carbs, the engine is simply superbly smooth as indeed a V8 should be.

DA3049AF

Replacement air filter for DA3049

DA2126

Series

To replace Solex use also STC541 adaptor

DA2206

Service kit for DA2126

DA2126A

Choke cable for DA2126

ERC2886W

Series

Replacements for the Zenith 36IV

Available for LHD, RHD, with or without fuel shut off solenoid, the Weber range of carburettor kits to replace the Zenith 36IV offer the optimum balance of power and economy together with the legendary quality and reliability of Weber. Shipped as complete turnkey solutions, all kits are supplied with every nut, bolt, washer and gasket required and comprehensive, easy to follow instructions ensure that installation can be carried out with no specialist carburettor knowledge.

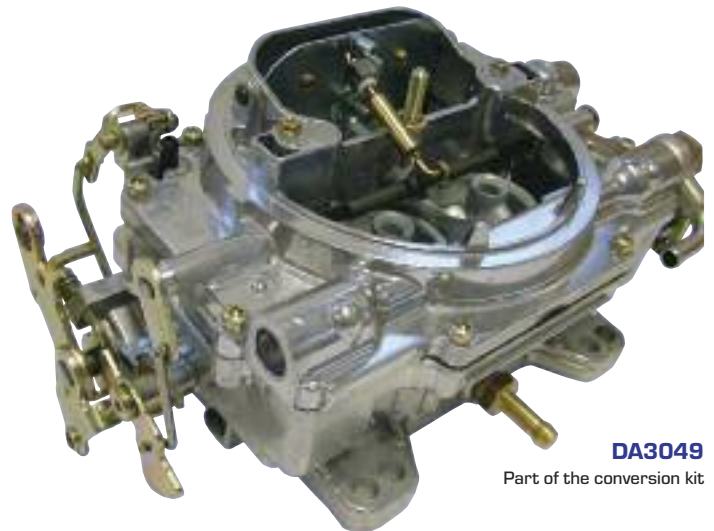

DA3049

Part of the conversion kit



DA2166



ERC2886W



Picture courtesy of Paul Wade

12

suspension equipment
SUSPENSION EQUIPMENT

Firm up your ride with some new shockers and springs or raise your game with a lifted suspension kit.

Section contents -

Air lift kits	104
Air spring conversion kits	104
Air springs - Britpart	105
Anti-roll bar kit	105
Britpart Cellular Dynamic shock absorbers	108
Britpart Super Gaz shock absorbers	109
Bump stops	105
Bush fitting tool	105
Bush sets - Britpart other	105
Bush sets - Britpart polyurethane	106
Dislocation cones	107
Panhard rod	107
Polybush sets	107
Radius arms	107
Shock absorber brackets	110
Shock absorbers - Delphi De Carbon	110
Shock absorbers - heavy-duty	111
Spring retainers	112
Springs - coil	111
Springs - parabolic	112
Steering arms - heavy-duty	112
Suspension kits - Britpart	113
Suspension matrix	114
Wide angle propshafts	113



AIR LIFT KITS NEW



Adjustable Air Helper Springs

The load and towing problem solver

Air adjustability is the difference! Stiff steel factory suspensions must compromise between ride comfort and load hauling capacity. Smooth ride suspensions can't carry heavy loads; heavy springs ride rough, especially when the vehicle is unloaded. Air Lift adjustable air springs solve these problems by allowing you to tune your suspension under all load and road conditions. Just add air when towing or hauling and then remove air for a softer ride when unloaded.

Features and benefits of Air Lift 1000

- > Improve ride, handling and stability by reducing roll, sway and "bottoming out"
- > Fits open coil springs, front or rear
- > Up to 1,000lbs of levelling capacity
- > Tough long-lasting moulded polyurethane construction
- > Quick connecting easy-to-use engineered polymer air fittings

Air Lift 1000

- DA5010** Defender 110 & 130
- DA5011** Defender 90 / Discovery 1 & Range Rover Classic



DA5010 / DA5011

DA5012 Load Controller II

The economical, popular, basic on board air system. This system controls the rear bags equally. All kits include wiring harness for fast, easy installation. To eliminate the major cause of air spring failure, the low pressure sensor automatically activates if pressure falls below the minimum safe level.



DA5012

AIR SPRING CONVERSION KITS

Discovery

It is a sad fact that sometimes the air suspension at the rear of a Discovery 2 will fail. You then have a choice to make. Do you replace it with a replacement air spring system which is comfortable but not comfortable on the wallet or replace with an equally comfortable but much more affordable coil suspension system. Well Britpart have the complete kit for air to coil suspension conversion making your decision that bit easier.

Kit - 2 x Rear springs; 2 x Isolators; 2 x Spring seats; 4 x Bolts;
1 x Instructions

- DA5136** Discovery 2 - air to coil conversion kit



DA5136

Conversion to coil springs provides a better, maintenance-free ride

Range Rover

The EAS (Electronic Air Suspension) System found on Range Rover 4.0 and 4.6 vehicles can present expensive, recurring maintenance problems. If you've had an air spring failure before, you know this first hand. Britpart now has a coil spring conversion kit for Range Rover 4.0/4.6 that makes switching to coil springs seamless and error-free. Conversion to coil springs provides a better, maintenance-free ride that will save you significant money over time. The EAS Override Module suppresses all typical false dashboard display errors and buzzers seen when converting to coil springs. Any mechanic or Range Rover owner can install this coil spring conversion kit without having to go to a Land Rover dealer or Autologic-equipped repair shop to eliminate false dash warning light errors. The kit features:

- > Detailed step-by-step instructions.
- > The EAS Override Module overrides all typical computer errors seen when converting to a coil spring system.
- > Eliminates the need for a costly shop visit.
- > Aluminium spring perch adapters.
- > Britpart custom made coil springs provide standard ride height and maximum articulation.
- > Affordable alternative to expensive, recurring air suspension failures.
- > Trip computer compatibility - maintains operation of your vehicle's trip computer.
- > Kit provides everything needed to complete a professional installation.

- DA4136** Range Rover P38 1995 - 2002 Petrol models and diesel light duty
- DA4136HD** Range Rover P38 1995 - 2002 Heavy-duty 1" lift including diesel models
- DA4179** Range Rover Classic No module



DA4136HD

AIR SPRINGS - BRITPART

Air springs can be susceptible to air leaks due to the fact the rubber seals dry out. Why not firm up your suspension and replace them with these quality air springs from Britpart.

Note - All sold individually.

DA2371	Discovery 2 - with self levelling	Rear
DA2372	Range Rover P38	Front
DA2373	Range Rover P38	Rear
NTC9819	Range Rover Classic	Front
NTC9820	Range Rover Classic	Rear
RKB101200	Discovery 2	Rear
REB101740	Range Rover P38	Front
RKB101460	Range Rover P38	Rear



NTC9819 & NTC9820



RKB101200



REB101740 / RKB101460

ANTI-ROLL BAR KIT

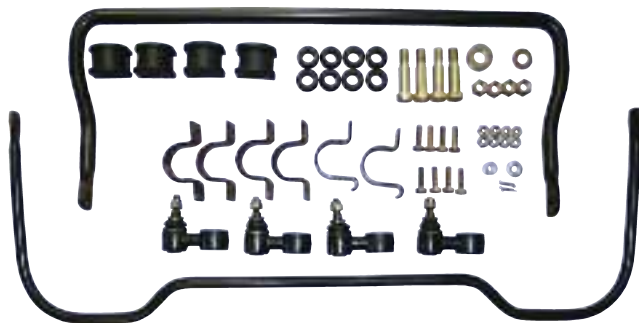

STC8156AA Defender 90/Discovery 1
Anti-roll bars for stiffening up your vehicle. Front and rear kit complete with fitting instructions.

BUMP STOPS **NEW**

Extended polyurethane bump stops should be used on vehicles with raised suspension to prevent the shock absorbers from bottoming out.

Normal - 56mm high
Extended - 80mm high

Note - All sold individually



ANR4188PY-YELLOW / ANR4188PYE-YELLOW

ANR4188PY	Defender/Discovery 1	Front	Normal	Black
ANR4188PY-YELLOW	Defender/Discovery 1	Front	Normal	Yellow
ANR4188PYE	Defender/Discovery 1	Front	Extended	Black
ANR4188PYE-YELLOW	Defender/Discovery 1	Front	Extended	Yellow
ANR4189PY	Defender/Discovery 1	Rear	Normal	Black
ANR4189PY-YELLOW	Defender/Discovery 1	Rear	Normal	Yellow
ANR4189PYE	Defender/Discovery 1	Rear	Extended	Black
ANR4189PYE-YELLOW	Defender/Discovery 1	Rear	Extended	Yellow

BUSH SETS - BRITPART

Britpart - Blue

DA4035BLUE
Defender 90/110/130 to 1993
with drum brakes

DA4036BLUE
Range Rover Classic- 1986 onwards/
Discovery 1/Defender 1994 onwards

Britpart - Other

DA2353
Front radius arm to chassis kit
Defender 1987-1997/Discovery 1/
Range Rover Classic 1986-1994

DA4035YELLOW
Defender 90/110/130 to 1993
with drum brakes



DA4035BLUE



DA2353

Bush Fitting Tool - for ANR3332

Fitting new front radius arm bushes (part number ANR3332) for the Range Rover 38A is impossible to do without using the Land Rover special tool.

LRT-60-004



LRT-60-004
Land Rover special tool

BUSH SETS - BRITPART POLYURETHANE

Britpart - Individual bush sets

548205PY	Shackle bush
548205PY-YELLOW	Shackle bush set
552818PY	Shock absorber bush set
552818PY-YELLOW	Shock absorber bush set
552819PY	Shock absorber bush set
552819PY-YELLOW	Shock absorber bush set
568858PY	Washer - steering damper
568858PY-YELLOW	Washer - steering damper
569746PY	Chassis bush set
569746PY-YELLOW	Chassis bush set
572068PY	Radius arm/chassis outer bush set
572068PY-YELLOW	Radius arm/chassis outer bush set
572180PY	Mounting
572180PY-YELLOW	Mounting
575580PY	Panhard rod bush set
575580PY-YELLOW	Panhard rod bush set
90577434PY	Bush chassis
90577434PY-YELLOW	Bush chassis
ANR1721PY	Shock absorber bush set
ANR1721PY-YELLOW	Shock absorber bush set
ANR2563PY	Bush
ANR2563PY-YELLOW	Bush
ANR3285PY	Bush rear radius
ANR3285PY-YELLOW	Bush rear radius
ANR3305PY	Bush
ANR3305PY-YELLOW	Bush
ANR3332PY	Bush - radius arm
ANR3332PY-YELLOW	Bush - radius arm

ANR3410PY	Panhard rod bush set
ANR3410PY-YELLOW	Panhard rod bush set
ANR6947PY	Rear radius arm to axle bush
ANR6947PY-YELLOW	Rear radius arm to axle bush
ANR6947PY-YELLOW	Rear radius arm to axle bush
NRC4514PY	Bush set - radius arm to chassis
NRC4514PY-YELLOW	Bush set - radius arm to chassis
NRC5593PY	Bush set - shock absorber
NRC5593PY-YELLOW	Shock absorber bush set
NTC1772PY	Bush set - lower link/axle
NTC1772PY-YELLOW	Bush set - lower link/axle
NTC1773PY	Bush set - upper mounting
NTC1773PY-YELLOW	Upper mounting bush set
NTC1775PY	Bush - steering damper
NTC1775PY-YELLOW	Bush - steering damper
NTC6781PY	Bush set - radius arm/axle
NTC6781PY-YELLOW	Bush set - radius arm/axle
NTC6828PY	Bush
NTC6828PY-YELLOW	Bush
NTC7307PY	Bush set - radius arm/axle
NTC7307PY-YELLOW	Bush set - radius arm/axle
NTC7394PY	Bush
NTC7394PY-YELLOW	Bush
RBX101240PY	Bush - anti-roll bar

RBX101240PY-YELLOW	Bush - anti-roll bar
RBX101340PY	Bush kit - front panhard rod
RBX101340PY-YELLOW	Front panhard rod
RBX101680PY	Bush - front radius arm to axle
RBX101680PY-YELLOW	Front radius arm to axle
RBX101690PY	Bush - anti-roll bar front
RBX101690PY-YELLOW	Bush - anti-roll bar front
RBX101730PY	Bush - radius arm to chassis
RBX101730PY-YELLOW	Radius arm to chassis
RBX101780PY	Bush - lower arm
RBX101780PY-YELLOW	Bush - lower arm
RBX101790PY	Bush - lower arm
RBX101790PY-YELLOW	Bush - lower arm
RDB100080PY	Bush
RDB100080PY-YELLOW	Bush
RGX100970PY	Bush assy polyurethane
RGX100970PY-YELLOW	Bush assy polyurethane
RGX101000PY	Bush - trailing link
RGX101000PY-YELLOW	Bush - trailing link
RGX101010PY	Bush
RGX101010PY-YELLOW	Bush
RGX101020PY	Bush - outer
RGX101020PY-YELLOW	Bush - outer
RGX101440PY	Bush
RGX101440PY-YELLOW	Bush
RNF100090PY	Mounting - rubber
RNF100090PY-YELLOW	Mounting - rubber
STC618PY	Bush kit
STC618PY-YELLOW	Bush kit

Britpart -

Black suspension bush sets

DC7100	Discovery 1
DC7101	Discovery 2
DC7102	Freelander
DC7103	Series 1, 2 & 3 - excluding 3 LWB (see DC7104)
DC7104	Series 3 LWB
DC7105	Range Rover up to 1986
DC7106	Range Rover 1986 - 1994
DC7107	Range Rover P38
DC7108	Defender 1999 - 2007
DC7109	Defender up to 1993
DC7110	Defender 1994 - 1999
DC7111	Defender 2007 onwards
DA2426	Defender - steering damper bush set

Britpart -

Yellow suspension bush sets

DC7000	Discovery 1
DC7001	Discovery 2
DC7002	Freelander
DC7003	Series 1, 2 & 3 - excluding 3 LWB (see DC7004)
DC7004	Series 3 LWB
DC7005	Range Rover up to 1986
DC7006	Range Rover 1986 - 1994
DC7007	Range Rover P38
DC7008	Defender 1999 - 2007
DC7009	Defender up to 1993
DC7010	Defender 1994 - 1999
DC7011	Defender 2007 onwards
DA2425	Defender - steering damper bush set

Note - Part numbers without yellow as a suffix indicate the bush colour is black.



DC7008

- > Britpart are proud to present an exclusive range of Yellow and Black polyurethane bushes.
- > Manufactured exclusively for Britpart using the latest Vulkollan™ polyurethane technology.
- > Machined to exact tolerances once cast to produce the highest finish available.
- > Produced in both yellow and black they are both the same compound which gives similar ride characteristics to the standard rubber bushes, but they offer improved articulation, vibration damping and last longer.
- > The black bushes are ideal for replacing individual bushes as they can be fitted without a press.
- > The DC range of kits include shock absorber and A-frame bushes.

Manufactured exclusively for Britpart using the latest Vulkollan™ polyurethane technology

also available in **black**



DISLOCATION CONES

DA1962 NEW	Defender 110 Rear	Pair
DA2186	Defender 90/Discovery 1 Rear	Pair

These clever products ensures your springs relocate correctly when using your Land Rover in extreme conditions. Manufactured from stainless steel. Use in conjunction with spring retainers.



DA1962



DA2186

PANHARD ROD NEW

DA1130
Adjustable panhard rod for Defender Td5 and 2007 onwards

If your Defender has raised suspension it is wise to use an adjustable panhard rod to correct the axle position which will in turn maintain and restore the steering geometry.



DA1130

POLYBUSH SETS

Polybush sets available from Britpart - full details supplied on request.



DA3144 NEW
Polybush Classic
Full kit for Discovery 3
Kit includes -

- > Front lower wishbone - front bushes
- > Front lower wishbone - rear bushes
- > Front upper wishbone bushes
- > Rear lower wishbone - front bush
- > Rear lower wishbone - rear bush
- > Rear upper wishbone - front bush
- > Rear upper wishbone - rear bush



RADIUS ARMS

Designed for vehicles with an extended 1 to 3" lift



DA5505 / DA5506



RADIUS ARMS FITTED

- > Designed for vehicles with an extended 1 to 3" lift.
- > Front radius arms correct castor alignment which in turn ensure safe driving.
- > Rear radius arms provide full rear axle articulation.
- > Fitting the radius arms will contribute to a much better off-road capability for your vehicle by fully utilising your spring and shock absorber set.
- > Zinc passivated with a heavy-duty powder coating finish to complement each component.

DA5505	3° Heavy-duty	Narrow	Use with NTC7307 bush	38mm
DA5506	3° Heavy-duty	Wide	Use with NTC6781 bush	45mm
DA5510	2" Lift rear radius arm			



DA5510



Wide Angle Propshafts...

See the end of this section for full details

SHOCK ABSORBERS - BRITPART CELLULAR DYNAMIC

including

BRITPART
CELLULAR DYNAMIC



- > cellular technology tube
- > sintered 18mm rod
- > piston diameter 41mm
- > polyurethane bush
- > teflon piston with multi-lip seal
- > single piece eye ring



The Britpart Cellular Dynamic Shock Absorber represents a significant advance in Land Rover suspension systems. It features a cellular foam insert instead of a normal nitrogen gas or air, this is to stop the oil from boiling. The foam takes up less room which means more room for oil, 50% more, which offers maximum heat dispersion. This heat dispersion translates to a very subtle but controlled ride that will not fade no matter how hard you push them. They are ideal for a driver who needs more control to complement performance improvements or to enhance a standard vehicle.

The unique design ensures ride comfort and cornering ability is maximised and of course they are superb off-road.



Note
*Terms & conditions apply
** Dimensions are +/- 5mm
*** The Plus 5" Cellular Dynamic Shock Absorbers are specialist suspension products and to install them additional fabrication work or brackets may be required. Please ensure that they are fitted by a competent expert.

Part Number	Application	Lift	Fitment	Open/Closed Dimensions**
DC6000	Defender/Discovery 1/Range Rover Classic		Front	600/380mm
DC6000L	Defender/Discovery 1/Range Rover Classic	50mm/2"	Front	665/425mm
DC6000LL	Defender/Discovery 1/Range Rover Classic	NEW 125mm/5" (see note***)	Front	765/455mm
DC6001	Defender/Discovery 1/Range Rover Classic		Rear	590/375mm
DC6001L	Defender/Discovery 1/Range Rover Classic	50mm/2"	Rear	625/385mm
DC6001LL	Defender/Discovery 1/Range Rover Classic	NEW 125mm/5" (see note***)	Rear	750/440mm
DC6010	Discovery 2		Front	590/370mm
DC6011	Discovery 2		Rear	585/365mm
DC6002	Range Rover P38 - air suspension		Front	560/365mm
DC6003	Range Rover P38 - air suspension		Rear	505/340mm
DC6004	Defender		Steering Damper	
DC6005	Discovery 1/Range Rover Classic/Series		Steering Damper	
DC6009	Discovery 2		Steering Damper	
DC6006	Range Rover P38		Steering Damper	



SHOCK ABSORBERS - BRITPART SUPER GAZ

Super Gaz Shock Absorbers



Part Number	Application	Lift	Fitment	Open/Closed Dimensions**
DC5002	Defender/Discovery 1/Range Rover Classic		Front	605/385mm
DC5002L	Defender/Discovery 1/Range Rover Classic	50mm/2"	Front	655/405mm
DC5003	Defender/Discovery 1/Range Rover Classic		Rear	590/375mm
DC5003L	Defender/Discovery 1/Range Rover Classic	50mm/2"	Rear	640/400mm
DC5000	Discovery 2		Front	590/370mm
DC5000L NEW	Discovery 2	50mm/2"	Front	640/400mm
DC5001	Discovery 2		Rear	585/365mm
DC5001L NEW	Discovery 2	50mm/2"	Rear	635/390mm
DC5004	Defender		Steering damper	
DC5005	Discovery 1/Range Rover Classic/Series		Steering damper	

24 month / 50,000 mile Warranty*

*Super Gaz Shock Absorbers
Terms and conditions apply

** +/- 5mm

Britpart Super Gaz Shock Absorbers offer a 35mm bore tube filled with Fuchs shock absorber fluid, using the best seal available, single piece eye rings, polyurethane bush mounts and a very durable powder coated finish. These offer a vast improvement in ride quality and damping performance. They are ideal for use with either of the Britpart Yellow Spring range or standard Land Rover Springs. Please ask for a CD of the shock absorbers in use or see the suspension section on the Britpart website!



SHOCK ABSORBER BRACKETS NEW



DA6323L

Any extreme force encountered is divided between the two shock absorbers for a more comfortable ride for you and your passengers.

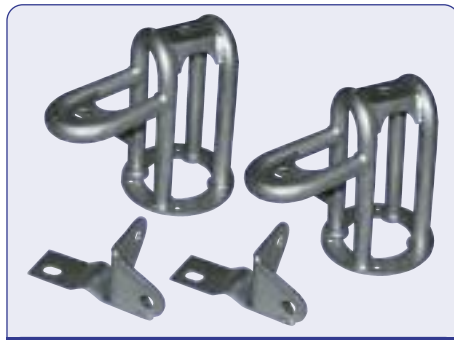

DA6322

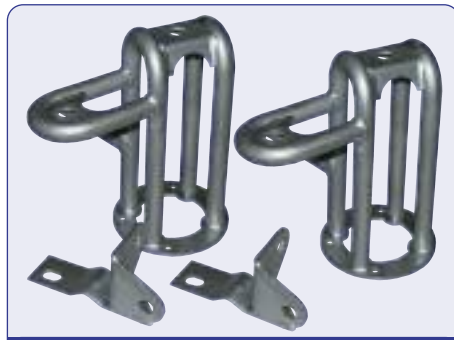

DA6322L



DA6323



Kit includes nuts, bolts & washers

DA6324

Sometimes off-road conditions can be serious enough to test the standard equipment on your Land Rover to its maximum. One of the critical components that takes most of the abuse is the suspension system. When using the standard single shock absorber configuration it is not unknown for the shock absorber to break the factory fitted turret mount. These new shock absorber brackets from Britpart give you confidence that your vehicles suspension will tackle the terrain you take it through with greater ease.

The single shock absorber bracket is manufactured from heavy-duty steel and replaces the existing turret mount which is susceptible to corrosion by allowing a build up of dirt inside which is hard to clean thoroughly. The new design is harder wearing and easier to clean.

The twin shock absorber bracket is manufactured from the same quality steel as the single shock absorber bracket but allows for the fitment of an additional shock absorber. The benefits of having extra shock absorbers fitted to your Land Rover is that any extreme force encountered is divided between the two shock absorbers for a more comfortable ride for you and your passengers. Using twin shocks is also beneficial when carrying loads both on and off-road as it improves the load carrying ability of the vehicle. An additional benefit is that when changing shock absorbers there is no need to remove the brackets. **Note** - rear brackets involve some welding to fit.

DA6322	Defender/Discovery 1/Range Rover Classic	Twin shock brackets	Front	Standard height
DA6322L	Defender/Discovery 1/Range Rover Classic	Twin shock brackets	Front	2" Lift
DA6323	Defender/Discovery 1/Range Rover Classic	Single shock brackets	Front	Standard height
DA6323L	Defender/Discovery 1/Range Rover Classic	Single shock brackets	Front	2" Lift
DA6324	Defender/Discovery 1/Range Rover Classic	Twin shock brackets - kit	Rear	
DA6324A	Defender/Discovery 1/Range Rover Classic	Lower twin shock brackets - axle	Rear	



Picture courtesy of Kristjan Kristjansson

SHOCK ABSORBERS - DELPHI DE CARBON

Shock Absorbers

DA4162	Series LWB/SWB	Front
DA4163	Series SWB	Rear
DA4164	Series LWB	Rear
DA4090	Range Rover Classic/Defender to 1999/Discovery to 1994 including air suspension	Front
DA4091	Range Rover Classic/Defender to 1999/Discovery to 1994 including air suspension	Rear
DA4092	Discovery - 1994 - 1999	Rear
DA4181	Range Rover Classic/Defender to 1999/Discovery to 1994	Front +2"
DA4182	Range Rover Classic/Defender to 1999/Discovery to 1994	Rear +2"

Note - Boxed as a pair, priced individually

Steering Dampers

DA4160	Series/Range Rover Classic/Discovery to 1998
DA4161	Defender





SHOCK ABSORBERS - HEAVY DUTY

Heavy-duty oil filled shock absorbers



DA4210	Defender 90/110	Rear
DA4211	Defender 90/110	Front

SPRINGS - COIL

Britpart Performance - Lifted Springs

Our yellow performance springs are high quality, versatile and competitively priced - the right choice when replacing the old sagging original springs.

Developed by one of the world's top spring manufacturers these high quality, powder coated springs have been designed with the needs of today's Land Rover owners in mind.

As Land Rovers are often working vehicles as well as the family car, uprated springs must offer the ability to carry loads, handle off-road terrain and provide a good ride on road. The progressive front springs offer a compliant ride when lightly loaded, but firm up as the load increases.

Note - Spring quantity 1 = 1 pair

The right choice when replacing the old sagging original springs!



				Lift	Load	Bar Diameter	Rate LBF/IN	Free Height	
DA4201	90/110/Discovery 1 & 2/Range Rover Classic	Front		25mm	25kg	16mm	200	400mm	
DA4202	90/110/130/Discovery 1 & 2/Range Rover Classic	Front		40mm	50kg	16mm	230	390mm	
DA4203	90 + Td5/Discovery 1 & 2/Range Rover Classic	Rear		40mm	Light	17mm	220	430mm	
DA4204	90/Discovery 1 & 2/Range Rover Classic	Rear		50mm	100kg	18mm	300-340	420mm	
DA4205	90 + Td5/Discovery 1 & 2/Range Rover Classic	Rear		50mm	200kg	19mm	360	420mm	
DA4206 NEW	110		Light-duty	Rear	40mm	100kg	17mm	270-295	445mm
DA4208	110/130		Heavy-duty	Rear	50mm	500kg	21mm	420	435mm
DA4197	Discovery 2		Heavy-duty	Rear	40mm	Medium	18mm	290	433mm
DA4198	Discovery 2		Heavy-duty	Front	40mm	50 - 100kg	16mm	180	390mm
DA4199	Discovery 2		Heavy-duty	Front	40mm	20 - 50kg	16mm	180	400mm

Britpart Performance - Standard Height Springs

Our yellow springs are designed for the enthusiast who wants a performance spring without having to raise the vehicle. They offer a firmer ride with less body roll, ideal for a vehicle with uprated performance or one used for carrying heavy loads. The springs are designed to offer full articulation off road with a compliant ride. They also look stunning in the Britpart yellow powder coating. **Note** - Spring quantity 1 = 1 pair

DA4277	90/110/Discovery to 1999/Range Rover Classic	Front springs	Rating - 225lbs/in	Height - 376mm
DA4278	90/Discovery 1/Range Rover Classic	Rear springs	Rating - 285lbs/in	Height - 376mm
DA4279	110	Rear springs	Rating - 330lbs/in	Height - 407mm



Picture courtesy of Paul Wade

SPRINGS - PARABOLIC



DA4106



DA4107

DA2003	4 Leaf	LWB	Rear kit pair
DA4106	2 Leaf	SWB/LWB	Front kit pair
DA4107	3 Leaf	SWB	Rear kit pair

High quality replacement parabolic springs from Britpart. Designed to match the original Santana specification, giving a very comfortable and controlled ride. **Note** - Includes 'U' bolts and nuts.

SPRING RETAINERS

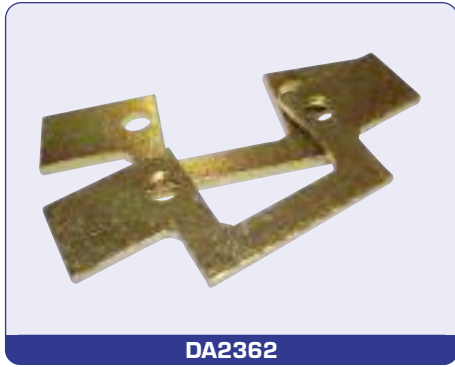

DA2362



DA2363

DA2362	Front
DA2363	Rear

STEERING ARMS - HEAVY-DUTY



DA5501	All Series vehicles	4 track rod ends
DA5502	All Defender 90 & 110	3 track rod ends
DA5503	Range Rover Classic/Discovery 1	3 track rod ends
DA5504	Discovery 1	4 track rod ends
DA5509	Discovery 2	4 track rod ends

- > All OEM track rod ends
- > Solid heavy-duty arms which are suitable for off-road use
- > Improves steering response
- > Zinc plate finish to increase corrosion resistance



DA5501



DA5504

Improves steering response



DA5502

SUSPENSION KITS - BRITPART



SUPER GAZ - STANDARD HEIGHT KIT

Britpart can offer a complete or partial **suspension package** suitable for whatever you intend to use your Land Rover for.



Super Gaz Suspension Kits

DA4284	Defender 90/Discovery 1/Range Rover Classic	Heavy-duty	Standard height
DA4285	Defender 110	Heavy-duty	Standard height
DA4286	Defender 90/Discovery 1/Range Rover Classic	Heavy-duty	40mm Lift
DA4287	Defender 110	Heavy-duty	40mm Lift
DA4288	Defender 90 - to 1994/Range Rover Classic to 1986 - narrow bush	Heavy-duty	40mm Lift
DA4289	Defender 90 - from 1994/Discovery 1/Range Rover Classic from 1986 - wide bush	Heavy-duty	40mm Lift
DA4299	Defender 110 - to 1994 - narrow bush	Heavy-duty	40mm Lift
DA4300	Defender 110 - from 1994 - wide bush	Heavy-duty	40mm Lift
DA4369 NEW	Discovery 2 - front springs - 20 to 50kg load	Heavy-duty	40mm Lift
DA4347 NEW	Discovery 2 - front springs - 50 to 100kg load - Ideal if a front winch bumper is fitted	Heavy-duty	40mm Lift
DA4301	Range Rover Classic	Heavy-duty	25mm Lift



CELLULAR DYNAMIC - COMPLETE KIT

24 month / 50,000 mile Warranty on Super Gaz & Cellular Dynamic Shock Absorbers **



*Note - The Plus 5" Cellular Dynamic Shock Absorbers are specialist suspension products and to install them additional fabrication work or brackets may be required. Please ensure that they are fitted by a competent expert.
Open and closed dimensions -
DC6000LL - 765-455mm
DC60001LL - 750-440mm

**Terms and conditions apply

Cellular Dynamic Suspension Kits

DA4284C	Defender 90/Discovery 1/Range Rover Classic	Heavy-duty	Standard height
DA4286C	Defender 90/Discovery 1/Range Rover Classic	Heavy-duty	40mm Lift
DA4363 NEW	Defender 90/Discovery 1/Range Rover Classic	Heavy-duty	[see note above]*
DA4285C	Defender 110	Heavy-duty	Standard height
DA4287C	Defender 110	Heavy-duty	40mm Lift
DA4364 NEW	Defender 110	Heavy-duty	[see note above]*
DA4288C	Defender 90 - to 1994/Range Rover Classic to 1986 - narrow bush	Heavy-duty	40mm Lift
DA4365 NEW	Defender 90 - to 1994/Range Rover Classic to 1986 - narrow bush	Heavy-duty	[see note above]*
DA4289C	Defender 90 - from 1994/Discovery 1/Range Rover Classic from 1986 - wide bush	Heavy-duty	40mm Lift
DA4366 NEW	Defender 90 - from 1994/Discovery 1/Range Rover Classic from 1986 - wide bush	Heavy-duty	[see note above]*
DA4299C	Defender 110 - to 1994 - narrow bush	Heavy-duty	40mm Lift
DA4367 NEW	Defender 110 - to 1994 - narrow bush	Heavy-duty	[see note above]*
DA4300C	Defender 110 - from 1994 - wide bush	Heavy-duty	40mm Lift
DA4368 NEW	Defender 110 - from 1994 - wide bush	Heavy-duty	[see note above]*
DA4301C	Range Rover Classic	Heavy-duty	25mm Lift

WIDE ANGLE PROPSHAFTS

If your Land Rover has raised suspension or been modified for extreme axle articulation then the joints on the existing prop shaft will become strained. This will cause the prop shaft to lock up or vibrate and wear the universal joints prematurely.

reduces vibration, universal joint 'bind-up' and premature wear

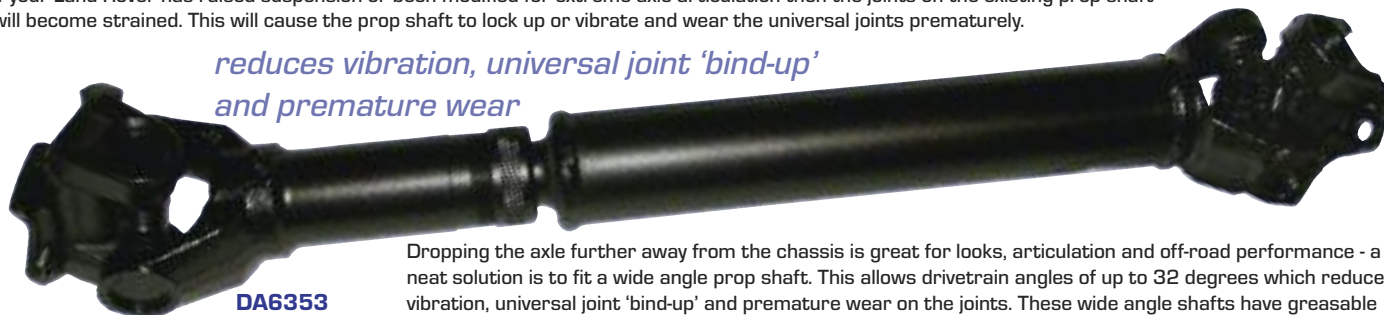

DA6353

Dropping the axle further away from the chassis is great for looks, articulation and off-road performance - a neat solution is to fit a wide angle prop shaft. This allows drivetrain angles of up to 32 degrees which reduces vibration, universal joint 'bind-up' and premature wear on the joints. These wide angle shafts have greasable universal joints which are more desirable where longer life is required.

DA6350	Front	Defender from MA - 300Tdi/Discovery 1/Range Rover Classic 1986-1991	FRC8386	DA6356 NEW	Replacement heavy-duty universal joint for wide angle propshafts
DA6352	Front	Defender up to LA (1993)	FRC8390/FRC5566		
DA6351	Rear	Defender 90 - 4 cylinder up to 2007	FRC8392		
DA6353	Rear	Defender 90 - V8 up to 2007 & diesel from MA	FRC8393		
DA6354	Rear	Discovery 1 - 1989-1994 and V8 from 1997	FRC8387		

SUSPENSION MATRIX

We've got suspension covered!

Britpart can offer a complete or partial suspension package suitable for whatever you intend to use your Land Rover for.



The Britpart Cellular Dynamic Shock Absorber represents a significant advance in Land Rover suspension systems. It features a cellular foam insert instead of normal

nitrogen gas or air, this is to stop the oil from boiling. The foam takes up less room which means more room for oil, 50% more, which offers maximum heat dispersion.

This heat dispersion translates to a very subtle but controlled ride that will not fade no matter how hard you push them. They are ideal for a driver who needs more control to complement performance improvements or to enhance a standard vehicle. The unique design ensures ride comfort and cornering ability is maximised and of course they are superb off-road.

Features

- > cellular technology tube
- > sintered 18mm rod
- > piston diameter 41mm
- > polyurethane bushes
- > teflon piston with multi-lip seal
- > single piece eye ring



Britpart Super Gaz shock absorbers offer a 35mm bore tube filled with Fuchs shock absorber fluid, using the best seal available, single piece eye rings,

polyurethane bush mounts and a very durable powder coated finish. These offer a vast improvement in ride quality and damping performance. They are ideal for use with either of the Britpart Yellow Spring range or standard Land Rover springs.

All suspension products now available from your local Britpart distributor and the Cellular Dynamic and Super Gaz shock absorbers have a **24 month / 50,000 mile warranty*****

	Super Gaz			Cellular Dynamic			FLS 5
	Standard Height	25mm Lift*	40mm Lift*	Standard Height	25mm Lift*	40mm Lift*	
Defender - 90							
Front spring	DA4277	DA4201	DA4202	DA4277	DA4201	DA4202	
Rear spring	DA4278		DA4203	DA4278		DA4203	
Front shock absorber	DC5002	DC5002L	DC5002L	DC6000	DC6000L	DC6000L	
Rear shock absorber	DC5003	DC5003L	DC5003L	DC6001	DC6001L	DC6001L	
Steering damper	DC5004	DC5004	DC5004	DC6004	DC6004	DC6004	
Suspension kit	DA4284	DA4301	DA4286	DA4284C	DA4301C	DA4286C	DA4363**
Complete kit - narrow bush			DA4288			DA4288C	DA4365**
Complete kit - wide bush			DA4289			DA4289C	DA4366**
Defender - 110							
Front spring	DA4277	DA4201	DA4202	DA4277	DA4201	DA4202	
Rear spring	DA4279		DA4208	DA4279		DA4208	
Front shock absorber	DC5002	DC5002L	DC5002L	DC6000	DC6000L	DC6000L	
Rear shock absorber	DC5003	DC5003L	DC5003L	DC6001	DC6001L	DC6001L	
Steering damper	DC5004	DC5004	DC5004	DC6004	DC6004	DC6004	
Suspension kit	DA4285		DA4287	DA4285C		DA4287C	DA4364**
Complete kit - narrow bush			DA4299			DA4299C	DA4367**
Complete kit - wide bush			DA4300			DA4300C	DA4368**
Discovery 1							
Front spring	DA4277	DA4201	DA4202	DA4277	DA4201	DA4202	
Rear spring	DA4278		DA4203	DA4278		DA4203	
Front shock absorber	DC5002	DC5002L	DC5002L	DC6000	DC6000L	DC6000L	
Rear shock absorber	DC5003	DC5003L	DC5003L	DC6001	DC6001L	DC6001L	
Steering damper	DC5005	DC5005	DC5005	DC6005	DC6005	DC6005	
Suspension kit	DA4284	DA4301	DA4286	DA4284C	DA4301C	DA4286C	DA4363**
Complete kit			DA4289			DA4289C	DA4366**
Discovery 2							
Front spring - 50-100kg load			DA4198			DA4198	
Front spring - 20-50kg load			DA4199			DA4199	
Rear spring - medium load			DA4197			DA4197	
Front shock absorber	DC5000	DC5000L	DC5000L	DC6010			
Rear shock absorber	DC5001	DC5001L	DC5001L	DC6011			
Steering damper				DC6009			
Suspension kit - 50-100kg load			DA4347				
Suspension kit - 20-50kg load			DA4369				
Range Rover Classic							
Front spring	DA4277	DA4201	DA4202	DA4277	DA4201	DA4202	
Rear spring	DA4278		DA4203	DA4278		DA4203	
Front shock absorber	DC5002	DC5002L	DC5002L	DC6000	DC6000L	DC6000L	
Rear shock absorber	DC5003	DC5003L	DC5003L	DC6001	DC6001L	DC6001L	
Steering damper	DC5005	DC5005	DC5005	DC6005	DC6005	DC6005	
Suspension kit	DA4284	DA4301	DA4286	DA4284C	DA4301C	DA4286C	DA4363**
Complete kit - narrow bush			DA4288			DA4288C	DA4365**
Complete kit - wide bush			DA4289			DA4289C	DA4366**
Range Rover P38 - air suspension							
Front shock absorber				DC6002			
Rear shock absorber				DC6003			
Steering damper				DC6006	DC6006	DC6006	
Series							
Steering damper	DC5005	DC5005	DC5005	DC6005	DC6005	DC6005	

Notes

- * Approximate lift height - check specification before ordering
- ** The Plus 5" Cellular Dynamic Shock Absorbers are specialist suspension products and to install them additional fabrication work or brackets may be required. Please ensure that they are fitted by a competent expert. Open and closed dimensions - **DC6000LL** - 765-455mm / **DC60001LL** - 750-440mm (dimensions +/- 5mm)
- *** Terms & conditions apply

13 exhausts

EXHAUSTS

An exhaust that'll last a life time? We've got them here.

Section contents -

Exhausts - stainless steel	116
Exhausts - stainless steel sports systems	117
Utility link and rear pipes	118



EXHAUSTS - STAINLESS STEEL

Double 'S' is recognised as one of Europe's leading manufacturers of stainless steel automotive components with a wide selection of systems for off-road.

Using only the finest austenitic and ferritic stainless steels and employing the latest in CNC mandrel and empty tube bending, measuring and inspection equipment, means increasingly high levels of product quality.

All Double 'S' exhaust systems carry a lifetime guarantee. Double 'S' will replace or repair any part of their Stainless Steel Exhaust Systems found defective through corrosion during the period that the system remains the property of the original owner. Provided that the system is inspected by a garage or exhaust fitting centre annually to ensure that the rubber and other mountings are in good condition.

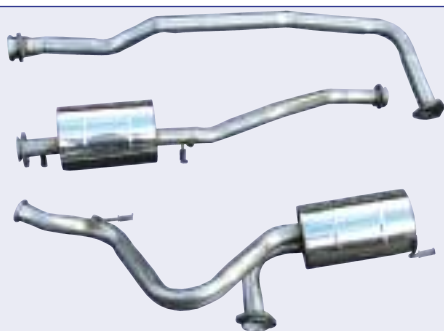
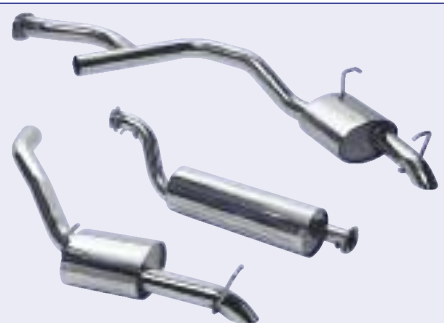
DA4528

DA4233

DA4240

DA4241

Series

Series	Model	Engine	Kit contents
DA4251	Series 3	2.25 Diesel	Front pipe Link pipe Rear silencer
DA4528	Series 3	2.25 Petrol	Front pipe Link pipe Rear silencer

Defender

Model	Year Range	Engine	Kit contents
DA4231	90	200Tdi	Front pipe Centre box Rear silencer
DA4232	90 - 1994 - 1995	300Tdi	Front pipe Centre box Rear silencer
DA4233	90 - 1995 - 1997	300Tdi	Front pipe Centre box Rear silencer
DA4234	90 - 1997 - onwards	300Tdi	Centre box Rear silencer
DA4235	90	Td5	Centre box Rear silencer
DA4244	110	Td5	Centre box Rear silencer
DA4228	110	200Tdi	Front pipe Centre box Rear silencer
DA4229	110	300Tdi	Front pipe Centre box Rear silencer

All Double 'S' exhaust systems carry a lifetime guarantee.

DA4246

Discovery

Model	Year Range	Engine	Kit contents
DA4221	Discovery 1	2.5Td & 200Tdi Manual	Front pipe Centre box Rear silencer
DA4222	Discovery 1	200Tdi Automatic	Centre box Rear silencer
DA4223	Discovery 1	300Tdi	Centre box Rear silencer
DA4224	Discovery 2	2.5 Td5	Centre box Rear silencer

Freelander

Model	Year Range	Engine	Kit contents
DA4226	Freelander 1	1.8 Petrol	Centre box Rear silencer
DA4227	Freelander 1	2.0 Diesel	Link pipe Rear silencer
DA4246	Freelander 1	1.8 Petrol	Transplex rear silencer (2 x 3" roll tailpipe)

Range Rover

Model	Year Range	Engine	Kit contents
DA4237	Range Rover Classic	3.9 V8 cat back	Centre box non-cat Rear silencer cat
DA4238	Range Rover P38	2.5 BMW diesel single tailpipe	Centre box Rear silencer
DA4239	Range Rover P38	4.0/4.6 single tailpipe	Centre box Rear silencer
DA4240	Range Rover P38	4.0/4.6 twin tailpipe	Centre box LH rear silencer RH rear silencer
DA4241	Range Rover P38	2.5 BMW twin tailpipe	Centre box LH rear silencer RH rear silencer

EXHAUSTS - STAINLESS STEEL SPORTS SYSTEMS

Defender

DA4236 90 3.5 V8
Sports system

Kit contents

- LH manifold
- RH manifold
- Y-Pipe
- Rear silencer
- Tailpipe
- Fitting bracket

DA4230 110 3.5 V8
Sports system

- LH manifold
- RH manifold
- Y-Pipe
- Extension pipe
- Centre box
- Tailpipe
- Fitting bracket

DA4249 90 Td5 - Sports

- Sports centre link pipe
- Rear silencer

Discovery

DA4225 Discovery 1 3.9 V8
Japanese spec sports

- Centre box
- Link pipe
- Rear silencer

Range Rover

DA4242 Range Rover Classic 3.5 V8 Efi
Sports system with tubular manifold

- LH manifold
- RH manifold
- Y-Pipe
- Centre box
- Rear silencer

DA4243 Range Rover Classic 3.9 V8 Efi
Sports system with tubular manifold

- LH manifold
- RH manifold
- Y-Pipe
- Centre box
- Link pipe
- Rear silencer

DA4245 Range Rover P38 4.0/4.6
Sports system with twin tailpipe

- LH rear silencer
- RH rear silencer
- Y-Pipe
- Centre box

DA4247 Range Rover P38 2.5 diesel
Sports system with twin tailpipe

- LH rear silencer
- RH rear silencer
- Y-Pipe
- Centre box



DA4236

All Double 'S' exhaust systems carry a lifetime guarantee.

DA4249



DA4225



DA4243



DA4245



Picture courtesy of Kristjan Kristjansson

UTILITY LINK & REAR PIPES

These are 304 stainless steel exhaust silencer replacement pipes. They are designed to directly replace the front silencer in your Td5 and Tdi exhaust system.

Quick and easy to install with more power.

Once replaced the pipe will give your vehicle more power or reduced fuel consumption with only a small increase in cabin noise.

Reduced fuel consumption

CNC mandrel formed for a perfect fit with laser cut flanges, the pipes have a sateen finish, deep luster appearance. Quick and easy to install.

Britpart Link Pipe
Part No. **Vehicle Model** **Double 'S' Rear silencer Part No.**

Defender

DA4292	90	Td5	DA3250
DA4348 NEW	90	Td5 - downpipe less cat Note - not stainless steel	
DA4359 NEW	90	Puma - downpipe less cat Note - not stainless steel	
DA4294	90	300Tdi 1994-1995	DA3251
DA4294	90	300Tdi 1995-1997	DA3252
DA4304	90	300Tdi 1997-1999	DA3253
DA4295	90	200Tdi	DA3254
DA4293	110	Td5	DA3255
DA4302	110	300Tdi	DA3256
DA4306	110	200Tdi	DA3257

Discovery

DA4291	Discovery 1	300Tdi	DA3258
		Note - Will only fit with Double 'S' rear silencer (DA3258)	
DA4223S	Discovery 1	300Tdi	N/A
		Note - Kit includes Double 'S' rear silencer (DA3258)	
DA4303	Discovery 1	200Tdi	DA3259
DA4290	Discovery 2	Td5	DA3260



Picture courtesy of Paul Wade

14

engines & transmission
ENGINES & TRANSMISSION

A wide range of new and reconditioned engines and gearboxes.

Section contents -

Engines - new	120
Engines - reconditioned	120
Gear boxes - new	121
Gear boxes - reconditioned	121
Transfer boxes - new	121



ENGINES

Complete Engines

Include fuel pump, injectors, injector pipes, timing assembly and bell housing. Complete engines are tested prior to despatch. Once tested the flywheel and manifolds are removed and the engine is packed without these parts. Outer timing covers, pulleys, manifolds, flywheel and turbo charger are not included.

Stripped Engines

Include sump, block, cylinder head, rocker cover, inner timing cover, camshaft and crankshaft gear.

Short Engines

Consist of block, crank, con-rods and pistons only.

Re-conditioned Engines

These engines have been through the following rigorous processes:

- > Complete strip down
- > Removal of all core plugs
- > Thorough cleaning in environmentally-friendly, solvent-free washing machines
- > Removal of all parts subject to wear
- > Inspection of casings for signs of damage and corrosion
- > Crack-testing of camshafts before and after re-grinding
- > Re-boring of blocks and machining of decks to the correct surface finishes
- > Fitting of perfectly-balanced, machined con-rods in accordance with manufacturers recommended piston protrusions
- > Meticulous re-building of engines in individual, contaminant-free workstations
- > Renewal of all bearings and gaskets throughout the engine
- > Renewal/overhaul of oil pumps
- > Replacement of all core plugs
- > Dyno-testing of complete engines
- > Final inspection
- > Wrapping in cellophane and fitting into rigid, steel transportation frames

A full range of engines available from Britpart.



STC4723N



LBB110410N



DA4220

Engines - New

STC1675		300Tdi	Short
STC4723N		300Tdi	Stripped
DA2047	Discovery 2	V8 4.0 56D	Short
DA2082		V8 4.0	Short
		Also need DA2999 crank spacer	
DA2079		V8 4.6	Short (MEMS) Bosch
DA2084		V8 4.6	Short (GEMS) Lucas
ERR5013ST		V8 4.6	Stripped
		With distributor drive for Range Rover Classic 3.5 and Discovery 1 with tin sump	
DA2109		V8 4.0	Stripped
STC4526		Td4	Complete
DA2039	Freelander	1.8K	Complete
LBB110410N	Freelander	2.0 D	Stripped
LBB000561	Freelander	2.5 V6	Complete

Engines - Reconditioned

DA4220		2.5 NA	Short
DA4215	Please enquire on availability for all these reconditioned engines.	2.5 NA	Stripped
DA4217		2.5 Td	Short
DA4218		2.5 Td	Stripped
DA4219		2.5 Td	Complete
DA4212		200Tdi	Short
DA4249DEF	Defender	200Tdi	Stripped
DA4249DIS	Discovery	200Tdi	Stripped
DA4250DEF	Defender	200Tdi	Complete
DA4250DIS	Discovery	200Tdi	Complete
DA4252		300Tdi	Complete
DA4214		Td5	Short
DA4256	Freelander	2.0D	Stripped - less injectors



GEAR BOXES

Gear Boxes - New

TRC103150	Defender	LT77 - 50A suffix L
TRC103330	Defender	R380 - oil cooled 74A Td5
TRC103270	Discovery 2	V8 efi
TRC103350	Discovery 2	Diesel - less oil cooler
TRC102900	Freelander	Petrol 1.8K16



Gear Boxes - Reconditioned

DA3050	Defender	4 Cylinder to 200Tdi	LT77/S	50G/H
DA3051	Defender	200Tdi	LT77/S	56G/H
TRC103160E	Defender	300Tdi	R380	56J
DA3058	Defender	Td5	R380	68A
DA3052	Discovery	200Tdi	LT77/S	55G/H
DA3054	Discovery	300Tdi	R380	55J
DA3055	New Range Rover	Diesel	R380	65J

TRANSFER BOXES

Transfer Boxes - New

IAB500104E	Defender	Prefix 57D Td5 from 3A
IAB500106	Defender	Prefix 58D 4 cylinder petrol from 3A
IAB000010	Discovery 2	Less diff lock
IAB500090	Discovery 2	Prefix 70D
IAB500100	Discovery 2	Prefix 68D & 69D





15

REPAIR & SERVICE PARTS

From a new complete chassis to a jubilee clip - we've got the lot.

Section contents -

Automatic transmission service kit	124
Brake kits	124
Chassis' - complete	125
Chassis & body components	
- Defender	126
- Discovery 1	127
- Freelander	127
- Range Rover Classic	128
- Series 2 & 3	129
Clips, clamps & nipples	124
Clutch kits	130
CV joint kits - Britpart	131
Cylinder liner kit	131
Damper kit	131
Diff coupling shaft	131
Diff repair pans	131
Door hinge kit	132
Door hinges - aluminium	132
Electronic conversion kits	132
Gasket kits	132
Hand barrier cream	132
Head bolt sets	132
Heater blower motor kit & resistor kit	133
Heater matrixes	133
Heater plug upgrade kit	133
Hylomar sealants & compounds	133
Ignition lead sets	134
Ignition module & link lead	134
Land Rover genuine consumables	134
Loctite consumables	135
Oil pump gear set	135
Pressure relief valve kit	135
Propshaft bearings	136
Propshaft kit	136
Swivel housing grease	136
Swivel housing kits	136
Swivel pin kits	137
Timing kits	137
Tools	138
Touch up paint pens	139
Wheel bearing kits	139
Wheel hub & bearing assembly	139
Window kits	140
Wing protectors	140



AUTOMATIC TRANSMISSION SERVICE KIT

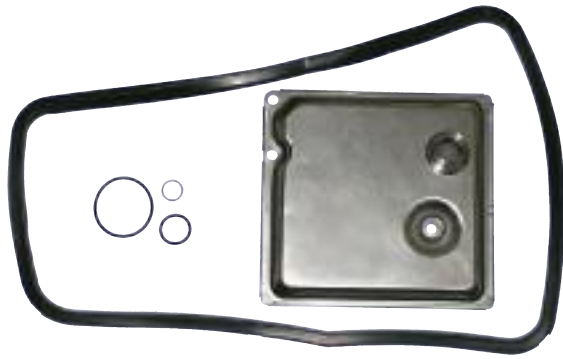

DA4500

DA4500

Kit comprises of oil screen, seals, o-rings and sealing washer

BRAKE KITS



DA6042



DA6047

Series SWB

DA6042 Front Up to June 1980

DA6043 Rear Up to June 1980

DA6044 Front From July 1980

DA6046 Rear From July 1980

Series LWB

DA6044 Front 4 cylinder except 1 ton

DA6045 Front 6 cylinder & 109 V8 Stage 1

DA6047 Rear Including V8

Kits include - Brake shoes, wheel cylinders, brake springs & screws (where applicable)

CLIPS, CLAMPS & NIPPLES



JUBILEE CLIPS



EXHAUST CLAMPS



GREASE NIPPLES

CN100208L	20mm	Qty 10
CN100508L	32 - 52mm	Qty 5
CN100909	70 - 90mm	Qty 1

DA4062	45mm	Qty 1
DA4063	60mm	Qty 1
DA4064	65mm	Qty 1

TYL100030	Short thread	Qty 10
234532	Long thread	Qty 10



Picture courtesy of Cyril Mischler

CHASSIS' - COMPLETE

IMPORTANT
 This page is a selection of the chassis' that we do. Please enquire if the chassis you require is not listed here.

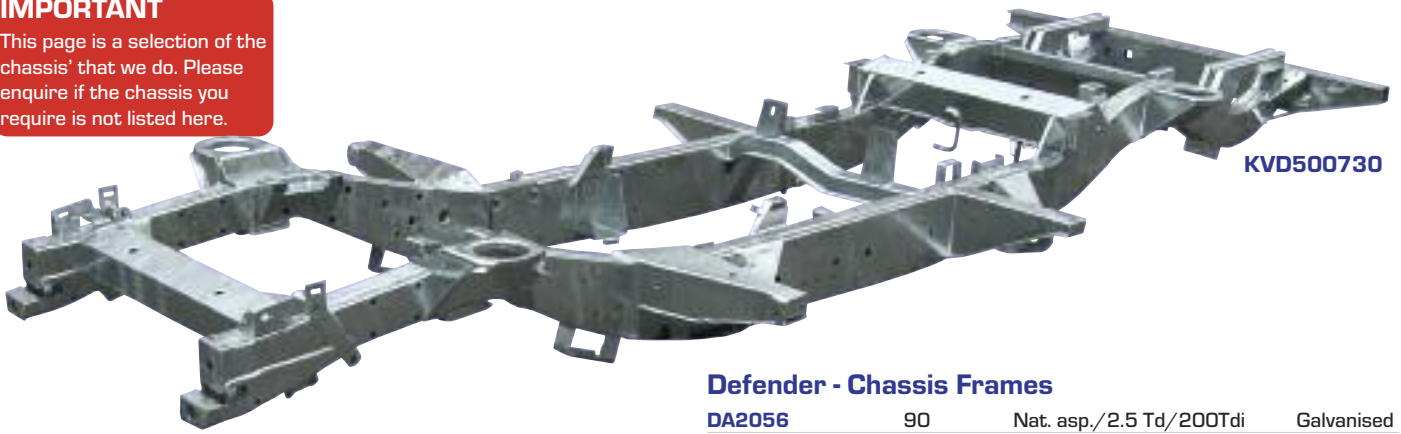

KVD500730

Defender - Chassis Frames

DA2056	90	Nat. asp./2.5 Td/200Tdi	Galvanised
DA2056-300TDI	90	300Tdi	Galvanised
KVD500710	90	Td5	Galvanised
DA2057*	110	Nat. asp./2.5 Td/200Tdi	Galvanised
DA2057-300TDI*	110	300Tdi	Galvanised
KVD500730	110	Td5	Galvanised
KVD500140	130	Td5	Galvanised

*suitable for pick-up and station wagons



DA2056

Series - Chassis Frames

NRC4356	Series	LWB	Galvanised
NRC4642G	Series	SWB	Galvanised



DA2057



DA2057-300TDI



KVD500710



KVD500140



NRC4356



NRC4624G

CHASSIS & BODY COMPONENTS - DEFENDER

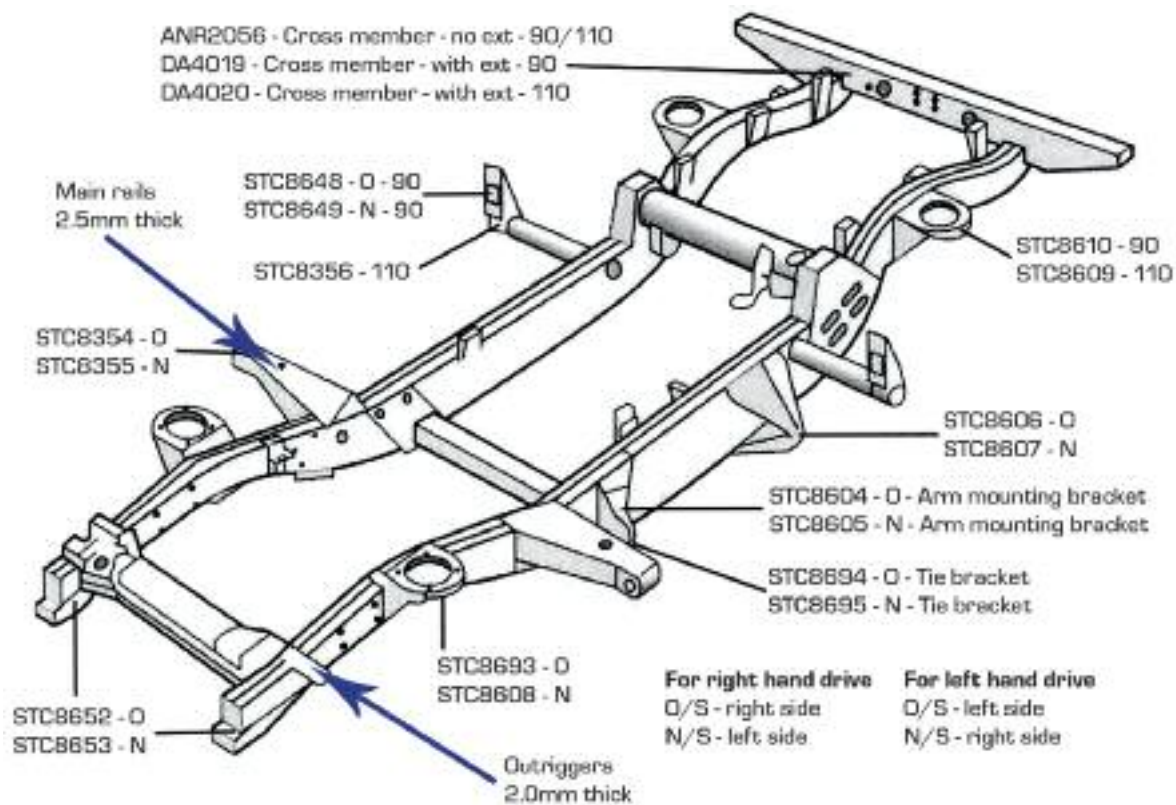

ABS Plastic Wings NEW

- DA2396** 90 & 110 Front outer wing N/S
 Replacement for
 RTC6352, ALR6677 & ASB710290
- DA2397** 90 & 110 Front outer wing O/S
 Replacement for ALR6678 & ASB710280
- DA2398** 90 & 110 Front outer wing N/S
 Replacement for
 RTC6350, ALR6121 & ASB710270
- DA2399** 90 & 110 Front outer wing O/S
 Replacement for
 ALR6122, RTC6351 & ASB710260



90

- DA4019** Rear crossmember plus extensions
- STC8610** Rear spring seat RH, LH
- STC8648** Rear tubular outrigger RH
- STC8649** Rear tubular outrigger LH

110

- DA4020** Rear crossmember plus extensions
- NRC4171** Rear body crossmember
- STC8356** Rear outrigger RH, LH
- STC8609** Rear spring seat RH, LH

90 & 110

- ANR2056** Rear crossmember no extensions
- KVB000290** Rear crossmember no extensions from VIN 2A627496
- DA40650** Bulkhead upper repair panel O/S
- DA4065N** Bulkhead upper repair panel N/S
- STC8354** Bulkhead outrigger RH
- STC8355** Bulkhead outrigger LH
- STC8604** Front radius arm mount RH
- STC8605** Front radius arm mount LH
- STC8606** Rear radius arm mount RH
- STC8607** Rear radius arm mount LH
- STC8608** Front spring seat LH
- STC8652** Front chassis leg RH
- STC8653** Front chassis leg LH
- STC8693** Front spring seat RH
- STC8694** Tie bracket from bulkhead rigger LH
- STC8695** Tie bracket from bulkhead rigger RH
- DA4515** Shock absorber bracket - pair
- DA4516** Tie bar mounting bracket - single

- DA4513 NEW** Front axle spring mount - standard LH
- DA4514 NEW** Front axle spring mount - standard RH
- DA4508 NEW** Front axle spring mount - 40mm lift LH
- DA4509 NEW** Front axle spring mount - 40mm lift RH
- DA4518** Rear axle spring mount - 40mm lift
- DA4527** Rear axle spring mount - standard
- MTC2248** Front floor LH
- ALR1742** Floor panel - front - Tdi/V8/Td5 RH
- ALR1743** Floor panel - front - Tdi/V8/Td5 LH
- BIC710260** Rear door - 1 piece
- QGB000140** Glass for BIC710250
- QGB000150** Heated glass for BIC710250
- CVW500010** Glazing rubber for BIC710250
- ALR6852** Rear door - less spare wheel carrier
 From MA939976 to 1A622423
- STC1424** Rear door - less spare wheel carrier
 From AA242000 to KA929577
- DA4143** Front door skin - push button handle RH
- DA4144** Front door skin - push button handle LH
- DA2024** Door skin safari - rear
- RTC6247** Safari rear door - unglazed with spare wheel
- RTC6248** Safari rear door - glazed without spare wheel
- RTC6248NG** Safari rear door - unglazed without spare wheel
- DA4032** Window kit - standard Clear
- DA4032GREEN** Window kit - standard Green tinted
- DA4032GREY** Window kit - standard Grey tinted
- DA4032BRONZE** Window kit - standard Bronze tinted
- DA4033** Window kit - deluxe Clear
- DA4033GREEN** Window kit - deluxe Green tinted
- DA4033BRONZE** Window kit - deluxe Bronze tinted

CHASSIS & BODY COMPONENTS - DISCOVERY 1

ASR1186	Rear floor plate		
ASR1594	Floor panel	RH	
ASR1595	Floor panel	LH	
ALR6272	Bulkhead - from MA081991	Front	
MWC6702	Bonnet assembly		
ALR8519	Front floor crossmember		
ASR1187	Rear floor crossmember		
ALR8520	Rear crossmember		
STC1066	Crossmember assembly rear floor		
DA4530	Rear crossmember end repair panels for crossmember STC1066	Pair	
STC2814	Outer sill	RH	3-Door
STC2813	Outer sill	LH	3-Door
STC2816	Outer sill	RH	5-Door
STC2815	Outer sill	LH	5-Door
MWC9060	Inner sill	RH	3/5-Door
MWC9061	Inner sill	LH	3/5-Door
ALR5822	Door outer skin - from MA163103	RH	Front
ALR5823	Door outer skin - from MA163103	LH	Front
ALR8576	Door outer skin - from TA163104	RH	Front
ALR8577	Door outer skin - from TA163101	LH	Front
ALR8572	Door outer skin - from TA163104	RH	Rear
ALR8573	Door outer skin - from TA163104	LH	Rear
MWC9084	Door outer skin - from MA112622	RH	Rear
MWC9085	Door outer skin - from MA112622	LH	Rear
ALR6682	Wing - from MA	RH	Front
ALR6681	Wing - from MA	LH	Front
ALR9878	Wing - from VA	RH	Front
ALR9877	Wing - from VA	LH	Front
MWC6754	Wing - to LA081991	RH	Front
MWC6755	Wing - to LA081991	LH	Front
MWC4840	Wheel arch panel	RH	5-Door
MWC4841	Wheel arch panel	LH	5-Door
DA4515	Shock absorber bracket	Pair	
DA4516	Tie bar mounting bracket	Single	
DA4519	Rear body mount		
DA4508 NEW	Front axle spring mount - 40mm lift	LH	
DA4509 NEW	Front axle spring mount - 40mm lift	RH	
DA4514	Front axle spring mount - standard	RH	
DA4513	Front axle spring mount - standard	LH	
DA4518	Rear axle spring mount - 40mm lift		
DA4527	Rear axle spring mount - standard		



STC1066



DA4530



MWC4840



DA4519



DA4513 / DA4514

CHASSIS & BODY COMPONENTS - FREELANDER 1

ALR8710	Bulkhead
Front	
ASR2512	Bonnet assembly



CHASSIS & BODY COMPONENTS - RANGE ROVER CLASSIC

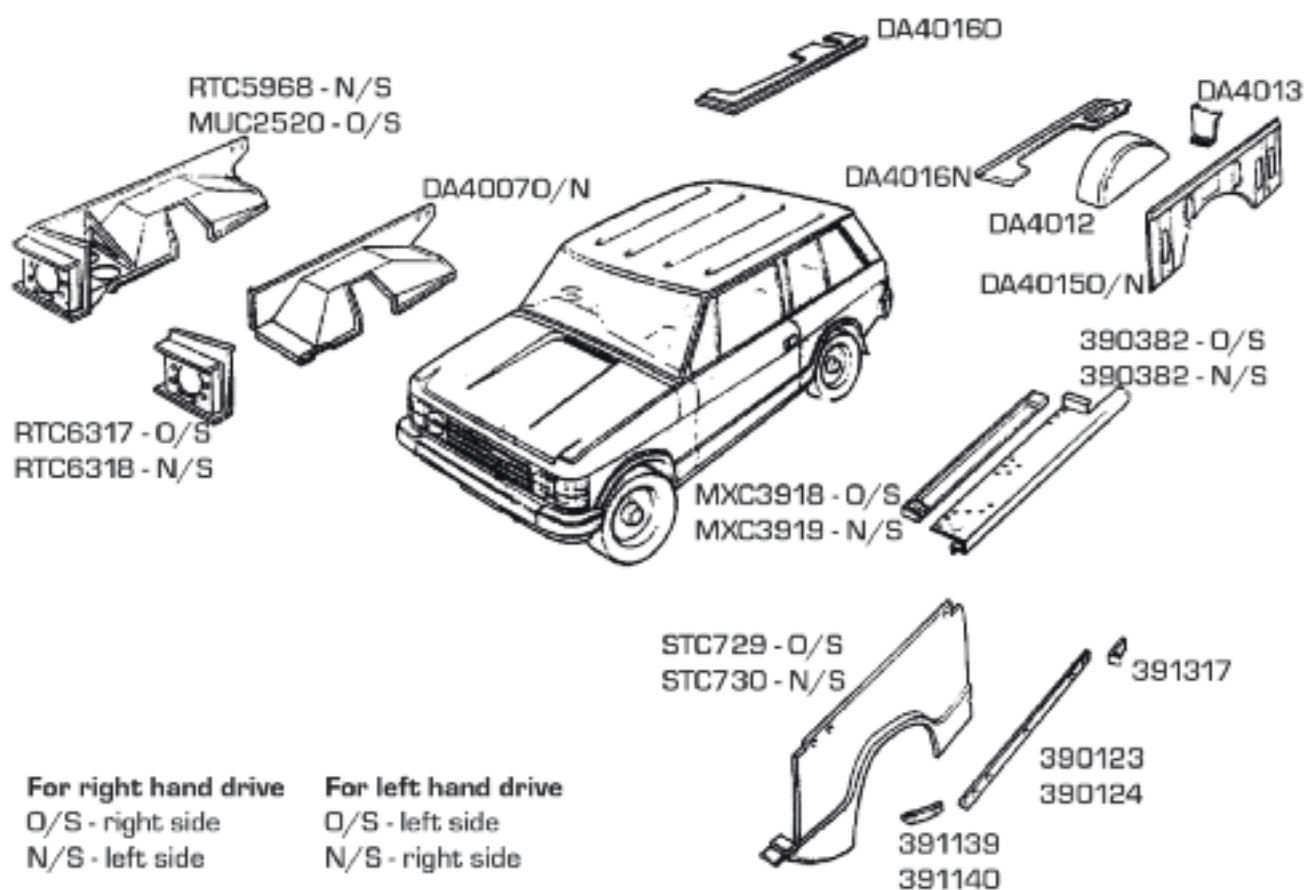

For right hand drive **For left hand drive**
 O/S - right side O/S - left side
 N/S - left side N/S - right side

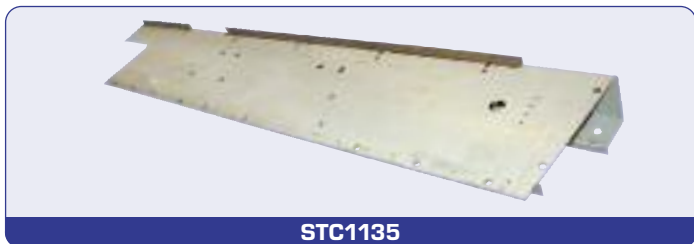

STC1135



DA3017



NRC4717



DA4515



DA4527

STC1135	Outer sills 4-door	N/S
STC1136	Outer sills 4-door	O/S
DA3016	Outer sills 2-door	O/S
DA3017	Outer sills 2-door	N/S
MXC3918	Sill inner 2-door	O/S
MXC3919	Sill inner 2-door	N/S
390381	Complete sill 2-door	
	Outer, no mounts	O/S
390382	Complete sill 2-door	
	Outer, no mounts	N/S
DA4120N	Half sill (repair) 4-door outer	N/S
DA4120O	Half sill (repair) 4-door outer	O/S
DA4007N	Inner wing	N/S
DA4007O	Inner wing	O/S
RTC6317	Headlamp box	O/S
RTC6318	Headlamp box	N/S
DA4013N	Rear arch extension	N/S rear
DA4013O	Rear arch extension	O/S rear
NRC4717	Tailgate crossmember	Rear
ALR5595	Door assembly - front	LH
ALR5596	Door assembly - front	RH
MXC1408	Wing - RH	O/S front
MXC1409	Wing - LH	N/S front
MXC2063	Door outer skin - 4-door - LH	Front
MXC2064	Door outer skin - 4-door - RH	Front
RTC6203	Light panel - RH	Rear
RTC6204	Light panel - LH	Rear
STC1653	Bonnet assembly - from MA647605	
STC729	Wing - RH	Front
STC730	Wing - LH	Front
DA4515	Shock absorber bracket - pair	
DA4516	Tie bar mounting bracket - single	
DA4513 NEW	Front axle spring mount - standard	LH
DA4514 NEW	Front axle spring mount - standard	RH
DA4508 NEW	Front axle spring mount - 40mm lift	LH
DA4509 NEW	Front axle spring mount - 40mm lift	RH
DA4518	Rear axle spring mount - 40mm lift	
DA4527	Rear axle spring mount - standard	

CHASSIS & BODY COMPONENTS - SERIES

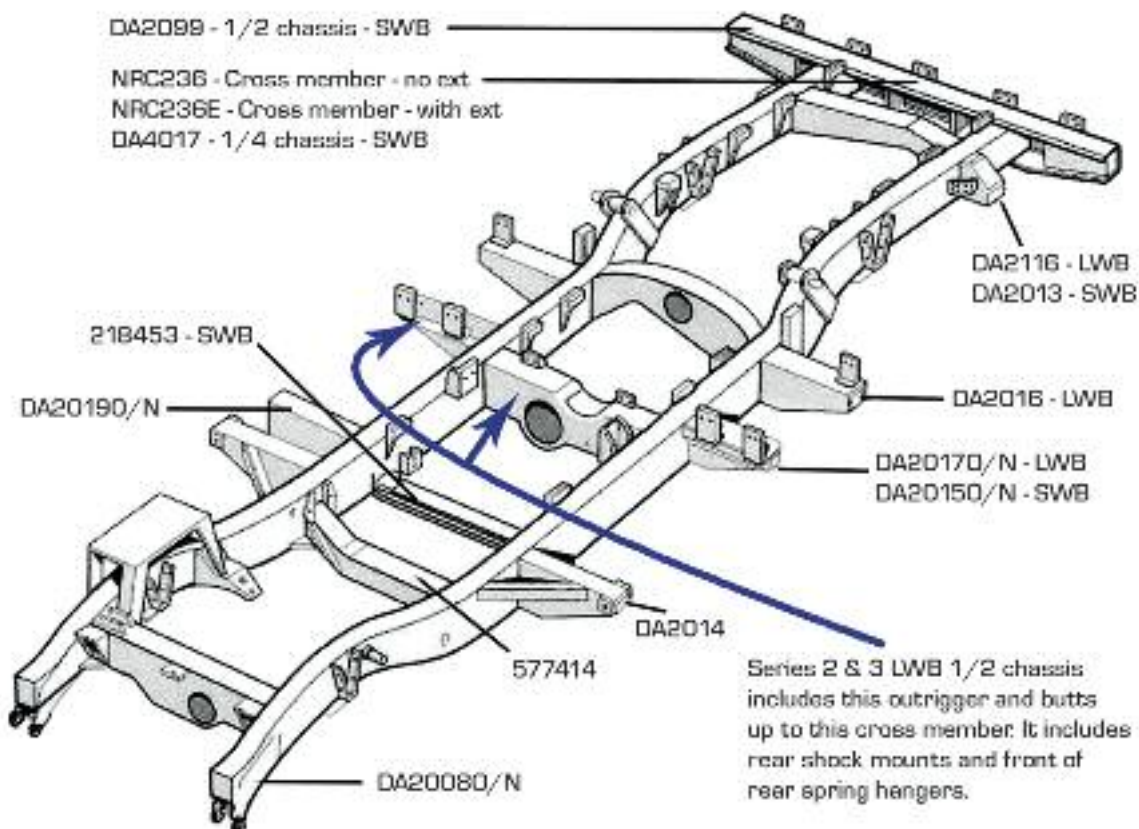

For right hand drive
O/S - right side
N/S - left side

For left hand drive
O/S - left side
N/S - right side

Series 2 & 3 LWB 1/2 chassis includes this outrigger and butts up to this cross member. It includes rear shock mounts and front of rear spring hangers.



DA20260



DA4017



DA20260



DA2156

Short Wheelbase

NRC4642G	Chassis frame	Galvanised
DA2013	Spring hanger	
DA2019N	Front tank outrigger	N/S
DA20190	Front tank outrigger	O/S
DA2015N	Rear tank outrigger	N/S
DA20150	Rear tank outrigger	O/S
DA2099	1/2 Chassis	
DA4017	Rear crossmember /1/4 chassis With extensions and hangers	
218453	Gearbox crossmember - weld on	

Long Wheelbase

DA2016	Spring hanger	Front
DA2017N	Rear tank outrigger	N/S
DA20170	Rear tank outrigger	O/S
DA2116	Spring hanger	Rear

Both Wheelbases

DA2008N	Chassis leg	N/S	Front
DA20080	Chassis leg	O/S	Front
DA2014	Bulkhead outrigger		
NRC236	Rear crossmember	No extensions	
NRC236E	Rear crossmember	With extensions, no hangers	
559822	Rear crossmember	Military	
DA2009	Extension piece (2 x 'U' shape sections) For rear crossmember		

DA4018N	Footwell	N/S	LHD
DA40180	Footwell	O/S	LHD
DA2001N	Footwell	N/S	RHD
DA20010	Footwell	O/S	RHD
DA2026N	Door pillar repair	N/S	Bulkhead/bracket
DA20260	Door pillar repair	O/S	Bulkhead/bracket
DA4054	Bracket for DA2026	O/S, N/S	Pair
MTC2248	Floor panel		Front LH
DA2156	Glazing kit	Door top	Series 3
DA2024	Door skin safari - rear		
RTC6247	Safari rear door - unglazed with spare wheel		
RTC6248	Safari rear door - glazed without spare wheel		
RTC6248NG	Safari rear door - unglazed without spare wheel		
395529	Door bottom		RH
395530	Door bottom		LH
DA2023N	Door skin		N/S
DA20230	Door skin		O/S
DA2169	Door top seal and caulk		
DA4086	Door bottom repair		
MTC5382	Door top unglazed		RH
MTC5383	Door top unglazed		LH
MTC5382G	Door top glazed		RH
MTC5383G	Door top glazed		LH
DA4032	Window kit - standard		Clear
DA4032GREEN	Window kit - standard		Green tinted
DA4032GREY	Window kit - standard		Grey tinted
DA4032BRONZE	Window kit - standard		Bronze tinted
DA4033	Window kit - deluxe		Clear
DA4033GREEN	Window kit - deluxe		Green tinted
DA4033BRONZE	Window kit - deluxe		Bronze tinted

CLUTCH KITS

Changing your clutch?

Then demand your dealer uses a clutch kit from Britpart!

Heavy-Duty Britpart Clutch Kits



DA5551

EXTREME USE CLUTCH KIT

DA5551 200 & 300Tdi
Clutch kit - plate, cover & bearing

DA5550	Td5	Clutch kit - plate, cover & bearing
DA2357HD	Td5	Clutch kit - plate, cover, heavy-duty flywheel & bearing
DA2357	Td5	Clutch kit - plate, cover, flywheel & bearing
STC8358	Defender - diesel (non Td5)/ Discovery 1 - diesel/ Range Rover Classic (non VM)	Clutch kit - plate, cover & bearing
FTC2957HD	Most applications	Clutch fork - heavy-duty
STC8363	Series 3	Clutch kit - plate, cover & bearing
DA2369	Series 2A	Clutch kit (9") - plate & cover
DA2370	Series 2A	Clutch kit (9 1/2") - plate & cover
URB500060	Freelander 1.8	Clutch kit - plate, cover & bearing



> Extensive testing determined the ultimate specification - see a video of the Britpart V8 in action at www.britpart.com/v8



Team Britpart recommend Britpart clutches -

- > Premier friction material gives longer life
- > Self centering bearing provides smooth operation
- > Intense quality control ensure fit first time

HEAVY-DUTY



DA2357HD
Heavy-duty one-piece dual mass replacement flywheel designed to outlast the original. Kit also includes modified release bearing.



FTC2957HD

CV JOINT KITS - BRITPART

Britpart has put together these boxed kits to help the fitter have all the necessary parts to do the job in one hit, saving time and money trying to find the necessary parts to do the job.

These kits are also helpful to pass over the trade counter instead of having to hunt for the individual parts.

One kit does one CV joint.

Save time and money with a Britpart CV Joint kit

DA6050

Range Rover to 1985

DA6051

Range Rover 1986 to 1988 non ABS axle suffix A to VIN EA305589

DA6052

Range Rover 1989 to 1991 non ABS axle suffix B from VIN EA305590 to HA610293

Range Rover 1992 on non ABS to VIN JA624755

DA6053

Range Rover 1986 to 1991 with ABS to VIN HA610293

DA6054 **Note** - 10 spline on half shaft to diff end

Range Rover 1992 on non ABS from VIN KA624756 to P38A

Range Rover 1992 on with ABS to P38A

DA6055 **Note** - 24 spline on half shaft to diff end

Range Rover 1992 on non ABS from VIN KA624756 to P38A

Range Rover 1992 on with ABS to P38A

DA6056

Range Rover P38A 1995 to 2002



DA6061

DA6057

Defender non ABS with 23 internal splines

DA6058

Defender 1986 on non ABS with 32 internal splines

DA6059

Defender non ABS and ABS models from VIN LA930456

DA6060

Discovery 1 non ABS to VIN JA32850

DA6061

Discovery 1 non ABS from VIN JA032851 10 splines axle shaft to diff end

DA6062

Discovery 1 no ABS from VIN JA032851 24 splines axle shaft to diff end

Discovery 1 ABS models from VIN JA032851

DA6063

Discovery 2

DA6064

Freelander To VIN YA999999 TCIE diesel and 1.8 petrol

CYLINDER LINER KIT



LCJ000050LKIT

Liner and piston for 1.8 litre K series engines.

DAMPER KIT

DA2352

Freelander pre-2006 4-cylinder
Why pay for a new and expensive viscous coupling on your Freelander when all you need to replace, to remedy the fault, is the damper?



DIFF COUPLING SHAFT

We are now able to offer a cheaper alternative!



DA2355

The Range Rover L322 - 2002 onwards, suffer from a common problem with the coupling shaft spline wearing between the front propshaft and front differential, thus losing drive to the differential. The problem purely relates to the coupling shaft and the differential itself is not affected. Currently the only solution offered by Land Rover is to replace the propshaft and the whole complete front differential assembly - a very expensive option! Using this new coupling shaft will enable you to replace just the propshaft and coupling shaft and leave the differential in place, therefore reducing both time (the differential need not be removed from the vehicle) and cost.

DIFF REPAIR PANS



DA1043

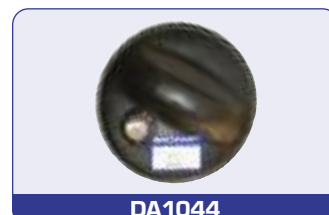

DA1044



DA1045

DA1043

Front - includes filler plug

DA1044

Rear - includes filler plug

DA1045

Front & rear - excludes filler plug

DOOR HINGE KIT



DA1069
Front door hinge kit for Series 3 and 90 & 110 Defender

DOOR HINGES - ALUMINIUM



DA1131
Series 3 & Defender
Replacement aluminium door hinges with stainless steel hinge pins
> 4 hinges per set
> Natural finish
> Complete with fixings

ELECTRONIC CONVERSION KITS



ERC4536K

ERC4536K
This electronic conversion kit is for V8 points and has built in dwell adjustment with rpm protection when not running.



ETC5835K

ETC5835K
The Britpart electronic conversion kit replaces the existing points and condenser with a new reliable electronic module. For 4-cylinder petrol engines the Britpart electronic ignition module has been developed to work with the standard ignition coil and provides service free and accurate ignition timing. The kit can be easily fitted to standard points type 45D4 distributors without having to fit a new electronic ignition coil.

We'd recommend fitting a new coil at the same time - PRC9858. Also available a new distributor with points to which this kit can be fitted - ETC5835.

Dodgy points and condenser?

GASKET KITS



DA2112B

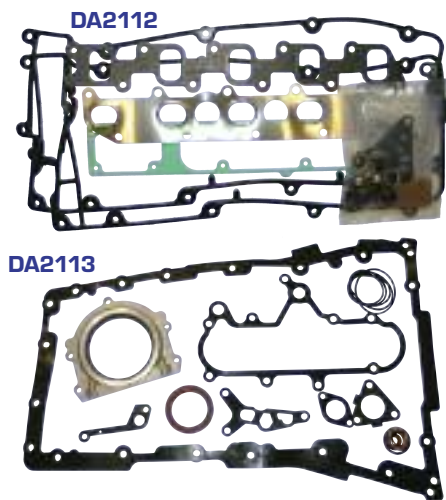

DA2112

DA2113

Td5

DA2112	Head set	No gasket
DA2112-1	Head set	1-hole gasket
DA2112-2	Head set	2-hole gasket
DA2112-3	Head set	3-hole gasket
DA2112B NEW	Head set & bolts	No gasket
DA2113	Bottom set	

300Tdi

STC2802B NEW	Head set & bolts	No gasket
---------------------	------------------	-----------

Freelander 1.8 16v

DA2114	Head set
DA2115	Bottom set

HAND BARRIER CREAM



DA5650
Britpart Liquid Gloves Hand Barrier Cream. No need to use hot water, soap or chemicals, easily removed with cold water! Biodegradable. Protects hands from grease and grime. Prevents ingrained dirt, cracks and calluses. Moisturises and softens hands. Specially designed for the automotive industry. Viable alternative to latex gloves.
1 litre bottle.

No need to use hot water, soap or chemicals to protect your hands!



HEAD BOLT SETS



DA2005 300Tdi
DA2006 200Tdi

HEATER BLOWER MOTOR KIT & RESISTOR KIT

DA4178

Range Rover Classic 1990 - 1994 & Discovery 200 Tdi with air con
Atlantic British has developed this all inclusive kit designed and engineered to replace failed heater motors. The kit includes heater blower motor, blower wheel, motor mounting bracket and mounting screws, heater assembly seals, nylon ties, solder, shrink tubing (for soldered connections) and complete instructions.

Note - When replacing the heater blower motor the vehicle's resistor must be upgraded to DA4178RESISTOR

DA4178RESISTOR

The air con blower motor resistor controls the speed of the blower motor and the force of the airflow out of the dash vents, it features a thermal-sink aluminium mounting plate that dissipates circuit heat effectively.



DA4178RESISTOR



DA4178

HEATER MATRIXES



DA2155



AAP817



UTP1725



STC250



STC3135



JEF100150

DA2155

Series 3

AAP817

Defender - downward facing pipes

UTP1725

Defender - horizontal inlet/outlet pipes

JEF100220

Defender - LHD from XA159807

STC250

Discovery 1/Range Rover Classic - 1986 -1994

STC3135

Discovery 1/Range Rover Classic - 1992 -1994

JEF100150

Freelander - to YA999999

STC3261

Range Rover P38

HEATER PLUG UPGRAGE KIT



DA1057

Series - 2¹/₄ diesel engine

HYLOMAR SEALANTS & COMPOUNDS

RTC3347 - Hylomar Universal Blue - gasket & jointing compound - 100g tube

- > Non setting universal jointing compound
- > Resistant to fuels, coolants and lubricants
- > Use on gaskets and machined metal surfaces
- > High temperature capability up to 250°C
- > Unlimited assembly time
- > Easy disassembly for service maintenance
- > Allows for differential thermal expansion of components
- > Excellent vibration resistance

- > Remains flexible, will not shrink
- > Bonds to metal, glass, ceramics, plastics, fibres and wood
- > Resists most solvents
- > Good fluid resistance - not petrol or diesel
- > Electrical insulator
- > Maximum constant operating temperature 250°C
- > Neutral curing
- > Tolerant of some oil and grease, ensure surfaces are clean

RTC3254 - Hylomar 101 Silicone Sealant - gasketing, sealing & bonding compound - 85g tube

- > Engineering grade
- > Forms any size or shape of gasket instantly
- > Remains flexible, will not shrink
- > Bonds to metal, glass, ceramics, plastics, fibres and wood
- > Resists most solvents
- > Electrical insulator
- > Maximum constant operating temperature 250°C
- > Neutral curing
- > Ensure surfaces are free from oil and grease

STC4600 - Hylomar 3400 Anaerobic Gasket Compound - 300ml cartridge

- > Excellent resistance to automotive fluids including fuels
- > Operating temperature -40°C to 150°C
- > Machined metal to metal surface only, not suitable for pressed steel
- > No gap filling
- > Latest generation anaerobic gasket compound
- > Single part product
- > Suitable for K-series engines
- > Ensure surfaces are free of oil and grease

STC4404 - Hylomar 607 Silicone Sealant - 300ml cartridge

- > Excellent gap filling properties
- > Engineering grade
- > Forms any size or shape of gasket instantly



RTC3347



RTC3254



STC4404



STC4600



IGNITION LEAD SETS



DA4104



NGC103740/810

DA4102

Range Rover P38 V8 up to 1999
Defender 4.0

DA4104

Discovery
Range Rover Classic V8

Note - Includes king lead STC9124

NGC103740/810

Range Rover P38A
Discovery 2 from 1999

NGC500370/410

Freelander 1.8K

IGNITION MODULE & LINK LEAD NEW

STC1184K

Module for V8 distributor. Kit to convert 3-pin to 2-pin applications.



STC1184K



LAND ROVER GENUINE CONSUMABLES

Antifreeze

PDA500300	Antifreeze	1 litre
PDA500310	Antifreeze	5 litres
STC50529	Antifreeze - extended life	1 litre
STC50530	Antifreeze - extended life	5 litres

Cleaners

STC8972	Brake cleaner	500ml
STC50543	General purpose/brake cleaner	200ml
STC50544	General purpose/brake cleaner	400ml
STC50547	Citrus hand cleaner	400ml
STC50549	Paint and resin hand cleaner	400ml
BAC500490	Leather & vinyl cleaner - contents 1 x 150ml leather protection cream 1 x 150ml leather soft cleaner 1 x sponge and cloth	

Fluids

SIJ500030	Brake fluid	500ml
SIJ500040	Brake fluid - Dot 4	1 litre
STC4862	Texamatic 7045E Dexron III ATF	1 litre
STC4863	Automatic transmission fluid LT71141	1 litre
STC50531	Automatic transmission fluid 402	1 litre
STC4861	Transmission fluid - transfer box	500ml
STC9157	Manual transmission fluid 94	5 litres
STC9158	Manual transmission fluid 94	1 litre
STC50519	Power assisted steering fluid	1 litre

Miscellaneous

STC4676	De-icer	500ml
STC4672	Screen wash	250ml
STC4687	Screen wash	500ml
STC9155	Specialised lubricant	250ml
STC50550	Loctite 5900 gasket adhesive	50ml
STC50551	Flexible adhesive sealant	300ml
CES500020	Glass repair kit	

Oils

VYK000020	Gear oil - MTF94	2.5 litres
TYK500070	Transmission oil - 75W/90	1 litre

Paints

STC2862A	Aerosol	Monza red	150ml
RTC6401VA	Aerosol	Windjammer blue	150ml
Touch up kit - contains paint stick and clear lacquer			
RTC6870VT	Touch-up kit	Alpine white	
STC2864VT	Touch-up kit	Oxford blue	
STC2828VT	Touch-up kit	Rioja red	
STC1774VT	Touch-up kit	Epsom green	
STC4235VT	Touch-up kit	Blenheim silver	
STC4596VT	Touch-up kit	Oslo blue	



LOCTITE CONSUMABLES



DA6300	Super Glue	3g tube	High performance instant adhesive with thousands of applications
DA6301	Super Glue Brushable	5g bottle	Brushable version for extra accuracy and greater coverage
DA6302	Spray Adhesive	500ml aerosol	Rapid bonding spray adhesive for bonding various materials
DA6303	Repair Express Power Putty	Blister pack	Fills, sticks, seals and re-builds thousands of items without tools
DA6304	Rear View Mirror Bonder	1 shot tube	Unique bonding system for rear view mirrors, car telephone aerials and all window mounted material
DA6305	Lock 'N Seal	24ml bottle	Fast acting thread lock and sealant. Replaces traditional locking methods.
DA6306	Stud 'N Bearing Fit	24ml bottle	Locks and seals studs into position. Seals against leaks and vibration.
DA6307	Lock 'N Seal 243	50ml bottle	Fast-acting thread lock and sealant. Prevents bolts, screws & nuts from vibrating loose.
DA6308	Stud 'N Bearing Fit 2701	50ml bottle	Retains bearings into new and used housings
DA6309	Instant Adhesive 401	20g tube	Surface insensitive formulation creates a permanent bond with virtually any material
DA6310	Freeze and Release	400ml aerosol	Shock freezing (-43°C) is a quick and convenient method for releasing seized and corroded parts
DA6311	Quick Gasket	200ml aerosol	Permanently flexible flange sealant for non-rigid flanges and for plastic-to-plastic and metal-to-metal assemblies
DA6312	Chemical Metal	Mini blister pack	The original rock-hard multi-purpose repair paste
DA6313	Leak Fix	Mini blister pack	Seals and repairs leaks in petrol tanks, radiators and sumps
DA6314	Super Steel Epoxy-Weld	2 x 25g tube	Sets like steel. Seals, repairs, bonds, fixes and replaces
DA6316	Terodicht Elastic Window Sealant	310ml cartridge	Ideal for re-sealing rubber mounted windscreens
DA6317	Terolan Special Sealant	1.4kg can & brush	Vehicle body sealant for application with special brush
DA6318	Fast Set Epoxy 3430	24ml syringe	Two part general purpose epoxy adhesive
DA6319	Teroson Etch Primer	500ml aerosol	Provides excellent adhesion to steel, galvanised steel and aluminium
DA6320	Glass Adhesive	3ml tube	Glass to glass or glass to metal. Adhesive is triggered by UV rays in normal daylight. Clear bond line, water and detergent resistant.
DA6326	Zinc Spray - NEW	400ml aerosol	Sprayable anti-corrosion primer paint for vehicle body repairs. Electrically conductive (wet and dry). Allow to cure for 8-12 hours before over painting.
DA6327	Terotex HV 350 - NEW	1 litre bottle	A solvent containing anticorrosive agent based on waxes, polymers and anti-corrosive additives. Contains high percentage of rust-proofing additives. Good creeping qualities. Penetrates to a depth of >35mm. Mild odour.
DA6328	Terotex Record 2000 - NEW	1 litre bottle	Non-bituminous coating material for permanently flexible corrosion protection of under bodies. To complement factory-applied under body sealant coats. For coating replacement parts like bumpers or wheel arches and for anti-drum coating.



The Loctite® brand, is renowned for the excellence of its adhesives and sealants. Since the original development of a unique anaerobic technology more than fifty years ago, Loctite® products have become vital components in many of the machines and products that are at the core of everyday life.



OIL PUMP GEAR SET



DA4189
Oil pump gear set for V8 engines
Discovery 1/Discovery 2
& Range Rover P38

PRESSURE RELIEF VALVE



DA2376
300 Tdi oil pump relief valve kit for
Defender/Discovery 1
& Range Rover Classic

PROPSHAFT BEARINGS

Centre bearing assembly for rear propshafts

DA2395

Discovery 3 - TVB500360

DA2427 NEW

Range Rover Sport - TVB500390

DA2428 NEW

Range Rover L322 - TVB500400



DA2395

Instead of replacing your whole propshaft - just replace the centre bearing!

PROPSHAFT KIT



DA6355

Defender/Discovery 1/Range Rover Classic

- > Double cardan extreme use front propshaft with flange and fitting kit
- > For vehicles with L230 transfer boxes
- > Ideal for use with lifted vehicles
- > Helps to reduce driveline vibration where diff and transfer flanges are not in-line

Note - Flange must be fitted to transfer box

SWIVEL HOUSING GREASE



STC3435



STC3435S

STC3435

370gm bottle

STC3435S

370ml sachet

- > Formulated for all leaf & coil spring Land Rover, Discovery and Range Rover models - 1951 - to date
- > Lubricates swivel pins and housing seals, protects spheres
- > A semi-fluid grease designed to withstand shock loading in oscillating joints
- > Reinforced with solid lubricants, highly resistant to water and salt corrosion
- > Better lubrication while driving, less leaks while standing
- > One shot gives 'filled for life' protection

SWIVEL HOUSING KITS **NEW**



DA3165

DA3163

Discovery 1 to JA32850 / Range Rover Classic to JA624516 - with 12mm seals

- > Swivel housing
- > Gasket
- > Plate
- > Joint washers
- > Swivel housing grease sachet
- > Swivel pin bearing
- > Seals
- > Shims
- > Swivel pin upper

DA3164

Discovery 1 to JA32850 / Range Rover Classic to JA624516 - with 8mm seals

- > Swivel housing
- > Gasket
- > Plate
- > Joint washers
- > Swivel housing grease sachet
- > Swivel pin bearing
- > Oil seals
- > Shims
- > Swivel pin upper

DA3165

Discovery 1 from JA32851 / Range Rover Classic from JA624517 - non-ABS

- > Swivel housing
- > Gasket
- > Plate
- > Joint washers
- > Swivel housing grease sachet
- > Swivel pin bearing
- > Seals
- > Shims
- > Swivel pin upper - non-ABS

DA3166

Discovery 1 / Range Rover Classic - with ABS

- > Swivel housing
- > Gasket
- > Plate
- > Joint washers
- > Swivel housing grease sachet
- > Swivel pin bearing
- > Seals
- > Shims
- > Swivel pin kit - upper - ABS

DA3167

Defender to KA930455

- > Swivel housing
- > Thrust washer
- > Joint washers
- > Shims
- > Swivel housing grease sachet
- > Housing and bush
- > Swivel pin bearing
- > Seals
- > Swivel pin upper

DA3178

Defender from LA to WA

- > Swivel housing
- > Gasket
- > Plate
- > Joint washers
- > Swivel housing grease sachet
- > Swivel pin bearing
- > Seals
- > Shims
- > Swivel pin upper - non-ABS

DA3179

Defender from XA non-ABS

- > Swivel housing
- > Gasket
- > Plate
- > Swivel pin kit
- > Swivel pin bearing
- > Seals
- > Joint washers
- > Swivel housing grease sachet

DA3180

Defender from XA with ABS

- > Swivel housing
- > Gasket
- > Plate
- > Swivel pin kit
- > Swivel pin bearing
- > Seals
- > Joint washers
- > Swivel housing grease sachet

DA3169

Series 2

- > Swivel housing
- > Railko bush
- > Swivel pin bearing
- > Lock washer
- > Shims
- > Retainer for oil seal
- > Swivel housing grease sachet
- > Swivel pin
- > Thrust washer
- > O-ring
- > Locker
- > Oil seal
- > Joint washers

DA3181

Series 2a & 3

- > Swivel housing
- > Railko bush
- > Swivel pin bearing
- > Lock washer
- > Shims
- > Retainer for oil seal
- > Swivel housing grease sachet
- > Swivel pin
- > Thrust washer
- > O-ring
- > Locker
- > Oil seal
- > Joint washers

Note - each kit is for one side only.

For full details of each kit list - www.britpart.com/swivelkits

Corroded, worn or leaking swivel housings?



DA3167

These ten swivel housing kits from Britpart are a convenient way to ensure you have all the quality parts needed to replace a Land Rover's swivel housing.

SWIVEL PIN KITS



DA2178



DA2211

- 532268 Series 2 conversion
- DA2178 Series
- DA2211 Defender - up to KA930455

TIMING KITS



DA1300

- DA1200 200Tdi
 - DA1300 300Tdi
- Contents -
- > Timing belt tensioner
 - > Timing belt - OEM
 - > Gaskets
 - > Seals



Picture courtesy of David Orritt

TOOLS

Prop shaft fastener tools

Specialist socket for prop shaft fasteners on most Land Rovers. The 9/16" socket end is a perfect hexagon with rounded tip profiles to ensure the whole turning power is transferred onto the flanks of the nuts instead of on the corners. The socket's slim wall construction and wine glass profile, coupled to an integral slimline extension means it fits perfectly between the UJ yokes and over the prop shaft nuts without fouling. The 9/16" AF nuts are common to Series Land Rovers, Defenders (90 & 110 up to latest vehicles), Discoverys (up to and including Discovery 2 model) and Range Rovers (up to and including P38 model).

- > Size: 9/16" 6 point (hexagon)
- > Total length: 150mm
- > Outside diameter: 20mm

- DA1065**
Specialist socket for propshaft
Drive - 3/8" square drive
- DA1119**
Specialist socket for propshaft
Drive - 1/2" square drive



- 606435 NEW**
Hub nut spanner
- DA1111 NEW**
Viscous fan coupling spanner
Two sizes - 32 & 36mm
- DA1118 NEW**
1/2" drive 52mm deep socket
- DA1120 NEW**
Flywheel locking tools & camshaft timing pins
Discovery 3 - 2.7TdV6/
Range Rover Sport - 2.7TdV6
- DA1121 NEW**
Timing tool kit for LR KV6 engines
The Land Rover KV6 quad cam engine has one front and two rear camshafts and these tools cover the replacement of all three belts
- DA3140**
Timing kit - 2.5D/Tdi - 12 piece
- LRT-12-093**
Viscous coupling holding tool
V8 petrol/Td5 diesel/2.5L Td diesel/
300 Tdi Diesel
- LRT-12-094**
Viscous fan coupling wrench
V8 petrol/Td5 diesel/V6 2.7L diesel/
2.5L Td diesel/Td6 diesel/300Tdi diesel
- LRT-12-058**
Timing pins - Td5
- LRT-60-004**
Bush fitting tool for front radius arm bushes (part number ANR3332) for the Range Rover P38A - impossible to do without using this Land Rover special tool.



Make the job easier with the right tool.

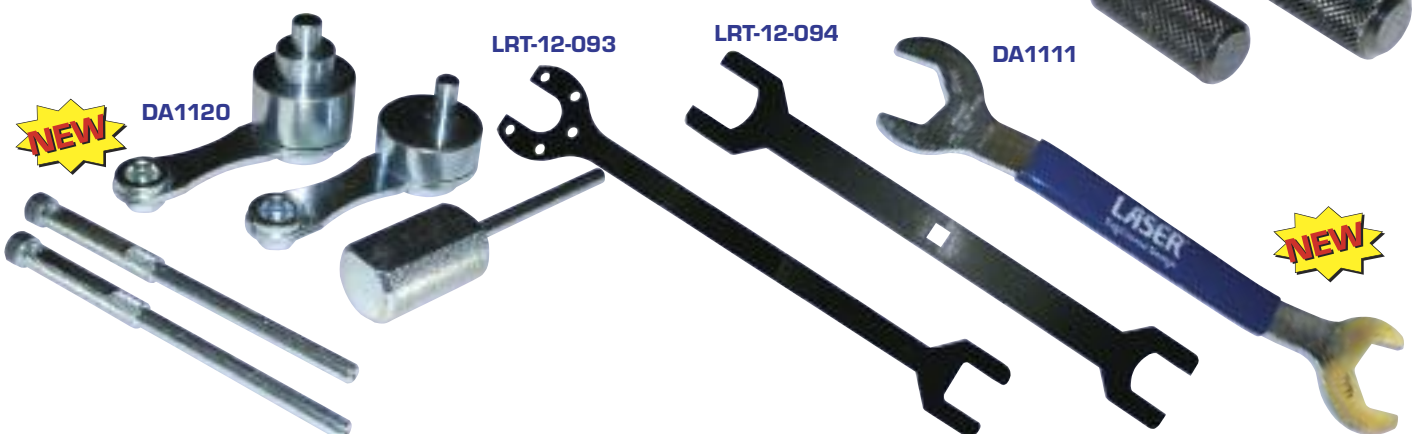

TOUCH UP PAINT PENS

Exclusive to Britpart in the UK!!

These superior touch up pens are made in the US and are as easy to use as a fine felt tip marker. They use a quality urethane paint for a superior colour match.

The best you can get without repainting!

The AutoSharp Pen has many unique features not otherwise available:

The Pen - Paint is held in a barrel and automatically dispensed through a fine felt tip, providing the user unparalleled control over their painting instrument.

The Paint - High quality urethane paint is used which is the same as your vehicles manufacturer. This paint provides the user with a much closer colour match than other companies which primarily use lacquer (old technology) paints.

The Results - The best you can get without refinishing the damaged areas.

More details and FAQs can be found at www.britpart.com/paintpens

Note - If your colour is not listed then please contact us.



DA6200	Beluga Black	DA6223	Atacama Sand
DA6201	Portofino Red	DA6224	Vesuvius Orange
DA6202	Alpine White	DA6225	Zermatt Silver
DA6203	British Racing Green	DA6226	Arctic Frost
DA6204	Epsom Green	DA6227	Rimmi Red
DA6205	Oxford Blue	DA6228	Narvik Black
DA6206	Rioja Red	DA6229	Caledonia Blue
DA6207	Rutland Red	DA6230	Belize Green
DA6208	White Gold	DA6231	Kinver Sand
DA6209	Woodcote Green	DA6232	Icelandic Blue Mica
DA6210	Chawton White	DA6233	Atlantis Blue
DA6211	Java Black	DA6234	Silver Sparkle - <i>Ideal for touching up alloy wheels</i>
DA6212	Alveston Red	DA6235	Stornoway Grey
DA6213	Oslo Blue	DA6236	Biarritz Blue
DA6214	Bonatti Grey	DA6237	Alaska White
DA6215	Vienna Green	DA6238	Tangiers Orange
DA6216	Zambezi Silver	DA6239 NEW	Kent Green
DA6217	Adriatic Blue	DA6240 NEW	Niagra Grey
DA6218	Giverny Green	DA6241 NEW	Lucerne Green
DA6219	Maya Gold	DA6242 NEW	Ipanema Sand
DA6220	Buckingham Blue	DA6243 NEW	Borrego Yellow
DA6221	Cairns Blue		
DA6222	Tonga Green		

WHEEL BEARING KITS

DA2379	Defender - up to KA	Front
DA2380	Defender - up to KA	Rear
DA2381	Defender - from LA	Front & rear
DA2382	Discovery 1 - up to JA032850	Front & rear
DA2383	Discovery 1 - from JA032851	Front & rear
DA2384	Range Rover Classic - non-ABS from JA624517	Rear
DA2385	Range Rover Classic - non-ABS to JA624516	Rear
DA2386	Range Rover Classic - ABS	Rear
DA2387	Range Rover Classic - ABS	Front
DA2388	Range Rover Classic - non-ABS	Front
RTC3534	Series 2 & 3 - short wheel base	Front & rear
RTC3537	Series 2 & 3 - long wheel base	Front & rear
FTC1507	Range Rover P38 Note - bearing only	Front & rear



RTC3534

WHEEL HUB & BEARING ASSEMBLY

LR014147

Wheel hub & bearing assembly kit

- > Discovery 3
- > Range Rover Sport



LR014147



WINDOW KITS



Standard - Defender & Series

DA4032	Clear
DA4032GREEN	Green tinted
DA4032GREY	Grey tinted
DA4032BRONZE	Bronze tinted

Standard kits have metal catch.

Deluxe - Defender & Series

DA4033	Clear
DA4033GREEN	Green tinted
DA4033BRONZE	Bronze tinted

Deluxe kits have rubber mounting strips to cover rivets and plastic catch.

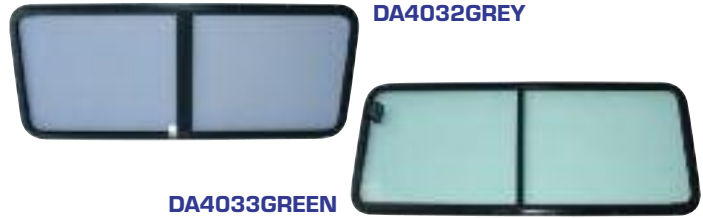

WING PROTECTORS

DA5631
Protect your Defender's wings with a pair of these sturdy easy to fit wing protectors.



Picture courtesy of John Redden

16

service kits & filters

SERVICE KITS & FILTERS

Don't forget that filter again with a Britpart service kit - all you'll need to complete the job.

Section contents -

Britpart bulk filters	144
Defender	142
Discovery	142
Freelander	142
Range Rover	143
Series	144



BRITPART SERVICE KITS



DEFENDER



DISCOVERY



FREELANDER

DA6000
Defender 2 1/2 petrol 7:1 compression ratio

1	ERR3340	Oil filter
1	NRC9238	Air filter
1	JS660L	Fuel filter
1	243959	Sump plug washer
or 1	FRC4808	Sump plug washer
4	RTC3571	Spark plugs 7:1 compression ratio

DA6001
Defender Turbo D

1	ERR3340	Oil filter
1	NRC9238	Air filter
1	RTC6079	Fuel filter
1	FRC4808	Sump plug washer

DA6002
Defender 200Tdi

1	ERR3340	Oil filter
1	NTC6660	Air filter
1	AEU2147L	Fuel filter
1	213961L	Sump plug washer
or 1	ETC7398	Sump plug washer

DA6003
Defender 300Tdi

1	ERR3340	Oil filter
1	ESR2623	Air filter
1	AEU2147L	Fuel filter
1	UAM2857L	Sump plug washer
or 1	ALU1403L	Sump plug washer

DA6004
Defender Td5

1	LPX100590	Oil filter
1	ESR4238	Air filter
1	ERR6299	Rotor filter
1	ESR4686	Fuel filter
1	CDU1001L	Sump plug washer

DA6040
Defender 2007 Duratorq Tdci

1	LRO04459	Oil filter
1	WJ1500040	Fuel filter
1	PHE500060	Air filter
1	1013938	Oil drain plug inc rubber seal

DA6005
Discovery 1 200Tdi to VIN JAO18272

1	ERR3340	Oil filter
1	NTC1435	Air filter
1	AEU2147L	Fuel filter
1	213961L	Sump plug washer

DA6006
Discovery 1 200Tdi from VIN JAO18273

1	ERR3340	Oil filter
1	ESR1049	Air filter
1	AEU2147L	Fuel filter
1	213961L	Sump plug washer

DA6007
Discovery 1 300Tdi

1	ERR3340	Oil filter
1	ESR1445	Air filter
1	AEU2147L	Fuel filter
1	UAM2857L	Sump plug washer
or 1	ALU1403L	Sump plug washer

DA6008
Discovery 1 3.5 Efi

1	ERR3340	Oil filter
1	RTC4683	Air filter
8	ERR3799	Spark plugs
1	ESR4065	Fuel filter in line
1	213961L	Sump plug washer

DA6009
Discovery 1 3.9 Efi

1	ERR3340	Oil filter
1	ESR1445	Air filter
1	ESR4065	Fuel filter
1	ETC7398	Sump plug washer

DA6004
Discovery 2 Td5

1	LPX100590	Oil filter
1	ESR4238	Air filter
1	ERR6299	Rotor filter
1	ESR4686	Fuel filter
1	CDU1001L	Sump plug washer

DA6010
Discovery 2 V8 4.0

1	ERR3340	Oil filter
1	ESR4238	Air filter
8	NLP100320	Spark plugs
1	ALU1403L	Sump plug washer

DA6035
Discovery 3 2.7 diesel to 6A999999

1	1311289	Oil filter
1	PHE000112	Air filter
1	LR010075	Fuel filter
1	JKR500010	Cabin filter
1	JKR500020	Cabin filter
1	1013938	Oil drain plug inc rubber seal

DA6041
Discovery 3 2.7 diesel from vin 7A

1	1311289	Oil filter
1	PHE000112	Air filter
1	JKR500010	Cabin filter
1	JKR500020	Cabin filter
1	LR009705	Fuel filter
1	1013938	Oil drain plug inc rubber seal

DA6037
Discovery 3 4.4 petrol

1	LRO07160	Oil filter
1	PHE000112	Air filter
8	LR005253	Spark plugs
1	JKR500010	Cabin filter
1	JKR500020	Cabin filter
1	1013938	Oil drain plug inc rubber seal

DA6011
Freelander 1.8 petrol to VIN YA999999

1	CDU1268	Oil filter
1	ESR4103	Air filter
1	JKR100200	Pollen filter
1	ALU1403L	Sump plug washer
4	NLP100290L	Spark plugs

DA6012
Freelander 1.8 petrol from VIN 1A000001

1	CDU1268	Oil filter
1	ESR4103	Air filter
1	JKR100280	Pollen filter
1	ALU1403L	Sump plug washer

DA6013
Freelander 2.0 diesel TCIE

1	ERR5542	Oil filter
1	ESR4103	Air filter
1	WJN10046	Fuel filter
1	JKR100200	Pollen filter
1	ALU1403L	Sump plug washer

DA6014
Freelander Td4 to VIN 2A209830

1	LRF100150L	Oil filter
1	PHE100500L	Air filter
1	JKR100280	Pollen filter
1	ALU1403L	Sump plug washer
1	MUN000010	Fuel filter

DA6015
Freelander Td4 from VIN 2A209831

1	LRF100150L	Oil filter
1	PHE100500L	Air filter
1	JKR100280	Pollen filter
1	ALU1403L	Sump plug washer
1	WJN000080	Fuel filter

DA6038
Freelander 2 - 2.2 diesel

1	LR001247	Oil filter
1	LR005816	Air filter
1	LR001313	Fuel filter
1	LR000899	Cabin filter
1	LR000901	Cabin filter
1	LR006295	Drain plug gasket

DA6039
Freelander 2 - 3.2 petrol

1	LRO01419	Oil filter
1	LR005816	Air filter
6	LR005483	Spark plugs
1	LR000899	Cabin filter
1	LR000901	Cabin filter
1	LR000506	Drain plug gasket

Servicing a Land Rover just got a whole lot easier with Britpart!

Ever started servicing a Land Rover and then suddenly realised you haven't ordered a filter or forgot the sump plug washers?

Well now thanks to Britpart with one simple part number you can order your Land Rover kit safe in the knowledge that all the parts you need will be there for you to complete the job. No more half finished services!

The Britpart service kits contain quality products which are -

- > Manufactured to O.E. specification
- > Competitively priced
- > Available from stock



DA6004

BRITPART SERVICE KITS - continued



RANGE ROVER

DA6016

Range Rover 3.5 1970 - 1975

1	RTC3186	Oil filter
2	605191	Air filters
1	JS660L	Fuel filter
8	RTC3573	Spark plugs
1	213961L	Sump plug washer
2	603330	Flame traps
1	RTC6623	Points (fixed)
1	RTC3472	Condenser

DA6017

Range Rover 3.5 1975 - 1982

1	ERR3340	Oil filter
2	605191	Air filters
1	JS660L	Fuel filter
8	RTC3573	Spark plugs
1	213961L	Sump plug washer
2	603330	Flame traps
1	RTC6623	Points (fixed)
1	RTC3472	Condenser

DA6018

Range Rover 3.5 1982 - 1983

1	ERR3340	Oil filter
2	605191	Air filters
1	JS660L	Fuel filter
8	RTC3570	Spark plugs
1	213961L	Sump plug washer
2	603330	Flame traps
1	RTC6626	Points (sliding)
1	RTC3472	Condenser

DA6019

Range Rover 3.5 1984 - 1986

1	ERR3340	Oil filter
2	605191	Air filters
1	JS660L	Fuel filter
8	RTC3570	Spark plugs
1	213961L	Sump plug washer
2	603330	Flame traps

DA6020

Range Rover 3.5 carb 1986 - 1991

1	ERR3340	Oil filter
2	605191	Air filters
1	JS660L	Fuel filter
8	RTC3812	Spark plugs
1	213961L	Sump plug washer
2	603330	Flame traps

DA6021

Range Rover 3.5 & 3.9 Efi 1986 - 1991 to GA464553

1	ERR3340	Oil filter
1	RTC4683	Air filter
1	NTC5958	Fuel filter
1	213961L	Sump plug washer

DA6022

Range Rover 3.9 Efi 1986 - 1994 from HA464554 to LA647644

1	ERR3340	Oil filter
1	RTC4683	Air filter
1	ESR4065	Fuel filter
1	213961L	Sump plug washer

DA6023

Range Rover 3.9 Efi 1992 - 1994 from MA647645

1	ERR3340	Oil filter
1	ESR1445	Air filter
1	ESR4065	Fuel filter
8	ETC7244	Spark plugs
1	213961L	Sump plug washer



"..all the parts you need will be there for you to complete the job."

DA6026

DA6024

Range Rover 4.2 1992 - 1994

1	ERR3340	Oil filter
1	ESR1445	Air filter
1	ESR4065	Fuel filter
8	ERR3799	Spark plugs
1	213961L	Sump plug washer

DA6006

Range Rover Classic - 200Tdi

1	ERR3340	Oil filter
1	ESR1049	Air filter
1	AEU2147L	Fuel filter
1	213961L	Sump plug washer

DA6007

Range Rover Classic - 300Tdi

1	ERR3340	Oil filter
1	ESR1445	Air filter
1	AEU2147L	Fuel filter
1	UAM2857L	Sump plug washer
or 1	ALU1403L	Sump plug washer

DA6025

Range Rover P38 4.0 & 4.6 to TA346793 & from WA376580 to WA385948

1	ERR3340	Oil filter
1	ESR341	Air filter
1	ESR4065	Fuel filter
8	ERR3799	Spark plugs
2	BTR8037	Pollen filters
1	UAM2857L	Sump plug washer
or 1	ALU1403L	Sump plug washer

DA6026

Range Rover P38 4.0 & 4.6 from VA346794 to VA376579 & from WA385949 onwards

1	ERR3340	Oil filter
1	ESR4238	Air filter
1	ESR4065	Fuel filter
8	ERR3799	Spark plugs
2	BTR8037	Pollen filters
1	UAM2857L	Sump plug washer
or 1	ALU1403L	Sump plug washer

DA6027

Range Rover P38 2.5 DT to engine no. 33978348 to (Dec 1995) type A oil filter

1	STC2180	Oil filter type A
1	ESR341	Air filter
1	STC2827	Fuel filter
2	BTR8037	Pollen filters
1	VYX000040	Sump plug washer

DA6028

Range Rover P38 2.5 DT from engine no. 33988348 from (Dec 1995) to VIN TA346793 type B oil filter

1	STC3350	Oil filter type B
1	ESR341	Air filter
1	STC2827	Fuel filter
2	BTR8037	Pollen filters
1	VYX000040	Sump plug washer

DA6029

Range Rover P38 2.5 DT from engine no. 33988348 from (Dec 1995) from VIN TA346794 type B oil filter

1	STC3350	Oil filter type B
1	ESR4238	Air filter
1	STC2827	Fuel filter
2	BTR8037	Pollen filters
1	VYX000040	Sump plug washer

DA6030

Range Rover L322 3.0 diesel

1	LPZ000020	Oil filter
1	PHE000040	Air filter
1	WFLO00070	Fuel filter
1	JM0000010	Pollen filter
1	VYX000040	Sump plug washer

DA6031

Range Rover L322 4.4 V8 M62

1	LPW000010	Oil filter
1	PHE000050	Air filter
1	JM0000010	Pollen filter
1	VYX000040	Sump plug washer
8	NLP000030	Spark plugs

DA6035

Range Rover Sport 2.7 diesel

1	1311289	Oil filter
1	PHE000112	Air filter
1	LRO10075	Fuel filter
1	JKR500010	Cabin filter
1	JKR500020	Cabin filter
1	1013938	Oil drain plug inc rubber seal

DA6036

Range Rover Sport 3.6 diesel

1	LRO02338	Oil filter
1	PHE000112	Air filter
1	LRO09705	Fuel filter
1	JKR500010	Cabin filter
1	JKR500020	Cabin filter
1	1013938	Oil drain plug inc rubber seal

DA6037

Range Rover Sport 4.2 & 4.4 petrol

1	LRO07160	Oil filter
1	PHE000112	Air filter
8	LRO05253	Spark plugs
1	JKR500010	Cabin filter
1	JKR500020	Cabin filter
1	1013938	Oil drain plug inc rubber seal

BRITPART SERVICE KITS - continued



SERIES

DA6033

2 1/4 petrol from 1964

- Lucas ignition (sliding points)

- 1 RTC3184 Oil filter
- 1 606168 Fuel filter (in line)
- 4 RTC3570 Spark plugs
- 1 RTC364 Points (sliding)
- or 1 RTC3288 Points (sliding)
- 1 RTC6621 Condenser
- 1 243959 Sump plug washer

DA6034

2 1/4 petrol from 1964

- (Ducellier ignition)

- 1 RTC3184 Oil filter
- 1 606168 Fuel filter (in line)
- 4 RTC3570 Spark plugs
- 1 RTC6625 Points
- 1 RTC6620 Condenser
- 1 243959 Sump plug washer

DA6032

2 1/4 petrol from 1964

- Lucas ignition (fixed points)

- 1 RTC3184 Oil filter
- 1 606168 Fuel filter (in line)
- 4 RTC3570 Spark plugs
- 1 RTC3270 Points (fixed)
- 1 RTC3472 Condenser
- 1 243959 Sump plug washer

*Get the best in service
from **Britpart's** range
of service kits!*

BRITPART BULK FILTERS

ESR1445X	Air	Discovery 1/Range Rover Classic
ESR2623X	Air	Defender 1987-2006
ESR4238X	Air	Defender 1987-2006/Discovery 2 1998-2004/Freelander/Range Rover P38
AEU2147LX	Fuel	Defender/Discovery 1/Range Rover Classic 1986-1994
ESR4686X	Fuel	Defender/Discovery 2
ERR3340X	Oil	Defender/Discovery 1/Discovery 2/Range Rover Classic/Range Rover P38
LPX100590X	Oil	Defender/Discovery 2
RTC3184X	Oil	Series 2/Series 3
BTR8037X	Pollen	Range Rover P38
JMO000010X	Pollen	Range Rover L322
JKR500010X	Pollen - air intake	Discovery 3/Range Rover Sport
JKR500020X	Pollen - odour & particles	Discovery 3/Range Rover Sport
JKR100200X	Pollen	Freelander - pre 1A
JKR100280X	Pollen	Freelander - 1A onwards
ERR6299X	Rotor	Defender/Discovery 2

**Minimum order
quantity - 50**

**Going to be doing any wading?
Prepare your vehicle with a raised
air intake - see the off-road
equipment section.**



17

vehicle enhancements
VEHICLE ENHANCEMENTS

Give your Land Rover that extra special look with some accessories from Britpart.

Section contents -

Defender	154
Discovery 3	150 - 151
Freelander 2	152 - 153
Range Rover Sport	148 - 149
Range Rover L322	146 - 147



RANGE ROVER L322



DA1071



REAR

DA1073

FRONT



DA1072



DA5108



DA5653 / DA5654



JAK500300LQV / JAK500310LQV



VUB503650



VUB503880MMM

RANGE ROVER L322 - continued



DA1071	Rear bumper cover		Stainless steel	Single
DA1072	Oval rear badge surround		Metal - chrome finish	Single
DA1073	Lower sill step covers - front & rear		Brushed finish	Pair
DA5108 NEW	Replacement grille - same as DHB500550LQV but with Brunel outer and chrome inner from VIN 6A			Single
DA5653 NEW	Door handle cover		Plastic - chrome finish	Set of 4
DA5654 NEW	Door handle surround		Plastic - chrome finish	Set of 4
JAK500300LQV NEW	Air intake grille		Right hand side	Single
JAK500310LQV NEW	Air intake grille		Left hand side	Single
VUB503650	Air intake grille		Plastic - chrome finish	Pair
VUB503880MMM	Wing mirror covers (from 5A onwards) - top		Plastic - chrome finish	Pair
LR003905 NEW	Wing mirror covers (from 5A onwards) - bottom (adhesive STC50551)		Plastic - chrome finish	Pair
LR005239 NEW	A Bar - moulded plastic includes spot lamp brackets		Black	Single
VUB001070	Lamp guard - pre 2006 - not compatible with wraparound protection bar	Front	Black	Pair
VUB502610	Lamp guard 2006 -	Front	Black	Pair
VUB001080	Lamp guard	Rear	Black	Pair
VUB001230	Side protection tubes		Stainless steel	Pair
VUB002510	Side protection tubes Note - Tubes can be fitted with or without front mudflaps		Black steel	Pair
VUB503660	Side step including front mudflaps with EPDM (synthetic rubber) top and hard plastic trimming			Pair
VUB001300	Side step replacement insert moulding for VUB503660		Right hand side	Single
VUB001310	Side step replacement insert moulding for VUB503660		Left hand side	Single

RANGE ROVER SPORT



RANGE ROVER SPORT - continued



NEW

REAR

EBN500040 / VPLSS0042



FRONT



NEW

Shown here fitted to Discovery 3

VUB503880MMM / LR003905



NEW

LR008713



VTK500020



VUB501930



VUB501920



VUB501980

DA1072 NEW	Oval rear badge surround	Metal - chrome finish	Single
DA3350	Air intake grille - left hand side	Plastic - chrome finish	Single
DA3351	Air intake grille - right hand side	Plastic - chrome finish	Single
DA3352	Air intake grille kit (DA3350 & DA3351)	Plastic - chrome finish	Pair
JAK500320WWH	Air intake grille - right hand side	Tungsten/Titan	Single
JAK500330WWH	Air intake grille - left hand side	Tungsten/Titan	Single
LR006304	Air intake grilles	Metal - chrome finish	Pair
DA5658 NEW	Door handle cover	Plastic - chrome finish	Set of 4
DA5659 NEW	Door handle bowl	Plastic - chrome finish	Set of 4
DA5661 NEW	Headlight washer jet caps	Plastic - chrome finish	Pair
	Headlight washer jet caps		Pair
DA7600 - Java Black;	DA7601 - Stornoway Grey; DA7602 - Zermatt Silver; DA7603 - Buckingham Blue; DA7604 - Alaska White		
DA7610	Indicator lamp with orange bulb	Clear	Single
DA7611 NEW	Indicator lamp with orange bulb	Smoked	Single
EBN500040 NEW	Side sill tread plate kit - from AA000001 to AA218728	Stainless steel	Set of 8
VPLSS0042 NEW	Side sill tread plate kit - from AA218729 onwards	Stainless steel	Set of 8
VUB503880MMM	Wing mirror covers - top	Plastic - chrome finish	Pair
LR003905 NEW	Wing mirror covers - bottom (adhesive STC50551)	Plastic - chrome finish	Pair
LR008713 NEW	Pedal set	Stainless steel	Set of 3
VTK500020	Side steps with thermo plastic elastomer side step top and brushed aluminium side trim		Pair
VUB501930	Lamp guards	Front	Pair
VUB501920	Lamp guards	Rear	Pair
VUB501980	A Bar - moulded plastic - includes spot lamp brackets	Grey	Single

Enhance the
look of your
Range Rover Sport!



DISCOVERY 3



DA5658



DA5661



DA7602 shown here fitted to Range Rover Sport

DA7602



DA7610



DA7611

Enhance the look of your *Discovery 3!*



REAR



FRONT

EBN500041



JAK000065MMM

DISCOVERY 3 - continued



VUB503880MMM / LR003905



LR005237



LR008713



VTD500010



VUB501200



VTD500020



VUB501380



VTK500010



VUB501270

DA5658 NEW	Door handle cover	Plastic - chrome finish	Set of 4
DA5661 NEW	Headlight washer jet caps	Plastic - chrome finish	Pair
	Headlight washer jet caps		Pair
DA7600 - Java Black;	DA7601 - Stornoway Grey;	DA7602 - Zermatt Silver;	DA7603 - Buckingham Blue;
DA7610	Indicator lamp with orange bulb	DA7604 - Alaska White	
DA7611 NEW	Indicator lamp with orange bulb	Clear	Single
EBN500041	Side sill tread plate kit	Smoked	Single
JAK000065MMM	Side vent trim	Stainless steel	Set of 4
VUB503880MMM	Wing mirror covers - top	Stainless steel	Single
LR003905 NEW	Wing mirror covers - bottom (adhesive STC50551)	Plastic - chrome finish	Pair
LR005237	A Bar includes spot lamp brackets - moulded rubber	Black	Single
LR008713 NEW	Pedal set	Stainless steel	Set of 3
VTD500010	Side protection tubes	Black steel	Pair
VTD500020	Side protection tubes	Stainless steel	Pair
VTK500010	Side runners with polypropylene side step top and a brushed aluminium side		Pair
VUB501200	Lamp guards - front	Black	Pair
VUB501380	Lamp guards - rear	Black	Pair
VUB501270	Bull/nudge bar - flat Note - Can only be supplied to non-EU countries	Black	Single

FREELANDER 2



Picture courtesy of Darren Whiley



Shown here fitted to Discovery 3

DA7610



DA7611

Enhance the look of your *Freelander 2!*



LR002408



LR003685



LR002525



LR002773



FREELANDER 2 - continued



LR003318



Picture courtesy of Darren Whiley



LR003840



Shown here fitted to Discovery 3

VUB503880MMM / LR003905

DA7610	Indicator lamp with orange bulb		Clear	Single
DA7611 NEW	Indicator lamp with orange bulb		Smoked	Single
LR002408	Lamp guards	Front	Black	Pair
LR003685	Lamp guards	Rear	Black	Pair
LR002525	Front and rear sill tread plate kit		Polished stainless steel	Set of 4
LR002773	Body side step with thermo plastic elastomer side step top and a brushed aluminium side trim			Pair
LR003318	Body side step - tube type		Stainless steel	Pair
LR003840	Body side step - tube type		Black	Pair
VUB503880MMM	Wing mirror covers - top		Plastic - chrome finish	Pair
LR003905 NEW	Wing mirror covers - bottom (adhesive STC50551)		Plastic - chrome finish	Pair



Picture courtesy of Darren Whiley

DEFENDER



Picture courtesy of Adam Rosenberg



DA5500 WITH DA5499



DA2356B



DA4000 / DA4001



DPT100070



DA4650 / DA4654



Shown with boss kit fitted

DA4653 / DA4657

Front grille - stainless steel	DA2356 - Natural	DA2356B - Black
Air intake grille - single	DA4000 - Left hand side	DA4001 - Right hand side
		Black
Replacement gear box gaiter - single	DA5498 - Grey	DA5499 - Black
DA5500	Gear lever and transfer gear lever set for R380 gearbox	Anodised alloy
DPT100070	Bumper end cap does not include fixings DZM100080	Rubber
		Single

Steering Wheels

DA4650	15" 3-spoke sports wheels	Black vinyl	Black centre
DA4653	15" 3-spoke sports wheels	Black leather	Polished centre
DA4654	14" 3-spoke sports wheels	Black vinyl	Black centre
DA4657	14" 3-spoke sports wheels	Black leather	Polished centre
Note - To fit steering wheel to vehicle you'll need a new boss kit			
DA4661 NEW	Defender 90	16mm shaft	36 splines
DA4659	Defender 110	16mm shaft	36 splines
DA4660	Series 2, 2A & 3	19mm shaft	48 splines

DEFENDER - continued

Enhance the look of *your* Defender

See exterior protection
section for our range of
A bars, lamp guards,
chequer plate etc.

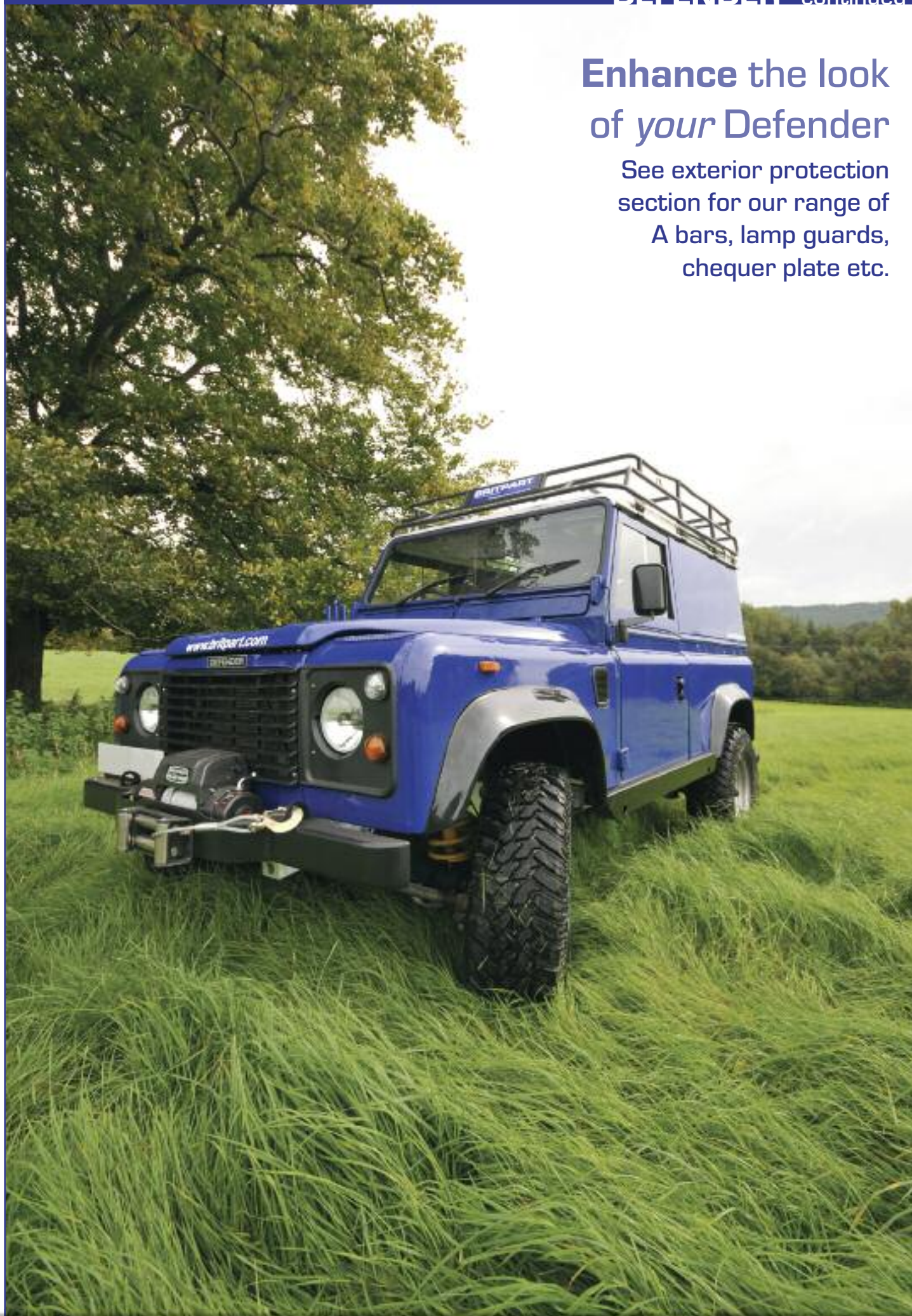

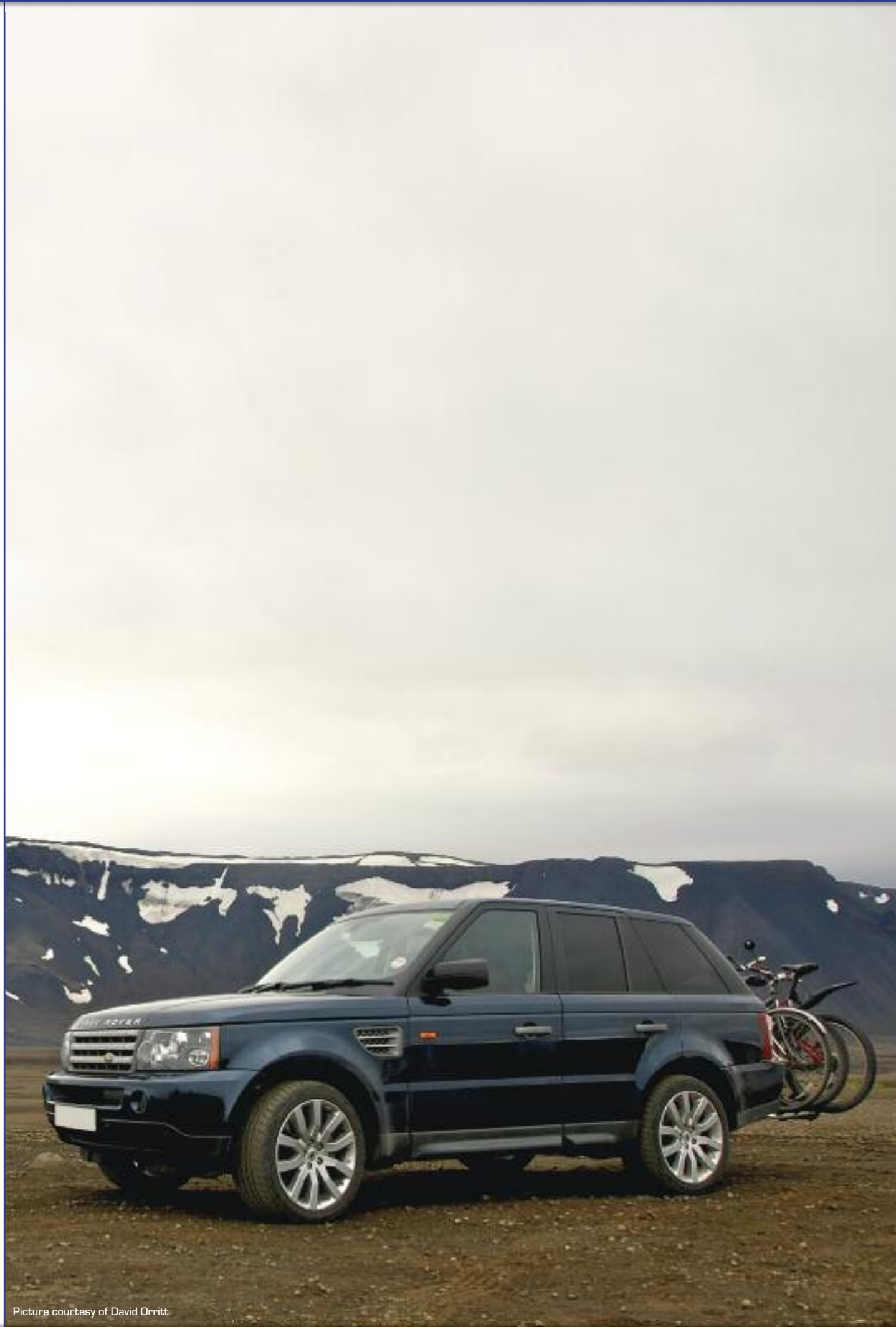

Picture courtesy of David Orritt

Britpart merchandise,
Land Rover gear,
workshop books
and much more...

Section contents -

Air conditioning kits	158
Britpart merchandise	159
First aid kit	158
Haynes books & manuals	160
Haynes internal combustion engine	161
Land Rover Gear	162 - 163
Original technical publications	164
Parts & general interest books	164
Wiper blades - heavy-duty	165



Old Land Rover badge
Picture courtesy of Kristjan Kristjansson

AIR CONDITIONING KITS

KEEP IT COOL

DA2343R	Defender 90/110 300Tdi	RHD
DA2342R	Defender 90/110 Td5	RHD
DA2342L	Defender 90/110 Td5	LHD
DA2344	Defender - 2007	RHD & LHD

- > As OE fitment, no drilling required
- > Once fitted the system is indistinguishable from factory fitted units
- > Plugs straight into the existing Land Rover wiring loom and fuse board
- > Easy to install as components are pre-assembled
- > Kit uses high performance condenser which eliminates need for an extended nose cone
- > Parts interchangeable with Land Rover parts

FIRST AID KIT



STC7642

STC7642

First aid kit - Land Rover

To DIN 13164, the industry standard first aid kit solution for cars, vans and commercial vehicles when on the move.



Picture courtesy of Piotr Kowal

BRITPART MERCHANDISE & CLOTHING



DA8000



DA8002



NEW

DA8023



NEW DESIGN

DA8003



NEW DESIGN

DA8004



DA8015



NEW DESIGN

DA8017



NEW

DA8022



NEW

DA8024



NEW

DA8025



DA8013



DA8021

Britpart Merchandise

- DA8000 Mouse & mug mat set
- DA8002 Key ring - karabiner style
- DA8023 **NEW** Key ring - single
- DA8003 Ball point pen
- DA8004 Mug - single
- DA8015 Stainless steel travel mug - single
- DA8016 5" Teddy bear
- DA8017 Drawstring bag
- DA8022 **NEW** Tax disc holder - pair

- DA8024 **NEW** 300mm Ruler
- DA8025 **NEW** Ice scraper

Britpart Clothing

- DA8005 Polo shirt - medium
- DA8006 Polo shirt - large
- DA8007 Polo shirt - x large
- DA8008 Polo shirt - xx large
- DA8020 T-shirt - x large
- DA8009 Sweat shirt - medium

- DA8010 Sweat shirt - large
- DA8011 Sweat shirt - x large
- DA8012 Sweat shirt - xx large
- DA8018 Fleece - x large
- DA8019 Fleece - xx large
- DA8013 Ski hat
- DA8021 Baseball cap



POLO SHIRT



SWEATSHIRT



LOGO ON BACK OF POLO & SWEATSHIRT



T-SHIRT



FLEECE



DA8016

We offer a wide range of Britpart branded merchandise for you or your customers!

HAYNES BOOKS & MANUALS

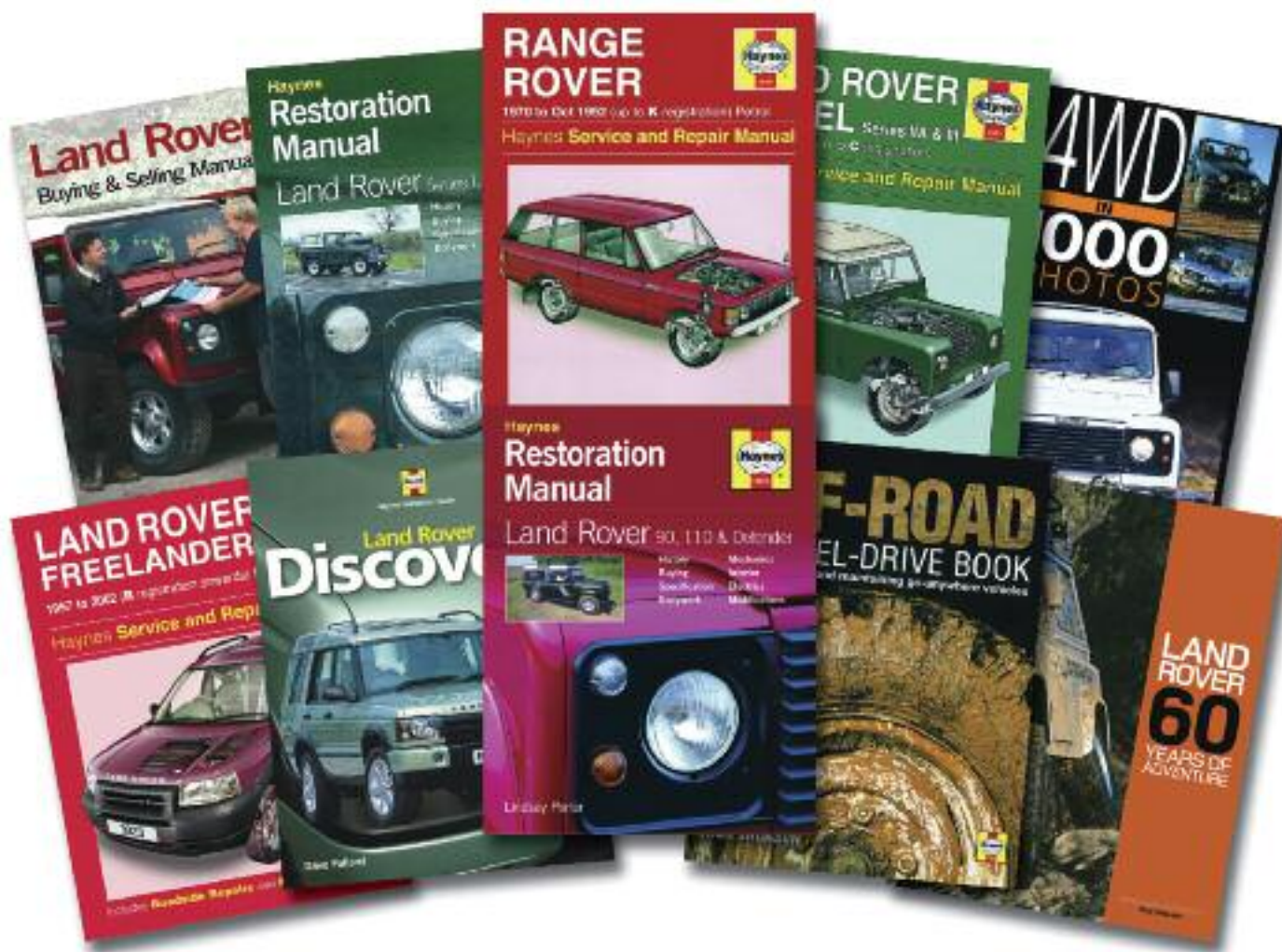
**Defender**

- DA2093** 90, 110 & Defender - 1983 - 2007 (up to 56 reg) - Diesel
- DA3040** Restoration Manual - Land Rover 90, 110 & Defender by Lindsay Porter
- DA3046** You and Your Land Rover 90, 110 & Defender - Buying, enjoying, maintaining & modifying by Martin Hodder

Discovery

- DA2093** Extreme - Discovery - The definitive guide to modifying
- DA3036** Discovery 1989 - 1998 (G to S reg) - Petrol & Diesel
- DA3106** Discovery: Enthusiast Guide by Dave Pollard
- DA4493** Discovery 1998 - 2004 (S to O4 reg) - Diesel

Freelander

- DA2980** Land Rover Freelander 1997 - 2002 (R reg onwards) - Petrol & Diesel
- DA4494** Freelander 2003 - 2006 (53 to 56 reg) - Petrol & Diesel

Range Rover

- DA3042** Restoration Manual - Range Rover Classic by Dave Pollard
- DA3048** Range Rover 1970 - Oct 1992 (up to K reg) - Petrol
- DA3105** You and Your Range Rover - Buying, enjoying, maintaining & modifying by Dave Pollard

Series

- DA3037** Series 2a & 3 (up to C reg) - Diesel
- DA3038** Series 2, 2a & 3 1958 - 1985 (up to C reg) 4-cylinder - Petrol
- DA3041** Restoration Manual - Land Rover Series 1, 2 & 3 by Lindsay Porter

General Interest

- DA3043** Land Rover - Simply The Best by Martin Hodder
- DA3044** The Off Road 4 Wheel Drive Book - Choosing, using and maintaining go anywhere vehicles by Jack Jackson
- DA3108** 4x4 Book - The essential guide to buying, owning, enjoying & maintaining an off road vehicle by Paul Guinness
- DA3159** Land Rover Expeditions - Where to go off-roading in the UK
- DA4490** Land Rover - Buying and Selling Manual - How to do the best deals by Les Roberts
- DA4491** Land Rover - 60 Years of Adventure by Nick Dimbleby
- DA4495** 4WD in 1,000 Photos



**Free stand with
10 manuals!**

Ask for full details

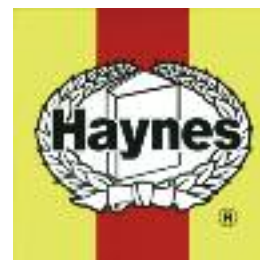

the worldwide market leader
in automotive repair manuals

HAYNES INTERNAL COMBUSTION ENGINE

DA4310

Build a realistic working model of a combustion engine. Includes light and sound features, light up spark plugs and moving pistons, valve gear and fan belt. Includes a 'Haynes Manual'.

Finished model size 180 x 270 x 140 mm (H x W x D)



Build a working model of an engine!



DA4310



LAND ROVER GEAR



LRO 1075



LRO 0008



LRO 0754



LRO 1355



LRO 0784



LRO 1621



LRO 1686



LRO 1685



LRO 1867

LAND ROVER GEAR



LRO 1867



LRO 1873



LRO 2033



LRO 2054



LRO 1753

Ideal birthday or Christmas gift ideas for any Land Rover enthusiast - what ever their age!



LRO 1986



LRO 2090



LRO 2278



SOX 0593

LRO 0008	Pin badge	Small pin badge of famous logo
LRO 0754	Key ring	Karabiner style made from aluminium alloy
LRO 0784	Pencils	Made from recycled materials - pack of 10
LRO 1075	Safari bear	A bear destined for an African safari
LRO 1355	Parking sign	Heavy-duty metal sign
LRO 1621	Dog tags	Circular metal with full colour Land Rover logo; suitable for engraving on the reverse
LRO 1685	Key ring	A key chain made from webbing, with a silicon badge Land Rover badge one side, Go Beyond on the reverse
LRO 1686	Radio controlled Land Rover	G4 Challenge Freelander with fully functional radio control, 4-wheel drive and working headlights
LRO 1753	Umbrella	Sturdy golfing size with carbon fibre shaft
LRO 1867	Key ring	Clip it compass & thermometer on clip-on key ring
LRO 1873	Hudson eyewear clip	Perfect for securing your driving glasses in the car
LRO 1986	Orang-utan	Loveable resident of Borneo
LRO 2033	Eco-lanyard	Earth friendly - made with organic inks and plant material
LRO 2054	Key ring	Silver with wire attachment
LRO 2090	Ripper wallet	Alberta style with multi-sectioned interior suitable for all currency and credit cards
LRO 2278	Travel mug	Insulated stainless steel for hot or cold drinks
SOX 0593	Socks	Navy, green & black sports socks with cushion foot - pack of 3

ORIGINAL TECHNICAL PUBLICATIONS



Screen shot for illustrative purposes only

These are a range of original technical publications on CD-Rom. On the CD you'll get original parts books, workshop manuals and handbooks. Each CD-Rom focuses on one model as shown and each has the same format:

the original parts catalogues (from parts book and/or microfiche, as appropriate) and are followed by the workshop manuals and driver's handbooks, all reproduced in an easy-to-use and easy-to-print PDF format.

Handy and easy to use!

Note - Minimum system requirements - Windows 2000 or XP/Pentium III/64MB RAM/Adobe Acrobat Reader Vr 6.0. They are not currently Vista compatible but will be when Windows issue Service Pack 1.0 for Vista. Due to copy protection the CDs only work on Macs with Intel processors running Windows.

19LHP1	Range Rover Classic - 1970 to 1985	Parts publications/service publications/owners literature
19LHP2	Range Rover Classic - 1986 to 1995	Parts publications/service publications/owners literature
19LHP3	Land Rover Discovery - 1989 to 1994	Parts publications/service publications/owners handbooks
LHP19	Land Rover Series 1 - 1948 to 1958	Parts publications/service publications/owners literature
LHP20	Land Rover Series 2 - 1958 to 1961	Parts publications/service publications/owners literature
LHP21	Land Rover Series 2A & 2B - 1961 to 1971	Parts publications/owners handbooks
LHP22	Land Rover Series 3 - 1971 to 1985	Parts publications/service publications/owners literature
LHP23	Land Rover 88 Half Ton Military - 1968 to 1984	Parts publications/service publications/owners handbooks
LHP24	Land Rover 101 One Tonne Military - 1975 to 1978	Parts publications/service publications/owners handbooks
LHP25	Land Rover 90, 110 & XD Military - 1984 to 1999	Parts publications/service publications/owners handbooks
LHP26	Land Rover 90, 110 & 127 - 1983 to 1989	Parts publications/service publications/owners handbooks
LHP27	Land Rover Defender 90, 110 & 130 - 1990 to 1999	Parts publications/service publications/owners handbooks
LHP28	Land Rover Defender 90 & 110 North America - 1993 to 1997	Parts publications/service publications/owners handbooks/supplementary information/sales brochures
LHP29	Range Rover Classic (North America) - 1987 to 1995	Parts publications/service publications/owners literature/supplementary information/sales brochures
LHP32	Land Rover Discovery - 1994 to 1998	Parts publications/service publications/owners literature
LHP33	Land Rover Discovery North America - 1994 to 1998	Parts publications/service publications/owners literature/supplementary information/sales brochures

PARTS & GENERAL INTEREST BOOKS



RTC9841CE

DA3156

Parts catalogues

RTC9841CE	Series 3
RTC9947CF	Discovery covering 1989 - 1998 MY - 2.0 Mpi & 3.5 & 3.9 V8 petrol and 200Tdi & 300Tdi diesel engines
STC9049CA NEW	Discovery 2 covering 1999 - 2003 MY
STC9021CC	Defender 90/110/130 - covering 1987 - 2006 MY
RTC9970CE	Range Rover P38 covering 1995 - 2001 MY - 4.0 & 4.6 petrol and BMW 2.5 diesel engines

Handbooks

DA3161	Discovery 2 covering 1999 - 2004 MY
DA3162	Defender 90/110/130 covering 1991 MY - February 1994 - 2.5 & 3.5 V8 petrol and 2.5 & 200Tdi diesel engines
LRL0087ENG	Defender 90/110/130 covering March 1994 - 1998 MY - 2.5 & 3.5 V8 petrol and 2.5 & 300Tdi diesel engines

Other publications

DA3147 NEW	Freelander 2001 - 2003 on workshop manual
DA3156	Winch In Safety - A5 book by Land Rover with pictures throughout, over 100 pages
DA3157	Defender Td5 1999-2006 MY Includes workshop manual and electrical manual
LRL0178ENG	Replacement service portfolio
SJR901FRWM	Discovery workshop manual

WIPER BLADES - HEAVY-DUTY

Heavy-duty winter wiper blades

DKC500010PMD

Discovery 2

Front

Pair

VUB500900 NEW

Freelander 1

Front

Pair



VUB500900

DKC500010PMD

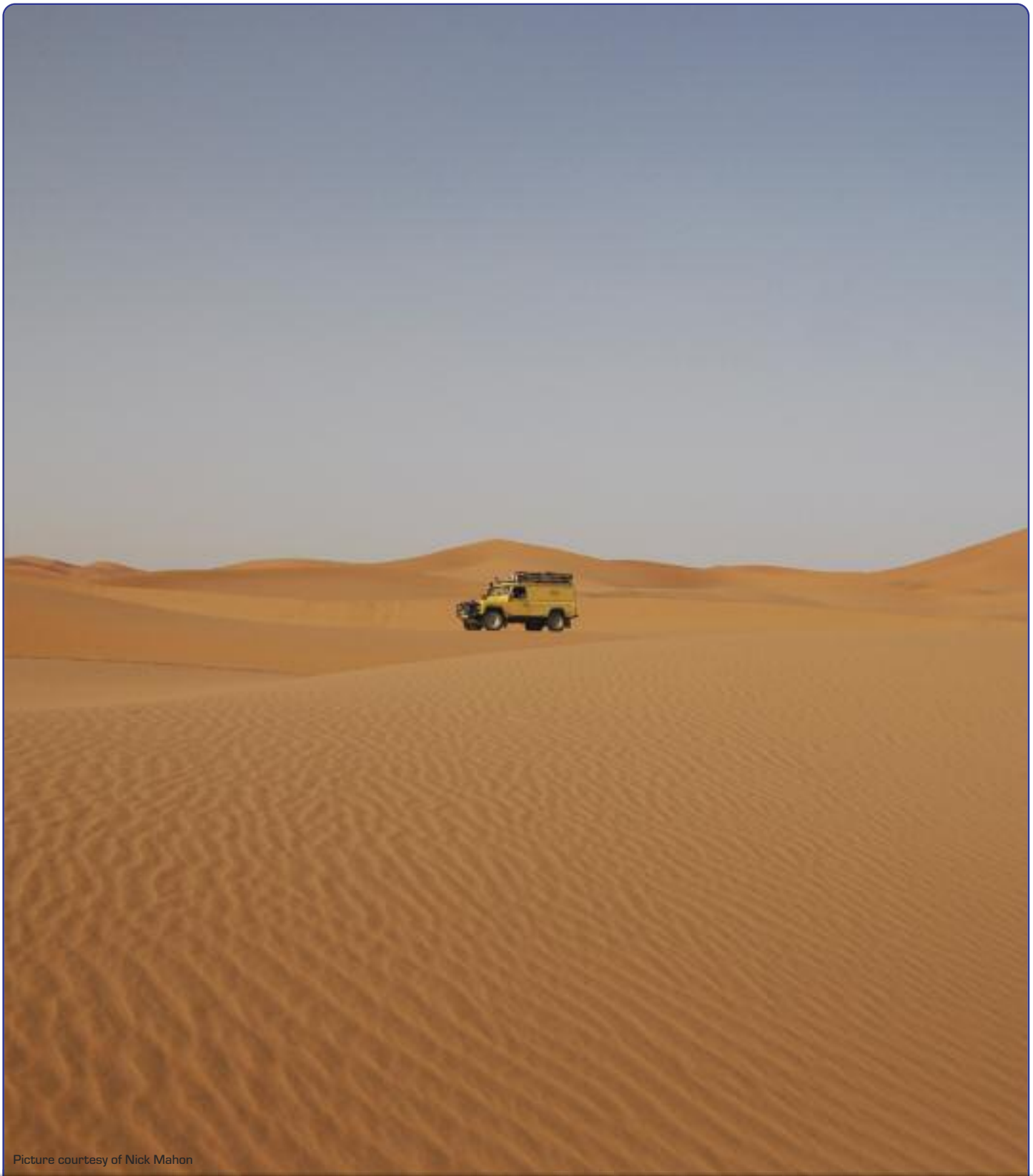

Picture courtesy of Nick Mahon



Picture courtesy of Malc Holmes

Part No.	Page No.	Part No.	Page No.	Part No.	Page No.	Part No.	Page No.	Part No.	Page No.	Part No.	Page No.
67187	44	ANR3635	44	DA1960	18	DA2134	46 & 48	DA240340	95	DA2810BLUE	58
201691	44	ANR3679	36	DA1961	18	DA2136	45	DA240340S	95	DA2810GREEN	58
218453	129	ANR3973	35	DA1962	107	DA2137	45	DA240440S	95	DA2810GREY	58
234532	124	ANR4188PY	105	DA2001N	129	DA2138	46	DA240540	95	DA2811BLACK	58
320698	66	ANR4188PYE	105	DA20010	129	DA2148	64	DA240640S	95	DA2811BLUE	58
320699	66	ANR4188PYE-YELLOW	105	DA2002	68	DA2149	62	DA240740S	95	DA2811GREEN	58
320726	66	ANR4188PYE-YELLOW	105	DA2003	112	DA2155	133	DA240840	95	DA2811GREY	58
320737	66	ANR4189PY	105	DA2004	8	DA2156	129	DA2409S	95	DA2812BLUE	58
331401	55	ANR4189PYE	105	DA2005	132	DA2160BLACK	16	DA2410	95	DA2812GREEN	58
345985	14	ANR4189PYE-YELLOW	105	DA2006	132	DA2160BLUE	16	DA241040S	95	DA2812GREY	58
349967	66	ANR4189PYE-YELLOW	105	DA2007	68	DA2160BROWN	16	DA2410S	95	DA2813BLUE	58
390381	128	ANR4489	76	DA2008N	129	DA2160GREEN	16	DA2411	95	DA2813GREEN	58
390382	128	ANR4583PM	35	DA20080	129	DA2161BLACK	16	DA241140	95	DA2813GREY	58
395529	129	ANR4583SILVER	35	DA2009	129	DA2161BLUE	16	DA241140S	95	DA2814BLUE	58
395530	129	ANR4635PM	35	DA2012	48	DA2161BROWN	16	DA2411S	95	DA2814GREEN	58
532268	137	ANR4636PM	35	DA2013	129	DA2161GREEN	16	DA2412	95	DA2814GREY	58
537179	34	ANR5307MNH	35	DA2014	129	DA2166	74	DA241240S	95	DA2815BLACK	57
559822	129	ANR5593PM	35	DA2015N	129	DA2169	129	DA2412S	95	DA2815BLUE	57
579408	44	ANR6094L	32	DA20150	129	DA2170	74	DA2413	95	DA2815GREEN	57
606435	138	ANR6947PY	106	DA2016	129	DA2171	74	DA241340	95	DA2815GREY	57
19LHP1	164	ANR6947PY-YELLOW	106	DA2017N	129	DA2172	74	DA241340S	95	DA2816BLACK	57
19LHP2	164	ASR1186	127	DA20170	129	DA2174	75	DA2413S	95	DA2816BLUE	57
19LHP3	164	ASR1187	127	DA2019N	129	DA2178	137	DA241440S	95	DA2816GREEN	57
320737CB	66	ASR1594	127	DA20190	129	DA2182	74	DA2414S	95	DA2816GREY	57
320737CG	66	ASR1595	127	DA2021	33	DA2186	107	DA2418	95	DA2817BLUE	57
320737LCS	66	ASR2512	127	DA2022	33	DA2194	44	DA241840	95	DA2817GREEN	57
320737RPI	66	AWR5700RPI	66	DA2023N	129	DA2195	44	DA241840S	95	DA2817GREY	57
320737T	66 & 67	AWR5701RPI	66	DA20230	129	DA2196	44	DA2418S	95	DA2818BLACK	57
331110AG	64	AWR5702RPI	66	DA2024	126 & 129	DA2197	44	DA2419	95	DA2819BLACK	58
331110SA	64	AWR5708RPI	66	DA2026	33	DA2206	101	DA241940	95	DA2820BLACK	58
331113AG	64	BAC500490	134	DA2026N	129	DA2211	137	DA241940S	95	DA2821BLACK	58
331113SA	64	BIC710260	126	DA20260	129	DA2215	33	DA2419S	95	DA2822BLACK	57
331259AG	64	BTR7895	55	DA2029	63	DA2225	77	DA2420	95	DA2980	160
331259SA	64	BTR7896	55	DA2030	63	DA2228	17	DA242040	95	DA2990	30
331260AG	64	BTR7897	55	DA2035	62	DA2231	76	DA242040S	95	DA2991	30
331260SA	64	BTR7898	55	DA2035BLUE	62	DA2232	33	DA2420S	95	DA2993	30
331308AG	64	BTR8037X	144	DA2035BROWN	62	DA2243	75	DA2421	95	DA2996	30
331371AG	64	BTR8140RPI	66	DA2035CHAR	62	DA2243EYE	75	DA242140	95	DA3000	32
345985P	14	BTR8141RPI	66	DA2035GREEN	62	DA2244	76	DA242140S	95	DA3002	30
548205PY	106	CAB000040PMA	28	DA2035GREY	62	DA2246	89	DA2421S	95	DA3010	40
548205PY-YELLOW	106	CAB500021PMA	28	DA2035LCS	62	DA2248	75	DA2425	106	DA3010B	40
552818PY	106	CAB500070PMA	28	DA2035RPI	62	DA2250	9	DA2426	106	DA3015	78
552818PY-YELLOW	106	CAB500130PMA	28	DA2037	62	DA2250B	9	DA2427	136	DA3016	128
552819PY	106	CAS000150PMA	15	DA2037T	90	DA2259	33	DA2428	136	DA3017	128
552819PY-YELLOW	106	CAS500010PCL	15	DA2039	120	DA2274	33	DA2430	36	DA3018	78
568858PY	106	CAS500060PMA	15	DA2047	120	DA2301	14	DA2431	36	DA3020	78
568858PY-YELLOW	106	CAS500070PCL	15	DA2050	8	DA2310	29	DA2432	36	DA3021	78
569746PY	106	CAT000180PMA	15	DA2051	8	DA2311	29	DA2433	36	DA3022	78
569746PY-YELLOW	106	CAT500010PCL	15	DA2052	8	DA2312	29	DA2434	36	DA3023	78
572068PY	106	CAT500070PMA	15	DA2053	8	DA2315	29	DA2435	36	DA3024	78
572068PY-YELLOW	106	CAT500120PCL	15	DA2054	8	DA2342L	158	DA2436	36	DA3025	78
572180PY	106	CAT500410PMA	15	DA2056	125	DA2342R	158	DA2437	36	DA3026	78
572180PY-YELLOW	106	CAT500450PMA	15	DA2056-300TDI	125	DA2343R	158	DA2438	36	DA3027	78
575580PY	106	CAT500540PMA	15	DA2057	125	DA2344	158	DA2439	36	DA3027LH	78
575580PY-YELLOW	106	CES500020	134	DA2057-300TDI	125	DA2351	64	DA2440	63	DA3028	89
90577434PY	106	CN100208L	124	DA2060	8	DA2352	131	DA2441	63	DA3029	89
90577434PY-YELLOW	106	CN100508L	124	DA2061	8	DA2353	105	DA2442	63	DA3030	89
AAP817	133	CN100909	124	DA2062	8	DA2354	33 & 70	DA2443	63	DA3031	89
AEU2147LX	144	CGB000140	126	DA2063	8	DA2355	131	DA2444	63	DA3032	89
AGP780020	26	CGB000150	126	DA2064	8	DA2356	154	DA2445	63	DA3033	89
ALR1742	126	CVW500010	126	DA2065	8	DA2356B	154	DA2446	63	DA3034	89
ALR1743	126	DA1003	76	DA2066	8	DA2357	130	DA2447	63	DA3035	160
ALR5595	128	DA1004	76	DA2067	8	DA2357HD	130	DA2500	79	DA3036	160
ALR5596	128	DA1043	131	DA2068	8	DA2362	111	DA2501	79	DA3037	160
ALR5822	127	DA1044	131	DA2069	8	DA2363	111	DA2800BLACK	57	DA3038	160
ALR5823	127	DA1045	131	DA2070	8	DA2364	18	DA2800BLUE	57	DA3040	160
ALR6272	127	DA1057	133	DA2071	7	DA2365	18	DA2800GREEN	57	DA3041	160
ALR6681	127	DA1059	18	DA2075	34	DA2366	18	DA2800GREY	57	DA3042	160
ALR6682	127	DA1062	40	DA2079	120	DA2369	130	DA2801BLACK	57	DA3043	160
ALR6852	126	DA1062AMBER	40	DA2082	120	DA2370	130	DA2801BLUE	57	DA3044	160
ALR8519	127	DA1062BLUE	40	DA2084	120	DA2371	105	DA2801GREEN	57	DA3046	160
ALR8520	127	DA1062COVER	40	DA2090	68	DA2372	105	DA2801GREY	57	DA3048	160
ALR8572	127	DA1063	40	DA2091	68	DA2373	105	DA2802BLUE	57	DA3049	101
ALR8573	127	DA1064	40	DA2093	160	DA2374	78	DA2802GREEN	57	DA3049AF	101
ALR8576	127	DA1065	138	DA2096	68	DA2376	135	DA2802GREY	57	DA3050	121
ALR8577	127	DA1069	132	DA2098	68	DA2379	139	DA2803BLACK	58	DA3051	121
ALR8710	127	DA1071	146-147	DA2099	129	DA2380	139	DA2803BLUE	58	DA3052	121
ALR9877	127	DA1072	146-149	DA2109	120	DA2381	139	DA2803GREEN	58	DA3054	121
ALR9878	127	DA1073	146-147	DA2112	132	DA2382	139	DA2803GREY	58	DA3055	121
AMR3850	41	DA1077	38	DA2112-1	132	DA2383	139	DA2804BLUE	58	DA3056	17
AMR4910	41	DA1079	40	DA2112-2	132	DA2384	139	DA2804GREEN	58	DA3057	17
AMR6526	41	DA1080	38	DA2112-3	132	DA2385	139	DA2804GREY	58	DA3057GLUE	17
AMR6527	41	DA1081	51	DA2112B	132	DA2386	139	DA2805BLUE	58	DA3058	121
AMR6528	41	DA1089	26 & 27	DA2113	132	DA2387	139	DA2805GREEN	58	DA3059	66
ANR1534PM	35	DA1090	27	DA2114	132	DA2388	139	DA2805GREY	58	DA3069	78
ANR1721PY	106	DA1091	27	DA2115	132	DA2389	95	DA2806BLUE	58	DA3070	28
ANR1721PY-YELLOW	106	DA1092	27	DA2116	129	DA2390	33 & 70	DA2806GREEN	58	DA3071	28
ANR2056	126	DA1093	27	DA2118	44	DA2392	33 & 70	DA2806GREY	58	DA3072	28
ANR2563PY	106	DA1108	99	DA2121	45	DA2394	70	DA2807BLACK	57	DA3073	26
ANR2563PY-YELLOW	106	DA1109	99	DA2122	48	DA2395	136	DA2807BLUE	57	DA3073B	26
ANR2763MMM	36	DA1111	138	DA2123	44	DA2396	126	DA2807GREEN	57	DA3075	28
ANR3285PY	106	DA1112	99	DA2123A	44	DA2397	126	DA2807GREY	57	DA3077	28
ANR3285PY-YELLOW	106	DA1118	138	DA2124	63	DA2398	126	DA2808BLACK	57	DA3078	8
ANR3305PY	106	DA1119	138	DA2125	46 & 48	DA2399	126	DA2808BLUE	57	DA3079	8
ANR3305PY-YELLOW	106	DA1120	138	DA2126	101	DA240040S	95	DA2808GREEN	57	DA3080	8
ANR3332PY	106	DA1121	138	DA2126A	101	DA2400S	95	DA2808GREY	57	DA3081	8
ANR3332PY-YELLOW	106	DA1130	107	DA2128	14	DA240140S	95	DA2809BLUE	57	DA3086	28
ANR3410PY	106	DA1131	132	DA2129	48	DA2401S	95	DA2809GREEN	57	DA3105	160
ANR3410PY-YELLOW	106	DA1200	137	DA2130	14	DA240240S	95	DA2809GREY	57	DA3106	160
ANR3631MNH	35	DA1300	137	DA2133	48	DA2402S	95	DA2810BLACK	58	DA3108	160

PART NUMBER FINDER - continued

Part No.	Page No.	Part No.	Page No.	Part No.	Page No.	Part No.	Page No.	Part No.	Page No.	Part No.	Page No.
DA3120	75	DA4032BRONZE		DA4178	133	DA4288C	113	DA4431	55	DA5507	17
DA3121	74	126, 129 & 140		DA4178RESISTOR	133	DA4289	113	DA4433	101	DA5507LHD	17
DA3122	74	DA4032GREEN		DA4179	104	DA4289C	113	DA4436	101	DA5508	17
DA3130	74	126, 129 & 140		DA4181	110	DA4290	118	DA4470	52	DA5509	112
DA3136	95	DA4032GREY		DA4182	110	DA4291	118	DA4472	97	DA5510	107
DA3137	95	126, 129 & 140		DA4183	52	DA4292	118	DA4473	97	DA5511	50
DA3138	94	DA4033		DA4185	98	DA4293	118	DA4474	97	DA5513	99
DA3139	94	126, 129 & 140		DA4187	97	DA4294	118	DA4475	97	DA5526	99
DA3140	138	DA4033BRONZE		DA4188	97	DA4295	118	DA4476	97	DA5550	130
DA3141	78	126, 129 & 140		DA4189	135	DA4296	8	DA4477	97	DA5551	130
DA3142	78	DA4033GREEN		DA4190	71	DA4297	8	DA4478	98	DA5554	53
DA3144	107	126, 129 & 140		DA4191	71	DA4298	66	DA4479	98	DA5555	53
DA3147	164	DA4034	14	DA4192	71	DA4299	113	DA4480	98	DA5556	53
DA3153	76	DA4035BLUE	105	DA4193	71	DA4299C	113	DA4481	98	DA5600	76
DA3154	76	DA4035YELLOW	105	DA4194	71	DA4300	113	DA4482	98	DA5601	76
DA3155	76	DA4036BLUE	105	DA4197	111	DA4300C	113	DA4483	98	DA5602	52
DA3156	90 & 164	DA4041	66	DA4198	111	DA4301	113	DA4484	98	DA5604	87
DA3157	164	DA4042	66	DA4199	111	DA4301C	113	DA4485	98	DA5607	76
DA3159	160	DA4049	8	DA4201	111	DA4302	118	DA4490	160	DA5609	87
DA3160	90	DA4054	129	DA4202	111	DA4303	118	DA4491	160	DA5610	67
DA3161	164	DA4055	66	DA4203	111	DA4304	118	DA4493	160	DA5611	67
DA3162	164	DA4056	66	DA4204	111	DA4305	66	DA4494	160	DA5612	67
DA3163	136	DA4058	74	DA4205	111	DA4306	118	DA4495	160	DA5613	67
DA3164	136	DA4059	74	DA4206	111	DA4310	161	DA4500	124	DA5614	67
DA3165	136	DA4060	20	DA4208	111	DA4311	29	DA4501	55	DA5615	67
DA3166	136	DA4061	74	DA4210	111	DA4312	29	DA4502	55	DA5616	67
DA3167	136	DA4062	124	DA4211	111	DA4313	29	DA4503	55	DA5617	67
DA3169	136	DA4063	124	DA4212	120	DA4314	29	DA4508	126-128	DA5618	67
DA3170	100	DA4064	124	DA4214	120	DA4315	29	DA4509	126-128	DA5619	67
DA3171	100	DA4065N	126	DA4215	120	DA4316	29	DA4510	16	DA5620	87
DA3173	100	DA4065O	126	DA4217	120	DA4317	29	DA4511	16	DA5621	87
DA3174	100	DA4067	66	DA4218	120	DA4318	29	DA4512	34	DA5622	87
DA3175	100	DA4070	20	DA4219	120	DA4319	29	DA4513	126-128	DA5623	87
DA3176	100	DA4070B	20	DA4220	120	DA4321	30	DA4514	126-128	DA5624	38
DA3177	100	DA4071	8	DA4221	116	DA4322	30	DA4515	126-128	DA5625	17
DA3178	136	DA4072	8	DA4222	116	DA4323	30	DA4516	126-128	DA5626	7
DA3179	136	DA4073	8	DA4223	116	DA4324	30	DA4518	126-128	DA5627	65
DA3180	136	DA4074	8	DA4223S	118	DA4325	30	DA4519	127	DA5628	65
DA3181	136	DA4075	66	DA4224	116	DA4326	30	DA4527	126-128	DA5629	65
DA3182	100	DA4075RPI	66	DA4225	117	DA4327	30	DA4528	116	DA5630	65
DA3250	118	DA4075T	66 & 67	DA4226	116	DA4328	30	DA4530	127	DA5631	140
DA3251	118	DA4077	10	DA4227	116	DA4329	30	DA4531	15	DA5632	65
DA3252	118	DA4083	58	DA4228	116	DA4331	29	DA4532	15	DA5633	65
DA3253	118	DA4086	129	DA4229	116	DA4332	29	DA4545	72	DA5634	65
DA3254	118	DA4088	39	DA4230	117	DA4333	29	DA4546	72	DA5635	65
DA3255	118	DA4088BULB	39	DA4231	116	DA4334	29	DA4600	96	DA5636	67
DA3256	118	DA4088C	39	DA4232	116	DA4335	98	DA4601	96	DA5643	87
DA3257	118	DA4088COVER	39	DA4233	116	DA4336	98	DA4602	96	DA5650	132
DA3258	118	DA4088W	39	DA4234	116	DA4337	98	DA4603	96	DA5653	146-147
DA3259	118	DA4090	110	DA4235	116	DA4338	98	DA4604	96	DA5654	146-147
DA3260	118	DA4091	110	DA4236	117	DA4339	98	DA4605	96	DA5658	148-151
DA3300	97	DA4092	110	DA4237	116	DA4340	98	DA4606	96	DA5659	148-149
DA3301	97	DA4099	39	DA4238	116	DA4341	98	DA4607	96	DA5661	148-151
DA3302	97	DA4100	8	DA4239	116	DA4342	8	DA4608	96	DA5700	72
DA3303	97	DA4101	20	DA4240	116	DA4343	8	DA4609	96	DA5701	72
DA3304	97	DA4102	134	DA4241	116	DA4344	71	DA4610	96	DA5704	72
DA3306	97	DA4104	134	DA4242	117	DA4345	71	DA4630	100	DA5705	72
DA3307	97	DA4106	112	DA4243	117	DA4347	113	DA4631	100	DA5706	72
DA3308	97	DA4107	112	DA4244	116	DA4348	118	DA4632	100	DA5709	72
DA3309	97	DA4118	26	DA4245	117	DA4349	10	DA4633	100	DA5710	72
DA3310	97	DA4119	26	DA4246	116	DA4350	75	DA4650	154	DA5711	72
DA3311	97	DA4120N	128	DA4247	117	DA4351	75	DA4653	154	DA5801	51
DA3312	97	DA4120O	128	DA4249	117	DA4352	75	DA4654	154	DA6000	142
DA3313	97	DA4121	26	DA4249DEF	120	DA4353	75	DA4657	154	DA6001	142
DA3314	97	DA4130	11	DA4249DIS	120	DA4354	75	DA4659	154	DA6002	142
DA3315	97	DA4133	10	DA4250DEF	120	DA4355	75	DA4660	154	DA6003	142
DA3316	97	DA4134	10	DA4250DIS	120	DA4356	75	DA4661	154	DA6004	142
DA3318	97	DA4136	104	DA4251	116	DA4357	75	DA5004	34	DA6005	142
DA3319	97	DA4136HD	104	DA4252	120	DA4358	75	DA5005	34	DA6006	142 & 143
DA3350	148-149	DA4141	51	DA4256	120	DA4359	71	DA5006	34	DA6007	142 & 143
DA3351	148-149	DA4143	126	DA4258	21	DA4360	118	DA5010	104	DA6008	142
DA3352	148-149	DA4144	126	DA4259	94	DA4361	71	DA5011	104	DA6009	142
DA4000	154	DA4147	97	DA4260	94	DA4362	71	DA5012	104	DA6010	142
DA4001	154	DA4148	97	DA4261	94	DA4363	113	DA5100	44	DA6011	142
DA4007N	128	DA4149	98	DA4262	94	DA4364	113	DA5101	63	DA6012	142
DA4007O	128	DA4150	98	DA4263	94	DA4365	113	DA5102	63	DA6013	142
DA4013N	128	DA4151	97	DA4264	94	DA4366	113	DA5103	63	DA6014	142
DA4013O	128	DA4152	97	DA4265	94	DA4367	113	DA5104	63	DA6015	142
DA4017	129	DA4153	98	DA4266	94	DA4368	113	DA5105	63	DA6016	143
DA4018N	129	DA4154	98	DA4267	94	DA4369	113	DA5106	63	DA6017	143
DA4018O	129	DA4155	98	DA4268	94	DA4400	10	DA5108	146-147	DA6018	143
DA4019	126	DA4156	98	DA4269	94	DA4404	14	DA5109	63	DA6019	143
DA4020	126	DA4157	98	DA4270	94	DA4405	14	DA5111	63	DA6020	143
DA4022BLACK	56	DA4158	97	DA4271	94	DA4406	14	DA5112	63	DA6021	143
DA4023BLACK	56	DA4159	98	DA4272	94	DA4407	14	DA5113	63	DA6022	143
DA4023BLUE	56	DA4160	110	DA4274	94	DA4408	14	DA5114	63	DA6023	143
DA4023GREY	56	DA4161	110	DA4275	95	DA4409	14	DA5115	63	DA6024	143
DA4024BLUE	56	DA4162	110	DA4276	95	DA4418	101	DA5116	63	DA6025	143
DA4025BLACK	16	DA4163	110	DA4277	111	DA4419	101	DA5117	63	DA6026	143
DA4025BLUE	16	DA4164	110	DA4278	111	DA4420	101	DA5118	63	DA6027	143
DA4025BROWN	16	DA4165	97	DA4279	111	DA4421	101	DA5136	104	DA6028	143
DA4025GREEN	16	DA4166	97	DA4284	113	DA4422	55	DA5498	51 & 154	DA6029	143
DA4026	34	DA4169	52	DA4284C	113	DA4423	55	DA5499	51 & 154	DA6030	143
DA4027	50	DA4170	53	DA4285	113	DA4424	55	DA5500	154	DA6031	143
DA4028	66	DA4171	53	DA4285C	113	DA4425	55	DA5501	112	DA6032	144
DA4029	66	DA4172	11	DA4286	113	DA4426	55	DA5502	112	DA6033	144
DA4030	48	DA4173	13	DA4286C	113	DA4427	55	DA5503	112	DA6034	144
DA4031	66	DA4175	59	DA4287	113	DA4428	55	DA5504	112	DA6035	142 & 143
DA4032	126, 129 & 140	DA4176	59	DA4287C	113	DA4429	55	DA5505	107	DA6036	143
		DA4177	59	DA4288	113	DA4430	55	DA5506	107	DA6037	142 & 143

PART NUMBER FINDER - continued

Part No.	Page No.	Part No.	Page No.	Part No.	Page No.	Part No.	Page No.	Part No.	Page No.	Part No.	Page No.
DA6038	142	DA6323L	110	DB1331	88	EAH500290SUN	56	LRO02525	152-153	MWC9061	127
DA6039	142	DA6324A	110	DB1332	88	EAH500320PMA	56	LRO02738	47	MWC9084	127
DA6040	142	DA6326	135	DB1333	88	EAH500330PMA	56	LRO02740	47	MWC9085	127
DA6041	142	DA6327	135	DB1334	88	EBF000040	53	LRO02742	47	MWC9843LCS	66
DA6042	124	DA6328	135	DB1336	88	EBF500010	52	LRO02773	22 & 152-153	MWC9844LCS	66
DA6043	124	DA6350	113	DB1337	88	EBN500040	148-149	LRO03106	47	MXC1408	128
DA6044	124	DA6351	113	DB1338	88	EBN500041	150-151	LRO03107	47	MXC1409	128
DA6045	124	DA6352	113	DB1339	88	ERC2886W	101	LRO03318	22 & 152-153	MXC2063	128
DA6046	124	DA6353	113	DB1340	88	ERC4536K	132	LRO03322	15	MXC2064	128
DA6047	124	DA6354	113	DB1341	88	ERR3340X	144	LRO03324	15	MXC3918	128
DA6050	131	DA6355	136	DB2000	85	ERR5013ST	120	LRO03685	12 & 152-153	MXC3919	128
DA6051	131	DA6356	113	DB6000	85	ERR6299X	144	LRO03840	22 & 152-153	NGC103740/810	134
DA6052	131	DA6500	73	DB8000	84	ESR1445X	144	LRO03894	53	NGC500370/410	134
DA6053	131	DA7011	20	DB9000C	84	ESR2623X	144	LRO03895	52	NRC2051	44
DA6054	131	DA7011SS	20	DB9500i	83	ESR4238X	144	LRO03905	146-153	NRC236	129
DA6055	131	DA7012	20	DB9500i24	83	ESR4686X	144	LRO04100	28	NRC236E	129
DA6056	131	DA7012SS	20	DC5000	109	ETC5835K	132	LRO04101	28	NRC4171	126
DA6057	131	DA7600	148-151	DC5000L	109	FTC1507	139	LRO04102	28	NRC4356	125
DA6058	131	DA7601	148-151	DC5001	109	FTC2957HD	130	LRO05039	55	NRC4514PY	106
DA6059	131	DA7602	148-151	DC5001L	109	FWJ500020PMA	62	LRO05058	58	NRC4514PPYYELLOW	106
DA6060	131	DA7603	148-151	DC5002	109	HAG100970LOY	67	LRO05059	58	NRC4642G	125 & 129
DA6061	131	DA7604	148-151	DC5002L	109	HAH103510LOY	67	LRO05235	6	NRC4717	128
DA6062	131	DA7610	148-153	DC5003	109	HAU101400LOY	67	LRO05237	6 & 150-151	NRC5593PY	106
DA6063	131	DA7611	148-153	DC5003L	109	HAU101410LOY	67	LRO05239	6 & 146-147	NRC5593PPYYELLOW	106
DA6064	131	DA8000	159	DC5004	109	HBA106180LOY	67	LRO05742	6	NRC6920	77
DA6070	59	DA8002	159	DC5005	109	HBA106190LOY	67	LRO06237	56	NTC1772PY	106
DA6071	59	DA8003	159	DC6000	108	HBD00032QJMN	58	LRO06238	56	NTC1772PPYYELLOW	106
DA6072	59	DA8004	159	DC6000L	108	HBD00032OLUP	58	LRO06241	56	NTC1773PY	106
DA6073	59	DA8005	159	DC6000LL	108	HBD00032OLYR	58	LRO06242	56	NTC1773PPYYELLOW	106
DA6074	59	DA8006	159	DC6001	108	HBD00032OSUN	58	LRO06304	148-149	NTC1775PY	106
DA6075	59	DA8007	159	DC6001L	108	HCA106010LOY	67	LRO06431	56	NTC1775PPYYELLOW	106
DA6076	59	DA8008	159	DC6001LL	108	HHD102280	67	LRO06432	56	NTC5193PM	35
DA6077	59	DA8009	159	DC6002	108	HHD102290	67	LRO06433	56	NTC6781PY	106
DA6200	139	DA8010	159	DC6003	108	IAB000010	121	LRO06434	56	NTC6781PPYYELLOW	106
DA6201	139	DA8011	159	DC6004	108	IAB500090	121	LRO06435	56	NTC6828PY	106
DA6202	139	DA8012	159	DC6005	108	IAB500100	121	LRO06436	56	NTC6828PPYYELLOW	106
DA6203	139	DA8013	159	DC6006	108	IAB500104E	121	LRO06437	56	NTC7307PY	106
DA6204	139	DA8015	159	DC6009	108	IAB500106	121	LRO06438	56	NTC7307PPYYELLOW	106
DA6205	139	DA8016	159	DC6010	108	JAK000065MMM	150-151	LRO06848	28	NTC7394PY	106
DA6206	139	DA8017	159	DC6011	108	JAK500300LGV	146-147	LRO06849	28	NTC7394PPYYELLOW	106
DA6207	139	DA8018	159	DC7000	106	JAK500310LGV	146-147	LRO07221	45	NTC7829	34
DA6208	139	DA8019	159	DC7001	106	JAK500320WWH	148-149	LRO07222	45	NTC7829HD	34
DA6209	139	DA8020	159	DC7002	106	JAK500330WWH	148-149	LRO07484	46 & 48	NTC9819	105
DA6210	139	DA8021	159	DC7003	106	JEF100150	133	LRO08713	148-151	NTC9820	105
DA6211	139	DA8022	159	DC7004	106	JEF100220	133	LRO14147	139	PDA500300	134
DA6212	139	DA8023	159	DC7005	106	JKR100200X	144	LRO1087ENG	164	PDA500310	134
DA6213	139	DA8024	159	DC7006	106	JKR100280X	144	LRO10178ENG	164	PHD500340	77
DA6214	139	DA8025	159	DC7007	106	JKR500010X	144	LRO 0008	162-163	PRC7994K	38
DA6215	139	DB1000	90	DC7008	106	JKR500020X	144	LRO 0754	162-163	PRC8238	39
DA6216	139	DB1001	91	DC7009	106	JMO000010X	144	LRO 0784	162-163	RBX101240PY	106
DA6217	139	DB1002	90	DC7010	106	KAH000050	76	LRO 1075	162-163	RBX101240PPYYELLOW	106
DA6218	139	DB1003	89	DC7011	106	KAJ100570	76	LRO 1355	162-163	RBX101340PY	106
DA6219	139	DB1004	89	DC7100	106	KBM100450	32	LRO 1621	162-163	RBX101340PPYYELLOW	106
DA6220	139	DB1005	89	DC7101	106	KBM100460	32	LRO 1685	162-163	RBX101680PY	106
DA6221	139	DB1006	89	DC7102	106	KBM100470	32	LRO 1686	162-163	RBX101680PPYYELLOW	106
DA6222	139	DB1007	89	DC7103	106	KBM100480	32	LRO 1753	162-163	RBX101680PY	106
DA6223	139	DB1008	90	DC7104	106	KBM100490	32	LRO 1867	162-163	RBX101680PPYYELLOW	106
DA6224	139	DB1009	90	DC7105	106	KBM100500	32	LRO 1873	162-163	RBX101690PY	106
DA6225	139	DB1010	90	DC7106	106	KBM100510	32	LRO 1986	162-163	RBX101690PPYYELLOW	106
DA6226	139	DB1011	89	DC7107	106	KBM100520	32	LRO 2033	162-163	RBX101730PY	106
DA6227	139	DB1012	90	DC7108	106	KBM100530	32	LRO 2054	162-163	RBX101730PPYYELLOW	106
DA6228	139	DB1013	91	DC7109	106	KBM100540	32	LRO 2090	162-163	RBX101780PY	106
DA6229	139	DB1014	91	DC7110	106	KBP10001	32	LRO 2278	162-163	RBX101780PPYYELLOW	106
DA6230	139	DB1015	91	DC7111	106	KNB100640	44	LRT-12-058	138	RBX101780PY	106
DA6231	139	DB1016	90	DGJ500020PCL	16	KNB500070	46 & 48	LRT-12-093	138	RBX101780PPYYELLOW	106
DA6232	139	DB1017	91	DGJ500140PMA	16	KNK500070	47	LRT-12-094	138	RBX101790PY	106
DA6233	139	DB1018	82	DKC500010PMD	165	KVB000290	126	LRT-60-004	105 & 138	RBX101790PPYYELLOW	106
DA6234	139	DB1019	82	DPB000270	7	KVD500140	125	MRC316	14	RBX101790PY	106
DA6235	139	DB1020	82	DPT100070	154	KVD500710	125	MRC316P	14	RBX101790PPYYELLOW	106
DA6236	139	DB1021	82	EAH000261PMA	56	KVD500730	125	MRC3519	64	RDB100080PY	106
DA6237	139	DB12000i	83	EAH000271PMA	56	KVL100040	21	MRC6980	66	RDB100080PPYYELLOW	106
DA6238	139	DB12000i24	83	EAH000300JMN	56	LB8000561	120	MRC6982	66	REB101740	105
DA6239	139	DB1300	88	EAH000300LUP	56	LBB110410N	120	MRC6982H	66	RGX100970PY	106
DA6240	139	DB1301	88	EAH000300PVA	56	LCJ000050LKIT	131	MRC6985	66	RGX100970PPYYELLOW	106
DA6241	139	DB1302	88	EAH000300SUN	56	LHP19	164	MTC2248	126 & 129	RGX101000PY	106
DA6242	139	DB1303	88	EAH000310JMN	56	LHP20	164	MTC3181	66	RGX101000PPYYELLOW	106
DA6243	139	DB1304	88	EAH000310LUP	56	LHP21	164	MTC5083	14	RGX101000PY	106
DA6300	135	DB1305	88	EAH000310PVA	56	LHP22	164	MTC5084	14	RGX101000PPYYELLOW	106
DA6301	135	DB1307	88	EAH000310SUN	56	LHP23	164	MTC5217	14	RGX101010PY	106
DA6302	135	DB1308	90	EAH500010PVJ	56	LHP24	164	MTC5382	129	RGX101010PPYYELLOW	106
DA6303	135	DB1309	91	EAH500011LUP	56	LHP25	164	MTC5382G	129	RGX101010PY	106
DA6304	135	DB1310	86	EAH500011PVJ	56	LHP26	164	MTC5383	129	RGX101010PPYYELLOW	106
DA6305	135	DB1313	86	EAH500012LUP	56	LHP27	164	MTC5383G	129	RGX101020PY	106
DA6306	135	DB1314	91	EAH500012PVJ	56	LHP28	164	MUC1488	66	RGX101020PPYYELLOW	106
DA6307	135	DB1315	89	EAH500015SMS	56	LHP29	164	MUC1520	66	RGX101440PY	106
DA6308	135	DB1316	89	EAH500050PMA	56	LHP32	164	MUC1520G	66	RGX101440PPYYELLOW	106
DA6309	135	DB1317	89	EAH500051PMA	56	LHP33	164	MUC2437	64	RBK101200	105
DA6310	135	DB1318	91	EAH500052PMA	56	LPX100590X	144	MUC4122ABE	64	RBK101460	105
DA6311	135	DB1319	86	EAH500054PMA	56	LRO02408	12 & 152-153	MWC1010	66	RNF100090PY	106
DA6312	135	DB1320	86	EAH500057PMA	56	LRO02417	28	MWC4840	127	RNF100090PPYYELLOW	106
DA6313	135	DB1321	86	EAH500058PMA	56	LRO02424	53	MWC4841	127	RRB100510	32
DA6314	135	DB1322	90	EAH500080PVJ	56	LRO02481	56	MWC5628LCS	66	RRB500100	32
DA6316	135	DB1323	90	EAH500100PMA	56	LRO02483	56	MWC5670LCS	66	RRC114560MUW	35
DA6317	135	DB1324	86	EAH500280JMN	56	LRO02484	56	MWC6702	127	RRC2970	7
DA6318	135	DB1325	86	EAH500280LUP	56	LRO02485	56	MWC6754	127	RRC2971	7
DA6319	135	DB1326	88	EAH500280PVA	56	LRO02486	56	MWC6755	127	RRC501470MCM	35
DA6320	135	DB1327	88	EAH500280SUN	56	LRO02497	56	MWC9060	127		
DA6322	110	DB1328	88 & 91	EAH500290JMN	56	LRO02516	53				
DA6322L	110	DB1329	90	EAH500290LUP	56	LRO02521	51				
DA6323	110	DB1330	88	EAH500290PVA	56	LRO02522	51				

PART NUMBER FINDER - continued

Part No.	Page No.	Part No.	Page No.	Part No.	Page No.	Part No.	Page No.	Part No.	Page No.	Part No.	Page No.
RRC503400MNH	35	RTC9505AC	21	STC4596VT	134	STC53037	6	STC8529AA	72	VUB000740	48
RRC503600PM	35	RTC9535	32	STC4600	133	STC53077	22	STC8587	82	VUB001070	13 & 146-147
RRC505360MNH	35	RTC9539AB	28	STC4637	41	STC53078	22	STC8604	126	VUB001080	13 & 146-147
RRC505370MNH	35	RTC9593AA	21	STC4672	134	STC53129	6	STC8605	126	VUB001090	39
RRC6681	7	RTC9841CE	164	STC4676	134	STC53157	10	STC8606	126	VUB001230	23 & 146-147
RRC6682	7	RTC9947CF	164	STC4687	134	STC53158	10	STC8607	126	VUB001300	23 & 146-147
RRC8443	14	RTC9970CE	164	STC4723N	120	STC53161	10	STC8608	126	VUB001310	23 & 146-147
RRD000100	32	SE105161L	41	STC4757	82	STC53181	11	STC8609	126	VUB002120	51
RRD000110	32	SIJ500030	134	STC4861	134	STC53193	11	STC8610	126	VUB002510	23 & 146-147
RRD000120	32	SIJ500040	134	STC4862	134	STC53194	11	STC8648	126	VUB500520	11
RRD000130	32	SJR901FRWVM	164	STC4863	134	STC618PY	106	STC8649	126	VUB500870	39
RRD100520	32	SOX 0593	162-163	STC50026	11	STC618PY-YELLOW	106	STC8652	126	VUB500900	165
RRD100530	32	STC1066	127	STC50027	11	STC729	128	STC8653	126	VUB501170	50
RRD100540	32	STC1135	128	STC50030	21	STC730	128	STC8693	126	VUB501200	11 & 150-151
RRD100550	32	STC1136	128	STC50031	21	STC7555	50	STC8694	126	VUB501270	7 & 150-151
RRD100560	32	STC1184K	134	STC50032	21	STC7570	50	STC8695	126	VUB501330	6
RRD100570	32	STC1188	41	STC50050	52	STC7582	28	STC8842	39	VUB501380	11 & 150-151
RRD100580	32	STC1424	126	STC50052AA	52	STC7623	32	STC8843AA	32	VUB501390	12
RRD100590	32	STC1653	128	STC50053AA	52	STC7631	20	STC8919AA	46, 48 & 89	VUB501400	12
RRD100600	32	STC1675	120	STC50063	26	STC7632	20	STC8972	134	VUB501500	47
RRD100610	32	STC1774VT	134	STC50064	11	STC7642	158	STC9021CC	164	VUB501920	13 & 148-149
RRJ000030	32	STC250	133	STC50080	32	STC7643	38	STC9049CA	164	VUB501930	13 & 148-149
RRJ500030MNH	36	STC2802B	132	STC50082AA	50	STC7644	39	STC9155	134	VUB501980	6 & 148-149
RTC3184X	144	STC2813	127	STC50134	26	STC7929	26	STC9157	134	VUB502130	28
RTC3254	133	STC2814	127	STC50172	55	STC7932	28	STC9158	134	VUB502390	59
RTC3347	133	STC2815	127	STC50176AA	28	STC7939AB	51	TRC102900	121	VUB502520	59
RTC3534	139	STC2816	127	STC50252	28	STC7960	12	TRC103150	121	VUB502610	13 & 146-147
RTC3537	139	STC2828VT	134	STC50269AA	20 & 45	STC7962AA	12	TRC103160E	121	VUB502790	28
RTC4615C	38	STC2862A	134	STC50287AB	46	STC7969	30	TRC103270	121	VUB503650	146-147
RTC4615K	38	STC2864VT	134	STC50289AB	46	STC8026	13	TRC103330	121	VUB503660	23 & 146-147
RTC4769	7	STC3135	133	STC50301	20 & 45	STC8027	13	TRC103350	121	VUB503880MMM	146-153
RTC6203	128	STC3261	133	STC50323	50	STC8056	10	TYK500070	134	VUB503960	48
RTC6204	128	STC3415	32	STC50327AA	28	STC8057AC	28	TYL100030	124	VUB504110	10
RTC6247	126 & 129	STC3417	32	STC50383	40	STC8130AB	21 & 23	URB500060	130	VYK000020	134
RTC6248	126 & 129	STC3420	32	STC50391	47	STC8138AB	72	UTP1725	133	XFDS00010	41
RTC6248NG	126 & 129	STC3421	32	STC50408	40	STC8156AA	105	VPLAP0035	21	XFES00010	41
RTC6317	128	STC3422	32	STC50413	6	STC8354	126	VPLAR0001	28	XQB500080	39
RTC6318	128	STC3423	32	STC50417	26	STC8355	126	VPLAS0022PVJ	56	YGD000271	82
RTC6401VA	134	STC3424	32	STC50433	28	STC8356	126	VPLAS0023PVJ	56	YGD100860	82
RTC6820	15	STC3425	32	STC50435	53	STC8358	130	VPLFS0014	53	YGD500100	82
RTC6821	15	STC3426	32	STC50479	50	STC8363	130	VPLSS0016	53	YGD500130	82
RTC6870VT	134	STC3427	32	STC50519	134	STC8414	50	VPLSS0042	148-149	YGD500190	82
RTC8093	51	STC3428	32	STC50529	134	STC8452	11	VTD500010	21 & 150-151	YWC000840	48
RTC8829	48	STC3429	32	STC50530	134	STC8453	11	VTD500020	21 & 150-151	YWJ101500	45
RTC8831	44	STC3435	136	STC50531	134	STC8480	39	VTK500010	21 & 150-151	YWJ500201	46
RTC8860AA	10	STC3435S	136	STC50543	134	STC8503AA	13	VTK500020	23 & 148-149	YWJ500450	48
RTC8891AA	45-46	STC3582	32	STC50544	134	STC8504AB	13	VUB000610	59		
RTC8922	38	STC3601	32	STC50547	134	STC8505AA	23	VUB000700	54		
RTC8969	10	STC4235VT	134	STC50549	134	STC8506	28	VUB000710	54		
RTC9479	15	STC4404	133	STC50550	134	STC8513	32	VUB000720	48		
RTC9503AA	11	STC4526	120	STC50551	134	STC8524	51	VUB000730	48		



THE SMALL PRINT

- > Part numbers used for identification purposes only and do not imply or indicate the identity of a manufacturer.
- > Genuine Land Rover parts and accessories are for sale in EU countries only.
- > Parts are subject to stock and supply.
- > Pictures are for reference only and specifications may alter without notice.
- > Colour swatches are for reference only - samples are available on request.
- > All products available at time of printing and we reserve the right to withdraw any product at any time.
- > Land Rover logos and trade names are for reference only.
- > No part of this catalogue may be used or reproduced by any means without the express permission of Britpart.
- > Product specifications are given but it is up to the end user to ensure that the product is fit for that purpose.
- > E&OE

KEEP UP TO DATE

Keep up to date with all the latest developments from Britpart by e-mail.

Simply log on to www.britpart.com and register your details in the 'Mailing List' section or simply send an e-mail to - marketing@britpart.co.uk



WE'D LOVE TO SEE YOUR PICTURES



If you have a great picture of your Land Rover and would like to see it featured in the next Britpart catalogue, then please send it to marketing@britpart.co.uk with all your details. We look forward to seeing them and for each one we feature we'll send you a small thank you gift!

Defender picture courtesy of Carol Dabill

INDEX

A Bars	6	Conversion kits, air spring	104	Intercoolers - performance	100
Accessories, winching	89-91	Conversion kits, electronic	132	Interior lamp	41
Adaptor kits, wheel	34	Cosmetic enhancements	146-154	Jacking equipment	76
Air compressors	33 & 70	Covers, waterproof seat	57-58	Jacks - Hi-Lift	74
Air conditioning kits	158	Covers, wheel	33	Jacks - Jackall	74
Air filters	94	Cubby boxes	62-63	Jerry cans	74
Air filters - Britpart	94	Cup holder	62-63	Jubilee clips	124
Air filters - K&N consumables	95	CV joint kits - Britpart	131	K&N consumables	95
Air intake grilles	146-154	Cycle carrier	26 & 29-30	Keys, wheel nut	32
Air lift kits	104	Cylinder liner kit	131	Kit, automatic transmission service	124
Air spring conversion kits	104	Damper kit	131	Kit, damper	131
Air springs - Britpart	105	Deflectors, wind	59	Kit, heater plug upgrade	133
Alloy wheels	35-36	De-icer	134	Kit, tyre repair	33 & 70
Antifreeze	134	Delphi, shock absorbers	110	Kits, brake hose	95
Anti-roll bar kit	105	Detroit diff lockers	72	Kits, clutch	130
ARB diff lockers	71	Diff coupling shaft	131	Kits, CV joint	131
Automatic transmission service kit	124	Diff guards - bolt on	9	Kits, electronic conversion	132
Batteries - Lucas	82	Diff lockers - uprated - ARB	71	Kits, re-trim	65
Batteries - Optima	82	Diff lockers - uprated - Detroit	72	Kits, suspension	113
Bearing, wheel	139	Diff repair pans	131	Kits, swivel housing gaiter	17
Bearings, propshaft	136	Dislocation cones	107	Kits, swivel pin	137
Bike racks	26	Dog guards	50-51	Kits, timing	137
Blanking kits	99	Door hinge kit	132	Kits, wheel bearing	139
Books	160 & 164	Door hinges - aluminium	132	Ladders - off-road	76
Boot liner	52-53	Door trim	63	Ladders - roof	26
Boxes, cubby	62-63	Down pipes	118	Lamp guards	10-14
Boxes, roof	29	Driving lights	39	Land meters	76
Brake discs	96-98	Dyneema rope	89-91	Land Rover gear	162-163
Brake fluid	134	EBC brake parts	97-98	Land Rover genuine consumables	134
Brake hose kits	95	EGR blanking kits	99	Lead sets, ignition	134
Brake kits	124	Electronic conversion kits	132	Light bar	38
Brake lubrication	95	Emergency hammer	73	Light conversion kits	38
Brake pads	97-98	Engines - new	120	Light kits	38
Brake parts	97-98	Engines - reconditioned	120	Light mounting kits	40
Britpart bulk filters	144	Exhaust clamps	124	Light upgrade kits	40
Britpart Cellular Dynamic shock absorbers	108	Exhausts - stainless steel	116	Lights - driving	39
Britpart clothing	159	Exhausts - stainless steel sports systems	117	Lights - fog	38
Britpart merchandise	159	Extended slide seat rails & bulkhead bars	64	Lights - Roo-lites	40
Britpart performance brake discs	96	Extinguishers, fire	72	Lights, NAS	41
Britpart service kits	142-144	Fairleads	89-91	Liner kit, cylinder	131
Britpart Super Gaz shock absorbers	109	Filters	144	Liner, boot	52-53
Britpart winches	83-85	Fire extinguishers	72	Link lead	134
Bulkhead bars	64	First aid kit	158	Loadspace liners	52-53
Bull bar	7	Fog lights	38	Loadspace nets & retention kit	54
Bump stops	105	Fuel tanks - additional	72	Locking wheel nuts, keys & caps	32
Bumper	7	Fume curtain	64	Loctite consumables	135
Bumper kits, winch	86	Gaiter kits	17	Lubrication, brake	95
Bumperettes	7	Gaiters, gear box	51	Lucas batteries	82
Bumpers, winch	87	Gasket kits	132	Manuals	160
Bush fitting tool	105	Gear box gaiters	51	Map reading lamp	41
Bush sets - Britpart other	105	Gear boxes - new	121	Matrix, heater	133
Bush sets - Britpart polyurethane	106	Gear boxes - reconditioned	121	Mats	55-56
Bushes	105-107	Gear lever set	146-154	Merchandise	159 & 162-163
Cans, Jerry	74	Gloves	89-91	Mirrors & fittings	14
Carburettors, Weber	101	Glue	135	Models	162-163
Carpet mats	55-56	Grease nipples	124	Mud flaps	15
Carriers, wheel	33	Grilles	146-154	Muffs, radiator	16
Chassis' - complete	125	Guard, transmission	17	NAS lights	41
Chassis & body components - Defender	126	Guards, dog	50-51	Net, loadspace	54
Chassis & body components - Discovery 1	127	Guards, lamp	10-14	Nipples, grease	124
Chassis & body components - Freelander	127	Guards, steering	17	Nudge bar	7
Chassis & body components - Range Rover	127	Guards, sump	17	Oil	134
Classic	128	Hammer - emergency	73	Oil pump gear set	135
Chassis & body components - Series 2 & 3	129	Hand barrier cream	132	Optima batteries	82
Chequer plate	8	Handbrake conversion kits	99	Original technical publications	164
Clamps, exhaust	124	Haynes internal combustion engine	161	Paints	134 & 139
Cleaners	134	Haynes manuals & books	160	Panhard rod	107
Clips, clamps & nipples	124	Head bolt sets	132	Pans, diff repair	131
Clips, Jubilee	124	Heater blower motor kit & resistor kit	133	Parabolic springs	112
Clothing	159 & 162-163	Heater matrixes	133	Parking sensors	16
Clutch kits	130	Heater plug upgrade kit	133	Parts & general interest books	164
Coil springs	111	Hinge kit, door	132	Pens, touch up	134 & 139
Compounds, Hylomar	133	Hoods	64	Plate	8
Compressors, air	33 & 70	Hoses	100	Polybush sets	107
Cones, dislocation	107	Hylomar sealants & compounds	133	Pressure relief valve kit	135
Consumables, Land Rover	134	Ignition lead sets	134	Propshaft bearings	136
Consumables, Loctite	135	Ignition module	134	Propshaft kit	136
Conversion kit, handbrake	99	Inner tube	32	Propshafts, wide angle	113
Conversion kit, light	38	Intercooler silicone hoses	100	Protection tubes	20-23

PSI power tuning products	101	Shock absorbers - Delphi De Carbon	110	Transmission guard	17
Radiator mufflers	16	Shock absorbers - heavy-duty	111	Tree straps	89-91
Radius arms	107	Side runners	20-23	Trim	68
Raised air intake - Britpart	77	Side steps	20-23	Tuning products	101
Raised air intake - Safari	78	Silencers	118	Tyre pressure monitoring system	34
Rear exhaust pipes	118	Silicone hoses	100	Tyre repair kit & air compressors	33
Rear steps	20-23	Snatch block	89-91	Utility link and rear pipes	118
Recovery eye	89-91	Snorkels	77-78	Vehicle enhancements	146-154
Remote control	89-91	Spare parts, winch	88	Vents	146-154
Repair kit, tyre	33 & 70	Spare wheel carriers	33	Waterproof seat covers	57-58
Retainers, spring	112	Spare wheel covers	33	Weber carburettors	101
Re-trim kits - Defender	65	Spring retainers	112	Wheel arch kit - standard	18
Rims	36	Springs - coil	111	Wheel arch kits - off-road	18
Roof boxes	29-30	Springs - parabolic	112	Wheel bearing kits	139
Roof rack ladder	26	Springs, air	105	Wheel carriers	33
Roof racks	27-30	Steel wheels	35	Wheel covers	33
Roof racks - galvanised flat pack kits	27	Steering arms - heavy-duty	112	Wheel hub & bearing assembly	139
Roof racks & boxes - Mont Blanc	29	Steering guards	17	Wheel keys	32
Roof racks & boxes - Thule	30	Steering wheels	146-154	Wheel nut caps	32
Roof rails	28-30	Stops	105	Wheel nuts	32
Roof tents	79	Sump guards	17	Wheel spacers & adaptor kits	34
Roo-lites	40	Suspension kits - Britpart	113	Wheel wrenches	34
Ropes, tow	89-91	Swivel housing gaiter kits	17	Wheels	35
Rubber mats	55-56	Swivel housing grease	136	Wide angle propshafts	113
Rubbing strips	16	Swivel housing kits	136	Winch bumper kits	86
Screen wash	134	Swivel pin kits	137	Winch bumpers	87
Sealant	135	Tanks, fuel tanks - additional	72	Winch spare parts	88
Sealants, Hylomar	133	Tents	79	Winches	83-85
Seat covers	57-58	Timing kits	137	Winching accessories	89-91
Seat rails	64	Tools	105 & 138	Winching accessory kits	91
Seats - Defender & Series	66	Touch up paint pens	139	Wind deflectors	59
Seats - Techno style	67	Tow electrics	44-48	Window kits	140
Seats - XS style	67	Tow hitch	44-48	Wing protectors	140
Sensors, parking	16	Tow kit	44-48	Wiper blades - heavy-duty	165
Service kits	142-144	Tow ropes	89-91	Wrenches	34
Shackle	89-91	Towing equipment - all models	44-48	Zu rims	36
Shock absorber brackets	110	Transfer boxes - new	121		
Shock absorbers	108-109	Transmission fluid	134		



Picture courtesy of Dimitris Karasavas

UK REGISTRATION YEARS

Suffix letter series 1963 - 1983

Letter	Dates of issue
A	1st January - 31st December 1963
B	1st January - 31st December 1964
C	1st January - 31st December 1965
D	1st January - 31st December 1966
E	1st January - 31st July 1967
F	1st August 1967 - 31st July 1968
G	1st August 1968 - 31st July 1969
H	1st August 1969 - 31st July 1970
J	1st August 1970 - 31st July 1971
K	1st August 1971 - 31st July 1972
L	1st August 1972 - 31st July 1973
M	1st August 1973 - 31st July 1974
N	1st August 1974 - 31st July 1975
P	1st August 1975 - 31st July 1976
R	1st August 1976 - 31st July 1977
S	1st August 1977 - 31st July 1978
T	1st August 1978 - 31st July 1979
V	1st August 1979 - 31st July 1980
W	1st August 1980 - 31st July 1981
X	1st August 1981 - 31st July 1982
Y	1st August 1982 - 31st July 1983

Prefix letter series 1983-2001

Letter	Dates of issue
A	1st August 1983 - 31st July 1984
B	1st August 1984 - 31st July 1985
C	1st August 1985 - 31st July 1986
D	1st August 1986 - 31st July 1987
E	1st August 1987 - 31st July 1988
F	1st August 1988 - 31st July 1989
G	1st August 1989 - 31st July 1990
H	1st August 1990 - 31st July 1991
J	1st August 1991 - 31st July 1992
K	1st August 1992 - 31st July 1993
L	1st August 1993 - 31st July 1994
M	1st August 1994 - 31st July 1995
N	1st August 1995 - 31st July 1996
P	1st August 1996 - 31st July 1997
R	1st August 1997 - 31st July 1998
S	1st August 1998 - 28th February 1999
T	1st March - 31st August 1999
V	1st September 1999 - 29 February 2000
W	1st March - 31st August 2000
X	1st September 2000 - 28th February 2001
Y	1st March - 31st August 2001



New style series 2001 - onwards

Year	1st March to 31st August	1st September to 28th February
2001/2002	N/A	51
2002/2003	02	52
2003/2004	03	53
2004/2005	04	54
2005/2006	05	55
2006/2007	06	56
2007/2008	07	57
2008/2009	08	58
2009/2010	09	59
2010/2011	10	60
2011/2012	11	61
2012/2013	12	62



BRITPART

The quality parts for Land Rovers



BRITPART

The quality parts for Land Rovers

Main Tel: +44 (0) 1588 672711
UK Sales Tel: +44 (0) 1588 674200
UK Sales Fax: +44 (0) 1588 672720
Export Sales Fax: +44 (0) 1588 674203

Email: sales@britpart.co.uk
Web: www.britpart.com

Britpart
The Grove
Craven Arms
Shropshire
SY7 8DA
United Kingdom

Available from -