

# DISCOVERY



## Electrical Troubleshooting Manual

---



## DISCOVERY

### 1996 Model

#### Contents

<b>Section Title</b>	
i	Introduction
A1	Multipoint Fuel Injection (MFI-V8)
A2	Multipoint Fuel Injection (MFI-T16)
A3	Sequential Multipoint Fuel Injection (SFI-V8) (NAS only)
A4	300Tdi
A5	300Tdi Glow Plug Control
B1	Starting and Charging
B5	Cruise Control
C1	Ignition and Shift Interlock
D1	Anti-Lock Brake System
D3	Data Link Connector
E1	Instruments
E2	Warnings and Indicators (except NAS)
E3	Warnings and Indicators (NAS)
E5	Horns
E6	Radio (except NAS)
E7	Radio (NAS)
F1	Front Wipe/Wash
F3	Rear Wipe/Wash
F8	Heated Rear Screen and Mirror Demisters
G1	Electrochromic Rear View Mirror
G4	Multi-Function Unit (MFU)
H1	Headlamps (except NAS)
H2	Headlamps (NAS)
H3	Headlamp Levelling
H4	Side Lamps
H5	Stop Lamps
H6	Direction Indicator Lamps
H7	Reversing Lamps
H9	Fog Guard Lamps
J1	Interior Lamps
J2	Cigar Lighter/Clock

K1	Blower Controls
K2	Compressor Controls
K5	Cooling Fans
L1	Power Windows
L4	Sunroof
L6	Central Locking
M1	Power Seats
M3	Power mirrors
P1	Trailer Auxiliary Socket
T1	Theft Alarm System (except NAS)
T2	Theft Alarm System (NAS)
Y1	Power Distribution
Y2	Fuse Details
Y5	Ground Distribution
Z4	Component Location Table
Z5	Component Location Views
Z6	Connector Views
Z8	Harness Routing
Z9	Index

Published by Land Rover

© Rover Group Limited 1995  
Publication Part No LRL0028ENX



## DISCOVERY

### 1996 Model

#### Contents

<b>Section</b>	<b>Title</b>
i	Introduction
A1	Multiport Fuel Injection (MFI-V8)
A2	Multiport Fuel Injection (MFI-T16)
A4	300Tdi
A5	300Tdi Glow Plug Control
B1	Starting and Charging
B5	Cruise Control
C1	Ignition and Shift Interlock
D1	Anti-Lock Brake System
D3	Data Link Connector
E1	Instruments
E2	Warnings and Indicators (except NAS)
E5	Horns
E6	Radio (except NAS)
F1	Front Wipe/Wash
F3	Rear Wipe/Wash
F8	Heated Rear Screen and Mirror Demisters
G1	Electrochromic Rear View Mirror
G4	Multi-Function Unit (MFU)
H1	Headlamps (except NAS)
H3	Headlamp Levelling
H4	Side Lamps
H5	Stop Lamps
H6	Direction Indicator Lamps
H7	Reversing Lamps
H9	Fog Guard Lamps
J1	Interior Lamps
J2	Cigar Lighter/Clock
K1	Blower Controls
K2	Compressor Controls

K5	Cooling Fans
L1	Power Windows
L4	Sunroof
L6	Central Locking
M1	Power Seats
M3	Power mirrors
P1	Trailer Auxiliary Socket
T1	Theft Alarm System (except NAS)
Y1	Power Distribution
Y2	Fuse Details
Y5	Ground Distribution
Z4	Component Location Table
Z5	Component Location Views
Z6	Connector Views
Z8	Harness Routing
Z9	Index

Published by Land Rover

© Rover Group Limited 1995  
Publication Part No LRL0028UK (2nd Edition)



**CIRCUIT DIAGRAMS**

- Circuit diagrams are arranged so that current flow is from the top of the diagram (current source) to the bottom of the diagram (ground).
- Only those components that work together in the circuit are shown. If only part of a component is used in the circuit, then only that part of the component is shown.
- Remember:

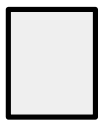

Entire component

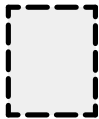

Part of a component

**TERMINAL NUMBER****DESIGNATION**

50	Battery voltage: Ignition Switch in position III
30	Battery voltage: supplied constantly
15	Battery voltage: Ignition Switch in position II or III
R	Battery voltage: Ignition Switch in positions I, II
31	Ground

See Introduction (i) for additional circuit diagram symbols.

**DIAGNOSIS**

- If the diagram is accompanied by text:
  - Read the Circuit Operation before proceeding with the electrical diagnosis.
  - Read the Troubleshooting Hints before performing the System Diagnosis.
  - Tests follow the System Diagnosis
  - When performing the System Diagnosis, be certain that all components disconnected in previous steps are reconnected unless otherwise directed.



Component is disconnected.  
Backprobe harness connector



Component is connected.  
Backprobe harness connector



Component is disconnected.  
Probe component



Component is disconnected.  
Probe harness connector



Probe in-line connector

## INTRODUCTION

This manual is intended for use by trained Land Rover technicians as an aid to diagnosing electrical concerns.

This manual is organized into sections. Most sections contain circuit diagrams. Each section has a unique alpha–numeric code that will normally remain the same from year to year. For example, the Headlights circuit is in Section H1, with the first page of the section numbered H1–1. The following pages of this section will be numbered H1–2, H1–3, H1–4, etc. The manual does not contain any information concerning removal, refit or overhaul of electrical components or harnesses. These details are contained in the Workshop Manual. The following information forms the basis of the troubleshooting routines:

- Circuit Diagrams
- System Diagnosis Flow Charts
- Component Location Table
- Component Locations Views

Additional information, such as Circuit Operation, is also contained in the manual to aid in your understanding of how the different circuits operate.

## DESCRIPTION OF MANUAL

### Circuit Operation and Diagram

The Circuit Operation information at the beginning of the section will give you an overview of how the circuit works.

The Circuit Diagrams should always be your starting point in using this Electrical Troubleshooting Manual. The diagram shows the electrical current paths when a circuit is operating properly. It is essential to understand how a circuit should work before trying to figure out why it doesn't. Diagrams are shown with the Ignition Switch in the OFF position and other switches in the OFF or 'at rest' position.

Notes are provided after certain switches to clarify switch positions. Abbreviations found in the notes are explained in the Abbreviation Table found in the SYMBOLS section of this chapter.

Circuit Diagrams (schematics) break the entire electrical system into individual circuits. Electrical components that work together are shown together.

Each diagram is arranged so current flows from positive, at the top of the page, to ground, at the

bottom of the page. The 'power' labels at the top of a fuse show when the Battery, Main Light Switch, or Ignition Switch supplies power to that fuse.

Wires that connect to another circuit are shown with an arrowhead pointing in the direction of current flow. The name of the circuit that shares the wiring is provided for reference.

Wire Colour charts are no longer provided on each circuit page. One chart is provided in the SYMBOLS section of this chapter.

'See Fuse Details' means there are more connections to other circuits that are not shown. All such shared circuits are shown on the Fuse Details diagrams. 'See Ground Distribution' means there are more shared ground circuits which are shown on the Ground Distribution diagrams.

No attempt is made on the diagrams to represent components and wiring as they physically appear on the car. For example, a long length of wire is treated no differently in a diagram from one which is only a few centimetres long. The number of cavities for each connector is listed in the Component Location Table rather than illustrated. Similarly, switches and other components are shown as simply as possible, showing function only.

---

**Power Distribution**

The Power Distribution diagrams are found in Section Y1. These diagrams show how voltage is supplied from the positive Battery terminal to the various circuits in the vehicle.

The individual Circuit Diagrams begin with a fuse or the Ignition Switch. Power Distribution shows the wiring from the Battery to the Fuse Boxes, the Ignition Switch, the Main Lighting Switch, and any circuit fuses not located in a Fuse Box.

---

**Fuse Details**

The Fuse Details diagrams are found in Section Y2. These diagrams show all the wiring between each fuse in the Fuse Boxes and the components connected to the output of the fuse. The Fuse Details diagrams are extremely helpful in locating a short circuit that causes a fuse to blow. These diagrams also aid in troubleshooting an inoperative circuit by showing a second circuit using the same fuse. If the second circuit works, then the fuse and certain wires of the inoperative circuit are good.

---

**Ground Distribution**

The Ground Distribution diagrams are found in Section Y5. These diagrams show which components share each ground point. This information can often be a timesaver when troubleshooting a poor ground.

For example, if the Fuel Pump does not run, you may suspect an open in its circuit to ground. However, if the Number Plate Lamps work, and they share the same ground point as the Fuel Pump, you know that the ground and the wire up to the common splice are good. You have learned this just by inspecting the diagram and knowing the vehicle's symptoms.

---

**Connector Views**

Connector Views are provided in section Z6. All connectors with 2 terminals or more will be shown. Pin-out tables with the appropriate wire colours will also be shown.

---

**Component Location Table**

A Component Location Table can be found in Section Z4. Except for the location of obvious components like the Left Headlight, the table lists the location of every component, connector and ground point depicted in the Circuit Diagrams. The table also gives references to Component Location Views located in Section Z5 and cross references to Workshop Manual remove and refit procedure sections. The number of cavities in each connector and the connector colour are also listed. Wires may not be used in all connector cavities.

## TROUBLESHOOTING TECHNIQUE

The following five–step troubleshooting procedure is recommended.

### 1. Verify the Problem

Check the operation of the circuit to be sure you understand the problem. Do not begin disassembly or testing until you have narrowed down the possible causes.

### 2. Analyze the Circuit Diagram (schematic)

Analyze the diagram. Check circuits that share the wiring with the problem circuit. The names of shared circuits are often given on each Circuit Diagram to aid troubleshooting. Shared power and ground circuits can be found in the Power and Ground Distribution sections. Try to operate the shared circuits. If these circuits work, then the shared wiring is OK. The cause must be within the wiring used only by the problem circuit. If several circuits fail at the same time, chances are the power (fuse) or ground circuit is faulty.

### 3. Find the Cause

- Narrow down the possible causes.
- Before you replace a component, check power, signal, and ground wires at the component harness connector.

### 4. Repair the Problem

Once the specific problem is identified, make the repair. Be sure to use the correct tools and safe procedures.

### 5. Check the Repair

Check the operation of the repaired circuit in all modes to make sure you fixed the entire problem. If the problem was a blown fuse, be sure to test all of the circuits on that fuse. Make sure no new problems are present.

multimeter. Never use a test light on circuits that contain solid state devices. Damage to the device may result.

On circuits without solid state devices, a test light may be used to check for voltage. A test light is made up of a 12 volt bulb with a pair of leads attached. After grounding one lead, touch the other lead to various points along the circuit where voltage should be present. The bulb will come on if the voltage at the point being tested is greater than 5 volts.

## TEST EQUIPMENT

Where applicable, Land Rover– recommended testers should be used.

### Voltmeter and Test Light

Use a voltmeter or test light to check for voltage. While a test light shows whether or not voltage is present, a voltmeter indicates how much voltage there is.

**CAUTION:** A number of circuits include solid state devices. Voltages in these circuits should be tested only with a 10 megohm or higher impedance digital

### Self-powered Test Light and Ohmmeter

Use a self-powered test light or ohmmeter to check for continuity. The ohmmeter shows how much resistance there is between two points along a circuit. Low resistance means good continuity.

**CAUTION:** Never use a self-powered test light on circuits that contain solid state devices. Damage to these devices may result.

Diodes and solid state devices in a circuit can make an ohmmeter give a false reading. To find out if a component is affecting a measurement, take one reading, reverse the leads, and take a second reading. If the readings differ, the component is affecting the measurement.

Circuits that contain solid state devices should only be tested with a 10 megohm or higher impedance digital multimeter.

A self-powered test light consists of a light bulb, battery and two leads. If the leads are touched together, the bulb will go on.

A self-powered test light is only used on an unpowered circuit. First, disconnect the battery or remove the fuse that feeds the circuit you are working on. Select two points along the circuit through which there should be continuity. Connect one lead of the self-powered test light to each point. If there is continuity, the test light's circuit will be completed and the bulb will go on.

### Fused Jumper Wire

Use a fused jumper wire to bypass an open circuit. A fuse jumper wire is made up of an in-line fuse holder connected to a set of test leads. Never use a jumper wire across any load. This direct battery short will blow the fuse.

The following symbol represents a fused jumper:

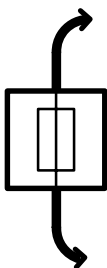



**SYMBOLS**

The abbreviations and symbols explained here are used throughout the manual; it is necessary to know what they mean in order to use the diagrams effectively.

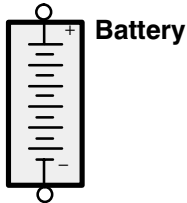

**Battery**



**F1 Fuse**



**MF2 Maxi-Fuse<sup>®</sup>**



**One-pole on/off switch**

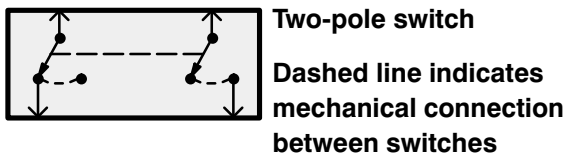

**Two-pole switch**

Dashed line indicates mechanical connection between switches



**Multiple Position Switch**

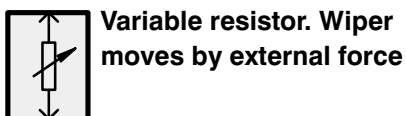

**Variable resistor. Wiper moves by external force**

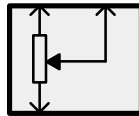

**Potentiometer. Wiper moves by external force**

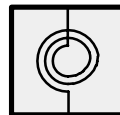

**Steering Column Rotary Coupler**



**Diode. Current flows in direction of arrow only**



**LED**



**Bulb**



**Electronic or Solid State device**

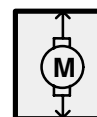

**Permanent magnet motor (one speed)**

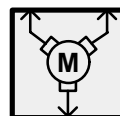

**Permanent magnet motor (two speed)**

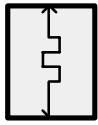

Heating Element



Antenna

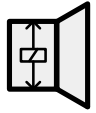

Loudspeaker or horn

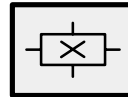

Hall Effect Sensor

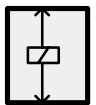

Coil

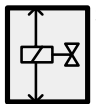

Solenoid



Relay

Switch is drawn into the closed position when current flows through coil

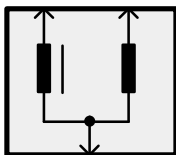

Ignition Coil

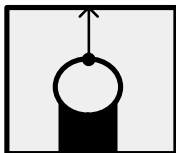

Steering Column  
Horn Brush/  
Slip Ring

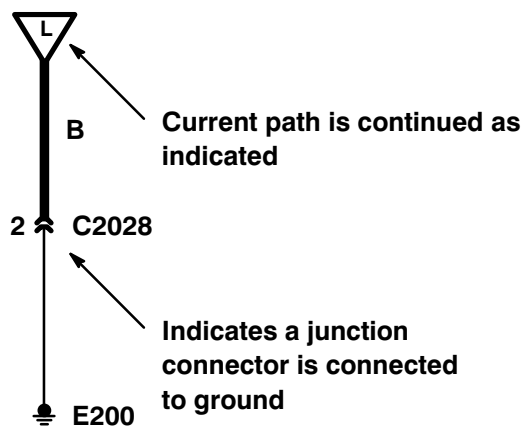
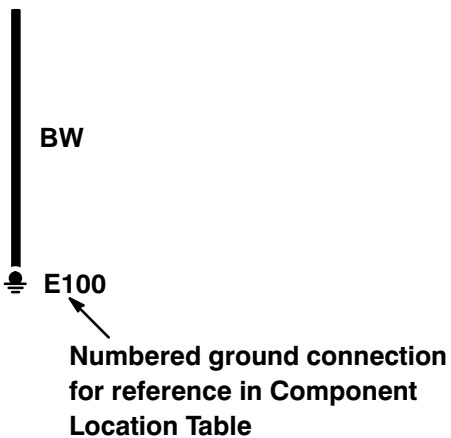
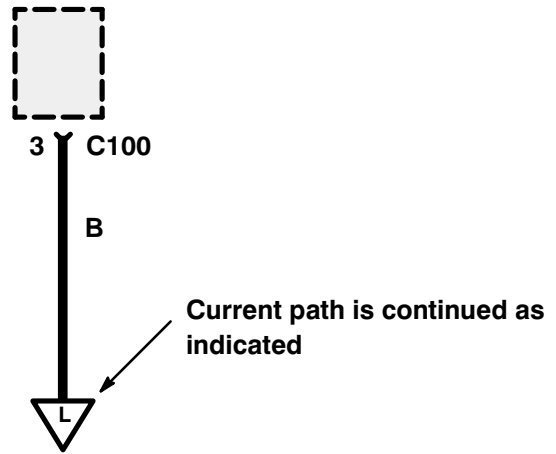
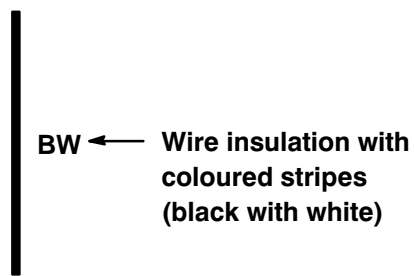
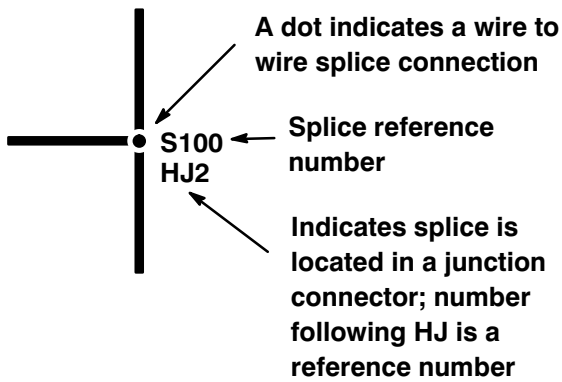
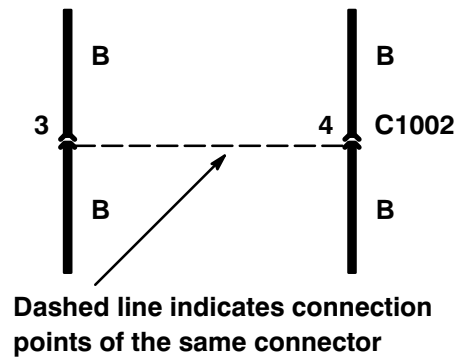
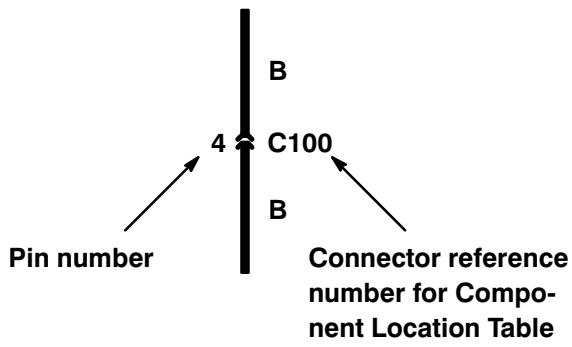

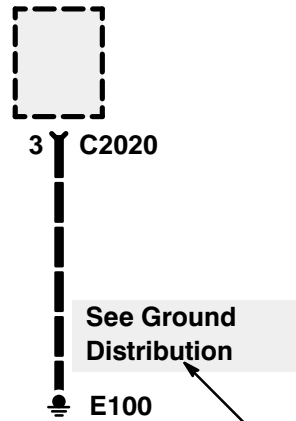
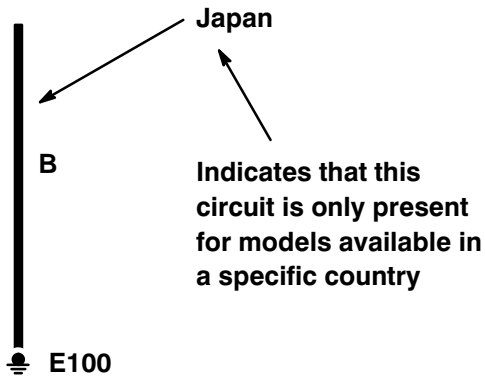
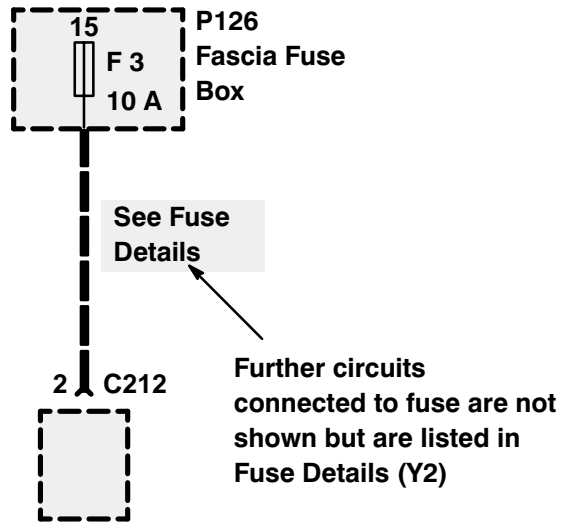
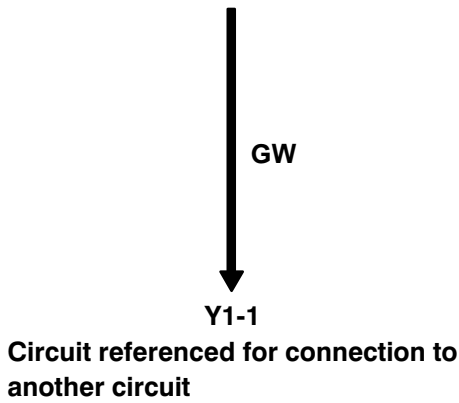

Further circuits connected at ground are not shown but are listed under Ground Distribution

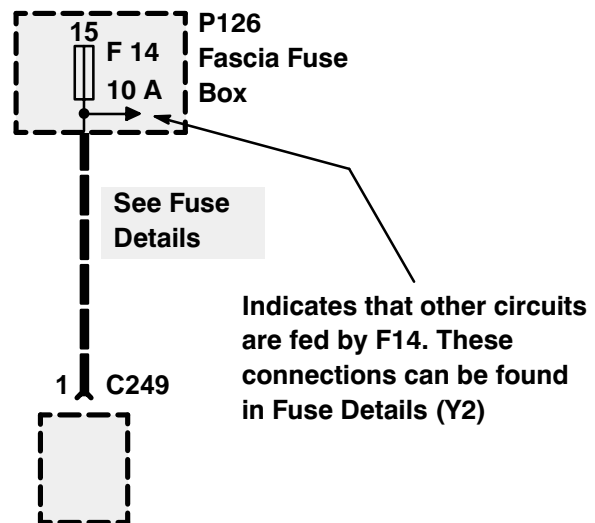
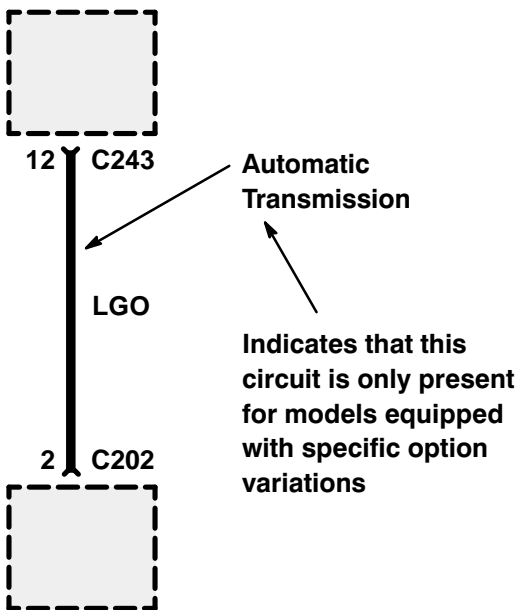

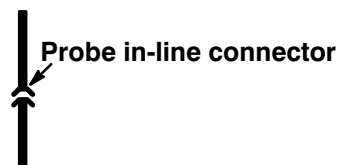
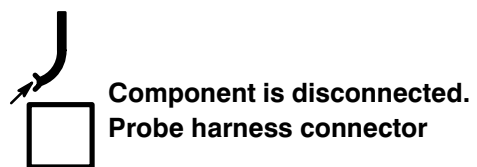
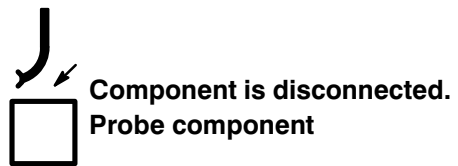
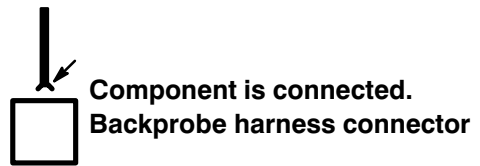
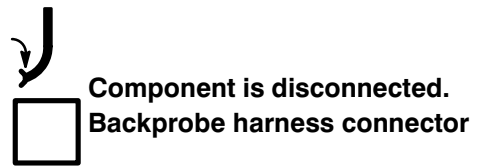
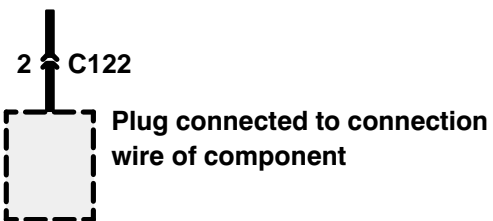
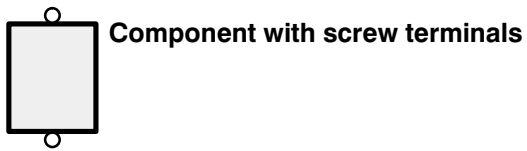
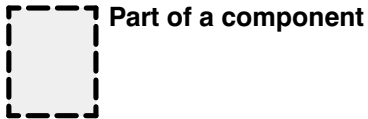

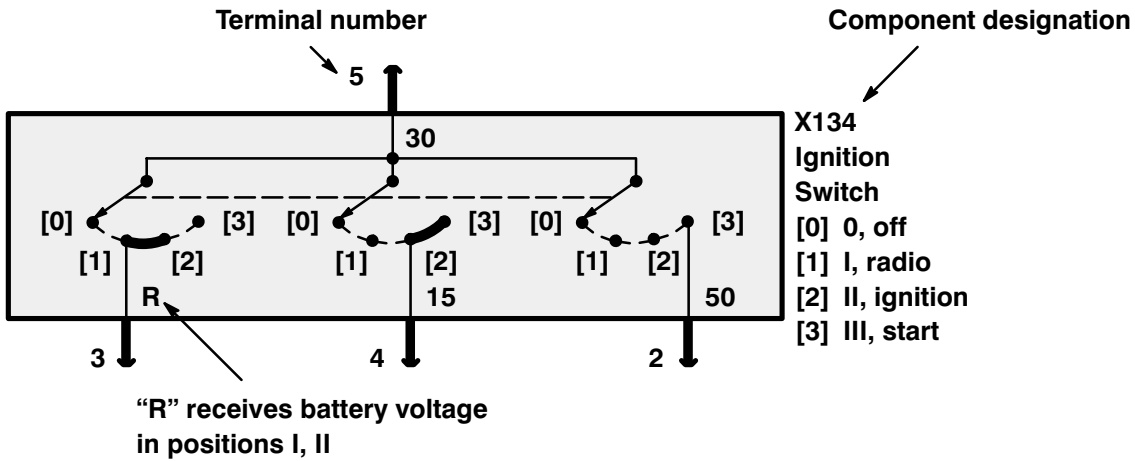

Terminal number	Designation	Terminal number	Designation
50	Battery voltage: Ignition Switch in position III	X	Switched battery voltage through the ignition load relay or accessory relay; ignition switch is in position I or II.
30	Battery voltage: supplied constantly	49	Flasher unit input
15	Battery voltage: Ignition Switch in position II or III	49a	Flasher unit output
R	Battery voltage: Ignition Switch in positions I, II	50	Start
31	Ground	56	Headlamp
		56a	High beam
		56b	Low beam
		56d	Headlamp flash
		58	Side lamps
		85	End of relay coil
		86	Start of relay coil
		87	Relay contact
		87a	Relay contact

**Definition of Vehicle Component Codes**

All components are identified by a letter followed by an arbitrary number assigned to the component. The letter assigned to the component indicates the type of component.

<b>B</b>	<b>Bulbs, Heated Screens, Mirror Demisters, Cigar Lighters, and Heated Washer Jets</b>
<b>K</b>	<b>Relays, Solenoids, Speakers, and Resistors</b>
<b>M</b>	<b>Motors</b>
<b>P</b>	<b>Fuse Boxes and Fusible Links</b>
<b>X</b>	<b>Switches and Sensors</b>
<b>Z</b>	<b>Electronic Control Units, Modules, Shields, Diodes, and Capacitors</b>

**Wire Colours**

All wires are identified by letters which indicate a certain colour. Wire colour and size will only be shown once if it does not change throughout the circuit. The following chart explains the wire colour abbreviations.

**Wire Colour Chart**

<b>B - Black</b>	<b>P - Purple</b>
<b>G - Green</b>	<b>R - Red</b>
<b>K - Pink</b>	<b>S - Grey</b>
<b>L - Light</b>	<b>U - Blue</b>
<b>N - Brown</b>	<b>W - White</b>
<b>O - Orange</b>	<b>Y - Yellow</b>

**Previous and Next Arrows**

A schematic page which follows another schematic page of the same chapter will have an arrow in the upper left hand corner. There is no arrow on the first schematic page of a chapter. Schematic pages which are followed by another schematic page will have an arrow in the lower right hand corner. If the page is the last page of the chapter, there will be a square instead of an arrow.

**Page Qualifiers**

Schematic pages which are specific to certain model, option or country variations will have a small "Qualifier" after the Previous Arrow in the upper left-hand corner. For example, a section might contain pages specific to petrol engines and some pages specific to diesel engines. "Petrol" will be shown in the upper left hand corner of petrol specific pages, and "Diesel" will be shown in the upper left hand corner of diesel specific pages.

**Circuit Qualifiers**

Certain abbreviations are used throughout the Electrical Troubleshooting Manual as circuit qualifiers. The following list explains all abbreviations used as qualifiers in the Circuit Diagrams.

<b>ABS</b>	<b>Anti-Lock Braking System</b>
<b>LHD</b>	<b>Lefthand Drive</b>
<b>RHD</b>	<b>Righthand Drive</b>
<b>LWB</b>	<b>Long Wheel Base</b>
<b>SWB</b>	<b>Short Wheel Base</b>
<b>NAS</b>	<b>North American Countries</b>
<b>MFI-V8</b>	<b>Multiport Fuel Injection (MFI-V8)</b>
<b>MFI-T16</b>	<b>Multiport Fuel Injection (MFI-T16)</b>
<b>300 Tdi</b>	<b>Tdi Diesel</b>
<b>300 Tdi with EGR</b>	<b>Tdi Diesel with Exhaust Gas Recirculation (EGR)</b>
<b>300 Tdi without EGR</b>	<b>Tdi Diesel without Exhaust Gas Recirculation (EGR)</b>
<b>300 Tdi with EDC</b>	<b>Tdi Diesel with Electronic Diesel Control (EDC)</b>
<b>300 Tdi without EDC</b>	<b>Tdi Diesel without Electronic Diesel Control (EDC) (applies to Tdi Diesels with and without EGR)</b>
<b>SFI-V8</b>	<b>Sequential Multiport Fuel Injection (SFI-V8)</b>
<b>A/C</b>	<b>Air Conditioning</b>
<b>BBUS</b>	<b>Battery Backed Up Alarm Sounder (Z272)</b>

**Switch Positions**

Certain abbreviations are used throughout the Electrical Troubleshooting Manual as Switch Position notes. The following list explains all abbreviations used as Switch Position notes in the Circuit Diagrams.

<b>&lt; 100°</b>	<b>Less than 100°</b>
<b>&gt; 100°</b>	<b>More than 100°</b>



Connectors, Grounds, and Splices are identified by a letter followed by a number. Connectors are identified by C, grounds by E, and splices by S. Some splices are contained in junction connectors. These splices are identified by the prefix "HJ" below the splice's reference number. The number assigned to the connector, ground, or splice corresponds to its location in the vehicle.

#### Connector, Ground, and Splice Identification by Location

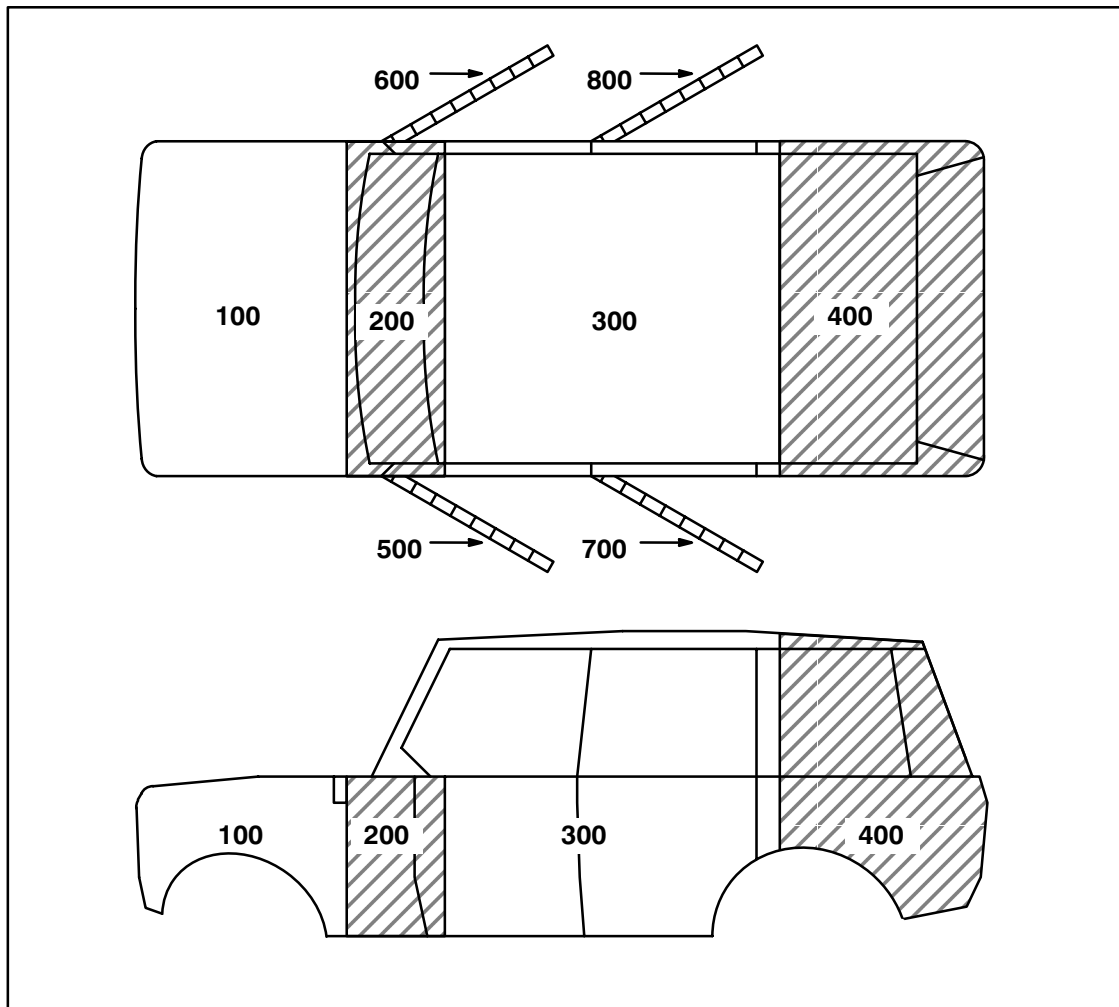

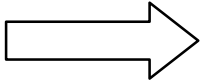
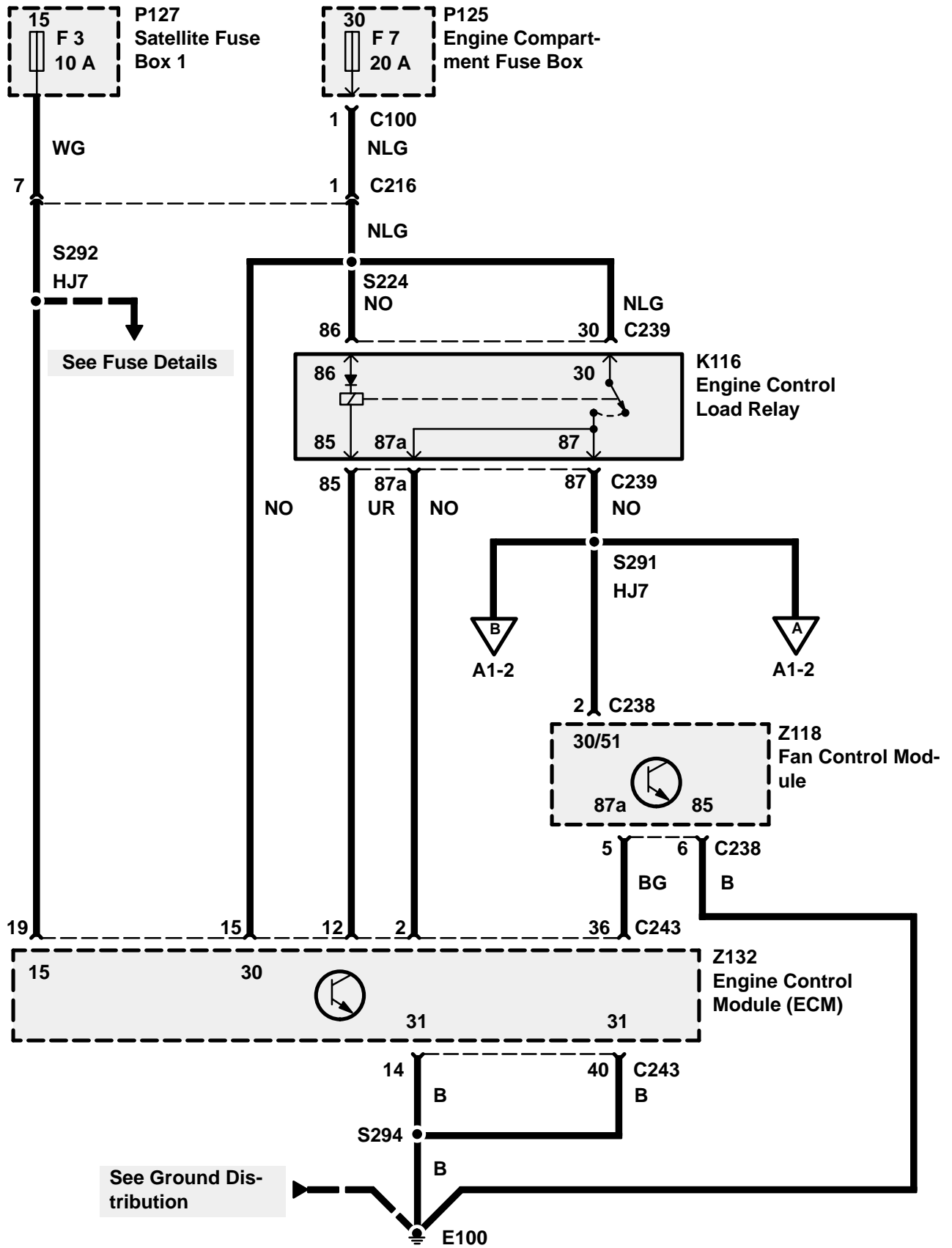

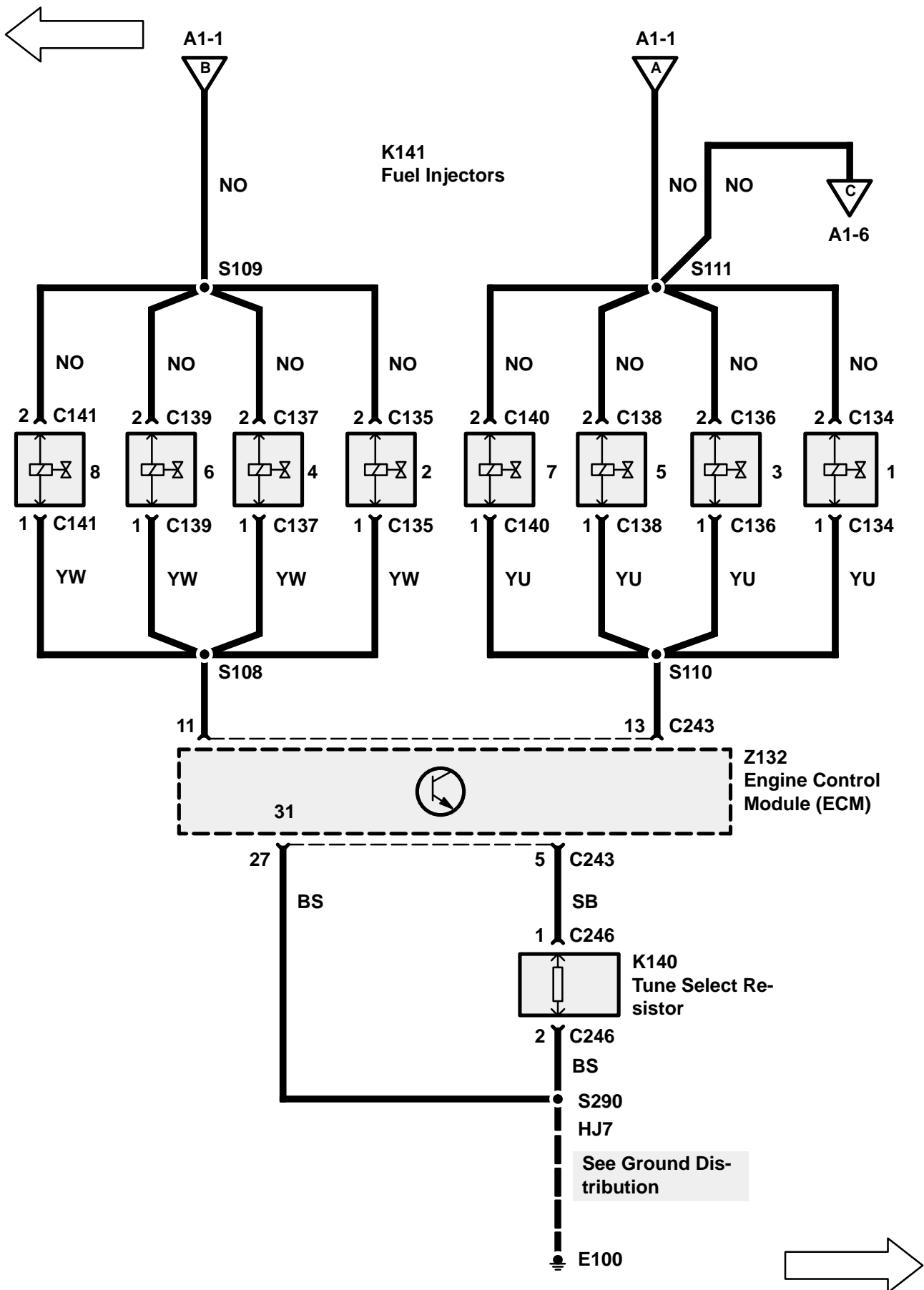

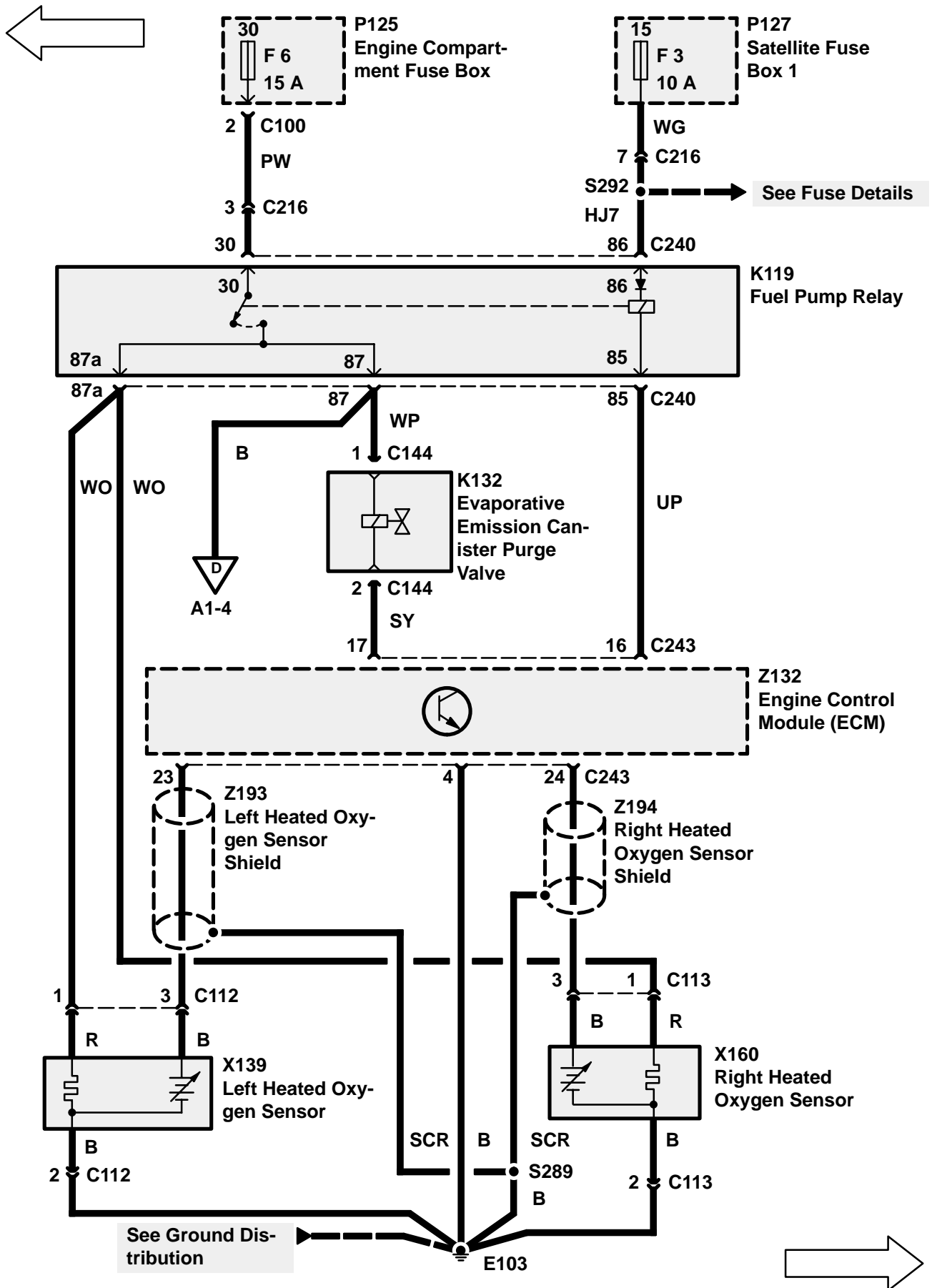

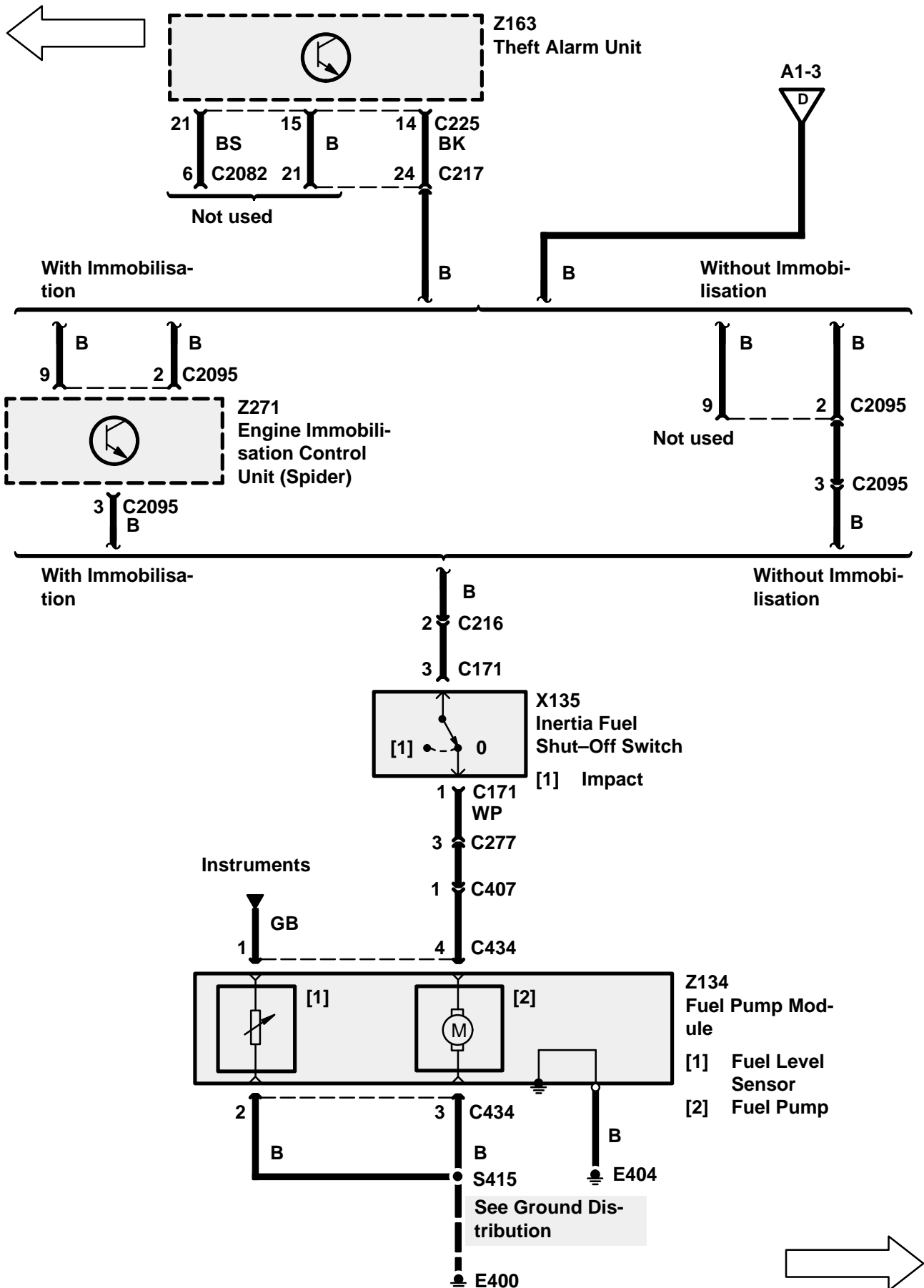

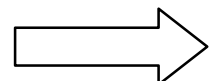
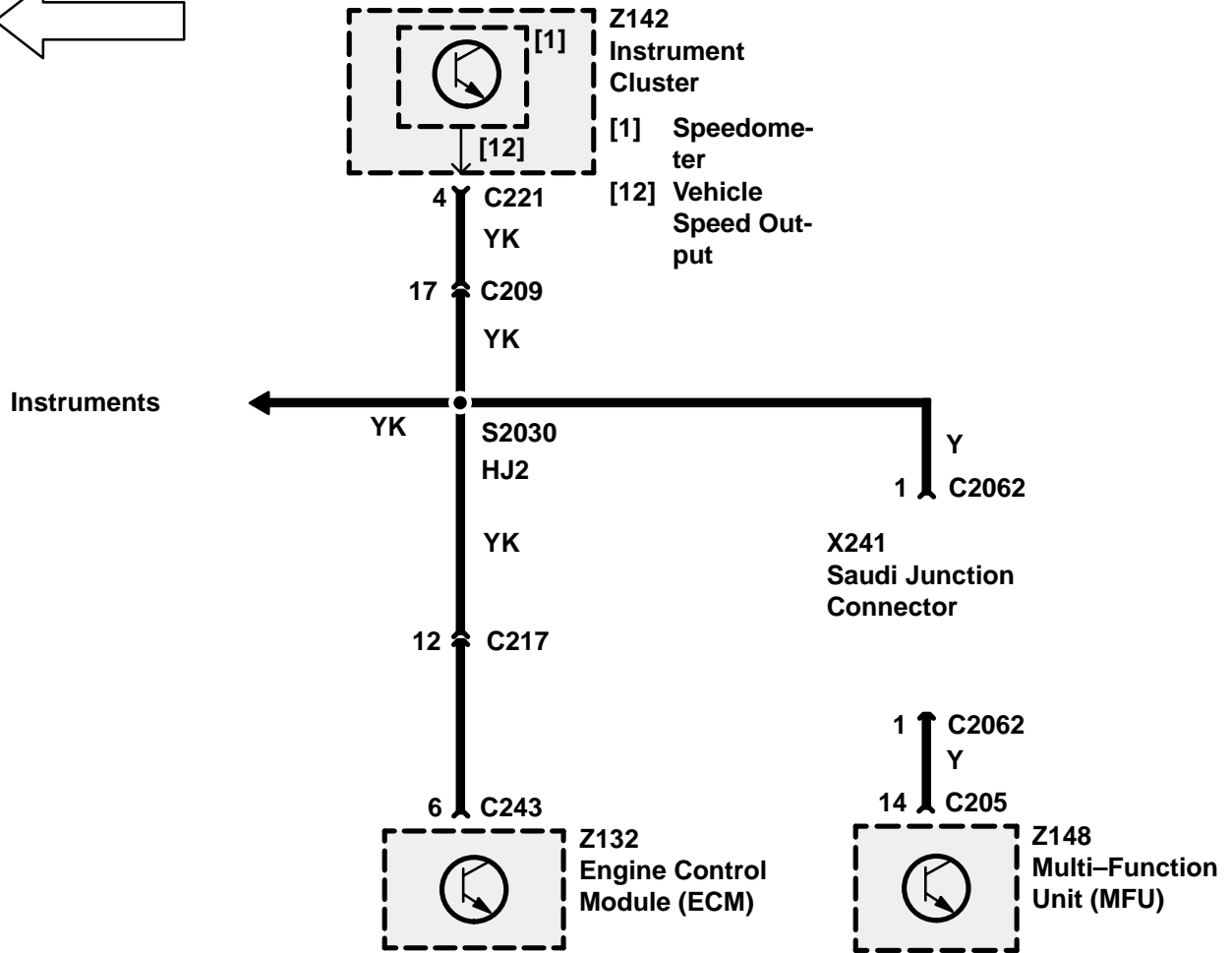
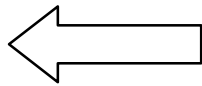

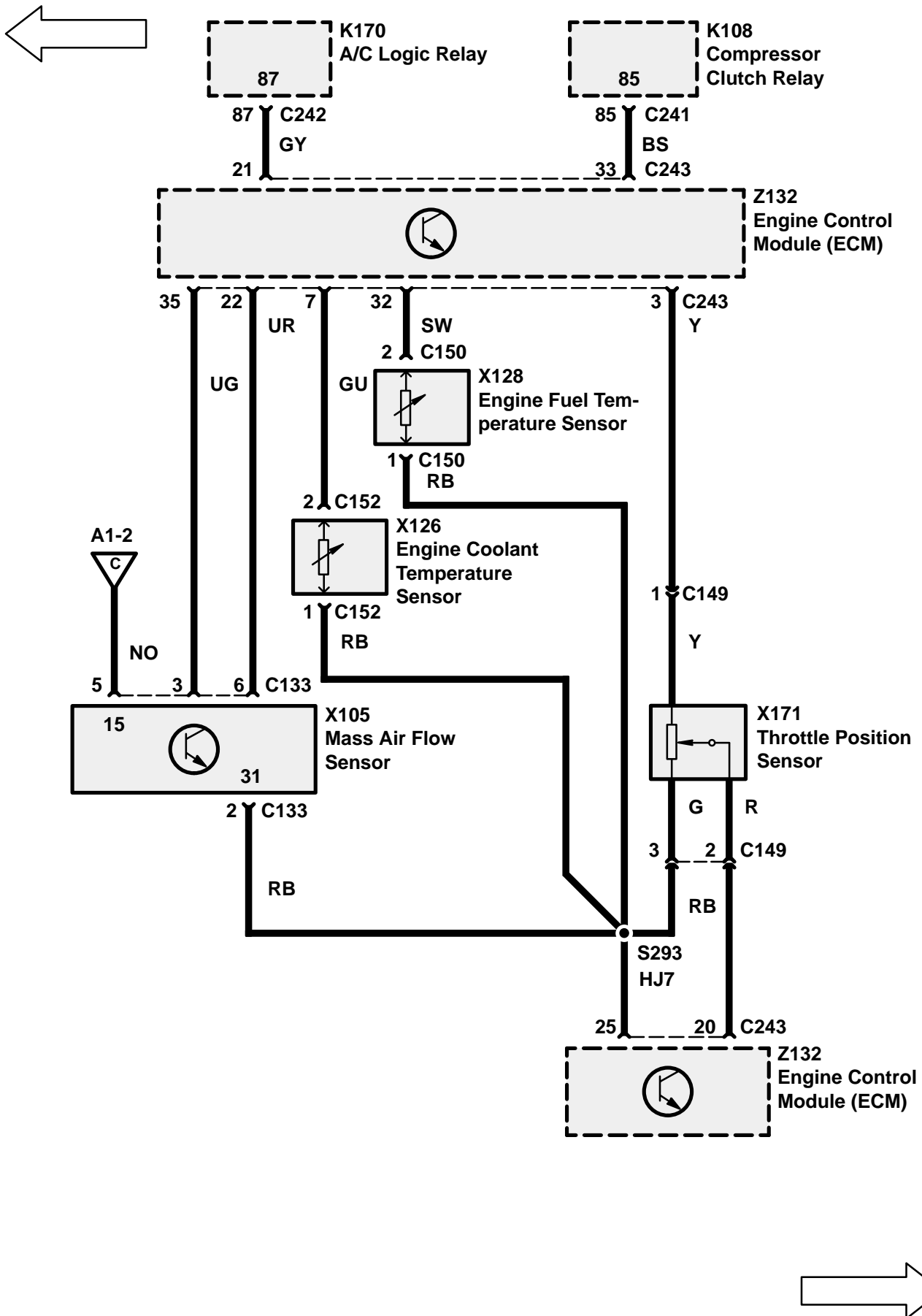

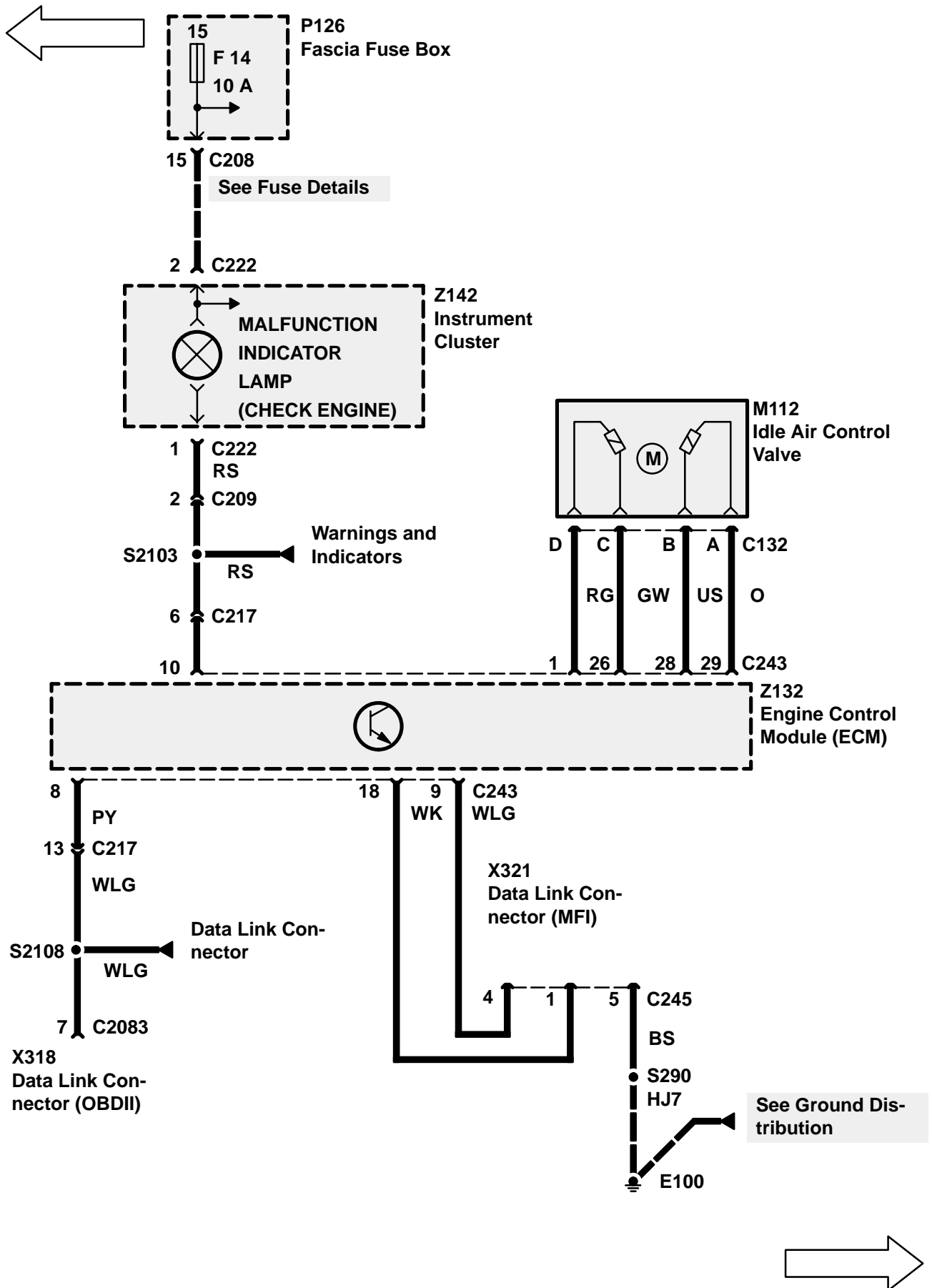



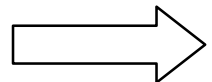
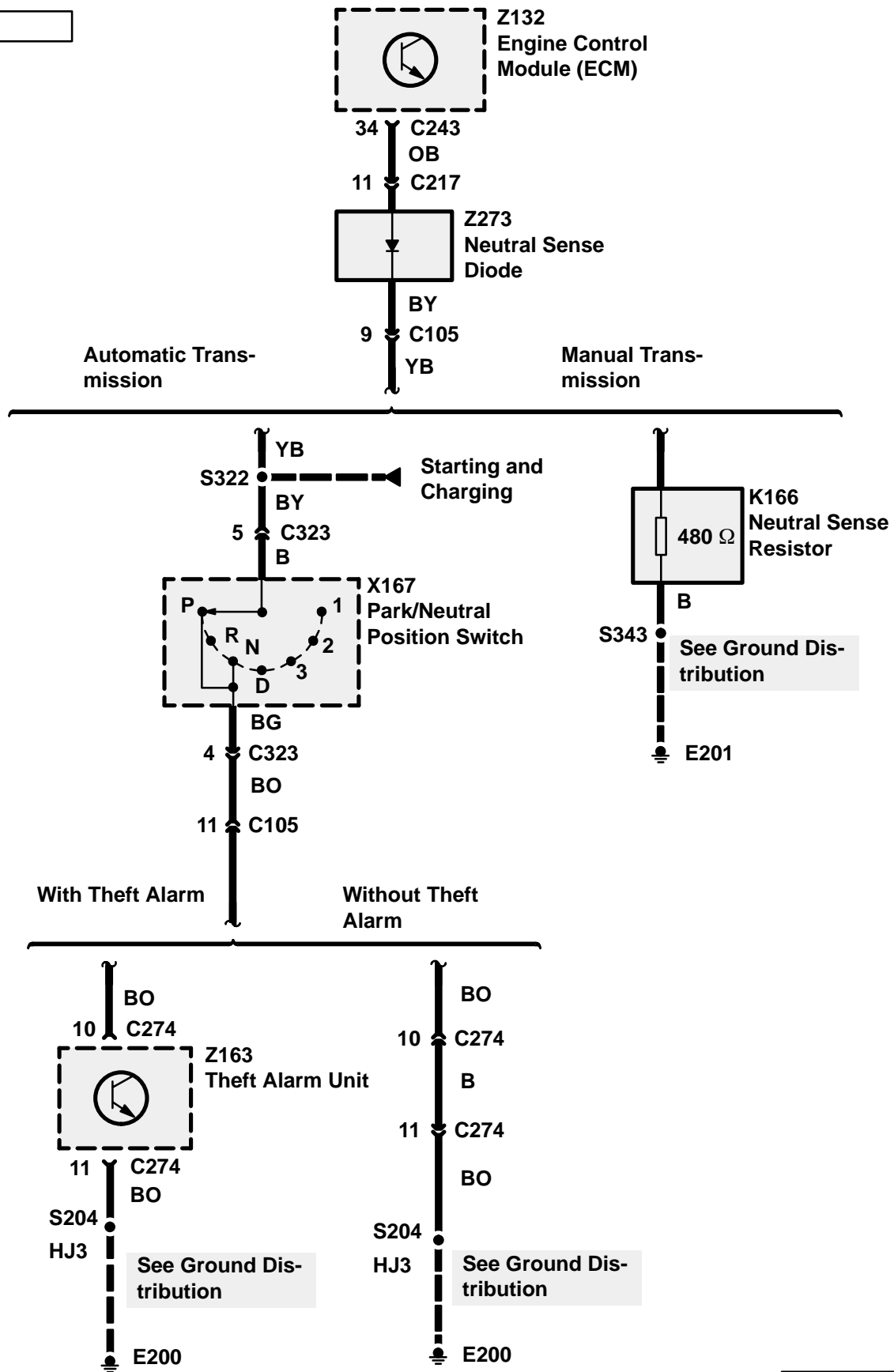
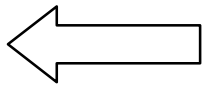

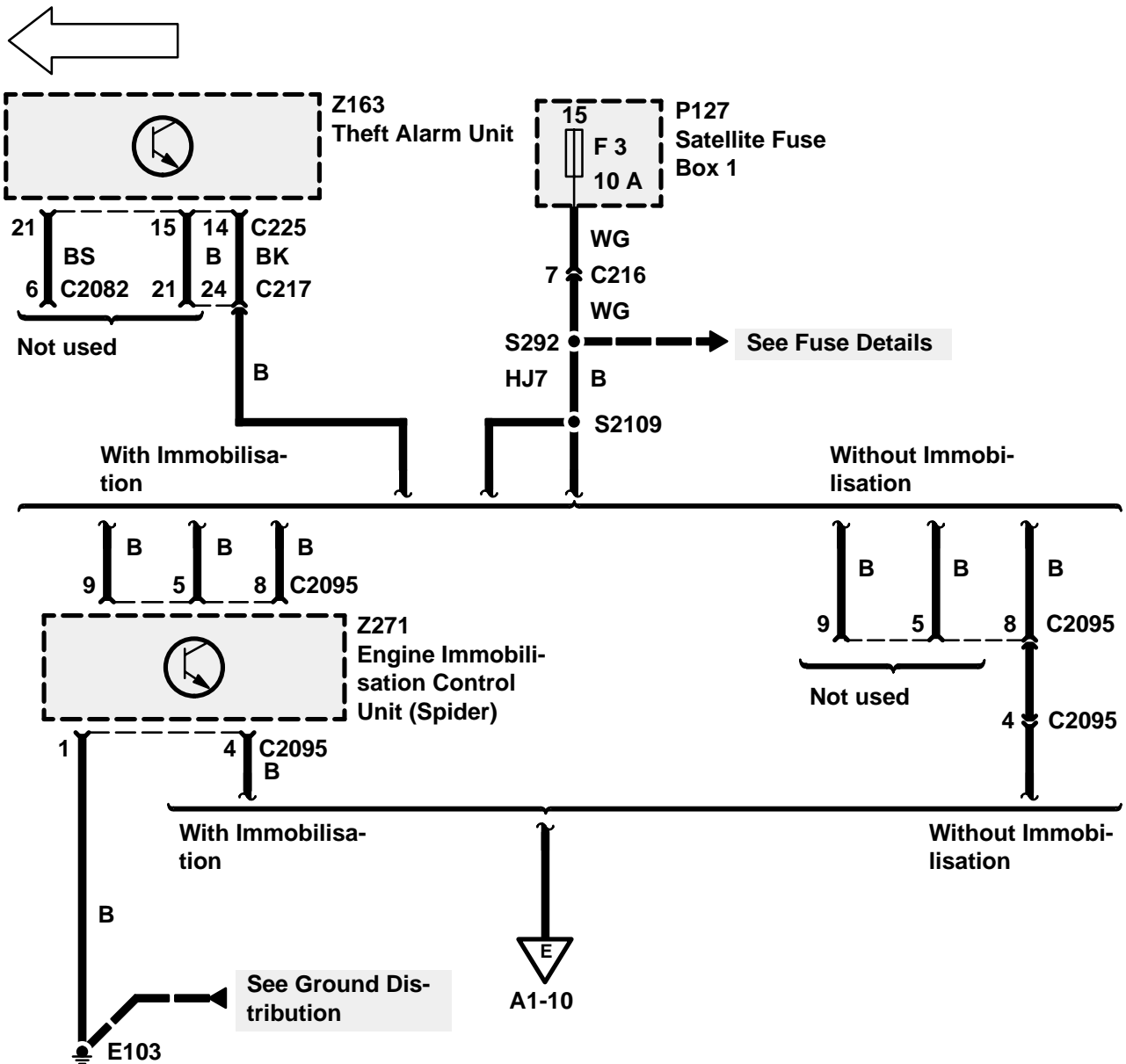

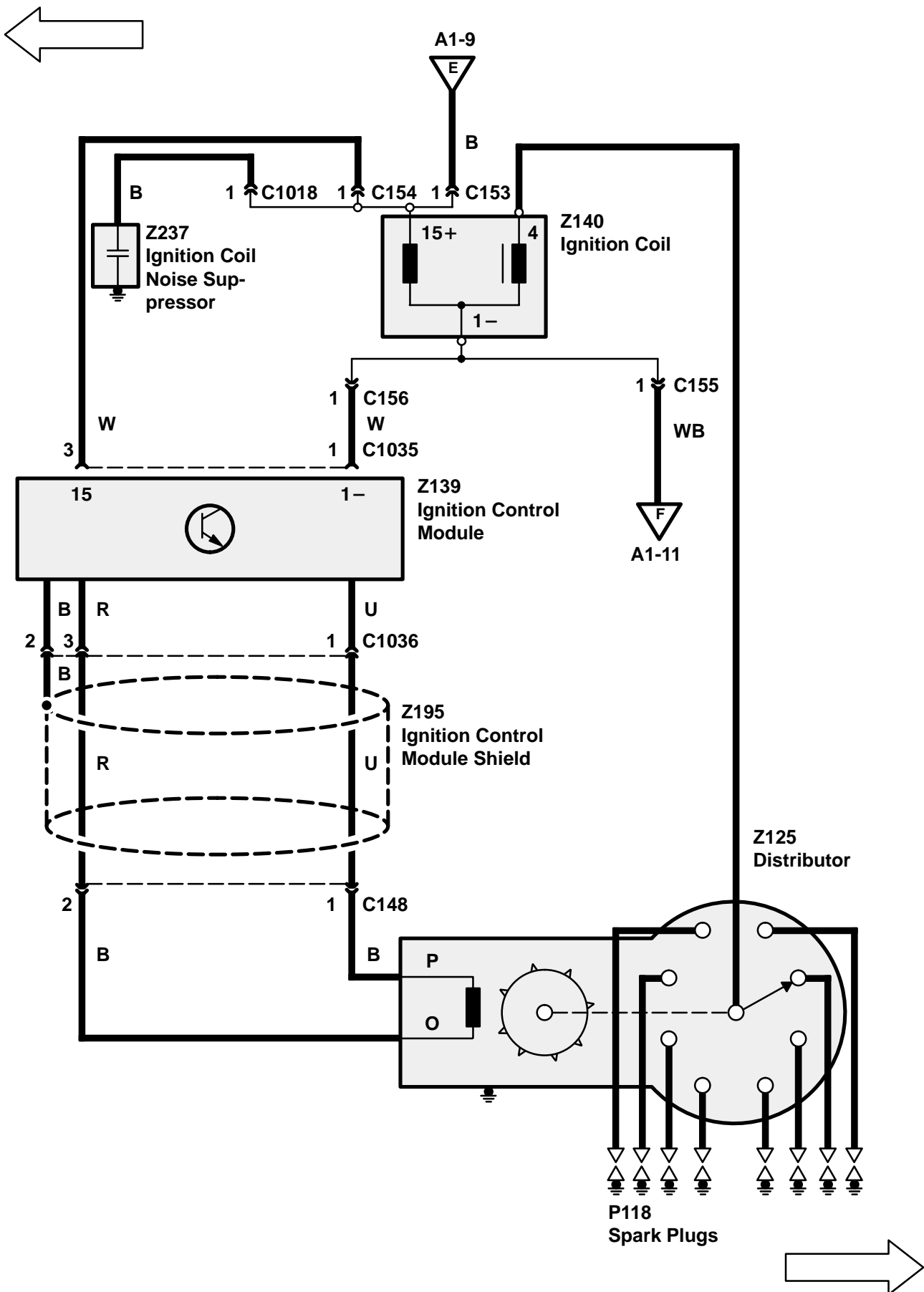

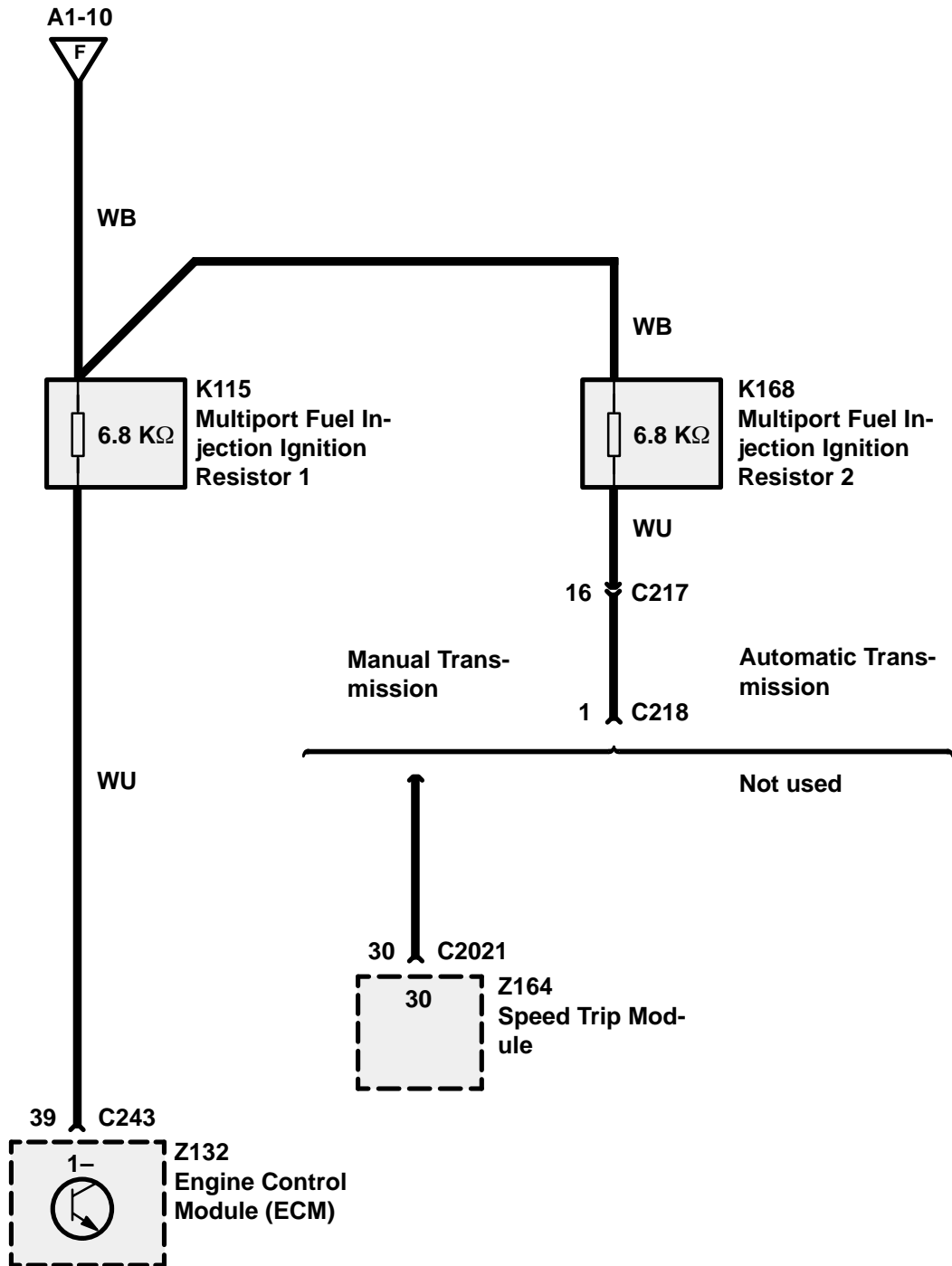
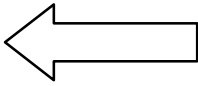

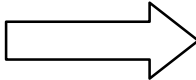
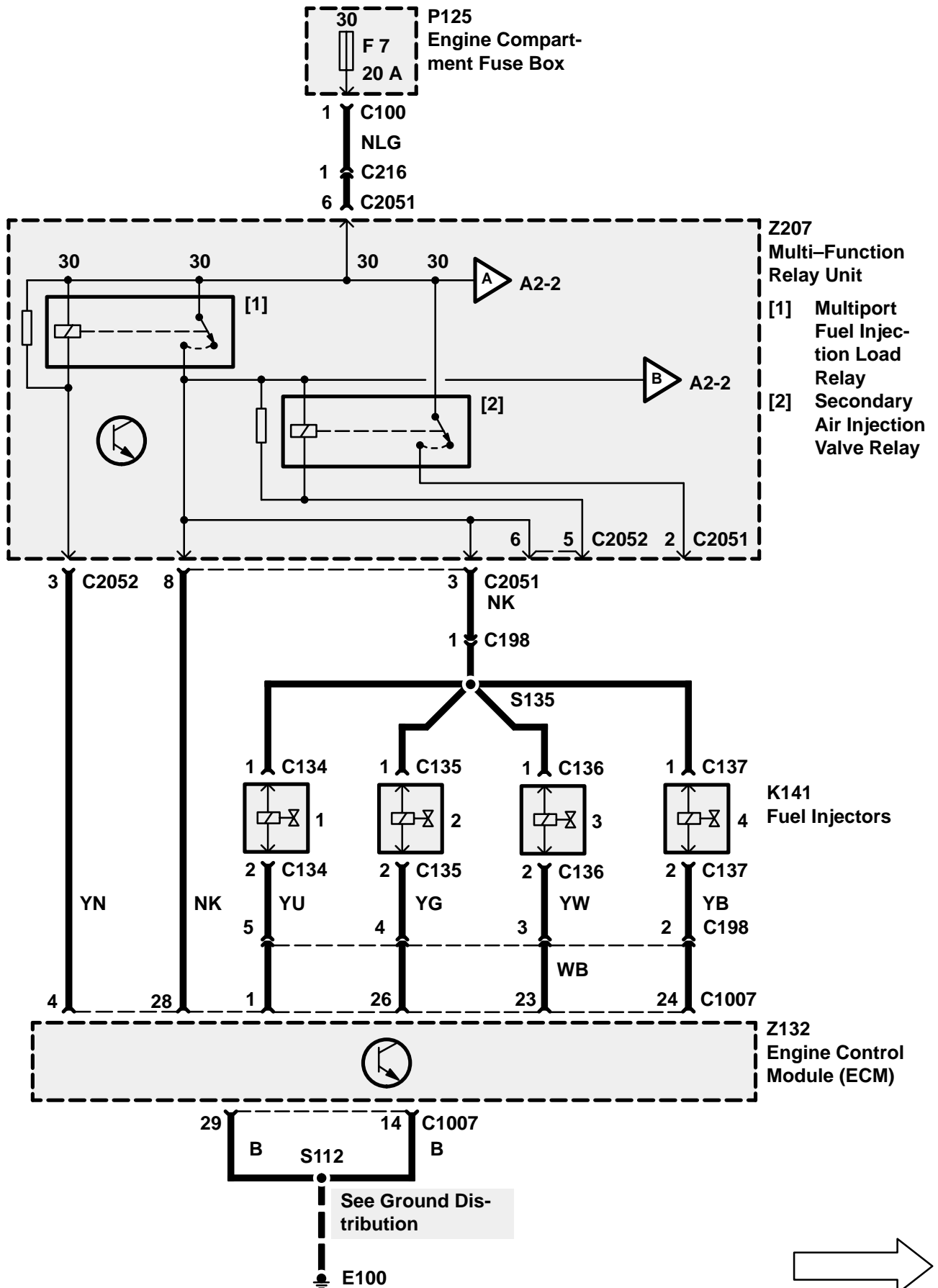

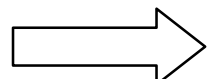
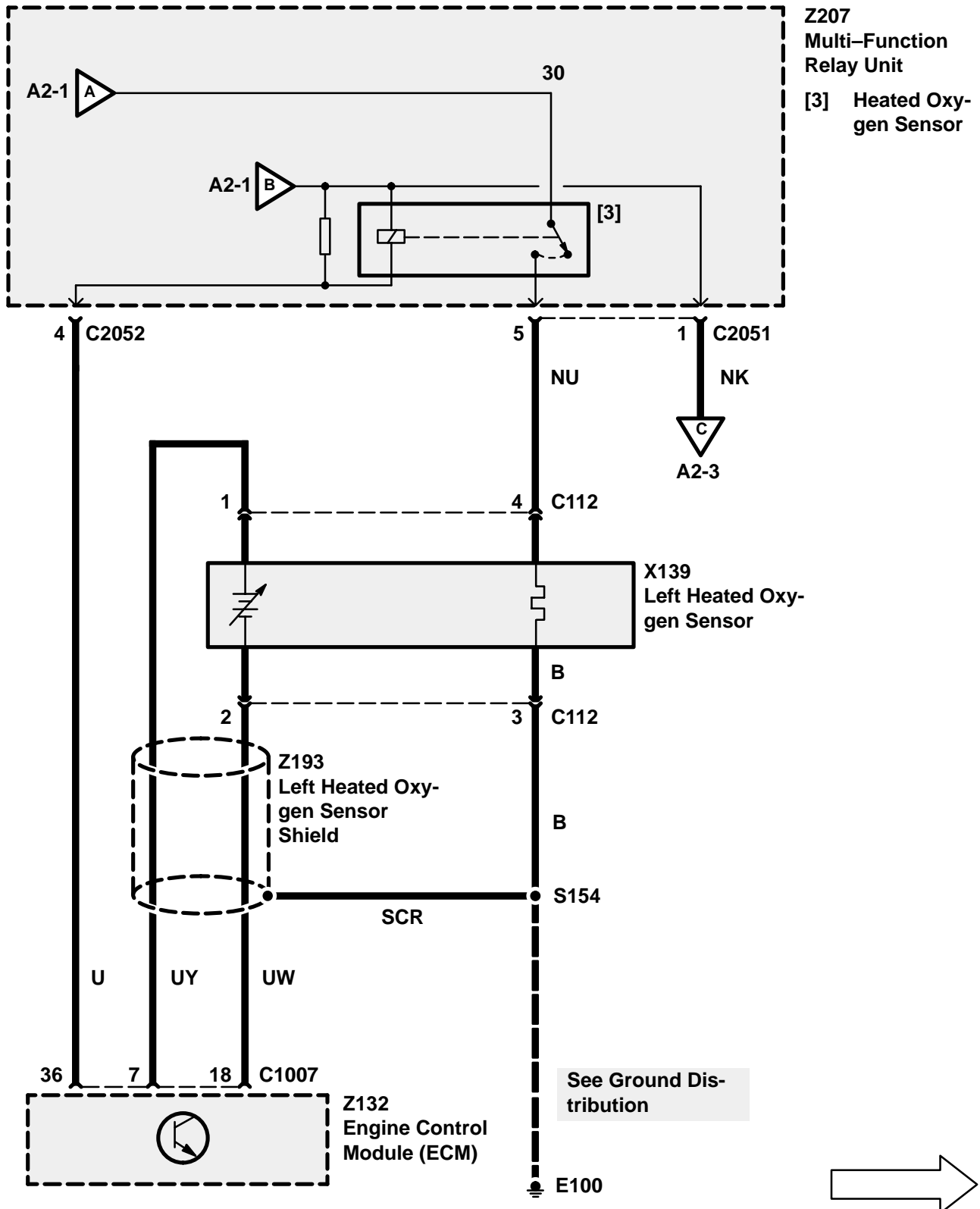
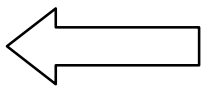

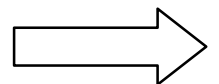
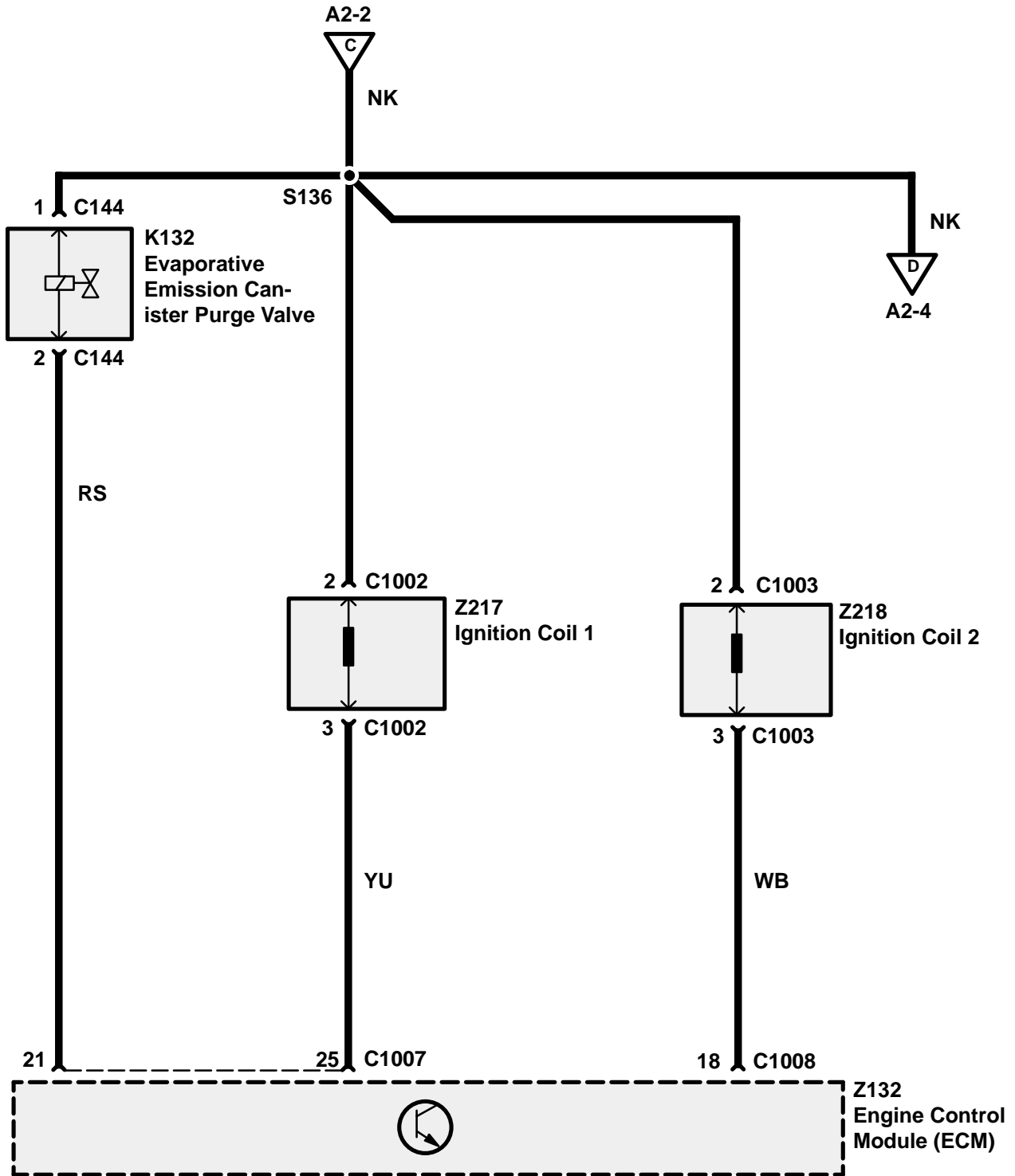
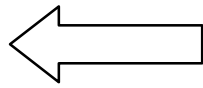

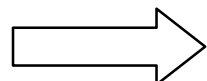
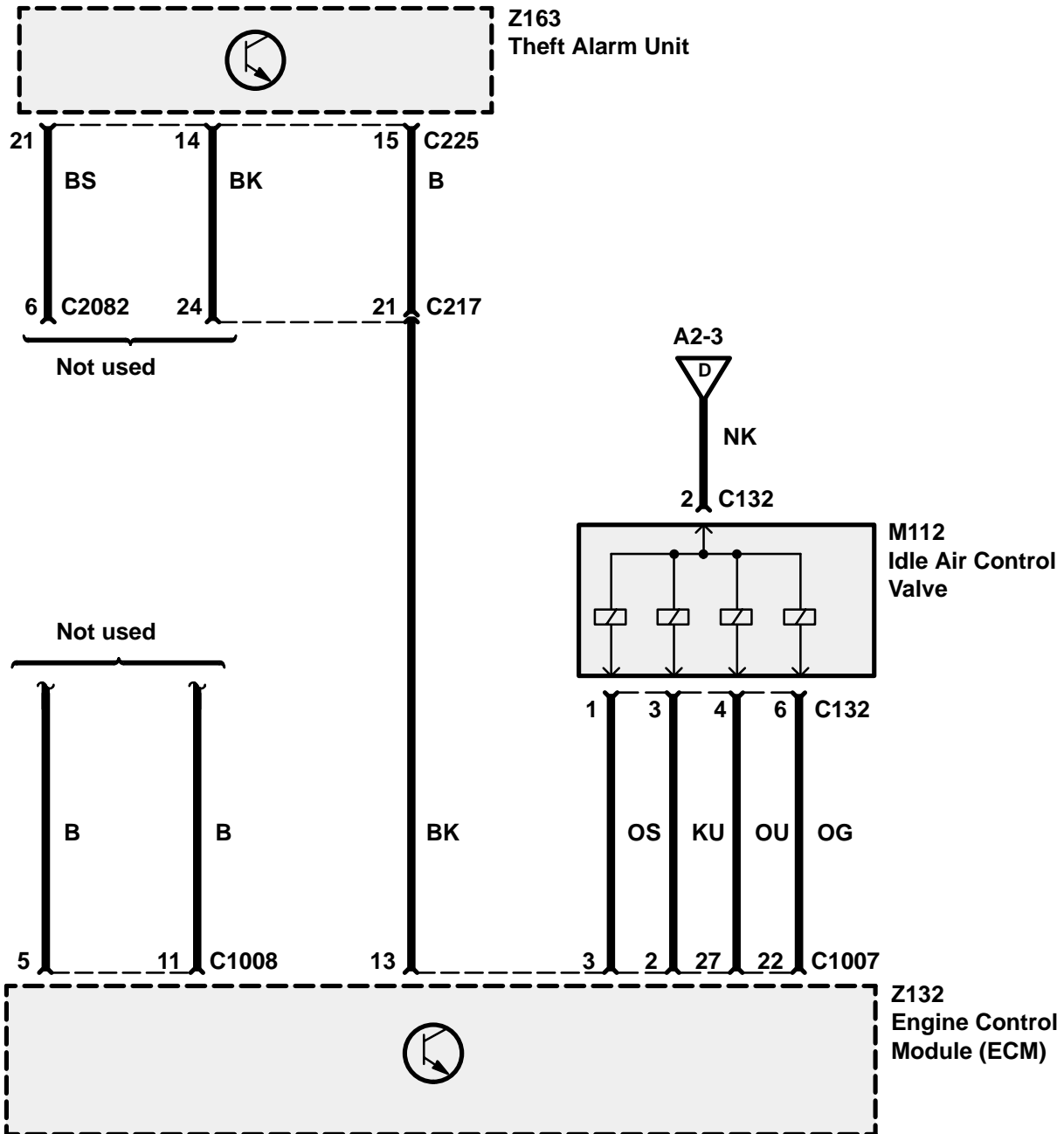
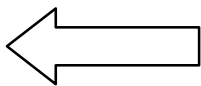



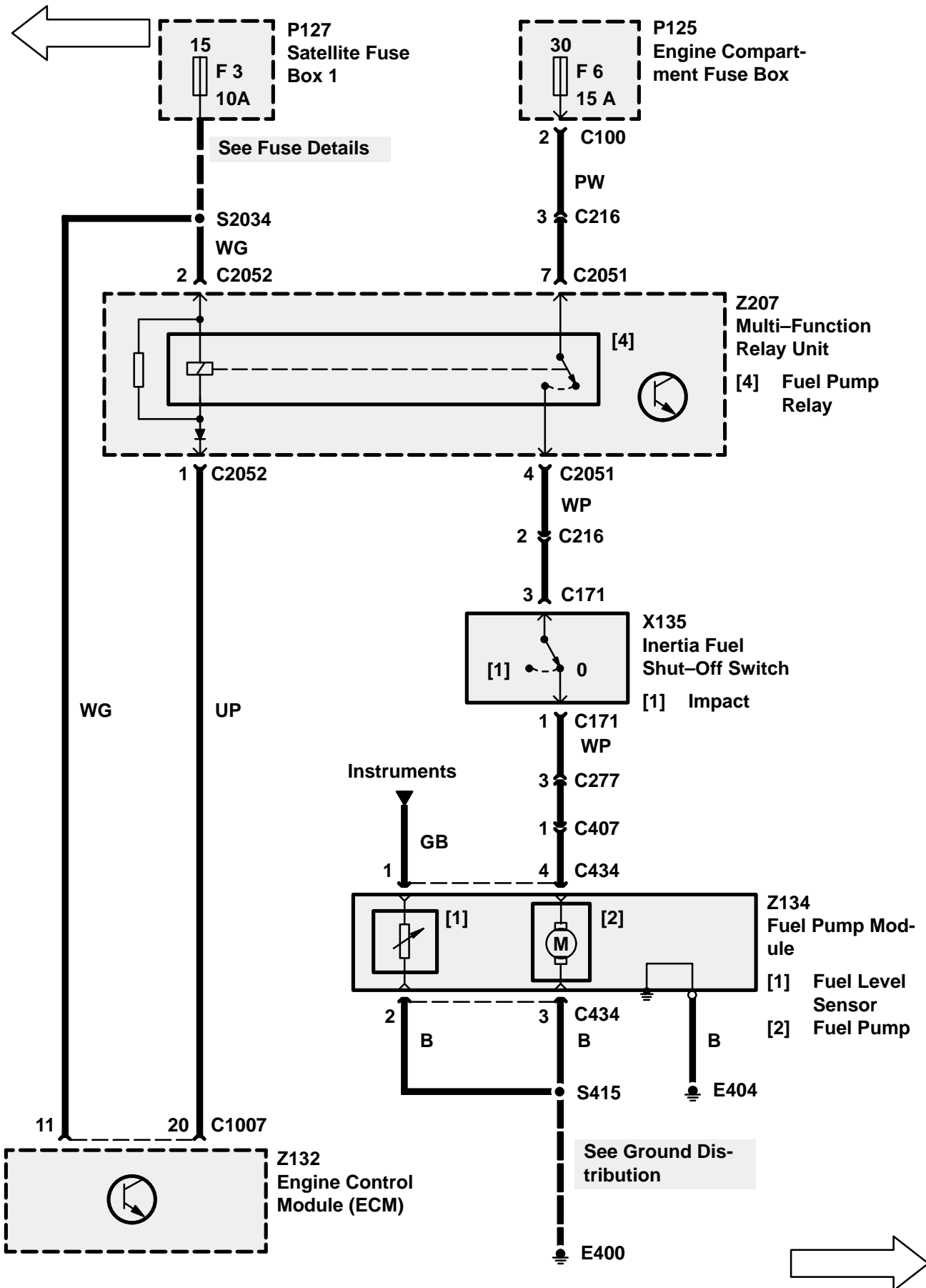

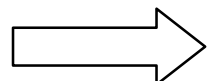
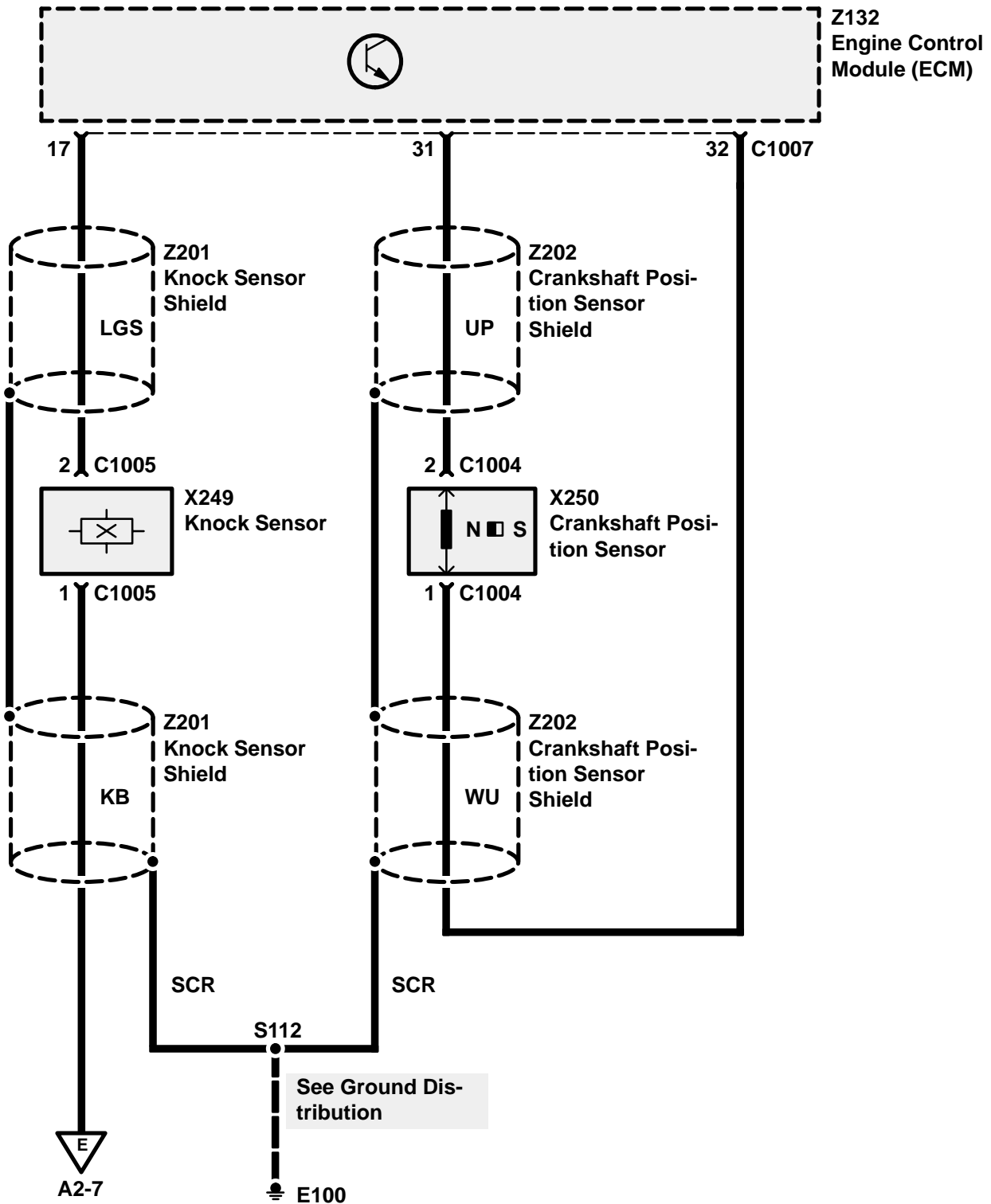
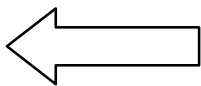

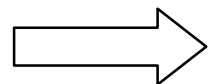
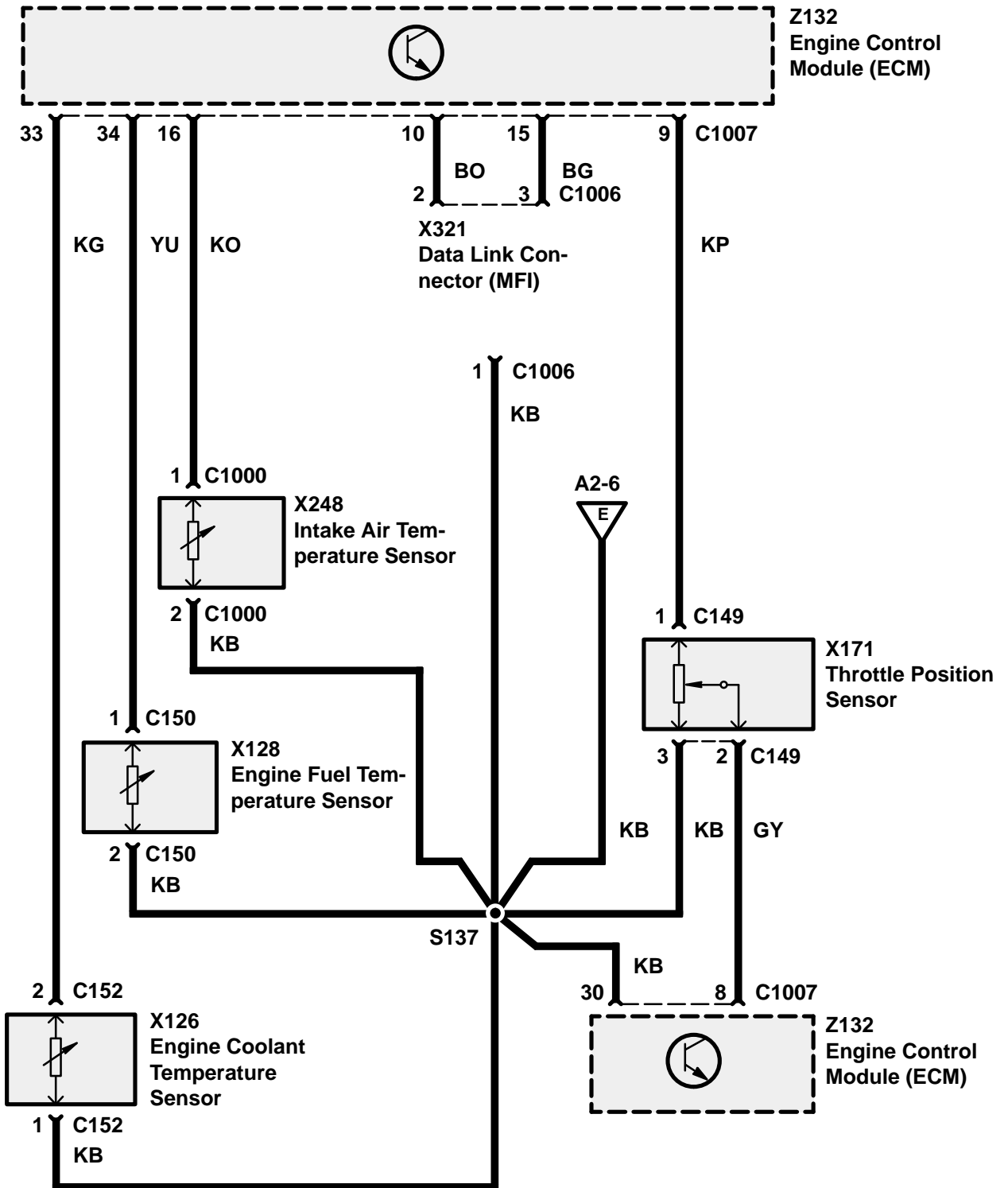
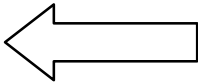

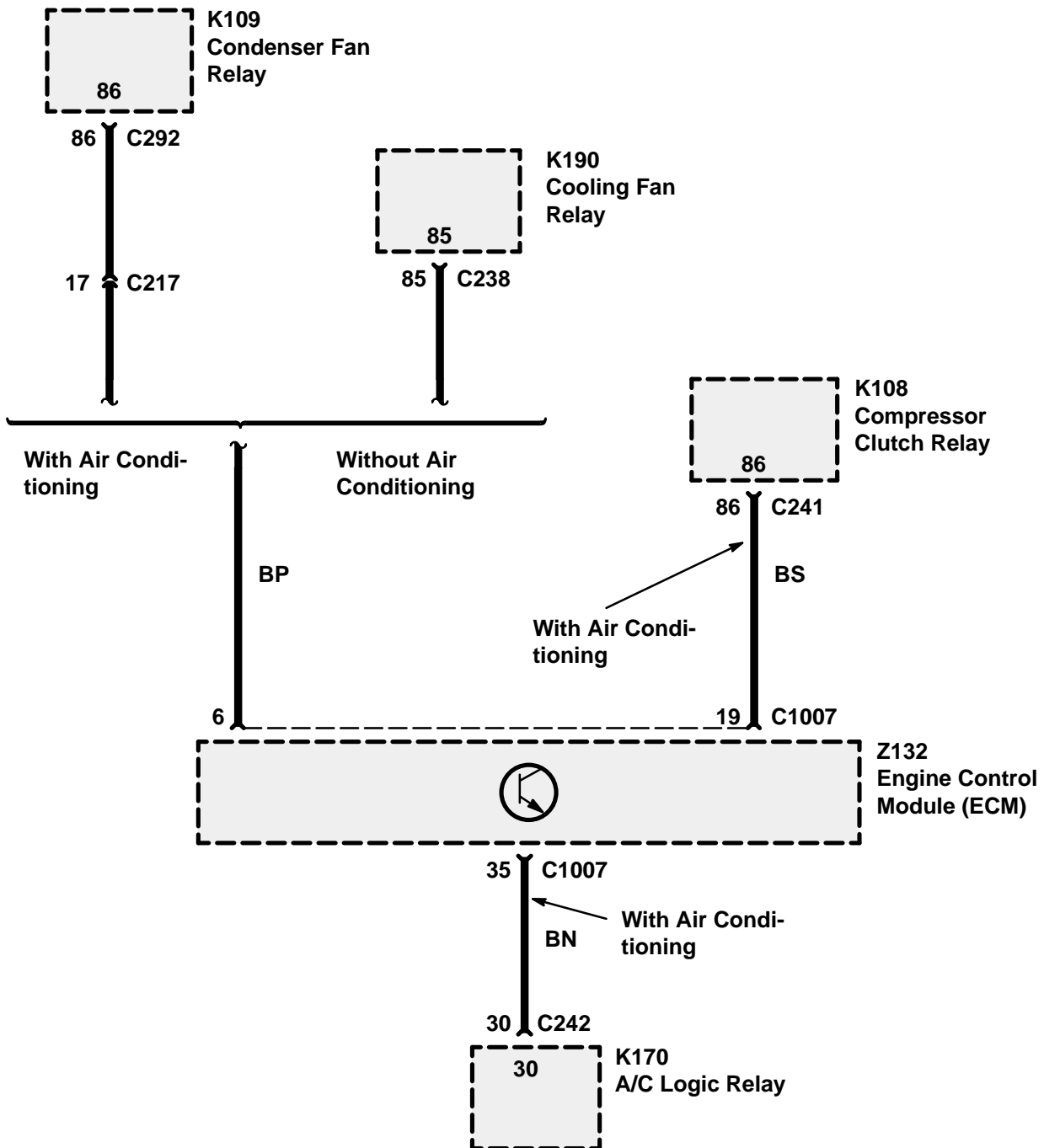
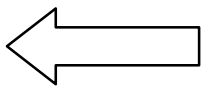

NAS

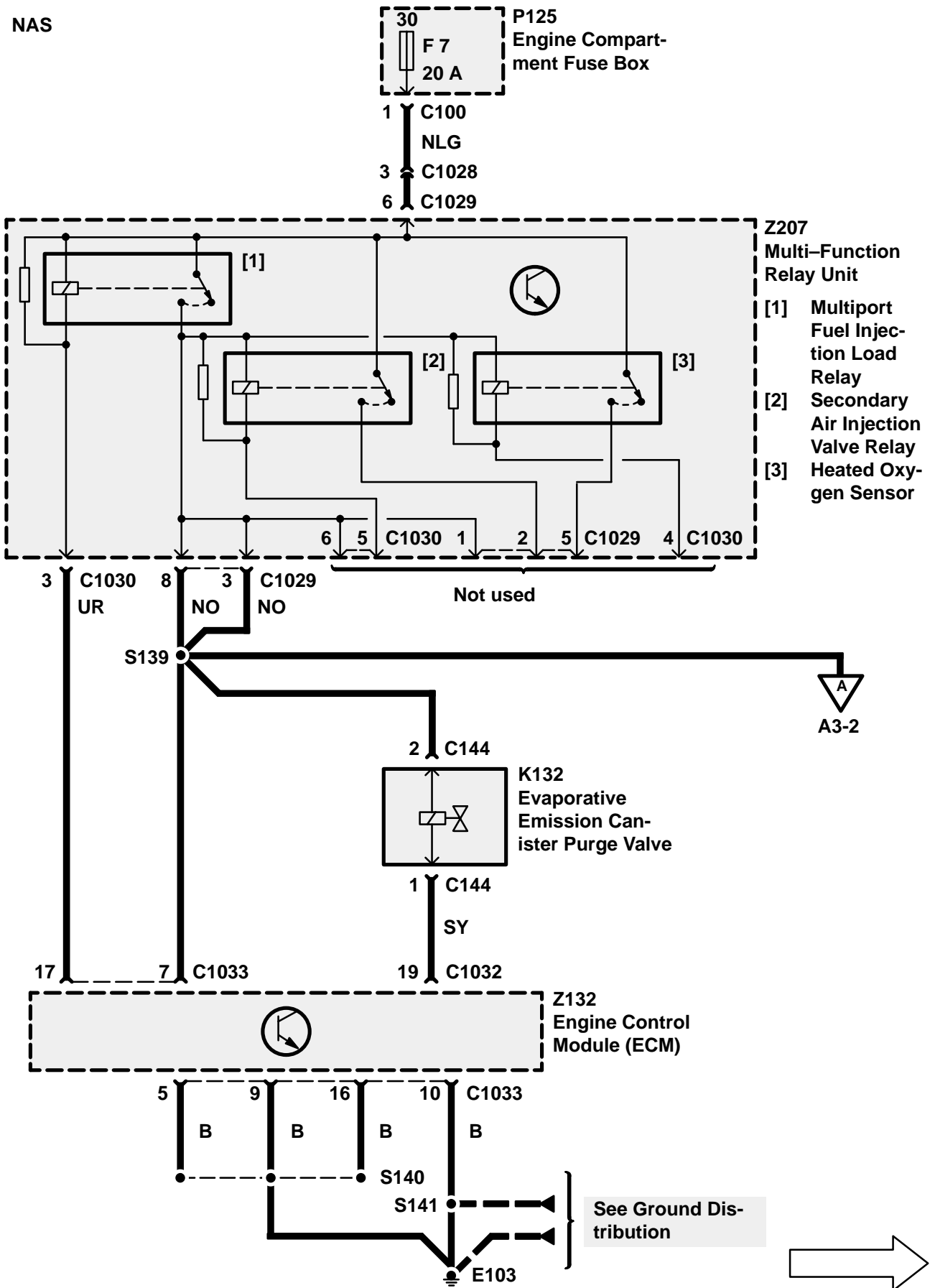

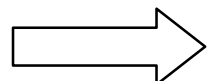
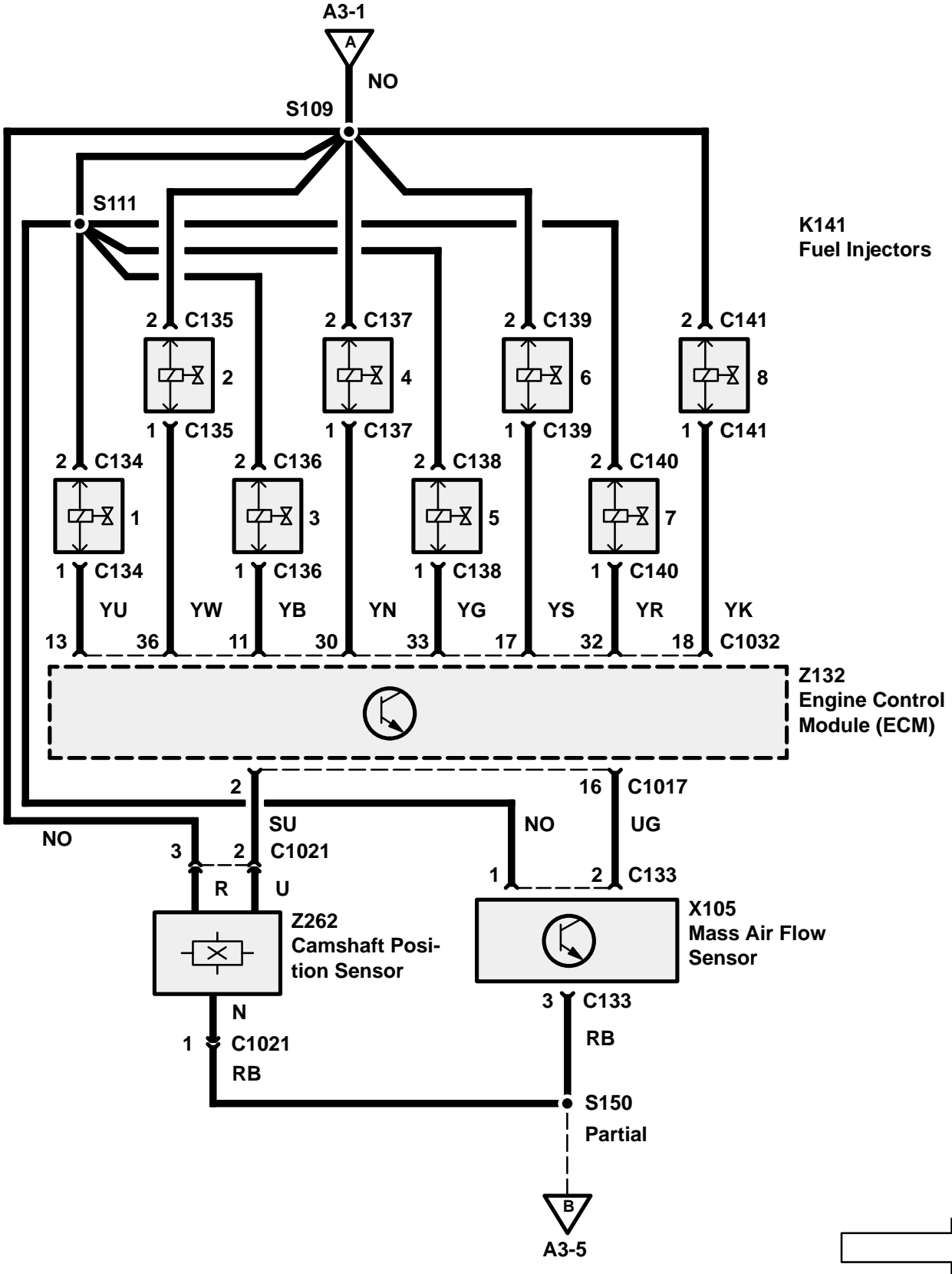
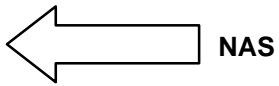

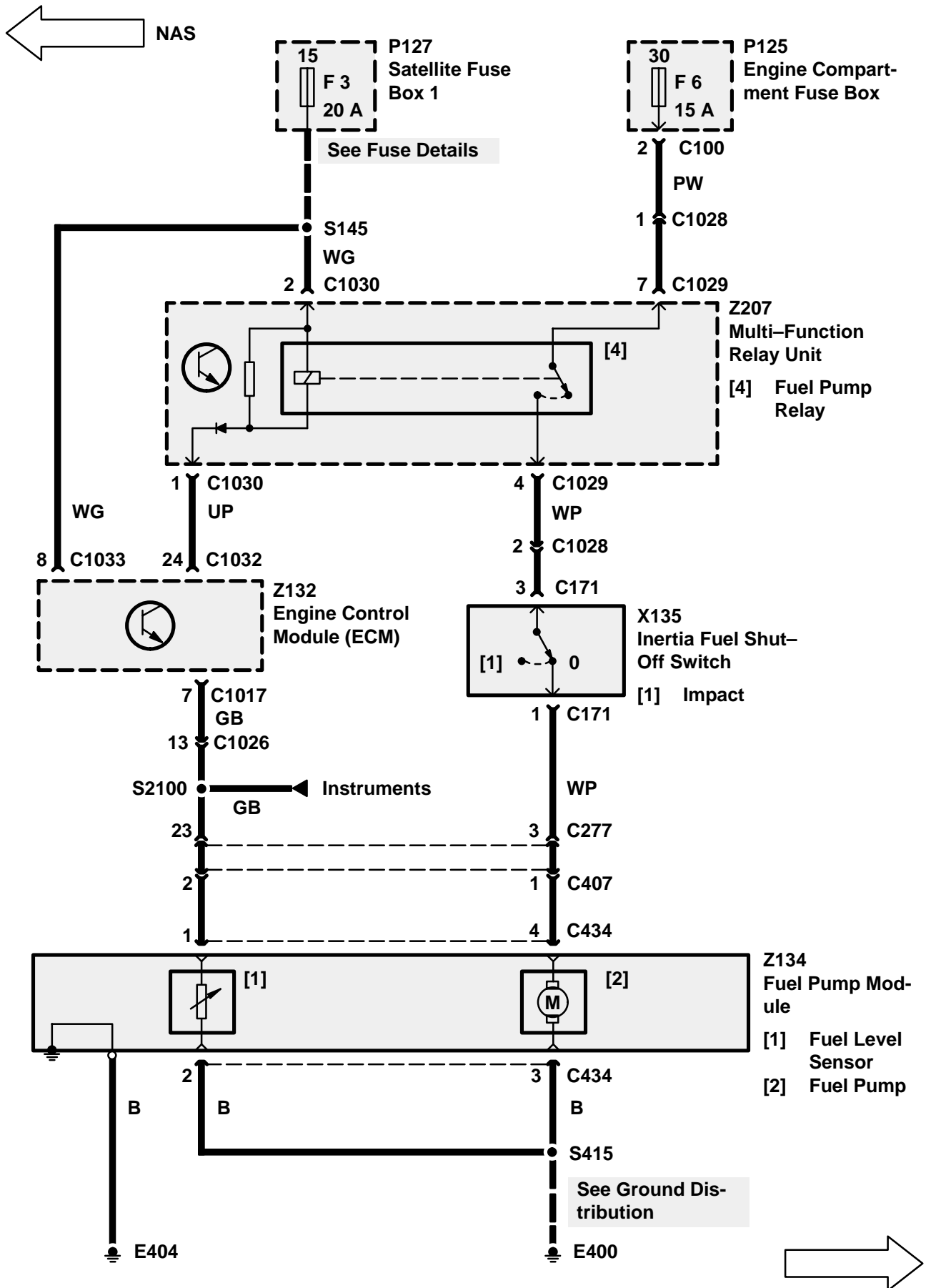

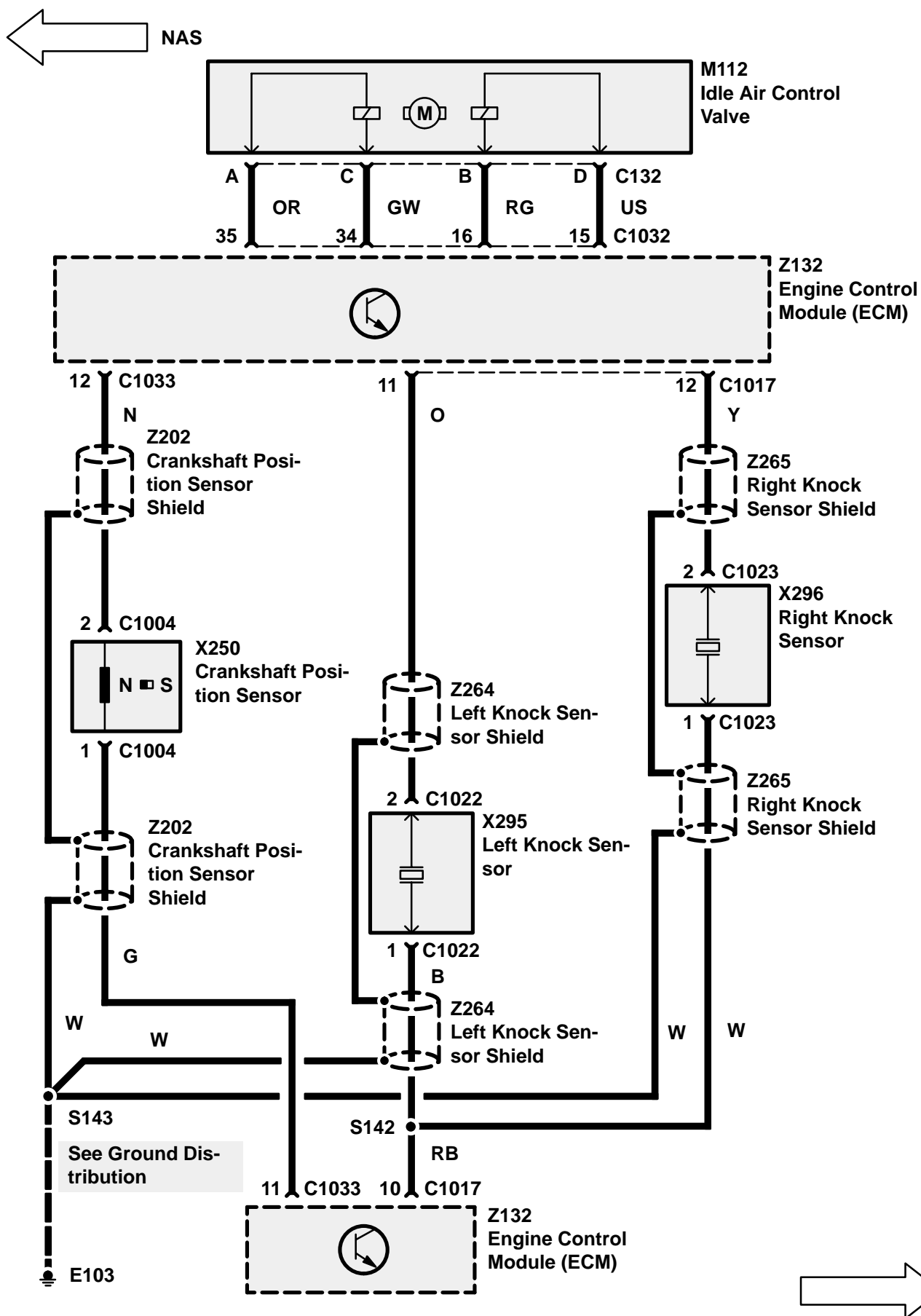



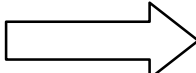
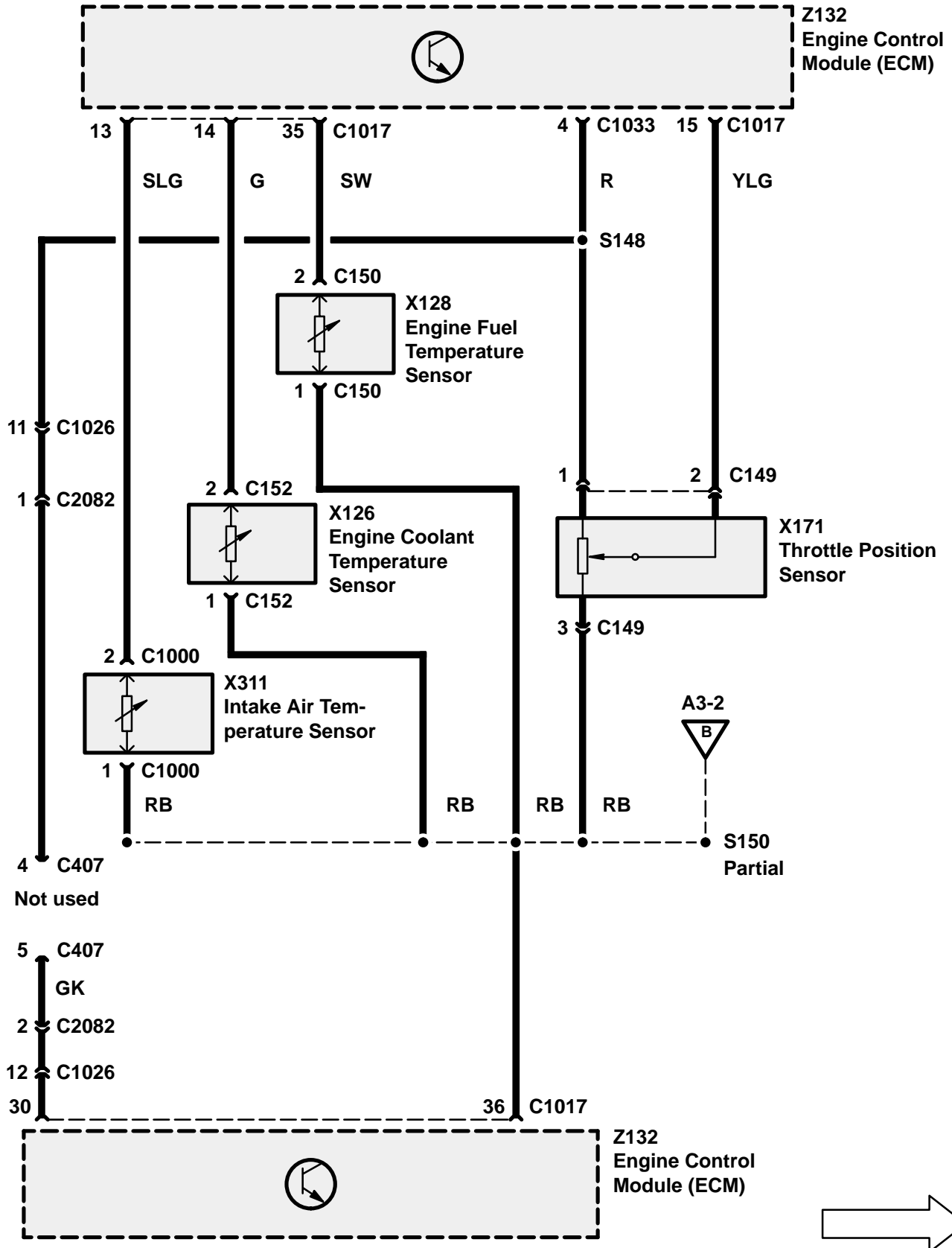
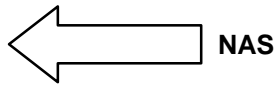

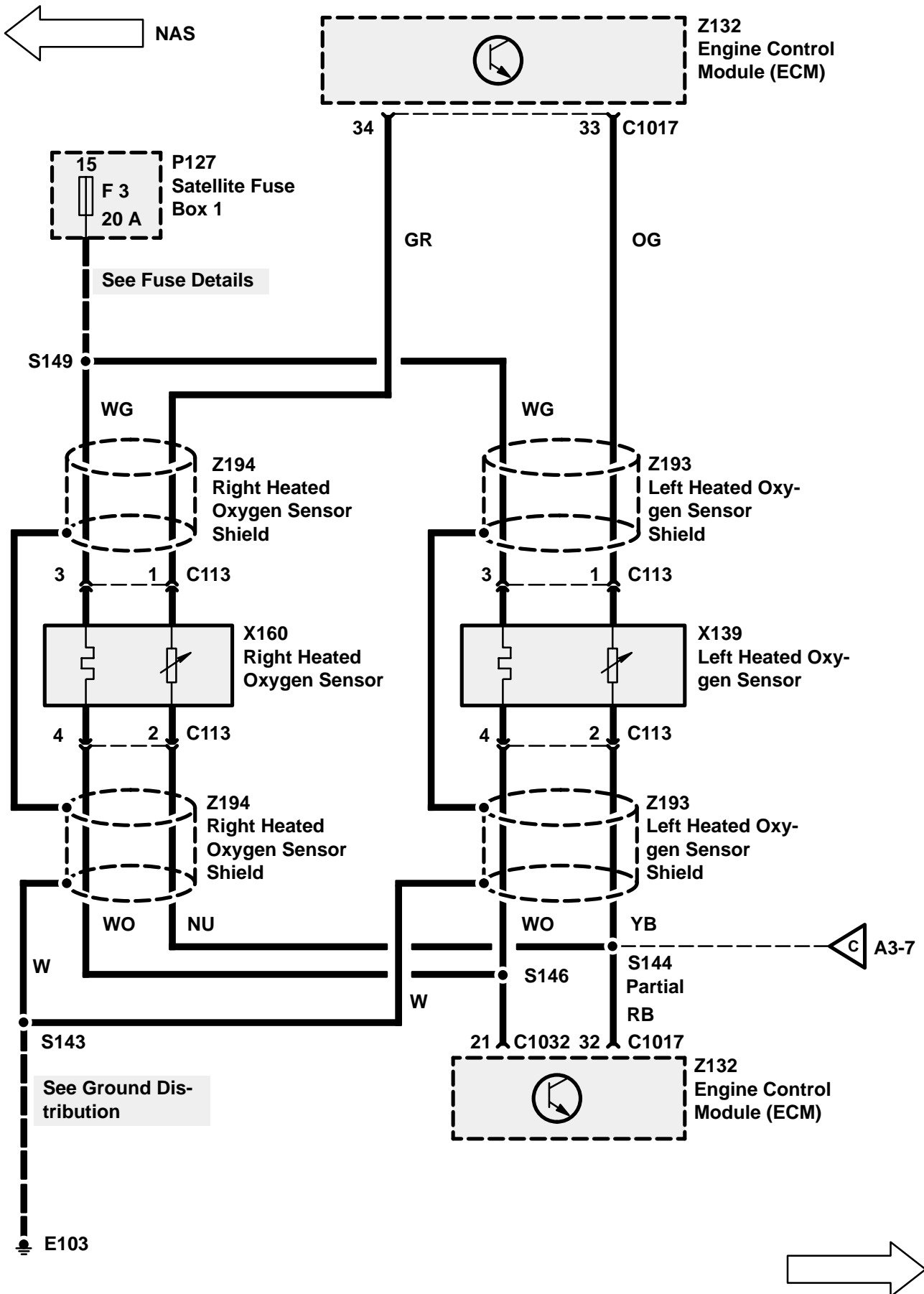

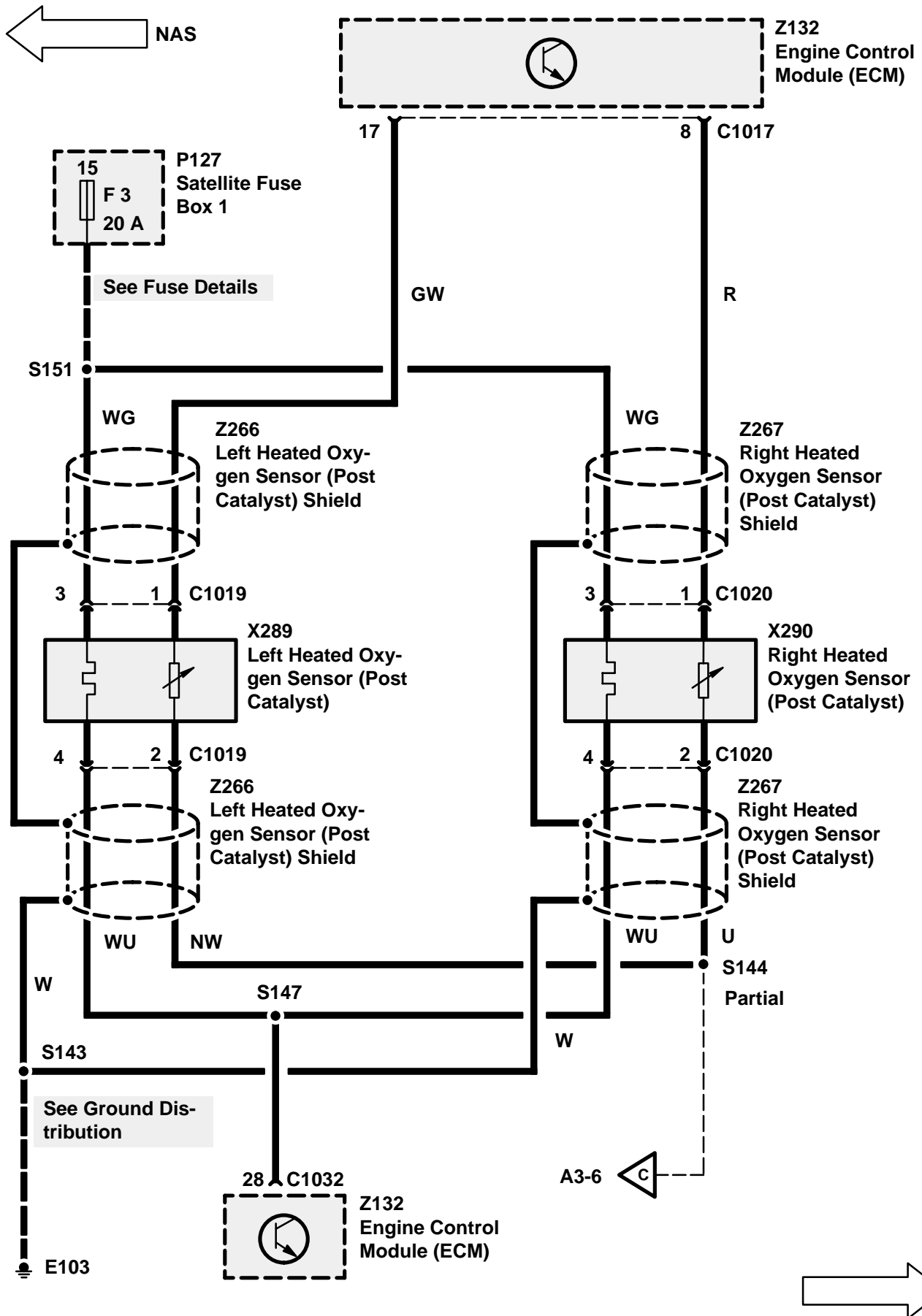

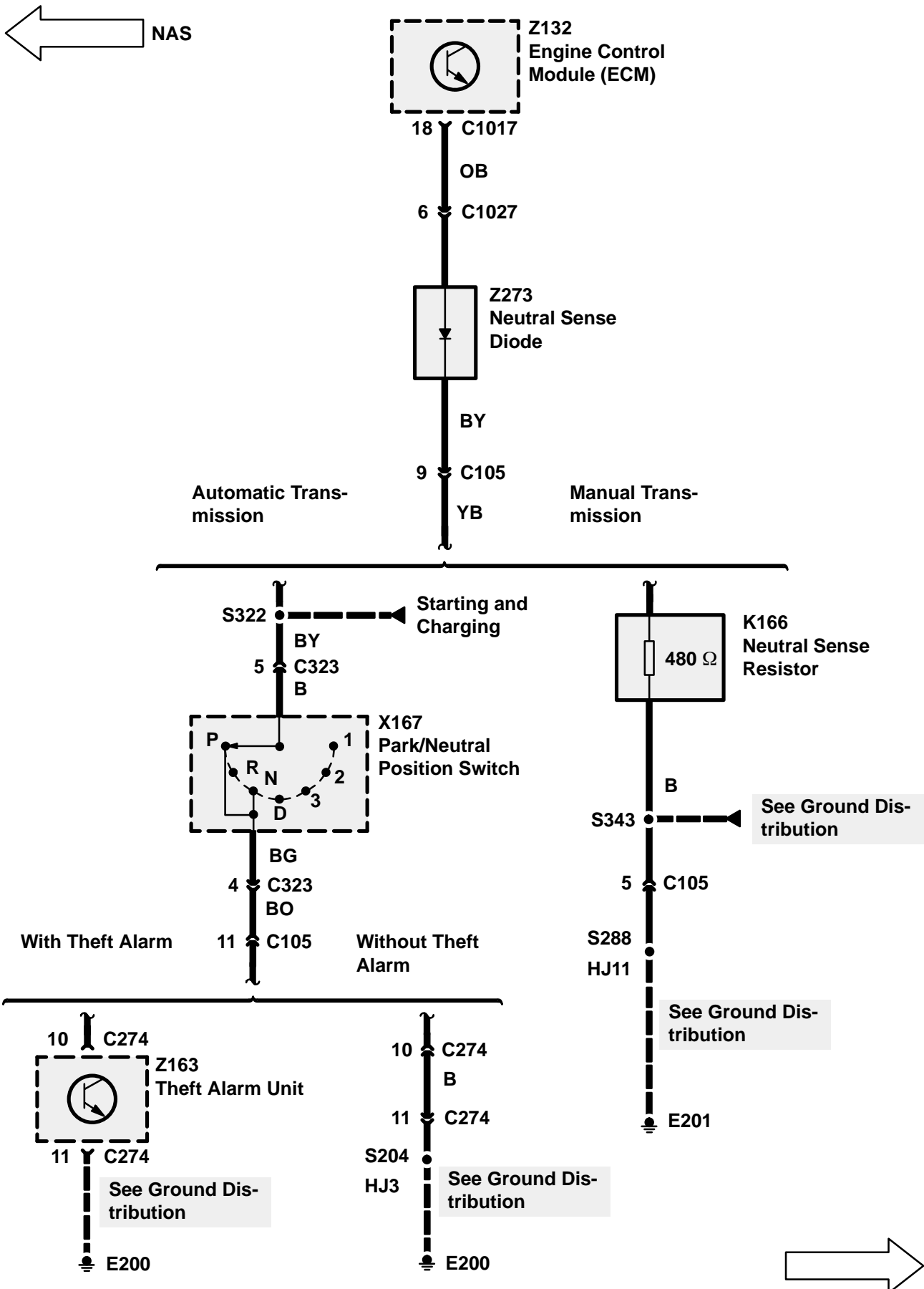

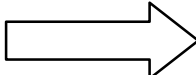
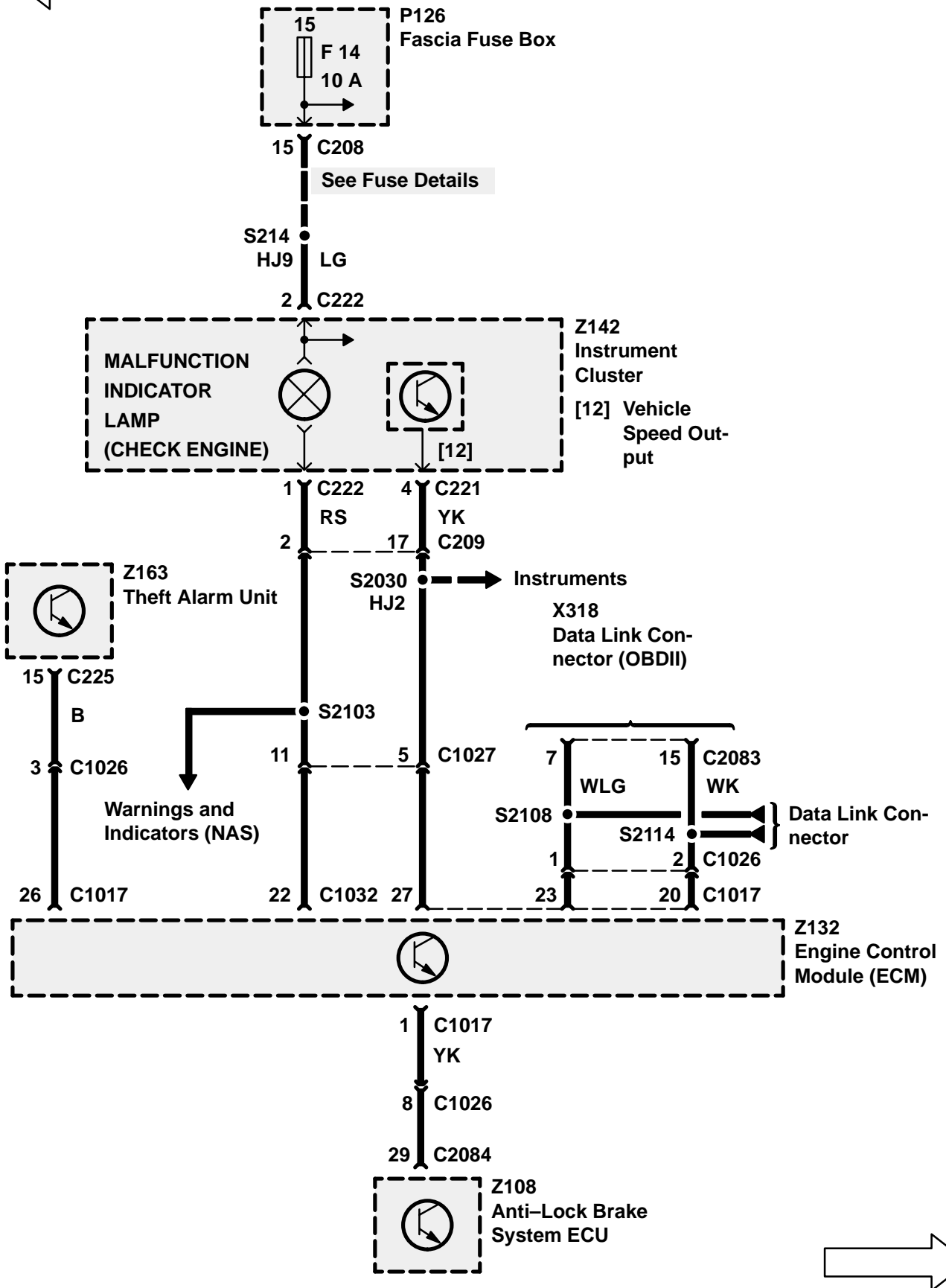
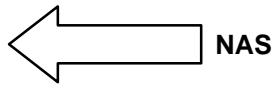



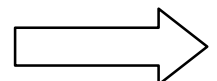
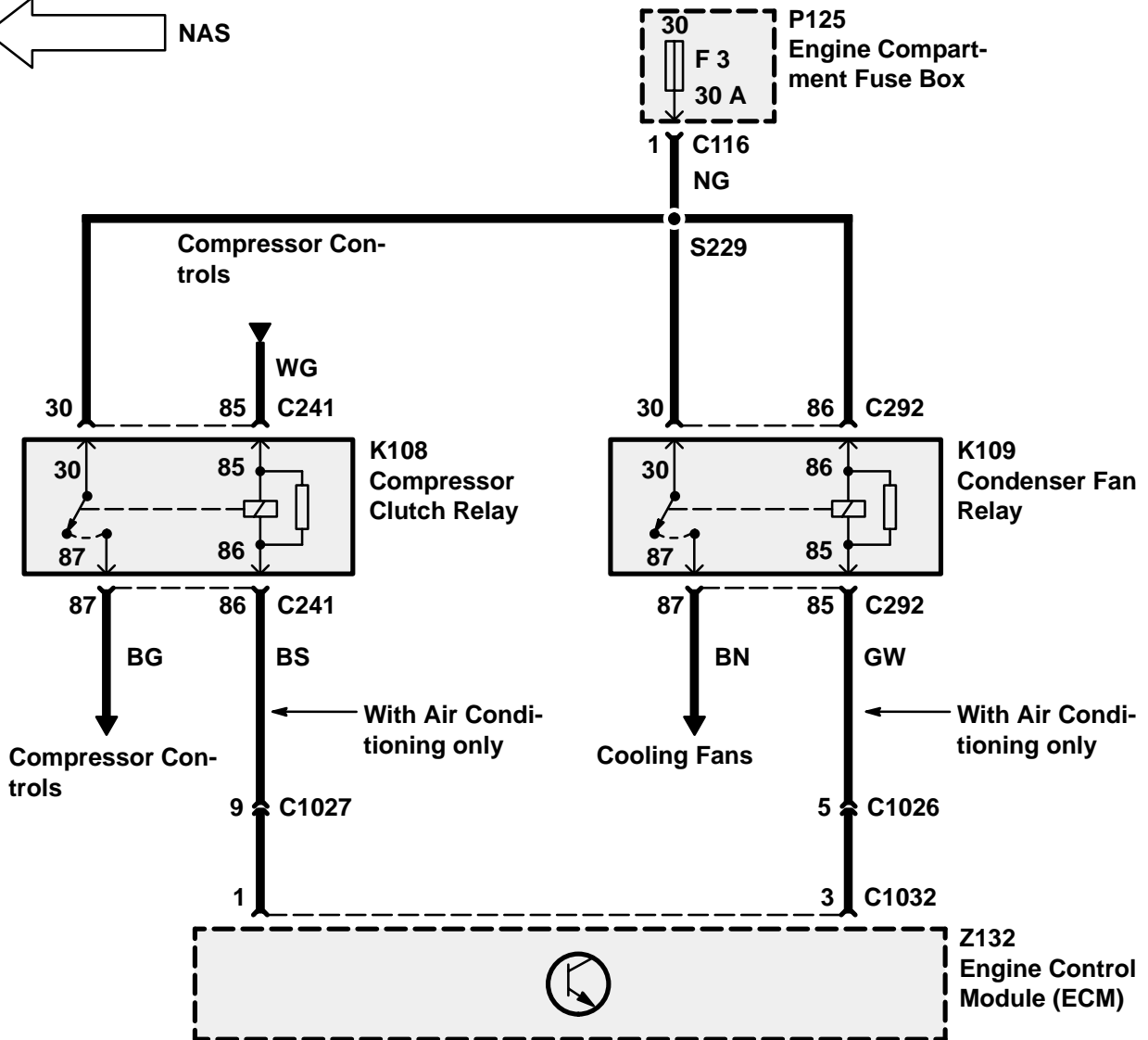
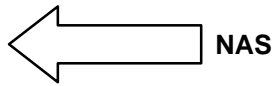

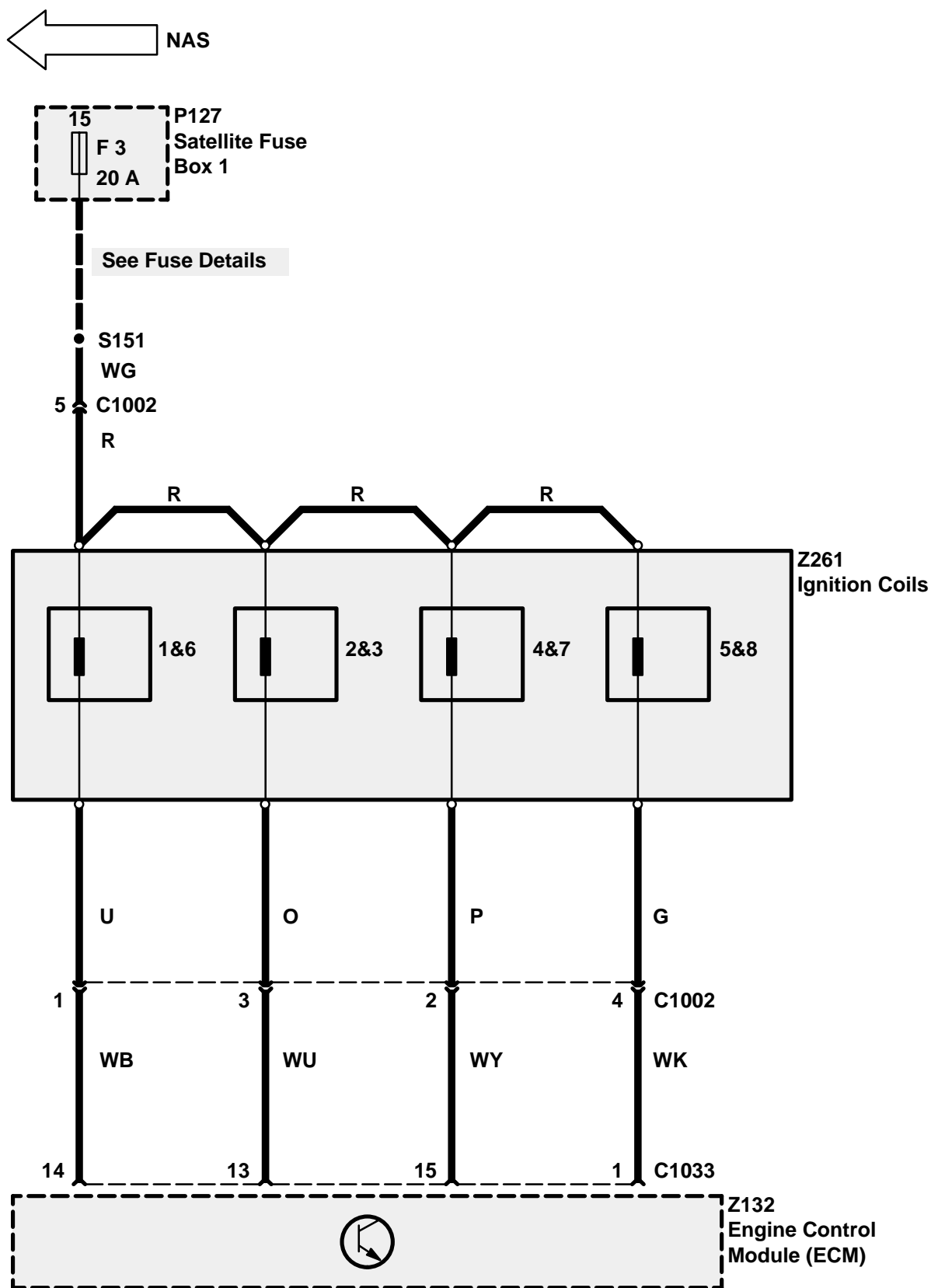



300Tdi without EGR

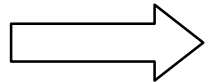
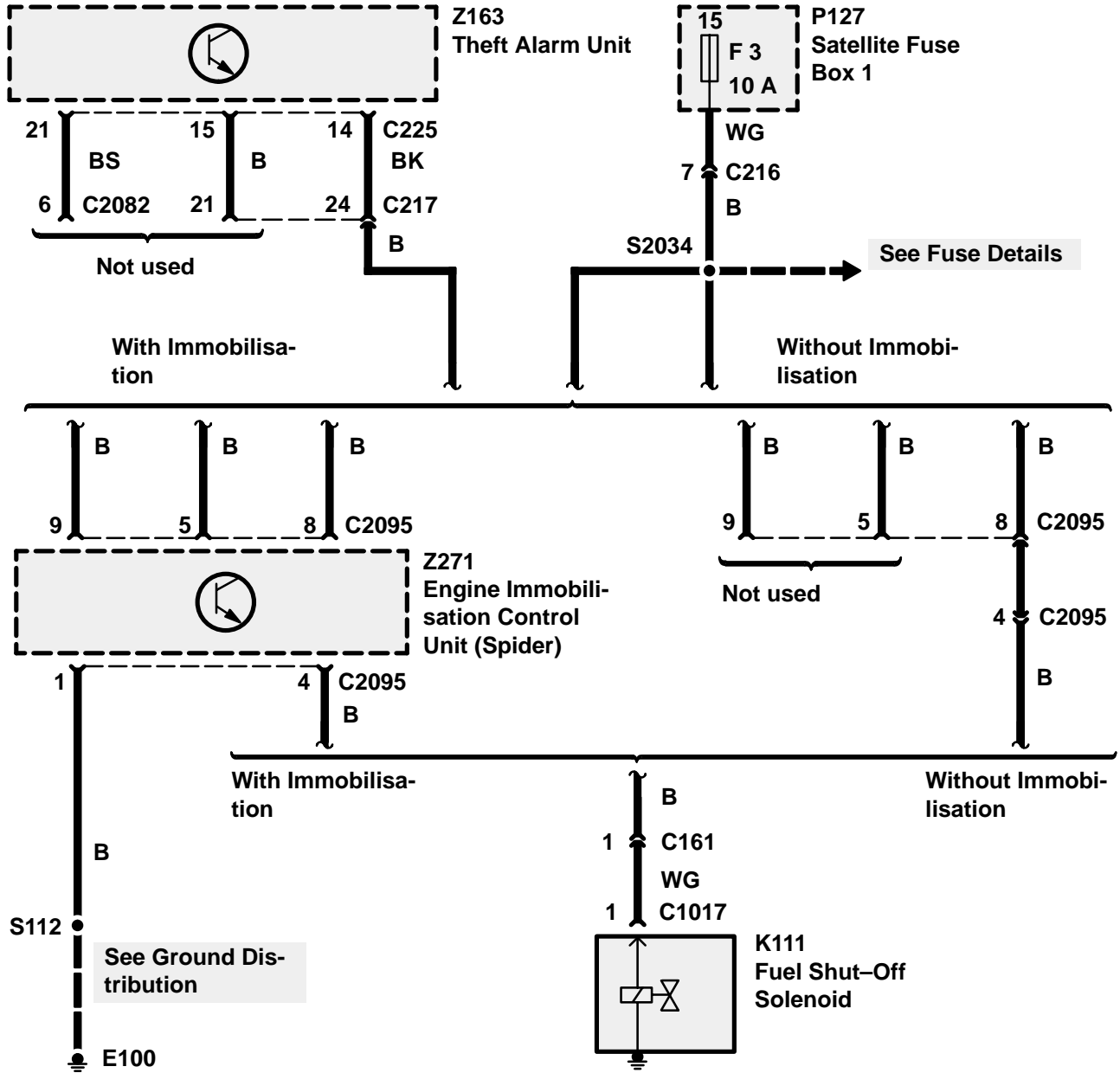



300Tdi with EGR

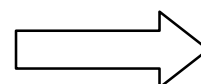
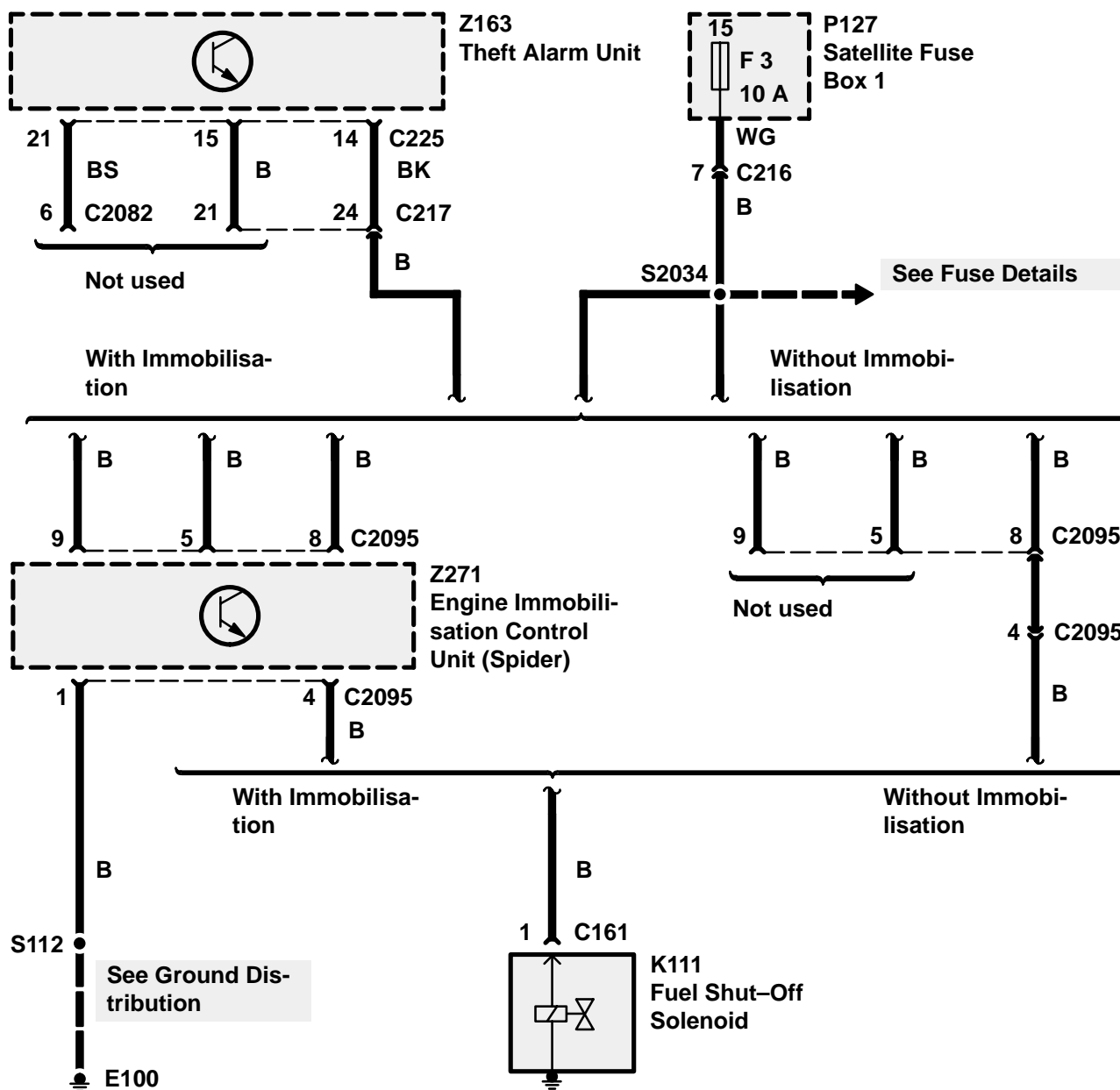

← 300Tdi with EGR

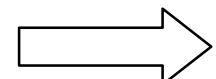
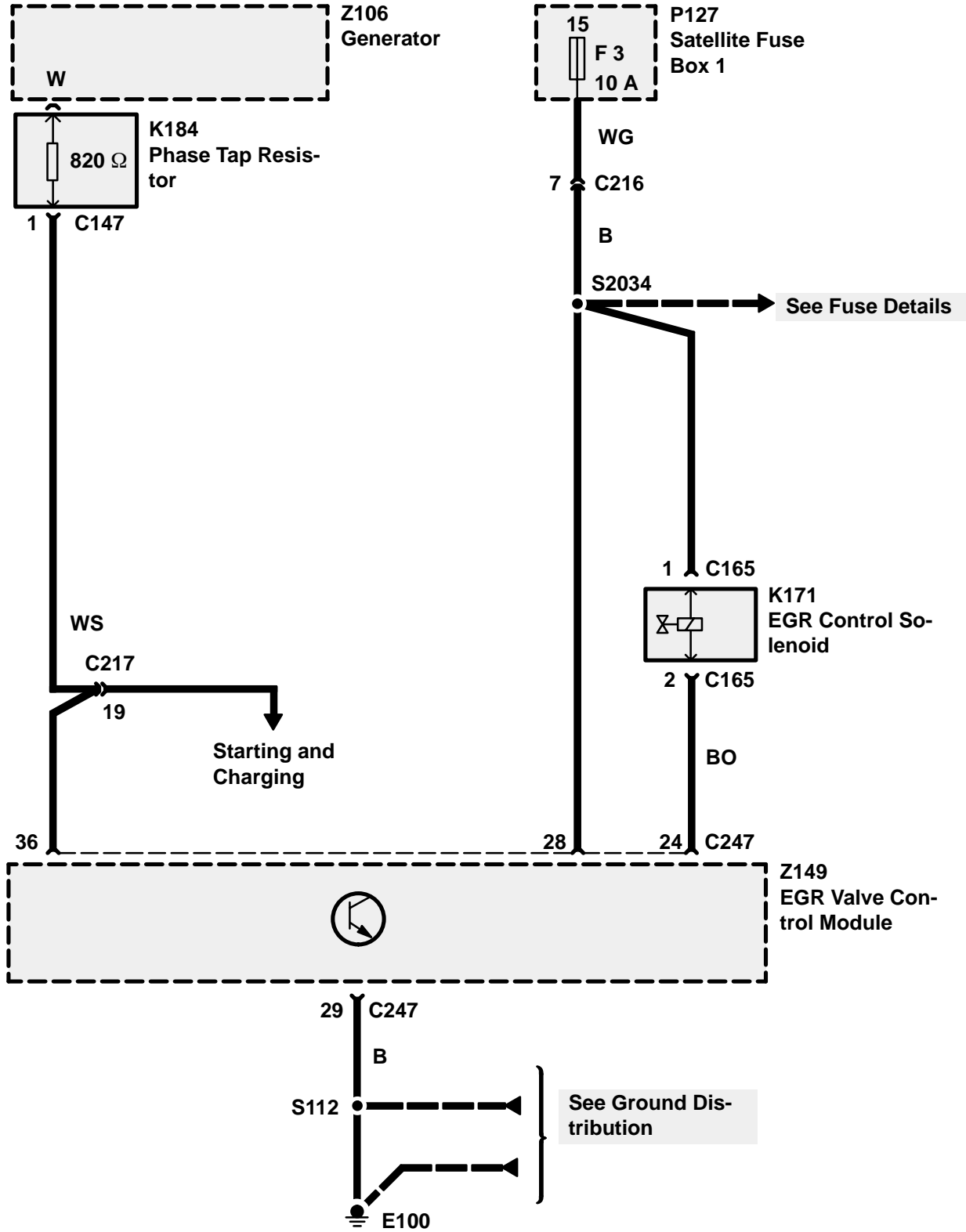

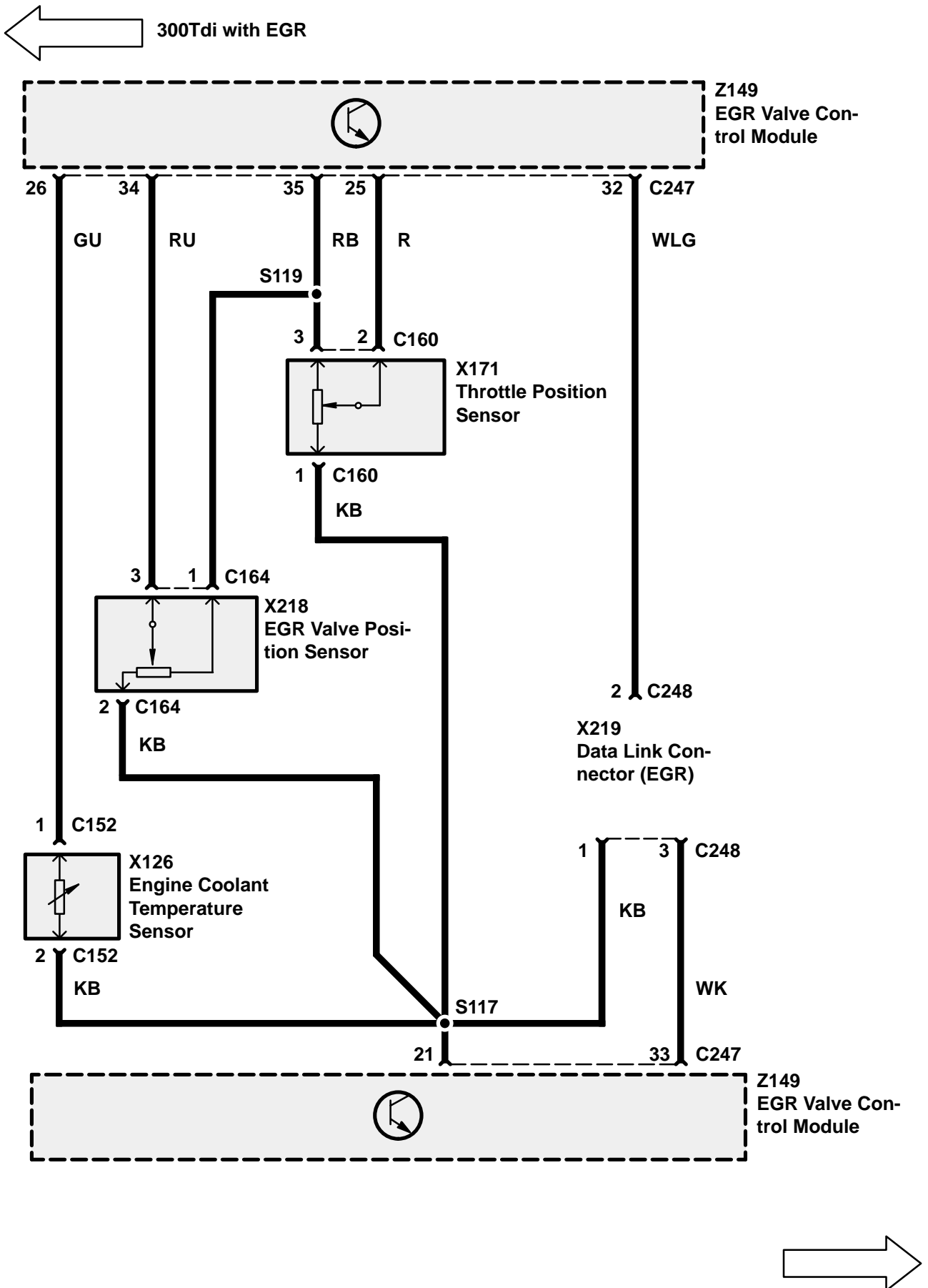

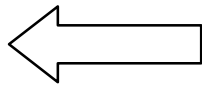

300Tdi with EDC

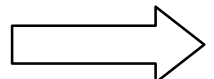
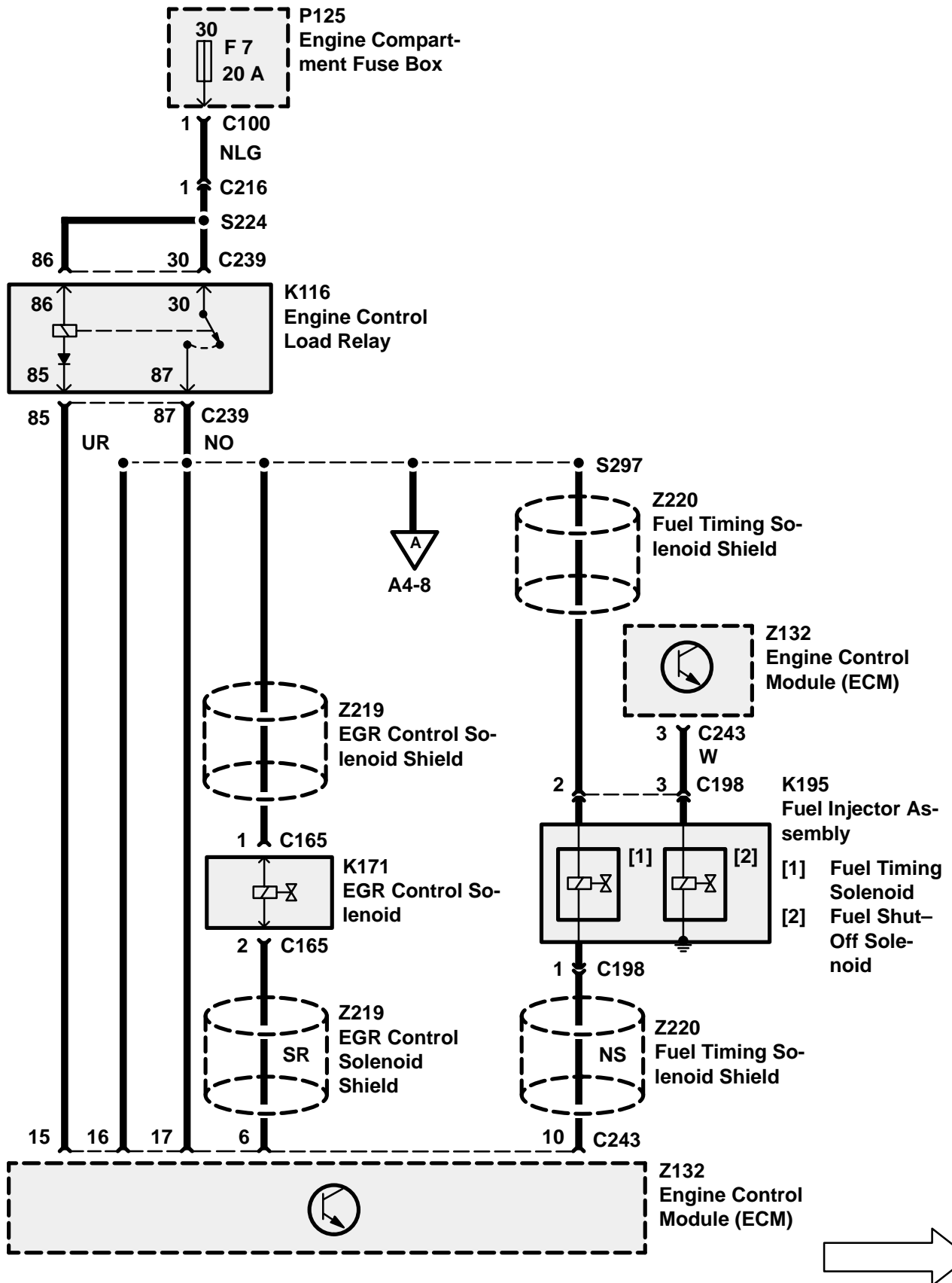

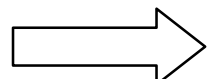
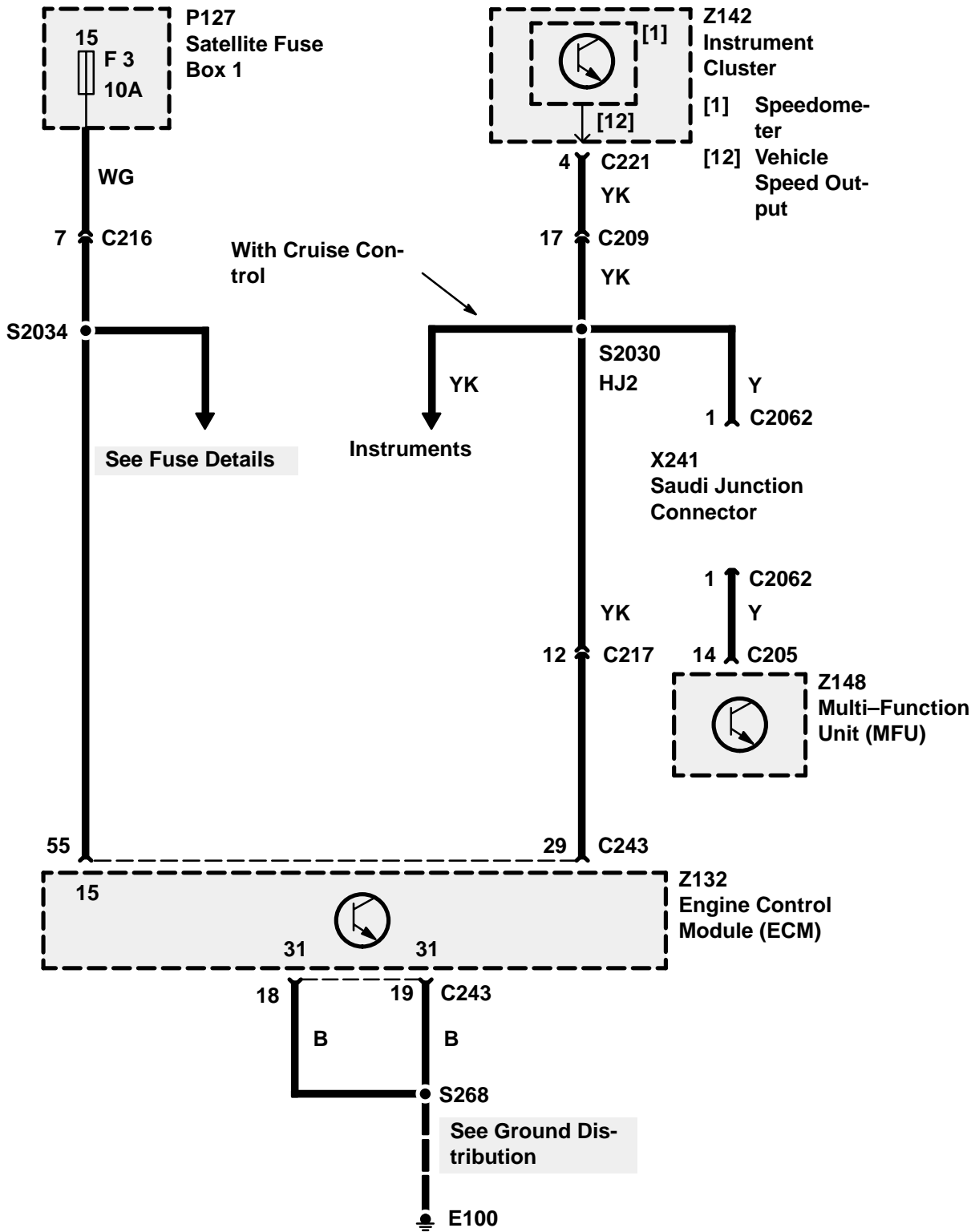
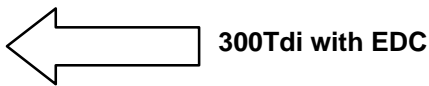

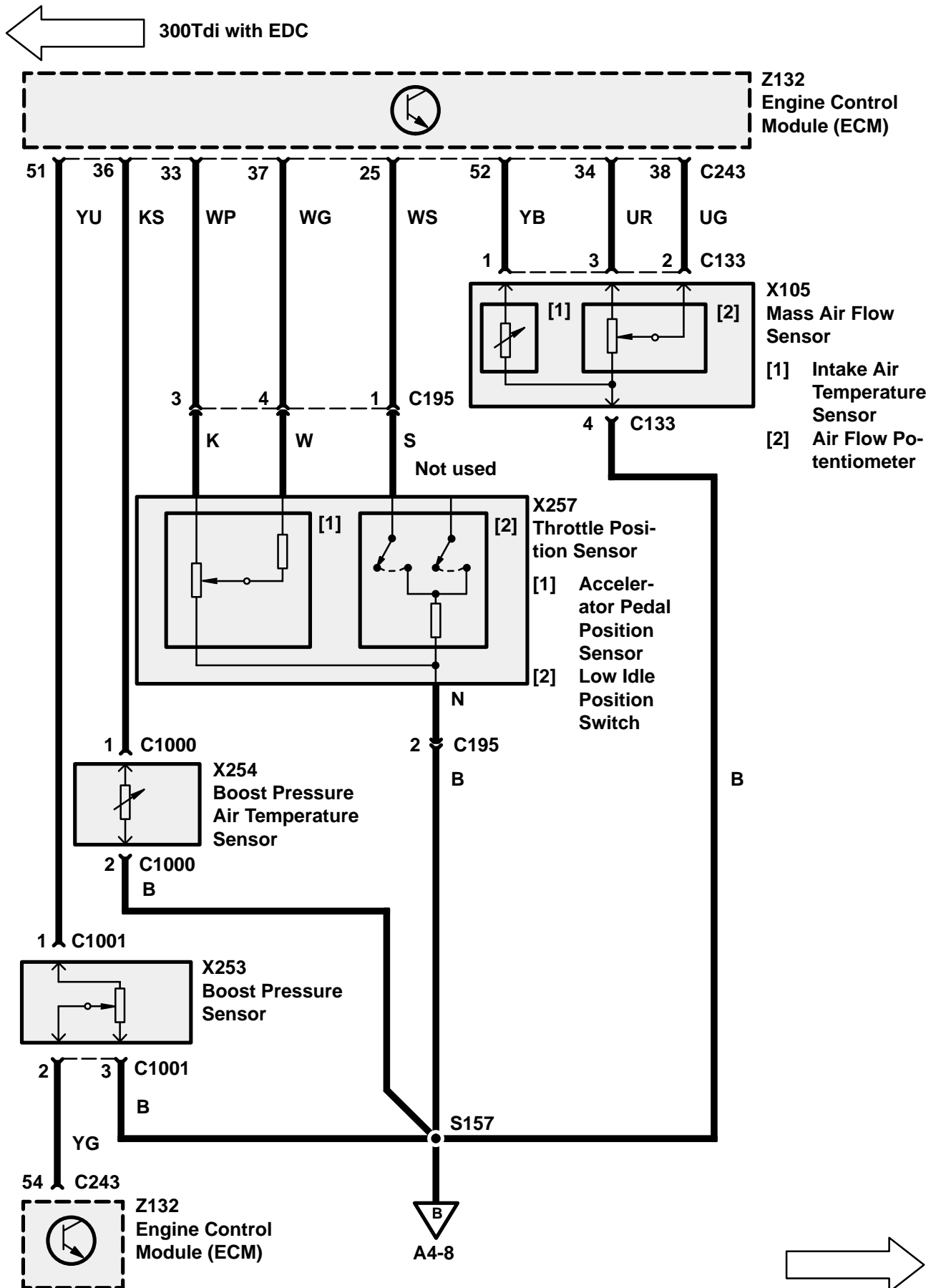

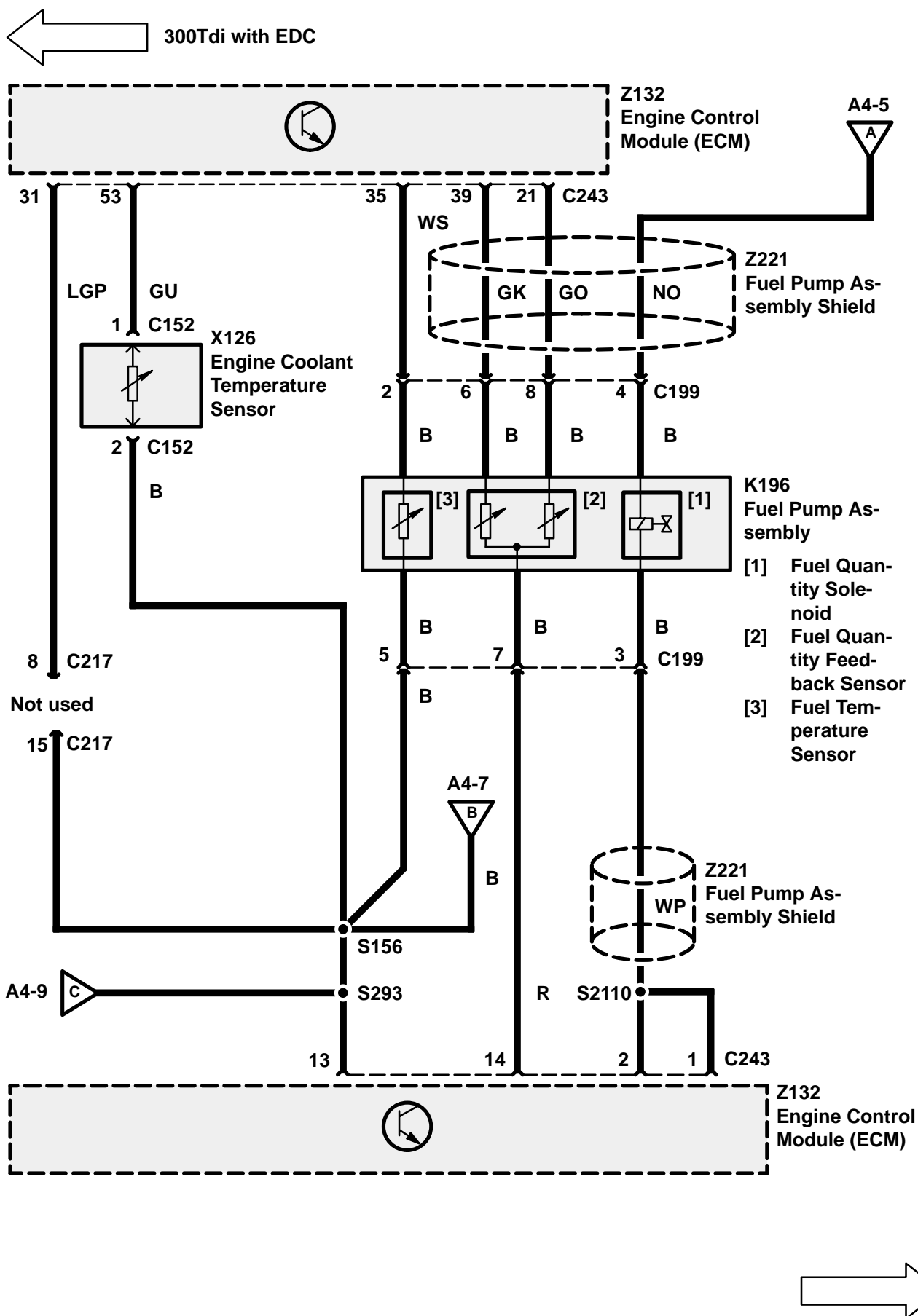



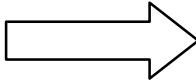
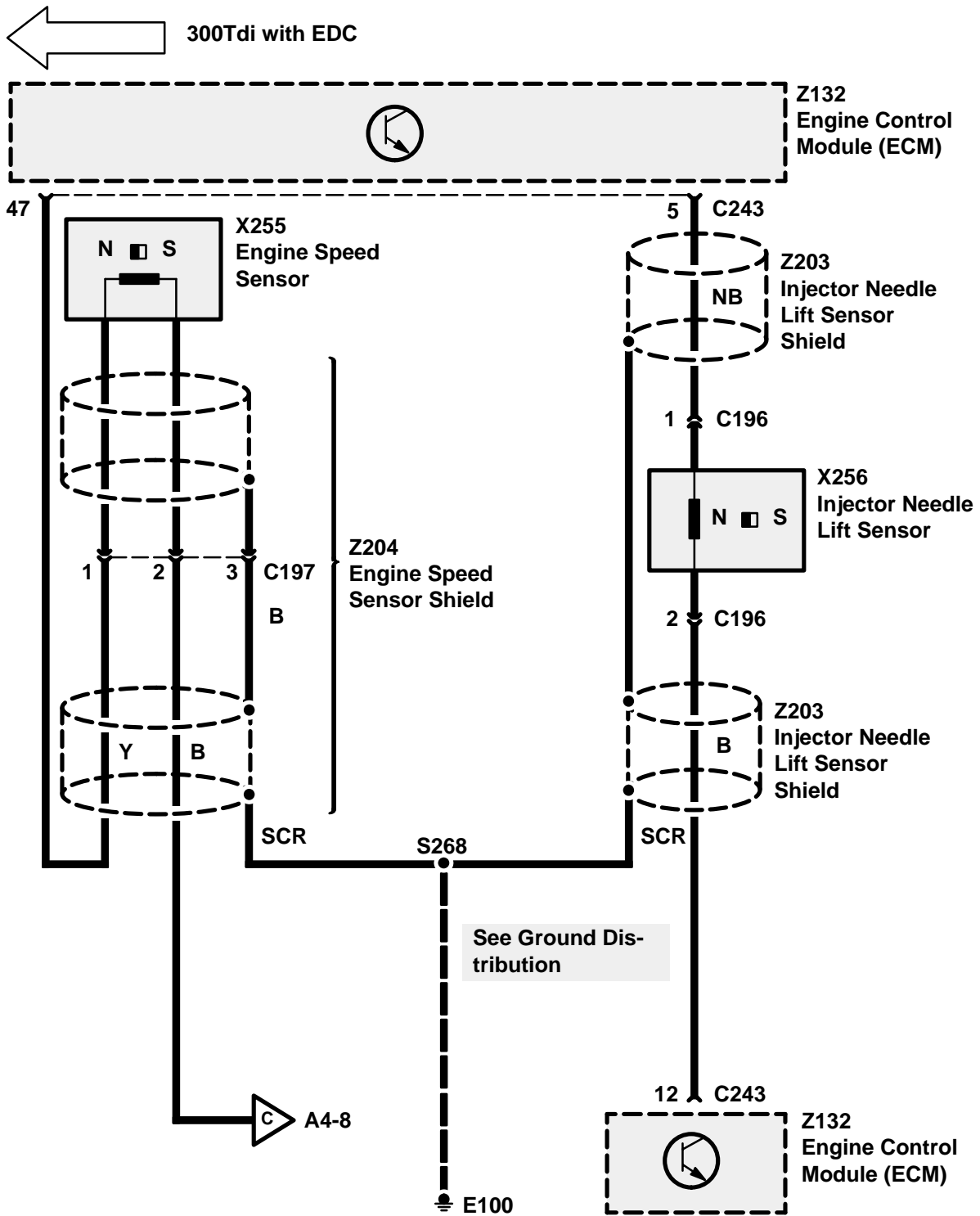

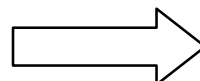
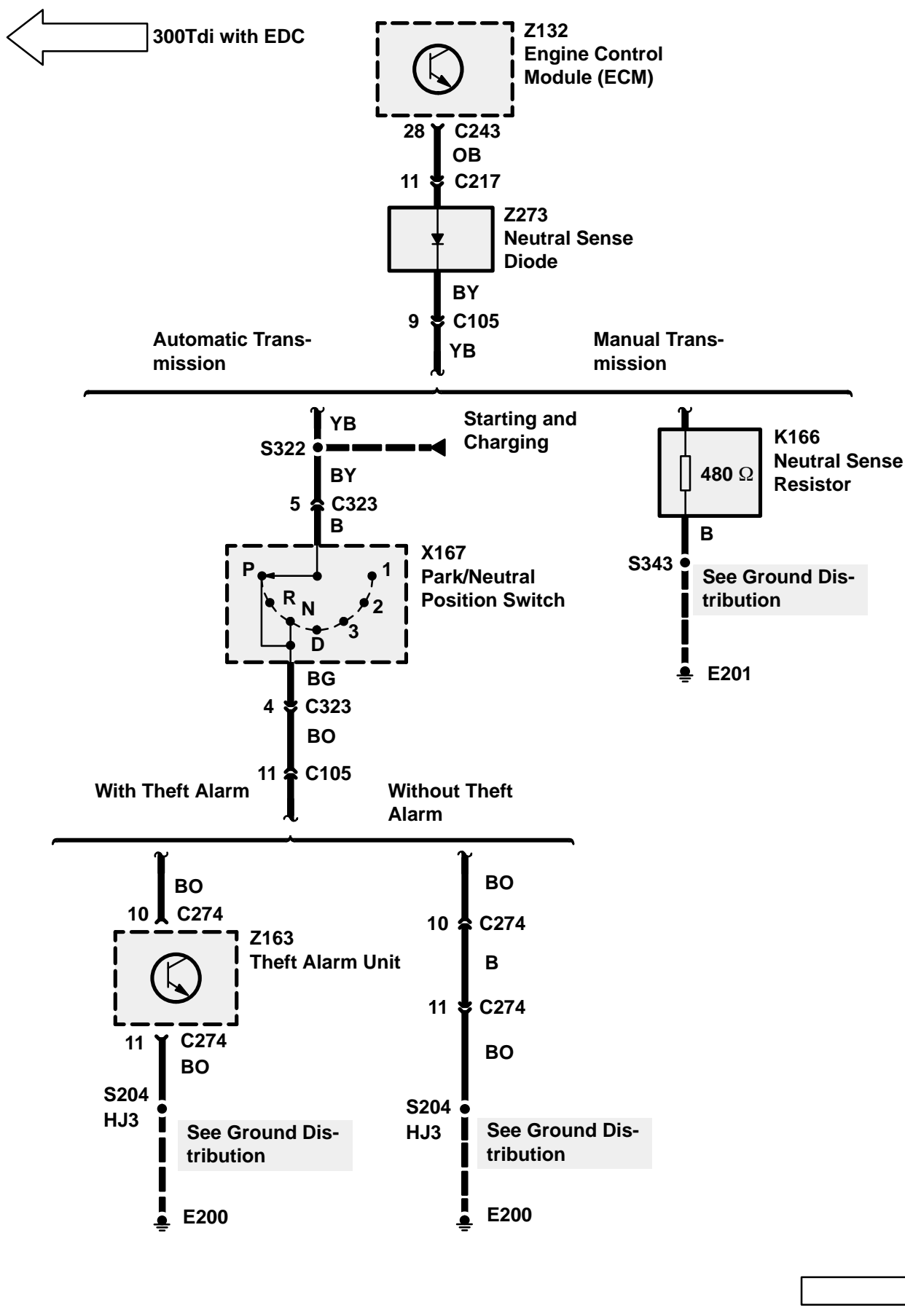

← 300Tdi with EDC

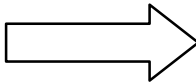
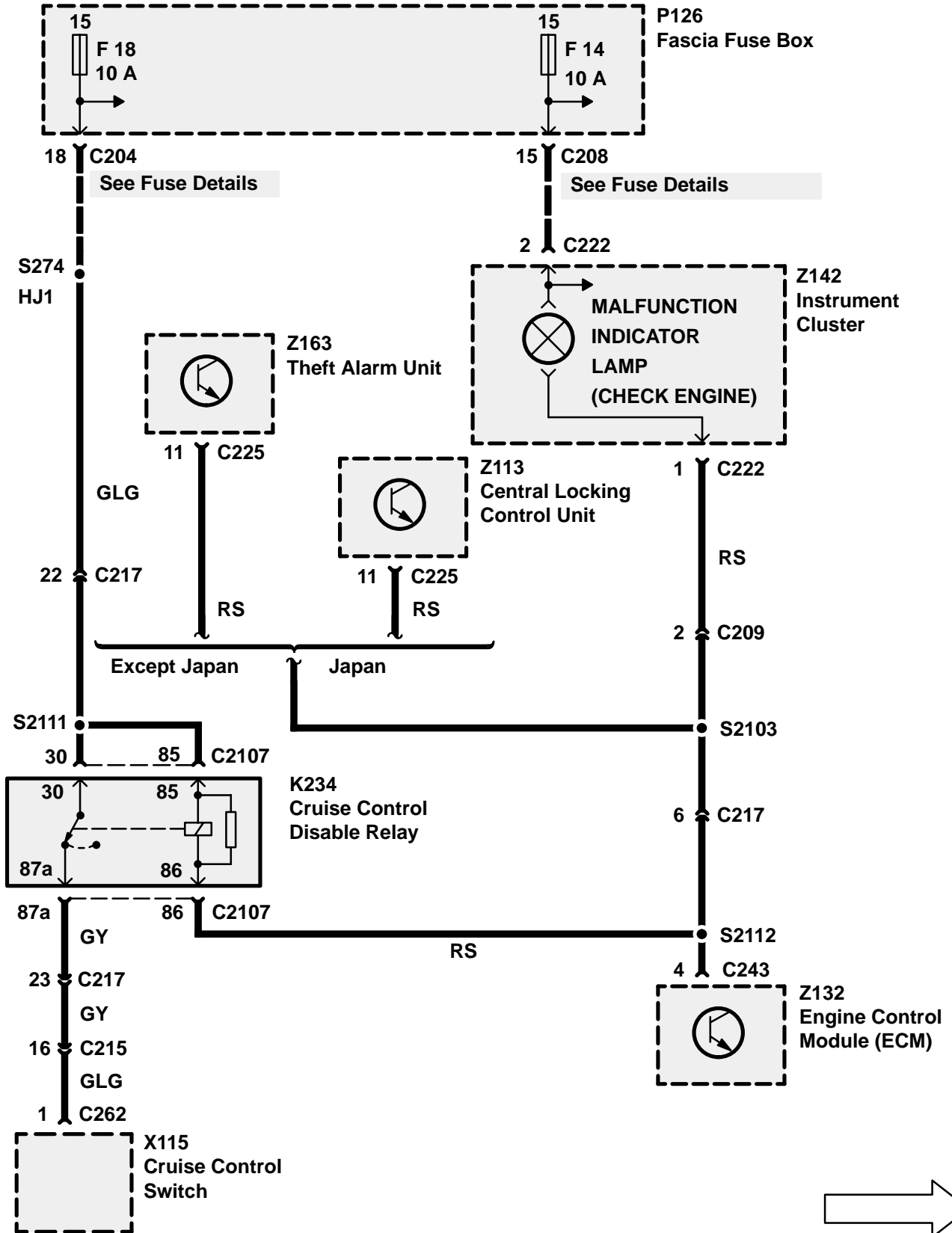

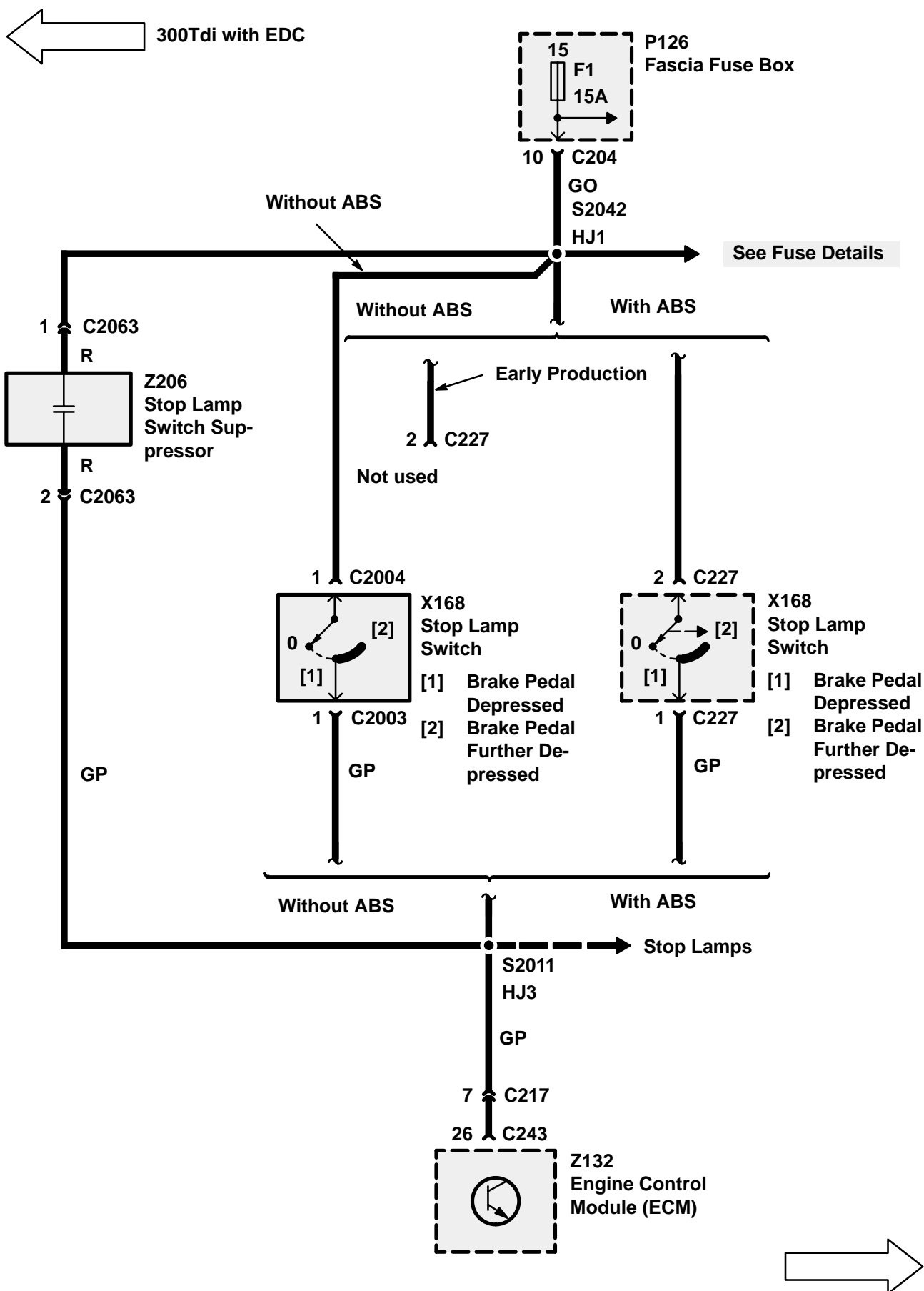

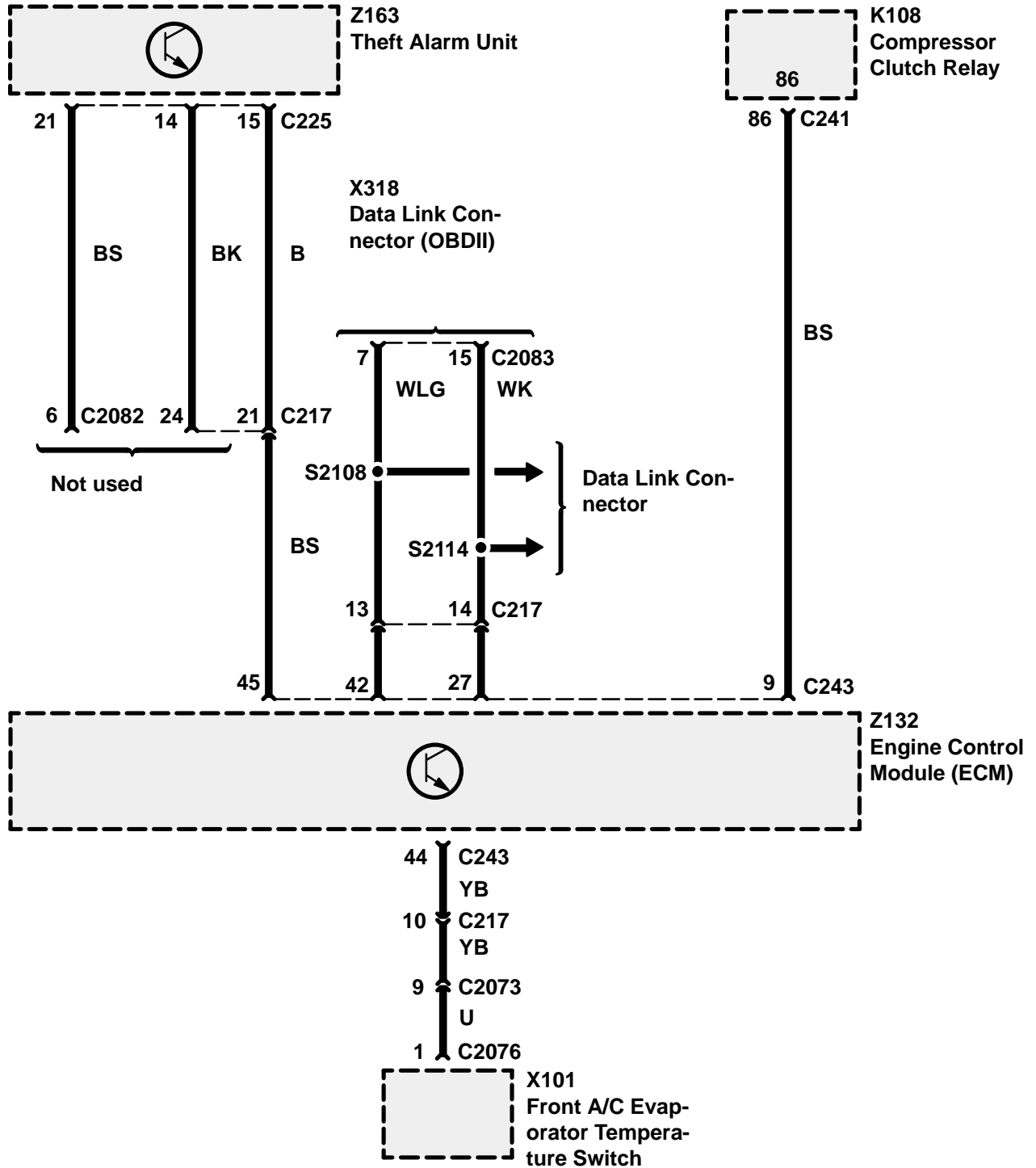
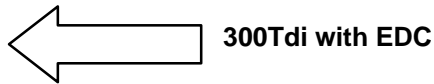

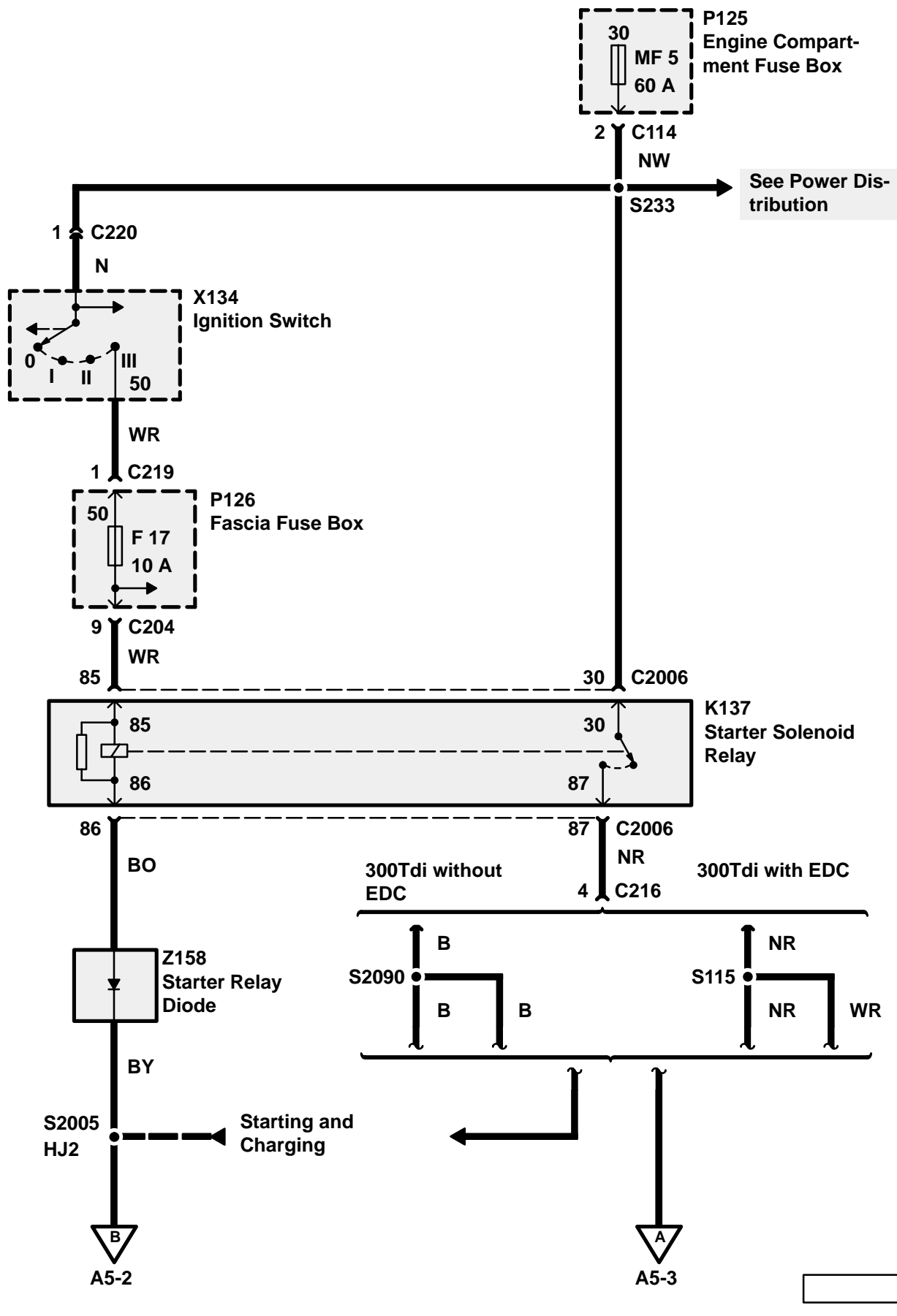

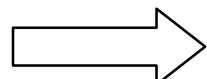
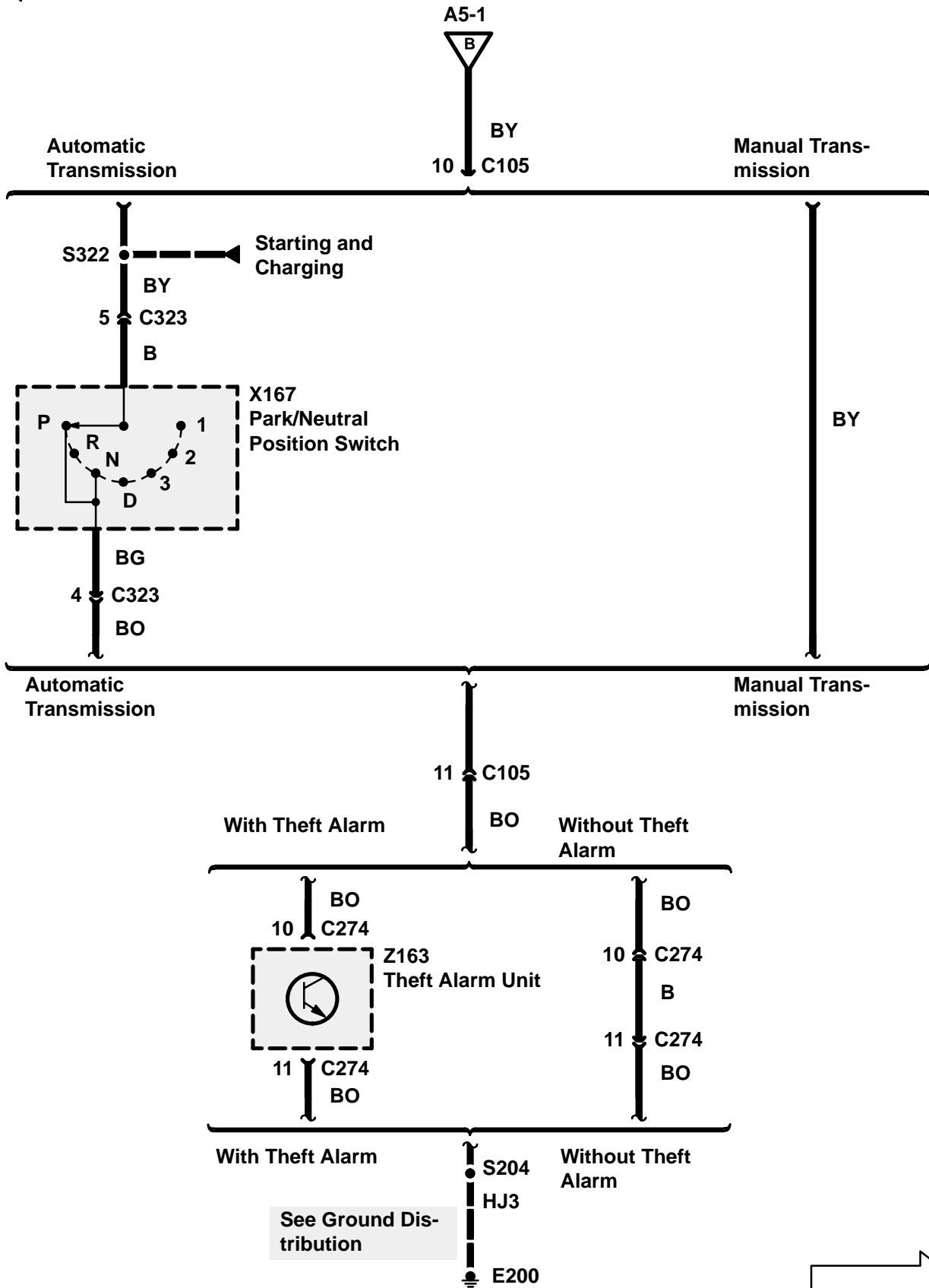
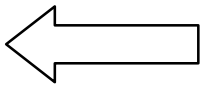

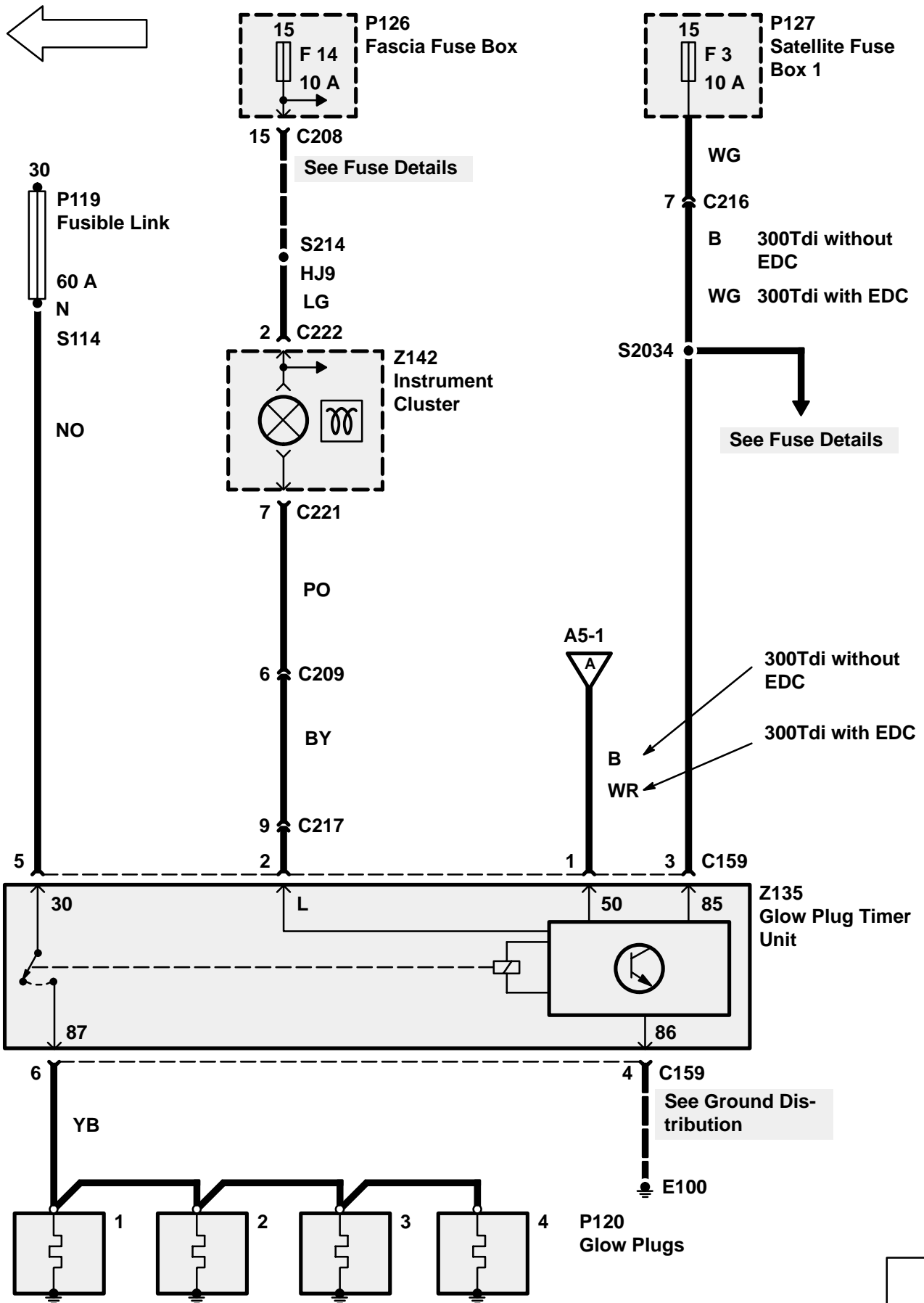



## CIRCUIT OPERATION

### Starting System (MFI–V8) (300 Tdi without EDC)

For vehicles equipped with Theft Alarm without Engine Immobilisation:

Putting the Ignition Switch (X134) in position III applies battery voltage to the Starter Solenoid Relay's (K137) terminal 85. With the vehicle in Park or Neutral (Automatic only) and the Theft Alarm de-activated, the Starter Solenoid Relay (K137) energises. Battery voltage is then applied directly to the Starter Solenoid (K136) and the Starter (M134) via the Engine Immobilisation Control Unit (Spider) (Z271) shorting plug.

On manual transmission vehicles, the Theft Alarm Unit (Z163) provides a ground circuit to the Starter Solenoid Relay's (K137) 86 terminal.

On automatic transmission vehicles, the Theft Alarm Unit (Z163) provides a ground circuit to the Starter Solenoid Relay's (K137) 86 terminal via the Park/Neutral Position Switch (X167).

If the theft alarm is activated, the Theft Alarm Unit (Z163) will interrupt the Starter Solenoid Relay's (K137) ground path. The Starter Solenoid Relay (K137) will remain de-energised and prevent starting the engine.

For vehicles equipped with Theft Alarm and Engine Immobilisation:

Putting the Ignition Switch (X134) in position III applies battery voltage to the Starter Solenoid Relay's (K137) terminal 85. With the vehicle in Park or Neutral (Automatic only) and the Theft Alarm de-activated, the Starter Solenoid Relay (K137) energises. Battery voltage is then applied to the Engine Immobilisation Control Unit (Spider) (Z271). If the Theft Alarm is activated, the Engine Immobilisation Control Unit (Spider) (Z271) will interrupt the battery supply to the Starter Solenoid (K136) and the Starter (M134).

On manual transmission vehicles, the Theft Alarm Unit (Z163) provides a ground circuit to the Starter Solenoid Relay's (K137) 86 terminal.

On automatic transmission vehicles, the Theft Alarm Unit (Z163) provides a ground circuit to the Starter Solenoid Relay's (K137) 86 terminal via the Park/Neutral Position Switch (X167).

If the theft alarm is activated, the Theft Alarm Unit (Z163) will interrupt the Starter Solenoid Relay's (K137) ground path. The Starter Solenoid Relay (K137) will remain de-energised and prevent starting the engine.

For vehicles not equipped with Theft Alarm and Engine Immobilisation:

Putting the Ignition Switch (X134) in position III applies battery voltage to the Starter Solenoid Relay's (K137) terminal 85. With the vehicle in Park or Neutral (Automatic only), the Starter Solenoid Relay (K137) energises. Battery voltage is then applied directly to the Starter Solenoid (K136) and the Starter (M134) via the Engine Immobilisation Control Unit (Spider) (Z271) shorting plug.

For vehicles not equipped with Theft Alarm, a black wire is used to short pins 10 and 11 of C274.

On Japan and manual transmission vehicles, a ground path is provided directly to the Starter Solenoid Relay's (K137) 86 terminal.

On automatic transmission vehicles, a ground path is provided to the Starter Solenoid Relay's (K137) 86 terminal via the Park/Neutral Position Switch (X167).

---

**Starting System (MFI–T16) (SFI–V8)****(300 Tdi with EDC)**

Putting the Ignition Switch (X134) in position III applies battery voltage to the Starter Solenoid Relay's (K137) terminal 85. With the vehicle in Park or Neutral (Automatic only) and/or the Theft Alarm de-activated, the Starter Solenoid Relay (K137) energises. Battery voltage is then applied directly to the Starter Solenoid (K136) and the Starter (M134).

On manual transmission vehicles equipped with a theft alarm, the Theft Alarm Unit (Z163) provides a ground circuit to the Starter Solenoid Relay's (K137) 86 terminal.

On automatic transmission vehicles equipped with a theft alarm, the Theft Alarm Unit (Z163) provides a ground circuit to the Starter Solenoid Relay's (K137) 86 terminal via the Park/Neutral Position Switch (X167).

If the theft alarm is activated, the Theft Alarm Unit (Z163) will interrupt the Starter Solenoid Relay's (K137) ground path. The Starter Solenoid Relay (K137) will remain de-energised and prevent starting the engine.

For vehicles not equipped with Theft Alarm, a black wire is used to short pins 10 and 11 of C274.

---

**Charging System**

When the Ignition Switch (X134) is in position II, battery voltage is applied to the charging system fault light. When the Generator (Z106) is being turned by the engine, its stator windings are excited by voltage applied to the Generator (Z106) via the charging system fault light. The Generator (Z106) begins to produce electricity in order to charge the vehicle Battery (P104). If the Generator (Z106) fails to produce power, the Generator (Z106) grounds the fault light control wire, causing the charging system fault light to glow.

The tachometer displays engine speed in rpm. Voltage pulses are taken from the Generator (Z106) and are generated when the engine drive belt turns the Generator pulley. The tachometer responds to the frequency of the voltage pulses, which increases proportionally to that of the engine speed.

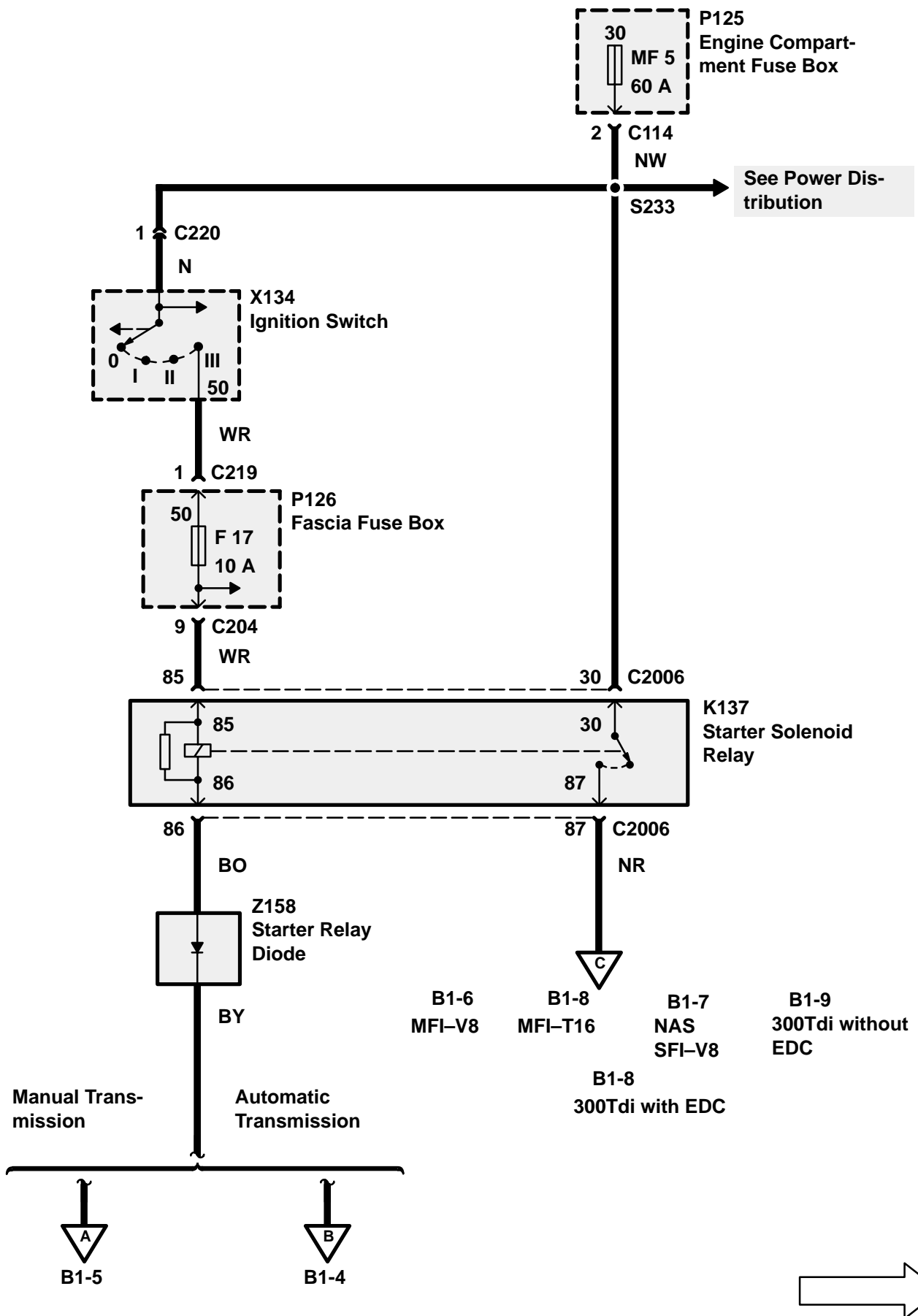

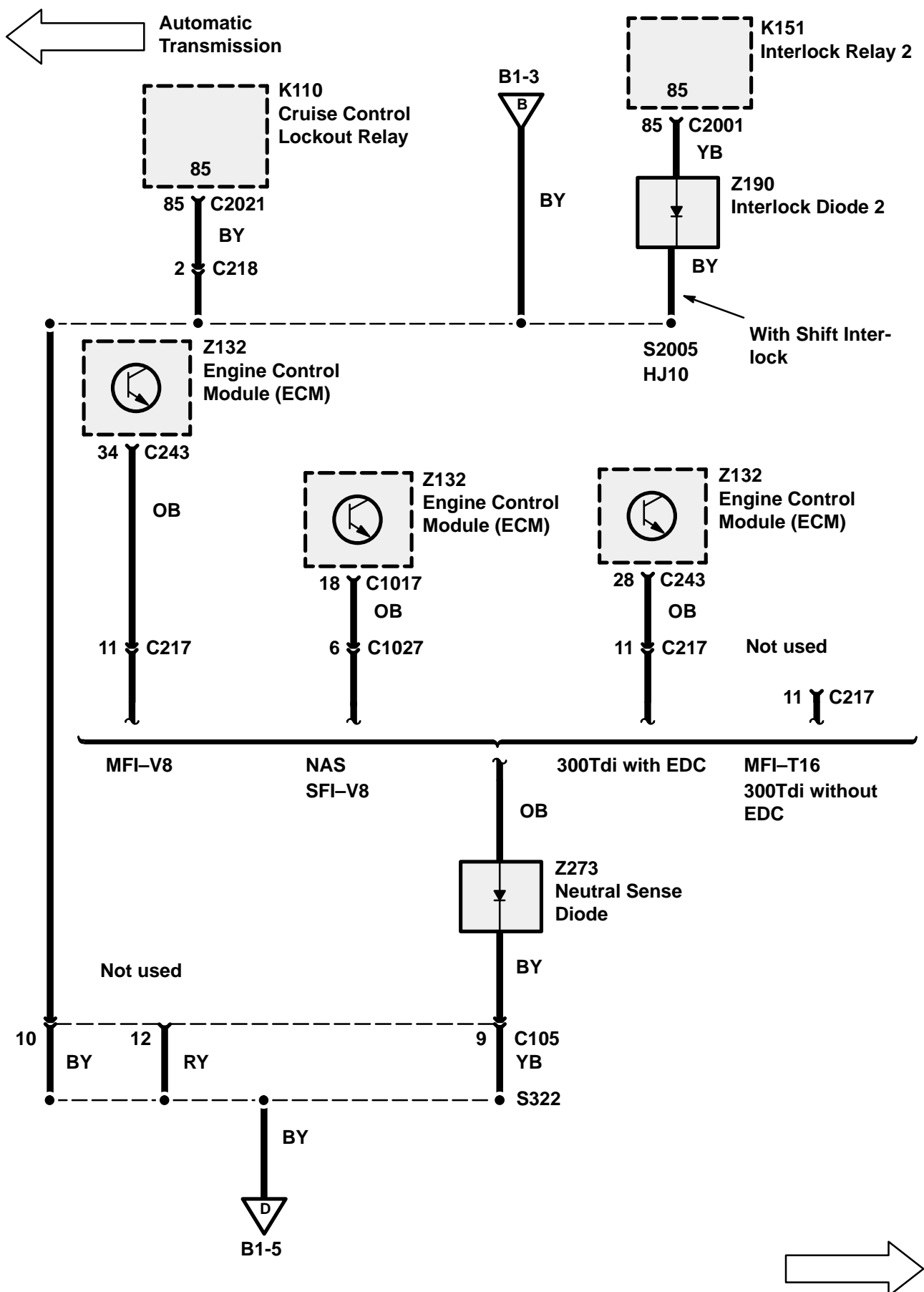

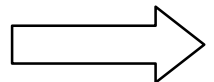
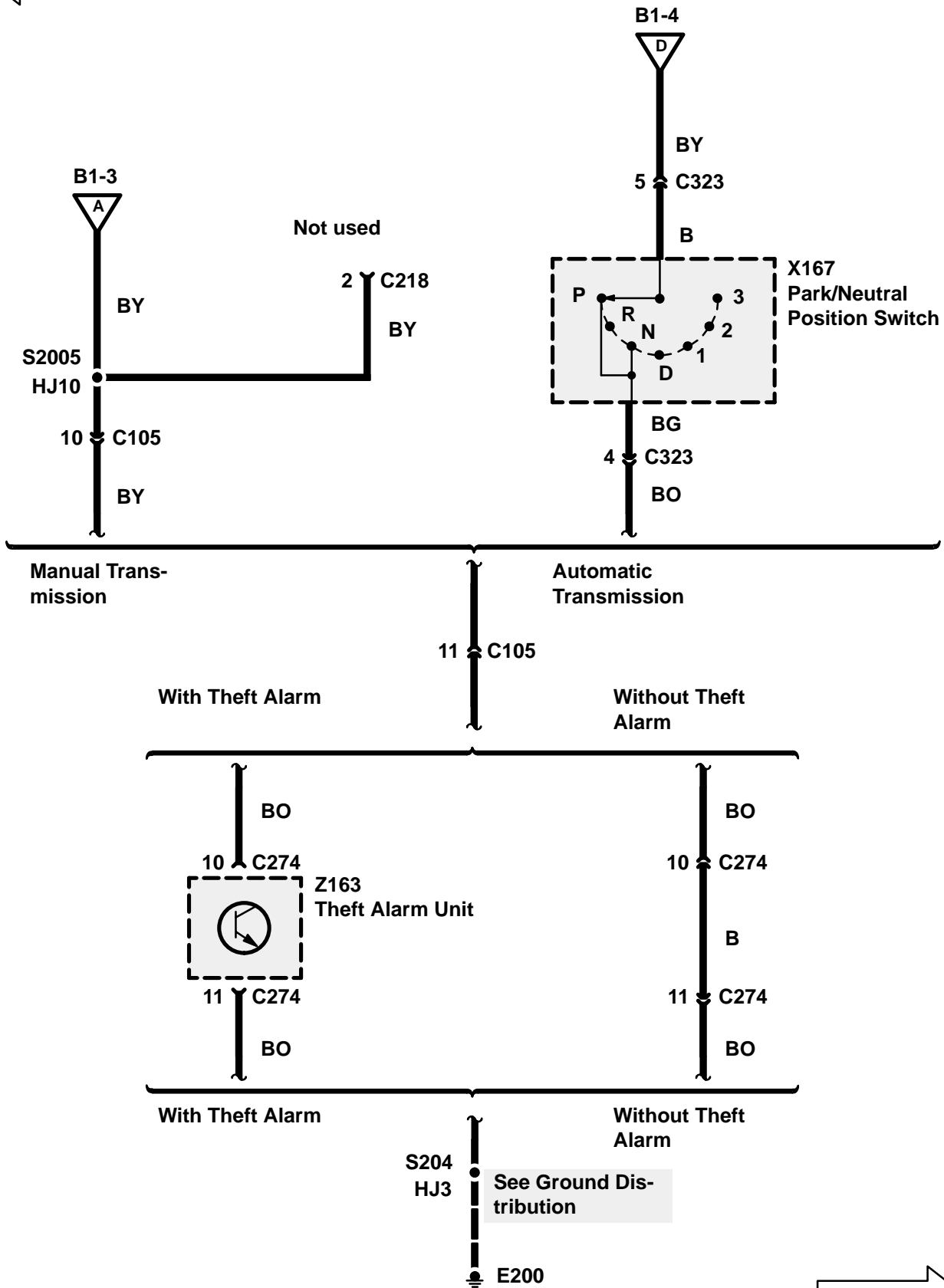
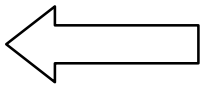

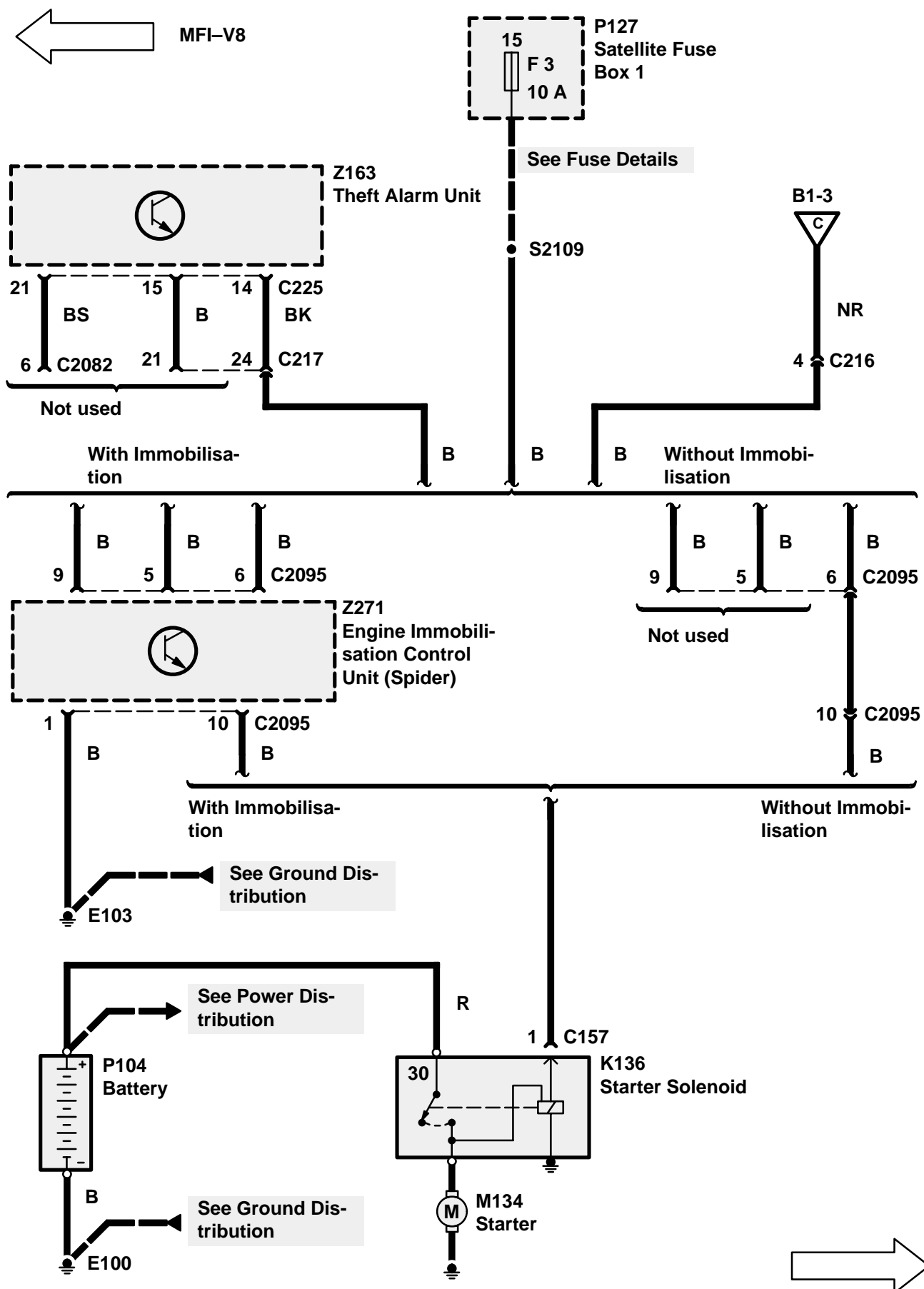

← NAS  
SFI-V8

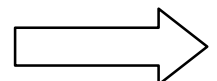
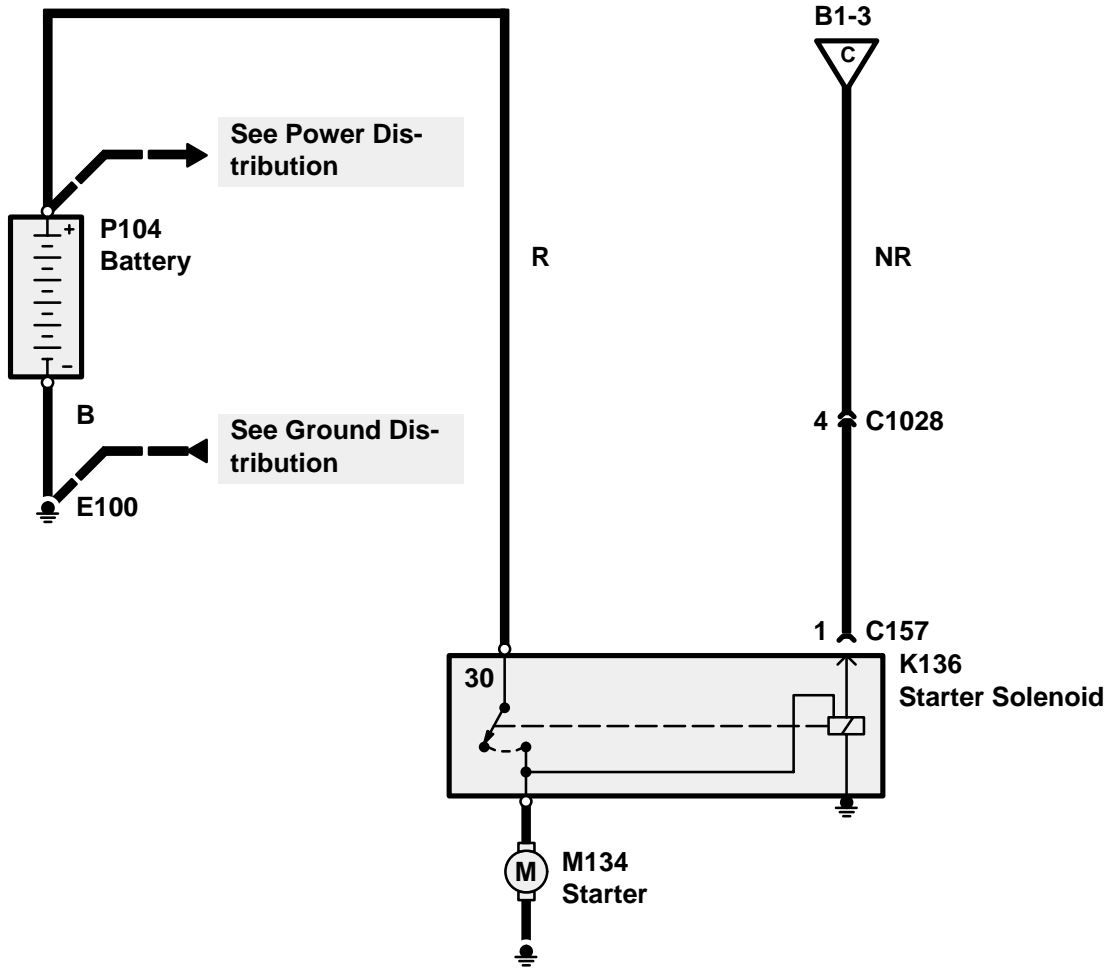

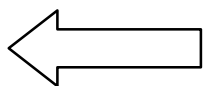

MFI-T16  
300Tdi with EDC

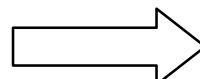
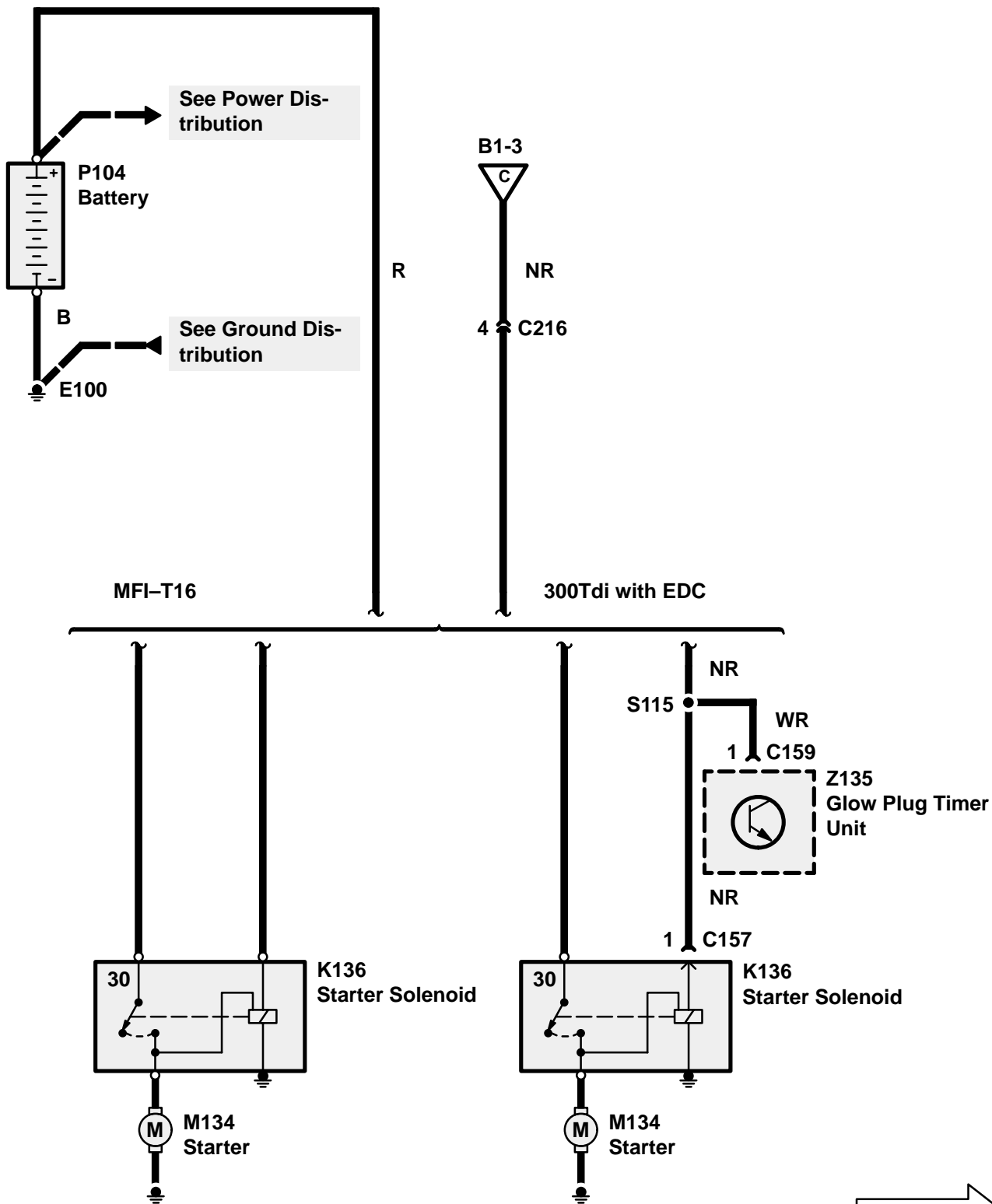



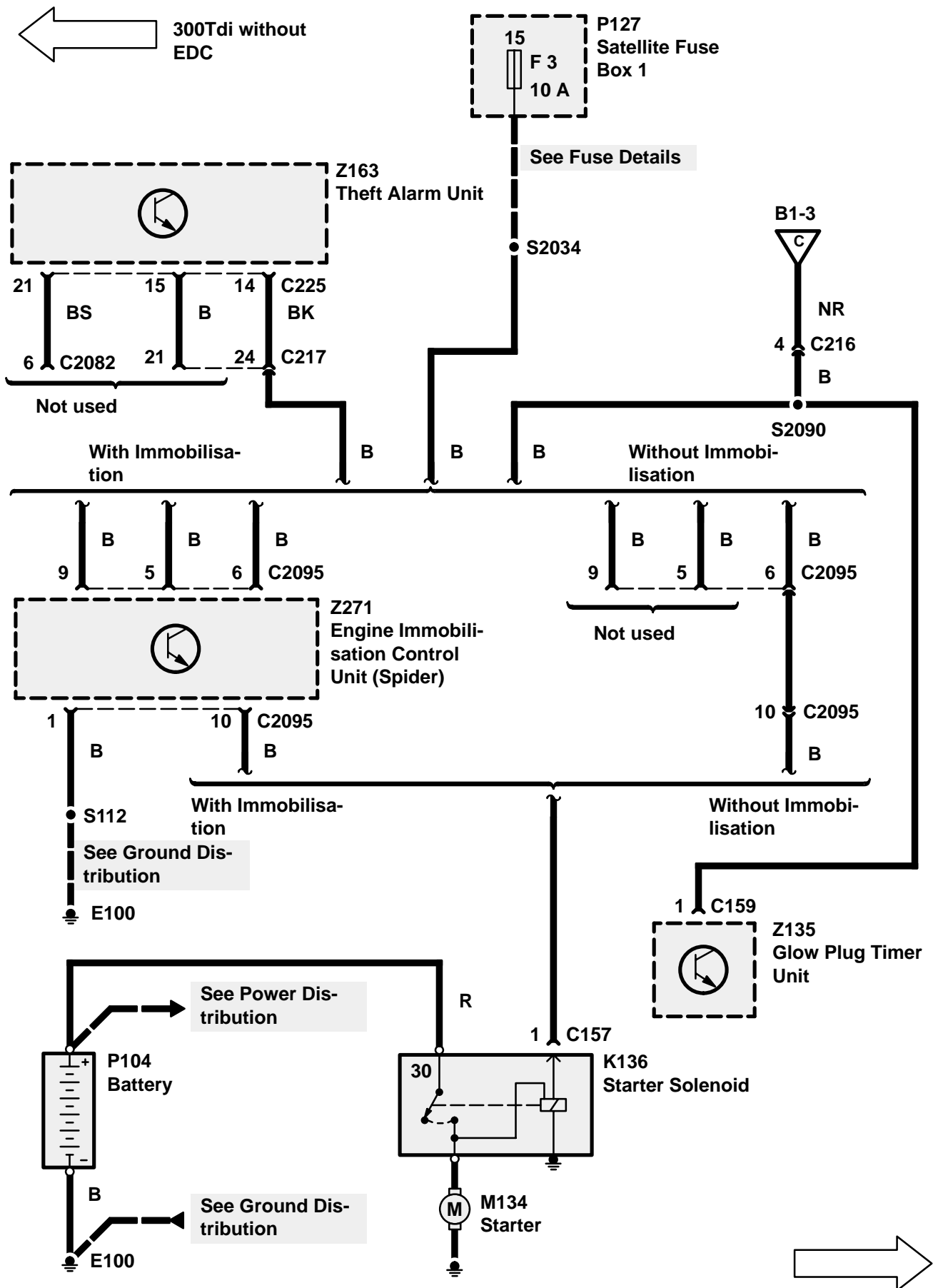

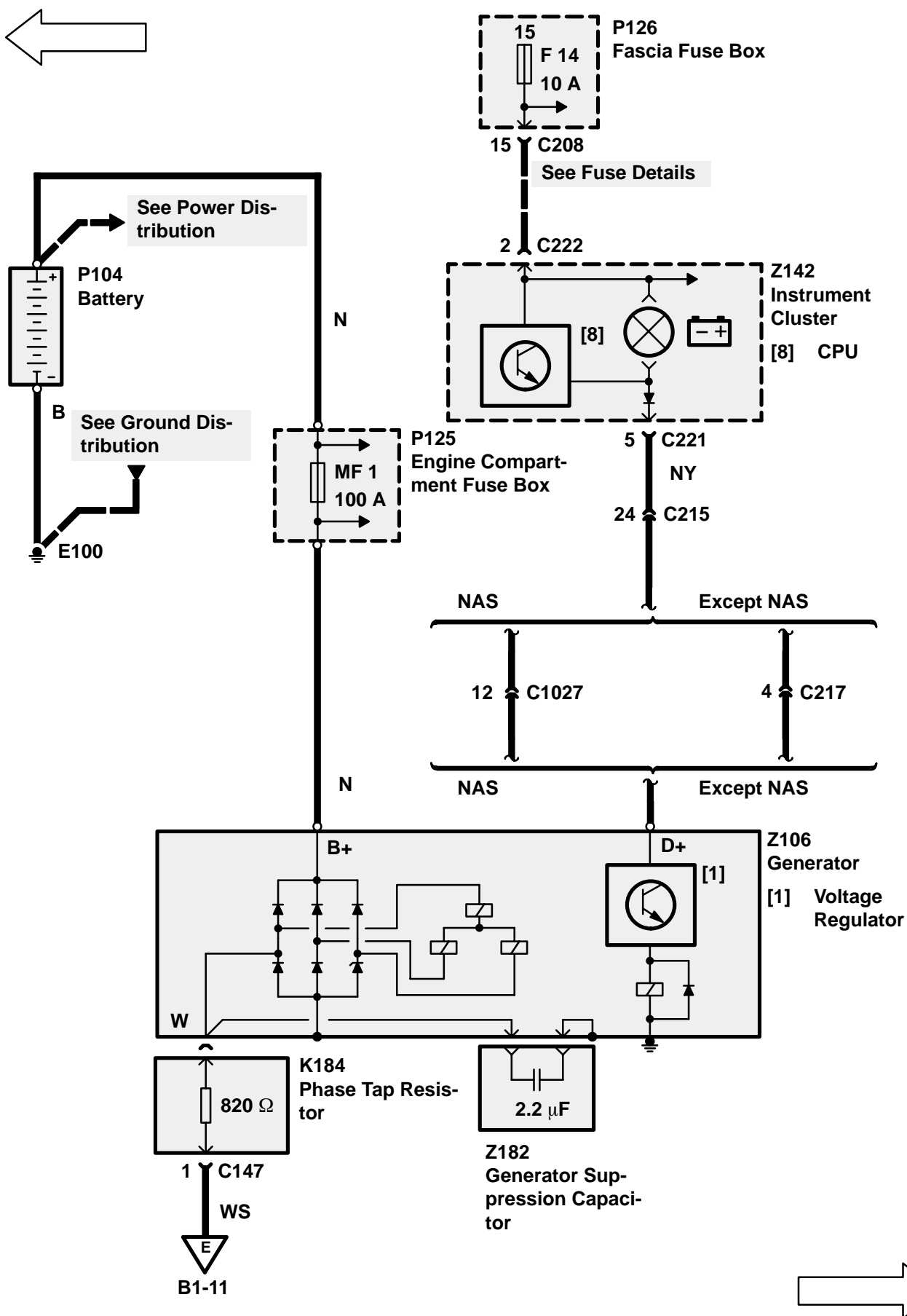

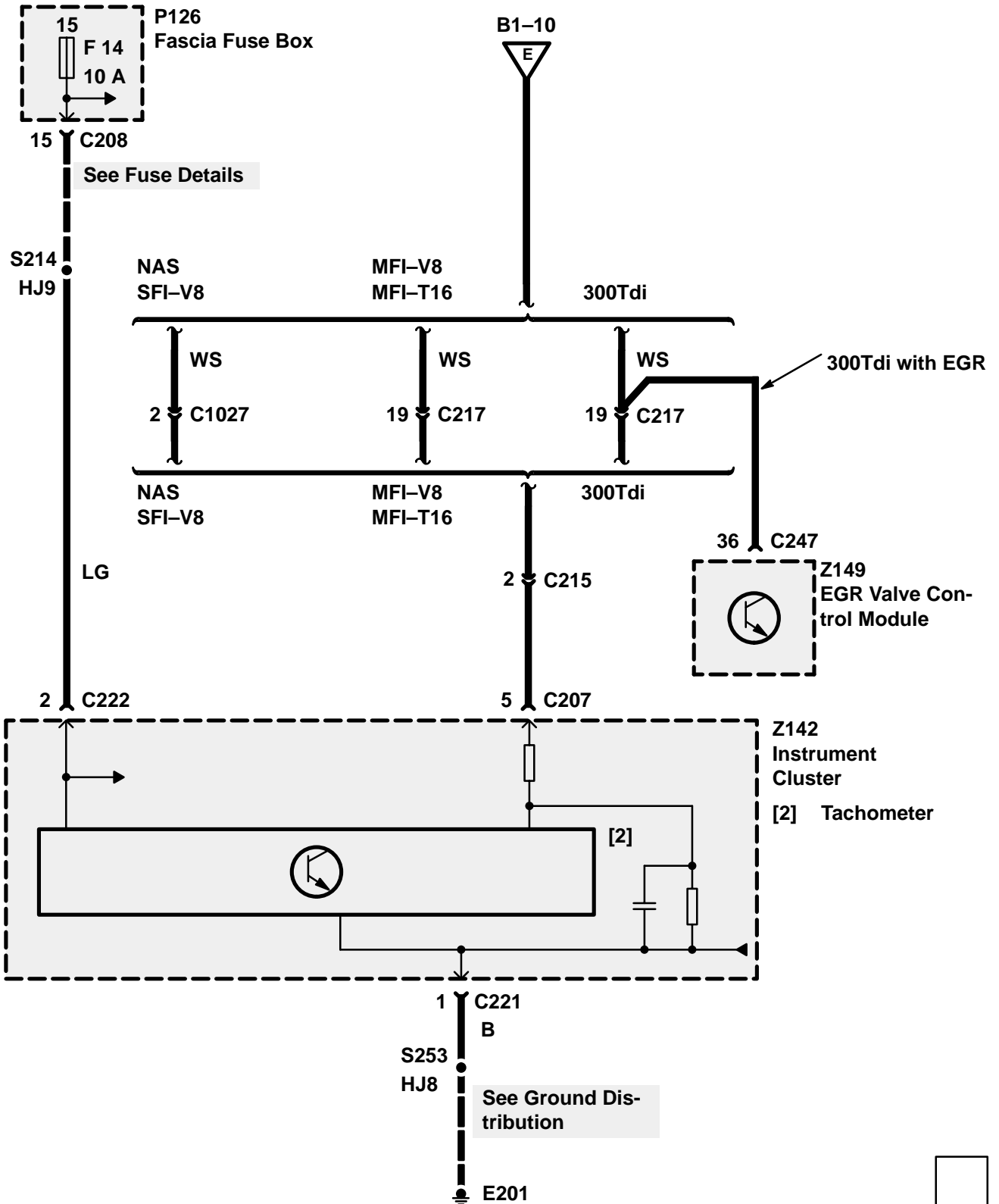
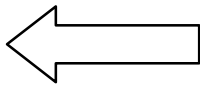

## CIRCUIT OPERATION

### Cruise Control Switch (MFI–V8) (MFI–T16) (SFI–V8) (300 Tdi without EDC)

With the Cruise Control Switch (X115) on, voltage from Fuse F18 is applied to the Cruise Control ECU (Z121), Cruise Control Lockout Relay (K110) (Except NAS Automatic), Speed Trip Module (Z164) (Except NAS Manual), Clutch Pedal Position Switch (X200) (NAS), and the Steering Wheel Cruise Switches (X266) through the WY wire, Rotary Coupler (Z104) and PB wire. The Cruise Control ECU (Z121) is grounded at terminal 8 through the B wire to E200.

### Cruise Control Switch (300 Tdi with EDC)

With the Ignition Switch (X134) in position II, battery voltage is applied to the Cruise Control Switch (X115) through the closed switch contacts of the Cruise Control Disable Relay (K234). The Engine Control Module (ECM) (Z132) applies ground to the coil of the Cruise Control Disable Relay (K234) if an engine fault is detected. The relay energises, opening the switch contacts. The battery supply to the Cruise Control Switch (X115) is interrupted, disabling the Cruise Control System.

With the Cruise Control Switch (X115) on, voltage from Fuse F18 is applied to the Cruise Control ECU (Z121), Cruise Control Lockout Relay (K110) (Automatic), Speed Trip Module (Z164) (Manual), and the Steering Wheel Cruise Switches (X266) through the WY wire, Rotary Coupler (Z104) and PB wire. The Cruise Control ECU (Z121) is grounded at terminal 8 through the B wire to E200.

### Cruise Control Vacuum Pump (M103)

With the Cruise Control Switch (X115) on, voltage is applied to the Cruise Control Vacuum Pump (M103) through the WU wire. When a cruise speed is set, the Cruise Control ECU (Z121) applies ground through the BR wire to operate the pump motor and applies ground through the BY wire to close the normally open solenoid valve in the pump. The pump applies vacuum to the actuator.

### SET/ACCEL

To set a cruise speed, the Cruise Control Switch (X115) must be on and vehicle speed must exceed 28 mph (45 km/h). When the SET/ACCEL Switch is depressed under these conditions, voltage from

Fuse F18 is applied to terminal 3 of the Cruise Control ECU (Z121) through the closed Cruise Control Switch (X115) and Steering Wheel Cruise Switches (X266), causing the vacuum pump to operate. When the SET/ACCEL Switch is released, voltage is removed from terminal 3, signalling the ECU to set the speed.

### RES/DECEL

When the RES/DECEL Switch is depressed, voltage is applied to terminal 4 of the Cruise Control ECU (Z121). This voltage signals the ECU to disengage the system, and the vehicle slows down. When the switch is depressed a second time, voltage is again applied to the ECU and the vehicle returns to the previously set speed.

---

**Speed Input**

Terminal 11 of the Cruise Control ECU (Z121) monitors the Vehicle Speed output signal from the Instrument Cluster (Z142) through the YK wire. This signal is a pulsing voltage, and its frequency changes with vehicle speed.

---

**System Disable**

The Cruise Control System can be disabled in one of four ways:

6. The Cruise Control Switch (X115) is put in the 0 position, removing power from the Cruise Control ECU (Z121) and vacuum pump and erasing the set speed memory.
7. The RES/DECEL Switch is depressed, signalling the Cruise Control ECU (Z121) to disengage the system.
8. The brake pedal is depressed, and a vacuum valve in the Brake Switch Vent Valve opens (X112). This vents vacuum to the actuator valve and releases the throttle.
9. The Voltage applied to Cruise Control ECU (Z121) terminal 9 is interrupted, causing the Cruise Control ECU (Z121) to turn off the vacuum pump and de-energise the vacuum solenoid valve. This voltage path is interrupted when the brake pedal is depressed, the Clutch Pedal is depressed, or the vehicle is in Park or Neutral. With the brake pedal depressed, the Brake Switch Vent Valve (X112) moves to 1 and the circuit is interrupted. With the vehicle in Park or Neutral, the Park/Neutral Position Switch (X167) energises the Cruise Control Lockout Relay (K110) by grounding the relay's coil. The relay then opens its contacts, interrupting the circuit. With the clutch pedal depressed, the Clutch Switch (X200) moves to 1 and the circuit is interrupted.

NOTE: For 300 Tdi vehicles equipped with an EDC Diesel engine, the Cruise Control System can also be disabled by the Engine Control Module (ECM) (Z132) when an engine fault has been detected.

---

### Road Test

CAUTION: DO NOT ENGAGE CRUISE CONTROL WHEN VEHICLE IS BEING USED IN LOW TRANSFER GEARS

WARNING: The use of cruise control is not recommended on winding, snow covered or slippery roads, or in heavy traffic conditions where a constant speed cannot be maintained.

1. Start the engine and depress the Cruise Control Switch (X115) to activate the Cruise Control System. Accelerate to approximately 30 mph (50 km/h) and press the SET/ACCEL Switch. Immediately release the switch and remove foot from the accelerator pedal. The vehicle should maintain the speed at which the SET/ACCEL Switch was pressed.
2. Press the SET/ACCEL Switch and hold at that position. The vehicle should accelerate smoothly until the switch is released. The vehicle should now maintain the new speed at which the SET/ACCEL Switch was released.
3. Press the RES/DECEL Switch while the vehicle is in the cruise control mode. The cruise control should disengage. Slow to approximately 35 mph (55 km/h) and press the RES/DECEL Switch. Immediately release the switch and remove foot from the accelerator. The vehicle should smoothly accelerate to the previously set speed. Increase speed using the accelerator pedal. Releasing the pedal should return the vehicle to the previously set speed.
4. Depressing the brake pedal should immediately disengage the Cruise Control System and return the vehicle to driver's control at accelerator pedal. Press the RES/DECEL Switch and the vehicle should accelerate to the previously set speed without operation of the accelerator pedal.
5. Press the RES/DECEL Switch and allow the vehicle to decelerate to below 26 mph (42 km/h). Press the RES/DECEL Switch and the Cruise Control System should remain disengaged.
6. Press the SET/ACCEL Switch below 28 mph (45 km/h) and the Cruise Control System should remain disengaged. Accelerate the vehicle above 28 mph (45 km/h), press the RES/DECEL Switch and remove foot from the accelerator pedal. The vehicle should smoothly adjust to the previously memorized speed.
7. Pressing the Cruise Control Switch (X115) should immediately disengage the Cruise Control System and erase the previously set speed from ECU memory.

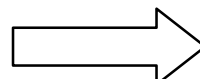
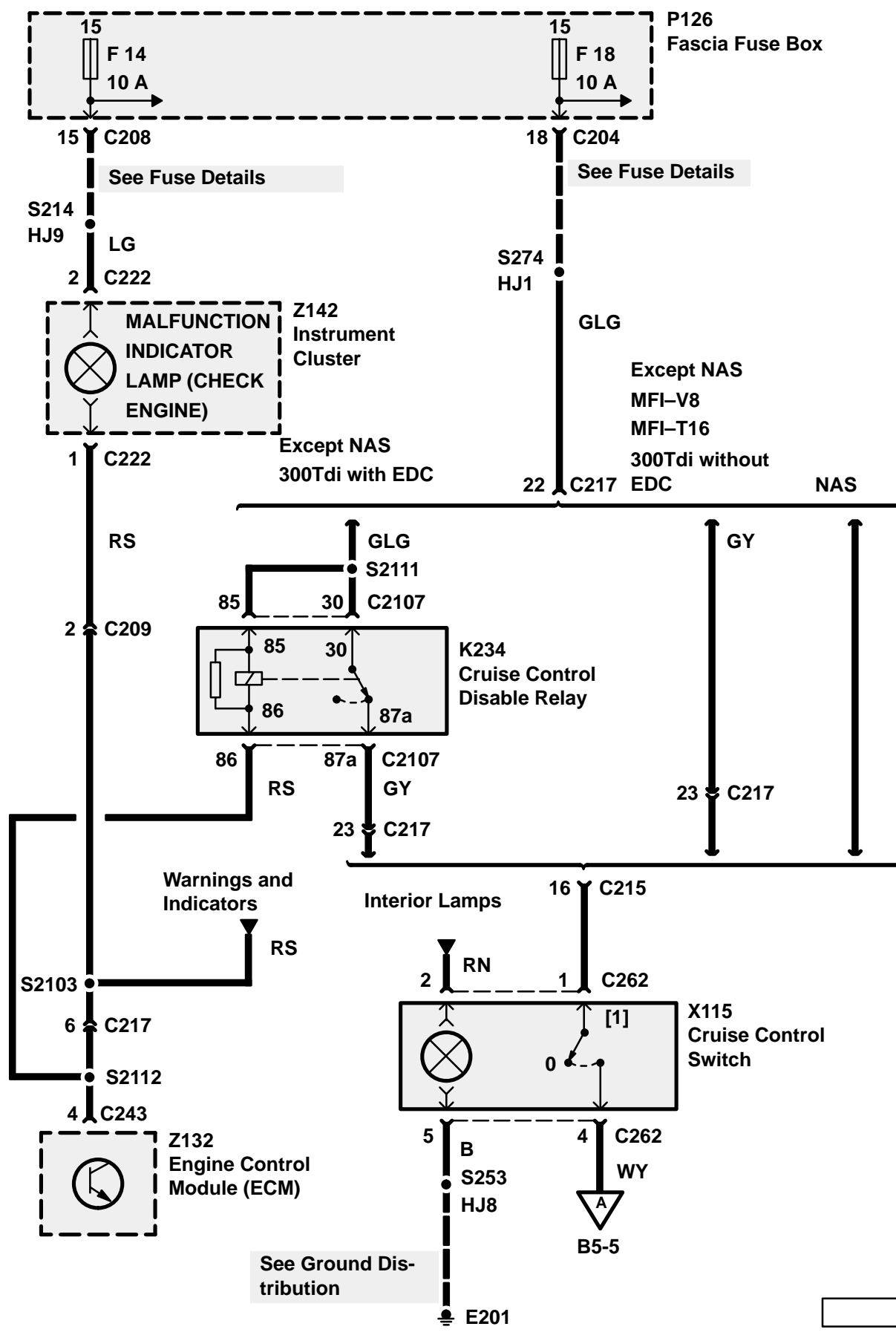

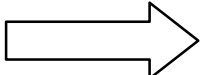
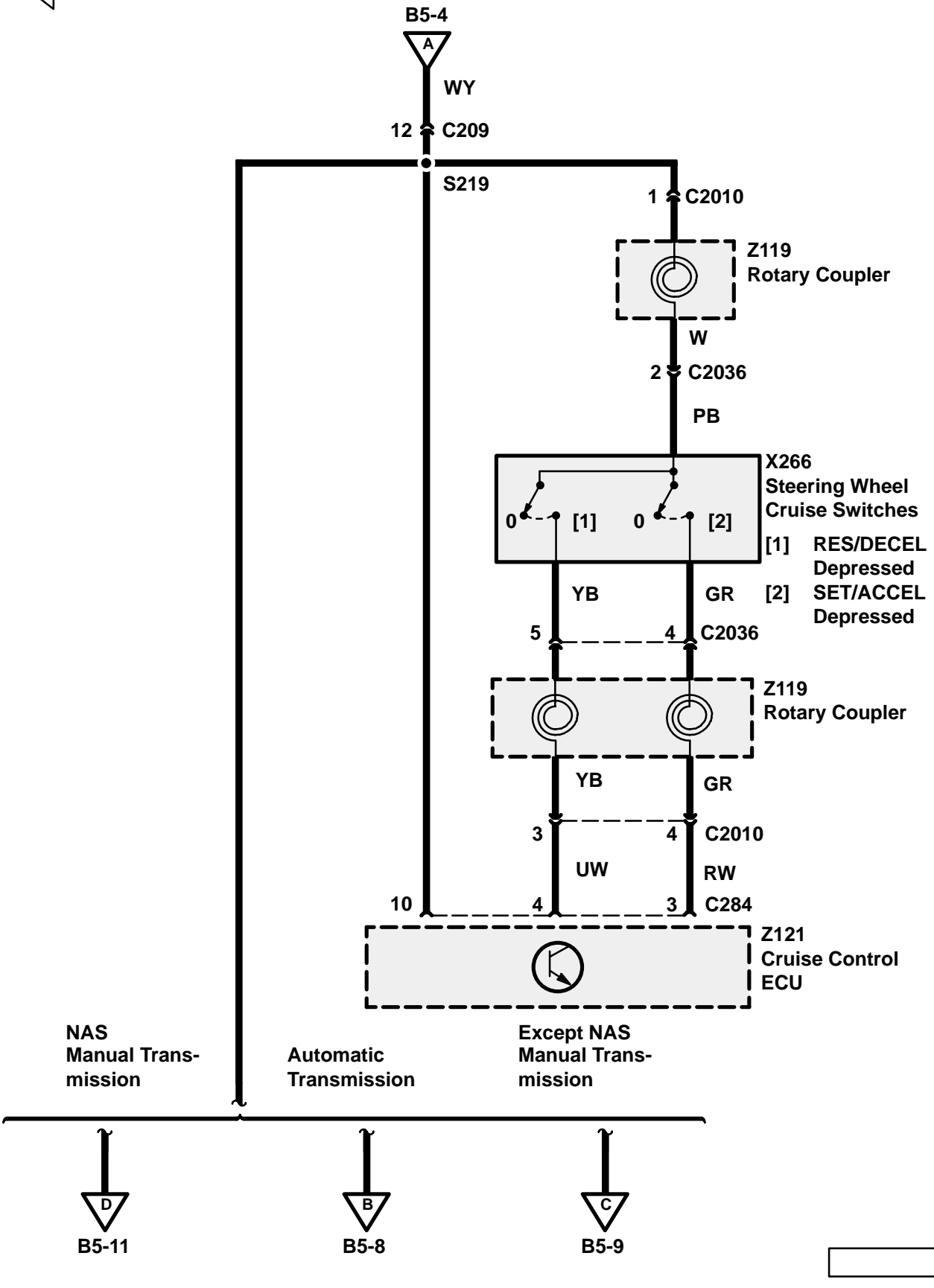
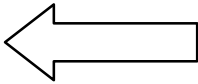



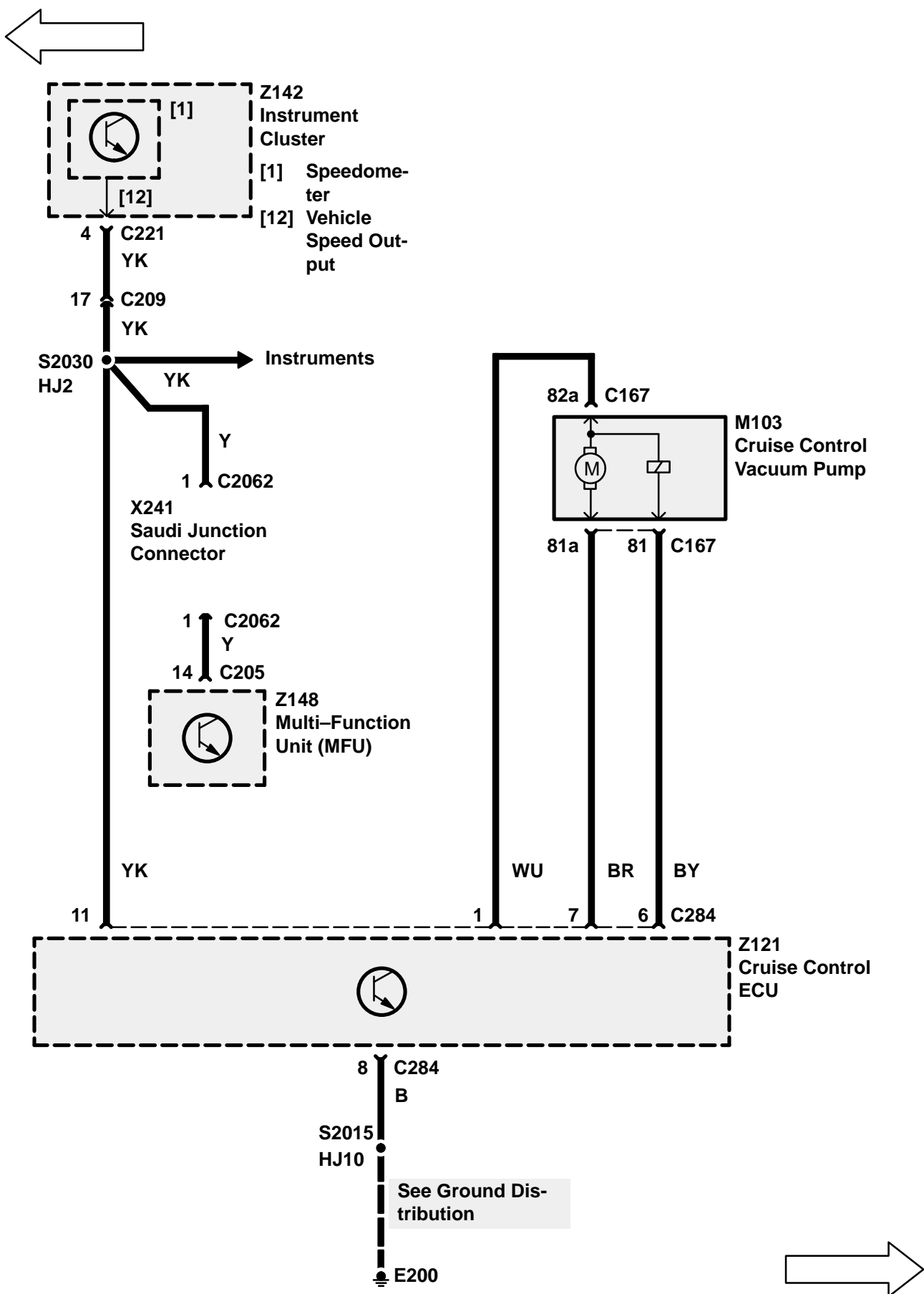

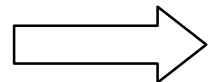
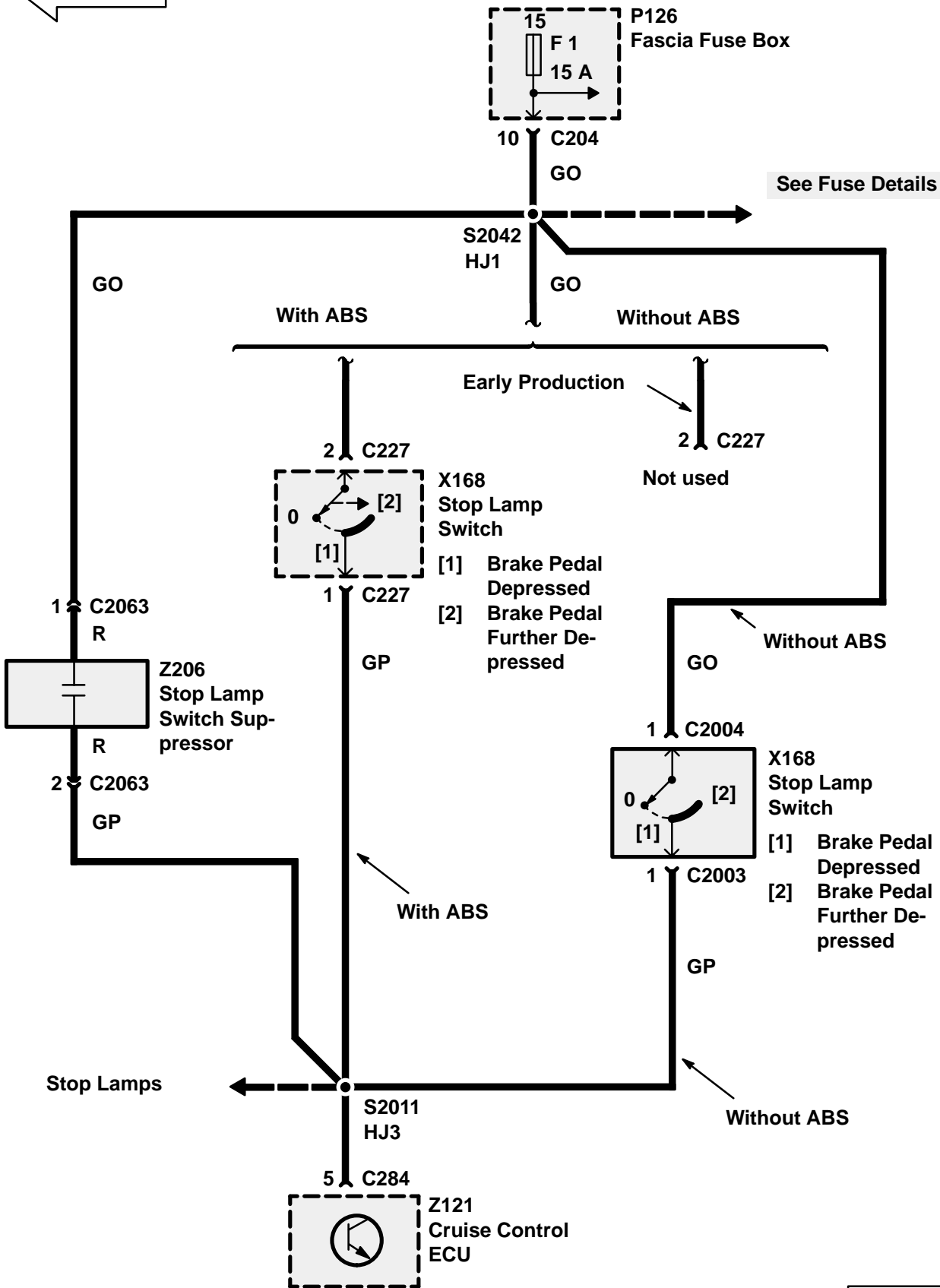
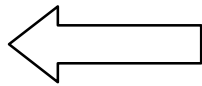

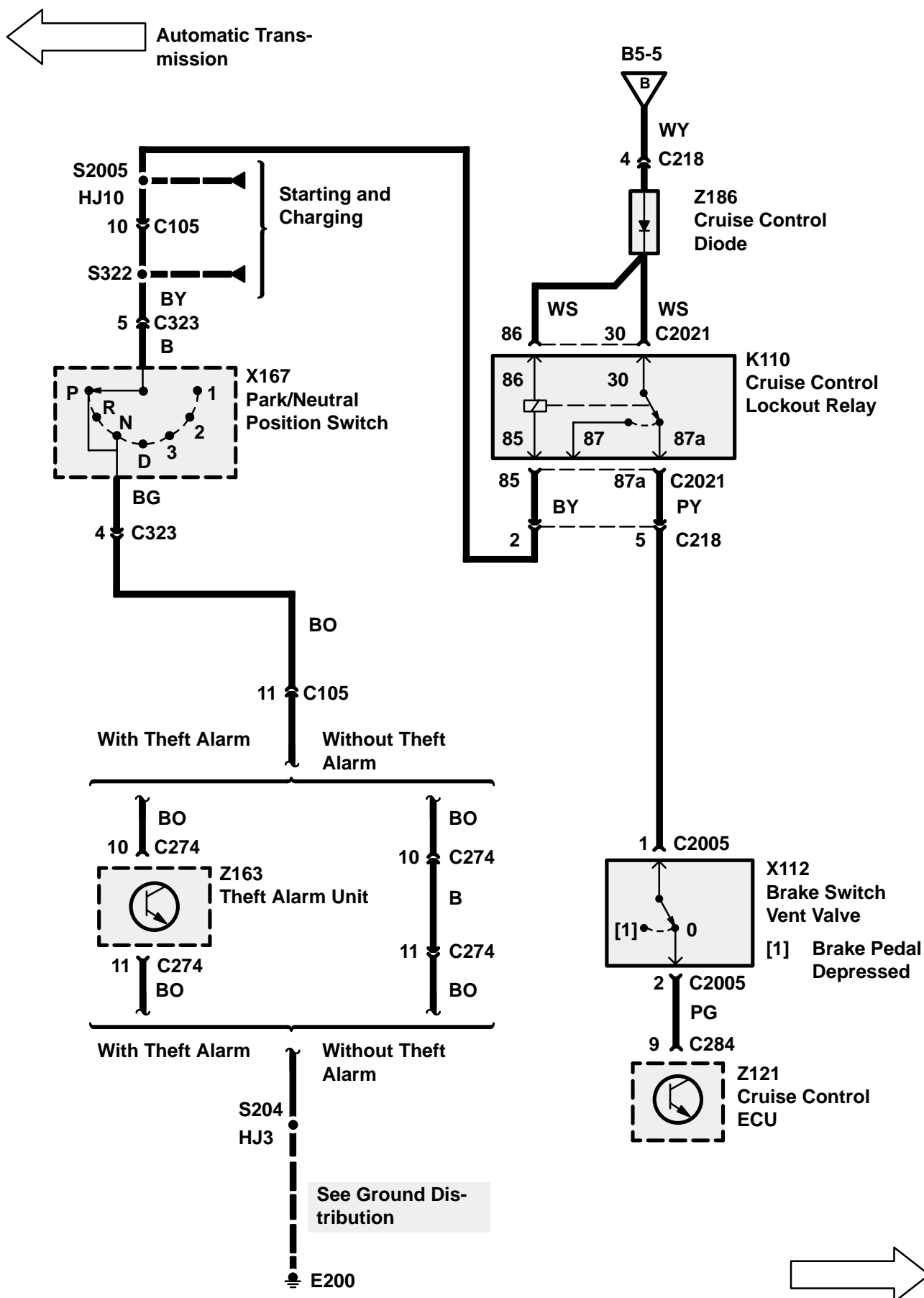

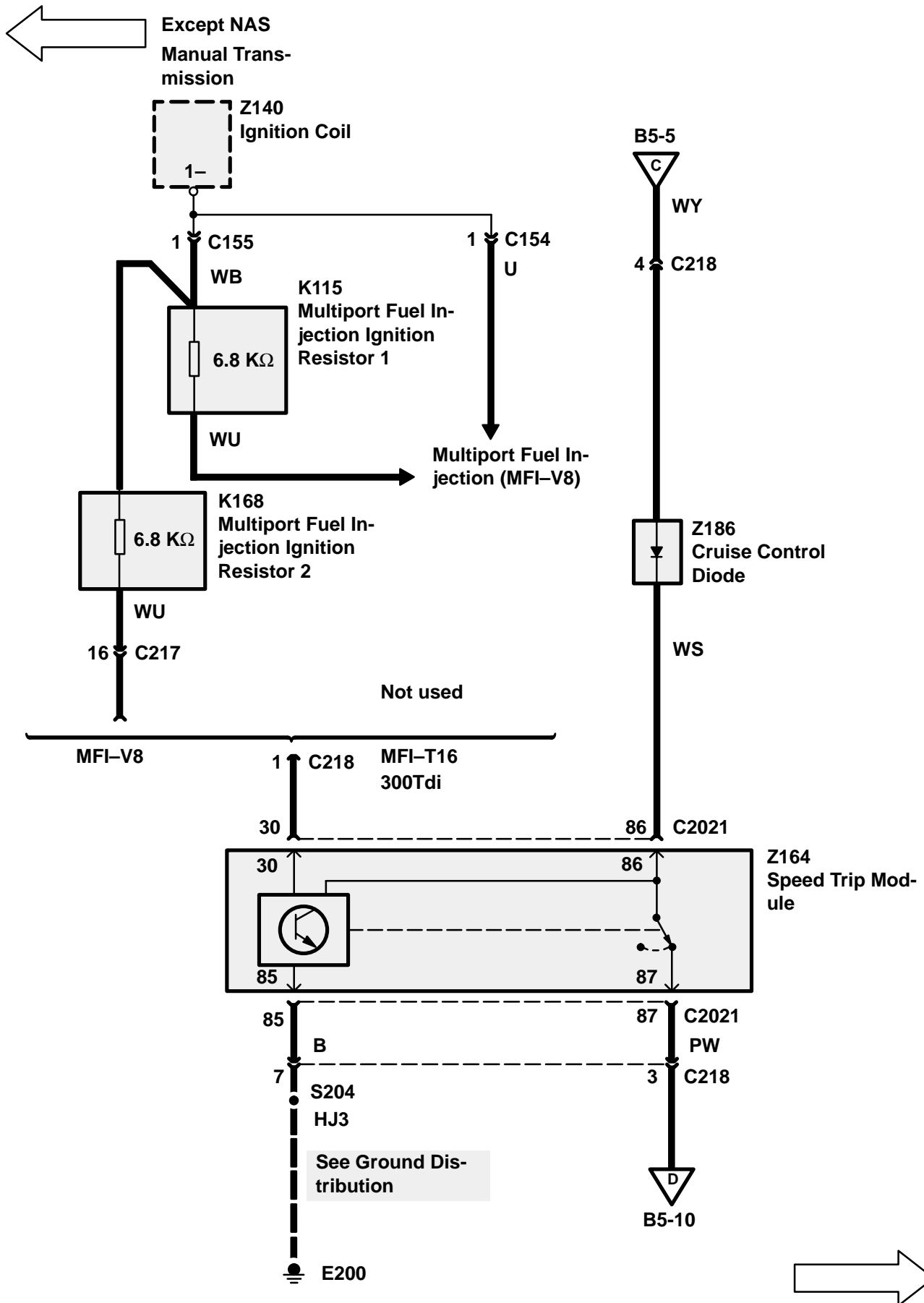

← Except NAS  
Manual Trans-  
mission

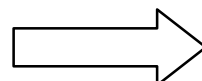
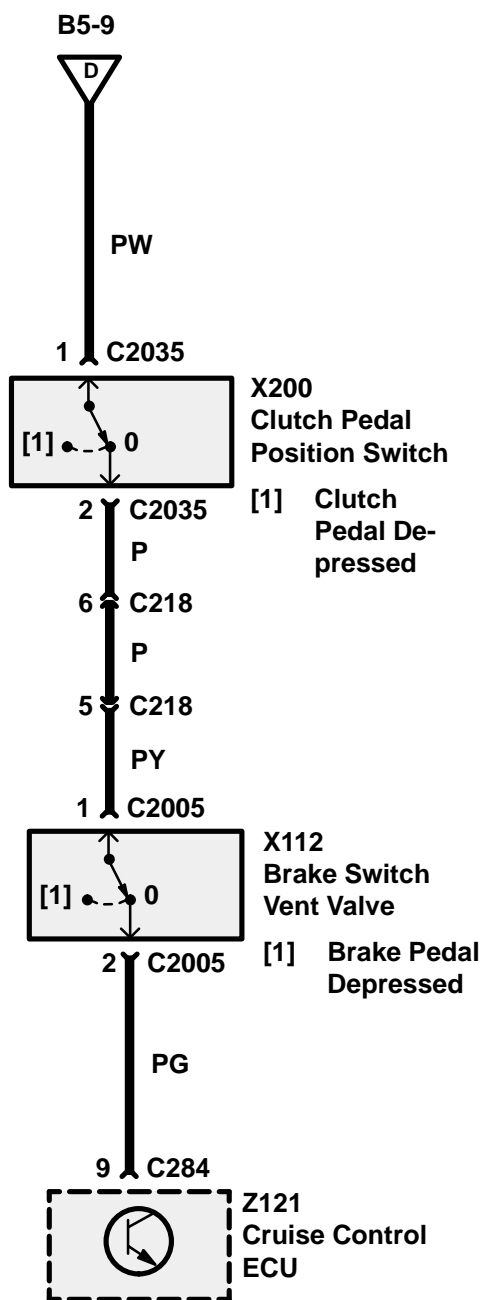

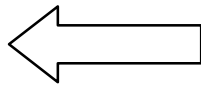

NAS  
Manual Trans-  
mission

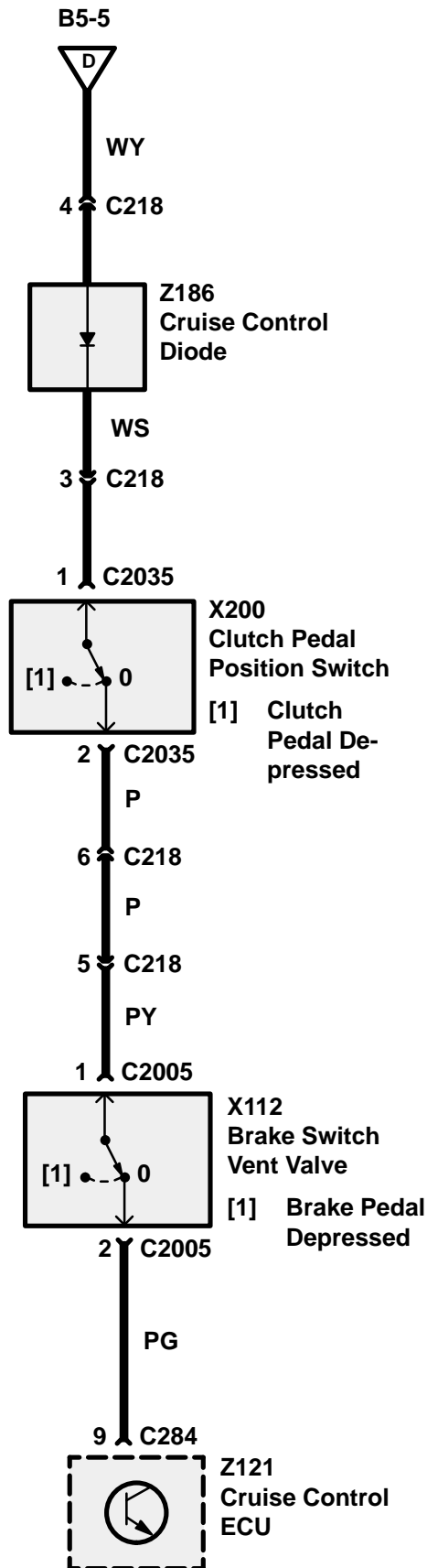

## CIRCUIT OPERATION

### Selector Interlock

When the gear selector is in the park position, the solenoid inside the Transmission Range Selector Switch (Z110) is de-energised and prevents the selector from being moved into another gear. To free the selector, the Ignition Switch (X134) must be in position II and the brake pedal must be depressed. When this occurs, voltage from Fuse F1 is applied to the Transmission Range Selector through the closed Stop Lamp Switch (X168). The solenoid inside the Transmission Range Selector Switch is grounded at E200 through the selector switch, the KS wire and the B wire. The solenoid now energises, freeing the selector.

### Ignition Key Interlock

On vehicles equipped with the interlock safety feature, the vehicle must be in park and the transfer case in high or low gear before the key can be removed from the ignition. If the gear selector or transfer gear is out of gear, the key must be cycled before removal.

If the vehicle is not in park, voltage from Fuse F12 is applied to the Key Barrel Switch (X230) through the closed contacts of the Transmission Range Selector Switch (Z110). When the ignition switch is placed in the 0 position, the Key Barrel Switch (X230) closes to energise the solenoid and prevent key removal.

If the key is in the ignition and the transfer box is in the neutral position, Interlock Relay 1 (K153) is de-energised since the relay coil is not grounded by the Transfer Box Position Switch (X175). When the relay is de-energised, voltage is applied to the Key Barrel Switch (X230) through the relay's switch contacts and the Key-In Switch (X229) causing the solenoid to energise and prevent key removal.

If the Transfer Box is in the "H" or "L" position, the Interlock Relay 1 (K153) is energised, since the relay coil is grounded by the Transfer Box Position Switch (X175). When the relay is energised, voltage to the Key Barrel Switch (X230) is interrupted. If the vehicle is in Park the Transmission Range Selector Switch (Z110) contacts are open. When the switch contacts are open, voltage to the Key Barrel Switch (X230) is also interrupted. The Ignition Key Lock Solenoid (K191) is then disabled, allowing removal of the key.

### Transfer Box Interlock

The Transfer Box Interlock safety feature is designed to prevent the transfer case shifter from being shifted out of "H" or "L" unless the vehicle's gear selector is in the neutral position.

When the gear selector is placed in the neutral position, voltage is applied to the Interlock Relay 2's coil through the Transmission Range Selector Switch (Z110). The relay's coil is grounded through the Park/Neutral Position Switch (X167).

Interlock Relay 2 now energises and applies voltage from Fuse F13 to the Transfer Box Solenoid (K161). When the Transfer Box Solenoid (K161) is energised the transfer box shifter can be operated.

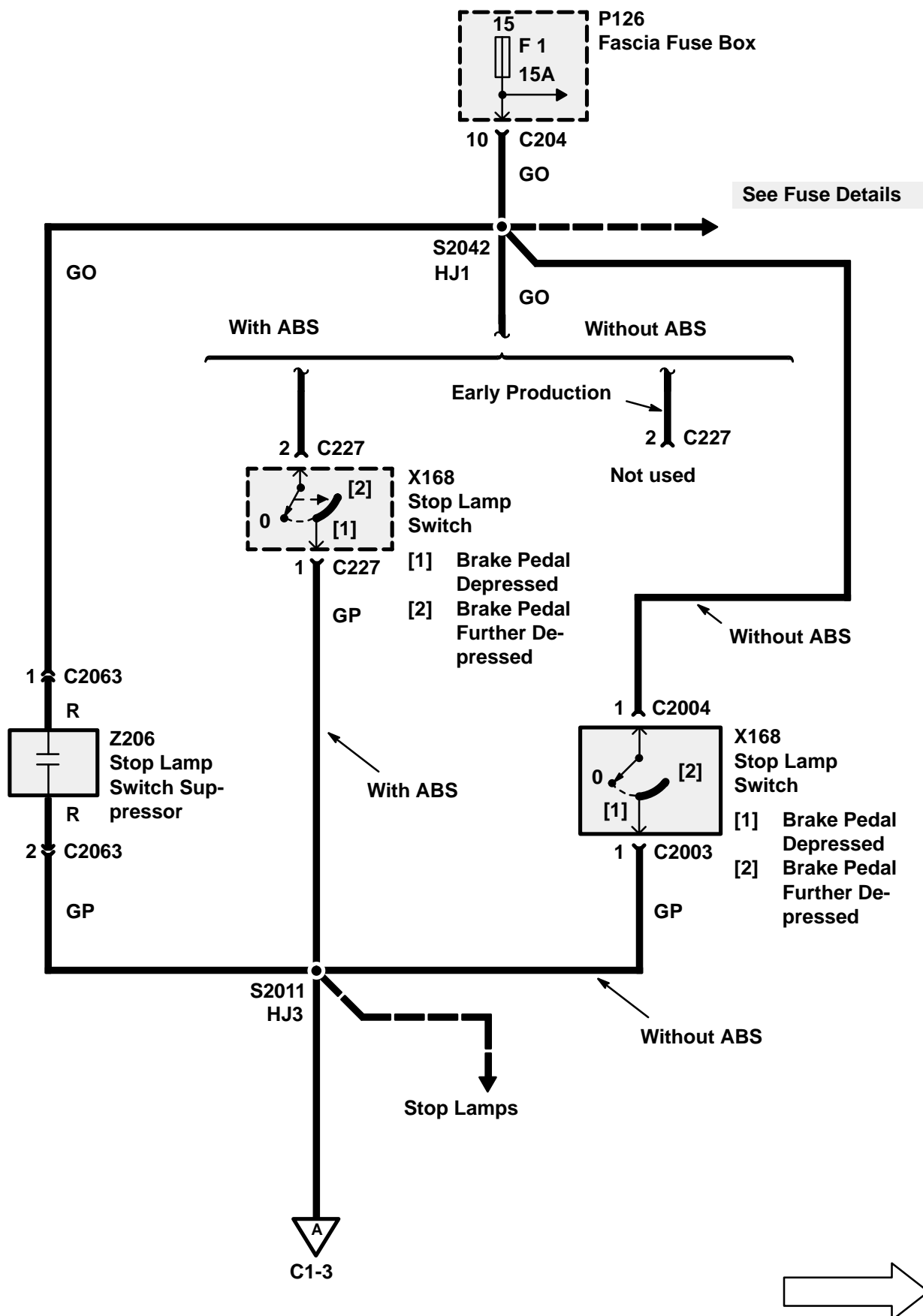



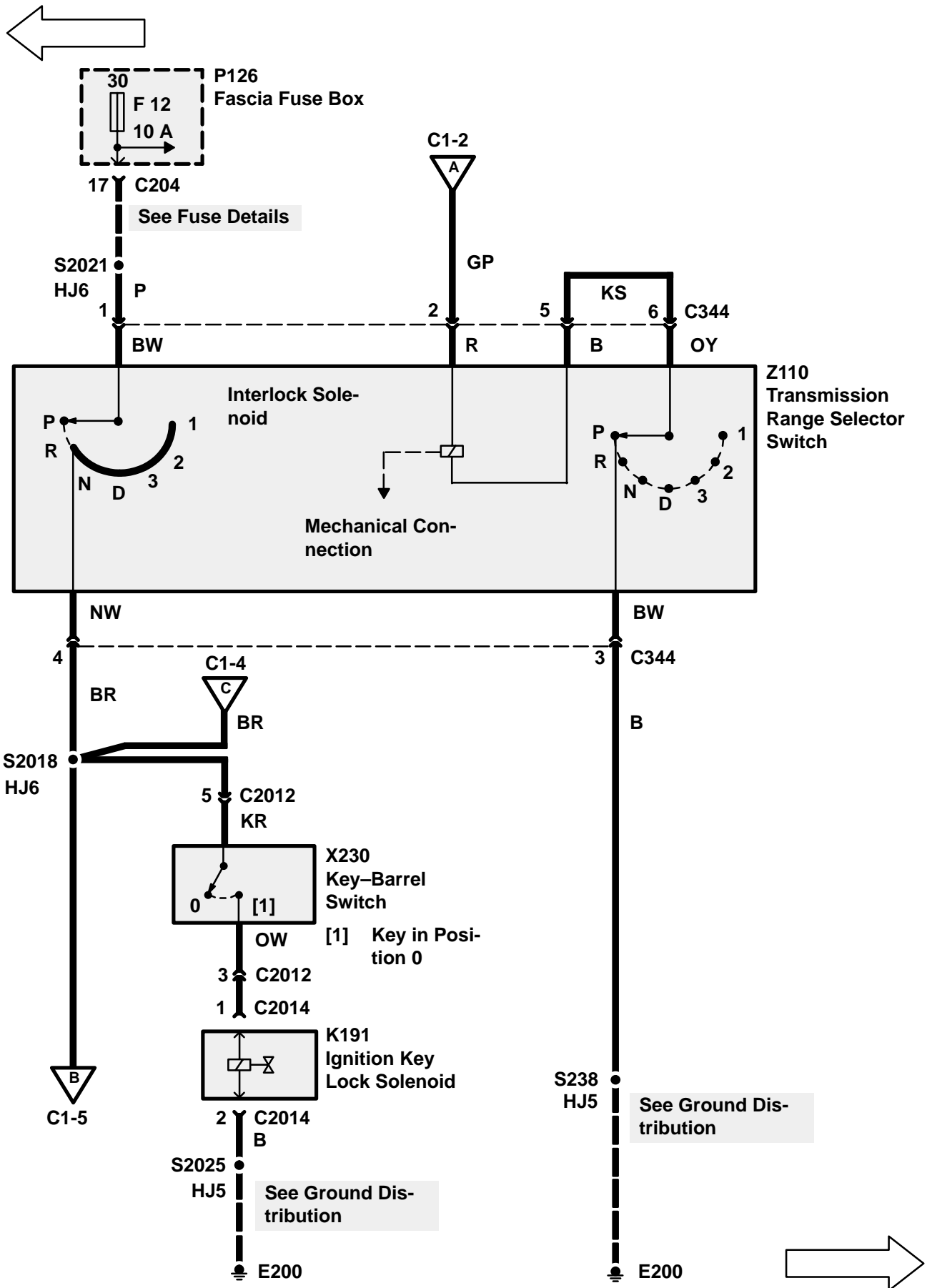



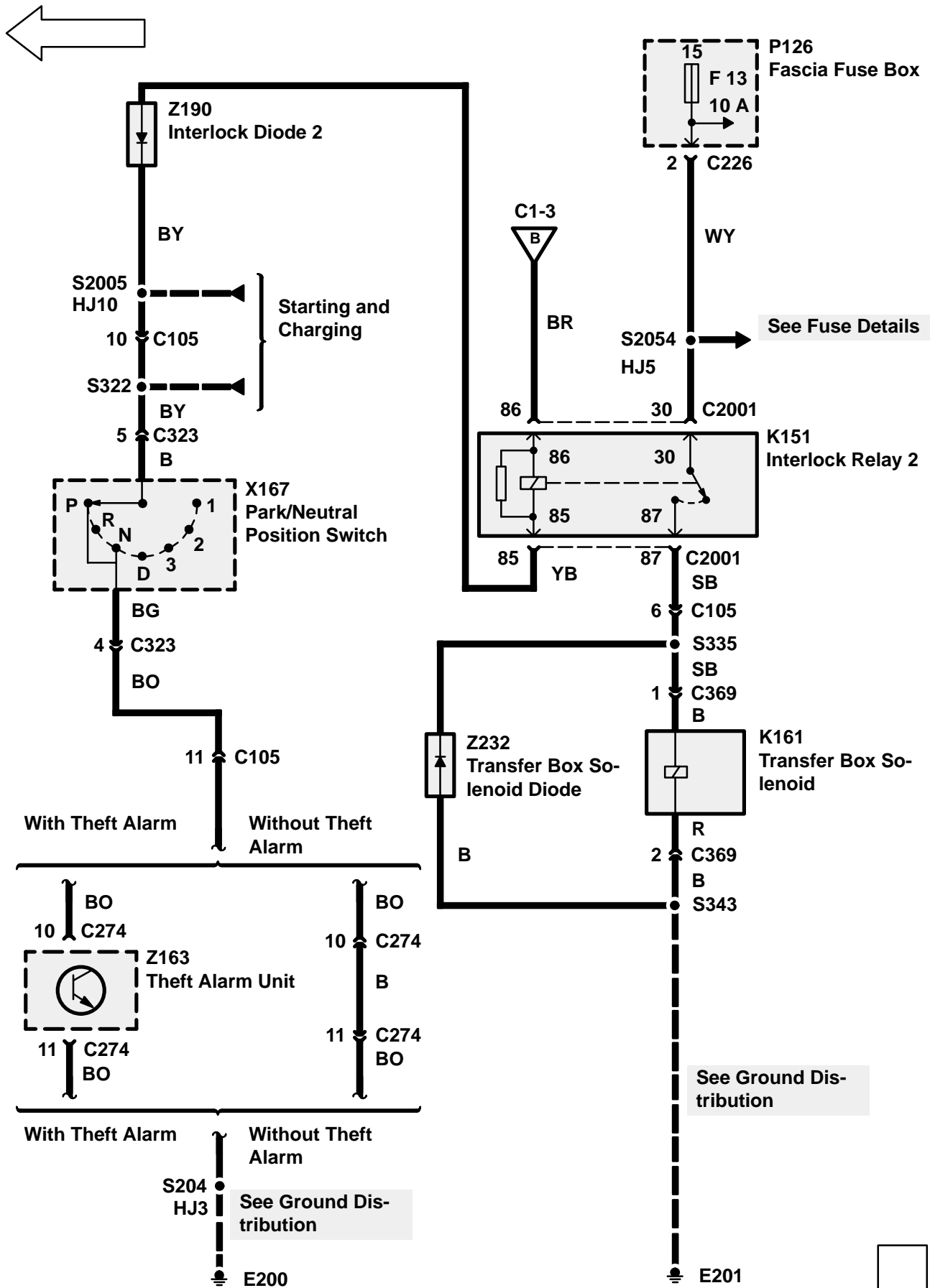

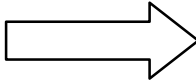
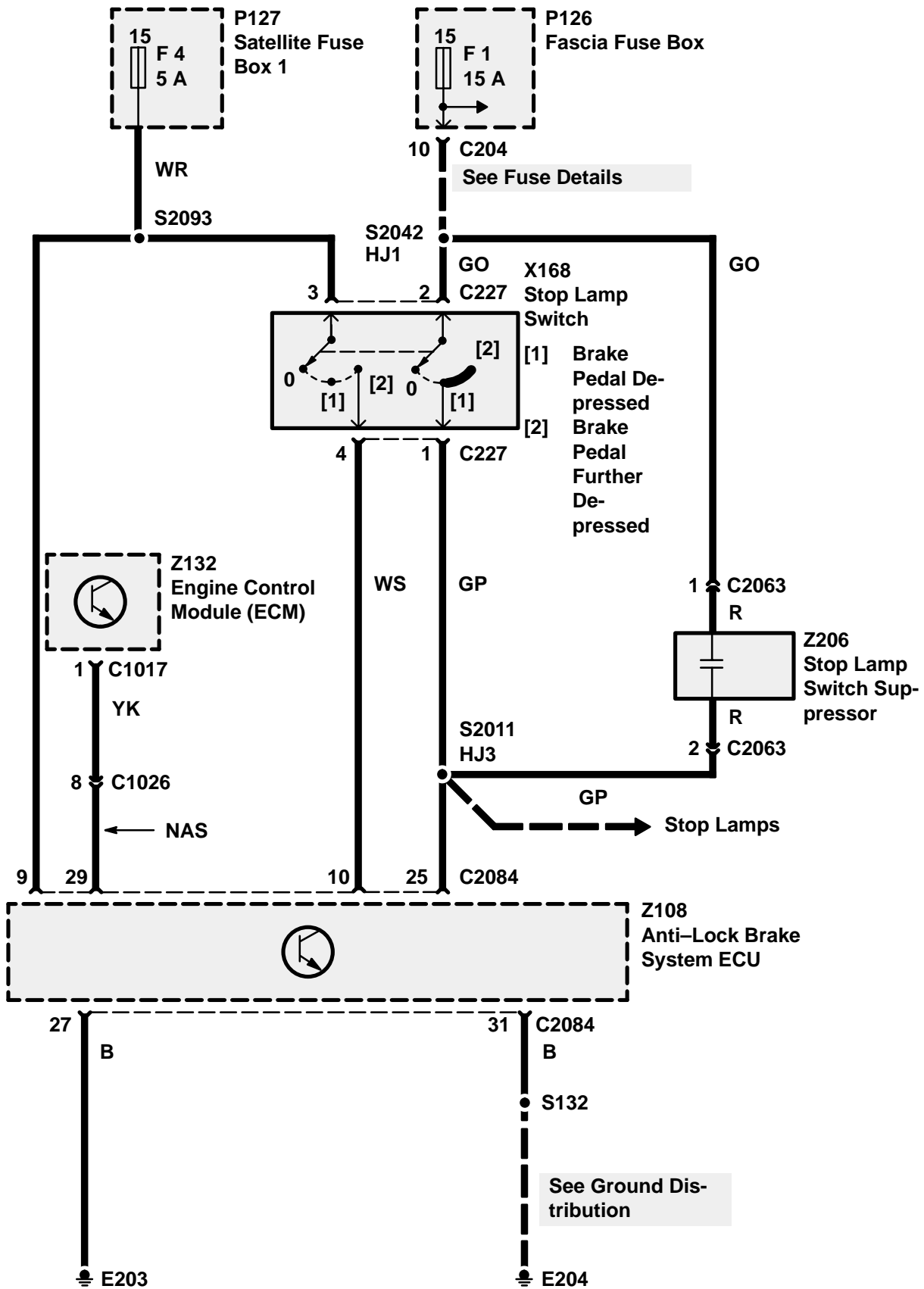

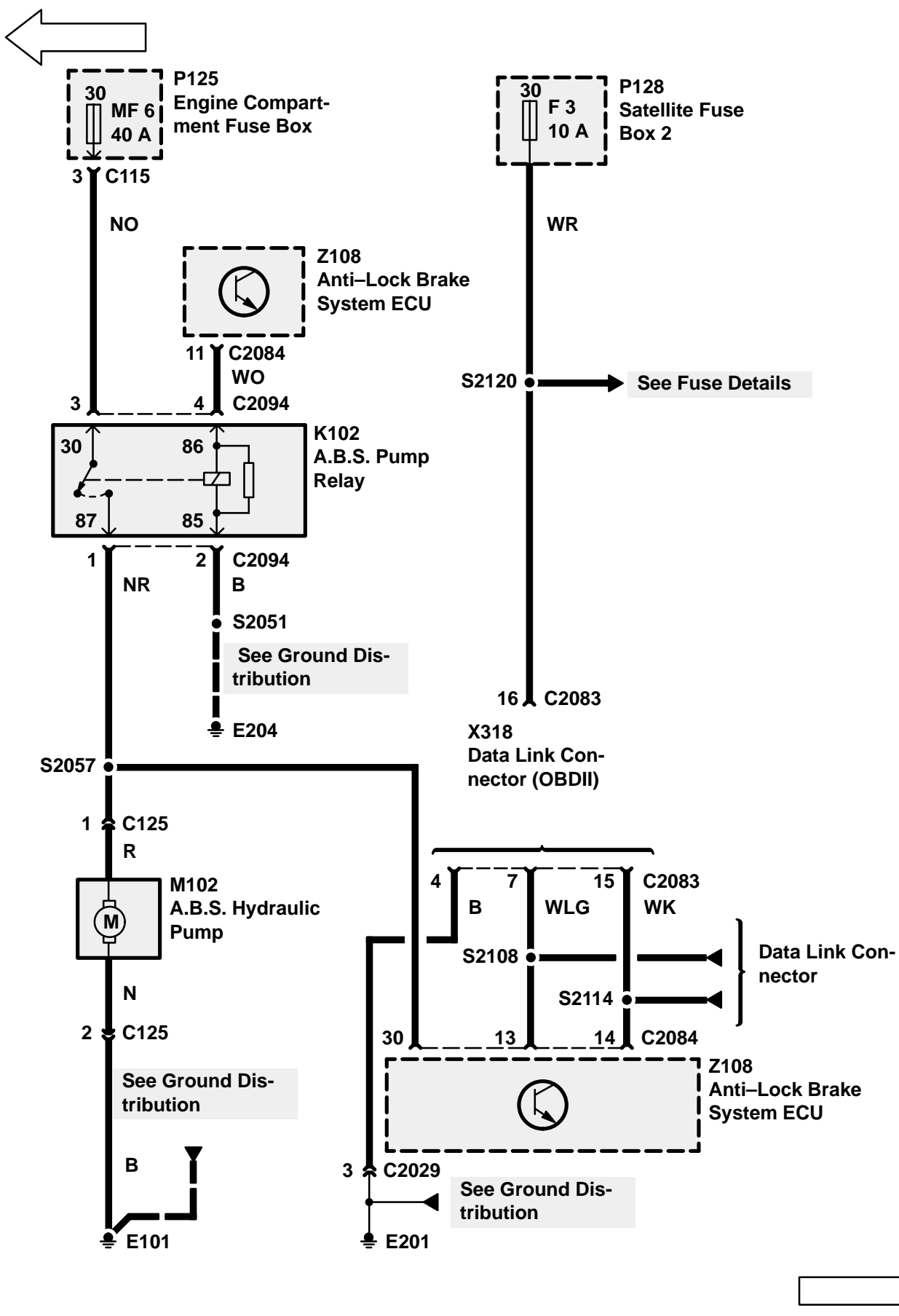

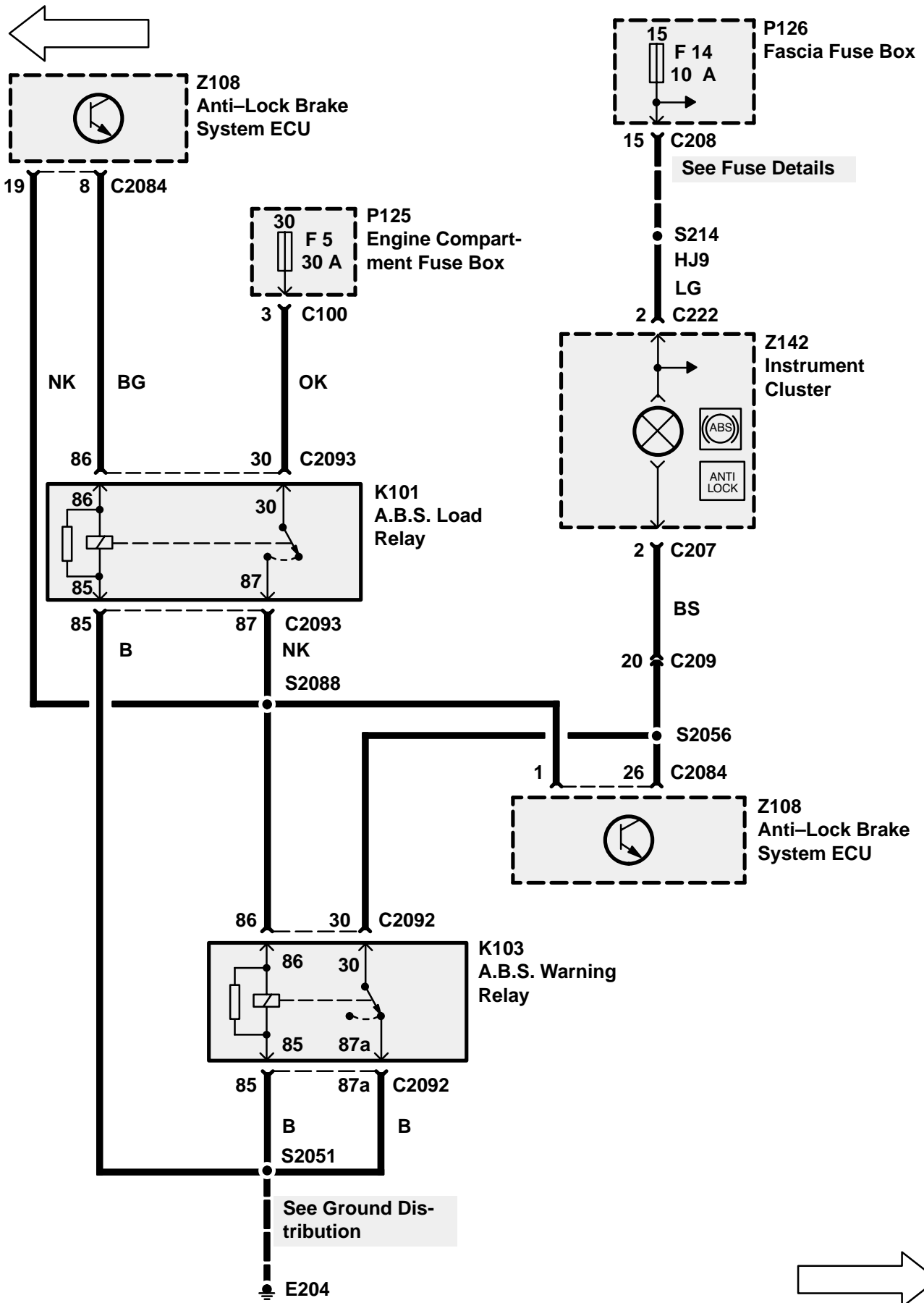

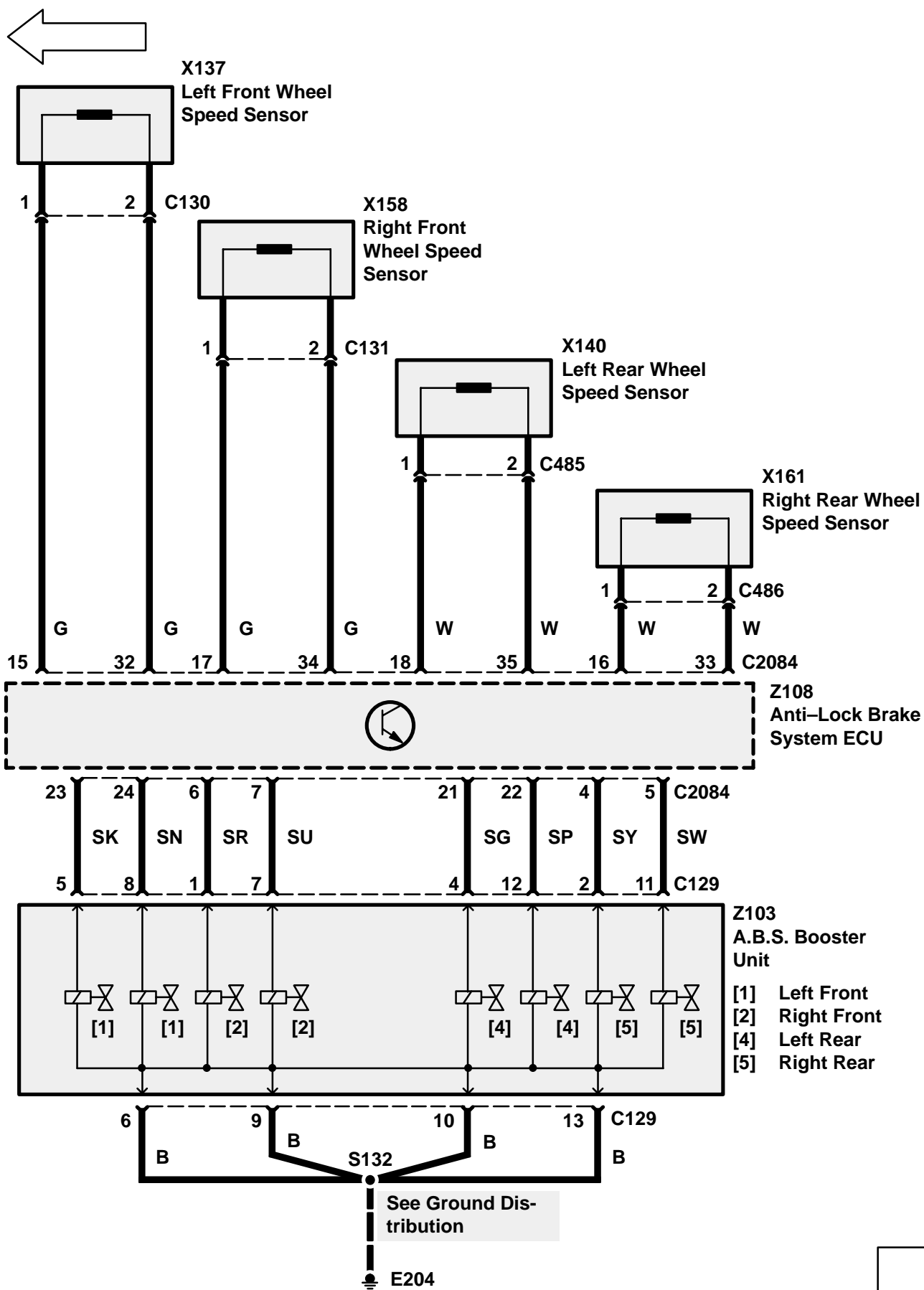

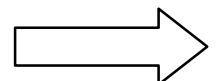
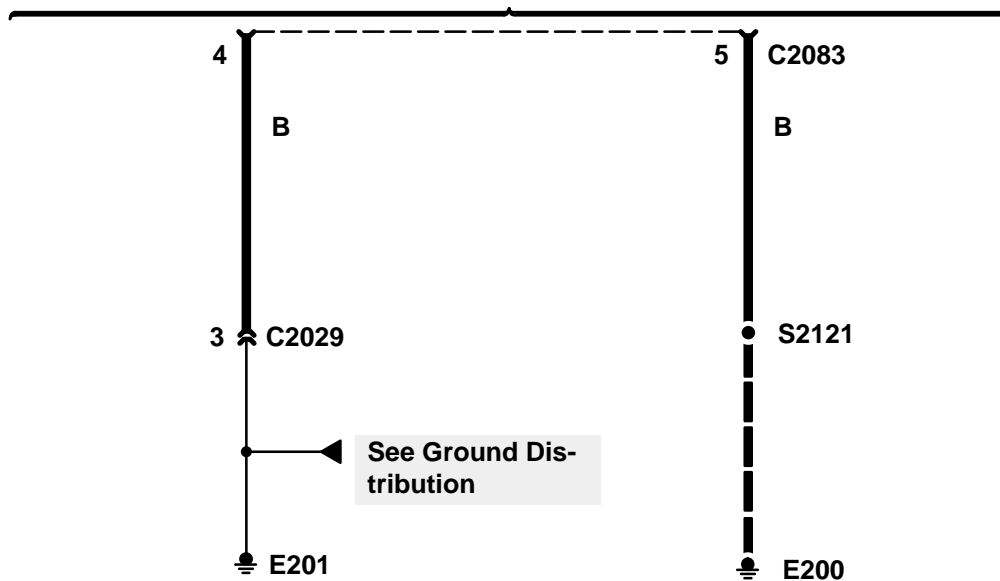
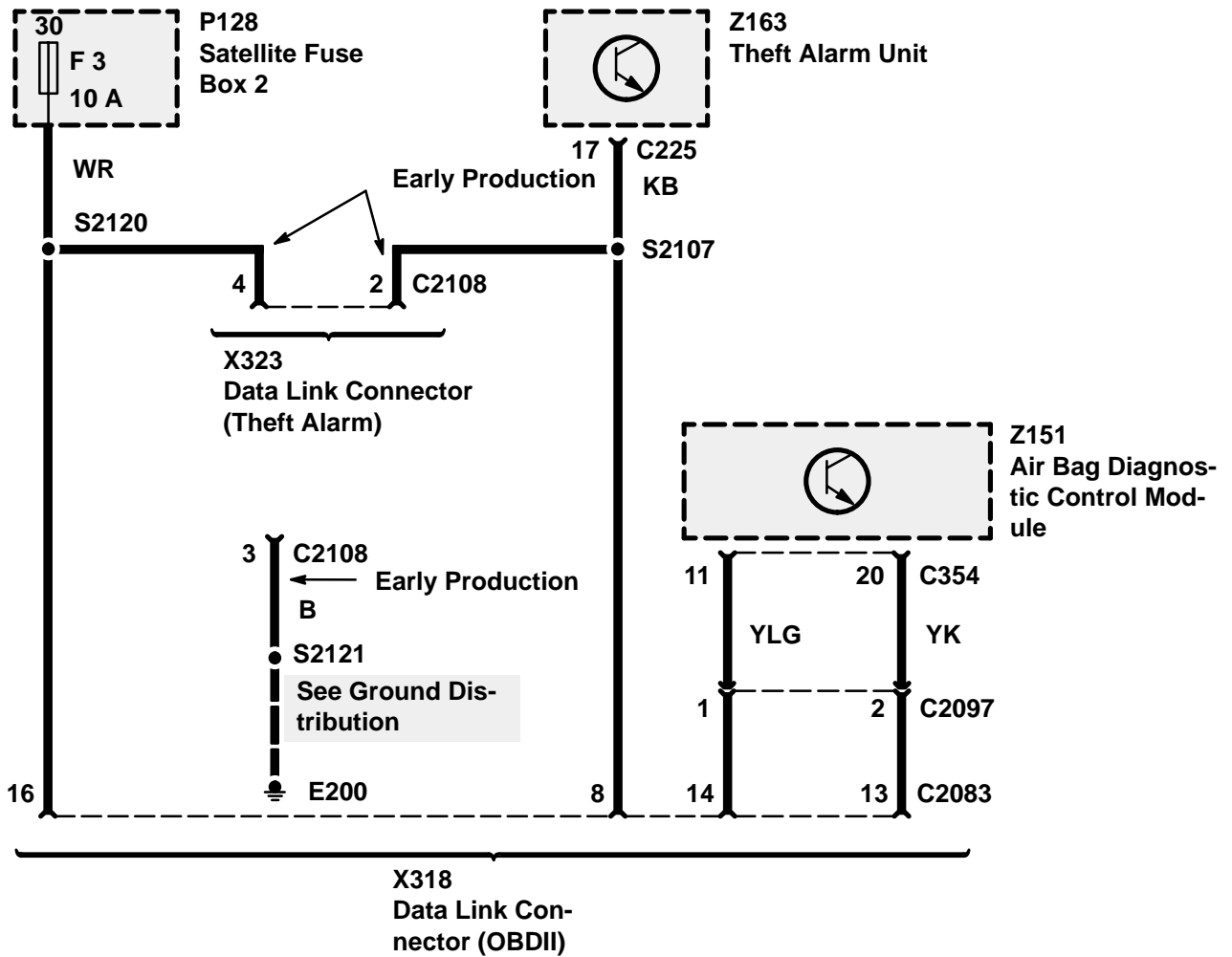



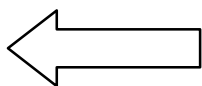

X318  
Data Link Con-  
nector (OBDII)

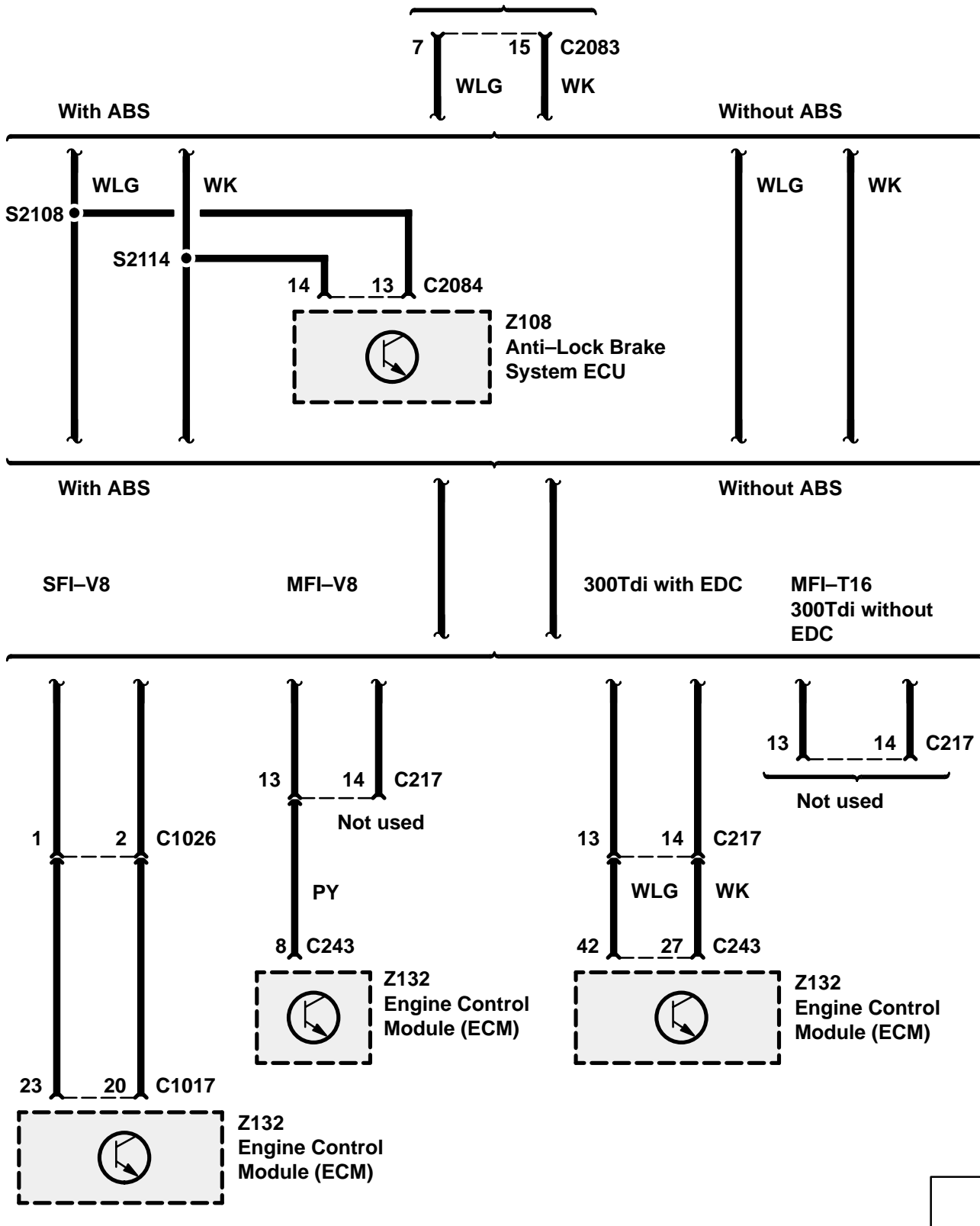

---

## CIRCUIT OPERATION

### Speedometer

The Vehicle Speed Sensor (X190) sends a signal to the speedometer in the form of voltage pulses. The pulses are filtered by a Vehicle Speed Sensor Buffer inside the speedometer. The voltage alternates between battery voltage and 0 volts 6 times per wheel revolution. The speed sensor signal is also sent to the Cruise Control ECU (Z121), Multifunction Unit (MFU) (Z148) (Persian Gulf States), and the Engine Control Module (Z132).

### Tachometer

The tachometer displays engine speed in rpm. Voltage pulses are taken from the Generator (Z106) and are generated when the engine drive belt turns the Generator pulley. The tachometer responds to the frequency of the voltage pulses, which increases proportionally to that of the engine speed.

### Engine Coolant Temperature Gauge

The Engine Coolant Temperature Gauge Sensor (X114) has approximately 136 ohms resistance when the coolant temperature is low. As coolant temperature increases, the resistance of the sensor decreases. This varying resistance causes the current through the sensor to change and the gauge to register the temperature. When the coolant is hot, the resistance of the sensor is approximately 17 ohms.

### Fuel Gauge

When the fuel tank level is low, the resistance of the fuel gauge sender is approximately 245 ohms. As the fuel level increases, the resistance of the sender decreases, causing the gauge to register the change. When the fuel tank is full, the resistance of the sender is approximately 19 ohms. When the fuel gauge sender's resistance falls below approximately 25 ohms (6 liters/1.5 US gallons), the fuel warning light will illuminate to warn the driver.



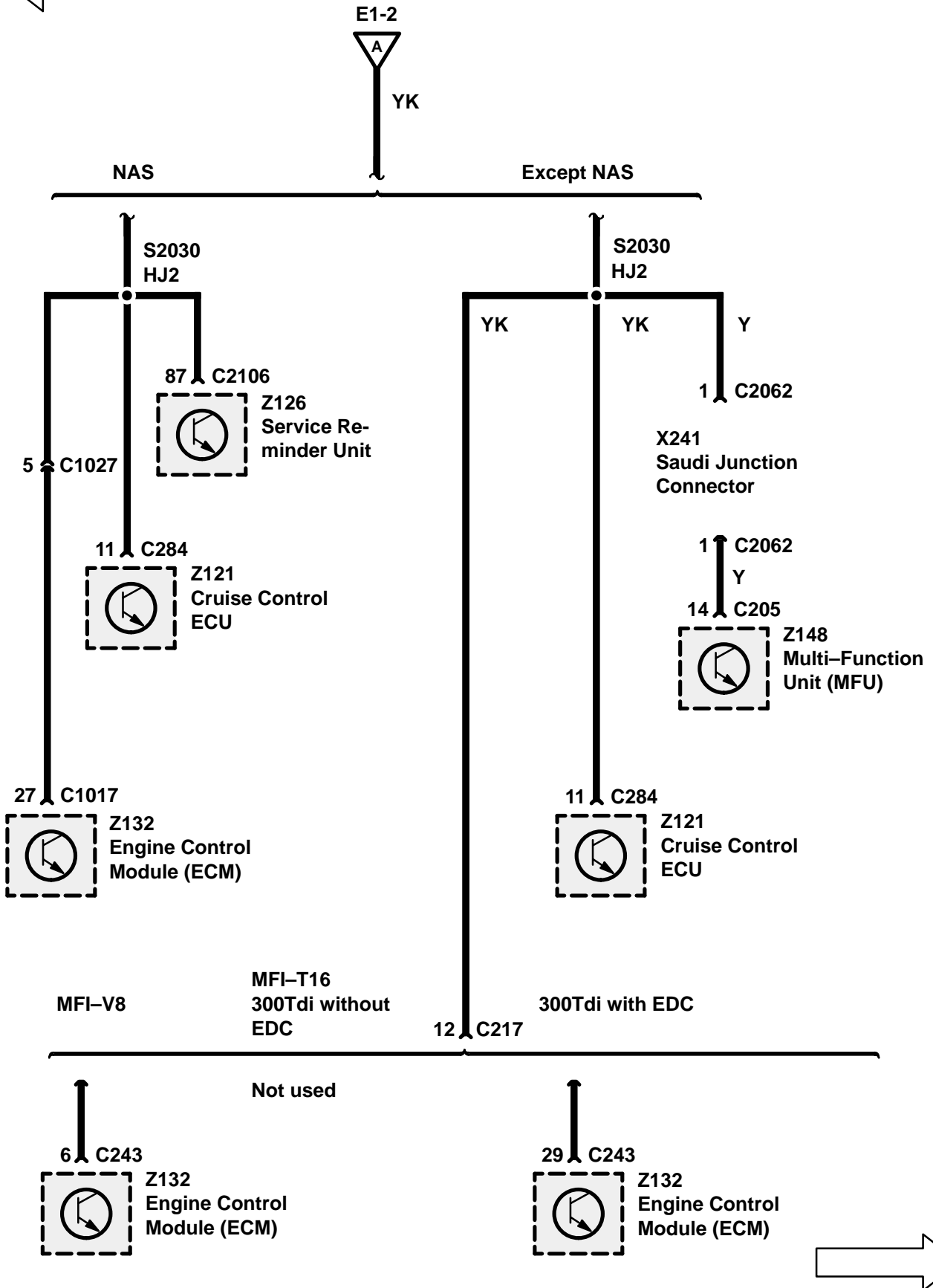
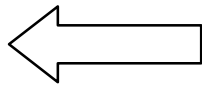

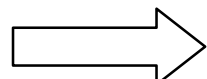
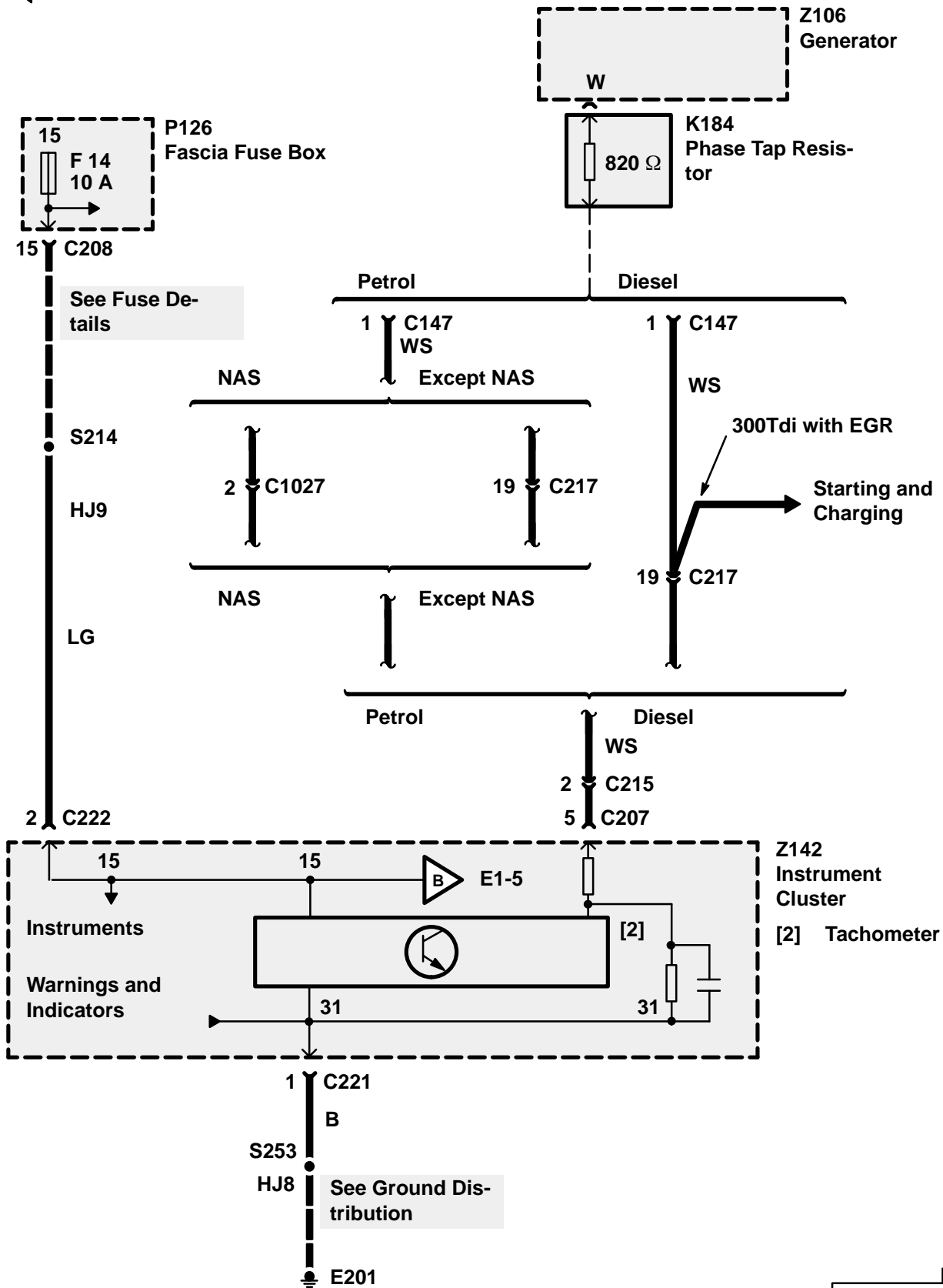
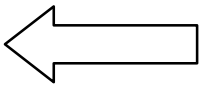

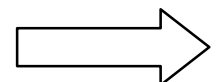
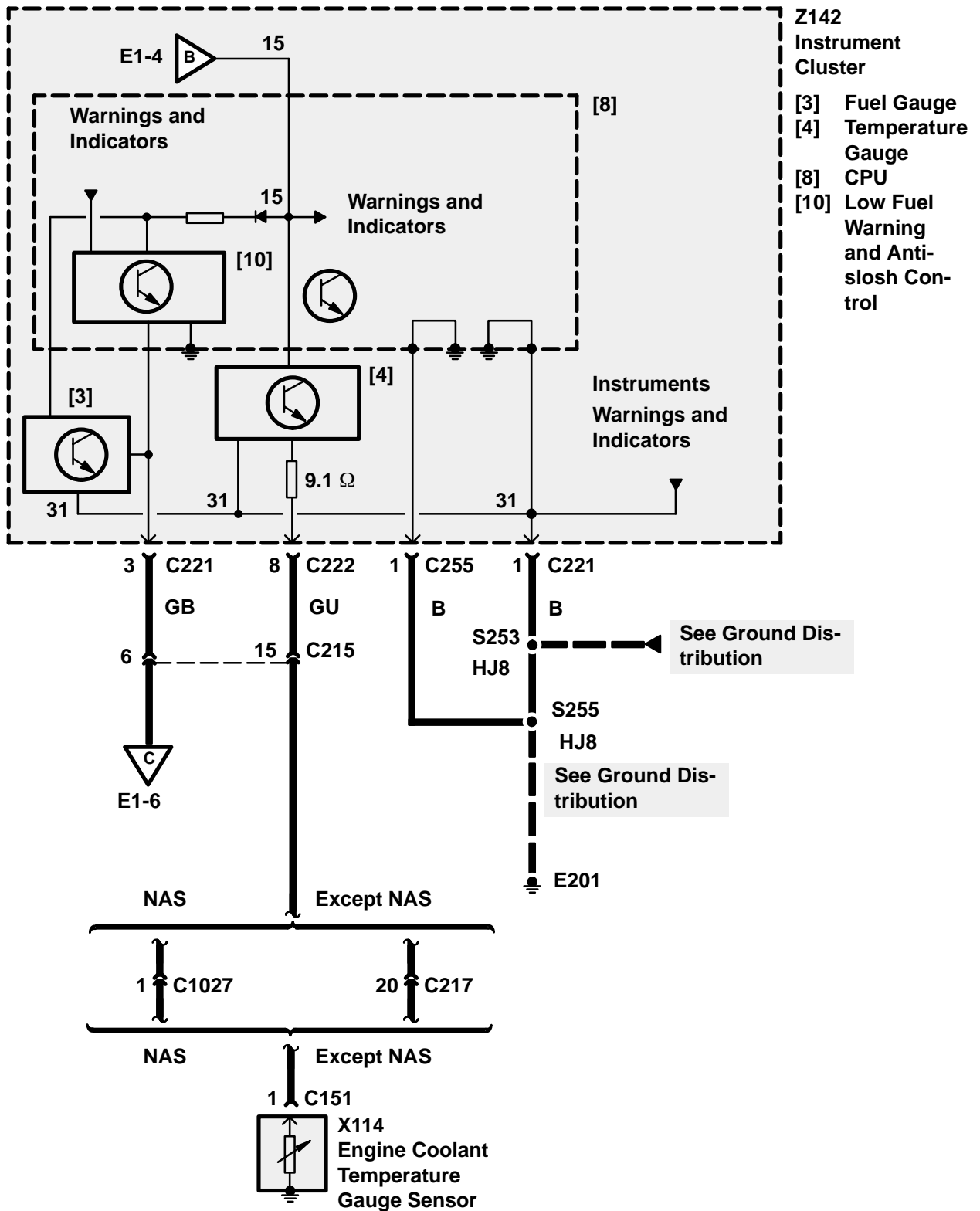
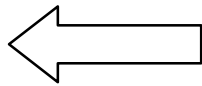

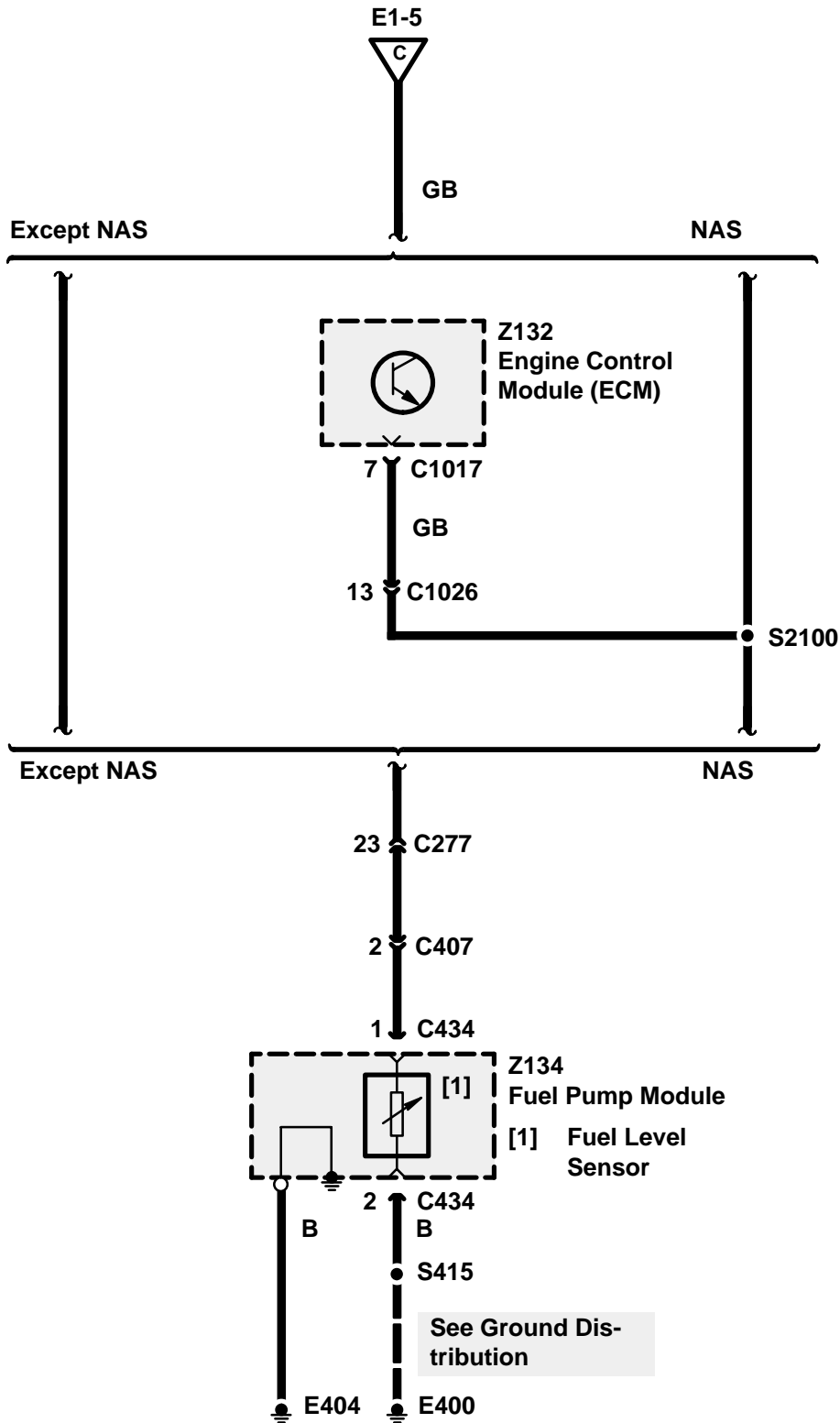
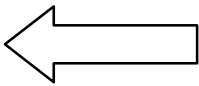

**CIRCUIT OPERATION****Hazard Indicator**

If the Hazard Switch (X220) is depressed, a pulsing voltage is applied to the Hazard Indicator which is permanently grounded by ground E200.

**Direction Indicator**

If the Direction Indicator Switch (X116) is turned on, a pulsing voltage is applied from the Flasher Unit (Z128) to the Direction Indicator which is permanently grounded by ground E200.

**Trailer Indicator**

With the Direction Indicator Switch (X116) turned on, the Flasher Unit (Z128) also applies a pulsing voltage to the Trailer Indicator which is permanently grounded by ground E200.

**Main Beam Indicator**

With the Headlamps turned on by the Main Lighting Switch (X145), battery voltage is applied to the Main Beam Indicator which is also permanently grounded by ground E200.

**MFI-V8 and 300Tdi with EDC****Malfunction Indicator Lamp (Check Engine)**

The Malfunction Indicator Lamp (Check Engine) is grounded by the Engine Control Module (ECM) (Z132) when a diagnostic trouble code is set.

**Diesel****Glow Plug Indicator**

The Glow Plug Indicator is grounded by the Glow Plug Timer Unit (Z135) to indicate that the Glow Plugs have been activated.

**Oil Pressure Warning Light**

The oil pressure warning light receives battery voltage with the Ignition Switch (X134) in position II. If the engine oil pressure is very low, the Oil Pressure Switch (X149) will apply ground to the warning light.

**Differential Lock Indicator**

The Differential Lock Indicator receives battery voltage with the Ignition Switch (X134) in position II. It is grounded by the Differential Lock Switch (X238) when the Differential is locked.

**Brake Warning Light**

The brake warning light receives battery voltage with the Ignition Switch (X134) in position II. It is grounded by the Brake Fluid Level Switch (X111) when the brake fluid level is low. It may also be grounded when the Handbrake Switch (X191) is closed.



---

**ABS Warning Light**

The ABS warning light receives battery voltage with the Ignition Switch (X134) in position II. It is grounded by the Anti-Lock Brake System ECU (Z108) or the ABS Warning Relay (K103) in the event of an ABS problem.

---

**Engine Immobilised Warning Lamp (EIWL)**

The EIWL receives battery voltage with the Ignition Switch (X134) in position II. It is grounded by the Theft Alarm Unit (Z163) to indicate the following conditions:

- Flashing = Immobilised
- Continuous = Immobilised (Cirrus Fail)

---

**Theft Alarm LED**

The Theft Alarm LED receives battery voltage at all times. It is grounded by the Theft Alarm Unit (Z163) to indicate the following conditions:

- Slow Flash = Immobilised or Immobilised and armed
- Rapid Flash = Perimetrically and Volumetrically armed
- Intermittent Rapid Flash = Perimetrically armed
- No Flash for 10 Seconds = Mislock
- Continuous = Driver's door open (or ignition on) and Immobilised

---

**Transmission/Transfer Box Oil Temperature Warning Light**

The transmission/transfer box oil temperature warning light is grounded by the Automatic Transmission Oil Temperature Switch (X108) when the temperature of the transmission fluid exceeds 130°C (266°F). The warning light is also grounded by the Transfer Box Oil Temperature Switch (X174) when the temperature of the transfer box fluid exceeds 145°C (266°F).

---

**Low Fuel Warning Indicator**

When the fuel gauge sender's resistance falls below approximately 25 Ohms (6 liters/1.5 US gallons), the Low Fuel Warning Indicator will illuminate to warn the driver.

---

**Charge Warning Light**

The charge warning light receives battery voltage with the Ignition Switch (X134) in position II. This warning light is grounded by the Generator (Z106) if the Generator is not producing normal power output or the Generator stops turning.

---

**SRS Indicators**

The SRS Indicators are controlled by the Air Bag Diagnostic Control Module (Z151) and the SRS Indicator Control Circuit of the Instrument Cluster (Z142) to indicate SRS System faults.

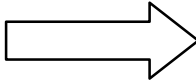
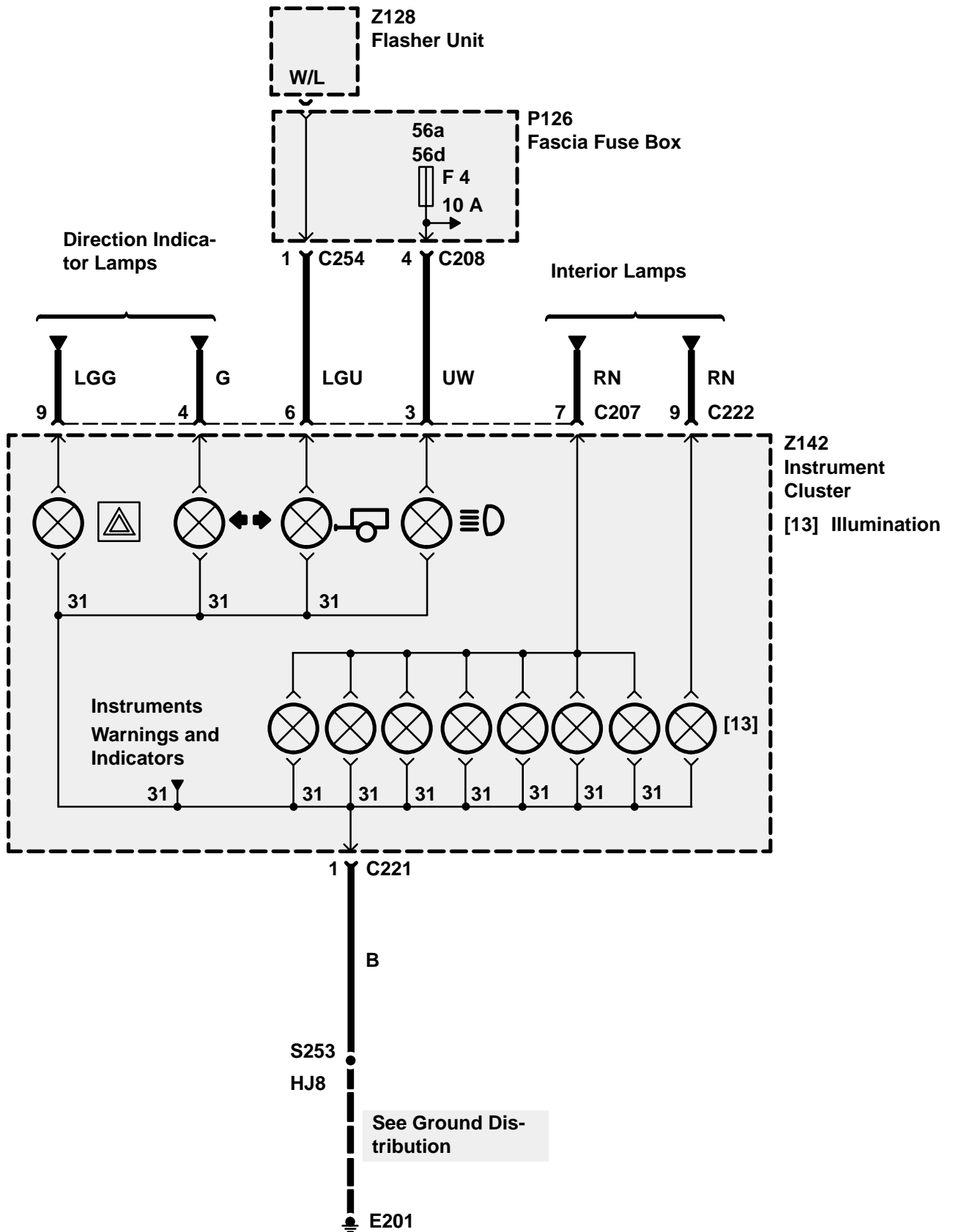

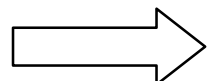
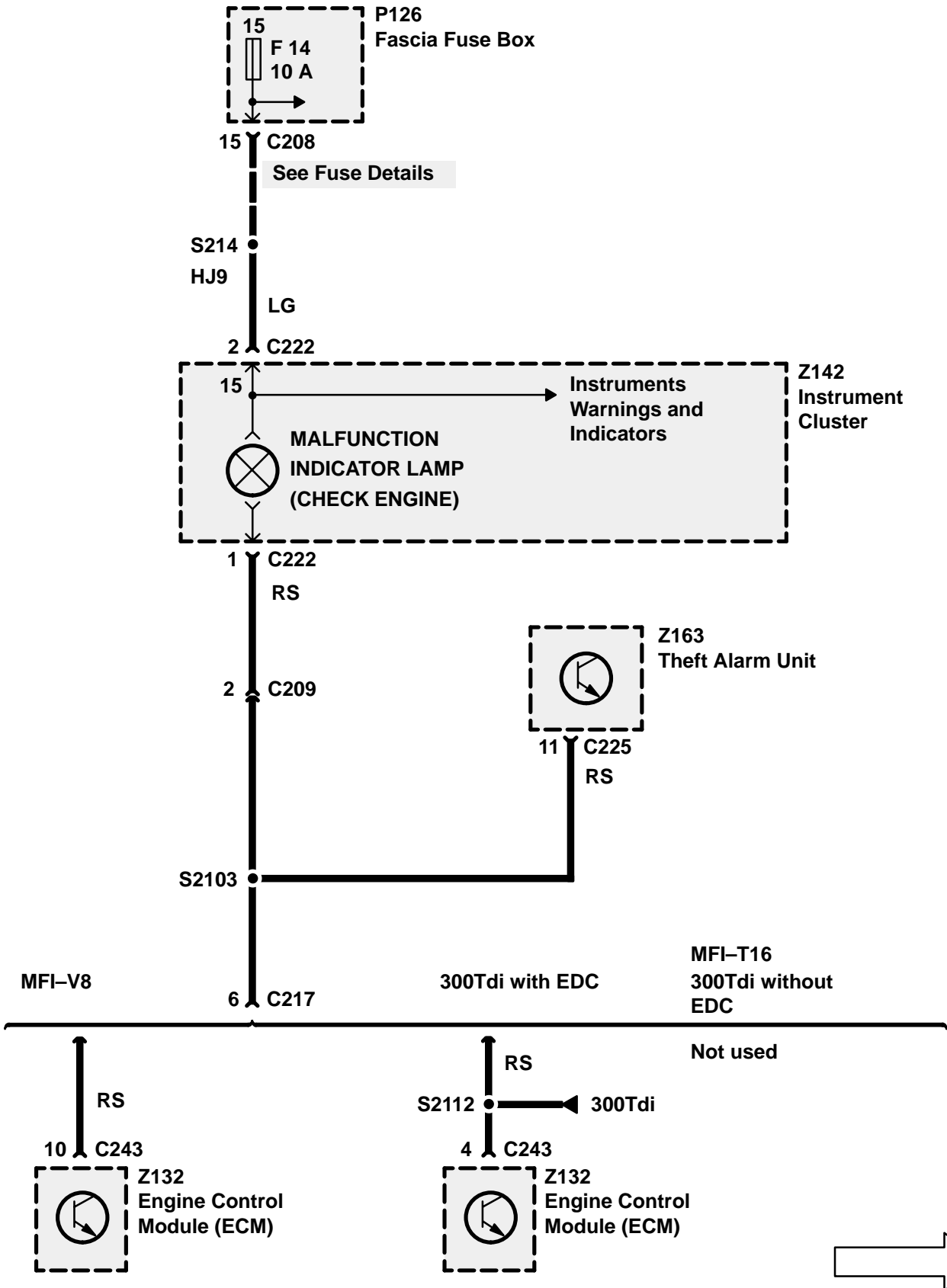
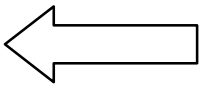

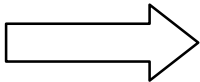
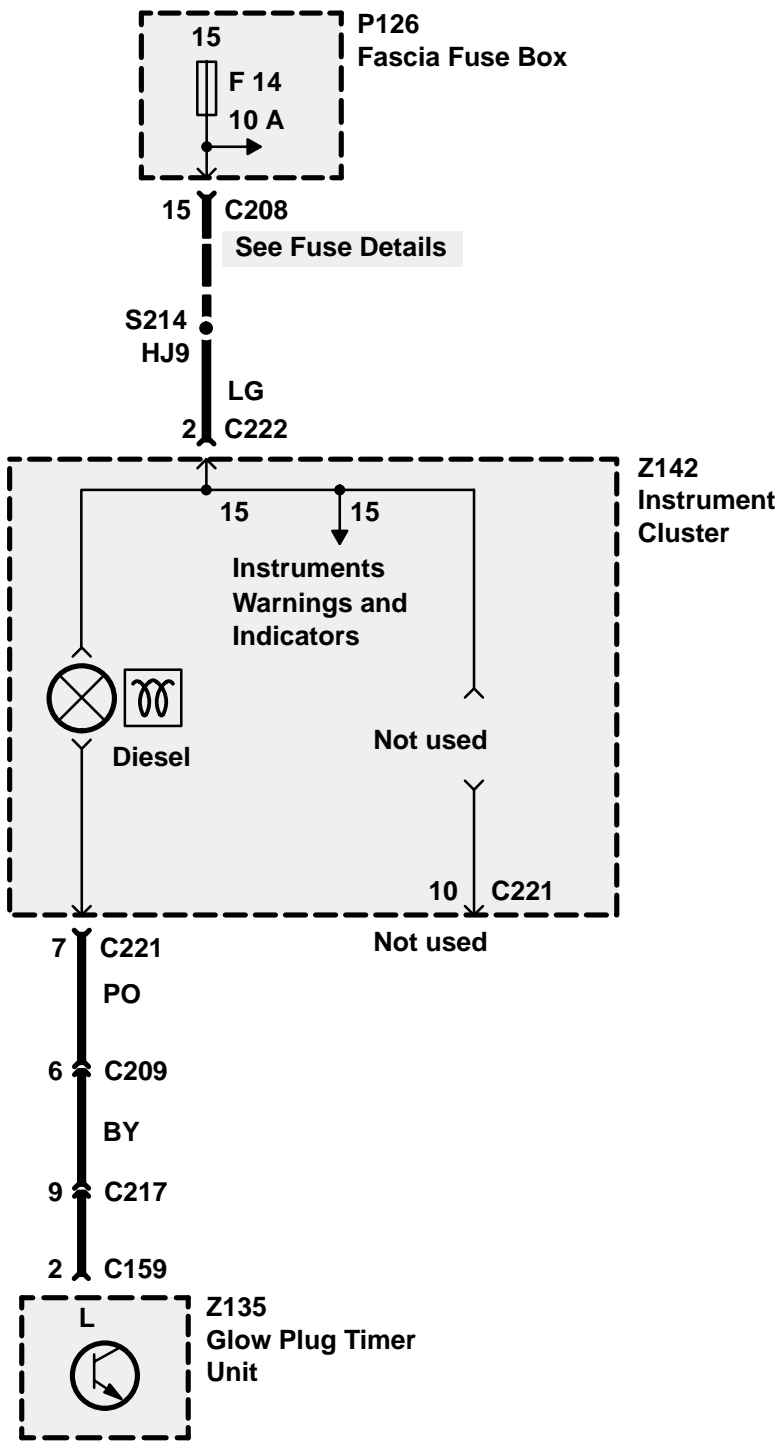
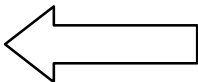

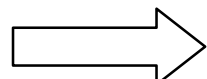
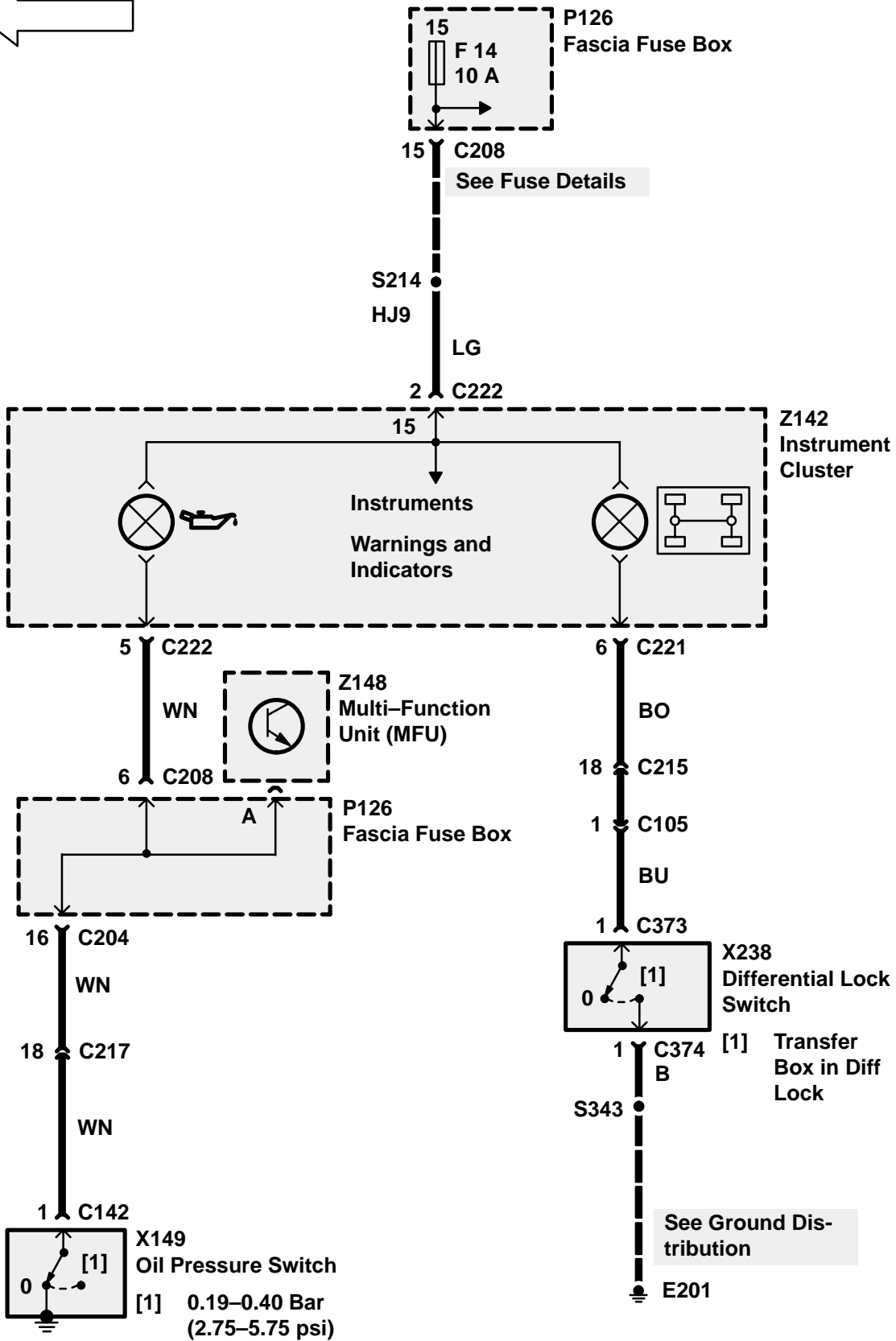
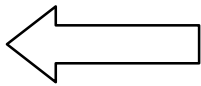

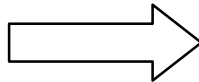
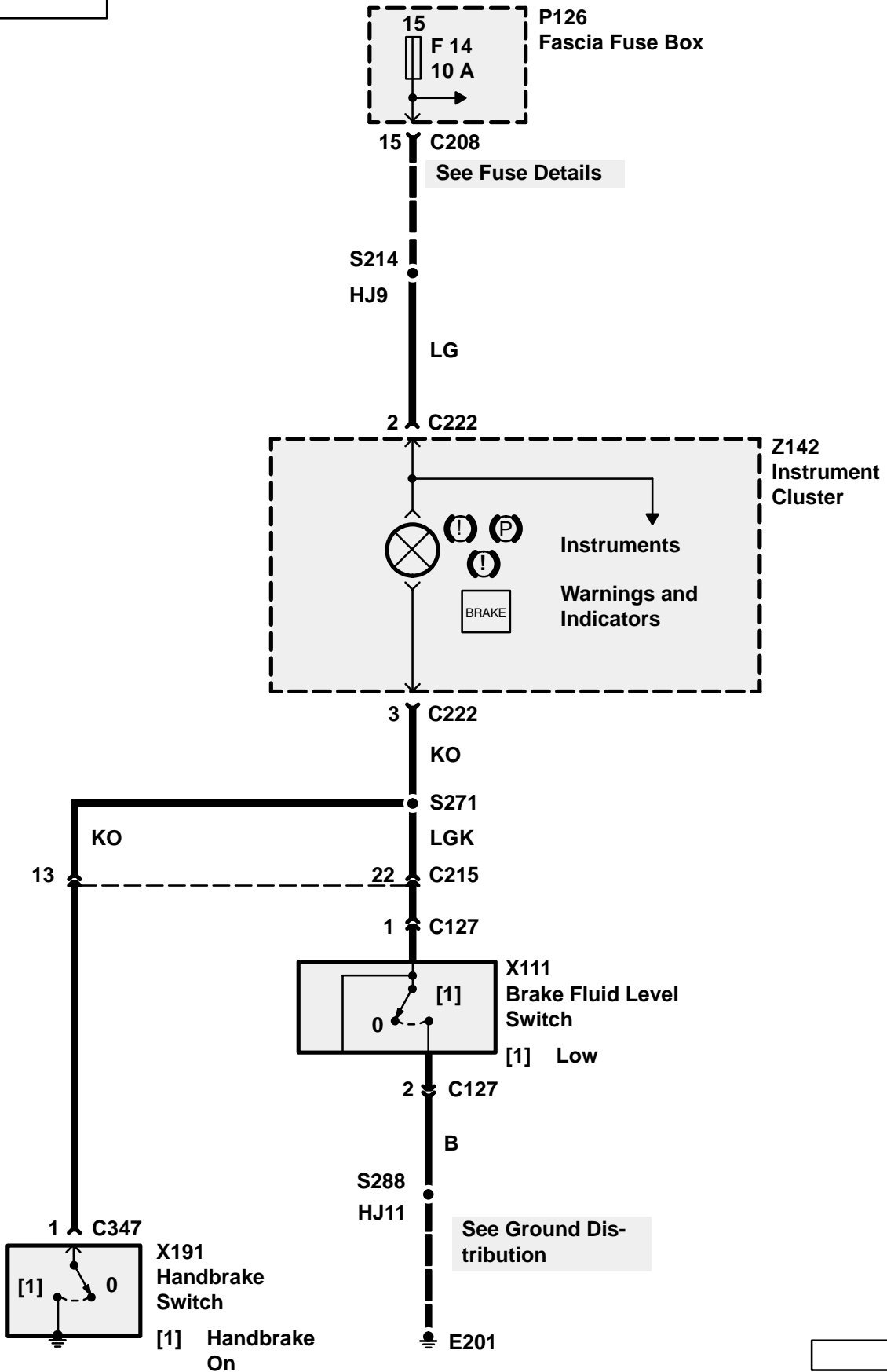
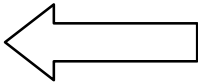

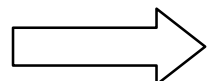
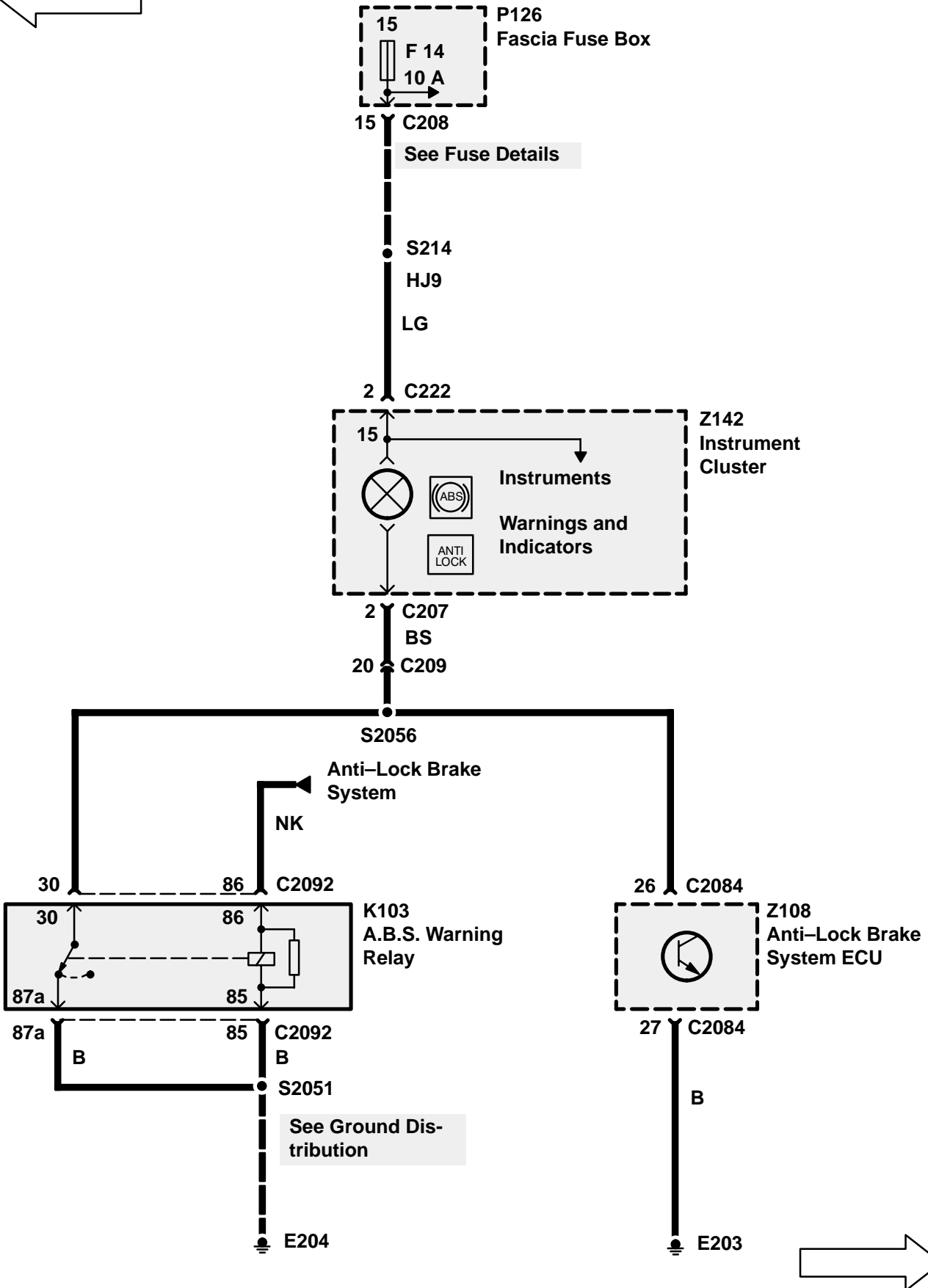
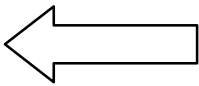

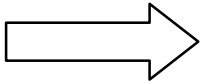
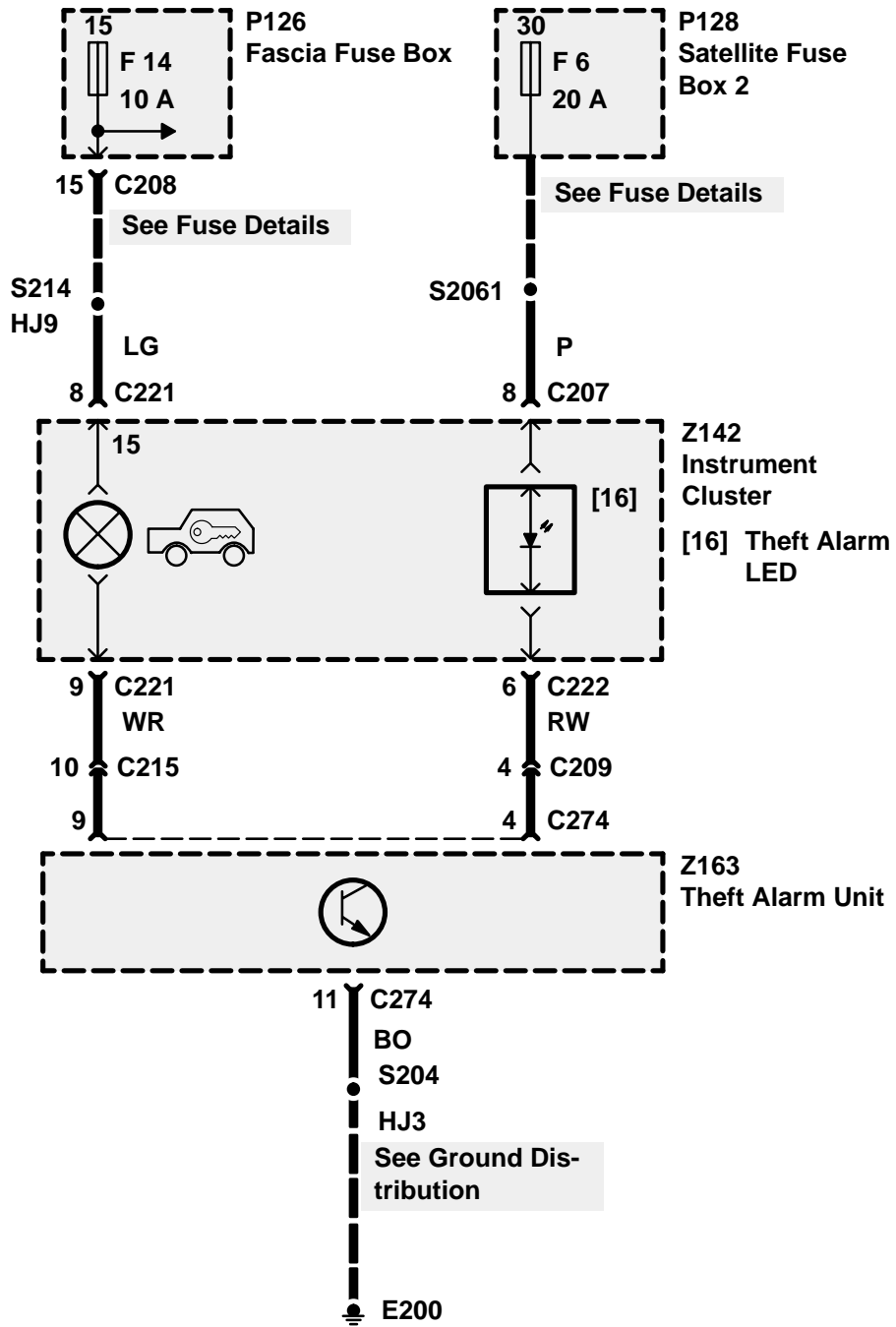
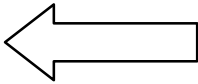



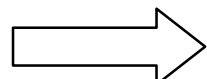
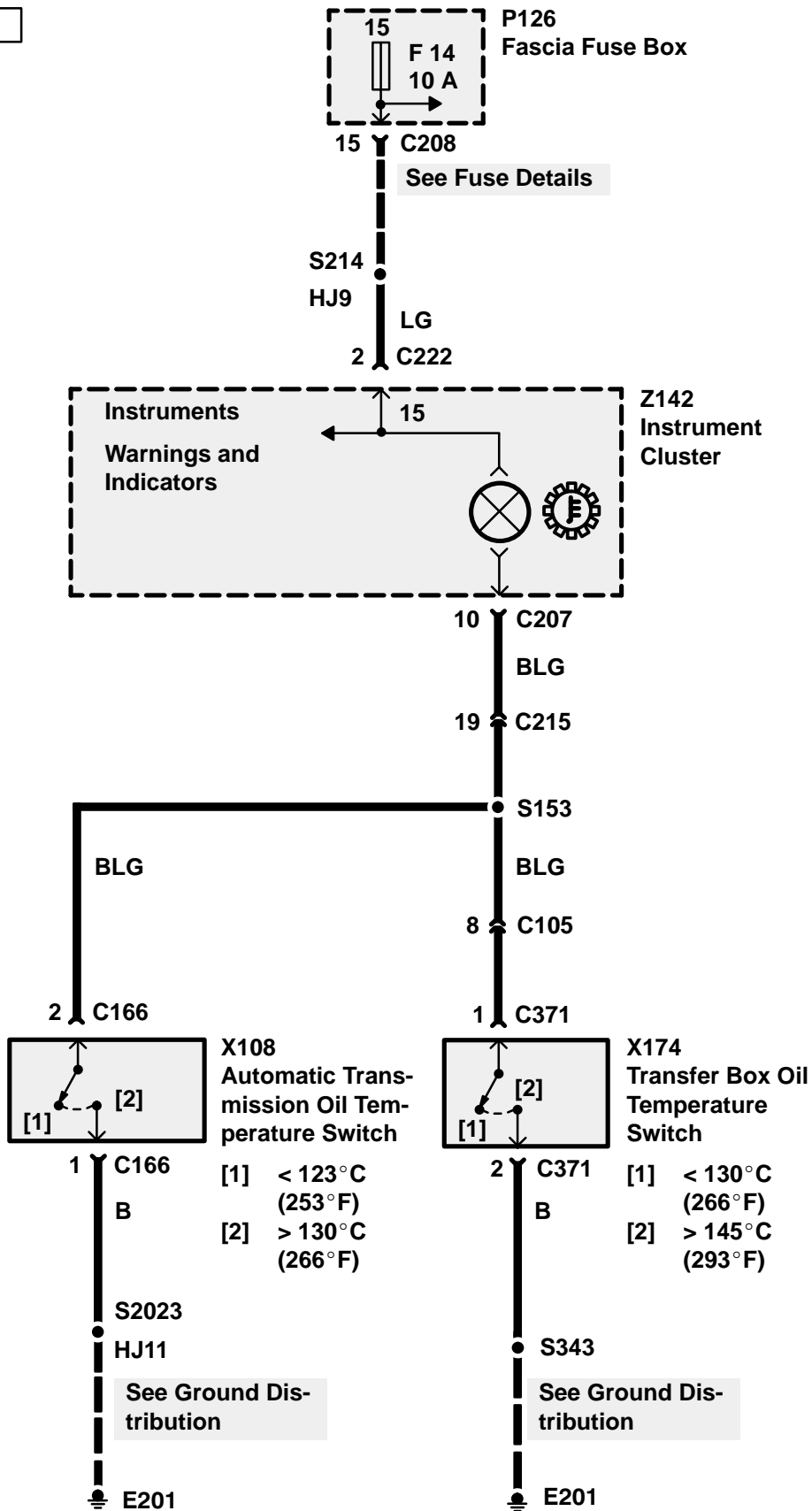
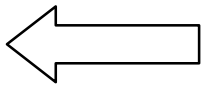

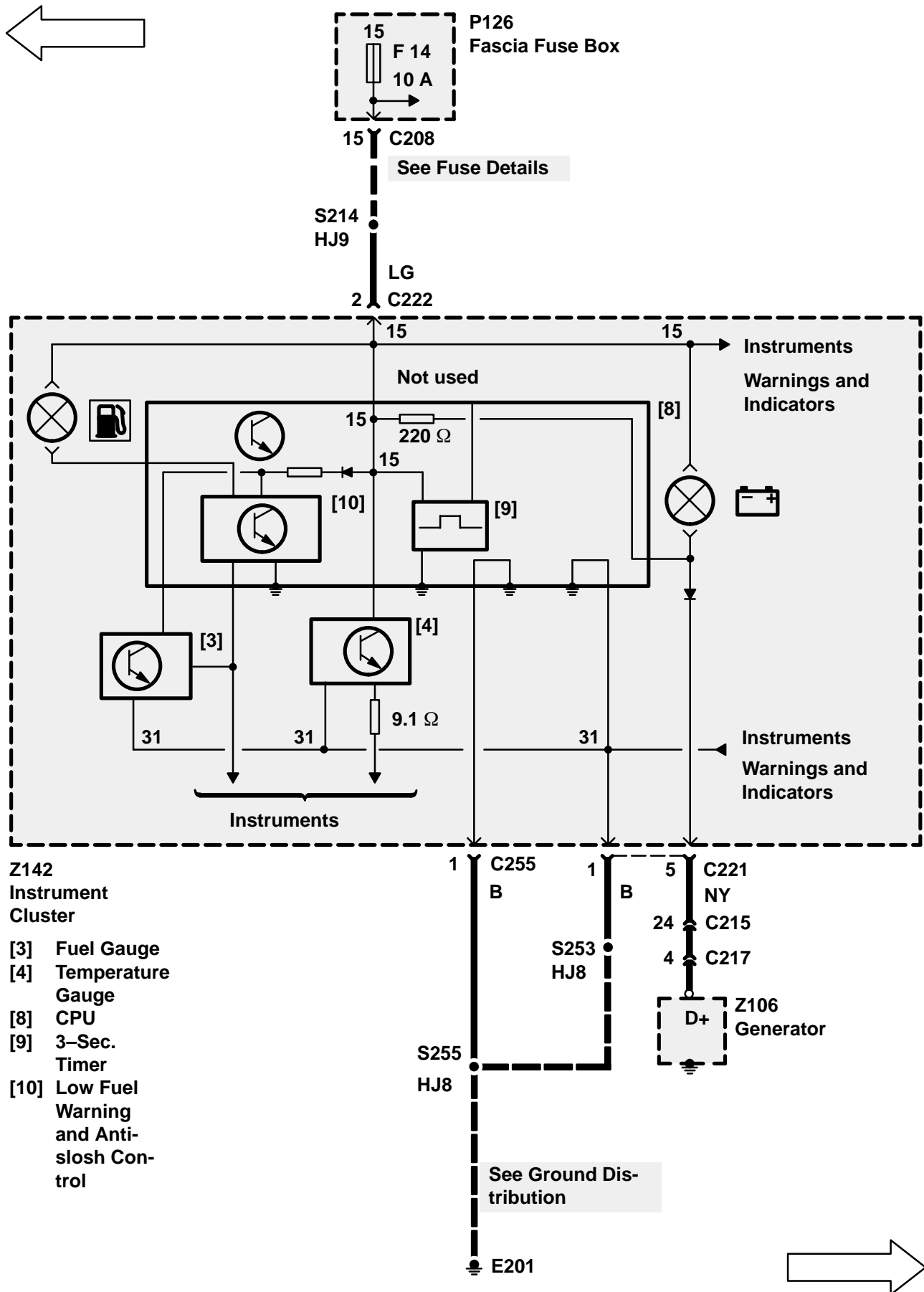

Z142  
 Instrument  
 Cluster

- [3] Fuel Gauge
- [4] Temperature Gauge
- [8] CPU
- [9] 3-Sec. Timer
- [10] Low Fuel Warning and Anti-slosh Control

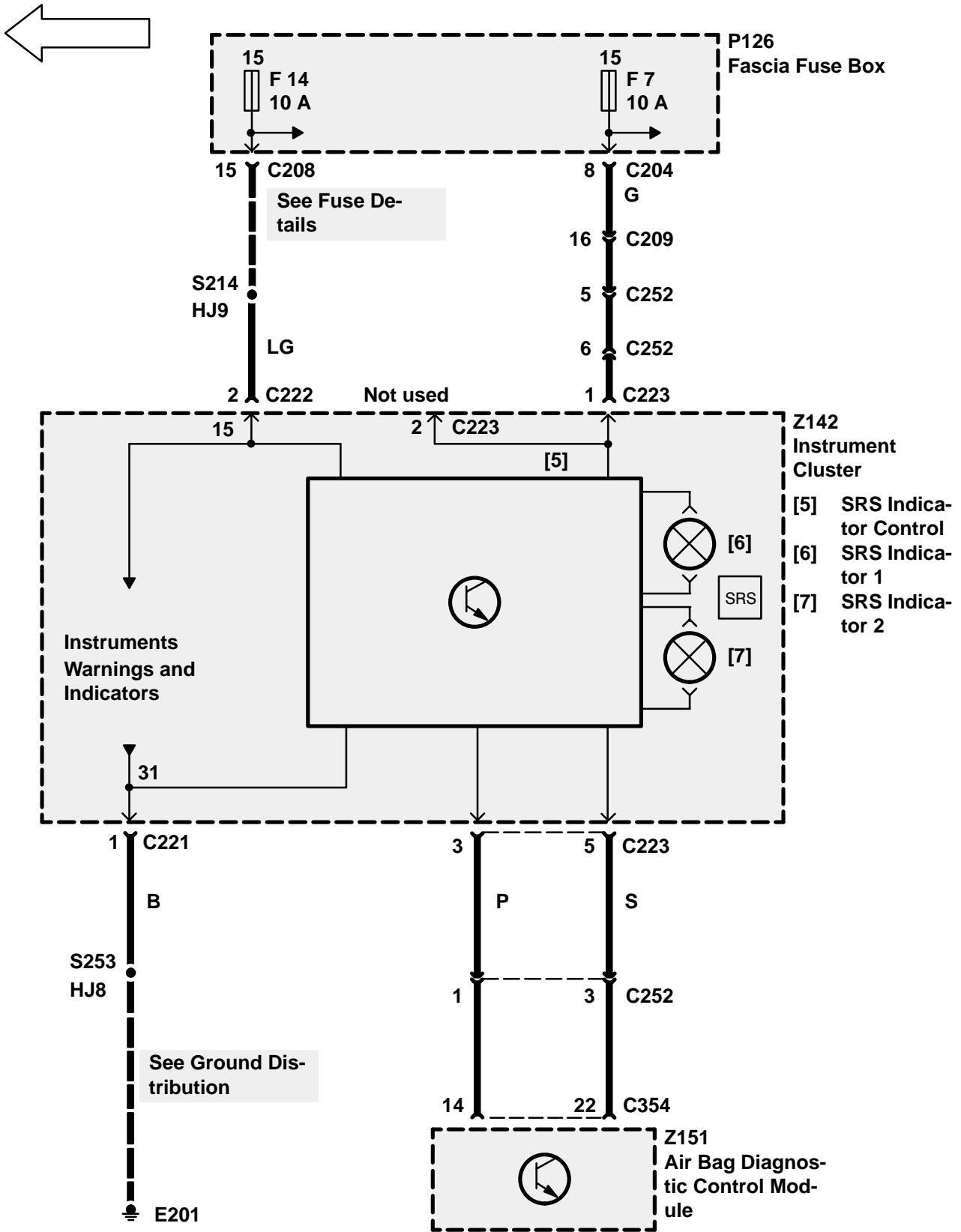

---

**CIRCUIT OPERATION****Hazard Indicator**

If the Hazard Switch (X220) is depressed, a pulsing voltage is applied to the Hazard Indicator which is permanently grounded by ground E200.

**Direction Indicator**

If the Direction Indicator Switch (X116) is turned on, a pulsing voltage is applied from the Flasher Unit (Z128) to the Direction Indicator which is permanently grounded by ground E200.

**Trailer Indicator**

With the Direction Indicator Switch (X116) turned on, the Flasher Unit (Z128) also applies a pulsing voltage to the Trailer Indicator which is permanently grounded by ground E200.

**Main Beam Indicator**

With the Headlamps turned on by the Main Lighting Switch (X145), battery voltage is applied to the Main Beam Indicator which is also permanently grounded by ground E200.

**Malfunction Indicator Lamp (Check Engine)**

The Malfunction Indicator Lamp (Check Engine) is grounded by the Engine Control Module (ECM) (Z132) when a diagnostic trouble code is set.

**Service Reminder Indicator**

The Service Reminder Indicator receives battery voltage with the Ignition Switch (X134) in position II. The Service Reminder Unit (Z126) grounds the Service Reminder Indicator when the vehicle requires service. The Service Reminder Indicator is also grounded by a 3 second timer as a bulb check.

**Oil Pressure Warning Light**

The oil pressure warning light receives battery voltage with the Ignition Switch (X134) in position II. If the engine oil pressure is very low, the Oil Pressure Switch (X149) will apply ground to the warning light.

**Differential Lock Indicator**

The Differential Lock Indicator receives battery voltage with the Ignition Switch (X134) in position II. It is grounded by the Differential Lock Switch (X238) when the Differential is locked.

**Brake Warning Light**

The brake warning light receives battery voltage with the Ignition Switch (X134) in position II. It is grounded by the Brake Fluid Level Switch (X111) when the brake fluid level is low. It may also be grounded when the Handbrake Switch (X191) is closed. The brake warning light is also grounded by a 3 second timer as a bulb check.

---

**ABS Warning Light**

The ABS warning light receives battery voltage with the Ignition Switch (X134) in position II. It is grounded by the Anti-Lock Brake System ECU (Z108) or the ABS Warning Relay (K103) in the event of an ABS problem.

---

**Fasten Seat Belt Indicator****(Japan and Gulf States Vehicles Only)**

The Fasten Seat Belt Indicator receives battery voltage with the Ignition Switch (X134) in position II. The indicator is grounded through the Multi-Function Unit (MFU) (Z148) and the Driver's Seat Buckle Switch (X120). If the Driver's Seat Belt is buckled, the Driver's Seat Belt Buckle Switch opens and the Indicator turns off.

---

**Theft Alarm LED**

The Theft Alarm LED receives battery voltage at all times. It is grounded by the Theft Alarm Unit (Z163) to indicate the following conditions:

- Slow Flash = Immobilised or Immobilised and armed
- Rapid Flash = Perimetrically and Volumetrically armed
- Intermittent Rapid Flash = Perimetrically armed
- No Flash for 10 Seconds = Mislock
- Continuous = Driver's door open (or ignition on) and Immobilised

---

**Transmission/Transfer Box Oil Temperature****Warning Light**

The transmission/transfer box oil temperature warning light is grounded by the Automatic Transmission Oil Temperature Switch (X108) when the temperature of the transmission fluid exceeds 130°C (266°F). The warning light is also grounded by the Transfer Box Oil Temperature Switch (X174) when the temperature of the transfer box fluid exceeds 145°C (266°F).

---

**Low Fuel Warning Indicator**

When the fuel gauge sender's resistance falls below approximately 25 Ohms (6 liters/1.5 US gallons), the Low Fuel Warning Indicator will illuminate to warn the driver.

---

**Charge Warning Light**

The charge warning light receives battery voltage with the Ignition Switch (X134) in position II. This warning light is grounded by the Generator (Z106) if the Generator is not producing normal power output or the Generator stops turning.

---

**SRS Indicators**

The SRS Indicators are controlled by the Air Bag Diagnostic Control Module (Z151) and the SRS Indicator Control Circuit of the Instrument Cluster (Z142) to indicate SRS System faults.

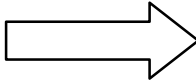
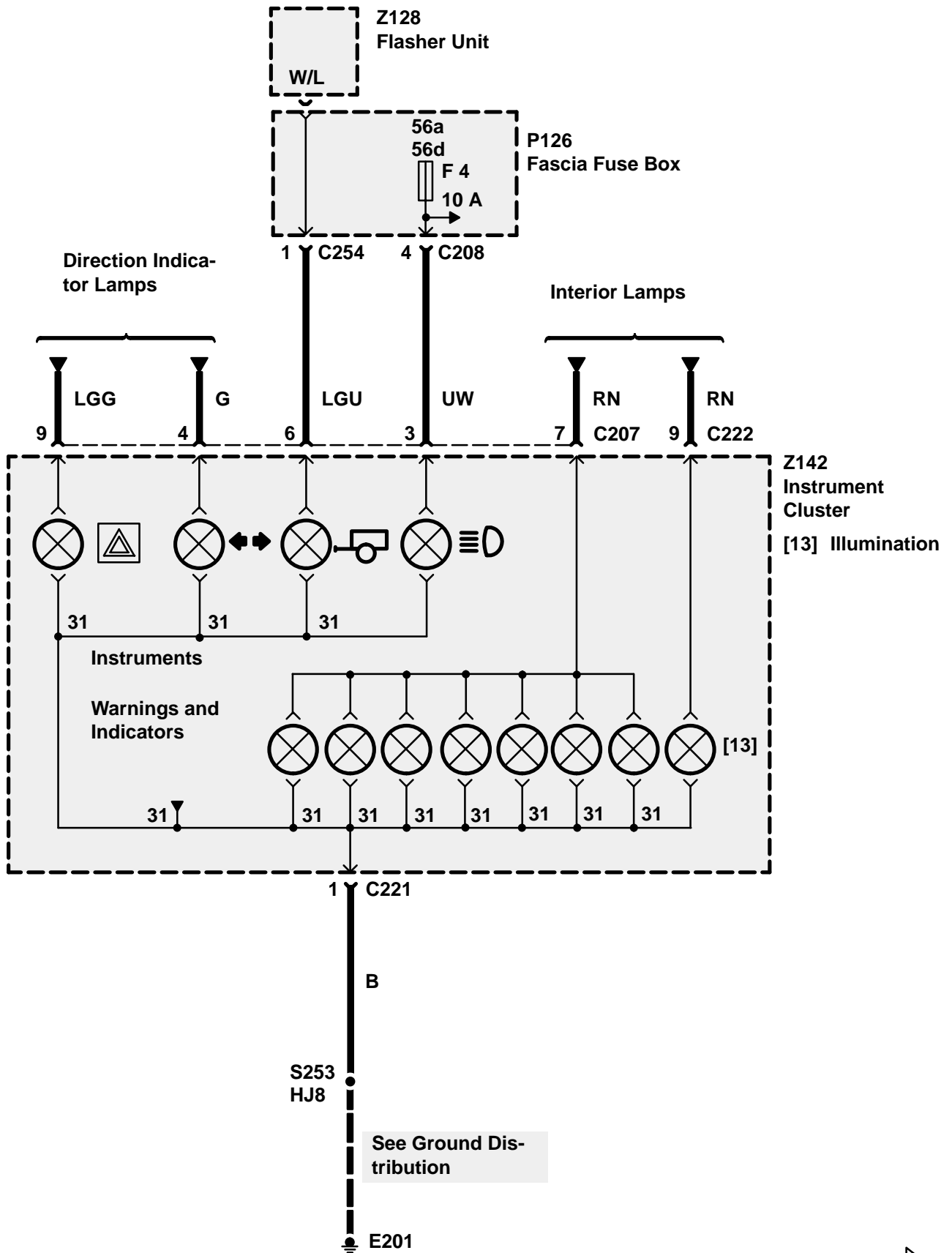

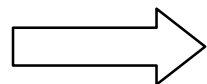
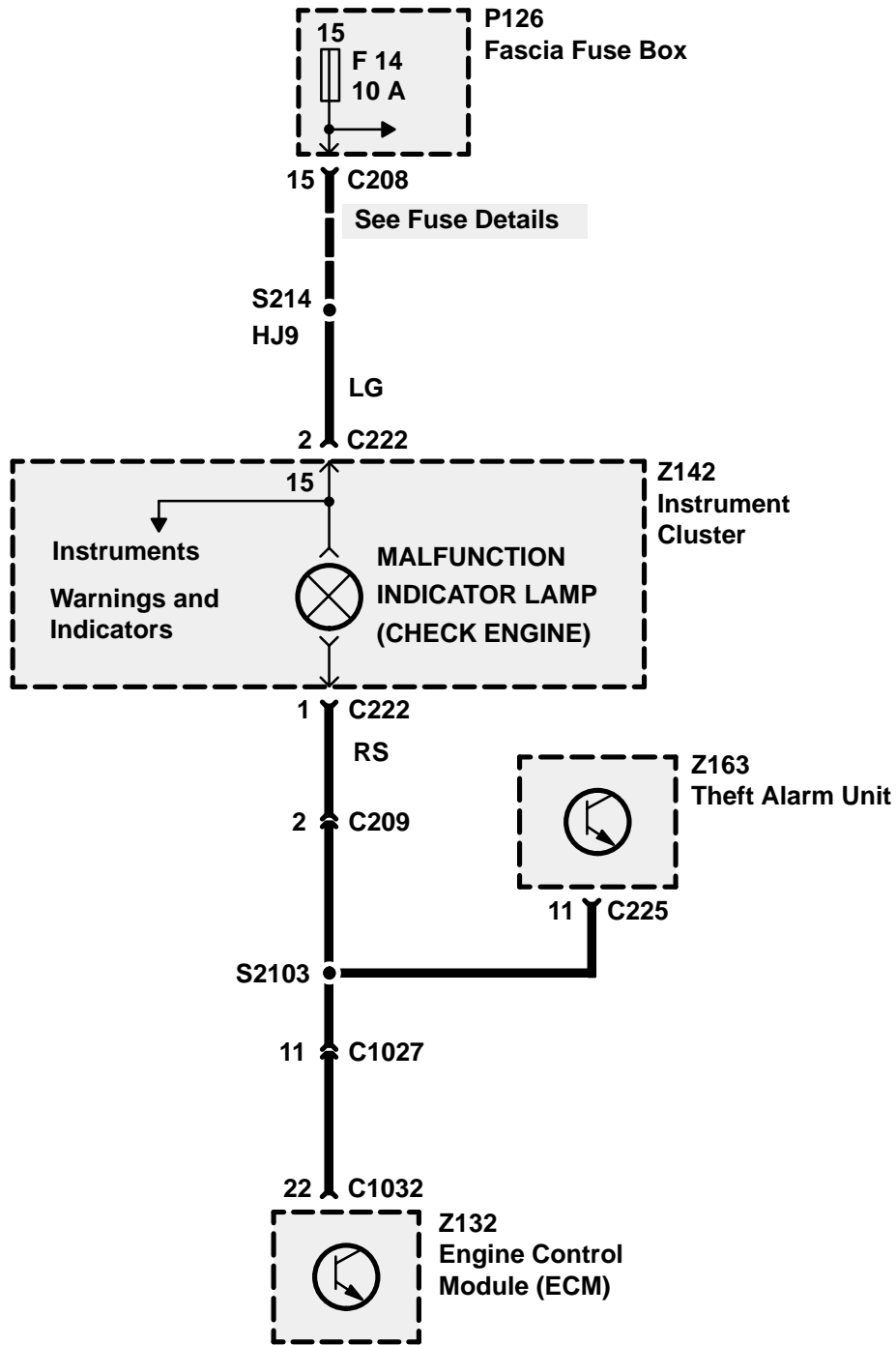
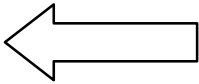

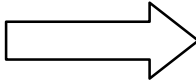
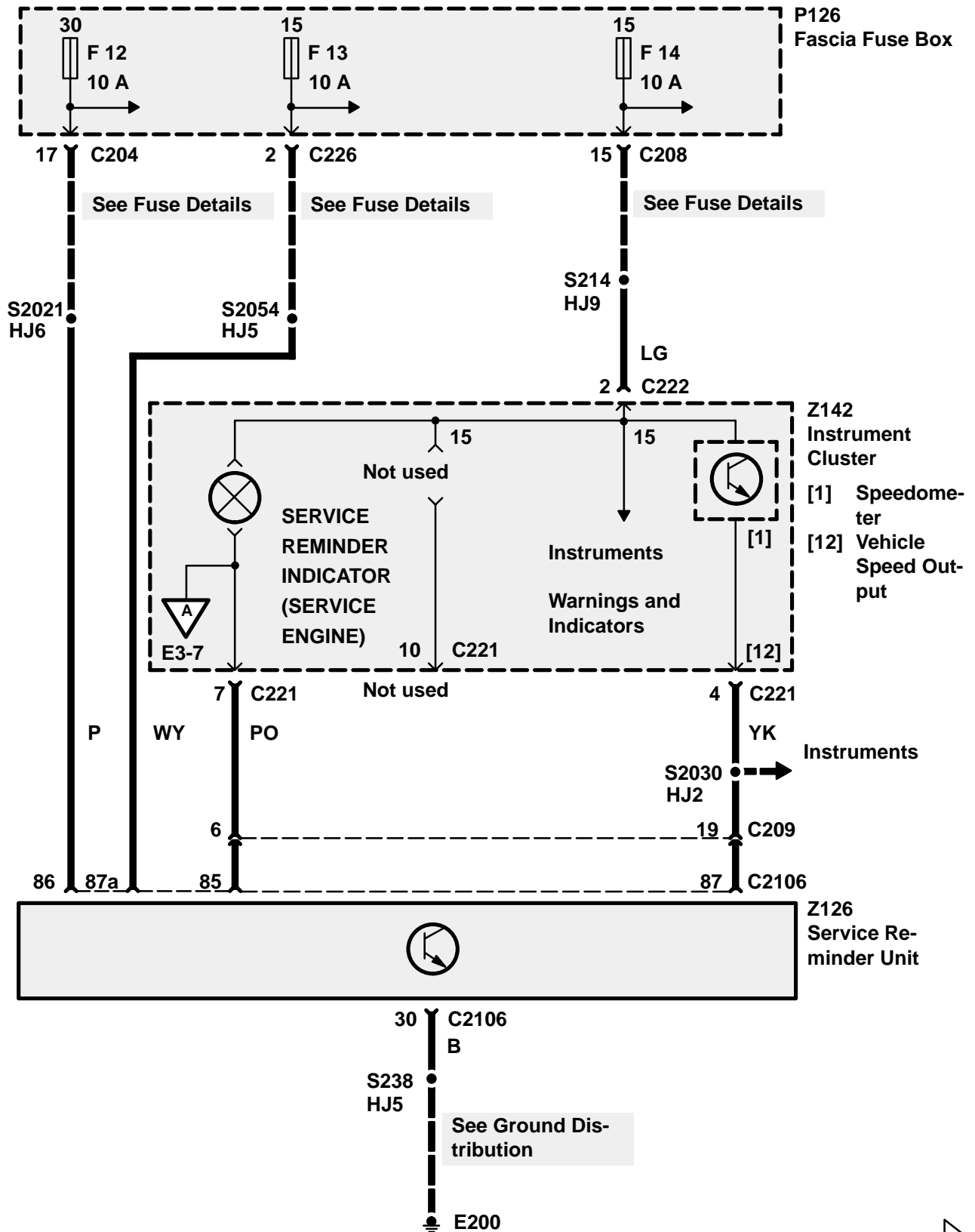
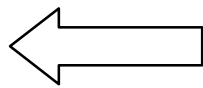



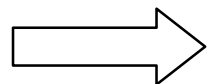
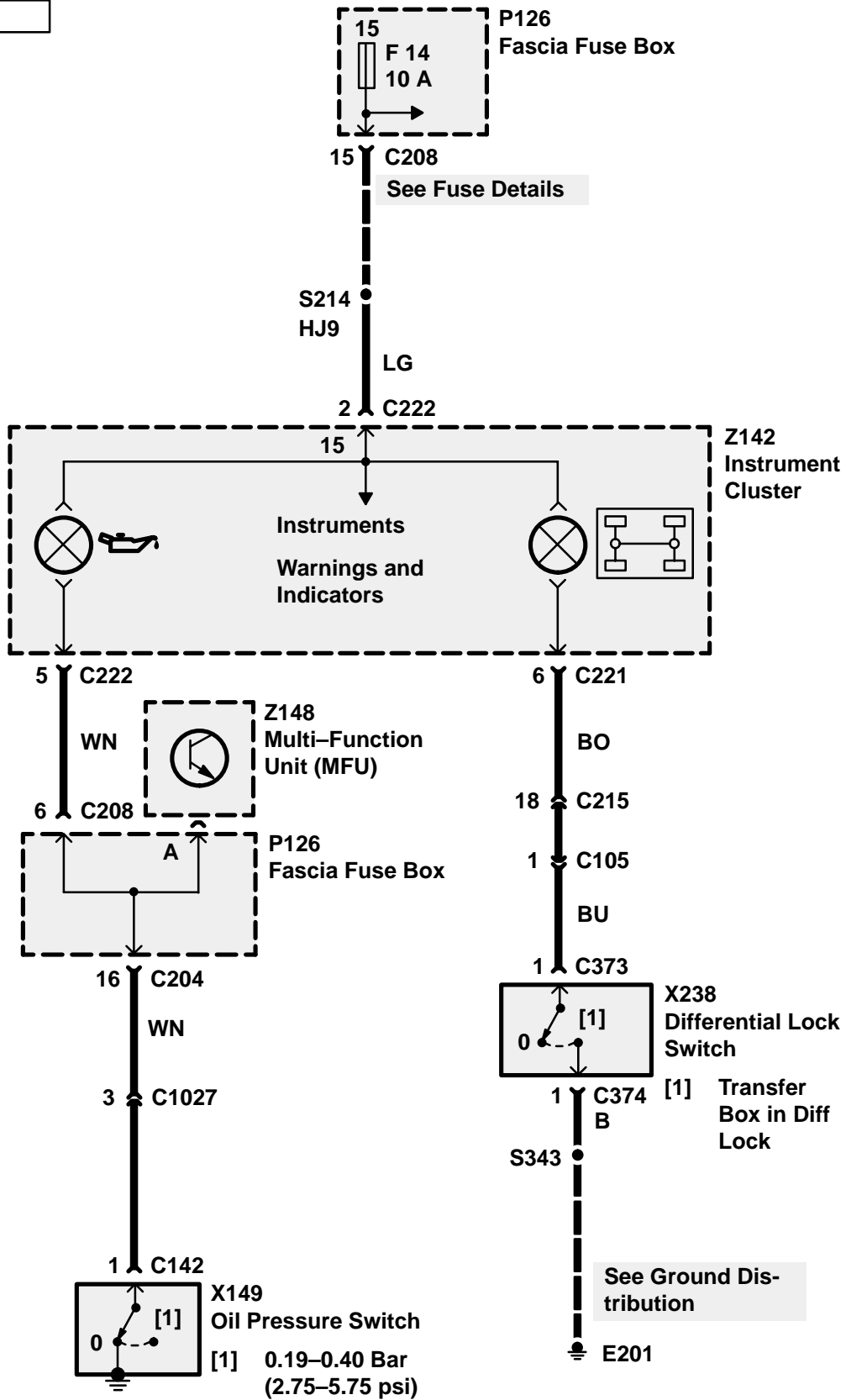
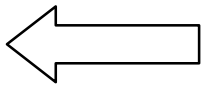

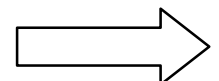
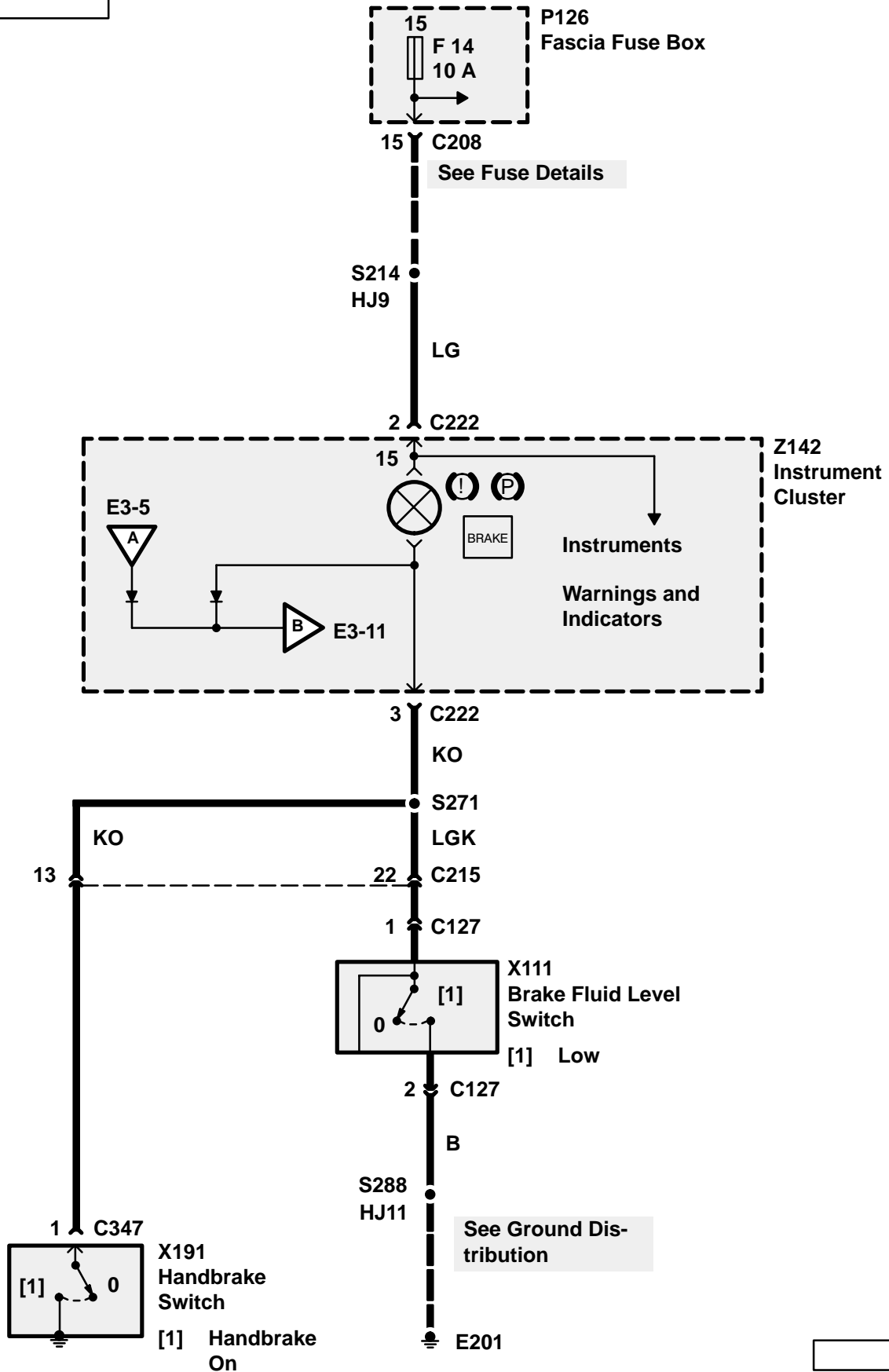
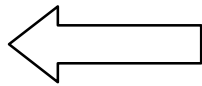

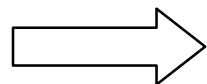
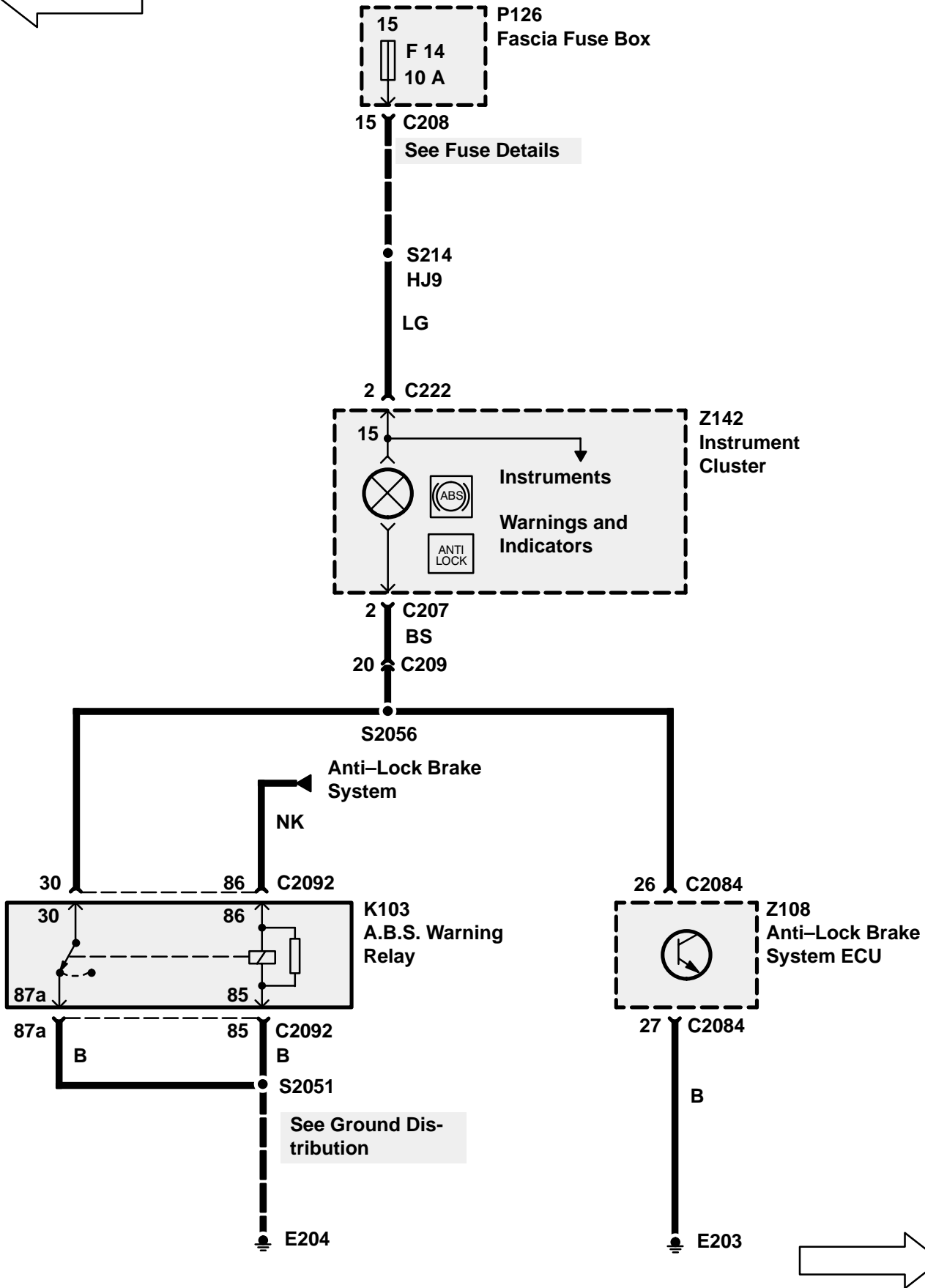
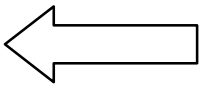

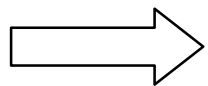
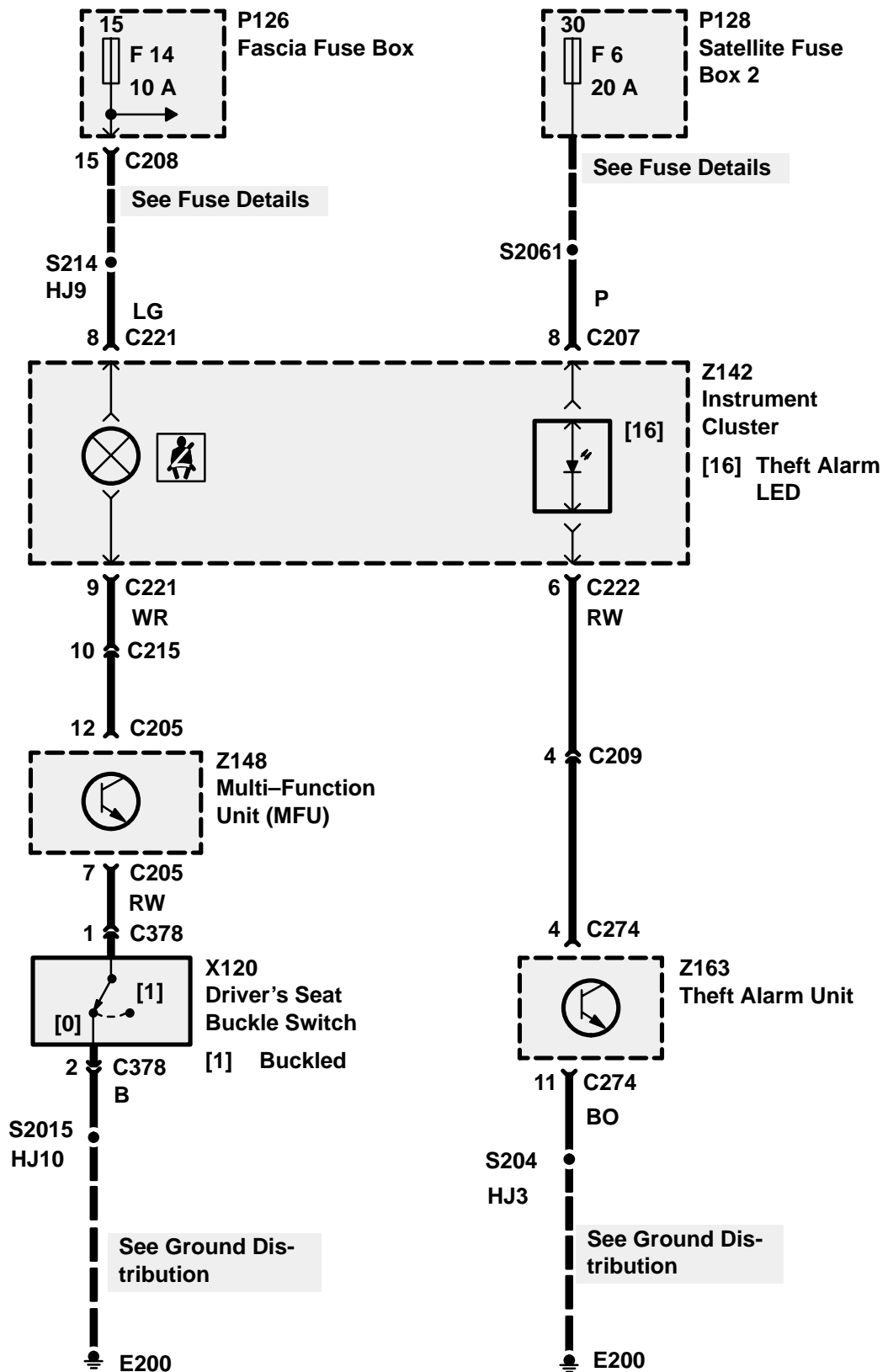
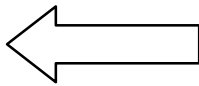

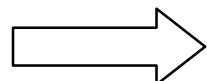
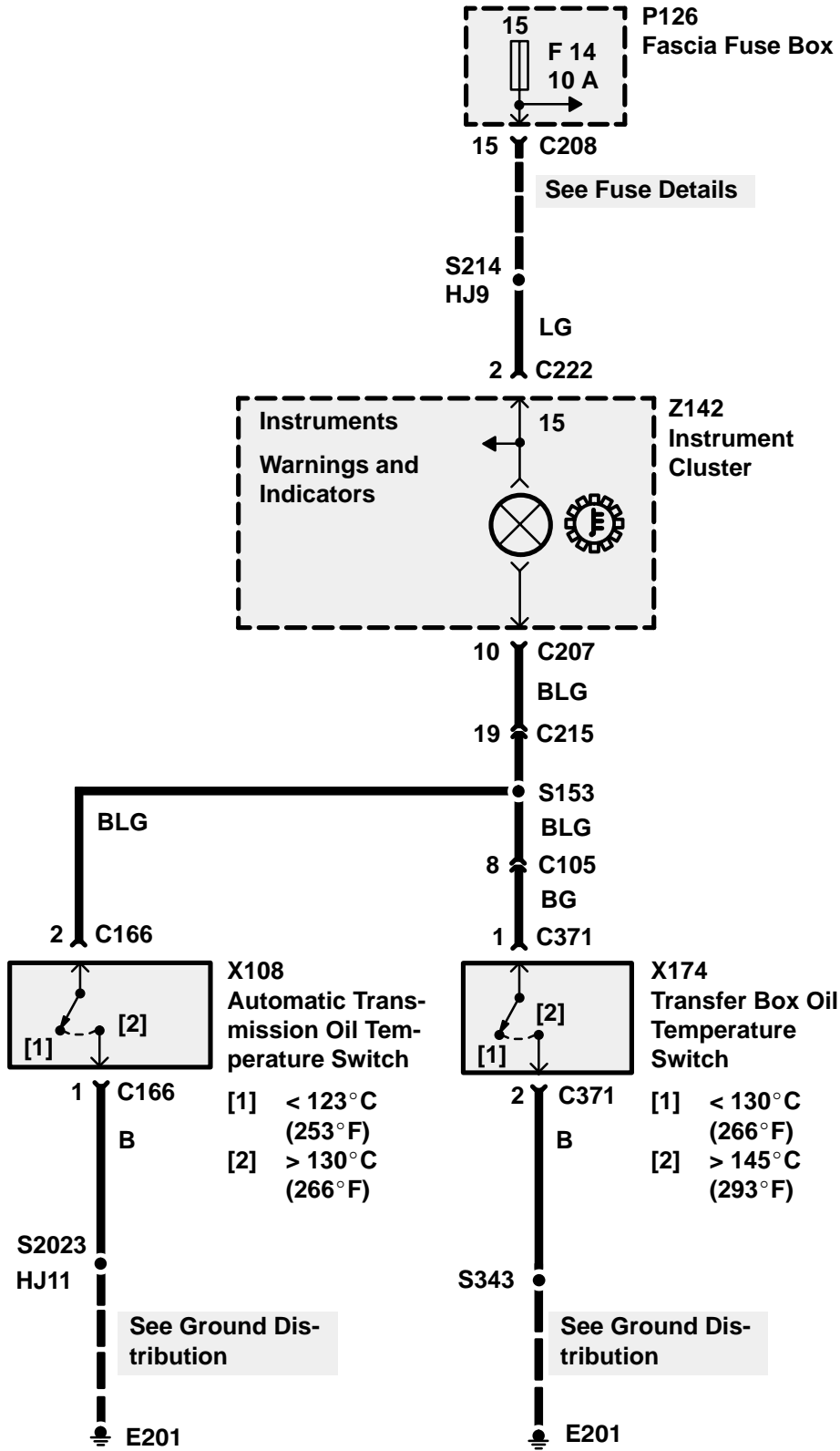
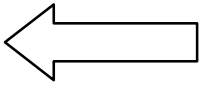

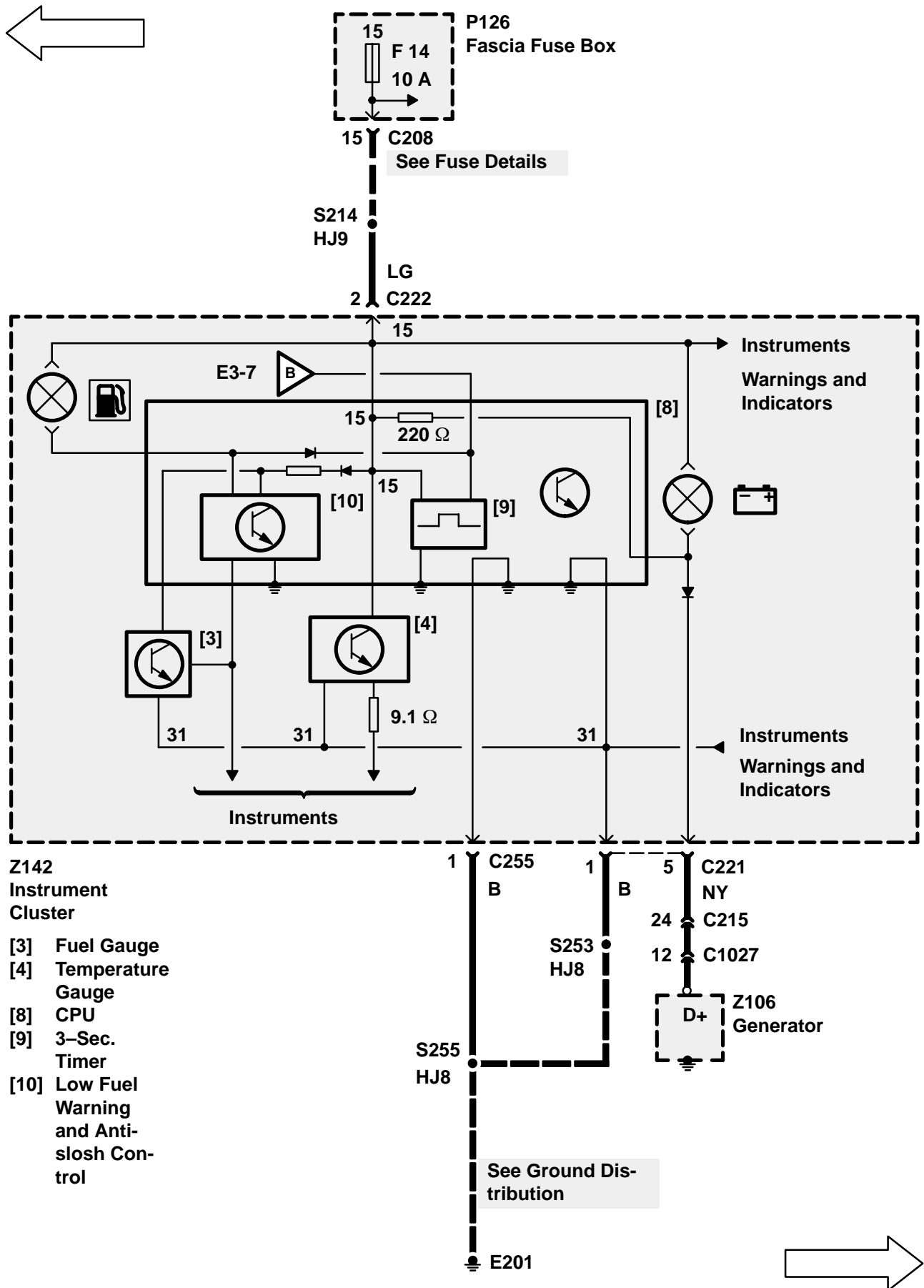

Z142  
Instrument  
Cluster

- [3] Fuel Gauge
- [4] Temperature Gauge
- [8] CPU
- [9] 3-Sec. Timer
- [10] Low Fuel Warning and Anti-slosh Control

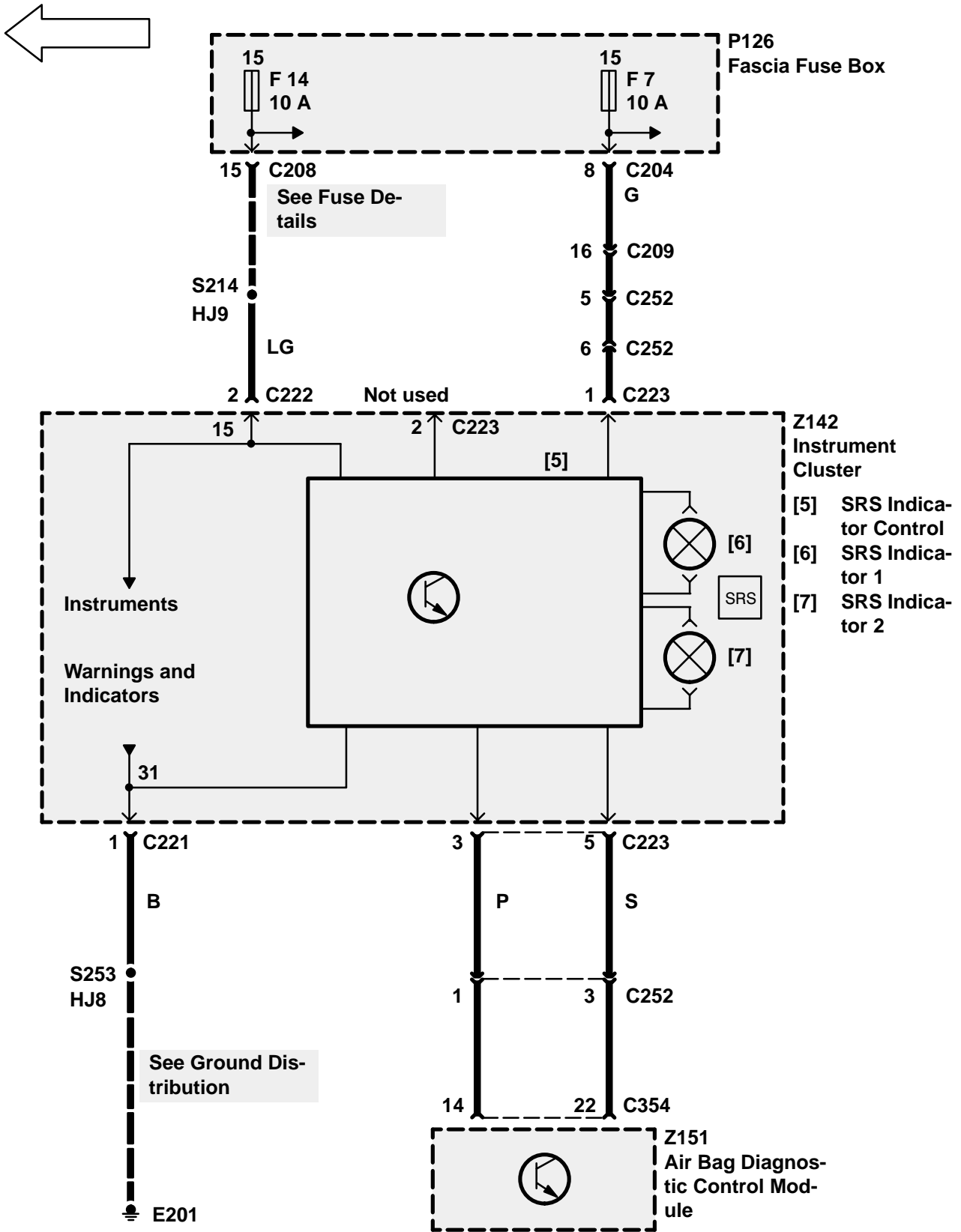

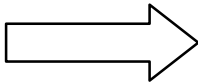
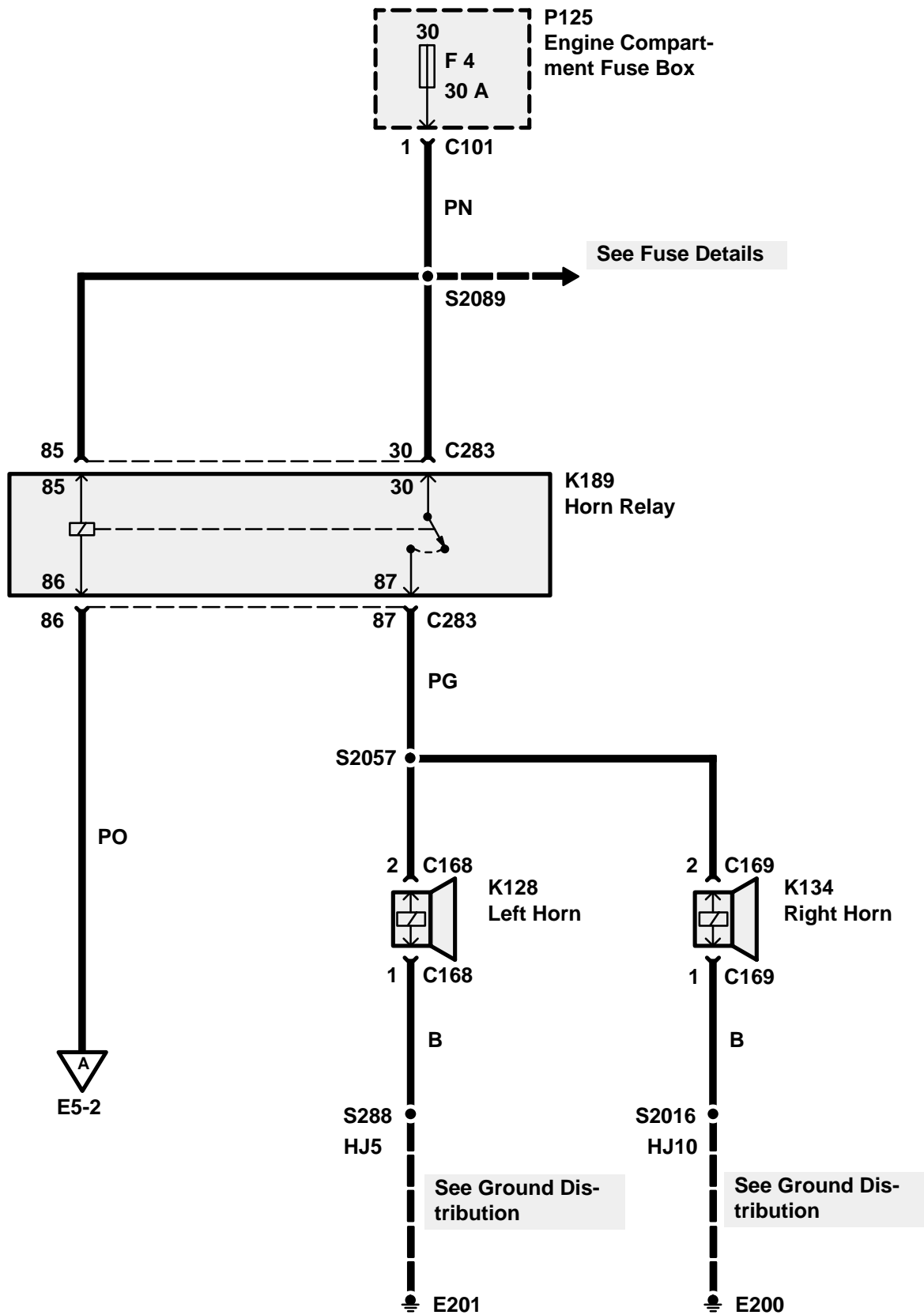



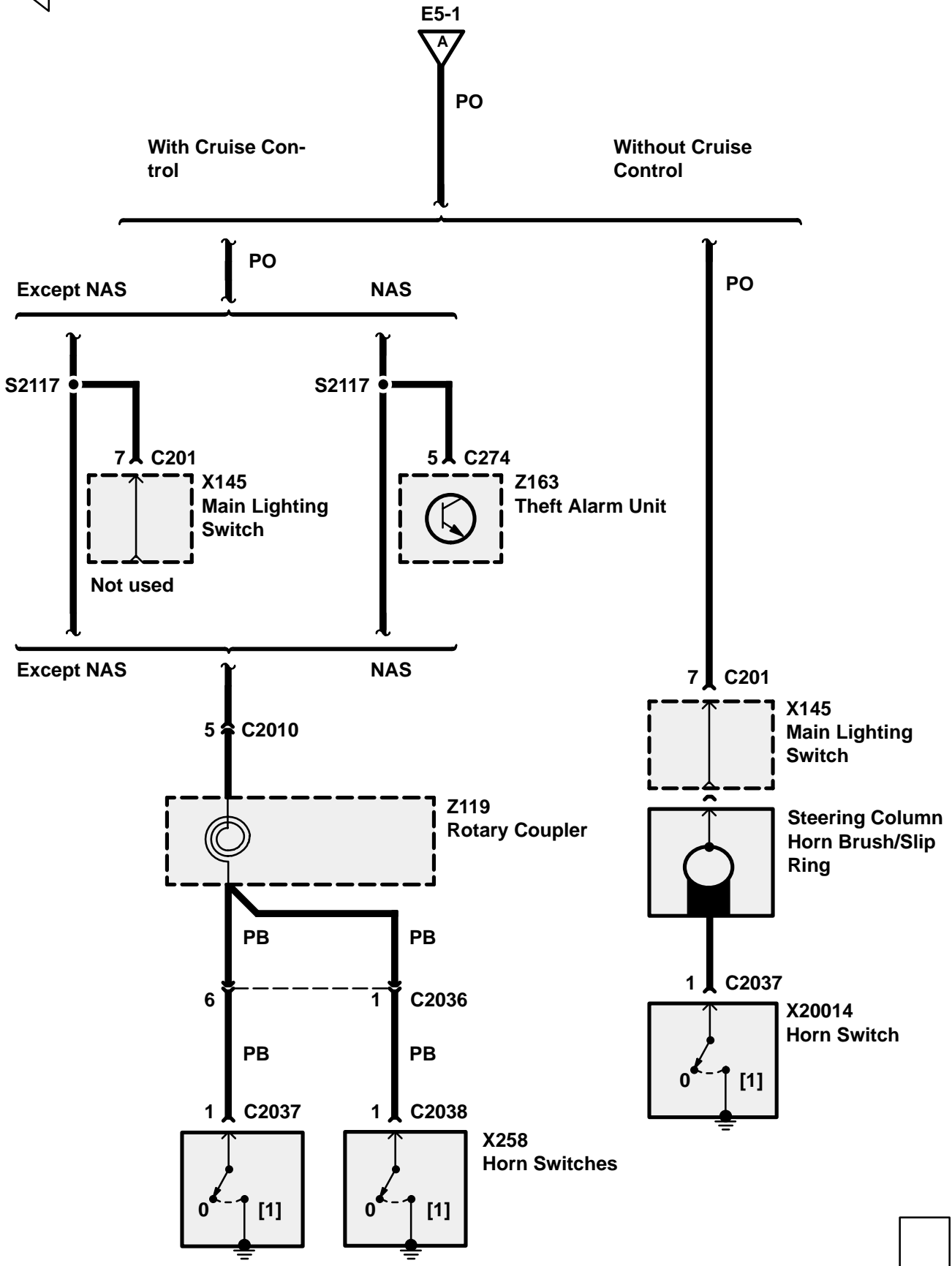
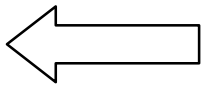

## CIRCUIT OPERATION

The audio system consists of a new head unit, and for mid/high-range, a subwoofer and subwoofer amplifier. For mid- and high-range, the system is also equipped with a radio waveband switch and a tune switch, a volume up and a volume down switch which are located on the fascia next to the instrument cluster.

The control head is equipped with an anti-theft feature which makes the unit inoperative once battery power is removed. A security code must be entered to restore power to the unit. On every level the system is equipped with two rear and two front speakers. Optional front tweeters are available for high line radio.

Battery voltage is provided to the control head at all times through the P wire. In addition to monitoring the anti-theft feature, this input keeps the preset station memory alive. Whenever battery power to the unit is lost, the anti-theft code must be entered and the preset stations must be reprogrammed.

When the Radio (Z111) and the ignition are turned on, the voltage signal through the LGO wire and the control head 'wakes up' the unit. The Radio (Z111) plays, the VF display comes on, and the control unit buttons illuminate. The VF display is dimmed when the headlights or park lights are turned on. When the lights are on, voltage from fuse F8 of the Fascia Fusebox (P126) is applied to the Radio (Z111) terminal 6, connector 230 signalling the Radio (Z111) to dim the display.

Except NAS  
Low Line Radio

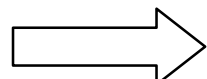
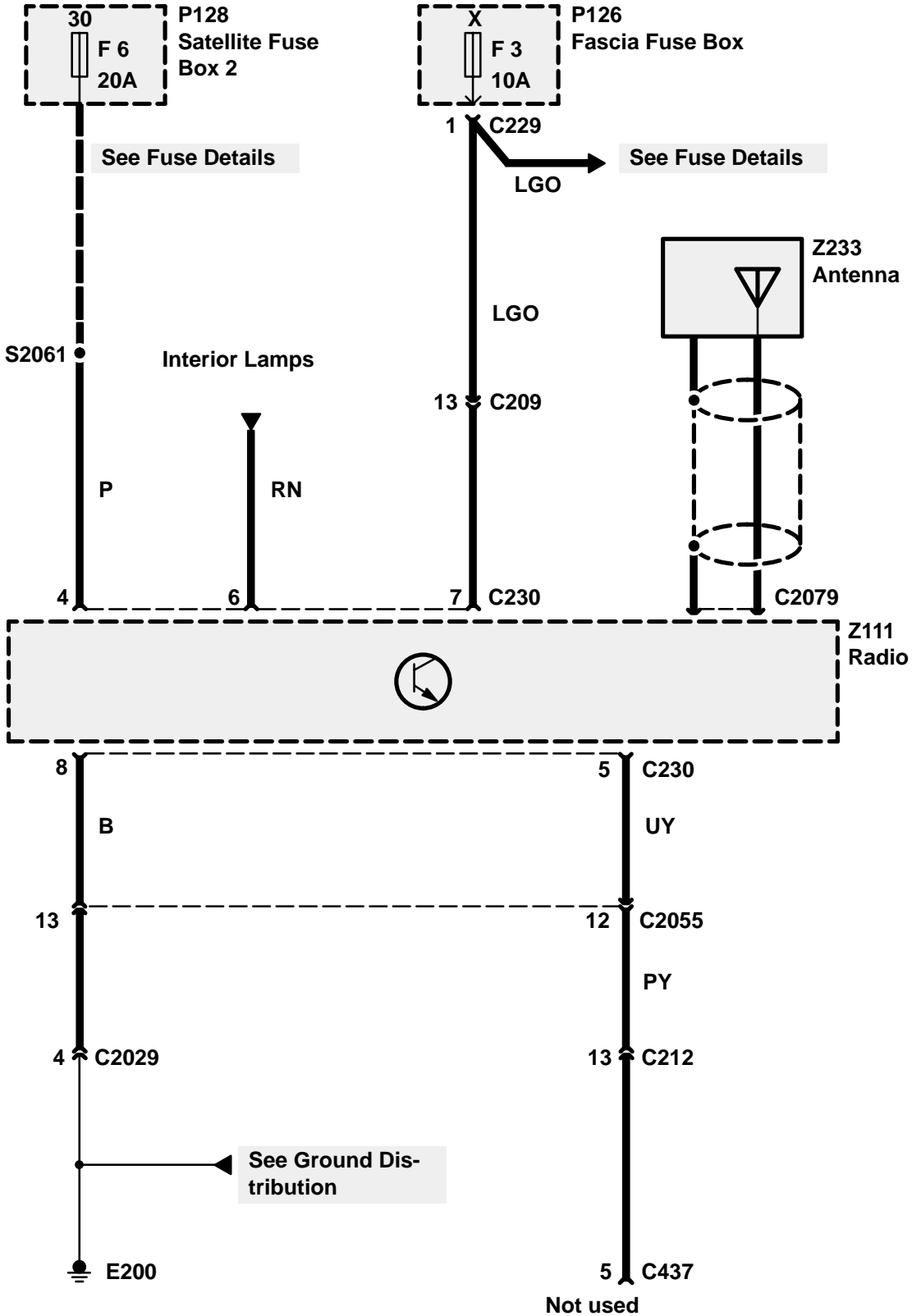

← Except NAS  
Low Line Radio

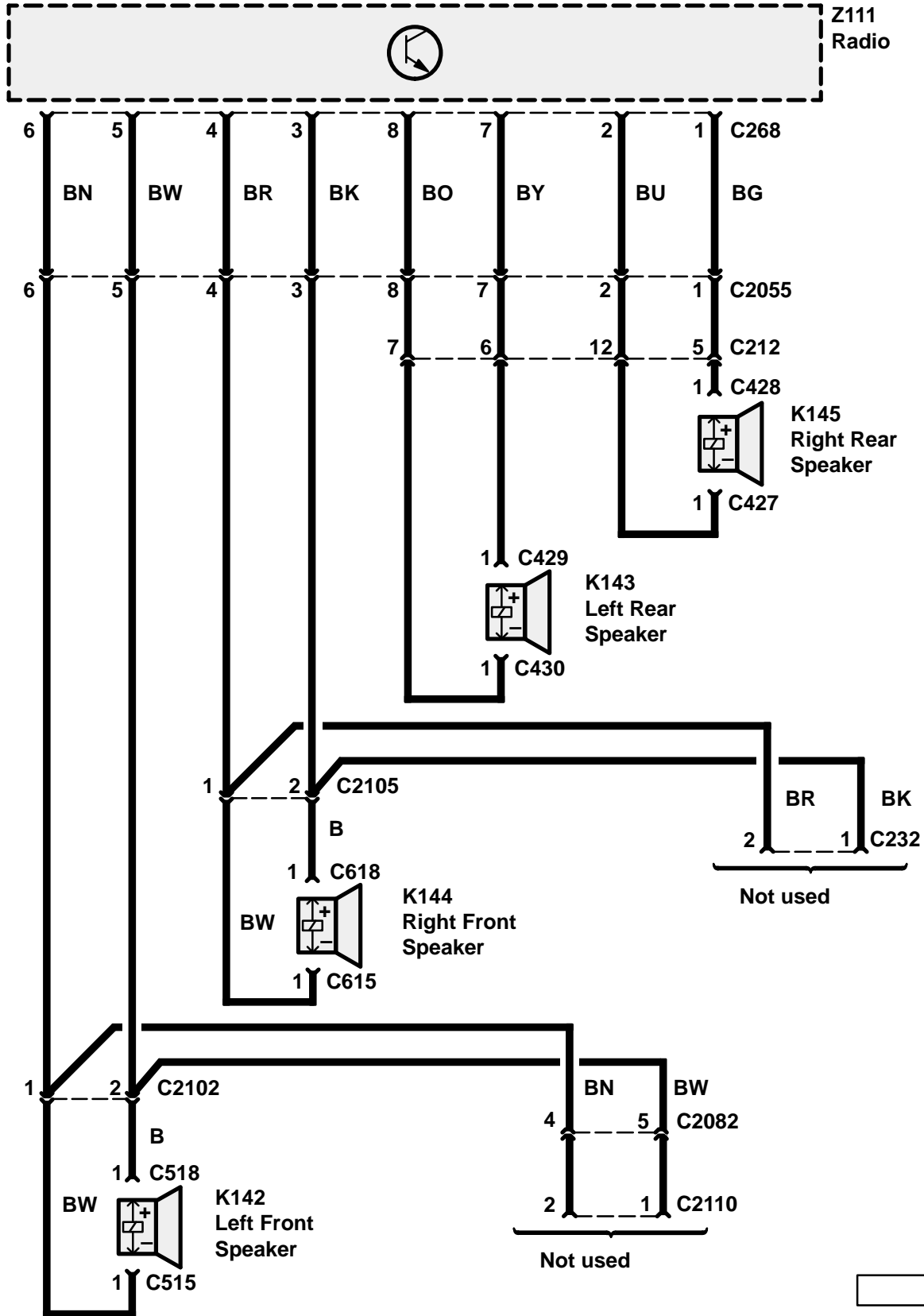



← Except NAS  
Mid Line Radio

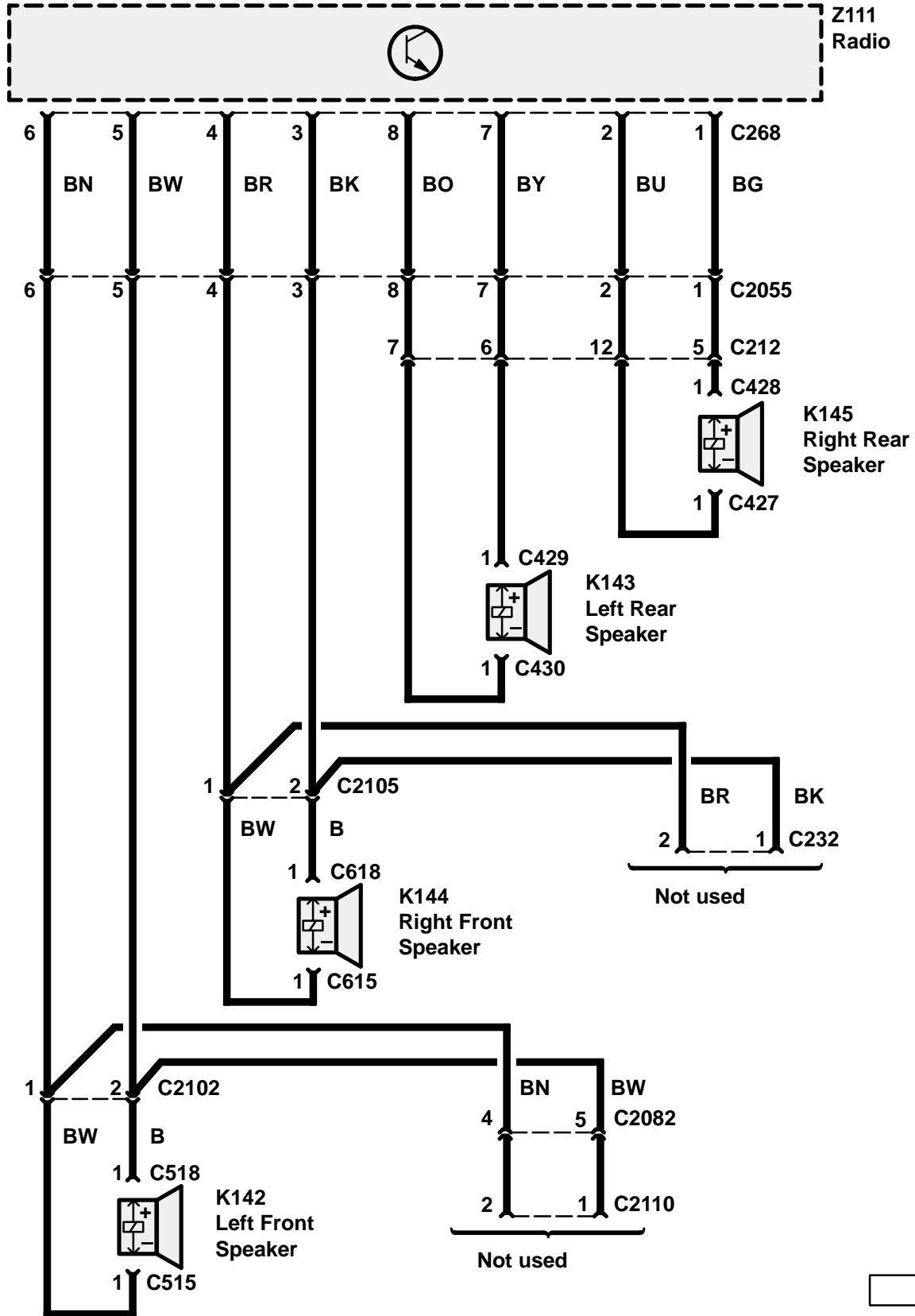

← Except NAS  
Mid Line Radio

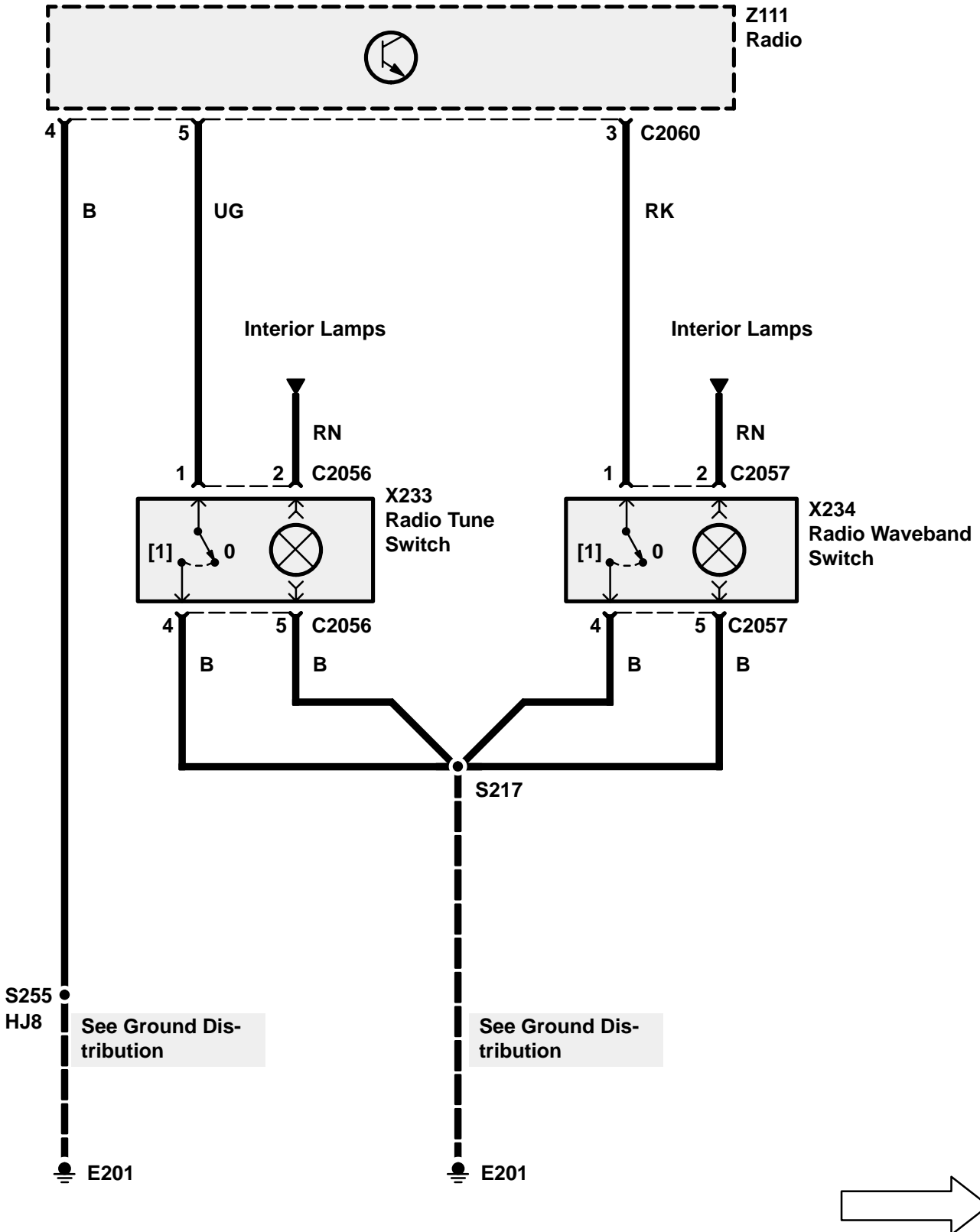

← Except NAS  
Mid Line Radio

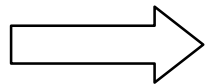
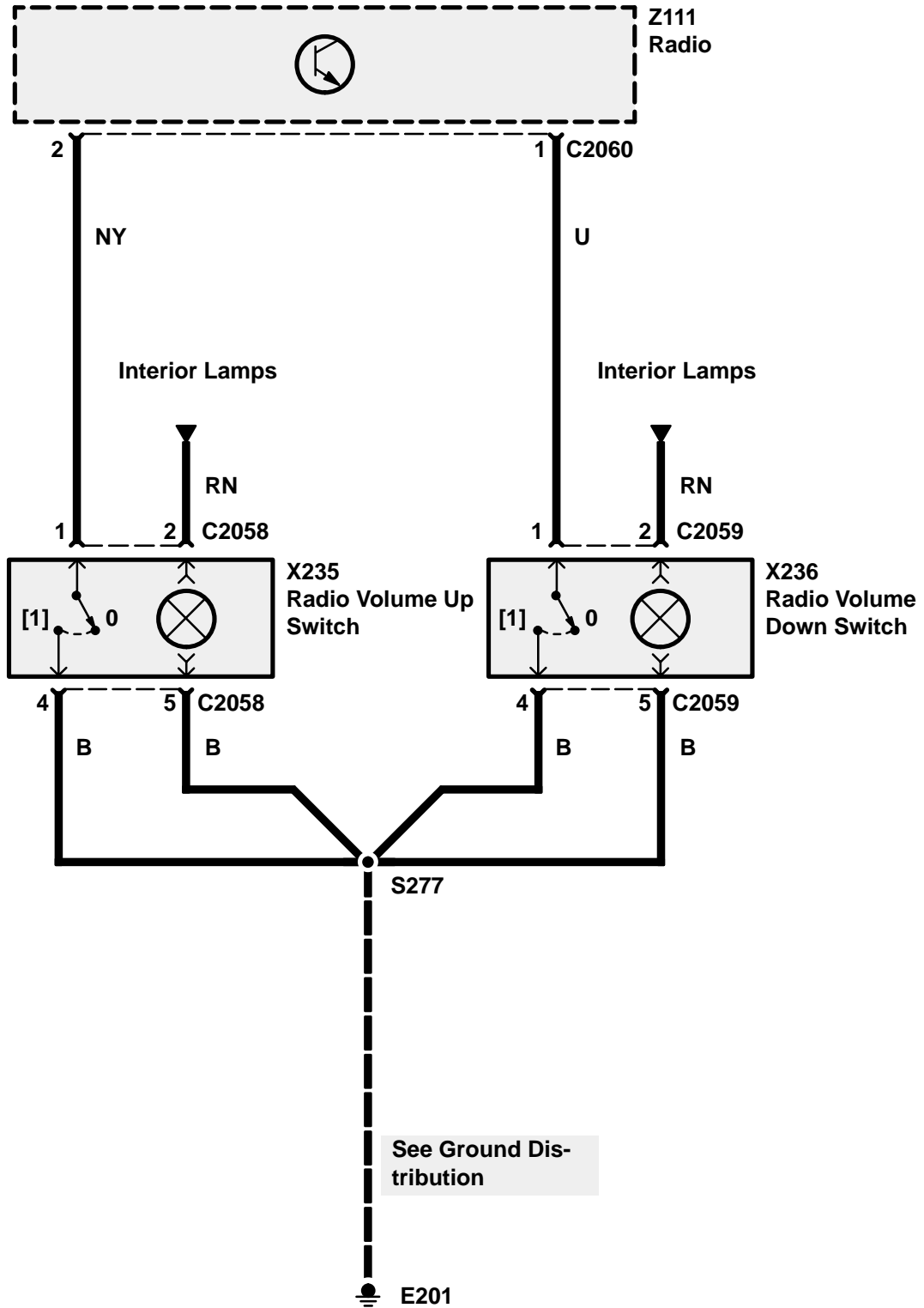



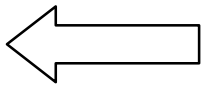

Except NAS  
Mid Line Radio

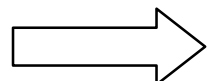
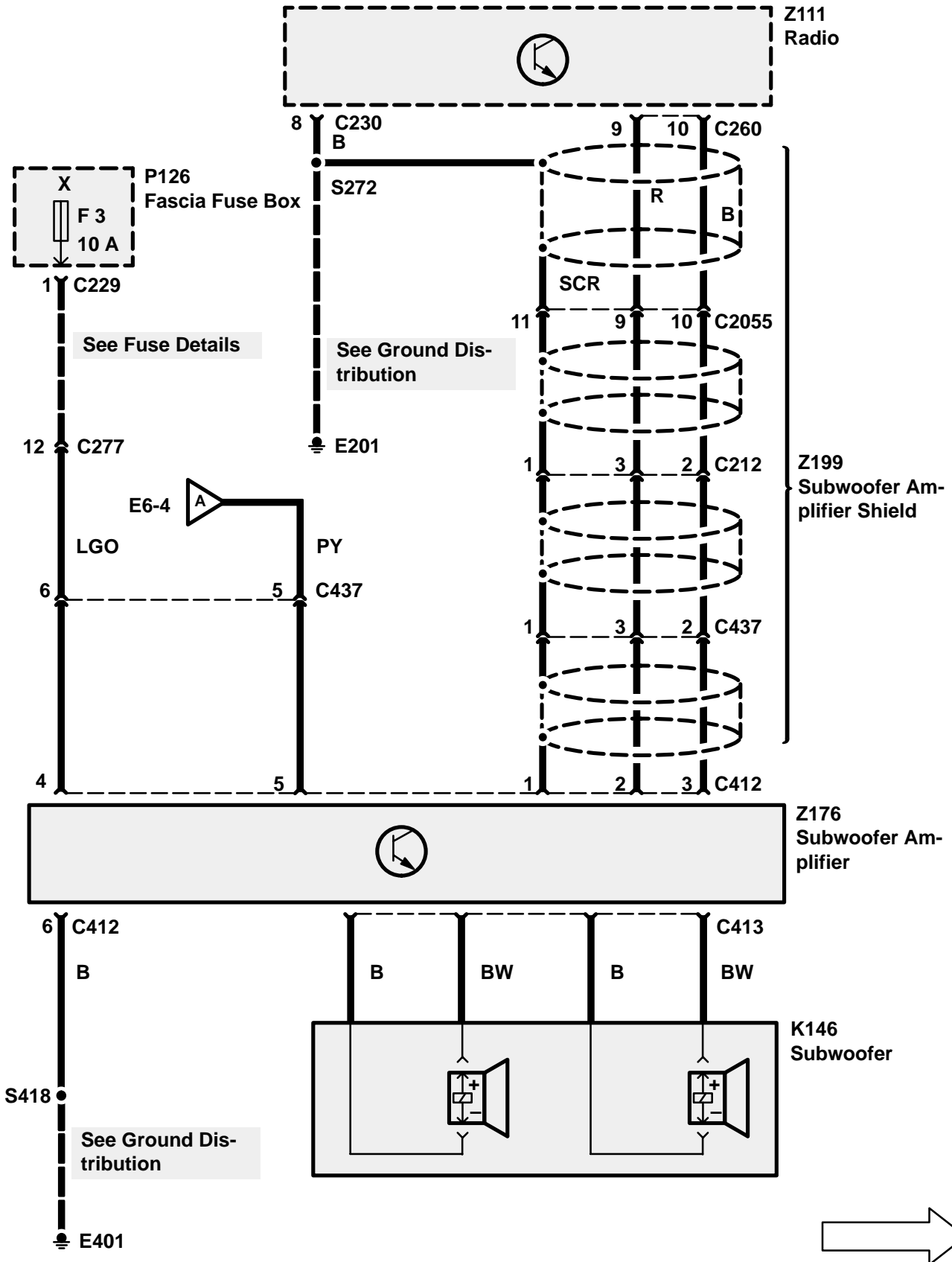

← Except NAS  
High Line Radio

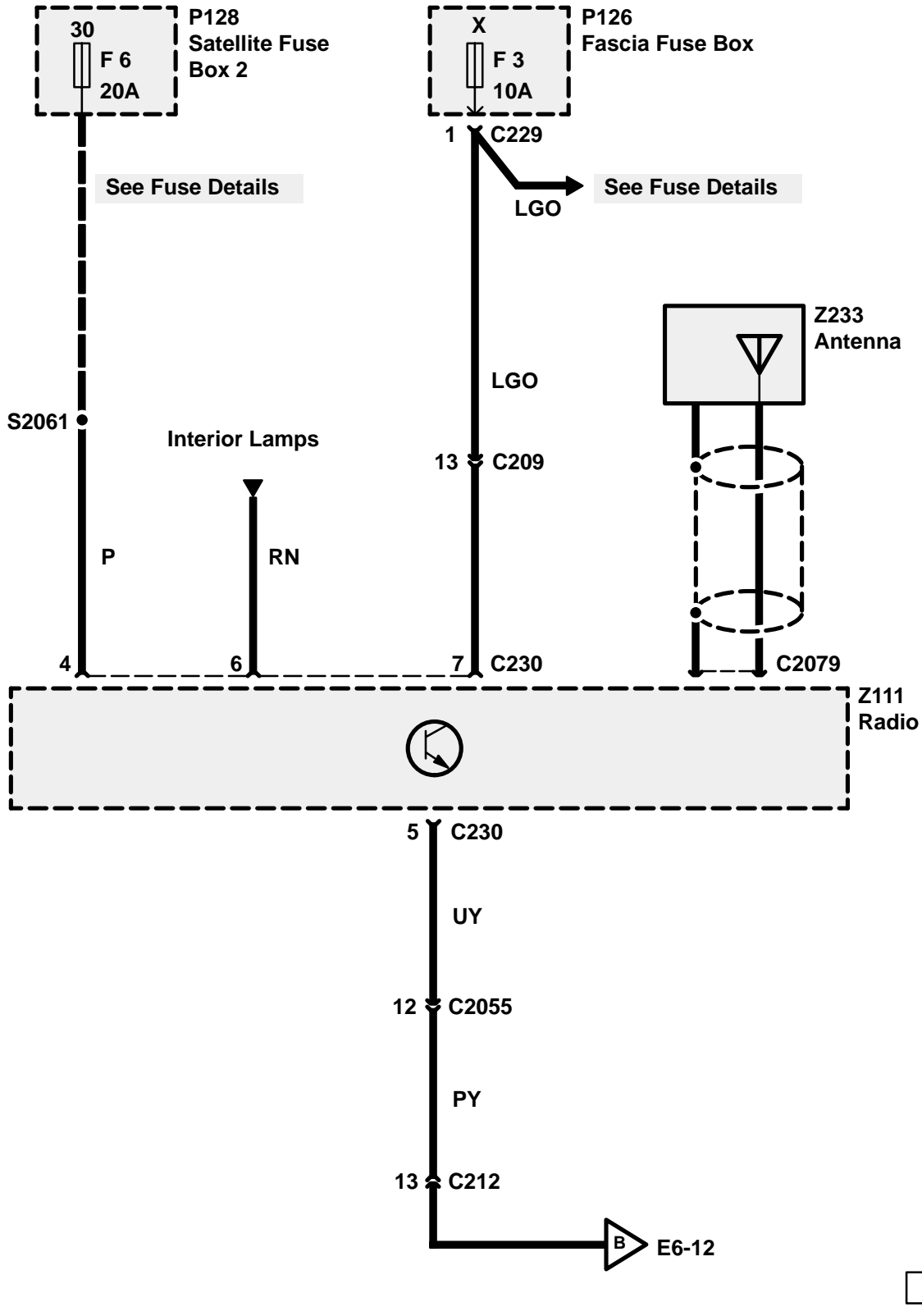

← Except NAS  
High Line Radio

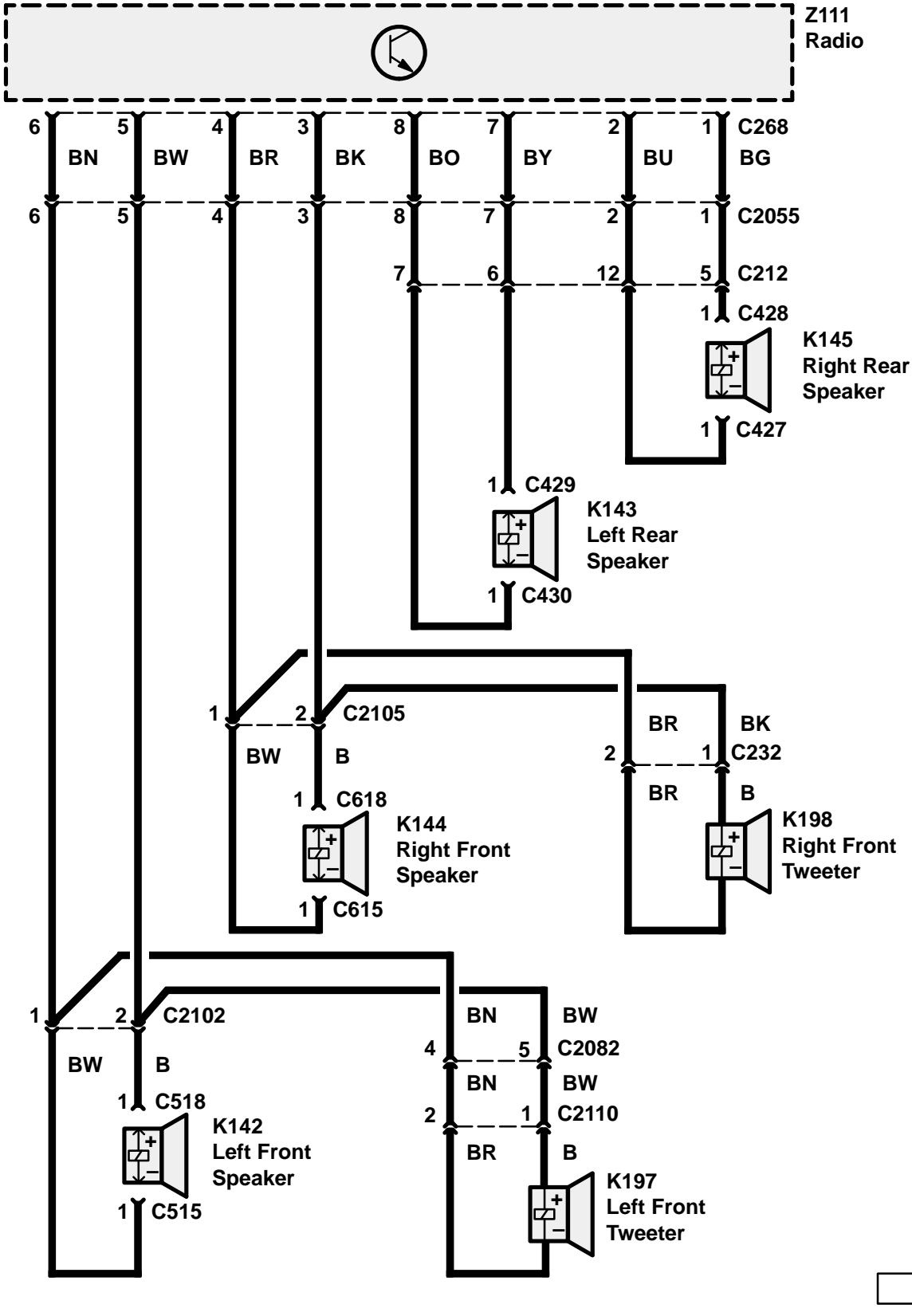

← Except NAS  
High Line Radio

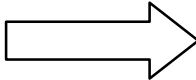
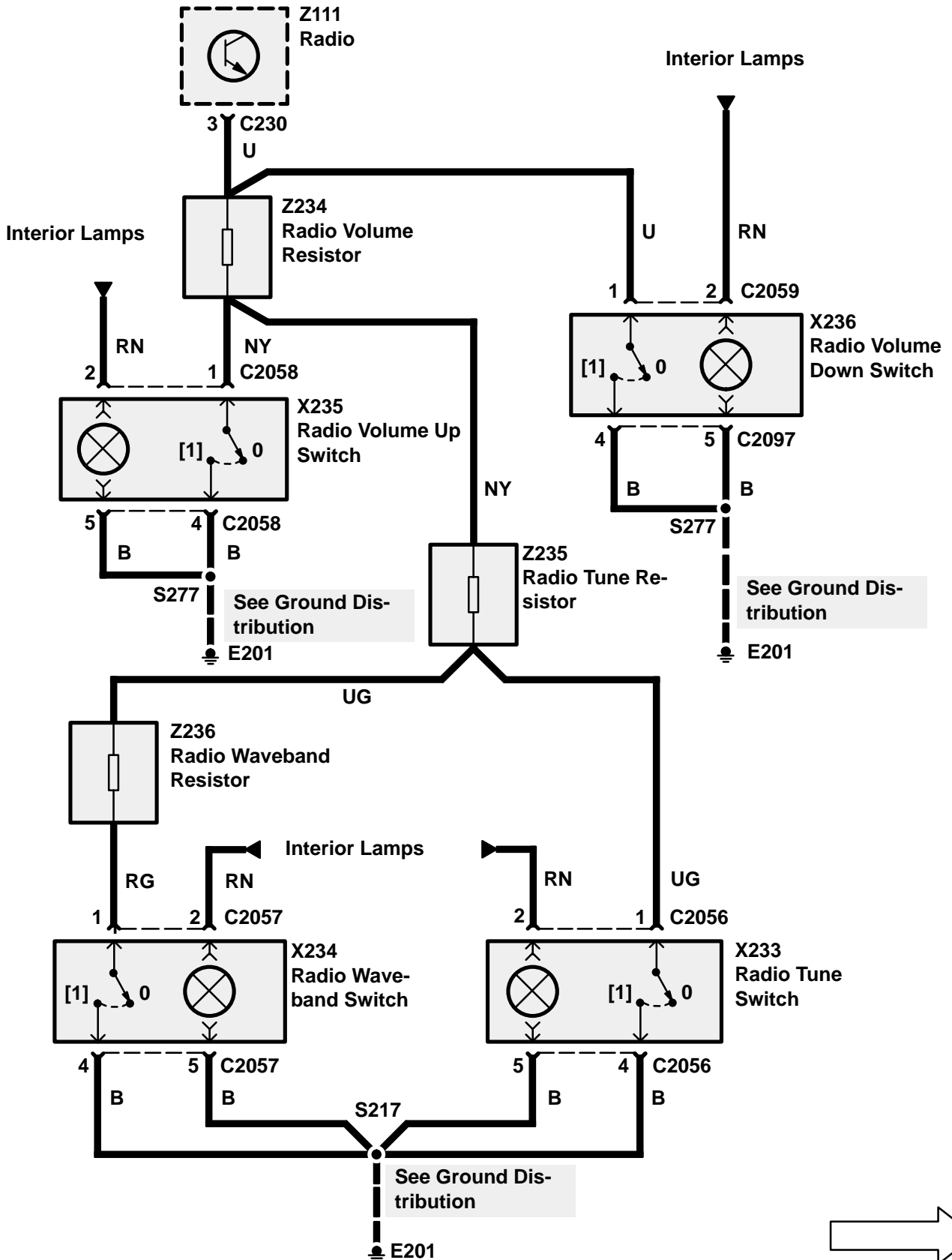



---

## CIRCUIT OPERATION

The audio system consists of a new head unit connected to a Radio Tune Switch, a waveband switch, a volume up and a volume down switch which are located on the fascia next to the Instrument Cluster. The system is also equipped with an amplifier, a subwoofer, a subwoofer amplifier and a CD changer which is connected to the Radio with a DIN cable. The amplifier is connected to power via a Power Amplifier Relay which is energised with ignition on.

The control head is equipped with an anti-theft feature which makes the unit inoperative once battery power is removed. A security code must be entered to restore power to the unit. The system is equipped with two rear and four front speakers.

Battery voltage is provided to the control head at all times through the P wire. In addition to monitoring the anti-theft feature, this input keeps the preset station memory alive. Whenever battery power to the unit is lost, the anti-theft code must be entered and the preset stations reprogrammed.

When the Radio (Z111) and the ignition are turned on, the voltage signal through the LGO wire and the control head 'wakes up' the unit. The Radio (Z111) plays, the VF display comes on, and the control unit buttons illuminate. The VF display is dimmed when the headlights or park lights are turned on. When the lights are on, voltage from fuse F8 of the Fascia Fusebox (P126) is applied to the Radio (Z111) terminal 6, Connector 230 signalling the Radio (Z111) to dim the display.

NAS

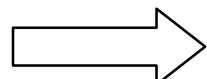
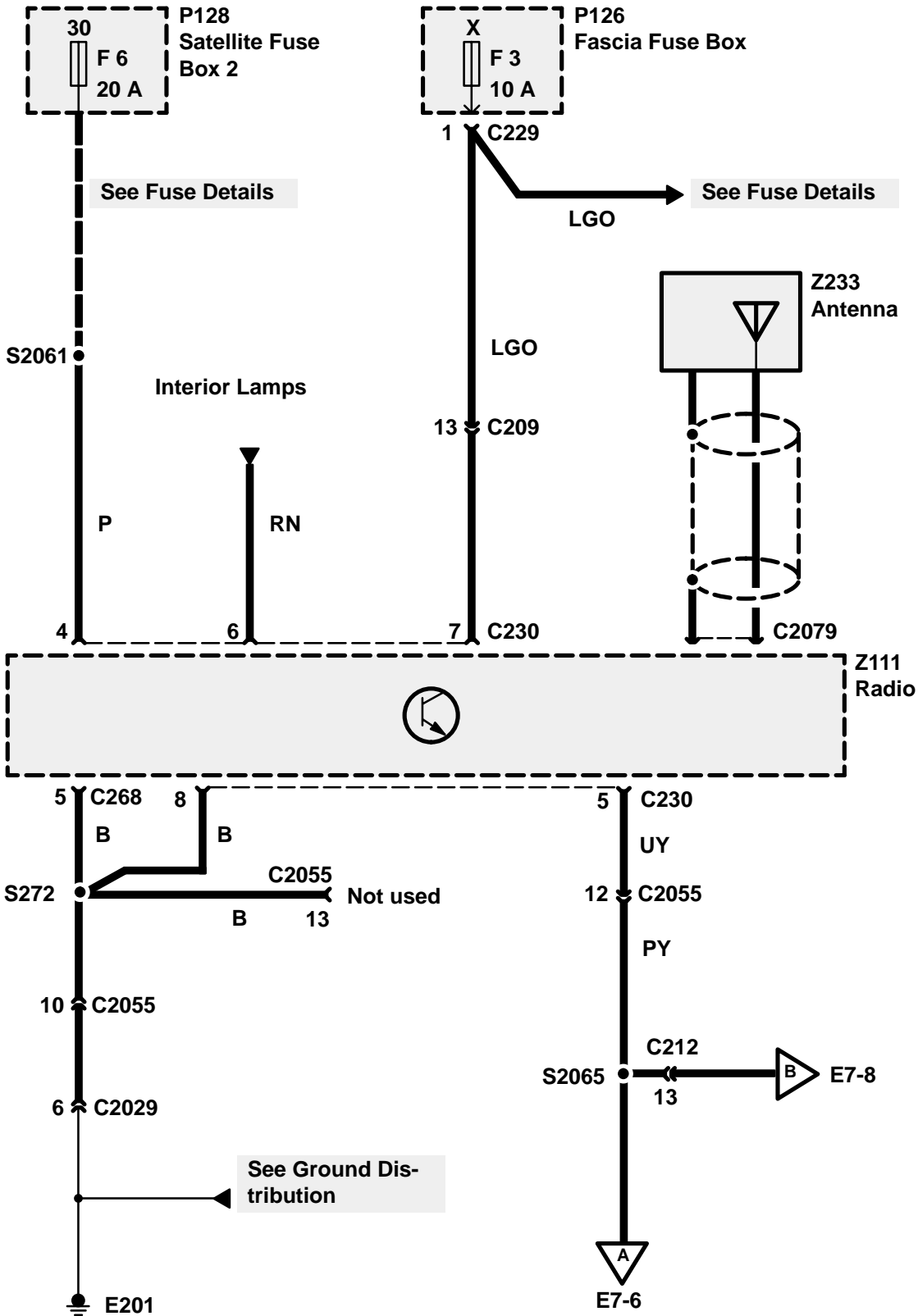

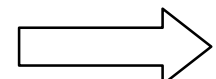
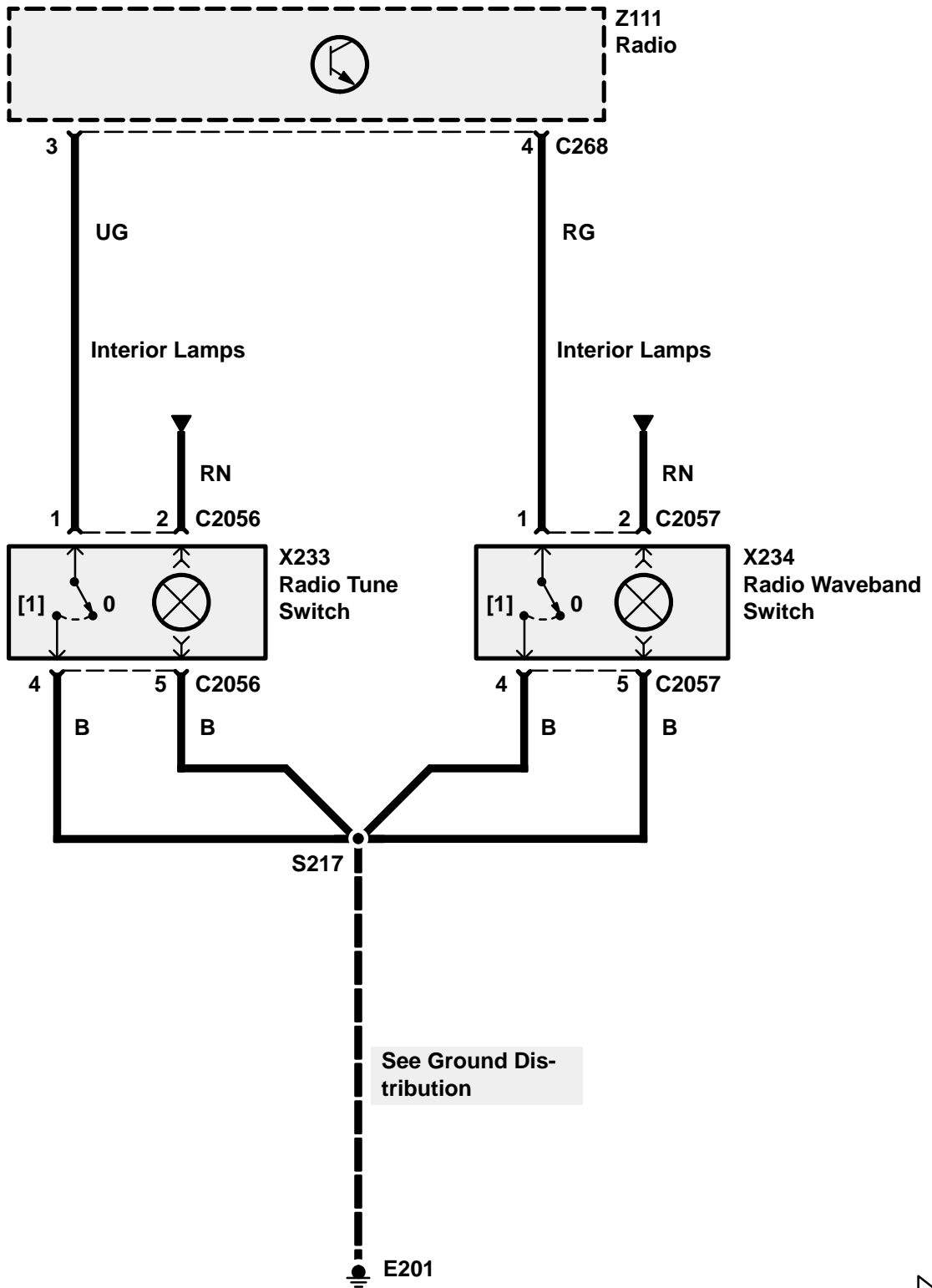
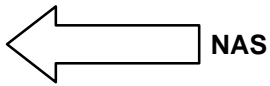



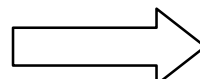
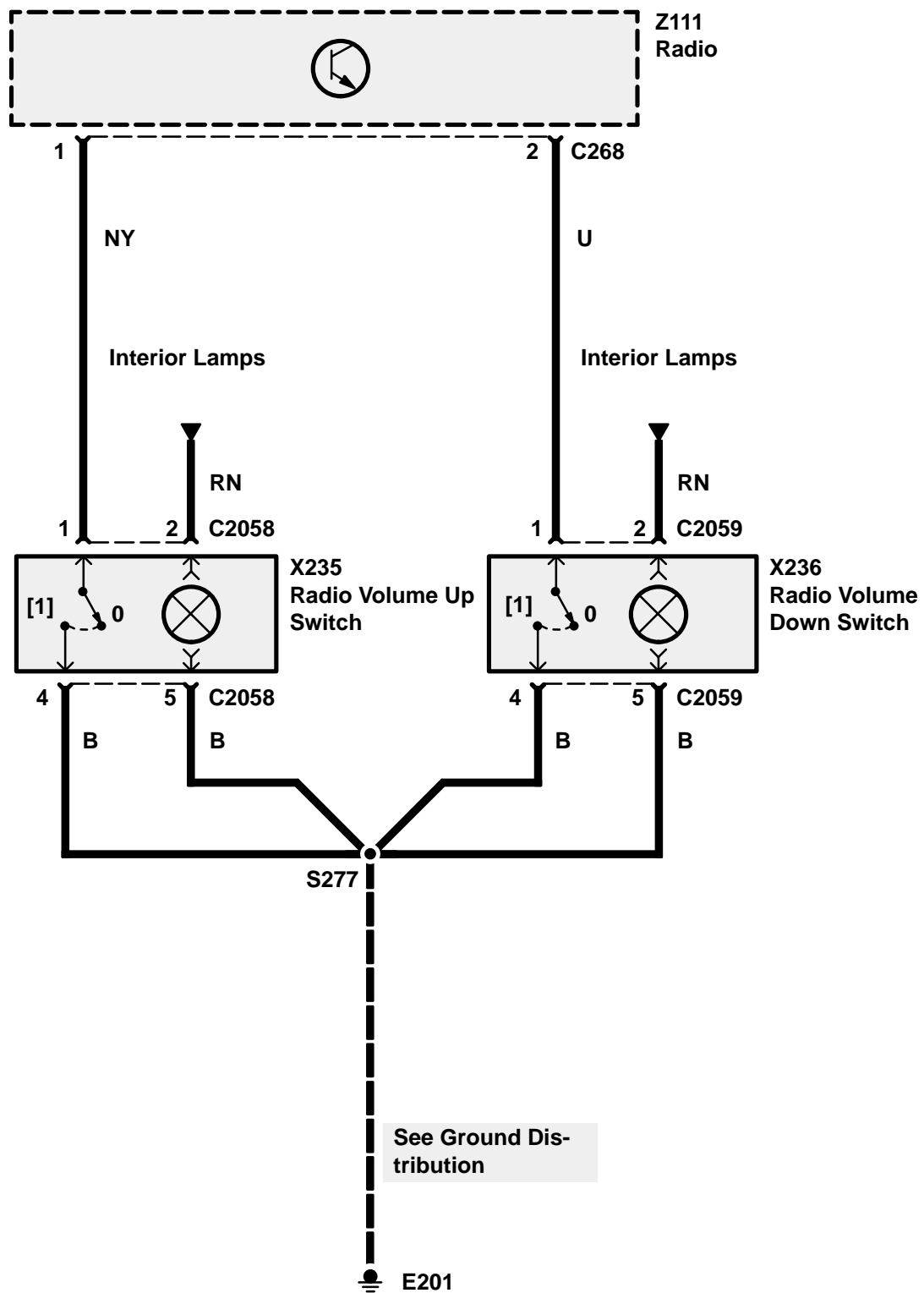
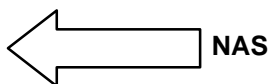

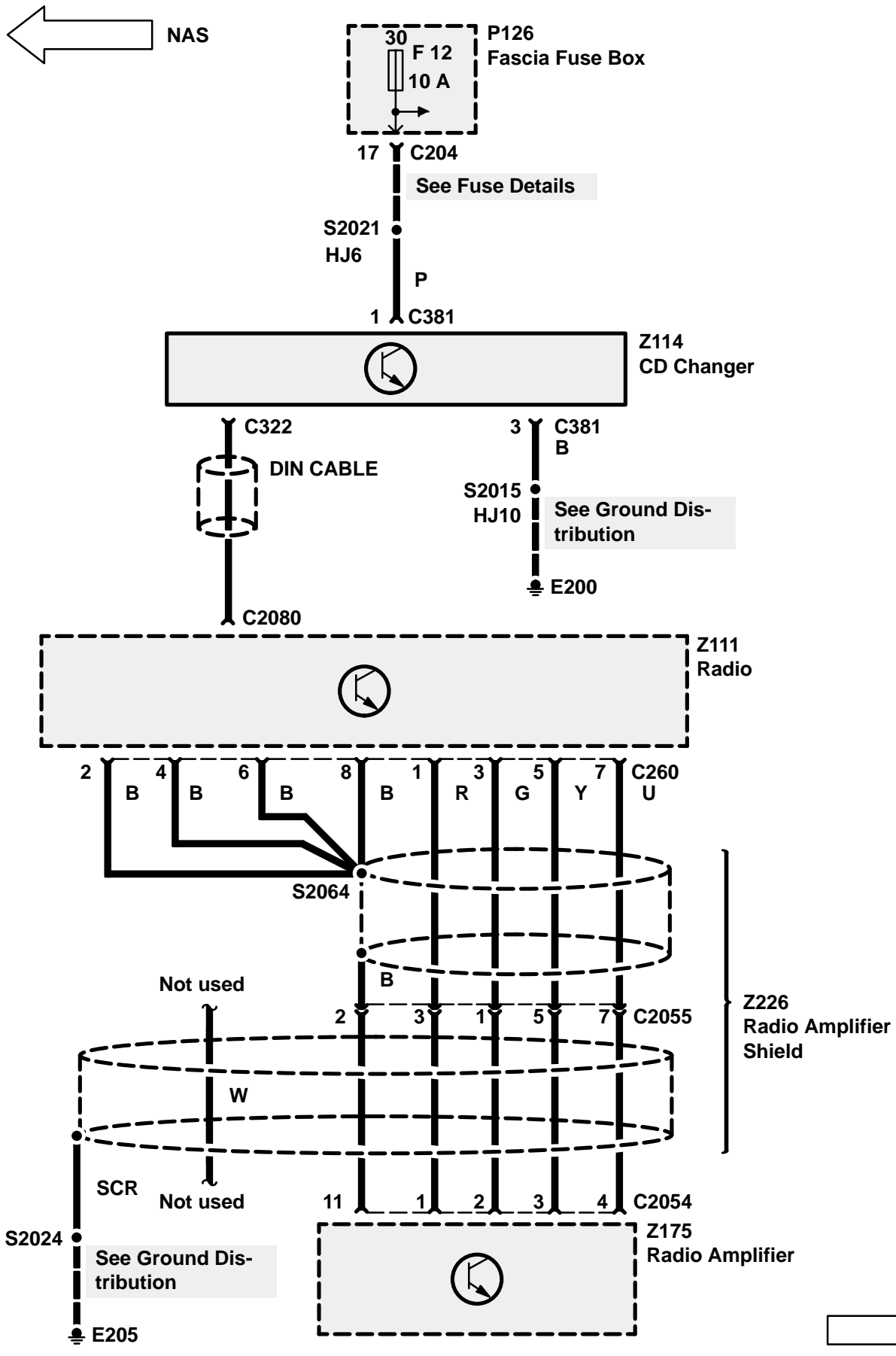

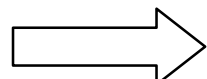
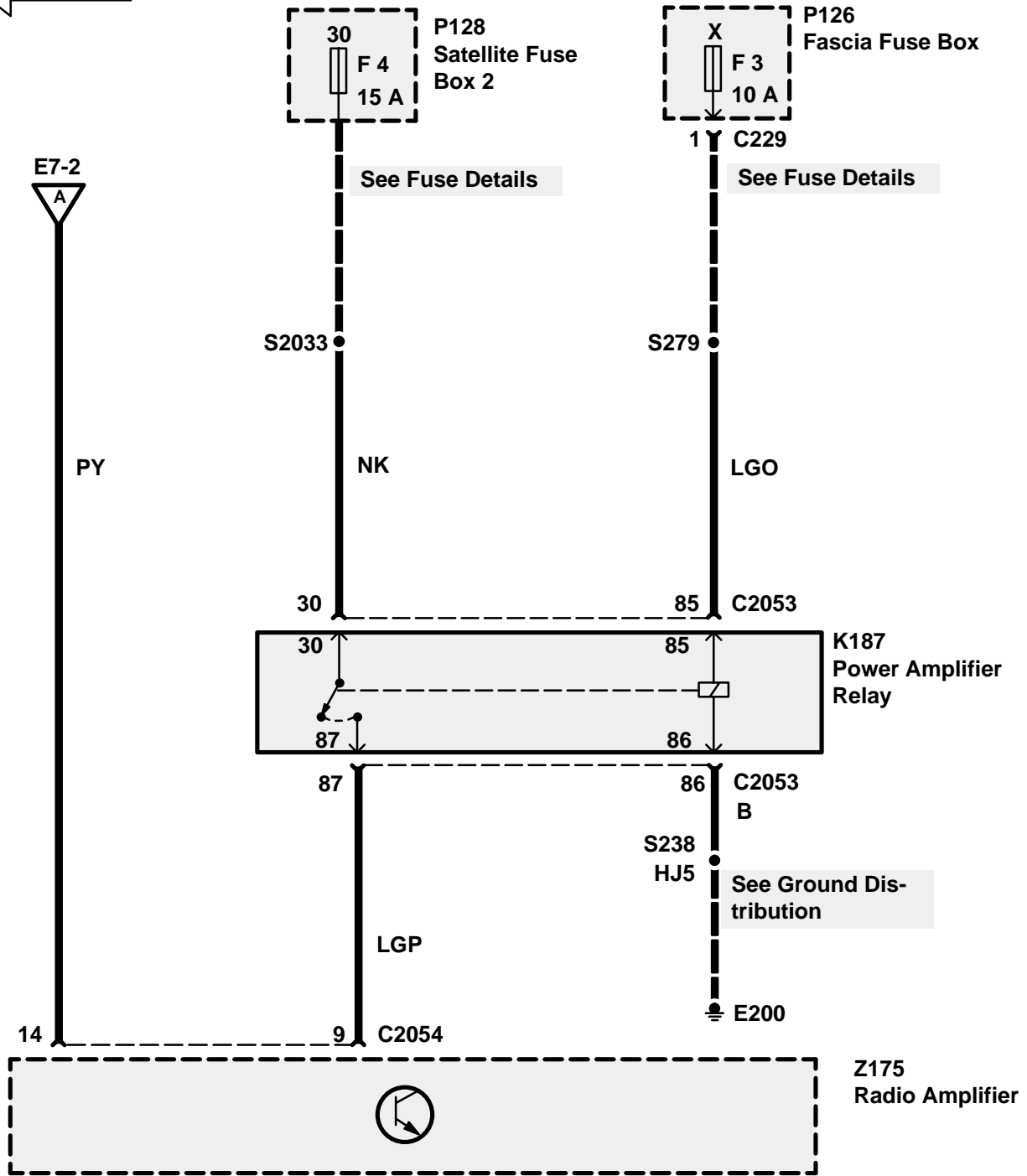
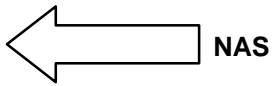

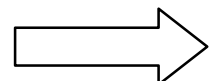
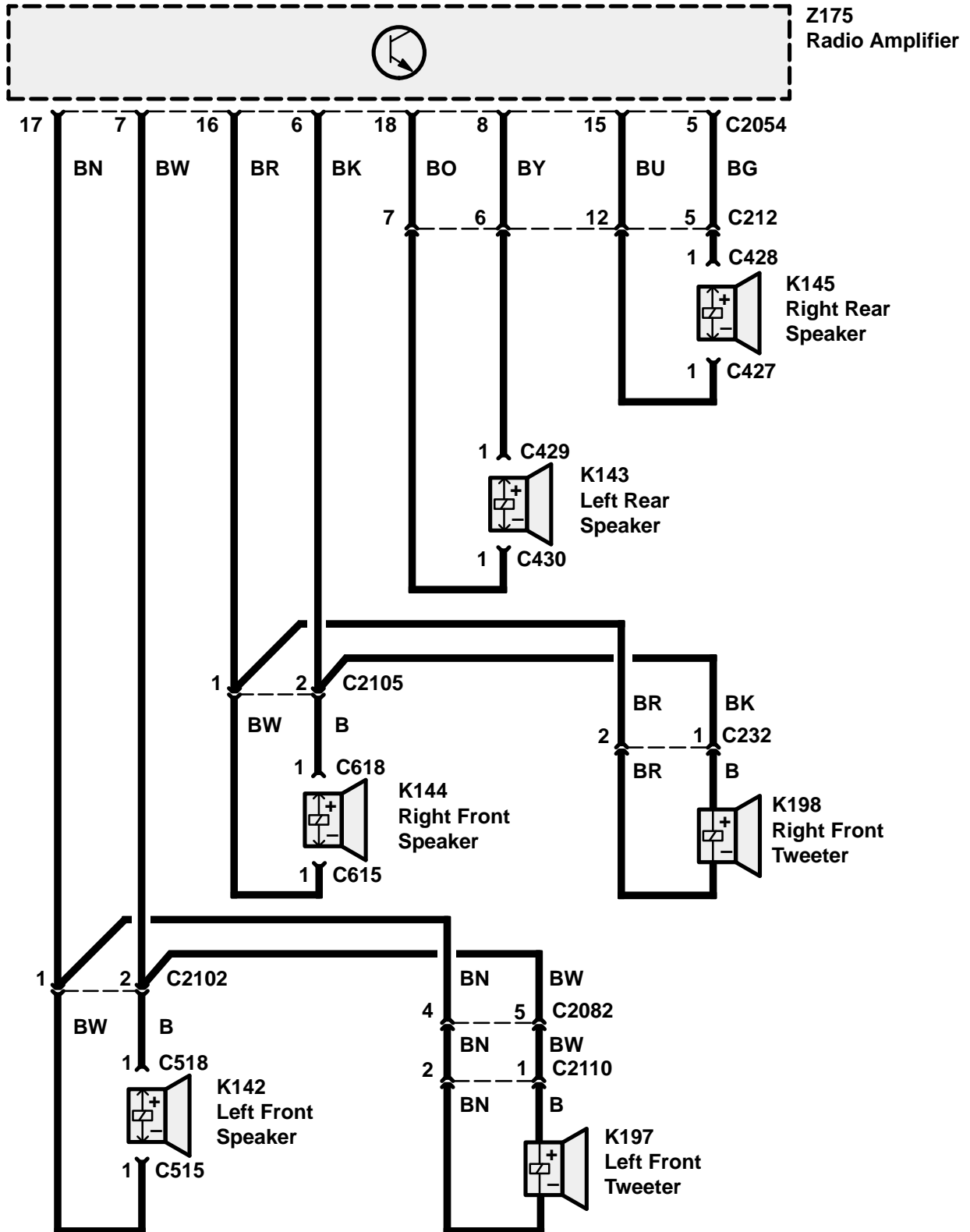
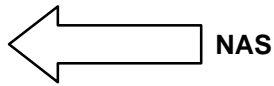

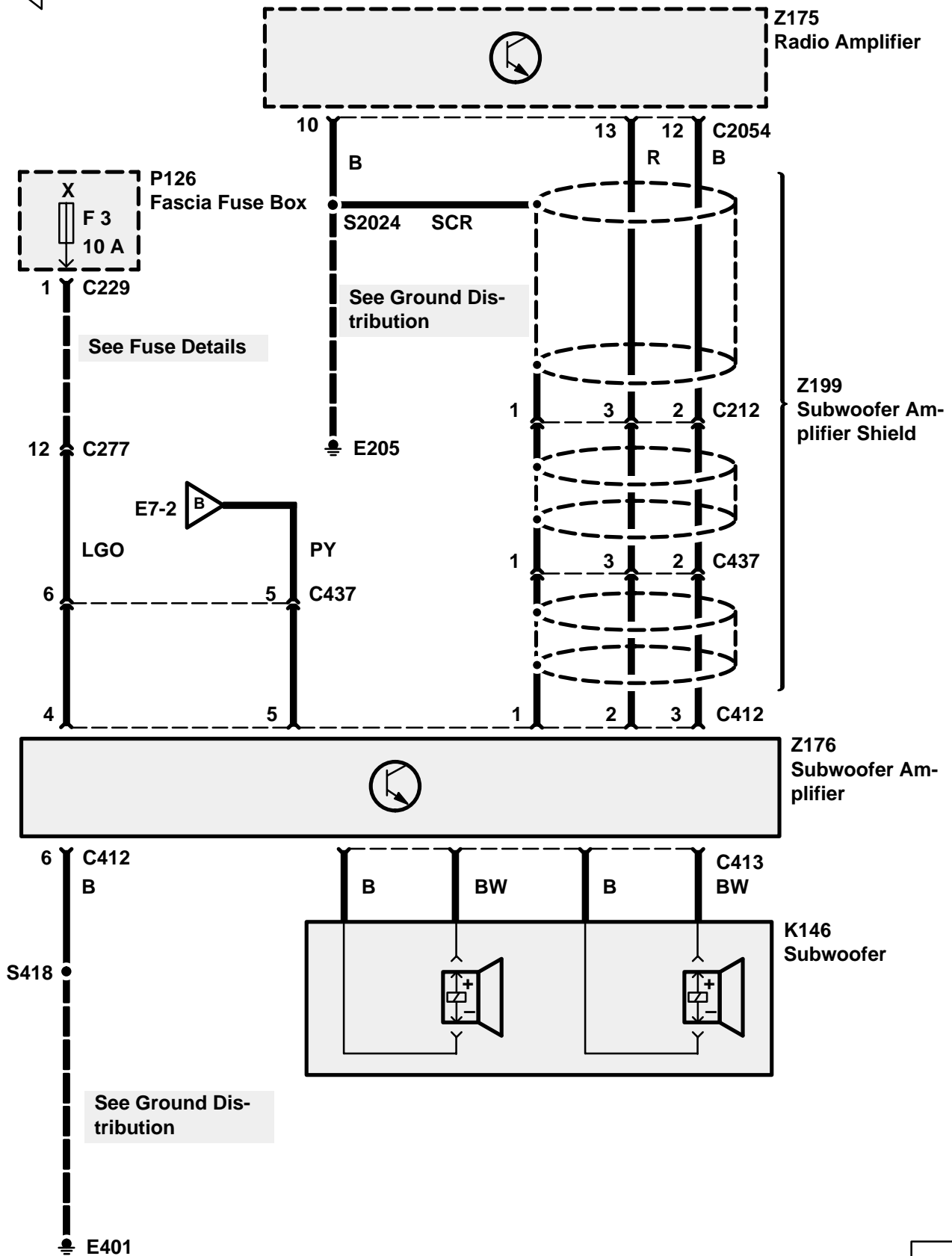
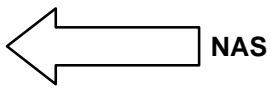

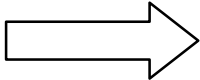
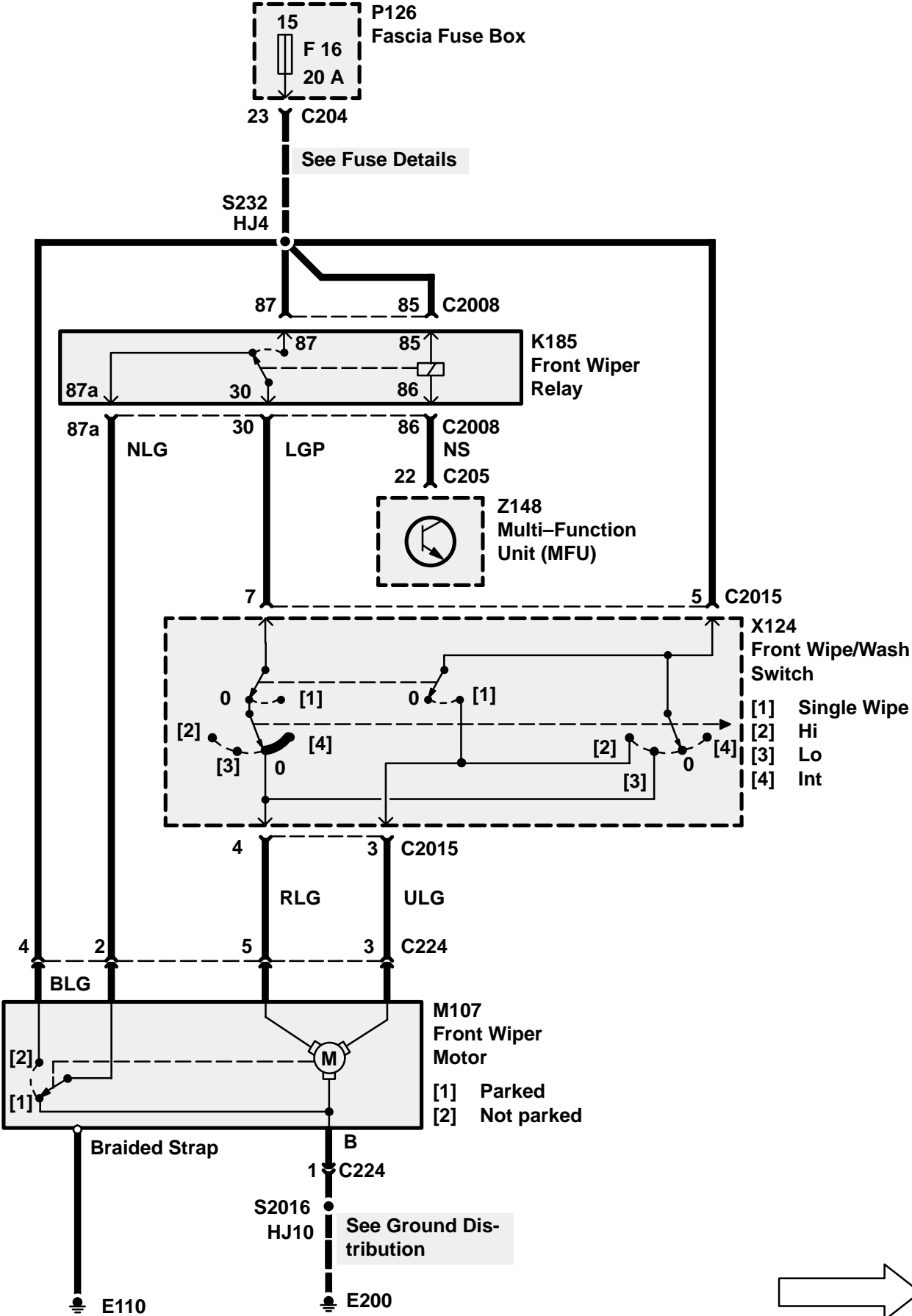

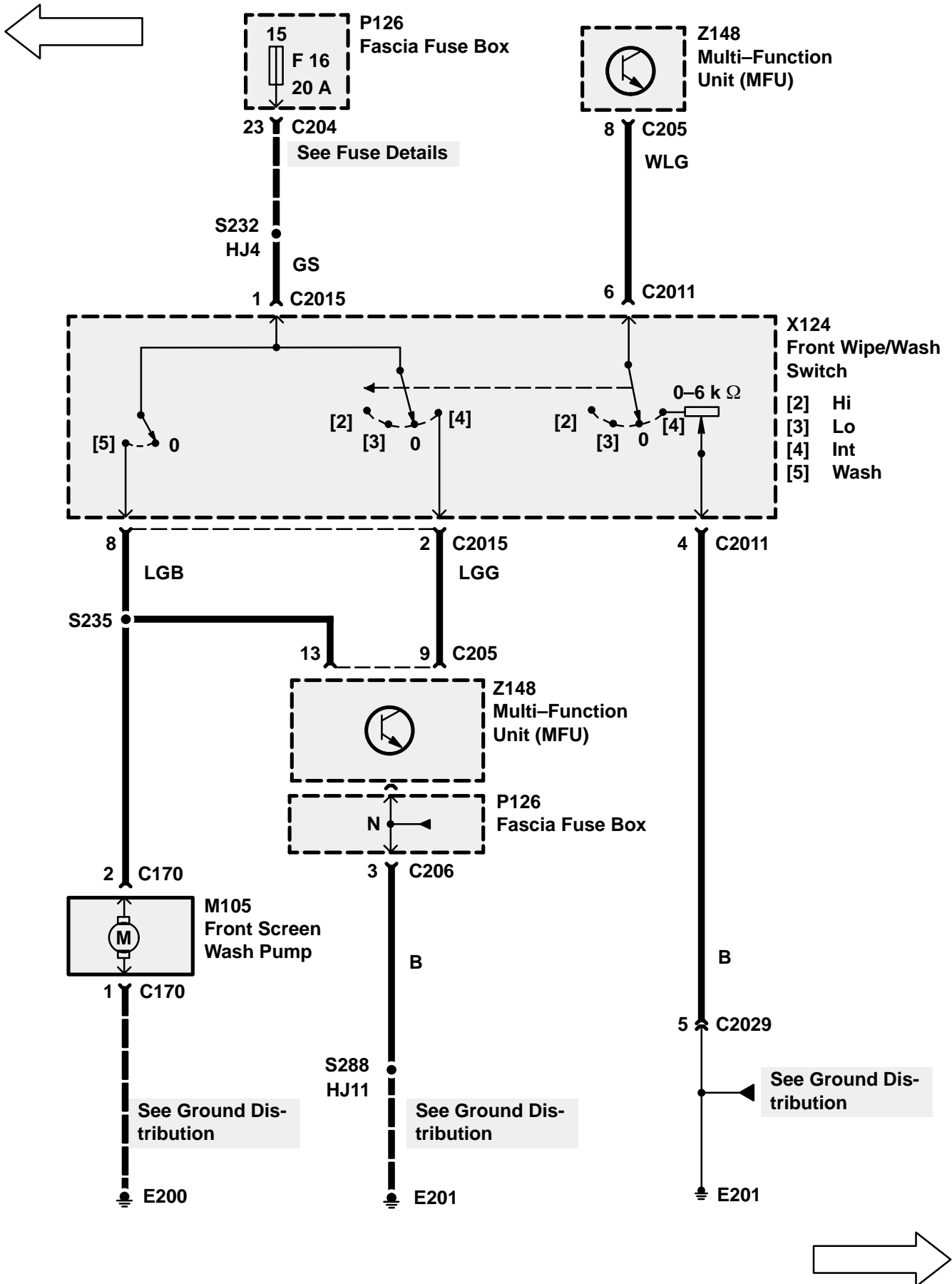

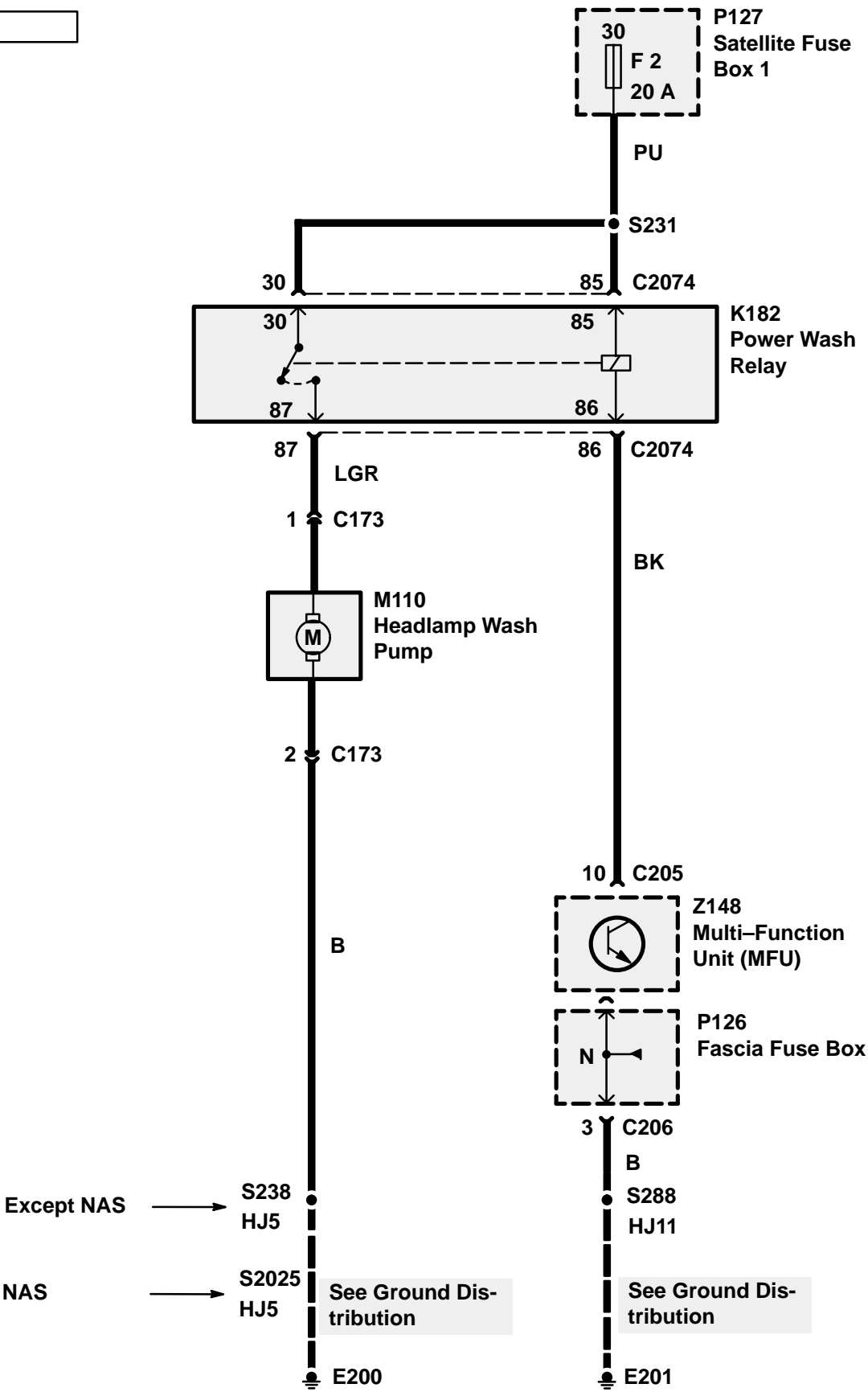
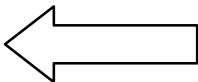



---

**CIRCUIT OPERATION****Washer**

The Rear Screen Wash Pump (M119) motor is grounded at all times. The motor runs when battery voltage is applied to the motor through the Rear Screen Wash Switch (X222) when the switch is switched to the WASH position.

**Wiper**

When the Rear Wipe Switch (X221) is pulled to the WIPE position, the Multifunction Unit (MFU) (Z148) applies ground to the Rear Wipe Relay (K183). Battery voltage is then applied to the Rear Wiper Motor (M120) from Fuse F18.

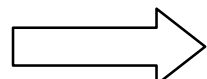
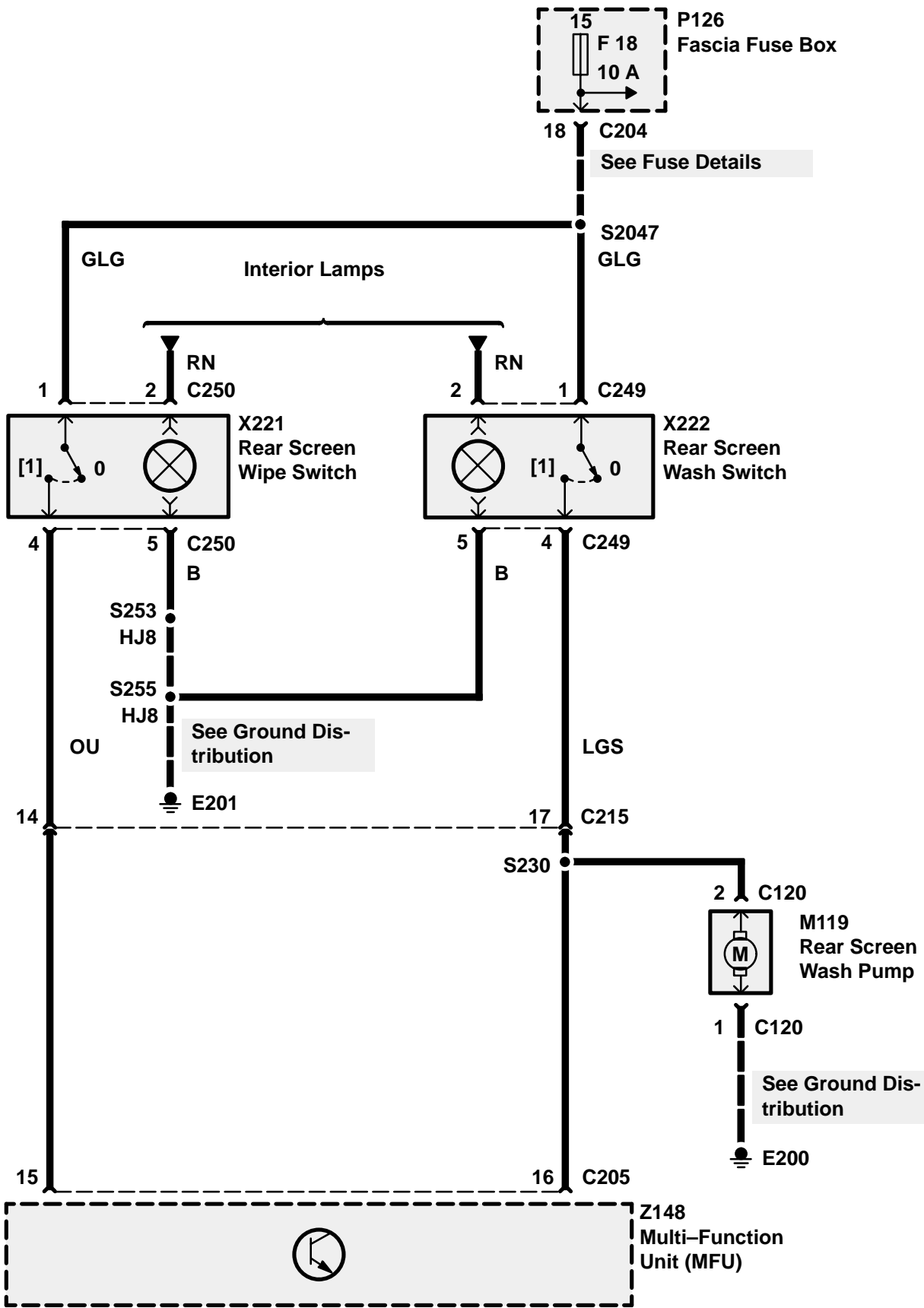

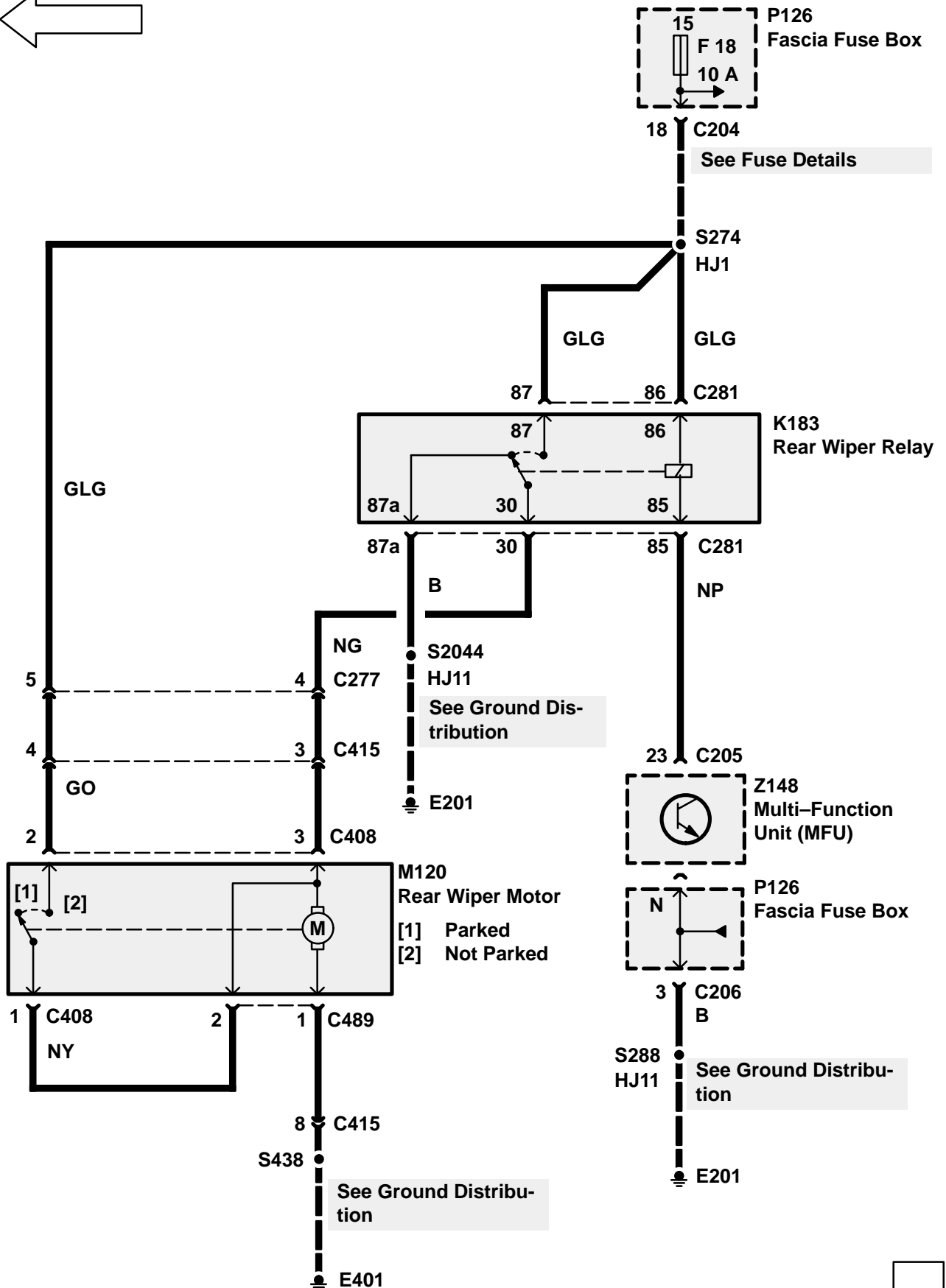
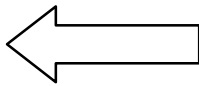

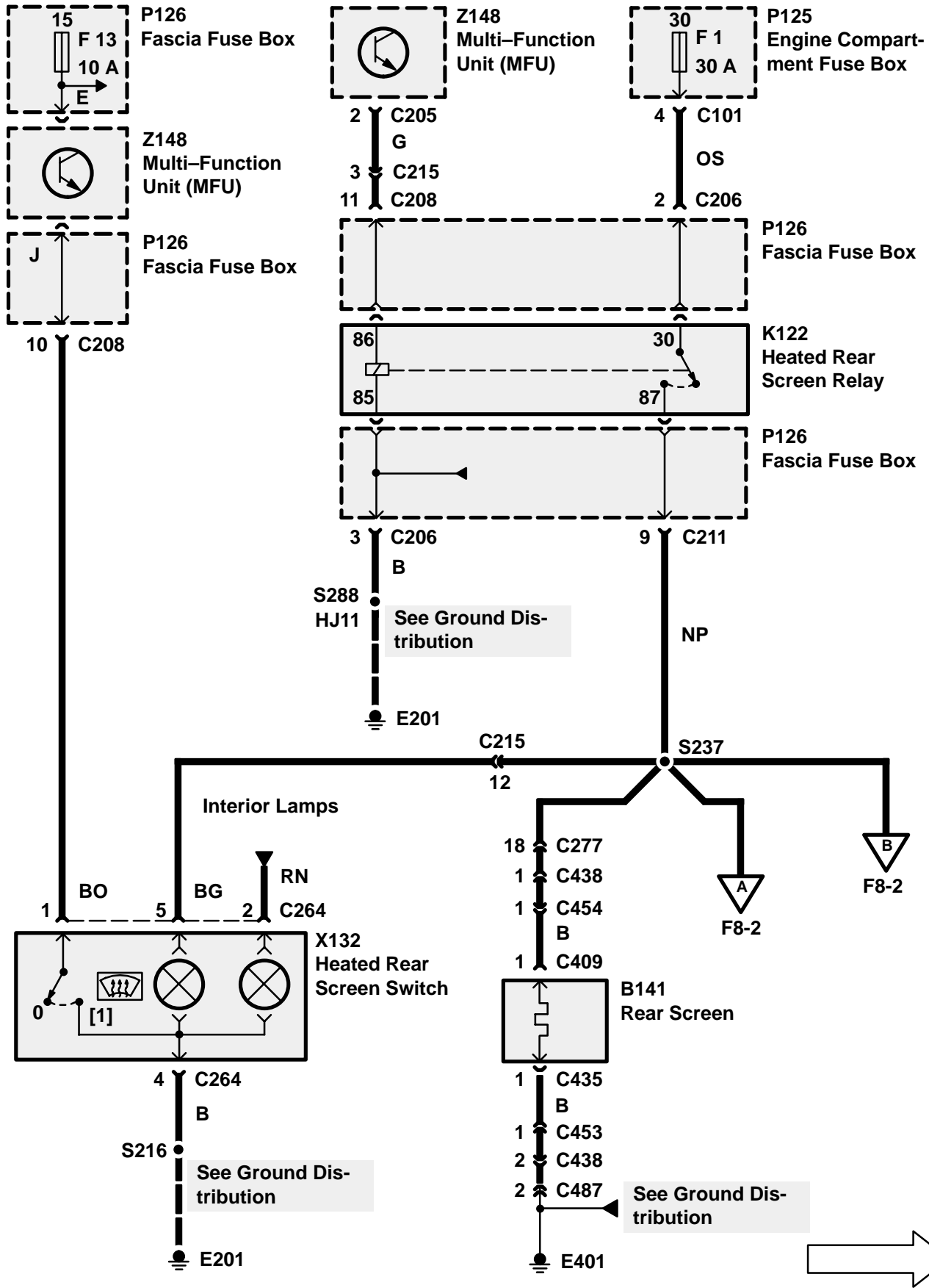

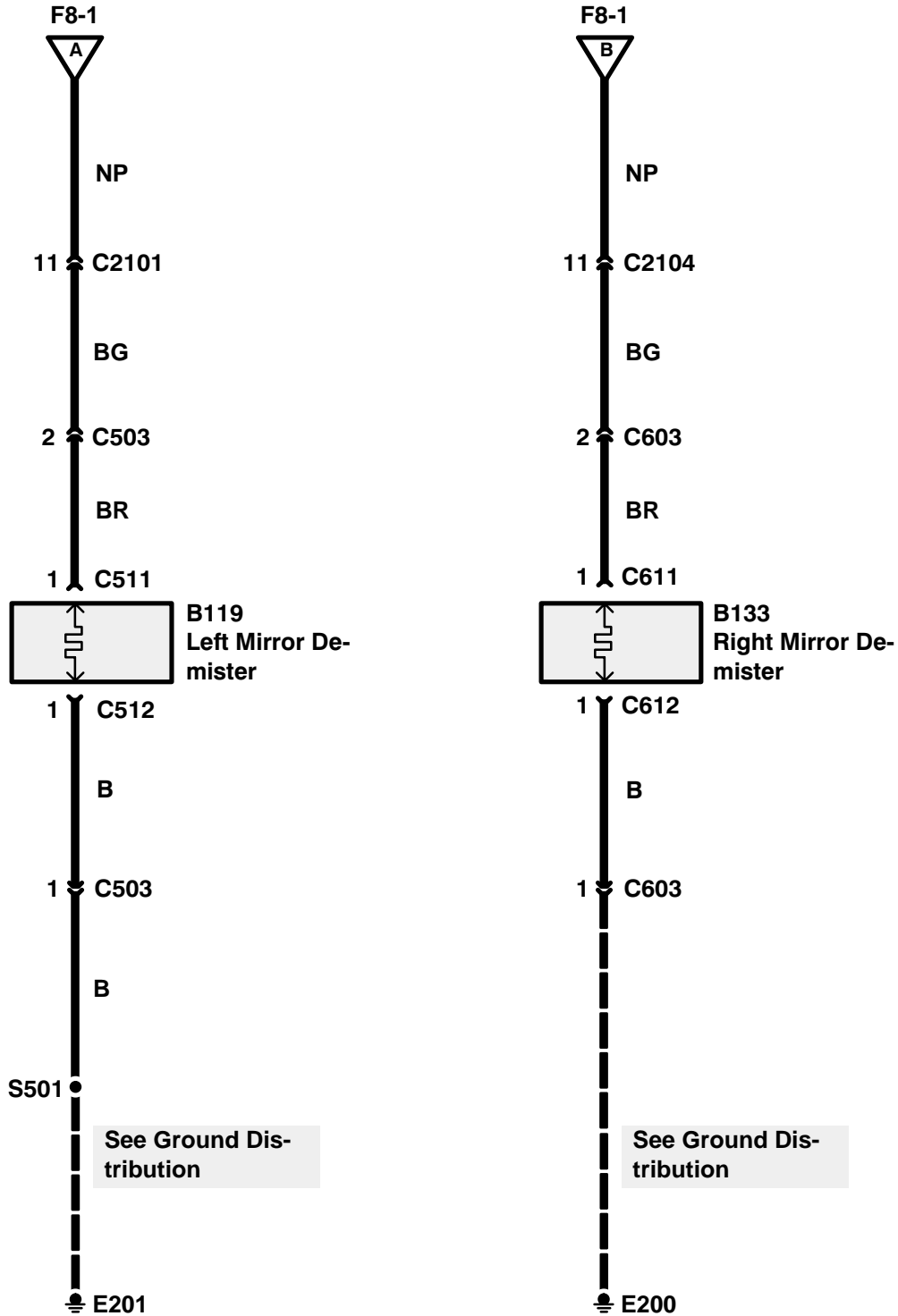
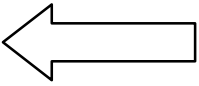

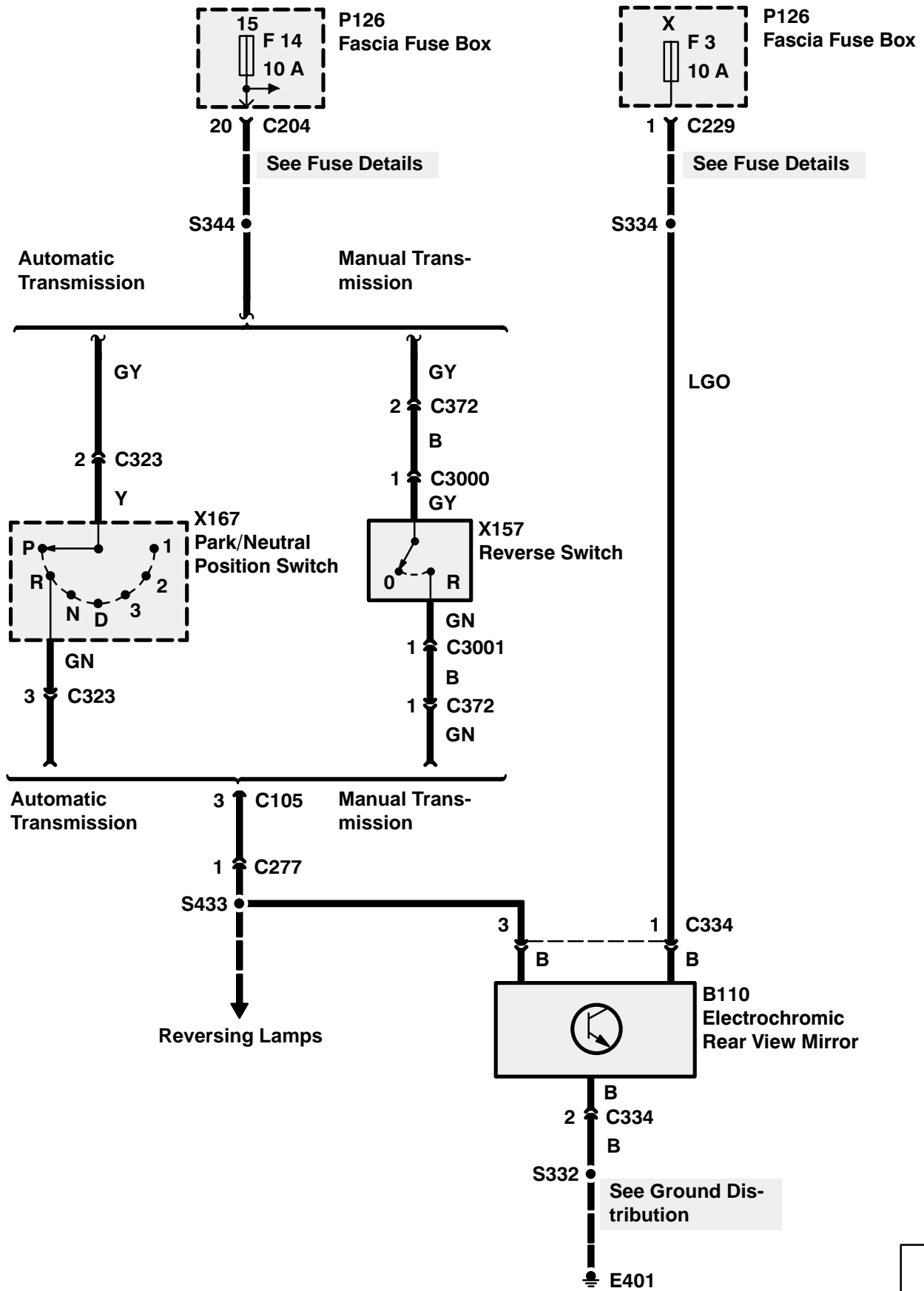

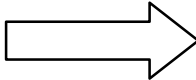
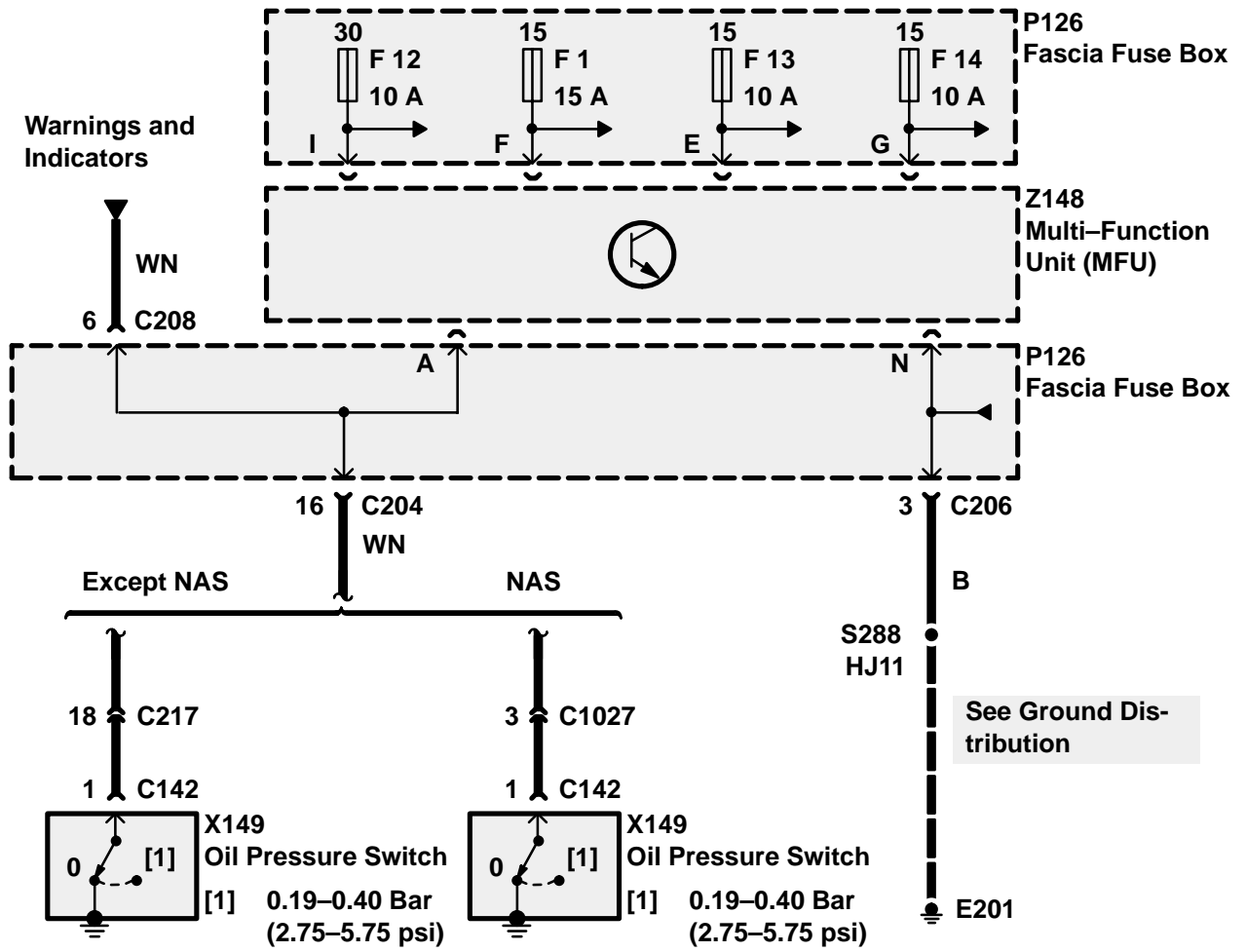





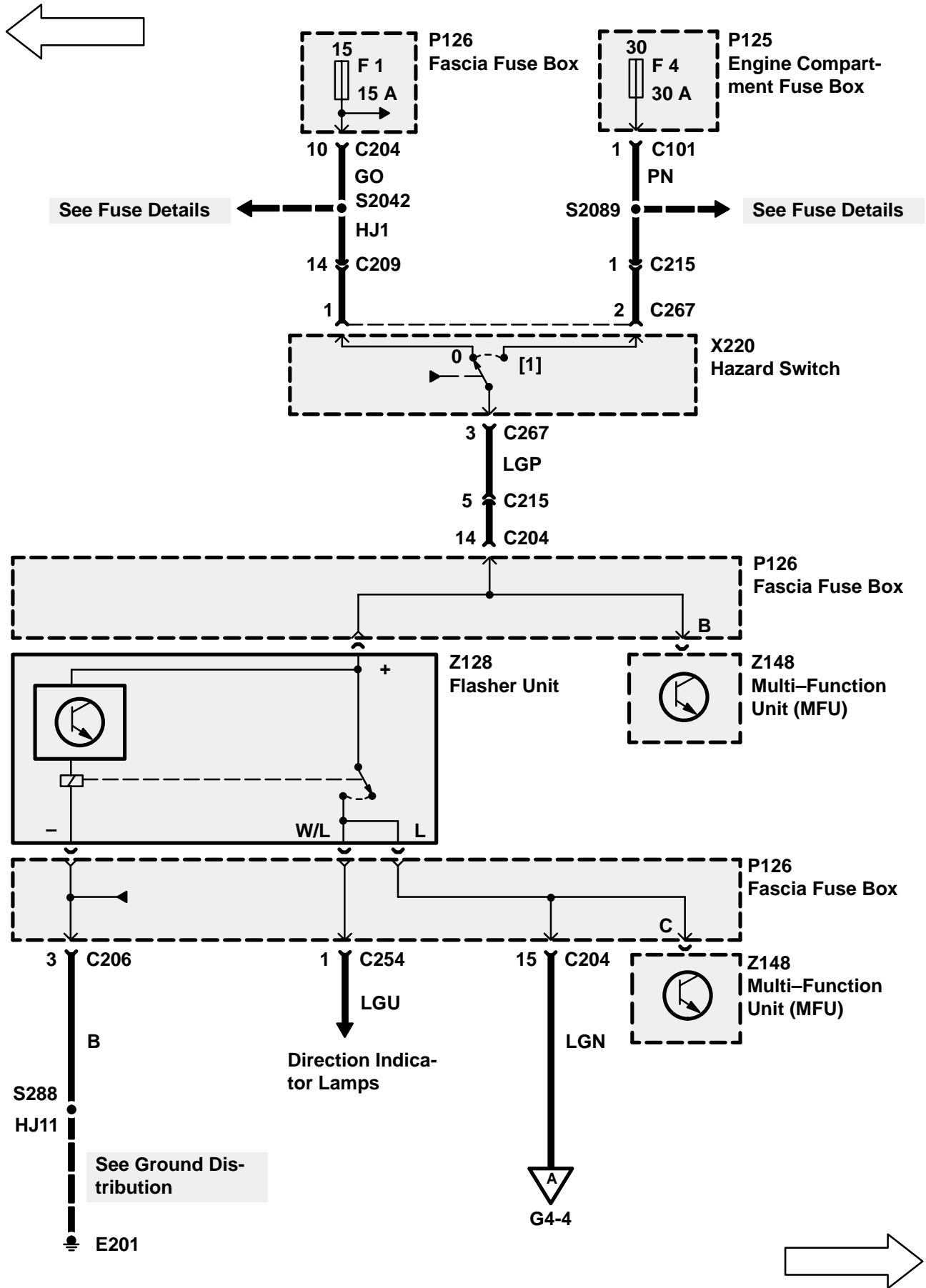



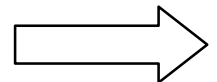
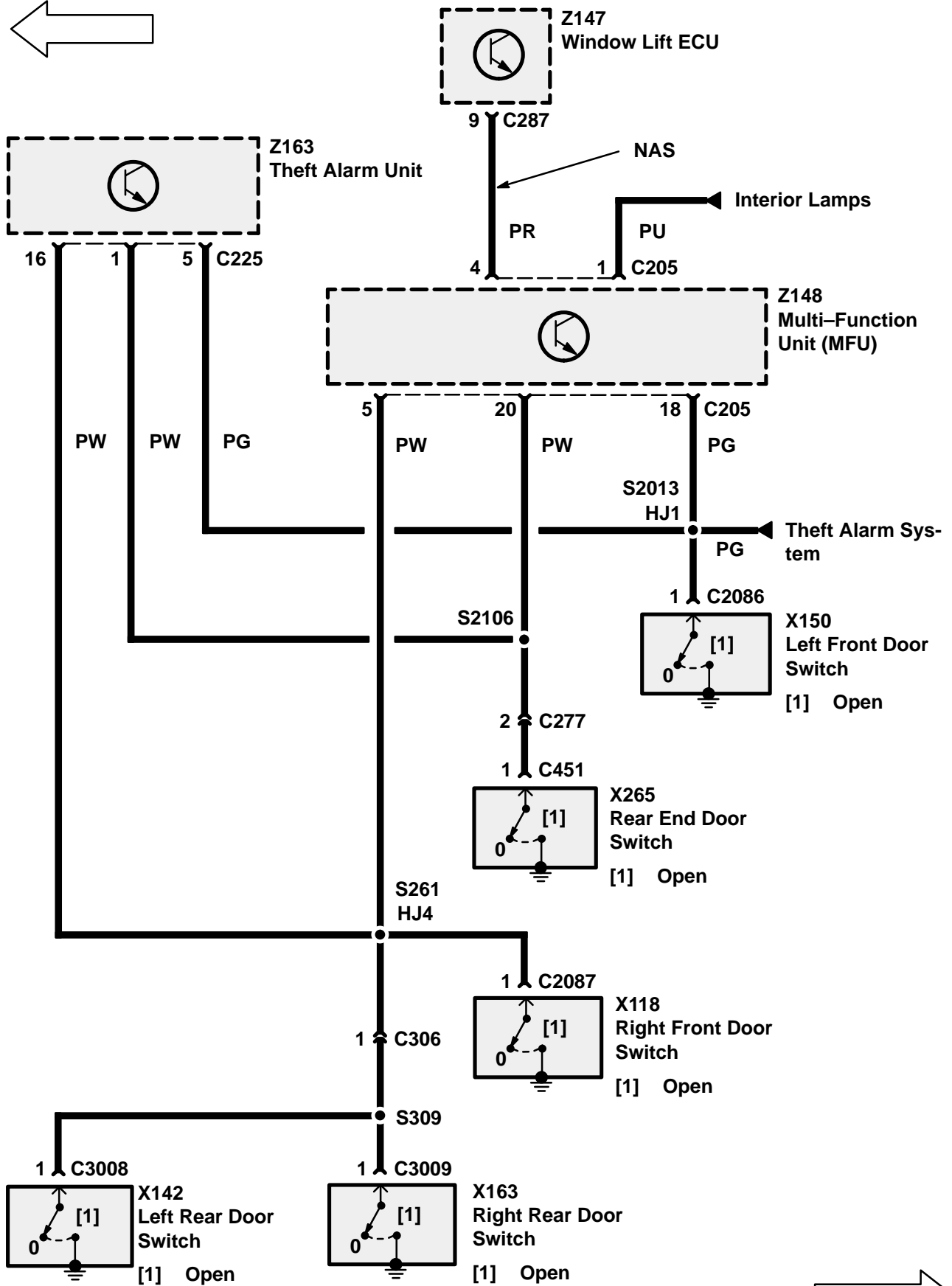
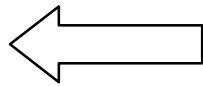

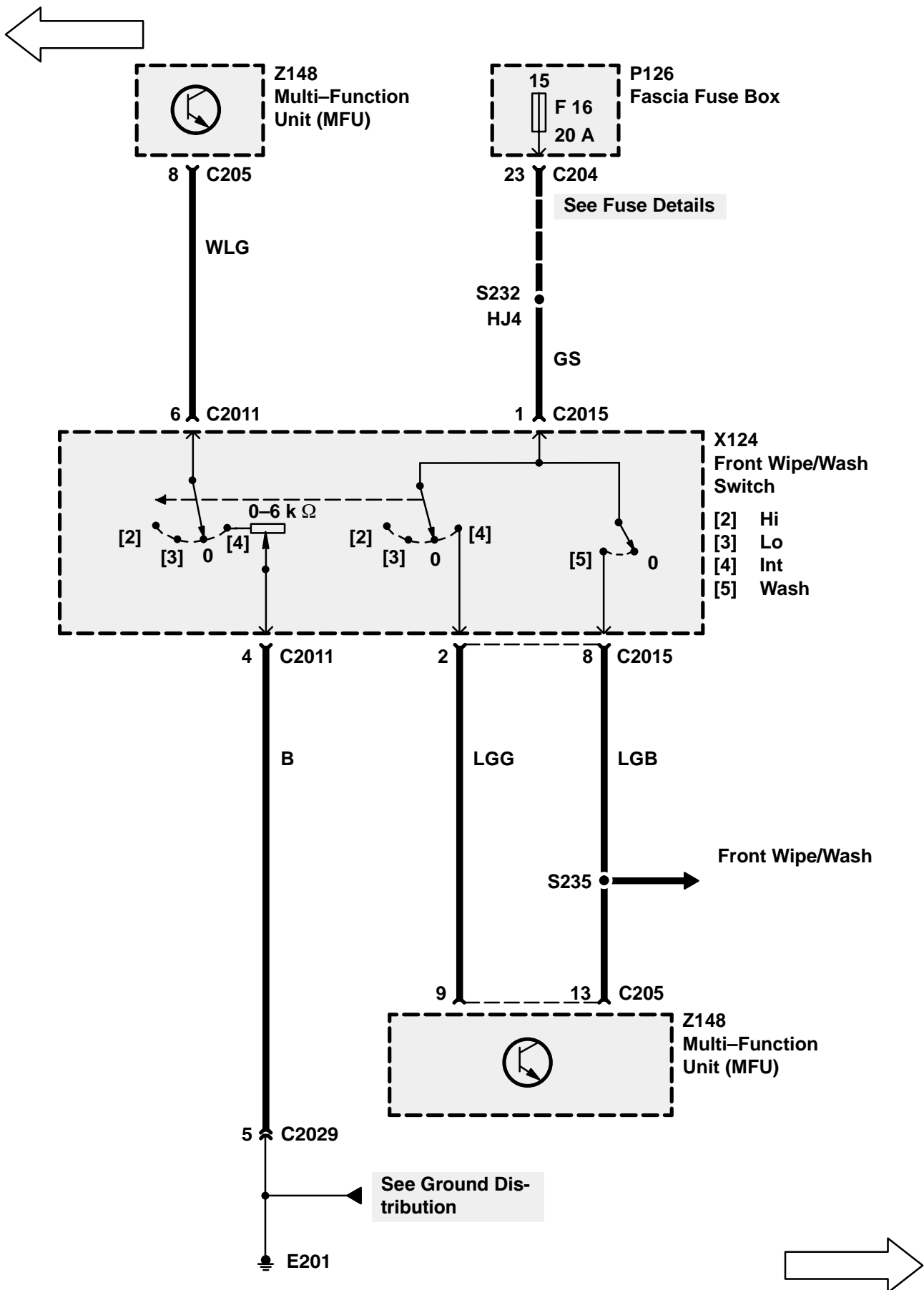

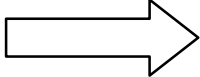
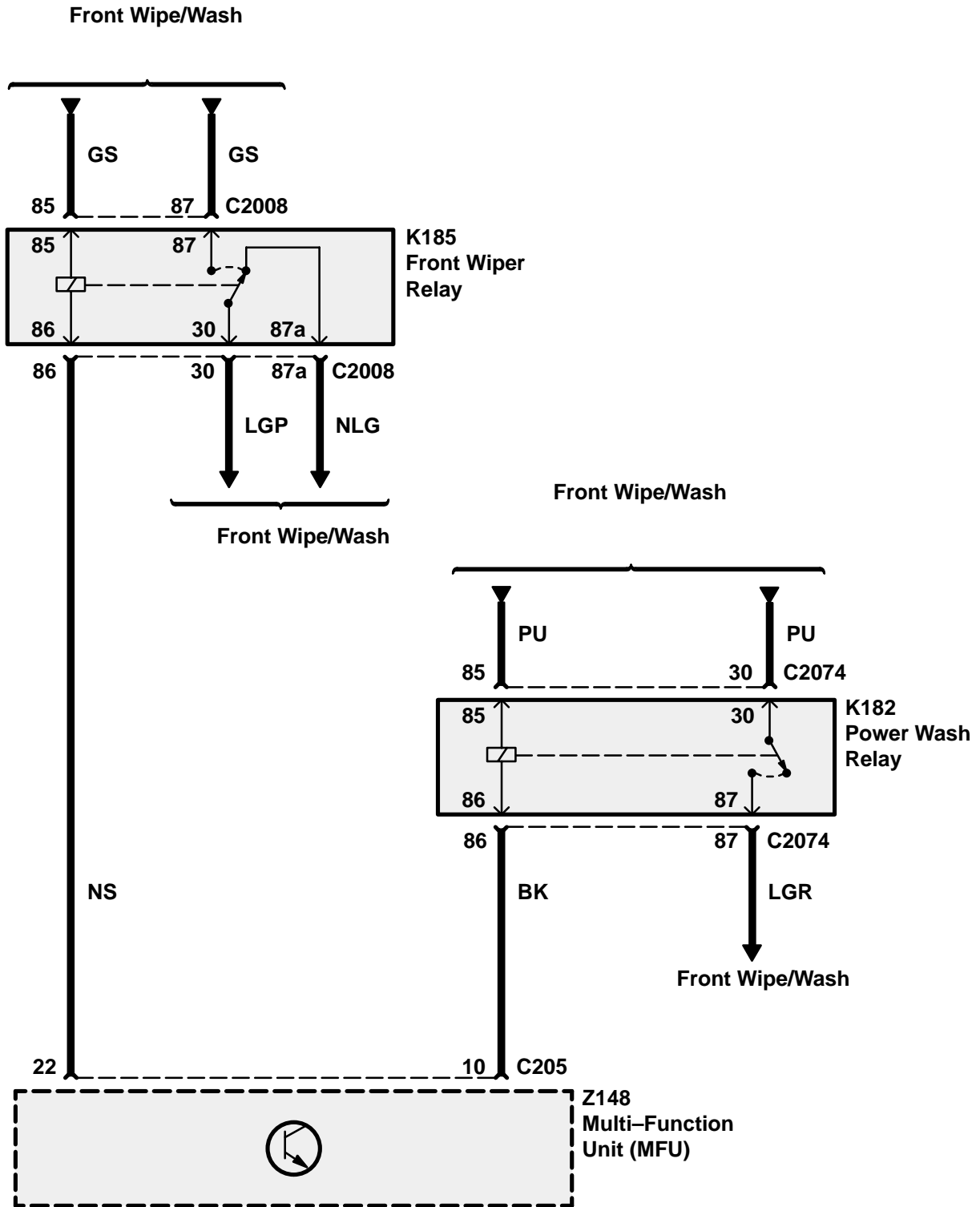
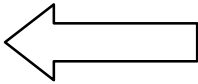

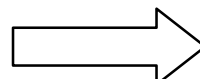
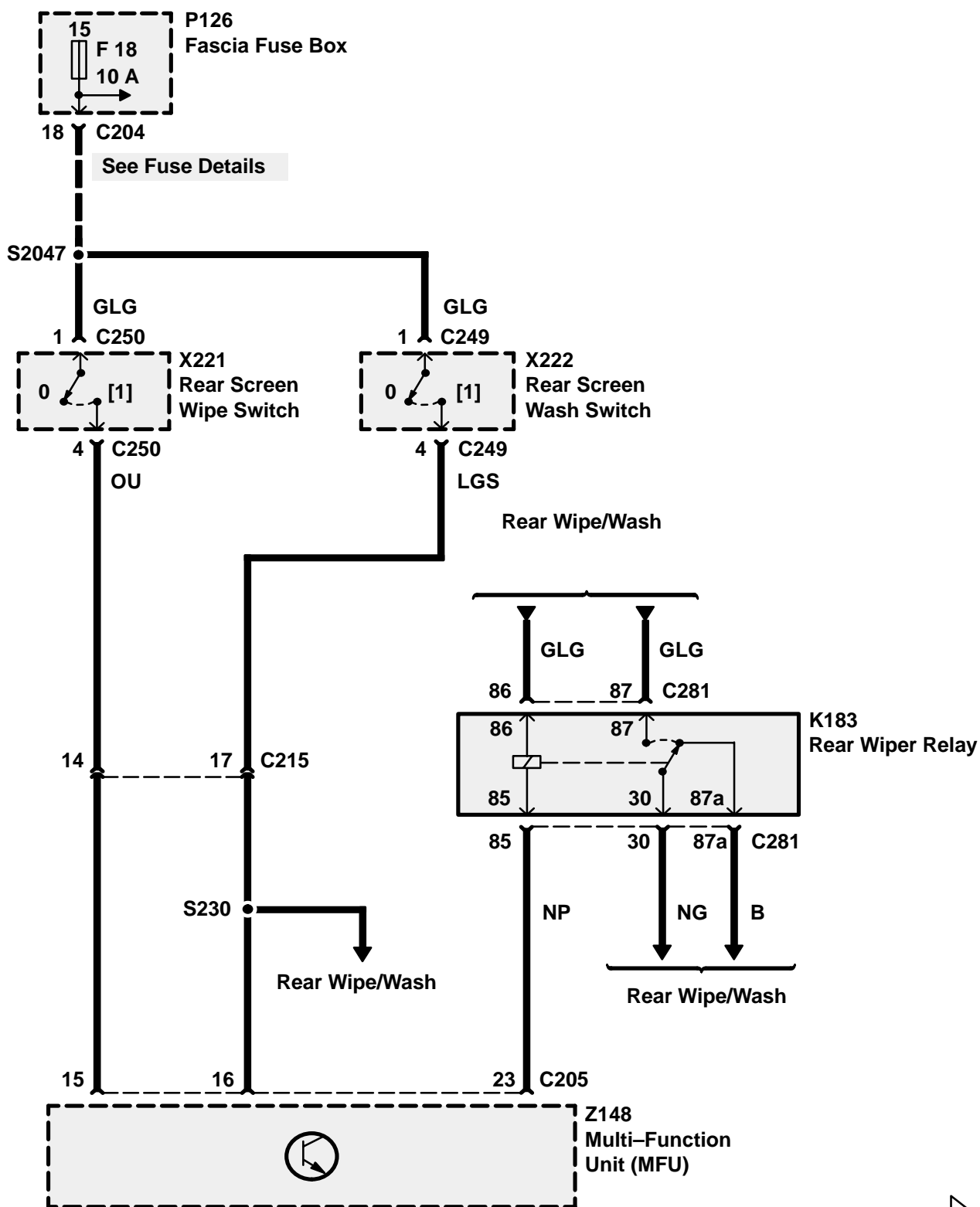
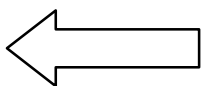



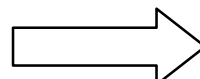
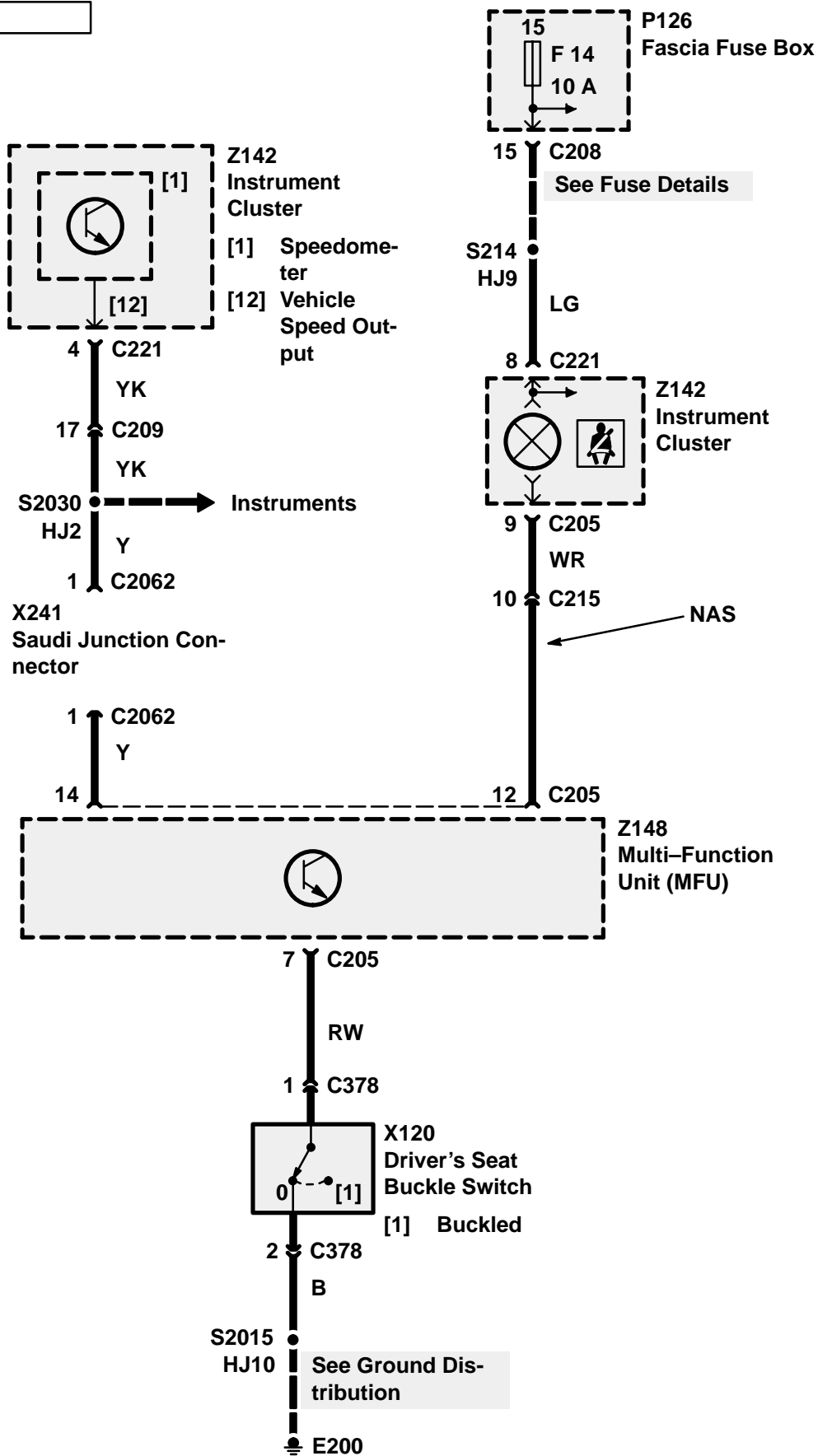
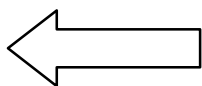



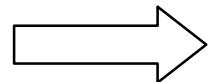
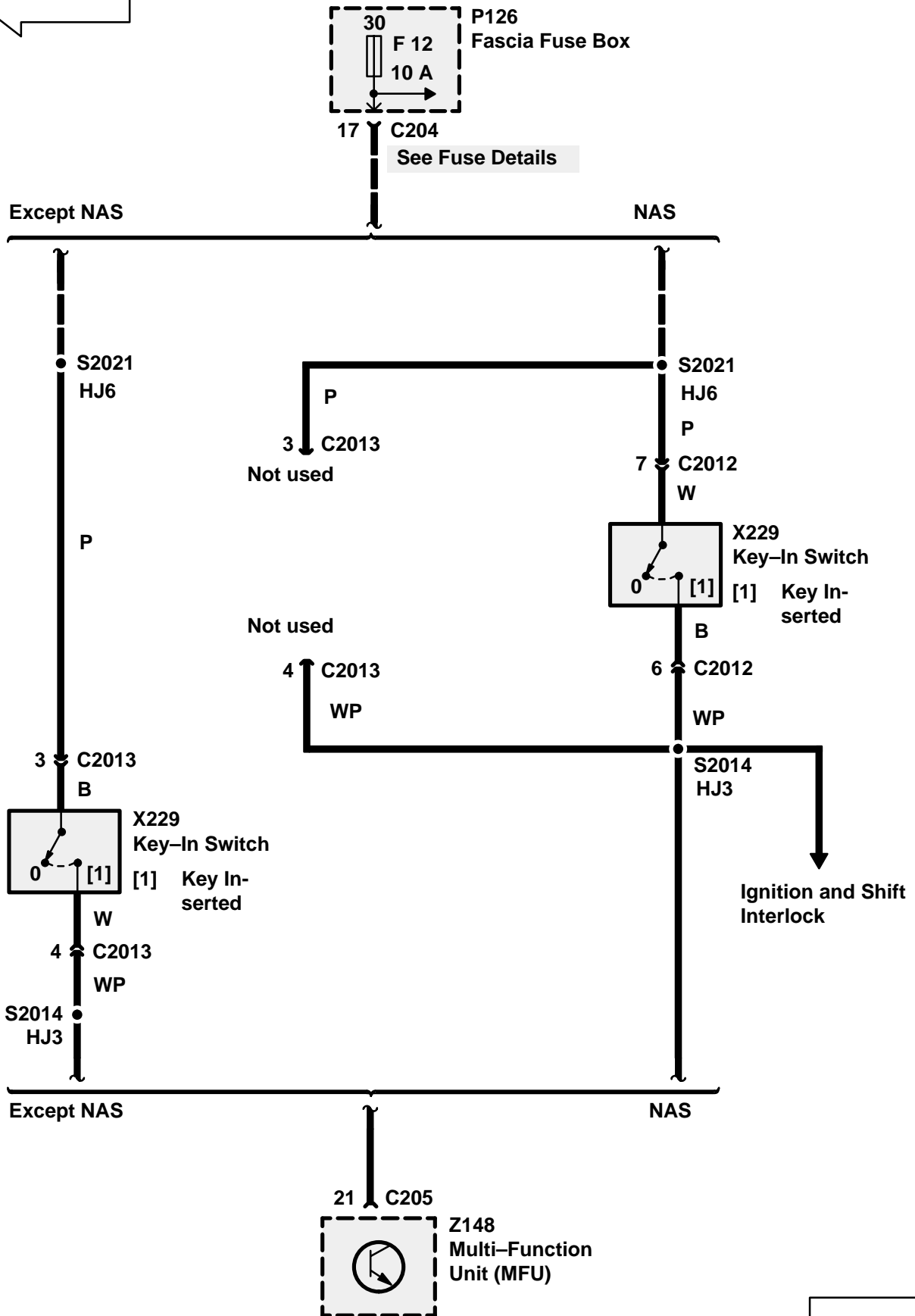
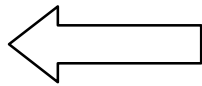

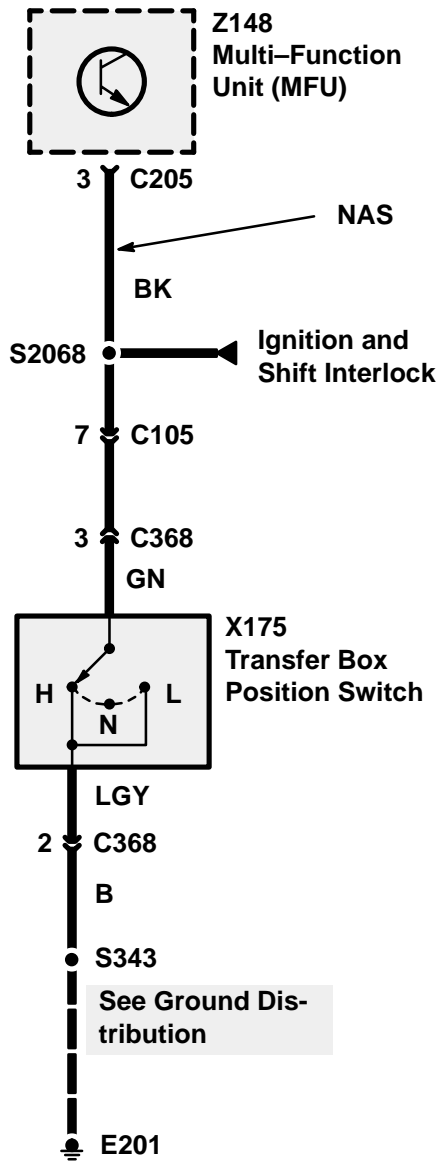
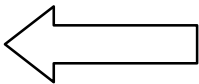

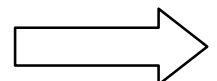
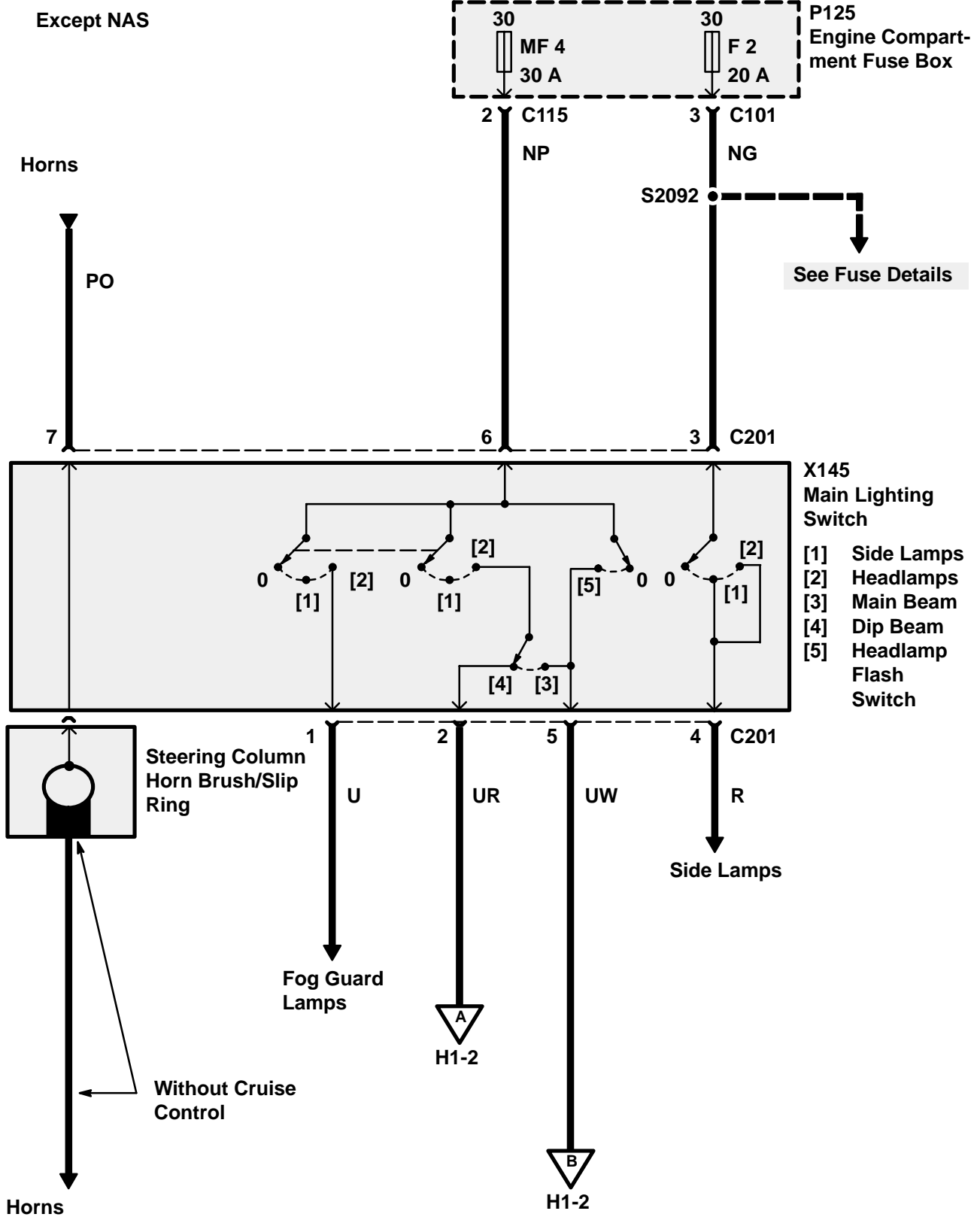

← Except NAS

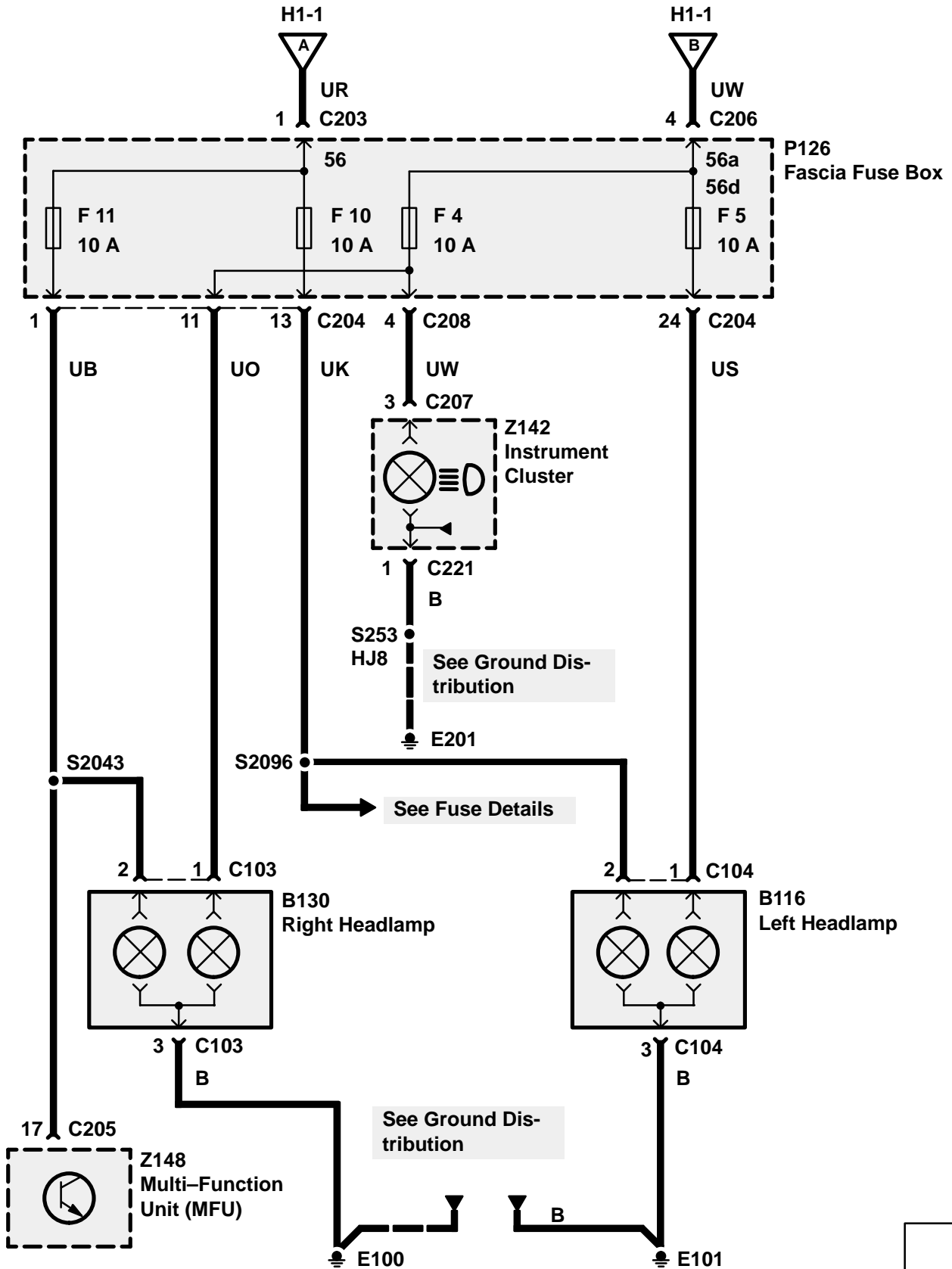

NAS

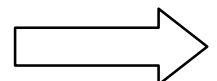
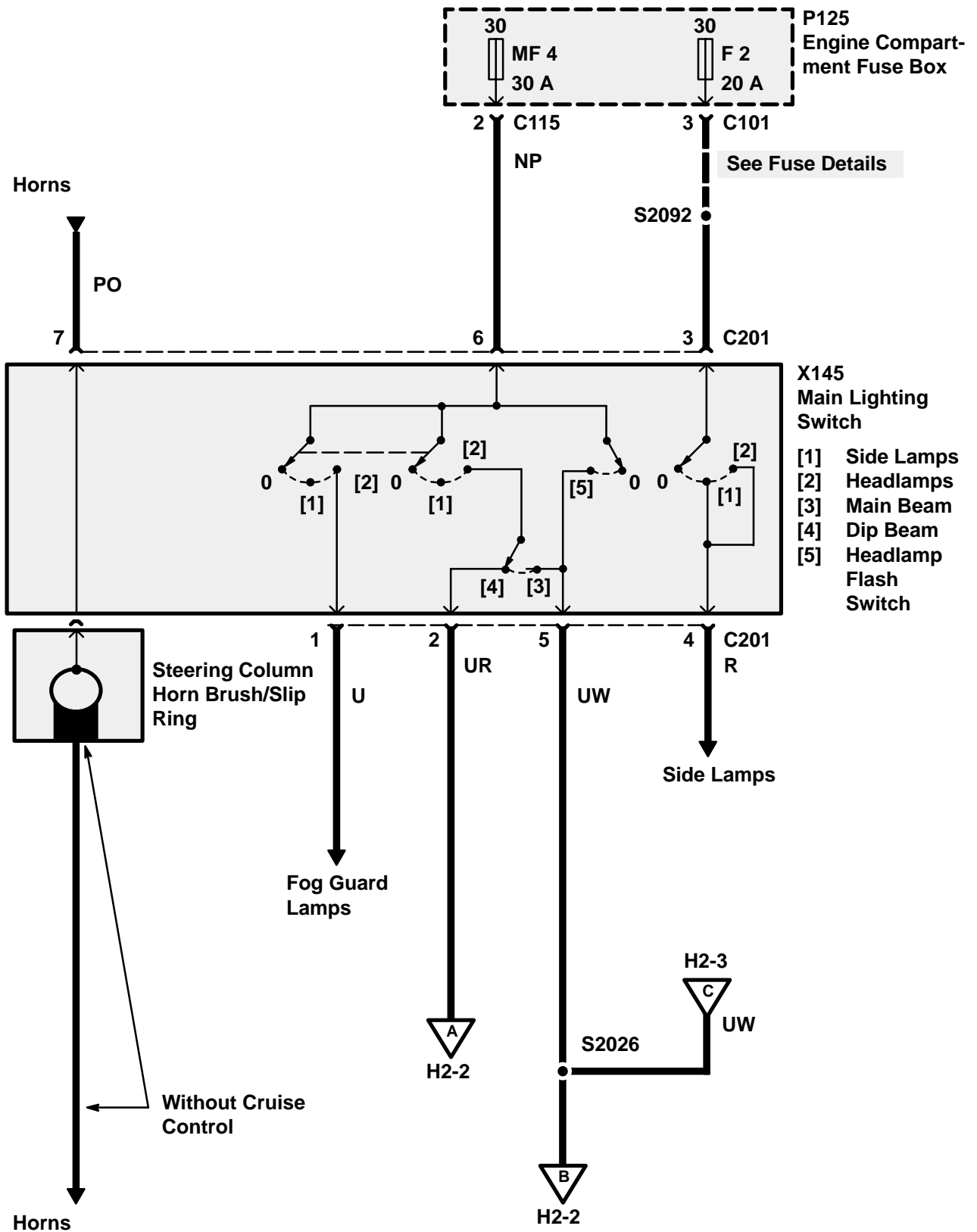

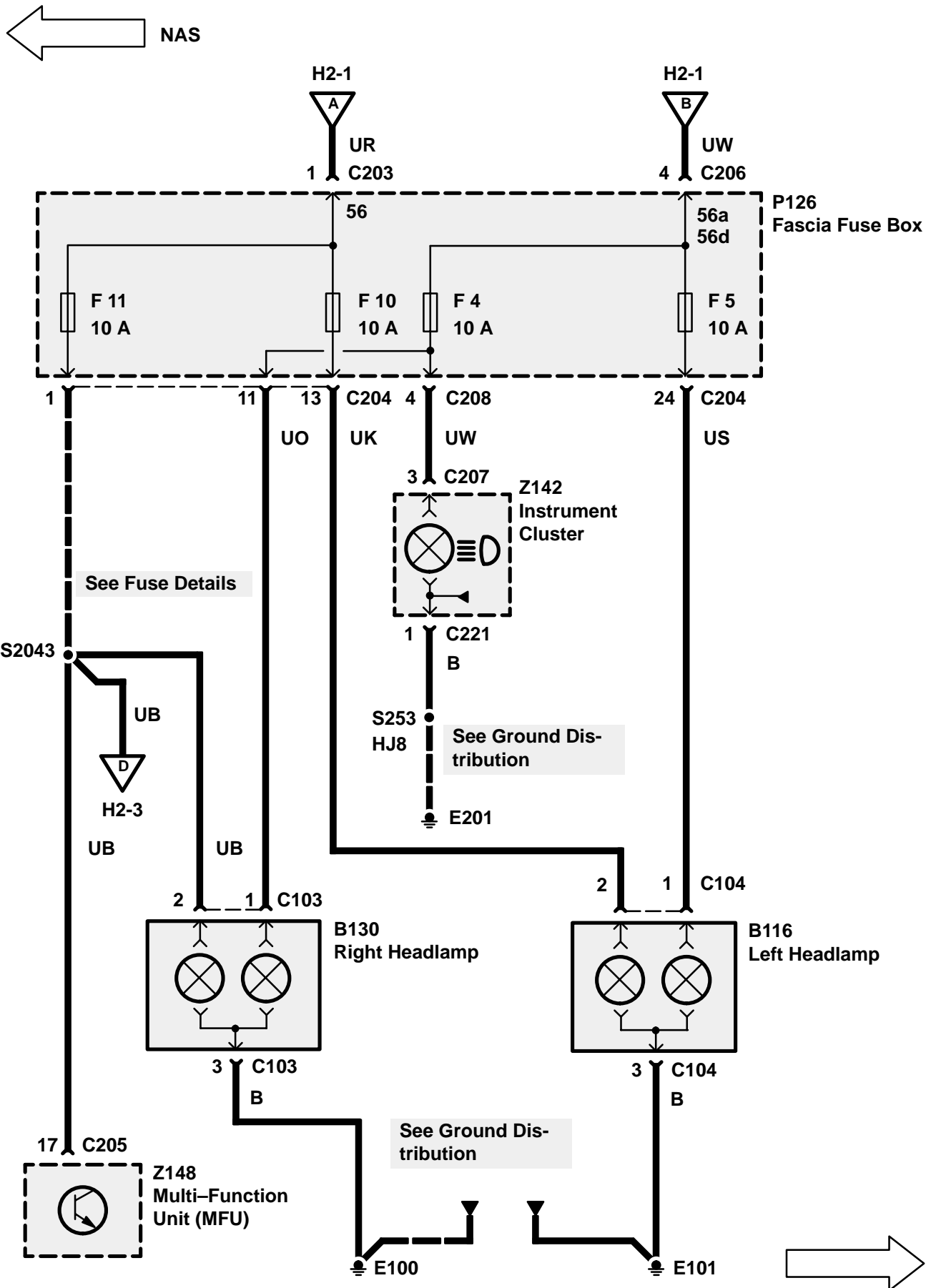

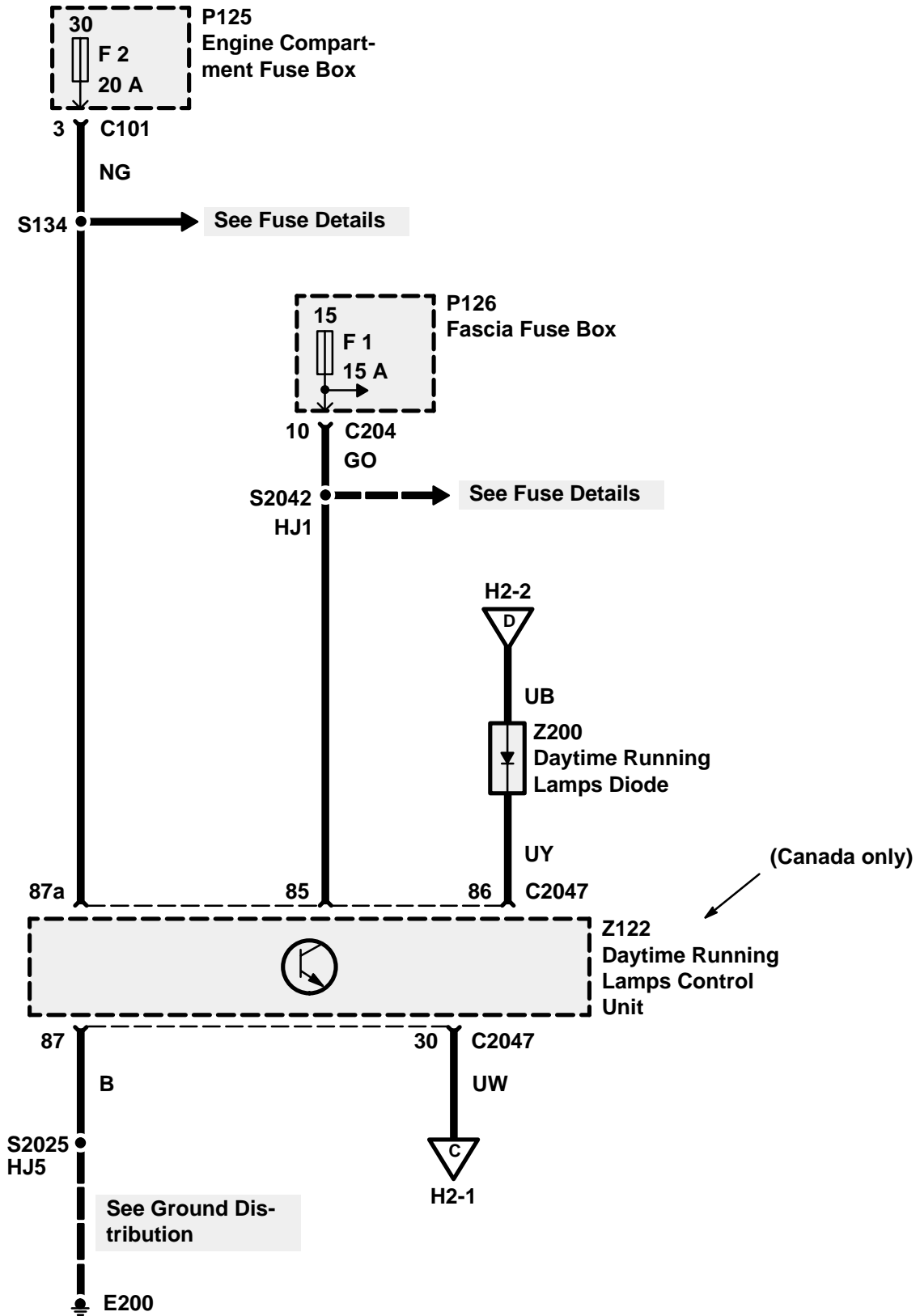
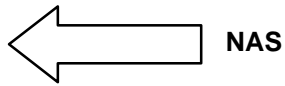

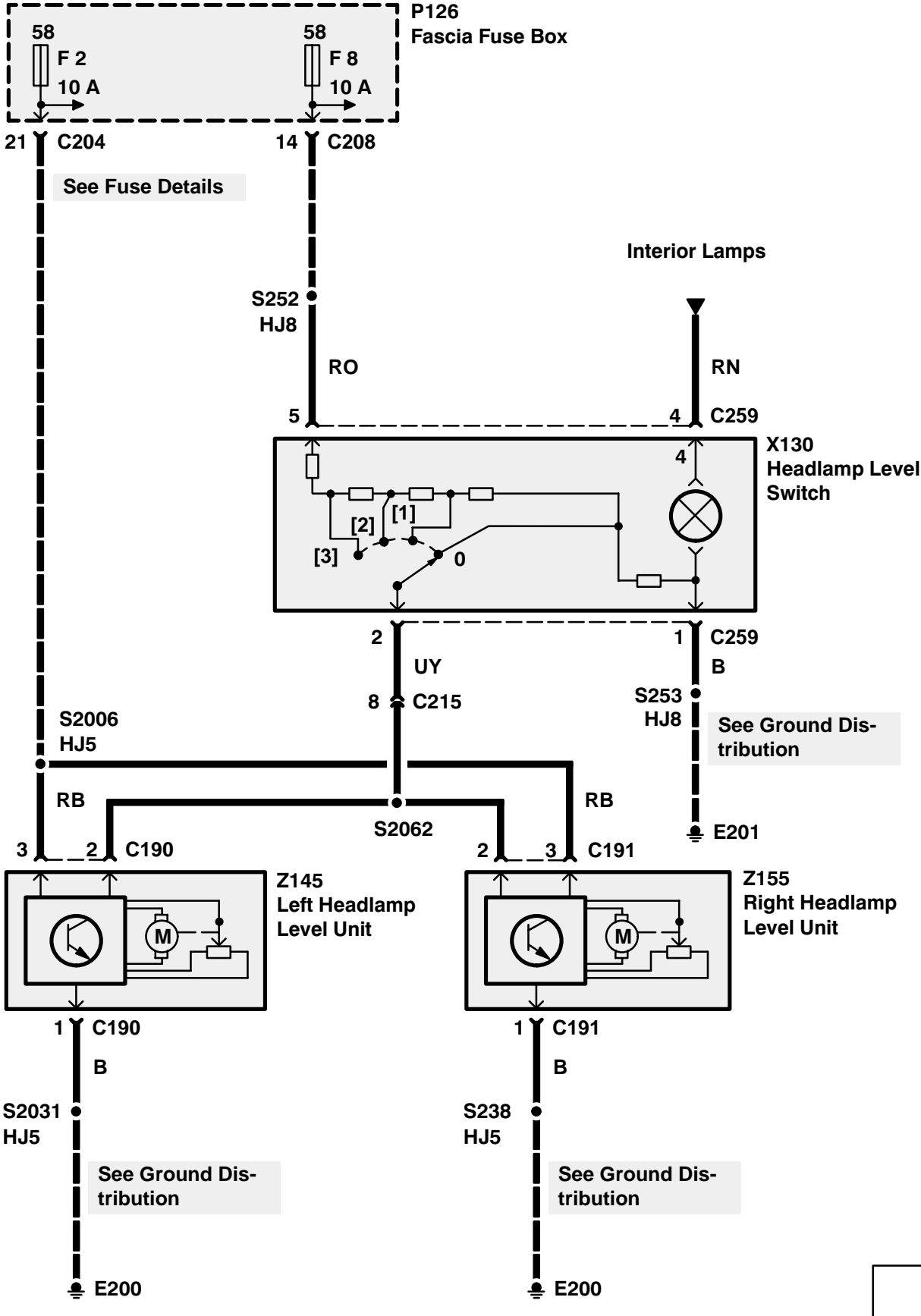



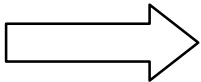
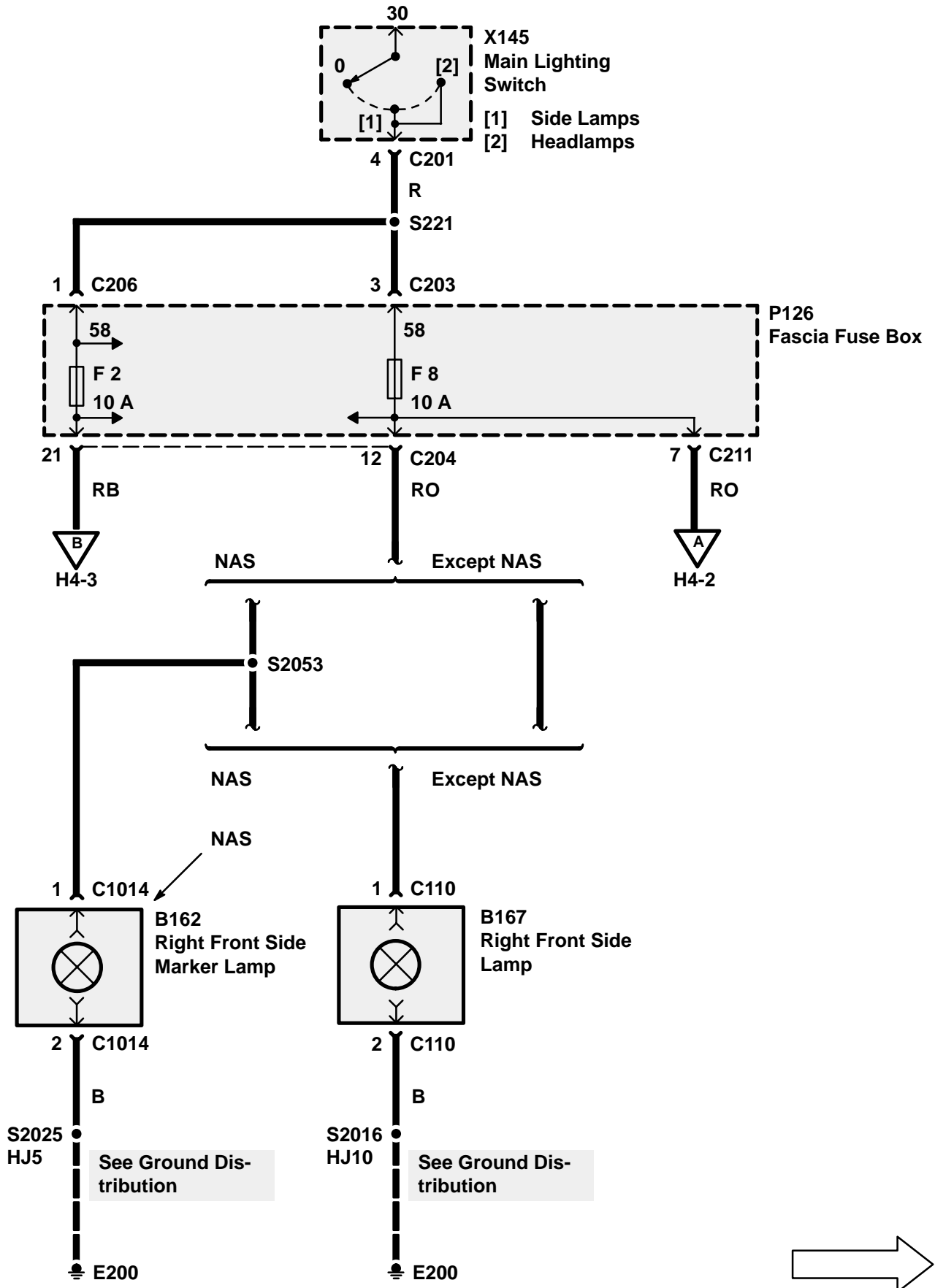

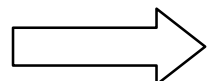
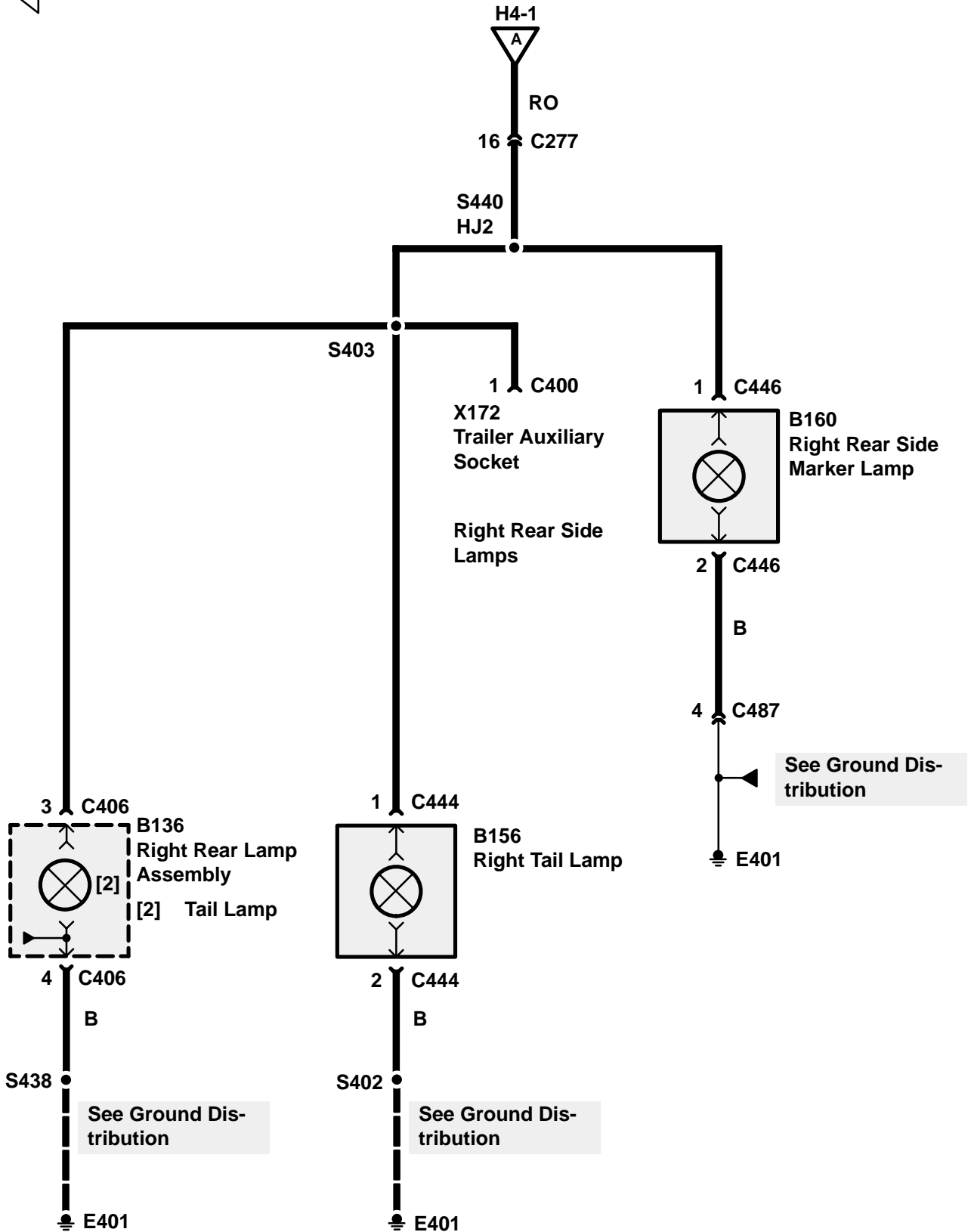
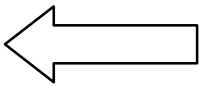

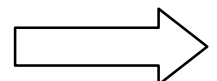
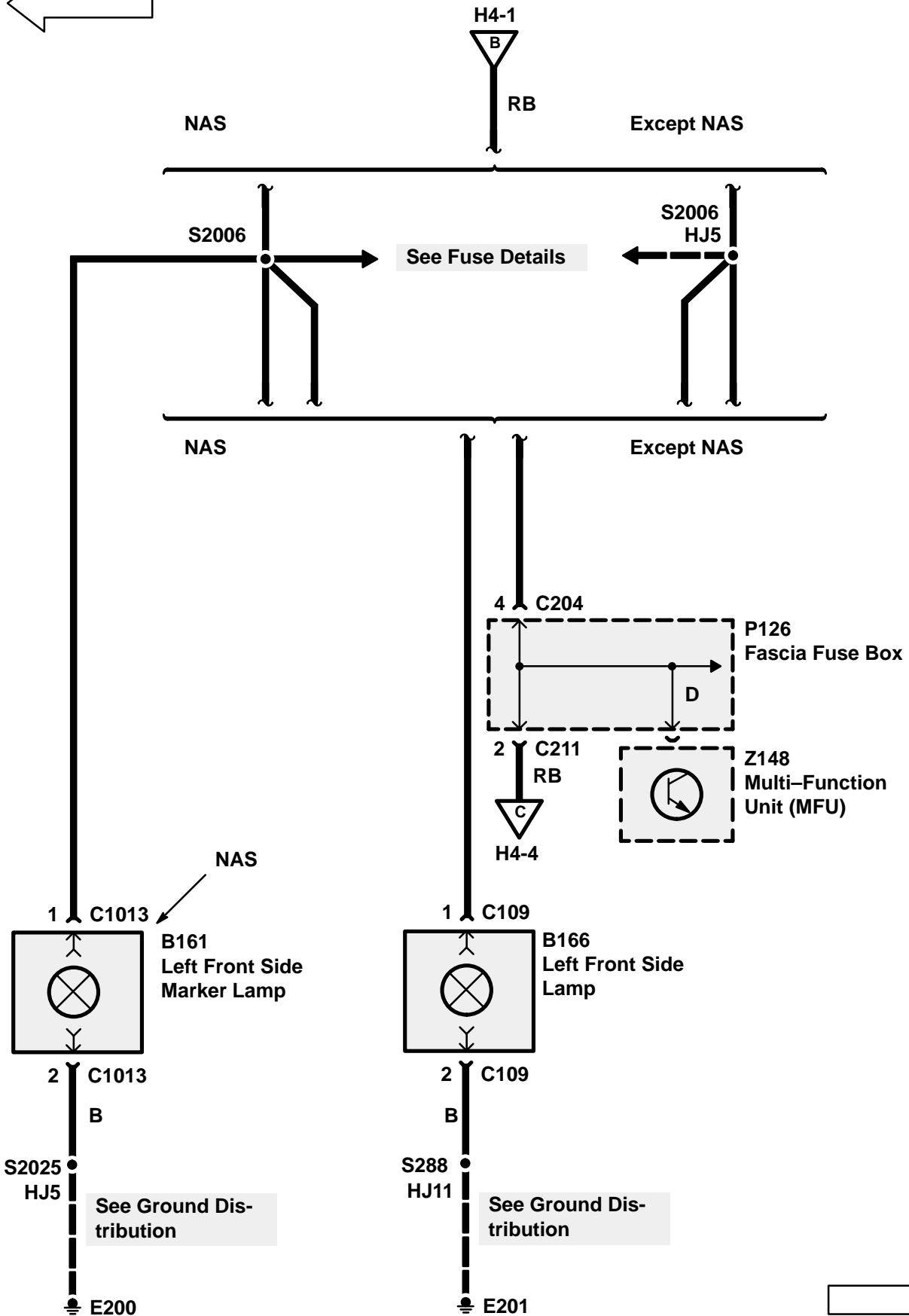
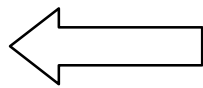

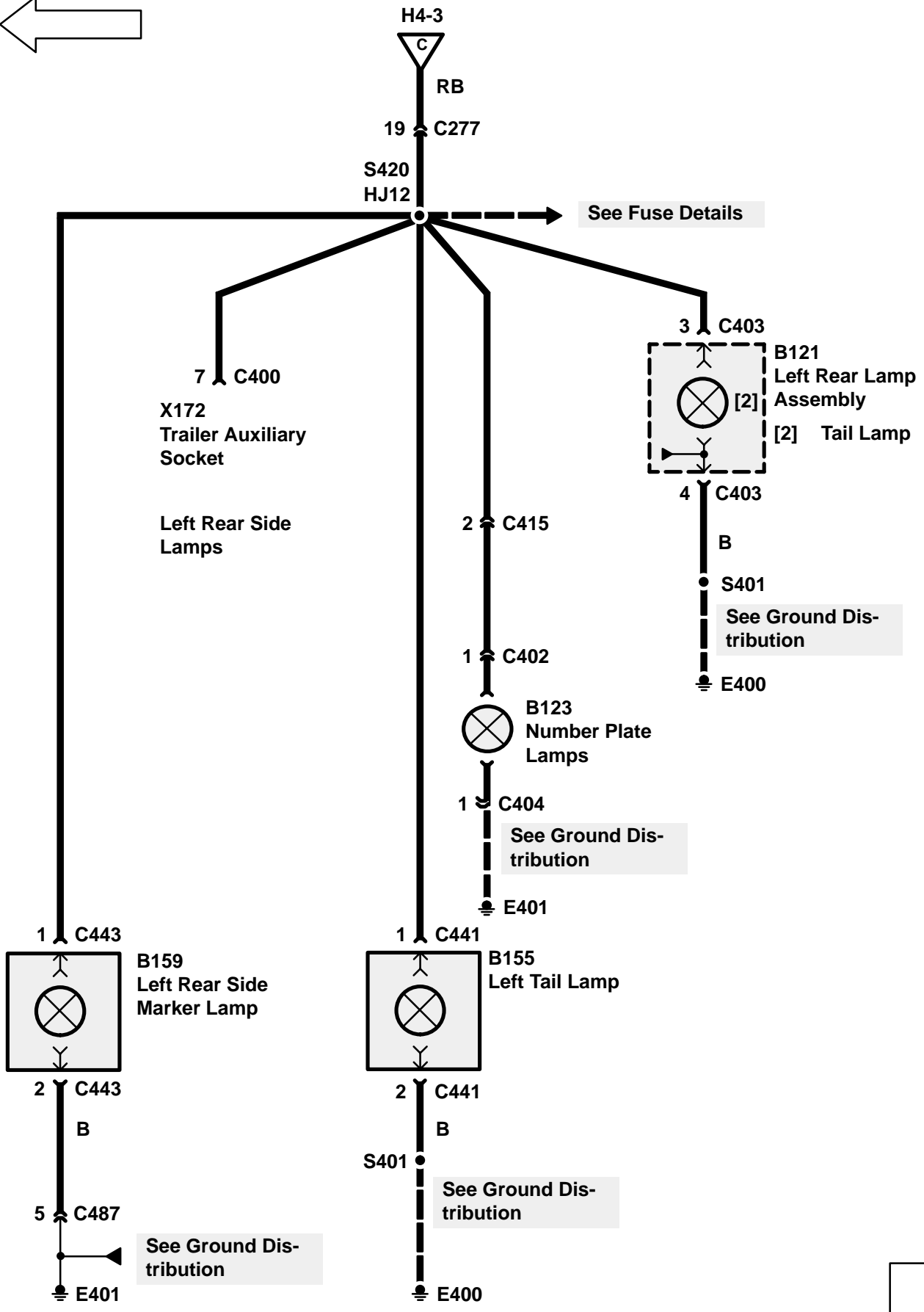
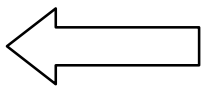

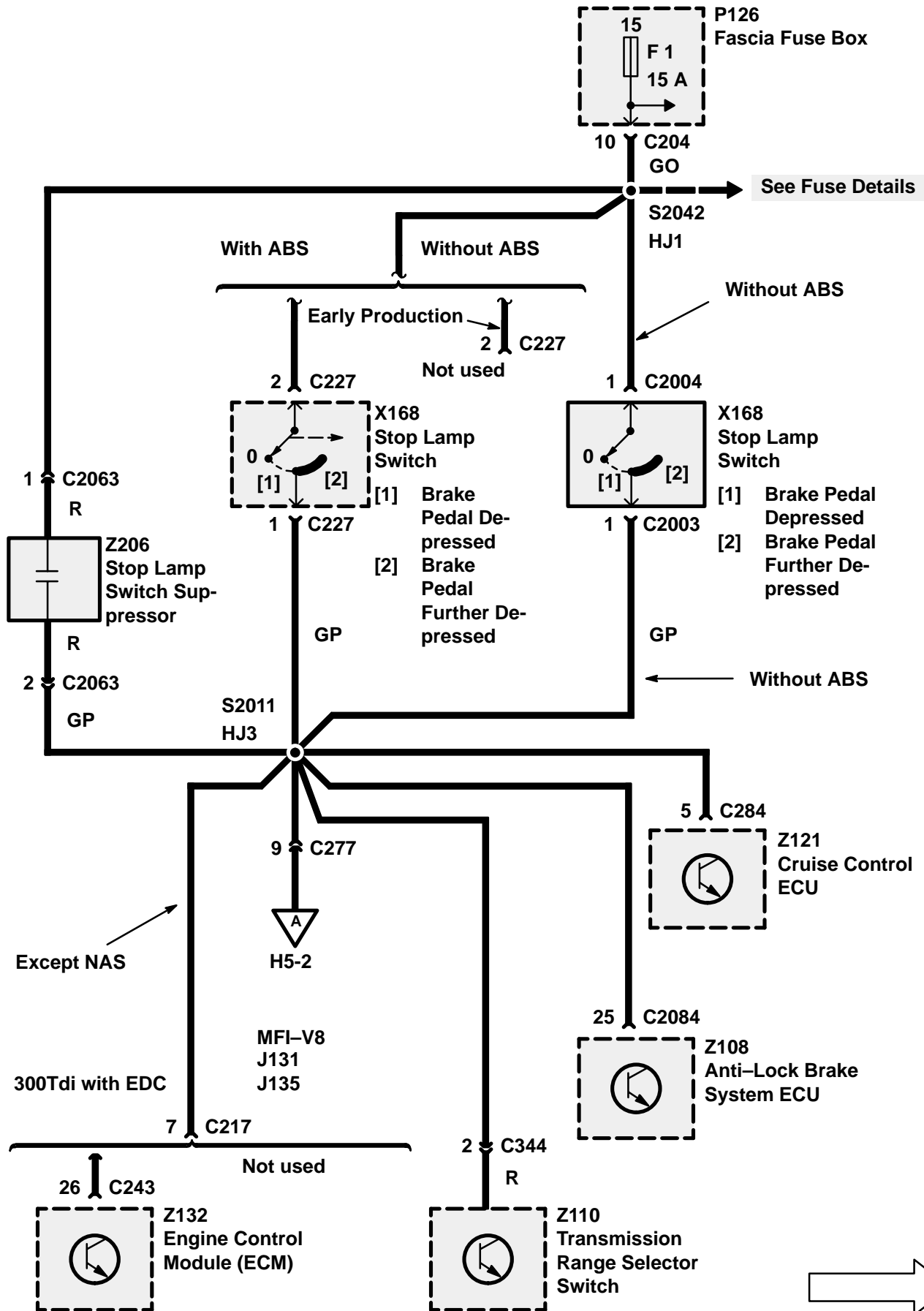

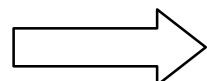
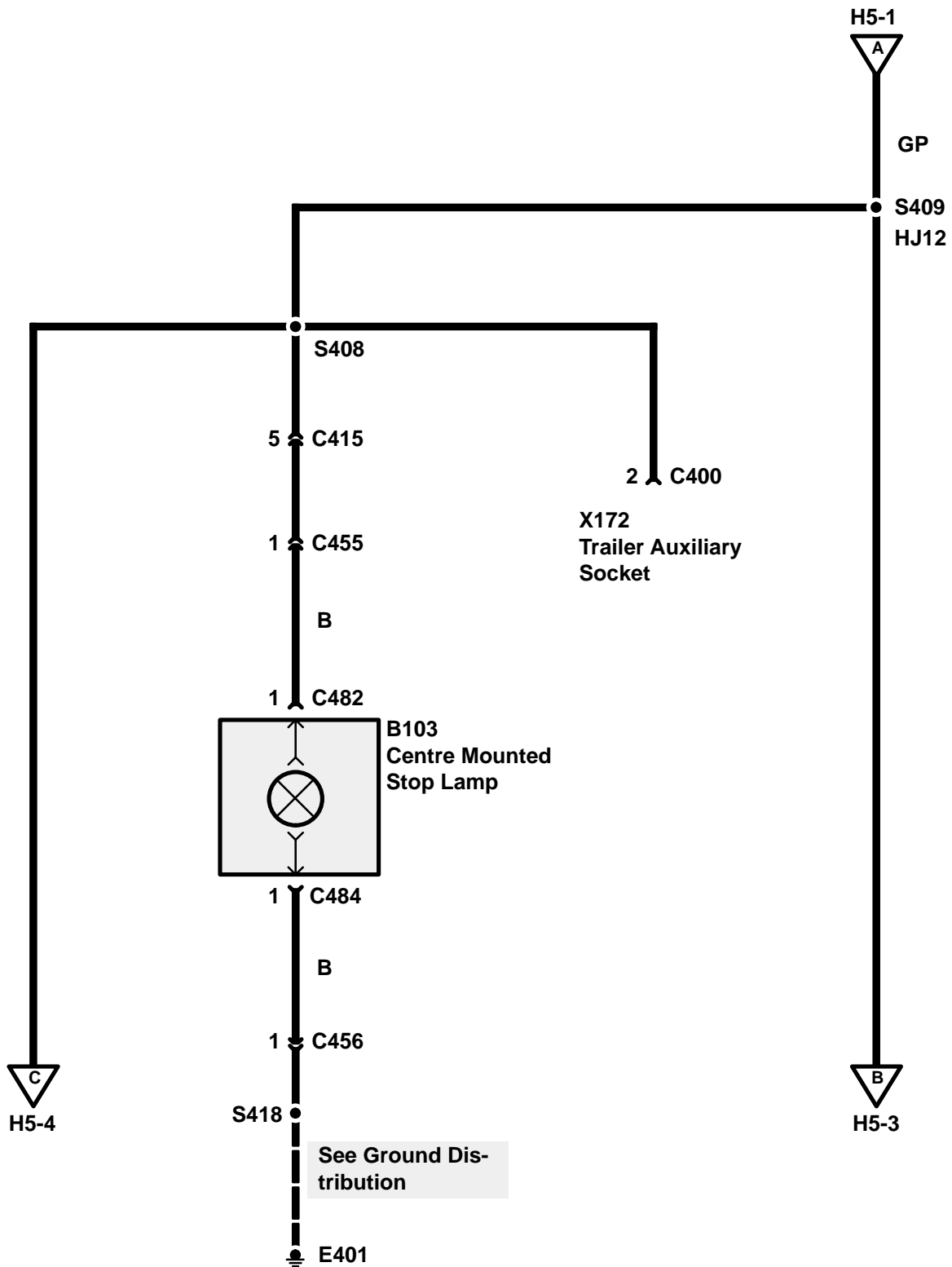
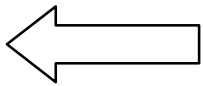

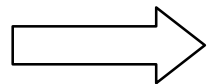
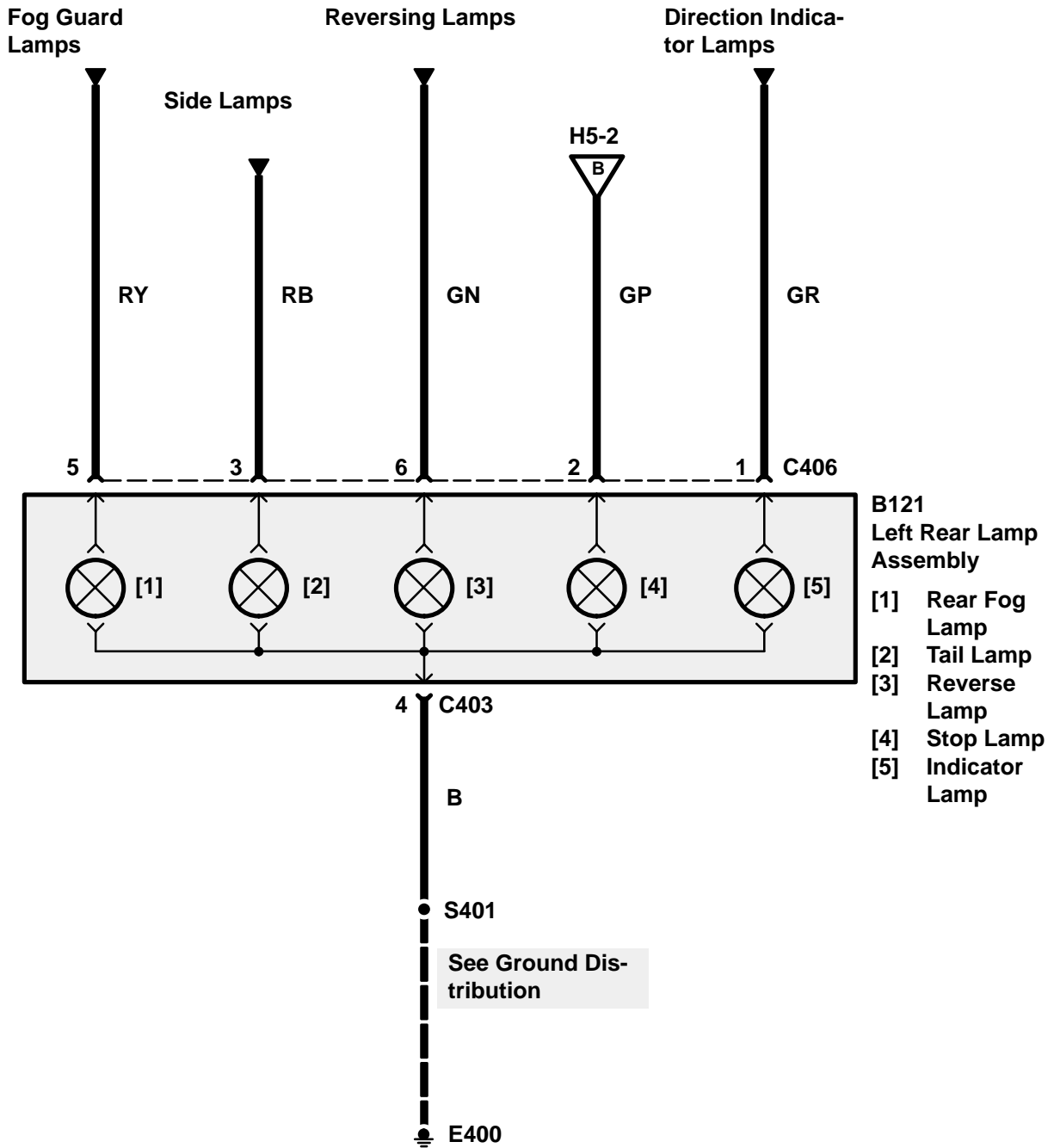
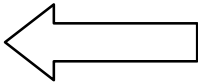

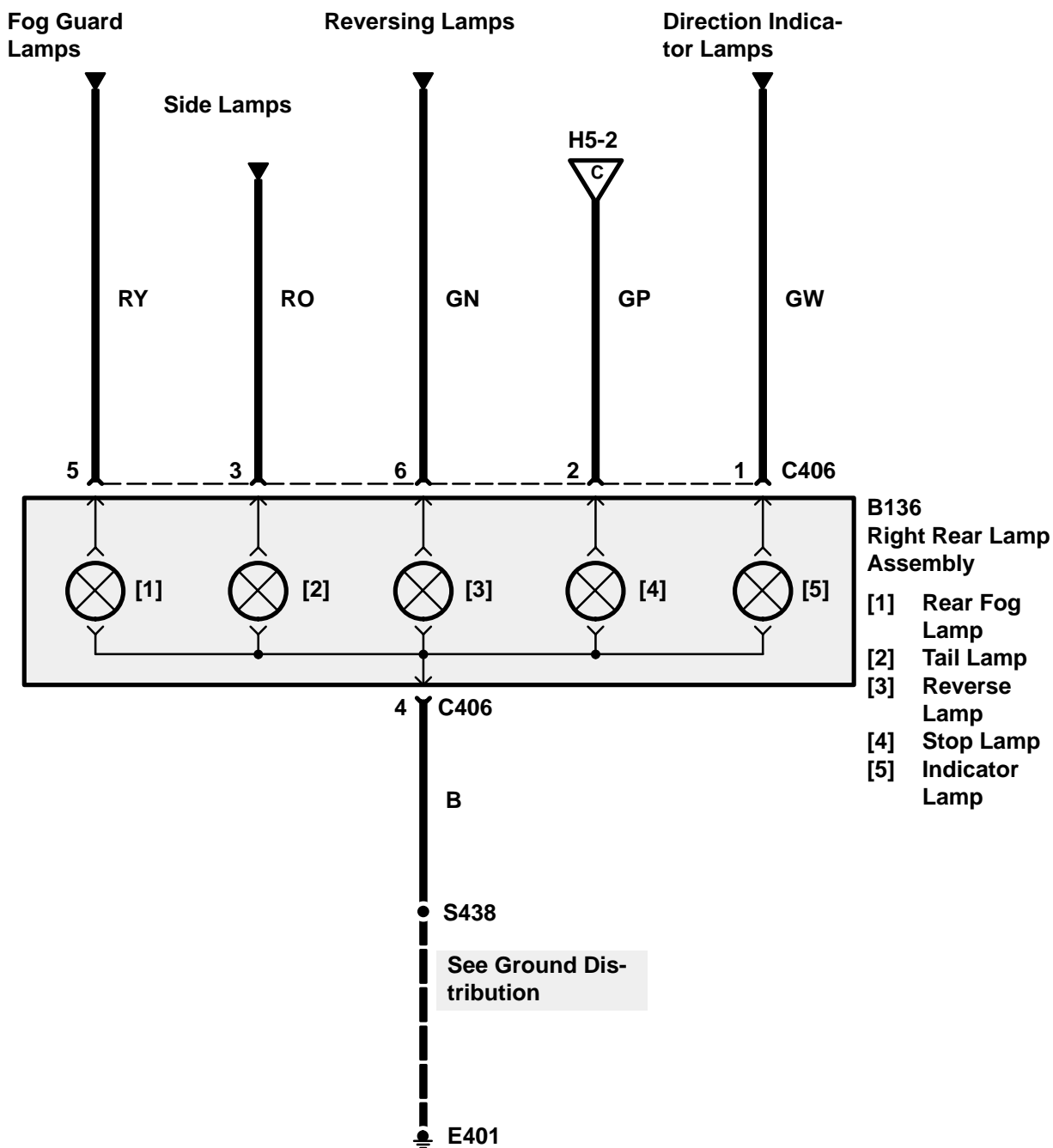
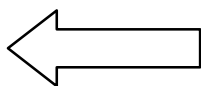



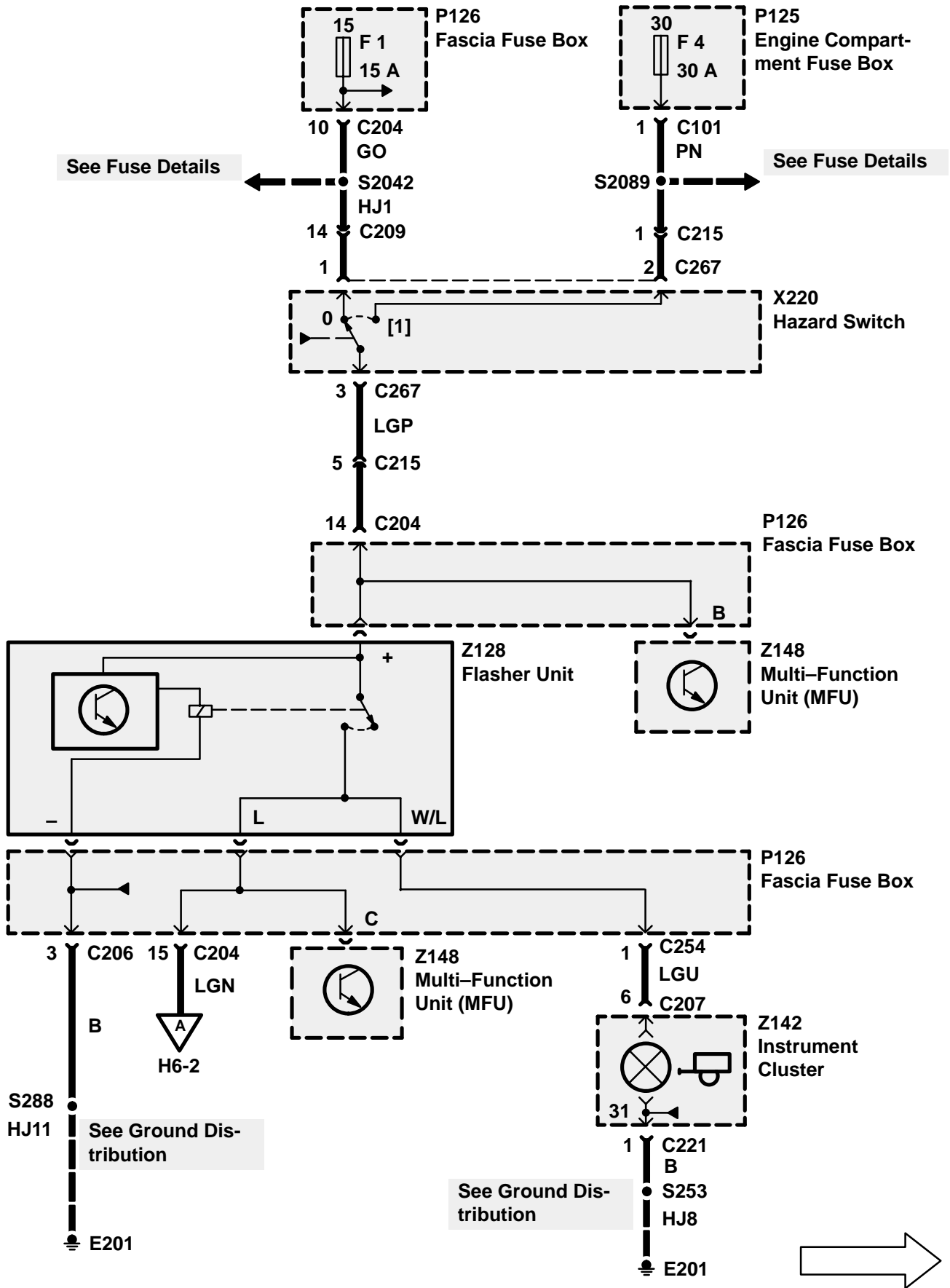

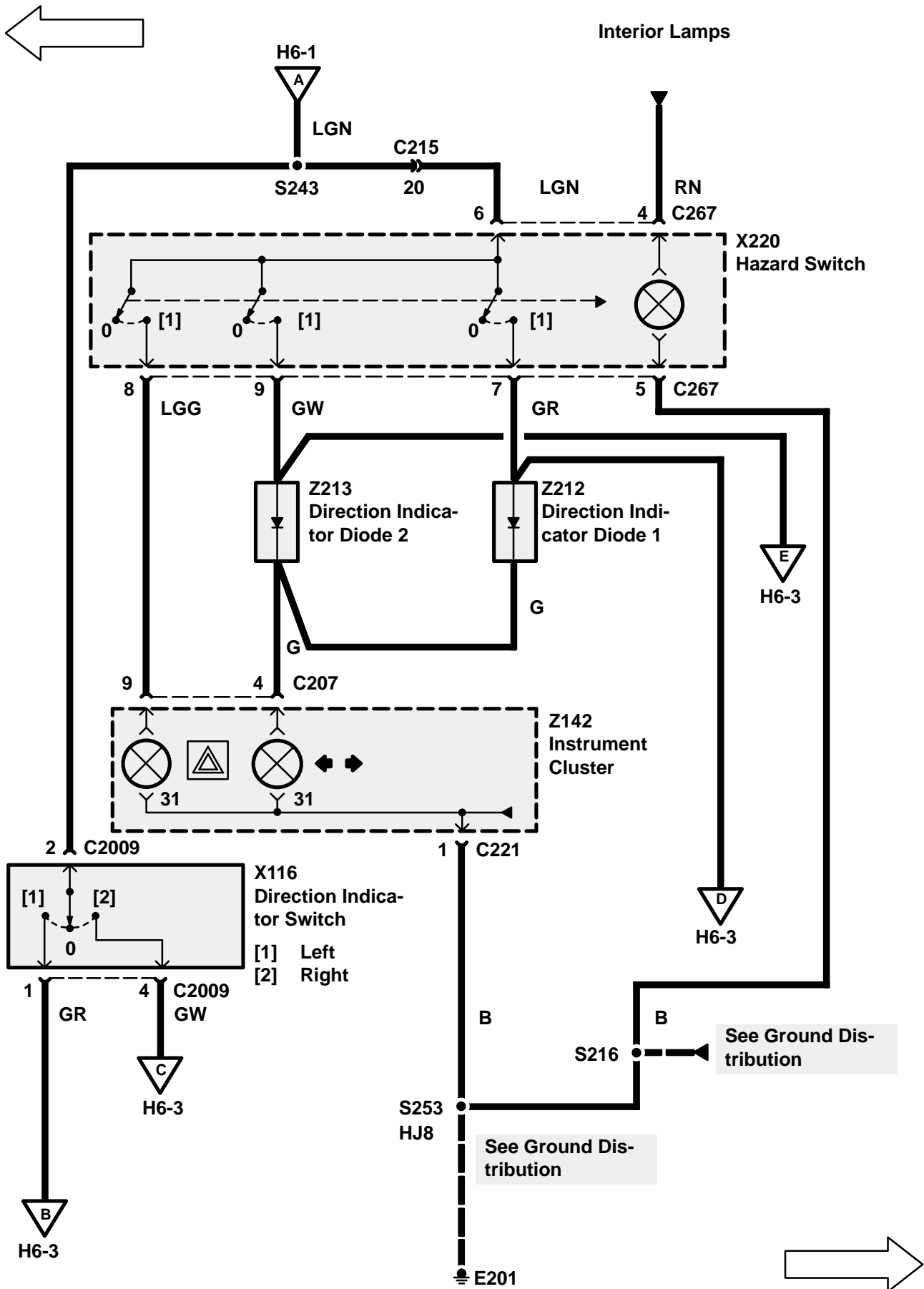

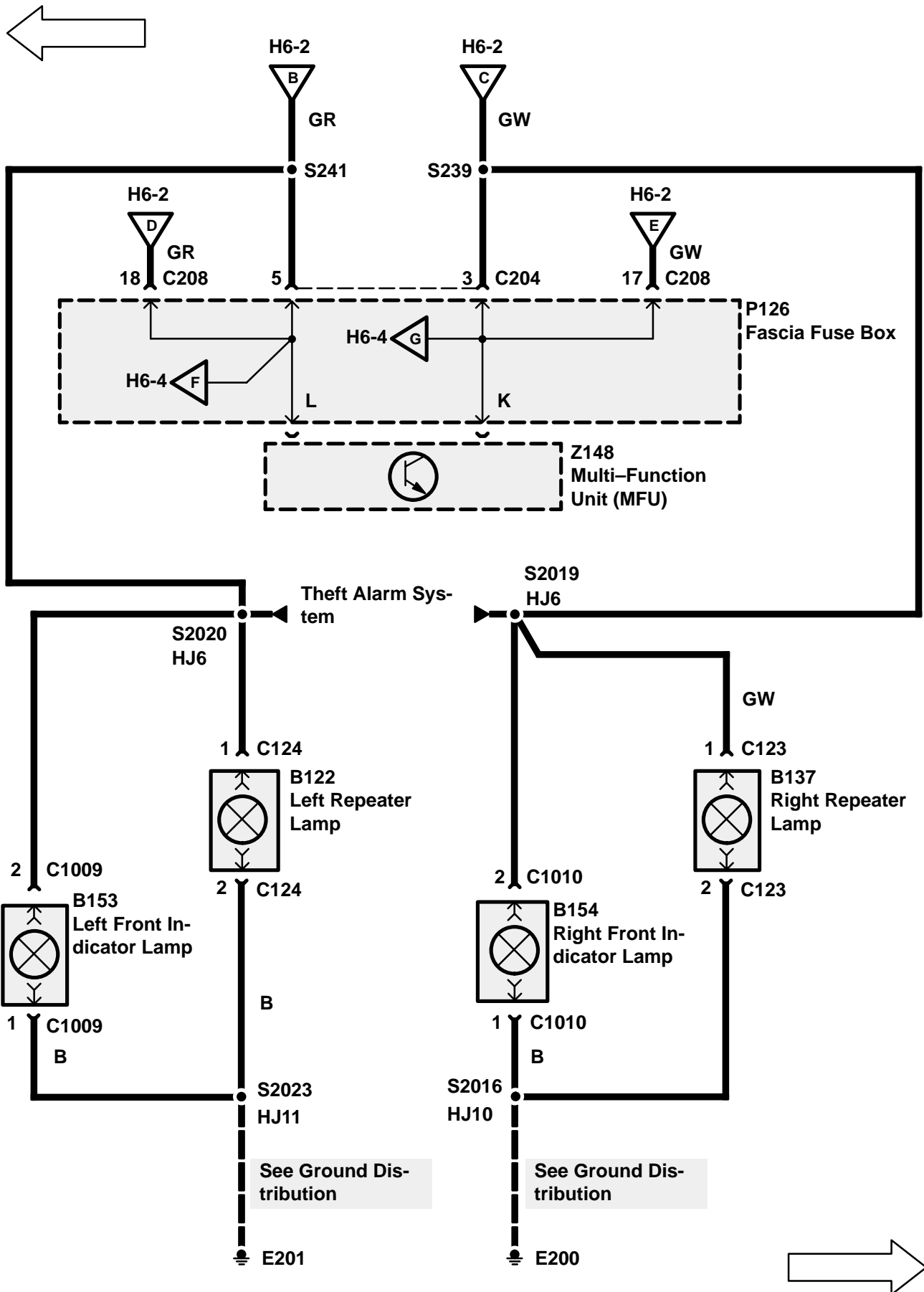



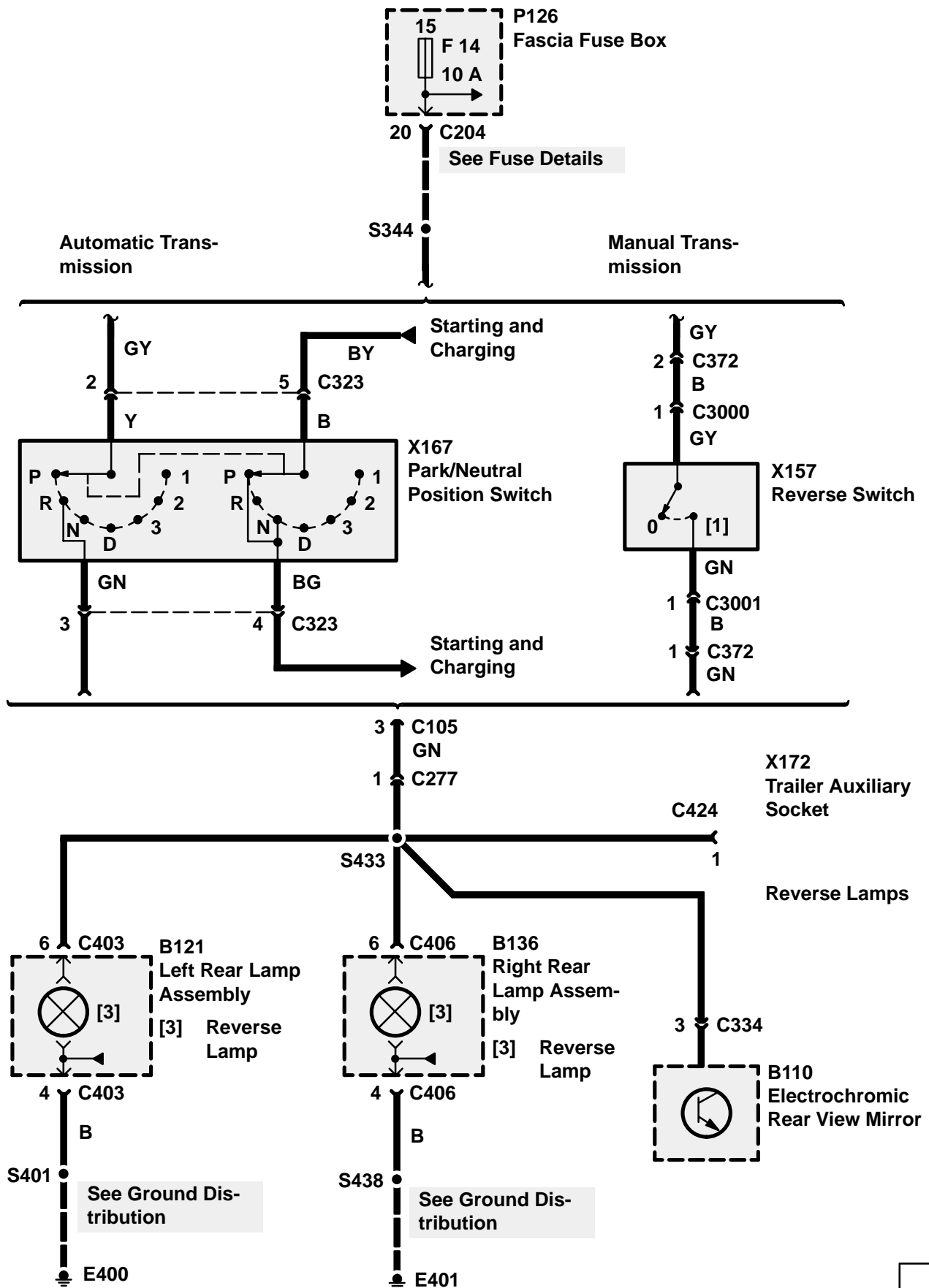

Except NAS

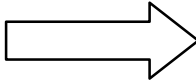
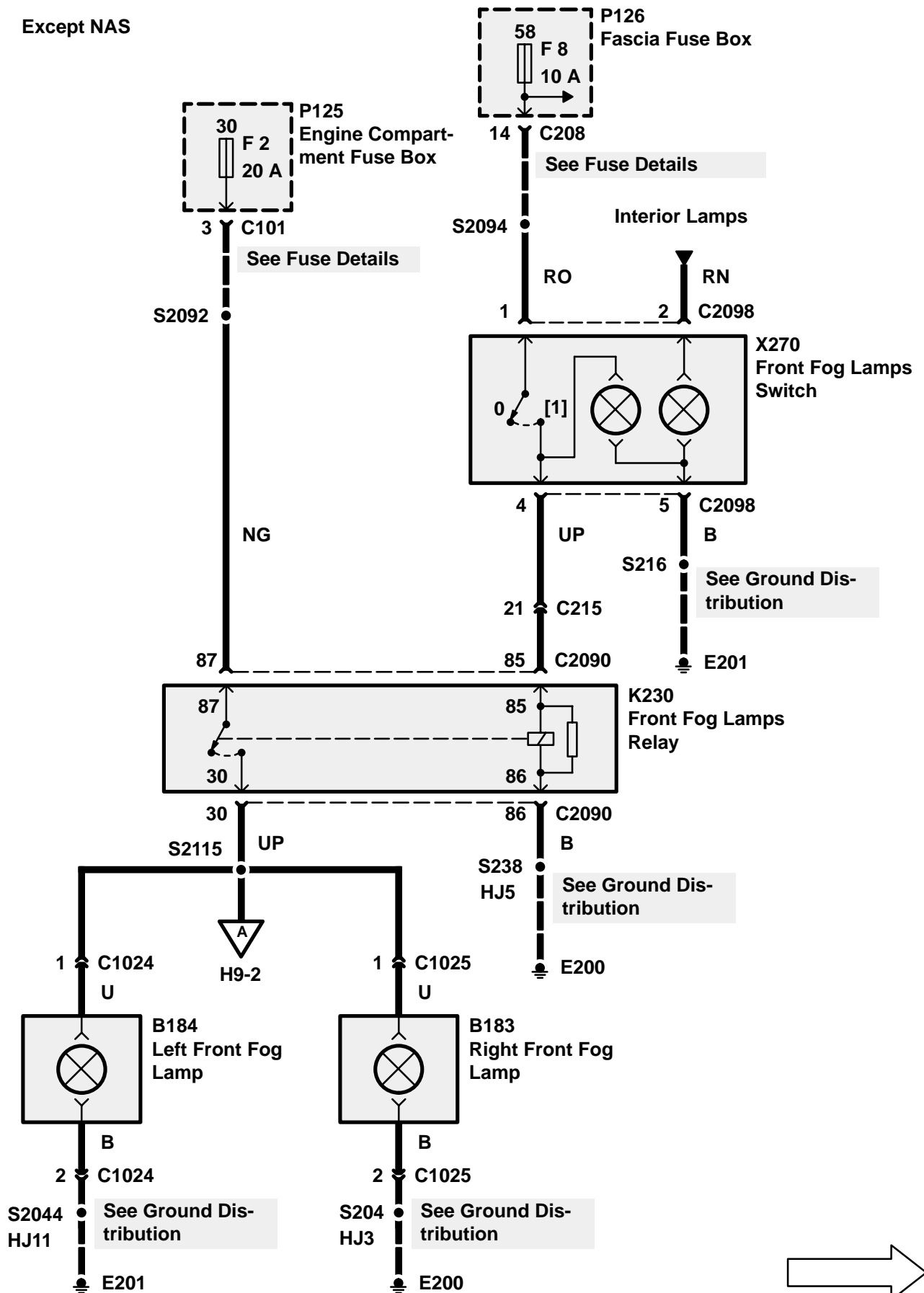







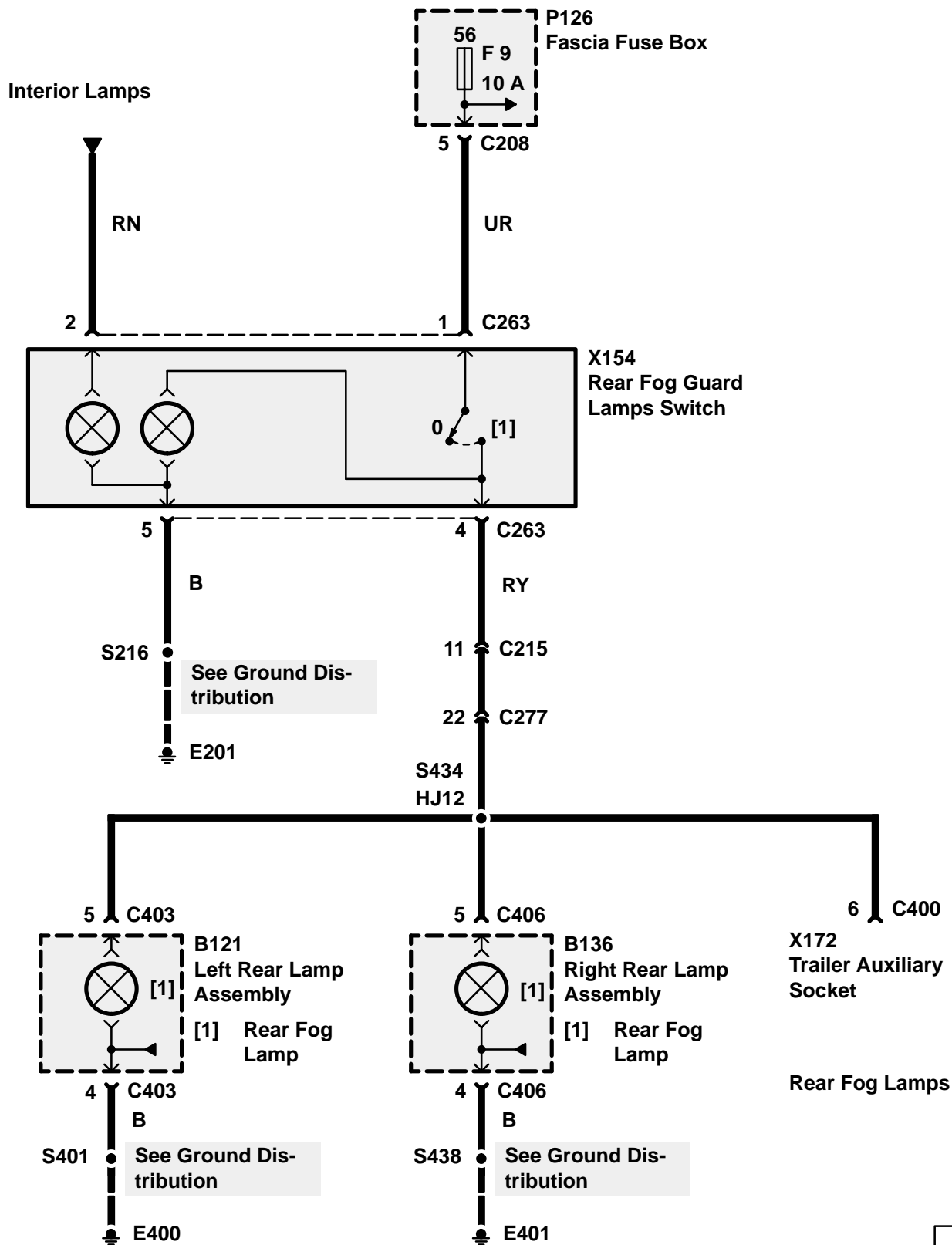
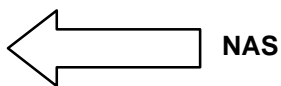

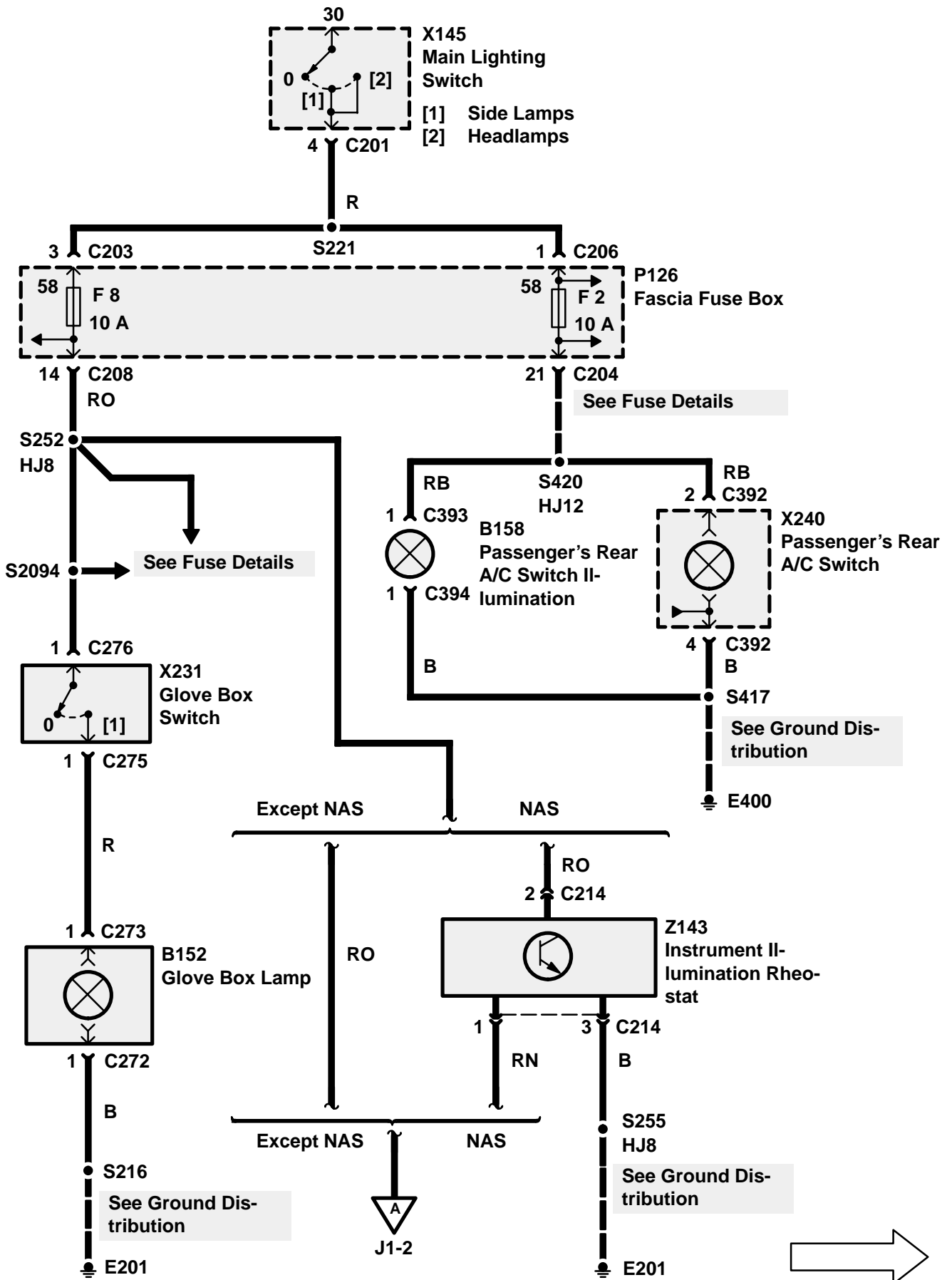

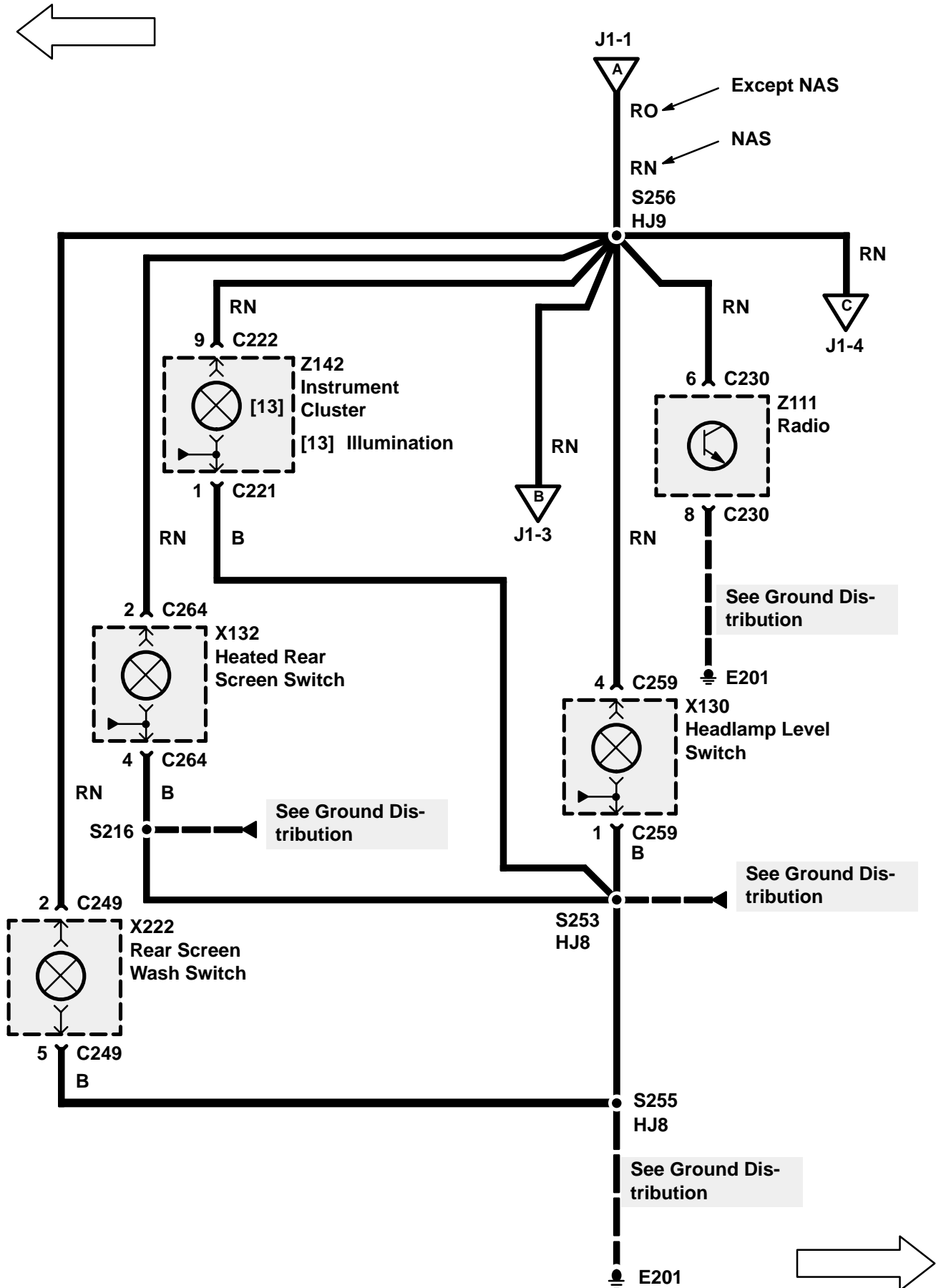

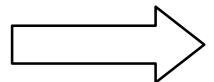
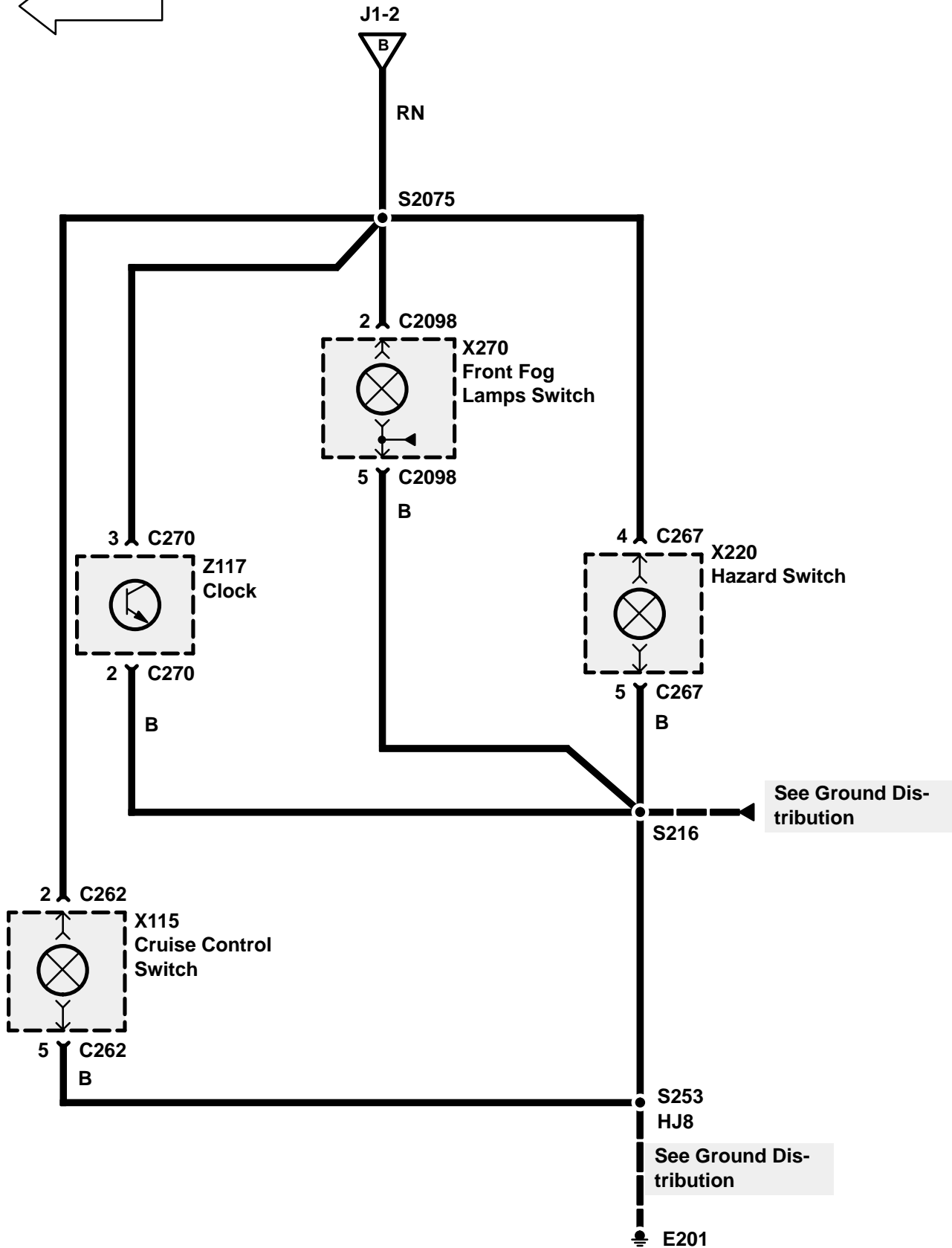
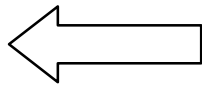

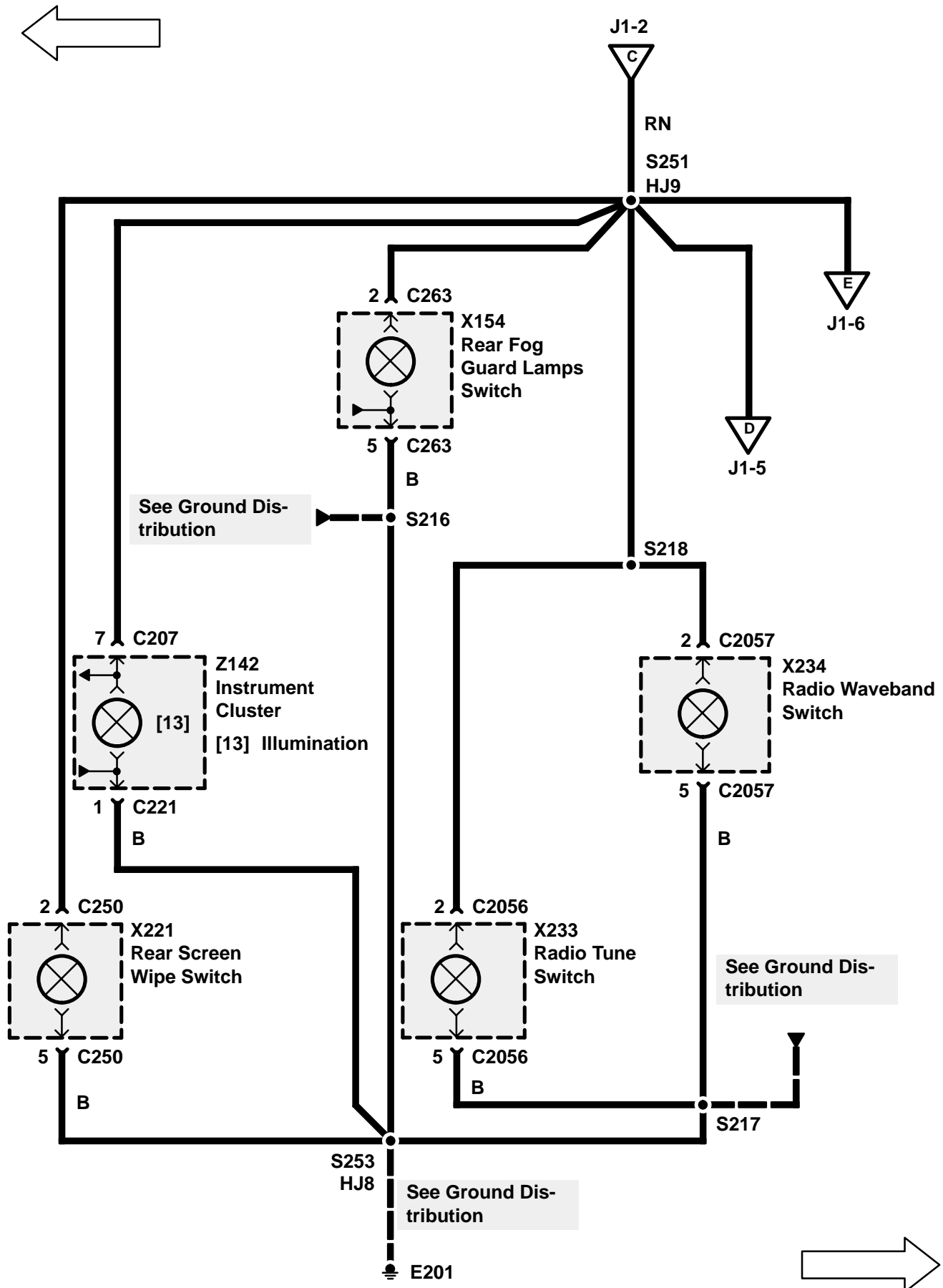

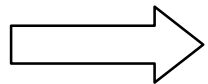
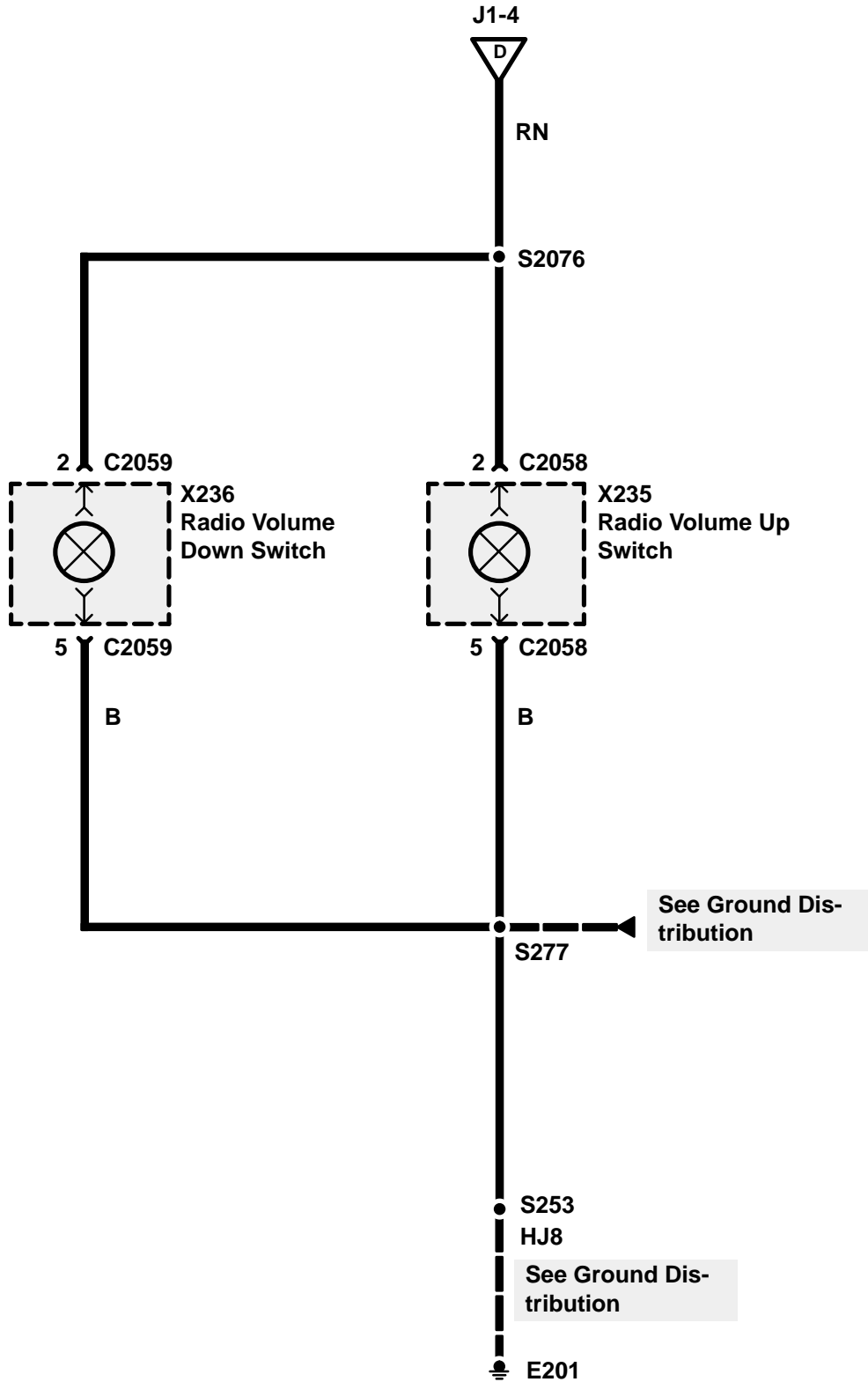
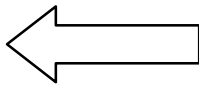

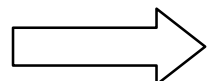
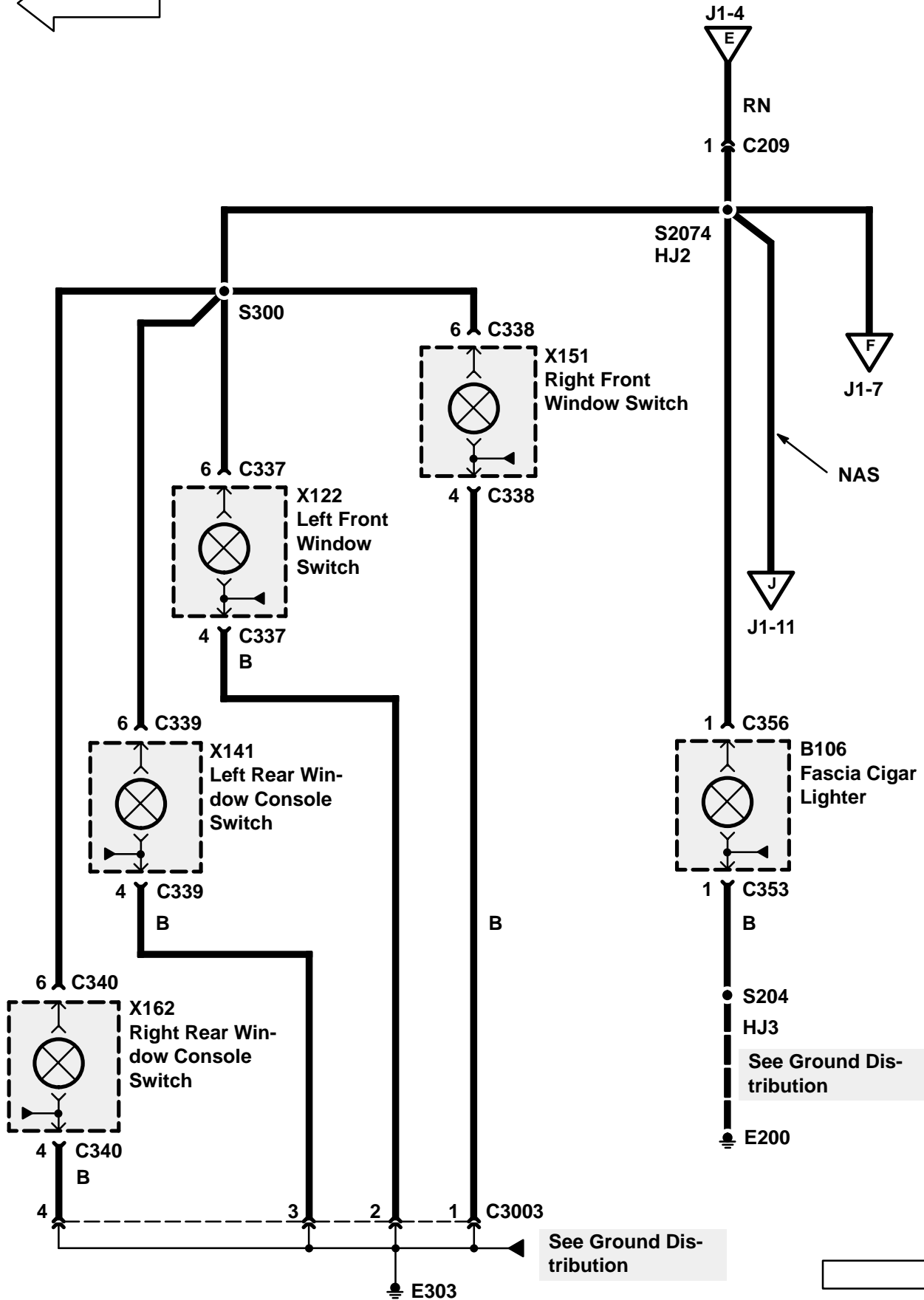
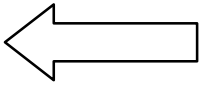

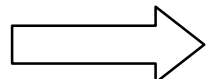
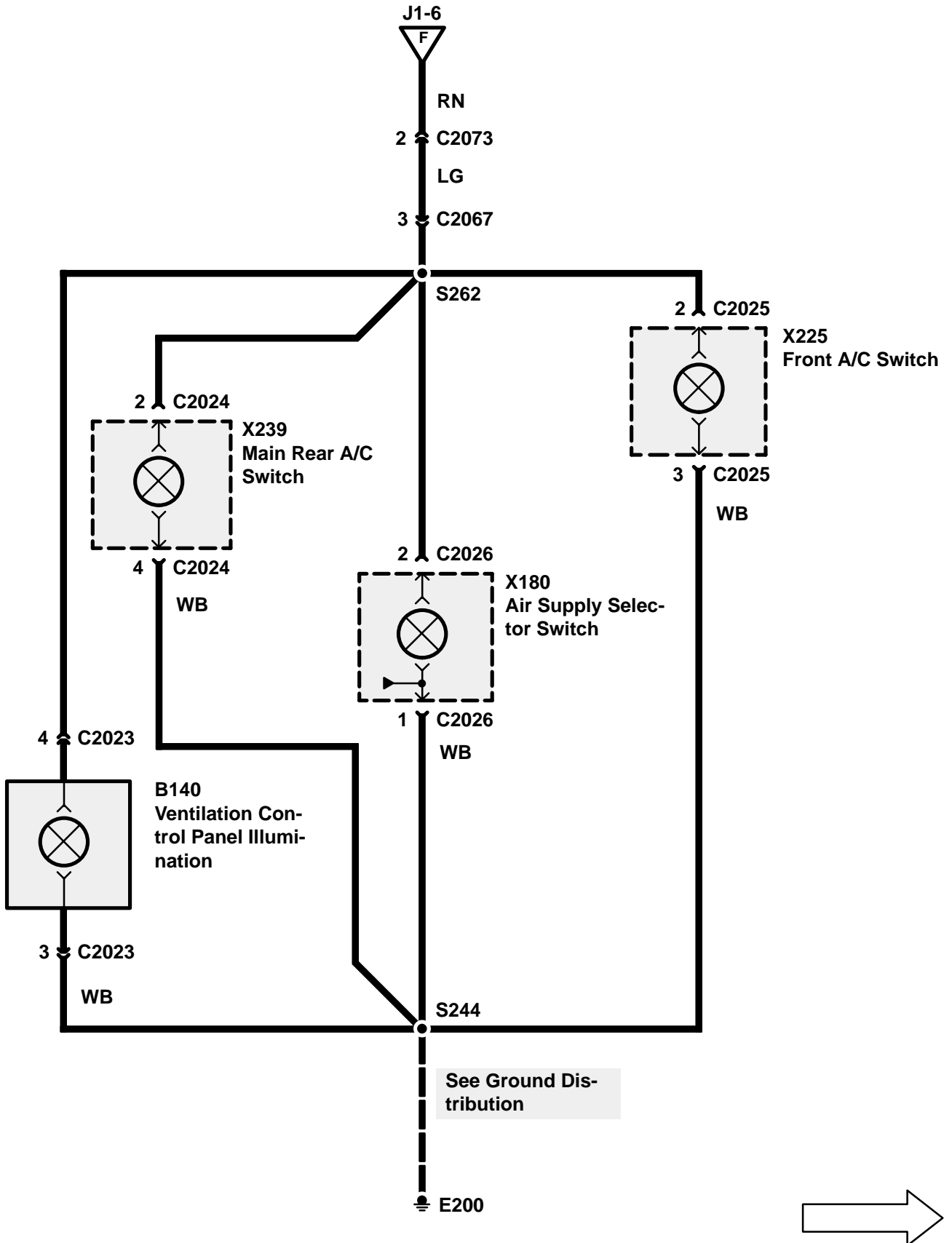
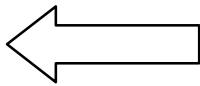



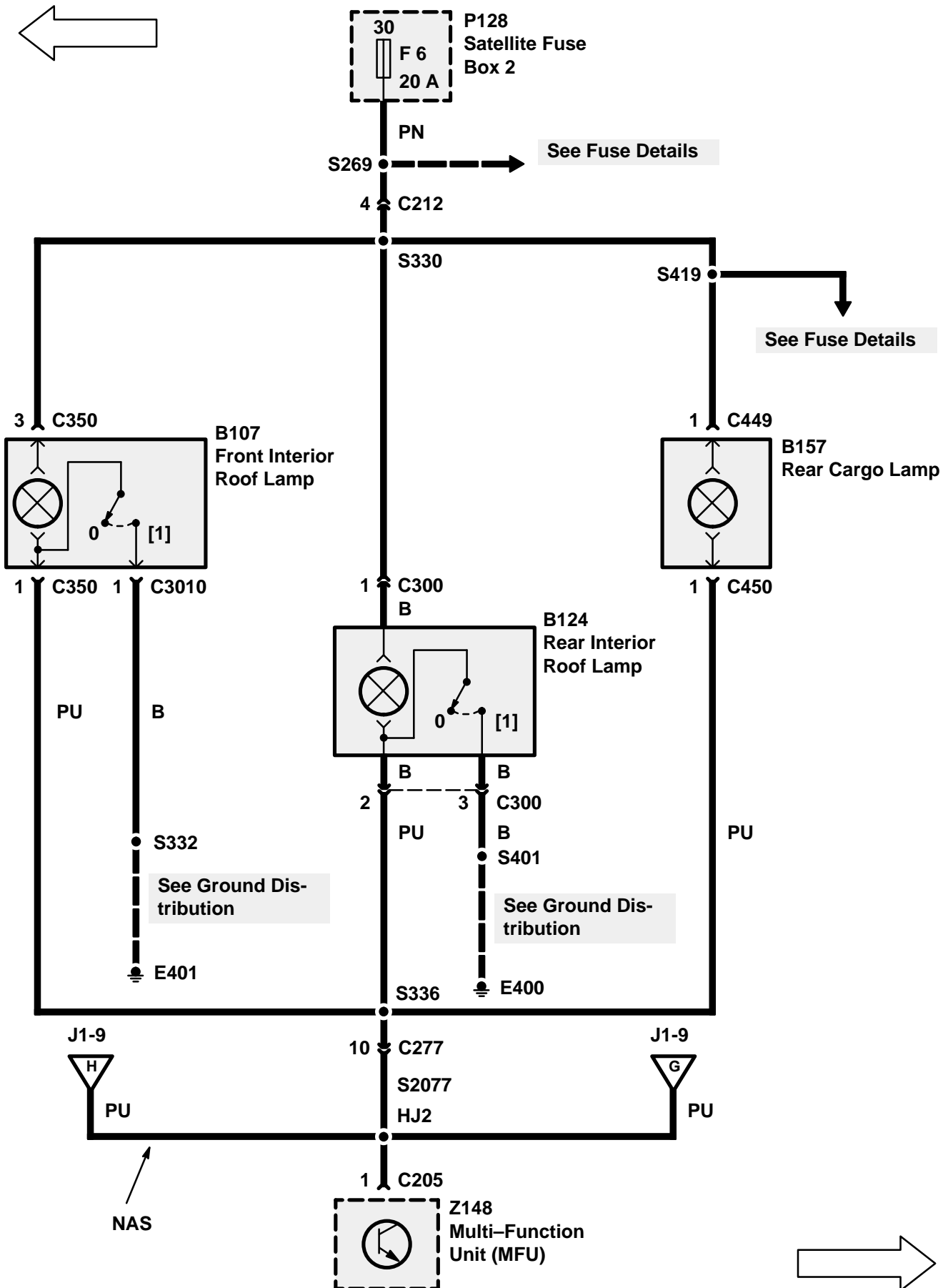

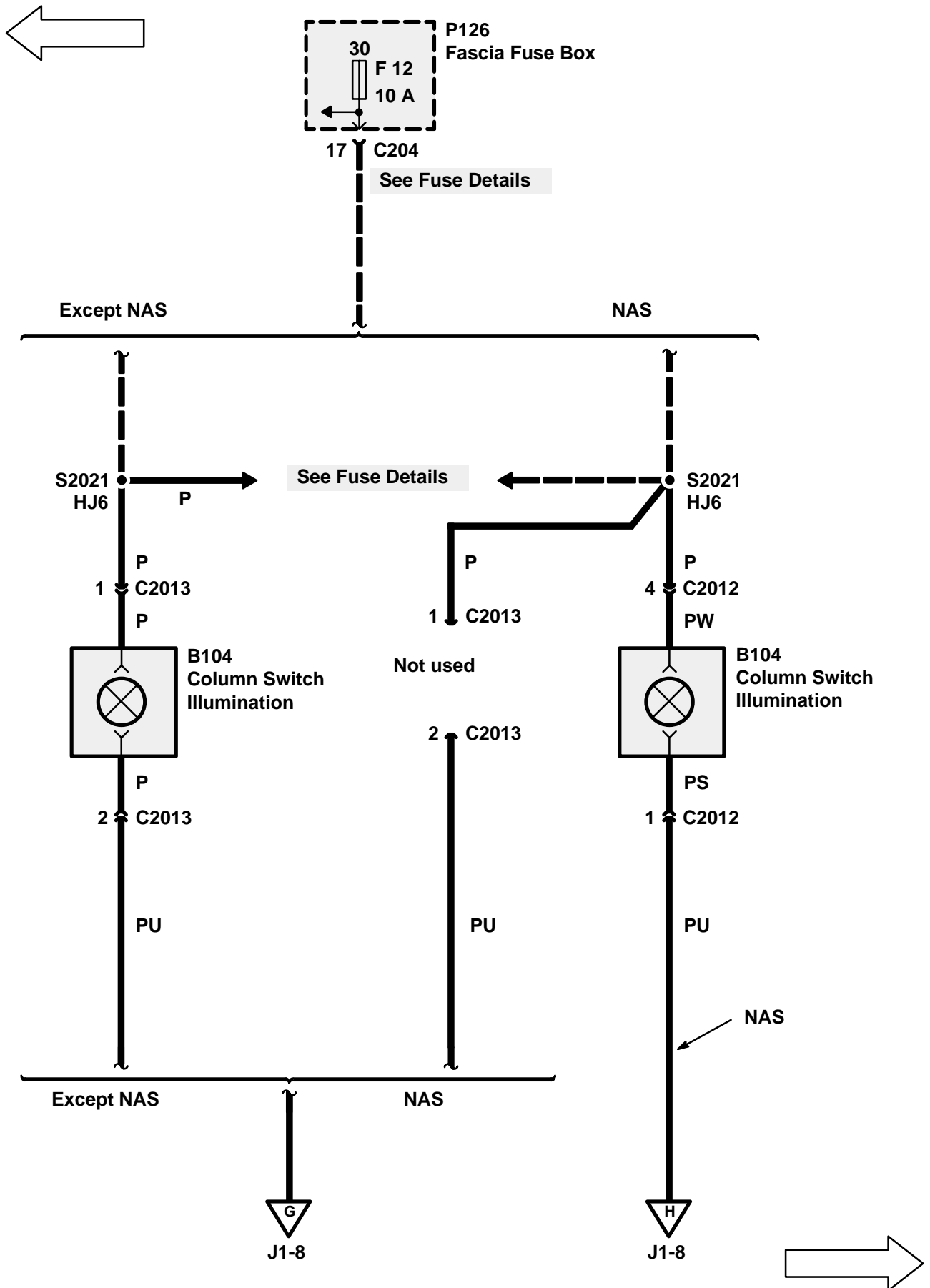

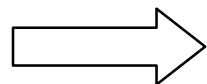
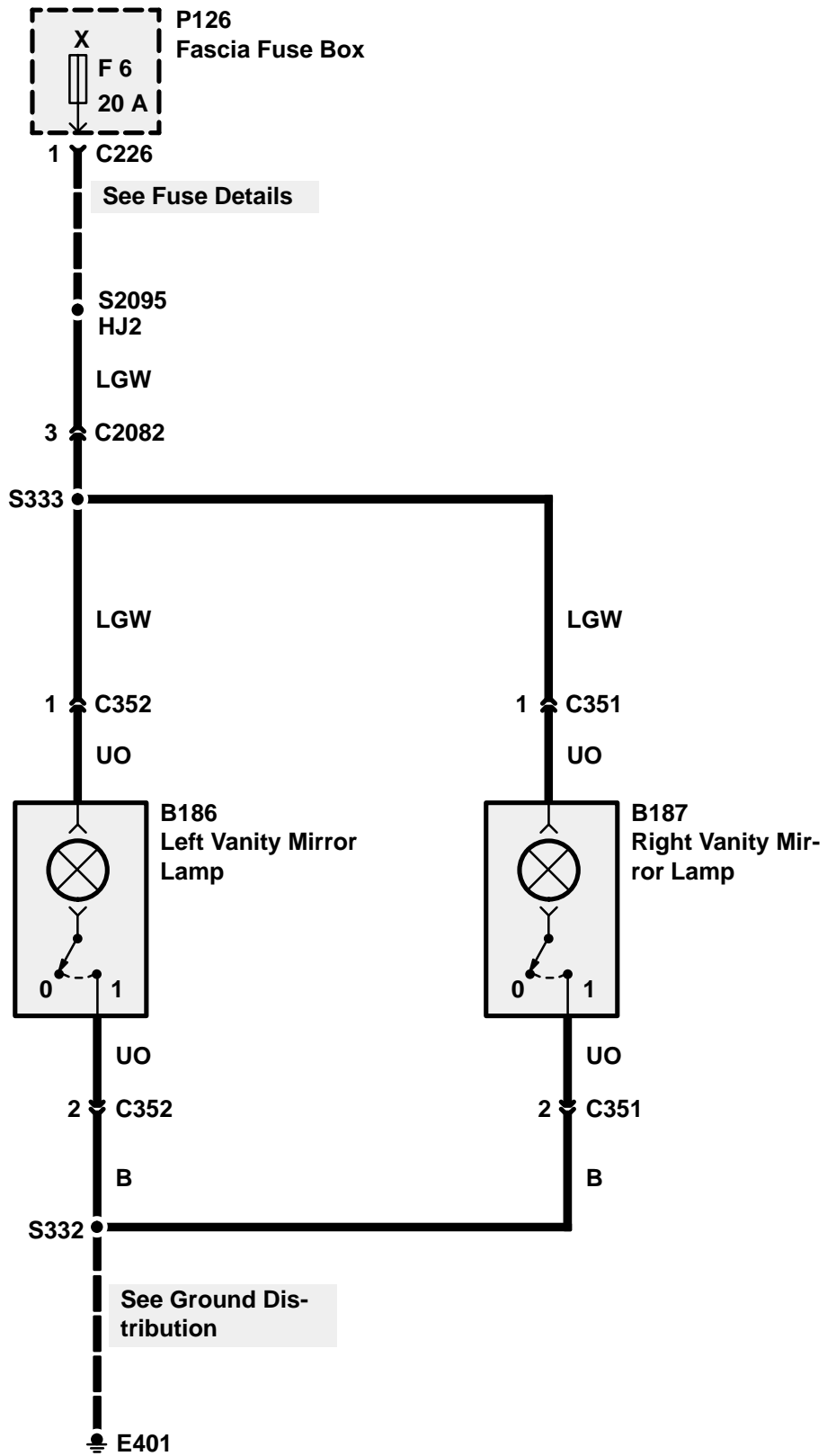
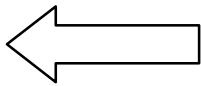

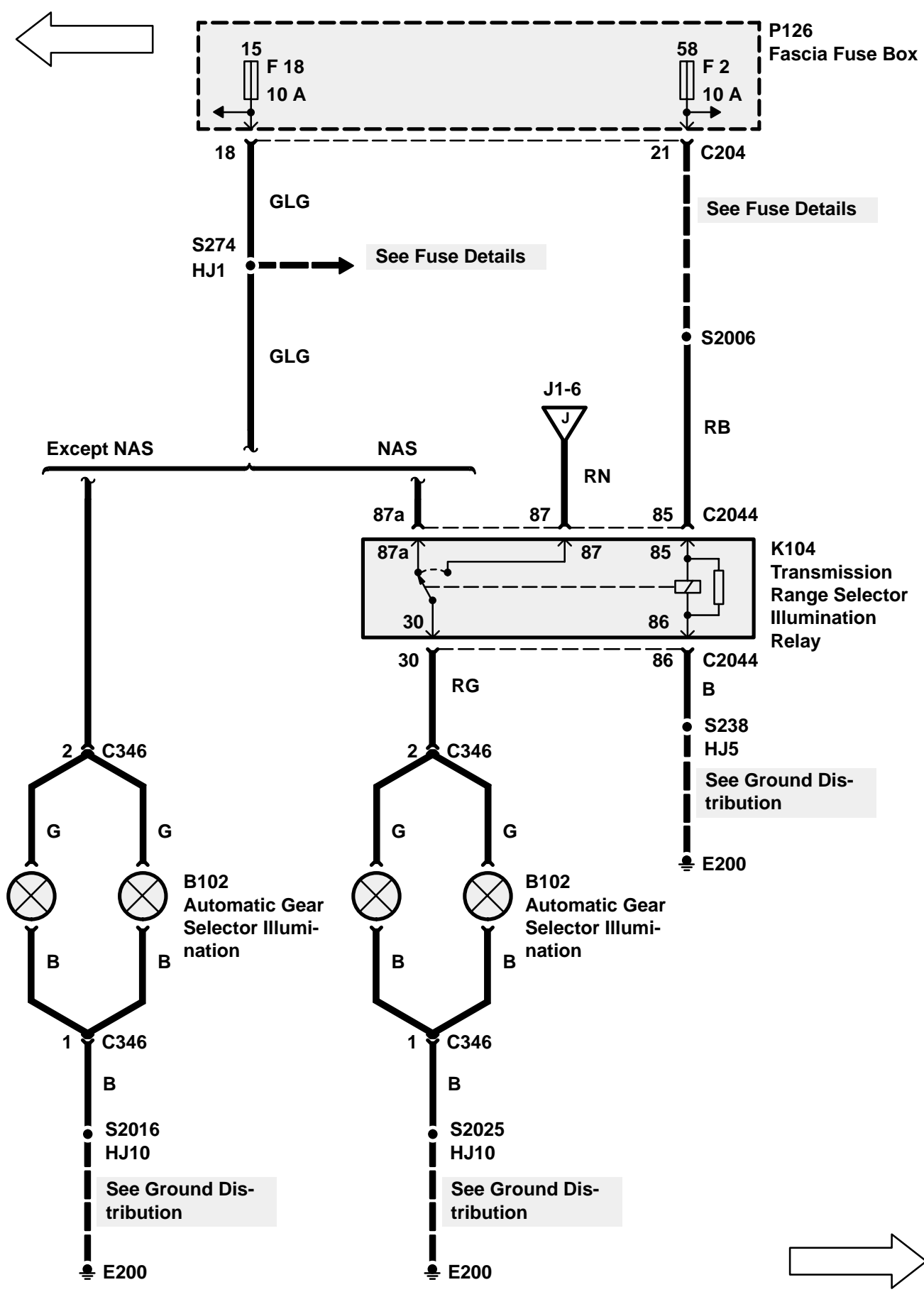

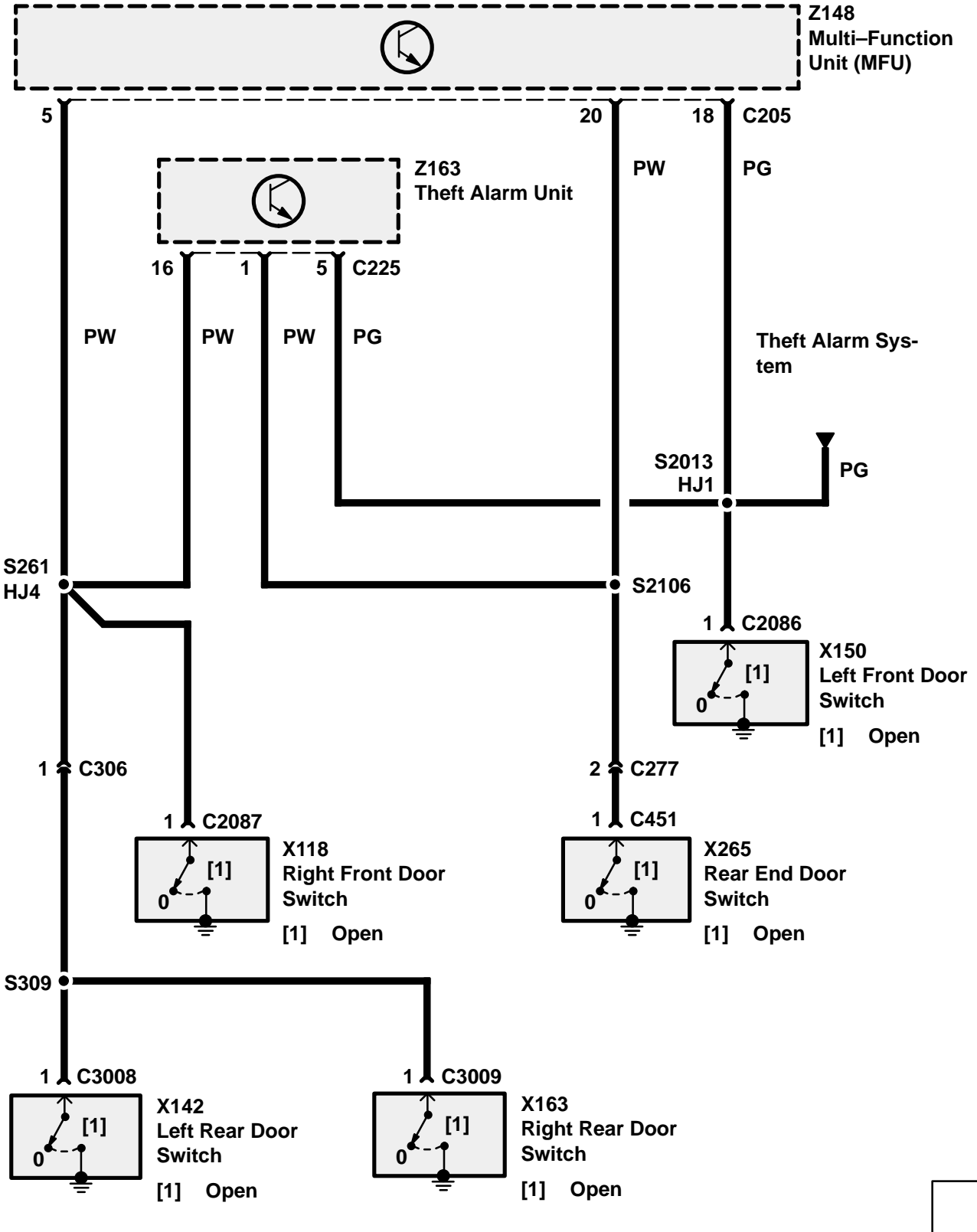
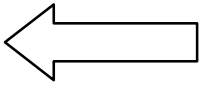

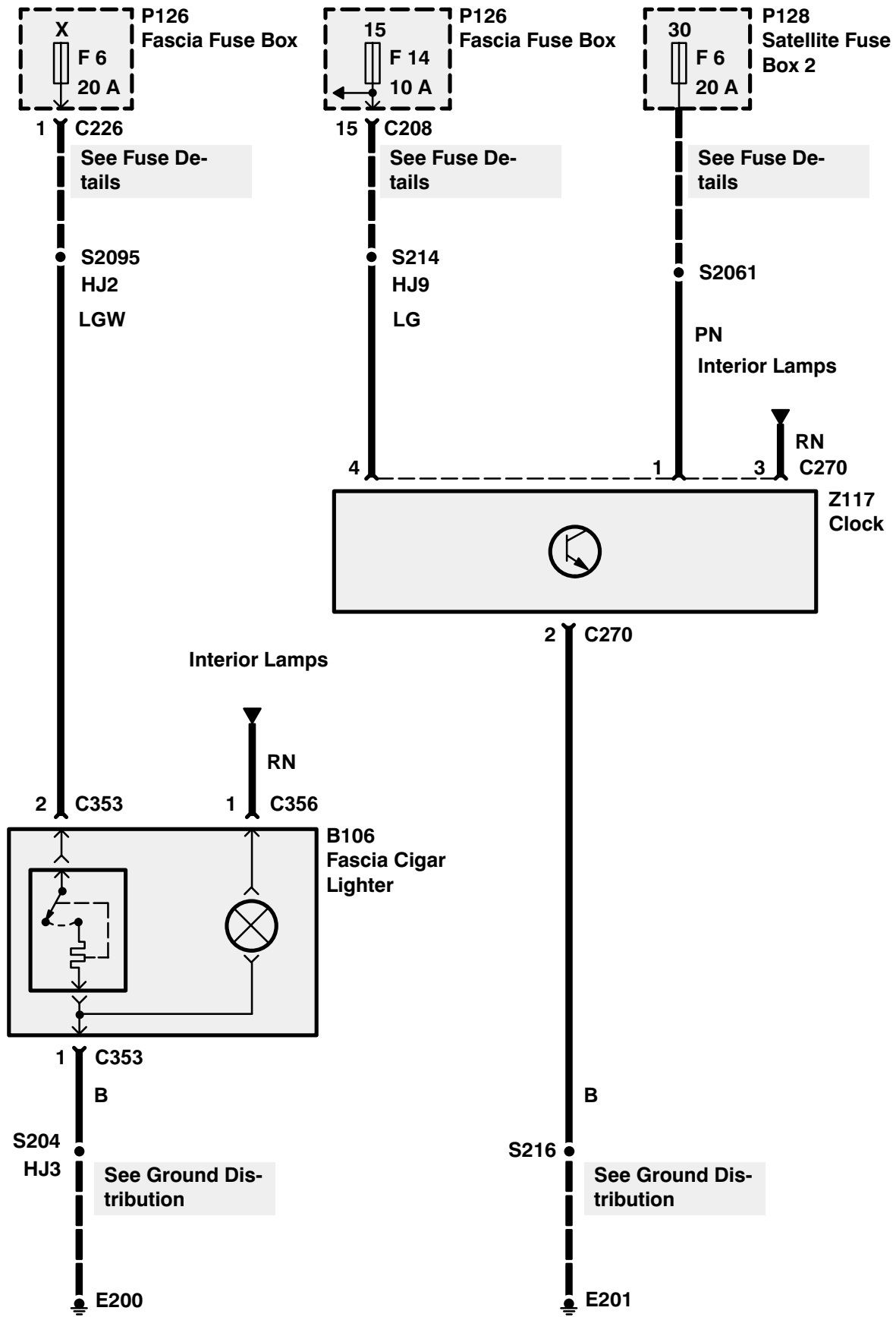

## CIRCUIT OPERATION

### Front Blower

With the Ignition Switch (X134) in position II, battery voltage is applied to the Ignition Load Relay (K127). The relay is energised, applying battery voltage to the Front Blower Motor Relay (K192).

When the Front Fan Speed Switch (X247) is turned to position I, ground is applied to terminal 85 of the Front Blower Motor Relay (K192). The relay is energised, applying battery voltage to terminal 2 of the Front Blower Motor (M101). Ground is applied to the Front Blower Motor (M101) through all three resistors of the Front Blower Resistor Unit (Z214). The Front Blower Motor (M101) then runs at low speed. When the Front Fan Speed Switch (X247) is turned to position II, the Front Blower Motor Relay (K192) remains energised. Battery voltage is still applied to terminal 2 of the Front Blower Motor (M101). Ground is now applied to the Front Blower Motor (M101) through two resistors of the Front Blower Resistor Unit (Z214) and the Front Fan Speed Switch (X247). The motor then runs at the low-medium speed. When the Front Fan Speed Switch (X247) is turned to position III, the Front Blower Motor Relay (K192) remains energised. Ground is now applied to the Front Blower Motor (M101) through one resistor of the Front Blower Resistor Unit (Z214) and the Front Fan Speed Switch (X247). The motor then runs at the medium-high speed. When the Front Fan Speed Switch (X247) is turned to position IV, the Front Blower Motor Relay (K192) remains energised. Ground is now applied directly to the Front Blower Motor (M101) through the Front Fan Speed Switch (X247). The motor then runs at high speed.

### Fresh Air Mode

With the Ignition Switch (X134) in position II, battery voltage is applied to the Ignition Load Relay (K127). The relay is energised, applying battery voltage to the Air Recirculation Solenoid In-Line Fuse (P138) and Air Recirculation Solenoid (K123). When the Air Supply Selector Switch is moved to the Fresh Air position, ground is applied to the Air Recirculation Solenoid (K123). The solenoid now opens the fresh air intake flap allowing fresh air to enter the vehicle cabin. When the fresh air intake flap has been fully opened, the microswitch inside the Air Recirculation Solenoid (K123) moves to the Fresh Air position interrupting the ground supply. The solenoid now stops and remains in the Fresh Air position.

### Recirculated Air Mode

With the Ignition Switch (X134) in position II, battery voltage is applied to the Ignition Load Relay (K127). The relay is energised, applying battery voltage to the Air Recirculation Solenoid In-Line Fuse (P138) and Air Recirculation Solenoid (K123). When the Air Supply Selector Switch is moved to Recirculate Air position, ground is applied to the Air Recirculation Solenoid (K123). The solenoid now closes the fresh air intake flap allowing only the air inside the vehicle cabin to circulate. When the fresh air intake flap has been fully closed, the microswitch inside the Air Recirculation Solenoid (K123) moves to the Recirculate Air position interrupting the ground supply. The solenoid now stops and remains in the Recirculate Air position.

### Rear Blower

With the Ignition Switch (X134) in position II, battery voltage is applied to the Ignition Load Relay (K127). The relay is energised, applying battery voltage to the Rear Blower Motor Relay (K193), the Rear A/C Fan Speed Relay (K205) and the Rear A/C Control Relay (K194).

When the Rear A/C System is turned on, the Rear A/C Switch Amplifier provides ground to the Rear A/C Control Relay (K194). The relay is energised, applying ground to the Rear A/C Fan Speed Relay (K205). The Rear A/C Fan Speed Relay (K205) then energises. When the Passenger's Rear Fan Speed Switch (X246) is turned to position I, ground is applied to terminal 85 of the Rear Blower Motor Relay (K193) through the closed switch contacts of the Rear A/C Fan Speed Relay (K205). The Rear Blower Motor Relay (K193) energises, applying battery voltage to terminal 1 of the Rear Blower Motor (M145).

Ground is applied to the Rear Blower Motor (M145) through all three resistors of the Rear Blower Resistor Unit (Z215). The Rear Blower Motor (M145) then runs at low speed. When the Passenger's Rear Fan Speed Switch (X246) is turned to position II, the Rear Blower Motor Relay (K193) remains energised. Battery voltage is still applied to terminal 1 of the Rear Blower Motor (M145). Ground is now applied to the Rear Blower Motor (M145) through two resistors of the Rear Blower Motor Resistor Unit (Z215) and the Passenger's Rear Fan Speed Switch (X246). The motor then runs at the low-medium speed. When the Passenger's Rear Fan Speed Switch (X246) is turned to position III, the Rear Blower Motor Relay (K193) remains energised. Ground is now applied to the Rear Blower Motor (M145) through one resistor of the Rear Blower Motor Resistor Unit (Z215) and the Passenger's Rear Fan Speed Switch (X246).

The motor then runs at medium-high speed. When the Passenger's Rear Fan Speed Switch (X246) is turned to position IV, the Rear Blower Motor Relay (K193) remains energised. Ground is now applied directly to the Rear Blower Motor (M145) through the Passenger's Rear Fan Speed Switch (X246). The motor then runs at high speed.



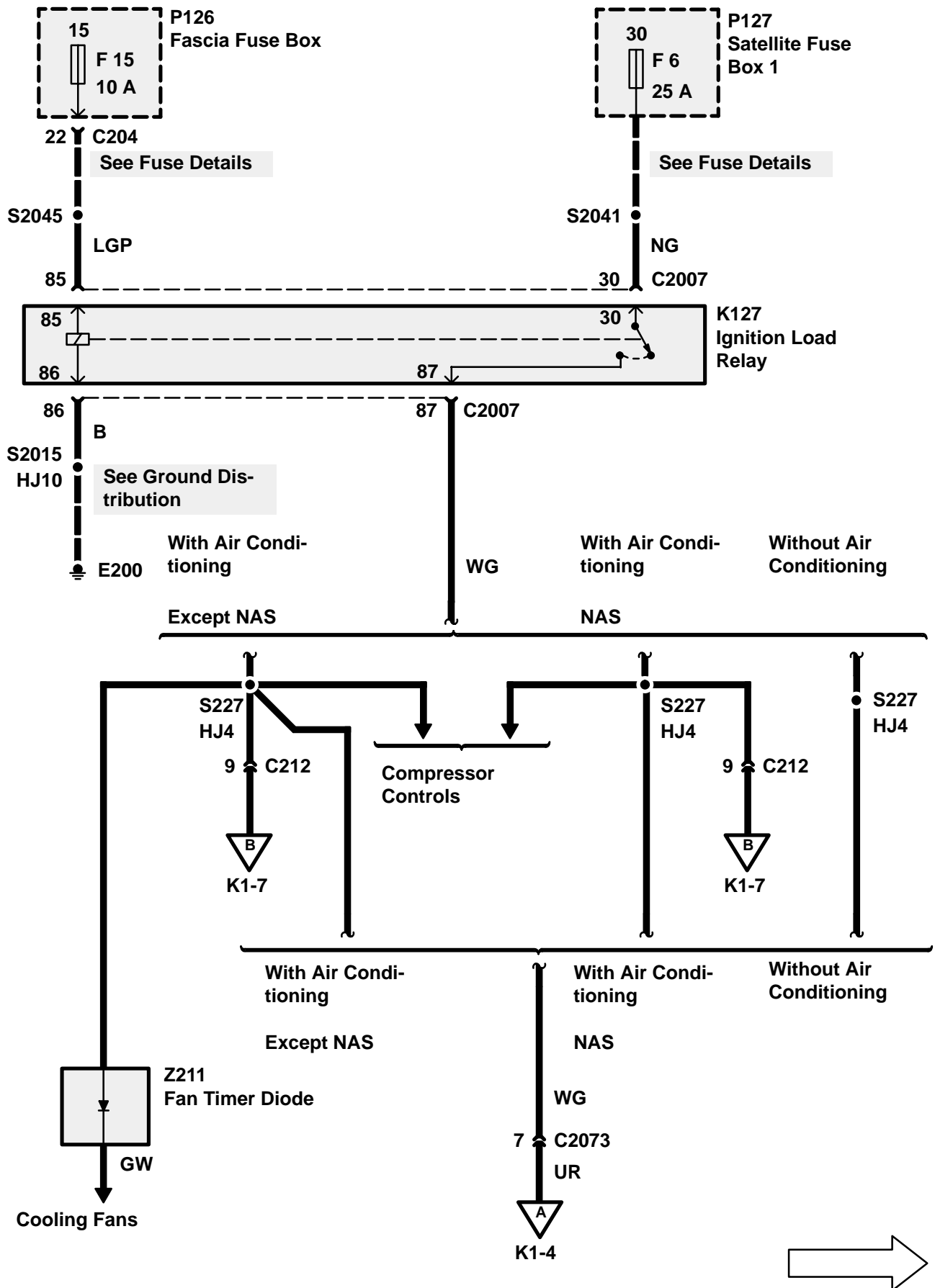

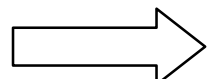
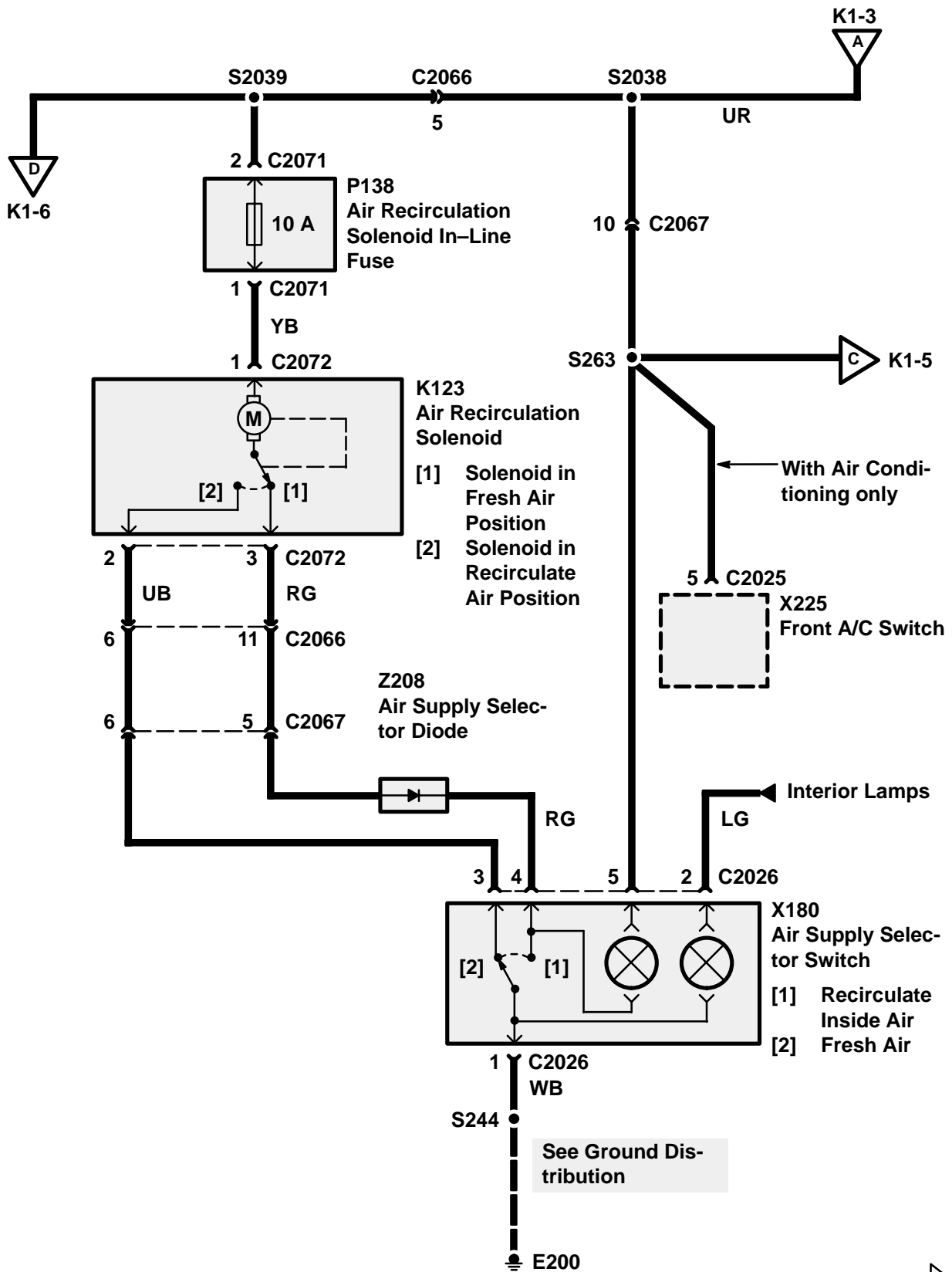
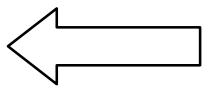

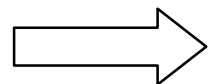
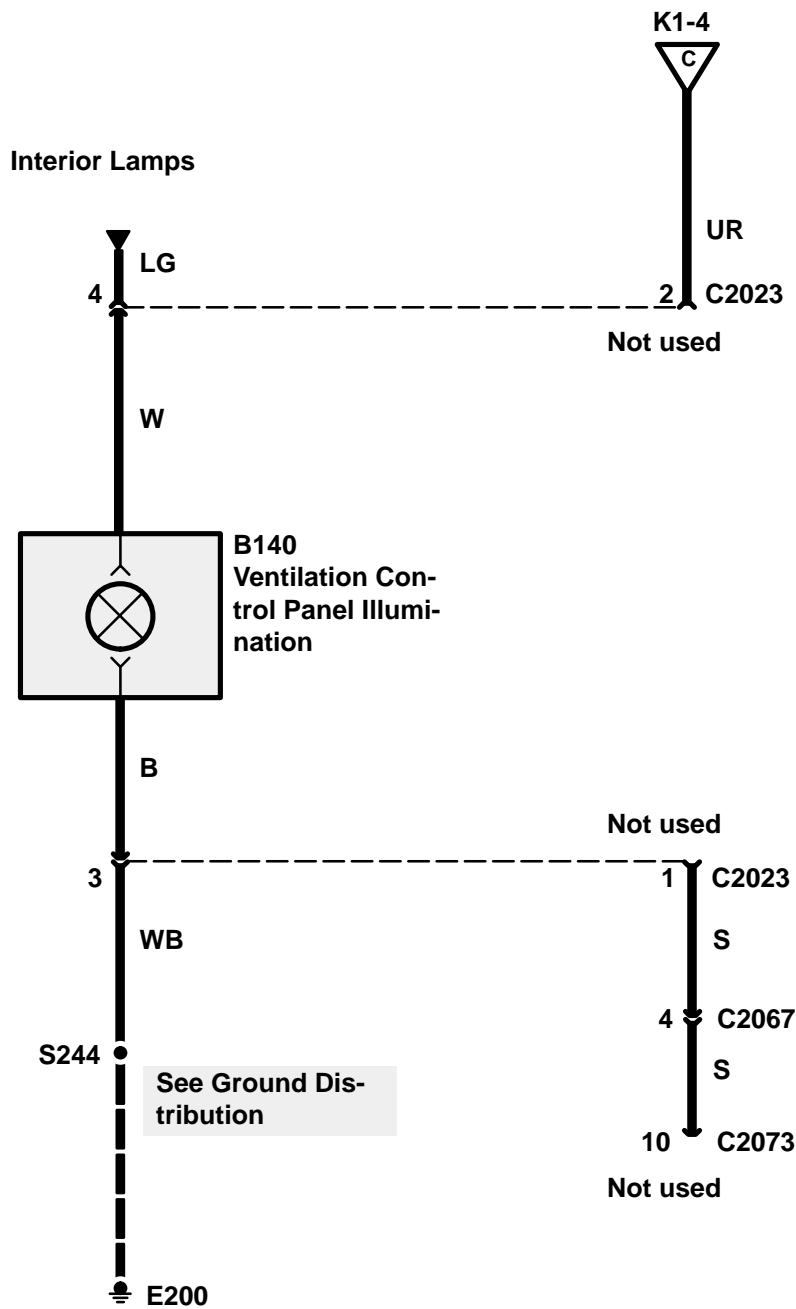
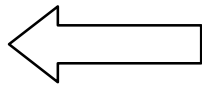

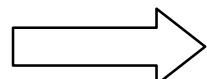
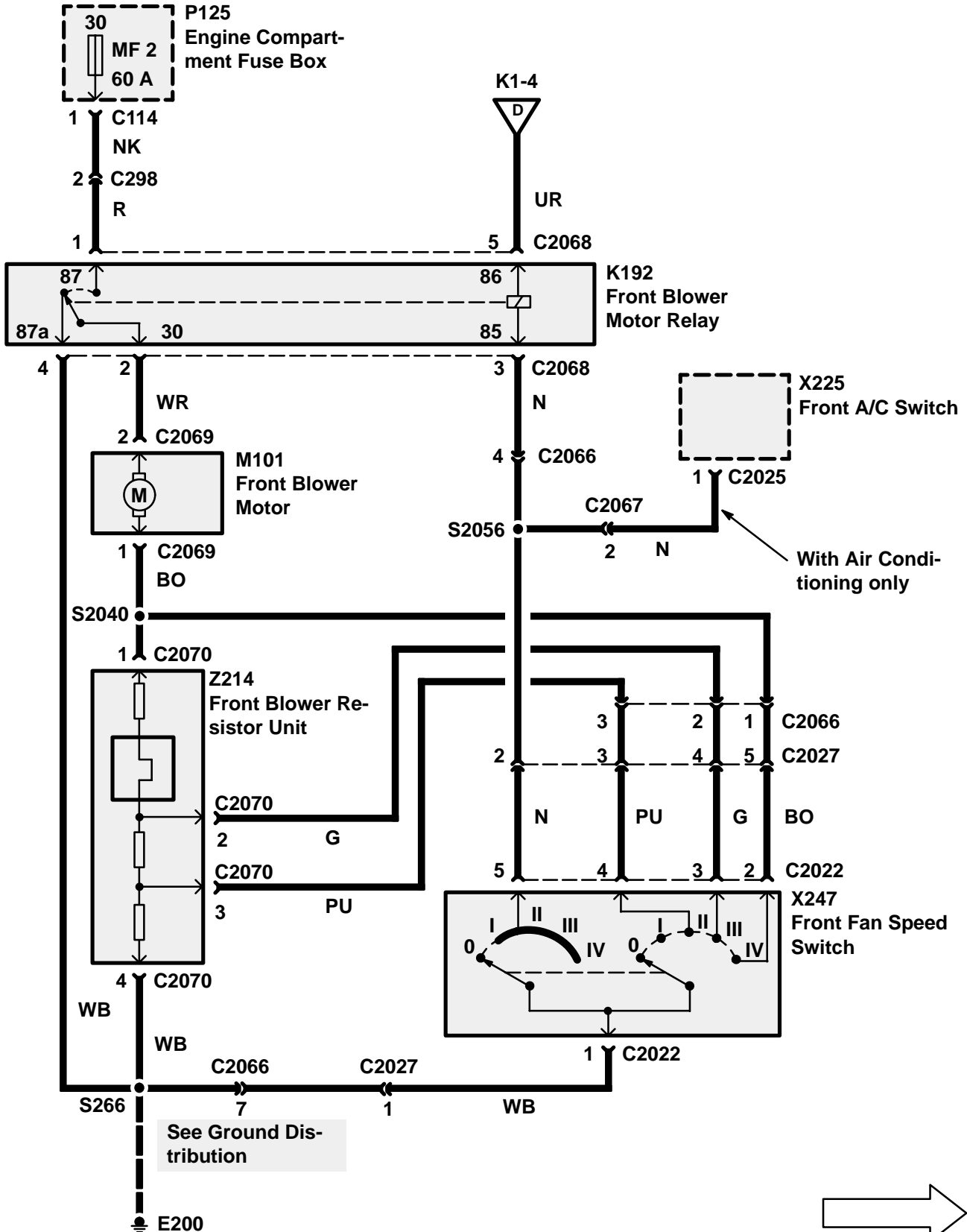
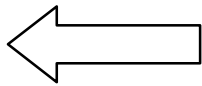

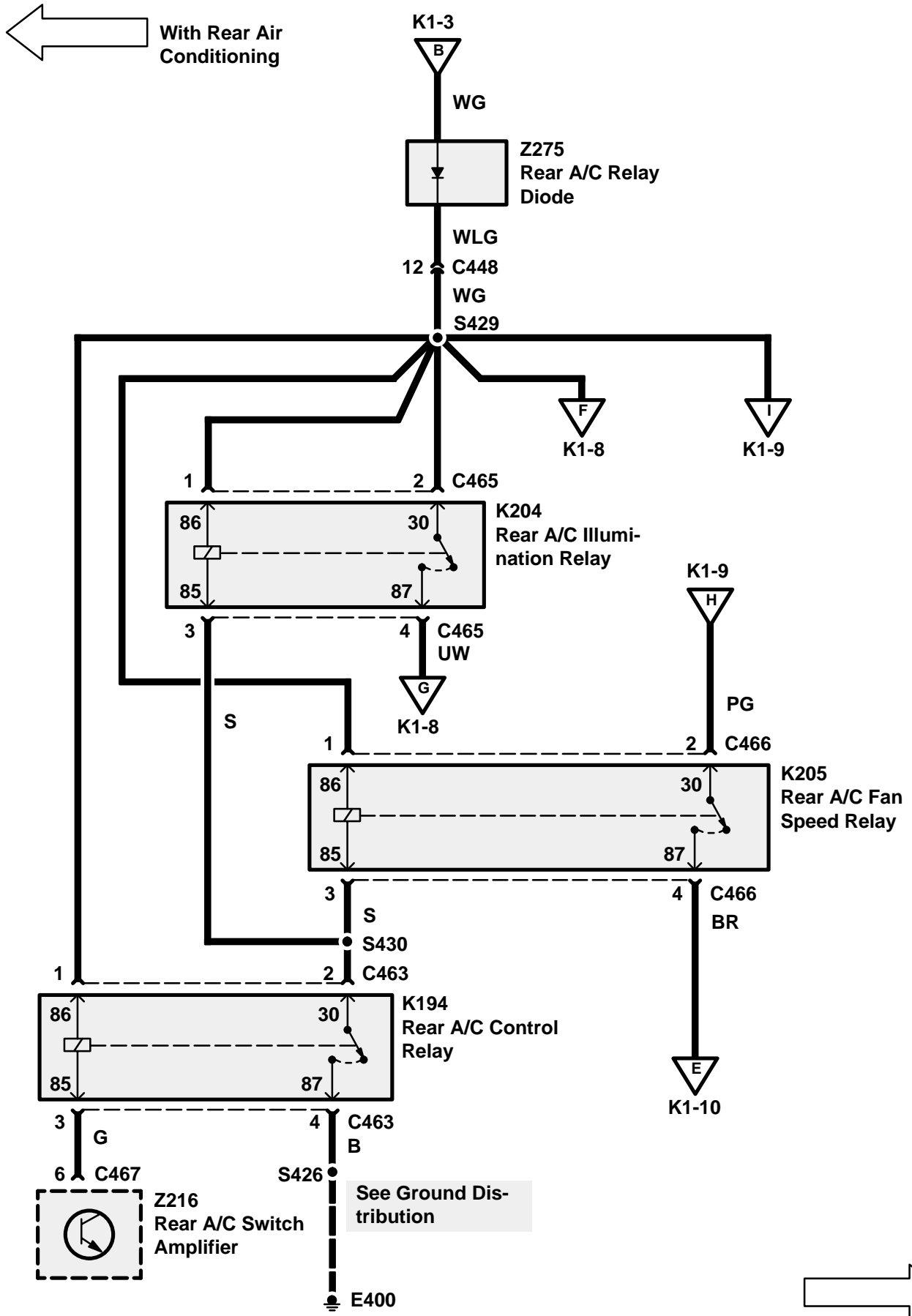

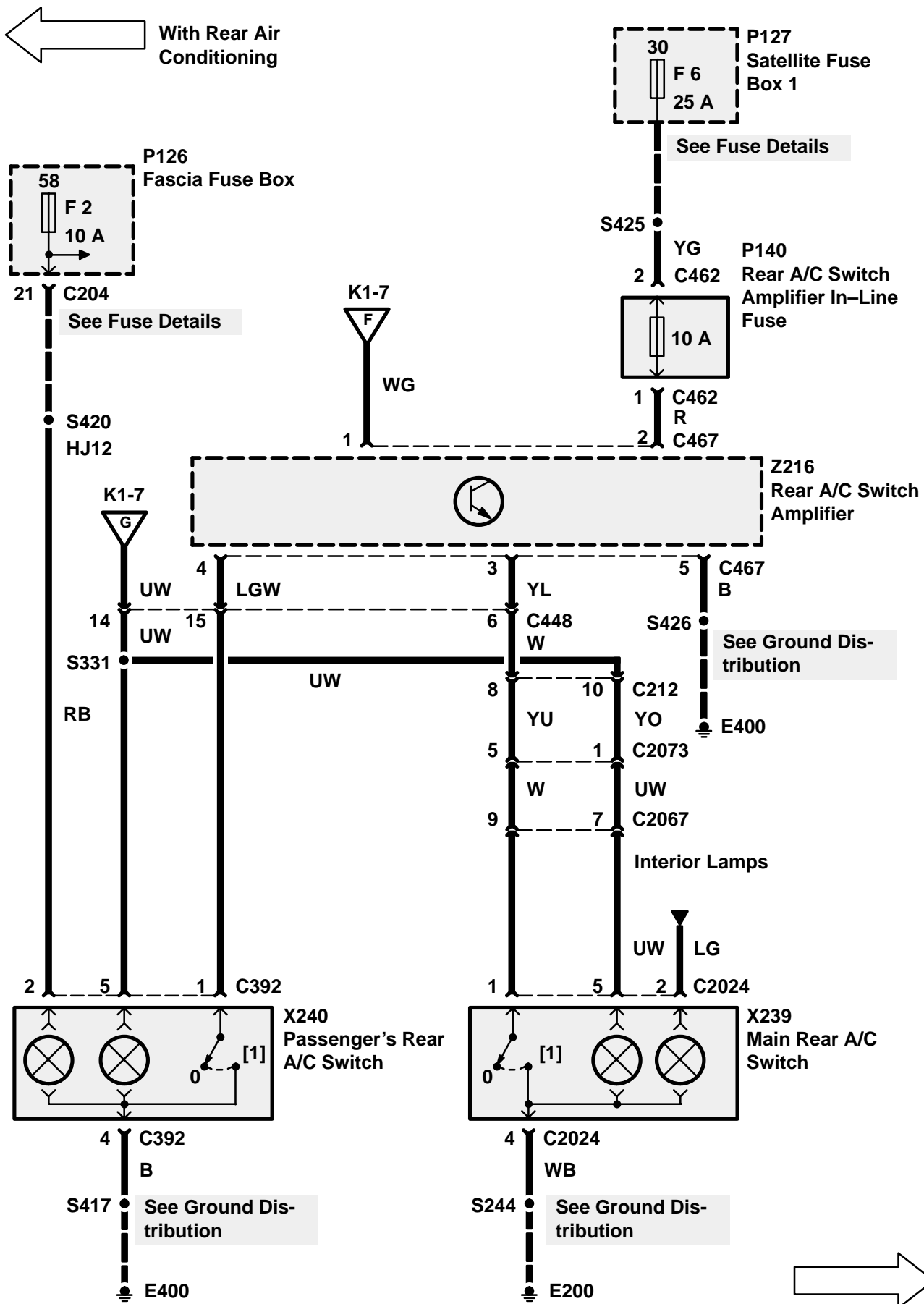

← With Rear Air Conditioning

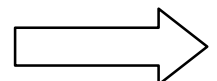
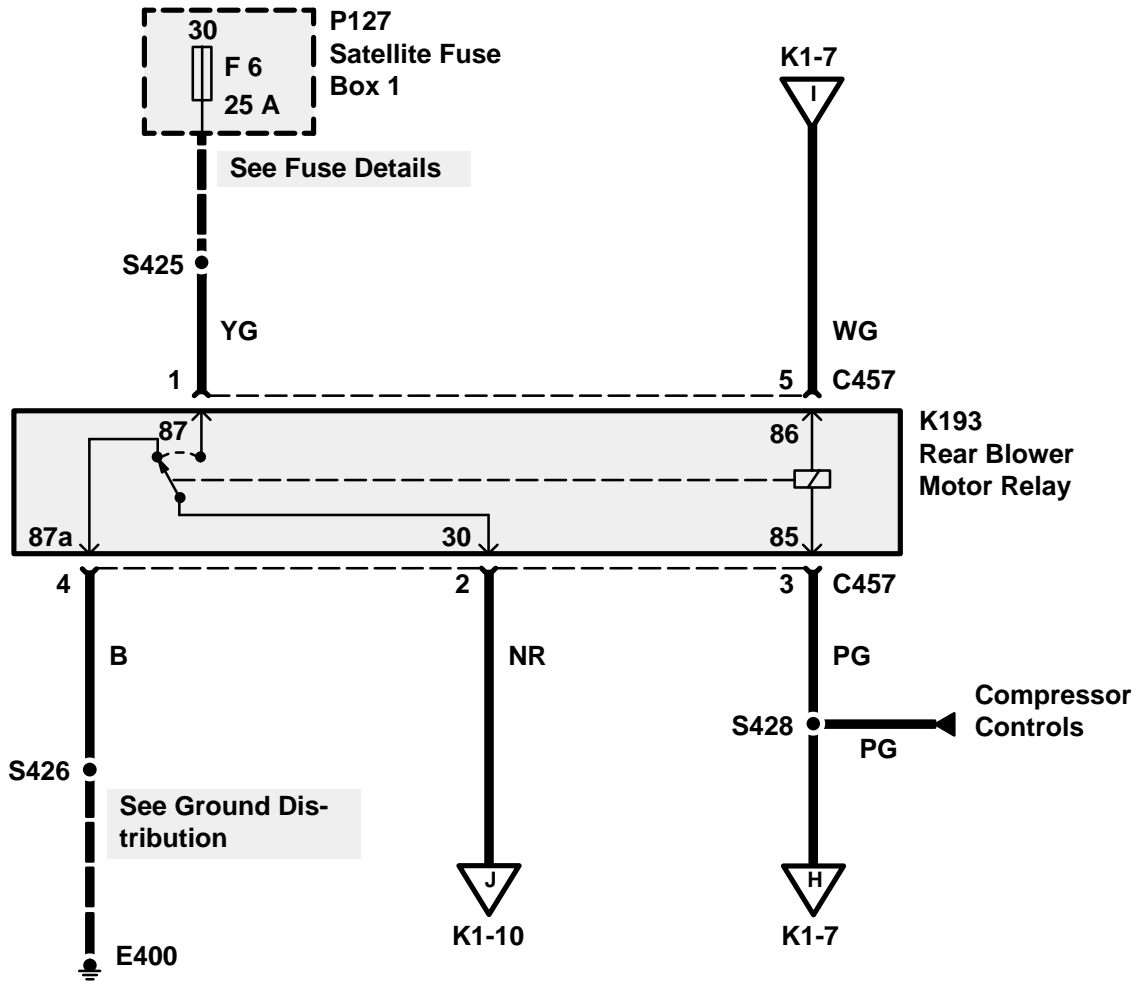

← With Rear Air Conditioning

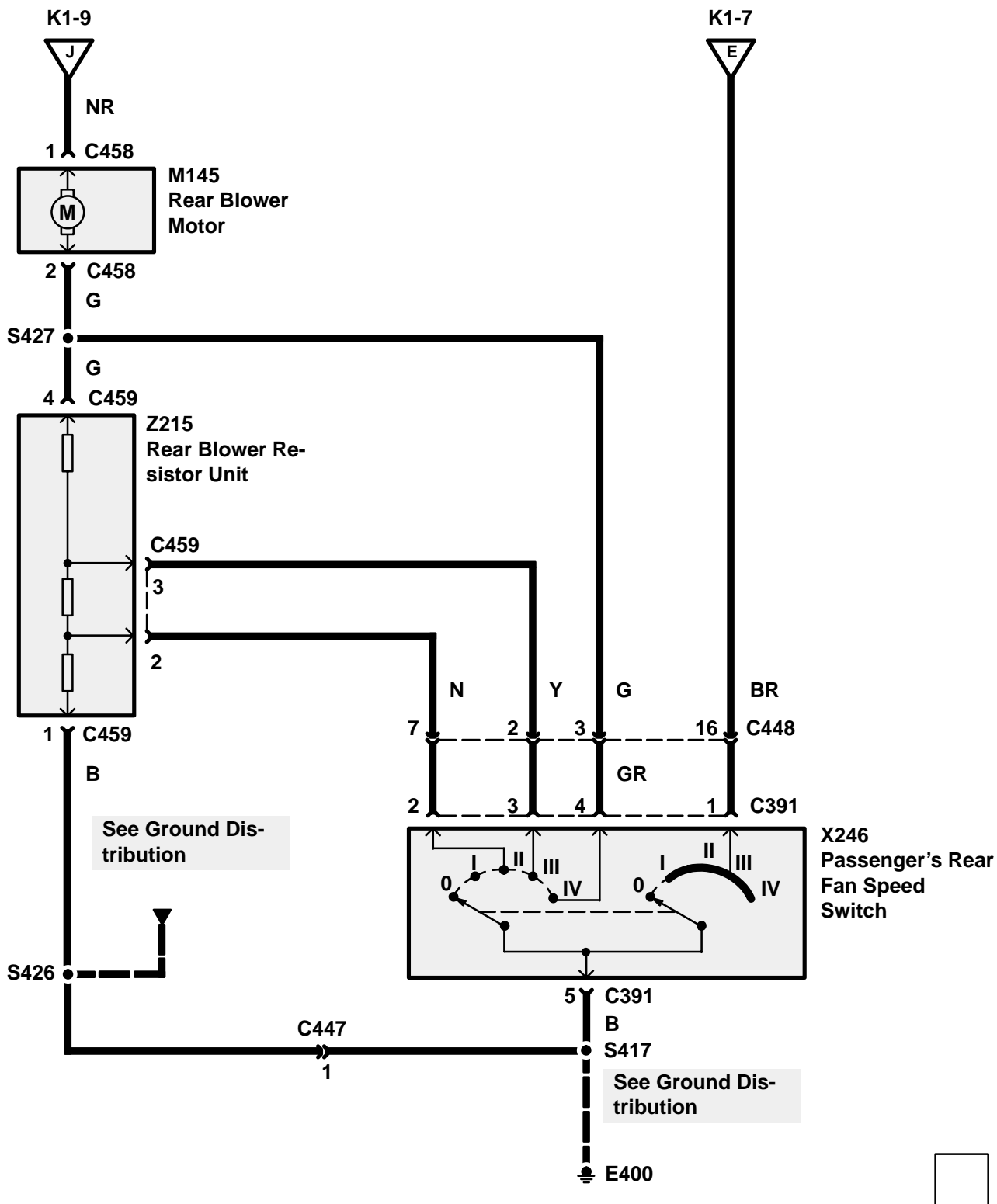



## CIRCUIT OPERATION

### Compressor Control (MFI-V8)

With the Ignition Switch (X134) in position II, battery voltage is applied to the Ignition Load Relay (K127). The relay is energised, applying battery voltage to the Compressor Clutch Relay (K108) and the A/C Logic Relay (K170). When the Front Fan Speed Switch (X247) is turned to positions I, II, III, or IV and the Front A/C Switch (X225) is turned on, ground is provided to terminal 86 of the A/C Logic Relay (K170) through the closed contacts of the A/C Dual Pressure Switch (X102) and the Front A/C Evaporator Temperature Switch (X101).

The relay is energised, applying battery voltage to the Engine Control Module (ECM) (Z132), which signals the ECM that compressor operation has been requested. The ECM then provides ground to the coil of the Compressor Clutch Relay (K108). The relay is energised, applying battery voltage to the Compressor Clutch (K107). Compressor Clutch operation is now controlled by the status of the A/C Dual Pressure Switch (X102) and the Front A/C Evaporator Temperature Switch (X101).

The Front A/C Evaporator Temperature Switch (X101) is fitted in the airflow out of the front evaporator to sense the temperature of the exterior fins. Should ice begin to form due to low temperature, the switch will open. The A/C Dual Pressure Switch (X102) monitors refrigerant pressure in the high pressure line. Should pressure become too high or too low, the switch will open. When one or both of these switches open, the ground supply to terminal 86 of the A/C Logic Relay (K170) will be interrupted. The relay de-energises, removing battery voltage from the Engine Control Module (ECM) (Z132), which signals the ECM that compressor operation should be turned off. The ECM removes the ground supply to the coil of the Compressor Clutch Relay (K108). The relay then de-energises, removing battery voltage from the Compressor Clutch (K107), thereby disengaging the Compressor.

### Compressor Control (MFI-T16)

With the Ignition Switch (X134) in position II, battery voltage is applied to the Compressor Clutch Relay (K108) and the A/C Logic Relay (K170). When the Front Fan Speed Switch (X247) is turned to positions I, II, III, or IV and the Front A/C Switch (X225) is turned on, ground is provided to terminal 85 of the A/C Logic Relay (K170) through the closed

contacts of the A/C Dual Pressure Switch (X102) and the Front A/C Evaporator Temperature Switch (X101).

The relay is energised, applying ground to terminal 35 of the Engine Control Module (ECM) (Z132), which signals the ECM that compressor operation has been requested. The ECM then provides ground to the terminal 86 of the Compressor Clutch Relay (K108). The relay is energised, applying battery voltage to the Compressor Clutch (K107).

Compressor Clutch operation is now controlled by the status of the A/C Dual Pressure Switch (X102) and the Front A/C Evaporator Temperature Switch (X101).

The Front A/C Evaporator Temperature Switch (X101) is fitted in the airflow out of the front evaporator to sense the temperature of the exterior fins. Should ice begin to form due to low temperature, the switch will open. The A/C Dual Pressure Switch (X102) monitors refrigerant pressure in the high pressure line. Should pressure become too high or too low, the switch will open. When one or both of these switches open, the ground supply to terminal 85 of the A/C Logic Relay (K170) will be interrupted. The relay de-energises, removing the ground supply from terminal 35 of the Engine Control Module (ECM) (Z132), which signals the ECM that compressor operation should be turned off. The ECM removes the ground supply to terminal 86 of the Compressor Clutch Relay (K108). The relay then de-energises, removing battery voltage from the Compressor Clutch (K107), thereby disengaging the Compressor.

### Compressor Control (NAS) (SFI-V8)

With the Ignition Switch (X134) in position II, battery voltage is applied to the Ignition Load Relay (K127). The relay is energised, applying battery voltage to the Compressor Clutch Relay (K108). When the Front Fan Speed Switch (X247) is turned to positions I, II, III, or IV and the Front A/C Switch (X225) is turned on, ground is provided to terminal 28 of the Engine Control Module (ECM) (Z132) through the closed contacts of the A/C Dual Pressure Switch (X102) and the Front A/C Evaporator Temperature Switch (X101). The signal informs the ECM that compressor operation has been requested. The ECM then provides ground to the coil of the Compressor Clutch Relay (K108). The relay is energised, applying battery voltage to the Compressor Clutch (K107). Compressor Clutch operation is now controlled by the status of the A/C Dual Pressure Switch (X102) and the Front A/C Evaporator Temperature Switch (X101).

The Front A/C Evaporator Temperature Switch (X101) is fitted in the airflow out of the front evaporator to sense the temperature of the exterior fins. Should ice begin to form due to low temperature, the switch will open. The A/C Dual Pressure Switch (X102) monitors refrigerant pressure in the high pressure line. Should pressure become too high or too low, the switch will open. When one or both of these switches open, the ground supply to terminal 28 of the ECM will be interrupted. This signal informs the ECM that compressor operation should be turned off. The ECM removes the ground supply to the coil of the Compressor Clutch Relay (K108). The relay then de-energises, removing battery voltage from the Compressor Clutch (K107), thereby disengaging the Compressor.

#### **Compressor Control (300Tdi without EDC)**

With the Ignition Switch (X134) in position II, battery voltage is applied to the Ignition Load Relay (K127). The relay is energised, applying battery voltage to the Compressor Clutch Relay (K108).

When the Front Fan Speed Switch (X247) is turned to positions I, II, III, or IV and the Front A/C Switch (X225) is turned on, ground is provided to terminal 86 of the Compressor Clutch Relay (K108) through the closed contacts of the A/C Dual Pressure Switch (X102), the Front A/C Evaporator Temperature Switch (X101), and the Compressor Clutch Cut-out Switch (X259).

The relay is energised, applying battery voltage to the Compressor Clutch (K107). Compressor Clutch operation is now controlled by the status of the A/C Dual Pressure Switch (X102), the Front A/C Evaporator Temperature Switch (X101), and the Compressor Clutch Cut-out Switch (X259).

The Front A/C Evaporator Temperature Switch (X101) is fitted in the airflow out of the front evaporator to sense the temperature of the exterior fins. Should ice begin to form due to low temperature, the switch will open. The A/C Dual Pressure Switch (X102) monitors refrigerant pressure in the high pressure line. Should pressure become too high or too low the switch will open. When one or more of these switches open, the ground supply to terminal 86 of the Compressor Clutch Relay (K108) will be interrupted. The relay de-energises, removing battery voltage from the Compressor Clutch (K107), thereby disengaging the Compressor.

#### **Compressor Control (300Tdi with EDC)**

With the Ignition Switch (X134) in position II, battery voltage is applied to the Ignition Load Relay (K127). The relay is energised, applying battery voltage to the Compressor Clutch Relay (K108). When the Front Fan Speed Switch (X247) is turned to positions I, II, III, or IV and the Front A/C Switch (X225) is turned on, ground is provided to terminal 44 of the Engine Control Module (ECM) (Z132) through the closed contacts of the A/C Dual Pressure Switch (X102) and the Front A/C Evaporator Temperature Switch (X101). The signal informs the ECM that compressor operation has been requested. The ECM then provides ground to the coil of the Compressor Clutch Relay (K108). The relay is energised, applying battery voltage to the Compressor Clutch (K107). Compressor Clutch operation is now controlled by the status of the A/C Dual Pressure Switch (X102) and the Front A/C Evaporator Temperature Switch (X101).

The Front A/C Evaporator Temperature Switch (X101) is fitted in the airflow out of the front evaporator to sense the temperature of the exterior fins. Should ice begin to form due to low temperature, the switch will open. The A/C Dual Pressure Switch (X102) monitors refrigerant pressure in the high pressure line. Should pressure become too high or too low, the switch will open. When one or both of these switches open, the ground supply to terminal 44 of the ECM will be interrupted. This signal informs the ECM that compressor operation should be turned off. The ECM removes the ground supply to the coil of the Compressor Clutch Relay (K108). The relay then de-energises, removing battery voltage from the Compressor Clutch (K107), thereby disengaging the Compressor.

#### **Rear A/C Refrigerant Control Valve**

When front A/C has been selected and the Compressor Clutch (K107) is engaged, the Compressor Clutch Relay (K108) is energised and voltage is applied on the BG wires to the Rear A/C Refrigerant Control Valve (K207). When rear A/C is selected a ground signal is applied to the Rear A/C Switch Amplifier (Z216). The Rear A/C Switch Amplifier (Z216) then applies a ground signal to energise the Rear A/C Control Relay (K194) and the Rear A/C Fan Speed Relay (K205). When the Passenger's Rear Fan Speed Switch (X246) is in any position other than Off,

ground is applied to the Rear A/C Refrigerant Control Valve (K207) through the closed contacts of the Passenger's Rear Fan Speed Switch (X246), BR wire, closed contacts of the Rear A/C Fan Speed Relay (K205), PG wire, UB wire, Rear A/C Refrigerant Control Valve Diode (Z228), P wire, closed contacts of the Rear A/C Evaporator Temperature Switch (X260), and the RG wire.

The Rear A/C Evaporator Temperature Switch (X260) senses the temperature of the exterior fins. Should ice begin to form due to low temperature, the switch will open and the ground supply to the Rear A/C Refrigerant Control Valve (K207) will then be interrupted. The valve de-energises and refrigerant flow is interrupted.

The Rear A/C Refrigerant Control Valve (K207) will also be de-energised if one or more of the following conditions occurs:

1. The Front A/C Switch (X225) has been turned OFF.
2. The Front Fan Speed Switch (X247) has been turned OFF.
3. The Rear A/C switches have been turned OFF.
4. The Passenger's Rear Fan Speed Switch (X246) has been turned OFF.
5. The ECM determines that compressor clutch operation is no longer required.
6. Compressor Clutch (K107) operation has been disabled by the A/C Dual Pressure Switch (X102) or the Front A/C Evaporator Temperature Switch (X101).
7. Compressor Clutch (K107) operation has been disabled by the Compressor Clutch Cut-Out Switch (X259) (300Tdi Without EDC Only).

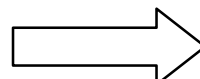
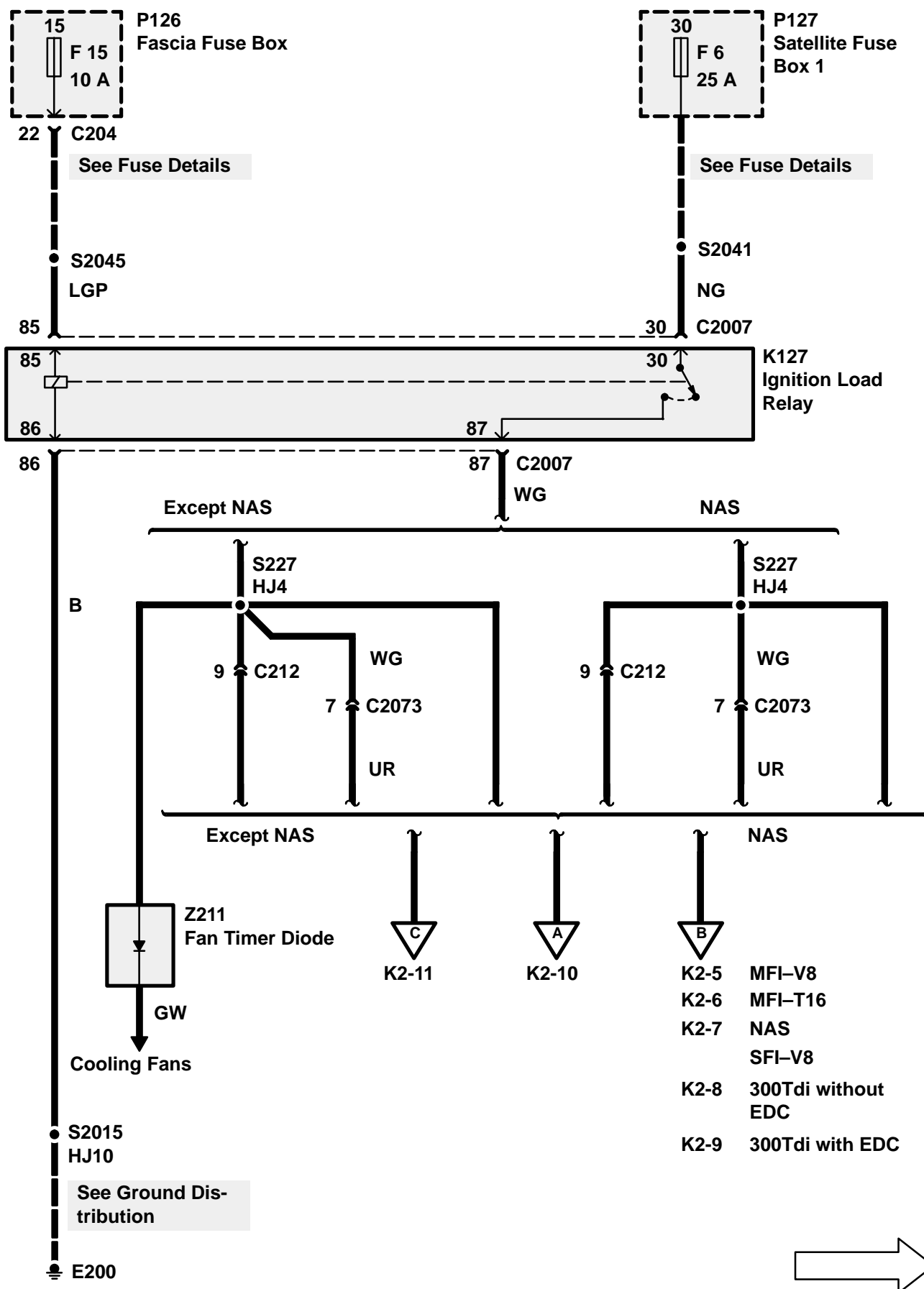

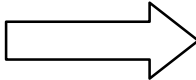
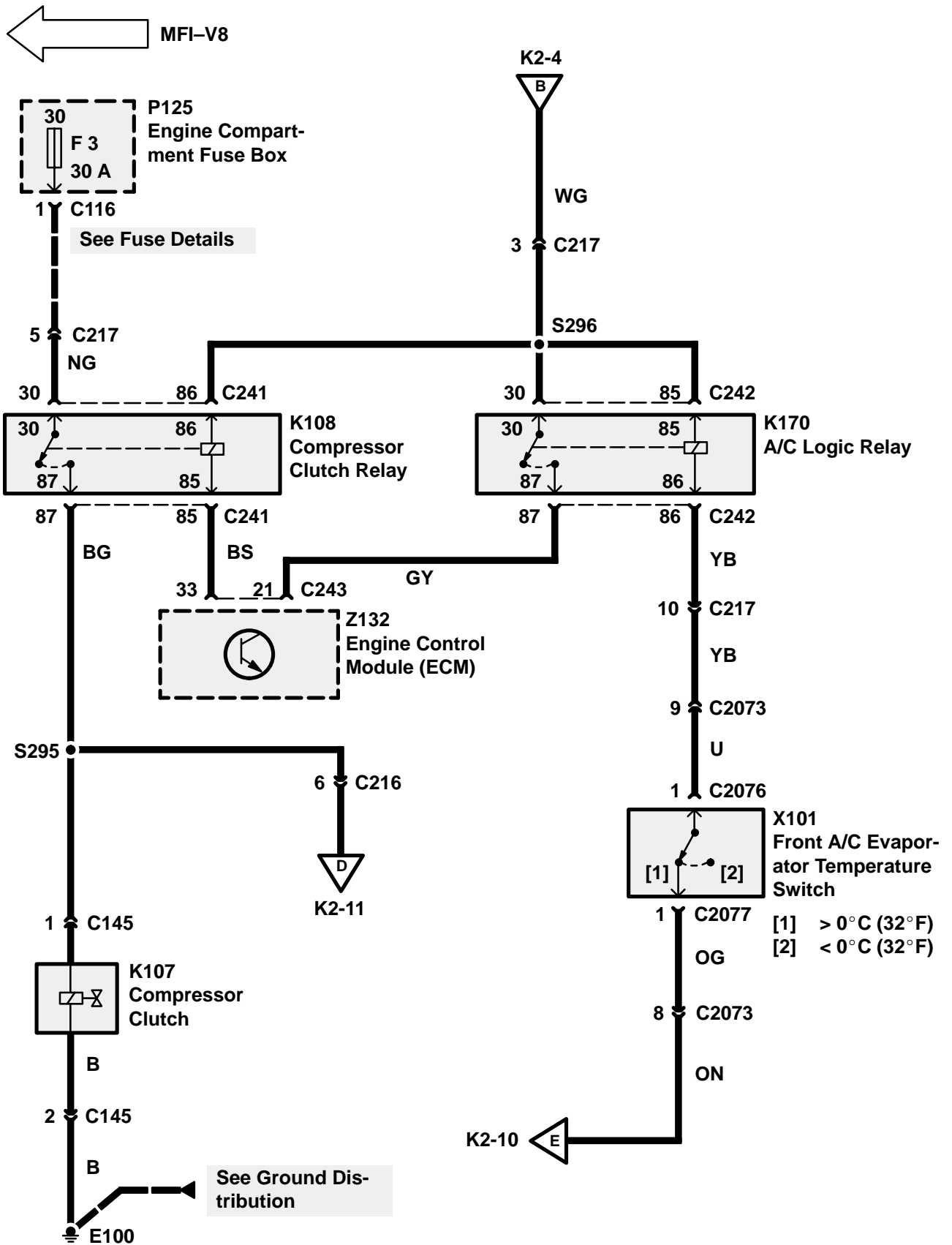





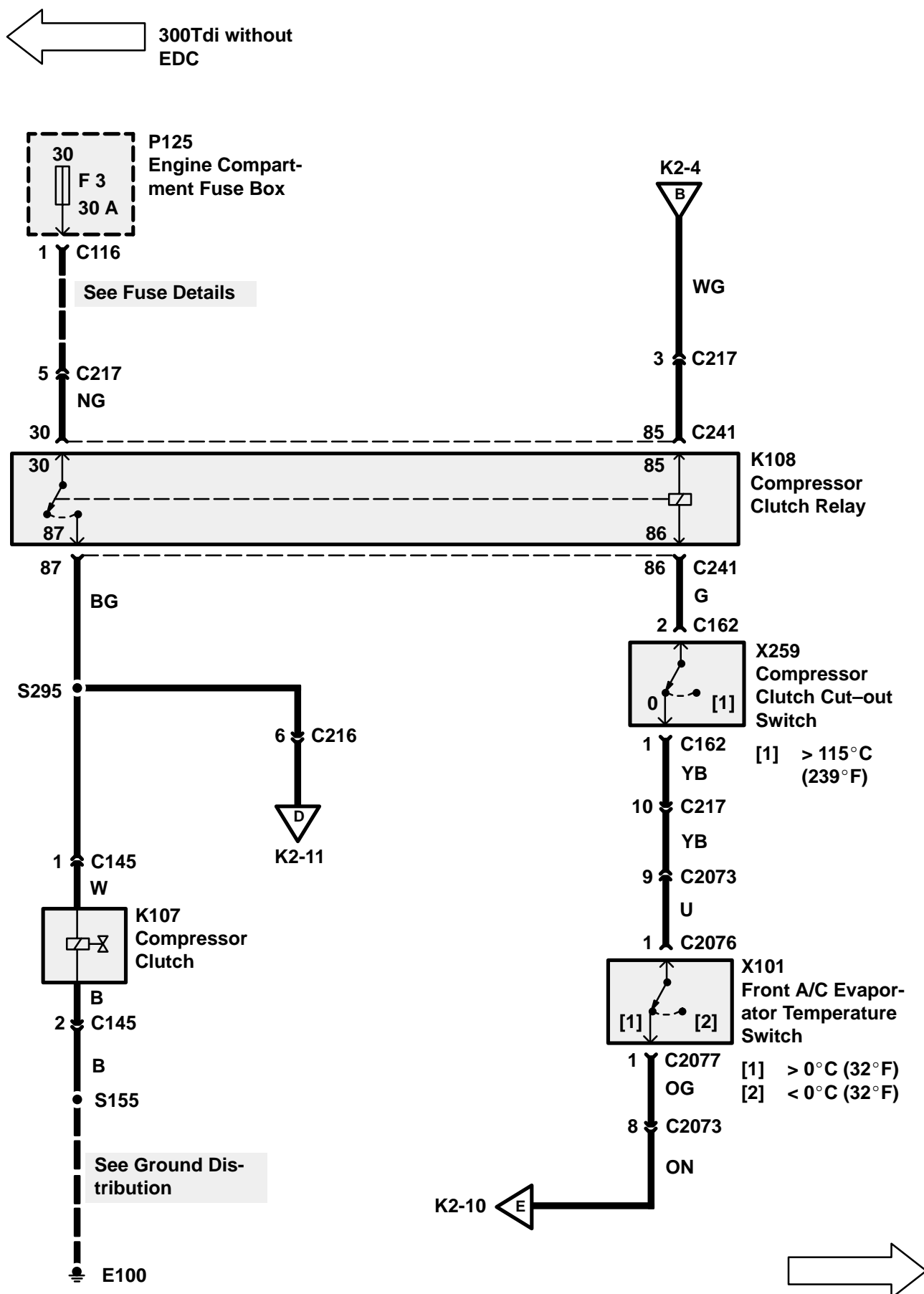



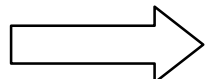
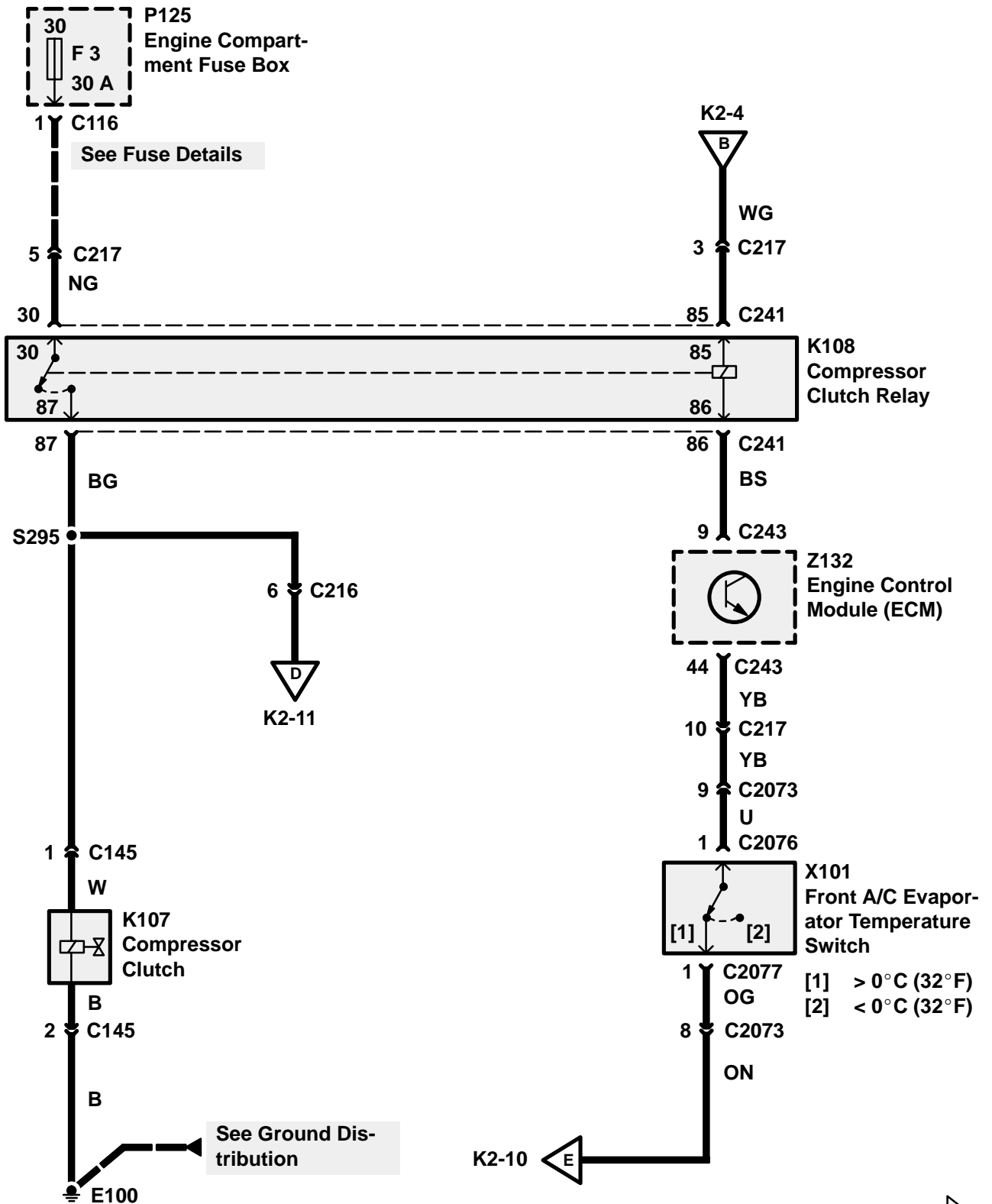
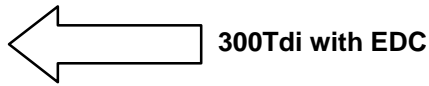

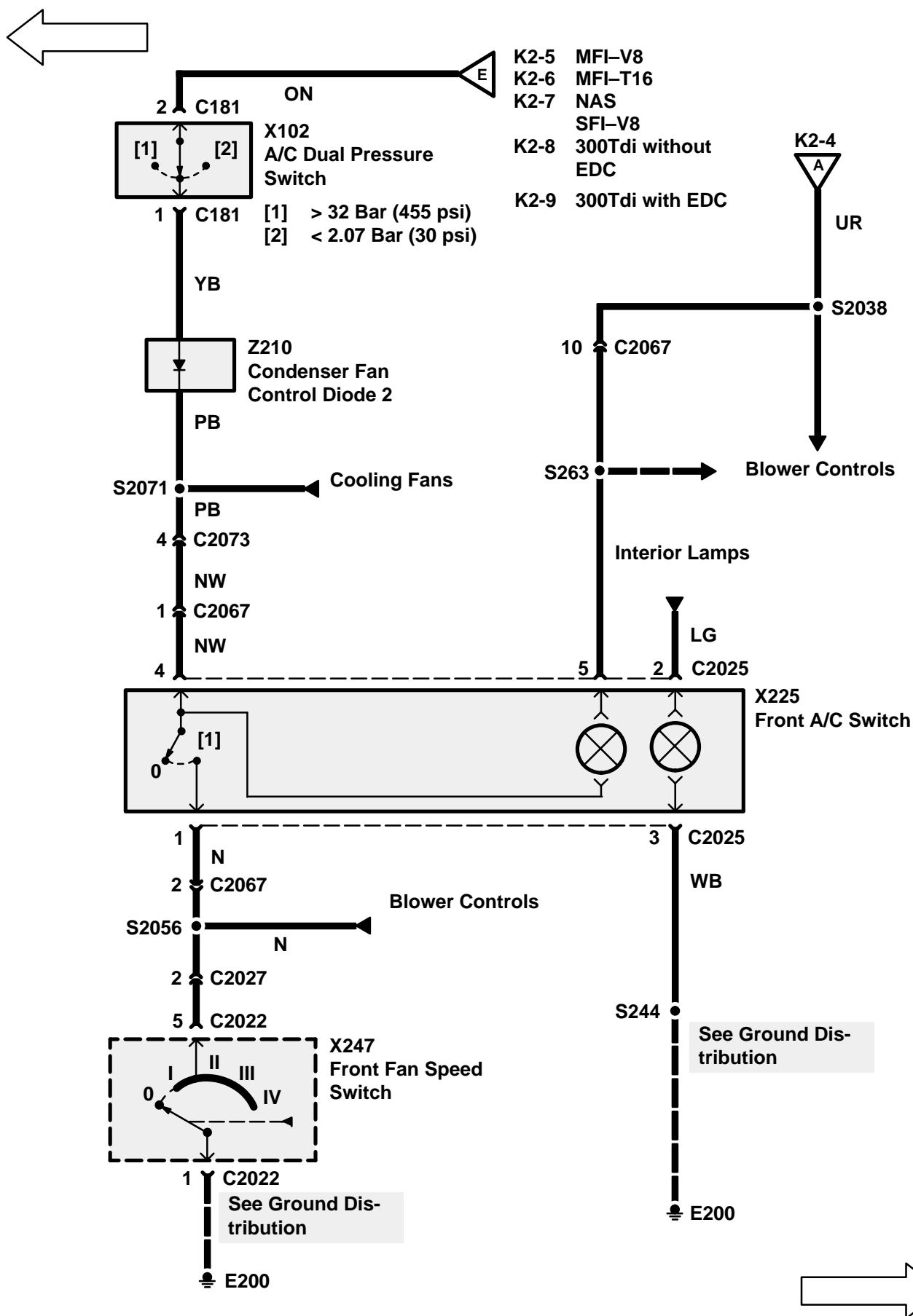

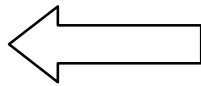

With Rear Air Conditioning

- K2-5 MFI-V8
- K2-6 MFI-T16
- K2-7 NAS SFI-V8
- K2-8 300Tdi without EDC
- K2-9 300Tdi with EDC

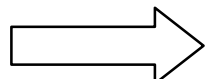
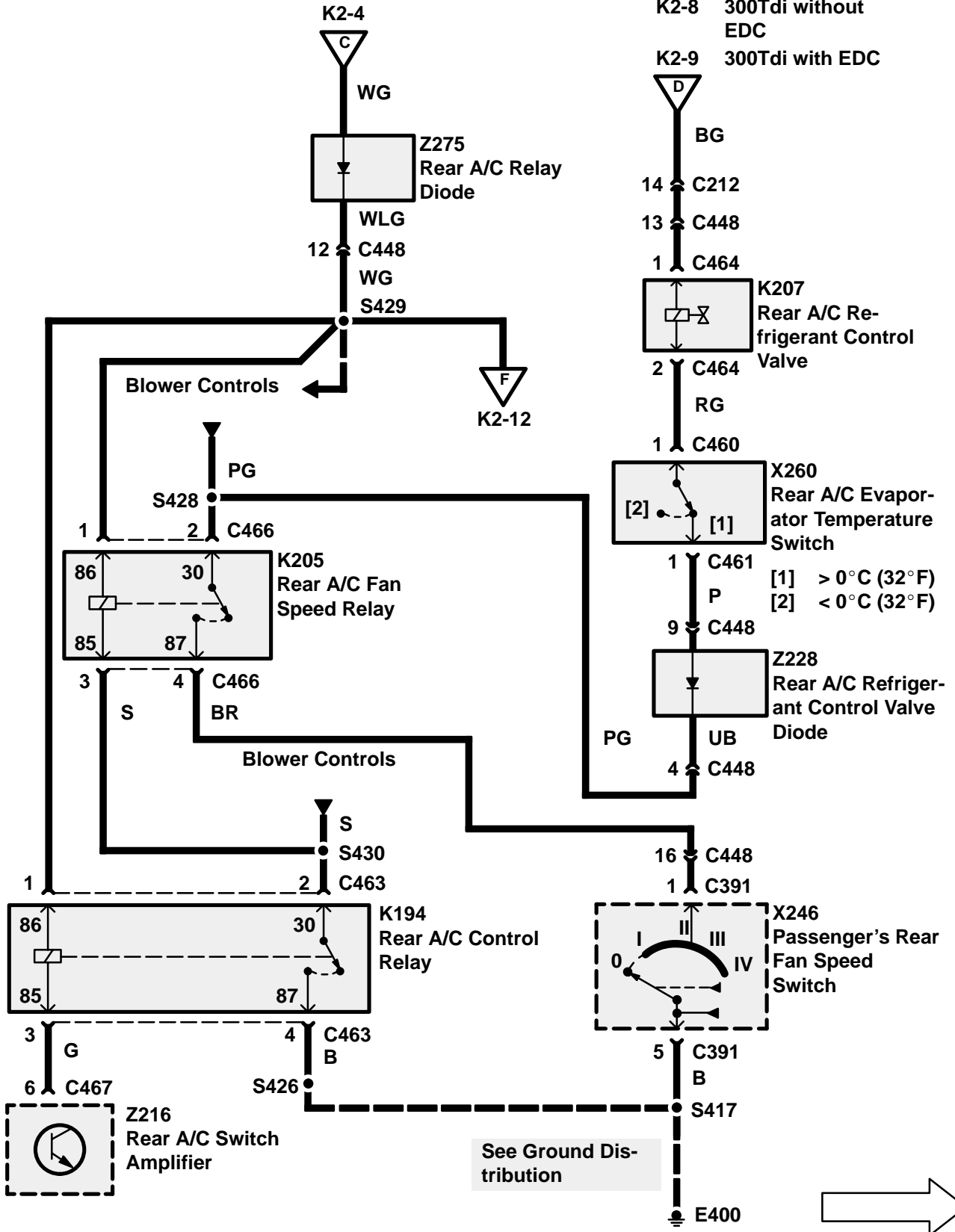

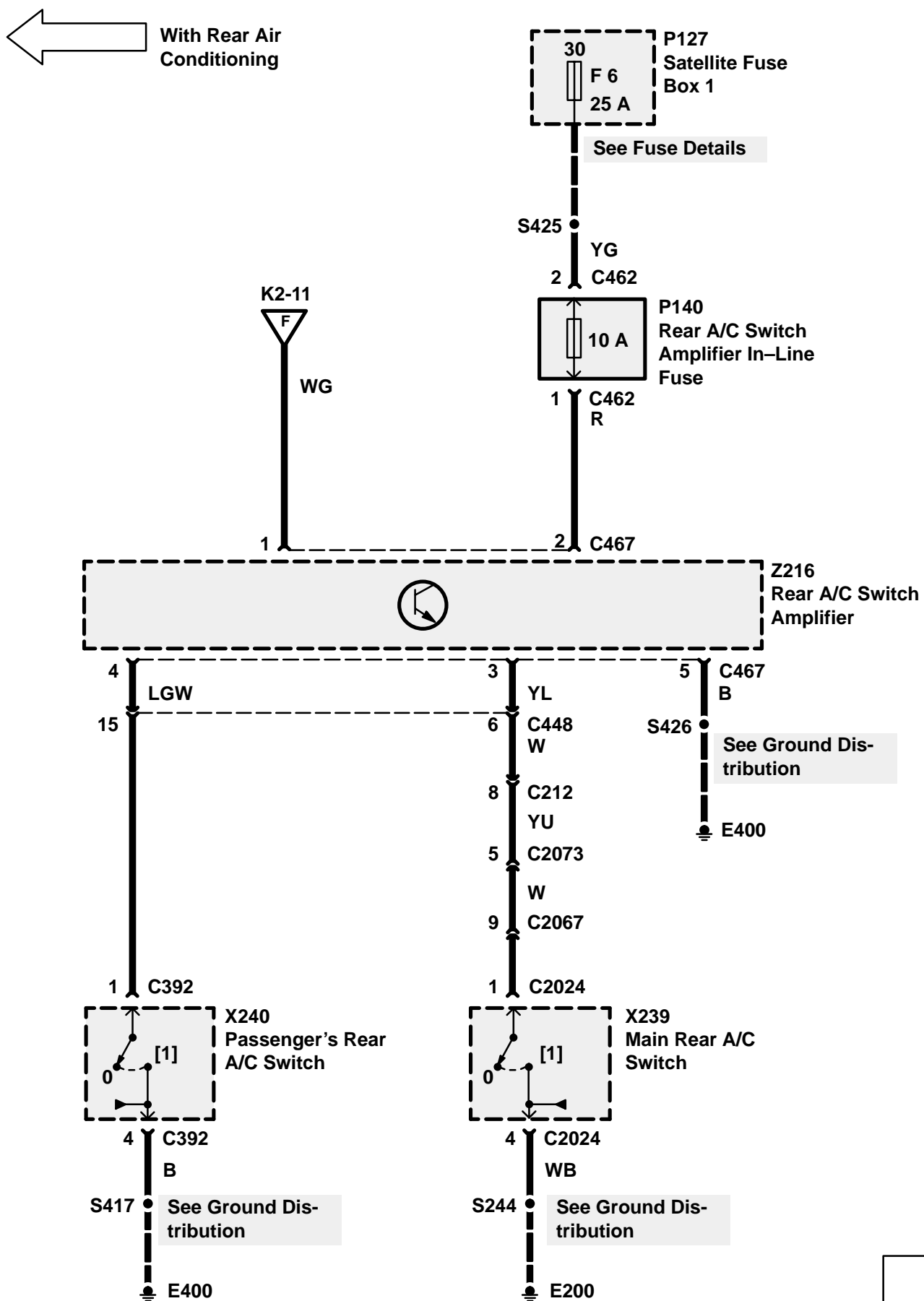

## CIRCUIT OPERATION

### Condenser Fan Operation (MFI-V8)

The Condenser Fans Motors (M113, M121) on vehicles equipped with MFI-V8 engines operate when any of the following conditions occur:

8. Coolant temperature exceeds 100°C (212°F).
9. The air conditioning system is operating.
10. The Engine Control Module (ECM) (Z132) determines that fuel temperature exceeds 70°C and coolant temperature exceeds 110°C after engine shutdown. When this occurs, the fans are turned on for approximately 10 minutes after the engine is shut off.

### Operation with High Coolant Temperature (MFI-V8)

When the Ignition Switch (X134) is in position II, battery voltage is applied to the Ignition Load Relay (K127). The relay is energised, applying battery voltage to the Condenser Fan Relay (K109) and the Fan Control Module (Z118). If the coolant temperature exceeds 100°C (212°F), the Condenser Fan Coolant Temperature Switch (X113) closes and energises the Condenser Fan Relay (K109) by applying ground to the relay's coil. When the relay is energised, voltage from fuse F3 is applied to the Condenser Fan Motors (M113, M121) through the relay's contacts.

### Fan Operation with A/C (MFI-V8)

With the Ignition Switch (X134) in position II, battery voltage is applied to the Ignition Load Relay (K127). The relay is energised, applying battery voltage to the Condenser Fan Relay (K109). When the Front A/C Switch (X225) is turned on and the Front Fan Speed Switch (X247) is turned to positions I, II, III, or IV, ground is applied to terminal 86 of the Condenser Fan Relay. The relay energises, applying battery voltage from fuse F3 to the Condenser Fan Motors (M113, M121).

### Operation with the Engine Off (MFI-V8)

The Engine Control Module (Z132) monitors fuel temperature and coolant temperature through sensors. When the ECM determines that fuel temperature is above 70°C and coolant temperature exceeds 110°C after engine shutdown, the ECM will command fan operation for approximately 10

minutes. The ECM turns on the fans by momentarily grounding the Fan Control Module (Z118) through the BG wire. When the timer unit is grounded, it starts a solid state timer and begins to apply ground from its terminal 9 to the Condenser Fan Relay (K109) through the BP wire. With the Condenser Fan Relay energised, voltage from fuse F3 is applied to the Condenser Fan Motors (M113, M121) through the relay contacts.

### Cooling Fan Operation (MFI–T16)

The Cooling Fan 1 (M141) or Cooling Fans (M141, M142) on vehicles equipped with MFI–T16 engines operate when any of the following conditions occur:

1. The A/C system is operating.
2. The Engine Control Module (ECM) determines that Cooling Fan Motor operation is required.

### Cooling Fan Operation (MFI–T16) without A/C

With the Ignition Switch (X134) in position II, battery voltage is applied to the Cooling Fan Relay (K190) from fuse F3 of the Satellite Fuse Box 1 (P127). When Cooling Fan Operation is required, the Engine Control Module (ECM) (Z132) grounds terminal 85 of the Cooling Fan Relay (K190). The relay energises, applying battery voltage from fuse F3 of the Engine Compartment Fuse Box (P125) to the Cooling Fan Motor 1 (M141). When Cooling Fan Operation is no longer required, the ECM removes the ground supply to the Cooling Fan Relay (K190). The Relay de–energises, removing the voltage supply to the Cooling Fan Motor 1 (M141).

### Cooling Fan Operation (MFI–T16) with A/C

With the Ignition Switch (X134) in position II, battery voltage is applied to the Ignition Load Relay (K127). The relay is energised, applying battery voltage to the Condenser Fan Relay (K109). When Cooling Fan operation is required, the Engine Control Module (ECM) (Z132) grounds terminal 85 of the Condenser Fan Relay (K109). The relay energises, applying battery voltage from fuse F3 of the Engine Compartment Fuse Box (P125) to the Cooling Fan Motors (M141, 142). When Cooling Fan operation is no longer required, the ECM removes the ground supply to the Condenser Fan Relay (K109). The relay de–energises, removing the voltage supply to the Cooling Fans (M141, M142).

### Condenser Fan Operation (NAS) (SFI–V8)

The Condenser Fan Motors (M113, M121) on vehicles equipped with SFI–V8 engines operate when any of the following conditions occur:

1. The A/C system is operating.
2. The Engine Control Module (ECM) determines that Condenser Fan Motor operation is required.

With the Ignition Switch (X134) in position II, battery voltage is applied to the Ignition Load Relay (K127). The relay is energised, applying battery voltage to the Condenser Fan Relay (K109). When Condenser Fan operation is required, the Engine Control Module (ECM) (Z132) grounds terminal 85 of the Condenser Fan Relay (K109). The relay energises, applying battery voltage from fuse F3 of the Engine Compartment Fuse Box (P125) to the Condenser Fan Motors (M113, M121). When Condenser Fan operation is no longer required, the ECM removes the ground supply to the Condenser Fan Relay (K109). The relay de–energises, removing the voltage supply to the Condenser Fan Motors (M113, M121).

---

### Condenser Fan Operation (300Tdi)

The Condenser Fan Motors (M113, M121) on vehicles equipped with diesel engines operate when any one of the following conditions occur:

1. Coolant temperature exceeds 100°C (212°F).
2. The A/C is operating.

---

### Condenser Fan with High Coolant Temperature Operation (300Tdi)

When the Ignition Switch (X134) is in position II, battery voltage is applied to the Ignition Load Relay (K127). The relay is energised, applying battery voltage to the Condenser Fan Relay (K109). If the coolant temperature exceeds 100°C (212°F), the Condenser Fan Coolant Temperature Switch (X113) closes and energises the Condenser Fan Relay (K109) by applying ground to the relay's coil. When the relay is energised, voltage from fuse F3 is applied to the Condenser Fan Motors (M113, M121) through the relay's contacts.

---

### Fan Operation with A/C (300Tdi)

With the Ignition Switch (X134) in position II, battery voltage is applied to the Ignition Load Relay (K127). The relay is energised, applying battery voltage to the Condenser Fan Relay (K109) when the Front A/C Switch (X225) is turned on and the Front Fan Speed Switch (X247) is turned to positions I, II, III, or IV and grounding terminal 86 of the Condenser Fan Relay (K109). The relay energises, applying battery voltage from fuse F3 to the Condenser Fan Motors (M113, M121).

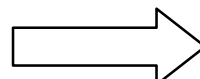
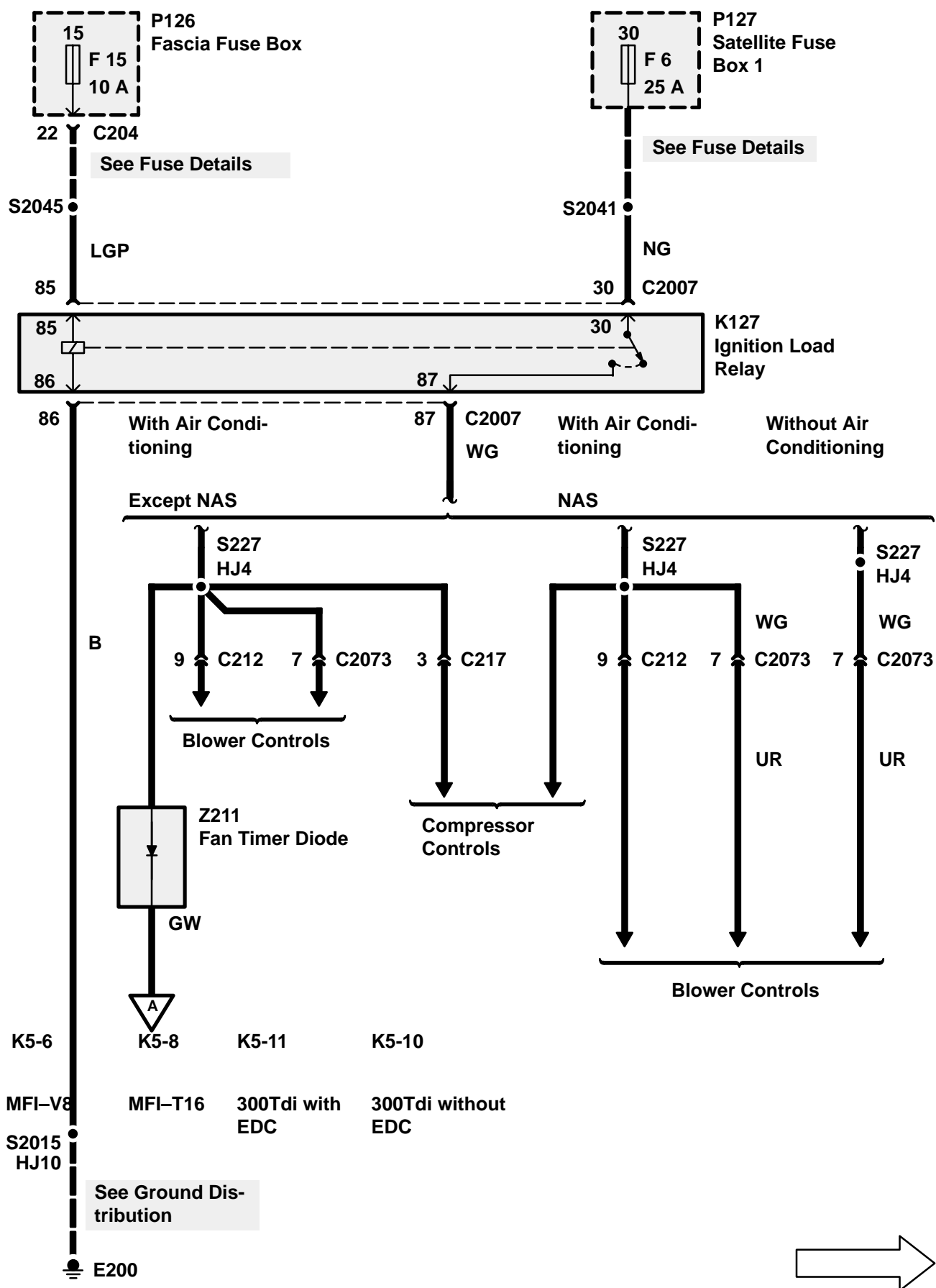



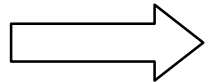
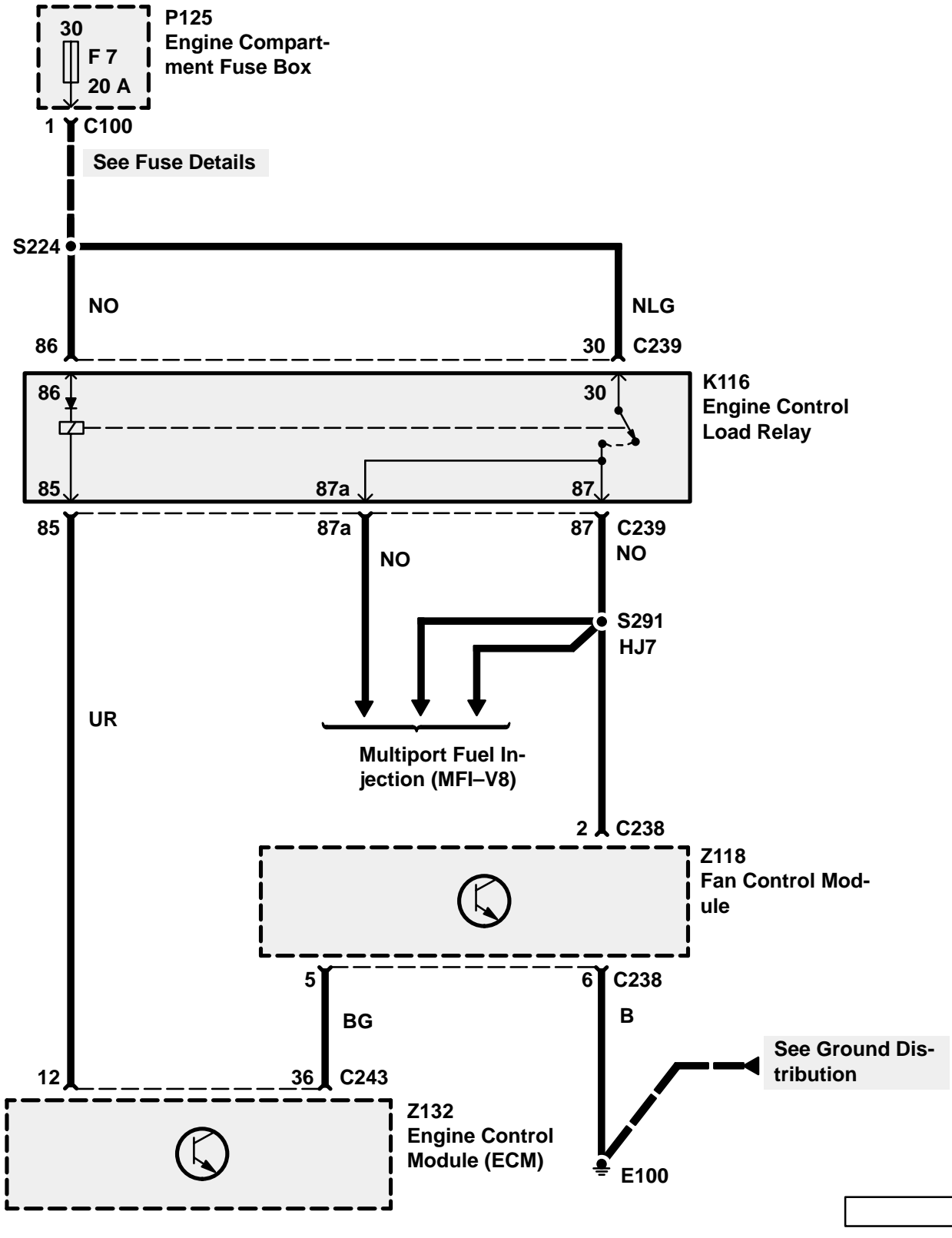
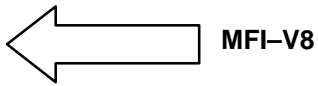

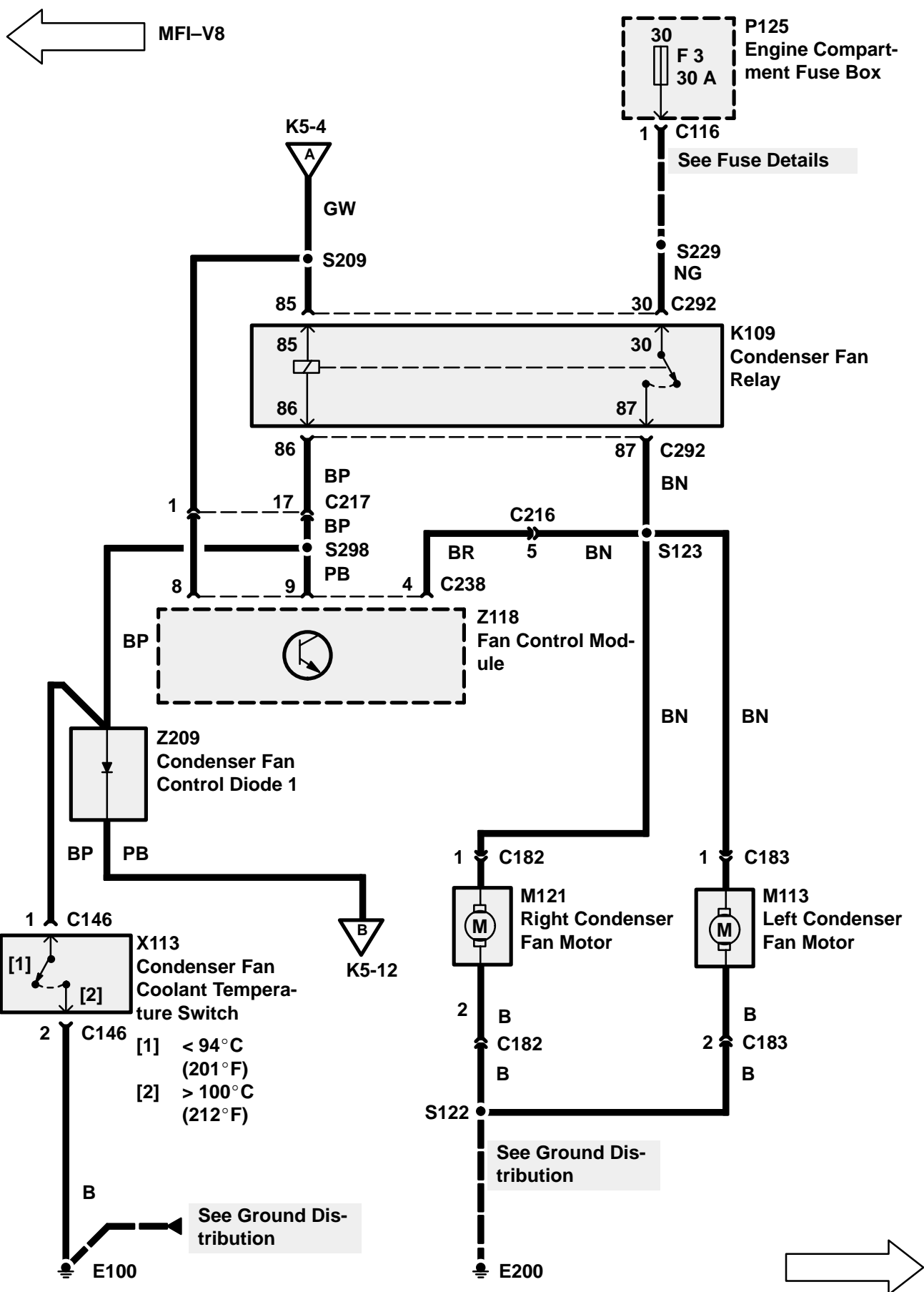

← MFI-T16 without Air Conditioning

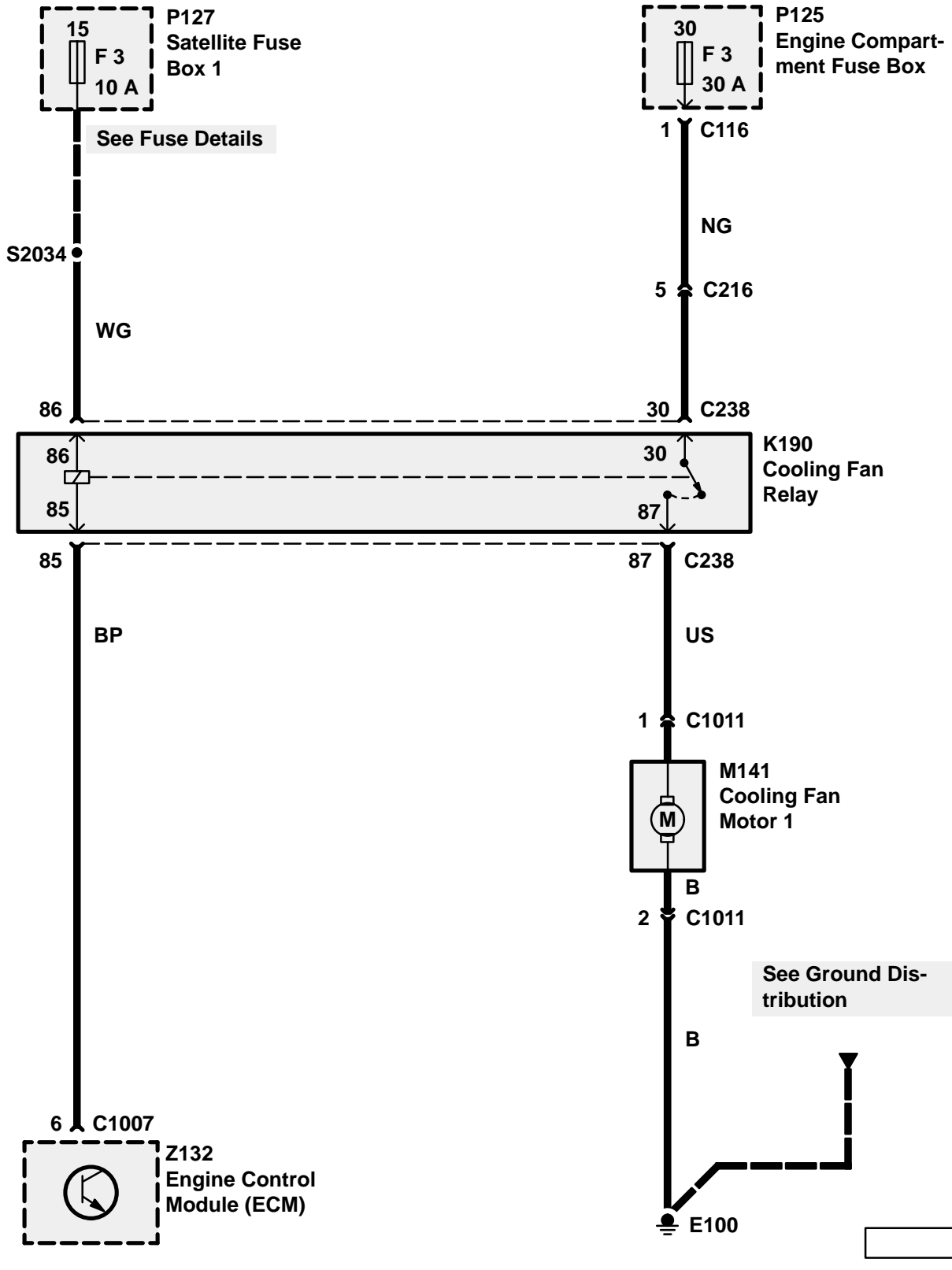

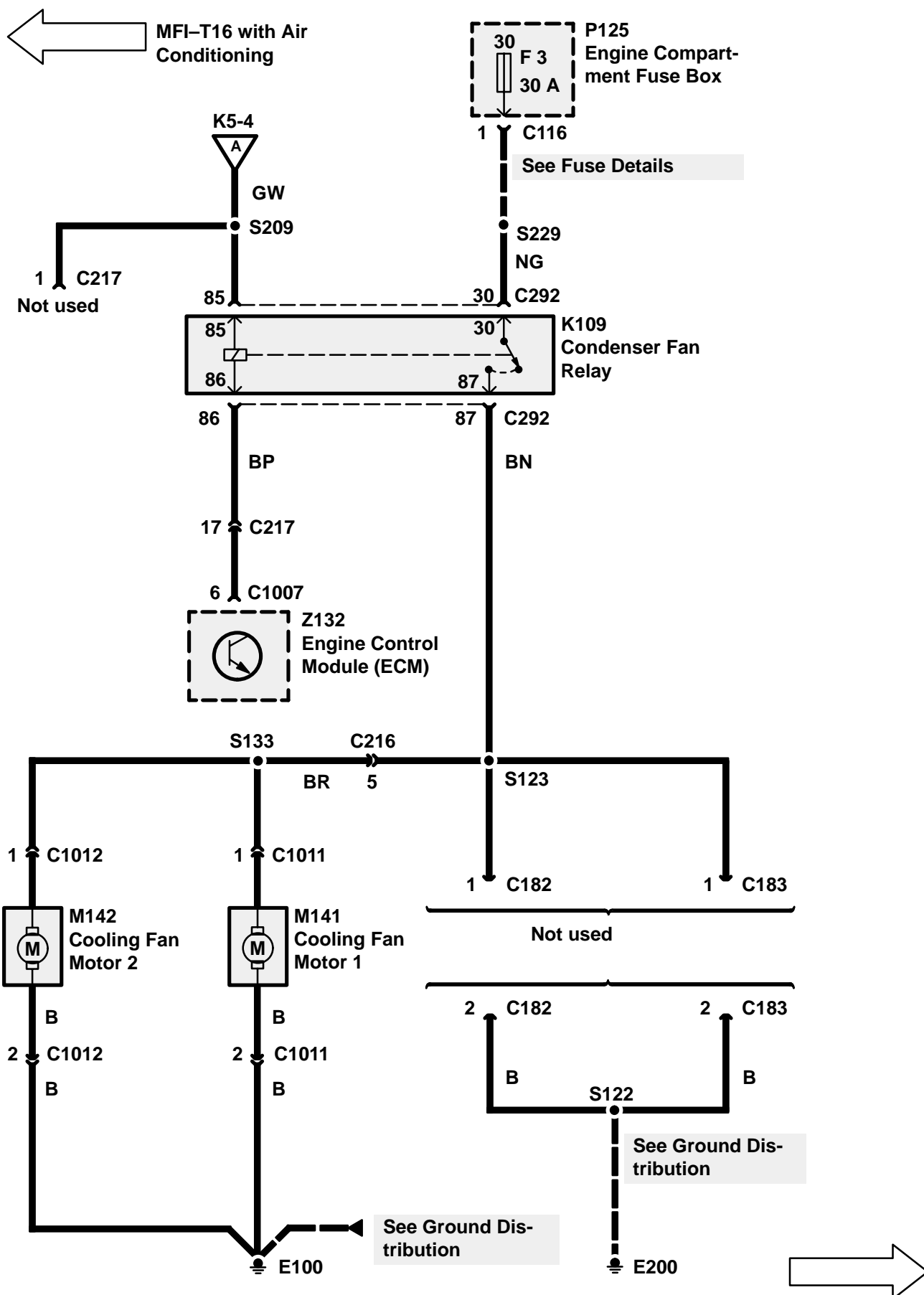

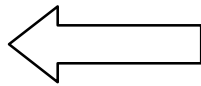

NAS  
SFI-V8

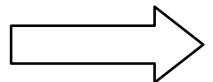
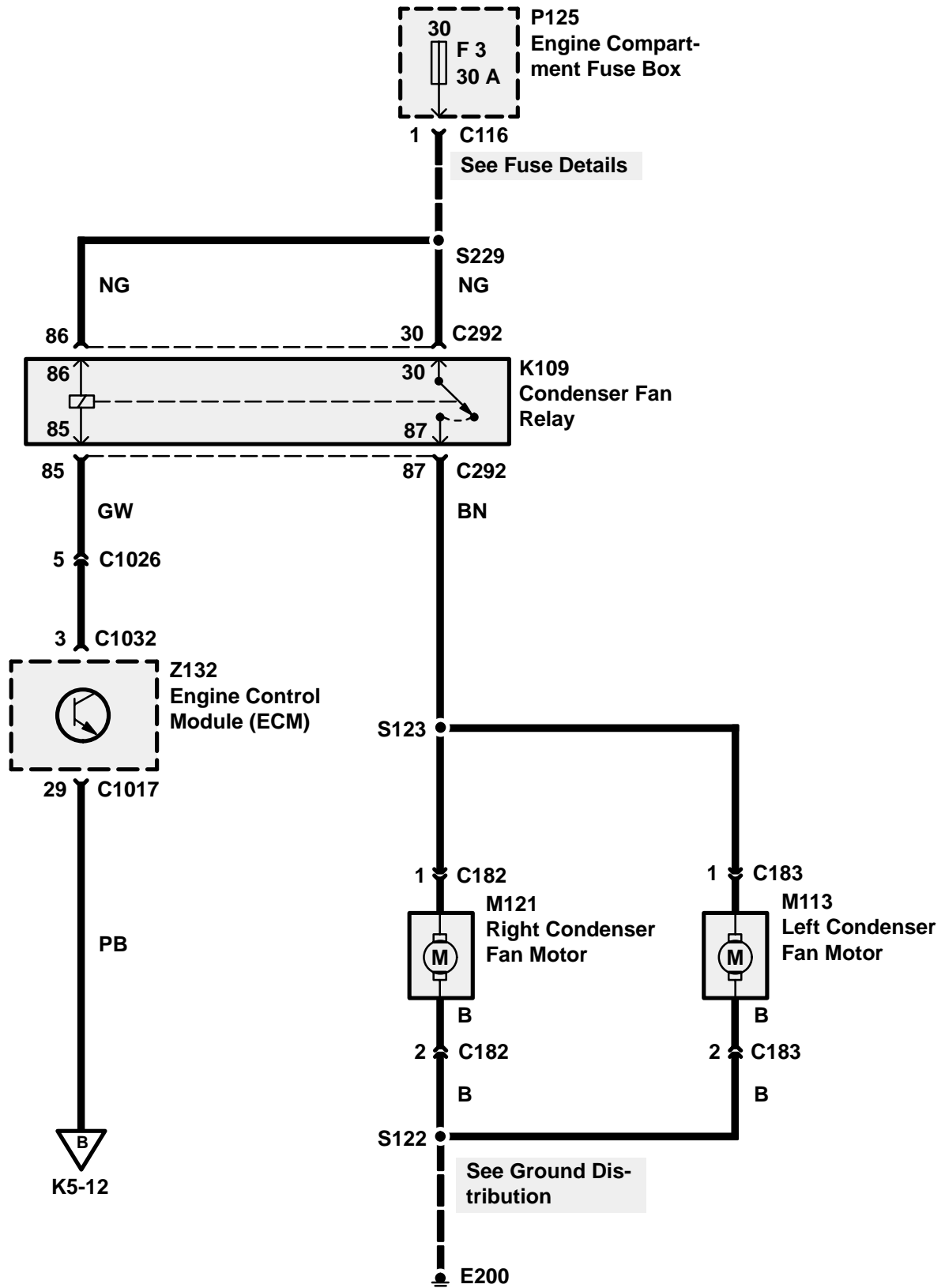

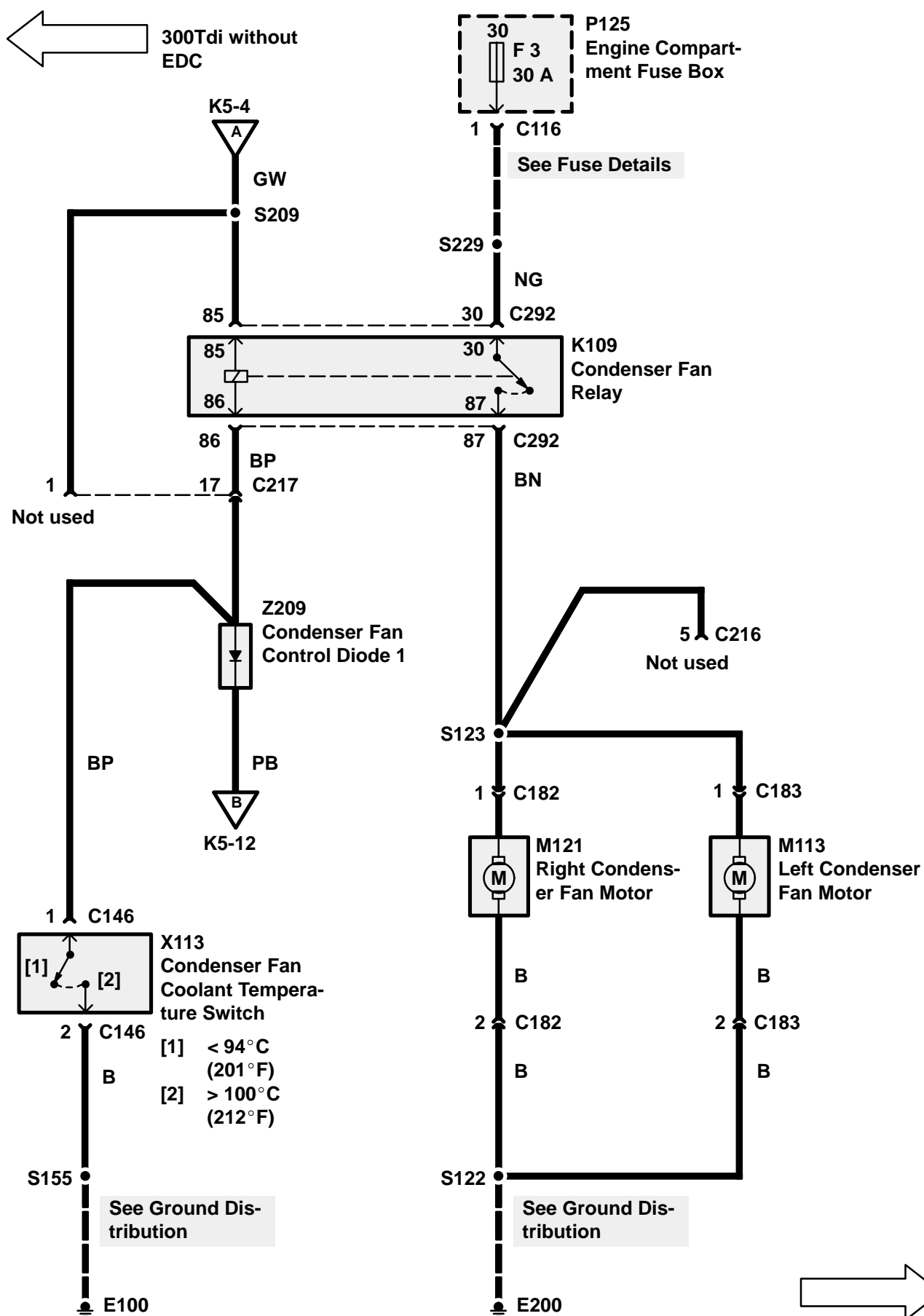

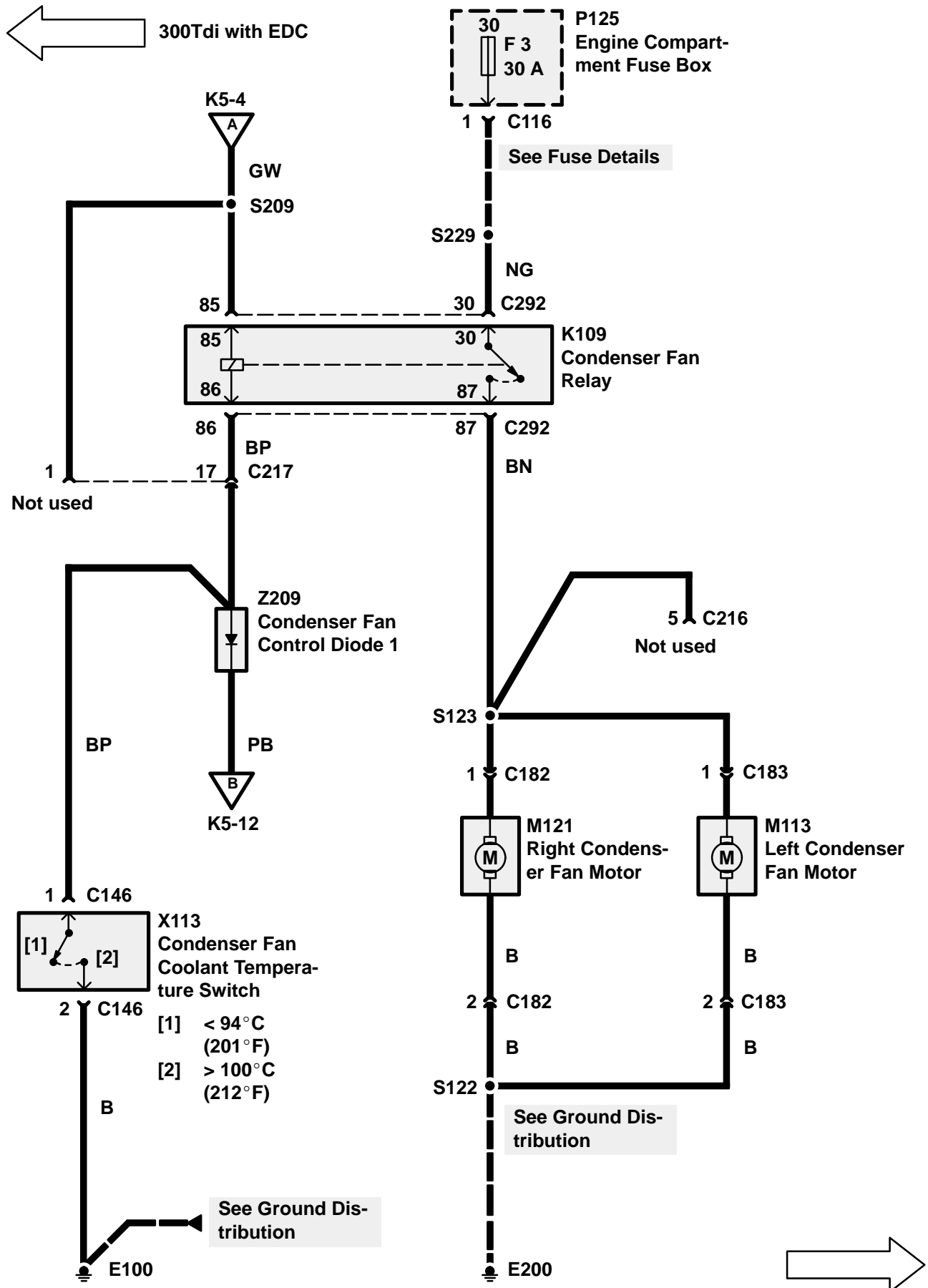

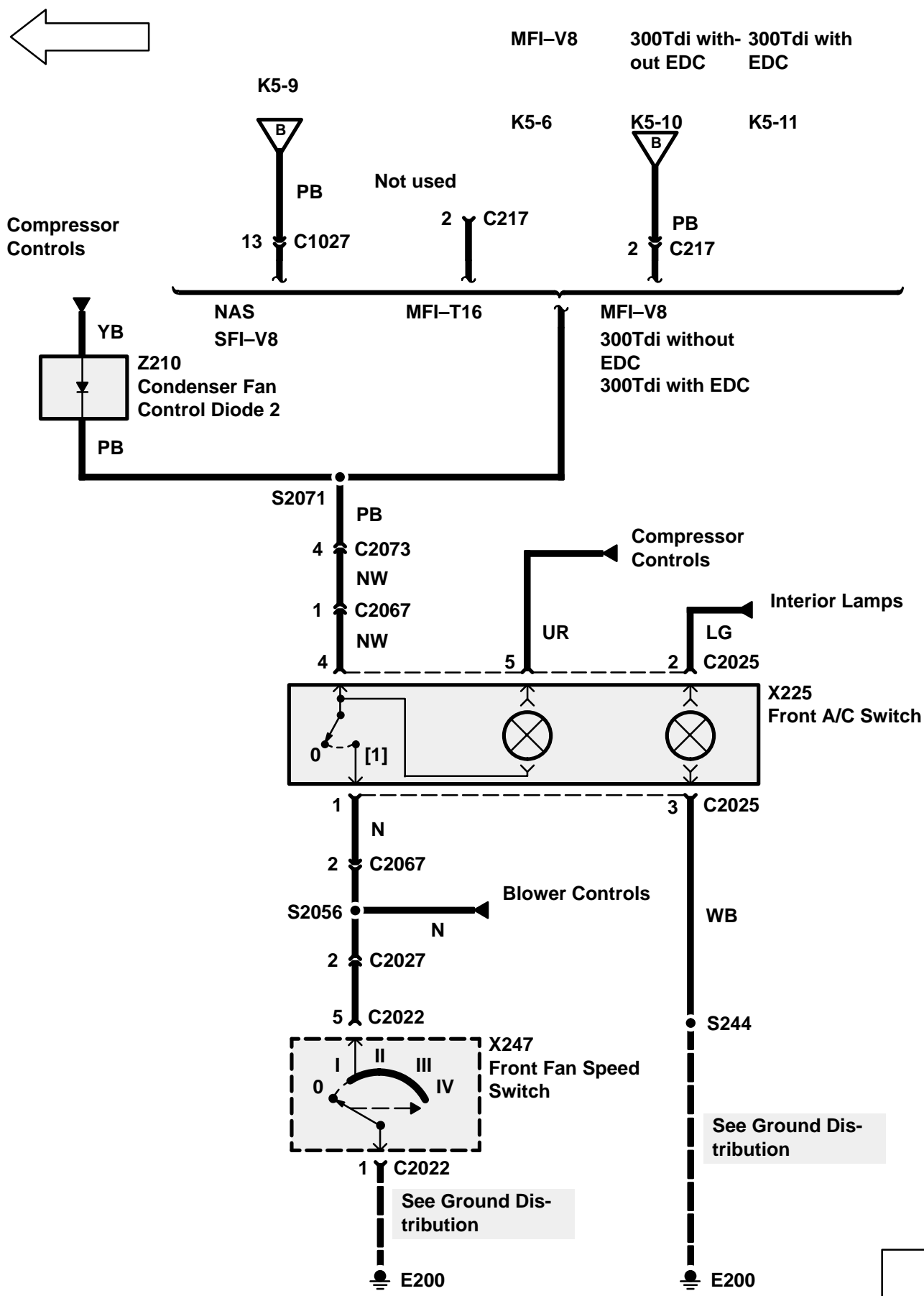



## CIRCUIT OPERATION

Voltage for window lift and sunroof operation is provided to the Window Lift ECU (Z147) from fuses F1 and F2. The Window Lift ECU is grounded through the B wire at ground E200.

### Timeout Feature

Fuse F15 applies voltage to the Window Lift ECU terminal 3 when the ignition switch is on. When the ignition switch is turned off, the absence of voltage at terminal 3 signals the Window Lift ECU to start the timeout feature. When the timeout feature is activated, the Window Lift ECU will allow window and sunroof operation for an additional 45 seconds.

For NAS vehicles only:

The timeout feature will be cancelled if the driver's door is opened and then closed. The Window Lift ECU monitors the door's position at terminal 9.

### Front Window Operation

When a Front Window Switch is operated, the switch grounds one of four Window Lift ECU input terminals. This signals the Window Lift ECU to apply voltage and ground to the respective window motor. If the front window switch is held in the down position for more than 1/2 second, the express down feature is activated. The Window Lift ECU will operate the window motor until it is completely lowered.

### Rear Window

The Window Lift ECU terminal 4 supplies voltage to the Rear Window Console and door switches for rear window operation.

When a window console switch is in the 'DOWN' position, voltage is applied to the window motor through the 'up' switch contacts. The window motors operate because they are grounded through the 'down' contacts of the window console switch.

When a switch is in the 'UP' position, the polarity applied to the window motor is reversed, causing the motor to run in the opposite direction and the window to close.

### Rear Window Isolation Switch (X187)

The Rear Window Isolation Switch (X187) is placed in series with the ground supply to the Rear Window Door Switches (X188, X189). If the isolation switch is opened, the ground supply is interrupted, preventing rear window operation using the rear door switches.

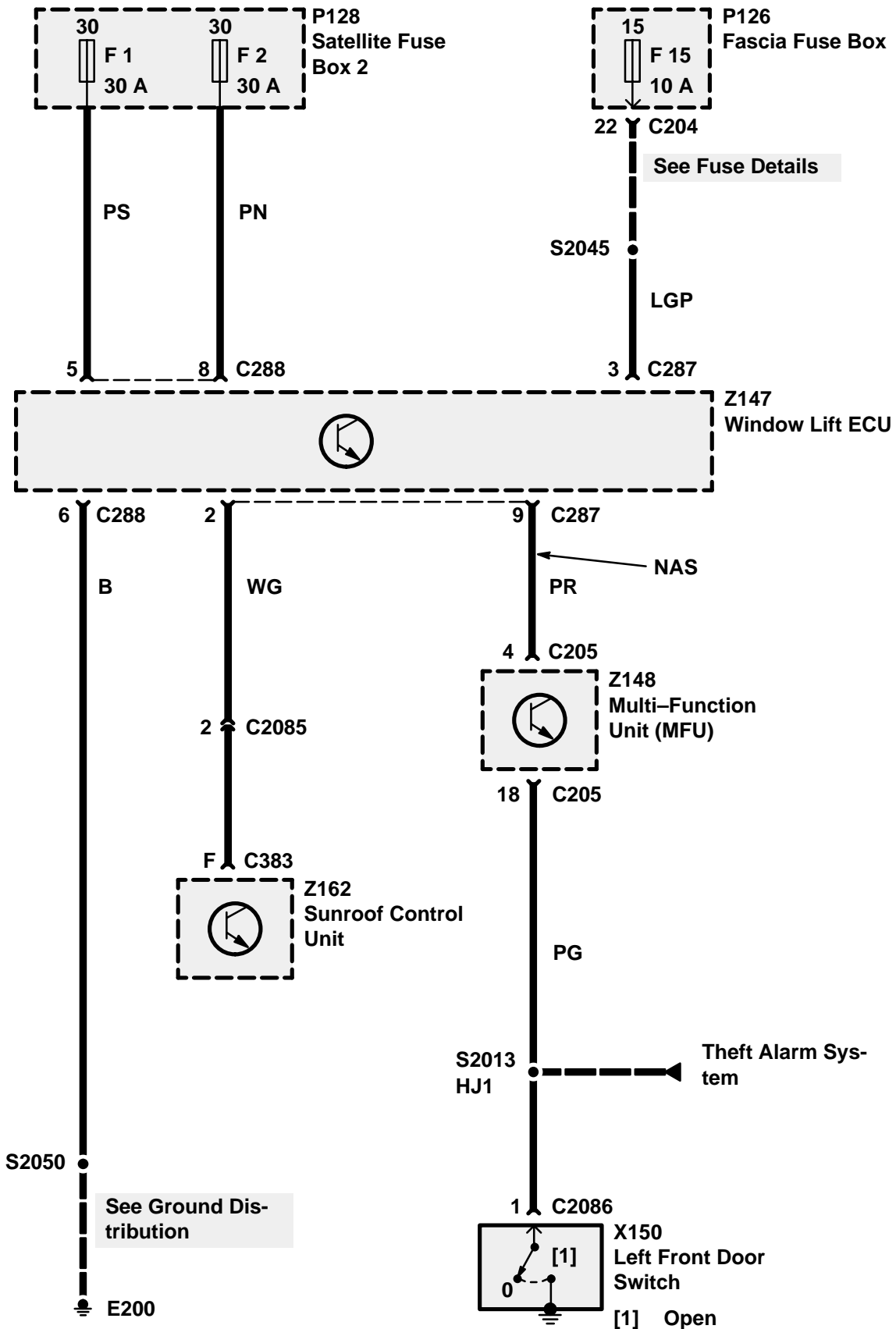

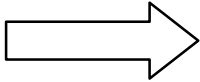
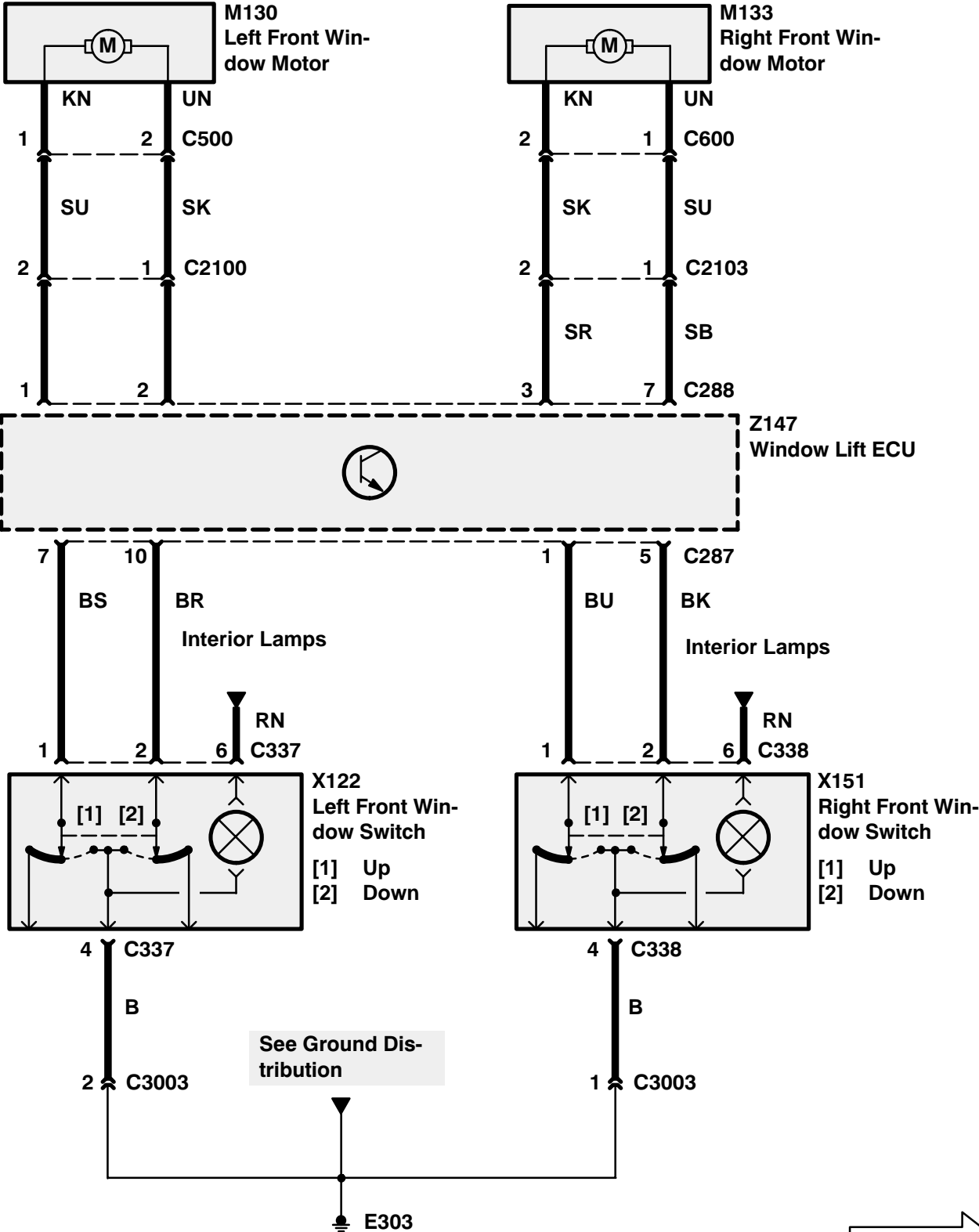
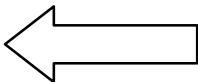

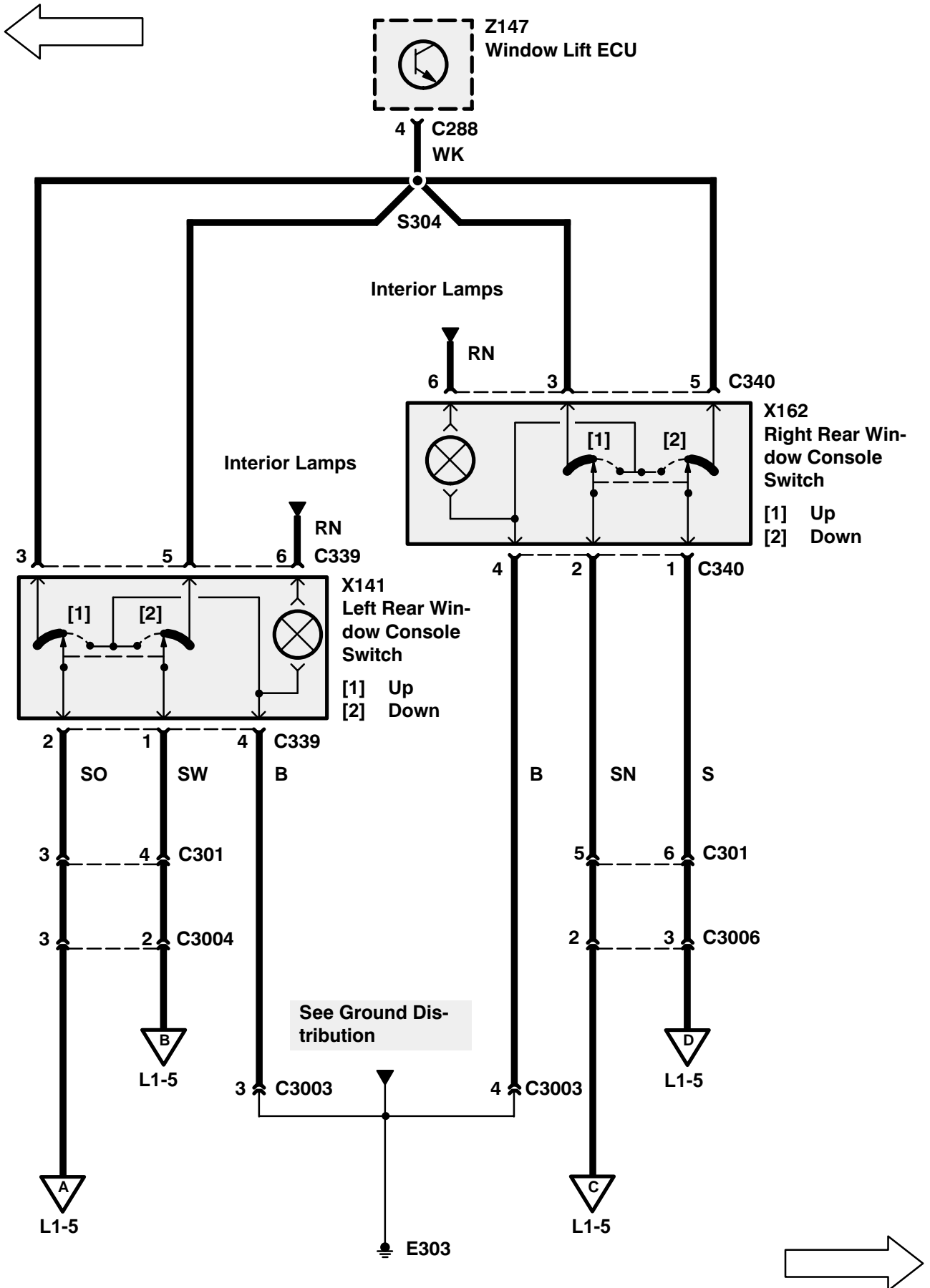

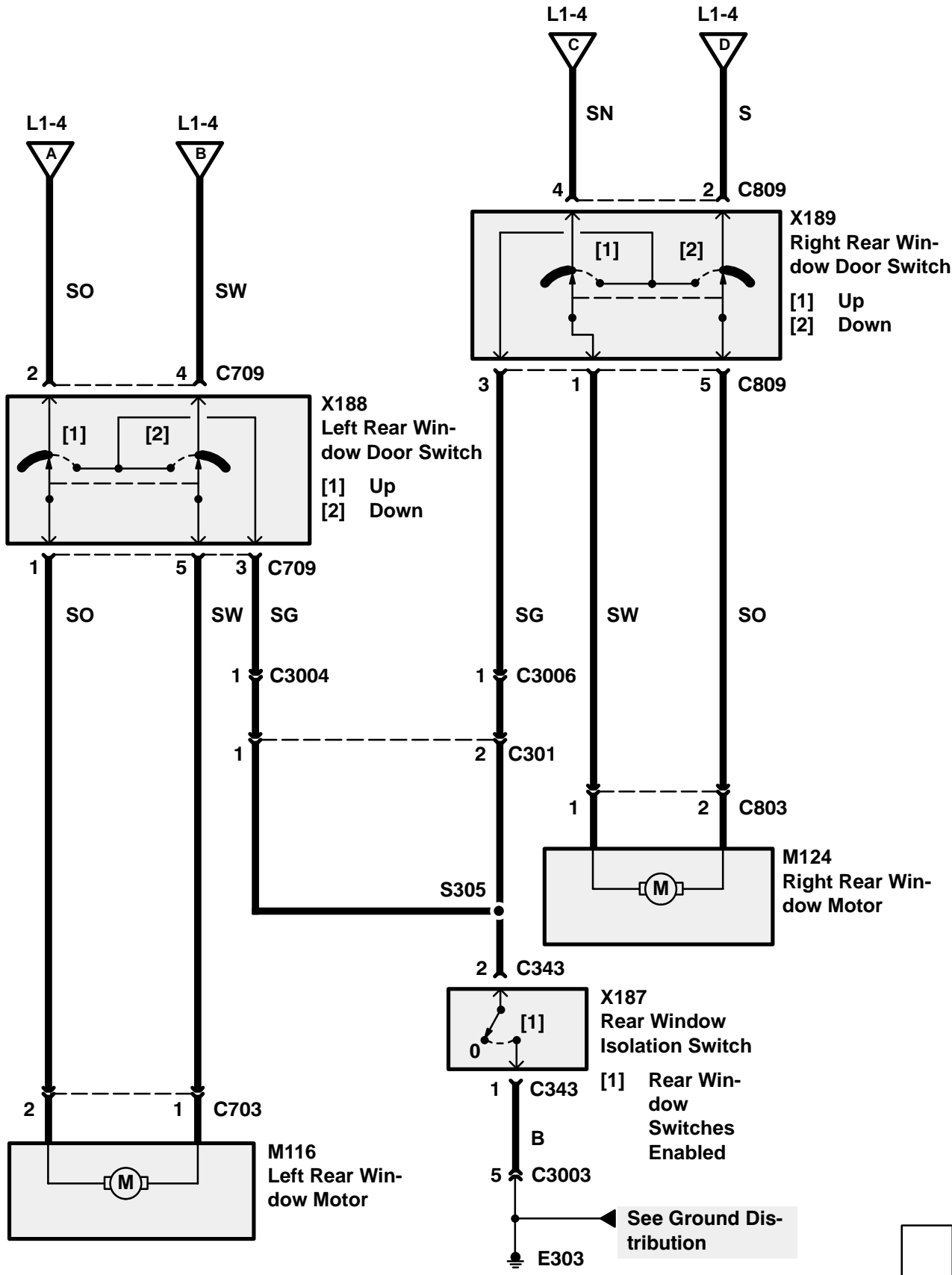
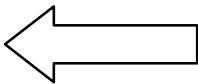

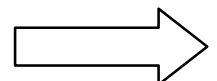
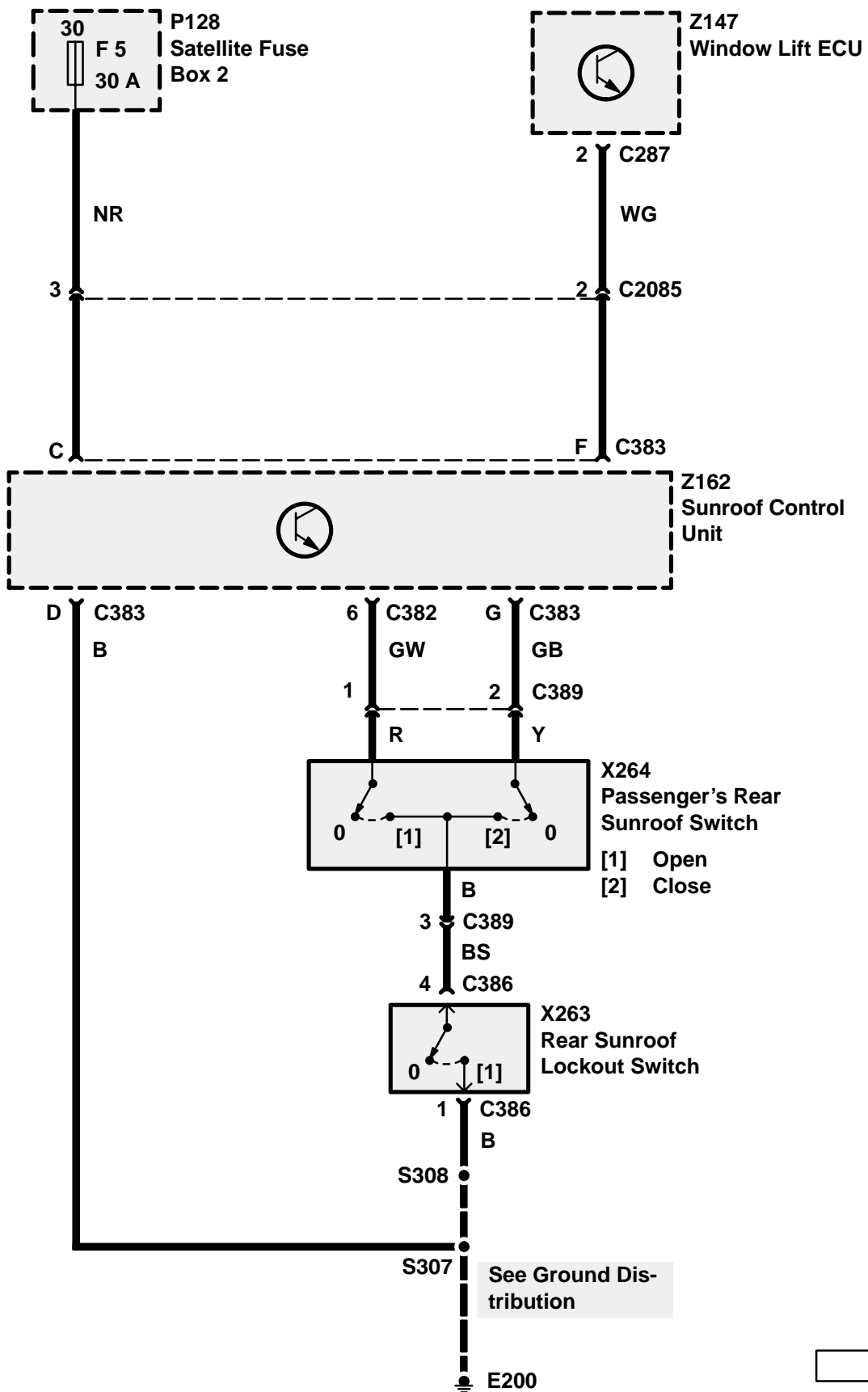

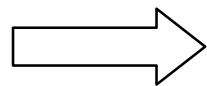
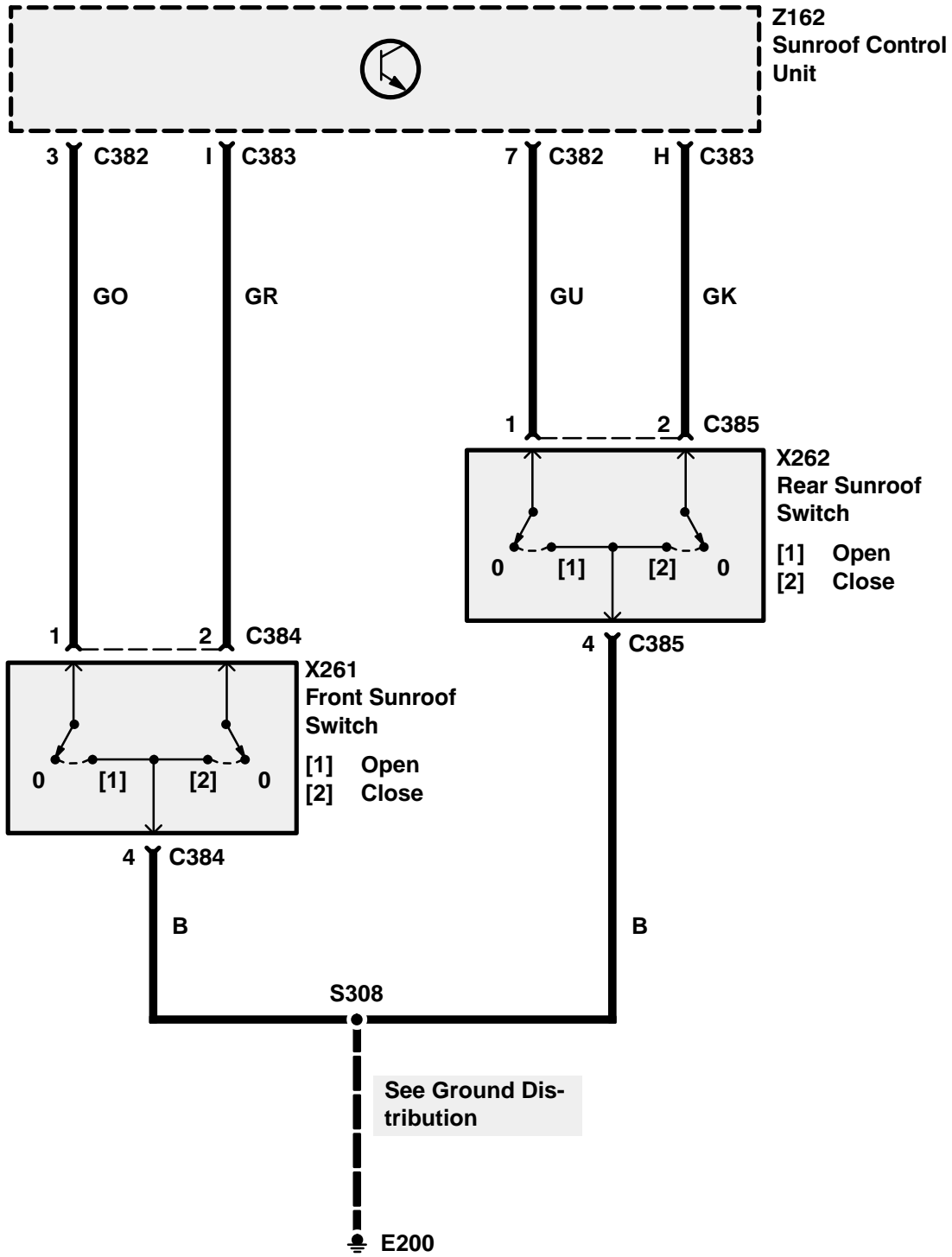
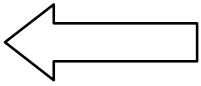

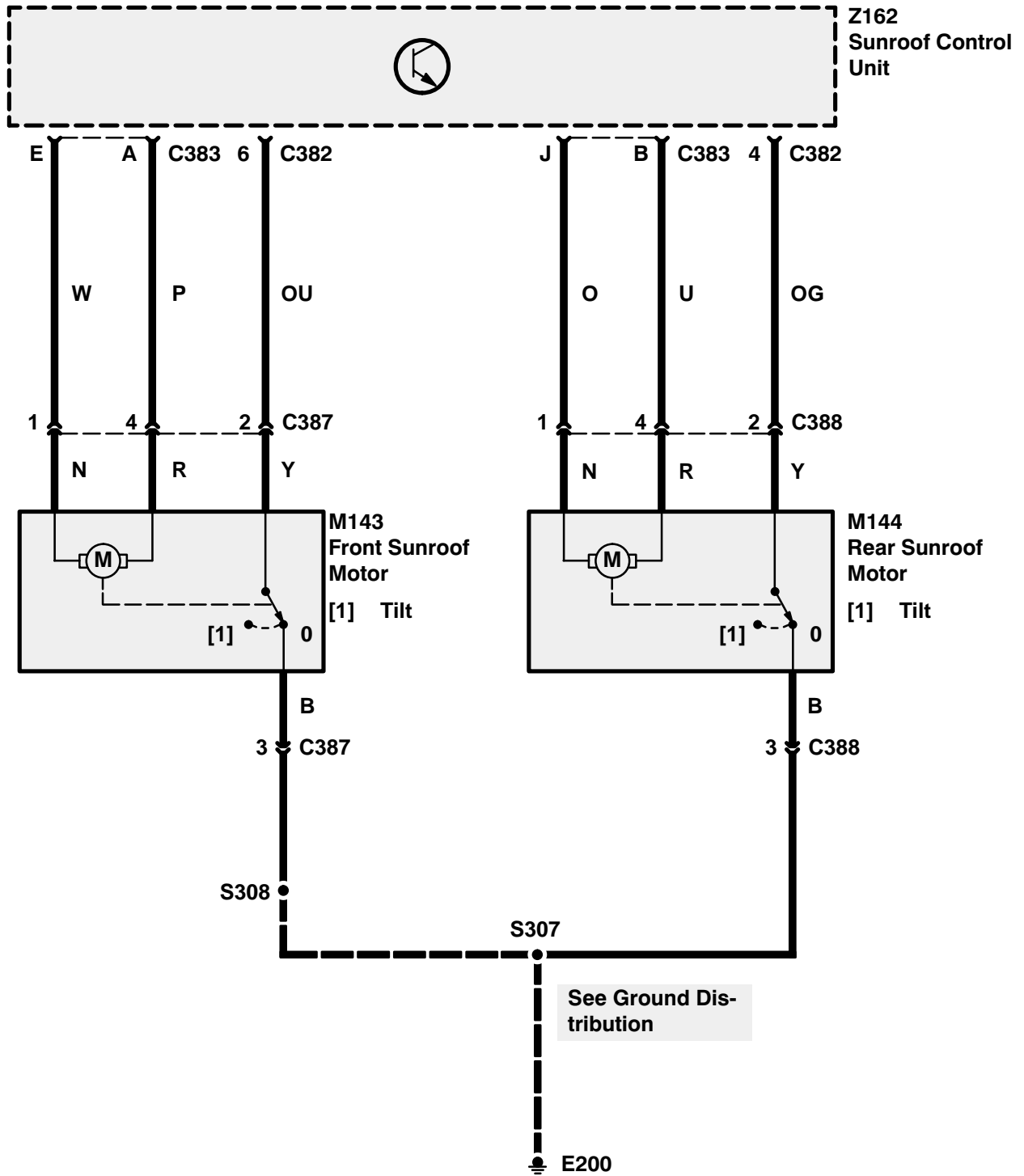
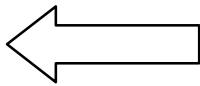



---

## CIRCUIT OPERATION

The locking functions on models with the Theft Alarm System are controlled by the Theft Alarm Unit (Z163). Refer to the Theft Alarm System (T1). The locking functions on models without the Theft Alarm System are controlled by the Left Front Door Lock Actuator (M114).

The four doors and the tailgate are locked or unlocked using the right front exterior key or the interior door sill knob. The rear doors can be independently locked or unlocked from the inside by using the appropriate door sill knob. These can be overridden when the lock controls in the right front door are used. The left front door and the rear doors may be locked or unlocked in isolation from the outside using the key or from the inside using the door sill knob.

### Lock

When the doors are locked by the right front exterior key or the interior door sill knob, the internal microswitches in the Left Front Door Lock Actuator (M114) move to the "Lock" position. Voltage from fuse F4 is applied to the lock actuators through the K wires. The lock actuators are grounded at E201 through the microswitch contacts and the O wires. The doors and the tailgate now lock. The solid state load sensor/timer ensures that the motors operate only for the time required to lock or unlock the doors and the tailgate.

### Unlock

When the doors are unlocked by the right front exterior key or the interior door sill knob, the internal microswitches in the Left Front Door Lock Actuator (M114) move to the "Unlock" position. Voltage from Fuse F4 is applied to the lock actuators through the O wires. The lock actuators are grounded at E201 through the microswitch contacts and the K wires. Since the polarity of the voltage is now reversed, the doors and the tailgate unlock.

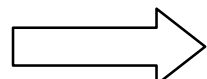
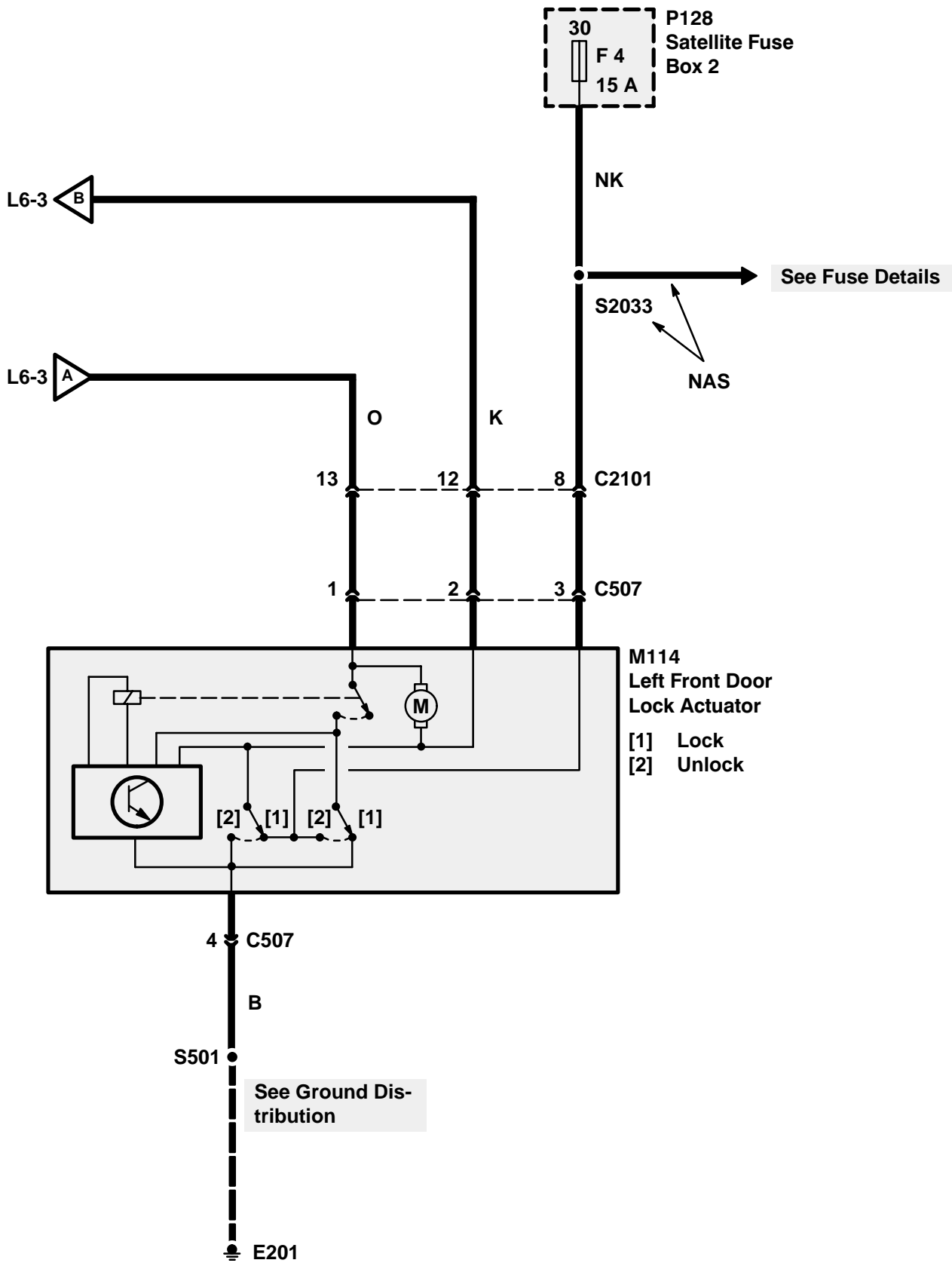

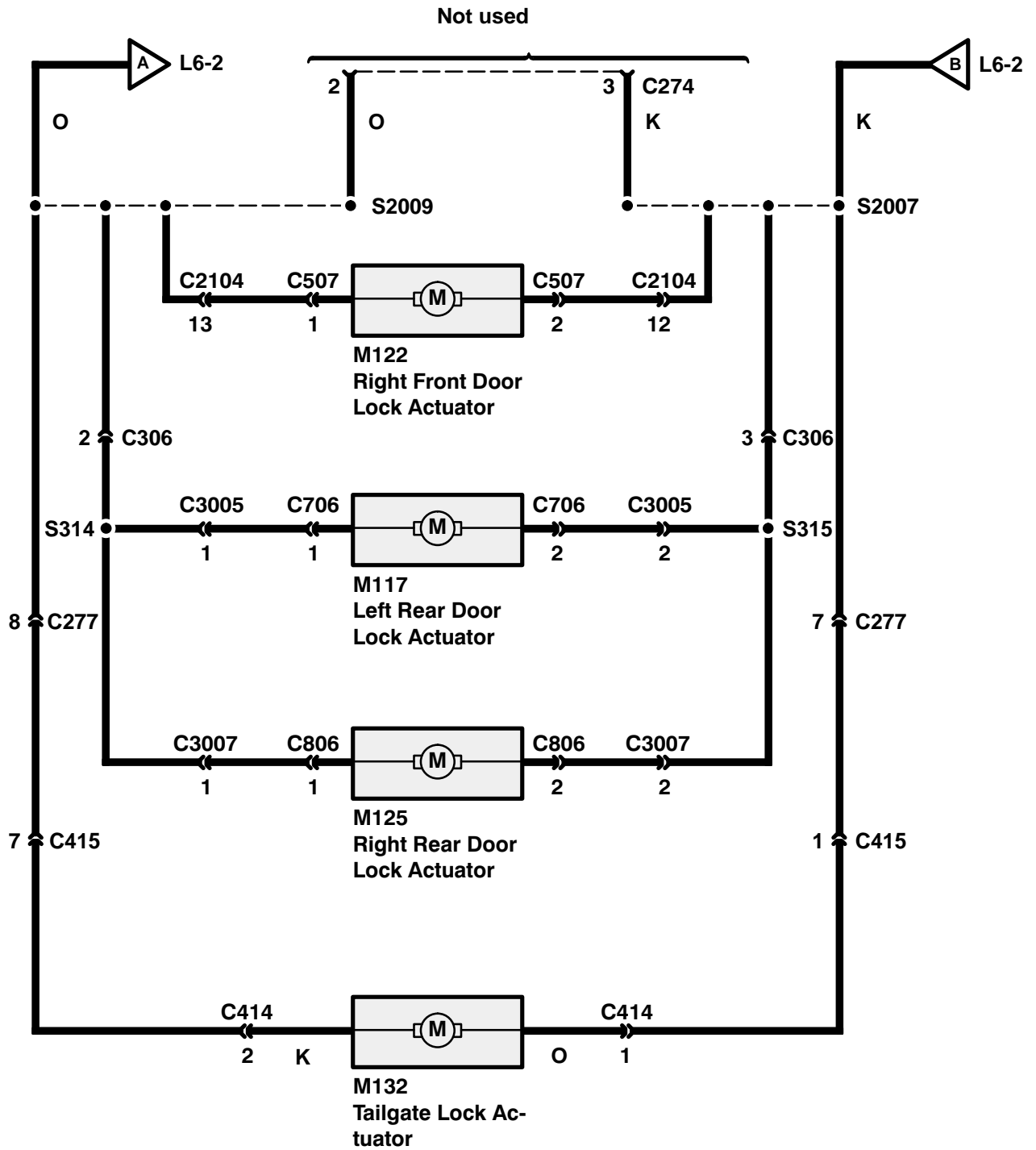
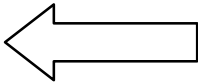

---

## CIRCUIT OPERATION

### Driver Seat

When the Ignition Switch (X134) is in position I or II, or the left front door is open, the Left Seat Power Relay (K113) is energised. Battery voltage is then applied to the Left Front Seat Control Switch (X152) through the closed relay contacts and the Driver's Underseat Fuse Box (P108). Ground is applied to the Left Front Seat Control Switch (X152) at all times. The Left Front Seat Control Switch (X152) controls 4 seat control motors via 8 switches. When each switch is moved to operate its corresponding motor, one seat switch applies ground while the other applies battery voltage to the respective seat motor. The motor turns to adjust the seat in the requested direction.

### Passenger Seat

Battery voltage is applied to the Right Front Seat Control Switch (X121) at all times. When the Ignition Switch (X134) is in position I or II, the Right Seat Power Relay (K131) is energised, applying ground to the Right Front Seat Control Switch (X121). The Right Front Seat Control Switch (X121) controls 4 seat control motors via 8 switches. When each switch is moved to operate its corresponding motor, one seat switch applies ground while the other applies battery voltage to the respective seat motor. The motor turns to adjust the seat in the requested direction.

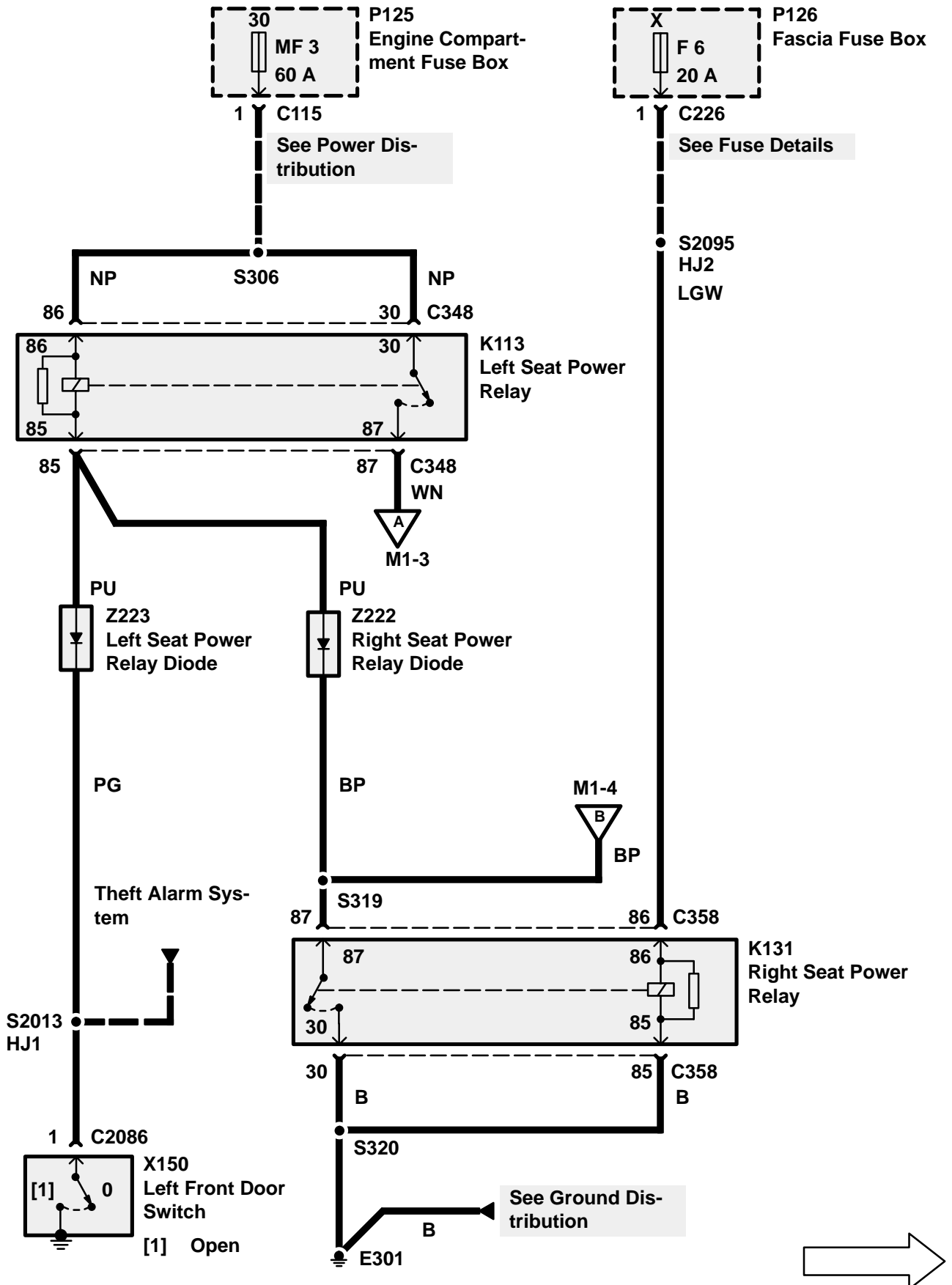

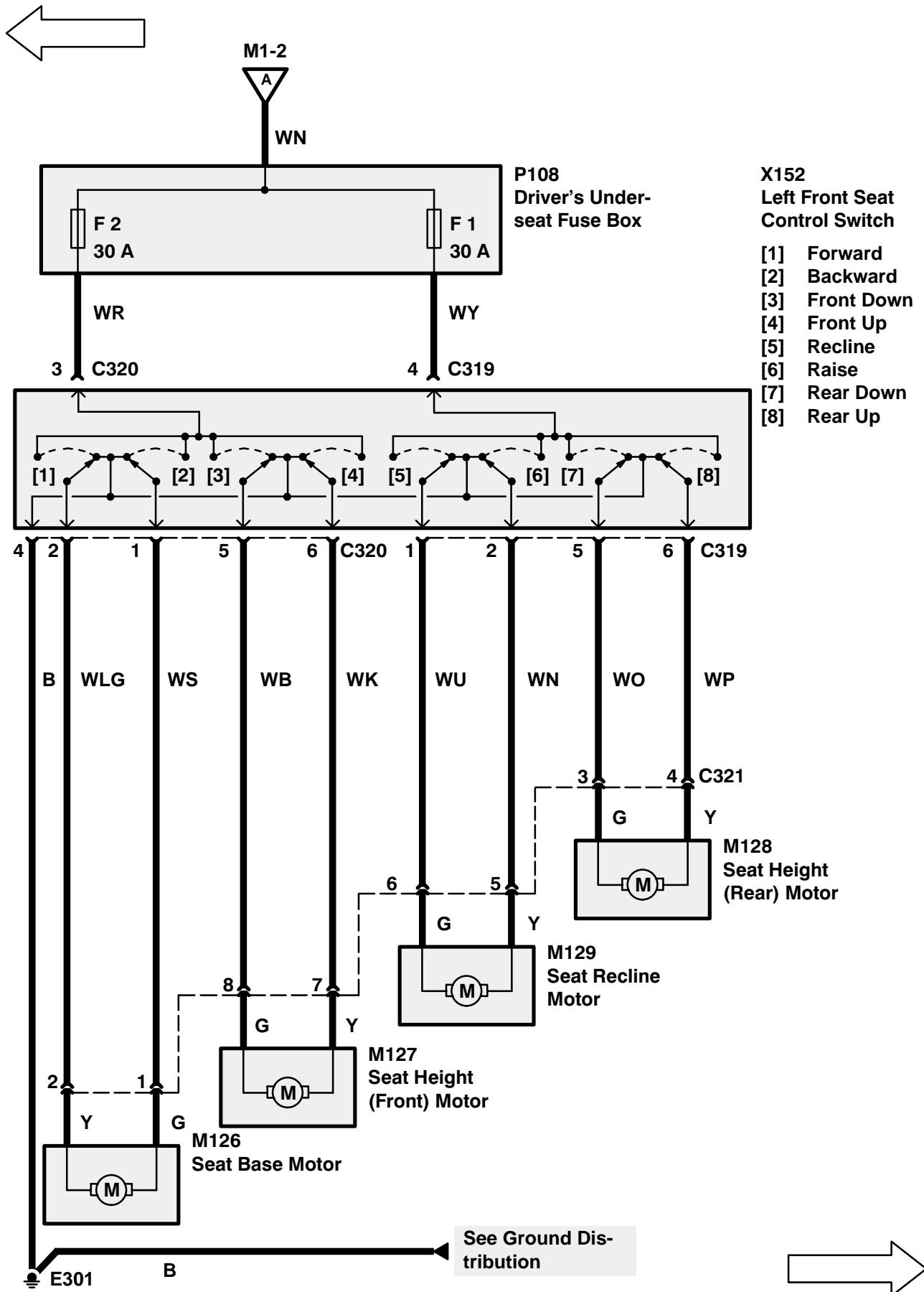

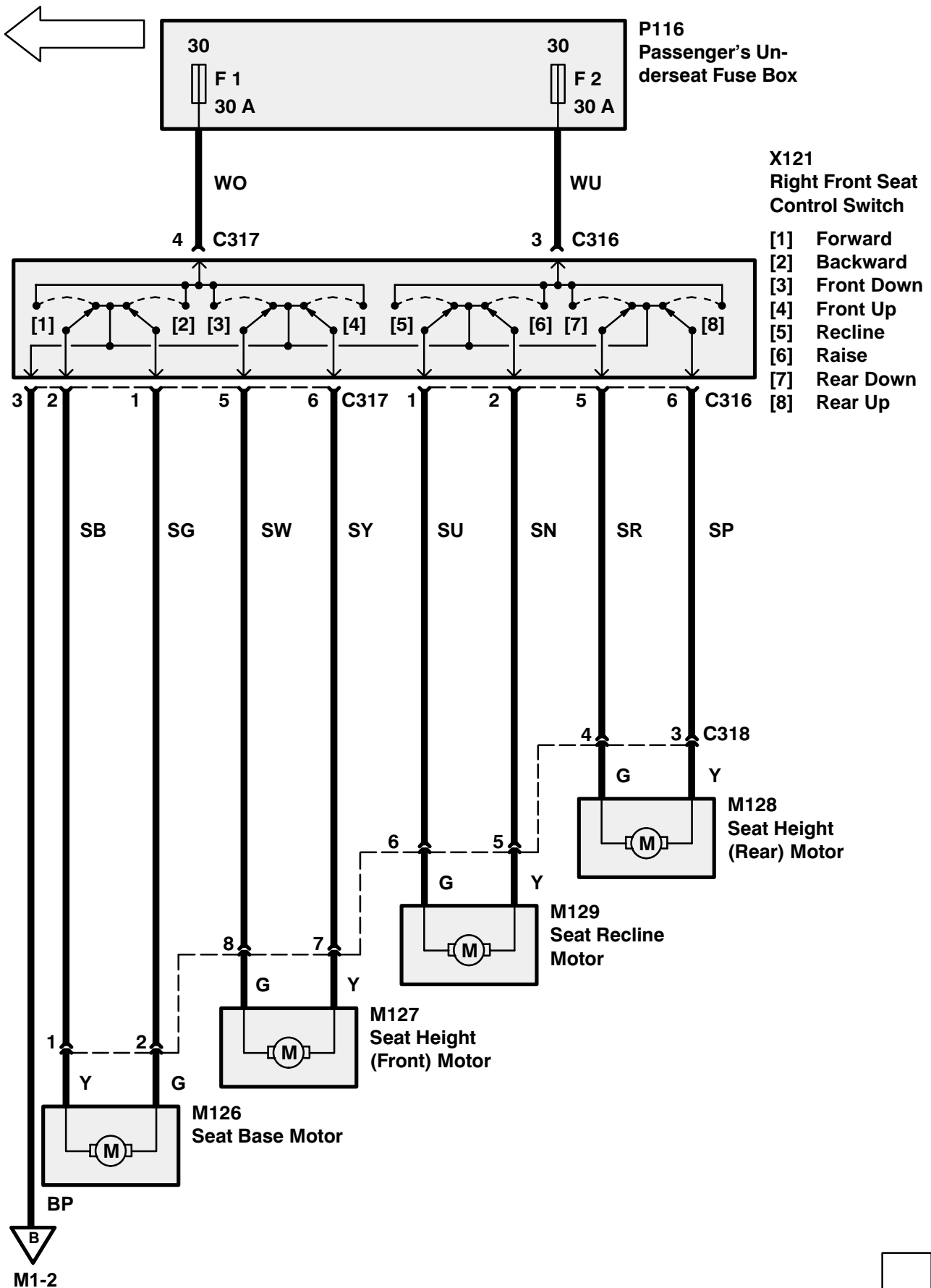

---

## CIRCUIT OPERATION

When the Ignition Switch (X134) is in position II, voltage is supplied to the power mirrors circuit by fuse F18.

### Left/Right Movement

When a selected mirror is moved to the left by the Mirror Adjustment Switch (X146), the internal contacts move to the "Move Down or Left" and the "Move Left" positions. The Left/Right motor of the selected actuator is grounded at E200 through the SW wires and the switch contacts. Voltage is applied to the Left/Right motor through the BP, BU wires. The mirror now moves left.

When a selected mirror is moved to the right by the Mirror Adjustment Switch (X146), the internal contacts move to the "Move Up or Right" and the "Move Right" positions. The Left/Right motor of the selected actuator is grounded at E200 through the BU, BP wires and the switch contacts. Voltage is applied to the Left/Right motor through the SW wires. Since the polarity of the voltage to the motor has been reversed, the mirror now moves right.

### Up/Down Movement

When a selected mirror is moved down by the Mirror Adjustment Switch (X146), the internal contacts move to the "Move Down or Left" and the "Move Down" positions. The Up/Down motor of the selected actuator is grounded at E200 through the SW wires and the switch contacts. Voltage is applied to the Up/Down motor through the BK, BN wires. The mirror now moves down.

When a selected mirror is moved up by the Mirror Adjustment Switch (X146), the internal contacts move to the "Move Up or Right" and the "Move Up" positions. The Up/Down motor of the selected actuator is grounded at E200 through the BN, BK wires and the switch contacts. Voltage is applied to the Up/Down motor through the SW wires. Since the polarity of the voltage to the motor has been reversed, the mirror now moves up.



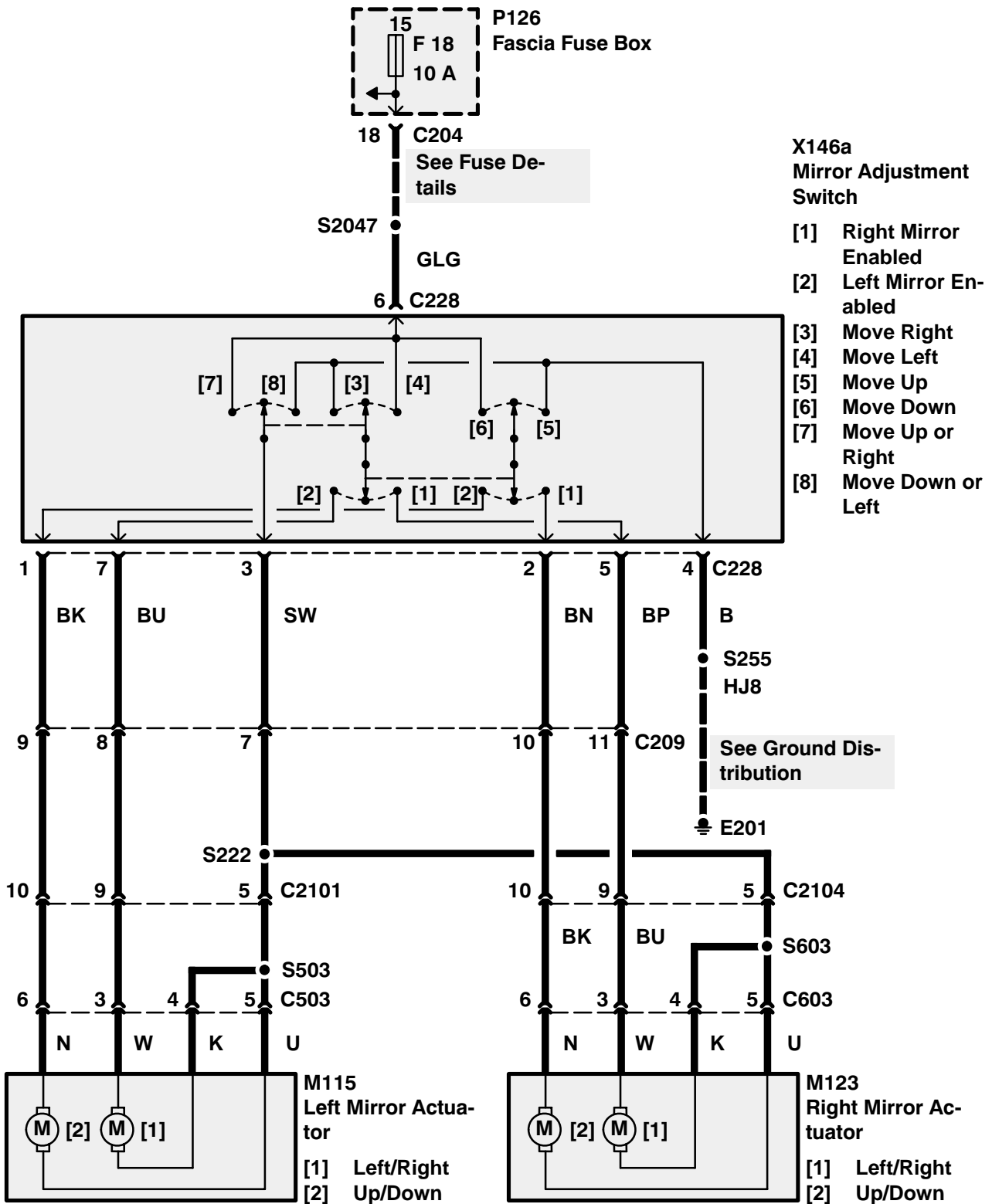

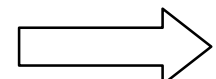
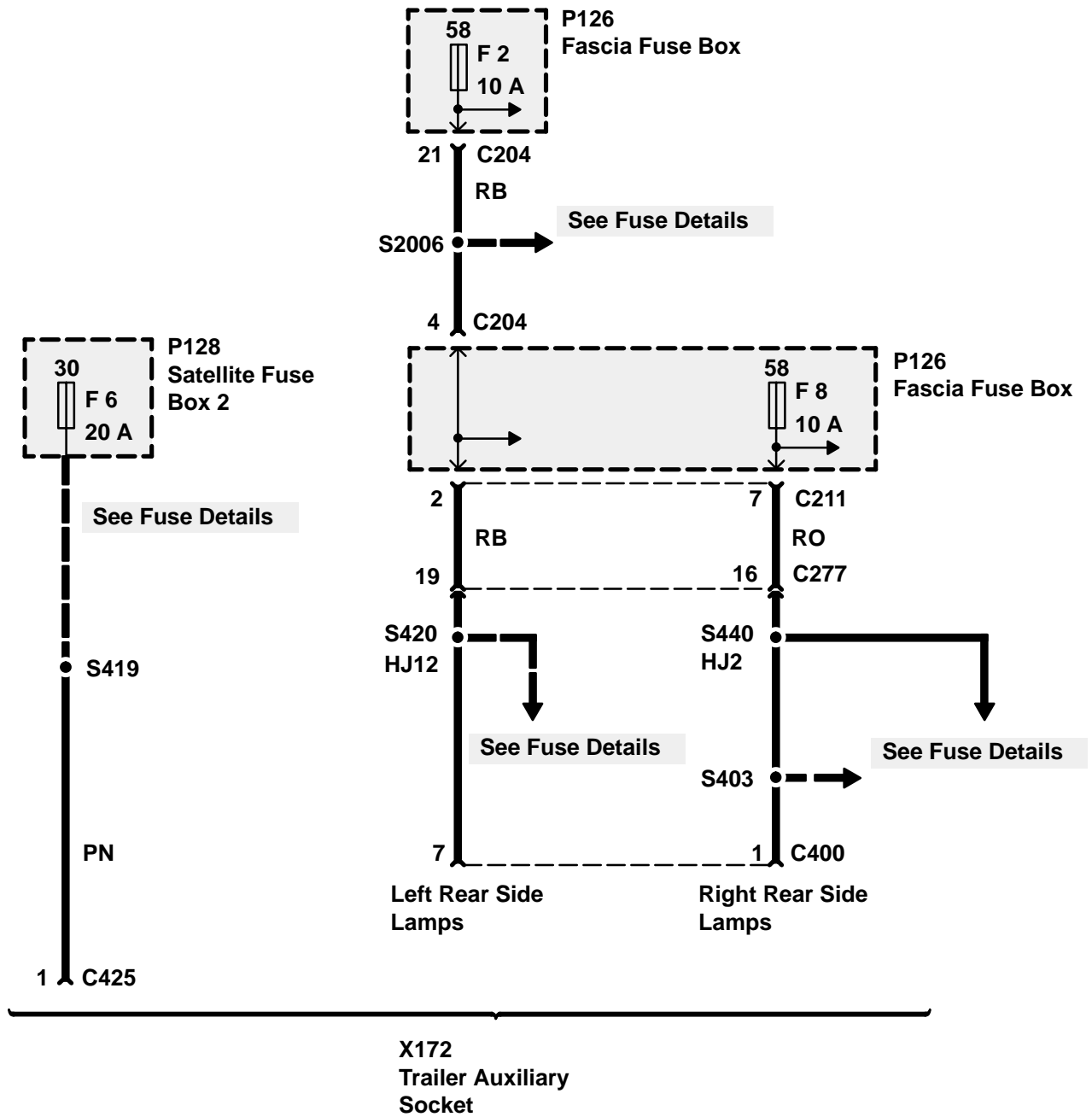

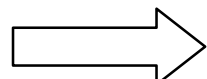
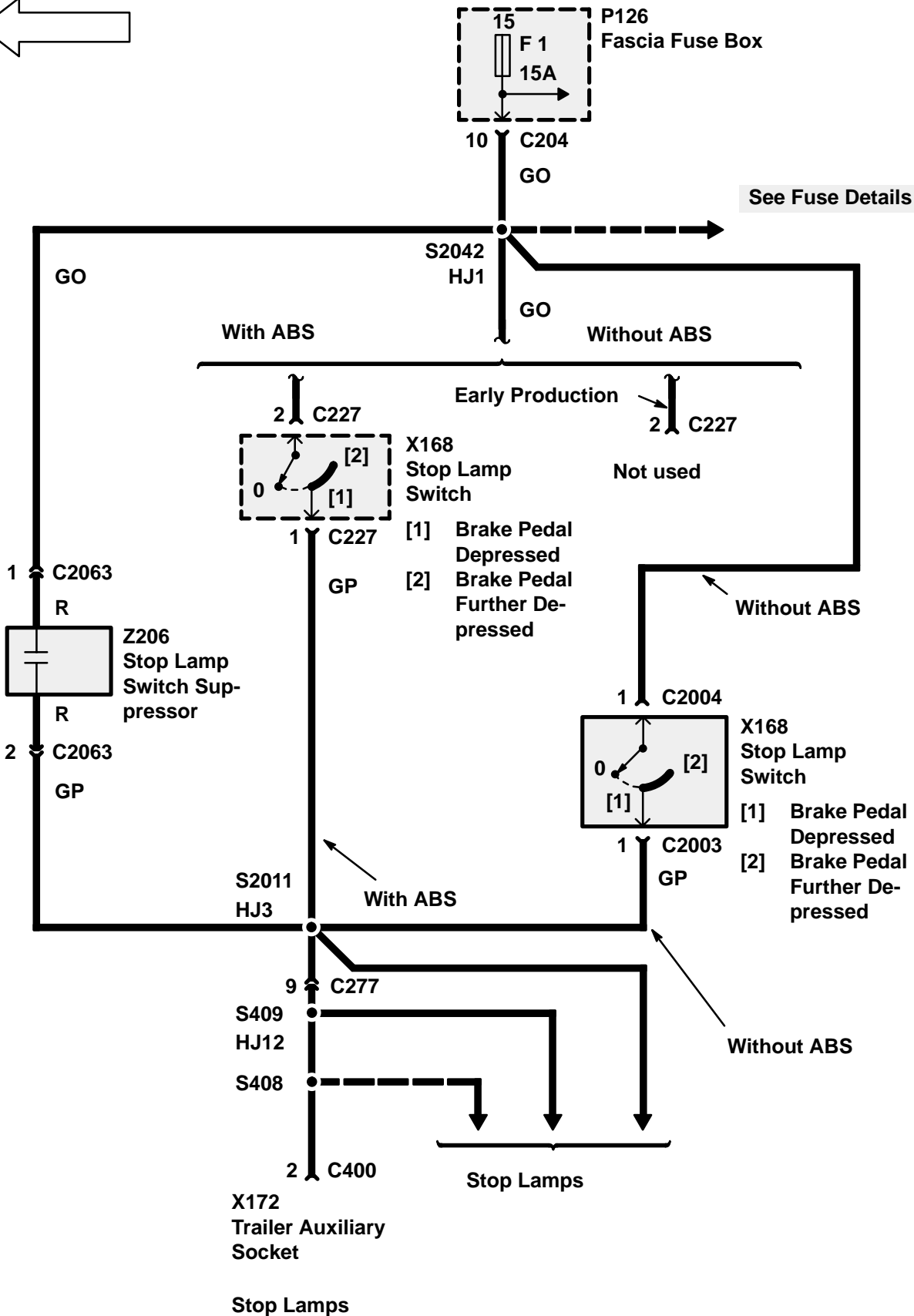
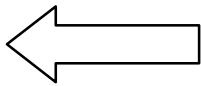

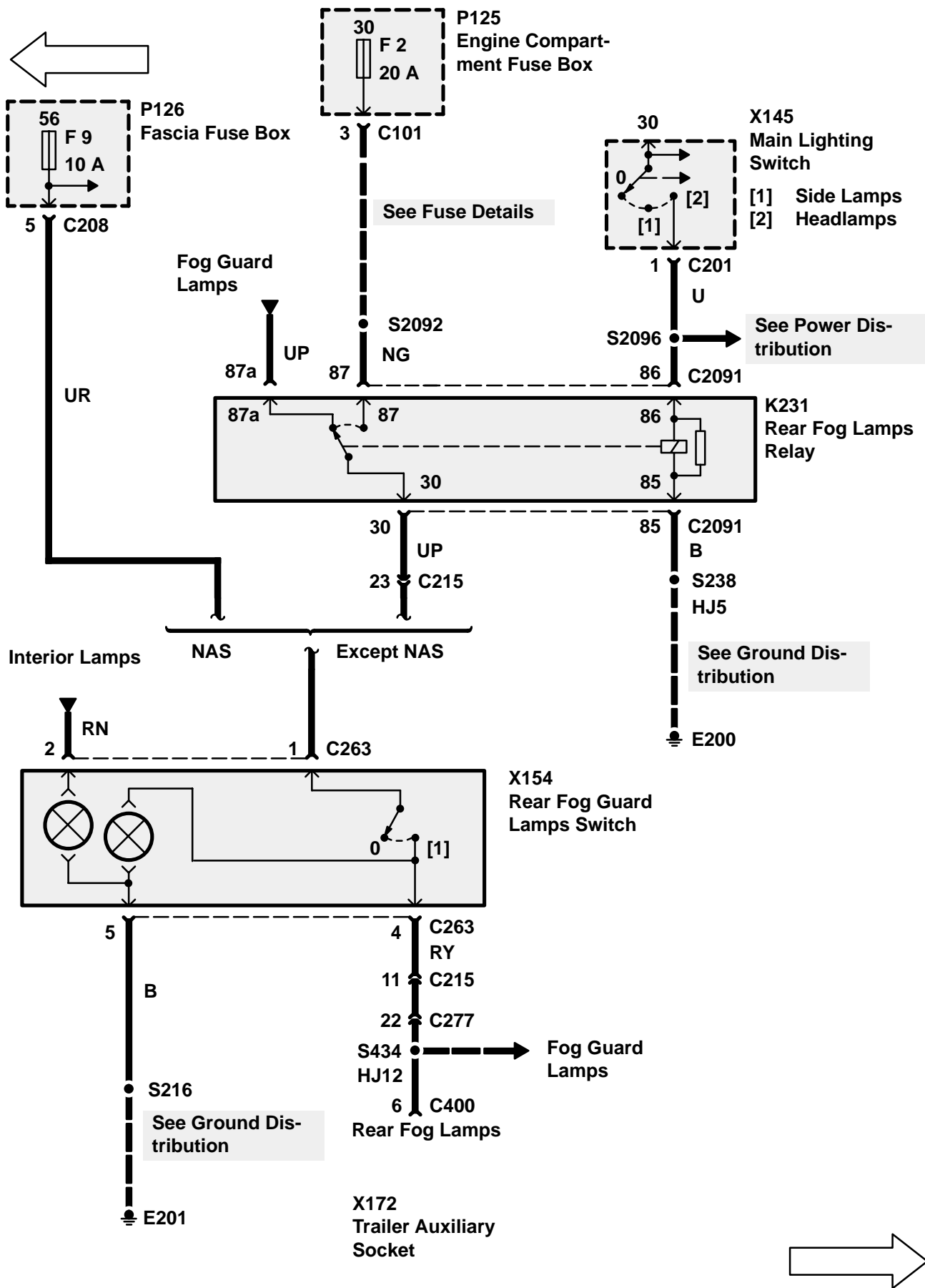

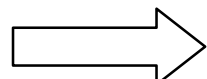
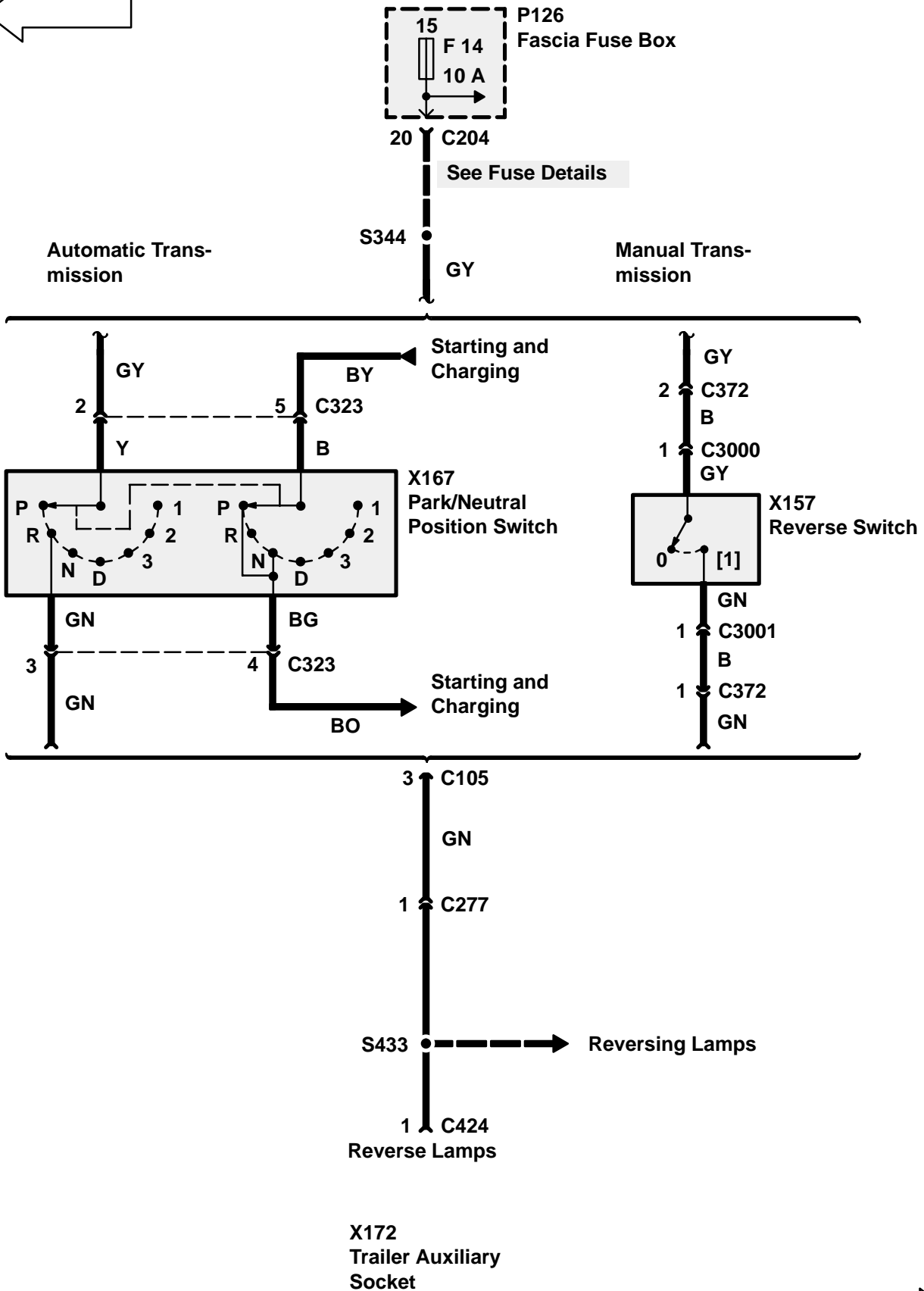
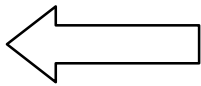

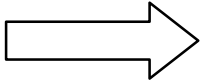
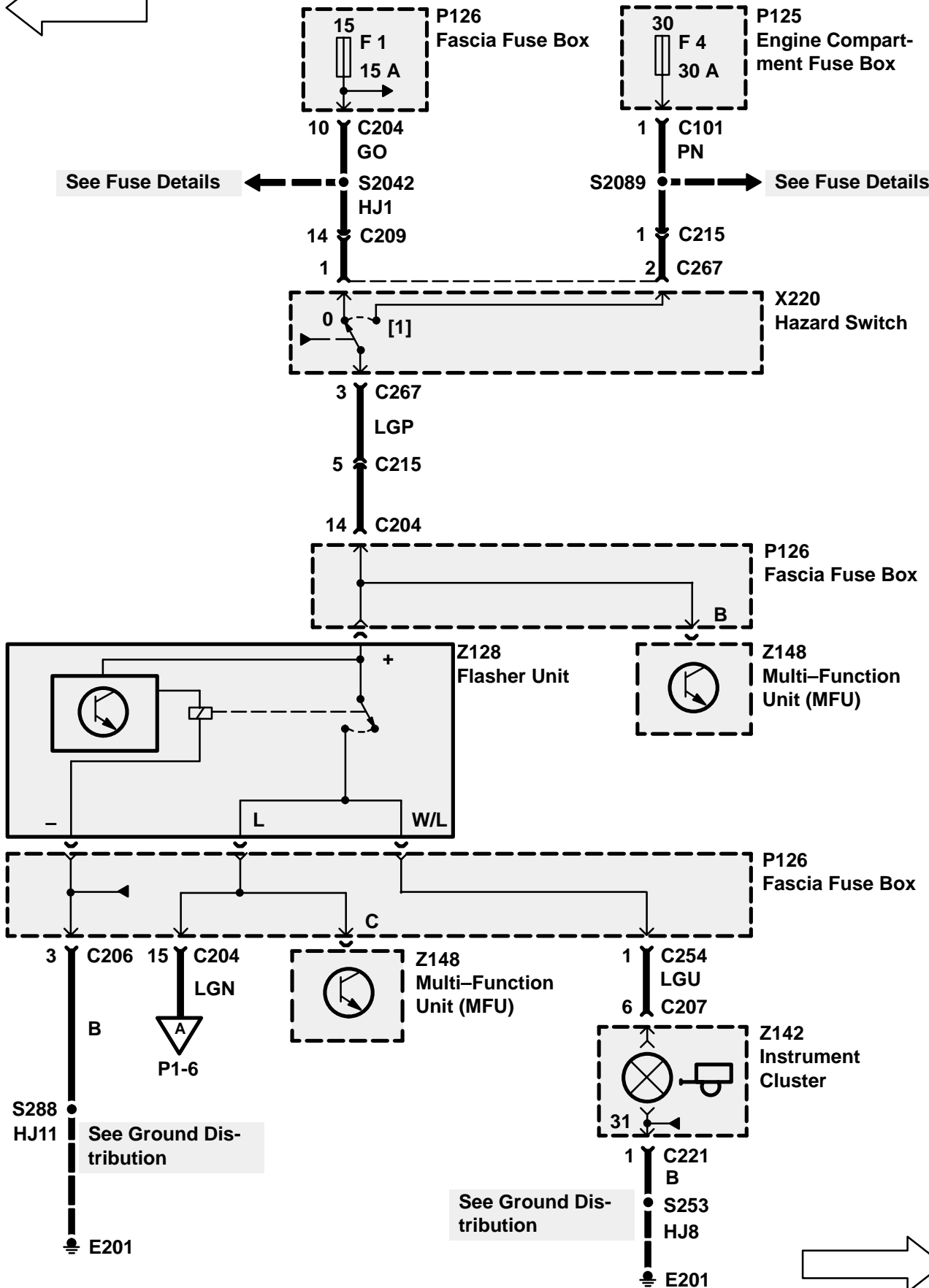
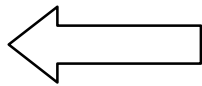

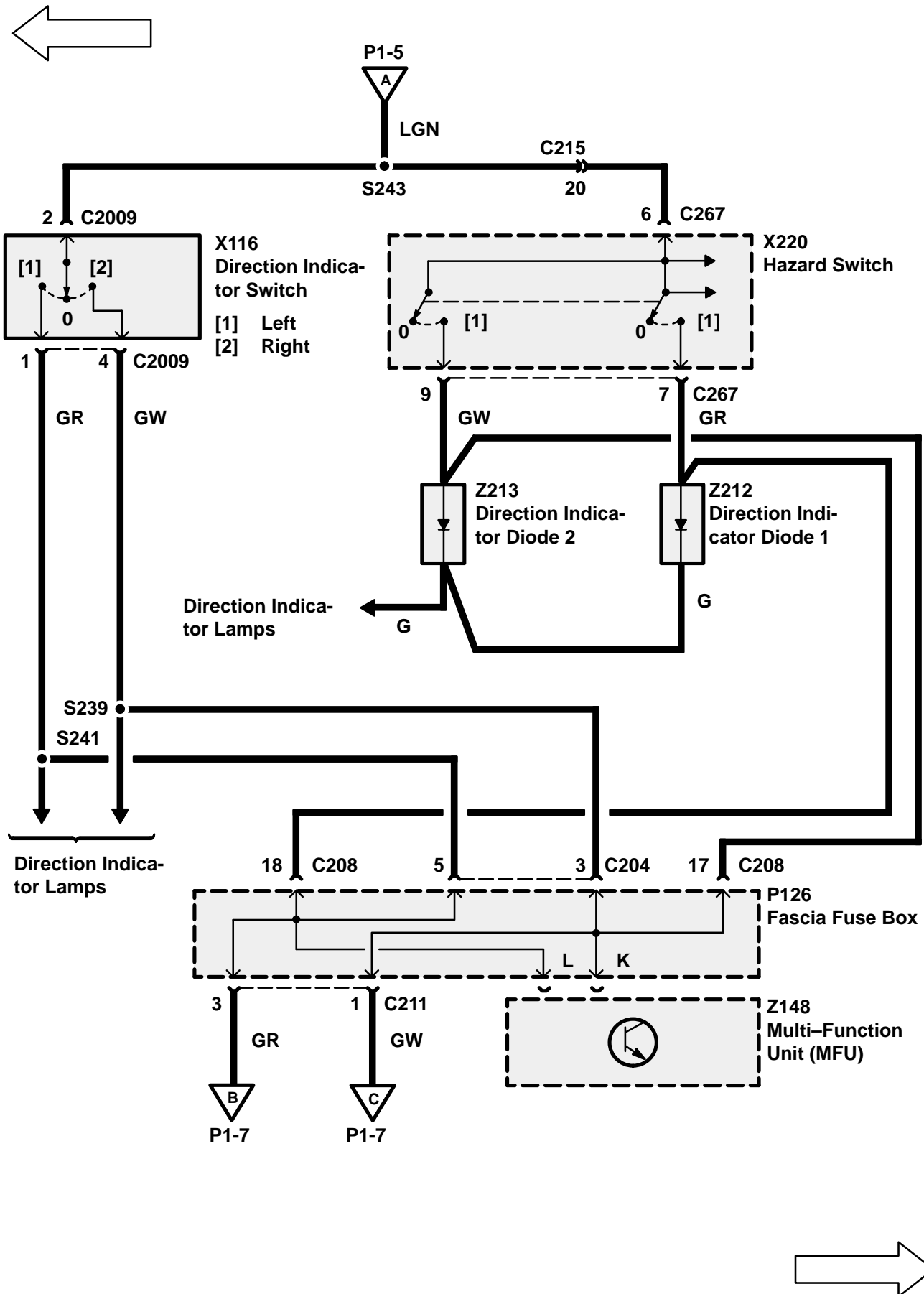

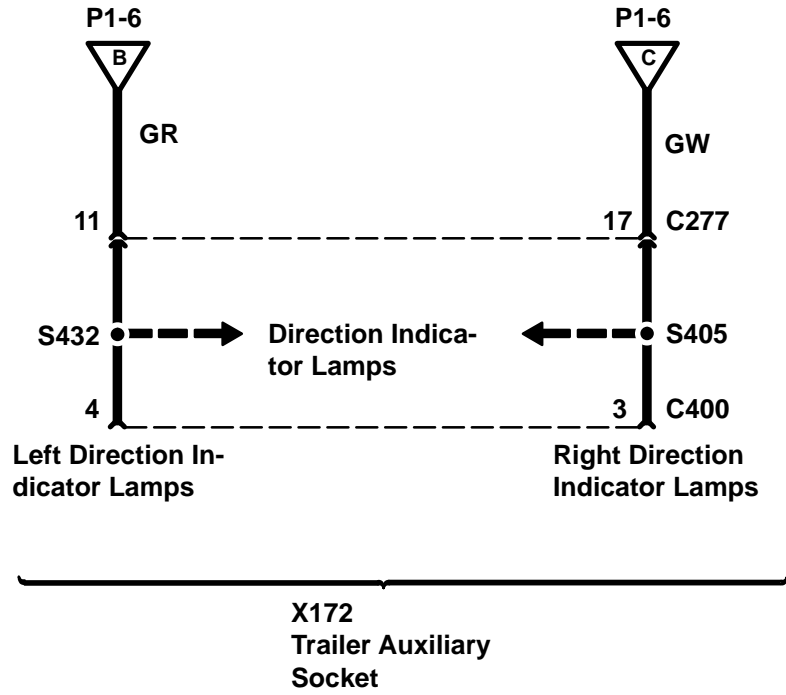
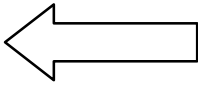



## CIRCUIT OPERATION

For 1996 models a vehicle alarm system is available as original equipment. Three different functions are integrated into the Theft Alarm System:

3. The main function of the system is to offer easy-to-use remote locking and unlocking of the vehicle (Central Locking).
4. Anti-Theft System function.
5. Engine Immobilisation function.

NOTE: The Theft Alarm ECU (Z163) is fully programmable to meet different market requirements; therefore some of the features listed will vary dependent on vehicle model or territory.

## ALARM COMPONENTS

1. Theft Alarm Unit (Z163)
2. Handset Transmitter
3. Passive Immobilisation Coil (Z270) (Not on all vehicles!)
4. Alarm Sensor (X213) (Not on all vehicles!)
5. Lock Actuators (M114, M122, M117, M125, M132)
6. Alarm Bonnet Switch (X212) (Not on all vehicles!)
7. Right Front Door Key Switch (X202)
8. Door Switches (X150, X118, X142, X163)
9. Rear End Door Switch (X265)
10. Direction Indicator Lamps (Hazard Lamps)
11. Battery Backed Up Alarm Sounder (Z272) (Not on all vehicles!)
12. Alarm Sounder (Z171) and Sounder Relay (K160) (Not on all vehicles!)
13. Theft Alarm LED and Engine Immobilised Warning Lamp (EIWL) (Included in the Instrument Cluster (Z142))
14. Engine Immobilisation Control Unit (Z171)  
MFI-V8 and 300 Tdi without EDC Engines only  
(Not on all vehicles!)

## Central Locking FUNCTION

Central Locking is controlled by the Theft Alarm Unit (Z163) and may be locked by using the driver's door key, sill button(s) or handset. The vehicle may be unlocked by using the handset or EKA code.

NOTE: The central door locking system will shut down for a period of approximately 15 seconds if the Theft Alarm Unit (Z163) determines that the Lock Actuators could be overheating.

## ANTI-Theft System Function

The alarm system offers the following forms of protection:

- Perimetric protection against unauthorised opening of all doors, tailgate, and bonnet.
- Engine crank inhibit against unauthorised engine crank.
- Electronic engine immobilisation against unauthorised engine start.
- Volumetric protection against intrusion into the passenger compartment.

NOTE: Perimetric protection is also triggered by the driver's door sill switch being lifted and the ignition switch being turned on.

### Perimetric Protection

The system is perimetrically armed whenever the vehicle is manually central door locked using the driver's door key. A lock request from the handset will volumetrically arm the theft alarm.

### Volumetric Protection

Using the handset transmitter will turn on and off volumetric protection. In volumetric mode all doors, tailgate, and bonnet are protected against unauthorised entry, and the Ignition Switch is protected from being switched on. In addition, the vehicle interior is protected using the Alarm Sensor (X213).

### Theft Alarm Disarming

#### (Perimetric and Volumetric Modes)

The theft alarm can only be disarmed with the handset (or EKA code).

NOTE: The theft alarm system cannot be disarmed using the driver's door key.

### Partially Armed Mode

The System will enter the "partially armed" mode whenever one of the following conditions is valid during theft alarm arming:

- movement takes place inside the vehicle within 15 seconds of the lock signal being received
- a door, tailgate, or bonnet is open.

The engine will be immobilised and cranking is inhibited. The alarm will sound if ignition is turned to start position. The alarm will protect the following:

- If any of the doors caused partial arming, then opening the tailgate or bonnet will sound the alarm.
- If the tailgate caused partial arming, then the opening of any doors or the bonnet will sound the alarm.
- If the bonnet caused partial arming, then the opening of any doors or tailgate will sound the alarm. Volumetric protection is also armed.
- If two of the above cause partial arming, then the third is still protected.

If the doors, tailgate or bonnet is subsequently closed, after a 5 second delay, the system will fully arm.

### Engine Cranking

It is only possible to crank the engine when ignition is ON and alarm disabled.

### Alarm Sounder

When an intrusion is detected, the Alarm Sounder (Z171) will sound and the hazard lamps flash (where territorial regulations allow) for 30 seconds. The alarm must be retriggered before the Alarm Sounder will sound again.

Two different types of Alarm Sounders are available:

1. Normal Alarm Klaxon (Alarm Sounder (Z171))
2. Battery Backed Up Alarm Sounder (Z272)

The Battery Backed Up Alarm Sounder (Z272) is an alarm sounder which contains its own internal battery. When the Ignition is on, the internal battery is charged via an Ignition feed. If either the connector is removed or the wires to it are cut, then the sounder will sound for 3 minutes.

To disconnect the Battery Backed Up Alarm Sounder (Z272):

- Turn Ignition On (Pos. II)
- Turn Ignition Off
- Disconnect within 15 seconds

To silence if triggered:

- Connect
- Disarm Alarm
- Turn Ignition On (Pos. II)

**Inertia Switch**

An inertia switch is incorporated in the Theft Alarm Unit (Z163). If ignition is on and the vehicle receives an impact sufficient to activate the inertia switch, the unit will signal to unlock central locking actuators and flash hazard lights. Central locking will remain disabled for a period of 0 to 5 minutes. To reset, turn ignition off and then on after the time period has elapsed.

**Alarm Sensor (X213)**

The sensor operates by emitting an air pressure carrier wave and receiving the wave back. Any disturbance within the vehicle which disturbs the wave will be detected, triggering the alarm. When the volumetric sensor is activated, it monitors movement within the vehicle for 15 seconds before detecting and responding to intrusions. If the sensor detects movement within the vehicle, it delays arming until a 15 seconds quiet period has elapsed. If continuous movement is detected, the alarm will not arm volumetrically.

**ENGINE IMMOBILISATION FUNCTION****(Not on all vehicles!)**

The engine will be immobilised whenever the theft alarm is armed or the Theft Alarm Unit (Z163) enters the Passive Immobilisation mode (regardless of whether or not the alarm is armed). There are two methods of Engine Immobilisation featured:

1. Electronic Engine Immobilisation (used on MFI-T16 and 300 Tdi with EDC engines)
2. Remote "Smart Spider" Immobilisation (used on MFI-V8 and 300 Tdi without EDC engines)

The vehicle may only be mobilised by using the handset or entering the correct EKA code.

**Electronic Engine Immobilisation****(MFI-V8) (300 Tdi with EDC)**

The electronic engine immobilisation is controlled jointly by the engine management system's Electronic Control Module (ECM) (Z132) and the Theft Alarm Unit (Z163).

When the Theft Alarm Unit (Z163) immobilises the vehicle, it sends a signal to the ECM. The ECM then immobilises the engine management system until a mobilise signal is received from the Theft Alarm Unit (Z163).

**Remote "Smart Spider" Immobilisation  
(MFI-V8) (300 Tdi without EDC)**

The Remote "Smart Spider" Immobilisation is controlled jointly by the Engine Immobilisation Control Unit (Spider) (Z271) and the Theft Alarm Unit (Z163). When the Theft Alarm Unit (Z163) immobilises the vehicle, it sends a signal to the Engine Immobilisation Control Unit (Spider) (Z271). The "Spider" then interrupts the starter circuit, fuel pump circuit, and Ignition coil circuit for MFI-V8 engines, or the starter circuit and the fuel pump shutoff solenoid circuit for 300 Tdi without EDC engines. These circuits will remain interrupted until the "Spider" receives a mobilise signal from the Theft Alarm Unit (Z163).

### Passive Immobilisation

The following conditions will passively immobilise the vehicle:

- 30 seconds after ignition has been turned off and the driver's door has been opened
- 5 minutes after ignition has been turned off
- 5 minutes after disarming the theft alarm

The vehicle can be mobilised by any of the following methods:

- Turn the ignition on (The handset must be functioning properly and within close proximity to the key!)
- Press unlock button on the handset (4 times if out of synch)
- Press lock button on the handset with Ignition Switch (X134) in position II (4 times if out of synch)
- Enter EKA code

NOTE: The vehicle will remain immobilised by attempting to turn the ignition on with the handset detached from the key ring (or with an improperly functioning handset)

### Passive Immobilisation Coil (Z270)

A magnetic field is generated by the passive Immobilisation Coil (Z270) contained in the steering column. This field excites a receiving coil in the handset causing it to transmit a mobilisation signal to the Theft Alarm Unit (Z163). If the Theft Alarm Unit (Z163) does not receive this signal from the handset, the vehicle will remain immobilised.

### Vehicle Status Indication

Vehicle status is indicated by up to four devices:

1. Hazard lamps
2. Theft Alarm LED (Contained in the Instrument Cluster (Z142))
3. Engine Immobilised Warning Lamp (EIWL) (Contained in the Instrument Cluster (Z142))
4. Alarm Sounder

#### Hazard Lamps

When the vehicle arms in either mode, the hazard lamps will flash up to three times when the alarm is armed and one time when disarmed.

#### Theft Alarm LED

- Slow Flash: Immobilised or immobilised and armed

- Rapid Flash: Volumetrically armed
- Intermittent Rapid Flash: Perimetrically armed
- No Flash for 10 Seconds: Mislock
- Continuous: Driver's door open (or ignition on) and immobilised

NOTE: The Theft Alarm LED may also be used to indicate other conditions.

Engine Immobilised Warning Lamp (EIWL) (Not on all vehicles!)

- Flashing: Immobilised
- Continuous: Immobilised (Cirrus Fail), or an attempt has been made to start the vehicle without the handset attached to the key ring (or handset battery needs to be replaced).

### Handset Transmitter Resynchronisation

The Theft Alarm Unit (Z163) will remain synchronised with the handset unless:

- The handset's batteries have been removed
- The vehicle's battery has been disconnected

NOTE: All handsets must be resynchronised when the vehicle's battery has been disconnected.

To resynchronise a handset the vehicle must be in an unlocked and disarmed state. Resynchronisation consists of 4 presses of either the lock or unlock button.

### Handset Low Battery Warning

When the handset batteries are low, the Theft Alarm Unit (Z163) will enter the "low battery mode". The Theft Alarm LED will flash to indicate "low battery mode", and the hazard lamps will not flash when the alarm is disarmed.

### Interior Lamps

The Theft Alarm Unit may be configured to perform full interior Lamp delay and soft-fade functionalities.

### Power Up Mode

The alarm system always remembers the state it was left in when power was removed. If the alarm powers up in an alarmed state, it will enter a special "power up mode".

### Emergency Key Access (EKA)

EKA is used to disarm the theft alarm and mobilise the vehicle in the event of a handset failure. This is possible through a series of locks and unlocks with the key in the driver's door lock cylinder. With the vehicle locked and the alarm armed, turn the key the required number of times according to the following sequence:

1. To enter the first digit, turn the key the required number of times to the unlock position.
2. To enter the second digit, turn the key the required number of times to the lock position.
3. To enter the third digit, turn the key the required number of times to the unlock position.
4. To enter the fourth digit, turn the key the required number of times to the lock position.

5. Turn the key to the unlock position to unlock the doors, disarm the alarm, and mobilise the vehicle.

NOTE: The key must be fully turned to the rest and lock/unlock position each time.

If the wrong EKA code has been entered, an audible warning will be heard. After 3 wrong attempts, you must wait 30 minutes. To clear a partially entered code, simply hold the key in the lock position for at least 5 seconds.

### BUILT IN TEST PROCEDURE

The handset should be detached from the key ring to allow perimetric testing. The system will automatically switch to volumetric testing if the handset is in close proximity to the Ignition Switch (X134).

The built in test procedure is accessed as follows:

1. Starting conditions: ignition off, doors unlocked, alarm disarmed, bonnet switch depressed.
2. Carry out instructions 3 to 7 within 5 seconds.
3. Release bonnet switch.
4. Switch ignition on.
5. Open driver's door.
6. Switch ignition off.
7. Switch ignition on.

If alarm is correctly accessed, the alarm sounder will sound briefly and the Theft Alarm LED and hazard lamps will flash. The following checks can then be made:

#### Perimetric Testing

1. Open and close driver's door or tailgate – Theft Alarm LED and Hazard lamps will flash.
2. Depress and release bonnet switch – Theft Alarm LED and Hazard lamps will flash.
3. Pull the driver's door sill button up – Theft alarm LED and Hazard lamps will flash.
4. Turn driver's door key lock cylinder – Theft Alarm LED and Hazard lamps will flash.

#### Volumetric Testing

1. Press the unlock button on the handset or move the handset close to the Ignition Switch (X134) to disable perimetric testing and enable volumetric testing.
2. Any movement within the vehicle will be detected by the Alarm Sensor (X213) and indicated by flashing the Theft Alarm LED and hazard lamps.
3. Turn off ignition to end test procedure.

### HANDSET INITIALISATION

The Theft Alarm Unit (Z163) must be programmed whenever handsets are replaced. The serial communications line is used to activate the "learn mode" of the Theft Alarm Unit (Z163). Then the handset(s) to be initialised must be made to transmit their coded data to the Theft Alarm Unit (Z163).

NOTE: All handset(s) must be programmed during the same learn mode period. It is not possible to

simply add a handset to the Theft Alarm Unit (Z163) which has been programmed to other handsets.

When the "learn mode" of the Theft Alarm Unit (Z163) has been accessed, the handset(s) are programmed using the following procedure:

1. Starting conditions: Theft Alarm disarmed and vehicle mobilised.
2. Press the handset unlock button a minimum of 8 times.
3. If the handset has been correctly programmed, the horn will sound briefly and the hazard lamps will flash once.
4. The next handset, up to a maximum of 4, can now be programmed using the same procedure.

NOTE: It is very important that each handset is programmed separately. If the Theft Alarm Unit (Z163) receives key presses from two handsets, then neither handset will be programmed.

The "learn mode" is terminated using the serial communications line. If the Theft Alarm Unit (Z163) would not accept reprogramming, the original handset(s) will still function.

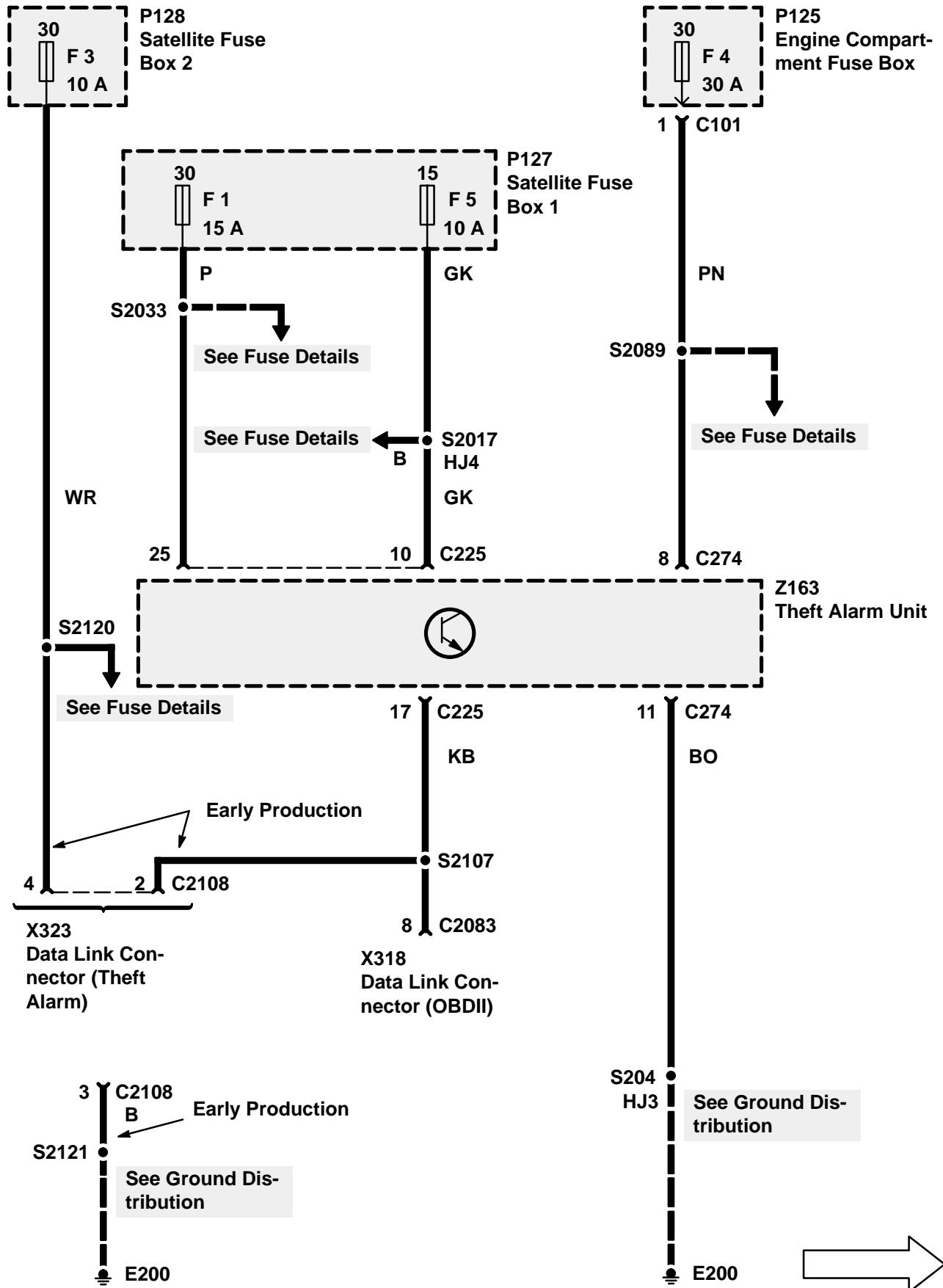

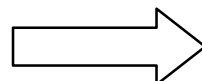
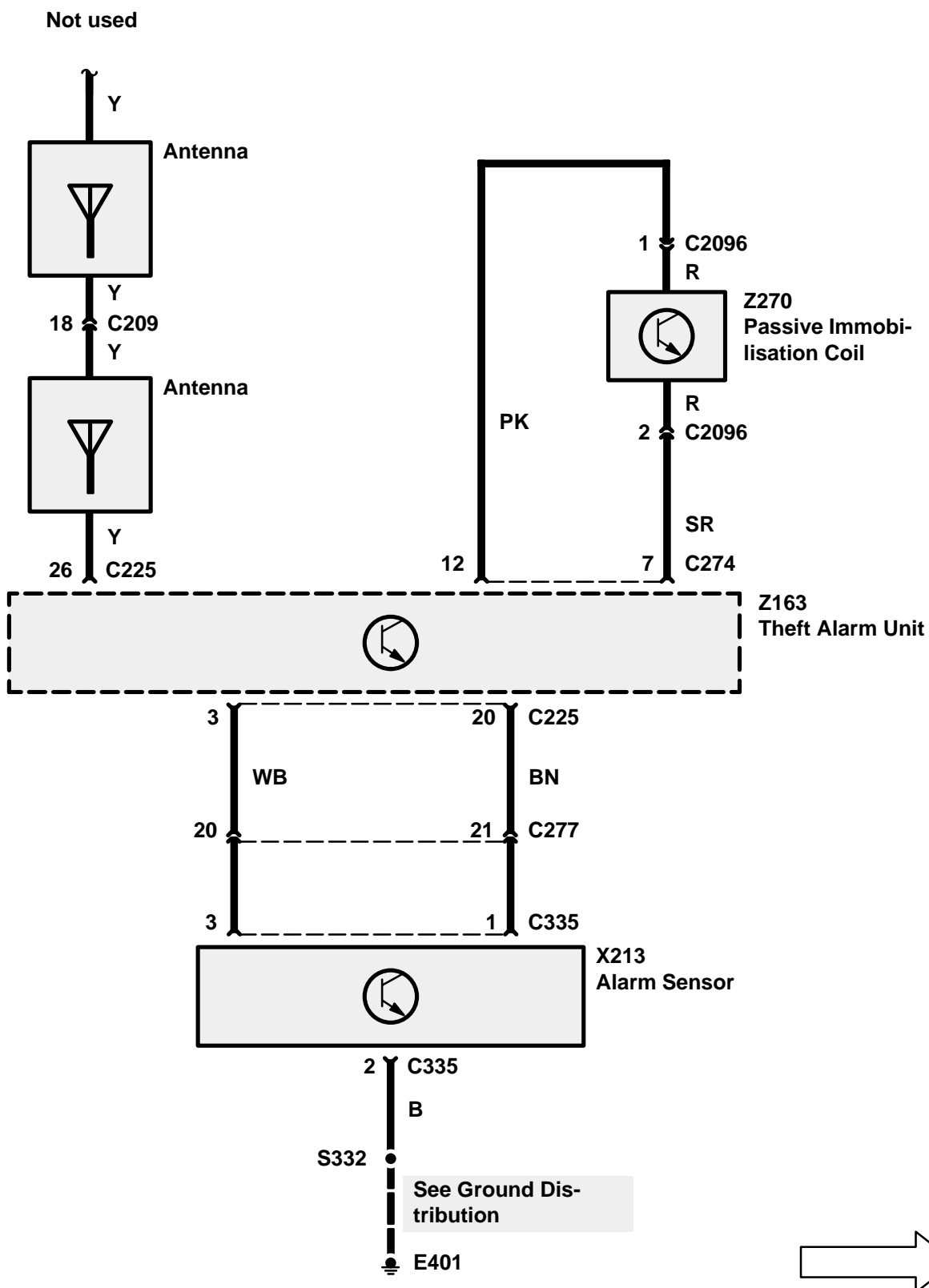
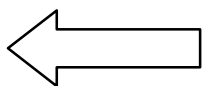



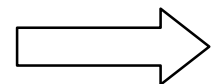
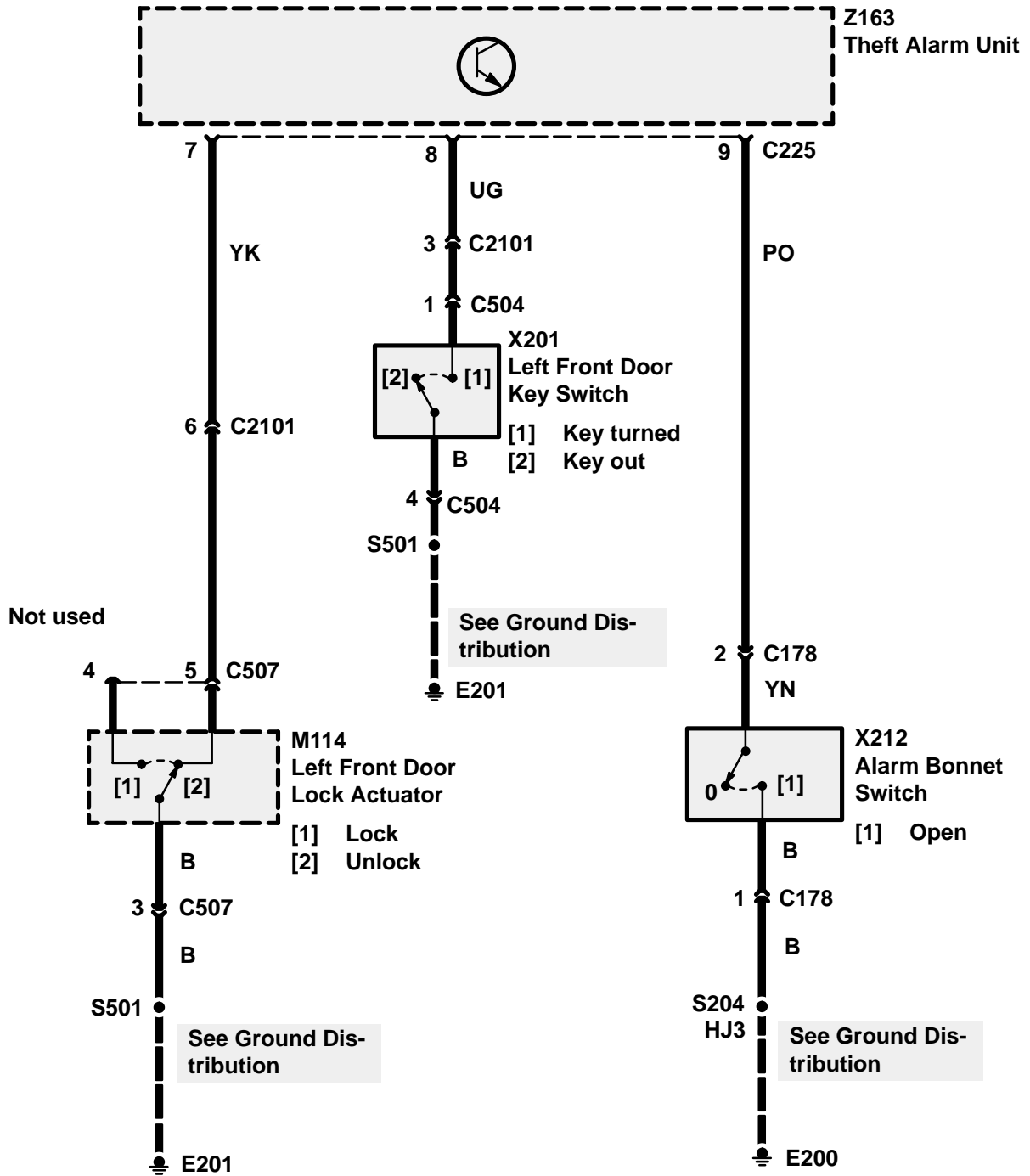
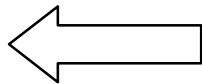

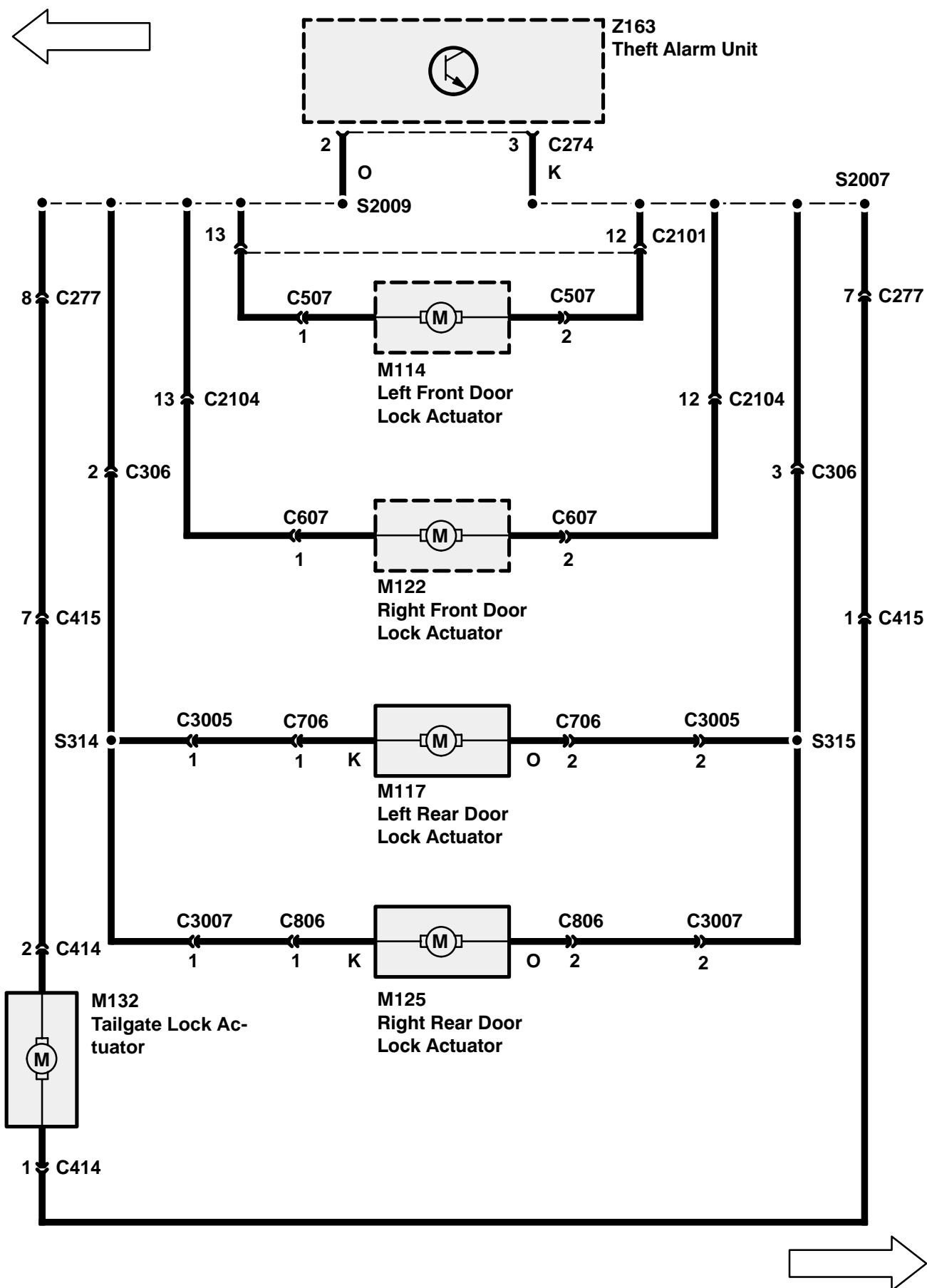

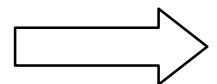
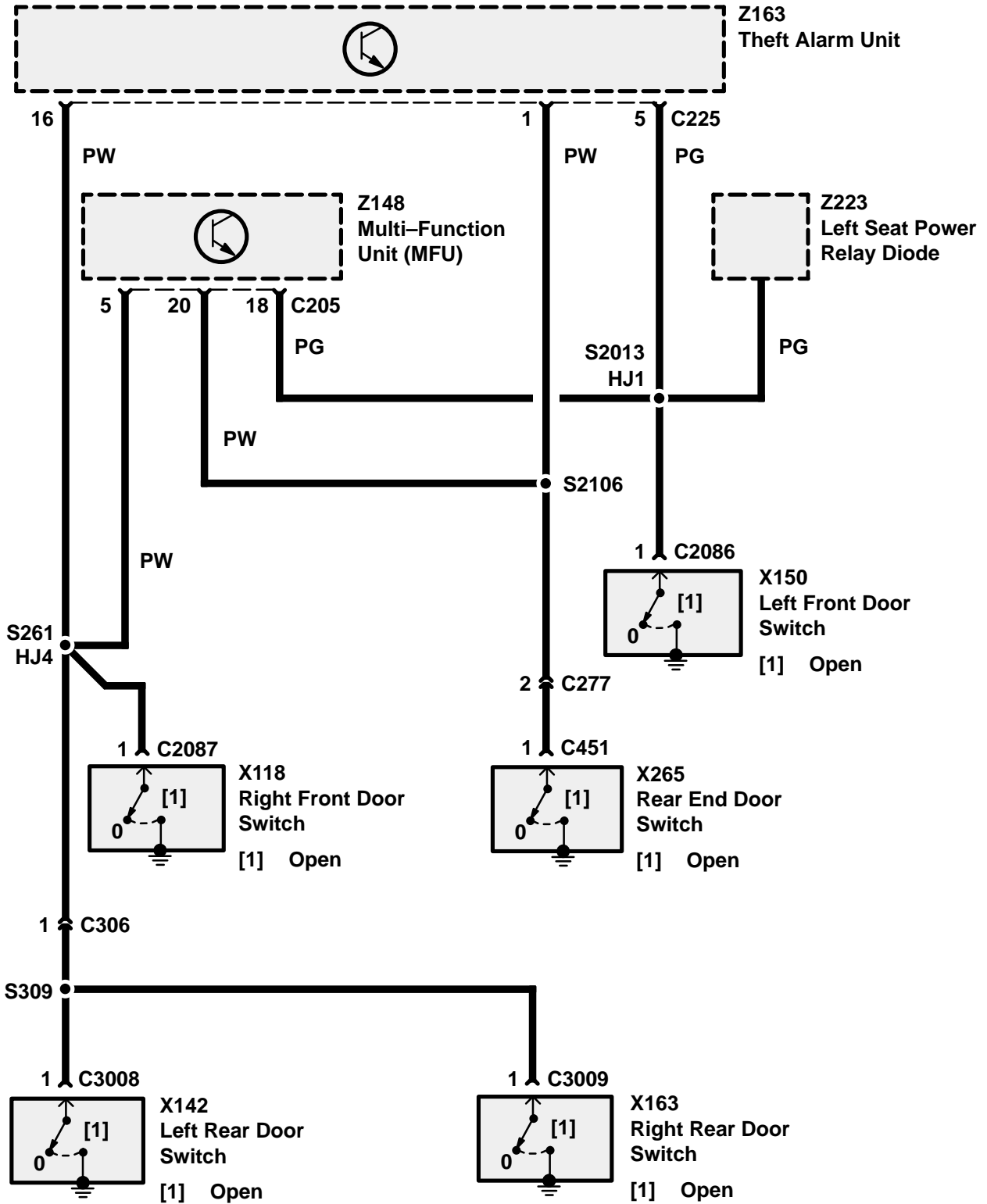
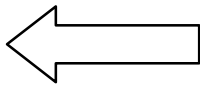

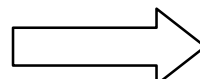
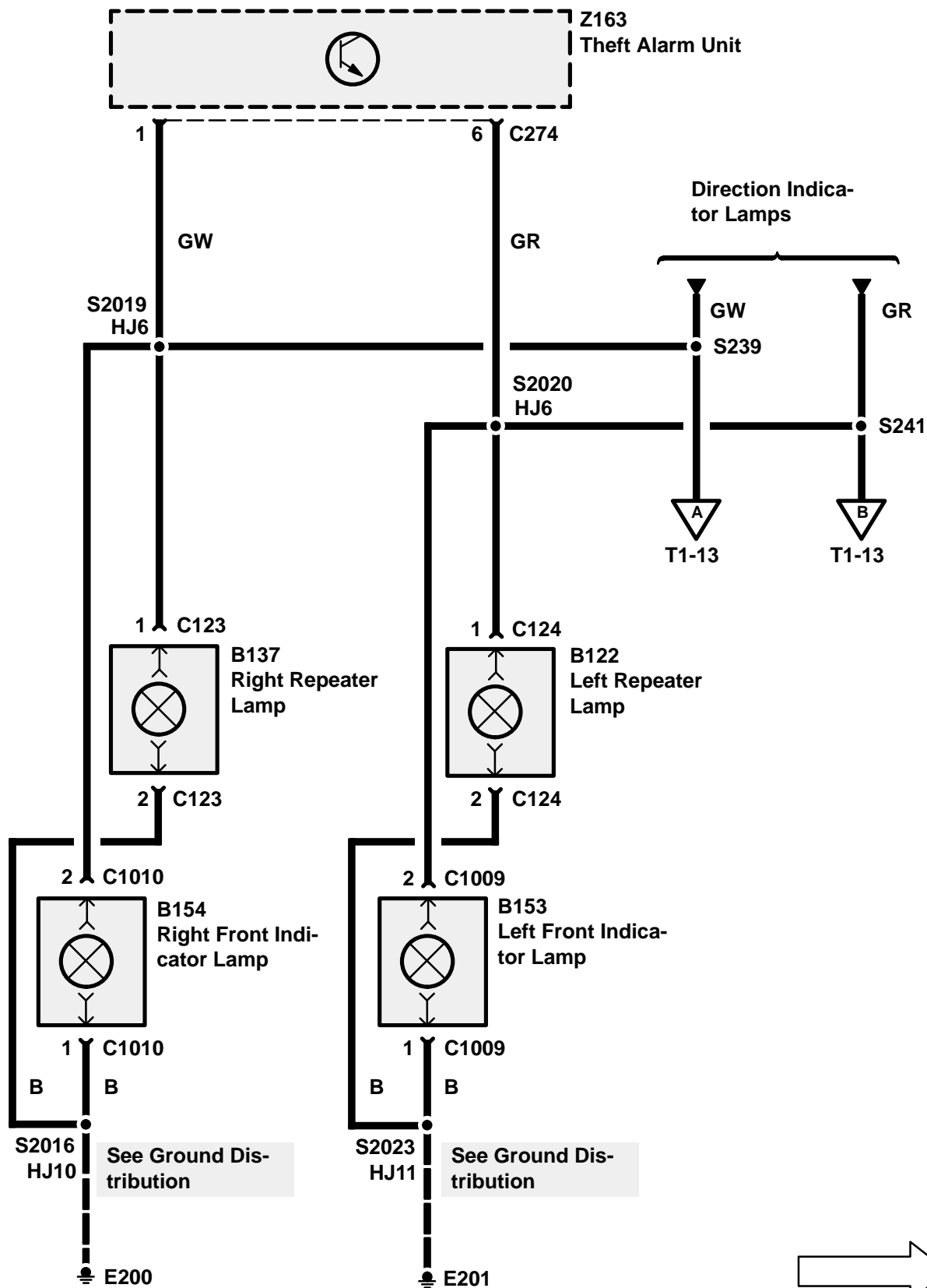
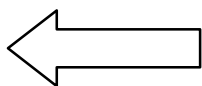

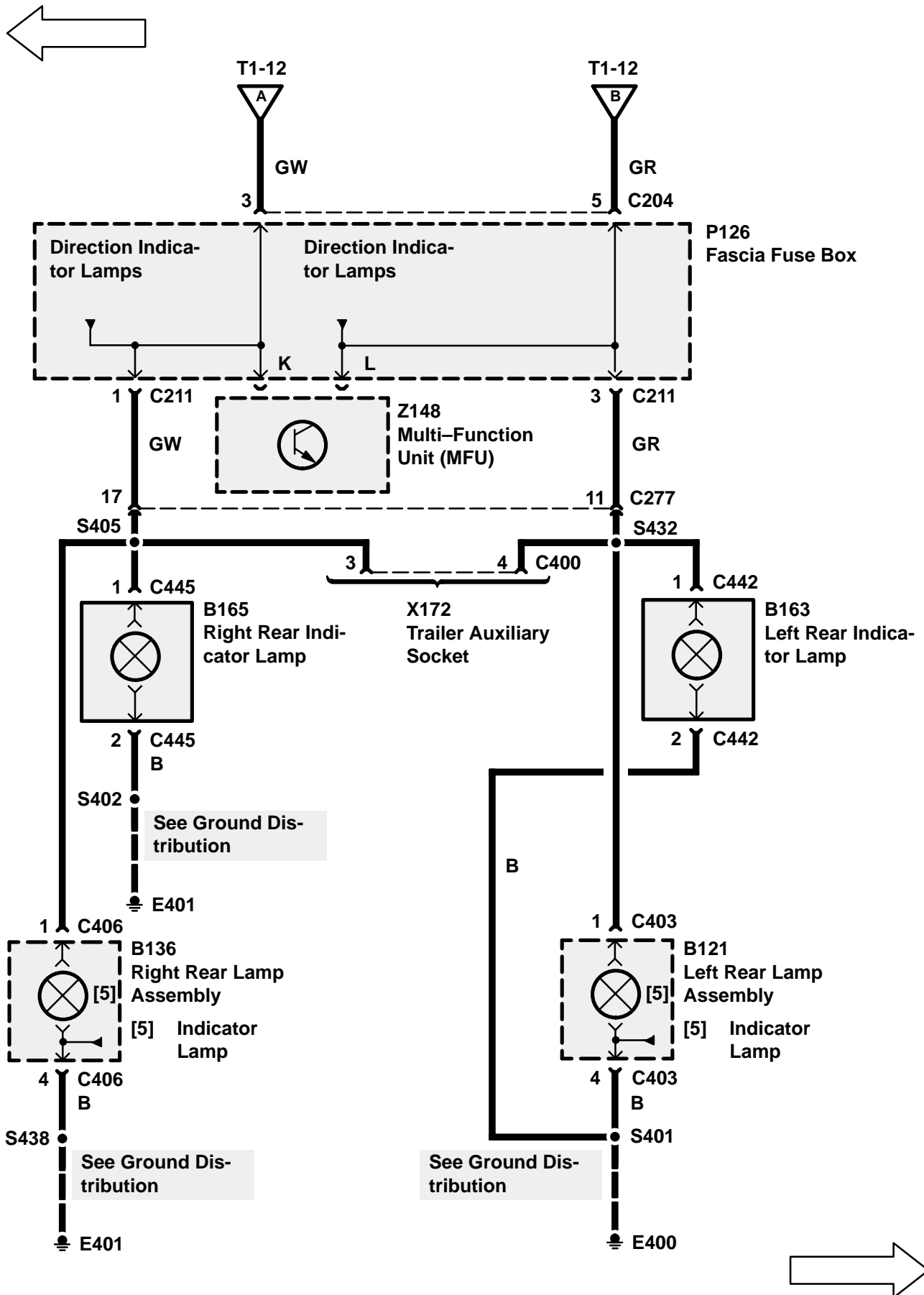

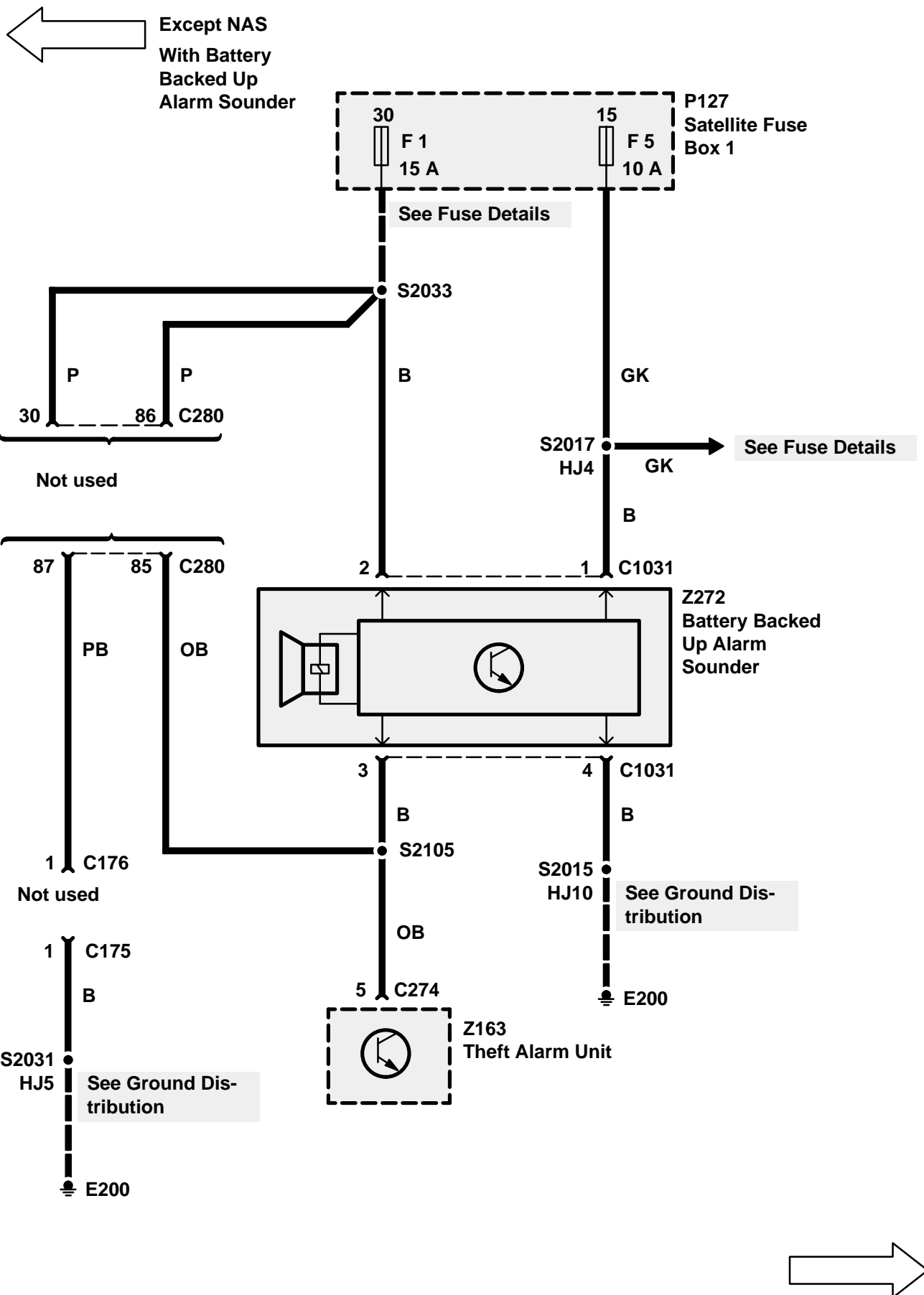

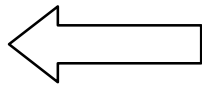

Except NAS  
Without Battery  
Backed Up  
Alarm Sounder

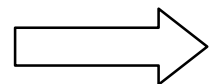
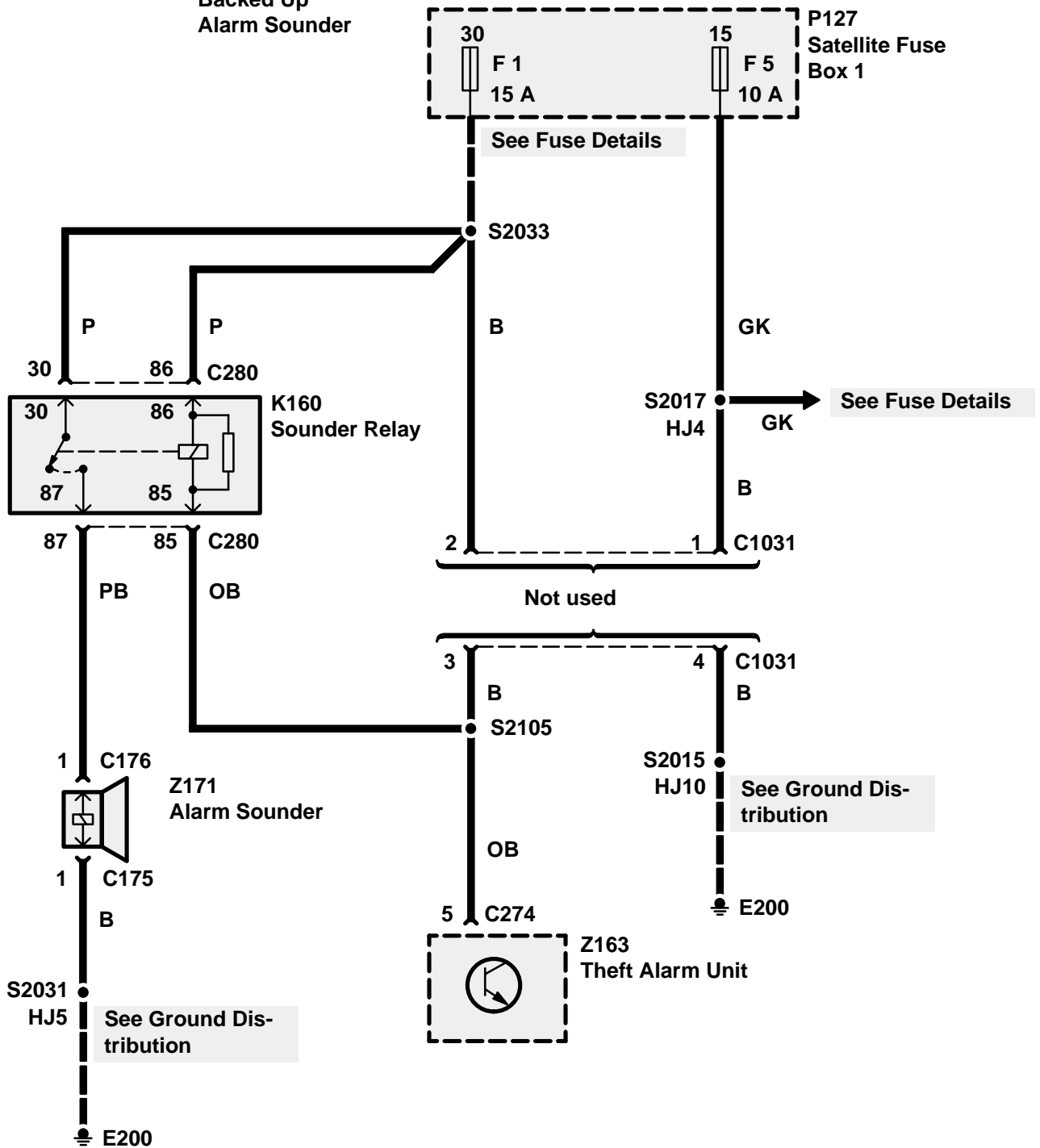

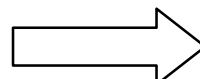
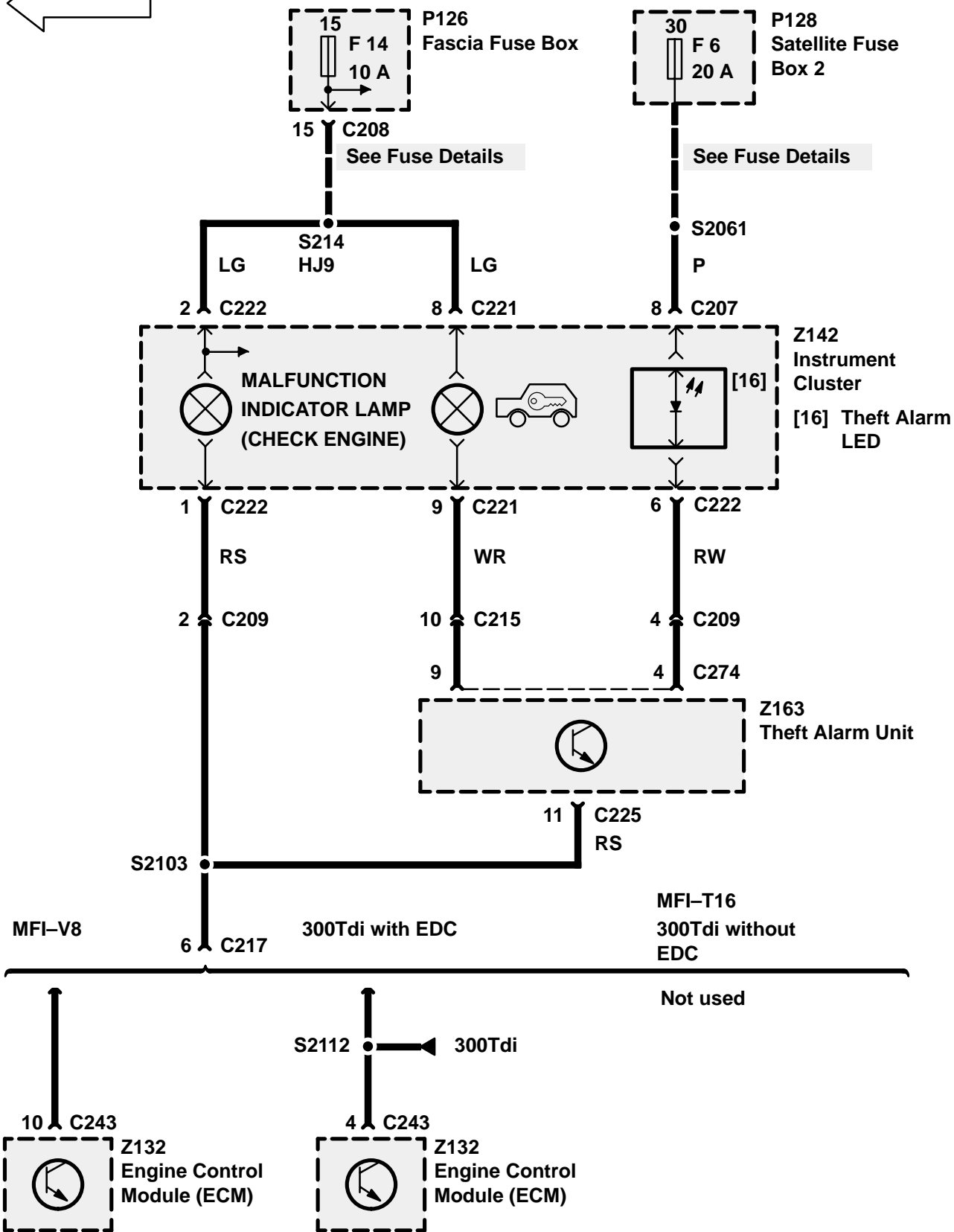
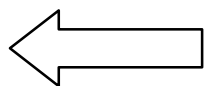



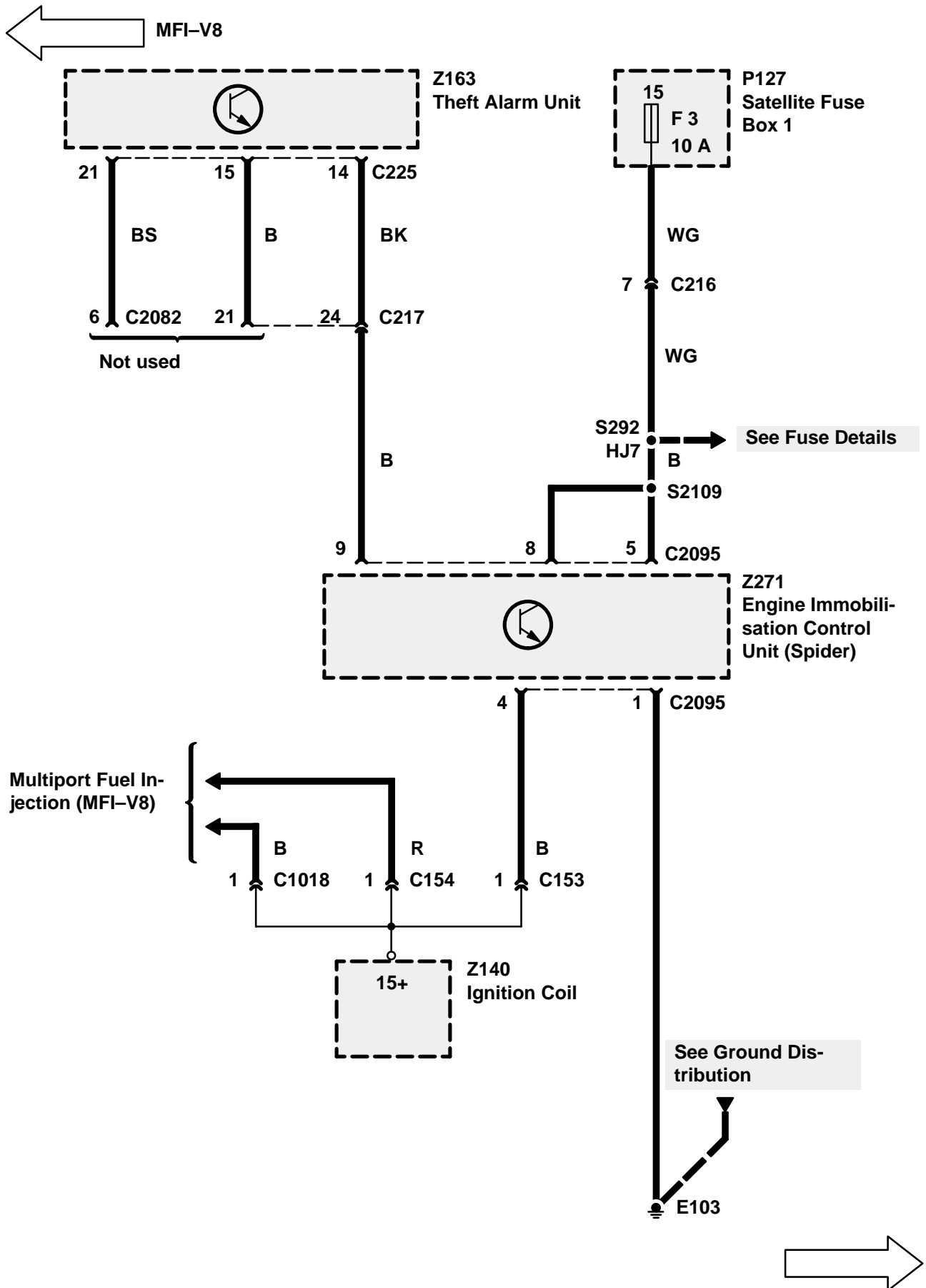

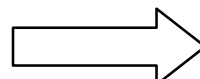
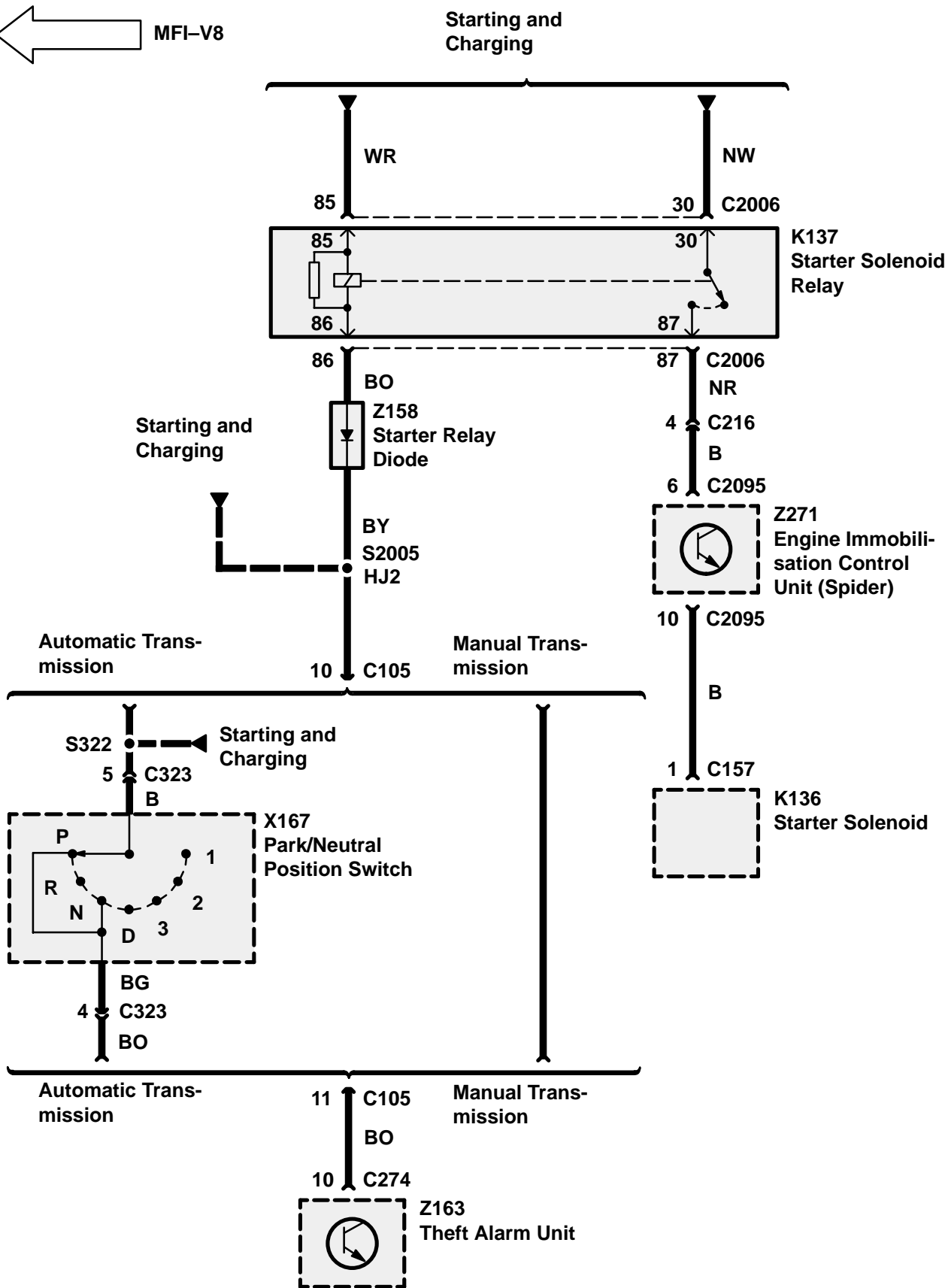
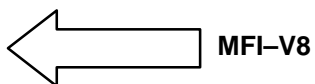

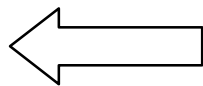

MFI-V8

Multiport Fuel Injection (MFI-V8)

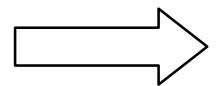
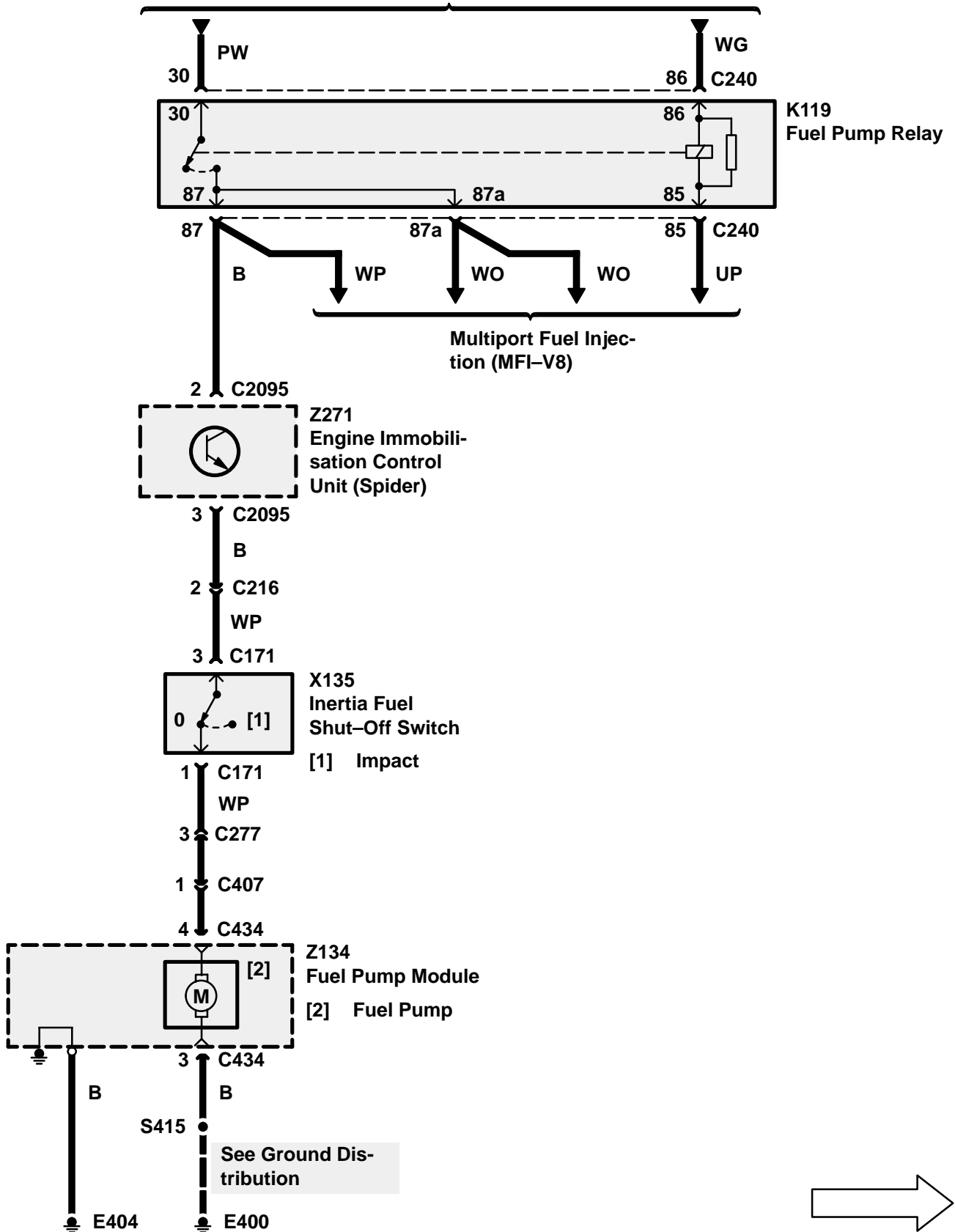

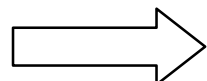
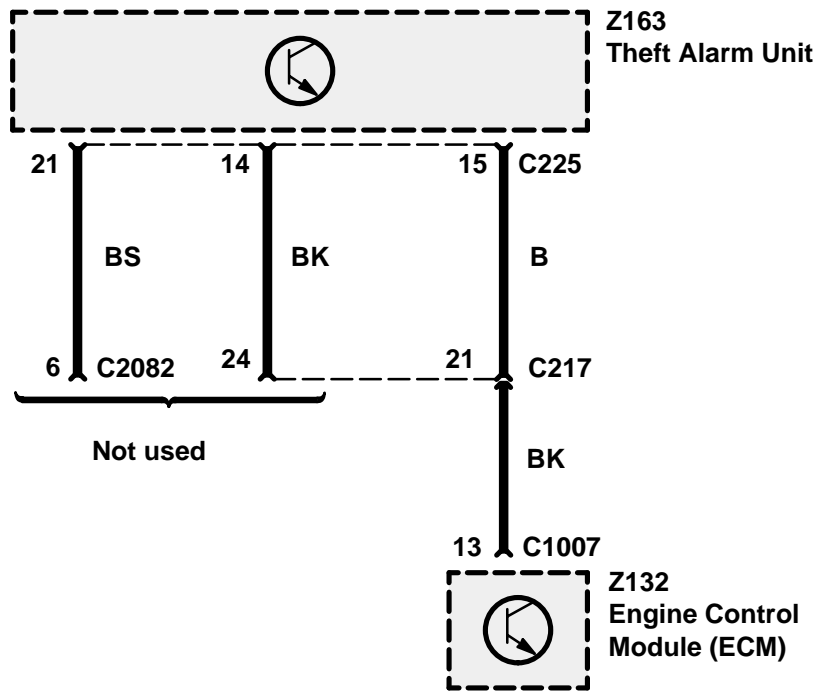
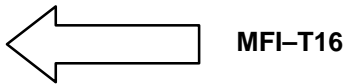

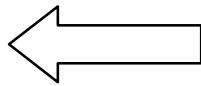

MFI-T16

Starting and Charging

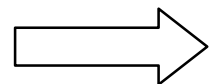
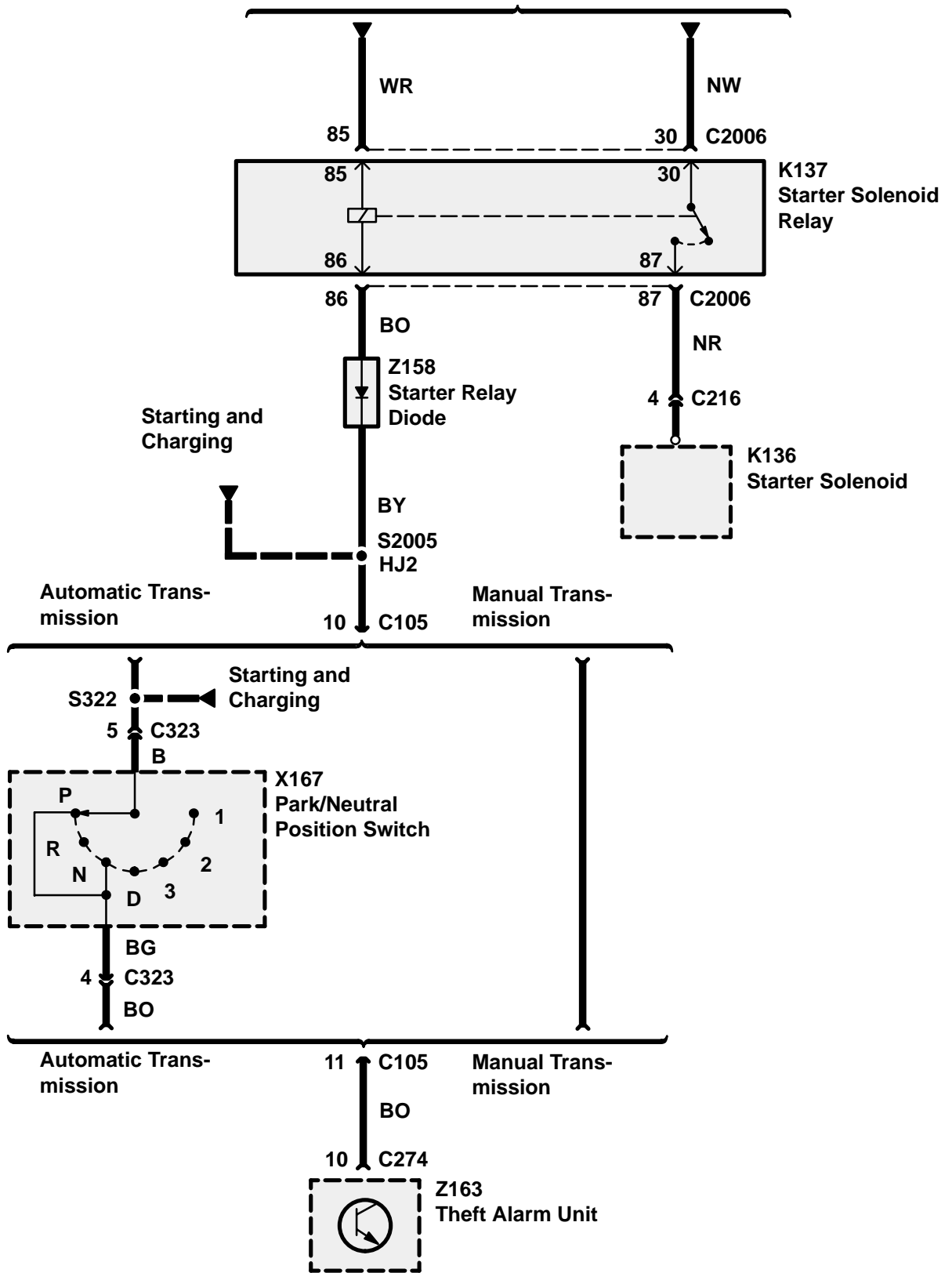

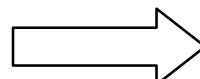
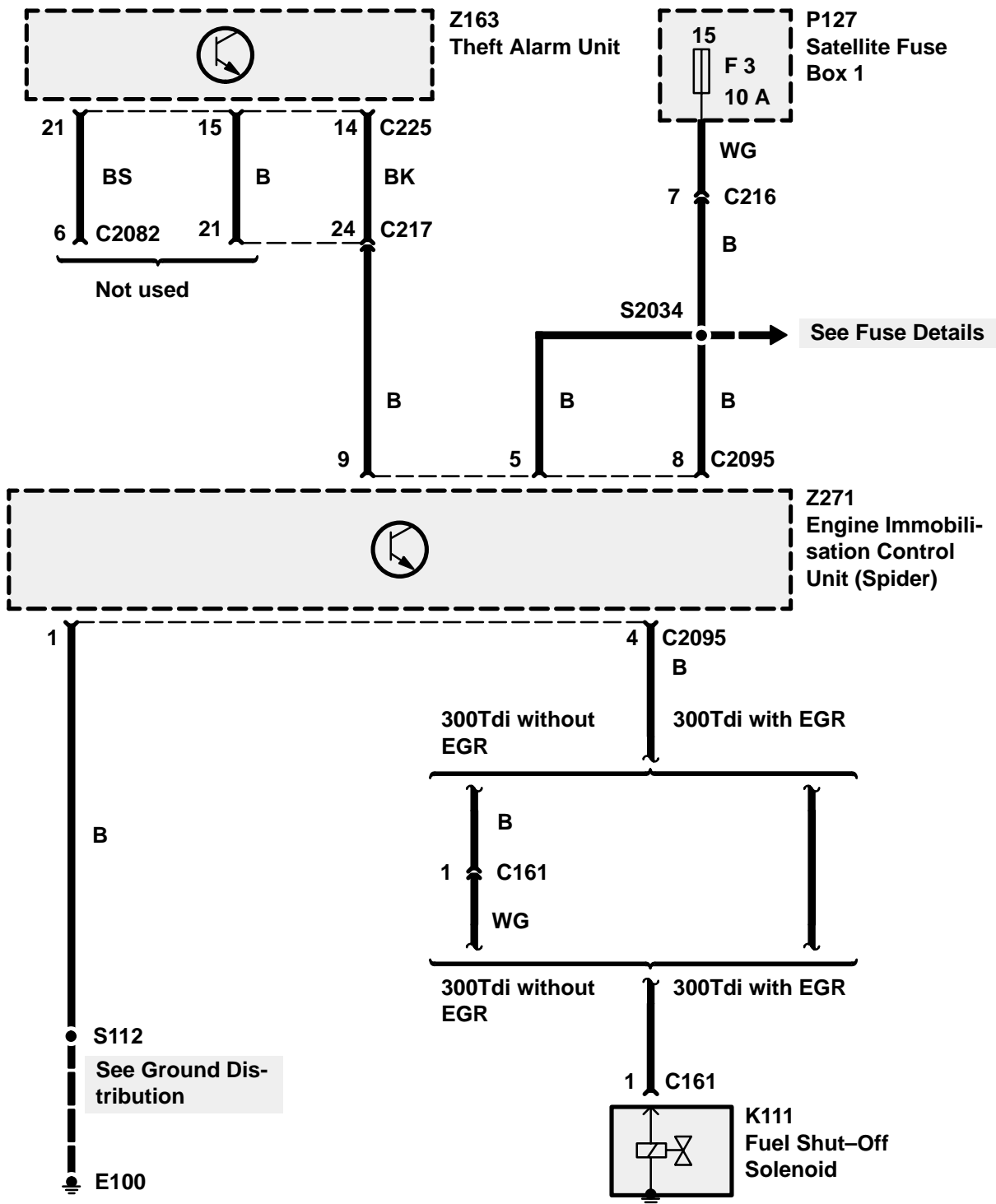
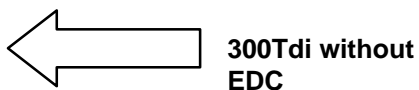

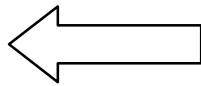

300Tdi without EDC

Starting and Charging

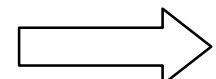
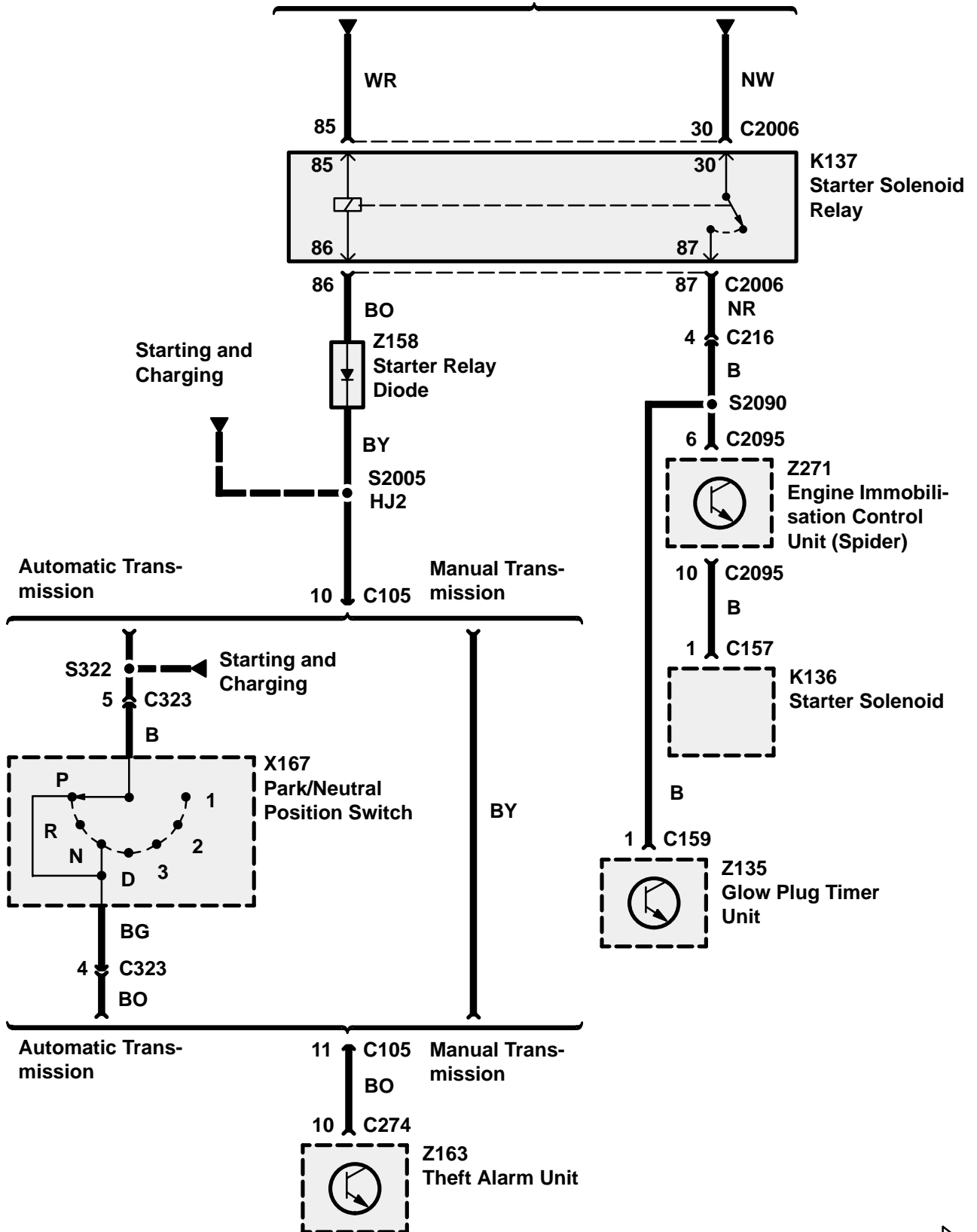

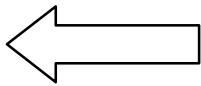
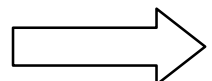
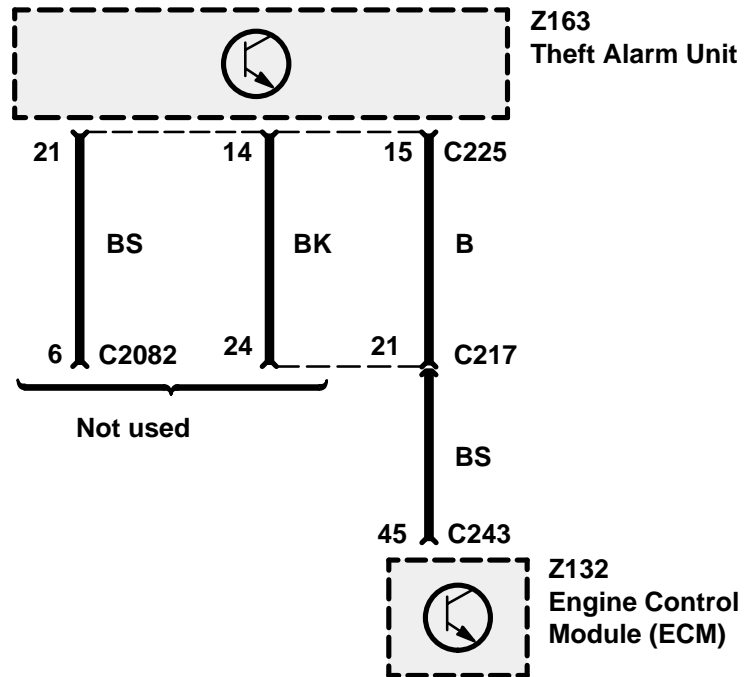
**300Tdi with EDC**



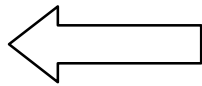

300Tdi with EDC

Starting and Charging

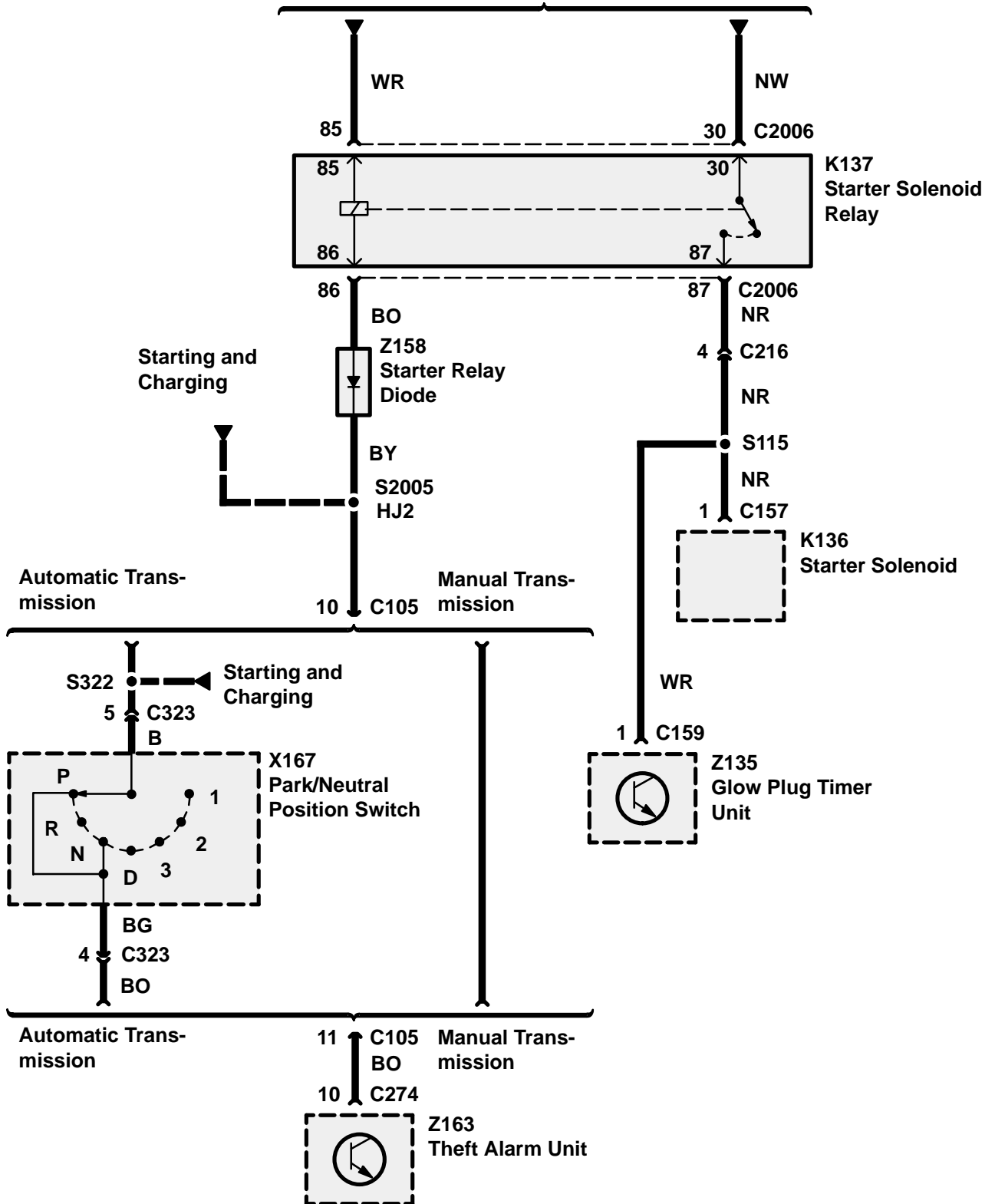

## CIRCUIT OPERATION

For 1996 models a vehicle alarm system is available as original equipment. Three different functions are integrated into the Theft Alarm System:

5. The main function of the system is to offer easy-to-use remote locking and unlocking of the vehicle (Central Locking).
6. Anti-Theft System function.
7. Engine Immobilisation function.

NOTE: The Theft Alarm ECU (Z163) is fully programmable to meet different market requirements; therefore some of features listed will vary dependent on vehicle model or territory.

## ALARM COMPONENTS

1. Theft Alarm Unit (Z163)
2. Handset Transmitter
3. Lock Actuators (M114, M122, M117, M125, M132)
4. Alarm Bonnet Switch (X212) (Not on all vehicles!)
5. Right Front Door Key Switch (X202)
6. Door Switches (X150, X118, X142, X163)
7. Rear End Door Switch (X265)
8. Direction Indicator Lamps (Hazard Lamps)
9. Horns (K128, K134)
10. Theft Alarm LED (Included in the Instrument Cluster (Z142))

## CENTRAL LOCKING FUNCTION

Central Locking is controlled by the Theft Alarm Unit (Z163) and may be locked by using the driver's door key, sill button(s) or handset. The vehicle may be unlocked by using the handset or EKA code.

NOTE: The central door locking system will shut down for a period of approximately 15 seconds if the Theft Alarm Unit (Z163) determines that the Lock Actuators could be overheating.

## ANTI-THEFT SYSTEM FUNCTION

The alarm system offers the following forms of protection:

- Perimetric protection against unauthorised opening of all doors, tailgate, and bonnet.

- Engine crank inhibit against unauthorised engine crank.
- Electronic engine immobilisation against unauthorised engine start.

NOTE: Perimetric protection is also triggered by the driver's door sill switch being lifted and the ignition switch being turned on.

### Perimetric Protection

The system is perimetrically armed whenever the vehicle is central door locked using the driver's door key or the handset.

### Theft Alarm Disarming

#### (Perimetric Mode)

The theft alarm can be disarmed with the handset or the driver's door key.

### **PARTIALLY ARMED MODE**

The system will enter the “partially armed” mode whenever one of the following conditions is valid during theft alarm arming:

- a door, tailgate, or bonnet is open.

The engine will be immobilised and cranking is inhibited. The alarm will sound if ignition is turned to start position. The alarm will protect the following:

- If any of the doors caused partial arming, then opening the tailgate or bonnet will sound the alarm.
- If the tailgate caused partial arming, then the opening of any doors or the bonnet will sound the alarm.
- If the bonnet caused partial arming, then the opening of any doors or tailgate will sound the alarm. Volumetric protection is also armed.
- If two of the above cause partial arming, then the third is still protected.

If the doors, tailgate or bonnet is subsequently closed, after a 5 second delay, the system will fully arm.

### **ENGINE CRANKING**

It is only possible to crank the engine when ignition is on and the alarm disabled.

### **HORNS (K128, K134)**

When an intrusion is detected the Horns (K128, K134) will sound and the hazard lamps flash (where territorial regulations allow) for 30 seconds . The alarm must be retriggered before the horns (K128, K134) will sound again.

### **INERTIA SWITCH**

An inertia switch is incorporated in the Theft Alarm Unit (Z163). If ignition is on and the vehicle receives an impact sufficient to activate the inertia switch, the unit will signal to unlock central locking actuators and flash hazard lights. Central locking will remain disabled for a period of 0 to 5 minutes. To reset, turn ignition off and then on after the time period has elapsed.

### **ENGINE IMMOBILISATION FUNCTION**

The engine will be immobilised whenever the theft alarm is armed.

The vehicle may only be mobilised by using the handset or the driver’s door key.

The electronic engine immobilisation is controlled jointly by the engine management system’s Electronic Control Module (ECM) (Z132) and the Theft Alarm Unit (Z163).

When the Theft Alarm Unit (Z163) immobilises the vehicle, it sends a signal to the ECM. The ECM then immobilises the engine management system until a mobilise signal is received from the Theft Alarm Unit (Z163).

### VEHICLE STATUS INDICATION

Vehicle status is indicated by up to three devices:

1. Hazard lamps
2. Theft Alarm LED (contained in the Instrument Cluster (Z142))
3. Horns (K128, K134)

#### Hazard Lamps

When the vehicle arms in either mode, the hazard lamps will flash up to three times when the alarm is armed and one time when disarmed.

#### Theft Alarm LED

- Slow Flash: Immobilised or immobilised and armed
- Rapid Flash: Volumetrically armed
- Intermittent Rapid Flash: Perimetrically armed
- No Flash for 10 Seconds: Mislock
- Continuous: Driver's door open (or ignition on) and immobilised

NOTE: The Theft Alarm LED may also be used to indicate other conditions.

### HANDSET TRANSMITTER RESYNCHRONISATION

The Theft Alarm Unit (Z163) will remain synchronised with the handset unless:

- The handset's batteries have been removed
- The vehicle's battery has been disconnected

NOTE: All handsets must be resynchronised when the vehicle's battery has been disconnected.

To resynchronise a handset the vehicle must be in an unlocked and disarmed state. Resynchronisation consists of 4 presses of either the lock or unlock button.

### HANDSET LOW BATTERY WARNING

When the handset batteries are low, the Theft Alarm Unit (Z163) will enter the "low battery mode". The Theft Alarm LED will flash to indicate "low battery mode", and the hazard lamps will not flash when the alarm is disarmed.

### POWER UP MODE

The alarm system always remembers the state it was left in when power was removed. If the alarm powers up in an armed state, it will enter a special "power up mode".

### BUILT IN TEST PROCEDURE

The built in test procedure is accessed as follows:

1. Starting conditions: ignition off, doors unlocked, alarm disarmed, bonnet switch depressed.
2. Carry out instructions 3 to 7 within 2 seconds.
3. Release bonnet switch.
4. Switch ignition on.
5. Open driver's door.
6. Switch ignition off.
7. Switch ignition on.

If alarm is correctly accessed, the horns will sound briefly and the Theft Alarm LED and hazard lamps will flash. The following checks can then be made:

**Perimetric Testing**

1. Open and close driver's door or tailgate – Theft Alarm LED and Hazard lamps will flash.
2. Depress and release bonnet switch – Theft Alarm LED and Hazard lamps will flash.
3. Pull the driver's door sill button up – Theft alarm LED and Hazard lamps will flash.
4. Turn driver's door key lock cylinder – Theft Alarm LED and Hazard lamps will flash.

---

**HANDSET INITIALISATION**

The Theft Alarm Unit (Z163) must be programmed whenever handsets are replaced. The serial communications line is used to activate the "learn mode" of the Theft Alarm Unit (Z163). Then the handset(s) to be initialised must be made to transmit their coded data to the Theft Alarm Unit (Z163).

NOTE: All handset(s) must be programmed during the same learn mode period. It is not possible to simply add a handset to the Theft Alarm Unit (Z163) which has been programmed to other handsets.

When the "learn mode" of the Theft Alarm Unit (Z163) has been accessed, the handset(s) are programmed using the following procedure:

1. Starting conditions: Theft Alarm disarmed and vehicle mobilised.
2. Press the handset unlock button a minimum of 8 times.
3. If the handset has been correctly programmed, the horn will briefly sound and the hazard lamps will flash once.
4. The next handset, up to a maximum of 4, can now be programmed using the same procedure.

NOTE: It is very important that each handset be programmed separately. If the Theft Alarm Unit (Z163) receives key presses from two handsets, then neither handset will be programmed.

The "learn mode" is terminated using the serial communications line. If the Theft Alarm Unit (Z163) would not accept reprogramming, the original handset(s) will still function.

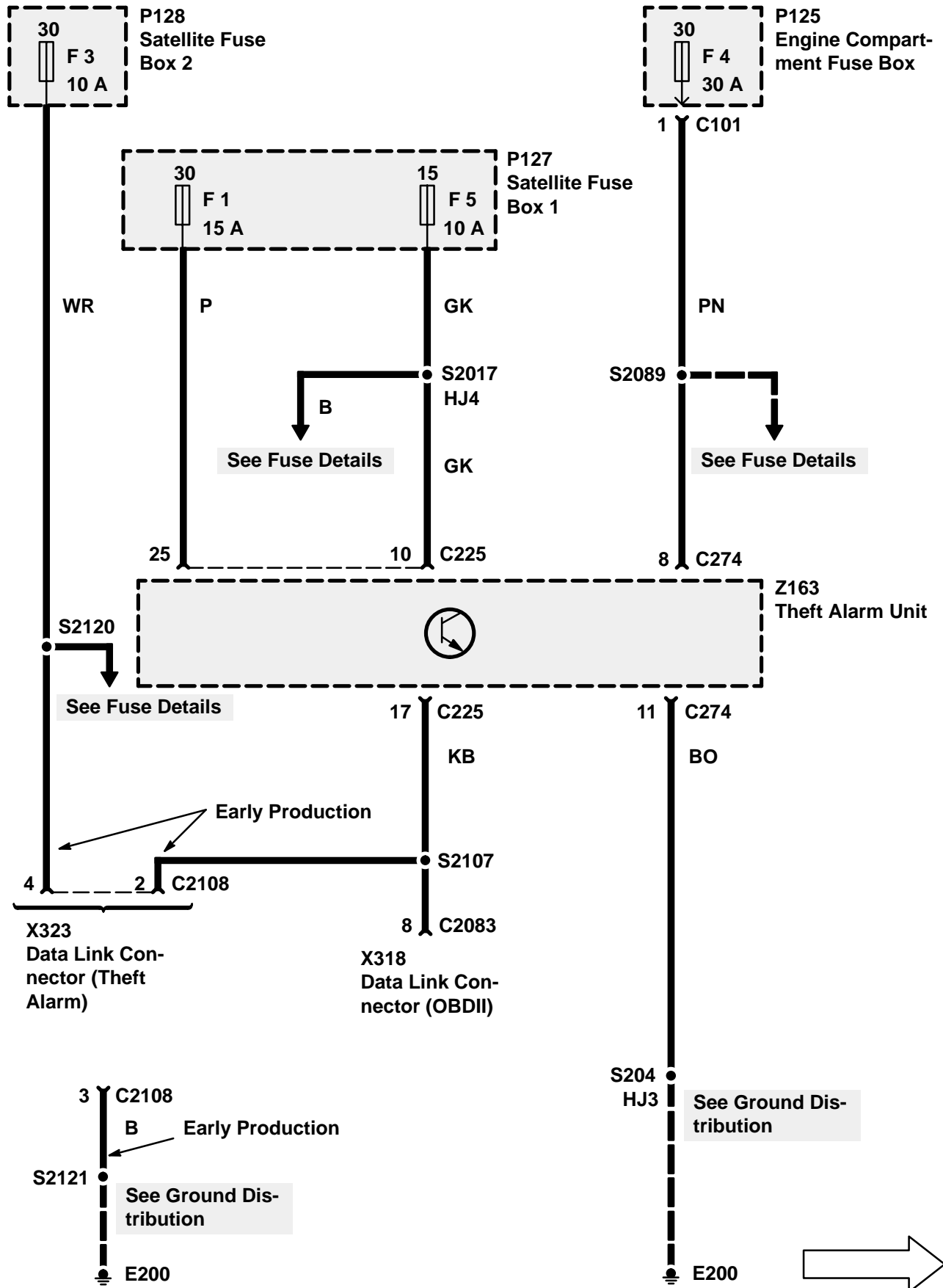

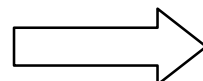
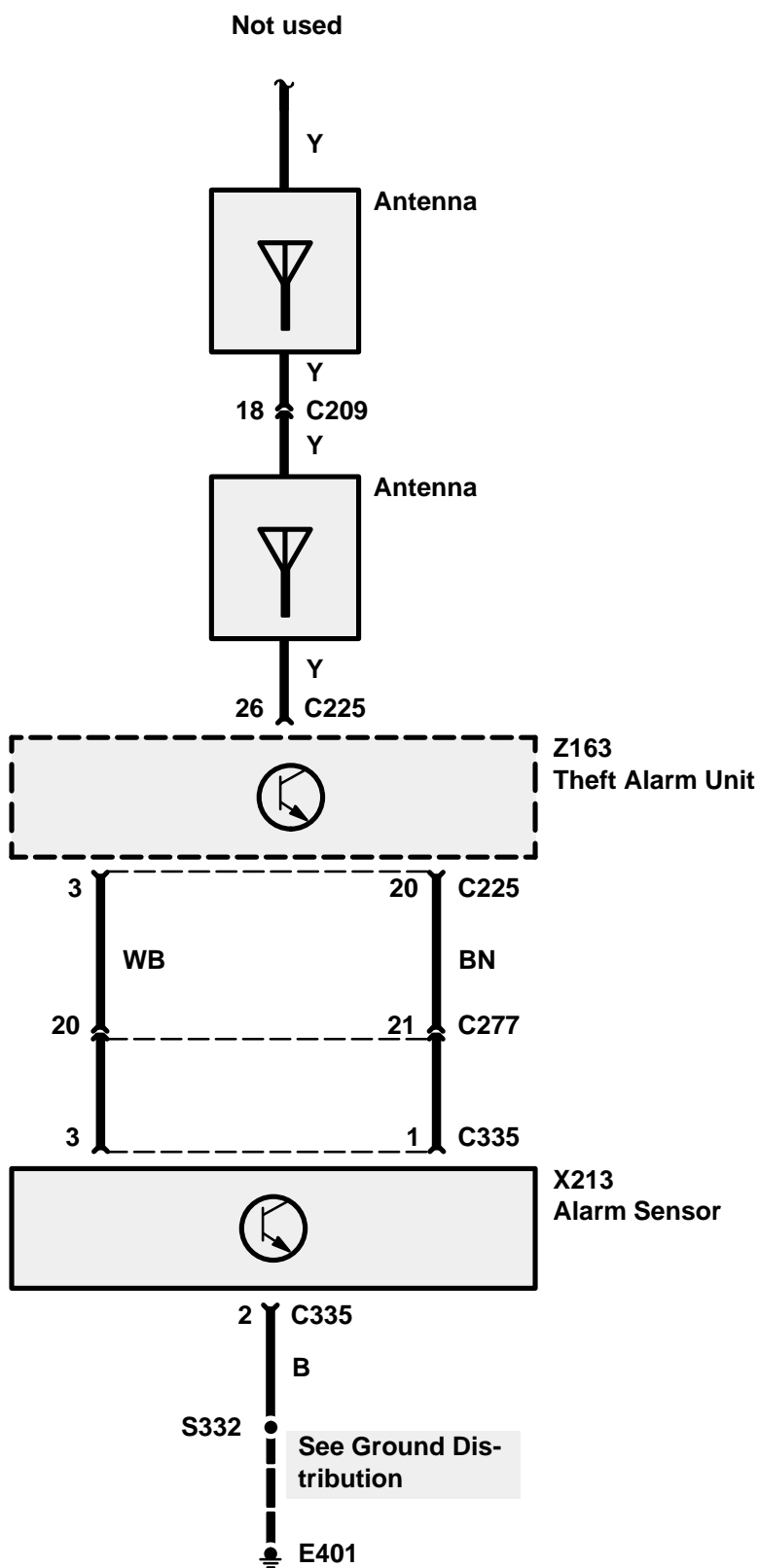
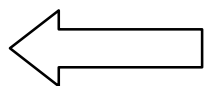

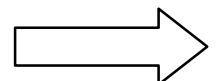
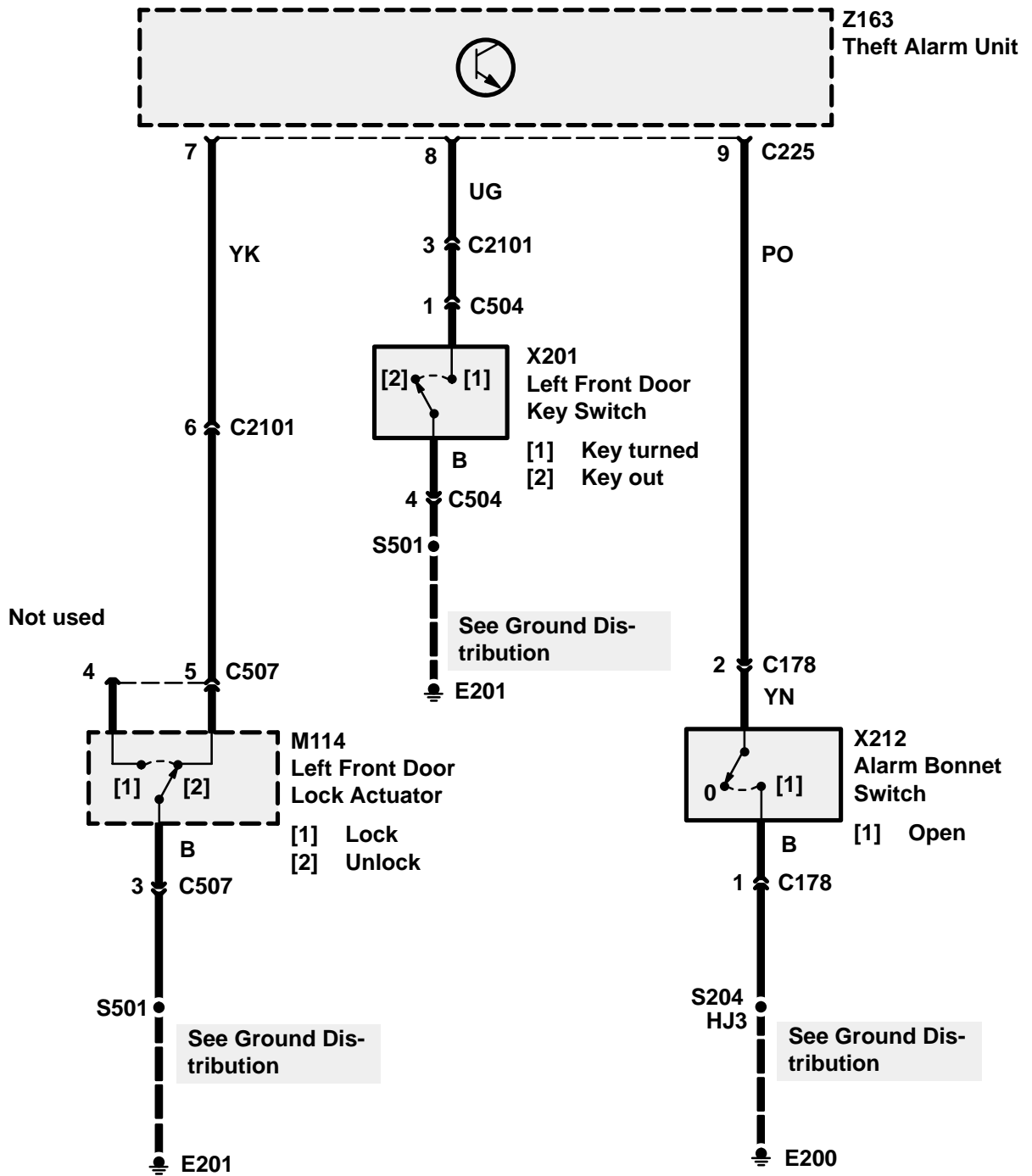
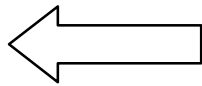



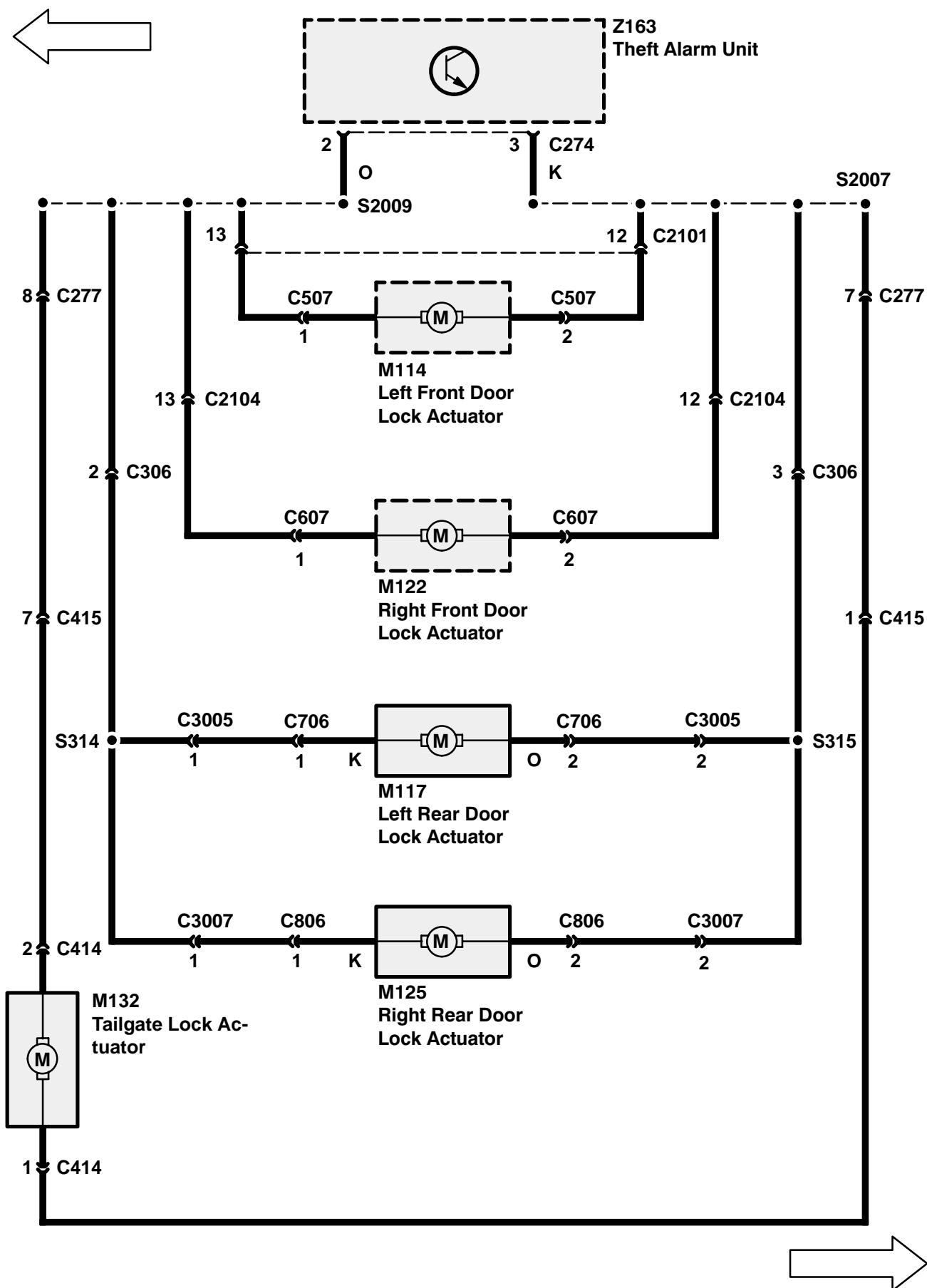

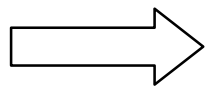
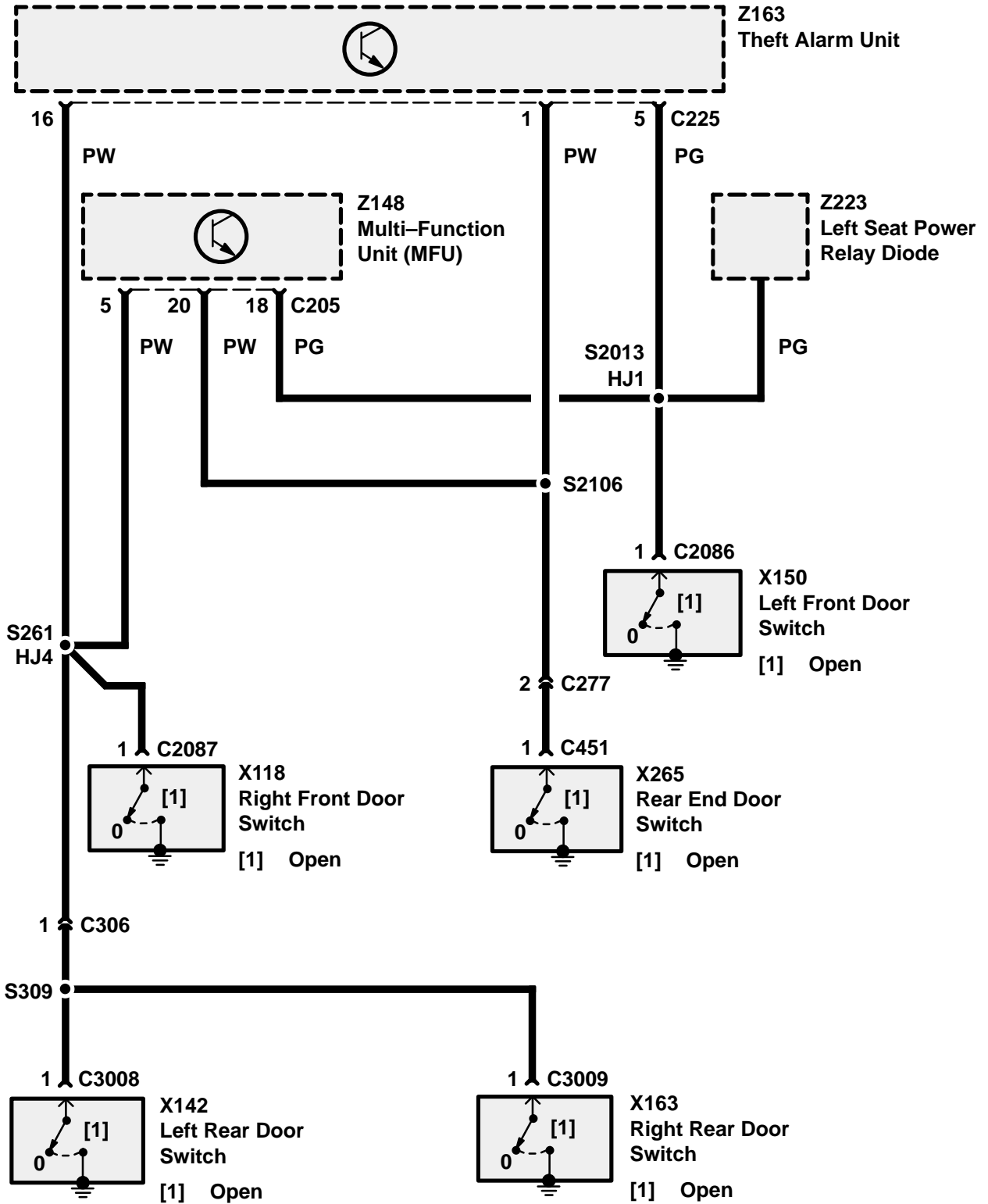
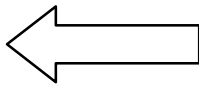

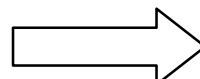
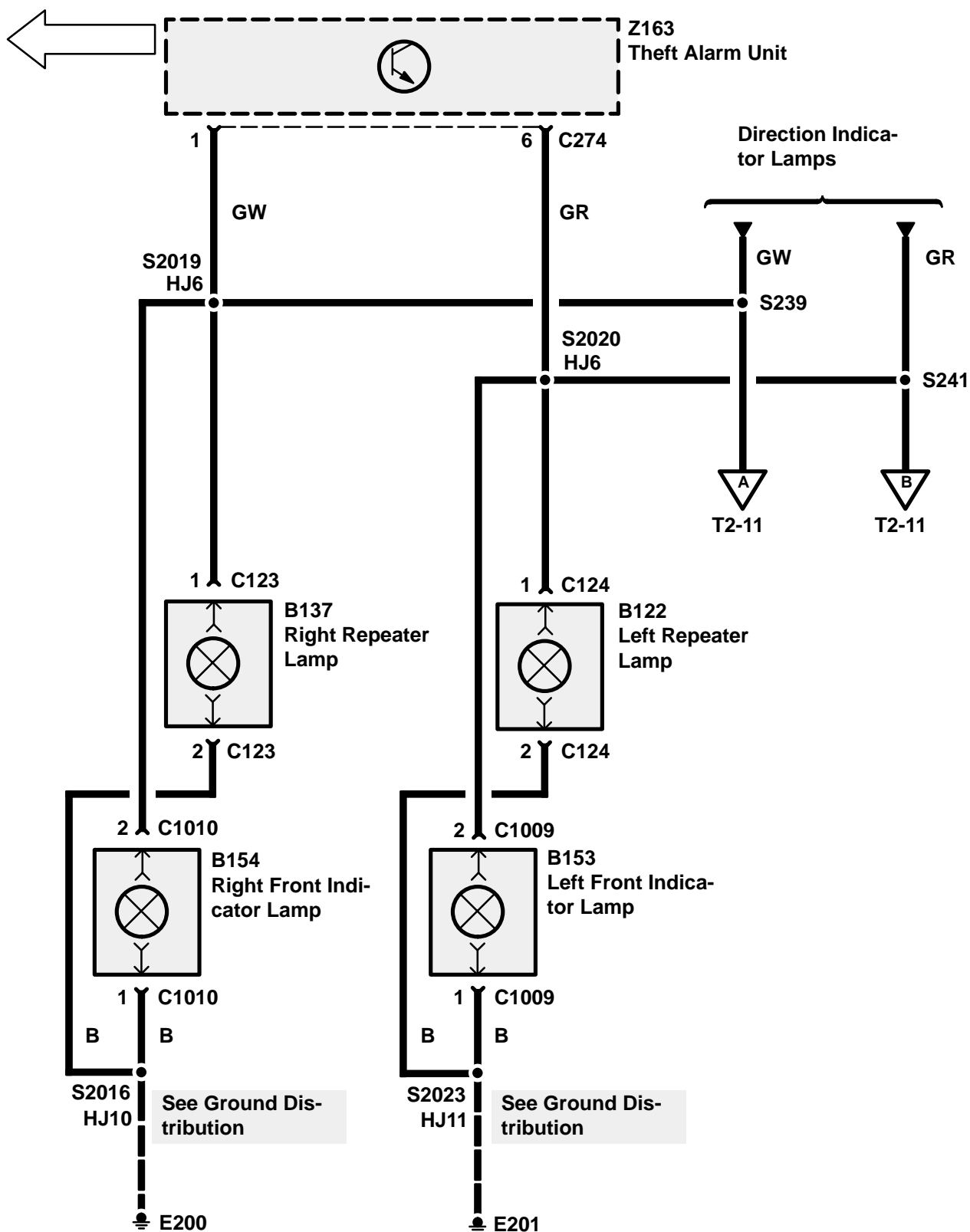

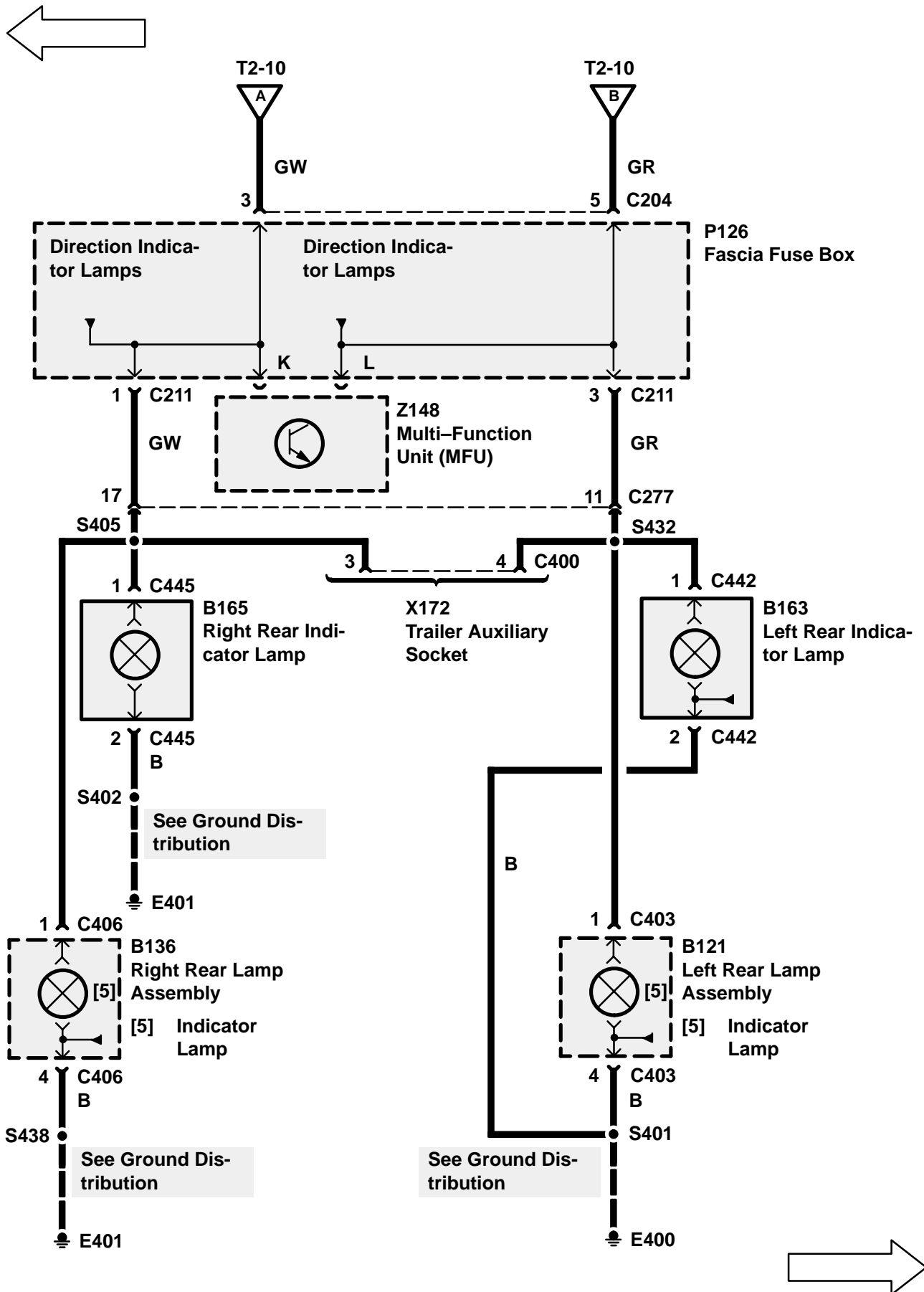

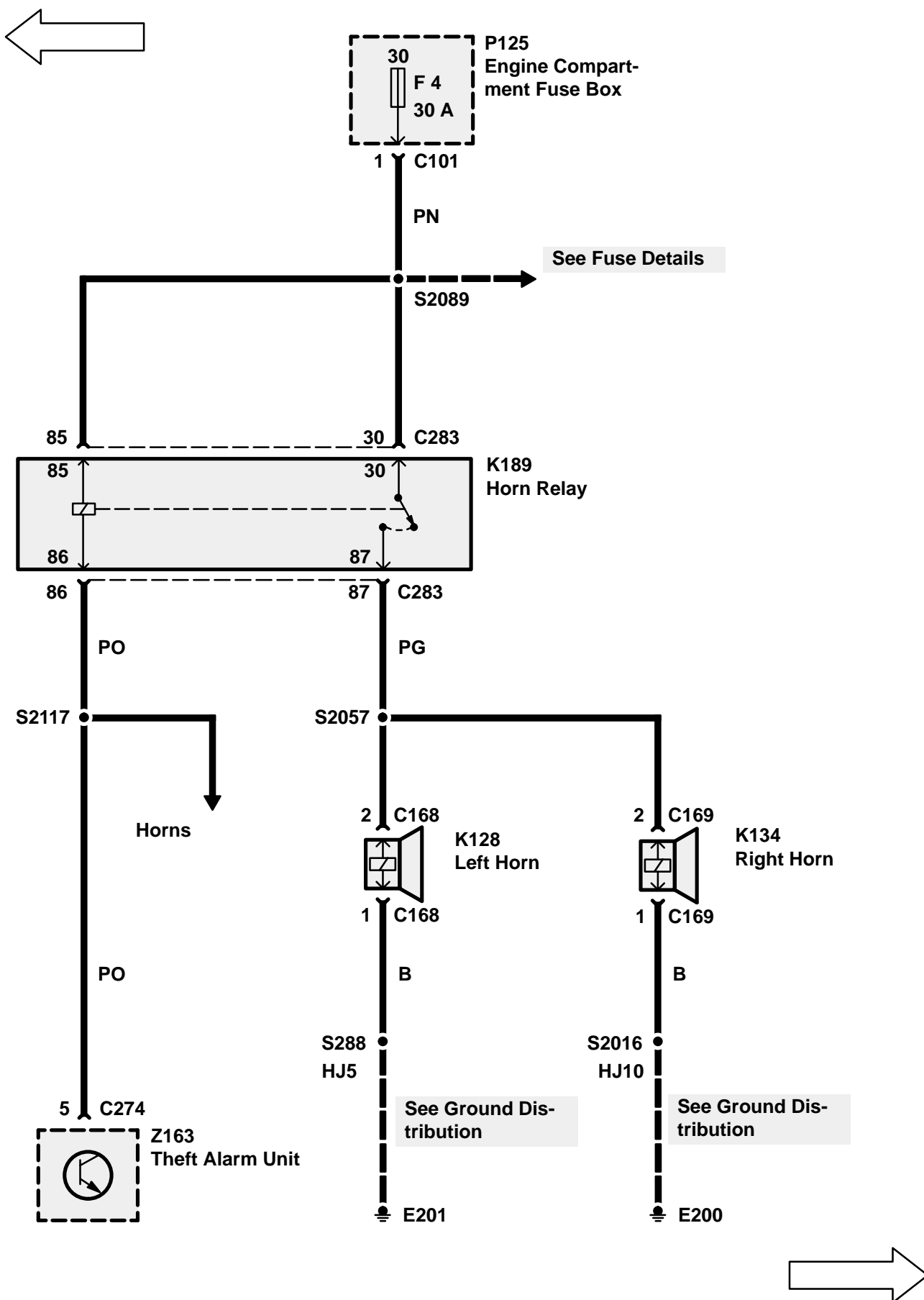

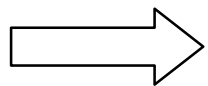
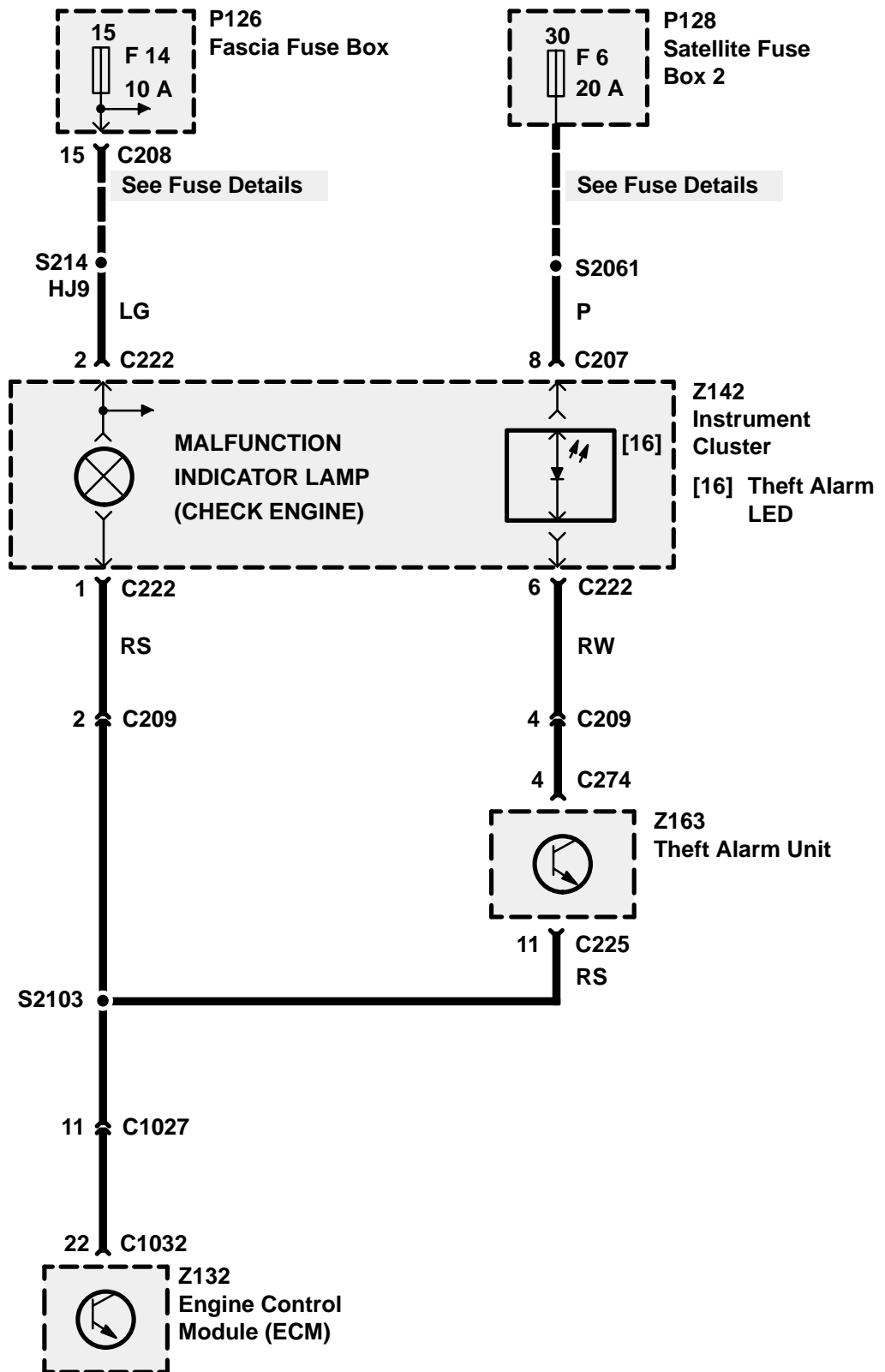
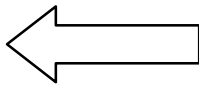

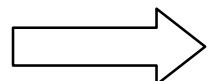
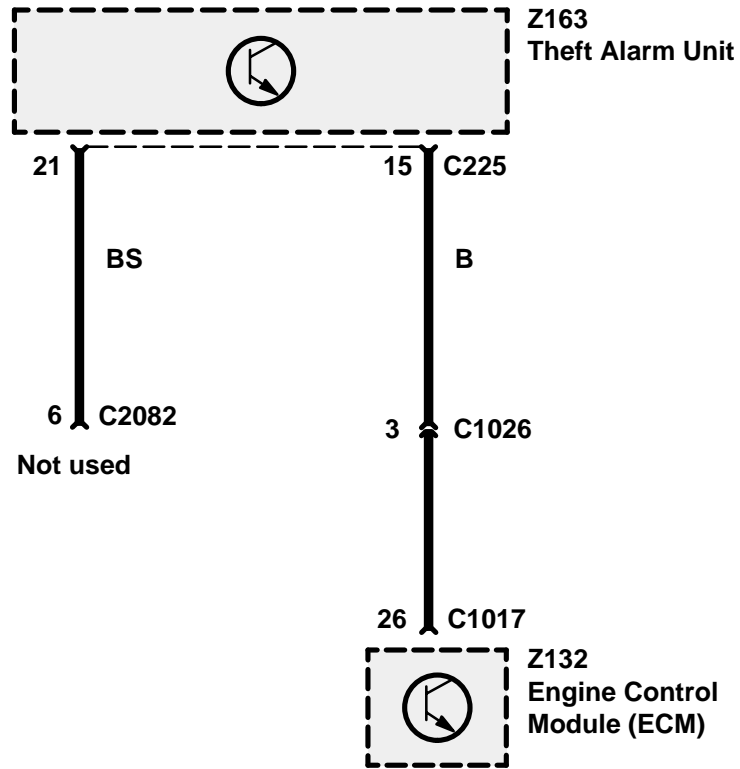
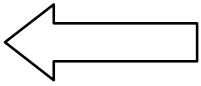

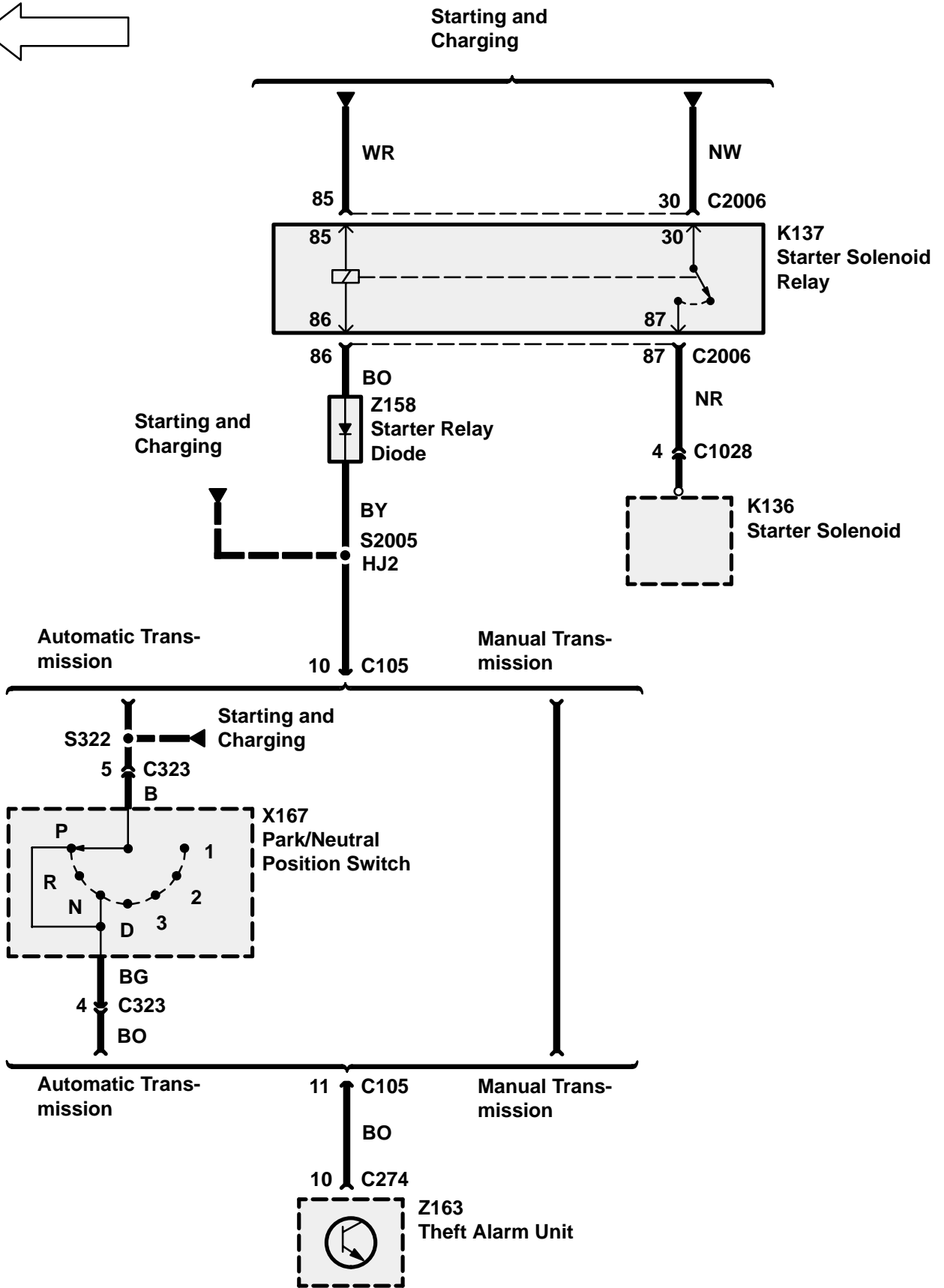
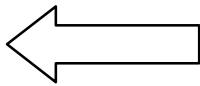



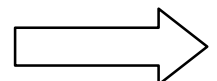
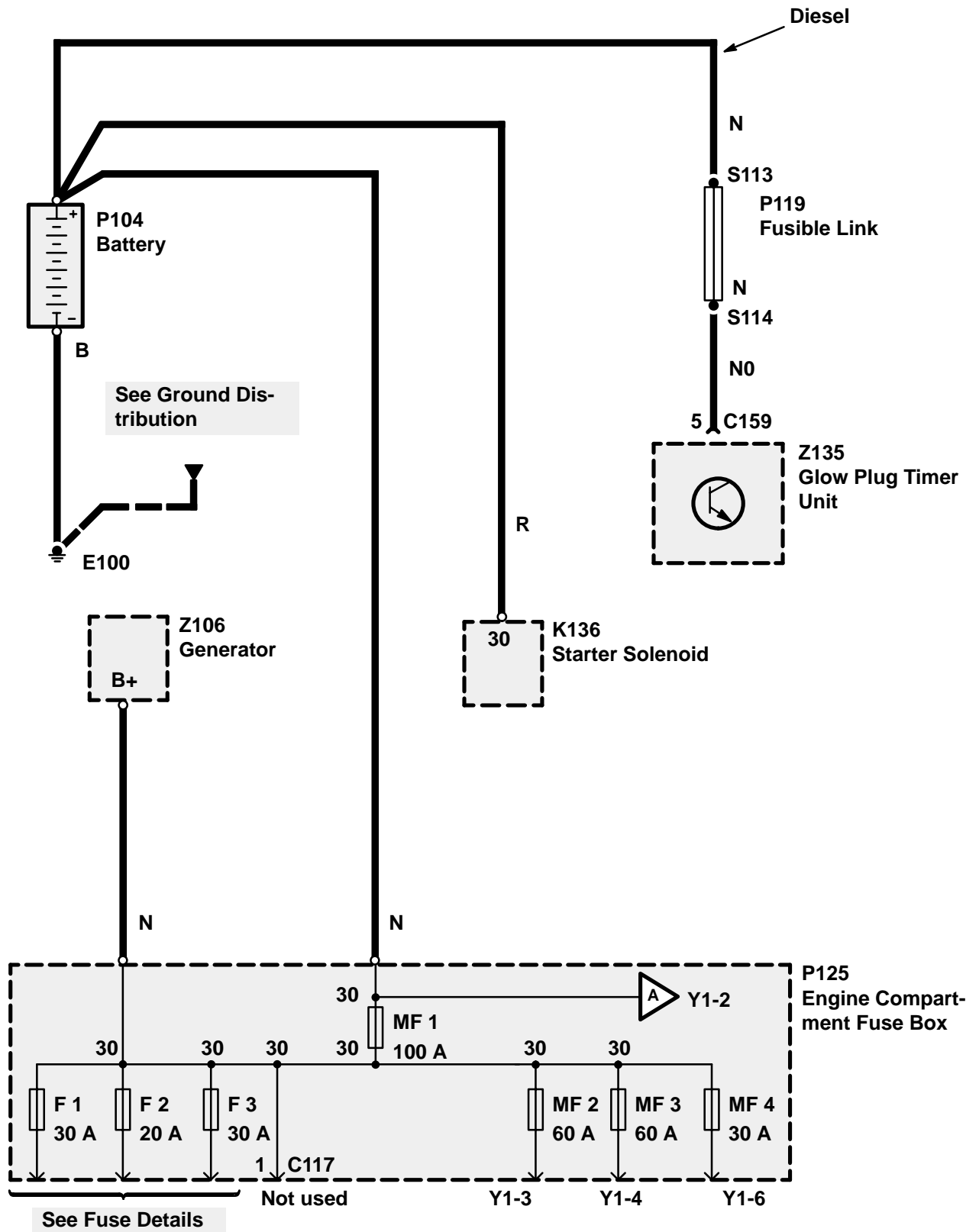

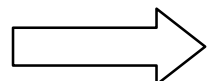
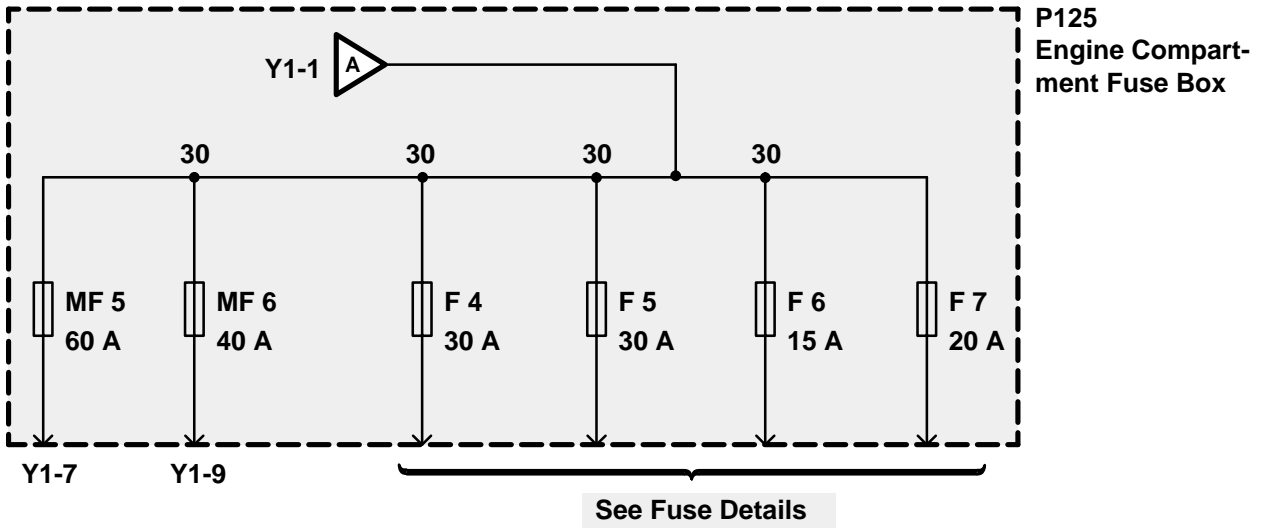
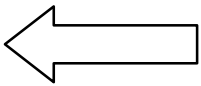

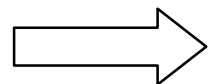
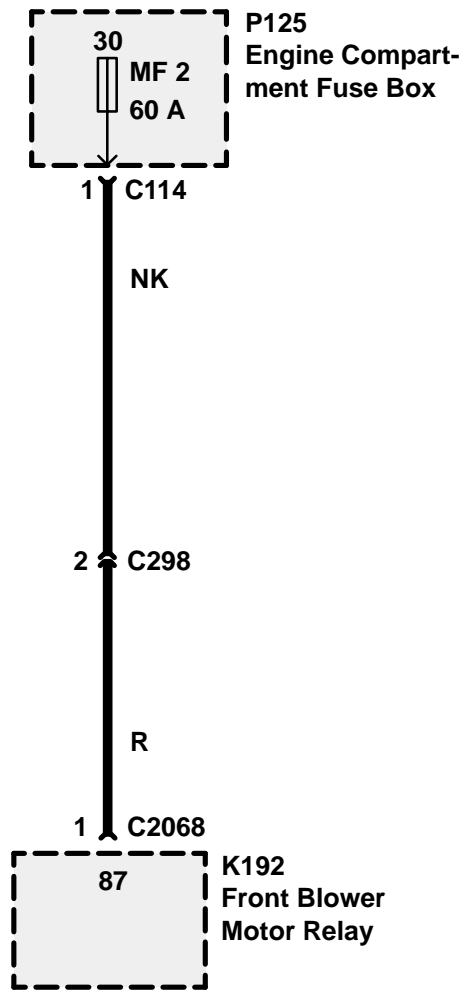
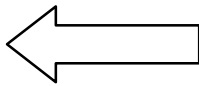

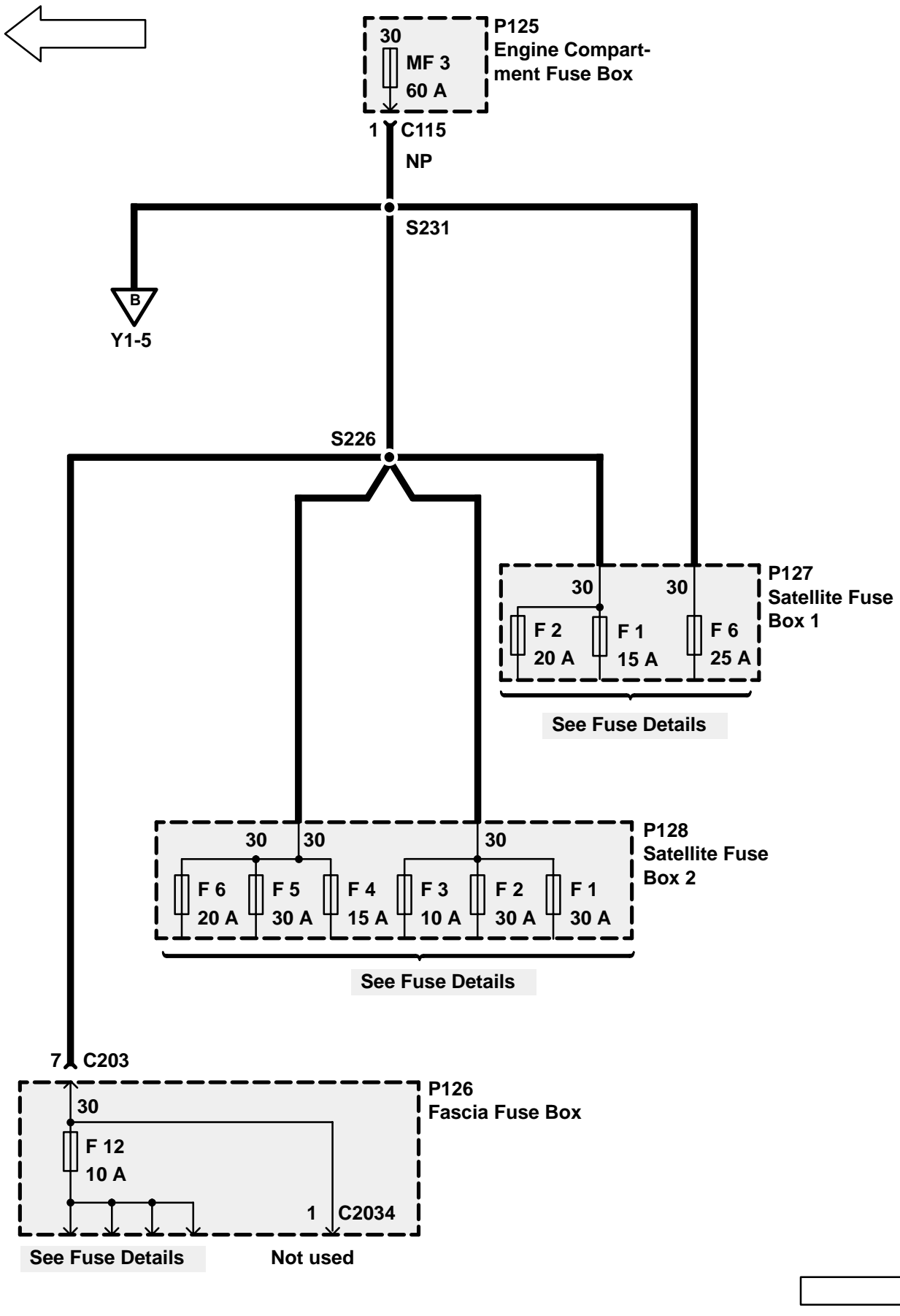

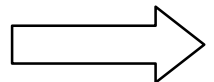
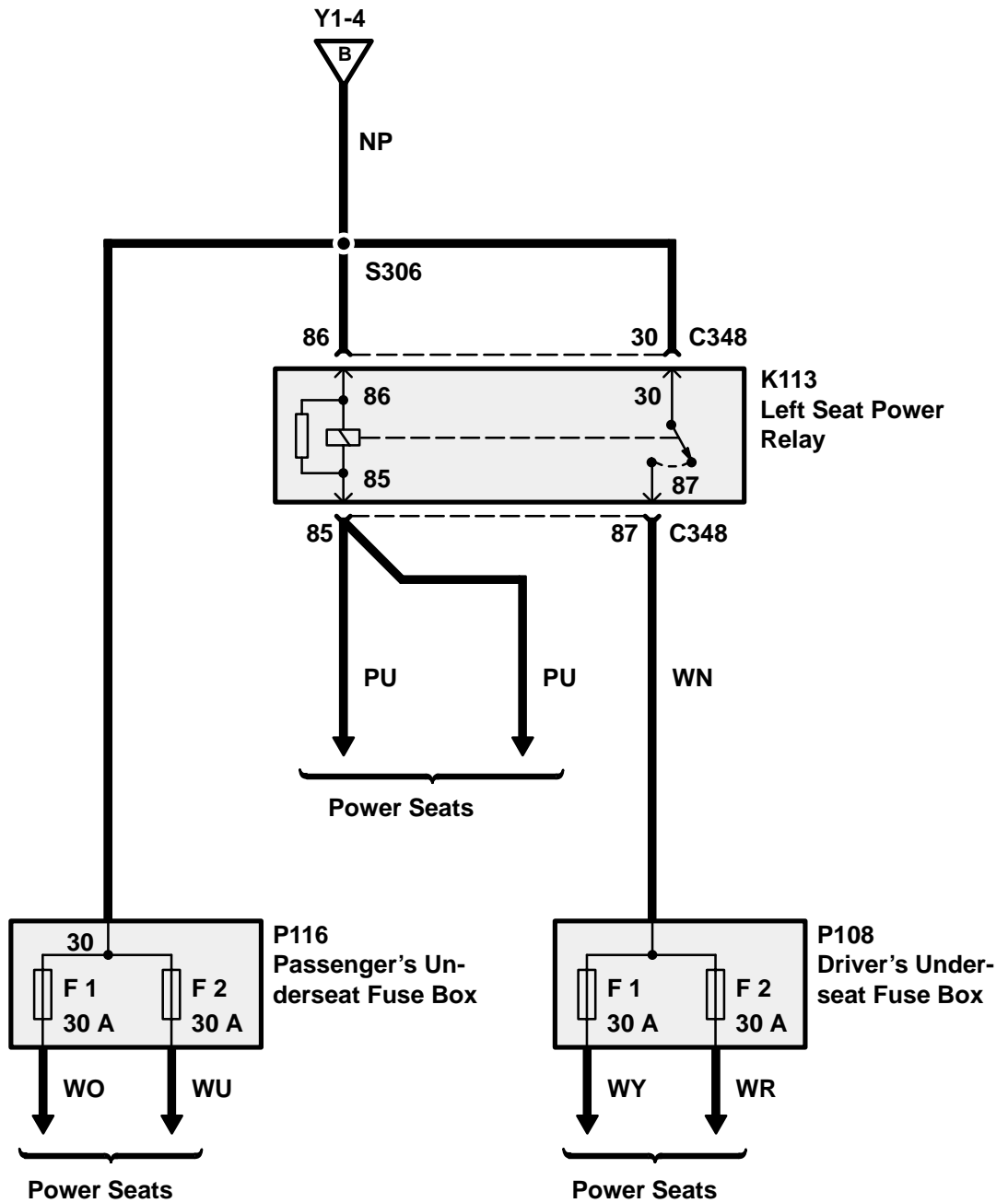
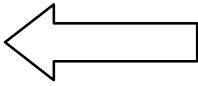

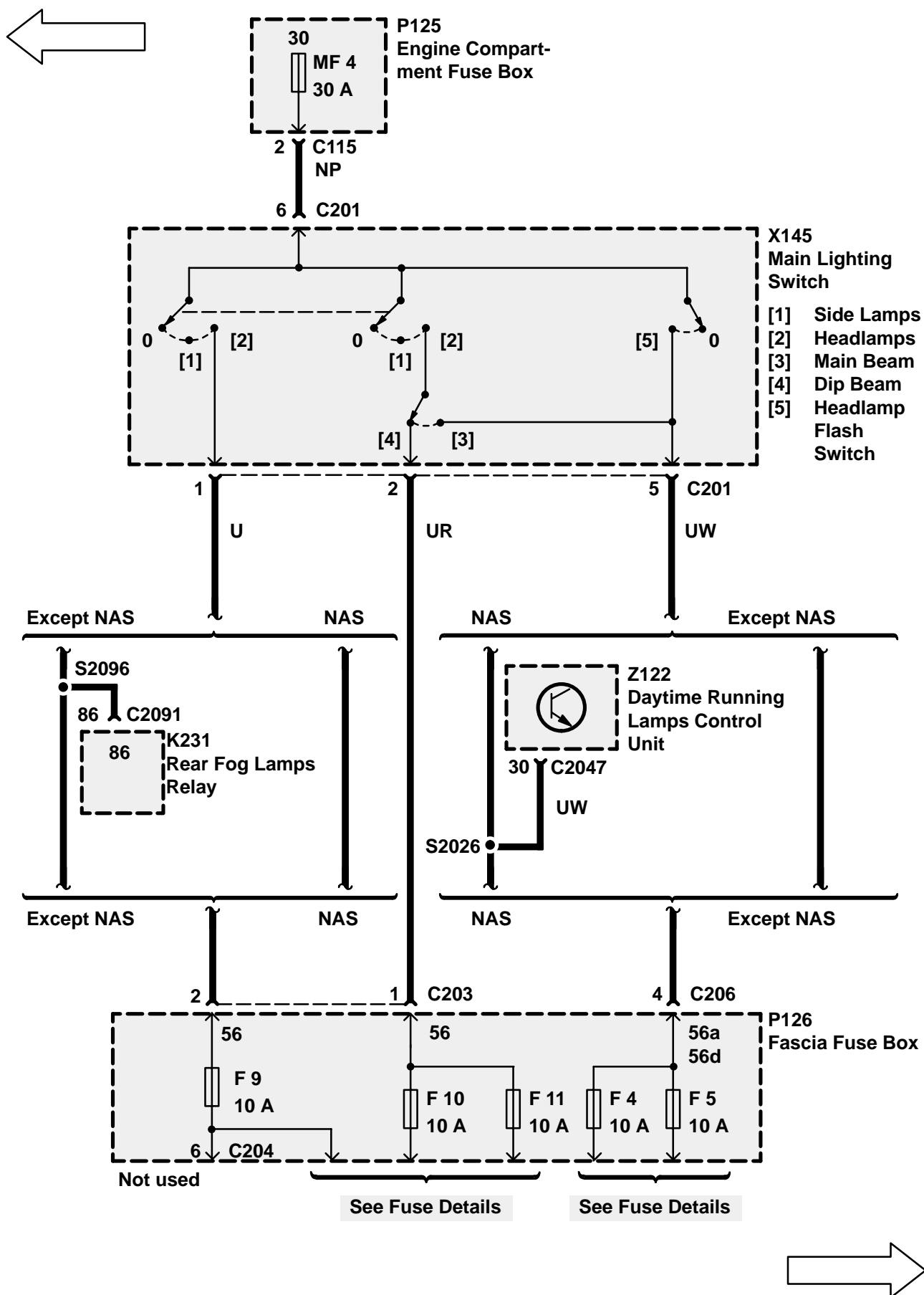

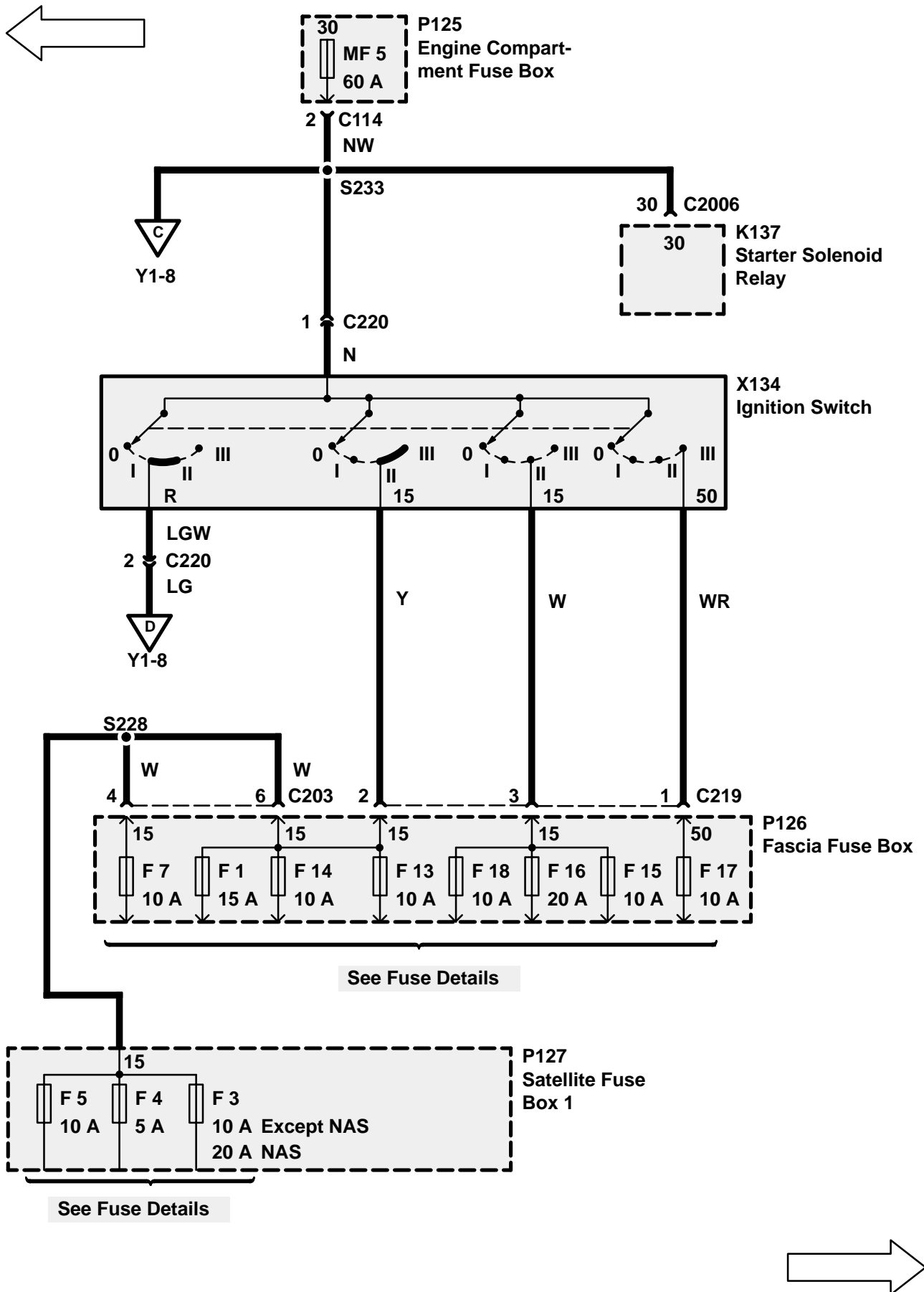

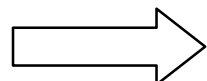
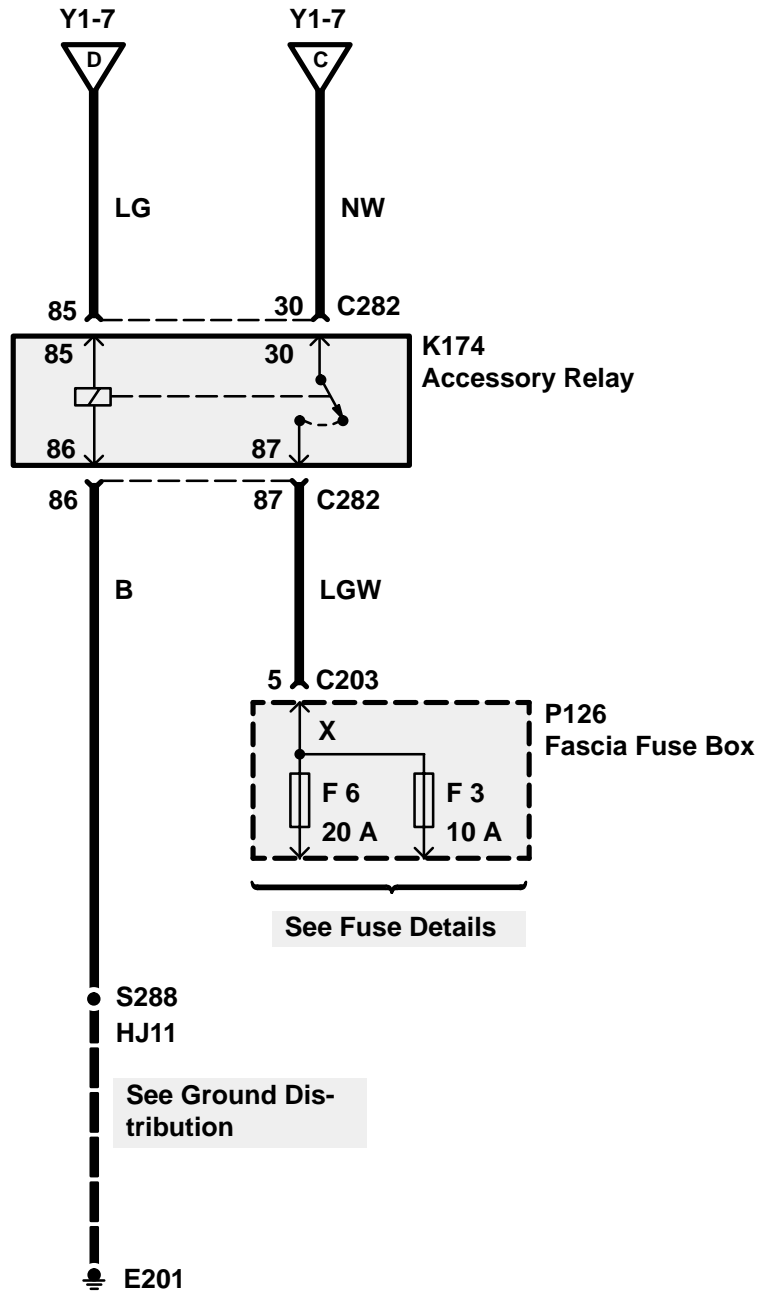
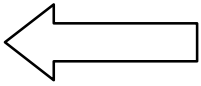



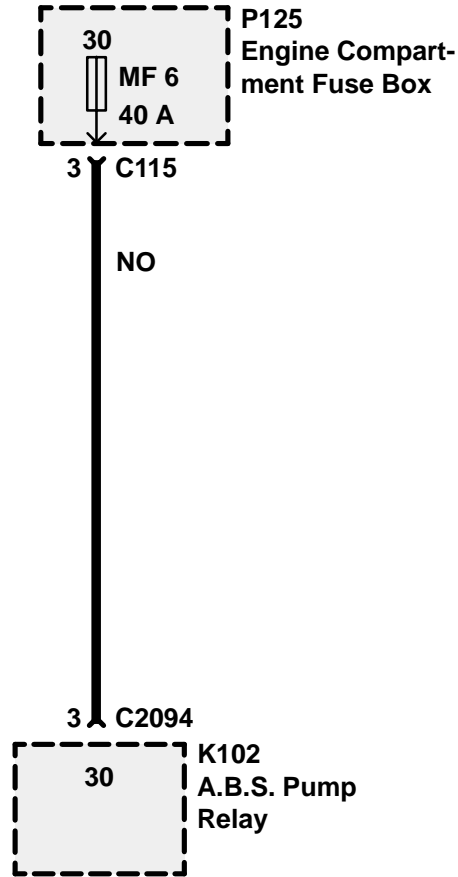
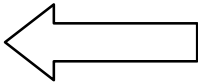

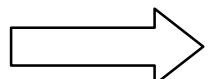
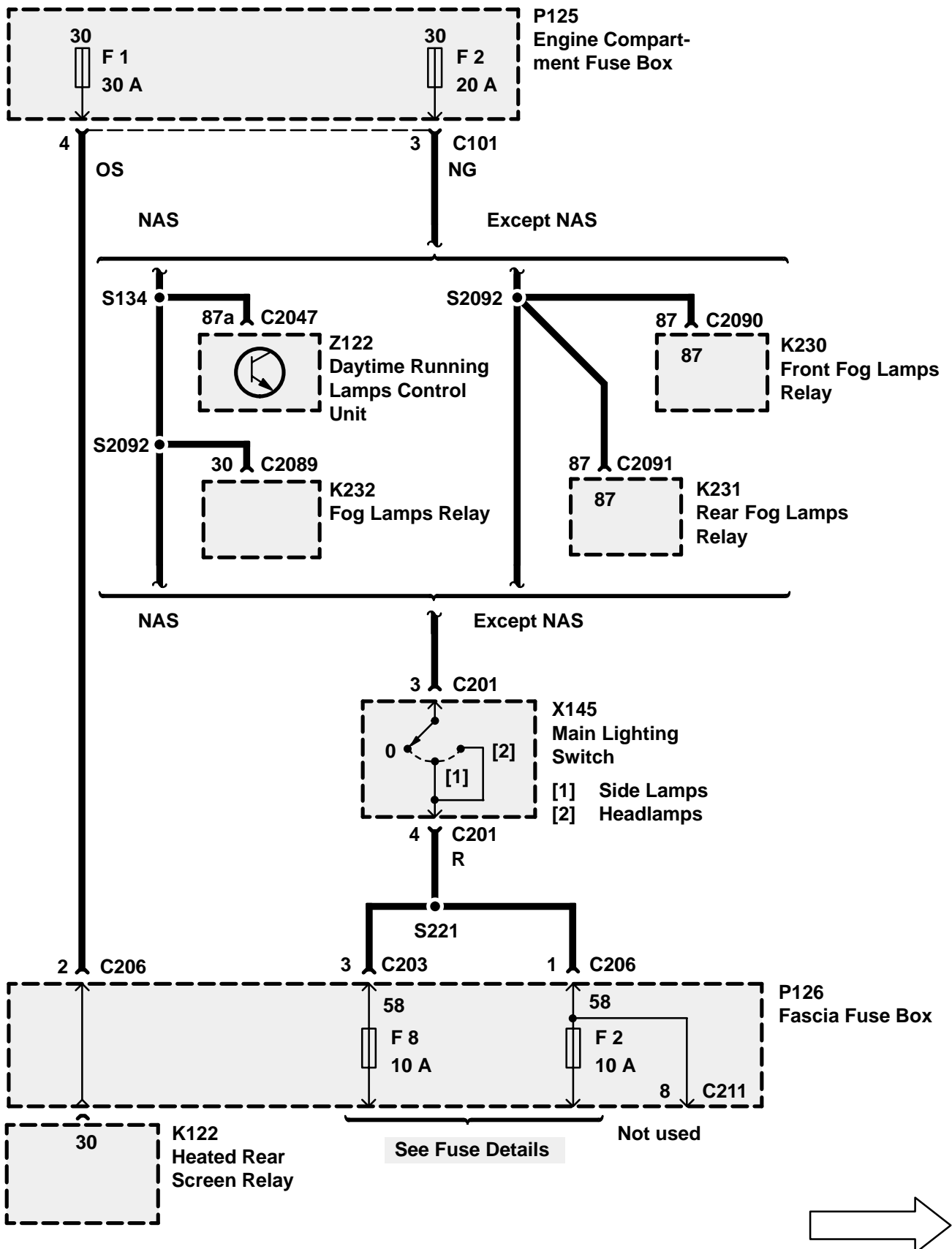

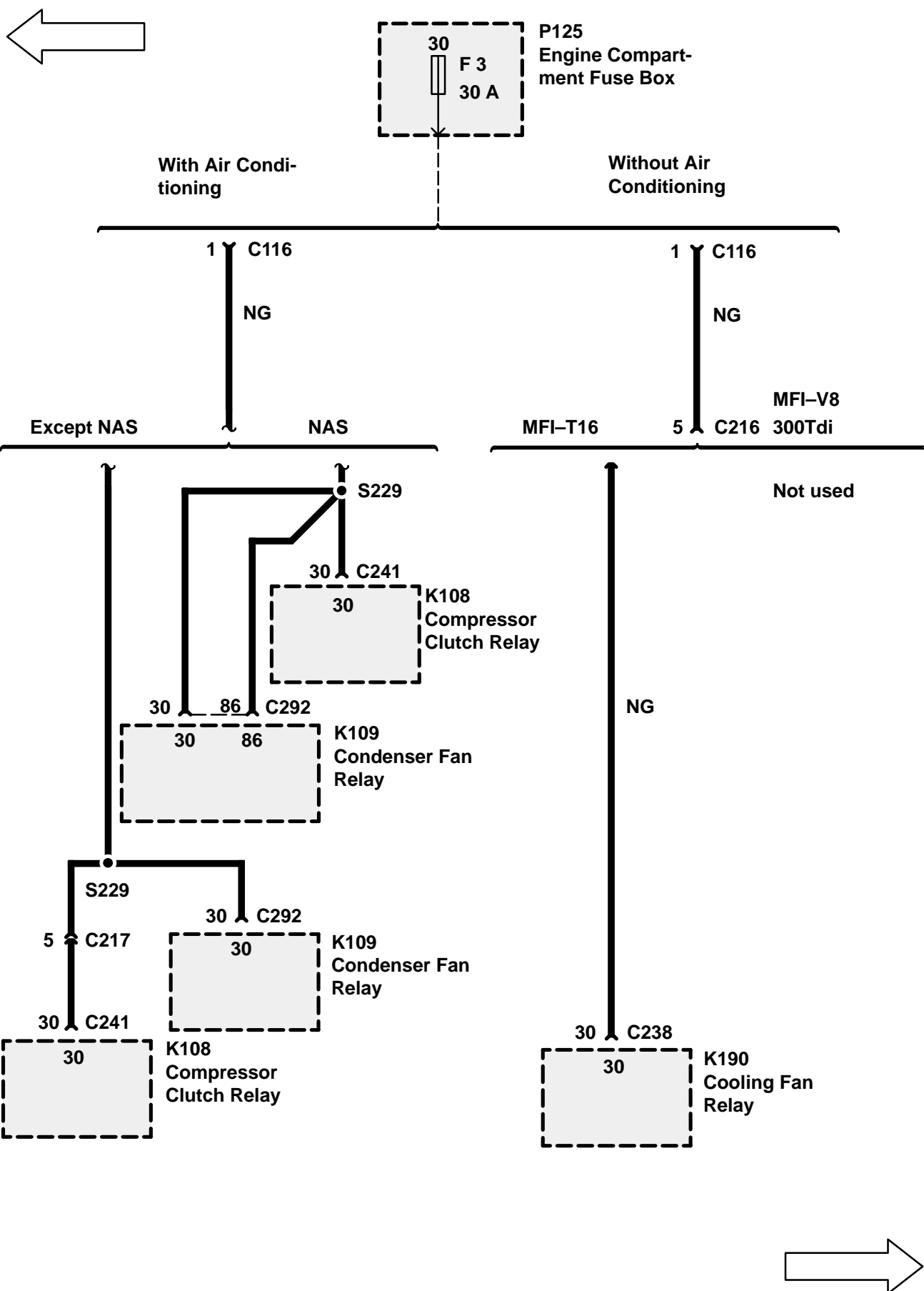

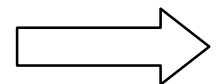
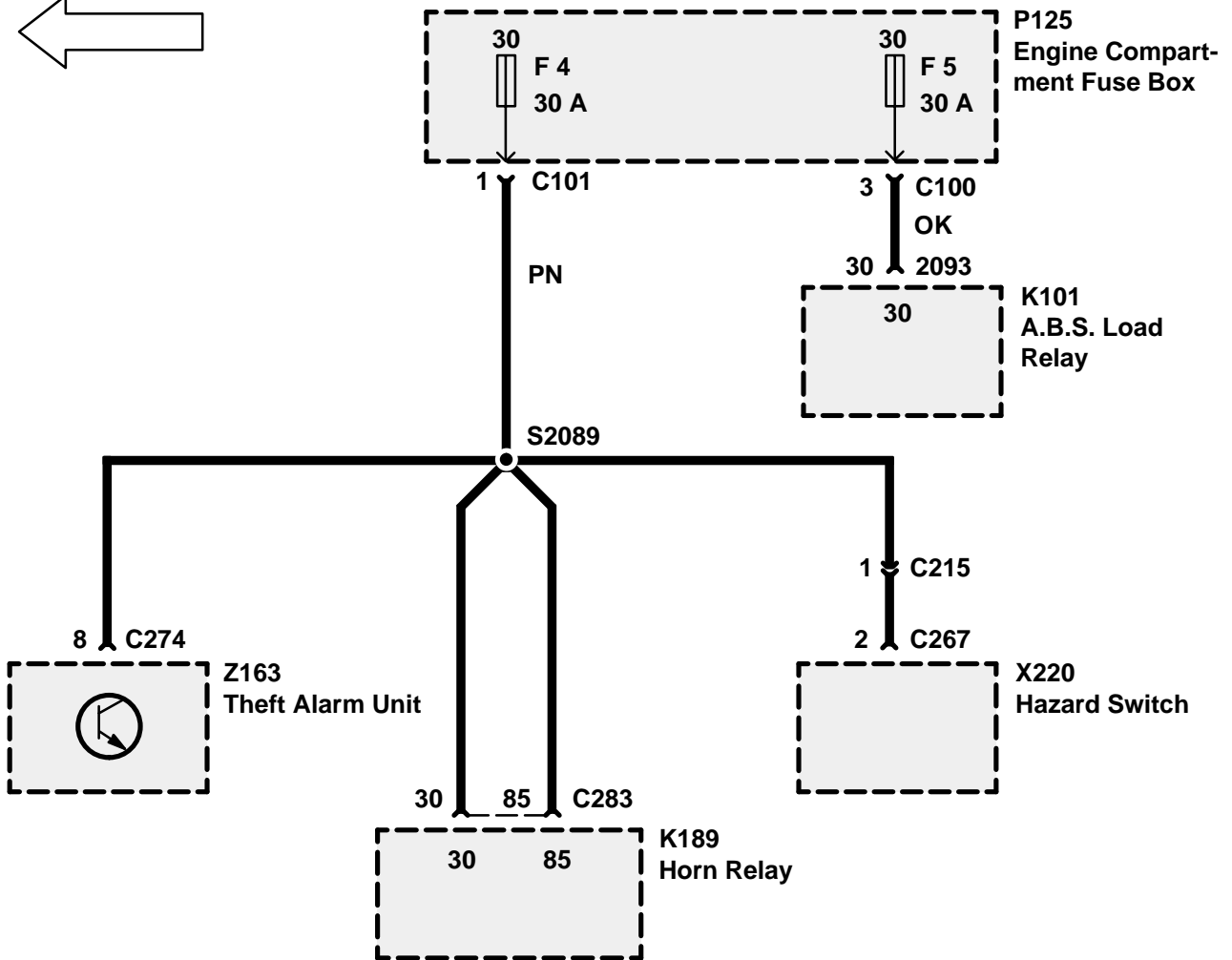
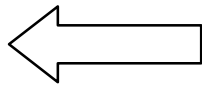

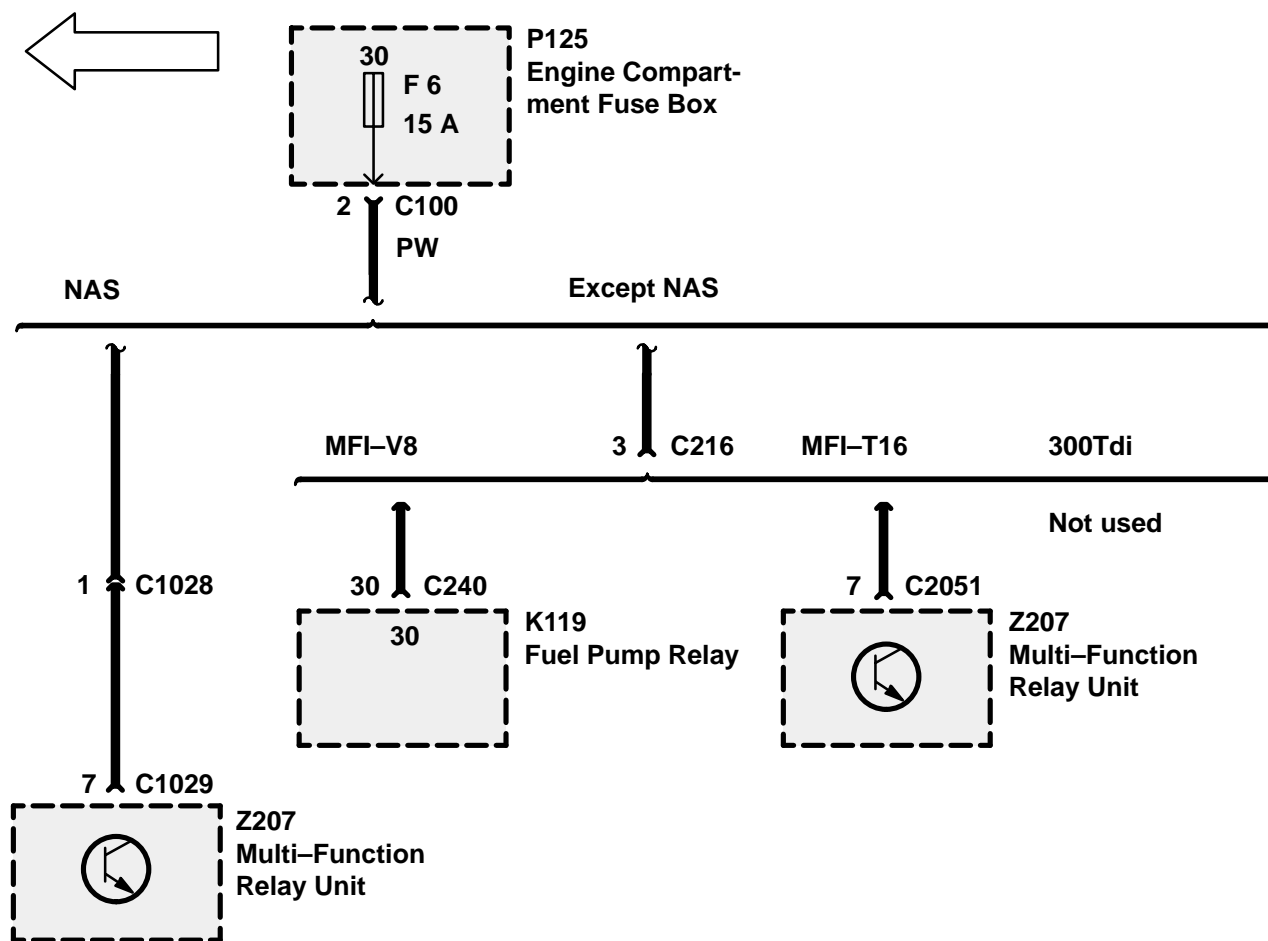

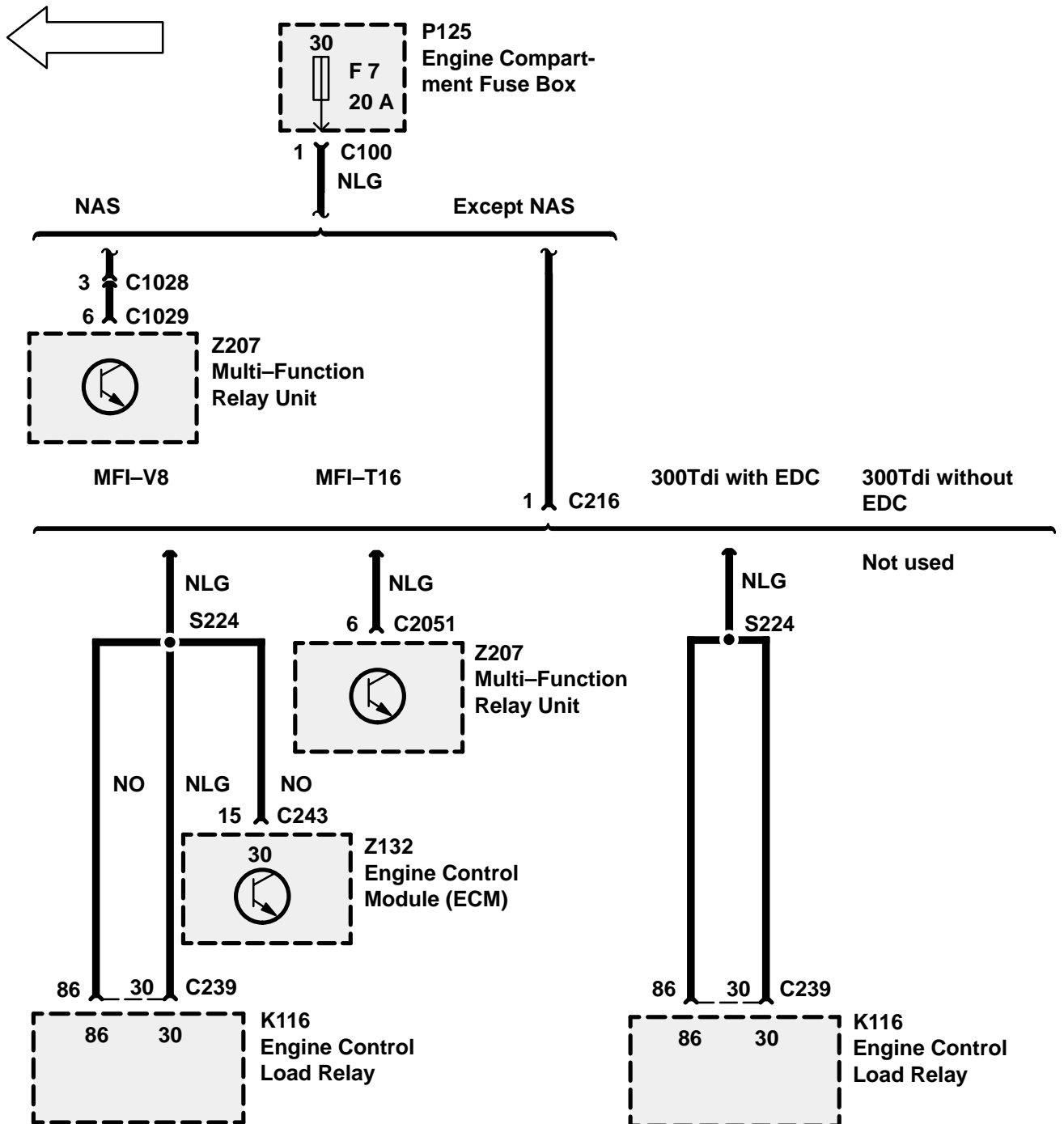

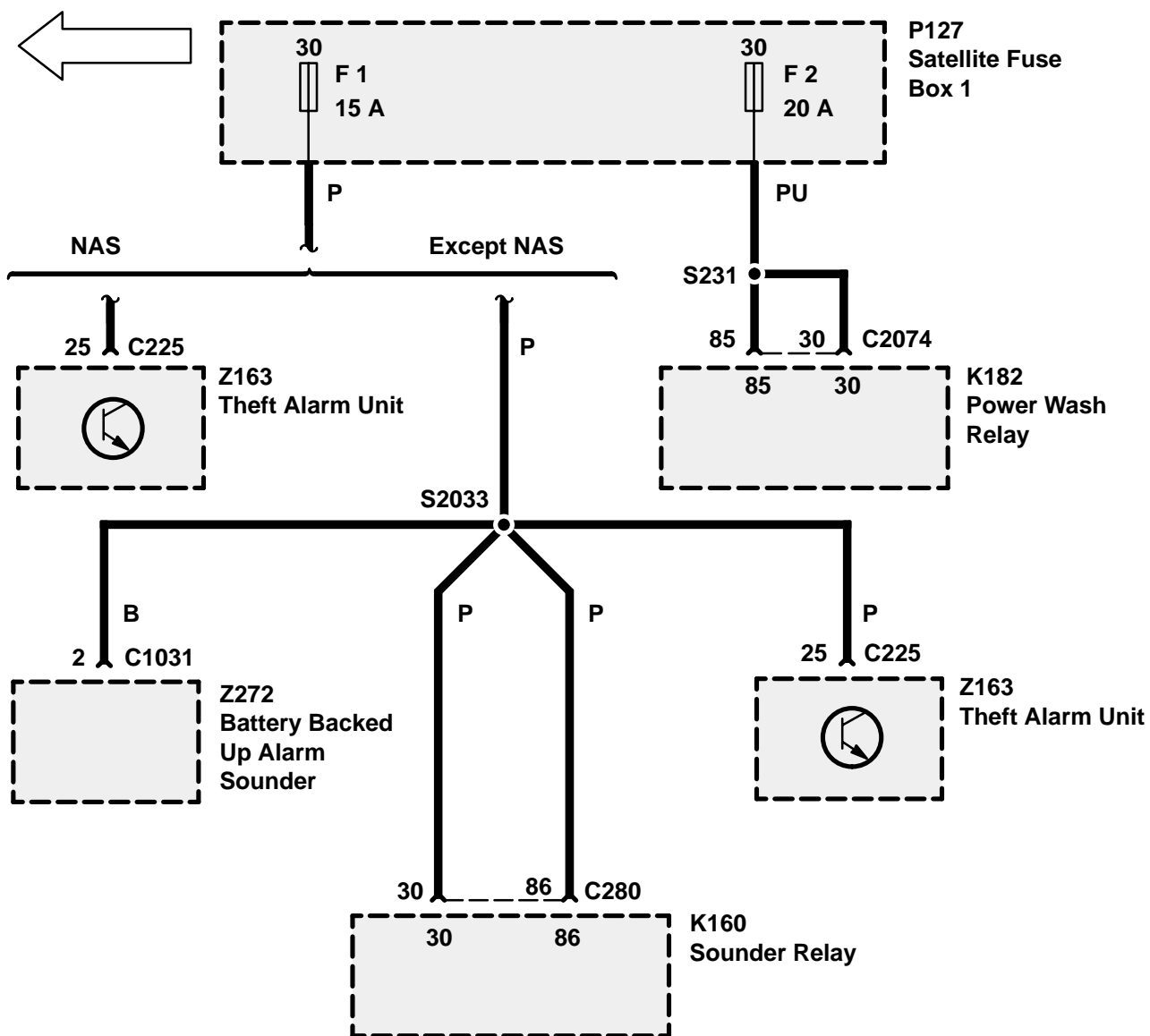

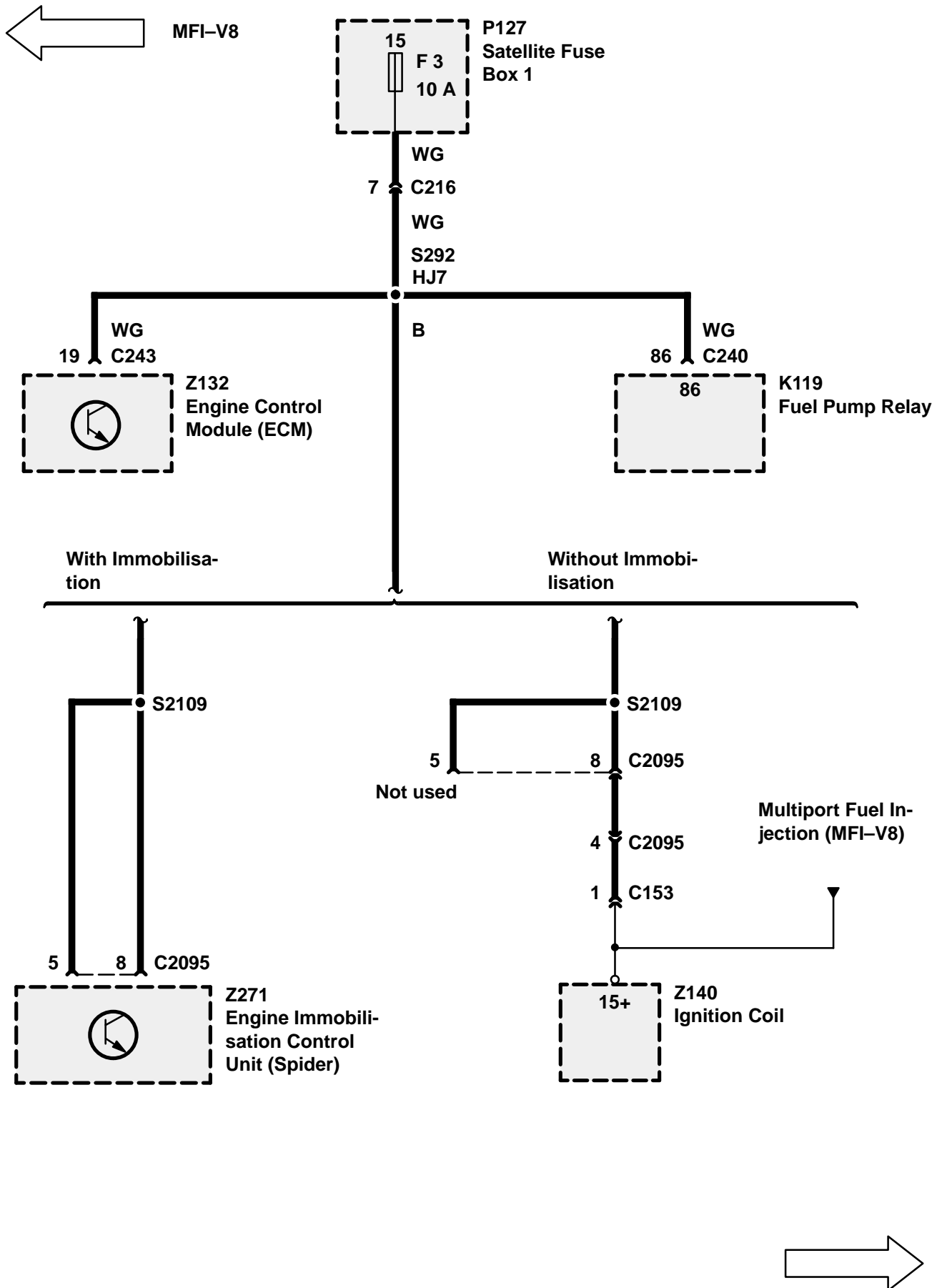



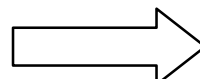
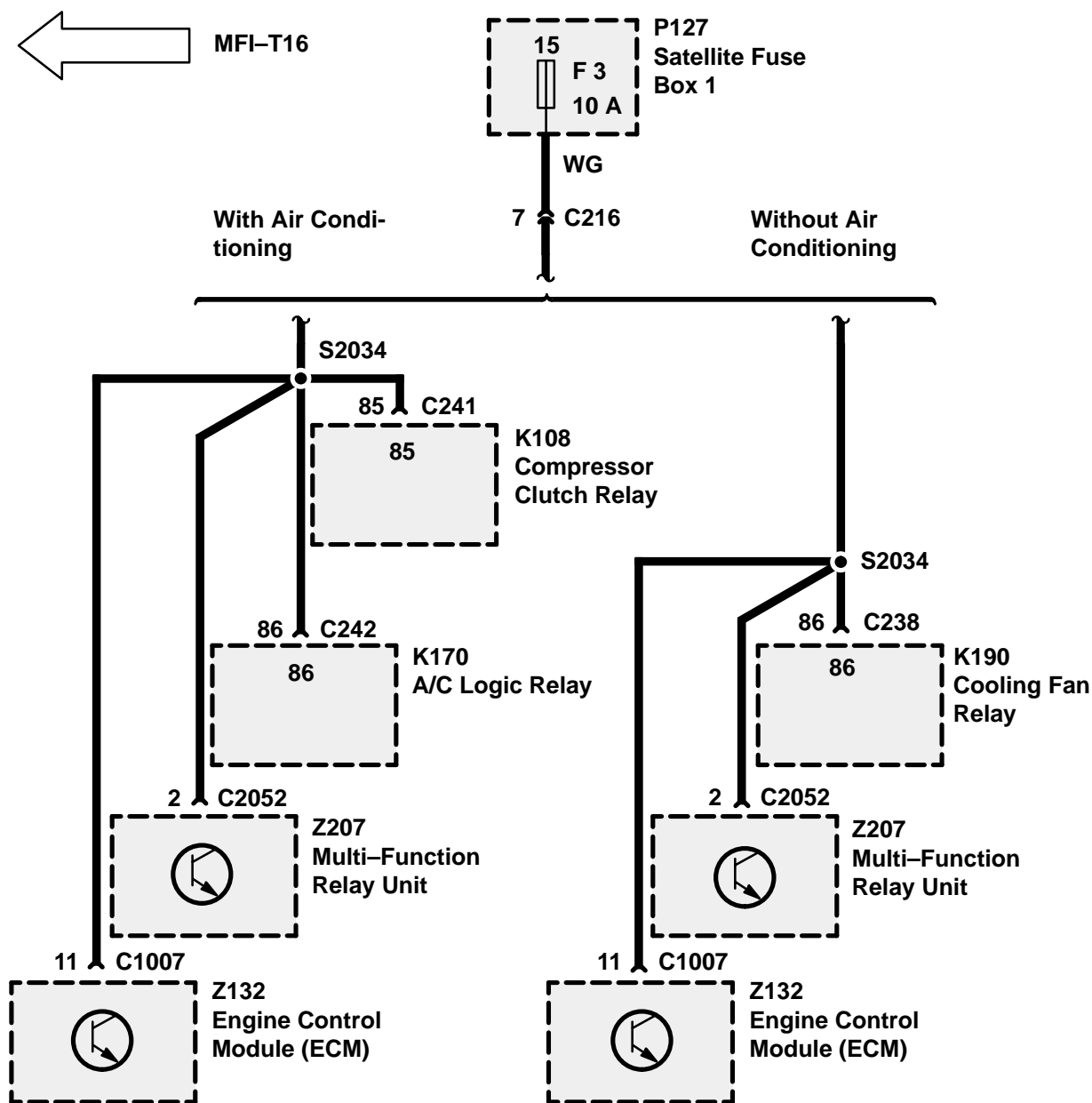

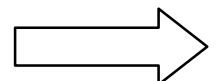
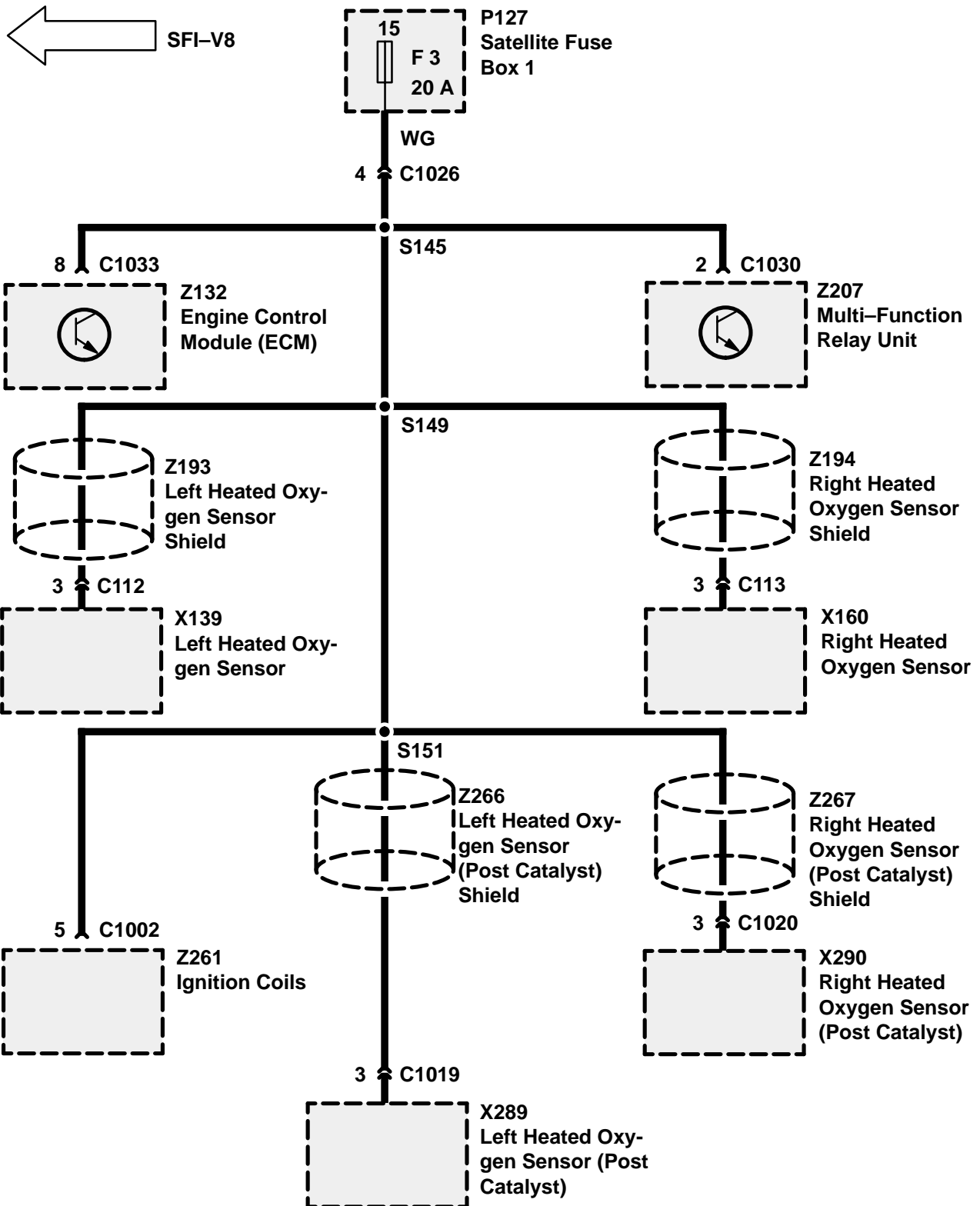

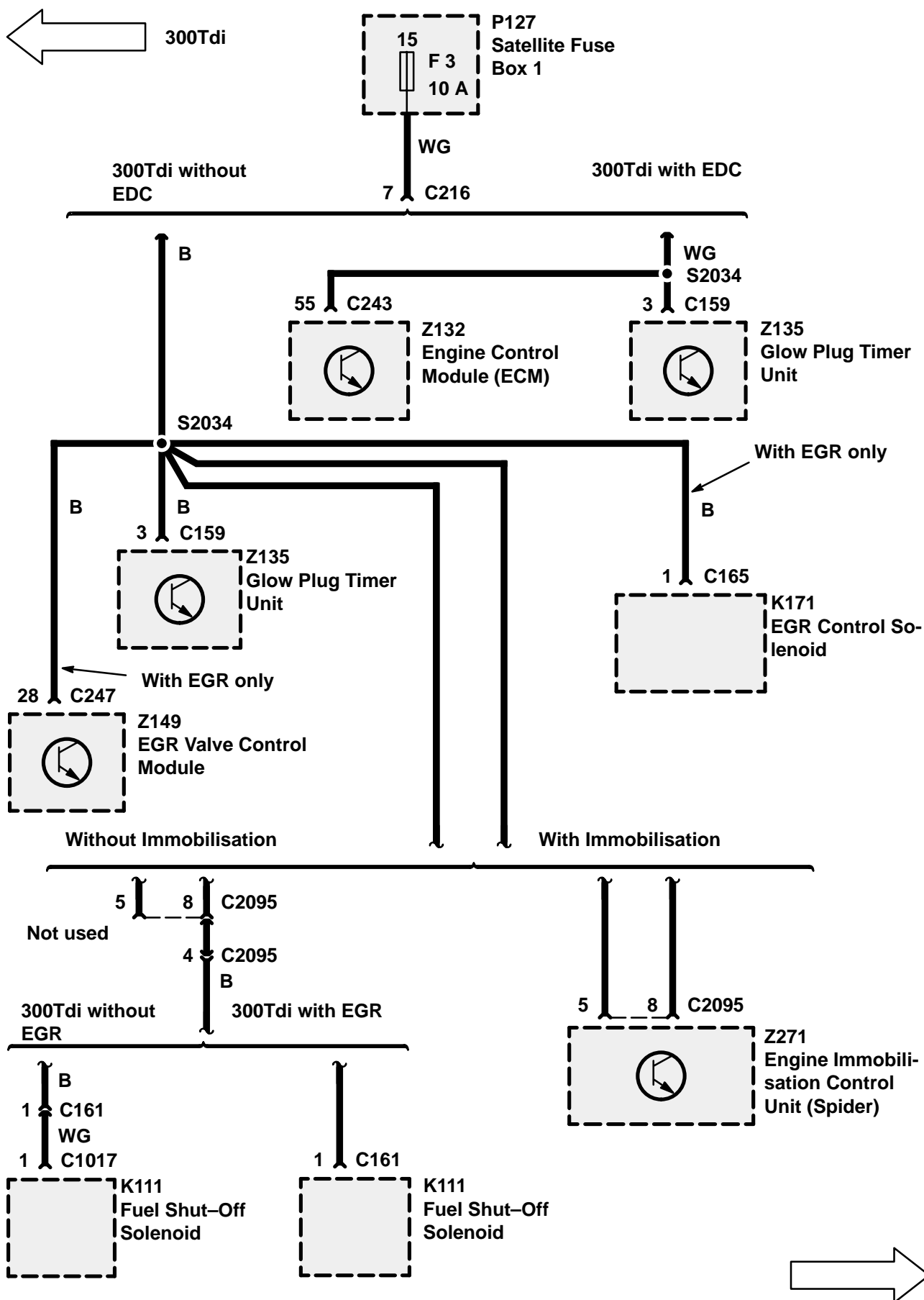

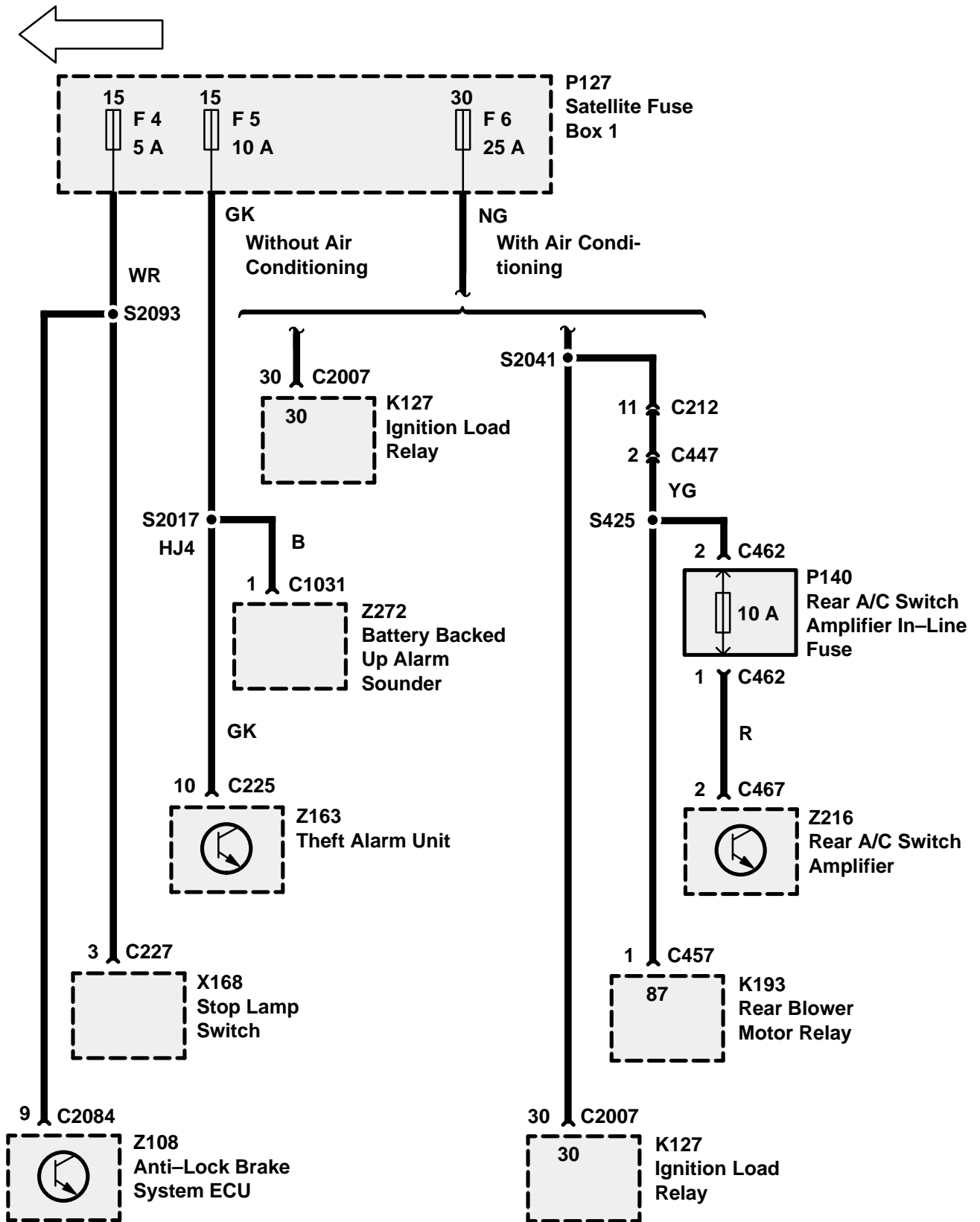

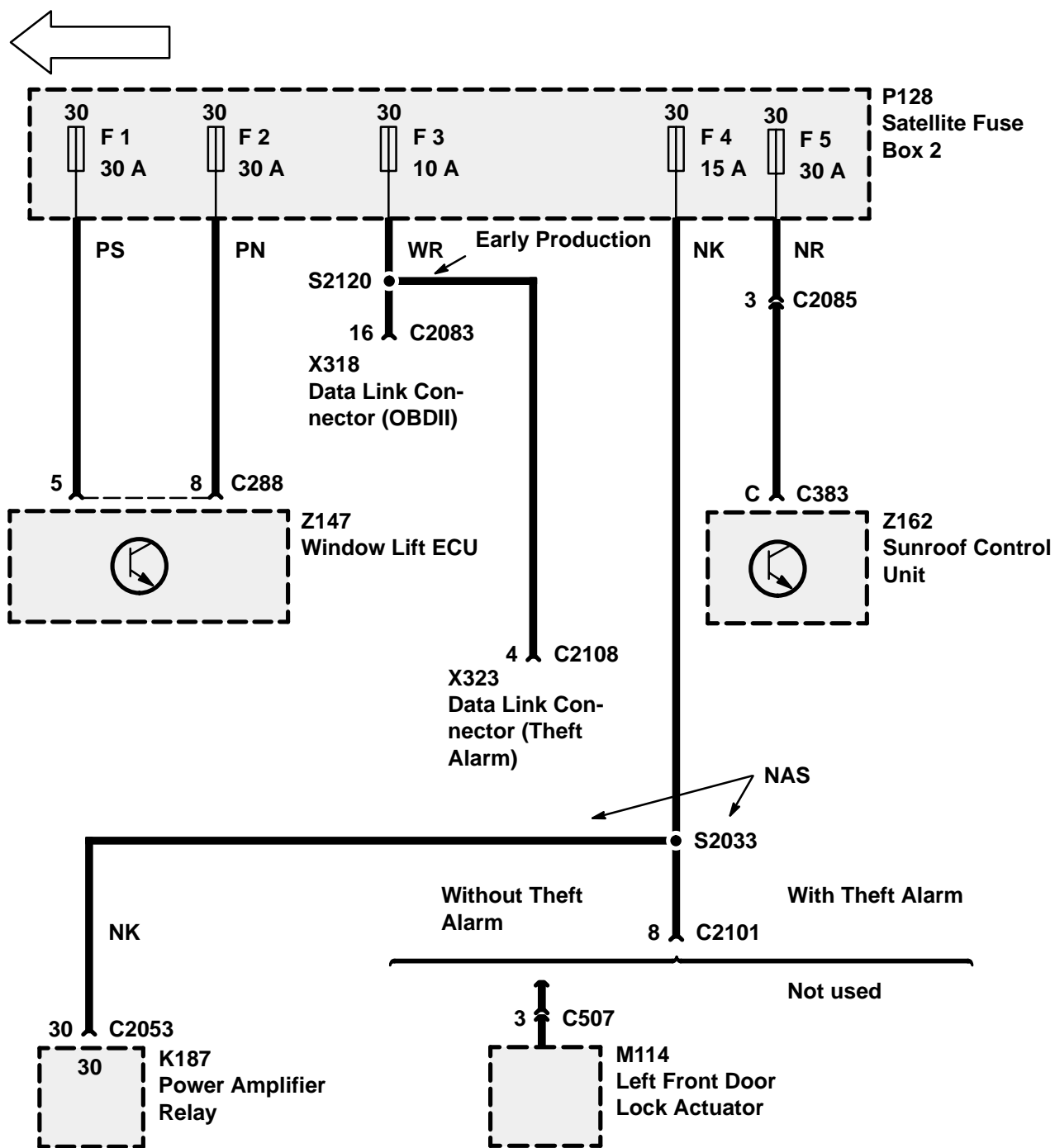

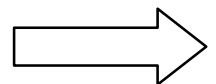
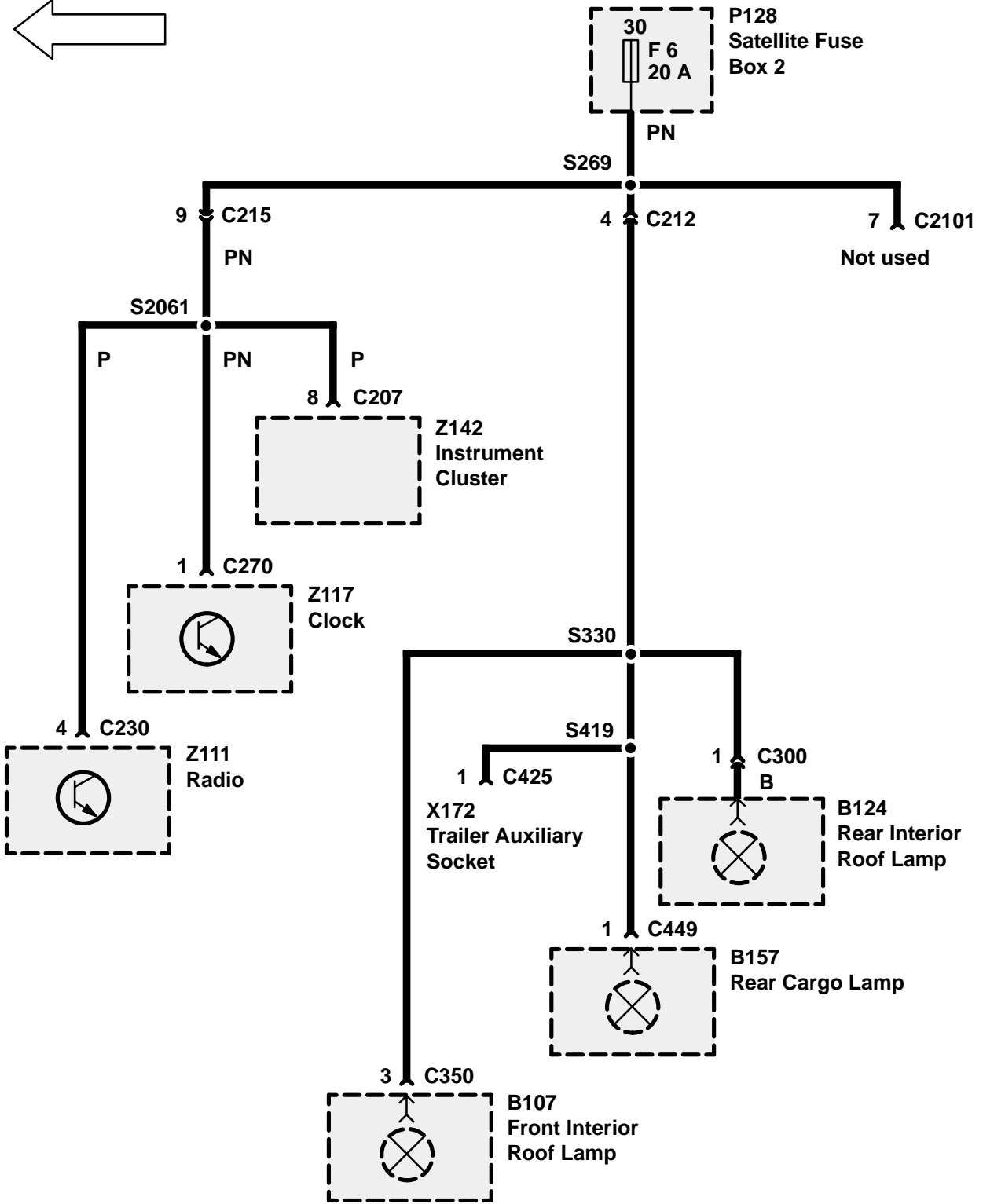
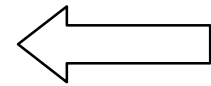

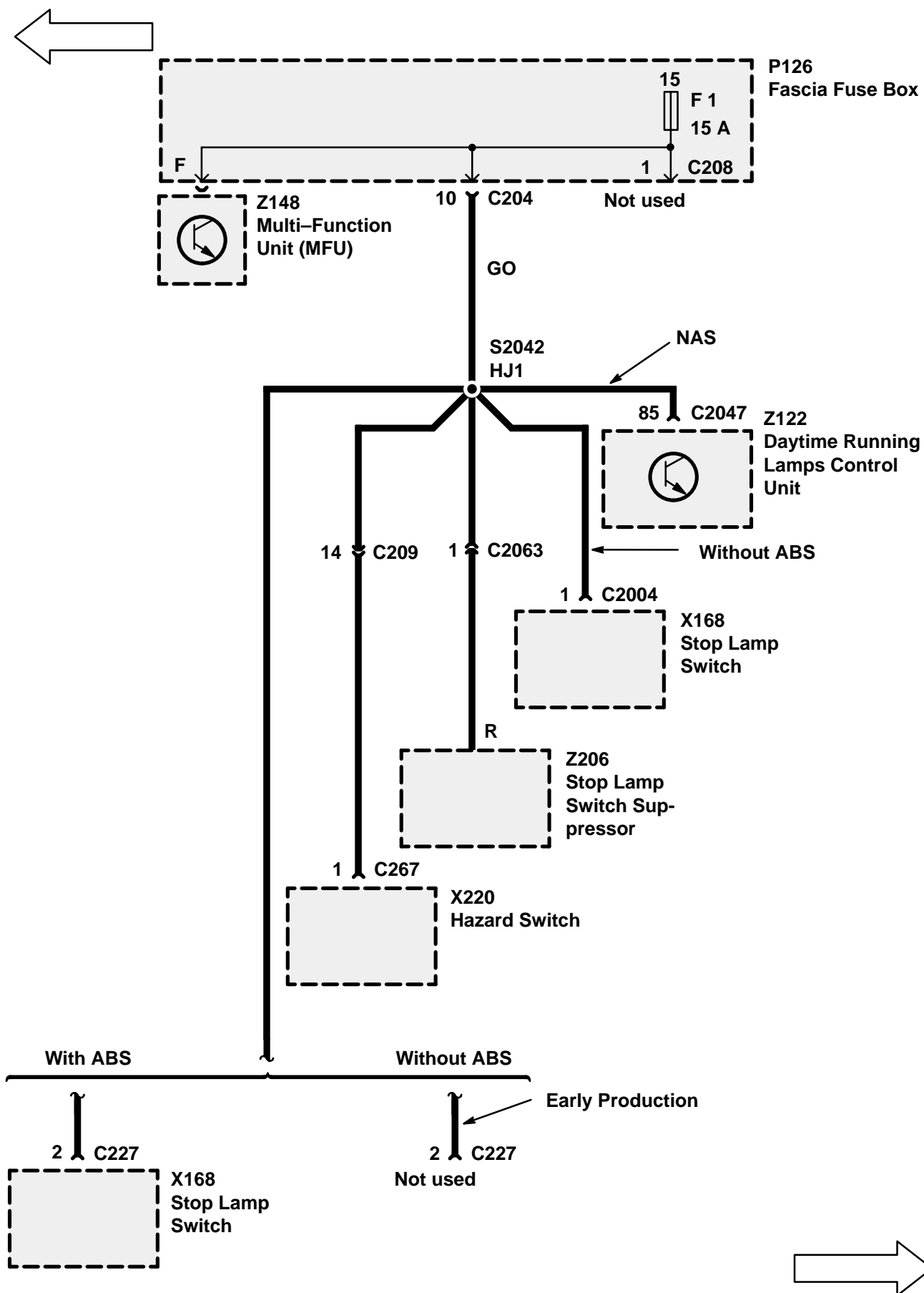

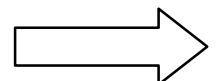
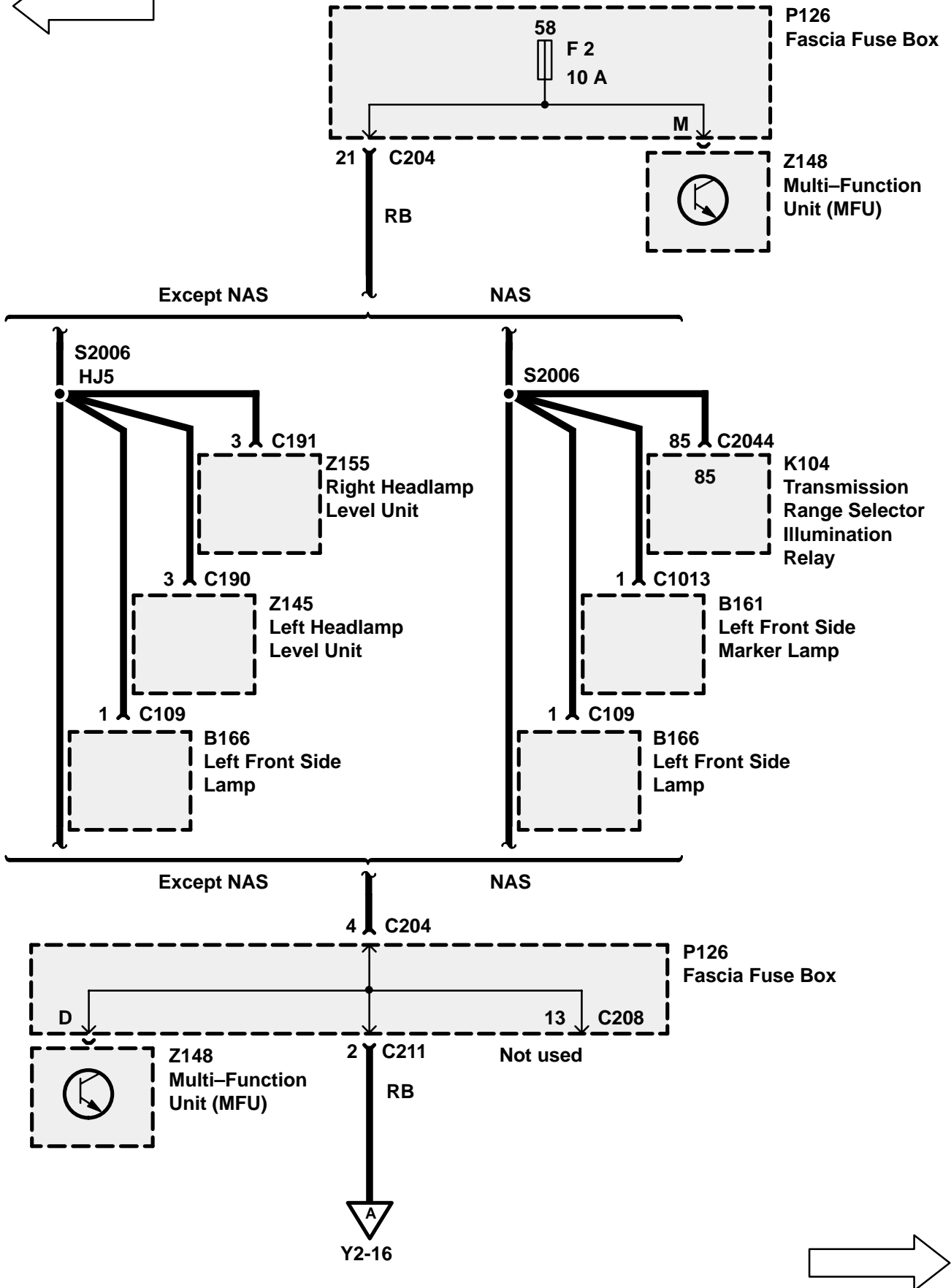
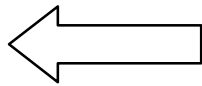



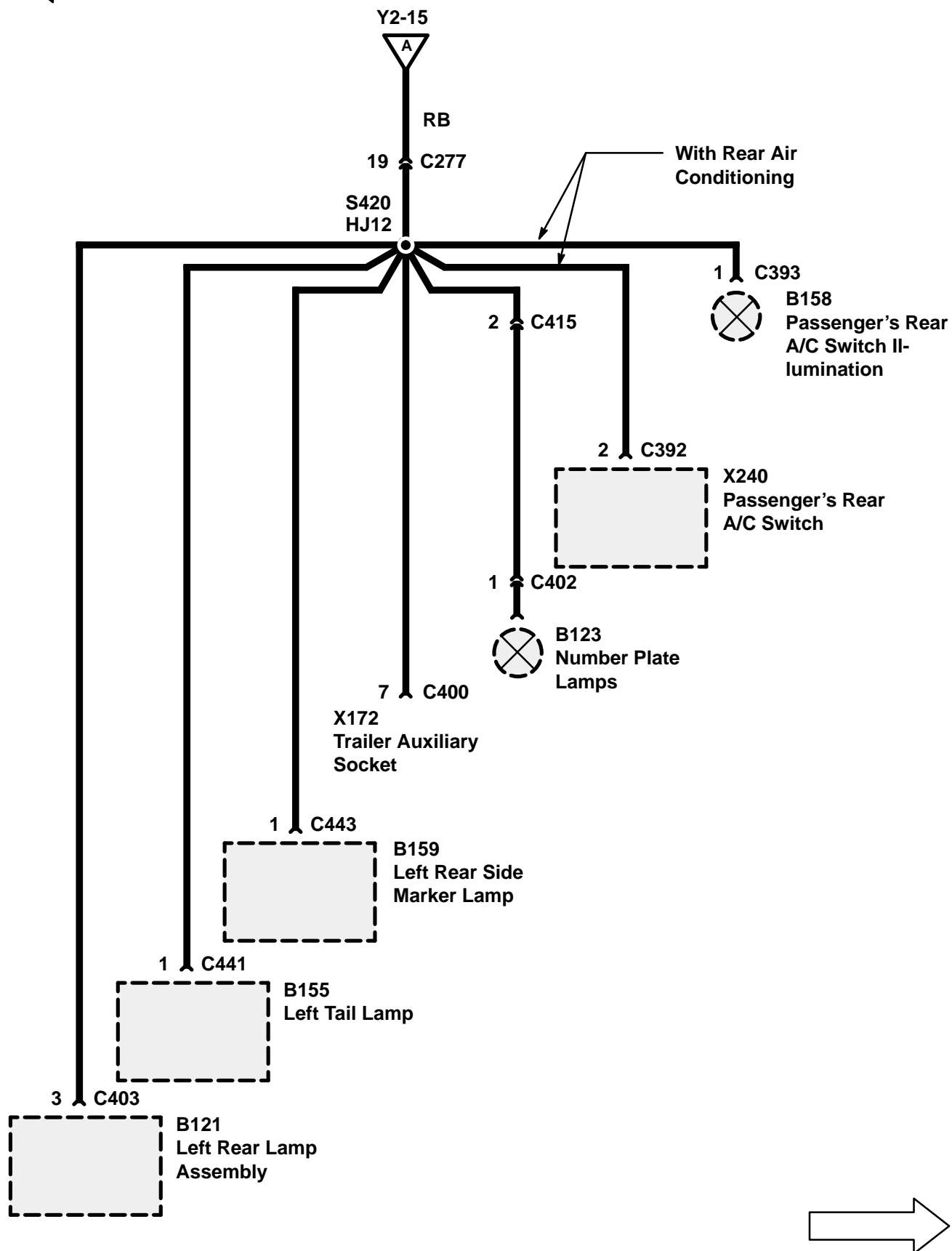
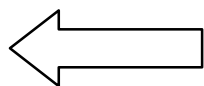

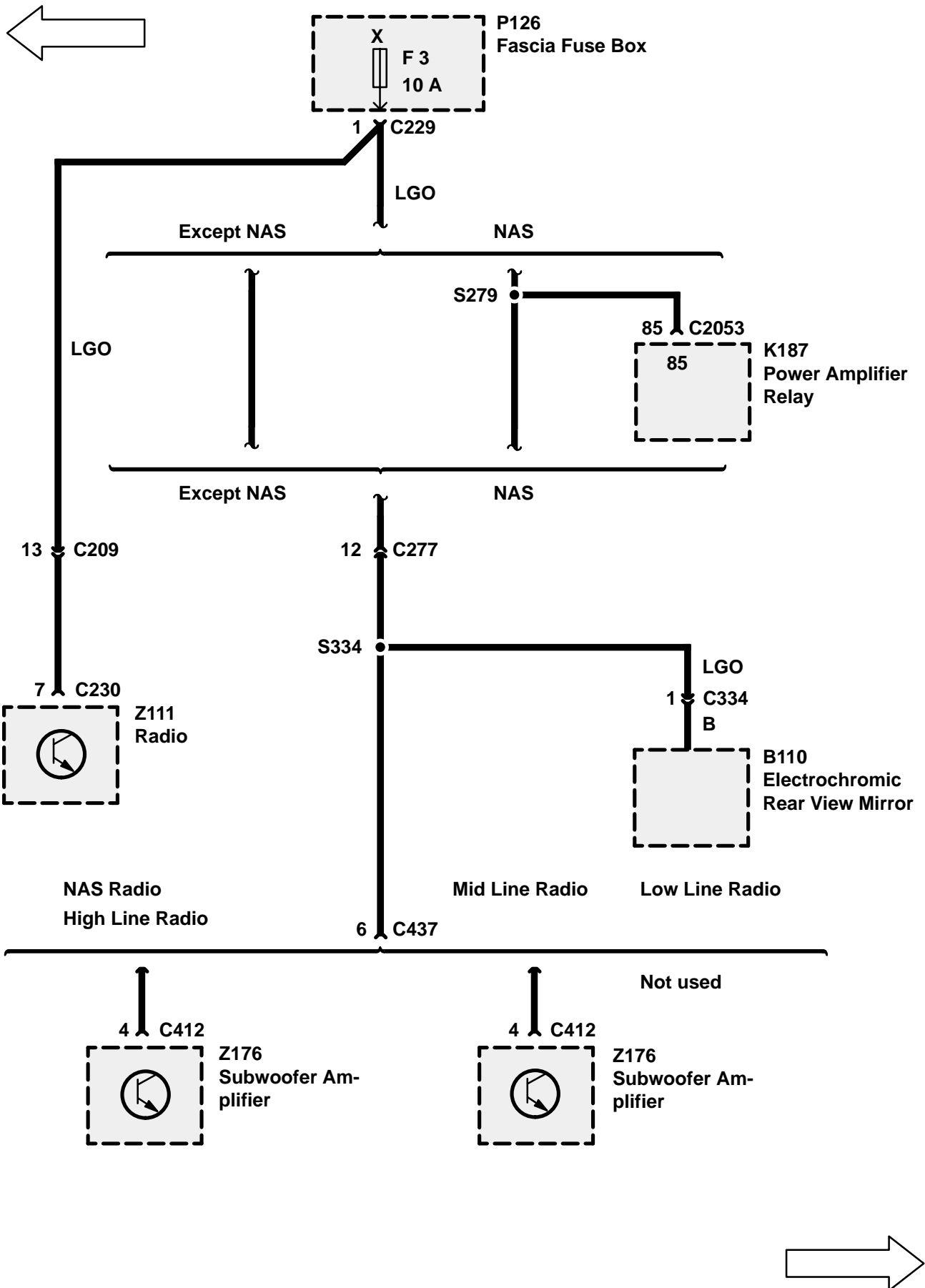

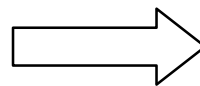
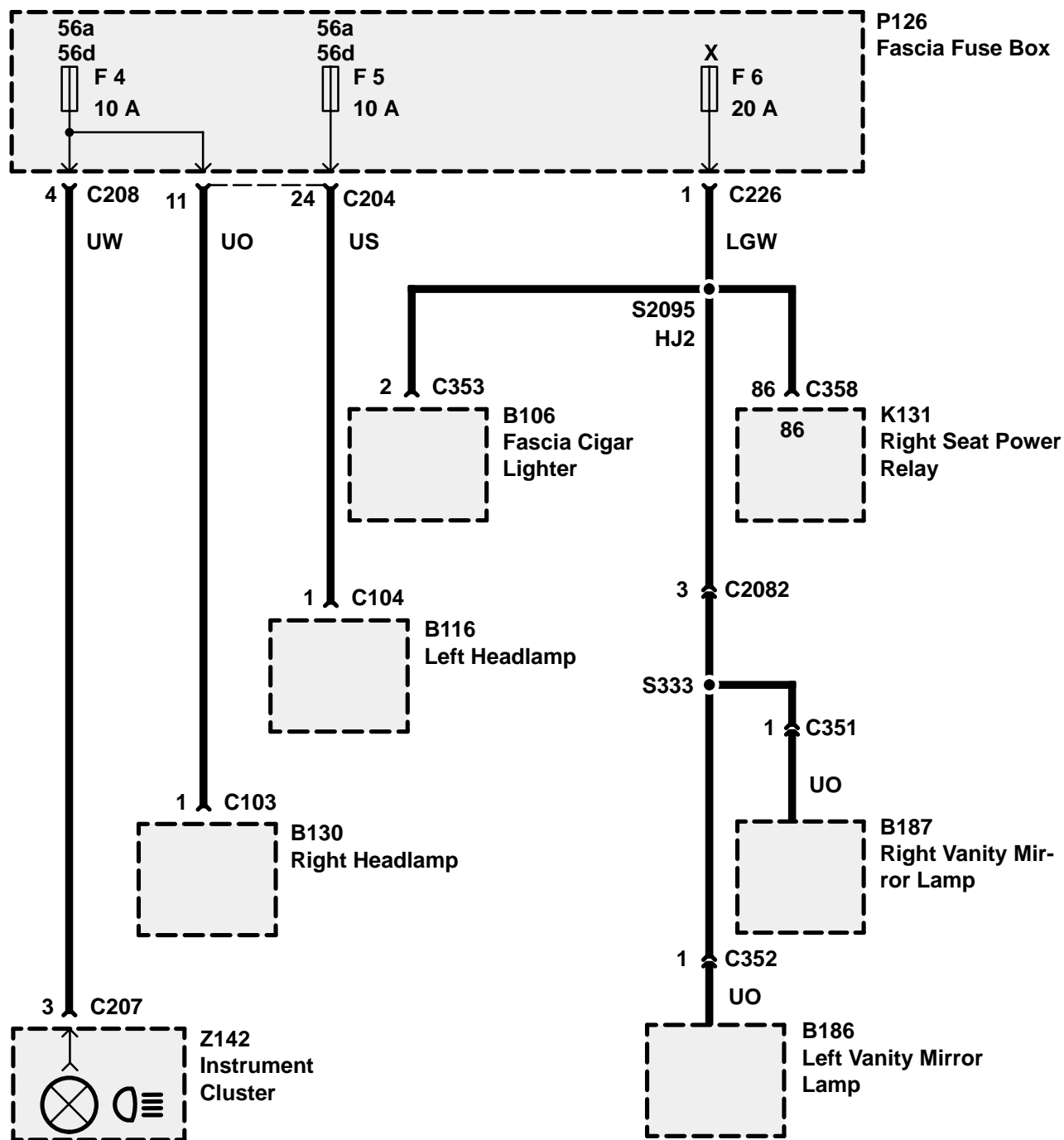
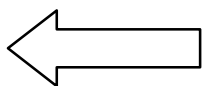

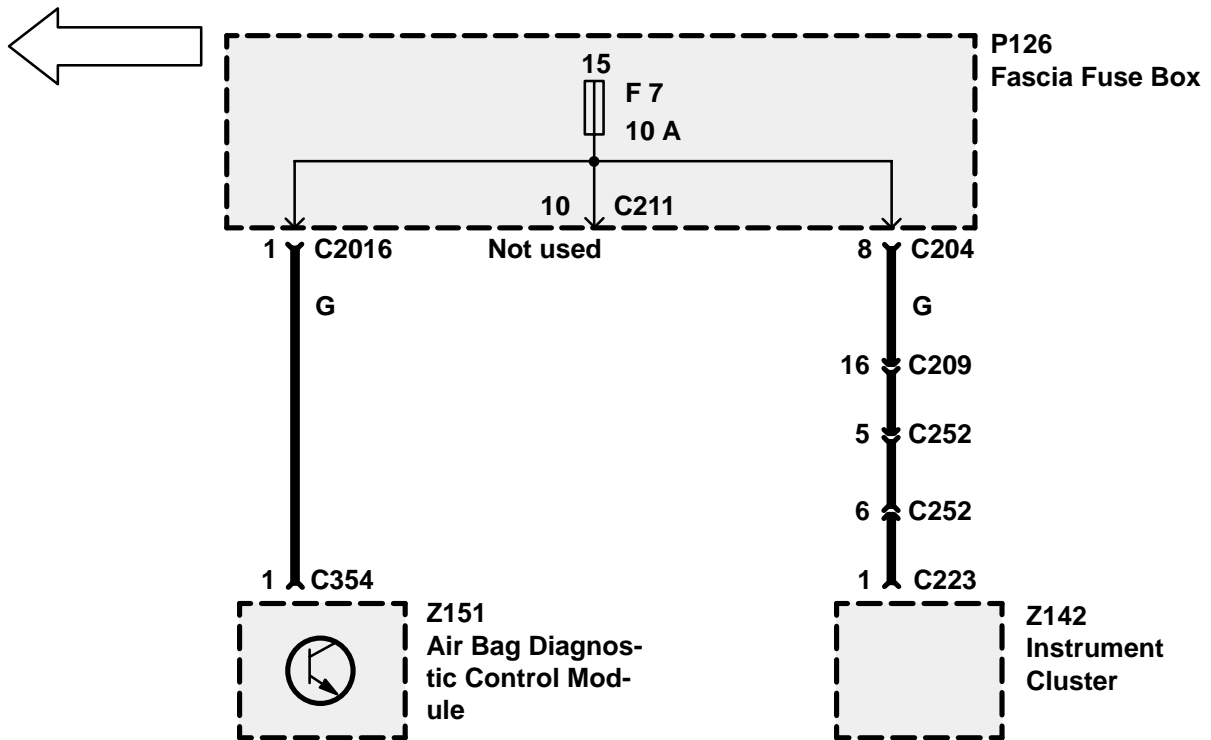

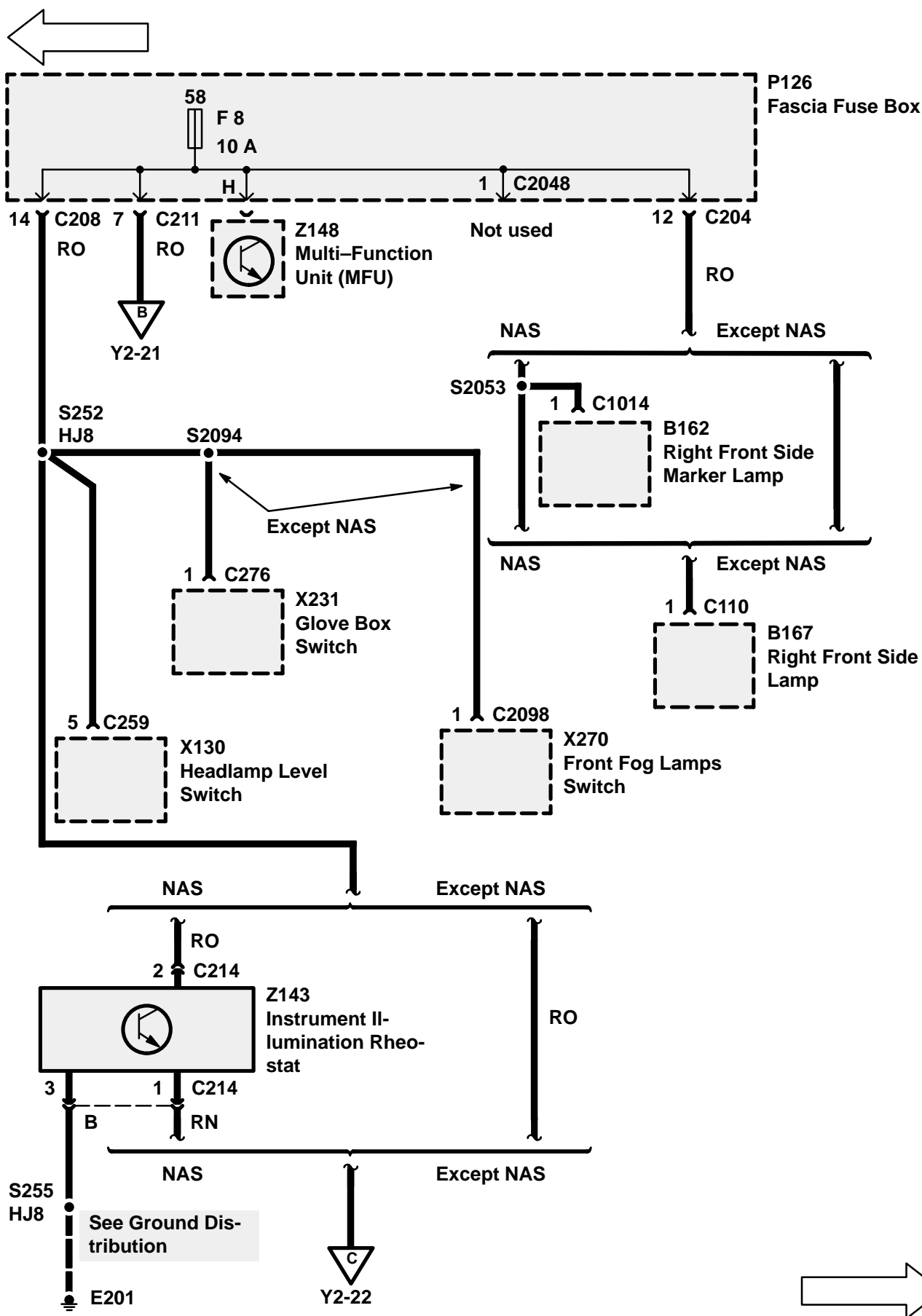

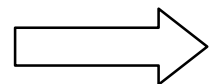
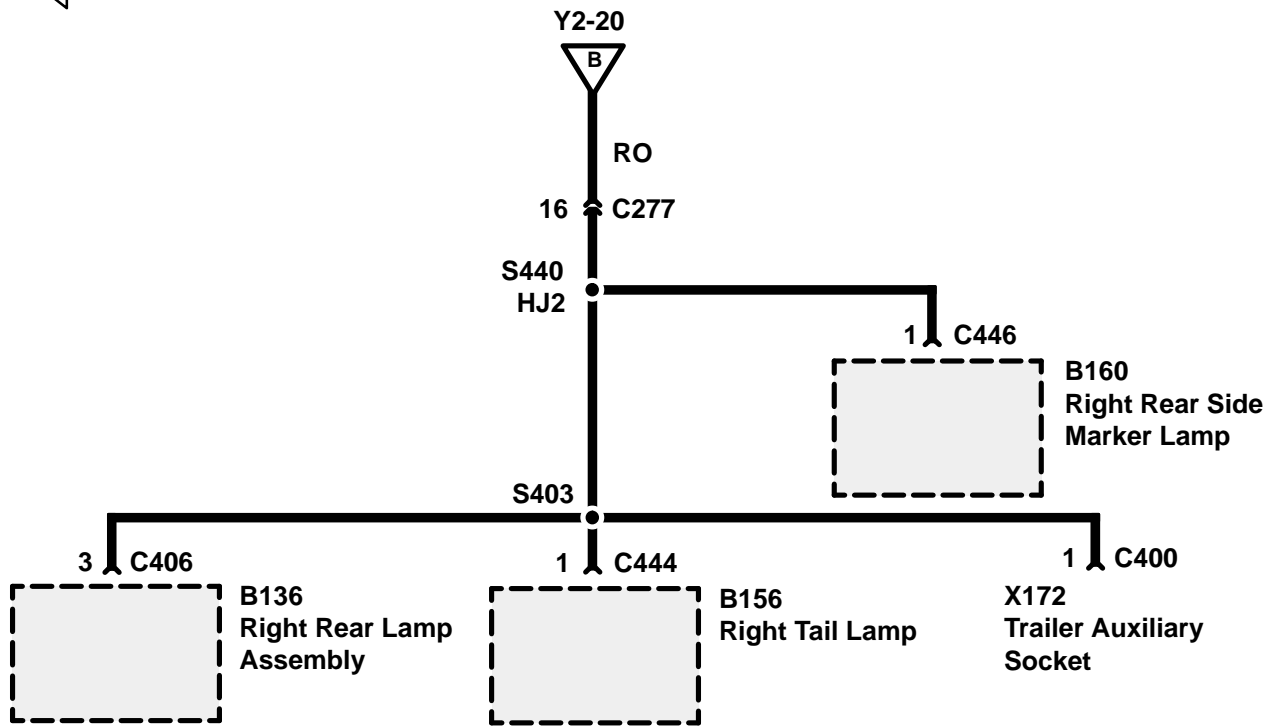
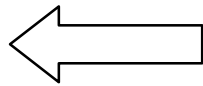

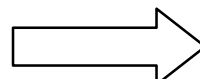
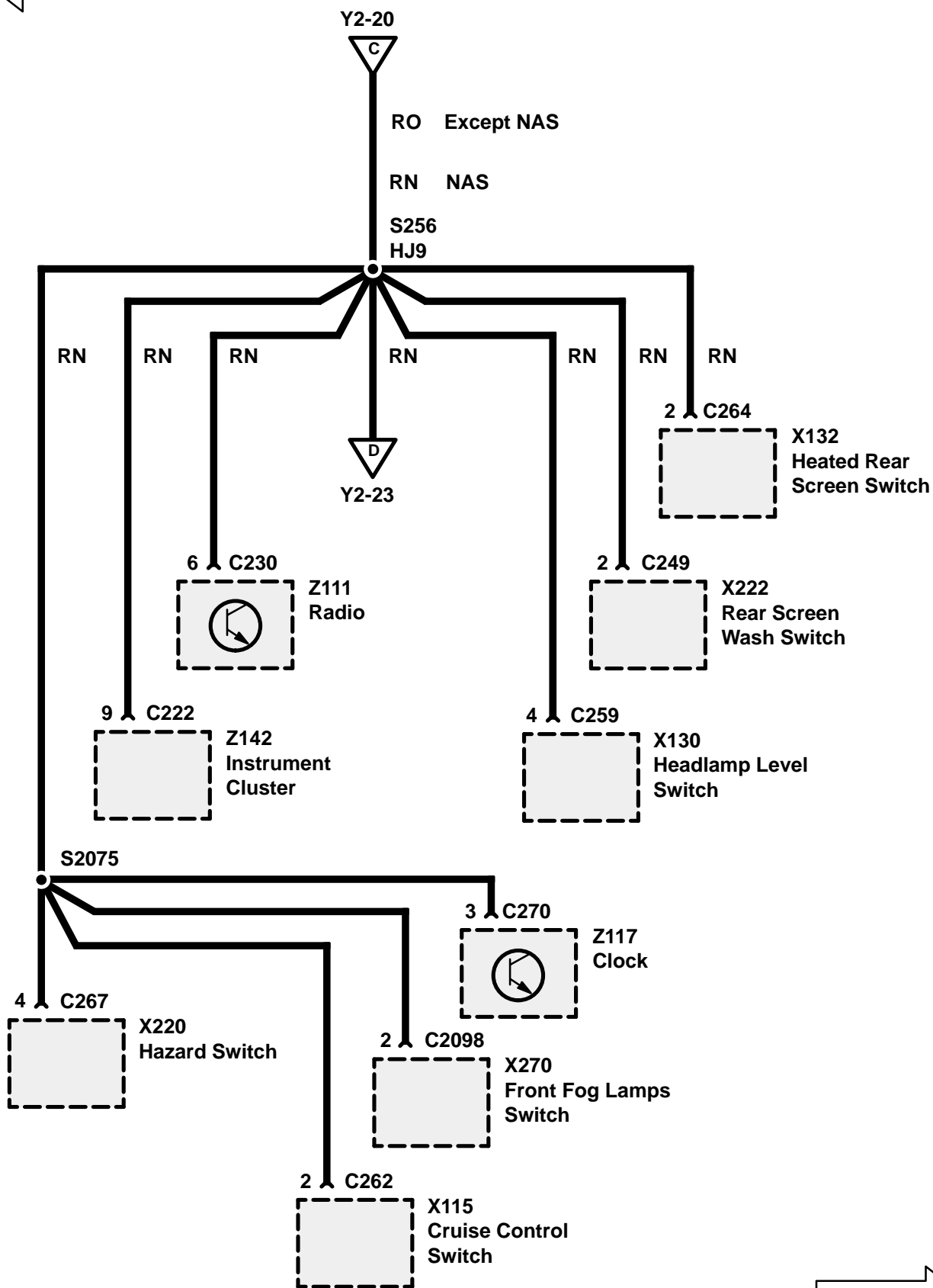
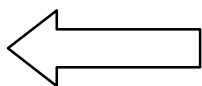

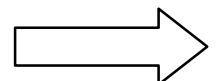
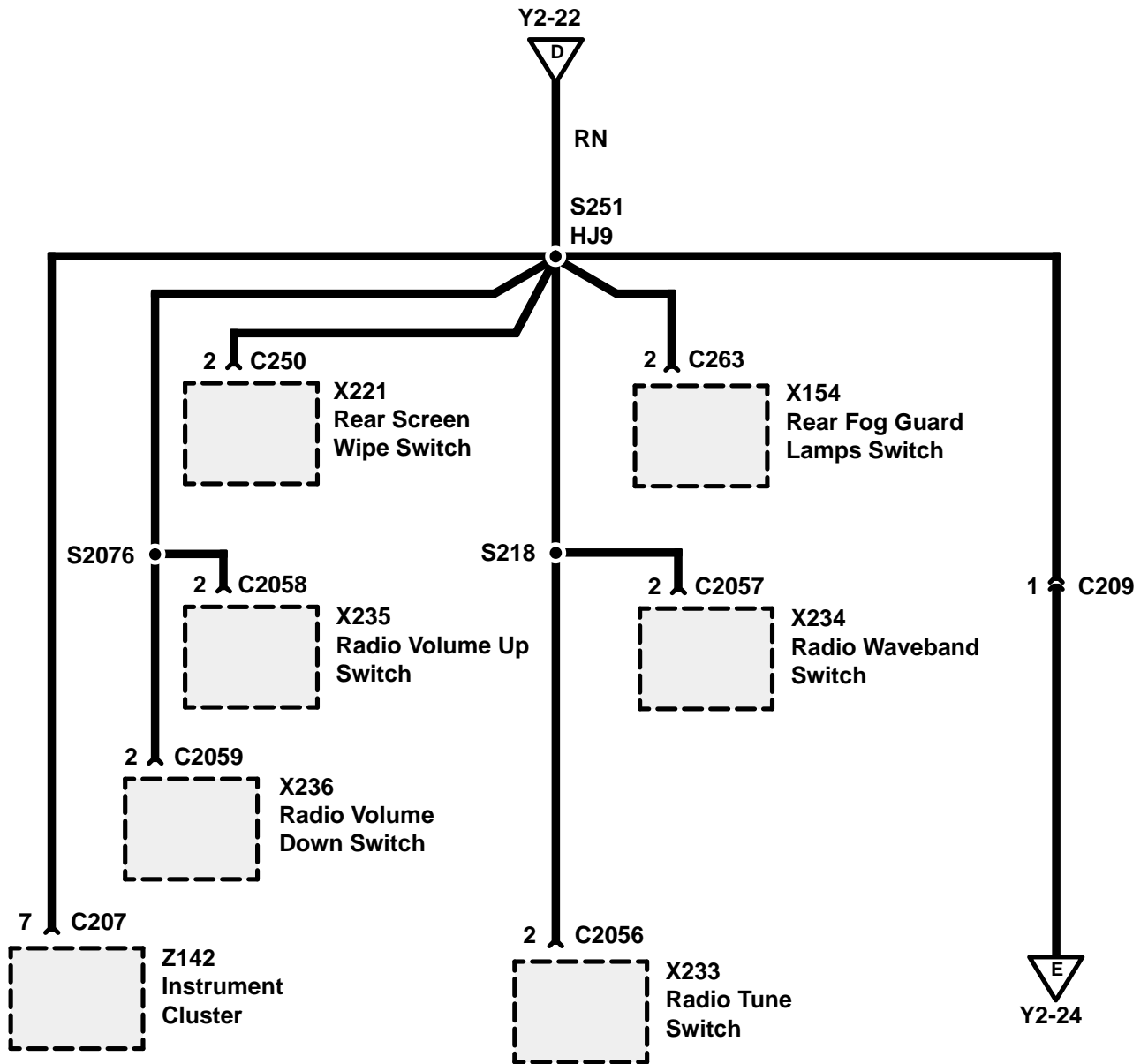
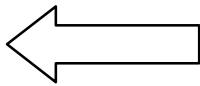



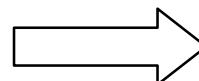
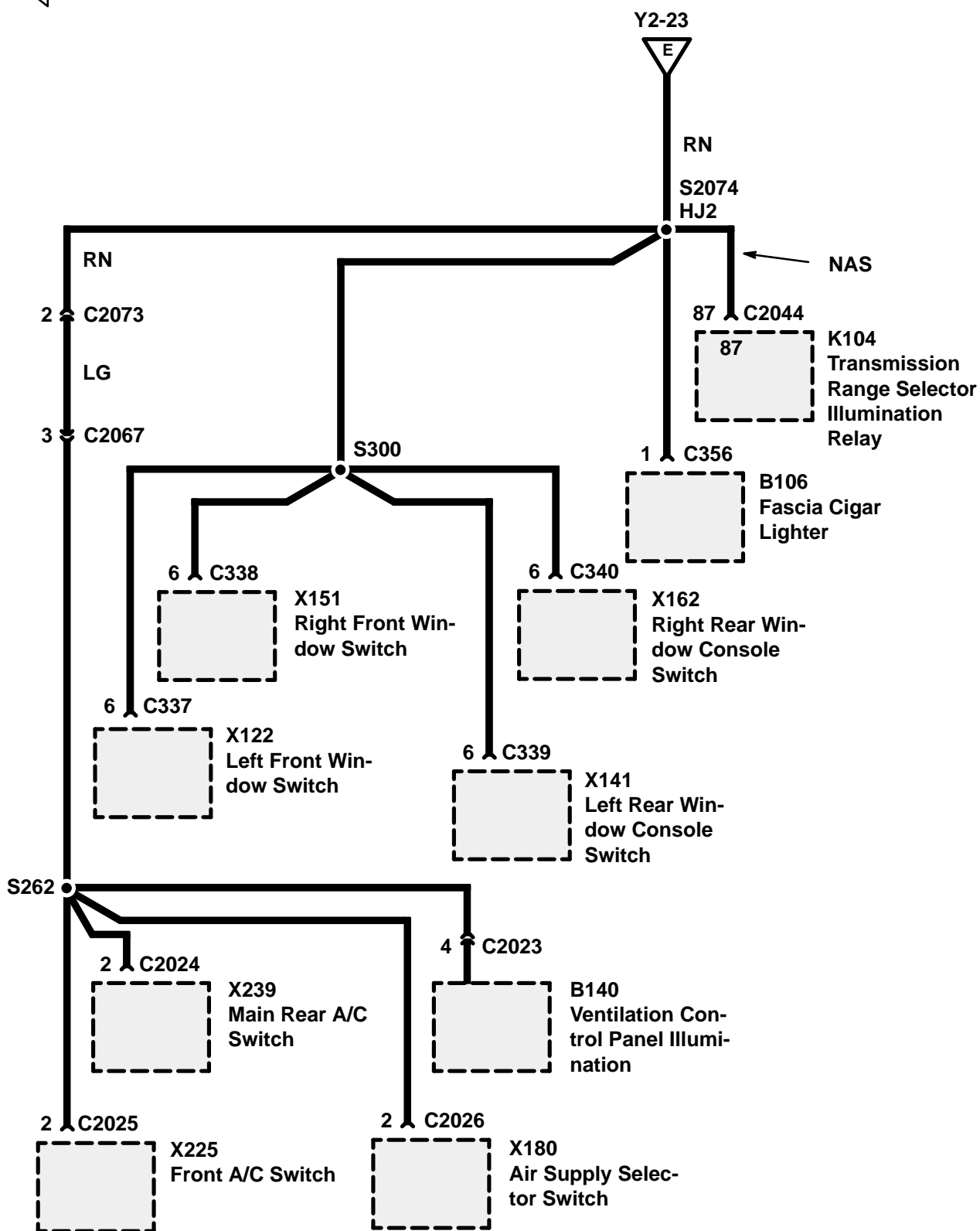
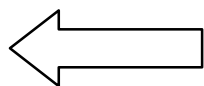

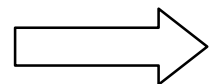
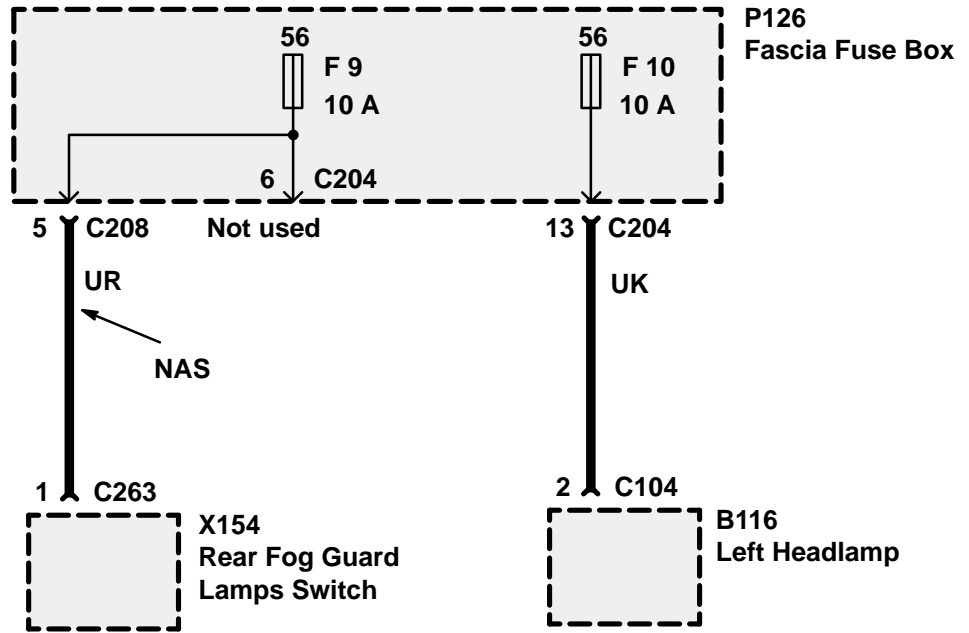
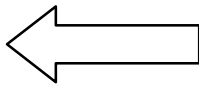

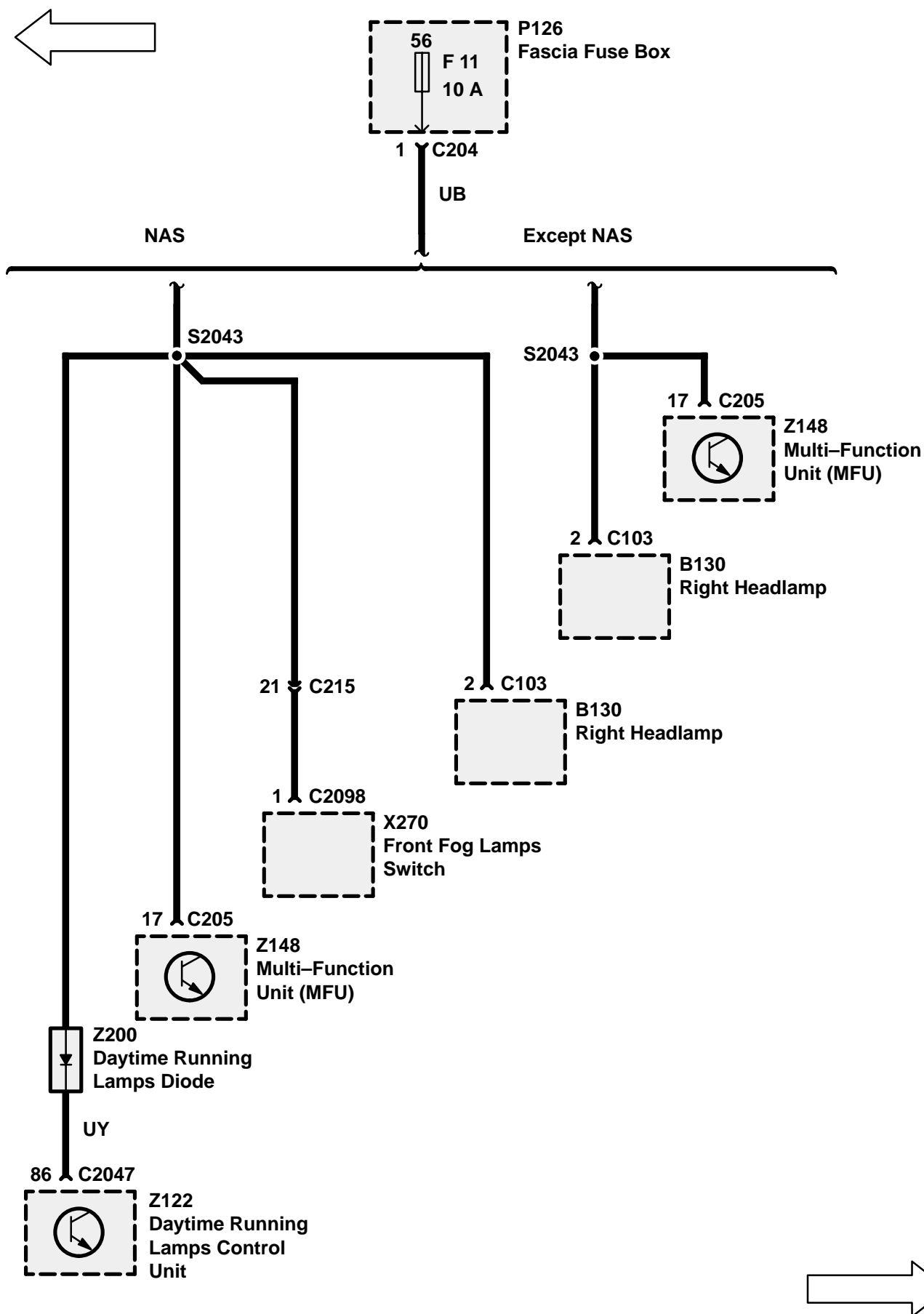

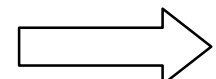
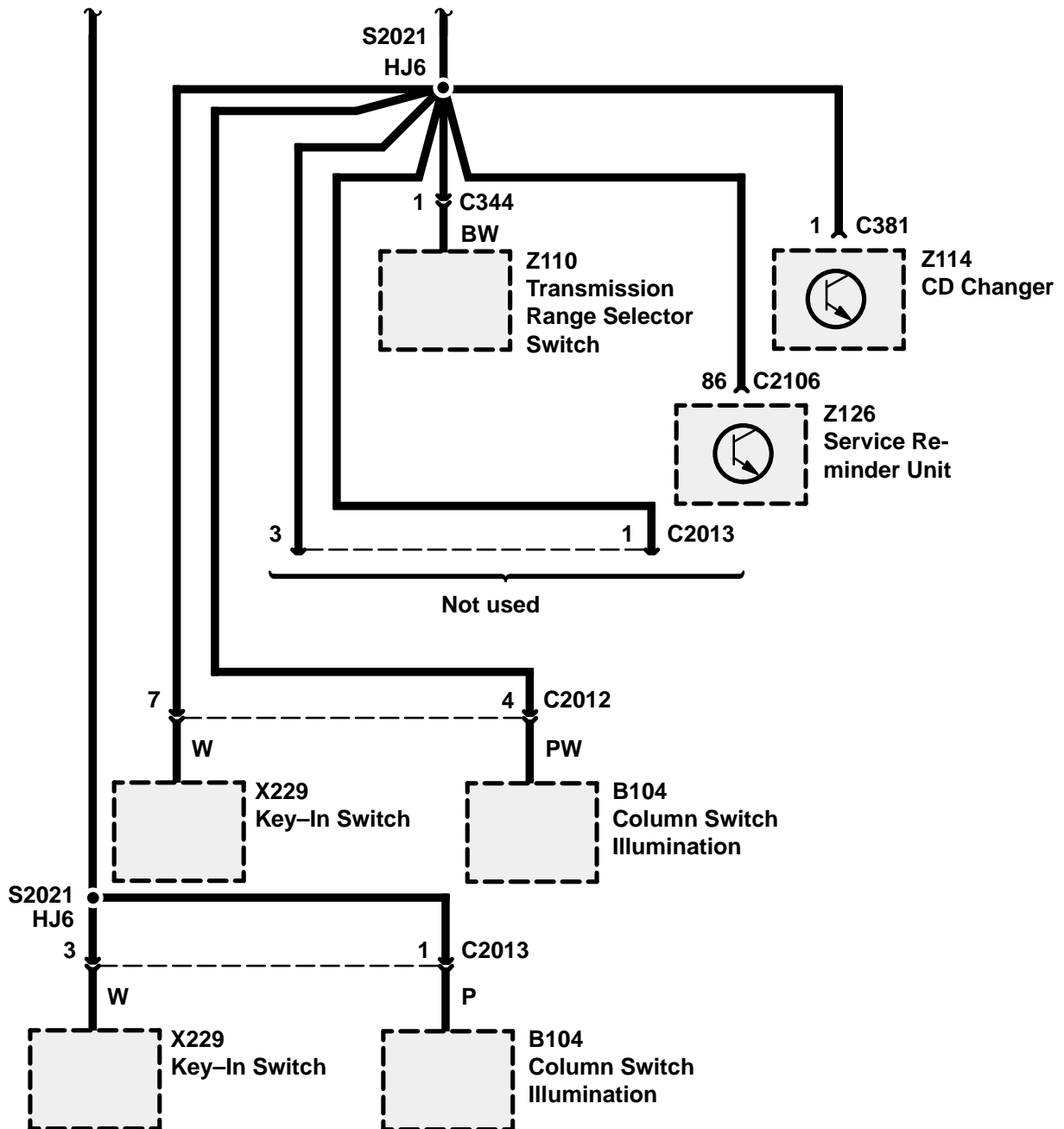
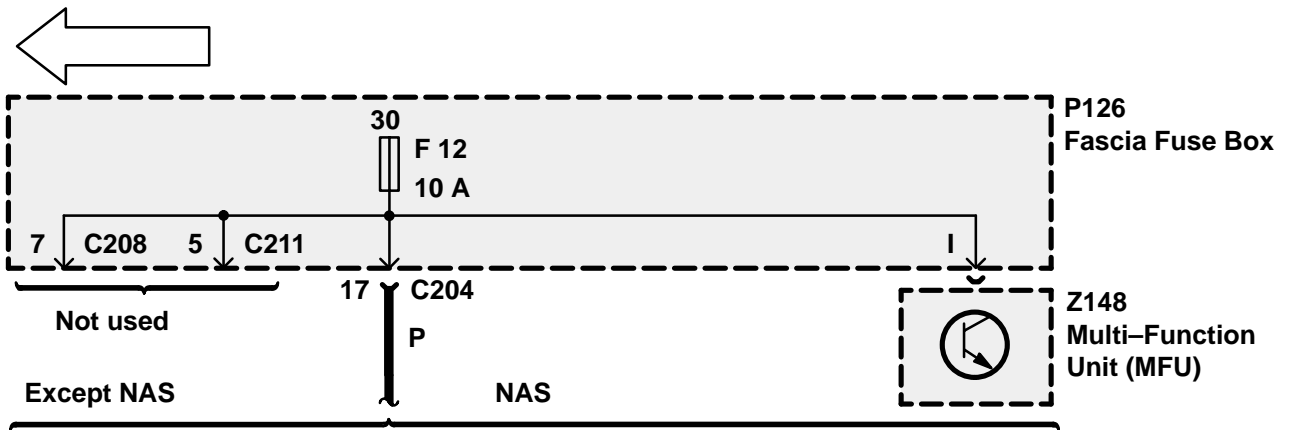

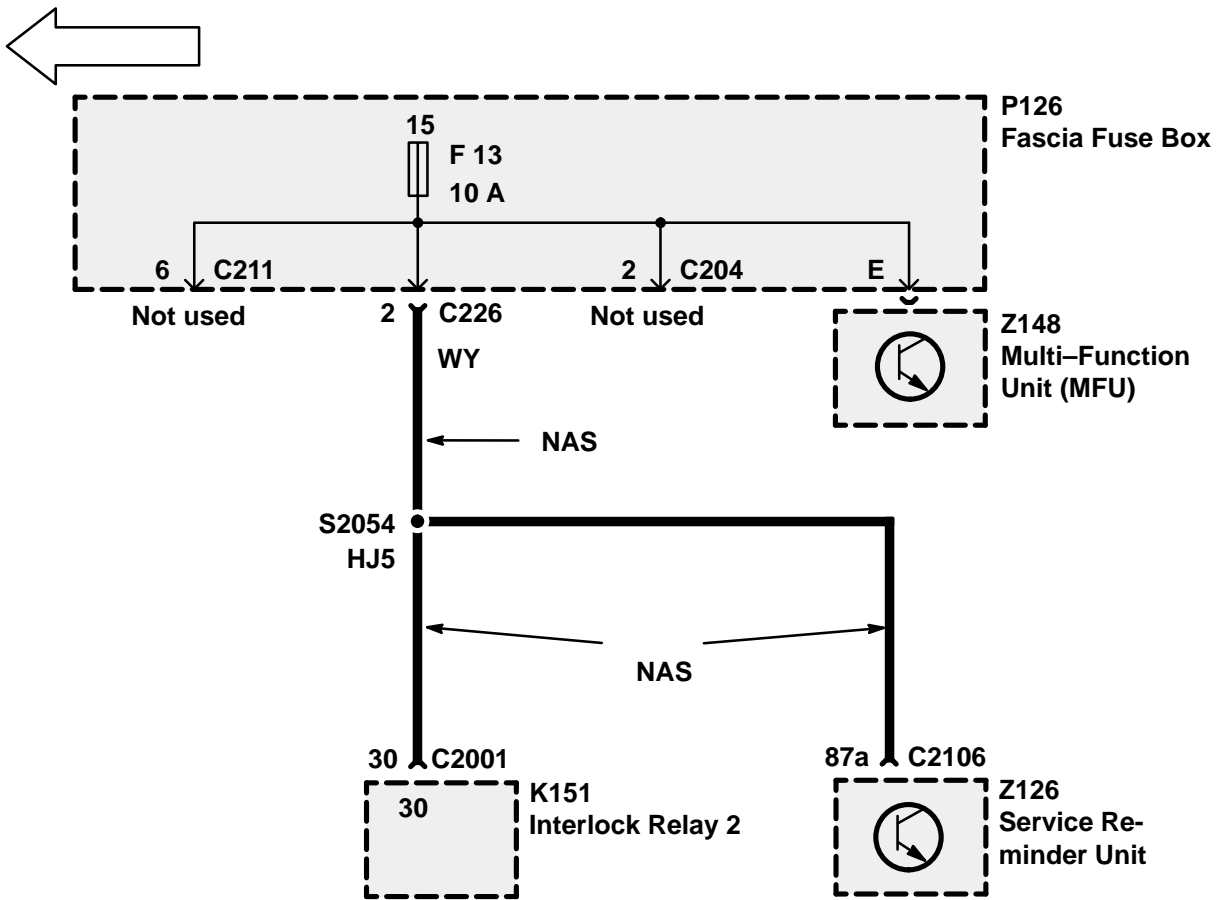

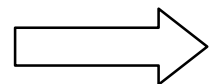
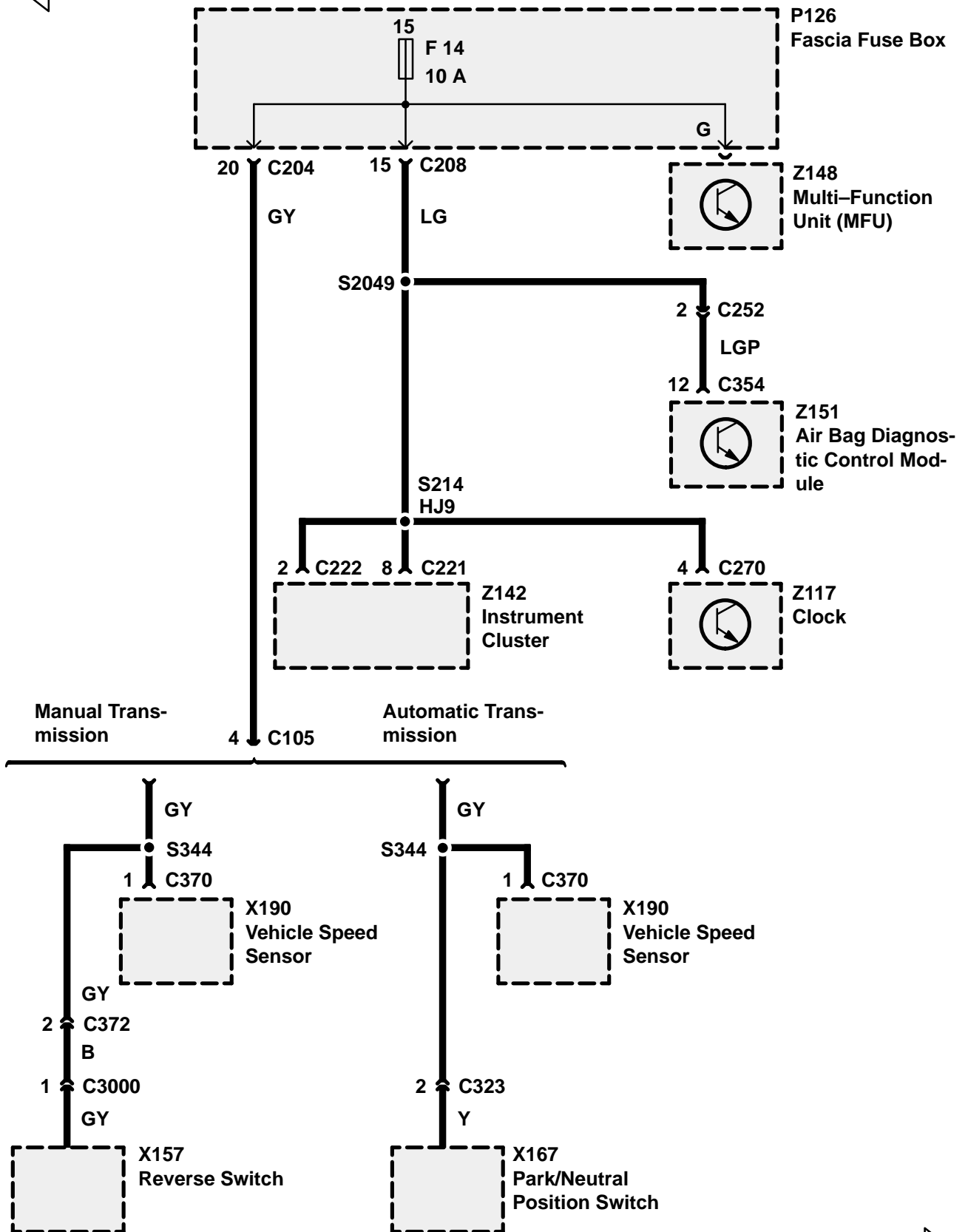
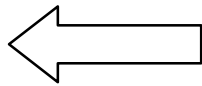

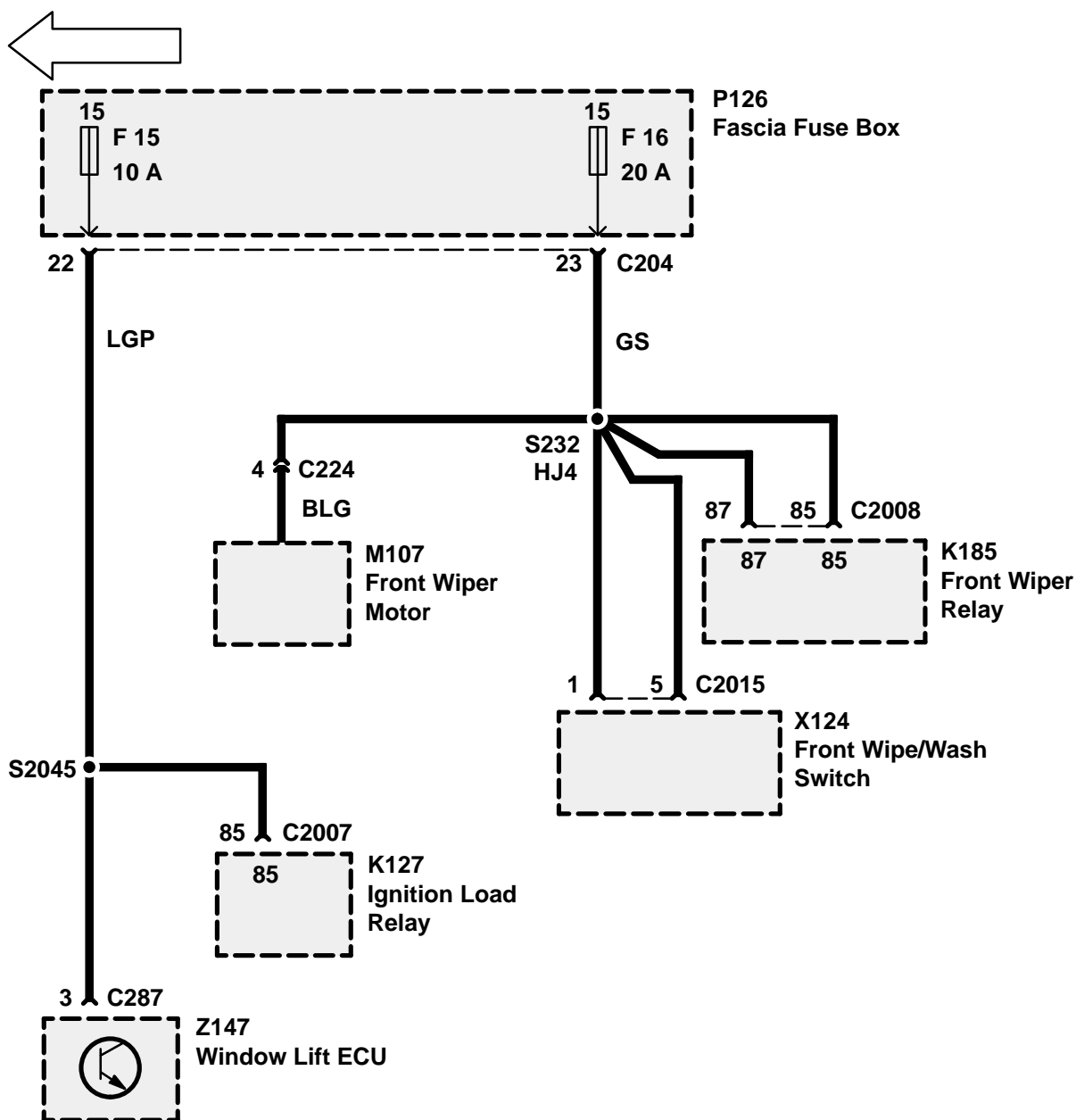

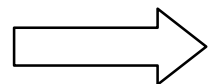
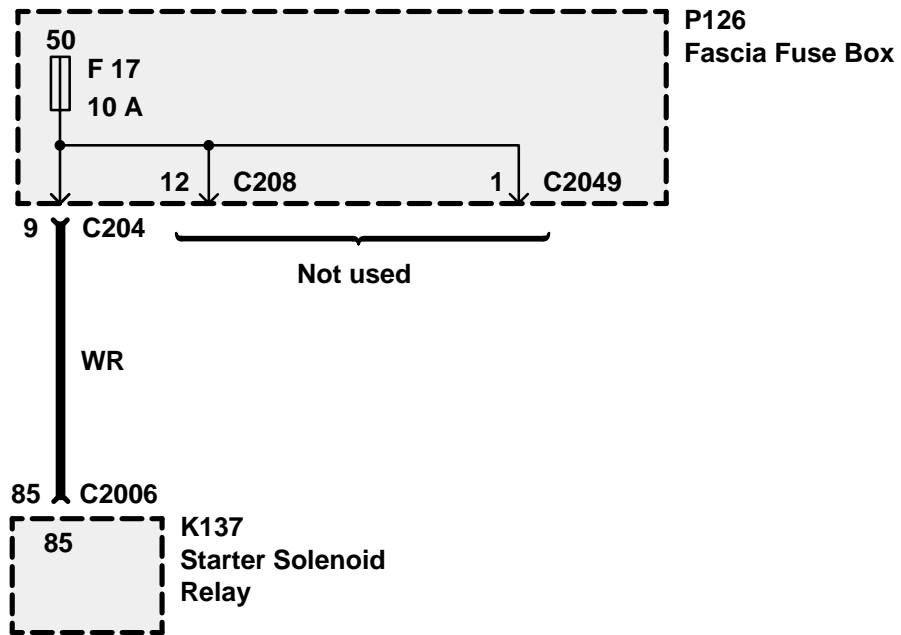
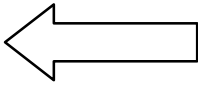



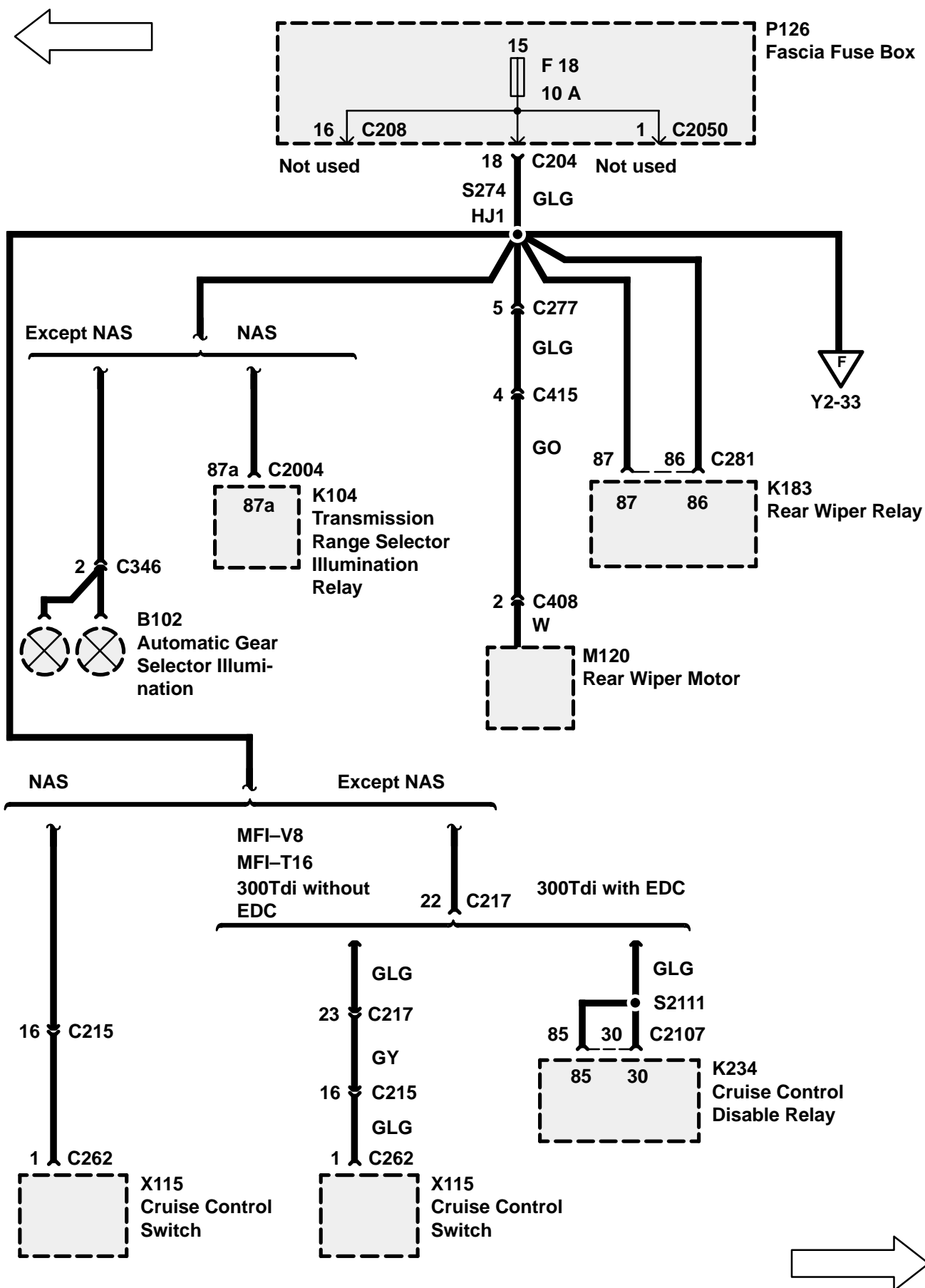

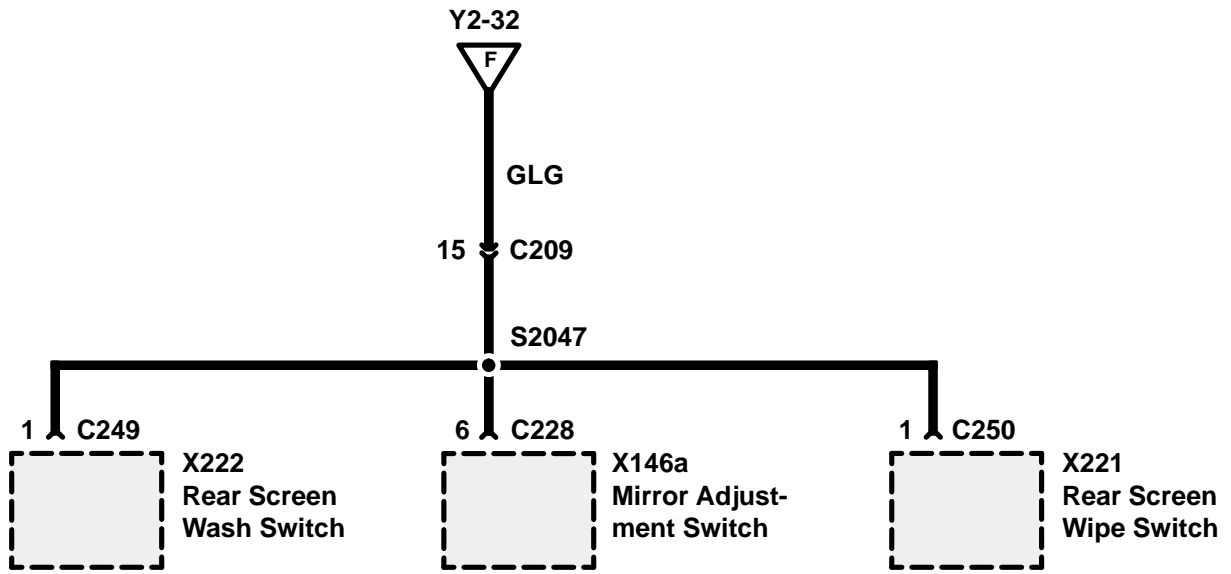

## GROUND AND SPLICE INDEX

<b>Ground</b>	<b>Page</b>	<b>Splice</b>	<b>Page</b>
E100 (MFI-V8) .....	Y5-2	S225/HJ8 .....	Y5-25
E100 (MFI-T16) .....	Y5-3, 4	S238/HJ5 (Except NAS) .....	Y5-18
E100 (NAS) (SFI-V8) .....	Y5-5	S238/HJ5 (NAS) .....	Y5-19
E100 (300Tdi without EDC) .....	Y5-7	S244 .....	Y5-21
E100 (300Tdi with EDC) .....	Y5-8, 9	S253/HJ8 .....	Y5-24
E101 .....	Y5-10	S255/HJ8 .....	Y5-25
E103 (MFI-V8) .....	Y5-11	S266 .....	Y5-14
E103 (NAS) (SFI-V8) .....	Y5-5, 6	S268 .....	Y5-8
E104 .....	Y5-12	S272 (Except NAS) .....	Y5-31
E105 .....	Y5-12	S272 (NAS) .....	Y5-32
E106 .....	Y5-12	S277 .....	Y5-23
E108 .....	Y5-12	S288/HJ11 .....	Y5-29
E109 (MFI-V8) .....	Y5-2	S289 .....	Y5-11
E109 (MFI-T16) .....	Y5-3	S290/HJ7 .....	Y5-2
E109 (NAS) (SFI-V8) .....	Y5-5	S294 .....	Y5-2
E109 (300Tdi without EDC) .....	Y5-7	S2005/HJ10 .....	Y5-15
E109 (300Tdi with EDC) .....	Y5-8	S2015/HJ10 .....	Y5-22
E110 .....	Y5-12	S2016/HJ10 .....	Y5-21
E200 .....	Y5-13-22	S2023/HJ11 .....	Y5-30
E201 .....	Y5-23-32	S2024 .....	Y5-34
E203 .....	Y5-33	S2025/HJ5 .....	Y5-20
E204 .....	Y5-33	S2031/HJ5 .....	Y5-18
E303 .....	Y5-36	S2044/HJ11 .....	Y5-29
E205 .....	Y5-34	S2050 .....	Y5-14
E301 .....	Y5-35	S2051 .....	Y5-33
E400 .....	Y5-37, 38	S2121 .....	Y5-17
E401 .....	Y5-39, 40	S307 .....	Y5-13
E404 .....	Y5-37	S308 .....	Y5-13
<b>Splice</b>	<b>Page</b>	S320 .....	Y5-35
S112 (MFI-V8) .....	Y5-3	S332 .....	Y5-39
S112 (300Tdi without EDC) .....	Y5-7	S343 .....	Y5-27, 28
S122 .....	Y5-14	S401 .....	Y5-37
S132 .....	Y5-33	S402 .....	Y5-40
S140 .....	Y5-5	S415 .....	Y5-37
S141 .....	Y5-5	S417 .....	Y5-38
S143 .....	Y5-6	S418 .....	Y5-40
S154 .....	Y5-3	S426 .....	Y5-38
S204/HJ3 .....	Y5-17	S438 .....	Y5-40
S216 .....	Y5-24	S501 .....	Y5-30
S217 .....	Y5-23	S601 .....	Y5-16

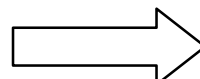
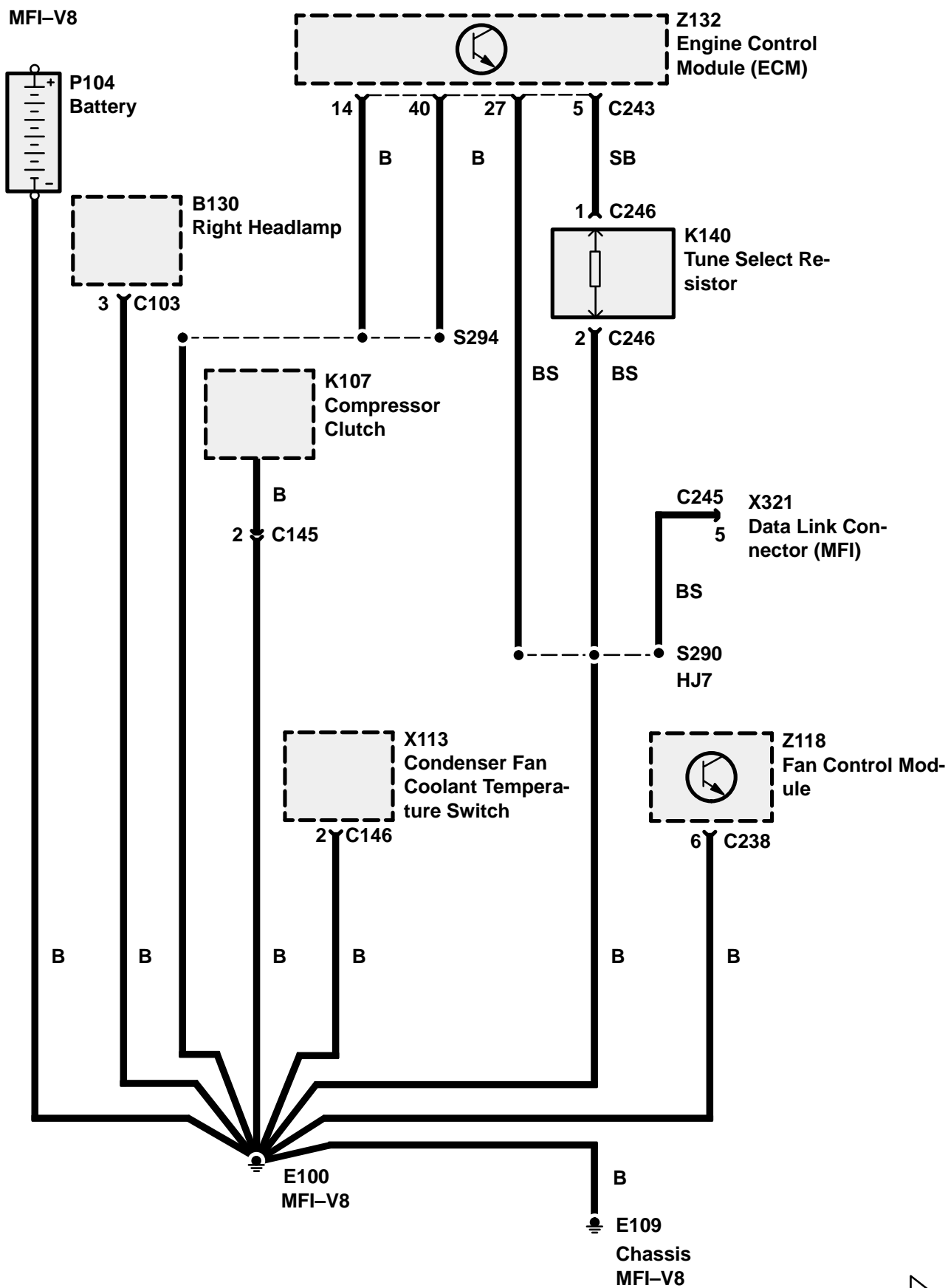

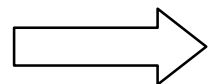
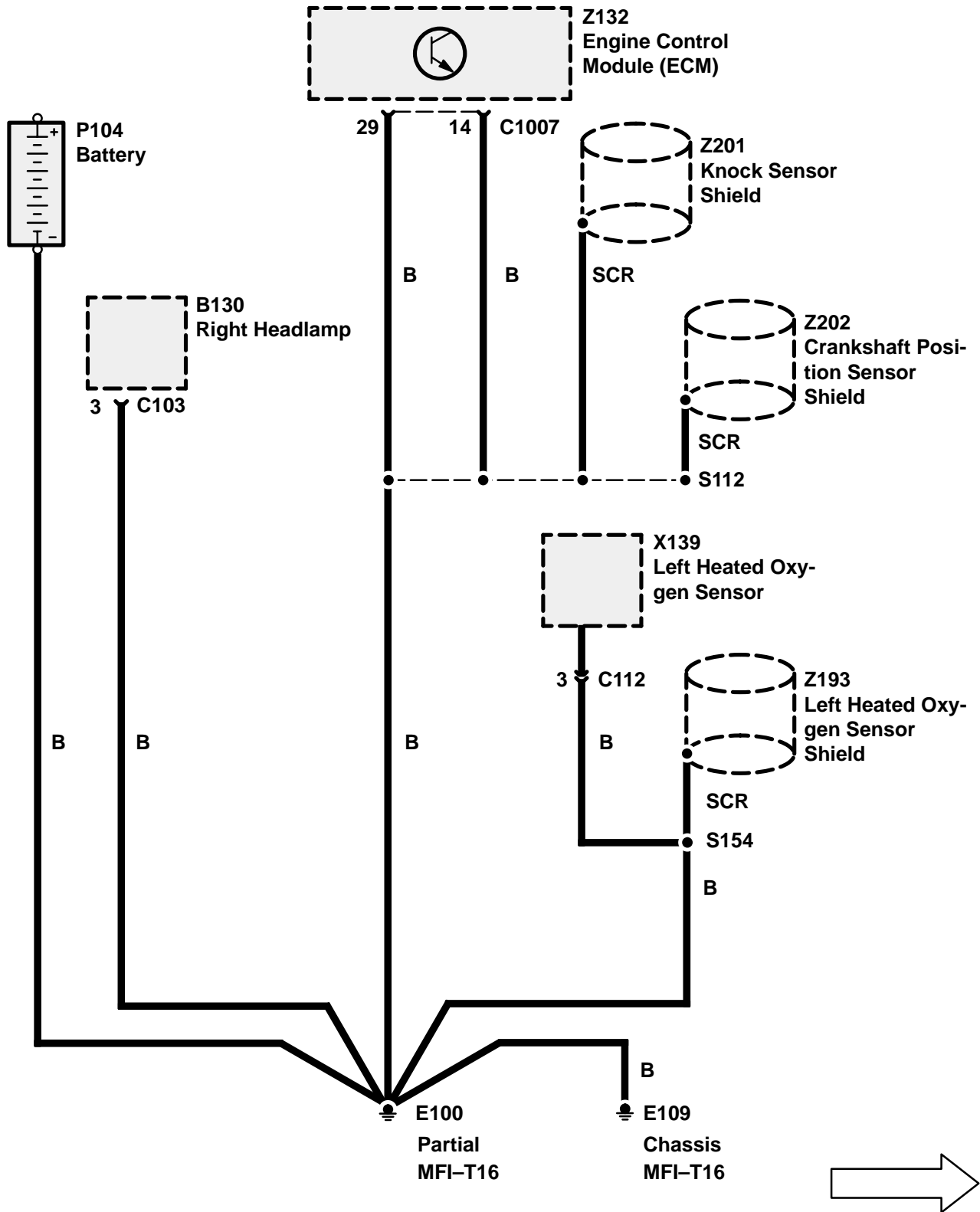
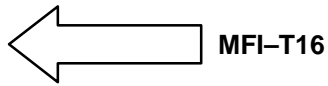

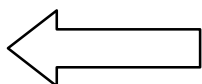

MFI-T16 with Air Conditioning

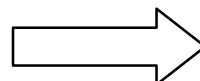
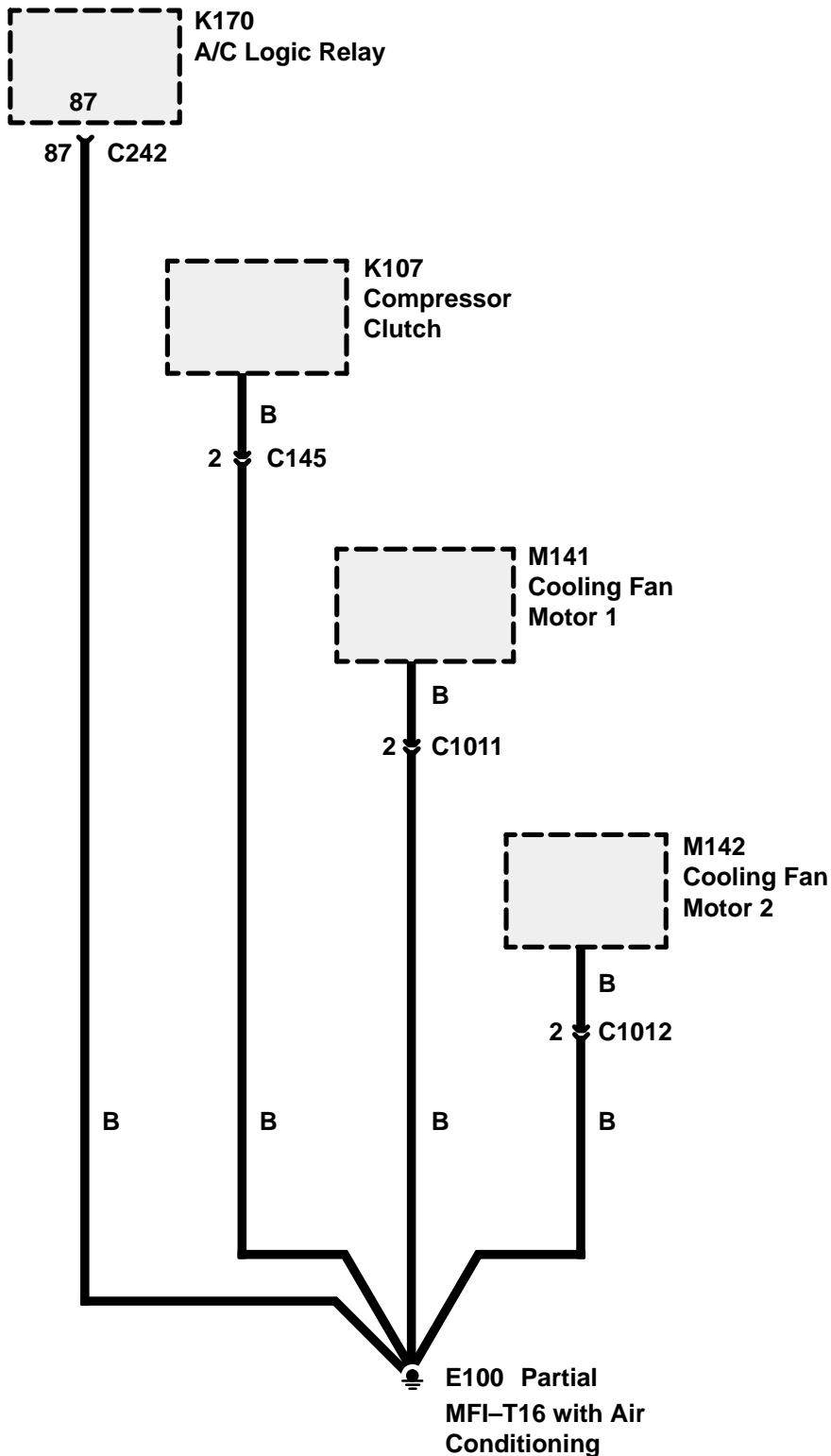

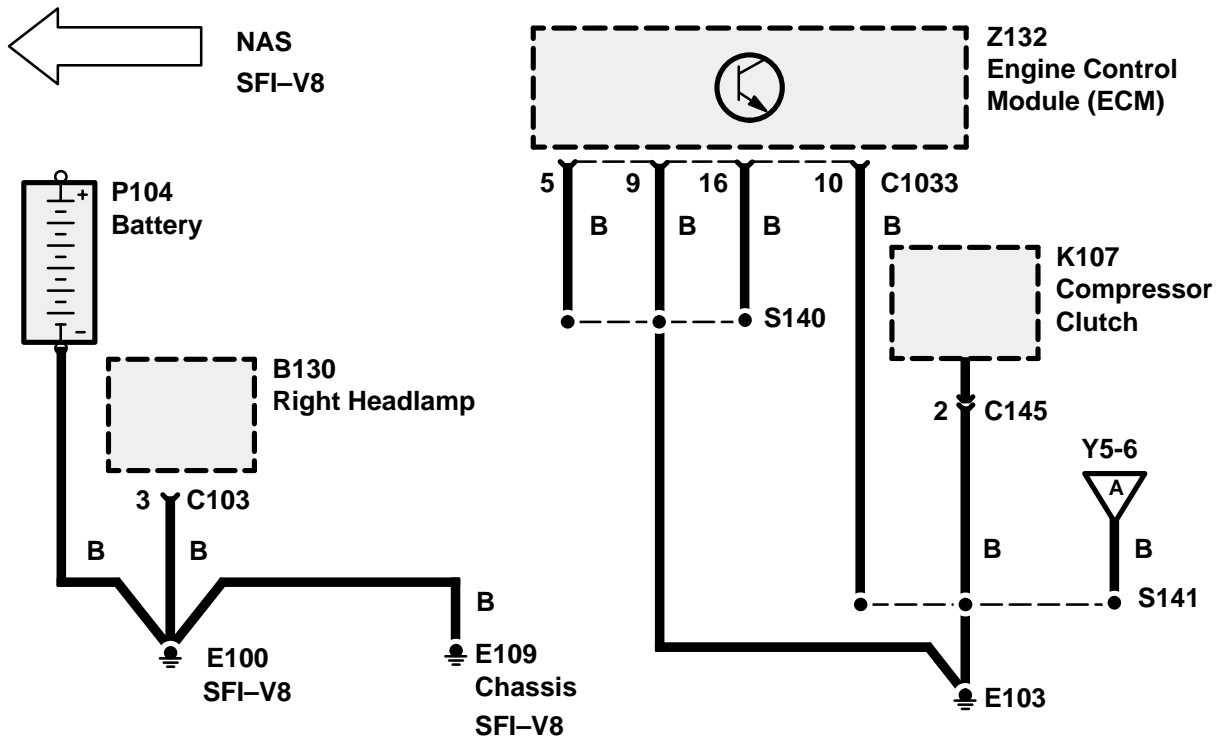

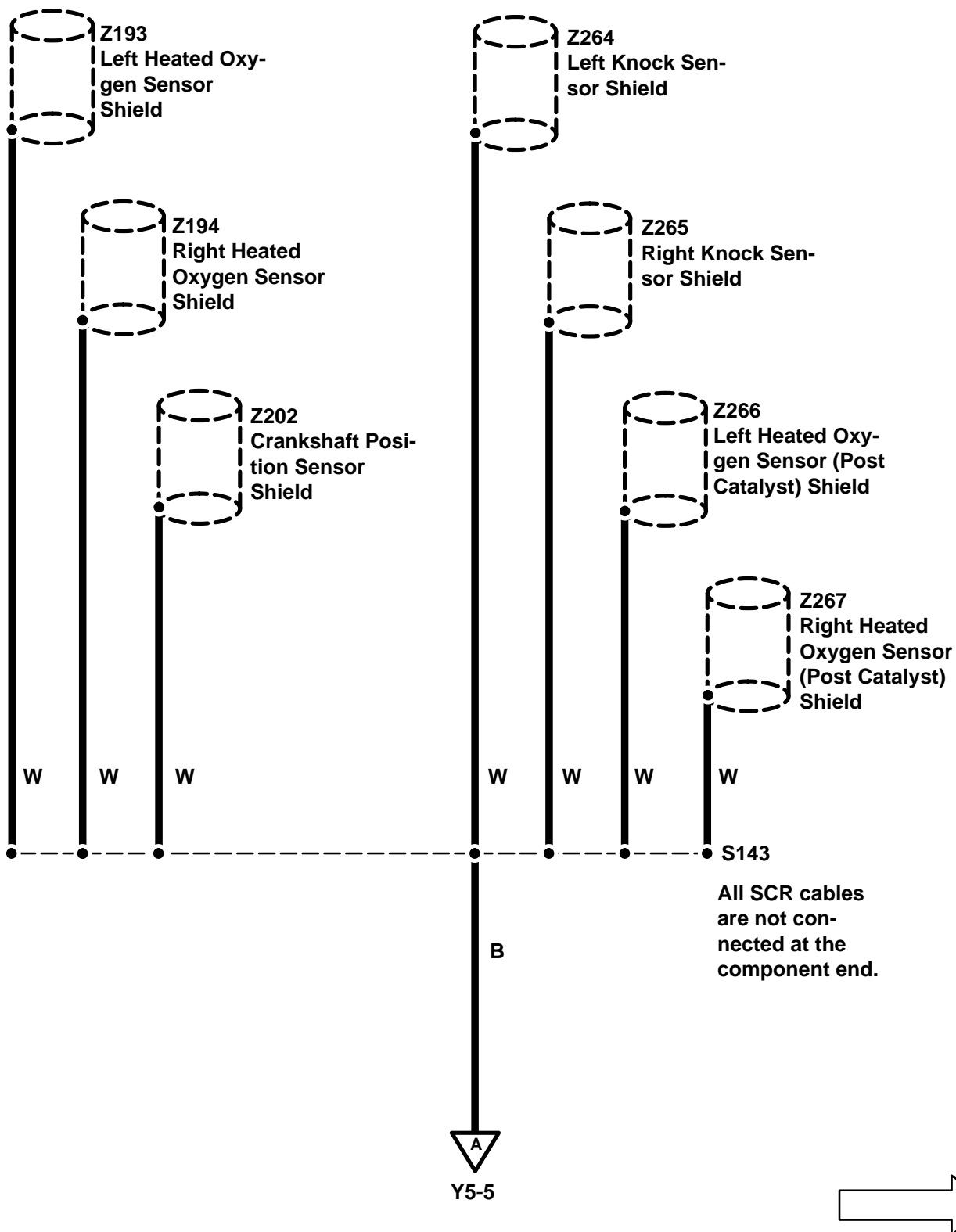
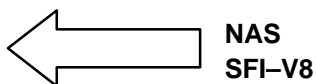



← 300Tdi without EDC

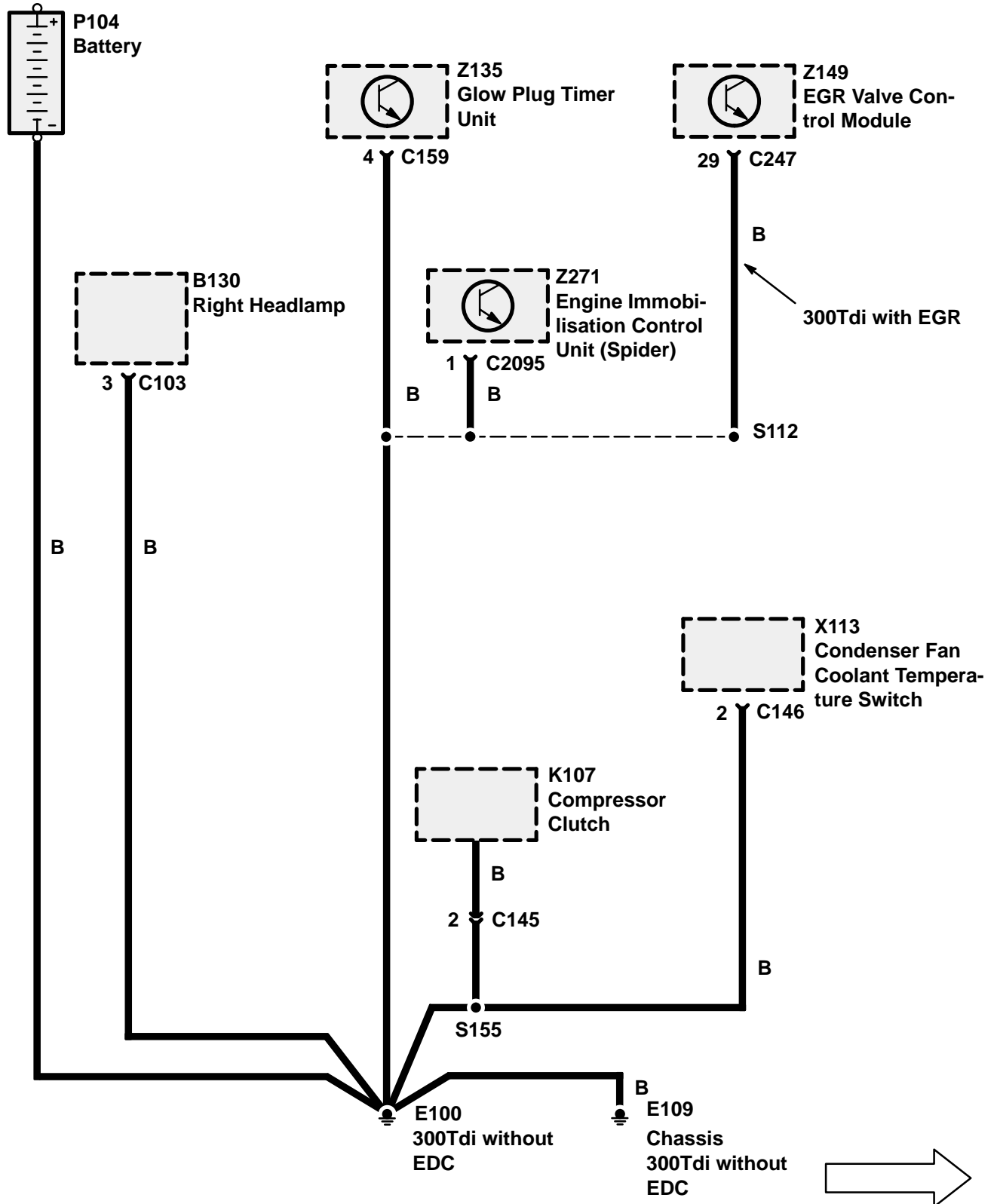

← 300Tdi with EDC

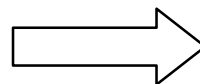
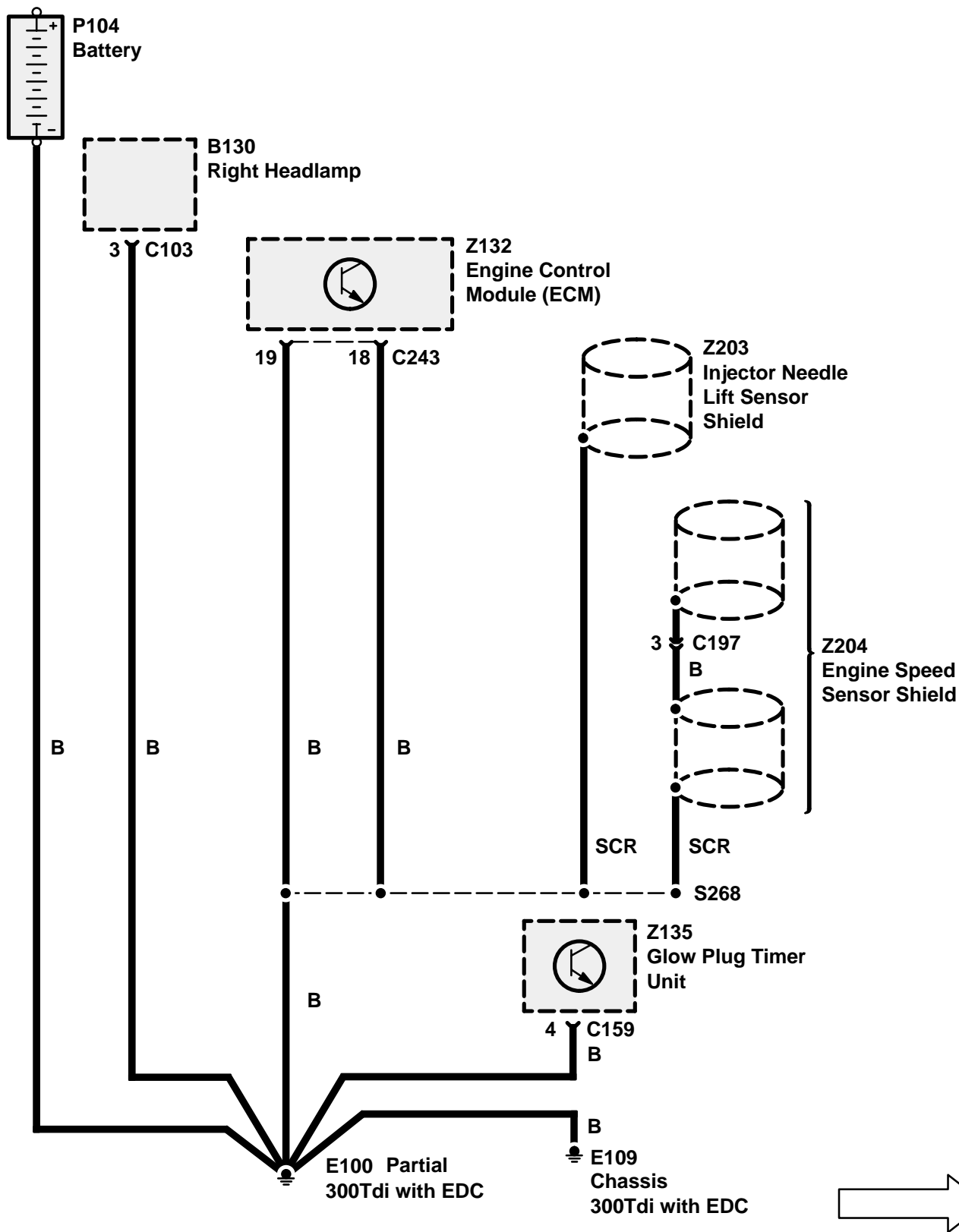

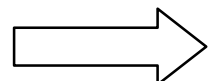
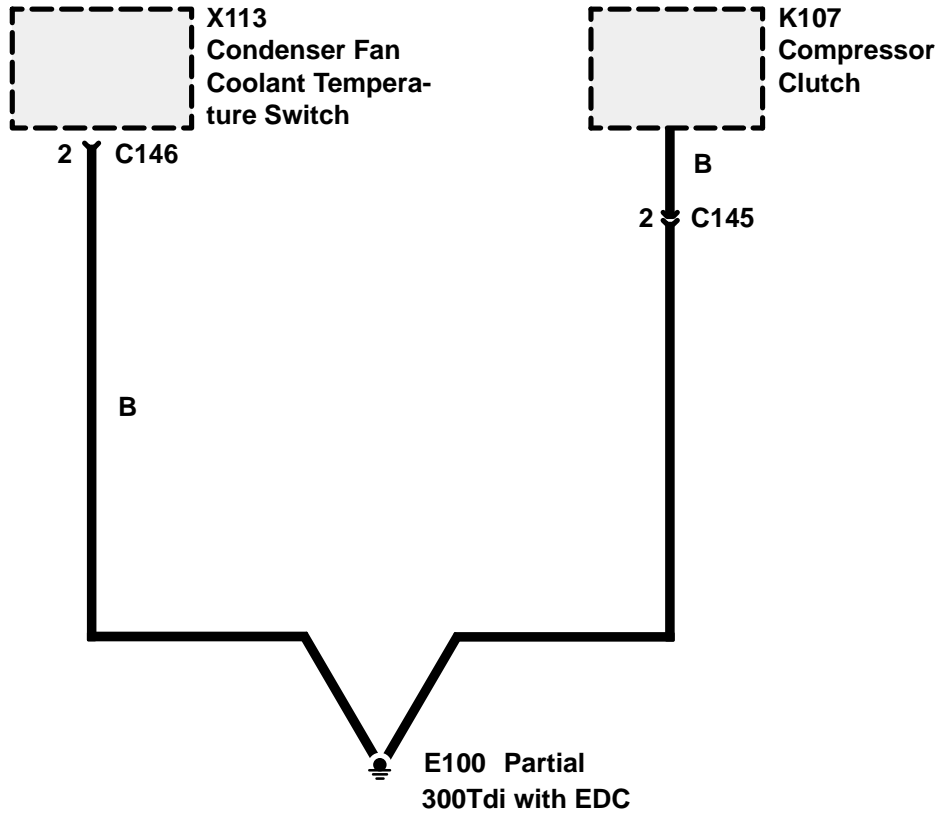

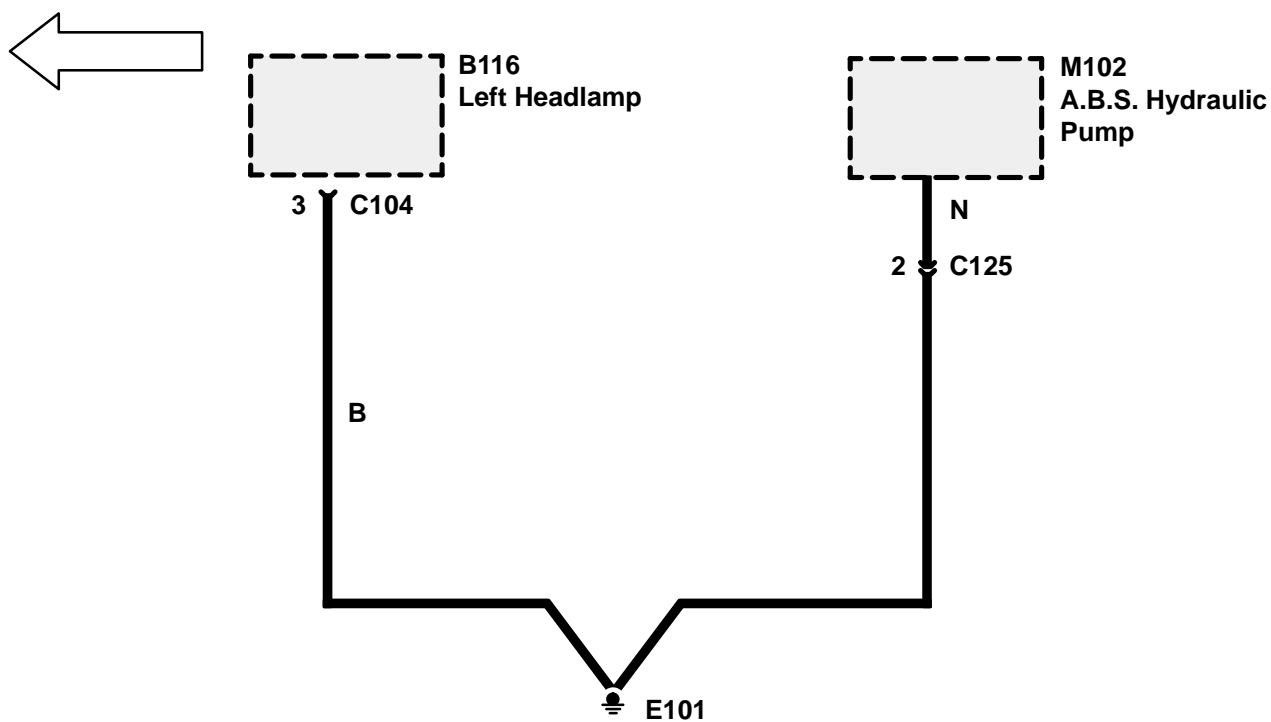

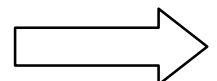
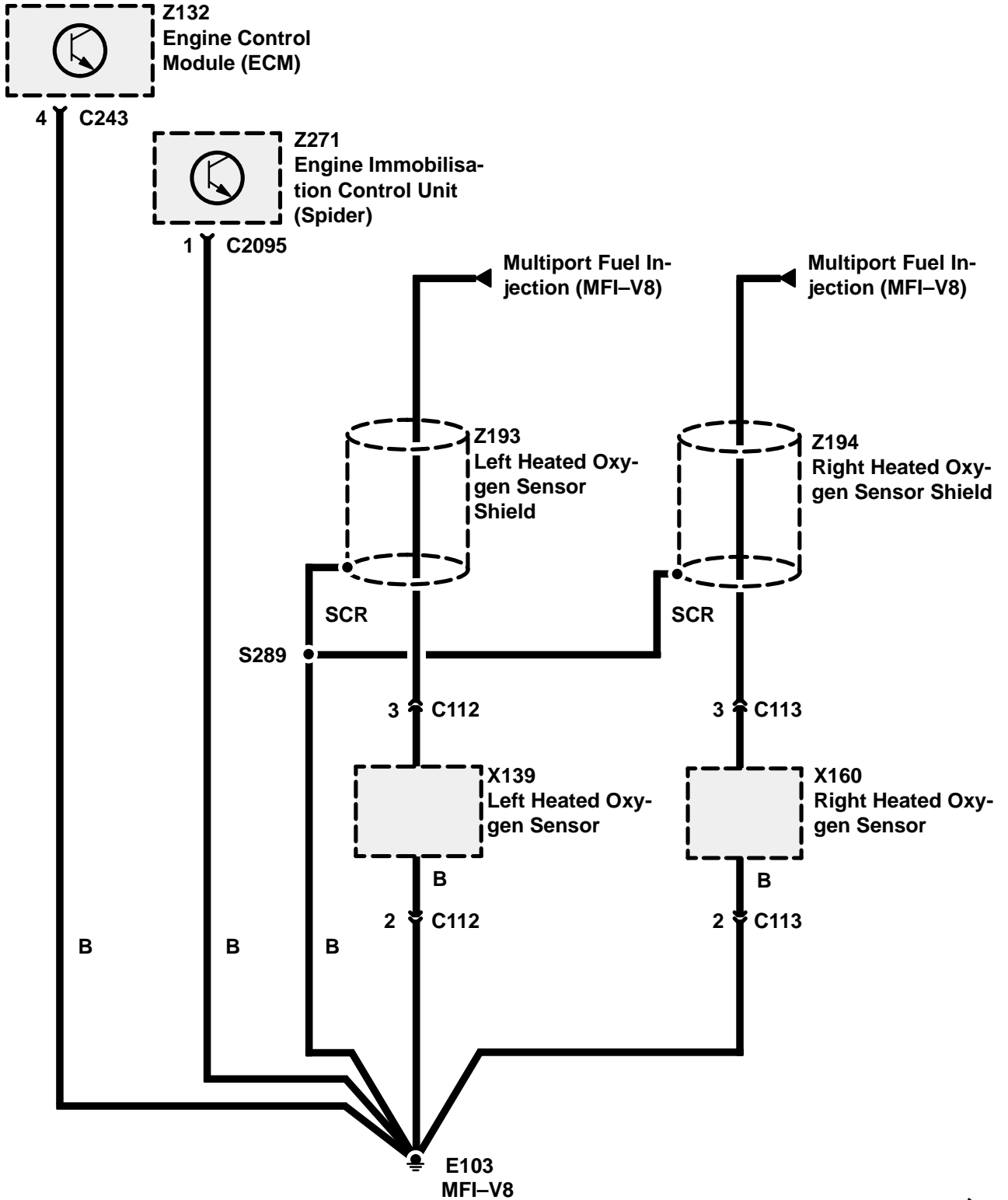
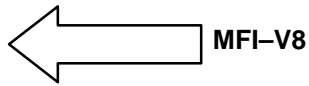

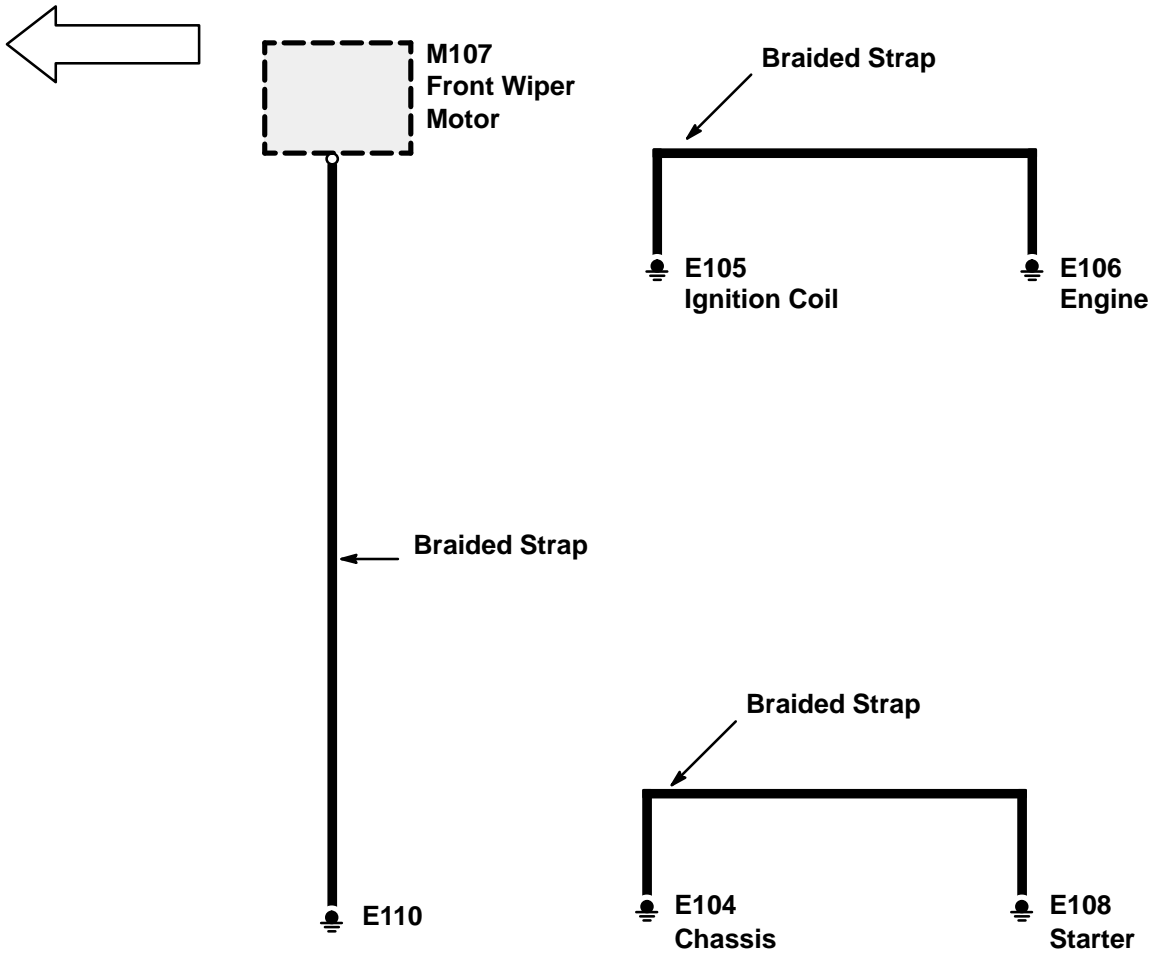

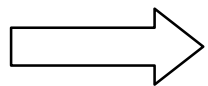
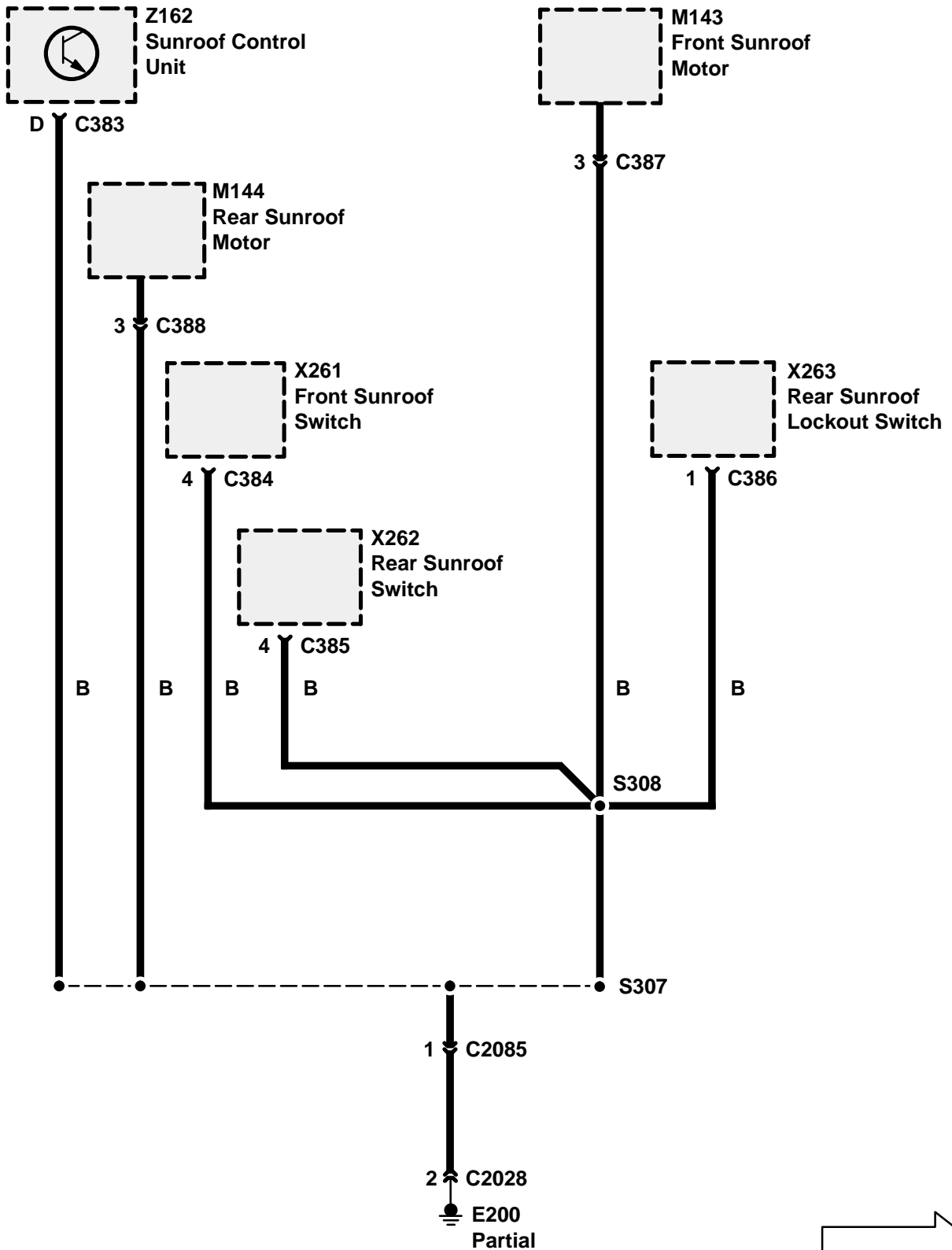
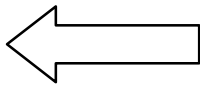

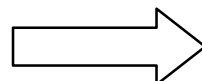
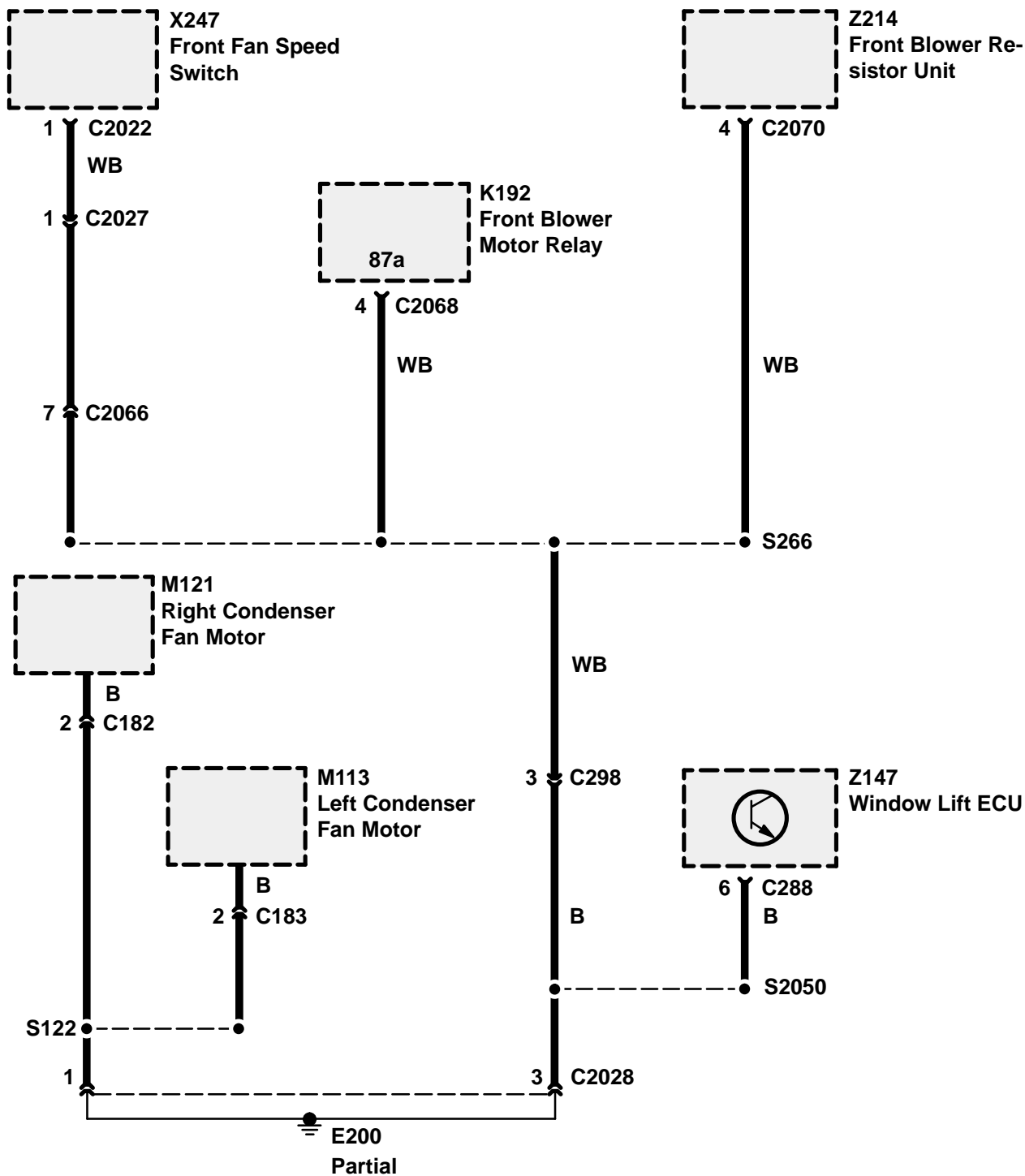
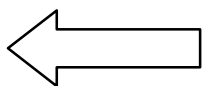



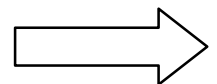
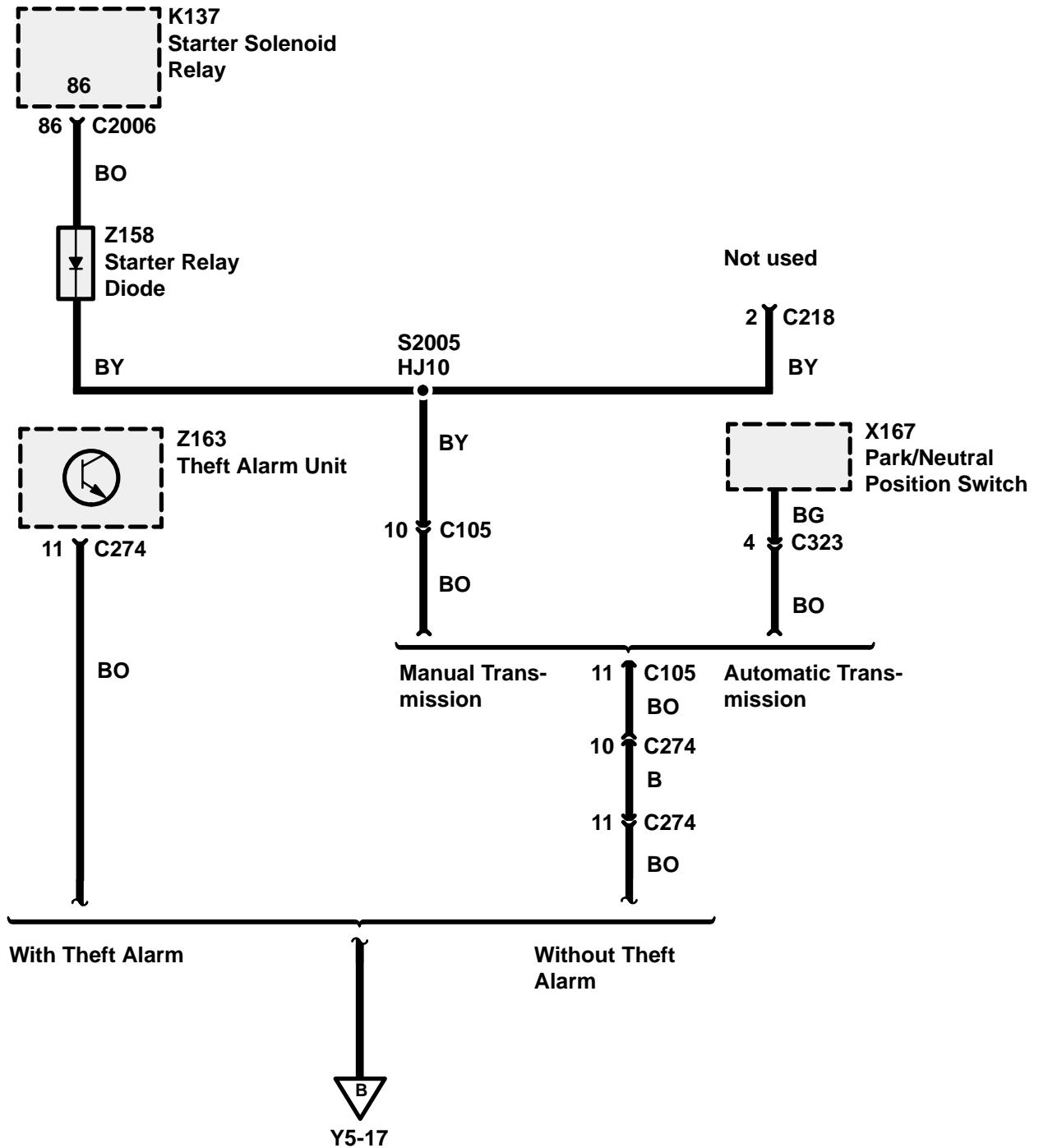
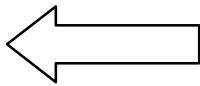

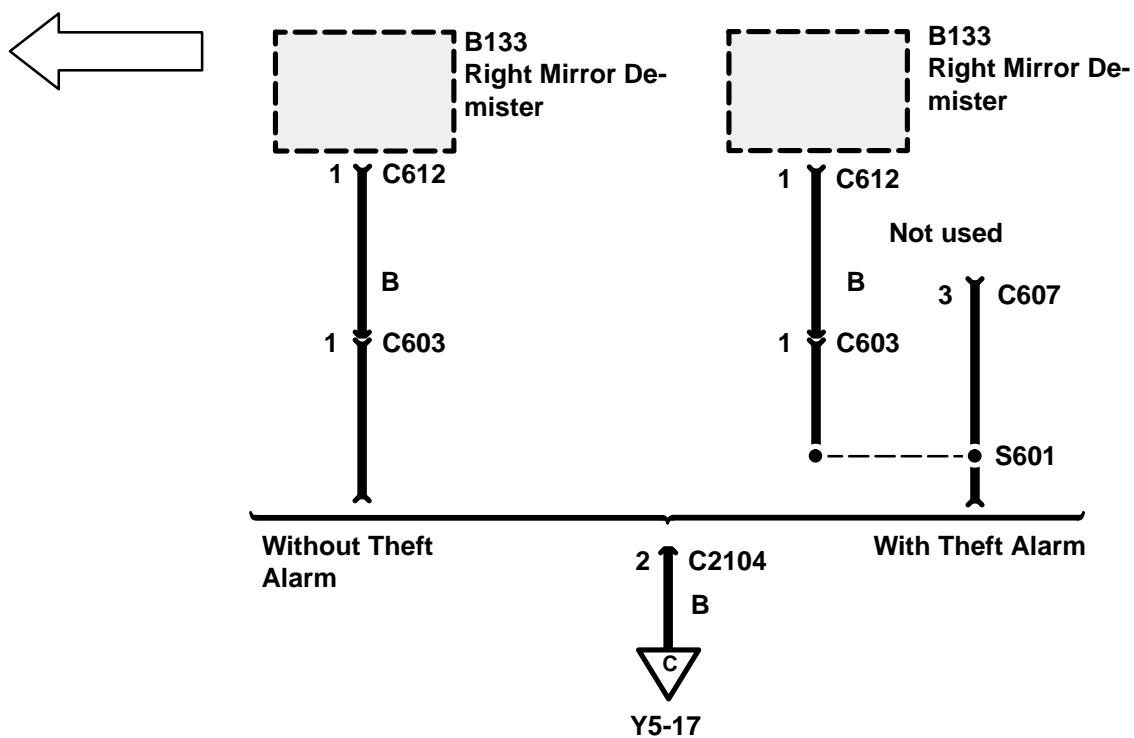

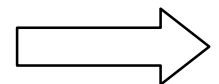
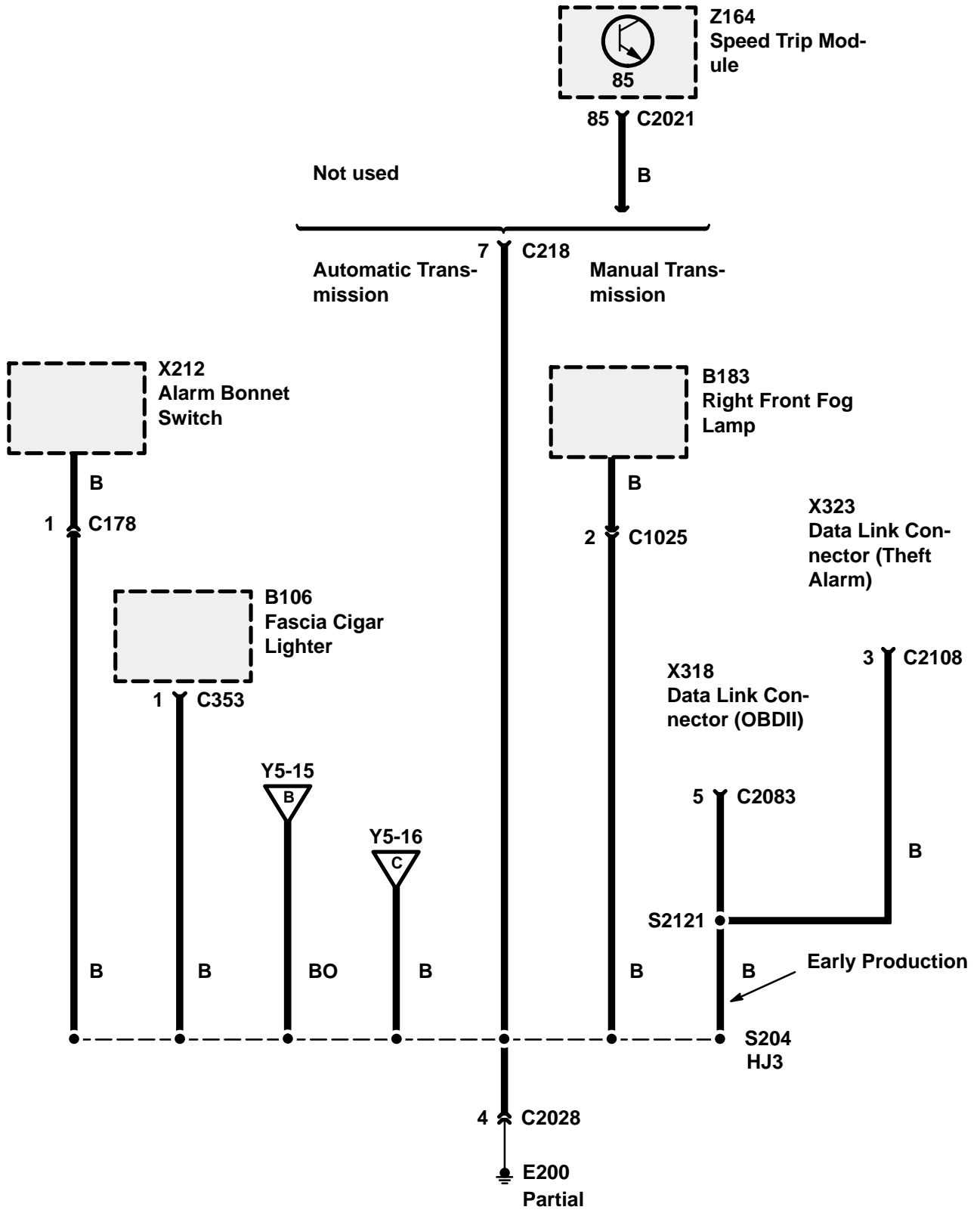
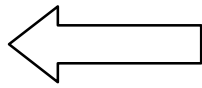

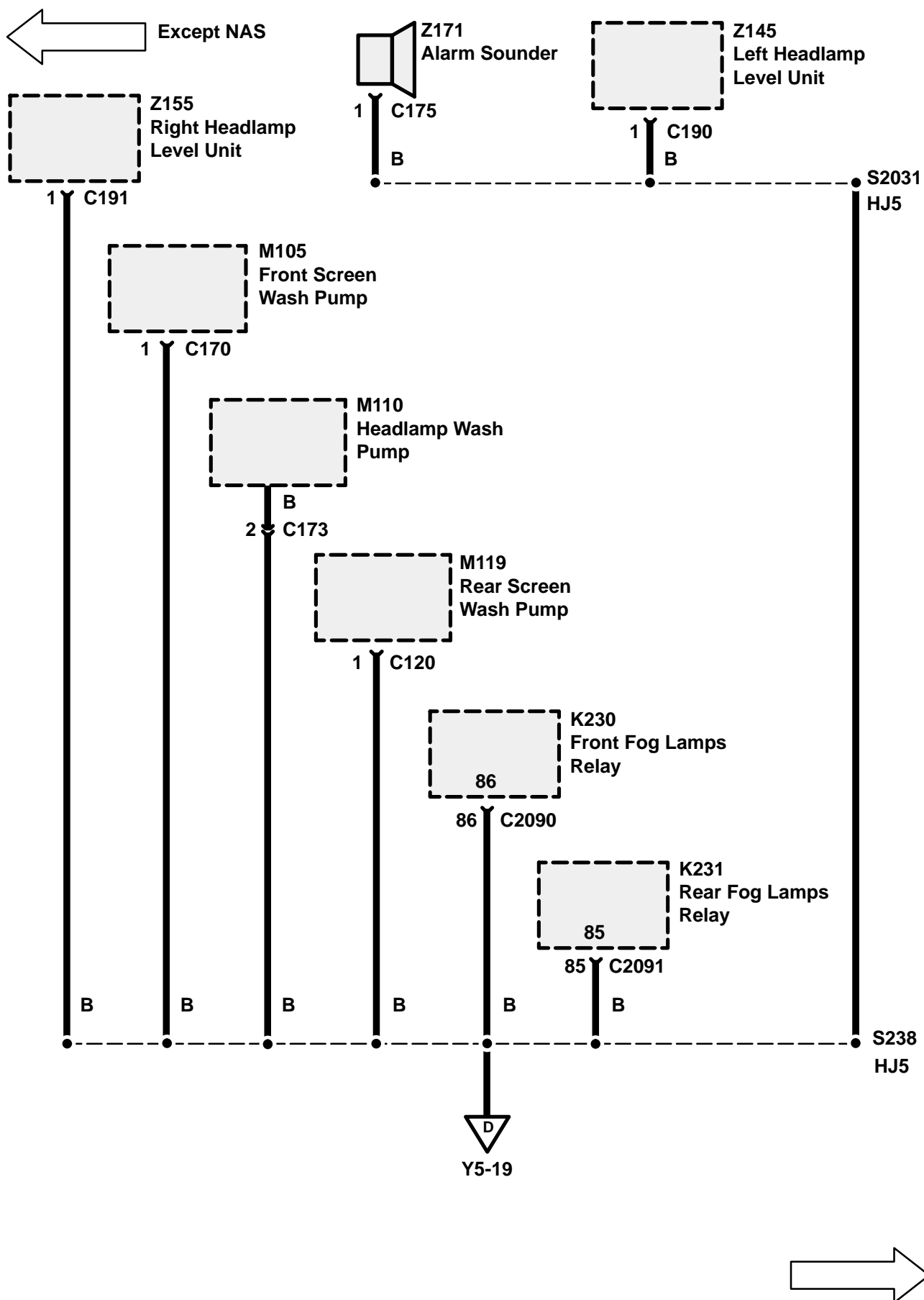

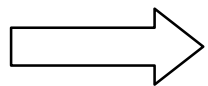
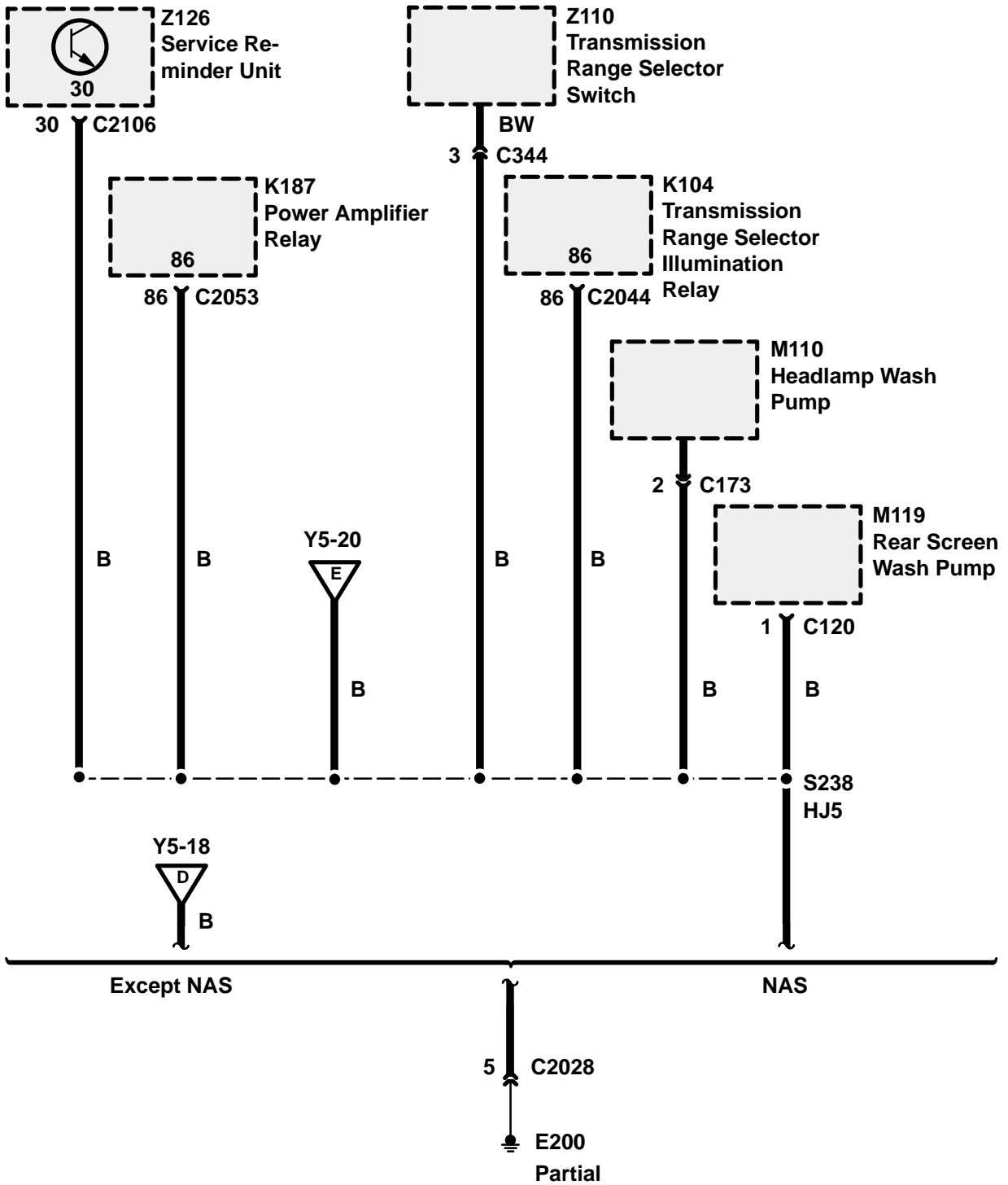
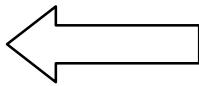

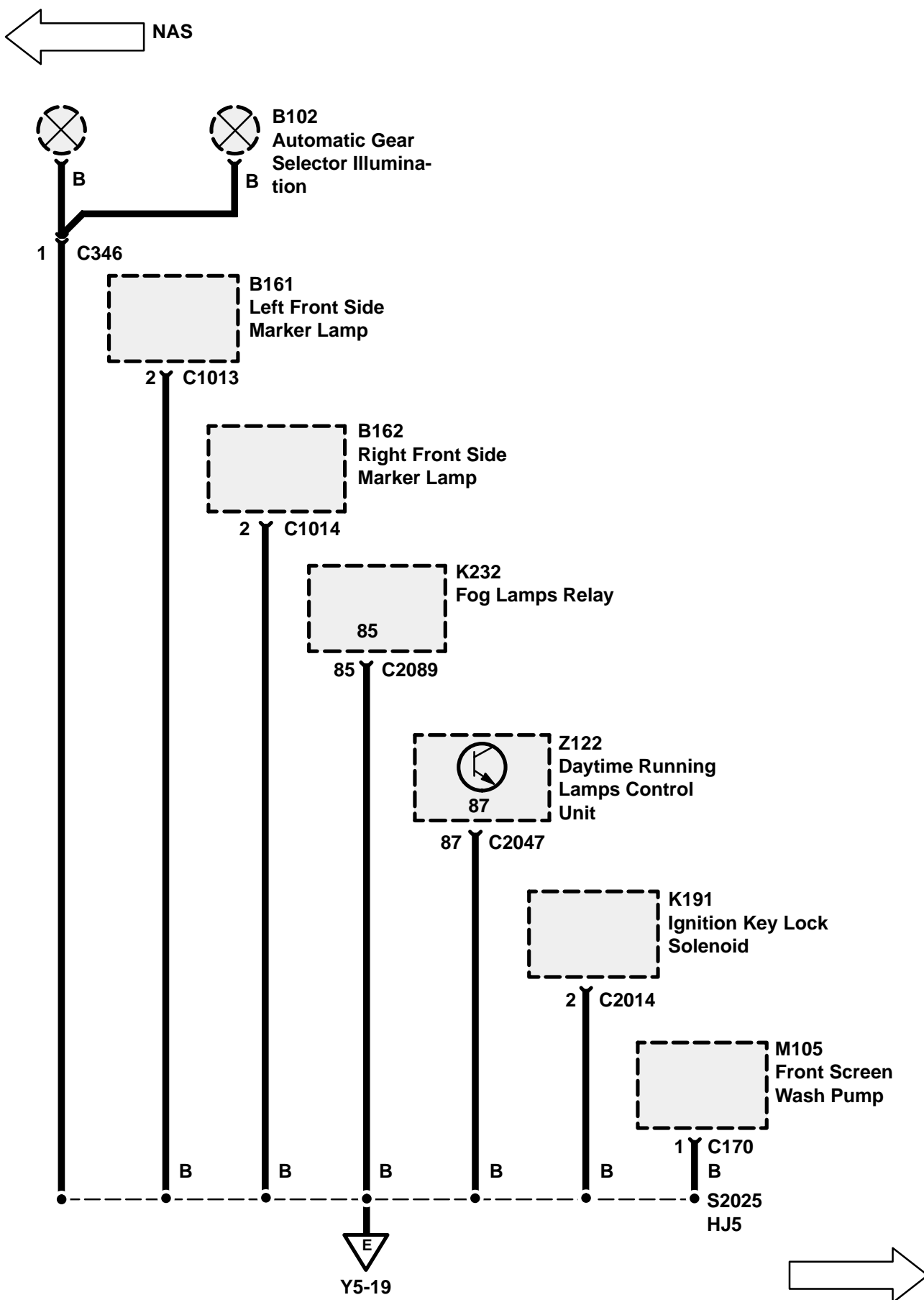

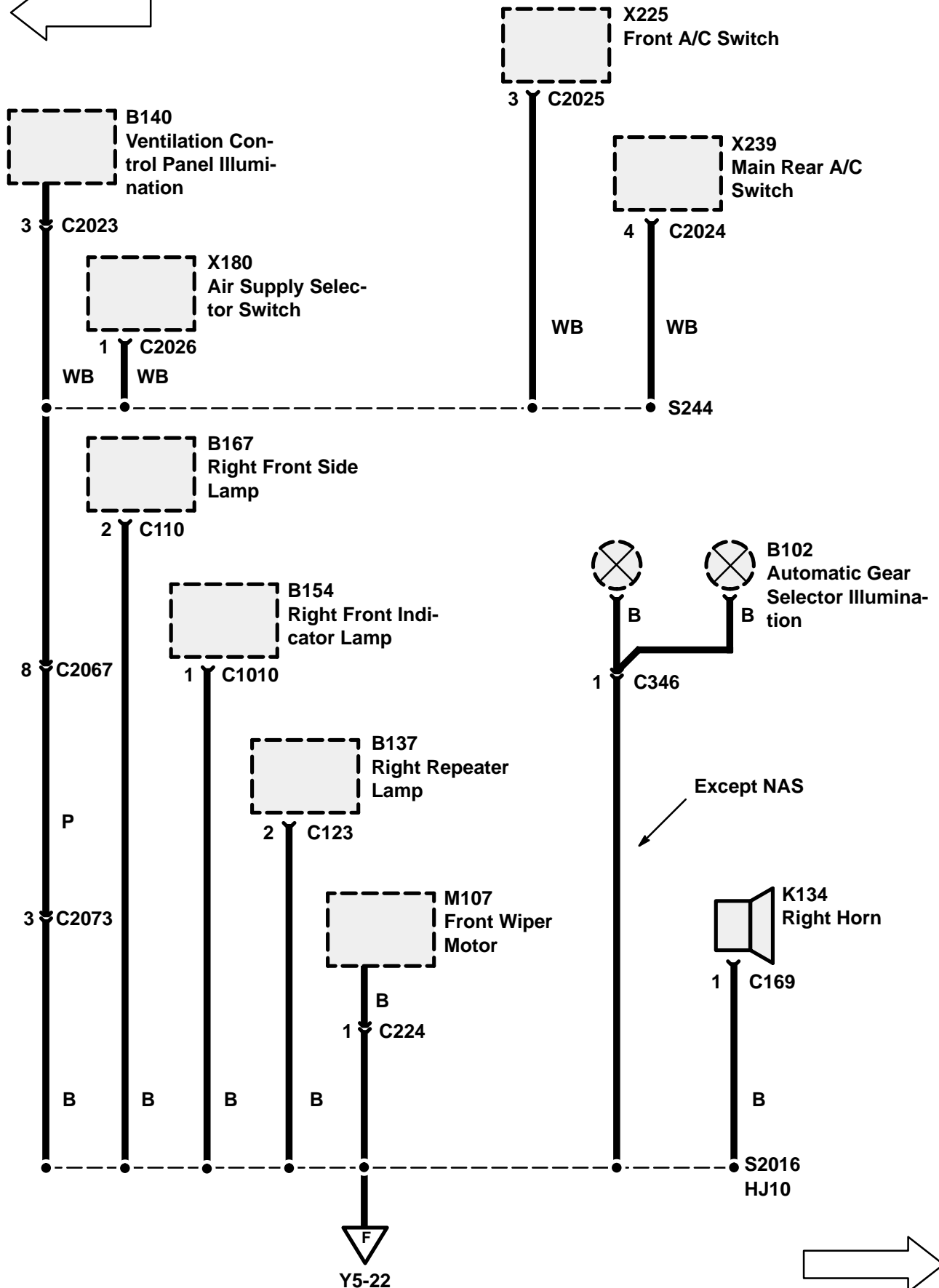
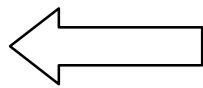

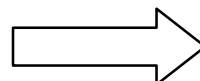
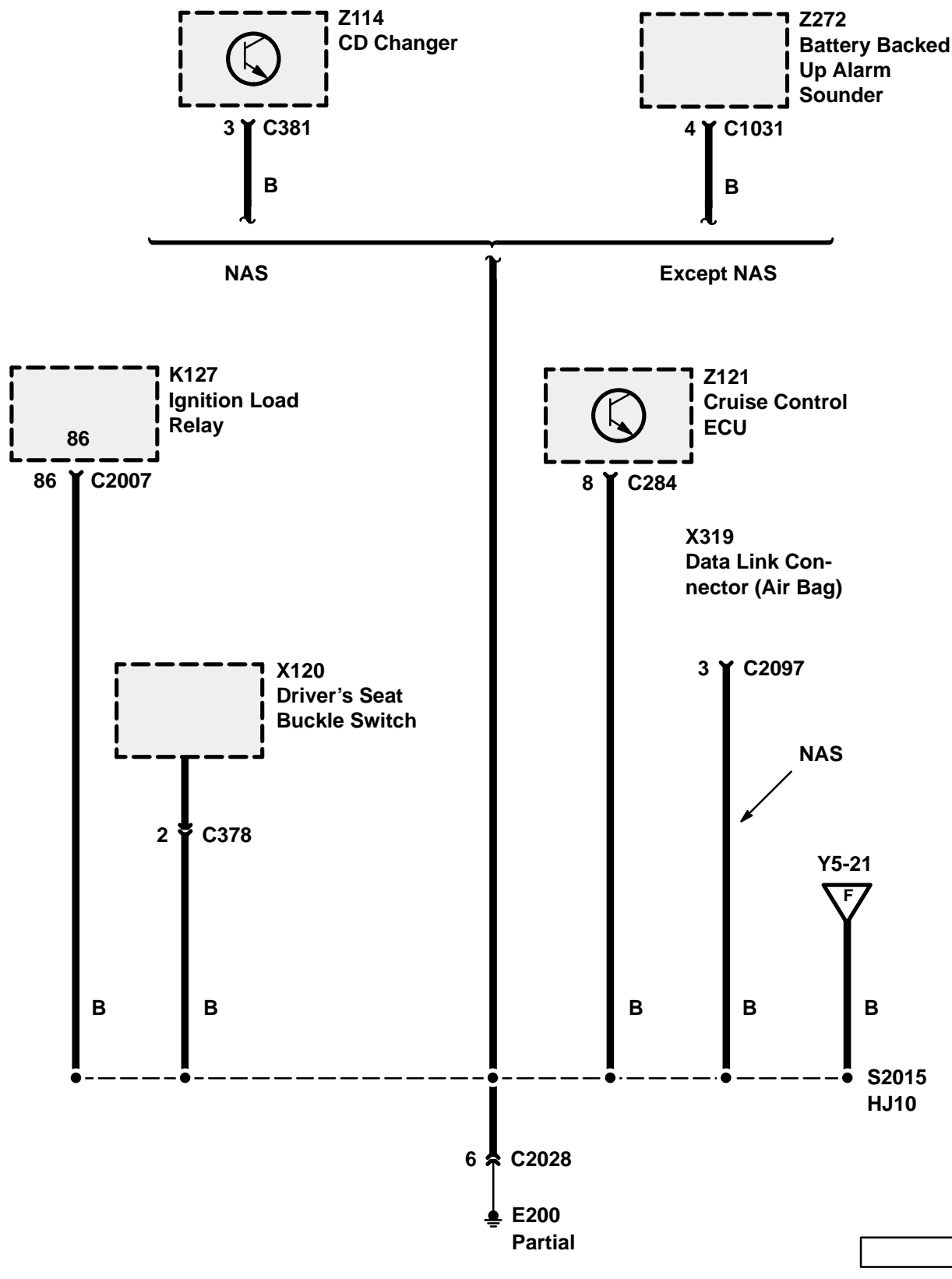
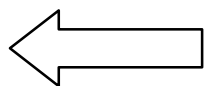



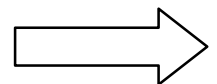
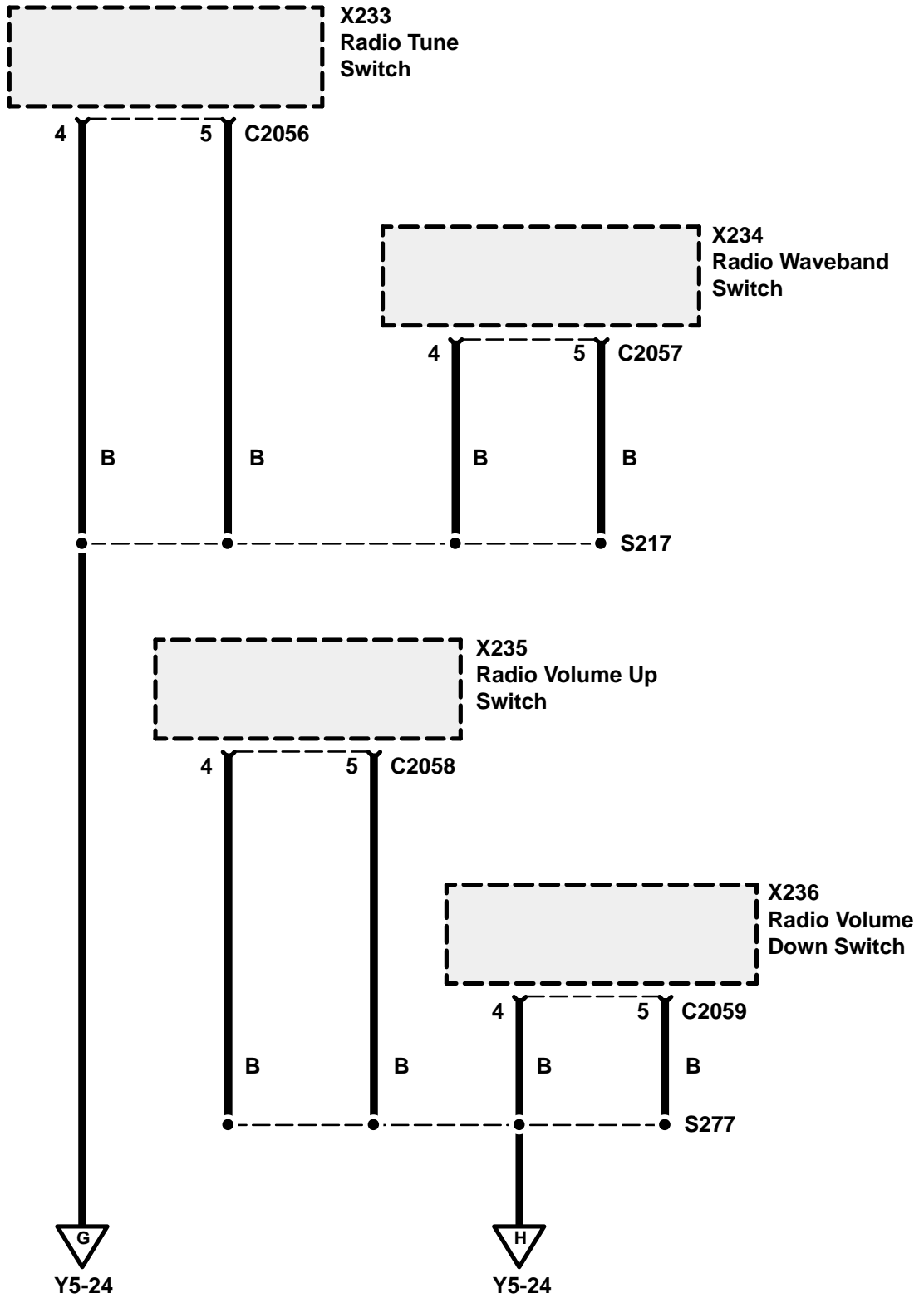
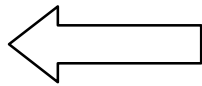

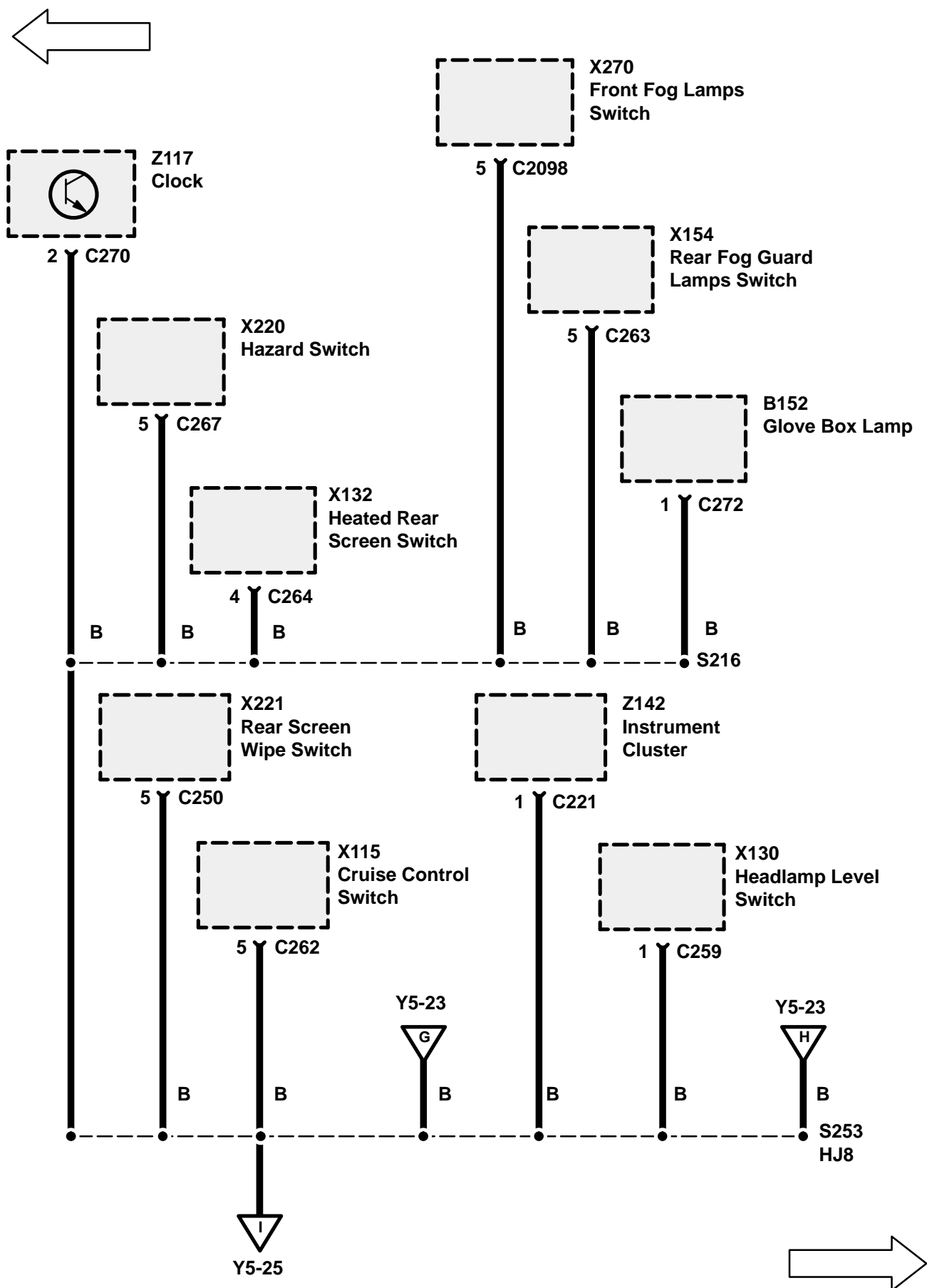

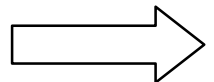
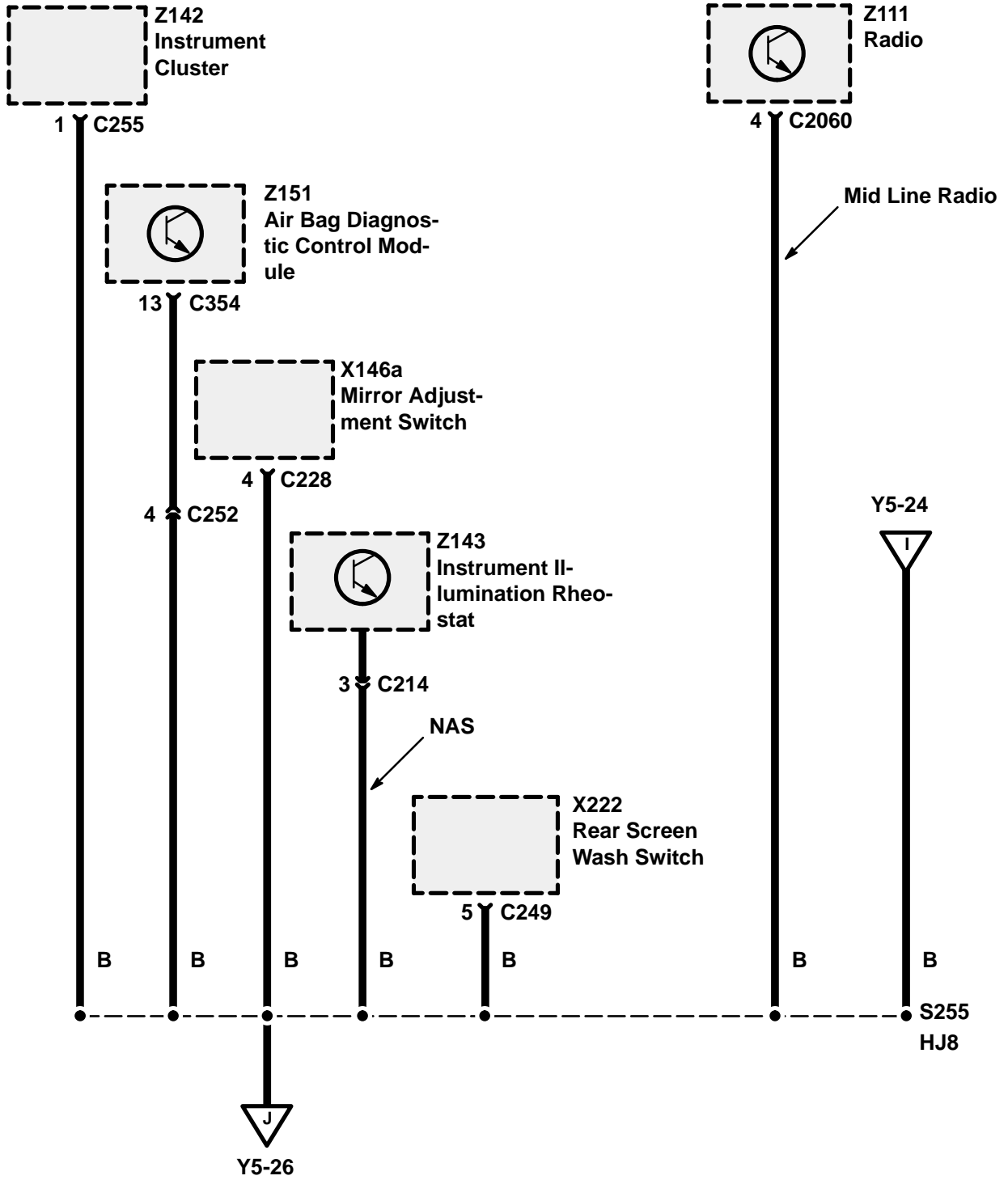
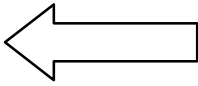

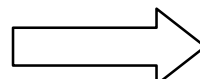
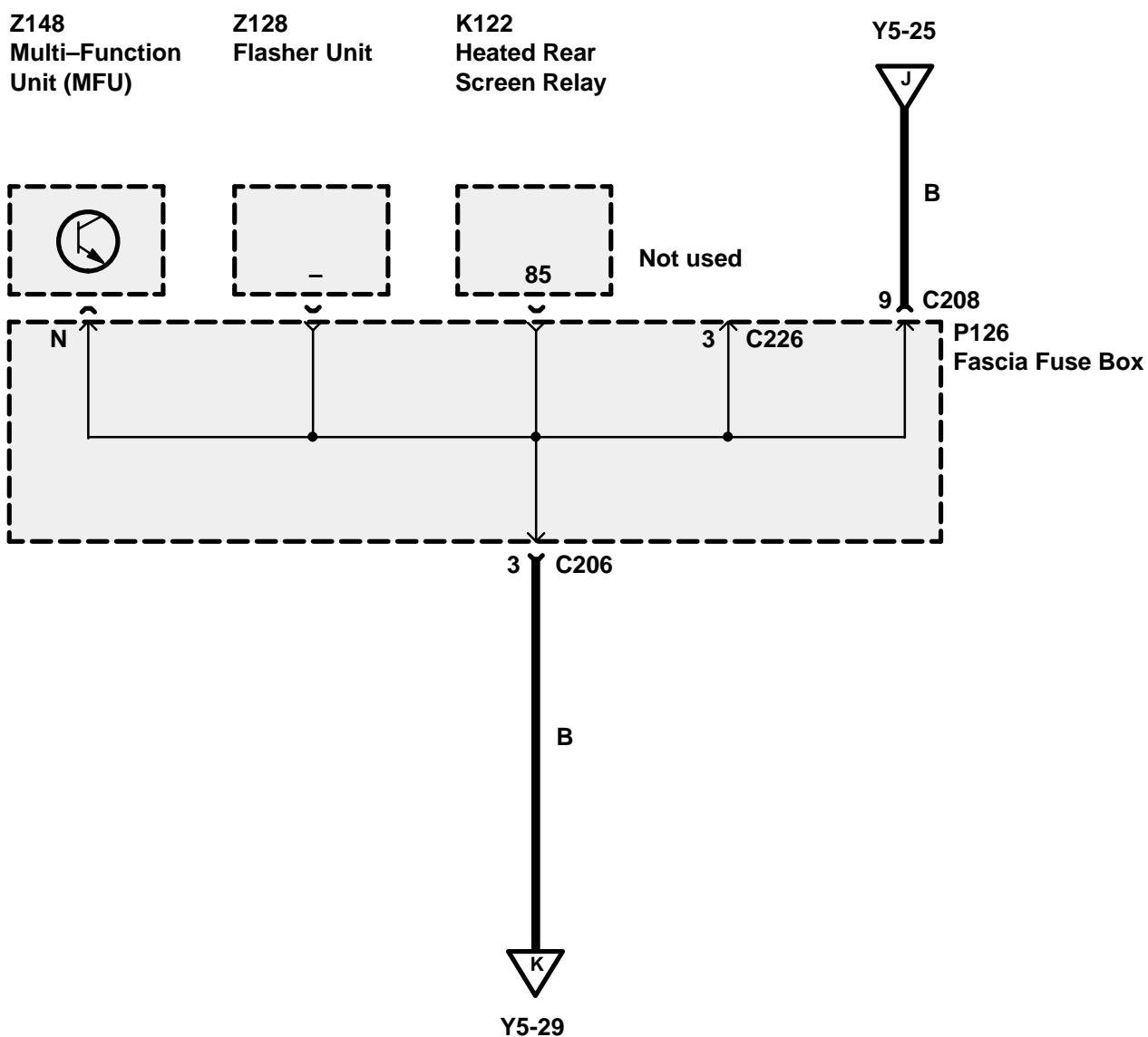
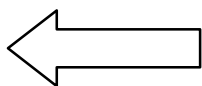

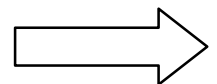
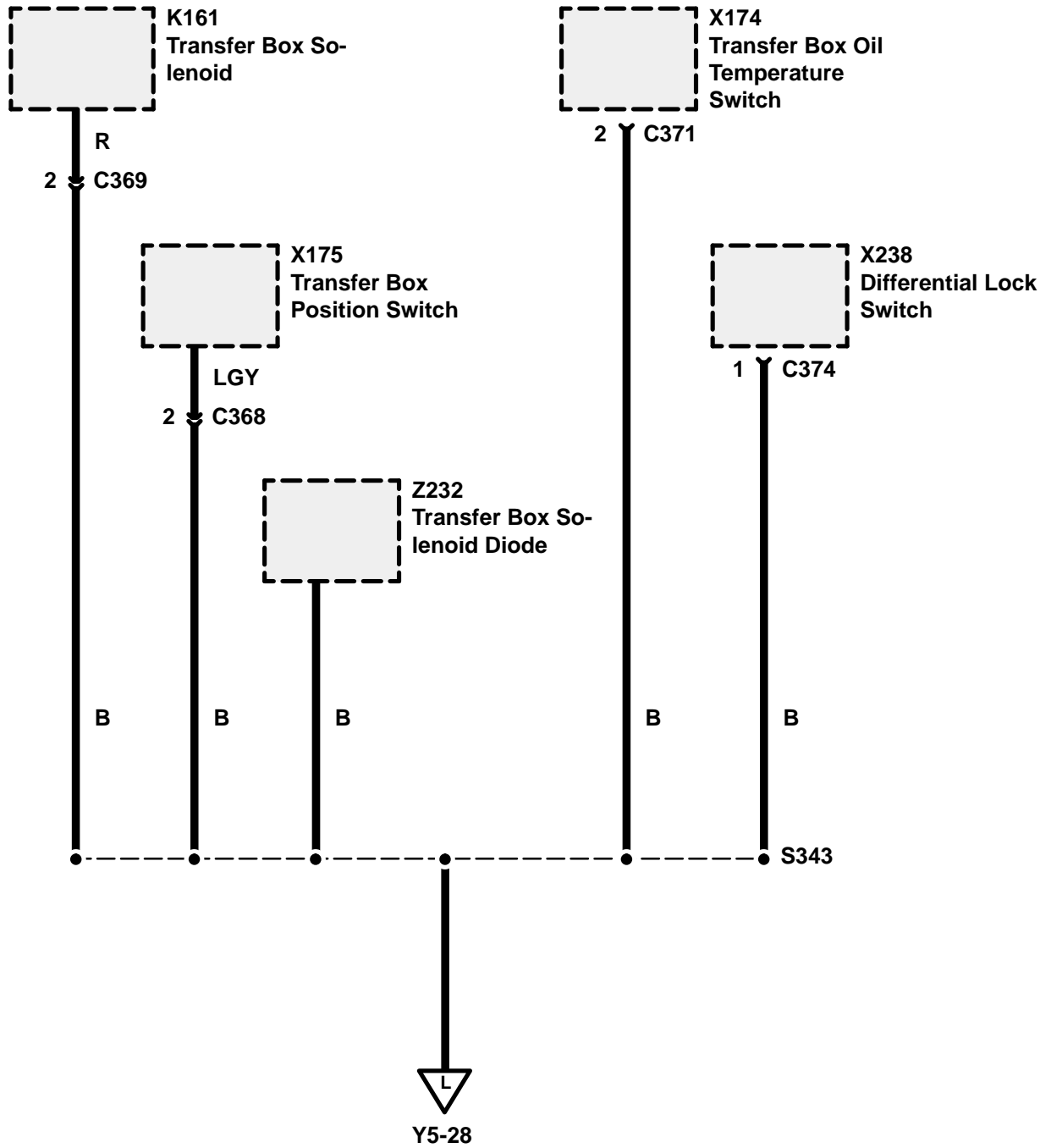

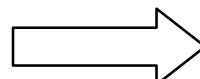
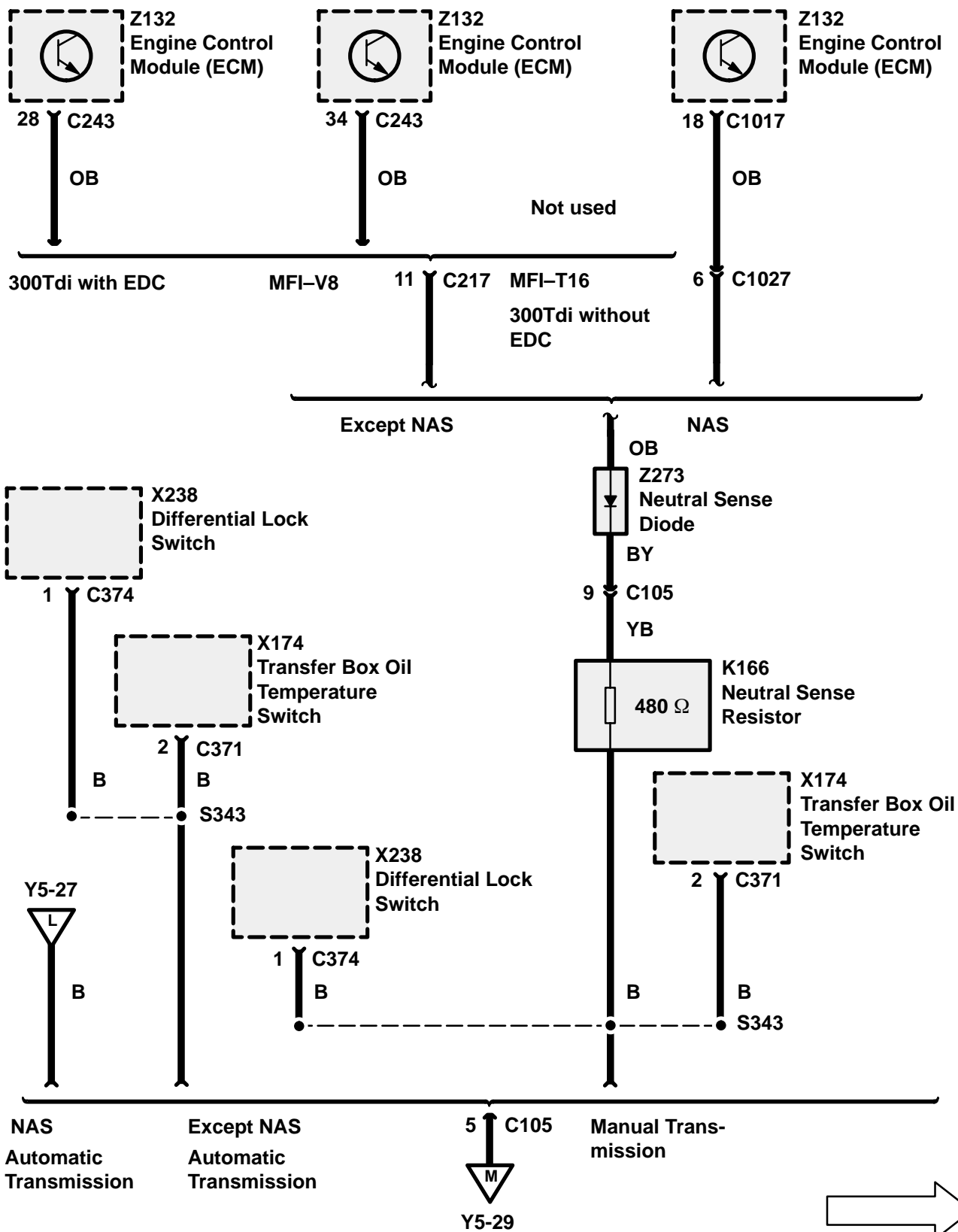
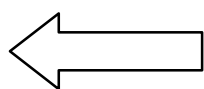

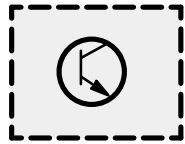
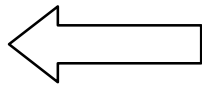

Z148  
Multi-Function  
Unit (MFU)

6 C205

K183  
Rear Wiper Relay

87a

87a C281

B184  
Left Front Fog  
Lamp

2 C1024

S2044  
HJ11

K174  
Accessory Relay

86

86 C282

K128  
Left Horn

1 C168

B166  
Left Front Side  
Lamp

2 C109

X111  
Brake Fluid Level  
Switch

2 C127

Y5-26



Y5-28



S288  
HJ11



Y5-30

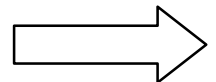

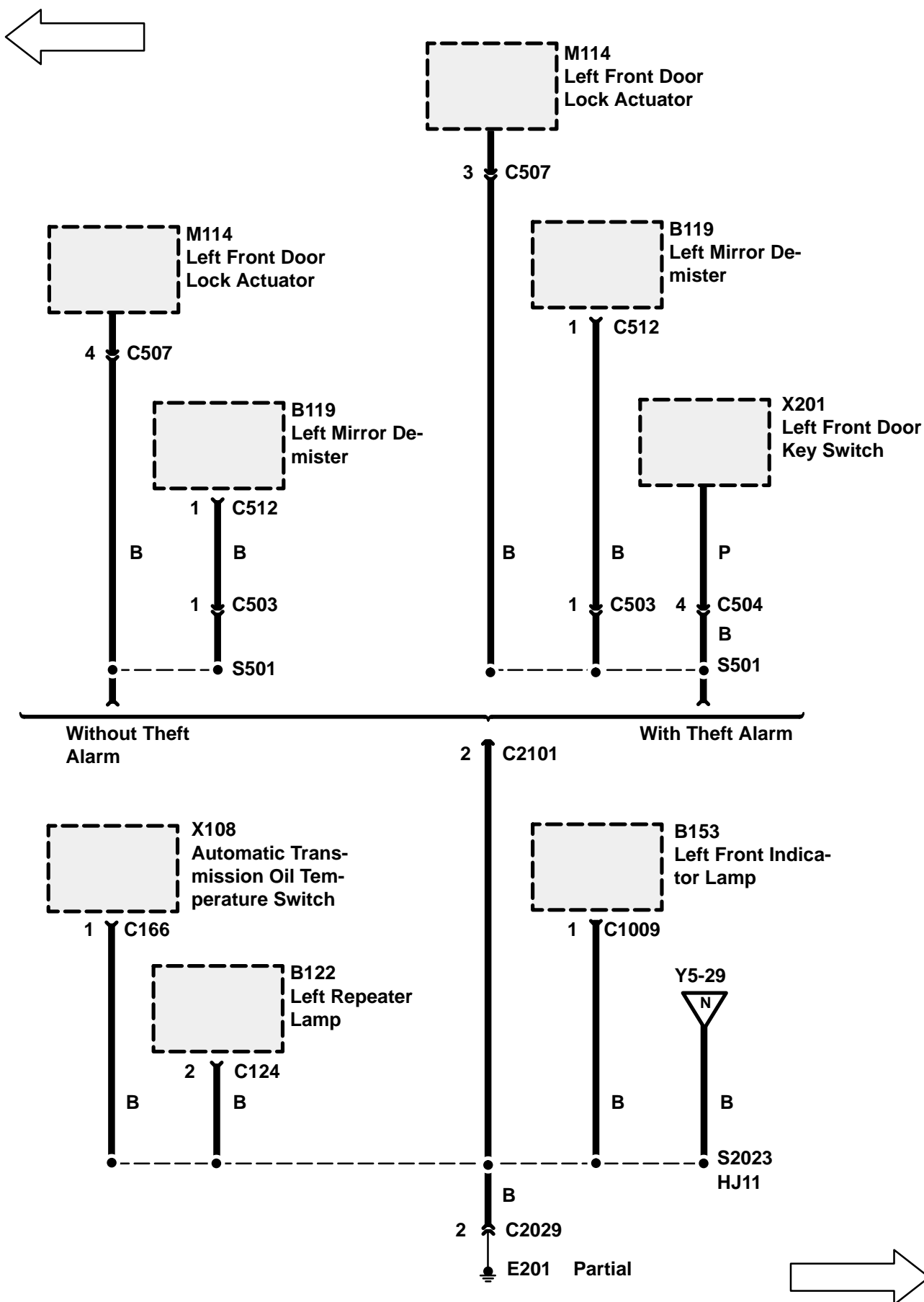



← Except NAS

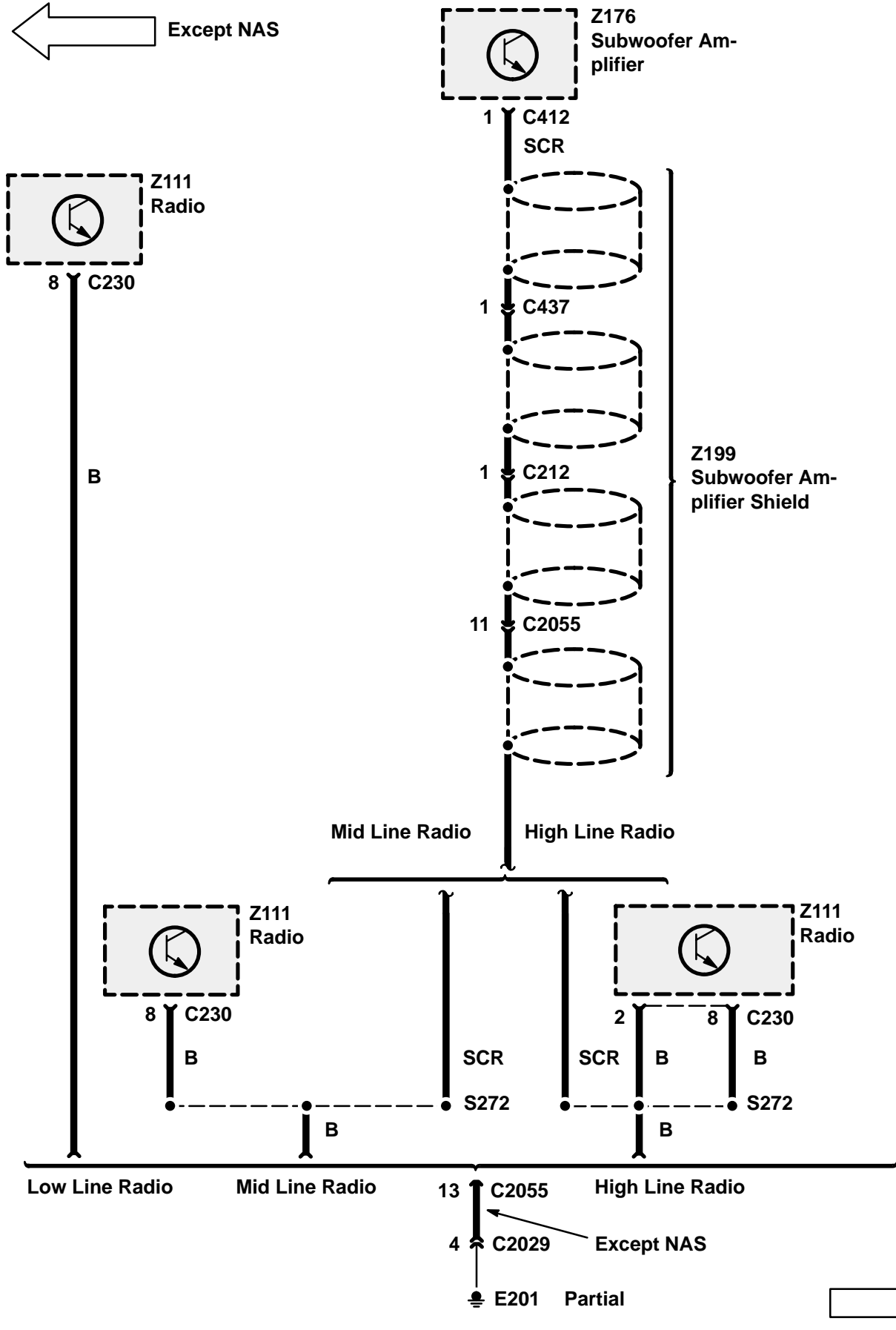

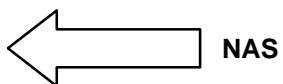

X318  
Data Link Con-  
nector (OBDII)

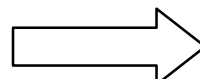
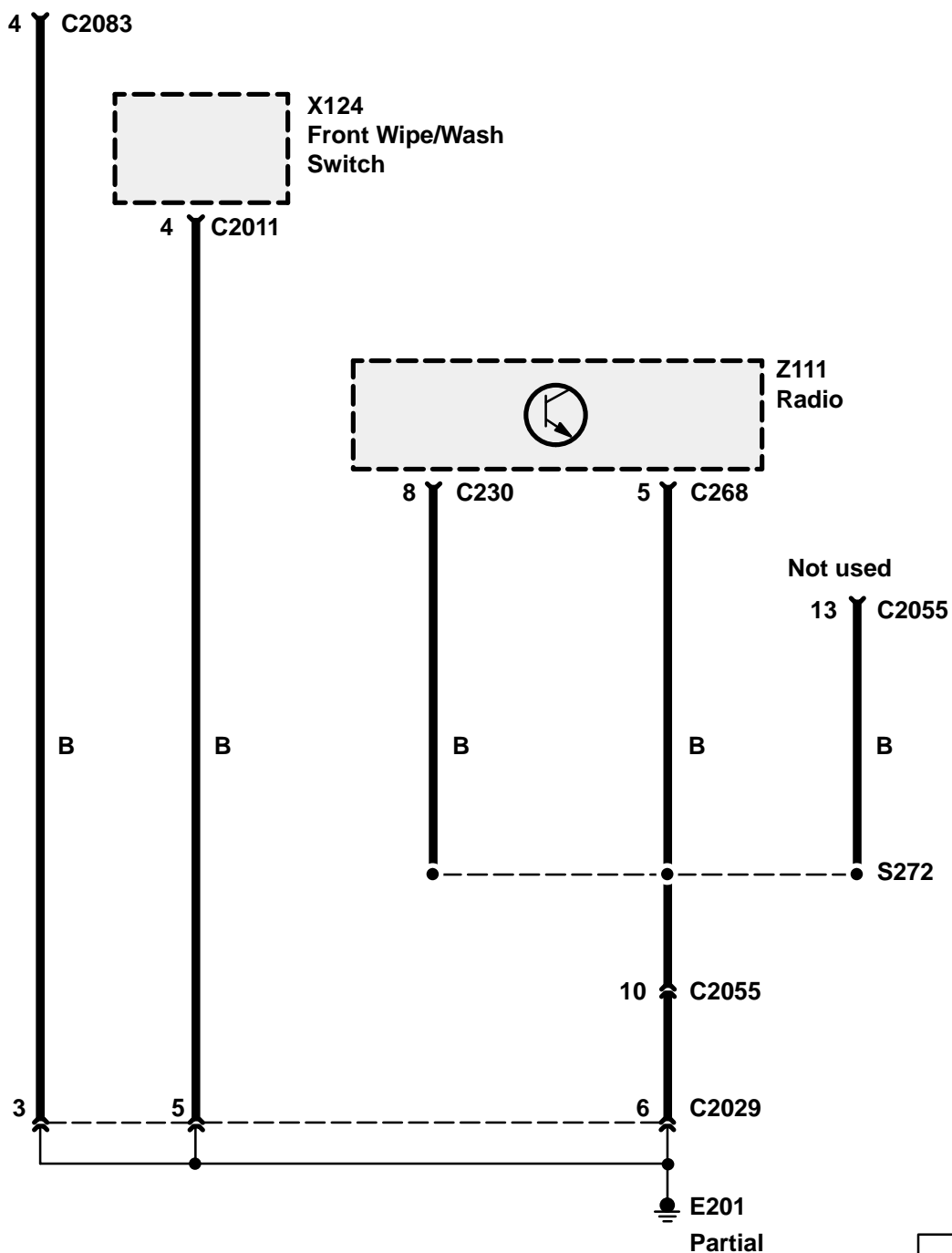

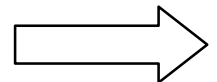
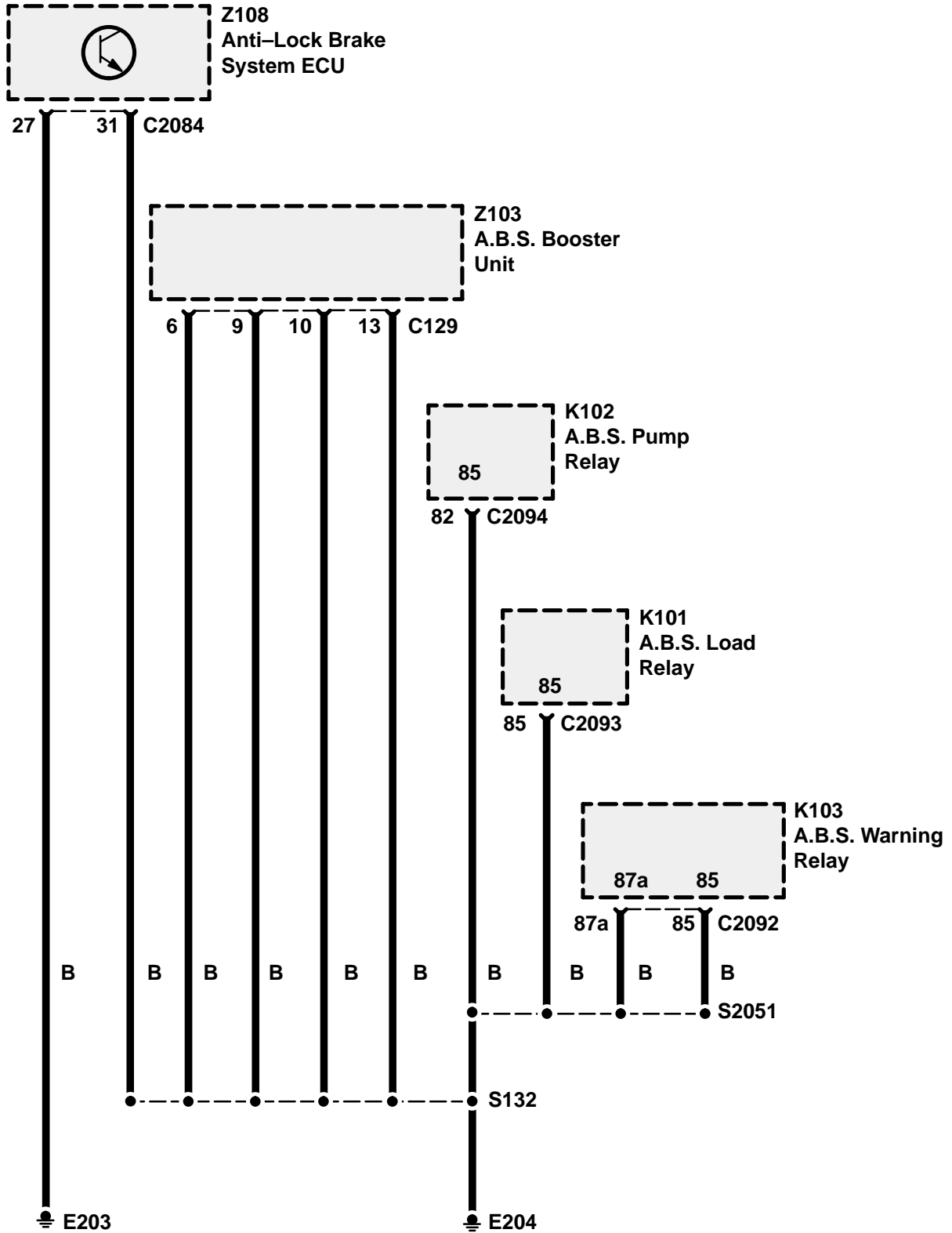
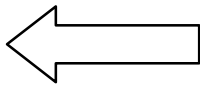

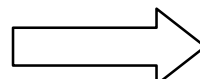
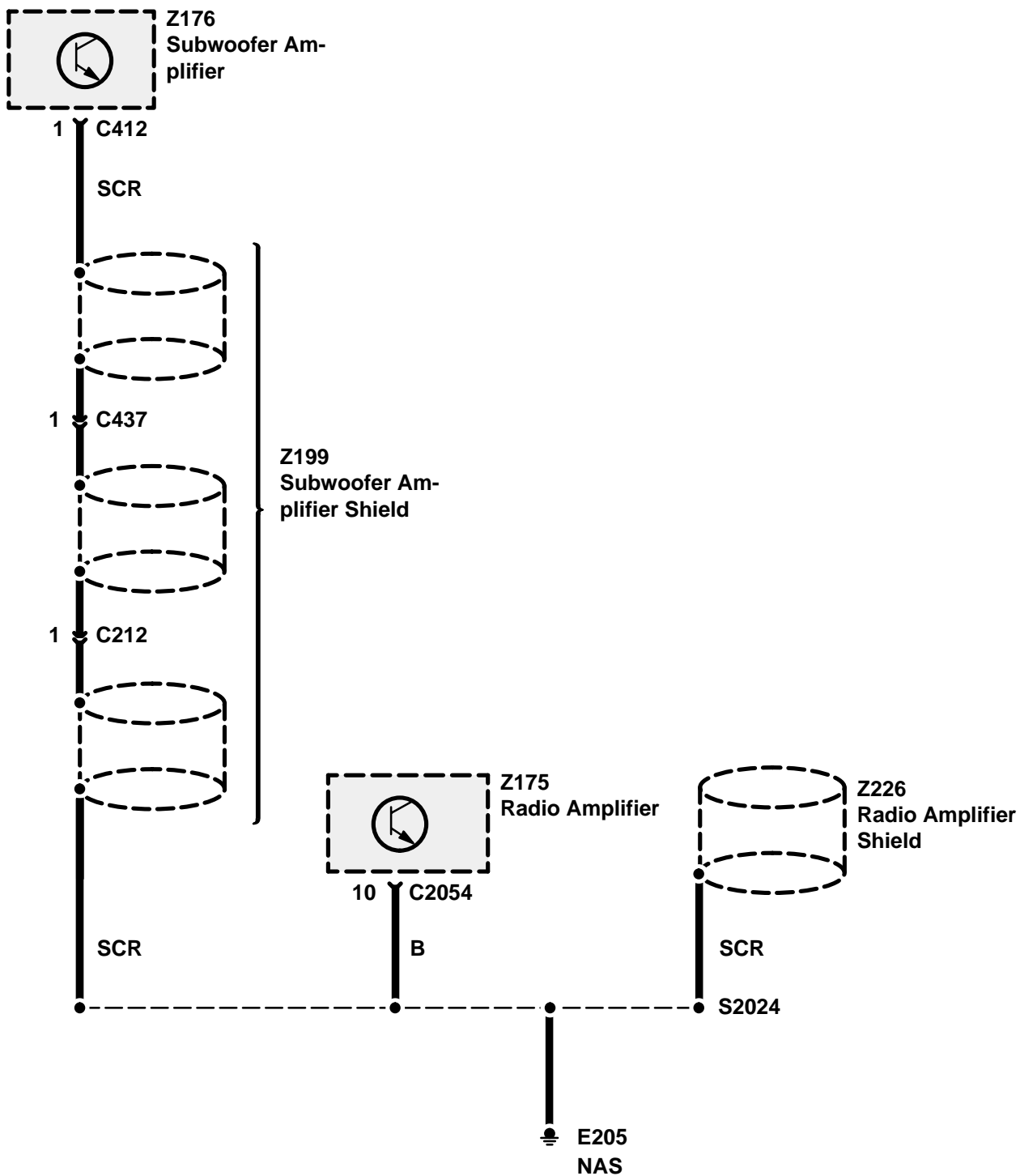
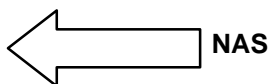

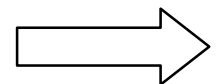
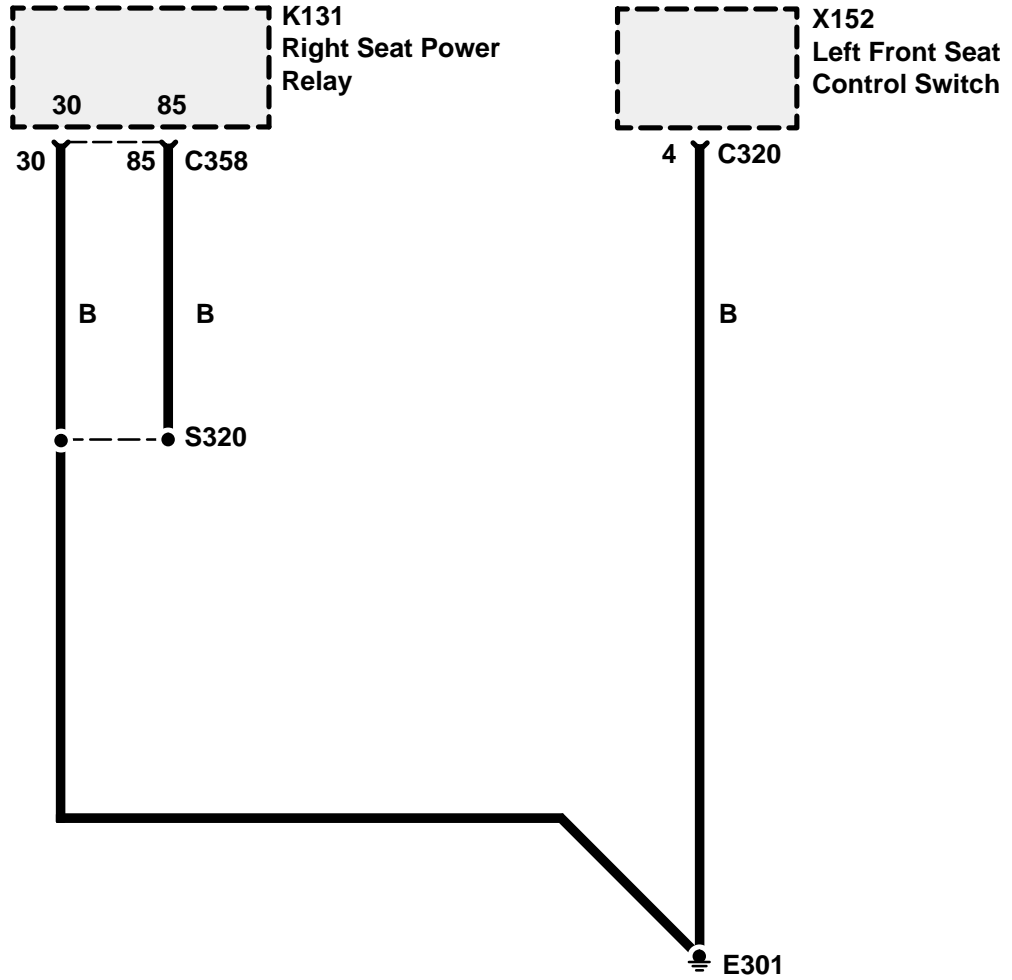
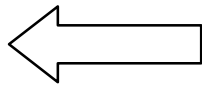

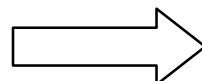
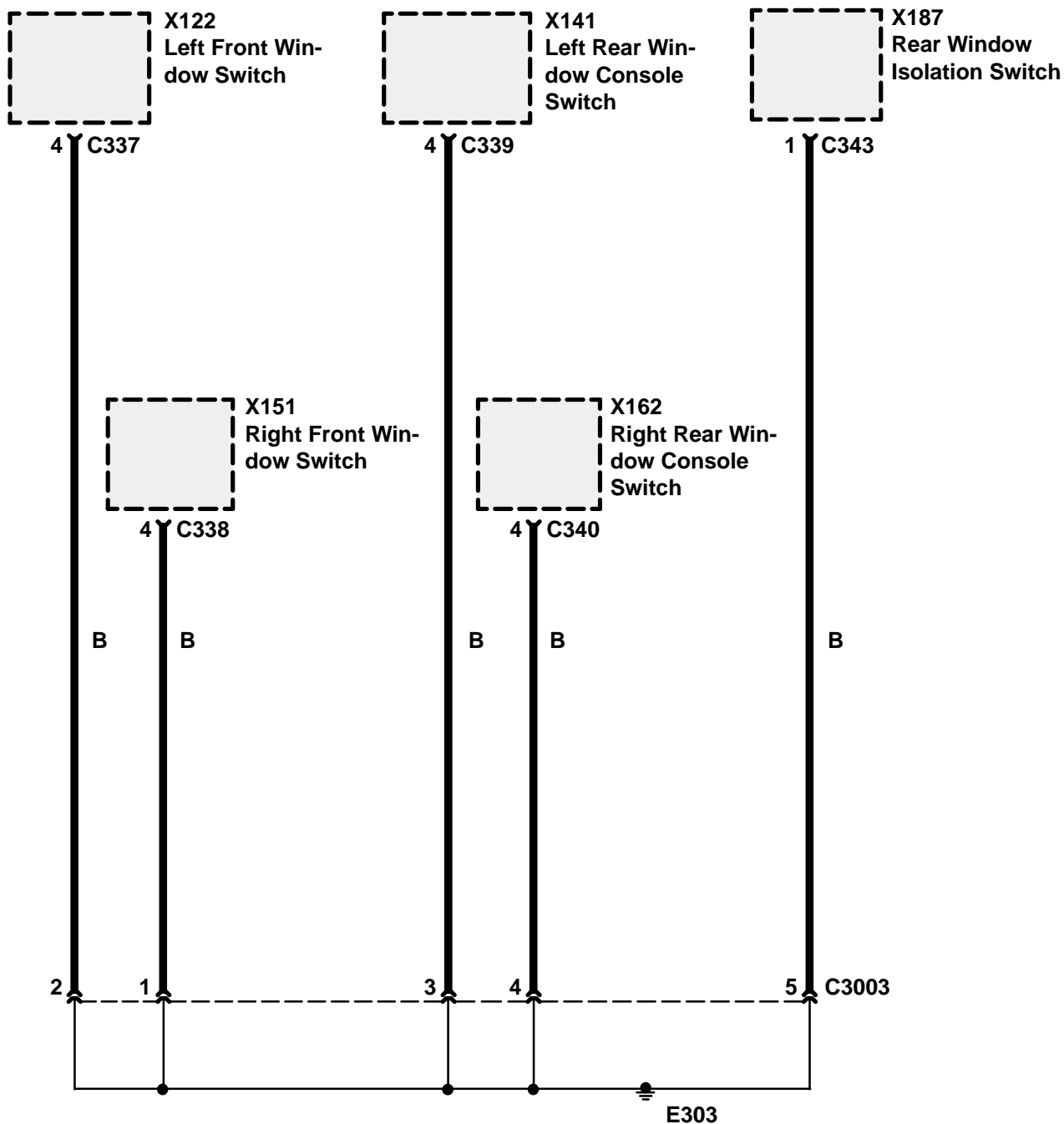
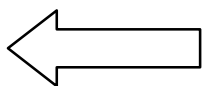

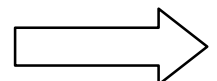
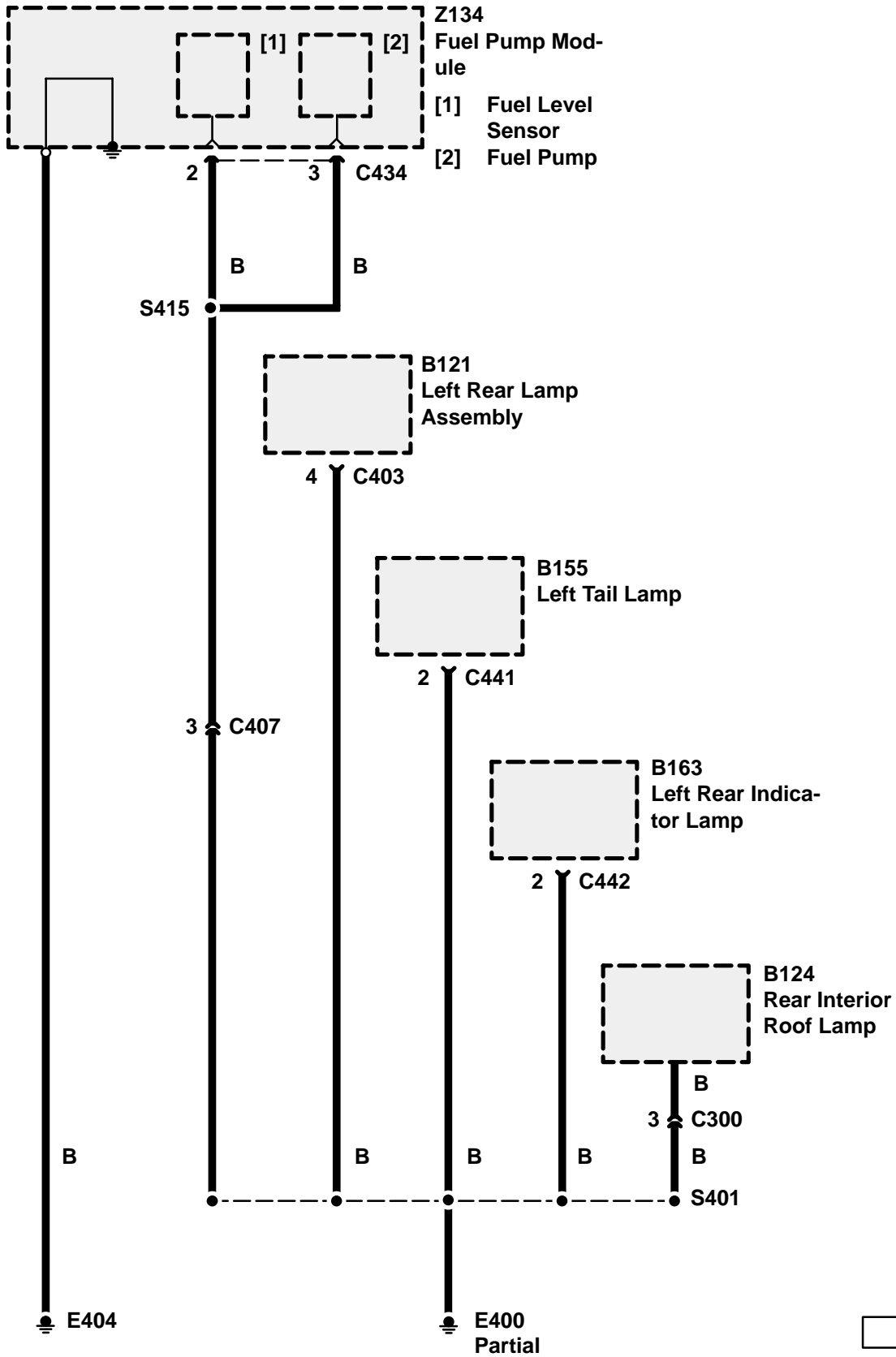
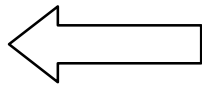

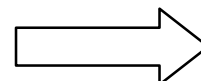
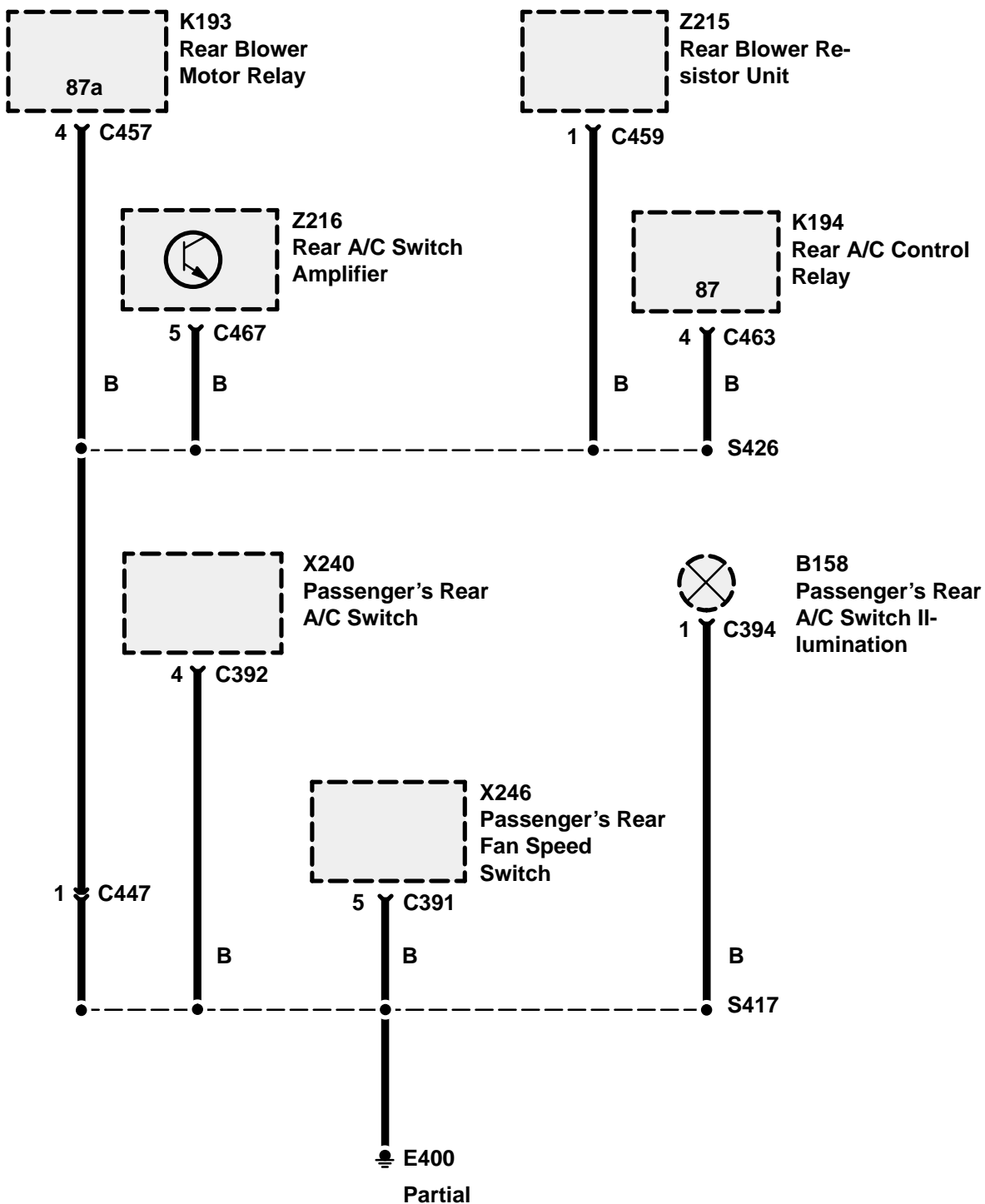
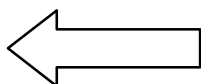



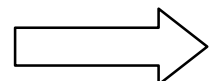
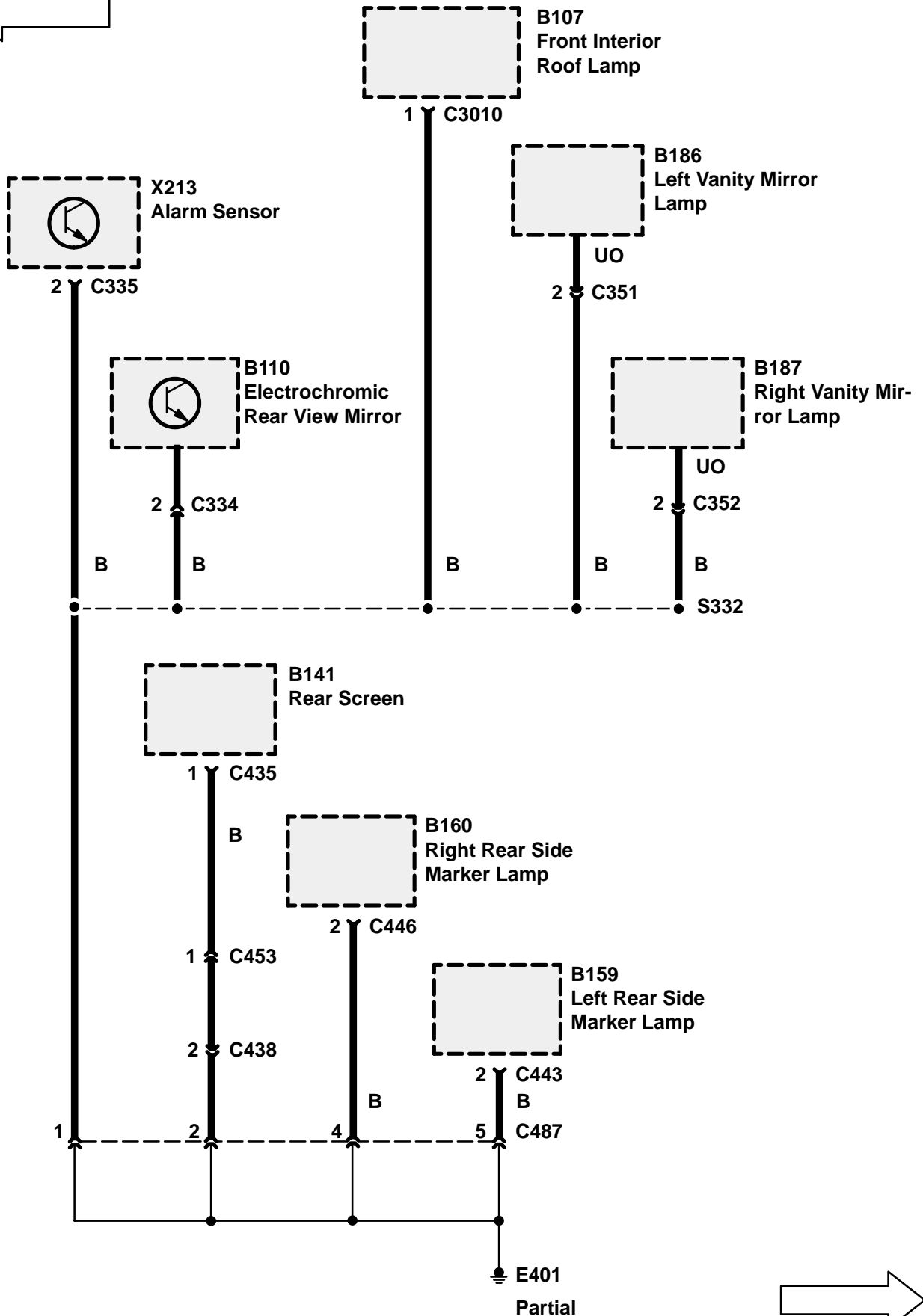
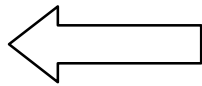



Component	Location	Manual	View
A.B.S. Booster Unit (Z103) ..	LH rear of engine compartment .....	70 .....	3
A.B.S. Hydraulic Pump (M102) .....	LH rear of engine compartment .....	70 .....	3
A.B.S. Load Relay (K101) (Except NAS) .....	behind RH side of fascia on bracket .....	70 .....	195
A.B.S. Load Relay (K101) (NAS) .....	behind RH side of fascia on bracket .....	70 .....	199
A.B.S. Pump Relay (K102) (Except NAS) .....	behind RH side of fascia on bracket .....	70 .....	196
A.B.S. Pump Relay (K102) (NAS) .....	behind RH side of fascia on bracket .....	70 .....	200
A.B.S. Warning Relay (K103) (Except NAS) .....	behind RH side of fascia on bracket .....	70 .....	195
A.B.S. Warning Relay (K103) (NAS) .....	behind RH side of fascia on bracket .....	70 .....	199
A/C Dual Pressure Switch (X102) (MFI-V8) (MFI-T16) (300Tdi) .....	RH rear of engine compartment .....	82 .....	95
A/C Dual Pressure Switch (X102) (SFI-V8) .....	RH rear of engine compartment .....	82 .....	98
A/C Logic Relay (K170) .....	behind RH footwell trim panel .....	82 .....	209
Accessory Relay (K174) .....	behind LH footwell trim panel .....	86 .....	121
Air Bag Diagnostic Control Module (Z151) .....	beneath centre console .....	76 .....	166
Air Recirculation Solenoid (K123) .....	behind RH side of fascia right of heater evaporator unit .....	82 .....	183
Air Recirculation Solenoid In-Line Fuse (P138) .....	behind RH side of fascia .....	82 .....	179
Air Supply Selector Diode (Z208) .....	Heater Switch Wire Harness near C2067 .....	82 .....	152
Air Supply Selector Switch (X180) .....	centre of fascia .....	82 .....	161
Alarm Bonnet Switch (X212) (300Tdi) .....	RH front of engine compartment .....	86 .....	54
Alarm Bonnet Switch (X212) (MFI-V8) (MFI-T16) .....	RH front of engine compartment .....	86 .....	52
Alarm Bonnet Switch (X212) (SFI-V8) .....	RH rear of engine compartment .....	86 .....	53
Alarm Sensor (X213) .....	front centre of roof .....	86 .....	171
Alarm Sounder (Z171) (300Tdi) .....	RH front of engine compartment .....	86 .....	54
Alarm Sounder (Z171) (MFI-V8) (MFI-T16) .....	RH front of engine compartment .....	86 .....	52
Anti-Lock Brake System ECU (Z108) .....	behind RH side of fascia on bracket .....	70 .....	184
Automatic Transmission Oil Temperature Switch (X108) ..	lower LH front of engine compartment .....	86 .....	31
Battery Backed Up Alarm Sounder (Z272) .....	RH front of engine compartment .....	86 .....	57
Boost Pressure Air Temperature Sensor (X254) .....	top rear of engine .....	19 .....	27

Component	Location	Manual	View
Boost Pressure Sensor (X253)	LH rear of engine compartment	19	13
Brake Fluid Level Switch (X111)	LH rear of engine compartment top of brake fluid reservoir	70	2
Brake Switch Vent Valve (X112)	behind LH side of fascia on brake pedal support	19	149
Camshaft Position Sensor (Z262)	lower front of engine near oil filter	19	48
CD Changer (Z114)	beneath RH front seat	86	230
Clock (Z117)	centre of fascia	86	155
Clutch Pedal Position Switch (X200)	behind LH side of fascia near steering column	86	130
Column Switch Illumination (B104)	top of steering column on Ignition Switch	86	144
Compressor Clutch (K107) (300Tdi with EDC)	RH side of engine on front of A/C compressor	82	69
Compressor Clutch (K107) (300Tdi without EDC)	RH side of engine on front of A/C compressor	82	68
Compressor Clutch (K107) (MFI-T16)	RH side of engine on front of A/C compressor	82	
Compressor Clutch (K107) (MFI-V8)	RH side of engine on front of A/C compressor	82	58
Compressor Clutch (K107) (SFI-V8)	top RH side of engine on front of A/C compressor	82	62
Compressor Clutch Cut-out Switch (X259)	RH front of engine	82	64
Compressor Clutch Relay (K108) (300Tdi with EDC)	behind RH footwell trim panel	82	212
Compressor Clutch Relay (K108) (MFI-V8) (MFI-T16) (300Tdi without EDC)	behind RH footwell trim panel	82	208
Compressor Clutch Relay (K108) (SFI-V8)	behind RH footwell trim panel	82	210
Condenser Fan Coolant Temperature Switch (X113) (300Tdi with EDC)	RH front of engine on thermostat housing	82	63
Condenser Fan Coolant Temperature Switch (X113) (MFI-V8)	top centre front of engine	82	75
Condenser Fan Coolant Temperature Switch (X113) (300Tdi without EDC)	RH front of engine	82	65
Condenser Fan Relay (K109) (Except NAS)	behind RH side of fascia on bracket	86	193
Condenser Fan Relay (K109) (NAS)	behind RH side of fascia on bracket	86	198
Condenser Fan Control Diode 1 (Z209)	Engine Wire Harness near C217	82	178
Condenser Fan Control Diode 2 (Z210)	Main Wire Harness behind RH side of fascia near C2073	82	176

Component	Location	Manual	View
Cooling Fan Motor 1 (M141) (MFI-T16 with Air Conditioning)	front of engine compartment	82	
Cooling Fan Motor 1 (M141) (MFI-T16 without Air Conditioning)	front of engine compartment	82	39
Cooling Fan Motor 2 (M142)	front of engine compartment	82	
Cooling Fan Relay (K190)	behind RH footwell trim panel	82	206
Crankshaft Position Sensor (X250) (MFI-T16)	lower RH rear of engine	19	87
Crankshaft Position Sensor (X250) (SFI-V8)	lower LH rear of engine	19	103
Cruise Control Diode (Z186) (Except NAS)	Cruise Control Wire Harness near C218	19	196
Cruise Control Diode (Z186) (NAS)	Cruise Control Wire Harness near C218	19	200
Cruise Control Disable Relay (K234)	behind RH footwell trim panel	19	212
Cruise Control ECU (Z121)	behind RH side of fascia on bracket	19	186
Cruise Control Lockout Relay (K110) (Except NAS)	behind RH side of fascia on bracket	19	197
Cruise Control Lockout Relay (K110) (NAS)	behind RH side of fascia on bracket	19	201
Cruise Control Switch (X115)	centre of fascia	19	156
Cruise Control Vacuum Pump (M103)	LH front corner of engine compartment	19	28
Data Link Connector (EGR) (X219) (300Tdi with EGR)	behind RH side of fascia	19	191
Data Link Connector (MFI) (X321) (MFI-T16)	RH rear corner of engine compartment	19	92
Data Link Connector (MFI) (X321) (MFI-V8)	behind RH side of fascia	19	189
Data Link Connector (OBDII) (X318)	behind LH side of fascia	19	151
Data Link Connector (Theft Alarm) (X323) (Early Production)	behind RH side of fascia near Window Lift ECU	86	185
Daytime Running Lamps Diode (Z200)	Main Wire Harness behind RH side of fascia near HJ2	86	180
Daytime Running Lamps Control Unit (Z122)	behind RH side of fascia on bracket	86	200
Differential Lock Switch (X238)	top RH side of transfer box	86	118
Direction Indicator Diode 1 (Z212)	behind instrument cluster	86	147
Direction Indicator Diode 2 (Z213)	behind instrument cluster	86	146
Direction Indicator Switch (X116)	top of steering column	86	133
Distributor (Z125) (MFI-T16)	top rear of engine	86	

Component	Location	Manual	View
Distributor (Z125) (MFI-V8)	top centre front of engine	86	24
Driver's Seat Buckle Switch (X120)	inside driver's seat belt buckle assembly	86	
Driver's Underseat Fuse Box (P108)	beneath LH front seat	86	226
EGR Control Solenoid (K171)	LH front of engine compartment	19	30
EGR Valve Control Module (Z149)	behind RH side of fascia	19	188
EGR Valve Position Sensor (X218)	LH side of engine	19	8
Electrochromic Rear View Mirror (B110)	front centre of roof	86	173
Engine Compartment Fuse Box (P125) (300Tdi)	RH front of engine compartment	86	51
Engine Compartment Fuse Box (P125) (MFI-V8) (MFI-T16)	RH front of engine compartment	86	49
Engine Compartment Fuse Box (P125) (SFI-V8)	RH front of engine compartment	86	50
Engine Control Load Relay (K116) (300Tdi with EDC)	behind RH footwell trim panel	19	211
Engine Control Load Relay (K116) (MFI-V8)	behind RH footwell trim panel	19	207
Engine Control Module (ECM) (Z132) (300Tdi with EDC)	behind RH side of fascia	19	211
Engine Control Module (ECM) (Z132) (MFI-T16)	RH rear corner of engine compartment	19	93
Engine Control Module (ECM) (Z132) (MFI-V8)	behind RH side of fascia	19	188
Engine Control Module (ECM) (Z132) (SFI-V8)	RH rear corner of engine compartment	19	94
Engine Coolant Temperature Gauge Sensor (X114) (300Tdi with EDC)	RH front of engine on thermostat housing	86	63
Engine Coolant Temperature Gauge Sensor (X114) (300Tdi without EDC)	RH front of engine	86	64
Engine Coolant Temperature Gauge Sensor (X114) (MFI-T16)	top LH front of engine	86	17
Engine Coolant Temperature Gauge Sensor (X114) (MFI-V8)	top LH front of engine on intake manifold	86	15
Engine Coolant Temperature Gauge Sensor (X114) (SFI-V8)	top LH front of engine	86	18
Engine Coolant Temperature Sensor (X126) (300Tdi with EDC)	top centre of engine	19	27
Engine Coolant Temperature Sensor (X126) (300Tdi without EDC)	top centre of engine	19	26

Component	Location	Manual	View
Engine Coolant Temperature Sensor (X126) (MFI-T16) . . .	top LH front of engine . . . . .	19 . . . . .	17
Engine Coolant Temperature Sensor (X126) (MFI-V8) . . . .	top LH front of engine on intake manifold . . . . .	19 . . . . .	15
Engine Coolant Temperature Sensor (X126) (SFI-V8) . . . . .	top LH front of engine . . . . .	19 . . . . .	18
Engine Fuel Temperature Sensor (X128) (MFI-T16) . . .	top RH side of engine . . . . .	19 . . . . .	60
Engine Fuel Temperature Sensor (X128) (MFI-V8) . . . .	top LH front of engine on fuel rail . . . . .	19 . . . . .	15
Engine Fuel Temperature Sensor (X128) (SFI-V8) . . . . .	top LH side of engine on fuel rail . . . . .	19 . . . . .	19
Engine Immobilisation Control Unit (Spider) (Z271) . . . . .	behind centre of fascia above heater evaporator unit	86 . . . . .	159
Engine Speed Sensor (X255)	RH rear of engine . . . . .	19 . . . . .	84
Evaporative Emission Canister Purge Valve (K132) (MFI-T16) . . . . .	RH rear of engine compartment . . . . .	17 . . . . .	92
Evaporative Emission Canister Purge Valve (K132) (MFI-V8) . . . . .	RH side of engine compartment . . . . .	17 . . . . .	91
Evaporative Emission Canister Purge Valve (K132) (SFI-V8) . . . . .	RH rear of engine compartment . . . . .	17 . . . . .	53
Fan Control Module (Z118) . .	behind RH footwell trim panel . . . . .	82 . . . . .	208
Fan Timer Diode (Z211) . . . .	Main Wire Harness behind RH side of fascia near HJ10 . . . . .	82 . . . . .	180
Fascia Cigar Lighter (B106) . .	in front of centre console . . . . .	86 . . . . .	162
Fascia Fuse Box (P126) . . . .	behind LH side of fascia . . . . .	86 . . . . .	124
Flasher Unit (Z128) . . . . .	behind LH side of fascia on Fascia Fuse Box . . . . .	86 . . . . .	125
Fog Lamps Relay (K232) . . . .	behind LH footwell trim panel . . . . .	86 . . . . .	123
Front A/C Evaporator Temperature Switch (X101) . . . . .	LH side of heater evaporator unit . . . . .	82 . . . . .	154
Front A/C Switch (X225) . . . .	centre of fascia . . . . .	82 . . . . .	160
Front Blower Motor (M101) . .	behind RH side of fascia right of heater evaporator unit . . . . .	82 . . . . .	179
Front Blower Motor Relay (K192) . . . . .	behind RH side of fascia right of heater evaporator unit . . . . .	82 . . . . .	183
Front Blower Resistor Unit (Z214) . . . . .	behind RH side of fascia right of heater evaporator unit . . . . .	80 . . . . .	175
Front Fan Speed Switch (X247) . . . . .	centre of fascia . . . . .	82 . . . . .	160
Front Fog Lamps Relay (K230) . . . . .	behind RH side of fascia on bracket . . . . .	86 . . . . .	194
Front Fog Lamps Switch (X270) . . . . .	centre of fascia . . . . .	86 . . . . .	156
Front Interior Roof Lamp (B107) . . . . .	front centre of roof . . . . .	86 . . . . .	171

Component	Location	Manual	View
Front Screen Wash Pump (M105)	RH rear corner of engine compartment on wash fluid reservoir	84	99
Front Sunroof Motor (M143)	front centre of roof	76	174
Front Sunroof Switch (X261)	front centre of roof	76	172
Front Wipe/Wash Switch (X124)	top of steering column	84	144
Front Wiper Motor (M107)	LH side of bulkhead	84	1
Front Wiper Relay (K185)	behind RH footwell trim panel	84	203
Fuel Injector Assembly (K195)	RH side of engine	19	72
Fuel Injectors (K141) (MFI-T16)	top centre of engine	19	25
Fuel Injectors (K141) (MFI-V8)	top centre of engine	19	14
Fuel Injectors (K141) (SFI-V8)	top centre of engine	19	20
Fuel Pump Assembly (K196)	RH side of engine	19	71
Fuel Pump Module (Z134)	top of fuel tank	86	256
Fuel Pump Relay (K119)	behind RH footwell trim panel	86	207
Fuel Shut-Off Solenoid (K111) (300Tdi with EGR)	RH side of engine on injector pump	19	67
Fuel Shut-Off Solenoid (K111) (300Tdi without EGR)	RH side of engine on injector pump	19	66
Fusible Link (P119)	RH front of engine compartment behind battery	86	51
Generator (Z106) (300Tdi)	lower LH side of engine	86	23
Generator (Z106) (MFI-T16 with Air Conditioning)	LH front of engine	86	
Generator (Z106) (MFI-T16 without Air Conditioning)	RH side of engine	86	80
Generator (Z106) (MFI-V8)	top centre front of engine	86	76
Generator (Z106) (SFI-V8)	top front of engine	86	61
Generator Suppression Capacitor (Z182) (300Tdi)	lower LH side of engine on Generator	86	23
Generator Suppression Capacitor (Z182) (MFI-T16 with Air Conditioning)	LH front of engine on Generator	86	
Generator Suppression Capacitor (Z182) (MFI-T16 without Air Conditioning)	RH side of engine on Generator	86	80
Generator Suppression Capacitor (Z182) (MFI-V8)	top centre front of engine on Generator	86	76
Generator Suppression Capacitor (Z182) (SFI-V8)	top front of engine on Generator	86	61
Glow Plug Timer Unit (Z135)	RH side of engine compartment	19	55
Glow Plugs (P120)	RH side of engine	19	70
Handbrake Switch (X191)	beneath centre console on handbrake lever	86	168
Hazard Switch (X220)	centre of fascia	86	155
Headlamp Level Switch (X130)	top LH side of fascia left of steering column	86	138



Component	Location	Manual	View
Headlamp Wash Pump (M110)	RH rear corner of engine compartment on wash fluid reservoir	86	99
Heated Rear Screen Relay (K122)	behind LH side of fascia on Fascia Fuse Box	86	125
Heated Rear Screen Switch (X132)	top LH side of fascia near Instrument Cluster	86	140
Horn Relay (K189)	behind LH footwell trim panel	86	121
Horn Switches (X258)	in steering wheel	86	132
Idle Air Control Valve (M112) (MFI-T16)	RH front of engine	19	59
Idle Air Control Valve (M112) (MFI-V8)	top rear of engine	19	79
Idle Air Control Valve (M112) (SFI-V8)	top LH side of engine	19	21
Ignition Coil (Z140) (MFI-V8)	LH front of engine compartment	86	36
Ignition Coil 1 (Z217) (MFI-T16)	top rear of engine	86	
Ignition Coil 2 (Z218) (MFI-T16)	top rear of engine	86	
Ignition Coils (Z261) (SFI-V8)	top rear of engine	86	5
Ignition Coil Noise Suppressor (Z237)	LH front corner of engine compartment on Ignition Coil	86	38
Ignition Control Module (Z139)	LH front of engine compartment near Ignition Coil	86	38
Ignition Key Lock Solenoid (K191)	top of steering column	86	136
Ignition Load Relay (K127)	behind RH footwell trim panel	86	204
Ignition Switch (X134)	top of steering column	86	134
Inertia Fuel Shut-Off Switch (X135) (MFI-V8) (MFI-T16) (300Tdi)	RH rear of engine compartment	19	97
Inertia Fuel Shut-Off Switch (X135) (SFI-V8)	RH rear of engine compartment	19	98
Injector Needle Lift Sensor (X256)	RH rear of engine	19	84
Instrument Cluster (Z142)	top LH side of fascia	86	145
Instrument Illumination Rheostat (Z143)	top LH side of fascia near Instrument Cluster	86	139
Intake Air Temperature Sensor (X248) (MFI-T16)	RH rear of engine	19	
Intake Air Temperature Sensor (X311) (SFI-V8)	LH side of engine compartment on air cleaner	19	12
Interlock Diode 1 (Z189)	Main Wire Harness near Cruise Control ECU	86	181
Interlock Diode 2 (Z190)	Main Wire Harness near Cruise Control ECU	86	181
Interlock Relay 1 (K153)	behind RH side of fascia above glove box	86	181
Interlock Relay 2 (K151)	behind RH side of fascia above glove box	86	181
Key-Barrel Switch (X230)	top of steering column on Ignition Switch	86	135

Component	Location	Manual	View
Key-In Switch (X229) (With Shift Interlock) .....	top of steering column on Ignition Switch .....	86 .....	135
Key-In Switch (X229) (Without Shift Interlock) .....	top of steering column on Ignition Switch .....	86 .....	134
Knock Sensor (X249) (MFI-T16) .....	RH side of engine .....	19 .....	60
Left Condenser Fan Motor (M113) .....	behind front grille .....	86 .....	41
Left Front Door Key Switch (X201) .....	in top rear of LH front door at door handle .....	86 .....	218
Left Front Door Lock Actuator (M114) .....	in rear of LH front door .....	76 .....	217
Left Front Door Switch (X150) .....	front of LH front door jamb .....	86 .....	213
Left Front Indicator Lamp (B153) .....	LH front of vehicle .....	86 .....	34
Left Front Seat Control Switch (X152) .....	LH side of centre console .....	86 .....	169
Left Front Side Lamp (B166) .....	LH front of vehicle .....	86 .....	44
Left Front Side Marker Lamp (B161) .....	LH front of vehicle .....	86 .....	33
Left Front Wheel Speed Sensor (X137) .....	behind LH front wheel .....	70 .....	107
Left Front Window Motor (M130) .....	in front of LH front door .....	86 .....	219
Left Front Window Switch (X122) .....	in rear of centre console .....	86 .....	164
Left Headlamp (B116) .....	LH front of vehicle .....	86 .....	43
Left Headlamp Level Unit (Z145) .....	behind LH headlamp .....	86 .....	35
Left Heated Oxygen Sensor (X139) (MFI-T16) .....	lower LH side of engine compartment .....	19 .....	10
Left Heated Oxygen Sensor (X139) (MFI-V8) .....	lower LH rear of engine compartment .....	19 .....	101
Left Heated Oxygen Sensor (X139) (SFI-V8) .....	lower LH rear of engine compartment .....	19 .....	102
Left Heated Oxygen Sensor (Post Catalyst) (X289) (SFI-V8) .....	beneath LH side of vehicle .....	19 .....	109
Left Horn (K128) .....	behind LH side of front grille .....	86 .....	40
Left Knock Sensor (X295) (SFI-V8) .....	lower LH side of engine .....	19 .....	104
Left Mirror Actuator (M115) .....	top front of LH front door .....	76 .....	216
Left Rear Door Lock Actuator (M117) .....	inside front of LH rear door .....	76 .....	222
Left Rear Door Switch (X142) .....	in lower part of LH B-post .....	86 .....	221
Left Rear Indicator Lamp (B163) .....	LH side of rear bumper .....	86 .....	257
Left Rear Lamp Assembly (B121) .....	LH rear of luggage compartment .....	86 .....	239
Left Rear Side Marker Lamp (B159) .....	LH side of rear bumper .....	86 .....	259

Component	Location	Manual	View
Left Rear Wheel Speed Sensor (X140)	behind LH rear wheel	70	108
Left Rear Window Console Switch (X141)	in rear of centre console	86	165
Left Rear Window Door Switch (X188)	inside front of LH rear door	86	223
Left Rear Window Motor (M116)	inside front of LH rear door	86	224
Left Repeater Lamp (B122)	LH front side of vehicle	86	32
Left Seat Power Relay (K113)	beneath LH front seat	86	225
Left Seat Power Relay Diode (Z223)	beneath centre console	86	
Left Tail Lamp (B155)	LH side of rear bumper	86	257
Left Vanity Mirror Lamp (B186)	LH front of roof	86	215
Main Lighting Switch (X145)	top of steering column	86	133
Main Rear A/C Switch (X239)	centre of fascia	82	161
Mass Air Flow Sensor (X105) (300Tdi with EDC)	LH side of engine compartment on air intake assembly	19	13
Mass Air Flow Sensor (X105) (MFI-V8)	LH side of engine compartment on air intake assembly	19	11
Mass Air Flow Sensor (X105) (SFI-V8)	LH side of engine compartment on air intake assembly	19	12
Mirror Adjustment Switch (X146a)	top LH side of fascia left of steering column	86	138
Multi-Function Relay Unit (Z207) (MFI-T16)	behind RH side of fascia	19	205
Multi-Function Relay Unit (Z207) (SFI-V8)	RH rear of engine compartment	19	78
Multi-Function Unit (MFU) (Z148)	behind LH side of fascia on Fascia Fuse Box	86	127
Multipoint Fuel Injection Ignition Resistor 1 (K115)	LH front of engine compartment near Ignition Coil	86	36
Multipoint Fuel Injection Ignition Resistor 2 (K168)	LH front of engine compartment near Ignition Coil	86	36
Neutral Sense Diode (Z273)	Main Wire Harness behind RH side of fascia near C2073	86	177
Neutral Sense Resistor (K166)	Gearbox Wire Harness near C105	86	
Oil Pressure Switch (X149) (300Tdi with EDC)	lower RH side of engine	86	71
Oil Pressure Switch (X149) (300Tdi with EGR)	lower RH side of engine	86	67
Oil Pressure Switch (X149) (300Tdi without EGR)	lower RH side of engine	86	66
Oil Pressure Switch (X149) (MFI-T16)	lower RH side of engine near oil filter	86	47
Oil Pressure Switch (X149) (MFI-V8)	lower RH side of engine near oil filter	86	46

Component	Location	Manual	View
Oil Pressure Switch (X149) (SFI-V8)	lower RH side of engine near oil filter	86	48
Park/Neutral Position Switch (X167)	LH side of transmission	86	113
Passenger's Rear A/C Switch (X240)	centre of roof	82	231
Passenger's Rear Fan Speed Switch (X246)	centre of roof	82	231
Passenger's Rear Sunroof Switch (X264)	centre of roof	76	233
Passenger's Underseat Fuse Box (P116)	beneath LH front seat	86	225
Passive Immobilisation Coil (Z270)	top of steering column on Ignition Switch	86	137
Phase Tap Resistor (K184) (300Tdi)	lower LH side of engine on Generator	86	23
Phase Tap Resistor (K184) (MFI-T16 with Air Condition- ing)	LH front of engine on Generator	86	
Phase Tap Resistor (K184) (MFI-T16 without Air Condi- tioning)	RH side of engine on Generator	86	80
Phase Tap Resistor (K184) (MFI-V8)	top centre front of engine on Generator	86	176
Phase Tap Resistor (K184) (SFI-V8)	top front of engine on Generator	86	61
Power Amplifier Relay (K187)	behind RH side of fascia above glove box	86	182
Power Wash Relay (K182) (Except NAS)	behind RH side of fascia on bracket	86	193
Power Wash Relay (K182) (NAS)	behind RH side of fascia on bracket	86	198
Radio (Z111) (High Line Radio)	centre of fascia	86	158
Radio (Z111) (Low Line Radio) (Mid Line Radio)	centre of fascia	86	157
Radio Amplifier (Z175)	behind RH side of fascia	86	187
Radio Tune Resistor (Z235)	Fascia Wire Harness behind instrument cluster near Rear Screen Wipe Switch	86	147
Radio Tune Switch (X233)	top LH side of fascia near Instrument Cluster	86	143
Radio Volume Down Switch (X236)	top LH side of fascia near Instrument Cluster	86	141
Radio Volume Resistor (Z234)	Fascia Wire Harness behind instrument cluster near Heated Rear Screen Switch	86	146
Radio Volume Up Switch (X235)	top LH side of fascia near Instrument Cluster	86	141
Radio Waveband Resistor (Z236)	Fascia Wire Harness behind instrument cluster near Rear Screen Wipe Switch	86	147
Radio Waveband Switch (X234)	top LH side of fascia near Instrument Cluster	86	143

Component	Location	Manual	View
Rear A/C Control Relay (K194)	LH side of luggage compartment on rear A/C evaporator	82	236
Rear A/C Evaporator Temperature Switch (X260)	LH side of luggage compartment on rear A/C evaporator	82	237
Rear A/C Fan Speed Relay (K205)	LH side of luggage compartment on rear A/C evaporator	82	238
Rear A/C Illumination Relay (K204)	LH side of luggage compartment on rear A/C evaporator	82	237
Rear A/C Refrigerant Control Valve (K207)	LH side of luggage compartment on rear A/C evaporator	82	236
Rear A/C Refrigerant Control Valve Diode (Z228)	LH rear of luggage compartment near C448	82	240
Rear A/C Relay Diode (Z275)	LH rear of luggage compartment near C448	82	240
Rear A/C Switch Amplifier (Z216)	LH side of luggage compartment on rear A/C evaporator	82	235
Rear A/C Switch Amplifier In-Line Fuse (P140)	LH rear of luggage compartment behind trim panel	82	239
Rear Blower Motor (M145)	LH side of luggage compartment on rear A/C evaporator	82	235
Rear Blower Motor Relay (K193)	LH side of luggage compartment on rear A/C evaporator	82	238
Rear Blower Resistor Unit (Z215)	LH side of luggage compartment on rear A/C evaporator	82	
Rear End Door Switch (X265)	in RH side of tailgate door jamb	86	246
Rear Fog Guard Lamps Switch (X154)	top LH side of fascia near Instrument Cluster	86	140
Rear Fog Lamps Relay (K231)	behind RH side of fascia on bracket	86	194
Rear Interior Roof Lamp (B124)	centre of roof	86	232
Rear Screen Wash Pump (M119)	RH rear corner of engine compartment on wash fluid reservoir	86	99
Rear Screen Wash Switch (X222)	top LH side of fascia near Instrument Cluster	86	142
Rear Screen Wipe Switch (X221)	top LH side of fascia near Instrument Cluster	86	142
Rear Sunroof Lockout Switch (X263)	front centre of roof	76	173
Rear Sunroof Motor (M144)	centre of roof	76	234
Rear Sunroof Switch (X262)	front centre of roof	76	172
Rear Window Isolation Switch (X187)	in rear of centre console	86	165
Rear Wiper Motor (M120)	RH side of tailgate	84	248
Rear Wiper Relay (K183)	behind LH footwell trim panel	86	122

Component	Location	Manual	View
Reverse Switch (X157)	LH side of transmission	86	115
Right Condenser Fan Motor (M121)	behind front grille	82	42
Right Front Door Lock Actuator (M122)	in rear of RH front door	76	220
Right Front Door Switch (X118)	front of RH front door jamb	86	213
Right Front Indicator Lamp (B154)	RH front of vehicle	86	34
Right Front Seat Control Switch (X121)	RH side of centre console	86	170
Right Front Side Lamp (B167)	RH front of vehicle	86	44
Right Front Side Marker Lamp (B162)	RH front of vehicle	86	33
Right Front Wheel Speed Sensor (X158)	behind RH front wheel	70	107
Right Front Window Motor (M133)	in front of RH front door	86	219
Right Front Window Switch (X151)	in rear of centre console	86	164
Right Headlamp (B130)	RH front of vehicle	86	43
Right Headlamp Level Unit (Z155)	behind RH headlamp	86	35
Right Heated Oxygen Sensor (X160) (MFI-V8)	lower RH rear of engine compartment	19	88
Right Heated Oxygen Sensor (X160) (SFI-V8)	lower RH rear of engine compartment	19	89
Right Heated Oxygen Sensor (Post Catalyst) (X290) (SFI-V8)	beneath RH side of vehicle	19	110
Right Horn (K134)	behind RH side of front grille	86	40
Right Knock Sensor (X296) (SFI-V8)	lower RH side of engine near Starter	19	105
Right Mirror Actuator (M123)	top front of RH front door	86	216
Right Rear Door Lock Actuator (M125)	inside front of RH rear door	76	222
Right Rear Door Switch (X163)	in lower part of RH B-post	86	221
Right Rear Indicator Lamp (B165)	RH side of rear bumper	86	258
Right Rear Lamp Assembly (B136)	RH rear of luggage compartment	86	244
Right Rear Side Marker Lamp (B160)	RH side of rear bumper	86	259
Right Rear Wheel Speed Sensor (X161)	behind RH rear wheel	70	108
Right Rear Window Console Switch (X162)	in rear of centre console	86	165
Right Rear Window Door Switch (X189)	inside front of RH rear door	86	223

Component	Location	Manual	View
Right Rear Window Motor (M124)	inside front of RH rear door	86	224
Right Repeater Lamp (B137)	RH front side of vehicle	86	32
Right Seat Power Relay (K131)	beneath LH front seat	86	226
Right Seat Power Relay Diode (Z222)	beneath centre console	86	
Right Tail Lamp (B156)	RH side of rear bumper	86	258
Right Vanity Mirror Lamp (B187)	RH front of roof	86	215
Rotary Coupler (Z119)	top of steering column	76	134
Satellite Fuse Box 1 (P127)	behind LH side of fascia on Fascia Fuse Box	86	124
Satellite Fuse Box 2 (P128)	behind LH side of fascia on Fascia Fuse Box	86	124
Saudi Junction Connector (X241)	behind LH side of fascia near Fascia Fuse Box	86	130
Seat Base Motor (M126)	underside of respective front seat	86	228
Seat Height (Front) Motor (M127)	underside of respective front seat	86	227
Seat Height (Rear) Motor (M128)	underside of respective front seat	86	228
Seat Recline Motor (M129)	underside of respective front seat	86	227
Service Reminder Unit (Z126)	behind RH footwell trim panel	86	210
Sounder Relay (K160)	behind LH footwell trim panel	86	123
Speed Trip Module (Z164) (Except NAS)	behind RH side of fascia on bracket	19	197
Speed Trip Module (Z164) (NAS)	behind RH side of fascia on bracket	19	201
Starter (M134) (300Tdi with EDC)	lower LH side of engine	86	9
Starter (M134) (300Tdi without EDC)	lower LH side of engine	86	8
Starter (M134) (MFI-T16)	lower RH side of engine	86	86
Starter (M134) (MFI-V8)	lower RH side of engine	86	85
Starter (M134) (SFI-V8)	lower RH rear of engine	86	106
Starter Relay Diode (Z158)	Main Wire Harness near Starter Solenoid Relay	86	202
Starter Solenoid (K136) (300Tdi with EDC)	lower LH side of engine	86	9
Starter Solenoid (K136) (300Tdi without EDC)	lower LH side of engine	86	8
Starter Solenoid (K136) (MFI-T16)	lower RH side of engine	86	86
Starter Solenoid (K136) (MFI-V8)	lower RH side of engine	86	85
Starter Solenoid (K136) (SFI-V8)	lower RH rear of engine	86	106
Starter Solenoid Relay (K137)	behind RH footwell trim panel	86	204
Steering Wheel Cruise Switches (X266)	in steering wheel	19	132
Stop Lamp Switch (X168)	behind LH side of fascia on brake pedal support	86	150

Component	Location	Manual	View
Stop Lamp Switch Suppressor (Z206)	behind LH side of fascia near steering column	86	150
Subwoofer (K146)	LH side of tailgate	86	251
Subwoofer Amplifier (Z176)	LH side of tailgate on Subwoofer	86	251
Sunroof Control Unit (Z162)	front centre of roof	76	174
Tailgate Lock Actuator (M132)	LH side of tailgate	76	249
Theft Alarm Unit (Z163)	behind RH side of fascia on bracket	86	192
Throttle Position Sensor (X257) (300Tdi with EDC)	behind LH side of fascia	19	
Throttle Position Sensor (X171) (300Tdi with EGR)	RH side of engine on injector pump	19	67
Throttle Position Sensor (X171) (MFI-T16)	RH front of engine	19	59
Throttle Position Sensor (X171) (MFI-V8)	top LH front of engine	19	16
Throttle Position Sensor (X171) (SFI-V8)	top LH side of engine	19	21
Trailer Auxiliary Socket (X172)	RH rear of luggage compartment behind trim panel	86	260
Transfer Box Oil Temperature Switch (X174)	LH side of transfer box	86	116
Transfer Box Position Switch (X175)	top RH side of transfer box	86	119
Transfer Box Solenoid (K161)	top RH side of transfer box	86	119
Transfer Box Solenoid Diode (Z232)	Gearbox Wire Harness near Differential Lock Switch	86	
Transmission Range Selector Illumination Relay (K104)	behind RH side of fascia above glove box	86	182
Transmission Range Selector Switch (Z110)	beneath centre console near transmission range selector	86	163
Tune Select Resistor (K140)	behind RH side of fascia	19	190
Vehicle Speed Sensor (X190)	LH side of transfer box	86	117
Window Lift ECU (Z147)	behind RH side of fascia on bracket	86	184
<b>Connector</b>	<b>Location</b>		<b>View</b>
C100 (3-W)	RH front of engine compartment on Engine Compartment Fuse Box		56
C101 (4-W)	RH front of engine compartment on Engine Compartment Fuse Box		56
C103 (3-B)	RH front of engine compartment on Right Headlamp		43
C104 (3-B)	LH front of engine compartment on Left Headlamp		43
C105 (13-B)	LH rear corner of engine compartment		2
C109 (2-B)	LH front of engine compartment on Left Front Side Lamp		44
C110 (2-B)	RH front of engine compartment on Right Front Side Lamp		44
C112 (3-W) (MFI-V8)	LH rear corner of engine to Left Heated Oxygen Sensor		101
C112 (4-B) (MFI-T16)	lower LH side of engine to Left Heated Oxygen Sensor		10
C112 (4-B) (SFI-V8)	lower LH rear of engine to Left Heated Oxygen Sensor		5
C113 (3-W) (MFI-V8)	RH rear corner of engine to Right Heated Oxygen Sensor		79
C113 (4-R) (SFI-V8)	lower RH rear of engine to Right Heated Oxygen Sensor		90
C114 (2-W)	RH front of engine compartment on Engine Compartment Fuse Box		56



Connector	Location	View
C115 (3-W)	RH front of engine compartment on Engine Compartment Fuse Box	56
C116 (1-W)	RH front of engine compartment on Engine Compartment Fuse Box	56
C120 (2-W)	RH rear corner of engine compartment on Rear Screen Wash Pump	99
C123 (2-B)	RH front side of vehicle on Right Repeater Lamp	32
C124 (2-B)	LH front side of vehicle on Left Repeater Lamp	32
C125 (2-B)	LH rear of engine compartment to A.B.S. Hydraulic Pump	3
C127 (3-B)	LH rear of engine compartment on Brake Fluid Level Switch	2
C129 (13-B)	LH rear of engine compartment on A.B.S. Booster Unit	3
C130 (2-WB)	LH rear of engine compartment to Left Front Wheel Speed Sensor	3
C131 (2-WB) (MFI-V8) (MFI-T16) (300Tdi)	RH side of engine compartment to Right Front Wheel Speed Sensor	82
C131 (2-WB) (SFI-V8)	RH side of engine compartment to Right Front Wheel Speed Sensor	98
C132 (4-B) (MFI-V8)	top rear of engine on Idle Air Control Valve	79
C132 (6-B) (MFI-T16)	RH front of engine on Idle Air Control Valve	59
C132 (4-B) (SFI-V8)	top LH side of engine on Idle Air Control Valve	21
C133 (5-B) (300Tdi with EDC)	LH side of engine compartment on Mass Air Flow Sensor	13
C133 (6-B) (MFI-V8)	LH side of engine compartment on Mass Air Flow Sensor	11
C133 (3-B) (SFI-V8)	LH side of engine compartment on Mass Air Flow Sensor	12
C134 (2-B) (MFI-V8)	top LH side of engine on Fuel Injectors	14
C134 (2-B) (MFI-T16)	top centre of engine on Fuel Injectors	25
C134 (2-B) (SFI-V8)	top LH front of engine on Fuel Injectors	19
C135 (2-B) (MFI-V8)	top RH side of engine on Fuel Injectors	73
C135 (2-B) (MFI-T16)	top centre of engine on Fuel Injectors	25
C135 (2-B) (SFI-V8)	top centre of engine on Fuel Injectors	74
C136 (2-B) (MFI-V8)	top LH side of engine on Fuel Injectors	14
C136 (2-B) (MFI-T16)	top centre of engine on Fuel Injectors	25
C136 (2-B) (SFI-V8)	top centre of engine on Fuel Injectors	20
C137 (2-B) (MFI-V8)	top RH side of engine on Fuel Injectors	73
C137 (2-B) (MFI-T16)	top centre of engine on Fuel Injectors	25
C137 (2-B) (SFI-V8)	top centre of engine on Fuel Injectors	74
C138 (2-B) (MFI-V8)	top LH side of engine on Fuel Injectors	14
C138 (2-B) (SFI-V8)	top centre of engine on Fuel Injectors	20
C139 (2-B) (MFI-V8)	top RH side of engine on Fuel Injectors	73
C139 (2-B) (SFI-V8)	top centre of engine on Fuel Injectors	74
C140 (2-B) (MFI-V8)	top LH rear of engine on Fuel Injectors	4
C140 (2-B) (SFI-V8)	top LH rear of engine on Fuel Injectors	6
C141 (2-B) (MFI-V8)	top RH side of engine on Fuel Injectors	79
C141 (2-B) (SFI-V8)	top RH side of engine on Fuel Injectors	74
C142 (2-N) (MFI-T16)	lower RH side of engine on Oil Pressure Switch	47
C144 (2-B) (MFI-V8)	RH side of engine compartment on Evaporative Emission Canister Purge Valve	91
C144 (2-B) (MFI-T16)	RH rear of engine compartment on Evaporative Emission Canister Purge Valve	92
C144 (2-B) (SFI-V8)	RH rear of engine compartment on Evaporative Emission Canister Purge Valve	53

Connector	Location	View
C145 (2-W) (MFI-V8) . . . . .	top RH side of engine to Compressor Clutch . . . . .	58
C145 (2-W) (MFI-T16) . . . . .	RH side of engine to Compressor Clutch	
C145 (2-W) (300Tdi with EDC) . . . . .	RH side of engine to Compressor Clutch . . . . .	69
C145 (2-W) (300Tdi without EDC) . . . . .	RH side of engine to Compressor Clutch . . . . .	68
C145 (2-W) (SFI-V8) . . . . .	top RH side of engine to Compressor Clutch . . . . .	62
C146 (2-B) (MFI-V8) . . . . .	top centre front of engine on Condenser Fan Coolant Temperature Switch . . . . .	75
C146 (2-B) (300Tdi with EDC) . . . . .	RH front of engine on Condenser Fan Coolant Temperature Switch . . . . .	63
C146 (2-B) (300Tdi without EDC) . . . . .	RH front of engine on Condenser Fan Coolant Temperature Switch . . . . .	65
C148 (2-B) . . . . .	top centre front of engine to Distributor . . . . .	24
C149 (3-B) (MFI-V8) . . . . .	top LH front of engine to Throttle Position Sensor . . . . .	16
C149 (3-B) (MFI-T16) . . . . .	RH front of engine on Throttle Position Sensor . . . . .	59
C149 (3-B) (SFI-V8) . . . . .	top LH side of engine on Throttle Position Sensor . . . . .	21
C150 (2-S) (MFI-V8) . . . . .	top LH front of engine on Engine Fuel Temperature Sensor . . . . .	15
C150 (2-S) (MFI-T16) . . . . .	RH side of engine on Engine Fuel Temperature Sensor . . . . .	60
C150 (2-S) (SFI-V8) . . . . .	top LH side of engine on Engine Fuel Temperature Sensor . . . . .	19
C152 (2-N) (MFI-V8) . . . . .	top LH front of engine on Engine Coolant Temperature Sensor . . . . .	15
C152 (2-N) (MFI-T16) . . . . .	top LH front of engine on Engine Coolant Temperature Sensor . . . . .	17
C152 (2-N) (300Tdi with EDC) . . . . .	top centre of engine on Engine Coolant Temperature Sensor . . . . .	27
C152 (2-N) (300Tdi without EDC) . . . . .	top centre of engine on Engine Coolant Temperature Sensor . . . . .	26
C152 (2-N) (SFI-V8) . . . . .	top LH front of engine on Engine Coolant Temperature Sensor . . . . .	18
C153 (1-B) . . . . .	LH front of engine compartment on Ignition Coil . . . . .	37
C154 (1-W) . . . . .	LH front of engine compartment on Ignition Coil . . . . .	37
C155 (1-B) . . . . .	LH front of engine compartment on Ignition Coil . . . . .	37
C156 (1-W) . . . . .	LH front of engine compartment on Ignition Coil . . . . .	37
C159 (6-B) . . . . .	RH side of engine compartment on Glow Plug Timer Unit . . . . .	55
C160 (3-B) . . . . .	RH side of engine to Throttle Position Sensor . . . . .	81
C161 (1-W) (300Tdi without EGR) . . . . .	RH side of engine to Fuel Shut-Off Solenoid . . . . .	66
C162 (2-B) . . . . .	RH front of engine on Compressor Clutch Cut-out Switch . . . . .	64
C164 (3-B) . . . . .	LH side of engine on EGR Valve Position Sensor . . . . .	8
C165 (2-B) (300Tdi without EDC) . . . . .	LH front of engine compartment on EGR Control Solenoid . . . . .	30
C165 (2-S) (300Tdi with EDC) . . . . .	LH front of engine compartment on EGR Control Solenoid . . . . .	30
C166 (2-B) . . . . .	lower LH front of engine compartment on Automatic Transmission Oil Temperature Switch . . . . .	31
C167 (3-W) . . . . .	LH front corner of engine compartment on Cruise Control Vacuum Pump . . . . .	28
C168 (2-B) . . . . .	behind LH side of front grille on Left Horn . . . . .	40
C169 (2-B) . . . . .	behind RH side of front grille on Right Horn . . . . .	40
C170 (2-R) . . . . .	RH rear corner of engine compartment on Front Screen Wash Pump . . . . .	99

Connector	Location	View
C171 (3-B) (MFI-V8) (MFI-T16) (300Tdi) . . . . .	RH rear of engine compartment on Inertia Fuel Shut-Off Switch . . . . .	97
C171 (3-B) (SFI-V8) . . . . .	RH rear of engine compartment on Inertia Fuel Shut-Off Switch . . . . .	98
C173 (2-B) . . . . .	RH rear corner of engine compartment on Headlamp Wash Pump . . . . .	99
C178 (2-B) (300Tdi) . . . . .	RH front of engine compartment to Alarm Bonnet Switch . . . . .	54
C178 (2-B) (MFI-V8) (MFI-T16) . . . . .	RH front of engine compartment to Alarm Bonnet Switch . . . . .	52
C178 (2-B) (SFI-V8) . . . . .	RH front of engine compartment to Alarm Bonnet Switch . . . . .	53
C181 (2-S) (MFI-V8) (MFI-T16) (300Tdi) . . . . .	RH rear of engine compartment on A/C Dual Pressure Switch . . . . .	95
C181 (2-S) (SFI-V8) . . . . .	RH rear of engine compartment on A/C Dual Pressure Switch . . . . .	98
C182 (2-B) . . . . .	behind front grille to Right Condenser Fan Motor . . . . .	42
C183 (2-B) . . . . .	behind front grille to Left Condenser Fan Motor . . . . .	41
C190 (3-B) . . . . .	behind LH headlamp on Left Headlamp Level Unit . . . . .	35
C191 (3-B) . . . . .	behind RH headlamp on Right Headlamp Level Unit . . . . .	35
C195 (4-W) . . . . .	RH rear of engine compartment . . . . .	96
C196 (2-NU) . . . . .	RH rear of engine to Injector Needle Lift Sensor . . . . .	84
C197 (3-B) . . . . .	RH rear of engine to Engine Speed Sensor . . . . .	84
C198 (3-W) (300Tdi with EDC) . . . . .	RH side of engine to Fuel Injector Assembly . . . . .	72
C198 (6-B) (MFI-T16) . . . . .	top rear of engine to Fuel Injectors . . . . .	83
C199 (8-W) . . . . .	RH side of engine to Fuel Pump Assembly . . . . .	71
C1000 (2-G) (MFI-T16) . . . . .	RH rear of engine on Intake Air Temperature Sensor	
C1000 (2-G) (300Tdi with EDC) . . . . .	top rear of engine on Boost Pressure Air Temperature Sensor . . . . .	27
C1000 (2-B) (SFI-V8) . . . . .	LH side of engine compartment on Intake Air Temperature Sensor . . . . .	12
C1001 (3-B) . . . . .	LH rear of engine compartment on Boost Pressure Sensor . . . . .	13
C1002 (3-B) (MFI-T16) . . . . .	top rear of engine on Ignition Coil 1	
C1002 (6-B) (SFI-V8) . . . . .	top rear of engine to Ignition Coils . . . . .	5
C1003 (3-B) . . . . .	top rear of engine on Ignition Coil 2	
C1004 (2-U) (MFI-T16) . . . . .	lower RH rear of engine to Crankshaft Position Sensor . . . . .	87
C1004 (2-B) (SFI-V8) . . . . .	lower LH rear of engine on Crankshaft Position Sensor . . . . .	103
C1005 (2-W) . . . . .	RH side of engine on Knock Sensor . . . . .	60
C1006 (3-W) . . . . .	RH rear corner of engine compartment Data Link Connector (MFI) . . . . .	92
C1007 (36-B) . . . . .	RH rear corner of engine compartment on Engine Control Module (ECM) . . . . .	93
C1008 (18-B) . . . . .	RH rear corner of engine compartment on Engine Control Module (ECM) . . . . .	93
C1009 (2-B) . . . . .	LH front of vehicle on Left Front Indicator Lamp . . . . .	34
C1010 (2-B) . . . . .	RH front of vehicle on Right Front Indicator Lamp . . . . .	34
C1011 (2-W) (MFI-T16 with Air Conditioning) . . . . .	front of engine compartment to Cooling Fan Motor 1	
C1011 (2-W) (MFI-T16 with- out Air Conditioning) . . . . .	front of engine compartment to Cooling Fan Motor 1 . . . . .	39
C1012 (2-W) . . . . .	front of engine compartment to Cooling Fan Motor 2	
C1013 (2-B) . . . . .	LH front of vehicle on Left Front Side Marker Lamp . . . . .	33
C1014 (2-B) . . . . .	RH front of vehicle on Right Front Side Marker Lamp . . . . .	33

Connector	Location	View
C1017 (36-R)	RH rear corner of engine compartment on Engine Control Module (ECM)	94
C1018 (1-W)	LH front of engine compartment on Ignition Coil	37
C1019 (4-RB)	beneath LH side of vehicle to Left Heated Oxygen Sensor (Post Catalyst)	112
C1020 (4-B)	beneath RH side of vehicle to Right Heated Oxygen Sensor (Post Catalyst)	111
C1021 (3-B)	lower RH side of engine to Camshaft Position Sensor	48
C1022 (2-B)	lower LH side of engine on Left Knock Sensor	104
C1023 (2-B)	lower RH side of engine on Right Knock Sensor	105
C1024 (2-B)	LH front of engine compartment to Left Front Fog Lamp	43
C1025 (2-B)	RH front of engine compartment to Right Front Fog Lamp	43
C1026 (13-BU)	RH rear corner of engine compartment	100
C1027 (13-B)	RH rear corner of engine compartment	100
C1028 (4-B)	RH rear corner of engine compartment	100
C1029 (8-B)	RH rear of engine compartment on Multi-Function Relay Unit	78
C1030 (6-B)	RH rear of engine compartment on Multi-Function Relay Unit	78
C1031 (4-N)	RH front of engine compartment on Battery Backed Up Alarm Sounder	57
C1032 (36-B)	RH rear corner of engine compartment on Engine Control Module (ECM)	94
C1033 (18-B)	RH rear corner of engine compartment on Engine Control Module (ECM)	94
C1035 (3-B)	LH front of engine compartment on Ignition Control Module	38
C1036 (3-B)	LH front of engine compartment to Ignition Control Module	38
C201 (7-W)	top of steering column on Main Lighting Switch	133
C203 (7-W)	behind LH side of fascia on Fascia Fuse Box	128
C204 (24-W)	behind LH side of fascia on Fascia Fuse Box	127
C205 (24-B)	behind LH side of fascia on Multi-Function Unit (MFU)	127
C206 (4-W)	behind LH side of fascia on Fascia Fuse Box	128
C207 (10-B)	on Instrument Cluster	145
C208 (18-W)	behind LH side of fascia on Fascia Fuse Box	126
C209 (20-R)	behind LH side of fascia LH side of heater evaporator unit	153
C211 (10-W)	behind LH side of fascia on Fascia Fuse Box	128
C212 (14-W)	behind LH side of fascia near Fascia Fuse Box	129
C214 (3-BU)	top LH side of fascia to Instrument Illumination Rheostat	139
C215 (24-Y)	behind LH side of fascia LH side of heater evaporator unit	153
C216 (7-N)	behind RH side of fascia right of heater evaporator unit	178
C217 (24-W)	behind RH side of fascia right of heater evaporator unit	178
C218 (8-W) (Except NAS)	behind RH side of fascia on bracket	197
C218 (8-W) (NAS)	behind RH side of fascia on bracket	201
C219 (4-W)	behind LH side of fascia on Fascia Fuse Box	126
C220 (3-N)	behind LH side of fascia to Ignition Switch	149
C221 (10-W)	on Instrument Cluster	147
C222 (10-W)	on Instrument Cluster	145
C223 (5-U)	on Instrument Cluster	145
C224 (6-W)	behind LH side of fascia to Front Wiper Motor	148

Connector	Location	View
C225 (26-S)	behind RH side of fascia on Theft Alarm Unit	192
C226 (3-W)	behind LH side of fascia on Fascia Fuse Box	128
C227 (4-B)	behind LH side of fascia on Stop Lamp Switch	150
C228 (8-B)	behind LH side of fascia on Mirror Adjustment Switch	138
C229 (1-W)	behind LH side of fascia on Fascia Fuse Box	127
C230 (8-S) (High Line Radio)	centre of fascia on Radio	158
C230 (8-S) (Low Line Radio) (Mid Line Radio)	centre of fascia on Radio	157
C232 (2-S)	RH A-post to Right Front Tweeter	214
C238 (5-Y) (MFI-T16)	behind RH footwell trim panel on Cooling Fan Relay	206
C238 (9-B) (MFI-V8)	behind RH footwell trim panel on Fan Control Module	208
C239 (5-B) (MFI-V8)	behind RH footwell trim panel on Engine Control Load Relay	207
C239 (5-Y) (300Tdi with EDC)	behind RH footwell trim panel on Engine Control Load Relay	211
C240 (5-U)	behind RH footwell trim panel on Fuel Pump Relay	207
C241 (5-Y) (300Tdi with EDC)	behind RH footwell trim panel on Compressor Clutch Relay	212
C241 (5-Y) (MFI-V8) (MFI-T16) (300Tdi)	behind RH footwell trim panel on Compressor Clutch Relay	208
C241 (5-Y) (SFI-V8)	behind RH footwell trim panel on Compressor Clutch Relay	210
C242 (5-Y)	behind RH footwell trim panel on A/C Logic Relay	209
C243 (40-B) (MFI-V8)	behind RH side of fascia on Engine Control Module (ECM)	188
C243 (55-B) (300Tdi with EDC)	behind RH side of fascia on Engine Control Module (ECM)	211
C245 (5-W)	behind RH side of fascia Data Link Connector (MFI)	189
C246 (2-U)	behind RH side of fascia on Tune Select Resistor	190
C247 (16-B)	behind RH side of fascia on EGR Valve Control Module	188
C248 (3-W)	behind RH side of fascia Data Link Connector (EGR)	191
C249 (5-G)	top LH side of fascia on Rear Screen Wash Switch	142
C250 (5-W)	top LH side of fascia on Rear Screen Wipe Switch	142
C252 (6-R)	behind LH side of fascia near steering column	131
C254 (1-W)	behind LH side of fascia on Fascia Fuse Box	126
C255 (1-B)	on Instrument Cluster	145
C259 (6-W)	behind LH side of fascia on Headlamp Level Switch	138
C260 (10-R)	centre of fascia on Radio	157
C262 (5-U)	centre of fascia on Cruise Control Switch	156
C263 (5-B)	top LH side of fascia on Rear Fog Guard Lamps Switch	140
C264 (5-U)	top LH side of fascia on Heated Rear Screen Switch	140
C267 (10-W)	centre of fascia on Hazard Switch	155
C268 (8-N) (High Line Radio)	centre of fascia on Radio	158
C268 (8-N) (Low Line Radio) (Mid Line Radio)	centre of fascia on Radio	157
C270 (4-B)	centre of fascia on Clock	155
C274 (12-W)	behind RH side of fascia on Theft Alarm Unit	192
C277 (23-W)	behind LH side of fascia near Fascia Fuse Box	129
C280 (5-W)	behind LH footwell trim panel on Sounder Relay	123

Connector	Location	View
C281 (5-G)	behind LH footwell trim panel on Rear Wiper Relay	122
C282 (5-Y)	behind LH footwell trim panel on Accessory Relay	121
C283 (5-Y)	behind LH footwell trim panel on Horn Relay	121
C284 (15-B)	behind RH side of fascia on Cruise Control ECU	186
C287 (10-W)	behind RH side of fascia on Window Lift ECU	184
C288 (8-W)	behind RH side of fascia on Window Lift ECU	184
C292 (5-Y) (Except NAS)	behind RH side of fascia on Condenser Fan Relay	193
C292 (5-Y) (NAS)	behind RH side of fascia on Condenser Fan Relay	198
C298 (3-W)	behind RH side of fascia	183
C2000 (5-Y)	behind RH side of fascia on Interlock Relay 1	181
C2001 (5-Y)	behind RH side of fascia on Interlock Relay 2	181
C2005 (2-W)	behind LH side of fascia on Brake Switch Vent Valve	149
C2006 (5-Y)	behind RH footwell trim panel on Starter Solenoid Relay	204
C2007 (5-Y)	behind RH footwell trim panel on Ignition Load Relay	204
C2008 (5-G)	behind RH footwell trim panel on Front Wiper Relay	203
C2009 (4-W)	top of steering column on Direction Indicator Switch	133
C2010 (6-W)	top of steering column to Rotary Coupler	134
C2011 (6-W)	top of steering column on Front Wipe/Wash Switch	144
C2012 (8-W)	top of steering column	135
C2013 (4-B)	top of steering column	144
C2014 (2-B)	top of steering column on Ignition Key Lock Solenoid	136
C2015 (8-W)	top of steering column on Front Wipe/Wash Switch	144
C2016 (1-W)	behind LH side of fascia on Fascia Fuse Box	126
C2021 (5-G) (Except NAS) (Automatic Transmission)	behind RH side of fascia on Cruise Control Lockout Relay	197
C2021 (5-B) (Except NAS) (Manual Transmission)	behind RH side of fascia on Speed Trip Module	197
C2021 (5-G) (NAS) (Auto- matic Transmission)	behind RH side of fascia on Cruise Control Lockout Relay	201
C2021 (5-B) (NAS) (Manual Transmission)	behind RH side of fascia on Speed Trip Module	201
C2022 (5-W)	behind heater and A/C control panel on Front Fan Speed Switch	160
C2023 (4-W)	behind heater and A/C control panel	160
C2024 (5-U)	behind heater and A/C control panel on Main Rear A/C Switch	161
C2025 (5-W)	behind heater and A/C control panel on Front A/C Switch	160
C2026 (5-B)	behind heater and A/C control panel on Air Supply Selector Switch	161
C2027 (5-W)	behind LH side of fascia LH side of heater evaporator unit	152
C2028 (6-W)	behind RH footwell trim panel on E200	203
C2029 (6-W)	behind LH footwell trim panel on E201	120
C2035 (2-W)	behind LH side of fascia on Clutch Pedal Position Switch	130
C2036 (7-BW)	in steering wheel to Rotary Coupler	132
C2044 (5-G)	behind RH side of fascia on Transmission Range Selector Illumination Relay	182
C2047 (5-B)	behind RH side of fascia on Daytime Running Lamps Control Unit	200
C2051 (8-B)	behind RH side of fascia on Multi-Function Relay Unit	205
C2052 (6-B)	behind RH side of fascia on Multi-Function Relay Unit	205

Connector	Location	View
C2053 (5-Y)	behind RH side of fascia on Power Amplifier Relay	182
C2054 (18-W)	behind RH side of fascia on Radio Amplifier	187
C2055 (13-W)	behind LH side of fascia LH side of heater evaporator unit	153
C2056 (5-B)	top LH side of fascia on Radio Tune Switch	143
C2057 (5-U)	top LH side of fascia on Radio Waveband Switch	143
C2058 (5-W)	top LH side of fascia on Radio Volume Up Switch	141
C2059 (5-G)	top LH side of fascia on Radio Volume Down Switch	141
C2060 (5-W)	centre of fascia to Radio	157
C2061 (7-B)	centre of fascia on Radio	158
C2062 (1-B)	behind LH side of fascia Saudi Junction Connector	130
C2063 (2-B)	behind LH side of fascia to Stop Lamp Switch Suppressor	150
C2066 (8-W)	behind RH side of fascia right of heater evaporator unit	175
C2067 (10-W)	behind LH side of fascia LH side of heater evaporator unit	152
C2068 (5-W)	behind RH side of fascia on Front Blower Motor Relay	183
C2069 (2-B)	behind RH side of fascia on Front Blower Motor	179
C2070 (4-B)	behind RH side of fascia on Front Blower Resistor Unit	175
C2071 (2-B)	behind RH side of fascia on Air Recirculation Solenoid In-Line Fuse	179
C2072 (4-Y)	behind RH side of fascia on Air Recirculation Solenoid	183
C2073 (10-W)	behind RH side of fascia right of heater evaporator unit	176
C2074 (5-Y) (Except NAS)	behind RH side of fascia on Power Wash Relay	193
C2074 (5-Y) (NAS)	behind RH side of fascia on Power Wash Relay	198
C2079 (2-B)	centre of fascia on Radio	157
C2080 (-B)	centre of fascia on Radio	158
C2082 (6-W)	behind LH side of fascia near Fascia Fuse Box	129
C2083 (16-S)	behind LH side of fascia Data Link Connector (OBDII)	151
C2084 (35-B)	behind RH side of fascia on Anti-Lock Brake System ECU	184
C2085 (3-W)	behind RH footwell trim panel	184
C2089 (5-W)	behind LH footwell trim panel on Fog Lamps Relay	123
C2090 (5-Y)	behind RH side of fascia on Front Fog Lamps Relay	194
C2091 (5-G)	behind RH side of fascia on Rear Fog Lamps Relay	194
C2092 (5-G) (Except NAS)	behind RH side of fascia on A.B.S. Warning Relay	195
C2092 (5-G) (NAS)	behind RH side of fascia on A.B.S. Warning Relay	199
C2093 (5-Y) (Except NAS)	behind RH side of fascia on A.B.S. Load Relay	195
C2093 (5-Y) (NAS)	behind RH side of fascia on A.B.S. Load Relay	199
C2094 (4-B) (Except NAS)	behind RH side of fascia on A.B.S. Pump Relay	196
C2094 (4-B) (NAS)	behind RH side of fascia on A.B.S. Pump Relay	200
C2095 (9-B) (With Immobilisation)	behind centre of fascia on Engine Immobilisation Control Unit (Spider)	159
C2095 (9-B) (Without Immobilisation)	behind centre of fascia above heater evaporator unit	159
C2096 (2-B)	top of steering column to Passive Immobilisation Coil	137
C2097 (4-W)	behind LH side of fascia near steering column	131
C2098 (5-G)	centre of fascia on Front Fog Lamps Switch	156
C2100 (2-W)	behind LH footwell trim panel	120
C2101 (13-W)	behind LH footwell trim panel	120

Connector	Location	View
C2102 (2-W)	behind LH footwell trim panel	120
C2103 (2-W)	behind RH footwell trim panel	202
C2104 (13-W)	behind RH footwell trim panel	202
C2105 (2-W)	behind RH footwell trim panel	202
C2106 (5-R)	behind RH footwell trim panel on Service Reminder Unit	210
C2107 (5-W)	behind RH footwell trim panel on Cruise Control Disable Relay	212
C2108 (4-B) (Early Production)	behind RH side of fascia Data Link Connector (Theft Alarm)	185
C2110 (2-S)	LH A-post to Left Front Tweeter	214
C300 (4-B)	centre of roof to Rear Interior Roof Lamp	232
C301 (6-W)	beneath centre console	167
C306 (3-W)	beneath centre console	167
C316 (6-B)	RH side of centre console on Right Front Seat Control Switch	170
C317 (6-B)	RH side of centre console on Right Front Seat Control Switch	170
C318 (9-R)	beneath RH front seat	230
C319 (6-B)	LH side of centre console on Left Front Seat Control Switch	169
C320 (6-B)	LH side of centre console on Left Front Seat Control Switch	169
C321 (9-U)	beneath LH front seat	226
C323 (5-B)	LH side of transmission to Park/Neutral Position Switch	113
C334 (3-B)	front centre of roof to Electrochromic Rear View Mirror	173
C335 (4-B)	front centre of roof on Alarm Sensor	171
C337 (7-G)	in rear of centre console on Left Front Window Switch	164
C338 (7-W)	in rear of centre console on Right Front Window Switch	164
C339 (7-Y)	in rear of centre console on Left Rear Window Console Switch	165
C340 (7-R)	in rear of centre console on Right Rear Window Console Switch	165
C343 (7-N)	in rear of centre console on Rear Window Isolation Switch	165
C344 (6-B)	beneath centre console to Transmission Range Selector Switch	163
C346 (2-U)	beneath centre console to Automatic Gear Selector Illumination	163
C348 (5-Y)	beneath LH front seat on Left Seat Power Relay	225
C350 (3-W)	front centre of roof on Front Interior Roof Lamp	171
C351 (2-B)	RH front of roof to Right Vanity Mirror Lamp	215
C352 (2-B)	LH front of roof to Left Vanity Mirror Lamp	215
C353 (2-W)	beneath centre console on Fascia Cigar Lighter	162
C354 (29-R)	beneath centre console on Air Bag Diagnostic Control Module	166
C356 (1-B)	beneath centre console on Fascia Cigar Lighter	162
C358 (5-Y)	beneath LH front seat on Right Seat Power Relay	226
C368 (3-B)	top RH side of transfer box to Transfer Box Position Switch	119
C369 (2-B)	top RH side of transfer box to Transfer Box Solenoid	119
C370 (3-B)	LH side of transfer box on Vehicle Speed Sensor	117
C371 (2-B)	LH side of transfer box on Transfer Box Oil Temperature Switch	116
C372 (2-B)	on top of transmission	114
C378 (2-B)	beneath centre console to Driver's Seat Buckle Switch	162
C381 (3-W)	beneath RH front seat on CD Changer	229
C382 (8-W)	front centre of roof on Sunroof Control Unit	174
C383 (10-W)	front centre of roof on Sunroof Control Unit	174



Connector	Location	View
C384 (7-G)	front centre of roof on Front Sunroof Switch	172
C385 (7-W)	front centre of roof on Rear Sunroof Switch	172
C386 (5-S)	front centre of roof on Rear Sunroof Lockout Switch	173
C387 (4-W)	front centre of roof to Front Sunroof Motor	174
C388 (4-W)	centre of roof to Rear Sunroof Motor	234
C389 (3-W)	centre of roof to Passenger's Rear Sunroof Switch	233
C391 (5-W)	centre of roof on Passenger's Rear Fan Speed Switch	231
C392 (5-U)	centre of roof on Passenger's Rear A/C Switch	231
C3000 (1-B)	on top of transmission to Reverse Switch	114
C3001 (1-B)	on top of transmission to Reverse Switch	114
C3003 (6-W)	beneath centre console on E303	168
C3004 (3-W)	in lower part of LH B-post	221
C3005 (2-W)	in lower part of LH B-post	221
C3006 (3-W)	in lower part of RH B-post	221
C3007 (2-W)	in lower part of RH B-post	221
C400 (7-B)	RH rear of luggage compartment Trailer Auxiliary Socket	260
C402 (1-B)	LH side of tailgate to Number Plate Lamps	250
C403 (6-W)	LH rear of luggage compartment on Left Rear Lamp Assembly	239
C404 (1-B)	LH side of tailgate to Number Plate Lamps	250
C406 (6-W)	RH rear of luggage compartment on Right Rear Lamp Assembly	244
C407 (6-B)	beneath LH rear of vehicle	252
C408 (3-B)	RH side of tailgate on Rear Wiper Motor	248
C412 (6-W)	LH side of tailgate on Subwoofer Amplifier	251
C413 (4-W)	LH side of tailgate on Subwoofer Amplifier	251
C414 (2-W)	LH side of tailgate to Tailgate Lock Actuator	249
C415 (8-W)	in RH side of tailgate door jamb	246
C424 (1-B)	RH rear of luggage compartment Trailer Auxiliary Socket	245
C425 (1-B)	RH rear of luggage compartment Trailer Auxiliary Socket	245
C434 (4-B)	top of fuel tank to Fuel Pump Module	256
C437 (6-W)	in RH side of tailgate door jamb	246
C438 (2-W)	in RH side of tailgate door jamb	246
C441 (2-R)	behind LH side of rear bumper on Left Tail Lamp	257
C442 (2-B)	behind LH side of rear bumper on Left Rear Indicator Lamp	257
C443 (2-B)	behind LH side of rear bumper on Left Rear Side Marker Lamp	259
C444 (2-R)	behind RH side of rear bumper on Right Tail Lamp	258
C445 (2-B)	behind RH side of rear bumper on Right Rear Indicator Lamp	258
C446 (2-B)	behind RH side of rear bumper on Right Rear Side Marker Lamp	259
C447 (2-W)	LH rear of luggage compartment	240
C448 (16-W)	LH rear of luggage compartment	240
C453 (1-B)	LH side of tailgate	250
C454 (1-B)	RH side of tailgate to Rear Screen	247
C455 (1-B)	RH side of tailgate	247
C456 (1-B)	LH side of tailgate	250
C457 (5-W)	LH side of luggage compartment on Rear Blower Motor Relay	238
C458 (2-B)	LH side of luggage compartment on Rear Blower Motor	235

Connector	Location	View
C459 (4-B)	LH side of luggage compartment on Rear Blower Resistor Unit	
C462 (2-B)	LH rear of luggage compartment on Rear A/C Switch Amplifier In-Line Fuse	239
C463 (4-W)	LH side of luggage compartment on Rear A/C Control Relay	236
C464 (2-S)	LH side of luggage compartment on Rear A/C Refrigerant Control Valve	236
C465 (4-W)	LH side of luggage compartment on Rear A/C Illumination Relay	237
C466 (4-W)	LH side of luggage compartment on Rear A/C Fan Speed Relay	238
C467 (6-W)	LH side of luggage compartment on Rear A/C Switch Amplifier	235
C485 (2-W)	beneath RH rear of vehicle to Left Rear Wheel Speed Sensor	254
C486 (2-W)	beneath LH rear of vehicle to Right Rear Wheel Speed Sensor	253
C487 (6-W)	RH rear of luggage compartment on E401	243
C489 (2-)	RH side of tailgate on Rear Wiper Motor	248
C500 (2-B)	in front of LH front door to Left Front Window Motor	219
C503 (6-W)	top front of LH front door to Left Mirror Actuator	216
C504 (4-W)	in top rear of LH front door to Left Front Door Key Switch	218
C507 (4-W) (Without Theft Alarm)	in rear of LH front door to Left Front Door Lock Actuator	217
C507 (6-W) (With Theft Alarm)	in rear of LH front door to Left Front Door Lock Actuator	217
C600 (2-B)	in front of RH front door to Right Front Window Motor	219
C603 (6-W)	top front of RH front door to Right Mirror Actuator	216
C607 (2-W) (Without Theft Alarm)	in rear of RH front door to Right Front Door Lock Actuator	220
C607 (6-W) (With Theft Alarm)	in rear of RH front door to Right Front Door Lock Actuator	220
C703 (2-B)	inside front of LH rear door to Left Rear Window Motor	224
C706 (2-W)	inside front of LH rear door to Left Rear Door Lock Actuator	222
C709 (5-W)	inside front of LH rear door on Left Rear Window Door Switch	223
C803 (2-B)	inside front of RH rear door to Right Rear Window Motor	224
C806 (2-W)	inside front of RH rear door to Right Rear Door Lock Actuator	222
C809 (5-W)	inside front of RH rear door on Right Rear Window Door Switch	223
Ground	Location	View
E100 (300Tdi)	RH front of engine compartment behind battery	51
E100 (MFI-V8) (MFI-T16)	RH front of engine compartment behind battery	49
E100 (SFI-V8)	RH front of engine compartment behind battery	50
E101 (300Tdi)	LH front of engine compartment on fender well	30
E101 (MFI-V8) (MFI-T16) (SFI-V8)	LH front of engine compartment on fender well	29
E103 (MFI-V8)	LH rear corner of engine below valve cover	7
E103 (SFI-V8)	RH side of engine compartment on fender well	77
E104	lower LH rear of engine compartment on frame rail	
E105	LH front of engine compartment on Ignition Coil	36
E106	lower LH side of engine	22
E108	near Starter	
E109	lower RH side of engine compartment on frame rail	45

<b>Ground</b>	<b>Location</b>	<b>View</b>
E110 .....	LH side of bulkhead .....	1
E200 .....	behind RH footwell trim panel .....	203
E201 .....	behind LH footwell trim panel .....	120
E203 .....	behind LH side of fascia .....	129
E204 .....	behind LH footwell trim panel .....	120
E205 .....	behind RH footwell trim panel .....	203
E301 .....	beneath LH front seat .....	225
E303 .....	beneath centre console .....	168
E400 .....	LH rear of luggage compartment .....	241
E401 .....	RH rear of luggage compartment .....	243
E404 .....	beneath RH rear of vehicle near fuel filler pipe .....	255
<b>Splice</b>	<b>Location</b>	<b>View</b>
HJ1 (20-S) .....	behind LH side of fascia near steering column .....	149
HJ2 (20-U) .....	behind RH side of fascia near C298 .....	180
HJ3 (20-S) .....	behind RH side of fascia .....	177
HJ4 (20-U) (Except NAS) ...	behind RH side of fascia near C298 .....	193
HJ4 (20-S) (NAS) .....	behind RH side of fascia near C298 .....	198
HJ5 (20-S) .....	behind RH side of fascia .....	177
HJ6 (20-G) .....	behind RH side of fascia near C2073 .....	177
HJ7 (20-U) .....	behind RH side of fascia .....	190
HJ8 (20-S) .....	behind instrument cluster .....	147
HJ9 (20-S) .....	behind instrument cluster .....	146
HJ10 (20-S) .....	behind RH side of fascia .....	180
HJ11 (20-S) .....	behind LH footwell trim panel .....	122
HJ12 (20-G) .....	LH rear of roof behind trim panel .....	242

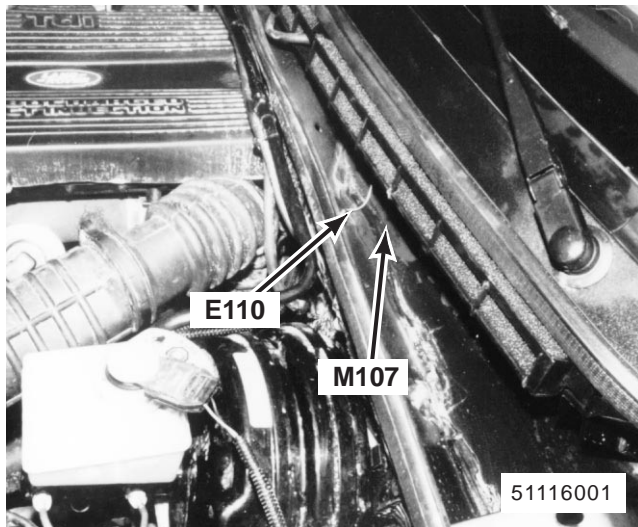

1. LH side of bulkhead  
M107 Front Wiper Motor  
E110

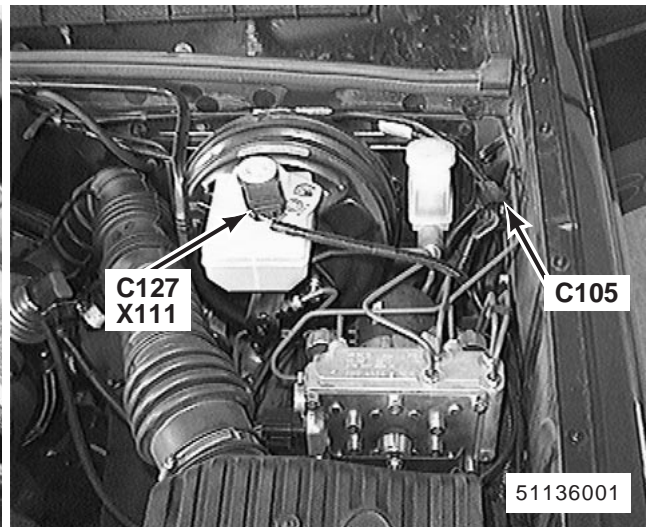

2. LH rear of engine compartment  
X111 Brake Fluid Level Switch  
C127 (3-B)  
C105 (13-B)

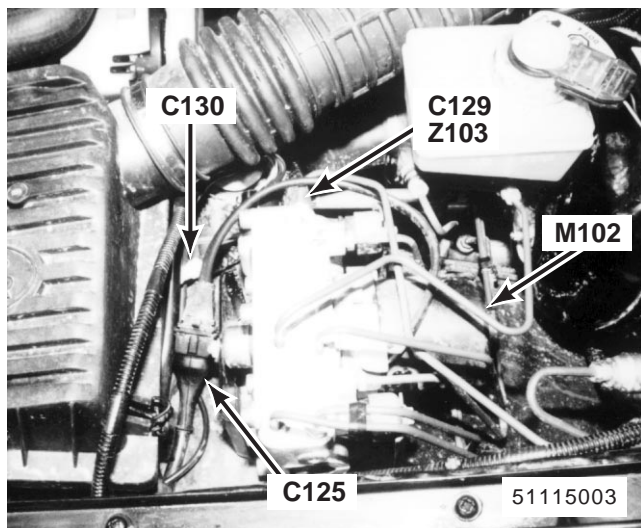

3. LH rear of engine compartment  
M102 A.B.S. Hydraulic Pump  
Z103 A.B.S. Booster Unit  
C125 (2-B)  
C129 (13-B)  
C130 (2-WB)

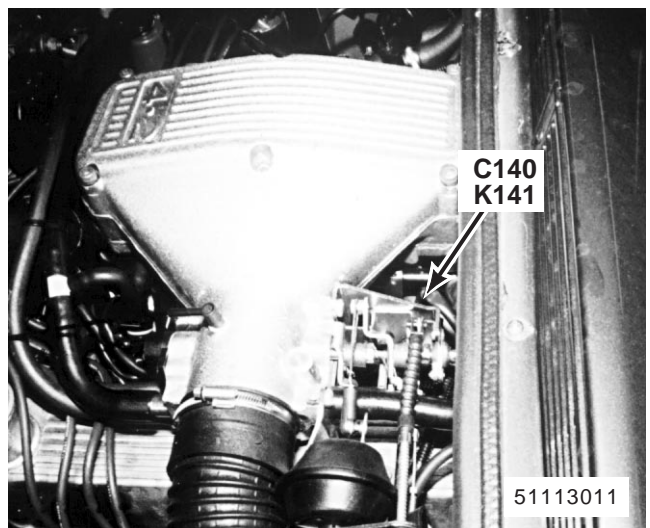

4. LH rear of engine (MFI-V8)  
K141 Fuel Injectors  
C140 (2-B)

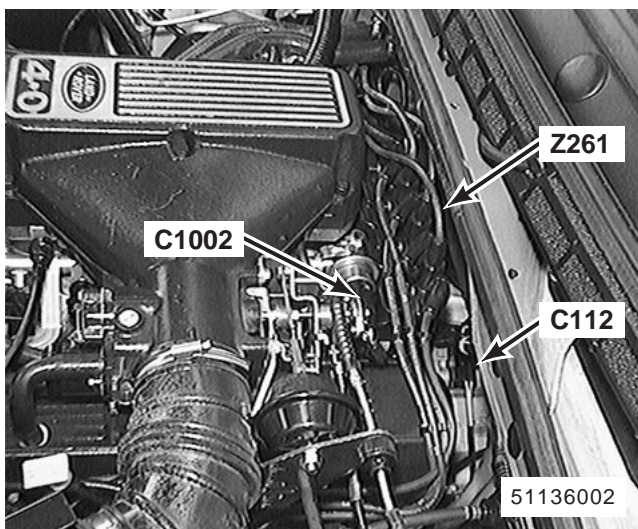

5. LH rear of engine (SFI-V8)  
 Z261 Ignition Coils  
 C112 (4-B)  
 C1002 (6-B)



6. LH rear of engine (SFI-V8)  
 K141 Fuel Injectors  
 C140 (2-B)

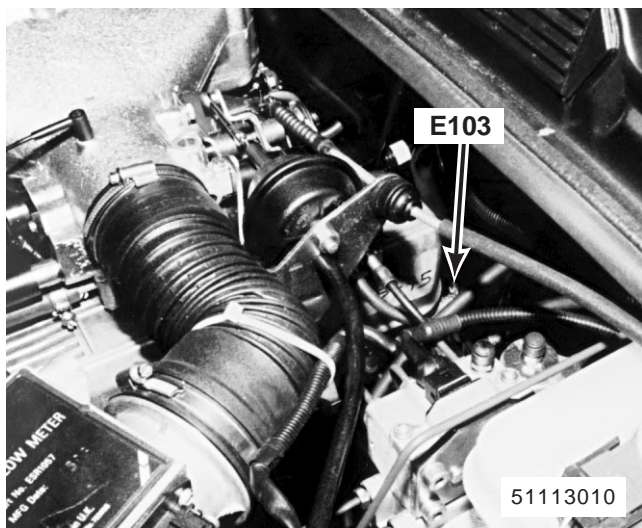

7. LH rear of engine (MFI-V8)  
 E103

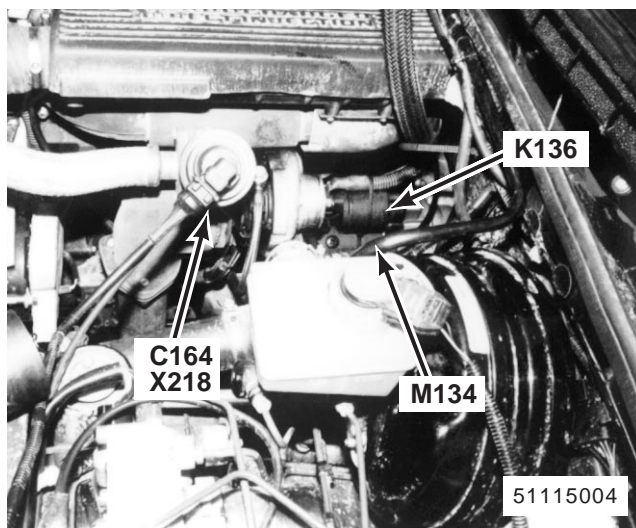

8. lower LH side of engine (300Tdi without EDC)  
 K136 Starter Solenoid  
 M134 Starter  
 X218 EGR Valve Position Sensor  
 C164 (3-B)

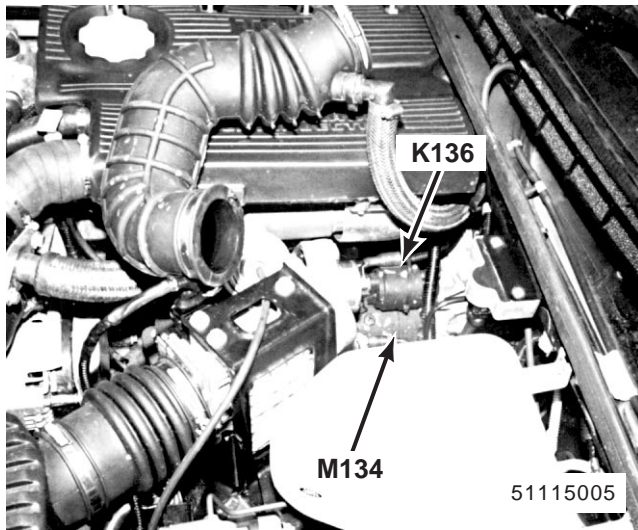

9. lower LH side of engine (300Tdi with EDC)  
K136 Starter Solenoid  
M134 Starter

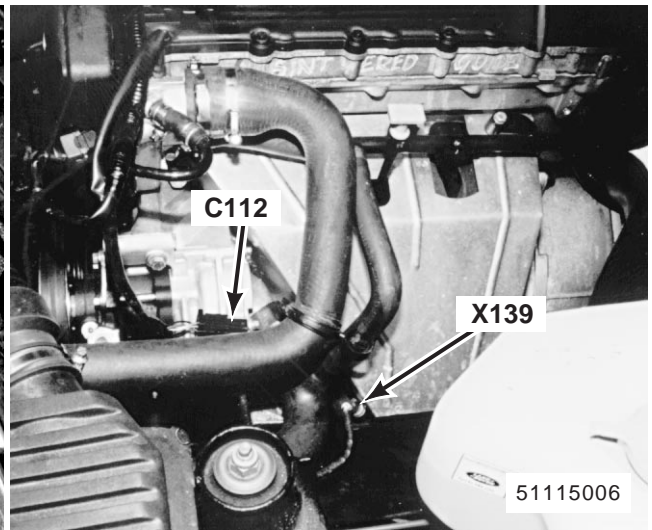

10. lower LH side of engine (MFI-T16)  
X139 Left Heated Oxygen Sensor  
C112 (4-B)

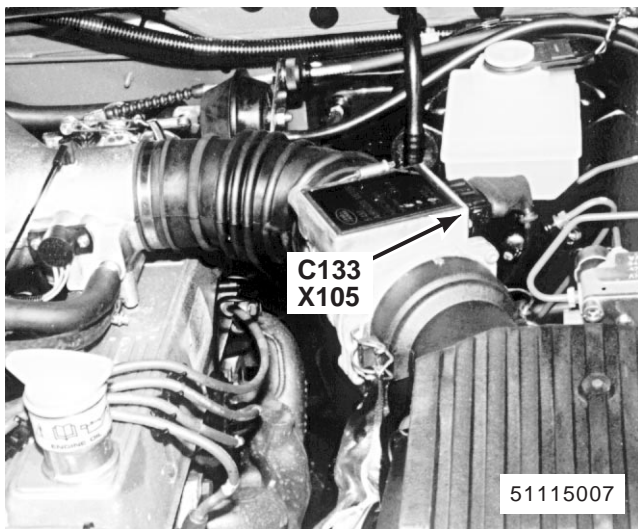

11. LH side of engine compartment (MFI-V8)  
X105 Mass Air Flow Sensor  
C133 (6-B)

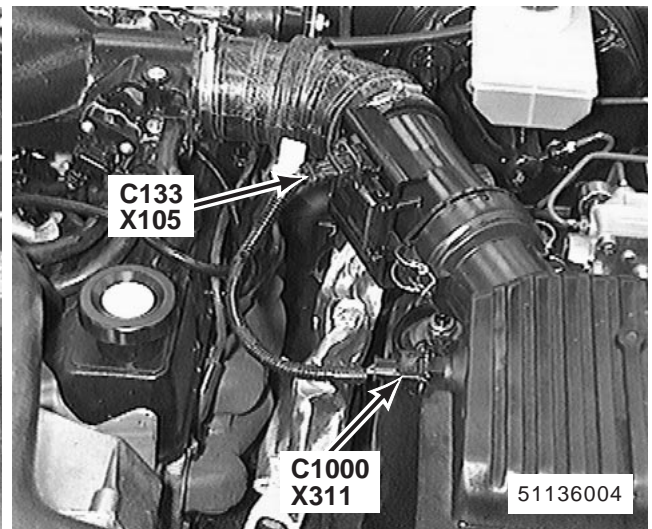

12. LH side of engine compartment (SFI-V8)  
X105 Mass Air Flow Sensor  
X311 Intake Air Temperature Sensor  
C133 (3-B)  
C1000 (2-B)

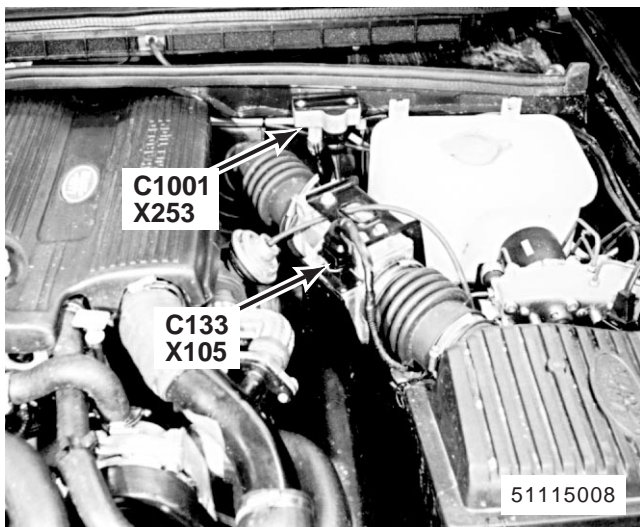

13. LH side of engine compartment (300Tdi with EDC)

X105 Mass Air Flow Sensor  
 X253 Boost Pressure Sensor  
 C1001 (3-B)  
 C133 (5-B)

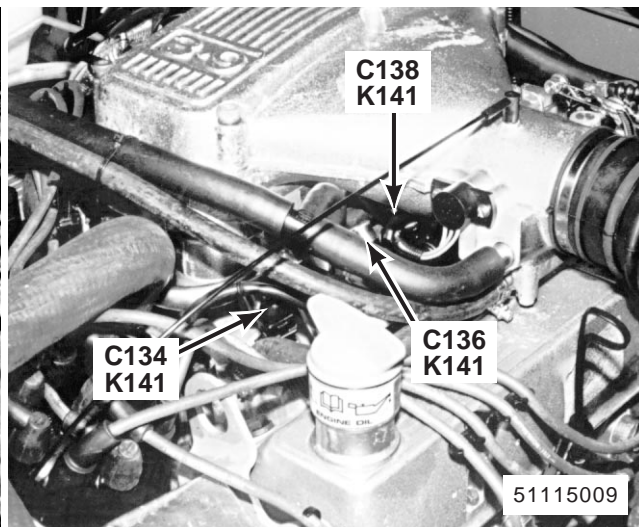

14. top LH side of engine (MFI-V8)

K141 Fuel Injectors  
 C134 (2-B)  
 C136 (2-B)  
 C138 (2-B)

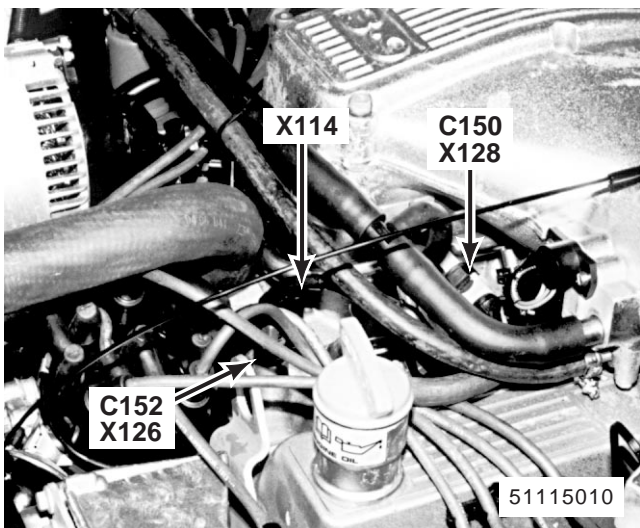

15. top LH front of engine (MFI-V8)

X114 Engine Coolant Temperature Gauge Sensor  
 X126 Engine Coolant Temperature Sensor  
 X128 Engine Fuel Temperature Sensor  
 C150 (2-S)  
 C152 (2-N)

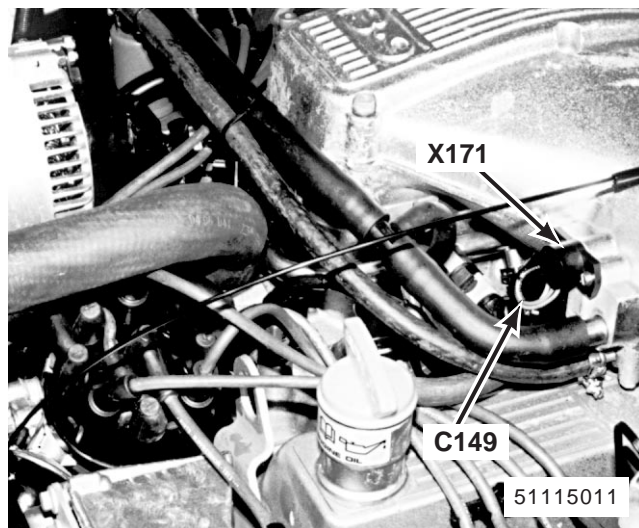

16. top LH front of engine (MFI-V8)

X171 Throttle Position Sensor  
 C149 (3-B)

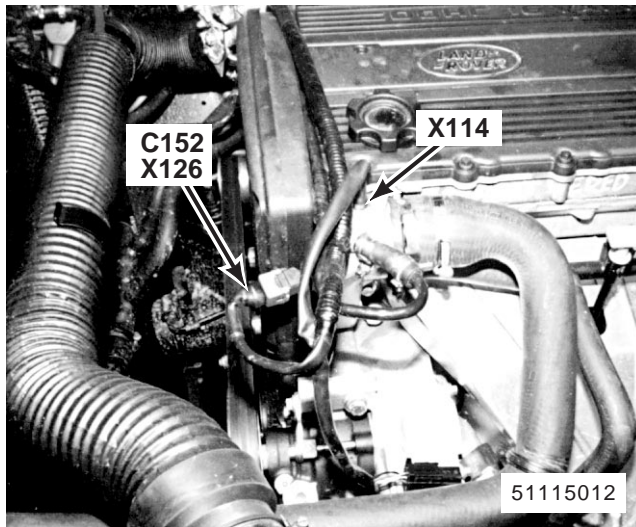

17. top LH front of engine (MFI-T16)  
 X114 Engine Coolant Temperature Gauge Sensor  
 X126 Engine Coolant Temperature Sensor  
 C152 (2-N)

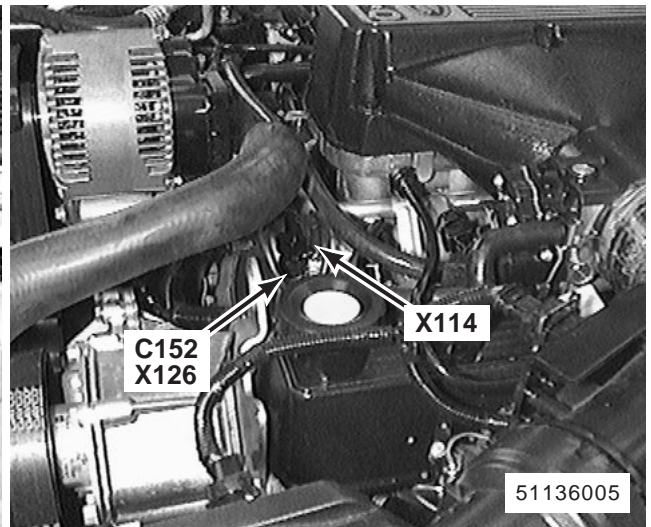

18. top LH front of engine (SFI-V8)  
 X114 Engine Coolant Temperature Gauge Sensor  
 X126 Engine Coolant Temperature Sensor  
 C152 (2-N)

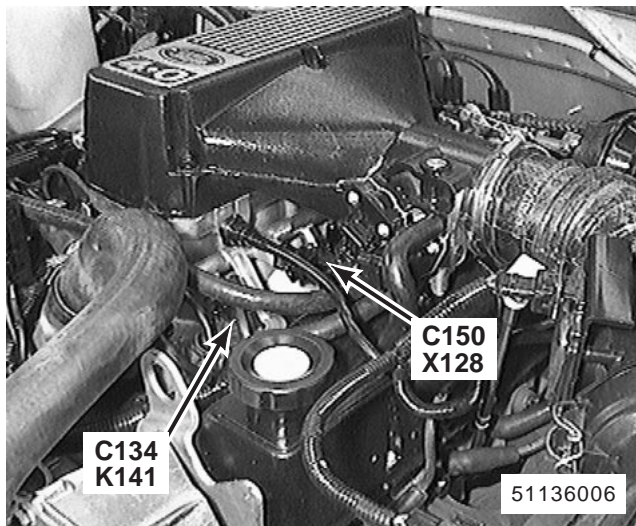

19. top LH front of engine (SFI-V8)  
 K141 Fuel Injectors  
 X128 Engine Fuel Temperature Sensor  
 C134 (2-B)  
 C150 (2-S)

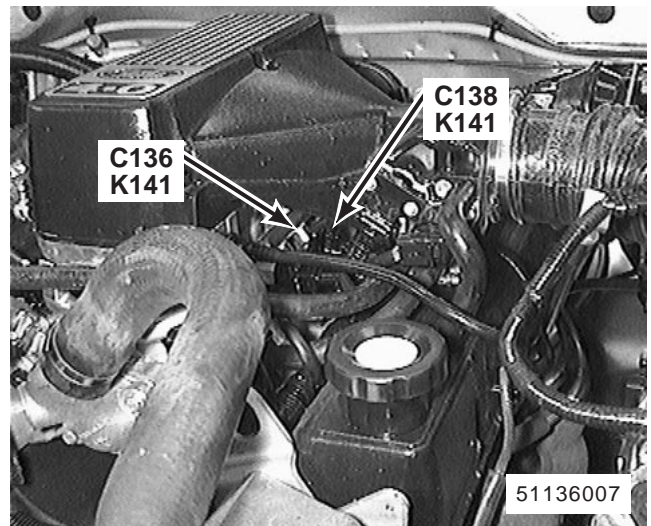

20. top LH front of engine (SFI-V8)  
 K141 Fuel Injectors  
 C136 (2-B)  
 C138 (2-B)



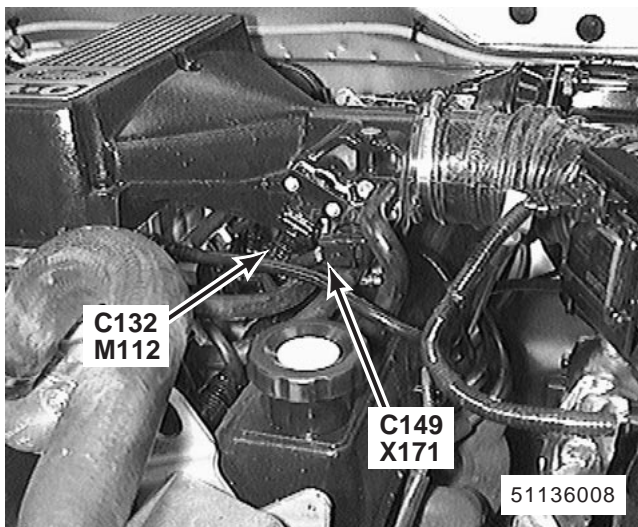

21. top LH front of engine (SFI-V8)  
 M112 Idle Air Control Valve  
 X171 Throttle Position Sensor  
 C132 (4-B)  
 C149 (3-B)

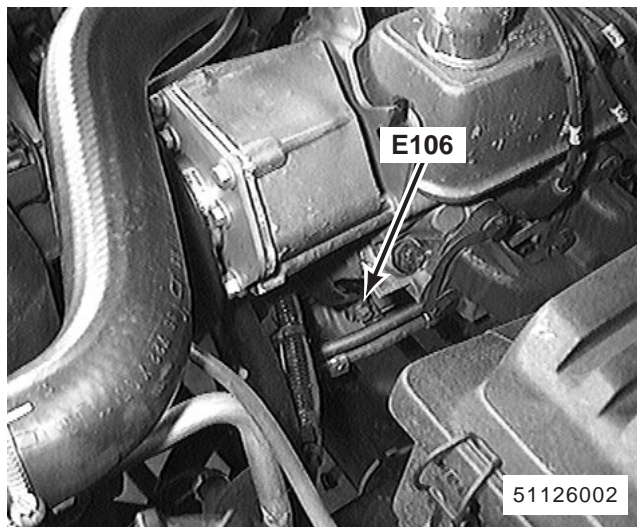

22. LH front of engine (MFI-V8)  
 E106

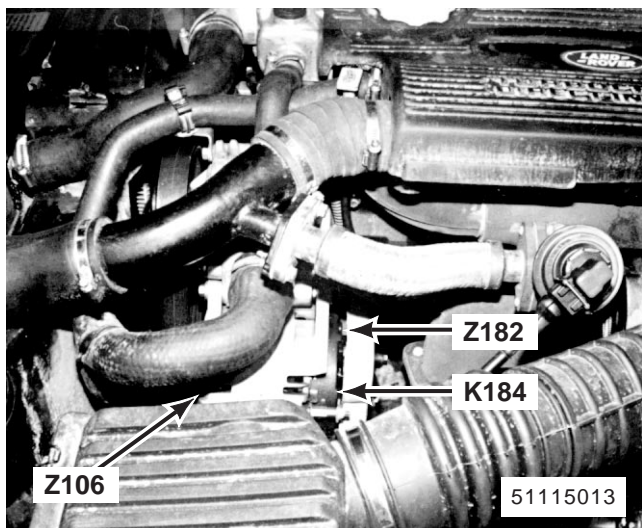

23. lower LH side of engine (300Tdi)  
 K184 Phase Tap Resistor  
 Z182 Generator Suppression Capacitor  
 Z106 Generator

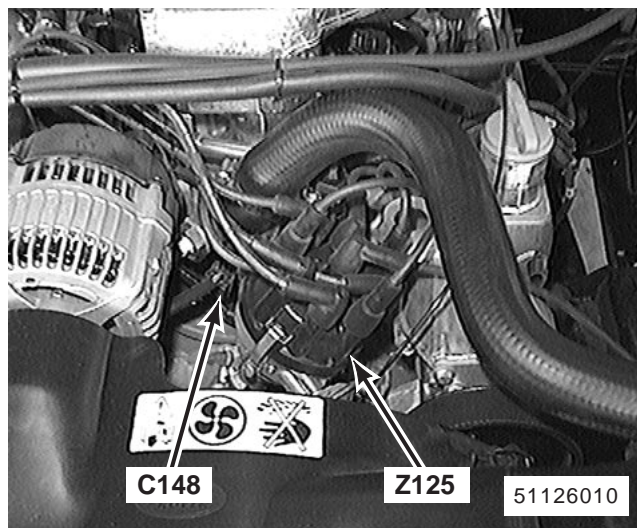

24. top centre front of engine (MFI-V8)  
 Z125 Distributor  
 C148 (2-B)

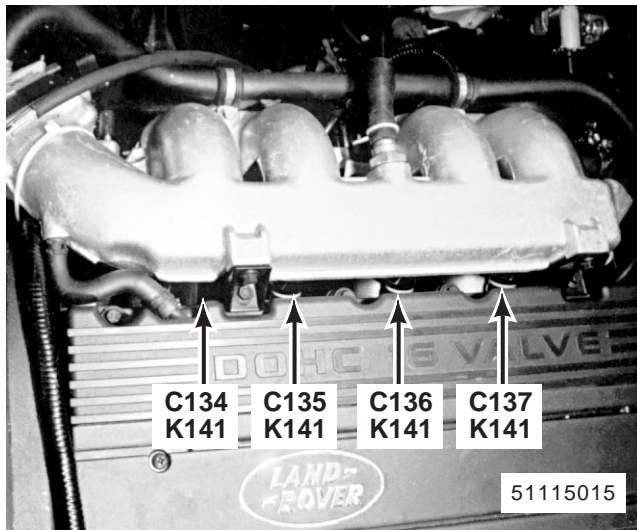

25. top centre front of engine (MFI-T16)

K141 Fuel Injectors

C134 (2-B)

C135 (2-B)

C136 (2-B)

C137 (2-B)



26. top centre front of engine (300Tdi without EDC)

X126 Engine Coolant Temperature Sensor

C152 (2-N)

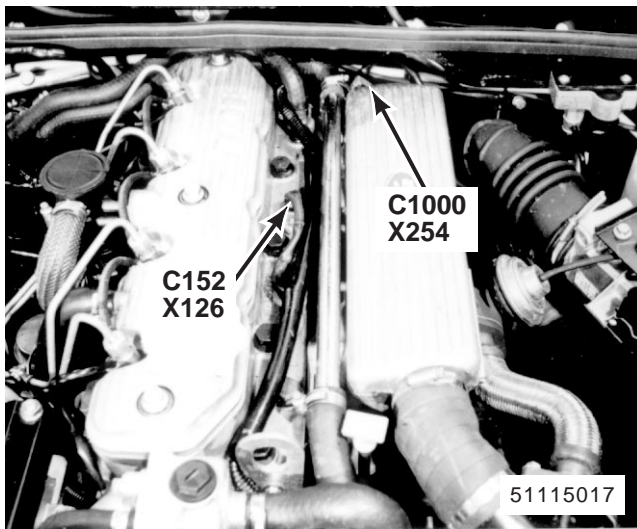

27. top centre front of engine (300Tdi with EDC)

X126 Engine Coolant Temperature Sensor

X254 Boost Pressure Air Temperature Sensor

C1000 (2-G)

C152 (2-N)

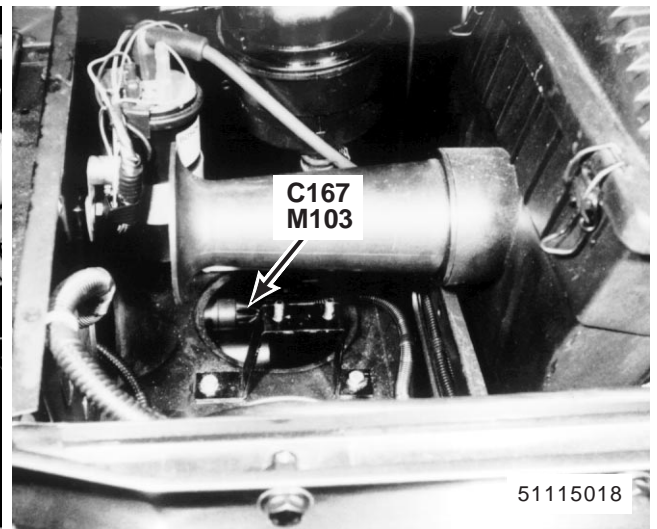

28. LH front corner of engine compartment (MFI-V8 shown; others similar)

M103 Cruise Control Vacuum Pump

C167 (3-W)

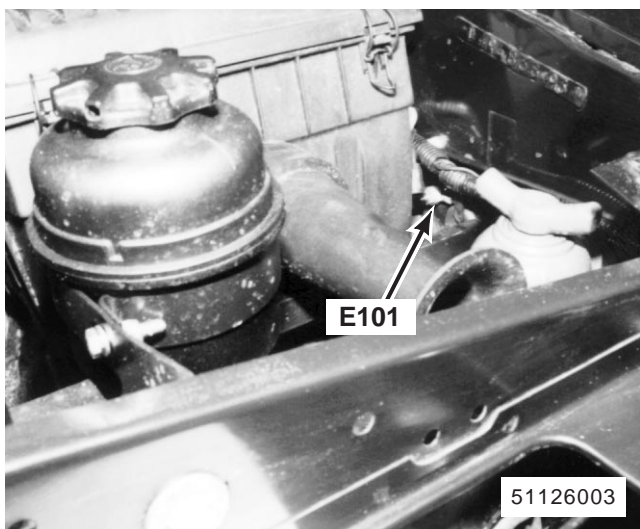

29. LH front of engine compartment (MFI-V8)  
(MFI-T16) (SFI-V8)  
E101

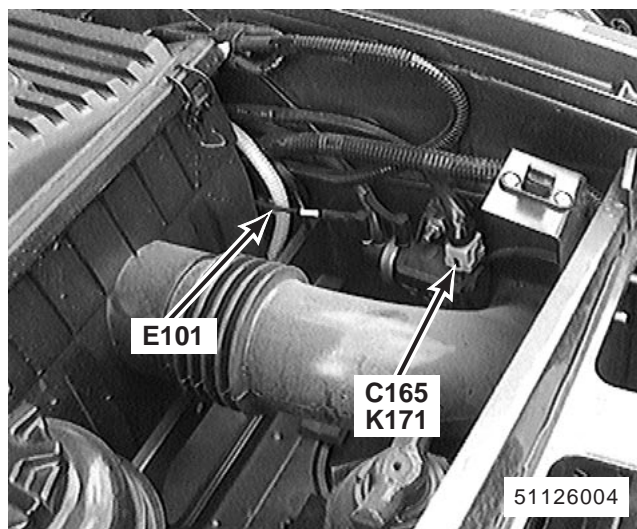

30. LH front of engine compartment (300Tdi)  
K171 EGR Control Solenoid  
C165 (2-B) (300Tdi without EDC)  
C165 (2-S) (300Tdi with EDC)  
E101

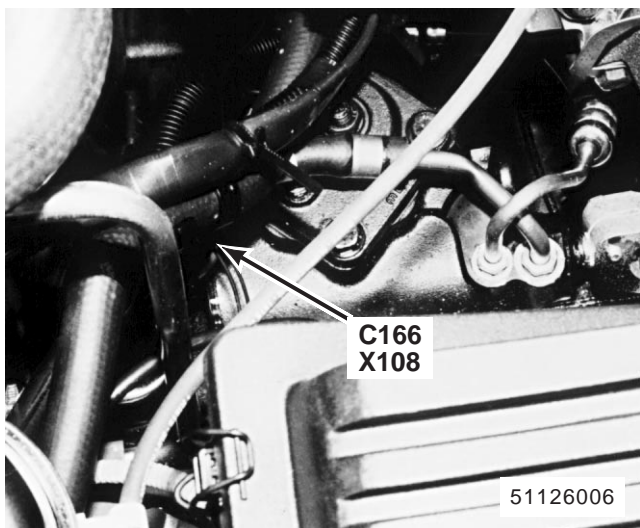

31. lower LH front of engine compartment (MFI-V8  
shown; others similar)  
X108 Automatic Transmission Oil Temperature  
Switch  
C166 (2-B)



32. LH front side of vehicle (RH similar)  
B122 Left Repeater Lamp  
B137 Right Repeater Lamp  
C123 (2-B) (Right)  
C124 (2-B) (Left)

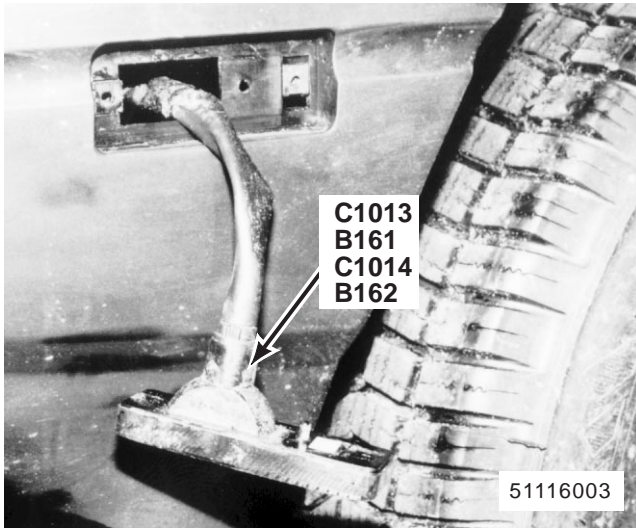

33. LH front of vehicle (RH similar)  
 B161 Left Front Side Marker Lamp  
 B162 Right Front Side Marker Lamp  
 C1013 (2-B) (Left)  
 C1014 (2-B) (Right)

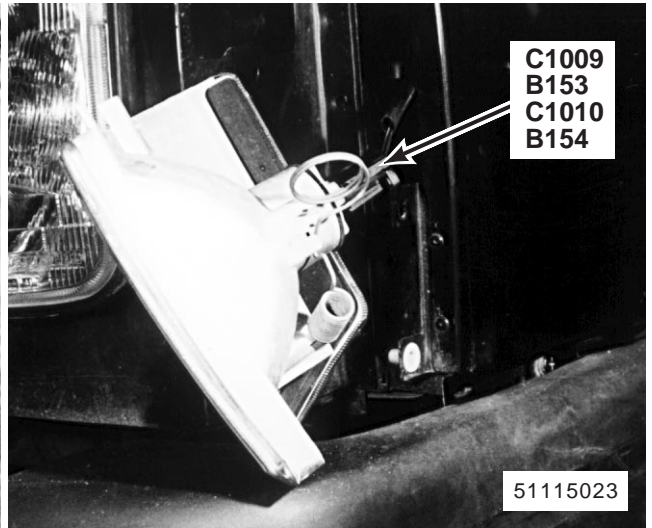

34. LH front of vehicle (RH similar)  
 B153 Left Front Indicator Lamp  
 B154 Right Front Indicator Lamp  
 C1009 (2-B) (Left)  
 C1010 (2-B) (Right)

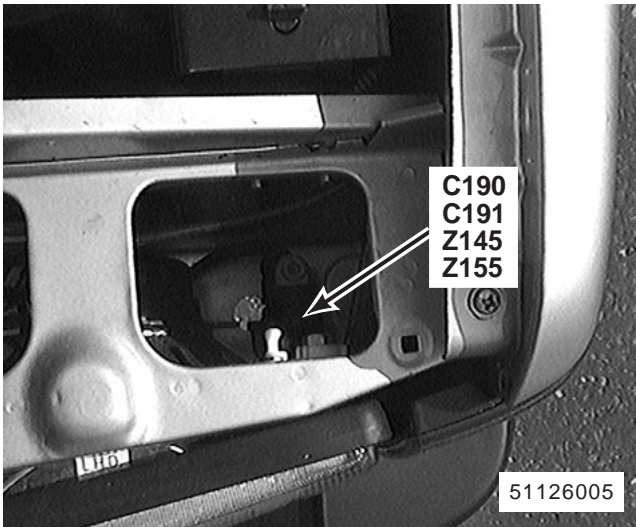

35. LH front of engine compartment (RH similar)  
 Z145 Left Headlamp Level Unit  
 Z155 Right Headlamp Level Unit  
 C190 (3-B) (Left)  
 C191 (3-B) (Right)

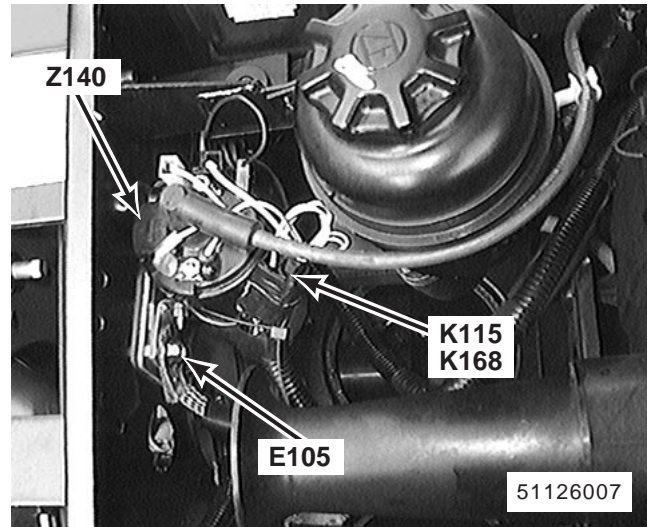

36. LH front of engine compartment (MFI-V8)  
 K115 Multiport Fuel Injection Ignition Resistor 1  
 K168 Multiport Fuel Injection Ignition Resistor 2  
 Z140 Ignition Coil  
 E105

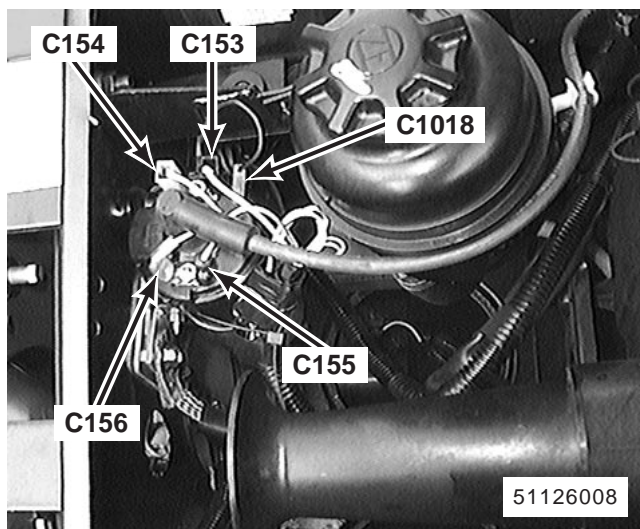

37. LH front of engine compartment (MFI-V8)

- C153 (1-B)
- C154 (1-W)
- C155 (1-B)
- C156 (1-W)
- C1018 (1-W)

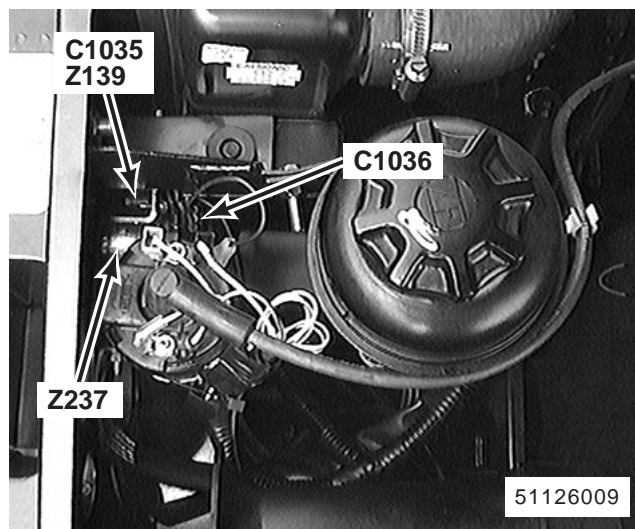

38. LH front of engine compartment (MFI-V8)

- Z139 Ignition Control Module
- Z237 Ignition Coil Noise Suppressor
- C1035 (3-B)
- C1036 (3-B)

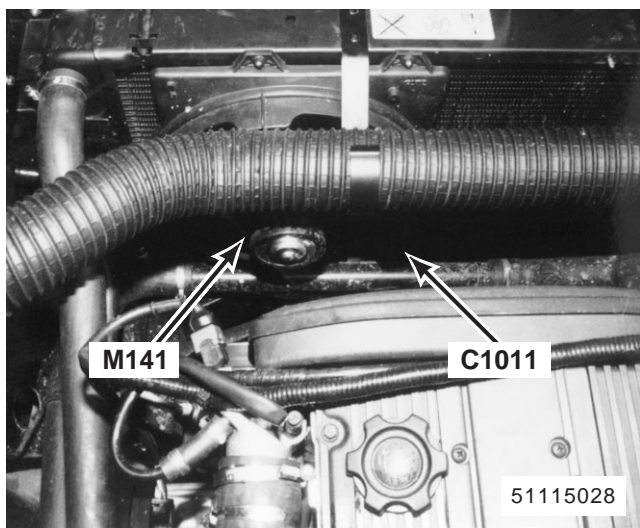

39. front of engine compartment (MFI-T16 without Air Conditioning)

- M141 Cooling Fan Motor 1
- C1011 (2-W)

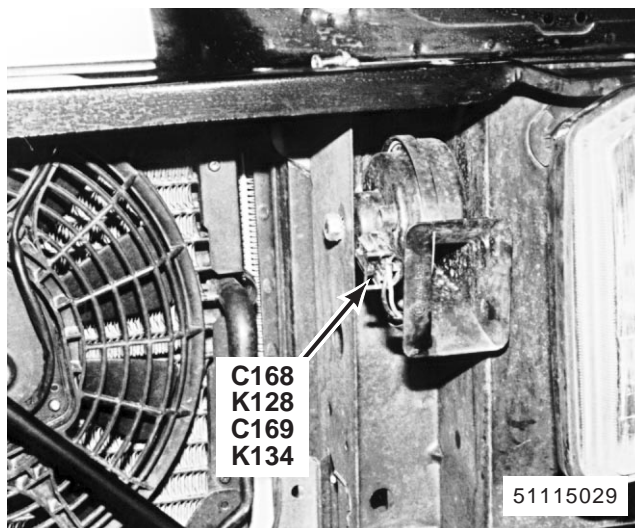

40. LH front of vehicle (RH similar)

- K128 Left Horn
- K134 Right Horn
- C168 (2-B) (Left)
- C169 (2-B) (Right)

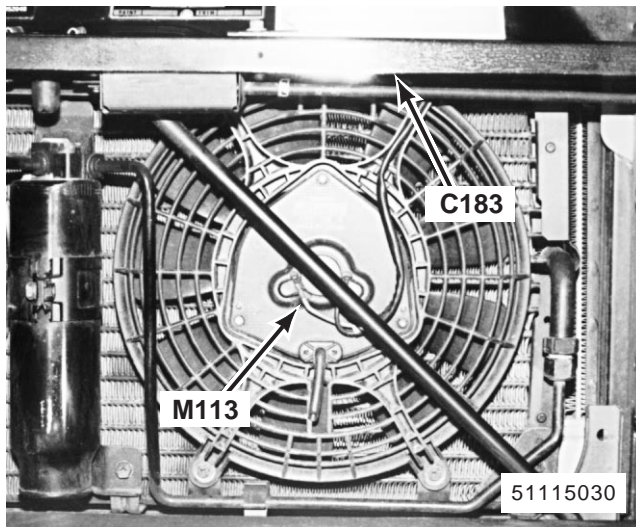

41. behind front grille  
 M113 Left Condenser Fan Motor  
 C183 (2-B)

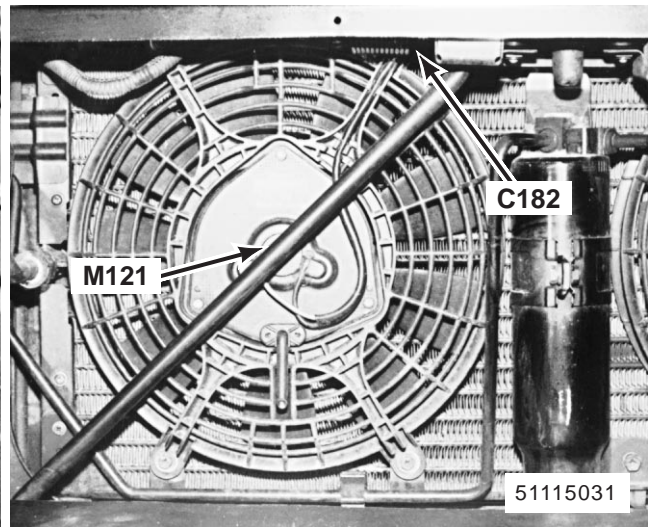

42. behind front grille  
 M121 Right Condenser Fan Motor  
 C182 (2-B)

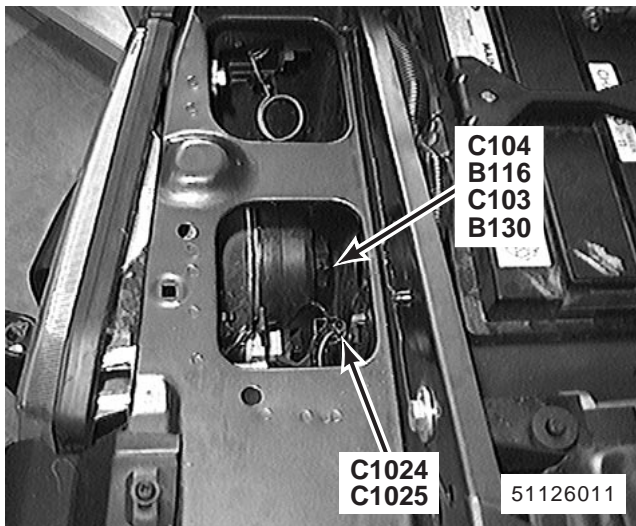

43. RH front of vehicle (LH similar)  
 B116 Left Headlamp  
 B130 Right Headlamp  
 C103 (3-B) (Right)  
 C104 (3-B) (Left)  
 C1024 (2-B) (Left)  
 C1025 (2-B) (Right)

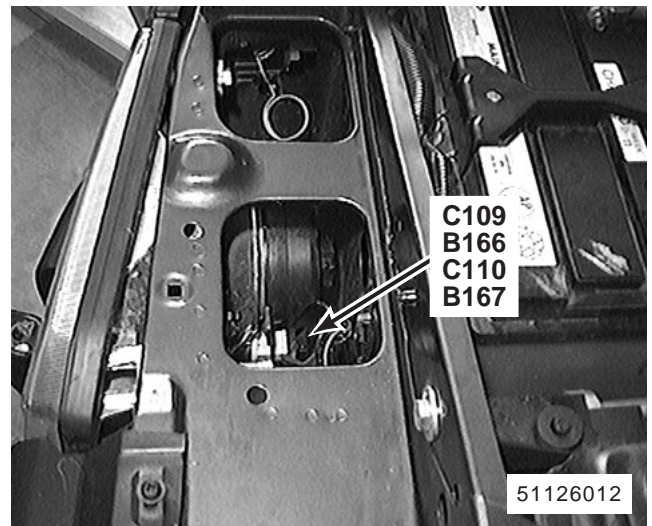

44. RH front of vehicle (LH similar)  
 B166 Left Front Side Lamp  
 B167 Right Front Side Lamp  
 C109 (2-B) (Left)  
 C110 (2-B) (Right)

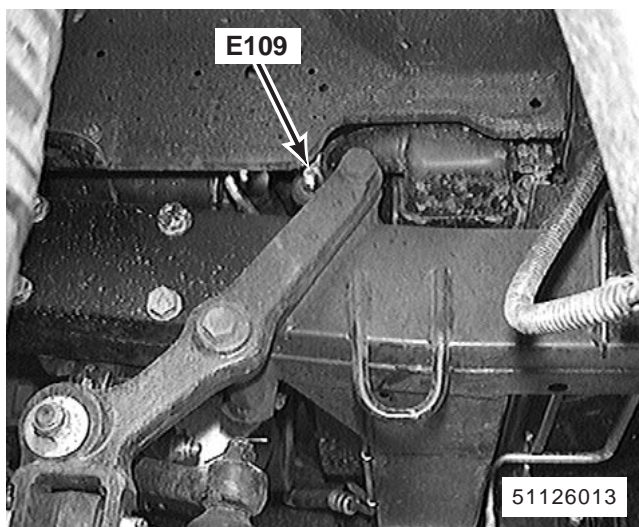

45. lower RH front of engine compartment behind  
RH front wheel  
E109

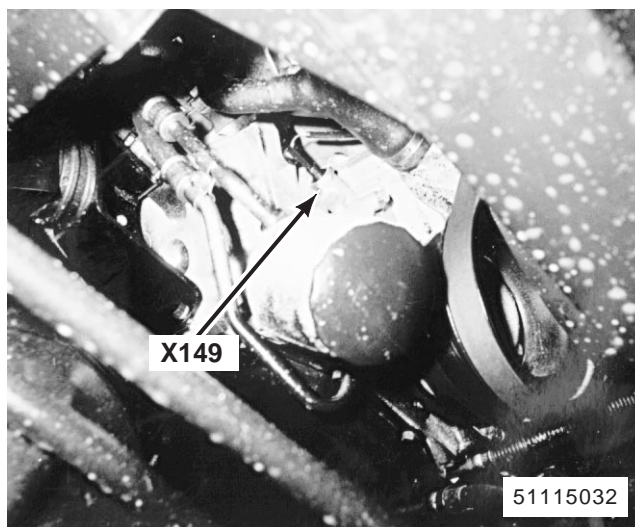

46. lower RH side of engine (MFI-V8)  
X149 Oil Pressure Switch



47. lower RH side of engine (MFI-T16)  
X149 Oil Pressure Switch  
C142 (2-N)

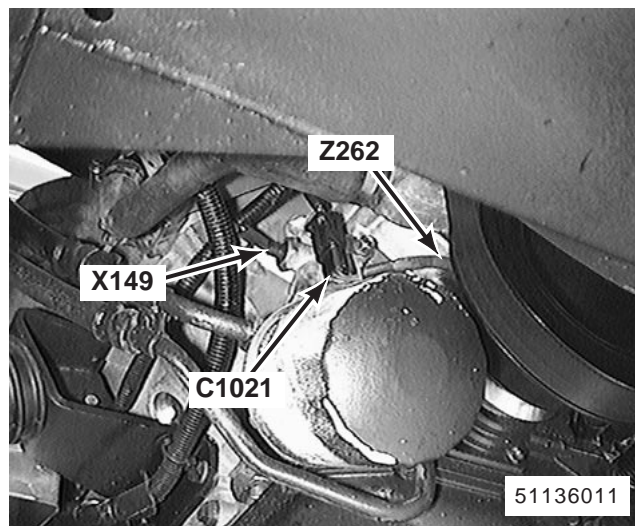

48. lower RH side of engine (SFI-V8)  
X149 Oil Pressure Switch  
Z262 Camshaft Position Sensor  
C1021 (3-B)

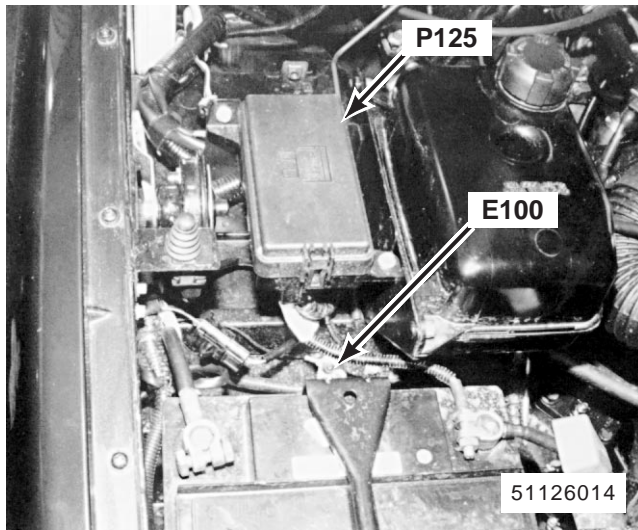

49. RH front of engine compartment (MFI-V8)  
(MFI-T16)  
P125 Engine Compartment Fuse Box  
E100

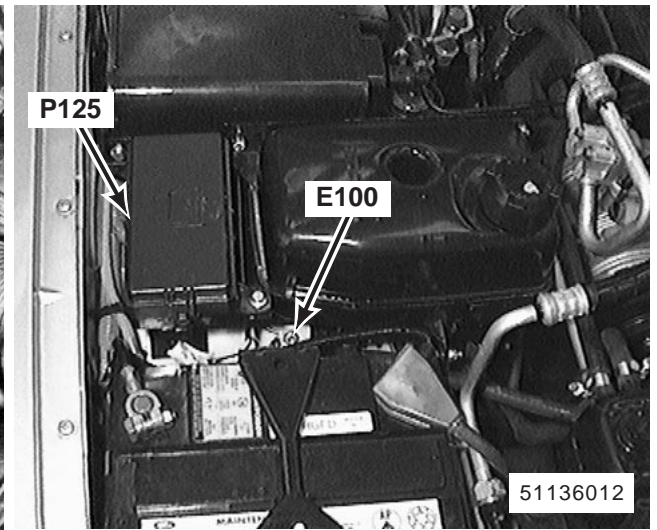

50. RH front of engine compartment (SFI-V8)  
P125 Engine Compartment Fuse Box  
E100

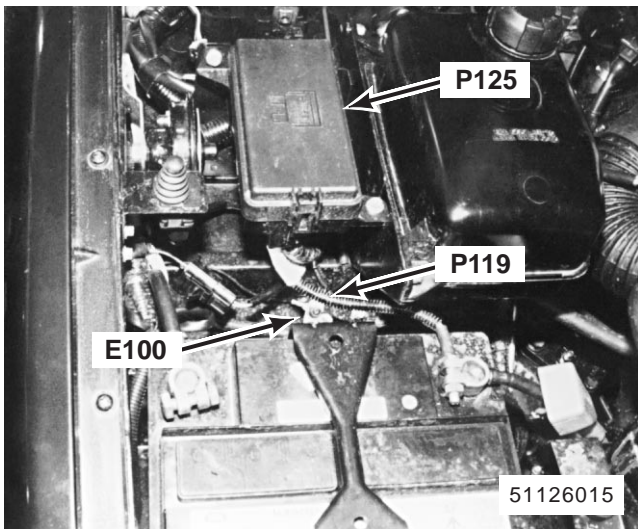

51. RH front of engine compartment (300Tdi)  
P119 Fusible Link  
P125 Engine Compartment Fuse Box  
E100

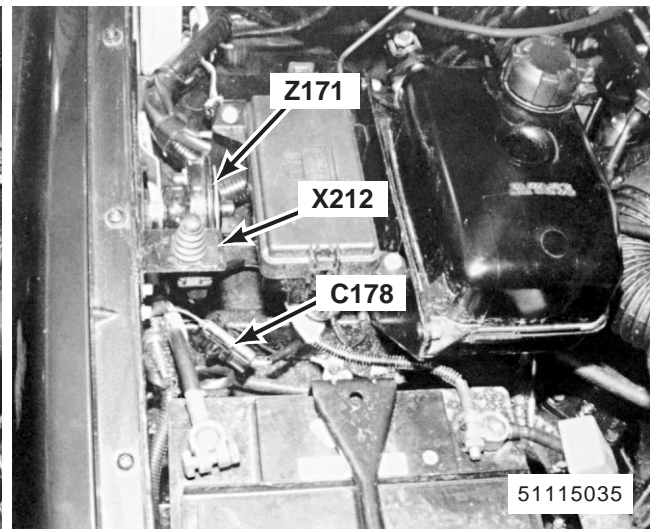

52. RH front of engine compartment (MFI-V8)  
(MFI-T16)  
X212 Alarm Bonnet Switch  
Z171 Alarm Sounder  
C178 (2-B)



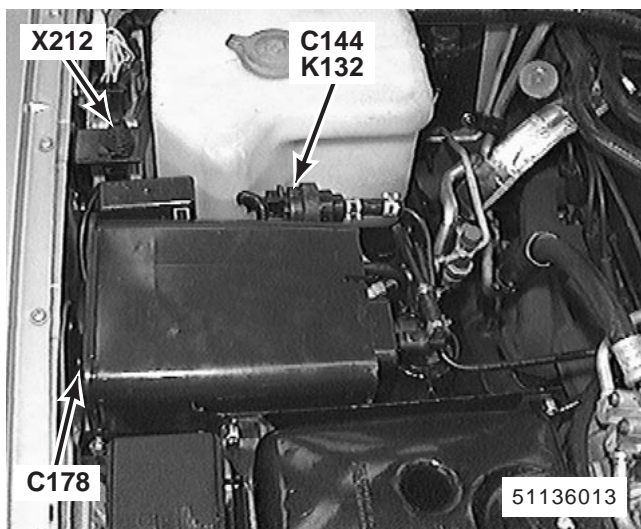

53. RH front of engine compartment (SFI-V8)  
 K132 Evaporative Emission Canister Purge Valve  
 X212 Alarm Bonnet Switch  
 C144 (2-B)  
 C178 (2-B)

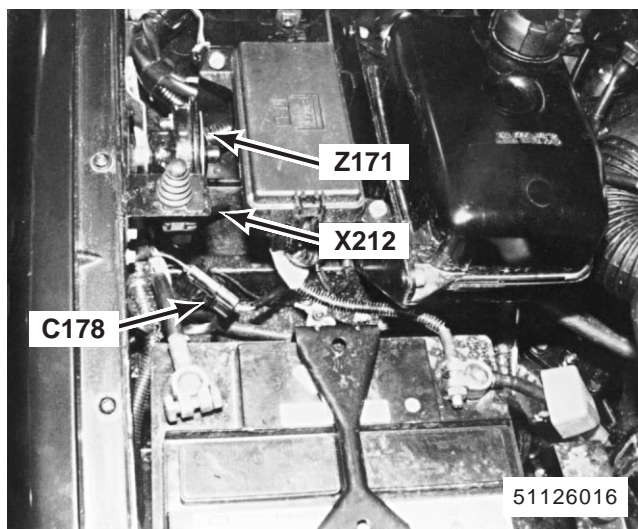

54. RH front of engine compartment (300Tdi)  
 X212 Alarm Bonnet Switch  
 Z171 Alarm Sounder  
 C178 (2-B)

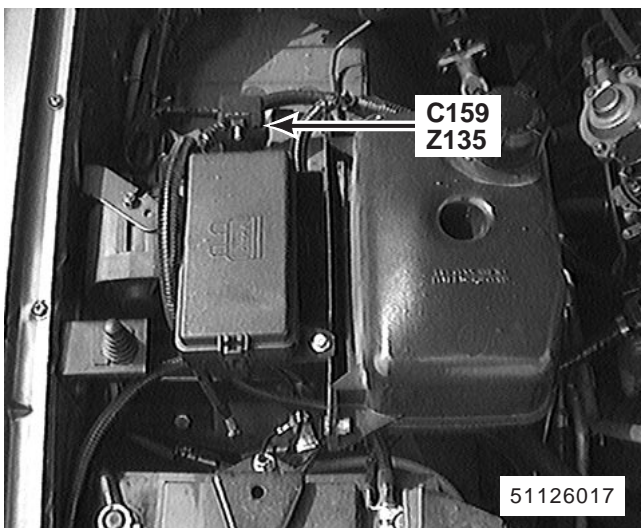

55. RH front of engine compartment (300Tdi)  
 Z135 Glow Plug Timer Unit  
 C159 (6-B)

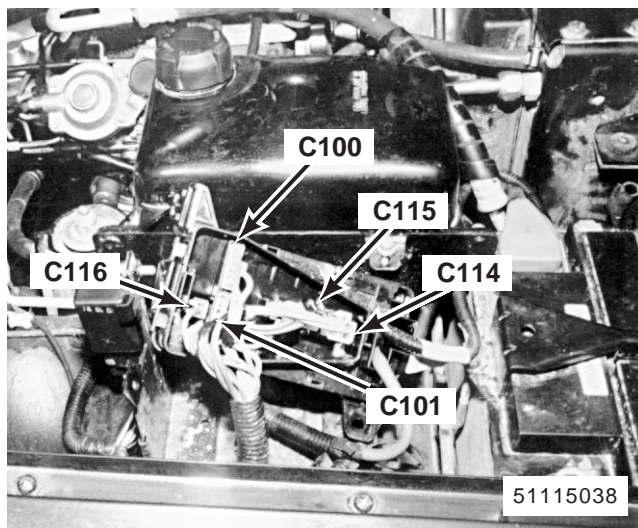

56. RH front of engine compartment  
 C100 (3-W)  
 C101 (4-W)  
 C114 (2-W)  
 C115 (3-W)  
 C116 (1-W)

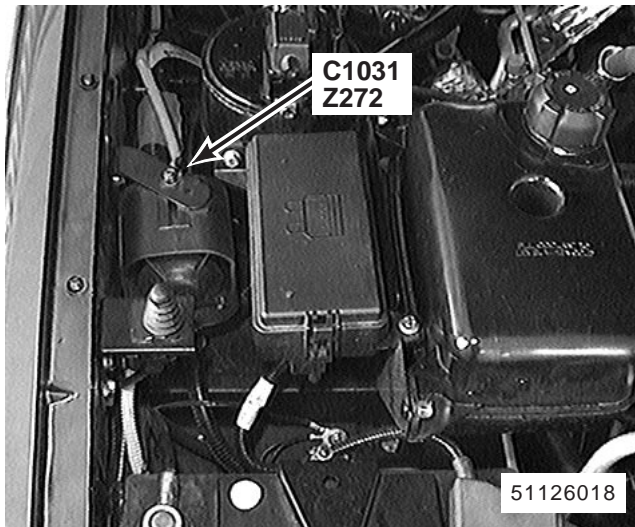

57. (RH front of engine compartment)  
Z272 Battery Backed Up Alarm Sounder  
C1031 (4-N)

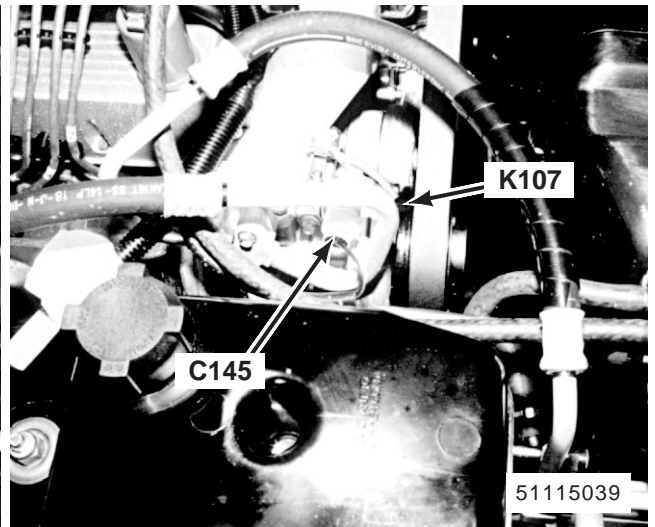

58. RH front of engine (MFI-V8)  
K107 Compressor Clutch  
C145 (2-W)

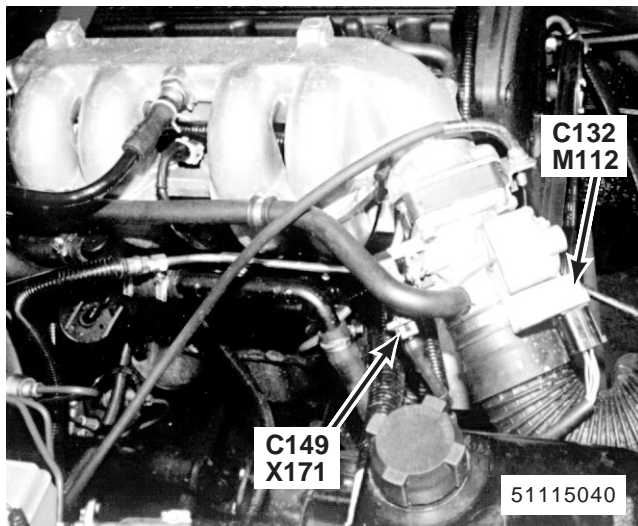

59. RH front of engine (MFI-T16)  
M112 Idle Air Control Valve  
X171 Throttle Position Sensor  
C132 (6-B)  
C149 (3-B)

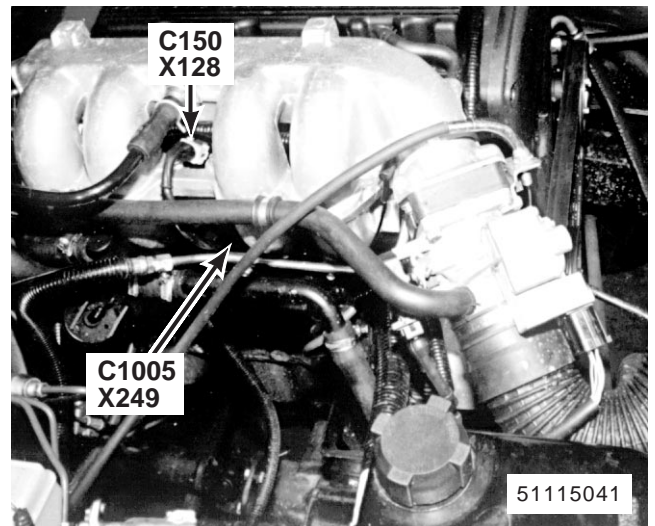

60. RH side of engine (MFI-T16)  
X128 Engine Fuel Temperature Sensor  
X249 Knock Sensor  
C150 (2-S)  
C1005 (2-W)

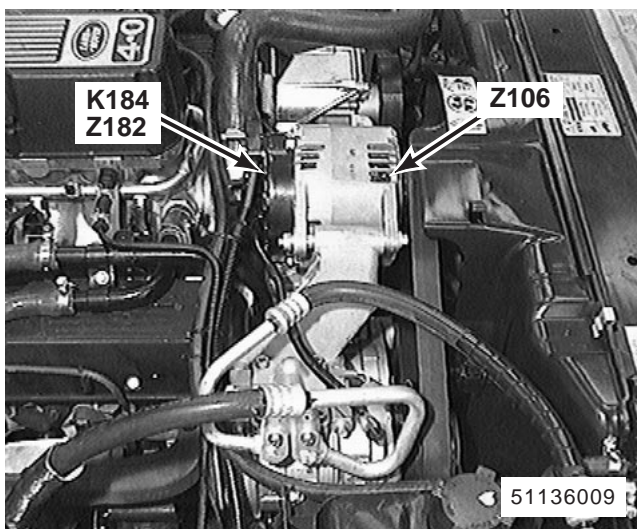

61. RH front of engine (SFI-V8)  
 K184 Phase Tap Resistor  
 Z106 Generator  
 Z182 Generator Suppression Capacitor

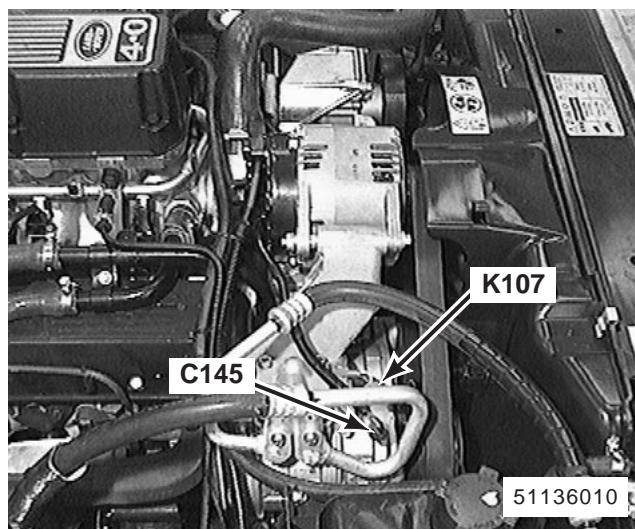

62. RH front of engine (SFI-V8)  
 K107 Compressor Clutch  
 C145 (2-W)

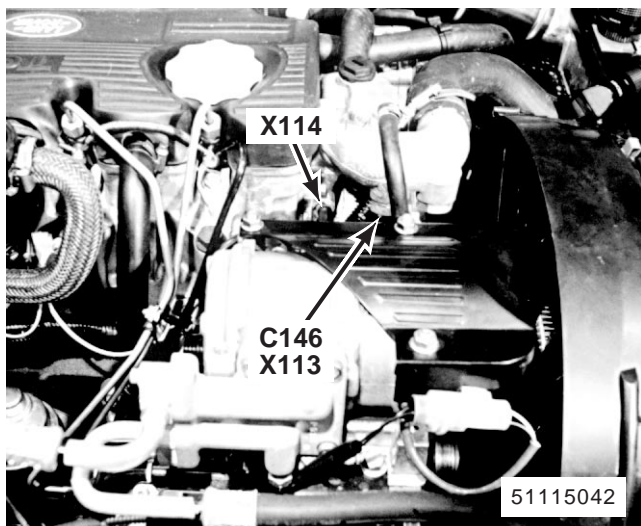

63. RH front of engine (300Tdi with EDC)  
 X113 Condenser Fan Coolant Temperature Switch  
 X114 Engine Coolant Temperature Gauge Sensor  
 C146 (2-B)

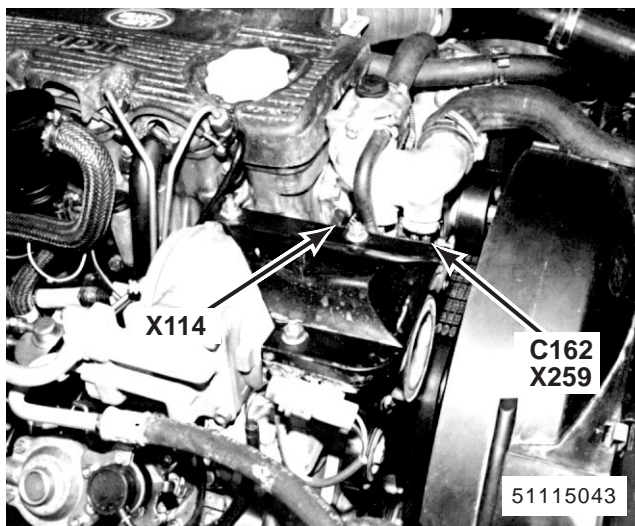

64. RH front of engine (300Tdi without EDC)  
 X114 Engine Coolant Temperature Gauge Sensor  
 X259 Compressor Clutch Cut-out Switch  
 C162 (2-B)

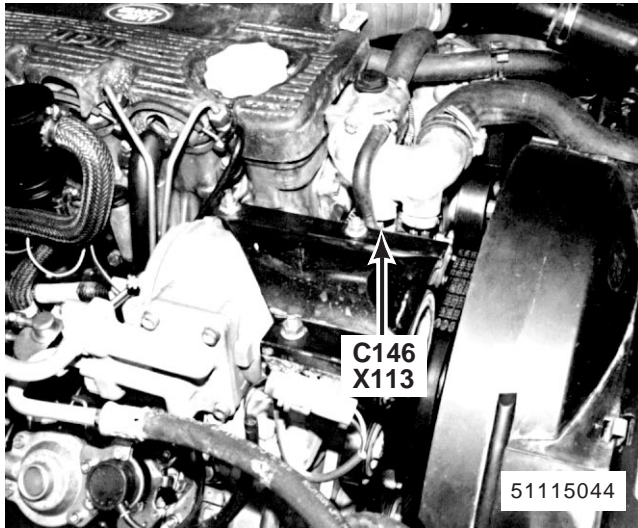

65. RH front of engine (300Tdi without EDC)  
 X113 Condenser Fan Coolant Temperature Switch  
 C146 (2-B)

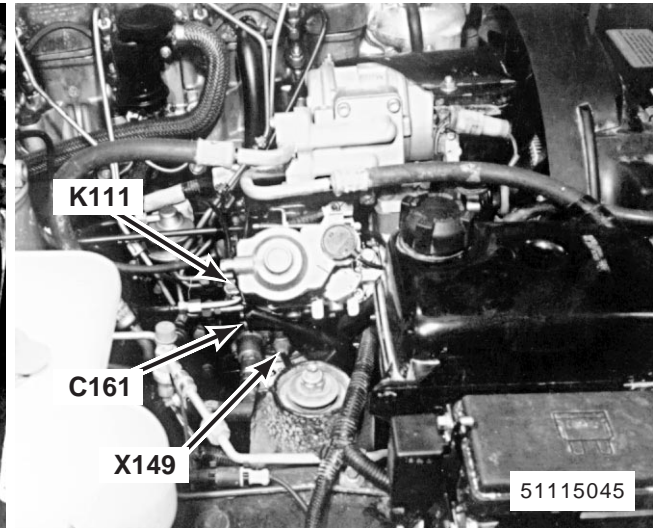

66. RH side of engine (300Tdi without EGR)  
 K111 Fuel Shut-Off Solenoid  
 X149 Oil Pressure Switch  
 C161 (1-W)

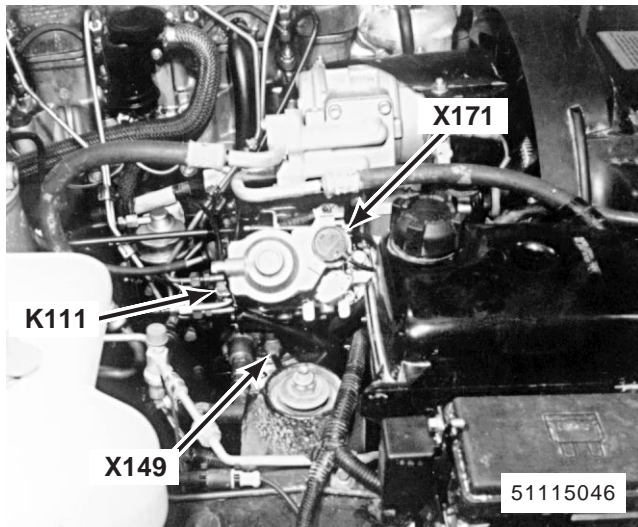

67. RH side of engine (300Tdi with EGR)  
 K111 Fuel Shut-Off Solenoid  
 X149 Oil Pressure Switch  
 X171 Throttle Position Sensor

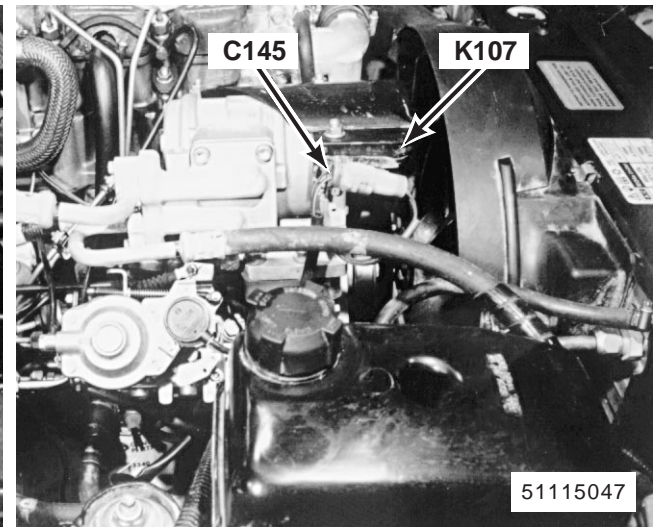

68. RH side of engine (300Tdi without EDC)  
 K107 Compressor Clutch  
 C145 (2-W)

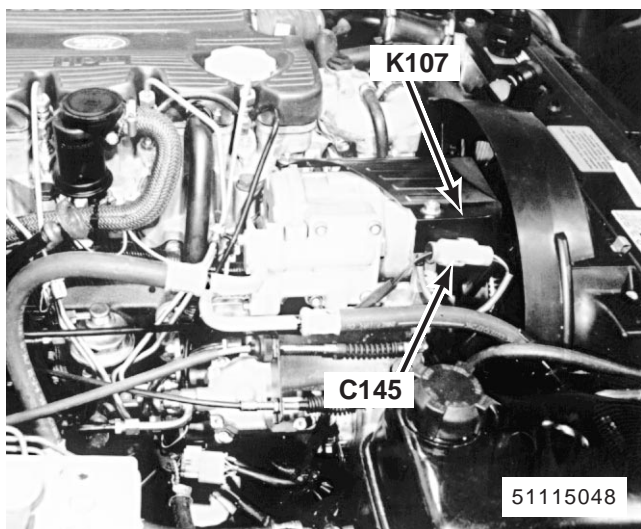

69. RH side of engine (300Tdi with EDC)  
 K107 Compressor Clutch  
 C145 (2-W)

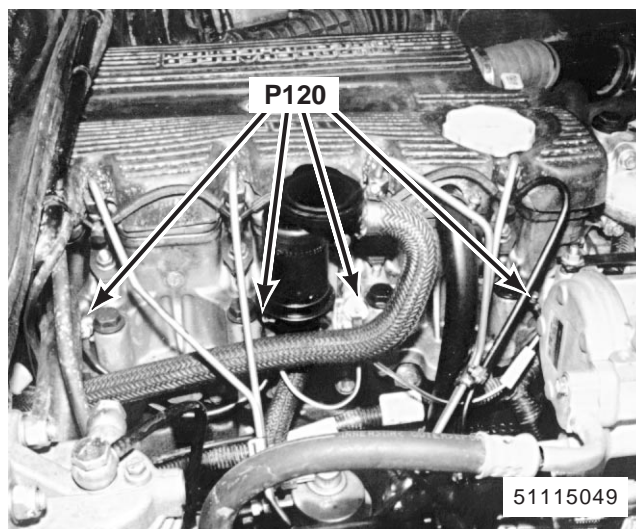

70. RH side of engine (300Tdi)  
 P120 Glow Plugs

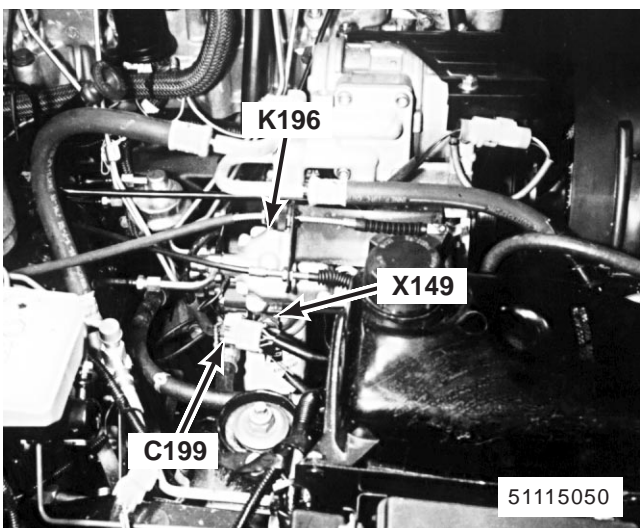

71. RH side of engine (300Tdi with EDC)  
 K196 Fuel Pump Assembly  
 X149 Oil Pressure Switch  
 C199 (8-W)

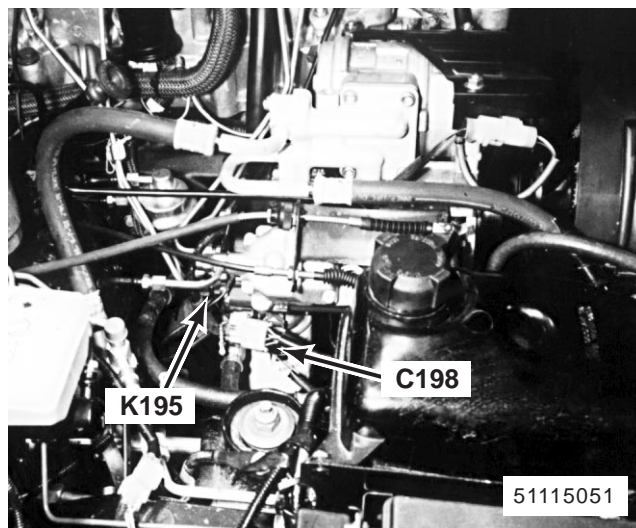

72. RH side of engine (300Tdi with EDC)  
 K195 Fuel Injector Assembly  
 C198 (3-W)

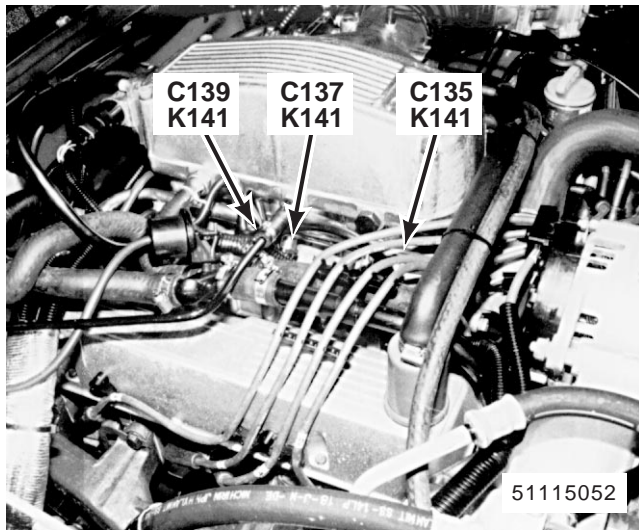

73. RH side of engine (MFI-V8)

K141 Fuel Injectors

C135 (2-B)

C137 (2-B)

C139 (2-B)

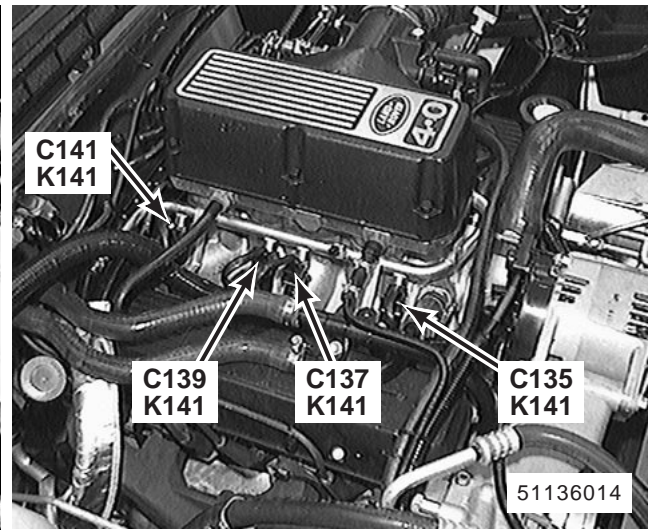

74. RH side of engine (SFI-V8)

K141 Fuel Injectors

C135 (2-B)

C137 (2-B)

C139 (2-B)

C141 (2-B)

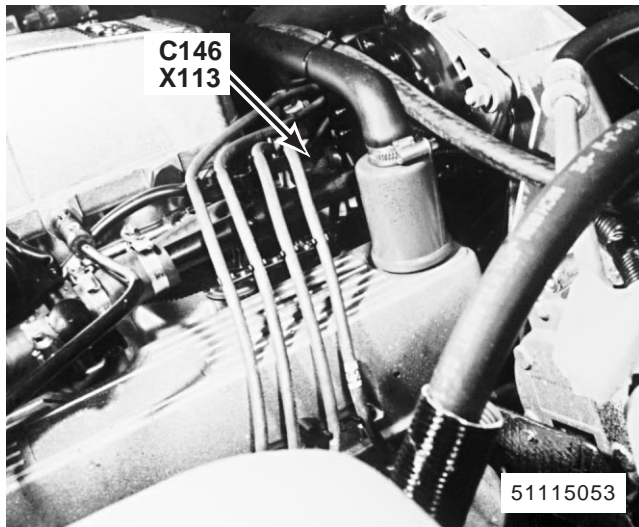

75. RH front of engine (MFI-V8)

X113 Condenser Fan Coolant Temperature Switch

C146 (2-B)

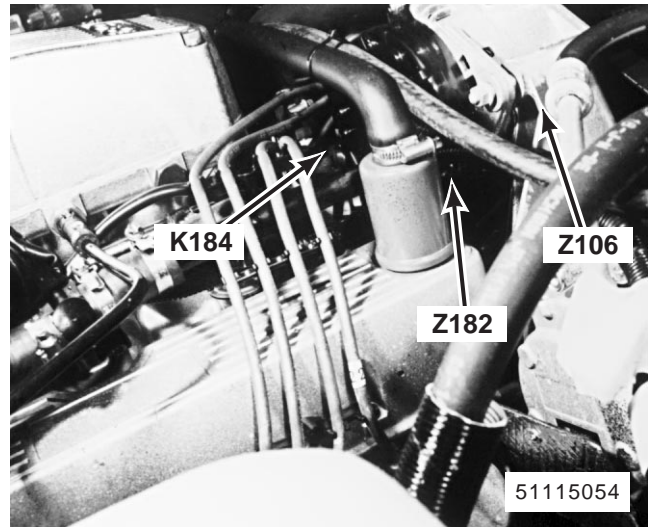

76. RH front of engine (MFI-V8)

K184 Phase Tap Resistor

Z106 Generator

Z182 Generator Suppression Capacitor



77. RH side of engine compartment (SFI-V8)  
E103

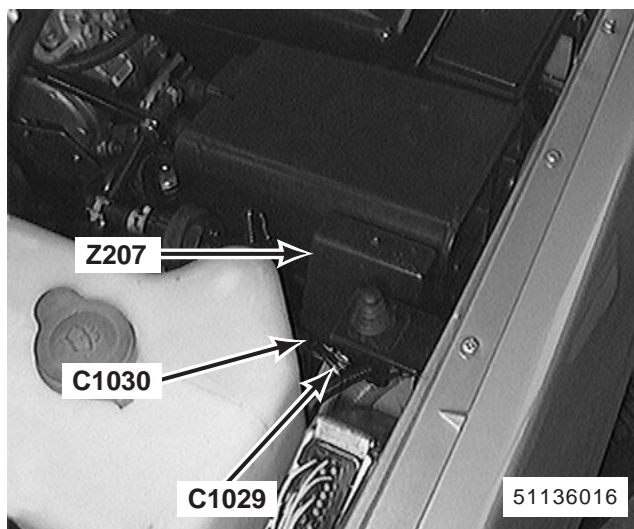

78. RH side of engine compartment (SFI-V8)  
Z207 Multi-Function Relay Unit  
C1029 (8-B)  
C1030 (6-B)

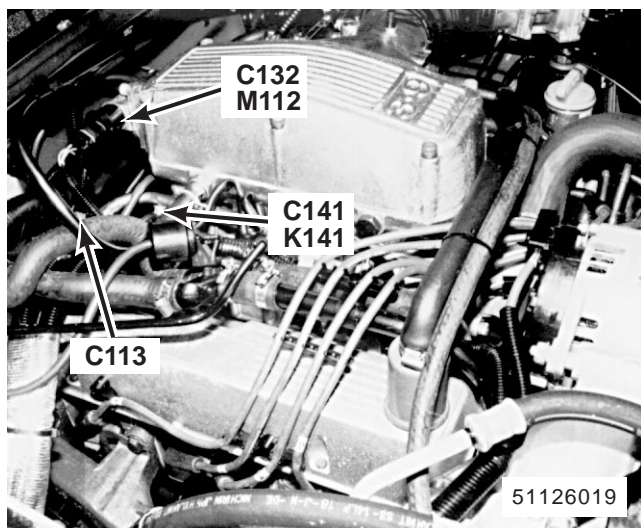

79. RH side of engine (MFI-V8)  
K141 Fuel Injectors  
M112 Idle Air Control Valve  
C113 (3-W)  
C132 (4-B)  
C141 (2-B)

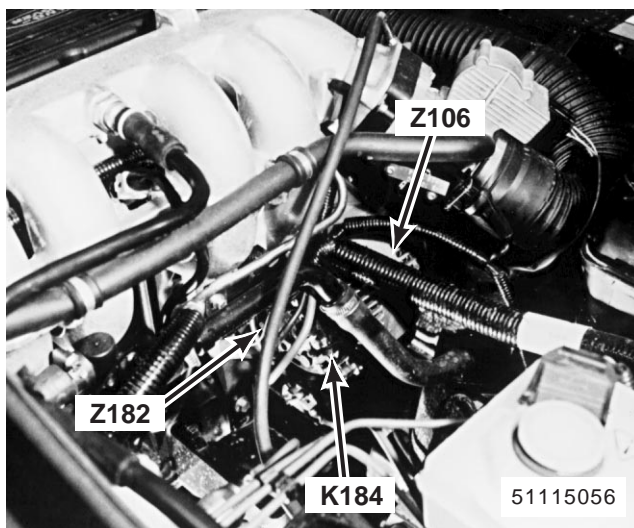

80. RH side of engine (MFI-T16 without Air Conditioning)  
K184 Phase Tap Resistor  
Z106 Generator  
Z182 Generator Suppression Capacitor

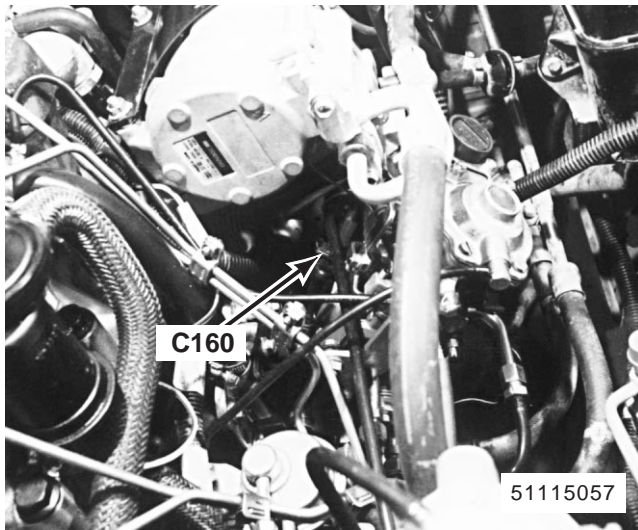

81. RH side of engine (300Tdi with EGR)  
C160 (3-B)

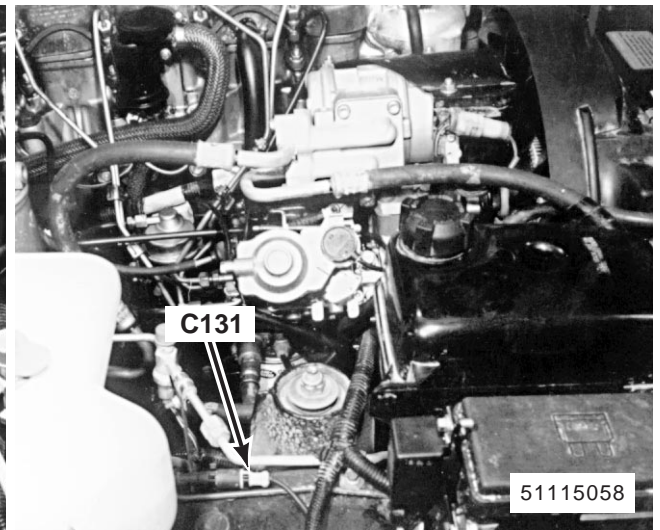

82. RH side of engine compartment (MFI-V8)  
(300Tdi) (MFI-T16)  
C131 (2-WB)

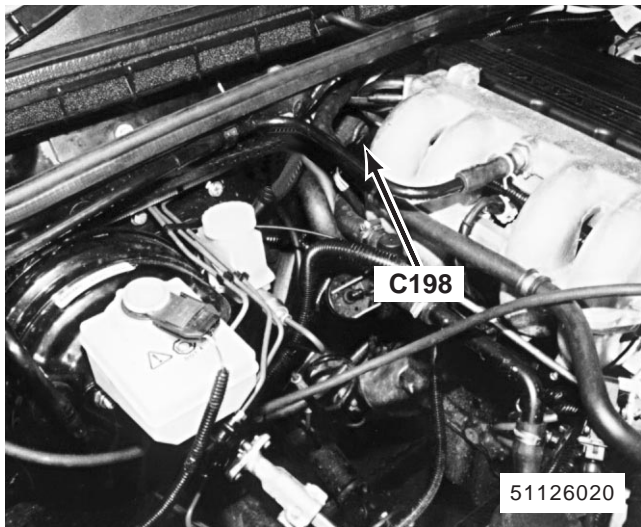

83. RH rear corner of engine compartment  
(MFI-T16)  
C198 (6-B)

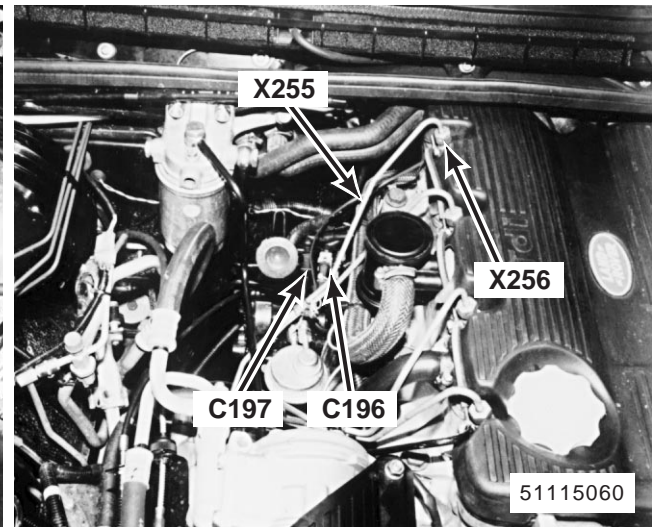

84. RH rear of engine (300Tdi with EDC)  
X255 Engine Speed Sensor  
X256 Injector Needle Lift Sensor  
C196 (2-NU)  
C197 (3-B)



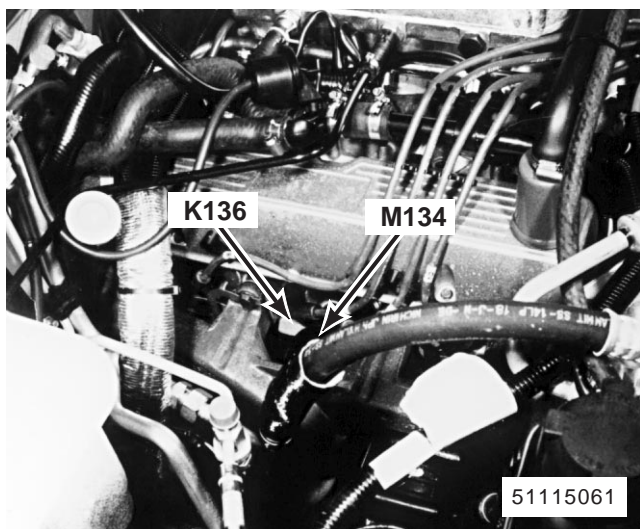

85. lower RH side of engine (MFI-V8)  
K136 Starter Solenoid  
M134 Starter

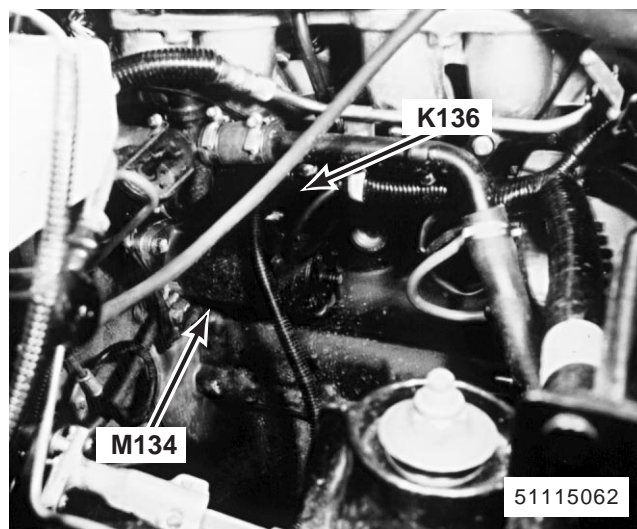

86. lower RH side of engine (MFI-T16)  
K136 Starter Solenoid  
M134 Starter

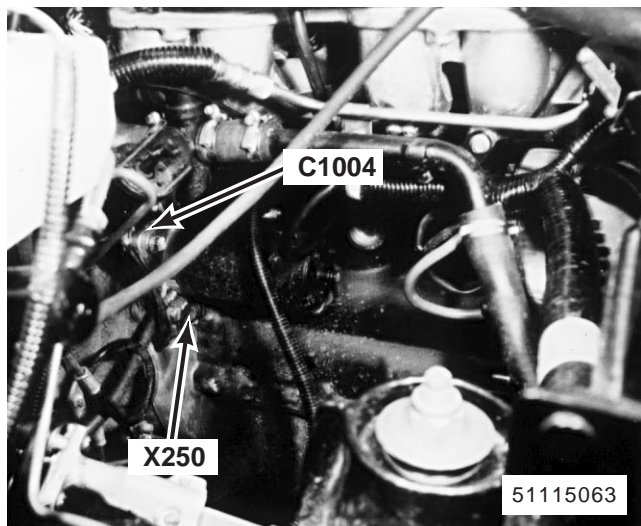

87. lower RH side of engine (MFI-T16)  
X250 Crankshaft Position Sensor  
C1004 (2-U)

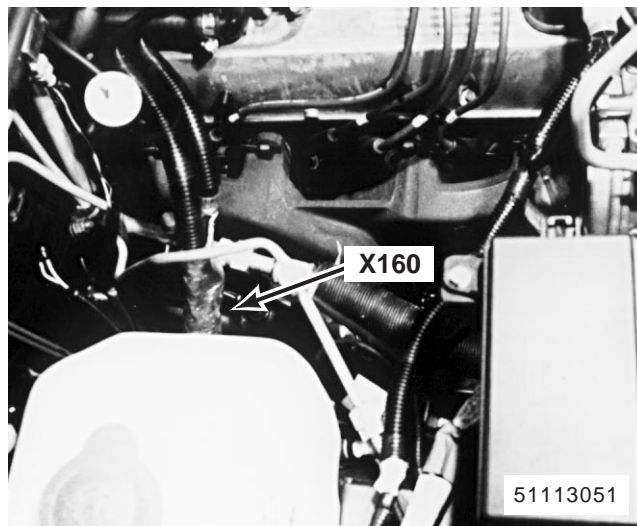

88. lower RH side of engine (MFI-V8)  
X160 Right Heated Oxygen Sensor

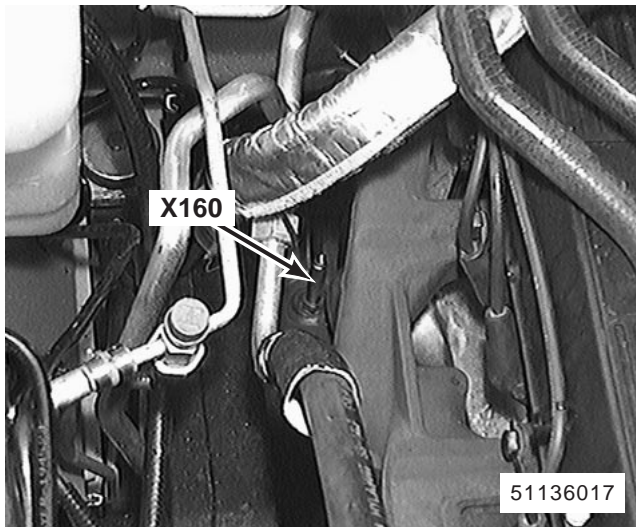

89. lower RH rear of engine compartment (SFI-V8)  
X160 Right Heated Oxygen Sensor

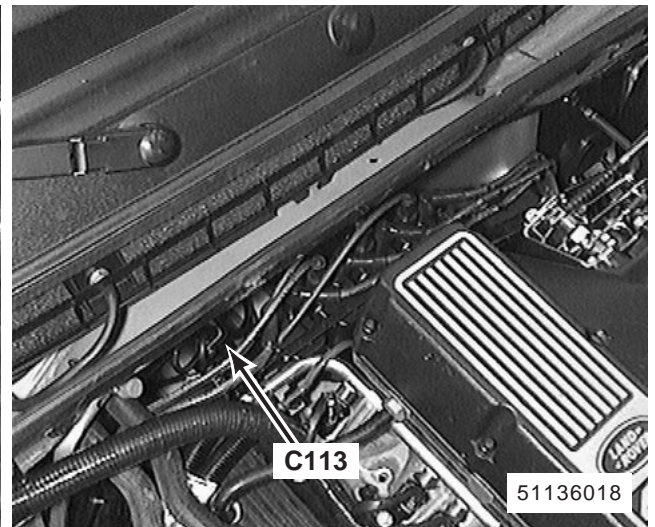

90. lower RH rear of engine (SFI-V8)  
C113 (4-R)

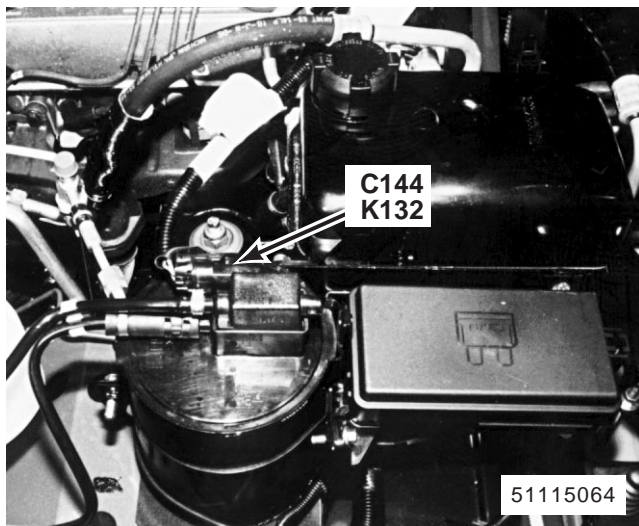

91. RH side of engine compartment (MFI-V8)  
K132 Evaporative Emission Canister Purge Valve  
C144 (2-B)

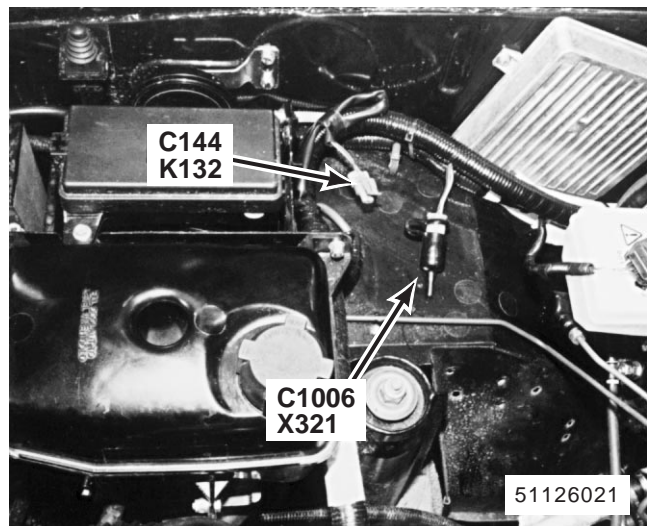

92. RH rear corner of engine compartment (MFI-T16)  
K132 Evaporative Emission Canister Purge Valve  
X321 Data Link Connector (MFI)  
C144 (2-B)  
C1006 (3-W)

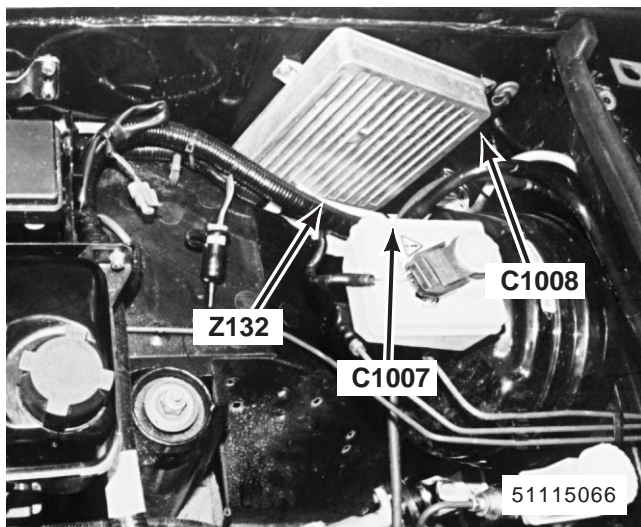

93. RH rear corner of engine compartment (MFI-T16)  
 Z132 Engine Control Module (ECM)  
 C1007 (36-B)  
 C1008 (18-B)

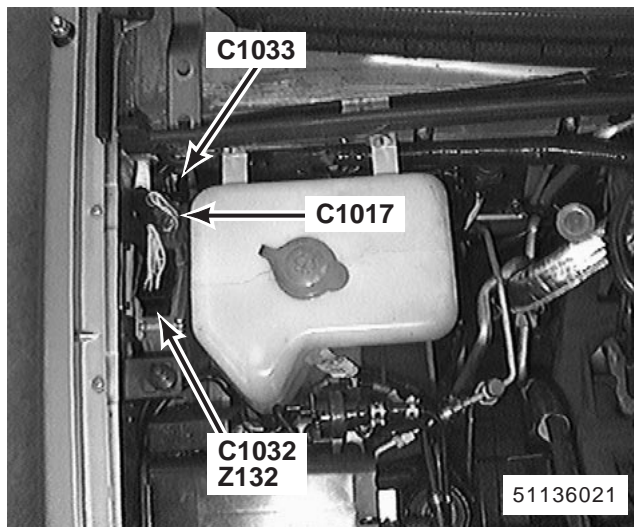

94. RH rear corner of engine compartment (SFI-V8)  
 Z132 Engine Control Module (ECM)  
 C1017 (36-R)  
 C1032 (36-B)  
 C1033 (18-B)

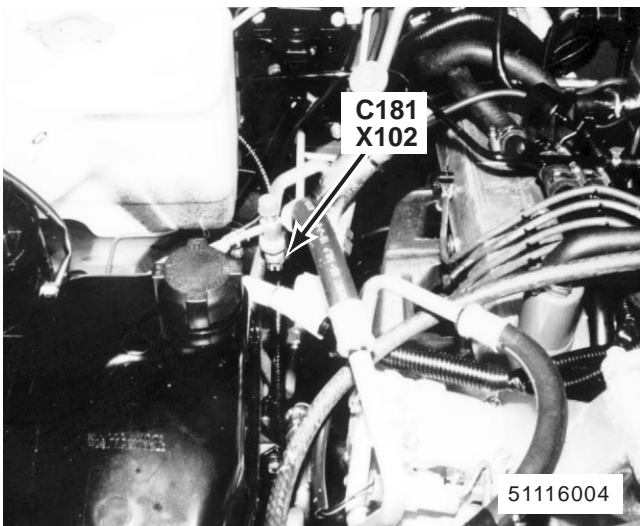

95. RH rear corner of engine compartment (MFI-V8) (MFI-T16) (300Tdi)  
 X102 A/C Dual Pressure Switch  
 C181 (2-S)

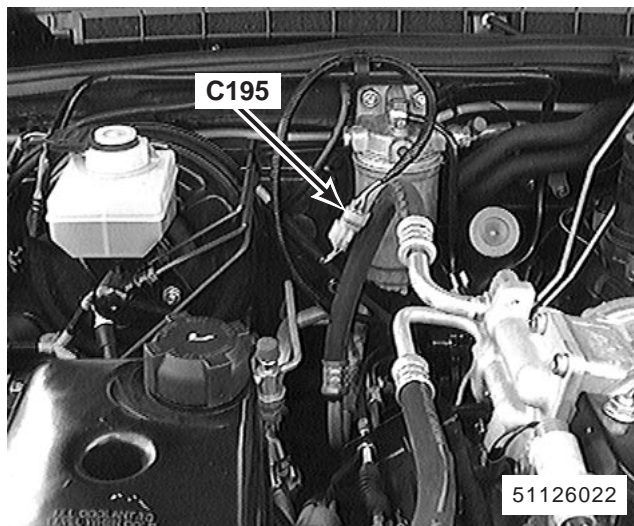

96. RH rear of engine compartment  
 C195 (4-W)

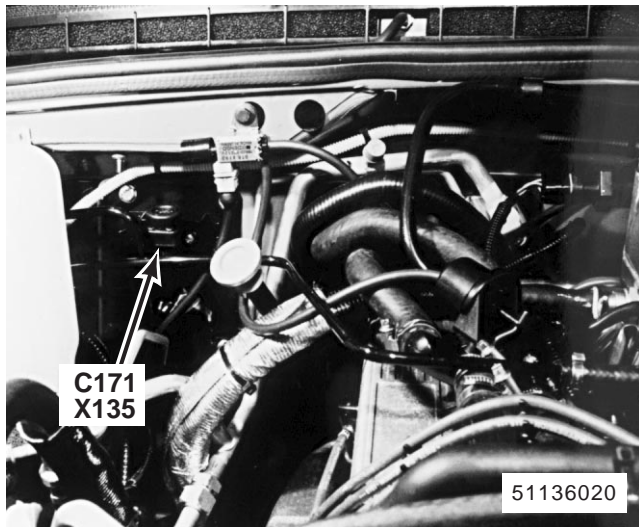

97. RH rear of engine compartment (MFI-V8)  
(MFI-T16) (300Tdi)  
X135 Inertia Fuel Shut-Off Switch  
C171 (3-B)

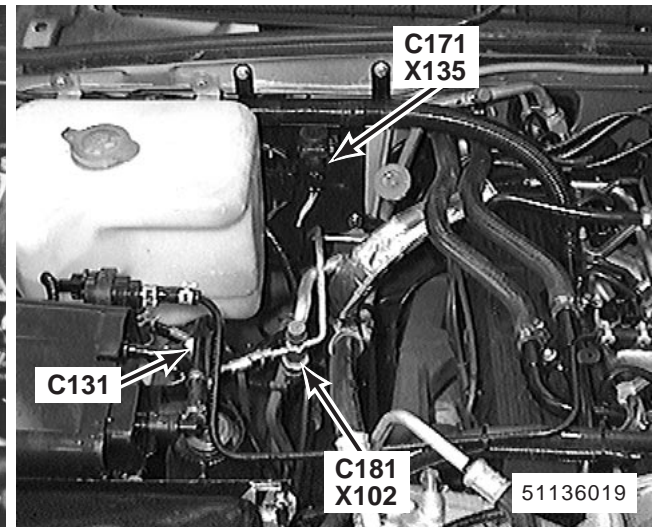

98. RH rear of engine compartment (SFI-V8)  
X102 A/C Dual Pressure Switch  
X135 Inertia Fuel Shut-Off Switch  
C131 (2-WB)  
C171 (3-B)  
C181 (2-S)

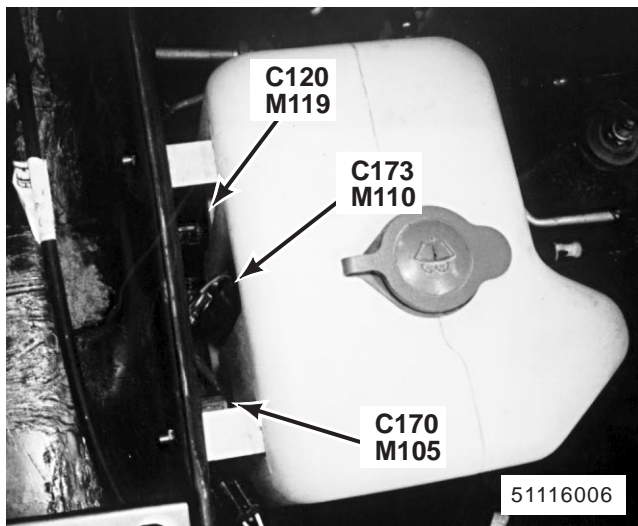

99. RH rear corner of engine compartment  
M119 Rear Screen Wash Pump  
M110 Headlamp Wash Pump  
M105 Front Screen Wash Pump  
C120 (2-W)  
C170 (2-R)  
C173 (2-B)

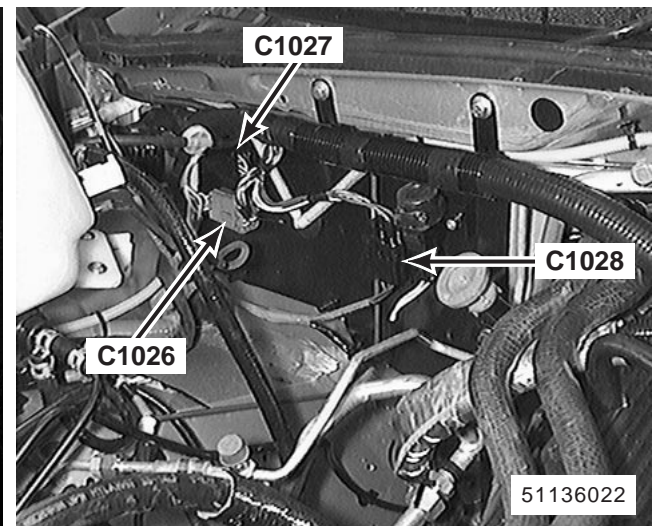

100. RH rear of engine compartment  
C1026 (13-BU)  
C1027 (13-B)  
C1028 (4-B)

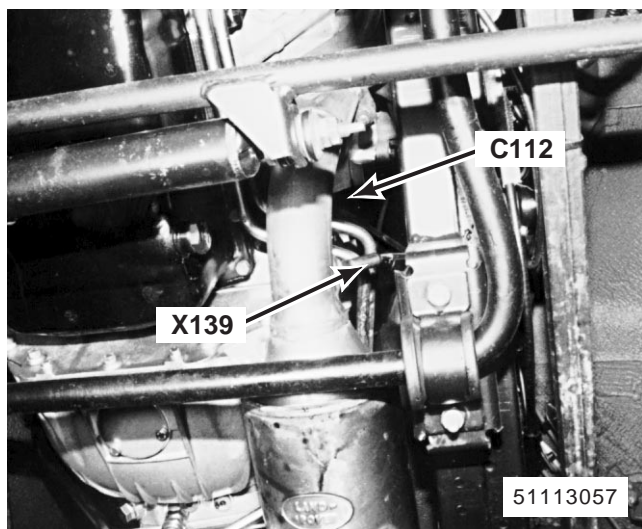

101. lower LH rear of engine compartment (MFI-V8)

X139 Left Heated Oxygen Sensor  
C112 (3-W)

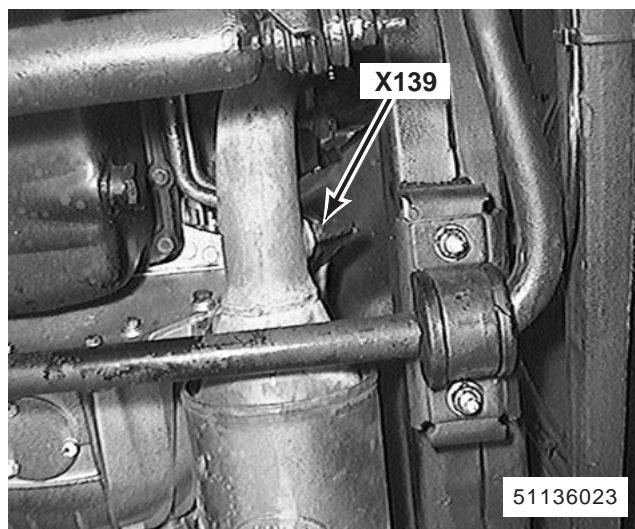

102. lower LH rear of engine compartment (SFI-V8)  
X139 Left Heated Oxygen Sensor

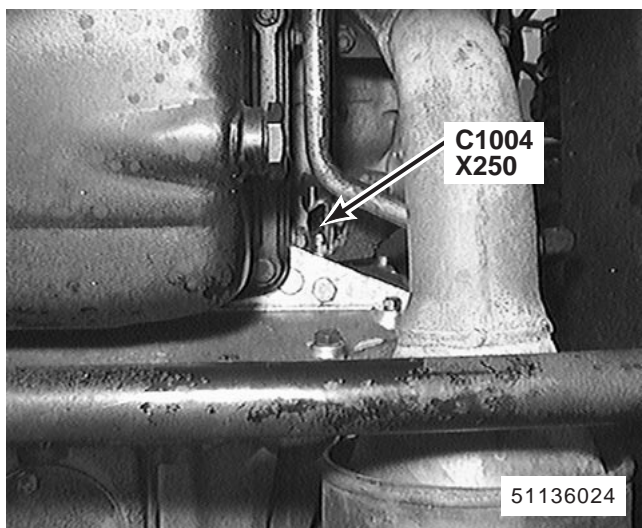

103. lower LH rear of engine (SFI-V8)

X250 Crankshaft Position Sensor  
C1004 (2-B)

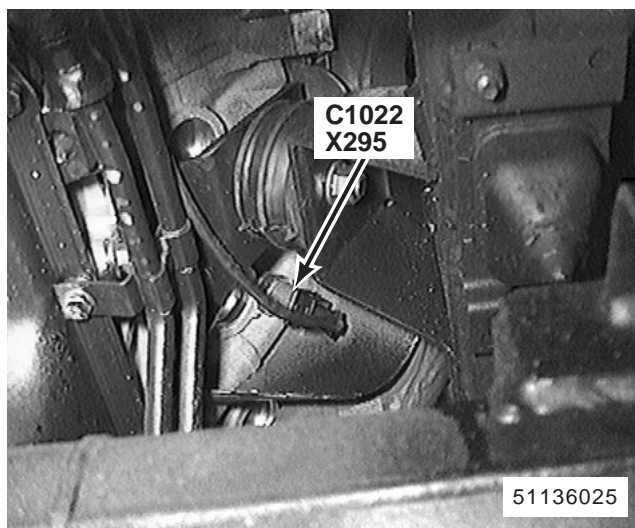

104. lower LH side of engine (SFI-V8)

X295 Left Knock Sensor  
C1022 (2-B)

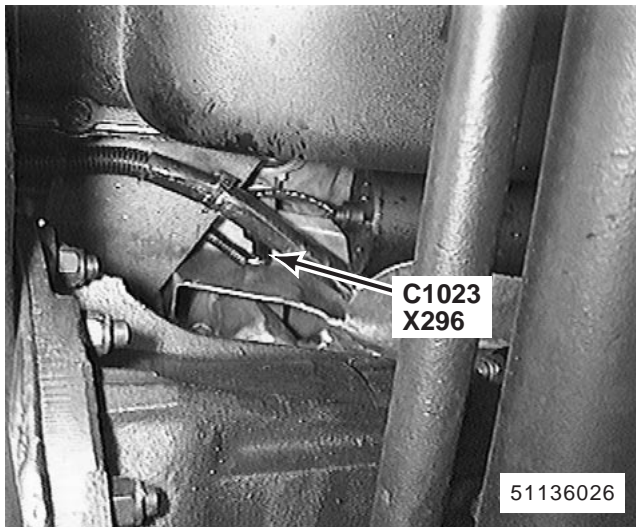

105. lower RH side of engine (SFI-V8)  
X296 Right Knock Sensor  
C1023 (2-B)

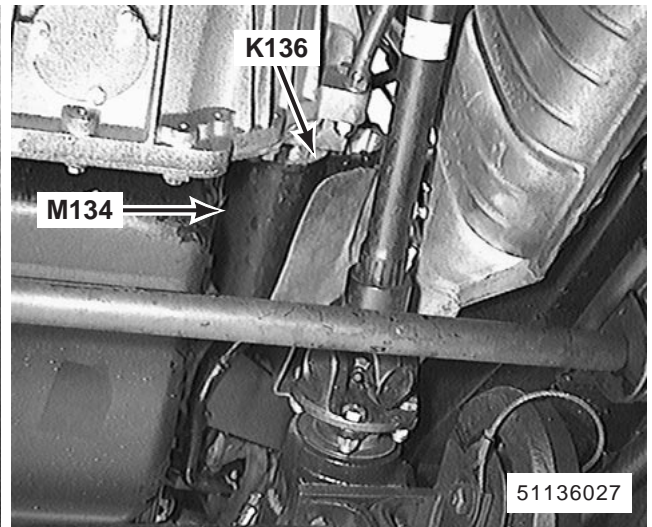

106. lower RH rear of engine (SFI-V8)  
K136 Starter Solenoid  
M134 Starter

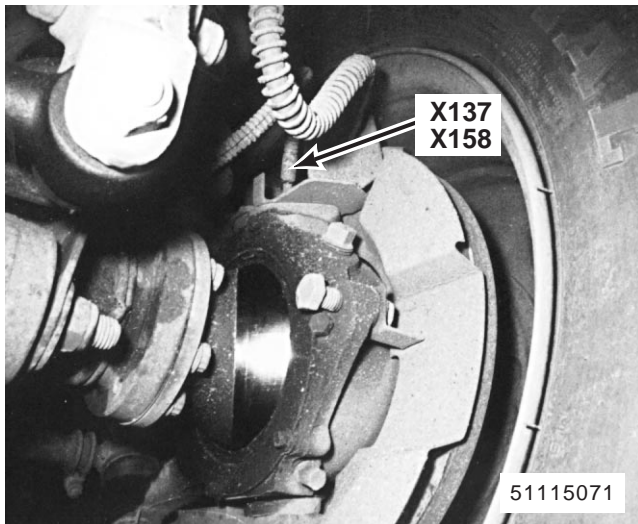

107. behind LH front wheel (RH front wheel similar)  
X137 Left Front Wheel Speed Sensor  
X158 Right Front Wheel Speed Sensor

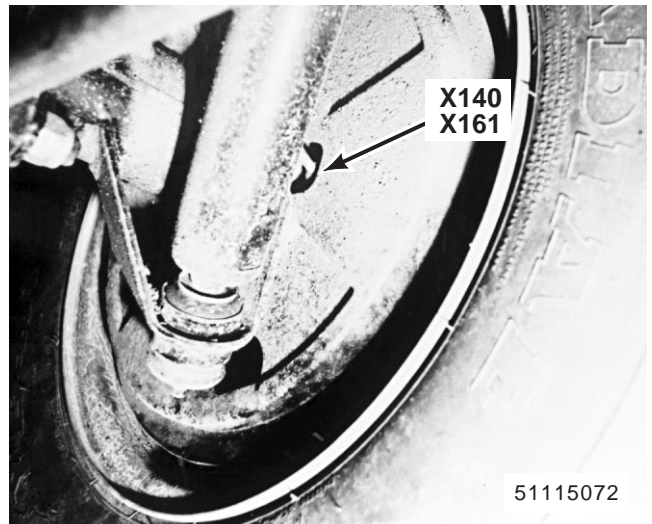

108. behind LH rear wheel (RH rear wheel similar)  
X140 Left Rear Wheel Speed Sensor  
X161 Right Rear Wheel Speed Sensor

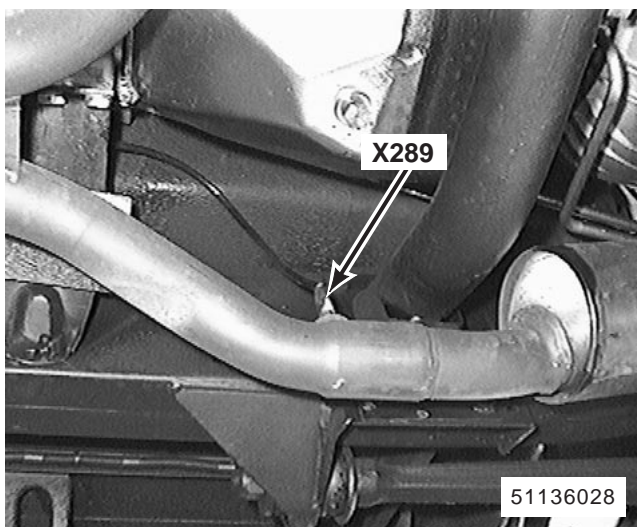

109. beneath LH side of vehicle (SFI-V8)  
X289 Left Heated Oxygen Sensor (Post Catalyst)

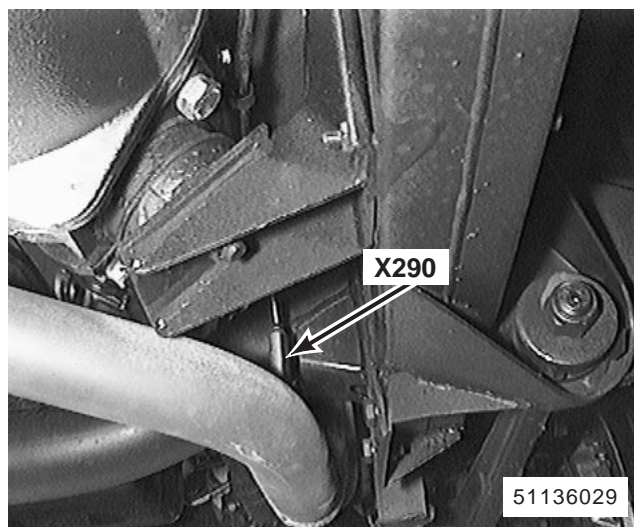

110. beneath RH side of vehicle (SFI-V8)  
X290 Right Heated Oxygen Sensor (Post Catalyst)

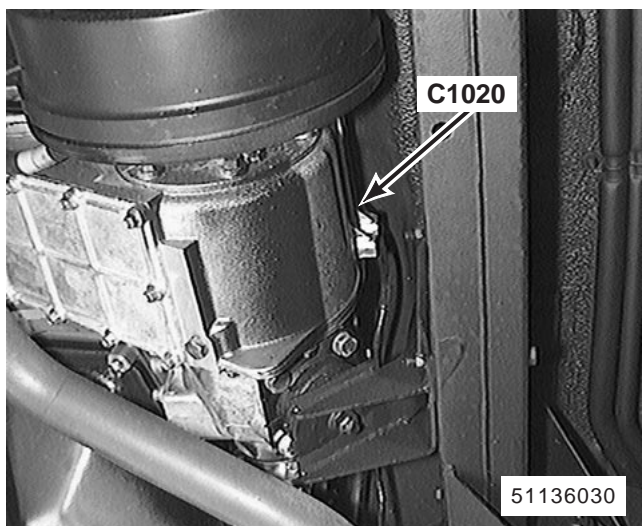

111. RH side of transfer box (SFI-V8)  
C1020 (4-B)

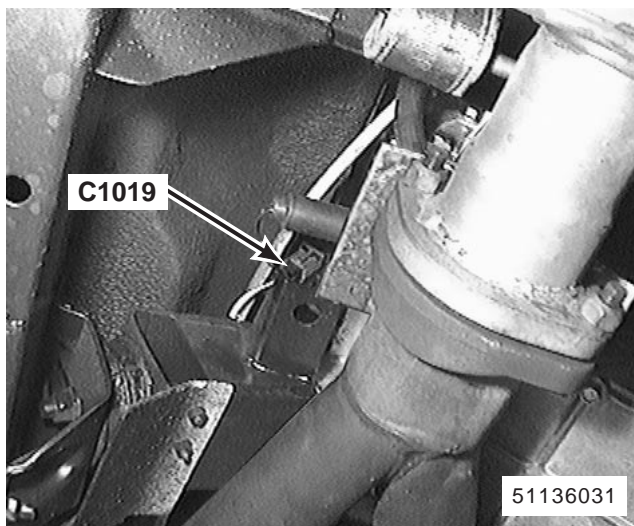

112. LH side of transfer box (SFI-V8)  
C1019 (4-RB)

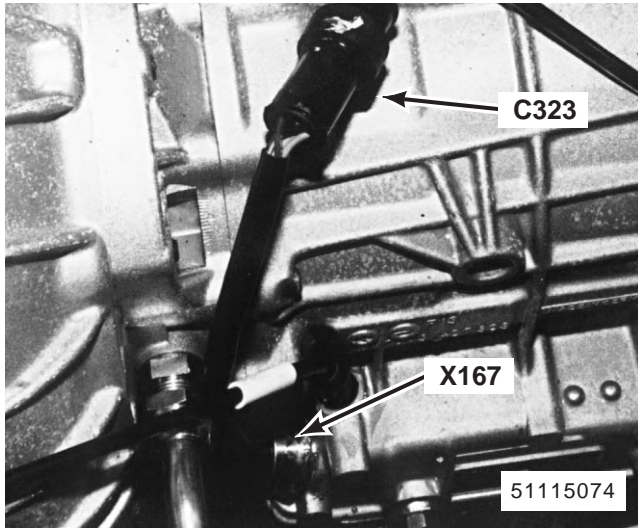

113. LH side of transmission  
X167 Park/Neutral Position Switch  
C323 (5-B)

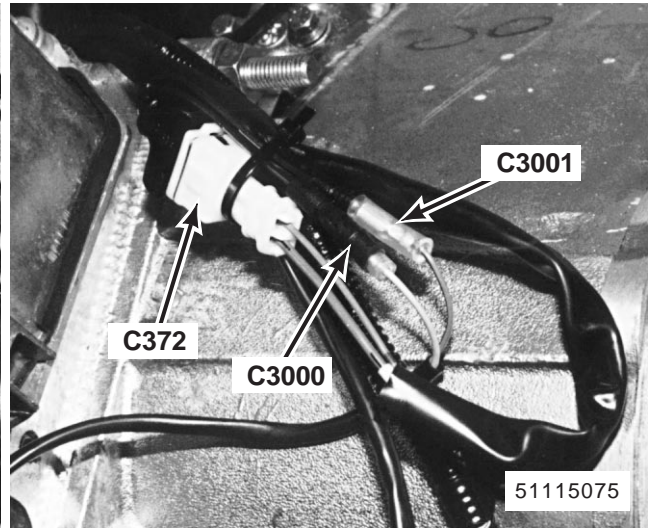

114. LH side of transmission  
C372 (2-B)  
C3000 (1-B)  
C3001 (1-B)

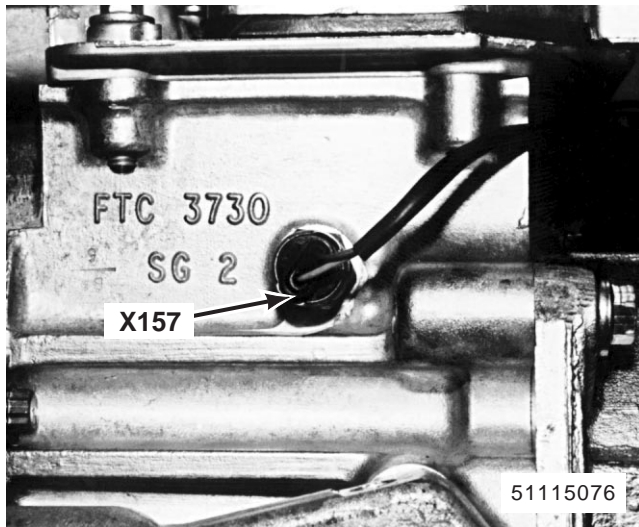

115. LH side of transmission  
X157 Reverse Switch

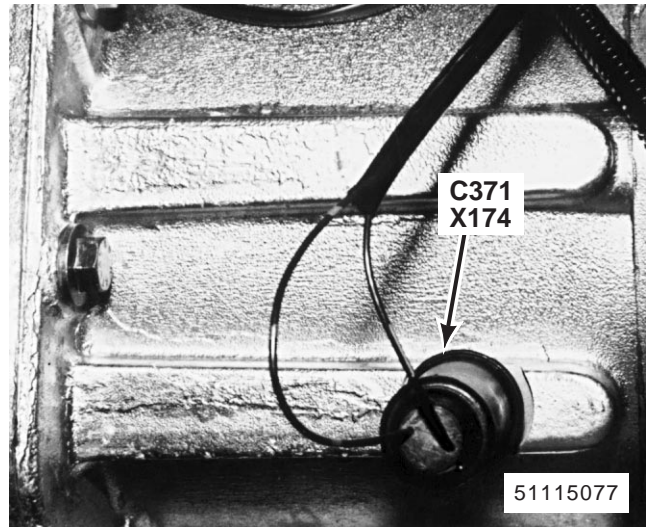

116. LH side of transfer box  
X174 Transfer Box Oil Temperature Switch  
C371 (2-B)



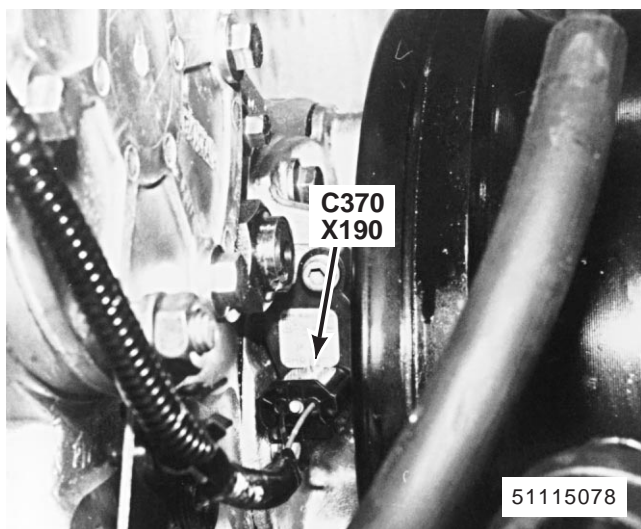

117. LH side of transfer box  
X190 Vehicle Speed Sensor  
C370 (3-B)

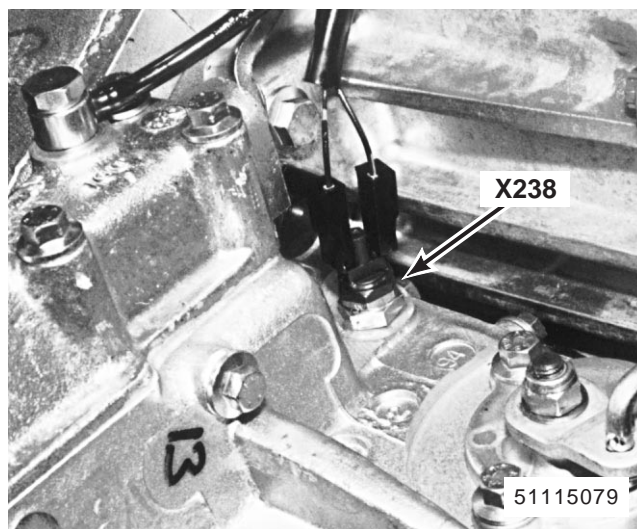

118. top RH side of transfer box  
X238 Differential Lock Switch

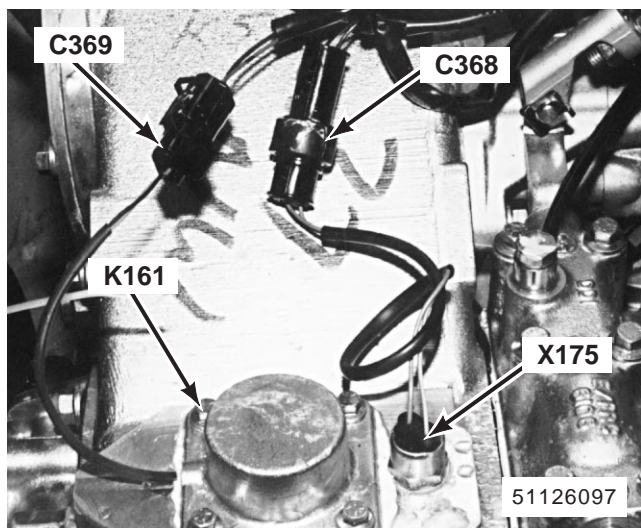

119. top RH side of transfer box  
K161 Transfer Box Solenoid  
X175 Transfer Box Position Switch  
C368 (3-B)  
C369 (2-B)

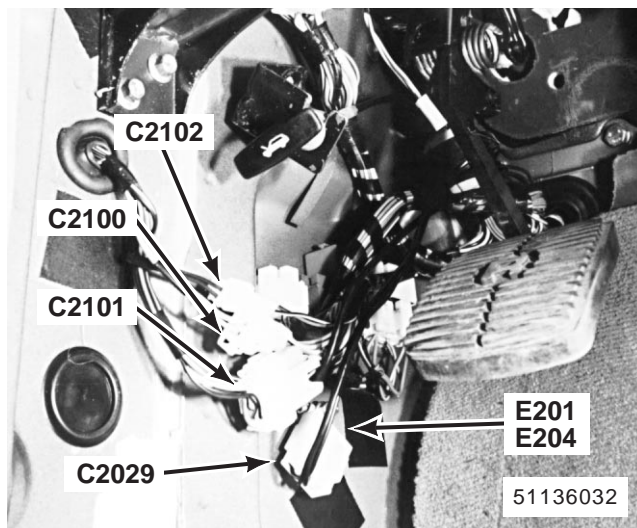

120. behind LH footwell trim panel  
C2029 (6-W)  
C2100 (2-W)  
C2101 (13-W)  
C2102 (2-W)  
E201  
E204

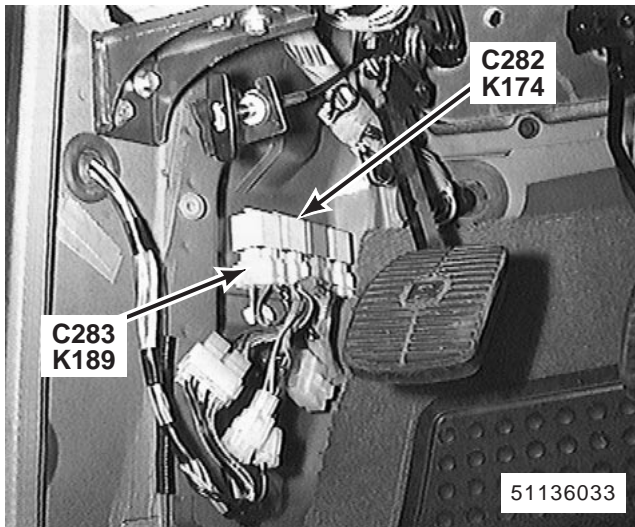

121. behind LH footwell trim panel  
 K174 Accessory Relay  
 K189 Horn Relay  
 C282 (5-Y)  
 C283 (5-Y)

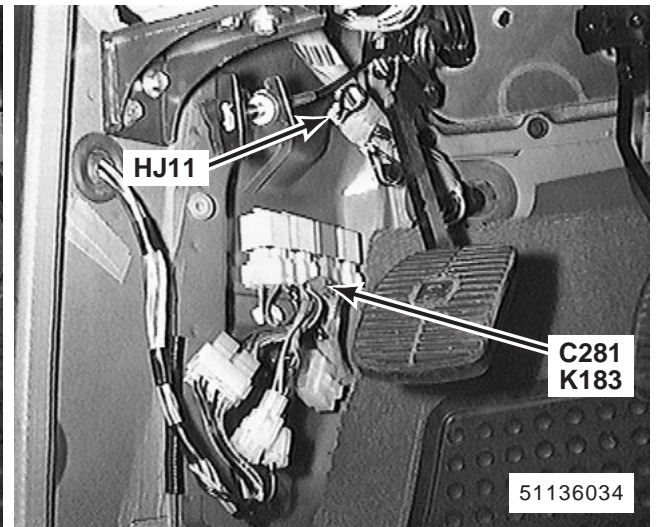

122. behind LH footwell trim panel  
 K183 Rear Wiper Relay  
 C281 (5-G)  
 HJ11 (20-S)

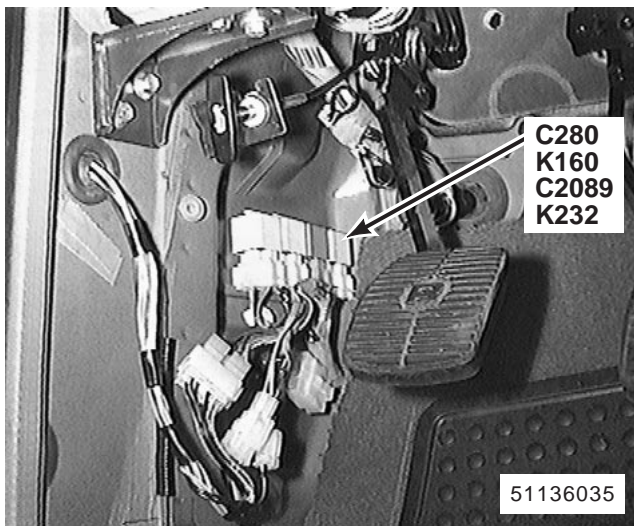

123. behind LH footwell trim panel  
 K160 Sounder Relay (Except NAS)  
 K232 Fog Lamps Relay (NAS)  
 C280 (5-W) (Except NAS)  
 C2089 (5-W) (NAS)

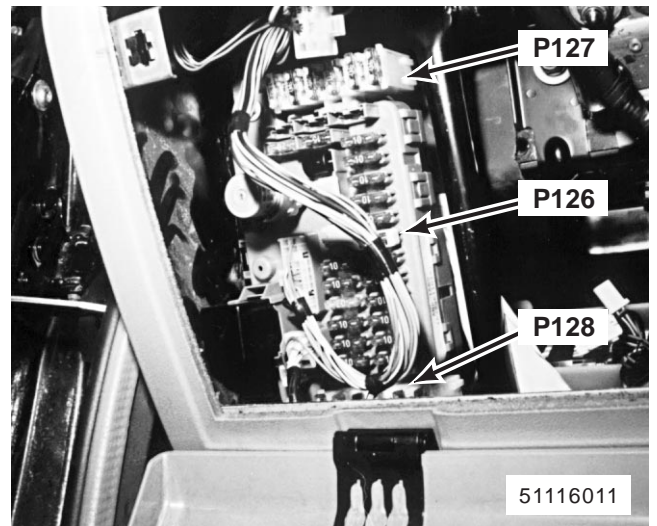

124. behind LH side of fascia left of steering column  
 P126 Fascia Fuse Box  
 P127 Satellite Fuse Box 1  
 P128 Satellite Fuse Box 2

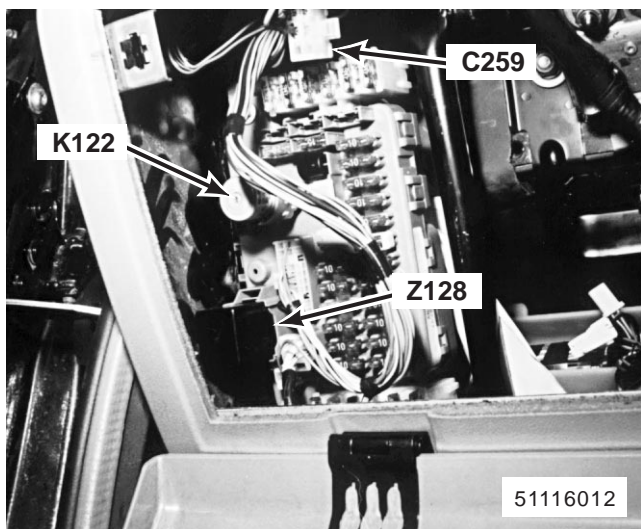

125. behind LH side of fascia left of steering column  
 K122 Heated Rear Screen Relay  
 Z128 Flasher Unit  
 C259 (6-W)

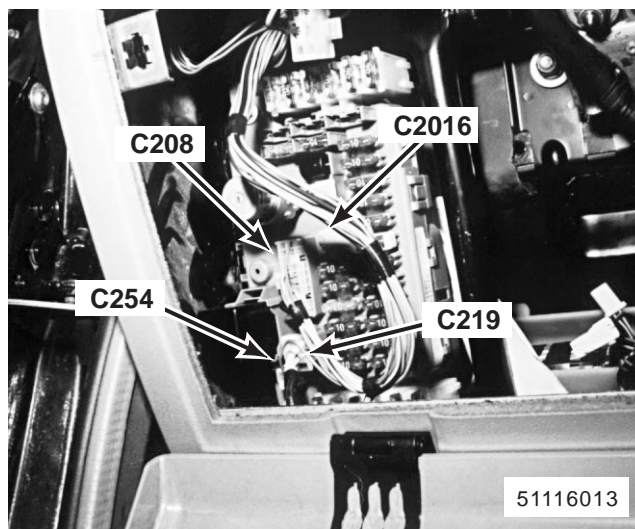

126. behind LH side of fascia left of steering column  
 C208 (18-W)  
 C219 (4-W)  
 C254 (1-W)  
 C2016 (1-W)

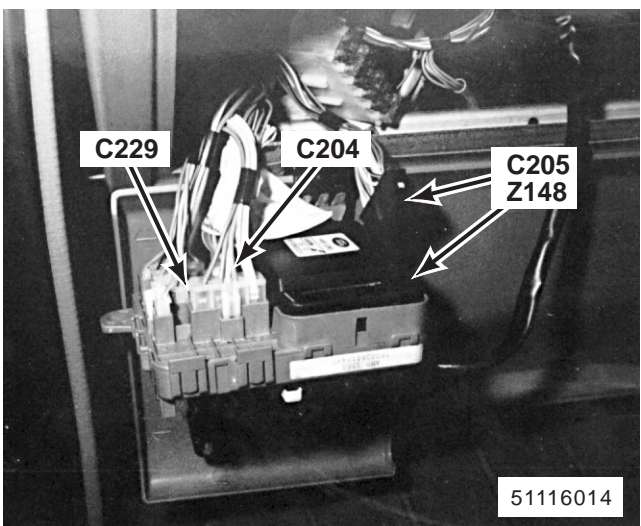

127. behind LH side of fascia left of steering column  
 Z148 Multi-Function Unit (MFU)  
 C204 (24-W)  
 C205 (24-B)  
 C229 (1-W)

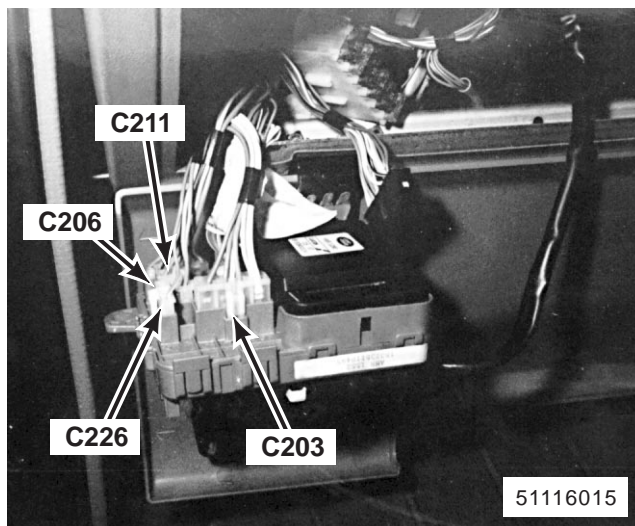

128. behind LH side of fascia left of steering column  
 C203 (7-W)  
 C206 (4-W)  
 C211 (10-W)  
 C226 (3-W)

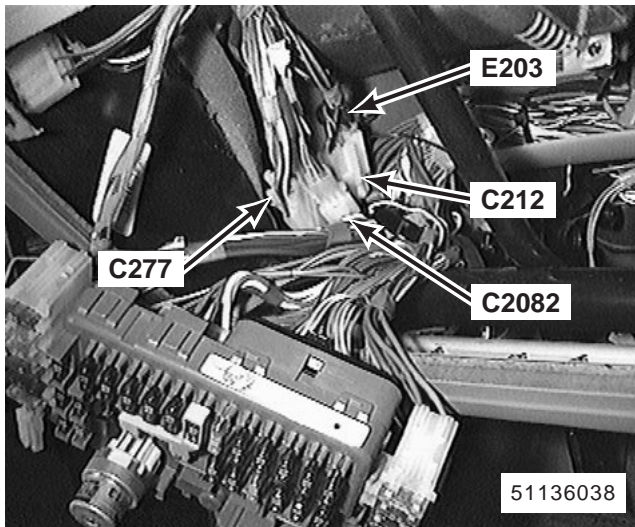

129. behind LH side of fascia left of steering column  
 C212 (14-W)  
 C277 (23-W)  
 C2082 (6-W)  
 E203

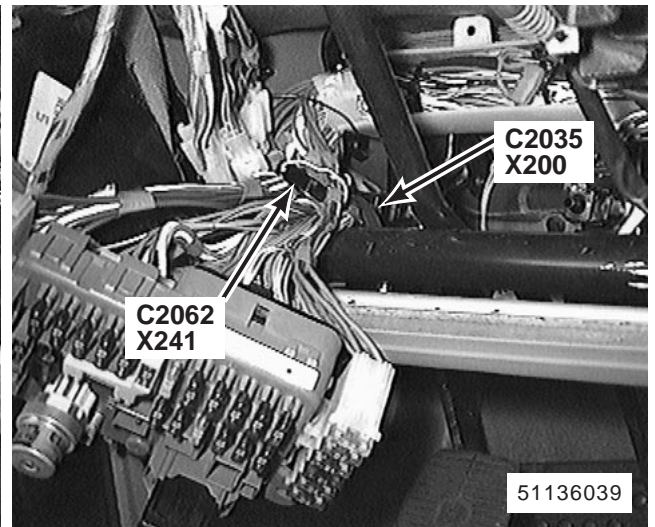

130. behind LH side of fascia left of steering column  
 X200 Clutch Pedal Position Switch  
 X241 Saudi Junction Connector  
 C2035 (2-W)  
 C2062 (1-B)

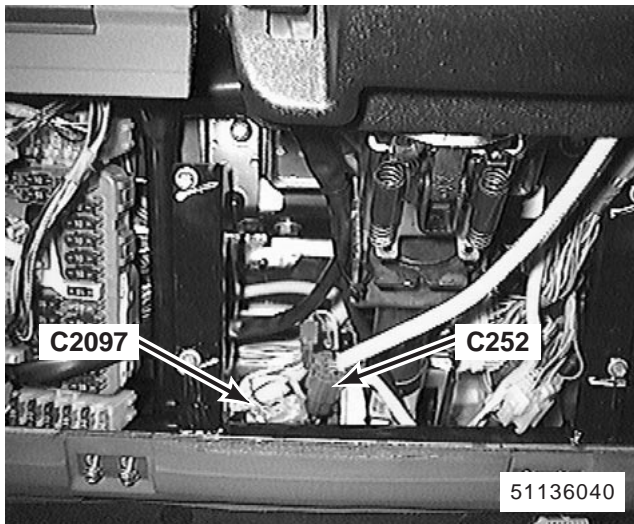

131. behind LH side of fascia left of steering column  
 C252 (6-R)  
 C2097 (4-W)

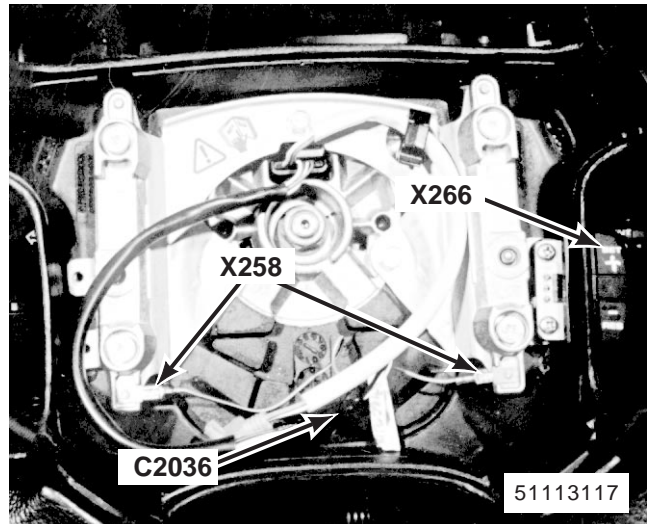

132. in steering wheel  
 X258 Horn Switches  
 X266 Steering Wheel Cruise Switches  
 C2036 (7-BW)

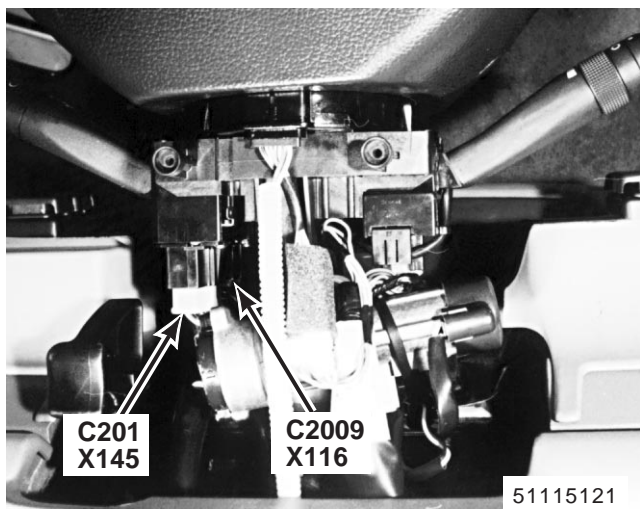

133. underside of steering column  
 X116 Direction Indicator Switch  
 X145 Main Lighting Switch  
 C201 (7-W)  
 C2009 (4-W)

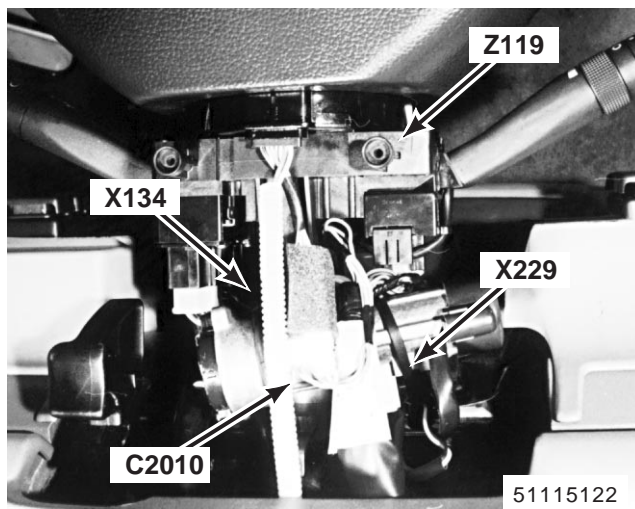

134. underside of steering column  
 X134 Ignition Switch  
 X229 Key-In Switch  
 Z119 Rotary Coupler  
 C2010 (6-W)

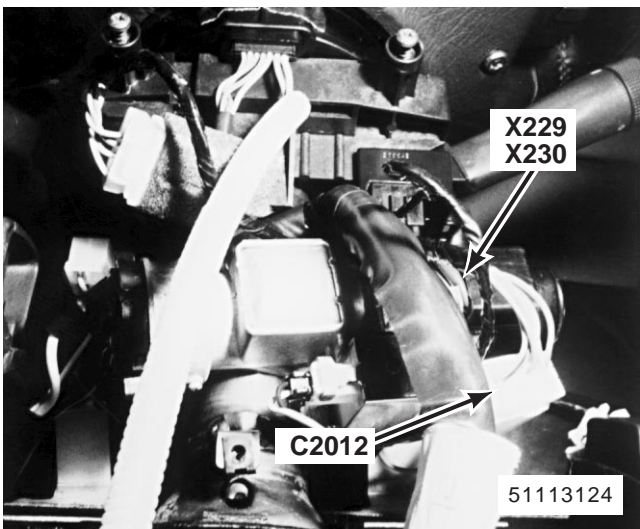

135. underside of steering column  
 X229 Key-In Switch  
 X230 Key-Barrel Switch  
 C2012 (8-W)

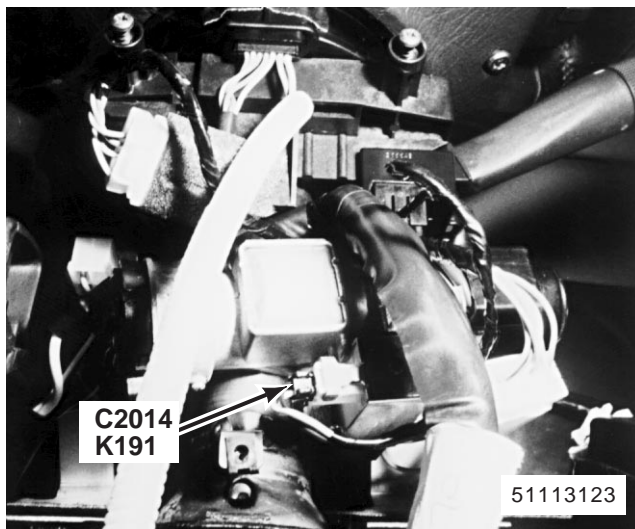

136. underside of steering column  
 K191 Ignition Key Lock Solenoid  
 C2014 (2-B)

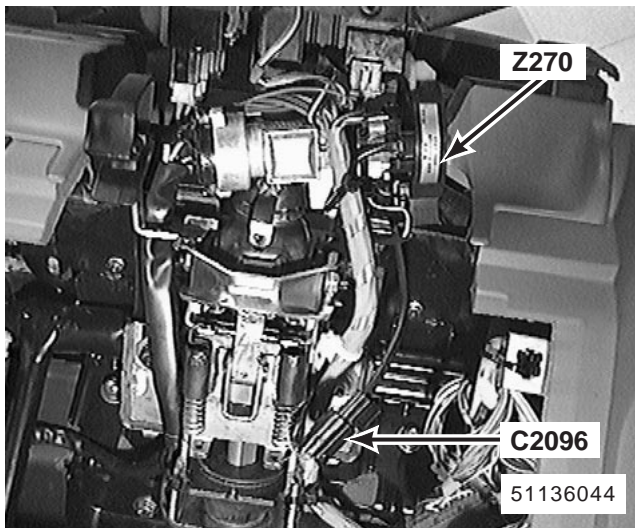

137. underside of steering column  
 Z270 Passive Immobilisation Coil  
 C2096 (2-B)

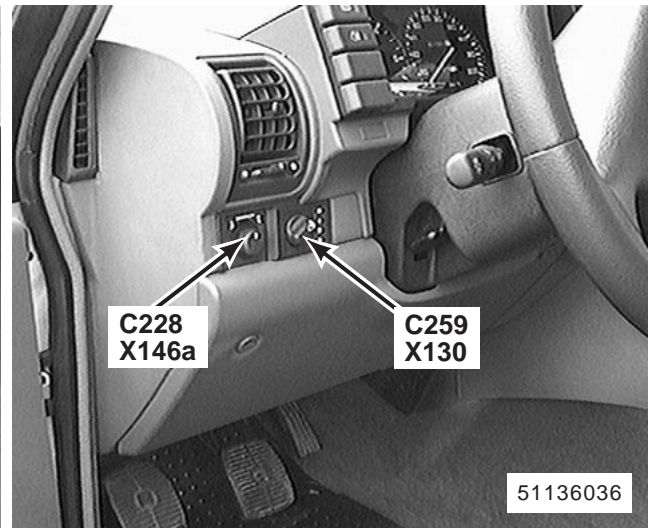

138. top LH side of fascia  
 X130 Headlamp Level Switch  
 X146a Mirror Adjustment Switch  
 C228 (8-B)  
 C259 (6-W)

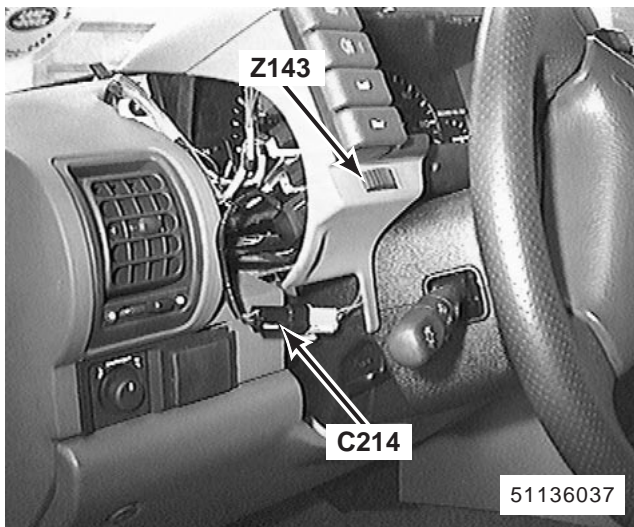

139. top LH side of fascia  
 Z143 Instrument Illumination Rheostat  
 C214 (3-BU)

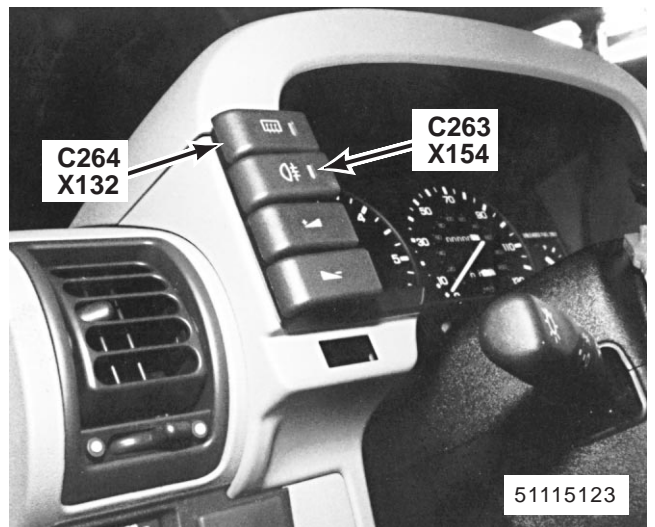

140. top LH side of fascia  
 X132 Heated Rear Screen Switch  
 X154 Rear Fog Guard Lamps Switch  
 C263 (5-B)  
 C264 (5-U)

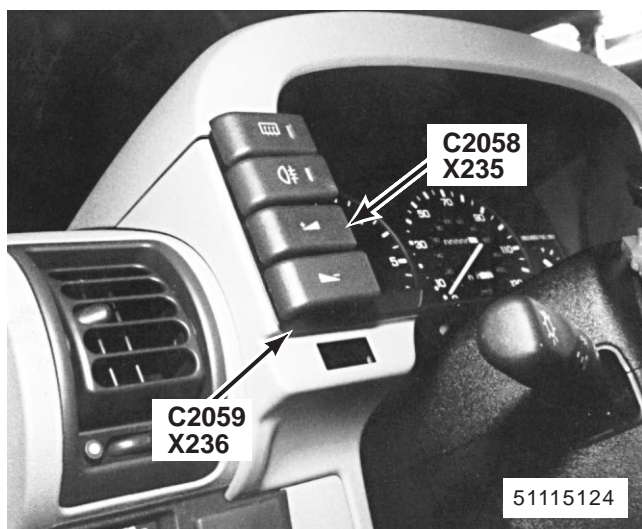

141. top LH side of fascia  
 X235 Radio Volume Up Switch  
 X236 Radio Volume Down Switch  
 C2058 (5-W)  
 C2059 (5-G)

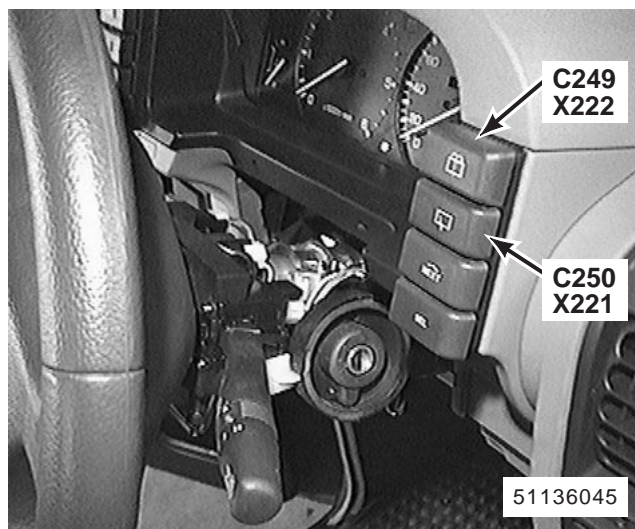

142. top LH side of fascia  
 X221 Rear Screen Wipe Switch  
 X222 Rear Screen Wash Switch  
 C249 (5-G)  
 C250 (5-W)

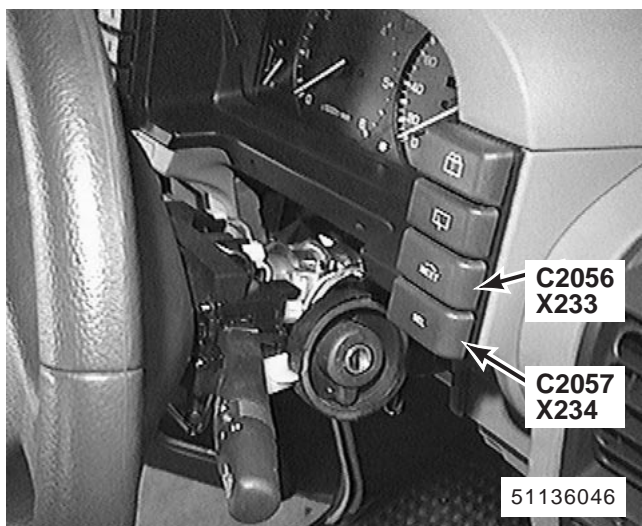

143. top LH side of fascia  
 X233 Radio Tune Switch  
 X234 Radio Waveband Switch  
 C2056 (5-B)  
 C2057 (5-U)

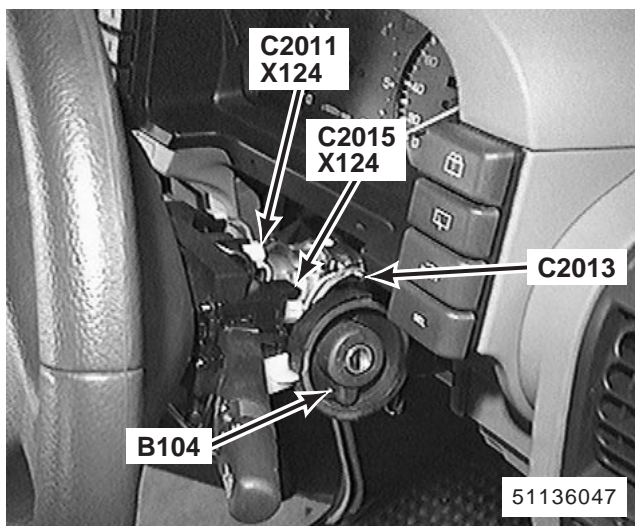

144. top of steering column  
 B104 Column Switch Illumination  
 X124 Front Wipe/Wash Switch  
 C2011 (6-W)  
 C2013 (4-B)  
 C2015 (8-W)

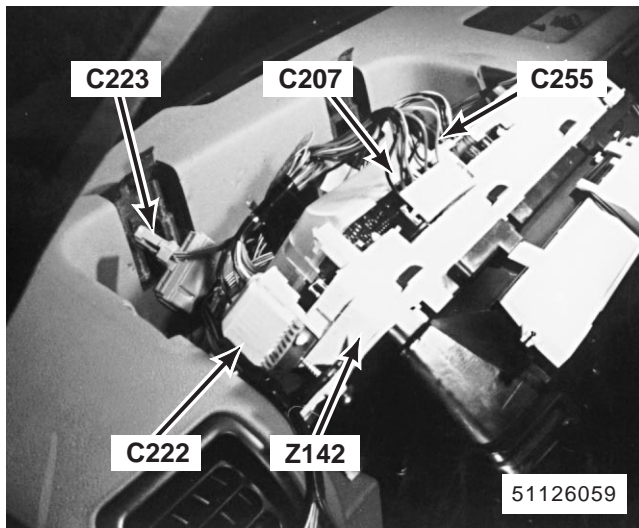

145. behind instrument cluster

- Z142 Instrument Cluster
- C207 (10-B)
- C222 (10-W)
- C223 (5-U)
- C255 (1-B)

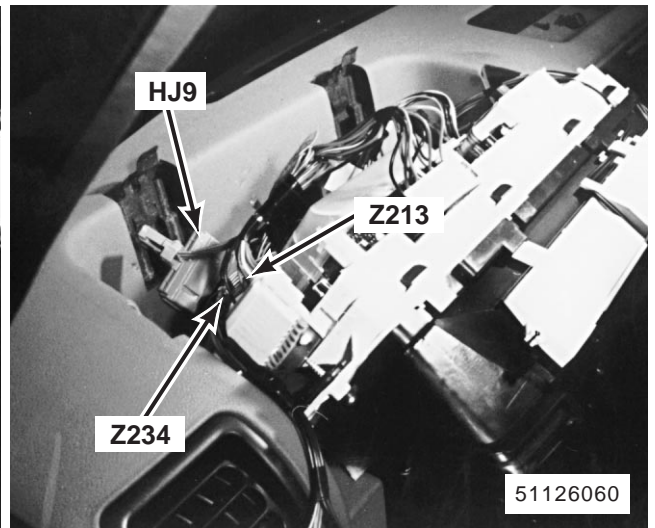

146. behind instrument cluster

- Z213 Direction Indicator Diode 2
- Z234 Radio Volume Resistor
- HJ9 (20-S)

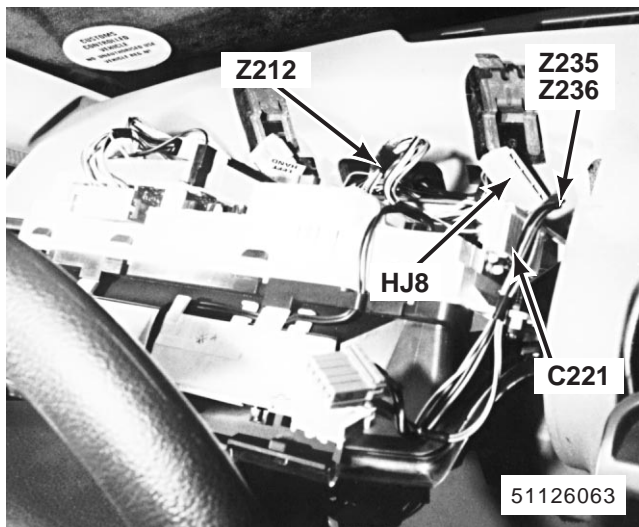

147. behind instrument cluster

- Z212 Direction Indicator Diode 1
- Z235 Radio Tune Resistor
- Z236 Radio Waveband Resistor
- C221 (10-W)
- HJ8 (20-S)

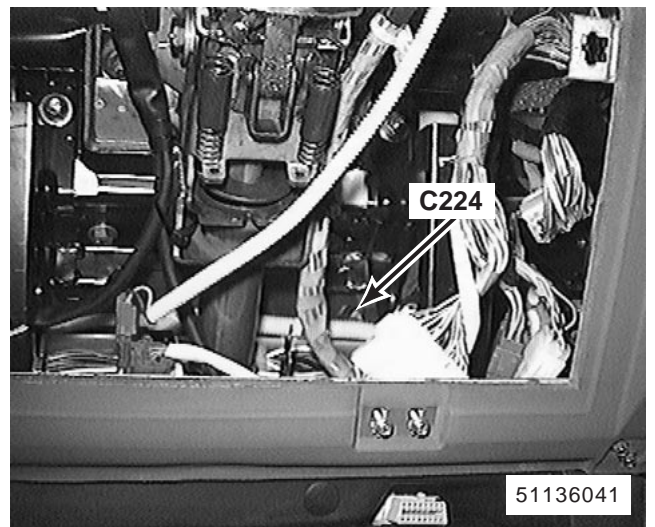

148. behind LH side of fascia right of steering column

- C224 (6-W)



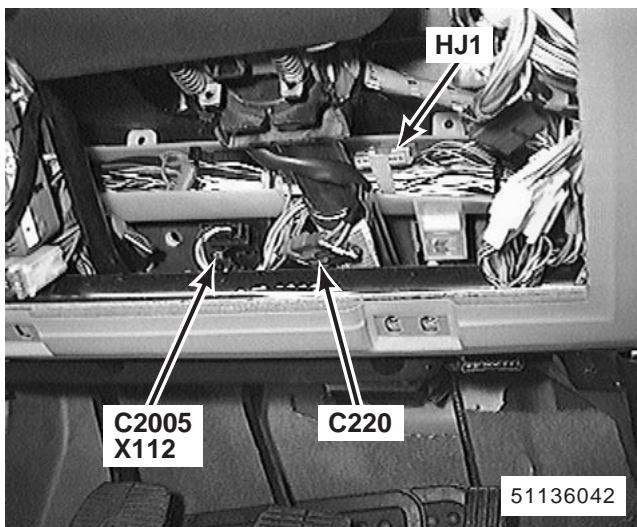

149. behind LH side of fascia right of steering column  
 X112 Brake Switch Vent Valve  
 C220 (3-N)  
 C2005 (2-W)  
 HJ1 (20-S)

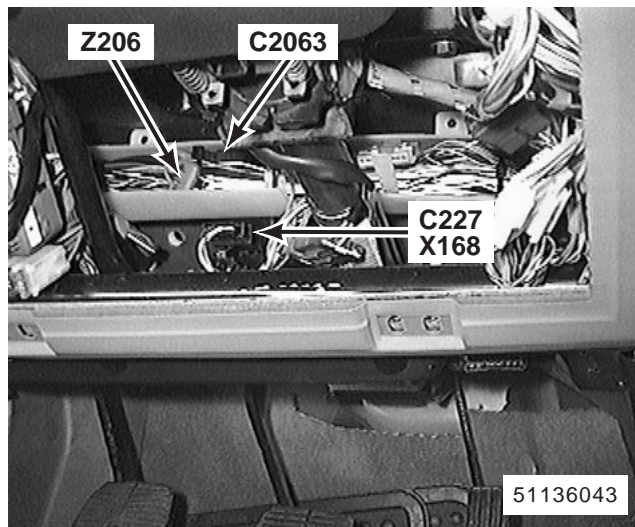

150. behind LH side of fascia right of steering column  
 X168 Stop Lamp Switch  
 Z206 Stop Lamp Switch Suppressor  
 C227 (4-B)  
 C2063 (2-B)

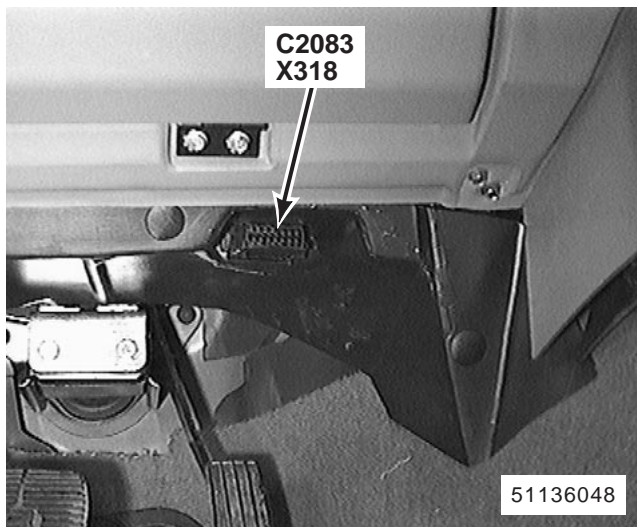

151. behind LH side of fascia right of steering column  
 X318 Data Link Connector (OBDII)  
 C2083 (16-S)

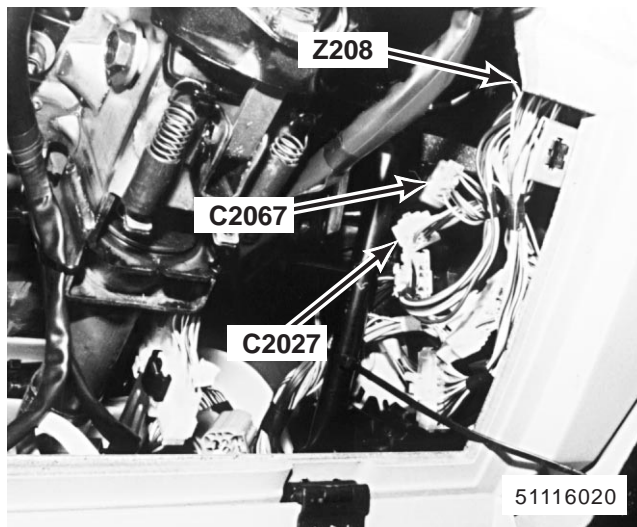

152. behind LH side of fascia right of steering column  
 Z208 Air Supply Selector Diode  
 C2027 (5-W)  
 C2067 (10-W)

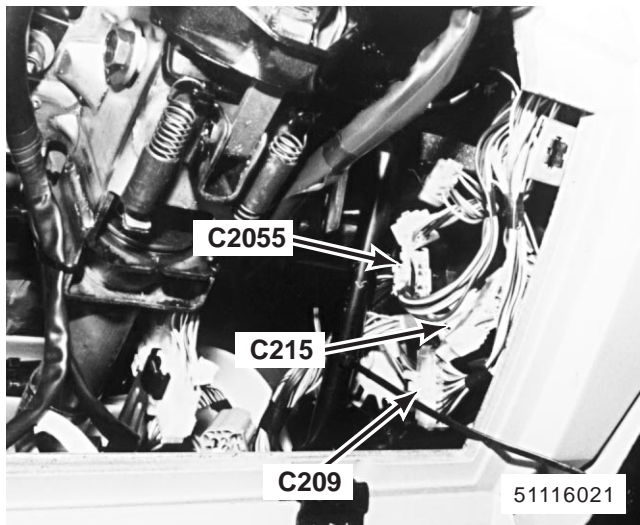

153. behind LH side of fascia right of steering column

- C209 (20-R)
- C215 (24-Y)
- C2055 (13-W)

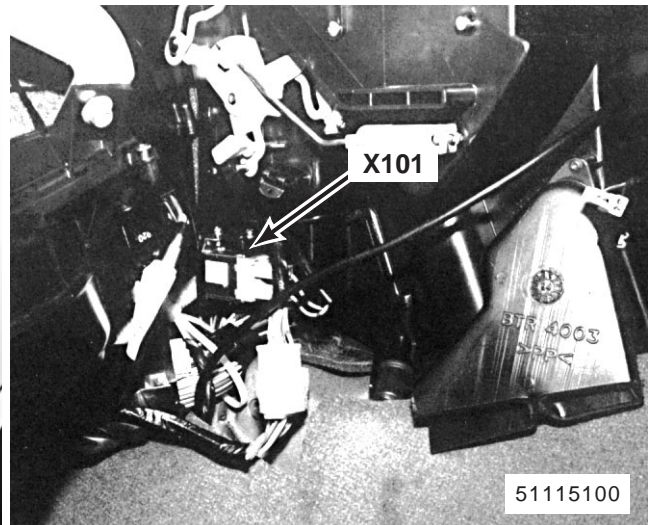

154. LH side of heater evaporator unit

- X101 Front A/C Evaporator Temperature Switch



155. centre of fascia

- X220 Hazard Switch
- Z117 Clock
- C267 (10-W)
- C270 (4-B)



156. centre of fascia

- X115 Cruise Control Switch
- X270 Front Fog Lamps Switch
- C262 (5-U)
- C2098 (5-G)

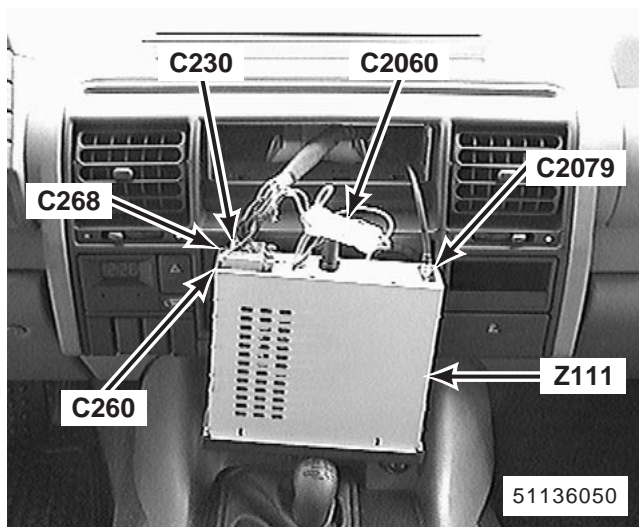

157. centre of fascia (Low Line Radio) (Mid Line Radio)

- Z111 Radio
- C230 (8-S)
- C260 (10-R)
- C268 (8-N)
- C2060 (5-W)
- C2079 (2-B)

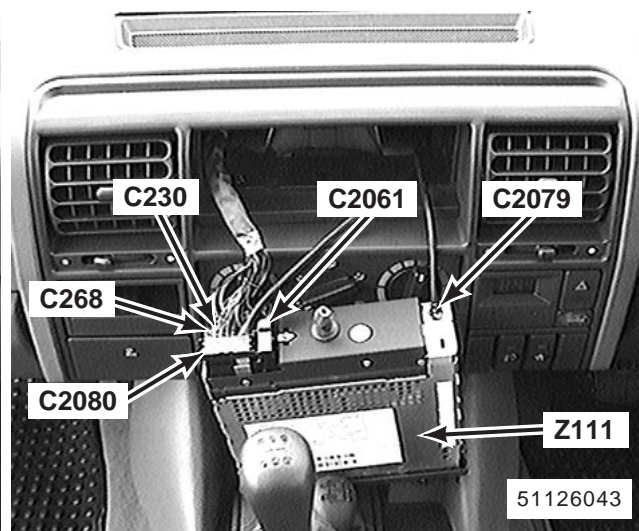

158. centre of fascia (High Line Radio)

- Z111 Radio
- C230 (8-S)
- C268 (8-N)
- C2061 (7-B)
- C2079 (2-B)
- C2080 DIN CABLE



159. behind centre of fascia

- Z271 Engine Immobilisation Control Unit (Spider)
- C2095 (9-B)

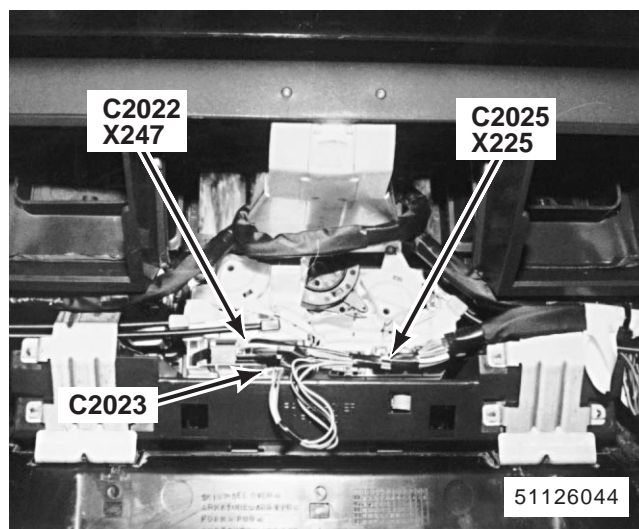

160. behind heater and A/C control panel

- X247 Front Fan Speed Switch
- X225 Front A/C Switch
- C2022 (5-W)
- C2023 (4-W)
- C2025 (5-W)

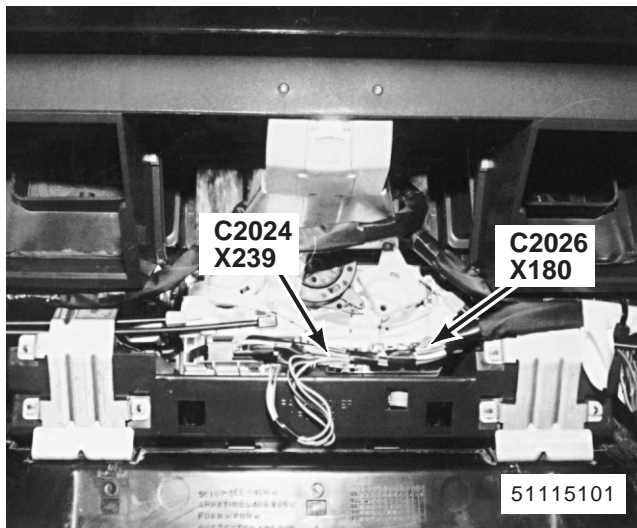

161. behind heater and A/C control panel  
 X180 Air Supply Selector Switch  
 X239 Main Rear A/C Switch  
 C2024 (5-U)  
 C2026 (5-B)

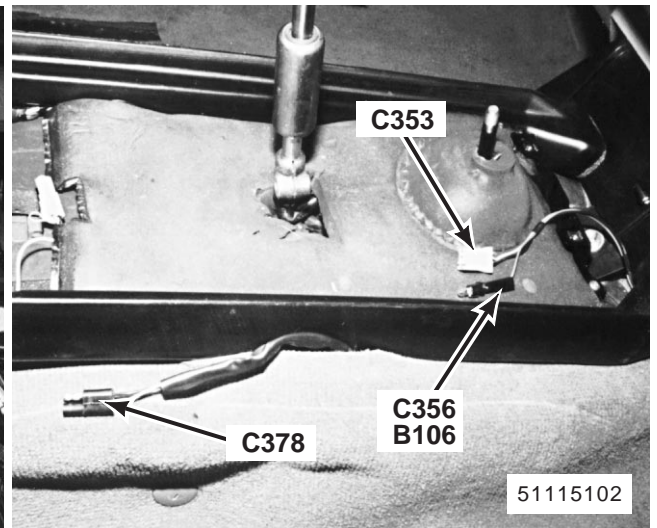

162. beneath centre console  
 B106 Fascia Cigar Lighter  
 C353 (2-W)  
 C356 (1-B)  
 C378 (2-B)

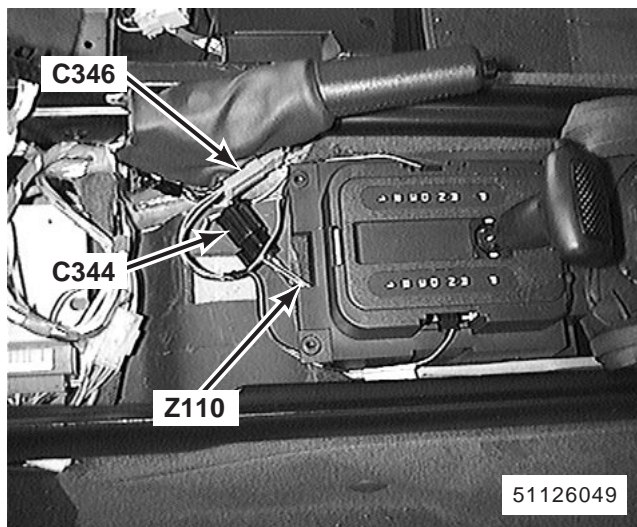

163. beneath centre console  
 Z110 Transmission Range Selector Switch  
 C344 (6-B)  
 C346 (2-U)

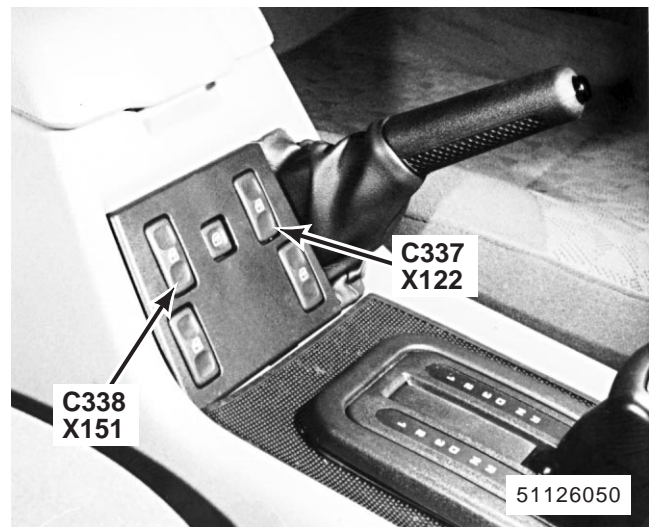

164. in rear of centre console  
 X122 Left Front Window Switch  
 X151 Right Front Window Switch  
 C337 (7-G)  
 C338 (7-W)

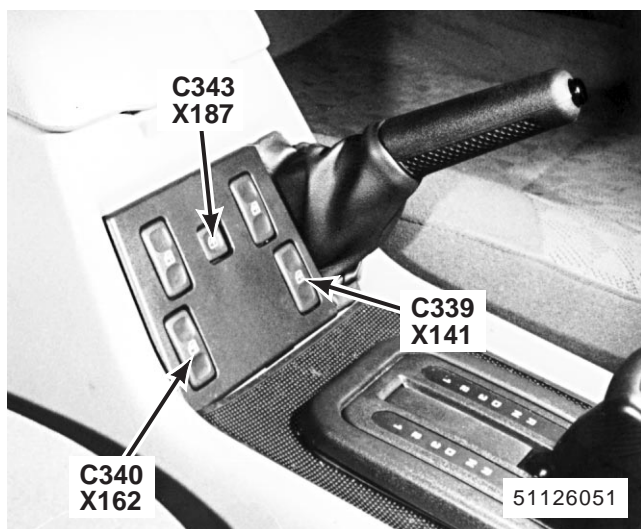

165. in rear of centre console  
 X141 Left Rear Window Console Switch  
 X162 Right Rear Window Console Switch  
 X187 Rear Window Isolation Switch  
 C339 (7-Y)  
 C340 (7-R)  
 C343 (7-N)

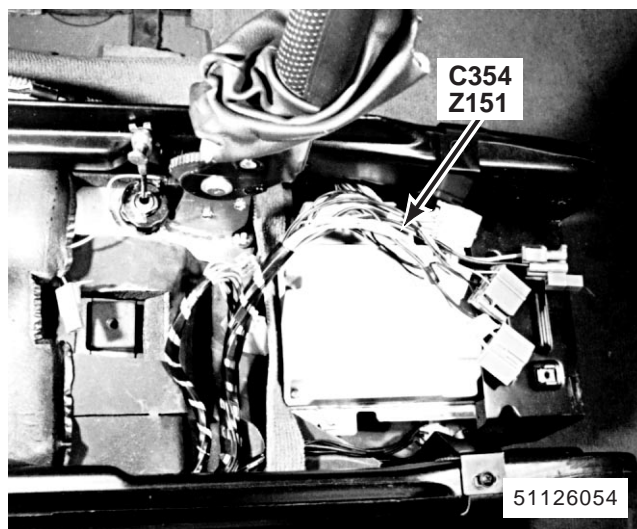

166. beneath centre console  
 Z151 Air Bag Diagnostic Control Module  
 C354 (29-R)

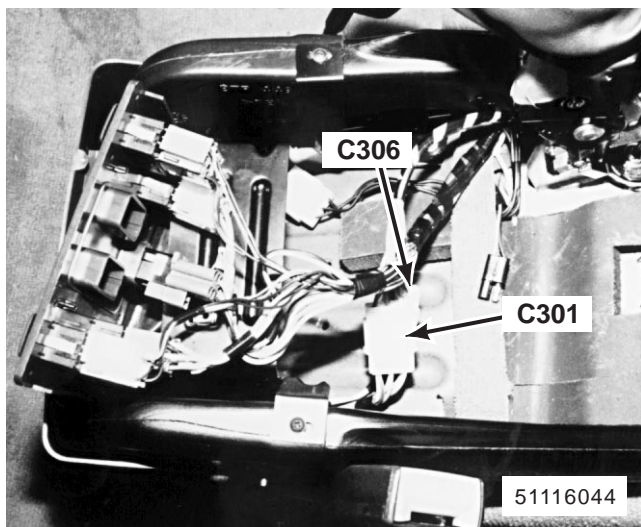

167. beneath centre console  
 C301 (6-W)  
 C306 (3-W)

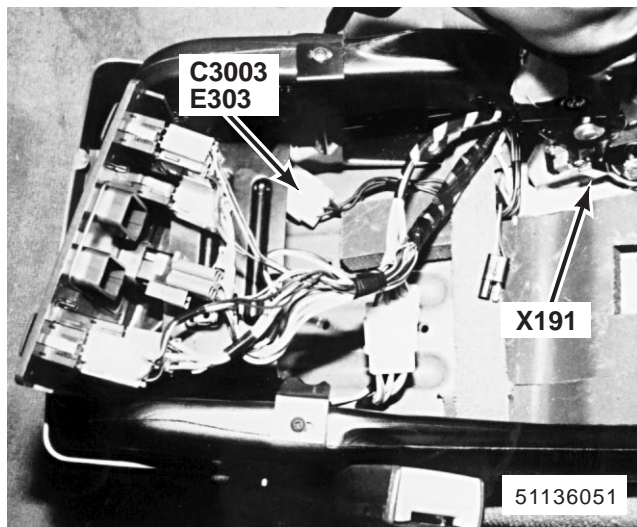

168. beneath centre console  
 X191 Handbrake Switch  
 C3003 (6-W)  
 E303

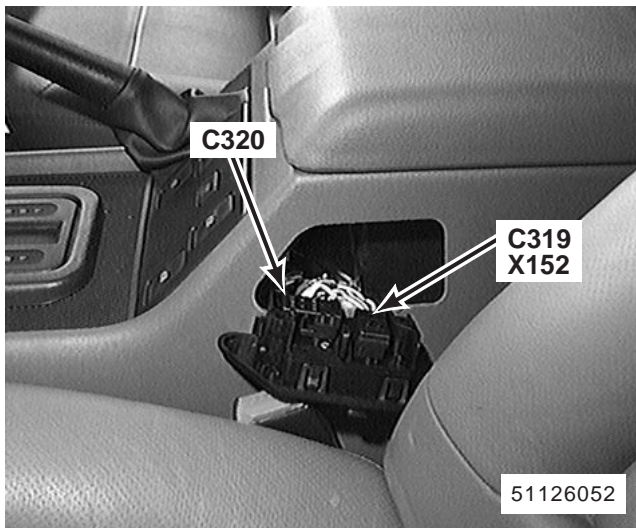

169. LH side of centre console  
 X152 Left Front Seat Control Switch  
 C319 (6-B)  
 C320 (6-B)

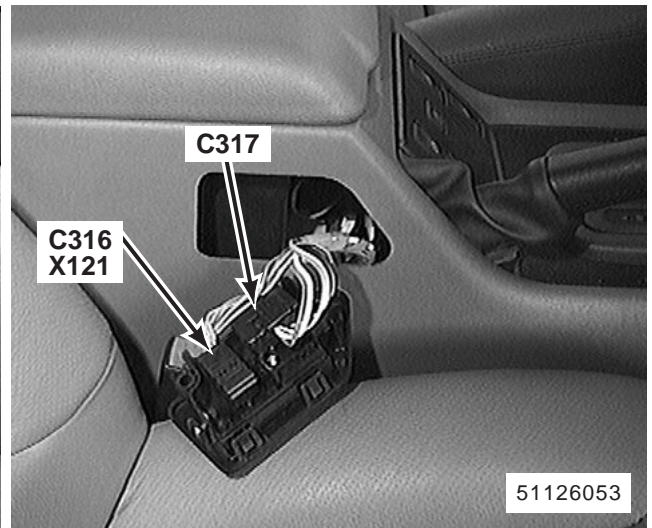

170. RH side of centre console  
 X121 Right Front Seat Control Switch  
 C316 (6-B)  
 C317 (6-B)

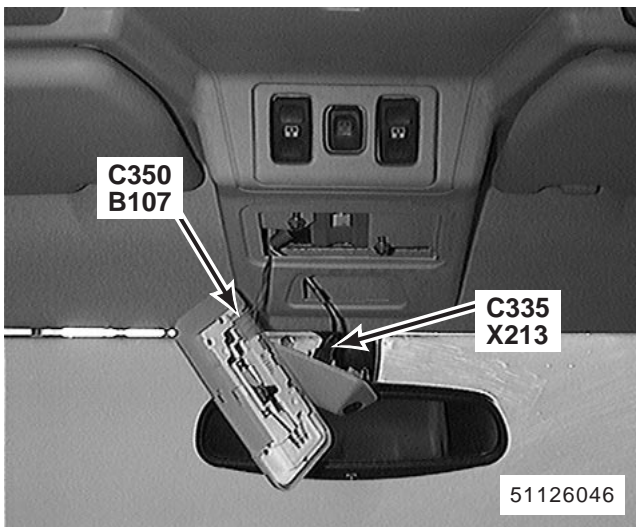

171. front centre of roof  
 B107 Front Interior Roof Lamp  
 X213 Alarm Sensor  
 C335 (4-B)  
 C350 (3-W)

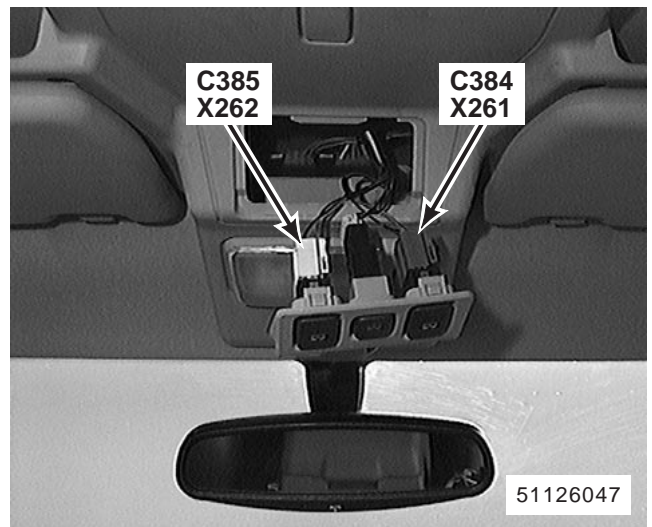

172. front centre of roof  
 X261 Front Sunroof Switch  
 X262 Rear Sunroof Switch  
 C384 (7-G)  
 C385 (7-W)

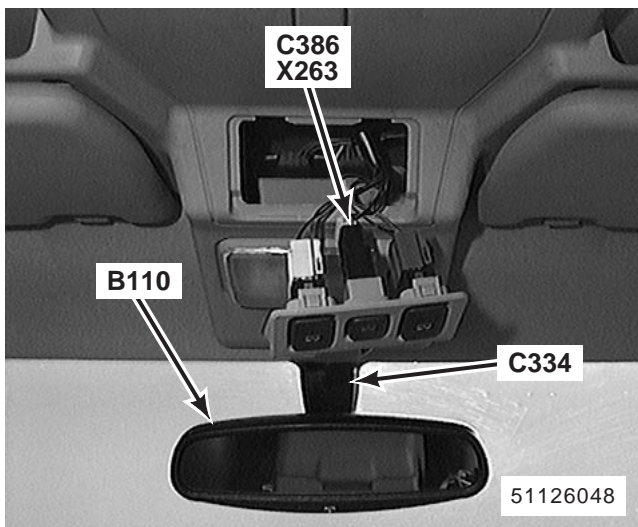

173. front centre of roof

- B110 Electrochromic Rear View Mirror
- X263 Rear Sunroof Lockout Switch
- C334 (3-B)
- C386 (5-S)

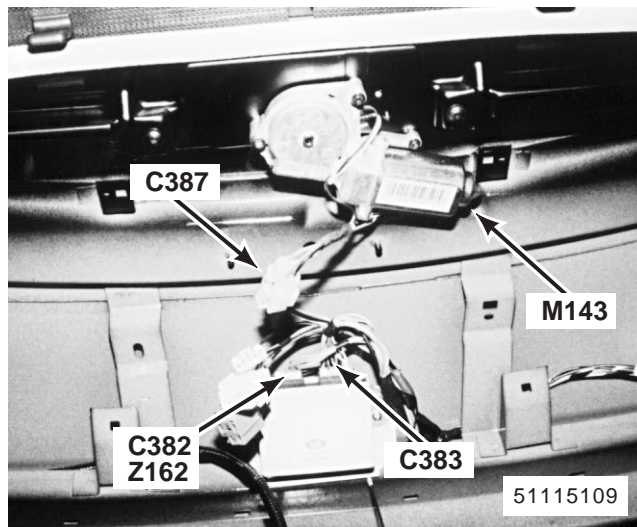

174. front centre of roof

- Z162 Sunroof Control Unit
- M143 Front Sunroof Motor
- C382 (8-W)
- C383 (10-W)
- C387 (4-W)

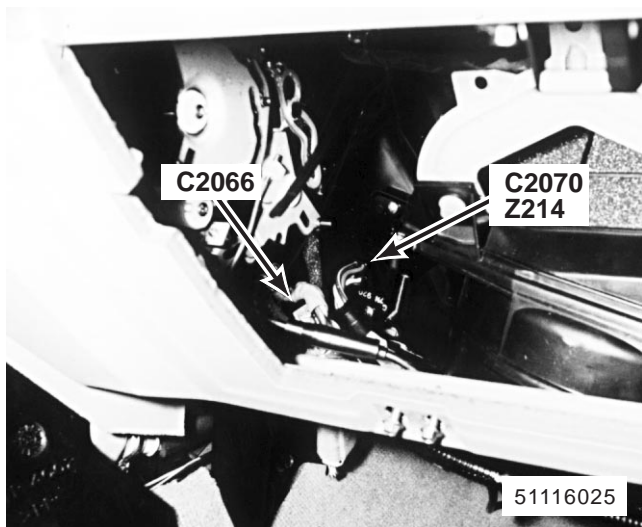

175. behind RH side of fascia right of heater evaporator unit

- Z214 Front Blower Resistor Unit
- C2066 (8-W)
- C2070 (4-B)

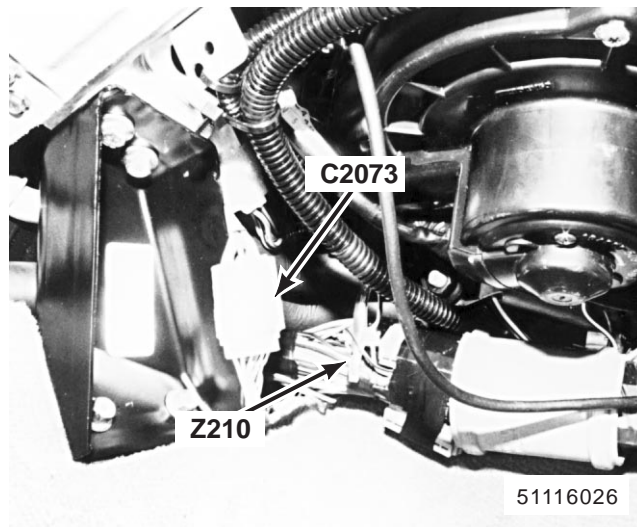

176. behind RH side of fascia right of heater evaporator unit

- Z210 Condenser Fan Control Diode 2
- C2073 (10-W)

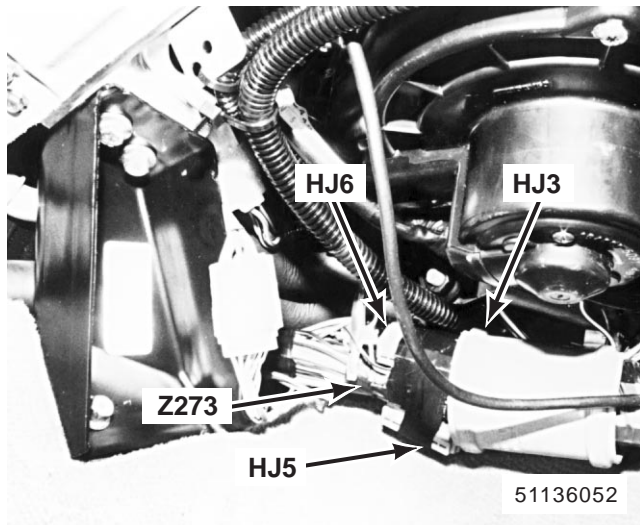

177. behind RH side of fascia  
 Z273 Neutral Sense Diode  
 HJ3 (20-S)  
 HJ5 (20-S)  
 HJ6 (20-G)

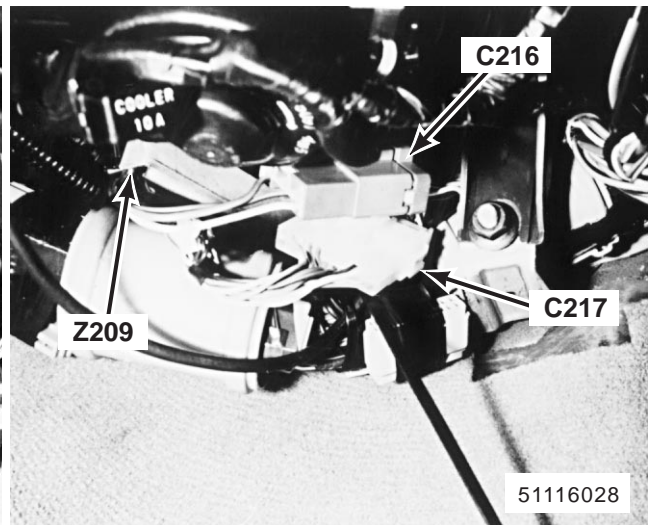

178. behind RH side of fascia  
 Z209 Condenser Fan Control Diode 1  
 C216 (7-N)  
 C217 (24-W)

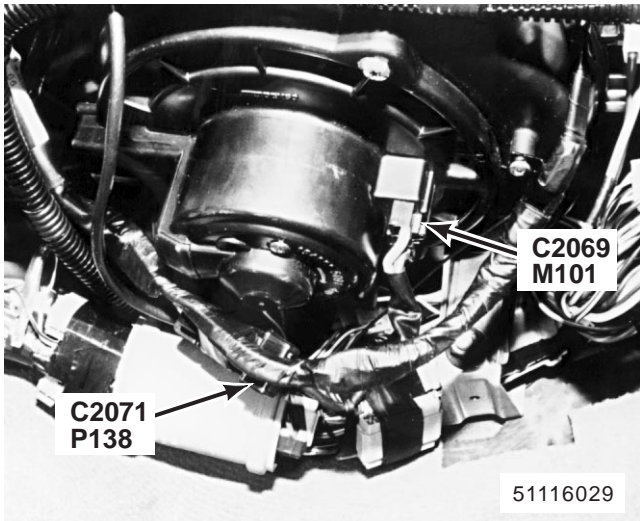

179. behind RH side of fascia  
 M101 Front Blower Motor  
 P138 Air Recirculation Solenoid In-Line Fuse  
 C2069 (2-B)  
 C2071 (2-B)

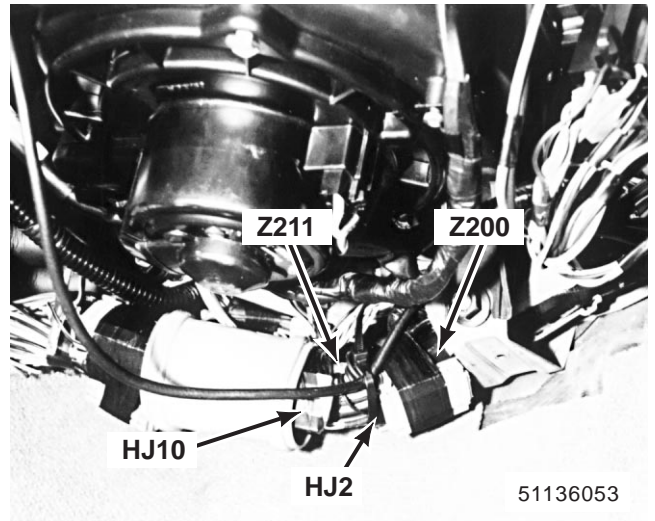

180. behind RH side of fascia  
 Z200 Daytime Running Lamps Diode  
 Z211 Fan Timer Diode  
 HJ2 (20-U)  
 HJ10 (20-S)



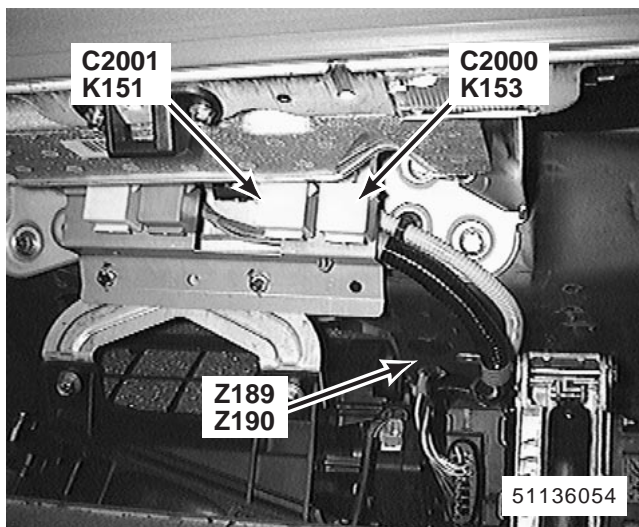

181. behind RH side of fascia above glove box

K151 Interlock Relay 2  
 K153 Interlock Relay 1  
 Z189 Interlock Diode 1  
 Z190 Interlock Diode 2  
 C2001 (5-Y)  
 C2000 (5-Y)

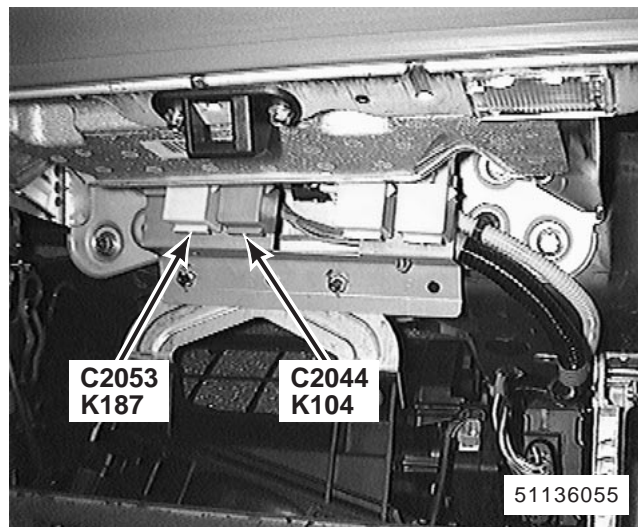

182. behind RH side of fascia above glove box

K104 Transmission Range Selector Illumination Relay  
 K187 Power Amplifier Relay  
 C2044 (5-G)  
 C2053 (5-Y)

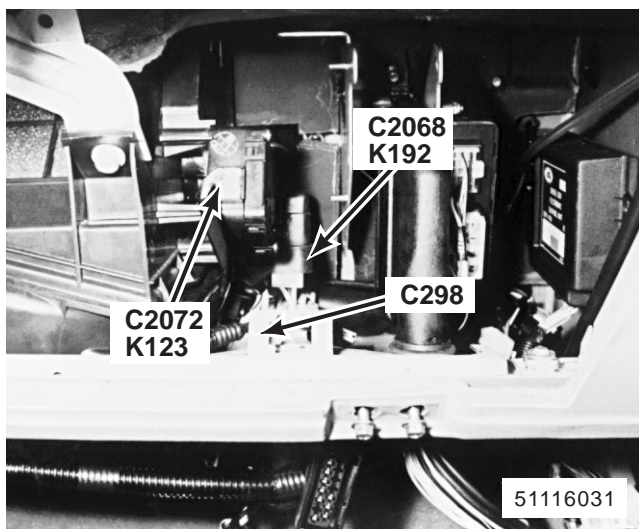

183. behind RH side of fascia

K123 Air Recirculation Solenoid  
 K192 Front Blower Motor Relay  
 C298 (3-W)  
 C2068 (5-W)  
 C2072 (4-Y)

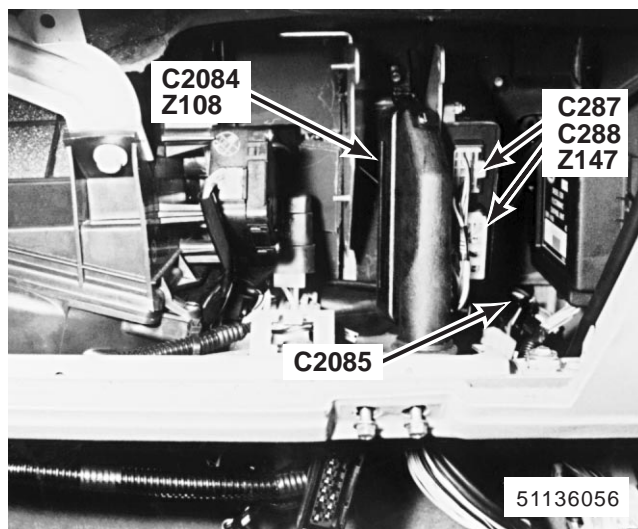

184. behind RH side of fascia

Z108 Anti-Lock Brake System ECU  
 Z147 Window Lift ECU  
 C287 (10-W)  
 C288 (8-W)  
 C2084 (35-B)  
 C2085 (3-W)



185. behind RH side of fascia (Early Production)  
 X323 Data Link Connector (Theft Alarm) (Early Production)  
 C2108 (4-B) (Early Production)

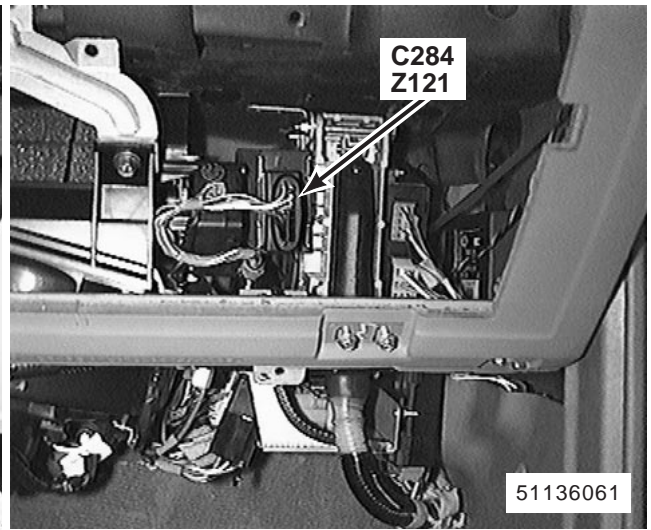

186. behind RH side of fascia  
 Z121 Cruise Control ECU  
 C284 (15-B)

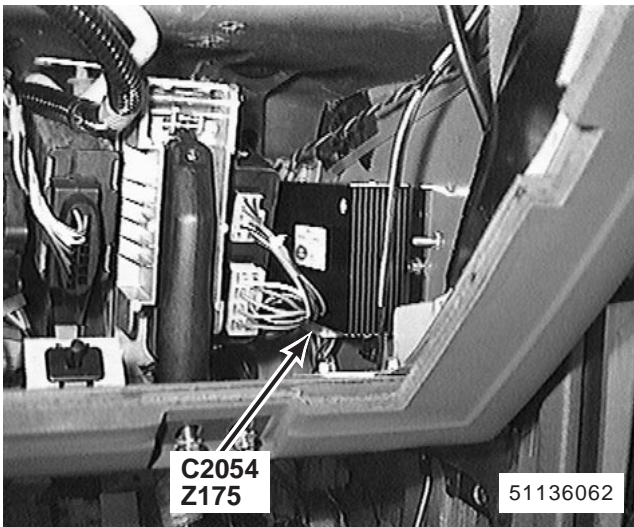

187. behind RH side of fascia  
 Z175 Radio Amplifier  
 C2054 (18-W)

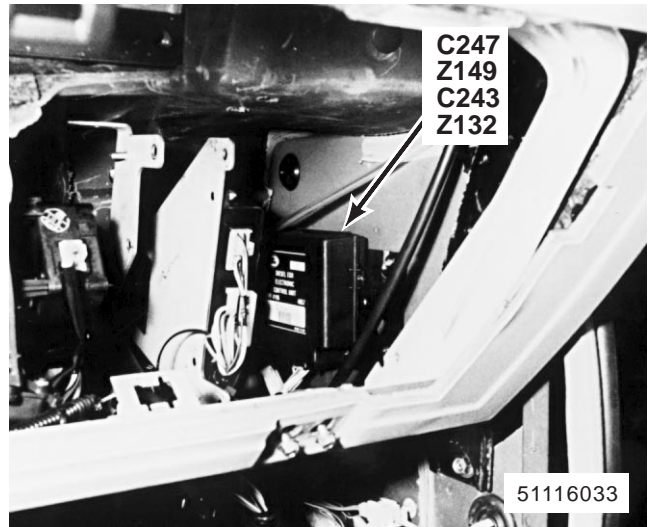

188. behind RH side of fascia (MFI-V8) (300Tdi without EDC)  
 Z132 Engine Control Module (ECM) (MFI-V8)  
 Z149 EGR Valve Control Module (300Tdi without EDC)  
 C243 (40-B) (MFI-V8)  
 C247 (16-B) (300Tdi without EDC)

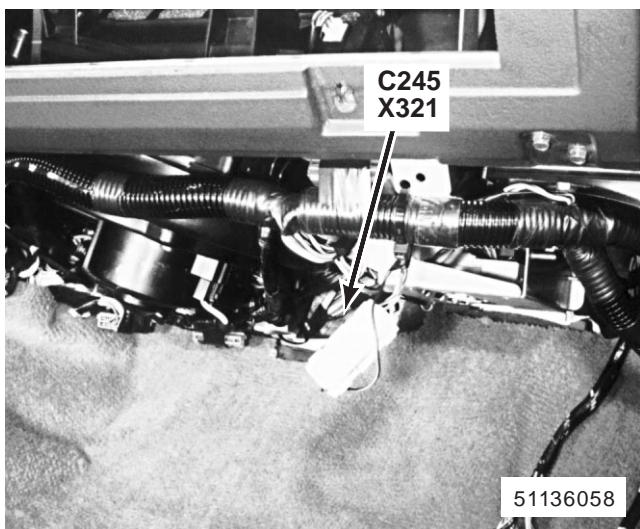

189. behind RH side of fascia (MFI-V8)  
 X321 Data Link Connector (MFI)  
 C245 (5-W)

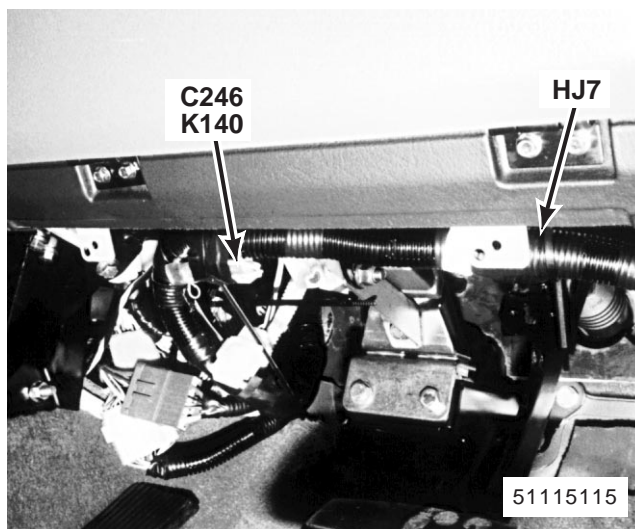

190. behind RH side of fascia (MFI-V8)  
 K140 Tune Select Resistor  
 C246 (2-U)  
 HJ7 (20-U)

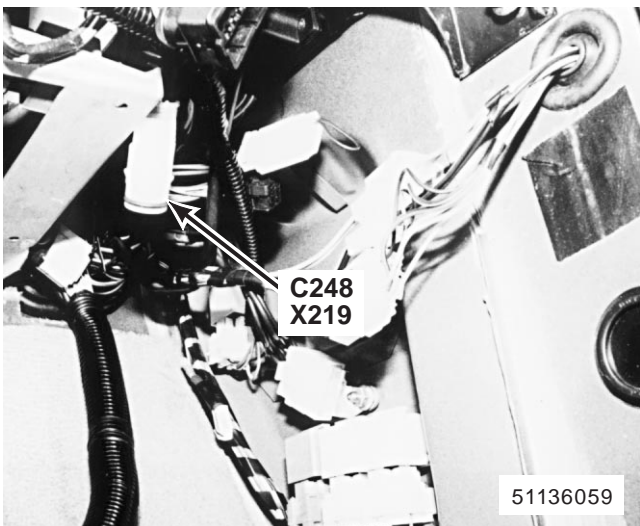

191. behind RH side of fascia (300Tdi)  
 X219 Data Link Connector (EGR)  
 C248 (3-W)

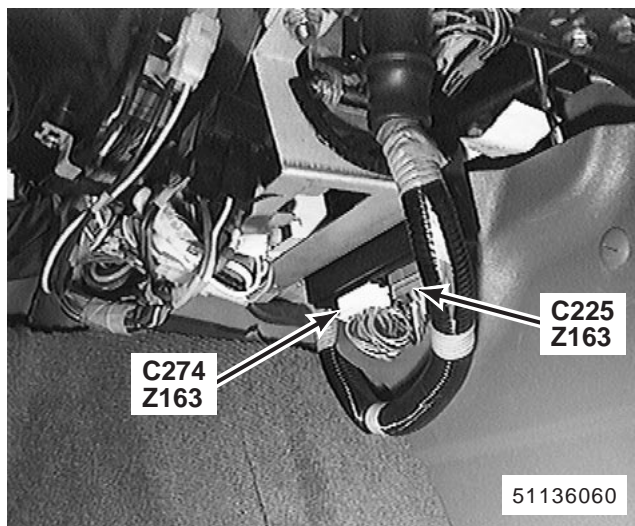

192. behind RH side of fascia  
 Z163 Theft Alarm Unit  
 C225 (26-S)  
 C274 (12-W)

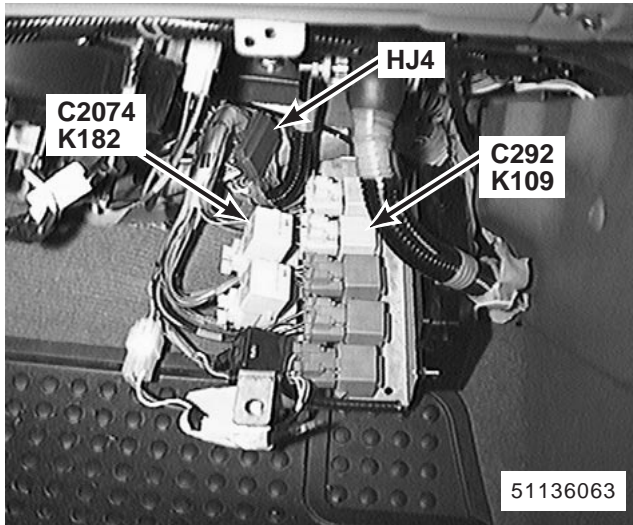

193. behind RH side of fascia (Except NAS)  
 K109 Condenser Fan Relay  
 K182 Power Wash Relay  
 C292 (5-Y)  
 C2074 (5-Y)  
 HJ4 (20-U)

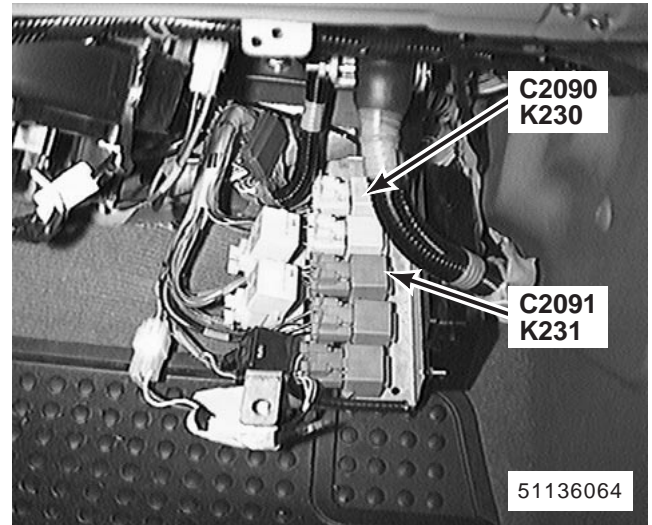

194. behind RH side of fascia (Except NAS)  
 K230 Front Fog Lamps Relay  
 K231 Rear Fog Lamps Relay  
 C2090 (5-Y)  
 C2091 (5-G)

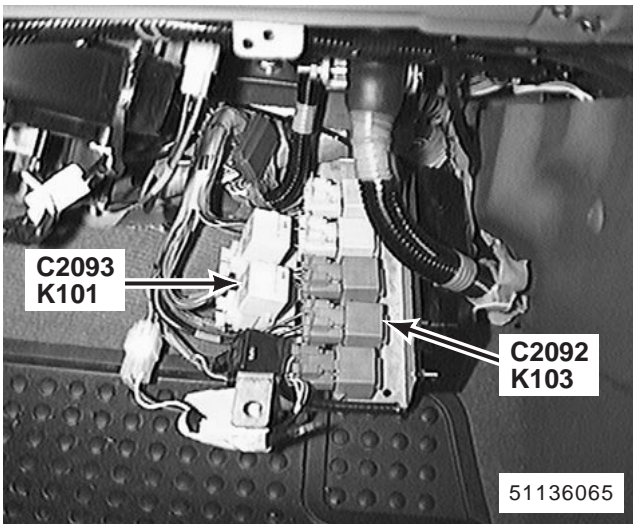

195. behind RH side of fascia (Except NAS)  
 K101 A.B.S. Load Relay  
 K103 A.B.S. Warning Relay  
 C2092 (5-G)  
 C2093 (5-Y)

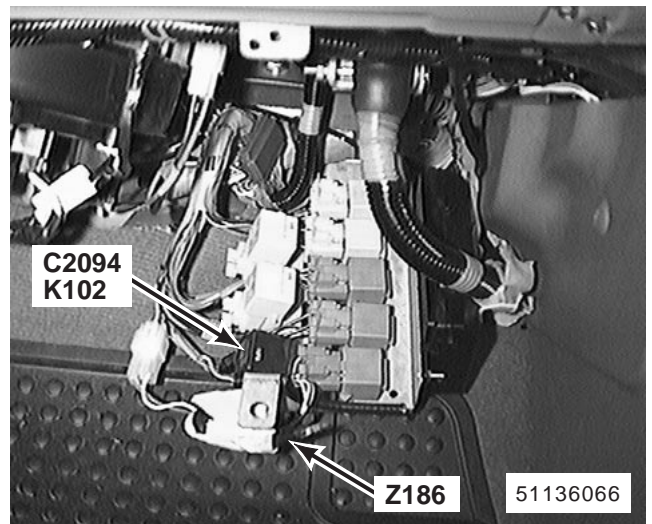

196. behind RH side of fascia (Except NAS)  
 K102 A.B.S. Pump Relay  
 Z186 Cruise Control Diode  
 C2094 (5-B)

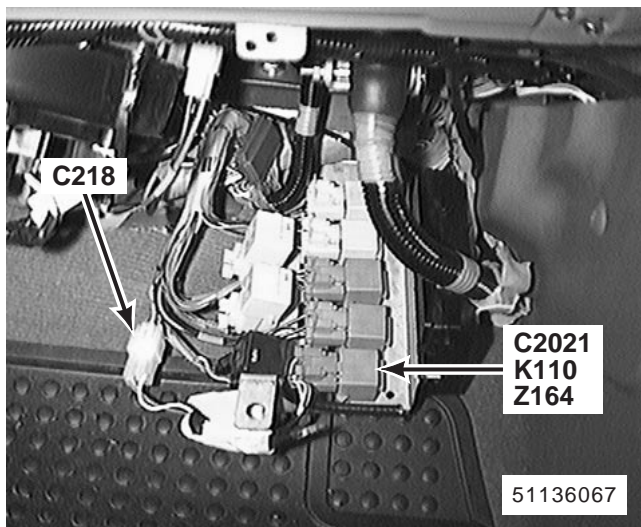

197. behind RH side of fascia (Except NAS)  
 K110 Cruise Control Lockout Relay (Automatic Transmission)  
 Z164 Speed Trip Module (Manual Transmission)  
 C218 (8-W)  
 C2021 (5-G) (Automatic Transmission)  
 C2021 (5-B) (Manual Transmission)

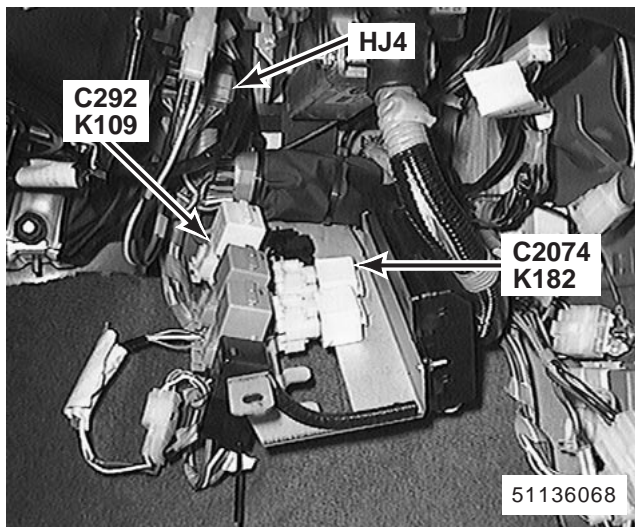

198. behind RH side of fascia (NAS)  
 K109 Condenser Fan Relay  
 K182 Power Wash Relay  
 C292 (5-Y)  
 C2074 (5-Y)  
 HJ4 (20-S)

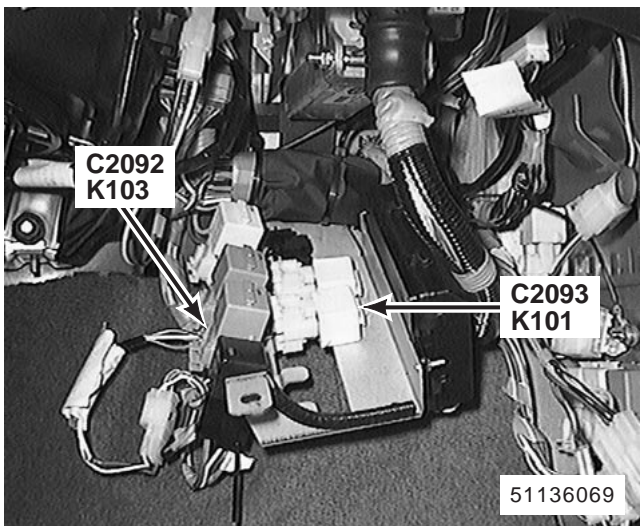

199. behind RH side of fascia (NAS)  
 K101 A.B.S. Load Relay  
 K103 A.B.S. Warning Relay  
 C2092 (5-G)  
 C2093 (5-Y)

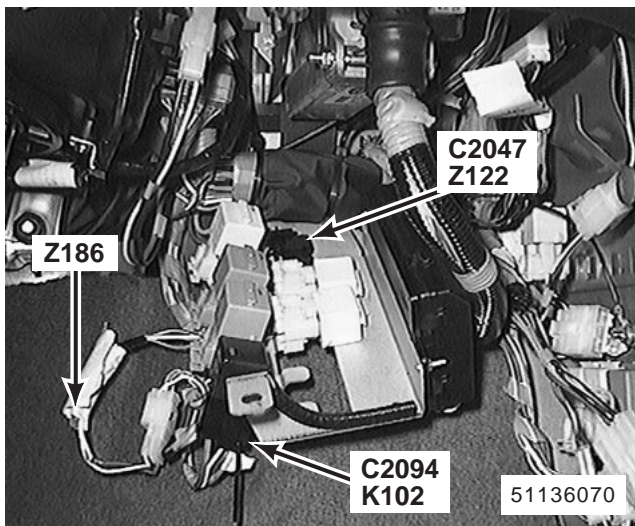

200. behind RH side of fascia (NAS)  
 K102 A.B.S. Pump Relay  
 Z122 Daytime Running Lamps Control Unit  
 Z186 Cruise Control Diode  
 C2047 (5-B)  
 C2094 (4-B)

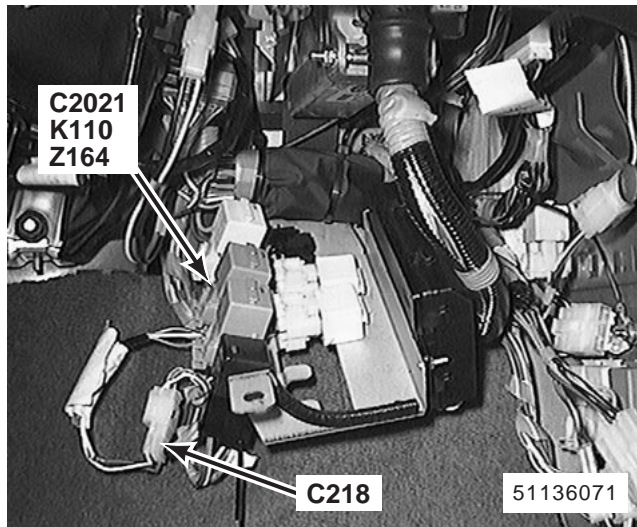

201. behind RH side of fascia (NAS)  
 K110 Cruise Control Lockout Relay (Automatic Transmission)  
 Z164 Speed Trip Module (Manual Transmission)  
 C218 (8-W)  
 C2021 (5-G) (Automatic Transmission)  
 C2021 (5-B) (Manual Transmission)

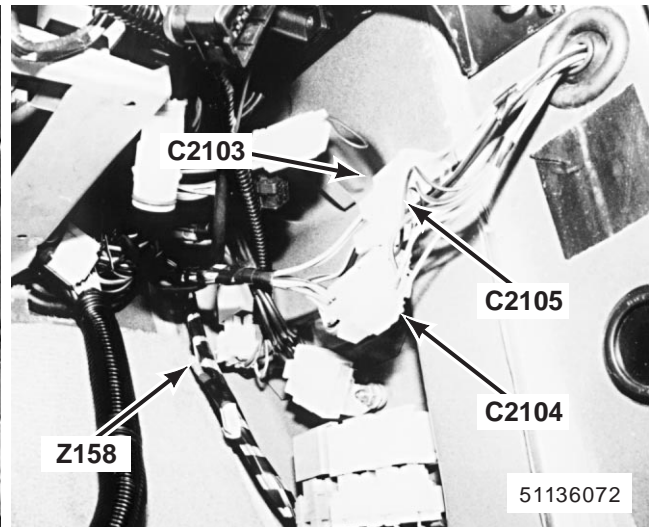

202. behind RH footwell trim panel  
 Z158 Starter Relay Diode  
 C2103 (2-W)  
 C2104 (13-W)  
 C2105 (2-W)

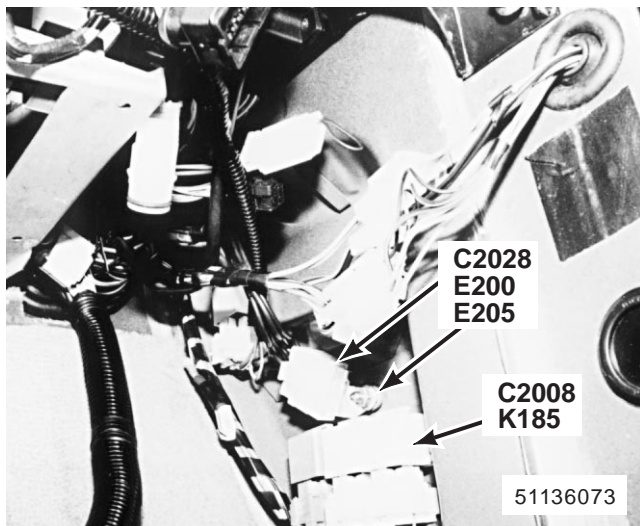

203. behind RH footwell trim panel  
 K185 Front Wiper Relay  
 C2008 (5-G)  
 C2028 (6-W)  
 E200  
 E205

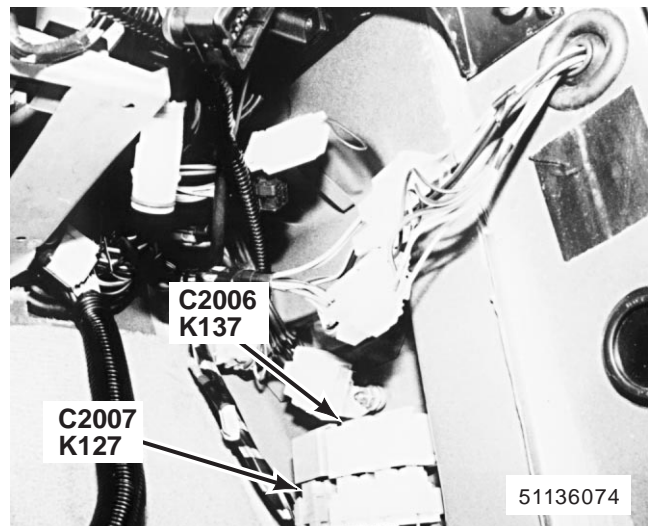

204. behind RH footwell trim panel  
 K127 Ignition Load Relay  
 K137 Starter Solenoid Relay  
 C2006 (5-Y)  
 C2007 (5-Y)

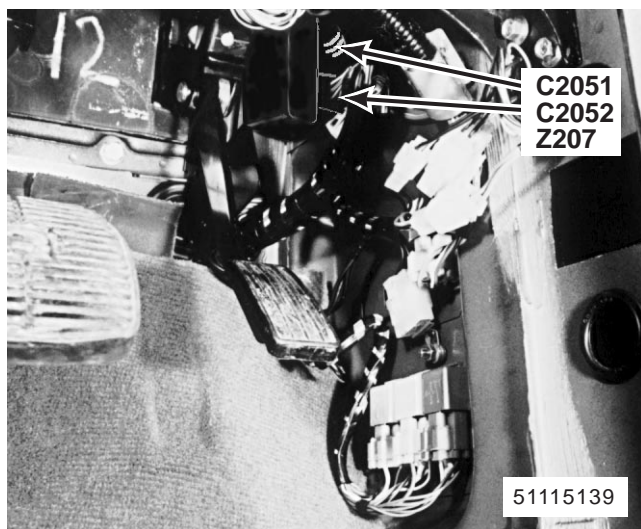

205. behind RH footwell trim panel (MFI-T16)  
Z207 Multi-Function Relay Unit  
C2051 (8-B)  
C2052 (6-B)

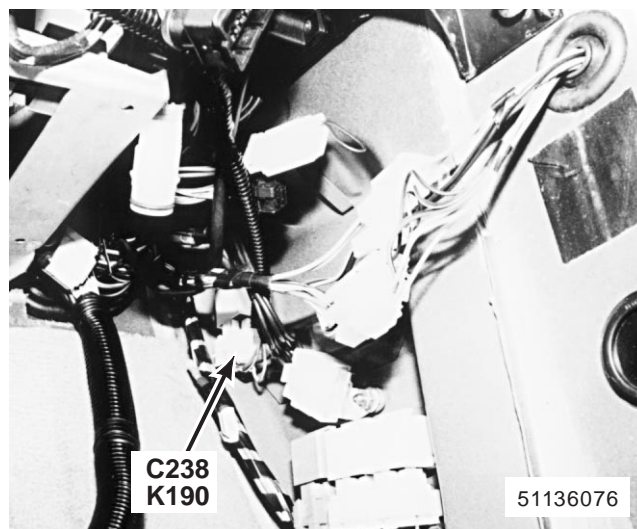

206. behind RH footwell trim panel (MFI-T16 without Air Conditioning)  
K190 Cooling Fan Relay  
C238 (5-Y)

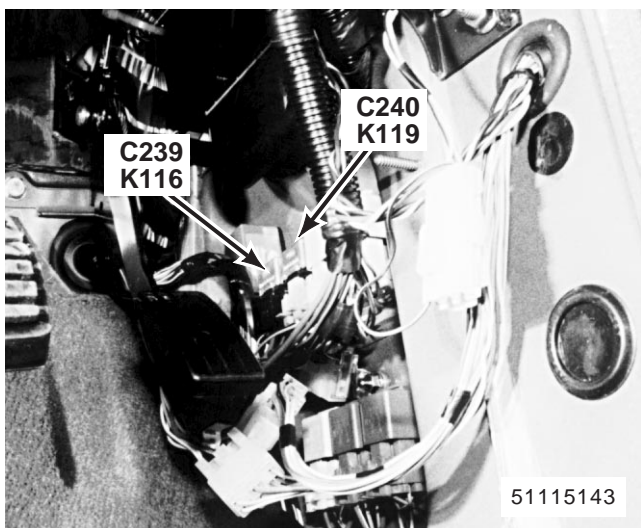

207. behind RH footwell trim panel (MFI-V8 shown; others similar)  
K116 Engine Control Load Relay  
K119 Fuel Pump Relay  
C239 (5-B)  
C240 (5-U)

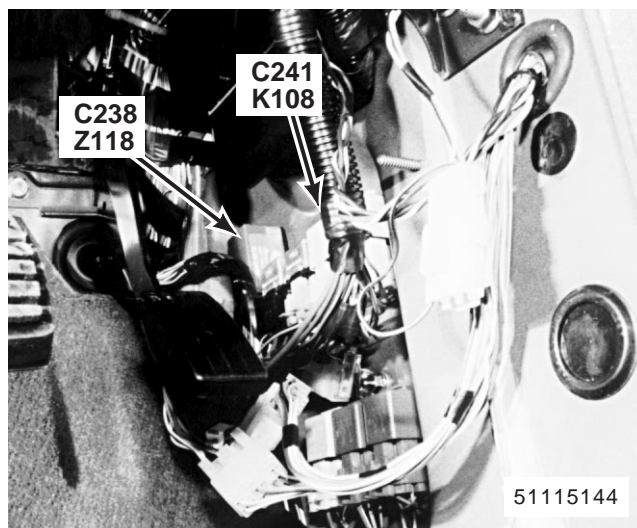

208. behind RH footwell trim panel (MFI-V8 shown; others similar)  
K108 Compressor Clutch Relay  
Z118 Fan Control Module  
C238 (9-B)  
C241 (5-Y)

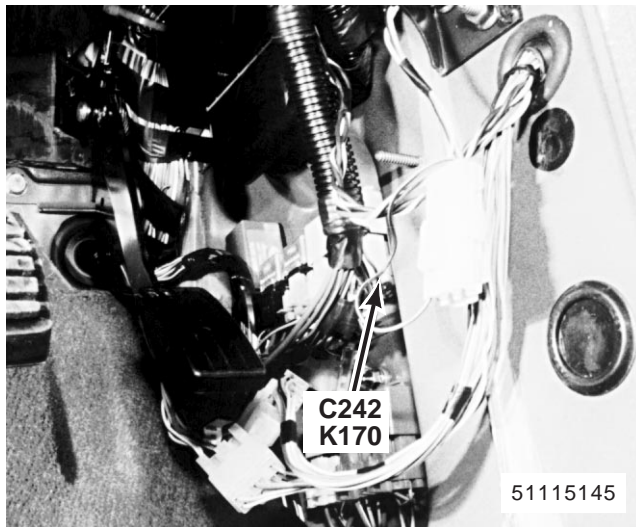

209. behind RH footwell trim panel (MFI-V8 shown; others similar)  
 K170 A/C Logic Relay  
 C242 (5-Y)

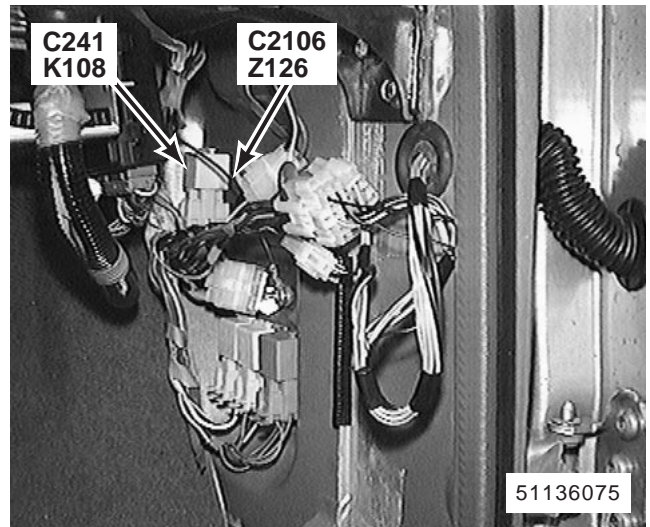

210. behind RH footwell trim panel (SFI-V8) (NAS)  
 K108 Compressor Clutch Relay  
 Z126 Service Reminder Unit  
 C241 (5-Y)  
 C2106 (5-R)

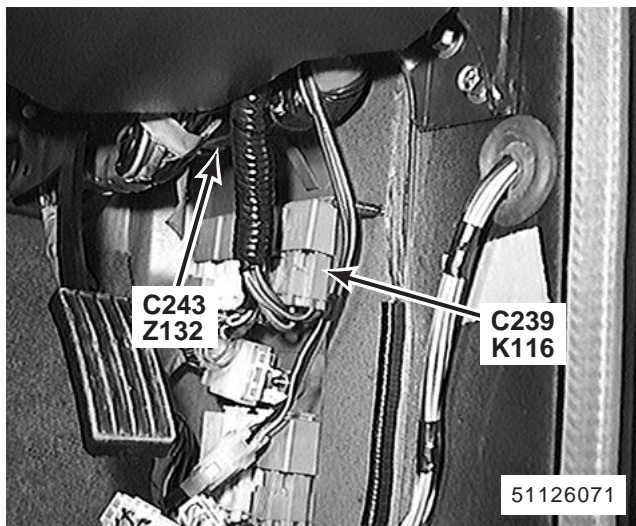

211. behind RH footwell trim panel (300Tdi with EDC)  
 K116 Engine Control Load Relay  
 Z132 Engine Control Module (ECM)  
 C239 (5-Y)  
 C243 (55-B)

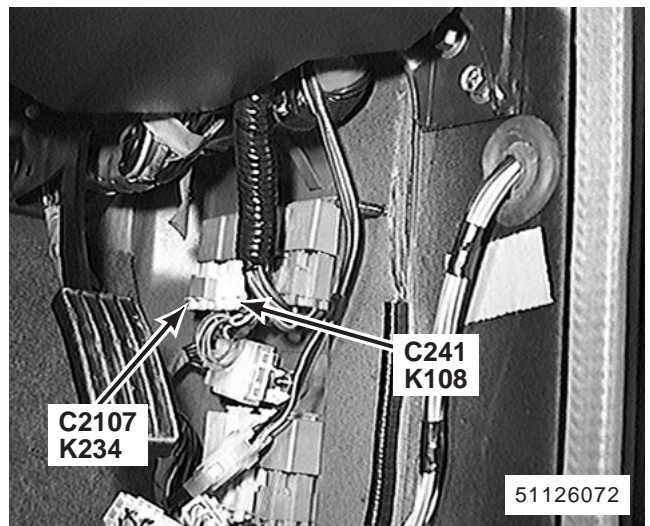

212. behind RH footwell trim panel (300Tdi with EDC)  
 K108 Compressor Clutch Relay  
 K234 Cruise Control Disable Relay  
 C241 (5-Y)  
 C2107 (5-W)



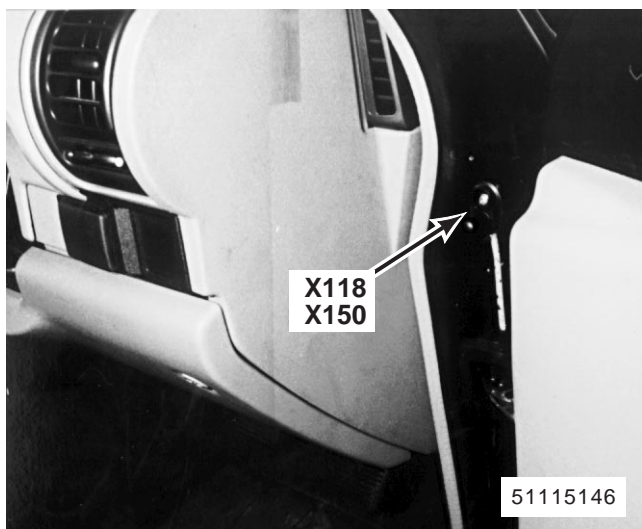

213. front of RH front door jamb (LH similar)  
 X118 Right Front Door Switch  
 X150 Left Front Door Switch

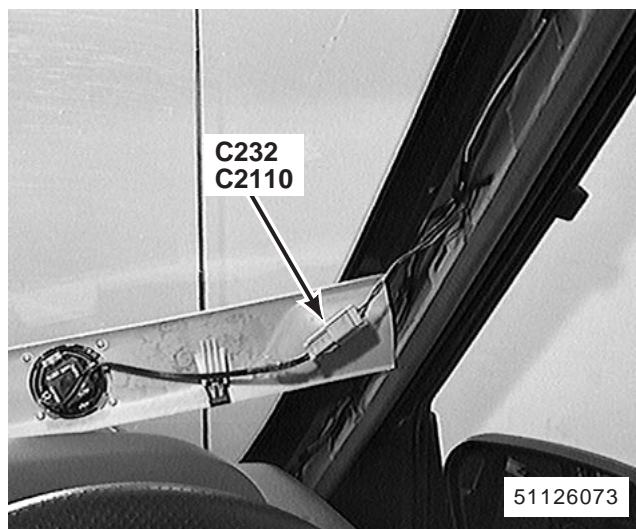

214. RH A-post (LH similar)  
 C232 (2-S) (Right)  
 C2110 (2-S) (Left)

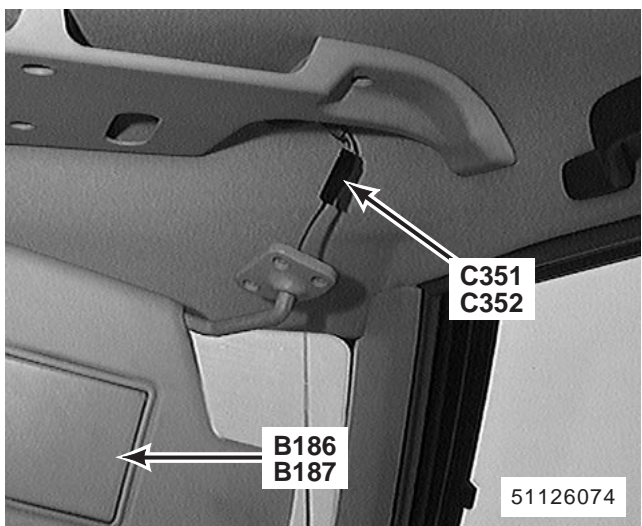

215. RH front of roof (LH similar)  
 B186 Left Vanity Mirror Lamp  
 B187 Right Vanity Mirror Lamp  
 C351 (2-B) (Right)  
 C352 (2-B) (Left)

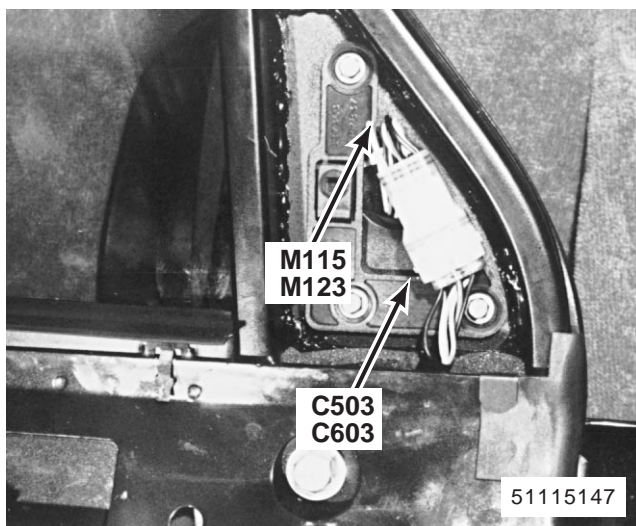

216. top front of LH front door (RH similar)  
 M115 Left Mirror Actuator  
 M123 Right Mirror Actuator  
 C503 (6-W) (Left)  
 C603 (6-W) (Right)

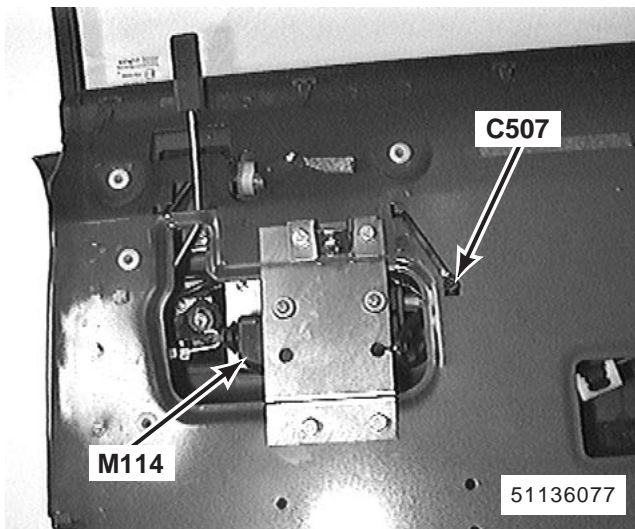

217. in rear of LH front door  
 M114 Left Front Door Lock Actuator  
 C507 (4-W) (Without Theft Alarm)  
 C507 (6-W) (With Theft Alarm)

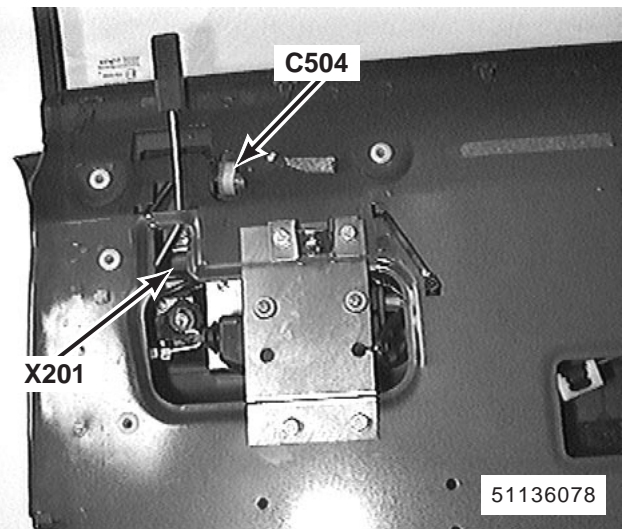

218. in rear of LH front door  
 X201 Left Front Door Key Switch  
 C504 (4-W)

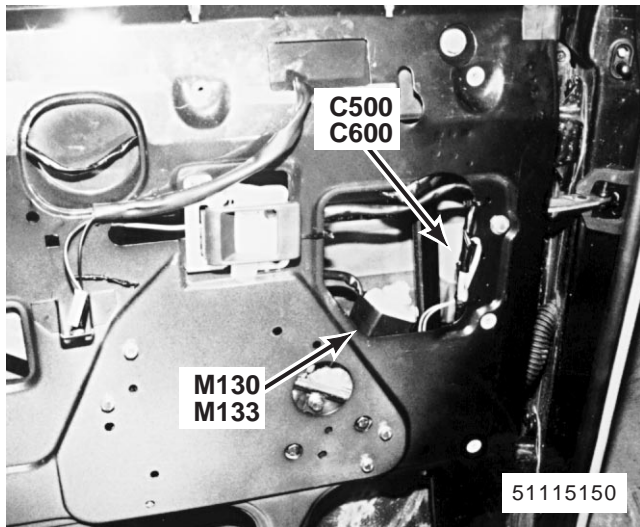

219. in front of LH front door (RH similar)  
 M130 Left Front Window Motor  
 M133 Right Front Window Motor  
 C500 (2-B) (Left)  
 C600 (2-B) (Right)

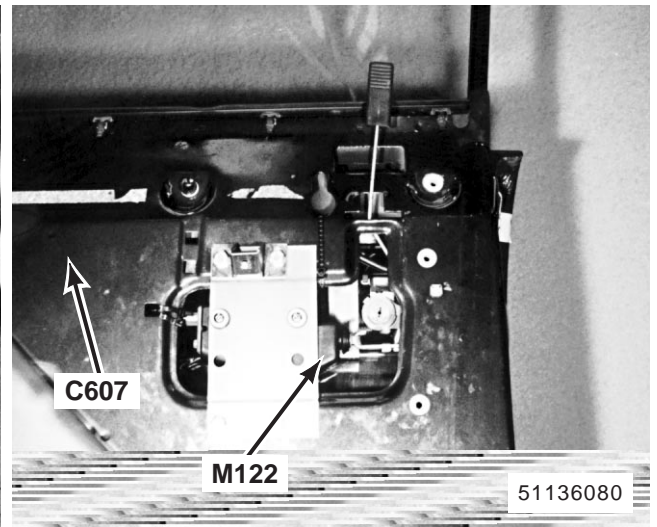

220. in top rear of RH front door  
 M122 Right Front Door Lock Actuator  
 C607 (2-W) (Without Theft Alarm)  
 C607 (6-W) (With Theft Alarm)

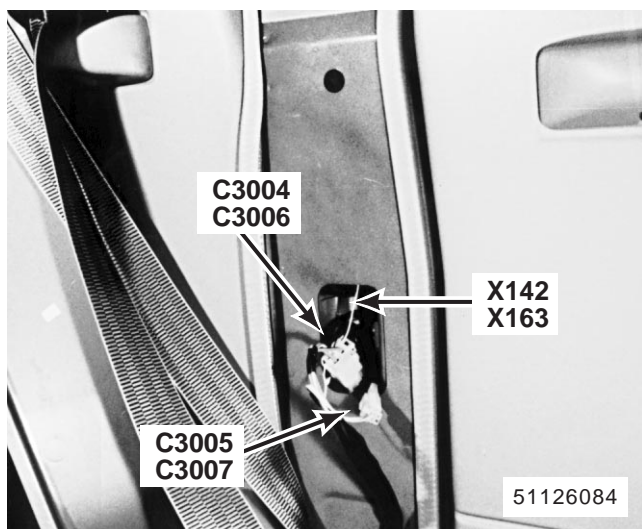

221. in lower part of LH B–post (RH similar)  
 X142 Left Rear Door Switch  
 X163 Right Rear Door Switch  
 C3004 (3–W) (Left)  
 C3005 (2–W) (Left)  
 C3006 (3–W) (Right)  
 C3007 (2–W) (Right)

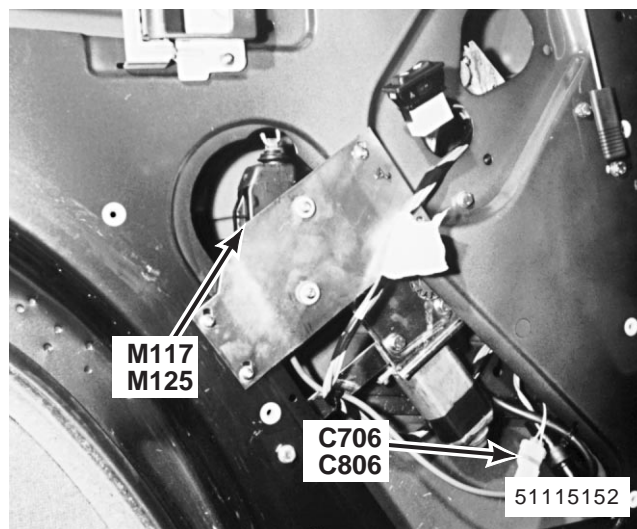

222. inside front of LH rear door (RH similar)  
 M117 Left Rear Door Lock Actuator  
 M125 Right Rear Door Lock Actuator  
 C706 (2–W) (Left)  
 C806 (2–W) (Right)

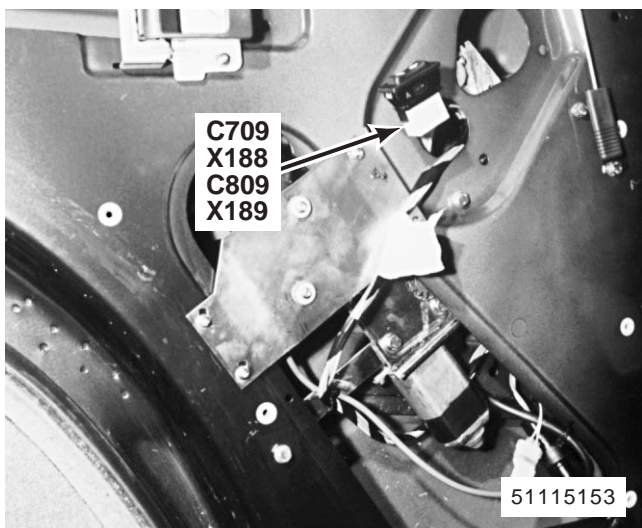

223. inside front of LH rear door (RH similar)  
 X188 Left Rear Window Door Switch  
 X189 Right Rear Window Door Switch  
 C709 (5–W) (Left)  
 C809 (5–W) (Right)

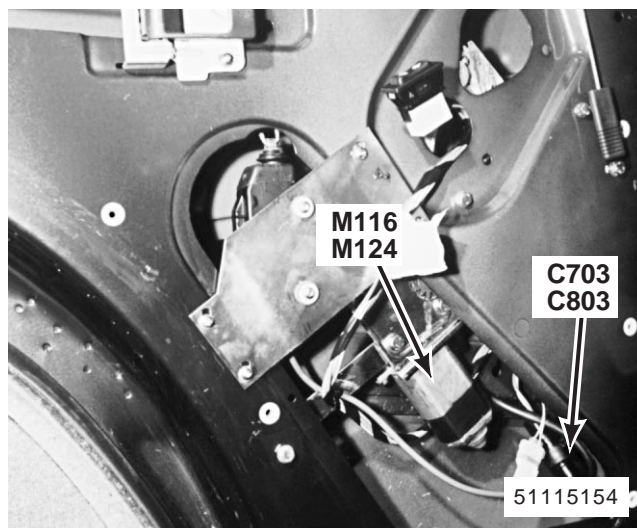

224. inside front of LH rear door (RH similar)  
 M116 Left Rear Window Motor  
 M124 Right Rear Window Motor  
 C703 (2–B) (Left)  
 C803 (2–B) (Right)

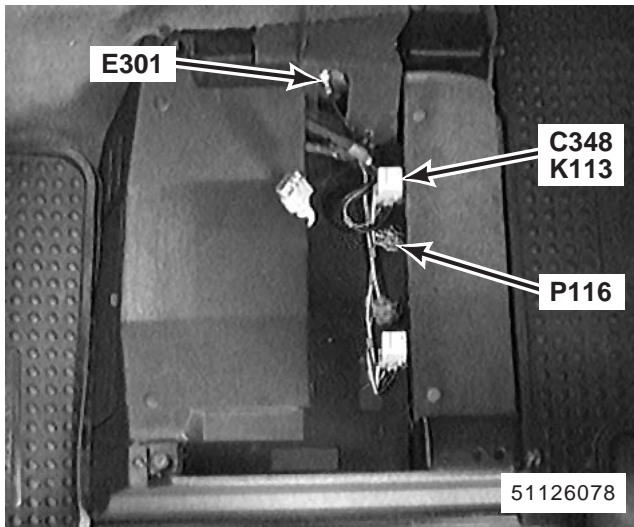

225. beneath LH front seat  
 K113 Left Seat Power Relay  
 P116 Passenger's Underseat Fuse Box  
 C348 (5-Y)  
 E301

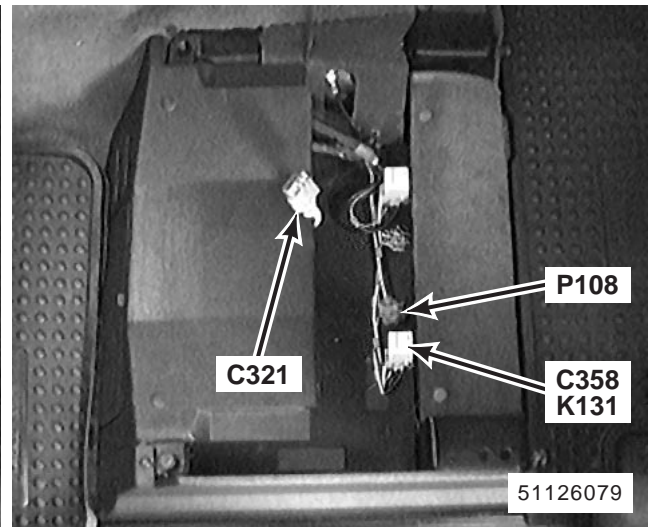

226. beneath LH front seat  
 K131 Right Seat Power Relay  
 P108 Driver's Underseat Fuse Box  
 C321 (9-U)  
 C358 (5-Y)

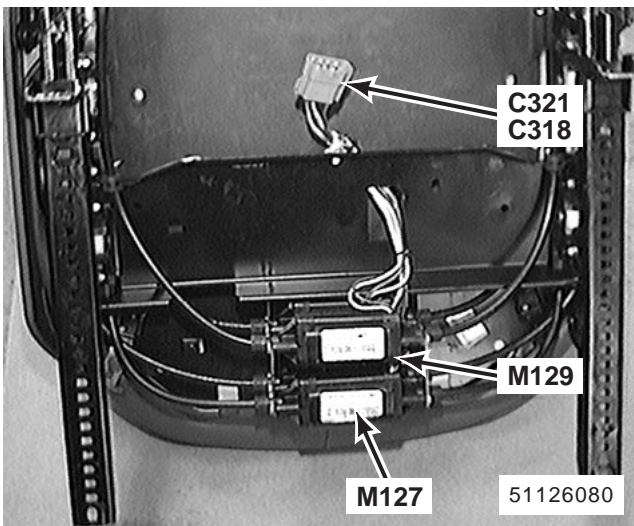

227. underside of LH front seat (RH similar)  
 M127 Seat Height (Front) Motor  
 M129 Seat Recline Motor  
 C318 (9-R) (Right)  
 C321 (9-U) (Left)

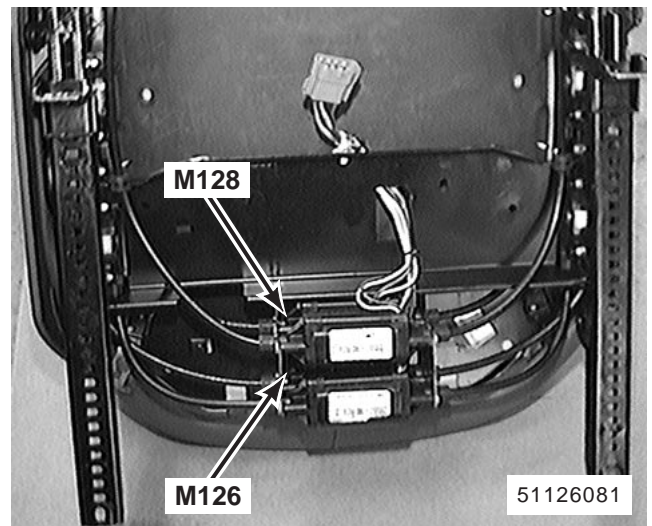

228. underside of LH front seat (RH similar)  
 M126 Seat Base Motor  
 M128 Seat Height (Rear) Motor

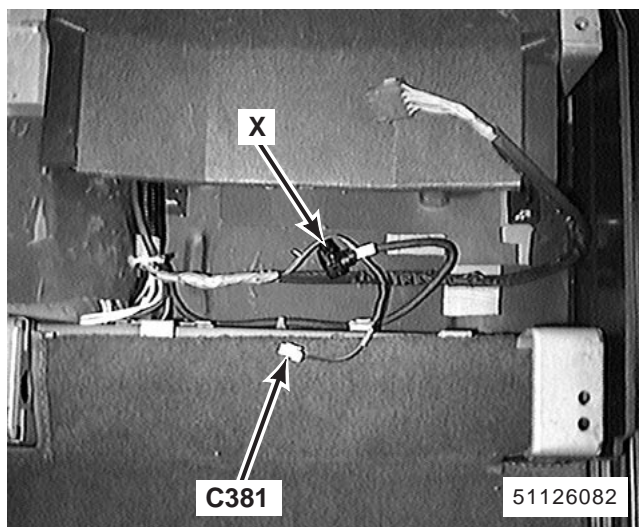

229. beneath RH front seat  
X DIN CABLE  
C381 (3-W)

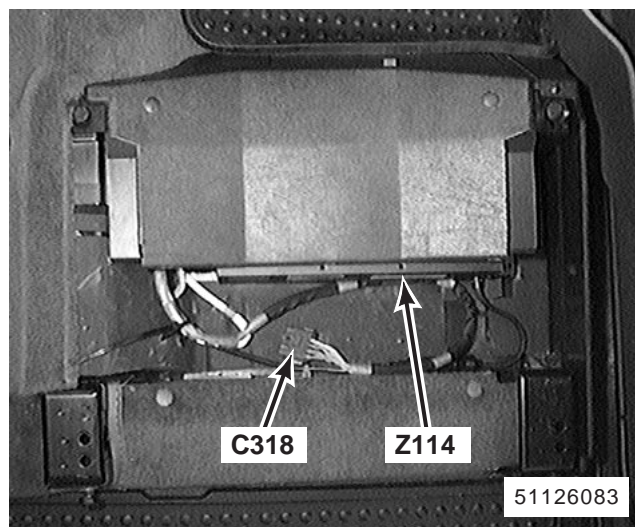

230. beneath RH front seat  
Z114 CD Changer  
C318 (9-R)

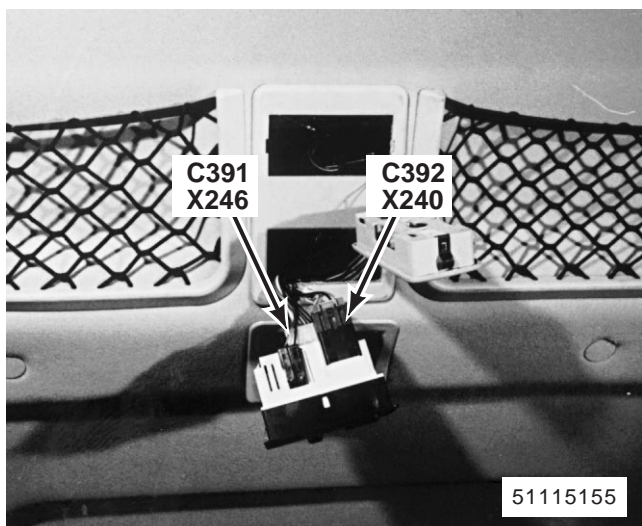

231. centre of roof  
X240 Passenger's Rear A/C Switch  
X246 Passenger's Rear Fan Speed Switch  
C391 (5-W)  
C392 (5-U)

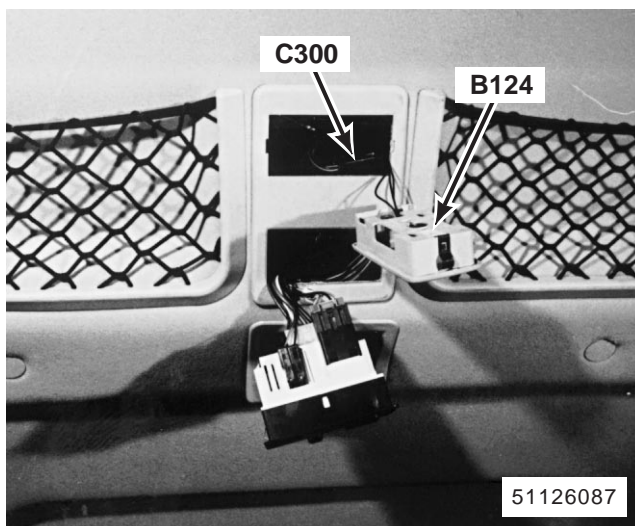

232. centre of roof  
B124 Rear Interior Roof Lamp  
C300 (4-B)



233. centre of roof  
 X264 Passenger's Rear Sunroof Switch  
 C389 (3-W)

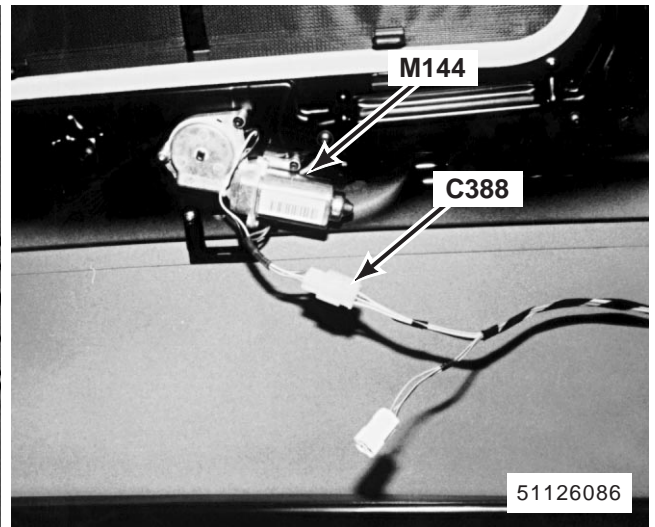

234. centre of roof  
 M144 Rear Sunroof Motor  
 C388 (4-W)

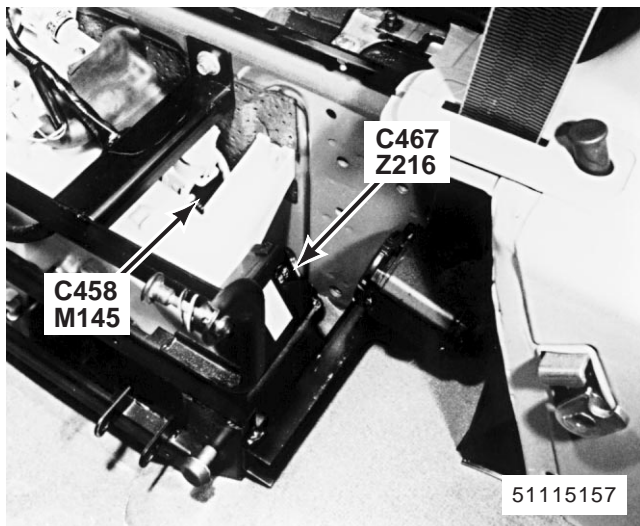

235. LH side of luggage compartment behind trim panel  
 M145 Rear Blower Motor  
 Z216 Rear A/C Switch Amplifier  
 C458 (2-B)  
 C467 (6-W)

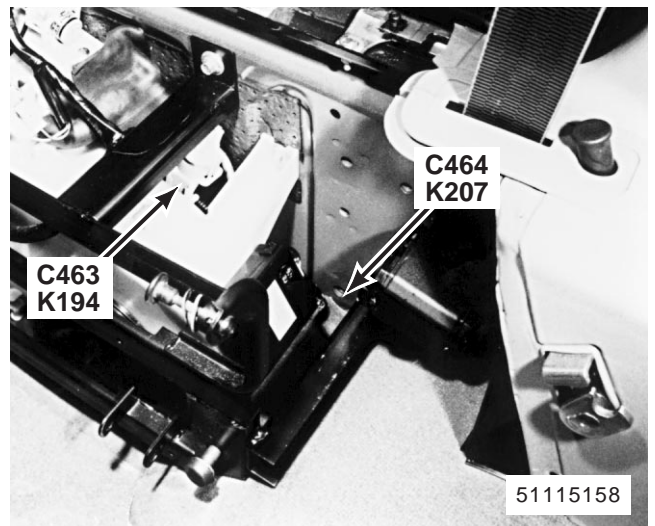

236. LH side of luggage compartment behind trim panel  
 K194 Rear A/C Control Relay  
 K207 Rear A/C Refrigerant Control Valve  
 C463 (4-W)  
 C464 (2-S)

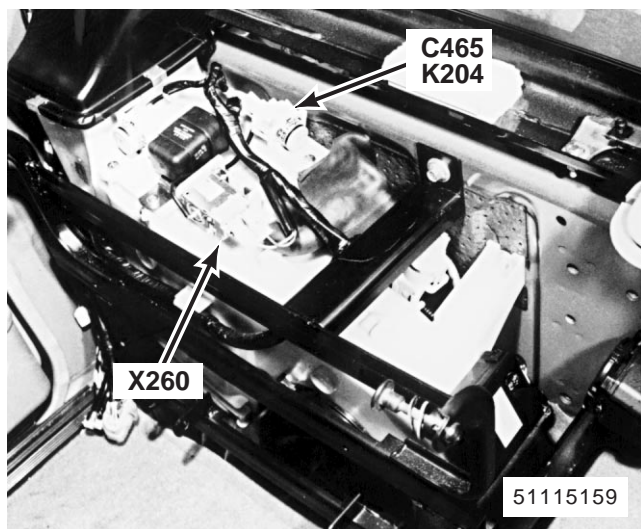

237. LH side of luggage compartment behind trim panel  
 X260 Rear A/C Evaporator Temperature Switch  
 K204 Rear A/C Illumination Relay  
 C465 (4-W)

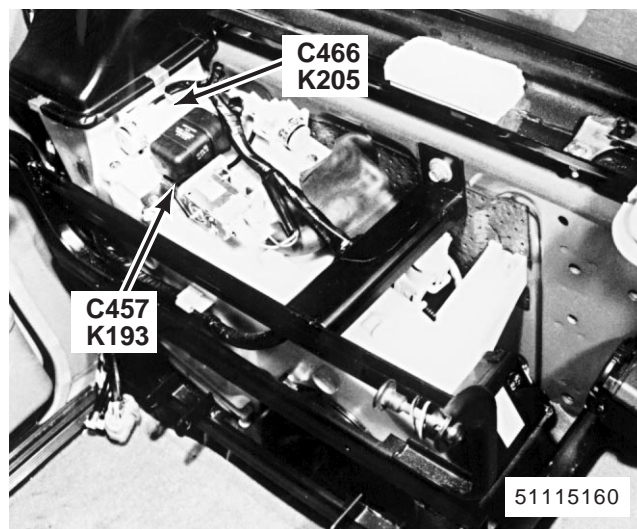

238. LH side of luggage compartment behind trim panel  
 K193 Rear Blower Motor Relay  
 K205 Rear A/C Fan Speed Relay  
 C457 (5-W)  
 C466 (4-W)

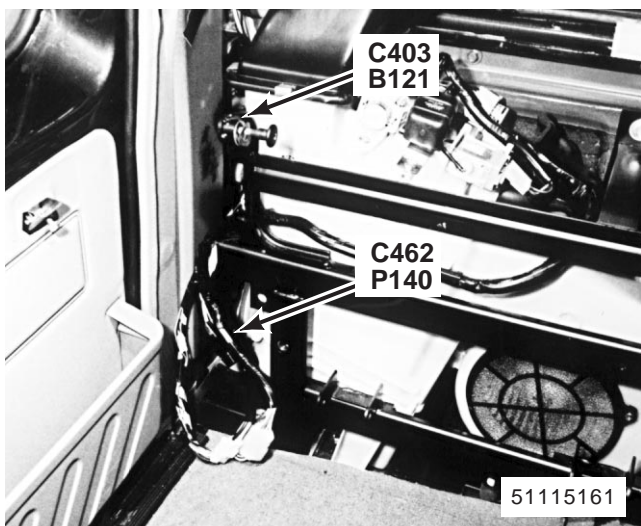

239. LH rear of luggage compartment behind trim panel  
 B121 Left Rear Lamp Assembly  
 P140 Rear A/C Switch Amplifier In-Line Fuse  
 C403 (6-W)  
 C462 (2-B)

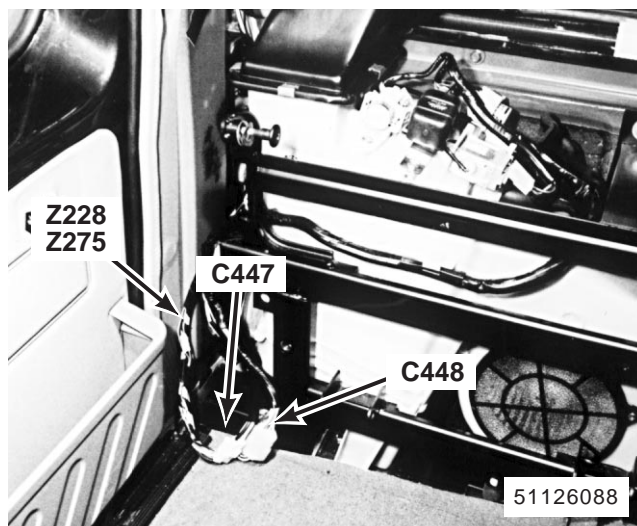

240. LH rear of luggage compartment behind trim panel  
 Z228 Rear A/C Refrigerant Control Valve Diode  
 Z275 Rear A/C Relay Diode  
 C447 (2-W)  
 C448 (16-W)

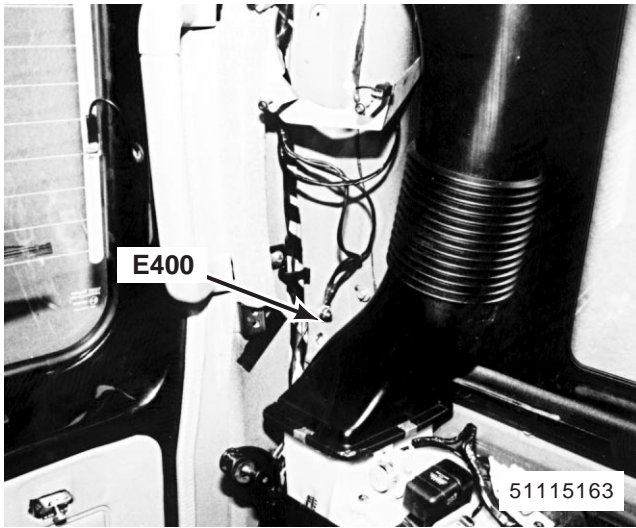

241. LH rear of luggage compartment behind trim panel  
E400

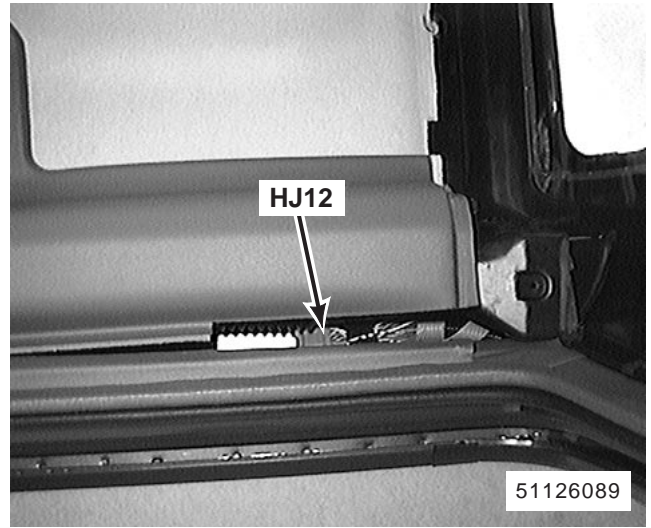

242. LH rear of roof behind trim panel  
HJ12 (20-G)

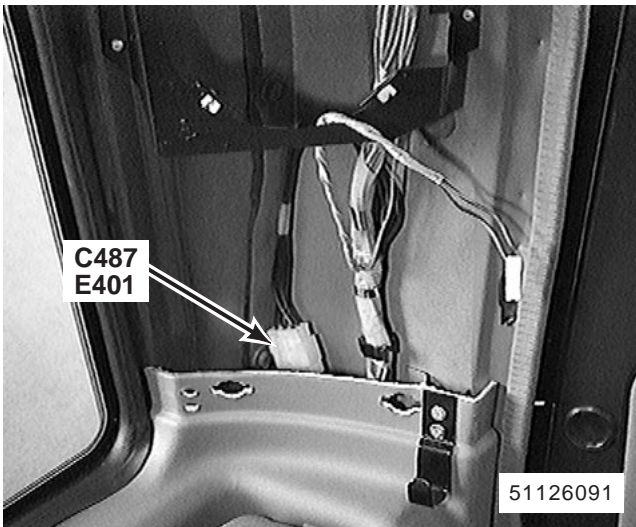

243. RH rear of luggage compartment behind trim panel  
C487 (6-W)  
E401

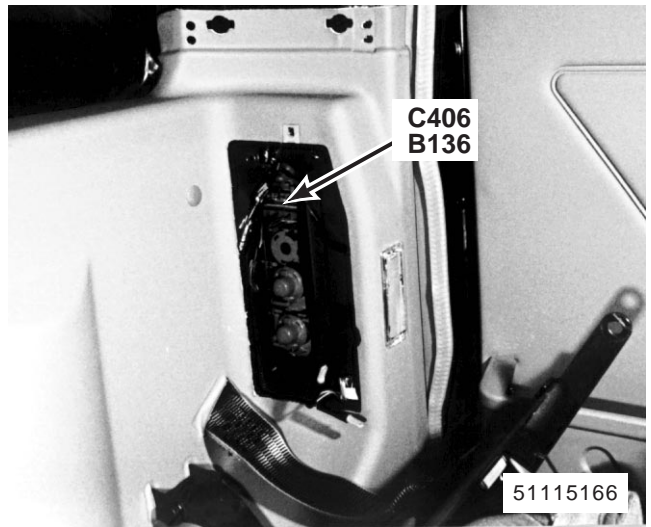

244. RH rear of luggage compartment behind trim panel  
B136 Right Rear Lamp Assembly  
C406 (6-W)



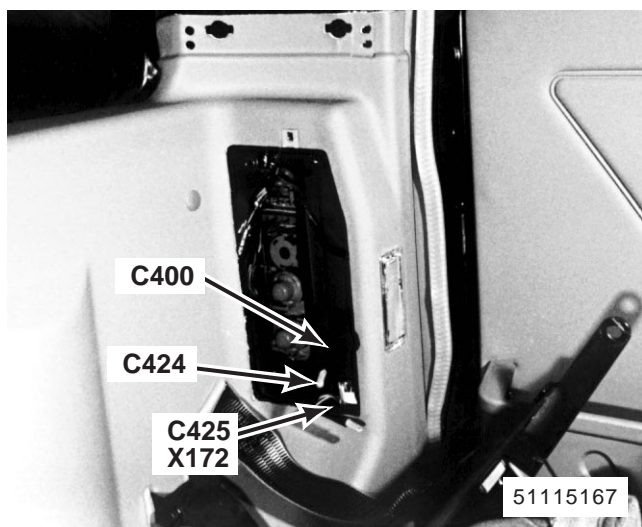

245. RH rear of luggage compartment behind trim panel

- X172 Trailer Auxiliary Socket
- C400 (7-B)
- C424 (1-B)
- C425 (1-B)

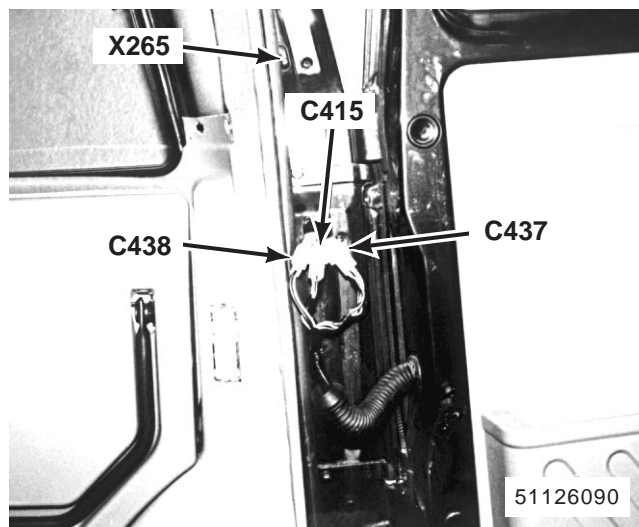

246. in RH side of tailgate door jamb

- X265 Rear End Door Switch
- C415 (8-W)
- C437 (6-W)
- C438 (2-W)

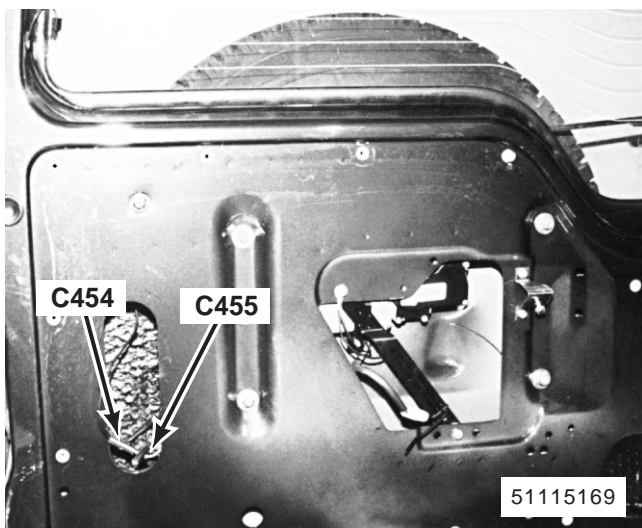

247. RH side of tailgate

- C454 (1-B)
- C455 (1-B)

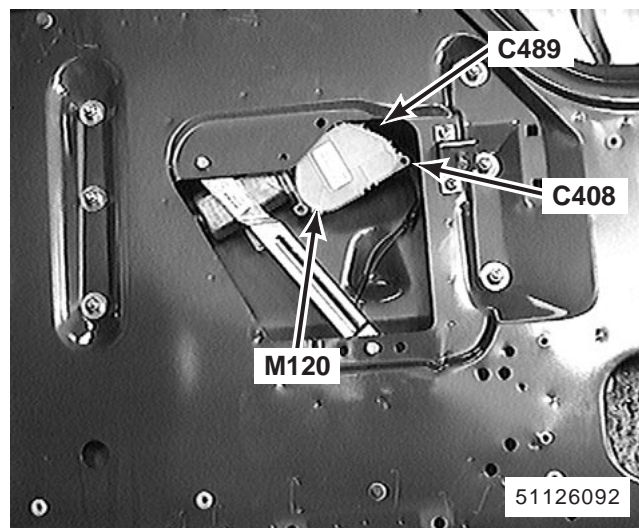

248. RH side of tailgate

- M120 Rear Wiper Motor
- C408 (3-B)
- C489 (2- )

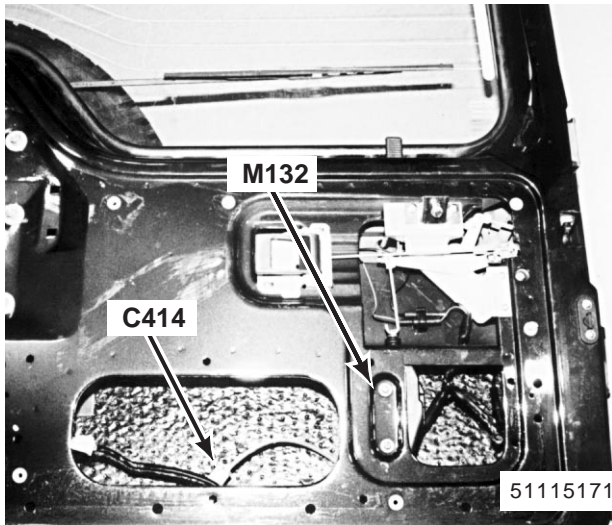

249. LH side of tailgate  
M132 Tailgate Lock Actuator  
C414 (2-W)

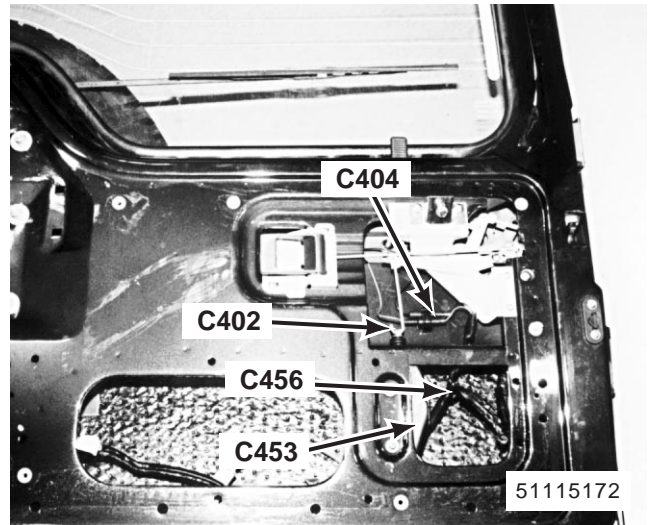

250. LH side of tailgate  
C402 (1-B)  
C404 (1-B)  
C453 (1-B)  
C456 (1-B)

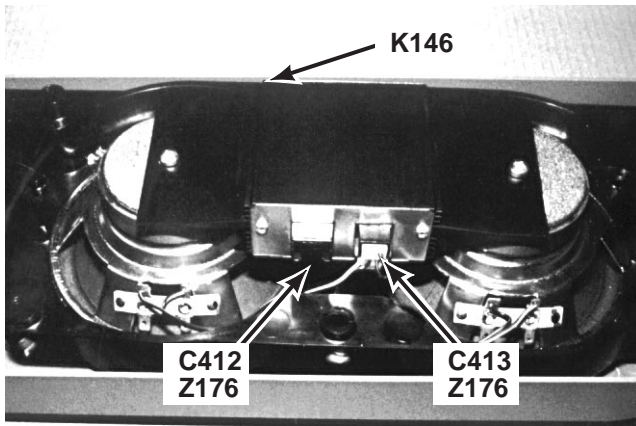

251. LH side of tailgate rear of Subwoofer  
K146 Subwoofer  
Z176 Subwoofer Amplifier  
C412 (6-W)  
C413 (4-W)

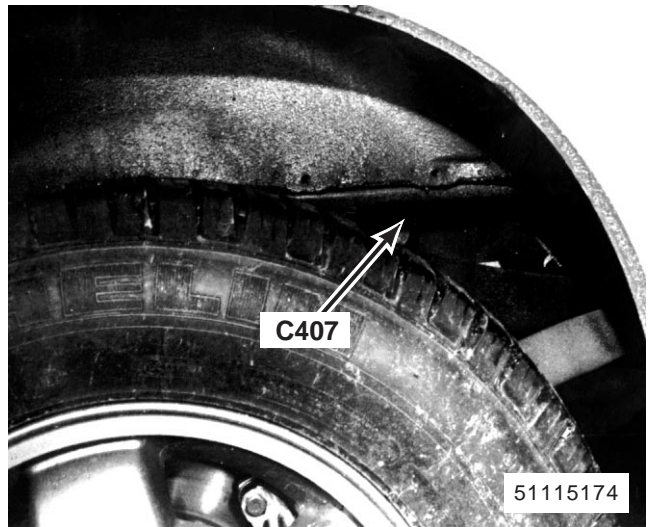

252 beneath LH rear of vehicle  
C407 (6-B)

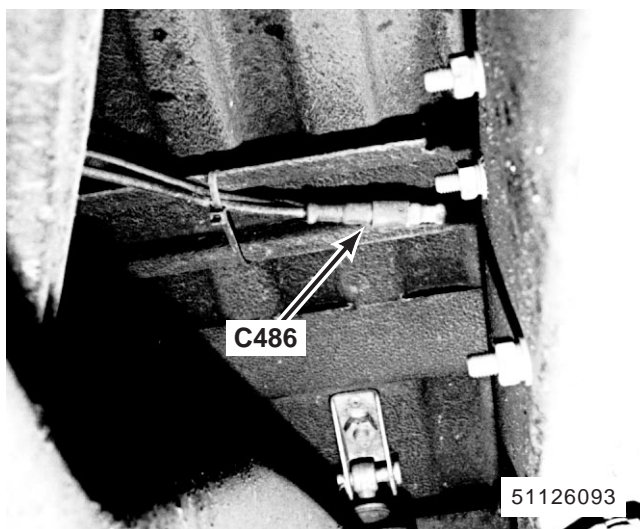

253. beneath LH rear of vehicle  
C486 (2-W)

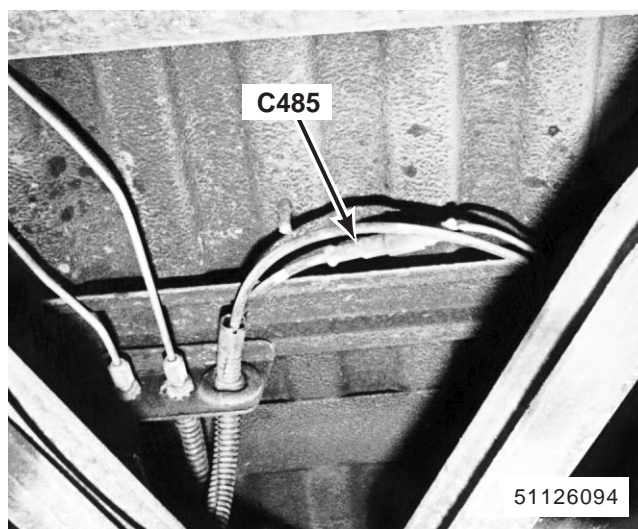

254. beneath RH rear of vehicle  
C485 (2-W)

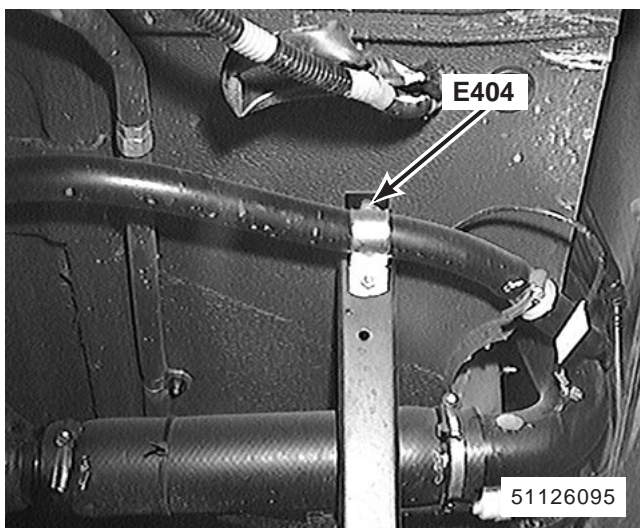

255. beneath RH rear of vehicle  
E404

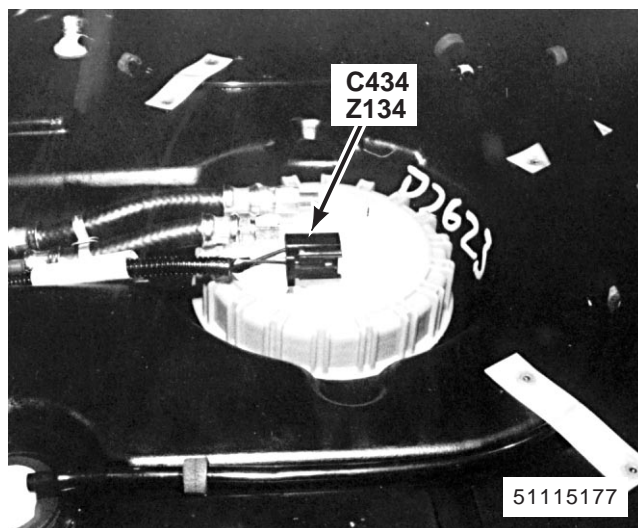

256. top of fuel tank  
Z134 Fuel Pump Module  
C434 (4-B)

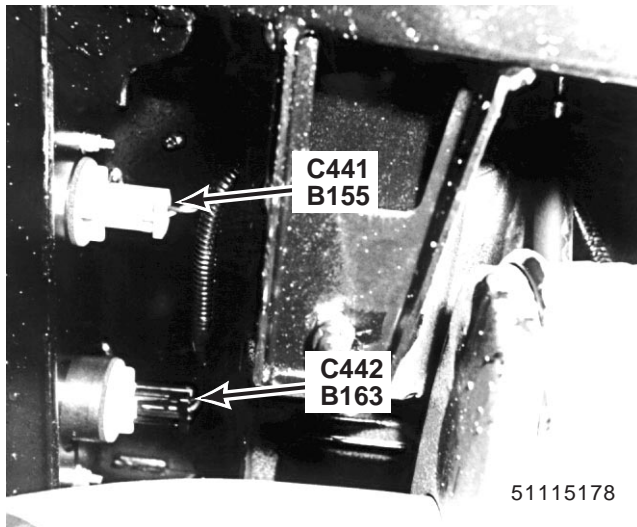

257. behind LH side of rear bumper  
 B155 Left Tail Lamp  
 B163 Left Rear Indicator Lamp  
 C441 (2-R)  
 C442 (2-B)

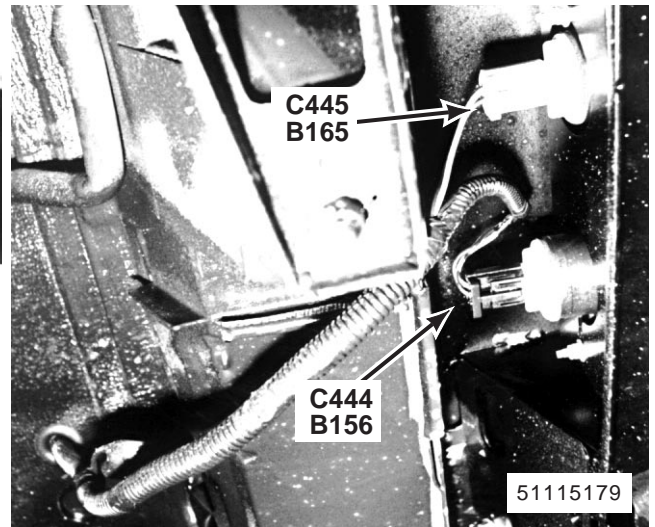

258. behind RH side of rear bumper  
 B165 Right Rear Indicator Lamp  
 B156 Right Tail Lamp  
 C444 (2-R)  
 C445 (2-B)



259. LH side of rear bumper (RH similar)  
 B159 Left Rear Side Marker Lamp  
 B160 Right Rear Side Marker Lamp  
 C443 (2-B)  
 C446 (2-B)

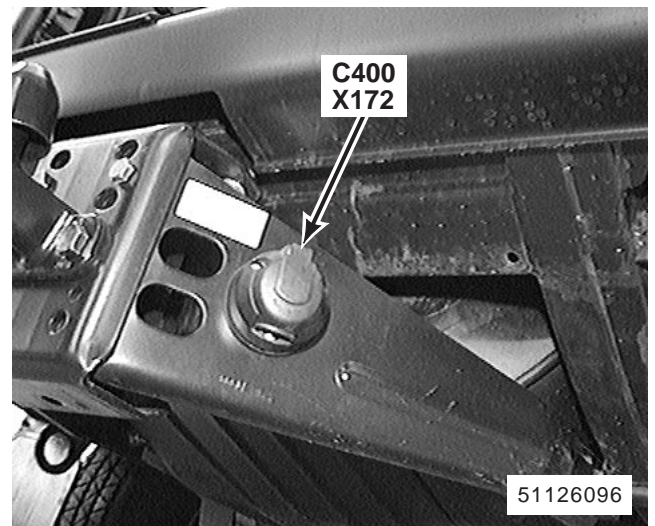

260. centre rear of vehicle  
 X172 Trailer Auxiliary Socket  
 C400 (7-B)

R030036

**C100**

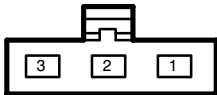

1	NLG
2	PW
3	OK

R030005

**C103**

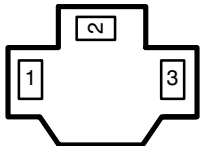

1	UO
2	UB
3	B

R040031

**C101**

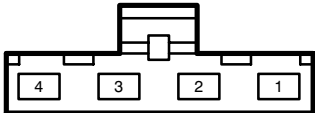

1	PN	3	NG
2	-	4	OS

R030005

**C104**

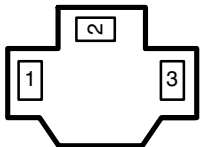

1	US
2	UK
3	B

R130001

**C105**

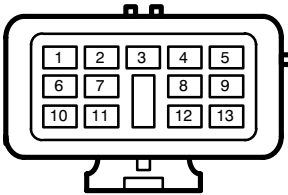

1	BU	6	SB	11	BO/BY
2	BR	7	BK	12	RY
3	GN	8	BG	13	-
4	GY	9	YB		
5	B	10	BY		

R130002

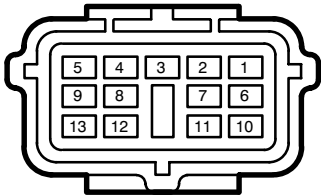

1	BO	6	SB	11	BO
2	BR	7	BK	12	-
3	GN	8	BLG	13	-
4	GY	9	BY		
5	B	10	BY		

### C109

R020058



1	RB
2	B

### C110

R020058



1	RO
2	B

R030039

### C112

R040001

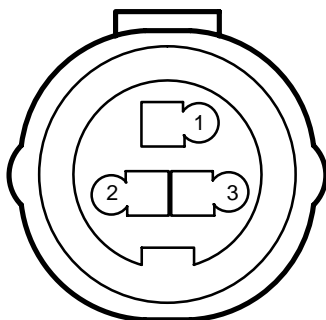

1	WO
2	B
3	CORE

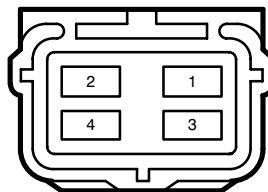

1	UY/GR	3	B/WG
2	UW/NU	4	NU/WO

R030039

### C113

R040001

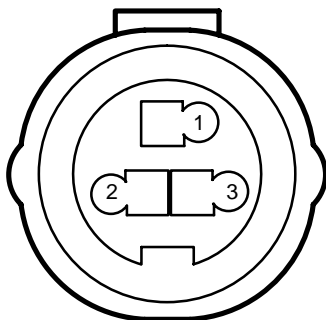

1	WO
2	B
3	CORE

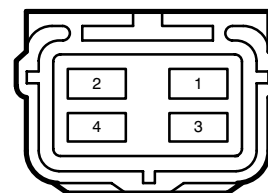

1	OG	3	WG
2	YB	4	WO

R020065

**C114**

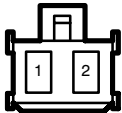

1	NK
2	NW

R020061

**C123**

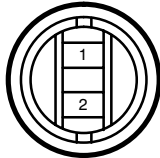

1	GW
2	B

R030035

**C115**

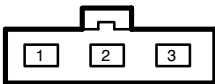

1	NP
2	NP
3	NO

R020061

**C124**

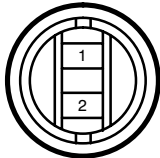

1	GR
2	B

R020037

**C120**

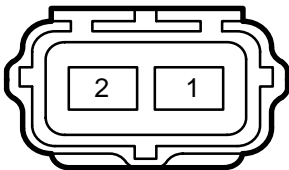

1	B
2	LGS

R020063

**C125**

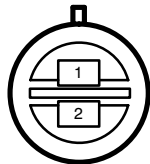

1	NR
2	B

### C127

R030037

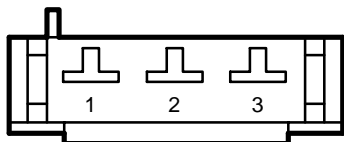

1	LGK
2	B
3	-

### C130

R020007

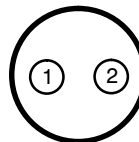

1	G
2	G

### C129

R130002

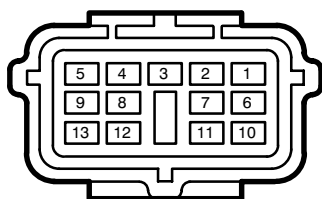

1	SR	6	B	11	SW
2	SY	7	SU	12	SP
3	-	8	SN	13	B
4	SG	9	B		
5	SK	10	B		

### C131

R020007

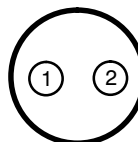

1	G
2	G



R040019

R060016

C132

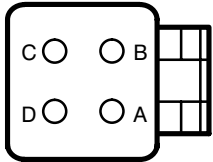

A	O	C	GW
B	US	D	RG

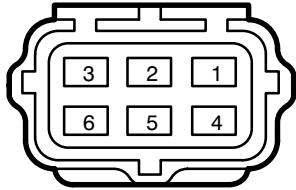

1	OS	4	OU
2	NK	5	-
3	KU	6	OG

R040030

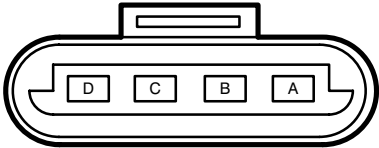

A	OR	C	GW
B	RG	D	US

R060025

### C133

R050023

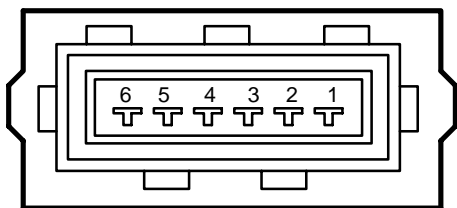

1	-	4	-
2	RB	5	NO
3	UG	6	UR

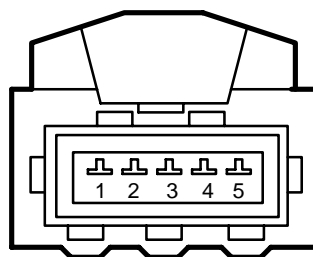

1	YB	4	B
2	UG	5	-
3	UR		

R030041

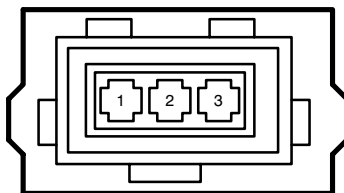

1	NO
2	UG
3	RB

R020060

### C134

R020060

### C135

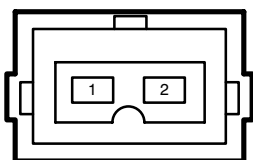

1	YU/NK
2	NO/YU

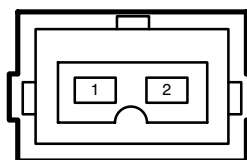

1	YW/NK
2	NO/YG

R020060

**C136**

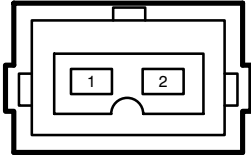

1	YU/NK/YB
2	NO/YW

R020060

**C139**

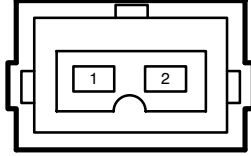

1	YW/YS
2	NO

R020060

**C137**

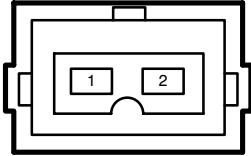

1	YW/NK/YN
2	NO/YB

R020060

**C140**

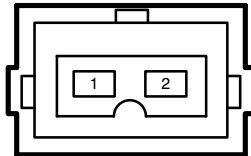

1	YU/YR
2	NO

R020060

**C138**

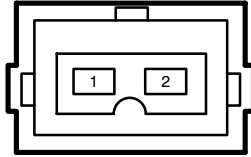

1	YU/YG
2	NO

R020060

**C141**

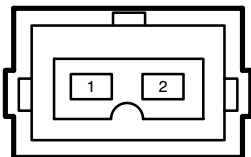

1	YW/YK
2	NO

R020060

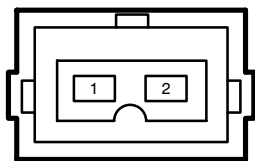
**C142**

1	WN
2	-

R020045

R020060

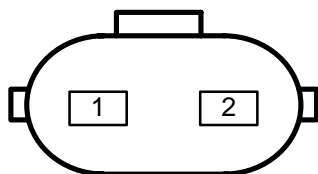
**C144**

1	WP/NK
2	SY/RS

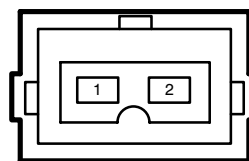

1	SY
2	NO

R020063

R020058

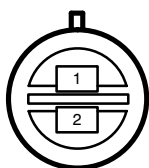
**C145****C146**

1	BG
2	B



1	BP
2	B

R020037

**C148**

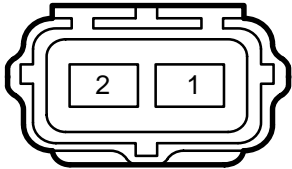

1	U
2	R

R030003

**C149**

R030041

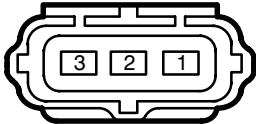

1	Y
2	R
3	RB

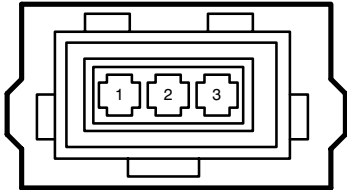

1	KP/R
2	GY/YLG
3	KB/RB

R020060

**C150**

R020060

**C152**

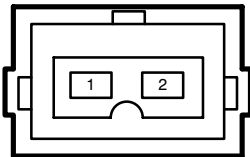

1	RB/YU
2	SW/KB

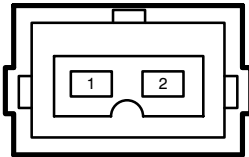

1	RB/GU/KB/GU
2	GU/KB/KG/B/G

R060023

**C159**

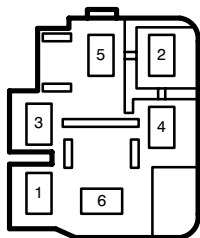

1	B/WR	4	B
2	BY	5	NO
3	B/WG	6	YB

R030041

**C164**

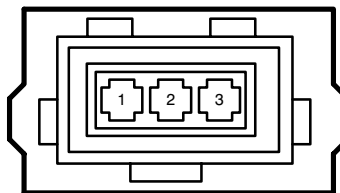

1	RB
2	KB
3	RU

R030041

**C160**

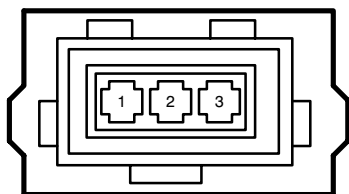

1	KB
2	R
3	RB

R020060

**C165**

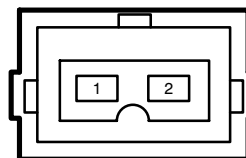

1	B/NO
2	BO/SR

R020058

**C162**



1	YB
2	G

R020058

**C166**



1	B
2	BLG

R030042

R020037

**C167**

**C170**

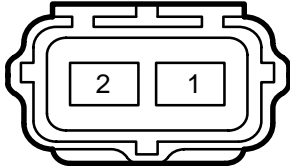
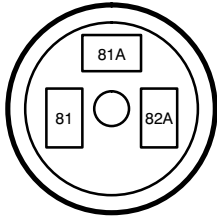

81	BY
81a	BR
82a	WU

1	B
2	LGB

R020037

R030003

**C168**

**C171**

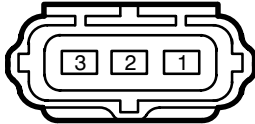
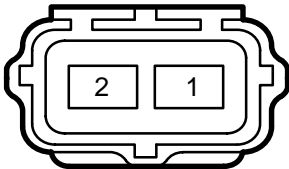

1	B
2	PG

1	WP
2	-
3	WP

R020037

R020015

**C169**

**C173**

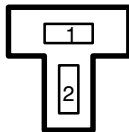
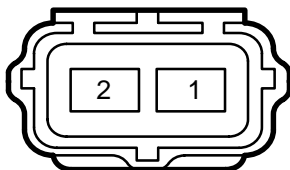

1	B
2	PG

1	LGR
2	B

**C178**

R020037

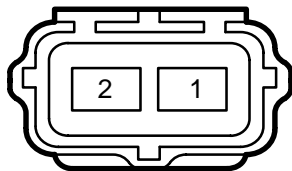

1	B
2	PO

**C183**

R020063

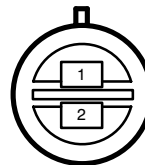

1	BN
2	B

**C181**

R020064



1	YB/PB
2	ON

**C190**

R030002

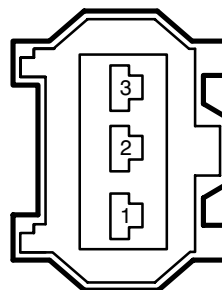

1	B
2	UY
3	RB

**C182**

R020063



1	BN
2	B

**C191**

R030002

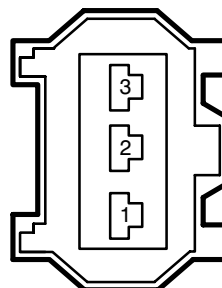

1	B
2	UY
3	RB



R040032

R040041

**C195**

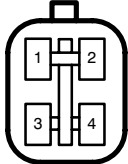

1	WS	3	WP
2	B	4	WG

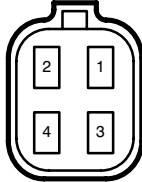

1	S	3	K
2	N	4	W

R020060

R030041

**C196**

**C197**

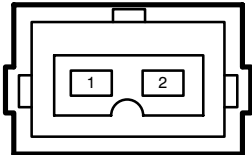

1	NB
2	B

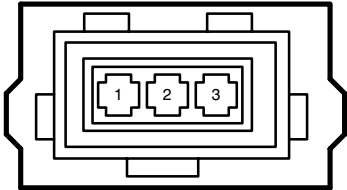

1	Y
2	B
3	B

R060016

### C198

R060017

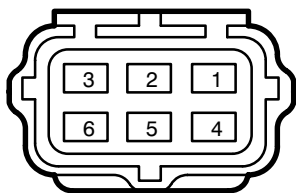

1	NK	4	YG
2	YB	5	YU
3	WB	6	-

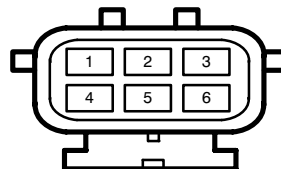

1	NK	4	YG
2	YB	5	YU
3	YW	6	-

R030034

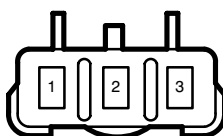

1	NS
2	NO
3	W

R080021

### C199

R020060

### C1000

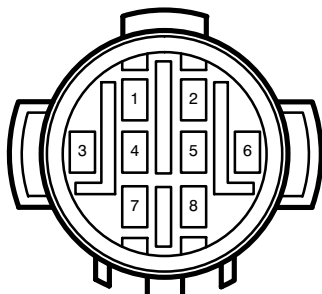

1	-	5	B
2	WS	6	GK
3	WP	7	R
4	NO	8	GO

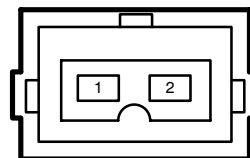

1	KO/KS/RB
2	KB/B/SLG

R030041

**C1001**

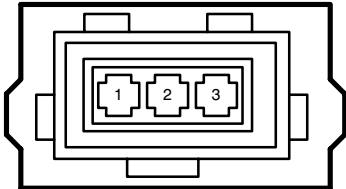

1	YU
2	YG
3	B

R030041

**C1002**

R060016

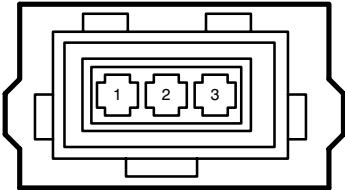

1	-
2	NK
3	YU

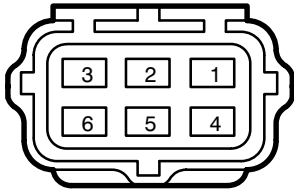

1	WB	4	WK
2	WY	5	WG
3	WU	6	-

R030041

**C1003**

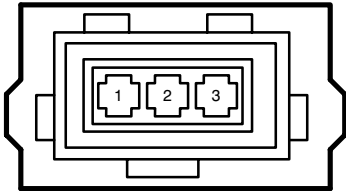

1	-
2	NK
3	WB

**C1004**

R020037

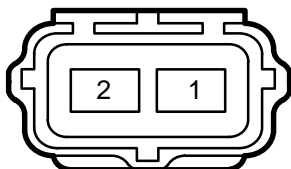

1	G
2	N

**C1005**

R020060

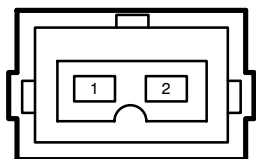

1	KB
2	LGS

**C1006**

R030038

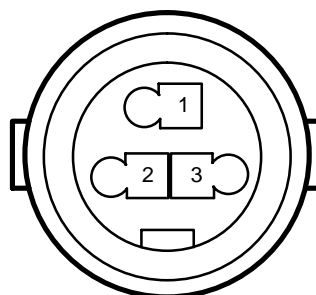

1	KB
2	BO
3	BG

**C1007**

R360002

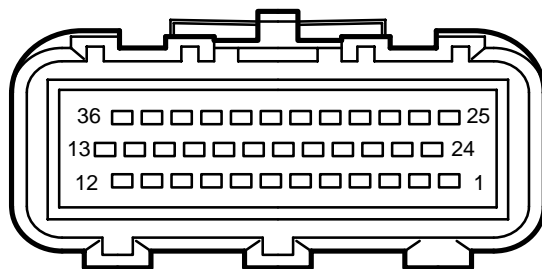

1	YU	7	UY	13	BK	19	BS	25	YU	31	UP
2	KU	8	GY	14	B	20	UP	26	YG	32	WU
3	OS	9	KP	15	BG	21	RS	27	OU	33	KG
4	YN	10	BO	16	KO	22	OG	28	NK	34	YU
5	-	11	WG	17	LGS	23	WB	29	B	35	BN
6	BP	12	-	18	UW	24	YB	30	KB	36	U

R180007

R020063

**C1008**

**C1011**

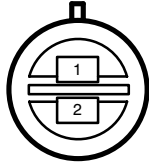
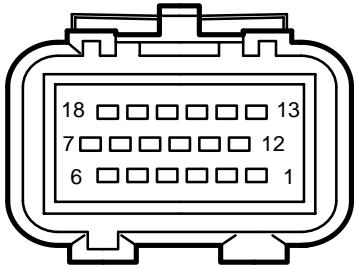

1	-	6	-	11	B	16	-
2	-	7	-	12	-	17	-
3	-	8	-	13	-	18	WB
4	-	9	-	14	-		
5	B	10	-	15	-		

1	US/BR
2	B

R020037

R020063

**C1009**

**C1012**

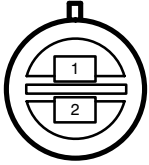
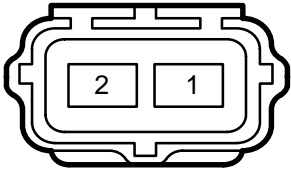

1	B
2	GR

1	BR
2	B

R020037

R020061

**C1010**

**C1013**

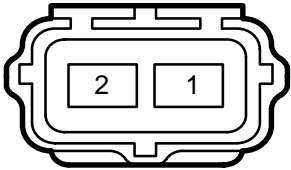

1	B
2	GW

1	RB
2	B

### C1014

R020061

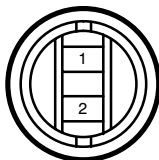

1	RO
2	B

### C1017

R360003

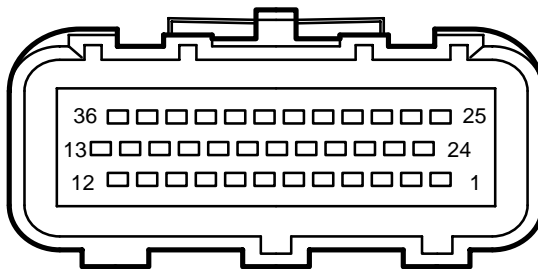

1	YK	7	GB	13	SLG	19	-	25	-	31	-
2	SU	8	R	14	G	20	WK	26	B	32	RB
3	-	9	-	15	YLG	21	-	27	YK	33	OG
4	-	10	RB	16	UG	22	-	28	YB	34	GR
5	-	11	O	17	GW	23	WLG	29	PB	35	SW
6	-	12	Y	18	OB	24	-	30	GK	36	RB

R040001

### C1019

### C1020

R040001

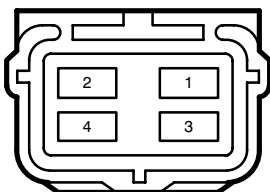

1	GW	3	WG
2	NW	4	WU

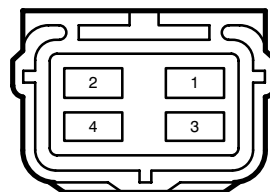

1	R	3	WG
2	U	4	WU

**C1021**

R030003

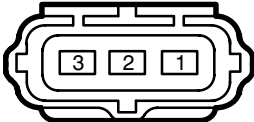

1	RB
2	SU
3	NO

**C1024**

R020037

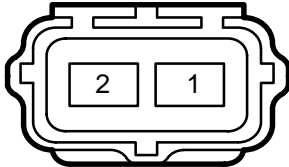

1	UP
2	B

**C1022**

R020060

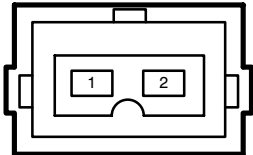

1	B
2	O

**C1025**

R020037

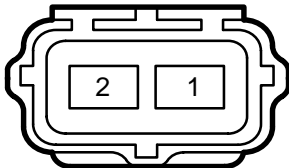

1	UP
2	B

**C1023**

R020060

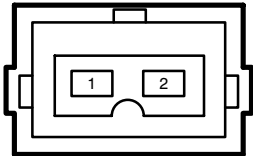

1	W
2	Y

R130001

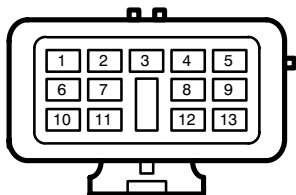

### C1026

YPC10594

R130002

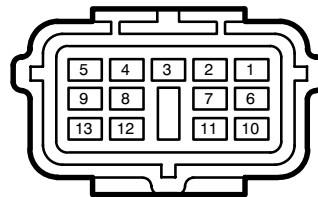

1	WLG	6	-	11	R
2	WK	7	BG	12	GK
3	B	8	YK	13	GB
4	WG	9	-		
5	GW	10	-		

1	WLG	6	-	11	R
2	WK	7	BG	12	GK
3	B	8	YK	13	GB
4	WG	9	-		
5	GW	10	B		

1	WLG	6	-	11	R
2	WK	7	BG	12	GK
3	B	8	YK	13	GB
4	WG	9	-		
5	GW	10	-		

R130001

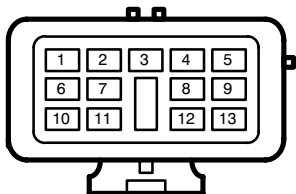

### C1027

YPC10594

R130002

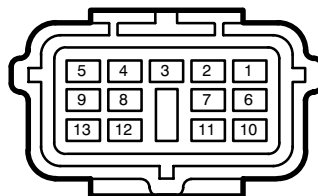

1	GU	6	OB	11	RS
2	WS	7	YB	12	NY
3	WN	8	-	13	PB
4	-	9	BS		
5	YK	10	-		

1	GU	6	OB	11	RS
2	WS	7	YB	12	NY
3	WN	8	-	13	PB
4	-	9	BS		
5	YK	1	PS		

1	GU	6	OB	11	RS
2	WS	7	YB	12	NY
3	WN	8	-	13	PB
4	-	9	BS		
5	YK	10	-		

R040002

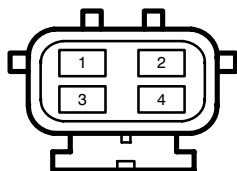

### C1028

R040003

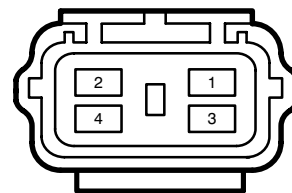

1	PW	3	NLG
2	WP	4	NR

1	PW	3	NLG
2	WP	4	NR



**C1029**

R080019

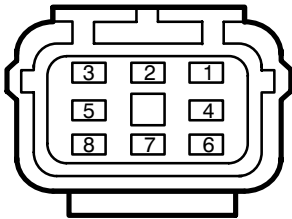

1	-	5	-
2	-	6	NLG
3	NO	7	PW
4	WP	8	NO

**C1031**

R040040

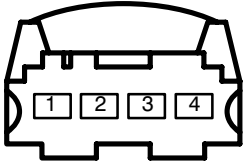

1	B	3	B
2	B	4	B

**C1030**

R060016

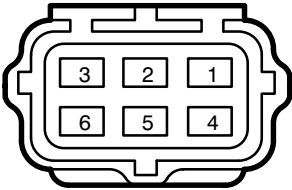

1	UP	4	-
2	WG	5	-
3	UR	6	-

**C1032**

R360002

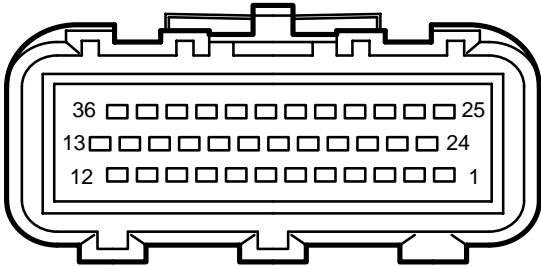

1	BS	7	-	13	YU	19	SY	25	-	31	-
2	-	8	-	14	-	20	-	26	-	32	YR
3	GW	9	-	15	US	21	WO	27	-	33	YG
4	-	10	-	16	RG	22	RS	28	WU	34	GW
5	-	11	YB	17	YS	23	-	29	-	35	OR
6	NR	12	-	18	YK	24	UP	30	YN	36	YW

### C1033

R180007

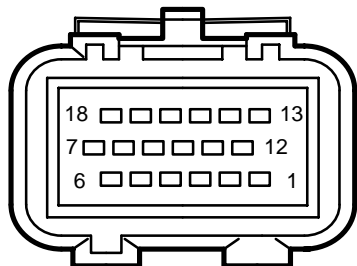

1	WK	7	NO	13	WU
2	-	8	WG	14	WB
3	-	9	B	15	WY
4	R	10	B	16	B
5	B	11	G	17	UR
6	-	12	N	18	-

R070013

### C201

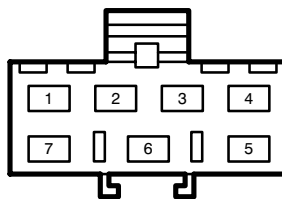

1	U	5	UW
2	UR	6	NP
3	NG	7	PO
4	R		

R030041

### C1035

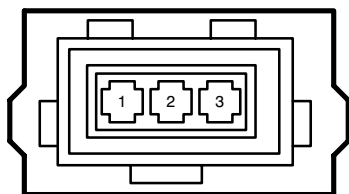

1	W
2	-
3	W

R070015

### C203

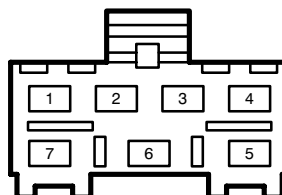

1	UR	5	LGW
2	U	6	W
3	R	7	NP
4	W		

R030003

### C1036

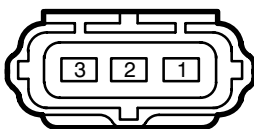

1	U
2	B
3	R

R240008

### C204

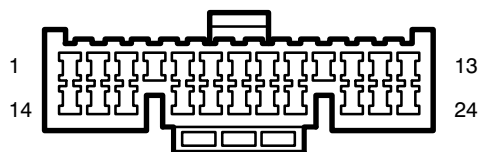

1	UB	7	-	13	UK	19	-
2	-	8	G	14	LGP	20	GY
3	GW	9	WR	15	LGN	21	RB
4	RB	10	GO	16	WN	22	LGP
5	GR	11	UO	17	P	23	GS
6	-	12	RO	18	GLG	24	US

R240003

**C205**

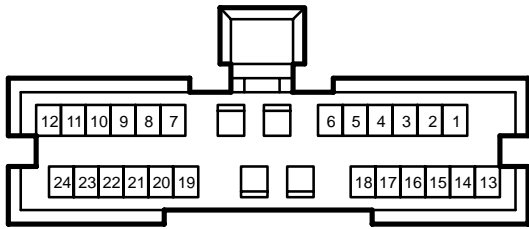

1	PU	7	RW	13	LGB	19	-
2	G	8	WLG	14	Y	20	PW
3	BK	9	LGG	15	OU	20	WP
4	PR	10	BK	16	LGS	22	NS
5	PW	11	-	17	UB	23	NP
6	B	12	WR	18	PG	24	-

R100023

**C207**

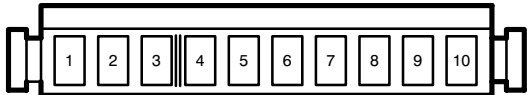

1	-	4	G	6	LGU	8	P
2	BS	5	WS	7	RN	9	LGG
3	UW					10	BLG

R040013

**C206**

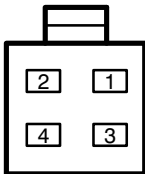

1	R	3	B
2	OS	4	UW

R180008

**C208**

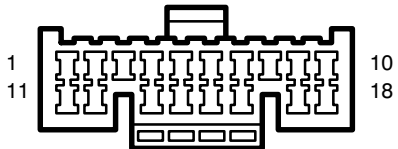

1	-	6	WN	11	G	16	-
2	-	7	-	12	-	17	GW
3	-	8	-	13	-	18	GR
4	UW	9	B	14	RO		
5	UR	10	BO	15	LG		

R200002

**C209**

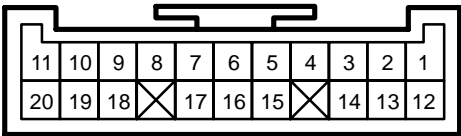

1	RN	6	BY/PO	11	BP	16	G
2	RS	7	SW	12	WY	17	YK
3	-	8	BU	13	LGO	18	Y
4	RW	9	BK	14	GO	19	-
5	BR	10	BN	15	GLG	20	BS

R200011

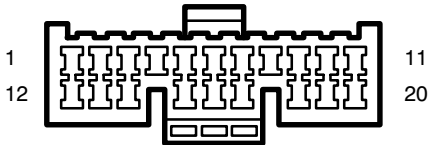

1	RN	6	PO	11	BP	16	G
2	RS	7	SW	12	WY	17	YK
3	-	8	BU	13	LGO	18	-
4	RW	9	BK	14	GO	19	-
5	BR	10	BN	15	GLG	20	BS

R100020

R030026

### C211

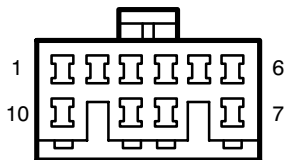

1	GW	4	-	6	-	8	-
2	RB	5	-	7	RO	9	NP
3	GR					10	-

### C214

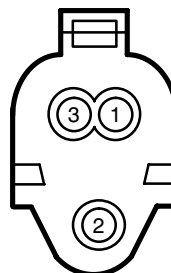

1	RN
2	RO
3	B

R140008

R140009

### C212

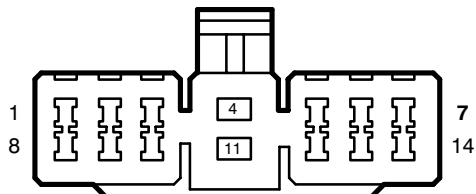

1	SCR	6	BY	11	NG
2	B	7	BO	12	BU
3	R	8	YU	13	PY
4	PN	9	WG	14	BG
5	BG	10	YO		

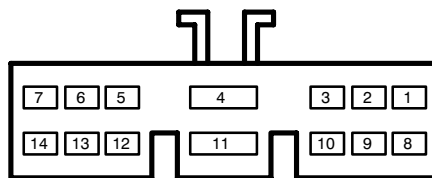

1	SCR	6	BY	11	NG
2	B	7	BO	12	BU
3	R	8	W	13	PY
4	PN	9	WG	14	BG
5	BG	10	UW		

R240008

R240007

### C215

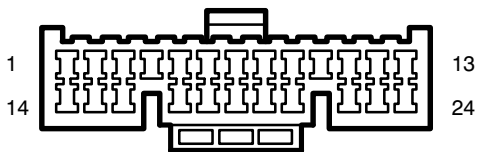

1	PN	7	-	13	KO	19	BLG
2	WS	8	UY	14	OU	20	LGN
3	G	9	PN	15	GU	21	UP/UB
4	BY/UP	10	WR	16	GLG	22	LGK
5	LGP	11	RY	17	LGS	23	UP
6	GB	12	BG	18	BO	24	NY

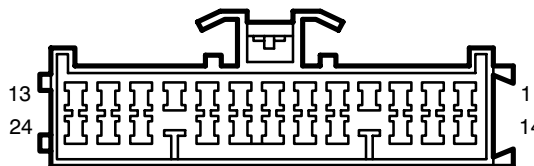

1	PN	7	-	13	KO	19	BLG
2	WS	8	UY	14	OU	20	LGN
3	G	9	PN	15	GU	21	UB
4	UP	10	WR	16	GY/GLG	22	LGK
5	LGP	11	RY	17	LGS	23	UP
6	GB	12	NP	18	BO	24	NY

R070012

**C216**

R070014

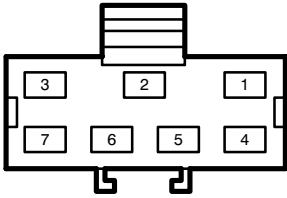

1	NLG/-	5	BR/-/NG
2	B/-/WP	6	BG
3	PW/-	7	WG/B
4	B/NR		

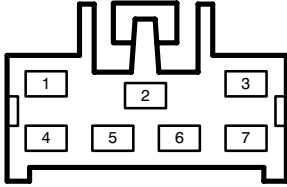

1	NLG	5	BN/NG
2	WP	6	BG
3	PW	7	WG
4	NR		

R240007

**C217**

R240008

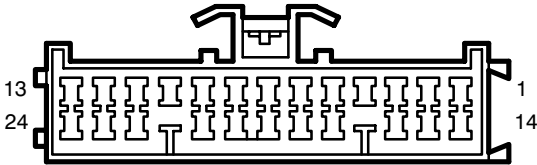

1	GW/-	7	-/GP	13	PY/-/WLG	19	WS
2	PB/-	8	-/LGP	14	-/WK	20	GU
3	WG/-	9	-/BY	15	-/B	21	-/BK/BS
4	NY	10	YB	16	WU/-	22	GLG
5	NG	11	OB/-	17	BP	23	GLG/GY
6	RS/-	12	YK/-	18	WN	24	B/-

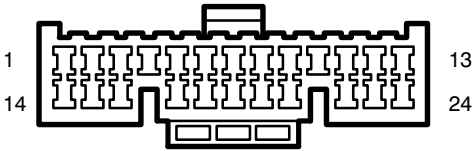

1	GW	7	GP	13	WLG	19	WS
2	PB	8	-	14	WK	20	GU
3	WG	9	BY	15	-	21	B
4	NY	10	YB	16	WU	22	GLG
5	NG	11	OB	17	BP	23	GY
6	RS	12	YK	18	WN	24	BK

R080026

**C218**

R080030

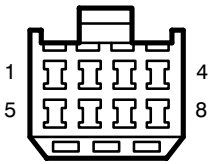

1	WU	5	PY
2	BY	6	P
3	PW	7	B
4	WY	8	-

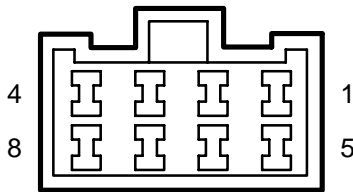

1	WU/-	5	P/PY
2	-/BY	6	P/-
3	PW/-	7	B/-
4	WY	8	-

**C219**

R040013

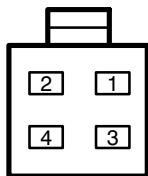

1	-	3	W
2	Y	4	WR

**C222**

R100022

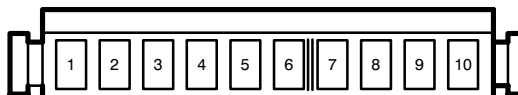

1	RS	4	-	6	RW	8	GU
2	LG	5	WN	7	-	9	RN
3	KO					10	-

**C220**

R030016



1	NW
2	LG
3	-

**C223**

R050025

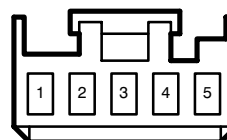

1	G	4	-
2	-	5	S
3	P		

**C221**

R100016

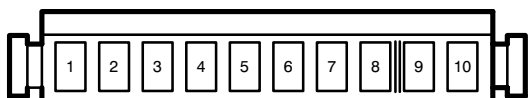

1	B	4	YK	6	BO	8	LG
2	BR	5	NY	7	PO	9	WR
3	GB					10	BY

**C224**

R060028

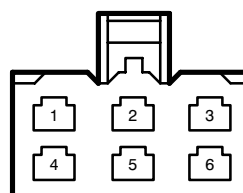

1	B	4	GS
2	NLG	5	RLG
3	ULG	6	-

**C225**

R260001

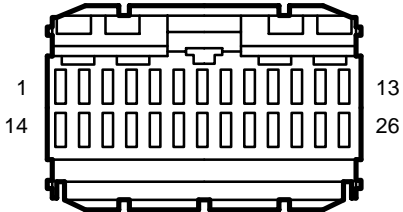

1	PW	8	UG	15	B	22	-
2	-	9	PO	16	PW	23	-
3	WB	10	GK	17	KB	24	-
4	-	11	RS	18	-	25	P
5	PG	12	-	19	-	26	Y
6	-	13	-	20	BN		
7	YK	14	BK	21	BS		

**C228**

R080022

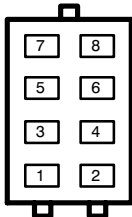

1	BK	5	BP
2	BN	6	GLG
3	SW	7	BU
4	B	8	-

**C226**

R030036

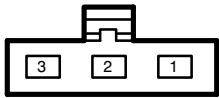

1	LGW
2	WY
3	-

**C230**

R080025

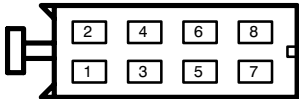

1	-	5	UY
2	B	6	RN
3	U	7	LGO
4	P	8	B

**C227**

R040038

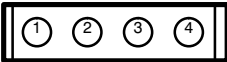

1	GP	3	WR
2	GO	4	WS

**C232**

R020066

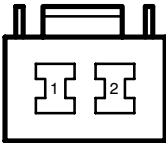

1	BK
2	BR

R090002

R050001

### C238

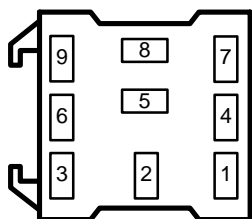

1	-	4	BR	7	-
2	NO	5	BG	8	GW
3	-	6	B	9	PB

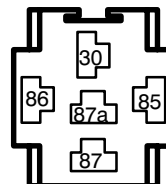

30	NG	87	US
85	BP	87a	-
86	WG		

R050001

R050001

### C239

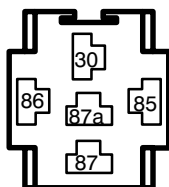

30	NLG	87	NO
85	UR	87a	NO/-
86	NO/NLG		

### C241

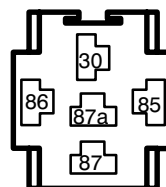

30	NG	87	BG
85	BS/WG	87a	-/BG
86	WG/G/BS		

R050001

R050001

### C240

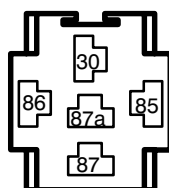

30	PW	87	B,WP
85	UP	87a	WO,WO
86	WG		

### C242

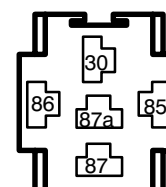

30	WG/BN/NG/YG	87	GY/B/BG/WG
85	WG/YB	87a	-
86	YB/WG/G		



R400001

**C243**

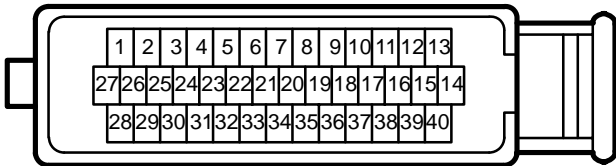

1	RG	7	GU	13	YU	19	WG	25	RB	31	-	37	-
2	NO	8	PY	14	B	20	R	26	GW	32	SW	38	-
3	Y	9	WLG	15	NO	21	GY	27	BS	33	BS	39	WU
4	B	10	RS	16	UP	22	UR	28	US	34	OB	40	B
5	SB	11	YW	17	SY	23	CORE	29	O	35	UG		
6	YK	12	UR	18	WK	24	CORE	30	-	36	BG		

R550002

**C243**

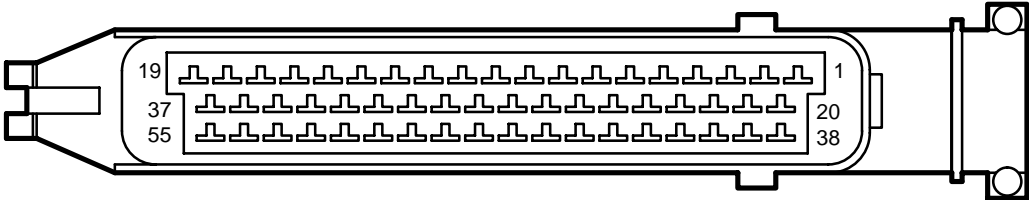

1	WP	8	-	15	UR	22	-	29	YK	36	KS	43	-	50	-
2	WP	9	BS	16	NO	23	-	30	-	37	WG	44	YB	51	YU
3	W	10	NS	17	NO	24	-	31	LGP	38	UG	45	BS	52	YB
4	RS	11	-	18	B	25	WS	32	-	39	GK	46	-	53	GU
5	NB	12	B	19	B	26	GP	33	WP	40	-	47	Y	54	YG
6	SR	13	B	20	-	27	WK	34	UR	41	-	48	-	55	WG
7	-	14	R	21	GO	28	OB	35	WS	42	WLG	49	-		

R050013

R020069

**C245**

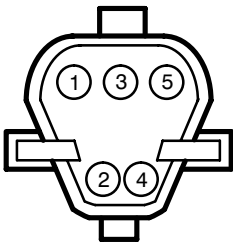

1	WK	4	WLG
2	-	5	BS
3	-		

**C246**

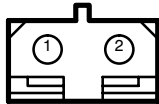

1	BS
2	SB

### C247

R160003

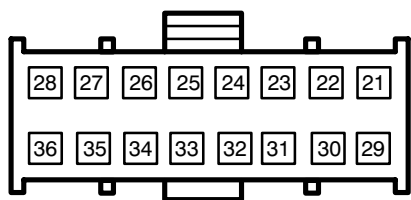

21	KB	25	R	29	B	33	WK
22	-	26	GU	30	-	34	RU
23	-	27	-	31	-	35	RB
24	BO	28	B	32	WLG	36	WS

### C249

R050024

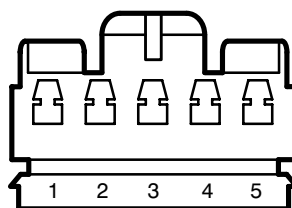

1	GLG	4	LGS
2	RN	5	B
3	-		

### C248

R030038

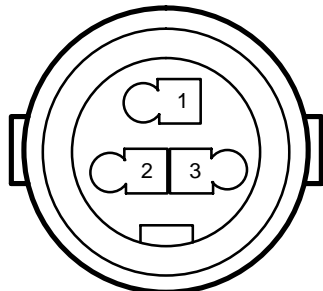

1	KB
2	WLG
3	WK

### C250

R050024

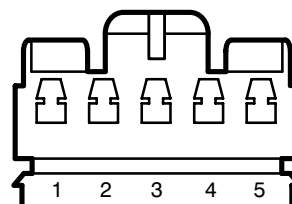

1	GLG	4	OU
2	RN	5	B
3	-		

R060017

### C252

R060016

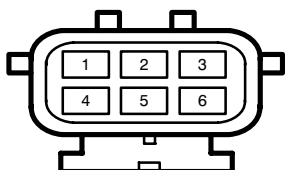

1	P	4	B
2	LGP	5	G
3	S	6	G

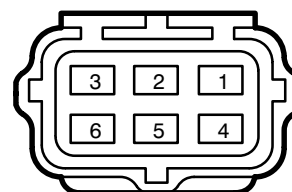

1	P	4	B
2	LG	5	G
3	S	6	G

R060028

**C259**

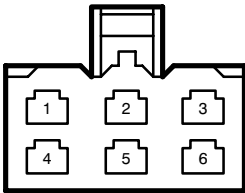

1	B	4	RN
2	UY	5	RO
3	-	6	-

R050024

**C263**

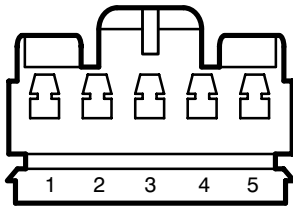

1	UR/UP	4	RY
2	RN	5	B
3	-		

R100015

**C260**

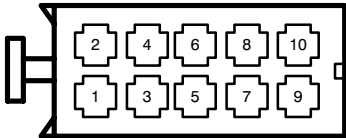

1	R	4	B	6	B	8	B
2	B	5	Y	7	U	9	R
3	G					10	B

R050024

**C264**

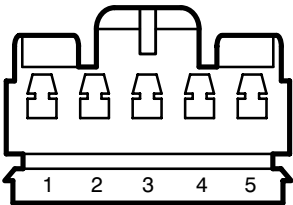

1	BO	4	B
2	RN	5	BG
3	-		

R050024

**C262**

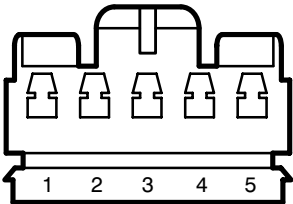

1	GLG	4	WY
2	RN	5	B
3	-		

R100017

**C267**

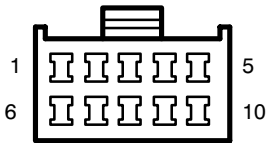

1	GO	4	RN	6	LGN	8	LGG
2	PN	5	B	7	GR	9	GW
3	LGP					10	-

### C268

R080025

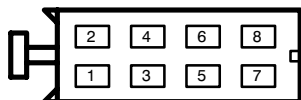

1	NY/BG	5	B/BW
2	U/BU	6	BN
3	UG/BK	7	BY
4	RG/BR	8	BO

### C274

R120005

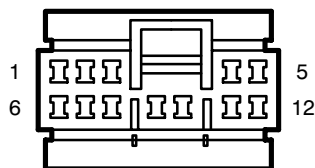

1	GW	5	OB/PO	9	WR
2	O	6	GR	10	BO
3	K	7	SR	11	BO
4	RW	8	PN	12	PK

### C270

R040008

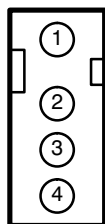

1	PN	3	RN
2	B	4	LG

R230004

**C277**

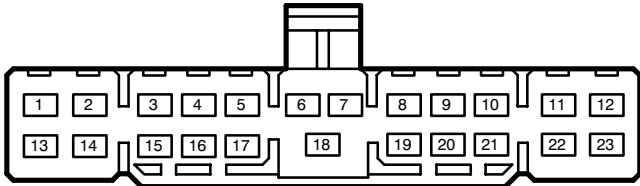

1	GN	7	K	13	-	19	RB
2	PW	8	O	14	-	20	WB
3	WP	9	GP	15	-	21	BN
4	NG	10	PU	16	RO	22	RY
5	GLG	11	GR	17	GW	23	GB
6	-	12	LGO	18	NP		

R230003

**C277**

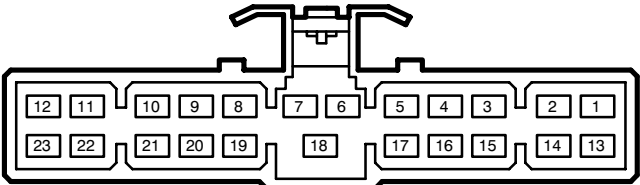

1	GN	7	K	13	-	19	RB
2	PW	8	O	14	-	20	WB
3	WP	9	GP	15	-	21	BN
4	NG	10	PU	16	RO	22	RY
5	GLG	11	GR	17	GW	23	GB
6	-	12	LGO	18	NP		

R050001

**C280**

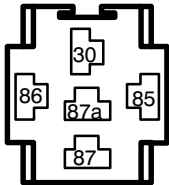

30	P	86	P
85	OB	87	PB
87a	-		

R050001

**C281**

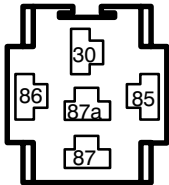

30	NG	86	GLG
85	NP	87	GLG
87a	B		

### C282

R050001

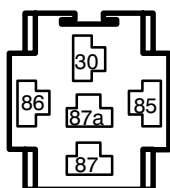

30	NW	86	B
85	LG	87	LGW
87a	-		

### C287

R100021

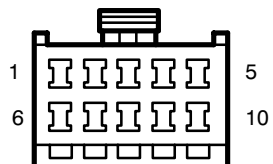

1	BU	4	-	6	-	8	-
2	WG	5	BK	7	BS	9	PR
3	LGP					10	BR

### C283

R050001

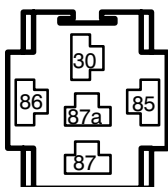

30	PN	86	PO
85	PN	87	PG
87a	-		

### C288

R080027

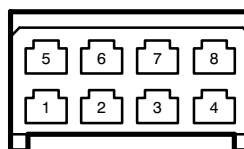

1	SU	5	PS
2	SK	6	B
3	SR	7	SB
4	WK	8	PN

### C284

R150001

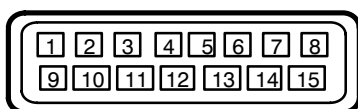

1	WU	6	BY	11	YK
2	-	7	BR	12	-
3	RW	8	B	13	-
4	UW	9	PG	14	-
5	GP	10	WY	15	-

### C292

R050001

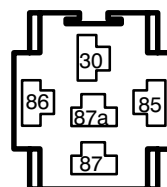

30	NG	86	BP/NG
85	GW	87	BN
87a	-		

R030043

**C298**

R030004

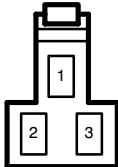

1	-
2	NK
3	B

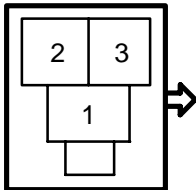

1	-
2	R
3	WB

R050001

**C2000**

R020032

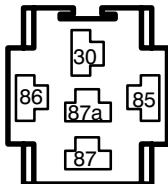

30	WP	86	WP
85	BK	87	RB
87a	-		

**C2005**

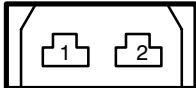

1	PY
2	PG

R050001

**C2001**

R050001

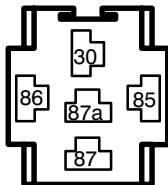

30	WY	86	BR
85	YB	87	SB
87a	-		

**C2006**

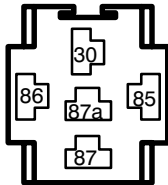

30	NW	86	BO
85	WR	87	NR
87a	-		

### C2007

R050001

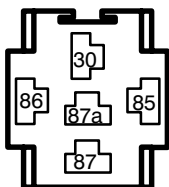

30	NG	86	B
85	LGP	87	WG
87a	-		

### C2010

R060030

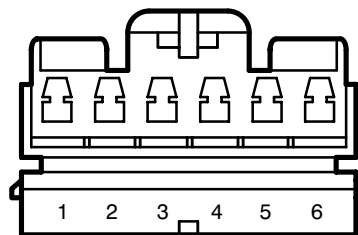

1	WY	4	RW
2	-	5	PO
3	UW	6	-

### C2008

R050001

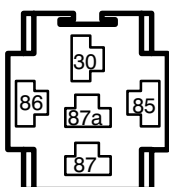

30	LGP	86	NS
85	GS	87	GS
87a	NLG		

### C2011

R060029

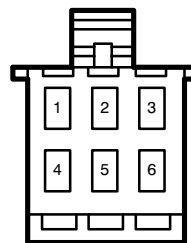

1	-	4	B
2	-	5	-
3	-	6	WLG

### C2009

R040037

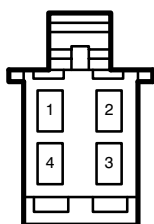

1	GR	3	-
2	LGN	4	GW

### C2012

R080023

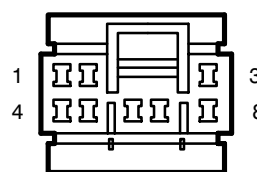

1	-	5	BR
2	-	6	WP
3	OW	7	P
4	P	8	PU



**C2013**

R040001

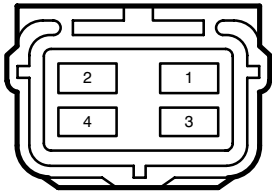

1	P	3	P
2	PU	4	WP

**C2021**

R050001

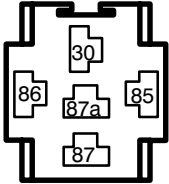

30	WS/WU	86	WS
85	BY/B	87	-/PW
87a	PY/-		

**C2014**

R020057

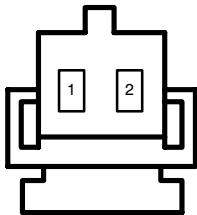

1	OW
2	B

**C2022**

R050006

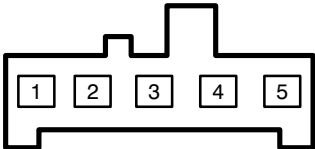

1	WB	4	PU
2	BO	5	N
3	G		

**C2015**

R080024

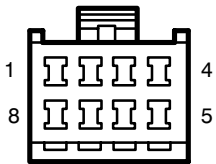

1	GS	5	GS
2	LGG	6	-
3	ULG	7	LGP
4	RLG	8	LGB

**C2023**

R040004

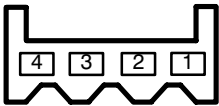

1	S	3	WB
2	UR	4	LG

R050024

### C2024

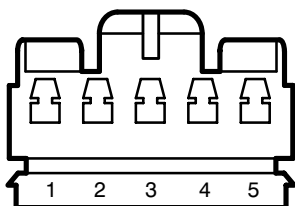

1	W	4	WB
2	LG	5	UW
3	-		

R050024

### C2025

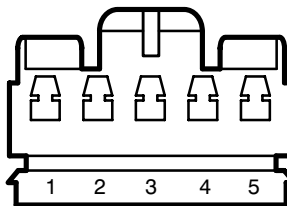

1	N	4	NW
2	LG	5	UR
3	WB		

R050024

### C2026

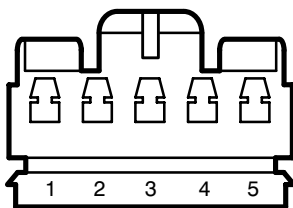

1	WB	4	RG
2	LG	5	UR
3	UB		

R050003

### C2027

R050027

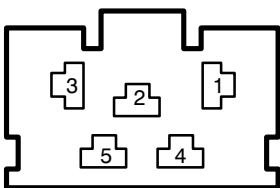

1	WB	4	G
2	N	5	BO
3	PU		

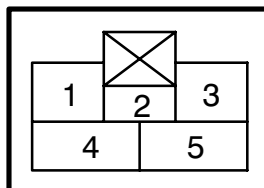

1	WB	4	G
2	N	5	BO
3	PU		

R060028

**C2028**

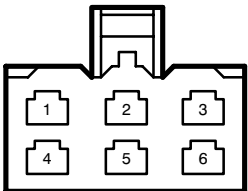

1	B	4	B
2	B	5	B
3	B	6	B

R020032

**C2035**

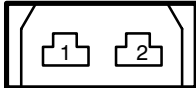

1	PW
2	P

R060028

**C2029**

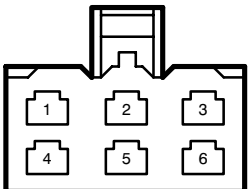

1	-	4	B
2	B	5	B
3	B	6	B

R070001

**C2036**

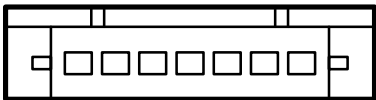

1	PB	5	YB
2	W	6	PB
3	R	7	PB
4	GR		

R070016

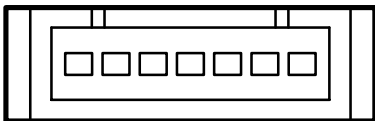

1	PB	5	YB
2	PB	6	PB
3	-	7	-
4	GR		

### C2044

R050001

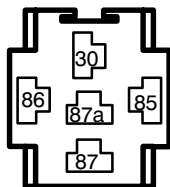

30	RG	86	B
85	RB	87	RN
87a	GLG		

### C2052

R060016

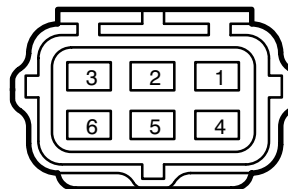

1	UP	4	U
2	WG	5	-
3	YN	6	-

### C2047

R050001

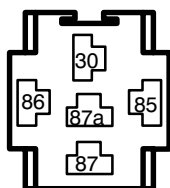

30	UW	86	UY
85	GO	87	B
87a	NG		

### C2053

R050001

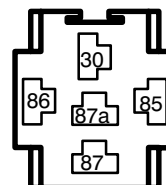

30	NK	86	B
85	LGO	87	LGP
87a	-		

### C2051

R080019

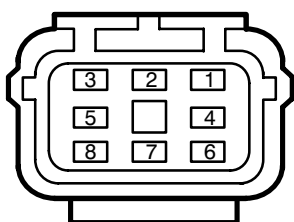

1	NK	5	NU
2	-	6	NLG
3	NK	7	PW
4	WP	8	NK

### C2054

R180006

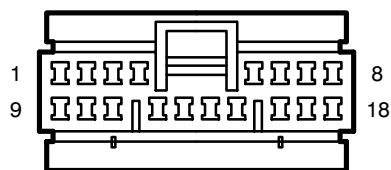

1	R	6	BK	11	B	16	BR
2	G	7	BW	12	B	17	BN
3	Y	8	BY	13	R	18	BO
4	U	9	LGP	14	PY		
5	BG	10	B	15	BU		

R130009

**C2055**

R130010

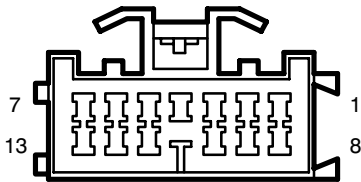
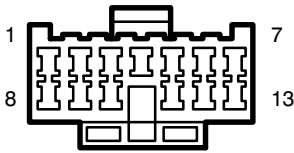

1	G/BG	6	BN	11	SCR
2	B/BU	7	U/BY	12	UY
3	R/BK	8	BO	13	B
4	BR	9	R		
5	Y/YB	10	B		

1	G/BG	6	BN	11	SCR
2	B/BU	7	U/BY	12	PY
3	R/BK	8	BO	13	B
4	BR	9	R		
5	Y/BW	10	B		

R050024

**C2056**

**C2058**

R050024

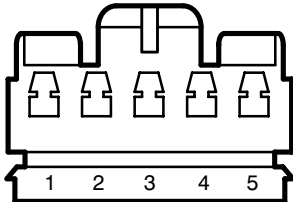
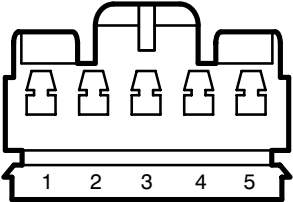

1	UG	4	B
2	RN	5	B
3	-		

1	NY	4	B
2	RN	5	B
3	-		

R050024

**C2057**

**C2059**

R050024

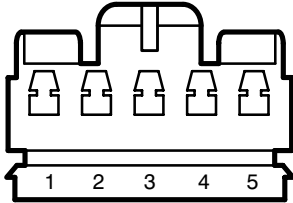
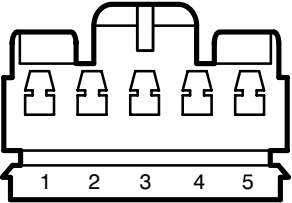

1	RG/RK	4	B
2	RN	5	B
3	-		

1	U	4	B
2	RN	5	B
3	-		

### C2060

R050019

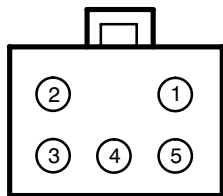

1	U	4	B
2	NY	5	UG
3	RK		

### C2063

R020069

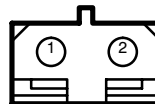

1	GO
2	GP

### C2061

R070002

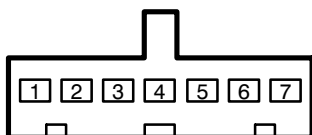

1	-	5	-
2	-	6	R
3	B	7	-
4	-		

R080001

### C2066

R080002

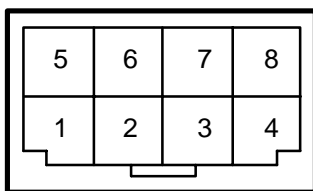

1	BO	5	UR
2	G	6	UB
3	PU	7	WB
4	N	8	RG

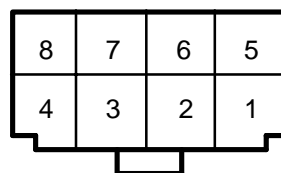

1	BO	5	UR
2	G	6	UB
3	PU	7	WB
4	N	8	RG

R100003

**C2067**

R100001

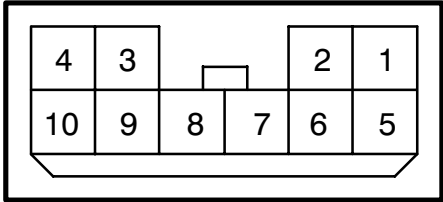
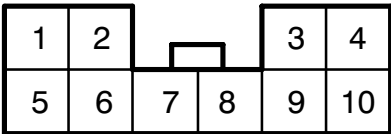

1	NW	4	S	6	UB	8	WB
2	N	5	RG	7	UW	9	W
3	LG					10	UR

1	NW	4	S	6	UB	8	WB
2	N	5	RG	7	UW	9	W
3	LG					10	UR

R050016

**C2068**

R040022

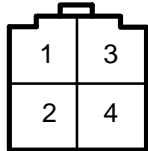
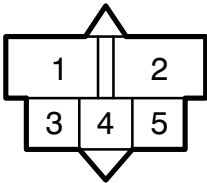

1	R	4	WB
2	WR	5	UR
3	N		

1	BO	3	PU
2	G	4	WB

R020049

**C2069**

R020046

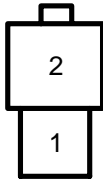
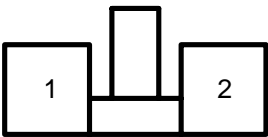

1	BO
2	WR

1	YB
2	UR

### C2072

R030015

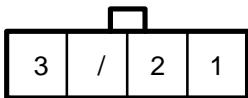

1	YB
2	UB
3	RG

R100019

### C2073

R100001

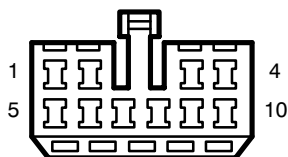

1	YO	4	PB	6	-	8	ON
2	RN	5	YU	7	WG	9	YB
3	B					10	-

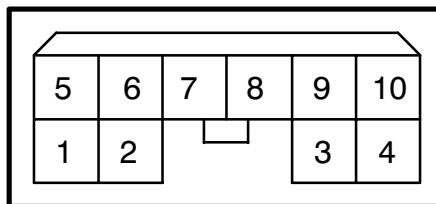

1	UW	4	NW	6	-	8	L
2	LG	5	W	7	UR	9	OG
3	P					10	S

### C2074

R050001

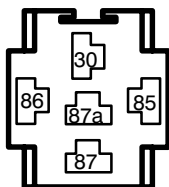

30	PU	86	BK
85	PU	87	LGR
87a	-		



R060029

**C2082**

R060027

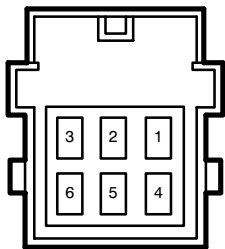
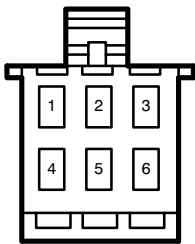

1	R	4	BN
2	GK	5	BW
3	LGW	6	BS

1	-	4	BN
2	-	5	BW
3	LGW	6	-

**C2083**

R160006

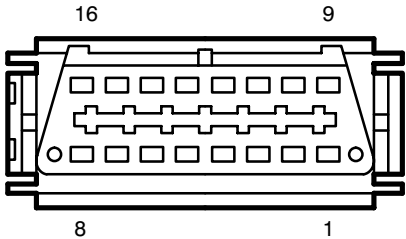

1	-	5	B	9	-	13	YK
2	-	6	-	10	-	14	YLG
3	-	7	WLG	11	-	15	WK
4	B	8	KB	12	-	16	WR

**C2084**

R350003

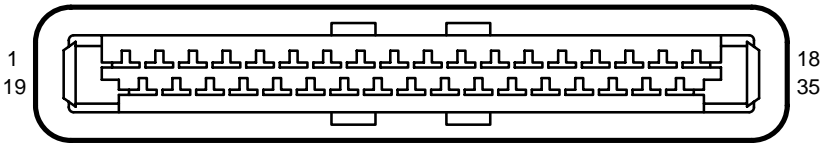

1	NK	6	SR	11	WO	16	W	21	SG	26	BS	31	B
2	-	7	SU	12	-	17	G	22	SP	27	B	32	G
3	-	8	BG	13	WLG	18	W	23	SK	28	-	33	W
4	SY	9	WR	14	WK	19	NK	24	SN	29	YK	34	G
5	SW	10	WS	15	G	20	-	25	GP	30	NR	35	W

R030033

R030007

**C2085**

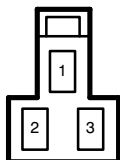

1	B
2	WG
3	NR



1	B
2	WG
3	NR

**C2089**

R050001

**C2091**

R050001

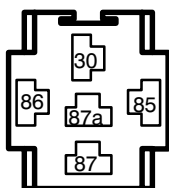

30	NG	86	UP
85	B	87	UP,UP
87a	-		

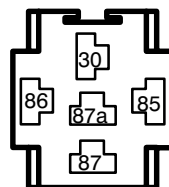

30	UP	86	U
85	B	87	NG
87a	UP		

**C2090**

R050001

**C2092**

R050001

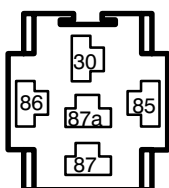

30	UP	86	B
85	UP	87	NG
87a	-		

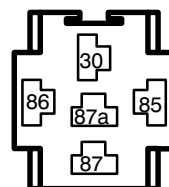

30	BS	87	-
86	NK	85	B
87a	B		

R050001

R100018

**C2093**

**C2095**

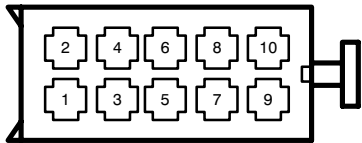
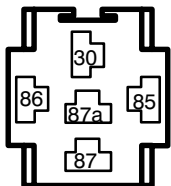

30	OK	86	BG
85	B	87	NK
87a	-		

1	B	4	B	6	B	8	B
2	B/-	5	B	7	-	9	B
3	B/-					10	B

R040033

R020037

**C2094**

**C2096**

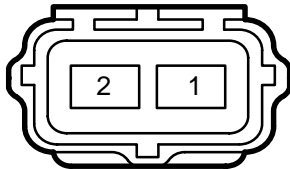
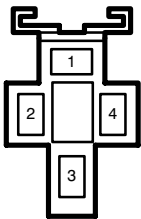

1	NR	3	NO
2	B	4	WO

1	PK
2	SR

R040036

R040021

**C2097**

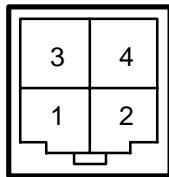
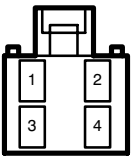

1	YLG	3	B
2	YK	4	-

1	YLG	3	B
2	YK	4	-

R050024

### C2098

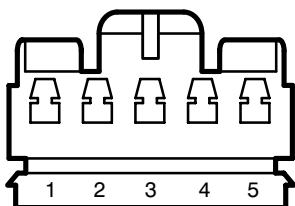

1	RO/UB	4	UP
2	RN	5	B
3	-		

R020067

### C2100

R020021

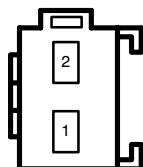

1	SK
2	SU

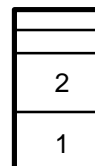

1	SK
2	SU

R130010

### C2101

R130009

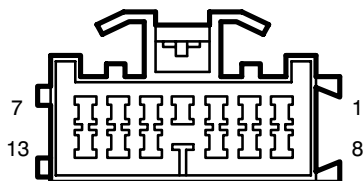

1	-	6	YK	11	NP
2	B	7	PN	12	K
3	UG	8	NK	13	O
4	-	9	BU		
5	SW	10	BK		

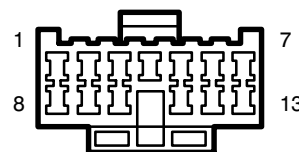

1	-	6	YK	11	BG
2	B	7	-	12	K
3	UG	8	NK	13	O
4	-	9	BU		
5	SW	10	BK		

R020062

R020028.00

**C2102**

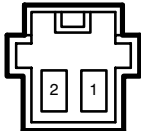

1	BN, BN
2	BW, BW

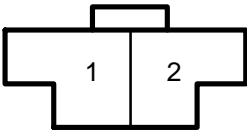

1	BW
2	B

R020067

R020021

**C2103**

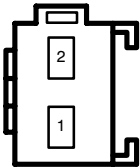

1	SB
2	SR

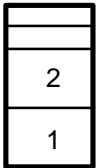

1	SU
2	SK

R130010

R130009

**C2104**

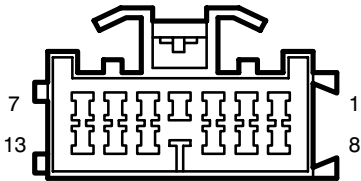

1	-	6	-	11	NP
2	B	7	-	12	K
3	-	8	-	13	O
4	-	9	BP		
5	SW	10	BN		

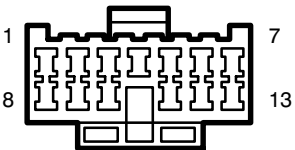

1	-	6	-	11	BG
2	B	7	-	12	K
3	-	8	-	13	O
4	-	9	BU		
5	SW	10	BK		

R020062

**C2105**

R020028.00

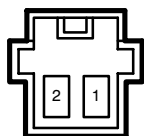

1	BR, BR
2	BK, BK

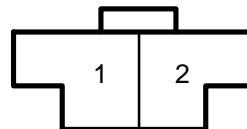

1	BW
2	B

**C2106**

R050001

**C2108**

R040001

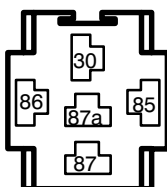

30	B	87	YK
85	PU	87a	WY
86	P		

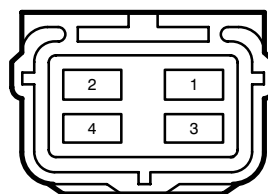

1	-	3	B
2	KB	4	WR

**C2107**

R050001

**C2110**

R020066

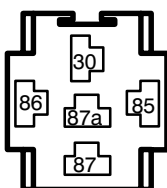

30	GLG	87	-
85	GLG	87a	GY
86	RS		

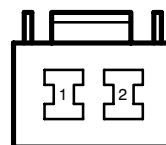

1	BW
2	BN

R040039

**C300**

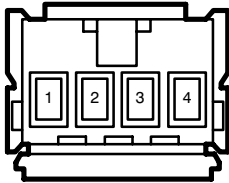

1	PN	3	B
2	PU	4	-

R060028

**C301**

R060006

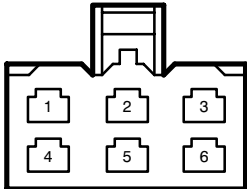

1	SG	4	SW
2	SG	5	SN
3	SO	6	S

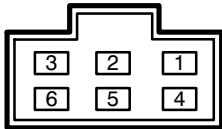

1	SG	4	SW
2	SG	5	SN
3	SO	6	S

R030044

**C306**

R030009

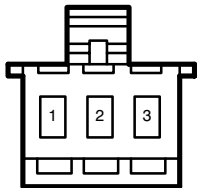

1	PW
2	O
3	K

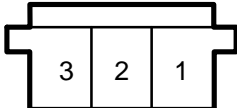

1	PW
2	O
3	K

### C316

R060014

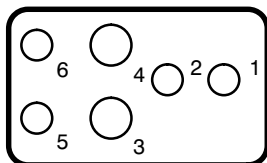

1	SU	4	-
2	SN	5	SR
3	WU	6	SP

### C317

R060015

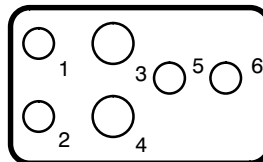

1	SG	4	WO
2	SB	5	SW
3	B	6	SY

R090001

### C318

R090004

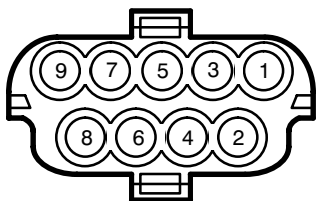

1	SB	4	SR	7	SY
2	SG	5	SN	8	SW
3	SP	6	SU	9	-

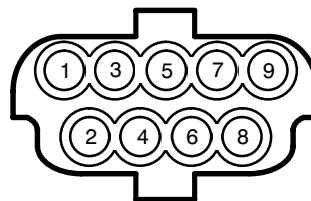

1	Y	4	G	7	Y
2	G	5	Y	8	G
3	Y	6	G	9	-

### C319

R060014

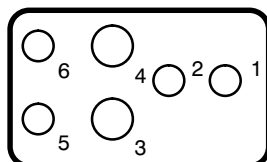

1	WU	4	WY
2	WN	5	WO
3	-	6	WP

### C320

R060015

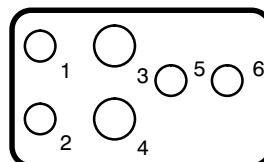

1	WS	4	B
2	WLG	5	WB
3	WR	6	WK



R090001

**C321**

R090004

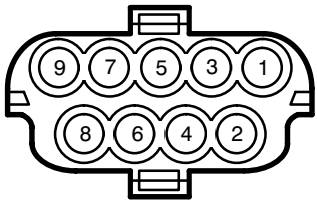

1	WS	4	WP	7	WK
2	WLG	5	WN	8	WB
3	WO	6	WU	9	-

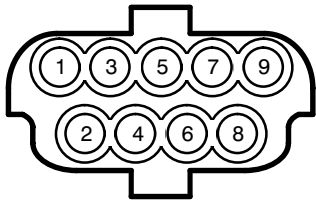

1	G	4	Y	7	Y
2	Y	5	Y	8	G
3	G	6	G	9	-

R050009

**C323**

R040034

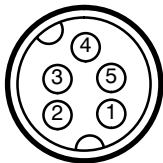

1	-	4	BO
2	GY	5	BY
3	GN		

**C335**

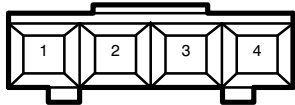

1	BN	3	WB
2	B	4	-

R030003

**C334**

R060026

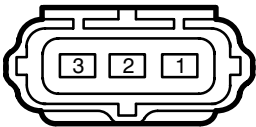

1	LGO
2	B
3	GN

**C337**

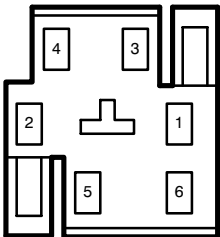

1	BS	4	B
2	BR	5	-
3	-	6	RN

R060026

### C338

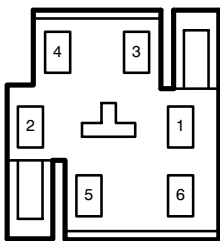

1	BU	4	B
2	BK	5	-
3	-	6	RN

R080029

### C343

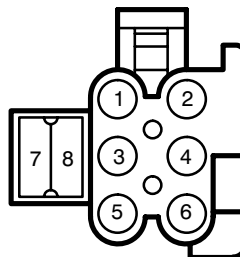

1	B	5	-
2	SG	6	-
3	-	7	-
4	-	8	-

R060026

### C339

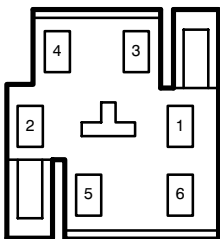

1	SW	4	B
2	SO	5	WK
3	WK	6	RN

R060016

### C344

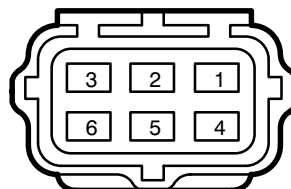

1	P	4	BR
2	GP	5	KS
3	B	6	KS

R060026

### C340

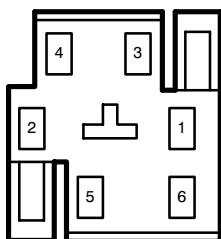

1	S	4	B
2	SN	5	WK
3	WK	6	RN

R020069

### C346

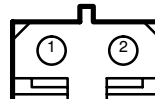

1	B
2	GLG

**C348**

R050001

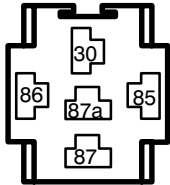

85	PU,PU	86	NP
87	WN	30	NP
87a	-		

**C352**

R020057

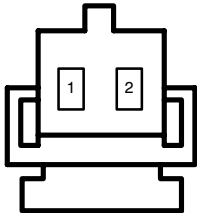

1	LGW
2	B

**C350**

R030040

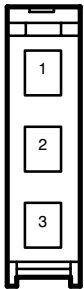

1	PU
2	-
3	PN

**C353**

R020015

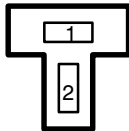

1	B
2	LGW

**C351**

R020057

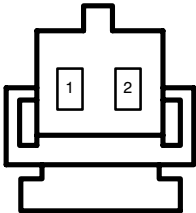

1	LGW
2	B

**C358**

R050001

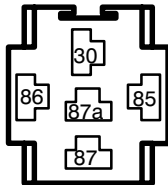

85	B	86	LGW
87	BP	30	B
87a	-		

**C368**

R030021

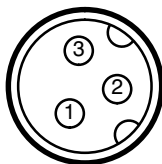

1	-
2	B
3	BK

**C371**

R020003

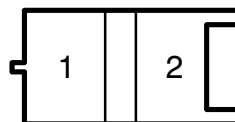

1	BG
2	B

**C369**

R020037

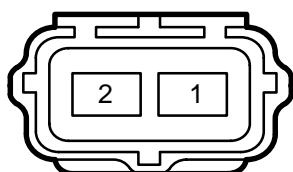

1	SB
2	B

**C372**

R020037

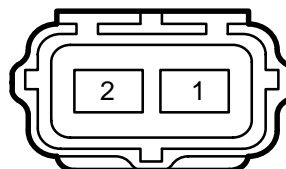

1	GN
2	GY

**C370**

R030003

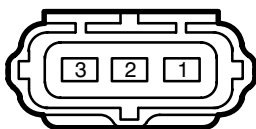

1	GY
2	-
3	BR

**C378**

R020005

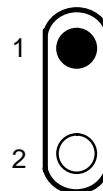

1	RW
2	B

**C381**

R030018

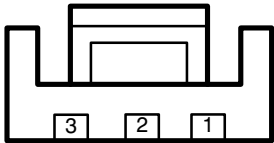

1	P
2	-
3	B

**C384**

R070008

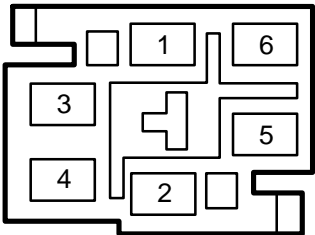

1	GO	5	-
2	GR	6	-
3	-	7	-
4	B		

**C382**

R080008

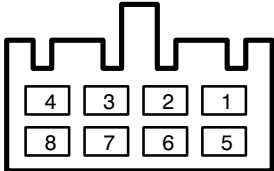

1	-	5	-
2	-	6	GW
3	GO	7	GU
4	OG	8	OU

**C385**

R070008

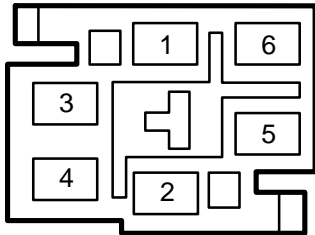

1	GU	5	-
2	GK	6	-
3	-	7	-
4	B		

**C383**

R100006

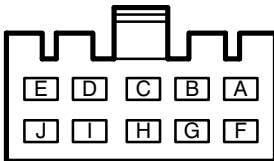

A	P	D	B	F	WG	H	GK
B	U	E	W	G	GB	I	GR
C	NR					J	O

**C386**

R050024

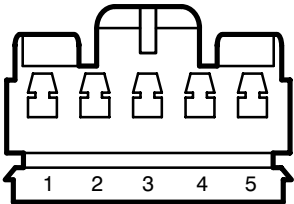

1	B	4	BS
2	-	5	-
3	-		

**C387**

R040018

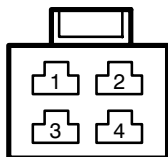

1	W	3	B
2	OU	4	P

**C391**

R050026

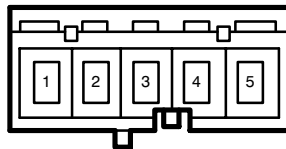

1	BR	4	GR
2	N	5	B
3	Y		

**C388**

R040018

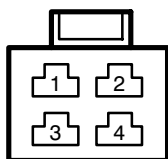

1	O	3	B
2	OG	4	U

**C392**

R050024

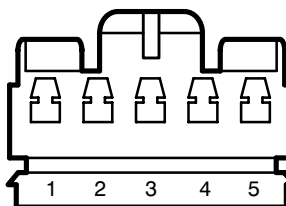

1	LGW	4	B
2	RB	5	UW
3	-		

**C389**

R030027

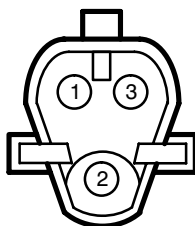

1	GW
2	GB
3	BS

**C3003**

R060028

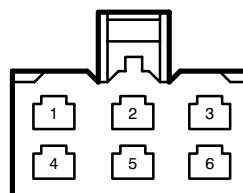

1	B	4	B
2	B	5	B
3	B	6	-

R030006

**C3004**

R030007

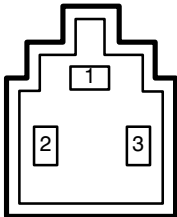

1	SG
2	SW
3	SO

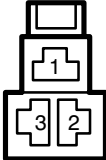

1	SG
2	SW
3	SO

R020012

**C3005**

R020028.01

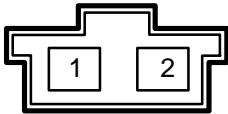

1	O
2	K

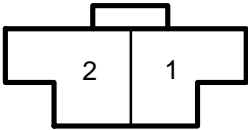

1	O
2	K

R030006

**C3006**

R030007

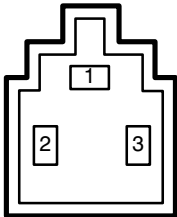

1	SG
2	SN
3	S

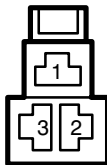

1	SG
2	SN
3	S

R020012

R020028.01

### C3007

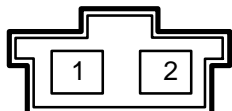

1	O
2	K

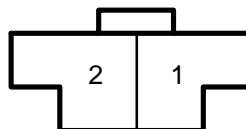

1	O
2	K

R070003

R060024

### C400

### C406

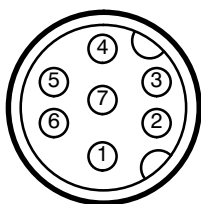

1	RO	5	B
2	GP	6	RY
3	GW	7	RB
4	GR		

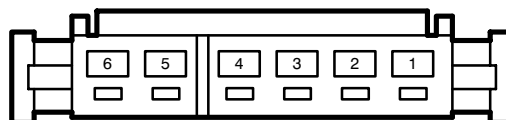

1	GW	4	B
2	GP	5	RY
3	RO	6	GN

R060024

### C403

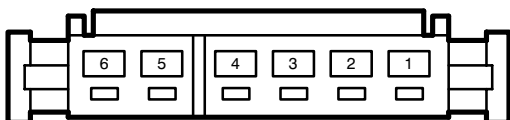

1	GR	4	B
2	GP	5	RY
3	RB	6	GN



R060017

**C407**

R060016

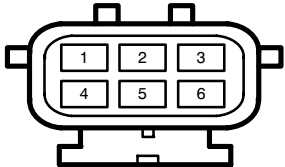

1	WP	4	-
2	GB	5	-
3	B	6	-

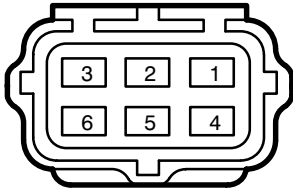

1	WP	4	-
2	GB	5	-
3	B	6	-

R030003

**C408**

R040037

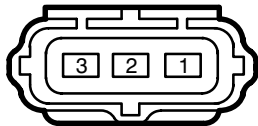

1	NY
2	GO
3	NG

**C413**

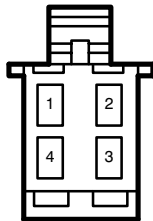

1	BW	3	BW
2	B	4	B

R060012

**C412**

R020031

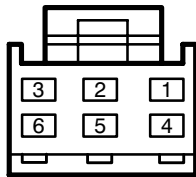

1	SCR	4	LGO
2	R	5	PY
3	B	6	B

**C414**

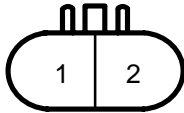

1	K
2	O

R080014

**C415**

R080013

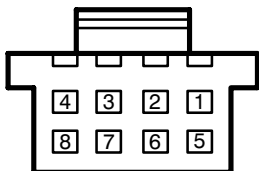

1	K	5	GP
2	RB	6	B
3	NG	7	O
4	GLG	8	B

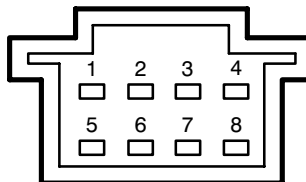

1	K	5	GP
2	RB	6	B
3	NG	7	O
4	GO	8	B

R040001

**C434**

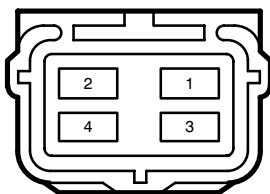

1	GB	3	B
2	B	4	WP

R060031

**C437**

R060029

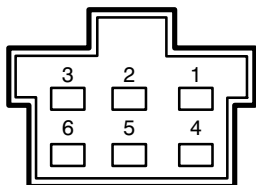

1	SCR	4	-
2	B	5	PY
3	R	6	LGO

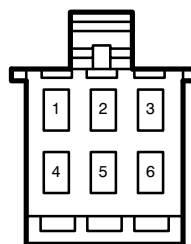

1	SCR	4	GP
2	B	5	PY
3	R	6	LGO

R020041

**C438**

R020056

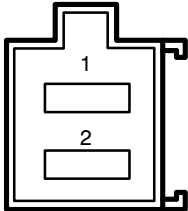

1	NP
2	B

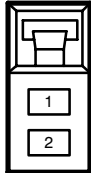

1	NP
2	B

R020037

**C441**

R020061

**C443**

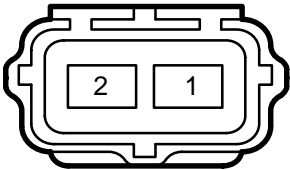

1	RB
2	B

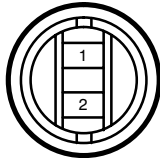

1	RB
2	B

R020037

**C442**

R020037

**C444**

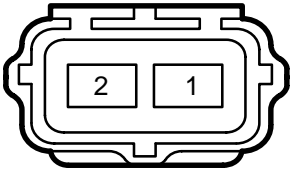

1	GR
2	B

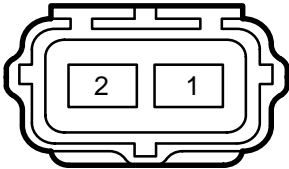

1	RO
2	B

### C445

R020037

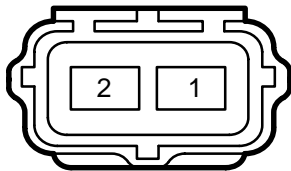

1	GW
2	B

### C446

R020061

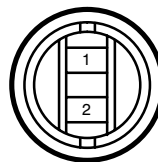

1	RO
2	B

R020050

### C447

R020059

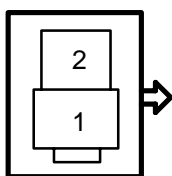

1	B
2	YG

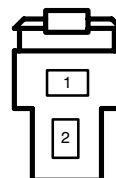

1	B
2	NG

R160001

### C448

R160007

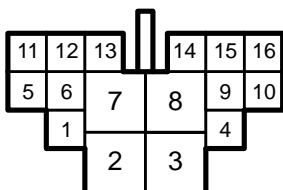

1	-	5	-	9	P	13	BG
2	Y	6	YL	10	-	14	UW
3	G	7	N	11	-	15	LGW
4	UB	8	-	12	WLG	16	BR

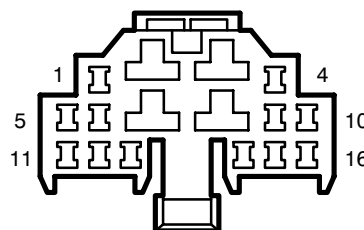

1	-	5	-	9	P	13	BG
2	Y	6	W	10	-	14	UW
3	GR	7	N	11	-	15	LGW
4	UB	8	-	12	WLG	16	BR

R050016

**C457**

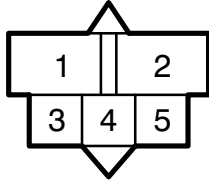

1	YG	4	B
2	NR	5	WG
3	PG		

R020046

**C462**

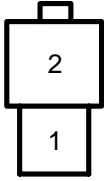

1	R
2	YG

R020047

**C458**

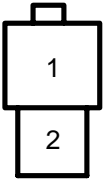

1	NR
2	G

R040023

**C463**

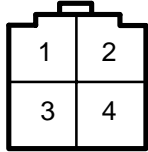

1	WG	3	G
2	S	4	B

R040022

**C459**

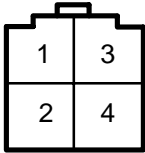

1	B	3	Y
2	N	4	G

R020048

**C464**

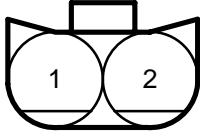

1	BG
2	RG

### C465

R040023

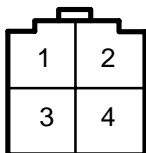

1	WG	3	S
2	WG	4	UW

### C485

R020007

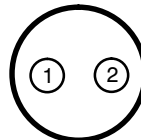

1	W
2	W

### C466

R040023

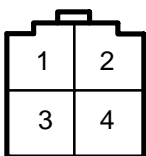

1	WG	3	S
2	PG	4	BR

### C486

R020007

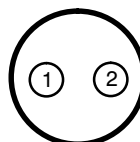

1	W
2	W

### C467

R060020

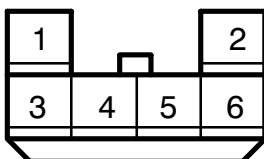

1	WG	4	LGW
2	R	5	B
3	YL	6	G

### C487

R060028

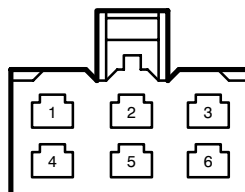

1	B	4	B
2	B	5	B
3	B	6	B

**C489**

R020071

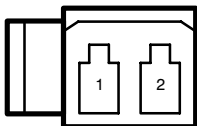

1	B
2	NY

**C503**

R060008

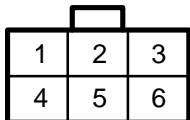

1	B	4	SW
2	BG	5	SW
3	BU	6	BK

**C500**

R020037

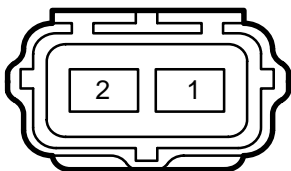

1	SU
2	SK

**C504**

R040016

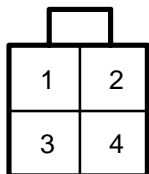

1	UG	3	-
2	-	4	B

**C507**

R060009

R040011

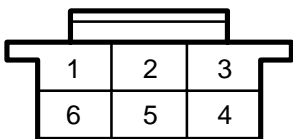

1	O	4	-
2	K	5	YK
3	B	6	-

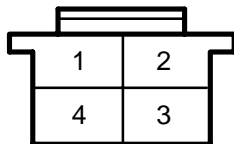

1	O	3	NK
2	K	4	B

**C600**

R020037

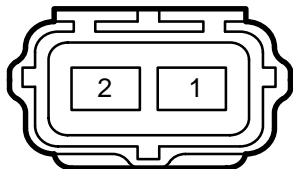

1	SU
2	SK

**C603**

R060008

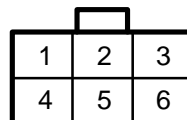

1	B	4	SW
2	BG	5	SW
3	BU	6	BK

R060009

**C607**

R040011

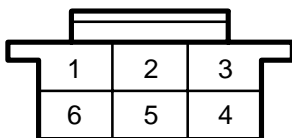

1	O	4	-
2	K	5	YK
3	B	6	-

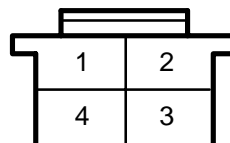

1	O	3	NK
2	K	4	B

R020053

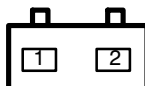

1	O
2	K



R020037

**C703**

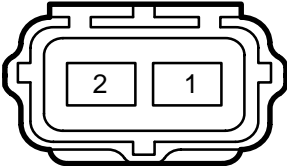

1	SW
2	SO

R020037

**C803**

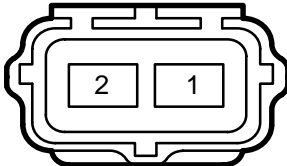

1	SW
2	SO

R020029

**C706**

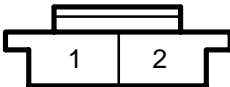

1	O
2	K

R020029

**C806**

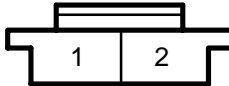

1	O
2	K

R050008

**C709**

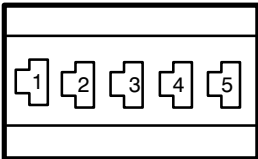

1	SO	4	SW
2	SO	5	SW
3	SG		

R050008

**C809**

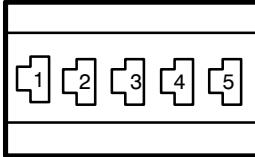

1	SW	4	SN
2	S	5	SO
3	SG		

R200001

### HJ1

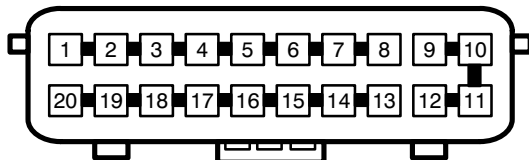

#### S2042

1	-
2	GO
3	GO
4	GO
5	GO
6	GO
7	-
8	-

#### S2045

9	LGP
10	-
11	LGP
12	LGP

#### S274

13	GLG
14	GLG
15	GLG
16	GLG
17	GLG
18	GLG
19	GLG
20	GLG

R200008

### HJ2

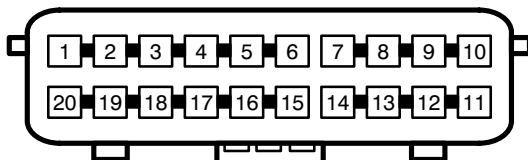

#### S2074

1	RN
2	RN
3	RN
4	RN
5	-
6	RN

#### S2095

7	LGW
8	LGW
9	LGW
10	LGW

#### S2077

11	PU
12	PU
13	PU
14	PU

#### S2030

15	YK
16	Y
17	YK
18	YK
19	YK
20	-

R200001

### HJ3

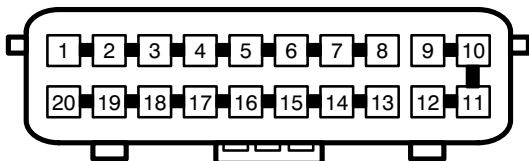

#### S204

1	B
2	B
3	B
4	BO
5	B
6	B
7	B
8	B

#### S2014

9	WP
10	WP
11	WP
12	WP

#### S2011

13	GP
14	GP
15	GP
16	GP
17	GP
18	GP
19	GP
20	GP

R200001

HJ4

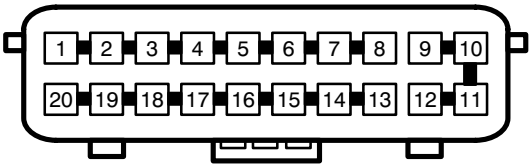

S232

1	GS
2	GS
3	GS
4	GS
5	GS
6	GS

S2017

7	-
8	GK
9	GK
10	B

S261

11	PW
12	PW
13	PW
14	PW

S227

15	WG
16	WG
17	WG
18	WG
19	WG
20	WG

R200001

HJ5

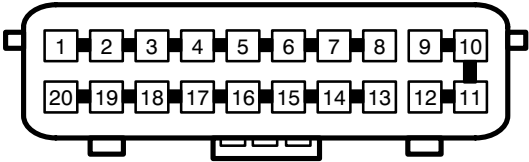

S238

1	B
2	B
3	B
4	B
5	B
6	B
7	B
8	B

S2054

9	B/WY
10	B/WY
11	B/WY
12	B/WY

S2006/S2025

13	-/B
14	-/B
15	RB/B
16	RB/B
17	RB/B
18	RB/B
19	RB/B
20	-/B

R200009

HJ6

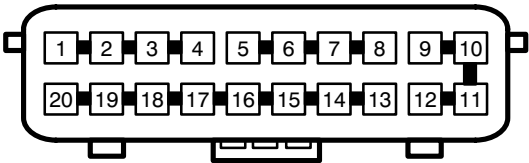

S2019

1	GW
2	GW
3	GW
4	GW

S2020

5	GR
6	GR
7	GR
8	GR

S2018

9	BR
10	BR
11	BR
12	BR

S2021

13	P
14	P
15	P
16	P
17	P
18	P
19	P
20	P

R200008

### HJ7

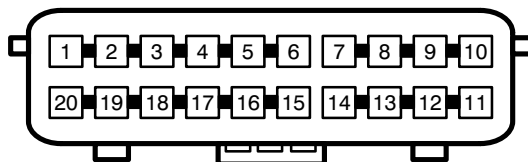

#### S290

1	BS
2	B
3	BS
4	-
5	-
6	BS

#### S291

7	NO
8	NO
9	NO
10	NO

#### S292

11	WG
12	B
13	WG
14	WG

#### S293

15	RB
16	RB
17	RB
18	RB
19	RB
20	-

R200001

### HJ8

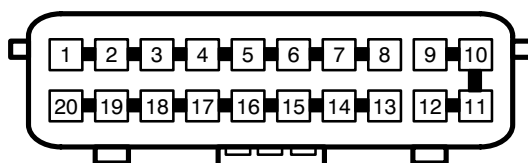

#### S253

1	B
2	B
3	B
4	B
5	B
6	B
7	B
8	B

#### S252

9	RO
10	RO
11	RO
12	RO

#### S255

13	B
14	B
15	B
16	B
17	B
18	B
19	B
20	B

R200001

### HJ9

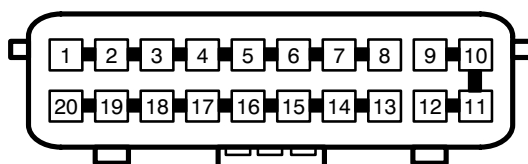

#### S256

1	RO/RN
2	RN
3	RN
4	RN
5	RN
6	RN
7	RN
8	RN

#### S214

9	LG
10	LG
11	LG
12	LG

#### S251

13	RN
14	RN
15	RN
16	RN
17	RN
18	RN
19	RN
20	-

R200001

HJ10

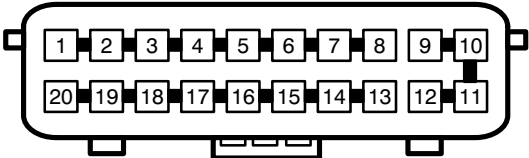

S2015

1	B
2	B
3	B
4	B
5	B
6	B
7	B
8	B

S2005

9	BY
10	BY
11	BY
12	BY

S2016

13	B
14	B
15	B
16	B
17	B
18	B
19	B
20	B

R200001

HJ11

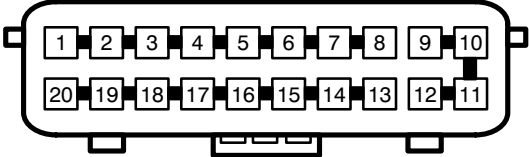

S2023

1	B
2	B
3	-
4	B
5	-
6	B
7	B
8	B

S2044

9	B
10	B
11	B
12	B

S288

13	B
14	B
15	B
16	B
17	-
18	B
19	B
20	B

R200009

HJ12

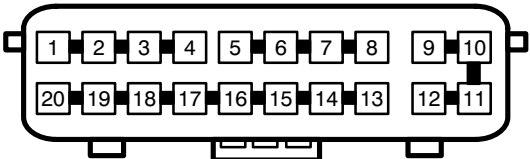

S434

1	RY
2	RY
3	RY
4	RY

S440

5	RO
6	RO
7	-
8	RO

S409

9	GP
10	GP
11	GP
12	-

S420

13	RB
14	RB
15	RB
16	RB
17	RB
18	RB
19	RB
20	RB

P126  
Fascia Fuse Box

P127  
Satellite Fuse  
Box 1

P125  
Engine Compart-  
ment Fuse Box

P128  
Satellite Fuse  
Box 2

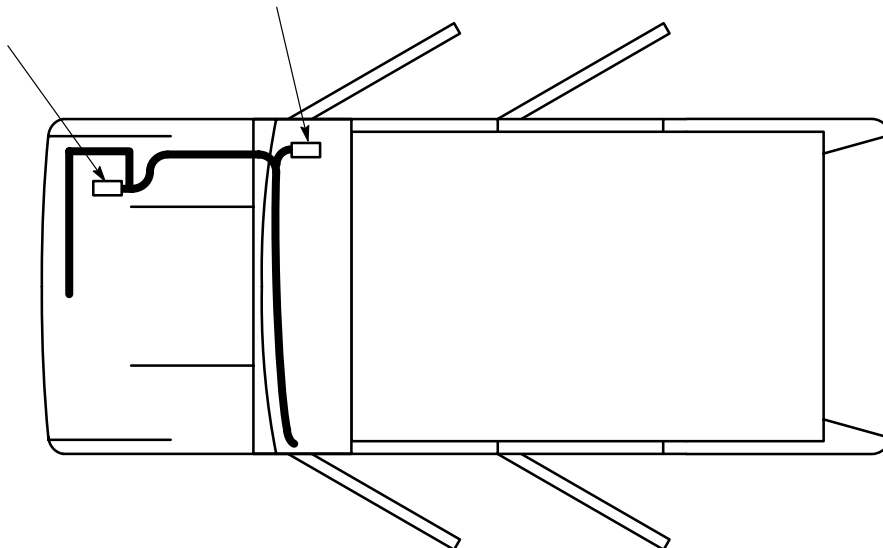

**MAIN HARNESS (PARTIAL)**

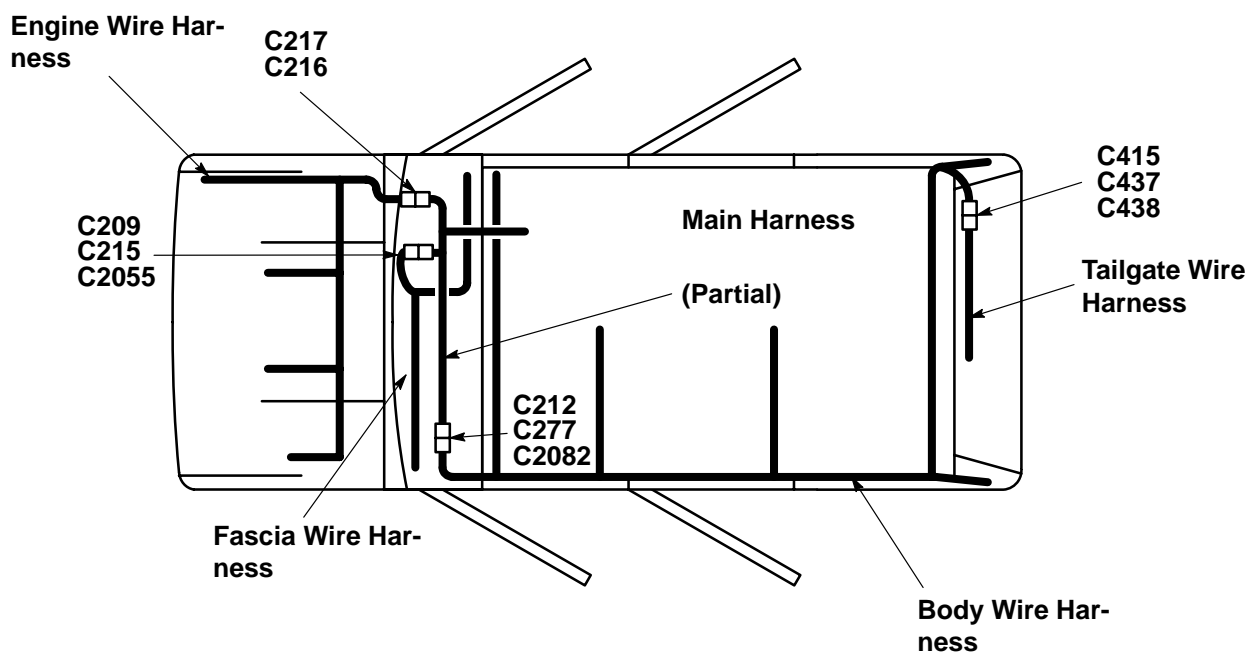

**EXCEPT NAS**

---

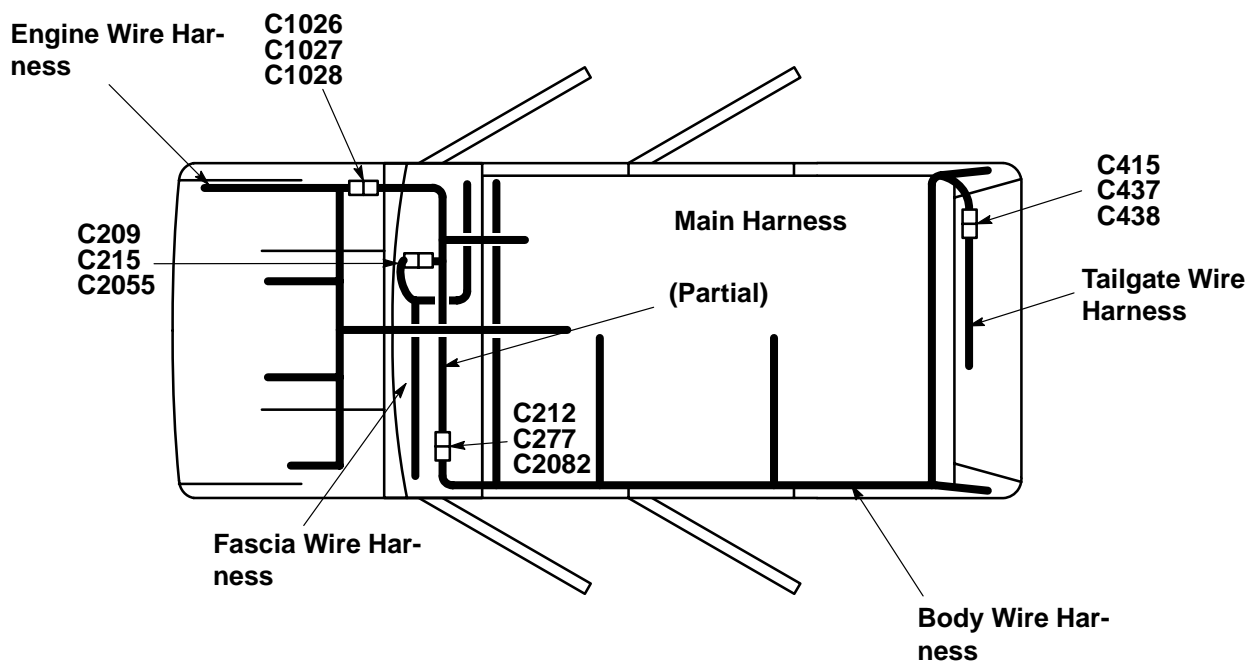

**NAS**

---

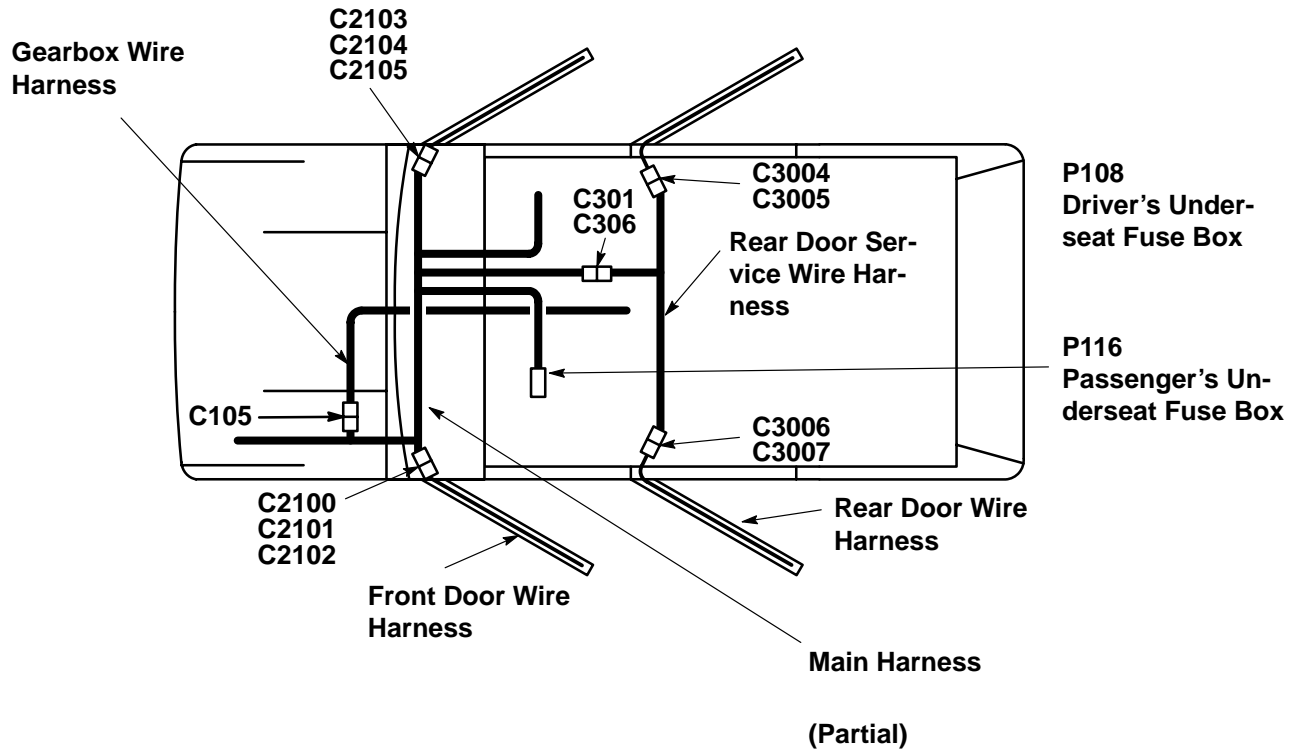



Accessory Relay .....	Y1-8
Air Recirculation Solenoid In-Line Fuse (P138) .....	K1-4
Anti-Lock Brake System .....	D1-1
Blower Controls .....	K1-1
Central Locking .....	L6-1
Cigar Lighter/Clock .....	J2-1
Component Location Table .....	Z4-1
Component Location Views .....	Z5-1
Compressor Controls .....	K2-1
Connector Views .....	Z6-1
Cooling Fans .....	K5-1
Cruise Control .....	B5-1
Data Link Connector .....	D3-1
Direction Indicator Lamps .....	H6-1
Electrochromic Rear View Mirror .....	G1-1
Fog Guard Lamps .....	H9-1
Front Wipe/Wash .....	F1-1
Fuse Details .....	Y2-1
Engine Compartment Fuse Box (P125)	
F1 .....	Y2-1
F2 .....	Y2-1
F3 .....	Y2-2
F4 .....	Y2-3
F5 .....	Y2-3
F6 .....	Y2-4
F7 .....	Y2-5
Fascia Fuse Box (P126)	
F1 .....	Y2-14
F2 .....	Y2-15, 16
F3 .....	Y2-17
F4 .....	Y2-18
F5 .....	Y2-18
F6 .....	Y2-18
F7 .....	Y2-19
F8 .....	Y2-20, 21, 22, 23, 24
F9 .....	Y2-25
F10 .....	Y2-25
F11 .....	Y2-26
F12 .....	Y2-27
F13 .....	Y2-28
F14 .....	Y2-29

F15 .....	Y2-30
F16 .....	Y2-30
F17 .....	Y2-31
F18 .....	Y2-32, 33
Satellite Fuse Box 1 (P127)	
F1 .....	Y2-6
F2 .....	Y2-6
F3 .....	Y2-7, 8, 9, 10
F4 .....	Y2-11
F5 .....	Y2-11
F6 .....	Y2-11
Satellite Fuse Box 2 (P128)	
F1 .....	Y2-12
F2 .....	Y2-12
F3 .....	Y2-12
F4 .....	Y2-12
F5 .....	Y2-12
F6 .....	Y2-13
Ground Distribution .....	Y5-1
Harness Routing .....	Z8-1
Headlamp Levelling .....	H3-1
Headlamps (except NAS) .....	H1-1
Headlamps (NAS) .....	H2-1
Heated Rear Screen and Mirror Demisters .....	F8-1
Horns .....	E5-1
Ignition and Shift Interlock .....	C1-1
Instruments .....	E1-1
Interior Lamps .....	J1-1
Introduction .....	i-1
Lights	
Automatic Gear Selector Illumination (B102) .....	J1-11
Centre Mounted Stop Lamp (B103) .....	H5-2
Column Switch Illumination (B104) .....	J1-9
Direction Indicator Lamps .....	H6-1
Fog Guard Lamps .....	H9-1
Front Interior Roof Lamp (B107) .....	J1-8
Glove Box Lamp (B152) .....	J1-1
Headlamps (except NAS) .....	H1-1
Headlamps (NAS) .....	H2-1
Interior Lamps .....	J1-1
Left Front Fog Lamp (B184) .....	H9-1, 3

Left Front Indicator Lamp (B153) .....	H6-3
Left Front Side Lamp (B166) .....	H4-3
Left Front Side Marker Lamp (B161) .....	H4-3
Left Headlamp (B116) .....	H1-2, H2-2
Left Rear Indicator Lamp (B163) .....	H6-4
Left Rear Lamp Assembly (B121) .....	H5-3
Left Rear Side Marker Lamp (B159) .....	H4-4
Left Repeater Lamp (B122) .....	H6-3
Left Tail Lamp (B155) .....	H4-4
Left Vanity Mirror Lamp (B186) .....	J1-10
Number Plate Lamps (B123) .....	H4-4
Passenger's Rear A/C Switch Illumination (B158) .....	J1-1
Rear Cargo Lamp (B157) .....	J1-8
Rear Interior Roof Lamp (B124) .....	J1-8
Reversing Lamps .....	H7-1
Right Front Fog Lamp (B183) .....	H9-1, 3
Right Front Indicator Lamp (B154) .....	H6-3
Right Front Side Lamp (B167) .....	H4-1
Right Front Side Marker Lamp (B162) .....	H4-1
Right Headlamp (B130) .....	H1-2, H2-2
Right Rear Indicator Lamp (B165) .....	H6-4
Right Rear Lamp Assembly (B136) .....	H5-4
Right Rear Side Marker Lamp (B160) .....	H4-2
Right Repeater Lamp (B137) .....	H6-3
Right Tail Lamp (B156) .....	H4-2
Right Vanity Mirror Lamp (B187) .....	J1-10
Side Lamps .....	H4-1
Stop Lamps .....	H5-1
Ventilation Control Panel Illumination (B140) .....	J1-7
Multi-Function Unit (MFU) .....	G4-1
Multiport Fuel Injection (MFI-T16) .....	A2-1
Multiport Fuel Injection (MFI-V8) .....	A1-1
Power Distribution .....	Y1-1
Engine Compartment Fuse Box (P125)	
MF1 .....	Y1-1
MF2 .....	Y1-3
MF3 .....	Y1-4, 5
MF4 .....	Y1-6
MF5 .....	Y1-7
MF6 .....	Y1-9
Fusible Link (P119) .....	Y1-1

Power Mirrors .....	M3-1
Power Seats .....	M1-1
Power Windows .....	L1-1
Radio (except NAS) .....	E6-1
Radio (NAS) .....	E7-1
Rear A/C Switch Amplifier In-Line Fuse (P140) .....	K1-8
Rear Wipe/Wash .....	F3-1
Reversing Lamps .....	H7-1
Sequential Multiport Fuel Injection (SFI-V8) (NAS only) .....	A3-1
Side Lamps .....	H4-1
Starting and Charging .....	B1-1
Stop Lamps .....	H5-1
Sunroof .....	L4-1
Theft Alarm System .....	T1-1
Trailer Auxiliary Socket .....	P1-1
Warnings and Indicators (except NAS) .....	E2-1
Warnings and Indicators (NAS) .....	E3-1
300Tdi .....	A4-1
300Tdi Glow Plug Control .....	A5-1