



RANGE ROVER

Electrical Library



RANGE ROVER

ELECTRICAL LIBRARY

LRL 0453ENG (4th Edition)

Published by Land Rover

© Land Rover 2003

All rights reserved. No part of this publication may be reproduced, stored in a retrieval system or transmitted in any form, electronic, mechanical, recording or other means without prior written permission from Land Rover.

INTRODUCTION	1
ABOUT THIS DOCUMENT	1-1
ELECTRICAL PRECAUTIONS	1-3
HARNESS REPAIRS	1-6
ABBREVIATIONS	1-9
HOW TO USE THIS DOCUMENT	1-11
FAULT DIAGNOSIS	1-15
WIRE COLOUR CODES	1-16
FUSE DETAILS	2
ENGINE COMPARTMENT FUSE BOX	2-7
PASSENGER COMPARTMENT FUSE BOX	2-8
REAR FUSE BOX	2-11
EARTH POINTS AND HEADERS	3
DESCRIPTION AND OPERATION	4
ANTI-THEFT ALARM AND CENTRAL DOOR LOCKING (CDL)	4-1
ENGINE IMMOBILISATION	4-9
WINDOWS	4-13
SUNROOF	4-17
DOOR MIRRORS	4-19
INTERIOR MIRROR	4-23
FRONT SEATS	4-25
FRONT HEATED SEATS	4-28
REAR HEATED SEATS	4-29
DIAGNOSTIC SOCKET	4-30
STARTING AND CHARGING – Td6	4-31
STARTING AND CHARGING – V8	4-35
CRUISE CONTROL	4-38
ELECTRONIC AUTOMATIC TRANSMISSION (EAT) – GM5	4-40
ELECTRONIC AUTOMATIC TRANSMISSION (EAT) – ZF	4-43
ANTI-LOCK BRAKING SYSTEM (ABS)	4-46
SUPPLEMENTARY RESTRAINT SYSTEM (SRS)	4-49
AUTOMATIC TEMPERATURE CONTROL (ATC)	4-53
AUTOMATIC TEMPERATURE CONTROL (ATC) – COMFORT	4-56
FUEL BURNING HEATER – Td6	4-61
FUEL BURNING HEATER – V8	4-62
COOLING FAN	4-64

CONTENTS

HEATED REAR WINDOW (HRW)	4-66
HEATED FRONT SCREEN (HFS)	4-67
WIPERS AND WASHERS	4-68
HEADLAMP WASH/WIPE	4-71
BRAKE AND REVERSE LAMPS	4-72
HEAD, SIDE AND TAIL LAMPS	4-74
AUTOMATIC HEADLAMP LEVELLING	4-78
FOG LAMPS	4-80
DIRECTION INDICATOR/HAZARD WARNING LAMPS	4-82
INTERIOR LAMPS	4-84
INTERIOR ILLUMINATION	4-87
INSTRUMENTS	4-90
HORNS	4-92
CLOCK	4-93
CIGAR LIGHTERS	4-94
ACCESSORY SOCKETS	4-95
TRAILER SOCKET	4-96
AUDIO SYSTEM – LOW LINE	4-98
AUDIO SYSTEM – MID-LINE	4-99
AUDIO SYSTEM – HIGH LINE	4-100
SATELLITE NAVIGATION SYSTEM	4-101
SATELLITE NAVIGATION SYSTEM – NAS	4-102
TELEPHONE	4-103
TELEPHONE – HANDS FREE	4-104
TELEPHONE – NAS	4-105
FUEL PUMP	4-106
ROTARY COUPLER	4-108
PARK DISTANCE CONTROL (PDC)	4-110
TYRE PRESSURE MONITORING (TPM)	4-113
STEERING COLUMN	4-114
AIR SUSPENSION	4-117

CONNECTOR 5

CIRCUIT REFERENCE NUMBERS	5-1
---------------------------------	-----

ABOUT THIS DOCUMENT

General

This document is intended to assist in diagnosing electrical faults, and should be used in conjunction with the Electrical Circuit Diagrams. The document is divided into the following sections.

1. **INTRODUCTION** – Includes Electrical Precautions, a list of Abbreviations and general information on how to use this document.
2. **FUSE DETAILS** – Provides details of location, rating in Amperes, and circuit(s) protected.
3. **EARTH POINTS AND HEADERS** – Provides details of earth points and earth headers, including a plan view of the vehicle to aid location.
4. **DESCRIPTION AND OPERATION** – Provides an explanation of how each of the systems operate.
5. **CIRCUIT REFERENCE NUMBERS** – Provides a list of circuit reference numbers against a model or feature to which they apply.
6. **CONNECTOR DETAIL** – Details of connectors including a location photograph, face view and pin-out table.

NOTE: Before starting electrical checks on the vehicle, ensure that relevant mechanical functions operate satisfactorily.

References

References to the LH or RH side given in this document are made when viewing the vehicle from the rear.

Operations covered in this document do not include reference to testing the vehicle after repair. It is essential that work is inspected and tested after completion and, if necessary, a road test of the vehicle is undertaken, particularly where safety related items are concerned.

CAUTION: Before undertaking any electrical work on a vehicle ALWAYS read the ELECTRICAL PRECAUTIONS.

INTRODUCTION

Battery Voltage

Open Circuit Voltage Test

Before commencing diagnosis of electrical problems, verify the condition of the battery is acceptable by using the open circuit voltage test.

1. Switch off all electrical loads on the vehicle.
2. Adjust digital multimeter to read dc volts on the appropriate scale.
3. Connect test probes across battery terminals ensuring that polarity is correct and record the voltage displayed.

A reading of 12.5 V or more is acceptable; any battery which reads less than this will need charging.

NOTE: If the vehicle has been used within a period of 8 hours prior to the test, surface charge must be removed from the battery by switching the headlamps on for approximately 30 seconds. Wait a further 60 seconds before checking the open circuit voltage.

Battery voltage is used as a known reference for ascertaining whether or not circuits are receiving sufficiently high voltage for components to function correctly. This reference is only a guide since most electronic circuits are designed to function over a wide range of voltages. In addition, consideration must be given to readings affected by voltage drop across certain components and fluctuations due to cable lengths.

ELECTRICAL PRECAUTIONS

General

The following guidelines are intended to ensure the safety of the operator whilst preventing damage to the electrical and electronic components fitted to the vehicle. Where necessary, specific precautions are detailed in the relevant sections of this document, reference to these precautions should be made prior to commencing repair operations.

Equipment – Prior to commencing any test procedure on the vehicle, ensure that the relevant test equipment is working correctly and any harnesses or connections are in good condition. This particularly applies to mains lead or connections.

WARNING: Before commencing work on an ignition system, all high tension terminals, adaptors and diagnostic equipment for testing should be inspected to ensure that they are adequately insulated and shielded to prevent accidental personal contact and to minimise the risk of shock. Wearers of surgically implanted pacemaker devices should not work in close proximity to ignition circuits or diagnostic equipment.

Polarity – Never reverse connect the vehicle battery and always observe correct polarity when connecting test equipment.

High Voltage Circuits – Whenever disconnecting live ht circuits, always use insulated pliers and never allow the open end of the ht lead to come into contact with other components, particularly ECU's. Since high voltage spikes can occur on the terminals of the coil while the engine is running, exercise caution when measuring the voltage at these points.

WARNING: The Xenon headlamp system generates up to 28,000 V and contact with this voltage could lead to fatality. Make sure that the headlamps are switched off before working on the system. Refer to the guidelines given in the 'General Information' section of the Service Repair Procedures Workshop Manual before any work is carried out.

Connectors and Harnesses – The engine compartment of a vehicle is a particularly hostile environment for electrical components and connectors. Always ensure these items are dry and oil free before disconnecting and connecting test equipment. Never force connectors apart either by using tools or by pulling on the wiring harness. Always ensure locking tabs are disengaged before removal and note orientation to enable correct reconnection. Ensure that any protective covers and substances are replaced if disturbed.

INTRODUCTION

Before removing a faulty component, refer to the Workshop Manual for removal procedures. Ensure the ignition switch is turned to the 'OFF' position, the battery is disconnected (**see *Battery Disconnecting***) and any disconnected harnesses are supported to avoid any undue strain at the terminals. When replacing the component keep oily hands away from electrical connection areas and push connectors home until any locking tabs fully engage.

Battery Disconnecting

It is imperative that the key is removed from the ignition switch before disconnecting the battery. A time of 2 minutes must also elapse (after the ignition has been switched off) before the battery should be disconnected. Failure to do so could result in:

- Navigation computer software damage
- Incorrect fuel gauge reading.

Before disconnecting the battery, disable the alarm system and switch off all electrical equipment. If the radio is to be serviced, ensure the security code has been deactivated.

CAUTION: Never disconnect the battery with the ignition switched on.

CAUTION: To prevent damage to the navigation computer software, a waiting period of two minutes must elapse after the ignition is switched off before the battery leads are disconnected.

CAUTION: To prevent damage to electrical components, always disconnect the battery when working on the vehicle's electrical system. The earth lead must be disconnected first and reconnected last.

CAUTION: Always ensure that battery leads are routed correctly and are not close to any potential chafing points.

After reconnecting the battery, the steering wheel must be turned to full LH and RH lock (with the engine running). This allows the Dynamic Stability Control (DSC) system to relearn the steering wheel position. Failure to do so will result in a variety of instrument pack warning lamps being illuminated.

Battery Charging

Only recharge the battery with it removed from the vehicle. Always ensure any battery charging area is well ventilated and that every precaution is taken to avoid naked flames and sparks.

The New Range Rover is fitted with a lead calcium battery, and can only be charged using equipment specifically designed to operate on this type of battery. Refer to the **Land Rover Equipment** bulletin for a list of recommended battery charging equipment.

Disciplines

Switch off ignition prior to making any connection or disconnection in the system as electrical surge caused by disconnecting 'live' connections can damage electrical components.

Ensure hands and work surfaces are clean and free of grease, swarf, etc. as grease collects dirt which can cause tracking or high-resistance contacts.

When handling printed circuit boards, treat them as you would a disc – hold by the edges only; note that some electrical components are susceptible to body static.

Connectors should never be subjected to forced removal or refit, especially inter-board connectors. Damaged contacts will cause short-circuit and open-circuit conditions.

Prior to commencing testing, and periodically during testing, touch a good earth, i.e. cigar lighter socket, to discharge body static as some electrical components are vulnerable to static electricity.

Grease for Electrical Connectors

Some under bonnet and under body connectors are protected against corrosion by the application of a special grease during production. Should connectors of this type be disturbed, repaired, or replaced, a grease of this type, available under part number BAU 5811, should again be applied. Do not apply grease to any connectors that do not have grease applied as standard.

NOTE: The use of other greases must be avoided as they can migrate into relays, switches, etc. contaminating the contacts and leading to intermittent operation or failure.

INTRODUCTION

HARNESSES REPAIRS

Introduction

Two Land Rover harness repair kits are available. Range Rover (LM) harness repairs can be carried out using repair kit LRT-86-010. Range Rover (LP), Discovery Series II, and Freelander (01MY onwards) are covered by Harness Repair Kit LRT-86-010/1.

The Harness Repair Kits contain the following components to enable the technician to carry out 'Right First Time' repairs:

- Crimping pliers.
- Wire cutter/stripping tool.
- Heat shrink tubing.
- Wire colour identification rings.
- Splice connectors.
- Pre-terminated leads (connector pins with 90mm wire 'pig tails').
- Connector housings.
- Connector pin extractor tools.

NOTE: Replacement connector housings and pre-terminated leads can be ordered from: SPX UK Ltd, Genoa House, Everdon Park, Daventry, Northants, NN11 5YJ. Tel: +44 (0)1327 303400

In order to carry out a repair, a suitable hot air gun and heat resistant blanket will also be required. These can be sourced locally.

The kits can be used to make repairs to all except the following:

- Any Media Orientated System Transport (MOST) network harnesses.
- Supplementary Restraint System (SRS) firing circuits.
- ABS wheel speed sensors with moulded connectors (Defender, Discovery Series II, and pre-02MY Freelanders only).
- Any wires with a Cross Sectional Area (CSA) of greater than 4.0mm.

If damage occurs in any of these areas, an overlay harness must be used.

WARNING: Repairs should only be carried out on wires that have been mechanically damaged, not electrically damaged (overheated/burned)

Repair Guidelines

The Harness Repair Kit includes an illustrated instruction booklet. However, there are additional repair guidelines that should be adhered to.

Twisted Pairs

Twisted pairs of wires (CAN bus, ABS wiring, etc.) can be repaired as required. When repairing a twisted pair of wires do not unwind the existing wires any more than necessary. Before completing the repair, replicate as closely as possible the original twisting pattern on any new wiring.

Splice Connectors

Whenever a repair is required, the position of the splice connectors must be staggered as follows:

- Small (red) and medium (blue) splice connectors = 40mm stagger.
- Large (yellow) splice connectors = 50mm stagger.

This keeps the bulk of the repaired area to a minimum, ensuring all trim etc. can be refitted correctly after the repair has been effected.

NOTE: Do not make more than 5 repairs per connector. If more than 5 wires are damaged, a part harness must be used to carry out the repair.

Replacement Connectors

If a connector is damaged and needs replacing, use the tools contained in the Harness Repair Kit to relocate the wires into the replacement connector. Only relocate one wire at a time, ensuring it is fitted to the correct cavity in the new connector.

Gold Connector Pins

A number of connector pins on the vehicle are gold plated. When a repair is required, these must be replaced by gold connector pins. Do not replace gold connector pins with tin connector pins as this will lead to early failure of the electrical contact.

Sealed Terminals

A number of terminals on the vehicle are sealed. When a repair is required, these must be replaced by a sealed terminal. An unsealed terminal fitted in place of a sealed terminal will result in early failure of the electrical contact.

INTRODUCTION

Repair Methods

The following process should be used when carrying out a repair:

CAUTION: Before starting any work, ensure the vehicle battery has been disconnected. Work must not start on the vehicle for a further ten minutes. This allows the SRS and Satellite Navigation systems time to de-energise.

1. Using the cutter/stripping tool, cut the wire to be repaired and strip the required amount of insulation from the wire.
2. Slide an appropriately sized heat shrink sleeve over the bare end wire for later fitment.
3. Remove the damaged connector pin from the connector housing using the appropriate extraction tools.
4. Select the correct connector pin pre-terminated lead and fit the appropriate wire colour identification rings.
5. Select the correct size of splice connector from the kit.
6. Using the crimping tool, crimp the splice connector to the harness bare end wire. The crimping tool contains three sets of jaws for crimping the splices. The jaw colours correspond to the splice connector colour.

CAUTION: The crimping tool jaws perform two different crimps simultaneously. One crimps the wire insulation, one crimps the bare wire. Ensure the splice connector is placed correctly in the crimping tool or the wire will be insufficiently crimped and a poor electrical contact may result.

7. Using the crimping tool, crimp the pre-terminated lead to the splice connector.
8. Slide the previously fitted heat shrink sleeve into position over the splice connector. Using the hot air gun to the manufacturers guidelines, apply heat evenly to the heat shrink tubing until it is tightly shrunk around the splice connector.

CAUTION: Place the asbestos blanket in a suitable position to avoid heat damage to adjacent components and trim.

CAUTION: Do not overheat the repair as degradation and subsequent failure of the connection may result.

9. Connect the repaired wire to the connector housing.
10. Repeat steps 1 to 9 for any further damaged wires.

ABBREVIATIONS

General

A	Ampere
ABS	Anti-lock Braking System
ac	Alternating current
A/C	Air Conditioning
ATC	Automatic Temperature Control
ATF	Automatic Transmission Fluid
BBUS	Battery Backed-Up Sounder
BCU	Body Control Unit
Bus	Databus
CAN	Controller Area Network
Cav	Cavity
CBC	Corner Braking Control
Cct	Circuit
CDL	Central Door Locking
CHMSL	Centre High Mounted Stop Lamp
CKP	Crankshaft Position
CMP	Camshaft Position
Col	Colour
CSA	Cross Sectional Area
dc	Direct current
DCU	Diagnostic Control Unit
DOT	Department of Transport
DSC	Dynamic Stability Control
DSP	Digital Signal Processor
EAT	Electronic Automatic Transmission
EBA	Emergency Brake Assist
EBD	Electronic Brake force Distribution
E-box	Environmental box
ECM	Engine Control Module
ECT	Engine Coolant Temperature
ECU	Electronic Control Unit
EPRS	Electronic Pressure Regulator Solenoid
ETC	Electronic Traction Control
F	Fuse
FBH	Fuel Burning Heater
FIP	Fuel Injection Pump

INTRODUCTION

FL	Fusible Link
HeVAC	Heating, Ventilation and Air Conditioning
HO2S	Heated Oxygen Sensor
HDC	Hill Descent Control
HFS	Heated Front Screen
HRW	Heated Rear Window
LCM	Light Check Module
LED	Light Emitting Diode
LH	Left Hand
MF	Maxi-fuse
MOSFET	Metal Oxide Semi-conductor Field Effect Transistor
MFD	Multi-Function Display
NAS	North American Specification
NTC	Negative Temperature Coefficient
PDC	Park Distance Control
PWM	Pulse Width Modulated
RF	Radio Frequency
RH	Right Hand
rpm	Revs per minute
SAI	Secondary Air Injection
SRS	Supplementary Restraint System
TCC	Torque Converter Clutch
TPM	Tyre Pressure Monitoring
TV	Television
V	Volts

HOW TO USE THIS DOCUMENT

Fuse Details

Contains information on fuse functions and values and should be used together with the power distribution circuit diagrams to establish which systems share a common power supply and to ensure that correct value fuses are fitted.

Earth Points and Headers

Shows a plan view of the vehicle with location of all earth points. Supporting photographs and connector detail information appear in the Connector section.

Description and Operation

Presented in the same order as the circuit diagrams in the Electrical Circuit Diagrams publication, each of the descriptions contains a brief overview of the main system functions and includes reference to the appropriate wire colours. Always read this section before starting work on a system so that a good understanding of system functionality is obtained.

Connector Details

This section is effectively an index of every electrical connector on the vehicle, including headers and eyelets. A page is dedicated to each connector, with the information presented in a standard format. The connector number is displayed on each page header to ease reference. Connector information comprises:

- **Connector Number** – The assigned number, prefixed 'C'.
- **Connector Name** – Usually derived from the component to which the connection is made.
- **Male/Female** – If applicable, identifies the gender of the connector pins (NOT the housing) as Male or Female. Generally, connectors mating directly into a component have Female pins.
- **Colour** – If applicable, the colour of the connector housing is shown. NATURAL is used to describe connectors with a clear/translucent plastic finish.
- **Location Statement** – Used in conjunction with the photograph to determine the location of the connector.
- **Photograph** – Shows the location of the subject connector. In most cases the photograph will indicate the amount of trim removal necessary to reveal the connector. For convenience some photographs identify more than one connector.
- **Face View** – An outline of the connector housing, viewed from the front, showing pin numbers (if applicable).
- **Ways** – This identifies the number of cavities within the connector.

INTRODUCTION

- **Service Repair Kits** – Gives details of all harness repair kits applicable to the connector. If a connector has different types of cavity, more than one service repair kit will be required.

NOTE: If more than 3 different Service Repair Kits are needed to work on a single connector, the Service Repair Kit tables are shown on the following page.

- **Pin-out Table** – A six column table, giving details of each wire within the connector.

Cav	Terminal	CSA	Col	Cct	Destn
1	AFU3728	4.50	GR	499	C0571-3
2	AFU3728	4.50	B	499	C0571-5

1. **Cav:** The connector pin (cavity) number.

NOTE: Wires may not be fitted to all cavities.

2. **Terminal:** Part number of the connector pin.

NOTE: Some wires do not have terminals. e.g. antenna's and earth eyelets.

3. **CSA:** The cross sectional area of the wire in mm². In some instances a wire type is given. For more information, refer to the **Wire Types** section on the following page.
4. **Col:** The colour of wire populating the connector pin.
5. **Cct:** Identifies the model or feature which uses the wire. 'ALL' means applicable to all models in the range fitted with the feature or system in question. In instances where different models, features or systems require different colour wires to be fitted in a cavity, each instance of the cavity is included in the pin-out table.
6. **Destn:** The destination of the wire.

Example – 6 Pin Connector

Cav	Terminal	CSA	Col	Cct	Destn
1	AFU3728	4.50	N	2	C0571-3
1	AFU3728	4.50	N	6	C0571-5
2	AFU3725	3.00	NW	6	C0588-6
2	AFU3725	3.00	NW	2	C0588-2
3	AFU3728	4.50	NR	2	C0571-3
3	AFU3728	4.50	NR	6	C0571-3
4	AFU3725	3.00	WR	6	C0588-4
4	AFU3725	3.00	WR	2	C0588-4
6	AFU3725	3.00	SU	6	C0588-6
6	AFU3725	3.00	SU	2	C0588-3

A table listing the circuit reference numbers against a description of the model or features which may or may not be fitted can be found at the beginning of the connector section. A sample of a typical table is shown below.

Cct	Model or Feature
58	Diesel
97	FBH
171	PDC
227	Sunroof
279	Headlamp wash/wipe
499	All vehicles
573	Petrol

INTRODUCTION

Wire Types

In some instances a wire type is shown instead of a CSA. This indicates that the wire is twisted with another wire. The table below shows the CSA of each twisted set of wires.

NOTE: The CSA shown is for each individual wire.

Wire Type	CSA (mm ²)	Outside Diameter (mm)
MA	0.50	4.0
MAQ	0.50	1.7
MB	0.50	1.8
MC	0.50	1.8
MM	0.50	1.8
MU	0.50	2.3

A third or fourth letter may also be shown. This is used as a counter, and identifies the wires that are twisted together. For example, a wire labelled MAC is twisted with a second wire labelled MAC. When the end of the alphabet is reached, a fourth letter is added.

Example Table

Cav	Terminal	CSA	Col	Cct	Destn
1	YPL101310	MMM	UB	587	C0816-3
2	YPL101310	MMM	UN	587	C0816-4
5	YPL101310	MML	UR	587	C1542-9
7	YPL101310	MMK	YB	587	C0816-10
8	YPL101310	MMK	YN	587	C0816-9
11	YPL101310	MML	UN	587	C1542-18

This table shows that the wires in cavity 1 and cavity 2 are twisted together, wires 5 and 11 are twisted together, and wires 7 and 8 are twisted together.

FAULT DIAGNOSIS

General

When diagnosing an electrical fault, follow the steps below:

1. Read the circuit description appropriate to the reported fault to ensure a good understanding of circuit operation.
2. Study the power distribution, fuse details and earth distribution diagrams and identify other circuits which share fuses and/or earth points. Check whether these circuits operate correctly.
3. Using the photographs contained in the Connector section, locate a point on the circuit (approximately half way between supply and earth) which is easily accessible.
4. Check that the pin-out details of the connector are correct and that the correct signals exist at the correct terminals.
5. Using a suitable non-permanent marker, mark the parts of the circuit you have verified.
6. Continue to the next point on the circuit which is easiest to access and repeat the above.
7. Continue with this approach until a fault is found, rectify the fault and then verify that the circuit operates correctly.

CAUTION: Never probe directly into the front face of a connector. This can damage the terminal and cause a failure. Always probe the back of a terminal, taking care not to damage the terminal or any seals.

Never probe wire insulation. On small diameter cables this can cut the conductors. It may also allow moisture into the cable, causing corrosion.

INTRODUCTION

WIRE COLOUR CODES

General

The following list contains wire colour codes used on the vehicle harness's.

Code	Colour
B	Black
G	Green
K	Pink
LG	Light green
N	Brown
O	Orange
P	Purple
R	Red
S	Slate (Grey)
SCR	Screen
T	Transparent (White)
U	Blue
W	White
Y	Yellow

Introduction

Fuses are mounted in one of three fuse boxes. The engine compartment fuse box is located in the environmental box (E-box). The passenger compartment fuse box is located behind the glove box, while the rear fuse box is located behind the luggage compartment RH trim casing.

The passenger compartment fuse box contains three different types of fuse:

1. **Blade type fuse** – Small, pull out, male fuse, used to protect circuits from 5 A to 30 A.
2. **Maxi-fuse** – A larger version of the blade type fuse. Used to protect circuits at 50 A. These are shown on the circuits using the same symbol as a fusible link. Each Maxi-fuse is shown with an MF prefix.
3. **Bolt down fuse** – Also known as a fusible link, used to protect circuits from 50 A to 100 A.

The engine compartment fuse box contains blade type fuses only. The rear fuse box contains blade and maxi-fuses.

NOTE: The lighting circuits are not protected by conventional fuses. Metal Oxide Semiconductor Field Effect Transistors (MOSFETS) within the Light Check Module (LCM) protect the lighting circuits. For more information, refer to the Lighting section of the System Description and Operation Workshop Manual.

Relays

Relays are installed on the passenger compartment and rear fuseboxes, behind the front passenger's side of the fascia, on the engine compartment bulkhead, and in the E-box.

FUSE DETAILS

Passenger Compartment Fusebox Relays

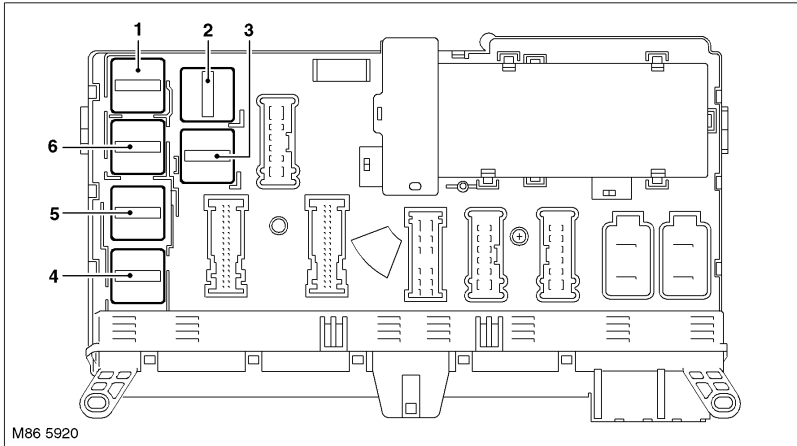

1. Heated washer jets and wiper heater relay
2. Electric seats relay
3. Not used
4. Horn relay
5. Door/Approach lamps relay
6. Steering wheel heater relay

Rear Fusebox Relays

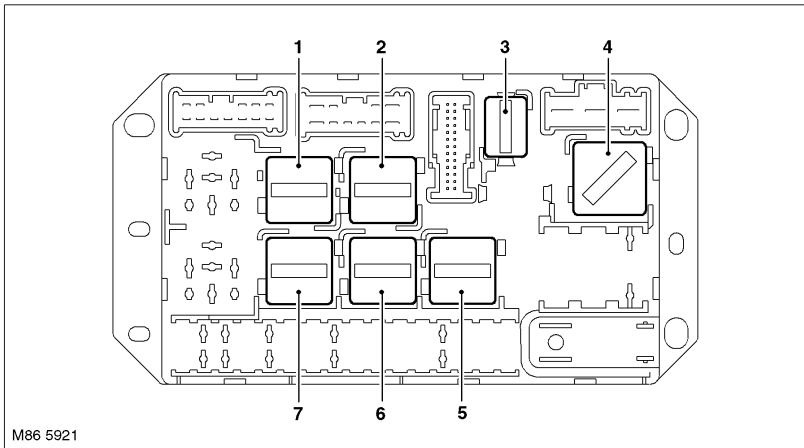

1. Cigar lighter relay (where fitted)
2. Rear blower relay
3. Lower tail door release relay
4. Air suspension supply unit relay
5. Fuel pump relay
6. Rear seat heaters relay
7. Heated rear window relay

FUSE DETAILS

Engine Compartment E-Box Relays and Fusebox

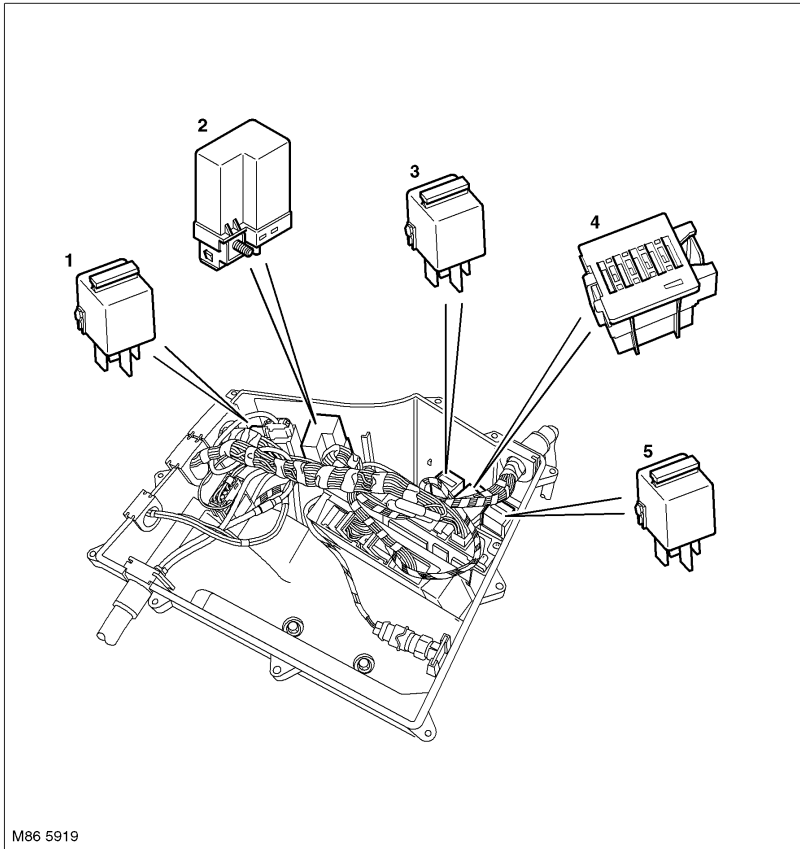

1. Ignition coil relay (V8 only)
2. Glow plugs relay (Td6 only)
3. Secondary air injection pump relay (V8 only)
4. Engine compartment fusebox
5. Main relay

Engine Compartment Bulkhead Relays and Fusible Links

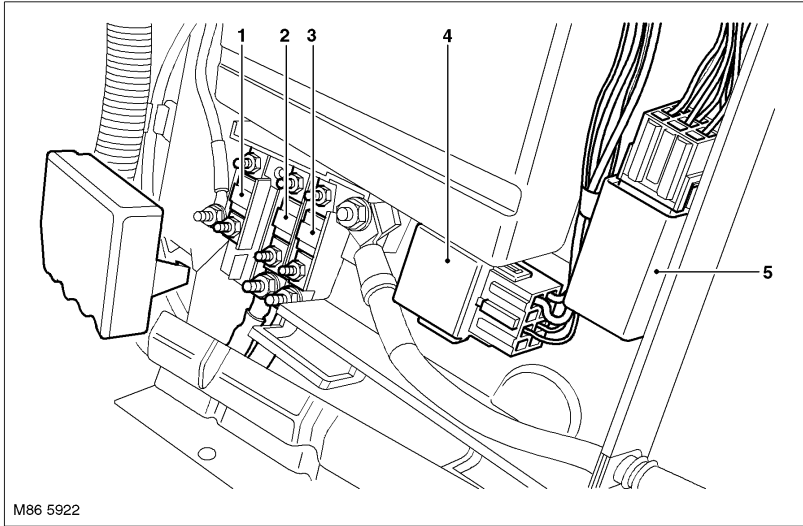

1. Transfer box supply fusible link
2. Glow plug relay supply fusible link (Td6 only)
3. Main relay supply fusible link (Td6 only)
4. Starter motor relay (V8 only)
5. Windscreen wipers relay

FUSE DETAILS

Passenger Side Fascia Relays

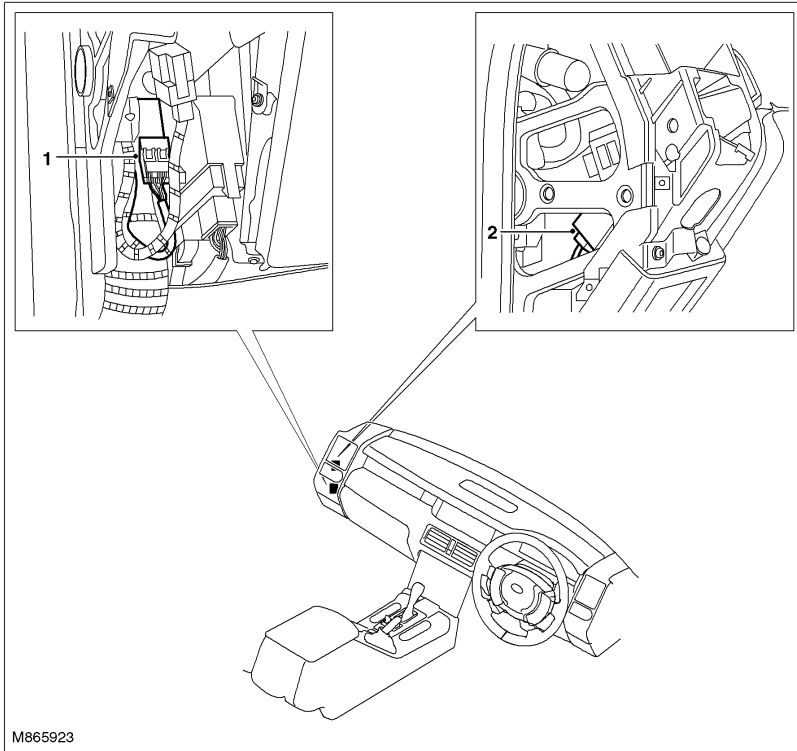

1. Headlamp wash/wipe relay
2. Heated windscreen relay

ENGINE COMPARTMENT FUSE BOX

Fuse	Rating	Vehicle	Function
F1	30 A	V8	ECM, EAT ECU.
F1	30 A	Td6	ECM.
F2	30 A	V8	Variable camshaft control solenoids.
F2	30 A	Td6	CMP sensor, MAF/IAT sensor.
F3	30 A	V8	LH front HO2S, RH front HO2S, LH rear HO2S, RH rear HO2S.
F3	30 A	Td6	EAT ECU.
F4	30 A	V8	ECM.
F5	30 A	V8	Ignition

FUSE DETAILS

PASSENGER COMPARTMENT FUSE BOX

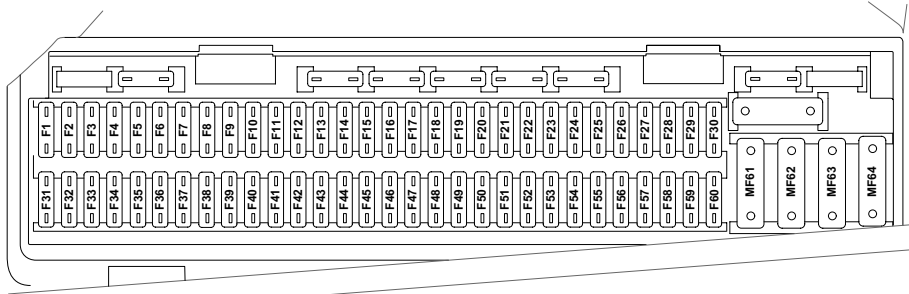

M86 5908

Link	Rating	Vehicle	Function
FL1	80 A	All	Heated front screen relay.
FL2	60 A	Td6	Ignition switch.
FL2	60 A	V8	Engine immobilisation ECU, header 499.
FL3	50 A	All	Light Check Module.
FL4	50 A	All	Light Check Module.
FL5	100 A	All	MF17, MF18, MF19, F1, F2, F3, F4, F6, F7, F9, F10, F11, F12, F13, F14, F15 and F16 of the rear fuse box.

Fuse	Rating	Vehicle	Function
F1	5 A	All	Instrument pack
F2	5 A	All	Heated rear screen relay, rear blower motor relay, seat heat relay, relay 2, F5 and F8 of the rear fuse box.
F3	7.5 A	All	Fuel cooling fan motor.
F4	5 A	All	Light Check Module, Door lamp module.
F5	7.5 A	All	Diagnostic socket, EAT ECU.
F6	5 A	All	Tyre Pressure Monitoring ECU, Interior mirror, Park Distance Control ECU.
F7	5 A	All	Not used.
F8	5 A	All	Radio/cassette player.
F9	5 A	All	Light Check Module, Brake pedal switch, Rotary coupler.
F10	15 A	All	Horn relay.

FUSE DETAILS

F11	30 A	All	Drivers door module.
F12	10 A	All	HeVAC control unit.
F13	5 A	All	Transmission selector indicator lamp, Steering angle sensor, Clock.
F14	5 A	All	Not used.
F15	5 A	All	Diagnostic socket, BCU.
F16	5 A	All	Tyre Pressure Monitoring ECU.
F17	5 A	All	Door lamp module.
F18	10 A	All	Engine immobilisation ECU, Steering column interlock ECU.
F20	30 A	All	LH seat switch pack.
F21	30 A	All	RH seat switch pack.
F22	7.5 A	All	Telephone module.
F23	15 A	All	Steering wheel relay.
F24	30 A	All	Passenger door module.
F25	5 A	V8	Ignition switch.
F26	30 A	All	Windscreen wiper delay ECU.
F27	20 A	All	BCU.
F28	30 A	All	Headlamp wash/wipe relay.
F29	10 A	All	Steering wheel heater ECU.
F30	15 A	All	Not used.
F31	5 A	All	ECM, Steering column interlock ECU.
F32	5 A	All	LH Xenon headlamp, RH Xenon headlamp.
F33	5 A	All	Transfer box ECU.
F34	7.5 A	All	HeVAC control module.
F35	5 A	All	Centre console switch pack, Hill Descent Control switch.
F36	5 A	All	Not used.
F37	5 A	All	Transfer box ECU – Only fitted for towing purposes.
F38	5 A	All	Not used.
F39	5 A	All	Steering column lighting switch.
F40	5 A	All	CD autochanger.
F41	5 A	All	BCU, Rain sensor, Rear screen wiper ECU.
F42	5 A	All	LH vanity mirror, RH vanity mirror.
F43	5 A	All	Tilt sensor, Interior mirror, BBUS, Volumetric sensor.
F44	5 A	All	SRS DCU, occupancy detector, LH seat belt buckle, RH seat belt buckle.

FUSE DETAILS

F45	5 A	All	Instrument pack.
F46	5 A	All	Instrument pack.
F47	30 A	All	Heated washer jet relay.
F48	15 A	All	Not used.
F49	30 A	All	Radio/cassette player.
F51	10 A	Td6	Steering angle sensor, ABS ECU, fuel pump relay.
F51	10 A	V8	Steering angle sensor, Secondary Air Injection pump relay, Secondary Air Injection pump, ABS ECU, fuel pump relay.
F52	25 A	All	HeVAC control module.
F53	30 A	All	Ignition switch.
F54	15 A	All	EAT ECU.
F55	30 A	All	ABS ECU.
F56	7.5 A	All	Relay 6.
F57	15 A	All	Air suspension ECU.
F58	20 A	All	Sunroof ECU.
F59	20 A	All	Fuel burning heater, Fuel burning heater receiver.
F60	30 A	All	BCU.

Maxi-fuse	Rating	Vehicle	Function
MF61	50 A	All	Cooling fan control unit.
MF62	50 A	V8	Secondary Air Injection pump relay.
MF63	50 A	All	ABS ECU.
MF64	50 A	All	Front blower motor control unit.

REAR FUSE BOX

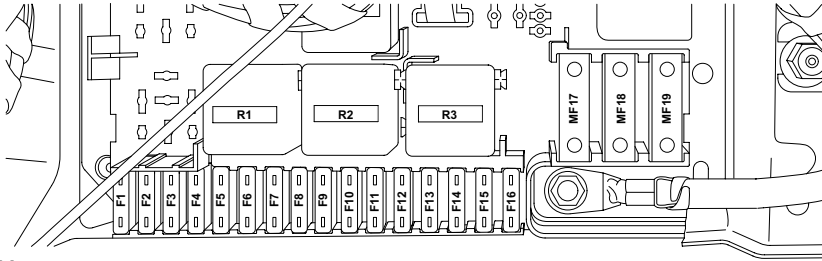

M86 5909

Fuse	Rating	Vehicle	Function
F1	20 A	All	Front cigar lighter, Rear cigar lighter, Front accessory socket.
F2	25 A	All	Relay 4.
F3	25 A	All	Relay 2.
F4	15 A	All	Trailer pick-up.
F6	20 A	All	Trailer pick-up.
F7	20 A	All	Rear accessory socket.
F9	30 A	All	Heated rear window relay.
F10	20 A	All	Rear screen wiper motor.
F11	20 A	All	Seat heat relay.
F12	15 A	All	Rear blower motor relay.
F14	5 A	All	RF receiver.
F15	25 A	All	Fuel pump relay.
F16	10 A	All	Tail door relay.

Maxi-fuse	Rating	Vehicle	Function
MF17	50 A	All	Trailer ECU.
MF18	50 A	All	Air suspension relay.
MF19	50 A	All	Not used.

FUSE DETAILS

EARTH POINTS AND HEADERS

General

The following illustration indicates the general position of each earth point and header on the vehicle. Refer to the **Connector** section for more information.

Refer to the **Circuit Diagrams** for details of electrical components and their associated earth points.

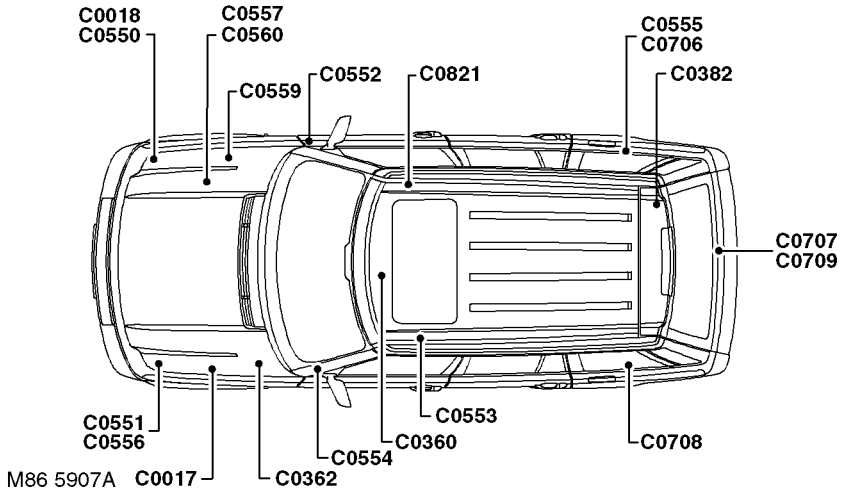

ANTI-THEFT ALARM AND CENTRAL DOOR LOCKING (CDL)

DESCRIPTION

Anti-Theft Alarm

The anti-theft alarm system fitted to New Range Rover consists three main areas:

- Perimetric protection.
- Volumetric protection.
- Vehicle angle monitoring.

Perimetric Protection

The Body Control Unit (BCU) protects the outside of the vehicle by monitoring the condition of all four door switches, the bonnet switch, and the upper tail door switch and sounds the alarm if any are triggered.

Volumetric Protection

The BCU protects the inside of the vehicle via an volumetric sensor mounted in the centre of the headlining. If the volumetric sensor detects movement within the passenger compartment, it informs the BCU to sound the alarm. When the alarm is first armed, the BCU allows 15 seconds for the air within the passenger compartment to stabilise. The alarm will then become fully armed after a further 15 seconds.

Vehicle Angle Monitoring

The BCU protects against the vehicle being illegally towed away, or any of the wheels being stolen by measuring the longitudinal and transverse angle of the vehicle. The angle of the vehicle is monitored by the tilt sensor, which is located beneath the front passenger seat. When the vehicle is first armed, the tilt sensor stores the angle of the vehicle in its memory. If the angle changes more than 1.2° (longitudinal) or 1.4° (transverse), the tilt sensor informs the BCU to sound the alarm. After the alarm has been triggered once, the threshold is lowered to 1.1 ° and 1.3 ° to make the alarm even more sensitive to vehicle angle movement.

NOTE: If the upper tail door is unlocked using the RF transmitter, the tail door switch, volumetric sensor, and tilt sensor will be disabled. These will be reactivated 30 seconds after the tail door is closed and locked.

An anti-theft alarm LED is mounted in the rear view mirror to act as a visual deterrent. The flashing sequence of the LED is dependent upon the status of the anti-theft alarm system. For detailed information on the anti-theft alarm system, refer to the **Anti-theft Alarm and Central Door Locking** section of the Description and Operation Workshop Manual.

DESCRIPTION AND OPERATION

Central Door Locking (CDL) and Superlocking

Two levels of locking are available; Central Door Locking (CDL) and Superlocking. CDL locks all doors, the tail door and the fuel filler flap. Superlocking carries out the same function as CDL but also inhibits operation of the interior door handles and sill buttons.

Superlocking is activated when either the Radio Frequency (RF) handset or the key is used to lock the vehicle. CDL is activated if the CDL master switch mounted on the fascia is pressed.

The RF handset, which is incorporated into the head of the ignition key, has three buttons. Pressing the large 'Land Rover' button once locks all doors and the tail door. This is followed by a single confirmation flash of the hazard warning lamps to inform that the vehicle has been locked successfully.

Pressing and holding the 'Land Rover' button for longer than 2 seconds locks all the doors and tail door and also closes any open windows (including the sunroof). Completion of this is again followed by a single confirmation flash of the hazard warning lamps to inform that the vehicle has been locked successfully.

Pressing the unlock 'Arrow' button once unlocks the drivers door. Pressing the unlock 'Arrow' button a second time unlocks the remaining three doors and the tail door. Pressing and holding the 'Arrow' button for longer than 2 seconds opens all the windows and the sunroof.

NOTE: Automatic opening and closing of the windows and sunroof is suspended if the lock or unlock button is released before the operation has been completed.

A third button on the handset operates the upper tail door lock. A single press of this button will unlock the upper tail door and temporarily suspend operation of the anti-theft alarm system. Once the tail door has been closed the tail door is automatically locked and the anti-theft alarm system reinstated. This is confirmed by a single flash of the hazard warning lamps.

For a detailed description of the CDL system, refer to the **Anti-theft Alarm and Central Door Locking** section of the Description and Operation Workshop Manual.

OPERATION

Anti-Theft Alarm

Power Distribution

Feed from the positive battery terminal (C0192) is supplied to fusible link 1, fuse 15, fuse 43, and fuse 53 (C0632) on an R wire. All are located in the passenger compartment fuse box. Fuse 15 (C0586) provides a constant battery feed to the Body Control Unit (BCU) (C0660) on an RS wire. The BCU (C0660) is earthed on an NB wire.

Fusible link 1 (C0588) provides a constant battery feed to fuse 14 of the rear fuse box (C2024) on an R wire. Fuse 14 (C2022) provides a constant battery feed to the radio frequency (RF) receiver (C0674) on an RB wire.

Fuse 43 of the passenger compartment fuse box (C0586) provides a constant battery feed to the following:

- The Battery Backed-Up Sounder (BBUS) (C0666) on an RN wire.
- The volumetric sensor (C0359) on an RW wire.
- The tilt sensor (C0960) on an RB wire.

Fuse 53 of the passenger compartment fuse box (C0583) provides a constant battery feed to the ignition switch (C0099 on Td6 vehicles, C0028 on V8 vehicles) on an R wire. When the ignition switch is turned to the 'ignition' position, current flows across the switch (C0099 on Td6 vehicles, C0028 on V8 vehicles) to fuse 6 of the passenger compartment fuse box (C0585) on a G wire. Fuse 6 (C0587) provides an ignition feed to the interior mirror (C0698) on a GW wire.

RF Receiver

The RF receiver (C0674) is located at the top of the upper tail door, and is provided a constant battery feed from fuse 14 of the rear fuse box (C2022) on an RB wire. The RF receiver is connected to an element in the rear screen via a pair of B wires. The RF receiver uses the rear screen element as an aerial.

NOTE: The B wires connecting the RF receiver to the rear screen element are not shown on the system circuit diagrams as they are fly leads incorporated into the manufacture of the rear screen.

The RF receiver converts high frequency wave forms transmitted by the remote handset into bi-phase, pulsed signals that can be understood by the BCU. The RF receiver (C0674) is connected to the BCU (C0660) by a WY wire.

DESCRIPTION AND OPERATION

Volumetric Sensor

The volumetric sensor monitors the inside of the vehicle by emitting a series of ultrasound pulses, and measuring the profile of the returned echo. The sensor (C0359) is located the centre of the headlining, and is provided a constant battery feed from fuse 43 of the passenger compartment fuse box (C0586) on an RW wire.

When the anti-theft alarm is armed, the BCU (C0661) 'switches on' the volumetric sensor by providing a pulsed voltage signal to the tilt sensor (C0960) on a BS wire. This signal is relayed to the volumetric sensor (C0359) on a BW wire. If the volumetric sensor detects movement within the passenger compartment, it provides a feed to the BCU (C0661) on a BY wire. The volumetric sensor (C0359) is earthed on an N wire.

Tilt Sensor

The tilt sensor monitors the angle of the vehicle. If the angle of the vehicle moves more than the thresholds outlined in the **Description** section, the alarm will be triggered. The sensor (C0960) is located beneath the front passenger seat, and is provided a constant battery feed from fuse 43 of the passenger compartment fuse box (C0586) on an RW wire. When the anti-theft alarm is armed, the BCU (C0661) 'switches on' the tilt sensor (C0960) by providing a pulsed voltage signal on a BS wire.

When the anti-theft alarm system is activated, the tilt sensor (C0960) provides a voltage pulse to the BCU (C0661) on a BU wire. If this isn't received within a set time, the BCU determines that the unit is defective.

If the tilt sensor is triggered, it provides a voltage pulse to the BCU (C0661) on a BU wire. Recognising this signal, the BCU (C0661) returns a pulsed voltage signal to the tilt sensor (C0960) on a BS wire.

Battery Backed-Up Sounder (BBUS)

The BBUS (C0666) is mounted adjacent the brake servo, and is provided a constant battery feed by fuse 43 of the passenger compartment fuse box (C0586) on an RN wire. Dependant upon market configuration, the BBUS can emit one of three tones:

- Continuous.
- Pulsed.
- Modulated.

When the anti-theft alarm is armed, the BCU (C0661) 'switches on' the BBUS by providing a pulsed voltage signal to the tilt sensor (C0960) on a BS wire. This signal is relayed to the BBUS (C0666) on a BG wire.

When the alarm is triggered, the BBUS (C0662) provides a feed to the BBUS (C0666) on a BU wire. The BBUS (C0666) is earthed on an N wire.

Perimetric Protection

The BCU (C0660) is located beneath the front passenger seat, and is provided a constant battery feed from fuse 15 of the passenger compartment fuse box (C0586) on an RS wire. The door, bonnet, and tail door switches are all normally open switches. When any of these panels are opened, the switch contacts close and an earth path is created. The BCU (C0660) monitors the condition of door bonnet and tail door switches as follows:

- The BCU monitors the condition of the drivers door switch (C1449) via the drivers door module (C2058) on a UR then NW wire. The drivers door switch (C1449) is earthed on an N wire.
- The BCU monitors the condition of the front passenger door switch (C1451) via the passenger door module (C2057) on a UR then NW wire. The passenger door switch (C1451) is earthed on an N wire.
- The BCU monitors the condition of the LH rear passenger door (C0442) on an NS then NG wire. The LH rear passenger door switch (C0442) is earthed on an N wire.
- The BCU monitors the condition of the RH rear passenger door (C0442) on an NW then NG wire. The RH rear passenger door switch (C0442) is earthed on an N wire.
- The BCU monitors the condition of the bonnet switch (C0007) on a PG wire. The bonnet switch (C0007) is earthed on an N wire.
- The BCU monitors the condition of the upper tail door switch (C0383) on an SW wire. The upper tail door switch (C0383) is earthed on an N wire.

NOTE: The LH rear and RH rear passenger door switches have the same connector number as they utilise the same harness.

Anti-theft Alarm LED

The anti-theft alarm LED is located in the rear view mirror. The flashing sequence of the LED (C0698) is controlled by the BCU (C0661) on an SBY wire.

DESCRIPTION AND OPERATION

Central Door Locking (CDL)

Power Distribution

Feed from the positive battery terminal (C0192) is supplied to the following on an R wire:

- Fusible link 1.
- Fuse 11.
- Fuse 15.
- Fuse 24.
- Fuse 60.

All are located in the passenger compartment fuse box (C0632). Fuse 15 (C0586) provides a constant battery feed to the BCU (C0660) on an RS wire. Fuse 60 (C0582) also provides a feed to the BCU (C0662) on an RW wire. The BCU (C0660) is earthed on an NB wire.

Fuse 24 (C0583) provides a constant battery feed to the passenger door module (C2016) on an RW wire. Fuse 11 (C0585) provides a constant battery feed to the drivers door module (C2017) on an RP wire.

Fusible link 1 (C0588) is connected to fuse 14 and fuse 16 of the rear fuse box (C2024) on an R wire. Fuse 14 (C2022) provides a constant battery feed to the RF receiver (C0674) on an RB wire. Fuse 16 provides a constant battery feed to relay 8, which is also located in the rear fuse box.

RF Receiver

The RF receiver (C0674) is located at the top of the upper tail door and is provided a constant battery feed from fuse 14 of the rear fuse box (C2022) on an RB wire. The RF receiver converts the radio frequency signals from the remote handset and converts them into a digital signals. The RF receiver (C0674) provides the digital signal to the BCU (C0660) on a WY wire. The BCU processes the signal from the RF receiver and carries out the appropriate function.

CDL Master Switch

The non-latching CDL master switch is mounted on the fascia, below the hazard warning switch. The BCU (C0661) monitors the condition of the switch (C0700) by providing a feed on an SN wire. When the switch is pressed, the switch contacts close and a momentary earth is created on an N wire. When the BCU registers this earth, it will lock all four doors, the tail door, and the fuel filler flap. Pressing the button a second time unlocks all four doors, the tail door and the fuel filler flap.

NOTE: Superlocking is not initiated when the CDL master switch is pressed.

Drivers Door

The BCU controls operation of the drivers door lock via the drivers door module. The drivers door module (C2017) is provided a constant battery feed from fuse 11 of the passenger compartment fuse box (C0585) on an RP wire. The module (C2017) is earthed on an N wire.

The BCU (C0660) communicates with the drivers door module (C2058) via the P-bus on a UR wire. If the drivers door module (C2058) receives an unlock signal from the BCU, it provides a feed to the door lock motor (C1449) on a U wire. Current flows across the motor (C1449) and is provided an earth path via the drivers door module (C2058) on a B wire.

The drivers door can also be unlocked using the key. The drivers door module (C2058) monitors the condition of the door lock barrel switch (C1449) on a WB wire. When the door lock is moved to the unlock position, the switch contacts close and an earth path is created on an N wire. Sensing this, the drivers door module unlocks the drivers door.

If the drivers door module (C2058) receives a lock signal from the BCU, it provides a feed to the door lock motor (C1449) on a B wire. Current flows across the motor (C1449) and is provided an earth path via the drivers door module (C2058) on a U wire.

If the drivers door module (C2058) receives a superlock signal from the BCU, it provides a feed to the superlock motor (C1449) on a W wire. Current flows across the superlock motor (C1449) and is provided an earth path via the drivers door module (C2058) on a U wire.

The drivers door can also be locked using the key. The drivers door module (C2058) monitors the condition of the door lock barrel switch (C1449) on a UR wire. When the door lock is moved to the lock position, the switch contacts close and an earth path is created on an N wire. Sensing this, the drivers door module locks the drivers door.

Front Passenger Door

The BCU controls operation of the front passenger door lock via the passenger door module. The passenger door module (C2016) is provided a constant battery feed from fuse 24 of the passenger compartment fuse box (C0583) on an RW wire. The module (C2016) is earthed on an N wire.

The BCU (C0660) communicates with the passenger door module (C2057) via the P-bus on a UR wire. If the passenger door module (C2057) receives an unlock signal from the BCU, it provides a feed to the door lock motor (C1451) on a U wire. Current flows across the motor (C1451) and is provided an earth path via the drivers door module (C2057) on a B wire.

If the passenger door module (C2057) receives a lock signal from the BCU, it provides a feed to the door lock motor (C1451) on a B wire. Current flows across the motor (C1451) and is provided an earth path via the passenger door module (C2057) on a U wire.

If the passenger door module (C2057) receives a superlock signal from the BCU, it provides a feed to the superlock motor (C1451) on a W wire. Current flows across the superlock motor (C1451) and is provided an earth path via the drivers door module (C2057) on a U wire.

DESCRIPTION AND OPERATION

Rear Passenger Doors

When the BCU (C0662) receives an unlock signal from the RF receiver, it provides a feed to the RH and LH rear (C0442) door lock motors on a pair of U wires. Current flows across the motors (C0442) to earth path via the BCU (C0662) on a pair of B wires.

When the BCU (C0662) receives a lock signal from the RF receiver, it provides a feed to the RH and LH rear door lock motors (C0442) on a pair of B wires. Current flows across the motors (C0442) to earth via the BCU (C0662) on a pair of U wires.

When the BCU (C0662) receives a superlock signal from the RF receiver, it provides a feed to the RH and LH rear (C0442) superlock motors on a pair of W wires. Current flows across the superlock motors (C0442) to earth via the BCU (C0662) on a pair of U wires.

Tail Door

The non-latching tail door switch is located on the centre console, adjacent to the clock. When the switch is pressed a momentary earth path is created. Sensing this, the BCU (C0662) provides a feed to the upper tail door motor (C0383) on a YN wire. The motor (C0383) is earthed on an N wire.

Once the upper tail door has been opened, the lower tail door can be opened. This can be carried out by pressing the non-latching switch located on the upper edge of the lower tail door.

The BCU (C0660) monitors the condition of the switch (C0615) by providing a feed on a YB wire. When pressed, the switch contacts close and a momentary earth path is created via the rear fuse box. Sensing this, the BCU (C0661) provides a feed to relay 8 of the rear fuse box (C2022) on an NY wire. This feed energises relay 8.

The energised relay 8 (C2022) allows a feed from fuse 16 of the rear fuse box to power the RH lower (C2052) and LH lower (C0617) tail door motors on UW wires. Both motors are earthed on N wires.

Fuel Filler Flap

When the BCU (C0662) receives an unlock signal from the RF receiver, it provides a feed to the fuel filler flap release motor (C0690) on a U wire. On European vehicles, current flows across the motor (C0690) and is provided an earth path via the BCU (C0662) on a W wire. On NAS vehicles, current flows across the motor (C0690) and is provided an earth path via the BCU (C0662) on a B wire.

When the BCU (C0662) receives a lock signal from the RF receiver, it provides a feed to the fuel filler flap release motor (C0690) on a W wire (B wire on NAS vehicles). Current flows across the motor (C0690) and is provided an earth path via the BCU (C0662) on a U wire.

ENGINE IMMOBILISATION

DESCRIPTION

General

The function of the engine immobilisation system is to prevent unauthorised starting of the vehicle. The system is controlled by an immobilisation ECU which is located beneath the centre console, adjacent to the handbrake. Re-mobilisation is achieved via a transponder in the vehicle key, which is read by a transponder coil when the ignition switch is turned to the 'auxiliary' position. The transponder coil is mounted around the ignition switch.

For a detailed description of the engine immobilisation system, refer to the **Security** section of the Description and Operation Workshop Manual.

OPERATION

Td6

Power Distribution

Feed from the positive battery terminal (C0192) is supplied to fusible link 2, fuse 18, and fuse 53 of the passenger compartment fuse box (C0632) on an R wire. Fuse 18 (C0584) provides a constant battery feed to the immobilisation ECU (C0059) and the steering column interlock ECU (C2055) on a pair of RY wires.

Fuse 53 (C0583) provides a constant battery feed to the ignition switch (C0099) on an R wire. When the ignition switch is turned to the 'auxiliary' position, current flows across the switch (C0099) to fuse 39 of the passenger compartment fuse box (C0585) on a PB wire. Fuse 39 (C0587) provides an auxiliary ignition feed to the immobilisation ECU (C0059) and the steering column interlock ECU (C2055) on a pair of PB wires.

When the ignition switch is turned to the 'ignition' position, current flows across the switch (C0099) to fuse 31 of the passenger compartment fuse box (C0585) on a G wire. Fuse 31 (C0587) provides an ignition feed to the steering column interlock ECU (C2055) on a GB wire.

Fusible link 2 of the passenger compartment fuse box (C0591) provides a constant battery feed to the ignition switch (C0099) on an R wire. When the ignition switch is turned to the 'crank' position, current flows across the switch (C0099) to the immobilisation ECU (C0059) on a BY wire.

DESCRIPTION AND OPERATION

Steering Column Interlock ECU

The steering column interlock ECU (C2055) receives the following power supplies:

- A constant battery feed from fuse 18 of the passenger compartment fuse box (C0584) on an RY wire.
- An auxiliary ignition feed from fuse 39 of the passenger compartment fuse box (C0587) on a PB wire.
- An 'ignition on' feed from fuse 31 of the passenger compartment fuse box (C0587) on a GB wire.

The ECU is earthed on an NB wire.

Transponder Coil

The transponder coil (C0049) is connected to the immobilisation ECU (C0059) by YU and YN wires. Both connections between the immobilisation ECU and the transponder coil switch between being both inputs and outputs. The transponder coil reads the vehicle identification information contained within the key transponder and relays it to the immobilisation ECU.

Immobilisation ECU

The immobilisation ECU (C0059) is located beneath the centre console, adjacent to the handbrake. It receives a constant battery feed from fuse 18 of the passenger compartment fuse box (C0584) on an RY wire, and an auxiliary ignition feed from fuse 39 of the passenger compartment fuse box (C0587) on a PB wire.

If the immobilisation ECU (C0059) has received a valid signal from both the transponder coil (C0049) and the steering column interlock ECU (C2055) when the ignition switch is turned to the 'crank' position, it transmits a rolling code to the Engine Control Module (ECM) (C0331) on a BP wire. The immobilisation ECU (C0059) also provides a feed to the starter motor relay (C0179) on a B wire.

For more information on operation of the starter motor, refer to the ***Starting and Charging*** – ***Td6*** section of this manual.

 **STARTING AND CHARGING – Td6.**

V8

Power Distribution

Feed from the positive battery terminal (C0192) is supplied to the following on an R wire:

- Fusible link 2.
- Fuse 18.
- Fuse 25.
- Fuse 53.

All are located in the passenger compartment fuse box (C0632).

Fusible link 2 (C0591) provides a constant battery feed to the immobilisation ECU (C0059) on an R wire. Fuse 18 (C0584) provides a constant battery feed to the immobilisation ECU (C0059) and the steering column interlock ECU (C2055) on a pair of RY wires.

Fuse 53 (C0583) provides a constant battery feed to the ignition switch (C0028) on an R wire. When the ignition switch is turned to the 'auxiliary' position, current flows across the switch (C0028) to fuse 39 of the passenger compartment fuse box (C0585) on a PB wire. Fuse 39 (C0587) provides an auxiliary ignition feed to the immobilisation ECU (C0059) and the steering column interlock ECU (C2055) on a pair of PB wires.

When the ignition switch is turned to the 'ignition' position, current flows across the switch (C0028) to fuse 31 of the passenger compartment fuse box (C0585) on a G wire. Fuse 31 (C0587) provides an ignition feed to the steering column interlock ECU (C2055) on a GB wire.

Fuse 25 of the passenger compartment fuse box (C0583) provides a constant battery feed to the ignition switch (C0028) on an RU wire. When the ignition switch is turned to the 'crank' position, current flows across the switch (C0028) to the Engine Control Module (ECM) (C0331) on a BY wire.

Steering Column Interlock ECU

The steering column interlock ECU (C2055) receives the following power supplies:

- A constant battery feed from fuse 18 of the passenger compartment fuse box (C0584) on an RY wire.
- An auxiliary ignition feed from fuse 39 of the passenger compartment fuse box (C0587) on a PB wire.
- An 'ignition on' feed from fuse 31 of the passenger compartment fuse box (C0587) on a GB wire.

The ECU is earthed on an NB wire.

DESCRIPTION AND OPERATION

Transponder Coil

The transponder coil (C0049) is connected to the immobilisation ECU (C0059) by YU and YN wires. Both connections between the immobilisation ECU and the transponder coil switch between being both inputs and outputs. The transponder coil reads the vehicle identification information contained within the key transponder and relays it to the immobilisation ECU.

Immobilisation ECU

The immobilisation ECU (C0059) is located beneath the centre console, adjacent to the handbrake. It receives a constant battery feed from fuse 18 of the passenger compartment fuse box (C0584) on an RY wire, and an auxiliary ignition feed from fuse 39 of the passenger compartment fuse box (C0587) on a PB wire.

If the immobilisation ECU (C0059) has received a valid signal from both the transponder coil (C0049) and the steering column interlock ECU (C2055) when the ignition switch is turned to the crank position, it transmits a rolling code to the Engine Control Module (ECM) (C0331) on a BP wire.

The immobilisation ECU (C0059) also provides a feed to the interlock relay (C1455) on a B wire. The energised interlock relay (C1455) provides a feed to the starter motor relay (C0179) on a B then BY wire.

For more information on operation of the starter motor, refer to the ***Starting and Charging*** – **V8** section of this manual.

 **STARTING AND CHARGING – V8.**

WINDOWS

DESCRIPTION

General

Operation of all four windows is controlled by the Body Control Unit (BCU) via the P-bus. The P-bus allows communication between the BCU and the drivers and passenger door modules. The door modules are mounted in the relevant front door. The drivers door module features four rocker switches, and a non-latching switch to inhibit operation of the rear windows. A rocker switch is also located on the front passenger door, and both rear passenger doors for operation of the relevant window.

Both front and rear windows feature an anti-trap function. If an obstacle is detected while the window is being closed, it will return to the fully open position.

For a detailed description of window lift operation, refer to the **Windows** section of the Description and Operation Workshop Manual.

For a detailed description of the P-bus, refer to the **Communication Databases** section of the Description and Operation Workshop Manual.

OPERATION

Front

Power Distribution

Feed from the positive battery terminal (C0192) is supplied to fuse 11, fuse 24, and fuse 53 of the passenger compartment fuse box (C0632) on an R wire. Fuse 11 (C0585) provides a constant battery feed to the drivers door module (C2017) on an RP wire. Fuse 24 (C0583) provides a constant battery feed to the passenger door module (C2016) on an RW wire.

Fuse 53 (C0583) provides a constant battery feed to the ignition switch (C0099 on Td6 vehicles, C0028 on V8 vehicles) on an R wire. When the ignition switch is turned to the 'auxiliary' position, current flows across the switch (C0099 on Td6 vehicles, C0028 on V8 vehicles) to fuse 41 of the passenger compartment fuse box (C0585) on a PB wire. Fuse 41 (C0586) provides an auxiliary ignition feed to the Body Control Unit (BCU) (C0660) on a PW wire. The BCU (C0662) is earthed on an N wire.

Drivers Window

When the drivers door switch is moved to the 'Up' position, the feed from fuse 11 of the passenger compartment fuse box (C0585) flows through the drivers door module (C2017) to earth on an N wire. The drivers door module (C2017) will now provide a feed to the window lift motor (C0740) on a BS wire. Current flows across the motor and back to the drivers door module (C2017) on a BG wire. The drivers door module provides an earth path for the motor on an N wire. When the current draw of the window lift motor increases, the BCU (via the P-bus) determines the window has reached the limit of its travel and cuts the supply from the drivers door module.

DESCRIPTION AND OPERATION

When the drivers door switch is moved to the 'Down' position, the feed from fuse 11 of the front passenger compartment fuse box (C0585) flows through the drivers door module (C2017) to earth on an N wire. The drivers door module (C2017) will now provide a feed to the window lift motor (C0740) on a BG wire. Current flows across the motor and back to the drivers door module (C2017) on a BS wire. The drivers door module provides an earth path for the motor on an N wire. When the current draw of the window lift motor increases, the BCU (via the P-bus) determines the window has reached the limit of its travel and cuts the supply from the drivers door module.

Front Passenger Window

When the passenger door switch is moved to the 'Up' position, the feed from fuse 24 of the passenger compartment fuse box (C0583) flows through the passenger door module (C2016) to earth on an N wire. The passenger door module (C2016) will now provide a feed to the window lift motor (C0741) on a BS wire. Current flows across the motor and back to the passenger door module (C2016) on a BG wire. The passenger door module provides an earth path for the motor on an N wire. When the current draw of the window lift motor increases, the BCU (via the P-bus) determines the window has reached the limit of its travel and cuts the supply from the passenger door module.

When the passenger door switch is moved to the 'Down' position, the feed from fuse 24 of the front passenger compartment fuse box (C0583) flows through the passenger door module (C2016) to earth on an N wire. The passenger door module (C2016) will now provide a feed to the window lift motor (C0741) on a BG wire. Current flows across the motor and back to the passenger door module (C2016) on a BS wire. The passenger door module provides an earth path for the motor on an N wire. When the current draw of the window lift motor increases, the BCU (via the P-bus) determines the window has reached the limit of its travel and cuts the supply from the passenger door module.

Anti-Trap

The anti-trap system consists of an anti-trap seal, which runs along the door glass frame. The seal contains two elements, with a combined resistance of 1.2 k Ω . This resistance is constantly monitored by the BCU via the P-bus. If the window meets an obstacle, it pushes it against the anti-trap seal. This 'shorts' the two elements together, reducing the seals resistance to approximately 500 Ω . When the BCU detects this drop in resistance, it reverses the feed to the window lift motor. Both the drivers door module (C2058) and the passenger door module (C2057) are connected to the anti-trap seals (C0599 & C0600 respectively) by NR wires. The anti-trap seals are both earthed on N wires.

Rear

Power Distribution

Feed from the positive battery terminal (C0192) is supplied to fuse 53 and fuse 60 of the passenger compartment fuse box (C0632) on an R wire. Fuse 60 (C0582) provides a constant battery feed to the BCU (C0662) on an RW wire.

Fuse 53 (C0583) provides a constant battery feed to the ignition switch (C0099 on Td6 vehicles, C0028 on V8 vehicles) on an R wire. When the ignition switch is turned to the 'auxiliary' position, current flows across the switch (C0099 on Td6 vehicles, C0028 on V8 vehicles) to fuse 41 of the passenger compartment fuse box (C0585) on a PB wire. Fuse 41 (C0586) provides an auxiliary ignition feed to the BCU (C0660) on a PW wire.

RH Rear Window

The BCU (C0660) provides a feed to the RH rear window switch (C0732) on SY then N and SU then SB wires. If the switch is moved to the 'Up' position, the switch contacts close momentarily, allowing the feed on the SY then N wire to flow to earth on an N wire. Sensing this earth path, the BCU (C0662) provides a feed to the RH rear window lift motor (C0304) on a BN then BG wire. Current flows across the motor (C0304) and back to the BCU (C0662) on a US then UP wire. When the current draw of the window lift motor increases, the BCU determines the window has reached the limit of its travel and cuts the supply to the motor.

If the switch is moved to the 'Down' position, the switch contacts close momentarily, allowing the feed on the SU then SB wire to flow to earth on an N wire. Sensing this earth path, the BCU (C0662) provides a feed to the RH rear window lift motor (C0304) on a UP then US wire. Current flows across the motor (C0304) and back to the BCU (C0662) on a BG then BN wire. When the current draw of the window lift motor increases, the BCU determines the window has reached the limit of its travel and cuts the supply to the motor.

LH Rear Window

The BCU (C0660) provides a feed to the LH rear window switch (C0732) on SN and SB wires. If the switch is moved to the 'Up' position, the switch contacts close momentarily, allowing the feed on the SN wire to flow to earth on an N wire. Sensing this earth path, the BCU (C0662) provides a feed to the LH rear window lift motor (C0304) on a BG wire. Current flows across the motor (C0304) and back to the BCU (C0662) on a US wire. When the current draw of the window lift motor increases, the BCU determines the window has reached the limit of its travel and cuts the supply to the motor.

If the switch is moved to the 'Down' position, the switch contacts close momentarily, allowing the feed on the SB wire to flow to earth on an N wire. Sensing this earth path, the BCU (C0662) provides a feed to the LH rear window lift motor (C0304) on a US wire. Current flows across the motor (C0304) and back to the BCU (C0662) on a BG wire. When the current draw of the window lift motor increases, the BCU determines the window has reached the limit of its travel and cuts the supply to the motor.

DESCRIPTION AND OPERATION

Anti-Trap

The anti-trap system consists of an anti-trap seal, which runs along the door glass frame. The seal contains two elements, with a combined resistance of 1.2 k. This resistance is constantly monitored by the BCU. If the window meets an obstacle, it pushes it against the anti-trap seal. This 'shorts' the two elements together, reducing the seals resistance to approximately 500 . When the BCU detects this drop in resistance, it reverses the feed to the window lift motor.

The BCU (C0661) is connected to the RH rear anti-trap seal (C2015) by an NR then NY wire, and to the LH rear anti-trap seal (C2015) by an NY wire. Both anti-trap seals (C2015) are earthed on N wires.

NOTE: Both rear anti-trap seals have the same connector number as they utilise the same harness.

SUNROOF

DESCRIPTION

General

Operation of the sunroof is controlled via the three position switch located on the front of the headlining. Moving the switch rearwards opens the sunroof. Similarly, moving the switch forward closes the sunroof. A single press in the centre of the switch opens or closes the sunroof from the tilt position.

All switch inputs are registered by the sunroof ECU, which is located behind the front of the headlining, adjacent the sunroof motor. The sunroof ECU also receives messages from the Body Control Unit (BCU) via the P-Bus to enable it to carry out its automatic closing and opening routine. Automatic closing is carried out when the 'Land Rover' button on the remote handset is pressed and held for longer than 2 seconds. Similarly, pressing and holding the 'Arrow' key on the remote handset for longer than 2 seconds opens both the sunroof and all windows.

For more information on P-Bus messages, refer to the **Communication Databases** section of the System Description and Operation Workshop Manual.

For more information on Sunroof operation, refer to the **Sunroof** section of the System Description and Operation Workshop Manual.

For more information on automatic opening and closing, refer to the **Anti-theft Alarm and Central Door Locking** section of this manual.

 **ANTI-THEFT ALARM AND CENTRAL DOOR LOCKING (CDL).**

OPERATION

Power Distribution

Feed from the positive battery terminal (C0192) is supplied to fuse 53, and fuse 58 of the passenger compartment fuse box (C0632) on an R wire. Fuse 58 (C0582) provides a constant battery feed to the sunroof ECU (C0784) on an RS wire. Fuse 53 (C0583) provides a constant battery feed to the ignition switch (C0099 on Td6 vehicles, C0028 on V8 vehicles) on an R wire. When the ignition switch is turned to the 'auxiliary' position, current flows across the switch (C0099 on Td6 vehicles, C0028 on V8 vehicles) to fuse 41 of the passenger compartment fuse box (C0585) on a PB wire. Fuse 41 (C0586) provides an auxiliary ignition feed to the Body Control Unit (BCU) (C0660) on a PW wire.

DESCRIPTION AND OPERATION

Sunroof ECU

The sunroof ECU (C0784) provides a feed to the sunroof switch (C0363) on a YS wire. If the switch is moved to the 'Open' position, a feed is returned to the ECU (C0784) on a YG wire. The ECU will now power the sunroof motor to open the sunroof. By measuring the voltage pulses returned from two Hall effect sensors located within the sunroof mechanism, the ECU can determine when the sunroof has reached the end of its travel and cut the voltage supply to the motor.

If the switch is moved to the 'Close' position, a feed is returned to the sunroof ECU (C0784) on an SB wire. The ECU will now power the sunroof motor to close the sunroof. By measuring the voltage pulses returned from the two Hall effect sensors, the ECU determines when the sunroof has reached the end of its travel and cuts the voltage supply to the motor.

If the centre of the switch is pressed, a feed is returned to the sunroof ECU (C0784) on a YW wire. The ECU will now power the sunroof motor in the 'Close' direction to raise the rear of the sunroof. By measuring the voltage pulses returned from the two Hall effect sensors, the ECU determines when the sunroof has reached the end of its travel and cuts the voltage supply to the motor.

If the centre of the switch is pressed a second time, a feed is returned to the sunroof ECU (C0784) on a YW wire. The ECU will now power the sunroof motor in the 'Open' direction to lower the sunroof. By measuring the voltage pulses returned from the two Hall effect sensors, the ECU determines when the sunroof has reached the end of its travel and cuts the voltage supply to the motor.

The sunroof ECU (C0784) is earthed on an N wire.

Body Control Unit (BCU)

The Body Control Unit (BCU) (C0660) communicates with the sunroof ECU (C0784) via the P-Bus. In addition to enabling automatic opening and closing to be carried out, the BCU also triggers the sunroof ECU into an energy saving 'sleep' mode.

For a detailed description of P-Bus operation and messages, refer to the **Communication Databases** section of the System Description Operation Workshop Manual.

DOOR MIRRORS

DESCRIPTION

General

The door mirrors operate when the ignition switch is turned to the 'auxiliary' position. Operation of the door mirrors is carried out by door modules located in each front door, in conjunction with the Body Control Unit (BCU).

The BCU can store up to three mirror positions in its memory, which it transmits to the door modules via the peripheral (P) bus. The BCU also initiates mirror heating if the outside temperature is between -10 °C and 35 °C.

If reverse gear is selected, the passenger door mirror will automatically lower to enable the driver to gain a better view of the kerb. When reverse gear is deselected, the mirror returns to its original position.

For a detailed description of door mirror operation, refer to the ***Exterior Fittings – Door Mirrors*** section of the Description and Operation Workshop Manual.

OPERATION

Power Distribution

Feed from the positive battery terminal (C0192) is supplied to fuse 11, fuse 24, and fuse 53 of the passenger compartment fuse box (C0632) on an R wire. Fuse 11 (C0585) provides a constant battery feed to the drivers door module (C2017) on an RP wire. Fuse 24 (C0583) provides a constant battery feed to the passenger door module (C2016) on an RW wire. The drivers (C2017) and passenger (C2016) door modules are both earthed on N wires.

Fuse 53 (C0583) provides a constant battery feed to the ignition switch (C0099 on Td6 vehicles, C0028 on V8 vehicles) on an R wire. When the ignition switch is turned to the 'auxiliary' position, current flows across the switch (C0099 on Td6 vehicles, C0028 on V8 vehicles) to fuse 41 of the passenger compartment fuse box (C0585) on a PB wire. Fuse 41 (C0586) provides an auxiliary ignition feed to the Body Control Unit (BCU) (C0660) on a PW wire. The BCU (C0662) is earthed on an N wire.

DESCRIPTION AND OPERATION

Drivers Door Mirror

Horizontal Adjustment

When RH adjustment of the drivers door mirror is required, the drivers door module (C2271) provides a feed to the horizontal motor on a G wire. Current flows across the motor and back to the drivers door module (C2271) on an R wire. If LH adjustment of the drivers door mirror is required, the feed to the horizontal motor is reversed. The motor is provided a feed on an R wire, with an earth path provided by the drivers door module (C2271) via a G wire.

To prevent the vertical motor from operating, the drivers door module (C2271) also provides a feed to the vertical motor on an S wire. As the potential difference across the motor is 0V, the motor does not operate.

Vertical Adjustment

When upwards adjustment of the drivers door mirror is required, the drivers door module (C2271) provides a feed to the vertical motor on an S wire. Current flows across the motor and back to the drivers door module (C2271) on an R wire. If downwards adjustment of the drivers door mirror is required, the feed to the vertical motor is reversed. The motor is provided a feed on an R wire, with an earth path provided by the drivers door module (C2271) via an S wire.

To prevent the horizontal motor from operating, the drivers door module (C2271) also provides a feed to the horizontal motor on a G wire. As the potential difference across the motor is 0V, the motor does not operate.

Mirror Memory

The door mirror memory function works in conjunction with the seat and steering wheel memory functions. The BCU (C0660) receives a memory request from the seat memory ECU (C0862) via the K-bus on a WRY wire. The BCU (C0660) relays this message to the drivers door module (C2058) via the P-bus on a UR wire.

When the drivers door module receives a memory request it moves the mirrors as described above. Two potentiometers are fitted within the mirror assembly to determine its position. The drivers door module (C2271) provides a feed to both potentiometers on an O wire. The horizontal potentiometer is provided an earth path by the drivers door module (C2271) on a B wire. By measuring the current returned on a W wire, the drivers door module can determine the mirror's horizontal position.

The vertical potentiometer is also provided an earth path by the drivers door module (C2271) on a B wire. By measuring the current returned on a K wire, the drivers door module can determine the mirror's vertical position.

Mirror Fold

A non-latching mirror folding switch is located on the drivers door module. When the switch is pressed a first time, the drivers door module (C2271) provides a feed to the mirror fold motor on an RU wire. Current flows across the motor and back to the drivers door module (C2271) on a GN wire. The drivers door mirror now moves to the folded position. If the switch is pressed a second time, the feed to the fold motor is reversed. The motor is provided a feed on a GN wire, with an earth path provided by the drivers door module (C2271) via an RU wire.

NOTE: Mirror fold is disabled if vehicle speed is greater than 10 km/h (6 mph).

The drivers door module (C2058) communicates the mirror fold request to the passenger door module (C2057) via the P-bus on a UR wire.

Mirror Heater

If the BCU (C0660) receives an outside temperature reading of between -10 °C and 35 °C, it informs the drivers door module (C2058) to initiate mirror heating via the P-bus on a UR wire. Pin 7 of the drivers door module (C2271) provides a feed to the door mirror heater on a B wire. An earth path is provided via pin 6 of the drivers door module (C2271), also on a B wire.

Passenger Door Mirror

Horizontal Adjustment

When RH adjustment of the passenger door mirror is required, the passenger door module (C2271) provides a feed to the horizontal motor on a G wire. Current flows across the motor and back to the passenger door module (C2271) on an R wire. If LH adjustment of the passenger door mirror is required, the feed to the horizontal motor is reversed. The motor is provided a feed on an R wire, with an earth path provided by the passenger door module (C2271) via a G wire.

To prevent the vertical motor from operating, the passenger door module (C2271) also provides a feed to the vertical motor on an S wire. As the potential difference across the motor is 0V, the motor does not operate.

Vertical Adjustment

When upwards adjustment of the passenger door mirror is required, the passenger door module (C2271) provides a feed to the vertical motor on an S wire. Current flows across the motor and back to the passenger door module (C2271) on an R wire. If downwards adjustment of the passenger door mirror is required, the feed to the vertical motor is reversed. The motor is provided a feed on an R wire, with an earth path provided by the passenger door module (C2271) via an S wire.

To prevent the horizontal motor from operating, the passenger door module (C2271) also provides a feed to the horizontal motor on a G wire. As the potential difference across the motor is 0V, the motor does not operate.

DESCRIPTION AND OPERATION

Mirror Memory

The door mirror memory function works in conjunction with the seat and steering wheel memory functions. The BCU (C0660) receives a memory request from the seat memory ECU (C0862) via the K-bus on a WRY wire. The BCU (C0660) relays this message to the passenger door module (C2057) via the P-bus on a UR wire.

When the passenger door module receives a memory request it moves the mirrors as described above. Two potentiometers are fitted within the mirror assembly to determine its position. The passenger door module (C2271) provides a feed to both potentiometers on an O wire. The horizontal potentiometer is provided an earth path by the passenger door module (C2271) on a B wire. By measuring the current returned on a W wire, the passenger door module can determine the mirror's horizontal position.

The vertical potentiometer is also provided an earth path by the passenger door module (C2271) on a B wire. By measuring the current returned on a K wire, the passenger door module can determine the mirror's vertical position.

Mirror Fold

When the passenger door module (C2057) receives a folding request from the drivers door module (C2058) via the P-bus, it provides a feed to the folding mirror motor on an RU wire. Current flows across the motor and back to the passenger door module (C2271) on a GN wire. The passenger door mirror now moves to the folded position. If the passenger door module receives a second fold request, the feed to the folding mirror is reversed. The motor is provided a feed on a GN wire, with an earth path provided by the passenger door module (C2271) via an RU wire.

NOTE: Mirror fold is disabled if vehicle speed is greater than 10 km/h (6 mph).

Mirror Heater

If the BCU (C0660) receives an outside temperature reading of between -10 °C and 35 °C, it informs the passenger door module (C2057) to initiate mirror heating via the P-bus on a UR wire. Pin 7 of the drivers door module (C2271) provides a feed to the door mirror heater on a B wire. An earth path is provided via pin 6 of the drivers door module (C2271), also on a B wire.

NOTE: The driver and passenger door modules have the same connector numbers as they utilise the same harness.

Door Mirror Memory

Door mirror memory information is stored in the driver and passenger door modules. When the memory function is selected, the BCU (C0660) informs the driver (C2058) and passenger (C2057) door modules to move the mirrors to the required position via the P-bus on a UR wire.

INTERIOR MIRROR

DESCRIPTION

General

New Range Rover is fitted with an automatically dimming 'electrochromic' interior mirror. A light sensor, incorporated into the interior mirror, dims the mirror if it detects a light source behind the vehicle. The interior mirror also provides an output to both door mirrors, allowing dimming of all three rear view mirrors.

OPERATION

Power Distribution

Feed from the positive battery terminal (C0192) is supplied to fuse 43 and fuse 53 of the passenger compartment fuse box (C0632) on an R wire. Fuse 43 (C0586) provides a constant battery feed to the interior mirror (C0698) on an RY wire.

Fuse 53 (C0583) provides a constant battery feed to the ignition switch (C0099 on Td6 vehicles, C0028 on V8 vehicles) on an R wire. When the ignition switch is turned to the 'ignition' position, current flows across the switch (C0099 on Td6 vehicles, C0028 on V8 vehicles) to fuse 6 of the passenger compartment fuse box (C0585) on a G wire. Fuse 6 (C0587) provides an auxiliary ignition feed to the interior mirror (C0698) on a GW wire. The interior mirror (C0698) is earthed on an NB wire.

Automatic Dimming

When the light sensor incorporated in the interior mirror detects a light source from behind the vehicle, it automatically dims the interior mirror. When this happens, the interior mirror will also dim both the drivers and passenger door mirrors.

Drivers Door Mirror

The interior mirror (C0698) provides an output to the drivers door mirror (C2292) on WR then P and WU then B wires. When the drivers door mirror receives these feeds, it automatically dims. When the light source is removed from behind the vehicle, the feeds are removed and the drivers door mirror returns to normal brightness.

Passenger Door Mirror

The interior mirror (C0698) provides an output to the passenger door mirror (C2292) on WG then P and WY then B wires. When the passenger door mirror receives these feeds, it automatically dims. When the light source is removed from behind the vehicle, the feeds are removed and the passenger door mirror returns to normal brightness.

NOTE: The drivers and passenger door mirrors have the same connector number as they utilise the same harness.

DESCRIPTION AND OPERATION

Reverse Gear Inhibit

The automatic dimming function of the electrochromic interior mirror is inhibited if reverse gear is selected. The Light Check Module (LCM) (C2040) provides a 'reverse gear selected' signal to the interior mirror (C0698) on a UY wire.

Anti-theft Alarm LED

The anti-theft alarm LED is located on the interior mirror (C0698) and receives a signal from the BCU (C0661) on an SBY wire. For more information on anti-theft alarm operation, refer to the ***Anti-theft Alarm and Central Door Locking (CDL)*** section of this manual.

 **ANTI-THEFT ALARM AND CENTRAL DOOR LOCKING (CDL).**

FRONT SEATS

DESCRIPTION

General

Two levels of electric front seats are fitted to Range Rover, with a memory function available as an option. The memory function is capable of storing up to three seat positions. The standard electric front seats have four motors to control the following:

- Horizontal movement
- Seat height
- Seat angle
- Seat backrest recline.

The higher specification 'Contour' seat has two additional motors which control the following:

- Headrest movement
- Additional upper backrest adjustment.

For a detailed description of front seat operation, refer to the **Body – Seats** section of the System Description and Operation Workshop manual.

OPERATION

Power Distribution

Feed from the positive battery terminal (C0192) is provided to the seat relay and fuse 53. Both are located in the passenger compartment fuse box (C0632). Fuse 53 (C0583) provides a constant battery feed to the ignition switch (C0099 on Td6 vehicles, C0028 on V8 vehicles) on an R wire.

When the ignition switch is turned to the 'ignition' position, current flows across the switch (C0099 on Td6 vehicles, C0028 on V8 vehicles) to the seat relay coil (C0585) on a G wire. Current flows through the seat relay coil (C0583) to earth on an N wire. This energises the seat relay. The energised seat relay provides a feed to fuse 20 and fuse 21, which are also located in the passenger compartment fuse box.

Non-Memory Drivers Seat

Fuse 20 (C0584) provides a feed to the LH seat switch pack (C0773) on an RN wire. Fuse 21 (C0584) provides a feed to the RH seat switch pack (C0774) on an RN wire. Both the LH (C0773) and the RH (C0774) seat switch packs are earthed on N wires.

Memory Drivers Seat

Fuse 20 (C0584) provides a feed to the seat memory ECU (C0722) on an RN wire, and the upper backrest motor (C2308) on an RN then R wire. The seat memory ECU (C0722) is earthed on an N and an NB wire. The upper backrest motor (C2308) is earthed on an N wire.

NOTE: The upper backrest motor is only fitted on the 'Comfort' seat.

DESCRIPTION AND OPERATION

RH Front Seat

Horizontal Movement

A single seat motor controls horizontal movement of the RH front seat. To move the seat forwards and backwards, the RH seat switch pack (C0774) provides feeds to the forward/backward seat motor (C0721) on GY and BY wires.

Vertical Movement

Two seat motors are used to control vertical movement of the RH front seat; one for the front of the seat, and one for the rear. To move the front of the seat up and down, the RH seat switch pack (C0774) provides feeds to the front up/down motor (C0097) on PR and UR wires. To move the rear of the seat up and down, the RH seat switch pack (C0774) provides feeds to the rear up/down motor (C0475) on UG and PG wires.

Recline

A single seat motor controls RH front seat backrest recline. To recline the backrest, the RH seat switch pack (C0774) provides feeds to the recline motor (C0718) on GP and BP wires.

Upper Backrest

A single seat motor controls movement of the RH front seat upper backrest. To move the upper backrest, the RH seat switch pack (C0774) provides feeds to the motor (C1418) on GR and GU wires.

LH Front Seat

Horizontal Movement

A single seat motor controls horizontal movement of the LH front seat. To move the seat forwards and backwards, the LH seat switch pack (C0773) provides feeds to the forward/backward seat motor (C0720) on GY and BY wires.

Vertical Movement

Two seat motors are used to control vertical movement of the LH front seat; one for the front of the seat, and one for the rear. To move the front of the seat up and down, the LH seat switch pack (C0773) provides feeds to the front up/down motor (C1637) on PR and UR wires. To move the rear of the seat up and down, the LH seat switch pack (C0773) provides feeds to the rear up/down motor (C1636) on UG and PG wires.

Recline

A single seat motor controls LH front seat backrest recline. To recline the backrest, the LH seat switch pack (C0773) provides feeds to the recline motor (C0518) on GP and BP wires.

Upper Backrest

A single seat motor controls movement of the LH front seat upper backrest. To move the upper backrest the LH seat switch pack (C0773) provides feeds to the motor (C1419) on GR and GU wires.

Memory Drivers Seat

When the memory function is selected, the seat memory ECU (C0722) transmits the relevant data along the K-bus to the Body Control Unit (BCU) (C0660) on a WRY wire. The BCU then moves both the steering column and the door mirrors to the required position. For more information on door mirror operation, refer to the **Door Mirrors** section of this manual.

 **DOOR MIRRORS.**

For more information on steering column operation, refer to the **Steering Column** section of this manual.

 **STEERING COLUMN.**

Horizontal Movement

When the memory function is selected, the seat memory ECU (C0772) provides feeds to the forward/backward seat motor (C0720) on a pair of R wires. The seat memory ECU (C0772) monitors the position of the seat by measuring the voltage pulses returned from the hall effect sensor (C0720) on an R wire.

Vertical Movement

When the memory function is selected, the seat memory ECU (C0772) provides feeds to the front (C1637) and rear (C1636) up/down motors on R wires. The seat memory ECU (C0772) monitors the position of the seat by measuring the voltage pulses returned from the hall effect sensors (C1637 & C1636) on R wires.

Recline

When the memory function is selected, the seat memory ECU (C0772) provides feeds to the backrest recline seat motor (C0518) on a pair of R wires. The seat memory ECU (C0772) monitors the position of the seat by measuring the voltage pulses returned from the hall effect sensor (C0518) on an R wire.

Headrest

When the memory function is selected, the seat memory ECU (C0772) provides feeds to the headrest seat motor (C1419) on a pair of R wires. The seat memory ECU (C0772) monitors the position of the headrest by measuring the voltage pulses returned from the hall effect sensor (C1419) on an R wire.

DESCRIPTION AND OPERATION

FRONT HEATED SEATS

DESCRIPTION

General

Operation of the front electric seats is controlled by the Automatic Temperature Control (ATC) ECU via the two centre console mounted switches. Pressing the relevant seat heat switch once will heat the seat to a temperature of 44 °C (111 °F) and illuminate two LED's on the switch face. Pressing the seat heat switch a second time will lower the temperature to 39 °C (102 °F) and illuminate one LED on the switch face. Pressing the switch a third time switches off the seat heat function and extinguishes the remaining LED.

OPERATION

Power Distribution

Feed from the positive battery terminal (C0192) is supplied to fuse 12 and fuse 52 of the passenger compartment fuse box (C0632) on an N wire. Fuse 12 (C0586) provides a constant battery feed to the ATC ECU (C1629) on an RP wire. Fuse 52 (C0582) provides a constant battery feed to the ATC ECU (C0249) on a PU wire. The ATC ECU (C1630) is earthed on an N wire.

RH Seat

When the non-latching RH seat heat switch is pressed, the ATC ECU (C0249) provides a feed to the cushion heater matrix (C0969) and the backrest heater matrix (C0971) on GY wires. Both matrices are earthed on N wires.

The ATC ECU (C1629) monitors the temperature of the cushion heater matrix (C0969) by providing a feed to a Negative Temperature Coefficient (NTC) sensor on a WU wire. The sensor is earthed on an N wire. By calculating the resistance of the NTC sensor, the ATC ECU can determine the temperature of the seat and regulate the supply voltage to the heater matrices accordingly.

LH Seat

When the non-latching LH seat heat switch is pressed, the ATC ECU (C0249) provides a feed to the cushion heater matrix (C2090) and the backrest heater matrix (C2091) on GP wires. Both matrices are earthed on N wires.

The ATC ECU (C1629) monitors the temperature of the cushion heater matrix (C2090) by providing a feed to a Negative Temperature Coefficient (NTC) sensor on a WG wire. The sensor is earthed on an N wire. By calculating the resistance of the NTC sensor, the ATC ECU can determine the temperature of the seat and regulate the supply voltage to the heater matrices accordingly.

REAR HEATED SEATS

DESCRIPTION

General

Operation of the rear electric seats is controlled by the two seat heat switches located on the rear face of the centre console. Pressing the relevant seat heat switch once will heat the seat to a temperature of 44 °C (111 °F) and illuminate two LED's on the switch face. Pressing the seat heat switch a second time will lower the temperature to 39 °C (102 °F) and illuminate one LED on the switch face. Pressing the switch a third time switches off the seat heat function and extinguishes the remaining LED.

OPERATION

Power Distribution

Feed from the positive battery terminal (C0192) is supplied to fusible link 1 and fuse 53 of the passenger compartment fuse box (C0632) on an R wire. Fusible link 1 (C0588) is connected to fuse 11 of the rear fuse box (C2024) by an R wire. Fuse 11 provides a constant battery feed to the rear heated seat relay, which is also located in the rear fuse box.

Fuse 53 of the passenger compartment fuse box (C0583) is connected to the ignition switch (C0099) by a G wire. When the ignition switch is turned to the 'ignition' position, current flows across the switch (C0099 on Td6 vehicles, C0028 on V8 vehicles) to fuse 2 of the passenger compartment fuse box (C0585) on a G wire. Fuse 2 (C0587) provides an ignition feed to the rear heated seat relay coil (C2022) on a GY wire. The relay coil (C2021) is earthed on an N wire. The energised rear heated seat relay (C2021) provides a feed to the LH rear seat heat switch (C1401) on a GW wire, and the RH rear seat heat switch (C1403) on a GN wire. Both switches are earthed on NB wires.

RH Rear Seat

When the RH rear seat heat switch (C1401) is pressed it provides a feed to the cushion heater matrix (C2085) on a WY wire. The heater matrix (C2085) is earthed on an N wire. The seat heat switch (C1401) monitors the temperature of the cushion heater matrix (C2085) by providing a feed to a Negative Temperature Coefficient (NTC) sensor on a YN wire. The sensor is earthed on an N wire. By calculating the resistance of the NTC sensor, the switch can determine the temperature of the seat and regulate the supply voltage to the RH rear heater matrix accordingly.

LH Rear Seat

When the LH rear seat heat switch (C1403) is pressed it provides a feed to the cushion heater matrix (C2084) on a BY wire. The heater matrix (C2084) is earthed on an N wire. The seat heat switch (C1403) monitors the temperature of the cushion heater matrix (C2084) by providing a feed to a Negative Temperature Coefficient (NTC) sensor on a WN wire. The sensor is earthed on an N wire. By calculating the resistance of the NTC sensor, the switch can determine the temperature of the seat and regulate the supply voltage to the LH rear heater matrix accordingly.

DESCRIPTION AND OPERATION

DIAGNOSTIC SOCKET

DESCRIPTION

General

The diagnostic socket is located behind an access panel on the drivers side of the fascia. The socket is constructed to SAE directive J1962 standard and allows attachment of TestBook or T4. The diagnostic socket allows detailed fault diagnosis checks to be carried out on the vehicle via an ISO 9141 K Line Bus and the Diagnostic DS2 Bus.

OPERATION

Power Distribution

Feed from the positive battery terminal (C0192) is supplied to fuse 15 and fuse 53 of the passenger compartment fuse box (C0632) on an R wire. Fuse 15 (C0586) provides a constant battery feed to the diagnostic socket (C0040) on an RUY wire.

Fuse 53 (C0583) provides a constant battery feed to the ignition switch (C0099 on Td6 vehicles, C0028 on V8 vehicles) on an R wire. When the ignition switch is turned to the 'ignition' position, current flows across the switch (C0099 on Td6 vehicles, C0028 on V8 vehicles) to fuse 5 of the passenger compartment fuse box (C0585) on a G wire. Fuse 5 (C0587) provides an ignition feed to the diagnostic socket (C0040) on a GW wire. The diagnostic socket (C0040) is earthed on a pair of NB wires.

Diagnostic DS2 Bus

The following are connected to the diagnostic socket (C0040) via the diagnostic DS2 Bus on WP wires:

- Transfer box ECU (C1319).
- ABS ECU (C0506).
- LH Xenon Lamp ECU (C0009).
- RH Xenon Lamp ECU (C0011).
- Steering angle sensor (C0862).
- Instrument pack (C0233).

K Line Bus

The following are connected to the diagnostic socket (C0040) via the K line Bus:

- The V8 ECM (C0331) on WPY and B wires.
- The Td6 ECM (C0331) on WPY and B wires.
- The ZF automatic transmission ECU (C0932) on a WPY then WP wire.

STARTING AND CHARGING – Td6

DESCRIPTION

Starting

The starting system on the vehicle comprises a 12 V starter motor which drives the engine to start the combustion process. The starter converts electrical energy into mechanical power. The vehicle electrical system must be capable of supplying sufficient power to enable the engine to be cranked.

Range Rover features 'lazy starting'. This entails the driver not having to hold the ignition key in the 'crank position'. Starting of the engine is controlled automatically by the Engine Control Module (ECM), which provides power to the starter motor until engine speed is greater than 400 rpm.

Charging

The charging system comprises a battery and an alternator. The battery must be of a sufficient capacity to operate the starter motor and operate the various electrical systems in the vehicle. The alternator charges the battery when the engine is running and increases its output as demand on the battery increases.

CAUTION: The battery positive terminal uses a pyrotechnic attachment which detaches the battery cable in the event of a crash severe enough to trigger the airbags. Refer to the Supplementary Restraint System section of the System Description and Operation Workshop manual for further details.

The alternator is located at the front LH side of the engine, below the steering pump. The alternator has an output of 90/150 Amps and is manufactured by Valeo. A polyvee belt drives the alternator pulley, which in turn is driven from the engine crankshaft pulley.

The instrument pack incorporates a charge warning lamp which illuminates when there is no output or a low output from the alternator. For a detailed description of the starting and charging system, refer to the **Engine Management System – Td6** section of the System Description and Operation Workshop manual.

DESCRIPTION AND OPERATION

OPERATION

Power Distribution

Feed from the positive battery terminal (C0192) is supplied to the fuse holder (C1875) on an R wire. A constant battery feed is also supplied to fusible link 2 and fuse 53 of the passenger compartment fuse box (C0632) on an R wire.

The 100A fuse located in the fuse holder (C1875) provides a constant battery feed to the glow plug timer (C0189) on an R wire. A second 100A fuse in the fuse holder (C1875) provides a constant battery feed to the Engine Control Module (ECM) relay (C1895) on an R wire.

Fuse 53 of the passenger compartment fuse box (C0583) provides a constant battery feed to the ignition switch (C0099) on an R wire. When the ignition switch is turned to the 'ignition' position, current flows across the switch (C0099) to fuse 5 of the passenger compartment fuse box (C0585) on an G wire. Fuse 5 (C0587) provides an ignition feed to the alternator (C0053) on a GW wire.

Fusible link 2 of the passenger compartment fuse box (C0591) is connected to the ignition switch (C0099) by an R wire. When the ignition switch is turned to the 'crank' position, current flows across the switch (C0099) to the immobilisation ECU (C0059) on a BY wire.

Starting

ECM Relay

The ECM relay coil (C1895) is provided a constant battery feed from the 100A fuse located in the fuse holder (C1875) on an R wire. The earth path for the relay coil (C1895) is controlled by the ECM (C0603) on an N wire. If the ECM has received a valid 'remobilisation' signal from the immobilisation ECU, it will energise the ECM relay. The energised ECM relay (C1895) provides a feed to fuse 2 of the engine compartment fuse box (C0570) on an RW wire. Fuse 2 (C0570) is connected to the glow plug timer (C0190) by an R then RW wire.

Glow Plug Timer

The glow plug timer receives a constant battery feed from the 100A fuse located in the fuse holder (C1875) on an R wire, and a second feed from the energised ECM relay (C1895) via fuse 2 of the engine compartment fuse box (C0570) on an R then RW wire.

When all starting parameters have been met, the ECM (C0606) provides a control feed to the glow plug timer (C0190) on a BR wire. The glow plug timer (C0190) will now power the glow plugs as follows:

- Glow plug number 1 (C0476) on a BG wire.
- Glow plug number 2 (C0477) on a BP wire.
- Glow plug number 3 (C0478) on a BY wire.
- Glow plug number 4 (C0479) on a BR wire.
- Glow plug number 5 (C1500) on a BW wire.
- Glow plug number 6 (C1501) on a BN wire.

All six glow plugs are earthed via their fixings. The glow plug timer (C0190) is earthed on an NO wire.

The ECM (C0606) monitors the fault status of the glow plug timer (C0190) via a BY wire.

Starter Motor

The battery (C1641) provides a constant battery feed to the starter motor solenoid (C0178) on an R wire. Operation of the starter solenoid is controlled by the immobilisation ECU. When the immobilisation ECU (C0059) receives an ignition crank feed from the ignition switch (and all other starting parameters have been met) it provides a feed to the starter motor solenoid (C0179) on a B then BY wire. The energised starter solenoid allows the battery feed to power the starter motor.

The starter motor (C0823) also provides an 'engine start' signal back to the ECM (C0606) on a BG wire.

Fuel Pump

When the engine is started, the ECM (C0331) provides an earth path for the fuel pump relay coil (C2022) on a BP wire. The energised fuel pump relay (C2022) provides a feed to the fuel pump (C0114) on a WU wire. The fuel pump (C0114) is earthed on an N wire.

DESCRIPTION AND OPERATION

Charging

The battery (C1641) provides a permanent feed to the alternator (C0183) via the starter motor (C0178) on an R wire. Fuse 5 of the passenger compartment fuse box (C0587) provides an ignition feed to the alternator (C0053) on a GW wire.

When the engine is cranked, the alternator (C0053) supplies the ECM (C0606) a Pulse Width Modulated (PWM) signal on a U wire. The ECM uses this PWM signal to calculate the electrical load on the alternator, and controls engine idle speed accordingly.

When the engine is started, the magnetised rotor within the stator windings generate 3 phase alternating current (ac) and voltage that rises rapidly with rotor speed. The field diodes in the rectifier pack convert the ac current into direct current (dc). Output current from the field diodes supplements the initial current flowing through the field windings. This causes an increase in the magnetic influence of the rotor, resulting in self-excitation of the alternator. The field current increases with rotor speed and thus increases the generated current and voltage until the alternator is fully excited. The alternator (C0178) charges the battery (C1641) by providing current on an R wire.

STARTING AND CHARGING – V8

DESCRIPTION

Starting

The starting system on the vehicle comprises a 12 V starter motor which drives the engine to start the combustion process. The starter converts electrical energy into mechanical power. The vehicle electrical system must be capable of supplying sufficient power to enable the engine to be cranked.

Range Rover features 'lazy starting'. This entails the driver not having to hold the ignition key in the 'crank position'. Starting of the engine is controlled automatically by the Engine Control Module (ECM), which provides power to the starter motor until engine speed is greater than 920 rpm (engine cold) or 680 rpm (engine warm).

Charging

The charging system comprises a battery and an alternator. The battery must be of a sufficient capacity to operate the starter motor and operate the various electrical systems in the vehicle. The alternator charges the battery when the engine is running and increases its output as demand on the battery increases.

CAUTION: The battery positive terminal uses a pyrotechnic attachment which detaches the battery cable in the event of a crash severe enough to trigger the airbags. Refer to the Supplementary Restraint System section of the System Description and Operation Workshop manual for further details.

The alternator is located at the front LH side of the engine. The alternator has an output of 90/150 Amps and is manufactured by Bosch. A polyvee belt drives the alternator pulley, which in turn is driven from the engine crankshaft pulley.

The instrument pack incorporates a charge warning lamp which illuminates when there is no output or a low output from the alternator. For a detailed description of the starting and charging system, refer to the **Engine Management System – V8** section of the System Description and Operation Workshop manual.

DESCRIPTION AND OPERATION

OPERATION

Power Distribution

Feed from the positive battery terminal (C0192) is supplied to fuse 25 and fuse 53 of the passenger compartment fuse box (C0632) on an R wire. Fuse 53 (C0583) is connected to the ignition switch (C0028) by an RU wire. When the ignition switch is turned to the 'ignition' position, current flows across the switch (C0028) to fuse 5 of the passenger compartment fuse box (C0585) on a G wire. Fuse 5 (C0587) provides an ignition feed to the alternator (C0053) on a GW wire.

Fuse 25 of the passenger compartment fuse box (C0583) is connected to the ignition switch (C0028) by an R wire. When the ignition switch is turned to the 'crank' position, current flows across the switch (C0028) to the Engine Control Module (ECM) (C0331) on a BY wire, and the ignition coil relay (C2089) on a G then GN wire.

Starting

Starter Motor

The starter motor solenoid (C0178) is provided a constant battery feed from the battery (C0192) on an R wire. If all parameters for starting have been met, the ECM (C0331) provides a feed to the automatic transmission interlock relay (C1455) on a YN wire. If the gear selector lever is in 'Park' or 'Neutral', the interlock relay (C1455) provides a feed to the starter solenoid (C0179) on a B then BY wire. The energised starter solenoid allows the battery feed to power the starter motor.

The starter motor (C0179) also provides an 'engine start' signal back to the ECM (C0606) on a BG wire.

Ignition Coils

The ignition coil relay (C2089) receives an 'engine crank' feed from the ignition switch (C0028) on a GN wire. The relay coil (C2089) is earthed on an N wire. The energised ignition coil relay (C2089) provides a feed to the following on G wires:

- Ignition coil 1 (C0156).
- Ignition coil 2 (C0052).
- Ignition coil 3 (C0276).
- Ignition coil 4 (C1770).
- Ignition coil 5 (C1771).
- Ignition coil 6 (C1772).
- Ignition coil 7 (C2087).
- Ignition coil 8 (C2088).

Fuel Pump

When the engine is started, the ECM (C0331) provides an earth path for the fuel pump relay coil (C2022) on a BP wire. The energised fuel pump relay (C2020) provides a feed to the fuel pump (C0114) on a WU wire. The fuel pump (C0114) is earthed on an N wire.

Charging

The battery (C0192) provides a permanent feed to the alternator (C0183) on an R wire. Fuse 5 of the passenger compartment fuse box (C0587) provides an ignition feed to the alternator (C0053) on a GW wire.

When the engine is cranked, the alternator (C0053) supplies the ECM (C0606) a Pulse Width Modulated (PWM) signal on a U wire. The ECM uses this PWM signal to calculate the electrical load on the alternator, and controls engine idle speed accordingly.

When the engine is started, the magnetised rotor within the stator windings generate 3 phase alternating current (ac) and voltage that rises rapidly with rotor speed. The field diodes in the rectifier pack convert the ac current into direct current (dc). Output current from the field diodes supplements the initial current flowing through the field windings. This causes an increase in the magnetic influence of the rotor, resulting in self-excitation of the alternator. The field current increases with rotor speed and thus increases the generated current and voltage until the alternator is fully excited. The alternator (C0183) charges the battery (C0192) by providing current on an R wire.

DESCRIPTION AND OPERATION

CRUISE CONTROL

DESCRIPTION

General

The cruise control system is enabled by pressing the non-latching master switch located on the LH steering wheel switch pack. The system is controlled by the Engine Control Module (ECM), which receives commands from the 'SET+' and 'RES' switches, which are also located on the LH steering wheel switch pack. The ECM interprets the messages sent from the steering wheel switches and then controls the speed of the vehicle using electric throttle intervention.

For a detailed description of cruise control operation, refer to the **Engine Management – Td6** or **Engine Management – V8** section of the Description and Operation Workshop Manual.

OPERATION

Power Distribution

Feed from the positive battery terminal (C0192) is supplied to fuse 53 of the passenger compartment fuse box (C0632) on an R wire. Fuse 53 (C0583) is connected to the ignition switch (C0099 on Td6 vehicles, C0028 on V8 vehicles) by an R wire. When the ignition switch is turned to the 'auxiliary' position, current flows across the switch (C0099 on Td6 vehicles, C0028 on V8 vehicles) to fuse 9 of the passenger compartment fuse box (C0585) on a PB wire. Fuse 9 (C0587) provides an auxiliary ignition feed to the rotary coupler (C0082) on a PY wire.

When the ignition switch is turned to the 'ignition' position, current flows across the switch (C0099 on Td6 vehicles, C0028 on V8 vehicles) to fuse 31 of the passenger compartment fuse box (C0585) on a G wire. Fuse 31 (C0587) provides an ignition feed to the Engine Control Module (ECM) (C0331) on a GB wire.

Throttle Position (TP) Sensor

The TP sensor (C0787) comprises two potentiometer tracks. Track 1 is provided a 5V reference feed by the ECM (C0331) on a Y wire. Track 2 is provided a 5V reference feed by the ECM (C0331) on a YG wire. Track 1 provides a throttle position signal back to the ECM on a W wire. This signal will be approximately 0.5V with the pedal at rest, and 2V at full throttle. Track 2 provides a throttle position signal back to the ECM on a WG wire. This signal will be approximately 0.5V with the throttle at rest, and 4.5V at full throttle. The ECM also provides an earth path for track 1 and track 2 on NG and UG wires respectively.

For more information of TP sensor operation, refer to the **Engine Management – Td6** or **Engine Management – V8** section of the System Description and Operation Workshop Manual.

Brake Pedal Switch

Fuse 9 of the passenger compartment fuse box (C0586) provides an auxiliary ignition feed to the brake pedal switch (C0075) on a PY wire. When the brake pedal is pressed, the switch (C0075) provides the ECM (C0331) a voltage of between 6 V and battery voltage on an NS wire. When the pedal is released, the switch provides the ECM a voltage of between approximately 0 and 2 V. Once the ECM registers the brake pedal has been pressed, it will suspend cruise control operation.

The brake pedal switch (C0075) also provides a test signal to the ECM (C0331) on a UR wire. The switch (C0075) is earthed on an NB wire.

CAN Bus

When cruise control is activated, the ECM (C0331) informs the automatic transmission ECU via the CAN Bus on YN (low) and YB (high) wires. The automatic transmission ECU will change its shift patterns accordingly. For more information on automatic transmission operation, refer to the **Automatic Transmission – ZF 5HP24** or **Automatic Transmission – GM5L40–E** section of the System Description and Operation Workshop Manual, and the **Electronic Automatic Transmission – ZF** or **Electronic Automatic Transmission – GM5** section of this manual.



ELECTRONIC AUTOMATIC TRANSMISSION (EAT) – ZF.



ELECTRONIC AUTOMATIC TRANSMISSION (EAT) – GM5.

Rotary Coupler

The rotary coupler (C0082) receives an ignition feed from fuse 9 of the passenger compartment fuse box (C0587) on a PY wire, and is earthed on an NB wire. The rotary coupler (C2287) receives voltage pulse messages from the LH steering wheel module (C2283) as follows:

- A cruise control on/off signal on a W wire.
- A set/accelerate signal on a U wire.
- A decelerate signal on an R wire.
- A resume signal on a B wire.

The messages from the LH steering wheel module are relayed from the rotary coupler (C0082) to the ECM (C0331) on a YB wire. The ECM interprets this message and controls the throttle pedal accordingly.

DESCRIPTION AND OPERATION

ELECTRONIC AUTOMATIC TRANSMISSION (EAT) – GM5

DESCRIPTION

General

The GM 5L40-E transmission is an electrically controlled, five speed unit and is mated with the Td6 diesel engine. The transmission is controlled by an Electronic Automatic Transmission (EAT) ECU which contains software to provide operation as a semi-automatic 'Steptronic' transmission. This allows the transmission to be operated as a conventional automatic unit by selecting P, R, N, or D on the selector lever. Movement of the selector lever across the gate to the 'M/S' position puts the transmission into electronic sport mode. Movement of the selector lever in a lateral position to the + or – positions puts the transmission into electronic manual 'Steptronic' mode.

For a detailed description of GM5 automatic transmission operation, refer to the **Automatic Transmission – GM 5L40–E** section of the System Description and Operation Workshop Manual.

OPERATION

Power Distribution

Feed from the positive battery terminal (C0192) is supplied to fuse 53 and fuse 54 of the passenger compartment fuse box (C0632) and the fuse holder (C1875) on R wires. The 100A fuse located in the fuse holder (C1878) provides a constant battery feed to the Engine Control Module (ECM) relay (C1895) on an R wire. The 50A fuse located in the fuse holder (C1876) provides a constant battery feed to the transfer box ECU (C1855) on a pair of R wires.

Fuse 54 of the passenger compartment fuse box (C0583) provides a constant battery feed to the EAT ECU (C0932) on a RY wire. Fuse 53 of the passenger compartment fuse box (C0583) provides a constant battery feed to the ignition switch (C0099) on an R wire. When the ignition switch is turned to the 'auxiliary' position, current flows across the switch (C0099) to fuse 37 of the passenger compartment fuse box (C0585) on a PB wire. Fuse 37 (C0587) provides an ignition feed to the transfer box ECU (C1319) on a PU wire.

When the ignition switch is turned to the 'ignition' position, current flows across the switch (C0099) to fuse 5, fuse 33, and fuse 35 of the passenger compartment fuse box (C0585) on a G wire. Fuse 5 (C0587) provides an ignition feed to the EAT ECU (C0932) on a GW wire. Fuse 33 (C0587) provides an ignition feed to the transfer box ECU (C1319) on a GP wire. Fuse 35 (C0587) provides an ignition feed to the Hill Descent Control (HDC) switch (C0365) on a GBY wire.

ECM Relay

The ECM (C0604) provides an earth path for the ECM relay coil (C1895) on an N wire. The energised relay (C1895) provides a feed to fuse 2 of the engine compartment fuse box (C0570) on an RW wire. Fuse 2 (C0570) is connected to the EAT ECU (C0932) by a pair of RU wires.

For more details on ECM relay operation, refer to the **Engine Management System – Td6** section of the System Description and Operation Workshop Manual.

EAT ECU

The EAT ECU controls operation of the transmission via the following:

Pressure Regulator Solenoid

The EAT ECU (C1835) provides a Pulse Width Modulated (PWM) signal to the pressure regulator solenoid (C0244) on a P wire. This enables the pressure regulator solenoid (in conjunction with the pressure regulator valve) to control line pressure supplied to the clutches and shift control valves. The EAT ECU (C1835) provides an earth path for the pressure regulator solenoid (C0244) on an R wire.

Torque Converter Clutch (TCC) Solenoid

The EAT ECU (C1835) provides a PWM signal to the TCC solenoid (C0244) on a G wire. The TCC solenoid is a normally closed solenoid, and controls the output fluid pressure to the torque converter clutch. The EAT ECU (C1835) provides an earth path for the TCC solenoid (C0244) on a BY wire.

Shift Control Solenoids

The EAT ECU (C1835) provides a PWM signal to the three identical shift control solenoids (C0244) on a G wire. The EAT ECU (C1835) provides an earth path for solenoid A (C0244) on an OB wire, solenoid B (C0244) on a GR wire, and solenoid C (C0244) on a Y wire. For details of solenoid opening and closing, refer to the **Automatic Transmission – GM 5L40–E** section of the System Description and Operation Workshop manual.

Input Shaft Speed Sensor

The EAT ECU (C1835) provides a feed to the input shaft speed sensor (C0244) on a U wire. The input shaft speed sensor (C0244) returns an ac voltage pulse back to the EAT ECU (C1835) on an O wire. By measuring the peak to peak voltage of the voltage wave form, the EAT ECU can determine the speed of the input shaft.

Output Shaft Speed Sensor

The EAT ECU (C1835) provides a feed to the output shaft speed sensor (C0244) on a W wire. The output shaft speed sensor (C0244) returns an ac voltage pulse back to the EAT ECU (C1835) on an N wire. By measuring the peak to peak voltage of the voltage wave form, the EAT ECU can determine the speed of the output shaft.

DESCRIPTION AND OPERATION

Transmission Temperature Sensor

The temperature of the Automatic Transmission Fluid (ATF) is measured by the Negative Temperature Coefficient (NTC) transmission temperature sensor. The EAT ECU (C1835) provides a feed to the temperature sensor (C0244) on a BR wire. By measuring the voltage returned on a WR wire, the EAT ECU can determine ATF temperature.

Inhibitor Switch

The inhibitor switch is mounted on the LH side of the transmission, and enables the EAT ECU to monitor the position of the manual selector spool valve and the selected drive program. The EAT ECU (C1835) provides an ignition feed to the inhibitor switch (C0244) on a YB wire. When Park or Neutral is selected, the inhibitor switch (C0244) returns a feed back to the EAT ECU (C1835) on an O wire. When Drive is selected, the inhibitor switch (C0244) returns a feed back to the EAT ECU (C1835) on a B wire.

When shift solenoid A is energised, the inhibitor switch (C0244) returns a feed back to the EAT ECU (C1835) on a PW wire. When shift solenoid B is energised, the inhibitor switch (C0244) returns a feed back to the EAT ECU (C1835) on a YB wire. When shift solenoid C is energised, the inhibitor switch (C0244) returns a feed back to the EAT ECU (C1835) on a TB wire.

NOTE: Wire colour TB is transparent with a black tracer.

Shift Interlock Solenoid

To lock the selector lever assembly, the EAT ECU (C0193) provides a feed to the shift interlock solenoid (C0673) on a BP wire. An earth path is provided by the EAT ECU (C0193) on an NP wire.

Steptronic

When manual (Steptronic) mode is selected, the EAT ECU selects gears according to inputs received from the Steptronic switch. The EAT ECU (C0193) provides two feeds to the Steptronic switch (C1664); one on a UY wire, one on a US wire. If a downshift is requested via the selector lever, a momentary earth is created. Current on the UY wire is allowed to flow across the switch to earth on an NB wire. Sensing this, the EAT ECU downshifts 1 gear.

If an upshift is requested via the selector lever, a momentary earth is created. Current on the US wire is now allowed to flow across the switch to earth on an NB wire. Sensing this, the EAT ECU upshifts 1 gear.

ELECTRONIC AUTOMATIC TRANSMISSION (EAT) – ZF

DESCRIPTION

General

The ZF 5HP24 transmission is an electronically controlled, five speed unit and is mated with the V8 petrol engine. The transmission is controlled by an Electronic Automatic Transmission (EAT) ECU, which contains software to provide operation as a semi-automatic 'Steptronic' transmission. This allows the transmission to be operated as a conventional automatic unit by selecting P, R, N, or D on the selector lever. Movement of the selector lever across the gate to the 'M/S' position puts the transmission into electronic 'Sport' mode. Movement of the selector lever in a lateral position to the + or – positions puts the transmission into electronic manual 'Steptronic' mode.

For a detailed description of ZF automatic transmission operation, refer to the ***Automatic Transmission – ZF 5HP24*** section of the System Description and Operation Workshop Manual.

OPERATION

Power Distribution

Feed from the positive battery terminal (C0192) is supplied to fusible link 2 and fuse 53 of the passenger compartment fuse box (C0632) on an R wire. A permanent battery feed is also supplied to the 50A fuse contained within the fuse holder (C1875) on an R wire. This fuse (C1876) provides a constant battery feed to the transfer box ECU (C1855) on a pair of R wires.

Fusible link 2 of the passenger compartment fuse box (C0591) provides a constant battery feed to the ECM relay (C1895) and fuse 4 of the engine compartment fuse box (C0570) on a pair of R wires. Operation of the ECM relay (C1895) is controlled by the ECM (C0604) on an N wire. The energised ECM relay (C1895) provides a feed to fuse 1 of the engine compartment fuse box (C0570) on an RW wire. Fuse 1 (C0570) is connected to the EAT ECU (C0932) by a pair of RU wires. The EAT ECU (C0932) is earthed on N wires.

Fuse 4 of the engine compartment fuse box (C0570) is connected to the EAT ECU (C0932) by an R wire.

Fuse 53 of the passenger compartment fuse box (C0583) is connected to the ignition switch (C0099) by an R wire. When the ignition switch is turned to the 'auxiliary' position, current flows across the switch (C0099) to fuse 37 of the passenger compartment fuse box (C0587) on a PB wire. Fuse 37 (C0587) provides an auxiliary ignition feed to the transfer box ECU (C1319) on a PU wire.

DESCRIPTION AND OPERATION

When the ignition switch is turned to the 'ignition' position, current flows across the switch (C0099) to fuse 5, fuse 33, and fuse 35 of the passenger compartment fuse box (C0585) on a G wire. Fuse 5 (C0587) provides an ignition feed to the EAT ECU (C1835) on a GW wire. Fuse 33 (C0587) provides an ignition feed to the transfer box ECU (C1319) on a GP wire. Fuse 35 (C0587) provides an ignition feed to the Hill Descent Control (HDC) switch (C0365) on a GBY wire.

EAT ECU

The EAT ECU controls operation of the transmission via the following:

Electronic Pressure Regulator Solenoids (EPRS)

The five EPRS located in the automatic transmission (C0244) are provided a Pulse Width Modulated (PWM) by the EAT ECU (C1835) on a P wire. The EAT ECU controls operation of the EPRS by providing earth paths on TB, R, B, K and YR wires.

NOTE: Wire colour TB is transparent with a black tracer.

Shift Control Solenoids

The three shift control solenoids located in the automatic transmission (C0244) are provided a feed by the EAT ECU (C1835) on a YU wire. The EAT ECU (C1835) energises the solenoids by providing earth paths on O, G, and Y wires.

Turbine Speed Sensor

The turbine speed sensor acts as an input speed sensor. The EAT ECU (C1835) provides a feed to the turbine speed sensor (C0244) on a U wire. The turbine speed sensor (C0244) returns an ac voltage pulse back to the EAT ECU (C1835) on an S wire. By measuring the peak to peak voltage of the voltage wave form, the EAT ECU can determine the speed of the turbine.

Output Shaft Speed Sensor

The EAT ECU (C1835) provides a feed to the output shaft speed sensor (C0244) on a W wire. The output shaft speed sensor (C0244) returns an ac voltage pulse back to the EAT ECU (C1835) on an N wire. By measuring the peak to peak voltage of the voltage wave form, the EAT ECU can determine the speed of the output shaft.

Transmission Temperature Sensor

The temperature of Automatic Transmission Fluid (ATF) is measured by the Positive Temperature Coefficient (PTC) transmission temperature sensor. The EAT ECU (C1835) provides a feed to the temperature sensor (C0244) on a BR wire. By measuring the voltage returned on a WR wire, the EAT ECU can determine ATF temperature.

Shift Interlock Solenoid

To lock the selector lever assembly, the EAT ECU (C0193) provides a feed to the shift interlock solenoid (C0673) on a BP wire. An earth path is provided by the EAT ECU (C0193) on an NP wire.

Steptronic

When manual (Steptronic) mode is selected, the EAT ECU selects gears according to inputs received from the Steptronic switch. The EAT ECU (C0193) provides two feeds to the Steptronic switch (C1664); one on a UY wire, one on a US wire. If a downshift is requested via the selector lever, a momentary earth is created. Current on the UY wire is allowed to flow across the switch to earth on an NB wire. Sensing this, the EAT ECU downshifts 1 gear.

If an upshift is requested via the selector lever, a momentary earth is created. Current on the US wire is now allowed to flow across the switch to earth on an NB wire. Sensing this, the EAT ECU upshifts 1 gear.

DESCRIPTION AND OPERATION

ANTI-LOCK BRAKING SYSTEM (ABS)

DESCRIPTION

General

New Range Rover is equipped with Dynamic Stability Control (DSC) for enhanced braking and stability control. Functions of the DSC include:

- Hill Decent Control (HDC).
- Electronic traction control (ETC).
- Anti-lock Braking System (ABS).

The DSC system for New Range Rover provides all of the following functions and features:

- Optimised traction under all driving conditions.
- Optimised directional control (Longitudinal Stability).
- Lateral stability (Correction for over steer/under steer).
- Corner Braking Control (CBC).
- Emergency Brake Assist (EBA).
- Electronic Brake Force Distribution (EBD).

For a detailed description of the ABS, HDC, and ETC systems, refer to the **Brakes** section of the System Description and Operation Workshop Manual.

OPERATION

Power Distribution

Feed from the positive battery terminal (C0192) is supplied to the following on R wires:

- Fusible link 2 (C0632) – V8 vehicles only.
- Maxi fuse 63 (C0632).
- Fuse 13 (C0632).
- Fuse 53 (C0632).
- Fuse 55 (C0632).
- Fuse holder (C1875) – Td6 vehicles only.

Maxi fuse 63 (C0580) and fuse 55 (C0583) provide constant battery feeds to the ABS ECU (C0506) on R and RB wires respectively. The ABS ECU is earthed on a pair of N wires. Fuse 13 (C0586) provides a constant battery feed to the steering angle sensor (C0862) on an RG wire.

Fuse 53 (C0583) provides a constant battery feed to the ignition switch (C0099 on Td6 vehicles, C0028 on V8 vehicles) on an R wire. When the ignition switch is turned to the 'auxiliary' position, current flows across the switch (C0099 on Td6 vehicles, C0028 on V8 vehicles) to fuse 37 of the passenger compartment fuse box (C0585) on a PB wire. Fuse 37 (C0587) provides an auxiliary ignition feed to the Dynamic Stability Control (DSC) switch (C0700), located on the centre console, on a GBY wire.

V8

Fusible link 2 (C0632) provides a constant battery feed to the ECM relay (C1895) on an R wire. Operation of the ECM relay (C1895) is controlled by the ECM (C0604) on an N wire. The energised ECM relay (C1895) provides a feed to fuse 51 of the passenger compartment fuse box (C0584) on an RW wire. Fuse 51 (C0584) is connected to the ABS ECU (C0506) and the steering angle sensor (C0862) by a pair of RW wires.

Td6

The 100A fuse within the fuse holder (C1878) provides a constant battery feed to the ECM relay (C1895) on an R wire. Operation of the ECM relay (C1895) is controlled by the ECM (C0604) on an N wire. The energised ECM relay (C1895) provides a feed to fuse 51 of the passenger compartment fuse box (C0584) on an RW wire. Fuse 51 (C0584) is connected to the ABS ECU (C0506) and the steering angle sensor (C0862) by a pair of RW wires.

ABS

Wheel Speed Sensors

The ABS ECU (C0506) provides a feed to all four wheel speed sensors as follows:

- To the LH front wheel speed sensor (C0516) on an R wire.
- To the RH front wheel speed sensor (C0517) on a Y wire.
- The LH rear wheel speed sensor (C0502) on a W wire.
- To the RH rear wheel speed sensor (C0503) on a G wire.

The wheel speed sensors are hall effect sensors, and provide the ABS ECU with a square wave form signal. This signal rises and falls between approximately 2.5V and 0.75V. By measuring the frequency of the waveform, the ABS ECU can calculate the speed of the road wheel. The sensors provide the ABS ECU (C0506) with a wheel speed signal as follows:

- From the LH front wheel speed sensor (C0516) on a UR wire.
- From the RH front wheel speed sensor (C0517) on a UY wire.
- From the LH rear wheel speed sensor (C0502) on a UW wire.
- From the RH rear wheel speed sensor (C0503) on a UG wire.

DSC

DSC Switch

DSC is active as soon as the ignition switch is turned to the 'ignition' position. DSC can be switched off by pressing the non-latching master switch located on the centre console. When the ABS ECU (C0506) receives a momentary feed from the DSC switch (C0700) on a BY wire, it suspends DSC operation. Pressing the switch a second time reinstates DSC.

DESCRIPTION AND OPERATION

Steering Angle Sensor

The steering angle sensor (C0862) receives a constant battery feed from fuse 13 of the passenger compartment fuse box (C0586) on an RG wire, and a feed from the energised ECM relay (C1895) via fuse 51 of the passenger compartment fuse box (C0584) on an RW wire. The sensor (C0862) is earthed on an NB wire.

The steering angle sensor (C0862) transmits steering angle and rate of steering messages via the Can bus on YN (low) and YB (high) wires. These signals are created by two potentiometers located within the sensor. The ABS ECU uses these messages to enable the DSC system control lateral stability.

Brake Fluid Level Warning Switch

If the brake fluid level is below the minimum level, DSC operation is suspended. The ABS ECU (C0506) monitors the condition of the brake fluid level switch (C0026) via an NGY wire.

HDC

The HDC switch (C0365) is mounted on the side of the gear selector lever, and is provided an auxiliary ignition feed from fuse 35 of the passenger compartment fuse box (C0587) on a GBY wire. The ABS ECU (C0506) monitors the condition of the HDC switch (C0365) via a BG wire.

EBA

Brake Pedal Switch

The brake pedal switch (C0075) is provided an auxiliary ignition feed from fuse 9 of the passenger compartment fuse box (C0587) on a PY wire. The ABS ECU (C0506) monitors the condition of the brake pedal switch (C0075) on a UR wire to enable it to operate its Emergency Brake Assist (EBA) function.

Diagnostic Socket

The diagnostic socket is located behind an access panel on the drivers side of the fascia. The ABS ECU (C0506) and the steering angle sensor (C0862) can be interrogated by T4 via the K line bus on WP wires.

SUPPLEMENTARY RESTRAINT SYSTEM (SRS)

DESCRIPTION

General

The Supplementary Restraint System (SRS) is controlled by the SRS Diagnostic Control Unit (DCU) which is mounted on the transmission tunnel, to the rear of the gear selector lever. The SRS DCU registers front and rear impacts via an integral accelerometer. Side impacts are registered via two side impact sensors; one mounted on the base of the RH B/C post, one mounted on the base of the LH B/C post.

The drivers and passenger airbags can be deployed in one of two stages. A lesser impact will result in stage 1 deployment. Both the drivers airbag and the passenger airbag contain two squibs. Stage 1 entails the SRS DCU delaying deployment of the second squib for a split second. This results in a less severe deployment of the airbags. A larger impact will result in stage 2 deployment. This entails both squibs within the drivers and passenger airbags being deployed simultaneously.

Front head airbags are also mounted in the 'A' post. These work in conjunction with the door mounted airbags. Rear head airbags, mounted in the 'D' post are available as an option.

OPERATION

Power Distribution

Feed from the positive battery terminal (C0192) is supplied to fuse 53 of the passenger compartment fuse box (C0632) on an R wire. Fuse 53 (C0583) is connected to the ignition switch (C0099 on Td6 vehicles, C0028 on V8 vehicles) by an R wire. When the ignition switch is turned to the 'auxiliary' position, current flows across the switch (C0099 on Td6 vehicles, C0028 on V8 vehicles) to fuse 44 of the passenger compartment fuse box (C0585) on a PB wire. Fuse 44 (C0586) provides an auxiliary ignition feed to the following:

- The SRS DCU (C0256) on a PU wire.
- The LH seat belt buckle switch (C0100) on a PG wire.
- The RH seat belt buckle switch (C0260) on a PG wire.
- The occupancy detector sensor (C0962) on a PG wire.

DESCRIPTION AND OPERATION

Drivers Airbag

The drivers airbag can deploy in one of two stages, depending upon the severity of impact. If a less severe impact is detected, stage 1 deployment is carried out. The SRS DCU (C0256) provides a firing signal to the drivers airbag (C1254) via the rotary coupler (C0082) on a YB then S wire. The SRS DCU (C0256) provides an earth path for the drivers airbag (C1254) via the rotary coupler (C0082) on an LG then YN wire.

A split second later, the SRS DCU (C0256) provides a second firing signal to the drivers airbag (C1254) via the rotary coupler (C0082) on an SN then U wire. The SRS DCU (C0256) provides a second earth path for the drivers airbag (C1254) via the rotary coupler (C0082) on a US then SB wire.

When stage two deployment is required, the SRS DCU provides simultaneous firing signals to both squibs as described previously.

Passenger Airbag

The passenger airbag can deploy in one of two stages, depending upon the severity of impact. If a less severe impact is detected, stage 1 deployment is carried out. The SRS DCU (C0256) provides a firing signal to the passenger airbag (C0251) on a UN wire. The SRS DCU (C0256) provides an earth path for the passenger airbag (C0251) on a UB wire.

A split second later, the SRS DCU (C0256) provides a second firing signal to the passenger airbag (C0251) on a WB wire. The SRS DCU (C0256) provides an earth path for the passenger airbag (C0251) on a WN wire.

When stage two deployment is required, the SRS DCU provides simultaneous firing signals to both squibs as described previously.

Door Airbags

The SRS DCU registers a side impact via the side impact sensors, which are mounted at the base of the LH and RH B/C posts. The SRS DCU monitors the condition of the RH sensor (C0951) and the LH sensor (C0950) on YR and YG wires respectively. Both sensors are earthed on NB wires. When the SRS DCU registers a side impact above its threshold level, it will fire the relevant door airbag.

The SRS DCU (C0256) provides a firing signal to the RH door airbag (C1499) on a U wire. An earth path is provided by the SRS DCU (C0256) on an N wire.

The SRS DCU (C0256) provides a firing signal to the LH door airbag (C1499) on an N wire. An earth path is provided by the SRS DCU (C0256) on a Y wire.

Head Airbags

The SRS DCU registers a side impact via the side impact sensors, which are mounted at the base of the LH and RH B/C posts. The SRS DCU monitors the condition of the RH sensor (C0951) and the LH sensor (C0950) on YR and YG wires respectively. Both sensors are earthed on NB wires. When the SRS DCU registers a side impact above its threshold level, it will fire the relevant head airbag.

LH Front

The SRS DCU (C0256) provides a firing signal to the LH front head airbag (C1477) on a UY wire. An earth path is provided by the SRS DCU (C0256) on a Y wire.

RH Front

The SRS DCU (C0256) provides a firing signal to the RH front head airbag (C1478) on a W wire. An earth path is provided by the SRS DCU (C0256) on a UW wire.

LH Rear

The SRS DCU (C0256) provides a firing signal to the LH rear head airbag (C1474) on a B wire. An earth path is provided by the SRS DCU (C0256) on a Y wire.

RH Rear

The SRS DCU (C0256) provides a firing signal to the RH rear head airbag (C0948) on a UG then UR wire. An earth path is provided by the SRS DCU (C0256) on an R then G wire.

Occupancy Detector

The occupancy detector determines if there is a passenger occupying the front seat. If the front seat passenger is not detected, the front passenger airbag, and front passenger head airbag deployment is suspended in the event of an impact. All other SRS components will operate as normal.

The occupancy detector (C0962) is provided an auxiliary ignition feed from fuse 44 of the passenger compartment fuse box (C0586) on a PG wire, and is earthed on an NB wire. The occupancy detector (C0962) provides a pulsed voltage signal to the SRS DCU (C0256) on a WR wire. The signal consists of 7 bits. A signal of '0 00 00 01' informs the SRS DCU the front passenger seat is unoccupied. A signal of '0 11 11 01' informs the SRS DCU the front passenger seat is occupied.

Seat Belt Switches

The SRS DCU determines if the front seat belts are being used by monitoring the status of the seat belt switches. If the seat belt tongue is inserted into the buckle, the switch contacts close and battery voltage is supplied to the SRS DCU (C0256) on UW (LH) and UP (RH) wires. If the SRS DCU detects a seat belt is not being used, it will not fire the relevant seat belt pre-tensioner.

DESCRIPTION AND OPERATION

Seat Belt Pre-tensioners

If the SRS DCU detects a front or rear impact, it will deploy the front seat belt pre-tensioners. The SRS DCU (C0256) provides a firing signal to the RH seat belt pre-tensioner (C0252) on a UN wire. An earth path is provided by the SRS DCU (C0256) on a UR wire. The SRS DCU (C0256) provides a firing signal to the LH seat belt pre-tensioner (C0254) on a YR wire. An earth path is provided by the SRS DCU (C0256) on a YN wire.

Battery Disconnection

In the event of an impact severe enough to implement stage 2 airbag deployment, a pyrotechnic charge on the positive battery terminal will disconnect the battery. The SRS DCU (C0256) provides a firing signal to the battery (C2250) on an NR then B wire. An earth path is provided by the SRS DCU (C0256) on a B then N wire.

Body Control Unit (BCU)

In the event of an impact severe enough to trigger the SRS system, the SRS DCU (C0256) provides a pulsed voltage signal to the BCU (C0661) on an SU wire. The BCU then enters its 'crash' mode, unlocking all the doors, illuminating the interior lamps, and powering the hazard warning lamps.

SRS Warning Lamp

The SRS DCU (C0256) controls operation of the SRS warning lamp (C0230) by providing a pulsed voltage feed on an NP wire.

AUTOMATIC TEMPERATURE CONTROL (ATC)

DESCRIPTION

General

The Automatic Temperature Control (ATC) system is controlled by the ATC ECU, which is located behind the centre console. ATC features automatic control of a common temperature setting for both sides of the passenger compartment, with manual control of the blower speed, air recirculation, and air distribution.

A Fuel Burning Heater (FBH) is fitted as standard on Td6 vehicles, and as an option on V8 vehicles. For more information on FBH operation, refer to the relevant **Fuel Burning Heater (FBH)** section of this manual.

 **FUEL BURNING HEATER – Td6.**

 **FUEL BURNING HEATER – V8.**

For more details on ATC operation, refer to the **Air Conditioning** section of the System Description and Operation Workshop manual.

OPERATION

Power Distribution

Feed from the positive battery terminal (C0192) is supplied to the following on an R wire:

- Maxi fuse 61.
- Maxi fuse 64.
- Fuse 12.
- Fuse 53.

All are located in the passenger compartment fuse box (C0632). Maxi fuse 61 (C0581) provides a constant battery feed to the cooling fan control unit (C0005) on an RU then U wire. Maxi fuse 64 (C0580) provides a constant battery feed to the blower motor control unit (C2281) on an RU then YG wire.

Fuse 12 (C0586) provides a constant battery feed to the ATC ECU (C1630) on an RP wire. The ATC ECU (C1630) is earthed on an N wire.

Fuse 53 (C0583) provides a constant battery feed to the ignition switch (C0099 on Td6 vehicles, C0028 on V8 vehicles) on an R wire. When the ignition switch is turned to the 'ignition' position, current flows across the switch (C0099 on Td6 vehicles, C0028 on V8 vehicles) to fuse 34 of the passenger compartment fuse box (C0585) on a G wire. Fuse 34 (C0587) provides an ignition feed to the ATC ECU (C1629) on a GY wire.

DESCRIPTION AND OPERATION

Compressor

When compressor operation is required, the ATC ECU (C1629) sends a message to the Engine Control Module (ECM) via the K bus on a WRY wire. Provided there are no engine management constraints, the ECM (C0331) responds by increasing throttle angle and fuelling and returns a signal granting operation of the compressor to the ATC ECU (C1629) on a BG wire. The ATC ECU (C1630) then provides a feed to the compressor clutch (C0182) on a BS wire.

For more details of compressor operation, refer to the **Air Conditioning** section of the System Description and Operation Workshop manual.

Refrigerant Pressure Sensor

The refrigerant pressure sensor is located in the refrigerant line between the condenser and the thermostatic expansion valve. It provides the ATC ECU with a pressure input from the high pressure side of the refrigerant system. The ATC ECU (C1629) provides a 5 V reference feed to the pressure sensor (C1610) on a GY wire. The pressure sensor (C1610) returns a signal voltage of between 0 V and 5 V, depending upon system pressure, to the ATC ECU (C1629) on a BS wire. The ATC ECU (C1629) provides an earth path for the pressure sensor (C1610) on an NB wire.

Evaporator Temperature Sensor

The evaporator temperature sensor is a Negative Temperature Coefficient (NTC) sensor. The ATC ECU (C0923) provides a feed to the evaporator temperature sensor (C0417) on an NB wire. By measuring the voltage returned on a YB wire, the ATC ECU (C0923) can determine evaporator temperature.

Blower Motor

Operation of the blower motor is controlled by the ATC ECU via the blower motor control unit. To control blower motor speed, the ATC ECU (C0923) provides a stepped voltage of between 0 V and 8 V to the control unit (C2281) on a UR wire. This is used by the control unit to regulate the supply voltage from maxi fuse 64 of the passenger compartment fuse box to the blower motor (C0056) on BG and RG wires.

The blower motor control unit (C2281) is earthed on an N wire.

Heater Coolant Temperature Sensor

The heater coolant temperature sensor is a Negative Temperature Coefficient (NTC) sensor. The ATC ECU (C0923) provides a feed to the temperature sensor (C0416) on an NB wire. By measuring the voltage returned on the YR wire, the ATC ECU (C0923) can determine the temperature of the air exiting the heater matrix.

Coolant Valve

A single coolant valve is fitted on the ATC system to control coolant flow to the heater matrix. The coolant valve (C2034) is controlled by a Pulse Width Modulated (PWM) signal from the ATC ECU (C1629) on a YN wire.

Auxiliary Coolant Pump

The auxiliary coolant pump is used to ensure a satisfactory flow rate through the heater matrix at low engine speeds. The ATC ECU (C1629) provides a feed to the pump (C2035) on a UG wire. The pump (C2035) is earthed on an N wire.

Cooling Fan

Operation of the cooling fan is controlled by the ECM. When the compressor is engaged, the ATC ECU (C1629) informs the ECM (C0331) via the K bus on a WRY wire that cooling fan operation is required. The ATC ECU also informs the ECM of the speed at which the fan should be driven.

The ECM also monitors Engine Coolant Temperature (ECT) to determine fan speed. The ECM (C0606) provides a feed to the ECT sensor (C0169) on an SU (Td6) or YG (V8) wire. The ECT sensor is a Negative Temperature Coefficient (NTC) sensor. By measuring the voltage returned on an NG (Td6) or NO (V8) wire, the ECM can determine engine coolant temperature.

The ECM (C0331) now provides a feed to the cooling fan control unit (C0005) on a BG wire. This is used by the control unit to regulate the supply voltage from maxi fuse 61 of the passenger compartment fuse box (C0581) on an RU wire.

DESCRIPTION AND OPERATION

AUTOMATIC TEMPERATURE CONTROL (ATC) – COMFORT

DESCRIPTION

General

The 'Comfort' Automatic Temperature Control (ATC) system is controlled by the ATC ECU, which is located behind the centre console. In addition to the features included on the low line system, the 'Comfort' ATC system also features a second coolant valve, a pollution sensor, and a rear blower unit.

The 'Comfort' ATC system is fully automatic, with separate temperature settings for the LH and RH sides of the passenger compartment. Manual override is available for blower speed, air recirculation, and air distribution.

A Fuel Burning Heater (FBH) is fitted as standard on Td6 vehicles, and as an option on V8 vehicles. For more information on FBH operation, refer to the relevant **Fuel Burning Heater (FBH)** section of this manual.

 **FUEL BURNING HEATER – Td6.**

 **FUEL BURNING HEATER – V8.**

For more details on ATC operation, refer to the **Air Conditioning** section of the System Description and Operation Workshop manual.

OPERATION

Power Distribution

Feed from the positive battery terminal (C0192) is supplied to the following on an R wire:

- Fusible link 5.
- Maxi fuse 61.
- Maxi fuse 64.
- Fuse 12.
- Fuse 53.

All are located in the passenger compartment fuse box (C0632). Maxi fuse 61 (C0581) provides a constant battery feed to the cooling fan control unit (C0005) on an RU wire. Maxi fuse 64 (C0580) provides a constant battery feed to the front blower motor control unit (C2281) on an RU then YG wire.

Fuse 12 (C0586) provides a constant battery feed to the ATC ECU (C1630) on an RP wire. The ATC ECU (C1630) is earthed on an N wire.

Fuse 53 (C0583) is connected to the ignition switch (C0099 on Td6 vehicles, C0028 on V8 vehicles) by an R wire. When the ignition switch is turned to the 'ignition' position, current flows across the switch (C0099 on Td6 vehicles, C0028 on V8 vehicles) to fuse 34 and fuse 2 of the passenger compartment fuse box (C0585) on a G wire. Fuse 34 (C0587) provides an ignition feed to the ATC ECU (C1629) on a GY wire.

Fuse 2 (C0587) provides an ignition feed to the rear blower relay coil (C2022) on a GY wire. The rear blower relay is located in the rear fuse box (C2021) and is earthed on an N wire.

Fusible link 5 of the passenger compartment fuse box (C0588) provides a constant battery feed to fuse 12R in the rear fuse box (C2024) on an R wire. Fuse 12R is connected to the rear blower relay switch. When the relay is energised, current flows across the closed switch contacts (C2021) to the rear blower motor control unit (C2282) on a GU then SUY then UG wire.

Compressor

When compressor operation is required, the ATC ECU (C1629) sends a message to the Engine Control Module (ECM) via the K bus on a WRY wire. Provided there are no engine management constraints, the ECM (C0331) responds by increasing throttle angle and fuelling and returns a signal granting operation of the compressor to the ATC ECU (C1629) on a BG wire. The ATC ECU (C1630) then provides a feed to the compressor clutch (C0182) on a BS wire.

For more details of compressor operation, refer to the **Air Conditioning** section of the System Description and Operation Workshop manual.

Refrigerant Pressure Sensor

The refrigerant pressure sensor provides the ATC ECU with a pressure input from the high pressure side of the refrigerant system. The ATC ECU (C1629) provides a 5 V reference feed to the pressure sensor (C1610) on a GY wire. The pressure sensor (C1610) returns a signal voltage of between 0 V and 5 V, depending upon system pressure, to the ATC ECU (C1629) on a BS wire. The ATC ECU (C1629) provides an earth path for the pressure sensor (C1610) on an NB wire.

Evaporator Temperature Sensor

The evaporator temperature sensor is a Negative Temperature Coefficient (NTC) sensor. The ATC ECU (C0923) provides a feed to the evaporator temperature sensor (C0417) on an NB wire. By measuring the voltage returned on a YB wire, the ATC ECU (C0923) can determine evaporator temperature.

DESCRIPTION AND OPERATION

Sunlight Sensor

The sunlight sensor consists of a LH and a RH photoelectric cell that provide the ATC ECU with inputs of light intensity. These are used by the ATC to adjust blower speed, temperature, and air distribution. The ATC ECU (C1629) provides a feed to the sunlight sensor (C0790) on a YB wire. The LH photoelectric cell (C0790) returns a signal back to the ATC ECU (C1629) on a YR wire. The RH photoelectric cell (C0790) returns a signal back to the ATC ECU (C1629) on a YG wire. The ATC ECU (C1629) provides an earth path for the sensor (C0790) on a YN wire.

Pollution Sensor

The pollution sensor allows the ATC ECU to monitor the ambient air for the level of hydrocarbons and oxidized gases. The ATC (C1629) provides two feeds to the sensor (C1548). The first is on a U wire, and is used to heat the sensor. A second feed is provided on a Y wire. This is a 5 V reference voltage to the sensor itself. A signal voltage of between 0 V and 5 V is returned from pin 3 of the sensor (C1548) to the ATC ECU (C1629) on an N wire. The ATC ECU (C1629) provides an earth path for the sensor (C1548) on a second N wire (pin 1 of the sensor connector).

Front Blower Motor

Operation of the front blower motor is controlled by the ATC ECU via the front blower motor control unit. To control front blower motor speed, the ATC ECU (C0923) provides a stepped voltage of between 0 V and 8 V to the control unit (C2281) on a UR wire. This is used by the control unit to regulate the supply voltage from maxi fuse 64 of the passenger compartment fuse box to the front blower motor (C0056) on BG and RG wires.

The front blower motor control unit (C2281) is earthed on an N wire.

Rear Blower Motor

Operation of the rear blower motor is controlled by the ATC ECU via the rear blower motor control unit. The ATC ECU (C0923) receives an input voltage of between 1.25 V (blower off) and 5 V (maximum blower speed) from the rear blower motor thumbwheel (C0846) on an RB wire. The thumbwheel is a potentiometer located in the rear ATC control unit. The ATC ECU (C0923) determines the blower speed requested from the voltage received from the thumbwheel and provides a stepped voltage of between 0 V and 5 V to the control unit (C2282) on a B then R wire. This is used by the control unit to regulate the supply voltage from the rear blower relay (C2021) to the rear blower motor (C2279) on GY and N wires.

The rear blower motor control unit (C2282) is earthed on an N wire.

Air Distribution Motors

Unless manually overridden, operation of the air distribution motor is controlled automatically by the ATC ECU. The ATC ECU (C2295) provides a feed to the following on BW wires:

- The face level air distribution motor (C2133).
- The screen air distribution motor (C2134).
- The footwell air distribution motor (C2135).

The ATC ECU (C2295) provides an earth path for all three motors on B wires.

Air Recirculation Motor

Unless manually overridden, operation of the recirculation motor is controlled automatically by the ATC ECU, using inputs from the pollution sensor and/or if rapid passenger compartment cooling is required. The ATC ECU (C2295) provides a feed to the recirculated air motor (C0006) on a BW wire. The ATC ECU (C2295) provides an earth path for the motor (C0006) on a B wire.

Heater Coolant Temperature Sensors

Two heater coolant temperature sensors are fitted on 'Comfort' ATC systems; on RH one LH. Both sensors are Negative Temperature Coefficient (NTC) sensors. The ATC ECU (C0923) provides a feed to the RH (C2296) and LH (C0416) temperature sensors on a pair of NB wires. By measuring the voltage returned on a YU (RH) and YR (LH) wire, the ATC ECU (C0923) can determine the temperature of the air exiting both sides of the heater matrix.

Coolant Valves

Two coolant valves are fitted to 'Comfort' ATC systems to control coolant flow to each side of the heater matrix. Both are controlled by Pulse Width Modulated (PWM) signals from the ATC ECU (C1629) on YN (LH) and YP (RH) wires.

Auxiliary Coolant Pump

The auxiliary coolant pump is used to ensure a satisfactory flow rate through the heater matrix at low engine speeds. The ATC ECU (C1629) provides a feed to the pump (C2035) on a UG wire. The pump (C2035) is earthed on an N wire.

DESCRIPTION AND OPERATION

Cooling Fan

Operation of the cooling fan is controlled by the ECM. When the compressor is engaged, the ATC ECU (C1629) informs the ECM (C0331) via the K bus on a WRY wire that cooling fan operation is required. The ATC ECU also informs the ECM of the speed at which the fan should be driven.

The ECM also monitors Engine Coolant Temperature (ECT) to determine fan speed. The ECM (C0606) provides a feed to the ECT sensor (C0169) on an SU (Td6) or YG (V8) wire. The ECT sensor is a Negative Temperature Coefficient (NTC) sensor. By measuring the voltage returned on an NG (Td6) or NO (V8) wire, the ECM can determine engine coolant temperature.

The ECM (C0331) now provides a feed to the cooling fan control unit (C0005) on a BG wire. This is used by the control unit to regulate the supply voltage from maxi fuse 61 of the passenger compartment fuse box (C0581) on an RU wire.

FUEL BURNING HEATER – Td6

DESCRIPTION

General

The Fuel Burning Heater (FBH) is mounted in the rear of the engine compartment on the passengers side, and is fitted as standard on Td6 vehicles. The FBH is an additional heater installed in the heater coolant circuit. The FBH can be operated without the engine running to pre-heat the passenger compartment and after the engine starts to reduce heater coolant warm-up time. The FBH also boosts the heater coolant temperature while the engine is running at low ambient air and engine coolant temperatures to maintain heater performance at an acceptable level.

For a detailed description of FBH operation, refer to the ***Air Conditioning*** section of the System Description and Operation Workshop Manual.

OPERATION

Power Distribution

Feed from the positive battery terminal (C0192) is supplied to fuse 59 of the passenger compartment fuse box (C0632) on an R wire. Fuse 59 (C0582) provides a constant battery feed to the FBH (C0925) on an RY wire. The FBH (C0925) is earthed on an N wire.

FBH Receiver

A remote request for park heating is received by the TV antenna located in the RH rear window. This is relayed to the FBH receiver (C2229) by the antenna amplifier (C2228) on an R wire. The FBH receiver (C2046) then provides a feed to the FBH (C0926) on a WG wire informing the FBH to operate the park heating function.

FBH Pump

The FBH pump is mounted below the RH side of the fuel tank. The FBH (C0926) provides a Pulse Width Modulated (PWM) signal to the pump (C0920) on a BR wire. The pump is earthed on an N wire.

K Bus

The instrument pack (C0233) communicates with the Air Temperature Control (ATC) ECU (C1629) and the FBH (C0926) via the K-bus on a WRY wire to initiate FBH operation. For a detailed description of the parameters for operation, and the messages sent via the K bus, refer to the ***Air Conditioning*** section of the System Description and Operation Workshop manual.

DESCRIPTION AND OPERATION

FUEL BURNING HEATER – V8

DESCRIPTION

General

The Fuel Burning Heater (FBH) is mounted in the rear of the engine compartment on the passengers side, and is fitted as an option on V8 vehicles. The FBH is an additional heater installed in the heater coolant circuit. The FBH can be operated without the engine running to pre-heat the passenger compartment and after the engine starts to reduce heater coolant warm-up time. The FBH also boosts the heater coolant temperature while the engine is running at low ambient air and engine coolant temperatures to maintain heater performance at an acceptable level.

For a detailed description of FBH operation, refer to the ***Air Conditioning*** section of the System Description and Operation Workshop Manual.

OPERATION

Power Distribution

Feed from the positive battery terminal (C0192) is supplied to fuse 59 of the passenger compartment fuse box (C0632) on an R wire. Fuse 59 (C0582) provides a constant battery feed to the FBH (C0925) and the FBH receiver (C2046) on a pair of RY wires. The FBH (C0925) is earthed on an N wire, FBH receiver (C2046) on an NB wire.

FBH Receiver

A remote request for park heating is received by the TV antenna located in the RH rear window. This is relayed to the FBH receiver (C2229) by the antenna amplifier (C2228) on an R wire. The FBH receiver (C2046) then provides a feed to the FBH (C0926) on a WG wire informing the FBH to operate the park heating function.

FBH Pump

The FBH pump is mounted below the RH side of the fuel tank. The FBH (C0926) provides a Pulse Width Modulated (PWM) signal to the pump (C0920) on a BR wire. The pump is earthed on an N wire.

Changeover Valve

The changeover valve isolates the heater coolant circuit from the engine coolant circuit. The changeover valve is a normally open solenoid. To close the valve, the ATC ECU (C1629) provides a feed to the valve (C2037) on an SB wire. The valve is earthed (C2037) on an NB wire.

K Bus

The instrument pack (C0233) communicates with the Air Temperature Control (ATC) ECU (C1629) and the FBH (C0926) via the K-bus on a WRY wire to initiate FBH operation. For a detailed description of the parameters for operation, and the messages sent via the K bus, refer to the ***Air Conditioning*** section of the System Description and Operation Workshop manual.

DESCRIPTION AND OPERATION

COOLING FAN

DESCRIPTION

General

The electrically powered cooling fan is mounted on the front of the radiator and works in conjunction with the cooling fan mounted on the front of the engine. Operation of the cooling fan is controlled by the Engine Control Module (ECM). The ECM determines cooling fan operating strategy after receiving inputs of Engine Coolant Temperature (ECT) from the ECT sensor, and requests for extra engine cooling from the Automatic Temperature Control (ATC) ECU via the K bus.

For more information on ATC operation, refer to the **Automatic Temperature Control (ATC)** or **Automatic Temperature Control – Comfort** section of this manual.

 **AUTOMATIC TEMPERATURE CONTROL (ATC).**

 **AUTOMATIC TEMPERATURE CONTROL (ATC) – COMFORT.**

OPERATION

Power Distribution

Feed from the positive battery terminal (C0192) is supplied to maxi fuse 61, fuse 12, and fuse 53 of the passenger compartment fuse box (C0632) on an R wire. Fuse 12 (C0586) provides a constant battery feed to the ATC ECU (C1630) on an RP wire. Maxi fuse 61 (C0581) provides a constant battery feed to the cooling fan control unit (C0005) on an RU wire.

Fuse 53 (C0583) provides a constant battery feed to the ignition switch (C0099 on Td6 vehicles, C0028 on V8 vehicles) by an R wire. When the ignition switch is turned to the 'ignition' position, current flows across the switch (C0099 on Td6 vehicles, C0028 on V8 vehicles) to fuse 34 of the passenger compartment fuse box (C0585) on a G wire. Fuse 34 (C0587) provides an ignition feed to the ATC ECU (C1629) on a GY wire.

Cooling Fan – Td6

Operation of the cooling fan is controlled by the ECM. The ECM monitors Engine Coolant Temperature (ECT) to determine fan speed. The ECM (C0606) provides a feed to the ECT sensor (C0169) on an SU wire. The ECT sensor is a Negative Temperature Coefficient (NTC) sensor. By measuring the voltage returned on an NG wire, the ECM can determine engine coolant temperature.

When the ATC ECU engages the A/C compressor clutch, the ATC ECU (C1629) informs the ECM (C0331) via the K bus on a WRY wire that cooling fan operation is required. The ATC ECU also informs the ECM of the speed to drive the motor. For more information on A/C operation, refer to the ***Automatic Temperature Control (ATC)*** or ***Automatic Temperature Control (ATC) – Comfort*** section of this manual.

 **AUTOMATIC TEMPERATURE CONTROL (ATC).**

 **AUTOMATIC TEMPERATURE CONTROL (ATC) – COMFORT.**

The ECM (C0331) now provides a feed to the cooling fan control unit (C0005) on a BG wire. This is used by the control unit to regulate the supply voltage from maxi fuse 61 of the passenger compartment fuse box (C0581) on an RU wire.

Cooling Fan – V8

Operation of the cooling fan is controlled by the ECM. The ECM also monitors Engine Coolant Temperature (ECT) to determine fan speed. The ECM (C0606) provides a feed to the ECT sensor (C0169) on a YG wire. The ECT sensor is a Negative Temperature Coefficient (NTC) sensor. By measuring the voltage returned on an NO wire, the ECM can determine engine coolant temperature.

When the ATC ECU engages the Air Conditioning (A/C) compressor clutch, the ATC ECU (C1629) informs the ECM (C0331) via the K bus on a WRY wire that cooling fan operation is required. The ATC ECU also informs the ECM of the speed to drive the motor. For more information on A/C operation, refer to the ***Automatic Temperature Control (ATC)*** or ***Automatic Temperature Control (ATC) – Comfort*** section of this manual.

 **AUTOMATIC TEMPERATURE CONTROL (ATC).**

 **AUTOMATIC TEMPERATURE CONTROL (ATC) – COMFORT.**

The ECM (C0331) now provides a feed to the cooling fan control unit (C0005) on a BG wire. This is used by the control unit to regulate the supply voltage from maxi fuse 61 of the passenger compartment fuse box (C0581) on an RU wire.

DESCRIPTION AND OPERATION

HEATED REAR WINDOW (HRW)

DESCRIPTION

General

Operation of the Heated Rear Window (HRW) is controlled by the Automatic Temperature Control (ATC) ECU via the non latching HRW switch. After 10 minutes of operation, (when ambient temperature is $-15\text{ }^{\circ}\text{C}$ ($5\text{ }^{\circ}\text{F}$) or above) or 17 minutes (when ambient temperature is less than $-15\text{ }^{\circ}\text{C}$ ($5\text{ }^{\circ}\text{F}$)), the ATC ECU operates the HRW at low power for 60 minutes. During the 60 minutes, the ATC ECU cycles the HRW relay off for 80 seconds and on for 40 seconds. If the HRW switch is pressed again during the low power phase, the ATC ECU returns the HRW to full power by keeping the HRW relay energised for 5 minutes. At the end of the 5 minutes the low power phase is repeated.

The ATC ECU outputs a K bus message when the HRW is active. The message allows the navigation computer to compensate for the effect of the magnetic field generated when the HRW is active. The BCU transfers the message onto the P bus for the door modules, which activate the door mirror heaters together with the HRW.

OPERATION

Power Distribution

Feed from the positive battery terminal (C0192) is supplied to fusible link 5 and fuse 53 of the passenger compartment fuse box (C0632) on an R wire. Fusible link 5 (C0588) is connected to fuse 9 of the rear fuse box (C2024) by an R wire. Fuse 9 provides a constant battery feed to the HRW relay, which is also located in the rear fuse box.

Fuse 53 of the passenger compartment fuse box (C0583) provides a constant battery feed to the ignition switch (C0099 on Td6 vehicles, C0028 on V8 vehicles) on an R wire. When the ignition switch is turned to the 'ignition' position, current flows across the switch (C0099 on Td6 vehicles, C0028 on V8 vehicles) to fuse 2 of the passenger compartment fuse box (C0585) on a G wire. Fuse 2 (C0587) provides an ignition feed to the HRW relay coil (C2022) on a GY wire. The earth path for the relay coil (C2022) is controlled by the ATC ECU (C1629) on a UN wire.

HRW

When the HRW switch is pressed, a momentary earth path (C1630) is created on an N wire. If all operational conditions are met (**see 'Description' above**), the ATC ECU energises the HRW relay. The energised HRW relay (C2021) provides a feed to the HRW (C0381) on a B wire. The HRW (C0382) is earthed on an N wire.

HEATED FRONT SCREEN (HFS)

DESCRIPTION

General

Operation of the Heated Front Screen (HFS) is controlled by the Automatic Temperature Control (ATC) ECU via the non latching HFS switch.

When the engine is running and the HFS is selected, the ATC ECU illuminates the LED above the switch and energises the HFS relay attached to the passenger end of the fascia cross tube. If not already active, the ATC ECU also activates the A/C compressor and the blower, and sets air distribution to windscreen. After 10 minutes (when ambient temperature is -15°C (5°F) or above) or 17 minutes (when ambient temperature is less than -15°C (5°F)), the ATC ECU extinguishes the LED and de-energises the heated front screen relay. After the heater times out or is switched off, the timer in the ATC ECU is reset to zero.

OPERATION

Power Distribution

Feed from the positive battery terminal (C0192) is supplied to fusible link 1 and fuse 53 of the passenger compartment fuse box (C0632) on an R wire. Fusible link 1 (C0592) provides a constant battery feed to the HFS relay (C0994) on an R wire.

Fuse 53 (C0583) provides a constant battery feed to the ignition switch (C0099 on Td6 vehicles, C0028 on V8 vehicles) on an R wire. When the ignition switch is turned to the 'ignition' position, current flows across the switch (C0099 on Td6 vehicles, C0028 on V8 vehicles) to fuse 34 of the passenger compartment fuse box (C0585) on a G wire. Fuse 34 (C0587) provides an ignition feed to the HFS relay coil (C0994) on a GY wire. The earth path for the relay coil (C0994) is controlled by the ATC ECU (C1629) on a UN wire.

HFS

When the HFS switch is pressed, a momentary earth path (C1630) is created on an N wire. If all operational conditions are met (*see 'Description' above*), the ATC ECU energises the HFS relay. The energised HFS relay (C0994) provides a feed to the LH (C0247) and RH (C0246) heater elements on a pair of B wires. Both elements are earthed on N wires.

DESCRIPTION AND OPERATION

WIPERS AND WASHERS

DESCRIPTION

General

The wipers and washers system is controlled by the Body Control Unit (BCU) on receipt of requests made by the driver or the rain sensor unit (if fitted). All wiper functions for the front and rear wipers are controlled from a multifunction wash/wipe switch assembly located on the right hand side of the steering column.

Optional equipment on Range Rover includes a rain sensor. The sensor, located below the interior rear view mirror, detects rain drops on the windscreen and automatically operates the wipers in the intermittent mode.

NOTE: The column stalk switch must be in the intermittent position for rain sensor controlled wiper operation.

The front wiper system has four stages of wiper operation with four different delay periods for intermittent wipe. The four stages are as follows:

- Flick wipe
- Intermittent
- Normal (slow) speed continuous
- Fast speed continuous.

The intermittent wiper delay periods change with the road speed, with the delay decreasing as the road speed increases. Normal continuous operation changes to intermittent operation when the vehicle is stationary. Fast speed operation changes to normal operation when the vehicle is stationary.

For a detailed description of the wipers and washers, refer to the ***Wipers and Washers*** section of the System Description and Operation Workshop manual.

OPERATION

Front

Power Distribution

Feed from the positive battery terminal (C0192) is supplied to fuse 26 and fuse 53 of the passenger compartment fuse box (C0632) on an R wire. Fuse 26 (C0583) provides a constant battery feed to the wiper delay ECU (C0546) on an RW wire.

Fuse 53 (C0583) provides a constant battery feed to the ignition switch (C0099 on Td6 vehicles, C0028 on V8 vehicles) on an R wire. When the ignition switch is turned to the 'auxiliary' position, current flows across the switch (C0099 on Td6 vehicles, C0028 on V8 vehicles) to fuse 41 of the passenger compartment fuse box (C0585) on a PB wire. Fuse 41 (C0586) provides an auxiliary ignition feed to the Body Control Unit (BCU) (C0660) on a PW wire, and the rain sensor (C0961) on a PR wire.

Rain Sensor

The rain sensor (C0961) is mounted on the upper edge of the windscreen. It is provided an auxiliary ignition feed from fuse 41 of the passenger compartment fuse box (C0586) on a PR wire, and is earthed on an NB wire. The rain sensor (C0961) provides information to the BCU (C0660) via the K bus on a WRY wire. This information is used by the BCU to determine optimum wiper operation for the prevailing conditions.

Steering Wheel Switch

The BCU (C0660) provides feeds to the steering wheel switches (C0278) on BW and BU wires. The steering wheel switch (C0278) is earthed on an NB wire. The BCU determines which function has been selected by the earth paths that are created by the switch. If slow wipe is selected, current on the BW wire flows across the switch to earth. If fast wipe is selected, current on both the BW and BU wires flows across the switch to earth. If intermittent wipe is selected, current on the BU wire flows across the switch to earth.

The steering wheel switch also contains a rotary potentiometer to control the intermittent wipe function. The intermittent wipe setting is interpreted by the BCU (C0661) from the feed returned from the switch (C0278) on a BG wire.

When the BCU (C0661) senses that wiper operation is required, it provides a feed to the wiper delay ECU (C0546) on an NU wire. The wiper delay ECU (C0546) is earthed on an N wire and provides two feeds to the wiper motor (C0546) on BG and BN wires.

Washer

If the steering wheel switch is pulled towards the driver, current flows from the BCU (C0660) to the steering wheel switch (C0278) on an NP wire, and then to earth on an NB wire. Sensing this earth, the BCU (C0662) provides a feed to the washer pump motor (C0008) on a B wire. Current flows across the washer pump motor (C0008) to earth on an N wire. The BCU powers the washer pump motor for as long as the switch is held in position, and also powers the wipers at slow speed.

DESCRIPTION AND OPERATION

Rear

Power Distribution

Feed from the positive battery terminal (C0192) is supplied to fuse 27, fuse 53, and fusible link 5 of the passenger compartment fuse box (C0632) on an R wire. Fuse 27 (C0585) provides a constant battery feed to the BCU (C0662) on an RU wire. Fusible link 5 (C0588) is connected to fuse 10 of the rear fuse box (C2024) on an R wire. Fuse 10 (C2021) provides a constant battery feed to the rear screen wiper ECU (C0388) on an RW wire.

Fuse 53 of the passenger compartment fuse box (C0583) is connected to the ignition switch (C0099 on Td6 vehicles, C0028 on V8 vehicles) by an R wire. When the ignition switch is turned to the 'auxiliary' position, current flows across the switch (C0099 on Td6 vehicles, C0028 on V8 vehicles) to fuse 41 of the passenger compartment fuse box (C0585) on a PB wire. Fuse 41 (C0586) provides an auxiliary ignition feed to the rear screen wiper ECU (C0835) on a PR wire. The ECU is earthed on an N (C0388) and an NB (C0835) wire.

Rear Wiper ECU

Operation of the rear wiper and washer system is controlled by the rear wiper ECU, which is integral with the motor assembly. The ECU (C0835) monitors the condition of the steering wheel switch (C0278) by providing feeds on BW and BU wires. If a request is made for rear wiper or washer operation, an earth path is created on an NB wire.

The rear wiper ECU (C0835) receives a 'reverse gear selected' signal from the Light Check Module (LCM) (C2040) on a UY wire. When the rear wiper ECU receives this feed it powers the rear wiper motor.

Washer

When the rear wiper ECU receives a washer request from the steering wheel switch, it provides a feed to the rear washer pump (C0021) on a BR wire. Current flows across the pump motor (C0021) to earth on an N wire.

HEADLAMP WASH/WIPE

DESCRIPTION

General

Operation of the headlamp wash/wipe system is controlled by the Body Control Unit (BCU) via the headlamp wash/wipe relay. Headlamp wash/wipe is activated automatically when the ignition and the headlamps are switched on, and windscreen wash/wipe is selected via the column switch. The headlamp wipers will operate through four cycles, with the washer jets spraying twice. This operation is only carried out on the first windscreen wash/wipe request, and then every fifth request from then on. This sequence is reset when the ignition is switched off.

For more information on headlamp wash/wipe, refer to the ***Wipers and Washers*** section of the System Description and Operation Workshop Manual.

OPERATION

Power Distribution

Feed from the positive battery terminal (C0192) is supplied to fuse 28 and fuse 53 of the passenger compartment fuse box (C0632) on an R wire. Fuse 28 (C0582) provides a constant battery feed to the following on RS wires:

- The headlamp wash/wipe relay (C2031)
- The RH headlamp wiper motor (C1341)
- The LH headlamp wiper motor (C1340).

Fuse 53 (C0583) provides a constant battery feed to the ignition switch (C0099 on Td6 vehicles, C0028 on V8 vehicles) on an R wire. When the ignition switch is turned to the 'auxiliary' position, current flows across the switch (C0099 on Td6 vehicles, C0028 on V8 vehicles) to fuse 41 of the passenger compartment fuse box (C0585) on a PB wire. Fuse 41 (C0586) provides an auxiliary ignition feed to the BCU (C0660) on a PW wire. The BCU (C0662) is earthed on an N wire.

Headlamp Wash/Wipe Relay

When the BCU (C0661) determines a wash/wipe selection has been made, it provides a pulsed voltage feed to the headlamp wash/wipe relay (C2031) on a UB wire. The headlamp wash/wipe relay (C2031) is earthed on an NB wire. When this feed is received, circuitry contained within the relay converts this signal into a headlamp wash/wipe request and closes the relay switch contacts. This allows a feed to be provided to the RH headlamp motor (C1341) and the LH headlamp motor (C1340) on a pair of BN wires. Current flows across the motors to earth on N wires.

DESCRIPTION AND OPERATION

BRAKE AND REVERSE LAMPS

DESCRIPTION

Brake Lamps

The brake lamps are active with the ignition switch in the 'auxiliary' or 'ignition' positions. The Light Check Module (LCM) receives an input from the brake switch, which is used as a signal to activate the brake lamps. When Hill Descent Control (HDC) is active, the ABS ECU outputs a signal on a separate hardwired connection to the LCM to activate the brake lamps when the HDC function is operating.

For more information on brake lamp operation, refer to the ***Exterior Lamps*** section of the System Description and Operation Workshop Manual.

Reverse Lamps

The reverse lamps will operate when the ignition switch is in the 'ignition' position. The LCM activates the reverse lamps on receipt of a message on the I Bus that reverse gear has been selected.

For more information on reverse lamp operation, refer to the ***Exterior Lamps*** section of the System Description and Operation Workshop Manual.

OPERATION

Power Distribution

Feed from the positive battery terminal (C0192) is supplied to fusible link 3 and fuse 53 of the passenger compartment fuse box (C0632) on an R wire. Fusible link 3 (C0589) provides a constant battery feed to the Light Check Module (LCM) (C0937) on an R wire.

Fuse 53 (C0583) provides a constant battery feed to the ignition switch (C0099 on Td6 vehicles, C0028 on V8 vehicles) on an R wire. When the ignition switch is turned to the 'auxiliary' position, current flows across the switch (C0099 on Td6 vehicles, C0028 on V8 vehicles) to fuse 9 of the passenger compartment fuse box (C0585) on a PB wire. Fuse 9 (C0587) provides an auxiliary ignition feed to the LCM (C2040) and the brake pedal switch (C0075) on a pair of PY wires.

Brake Lamps

The LCM (C2040) monitors the condition of the brake pedal via the brake pedal switch (C0075) on a UR wire. When the brake pedal is pressed, the switch contacts close and an earth path is created on an NB wire. Sensing this, the LCM (C0937) provides a feed to the following on BU wires:

- The RH brake lamp (C0125)
- The LH brake lamp (C0121)
- The Centre High Mounted Stop Lamp (CHMSL) (C0613).

All are earthed on N wires.

When HDC is functioning, the ABS ECU (C0506) outputs a signal to the LCM (C2040) on a YN wire. When the LCM receives this signal, it operates the brake lamps as described above. For more information on ABS operation, refer to the **Anti-Lock Braking System (ABS)** section of this manual, and the **Brakes** section of the System Description and Operation Workshop manual.

 **ANTI-LOCK BRAKING SYSTEM (ABS).**

Reverse Lamps

When reverse gear is selected, a message is sent from the Electronic Automatic Transmission (EAT) ECU (C1835) to the Engine Control Module (ECM) (C0604) via the CAN Bus on YN (low) and YB (high) wires. This message is relayed from the ECM (C0331) to the instrument pack (C0234) via the CAN Bus on YN (low) and YB (high) wires

When the instrument pack receives this message, it outputs a signal to the LCM (C2040) via the I Bus on a WSY wire. When the LCM (C2039) receives a reverse gear selected signal, it provides a feed to the following on WY wires:

- The RH reverse lamp (C0455)
- The LH reverse lamp (C0472).

Both lamps are earthed on N wires.

DESCRIPTION AND OPERATION

HEAD, SIDE AND TAIL LAMPS

DESCRIPTION

General

Operation of the head, side, tail, and side marker (NAS vehicles only) is controlled by the Light Check Module (LCM). The LCM receives inputs from other systems via the I Bus.

Two headlamp systems are available; Halogen or bi-xenon. The two types of headlamps share a common lens.

NOTE: NAS vehicles are fitted with headlamp lenses marked with a Department of Transport (DOT) rating.

The bi-xenon headlamps illuminate when an arc of electrical current is established between two electrodes within the bulb. The xenon gas sealed in the bulb reacts to the electrical excitation and the heat generated by the current flow. This causes the gas to produce a blue/white light.

WARNING: The bi-xenon system generates up to 28000 volts and contact with this voltage could lead to fatality. Ensure the headlamps are switched off before working on the system.

For more details of headlamp operation, refer to the **Lighting** section of the System Description and Operation Workshop Manual.

OPERATION

Halogen System

Power Distribution

Feed from the positive battery terminal (C0192) is supplied to fuse 53, fusible link 3, and fusible link 4 on an R wire. All are located in the passenger compartment fuse box. Fusible link 3 (C0589) and fusible link 4 (C0590) provide constant battery feeds to the Light Check Module (LCM) (C0937 & C2039 respectively) on a pair of R wires. The LCM (C2039) is earthed on an N wire.

Fuse 53 (C0583) provides a constant battery feed to the ignition switch (C0099 on Td6 vehicles, C0028 on V8 vehicles) on an R wire. When the ignition switch is turned to the 'auxiliary' position, current flows across the switch (C0099 on Td6 vehicles, C0028 on V8 vehicles) to fuse 9 of the passenger compartment fuse box (C0585) on a PB wire. Fuse 9 (C0587) provides an auxiliary ignition feed to the LCM (C2040) on a PY wire.

When the ignition switch is turned to the 'ignition' position, current flows across the switch (C0099 on Td6 vehicles, C0028 on V8 vehicles) to fuse 4 of the passenger compartment fuse box (C0585) on a G wire. Fuse 4 (C0587) provides an ignition feed to the LCM (C2040) on a GS wire.

Light Check Module

The LCM (C2040) is located at the base of the RH 'A' post, and monitors the condition of the fascia mounted rotary lighting switch (C0041) by providing a feed on an NB wire. The LCM can determine the position of the switch by sensing if a feed is returned on a Y (side lamps) or a B (headlamps) wire. The LCM also monitors the condition of the column mounted main/dipped beam switch (C1832) via a U wire.

Side Lamps

If the LCM detects that side lamps have been selected, it provides a feed to the following:

- To the RH side lamp (C0537) on an SU wire
- To the LH side lamp (C0538) on an SG wire
- To the RH tail lamp (C0125) on an SW wire
- To the LH tail lamp (C0121) on an SP wire
- The rear number plate lamp (C1495) on an SN and an SB wire
- To the RH front side marker lamp (C0916) on an SU wire (NAS vehicles only)
- To the RH rear side marker lamp (C0918) on an SU wire (NAS vehicles only)
- To the LH front side marker lamp (C0917) on an SG wire (NAS vehicles only)
- To the LH rear side marker lamp (C0919) on an SG wire (NAS vehicles only).

All are earthed on N wires.

Headlamp Dipped Beam

In addition to the lamps outlined in the side lamps section, the LCM will provide feeds to the following lamps if it detects that headlamp dipped beam has been selected:

- To the RH headlamp dipped beam bulb (C0011) on a YU wire
- To the LH headlamp dipped beam bulb (C0009) on a WG wire.

Both are earthed on N wires.

Headlamp Main Beam

In addition to the lamps outlined in the side lamps and headlamp dipped beam sections, the LCM will provide feeds to the following lamps if it detects that headlamp main beam has been selected:

- To the RH headlamp main beam bulb (C0011) on a WU wire
- To the LH headlamp main beam bulb (C0009) on a YG wire.

Both are earthed on N wires.

DESCRIPTION AND OPERATION

Bi-Xenon System

Power Distribution

Feed from the positive battery terminal (C0192) is supplied to fuse 53, fusible link 3, and fusible link 4 on an R wire. All are located in the passenger compartment fuse box. Fusible link 3 (C0589) and fusible link 4 (C0590) provide constant battery feeds to the Light Check Module (LCM) (C0937 & C2039 respectively) on a pair of R wires. The LCM (C2039) is earthed on an N wire.

Fuse 53 (C0583) provides a constant battery feed to the ignition switch (C0099 on Td6 vehicles, C0028 on V8 vehicles) on an R wire. When the ignition switch is turned to the 'auxiliary' position, current flows across the switch (C0099 on Td6 vehicles, C0028 on V8 vehicles) to fuse 9 of the passenger compartment fuse box (C0585) on a PB wire. Fuse 9 (C0587) provides an auxiliary ignition feed to the LCM (C2040) on a PY wire.

When the ignition switch is turned to the 'ignition' position, current flows across the switch (C0099 on Td6 vehicles, C0028 on V8 vehicles) to fuse 4 and fuse 32 of the passenger compartment fuse box (C0585) on a G wire. Fuse 4 (C0587) provides an ignition feed to the LCM (C2040) on a GS wire.

Fuse 32 of the passenger compartment fuse box (C0585) provides an ignition feed to LH bi-xenon headlamp (C0009) on a GR wire. Fuse 32 (C0587) also provides an ignition feed to the RH bi-xenon headlamp (C0011) on a GR wire.

Light Check Module

The LCM (C2040) is located at the base of the RH 'A' post, and monitors the condition of the fascia mounted rotary lighting switch (C0041) by providing a feed on an NB wire. The LCM can determine the position of the switch by sensing if a feed is returned on a Y (side lamps) or a B (headlamps) wire. The LCM also monitors the condition of the column mounted main/dipped beam switch (C1832) via a U wire.

Side Lamps

If the LCM detects that side lamps have been selected, it provides a feed to the following:

- To the RH side lamp (C0537) on an SU wire
- To the LH side lamp (C0538) on an SG wire
- To the RH tail lamp (C0125) on an SW wire
- To the LH tail lamp (C0121) on an SP wire
- The rear number plate lamp (C1495) on an SN and an SB wire
- To the RH front side marker lamp (C0916) on an SU wire (NAS vehicles only)
- To the RH rear side marker lamp (C0918) on an SU wire (NAS vehicles only)
- To the LH front side marker lamp (C0917) on an SG wire (NAS vehicles only)
- To the LH rear side marker lamp (C0919) on an SG wire (NAS vehicles only).

All are earthed on N wires.

Headlamp Dipped Beam

In addition to the lamps outlined in the side lamps section, the LCM will provide feeds to the following lamps if it detects that headlamp dipped beam has been selected:

- To the RH headlamp dipped beam bulb (C0011) on a YU wire
- To the LH headlamp dipped beam bulb (C0009) on a WG wire.

Both are earthed on N wires.

Headlamp Main Beam

In addition to the lamps outlined in the side lamps and headlamp dipped beam sections, the LCM will provide feeds to the following lamps if it detects that headlamp main beam has been selected:

- To the RH headlamp bi-xenon unit (C0011) on a WU and a WB wire
- To the LH headlamp bi-xenon unit (C0009) on a YG and a WB wire.

Both are earthed on N wires.

Diagnostic Socket

The bi-xenon headlamp system can be interrogated using TestBook or T4 via the diagnostic socket. The diagnostic socket (C0040) is connected to the RH (C0011) and LH (C0009) bi-xenon units via a pair of WP wires.

DESCRIPTION AND OPERATION

AUTOMATIC HEADLAMP LEVELLING

DESCRIPTION

General

Automatic headlamp levelling is only fitted to vehicles with bi-xenon headlamps. The system adjusts the vertical positioning of the headlamps to provide optimum headlamp beam position for maximum driving visibility and preventing glare to oncoming drivers.

WARNING: The bi-xenon headlamp system generates up to 28000 volts and contact with this voltage could lead to fatality. Ensure the headlamps are switched off before working on the system.

The system is controlled by the headlamp levelling ECU, which is located at the base of the LH 'A' post. The ECU receives information from the front and rear height sensors and the ABS ECU to maintain the headlamps in the optimum vertical position.

For more information on automatic headlamp levelling, refer to the ***Lighting*** section of the System Description and Operation Workshop Manual.

OPERATION

Power Distribution

Feed from the positive battery terminal (C0192) is supplied to fusible link 4 and fuse 53 of the passenger compartment fuse box (C0632) on an R wire. Fusible link 4 (C0590) provides a constant battery feed to the Light Check Module (LCM) (C2039) on an R wire.

Fuse 53 (C0583) provides a constant battery feed to the ignition switch (C0099 on Td6 vehicles, C0028 on V8 vehicles) on an R wire. When the ignition switch is turned to the 'auxiliary' position, current flows across the switch (C0099 on Td6 vehicles, C0028 on V8 vehicles) to fuse 9 of the passenger compartment fuse box (C0585) on a PB wire. Fuse 9 (C0587) provides an auxiliary ignition feed to the LCM (C2040) on a PY wire.

Light Check Module

When the engine is running, the Light Check Module (LCM) (C2040) provides a feed to the headlamp levelling ECU (C1543) on a YR wire to initiate the automatic headlamp levelling function.

The LCM (C2040) also monitors the condition of the brake pedal switch (C0075) by providing a feed on a UR wire. This feed allows the headlamp levelling ECU to register when the vehicle is about to decelerate and adjust the vertical position of the headlamps accordingly.

For more information on the brake pedal switch, refer to the ***Brake and Reverse Lamps*** section of this manual.

 **BRAKE AND REVERSE LAMPS.**

ABS ECU

The ABS ECU (C0506) provides a vehicle speed signal to the headlamp levelling ECU (C1543) on a YW wire. This allows the headlamp levelling ECU to monitor the acceleration of the vehicle and adjust the vertical position of the headlamps accordingly.

RH Front Height Sensor

The headlamp levelling ECU (C1543) provides a 5V reference feed to the RH front height sensor (C1697) on a WB wire, and provides an earth path on a WN wire. The height sensor (C1697) returns a signal feed back to the headlamp levelling ECU (C1543) on a WS wire. By measuring this signal feed the headlamp ECU can determine the height of the front of the vehicle, compare this to the signal supplied by the RH rear height sensor and adjust the vertical position of the headlamps accordingly.

RH Rear Height Sensor

The headlamp levelling ECU (C1543) provides a 5V reference feed to the RH rear height sensor (C1698) on an SB wire, and provides an earth path on an SN wire. The height sensor (C1698) returns a signal feed back to the headlamp levelling ECU (C1543) on an SW wire. By measuring this signal feed the headlamp ECU can determine the height of the rear of the vehicle, compare this to the signal supplied by the RH front height sensor and adjust the vertical position of the headlamps accordingly.

DESCRIPTION AND OPERATION

FOG LAMPS

DESCRIPTION

General

Operation of both the front and rear fog lamps is controlled by the Light Check Module (LCM). The front fog lamps are only active when the ignition switch is in the 'ignition' position and the fascia mounted rotary lighting switch is in the side or headlamp position.

When the lighting switch is in the side lamp position, the rear fog lamps will only operate if the front fog lamps are operational. If the lighting switch is in the headlamp position, the rear fog lamps can be switched on separately from the front fog lamps.

For more information on fog lamp operation, refer to the **Lighting** section of the System Description and Operation Workshop Manual.

OPERATION

Front Fog Lamps

Power Distribution

Feed from the positive battery terminal (C0192) is supplied to fusible link 3 and fuse 53 of the passenger compartment fuse box (C0632) on an R wire. Fusible link 3 (C0589) provides a constant battery feed to the LCM (C0937) on an R wire.

Fuse 53 (C0583) provides a constant battery feed to the ignition switch (C0099 on Td6 vehicles, C0028 on V8 vehicles) on an R wire. When the ignition switch is turned to the 'auxiliary' position, current flows across the switch (C0099 on Td6 vehicles, C0028 on V8 vehicles) to fuse 9 of the passenger compartment fuse box (C0585) on a PB wire. Fuse 9 (C0587) provides an auxiliary ignition feed to the LCM (C2040) on a PY wire. The LCM (C2039) is earthed on an N wire.

Light Check Module

The Light Check Module (LCM) (C2040) provides a feed to the lighting switch (C0041) on a YW wire. When front fog lamps are selected, the switch contacts close momentarily. Current flows across the switch to the LCM on an NB wire. Sensing this, the LCM powers the front fog lamps.

The LCM (C0937) provides a feed to the RH front fog lamp (C0513) on a YN wire. The lamp is earthed on an N wire. The LCM (C2039) also provides a feed to the LH front fog lamp (C0514) on a YR wire. The lamp is earthed on an N wire.

Rear Fog Lamps

Power Distribution

Feed from the positive battery terminal (C0192) is supplied to fusible link 3 and fuse 53 of the passenger compartment fuse box (C0632) on an R wire. Fusible link 3 (C0589) provides a constant battery feed to the LCM (C0937) on an R wire.

Fuse 53 (C0583) provides a constant battery feed to the ignition switch (C0099 on Td6 vehicles, C0028 on V8 vehicles) on an R wire. When the ignition switch is turned to the 'auxiliary' position, current flows across the switch (C0099 on Td6 vehicles, C0028 on V8 vehicles) to fuse 9 of the passenger compartment fuse box (C0585) on a PB wire. Fuse 9 (C0587) provides an auxiliary ignition feed to the LCM (C2040) on a PY wire. The LCM (C2039) is earthed on an N wire.

Light Check Module

The Light Check Module (LCM) (C2040) provides a feed to the lighting switch (C0041) on a YB wire. When rear fog lamps are selected, the switch contacts close momentarily. Current flows across the switch to the LCM on an NB wire. Sensing this, the LCM powers the rear fog lamps.

The LCM (C0937) provides a feed to the RH rear fog lamp (C0125) on a YB wire. The lamp is earthed on an N wire. The LCM (C2039) also provides a feed to the LH rear fog lamp (C0121) on a YB wire. The lamp is earthed on an N wire.

DESCRIPTION AND OPERATION

DIRECTION INDICATOR/HAZARD WARNING LAMPS

DESCRIPTION

General

Operation of the direction indicator lamps is controlled by the column mounted switch via the Light Check Module (LCM). The direction indicator lamps operate when the ignition switch is in either the 'auxiliary' or 'ignition' positions.

The front direction indicator lamps are located within the side lamp assemblies, outboard of the headlamps. The rear direction indicator lamps are located within the tail lamp assemblies. The rear direction indicators are mounted behind the brake lamp LED assemblies. When the direction indicators are selected, a lens within the tail lamp directs the light around the outer diameter of the brake lamp LED assembly.

The hazard warning switch is mounted on the centre of the fascia. When pressed, both sets of direction indicator lamps operate simultaneously.

For more details on direction indicator and hazard warning lamp operation, refer to the **Lighting** section of the System Description and Operation Workshop manual.

OPERATION

Power Distribution

Feed from the positive battery terminal (C0192) is supplied to fusible link 3, fusible link 4, and fuse 53 of the passenger compartment fuse box (C0632) on an R wire. Fusible link 3 (C0589) and fusible link 4 (C0590) provide constant battery feeds to the Light Check Module (LCM) (C0937 & C2039 respectively) on a pair of R wires.

Fuse 53 of the passenger compartment fuse box (C0583) provides a constant battery feed to the ignition switch (C0099 on Td6 vehicles, C0028 on V8 vehicles) on an R wire. When the ignition switch is turned to the 'auxiliary' position, current flows across the switch (C0099 on Td6 vehicles, C0028 on V8 vehicles) to fuse 9 of the passenger compartment fuse box (C0585) on a PB wire. Fuse 9 (C0587) provides an auxiliary ignition feed to the Light Check Module (LCM) (C2040) on a PY wire.

When the ignition switch is turned to the 'ignition' position, current flows across the switch (C0099 on Td6 vehicles, C0028 on V8 vehicles) to fuse 4 of the passenger compartment fuse box (C0585) on a G wire. Fuse 4 (C0587) provides an ignition feed to the LCM (C2040) on a GS wire.

The LCM (C2039) is earthed on an N wire.

RH Turn

The LCM (C2040) monitors the condition of the column mounted direction indicator switch (C1832) by providing a feed on an NB wire. If a RH turn is selected, the LCM provides the following outputs:

- From the LCM (C0937) to the RH front direction indicator lamp (C0002) on a UN wire.
- From the LCM (C2039) to the RH rear direction indicator lamp (C0125) on a UN wire.
- From the LCM (C0937) to the RH rear side repeater lamp (C0012) on a UY wire.

All are earthed on N wires.

LH Turn

The LCM (C2040) monitors the condition of the column mounted direction indicator switch (C1832) by providing a feed on an NB wire. If a LH turn is selected, the LCM provides the following outputs:

- From the LCM (C2039) to the LH front direction indicator lamp (C0001) on a UG wire.
- From the LCM (C0937) to the LH rear direction indicator lamp (C0121) on a UG wire.
- From the LCM (C2039) to the LH rear side repeater lamp (C0013) on a UY wire.

All are earthed on N wires.

Hazard Warning Lamps

If an impact severe enough to trigger the airbags is detected, the SRS DCU sends a K bus message to the instrument pack requesting the hazard warning lamps be initiated. This is relayed to the LCM (C2040) via the I bus on a WSY wire.

DESCRIPTION AND OPERATION

INTERIOR LAMPS

DESCRIPTION

General

Operation of the interior lamps is controlled by the Body Control Unit (BCU) which is located beneath the front passenger seat.

The interior lamps have two modes of operation; automatic or manual. In the automatic mode the interior lamp functionality is controlled by the BCU on receipt of various input signals. In manual mode, the lamps can be switched on and off using the non-latching switch adjacent to the front interior lamp, or can be disabled completely using the same switch.

For more information on interior lamp functionality, refer to the **Lighting** section of the System Description and Operation Workshop manual.

OPERATION

Power Distribution

Feed from the positive battery terminal (C0192) is supplied to fuse 17, fuse 27 and fuse 53 of the passenger compartment fuse box (C0632) on an R wire. Fuse 17 is connected to the door lamp module, which is also located in the passenger compartment fuse box.

Fuse 27 (C0582) provides a constant battery feed to the Body Control Unit (BCU) (C0662) on an RP wire.

Fuse 53 (C0583) provides a constant battery feed to the ignition switch (C0099 on Td6 vehicles, C0028 on V8 vehicles) on an R wire. When the ignition switch is turned to the 'auxiliary' position, current flows across the switch (C0099 on Td6 vehicles, C0028 on V8 vehicles) to fuse 42 of the passenger compartment fuse box (C0585) on a PB wire. Fuse 42 (C0586) provides an auxiliary ignition feed to the RH (C0736) and LH (C0737) vanity mirrors on a pair of PS wires.

When the ignition switch is turned to the 'ignition' position, current flows across the switch (C0099 on Td6 vehicles, C0028 on V8 vehicles) to fuse 4 of the passenger compartment fuse box (C0585) on a G wire. Fuse 4 provides an ignition feed to the door lamp module, which is also located in the passenger compartment fuse box.

Body Control Unit (BCU)

The BCU (C0662) monitors the condition of all four doors and provides feeds to the following lamps via the passenger compartment fuse box on RU wires if any are opened:

- The RH front footwell lamp (C0076)
- The LH front footwell lamp (C0077)
- The RH front sill lamp (C1794)
- The LH front sill lamp (C1795)
- The LH rear puddle lamp (C2212)
- The RH front puddle lamp (C2211)
- The RH rear puddle lamp (C2212)
- The LH front puddle lamp (C2210)
- The front interior lamp (C0355)
- The rear interior lamp (C0357).

All are earthed on N wires.

NOTE: The LH rear and RH rear puddle lamps have the same connector number as they utilise the same harness.

Approach Lamps

When the BCU receives a valid unlocking signal from the remote handset, it will illuminate the approach lamps via the door lamp module. The door lamp module (C0587) is located in the passenger compartment fuse box and provides a feed to the LH (C2291) and RH (C2291) approach lamps on a pair of RG then K wires. Both lamps are earthed on Y then N wires.

NOTE: The LH and RH approach lamps have the same connector number as they utilise the same harness.

Luggage Compartment Lamps

The BCU (C0662) provides a feed to the LH (C0120) and RH (C0119) upper tail door lamps, and the luggage compartment lamp (C2047) on RY wires. The earth path for the lamps is controlled by the tail door tail door motor (C0383).

Map Reading Lamps

The front and rear interior lamps both contain 2 map reading lamps. The BCU (C0662) provides a feed to the front (C0355) and rear (C0357) map reading lamps on a pair of RY wires. When any of the map reading lamp switches are pressed, the switch contacts close allowing current to flow to earth on an N wire to illuminate the lamp.

DESCRIPTION AND OPERATION

Glove Box Lamp

The BCU (C0662) monitors the condition of the glove box switch (C0227) by providing a feed on a RY wire. When the glove box is opened, the switch contacts close creating a path to earth on an N wire.

Automatic Mode

When the interior lamps are in automatic mode and any of the doors are opened, the BCU (C0662) provides a feed to all the interior lamps listed in the **Body Control Unit (BCU)** section previously. Current flows across the lamps to earth on N wires. When all the doors are closed, the BCU withdraws the feed to the interior lamps.

Manual Mode

When the switch located on the front interior lamp is pressed to enter the manual 'continuously on' mode, current flows across the front interior lamp to the BCU (C0660) on a WN wire. Sensing this, the BCU illuminates all the interior lamps listed in the **Body Control Unit (BCU)** section irrespective of door status.

INTERIOR ILLUMINATION

DESCRIPTION

General

Operation of the interior illumination LED's and lamps is controlled by the Light Check Module (LCM). The LCM is located at the base of the RH 'A' post, and powers the LED's and lamps when the ignition switch is in either the auxiliary or ignition position, and the lighting switch is in either the side or headlamp position.

OPERATION

Power Distribution

Feed from the positive battery terminal (C0192) is supplied to fusible link 3, fusible link 4, and fuse 53 of the passenger compartment fuse box (C0632) on an R wire. Fusible link 3 (C0589) and fusible link 4 (C0590) provide constant battery feeds to the LCM on R wires.

Fuse (C0583) provides a constant battery feed to the ignition switch (C0099 on Td6 vehicles, C0028 on V8 vehicles) on an R wire. When the ignition switch is turned to the 'auxiliary' position, current flows across the switch (C0099 on Td6 vehicles, C0028 on V8 vehicles) to fuse 9 of the passenger compartment fuse box (C0585) on a PB wire. Fuse 9 (C0587) provides an auxiliary ignition feed to the LCM (C2040) on a PY wire.

When the ignition switch is turned to the 'ignition' position, current flows across the switch (C0099 on Td6 vehicles, C0028 on V8 vehicles) to fuse 4 of the passenger compartment fuse box (C0585) on a G wire. Fuse 4 (C0587) provides an ignition feed to the LCM (C2040) on a GS wire.

Lighting Switch

The LCM (C2040) monitors the condition of the fascia mounted rotary lighting switch (C0041) by providing a feed on an NB wire. When the lighting switch is turned to the side lamp position, it returns a feed to the LCM (C2040) on a Y wire. When the lighting switch is turned to the headlamp position, it returns a feed to the LCM (C2040) on a B wire.

DESCRIPTION AND OPERATION

Light Check Module (LCM)

When the LCM (C2039) senses that the ignition switch is in either the auxiliary or ignition position, and the lighting switch is in either the side or headlamp position, it provides a feed to the following lamps on SR wires:

- RH inner face level air vent illumination (C1295)
- RH outer face level air vent illumination (C1200)
- LH inner face level air vent illumination (C1294)
- LH outer face level air vent illumination (C1199)
- Clock illumination (C0232)
- Rear heater illumination (C0846)
- Sunroof switch illumination (C0363)
- Automatic Temperature Control (ATC) control panel (C1629)
- Emergency switch illumination (C2082)
- Instrument pack illumination (C0230)
- Hazard warning switch illumination (C0096)
- Centre console switch pack illumination (C0700)
- Radio remote display illumination (C0241)
- Multi Function Display (MFD) illumination (C0816)
- Radio/cassette player illumination (C0098)
- Rear radio illumination (C0818)
- LH rear window switch illumination (C0732)
- RH rear window switch illumination (C0732)

NOTE: The LH and RH rear window switches have the same connector number as they utilise the same harness.

- Air suspension ride height switch illumination (C2186)
- Drivers door module illumination (C2058)
- Passenger door module illumination (C2057)
- Front cigar lighter (C0074)
- Rear cigar lighter (C1596)
- Ashtray illumination (C2322)
- RH seat heat switch (C1401)
- LH seat heat switch (C1403)
- Automatic transmission selector indicator illumination (C0245)
- Telephone eject box illumination (C1252).

All the above are earthed on N wires. The LCM also provides a feed to the following LED's on SR wires:

- Front interior lamp LED's (C0355)
- Rear interior lamp LED (C0357)
- RH rear door handle LED (C2335)
- LH rear door handle LED (C2335)

NOTE: The LH and RH rear door handle LED's have the same connector number as they utilise the same harness.

All the above are earthed on N wires.

Drivers Door Module

When the drivers door module (C2058) receives an illumination feed from the LCM, it illuminates the following LED's by providing a feed on SR then SU wires:

- Drivers door interior handle LED
- Door pocket front LED
- Door pocket rear LED.

Passenger Door Module

When the passenger door module (C2057) receives an illumination feed from the LCM, it illuminates the following LED's by providing a feed on SR then SU wires:

- Passenger door interior handle LED
- Door pocket front LED
- Door pocket rear LED.

DESCRIPTION AND OPERATION

INSTRUMENTS

DESCRIPTION

General

The instrument pack is a totally electronic device which receives analogue or digital signals via hardwired or bus systems for instrumentation operation. The instrument pack has two main functions:

- To provide the driver information on vehicle status
- To process and relay digital signals to and from other system controlling ECU's.

The signals are processed by two microprocessors which transpose the data into analogue gauge indications or warning lamp illumination. For more details on instrument pack operation, refer to the ***Instruments*** section of the System Description and Operation Workshop Manual.

OPERATION

Power Distribution

Feed from the positive battery terminal (C0192) is supplied to fuse 27, fuse 46, and fuse 53 of the passenger compartment fuse box (C0632) on an R wire. Fuse 27 (C0582) provides a constant battery feed to the Body Control Unit (BCU) (C0662) on an RP wire. Fuse 46 (C0586) provides two constant battery feeds to the instrument pack (C0230 & C0233) on a pair of RY wires.

Fuse 53 (C0583) provides a constant battery feed to the ignition switch (C0099 on Td6 vehicles, C0028 on V8 vehicles) on an R wire. When the ignition switch is turned to the 'auxiliary' position, current flows across the switch (C0099 on Td6 vehicles, C0028 on V8 vehicles) to fuse 45 of the passenger compartment fuse box (C0585) on a PB wire. Fuse 45 (C0586) provides an auxiliary ignition feed to the instrument pack (C0233) on a PG wire.

When the ignition switch is turned to the 'ignition' position, current flows across the switch (C0099 on Td6 vehicles, C0028 on V8 vehicles) to fuse 1 of the passenger compartment fuse box (C0585) on a G wire. Fuse 1 (C0587) provides two ignition feeds to the instrument pack (C0230 & C0233) on a pair of GU wires.

The instrument pack (C0230 & C0233) is earthed on NB wires.

Analogue Instruments

Speedometer

The ABS ECU (C0506) provides the instrument pack (C0230) a pulsed signal on an SB wire. The instrument pack calculates the vehicle speed from this signal and broadcasts it to other systems via the CAN, I, and K buses.

Tachometer

The instrument pack (C0234) receives an engine speed signal from the Engine Control Module (ECM) via the CAN bus on YN (low) and YB (high) wires.

Fuel Level Gauge

The instrument pack (C0234) provides a feed to the LH fuel tank level sensor (C0114) and the RH fuel tank level sensor (C0114) on BRW and BRV wires respectively. Each level sensor is a float operated potentiometer. By measuring the current returned on an NBW (LH) and an NBY (RH) wire, the instrument pack can determine how much fuel is in the tank.

Engine Coolant Temperature (ECT) Gauge

The instrument pack (C0234) provides a feed to the ECT sensor (C0169) on an NP wire. The ECT sensor is a Negative Temperature Coefficient (NTC) sensor. As ECT rises, the resistance of the sensor falls. By measuring the signal returned on an NY wire, the instrument pack can determine the ECT.

Warning Lamps

For details on warning lamp operation, refer to the ***Instruments*** section of the Service Description and Operation Workshop manual.

DESCRIPTION AND OPERATION

HORNS

DESCRIPTION

General

Two horns are located behind the RH side of the front bumper. Operation of the horns is controlled by the two steering wheel mounted switches when the ignition switch is in either the 'auxiliary' or 'ignition' position.

OPERATION

Power Distribution

Feed from the positive battery terminal (C0192) is supplied to fuse 10 and fuse 53 of the passenger compartment fuse box (C0632) on an R wire. Fuse 10 is connected to the switch contacts of the horn relay, which is also located in the passenger compartment fuse box.

Fuse 53 (C0583) is connected to the ignition switch (C0099 on Td6 vehicles, C0028 on V8 vehicles) by an R wire. When the ignition switch is turned to the 'auxiliary' position, current flows across the switch (C0099 on Td6 vehicles, C0028 on V8 vehicles) to the horn relay coil (C0585) on a PB wire.

Horn Relay

The earth path for the horn relay coil (C0587) is controlled by the steering wheel modules (C2285) via the rotary coupler (C0082) on an NR wire. When either of the horn switches are pressed, an earth path is created via the rotary coupler (C0082) on an NB wire. This energises the horn relay (C0585) allowing fuse 10 of the passenger compartment fuse box to supply a battery feed to the LH (C0003) and RH (C0004) horns on a pair of PS wires. Both horns are earthed on N wires.

CLOCK

DESCRIPTION

General

The analogue clock is mounted on the passenger side of the centre console, and is illuminated when the fascia mounted rotary lighting switch is turned to either the side or headlamp position.

OPERATION

Power Distribution

Feed from the positive battery terminal (C0192) is supplied to fuse 13 of the passenger compartment fuse box (C0632) on an R wire. Fuse 13 (C0586) provides a constant battery feed to the clock (C0232) on an RG wire. The clock (C0232) is earthed on an NB wire.

Illumination

When the Light Check Module (LCM) (C2039) senses that the ignition switch is in either the auxiliary or ignition position, and the lighting switch is in either the side or headlamp position, it provides a feed to the lamp contained within the clock assembly (C0232) on an SR wire. The lamp is earthed on an NB wire.

DESCRIPTION AND OPERATION

CIGAR LIGHTERS

DESCRIPTION

General

Two cigar lighters are fitted to Range Rover. The front cigar lighter is located in the front of the centre console for use by the driver and front passenger. The rear cigar lighter is located in the rear of the centre console for use by the rear seat passengers.

When the cigar lighter element is pushed into the cigar lighter, power is automatically switched through its locking clips to the heater coil. As current passes through the heater coil, the element will heat up to the point where the locking clips expand and release the cigar lighter element.

CAUTION: The cigar lighter should NOT be used for accessory power or damage may result.

OPERATION

Power Distribution

Feed from the positive battery terminal (C0192) is supplied to fusible link 1 of the passenger compartment fuse box (C0632) on an R wire. Fusible link 1 (C0588) is connected to fuse 1 of the rear fuse box (C2024) on an R wire.

Front Cigar Lighter

Fuse 1 of the rear fuse box (C2020) provides a constant battery feed to the front cigar lighter (C0089) on an RBY wire. When the cigar lighter element is pushed into the cigar lighter, an earth path is created (C0086) on an N wire. When the element reaches the correct temperature and is ejected, the circuit is broken.

Rear Cigar Lighter

Fuse 1 of the rear fuse box (C2020) provides a constant battery feed to the rear cigar lighter (C1594) on an RG wire. When the cigar lighter element is pushed into the cigar lighter, an earth path is created (C1595) on an N wire. When the element reaches the correct temperature and is ejected, the circuit is broken.

ACCESSORY SOCKETS

DESCRIPTION

General

Two accessory sockets are fitted to Range Rover. The front accessory socket is located in the storage compartment at the rear of the centre console. The rear accessory socket is located on the RH side of the luggage compartment, behind a protective cover.

Both accessory sockets provide battery voltage to any approved Land Rover accessory.

CAUTION: The cigar lighter should NOT be used for accessory power or damage may result.

OPERATION

Power Distribution

Feed from the positive battery terminal (C0192) is supplied to fusible link 1 (C0632) of the passenger compartment fuse box on an R wire. Fusible link 1 (C0588) is connected to fuse 1 and fuse 7 of the rear fuse box (C2024) by an R wire.

Front Accessory Socket

Fuse 1 of the rear fuse box (C2020) provides a constant battery feed to the front accessory socket (C0350) on an RG wire. The front accessory socket (C0942) is earthed on an N wire.

Rear Accessory Socket

Fuse 7 of the rear fuse box (C2020) provides a constant battery feed to the rear accessory socket (C1632) on an RB wire. The rear accessory socket (C1632) is earthed on an N wire.

DESCRIPTION AND OPERATION

TRAILER SOCKET

DESCRIPTION

General

The trailer socket is mounted at the rear of the vehicle, and receives inputs from the trailer ECU. The trailer ECU is mounted behind the rear fuse box, on the RH side of the luggage compartment. The trailer ECU receives inputs from the Light Check Module (LCM), which is located at the base of the RH 'A' post.

For more information on the LCM, refer to the **Lighting** section of the System Description and Operation Workshop Manual.

OPERATION

Power Distribution

Feed from the positive battery terminal (C0192) is supplied to fusible link 5 and fuse 53 of the passenger compartment fuse box (C0632) on an R wire. Fusible link 5 (C0588) is connected to fuse 4, fuse 6, and fuse 17 of the rear fuse box (C2024) by an R wire. Fuse 4 and fuse 6 (C2020) supply constant battery feeds to the trailer socket (C0499) on RY and RU wires respectively. Fuse 17 (C2022) provides a constant battery feed to the trailer ECU (C0380) on an RW wire.

Fuse 53 of the passenger compartment fuse box (C0583) provides a constant battery feed to the ignition switch (C0099 on Td6 vehicles, C0028 on V8 vehicles) on an R wire. When the ignition switch is turned to the 'auxiliary' position, current flows across the switch (C0099 on Td6 vehicles, C0028 on V8 vehicles) to fuse 2 of the passenger compartment fuse box (C0585) on a G wire. Fuse 2 (C0587) provides an auxiliary ignition feed to the trailer socket (C0499) via the rear fuse box (C2022) on a GY wire.

Light Check Module (LCM)

The LCM provides signal inputs to the trailer ECU as follows:

Rear Fog Lamp

The rear fog lamp function of the trailer ECU is controlled via a bi-directional data line between the LCM (C2040) and the trailer ECU (C0380) on a UNY wire. When the trailer ECU receives a rear fog lamp signal, it provides a feed to the trailer socket (C0499) on a YR wire.

Reverse Lamp

The reverse lamp function of the trailer ECU is controlled via a bi-directional data line between the LCM (C2040) and the trailer ECU (C0380) on a UNY wire. When the trailer ECU receives a reverse lamp signal, it provides a feed to the trailer socket (C0499) on a YU wire.

RH Tail Lamp

When the LCM (C0937) detects that side or headlamps have been selected, it provides a feed to the trailer ECU (C0380) on an SP wire. The trailer ECU (C0380) will now provide a feed to the trailer socket (C0499) on an SR wire.

LH Tail Lamp

When the LCM (C2040) detects that side or headlamps have been selected, it provides a feed to the trailer ECU (C0380) on an SW wire. The trailer ECU (C0380) will now provide a feed to the trailer socket (C0499) on an SB wire.

RH Direction Indicator Lamp

When the LCM (C2039) detects that a right turn has been selected, it provides a feed to the trailer ECU (C0380) on a UN wire. The trailer ECU (C0380) will now provide a feed to the trailer socket (C0499) on a UY wire.

LH Direction Indicator Lamp

When the LCM (C0937) detects that a left turn has been selected, it provides a feed to the trailer ECU (C0380) on a UG wire. The trailer ECU (C0380) will now provide a feed to the trailer socket (C0499) on a UR wire.

Brake Lamps

When the LCM (C0937) detects that the brake pedal has been pressed, it provides a feed to the trailer ECU (C0380) on a BU wire. The trailer ECU (C0380) will now provide a feed to the trailer socket (C0499) on a BW wire.

DESCRIPTION AND OPERATION

AUDIO SYSTEM – LOW LINE

DESCRIPTION

General

For a detailed description of the audio systems fitted to New Range Rover, refer to the ***Entertainment and Information Systems*** section of the System Description and Operation Workshop Manual.

OPERATION

General

For a detailed description of audio system operation, refer to the ***Entertainment and Information Systems*** section of the System Description and Operation Workshop Manual.

AUDIO SYSTEM – MID-LINE

DESCRIPTION

General

For a detailed description of the audio systems fitted to New Range Rover, refer to the ***Entertainment and Information Systems*** section of the System Description and Operation Workshop Manual.

OPERATION

General

For a detailed description of audio system operation, refer to the ***Entertainment and Information Systems*** section of the System Description and Operation Workshop Manual.

DESCRIPTION AND OPERATION

AUDIO SYSTEM – HIGH LINE

DESCRIPTION

General

For a detailed description of the audio systems fitted to New Range Rover, refer to the ***Entertainment and Information Systems*** section of the System Description and Operation Workshop Manual.

OPERATION

General

For a detailed description of audio system operation, refer to the ***Entertainment and Information Systems*** section of the System Description and Operation Workshop Manual.

SATELLITE NAVIGATION SYSTEM

DESCRIPTION

General

For a detailed description of the satellite navigation system fitted to New Range Rover, refer to the ***Entertainment and Information Systems*** section of the System Description and Operation Workshop Manual.

OPERATION

General

For a detailed description of satellite navigation operation, refer to the ***Entertainment and Information Systems*** section of the System Description and Operation Workshop Manual.

DESCRIPTION AND OPERATION

SATELLITE NAVIGATION SYSTEM – NAS

DESCRIPTION

General

For a detailed description of the satellite navigation systems fitted to New Range Rover, refer to the ***Entertainment and Information Systems*** section of the System Description and Operation Workshop Manual.

OPERATION

General

For a detailed description of satellite navigation system operation, refer to the ***Entertainment and Information Systems*** section of the System Description and Operation Workshop Manual.

TELEPHONE

DESCRIPTION

General

For a detailed description of the telephone systems fitted to New Range Rover, refer to the ***Entertainment and Information Systems*** section of the System Description and Operation Workshop Manual.

OPERATION

General

For a detailed description of telephone system operation, refer to the ***Entertainment and Information Systems*** section of the System Description and Operation Workshop Manual.

DESCRIPTION AND OPERATION

TELEPHONE – HANDS FREE

DESCRIPTION

General

For a detailed description of the telephone systems fitted to New Range Rover, refer to the ***Entertainment and Information Systems*** section of the System Description and Operation Workshop Manual.

OPERATION

General

For a detailed description of telephone system operation, refer to the ***Entertainment and Information Systems*** section of the System Description and Operation Workshop Manual.

TELEPHONE – NAS

DESCRIPTION

General

For a detailed description of the telephone systems fitted to New Range Rover, refer to the ***Entertainment and Information Systems*** section of the System Description and Operation Workshop Manual.

OPERATION

General

For a detailed description of telephone system operation, refer to the ***Entertainment and Information Systems*** section of the System Description and Operation Workshop Manual.

DESCRIPTION AND OPERATION

FUEL PUMP

DESCRIPTION

Td6

The fuel system on Td6 vehicles features three fuel pumps. A primary fuel pump is mounted in the plastic fuel tank. This pump supplies fuel to the secondary pump mounted externally to the tank. The secondary pump supplies fuel to the high pressure Fuel Injection Pump (FIP) mounted on the engine. For more information on the Td6 fuel system, refer to the ***Fuel Delivery – Td6*** section of the System Description and Operation Workshop manual.

V8

The fuel pump fitted on V8 vehicles is mounted in the plastic fuel tank, and supplies fuel at a constant 3.5 bar pressure to the fuel rail. The fuel rail distributes fuel evenly to each of the eight injectors. For more information on the V8 fuel system, refer to the ***Fuel Delivery – V8*** section of the System Description and Operation Workshop manual.

OPERATION

Td6

Power Distribution

Feed from the positive battery terminal (C0192) is supplied to fusible link 5 of the passenger compartment fuse box (C0632) on an R wire. A constant battery feed is also supplied to the 100A fuse located within the fuse holder (C1875) on an R wire. The 100A fuse (C1878) provides a constant battery feed to the Engine Control Module (ECM) relay (C1895) on an R wire.

Fusible link 5 of the passenger compartment fuse box (C0588) is connected to fuse 15 of the rear passenger compartment fuse box (C2024) by an R wire. Fuse 15 provides a constant battery feed to the fuel pump relay, which is also located in the rear fuse box.

ECM Relay

The 100A fuse located in the fuse holder (C1878) provides a constant battery feed to the ECM relay coil (C1895) on an R wire. The earth path for the relay coil (C1895) is controlled by the ECM (C0603) on an N wire. The energised ECM relay (C1895) provides a feed to fuse 51 of the passenger compartment fuse box (C0584) on an RW wire. Fuse 51 (C0585) supplies a feed to the fuel pump relay coil (C2022) on an RW wire.

Fuel Pump Relay

The fuel pump relay coil (C2022) receives a feed from fuse 51 of the passenger compartment fuse box (C0585) on an RW wire. The earth path for the relay coil (C2022) is controlled by the ECM (C0331) on a BP wire. The energised fuel pump relay provides a battery feed from fuse 15 of the rear fuse box to the primary (C0114) and secondary (C0205) fuel pumps on a pair of WU wires. Both pumps are earthed on N wires.

V8

Power Distribution

Feed from the positive battery terminal (C0192) is supplied to fusible link 2 and fusible link 5 of the passenger compartment fuse box (C0632) on an R wire. Fusible link 2 (C0591) provides a constant battery feed to the Engine Control Module (ECM) relay (C1895) on an R wire.

Fusible link 5 of the passenger compartment fuse box (C0588) is connected to fuse 15 of the rear passenger compartment fuse box (C2024) by an R wire. Fuse 15 provides a constant battery feed to the fuel pump relay, which is also located in the rear fuse box.

ECM Relay

Fusible link 2 of the passenger compartment fuse box (C0591) provides a constant battery feed to the ECM relay coil (C1895) on an R wire. The earth path for the relay coil (C1895) is controlled by the ECM (C0604) on an N wire. The energised ECM relay (C1895) provides a feed to fuse 51 of the passenger compartment fuse box (C0584) on an RW wire. Fuse 51 (C0585) supplies a feed to the fuel pump relay coil (C2022) on an RW wire.

Fuel Pump Relay

The fuel pump relay coil (C2022) receives a feed from fuse 51 of the passenger compartment fuse box (C0585) on an RW wire. The earth path for the relay coil (C2022) is controlled by the ECM (C0331) on a BP wire. The energised fuel pump relay provides a battery feed from fuse 15 of the rear fuse box to the fuel pump (C0114) on a WU wire. The fuel pump is earthed on an N wire.

DESCRIPTION AND OPERATION

ROTARY COUPLER

DESCRIPTION

General

The rotary coupler is a rotating link harness, acting as a bridge between the electrical circuits contained within the steering wheel and the steering column. It relays signals for the following systems:

- Horns
- Audio system
- Telephone
- Cruise Control
- Heated steering wheel
- Driver airbag.

WARNING: Before carrying out any work on the rotary coupler, refer to the warning information contained within the Service Procedures Workshop Manual.

OPERATION

Horns

For detailed information on horn operation, refer to the **Horns** section of this manual.

 **HORNS.**

Audio System

For detailed information on audio system operation, refer to the **Entertainment and Information Systems** section of the System Description and Operation Workshop manual.

Telephone

For detailed information on telephone operation, refer to the **Entertainment and Information Systems** section of the System Description and Operation Workshop manual.

Cruise Control

For detailed information on cruise control operation, refer to the **Supplementary Restraint System (SRS)** section of this manual.

 **CRUISE CONTROL.**

Heated Steering Wheel

For detailed information on heated steering wheel operation, refer to the **Steering Column** section of this manual.

 **STEERING COLUMN.**

Driver Airbag

For detailed information on driver airbag operation, refer to the **Supplementary Restraint System (SRS)** section of this manual.



SUPPLEMENTARY RESTRAINT SYSTEM (SRS).

DESCRIPTION AND OPERATION

PARK DISTANCE CONTROL (PDC)

DESCRIPTION

General

Park Distance Control (PDC) provides an audible warning to the driver when any obstacles are in the path of the vehicle during forward and reverse parking manoeuvres. The system consists of four ultrasonic sensors in each bumper, an ECU, a sounder and a parking switch.

For detailed information on PDC, refer to the ***Driving Aids*** section of the System Description and Operation Workshop Manual.

OPERATION

Power Distribution

Feed from the positive battery terminal (C0192) is supplied to fuse 27 and fuse 53 of the passenger compartment fuse box (C0632) on an R wire. Fuse 27 (C0582) provides a constant battery feed to the Body Control Unit (BCU) (C0662) on an RP wire.

Fuse 53 (C0583) provides a constant battery feed to the ignition switch (C0099 on Td6 vehicles, C0028 on V8 vehicles) on an R wire. When the ignition switch is turned to the 'ignition' position, current flows across the switch (C0099 on Td6 vehicles, C0028 on V8 vehicles) to fuse 6 of the passenger compartment fuse box (C0585) on a G wire. Fuse 6 (C0587) provides an ignition feed to the PDC ECU (C0957) on a GN wire. The PDC ECU (C0957) is earthed on an NB wire.

PDC Switch

The PDC ECU (C0957) monitors the condition of the PDC switch (C0700) by providing a feed on an NUY wire. When the switch is pressed, an earth path is created on an N wire. Sensing this, the PDC initiates the PDC system, and provides a feed to the switch tell-tale LED (C0700) on an NUY wire.

Rear PDC

RH Outer Sensor

The PDC ECU (C0958) provides a feed to the RH outer PDC sensor (C0966) on a GP wire. An earth path is provided for the sensor by the PDC ECU on an NY wire. The PDC sensor outputs a pulsed signal to the PDC ECU on a YN wire, which the PDC ECU translates into a distance reading.

RH Inner Sensor

The PDC ECU (C0958) provides a feed to the RH inner PDC sensor (C0965) on a GS wire. An earth path is provided for the sensor by the PDC ECU on an NU wire. The PDC sensor outputs a pulsed signal to the PDC ECU on a YB wire, which the PDC ECU translates into a distance reading.

LH Inner Sensor

The PDC ECU (C0958) provides a feed to the LH inner PDC sensor (C0964) on a GN wire. An earth path is provided for the sensor by the PDC ECU on an NB wire. The PDC sensor outputs a pulsed signal to the PDC ECU on a YG wire, which the PDC ECU translates into a distance reading.

LH Outer Sensor

The PDC ECU (C0958) provides a feed to the LH outer PDC sensor (C0963) on a GB wire. An earth path is provided for the sensor by the PDC ECU on an NW wire. The PDC sensor outputs a pulsed signal to the PDC ECU on a YS wire, which the PDC ECU translates into a distance reading.

PDC Sounder

The PDC ECU converts the signals received from the rear PDC sensors and outputs a pulsed signal to the PDC sounder. The PDC sounder (C0987) is located on the RH side of the luggage and is provided a positive signal on a UR wire, and a negative signal on a US wire.

Front PDC

RH Outer Sensor

The PDC ECU (C1457) provides a feed to the RH outer PDC sensor (C0403) on a GP wire. An earth path is provided for the sensor by the PDC ECU on an NY wire. The PDC sensor outputs a pulsed signal to the PDC ECU on a YN wire, which the PDC ECU translates into a distance reading.

RH Inner Sensor

The PDC ECU (C1457) provides a feed to the RH inner PDC sensor (C0401) on a GS wire. An earth path is provided for the sensor by the PDC ECU on an NU wire. The PDC sensor outputs a pulsed signal to the PDC ECU on a YB wire, which the PDC ECU translates into a distance reading.

LH Inner Sensor

The PDC ECU (C1457) provides a feed to the LH inner PDC sensor (C0400) on a GN wire. An earth path is provided for the sensor by the PDC ECU on an NB wire. The PDC sensor outputs a pulsed signal to the PDC ECU on a YG wire, which the PDC ECU translates into a distance reading.

DESCRIPTION AND OPERATION

LH Outer Sensor

The PDC ECU (C1457) provides a feed to the LH outer PDC sensor (C0402) on a GB wire. An earth path is provided for the sensor by the PDC ECU on an NW wire. The PDC sensor outputs a pulsed signal to the PDC ECU on a YS wire, which the PDC ECU translates into a distance reading.

PDC Sounder

The PDC ECU converts the signals received from the front PDC sensors a feed to the front sounder (C0405) on a US wire. The PDC sounder is located behind the lower edge of the fascia, above the drivers footwell and is earthed (C0369) on an NB wire.

I Bus

The PDC ECU (C0957) receives the following information on the I-bus via the instrument pack (C0233) on a WSY wire:

- Vehicle speed
- Reverse gear selected
- Trailer fitted.

TYRE PRESSURE MONITORING (TPM)

DESCRIPTION

General

The Tyre Pressure Monitoring (TPM) system continuously monitors tyre pressures so long as vehicle battery power is available. If a low tyre pressure is detected, the system alerts the driver via the message centre when the ignition is on. The system monitors the tyre pressure of each road wheel and the full size spare wheel.

NOTE: The tyre pressure of a space saver spare wheel is not monitored.

For a detailed description of the TPM system, refer to the **Driving Aids** section of the System Description and Operation Workshop Manual.

OPERATION

Power Distribution

Feed from the positive battery terminal (C0192) is supplied to fuse 16 and fuse 53 of the passenger compartment fuse box (C0632) on an R wire. Fuse 16 (C0586) provides a constant battery feed to the TPM ECU (C1537) on an RNY wire. The TPM ECU (C1537) is located under the front passenger seat and is earthed on an NB wire.

Fuse 53 (C0583) provides a constant battery feed to the ignition switch (C0099 on Td6 vehicles, C0028 on V8 vehicles) on an R wire. When the ignition switch is turned to the 'ignition' position, current flows across the switch (C0099 on Td6 vehicles, C0028 on V8 vehicles) to fuse 6 of the passenger compartment fuse box (C0585) on a G wire. Fuse 6 (C0587) provides an ignition feed to the TPM ECU (C1537) on a GN wire.

TPM Antennae

An air pressure and temperature sensor is fitted to the rim of each road wheel and the full size spare wheel. The sensors transmit radio signals to the relevant antenna at a frequency of 433 MHz. The TPM ECU (C1537) is connected to the antennae as follows:

- To the RH front TPM antenna (C2027) by a W and a U wire
- To the LH front TPM antenna (C2026) by a W and a G wire
- To the RH rear TPM antenna (C2029) by a W and a Y wire
- To the LH rear TPM antenna (C2028) by a W and an R wire.

TPM Reset Switch

The TPM ECU (C1537) provides a feed to the TPM reset switch (C0700) on a UR wire. When the switch is pressed, a feed is returned to the TPM ECU (C1537) on a UN wire. When the TPM registers that the reset switch has been pressed, it takes the current tyre pressure readings as the nominal pressures.

DESCRIPTION AND OPERATION

STEERING COLUMN

DESCRIPTION

General

The steering column fitted to New Range Rover features fully electrical adjustment for tilt and reach. On vehicles fitted with memory seats, the steering wheel position is incorporated into the memory of the seat ECU. On certain models, a heater is fitted around the rim of the steering wheel.

For a detailed description of the steering column, refer to the **Steering** section of the System Description and Operation Workshop Manual.

OPERATION

Non-Memory Steering Column

Power Distribution

Feed from the positive battery terminal (C0192) is supplied to fuse 23 of the passenger compartment fuse box (C0632) on an R wire. Fuse 23 (C0583) provides a constant battery feed to the steering column adjustment control unit (C1392) on an RN wire. The control unit (C1392) is earthed on an N wire.

Steering Column Switch

Movement of the steering column is controlled via the 4 way switch mounted on the LH side of the steering column. The control unit (C1392) is connected to the switch (C1393) as follows:

- If forward movement is selected, an earth path is created via the switch on an NU wire
- If backward movement is selected, an earth path is created via the switch on an NR wire
- If upwards movement is selected, an earth path is created via the switch on an NB wire
- If downwards movement is selected, an earth path is created via the switch on an NW wire.

The switch is earthed on an NB wire.

Tilt Movement

If tilt movement of the steering column is requested, the control unit (C1392) powers the height motor (C1397) via BU and UB wires.

Reach Movement

If reach movement of the steering column is requested, the control unit (C1392) powers the telescope motor (C1396) via B and U wires.

Memory Steering Column

Power Distribution

Feed from the positive battery terminal (C0192) is supplied to the seat relay and fuse 53 of the passenger compartment fuse box (C0632) on an R wire. Fuse 53 (C0583) provides a constant battery feed to the ignition switch (C0099 on Td6 vehicles, C0028 on V8 vehicles) on an R wire. When the ignition switch is turned to the 'ignition' position, current flows across the switch (C0099 on Td6 vehicles, C0028 on V8 vehicles) to the seat relay (C0585) on a G wire. The seat relay is located in the passenger compartment fuse box and is earthed (C0585) on an N wire.

Steering Column Switch

Movement of the steering column is controlled via the 4 way switch mounted on the LH side of the steering column. The seat memory ECU (C0773) is connected to the switch (C1393) as follows:

- If forward movement is selected, an earth path is created via the switch on an NU wire
- If backward movement is selected, an earth path is created via the switch on an NR wire
- If upwards movement is selected, an earth path is created via the switch on an NB wire
- If downwards movement is selected, an earth path is created via the switch on an NW wire.

The switch is earthed on an NB wire.

Seat Memory ECU

The seat memory ECU (C0773) interprets the signals received from the steering column switch (C0773) and adjusts the steering column as follows:

- If vertical adjustment is requested, the seat memory ECU provides a feed to the height motor (C1395) on a B wire
- If height adjustment is requested, the seat memory ECU provides a feed to the telescope motor (C1394) on a BU wire.

Both motors are earthed on N wires.

DESCRIPTION AND OPERATION

Steering Wheel Heater

Power Distribution

Feed from the positive battery terminal (C0192) is supplied to the steering wheel relay and fuse 53 of the passenger compartment fuse box (C0632) on an R wire. Fuse 53 (C0583) is connected to the ignition switch (C0099 on Td6 vehicles, C0028 on V8 vehicles) by an R wire. When the ignition switch is turned to the 'ignition' position, current flows across the switch (C0099 on Td6 vehicles, C0028 on V8 vehicles) to the steering wheel relay coil (C0585) on a G wire. The steering wheel relay coil (C0585) is earthed on an N wire.

Steering Wheel Heater

The energised steering wheel relay provides a feed to fuse 29. Fuse 29 (C0582) is connected to the rotary coupler (C0374) by a GB wire, allowing the rotary coupler to provide a feed to the heated steering wheel ECU (C1948) on an N wire. The steering wheel ECU is earthed via the rotary coupler on an R then N wire.

AIR SUSPENSION

DESCRIPTION

General

The main function of the four wheel air suspension system is to maintain the vehicle at the correct ride height, irrespective of load. Additionally, the system allows the driver to request ride height changes to improve off-road performance or ease of access or for loading. The system automatically adjusts the ride height to improve the vehicle handling and dynamics when speed increases or decreases.

The air suspension system fitted to Range Rover is controlled by an ECU located behind the passenger side of the fascia. The ECU monitors the height of each corner of the vehicle via four height sensors, which are mounted in-board of each road wheel. The ECU also performs an 'on-board diagnostic' function to perform 'health checks' on the system. If faults are detected, codes are stored in the ECU and can be retrieved using TestBook or T4.

For a detailed description of the air suspension system, refer to the ***Suspension*** section of the System Description and Operation Workshop Manual.

OPERATION

Power Distribution

Feed from the positive battery terminal (C0192) is supplied to fusible link 5 and fuse 57 of the passenger compartment fuse box (C0632) on an R wire. Fuse 57 (C0582) provides a constant battery feed to the air suspension ECU (C2030) on an RN wire. The air suspension ECU (C2030) is earthed on an N wire.

Fusible link 5 (C0588) is connected to fuse 18 of the rear fuse box (C2024) by an R wire. Fuse 18 provides a constant battery feed to the air suspension relay, which is also located in the rear fuse box.

DESCRIPTION AND OPERATION

Air Suspension ECU

The air suspension ECU (C0867) is located behind the LH side of the fascia, and is connected to the centre console rotary switch (C0700) as follows:

- If the rotary switch is turned to select a lower suspension setting, an earth path is created via the switch on a UP wire
- If the rotary switch is turned to select a higher suspension setting, an earth path is created via the switch on an SR wire
- If the 'Hold' switch has been selected, an earth path is created via the switch on a YW wire.

NOTE: The air suspension ECU will only allow the suspension settings to change if all the conditions described in the 'Suspension' section of the System Description and Operation Workshop manual have been met.

The air suspension ECU (C0867) also provides a feed to the LED's contained on the face of the centre console rotary switch (C0700) as follows:

- To the 'Motorway' LED on an SY wire
- To the 'Off Road' LED on an SG wire
- To the 'Access' LED on an SP wire
- To the 'Standard' LED on a WY wire
- To the 'Hold' LED on an SU wire.

Height Sensors

The Air Suspension ECU monitors the height of the vehicle via four height sensors. The air suspension ECU is connected to the height sensors as follows:

RH Front Height Sensor

The air suspension ECU (C0867) provides a feed to the RH front height sensor (C1697) on a BW wire. An earth path is provided for the sensor on a BN wire. By measuring the voltage returned on a BS wire, the air suspension ECU can determine the height of the RH front of the vehicle.

LH Front Height Sensor

The air suspension ECU (C0867) provides a feed to the LH front height sensor (C1696) on an SB wire. An earth path is provided for the sensor on an SN wire. By measuring the voltage returned on an SW wire, the air suspension ECU can determine the height of the LH front of the vehicle.

RH Rear Height Sensor

The air suspension ECU (C0867) provides a feed to the RH rear height sensor (C1698) on a YB wire. An earth path is provided for the sensor on a YN wire. By measuring the voltage returned on a YS wire, the air suspension ECU can determine the height of the RH rear of the vehicle.

LH Rear Height Sensor

The air suspension ECU (C0867) provides a feed to the LH rear height sensor (C1699) on a WB wire. An earth path is provided for the sensor on a WN wire. By measuring the voltage returned on a WS wire, the air suspension ECU can determine the height of the LH rear of the vehicle.

Cross Link Valves

The cross link valves connect the height sensors in pairs, front and rear. When air is required to flow between the two rear height sensors, the air suspension ECU (C2030) provides a feed to the rear cross link valve (C2033) on a UR wire. The air suspension ECU provides an earth path for the cross link valve on a UP wire.

When air is required to flow between the two front height sensors, the air suspension ECU (C2030) provides a feed to the front cross link valve (C2032) on a UN wire. The air suspension ECU provides an earth path for the cross link valve on a WU wire.

Air Supply Unit

The air supply unit is located in a sealed housing in the spare wheel well. Located within the unit is the compressor. To power the compressor, the air suspension ECU (C0867) provides a feed to the air suspension relay coil (C2022) on a B wire. The relay is located in the rear fuse box and is earthed (C2021) on an N wire. The energised relay (C2023) provides a battery feed from fuse 18 of the rear fuse box to the compressor (C0873) on an RY wire. The compressor (C0873) is earthed on an N wire.

The air suspension ECU (C0867) monitors the temperature within the air supply unit (C0873) by providing a feed to the temperature sensor on a BRY wire. The air suspension ECU determines the temperature within the air supply unit by measuring the voltage returned on an S wire.

DESCRIPTION AND OPERATION

Valve Block

The valve block contains five solenoid valves which control the air supply as follows:

RH Front

If air is required in the RH front air spring, the air suspension ECU (C0867) provides a feed to the valve block (C0770) on a UB wire. An earth path is provided by the ECU on a UY wire.

LH Front

If air is required in the LH front air spring, the air suspension ECU (C0867) provides a feed to the valve block (C0770) on a UB wire. An earth path is provided by the ECU on a US wire.

RH Rear

If air is required in the RH rear air spring, the air suspension ECU (C0867) provides a feed to the valve block (C0274) on a WP wire. An earth path is provided by the ECU on a WR wire.

LH Rear

If air is required in the LH rear air spring, the air suspension ECU (C0867) provides a feed to the valve block (C0274) on a WP wire. An earth path is provided by the ECU on a YP wire.

Reservoir Valve

The reservoir valve controls the air pressure supply from the reservoir to the air springs. The air suspension ECU (C0867) provides a feed to the valve block (C0771) on a UW wire, and an earth path on a UG wire.

Air Pressure Sensor

The air pressure sensor measures the pressure within the air reservoir. The air suspension ECU (C0867) provides a feed to the pressure sensor (C1611) on a Y wire. An earth path is provided for the sensor on a W wire. By measuring the voltage returned on a U wire, the air suspension ECU can determine the pressure within the air reservoir.

CIRCUIT REFERENCE NUMBERS**CONNECTOR APPLICABILITY****General**

The following table lists the circuit reference numbers against a description of the model or feature to which they apply.

This information should be used in conjunction with the connector pin-out tables on the following pages to determine the wire configuration of the vehicle being worked on.

Cct	Model or Feature
1	ABS
16	AIR SUSPENSION
19	AIR CONDITIONING – HIGH LINE
20	AIR CONDITIONING – LOW LINE
40	CENTRAL DOOR LOCKING
43	CIGAR LIGHTER
51	CRUISE CONTROL
58	DIESEL VEHICLES
65	DOOR SECURITY LAMPS
97	FUEL BURNING HEATER
109	HEATED FRONT SCREEN
125	IN-CAR ENTERTAINMENT – LOW LINE
126	IN-CAR ENTERTAINMENT – HI-FI
130	REMOTE HANDSET – INFRA-RED
133	INTERIOR ILLUMINATION
134	INTERIOR LAMPS
136	RAIN SENSOR
148	SATELLITE NAVIGATION
171	PARK DISTANCE CONTROL
198	REVERSE LAMP
203	SEAT BELT WARNING
204	HEATED SEATS
208	SEATS
216	SRS
221	SRS – SIDE IMPACT/HEAD
227	SUNROOF
247	WINDOW LIFT
279	HEADLAMP WASH/WIPE
310	TELEVISION

CONNECTOR

337	TYRE PRESSURE MONITORING
340	SATELLITE NAVIGATION – JAPAN
341	ELECTROCHROMIC MIRROR
385	HEATED STEERING WHEEL
386	ELECTROCHROMIC INTERIOR MIRROR
387	ELECTROCHROMIC INTERIOR & DOOR MIRRORS
388	STEERING COLUMN
389	STEERING COLUMN – MEMORY
390	REMOTE HANDSET – RADIO FREQUENCY
391	FUEL BURNING HEATER – DIESEL
392	AUXILIARY MODULE – EUROPE
393	AUXILIARY MODULE – NAS
394	TRAILER SOCKET
499	ALL VEHICLES
500	PARK DISTANCE CONTROL – JAPAN
545	SATELLITE NAVIGATION AERIAL
565	ACCELERATOR PEDAL POSITION SENSOR
566	TELEPHONE – NAS
567	TELEPHONE – VOICE RECOGNITION – NAS
568	SATELLITE NAVIGATION – JAPAN
569	SATELLITE NAVIGATION – EUROPE
570	SATELLITE NAVIGATION – NAS
571	RADIO AERIAL
572	SEAT HEAT – REAR
573	PETROL VEHICLES
574	HEADLAMP LEVELLING – AUTOMATIC
575	CIGAR LIGHTER – AUSTRALIA
576	TRAILER SOCKET – EUROPE
578	TELEPHONE – EUROPE
579	WASHER TUBE
581	IN-CAR ENTERTAINMENT – STEREO
582	IN-CAR ENTERTAINMENT – HI-FI
583	IN-CAR ENTERTAINMENT – TOP HI-FI
584	SATELLITE NAVIGATION – STEREO
585	SATELLITE NAVIGATION – HI-FI
586	SATELLITE NAVIGATION – TOP HI-FI
587	SATELLITE NAVIGATION – TOP HI-FI – NAS
589	NO MULTI-FUNCTION DISPLAY

Description: Lamp-Direction indicator/hazard warning-Front-LH

Location: Front of vehicle - LH side

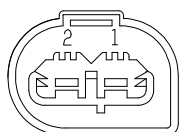
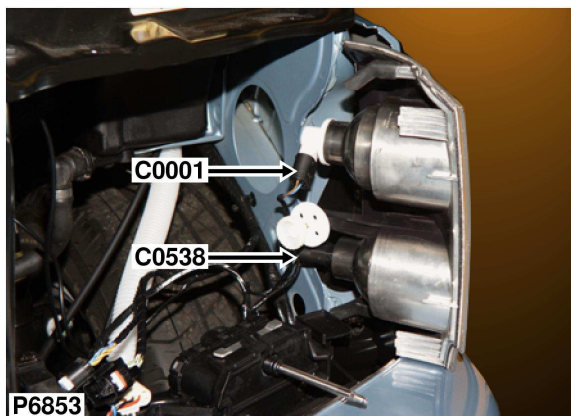

BLACK

Wire Chart

CAV	TERMINAL	CSA	COL	CCT	DESTN
1	YPL102740	0.75	UG	ALL	C2039-11
2	YPL102740	0.75	N	ALL	C0551-0

Service Repair Kits

YPL102740		0.50 - 1.00 csa
Cavities 1,2		
VDK500010	INSTRUCTION; REPAIR KIT	1
VDK500030	INSTRUCTION; EXTRACT TOOL	1
YMI001140	PRE-TERMINATED LEAD	1
YPQ000100	IDENTS (SMALL)	1
YQD000210	HEAT SHRINK SLEEVE	1
YRV000040	SPLICE (RED, CSA; 0.25-1.6)	1
YRW000390	WIRE STRIPPER	1
YRW500010	APPLICATOR	1

[VUB500340]

Part No. YPC115060
Colour: BLACK
Gender: F
Type: MICRO POWER QUADLOK
No. of Ways: 2WY

Description: Lamp-Direction indicator/hazard warning-Front-RH

Location: Front of vehicle - RH side

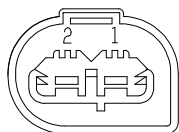
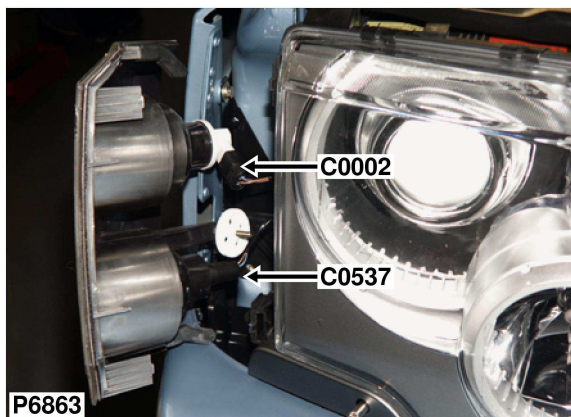

BLACK

Wire Chart

CAV	TERMINAL	CSA	COL	CCT	DESTN
1	YPL102740	0.75	UN	ALL	C0937-6
2	YPL102740	0.75	N	ALL	C0550-0

Service Repair Kits

YPL102740		0.50 - 1.00 csa
Cavities 1,2		
VDK500010	INSTRUCTION; REPAIR KIT	1
VDK500030	INSTRUCTION; EXTRACT TOOL	1
YMI001140	PRE-TERMINATED LEAD	1
YPQ000100	IDENTS (SMALL)	1
YQD000210	HEAT SHRINK SLEEVE	1
YRV000040	SPLICE (RED, CSA; 0.25-1.6)	1
YRW000390	WIRE STRIPPER	1
YRW500010	APPLICATOR	1

[VUB500340]

Part No. YPC115060
Colour: BLACK
Gender: F
Type: MICRO POWER QUADLOK
No. of Ways: 2WY

Description: Horn (s)
Location: Behind RH side of front bumper

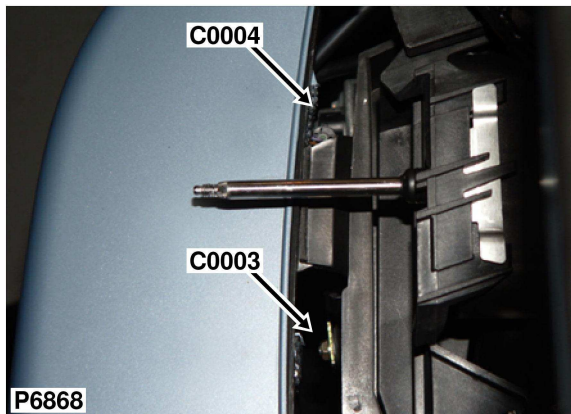

Wire Chart

CAV	TERMINAL	CSA	COL	CCT	DESTN
1	YPL101510	0.75	N	ALL	C0550-0
2	YPL101510	0.75	PS	ALL	C0585-3

Service Repair Kits

YPL101510		0.75 - 0.75 CSA
Cavities 1,2		
VDK500010	INSTRUCTION; REPAIR KIT	1
VDK500070	INSTRUCTION; EXTRACT TOOL	1
VDK500080	INSTRUCTION; EXTRACT TOOL	1
YMI000950	PRE-TERMINATED LEAD	1
YPQ000100	IDENTS (SMALL)	1
YQD000210	HEAT SHRINK SLEEVE	1
YRV000040	SPLICE (RED, CSA; 0.25-1.6)	1
YRW000390	WIRE STRIPPER	1
YRW500010	APPLICATOR	1

[VUB500150]



Part No. YPC116830
Colour: GREY
Gender: F
Type: MQS
No. of Ways: 2WY

Description: Horn (s)
Location: Behind RH side of front bumper

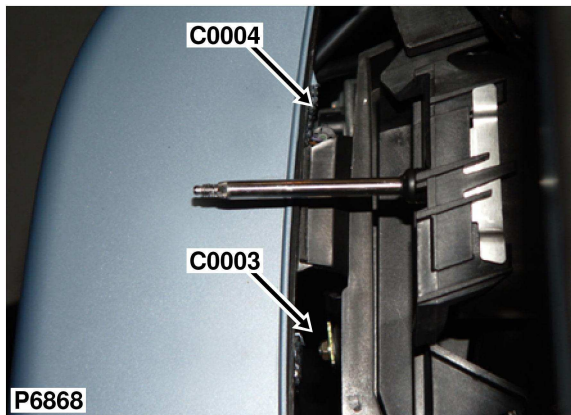

Wire Chart

CAV	TERMINAL	CSA	COL	CCT	DESTN
1	YPL101510	0.75	N	ALL	C0550-0
2	YPL101510	0.75	PS	ALL	C0585-9

Service Repair Kits

YPL101510		0.75 - 0.75 CSA
Cavities 1,2		
VDK500010	INSTRUCTION; REPAIR KIT	1
VDK500070	INSTRUCTION; EXTRACT TOOL	1
VDK500080	INSTRUCTION; EXTRACT TOOL	1
YMI000950	PRE-TERMINATED LEAD	1
YPQ000100	IDENTS (SMALL)	1
YQD000210	HEAT SHRINK SLEEVE	1
YRV000040	SPLICE (RED, CSA; 0.25-1.6)	1
YRW000390	WIRE STRIPPER	1
YRW500010	APPLICATOR	1

[VUB500150]



Part No. YPC116830
Colour: GREY
Gender: F
Type: MQS
No. of Ways: 2WY

Description: Cooling fan
Location: Front of engine compartment - centre

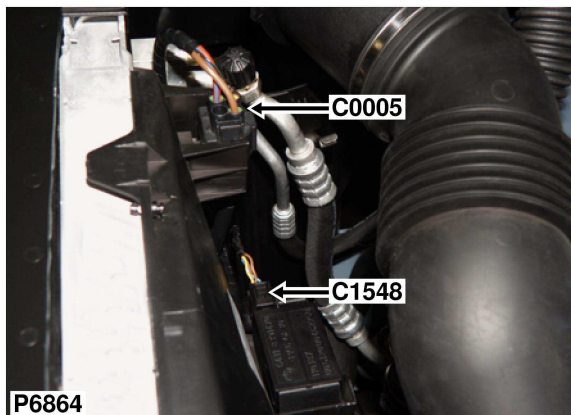

Wire Chart

CAV	TERMINAL	CSA	COL	CCT	DESTN
1	YPL103140	6.0	N	ALL	C0018-0
2	YPL103130	0.5	BG	ALL	C0331-4
4	YPL103140	6.0	RU	ALL	C0581-1

No repair kit
 Geen reparatiepakke
 Pas de nécessaire de reparation
 Kein Werkzeug
 Senza kit per le riparazioni
 Sem kit de reparaçao
 No hay kit de reparación

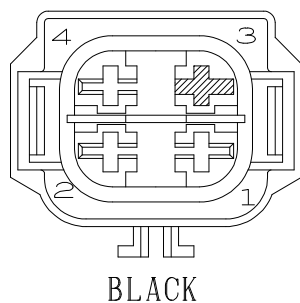

Part No. YPC116470
Colour: BLACK
Gender: F
Type: DFK40 PLUS
No. of Ways: 3WY

Description: Switch-Bonnet
Location: Rear of engine compartment - centre

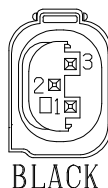
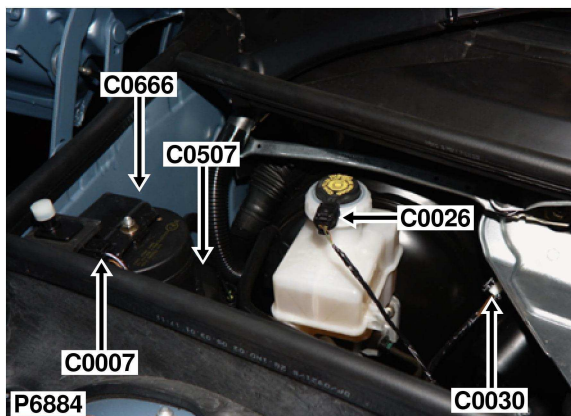

Wire Chart

CAV	TERMINAL	CSA	COL	CCT	DESTN
1	YPL101500	0.5	N	ALL	C0018-0
3	YPL101500	0.5	PG	ALL	C0661-2

Service Repair Kits

YPL101500		0.20 - 0.50 CSA
Cavities 1,3		
VDK500010	INSTRUCTION; REPAIR KIT	1
VDK500070	INSTRUCTION; EXTRACT TOOL	1
VDK500080	INSTRUCTION; EXTRACT TOOL	1
YMI000950	PRE-TERMINATED LEAD	1
YPQ000100	IDENTS (SMALL)	1
YQD000210	HEAT SHRINK SLEEVE	1
YRV000040	SPLICE (RED, CSA; 0.25-1.6)	1
YRW000390	WIRE STRIPPER	1
YRW500010	APPLICATOR	1

[VUB500150]

Part No. YPC116850
Colour: BLACK
Gender: F
Type: MQS
No. of Ways: 3WY

Description: Pump-Washer-Windscreen
Location: Front LH side of engine compartment

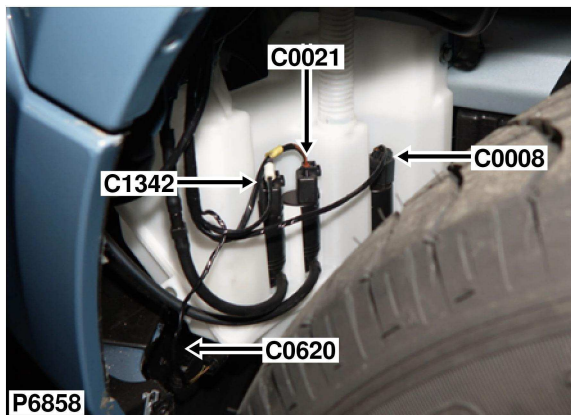

Wire Chart

CAV	TERMINAL	CSA	COL	CCT	DESTN
1	YPL103490	1.0	B	ALL	C0662-18
2	YPL103490	1.0	N	ALL	C0017-0

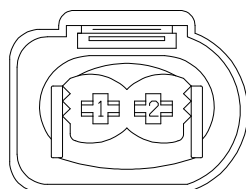

BLACK

No repair kit
 Geen reparatiepakke
 Pas de nécessaire de reparation
 Kein Werkzeug
 Senza kit per le riparazioni
 Sem kit de reparaçã
 No hay kit de reparaci3n

Part No. YPC116370
Colour: BLACK
Gender: F
Type: MDK3 PLUS
No. of Ways: 2WY

Description: Headlamp-LH
Location: Front of vehicle - LH side

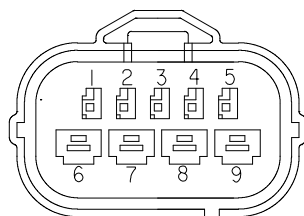
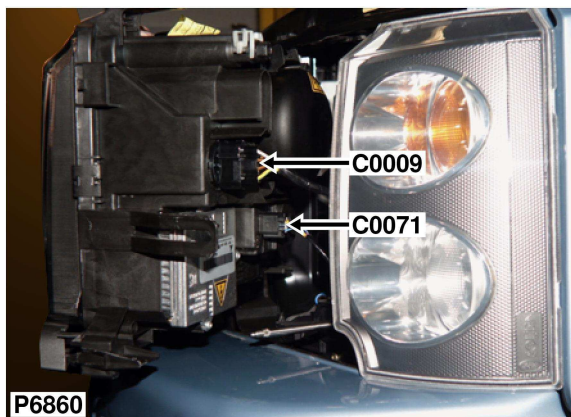

BLACK

Wire Chart

CAV	TERMINAL	CSA	COL	CCT	DESTN
3	YPL103010	0.5	WP	574	SJ X183-
4	YPL103010	0.5	GR	574	C0585-6
5	YPL103010	0.5	WB	574	SJ X13727-
6	YPL103050	2.5	YG	ALL	C0937-11
7	YPL102750	1.5	N	ALL	C0551-0

CAV	TERMINAL	CSA	COL	CCT	DESTN
8	YPL102750	1.5	N	ALL	C0551-0
9	YPL102750	1.5	WG	ALL	C2039-6

Service Repair Kits

YPL103050		1.50 - 2.50 CSA
Cavities 6-9		
VDK500010	INSTRUCTION; REPAIR KIT	1
VDK500030	INSTRUCTION; EXTRACT TOOL	1
YMI000970	PRE-TERMINATED LEAD	1
YPQ000110	IDENTS (MEDIUM)	1
YQD000210	HEAT SHRINK SLEEVE	1
YRV000050	SPLICE (BLUE, CSA; 1.0-2.6)	1
YRW000390	WIRE STRIPPER	1
YRW500010	APPLICATOR	1

[VUB500170]

YPL103010		0.50 - 0.75 CSA
Cavities 3-5,7-9		
VDK500010	INSTRUCTION; REPAIR KIT	1
VDK500070	INSTRUCTION; EXTRACT TOOL	1
VDK500080	INSTRUCTION; EXTRACT TOOL	1
YMI000950	PRE-TERMINATED LEAD	1
YPQ000100	IDENTS (SMALL)	1
YQD000210	HEAT SHRINK SLEEVE	1
YRV000040	SPLICE (RED, CSA; 0.25-1.6)	1
YRW000390	WIRE STRIPPER	1
YRW500010	APPLICATOR	1

[VUB500150]

Part No. 6906560
Colour: BLACK
Gender: F
Type: WBS 2.80
No. of Ways: 9WY

Description: Headlamp-RH
Location: Front of vehicle - RH side

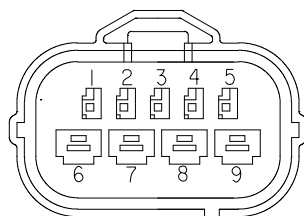
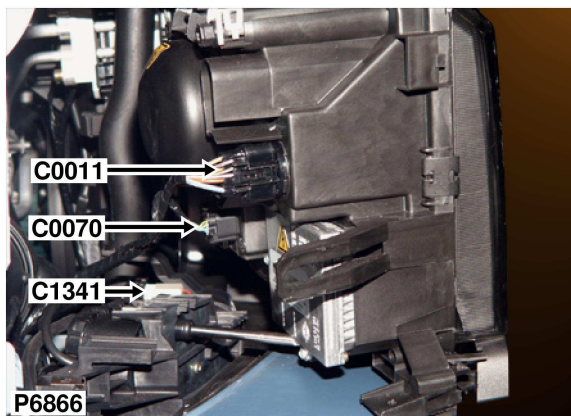

BLACK

Wire Chart

CAV	TERMINAL	CSA	COL	CCT	DESTN
3	YPL103010	0.5	WP	574	SJ X183-
4	YPL103010	0.5	GR	574	C0587-7
5	YPL103010	0.5	WB	574	SJ X13727-
6	YPL103050	2.5	WU	ALL	C2039-3
7	YPL102750	1.5	N	ALL	C0018-0

CAV	TERMINAL	CSA	COL	CCT	DESTN
8	YPL102750	1.5	N	ALL	C0018-0
9	YPL102750	1.5	YU	ALL	C0937-13

Service Repair Kits

YPL103050		1.50 - 2.50 CSA
Cavities 6-9		
VDK500010	INSTRUCTION; REPAIR KIT	1
VDK500030	INSTRUCTION; EXTRACT TOOL	1
YMI000970	PRE-TERMINATED LEAD	1
YPQ000110	IDENTS (MEDIUM)	1
YQD000210	HEAT SHRINK SLEEVE	1
YRV000050	SPLICE (BLUE, CSA; 1.0-2.6)	1
YRW000390	WIRE STRIPPER	1
YRW500010	APPLICATOR	1

[VUB500170]

YPL103010		0.50 - 0.75 CSA
Cavities 3-5,7-9		
VDK500010	INSTRUCTION; REPAIR KIT	1
VDK500070	INSTRUCTION; EXTRACT TOOL	1
VDK500080	INSTRUCTION; EXTRACT TOOL	1
YMI000950	PRE-TERMINATED LEAD	1
YPQ000100	IDENTS (SMALL)	1
YQD000210	HEAT SHRINK SLEEVE	1
YRV000040	SPLICE (RED, CSA; 0.25-1.6)	1
YRW000390	WIRE STRIPPER	1
YRW500010	APPLICATOR	1

[VUB500150]

Part No. 6906560
Colour: BLACK
Gender: F
Type: WBS 2.80
No. of Ways: 9WY

Description: Lamp-Side repeater-Front-RH

Location: Front of vehicle - RH side

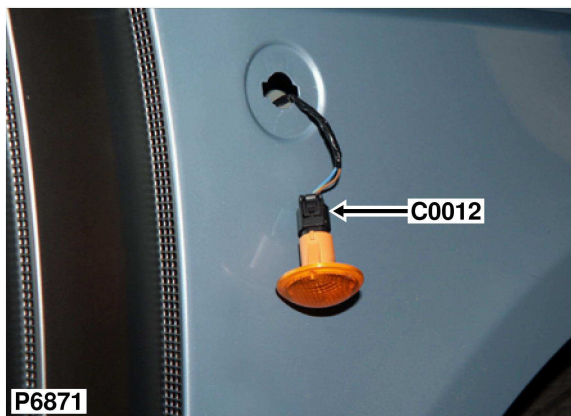

Wire Chart

CAV	TERMINAL	CSA	COL	CCT	DESTN
1	YPL101500	0.5	N	ALL	C0550-0
2	YPL101500	0.5	UY	ALL	C0937-14

Service Repair Kits

YPL101500		0.20 - 0.50 CSA
Cavities 1,2		
VDK500010	INSTRUCTION; REPAIR KIT	1
VDK500070	INSTRUCTION; EXTRACT TOOL	1
VDK500080	INSTRUCTION; EXTRACT TOOL	1
YMI000950	PRE-TERMINATED LEAD	1
YPQ000100	IDENTS (SMALL)	1
YQD000210	HEAT SHRINK SLEEVE	1
YRV000040	SPLICE (RED, CSA; 0.25-1.6)	1
YRW000390	WIRE STRIPPER	1
YRW500010	APPLICATOR	1

[VUB500150]



Part No. YPC116820
Colour: BLACK
Gender: F
Type: MQS
No. of Ways: 2WY

Description: Lamp-Side repeater-Front-LH

Location: Front of vehicle - LH side

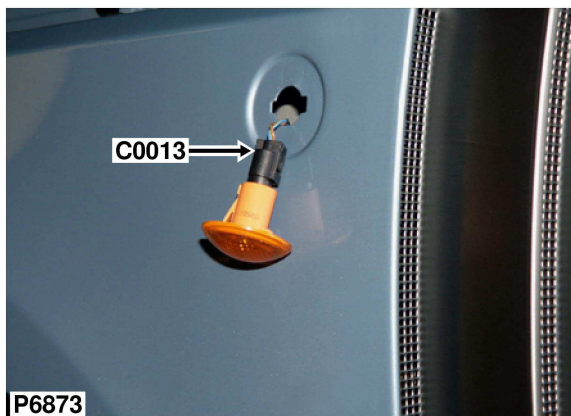

Wire Chart

CAV	TERMINAL	CSA	COL	CCT	DESTN
1	YPL101500	0.5	N	ALL	C0017-0
2	YPL101500	0.5	UY	ALL	C2039-4

Service Repair Kits

YPL101500		0.20 - 0.50 CSA
Cavities 1,2		
VDK500010	INSTRUCTION; REPAIR KIT	1
VDK500070	INSTRUCTION; EXTRACT TOOL	1
VDK500080	INSTRUCTION; EXTRACT TOOL	1
YMI000950	PRE-TERMINATED LEAD	1
YPQ000100	IDENTS (SMALL)	1
YQD000210	HEAT SHRINK SLEEVE	1
YRV000040	SPLICE (RED, CSA; 0.25-1.6)	1
YRW000390	WIRE STRIPPER	1
YRW500010	APPLICATOR	1

[VUB500150]



Part No. YPC116820
Colour: BLACK
Gender: F
Type: MQS
No. of Ways: 2WY

Description: Header-Earth
Location: LH side of engine compartment

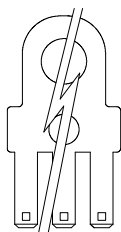
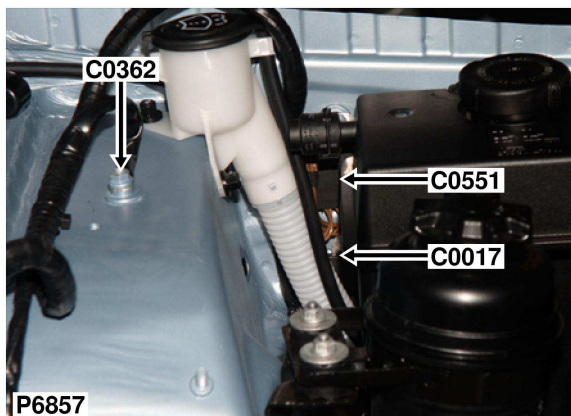

Wire Chart

CAV	TERMINAL	CSA	COL	CCT	DESTN
0	YPL103890	1.0	N	ALL	C0021-2
0	YPL103900	1.5	N	279	C1342-1
0	YPL103900	1.5	N	279	C1340-3

CAV	TERMINAL	CSA	COL	CCT	DESTN
0	YPL103890	1.0	N	ALL	C0008-2
0	YPL103880	0.5	N	ALL	C0013-1
0	YPL103890	1.0	N	ALL	C0514-1

Service Repair Kits

YPL103890		0.75 - 1.00 CSA	
Cavities 0			
VDK500010	INSTRUCTION; REPAIR KIT	1	
VDK500030	INSTRUCTION; EXTRACT TOOL	1	
YMI000880	PRE-TERMINATED LEAD	1	
YPQ000100	IDENTS (SMALL)	1	
YRV000040	SPLICE (RED, CSA; 0.25-1.6)	1	
YRW000390	WIRE STRIPPER	1	
YRW500010	APPLICATOR	1	
YRW500020	EXTRACT TOOL	1	
[VUB500090]			

YPL103880		0.20 - 0.50 CSA	
Cavities 0			
VDK500010	INSTRUCTION; REPAIR KIT	1	
VDK500030	INSTRUCTION; EXTRACT TOOL	1	
YMI000850	PRE-TERMINATED LEAD	1	
YPQ000100	IDENTS (SMALL)	1	
YRV000040	SPLICE (RED, CSA; 0.25-1.6)	1	
YRW000390	WIRE STRIPPER	1	
YRW500010	APPLICATOR	1	
YRW500020	EXTRACT TOOL	1	
[VUB500060]			

YPL103900		1.50 - 2.50 CSA	
Cavities 0			
VDK500010	INSTRUCTION; REPAIR KIT	1	
VDK500030	INSTRUCTION; EXTRACT TOOL	1	
YMI000890	PRE-TERMINATED LEAD	1	
YPQ000110	IDENTS (MEDIUM)	1	
YRV000050	SPLICE (BLUE, CSA; 1.0-2.6)	1	
YRW000390	WIRE STRIPPER	1	
YRW500010	APPLICATOR	1	
[VUB500100]			

Part No. YPH900780
Colour: COPPER, TIN PLATED
Gender: M
Type: HEADER COVER
No. of Ways: 17WY

Description: Header-Earth
Location: Front RH side of engine compartment

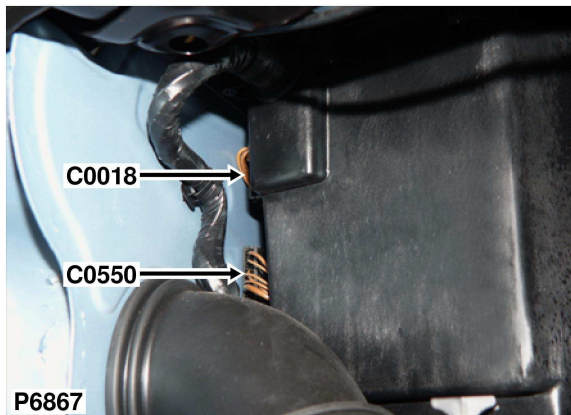

Wire Chart

CAV	TERMINAL	CSA	COL	CCT	DESTN
0	YPL103900	1.5	N	ALL	C0011-7
0	YPL103900	1.5	N	ALL	C0011-8
0	YPL103890	0.75	N	ALL	C0646-1
0	YPL103880	0.5	N	ALL	C0537-1

CAV	TERMINAL	CSA	COL	CCT	DESTN
0	YPL103880	0.5	N	ALL	C0007-1
0	YPL104290	6.0	N	ALL	C0005-1
0	YPL103900	2.5	N	ALL	C0030-1
0	YPL103890	1.0	N	ALL	C0513-1

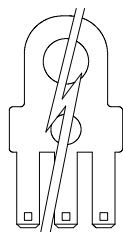

Part No. YPH900780
Colour: COPPER, TIN PLATED
Gender: M
Type: HEADER COVER
No. of Ways: 17WY

Description: Header-Earth
Location: Front RH side of engine compartment

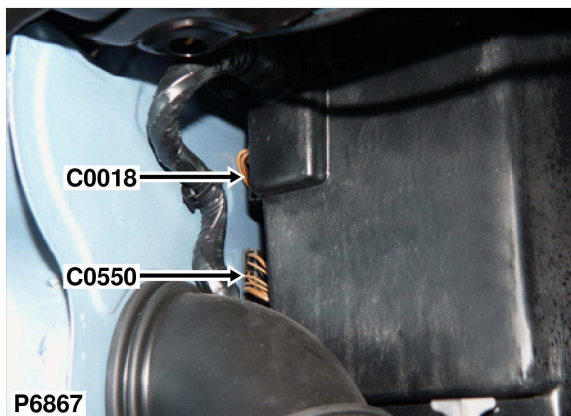

Service Repair Kits

YPL103890		0.75 - 1.00 CSA
Cavities 0		
VDK500010	INSTRUCTION; REPAIR KIT	1
VDK500030	INSTRUCTION; EXTRACT TOOL	1
YMI000880	PRE-TERMINATED LEAD	1
YPQ000100	IDENTS (SMALL)	1
YRV000040	SPLICE (RED, CSA; 0.25-1.6)	1
YRW000390	WIRE STRIPPER	1
YRW500010	APPLICATOR	1
YRW500020	EXTRACT TOOL	1
[VUB500090]		

YPL103880		0.20 - 0.50 CSA
Cavities 0		
VDK500010	INSTRUCTION; REPAIR KIT	1
VDK500030	INSTRUCTION; EXTRACT TOOL	1
YMI000850	PRE-TERMINATED LEAD	1
YPQ000100	IDENTS (SMALL)	1
YRV000040	SPLICE (RED, CSA; 0.25-1.6)	1
YRW000390	WIRE STRIPPER	1
YRW500010	APPLICATOR	1
YRW500020	EXTRACT TOOL	1
[VUB500060]		

YPL103900		1.50 - 2.50 CSA
Cavities 0		
VDK500010	INSTRUCTION; REPAIR KIT	1
VDK500030	INSTRUCTION; EXTRACT TOOL	1
YMI000890	PRE-TERMINATED LEAD	1
YPQ000110	IDENTS (MEDIUM)	1
YRV000050	SPLICE (BLUE, CSA; 1.0-2.6)	1
YRW000390	WIRE STRIPPER	1
YRW500010	APPLICATOR	1
[VUB500100]		

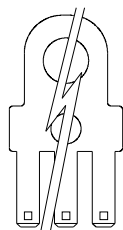

YPL104290		4.00 - 6.00 CSA
Cavities 0		
VDK500010	INSTRUCTION; REPAIR KIT	1
VDK500030	INSTRUCTION; EXTRACT TOOL	1
YMI000960	PRE-TERMINATED LEAD	1
YPQ000120	IDENTS (LARGE)	1
YRV000060	SPLICE (YELLOW, CSA; 2.7-6.6)	1
YRW000390	WIRE STRIPPER	1
YRW500010	APPLICATOR	1
[VUB500160]		

Part No. YPH900780
Colour: COPPER, TIN PLATED
Gender: M
Type: HEADER COVER
No. of Ways: 17WY

[continuation]

Description: Pump-Washer-Rear screen
Location: Front LH side of engine compartment

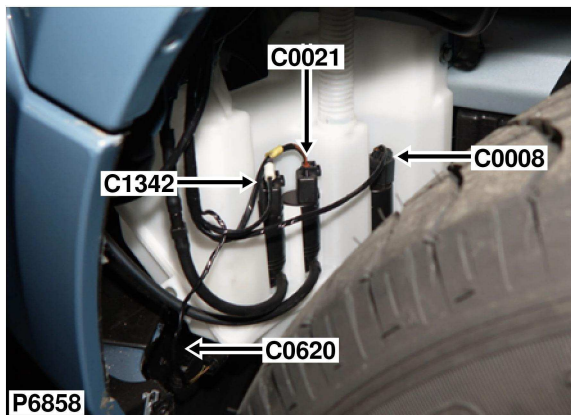

Wire Chart

CAV	TERMINAL	CSA	COL	CCT	DESTN
1	YPL103540	2.5	BR	ALL	C0388-3
2	YPL103490	1.0	N	ALL	C0017-0

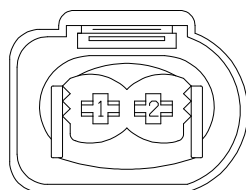

BLACK

No repair kit
 Geen reparatiepakke
 Pas de nécessaire de reparation
 Kein Werkzeug
 Senza kit per le riparazioni
 Sem kit de reparaçã
 No hay kit de reparaci3n

Part No. YPC116370
Colour: BLACK
Gender: F
Type: MDK3 PLUS
No. of Ways: 2WY

Description: Amplifier-Aerial
Location: Top of rear screen

No photo
 Geen photo
 Pas de photo
 Kein foto
 Senza foto
 Sem fotografia
 No hay foto

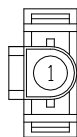

BROWN

Wire Chart

CAV	TERMINAL	CSA	COL	CCT	DESTN
1	YPE10020	0.5	W	581	SJ X830-

Service Repair Kits

YPE10020		0.50 - 1.00 csa
Cavities 1		
VDK500010	INSTRUCTION; REPAIR KIT	1
VDK500130	INSTRUCTION; EXTRACT TOOL	1
YMI000860	PRE-TERMINATED LEAD	1
YPQ000100	IDENTS (SMALL)	1
YRV000040	SPLICE (RED, CSA; 0.25-1.6)	1
YRW000390	WIRE STRIPPER	1
YRW500010	APPLICATOR	1

[VUB500070]

Part No. YPC113930
Colour: BROWN
Gender: F
Type: 2.5MM SYSTEM
No. of Ways: 1WY

Description: Switch-Brake fluid level
Location: Rear of engine compartment

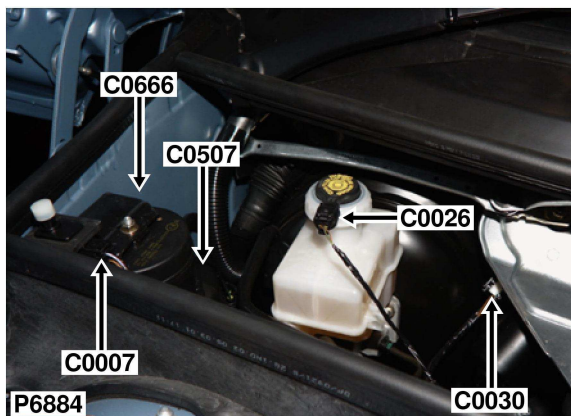

Wire Chart

CAV	TERMINAL	CSA	COL	CCT	DESTN
1	YPL101500	0.35	NB	ALL	C0554-0
2	YPL101500	0.35	NGY	ALL	SJ X1123-

Service Repair Kits

YPL101500		0.20 - 0.50 csa
Cavities 1,2		
VDK500010	INSTRUCTION; REPAIR KIT	1
VDK500070	INSTRUCTION; EXTRACT TOOL	1
VDK500080	INSTRUCTION; EXTRACT TOOL	1
YMI000950	PRE-TERMINATED LEAD	1
YPQ000100	IDENTS (SMALL)	1
YQD000210	HEAT SHRINK SLEEVE	1
YRV000040	SPLICE (RED, CSA; 0.25-1.6)	1
YRW000390	WIRE STRIPPER	1
YRW500010	APPLICATOR	1

[VUB500150]



Part No. YPC116820
Colour: BLACK
Gender: F
Type: MQS
No. of Ways: 2WY

Description: Switch-Ignition
Location: Beneath centre console

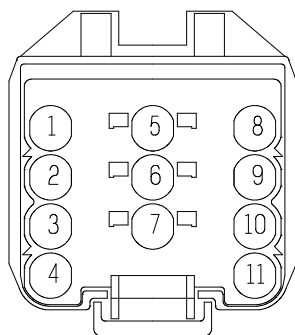
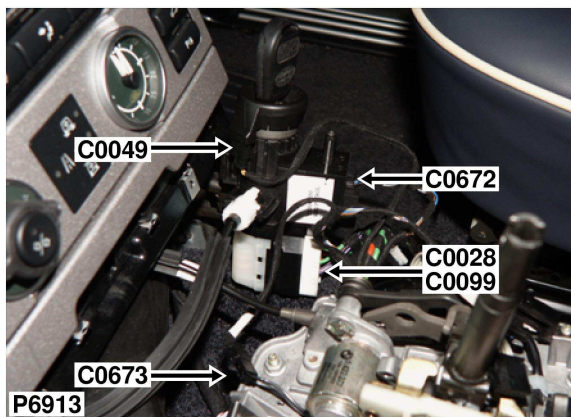

WHITE

Wire Chart

CAV	TERMINAL	CSA	COL	CCT	DESTN
1	YPE10020	0.75	G	573	C0448-3
2	YPE100520	4.0	PB	573	C0585-5
5	YPE10020	0.75	RU	573	C0583-3

CAV	TERMINAL	CSA	COL	CCT	DESTN
6	YPE100520	4.0	R	573	C0583-5
8	YPE10020	0.75	BY	573	C0331-6
9	YPE100520	4.0	G	573	C0585-10

Service Repair Kits

YPE100520		2.51 - 4.00 CSA
Cavities 2,6,9		
VDK500010	INSTRUCTION; REPAIR KIT	1
VDK500130	INSTRUCTION; EXTRACT TOOL	1
YMI000980	PRE-TERMINATED LEAD	1
YPQ000120	IDENTS (LARGE)	1
YRV000060	SPLICE (YELLOW, CSA; 2.7-6.6)	1
YRW000390	WIRE STRIPPER	1
YRW500010	APPLICATOR	1
[VUB500180]		

YPE10020		0.50 - 1.00 CSA
Cavities 1,5,8		
VDK500010	INSTRUCTION; REPAIR KIT	1
VDK500130	INSTRUCTION; EXTRACT TOOL	1
YMI000860	PRE-TERMINATED LEAD	1
YPQ000100	IDENTS (SMALL)	1
YRV000040	SPLICE (RED, CSA; 0.25-1.6)	1
YRW000390	WIRE STRIPPER	1
YRW500010	APPLICATOR	1
[VUB500070]		

Part No. 1393792
Colour: NATURAL
Gender: F
Type: 2.5MM SYSTEM
No. of Ways: 11WY

Description: Motor-Wiper-Windscreen
Location: Rear of engine compartment

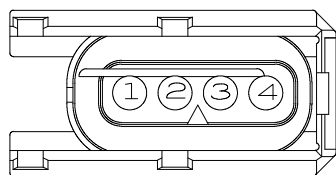
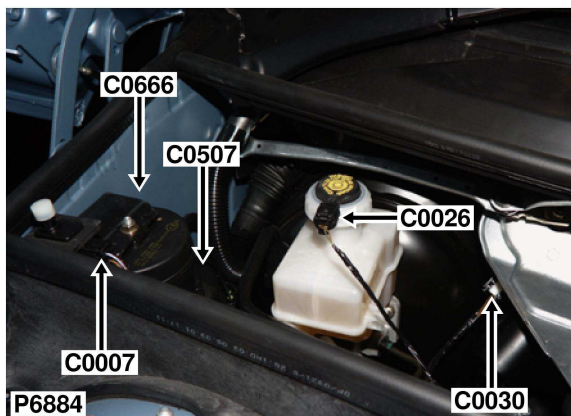

NATURAL

Wire Chart

CAV	TERMINAL	CSA	COL	CCT	DESTN
1	YPE100500	2.5	N	ALL	C0018-0
2	YPE100500	2.5	BG	ALL	C0546-4
3	YPE100500	2.5	BN	ALL	C0546-6
4	YPE100480	0.35	NG	ALL	SJ X1596-

Service Repair Kits

YPE100480		0.20 - 0.40 CSA
Cavities 4		
VDK500010	INSTRUCTION; REPAIR KIT	1
VDK500130	INSTRUCTION; EXTRACT TOOL	1
YMI000860	PRE-TERMINATED LEAD	1
YPQ000100	IDENTS (SMALL)	1
YRV000040	SPLICE (RED, CSA; 0.25-1.6)	1
YRW000390	WIRE STRIPPER	1
YRW500010	APPLICATOR	1

[VUB500070]

YPE100500		1.01 - 2.50 CSA
Cavities 1-3		
VDK500010	INSTRUCTION; REPAIR KIT	1
VDK500030	INSTRUCTION; EXTRACT TOOL	1
YMI000900	PRE-TERMINATED LEAD	1
YPQ000110	IDENTS (MEDIUM)	1
YRV000050	SPLICE (BLUE, CSA; 1.0-2.6)	1
YRW000390	WIRE STRIPPER	1
YRW500010	APPLICATOR	1

[VUB500110]

Part No. 8352356
Colour: BLACK
Gender: F
Type: 2.5MM SYSTEM
No. of Ways: 4WY

Description: Diagnostic socket
Location: Behind driver side of fascia

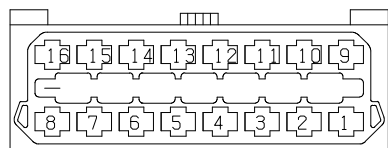
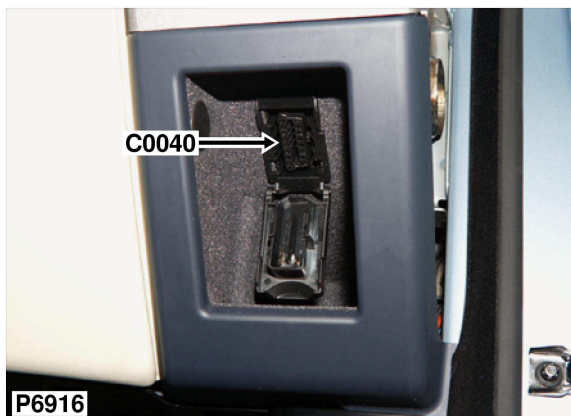

BLACK

Part No. 8380698
Colour: BLACK
Gender: F
Type: MICRO TIMER 3
No. of Ways: 16WY

Wire Chart

CAV	TERMINAL	CSA	COL	CCT	DESTN
1	YPL103470	0.5	GW	ALL	C0587-13
4	YPL103470	0.5	NB	ALL	C0287-0
5	YPL103470	0.5	NB	ALL	C0287-0
7	YPL103470	0.35	WPY	573	SJ X442-

CAV	TERMINAL	CSA	COL	CCT	DESTN
7	YPL103470	0.35	WPY	58	C0331-32
8	YPL103470	0.35	WP	ALL	SJ X183-
9	YPL103470	0.35	B	ALL	C0331-17
16	YPL103470	0.5	RUY	ALL	C0586-26

Service Repair Kits

YPL103470		0.20 - 0.50 CSA
Cavities 1,4,5,7-9,16		
VDK500010	INSTRUCTION; REPAIR KIT	1
VDK500120	INSTRUCTION; EXTRACT TOOL	1
YMI001070	PRE-TERMINATED LEAD	1
YPQ000100	IDENTS (SMALL)	1
YRV000040	SPLICE (RED, CSA; 0.25-1.6)	1
YRW000390	WIRE STRIPPER	1
YRW500010	APPLICATOR	1
YRW500110	EXTRACT TOOL	1

[VUB500270]

Description: Switch-Lighting
Location: Behind driver side of fascia

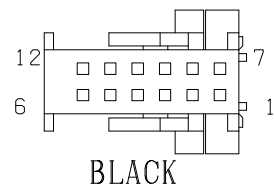
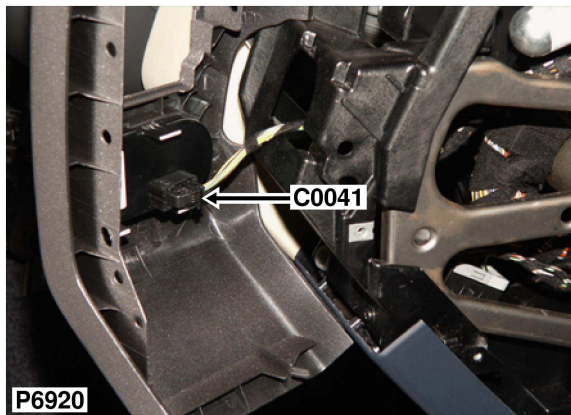

Wire Chart

CAV	TERMINAL	CSA	COL	CCT	DESTN
1	YPL101310	0.35	YG	ALL	C2040-1
2	YPL101310	0.35	B	ALL	C2040-51
3	YPL101310	0.5	SB	ALL	C2040-16
7	YPL101310	0.35	NB	ALL	C2040-52

CAV	TERMINAL	CSA	COL	CCT	DESTN
8	YPL101310	0.35	YB	ALL	C2040-45
9	YPL101310	0.35	YW	ALL	C2040-8
10	YPL101310	0.35	G	ALL	C2040-29
11	YPL101310	0.35	Y	ALL	C2040-33

Service Repair Kits

YPL101310		0.20 - 0.50 CSA
Cavities 1-3,7-11		
VDK500010	INSTRUCTION; REPAIR KIT	1
VDK500070	INSTRUCTION; EXTRACT TOOL	1
VDK500080	INSTRUCTION; EXTRACT TOOL	1
YMI000870	PRE-TERMINATED LEAD	1
YPQ000100	IDENTS (SMALL)	1
YRV000040	SPLICE (RED, CSA; 0.25-1.6)	1
YRW000390	WIRE STRIPPER	1
YRW500010	APPLICATOR	1
YRW500060	EXTRACT TOOL	1
YRW500070	EXTRACT TOOL	1

[VUB500080]

Part No. YPC111790
Colour: BLACK
Gender: F
Type: MQS
No. of Ways: 12WY

Description: Coil-Transponder
Location: Beneath centre console

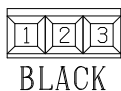
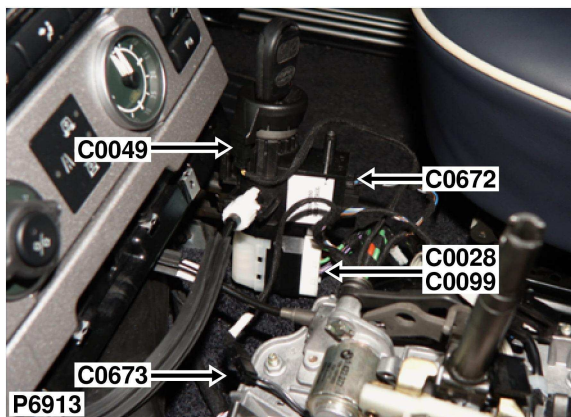

Part No. YPC117800
Colour: BLACK
Gender: F
Type: MQS
No. of Ways: 3WY

Wire Chart

CAV	TERMINAL	CSA	COL	CCT	DESTN
1	YPL101310	0.35	YU	ALL	C0059-5
3	YPL101310	0.35	YN	ALL	C0059-12

Service Repair Kits

YPL101310		0.20 - 0.50 csa
Cavities 1,3		
VDK500010	INSTRUCTION; REPAIR KIT	1
VDK500070	INSTRUCTION; EXTRACT TOOL	1
VDK500080	INSTRUCTION; EXTRACT TOOL	1
YMI000870	PRE-TERMINATED LEAD	1
YPQ000100	IDENTS (SMALL)	1
YRV000040	SPLICE (RED, CSA; 0.25-1.6)	1
YRW000390	WIRE STRIPPER	1
YRW500010	APPLICATOR	1
YRW500060	EXTRACT TOOL	1
YRW500070	EXTRACT TOOL	1

[VUB500080]

Description: Sensor-Pad wear
Location: Behind LH front wheel arch liner

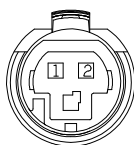
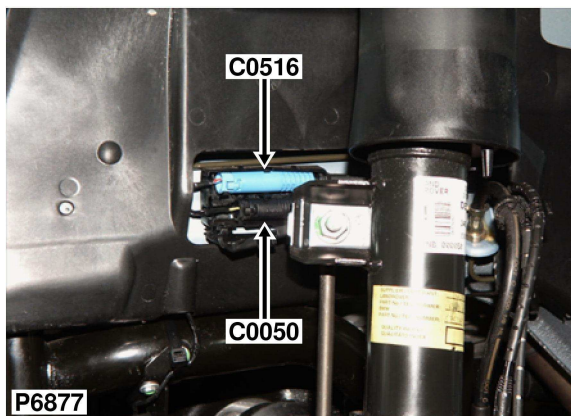

BLACK

Part No. YPC110480
Colour: BLACK
Gender: F
Type: MQS
No. of Ways: 2WY

Wire Chart

CAV	TERMINAL	CSA	COL	CCT	DESTN
1	YPL101500	0.35	Y	ALL	C0234-4
2	YPL101500	0.35	B	ALL	C0968-2

Service Repair Kits

YPL101500		0.20 - 0.50 CSA
Cavities 1,2		
VDK500010	INSTRUCTION; REPAIR KIT	1
VDK500070	INSTRUCTION; EXTRACT TOOL	1
VDK500080	INSTRUCTION; EXTRACT TOOL	1
YMI000950	PRE-TERMINATED LEAD	1
YPQ000100	IDENTS (SMALL)	1
YQD000210	HEAT SHRINK SLEEVE	1
YRV000040	SPLICE (RED, CSA; 0.25-1.6)	1
YRW000390	WIRE STRIPPER	1
YRW500010	APPLICATOR	1

[VUB500150]

Description: ECU-Engine Immobilisation
Location: Beneath centre console

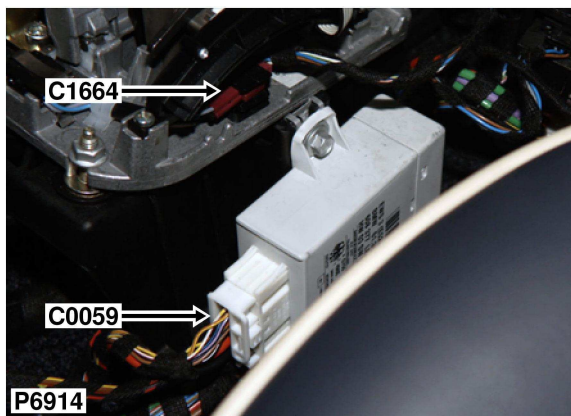

Wire Chart

CAV	TERMINAL	CSA	COL	CCT	DESTN
1	YPL102730	4.0	B	573	C1455-6
1	YPL102730	4.0	B	58	C0448-1
2	YPL102730	4.0	R	573	C0591-1
2	YPL102730	4.0	BY	58	C0099-8
4	YPL101310	0.5	BP	ALL	C0331-33
5	YPL101310	0.35	YU	ALL	C0049-1

CAV	TERMINAL	CSA	COL	CCT	DESTN
6	YPL101310	0.35	BU	ALL	C2055-5
9	YPL101310	0.5	NB	ALL	SJ X230-
10	YPL101910	0.75	RY	ALL	SJ X18316-
11	YPL101310	0.5	PB	ALL	C0289-0
12	YPL101310	0.35	YN	ALL	C0049-3
13	YPL101310	0.35	WRY	ALL	C0296-0

Service Repair Kits

YPL101910		0.75 - 0.75 CSA
Cavities 4-6,9-13		
VDK500010	INSTRUCTION; REPAIR KIT	1
VDK500070	INSTRUCTION; EXTRACT TOOL	1
VDK500080	INSTRUCTION; EXTRACT TOOL	1
YMI000870	PRE-TERMINATED LEAD	1
YPQ000100	IDENTS (SMALL)	1
YRV000040	SPLICE (RED, CSA; 0.25-1.6)	1
YRW000390	WIRE STRIPPER	1
YRW500010	APPLICATOR	1
YRW500060	EXTRACT TOOL	1
YRW500070	EXTRACT TOOL	1

[VUB500080]

YPL102730		2.51 - 4.00 CSA
Cavities 1-2		
VDK500010	INSTRUCTION; REPAIR KIT	1
VDK500050	INSTRUCTION; EXTRACT TOOL	1
YMI001150	PRE-TERMINATED LEAD	1
YPQ000120	IDENTS (LARGE)	1
YRV000060	SPLICE (YELLOW, CSA; 2.7-6.6)	1
YRW000390	WIRE STRIPPER	1
YRW500010	APPLICATOR	1
YRW500040	EXTRACT TOOL	1

[VUB500350]

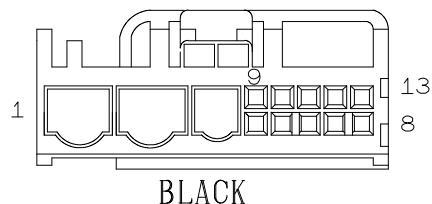

Part No.: YPC114780
Colour: BLACK
Gender: F
Type: MQS/MPQ/PQ HYBRID
No. of Ways: 13WY

Description: Motor-Headlamp levelling-RH

Location: Front of vehicle - RH side

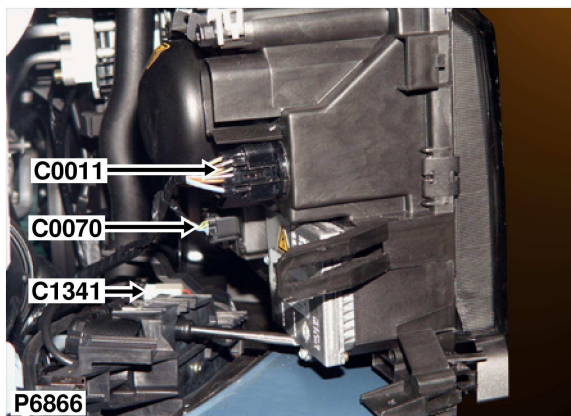

Wire Chart

CAV	TERMINAL	CSA	COL	CCT	DESTN
1	YPL101500	MMAD	YB	574	C1543-10
2	YPL101500	MMAD	YN	574	C1543-11
3	YPL101500	MMAH	UB	574	C1543-9
4	YPL101500	MMAH	UN	574	C1543-8

Service Repair Kits

YPL101500		0.20 - 0.50 CSA
Cavities 1-4		
VDK500010	INSTRUCTION; REPAIR KIT	1
VDK500070	INSTRUCTION; EXTRACT TOOL	1
VDK500080	INSTRUCTION; EXTRACT TOOL	1
YMI000950	PRE-TERMINATED LEAD	1
YPQ000100	IDENTS (SMALL)	1
YQD000210	HEAT SHRINK SLEEVE	1
YRV000040	SPLICE (RED, CSA; 0.25-1.6)	1
YRW000390	WIRE STRIPPER	1
YRW500010	APPLICATOR	1

[VUB500150]

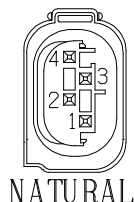

Part No. YPC117060
Colour: NATURAL
Gender: F
Type: MQS
No. of Ways: 4WY

Description: Motor-Headlamp levelling-LH

Location: Front of vehicle - LH side

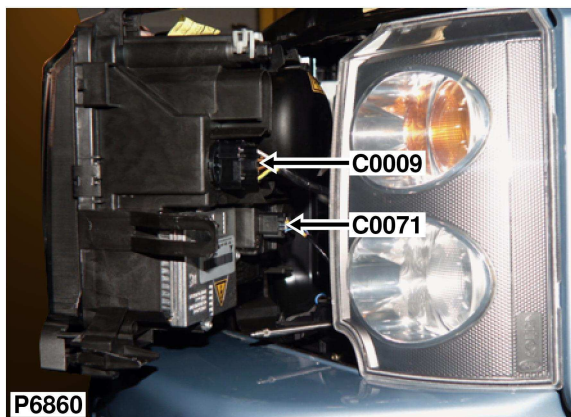

Wire Chart

CAV	TERMINAL	CSA	COL	CCT	DESTN
1	YPL101500	MMW	YR	574	C1543-1
2	YPL101500	MMW	YN	574	C1543-2
3	YPL101500	MMP	UR	574	C1543-3
4	YPL101500	MMP	UN	574	C1543-4

Service Repair Kits

YPL101500		0.20 - 0.50 CSA
Cavities 1-4		
VDK500010	INSTRUCTION; REPAIR KIT	1
VDK500070	INSTRUCTION; EXTRACT TOOL	1
VDK500080	INSTRUCTION; EXTRACT TOOL	1
YMI000950	PRE-TERMINATED LEAD	1
YPQ000100	IDENTS (SMALL)	1
YQD000210	HEAT SHRINK SLEEVE	1
YRV000040	SPLICE (RED, CSA; 0.25-1.6)	1
YRW000390	WIRE STRIPPER	1
YRW500010	APPLICATOR	1

[VUB500150]

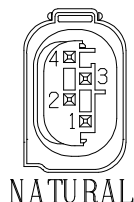

NATURAL

Part No. YPC117060

Colour: NATURAL

Gender: F

Type: MQS

No. of Ways: 4WY

Description: Switch-Brake pedal
Location: Driver's footwell

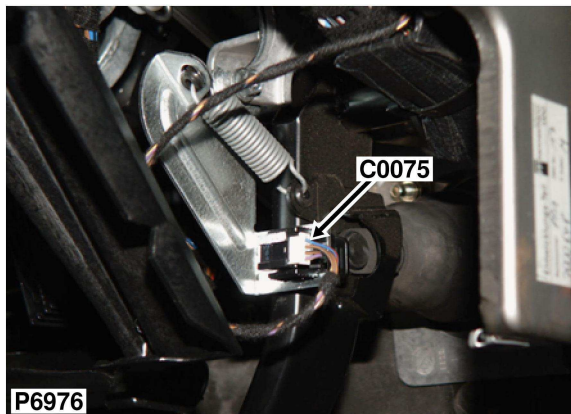

Wire Chart

CAV	TERMINAL	CSA	COL	CCT	DESTN
1	YPL101310	0.5	PY	ALL	C0587-8
2	YPL101310	0.5	NB	ALL	SJ X3361-
3	YPL101310	0.35	NS	ALL	C0331-28
4	YPL101310	0.35	UR	ALL	SJ X181-

Service Repair Kits

YPL101310		0.20 - 0.50 CSA
Cavities 1-4		
VDK500010	INSTRUCTION; REPAIR KIT	1
VDK500070	INSTRUCTION; EXTRACT TOOL	1
VDK500080	INSTRUCTION; EXTRACT TOOL	1
YMI000870	PRE-TERMINATED LEAD	1
YPQ000100	IDENTS (SMALL)	1
YRV000040	SPLICE (RED, CSA; 0.25-1.6)	1
YRW000390	WIRE STRIPPER	1
YRW500010	APPLICATOR	1
YRW500060	EXTRACT TOOL	1
YRW500070	EXTRACT TOOL	1

[VUB500080]

Part No. YPC117850
Colour: NATURAL
Gender: F
Type: MQS
No. of Ways: 4WY

Description: Lamp-Footwell-Front-RH
Location: Behind footwell trim panel - RH side

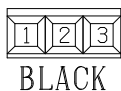
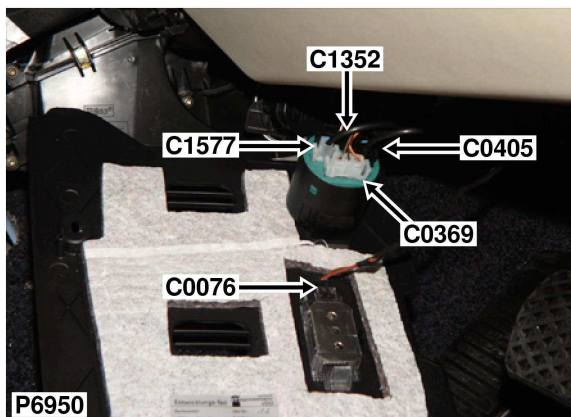

BLACK

Part No. YPC117800
Colour: BLACK
Gender: F
Type: MQS
No. of Ways: 3WY

Wire Chart

CAV	TERMINAL	CSA	COL	CCT	DESTN
1	YPL101310	0.5	N	ALL	SJ X215-
3	YPL101910	0.75	RU	ALL	C0586-18

Service Repair Kits

YPL101910		0.75 - 0.75 CSA
Cavities 1,3		
VDK500010	INSTRUCTION; REPAIR KIT	1
VDK500070	INSTRUCTION; EXTRACT TOOL	1
VDK500080	INSTRUCTION; EXTRACT TOOL	1
YMI000870	PRE-TERMINATED LEAD	1
YPQ000100	IDENTS (SMALL)	1
YRV000040	SPLICE (RED, CSA; 0.25-1.6)	1
YRW000390	WIRE STRIPPER	1
YRW500010	APPLICATOR	1
YRW500060	EXTRACT TOOL	1
YRW500070	EXTRACT TOOL	1

[VUB500080]

Description: Lamp-Footwell-Front-LH
Location: Behind footwell trim panel - LH side

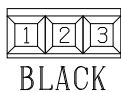
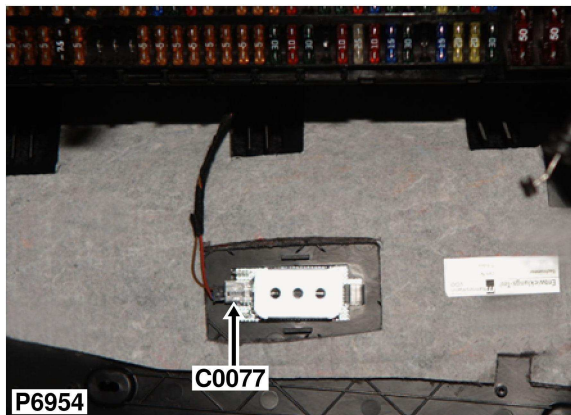

Part No. YPC117800
Colour: BLACK
Gender: F
Type: MQS
No. of Ways: 3WY

Wire Chart

CAV	TERMINAL	CSA	COL	CCT	DESTN
1	YPL101310	0.5	N	ALL	C0285-0
3	YPL101910	0.75	RU	ALL	C0586-19

Service Repair Kits

YPL101910		0.75 - 0.75 CSA
Cavities 1,3		
VDK500010	INSTRUCTION; REPAIR KIT	1
VDK500070	INSTRUCTION; EXTRACT TOOL	1
VDK500080	INSTRUCTION; EXTRACT TOOL	1
YMI000870	PRE-TERMINATED LEAD	1
YPQ000100	IDENTS (SMALL)	1
YRV000040	SPLICE (RED, CSA; 0.25-1.6)	1
YRW000390	WIRE STRIPPER	1
YRW500010	APPLICATOR	1
YRW500060	EXTRACT TOOL	1
YRW500070	EXTRACT TOOL	1

[VUB500080]

Description: Rotary coupler
Location: Underside of steering column

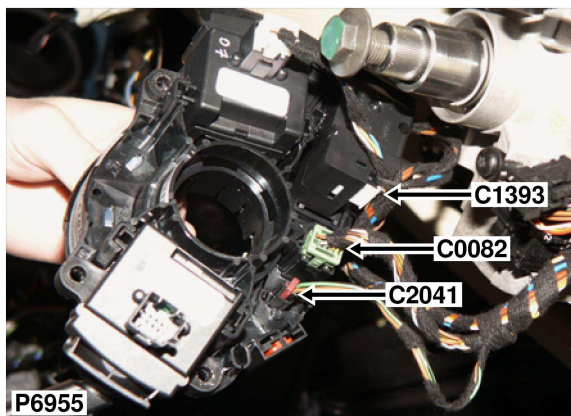

Wire Chart

CAV	TERMINAL	CSA	COL	CCT	DESTN
2	YPL101310	MMK	SN	ALL	C0256-27
3	YPL101310	MMK	SB	ALL	C0256-26
4	YPL101310	MMI	YN	ALL	C0256-11
5	YPL101310	MMI	YB	ALL	C0256-10
6	YPL101310	0.35	NR	ALL	C0587-2

CAV	TERMINAL	CSA	COL	CCT	DESTN
7	YPL101310	0.5	NB	ALL	SJ X3361-
8	YPL101310	0.35	YB	51	C0331-27
9	YPL101310	0.35	WSY	51	SJ X939-
10	YPL101310	0.5	PY	ALL	C0587-25

Service Repair Kits

YPL101310		0.20 - 0.50 CSA
Cavities 2-10		
VDK500010	INSTRUCTION; REPAIR KIT	1
VDK500070	INSTRUCTION; EXTRACT TOOL	1
VDK500080	INSTRUCTION; EXTRACT TOOL	1
YMI000870	PRE-TERMINATED LEAD	1
YPQ000100	IDENTS (SMALL)	1
YRV000040	SPLICE (RED, CSA; 0.25-1.6)	1
YRW000390	WIRE STRIPPER	1
YRW500010	APPLICATOR	1
YRW500060	EXTRACT TOOL	1
YRW500070	EXTRACT TOOL	1

[VUB500080]

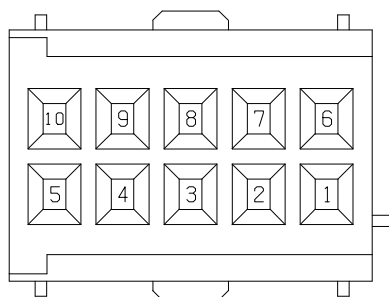

GREEN

Part No. 6909006
Colour: GREEN
Gender: F
Type: MQS
No. of Ways: 10WY

Description: Cigar lighter
Location: Beneath centre console

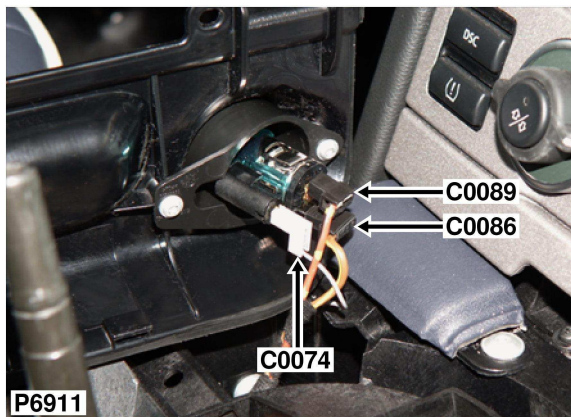

Wire Chart

CAV	TERMINAL	CSA	COL	CCT	DESTN
1	1377193	2.5	N	ALL	C0553-0

No repair kit
 Geen reparatiepakke
 Pas de nécessaire de reparation
 Kein Werkzeug
 Senza kit per le riparazioni
 Sem kit de reparação
 No hay kit de reparación

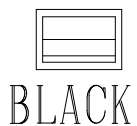

Part No. 8371473
Colour: BLACK
Gender: F
Type: ?
No. of Ways: 1WY

Description: Cigar lighter
Location: Beneath centre console

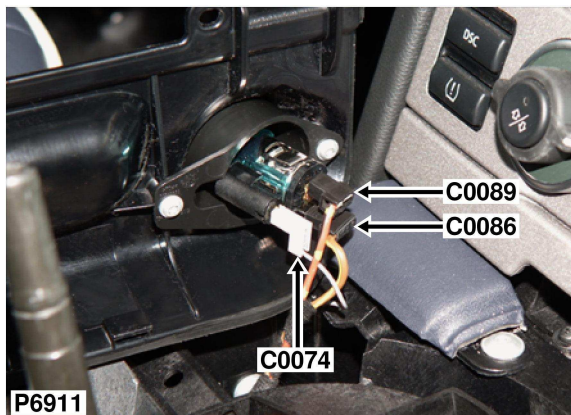

Wire Chart

CAV	TERMINAL	CSA	COL	CCT	DESTN
1	YPL901301	1.5	RBV	575	C2021-3
1	YPL901301	1.5	RBV	43	C2020-5



Part No. 1359131
Colour: BLACK
Gender: F
Type: ?
No. of Ways: 1WY

No repair kit
 Geen reparatiepakke
 Pas de nécessaire de reparation
 Kein Werkzeug
 Senza kit per le riparazioni
 Sem kit de reparaçao
 No hay kit de reparación

Description: Switch-Handbrake
Location: Beneath centre console

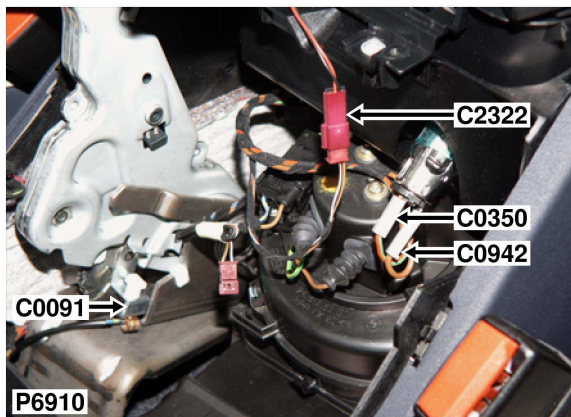

Wire Chart

CAV	TERMINAL	CSA	COL	CCT	DESTN
1	SEE DRAWING	0.75	UNY	ALL	C0230-5



Part No. 1370069
Colour: TIN PLATED
Gender: M
Type: WIRE END CRIMP
No. of Ways: 1WY

No repair kit
 Geen reparatiepakke
 Pas de nécessaire de réparation
 Kein Werkzeug
 Senza kit per le riparazioni
 Sem kit de reparação
 No hay kit de reparación

Description: Switch-Hazard Warning and CDL Master

Location: Beneath centre console

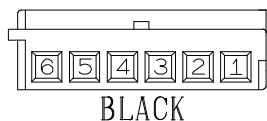
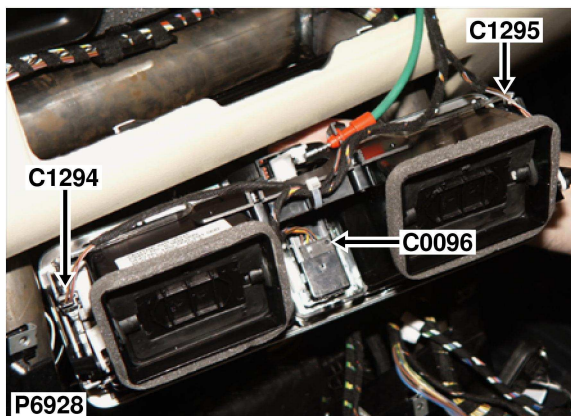

Wire Chart

CAV	TERMINAL	CSA	COL	CCT	DESTN
2	YPL101310	0.35	NB	ALL	C0287-0
3	YPL101310	0.35	NU	ALL	C2040-7
4	YPL101310	0.35	UN	ALL	C2040-19
5	YPL101310	0.35	YR	ALL	C0660-24
6	YPL101310	0.5	SR	ALL	C0286-0

Service Repair Kits

YPL101310		0.20 - 0.50 CSA
Cavities 2-6		
VDK500010	INSTRUCTION; REPAIR KIT	1
VDK500070	INSTRUCTION; EXTRACT TOOL	1
VDK500080	INSTRUCTION; EXTRACT TOOL	1
YMI000870	PRE-TERMINATED LEAD	1
YPQ000100	IDENTS (SMALL)	1
YRV000040	SPLICE (RED, CSA; 0.25-1.6)	1
YRW000390	WIRE STRIPPER	1
YRW500010	APPLICATOR	1
YRW500060	EXTRACT TOOL	1
YRW500070	EXTRACT TOOL	1

[VUB500080]

Part No. 6909052
Colour: BLACK
Gender: F
Type: MQS
No. of Ways: 6WY

Description: Head Unit-Audio System

Location: Behind radio

No photo
 Geen photo
 Pas de photo
 Kein foto
 Senza foto
 Sem fotografia
 No hay foto

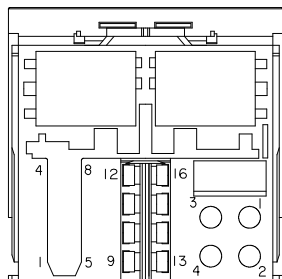

BLACK

Part No. 8384580
Colour: BLACK
Gender: F
Type: MQS/MPQ
No. of Ways: 16WY

Wire Chart

CAV	TERMINAL	CSA	COL	CCT	DESTN
9	8377162	0.35	WSY	581	SJ X18344-
10	8377162	0.35	WN	581	C0395-8
11	8377162	0.35	WG	581	C0395-11
12	YPL102710	2.5	N	581	C0708-0

CAV	TERMINAL	CSA	COL	CCT	DESTN
13	8377162	0.5	W	581	SJ X830-
14	8377162	0.5	SR	581	SJ X1362-
15	YPL102710	2.5	RG	581	SJ X3206-
16	8377162	0.5	PW	581	SJ X229-

Service Repair Kits

YPL102710		1.01 - 2.50 CSA
Cavities 12,15		
VDK500010	INSTRUCTION; REPAIR KIT	1
VDK500050	INSTRUCTION; EXTRACT TOOL	1
YMI001010	PRE-TERMINATED LEAD	1
YPQ000110	IDENTS (MEDIUM)	1
YRV000050	SPLICE (BLUE, CSA; 1.0-2.6)	1
YRW000390	WIRE STRIPPER	1
YRW500010	APPLICATOR	1

[VUB500210]

Description: Switch-Ignition
Location: Beneath centre console

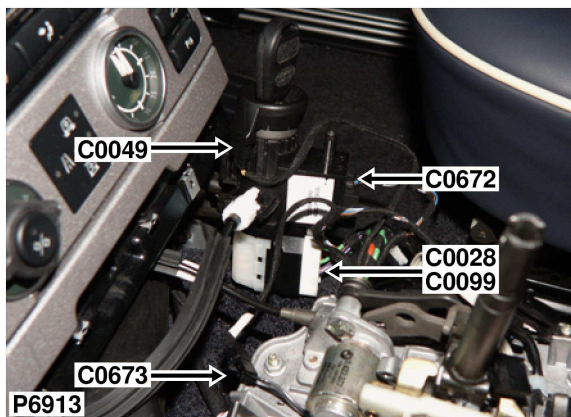

Wire Chart

CAV	TERMINAL	CSA	COL	CCT	DESTN
2	YPE100520	4.0	PB	58	C0585-5
5	YPE100520	4.0	R	58	C0591-3
6	YPE100520	4.0	R	58	C0583-5
8	YPE100520	4.0	BY	58	C0059-2
9	YPE100520	4.0	G	58	C0585-10

Service Repair Kits

YPE100520		2.51 - 4.00 CSA
Cavities 2,5,6,8,9		
VDK500010	INSTRUCTION; REPAIR KIT	1
VDK500130	INSTRUCTION; EXTRACT TOOL	1
YMI000980	PRE-TERMINATED LEAD	1
YPQ000120	IDENTS (LARGE)	1
YRV000060	SPLICE (YELLOW, CSA; 2.7-6.6)	1
YRW000390	WIRE STRIPPER	1
YRW500010	APPLICATOR	1

[VUB500180]

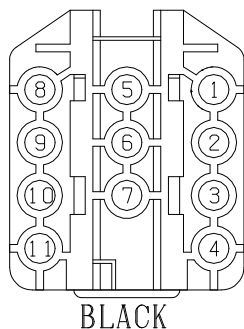

Part No. YPC115200
Colour: BLACK
Gender: F
Type: 2.5MM SYSTEM
No. of Ways: 11WY

Description: Pump-Fuel
Location: Above fuel tank

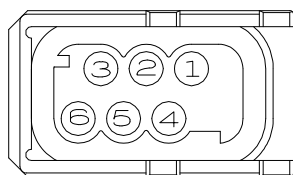
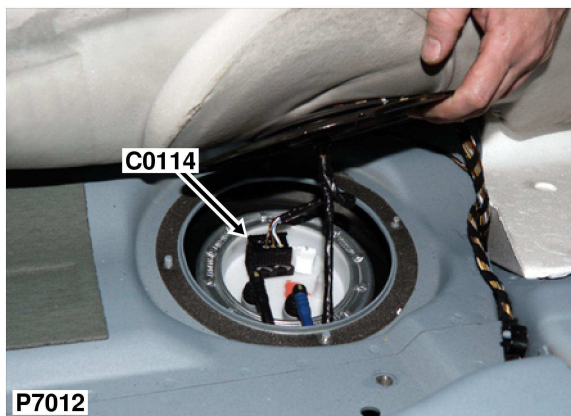

BLACK

Wire Chart

CAV	TERMINAL	CSA	COL	CCT	DESTN
1	YPE100330	2.5	WU	ALL	C2020-3
2	YPE100320	0.5	NBY	ALL	C0234-12
3	YPE100320	0.5	NBW	ALL	C0234-16

CAV	TERMINAL	CSA	COL	CCT	DESTN
4	YPE100330	1.5	N	ALL	C0555-0
5	YPE100320	0.5	BRY	ALL	C0234-7
6	YPE100320	0.5	BRW	ALL	C0234-23

Service Repair Kits

YPE100330		1.01 - 2.50 CSA	
Cavities 1,4			
VDK500010	INSTRUCTION; REPAIR KIT	1	
VDK500130	INSTRUCTION; EXTRACT TOOL	1	
YMI001000	PRE-TERMINATED LEAD	1	
YPQ000110	IDENTS (MEDIUM)	1	
YQD000210	HEAT SHRINK SLEEVE	1	
YRV000050	SPLICE (BLUE, CSA; 1.0-2.6)	1	
YRW000390	WIRE STRIPPER	1	
YRW500010	APPLICATOR	1	
YRW500120	EXTRACT TOOL	1	

[VUB500200]

YPE100320		0.50 - 1.00 CSA	
Cavities 2,3,5,6			
VDK500010	INSTRUCTION; REPAIR KIT	1	
VDK500090	INSTRUCTION; EXTRACT TOOL	1	
VDK500100	INSTRUCTION; EXTRACT TOOL	1	
YMI001160	PRE-TERMINATED LEAD	1	
YPQ000100	IDENTS (SMALL)	1	
YQD000210	HEAT SHRINK SLEEVE	1	
YRV000040	SPLICE (RED, CSA; 0.25-1.6)	1	
YRW000390	WIRE STRIPPER	1	
YRW500010	APPLICATOR	1	

[VUB500360]

Part No. YPC114770
Colour: BLACK
Gender: F
Type: 2.5MM SYSTEM
No. of Ways: 6WY

Description: Main harness to tail door harness

Location: Rear of luggage compartment

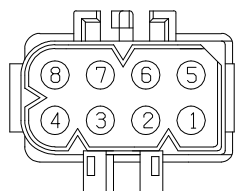
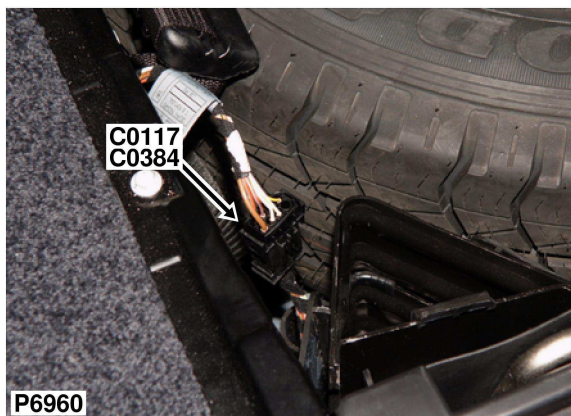

BLACK

Wire Chart

CAV	TERMINAL	CSA	COL	CCT	DESTN
1	YPD10010	0.75	UY	ALL	C2022-15
2	YPD10010	0.75	UW	ALL	C2022-16
3	YPD10010	0.75	RS	ALL	C2022-17
4	YPD10010	0.75	YB	ALL	C0660-22
5	YPD10009	2.5	N	ALL	C0707-0

CAV	TERMINAL	CSA	COL	CCT	DESTN
6	YPD10010	0.75	WY	ALL	SJ X428-
7	YPD10010	0.75	WY	ALL	SJ X428-

Service Repair Kits

YPD10009		1.50 - 2.50 CSA
Cavities 5		
VDK500010	INSTRUCTION; REPAIR KIT	1
VDK500030	INSTRUCTION; EXTRACT TOOL	1
YMI001130	PRE-TERMINATED LEAD	1
YPQ000110	IDENTS (MEDIUM)	1
YRV000050	SPLICE (BLUE, CSA; 1.0-2.6)	1
YRW000390	WIRE STRIPPER	1
YRW500010	APPLICATOR	1

[VUB500330]

YPD10010		0.50 - 1.00 CSA
Cavities 1-4,6,7		
VDK500010	INSTRUCTION; REPAIR KIT	1
VDK500130	INSTRUCTION; EXTRACT TOOL	1
YMI000920	PRE-TERMINATED LEAD	1
YPQ000100	IDENTS (SMALL)	1
YRV000040	SPLICE (RED, CSA; 0.25-1.6)	1
YRW000390	WIRE STRIPPER	1
YRW500010	APPLICATOR	1
YRW500120	EXTRACT TOOL	1

[VUB500130]

Part No. YPC112730
Colour: BLACK
Gender: M
Type: 2.5MM SYSTEM
No. of Ways: 8WY

Description: Lamp-Load space-RH
Location: RH side of tail door

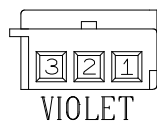
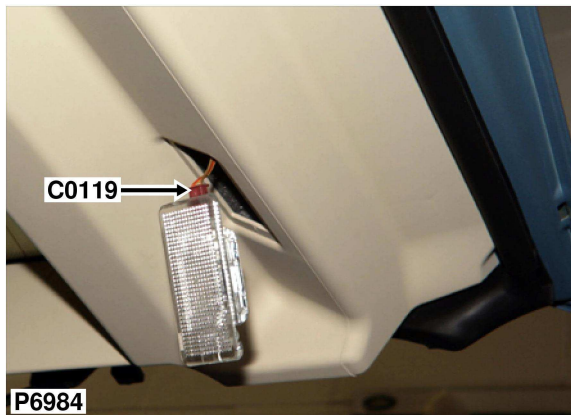

Part No. 8377070
Colour: VIOLET
Gender: F
Type: MQS
No. of Ways: 3WY

Wire Chart

CAV	TERMINAL	CSA	COL	CCT	DESTN
1	YPL101910	0.75	NY	ALL	SJ X465-
3	YPL101910	0.75	RY	ALL	SJ X10189-

Service Repair Kits

YPL101910		0.75 - 0.75 CSA
Cavities 1,3		
VDK500010	INSTRUCTION; REPAIR KIT	1
VDK500070	INSTRUCTION; EXTRACT TOOL	1
VDK500080	INSTRUCTION; EXTRACT TOOL	1
YMI000870	PRE-TERMINATED LEAD	1
YPQ000100	IDENTS (SMALL)	1
YRV000040	SPLICE (RED, CSA; 0.25-1.6)	1
YRW000390	WIRE STRIPPER	1
YRW500010	APPLICATOR	1
YRW500060	EXTRACT TOOL	1
YRW500070	EXTRACT TOOL	1

[VUB500080]

Description: Lamp-Load space-LH
Location: LH side of taildoor

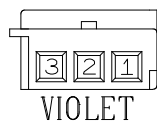
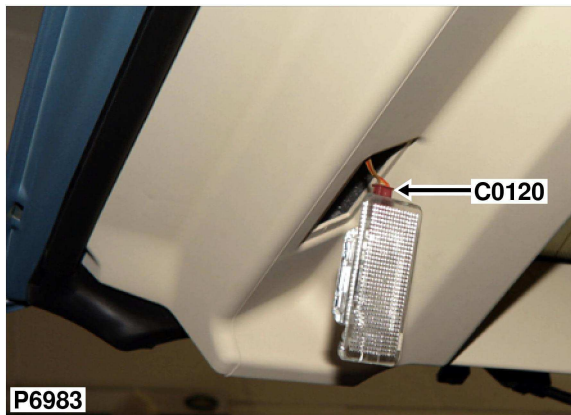

Part No. 8377070
Colour: VIOLET
Gender: F
Type: MQS
No. of Ways: 3WY

Wire Chart

CAV	TERMINAL	CSA	COL	CCT	DESTN
1	YPL101910	0.75	NY	ALL	SJ X465-
3	YPL101910	0.75	RY	ALL	SJ X10189-

Service Repair Kits

YPL101910		0.75 - 0.75 csa
Cavities 1,3		
VDK500010	INSTRUCTION; REPAIR KIT	1
VDK500070	INSTRUCTION; EXTRACT TOOL	1
VDK500080	INSTRUCTION; EXTRACT TOOL	1
YMI000870	PRE-TERMINATED LEAD	1
YPQ000100	IDENTS (SMALL)	1
YRV000040	SPLICE (RED, CSA; 0.25-1.6)	1
YRW000390	WIRE STRIPPER	1
YRW500010	APPLICATOR	1
YRW500060	EXTRACT TOOL	1
YRW500070	EXTRACT TOOL	1

[VUB500080]

Description: Lamp-Tail-LH
Location: LH rear of vehicle

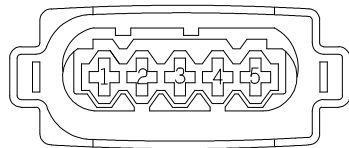
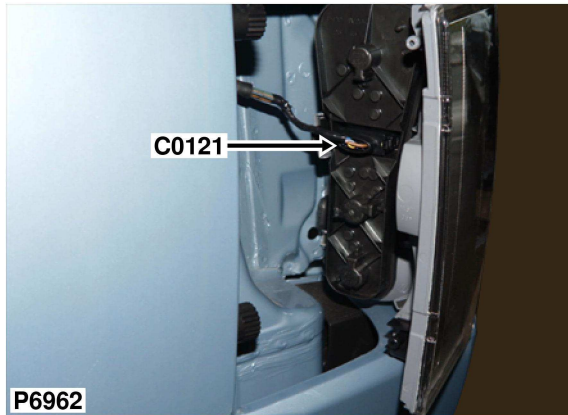

BLACK

Part No. YPC113350
Colour: BLACK
Gender: F
Type: SLK (VDA)
No. of Ways: 5WY

Wire Chart

CAV	TERMINAL	CSA	COL	CCT	DESTN
1	YPL102220	0.75	UG	394	SJ X184-
2	YPL102220	0.75	BU	ALL	SJ X10197-
3	YPL102220	0.75	YB	ALL	C2039-14
4	YPL102200	0.5	SP	394	SJ X246-
5	YPL102240	1.5	N	ALL	C0707-0

Service Repair Kits

YPL102240		1.01 - 2.50 CSA
Cavities 5		
VDK500010	INSTRUCTION; REPAIR KIT	1
VDK500030	INSTRUCTION; EXTRACT TOOL	1
YMI001200	PRE-TERMINATED LEAD	1
YPQ000110	IDENTS (MEDIUM)	1
YQD000210	HEAT SHRINK SLEEVE	1
YRV000050	SPLICE (BLUE, CSA; 1.0-2.6)	1
YRW000390	WIRE STRIPPER	1
YRW500010	APPLICATOR	1
YRW500020	EXTRACT TOOL	1

[VUB500400]

YPL102220		0.51 - 1.00 CSA
Cavities 1-3		
VDK500010	INSTRUCTION; REPAIR KIT	1
VDK500030	INSTRUCTION; EXTRACT TOOL	1
YMI001020	PRE-TERMINATED LEAD	1
YPQ000100	IDENTS (SMALL)	1
YQD000210	HEAT SHRINK SLEEVE	1
YRV000040	SPLICE (RED, CSA; 0.25-1.6)	1
YRW000390	WIRE STRIPPER	1
YRW500010	APPLICATOR	1

[VUB500220]

Description: Lamp-Tail-RH
Location: RH rear of vehicle

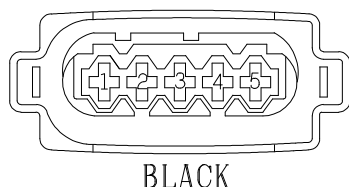
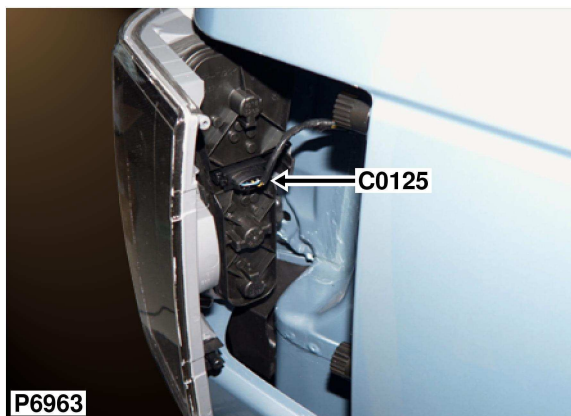

Wire Chart

CAV	TERMINAL	CSA	COL	CCT	DESTN
1	YPL102220	0.75	UN	394	SJ X185-
2	YPL102220	0.75	BU	ALL	SJ X10197-
3	YPL102220	0.75	YB	ALL	C0937-9
4	YPL102200	0.5	SW	394	SJ X245-
5	YPL102240	1.5	N	ALL	C0555-0

Service Repair Kits

YPL102240		1.01 - 2.50 CSA
Cavities 5		
VDK500010	INSTRUCTION; REPAIR KIT	1
VDK500030	INSTRUCTION; EXTRACT TOOL	1
YMI001200	PRE-TERMINATED LEAD	1
YPQ000110	IDENTS (MEDIUM)	1
YQD000210	HEAT SHRINK SLEEVE	1
YRV000050	SPLICE (BLUE, CSA; 1.0-2.6)	1
YRW000390	WIRE STRIPPER	1
YRW500010	APPLICATOR	1
YRW500020	EXTRACT TOOL	1

[VUB500400]

YPL102220		0.51 - 1.00 CSA
Cavities 1-3		
VDK500010	INSTRUCTION; REPAIR KIT	1
VDK500030	INSTRUCTION; EXTRACT TOOL	1
YMI001020	PRE-TERMINATED LEAD	1
YPQ000100	IDENTS (SMALL)	1
YQD000210	HEAT SHRINK SLEEVE	1
YRV000040	SPLICE (RED, CSA; 0.25-1.6)	1
YRW000390	WIRE STRIPPER	1
YRW500010	APPLICATOR	1

[VUB500220]

Part No. YPC113350
Colour: BLACK
Gender: F
Type: SLK (VDA)
No. of Ways: 5WY

Description: Clutch-Compressor-Air conditioning (A/C)
Location: RH side of engine

No photo
 Geen photo
 Pas de photo
 Kein foto
 Senza foto
 Sem fotografia
 No hay foto

Wire Chart

CAV	TERMINAL	CSA	COL	CCT	DESTN
1	YPE100320	0.5	BS	573	C1630-2

Service Repair Kits

YPE100320		0.50 - 1.00 CSA
Cavities 1		
VDK500010	INSTRUCTION; REPAIR KIT	1
VDK500090	INSTRUCTION; EXTRACT TOOL	1
VDK500100	INSTRUCTION; EXTRACT TOOL	1
YMI001160	PRE-TERMINATED LEAD	1
YPQ000100	IDENTS (SMALL)	1
YQD000210	HEAT SHRINK SLEEVE	1
YRV000040	SPLICE (RED, CSA; 0.25-1.6)	1
YRW000390	WIRE STRIPPER	1
YRW500010	APPLICATOR	1

[VUB500360]

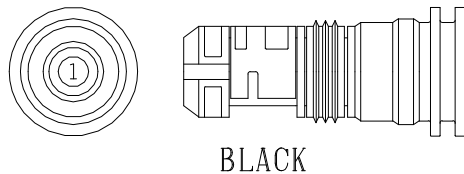

Part No. YPC110230
Colour: BLACK
Gender: F
Type: 2.5MM SYSTEM
No. of Ways: 1WY

Description: Main harness to tail door harness

Location: Location Not in APD

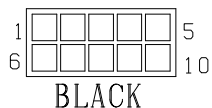

Wire Chart

CAV	TERMINAL	CSA	COL	CCT	DESTN
1	YPL101910	MAQA	UG	589	C2476-1
5	YPL101910	MAQB	UO	589	C2476-3
6	YPL101910	MAQA	NO	589	C2476-2
10	YPL101910	MAQB	NO	589	C2476-4

Service Repair Kits

YPL101910		0.75 - 0.75 CSA
Cavities 1,5,6,10		
VDK500010	INSTRUCTION; REPAIR KIT	1
VDK500070	INSTRUCTION; EXTRACT TOOL	1
VDK500080	INSTRUCTION; EXTRACT TOOL	1
YMI000870	PRE-TERMINATED LEAD	1
YPQ000100	IDENTS (SMALL)	1
YRV000040	SPLICE (RED, CSA; 0.25-1.6)	1
YRW000390	WIRE STRIPPER	1
YRW500010	APPLICATOR	1
YRW500060	EXTRACT TOOL	1
YRW500070	EXTRACT TOOL	1

[VUB500080]

Part No. YPC111780
Colour: BLACK
Gender: F
Type: MQS
No. of Ways: 10WY

Description: Sensor-Engine coolant level
Location: Front LH side of engine compartment

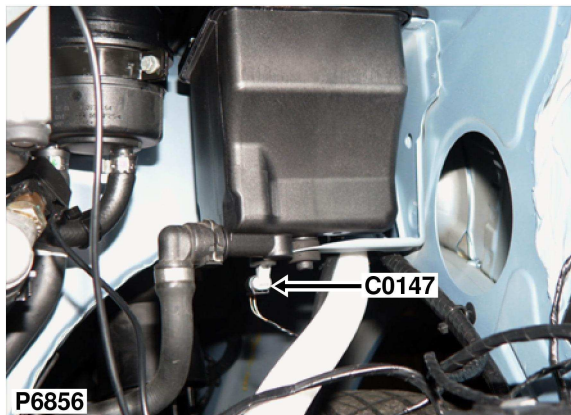

Wire Chart

CAV	TERMINAL	CSA	COL	CCT	DESTN
1	YPL101500	0.35	NB	ALL	C0554-0
2	YPL101500	0.35	NW	ALL	C2040-24

Service Repair Kits

YPL101500		0.20 - 0.50 <small>CSA</small>
Cavities 1,2		
VDK500010	INSTRUCTION; REPAIR KIT	1
VDK500070	INSTRUCTION; EXTRACT TOOL	1
VDK500080	INSTRUCTION; EXTRACT TOOL	1
YMI000950	PRE-TERMINATED LEAD	1
YPQ000100	IDENTS (SMALL)	1
YQD000210	HEAT SHRINK SLEEVE	1
YRV000040	SPLICE (RED, CSA; 0.25-1.6)	1
YRW000390	WIRE STRIPPER	1
YRW500010	APPLICATOR	1

[VUB500150]



Part No. YPC116820
Colour: BLACK
Gender: F
Type: MQS
No. of Ways: 2WY

Description: Switch-Oil pressure
Location: Front LH side of engine compartment

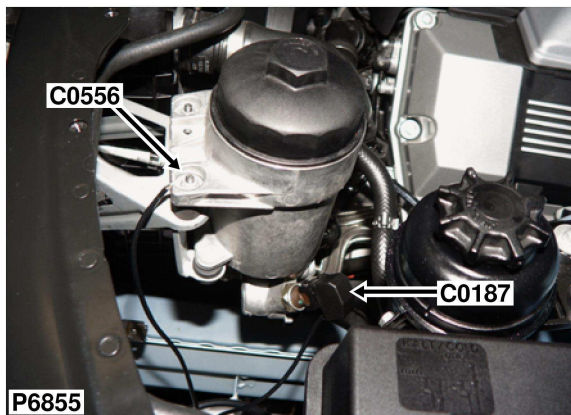

Wire Chart

CAV	TERMINAL	CSA	COL	CCT	DESTN
1	YPL103300	0.75	NG	573	C0230-4

No repair kit
 Geen reparatiepakke
 Pas de nécessaire de réparation
 Kein Werkzeug
 Senza kit per le riparazioni
 Sem kit de reparação
 No hay kit de reparación

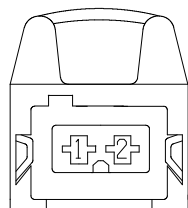

BLACK

Part No. 1732460
Colour: BLACK
Gender: F
Type: MINITIMER
No. of Ways: 2WY

Description: ECU-Electronic automatic transmission

Location: Inside E-box

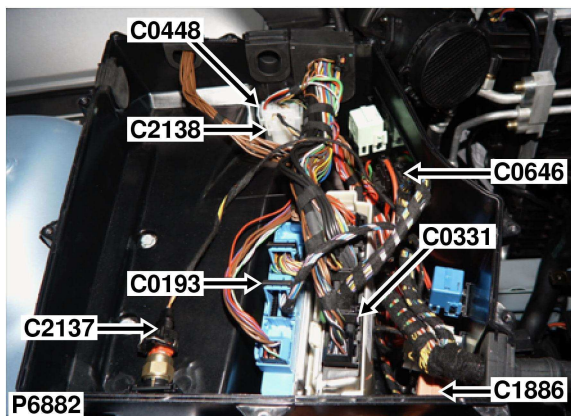

Wire Chart

CAV	TERMINAL	CSA	COL	CCT	DESTN
1	YPL101310	0.5	NP	ALL	C0673-3
2	YPL101310	0.5	BP	ALL	C0673-1
3	YPL101310	0.35	UB	ALL	SJ X197-
9	YPL101310	0.35	WR	ALL	C1319-17

CAV	TERMINAL	CSA	COL	CCT	DESTN
10	YPL101310	0.35	WB	ALL	C1319-18
18	YPL101310	0.35	WU	ALL	C0685-3
19	YPL101310	0.35	US	ALL	C1664-3
20	YPL101310	0.35	UY	ALL	C1664-2

Service Repair Kits

YPL101310		0.20 - 0.50 CSA
Cavities 1-3,9,10,18-20		
VDK500010	INSTRUCTION; REPAIR KIT	1
VDK500070	INSTRUCTION; EXTRACT TOOL	1
VDK500080	INSTRUCTION; EXTRACT TOOL	1
YMI000870	PRE-TERMINATED LEAD	1
YPQ000100	IDENTS (SMALL)	1
YRV000040	SPLICE (RED, CSA; 0.25-1.6)	1
YRW000390	WIRE STRIPPER	1
YRW500010	APPLICATOR	1
YRW500060	EXTRACT TOOL	1
YRW500070	EXTRACT TOOL	1

[VUB500080]

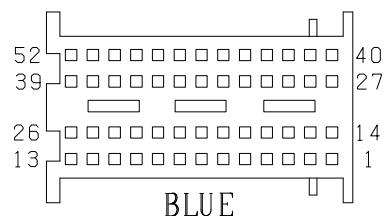

Part No. YPH100670
Colour: BLUE
Gender: F
Type: MQS
No. of Ways: 52WY

Description: Accelerometer
Location: Beneath centre console

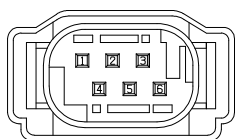
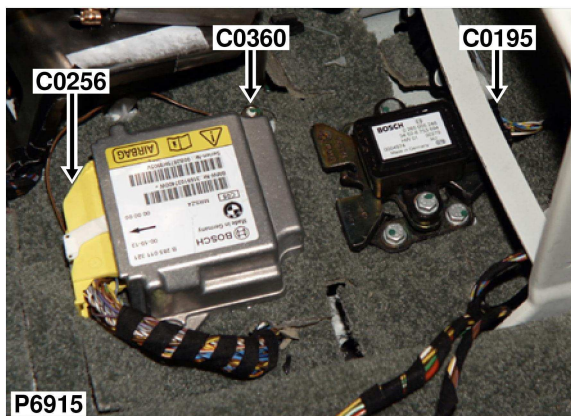

BLACK

Part No. YPC110680
Colour: BLACK
Gender: F
Type: MQS
No. of Ways: 6WY

Wire Chart

CAV	TERMINAL	CSA	COL	CCT	DESTN
1	YPL101500	0.5	WUY	ALL	C0506-10
2	YPL101500	0.5	WRV	ALL	C0506-9
3	YPL101500	0.5	WSY	ALL	C0506-39

CAV	TERMINAL	CSA	COL	CCT	DESTN
4	YPL101500	0.5	BRY	ALL	C0506-41
5	YPL101500	0.5	NBY	ALL	C0506-8
6	YPL101500	0.5	UWY	ALL	C0506-21

Service Repair Kits

YPL101500		0.20 - 0.50 CSA
Cavities 1-6		
VDK500010	INSTRUCTION; REPAIR KIT	1
VDK500070	INSTRUCTION; EXTRACT TOOL	1
VDK500080	INSTRUCTION; EXTRACT TOOL	1
YMI000950	PRE-TERMINATED LEAD	1
YPQ000100	IDENTS (SMALL)	1
YQD000210	HEAT SHRINK SLEEVE	1
YRV000040	SPLICE (RED, CSA; 0.25-1.6)	1
YRW000390	WIRE STRIPPER	1
YRW500010	APPLICATOR	1

[VUB500150]

Description: Pump-Fuel
Location: LH side of fuel tank

No photo
 Geen photo
 Pas de photo
 Kein foto
 Senza foto
 Sem fotografia
 No hay foto

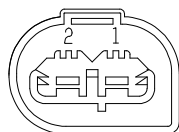

BLACK

Wire Chart

CAV	TERMINAL	CSA	COL	CCT	DESTN
1	YPL102750	1.5	N	58	C0555-0
2	YPL102750	2.5	WU	58	C2020-4

Service Repair Kits

YPL102750		1.01 - 2.50 csa
Cavities 1,2		
VDK500010	INSTRUCTION; REPAIR KIT	1
VDK500030	INSTRUCTION; EXTRACT TOOL	1
YMI000970	PRE-TERMINATED LEAD	1
YPQ000110	IDENTS (MEDIUM)	1
YQD000210	HEAT SHRINK SLEEVE	1
YRV000050	SPLICE (BLUE, CSA; 1.0-2.6)	1
YRW000390	WIRE STRIPPER	1
YRW500010	APPLICATOR	1

[VUB500170]

Part No. YPC115060
Colour: BLACK
Gender: F
Type: MICRO POWER QUADLOK
No. of Ways: 2WY

Description: Lamp-Glove box
Location: Behind glovebox

No photo
 Geen photo
 Pas de photo
 Kein foto
 Senza foto
 Sem fotografia
 No hay foto



BLACK

Part No. YPC117840
Colour: BLACK
Gender: F
Type: MQS
No. of Ways: 4WY

Wire Chart

CAV	TERMINAL	CSA	COL	CCT	DESTN
1	YPL101910	0.75	RY	ALL	C0723-0
4	YPL101910	0.75	N	ALL	C0285-0

Service Repair Kits

YPL101910		0.75 - 0.75 CSA
Cavities 1,4		
VDK500010	INSTRUCTION; REPAIR KIT	1
VDK500070	INSTRUCTION; EXTRACT TOOL	1
VDK500080	INSTRUCTION; EXTRACT TOOL	1
YMI000870	PRE-TERMINATED LEAD	1
YPQ000100	IDENTS (SMALL)	1
YRV000040	SPLICE (RED, CSA; 0.25-1.6)	1
YRW000390	WIRE STRIPPER	1
YRW500010	APPLICATOR	1
YRW500060	EXTRACT TOOL	1
YRW500070	EXTRACT TOOL	1

[VUB500080]

Description: Instrument Pack
Location: Behind instrument pack

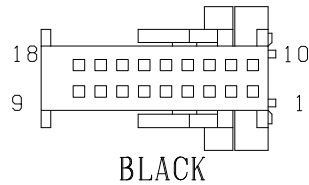
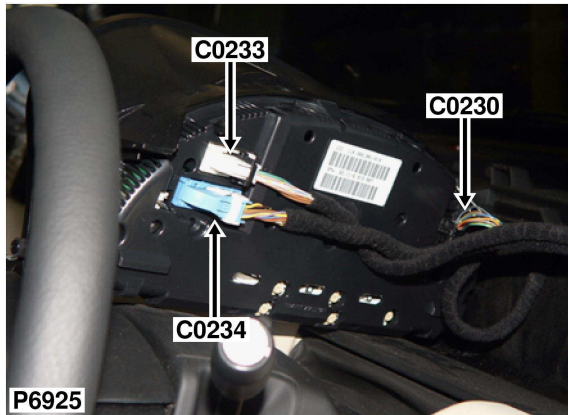

Part No. YPC111800
Colour: BLACK
Gender: F
Type: MQS
No. of Ways: 18WY

Wire Chart

CAV	TERMINAL	CSA	COL	CCT	DESTN
1	YPL101310	0.5	NB	ALL	SJ X217-
3	YPL101310	0.35	U	ALL	C0331-1
4	YPL101910	0.75	NG	573	C0187-1
4	YPL101310	0.35	NG	58	C0331-11
5	YPL101910	0.75	UNY	ALL	C0091-1

CAV	TERMINAL	CSA	COL	CCT	DESTN
7	YPL101310	0.5	RY	ALL	C0586-4
8	YPL101310	0.5	SR	ALL	C0286-0
13	YPL101310	0.35	NP	ALL	C0256-7
15	YPL101310	0.35	SB	ALL	C0506-20
17	YPL101310	0.5	GU	ALL	C0587-19

Service Repair Kits

YPL101910		0.75 - 0.75 CSA
Cavities 1,3-5,7,8,13,15,17		
VDK500010	INSTRUCTION; REPAIR KIT	1
VDK500070	INSTRUCTION; EXTRACT TOOL	1
VDK500080	INSTRUCTION; EXTRACT TOOL	1
YMI000870	PRE-TERMINATED LEAD	1
YPQ000100	IDENTS (SMALL)	1
YRV000040	SPLICE (RED, CSA; 0.25-1.6)	1
YRW000390	WIRE STRIPPER	1
YRW500010	APPLICATOR	1
YRW500060	EXTRACT TOOL	1
YRW500070	EXTRACT TOOL	1

[VUB500080]

Description: Clock-Analogue
Location: Behind centre console

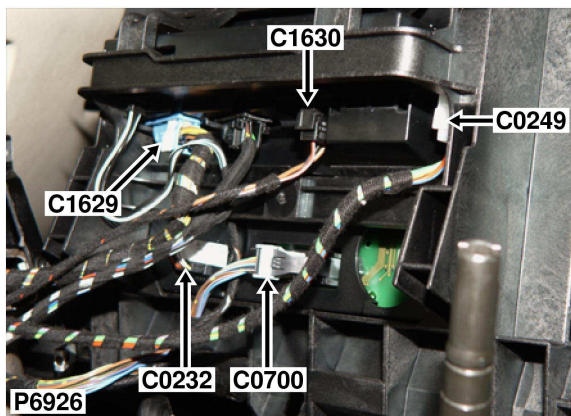

Part No. YPC117840
Colour: BLACK
Gender: F
Type: MQS
No. of Ways: 4WY

Wire Chart

CAV	TERMINAL	CSA	COL	CCT	DESTN
1	YPL101310	0.5	RG	ALL	SJ X18061-
2	YPL101310	0.35	NB	ALL	C0287-0
3	YPL101310	0.5	SR	ALL	C0286-0
4	YPL101310	0.35	WSY	ALL	SJ X939-

Service Repair Kits

YPL101310		0.20 - 0.50 CSA
Cavities 1-4		
VDK500010	INSTRUCTION; REPAIR KIT	1
VDK500070	INSTRUCTION; EXTRACT TOOL	1
VDK500080	INSTRUCTION; EXTRACT TOOL	1
YMI000870	PRE-TERMINATED LEAD	1
YPQ000100	IDENTS (SMALL)	1
YRV000040	SPLICE (RED, CSA; 0.25-1.6)	1
YRW000390	WIRE STRIPPER	1
YRW500010	APPLICATOR	1
YRW500060	EXTRACT TOOL	1
YRW500070	EXTRACT TOOL	1

[VUB500080]

Description: Instrument Pack
Location: Behind instrument pack

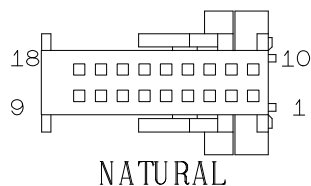
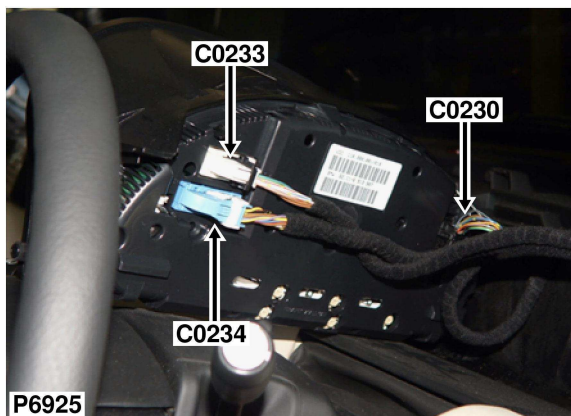

Part No. YPH100540
Colour: NATURAL
Gender: F
Type: MQS
No. of Ways: 18WY

Wire Chart

CAV	TERMINAL	CSA	COL	CCT	DESTN
1	YPL101310	0.35	WP	ALL	SJ X183-
3	YPL101310	0.35	BW	148	C1604-2
7	YPL101310	0.35	WRY	ALL	SJ X10116-
8	YPL101310	0.35	WSY	ALL	SJ X939-
9	YPL101310	0.5	NB	ALL	SJ X217-
10	YPL101310	0.5	NB	ALL	SJ X217-
11	YPL101310	0.35	BR	ALL	C0369-2

CAV	TERMINAL	CSA	COL	CCT	DESTN
12	YPL101310	0.5	PG	ALL	C0586-24
14	YPL101310	0.35	BG	ALL	C0331-2
15	YPL101310	0.5	RY	ALL	C0586-20
16	YPL101310	0.5	GU	ALL	C0587-3
17	YPL101310	0.35	WU	ALL	C1352-3
18	YPL101310	0.35	WR	ALL	C1352-2

Service Repair Kits

YPL101310		0.20 - 0.50 CSA
Cavities 1,3,7-12,14-18		
VDK500010	INSTRUCTION; REPAIR KIT	1
VDK500070	INSTRUCTION; EXTRACT TOOL	1
VDK500080	INSTRUCTION; EXTRACT TOOL	1
YMI000870	PRE-TERMINATED LEAD	1
YPQ000100	IDENTS (SMALL)	1
YRV000040	SPLICE (RED, CSA; 0.25-1.6)	1
YRW000390	WIRE STRIPPER	1
YRW500010	APPLICATOR	1
YRW500060	EXTRACT TOOL	1
YRW500070	EXTRACT TOOL	1

[VUB500080]

Description: Instrument Pack
Location: Behind instrument pack

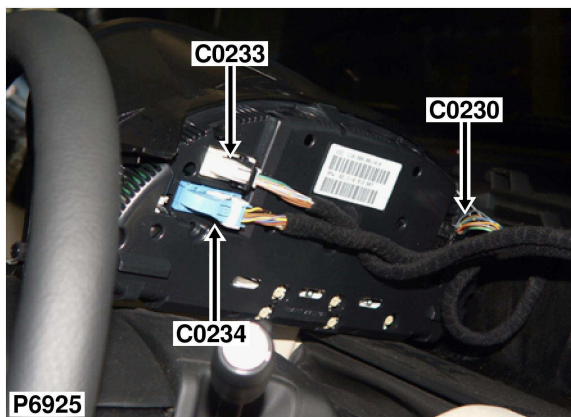

Wire Chart

CAV	TERMINAL	CSA	COL	CCT	DESTN
1	YPL101310	0.35	NR	ALL	SJ X1101-
4	YPL101310	0.35	Y	ALL	C0050-1
5	YPL101310	0.35	YR	ALL	C1832-1
7	YPL101310	0.5	BRY	ALL	C0114-5
8	YPL101310	MMX	YB	58	SJ X18836-
9	YPL101310	MMX	YN	58	SJ X18835-
12	YPL101310	0.5	NBY	ALL	C0114-2
14	YPL101310	0.5	UR	ALL	C0884-2

CAV	TERMINAL	CSA	COL	CCT	DESTN
16	YPL101310	0.5	NBW	ALL	C0114-3
18	YPL101310	0.5	NY	ALL	C0448-11
19	YPL101310	0.5	NP	ALL	C0448-10
20	YPL101310	0.35	YN	ALL	C0968-1
22	YPL101310	0.5	UN	ALL	C0884-1
23	YPL101310	0.5	BRW	ALL	C0114-6
24	YPL101310	0.5	YU	573	C0234-11
25	YPL101310	0.35	SP	ALL	C0331-19

Service Repair Kits

YPL101310		0.20 - 0.50 CSA
Cavities 1,4,5,7-9,12,14,16,18-20,22-25		
VDK500010	INSTRUCTION; REPAIR KIT	1
VDK500070	INSTRUCTION; EXTRACT TOOL	1
VDK500080	INSTRUCTION; EXTRACT TOOL	1
YMI000870	PRE-TERMINATED LEAD	1
YPQ000100	IDENTS (SMALL)	1
YRV000040	SPLICE (RED, CSA; 0.25-1.6)	1
YRW000390	WIRE STRIPPER	1
YRW500010	APPLICATOR	1
YRW500060	EXTRACT TOOL	1
YRW500070	EXTRACT TOOL	1

[VUB500080]

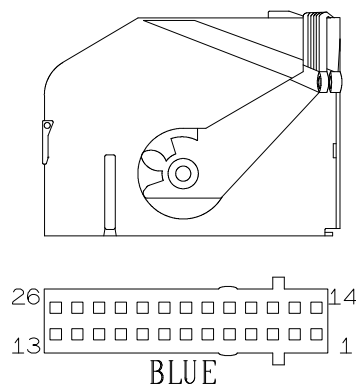

Part No. YPH900740
Colour: BLUE
Gender: F
Type: MQS
No. of Ways: 26WY

Description: Radio remote display
Location: Behind centre console

No photo
 Geen photo
 Pas de photo
 Kein foto
 Senza foto
 Sem fotografia
 No hay foto

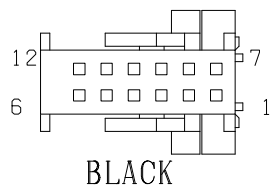

Part No. YPC111790
Colour: BLACK
Gender: F
Type: MQS
No. of Ways: 12WY

Wire Chart

CAV	TERMINAL	CSA	COL	CCT	DESTN
1	YPL101910	0.75	N	581	C0708-0
2	YPL101910	0.75	RG	581	SJ X3206-
3	YPL101310	0.5	SR	581	SJ X1362-
4	YPL101310	0.5	WSY	581	SJ X18344-
8	YPL101310	0.5	PW	581	SJ X229-

Service Repair Kits

YPL101910		0.75 - 0.75 CSA
Cavities 1-4,8		
VDK500010	INSTRUCTION; REPAIR KIT	1
VDK500070	INSTRUCTION; EXTRACT TOOL	1
VDK500080	INSTRUCTION; EXTRACT TOOL	1
YMI000870	PRE-TERMINATED LEAD	1
YPQ000100	IDENTS (SMALL)	1
YRV000040	SPLICE (RED, CSA; 0.25-1.6)	1
YRW000390	WIRE STRIPPER	1
YRW500010	APPLICATOR	1
YRW500060	EXTRACT TOOL	1
YRW500070	EXTRACT TOOL	1

[VUB500080]

Description: Lamp-Automatic gearbox selector indicator

Location: Beneath centre console

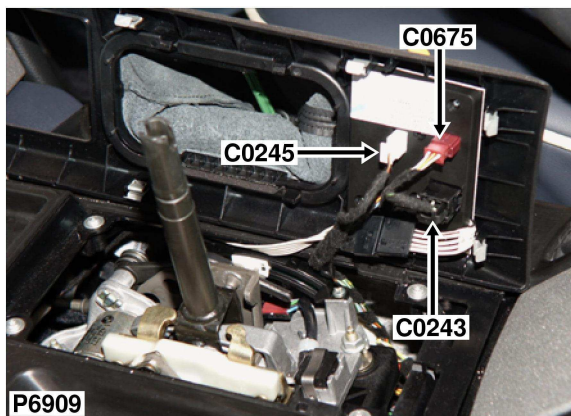

Part No. 8377066
Colour: NATURAL
Gender: F
Type: MQS
No. of Ways: 3WY

Wire Chart

CAV	TERMINAL	CSA	COL	CCT	DESTN
1	YPL101310	0.5	SR	ALL	SJ X1019-
2	YPL101910	0.75	NB	ALL	SJ X230-

Service Repair Kits

YPL101910		0.75 - 0.75 csa
Cavities 1,2		
VDK500010	INSTRUCTION; REPAIR KIT	1
VDK500070	INSTRUCTION; EXTRACT TOOL	1
VDK500080	INSTRUCTION; EXTRACT TOOL	1
YMI000870	PRE-TERMINATED LEAD	1
YPQ000100	IDENTS (SMALL)	1
YRV000040	SPLICE (RED, CSA; 0.25-1.6)	1
YRW000390	WIRE STRIPPER	1
YRW500010	APPLICATOR	1
YRW500060	EXTRACT TOOL	1
YRW500070	EXTRACT TOOL	1

[VUB500080]

Description: Heated screen-Front
Location: Behind RH side of fascia

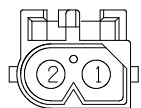
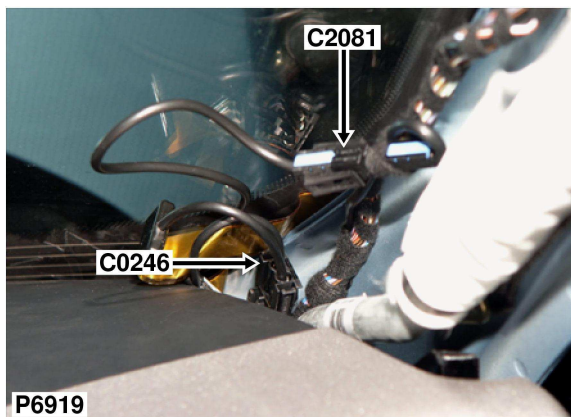

BLACK

Part No. 8380381
Colour: BLACK
Gender: M
Type: 2.5MM SYSTEM
No. of Ways: 2WY

Wire Chart

CAV	TERMINAL	CSA	COL	CCT	DESTN
1	YPD100220	4.0	N	109	C0553-0
2	YPD100220	4.0	B	109	C0994-5

Service Repair Kits

YPD100220		2.51 - 4.00 csa
Cavities 1,2		
VDK500010	INSTRUCTION; REPAIR KIT	1
VDK500130	INSTRUCTION; EXTRACT TOOL	1
YMI001110	PRE-TERMINATED LEAD	1
YPQ000120	IDENTS (LARGE)	1
YRV000060	SPLICE (YELLOW, CSA; 2.7-6.6)	1
YRW000390	WIRE STRIPPER	1
YRW500010	APPLICATOR	1

[VUB500310]

Description: Heated screen-Front
Location: Behind LH side of fascia

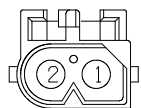
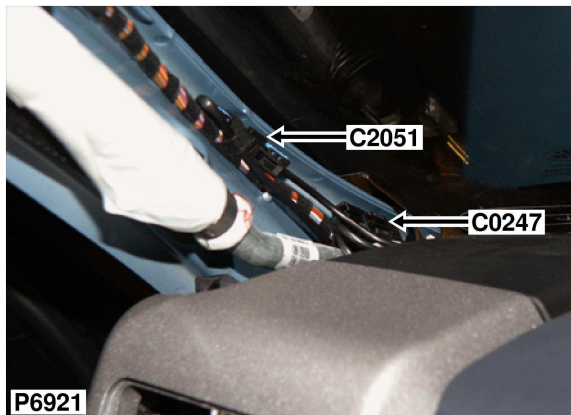

BLACK

Part No. 8380381
Colour: BLACK
Gender: M
Type: 2.5MM SYSTEM
No. of Ways: 2WY

Wire Chart

CAV	TERMINAL	CSA	COL	CCT	DESTN
1	YPD100220	4.0	N	109	C0821-0
2	YPD100220	4.0	B	109	C0994-5

Service Repair Kits

YPD100220		2.51 - 4.00 CSA
Cavities 1,2		
VDK500010	INSTRUCTION; REPAIR KIT	1
VDK500130	INSTRUCTION; EXTRACT TOOL	1
YMI001110	PRE-TERMINATED LEAD	1
YPQ000120	IDENTS (LARGE)	1
YRV000060	SPLICE (YELLOW, CSA; 2.7-6.6)	1
YRW000390	WIRE STRIPPER	1
YRW500010	APPLICATOR	1

[VUB500310]

Description: Heater-Seat
Location: Behind centre console

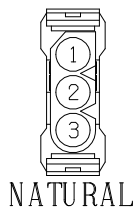
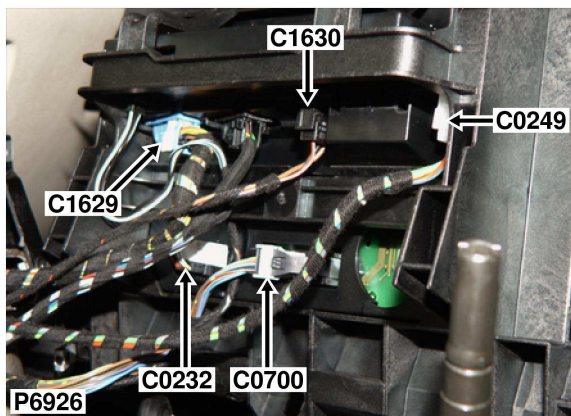

Wire Chart

CAV	TERMINAL	CSA	COL	CCT	DESTN
1	YPE100500	2.5	RU	204	C0582-8
2	YPE100500	2.5	GY	204	C0255-25
3	YPE100500	2.5	GP	204	C0253-25

Service Repair Kits

YPE100500		1.01 - 2.50 CSA
Cavities 1-3		
VDK500010	INSTRUCTION; REPAIR KIT	1
VDK500030	INSTRUCTION; EXTRACT TOOL	1
YMI000900	PRE-TERMINATED LEAD	1
YPQ000110	IDENTS (MEDIUM)	1
YRV000050	SPLICE (BLUE, CSA; 1.0-2.6)	1
YRW000390	WIRE STRIPPER	1
YRW500010	APPLICATOR	1

[VUB500110]

Part No. YPC112540
Colour: NATURAL
Gender: F
Type: 2.5MM SYSTEM
No. of Ways: 3WY

Description: Air bag-Passenger
Location: Behind passenger side of fascia

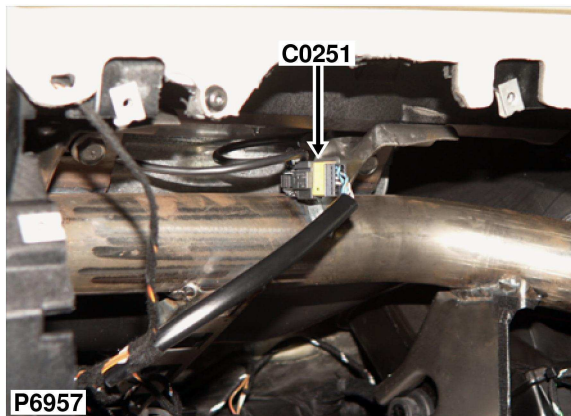

Wire Chart

CAV	TERMINAL	CSA	COL	CCT	DESTN
1	YPJ101310	MMG	UB	ALL	C0256-13
2	YPJ101310	MMG	UN	ALL	C0256-14
3	YPJ101310	MMJ	WB	ALL	C0256-33
4	YPJ101310	MMJ	WN	ALL	C0256-40

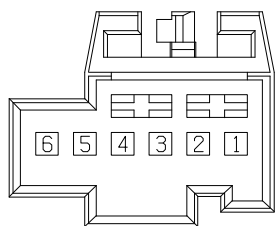

BLACK

Part No. YPC118190
Colour: BLACK
Gender: M
Type: ELO SRS
No. of Ways: 6WY

No repair kit
 Geen reparatiepakke
 Pas de nécessaire de reparation
 Kein Werkzeug
 Senza kit per le riparazioni
 Sem kit de reparação
 No hay kit de reparación

Description: Main harness to seat harness

Location: Beneath RH seat

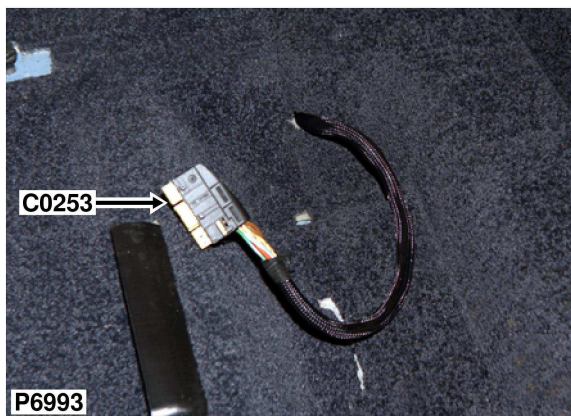

Wire Chart

CAV	TERMINAL	CSA	COL	CCT	DESTN
5	YPL101310	0.35	PG	203	C0586-29
7	YPL101310	0.35	UW	203	C0256-12
9	YPL901110	MMD	YR	ALL	C0256-1
10	YPL901110	MMD	YN	ALL	C0256-2
13	YPL102730	4.0	RN	208	SJ X206-
14	YPL102730	4.0	N	208	C0553-0
15	YPL101310	0.35	WRY	208	SJ X10116-
16	YPL101310	0.35	NB	208	SJ X230-
17	YPL101310	0.35	NU	389	SJ X13332-

CAV	TERMINAL	CSA	COL	CCT	DESTN
18	YPL101310	0.35	NR	389	SJ X13333-
19	YPL101310	0.35	NB	389	SJ X13334-
20	YPL101310	0.35	NW	389	SJ X13335-
21	YPL101310	0.35	B	389	C1395-1
22	YPL101310	0.35	BU	389	C1394-1
23	YPL101310	0.35	WG	204	C1629-16
24	YPL102710	2.5	N	204	C0553-0
25	YPL102710	2.5	GP	204	C0249-3

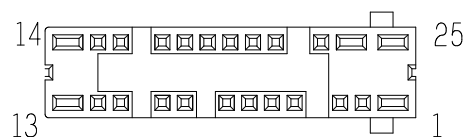

Part No. YPC119240
Colour: YELLOW
Gender: F
Type: MQS/MPQ/PQ HYBRID
No. of Ways: 24WY

Description: Main harness to seat harness

Location: Beneath RH seat

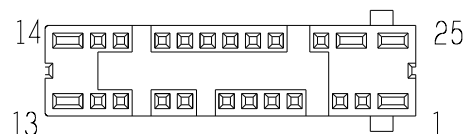
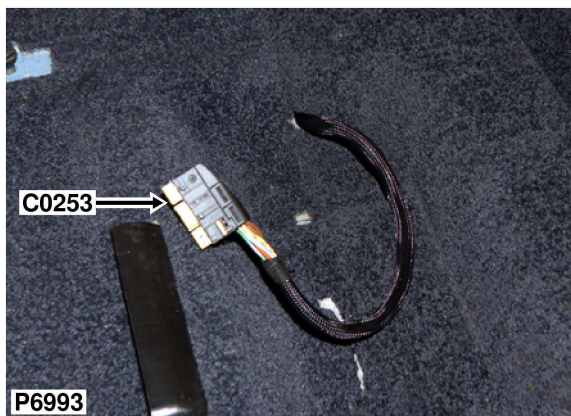

YELLOW

Part No. YPC119240
Colour: YELLOW
Gender: F
Type: MQS/MPQ/PQ HYBRID
No. of Ways: 24WY

Service Repair Kits

YPL901110		0.20 - 0.50 CSA
Cavities 9,10		
VDK500010	INSTRUCTION; REPAIR KIT	1
VDK500070	INSTRUCTION; EXTRACT TOOL	1
VDK500080	INSTRUCTION; EXTRACT TOOL	1
YMI000940	PRE-TERMINATED LEAD	1
YPQ000100	IDENTS (SMALL)	1
YRV000040	SPLICE (RED, CSA; 0.25-1.6)	1
YRW000390	WIRE STRIPPER	1
YRW500010	APPLICATOR	1

[VUB500140]

YPL101310		0.20 - 0.50 CSA
Cavities 5,7,15-23		
VDK500010	INSTRUCTION; REPAIR KIT	1
VDK500070	INSTRUCTION; EXTRACT TOOL	1
VDK500080	INSTRUCTION; EXTRACT TOOL	1
YMI000870	PRE-TERMINATED LEAD	1
YPQ000100	IDENTS (SMALL)	1
YRV000040	SPLICE (RED, CSA; 0.25-1.6)	1
YRW000390	WIRE STRIPPER	1
YRW500010	APPLICATOR	1
YRW500060	EXTRACT TOOL	1
YRW500070	EXTRACT TOOL	1

[VUB500080]

YPL102730		2.51 - 4.00 CSA
Cavities 13,14		
VDK500010	INSTRUCTION; REPAIR KIT	1
VDK500050	INSTRUCTION; EXTRACT TOOL	1
YMI001150	PRE-TERMINATED LEAD	1
YPQ000120	IDENTS (LARGE)	1
YRV000060	SPLICE (YELLOW, CSA; 2.7-6.6)	1
YRW000390	WIRE STRIPPER	1
YRW500010	APPLICATOR	1
YRW500040	EXTRACT TOOL	1

[VUB500350]

YPL102710		1.01 - 2.50 CSA
Cavities 24,25		
VDK500010	INSTRUCTION; REPAIR KIT	1
VDK500050	INSTRUCTION; EXTRACT TOOL	1
YMI001010	PRE-TERMINATED LEAD	1
YPQ000110	IDENTS (MEDIUM)	1
YRV000050	SPLICE (BLUE, CSA; 1.0-2.6)	1
YRW000390	WIRE STRIPPER	1
YRW500010	APPLICATOR	1

[VUB500210]

[continuation]

Description: Main harness to seat harness

Location: Beneath LH seat

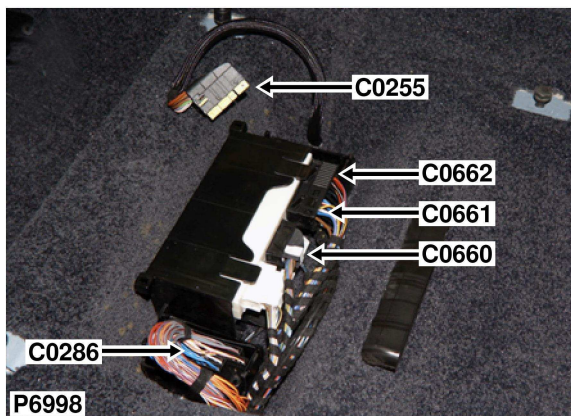

Wire Chart

CAV	TERMINAL	CSA	COL	CCT	DESTN
9	YPL901110	MMF	UR	ALL	C0256-3
10	YPL901110	MMF	UN	ALL	C0256-4
13	YPL102730	4.0	RN	208	C0584-5
14	YPL102730	4.0	N	208	C0821-0
17	YPL101310	0.5	PG	ALL	C0586-15

CAV	TERMINAL	CSA	COL	CCT	DESTN
18	YPL101310	0.35	WR	ALL	C0256-15
19	YPL101310	0.5	NB	ALL	SJ X18358-
23	YPL101310	0.35	WU	204	C1629-15
24	YPL102710	2.5	N	204	C0821-0
25	YPL102710	2.5	GY	204	C0249-2

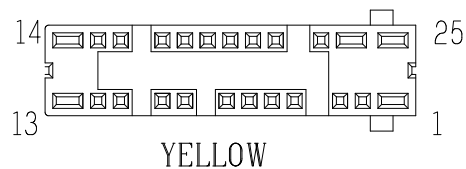

Part No. YPC119240
Colour: YELLOW
Gender: F
Type: MQS/MPQ/PQ HYBRID
No. of Ways: 24WY

Description: Main harness to seat harness

Location: Beneath LH seat

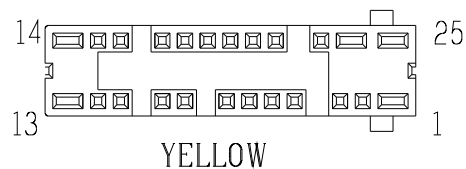
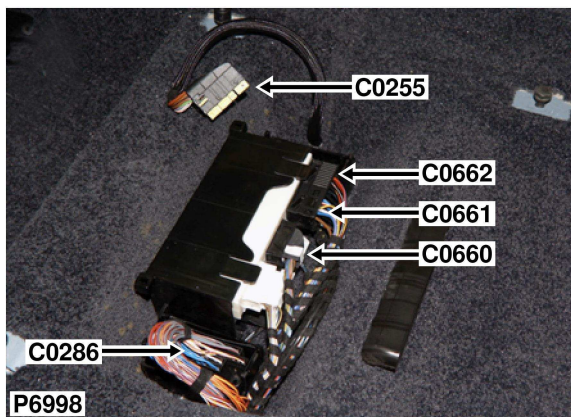

Part No. YPC119240
Colour: YELLOW
Gender: F
Type: MQS/MPQ/PQ HYBRID
No. of Ways: 24WY

Service Repair Kits

YPL901110	0.20 - 0.50 CSA	
Cavities 9,10		
VDK500010	INSTRUCTION; REPAIR KIT	1
VDK500070	INSTRUCTION; EXTRACT TOOL	1
VDK500080	INSTRUCTION; EXTRACT TOOL	1
YMI000940	PRE-TERMINATED LEAD	1
YPQ000100	IDENTS (SMALL)	1
YRV000040	SPLICE (RED, CSA; 0.25-1.6)	1
YRW000390	WIRE STRIPPER	1
YRW500010	APPLICATOR	1
[VUB500140]		

YPL101310	0.20 - 0.50 CSA	
Cavities 17-19,23		
VDK500010	INSTRUCTION; REPAIR KIT	1
VDK500070	INSTRUCTION; EXTRACT TOOL	1
VDK500080	INSTRUCTION; EXTRACT TOOL	1
YMI000870	PRE-TERMINATED LEAD	1
YPQ000100	IDENTS (SMALL)	1
YRV000040	SPLICE (RED, CSA; 0.25-1.6)	1
YRW000390	WIRE STRIPPER	1
YRW500010	APPLICATOR	1
YRW500060	EXTRACT TOOL	1
YRW500070	EXTRACT TOOL	1
[VUB500080]		

YPL102730	2.51 - 4.00 CSA	
Cavities 13,14		
VDK500010	INSTRUCTION; REPAIR KIT	1
VDK500050	INSTRUCTION; EXTRACT TOOL	1
YMI001150	PRE-TERMINATED LEAD	1
YPQ000120	IDENTS (LARGE)	1
YRV000060	SPLICE (YELLOW, CSA; 2.7-6.6)	1
YRW000390	WIRE STRIPPER	1
YRW500010	APPLICATOR	1
YRW500040	EXTRACT TOOL	1
[VUB500350]		

YPL102710	1.01 - 2.50 CSA	
Cavities 24,25		
VDK500010	INSTRUCTION; REPAIR KIT	1
VDK500050	INSTRUCTION; EXTRACT TOOL	1
YMI001010	PRE-TERMINATED LEAD	1
YPQ000110	IDENTS (MEDIUM)	1
YRV000050	SPLICE (BLUE, CSA; 1.0-2.6)	1
YRW000390	WIRE STRIPPER	1
YRW500010	APPLICATOR	1
[VUB500210]		

[continuation]

Description: DCU-Airbag
Location: Beneath centre console

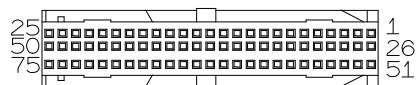
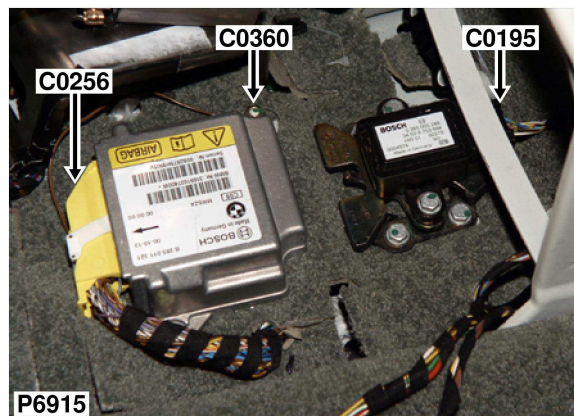

YELLOW

Part No. 6906030
Colour: YELLOW
Gender: F
Type: ELO
No. of Ways: 75WY

Wire Chart

CAV	TERMINAL	CSA	COL	CCT	DESTN
1	8369698	MMD	YR	ALL	C0253-9
2	8369698	MMD	YN	ALL	C0253-10
3	8369698	MMF	UR	ALL	C0255-9
4	8369698	MMF	UN	ALL	C0255-10
5	8369698	0.5	PU	ALL	C0586-14
6	8369698	0.5	NB	ALL	SJ X18358-
7	8369698	0.35	NP	ALL	C0230-13
9	8369698	0.35	WRY	ALL	C0296-0
10	8369698	MMI	YB	ALL	C0082-5
11	8369698	MMI	YN	ALL	C0082-4
12	8369698	0.35	UW	203	C0253-7
13	8369698	MMG	UB	ALL	C0251-1
14	8369698	MMG	UN	ALL	C0251-2
15	8369698	0.35	WR	ALL	C0255-18
16	8369698	MMM	U	ALL	C0463-9
17	8369698	MMM	N	ALL	C0463-10
18	8369698	MMAK	Y	ALL	C0459-9
19	8369698	MMAK	N	ALL	C0459-10
20	8369698	MMA	YG	ALL	C0950-3

CAV	TERMINAL	CSA	COL	CCT	DESTN
21	8369698	MMB	YR	ALL	C0951-3
26	8369698	MMK	SB	ALL	C0082-3
27	8369698	MMK	SN	ALL	C0082-2
28	8369698	MMY	Y	221	C1474-1
29	8369698	MMY	B	221	C1474-2
33	8369698	MMJ	WB	ALL	C0251-3
34	8369698	0.35	SU	ALL	C0661-13
40	8369698	MMJ	WN	ALL	C0251-4
41	8369698	MMAJ	G	221	C1475-1
42	8369698	MMAJ	B	221	C1475-2
45	8369698	MMC	Y	ALL	C1477-1
46	8369698	MMC	UY	ALL	C1477-2
47	8369698	MME	W	ALL	C1478-1
48	8369698	MME	UW	ALL	C1478-2
49	8369698	MMH	N	ALL	C1704-1
50	8369698	MMH	NR	ALL	C1704-2

Service Repair Kits

8369698		0.35 - 0.50 CSA
Cavities 1-7,9-21,26-29,33,34,40-42,45-50		
VDK500010	INSTRUCTION; REPAIR KIT	1
VDK500040	INSTRUCTION; EXTRACT TOOL	1
YMI000910	PRE-TERMINATED LEAD	1
YPQ000100	IDENTS (SMALL)	1
YRV000040	SPLICE (RED, CSA; 0.25-1.6)	1
YRW000390	WIRE STRIPPER	1
YRW500010	APPLICATOR	1

[VUB500120]

Description: Switch-Wash/wipe-Windscreen

Location: Top of rear screen

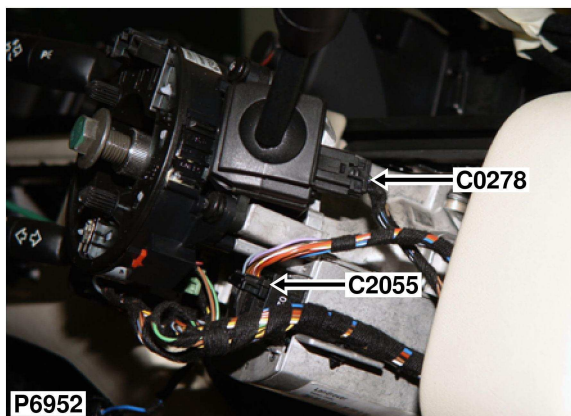

Wire Chart

CAV	TERMINAL	CSA	COL	CCT	DESTN
1	YPL101310	0.35	BW	ALL	C0660-4
3	YPL101310	0.35	BW	ALL	C0835-1
4	YPL101310	0.35	NP	ALL	C0660-3
6	YPL101310	0.5	NB	ALL	SJ X3361-

CAV	TERMINAL	CSA	COL	CCT	DESTN
7	YPL101310	0.35	BU	ALL	C0660-5
8	YPL101310	0.35	BU	ALL	C0835-2
9	YPL101310	0.35	BG	ALL	C0661-25
10	YPL101310	0.35	NW	ALL	C0278-5

Service Repair Kits

YPL101310		0.20 - 0.50 CSA
Cavities 1,3,4,6-10		
VDK500010	INSTRUCTION; REPAIR KIT	1
VDK500070	INSTRUCTION; EXTRACT TOOL	1
VDK500080	INSTRUCTION; EXTRACT TOOL	1
YMI000870	PRE-TERMINATED LEAD	1
YPQ000100	IDENTS (SMALL)	1
YRV000040	SPLICE (RED, CSA; 0.25-1.6)	1
YRW000390	WIRE STRIPPER	1
YRW500010	APPLICATOR	1
YRW500060	EXTRACT TOOL	1
YRW500070	EXTRACT TOOL	1

[VUB500080]

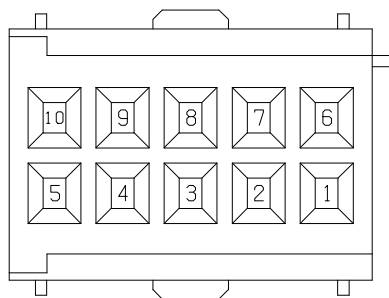

BLACK

Part No. 6909000
Colour: BLACK
Gender: F
Type: MQS
No. of Ways: 10WY

Description: Header
Location: Behind centre of fascia

No photo
 Geen photo
 Pas de photo
 Kein foto
 Senza foto
 Sem fotografia
 No hay foto

Wire Chart

CAV	TERMINAL	CSA	COL	CCT	DESTN
0	YPL103900	2.5	N	ALL	C2081-1
0	YPL104290	4.0	N	ALL	C0821-0
0	YPL103900	2.5	N	ALL	C2030-5
0	YPL103880	0.5	N	134	C1794-1
0	YPL103880	0.5	N	ALL	C0666-1
0	YPL103900	1.5	N	388	C1392-1
0	YPL103900	2.5	N	279	C2031-5
0	YPL103900	2.5	N	19	C0839-1
0	YPL103880	0.5	N	573	C1886-5

CAV	TERMINAL	CSA	COL	CCT	DESTN
0	YPL103890	0.75	N	ALL	C0227-4
0	YPL103880	0.5	N	ALL	C0077-1
0	YPL103900	1.5	N	ALL	C1630-3
0	YPL103890	0.75	N	ALL	C0355-6
0	YPL103900	2.5	N	ALL	C0546-5
0	YPL103900	1.5	N	ALL	C0585-8
0	YPL103900	2.5	N	227	C0784-2
0	YPL103900	1.5	N	389	C1392-1

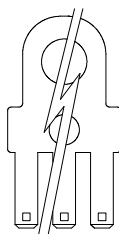

Part No. YPH900780
Colour: COPPER, TIN PLATED
Gender: M
Type: HEADER COVER
No. of Ways: 17WY

Description: Header
Location: Behind centre of fascia

No photo
 Geen photo
 Pas de photo
 Kein foto
 Senza foto
 Sem fotografia
 No hay foto

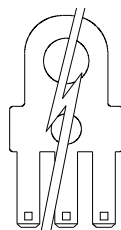

Service Repair Kits

YPL103890		0.75 - 1.00 CSA
Cavities 0		
VDK500010	INSTRUCTION; REPAIR KIT	1
VDK500030	INSTRUCTION; EXTRACT TOOL	1
YMI000880	PRE-TERMINATED LEAD	1
YPQ000100	IDENTS (SMALL)	1
YRV000040	SPLICE (RED, CSA; 0.25-1.6)	1
YRW000390	WIRE STRIPPER	1
YRW500010	APPLICATOR	1
YRW500020	EXTRACT TOOL	1

[VUB500090]

YPL103880		0.20 - 0.50 CSA
Cavities 0		
VDK500010	INSTRUCTION; REPAIR KIT	1
VDK500030	INSTRUCTION; EXTRACT TOOL	1
YMI000850	PRE-TERMINATED LEAD	1
YPQ000100	IDENTS (SMALL)	1
YRV000040	SPLICE (RED, CSA; 0.25-1.6)	1
YRW000390	WIRE STRIPPER	1
YRW500010	APPLICATOR	1
YRW500020	EXTRACT TOOL	1

[VUB500060]

YPL104290		4.00 - 6.00 CSA
Cavities 0		
VDK500010	INSTRUCTION; REPAIR KIT	1
VDK500030	INSTRUCTION; EXTRACT TOOL	1
YMI000960	PRE-TERMINATED LEAD	1
YPQ000120	IDENTS (LARGE)	1
YRV000060	SPLICE (YELLOW, CSA; 2.7-6.6)	1
YRW000390	WIRE STRIPPER	1
YRW500010	APPLICATOR	1

[VUB500160]

YPL103900		1.50 - 2.50 CSA
Cavities 0		
VDK500010	INSTRUCTION; REPAIR KIT	1
VDK500030	INSTRUCTION; EXTRACT TOOL	1
YMI000890	PRE-TERMINATED LEAD	1
YPQ000110	IDENTS (MEDIUM)	1
YRV000050	SPLICE (BLUE, CSA; 1.0-2.6)	1
YRW000390	WIRE STRIPPER	1
YRW500010	APPLICATOR	1

[VUB500100]

Part No. YPH900780
Colour: COPPER, TIN PLATED
Gender: M
Type: HEADER COVER
No. of Ways: 17WY

[continuation]

Description: Header
Location: Beneath front passenger's seat

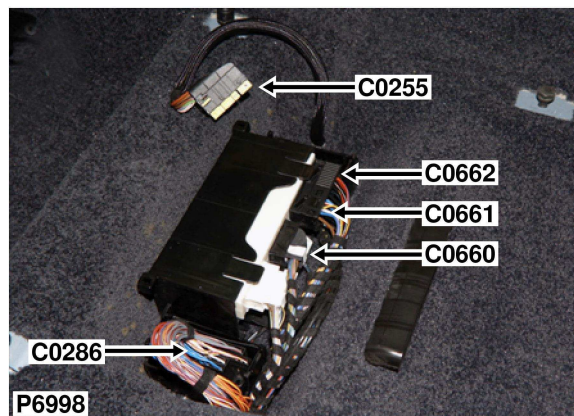

Wire Chart

CAV	TERMINAL	CSA	COL	CCT	DESTN
0	YPL103880	0.5	SR	ALL	C1294-2
0	YPL103890	0.75	SR	ALL	C0981-5
0	YPL103880	0.5	SR	ALL	C0232-3
0	YPL103880	0.5	SR	ALL	C0700-11
0	YPL103880	0.5	SR	ALL	C1295-2
0	YPL103880	0.5	SR	19	C0839-3
0	YPL103900	2.5	SR	ALL	C0724-0
0	YPL103880	0.5	SR	227	C0363-2
0	YPL103900	2.5	SR	ALL	C2039-1

CAV	TERMINAL	CSA	COL	CCT	DESTN
0	YPL103880	0.5	SR	ALL	C0230-8
0	YPL103880	0.5	SR	ALL	C0096-6
0	YPL103880	0.5	SR	ALL	C0355-5
0	YPL103880	0.5	SR	ALL	C1629-23
0	YPL103900	2.5	SR	ALL	SJ X1019-
0	YPL103880	0.5	SR	ALL	C0459-5

Service Repair Kits

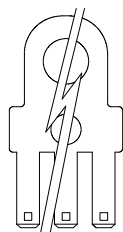

YPL103890		0.75 - 1.00 CSA	
Cavities 0			
VDK500010	INSTRUCTION; REPAIR KIT	1	
VDK500030	INSTRUCTION; EXTRACT TOOL	1	
YMI000880	PRE-TERMINATED LEAD	1	
YPQ000100	IDENTS (SMALL)	1	
YRV000040	SPLICE (RED, CSA; 0.25-1.6)	1	
YRW000390	WIRE STRIPPER	1	
YRW500010	APPLICATOR	1	
YRW500020	EXTRACT TOOL	1	
[VUB500090]			

YPL103880		0.20 - 0.50 CSA	
Cavities 0			
VDK500010	INSTRUCTION; REPAIR KIT	1	
VDK500030	INSTRUCTION; EXTRACT TOOL	1	
YMI000850	PRE-TERMINATED LEAD	1	
YPQ000100	IDENTS (SMALL)	1	
YRV000040	SPLICE (RED, CSA; 0.25-1.6)	1	
YRW000390	WIRE STRIPPER	1	
YRW500010	APPLICATOR	1	
YRW500020	EXTRACT TOOL	1	
[VUB500060]			

YPL103900		1.50 - 2.50 CSA	
Cavities 0			
VDK500010	INSTRUCTION; REPAIR KIT	1	
VDK500030	INSTRUCTION; EXTRACT TOOL	1	
YMI000890	PRE-TERMINATED LEAD	1	
YPQ000110	IDENTS (MEDIUM)	1	
YRV000050	SPLICE (BLUE, CSA; 1.0-2.6)	1	
YRW000390	WIRE STRIPPER	1	
YRW500010	APPLICATOR	1	
[VUB500100]			

Part No. YPH900780
Colour: COPPER, TIN PLATED
Gender: M
Type: HEADER COVER
No. of Ways: 17WY

Description: Header-Earth
Location: Behind centre of fascia

No photo
 Geen photo
 Pas de photo
 Kein foto
 Senza foto
 Sem fotografia
 No hay foto

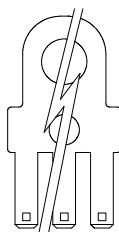

Wire Chart

CAV	TERMINAL	CSA	COL	CCT	DESTN
0	YPL103880	0.35	NB	ALL	C1295-1
0	YPL103880	0.35	NB	ALL	C1294-1
0	YPL103880	0.5	NB	ALL	C0040-5
0	YPL103880	0.5	NB	386	C0698-10
0	YPL103880	0.35	NB	ALL	C0232-2
0	YPL103880	0.35	NB	279	C2031-4

CAV	TERMINAL	CSA	COL	CCT	DESTN
0	YPL103880	0.35	NB	136	C0961-2
0	YPL103900	2.5	NB	ALL	C0554-0
0	YPL103880	0.35	NB	ALL	C0096-2
0	YPL103880	0.5	NB	ALL	C0040-4
0	YPL103880	0.5	NB	337	C1537-16
0	YPL103880	0.5	NB	387	C0698-10

Service Repair Kits

YPL103880		0.20 - 0.50 CSA
Cavities 0		
VDK500010	INSTRUCTION; REPAIR KIT	1
VDK500030	INSTRUCTION; EXTRACT TOOL	1
YMI000850	PRE-TERMINATED LEAD	1
YPQ000100	IDENTS (SMALL)	1
YRV000040	SPLICE (RED, CSA; 0.25-1.6)	1
YRW000390	WIRE STRIPPER	1
YRW500010	APPLICATOR	1
YRW500020	EXTRACT TOOL	1

[VUB500060]

YPL103900		1.50 - 2.50 CSA
Cavities 0		
VDK500010	INSTRUCTION; REPAIR KIT	1
VDK500030	INSTRUCTION; EXTRACT TOOL	1
YMI000890	PRE-TERMINATED LEAD	1
YPQ000110	IDENTS (MEDIUM)	1
YRV000050	SPLICE (BLUE, CSA; 1.0-2.6)	1
YRW000390	WIRE STRIPPER	1
YRW500010	APPLICATOR	1

[VUB500100]

Part No.: YPH900780
Colour: COPPER, TIN PLATED
Gender: M
Type: HEADER COVER
No. of Ways: 17WY

Description: Header
Location: Behind centre of fascia

No photo
 Geen photo
 Pas de photo
 Kein foto
 Senza foto
 Sem fotografia
 No hay foto

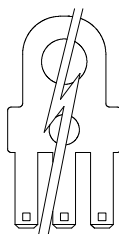

Wire Chart

CAV	TERMINAL	CSA	COL	CCT	DESTN
0	YPL103900	2.5	RS	279	C0582-4
0	YPL103900	2.5	RS	279	C2031-2
0	YPL103900	2.5	RS	279	C1340-2
0	YPL103900	2.5	RS	279	C1341-2

Service Repair Kits

YPL103900		1.50 - 2.50 CSA
Cavities 0		
VDK500010	INSTRUCTION; REPAIR KIT	1
VDK500030	INSTRUCTION; EXTRACT TOOL	1
YMI000890	PRE-TERMINATED LEAD	1
YPQ000110	IDENTS (MEDIUM)	1
YRV000050	SPLICE (BLUE, CSA; 1.0-2.6)	1
YRW000390	WIRE STRIPPER	1
YRW500010	APPLICATOR	1

[VUB500100]

Part No. YPH900780
Colour: COPPER, TIN PLATED
Gender: M
Type: HEADER COVER
No. of Ways: 17WY

Description: Header
Location: Behind centre of fascia

No photo
 Geen photo
 Pas de photo
 Kein foto
 Senza foto
 Sem fotografia
 No hay foto

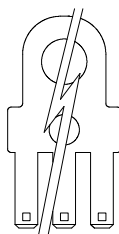

Wire Chart

CAV	TERMINAL	CSA	COL	CCT	DESTN
0	YPL103880	0.5	PB	ALL	C0587-21
0	YPL103880	0.5	PB	ALL	C2055-11
0	YPL103880	0.5	PB	ALL	C0059-11

Service Repair Kits

YPL103880		0.20 - 0.50 CSA
Cavities 0		
VDK500010	INSTRUCTION; REPAIR KIT	1
VDK500030	INSTRUCTION; EXTRACT TOOL	1
YMI000850	PRE-TERMINATED LEAD	1
YPQ000100	IDENTS (SMALL)	1
YRV000040	SPLICE (RED, CSA; 0.25-1.6)	1
YRW000390	WIRE STRIPPER	1
YRW500010	APPLICATOR	1
YRW500020	EXTRACT TOOL	1

[VUB500060]

Part No. YPH900780
Colour: COPPER, TIN PLATED
Gender: M
Type: HEADER COVER
No. of Ways: 17WY

Description: Header
Location: Behind centre of fascia

No photo
 Geen photo
 Pas de photo
 Kein foto
 Senza foto
 Sem fotografia
 No hay foto

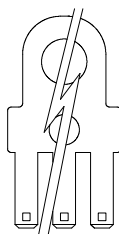

Wire Chart

CAV	TERMINAL	CSA	COL	CCT	DESTN
0	YPL103890	0.75	PW	ALL	C0587-27
0	YPL103890	0.75	PW	ALL	C2045-2
0	YPL103880	0.5	PW	ALL	C0981-2

Service Repair Kits

YPL103890		0.75 - 1.00 CSA	
Cavities 0			
VDK500010	INSTRUCTION; REPAIR KIT	1	
VDK500030	INSTRUCTION; EXTRACT TOOL	1	
YMI000880	PRE-TERMINATED LEAD	1	
YPQ000100	IDENTS (SMALL)	1	
YRV000040	SPLICE (RED, CSA; 0.25-1.6)	1	
YRW000390	WIRE STRIPPER	1	
YRW500010	APPLICATOR	1	
YRW500020	EXTRACT TOOL	1	
[VUB500090]			

YPL103880		0.20 - 0.50 CSA	
Cavities 0			
VDK500010	INSTRUCTION; REPAIR KIT	1	
VDK500030	INSTRUCTION; EXTRACT TOOL	1	
YMI000850	PRE-TERMINATED LEAD	1	
YPQ000100	IDENTS (SMALL)	1	
YRV000040	SPLICE (RED, CSA; 0.25-1.6)	1	
YRW000390	WIRE STRIPPER	1	
YRW500010	APPLICATOR	1	
YRW500020	EXTRACT TOOL	1	
[VUB500060]			

Part No. YPH900780
Colour: COPPER, TIN PLATED
Gender: M
Type: HEADER COVER
No. of Ways: 17WY

Description: Header
Location: Beneath front passenger's seat

No photo
 Geen photo
 Pas de photo
 Kein foto
 Senza foto
 Sem fotografia
 No hay foto

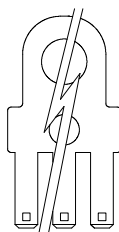

Wire Chart

CAV	TERMINAL	CSA	COL	CCT	DESTN
0	YPL103890	0.75	U	ALL	C0436-2
0	YPL103900	2.5	U	ALL	C0690-1
0	YPL103900	2.5	U	ALL	C0662-14
0	YPL103890	0.75	U	ALL	C0435-2

Service Repair Kits

YPL103890		0.75 - 1.00 CSA
Cavities 0		
VDK500010	INSTRUCTION; REPAIR KIT	1
VDK500030	INSTRUCTION; EXTRACT TOOL	1
YMI000880	PRE-TERMINATED LEAD	1
YPQ000100	IDENTS (SMALL)	1
YRV000040	SPLICE (RED, CSA; 0.25-1.6)	1
YRW000390	WIRE STRIPPER	1
YRW500010	APPLICATOR	1
YRW500020	EXTRACT TOOL	1

[VUB500090]

YPL103900		1.50 - 2.50 CSA
Cavities 0		
VDK500010	INSTRUCTION; REPAIR KIT	1
VDK500030	INSTRUCTION; EXTRACT TOOL	1
YMI000890	PRE-TERMINATED LEAD	1
YPQ000110	IDENTS (MEDIUM)	1
YRV000050	SPLICE (BLUE, CSA; 1.0-2.6)	1
YRW000390	WIRE STRIPPER	1
YRW500010	APPLICATOR	1

[VUB500100]

Part No. YPH900780
Colour: COPPER, TIN PLATED
Gender: M
Type: HEADER COVER
No. of Ways: 17WY

Description: Header
Location: Beneath front passenger's seat

No photo
 Geen photo
 Pas de photo
 Kein foto
 Senza foto
 Sem fotografia
 No hay foto

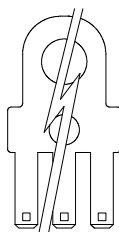

Wire Chart

CAV	TERMINAL	CSA	COL	CCT	DESTN
0	YPL103890	0.75	W	ALL	C0436-1
0	YPL103900	2.5	W	ALL	C0690-2
0	YPL103900	2.5	W	ALL	C0662-13
0	YPL103890	0.75	W	ALL	C0435-1

Service Repair Kits

YPL103890		0.75 - 1.00 CSA
Cavities 0		
VDK500010	INSTRUCTION; REPAIR KIT	1
VDK500030	INSTRUCTION; EXTRACT TOOL	1
YMI000880	PRE-TERMINATED LEAD	1
YPQ000100	IDENTS (SMALL)	1
YRV000040	SPLICE (RED, CSA; 0.25-1.6)	1
YRW000390	WIRE STRIPPER	1
YRW500010	APPLICATOR	1
YRW500020	EXTRACT TOOL	1

[VUB500090]

YPL103900		1.50 - 2.50 CSA
Cavities 0		
VDK500010	INSTRUCTION; REPAIR KIT	1
VDK500030	INSTRUCTION; EXTRACT TOOL	1
YMI000890	PRE-TERMINATED LEAD	1
YPQ000110	IDENTS (MEDIUM)	1
YRV000050	SPLICE (BLUE, CSA; 1.0-2.6)	1
YRW000390	WIRE STRIPPER	1
YRW500010	APPLICATOR	1

[VUB500100]

Part No. YPH900780
Colour: COPPER, TIN PLATED
Gender: M
Type: HEADER COVER
No. of Ways: 17WY

Description: Header-Earth
Location: Beneath front passenger's seat

No photo
 Geen photo
 Pas de photo
 Kein foto
 Senza foto
 Sem fotografia
 No hay foto

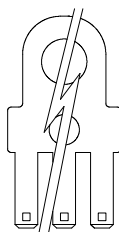

Wire Chart

CAV	TERMINAL	CSA	COL	CCT	DESTN
0	YPL103890	0.75	B	ALL	C0436-3
0	YPL103890	0.75	B	ALL	C0435-3
0	YPL103900	2.5	B	ALL	C0662-6

Service Repair Kits

YPL103890		0.75 - 1.00 CSA	
Cavities 0			
VDK500010	INSTRUCTION; REPAIR KIT	1	
VDK500030	INSTRUCTION; EXTRACT TOOL	1	
YMI000880	PRE-TERMINATED LEAD	1	
YPQ000100	IDENTS (SMALL)	1	
YRV000040	SPLICE (RED, CSA; 0.25-1.6)	1	
YRW000390	WIRE STRIPPER	1	
YRW500010	APPLICATOR	1	
YRW500020	EXTRACT TOOL	1	

[VUB500090]

YPL103900		1.50 - 2.50 CSA	
Cavities 0			
VDK500010	INSTRUCTION; REPAIR KIT	1	
VDK500030	INSTRUCTION; EXTRACT TOOL	1	
YMI000890	PRE-TERMINATED LEAD	1	
YPQ000110	IDENTS (MEDIUM)	1	
YRV000050	SPLICE (BLUE, CSA; 1.0-2.6)	1	
YRW000390	WIRE STRIPPER	1	
YRW500010	APPLICATOR	1	

[VUB500100]

Part No. YPH900780
Colour: COPPER, TIN PLATED
Gender: M
Type: HEADER COVER
No. of Ways: 17WY

Description: Header
Location: Beneath front passenger's seat

No photo
 Geen photo
 Pas de photo
 Kein foto
 Senza foto
 Sem fotografia
 No hay foto

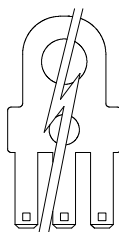

Wire Chart

CAV	TERMINAL	CSA	COL	CCT	DESTN
0	YPL103880	0.35	UR	ALL	C0459-23
0	YPL103880	0.35	UR	227	C0784-10
0	YPL103880	0.35	UR	ALL	C0660-25
0	YPL103880	0.35	UR	ALL	C0463-23

Service Repair Kits

YPL103880		0.20 - 0.50 CSA
Cavities 0		
VDK500010	INSTRUCTION; REPAIR KIT	1
VDK500030	INSTRUCTION; EXTRACT TOOL	1
YMI000850	PRE-TERMINATED LEAD	1
YPQ000100	IDENTS (SMALL)	1
YRV000040	SPLICE (RED, CSA; 0.25-1.6)	1
YRW000390	WIRE STRIPPER	1
YRW500010	APPLICATOR	1
YRW500020	EXTRACT TOOL	1

[VUB500060]

Part No. YPH900780
Colour: COPPER, TIN PLATED
Gender: M
Type: HEADER COVER
No. of Ways: 17WY

Description: Header
Location: Behind RH side of fascia

No photo
 Geen photo
 Pas de photo
 Kein foto
 Senza foto
 Sem fotografia
 No hay foto

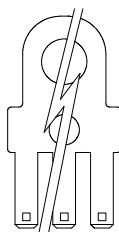

Wire Chart

CAV	TERMINAL	CSA	COL	CCT	DESTN
0	YPL103890	0.75	RU	ALL	C0586-2
0	YPL103890	0.75	RU	134	C1795-2
0	YPL103890	0.75	RU	134	C1794-2

CAV	TERMINAL	CSA	COL	CCT	DESTN
0	YPL103890	0.75	RU	ALL	C0463-11
0	YPL103890	0.75	RU	ALL	C0435-11
0	YPL103890	0.75	RU	ALL	C0436-11

Service Repair Kits

YPL103890		0.75 - 1.00 CSA
Cavities 0		
VDK500010	INSTRUCTION; REPAIR KIT	1
VDK500030	INSTRUCTION; EXTRACT TOOL	1
YMI000880	PRE-TERMINATED LEAD	1
YPQ000100	IDENTS (SMALL)	1
YRV000040	SPLICE (RED, CSA; 0.25-1.6)	1
YRW000390	WIRE STRIPPER	1
YRW500010	APPLICATOR	1
YRW500020	EXTRACT TOOL	1

[VUB500090]

Part No. YPH900780
Colour: COPPER, TIN PLATED
Gender: M
Type: HEADER COVER
No. of Ways: 17WY

Description: Header
Location: Behind centre of fascia

No photo
 Geen photo
 Pas de photo
 Kein foto
 Senza foto
 Sem fotografia
 No hay foto

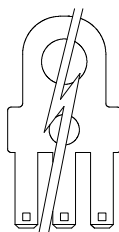

Wire Chart

CAV	TERMINAL	CSA	COL	CCT	DESTN
0	YPL103880	0.35	WRY	337	C1537-1
0	YPL103880	0.35	WRY	ALL	C0867-37
0	YPL103880	0.35	WRY	574	C1543-14
0	YPL103880	0.35	WRY	136	C0961-3

CAV	TERMINAL	CSA	COL	CCT	DESTN
0	YPL103880	0.35	WRY	ALL	C0256-9
0	YPL103880	0.35	WRY	ALL	C0660-12
0	YPL103880	0.35	WRY	ALL	SJ X10116-
0	YPL103880	0.35	WRY	ALL	C0059-13

Service Repair Kits

YPL103880		0.20 - 0.50 CSA
Cavities 0		
VDK500010	INSTRUCTION; REPAIR KIT	1
VDK500030	INSTRUCTION; EXTRACT TOOL	1
YMI000850	PRE-TERMINATED LEAD	1
YPQ000100	IDENTS (SMALL)	1
YRV000040	SPLICE (RED, CSA; 0.25-1.6)	1
YRW000390	WIRE STRIPPER	1
YRW500010	APPLICATOR	1
YRW500020	EXTRACT TOOL	1

[VUB500060]

Part No. YPH900780
Colour: COPPER, TIN PLATED
Gender: M
Type: HEADER COVER
No. of Ways: 17WY

Description: Motor-Window-Rear
Location: Behind rear door trim panel

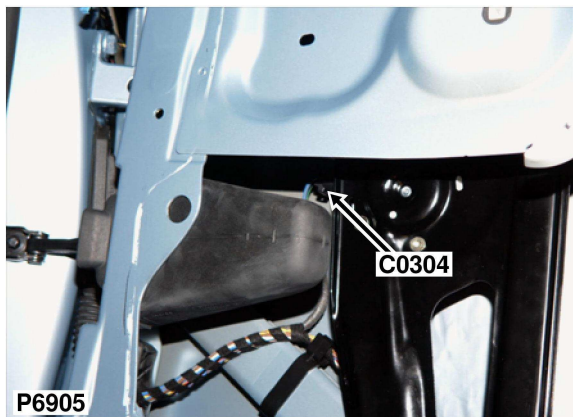

Wire Chart

CAV	TERMINAL	CSA	COL	CCT	DESTN
1	YPL103540	2.5	BG	247	C0803-26
2	YPL103540	2.5	US	247	C0803-27

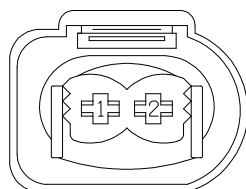

BLACK

Part No. YPC116370
Colour: BLACK
Gender: F
Type: MDK3 PLUS
No. of Ways: 2WY

No repair kit
 Geen reparatiepakke
 Pas de nécessaire de réparation
 Kein Werkzeug
 Senza kit per le riparazioni
 Sem kit de reparaçã
 No hay kit de reparaci3n

Description: Speaker-Low range-Rear-RH
Location: Behind rear door trim panel

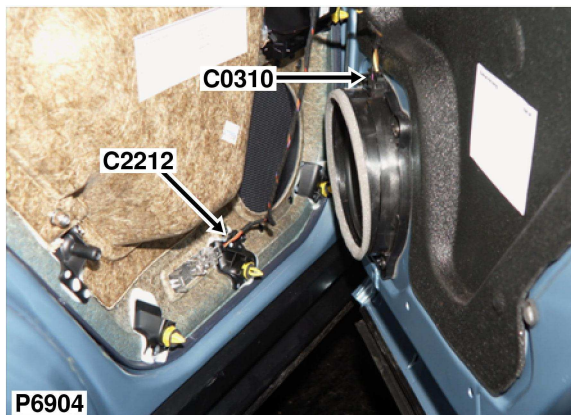

Wire Chart

CAV	TERMINAL	CSA	COL	CCT	DESTN
1	YPL102580	MAQA	N	125	C0803-29
1	YPL102600	MUA	N	126	C0803-29
2	YPL102580	MAQA	Y	125	C0803-28
2	YPL102600	MUA	Y	126	C0803-28

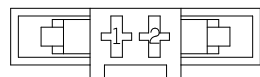

BLACK

Part No. YPC113640
Colour: BLACK
Gender: F
Type: JUNIOR POWER TIMER
No. of Ways: 2WY

No repair kit
 Geen reparatiepakke
 Pas de nécessaire de reparation
 Kein Werkzeug
 Senza kit per le riparazioni
 Sem kit de reparação
 No hay kit de reparación

Description: Speaker-Mid range-Rear-RH

Location: Behind rear door trim panel

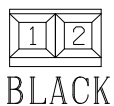
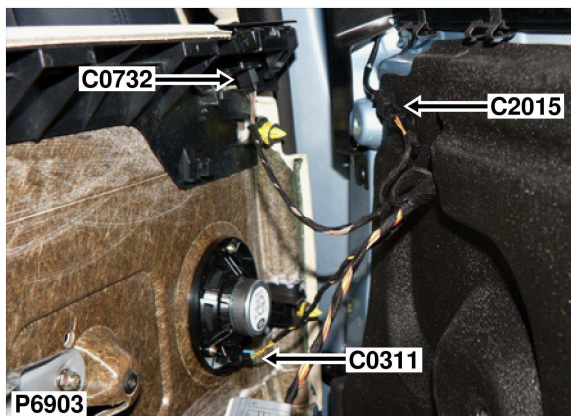

Wire Chart

CAV	TERMINAL	CSA	COL	CCT	DESTN
1	YPL101310	MMB	YN	126	C0803-15
2	YPL101310	MMB	YB	126	C0803-14

Service Repair Kits

YPL101310		0.20 - 0.50 csa
Cavities 1,2		
VDK500010	INSTRUCTION; REPAIR KIT	1
VDK500070	INSTRUCTION; EXTRACT TOOL	1
VDK500080	INSTRUCTION; EXTRACT TOOL	1
YMI000870	PRE-TERMINATED LEAD	1
YPQ000100	IDENTS (SMALL)	1
YRV000040	SPLICE (RED, CSA; 0.25-1.6)	1
YRW000390	WIRE STRIPPER	1
YRW500010	APPLICATOR	1
YRW500060	EXTRACT TOOL	1
YRW500070	EXTRACT TOOL	1

[VUB500080]

Part No. YPC111740
Colour: BLACK
Gender: F
Type: MQS
No. of Ways: 2WY

Description: Passenger door harness to main harness

Location: Base of passenger side 'A' post

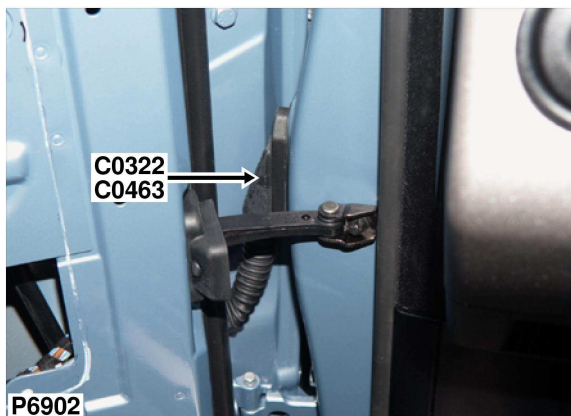

Wire Chart

CAV	TERMINAL	CSA	COL	CCT	DESTN
5	YPL101310	0.5	SR	247	C2057-2
9	YPL101870	MMA	U	216	C1498-1
10	YPL101870	MMA	N	216	C1498-2
11	YPL101910	0.75	RU	134	C2211-2
14	YPL101310	MMC	UB	126	C0531-2
15	YPL101310	MMC	UN	126	C0531-1
16	YPL101310	MMB	UY	126	C2059-2
17	YPL101310	MMB	N	126	C2059-1
19	YPL101310	0.5	RG	65	C0353-4

CAV	TERMINAL	CSA	COL	CCT	DESTN
20	YPL101310	0.35	WG	341	C0353-1
21	YPL101310	0.35	WY	341	C0353-2
23	YPL101310	0.35	UR	247	C2057-1
26	YPL102730	4.0	N	247	SJ X891-
27	YPL102720	2.5	RW	40	C2016-1
28	YPL102710	MUA	UR	126	C0726-2
28	YPL102700	MAQA	UR	125	C0726-2
29	YPL102710	MUA	UN	126	C0726-1
29	YPL102700	MAQA	UN	125	C0726-1

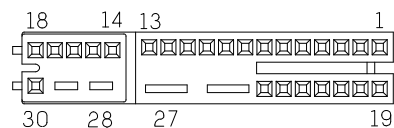

BLACK

Part No. YPC114720
Colour: BLACK
Gender: F
Type: MQS/MPQ
No. of Ways: 30WY

Description: Passenger door harness to main harness

Location: Base of passenger side 'A' post

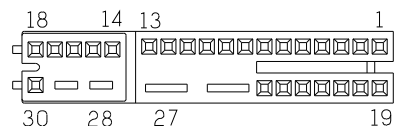
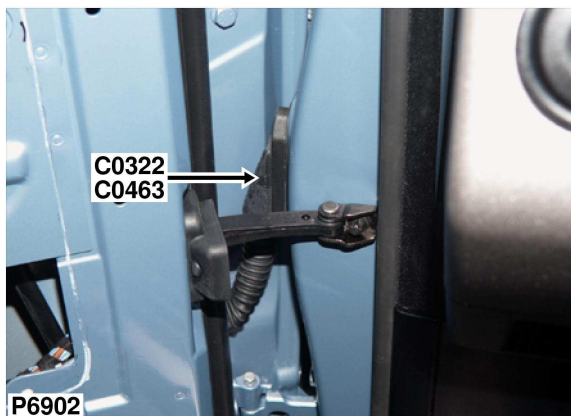

BLACK

Part No. YPC114720
Colour: BLACK
Gender: F
Type: MQS/MPQ
No. of Ways: 30WY

Service Repair Kits

YPL101910		0.75 - 0.75 CSA
Cavities 5,11,14-17,19-21,23		
VDK500010	INSTRUCTION; REPAIR KIT	1
VDK500070	INSTRUCTION; EXTRACT TOOL	1
VDK500080	INSTRUCTION; EXTRACT TOOL	1
YMI000870	PRE-TERMINATED LEAD	1
YPQ000100	IDENTS (SMALL)	1
YRV000040	SPLICE (RED, CSA; 0.25-1.6)	1
YRW000390	WIRE STRIPPER	1
YRW500010	APPLICATOR	1
YRW500060	EXTRACT TOOL	1
YRW500070	EXTRACT TOOL	1
[VUB500080]		

YPL101870		0.20 - 0.50 CSA
Cavities 5,9,10,14-17,19-21,23		
VDK500010	INSTRUCTION; REPAIR KIT	1
VDK500070	INSTRUCTION; EXTRACT TOOL	1
VDK500080	INSTRUCTION; EXTRACT TOOL	1
YMI000940	PRE-TERMINATED LEAD	1
YPQ000100	IDENTS (SMALL)	1
YRV000040	SPLICE (RED, CSA; 0.25-1.6)	1
YRW000390	WIRE STRIPPER	1
YRW500010	APPLICATOR	1
[VUB500140]		

YPL102730		2.51 - 4.00 CSA
Cavities 26		
VDK500010	INSTRUCTION; REPAIR KIT	1
VDK500050	INSTRUCTION; EXTRACT TOOL	1
YMI001150	PRE-TERMINATED LEAD	1
YPQ000120	IDENTS (LARGE)	1
YRV000060	SPLICE (YELLOW, CSA; 2.7-6.6)	1
YRW000390	WIRE STRIPPER	1
YRW500010	APPLICATOR	1
YRW500040	EXTRACT TOOL	1
[VUB500350]		

YPL102710		1.01 - 2.50 CSA
Cavities 28,29		
VDK500010	INSTRUCTION; REPAIR KIT	1
VDK500050	INSTRUCTION; EXTRACT TOOL	1
YMI001010	PRE-TERMINATED LEAD	1
YPQ000110	IDENTS (MEDIUM)	1
YRV000050	SPLICE (BLUE, CSA; 1.0-2.6)	1
YRW000390	WIRE STRIPPER	1
YRW500010	APPLICATOR	1
[VUB500210]		

YPL102700		0.50 - 1.00 CSA
Cavities 28,29		
VDK500010	INSTRUCTION; REPAIR KIT	1
VDK500030	INSTRUCTION; EXTRACT TOOL	1
YMI001060	PRE-TERMINATED LEAD	1
YPQ000100	IDENTS (SMALL)	1
YRV000040	SPLICE (RED, CSA; 0.25-1.6)	1
YRW000390	WIRE STRIPPER	1
YRW500010	APPLICATOR	1
[VUB500260]		

[continuation]

Description: Engine control module (ECM)

Location: Inside E-box

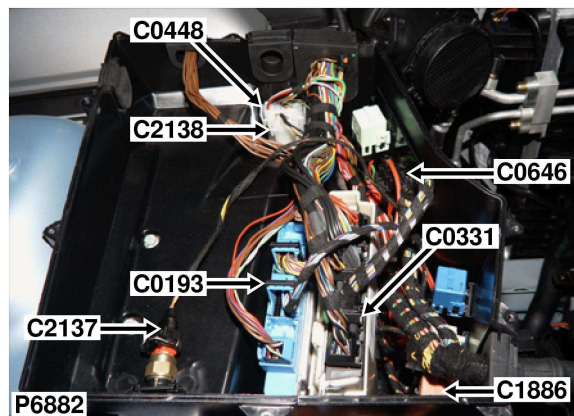

Wire Chart

CAV	TERMINAL	CSA	COL	CCT	DESTN
1	YPL101310	0.35	U	ALL	C0230-3
2	YPL101310	0.35	BG	ALL	C0233-14
3	YPL101310	0.35	NU	573	C1886-4
4	YPL101310	0.5	BG	ALL	C0005-2
6	YPL101910	0.75	BY	573	C0028-8
7	YPL101310	0.35	NG	ALL	C0787-1
8	YPL101310	0.35	W	ALL	C0787-4
9	YPL101310	0.35	Y	ALL	C0787-5
10	YPL101310	0.35	BP	ALL	C2022-22
11	YPL101310	0.35	NG	58	C0230-4
12	YPL101310	0.35	UG	ALL	C0787-2
13	YPL101310	0.35	WG	ALL	C0787-6
14	YPL101310	0.35	YG	ALL	C0787-3
17	YPL101310	0.35	B	ALL	C0040-9
19	YPL101310	0.35	SP	ALL	C0234-25
21	YPL101310	0.35	SN	ALL	C2040-15

CAV	TERMINAL	CSA	COL	CCT	DESTN
22	YPL101310	0.35	YG	ALL	C0506-19
24	YPL101310	0.35	UR	ALL	SJ X181-
26	YPL101310	0.5	GB	ALL	C0587-5
27	YPL101310	0.35	YB	51	C0082-8
28	YPL101310	0.35	NS	ALL	C0075-3
29	YPL101310	0.35	BG	ALL	C1629-17
32	YPL101310	0.35	WPY	573	SJ X442-
32	YPL101310	0.35	WPY	58	C0040-7
33	YPL101310	0.5	BP	ALL	C0059-4
36	YPL101310	MML	YB	58	SJ X18836-
36	YPL101310	MMAC	YB	573	SJ X18832-
37	YPL101310	MMAC	YN	573	SJ X18831-
37	YPL101310	MML	YN	58	SJ X18835-
38	YPL101310	0.35	US	573	C2348-1
39	YPL101310	0.35	BS	573	C2348-2
40	YPL101310	0.35	YN	573	C1455-4

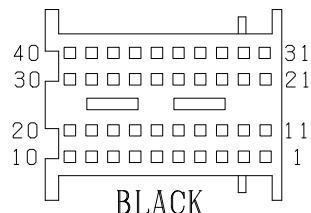

Service Repair Kits

YPL101910		0.75 - 0.75 CSA
Cavities 1-4,6-14,17,19,21,22,24,26-29,32-33,36-40		
VDK500010	INSTRUCTION; REPAIR KIT	1
VDK500070	INSTRUCTION; EXTRACT TOOL	1
VDK500080	INSTRUCTION; EXTRACT TOOL	1
YMI000870	PRE-TERMINATED LEAD	1
YPQ000100	IDENTS (SMALL)	1
YRV000040	SPLICE (RED, CSA; 0.25-1.6)	1
YRW000390	WIRE STRIPPER	1
YRW500010	APPLICATOR	1
YRW500060	EXTRACT TOOL	1
YRW500070	EXTRACT TOOL	1

[VUB500080]

Part No. YPH100430
Colour: BLACK
Gender: F
Type: MQS
No. of Ways: 40WY

Description: Main harness to air suspension harness

Location: Behind RH front wheel arch liner

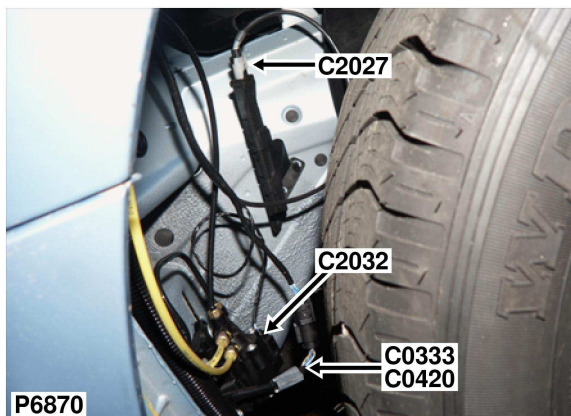

Wire Chart

CAV	TERMINAL	CSA	COL	CCT	DESTN
1	YPL101500	0.5	UW	ALL	C0867-13
2	YPL101510	0.75	WP	ALL	C0867-10
3	YPL101500	0.5	WR	ALL	C0867-9
4	YPL101500	0.5	YP	ALL	C0867-11

CAV	TERMINAL	CSA	COL	CCT	DESTN
5	YPL101500	0.5	UG	ALL	C0867-12
6	YPL101510	0.75	UB	ALL	C0867-7
7	YPL101500	0.5	UY	ALL	C0867-6
8	YPL101500	0.5	US	ALL	C0867-8

Service Repair Kits

YPL101510		0.75 - 0.75 CSA
Cavities 1-8		
VDK500010	INSTRUCTION; REPAIR KIT	1
VDK500070	INSTRUCTION; EXTRACT TOOL	1
VDK500080	INSTRUCTION; EXTRACT TOOL	1
YMI000950	PRE-TERMINATED LEAD	1
YPQ000100	IDENTS (SMALL)	1
YQD000210	HEAT SHRINK SLEEVE	1
YRV000040	SPLICE (RED, CSA; 0.25-1.6)	1
YRW000390	WIRE STRIPPER	1
YRW500010	APPLICATOR	1

[VUB500150]

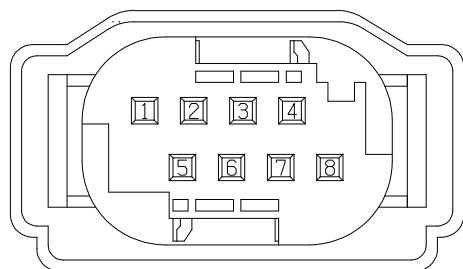

BLACK

Part No. YPC108040
Colour: BLACK
Gender: F
Type: MQS
No. of Ways: 8WY

Description: Door harness to main harness

Location: Base of driver side 'A' post

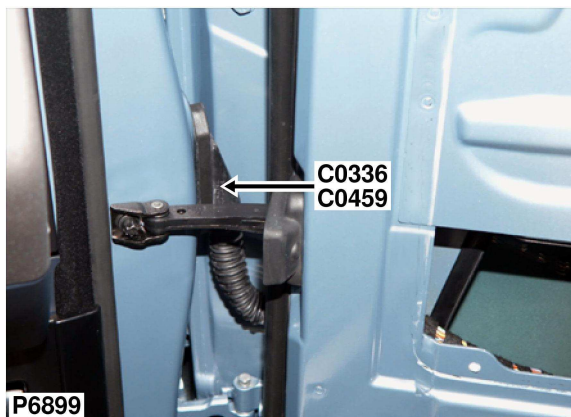

Wire Chart

CAV	TERMINAL	CSA	COL	CCT	DESTN
1	YPL101310	0.35	YG	16	C2186-4
5	YPL101310	0.5	SR	247	SJ X1720-
9	YPL101870	MMA	Y	216	C1499-1
10	YPL101870	MMA	N	216	C1499-2
11	YPL101910	0.75	RU	134	C2210-2
14	YPL101310	MMB	YR	126	C0530-2
15	YPL101310	MMB	YN	126	C0530-1
16	YPL101310	MMC	SB	126	C2060-2
17	YPL101310	MMC	SN	126	C2060-1
19	YPL101310	0.5	RG	65	C0352-4
20	YPL101310	0.35	WR	341	C0352-1

CAV	TERMINAL	CSA	COL	CCT	DESTN
21	YPL101310	0.35	WU	341	C0352-2
23	YPL101310	0.35	UR	247	C2058-1
26	YPL102730	4.0	N	247	SJ X849-
27	YPL102720	2.5	RP	40	C2017-1
28	YPL102710	MUA	UW	126	C0688-2
28	YPL102700	MAQA	UW	125	C0688-2
29	YPL102700	MAQA	UN	125	C0688-1
29	YPL102710	MUA	UN	126	C0688-1

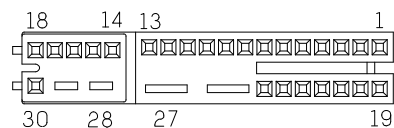

BLACK

Part No. YPC114720
Colour: BLACK
Gender: F
Type: MQS/MPQ
No. of Ways: 30WY

Description: Door harness to main harness

Location: Base of driver side 'A' post

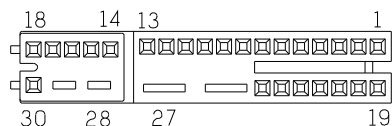
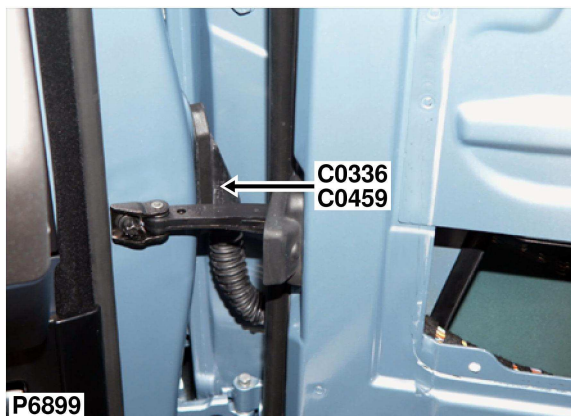

BLACK

Part No. YPC114720
Colour: BLACK
Gender: F
Type: MQS/MPQ
No. of Ways: 30WY

Service Repair Kits

YPL101910		0.75 - 0.75 CSA
Cavities 1,5,11,14-17,19-21,23		
VDK500010	INSTRUCTION; REPAIR KIT	1
VDK500070	INSTRUCTION; EXTRACT TOOL	1
VDK500080	INSTRUCTION; EXTRACT TOOL	1
YMI000870	PRE-TERMINATED LEAD	1
YPQ000100	IDENTS (SMALL)	1
YRV000040	SPLICE (RED, CSA; 0.25-1.6)	1
YRW000390	WIRE STRIPPER	1
YRW500010	APPLICATOR	1
YRW500060	EXTRACT TOOL	1
YRW500070	EXTRACT TOOL	1

[VUB500080]

YPL101870		0.20 - 0.50 CSA
Cavities 1,5,9,10,14-17,19-21,23		
VDK500010	INSTRUCTION; REPAIR KIT	1
VDK500070	INSTRUCTION; EXTRACT TOOL	1
VDK500080	INSTRUCTION; EXTRACT TOOL	1
YMI000940	PRE-TERMINATED LEAD	1
YPQ000100	IDENTS (SMALL)	1
YRV000040	SPLICE (RED, CSA; 0.25-1.6)	1
YRW000390	WIRE STRIPPER	1
YRW500010	APPLICATOR	1

[VUB500140]

YPL102730		2.51 - 4.00 CSA
Cavities 26		
VDK500010	INSTRUCTION; REPAIR KIT	1
VDK500050	INSTRUCTION; EXTRACT TOOL	1
YMI001150	PRE-TERMINATED LEAD	1
YPQ000120	IDENTS (LARGE)	1
YRV000060	SPLICE (YELLOW, CSA; 2.7-6.6)	1
YRW000390	WIRE STRIPPER	1
YRW500010	APPLICATOR	1
YRW500040	EXTRACT TOOL	1

[VUB500350]

YPL102710		1.01 - 2.50 CSA
Cavities 28,29		
VDK500010	INSTRUCTION; REPAIR KIT	1
VDK500050	INSTRUCTION; EXTRACT TOOL	1
YMI001010	PRE-TERMINATED LEAD	1
YPQ000110	IDENTS (MEDIUM)	1
YRV000050	SPLICE (BLUE, CSA; 1.0-2.6)	1
YRW000390	WIRE STRIPPER	1
YRW500010	APPLICATOR	1

[VUB500210]

YPL102700		0.50 - 1.00 CSA
Cavities 28,29		
VDK500010	INSTRUCTION; REPAIR KIT	1
VDK500030	INSTRUCTION; EXTRACT TOOL	1
YMI001060	PRE-TERMINATED LEAD	1
YPQ000100	IDENTS (SMALL)	1
YRV000040	SPLICE (RED, CSA; 0.25-1.6)	1
YRW000390	WIRE STRIPPER	1
YRW500010	APPLICATOR	1

[VUB500260]

[continuation]

Description: Socket-Accessory-Front
Location: Beneath centre console

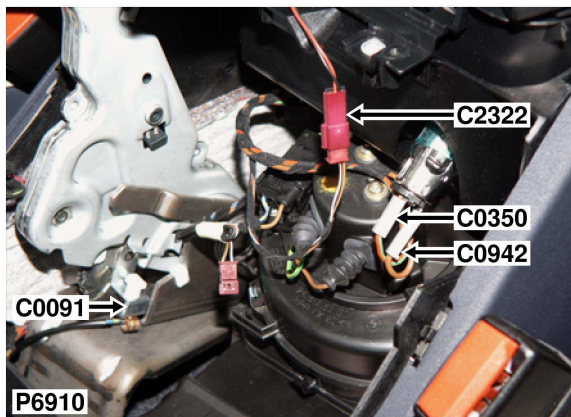

Wire Chart

CAV	TERMINAL	CSA	COL	CCT	DESTN
1	YPL500830	2.5	RG	43	SJ X1483-

No repair kit
 Geen reparatiepakke
 Pas de nécessaire de réparation
 Kein Werkzeug
 Senza kit per le riparazioni
 Sem kit de reparação
 No hay kit de reparación

Part No. YPC10395
Colour: WHITE
Gender: F
Type: 187 FASTON PIP-POD
No. of Ways: 1WY

Description: Mirror-Door-Driver side
Location: Behind driver's door trim panel

No photo
 Geen photo
 Pas de photo
 Kein foto
 Senza foto
 Sem fotografia
 No hay foto

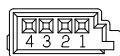

BLACK

Part No. YPC115170
Colour: BLACK
Gender: M
Type: MQS
No. of Ways: 4WY

Wire Chart

CAV	TERMINAL	CSA	COL	CCT	DESTN
1	YPJ100830	0.35	WR	341	C0336-20
2	YPJ100830	0.35	WU	341	C0336-21
3	YPJ100830	0.5	N	65	SJ X850-
4	YPJ100830	0.5	RG	65	C0336-19

Service Repair Kits

YPJ100830		0.20 - 0.50 CSA
Cavities 1-4		
VDK500010	INSTRUCTION; REPAIR KIT	1
VDK500070	INSTRUCTION; EXTRACT TOOL	1
VDK500080	INSTRUCTION; EXTRACT TOOL	1
YMI000990	PRE-TERMINATED LEAD	1
YPQ000100	IDENTS (SMALL)	1
YRV000040	SPLICE (RED, CSA; 0.25-1.6)	1
YRW000390	WIRE STRIPPER	1
YRW500010	APPLICATOR	1
YRW500060	EXTRACT TOOL	1
YRW500070	EXTRACT TOOL	1

[VUB500190]

Description: Mirror-Door-Passenger side
Location: Behind passenger's door trim panel

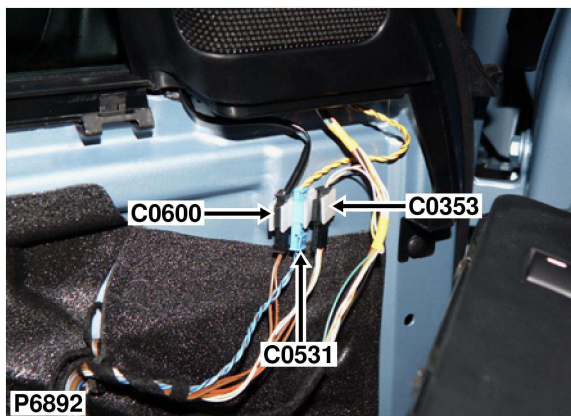

Wire Chart

CAV	TERMINAL	CSA	COL	CCT	DESTN
1	YPJ100830	0.35	WG	341	C0322-20
2	YPJ100830	0.35	WY	341	C0322-21
3	YPJ100830	0.5	N	65	SJ X892-
4	YPJ100830	0.5	RG	65	C0322-19

Service Repair Kits

YPJ100830		0.20 - 0.50 CSA
Cavities 1-4		
VDK500010	INSTRUCTION; REPAIR KIT	1
VDK500070	INSTRUCTION; EXTRACT TOOL	1
VDK500080	INSTRUCTION; EXTRACT TOOL	1
YMI000990	PRE-TERMINATED LEAD	1
YPQ000100	IDENTS (SMALL)	1
YRV000040	SPLICE (RED, CSA; 0.25-1.6)	1
YRW000390	WIRE STRIPPER	1
YRW500010	APPLICATOR	1
YRW500060	EXTRACT TOOL	1
YRW500070	EXTRACT TOOL	1

[VUB500190]

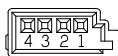

BLACK

Part No. YPC115170
Colour: BLACK
Gender: M
Type: MQS
No. of Ways: 4WY

Description: Lamp-Interior-Front
Location: Front of headlining in the centre

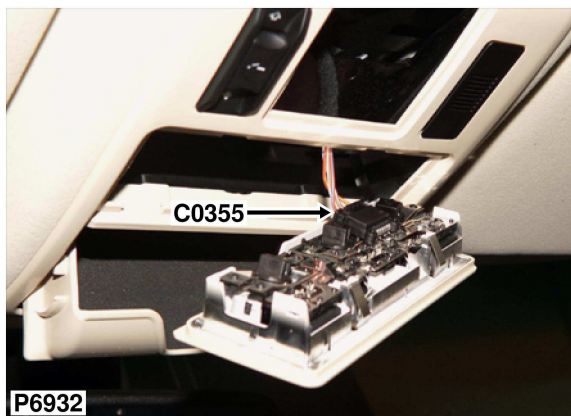

Wire Chart

CAV	TERMINAL	CSA	COL	CCT	DESTN
1	YPL101910	0.75	RY	ALL	C0723-0
5	YPL101310	0.5	SR	ALL	C0286-0
6	YPL101910	0.75	N	ALL	C0285-0
7	YPL101310	0.35	WN	ALL	C0660-2
8	YPL101910	0.75	RU	ALL	C0586-1

Service Repair Kits

YPL101910		0.75 - 0.75 CSA
Cavities 1,5-8		
VDK500010	INSTRUCTION; REPAIR KIT	1
VDK500070	INSTRUCTION; EXTRACT TOOL	1
VDK500080	INSTRUCTION; EXTRACT TOOL	1
YMI000870	PRE-TERMINATED LEAD	1
YPQ000100	IDENTS (SMALL)	1
YRV000040	SPLICE (RED, CSA; 0.25-1.6)	1
YRW000390	WIRE STRIPPER	1
YRW500010	APPLICATOR	1
YRW500060	EXTRACT TOOL	1
YRW500070	EXTRACT TOOL	1

[VUB500080]

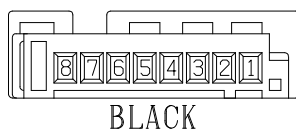

Part No. YPC117320
Colour: BLACK
Gender: F
Type: MQS
No. of Ways: 8WY

Description: Lamp-Interior-Rear
Location: Behind centre headlining

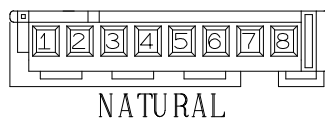
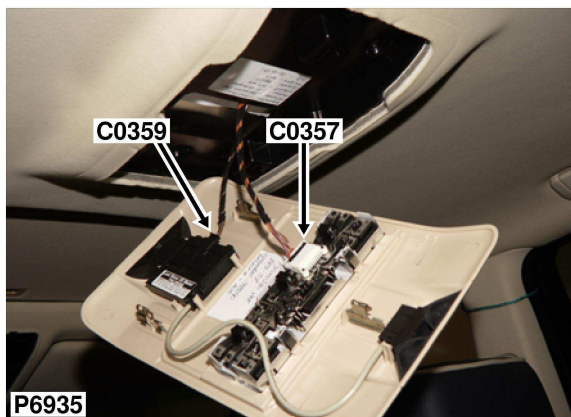

Wire Chart

CAV	TERMINAL	CSA	COL	CCT	DESTN
1	YPL101910	0.75	RY	ALL	SJ X18121-
5	YPL101310	0.5	SR	ALL	SJ X1019-
6	YPL101910	0.75	N	ALL	C0555-0
7	YPL101910	0.75	RY	ALL	SJ X18121-
8	YPL101910	0.75	RU	ALL	C0587-20

Service Repair Kits

YPL101910		0.75 - 0.75 CSA
Cavities 1,5-8		
VDK500010	INSTRUCTION; REPAIR KIT	1
VDK500070	INSTRUCTION; EXTRACT TOOL	1
VDK500080	INSTRUCTION; EXTRACT TOOL	1
YMI000870	PRE-TERMINATED LEAD	1
YPQ000100	IDENTS (SMALL)	1
YRV000040	SPLICE (RED, CSA; 0.25-1.6)	1
YRW000390	WIRE STRIPPER	1
YRW500010	APPLICATOR	1
YRW500060	EXTRACT TOOL	1
YRW500070	EXTRACT TOOL	1

[VUB500080]

Part No. 8383296
Colour: NATURAL
Gender: F
Type: MQS
No. of Ways: 8WY

Description: Sensor-Volumetric
Location: Behind centre headlining

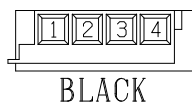
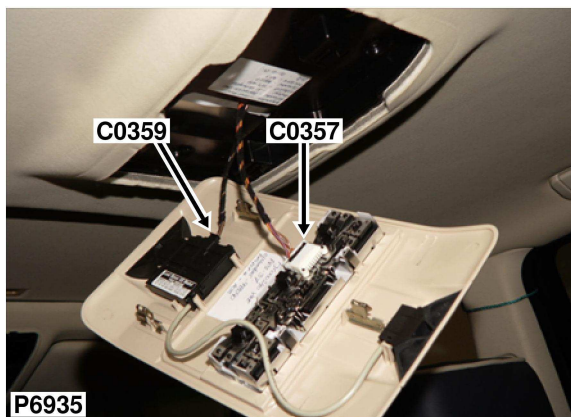

Part No. YPC117840
Colour: BLACK
Gender: F
Type: MQS
No. of Ways: 4WY

Wire Chart

CAV	TERMINAL	CSA	COL	CCT	DESTN
1	YPL101310	0.5	NB	ALL	C0706-0
2	YPL101310	0.5	BW	ALL	C0960-2
3	YPL101310	0.5	BY	ALL	C0661-5
4	YPL101310	0.5	RW	ALL	C0586-27

Service Repair Kits

YPL101310		0.20 - 0.50 CSA
Cavities 1-4		
VDK500010	INSTRUCTION; REPAIR KIT	1
VDK500070	INSTRUCTION; EXTRACT TOOL	1
VDK500080	INSTRUCTION; EXTRACT TOOL	1
YMI000870	PRE-TERMINATED LEAD	1
YPQ000100	IDENTS (SMALL)	1
YRV000040	SPLICE (RED, CSA; 0.25-1.6)	1
YRW000390	WIRE STRIPPER	1
YRW500010	APPLICATOR	1
YRW500060	EXTRACT TOOL	1
YRW500070	EXTRACT TOOL	1

[VUB500080]

Description: Earth-SRS
Location: Beneath centre console

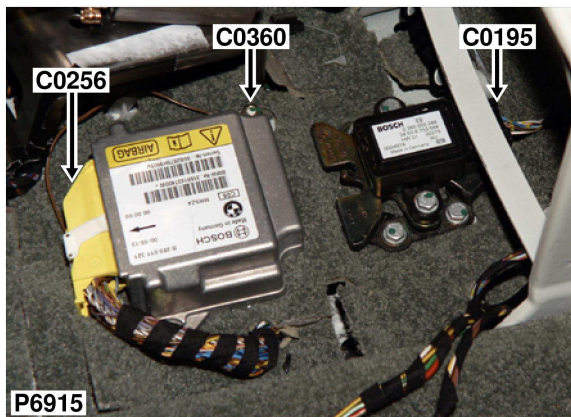

Wire Chart

CAV	TERMINAL	CSA	COL	CCT	DESTN
1	SEE DRAWING	0.75	NB	ALL	SJ X18358-

No repair kit
 Geen reparatiepakke
 Pas de nécessaire de reparation
 Kein Werkzeug
 Senza kit per le riparazioni
 Sem kit de reparaçao
 No hay kit de reparación

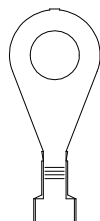

Part No. 8353763
Colour: TIN PLATED
Gender: F
Type: EYELET
No. of Ways: 1WY

Description: Earth-ABS
Location: Rear LH side of engine compartment

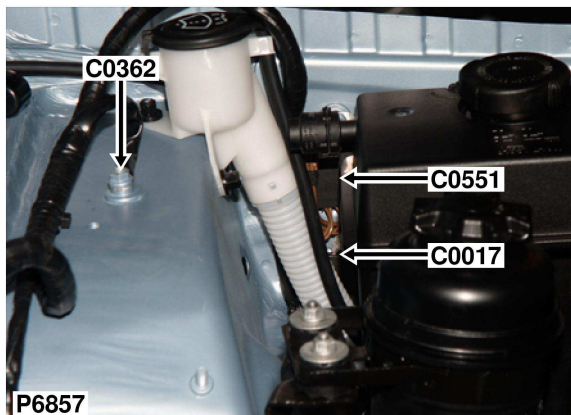

Wire Chart

CAV	TERMINAL	CSA	COL	CCT	DESTN
0	SEE DRAWING	2.5	N	ALL	C0506-5
0	SEE DRAWING	4.0	N	ALL	C0506-1

No repair kit
 Geen reparatiepakke
 Pas de nécessaire de reparation
 Kein Werkzeug
 Senza kit per le riparazioni
 Sem kit de reparaçao
 No hay kit de reparación

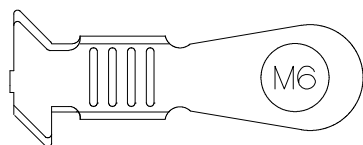

Part No. 1388865
Colour: TIN PLATED
Gender: F
Type: EYELET
No. of Ways: 1WY

Description: Switch-Sunroof-Front
Location: Front of headlining in the centre

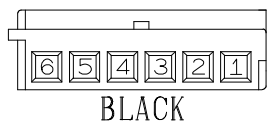
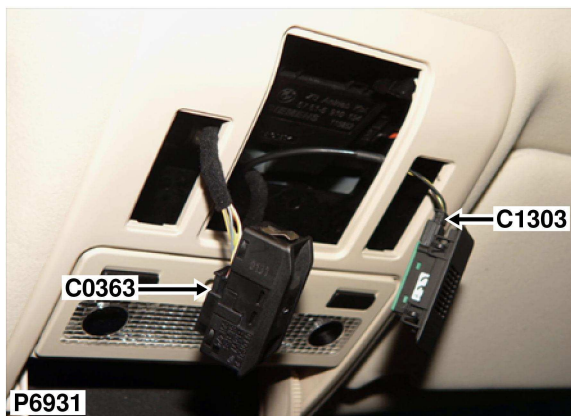

Wire Chart

CAV	TERMINAL	CSA	COL	CCT	DESTN
2	YPL101310	0.5	SR	227	C0286-0
3	YPL101310	0.35	YW	227	C0784-13
4	YPL101310	0.35	YG	227	C0784-9
5	YPL101310	0.35	SB	227	C0784-11
6	YPL101910	0.75	YS	227	C0784-3

Service Repair Kits

YPL101910		0.75 - 0.75 CSA
Cavities 2-6		
VDK500010	INSTRUCTION; REPAIR KIT	1
VDK500070	INSTRUCTION; EXTRACT TOOL	1
VDK500080	INSTRUCTION; EXTRACT TOOL	1
YMI000870	PRE-TERMINATED LEAD	1
YPQ000100	IDENTS (SMALL)	1
YRV000040	SPLICE (RED, CSA; 0.25-1.6)	1
YRW000390	WIRE STRIPPER	1
YRW500010	APPLICATOR	1
YRW500060	EXTRACT TOOL	1
YRW500070	EXTRACT TOOL	1

[VUB500080]

Part No. 6909052
Colour: BLACK
Gender: F
Type: MQS
No. of Ways: 6WY

Description: Switch-Hill descent
Location: Beneath centre console

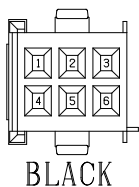
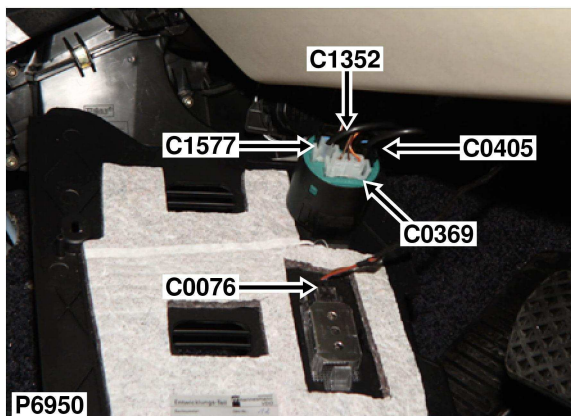

Part No. YPC115290
Colour: BLACK
Gender: F
Type: MQS
No. of Ways: 6WY

Wire Chart

CAV	TERMINAL	CSA	COL	CCT	DESTN
1	YPL101310	0.35	WG	ALL	C1319-8
3	YPL101310	0.35	BG	ALL	C0506-17
6	YPL101310	0.5	GBY	ALL	SJ X1397-

Service Repair Kits

YPL101310		0.20 - 0.50 CSA
Cavities 1,3,6		
VDK500010	INSTRUCTION; REPAIR KIT	1
VDK500070	INSTRUCTION; EXTRACT TOOL	1
VDK500080	INSTRUCTION; EXTRACT TOOL	1
YMI000870	PRE-TERMINATED LEAD	1
YPQ000100	IDENTS (SMALL)	1
YRV000040	SPLICE (RED, CSA; 0.25-1.6)	1
YRW000390	WIRE STRIPPER	1
YRW500010	APPLICATOR	1
YRW500060	EXTRACT TOOL	1
YRW500070	EXTRACT TOOL	1

[VUB500080]

Description: Speaker-PDC
Location: Driver's footwell

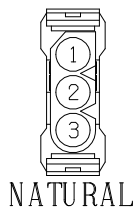
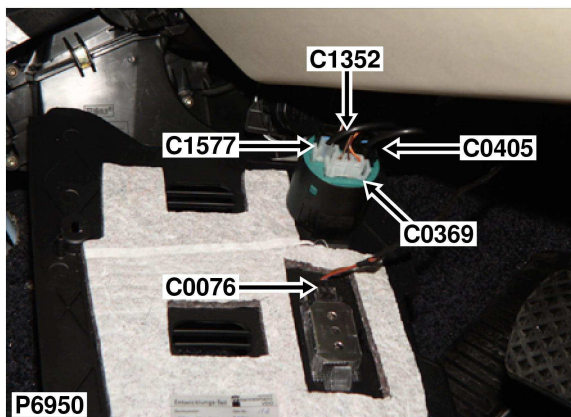

Wire Chart

CAV	TERMINAL	CSA	COL	CCT	DESTN
1	YPE10020	0.5	NB	ALL	SJ X217-
2	YPE100480	0.35	BR	ALL	C0233-11
3	YPE10020	0.75	RY	ALL	C0723-0

Service Repair Kits

YPE100480		0.20 - 0.40 CSA
Cavities 1-3		
VDK500010	INSTRUCTION; REPAIR KIT	1
VDK500130	INSTRUCTION; EXTRACT TOOL	1
YMI000860	PRE-TERMINATED LEAD	1
YPQ000100	IDENTS (SMALL)	1
YRV000040	SPLICE (RED, CSA; 0.25-1.6)	1
YRW000390	WIRE STRIPPER	1
YRW500010	APPLICATOR	1

[VUB500070]

Part No. YPC112540
Colour: NATURAL
Gender: F
Type: 2.5MM SYSTEM
No. of Ways: 3WY

Description: Rotary coupler
Location: Top of steering column

No photo
 Geen photo
 Pas de photo
 Kein foto
 Senza foto
 Sem fotografia
 No hay foto



YELLOW

Part No. YPW101170
Colour: YELLOW
Gender: F
Type: MQS LOCK PLATE
No. of Ways: 2WY

Wire Chart

CAV	TERMINAL	CSA	COL	CCT	DESTN
1	YPL101910	0.75	N	385	SJ X215-
2	YPL101910	0.75	GB	385	C0582-9

Service Repair Kits

YPL101910		0.75 - 0.75 csa
Cavities 1,2		
VDK500010	INSTRUCTION; REPAIR KIT	1
VDK500070	INSTRUCTION; EXTRACT TOOL	1
VDK500080	INSTRUCTION; EXTRACT TOOL	1
YMI000870	PRE-TERMINATED LEAD	1
YPO000100	IDENTS (SMALL)	1
YRV000040	SPLICE (RED, CSA; 0.25-1.6)	1
YRW000390	WIRE STRIPPER	1
YRW500010	APPLICATOR	1
YRW500060	EXTRACT TOOL	1
YRW500070	EXTRACT TOOL	1

[VUB500080]

Description: Heated rear window (HRW)
Location: LH side of taildoor

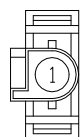
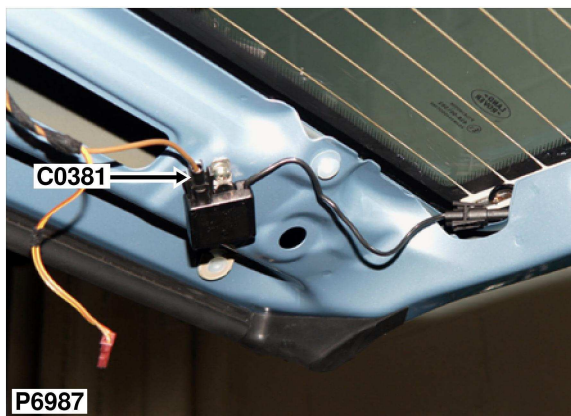

BLACK

Part No. YPC113890
Colour: BLACK
Gender: F
Type: 2.5MM SYSTEM
No. of Ways: 1WY

Wire Chart

CAV	TERMINAL	CSA	COL	CCT	DESTN
1	YPE100520	4.0	B	ALL	C2021-5

Service Repair Kits

YPE100520		2.51 - 4.00 CSA
Cavities 1		
VDK500010	INSTRUCTION; REPAIR KIT	1
VDK500130	INSTRUCTION; EXTRACT TOOL	1
YMI000980	PRE-TERMINATED LEAD	1
YPQ000120	IDENTS (LARGE)	1
YRV000060	SPLICE (YELLOW, CSA; 2.7-6.6)	1
YRW000390	WIRE STRIPPER	1
YRW500010	APPLICATOR	1

[VUB500180]

Description: Heated rear window (HRW)
Location: RH side of tail door

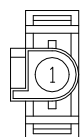
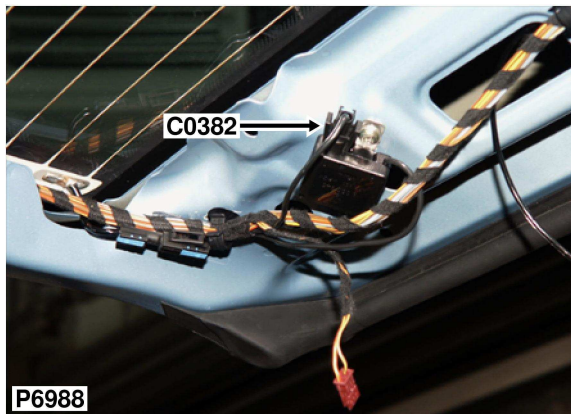

BLACK

Wire Chart

CAV	TERMINAL	CSA	COL	CCT	DESTN
1	YPE100520	4.0	N	ALL	C0555-0

Service Repair Kits

YPE100520		2.51 - 4.00 CSA
Cavities 1		
VDK500010	INSTRUCTION; REPAIR KIT	1
VDK500130	INSTRUCTION; EXTRACT TOOL	1
YMI000980	PRE-TERMINATED LEAD	1
YPQ000120	IDENTS (LARGE)	1
YRV000060	SPLICE (YELLOW, CSA; 2.7-6.6)	1
YRW000390	WIRE STRIPPER	1
YRW500010	APPLICATOR	1

[VUB500180]

Part No. YPC113890
Colour: BLACK
Gender: F
Type: 2.5MM SYSTEM
No. of Ways: 1WY

Description: Motor-Lock-Tail door
Location: Centre of taildoor, behind trim panel

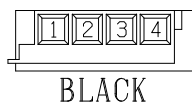
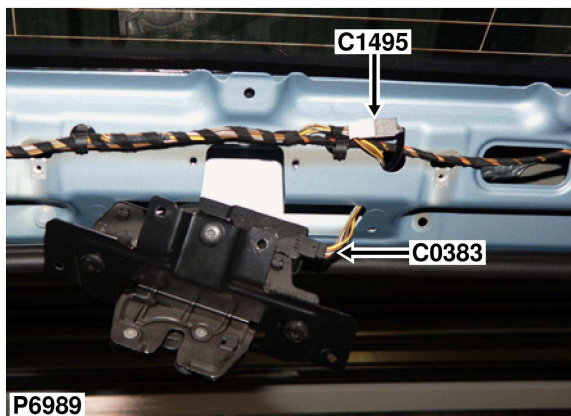

Wire Chart

CAV	TERMINAL	CSA	COL	CCT	DESTN
1	YPL101910	0.75	NY	ALL	SJ X465-
2	YPL101310	0.35	SW	ALL	C0660-19
3	YPL101910	0.75	N	ALL	SJ X11273-
4	YPL101910	0.75	YN	ALL	C0662-3

Service Repair Kits

YPL101910		0.75 - 0.75 CSA
Cavities 1-4		
VDK500010	INSTRUCTION; REPAIR KIT	1
VDK500070	INSTRUCTION; EXTRACT TOOL	1
VDK500080	INSTRUCTION; EXTRACT TOOL	1
YMI000870	PRE-TERMINATED LEAD	1
YPQ000100	IDENTS (SMALL)	1
YRV000040	SPLICE (RED, CSA; 0.25-1.6)	1
YRW000390	WIRE STRIPPER	1
YRW500010	APPLICATOR	1
YRW500060	EXTRACT TOOL	1
YRW500070	EXTRACT TOOL	1

[VUB500080]

Part No. YPC117840
Colour: BLACK
Gender: F
Type: MQS
No. of Ways: 4WY

Description: Tail door harness to main harness

Location: Rear of luggage compartment

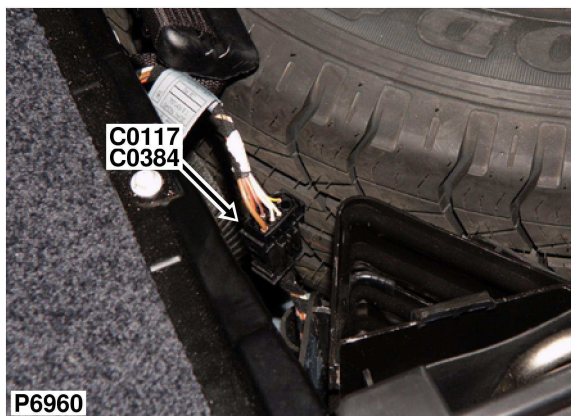

Wire Chart

CAV	TERMINAL	CSA	COL	CCT	DESTN
1	YPE100500	1.5	UY	40	C2052-2
2	YPE100500	1.5	UW	40	C0617-2
3	YPE10020	0.75	RS	40	C0615-6
4	YPE10020	0.75	YB	40	C0615-5
5	YPE100500	2.5	N	40	SJ X13276-

CAV	TERMINAL	CSA	COL	CCT	DESTN
6	YPE10020	0.75	WY	198	C0472-2
7	YPE10020	0.75	WY	198	C0455-2

Service Repair Kits

YPE100500		1.01 - 2.50 CSA
Cavities 1,2,5		
VDK500010	INSTRUCTION; REPAIR KIT	1
VDK500030	INSTRUCTION; EXTRACT TOOL	1
YMI000900	PRE-TERMINATED LEAD	1
YPQ000110	IDENTS (MEDIUM)	1
YRV000050	SPLICE (BLUE, CSA; 1.0-2.6)	1
YRW000390	WIRE STRIPPER	1
YRW500010	APPLICATOR	1

[VUB500110]

YPE10020		0.50 - 1.00 CSA
Cavities 3,4,6,7		
VDK500010	INSTRUCTION; REPAIR KIT	1
VDK500130	INSTRUCTION; EXTRACT TOOL	1
YMI000860	PRE-TERMINATED LEAD	1
YPQ000100	IDENTS (SMALL)	1
YRV000040	SPLICE (RED, CSA; 0.25-1.6)	1
YRW000390	WIRE STRIPPER	1
YRW500010	APPLICATOR	1

[VUB500070]

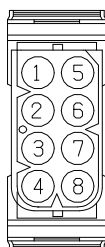

BLACK

Part No. YPC112390
Colour: BLACK
Gender: F
Type: 2.5MM SYSTEM
No. of Ways: 8WY

Description: Main harness to tail door harness

Location: Location Not in APD

No photo
 Geen photo
 Pas de photo
 Kein foto
 Senza foto
 Sem fotografia
 No hay foto

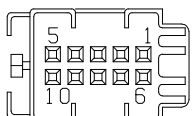

BLACK

Part No. YPC114560
Colour: BLACK
Gender: M
Type: MQS
No. of Ways: 10WY

Wire Chart

CAV	TERMINAL	CSA	COL	CCT	DESTN
1	YPJ100850	MAQA	UG	ALL	C2502-2
5	YPJ100850	MAQB	UO	ALL	C2503-2
6	YPJ100850	MAQA	NO	ALL	C2502-1
10	YPJ100850	MAQB	NO	ALL	C2503-1

Service Repair Kits

YPJ100850		0.75 - 0.75 CSA
Cavities 1,5,6,10		
VDK500010	INSTRUCTION; REPAIR KIT	1
VDK500070	INSTRUCTION; EXTRACT TOOL	1
VDK500080	INSTRUCTION; EXTRACT TOOL	1
YMI000990	PRE-TERMINATED LEAD	1
YPQ000100	IDENTS (SMALL)	1
YRV000040	SPLICE (RED, CSA; 0.25-1.6)	1
YRW000390	WIRE STRIPPER	1
YRW500010	APPLICATOR	1
YRW500060	EXTRACT TOOL	1
YRW500070	EXTRACT TOOL	1

[VUB500190]

Description: Motor-Wiper-Rear screen
Location: Centre of taildoor, behind trim panel

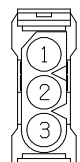
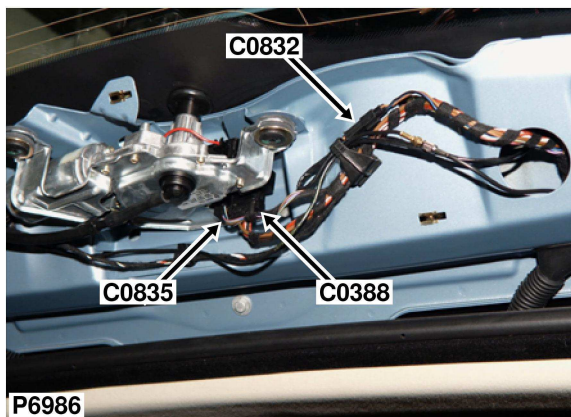

BLACK

Wire Chart

CAV	TERMINAL	CSA	COL	CCT	DESTN
1	YPE100500	2.5	N	ALL	SJ X11273-
2	YPE100500	2.5	RW	ALL	C2021-9
3	YPE100500	2.5	BR	ALL	C0021-1

Service Repair Kits

YPE100500		1.01 - 2.50 CSA
Cavities 1-3		
VDK500010	INSTRUCTION; REPAIR KIT	1
VDK500030	INSTRUCTION; EXTRACT TOOL	1
YMI000900	PRE-TERMINATED LEAD	1
YPQ000110	IDENTS (MEDIUM)	1
YRV000050	SPLICE (BLUE, CSA; 1.0-2.6)	1
YRW000390	WIRE STRIPPER	1
YRW500010	APPLICATOR	1
[VUB500110]		

Part No. YPC112530
Colour: BLACK
Gender: F
Type: 2.5MM SYSTEM
No. of Ways: 3WY

Description: Radio harness to main harness

Location: Behind centre of fascia

No photo
 Geen photo
 Pas de photo
 Kein foto
 Senza foto
 Sem fotografia
 No hay foto

Wire Chart

CAV	TERMINAL	CSA	COL	CCT	DESTN
1	YPE100520	4.0	RG	581	SJ X812-
2	YPE10020	0.5	PW	581	SJ X229-
4	YPE100480	0.35	WSY	581	SJ X18344-
5	YPE10020	0.75	SR	581	SJ X1362-
6	YPE10020	0.5	N	581	C0708-0

CAV	TERMINAL	CSA	COL	CCT	DESTN
8	YPE100480	0.35	WN	581	C0098-10
9	YPE10020	MAQA	BW	581	C0983-6
10	YPE10020	MAQA	BN	581	C0983-12
11	YPE100480	0.35	WG	581	C0098-11
12	YPE10020	0.5	W	581	SJ X830-

Service Repair Kits

YPE100480		0.20 - 0.40 CSA
Cavities 2,4-6,8-12		
VDK500010	INSTRUCTION; REPAIR KIT	1
VDK500130	INSTRUCTION; EXTRACT TOOL	1
YMI000860	PRE-TERMINATED LEAD	1
YPQ000100	IDENTS (SMALL)	1
YRV000040	SPLICE (RED, CSA; 0.25-1.6)	1
YRW000390	WIRE STRIPPER	1
YRW500010	APPLICATOR	1

[VUB500070]

YPE100520		2.51 - 4.00 CSA
Cavities 1,2,5,6,9,10,12		
VDK500010	INSTRUCTION; REPAIR KIT	1
VDK500130	INSTRUCTION; EXTRACT TOOL	1
YMI000980	PRE-TERMINATED LEAD	1
YPQ000120	IDENTS (LARGE)	1
YRV000060	SPLICE (YELLOW, CSA; 2.7-6.6)	1
YRW000390	WIRE STRIPPER	1
YRW500010	APPLICATOR	1

[VUB500180]

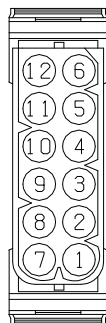

BLACK

Part No. YPC112660
Colour: BLACK
Gender: F
Type: 2.5MM SYSTEM
No. of Ways: 12WY

Description: Sensor-PDC-Inner-Front-LH
Location: Behind LH side of front bumper

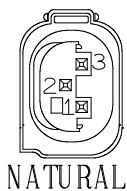
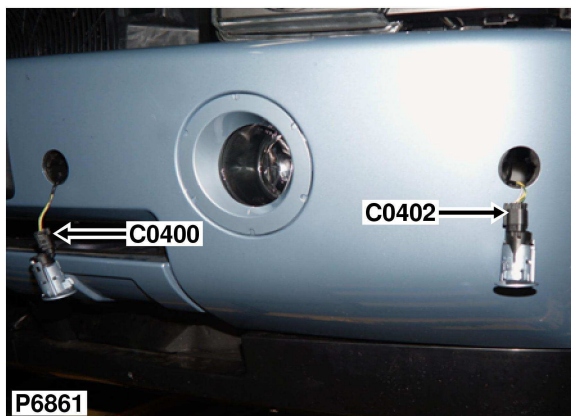

Wire Chart

CAV	TERMINAL	CSA	COL	CCT	DESTN
1	YPL101500	0.35	GN	171	C1457-5
2	YPL101500	0.35	YG	171	C1457-9
3	YPL101500	0.35	NB	171	C1457-1

Service Repair Kits

YPL101500		0.20 - 0.50 CSA
Cavities 1-3		
VDK500010	INSTRUCTION; REPAIR KIT	1
VDK500070	INSTRUCTION; EXTRACT TOOL	1
VDK500080	INSTRUCTION; EXTRACT TOOL	1
YMI000950	PRE-TERMINATED LEAD	1
YPQ000100	IDENTS (SMALL)	1
YQD000210	HEAT SHRINK SLEEVE	1
YRV000040	SPLICE (RED, CSA; 0.25-1.6)	1
YRW000390	WIRE STRIPPER	1
YRW500010	APPLICATOR	1

[VUB500150]

Part No. YPC116860
Colour: GREY
Gender: F
Type: MQS
No. of Ways: 3WY

Description: Sensor-PDC-Inner-Front-RH
Location: Behind RH side of front bumper

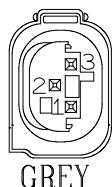
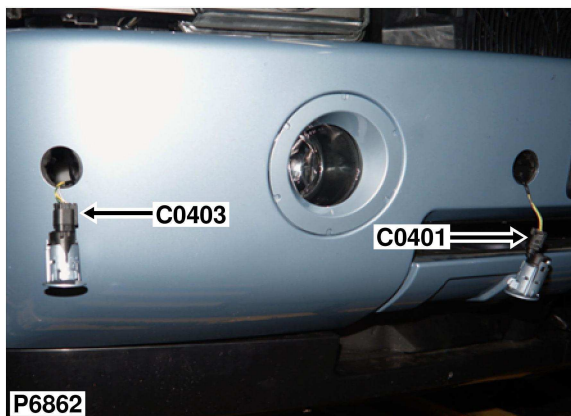

Wire Chart

CAV	TERMINAL	CSA	COL	CCT	DESTN
1	YPL101500	0.35	GS	171	C1457-4
2	YPL101500	0.35	YB	171	C1457-8
3	YPL101500	0.35	NU	171	C1457-7

Service Repair Kits

YPL101500		0.20 - 0.50 CSA
Cavities 1-3		
VDK500010	INSTRUCTION; REPAIR KIT	1
VDK500070	INSTRUCTION; EXTRACT TOOL	1
VDK500080	INSTRUCTION; EXTRACT TOOL	1
YMI000950	PRE-TERMINATED LEAD	1
YPQ000100	IDENTS (SMALL)	1
YQD000210	HEAT SHRINK SLEEVE	1
YRV000040	SPLICE (RED, CSA; 0.25-1.6)	1
YRW000390	WIRE STRIPPER	1
YRW500010	APPLICATOR	1

[VUB500150]

Part No. YPC906260
Colour: GREY
Gender: F
Type: MQS
No. of Ways: 3WY

Description: Sensor-PDC-Outer-Front-LH
Location: Behind LH side of front bumper

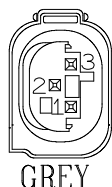
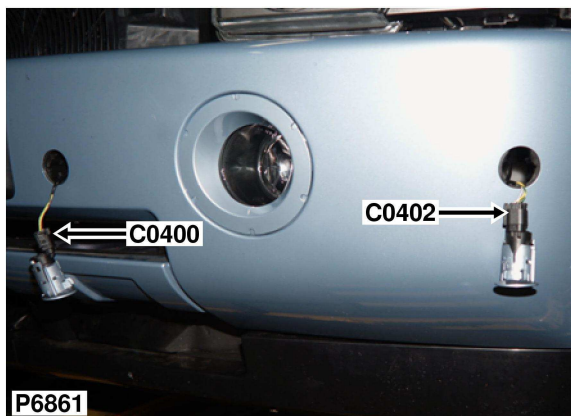

Wire Chart

CAV	TERMINAL	CSA	COL	CCT	DESTN
1	YPL101500	0.35	GB	171	C1457-12
2	YPL101500	0.35	YS	171	C1457-11
3	YPL101500	0.35	NW	171	C1457-3

Service Repair Kits

YPL101500		0.20 - 0.50 CSA
Cavities 1-3		
VDK500010	INSTRUCTION; REPAIR KIT	1
VDK500070	INSTRUCTION; EXTRACT TOOL	1
VDK500080	INSTRUCTION; EXTRACT TOOL	1
YMI000950	PRE-TERMINATED LEAD	1
YPQ000100	IDENTS (SMALL)	1
YQD000210	HEAT SHRINK SLEEVE	1
YRV000040	SPLICE (RED, CSA; 0.25-1.6)	1
YRW000390	WIRE STRIPPER	1
YRW500010	APPLICATOR	1

[VUB500150]

Part No. YPC906260
Colour: GREY
Gender: F
Type: MQS
No. of Ways: 3WY

Description: Sensor-PDC-Outer-Front-RH
Location: Behind RH side of front bumper

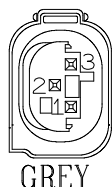
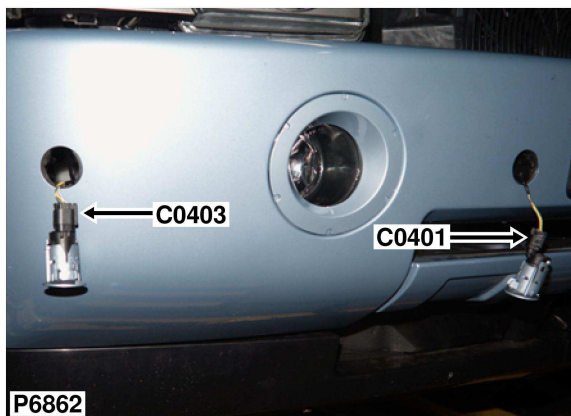

Wire Chart

CAV	TERMINAL	CSA	COL	CCT	DESTN
1	YPL101500	0.35	GP	171	C1457-6
2	YPL101500	0.35	YN	171	C1457-10
3	YPL101500	0.35	NY	171	C1457-2

Service Repair Kits

YPL101500		0.20 - 0.50 CSA
Cavities 1-3		
VDK500010	INSTRUCTION; REPAIR KIT	1
VDK500070	INSTRUCTION; EXTRACT TOOL	1
VDK500080	INSTRUCTION; EXTRACT TOOL	1
YMI000950	PRE-TERMINATED LEAD	1
YPQ000100	IDENTS (SMALL)	1
YQD000210	HEAT SHRINK SLEEVE	1
YRV000040	SPLICE (RED, CSA; 0.25-1.6)	1
YRW000390	WIRE STRIPPER	1
YRW500010	APPLICATOR	1

[VUB500150]

Part No. YPC906260
Colour: GREY
Gender: F
Type: MQS
No. of Ways: 3WY

Description: Speaker-PDC
Location: Driver's footwell

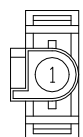
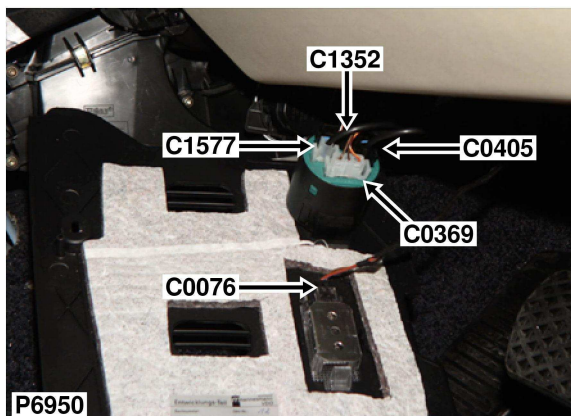

BLACK

Wire Chart

CAV	TERMINAL	CSA	COL	CCT	DESTN
1	YPE100480	0.35	US	171	C0957-9

Service Repair Kits

YPE100480		0.20 - 0.40 CSA
Cavities 1		
VDK500010	INSTRUCTION; REPAIR KIT	1
VDK500130	INSTRUCTION; EXTRACT TOOL	1
YMI000860	PRE-TERMINATED LEAD	1
YPQ000100	IDENTS (SMALL)	1
YRV000040	SPLICE (RED, CSA; 0.25-1.6)	1
YRW000390	WIRE STRIPPER	1
YRW500010	APPLICATOR	1

[VUB500070]

Part No. YPC113890
Colour: BLACK
Gender: F
Type: 2.5MM SYSTEM
No. of Ways: 1WY

Description: Main harness to door harness

Location: LH 'C' post

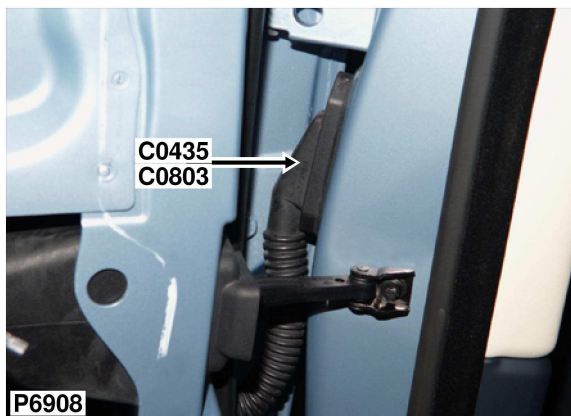

Wire Chart

CAV	TERMINAL	CSA	COL	CCT	DESTN
1	YPJ100850	0.75	W	ALL	C0292-0
2	YPJ100850	0.75	U	ALL	C0291-0
3	YPJ100850	0.75	B	ALL	C0293-0
4	YPJ100850	0.75	N	ALL	C0821-0
5	YPJ100830	0.5	SR	ALL	C0724-0
6	YPJ100830	0.35	SN	ALL	C0660-18

CAV	TERMINAL	CSA	COL	CCT	DESTN
7	YPJ100830	0.35	SB	ALL	C0660-17
8	YPJ100830	0.35	NY	ALL	C0661-24
11	YPJ100850	0.75	RU	ALL	C0295-0
12	YPJ100830	0.35	NS	ALL	C0660-6
26	YPJ100970	2.5	BG	ALL	C0662-15
27	YPJ100970	2.5	US	ALL	C0662-5

Service Repair Kits

YPJ100970		1.01 - 2.50 CSA
Cavities 26,27		
VDK500010	INSTRUCTION; REPAIR KIT	1
VDK500050	INSTRUCTION; EXTRACT TOOL	1
YMI001180	PRE-TERMINATED LEAD	1
YPQ000110	IDENTS (MEDIUM)	1
YRV000050	SPLICE (BLUE, CSA; 1.0-2.6)	1
YRW000390	WIRE STRIPPER	1
YRW500010	APPLICATOR	1
[VUB500380]		

YPJ100850		0.75 - 0.75 CSA
Cavities 1-8,11,12		
VDK500010	INSTRUCTION; REPAIR KIT	1
VDK500070	INSTRUCTION; EXTRACT TOOL	1
VDK500080	INSTRUCTION; EXTRACT TOOL	1
YMI000990	PRE-TERMINATED LEAD	1
YPQ000100	IDENTS (SMALL)	1
YRV000040	SPLICE (RED, CSA; 0.25-1.6)	1
YRW000390	WIRE STRIPPER	1
YRW500010	APPLICATOR	1
YRW500060	EXTRACT TOOL	1
YRW500070	EXTRACT TOOL	1
[VUB500190]		

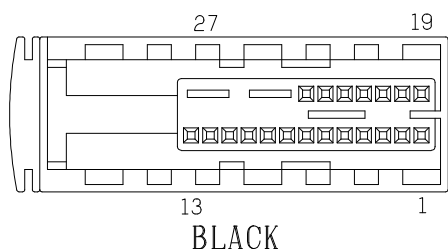

Part No. YPC114730
Colour: BLACK
Gender: M
Type: MQS/MPQ/PQ
No. of Ways: 30WY

Description: Main harness to door harness

Location: RH 'C' post

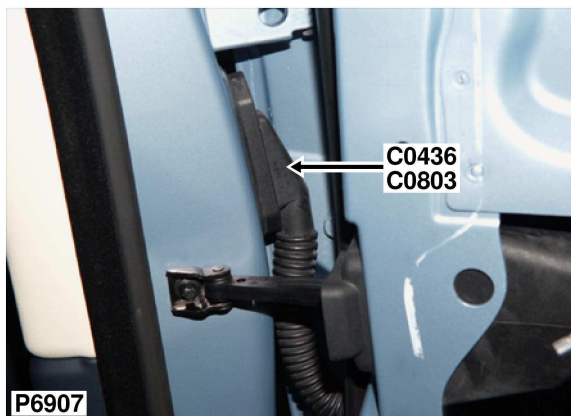

Wire Chart

CAV	TERMINAL	CSA	COL	CCT	DESTN
1	YPJ100850	0.75	W	ALL	C0292-0
2	YPJ100850	0.75	U	ALL	C0291-0
3	YPJ100850	0.75	B	ALL	C0293-0
4	YPJ100850	0.75	N	ALL	C0553-0
5	YPJ100830	0.5	SR	ALL	SJ X1019-
6	YPJ100830	0.35	SY	ALL	C0660-15

CAV	TERMINAL	CSA	COL	CCT	DESTN
7	YPJ100830	0.35	SU	ALL	C0660-26
8	YPJ100830	0.35	NR	ALL	C0661-12
11	YPJ100850	0.75	RU	ALL	C0295-0
12	YPJ100830	0.35	NW	ALL	C0660-7
26	YPJ100970	2.5	BN	ALL	C0662-12
27	YPJ100970	2.5	UP	ALL	C0662-2

Service Repair Kits

YPJ100970		1.01 - 2.50 CSA
Cavities 26,27		
VDK500010	INSTRUCTION; REPAIR KIT	1
VDK500050	INSTRUCTION; EXTRACT TOOL	1
YMI001180	PRE-TERMINATED LEAD	1
YPQ000110	IDENTS (MEDIUM)	1
YRV000050	SPLICE (BLUE, CSA; 1.0-2.6)	1
YRW000390	WIRE STRIPPER	1
YRW500010	APPLICATOR	1
[VUB500380]		

YPJ100850		0.75 - 0.75 CSA
Cavities 1-8,11,12		
VDK500010	INSTRUCTION; REPAIR KIT	1
VDK500070	INSTRUCTION; EXTRACT TOOL	1
VDK500080	INSTRUCTION; EXTRACT TOOL	1
YMI000990	PRE-TERMINATED LEAD	1
YPQ000100	IDENTS (SMALL)	1
YRV000040	SPLICE (RED, CSA; 0.25-1.6)	1
YRW000390	WIRE STRIPPER	1
YRW500010	APPLICATOR	1
YRW500060	EXTRACT TOOL	1
YRW500070	EXTRACT TOOL	1
[VUB500190]		

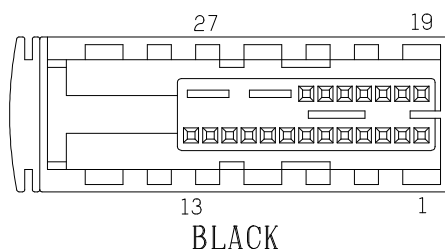

Part No. YPC114730
Colour: BLACK
Gender: M
Type: MQS/MPQ/PQ
No. of Ways: 30WY

Description: Motor-Door lock-Rear
Location: Behind rear door trim panel

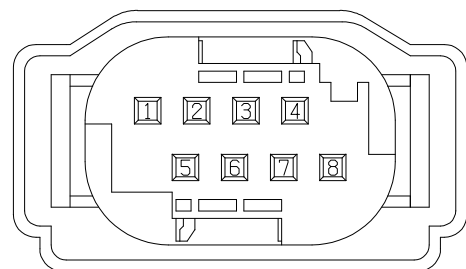
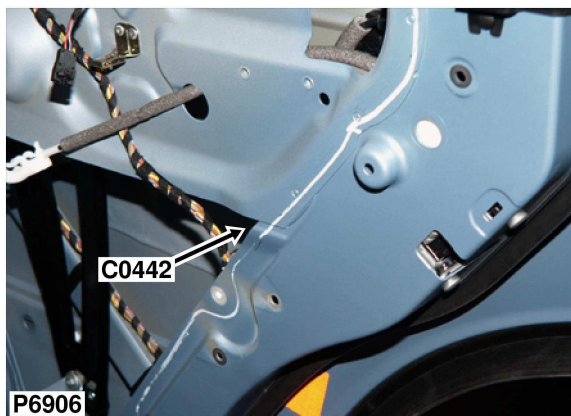

WATERBLUE

Part No. YPC110420
Colour: WATERBLUE
Gender: F
Type: MQS
No. of Ways: 8WY

Wire Chart

CAV	TERMINAL	CSA	COL	CCT	DESTN
4	YPL101510	0.75	W	40	C0803-1
5	YPL101500	0.35	N	134	SJ X834-
6	YPL101500	0.35	NS	134	C0803-12
7	YPL101510	0.75	U	40	C0803-2
8	YPL101510	0.75	B	40	C0803-3

Service Repair Kits

YPL101510		0.75 - 0.75 CSA
Cavities 4-8		
VDK500010	INSTRUCTION; REPAIR KIT	1
VDK500070	INSTRUCTION; EXTRACT TOOL	1
VDK500080	INSTRUCTION; EXTRACT TOOL	1
YMI000950	PRE-TERMINATED LEAD	1
YPQ000100	IDENTS (SMALL)	1
YQD000210	HEAT SHRINK SLEEVE	1
YRV000040	SPLICE (RED, CSA; 0.25-1.6)	1
YRW000390	WIRE STRIPPER	1
YRW500010	APPLICATOR	1

[VUB500150]

Description: Main harness to engine harness

Location: Inside E-box

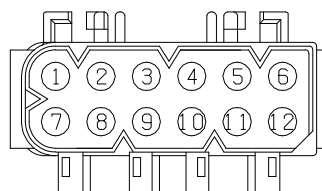
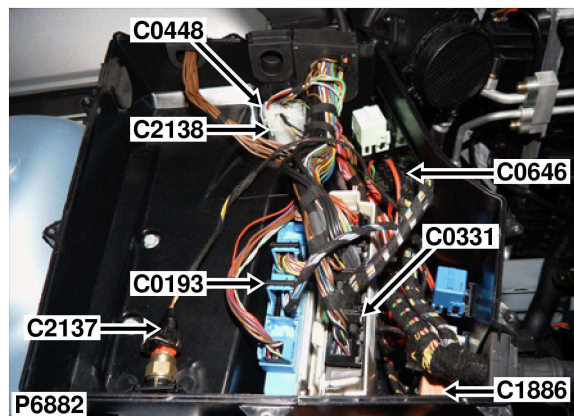

NATURAL

Wire Chart

CAV	TERMINAL	CSA	COL	CCT	DESTN
1	YPD100220	4.0	B	58	C0059-1
1	YPD100220	4.0	B	573	C1455-2
2	YPD10009	1.5	RY	58	C0583-2
3	YPD10010	0.75	G	573	C0028-1
4	YPD100280	0.35	WPY	573	SJ X442-

CAV	TERMINAL	CSA	COL	CCT	DESTN
6	YPD10010	0.75	GW	ALL	C0587-14
7	YPD100220	4.0	RW	ALL	C0584-1
10	YPD10010	0.5	NP	ALL	C0234-19
11	YPD10010	0.5	NY	ALL	C0234-18
12	YPD10010	0.75	GR	58	C0587-9

Service Repair Kits

YPD100220		2.51 - 4.00 CSA
Cavities 1,7		
VDK500010	INSTRUCTION; REPAIR KIT	1
VDK500130	INSTRUCTION; EXTRACT TOOL	1
YMI001110	PRE-TERMINATED LEAD	1
YPQ000120	IDENTS (LARGE)	1
YRV000060	SPLICE (YELLOW, CSA; 2.7-6.6)	1
YRW000390	WIRE STRIPPER	1
YRW500010	APPLICATOR	1

[VUB500310]

YPD10009		1.50 - 2.50 CSA
Cavities 2		
VDK500010	INSTRUCTION; REPAIR KIT	1
VDK500030	INSTRUCTION; EXTRACT TOOL	1
YMI001130	PRE-TERMINATED LEAD	1
YPQ000110	IDENTS (MEDIUM)	1
YRV000050	SPLICE (BLUE, CSA; 1.0-2.6)	1
YRW000390	WIRE STRIPPER	1
YRW500010	APPLICATOR	1

[VUB500330]

YPD100280		0.20 - 0.40 CSA
Cavities 3,4,6,10-12		
VDK500010	INSTRUCTION; REPAIR KIT	1
VDK500130	INSTRUCTION; EXTRACT TOOL	1
YMI000920	PRE-TERMINATED LEAD	1
YPQ000100	IDENTS (SMALL)	1
YRV000040	SPLICE (RED, CSA; 0.25-1.6)	1
YRW000390	WIRE STRIPPER	1
YRW500010	APPLICATOR	1
YRW500120	EXTRACT TOOL	1

[VUB500130]

Part No. YPC112190
Colour: NATURAL
Gender: M
Type: 2.5MM SYSTEM
No. of Ways: 12WY

Description: Main harness to engine harness
Location: Behind passenger side of fascia

No photo
Geen photo
Pas de photo
Kein foto
Senza foto
Sem fotografia
No hay foto

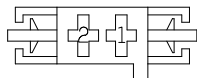

BLACK

Wire Chart

CAV	TERMINAL	CSA	COL	CCT	DESTN
1	8377734	6.0	R	573	C0591-2

No repair kit
Geen reparatiepakke
Pas de nécessaire de reparation
Kein Werkzeug
Senza kit per le riparazioni
Sem kit de reparação
No hay kit de reparación

Part No. 8377082
Colour: BLACK
Gender: F
Type: DFK40
No. of Ways: 2WY

Description: Lamp-Reverse-RH
Location: RH rear of vehicle

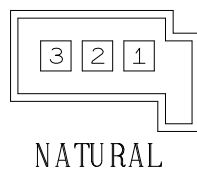
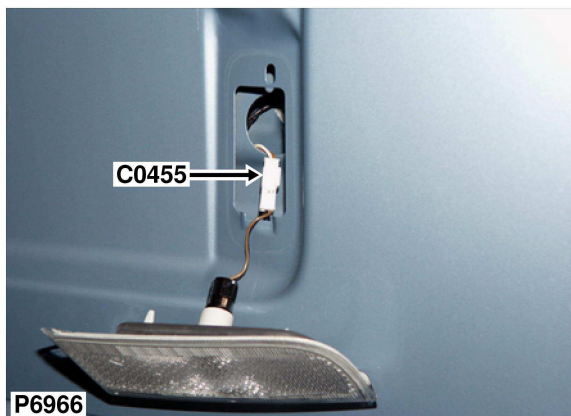

Wire Chart

CAV	TERMINAL	CSA	COL	CCT	DESTN
1	YPJ100850	0.75	N	198	SJ X13276-
2	YPJ100850	0.75	WY	198	C0384-7

Service Repair Kits

YPJ100850		0.75 - 0.75 csa
Cavities 1,2		
VDK500010	INSTRUCTION; REPAIR KIT	1
VDK500070	INSTRUCTION; EXTRACT TOOL	1
VDK500080	INSTRUCTION; EXTRACT TOOL	1
YMI000990	PRE-TERMINATED LEAD	1
YPQ000100	IDENTS (SMALL)	1
YRV000040	SPLICE (RED, CSA; 0.25-1.6)	1
YRW000390	WIRE STRIPPER	1
YRW500010	APPLICATOR	1
YRW500060	EXTRACT TOOL	1
YRW500070	EXTRACT TOOL	1

[VUB500190]

Part No. 6905979
Colour: NATURAL
Gender: M
Type: MQS
No. of Ways: 3WY

Description: Main harness to door harness
Location: Base of driver side 'A' post

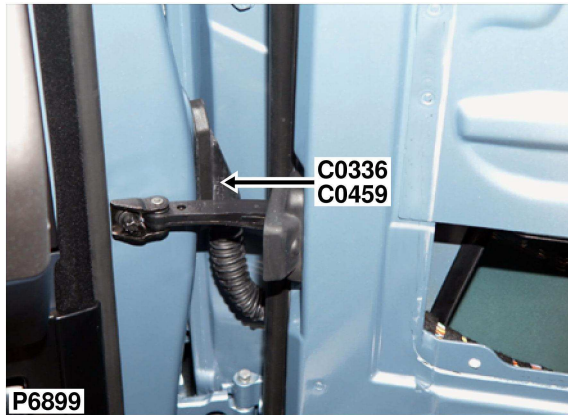

Wire Chart

CAV	TERMINAL	CSA	COL	CCT	DESTN
1	YPJ100830	0.35	YG	ALL	C0867-39
5	YPJ100830	0.5	SR	ALL	C0286-0
9	YPJ100840	MMAK	Y	ALL	C0256-18
10	YPJ100840	MMAK	N	ALL	C0256-19
11	YPJ100850	0.75	RU	ALL	C0586-3
19	YPJ100830	0.5	RG	134	C0587-1
20	YPJ100830	0.35	WR	387	C0698-5

CAV	TERMINAL	CSA	COL	CCT	DESTN
21	YPJ100830	0.35	WU	387	C0698-4
23	YPJ100830	0.35	UR	ALL	C0294-0
26	YPJ100980	4.0	N	ALL	C0553-0
27	YPJ100980	4.0	RP	ALL	C0585-1

Service Repair Kits

YPJ100980		2.51 - 4.00 CSA	
Cavities 26,27			
VDK500010	INSTRUCTION; REPAIR KIT	1	
VDK500050	INSTRUCTION; EXTRACT TOOL	1	
YMI001190	PRE-TERMINATED LEAD	1	
YPQ000120	IDENTS (LARGE)	1	
YRV000060	SPLICE (YELLOW, CSA; 2.7-6.6)	1	
YRW000390	WIRE STRIPPER	1	
YRW500010	APPLICATOR	1	

[VUB500390]

YPJ100850		0.75 - 0.75 CSA	
Cavities 1,5,11,19-21,23			
VDK500010	INSTRUCTION; REPAIR KIT	1	
VDK500070	INSTRUCTION; EXTRACT TOOL	1	
VDK500080	INSTRUCTION; EXTRACT TOOL	1	
YMI000990	PRE-TERMINATED LEAD	1	
YPQ000100	IDENTS (SMALL)	1	
YRV000040	SPLICE (RED, CSA; 0.25-1.6)	1	
YRW000390	WIRE STRIPPER	1	
YRW500010	APPLICATOR	1	
YRW500060	EXTRACT TOOL	1	
YRW500070	EXTRACT TOOL	1	

[VUB500190]

YPJ100840		0.20 - 0.50 CSA	
Cavities 1,5,9,10,19-21,23			
VDK500010	INSTRUCTION; REPAIR KIT	1	
VDK500070	INSTRUCTION; EXTRACT TOOL	1	
VDK500080	INSTRUCTION; EXTRACT TOOL	1	
YMI500010	PRE-TERMINATED LEAD	1	
YPQ000100	IDENTS (SMALL)	1	
YRV000040	SPLICE (RED, CSA; 0.25-1.6)	1	
YRW000390	WIRE STRIPPER	1	
YRW500010	APPLICATOR	1	

[VUB500250]

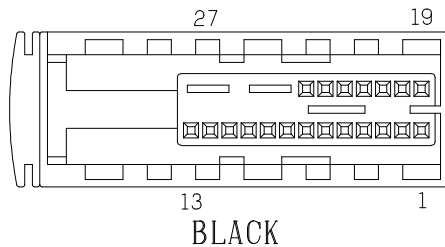

Part No. YPC114730
Colour: BLACK
Gender: M
Type: MQS/MPQ/PQ
No. of Ways: 30WY

Description: Main harness to door harness
Location: Base of passenger side 'A' post

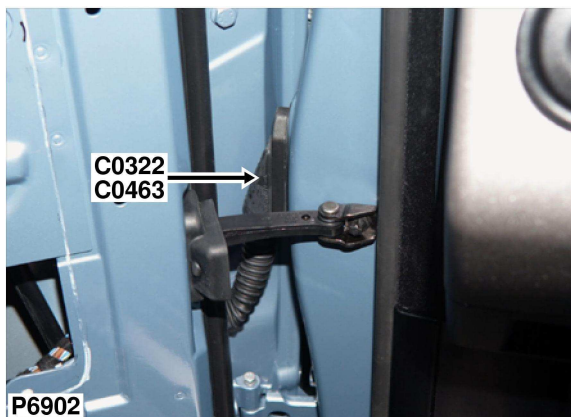

Wire Chart

CAV	TERMINAL	CSA	COL	CCT	DESTN
5	YPJ100830	0.5	SR	ALL	C0724-0
9	YPJ100840	MMM	U	ALL	C0256-16
10	YPJ100840	MMM	N	ALL	C0256-17
11	YPJ100850	0.75	RU	ALL	C0295-0
19	YPJ100830	0.5	RG	134	C0587-17

CAV	TERMINAL	CSA	COL	CCT	DESTN
20	YPJ100830	0.35	WG	387	C0698-7
21	YPJ100830	0.35	WY	387	C0698-6
23	YPJ100830	0.35	UR	ALL	C0294-0
26	YPJ100980	4.0	N	ALL	C0821-0
27	YPJ100980	4.0	RW	ALL	C0583-1

Service Repair Kits

YPJ100980		2.51 - 4.00 CSA
Cavities 26,27		
VDK500010	INSTRUCTION; REPAIR KIT	1
VDK500050	INSTRUCTION; EXTRACT TOOL	1
YMI001190	PRE-TERMINATED LEAD	1
YPQ000120	IDENTS (LARGE)	1
YRV000060	SPLICE (YELLOW, CSA; 2.7-6.6)	1
YRW000390	WIRE STRIPPER	1
YRW500010	APPLICATOR	1

[VUB500390]

YPJ100850		0.75 - 0.75 CSA
Cavities 5,11,19-21,23		
VDK500010	INSTRUCTION; REPAIR KIT	1
VDK500070	INSTRUCTION; EXTRACT TOOL	1
VDK500080	INSTRUCTION; EXTRACT TOOL	1
YMI000990	PRE-TERMINATED LEAD	1
YPQ000100	IDENTS (SMALL)	1
YRV000040	SPLICE (RED, CSA; 0.25-1.6)	1
YRW000390	WIRE STRIPPER	1
YRW500010	APPLICATOR	1
YRW500060	EXTRACT TOOL	1
YRW500070	EXTRACT TOOL	1

[VUB500190]

YPJ100840		0.20 - 0.50 CSA
Cavities 5,9,10,19-21,23		
VDK500010	INSTRUCTION; REPAIR KIT	1
VDK500070	INSTRUCTION; EXTRACT TOOL	1
VDK500080	INSTRUCTION; EXTRACT TOOL	1
YMI500010	PRE-TERMINATED LEAD	1
YPQ000100	IDENTS (SMALL)	1
YRV000040	SPLICE (RED, CSA; 0.25-1.6)	1
YRW000390	WIRE STRIPPER	1
YRW500010	APPLICATOR	1

[VUB500250]

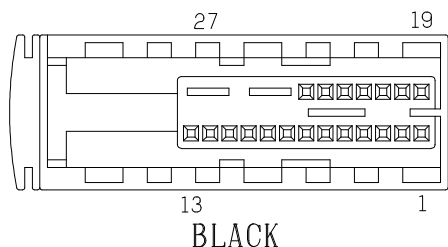

Part No. YPC114730
Colour: BLACK
Gender: M
Type: MQS/MPQ/PQ
No. of Ways: 30WY

Description: Lamp-Reverse-LH

Location: LH rear of vehicle

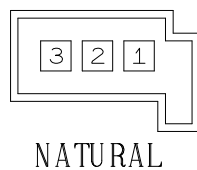
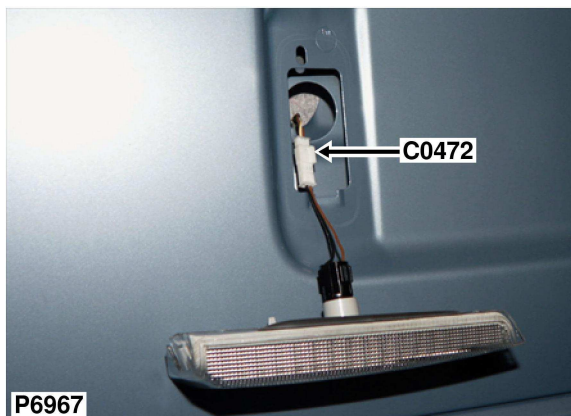

Wire Chart

CAV	TERMINAL	CSA	COL	CCT	DESTN
1	YPJ100850	0.75	N	198	SJ X13276-
2	YPJ100850	0.75	WY	198	C0384-6

Service Repair Kits

YPJ100850		0.75 - 0.75 csa
Cavities 1,2		
VDK500010	INSTRUCTION; REPAIR KIT	1
VDK500070	INSTRUCTION; EXTRACT TOOL	1
VDK500080	INSTRUCTION; EXTRACT TOOL	1
YMI000990	PRE-TERMINATED LEAD	1
YPQ000100	IDENTS (SMALL)	1
YRV000040	SPLICE (RED, CSA; 0.25-1.6)	1
YRW000390	WIRE STRIPPER	1
YRW500010	APPLICATOR	1
YRW500060	EXTRACT TOOL	1
YRW500070	EXTRACT TOOL	1

[VUB500190]

Part No. 6905979
Colour: NATURAL
Gender: M
Type: MQS
No. of Ways: 3WY

Description: Main harness to trailer harness
Location: Rear of luggage compartment - RH side

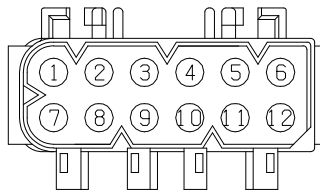
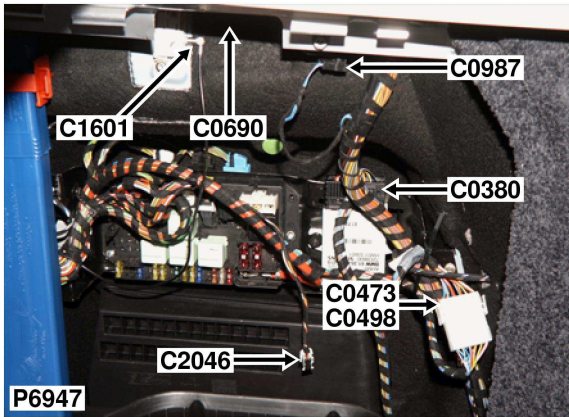

NATURAL

Wire Chart

CAV	TERMINAL	CSA	COL	CCT	DESTN
1	YPD100220	4.0	RW	394	C2023-3
2	YPD10010	0.5	GY	394	C2022-9
3	YPD10009	1.5	RY	394	C2020-7
4	YPD10009	2.5	RU	394	C2020-1
5	YPD100280	0.35	UNY	394	C2040-35

CAV	TERMINAL	CSA	COL	CCT	DESTN
6	YPD10010	0.5	UG	394	SJ X184-
9	YPD10010	0.5	UN	394	SJ X185-
10	YPD10010	0.5	BU	394	SJ X10197-
11	YPD10010	0.5	SW	394	SJ X245-
12	YPD10010	0.5	SP	394	SJ X246-

Service Repair Kits

YPD100220		2.51 - 4.00 CSA
Cavities 1		
VDK500010	INSTRUCTION; REPAIR KIT	1
VDK500130	INSTRUCTION; EXTRACT TOOL	1
YMI001110	PRE-TERMINATED LEAD	1
YPQ000120	IDENTS (LARGE)	1
YRV000060	SPLICE (YELLOW, CSA; 2.7-6.6)	1
YRW000390	WIRE STRIPPER	1
YRW500010	APPLICATOR	1

[VUB500310]

YPD10009		1.50 - 2.50 CSA
Cavities 3,4		
VDK500010	INSTRUCTION; REPAIR KIT	1
VDK500030	INSTRUCTION; EXTRACT TOOL	1
YMI001130	PRE-TERMINATED LEAD	1
YPQ000110	IDENTS (MEDIUM)	1
YRV000050	SPLICE (BLUE, CSA; 1.0-2.6)	1
YRW000390	WIRE STRIPPER	1
YRW500010	APPLICATOR	1

[VUB500330]

YPD100280		0.20 - 0.40 CSA
Cavities 2,5,6,9-12		
VDK500010	INSTRUCTION; REPAIR KIT	1
VDK500130	INSTRUCTION; EXTRACT TOOL	1
YMI000920	PRE-TERMINATED LEAD	1
YPQ000100	IDENTS (SMALL)	1
YRV000040	SPLICE (RED, CSA; 0.25-1.6)	1
YRW000390	WIRE STRIPPER	1
YRW500010	APPLICATOR	1
YRW500120	EXTRACT TOOL	1

[VUB500130]

Part No. YPC112190
Colour: NATURAL
Gender: M
Type: 2.5MM SYSTEM
No. of Ways: 12WY

Description: Sensor-ABS-Rear-LH
Location: Below LH rear wheelarch

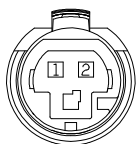
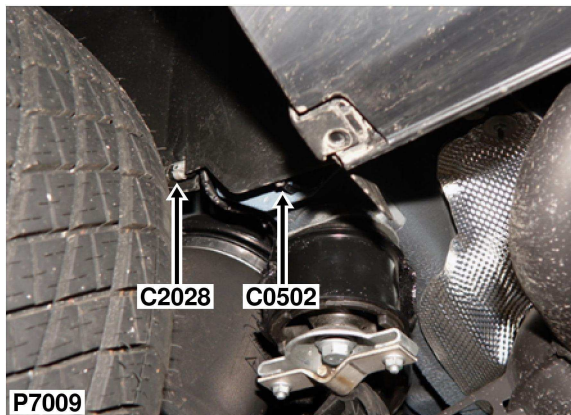

BLUE

Wire Chart

CAV	TERMINAL	CSA	COL	CCT	DESTN
1	YPL101500	MMS	W	ALL	C0506-29
2	YPL101500	MMS	UW	ALL	C0506-13

Service Repair Kits

YPL101500		0.20 - 0.50 CSA
Cavities 1,2		
VDK500010	INSTRUCTION; REPAIR KIT	1
VDK500070	INSTRUCTION; EXTRACT TOOL	1
VDK500080	INSTRUCTION; EXTRACT TOOL	1
YMI000950	PRE-TERMINATED LEAD	1
YPQ000100	IDENTS (SMALL)	1
YQD000210	HEAT SHRINK SLEEVE	1
YRV000040	SPLICE (RED, CSA; 0.25-1.6)	1
YRW000390	WIRE STRIPPER	1
YRW500010	APPLICATOR	1

[VUB500150]

Part No. YPC110510
Colour: BLUE
Gender: F
Type: MQS
No. of Ways: 2WY

Description: Sensor-ABS-Rear-RH
Location: Below RH rear wheelarch

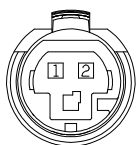
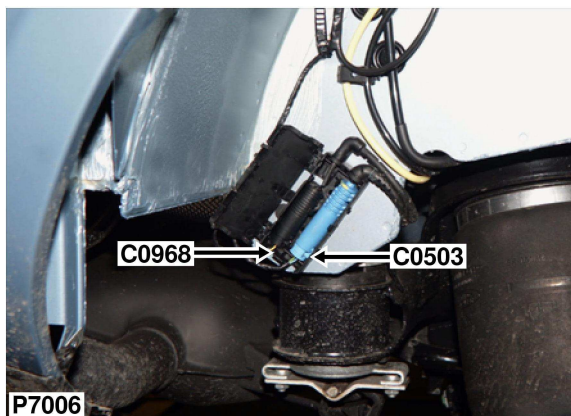

BLUE

Wire Chart

CAV	TERMINAL	CSA	COL	CCT	DESTN
1	YPL101500	MMU	G	ALL	C0506-31
2	YPL101500	MMU	UG	ALL	C0506-14

Service Repair Kits

YPL101500		0.20 - 0.50 CSA
Cavities 1,2		
VDK500010	INSTRUCTION; REPAIR KIT	1
VDK500070	INSTRUCTION; EXTRACT TOOL	1
VDK500080	INSTRUCTION; EXTRACT TOOL	1
YMI000950	PRE-TERMINATED LEAD	1
YPQ000100	IDENTS (SMALL)	1
YQD000210	HEAT SHRINK SLEEVE	1
YRV000040	SPLICE (RED, CSA; 0.25-1.6)	1
YRW000390	WIRE STRIPPER	1
YRW500010	APPLICATOR	1

[VUB500150]

Part No. YPC110510
Colour: BLUE
Gender: F
Type: MQS
No. of Ways: 2WY

Description: ECU-ABS
Location: Rear LH side of engine compartment

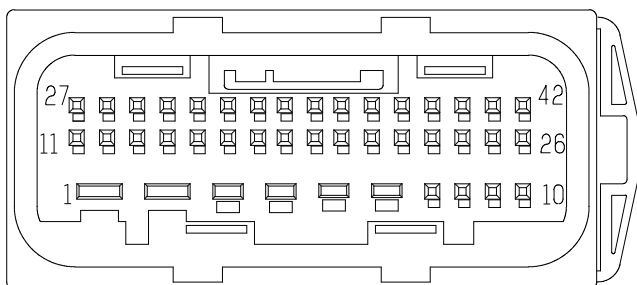
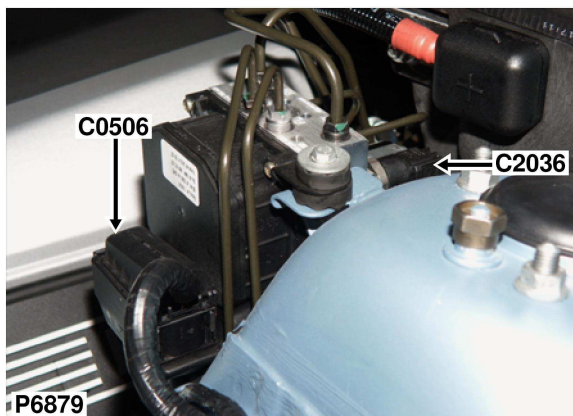

BLACK/BLUE

Part No. 6908994
Colour: BLACK
Gender: F
Type: MICRO POWER QUADLOK
No. of Ways: 42WY

Wire Chart

CAV	TERMINAL	CSA	COL	CCT	DESTN
1	YPL102770	4.0	N	ALL	C0362-0
2	YPL102770	4.0	R	ALL	C0580-1
3	YPL102750	2.5	BG	ALL	C0507-2
4	YPL102750	2.5	BN	ALL	C0507-1
5	YPL102750	2.5	N	ALL	C0362-0
6	YPL102750	2.5	RB	ALL	C0583-4
7	YPL101500	0.35	YN	ALL	C2040-47
8	YPL101500	0.5	NBY	ALL	C0195-5
9	YPL101500	0.5	WRY	ALL	C0195-2
10	YPL101500	0.5	WUY	ALL	C0195-1
11	YPL101500	0.35	WP	ALL	SJ X183-
12	YPL101500	MMN	R	ALL	C0516-1
13	YPL101500	MMS	UW	ALL	C0502-2
14	YPL101500	MMU	UG	ALL	C0503-2
15	YPL101500	MMV	UY	ALL	C0517-2
16	YPL101500	MMV	Y	ALL	C0517-1
17	YPL101500	0.35	BG	ALL	C0365-3
18	YPL101500	0.35	YW	574	C1543-24
19	YPL101500	0.35	YG	ALL	C0331-22

CAV	TERMINAL	CSA	COL	CCT	DESTN
20	YPL101500	0.35	SB	ALL	C0230-15
21	YPL101500	0.5	UWY	ALL	C0195-6
23	YPL101510	0.75	RW	ALL	C0584-6
24	YPL101500	MMT	YB	ALL	SJ X18827-
25	YPL101510	0.75	WU	ALL	C2036-1
26	YPL101510	0.75	UB	ALL	C2036-2
27	YPL101500	0.5	BY	ALL	C0700-7
28	YPL101500	MMN	UR	ALL	C0516-2
29	YPL101500	MMS	W	ALL	C0502-1
31	YPL101500	MMU	G	ALL	C0503-1
32	YPL101500	0.35	UR	ALL	SJ X181-
34	YPL101500	0.35	NR	ALL	SJ X1101-
35	YPL101500	0.35	YR	148	C1604-1
36	YPL101500	0.35	NGY	ALL	SJ X1123-
39	YPL101500	0.5	WSY	ALL	C0195-3
40	YPL101500	MMT	YN	ALL	SJ X18826-
41	YPL101500	0.5	BRY	ALL	C0195-4
42	YPL101510	0.75	BP	ALL	C2036-3

Service Repair Kits

YPL102770		2.51 - 4.00 CSA
Cavities 1,2		
VDK500010	INSTRUCTION; REPAIR KIT	1
VDK500050	INSTRUCTION; EXTRACT TOOL	1
YMI001210	PRE-TERMINATED LEAD	1
YPQ000120	IDENTS (LARGE)	1
YQD000220	HEAT SHRINK SLEEVE	1
YRV000060	SPLICE (YELLOW, CSA; 2.7-6.6)	1
YRW000390	WIRE STRIPPER	1
YRW500010	APPLICATOR	1
YRW500040	EXTRACT TOOL	1

[VUB500410]

YPL102750		1.01 - 2.50 CSA
Cavities 3-6		
VDK500010	INSTRUCTION; REPAIR KIT	1
VDK500030	INSTRUCTION; EXTRACT TOOL	1
YMI000970	PRE-TERMINATED LEAD	1
YPQ000110	IDENTS (MEDIUM)	1
YQD000210	HEAT SHRINK SLEEVE	1
YRV000050	SPLICE (BLUE, CSA; 1.0-2.6)	1
YRW000390	WIRE STRIPPER	1
YRW500010	APPLICATOR	1

[VUB500170]

YPL101510		0.75 - 0.75 CSA
Cavities 7-21,23-29,31,32,34-36,39-42		
VDK500010	INSTRUCTION; REPAIR KIT	1
VDK500070	INSTRUCTION; EXTRACT TOOL	1
VDK500080	INSTRUCTION; EXTRACT TOOL	1
YMI000950	PRE-TERMINATED LEAD	1
YPQ000100	IDENTS (SMALL)	1
YQD000210	HEAT SHRINK SLEEVE	1
YRV000040	SPLICE (RED, CSA; 0.25-1.6)	1
YRW000390	WIRE STRIPPER	1
YRW500010	APPLICATOR	1

[VUB500150]

Description: Pump-Return-ABS
Location: Rear of engine compartment

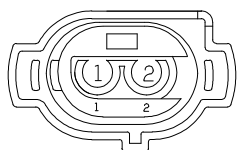
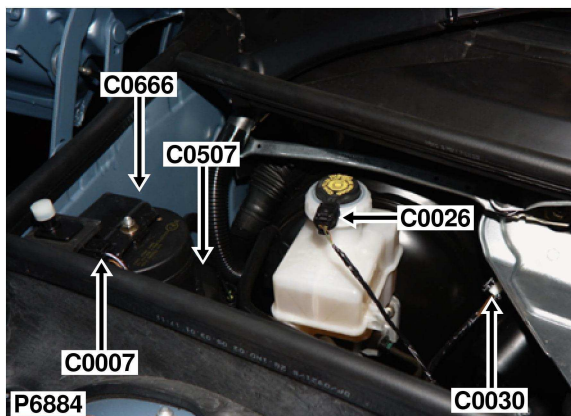

BLACK

Wire Chart

CAV	TERMINAL	CSA	COL	CCT	DESTN
1	YPE100330	2.5	BN	ALL	C0506-4
2	YPE100330	2.5	BG	ALL	C0506-3

Service Repair Kits

YPE100330		1.01 - 2.50 csa
Cavities 1,2		
VDK500010	INSTRUCTION; REPAIR KIT	1
VDK500130	INSTRUCTION; EXTRACT TOOL	1
YMI001000	PRE-TERMINATED LEAD	1
YPQ000110	IDENTS (MEDIUM)	1
YQD000210	HEAT SHRINK SLEEVE	1
YRV000050	SPLICE (BLUE, CSA; 1.0-2.6)	1
YRW000390	WIRE STRIPPER	1
YRW500010	APPLICATOR	1
YRW500120	EXTRACT TOOL	1

[VUB500200]

Part No. YPC110300
Colour: BLACK
Gender: F
Type: 2.5MM SYSTEM
No. of Ways: 2WY

Description: Lamp-Fog-Front-RH
Location: Front of vehicle - RH side

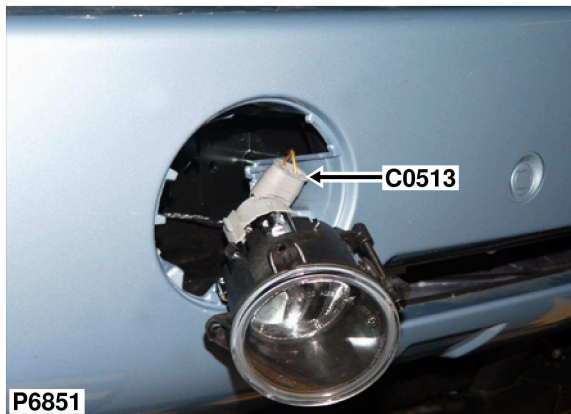

Wire Chart

CAV	TERMINAL	CSA	COL	CCT	DESTN
1	YPL101450	1.0	N	ALL	C0018-0
2	YPL101450	1.0	YN	ALL	C0937-4

Service Repair Kits

YPL101450		0.50 - 1.00 <small>CSA</small>
Cavities 1,2		
VDK500010	INSTRUCTION; REPAIR KIT	1
YMI000500	PRE-TERMINATED LEAD	1
YPQ000100	IDENTS (SMALL)	1
YQD000210	HEAT SHRINK SLEEVE	1
YRV000040	SPLICE (RED, CSA; 0.25-1.6)	1
YRW000390	WIRE STRIPPER	1
YRW500010	APPLICATOR	1

[VUB001860]

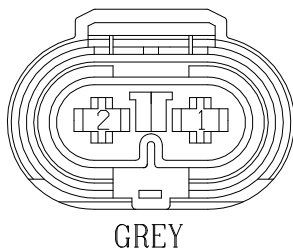

Part No. YPC118750
Colour: GREY
Gender: F
Type: JUNIOR POWER TIMER
No. of Ways: 2WY

Description: Lamp-Fog-Front-LH
Location: Front of vehicle - LH side



Wire Chart

CAV	TERMINAL	CSA	COL	CCT	DESTN
1	YPL101450	1.0	N	ALL	C0017-0
2	YPL101450	1.0	YR	ALL	C2039-7

Service Repair Kits

YPL101450		0.50 - 1.00 <small>CSA</small>
Cavities 1,2		
VDK500010	INSTRUCTION; REPAIR KIT	1
YMI000500	PRE-TERMINATED LEAD	1
YPQ000100	IDENTS (SMALL)	1
YQD000210	HEAT SHRINK SLEEVE	1
YRV000040	SPLICE (RED, CSA; 0.25-1.6)	1
YRW000390	WIRE STRIPPER	1
YRW500010	APPLICATOR	1

[VUB001860]

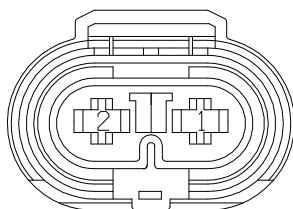

GREY

Part No. YPC118750
Colour: GREY
Gender: F
Type: JUNIOR POWER TIMER
No. of Ways: 2WY

Description: Sensor-ABS-Front-LH
Location: Behind LH front wheel arch liner

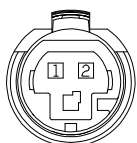
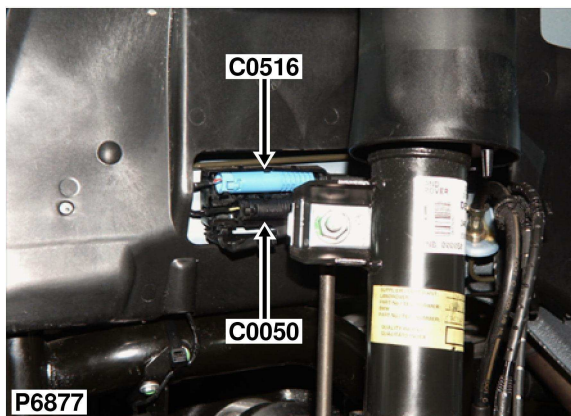

BLUE

Wire Chart

CAV	TERMINAL	CSA	COL	CCT	DESTN
1	YPL101500	MMN	R	ALL	C0506-12
2	YPL101500	MMN	UR	ALL	C0506-28

Service Repair Kits

YPL101500		0.20 - 0.50 CSA
Cavities 1,2		
VDK500010	INSTRUCTION; REPAIR KIT	1
VDK500070	INSTRUCTION; EXTRACT TOOL	1
VDK500080	INSTRUCTION; EXTRACT TOOL	1
YMI000950	PRE-TERMINATED LEAD	1
YPQ000100	IDENTS (SMALL)	1
YQD000210	HEAT SHRINK SLEEVE	1
YRV000040	SPLICE (RED, CSA; 0.25-1.6)	1
YRW000390	WIRE STRIPPER	1
YRW500010	APPLICATOR	1

[VUB500150]

Part No. YPC110510
Colour: BLUE
Gender: F
Type: MQS
No. of Ways: 2WY

Description: Sensor-ABS-Front-RH
Location: Behind RH front wheel arch liner

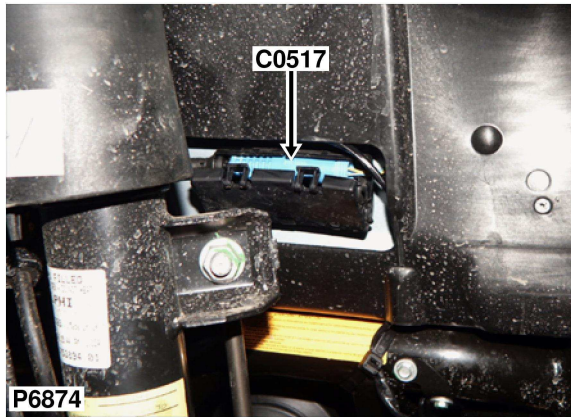

Wire Chart

CAV	TERMINAL	CSA	COL	CCT	DESTN
1	YPL101500	MMV	Y	ALL	C0506-16
2	YPL101500	MMV	UY	ALL	C0506-15

Service Repair Kits

YPL101500		0.20 - 0.50 CSA
Cavities 1,2		
VDK500010	INSTRUCTION; REPAIR KIT	1
VDK500070	INSTRUCTION; EXTRACT TOOL	1
VDK500080	INSTRUCTION; EXTRACT TOOL	1
YMI000950	PRE-TERMINATED LEAD	1
YPQ000100	IDENTS (SMALL)	1
YQD000210	HEAT SHRINK SLEEVE	1
YRV000040	SPLICE (RED, CSA; 0.25-1.6)	1
YRW000390	WIRE STRIPPER	1
YRW500010	APPLICATOR	1

[VUB500150]

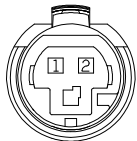

BLUE

Part No. YPC110510
Colour: BLUE
Gender: F
Type: MQS
No. of Ways: 2WY

Description: Speakers-High Range
Location: Behind driver's door trim panel

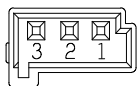
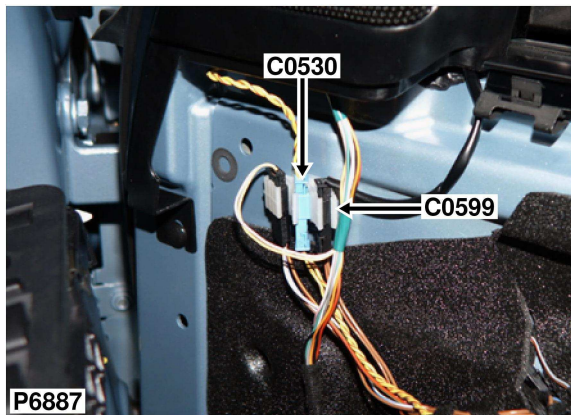

BLUE

Part No. 6905981
Colour: BLUE
Gender: M
Type: MQS
No. of Ways: 3WY

Wire Chart

CAV	TERMINAL	CSA	COL	CCT	DESTN
1	YPJ100830	MMB	YN	126	C0336-15
2	YPJ100830	MMB	YR	126	C0336-14

Service Repair Kits

YPJ100830		0.20 - 0.50 csa
Cavities 1,2		
VDK500010	INSTRUCTION; REPAIR KIT	1
VDK500070	INSTRUCTION; EXTRACT TOOL	1
VDK500080	INSTRUCTION; EXTRACT TOOL	1
YMI000990	PRE-TERMINATED LEAD	1
YPQ000100	IDENTS (SMALL)	1
YRV000040	SPLICE (RED, CSA; 0.25-1.6)	1
YRW000390	WIRE STRIPPER	1
YRW500010	APPLICATOR	1
YRW500060	EXTRACT TOOL	1
YRW500070	EXTRACT TOOL	1

[VUB500190]

Description: Speakers-High Range
Location: Behind passenger's door trim panel

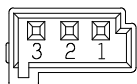
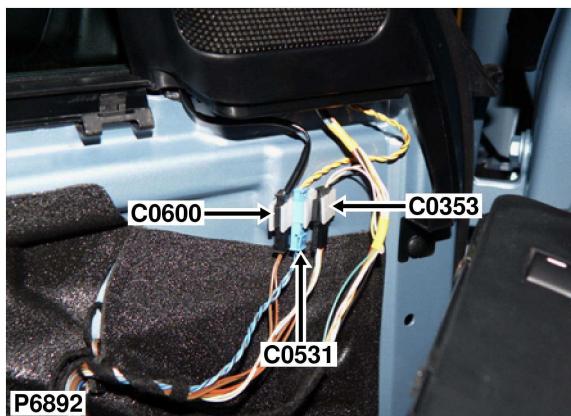

BLUE

Part No. 6905981
Colour: BLUE
Gender: M
Type: MQS
No. of Ways: 3WY

Wire Chart

CAV	TERMINAL	CSA	COL	CCT	DESTN
1	YPJ100830	MMC	UN	126	C0322-15
2	YPJ100830	MMC	UB	126	C0322-14

Service Repair Kits

YPJ100830		0.20 - 0.50 csa
Cavities 1,2		
VDK500010	INSTRUCTION; REPAIR KIT	1
VDK500070	INSTRUCTION; EXTRACT TOOL	1
VDK500080	INSTRUCTION; EXTRACT TOOL	1
YMI000990	PRE-TERMINATED LEAD	1
YPQ000100	IDENTS (SMALL)	1
YRV000040	SPLICE (RED, CSA; 0.25-1.6)	1
YRW000390	WIRE STRIPPER	1
YRW500010	APPLICATOR	1
YRW500060	EXTRACT TOOL	1
YRW500070	EXTRACT TOOL	1

[VUB500190]

Description: Lamp-Side-Front-RH
Location: Behind RH side of front bumper

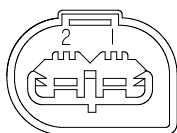
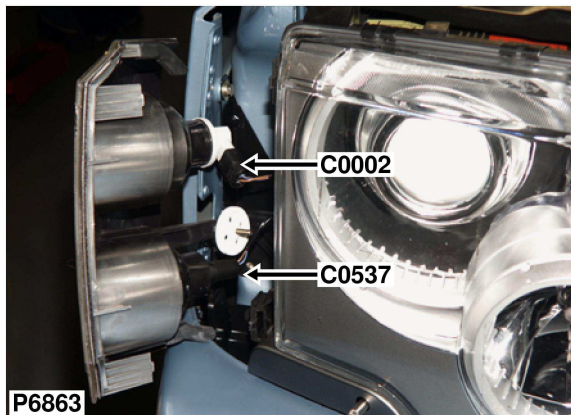

NATURAL

Wire Chart

CAV	TERMINAL	CSA	COL	CCT	DESTN
1	YPL102740	0.5	N	ALL	C0018-0
2	YPL102740	0.5	SU	ALL	C0937-3

Service Repair Kits

YPL102740		0.50 - 1.00 CSA
Cavities 1,2		
VDK500010	INSTRUCTION; REPAIR KIT	1
VDK500030	INSTRUCTION; EXTRACT TOOL	1
YMI001140	PRE-TERMINATED LEAD	1
YPQ000100	IDENTS (SMALL)	1
YQD000210	HEAT SHRINK SLEEVE	1
YRV000040	SPLICE (RED, CSA; 0.25-1.6)	1
YRW000390	WIRE STRIPPER	1
YRW500010	APPLICATOR	1

[VUB500340]

Part No. 8373330
Colour: NATURAL
Gender: F
Type: MICRO POWER QUADLOK
No. of Ways: 2WY

Description: Lamp-Side-Front-LH
Location: Behind LH side of front bumper

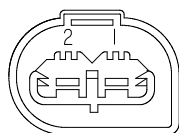
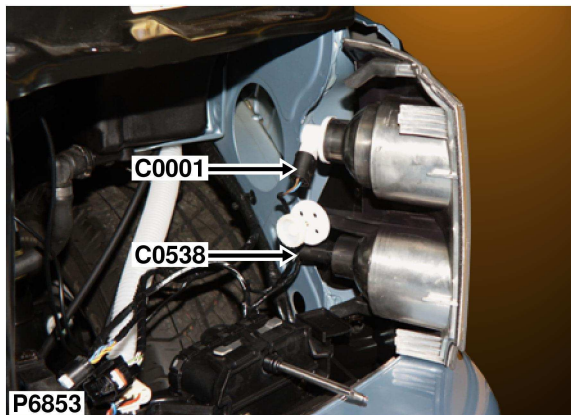

NATURAL

Wire Chart

CAV	TERMINAL	CSA	COL	CCT	DESTN
1	YPL102740	0.5	N	ALL	C0551-0
2	YPL102740	0.5	SG	ALL	C2040-18

Service Repair Kits

YPL102740		0.50 - 1.00 csa
Cavities 1,2		
VDK500010	INSTRUCTION; REPAIR KIT	1
VDK500030	INSTRUCTION; EXTRACT TOOL	1
YMI001140	PRE-TERMINATED LEAD	1
YPQ000100	IDENTS (SMALL)	1
YQD000210	HEAT SHRINK SLEEVE	1
YRV000040	SPLICE (RED, CSA; 0.25-1.6)	1
YRW000390	WIRE STRIPPER	1
YRW500010	APPLICATOR	1

[VUB500340]

Part No. 8373330
Colour: NATURAL
Gender: F
Type: MICRO POWER QUADLOK
No. of Ways: 2WY

Description: ECU-Delay-Windscreen wiper
Location: Rear LH side of engine compartment

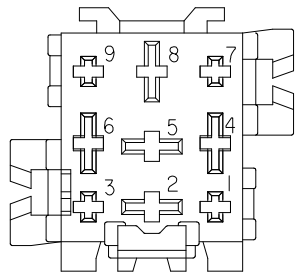
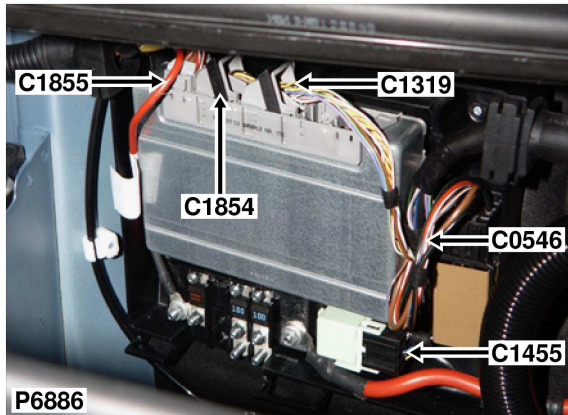

BLACK

Part No. YPP100210
Colour: BLACK
Gender: F
Type: BASE - F4 RELAY
No. of Ways: 9WY

Wire Chart

CAV	TERMINAL	CSA	COL	CCT	DESTN
1	1393785	0.35	NU	ALL	C0661-15
2	YPL102900	2.5	RW	ALL	C0583-10
3	1393785	0.35	NW	ALL	C0661-16

CAV	TERMINAL	CSA	COL	CCT	DESTN
4	YPL102900	2.5	BG	ALL	C0030-2
5	YPL102900	2.5	N	ALL	C0285-0
6	YPL102900	2.5	BN	ALL	C0030-3

Service Repair Kits

YPL102900		1.50 - 2.50 CSA
Cavities 2,4-6		
VDK500010	INSTRUCTION; REPAIR KIT	1
VDK500110	INSTRUCTION; EXTRACT TOOL	1
YMI001120	PRE-TERMINATED LEAD	1
YPQ000110	IDENTS (MEDIUM)	1
YRV000050	SPLICE (BLUE, CSA; 1.0-2.6)	1
YRW000390	WIRE STRIPPER	1
YRW500010	APPLICATOR	1

[VUB500320]

Description: Earth

Location: Front RH side of engine compartment

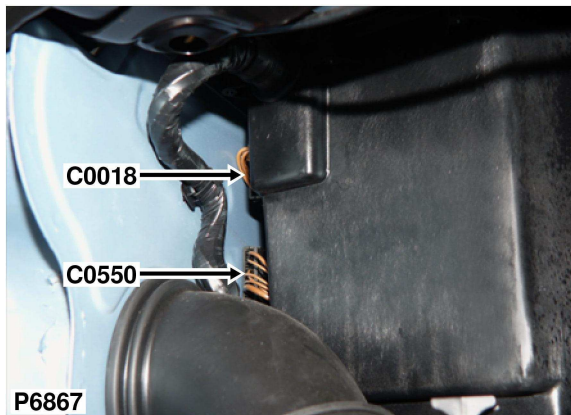

Wire Chart

CAV	TERMINAL	CSA	COL	CCT	DESTN
0	YPL103890	0.75	N	ALL	C0003-1
0	YPL103890	0.75	N	ALL	C0004-1
0	YPL103900	1.5	N	279	C1341-3

CAV	TERMINAL	CSA	COL	CCT	DESTN
0	YPL103890	0.75	N	ALL	C0002-2
0	YPL104290	4.0	N	573	C0879-1
0	YPL103880	0.5	N	ALL	C0012-1

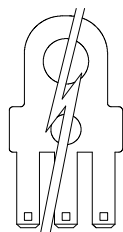

Part No. YPH900780
Colour: COPPER, TIN PLATED
Gender: M
Type: HEADER COVER
No. of Ways: 17WY

Description: Earth
Location: Front RH side of engine compartment

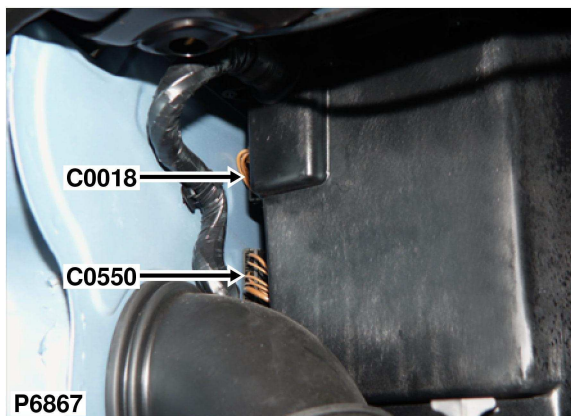

Service Repair Kits

YPL103890		0.75 - 1.00 CSA
Cavities 0		
VDK500010	INSTRUCTION; REPAIR KIT	1
VDK500030	INSTRUCTION; EXTRACT TOOL	1
YMI000880	PRE-TERMINATED LEAD	1
YPQ000100	IDENTS (SMALL)	1
YRV000040	SPLICE (RED, CSA; 0.25-1.6)	1
YRW000390	WIRE STRIPPER	1
YRW500010	APPLICATOR	1
YRW500020	EXTRACT TOOL	1

[VUB500090]

YPL103880		0.20 - 0.50 CSA
Cavities 0		
VDK500010	INSTRUCTION; REPAIR KIT	1
VDK500030	INSTRUCTION; EXTRACT TOOL	1
YMI000850	PRE-TERMINATED LEAD	1
YPQ000100	IDENTS (SMALL)	1
YRV000040	SPLICE (RED, CSA; 0.25-1.6)	1
YRW000390	WIRE STRIPPER	1
YRW500010	APPLICATOR	1
YRW500020	EXTRACT TOOL	1

[VUB500060]

YPL103900		1.50 - 2.50 CSA
Cavities 0		
VDK500010	INSTRUCTION; REPAIR KIT	1
VDK500030	INSTRUCTION; EXTRACT TOOL	1
YMI000890	PRE-TERMINATED LEAD	1
YPQ000110	IDENTS (MEDIUM)	1
YRV000050	SPLICE (BLUE, CSA; 1.0-2.6)	1
YRW000390	WIRE STRIPPER	1
YRW500010	APPLICATOR	1

[VUB500100]

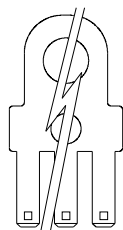

YPL104290		4.00 - 6.00 CSA
Cavities 0		
VDK500010	INSTRUCTION; REPAIR KIT	1
VDK500030	INSTRUCTION; EXTRACT TOOL	1
YMI000960	PRE-TERMINATED LEAD	1
YPQ000120	IDENTS (LARGE)	1
YRV000060	SPLICE (YELLOW, CSA; 2.7-6.6)	1
YRW000390	WIRE STRIPPER	1
YRW500010	APPLICATOR	1

[VUB500160]

Part No. YPH900780
Colour: COPPER, TIN PLATED
Gender: M
Type: HEADER COVER
No. of Ways: 17WY

[continuation]

Description: Header-Earth
Location: Front LH side of engine compartment

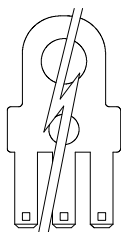
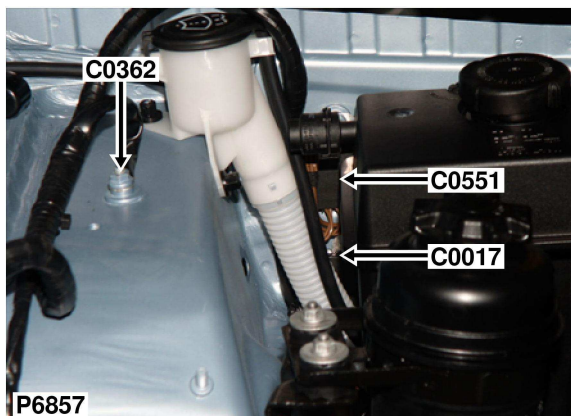

Wire Chart

CAV	TERMINAL	CSA	COL	CCT	DESTN
0	YPL103900	1.5	N	ALL	C0009-8
0	YPL103900	1.5	N	ALL	C0009-7
0	YPL103900	2.5	N	391	C0925-2
0	YPL103880	0.5	N	ALL	C0538-1
0	YPL103890	0.75	N	ALL	C2035-1

CAV	TERMINAL	CSA	COL	CCT	DESTN
0	YPL103890	0.75	N	ALL	C0001-2
0	YPL103900	2.5	N	97	C0925-2

Service Repair Kits

YPL103890		0.75 - 1.00 CSA	
Cavities 0			
VDK500010	INSTRUCTION; REPAIR KIT	1	
VDK500030	INSTRUCTION; EXTRACT TOOL	1	
YMI000880	PRE-TERMINATED LEAD	1	
YPQ000100	IDENTS (SMALL)	1	
YRV000040	SPLICE (RED, CSA; 0.25-1.6)	1	
YRW000390	WIRE STRIPPER	1	
YRW500010	APPLICATOR	1	
YRW500020	EXTRACT TOOL	1	

[VUB500090]

YPL103880		0.20 - 0.50 CSA	
Cavities 0			
VDK500010	INSTRUCTION; REPAIR KIT	1	
VDK500030	INSTRUCTION; EXTRACT TOOL	1	
YMI000880	PRE-TERMINATED LEAD	1	
YPQ000100	IDENTS (SMALL)	1	
YRV000040	SPLICE (RED, CSA; 0.25-1.6)	1	
YRW000390	WIRE STRIPPER	1	
YRW500010	APPLICATOR	1	
YRW500020	EXTRACT TOOL	1	

[VUB500060]

YPL103900		1.50 - 2.50 CSA	
Cavities 0			
VDK500010	INSTRUCTION; REPAIR KIT	1	
VDK500030	INSTRUCTION; EXTRACT TOOL	1	
YMI000880	PRE-TERMINATED LEAD	1	
YPQ000110	IDENTS (MEDIUM)	1	
YRV000050	SPLICE (BLUE, CSA; 1.0-2.6)	1	
YRW000390	WIRE STRIPPER	1	
YRW500010	APPLICATOR	1	

[VUB500100]

Part No. YPH900780
Colour: COPPER, TIN PLATED
Gender: M
Type: HEADER COVER
No. of Ways: 17WY

Description: Header-Earth
Location: Base of RH 'A' post

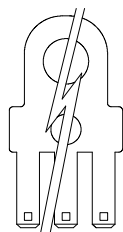
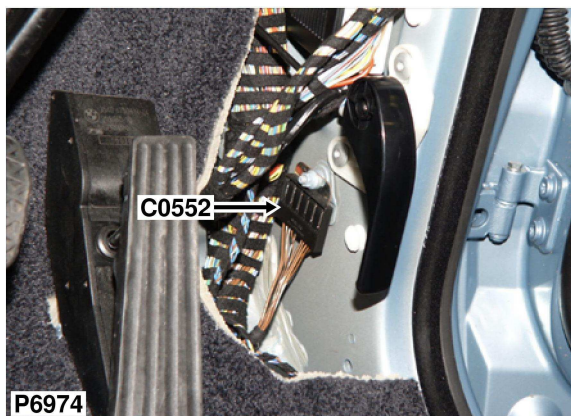

Wire Chart

CAV	TERMINAL	CSA	COL	CCT	DESTN
0	YPL103880	0.5	NB	ALL	C0937-7
0	YPL103890	1.0	NB	ALL	SJ X230-
0	YPL103890	1.0	NB	ALL	SJ X3361-
0	YPL103890	1.0	NB	ALL	SJ X217-
0	YPL103880	0.5	NB	ALL	C0736-1

Service Repair Kits

YPL103890		0.75 - 1.00 CSA
Cavities 0		
VDK500010	INSTRUCTION; REPAIR KIT	1
VDK500030	INSTRUCTION; EXTRACT TOOL	1
YMI000880	PRE-TERMINATED LEAD	1
YPQ000100	IDENTS (SMALL)	1
YRV000040	SPLICE (RED, CSA; 0.25-1.6)	1
YRW000390	WIRE STRIPPER	1
YRW500010	APPLICATOR	1
YRW500020	EXTRACT TOOL	1

[VUB500090]

YPL103880		0.20 - 0.50 CSA
Cavities 0		
VDK500010	INSTRUCTION; REPAIR KIT	1
VDK500030	INSTRUCTION; EXTRACT TOOL	1
YMI000850	PRE-TERMINATED LEAD	1
YPQ000100	IDENTS (SMALL)	1
YRV000040	SPLICE (RED, CSA; 0.25-1.6)	1
YRW000390	WIRE STRIPPER	1
YRW500010	APPLICATOR	1
YRW500020	EXTRACT TOOL	1

[VUB500060]

Part No. YPH900780
Colour: COPPER, TIN PLATED
Gender: M
Type: HEADER COVER
No. of Ways: 17WY

Description: Header-Earth
Location: Beneath LH seat

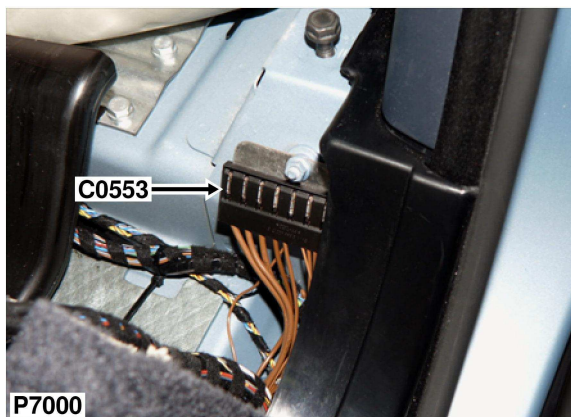

Wire Chart

CAV	TERMINAL	CSA	COL	CCT	DESTN
0	YPL103890	1.0	N	572	C2042-3
0	YPL103900	2.5	N	204	C0253-24
0	YPL103890	1.0	N	572	C2043-3
0	YPL103880	0.5	N	ALL	C2039-2
0	YPL103900	2.5	N	ALL	C0868-5

CAV	TERMINAL	CSA	COL	CCT	DESTN
0	YPL103890	0.75	N	ALL	C0436-4
0	YPL104290	4.0	N	ALL	C0459-26
0	YPL104290	4.0	N	109	C0246-1
0	YPL104290	4.0	N	208	C0253-14
0	YPL103900	2.5	N	ALL	C0086-1

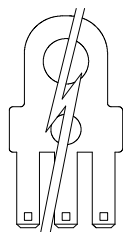

Part No. YPH900780
Colour: COPPER, TIN PLATED
Gender: M
Type: HEADER COVER
No. of Ways: 17WY

Description: Header-Earth
Location: Beneath LH seat

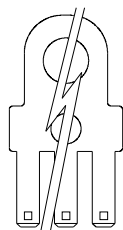

Service Repair Kits

YPL103890		0.75 - 1.00 CSA
Cavities 0		
VDK500010	INSTRUCTION; REPAIR KIT	1
VDK500030	INSTRUCTION; EXTRACT TOOL	1
YMI000880	PRE-TERMINATED LEAD	1
YPQ000100	IDENTS (SMALL)	1
YRV000040	SPLICE (RED, CSA; 0.25-1.6)	1
YRW000390	WIRE STRIPPER	1
YRW500010	APPLICATOR	1
YRW500020	EXTRACT TOOL	1

[VUB500090]

YPL103880		0.20 - 0.50 CSA
Cavities 0		
VDK500010	INSTRUCTION; REPAIR KIT	1
VDK500030	INSTRUCTION; EXTRACT TOOL	1
YMI000850	PRE-TERMINATED LEAD	1
YPQ000100	IDENTS (SMALL)	1
YRV000040	SPLICE (RED, CSA; 0.25-1.6)	1
YRW000390	WIRE STRIPPER	1
YRW500010	APPLICATOR	1
YRW500020	EXTRACT TOOL	1

[VUB500060]

YPL103900		1.50 - 2.50 CSA
Cavities 0		
VDK500010	INSTRUCTION; REPAIR KIT	1
VDK500030	INSTRUCTION; EXTRACT TOOL	1
YMI000890	PRE-TERMINATED LEAD	1
YPQ000110	IDENTS (MEDIUM)	1
YRV000050	SPLICE (BLUE, CSA; 1.0-2.6)	1
YRW000390	WIRE STRIPPER	1
YRW500010	APPLICATOR	1

[VUB500100]

YPL104290		4.00 - 6.00 CSA
Cavities 0		
VDK500010	INSTRUCTION; REPAIR KIT	1
VDK500030	INSTRUCTION; EXTRACT TOOL	1
YMI000960	PRE-TERMINATED LEAD	1
YPQ000120	IDENTS (LARGE)	1
YRV000060	SPLICE (YELLOW, CSA; 2.7-6.6)	1
YRW000390	WIRE STRIPPER	1
YRW500010	APPLICATOR	1

[VUB500160]

Part No. YPH900780
Colour: COPPER, TIN PLATED
Gender: M
Type: HEADER COVER
No. of Ways: 17WY

Description: Header-Earth
Location: Beneath footwell carpet - LH side

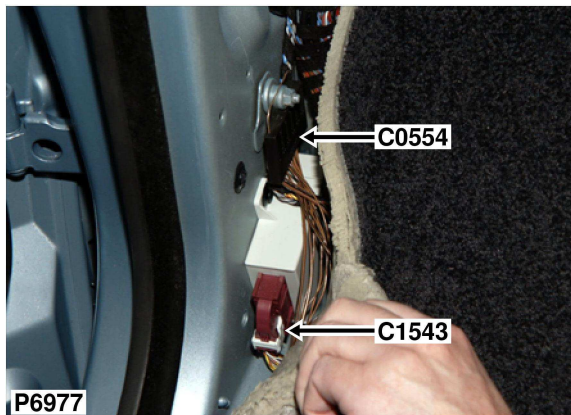

Wire Chart

CAV	TERMINAL	CSA	COL	CCT	DESTN
0	YPL103890	1.0	NB	573	C0556-1
0	YPL103880	0.5	NB	ALL	C0737-1
0	YPL103880	0.5	NB	97	C2037-1
0	YPL103880	0.5	NB	574	C1543-26
0	YPL103880	0.35	NB	ALL	C0026-1
0	YPL103880	0.35	NB	ALL	C0147-1
0	YPL103880	0.5	NB	ALL	C0661-26

CAV	TERMINAL	CSA	COL	CCT	DESTN
0	YPL103880	0.35	NB	ALL	C0620-1
0	YPL103880	0.5	NB	ALL	C0660-14
0	YPL103880	0.5	NB	ALL	C2034-1
0	YPL103900	2.5	NB	ALL	C0287-0

Service Repair Kits

YPL103890		0.75 - 1.00 CSA	
Cavities 0			
VDK500010	INSTRUCTION; REPAIR KIT	1	
VDK500030	INSTRUCTION; EXTRACT TOOL	1	
YMI000880	PRE-TERMINATED LEAD	1	
YPQ000100	IDENTS (SMALL)	1	
YRV000040	SPLICE (RED, CSA; 0.25-1.6)	1	
YRW000390	WIRE STRIPPER	1	
YRW500010	APPLICATOR	1	
YRW500020	EXTRACT TOOL	1	
[VUB500090]			

YPL103880		0.20 - 0.50 CSA	
Cavities 0			
VDK500010	INSTRUCTION; REPAIR KIT	1	
VDK500030	INSTRUCTION; EXTRACT TOOL	1	
YMI000850	PRE-TERMINATED LEAD	1	
YPQ000100	IDENTS (SMALL)	1	
YRV000040	SPLICE (RED, CSA; 0.25-1.6)	1	
YRW000390	WIRE STRIPPER	1	
YRW500010	APPLICATOR	1	
YRW500020	EXTRACT TOOL	1	
[VUB500060]			

YPL103900		1.50 - 2.50 CSA	
Cavities 0			
VDK500010	INSTRUCTION; REPAIR KIT	1	
VDK500030	INSTRUCTION; EXTRACT TOOL	1	
YMI000890	PRE-TERMINATED LEAD	1	
YPQ000110	IDENTS (MEDIUM)	1	
YRV000050	SPLICE (BLUE, CSA; 1.0-2.6)	1	
YRW000390	WIRE STRIPPER	1	
YRW500010	APPLICATOR	1	
[VUB500100]			

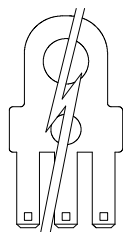

Part No. YPH900780
Colour: COPPER, TIN PLATED
Gender: M
Type: HEADER COVER
No. of Ways: 17WY

Description: Header-Earth
Location: Beneath footwell carpet - LH side

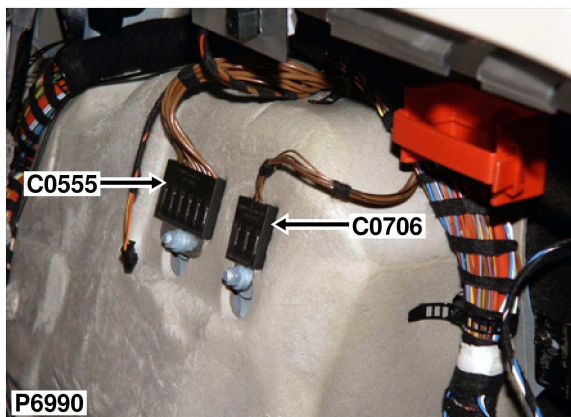

Wire Chart

CAV	TERMINAL	CSA	COL	CCT	DESTN
0	YPL103880	0.5	N	ALL	C1495-2
0	YPL103900	1.5	N	ALL	C0125-5
0	YPL104290	4.0	N	ALL	C2021-10
0	YPL103890	0.75	N	391	C0920-2
0	YPL103890	0.75	N	97	C0920-2
0	YPL103900	1.5	N	58	C0205-1

CAV	TERMINAL	CSA	COL	CCT	DESTN
0	YPL103900	1.5	N	ALL	C0114-4
0	YPL104290	4.0	N	ALL	C0382-1
0	YPL103880	0.5	N	ALL	C0613-1
0	YPL103890	0.75	N	ALL	C0357-6
0	YPL103900	2.5	N	ALL	SJ X11273-
0	YPL103900	2.5	N	ALL	C1632-1

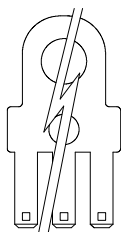

Part No. YPH900780
Colour: COPPER, TIN PLATED
Gender: M
Type: HEADER COVER
No. of Ways: 17WY

Description: Header-Earth
Location: Beneath footwell carpet - LH side

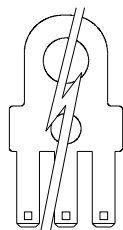
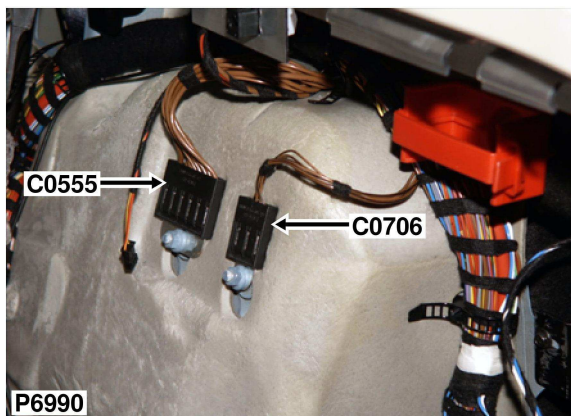

Part No. YPH900780
Colour: COPPER, TIN PLATED
Gender: M
Type: HEADER COVER
No. of Ways: 17WY

Service Repair Kits

YPL103890		0.75 - 1.00 CSA
Cavities 0		
VDK500010	INSTRUCTION; REPAIR KIT	1
VDK500030	INSTRUCTION; EXTRACT TOOL	1
YMI000880	PRE-TERMINATED LEAD	1
YPQ000100	IDENTS (SMALL)	1
YRV000040	SPLICE (RED, CSA; 0.25-1.6)	1
YRW000390	WIRE STRIPPER	1
YRW500010	APPLICATOR	1
YRW500020	EXTRACT TOOL	1

[VUB500090]

YPL103880		0.20 - 0.50 CSA
Cavities 0		
VDK500010	INSTRUCTION; REPAIR KIT	1
VDK500030	INSTRUCTION; EXTRACT TOOL	1
YMI000850	PRE-TERMINATED LEAD	1
YPQ000100	IDENTS (SMALL)	1
YRV000040	SPLICE (RED, CSA; 0.25-1.6)	1
YRW000390	WIRE STRIPPER	1
YRW500010	APPLICATOR	1
YRW500020	EXTRACT TOOL	1

[VUB500060]

YPL103900		1.50 - 2.50 CSA
Cavities 0		
VDK500010	INSTRUCTION; REPAIR KIT	1
VDK500030	INSTRUCTION; EXTRACT TOOL	1
YMI000890	PRE-TERMINATED LEAD	1
YPQ000110	IDENTS (MEDIUM)	1
YRV000050	SPLICE (BLUE, CSA; 1.0-2.6)	1
YRW000390	WIRE STRIPPER	1
YRW500010	APPLICATOR	1

[VUB500100]

YPL104290		4.00 - 6.00 CSA
Cavities 0		
VDK500010	INSTRUCTION; REPAIR KIT	1
VDK500030	INSTRUCTION; EXTRACT TOOL	1
YMI000960	PRE-TERMINATED LEAD	1
YPQ000120	IDENTS (LARGE)	1
YRV000060	SPLICE (YELLOW, CSA; 2.7-6.6)	1
YRW000390	WIRE STRIPPER	1
YRW500010	APPLICATOR	1

[VUB500160]

[continuation]

Description: Earth
Location: Front LH side of engine compartment

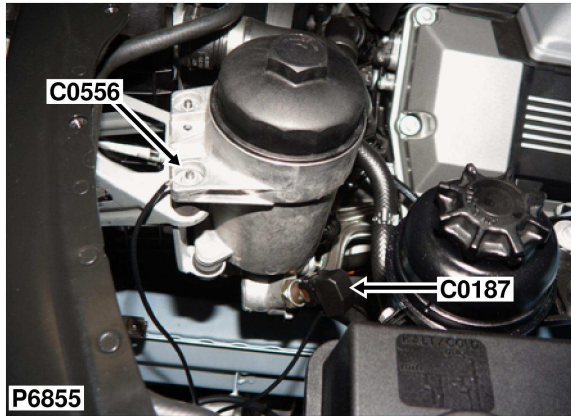

Wire Chart

CAV	TERMINAL	CSA	COL	CCT	DESTN
1	SEE DRAWING	1.0	NB	573	C0554-0

No repair kit
 Geen reparatiepakke
 Pas de nécessaire de reparation
 Kein Werkzeug
 Senza kit per le riparazioni
 Sem kit de reparação
 No hay kit de reparación

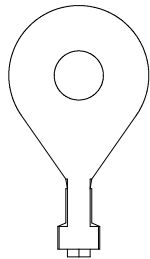

Part No. 0437599
Colour: TIN PLATED
Gender: F
Type: ?
No. of Ways: 1WY

Description: Fuse box-Passenger compartment
Location: Behind glovebox

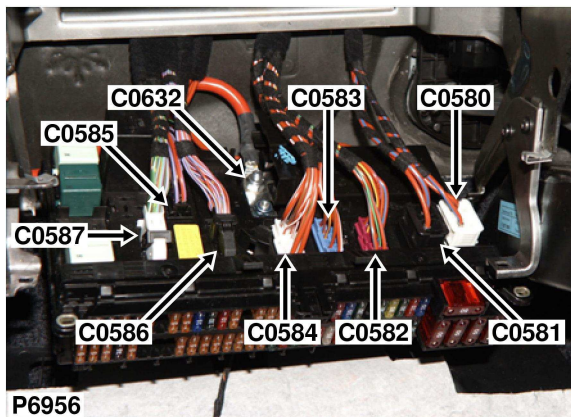

Wire Chart

CAV	TERMINAL	CSA	COL	CCT	DESTN
1	YPL102500	4.0	R	ALL	C0506-2
2	YPL102500	4.0	RU	ALL	C0786-2

No repair kit
 Geen reparatiepakke
 Pas de nécessaire de réparation
 Kein Werkzeug
 Senza kit per le riparazioni
 Sem kit de reparação
 No hay kit de reparaci3n

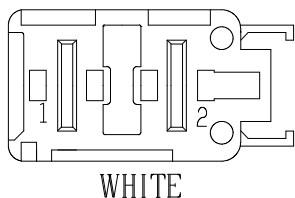

Part No. 8380404
Colour: WHITE
Gender: F
Type: ?
No. of Ways: 1WY

Description: Fuse box-Passenger compartment
Location: Behind glovebox

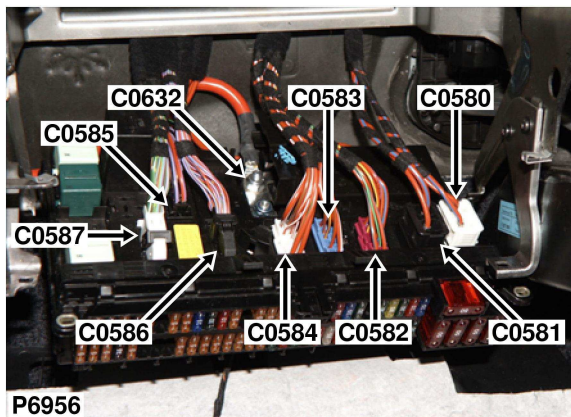

Wire Chart

CAV	TERMINAL	CSA	COL	CCT	DESTN
1	YPL104330	6.0	RU	ALL	C0005-4
2	YPL102500	4.0	R	573	C1886-2

No repair kit
 Geen reparatiepakke
 Pas de nécessaire de réparation
 Kein Werkzeug
 Senza kit per le riparazioni
 Sem kit de reparação
 No hay kit de reparación

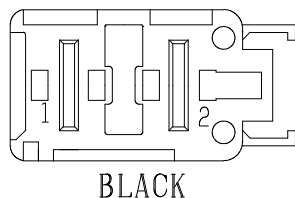

Part No. 8380402
Colour: BLACK
Gender: F
Type: ?
No. of Ways: 2WY

Description: Fuse box-Passenger compartment

Location: Behind glovebox

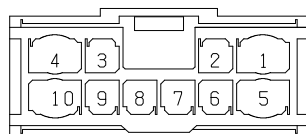
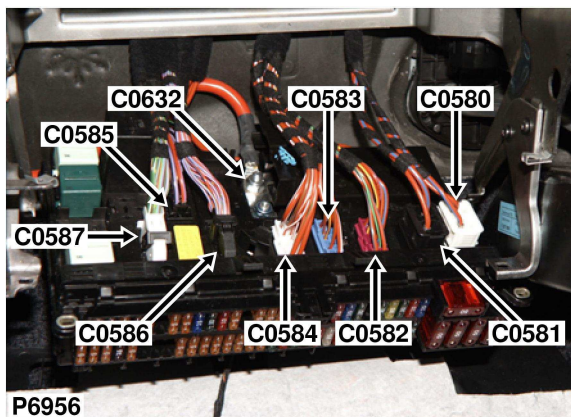

PURPLE

Part No. 6901810
Colour: VIOLET
Gender: F
Type: 2.8 & 5.2 -UNSEALED
No. of Ways: 10WY

Wire Chart

CAV	TERMINAL	CSA	COL	CCT	DESTN
1	6901664	2.5	RP	ALL	C0662-10
2	YPL102710	2.5	RY	97	C0925-1
2	YPL102710	2.5	RY	391	C0925-1
3	YPL102710	2.5	RN	ALL	C2030-10
4	6901664	2.5	RS	279	C0288-0

CAV	TERMINAL	CSA	COL	CCT	DESTN
5	6901664	2.5	RW	ALL	C0662-4
7	YPL102700	0.75	RY	97	C2046-1
8	YPL102710	2.5	RU	204	C0249-1
9	YPL102700	0.75	GB	385	C0374-2
10	6901664	2.5	RS	227	C0784-1

Service Repair Kits

YPL102710		1.01 - 2.50 CSA
Cavities 2-3,8		
VDK500010	INSTRUCTION; REPAIR KIT	1
VDK500050	INSTRUCTION; EXTRACT TOOL	1
YMI001010	PRE-TERMINATED LEAD	1
YPQ000110	IDENTS (MEDIUM)	1
YRV000050	SPLICE (BLUE, CSA; 1.0-2.6)	1
YRW000390	WIRE STRIPPER	1
YRW500010	APPLICATOR	1

[VUB500210]

YPL102700		0.50 - 1.00 CSA
Cavities 7,9		
VDK500010	INSTRUCTION; REPAIR KIT	1
VDK500030	INSTRUCTION; EXTRACT TOOL	1
YMI001060	PRE-TERMINATED LEAD	1
YPQ000100	IDENTS (SMALL)	1
YRV000040	SPLICE (RED, CSA; 0.25-1.6)	1
YRW000390	WIRE STRIPPER	1
YRW500010	APPLICATOR	1

[VUB500260]

6901664		2.50 - 4.00 CSA
Cavities 1,4,5,10		
VDK500010	INSTRUCTION; REPAIR KIT	1
VDK500040	INSTRUCTION; EXTRACT TOOL	1
YMI001030	PRE-TERMINATED LEAD	1
YPQ000120	IDENTS (LARGE)	1
YRV000060	SPLICE (YELLOW, CSA; 2.7-6.6)	1
YRW000390	WIRE STRIPPER	1
YRW500010	APPLICATOR	1
YRW500030	EXTRACT TOOL	1

[VUB500230]

Description: Fuse box-Passenger compartment

Location: Behind glovebox

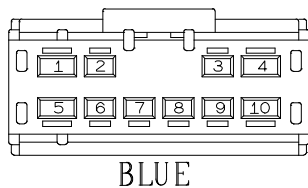
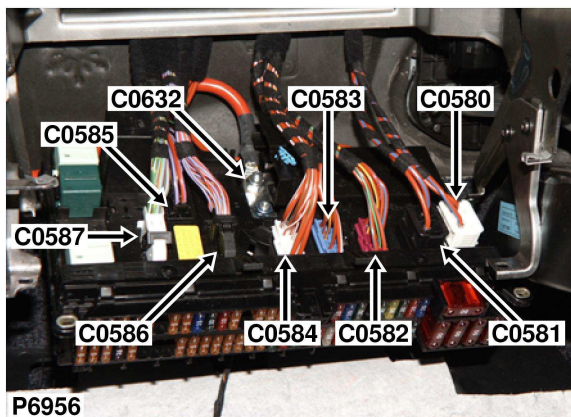

Part No. 6901808
Colour: BLUE
Gender: F
Type: 2.8 & 5.2 -UNSEALED
No. of Ways: 10WY

Wire Chart

CAV	TERMINAL	CSA	COL	CCT	DESTN
1	6901664	4.0	RW	ALL	C0463-27
2	YPL102710	1.5	RY	58	C0448-2
3	YPL102700	0.75	RU	573	C0028-5
4	6901664	2.5	RB	ALL	C0506-6
5	6901664	4.0	R	573	C0028-6
5	6901664	4.0	R	58	C0099-6
6	YPL102710	1.5	RN	388	C1392-2

CAV	TERMINAL	CSA	COL	CCT	DESTN
6	YPL102710	1.5	RN	389	C1392-2
8	YPL102700	1.0	RY	ALL	C2045-1
9	YPL102700	0.75	RY	208	C0723-0
10	6901664	2.5	RW	ALL	C0546-2

Service Repair Kits

YPL102710		1.01 - 2.50 CSA	
Cavities 2,6			
VDK500010	INSTRUCTION; REPAIR KIT	1	
VDK500050	INSTRUCTION; EXTRACT TOOL	1	
YMI001010	PRE-TERMINATED LEAD	1	
YPQ000110	IDENTS (MEDIUM)	1	
YRV000050	SPLICE (BLUE, CSA; 1.0-2.6)	1	
YRW000390	WIRE STRIPPER	1	
YRW500010	APPLICATOR	1	
[VUB500210]			

YPL102700		0.50 - 1.00 CSA	
Cavities 3,8,9			
VDK500010	INSTRUCTION; REPAIR KIT	1	
VDK500030	INSTRUCTION; EXTRACT TOOL	1	
YMI001060	PRE-TERMINATED LEAD	1	
YPQ000100	IDENTS (SMALL)	1	
YRV000040	SPLICE (RED, CSA; 0.25-1.6)	1	
YRW000390	WIRE STRIPPER	1	
YRW500010	APPLICATOR	1	
[VUB500260]			

6901664		2.50 - 4.00 CSA	
Cavities 1,4,5,10			
VDK500010	INSTRUCTION; REPAIR KIT	1	
VDK500040	INSTRUCTION; EXTRACT TOOL	1	
YMI001030	PRE-TERMINATED LEAD	1	
YPQ000120	IDENTS (LARGE)	1	
YRV000060	SPLICE (YELLOW, CSA; 2.7-6.6)	1	
YRW000390	WIRE STRIPPER	1	
YRW500010	APPLICATOR	1	
YRW500030	EXTRACT TOOL	1	
[VUB500230]			

Description: Fuse box-Passenger compartment
Location: Behind glovebox

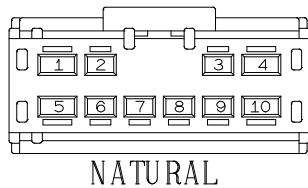
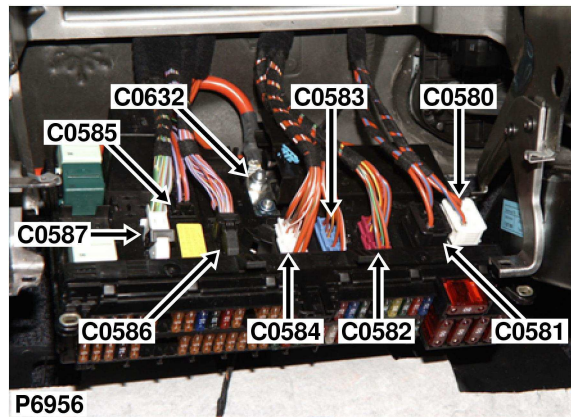

Wire Chart

CAV	TERMINAL	CSA	COL	CCT	DESTN
1	6901664	4.0	RW	ALL	C0448-7
2	YPL102700	0.75	RW	ALL	C0862-2
4	6901664	4.0	RG	ALL	C0981-1
5	6901664	4.0	RN	208	C0255-13

CAV	TERMINAL	CSA	COL	CCT	DESTN
6	YPL102700	0.75	RW	ALL	C0506-23
7	YPL102700	0.75	RW	573	C1886-8
8	YPL102700	0.75	RY	ALL	SJ X18316-
10	6901664	4.0	RN	208	SJ X206-

Service Repair Kits

6901664		2.50 - 4.00 CSA
Cavities 1,4,5,10		
VDK500010	INSTRUCTION; REPAIR KIT	1
VDK500040	INSTRUCTION; EXTRACT TOOL	1
YMI001030	PRE-TERMINATED LEAD	1
YPQ000120	IDENTS (LARGE)	1
YRV000060	SPLICE (YELLOW, CSA; 2.7-6.6)	1
YRW000390	WIRE STRIPPER	1
YRW500010	APPLICATOR	1
YRW500030	EXTRACT TOOL	1

[VUB500230]

YPL102700		0.50 - 1.00 CSA
Cavities 2,6-8		
VDK500010	INSTRUCTION; REPAIR KIT	1
VDK500030	INSTRUCTION; EXTRACT TOOL	1
YMI001060	PRE-TERMINATED LEAD	1
YPQ000100	IDENTS (SMALL)	1
YRV000040	SPLICE (RED, CSA; 0.25-1.6)	1
YRW000390	WIRE STRIPPER	1
YRW500010	APPLICATOR	1

[VUB500260]

Part No. 6901806
Colour: NATURAL
Gender: F
Type: 2.8 & 5.2 -UNSEALED
No. of Ways: 10WY

Description: Fuse box-Passenger compartment

Location: Behind glovebox

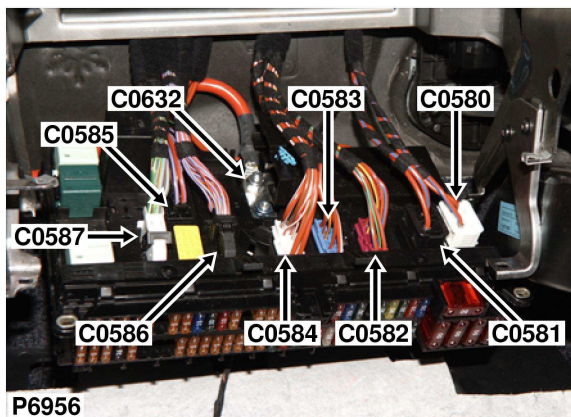

Wire Chart

CAV	TERMINAL	CSA	COL	CCT	DESTN
1	6901664	4.0	RP	ALL	C0459-27
2	YPL102700	0.75	RW	ALL	SJ X8066-
3	YPL102700	0.75	PS	ALL	C0003-2
4	6901664	2.5	BG	ALL	SJ X1301-
5	6901664	4.0	PB	573	C0028-2
5	6901664	4.0	PB	58	C0099-2

CAV	TERMINAL	CSA	COL	CCT	DESTN
6	YPL102700	0.5	GR	574	C0009-4
7	YPL102710	2.5	RU	ALL	C0662-20
8	YPL102710	1.5	N	ALL	C0285-0
9	YPL102700	0.75	PS	ALL	C0004-2
10	6901664	4.0	G	58	C0099-9
10	6901664	4.0	G	573	C0028-9

Service Repair Kits

YPL102710		1.01 - 2.50 CSA
Cavities 7,8		
VDK500010	INSTRUCTION; REPAIR KIT	1
VDK500050	INSTRUCTION; EXTRACT TOOL	1
YMI001010	PRE-TERMINATED LEAD	1
YPQ000110	IDENTS (MEDIUM)	1
YRV000050	SPLICE (BLUE, CSA; 1.0-2.6)	1
YRW000390	WIRE STRIPPER	1
YRW500010	APPLICATOR	1

[VUB500210]

6901664		2.50 - 4.00 CSA
Cavities 1,4,5,10		
VDK500010	INSTRUCTION; REPAIR KIT	1
VDK500040	INSTRUCTION; EXTRACT TOOL	1
YMI001030	PRE-TERMINATED LEAD	1
YPQ000120	IDENTS (LARGE)	1
YRV000060	SPLICE (YELLOW, CSA; 2.7-6.6)	1
YRW000390	WIRE STRIPPER	1
YRW500010	APPLICATOR	1
YRW500030	EXTRACT TOOL	1

[VUB500230]

YPL102700		0.50 - 1.00 CSA
Cavities 2,3,6,9		
VDK500010	INSTRUCTION; REPAIR KIT	1
VDK500030	INSTRUCTION; EXTRACT TOOL	1
YMI001060	PRE-TERMINATED LEAD	1
YPQ000100	IDENTS (SMALL)	1
YRV000040	SPLICE (RED, CSA; 0.25-1.6)	1
YRW000390	WIRE STRIPPER	1
YRW500010	APPLICATOR	1

[VUB500260]

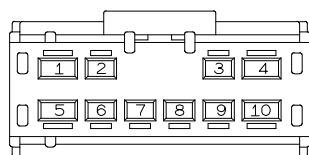

BLACK

Part No. 6901804
Colour: BLACK
Gender: F
Type: 2.8 & 5.2 -UNSEALED
No. of Ways: 10WY

Description: Fuse box-Passenger compartment

Location: Behind glovebox

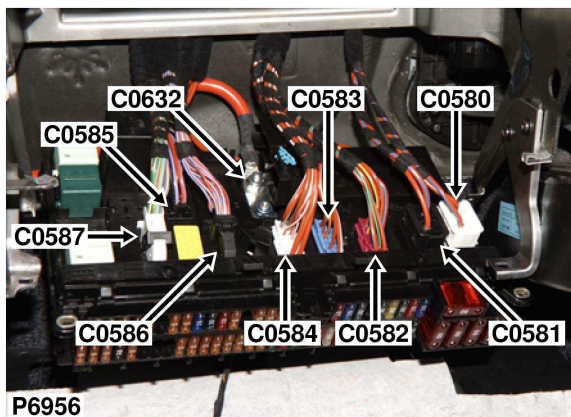

Wire Chart

CAV	TERMINAL	CSA	COL	CCT	DESTN
1	YPL101910	0.75	RU	ALL	C0355-8
2	YPL101910	0.75	RU	ALL	C0295-0
3	YPL101910	0.75	RU	ALL	C0459-11
4	YPL101310	0.5	RY	ALL	C0230-7
5	YPL101310	0.5	RG	ALL	C0941-2
6	YPL101910	0.75	PR	ALL	C0835-3
7	YPL101910	0.75	RP	ALL	C1630-1
8	YPL101310	0.5	PS	ALL	C0736-3
9	YPL101310	0.5	PS	ALL	C0737-3
11	YPL101310	0.5	RG	ALL	SJ X18061-
12	YPL101310	0.5	RN	ALL	C0666-3
13	YPL101310	0.5	RY	ALL	C0698-8
14	YPL101310	0.5	PU	ALL	C0256-5
15	YPL101310	0.5	PG	ALL	C0255-17
17	YPL101910	0.75	SY	ALL	C1629-8

CAV	TERMINAL	CSA	COL	CCT	DESTN
18	YPL101910	0.75	RU	ALL	C0076-3
19	YPL101910	0.75	RU	ALL	C0077-3
20	YPL101310	0.5	RY	ALL	C0233-15
21	YPL101310	0.35	PR	136	C0961-1
22	YPL101310	0.35	PW	ALL	C0660-23
23	YPL101310	0.5	RNY	337	C1537-15
24	YPL101310	0.5	PG	ALL	C0233-12
25	YPL101310	0.5	RS	ALL	C0660-1
26	YPL101310	0.5	RUY	ALL	C0040-16
27	YPL101310	0.5	RW	ALL	C0359-4
28	YPL101310	0.5	RB	ALL	C0960-3
29	YPL101310	0.35	PG	203	C0253-5

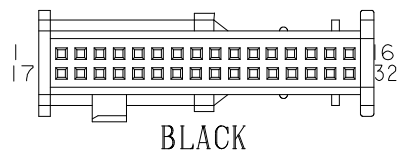

Service Repair Kits

YPL101910		0.75 - 0.75 csa
Cavities 1-9,11-15,17-29		
VDK500010	INSTRUCTION; REPAIR KIT	1
VDK500070	INSTRUCTION; EXTRACT TOOL	1
VDK500080	INSTRUCTION; EXTRACT TOOL	1
YMI000870	PRE-TERMINATED LEAD	1
YPQ000100	IDENTS (SMALL)	1
YRV000040	SPLICE (RED, CSA; 0.25-1.6)	1
YRW000390	WIRE STRIPPER	1
YRW500010	APPLICATOR	1
YRW500060	EXTRACT TOOL	1
YRW500070	EXTRACT TOOL	1

[VUB500080]

Part No. 8373646
Colour: BLACK
Gender: F
Type: MQS
No. of Ways: 32WY

Description: Fuse box-Passenger compartment

Location: Behind glovebox

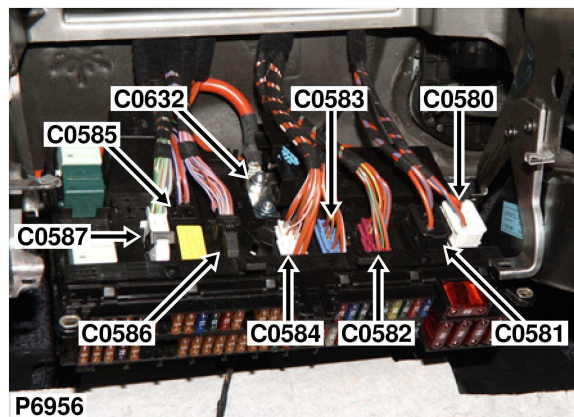

Wire Chart

CAV	TERMINAL	CSA	COL	CCT	DESTN
1	YPL101310	0.5	RG	134	C0459-19
2	YPL101310	0.35	NR	ALL	C0082-6
3	YPL101310	0.5	GU	ALL	C0233-16
4	YPL101310	0.5	GB	ALL	C2055-10
5	YPL101310	0.5	GB	ALL	C0331-26
6	YPL101310	0.5	GY	ALL	C2022-10
7	YPL101310	0.5	GR	574	C0011-4
8	YPL101310	0.5	PY	ALL	C0075-1
9	YPL101910	0.75	GR	58	C0448-12
10	YPL101310	0.5	GP	ALL	C1319-15
11	YPL101310	0.35	GS	ALL	C2040-31
12	YPL101910	0.75	GY	ALL	SJ X1269-
13	YPL101310	0.5	GW	ALL	C0040-1
14	YPL101910	0.75	GW	ALL	C0448-6
15	YPL101310	0.5	GN	337	C1537-31

CAV	TERMINAL	CSA	COL	CCT	DESTN
16	YPL101310	0.5	GBY	ALL	SJ X1397-
17	YPL101310	0.5	RG	134	C0463-19
19	YPL101310	0.5	GU	ALL	C0230-17
20	YPL101910	0.75	RU	ALL	C0357-8
21	YPL101310	0.5	PB	ALL	C0289-0
23	YPL101310	0.5	PY	ALL	C2040-13
25	YPL101310	0.5	PY	ALL	C0082-10
27	YPL101910	0.75	PW	ALL	C0290-0
28	YPL101310	0.35	PU	ALL	C1319-7
31	YPL101310	0.5	GW	386	C0698-3
31	YPL101310	0.5	GW	387	C0698-3
32	YPL101310	0.5	GN	171	C0957-1

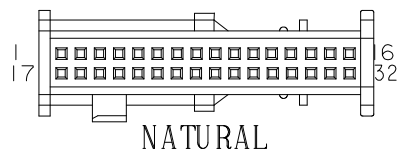

Service Repair Kits

YPL101910		
0.75 - 0.75 CSA		
Cavities 1-17,19-21,23,25,27,28,31-32		
VDK500010	INSTRUCTION; REPAIR KIT	1
VDK500070	INSTRUCTION; EXTRACT TOOL	1
VDK500080	INSTRUCTION; EXTRACT TOOL	1
YMI000870	PRE-TERMINATED LEAD	1
YPQ000100	IDENTS (SMALL)	1
YRV000040	SPLICE (RED, CSA; 0.25-1.6)	1
YRW000390	WIRE STRIPPER	1
YRW500010	APPLICATOR	1
YRW500060	EXTRACT TOOL	1
YRW500070	EXTRACT TOOL	1

[VUB500080]

Part No. 8383274
Colour: NATURAL
Gender: F
Type: MQS
No. of Ways: 32WY

Description: Fuse box-Passenger compartment
Location: Behind passenger compartment fusebox

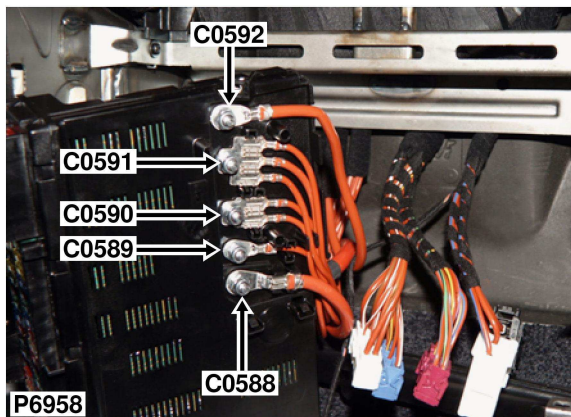

Wire Chart

CAV	TERMINAL	CSA	COL	CCT	DESTN
1	SEE DRAWING	16.0	R	ALL	C2024-1

No repair kit
 Geen reparatiepakke
 Pas de nécessaire de reparation
 Kein Werkzeug
 Senza kit per le riparazioni
 Sem kit de reparaçã
 No hay kit de reparaci3n

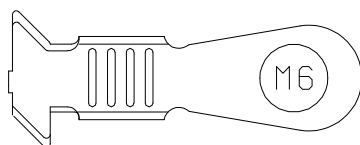

Part No. YPG101740
Colour: TIN PLATED
Gender: F
Type: STUD SIZE 6.0MM
No. of Ways: 1WY

Description: Fuse box-Passenger compartment
Location: Behind passenger compartment fusebox

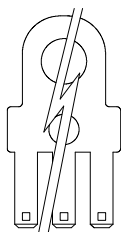
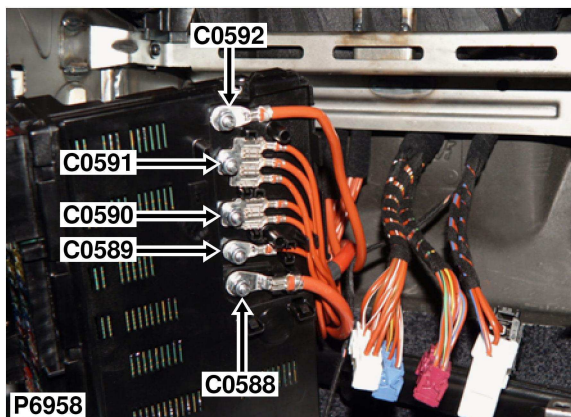

Wire Chart

CAV	TERMINAL	CSA	COL	CCT	DESTN
1	YPL104290	4.0	R	ALL	C0937-15

Service Repair Kits

YPL104290		4.00 - 6.00 CSA
Cavities 1		
VDK500010	INSTRUCTION; REPAIR KIT	1
VDK500030	INSTRUCTION; EXTRACT TOOL	1
YMI000960	PRE-TERMINATED LEAD	1
YPQ000120	IDENTS (LARGE)	1
YRV000060	SPLICE (YELLOW, CSA; 2.7-6.6)	1
YRW000390	WIRE STRIPPER	1
YRW500010	APPLICATOR	1

[VUB500160]

Part No. YPH900780
Colour: COPPER, TIN PLATED
Gender: M
Type: HEADER COVER
No. of Ways: 17WY

Description: Fuse box-Passenger compartment
Location: Behind passenger compartment fusebox

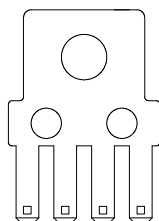
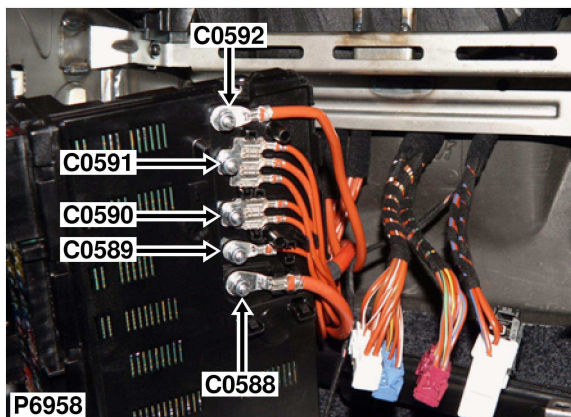

Wire Chart

CAV	TERMINAL	CSA	COL	CCT	DESTN
1	YPL104290	4.0	R	ALL	C0937-15

Service Repair Kits

YPL104290		4.00 - 6.00 CSA
Cavities 1		
VDK500010	INSTRUCTION; REPAIR KIT	1
VDK500030	INSTRUCTION; EXTRACT TOOL	1
YMI000960	PRE-TERMINATED LEAD	1
YPQ000120	IDENTS (LARGE)	1
YRV000060	SPLICE (YELLOW, CSA; 2.7-6.6)	1
YRW000390	WIRE STRIPPER	1
YRW500010	APPLICATOR	1

[VUB500160]

Part No. 8380414
Colour: COPPER, TIN PLATED
Gender: M
Type: EARTHING COMB
No. of Ways: 4WY

Description: Fuse box-Passenger compartment
Location: Behind passenger compartment fusebox

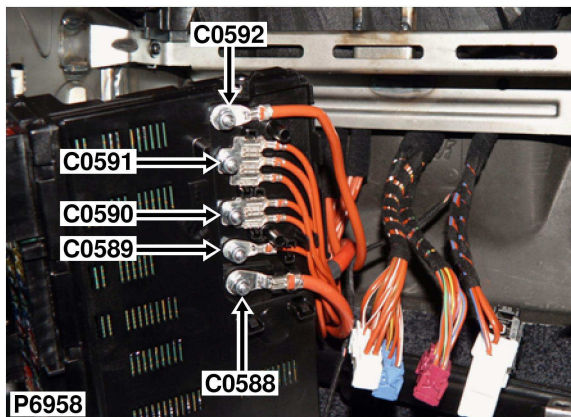

Wire Chart

CAV	TERMINAL	CSA	COL	CCT	DESTN
1	SEE DRAWING	4.0	R	ALL	C2039-8

No repair kit
 Geen reparatiepakke
 Pas de nécessaire de reparation
 Kein Werkzeug
 Senza kit per le riparazioni
 Sem kit de reparaçao
 No hay kit de reparaci3n

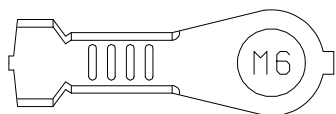

Part No. 1388431
Colour: TIN PLATED
Gender: F
Type: STUD SIZE 6.5MM
No. of Ways: 1WY

Description: Fuse box-Passenger compartment
Location: Behind passenger compartment fusebox

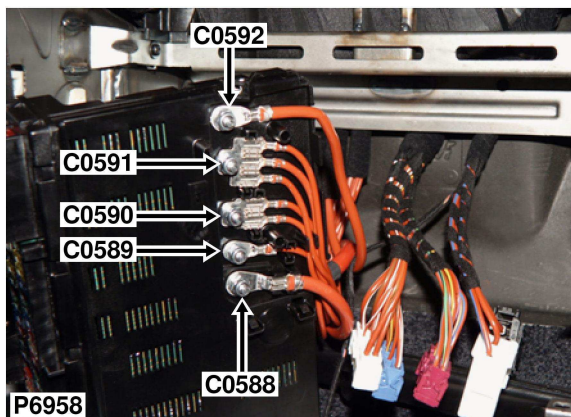

Wire Chart

CAV	TERMINAL	CSA	COL	CCT	DESTN
1	YPL104290	4.0	R	573	C0059-2
2	YPL104290	6.0	R	573	C0449-1
3	YPL104290	4.0	R	58	C0099-5

Service Repair Kits

YPL104290		4.00 - 6.00 CSA
Cavities 1-3		
VDK500010	INSTRUCTION; REPAIR KIT	1
VDK500030	INSTRUCTION; EXTRACT TOOL	1
YMI000960	PRE-TERMINATED LEAD	1
YPQ000120	IDENTS (LARGE)	1
YRV000060	SPLICE (YELLOW, CSA; 2.7-6.6)	1
YRW000390	WIRE STRIPPER	1
YRW500010	APPLICATOR	1

[VUB500160]

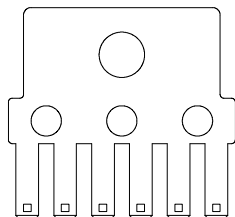

Part No. 8380416
Colour: COPPER, TIN PLATED
Gender: M
Type: EARTHING COMB
No. of Ways: 6WY

Description: Fuse box-Passenger compartment
Location: Behind passenger compartment fusebox

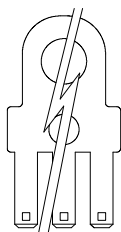
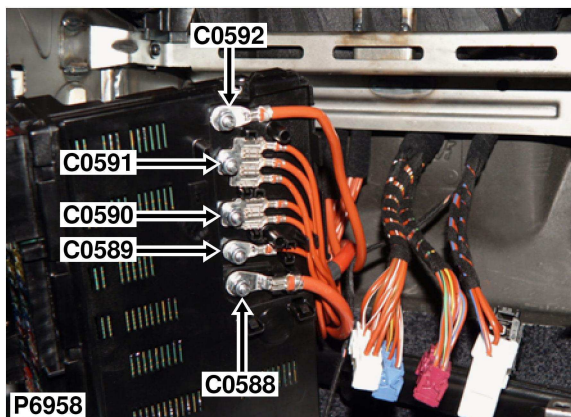

Wire Chart

CAV	TERMINAL	CSA	COL	CCT	DESTN
1	YPL104290	4.0	R	573	C0059-2
2	YPL104290	6.0	R	573	C0449-1
3	YPL104290	4.0	R	58	C0099-5

Service Repair Kits

YPL104290		4.00 - 6.00 CSA
Cavities 1-3		
VDK500010	INSTRUCTION; REPAIR KIT	1
VDK500030	INSTRUCTION; EXTRACT TOOL	1
YMI000960	PRE-TERMINATED LEAD	1
YPQ000120	IDENTS (LARGE)	1
YRV000060	SPLICE (YELLOW, CSA; 2.7-6.6)	1
YRW000390	WIRE STRIPPER	1
YRW500010	APPLICATOR	1

[VUB500160]

Part No. YPH900780
Colour: COPPER, TIN PLATED
Gender: M
Type: HEADER COVER
No. of Ways: 17WY

Description: Fuse box-Passenger compartment
Location: Behind passenger compartment fusebox

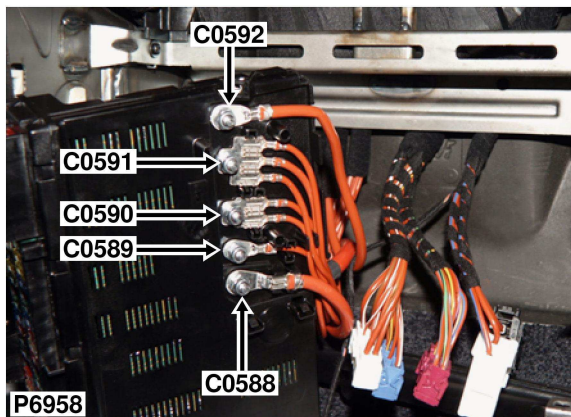

Wire Chart

CAV	TERMINAL	CSA	COL	CCT	DESTN
1	SEE DRAWING	10.0	R	109	C0994-3

No repair kit
 Geen reparatiepakke
 Pas de nécessaire de reparation
 Kein Werkzeug
 Senza kit per le riparazioni
 Sem kit de reparação
 No hay kit de reparación

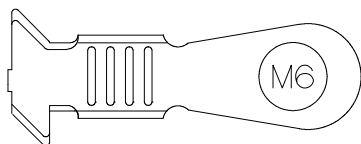

Part No. 1388865
Colour: TIN PLATED
Gender: F
Type: EYELET
No. of Ways: 1WY

Description: Sensor-Anti-trap-Driver
Location: Behind driver's door trim panel

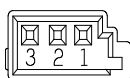
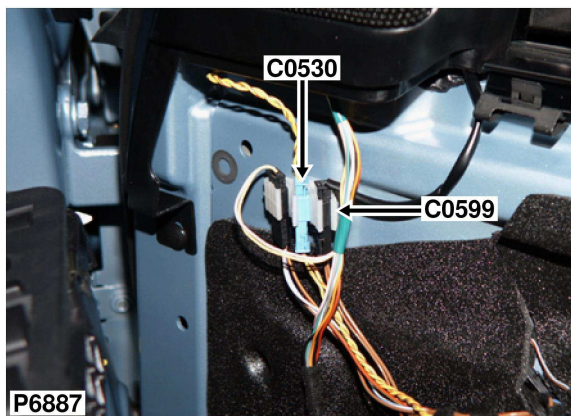

BLACK

Part No. 6905977
Colour: BLACK
Gender: M
Type: MQS
No. of Ways: 3WY

Wire Chart

CAV	TERMINAL	CSA	COL	CCT	DESTN
1	YPJ100830	0.5	N	247	SJ X850-
2	YPJ100830	0.35	NR	247	C2058-9

Service Repair Kits

YPJ100830		0.20 - 0.50 csa
Cavities 1,2		
VDK500010	INSTRUCTION; REPAIR KIT	1
VDK500070	INSTRUCTION; EXTRACT TOOL	1
VDK500080	INSTRUCTION; EXTRACT TOOL	1
YMI000990	PRE-TERMINATED LEAD	1
YPQ000100	IDENTS (SMALL)	1
YRV000040	SPLICE (RED, CSA; 0.25-1.6)	1
YRW000390	WIRE STRIPPER	1
YRW500010	APPLICATOR	1
YRW500060	EXTRACT TOOL	1
YRW500070	EXTRACT TOOL	1

[VUB500190]

Description: Sensor-Anti-trap-Passenger
Location: Behind passenger's door trim panel

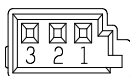
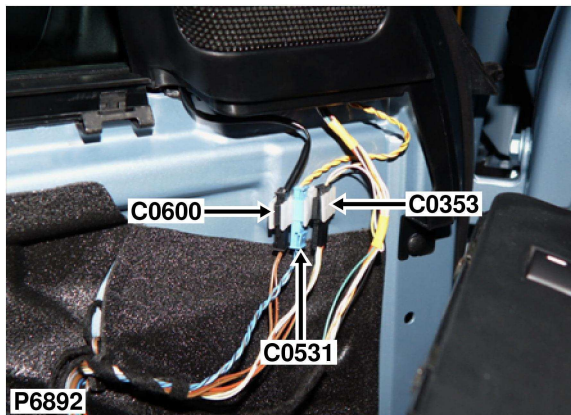

BLACK

Part No. 6905977
Colour: BLACK
Gender: M
Type: MQS
No. of Ways: 3WY

Wire Chart

CAV	TERMINAL	CSA	COL	CCT	DESTN
1	YPJ100830	0.5	N	247	SJ X892-
2	YPJ100830	0.35	NR	247	C2057-9

Service Repair Kits

YPJ100830		0.20 - 0.50 csa
Cavities 1,2		
VDK500010	INSTRUCTION; REPAIR KIT	1
VDK500070	INSTRUCTION; EXTRACT TOOL	1
VDK500080	INSTRUCTION; EXTRACT TOOL	1
YMI000990	PRE-TERMINATED LEAD	1
YPO000100	IDENTS (SMALL)	1
YRV000040	SPLICE (RED, CSA; 0.25-1.6)	1
YRW000390	WIRE STRIPPER	1
YRW500010	APPLICATOR	1
YRW500060	EXTRACT TOOL	1
YRW500070	EXTRACT TOOL	1

[VUB500190]

Description: Lamp-brake-high mounted
Location: Centre of taildoor, behind trim panel

No photo
 Geen photo
 Pas de photo
 Kein foto
 Senza foto
 Sem fotografia
 No hay foto

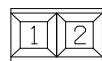

BLACK

Part No. YPC111740
Colour: BLACK
Gender: F
Type: MQS
No. of Ways: 2WY

Wire Chart

CAV	TERMINAL	CSA	COL	CCT	DESTN
1	YPL101310	0.5	N	ALL	C0555-0
2	YPL101910	0.75	BU	ALL	SJ X10197-

Service Repair Kits

YPL101910		0.75 - 0.75 csa
Cavities 1,2		
VDK500010	INSTRUCTION; REPAIR KIT	1
VDK500070	INSTRUCTION; EXTRACT TOOL	1
VDK500080	INSTRUCTION; EXTRACT TOOL	1
YMI000870	PRE-TERMINATED LEAD	1
YPQ000100	IDENTS (SMALL)	1
YRV000040	SPLICE (RED, CSA; 0.25-1.6)	1
YRW000390	WIRE STRIPPER	1
YRW500010	APPLICATOR	1
YRW500060	EXTRACT TOOL	1
YRW500070	EXTRACT TOOL	1

[VUB500080]

Description: Switch-Tail door open
Location: Centre of taildoor, behind trim panel

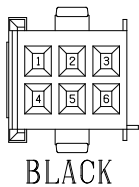
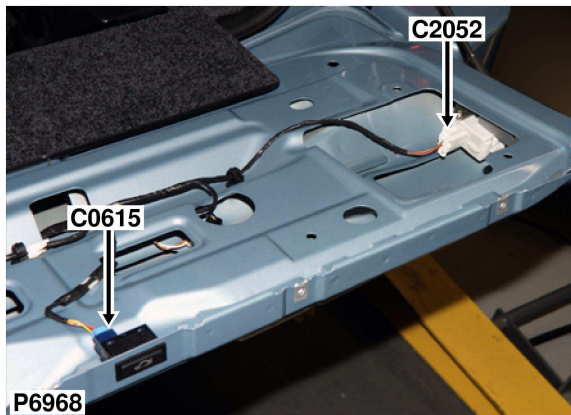

Part No. YPC115290
Colour: BLACK
Gender: F
Type: MQS
No. of Ways: 6WY

Wire Chart

CAV	TERMINAL	CSA	COL	CCT	DESTN
5	YPL101910	0.75	YB	40	C0384-4
6	YPL101910	0.75	RS	40	C0384-3

Service Repair Kits

YPL101910		0.75 - 0.75 CSA
Cavities 5,6		
VDK500010	INSTRUCTION; REPAIR KIT	1
VDK500070	INSTRUCTION; EXTRACT TOOL	1
VDK500080	INSTRUCTION; EXTRACT TOOL	1
YMI000870	PRE-TERMINATED LEAD	1
YPQ000100	IDENTS (SMALL)	1
YRV000040	SPLICE (RED, CSA; 0.25-1.6)	1
YRW000390	WIRE STRIPPER	1
YRW500010	APPLICATOR	1
YRW500060	EXTRACT TOOL	1
YRW500070	EXTRACT TOOL	1

[VUB500080]

Description: Motor-Lock-Tail door
Location: LH side of taildoor

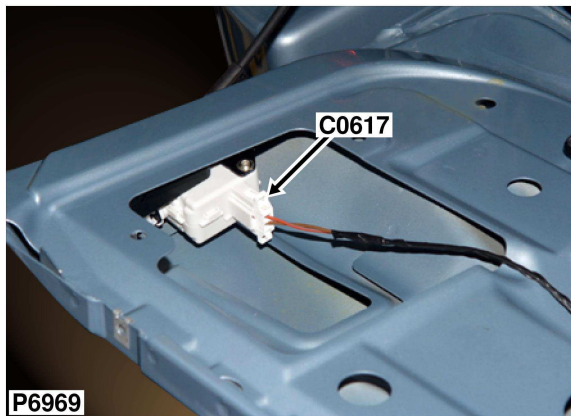

Wire Chart

CAV	TERMINAL	CSA	COL	CCT	DESTN
1	YPL102600	1.5	N	40	SJ X13276-
2	YPL102600	1.5	UW	40	C0384-2

No repair kit
 Geen reparatiepakke
 Pas de nécessaire de reparation
 Kein Werkzeug
 Senza kit per le riparazioni
 Sem kit de reparação
 No hay kit de reparaci3n

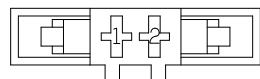

WHITE

Part No. YPC113630
Colour: WHITE
Gender: F
Type: JUNIOR POWER TIMER
No. of Ways: 2WY

Description: Sensor-Low washer fluid level
Location: Front LH side of engine compartment

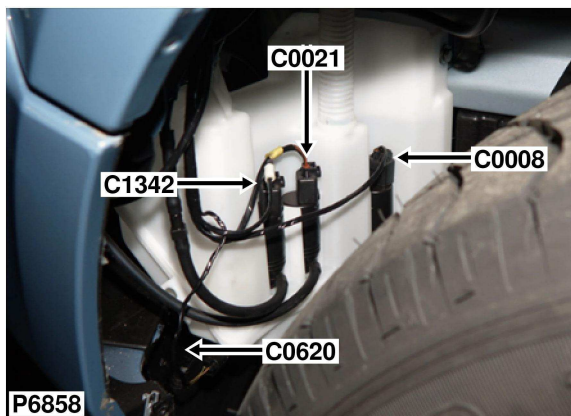

Wire Chart

CAV	TERMINAL	CSA	COL	CCT	DESTN
1	YPL101500	0.35	NB	ALL	C0554-0
2	YPL101500	0.35	NG	ALL	C2040-10

Service Repair Kits

YPL101500		0.20 - 0.50 CSA
Cavities 1,2		
VDK500010	INSTRUCTION; REPAIR KIT	1
VDK500070	INSTRUCTION; EXTRACT TOOL	1
VDK500080	INSTRUCTION; EXTRACT TOOL	1
YMI000950	PRE-TERMINATED LEAD	1
YPQ000100	IDENTS (SMALL)	1
YQD000210	HEAT SHRINK SLEEVE	1
YRV000040	SPLICE (RED, CSA; 0.25-1.6)	1
YRW000390	WIRE STRIPPER	1
YRW500010	APPLICATOR	1

[VUB500150]



Part No. YPC116820
Colour: BLACK
Gender: F
Type: MQS
No. of Ways: 2WY

Description: Fan-E-box
Location: Inside E-box

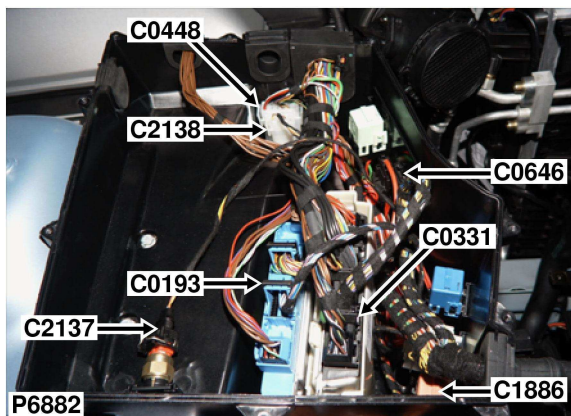

Wire Chart

CAV	TERMINAL	CSA	COL	CCT	DESTN
1	YPE10020	0.75	N	ALL	C0018-0
3	YPE10020	0.75	YU	ALL	C2137-1

Service Repair Kits

YPE10020		0.50 - 1.00 CSA
Cavities 1,3		
VDK500010	INSTRUCTION; REPAIR KIT	1
VDK500130	INSTRUCTION; EXTRACT TOOL	1
YMI000860	PRE-TERMINATED LEAD	1
YPQ000100	IDENTS (SMALL)	1
YRV000040	SPLICE (RED, CSA; 0.25-1.6)	1
YRW000390	WIRE STRIPPER	1
YRW500010	APPLICATOR	1

[VUB500070]

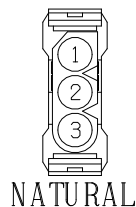

Part No. YPC112540
Colour: NATURAL
Gender: F
Type: 2.5MM SYSTEM
No. of Ways: 3WY

Description: Body control unit (BCU)
Location: Beneath front passenger's seat

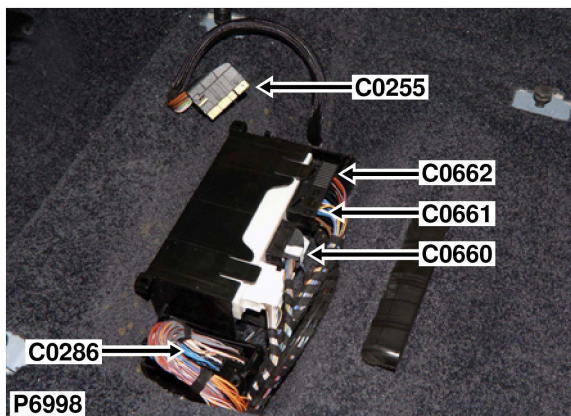

Wire Chart

CAV	TERMINAL	CSA	COL	CCT	DESTN
1	YPL101310	0.5	RS	ALL	C0586-25
2	YPL101310	0.35	WN	ALL	C0355-7
3	YPL101310	0.35	NP	ALL	C0278-4
4	YPL101310	0.35	BW	ALL	C0278-1
5	YPL101310	0.35	BU	ALL	C0278-7
6	YPL101310	0.35	NS	ALL	C0435-12
7	YPL101310	0.35	NW	ALL	C0436-12
12	YPL101310	0.35	WRY	ALL	C0296-0
13	YPL101310	0.35	WY	390	C0674-3
13	YPL101310	0.35	WY	130	SJ X13141-
14	YPL101310	0.5	NB	ALL	C0554-0

CAV	TERMINAL	CSA	COL	CCT	DESTN
15	YPL101310	0.35	SY	ALL	C0436-6
17	YPL101310	0.35	SB	ALL	C0435-7
18	YPL101310	0.35	SN	ALL	C0435-6
19	YPL101310	0.35	SW	ALL	C0383-2
20	YPL101310	0.35	NG	ALL	SJ X1596-
22	YPL101910	0.75	YB	ALL	C0117-4
23	YPL101310	0.35	PW	ALL	C0586-22
24	YPL101310	0.35	YR	ALL	C0096-5
25	YPL101310	0.35	UR	ALL	C0294-0
26	YPL101310	0.35	SU	ALL	C0436-7

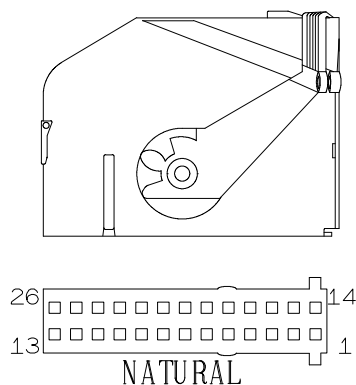

Service Repair Kits

YPL101910 0.75 - 0.75 CSA Cavities 1-7,12-15,17-20,22-26

VDK500010	INSTRUCTION; REPAIR KIT	1
VDK500070	INSTRUCTION; EXTRACT TOOL	1
VDK500080	INSTRUCTION; EXTRACT TOOL	1
YMI000870	PRE-TERMINATED LEAD	1
YPQ000100	IDENTS (SMALL)	1
YRV000040	SPLICE (RED, CSA; 0.25-1.6)	1
YRW000390	WIRE STRIPPER	1
YRW500010	APPLICATOR	1
YRW500060	EXTRACT TOOL	1
YRW500070	EXTRACT TOOL	1

[VUB500080]

Part No. YPH900750
Colour: NATURAL
Gender: F
Type: MQS
No. of Ways: 26WY

Description: Body control unit (BCU)
Location: Beneath front passenger's seat

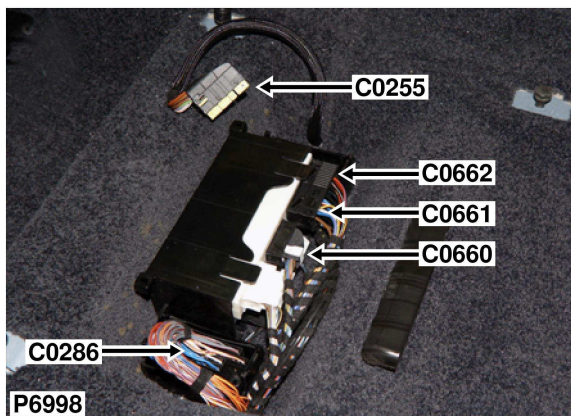

Wire Chart

CAV	TERMINAL	CSA	COL	CCT	DESTN
2	YPL101310	0.5	PG	ALL	C0007-3
5	YPL101310	0.5	BY	ALL	C0359-3
8	YPL101310	0.5	BU	ALL	C0960-1
10	YPL101310	0.35	SY	ALL	C1495-3
11	YPL101310	0.35	SN	ALL	C0700-2
12	YPL101310	0.35	NR	ALL	C0436-8
13	YPL101310	0.35	SU	ALL	C0256-34
15	YPL101310	0.35	NU	ALL	C0546-1
16	YPL101310	0.35	NW	ALL	C0546-3

CAV	TERMINAL	CSA	COL	CCT	DESTN
17	YPL101310	0.35	UB	279	C2031-6
19	YPL101310	0.5	SBY	ALL	C0698-9
20	YPL101310	0.5	BS	ALL	C0960-4
22	YPL101310	0.35	NY	ALL	C2022-14
23	YPL101310	0.35	NR	ALL	SJ X1101-
24	YPL101310	0.35	NY	ALL	C0435-8
25	YPL101310	0.35	BG	ALL	C0278-9
26	YPL101310	0.5	NB	ALL	C0554-0

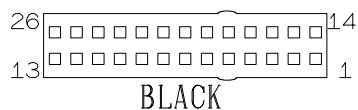

Service Repair Kits

YPL101310		0.20 - 0.50 CSA
Cavities 2,5,8,10-13,15-17,19,20,22-26		
VDK500010	INSTRUCTION; REPAIR KIT	1
VDK500070	INSTRUCTION; EXTRACT TOOL	1
VDK500080	INSTRUCTION; EXTRACT TOOL	1
YMI000870	PRE-TERMINATED LEAD	1
YPQ000100	IDENTS (SMALL)	1
YRV000040	SPLICE (RED, CSA; 0.25-1.6)	1
YRW000390	WIRE STRIPPER	1
YRW500010	APPLICATOR	1
YRW500060	EXTRACT TOOL	1
YRW500070	EXTRACT TOOL	1

[VUB500080]

Part No. YPH900770
Colour: BLACK
Gender: F
Type: MQS
No. of Ways: 26WY

Description: Body control unit (BCU)
Location: Beneath front passenger's seat

Wire Chart

CAV	TERMINAL	CSA	COL	CCT	DESTN
1	YPE100500	2.5	N	ALL	C0821-0
2	YPE100500	2.5	UP	ALL	C0436-27
3	YPE10020	0.75	YN	ALL	C0383-4
4	YPE100500	2.5	RW	ALL	C0582-5
5	YPE100500	2.5	US	ALL	C0435-27
6	YPE100500	2.5	B	ALL	C0293-0
9	YPE10020	0.5	BW	ALL	C2038-1
10	YPE100500	2.5	RP	ALL	C0582-1
11	YPE10020	0.5	BR	ALL	C2038-2

CAV	TERMINAL	CSA	COL	CCT	DESTN
12	YPE100500	2.5	BN	ALL	C0436-26
13	YPE100500	2.5	W	ALL	C0292-0
14	YPE100500	2.5	U	ALL	C0291-0
15	YPE100500	2.5	BG	ALL	C0435-26
17	YPE10020	0.5	BU	ALL	C0666-4
18	YPE10020	1.0	B	ALL	C0008-1
19	YPE100500	2.5	RY	ALL	C0723-0
20	YPE100500	2.5	RU	ALL	C0585-7

Service Repair Kits

YPE100500		1.01 - 2.50 CSA
Cavities 1,2,4-6,10,12-15,19,20		
VDK500010	INSTRUCTION; REPAIR KIT	1
VDK500030	INSTRUCTION; EXTRACT TOOL	1
YMI000900	PRE-TERMINATED LEAD	1
YPQ000110	IDENTS (MEDIUM)	1
YRV000050	SPLICE (BLUE, CSA; 1.0-2.6)	1
YRW000390	WIRE STRIPPER	1
YRW500010	APPLICATOR	1

YPE10020		0.50 - 1.00 CSA
Cavities 3,9,11,17,18		
VDK500010	INSTRUCTION; REPAIR KIT	1
VDK500130	INSTRUCTION; EXTRACT TOOL	1
YMI000860	PRE-TERMINATED LEAD	1
YPQ000100	IDENTS (SMALL)	1
YRV000040	SPLICE (RED, CSA; 0.25-1.6)	1
YRW000390	WIRE STRIPPER	1
YRW500010	APPLICATOR	1

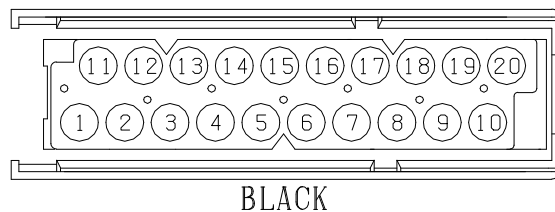
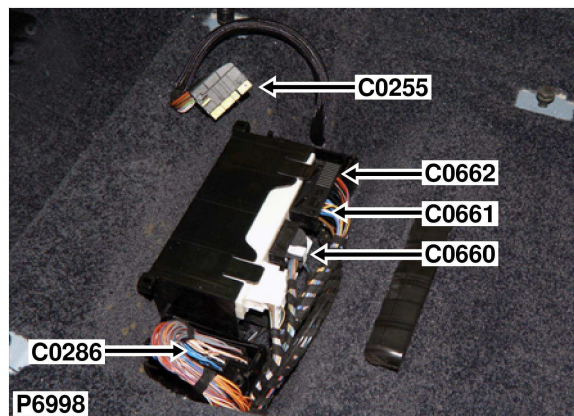

Part No. YPC113130
Colour: BLACK
Gender: F
Type: 2.5MM SYSTEM
No. of Ways: 20WY

Description: Sounder-Alarm-Battery backed up

Location: Rear of engine compartment

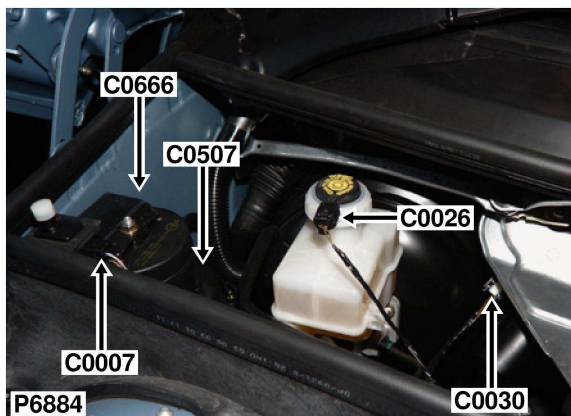

Wire Chart

CAV	TERMINAL	CSA	COL	CCT	DESTN
1	YPL101500	0.5	N	ALL	C0285-0
2	YPL101500	0.5	BG	ALL	C0960-5
3	YPL101500	0.5	RN	ALL	C0586-12
4	YPL101500	0.5	BU	ALL	C0662-17

Service Repair Kits

YPL101500		0.20 - 0.50 CSA
Cavities 1-4		
VDK500010	INSTRUCTION; REPAIR KIT	1
VDK500070	INSTRUCTION; EXTRACT TOOL	1
VDK500080	INSTRUCTION; EXTRACT TOOL	1
YMI000950	PRE-TERMINATED LEAD	1
YPQ000100	IDENTS (SMALL)	1
YQD000210	HEAT SHRINK SLEEVE	1
YRV000040	SPLICE (RED, CSA; 0.25-1.6)	1
YRW000390	WIRE STRIPPER	1
YRW500010	APPLICATOR	1

[VUB500150]

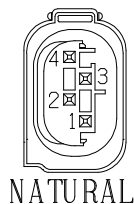

NATURAL

Part No. YPC117060

Colour: NATURAL

Gender: F

Type: MQS

No. of Ways: 4WY

Description: Sensor-Key in
Location: Beneath centre console

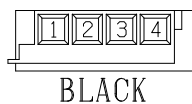
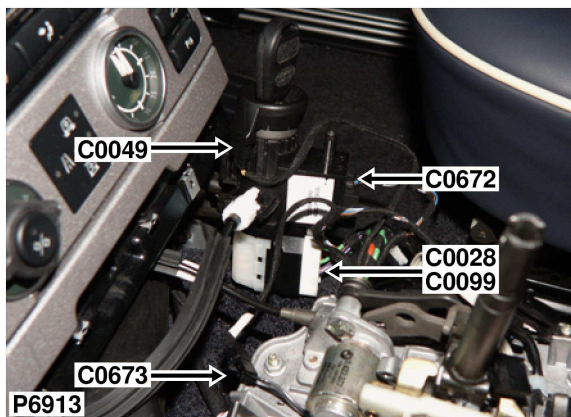

Part No. YPC117840
Colour: BLACK
Gender: F
Type: MQS
No. of Ways: 4WY

Wire Chart

CAV	TERMINAL	CSA	COL	CCT	DESTN
1	YPL101310	0.35	B	ALL	C2055-2
2	YPL101310	0.35	S	ALL	C2055-6
3	YPL101310	0.35	U	ALL	C2055-1
4	YPL101310	0.35	NB	ALL	SJ X230-

Service Repair Kits

YPL101310		0.20 - 0.50 CSA
Cavities 1-4		
VDK500010	INSTRUCTION; REPAIR KIT	1
VDK500070	INSTRUCTION; EXTRACT TOOL	1
VDK500080	INSTRUCTION; EXTRACT TOOL	1
YMI000870	PRE-TERMINATED LEAD	1
YPQ000100	IDENTS (SMALL)	1
YRV000040	SPLICE (RED, CSA; 0.25-1.6)	1
YRW000390	WIRE STRIPPER	1
YRW500010	APPLICATOR	1
YRW500060	EXTRACT TOOL	1
YRW500070	EXTRACT TOOL	1

[VUB500080]

Description: Solenoid-Interlock
Location: Beneath centre console

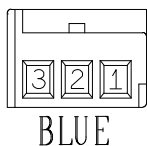
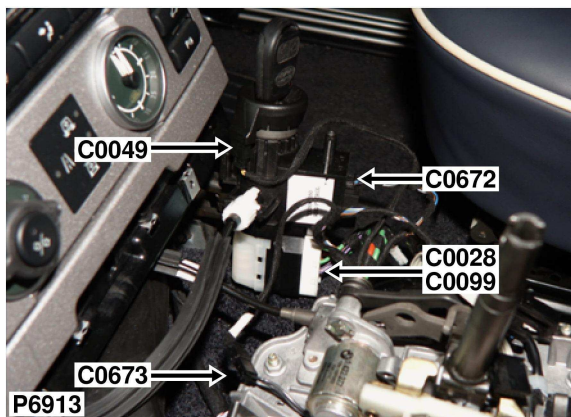

Part No. 8377068
Colour: BLUE
Gender: F
Type: MQS
No. of Ways: 3WY

Wire Chart

CAV	TERMINAL	CSA	COL	CCT	DESTN
1	YPL101310	0.5	BP	ALL	C0193-2
3	YPL101310	0.5	NP	ALL	C0193-1

Service Repair Kits

YPL101310		0.20 - 0.50 CSA
Cavities 1,3		
VDK500010	INSTRUCTION; REPAIR KIT	1
VDK500070	INSTRUCTION; EXTRACT TOOL	1
VDK500080	INSTRUCTION; EXTRACT TOOL	1
YMI000870	PRE-TERMINATED LEAD	1
YPQ000100	IDENTS (SMALL)	1
YRV000040	SPLICE (RED, CSA; 0.25-1.6)	1
YRW000390	WIRE STRIPPER	1
YRW500010	APPLICATOR	1
YRW500060	EXTRACT TOOL	1
YRW500070	EXTRACT TOOL	1

[VUB500080]

Description: Receiver-Radio frequency (RF)
Location: Centre of taildoor, behind trim panel

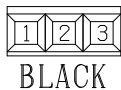
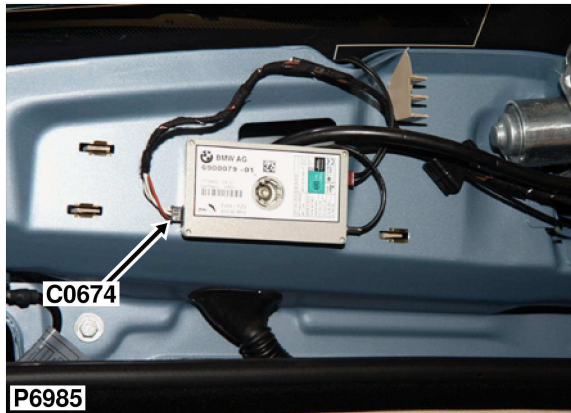

Part No. YPC117800
Colour: BLACK
Gender: F
Type: MQS
No. of Ways: 3WY

Wire Chart

CAV	TERMINAL	CSA	COL	CCT	DESTN
1	YPL101310	0.5	RB	ALL	C2022-21
2	YPL101310	0.5	W	ALL	C0981-12
3	YPL101310	0.35	WY	390	C0660-13
3	YPL101310	0.35	WY	130	SJ X13141-

Service Repair Kits

YPL101310		0.20 - 0.50 CSA
Cavities 1-3		
VDK500010	INSTRUCTION; REPAIR KIT	1
VDK500070	INSTRUCTION; EXTRACT TOOL	1
VDK500080	INSTRUCTION; EXTRACT TOOL	1
YMI000870	PRE-TERMINATED LEAD	1
YPQ000100	IDENTS (SMALL)	1
YRV000040	SPLICE (RED, CSA; 0.25-1.6)	1
YRW000390	WIRE STRIPPER	1
YRW500010	APPLICATOR	1
YRW500060	EXTRACT TOOL	1
YRW500070	EXTRACT TOOL	1

[VUB500080]

Description: Switch-Transmission-High-Low

Location: Beneath centre console

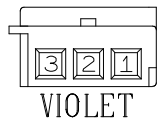
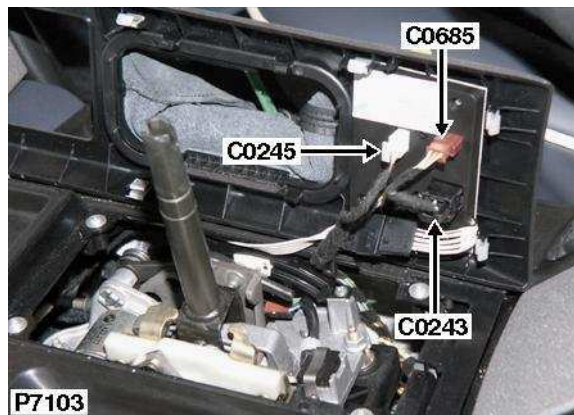

Part No. 8377070
Colour: VIOLET
Gender: F
Type: MQS
No. of Ways: 3WY

Wire Chart

CAV	TERMINAL	CSA	COL	CCT	DESTN
1	YPL101310	0.35	WG	ALL	C1664-4
2	YPL101910	0.75	RY	ALL	SJ X18121-
3	YPL101310	0.35	WU	ALL	C0193-18

Service Repair Kits

YPL101910		0.75 - 0.75 CSA
Cavities 1-3		
VDK500010	INSTRUCTION; REPAIR KIT	1
VDK500070	INSTRUCTION; EXTRACT TOOL	1
VDK500080	INSTRUCTION; EXTRACT TOOL	1
YMI000870	PRE-TERMINATED LEAD	1
YPQ000100	IDENTS (SMALL)	1
YRV000040	SPLICE (RED, CSA; 0.25-1.6)	1
YRW000390	WIRE STRIPPER	1
YRW500010	APPLICATOR	1
YRW500060	EXTRACT TOOL	1
YRW500070	EXTRACT TOOL	1

[VUB500080]

Description: Speaker-Low range-Front door-RH
Location: Behind front door trim panel

No photo
 Geen photo
 Pas de photo
 Kein foto
 Senza foto
 Sem fotografia
 No hay foto

Wire Chart

CAV	TERMINAL	CSA	COL	CCT	DESTN
1	YPL102600	MUA	UN	126	C0336-29
1	YPL102580	MAQA	UN	125	C0336-29
2	YPL102600	MUA	UW	126	C0336-28
2	YPL102580	MAQA	UW	125	C0336-28

No repair kit
 Geen reparatiepakke
 Pas de nécessaire de reparation
 Kein Werkzeug
 Senza kit per le riparazioni
 Sem kit de reparaçã
 No hay kit de reparaci3n

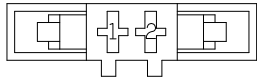

WHITE

Part No. YPC113630
Colour: WHITE
Gender: F
Type: JUNIOR POWER TIMER
No. of Ways: 2WY

Description: Solenoid-Fuel flap release
Location: Rear of luggage compartment - RH side

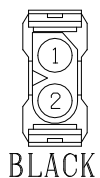
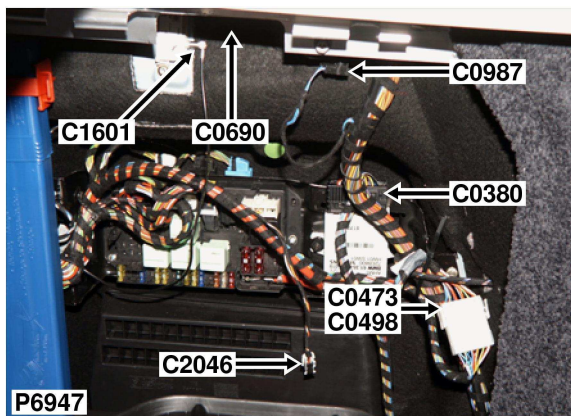

Wire Chart

CAV	TERMINAL	CSA	COL	CCT	DESTN
1	YPE100500	2.5	U	ALL	C0291-0
2	YPE100500	2.5	W	ALL	C0292-0

Service Repair Kits

YPE100500		1.01 - 2.50 <small>CSA</small>
Cavities 1,2		
VDK500010	INSTRUCTION; REPAIR KIT	1
VDK500030	INSTRUCTION; EXTRACT TOOL	1
YMI000900	PRE-TERMINATED LEAD	1
YPQ000110	IDENTS (MEDIUM)	1
YRV000050	SPLICE (BLUE, CSA; 1.0-2.6)	1
YRW000390	WIRE STRIPPER	1
YRW500010	APPLICATOR	1

[VUB500110]

Part No. YPC112260
Colour: BLACK
Gender: F
Type: 2.5MM SYSTEM
No. of Ways: 2WY

Description: Mirror-interior
Location: Top of windscreen

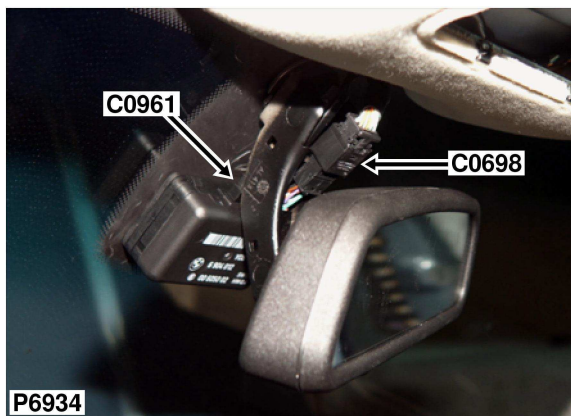

Wire Chart

CAV	TERMINAL	CSA	COL	CCT	DESTN
1	YPL101310	0.35	UY	386	C2040-39
1	YPL101310	0.35	UY	387	C2040-39
2	YPL101310	0.35	WY	130	SJ X13141-
3	YPL101310	0.5	GW	387	C0587-31
3	YPL101310	0.5	GW	386	C0587-31
4	YPL101310	0.35	WU	387	C0459-21
5	YPL101310	0.35	WR	387	C0459-20

CAV	TERMINAL	CSA	COL	CCT	DESTN
6	YPL101310	0.35	WY	387	C0463-21
7	YPL101310	0.35	WG	387	C0463-20
8	YPL101310	0.5	RY	ALL	C0586-13
9	YPL101310	0.5	SBY	ALL	C0661-19
10	YPL101310	0.5	NB	386	C0287-0
10	YPL101310	0.5	NB	387	C0287-0

Service Repair Kits

YPL101310		0.20 - 0.50 CSA
Cavities 1-10		
VDK500010	INSTRUCTION; REPAIR KIT	1
VDK500070	INSTRUCTION; EXTRACT TOOL	1
VDK500080	INSTRUCTION; EXTRACT TOOL	1
YMI000870	PRE-TERMINATED LEAD	1
YPQ000100	IDENTS (SMALL)	1
YRV000040	SPLICE (RED, CSA; 0.25-1.6)	1
YRW000390	WIRE STRIPPER	1
YRW500010	APPLICATOR	1
YRW500060	EXTRACT TOOL	1
YRW500070	EXTRACT TOOL	1

[VUB500080]

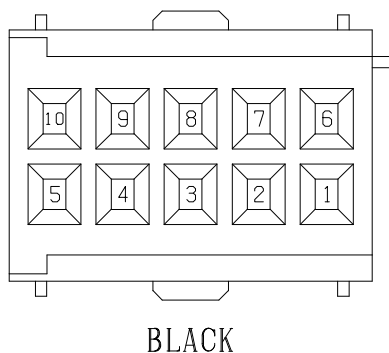

Part No. 6909000
Colour: BLACK
Gender: F
Type: MQS
No. of Ways: 10WY

Description: Switch pack-Centre console

Location: Behind centre console

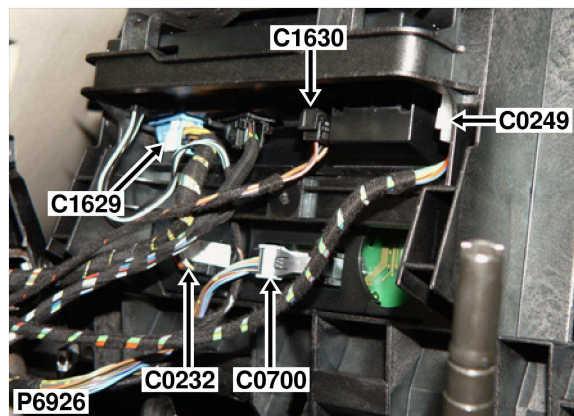

Wire Chart

CAV	TERMINAL	CSA	COL	CCT	DESTN
2	YPL101310	0.35	SN	ALL	C0661-11
4	YPL101310	0.35	YW	ALL	C0867-4
5	YPL101310	0.35	SR	ALL	C0867-3
6	YPL101310	0.35	UP	ALL	C0867-21
7	YPL101310	0.5	BY	ALL	C0506-27
11	YPL101310	0.5	SR	ALL	C0286-0
12	YPL101310	0.35	NUY	171	C0957-10
14	YPL101310	0.35	UR	337	C1537-3
15	YPL101310	0.5	GBY	ALL	SJ X1397-

CAV	TERMINAL	CSA	COL	CCT	DESTN
17	YPL101310	0.35	SU	ALL	C0867-41
18	YPL101310	0.35	SP	ALL	C0867-23
19	YPL101310	0.35	SY	ALL	C0867-5
20	YPL101310	0.35	SG	ALL	C0867-22
21	YPL101310	0.35	WY	ALL	C0867-40
22	YPL101310	0.35	NWY	171	C0957-7
25	YPL101310	0.35	UN	337	C1537-14
26	YPL101310	0.5	N	ALL	SJ X215-

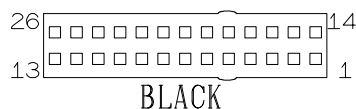

Service Repair Kits

YPL101310		0.20 - 0.50 CSA
Cavities 2,4-7,11,12,14,15,17-22,25,26		
VDK500010	INSTRUCTION; REPAIR KIT	1
VDK500070	INSTRUCTION; EXTRACT TOOL	1
VDK500080	INSTRUCTION; EXTRACT TOOL	1
YMI000870	PRE-TERMINATED LEAD	1
YPQ000100	IDENTS (SMALL)	1
YRV000040	SPLICE (RED, CSA; 0.25-1.6)	1
YRW000390	WIRE STRIPPER	1
YRW500010	APPLICATOR	1
YRW500060	EXTRACT TOOL	1
YRW500070	EXTRACT TOOL	1

[VUB500080]

Part No. YPH900770
Colour: BLACK
Gender: F
Type: MQS
No. of Ways: 26WY

Description: Header-Earth
Location: Luggage compartment - RH side

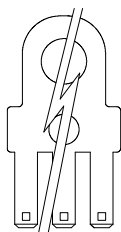
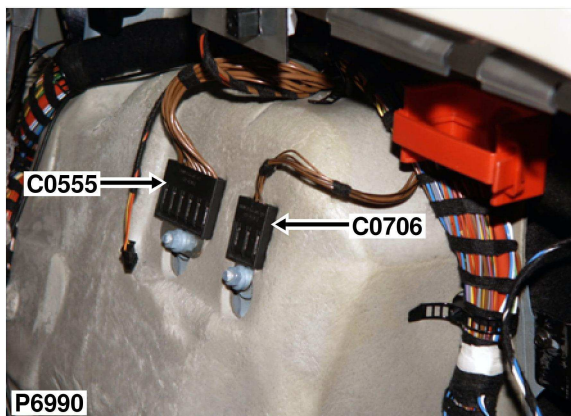

Wire Chart

CAV	TERMINAL	CSA	COL	CCT	DESTN
0	YPL103880	0.5	NB	171	C0957-6
0	YPL103880	0.5	NB	ALL	C0359-1
0	YPL103880	0.35	NB	ALL	C0835-4
0	YPL103890	1.0	NB	ALL	C2045-7
0	YPL103880	0.35	NB	97	C2046-6

Service Repair Kits

YPL103890		0.75 - 1.00 CSA
Cavities 0		
VDK500010	INSTRUCTION; REPAIR KIT	1
VDK500030	INSTRUCTION; EXTRACT TOOL	1
YMI000880	PRE-TERMINATED LEAD	1
YPQ000100	IDENTS (SMALL)	1
YRV000040	SPLICE (RED, CSA; 0.25-1.6)	1
YRW000390	WIRE STRIPPER	1
YRW500010	APPLICATOR	1
YRW500020	EXTRACT TOOL	1

[VUB500090]

YPL103880		0.20 - 0.50 CSA
Cavities 0		
VDK500010	INSTRUCTION; REPAIR KIT	1
VDK500030	INSTRUCTION; EXTRACT TOOL	1
YMI000850	PRE-TERMINATED LEAD	1
YPQ000100	IDENTS (SMALL)	1
YRV000040	SPLICE (RED, CSA; 0.25-1.6)	1
YRW000390	WIRE STRIPPER	1
YRW500010	APPLICATOR	1
YRW500020	EXTRACT TOOL	1

[VUB500060]

Part No. YPH900780
Colour: COPPER, TIN PLATED
Gender: M
Type: HEADER COVER
No. of Ways: 17WY

Description: Header-Earth
Location: Luggage compartment - RH side

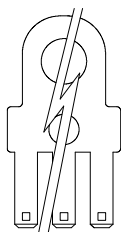
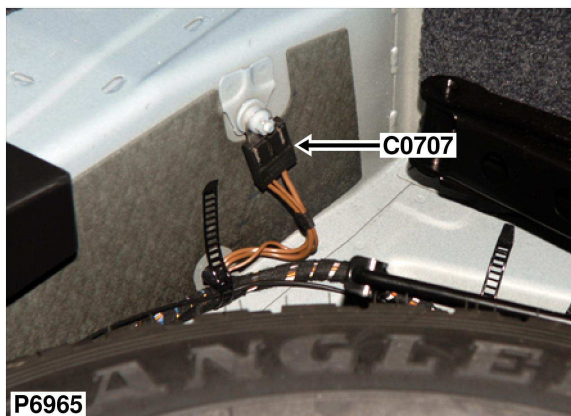

Wire Chart

CAV	TERMINAL	CSA	COL	CCT	DESTN
0	YPL103900	2.5	N	ALL	C0117-5
0	YPL103900	1.5	N	ALL	C0121-5
0	YPL104290	4.0	N	ALL	C0873-7

Service Repair Kits

YPL103900		1.50 - 2.50 CSA
Cavities 0		
VDK500010	INSTRUCTION; REPAIR KIT	1
VDK500030	INSTRUCTION; EXTRACT TOOL	1
YMI000890	PRE-TERMINATED LEAD	1
YPQ000110	IDENTS (MEDIUM)	1
YRV000050	SPLICE (BLUE, CSA; 1.0-2.6)	1
YRW000390	WIRE STRIPPER	1
YRW500010	APPLICATOR	1
[VUB500100]		

YPL104290		4.00 - 6.00 CSA
Cavities 0		
VDK500010	INSTRUCTION; REPAIR KIT	1
VDK500030	INSTRUCTION; EXTRACT TOOL	1
YMI000960	PRE-TERMINATED LEAD	1
YPQ000120	IDENTS (LARGE)	1
YRV000060	SPLICE (YELLOW, CSA; 2.7-6.6)	1
YRW000390	WIRE STRIPPER	1
YRW500010	APPLICATOR	1
[VUB500160]		

Part No. YPH900780
Colour: COPPER, TIN PLATED
Gender: M
Type: HEADER COVER
No. of Ways: 17WY

Description: Header-Earth
Location: Luggage compartment - LH side

No photo
 Geen photo
 Pas de photo
 Kein foto
 Senza foto
 Sem fotografia
 No hay foto

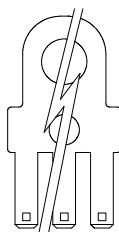

Wire Chart

CAV	TERMINAL	CSA	COL	CCT	DESTN
0	YPL103880	0.5	N	581	C0395-6
0	YPL103900	2.5	N	581	C0098-12
0	YPL103890	0.75	N	581	C0241-1

Service Repair Kits

YPL103890		0.75 - 1.00 CSA
Cavities 0		
VDK500010	INSTRUCTION; REPAIR KIT	1
VDK500030	INSTRUCTION; EXTRACT TOOL	1
YMI000880	PRE-TERMINATED LEAD	1
YPQ000100	IDENTS (SMALL)	1
YRV000040	SPLICE (RED, CSA; 0.25-1.6)	1
YRW000390	WIRE STRIPPER	1
YRW500010	APPLICATOR	1
YRW500020	EXTRACT TOOL	1
[VUB500090]		

YPL103880		0.20 - 0.50 CSA
Cavities 0		
VDK500010	INSTRUCTION; REPAIR KIT	1
VDK500030	INSTRUCTION; EXTRACT TOOL	1
YMI000850	PRE-TERMINATED LEAD	1
YPQ000100	IDENTS (SMALL)	1
YRV000040	SPLICE (RED, CSA; 0.25-1.6)	1
YRW000390	WIRE STRIPPER	1
YRW500010	APPLICATOR	1
YRW500020	EXTRACT TOOL	1
[VUB500060]		

YPL103900		1.50 - 2.50 CSA
Cavities 0		
VDK500010	INSTRUCTION; REPAIR KIT	1
VDK500030	INSTRUCTION; EXTRACT TOOL	1
YMI000890	PRE-TERMINATED LEAD	1
YPQ000110	IDENTS (MEDIUM)	1
YRV000050	SPLICE (BLUE, CSA; 1.0-2.6)	1
YRW000390	WIRE STRIPPER	1
YRW500010	APPLICATOR	1
[VUB500100]		

Part No. YPH900780
Colour: COPPER, TIN PLATED
Gender: M
Type: HEADER COVER
No. of Ways: 17WY

Description: Header
Location: Beneath front passenger's seat

No photo
 Geen photo
 Pas de photo
 Kein foto
 Senza foto
 Sem fotografia
 No hay foto

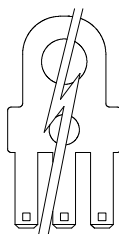

Wire Chart

CAV	TERMINAL	CSA	COL	CCT	DESTN
0	YPL103890	0.75	RY	208	C0583-9
0	YPL103890	0.75	RY	ALL	C0369-3
0	YPL103890	0.75	RY	ALL	C0867-38
0	YPL103890	0.75	RY	ALL	C2137-2
0	YPL103900	2.5	RY	ALL	SJ X18121-

CAV	TERMINAL	CSA	COL	CCT	DESTN
0	YPL103880	0.5	RY	ALL	C1629-4
0	YPL103900	2.5	RY	ALL	C0662-19
0	YPL103890	0.75	RY	ALL	C0227-1
0	YPL103890	0.75	RY	ALL	C0355-1

Service Repair Kits

YPL103890		0.75 - 1.00 CSA	
Cavities 0			
VDK500010	INSTRUCTION; REPAIR KIT	1	
VDK500030	INSTRUCTION; EXTRACT TOOL	1	
YMI000880	PRE-TERMINATED LEAD	1	
YPQ000100	IDENTS (SMALL)	1	
YRV000040	SPLICE (RED, CSA; 0.25-1.6)	1	
YRW000390	WIRE STRIPPER	1	
YRW500010	APPLICATOR	1	
YRW500020	EXTRACT TOOL	1	

[VUB500090]

YPL103880		0.20 - 0.50 CSA	
Cavities 0			
VDK500010	INSTRUCTION; REPAIR KIT	1	
VDK500030	INSTRUCTION; EXTRACT TOOL	1	
YMI000850	PRE-TERMINATED LEAD	1	
YPQ000100	IDENTS (SMALL)	1	
YRV000040	SPLICE (RED, CSA; 0.25-1.6)	1	
YRW000390	WIRE STRIPPER	1	
YRW500010	APPLICATOR	1	
YRW500020	EXTRACT TOOL	1	

[VUB500060]

YPL103900		1.50 - 2.50 CSA	
Cavities 0			
VDK500010	INSTRUCTION; REPAIR KIT	1	
VDK500030	INSTRUCTION; EXTRACT TOOL	1	
YMI000890	PRE-TERMINATED LEAD	1	
YPQ000110	IDENTS (MEDIUM)	1	
YRV000050	SPLICE (BLUE, CSA; 1.0-2.6)	1	
YRW000390	WIRE STRIPPER	1	
YRW500010	APPLICATOR	1	

[VUB500100]

Part No. YPH900780
Colour: COPPER, TIN PLATED
Gender: M
Type: HEADER COVER
No. of Ways: 17WY

Description: Header
Location: Beneath front passenger's seat

No photo
 Geen photo
 Pas de photo
 Kein foto
 Senza foto
 Sem fotografia
 No hay foto

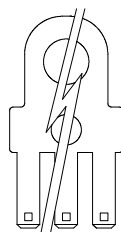

Wire Chart

CAV	TERMINAL	CSA	COL	CCT	DESTN
0	YPL103880	0.5	SR	ALL	C0435-5
0	YPL103880	0.5	SR	ALL	C0463-5
0	YPL103900	2.5	SR	ALL	C0286-0

Service Repair Kits

YPL103880		0.20 - 0.50 CSA	
Cavities 0			
VDK500010	INSTRUCTION; REPAIR KIT	1	
VDK500030	INSTRUCTION; EXTRACT TOOL	1	
YMI000850	PRE-TERMINATED LEAD	1	
YPQ000100	IDENTS (SMALL)	1	
YRV000040	SPLICE (RED, CSA; 0.25-1.6)	1	
YRW000390	WIRE STRIPPER	1	
YRW500010	APPLICATOR	1	
YRW500020	EXTRACT TOOL	1	

[VUB500060]

YPL103900		1.50 - 2.50 CSA	
Cavities 0			
VDK500010	INSTRUCTION; REPAIR KIT	1	
VDK500030	INSTRUCTION; EXTRACT TOOL	1	
YMI000890	PRE-TERMINATED LEAD	1	
YPQ000110	IDENTS (MEDIUM)	1	
YRV000050	SPLICE (BLUE, CSA; 1.0-2.6)	1	
YRW000390	WIRE STRIPPER	1	
YRW500010	APPLICATOR	1	

[VUB500100]

Part No. YPH900780
Colour: COPPER, TIN PLATED
Gender: M
Type: HEADER COVER
No. of Ways: 17WY

Description: Speakers-Low range
Location: Behind passenger's door trim panel

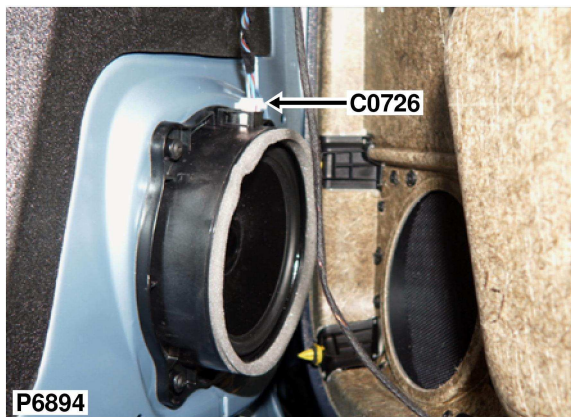

Wire Chart

CAV	TERMINAL	CSA	COL	CCT	DESTN
1	YPL102600	MUA	UN	126	C0322-29
1	YPL102580	MAQA	UN	125	C0322-29
2	YPL102600	MUA	UR	126	C0322-28
2	YPL102580	MAQA	UR	125	C0322-28

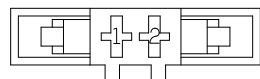

WHITE

Part No. YPC113630
Colour: WHITE
Gender: F
Type: JUNIOR POWER TIMER
No. of Ways: 2WY

No repair kit
 Geen reparatiepakke
 Pas de nécessaire de reparation
 Kein Werkzeug
 Senza kit per le riparazioni
 Sem kit de reparação
 No hay kit de reparación

Description: Switch-Window-Rear
Location: Behind rear door trim panel

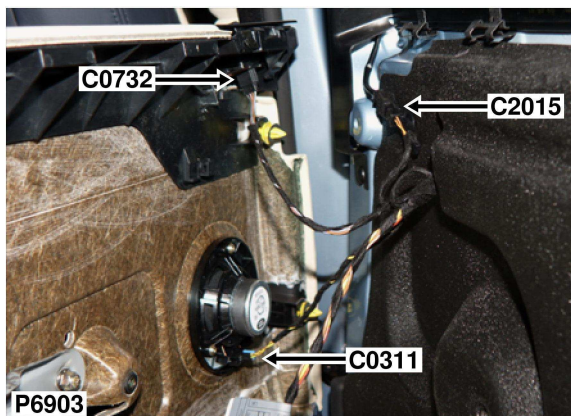

Part No. YPC117840
Colour: BLACK
Gender: F
Type: MQS
No. of Ways: 4WY

Wire Chart

CAV	TERMINAL	CSA	COL	CCT	DESTN
1	YPL101310	0.35	SN	247	C0803-6
2	YPL101310	0.35	N	247	SJ X834-
3	YPL101310	0.35	SR	247	SJ X1436-
4	YPL101310	0.35	SB	247	C0803-7

Service Repair Kits

YPL101310		0.20 - 0.50 CSA
Cavities 1-4		
VDK500010	INSTRUCTION; REPAIR KIT	1
VDK500070	INSTRUCTION; EXTRACT TOOL	1
VDK500080	INSTRUCTION; EXTRACT TOOL	1
YMI000870	PRE-TERMINATED LEAD	1
YPQ000100	IDENTS (SMALL)	1
YRV000040	SPLICE (RED, CSA; 0.25-1.6)	1
YRW000390	WIRE STRIPPER	1
YRW500010	APPLICATOR	1
YRW500060	EXTRACT TOOL	1
YRW500070	EXTRACT TOOL	1

[VUB500080]

Description: Mirror-Vanity-RH
Location: Headlining - front RH side

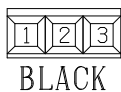

Part No. YPC117800
Colour: BLACK
Gender: F
Type: MQS
No. of Ways: 3WY

Wire Chart

CAV	TERMINAL	CSA	COL	CCT	DESTN
1	YPL101310	0.5	NB	ALL	C0552-0
3	YPL101310	0.5	PS	ALL	C0586-8

Service Repair Kits

YPL101310		0.20 - 0.50 CSA
Cavities 1,3		
VDK500010	INSTRUCTION; REPAIR KIT	1
VDK500070	INSTRUCTION; EXTRACT TOOL	1
VDK500080	INSTRUCTION; EXTRACT TOOL	1
YMI000870	PRE-TERMINATED LEAD	1
YPQ000100	IDENTS (SMALL)	1
YRV000040	SPLICE (RED, CSA; 0.25-1.6)	1
YRW000390	WIRE STRIPPER	1
YRW500010	APPLICATOR	1
YRW500060	EXTRACT TOOL	1
YRW500070	EXTRACT TOOL	1

[VUB500080]

Description: Mirror-Vanity-LH
Location: Headlining - front LH side

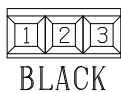

Part No. YPC117800
Colour: BLACK
Gender: F
Type: MQS
No. of Ways: 3WY

Wire Chart

CAV	TERMINAL	CSA	COL	CCT	DESTN
1	YPL101310	0.5	NB	ALL	C0554-0
3	YPL101310	0.5	PS	ALL	C0586-9

Service Repair Kits

YPL101310		0.20 - 0.50 csa
Cavities 1,3		
VDK500010	INSTRUCTION; REPAIR KIT	1
VDK500070	INSTRUCTION; EXTRACT TOOL	1
VDK500080	INSTRUCTION; EXTRACT TOOL	1
YMI000870	PRE-TERMINATED LEAD	1
YPQ000100	IDENTS (SMALL)	1
YRV000040	SPLICE (RED, CSA; 0.25-1.6)	1
YRW000390	WIRE STRIPPER	1
YRW500010	APPLICATOR	1
YRW500060	EXTRACT TOOL	1
YRW500070	EXTRACT TOOL	1

[VUB500080]

Description: Motor-Window-Driver
Location: Behind driver's door trim panel

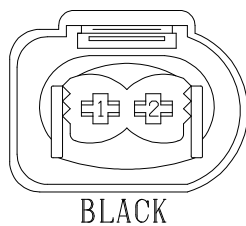
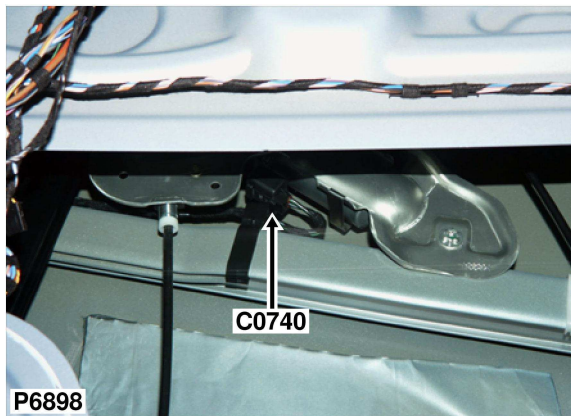

Wire Chart

CAV	TERMINAL	CSA	COL	CCT	DESTN
1	YPL103540	2.5	BG	247	C2017-4
2	YPL103540	2.5	BS	247	C2017-5

No repair kit
 Geen reparatiepakke
 Pas de nécessaire de reparation
 Kein Werkzeug
 Senza kit per le riparazioni
 Sem kit de reparaçã
 No hay kit de reparaci3n

Part No. YPC116370
Colour: BLACK
Gender: F
Type: MDK3 PLUS
No. of Ways: 2WY

Description: Motor-Window-Passenger
Location: Behind passenger's door trim panel

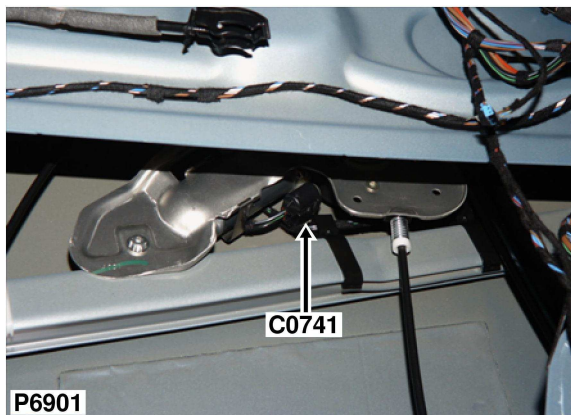

Wire Chart

CAV	TERMINAL	CSA	COL	CCT	DESTN
1	YPL103540	2.5	BG	247	C2016-4
2	YPL103540	2.5	BS	247	C2016-5

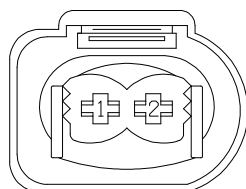

BLACK

Part No. YPC116370
Colour: BLACK
Gender: F
Type: MDK3 PLUS
No. of Ways: 2WY

No repair kit
 Geen reparatiepakke
 Pas de nécessaire de reparation
 Kein Werkzeug
 Senza kit per le riparazioni
 Sem kit de reparaçã
 No hay kit de reparaci3n

Description: ECU-Sunroof-1
Location: Front of headlining in the centre

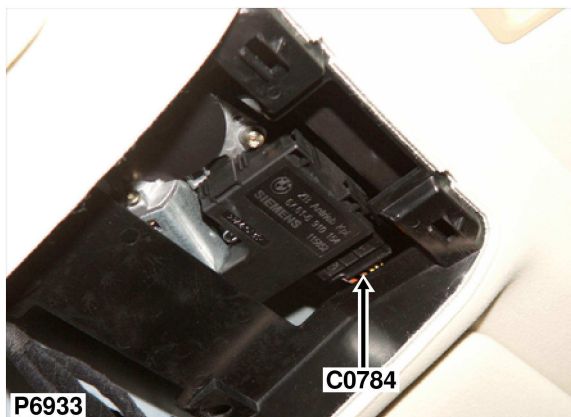

Wire Chart

CAV	TERMINAL	CSA	COL	CCT	DESTN
1	YPL102720	2.5	RS	227	C0582-10
2	YPL102720	2.5	N	227	C0285-0
3	YPL102700	0.75	YS	227	C0363-6
9	YPL101310	0.35	YG	227	C0363-4
10	YPL101310	0.35	UR	227	C0294-0

CAV	TERMINAL	CSA	COL	CCT	DESTN
11	YPL101310	0.35	SB	227	C0363-5
13	YPL101310	0.35	YW	227	C0363-3

Service Repair Kits

YPL101310		0.20 - 0.50 CSA
Cavities 9-11,13		
VDK500010	INSTRUCTION; REPAIR KIT	1
VDK500070	INSTRUCTION; EXTRACT TOOL	1
VDK500080	INSTRUCTION; EXTRACT TOOL	1
YMI000870	PRE-TERMINATED LEAD	1
YPQ000100	IDENTS (SMALL)	1
YRV000040	SPLICE (RED, CSA; 0.25-1.6)	1
YRW000390	WIRE STRIPPER	1
YRW500010	APPLICATOR	1
YRW500060	EXTRACT TOOL	1
YRW500070	EXTRACT TOOL	1

[VUB500080]

YPL102700		0.50 - 1.00 CSA
Cavities 3		
VDK500010	INSTRUCTION; REPAIR KIT	1
VDK500030	INSTRUCTION; EXTRACT TOOL	1
YMI001060	PRE-TERMINATED LEAD	1
YPQ000100	IDENTS (SMALL)	1
YRV000040	SPLICE (RED, CSA; 0.25-1.6)	1
YRW000390	WIRE STRIPPER	1
YRW500010	APPLICATOR	1

[VUB500260]

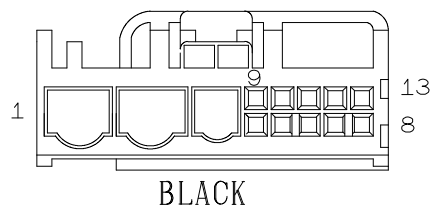

Part No. YPC114780
Colour: BLACK
Gender: F
Type: MQS/MPQ/PQ HYBRID
No. of Ways: 13WY

Description: Main harness to air conditioning (A/C) harness

Location: Behind centre console

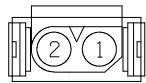
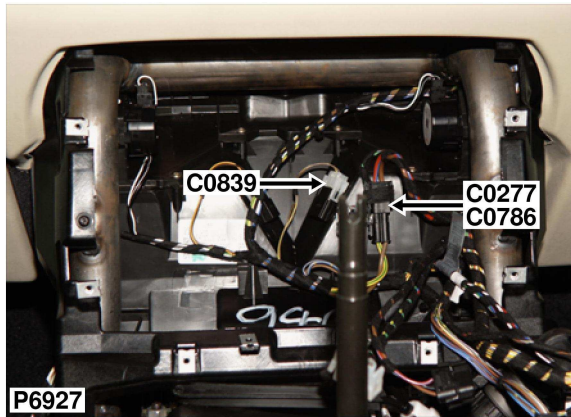

BLACK

Wire Chart

CAV	TERMINAL	CSA	COL	CCT	DESTN
1	YPE100520	4.0	N	ALL	C0821-0
2	YPE100520	4.0	RU	ALL	C0580-2

Service Repair Kits

YPE100520		2.51 - 4.00 csa
Cavities 1,2		
VDK500010	INSTRUCTION; REPAIR KIT	1
VDK500130	INSTRUCTION; EXTRACT TOOL	1
YMI000980	PRE-TERMINATED LEAD	1
YPQ000120	IDENTS (LARGE)	1
YRV000060	SPLICE (YELLOW, CSA; 2.7-6.6)	1
YRW000390	WIRE STRIPPER	1
YRW500010	APPLICATOR	1

[VUB500180]

Part No. 8378970
Colour: BLACK
Gender: F
Type: 2.5MM SYSTEM
No. of Ways: 2WY

Description: Sensor-Throttle position (TP)
Location: Driver's footwell

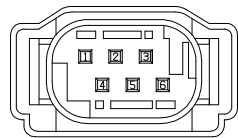
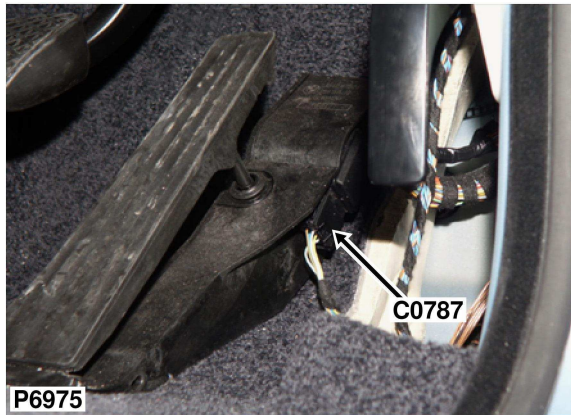

BLACK

Wire Chart

CAV	TERMINAL	CSA	COL	CCT	DESTN
1	YPL101880	0.35	NG	ALL	C0331-7
2	YPL101880	0.35	UG	ALL	C0331-12
3	YPL101880	0.35	YG	ALL	C0331-14

CAV	TERMINAL	CSA	COL	CCT	DESTN
4	YPL101880	0.35	W	ALL	C0331-8
5	YPL101880	0.35	Y	ALL	C0331-9
6	YPL101880	0.35	WG	ALL	C0331-13

Service Repair Kits

YPL101880		0.20 - 0.50 CSA
Cavities 1-6		
VDK500010	INSTRUCTION; REPAIR KIT	1
VDK500070	INSTRUCTION; EXTRACT TOOL	1
VDK500080	INSTRUCTION; EXTRACT TOOL	1
YMI001080	PRE-TERMINATED LEAD	1
YPQ000100	IDENTS (SMALL)	1
YQD000210	HEAT SHRINK SLEEVE	1
YRV000040	SPLICE (RED, CSA; 0.25-1.6)	1
YRW000390	WIRE STRIPPER	1
YRW500010	APPLICATOR	1

[VUB500280]

Part No. YPC110680
Colour: BLACK
Gender: F
Type: MQS
No. of Ways: 6WY

Description: Sensor-Sunlight
Location: Fascia - top centre

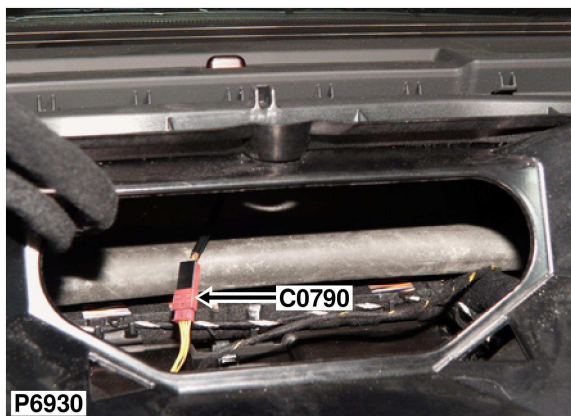

Wire Chart

CAV	TERMINAL	CSA	COL	CCT	DESTN
1	YPL101310	0.35	YN	19	C1629-2
2	YPL101310	0.35	YG	19	C1629-19
3	YPL101310	0.35	YR	19	C1629-18
4	YPL101310	0.35	YB	19	C1629-24

Service Repair Kits

YPL101310		0.20 - 0.50 CSA
Cavities 1-4		
VDK500010	INSTRUCTION; REPAIR KIT	1
VDK500070	INSTRUCTION; EXTRACT TOOL	1
VDK500080	INSTRUCTION; EXTRACT TOOL	1
YMI000870	PRE-TERMINATED LEAD	1
YPQ000100	IDENTS (SMALL)	1
YRV000040	SPLICE (RED, CSA; 0.25-1.6)	1
YRW000390	WIRE STRIPPER	1
YRW500010	APPLICATOR	1
YRW500060	EXTRACT TOOL	1
YRW500070	EXTRACT TOOL	1

[VUB500080]

Part No. YPC117870
Colour: BORDEAUX VIOLET
Gender: F
Type: MQS
No. of Ways: 4WY

Description: Door harness to main harness

Location: Base of 'C' post RH side

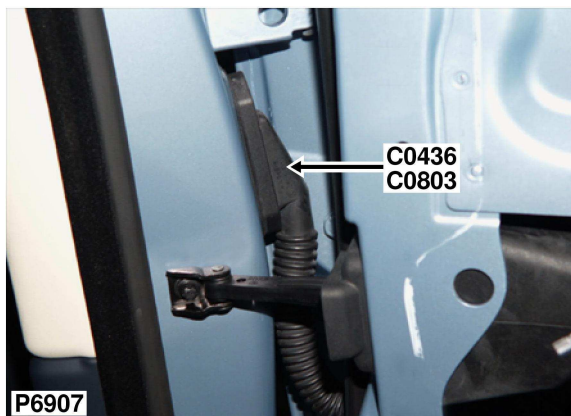

Wire Chart

CAV	TERMINAL	CSA	COL	CCT	DESTN
1	YPL101910	0.75	W	40	C0442-4
2	YPL101910	0.75	U	40	C0442-7
3	YPL101910	0.75	B	40	C0442-8
4	YPL101910	0.75	N	247	SJ X834-
5	YPL101310	0.5	SR	247	SJ X1436-
6	YPL101310	0.35	SN	247	C0732-1
7	YPL101310	0.35	SB	247	C0732-4
8	YPL101310	0.35	NY	247	C2015-2
11	YPL101910	0.75	RU	134	C2212-2

CAV	TERMINAL	CSA	COL	CCT	DESTN
12	YPL101310	0.35	NS	134	C0442-6
14	YPL101310	MMB	YB	126	C0311-2
15	YPL101310	MMB	YN	126	C0311-1
26	YPL102720	2.5	BG	247	C0304-1
27	YPL102720	2.5	US	247	C0304-2
28	YPL102700	MAQA	Y	125	C0310-2
28	YPL102710	MUA	Y	126	C0310-2
29	YPL102700	MAQA	N	125	C0310-1
29	YPL102710	MUA	N	126	C0310-1

Service Repair Kits

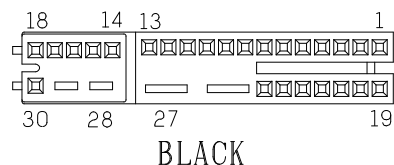

Part No. YPC114720
Colour: BLACK
Gender: F
Type: MQS/MPQ
No. of Ways: 30WY

YPL101910		0.75 - 0.75 CSA	
Cavities 1-8,11,12,14,15			
VDK500010	INSTRUCTION; REPAIR KIT	1	
VDK500070	INSTRUCTION; EXTRACT TOOL	1	
VDK500080	INSTRUCTION; EXTRACT TOOL	1	
YMI000870	PRE-TERMINATED LEAD	1	
YPQ000100	IDENTS (SMALL)	1	
YRV000040	SPLICE (RED, CSA; 0.25-1.6)	1	
YRW000390	WIRE STRIPPER	1	
YRW500010	APPLICATOR	1	
YRW500060	EXTRACT TOOL	1	
YRW500070	EXTRACT TOOL	1	

[VUB500080]

YPL102710		1.01 - 2.50 CSA	
Cavities 28,29			
VDK500010	INSTRUCTION; REPAIR KIT	1	
VDK500050	INSTRUCTION; EXTRACT TOOL	1	
YMI001010	PRE-TERMINATED LEAD	1	
YPQ000110	IDENTS (MEDIUM)	1	
YRV000050	SPLICE (BLUE, CSA; 1.0-2.6)	1	
YRW000390	WIRE STRIPPER	1	
YRW500010	APPLICATOR	1	

[VUB500210]

YPL102700		0.50 - 1.00 CSA	
Cavities 28,29			
VDK500010	INSTRUCTION; REPAIR KIT	1	
VDK500030	INSTRUCTION; EXTRACT TOOL	1	
YMI001060	PRE-TERMINATED LEAD	1	
YPQ000100	IDENTS (SMALL)	1	
YRV000040	SPLICE (RED, CSA; 0.25-1.6)	1	
YRW000390	WIRE STRIPPER	1	
YRW500010	APPLICATOR	1	

[VUB500260]

Description: Module-Video
Location: Luggage compartment - LH side

No photo
 Geen photo
 Pas de photo
 Kein foto
 Senza foto
 Sem fotografia
 No hay foto

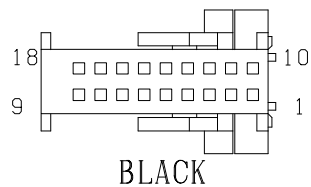

Part No. YPC111800
Colour: BLACK
Gender: F
Type: MQS
No. of Ways: 18WY

Wire Chart

CAV	TERMINAL	CSA	COL	CCT	DESTN
7	YPL101310	MCHA	SCRN	569	C0898-15
7	YPL101310	MCHC	SCRN	568	C0899-15
8	YPL101310	MCHC	W	568	C0899-16
8	YPL101310	MCHA	W	569	C0898-17
16	YPL101310	MCHC	S	568	C0899-6

CAV	TERMINAL	CSA	COL	CCT	DESTN
16	YPL101310	MCHA	S	569	C0898-8
17	YPL101310	MCHC	B	568	C0899-7
17	YPL101310	MCHA	B	569	C0898-13
18	YPL101310	MCHA	R	569	C0898-4
18	YPL101310	MCHC	R	568	C0899-5

Service Repair Kits

YPL101310		0.20 - 0.50 CSA
Cavities 7-8,16-18		
VDK500010	INSTRUCTION; REPAIR KIT	1
VDK500070	INSTRUCTION; EXTRACT TOOL	1
VDK500080	INSTRUCTION; EXTRACT TOOL	1
YMI000870	PRE-TERMINATED LEAD	1
YPQ000100	IDENTS (SMALL)	1
YRV000040	SPLICE (RED, CSA; 0.25-1.6)	1
YRW000390	WIRE STRIPPER	1
YRW500010	APPLICATOR	1
YRW500060	EXTRACT TOOL	1
YRW500070	EXTRACT TOOL	1

[VUB500080]

Description: Header-Earth
Location: Beneath RH seat

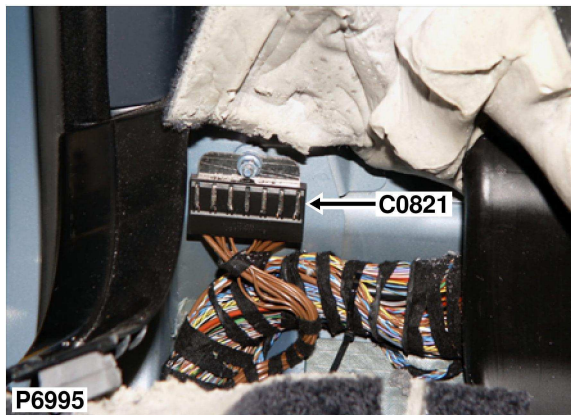

Wire Chart

CAV	TERMINAL	CSA	COL	CCT	DESTN
0	YPL104290	4.0	N	109	C0247-1
0	YPL103900	1.5	N	ALL	SJ X215-
0	YPL103900	2.5	N	204	C0255-24
0	YPL103890	0.75	N	ALL	C0934-2
0	YPL103890	0.75	N	ALL	C0946-2
0	YPL104290	4.0	N	ALL	C0285-0

CAV	TERMINAL	CSA	COL	CCT	DESTN
0	YPL104290	4.0	N	ALL	C0786-1
0	YPL103890	0.75	N	ALL	C0435-4
0	YPL103900	2.5	N	ALL	C0662-1
0	YPL104290	4.0	N	208	C0255-14
0	YPL104290	4.0	N	ALL	C0463-26
0	YPL103880	0.5	N	134	C1795-1

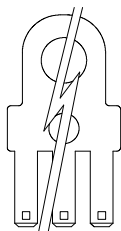

Part No. YPH900780
Colour: COPPER, TIN PLATED
Gender: M
Type: HEADER COVER
No. of Ways: 17WY

Description: Header-Earth
Location: Beneath RH seat

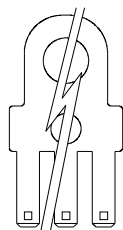
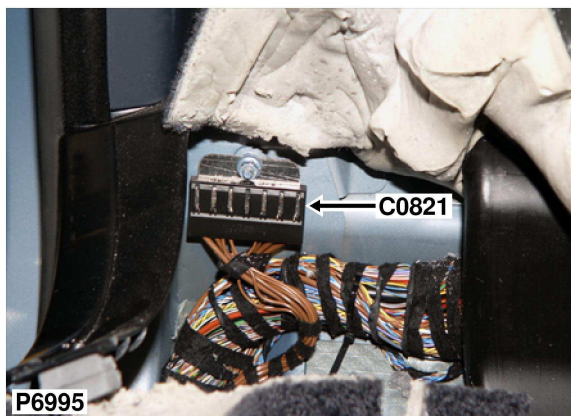

Part No. YPH900780
Colour: COPPER, TIN PLATED
Gender: M
Type: HEADER COVER
No. of Ways: 17WY

Service Repair Kits

YPL103890	0.75 - 1.00 CSA
Cavities 0	
VDK500010	INSTRUCTION; REPAIR KIT 1
VDK500030	INSTRUCTION; EXTRACT TOOL 1
YMI000880	PRE-TERMINATED LEAD 1
YPQ000100	IDENTS (SMALL) 1
YRV000040	SPLICE (RED, CSA; 0.25-1.6) 1
YRW000390	WIRE STRIPPER 1
YRW500010	APPLICATOR 1
YRW500020	EXTRACT TOOL 1
[VUB500090]	

YPL103880	0.20 - 0.50 CSA
Cavities 0	
VDK500010	INSTRUCTION; REPAIR KIT 1
VDK500030	INSTRUCTION; EXTRACT TOOL 1
YMI000850	PRE-TERMINATED LEAD 1
YPQ000100	IDENTS (SMALL) 1
YRV000040	SPLICE (RED, CSA; 0.25-1.6) 1
YRW000390	WIRE STRIPPER 1
YRW500010	APPLICATOR 1
YRW500020	EXTRACT TOOL 1
[VUB500060]	

YPL104290	4.00 - 6.00 CSA
Cavities 0	
VDK500010	INSTRUCTION; REPAIR KIT 1
VDK500030	INSTRUCTION; EXTRACT TOOL 1
YMI000960	PRE-TERMINATED LEAD 1
YPQ000120	IDENTS (LARGE) 1
YRV000060	SPLICE (YELLOW, CSA; 2.7-6.6) 1
YRW000390	WIRE STRIPPER 1
YRW500010	APPLICATOR 1
[VUB500160]	

YPL103900	1.50 - 2.50 CSA
Cavities 0	
VDK500010	INSTRUCTION; REPAIR KIT 1
VDK500030	INSTRUCTION; EXTRACT TOOL 1
YMI000890	PRE-TERMINATED LEAD 1
YPQ000110	IDENTS (MEDIUM) 1
YRV000050	SPLICE (BLUE, CSA; 1.0-2.6) 1
YRW000390	WIRE STRIPPER 1
YRW500010	APPLICATOR 1
[VUB500100]	

[continuation]

Description: Motor-Wiper-Rear screen
Location: Centre of taildoor, behind trim panel

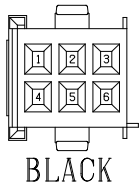
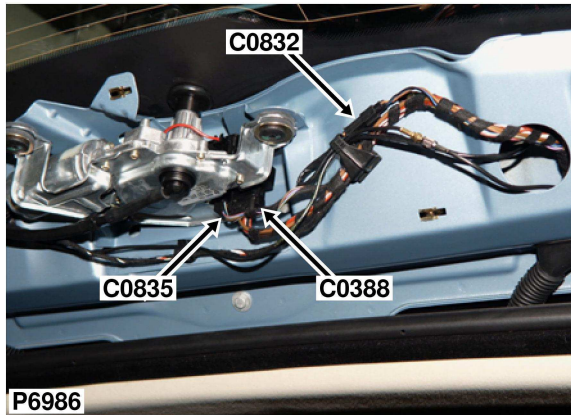

Part No. YPC115290
Colour: BLACK
Gender: F
Type: MQS
No. of Ways: 6WY

Wire Chart

CAV	TERMINAL	CSA	COL	CCT	DESTN
1	YPL101310	0.35	BW	ALL	C0278-3
2	YPL101310	0.35	BU	ALL	C0278-8
3	YPL101910	0.75	PR	ALL	C0586-6
4	YPL101310	0.35	NB	ALL	C0706-0
6	YPL101310	0.35	UY	ALL	C2040-28

Service Repair Kits

YPL101910		0.75 - 0.75 CSA
Cavities 1-4,6		
VDK500010	INSTRUCTION; REPAIR KIT	1
VDK500070	INSTRUCTION; EXTRACT TOOL	1
VDK500080	INSTRUCTION; EXTRACT TOOL	1
YMI000870	PRE-TERMINATED LEAD	1
YPQ000100	IDENTS (SMALL)	1
YRV000040	SPLICE (RED, CSA; 0.25-1.6)	1
YRW000390	WIRE STRIPPER	1
YRW500010	APPLICATOR	1
YRW500060	EXTRACT TOOL	1
YRW500070	EXTRACT TOOL	1

[VUB500080]

Description: Main harness to air conditioning (A/C) harness

Location: Behind centre console

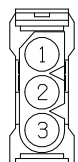
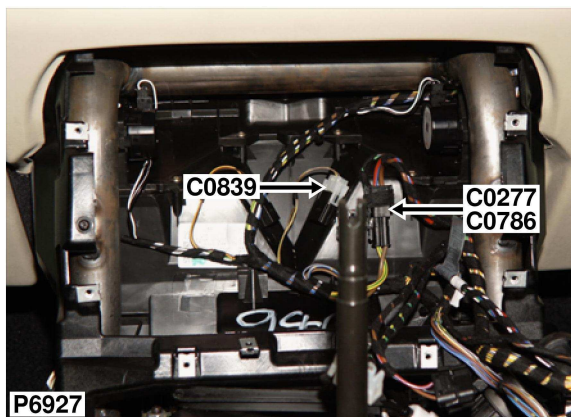

BLACK

Wire Chart

CAV	TERMINAL	CSA	COL	CCT	DESTN
1	YPE100500	2.5	N	19	C0285-0
2	YPE100500	2.5	GU	19	C2021-2
3	YPE10020	0.5	SR	19	C0286-0

Service Repair Kits

YPE100500		1.01 - 2.50 CSA	
Cavities 1,2			
VDK500010	INSTRUCTION; REPAIR KIT	1	
VDK500030	INSTRUCTION; EXTRACT TOOL	1	
YMI000900	PRE-TERMINATED LEAD	1	
YPQ000110	IDENTS (MEDIUM)	1	
YRV000050	SPLICE (BLUE, CSA; 1.0-2.6)	1	
YRW000390	WIRE STRIPPER	1	
YRW500010	APPLICATOR	1	
[VUB500110]			

YPE10020		0.50 - 1.00 CSA	
Cavities 3			
VDK500010	INSTRUCTION; REPAIR KIT	1	
VDK500130	INSTRUCTION; EXTRACT TOOL	1	
YMI000860	PRE-TERMINATED LEAD	1	
YPQ000100	IDENTS (SMALL)	1	
YRV000040	SPLICE (RED, CSA; 0.25-1.6)	1	
YRW000390	WIRE STRIPPER	1	
YRW500010	APPLICATOR	1	
[VUB500070]			

Part No. YPC112530
Colour: BLACK
Gender: F
Type: 2.5MM SYSTEM
No. of Ways: 3WY

Description: Sensor-Steering angle
Location: Underside of steering column

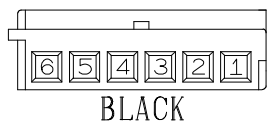
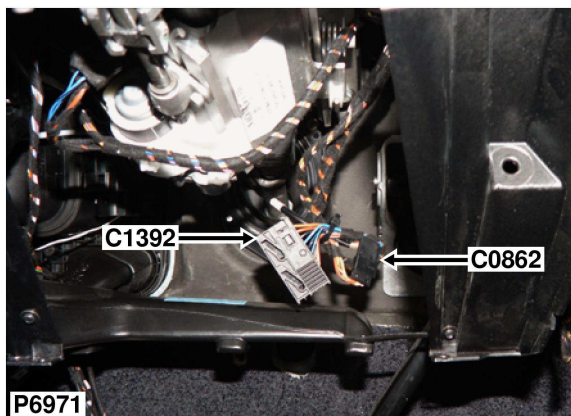

Wire Chart

CAV	TERMINAL	CSA	COL	CCT	DESTN
1	YPL101310	0.5	RG	ALL	SJ X18061-
2	YPL101910	0.75	RW	ALL	C0584-2
3	YPL101310	MMAF	YB	58	SJ X18836-

CAV	TERMINAL	CSA	COL	CCT	DESTN
4	YPL101310	MMAF	YN	58	SJ X18835-
5	YPL101310	0.5	NB	ALL	SJ X217-
6	YPL101310	0.35	WP	ALL	SJ X183-

Service Repair Kits

YPL101910		0.75 - 0.75 CSA
Cavities 1-6		
VDK500010	INSTRUCTION; REPAIR KIT	1
VDK500070	INSTRUCTION; EXTRACT TOOL	1
VDK500080	INSTRUCTION; EXTRACT TOOL	1
YMI000870	PRE-TERMINATED LEAD	1
YPQ000100	IDENTS (SMALL)	1
YRV000040	SPLICE (RED, CSA; 0.25-1.6)	1
YRW000390	WIRE STRIPPER	1
YRW500010	APPLICATOR	1
YRW500060	EXTRACT TOOL	1
YRW500070	EXTRACT TOOL	1

[VUB500080]

Part No. 6909052
Colour: BLACK
Gender: F
Type: MQS
No. of Ways: 6WY

Description: ECU-Air suspension
Location: Behind LH side of fascia

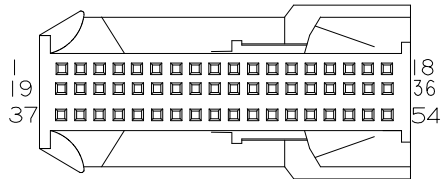
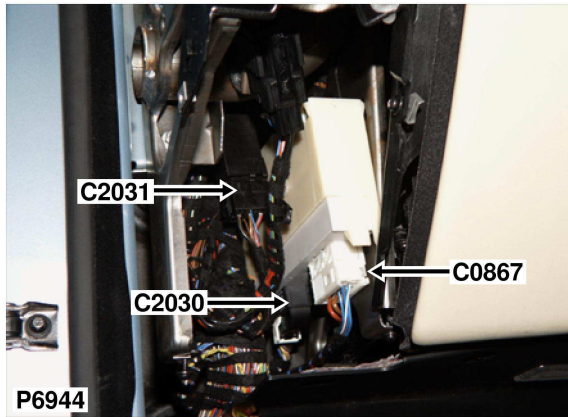

BLACK

Part No. 6909076
Colour: BLACK
Gender: F
Type: ELO
No. of Ways: 54WY

Wire Chart

CAV	TERMINAL	CSA	COL	CCT	DESTN
2	YPE100920	MMAA	YB	ALL	SJ X18827-
3	YPE100920	0.35	SR	ALL	C0700-5
4	YPE100920	0.35	YW	ALL	C0700-4
5	YPE100920	0.35	SY	ALL	C0700-19
6	YPE100920	0.5	UY	ALL	C0333-7
7	YPE100890	0.75	UB	ALL	C0333-6
8	YPE100920	0.5	US	ALL	C0333-8
9	YPE100920	0.5	WR	ALL	C0333-3
10	YPE100890	0.75	WP	ALL	C0333-2
11	YPE100920	0.5	YP	ALL	C0333-4
12	YPE100920	0.5	UG	ALL	C0333-5
13	YPE100920	0.5	UW	ALL	C0333-1
14	YPE100920	0.5	WG	ALL	C0873-2
15	YPE100920	0.5	WU	ALL	C0873-12
16	YPE100920	0.35	B	ALL	C2022-1
17	YPE100920	0.5	BU	ALL	C0873-5
20	YPE100920	MMAA	YN	ALL	SJ X18826-
21	YPE100920	0.35	UP	ALL	C0700-6
22	YPE100920	0.35	SG	ALL	C0700-20
23	YPE100920	0.35	SP	ALL	C0700-18
24	YPE100920	0.35	BS	ALL	C1697-4
25	YPE100920	0.35	SW	ALL	C1696-4
26	YPE100920	0.35	YS	ALL	C1698-4

CAV	TERMINAL	CSA	COL	CCT	DESTN
27	YPE100920	0.35	WS	ALL	C1699-4
28	YPE100920	0.35	U	ALL	C1611-2
31	YPE100920	0.35	BRY	ALL	C0873-6
32	YPE100920	0.35	SB	ALL	C1696-5
33	YPE100920	0.35	BW	ALL	C1697-5
34	YPE100920	0.35	Y	ALL	C1611-3
35	YPE100920	0.5	BY	ALL	C0873-11
37	YPE100920	0.35	WRY	ALL	C0296-0
38	YPE100890	0.75	RY	ALL	C0723-0
39	YPE100920	0.35	YG	ALL	C0459-1
40	YPE100920	0.35	WY	ALL	C0700-21
41	YPE100920	0.35	SU	ALL	C0700-17
42	YPE100920	0.35	BN	ALL	C1697-1
43	YPE100920	0.35	SN	ALL	C1696-1
44	YPE100920	0.35	YN	ALL	C1698-1
45	YPE100920	0.35	WN	ALL	C1699-1
46	YPE100920	0.35	W	ALL	C1611-1
49	YPE100920	0.35	S	ALL	C0873-4
50	YPE100920	0.35	YB	ALL	C1698-5
51	YPE100920	0.35	WB	ALL	C1699-5

Service Repair Kits

YPE100890		0.75 - 0.75 CSA
Cavities 2-17,20-28,31-35,37-46,49-51		
VDK500010	INSTRUCTION; REPAIR KIT	1
VDK500040	INSTRUCTION; EXTRACT TOOL	1
YMI001040	PRE-TERMINATED LEAD	1
YPQ000100	IDENTS (SMALL)	1
YRV000040	SPLICE (RED, CSA; 0.25-1.6)	1
YRW000390	WIRE STRIPPER	1
YRW500010	APPLICATOR	1

[VUB500240]

Description: Main harness to console harness

Location: Behind centre of fascia

No photo
 Geen photo
 Pas de photo
 Kein foto
 Senza foto
 Sem fotografia
 No hay foto

Wire Chart

CAV	TERMINAL	CSA	COL	CCT	DESTN
1	YPE100500	1.5	GW	572	C2021-6
2	YPE100500	1.5	GN	572	C2021-7
3	YPE10020	1.0	WY	572	C2042-2
4	YPE10020	1.0	BY	572	C2043-2
5	YPE100500	2.5	N	ALL	C0553-0
6	YPE100500	2.5	RG	43	C2020-12
6	YPE100500	2.5	RG	575	C2021-4

CAV	TERMINAL	CSA	COL	CCT	DESTN
8	YPE10020	0.5	YN	572	C2042-1
9	YPE10020	0.5	WN	572	C2043-1
10	YPE10020	0.75	NB	ALL	SJ X230-
11	YPE10020	0.5	SR	ALL	SJ X1019-

Service Repair Kits

YPE100500		1.01 - 2.50 CSA
Cavities 1,2,5,6		
VDK500010	INSTRUCTION; REPAIR KIT	1
VDK500030	INSTRUCTION; EXTRACT TOOL	1
YMI000900	PRE-TERMINATED LEAD	1
YPQ000110	IDENTS (MEDIUM)	1
YRV000050	SPLICE (BLUE, CSA; 1.0-2.6)	1
YRW000390	WIRE STRIPPER	1
YRW500010	APPLICATOR	1
[VUB500110]		

YPE10020		0.50 - 1.00 CSA
Cavities 3,4,8-11		
VDK500010	INSTRUCTION; REPAIR KIT	1
VDK500130	INSTRUCTION; EXTRACT TOOL	1
YMI000860	PRE-TERMINATED LEAD	1
YPQ000100	IDENTS (SMALL)	1
YRV000040	SPLICE (RED, CSA; 0.25-1.6)	1
YRW000390	WIRE STRIPPER	1
YRW500010	APPLICATOR	1
[VUB500070]		

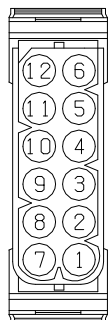

NATURAL

Part No. YPC112670
Colour: NATURAL
Gender: F
Type: 2.5MM SYSTEM
No. of Ways: 12WY

Description: Pump-Air suspension
Location: Rear of luggage compartment

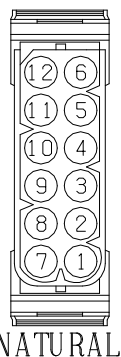
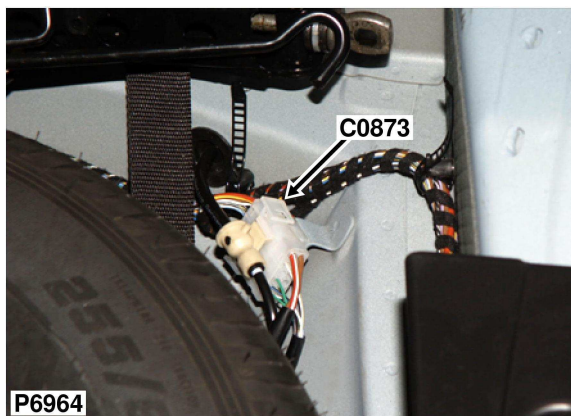

Wire Chart

CAV	TERMINAL	CSA	COL	CCT	DESTN
1	YPE100520	4.0	RY	ALL	C2023-2
2	YPE10020	0.5	WG	ALL	C0867-14
4	YPE100480	0.35	S	ALL	C0867-49
5	YPE10020	0.5	BU	ALL	C0867-17

CAV	TERMINAL	CSA	COL	CCT	DESTN
6	YPE100480	0.35	BRY	ALL	C0867-31
7	YPE100520	4.0	N	ALL	C0707-0
11	YPE10020	0.5	BY	ALL	C0867-35
12	YPE10020	0.5	WU	ALL	C0867-15

Service Repair Kits

YPE100480		0.20 - 0.40 CSA
Cavities 2,4-6,11,12		
VDK500010	INSTRUCTION; REPAIR KIT	1
VDK500130	INSTRUCTION; EXTRACT TOOL	1
YMI000860	PRE-TERMINATED LEAD	1
YPQ000100	IDENTS (SMALL)	1
YRV000040	SPLICE (RED, CSA; 0.25-1.6)	1
YRW000390	WIRE STRIPPER	1
YRW500010	APPLICATOR	1
[VUB500070]		

YPE100520		2.51 - 4.00 CSA
Cavities 1,2,5,7,11,12		
VDK500010	INSTRUCTION; REPAIR KIT	1
VDK500130	INSTRUCTION; EXTRACT TOOL	1
YMI000980	PRE-TERMINATED LEAD	1
YPQ000120	IDENTS (LARGE)	1
YRV000060	SPLICE (YELLOW, CSA; 2.7-6.6)	1
YRW000390	WIRE STRIPPER	1
YRW500010	APPLICATOR	1
[VUB500180]		

Part No. YPC112670
Colour: NATURAL
Gender: F
Type: 2.5MM SYSTEM
No. of Ways: 12WY

Description: Main harness to PDC harness
Location: Rear of luggage compartment - RH side

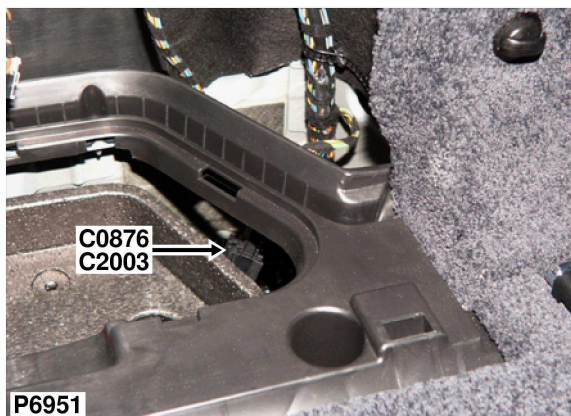

Wire Chart

CAV	TERMINAL	CSA	COL	CCT	DESTN
1	YPJ100830	0.35	NB	171	C0958-1
2	YPJ100830	0.35	NY	171	C0958-2
3	YPJ100830	0.35	NW	171	C0958-3
4	YPJ100830	0.35	GS	171	C0958-4
5	YPJ100830	0.35	GN	171	C0958-5
6	YPJ100830	0.35	GP	171	C0958-6

CAV	TERMINAL	CSA	COL	CCT	DESTN
7	YPJ100830	0.35	NU	171	C0958-7
8	YPJ100830	0.35	YB	171	C0958-8
9	YPJ100830	0.35	YG	171	C0958-9
10	YPJ100830	0.35	YN	171	C0958-10
11	YPJ100830	0.35	YS	171	C0958-11
12	YPJ100830	0.35	GB	171	C0958-12

Service Repair Kits

YPJ100830		0.20 - 0.50 CSA
Cavities 1-12		
VDK500010	INSTRUCTION; REPAIR KIT	1
VDK500070	INSTRUCTION; EXTRACT TOOL	1
VDK500080	INSTRUCTION; EXTRACT TOOL	1
YMI000990	PRE-TERMINATED LEAD	1
YPQ000100	IDENTS (SMALL)	1
YRV000040	SPLICE (RED, CSA; 0.25-1.6)	1
YRW000390	WIRE STRIPPER	1
YRW500010	APPLICATOR	1
YRW500060	EXTRACT TOOL	1
YRW500070	EXTRACT TOOL	1

[VUB500190]

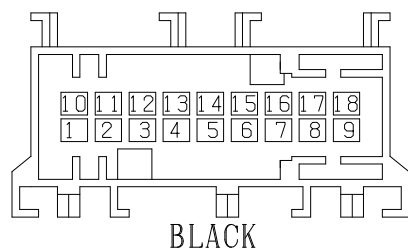

Part No. YPC113590
Colour: BLACK
Gender: M
Type: MQS
No. of Ways: 18WY

Description: Pump-Air injection
Location: Behind RH front wheel arch liner

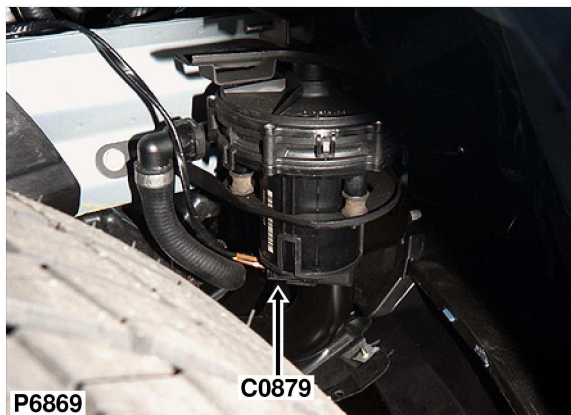

Wire Chart

CAV	TERMINAL	CSA	COL	CCT	DESTN
1	YPE100560	4.0	N	573	C0550-0
2	YPE100560	4.0	BRY	573	C1886-6

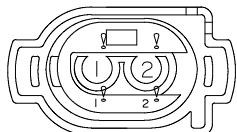

VIOLET

Part No. YPC110340
Colour: BLACK
Gender: F
Type: 2.5MM SYSTEM
No. of Ways: 2WY

No repair kit
 Geen reparatiepakke
 Pas de nécessaire de reparation
 Kein Werkzeug
 Senza kit per le riparazioni
 Sem kit de reparação
 No hay kit de reparaci3n

Description: Sensor-Ambient air temperature

Location: Behind the front grille

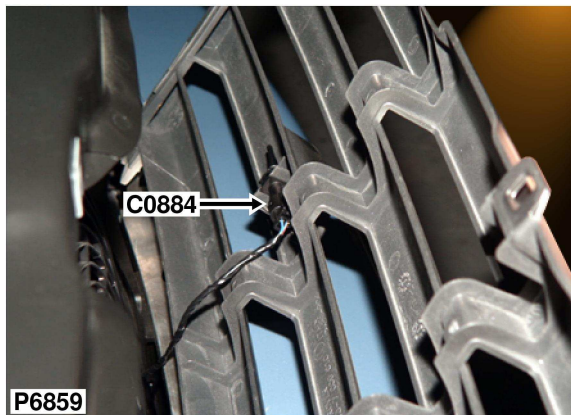

Wire Chart

CAV	TERMINAL	CSA	COL	CCT	DESTN
1	YPL101500	0.5	UN	ALL	C0234-22
2	YPL101500	0.5	UR	ALL	C0234-14

Service Repair Kits

YPL101500		0.20 - 0.50 <small>CSA</small>
Cavities 1,2		
VDK500010	INSTRUCTION; REPAIR KIT	1
VDK500070	INSTRUCTION; EXTRACT TOOL	1
VDK500080	INSTRUCTION; EXTRACT TOOL	1
YMI000950	PRE-TERMINATED LEAD	1
YPQ000100	IDENTS (SMALL)	1
YQD000210	HEAT SHRINK SLEEVE	1
YRV000040	SPLICE (RED, CSA; 0.25-1.6)	1
YRW000390	WIRE STRIPPER	1
YRW500010	APPLICATOR	1

[VUB500150]



Part No. YPC116820
Colour: BLACK
Gender: F
Type: MQS
No. of Ways: 2WY

Description: ECU-Navigation
Location: Luggage compartment - LH side

No photo
 Geen photo
 Pas de photo
 Kein foto
 Senza foto
 Sem fotografia
 No hay foto

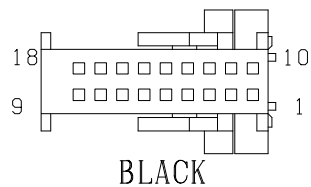

Part No. YPC111800
Colour: BLACK
Gender: F
Type: MQS
No. of Ways: 18WY

Wire Chart

CAV	TERMINAL	CSA	COL	CCT	DESTN
1	YPL101310	0.35	UY	570	C1605B NAVIGATION/MA-3
1	YPL101310	0.35	UY	569	C1605A NAVIGATION/MA-3
10	YPL101310	0.35	YR	570	C1605B NAVIGATION/MA-1
10	YPL101310	0.35	YR	569	C1605A NAVIGATION/MA-1
12	YPL101310	MCHB	S	569	C2094-5

CAV	TERMINAL	CSA	COL	CCT	DESTN
13	YPL101310	MCHB	R	569	C2094-2
14	YPL101310	MCHB	B	569	C2094-3
15	YPL101310	MCHB	SCRN	569	C2094-1
16	YPL101310	MCHB	W	569	C2094-4

Service Repair Kits

YPL101310		0.20 - 0.50 CSA
Cavities 1,10,12-16		
VDK500010	INSTRUCTION; REPAIR KIT	1
VDK500070	INSTRUCTION; EXTRACT TOOL	1
VDK500080	INSTRUCTION; EXTRACT TOOL	1
YMI000870	PRE-TERMINATED LEAD	1
YPQ000100	IDENTS (SMALL)	1
YRV000040	SPLICE (RED, CSA; 0.25-1.6)	1
YRW000390	WIRE STRIPPER	1
YRW500010	APPLICATOR	1
YRW500060	EXTRACT TOOL	1
YRW500070	EXTRACT TOOL	1

[VUB500080]

Description: ECU-Navigation
Location: Luggage compartment - LH side

No photo
 Geen photo
 Pas de photo
 Kein foto
 Senza foto
 Sem fotografia
 No hay foto

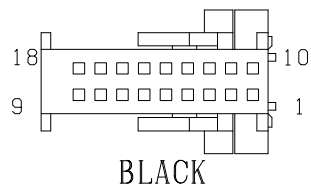

Part No. YPC111800
Colour: BLACK
Gender: F
Type: MQS
No. of Ways: 18WY

Wire Chart

CAV	TERMINAL	CSA	COL	CCT	DESTN
1	YPL101910	0.75	RG	569	C2072-1
3	YPL101310	0.5	WSY	569	C2072-3
4	YPL101310	MCHA	R	569	C0820-18
8	YPL101310	MCHA	S	569	C0820-16
9	YPL101310	MMB	UR	569	C2072-7

CAV	TERMINAL	CSA	COL	CCT	DESTN
10	YPL101910	0.75	N	569	C2072-2
13	YPL101310	MCHA	B	569	C0820-17
15	YPL101310	MCHA	SCRN	569	C0820-7
17	YPL101310	MCHA	W	569	C0820-8
18	YPL101310	MMB	UN	569	C2072-6

Service Repair Kits

YPL101910		
0.75 - 0.75 CSA		
Cavities 1,3,4,8-10,13,15,17,18		
VDK500010	INSTRUCTION; REPAIR KIT	1
VDK500070	INSTRUCTION; EXTRACT TOOL	1
VDK500080	INSTRUCTION; EXTRACT TOOL	1
YMI000870	PRE-TERMINATED LEAD	1
YPQ000100	IDENTS (SMALL)	1
YRV000040	SPLICE (RED, CSA; 0.25-1.6)	1
YRW000390	WIRE STRIPPER	1
YRW500010	APPLICATOR	1
YRW500060	EXTRACT TOOL	1
YRW500070	EXTRACT TOOL	1

[VUB500080]

Description: ECU-Navigation
Location: Luggage compartment - LH side

No photo
 Geen photo
 Pas de photo
 Kein foto
 Senza foto
 Sem fotografia
 No hay foto

Wire Chart

CAV	TERMINAL	CSA	COL	CCT	DESTN
1	YPL10036	0.5	UW	568	C1608-4
2	YPL10036	0.5	GS	568	C1608-2
3	YPL10036	0.5	RG	568	C1608-7
4	YPL10036	0.5	NB	568	C1608-1
5	YPL10036	MCHC	R	568	C0820-18
6	YPL10036	MCHC	S	568	C0820-16
7	YPL10036	MCHC	B	568	C0820-17
8	YPL10036	0.5	WSY	568	C2072-3
9	YPL10036	0.5	PW	568	C2072-5
10	YPL10036	0.5	RG	568	C2072-1
11	YPL10036	0.5	YG	568	C1608-5

CAV	TERMINAL	CSA	COL	CCT	DESTN
12	YPL10036	0.5	GW	568	C1608-3
13	YPL10036	0.5	PU	568	C1608-6
15	YPL10036	MCHC	SCRN	568	C0820-7
16	YPL10036	MCHC	W	568	C0820-8
17	YPL10036	MMA	UR	568	C2072-7
18	YPL10036	MMA	UN	568	C2072-6
19	YPL10036	0.5	N	568	C2072-2
20	YPL10036	0.35	BW	568	C1605A NAVIGATION/MA-2

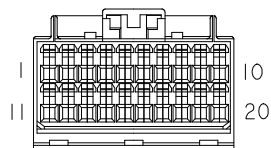

BLACK

Service Repair Kits

YPL10036		0.30 - 0.50 CSA
Cavities 1-13,15-20		
VDK500010	INSTRUCTION; REPAIR KIT	1
YMI000640	PRE-TERMINATED LEAD	1
YPQ000100	IDENTS (SMALL)	1
YQD000210	HEAT SHRINK SLEEVE	1
YRV000040	SPLICE (RED, CSA; 0.25-1.6)	1
YRW500010	APPLICATOR	1
[VUB002000]		

Part No. 8383286
Colour: BLACK
Gender: F
Type: MULTILOCK 040
No. of Ways: 20WY

Description: Console harness to main harness

Location: Behind centre of fascia

No photo
 Geen photo
 Pas de photo
 Kein foto
 Senza foto
 Sem fotografia
 No hay foto

Wire Chart

CAV	TERMINAL	CSA	COL	CCT	DESTN
1	YPD10009	1.5	GW	572	C1401-5
2	YPD10009	1.5	GN	572	C1403-5
3	YPD10010	1.0	WY	572	C1401-1
4	YPD10010	1.0	BY	572	C1403-1
5	YPD10009	2.5	N	43	SJ X13005-

CAV	TERMINAL	CSA	COL	CCT	DESTN
6	YPD10009	2.5	RG	43	SJ X1483-
8	YPD10010	0.5	YN	572	C1401-2
9	YPD10010	0.5	WN	572	C1403-2
10	YPD10010	0.75	NB	43	SJ X3361-
11	YPD10010	0.5	SR	43	SJ X1720-

Service Repair Kits

YPD10009		1.50 - 2.50 CSA
Cavities 1,2,5,6		
VDK500010	INSTRUCTION; REPAIR KIT	1
VDK500030	INSTRUCTION; EXTRACT TOOL	1
YMI001130	PRE-TERMINATED LEAD	1
YPQ000110	IDENTS (MEDIUM)	1
YRV000050	SPLICE (BLUE, CSA; 1.0-2.6)	1
YRW000390	WIRE STRIPPER	1
YRW500010	APPLICATOR	1

[VUB500330]

YPD10010		0.50 - 1.00 CSA
Cavities 3,4,8-11		
VDK500010	INSTRUCTION; REPAIR KIT	1
VDK500130	INSTRUCTION; EXTRACT TOOL	1
YMI000920	PRE-TERMINATED LEAD	1
YPQ000100	IDENTS (SMALL)	1
YRV000040	SPLICE (RED, CSA; 0.25-1.6)	1
YRW000390	WIRE STRIPPER	1
YRW500010	APPLICATOR	1
YRW500120	EXTRACT TOOL	1

[VUB500130]

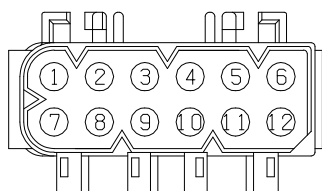

NATURAL

Part No. YPC112190
Colour: NATURAL
Gender: M
Type: 2.5MM SYSTEM
No. of Ways: 12WY

Description: Lamp-Side marker-Front-RH
Location: Front of vehicle - RH side



Wire Chart

CAV	TERMINAL	CSA	COL	CCT	DESTN
1	YPL101500	0.5	N	393	C0550-0
2	YPL101500	0.5	SU	393	SJ X13503-

Service Repair Kits

YPL101500		0.20 - 0.50 <small>CSA</small>
Cavities 1,2		
VDK500010	INSTRUCTION; REPAIR KIT	1
VDK500070	INSTRUCTION; EXTRACT TOOL	1
VDK500080	INSTRUCTION; EXTRACT TOOL	1
YMI000950	PRE-TERMINATED LEAD	1
YPQ000100	IDENTS (SMALL)	1
YQD000210	HEAT SHRINK SLEEVE	1
YRV000040	SPLICE (RED, CSA; 0.25-1.6)	1
YRW000390	WIRE STRIPPER	1
YRW500010	APPLICATOR	1

[VUB500150]



Part No. YPC116820
Colour: BLACK
Gender: F
Type: MQS
No. of Ways: 2WY

Description: Lamp-Side marker-Front-LH

Location: Front of vehicle - LH side

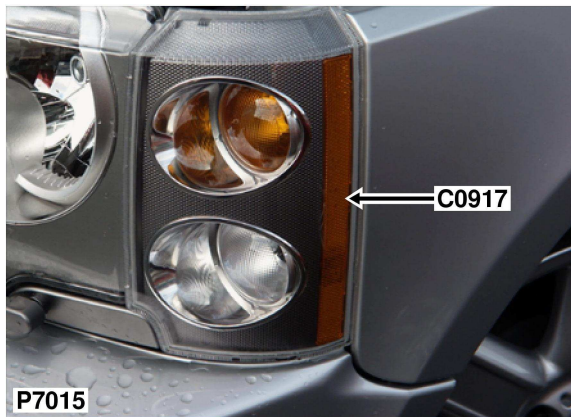

Wire Chart

CAV	TERMINAL	CSA	COL	CCT	DESTN
1	YPL101500	0.5	SG	393	SJ X13502-
2	YPL101500	0.5	N	393	C0551-0

Service Repair Kits

YPL101500		0.20 - 0.50 <small>CSA</small>
Cavities 1,2		
VDK500010	INSTRUCTION; REPAIR KIT	1
VDK500070	INSTRUCTION; EXTRACT TOOL	1
VDK500080	INSTRUCTION; EXTRACT TOOL	1
YMI000950	PRE-TERMINATED LEAD	1
YPQ000100	IDENTS (SMALL)	1
YQD000210	HEAT SHRINK SLEEVE	1
YRV000040	SPLICE (RED, CSA; 0.25-1.6)	1
YRW000390	WIRE STRIPPER	1
YRW500010	APPLICATOR	1

[VUB500150]



Part No. YPC116820

Colour: BLACK

Gender: F

Type: MQS

No. of Ways: 2WY

Description: Lamp-Side marker-Rear-RH

Location: RH rear of vehicle

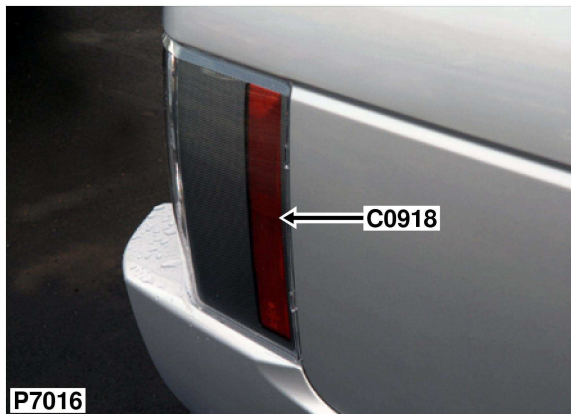

Wire Chart

CAV	TERMINAL	CSA	COL	CCT	DESTN
1	YPL101500	0.5	SU	393	SJ X13503-
2	YPL101500	0.5	N	393	C0555-0

Service Repair Kits

YPL101500		0.20 - 0.50 CSA
Cavities 1,2		
VDK500010	INSTRUCTION; REPAIR KIT	1
VDK500070	INSTRUCTION; EXTRACT TOOL	1
VDK500080	INSTRUCTION; EXTRACT TOOL	1
YMI000950	PRE-TERMINATED LEAD	1
YPQ000100	IDENTS (SMALL)	1
YQD000210	HEAT SHRINK SLEEVE	1
YRV000040	SPLICE (RED, CSA; 0.25-1.6)	1
YRW000390	WIRE STRIPPER	1
YRW500010	APPLICATOR	1

[VUB500150]



Part No. YPC116820

Colour: BLACK

Gender: F

Type: MQS

No. of Ways: 2WY

Description: Lamp-Side marker-Rear-LH
Location: LH rear of vehicle



Wire Chart

CAV	TERMINAL	CSA	COL	CCT	DESTN
1	YPL101500	0.5	SG	393	SJ X13502-
2	YPL101500	0.5	N	393	C0707-0

Service Repair Kits

YPL101500		0.20 - 0.50 CSA
Cavities 1,2		
VDK500010	INSTRUCTION; REPAIR KIT	1
VDK500070	INSTRUCTION; EXTRACT TOOL	1
VDK500080	INSTRUCTION; EXTRACT TOOL	1
YMI000950	PRE-TERMINATED LEAD	1
YPQ000100	IDENTS (SMALL)	1
YQD000210	HEAT SHRINK SLEEVE	1
YRV000040	SPLICE (RED, CSA; 0.25-1.6)	1
YRW000390	WIRE STRIPPER	1
YRW500010	APPLICATOR	1

[VUB500150]



Part No. YPC116820
Colour: BLACK
Gender: F
Type: MQS
No. of Ways: 2WY

Description: Pump-Fuel burning heater (FBH)
Location: Rear of engine compartment

No photo
 Geen photo
 Pas de photo
 Kein foto
 Senza foto
 Sem fotografia
 No hay foto

Wire Chart

CAV	TERMINAL	CSA	COL	CCT	DESTN
1	YPL103300	0.75	BR	391	C0926-6
1	YPL103300	0.75	BR	97	C0926-6
2	YPL103300	0.75	N	391	C0555-0
2	YPL103300	0.75	N	97	C0555-0

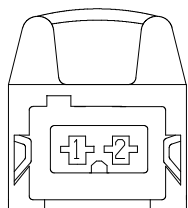

BLACK

No repair kit
 Geen reparatiepakke
 Pas de nécessaire de reparation
 Kein Werkzeug
 Senza kit per le riparazioni
 Sem kit de reparação
 No hay kit de reparación

Part No. 1732460
Colour: BLACK
Gender: F
Type: MINITIMER
No. of Ways: 2WY

Description: Head Unit-Audio System

Location: Behind centre of fascia

No photo
 Geen photo
 Pas de photo
 Kein foto
 Senza foto
 Sem fotografia
 No hay foto

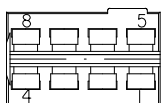

BLACK

Part No. 6905788
Colour: BLACK
Gender: F
Type: MPQ
No. of Ways: 8WY

Wire Chart

CAV	TERMINAL	CSA	COL	CCT	DESTN
1	YPL102700	MAQD	U	581	C2216-28
2	YPL102700	MAQB	UR	581	C2215-28
3	YPL102700	MAQC	UW	581	C2214-28
4	YPL102700	MAQE	Y	581	C2217-28

CAV	TERMINAL	CSA	COL	CCT	DESTN
5	YPL102700	MAQD	N	581	C2216-29
6	YPL102700	MAQB	UN	581	C2215-29
7	YPL102700	MAQC	UN	581	C2214-29
8	YPL102700	MAQE	N	581	C2217-29

Service Repair Kits

YPL102700		0.50 - 1.00 CSA
Cavities 1-8		
VDK500010	INSTRUCTION; REPAIR KIT	1
VDK500030	INSTRUCTION; EXTRACT TOOL	1
YMI001060	PRE-TERMINATED LEAD	1
YPQ000100	IDENTS (SMALL)	1
YRV000040	SPLICE (RED, CSA; 0.25-1.6)	1
YRW000390	WIRE STRIPPER	1
YRW500010	APPLICATOR	1

[VUB500260]

Description: Head Unit-Audio System

Location: Behind centre of fascia

No photo
 Geen photo
 Pas de photo
 Kein foto
 Senza foto
 Sem fotografia
 No hay foto

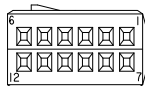

BLACK

Part No. 8384550
Colour: BLACK
Gender: F
Type: MQS
No. of Ways: 12WY

Wire Chart

CAV	TERMINAL	CSA	COL	CCT	DESTN
2	YPL101310	MMA	WN	581	C1353-2
8	YPL101310	MMA	WR	581	C1353-1
9	YPL101310	MMA	WU	581	C1353-4

Service Repair Kits

YPL101310		0.20 - 0.50 CSA
Cavities 2,8,9		
VDK500010	INSTRUCTION; REPAIR KIT	1
VDK500070	INSTRUCTION; EXTRACT TOOL	1
VDK500080	INSTRUCTION; EXTRACT TOOL	1
YMI000870	PRE-TERMINATED LEAD	1
YPQ000100	IDENTS (SMALL)	1
YRV000040	SPLICE (RED, CSA; 0.25-1.6)	1
YRW000390	WIRE STRIPPER	1
YRW500010	APPLICATOR	1
YRW500060	EXTRACT TOOL	1
YRW500070	EXTRACT TOOL	1

[VUB500080]

Description: Heater-Fuel burning
Location: Rear of engine compartment

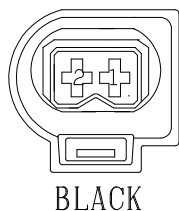
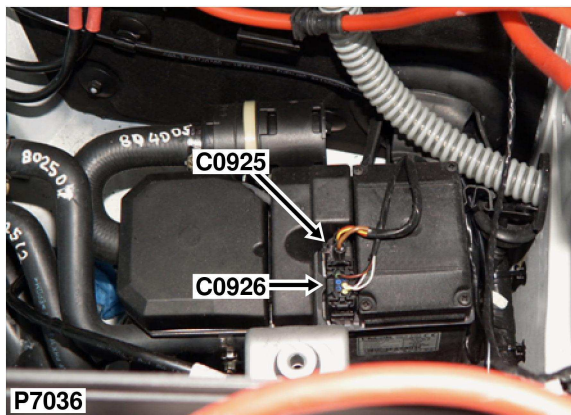

Wire Chart

CAV	TERMINAL	CSA	COL	CCT	DESTN
1	YPL102810	2.5	RY	391	C0582-2
1	YPL102810	2.5	RY	97	C0582-2
2	YPL102810	2.5	N	391	C0551-0
2	YPL102810	2.5	N	97	C0551-0

No repair kit

Geen reparatiepakke

Pas de nécessaire de reparation

Kein Werkzeug

Senza kit per le riparazioni

Sem kit de reparação

No hay kit de reparación

Part No. YPC115080
Colour: BLACK
Gender: F
Type: MDK4 PLUS
No. of Ways: 2WY

Description: Heater-Fuel burning
Location: Rear of engine compartment

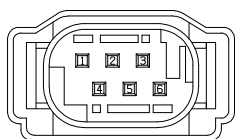
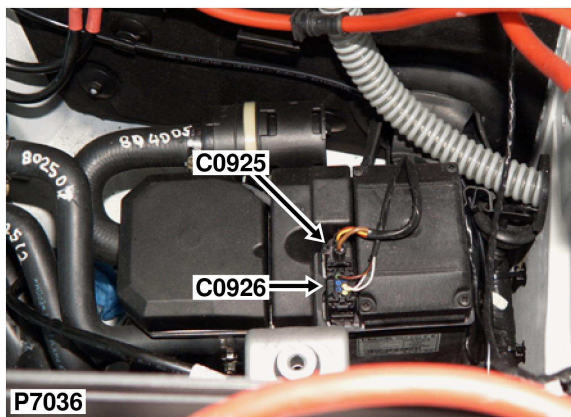

BLACK

Part No. YPC110680
Colour: BLACK
Gender: F
Type: MQS
No. of Ways: 6WY

Wire Chart

CAV	TERMINAL	CSA	COL	CCT	DESTN
1	YPL101500	0.35	WG	97	C2046-3
2	YPL101500	0.35	WRV	97	SJ X10116-
2	YPL101500	0.35	WRV	391	SJ X10116-
6	YPL101510	0.75	BR	391	C0920-1
6	YPL101510	0.75	BR	97	C0920-1

Service Repair Kits

YPL101510		0.75 - 0.75 CSA
Cavities 1,2,6		
VDK500010	INSTRUCTION; REPAIR KIT	1
VDK500070	INSTRUCTION; EXTRACT TOOL	1
VDK500080	INSTRUCTION; EXTRACT TOOL	1
YMI000950	PRE-TERMINATED LEAD	1
YPQ000100	IDENTS (SMALL)	1
YQD000210	HEAT SHRINK SLEEVE	1
YRV000040	SPLICE (RED, CSA; 0.25-1.6)	1
YRW000390	WIRE STRIPPER	1
YRW500010	APPLICATOR	1

[VUB500150]

Description: Washer jet-Heated
Location: Under bonnet, RH side

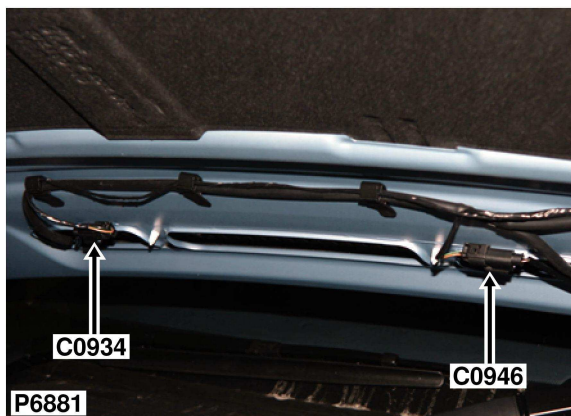

Wire Chart

CAV	TERMINAL	CSA	COL	CCT	DESTN
1	YPL101510	0.75	BG	ALL	SJ X1301-
2	YPL101510	0.75	N	ALL	C0821-0

Service Repair Kits

YPL101510		0.75 - 0.75 CSA
Cavities 1,2		
VDK500010	INSTRUCTION; REPAIR KIT	1
VDK500070	INSTRUCTION; EXTRACT TOOL	1
VDK500080	INSTRUCTION; EXTRACT TOOL	1
YMI000950	PRE-TERMINATED LEAD	1
YPQ000100	IDENTS (SMALL)	1
YQD000210	HEAT SHRINK SLEEVE	1
YRV000040	SPLICE (RED, CSA; 0.25-1.6)	1
YRW000390	WIRE STRIPPER	1
YRW500010	APPLICATOR	1

[VUB500150]



Part No. YPC116820
Colour: BLACK
Gender: F
Type: MQS
No. of Ways: 2WY

Description: Module-Lighting switch

Location: Base of RH 'A' post

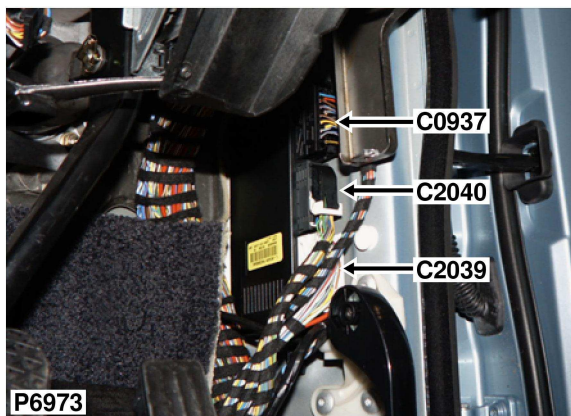

Wire Chart

CAV	TERMINAL	CSA	COL	CCT	DESTN
2	YPE10020	0.5	SP	394	SJ X246-
3	YPE10020	0.5	SU	ALL	C0537-2
4	YPE10020	1.0	YN	ALL	C0513-2
5	YPE10020	0.5	SN	ALL	C1495-1
6	YPE10020	0.75	UN	ALL	C0002-1
7	YPE10020	0.5	NB	ALL	C0552-0
8	YPE10020	0.75	UG	394	SJ X184-

CAV	TERMINAL	CSA	COL	CCT	DESTN
9	YPE10020	0.75	YB	ALL	C0125-3
10	YPE100500	1.5	BU	ALL	SJ X10197-
11	YPE100500	2.5	YG	ALL	C0009-6
12	YPE10020	0.5	SB	ALL	SJ X1232-
13	YPE100500	1.5	YU	ALL	C0011-9
14	YPE10020	0.5	UY	ALL	C0012-2
15	YPE100520	4.0	R	ALL	C0589-1

Service Repair Kits

YPE100520		2.51 - 4.00 CSA	
Cavities 15			
VDK500010	INSTRUCTION; REPAIR KIT	1	
VDK500130	INSTRUCTION; EXTRACT TOOL	1	
YMI000980	PRE-TERMINATED LEAD	1	
YPQ000120	IDENTS (LARGE)	1	
YRV000060	SPLICE (YELLOW, CSA; 2.7-6.6)	1	
YRW000390	WIRE STRIPPER	1	
YRW500010	APPLICATOR	1	

[VUB500180]

YPE100500		1.01 - 2.50 CSA	
Cavities 10,11,13			
VDK500010	INSTRUCTION; REPAIR KIT	1	
VDK500030	INSTRUCTION; EXTRACT TOOL	1	
YMI000900	PRE-TERMINATED LEAD	1	
YPQ000110	IDENTS (MEDIUM)	1	
YRV000050	SPLICE (BLUE, CSA; 1.0-2.6)	1	
YRW000390	WIRE STRIPPER	1	
YRW500010	APPLICATOR	1	

[VUB500110]

YPE10020		0.50 - 1.00 CSA	
Cavities 2-9,12,14			
VDK500010	INSTRUCTION; REPAIR KIT	1	
VDK500130	INSTRUCTION; EXTRACT TOOL	1	
YMI000860	PRE-TERMINATED LEAD	1	
YPQ000100	IDENTS (SMALL)	1	
YRV000040	SPLICE (RED, CSA; 0.25-1.6)	1	
YRW000390	WIRE STRIPPER	1	
YRW500010	APPLICATOR	1	

[VUB500070]

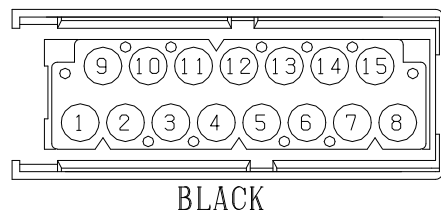

Part No. YPC112210
Colour: BLACK
Gender: F
Type: 2.5MM SYSTEM
No. of Ways: 15WY

Description: CD auto changer
Location: Luggage compartment - LH side

No photo
 Geen photo
 Pas de photo
 Kein foto
 Senza foto
 Sem fotografia
 No hay foto

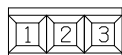

BLACK

Part No. YPC117800
Colour: BLACK
Gender: F
Type: MQS
No. of Ways: 3WY

Wire Chart

CAV	TERMINAL	CSA	COL	CCT	DESTN
1	YPL101310	0.5	N	ALL	C0981-6
2	YPL101310	0.5	RG	ALL	C0586-5
3	YPL101310	0.35	WSY	ALL	SJ X939-

Service Repair Kits

YPL101310		0.20 - 0.50 CSA
Cavities 1-3		
VDK500010	INSTRUCTION; REPAIR KIT	1
VDK500070	INSTRUCTION; EXTRACT TOOL	1
VDK500080	INSTRUCTION; EXTRACT TOOL	1
YMI000870	PRE-TERMINATED LEAD	1
YPQ000100	IDENTS (SMALL)	1
YRV000040	SPLICE (RED, CSA; 0.25-1.6)	1
YRW000390	WIRE STRIPPER	1
YRW500010	APPLICATOR	1
YRW500060	EXTRACT TOOL	1
YRW500070	EXTRACT TOOL	1

[VUB500080]

Description: Socket-Accessory
Location: Beneath centre console

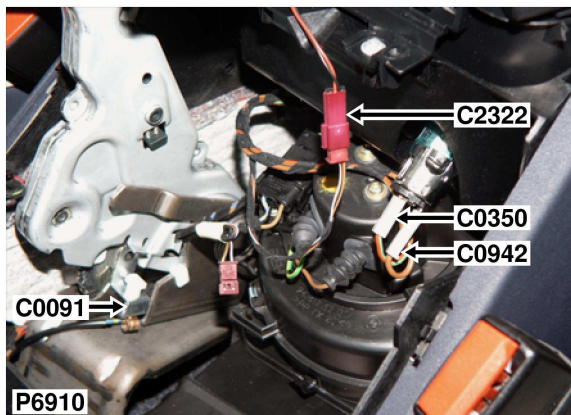

Wire Chart

CAV	TERMINAL	CSA	COL	CCT	DESTN
1	1376460	2.5	N	43	SJ X13005-

No repair kit
 Geen reparatiepakke
 Pas de nécessaire de reparation
 Kein Werkzeug
 Senza kit per le riparazioni
 Sem kit de reparação
 No hay kit de reparación



Part No. 1352598
Colour: TRANSPARENT
Gender: F
Type: 2.8 UNSEALED
No. of Ways: 1WY

Description: Heater-Washer jet-LH
Location: Under bonnet, LH side

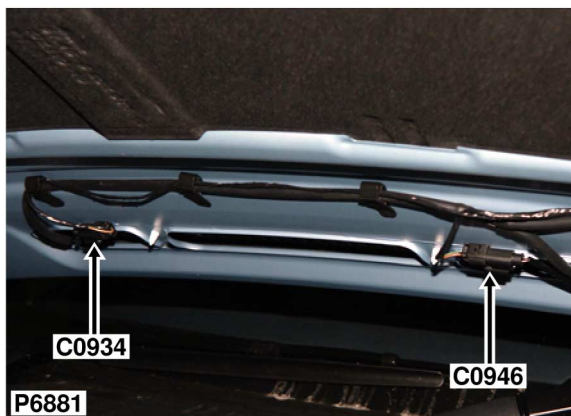

Wire Chart

CAV	TERMINAL	CSA	COL	CCT	DESTN
1	YPL101510	0.75	BG	ALL	SJ X1301-
2	YPL101510	0.75	N	ALL	C0821-0

Service Repair Kits

YPL101510		0.75 - 0.75 csa
Cavities 1,2		
VDK500010	INSTRUCTION; REPAIR KIT	1
VDK500070	INSTRUCTION; EXTRACT TOOL	1
VDK500080	INSTRUCTION; EXTRACT TOOL	1
YMI000950	PRE-TERMINATED LEAD	1
YPQ000100	IDENTS (SMALL)	1
YQD000210	HEAT SHRINK SLEEVE	1
YRV000040	SPLICE (RED, CSA; 0.25-1.6)	1
YRW000390	WIRE STRIPPER	1
YRW500010	APPLICATOR	1

[VUB500150]

Part No. YPC116820
Colour: BLACK
Gender: F
Type: MQS
No. of Ways: 2WY

Description: Module-Telephone
Location: Luggage compartment - LH side

No photo
 Geen photo
 Pas de photo
 Kein foto
 Senza foto
 Sem fotografia
 No hay foto

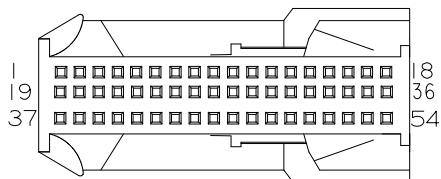

BLACK

Part No. 6909076
Colour: BLACK
Gender: F
Type: ELO
No. of Ways: 54WY

Wire Chart

CAV	TERMINAL	CSA	COL	CCT	DESTN
1	YPE100920	0.35	R	507	C1644-11
2	YPE100920	MCDA	W	507	C1644-6
9	YPE100920	MCHA	SCRN	506	C1670-1
10	YPE100920	MCHA	W	506	C1670-4
11	YPE100920	MCHA	S	506	C1670-5
12	YPE100890	0.75	PW	505	C2066-2
12	YPE100920	0.5	PW	508	SJ X229-
13	YPE100920	0.35	WSY	508	SJ X939-
13	YPE100920	0.35	WSY	505	C2066-4
17	YPE100890	MAQB	BN	505	C2066-10
17	YPE100920	MCGA	UN	508	C2136-25
18	YPE100890	MAQB	BW	505	C2066-9
18	YPE100920	MCGA	UB	508	C2136-26
19	YPE100920	MCDA	R	507	C1644-5
20	YPE100920	MCDA	B	507	C1644-10
24	YPE100920	0.5	NB	507	SJ X3279-
25	YPE100920	0.5	RY	507	SJ X3368-
28	YPE100920	MCHA	B	506	C1670-3
29	YPE100920	0.35	WN	505	C2066-8
29	YPE100920	0.35	WN	508	SJ X1293-
31	YPE100920	0.5	RY	507	SJ X3368-

CAV	TERMINAL	CSA	COL	CCT	DESTN
32	YPE100920	0.5	RY	507	SJ X3368-
33	YPE100920	0.5	NB	507	SJ X3279-
34	YPE100920	0.5	NB	507	SJ X3279-
37	YPE100920	MCDA	Y	507	C1644-12
38	YPE100920	MCDA	G	507	C1644-14
39	YPE100920	MCDA	SCRN	507	C1644-7
42	YPE100920	0.5	NB	507	SJ X3279-
43	YPE100920	0.5	RY	507	SJ X3368-
46	YPE100920	MCHA	R	506	C1670-2
47	YPE100920	0.35	WG	505	C2066-11
47	YPE100920	0.5	YU	508	C2136-23
48	YPE100920	0.5	UW	507	C1644-4
52	YPE100920	MCCB	G	508	C2136-10
52	YPE100920	MCCA	NW	505	C1669-3
53	YPE100920	MCCA	SCRN	505	C1669-2
53	YPE100920	MCCB	SCRN	508	SJ X11350-
54	YPE100920	MCCB	YB	508	C2136-11
54	YPE100920	MCCA	W	505	C1669-1

Service Repair Kits

YPE100890		0.75 - 0.75 CSA
Cavities 1,2,9-13,17-20,24,25,28,29,31-34,37-39,42,43,46-48,52-54		
VDK500010	INSTRUCTION; REPAIR KIT	1
VDK500040	INSTRUCTION; EXTRACT TOOL	1
YMI001040	PRE-TERMINATED LEAD	1
YPQ000100	IDENTS (SMALL)	1
YRV000040	SPLICE (RED, CSA; 0.25-1.6)	1
YRW0000390	WIRE STRIPPER	1
YRW500010	APPLICATOR	1

[VUB500240]

Description: Sensor-Airbag-Side-LH
Location: Base of 'B' post LH side

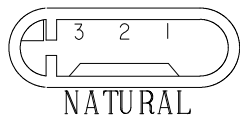
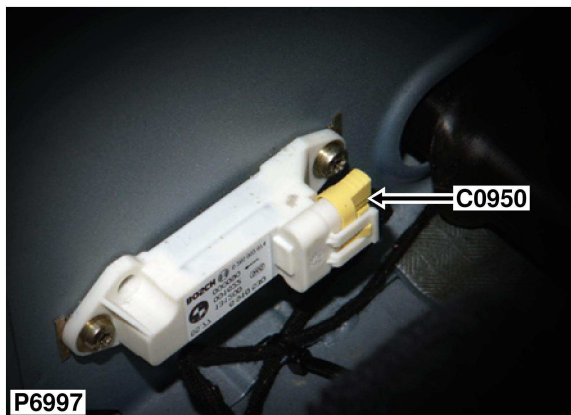

Wire Chart

CAV	TERMINAL	CSA	COL	CCT	DESTN
1	YPE100930	MMA	NB	ALL	SJ X18358-
3	YPE100930	MMA	YG	ALL	C0256-20

No repair kit
 Geen reparatiepakke
 Pas de nécessaire de reparation
 Kein Werkzeug
 Senza kit per le riparazioni
 Sem kit de reparaçao
 No hay kit de reparación

Part No. 6908996
Colour: NATURAL
Gender: F
Type: ELO
No. of Ways: 3WY

Description: Sensor-Airbag-Side-RH
Location: Base of 'B' post RH side

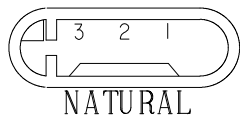
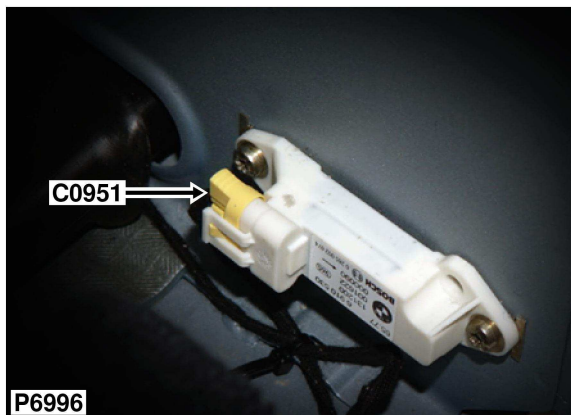

Part No. 6908996
Colour: NATURAL
Gender: F
Type: ELO
No. of Ways: 3WY

Wire Chart

CAV	TERMINAL	CSA	COL	CCT	DESTN
1	YPE100930	MMB	NB	ALL	SJ X18358-
3	YPE100930	MMB	YR	ALL	C0256-21

No repair kit
 Geen reparatiepakke
 Pas de nécessaire de reparation
 Kein Werkzeug
 Senza kit per le riparazioni
 Sem kit de reparaçao
 No hay kit de reparación

Description: ECU-Park-Distance control
Location: Luggage compartment - RH side

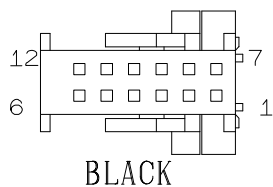
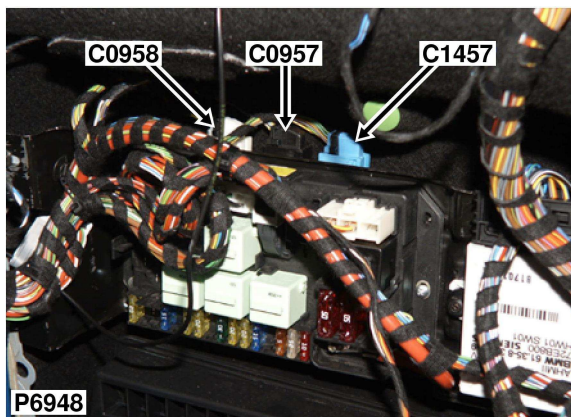

Wire Chart

CAV	TERMINAL	CSA	COL	CCT	DESTN
1	YPL101310	0.5	GN	171	C0587-32
2	YPL101310	0.35	UR	171	C0987-2
4	YPL101310	0.35	WSY	171	SJ X18226-
6	YPL101310	0.5	NB	171	C0706-0
7	YPL101310	0.35	NWY	171	C0700-22

CAV	TERMINAL	CSA	COL	CCT	DESTN
8	YPL101310	0.35	US	171	C0987-1
9	YPL101310	0.35	US	171	C0405-1
10	YPL101310	0.35	NUY	171	C0700-12
11	YPL101310	0.5	WY	500	C2475-1

Service Repair Kits

YPL101310		0.20 - 0.50 CSA
Cavities 1,2,4,6-11		
VDK500010	INSTRUCTION; REPAIR KIT	1
VDK500070	INSTRUCTION; EXTRACT TOOL	1
VDK500080	INSTRUCTION; EXTRACT TOOL	1
YMI000870	PRE-TERMINATED LEAD	1
YPQ000100	IDENTS (SMALL)	1
YRV000040	SPLICE (RED, CSA; 0.25-1.6)	1
YRW000390	WIRE STRIPPER	1
YRW500010	APPLICATOR	1
YRW500060	EXTRACT TOOL	1
YRW500070	EXTRACT TOOL	1

[VUB500080]

Part No. YPW101060
Colour: BLACK
Gender: F
Type: MQS
No. of Ways: 12WY

Description: ECU-Park-Distance control
Location: Luggage compartment - RH side

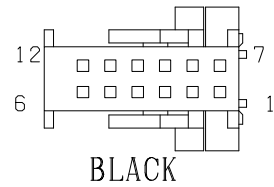
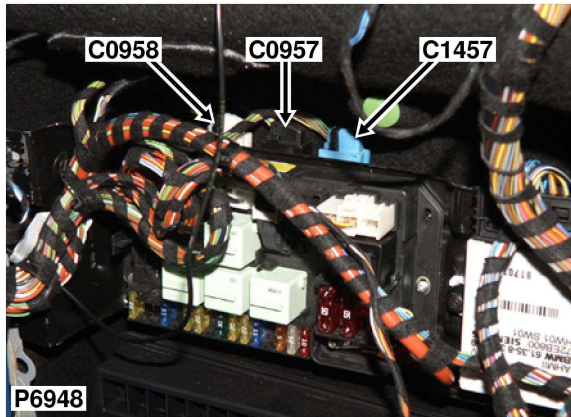

Part No. YPC111790
Colour: BLACK
Gender: F
Type: MQS
No. of Ways: 12WY

Wire Chart

CAV	TERMINAL	CSA	COL	CCT	DESTN
1	YPL101310	0.5	GN	171	C0587-32
2	YPL101310	0.35	UR	171	C0987-2
4	YPL101310	0.35	WSY	171	SJ X18226-
6	YPL101310	0.5	NB	171	C0706-0

CAV	TERMINAL	CSA	COL	CCT	DESTN
7	YPL101310	0.35	NWY	171	C0700-22
8	YPL101310	0.35	US	171	C0987-1
9	YPL101310	0.35	US	171	C0405-1
10	YPL101310	0.35	NUY	171	C0700-12

Service Repair Kits

YPL101310		0.20 - 0.50 CSA
Cavities 1,2,4,6-10		
VDK500010	INSTRUCTION; REPAIR KIT	1
VDK500070	INSTRUCTION; EXTRACT TOOL	1
VDK500080	INSTRUCTION; EXTRACT TOOL	1
YMI000870	PRE-TERMINATED LEAD	1
YPQ000100	IDENTS (SMALL)	1
YRV000040	SPLICE (RED, CSA; 0.25-1.6)	1
YRW000390	WIRE STRIPPER	1
YRW500010	APPLICATOR	1
YRW500060	EXTRACT TOOL	1
YRW500070	EXTRACT TOOL	1

[VUB500080]

Description: ECU-Park-Distance control
Location: Luggage compartment - RH side

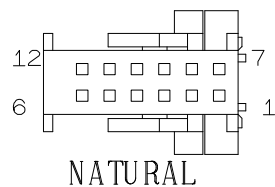
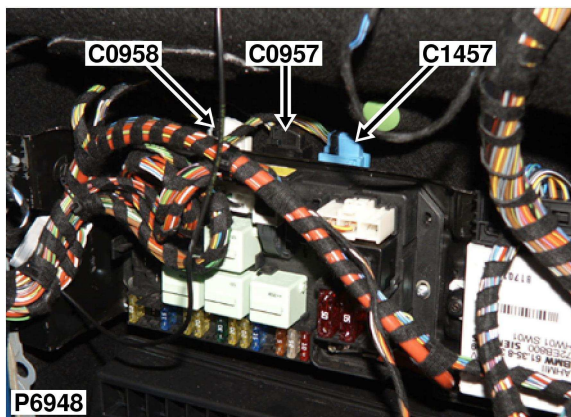

Part No. YPW101070
Colour: NATURAL
Gender: F
Type: MQS
No. of Ways: 12WY

Wire Chart

CAV	TERMINAL	CSA	COL	CCT	DESTN
1	YPL101310	0.35	NB	171	C0876-1
2	YPL101310	0.35	NY	171	C0876-2
3	YPL101310	0.35	NW	171	C0876-3
4	YPL101310	0.35	GS	171	C0876-4
5	YPL101310	0.35	GN	171	C0876-5
6	YPL101310	0.35	GP	171	C0876-6

CAV	TERMINAL	CSA	COL	CCT	DESTN
7	YPL101310	0.35	NU	171	C0876-7
8	YPL101310	0.35	YB	171	C0876-8
9	YPL101310	0.35	YG	171	C0876-9
10	YPL101310	0.35	YN	171	C0876-10
11	YPL101310	0.35	YS	171	C0876-11
12	YPL101310	0.35	GB	171	C0876-12

Service Repair Kits

YPL101310		0.20 - 0.50 csa
Cavities 1-12		
VDK500010	INSTRUCTION; REPAIR KIT	1
VDK500070	INSTRUCTION; EXTRACT TOOL	1
VDK500080	INSTRUCTION; EXTRACT TOOL	1
YMI000870	PRE-TERMINATED LEAD	1
YPQ000100	IDENTS (SMALL)	1
YRV000040	SPLICE (RED, CSA; 0.25-1.6)	1
YRW000390	WIRE STRIPPER	1
YRW500010	APPLICATOR	1
YRW500060	EXTRACT TOOL	1
YRW500070	EXTRACT TOOL	1

[VUB500080]

Description: Sensor-tilt
Location: Beneath front passenger's seat

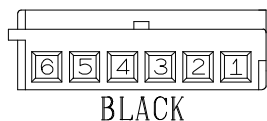
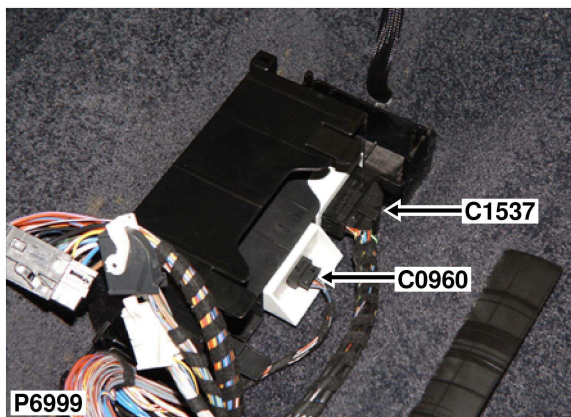

Part No. 6909052
Colour: BLACK
Gender: F
Type: MQS
No. of Ways: 6WY

Wire Chart

CAV	TERMINAL	CSA	COL	CCT	DESTN
1	YPL101310	0.5	BU	ALL	C0661-8
2	YPL101310	0.5	BW	ALL	C0359-2
3	YPL101310	0.5	RB	ALL	C0586-28
4	YPL101310	0.5	BS	ALL	C0661-20
5	YPL101310	0.5	BG	ALL	C0666-2

Service Repair Kits

YPL101310		0.20 - 0.50 CSA
Cavities 1-5		
VDK500010	INSTRUCTION; REPAIR KIT	1
VDK500070	INSTRUCTION; EXTRACT TOOL	1
VDK500080	INSTRUCTION; EXTRACT TOOL	1
YMI000870	PRE-TERMINATED LEAD	1
YPQ000100	IDENTS (SMALL)	1
YRV000040	SPLICE (RED, CSA; 0.25-1.6)	1
YRW000390	WIRE STRIPPER	1
YRW500010	APPLICATOR	1
YRW500060	EXTRACT TOOL	1
YRW500070	EXTRACT TOOL	1

[VUB500080]

Description: Sensor-Rain
Location: Top of windscreen

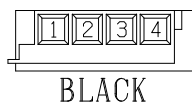
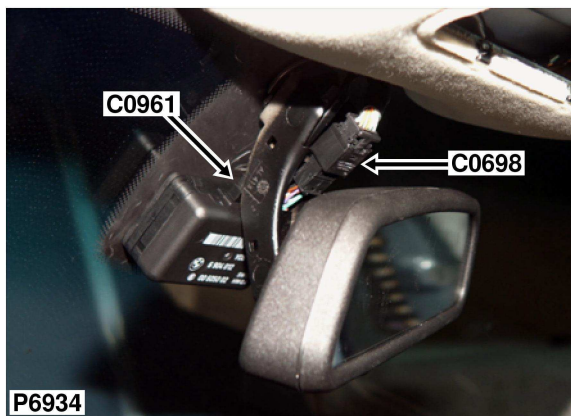

Part No. YPC117840
Colour: BLACK
Gender: F
Type: MQS
No. of Ways: 4WY

Wire Chart

CAV	TERMINAL	CSA	COL	CCT	DESTN
1	YPL101310	0.35	PR	136	C0586-21
2	YPL101310	0.35	NB	136	C0287-0
3	YPL101310	0.35	WRV	136	C0296-0
4	YPL101310	0.35	NG	136	SJ X1596-

Service Repair Kits

YPL101310		0.20 - 0.50 CSA
Cavities 1-4		
VDK500010	INSTRUCTION; REPAIR KIT	1
VDK500070	INSTRUCTION; EXTRACT TOOL	1
VDK500080	INSTRUCTION; EXTRACT TOOL	1
YMI000870	PRE-TERMINATED LEAD	1
YPQ000100	IDENTS (SMALL)	1
YRV000040	SPLICE (RED, CSA; 0.25-1.6)	1
YRW000390	WIRE STRIPPER	1
YRW500010	APPLICATOR	1
YRW500060	EXTRACT TOOL	1
YRW500070	EXTRACT TOOL	1

[VUB500080]

Description: Sensor-PDC-Outer-Rear-LH
Location: Behind LH side of rear bumper

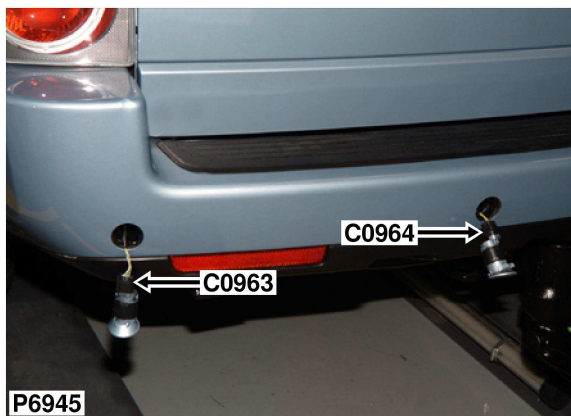

Wire Chart

CAV	TERMINAL	CSA	COL	CCT	DESTN
1	YPL101500	0.35	GB	171	C2003-12
2	YPL101500	0.35	YS	171	C2003-11
3	YPL101500	0.35	NW	171	C2003-3

Service Repair Kits

YPL101500		0.20 - 0.50 CSA
Cavities 1-3		
VDK500010	INSTRUCTION; REPAIR KIT	1
VDK500070	INSTRUCTION; EXTRACT TOOL	1
VDK500080	INSTRUCTION; EXTRACT TOOL	1
YMI000950	PRE-TERMINATED LEAD	1
YPQ000100	IDENTS (SMALL)	1
YQD000210	HEAT SHRINK SLEEVE	1
YRV000040	SPLICE (RED, CSA; 0.25-1.6)	1
YRW000390	WIRE STRIPPER	1
YRW500010	APPLICATOR	1

[VUB500150]

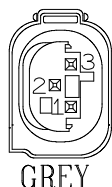

Part No. YPC906260
Colour: GREY
Gender: F
Type: MQS
No. of Ways: 3WY

Description: Sensor-PDC-Inner-Rear-LH
Location: Behind LH side of rear bumper

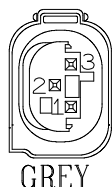
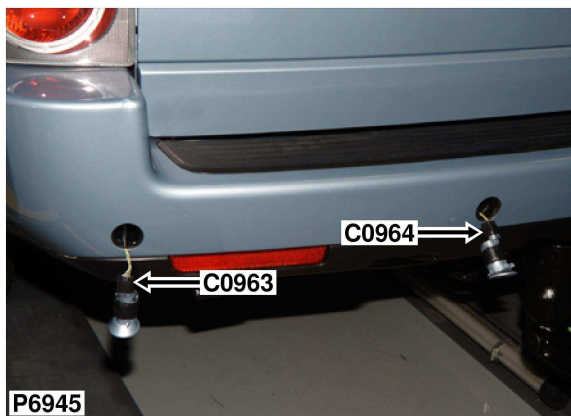

Wire Chart

CAV	TERMINAL	CSA	COL	CCT	DESTN
1	YPL101500	0.35	GN	171	C2003-5
2	YPL101500	0.35	YG	171	C2003-9
3	YPL101500	0.35	NB	171	C2003-1

Service Repair Kits

YPL101500		0.20 - 0.50 CSA
Cavities 1-3		
VDK500010	INSTRUCTION; REPAIR KIT	1
VDK500070	INSTRUCTION; EXTRACT TOOL	1
VDK500080	INSTRUCTION; EXTRACT TOOL	1
YMI000950	PRE-TERMINATED LEAD	1
YPQ000100	IDENTS (SMALL)	1
YQD000210	HEAT SHRINK SLEEVE	1
YRV000040	SPLICE (RED, CSA; 0.25-1.6)	1
YRW000390	WIRE STRIPPER	1
YRW500010	APPLICATOR	1

[VUB500150]

Part No. YPC906260
Colour: GREY
Gender: F
Type: MQS
No. of Ways: 3WY

Description: Sensor-PDC-Inner-Rear-RH
Location: Behind RH side of rear bumper

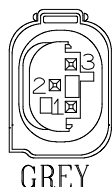
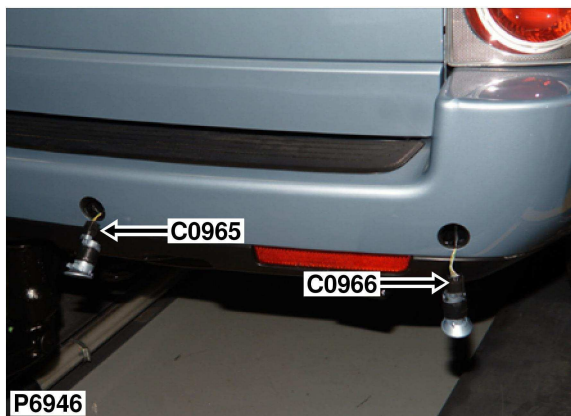

Wire Chart

CAV	TERMINAL	CSA	COL	CCT	DESTN
1	YPL101500	0.35	GS	171	C2003-4
2	YPL101500	0.35	YB	171	C2003-8
3	YPL101500	0.35	NU	171	C2003-7

Service Repair Kits

YPL101500		0.20 - 0.50 CSA
Cavities 1-3		
VDK500010	INSTRUCTION; REPAIR KIT	1
VDK500070	INSTRUCTION; EXTRACT TOOL	1
VDK500080	INSTRUCTION; EXTRACT TOOL	1
YMI000950	PRE-TERMINATED LEAD	1
YPQ000100	IDENTS (SMALL)	1
YQD000210	HEAT SHRINK SLEEVE	1
YRV000040	SPLICE (RED, CSA; 0.25-1.6)	1
YRW000390	WIRE STRIPPER	1
YRW500010	APPLICATOR	1

[VUB500150]

Part No. YPC906260
Colour: GREY
Gender: F
Type: MQS
No. of Ways: 3WY

Description: Sensor-PDC-Outer-Rear-RH
Location: Behind RH side of rear bumper

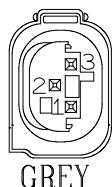
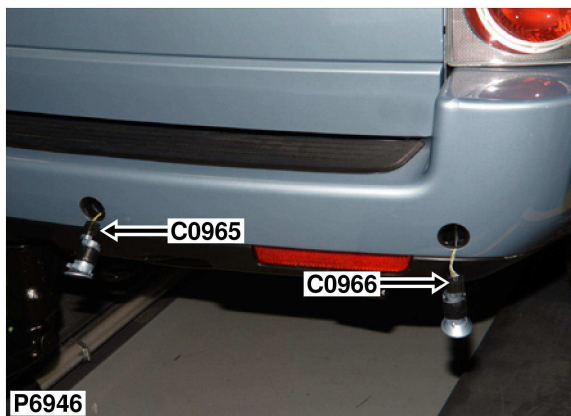

Wire Chart

CAV	TERMINAL	CSA	COL	CCT	DESTN
1	YPL101500	0.35	GP	171	C2003-6
2	YPL101500	0.35	YN	171	C2003-10
3	YPL101500	0.35	NY	171	C2003-2

Service Repair Kits

YPL101500		0.20 - 0.50 CSA
Cavities 1-3		
VDK500010	INSTRUCTION; REPAIR KIT	1
VDK500070	INSTRUCTION; EXTRACT TOOL	1
VDK500080	INSTRUCTION; EXTRACT TOOL	1
YMI000950	PRE-TERMINATED LEAD	1
YPQ000100	IDENTS (SMALL)	1
YQD000210	HEAT SHRINK SLEEVE	1
YRV000040	SPLICE (RED, CSA; 0.25-1.6)	1
YRW000390	WIRE STRIPPER	1
YRW500010	APPLICATOR	1

[VUB500150]

Part No. YPC906260
Colour: GREY
Gender: F
Type: MQS
No. of Ways: 3WY

Description: Sensor-Pad wear
Location: Below RH rear wheelarch

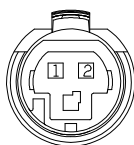
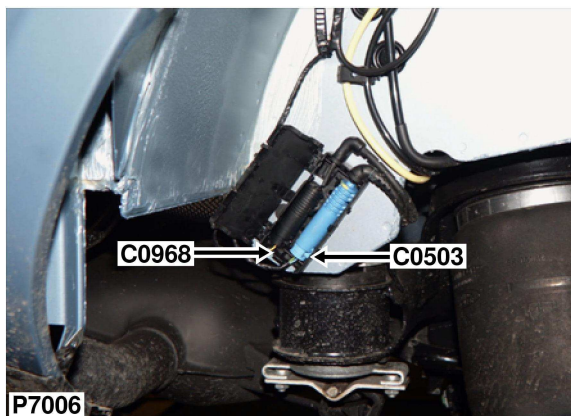

BLACK

Wire Chart

CAV	TERMINAL	CSA	COL	CCT	DESTN
1	YPL101500	0.35	YN	ALL	C0234-20
2	YPL101500	0.35	B	ALL	C0050-2

Service Repair Kits

YPL101500		0.20 - 0.50 CSA
Cavities 1,2		
VDK500010	INSTRUCTION; REPAIR KIT	1
VDK500070	INSTRUCTION; EXTRACT TOOL	1
VDK500080	INSTRUCTION; EXTRACT TOOL	1
YMI000950	PRE-TERMINATED LEAD	1
YPQ000100	IDENTS (SMALL)	1
YQD000210	HEAT SHRINK SLEEVE	1
YRV000040	SPLICE (RED, CSA; 0.25-1.6)	1
YRW000390	WIRE STRIPPER	1
YRW500010	APPLICATOR	1

[VUB500150]

Part No. YPC110480
Colour: BLACK
Gender: F
Type: MQS
No. of Ways: 2WY

Description: Main harness to radio harness

Location: Behind centre of fascia

No photo
 Geen photo
 Pas de photo
 Kein foto
 Senza foto
 Sem fotografia
 No hay foto

Wire Chart

CAV	TERMINAL	CSA	COL	CCT	DESTN
1	YPD100220	4.0	RG	ALL	C0584-4
2	YPD10010	0.5	PW	ALL	C0290-0
4	YPD100280	0.35	WSY	ALL	SJ X939-
5	YPD10010	0.75	SR	ALL	C0286-0
6	YPD10010	0.5	N	ALL	C0941-1

CAV	TERMINAL	CSA	COL	CCT	DESTN
8	YPD100280	0.35	WN	ALL	C2045-8
9	YPD10010	MAQC	BW	ALL	C2045-9
10	YPD10010	MAQC	BN	ALL	C2045-10
11	YPD100280	0.35	WG	ALL	C2045-11
12	YPD10010	0.5	W	ALL	C0674-2

Service Repair Kits

YPD100220		2.51 - 4.00 CSA
Cavities 1		
VDK500010	INSTRUCTION; REPAIR KIT	1
VDK500130	INSTRUCTION; EXTRACT TOOL	1
YMI001110	PRE-TERMINATED LEAD	1
YPQ000120	IDENTS (LARGE)	1
YRV000060	SPLICE (YELLOW, CSA; 2.7-6.6)	1
YRW000390	WIRE STRIPPER	1
YRW500010	APPLICATOR	1

[VUB500310]

YPD100280		0.20 - 0.40 CSA
Cavities 2,4-6,8-12		
VDK500010	INSTRUCTION; REPAIR KIT	1
VDK500130	INSTRUCTION; EXTRACT TOOL	1
YMI000920	PRE-TERMINATED LEAD	1
YPQ000100	IDENTS (SMALL)	1
YRV000040	SPLICE (RED, CSA; 0.25-1.6)	1
YRW000390	WIRE STRIPPER	1
YRW500010	APPLICATOR	1
YRW500120	EXTRACT TOOL	1

[VUB500130]

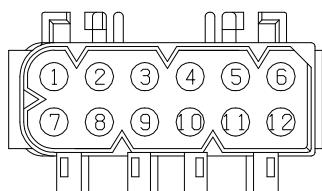

BLACK

Part No. YPC112180
Colour: BLACK
Gender: M
Type: 2.5MM SYSTEM
No. of Ways: 12WY

Description: Head Unit-Audio System

Location: Behind centre console

No photo
 Geen photo
 Pas de photo
 Kein foto
 Senza foto
 Sem fotografia
 No hay foto

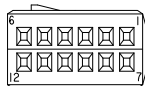

BLACK

Part No. 8384550
Colour: BLACK
Gender: F
Type: MQS
No. of Ways: 12WY

Wire Chart

CAV	TERMINAL	CSA	COL	CCT	DESTN
6	YPL101910	MAQA	BW	581	C0395-9
12	YPL101910	MAQA	BN	581	C0395-10

Service Repair Kits

YPL101910		0.75 - 0.75 CSA
Cavities 6,12		
VDK500010	INSTRUCTION; REPAIR KIT	1
VDK500070	INSTRUCTION; EXTRACT TOOL	1
VDK500080	INSTRUCTION; EXTRACT TOOL	1
YMI000870	PRE-TERMINATED LEAD	1
YPO000100	IDENTS (SMALL)	1
YRV000040	SPLICE (RED, CSA; 0.25-1.6)	1
YRW000390	WIRE STRIPPER	1
YRW500010	APPLICATOR	1
YRW500060	EXTRACT TOOL	1
YRW500070	EXTRACT TOOL	1

[VUB500080]

Description: Speaker-PDC
Location: Luggage compartment - RH side

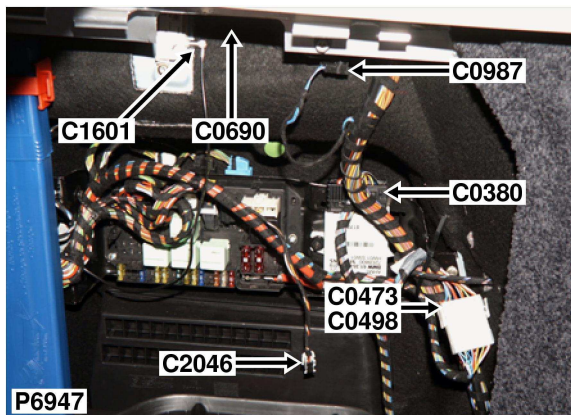

Wire Chart

CAV	TERMINAL	CSA	COL	CCT	DESTN
1	YPE100580	0.35	US	171	C0957-8
2	YPE100580	0.35	UR	171	C0957-2

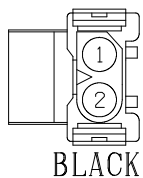

Part No. 1378110
Colour: BLACK
Gender: F
Type: 2.5MM SYSTEM
No. of Ways: 2WY

No repair kit
 Geen reparatiepakke
 Pas de nécessaire de reparation
 Kein Werkzeug
 Senza kit per le riparazioni
 Sem kit de reparaçao
 No hay kit de reparación

Description: Relay-Heated front screen
Location: Behind driver side of fascia

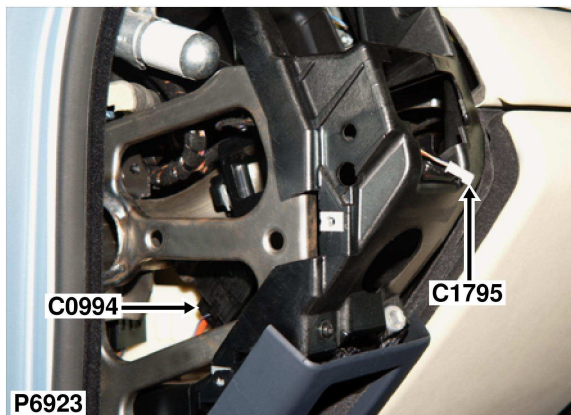

Wire Chart

CAV	TERMINAL	CSA	COL	CCT	DESTN
1	8377724	0.35	UN	109	C1629-14
2	YPL102890	0.5	GY	109	SJ X1269-
3	YPL104330	10.0	R	109	C0592-1
5	YPL104330	4.0	B	109	C0247-2
5	WITH WIRE 649	4.0	B	109	C0246-2

No repair kit
 Geen reparatiepakke
 Pas de nécessaire de réparation
 Kein Werkzeug
 Senza kit per le riparazioni
 Sem kit de reparação
 No hay kit de reparación

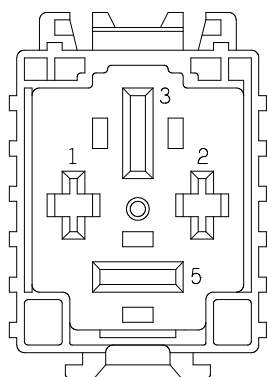

BLACK

Part No. 8380420
Colour: BLACK
Gender: F
Type: BASE - F7 RELAY
No. of Ways: 4WY

Description: Eject box-Telephone
Location: Beneath centre console

No photo
 Geen photo
 Pas de photo
 Kein foto
 Senza foto
 Sem fotografia
 No hay foto

Wire Chart

CAV	TERMINAL	CSA	COL	CCT	DESTN
1	YPJ100830	0.5	RY	578	C1646-1
1	YPJ100830	0.35	U	566	C1646-1
2	YPJ100830	0.5	NB	578	C1646-2
2	YPJ100830	0.35	WR	566	C1646-2
3	YPJ100830	0.35	WG	566	C1646-3
3	YPJ100830	0.5	SR	578	C1646-3
4	YPJ100830	0.5	UW	578	C1646-4
4	YPJ100830	0.35	YR	566	C1646-4
5	YPJ100830	MCDA	R	578	C1646-5
6	YPJ100830	0.35	UG	566	C1646-6
6	YPJ100830	MCDA	W	578	C1646-6
7	YPJ100830	0.35	Y	566	C1646-7
7	SCREEN	MCDA	SCR	578	C1646-7
8	YPJ100830	0.5	VR	566	C1646-8
9	YPJ100830	0.35	WSY	566	C1646-9

CAV	TERMINAL	CSA	COL	CCT	DESTN
10	YPJ100830	0.5	RY	566	C1646-10
10	YPJ100830	MCDA	B	578	C1646-10
11	YPJ100830	0.35	WY	566	C1646-11
11	YPJ100830	0.35	R	578	C1646-11
12	YPJ100830	MCDA	Y	578	C1646-12
13	YPJ100830	0.35	O	566	C1646-13
14	YPJ100830	0.35	WS	566	C1646-14
14	YPJ100830	MCDA	G	578	C1646-14
15	YPJ100830	0.5	SR	566	C1646-15
16	YPJ100830	0.35	WU	566	C1646-16
17	YPJ100830	0.5	NB	566	C1646-17
18	YPJ100830	0.35	WB	566	C1646-18

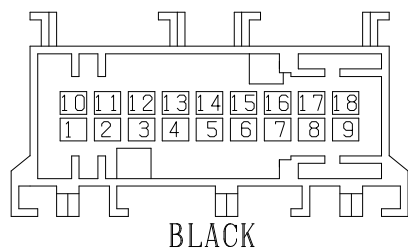

Service Repair Kits

YPJ100830		0.20 - 0.50 csa
Cavities 1-18		
VDK500010	INSTRUCTION; REPAIR KIT	1
VDK500070	INSTRUCTION; EXTRACT TOOL	1
VDK500080	INSTRUCTION; EXTRACT TOOL	1
YMI000990	PRE-TERMINATED LEAD	1
YPQ000100	IDENTS (SMALL)	1
YRV000040	SPLICE (RED, CSA; 0.25-1.6)	1
YRW000390	WIRE STRIPPER	1
YRW500010	APPLICATOR	1
YRW500060	EXTRACT TOOL	1
YRW500070	EXTRACT TOOL	1

[VUB500190]

Part No.: YPC113590
Colour: BLACK
Gender: M
Type: MQS
No. of Ways: 18WY

Description: Antenna-Eject box
Location: Beneath centre console

No photo
Geen photo
Pas de photo
Kein foto
Senza foto
Sem fotografia
No hay foto



HF

Wire Chart

CAV	TERMINAL	CSA	COL	CCT	DESTN
0	SCREEN	MCBA	SCR	566	C1647-0
1	ASSEMBLY	MCBA	B	566	C1647-1

No repair kit
Geen reparatiepakke
Pas de nécessaire de reparation
Kein Werkzeug
Senza kit per le riparazioni
Sem kit de reparaçao
No hay kit de reparación

Part No. 6906056
Colour: BLACK
Gender: M
Type: ASSEMBLY
No. of Ways: 1WY

Description: Illumination-Heater Control-LH

Location: Behind centre of fascia

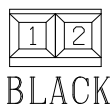
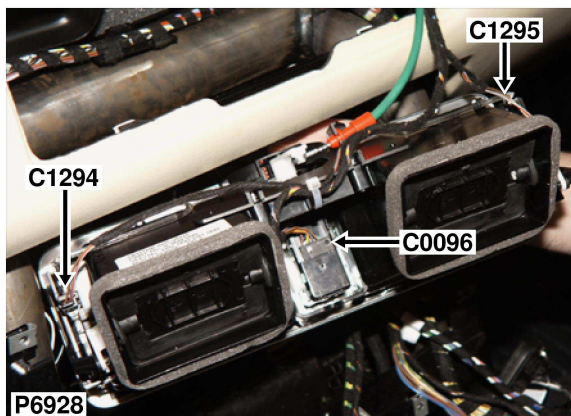

Wire Chart

CAV	TERMINAL	CSA	COL	CCT	DESTN
1	YPL101310	0.35	NB	ALL	C0287-0
2	YPL101310	0.5	SR	ALL	C0286-0

Service Repair Kits

YPL101310		0.20 - 0.50 csa
Cavities 1,2		
VDK500010	INSTRUCTION; REPAIR KIT	1
VDK500070	INSTRUCTION; EXTRACT TOOL	1
VDK500080	INSTRUCTION; EXTRACT TOOL	1
YMI000870	PRE-TERMINATED LEAD	1
YPQ000100	IDENTS (SMALL)	1
YRV000040	SPLICE (RED, CSA; 0.25-1.6)	1
YRW000390	WIRE STRIPPER	1
YRW500010	APPLICATOR	1
YRW500060	EXTRACT TOOL	1
YRW500070	EXTRACT TOOL	1

[VUB500080]

Part No. YPC111740
Colour: BLACK
Gender: F
Type: MQS
No. of Ways: 2WY

Description: Illumination-Heater Control-LH

Location: Behind centre of fascia

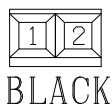
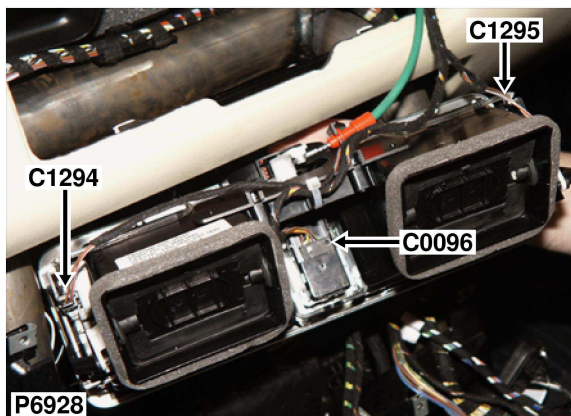

Part No. YPC111740
Colour: BLACK
Gender: F
Type: MQS
No. of Ways: 2WY

Wire Chart

CAV	TERMINAL	CSA	COL	CCT	DESTN
1	YPL101310	0.35	NB	ALL	C0287-0
2	YPL101310	0.5	SR	ALL	C0286-0

Service Repair Kits

YPL101310		0.20 - 0.50 CSA
Cavities 1,2		
VDK500010	INSTRUCTION; REPAIR KIT	1
VDK500070	INSTRUCTION; EXTRACT TOOL	1
VDK500080	INSTRUCTION; EXTRACT TOOL	1
YMI000870	PRE-TERMINATED LEAD	1
YPQ000100	IDENTS (SMALL)	1
YRV000040	SPLICE (RED, CSA; 0.25-1.6)	1
YRW000390	WIRE STRIPPER	1
YRW500010	APPLICATOR	1
YRW500060	EXTRACT TOOL	1
YRW500070	EXTRACT TOOL	1

[VUB500080]

Description: Microphone-Telephone
Location: Front of headlining in the centre

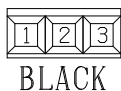
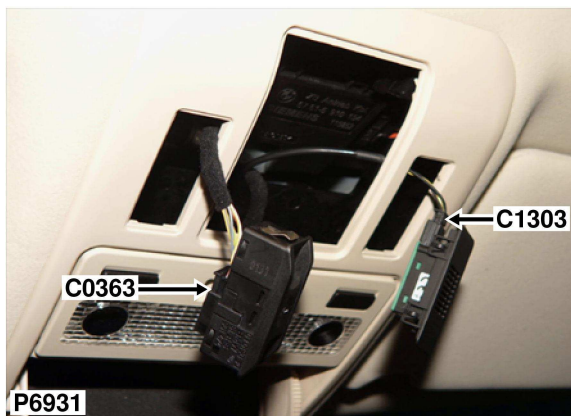

Part No. YPC117800
Colour: BLACK
Gender: F
Type: MQS
No. of Ways: 3WY

Wire Chart

CAV	TERMINAL	CSA	COL	CCT	DESTN
1	YPL101310	MCCB	B	ALL	C2044-1
2	YPL101310	MCCB	Y	ALL	C2044-3
3	SCREEN	MCCB	SCR	ALL	C2044-2

Service Repair Kits

YPL101310		0.20 - 0.50 CSA
Cavities 1,2		
VDK500010	INSTRUCTION; REPAIR KIT	1
VDK500070	INSTRUCTION; EXTRACT TOOL	1
VDK500080	INSTRUCTION; EXTRACT TOOL	1
YMI000870	PRE-TERMINATED LEAD	1
YPQ000100	IDENTS (SMALL)	1
YRV000040	SPLICE (RED, CSA; 0.25-1.6)	1
YRW000390	WIRE STRIPPER	1
YRW500010	APPLICATOR	1
YRW500060	EXTRACT TOOL	1
YRW500070	EXTRACT TOOL	1

[VUB500080]

Description: ECU-Transfer box
Location: Rear LH side of engine compartment

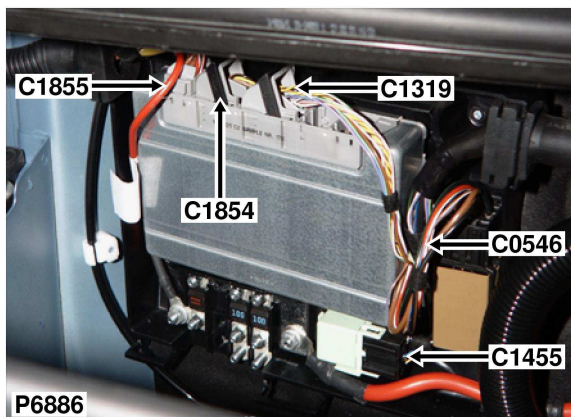

Wire Chart

CAV	TERMINAL	CSA	COL	CCT	DESTN
7	YPL101310	0.35	PU	ALL	C0587-28
8	YPL101310	0.35	WG	ALL	C0365-1
13	YPL101310	MMAG	YN	ALL	SJ X18826-
15	YPL101310	0.5	GP	ALL	C0587-10

CAV	TERMINAL	CSA	COL	CCT	DESTN
17	YPL101310	0.35	WR	ALL	C0193-9
18	YPL101310	0.35	WB	ALL	C0193-10
19	YPL101310	0.35	WP	ALL	SJ X183-
26	YPL101310	MMAG	YB	ALL	SJ X18827-

Service Repair Kits

YPL101310		0.20 - 0.50 CSA
Cavities 7,8,13,15,17-19,26		
VDK500010	INSTRUCTION; REPAIR KIT	1
VDK500070	INSTRUCTION; EXTRACT TOOL	1
VDK500080	INSTRUCTION; EXTRACT TOOL	1
YMI000870	PRE-TERMINATED LEAD	1
YPQ000100	IDENTS (SMALL)	1
YRV000040	SPLICE (RED, CSA; 0.25-1.6)	1
YRW000390	WIRE STRIPPER	1
YRW500010	APPLICATOR	1
YRW500060	EXTRACT TOOL	1
YRW500070	EXTRACT TOOL	1

[VUB500080]

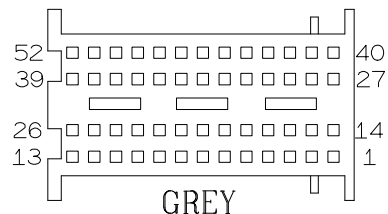

Part No. YPH100650
Colour: GREY
Gender: F
Type: MQS
No. of Ways: 52WY

Description: Pump-Leak detection
Location: Below RH rear wheelarch

No photo
 Geen photo
 Pas de photo
 Kein foto
 Senza foto
 Sem fotografia
 No hay foto

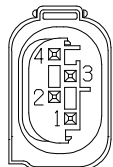

BLACK

Wire Chart

CAV	TERMINAL	CSA	COL	CCT	DESTN
1	YPL101500	0.5	BG	393	C0331-20
2	YPL101500	0.5	S	393	C0331-18
3	YPL101510	0.75	NU	393	C0331-30
4	YPL101510	0.75	RW	393	SJ X8066-

Service Repair Kits

YPL101510		0.75 - 0.75 CSA
Cavities 1-4		
VDK500010	INSTRUCTION; REPAIR KIT	1
VDK500070	INSTRUCTION; EXTRACT TOOL	1
VDK500080	INSTRUCTION; EXTRACT TOOL	1
YMI000950	PRE-TERMINATED LEAD	1
YPQ000100	IDENTS (SMALL)	1
YQD000210	HEAT SHRINK SLEEVE	1
YRV000040	SPLICE (RED, CSA; 0.25-1.6)	1
YRW000390	WIRE STRIPPER	1
YRW500010	APPLICATOR	1

[VUB500150]

Part No. YPC117050
Colour: BLACK
Gender: F
Type: MQS
No. of Ways: 4WY

Description: Motor-Wiper-Headlamp-LH

Location: Front of vehicle - LH side

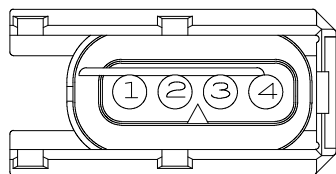
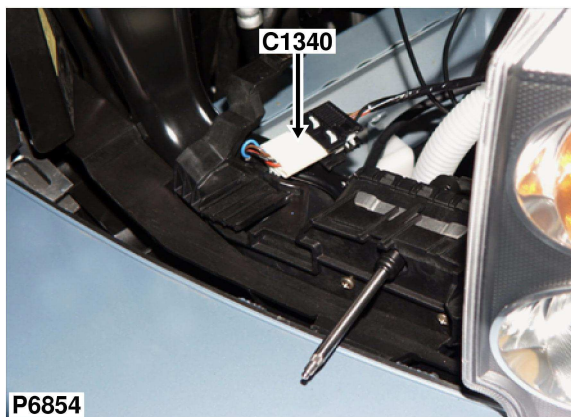

NATURAL

Wire Chart

CAV	TERMINAL	CSA	COL	CCT	DESTN
1	YPE100500	2.5	BN	279	SJ X10087-
2	YPE100500	2.5	RS	279	C0288-0
3	YPE100500	1.5	N	279	C0017-0
4	YPE100500	1.5	BY	279	C1342-2

Service Repair Kits

YPE100500		1.01 - 2.50 CSA
Cavities 1-4		
VDK500010	INSTRUCTION; REPAIR KIT	1
VDK500030	INSTRUCTION; EXTRACT TOOL	1
YMI000900	PRE-TERMINATED LEAD	1
YPQ000110	IDENTS (MEDIUM)	1
YRV000050	SPLICE (BLUE, CSA; 1.0-2.6)	1
YRW000390	WIRE STRIPPER	1
YRW500010	APPLICATOR	1

[VUB500110]

Part No. 8352356
Colour: BLACK
Gender: F
Type: 2.5MM SYSTEM
No. of Ways: 4WY

Description: Motor-Wiper-Headlamp-RH

Location: Front of vehicle - RH side

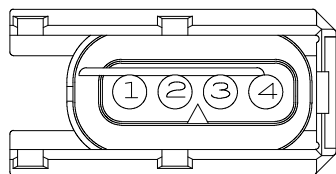
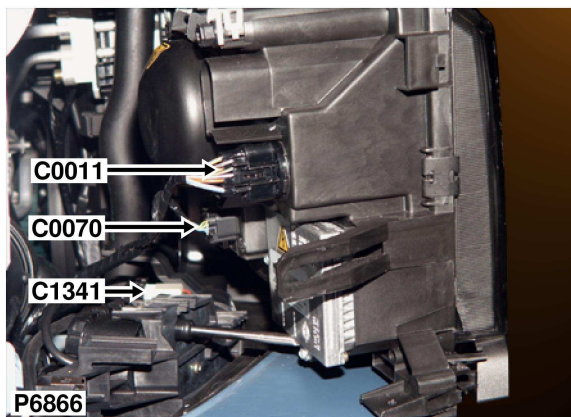

NATURAL

Wire Chart

CAV	TERMINAL	CSA	COL	CCT	DESTN
1	YPE100500	2.5	BN	279	SJ X10087-
2	YPE100500	2.5	RS	279	C0288-0
3	YPE100500	1.5	N	279	C0550-0

Service Repair Kits

YPE100500		1.01 - 2.50 CSA
Cavities 1-3		
VDK500010	INSTRUCTION; REPAIR KIT	1
VDK500030	INSTRUCTION; EXTRACT TOOL	1
YMI000900	PRE-TERMINATED LEAD	1
YPQ000110	IDENTS (MEDIUM)	1
YRV000050	SPLICE (BLUE, CSA; 1.0-2.6)	1
YRW000390	WIRE STRIPPER	1
YRW500010	APPLICATOR	1

[VUB500110]

Part No. 8352356
Colour: BLACK
Gender: F
Type: 2.5MM SYSTEM
No. of Ways: 4WY

Description: Pump-Power wash
Location: Front LH side of engine compartment

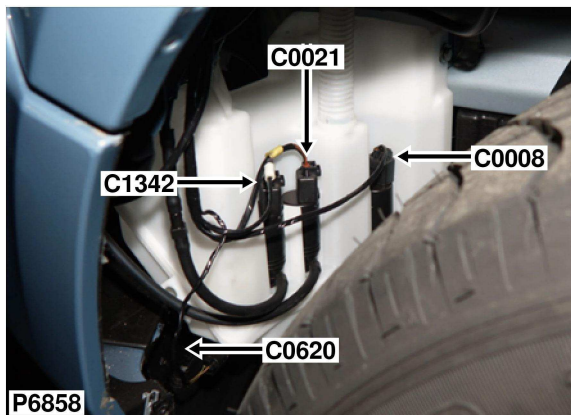

Wire Chart

CAV	TERMINAL	CSA	COL	CCT	DESTN
1	YPL103540	1.5	N	279	C0017-0
2	YPL103540	1.5	BY	279	C1340-4

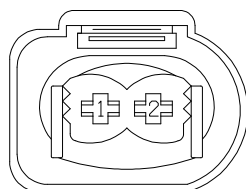

BLACK

No repair kit
 Geen reparatiepakke
 Pas de nécessaire de reparation
 Kein Werkzeug
 Senza kit per le riparazioni
 Sem kit de reparaçã
 No hay kit de reparaci3n

Part No. YPC116370
Colour: BLACK
Gender: F
Type: MDK3 PLUS
No. of Ways: 2WY

Description: Speaker-PDC
Location: Driver's footwell

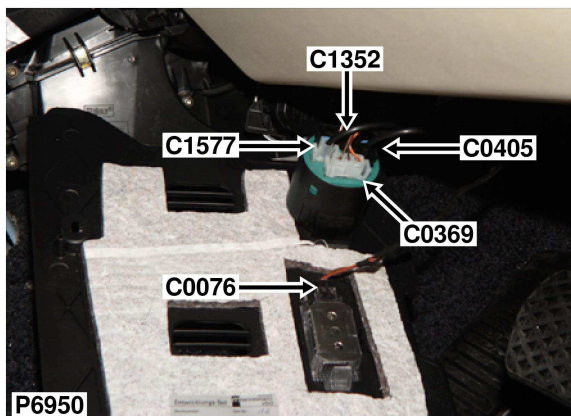

Wire Chart

CAV	TERMINAL	CSA	COL	CCT	DESTN
2	YPE100480	0.35	WR	ALL	C0233-18
3	YPE100480	0.35	WU	ALL	C0233-17

Service Repair Kits

YPE100480		0.20 - 0.40 csa
Cavities 2,3		
VDK500010	INSTRUCTION; REPAIR KIT	1
VDK500130	INSTRUCTION; EXTRACT TOOL	1
YMI000860	PRE-TERMINATED LEAD	1
YPQ000100	IDENTS (SMALL)	1
YRV000040	SPLICE (RED, CSA; 0.25-1.6)	1
YRW000390	WIRE STRIPPER	1
YRW500010	APPLICATOR	1

[VUB500070]

Part No. YPC10444
Colour: BLACK
Gender: F
Type: 2.5MM SYSTEM
No. of Ways: 4WY

Description: CD auto changer
Location: Luggage compartment - LH side

No photo
 Geen photo
 Pas de photo
 Kein foto
 Senza foto
 Sem fotografia
 No hay foto

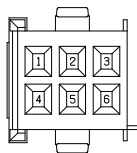

BLACK

Part No. YPC115290
Colour: BLACK
Gender: F
Type: MQS
No. of Ways: 6WY

Wire Chart

CAV	TERMINAL	CSA	COL	CCT	DESTN
1	YPL101310	MMA	WR	581	C0922-8
2	YPL101310	MMA	WN	581	C0922-2
4	YPL101310	MMA	WU	581	C0922-9

Service Repair Kits

YPL101310		0.20 - 0.50 CSA
Cavities 1,2,4		
VDK500010	INSTRUCTION; REPAIR KIT	1
VDK500070	INSTRUCTION; EXTRACT TOOL	1
VDK500080	INSTRUCTION; EXTRACT TOOL	1
YMI000870	PRE-TERMINATED LEAD	1
YPQ000100	IDENTS (SMALL)	1
YRV000040	SPLICE (RED, CSA; 0.25-1.6)	1
YRW000390	WIRE STRIPPER	1
YRW500010	APPLICATOR	1
YRW500060	EXTRACT TOOL	1
YRW500070	EXTRACT TOOL	1

[VUB500080]

Description: Relay-Steering column
Location: Underside of steering column

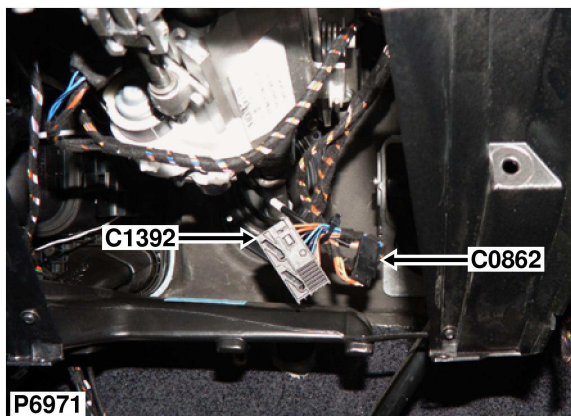

Wire Chart

CAV	TERMINAL	CSA	COL	CCT	DESTN
1	YPE100500	1.5	N	389	C0285-0
1	YPE100500	1.5	N	388	C0285-0
2	YPE100500	1.5	RN	389	C0583-6
2	YPE100500	1.5	RN	388	C0583-6
3	YPE10020	1.0	B	388	C1396-2
3	YPE10020	1.0	B	389	C1396-2
4	YPE10020	1.0	U	388	C1396-1
4	YPE10020	1.0	U	389	C1396-1
5	YPE10020	1.0	BU	388	C1397-2
5	YPE10020	1.0	BU	389	C1397-2

CAV	TERMINAL	CSA	COL	CCT	DESTN
6	YPE10020	1.0	UB	389	C1397-1
6	YPE10020	1.0	UB	388	C1397-1
7	YPE100480	0.35	NU	388	C1393-1
7	YPE100480	0.35	NU	389	SJ X13332-
8	YPE100480	0.35	NR	389	SJ X13333-
8	YPE100480	0.35	NR	388	C1393-2
14	YPE100480	0.35	NB	388	C1393-3
14	YPE100480	0.35	NB	389	SJ X13334-
15	YPE100480	0.35	NW	389	SJ X13335-
15	YPE100480	0.35	NW	388	C1393-4

Service Repair Kits

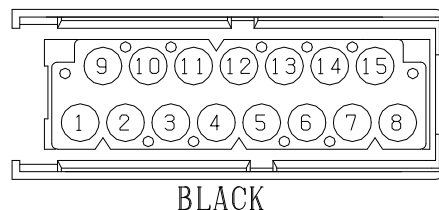

YPE100480		0.20 - 0.40 CSA	
Cavities 3-8,14-15			
VDK500010	INSTRUCTION; REPAIR KIT	1	
VDK500130	INSTRUCTION; EXTRACT TOOL	1	
YMI000860	PRE-TERMINATED LEAD	1	
YPQ000100	IDENTS (SMALL)	1	
YRV000040	SPLICE (RED, CSA; 0.25-1.6)	1	
YRW000390	WIRE STRIPPER	1	
YRW500010	APPLICATOR	1	
[VUB500070]			

YPE100500		1.01 - 2.50 CSA	
Cavities 1-6			
VDK500010	INSTRUCTION; REPAIR KIT	1	
VDK500030	INSTRUCTION; EXTRACT TOOL	1	
YMI000900	PRE-TERMINATED LEAD	1	
YPQ000110	IDENTS (MEDIUM)	1	
YRV000050	SPLICE (BLUE, CSA; 1.0-2.6)	1	
YRW000390	WIRE STRIPPER	1	
YRW500010	APPLICATOR	1	
[VUB500110]			

Part No. YPC112210
Colour: BLACK
Gender: F
Type: 2.5MM SYSTEM
No. of Ways: 15WY

Description: Switch-Steering column
Location: Underside of steering column

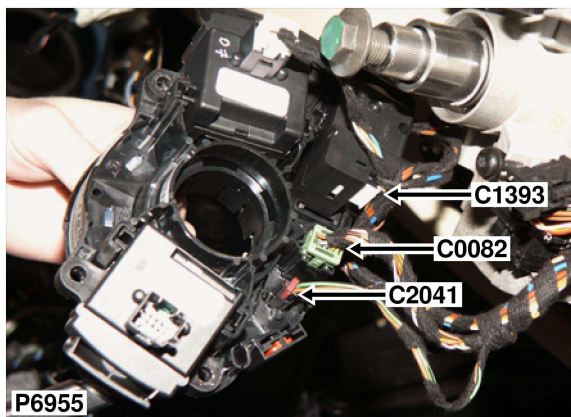

Part No. 6909054
Colour: NATURAL
Gender: F
Type: MQS
No. of Ways: 6WY

Wire Chart

CAV	TERMINAL	CSA	COL	CCT	DESTN
1	YPL101310	0.35	NU	389	SJ X13332-
1	YPL101310	0.35	NU	388	C1392-7
2	YPL101310	0.35	NR	388	C1392-8
2	YPL101310	0.35	NR	389	SJ X13333-
3	YPL101310	0.35	NB	389	SJ X13334-

CAV	TERMINAL	CSA	COL	CCT	DESTN
3	YPL101310	0.35	NB	388	C1392-14
4	YPL101310	0.35	NW	389	SJ X13335-
4	YPL101310	0.35	NW	388	C1392-15
5	YPL101310	0.35	NB	388	SJ X3361-
5	YPL101310	0.35	NB	389	SJ X3361-

Service Repair Kits

YPL101310		0.20 - 0.50 CSA
Cavities 1-5		
VDK500010	INSTRUCTION; REPAIR KIT	1
VDK500070	INSTRUCTION; EXTRACT TOOL	1
VDK500080	INSTRUCTION; EXTRACT TOOL	1
YMI000870	PRE-TERMINATED LEAD	1
YPQ000100	IDENTS (SMALL)	1
YRV000040	SPLICE (RED, CSA; 0.25-1.6)	1
YRW000390	WIRE STRIPPER	1
YRW500010	APPLICATOR	1
YRW500060	EXTRACT TOOL	1
YRW500070	EXTRACT TOOL	1

[VUB500080]

Description: Motor-Column-Telescope
Location: Underside of steering column

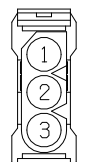
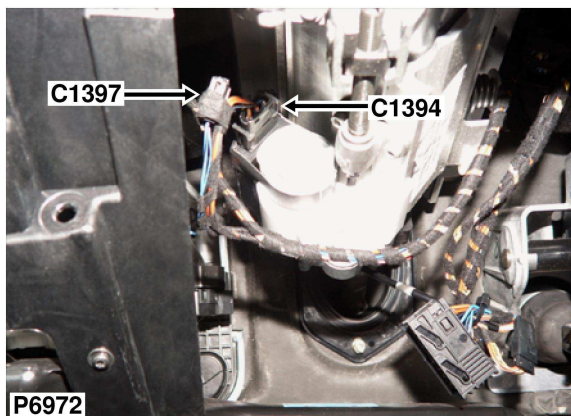

BLACK

Wire Chart

CAV	TERMINAL	CSA	COL	CCT	DESTN
1	YPE100480	0.35	BU	389	C0253-22
2	YPE100500	2.5	RN	389	SJ X206-
3	YPE100500	1.5	N	389	SJ X215-

Service Repair Kits

YPE100480		0.20 - 0.40 CSA	
Cavities 1			
VDK500010	INSTRUCTION; REPAIR KIT	1	
VDK500130	INSTRUCTION; EXTRACT TOOL	1	
YMI000860	PRE-TERMINATED LEAD	1	
YPQ000100	IDENTS (SMALL)	1	
YRV000040	SPLICE (RED, CSA; 0.25-1.6)	1	
YRW000390	WIRE STRIPPER	1	
YRW500010	APPLICATOR	1	
[VUB500070]			

YPE100500		1.01 - 2.50 CSA	
Cavities 2,3			
VDK500010	INSTRUCTION; REPAIR KIT	1	
VDK500030	INSTRUCTION; EXTRACT TOOL	1	
YMI000900	PRE-TERMINATED LEAD	1	
YPQ000110	IDENTS (MEDIUM)	1	
YRV000050	SPLICE (BLUE, CSA; 1.0-2.6)	1	
YRW000390	WIRE STRIPPER	1	
YRW500010	APPLICATOR	1	
[VUB500110]			

Part No. YPC112530
Colour: BLACK
Gender: F
Type: 2.5MM SYSTEM
No. of Ways: 3WY

Description: Motor-Column-Height
Location: Top of steering column

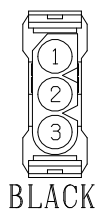
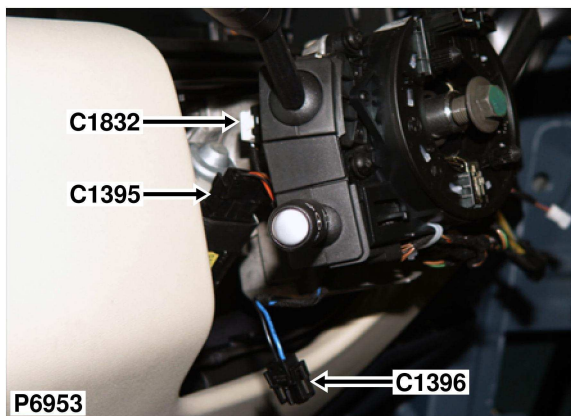

Wire Chart

CAV	TERMINAL	CSA	COL	CCT	DESTN
1	YPE100480	0.35	B	389	C0253-21
2	YPE100500	2.5	RN	389	SJ X206-
3	YPE100500	1.5	N	389	SJ X215-

Service Repair Kits

YPE100480		0.20 - 0.40 CSA	
Cavities 1			
VDK500010	INSTRUCTION; REPAIR KIT	1	
VDK500130	INSTRUCTION; EXTRACT TOOL	1	
YMI000860	PRE-TERMINATED LEAD	1	
YPQ000100	IDENTS (SMALL)	1	
YRV000040	SPLICE (RED, CSA; 0.25-1.6)	1	
YRW000390	WIRE STRIPPER	1	
YRW500010	APPLICATOR	1	
[VUB500070]			

YPE100500		1.01 - 2.50 CSA	
Cavities 2,3			
VDK500010	INSTRUCTION; REPAIR KIT	1	
VDK500030	INSTRUCTION; EXTRACT TOOL	1	
YMI000900	PRE-TERMINATED LEAD	1	
YPQ000110	IDENTS (MEDIUM)	1	
YRV000050	SPLICE (BLUE, CSA; 1.0-2.6)	1	
YRW000390	WIRE STRIPPER	1	
YRW500010	APPLICATOR	1	
[VUB500110]			

Part No. YPC112530
Colour: BLACK
Gender: F
Type: 2.5MM SYSTEM
No. of Ways: 3WY

Description: Motor-Column-Height
Location: Top of steering column

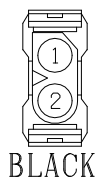
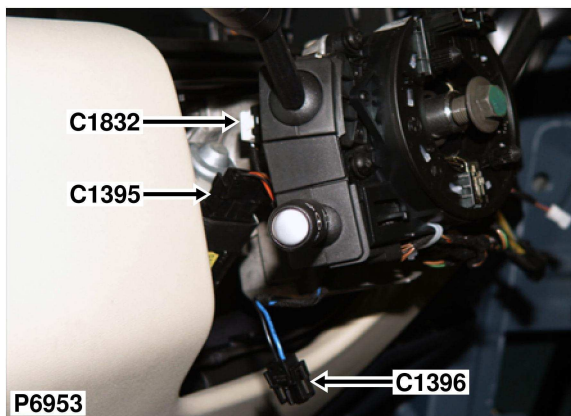

Wire Chart

CAV	TERMINAL	CSA	COL	CCT	DESTN
1	YPE10020	1.0	U	389	C1392-4
1	YPE10020	1.0	U	388	C1392-4
2	YPE10020	1.0	B	388	C1392-3
2	YPE10020	1.0	B	389	C1392-3

Service Repair Kits

YPE10020		0.50 - 1.00 CSA
Cavities 1-2		
VDK500010	INSTRUCTION; REPAIR KIT	1
VDK500130	INSTRUCTION; EXTRACT TOOL	1
YMI000860	PRE-TERMINATED LEAD	1
YPQ000100	IDENTS (SMALL)	1
YRV000040	SPLICE (RED, CSA; 0.25-1.6)	1
YRW000390	WIRE STRIPPER	1
YRW500010	APPLICATOR	1

[VUB500070]

Part No. YPC112260
Colour: BLACK
Gender: F
Type: 2.5MM SYSTEM
No. of Ways: 2WY

Description: Motor-Column-Height
Location: Underside of steering column

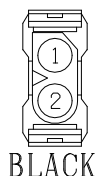
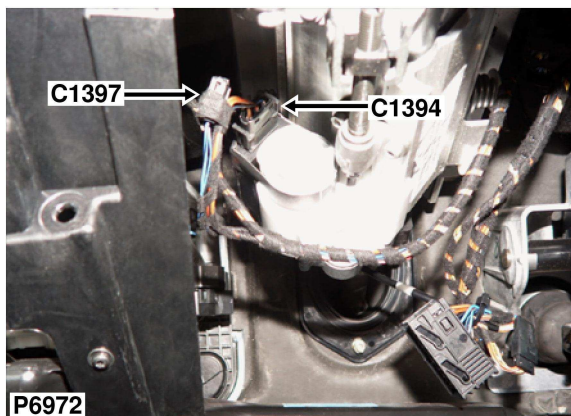

Wire Chart

CAV	TERMINAL	CSA	COL	CCT	DESTN
1	YPE10020	1.0	UB	389	C1392-6
1	YPE10020	1.0	UB	388	C1392-6
2	YPE10020	1.0	BU	388	C1392-5
2	YPE10020	1.0	BU	389	C1392-5

Service Repair Kits

YPE10020		0.50 - 1.00 CSA
Cavities 1-2		
VDK500010	INSTRUCTION; REPAIR KIT	1
VDK500130	INSTRUCTION; EXTRACT TOOL	1
YMI000860	PRE-TERMINATED LEAD	1
YPQ000100	IDENTS (SMALL)	1
YRV000040	SPLICE (RED, CSA; 0.25-1.6)	1
YRW000390	WIRE STRIPPER	1
YRW500010	APPLICATOR	1

[VUB500070]

Part No. YPC112260
Colour: BLACK
Gender: F
Type: 2.5MM SYSTEM
No. of Ways: 2WY

Description: Switch-Heater-Seat-LH

Location: Behind centre console

No photo
 Geen photo
 Pas de photo
 Kein foto
 Senza foto
 Sem fotografia
 No hay foto

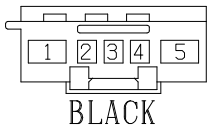

Wire Chart

CAV	TERMINAL	CSA	COL	CCT	DESTN
1	YPL102700	1.0	WY	572	C0903-3
2	YPL101310	0.5	YN	572	C0903-8
3	YPL101310	0.5	NB	572	SJ X3361-
4	YPL101310	0.35	SR	572	SJ X1720-
5	YPL102710	1.5	GW	572	C0903-1

Service Repair Kits

YPL101310		0.20 - 0.50 CSA
Cavities 2-4		
VDK500010	INSTRUCTION; REPAIR KIT	1
VDK500070	INSTRUCTION; EXTRACT TOOL	1
VDK500080	INSTRUCTION; EXTRACT TOOL	1
YMI000870	PRE-TERMINATED LEAD	1
YPQ000100	IDENTS (SMALL)	1
YRV000040	SPLICE (RED, CSA; 0.25-1.6)	1
YRW000390	WIRE STRIPPER	1
YRW500010	APPLICATOR	1
YRW500060	EXTRACT TOOL	1
YRW500070	EXTRACT TOOL	1

[VUB500080]

YPL102710		1.01 - 2.50 CSA
Cavities 5		
VDK500010	INSTRUCTION; REPAIR KIT	1
VDK500050	INSTRUCTION; EXTRACT TOOL	1
YMI001010	PRE-TERMINATED LEAD	1
YPQ000110	IDENTS (MEDIUM)	1
YRV000050	SPLICE (BLUE, CSA; 1.0-2.6)	1
YRW000390	WIRE STRIPPER	1
YRW500010	APPLICATOR	1

[VUB500210]

YPL102700		0.50 - 1.00 CSA
Cavities 1		
VDK500010	INSTRUCTION; REPAIR KIT	1
VDK500030	INSTRUCTION; EXTRACT TOOL	1
YMI001060	PRE-TERMINATED LEAD	1
YPQ000100	IDENTS (SMALL)	1
YRV000040	SPLICE (RED, CSA; 0.25-1.6)	1
YRW000390	WIRE STRIPPER	1
YRW500010	APPLICATOR	1

[VUB500260]

Part No. YPC115600
Colour: BLACK
Gender: F
Type: MQS/MPQ
No. of Ways: 5WY

Description: Switch-Heater-Seat-RH

Location: Behind centre console

No photo
 Geen photo
 Pas de photo
 Kein foto
 Senza foto
 Sem fotografia
 No hay foto

Wire Chart

CAV	TERMINAL	CSA	COL	CCT	DESTN
1	YPL102700	1.0	BY	572	C0903-4
2	YPL101310	0.5	WN	572	C0903-9
3	YPL101310	0.5	NB	572	SJ X3361-
4	YPL101310	0.35	SR	572	SJ X1720-
5	YPL102710	1.5	GN	572	C0903-2

Service Repair Kits

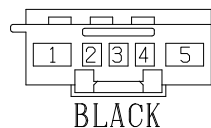

YPL101310		0.20 - 0.50 CSA
Cavities 2-4		
VDK500010	INSTRUCTION; REPAIR KIT	1
VDK500070	INSTRUCTION; EXTRACT TOOL	1
VDK500080	INSTRUCTION; EXTRACT TOOL	1
YMI000870	PRE-TERMINATED LEAD	1
YPQ000100	IDENTS (SMALL)	1
YRV000040	SPLICE (RED, CSA; 0.25-1.6)	1
YRW000390	WIRE STRIPPER	1
YRW500010	APPLICATOR	1
YRW500060	EXTRACT TOOL	1
YRW500070	EXTRACT TOOL	1

[VUB500080]

YPL102710		1.01 - 2.50 CSA
Cavities 5		
VDK500010	INSTRUCTION; REPAIR KIT	1
VDK500050	INSTRUCTION; EXTRACT TOOL	1
YMI001010	PRE-TERMINATED LEAD	1
YPQ000110	IDENTS (MEDIUM)	1
YRV000050	SPLICE (BLUE, CSA; 1.0-2.6)	1
YRW000390	WIRE STRIPPER	1
YRW500010	APPLICATOR	1

[VUB500210]

YPL102700		0.50 - 1.00 CSA
Cavities 1		
VDK500010	INSTRUCTION; REPAIR KIT	1
VDK500030	INSTRUCTION; EXTRACT TOOL	1
YMI001060	PRE-TERMINATED LEAD	1
YPQ000100	IDENTS (SMALL)	1
YRV000040	SPLICE (RED, CSA; 0.25-1.6)	1
YRW000390	WIRE STRIPPER	1
YRW500010	APPLICATOR	1

[VUB500260]

Part No. YPC115600
Colour: BLACK
Gender: F
Type: MQS/MPQ
No. of Ways: 5WY

Description: Motor-Central door locking-Driver

Location: Behind driver's door trim panel



Wire Chart

CAV	TERMINAL	CSA	COL	CCT	DESTN
1	YPL101500	0.35	UR	40	C2058-4
3	YPL101500	0.35	WB	40	C2058-3
4	YPL101510	0.75	W	40	C2058-6
5	YPL101500	0.5	N	40	SJ X850-
6	YPL101500	0.35	NW	40	C2058-11

CAV	TERMINAL	CSA	COL	CCT	DESTN
7	YPL101510	0.75	U	40	C2058-12
8	YPL101510	0.75	B	40	C2058-7

Service Repair Kits

YPL101510		0.75 - 0.75 CSA
Cavities 1,3-8		
VDK500010	INSTRUCTION; REPAIR KIT	1
VDK500070	INSTRUCTION; EXTRACT TOOL	1
VDK500080	INSTRUCTION; EXTRACT TOOL	1
YMI000950	PRE-TERMINATED LEAD	1
YPQ000100	IDENTS (SMALL)	1
YQD000210	HEAT SHRINK SLEEVE	1
YRV000040	SPLICE (RED, CSA; 0.25-1.6)	1
YRW000390	WIRE STRIPPER	1
YRW500010	APPLICATOR	1

[VUB500150]

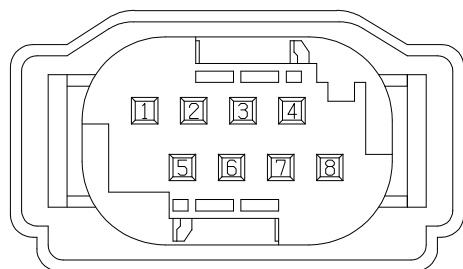

WATERBLUE

Part No. YPC110420
Colour: WATERBLUE
Gender: F
Type: MQS
No. of Ways: 8WY

Description: Motor-Central door locking-Passenger

Location: Behind passenger's door trim panel

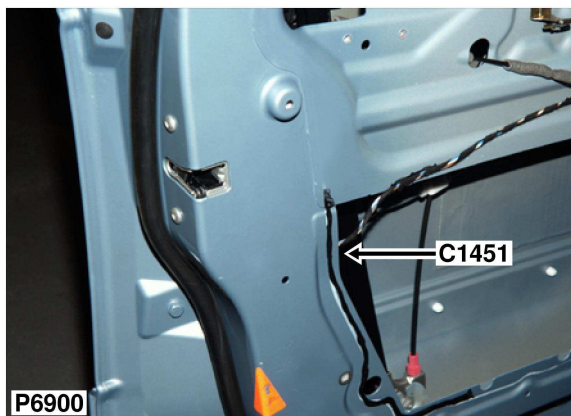

Wire Chart

CAV	TERMINAL	CSA	COL	CCT	DESTN
4	YPL101510	0.75	W	40	C2057-6
5	YPL101500	0.5	N	40	SJ X892-
6	YPL101500	0.5	NW	40	C2057-11
7	YPL101510	0.75	U	40	C2057-12
8	YPL101510	0.75	B	40	C2057-7

Service Repair Kits

YPL101510		0.75 - 0.75 CSA
Cavities 4-8		
VDK500010	INSTRUCTION; REPAIR KIT	1
VDK500070	INSTRUCTION; EXTRACT TOOL	1
VDK500080	INSTRUCTION; EXTRACT TOOL	1
YMI000950	PRE-TERMINATED LEAD	1
YPQ000100	IDENTS (SMALL)	1
YQD000210	HEAT SHRINK SLEEVE	1
YRV000040	SPLICE (RED, CSA; 0.25-1.6)	1
YRW000390	WIRE STRIPPER	1
YRW500010	APPLICATOR	1

[VUB500150]

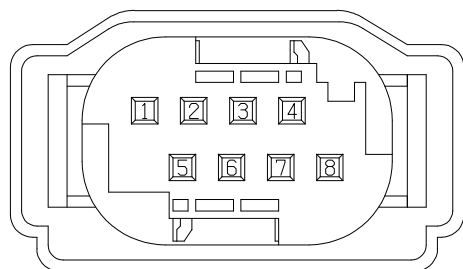

WATERBLUE

Part No. YPC110420
Colour: WATERBLUE
Gender: F
Type: MQS
No. of Ways: 8WY

Description: Receiver-VICS
Location: Luggage compartment - LH side

No photo
 Geen photo
 Pas de photo
 Kein foto
 Senza foto
 Sem fotografia
 No hay foto

Wire Chart

CAV	TERMINAL	CSA	COL	CCT	DESTN
0	SCREEN	MCBC	SCR	340	C2213-0
1	ASSEMBLY	MCBC	B	340	C2213-1

No repair kit
 Geen reparatiepakke
 Pas de nécessaire de reparation
 Kein Werkzeug
 Senza kit per le riparazioni
 Sem kit de reparação
 No hay kit de reparación

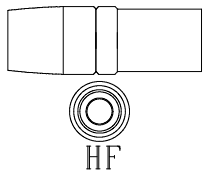

Part No. 8380718
Colour: BLACK
Gender: F
Type: HF
No. of Ways: 1WY

Description: Relay-Interlock
Location: Rear LH side of engine compartment

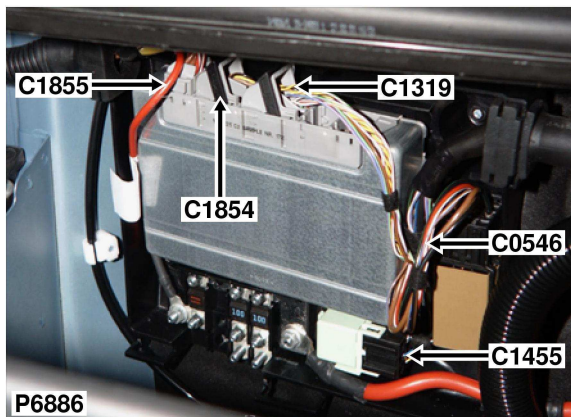

Wire Chart

CAV	TERMINAL	CSA	COL	CCT	DESTN
2	YPL102910	4.0	B	573	C0448-1
4	8377724	0.35	YN	573	C0331-40
6	YPL102910	4.0	B	573	C0059-1
8	8377724	0.35	UB	573	SJ X197-

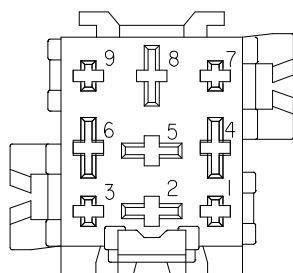

GREEN

Part No. YPP100240
Colour: GREEN
Gender: F
Type: BASE - F4 RELAY
No. of Ways: 9WY

No repair kit
 Geen reparatiepakke
 Pas de nécessaire de reparation
 Kein Werkzeug
 Senza kit per le riparazioni
 Sem kit de reparação
 No hay kit de reparaci3n

Description: ECU-Park-Distance control
Location: Luggage compartment - RH side

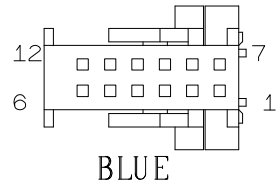
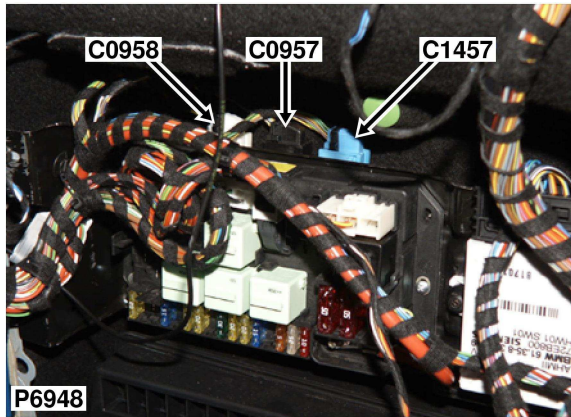

Part No. YPW101080
Colour: BLUE
Gender: F
Type: MQS
No. of Ways: 12WY

Wire Chart

CAV	TERMINAL	CSA	COL	CCT	DESTN
1	YPL101310	0.35	NB	171	C0400-3
2	YPL101310	0.35	NY	171	C0403-3
3	YPL101310	0.35	NW	171	C0402-3
4	YPL101310	0.35	GS	171	C0401-1
5	YPL101310	0.35	GN	171	C0400-1
6	YPL101310	0.35	GP	171	C0403-1

CAV	TERMINAL	CSA	COL	CCT	DESTN
7	YPL101310	0.35	NU	171	C0401-3
8	YPL101310	0.35	YB	171	C0401-2
9	YPL101310	0.35	YG	171	C0400-2
10	YPL101310	0.35	YN	171	C0403-2
11	YPL101310	0.35	YS	171	C0402-2
12	YPL101310	0.35	GB	171	C0402-1

Service Repair Kits

YPL101310		0.20 - 0.50 csa
Cavities 1-12		
VDK500010	INSTRUCTION; REPAIR KIT	1
VDK500070	INSTRUCTION; EXTRACT TOOL	1
VDK500080	INSTRUCTION; EXTRACT TOOL	1
YMI000870	PRE-TERMINATED LEAD	1
YPQ000100	IDENTS (SMALL)	1
YRV000040	SPLICE (RED, CSA; 0.25-1.6)	1
YRW000390	WIRE STRIPPER	1
YRW500010	APPLICATOR	1
YRW500060	EXTRACT TOOL	1
YRW500070	EXTRACT TOOL	1

[VUB500080]

Description: Airbag-ITS-Rear-LH
Location: Rear of headlining

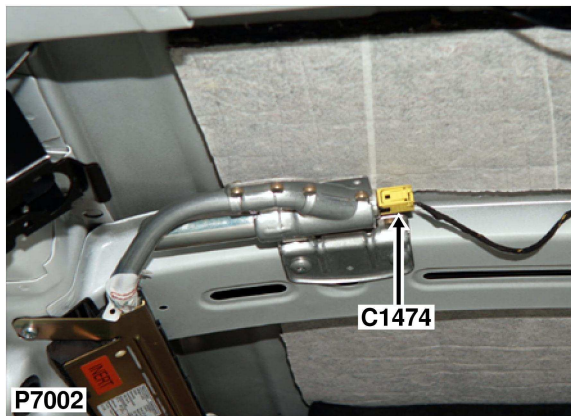

Wire Chart

CAV	TERMINAL	CSA	COL	CCT	DESTN
1	8383270	MMY	Y	221	C0256-28
2	8383270	MMY	B	221	C0256-29

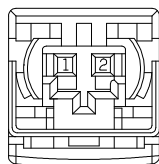

BLACK

Part No. 8380742
Colour: BLACK
Gender: F
Type: AIR-BAG SQUIB (11MM)
No. of Ways: 2WY

No repair kit
 Geen reparatiepakke
 Pas de nécessaire de reparation
 Kein Werkzeug
 Senza kit per le riparazioni
 Sem kit de reparaçao
 No hay kit de reparación

Description: Airbag-ITS-Rear-RH
Location: Rear of headlining

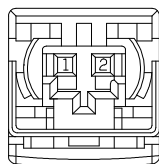
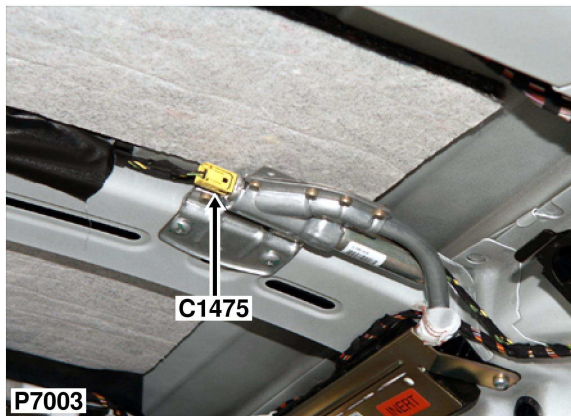

BLACK

Wire Chart

CAV	TERMINAL	CSA	COL	CCT	DESTN
1	8383270	MMAJ	G	221	C0256-41
2	8383270	MMAJ	B	221	C0256-42

No repair kit

Geen reparatiepakke

Pas de nécessaire de reparation

Kein Werkzeug

Senza kit per le riparazioni

Sem kit de reparaçã

No hay kit de reparaci3n

Part No. 8380742
Colour: BLACK
Gender: F
Type: AIR-BAG SQUIB (11MM)
No. of Ways: 2WY

Description: Airbag-ITS-Front-LH
Location: Behind LH side of fascia

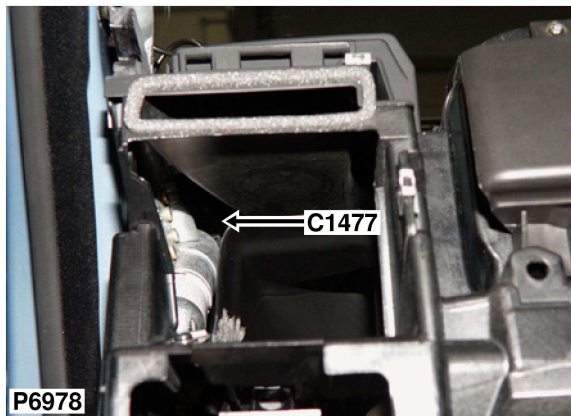

Wire Chart

CAV	TERMINAL	CSA	COL	CCT	DESTN
1	YPL104190	MMC	Y	ALL	C0256-45
2	YPL104190	MMC	UY	ALL	C0256-46

No repair kit
 Geen reparatiepakke
 Pas de nécessaire de reparation
 Kein Werkzeug
 Senza kit per le riparazioni
 Sem kit de reparaçao
 No hay kit de reparación

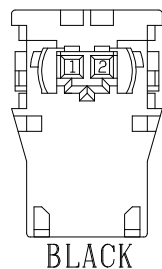

Part No. YPC118590
Colour: BLACK
Gender: F
Type: AIR-BAG SQUIB (11MM)
No. of Ways: 2WY

Description: Airbag-ITS-Front-RH
Location: Behind RH side of fascia

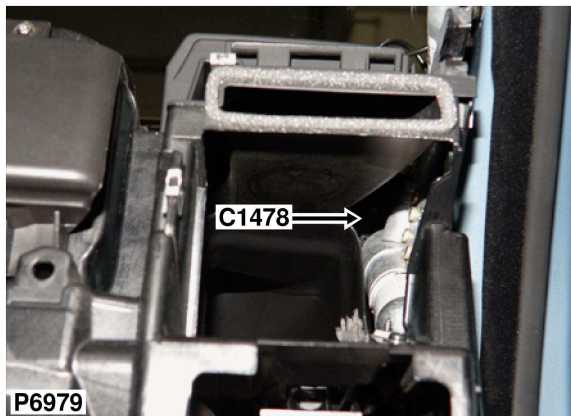

Wire Chart

CAV	TERMINAL	CSA	COL	CCT	DESTN
1	YPL104190	MME	W	ALL	C0256-47
2	YPL104190	MME	UW	ALL	C0256-48

No repair kit
 Geen reparatiepakke
 Pas de nécessaire de reparation
 Kein Werkzeug
 Senza kit per le riparazioni
 Sem kit de reparaçao
 No hay kit de reparación

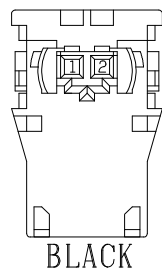

Part No. YPC118590
Colour: BLACK
Gender: F
Type: AIR-BAG SQUIB (11MM)
No. of Ways: 2WY

Description: Lamp-Number plate and tail door switch

Location: Centre of taildoor, behind trim panel

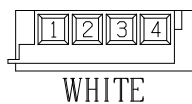
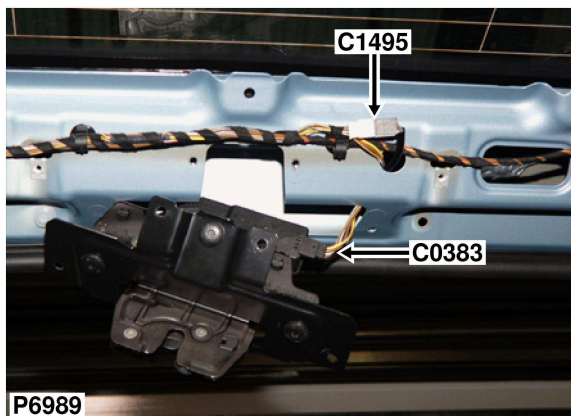

Wire Chart

CAV	TERMINAL	CSA	COL	CCT	DESTN
1	YPL101310	0.5	SN	ALL	C0937-5
2	YPL101310	0.5	N	ALL	C0555-0
3	YPL101310	0.35	SY	ALL	C0661-10
4	YPL101310	0.5	SB	ALL	SJ X1232-

Service Repair Kits

YPL101310		0.20 - 0.50 CSA
Cavities 1-4		
VDK500010	INSTRUCTION; REPAIR KIT	1
VDK500070	INSTRUCTION; EXTRACT TOOL	1
VDK500080	INSTRUCTION; EXTRACT TOOL	1
YMI000870	PRE-TERMINATED LEAD	1
YPQ000100	IDENTS (SMALL)	1
YRV000040	SPLICE (RED, CSA; 0.25-1.6)	1
YRW000390	WIRE STRIPPER	1
YRW500010	APPLICATOR	1
YRW500060	EXTRACT TOOL	1
YRW500070	EXTRACT TOOL	1

[VUB500080]

Part No. YPC117850
Colour: NATURAL
Gender: F
Type: MQS
No. of Ways: 4WY

Description: Airbag-Side-Passenger
Location: Behind passenger's door trim panel

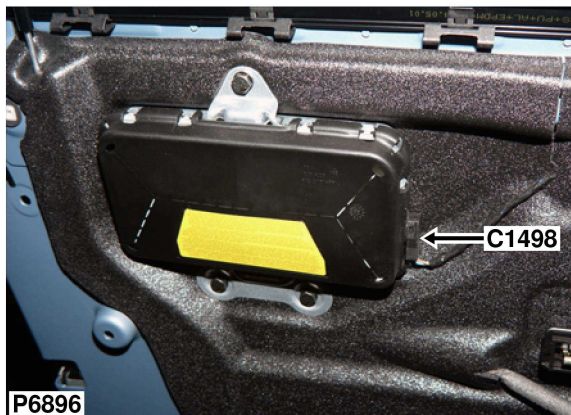

Wire Chart

CAV	TERMINAL	CSA	COL	CCT	DESTN
1	YPL104190	MMA	U	216	C0322-9
2	YPL104190	MMA	N	216	C0322-10

No repair kit
 Geen reparatiepakke
 Pas de nécessaire de réparation
 Kein Werkzeug
 Senza kit per le riparazioni
 Sem kit de reparação
 No hay kit de reparación

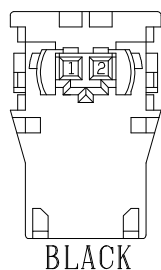

Part No. YPC118590
Colour: BLACK
Gender: F
Type: AIR-BAG SQUIB (11MM)
No. of Ways: 2WY

Description: Airbag-Side-Driver
Location: Behind driver's door trim panel



Wire Chart

CAV	TERMINAL	CSA	COL	CCT	DESTN
1	YPL104190	MMA	Y	216	C0336-9
2	YPL104190	MMA	N	216	C0336-10

No repair kit
 Geen reparatiepakke
 Pas de nécessaire de reparation
 Kein Werkzeug
 Senza kit per le riparazioni
 Sem kit de reparaçao
 No hay kit de reparación

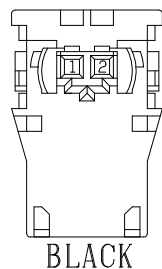

Part No. YPC118590
Colour: BLACK
Gender: F
Type: AIR-BAG SQUIB (11MM)
No. of Ways: 2WY

Description: ECU-Tyre Pressure Monitoring
Location: Beneath front passenger's seat

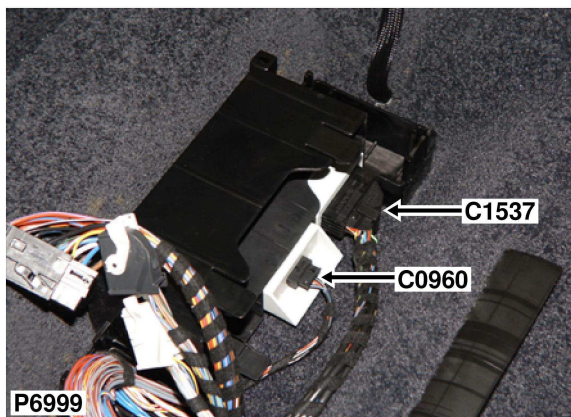

Wire Chart

CAV	TERMINAL	CSA	COL	CCT	DESTN
1	YPL101310	0.35	WRY	337	C0296-0
3	YPL101310	0.35	UR	337	C0700-14
5	YPL101310	MCCC	W	337	C2026-1
6	SCREEN	MCCC	SCR	337	C1114-0
7	YPL101310	MCCA	W	337	C2027-1
8	YPL101310	MCCE	W	337	C2028-1
9	SCREEN	MCCE	SCR	337	C1116-0
10	YPL101310	MCCD	W	337	C2029-1
14	YPL101310	0.35	UN	337	C0700-25

CAV	TERMINAL	CSA	COL	CCT	DESTN
15	YPL101310	0.5	RNY	337	C0586-23
16	YPL101310	0.5	NB	337	C0287-0
21	YPL101310	MCCC	G	337	C2026-2
22	SCREEN	MCCA	SCR	337	C1113-0
23	YPL101310	MCCA	U	337	C2027-2
24	YPL101310	MCCE	R	337	C2028-2
25	SCREEN	MCCD	SCR	337	C1115-0
26	YPL101310	MCCD	Y	337	C2029-2
31	YPL101310	0.5	GN	337	C0587-15

Service Repair Kits

YPL101310		0.20 - 0.50 CSA
Cavities 1,3,5,7,8,10,14-16,21,23,24,26,31		
VDK500010	INSTRUCTION; REPAIR KIT	1
VDK500070	INSTRUCTION; EXTRACT TOOL	1
VDK500080	INSTRUCTION; EXTRACT TOOL	1
YMI000870	PRE-TERMINATED LEAD	1
YPQ000100	IDENTS (SMALL)	1
YRV000040	SPLICE (RED, CSA; 0.25-1.6)	1
YRW000390	WIRE STRIPPER	1
YRW500010	APPLICATOR	1
YRW500060	EXTRACT TOOL	1
YRW500070	EXTRACT TOOL	1

[VUB500080]

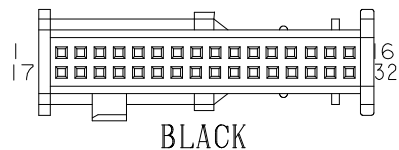

Part No. 8373646
Colour: BLACK
Gender: F
Type: MQS
No. of Ways: 32WY

Description: ECU-Headlamp levelling
Location: Passenger's footwell

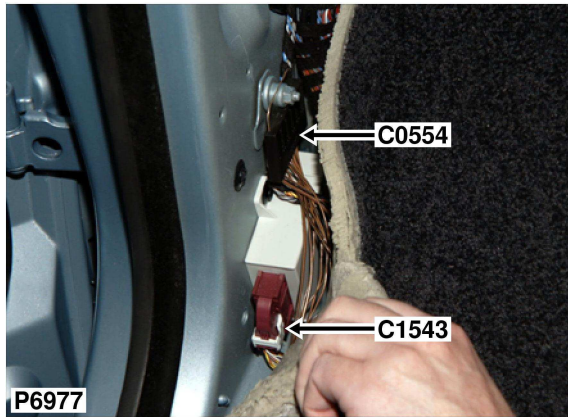

Wire Chart

CAV	TERMINAL	CSA	COL	CCT	DESTN
1	YPL101310	MMW	YR	574	C0071-1
2	YPL101310	MMW	YN	574	C0071-2
3	YPL101310	MMP	UR	574	C0071-3
4	YPL101310	MMP	UN	574	C0071-4
5	YPL101310	0.35	WN	574	C1697-2
7	YPL101310	0.35	SN	574	C1698-2
8	YPL101310	MMAH	UN	574	C0070-4
9	YPL101310	MMAH	UB	574	C0070-3
10	YPL101310	MMAD	YB	574	C0070-1
11	YPL101310	MMAD	YN	574	C0070-2
13	YPL101310	0.5	YR	574	C2040-27

CAV	TERMINAL	CSA	COL	CCT	DESTN
14	YPL101310	0.35	WRY	574	C0296-0
16	YPL101310	0.35	WS	574	C1697-6
18	YPL101310	0.35	WB	574	C1697-3
20	YPL101310	0.35	SW	574	C1698-6
21	YPL101310	0.35	UR	574	SJ X181-
22	YPL101310	0.35	SB	574	C1698-3
24	YPL101310	0.35	YW	574	C0506-18
26	YPL101310	0.5	NB	574	C0554-0

Service Repair Kits

YPL101310 0.20 - 0.50 CSA Cavities 1-5,7-11,13,14,16,18,20-22,24,26

VDK500010	INSTRUCTION; REPAIR KIT	1
VDK500070	INSTRUCTION; EXTRACT TOOL	1
VDK500080	INSTRUCTION; EXTRACT TOOL	1
YMI000870	PRE-TERMINATED LEAD	1
YPQ000100	IDENTS (SMALL)	1
YRV000040	SPLICE (RED, CSA; 0.25-1.6)	1
YRW000390	WIRE STRIPPER	1
YRW500010	APPLICATOR	1
YRW500060	EXTRACT TOOL	1
YRW500070	EXTRACT TOOL	1

[VUB500080]

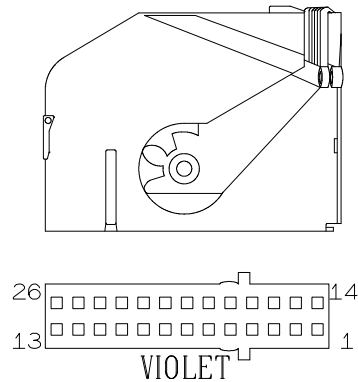

Part No. YPH900760
Colour: PURPLE
Gender: F
Type: MQS
No. of Ways: 26WY

Description: Sensor-Air Temperature Control (ATC)

Location: Front of engine compartment - centre

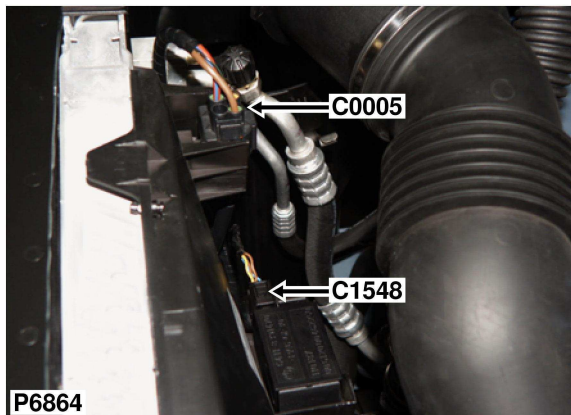

Wire Chart

CAV	TERMINAL	CSA	COL	CCT	DESTN
1	YPL101500	MMAI	N	19	C1629-25
2	YPL101500	MMQ	Y	19	C1629-13
3	YPL101500	MMQ	N	19	C1629-12
4	YPL101500	MMAI	U	19	C1629-26

Service Repair Kits

YPL101500		0.20 - 0.50 CSA
Cavities 1-4		
VDK500010	INSTRUCTION; REPAIR KIT	1
VDK500070	INSTRUCTION; EXTRACT TOOL	1
VDK500080	INSTRUCTION; EXTRACT TOOL	1
YMI000950	PRE-TERMINATED LEAD	1
YPQ000100	IDENTS (SMALL)	1
YQD000210	HEAT SHRINK SLEEVE	1
YRV000040	SPLICE (RED, CSA; 0.25-1.6)	1
YRW000390	WIRE STRIPPER	1
YRW500010	APPLICATOR	1

[VUB500150]

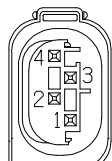

BLACK

Part No. YPC117050
Colour: BLACK
Gender: F
Type: MQS
No. of Ways: 4WY

Description: Speaker-PDC
Location: Driver's footwell

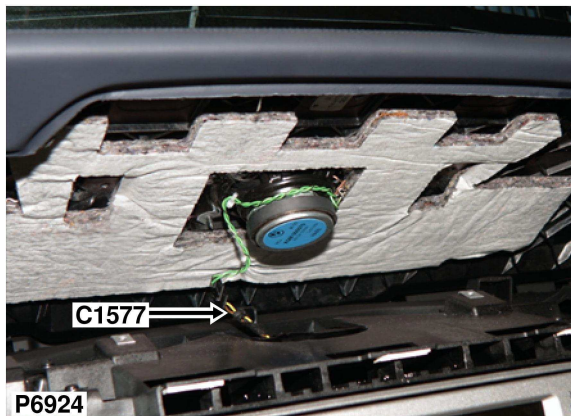

Wire Chart

No repair kit
Geen reparatiepakke
Pas de nécessaire de reparation
Kein Werkzeug
Senza kit per le riparazioni
Sem kit de reparaçao
No hay kit de reparación

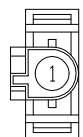

NATURAL

Part No. YPC113900
Colour: NATURAL
Gender: F
Type: 2.5MM SYSTEM
No. of Ways: 1WY

Description: Cigar lighter-Rear
Location: In rear of centre console

No photo
Geen photo
Pas de photo
Kein foto
Senza foto
Sem fotografia
No hay foto



Wire Chart

CAV	TERMINAL	CSA	COL	CCT	DESTN
1	YPL500830	2.5	RG	43	SJ X1483-

No repair kit
Geen reparatiepakke
Pas de nécessaire de reparation
Kein Werkzeug
Senza kit per le riparazioni
Sem kit de reparaçã
No hay kit de reparaci3n

Part No. YPC10395
Colour: WHITE
Gender: F
Type: 187 FASTON PIP-POD
No. of Ways: 1WY

Description: Cigar lighter-Rear
Location: In rear of centre console

No photo
Geen photo
Pas de photo
Kein foto
Senza foto
Sem fotografia
No hay foto



Part No. 1352598
Colour: TRANSPARENT
Gender: F
Type: 2.8 UNSEALED
No. of Ways: 1WY

Wire Chart

CAV	TERMINAL	CSA	COL	CCT	DESTN
1	1376460	2.5	N	43	SJ X13005-

No repair kit
Geen reparatiepakke
Pas de nécessaire de reparation
Kein Werkzeug
Senza kit per le riparazioni
Sem kit de reparaçã
No hay kit de reparaci3n

Description: Main harness to navigation harness

Location: Luggage compartment - LH side

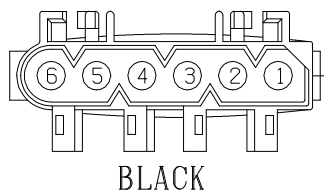
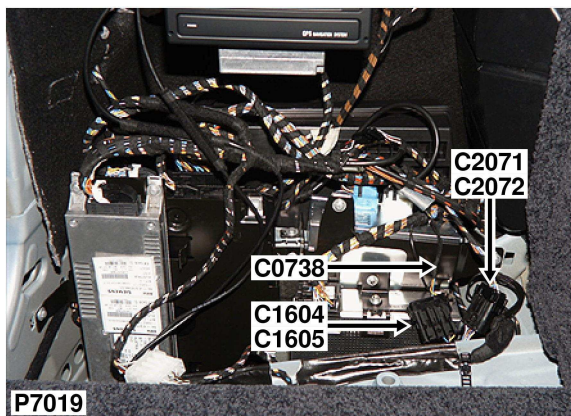

Wire Chart

CAV	TERMINAL	CSA	COL	CCT	DESTN
1	YPD100280	0.35	YR	148	C0506-35
2	YPD100280	0.35	BW	148	C0233-3
3	YPD100280	0.35	UY	148	C2040-26

Service Repair Kits

YPD100280		0.20 - 0.40 CSA
Cavities 1-3		
VDK500010	INSTRUCTION; REPAIR KIT	1
VDK500130	INSTRUCTION; EXTRACT TOOL	1
YMI000920	PRE-TERMINATED LEAD	1
YPQ000100	IDENTS (SMALL)	1
YRV000040	SPLICE (RED, CSA; 0.25-1.6)	1
YRW000390	WIRE STRIPPER	1
YRW500010	APPLICATOR	1
YRW500120	EXTRACT TOOL	1

[VUB500130]

Part No. YPC112110
Colour: BLACK
Gender: M
Type: 2.5MM SYSTEM
No. of Ways: 6WY

Description: Navigation harness to main harness

Location: Luggage compartment - LH side

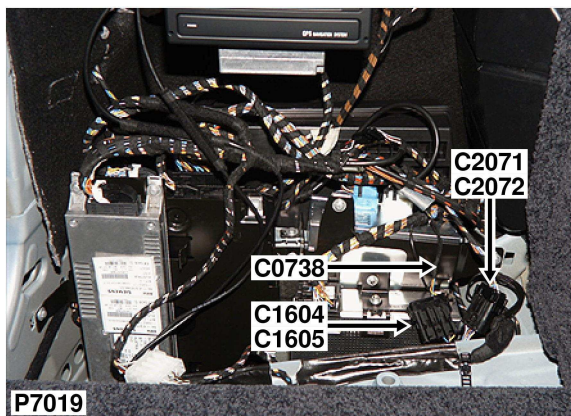

Wire Chart

CAV	TERMINAL	CSA	COL	CCT	DESTN
1	YPE100480	0.35	YR	569	C0897-10
1	YPE100480	0.35	YR	570	C0897-10
2	YPE100480	0.35	BW	568	C0899-20
3	YPE100480	0.35	UY	569	C0897-1
3	YPE100480	0.35	UY	570	C0897-1

Service Repair Kits

YPE100480		0.20 - 0.40 CSA
Cavities 1-3		
VDK500010	INSTRUCTION; REPAIR KIT	1
VDK500130	INSTRUCTION; EXTRACT TOOL	1
YMI000860	PRE-TERMINATED LEAD	1
YPQ000100	IDENTS (SMALL)	1
YRV000040	SPLICE (RED, CSA; 0.25-1.6)	1
YRW000390	WIRE STRIPPER	1
YRW500010	APPLICATOR	1

[VUB500070]



BLACK

Part No. YPC112330
Colour: BLACK
Gender: F
Type: 2.5MM SYSTEM
No. of Ways: 6WY

Description: Receiver-Global Positioning System (GPS)
Location: Luggage compartment - LH side

No photo
 Geen photo
 Pas de photo
 Kein foto
 Senza foto
 Sem fotografia
 No hay foto

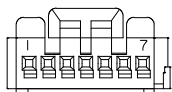

GREEN

Part No. 6901816
Colour: BLACK
Gender: F
Type: 2.8 UNSEALED
No. of Ways: 7WY

Wire Chart

CAV	TERMINAL	CSA	COL	CCT	DESTN
1	8384584	0.5	NB	568	C0899-4
2	8384584	0.5	GS	568	C0899-2
3	8384584	0.5	GW	568	C0899-12
4	8384584	0.5	UW	568	C0899-1
5	8384584	0.5	YG	568	C0899-11

CAV	TERMINAL	CSA	COL	CCT	DESTN
6	8384584	0.5	PU	568	C0899-13
7	8384584	0.5	RG	568	C0899-3

No repair kit
 Geen reparatiepakke
 Pas de nécessaire de reparation
 Kein Werkzeug
 Senza kit per le riparazioni
 Sem kit de reparaçã
 No hay kit de reparaci3n

Description: Sensor-Pressure-Air
Location: RH side of engine compartment

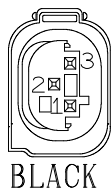
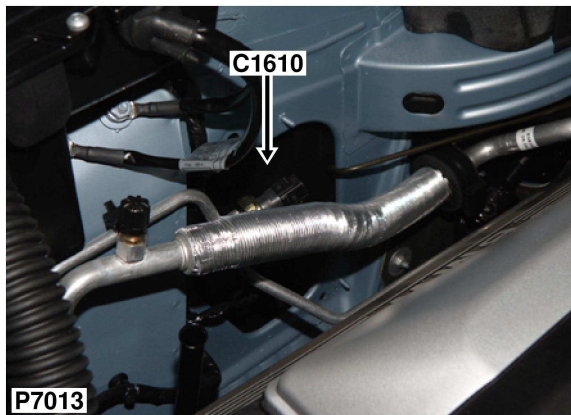

Wire Chart

CAV	TERMINAL	CSA	COL	CCT	DESTN
1	YPL101500	0.35	NB	ALL	C1629-20
2	YPL101500	0.35	BS	ALL	C1629-10
3	YPL101500	0.5	GY	ALL	C1629-21

Service Repair Kits

YPL101500		0.20 - 0.50 CSA
Cavities 1-3		
VDK500010	INSTRUCTION; REPAIR KIT	1
VDK500070	INSTRUCTION; EXTRACT TOOL	1
VDK500080	INSTRUCTION; EXTRACT TOOL	1
YMI000950	PRE-TERMINATED LEAD	1
YPQ000100	IDENTS (SMALL)	1
YQD000210	HEAT SHRINK SLEEVE	1
YRV000040	SPLICE (RED, CSA; 0.25-1.6)	1
YRW000390	WIRE STRIPPER	1
YRW500010	APPLICATOR	1

[VUB500150]

Part No. YPC906320
Colour: BLACK
Gender: F
Type: MQS
No. of Ways: 3WY

Description: Sensor-Pressure-Air
Location: Beneath vehicle - RH side

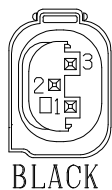
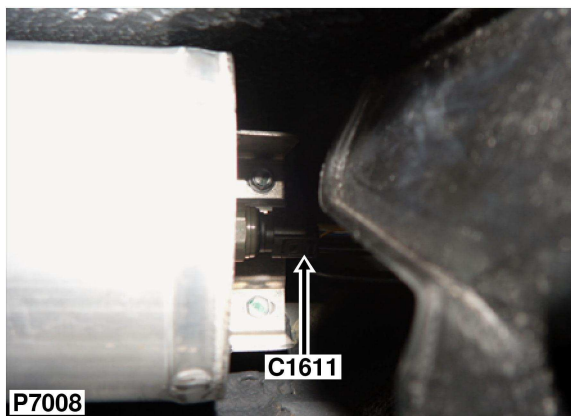

Wire Chart

CAV	TERMINAL	CSA	COL	CCT	DESTN
1	YPL101500	0.35	W	ALL	C0867-46
2	YPL101500	0.35	U	ALL	C0867-28
3	YPL101500	0.35	Y	ALL	C0867-34

Service Repair Kits

YPL101500		0.20 - 0.50 CSA
Cavities 1-3		
VDK500010	INSTRUCTION; REPAIR KIT	1
VDK500070	INSTRUCTION; EXTRACT TOOL	1
VDK500080	INSTRUCTION; EXTRACT TOOL	1
YMI000950	PRE-TERMINATED LEAD	1
YPQ000100	IDENTS (SMALL)	1
YQD000210	HEAT SHRINK SLEEVE	1
YRV000040	SPLICE (RED, CSA; 0.25-1.6)	1
YRW000390	WIRE STRIPPER	1
YRW500010	APPLICATOR	1

[VUB500150]

Part No. YPC116850
Colour: BLACK
Gender: F
Type: MQS
No. of Ways: 3WY

Description: Module-HEVAC control
Location: Behind centre console

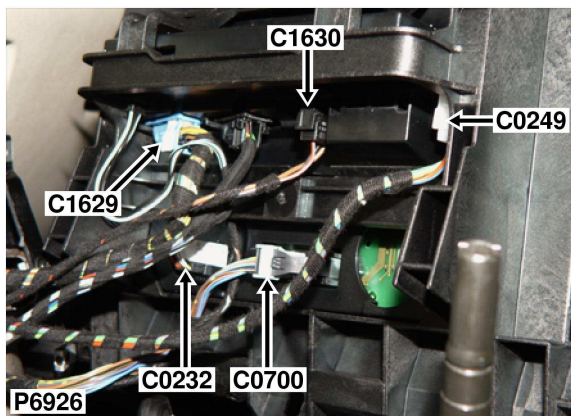

Wire Chart

CAV	TERMINAL	CSA	COL	CCT	DESTN
1	YPL101910	0.75	GY	ALL	SJ X1269-
2	YPL101310	0.35	YN	19	C0790-1
3	YPL101310	0.35	WRY	ALL	SJ X10116-
4	YPL101310	0.5	RY	ALL	C0723-0
5	YPL101310	0.5	YN	ALL	C2034-2
6	YPL101310	0.5	YP	19	C2034-3
7	YPL101310	0.35	UN	ALL	C2022-26
8	YPL101910	0.75	SY	ALL	C0586-17
9	YPL101310	0.5	UG	ALL	C2035-2
10	YPL101310	0.35	BS	ALL	C1610-2
12	YPL101310	MMQ	N	19	C1548-3
13	YPL101310	MMQ	Y	19	C1548-2
14	YPL101310	0.35	UN	109	C0994-1

CAV	TERMINAL	CSA	COL	CCT	DESTN
15	YPL101310	0.35	WU	204	C0255-23
16	YPL101310	0.35	WG	204	C0253-23
17	YPL101310	0.35	BG	ALL	C0331-29
18	YPL101310	0.35	YR	19	C0790-3
19	YPL101310	0.35	YG	19	C0790-2
20	YPL101310	0.35	NB	ALL	C1610-1
21	YPL101310	0.5	GY	ALL	C1610-3
22	YPL101310	0.5	SB	97	C2037-2
23	YPL101310	0.5	SR	ALL	C0286-0
24	YPL101310	0.35	YB	19	C0790-4
25	YPL101310	MMAI	N	19	C1548-1
26	YPL101310	MMAI	U	19	C1548-4

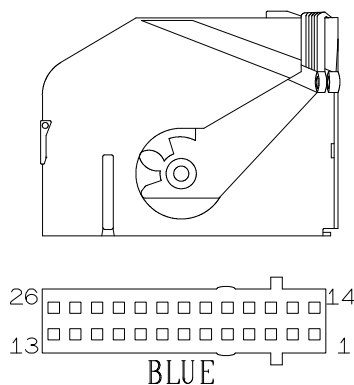

Service Repair Kits

YPL101910		0.75 - 0.75 CSA
Cavities 1-10,12-26		
VDK500010	INSTRUCTION; REPAIR KIT	1
VDK500070	INSTRUCTION; EXTRACT TOOL	1
VDK500080	INSTRUCTION; EXTRACT TOOL	1
YMI000870	PRE-TERMINATED LEAD	1
YPQ000100	IDENTS (SMALL)	1
YRV000040	SPLICE (RED, CSA; 0.25-1.6)	1
YRW000390	WIRE STRIPPER	1
YRW500010	APPLICATOR	1
YRW500060	EXTRACT TOOL	1
YRW500070	EXTRACT TOOL	1

[VUB500080]

Part No. YPH900740
Colour: BLUE
Gender: F
Type: MQS
No. of Ways: 26WY

Description: Module-HEVAC control
Location: Behind centre console

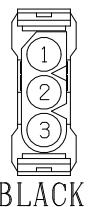
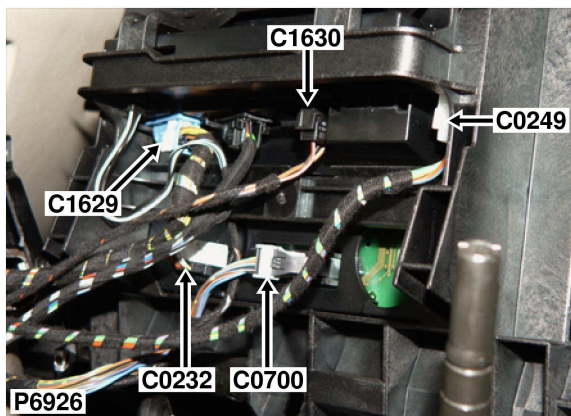

BLACK

Wire Chart

CAV	TERMINAL	CSA	COL	CCT	DESTN
1	YPE10020	0.75	RP	ALL	C0586-7
2	YPE10020	0.5	BS	58	C2352-1
2	YPE10020	0.5	BS	573	C0127-1
3	YPE100500	1.5	N	ALL	C0285-0

Service Repair Kits

YPE100500		1.01 - 2.50 CSA
Cavities 3		
VDK500010	INSTRUCTION; REPAIR KIT	1
VDK500030	INSTRUCTION; EXTRACT TOOL	1
YMI000900	PRE-TERMINATED LEAD	1
YPQ000110	IDENTS (MEDIUM)	1
YRV000050	SPLICE (BLUE, CSA; 1.0-2.6)	1
YRW000390	WIRE STRIPPER	1
YRW500010	APPLICATOR	1
[VUB500110]		

YPE10020		0.50 - 1.00 CSA
Cavities 1,2		
VDK500010	INSTRUCTION; REPAIR KIT	1
VDK500130	INSTRUCTION; EXTRACT TOOL	1
YMI000860	PRE-TERMINATED LEAD	1
YPQ000100	IDENTS (SMALL)	1
YRV000040	SPLICE (RED, CSA; 0.25-1.6)	1
YRW000390	WIRE STRIPPER	1
YRW500010	APPLICATOR	1
[VUB500070]		

Part No. YPC112530
Colour: BLACK
Gender: F
Type: 2.5MM SYSTEM
No. of Ways: 3WY

Description: Socket-Accessory-Rear
Location: Luggage compartment - RH side

No photo
 Geen photo
 Pas de photo
 Kein foto
 Senza foto
 Sem fotografia
 No hay foto

Wire Chart

CAV	TERMINAL	CSA	COL	CCT	DESTN
1	YPL10009	2.5	N	ALL	C0555-0
2	YPL10009	2.5	RB	ALL	C2020-2

No repair kit
 Geen reparatiepakke
 Pas de nécessaire de reparation
 Kein Werkzeug
 Senza kit per le riparazioni
 Sem kit de reparação
 No hay kit de reparaci3n



Part No. 1351144
Colour: NATURAL
Gender: F
Type: 6.3MM FASTIN-FASTON
No. of Ways: 2WY

Description: Telephone link harness to telephone harness

Location: In rear of centre console

No photo
 Geen photo
 Pas de photo
 Kein foto
 Senza foto
 Sem fotografia
 No hay foto

Wire Chart

CAV	TERMINAL	CSA	COL	CCT	DESTN
1	YPL101910	0.75	RY	507	SJ X1483-
2	YPL101910	0.75	NB	507	SJ X3361-
3	YPL101910	0.75	SR	507	SJ X18056-
4	YPL101310	0.5	UW	507	C0947-48
5	YPL101310	MCDA	R	507	C0947-19
6	YPL101310	MCDA	W	507	C0947-2
7	YPL101310	MCDA	SCRN	507	C0947-39

CAV	TERMINAL	CSA	COL	CCT	DESTN
10	YPL101310	MCDA	B	507	C0947-20
11	YPL101310	0.35	R	507	C0947-1
12	YPL101310	MCDA	Y	507	C0947-37
14	YPL101310	MCDA	G	507	C0947-38

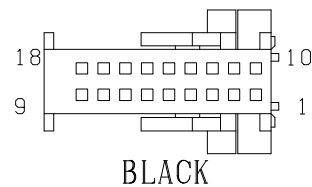

Service Repair Kits

YPL101910		0.75 - 0.75 CSA
Cavities 1-7,10-12,14		
VDK500010	INSTRUCTION; REPAIR KIT	1
VDK500070	INSTRUCTION; EXTRACT TOOL	1
VDK500080	INSTRUCTION; EXTRACT TOOL	1
YMI000870	PRE-TERMINATED LEAD	1
YPQ000100	IDENTS (SMALL)	1
YRV000040	SPLICE (RED, CSA; 0.25-1.6)	1
YRW000390	WIRE STRIPPER	1
YRW500010	APPLICATOR	1
YRW500060	EXTRACT TOOL	1
YRW500070	EXTRACT TOOL	1

[VUB500080]

Part No. YPC111800
Colour: BLACK
Gender: F
Type: MQS
No. of Ways: 18WY

Description: Telephone link harness to telephone harness

Location: In rear of centre console

No photo
 Geen photo
 Pas de photo
 Kein foto
 Senza foto
 Sem fotografia
 No hay foto

Wire Chart

CAV	TERMINAL	CSA	COL	CCT	DESTN
1	YPJ100830	0.5	RY	578	C1252-1
1	YPJ100830	0.35	U	566	C1252-1
2	YPJ100830	0.5	NB	578	C1252-2
2	YPJ100830	0.35	WR	566	C1252-2
3	YPJ100830	0.35	WG	566	C1252-3
3	YPJ100830	0.5	SR	578	C1252-3
4	YPJ100830	0.5	UW	578	C1252-4
4	YPJ100830	0.35	YR	566	C1252-4
5	YPJ100830	MCDA	R	578	C1252-5
6	YPJ100830	0.35	UG	566	C1252-6
6	YPJ100830	MCDA	W	578	C1252-6
7	YPJ100830	0.35	Y	566	C1252-7
7	SCREEN	MCDA	SCR	578	C1252-7
8	YPJ100830	0.5	VR	566	C1252-8
9	YPJ100830	0.35	WSY	566	C1252-9

CAV	TERMINAL	CSA	COL	CCT	DESTN
10	YPJ100830	0.5	RY	566	C1252-10
10	YPJ100830	MCDA	B	578	C1252-10
11	YPJ100830	0.35	WY	566	C1252-11
11	YPJ100830	0.35	R	578	C1252-11
12	YPJ100830	MCDA	Y	578	C1252-12
13	YPJ100830	0.35	O	566	C1252-13
14	YPJ100830	MCDA	G	578	C1252-14
14	YPJ100830	0.35	WS	566	C1252-14
15	YPJ100830	0.5	SR	566	C1252-15
16	YPJ100830	0.35	WU	566	C1252-16
17	YPJ100830	0.5	NB	566	C1252-17
18	YPJ100830	0.35	WB	566	C1252-18

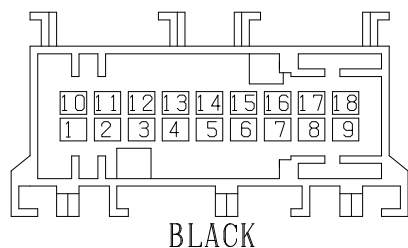

Service Repair Kits

YPJ100830		0.20 - 0.50 csa
Cavities 1-18		
VDK500010	INSTRUCTION; REPAIR KIT	1
VDK500070	INSTRUCTION; EXTRACT TOOL	1
VDK500080	INSTRUCTION; EXTRACT TOOL	1
YMI000990	PRE-TERMINATED LEAD	1
YPQ000100	IDENTS (SMALL)	1
YRV000040	SPLICE (RED, CSA; 0.25-1.6)	1
YRW000390	WIRE STRIPPER	1
YRW500010	APPLICATOR	1
YRW500060	EXTRACT TOOL	1
YRW500070	EXTRACT TOOL	1

[VUB500190]

Part No.: YPC113590
Colour: BLACK
Gender: M
Type: MQS
No. of Ways: 18WY

Description: Telephone link harness to telephone harness

Location: In rear of centre console

No photo

Geen photo

Pas de photo

Kein foto

Senza foto

Sem fotografia

No hay foto



HF BLACK

Wire Chart

CAV	TERMINAL	CSA	COL	CCT	DESTN
0	SCREEN	MCBA	SCR	566	C1253-0
1	ASSEMBLY	MCBA	B	566	C1253-1

No repair kit

Geen reparatiepakke

Pas de nécessaire de reparation

Kein Werkzeug

Senza kit per le riparazioni

Sem kit de reparação

No hay kit de reparación

Part No. 6906026

Colour: BLACK

Gender: F

Type: HF

No. of Ways: 1WY

Description: Switch-Command Shift
Location: Beneath centre console

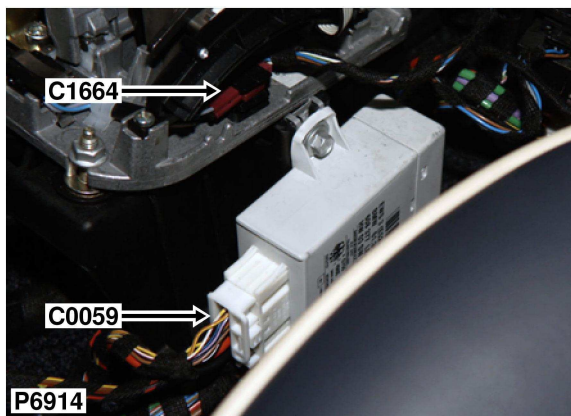

Part No. YPC117870
Colour: BORDEAUX VIOLET
Gender: F
Type: MQS
No. of Ways: 4WY

Wire Chart

CAV	TERMINAL	CSA	COL	CCT	DESTN
1	YPL101310	0.35	NB	ALL	SJ X230-
2	YPL101310	0.35	UY	ALL	C0193-20
3	YPL101310	0.35	US	ALL	C0193-19
4	YPL101310	0.35	WG	ALL	C0685-1

Service Repair Kits

YPL101310		0.20 - 0.50 CSA
Cavities 1-4		
VDK500010	INSTRUCTION; REPAIR KIT	1
VDK500070	INSTRUCTION; EXTRACT TOOL	1
VDK500080	INSTRUCTION; EXTRACT TOOL	1
YMI000870	PRE-TERMINATED LEAD	1
YPQ000100	IDENTS (SMALL)	1
YRV000040	SPLICE (RED, CSA; 0.25-1.6)	1
YRW000390	WIRE STRIPPER	1
YRW500010	APPLICATOR	1
YRW500060	EXTRACT TOOL	1
YRW500070	EXTRACT TOOL	1

[VUB500080]

Description: Telephone harness to main harness

Location: Beneath centre console

No photo
 Geen photo
 Pas de photo
 Kein foto
 Senza foto
 Sem fotografia
 No hay foto

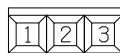

BLACK

Part No. YPC117800
Colour: BLACK
Gender: F
Type: MQS
No. of Ways: 3WY

Wire Chart

CAV	TERMINAL	CSA	COL	CCT	DESTN
1	YPL101310	MCCA	W	505	C0947-54
1	YPL101310	MCCC	W	508	C2136-9
2	YPL101310	MCCC	SCRN	508	SJ X11350-

CAV	TERMINAL	CSA	COL	CCT	DESTN
2	YPL101310	MCCA	SCRN	505	C0947-53
3	YPL101310	MCCA	NW	505	C0947-52
3	YPL101310	MCCC	NW	508	C2136-8

Service Repair Kits

YPL101310		0.20 - 0.50 CSA
Cavities 1-3		
VDK500010	INSTRUCTION; REPAIR KIT	1
VDK500070	INSTRUCTION; EXTRACT TOOL	1
VDK500080	INSTRUCTION; EXTRACT TOOL	1
YMI000870	PRE-TERMINATED LEAD	1
YPQ000100	IDENTS (SMALL)	1
YRV000040	SPLICE (RED, CSA; 0.25-1.6)	1
YRW000390	WIRE STRIPPER	1
YRW500010	APPLICATOR	1
YRW500060	EXTRACT TOOL	1
YRW500070	EXTRACT TOOL	1

[VUB500080]

Description: Module-Telephone
Location: Beneath centre console

No photo
 Geen photo
 Pas de photo
 Kein foto
 Senza foto
 Sem fotografia
 No hay foto

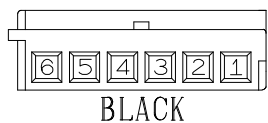

Part No. 6909052
Colour: BLACK
Gender: F
Type: MQS
No. of Ways: 6WY

Wire Chart

CAV	TERMINAL	CSA	COL	CCT	DESTN
1	YPL101310	MCHA	SCRN	506	C0947-9
2	YPL101310	MCHA	R	506	C0947-46
3	YPL101310	MCHA	B	506	C0947-28
4	YPL101310	MCHA	W	506	C0947-10
5	YPL101310	MCHA	S	506	C0947-11

Service Repair Kits

YPL101310		0.20 - 0.50 CSA
Cavities 1-5		
VDK500010	INSTRUCTION; REPAIR KIT	1
VDK500070	INSTRUCTION; EXTRACT TOOL	1
VDK500080	INSTRUCTION; EXTRACT TOOL	1
YMI000870	PRE-TERMINATED LEAD	1
YPQ000100	IDENTS (SMALL)	1
YRV000040	SPLICE (RED, CSA; 0.25-1.6)	1
YRW000390	WIRE STRIPPER	1
YRW500010	APPLICATOR	1
YRW500060	EXTRACT TOOL	1
YRW500070	EXTRACT TOOL	1

[VUB500080]

Description: Sensor-Height-Front-LH
Location: Behind LH front wheel arch liner

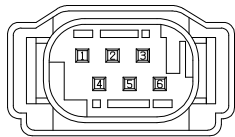
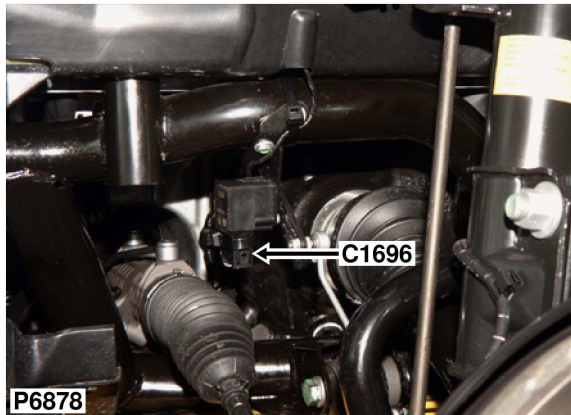

BLACK

Wire Chart

CAV	TERMINAL	CSA	COL	CCT	DESTN
1	YPL101500	0.35	SN	ALL	C0867-43
4	YPL101500	0.35	SW	ALL	C0867-25
5	YPL101500	0.35	SB	ALL	C0867-32

Service Repair Kits

YPL101500		0.20 - 0.50 CSA
Cavities 1,4,5		
VDK500010	INSTRUCTION; REPAIR KIT	1
VDK500070	INSTRUCTION; EXTRACT TOOL	1
VDK500080	INSTRUCTION; EXTRACT TOOL	1
YMI000950	PRE-TERMINATED LEAD	1
YPQ000100	IDENTS (SMALL)	1
YQD000210	HEAT SHRINK SLEEVE	1
YRV000040	SPLICE (RED, CSA; 0.25-1.6)	1
YRW000390	WIRE STRIPPER	1
YRW500010	APPLICATOR	1

[VUB500150]

Part No. YPC110680
Colour: BLACK
Gender: F
Type: MQS
No. of Ways: 6WY

Description: Sensor-Height-Front-RH
Location: Behind RH front wheel arch liner

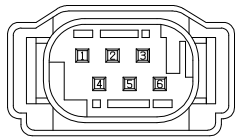
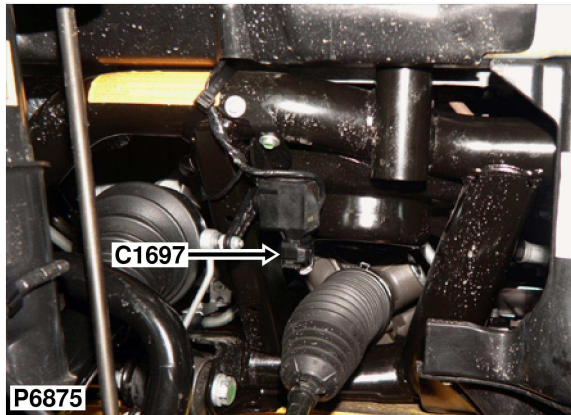

BLACK

Wire Chart

CAV	TERMINAL	CSA	COL	CCT	DESTN
1	YPL101500	0.35	BN	ALL	C0867-42
2	YPL101500	0.35	WN	574	C1543-5
3	YPL101500	0.35	WB	574	C1543-18

CAV	TERMINAL	CSA	COL	CCT	DESTN
4	YPL101500	0.35	BS	ALL	C0867-24
5	YPL101500	0.35	BW	ALL	C0867-33
6	YPL101500	0.35	WS	574	C1543-16

Service Repair Kits

YPL101500		0.20 - 0.50 CSA
Cavities 1-6		
VDK500010	INSTRUCTION; REPAIR KIT	1
VDK500070	INSTRUCTION; EXTRACT TOOL	1
VDK500080	INSTRUCTION; EXTRACT TOOL	1
YMI000950	PRE-TERMINATED LEAD	1
YPQ000100	IDENTS (SMALL)	1
YQD000210	HEAT SHRINK SLEEVE	1
YRV000040	SPLICE (RED, CSA; 0.25-1.6)	1
YRW000390	WIRE STRIPPER	1
YRW500010	APPLICATOR	1

[VUB500150]

Part No. YPC110680
Colour: BLACK
Gender: F
Type: MQS
No. of Ways: 6WY

Description: Sensor-Height-Rear-RH
Location: Below RH rear wheelarch

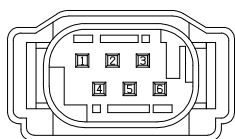
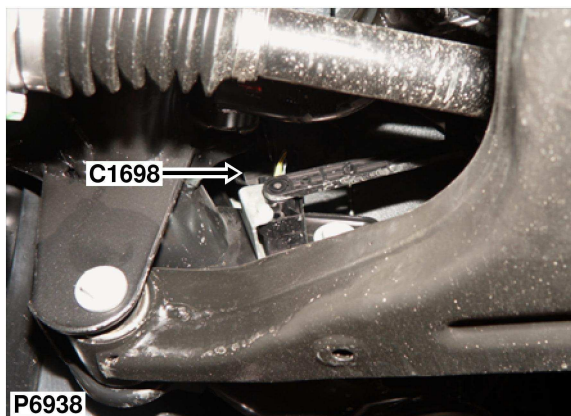

BLACK

Part No. YPC110680
Colour: BLACK
Gender: F
Type: MQS
No. of Ways: 6WY

Wire Chart

CAV	TERMINAL	CSA	COL	CCT	DESTN
1	YPL101500	0.35	YN	ALL	C0867-44
2	YPL101500	0.35	SN	574	C1543-7
3	YPL101500	0.35	SB	574	C1543-22

CAV	TERMINAL	CSA	COL	CCT	DESTN
4	YPL101500	0.35	YS	ALL	C0867-26
5	YPL101500	0.35	YB	ALL	C0867-50
6	YPL101500	0.35	SW	574	C1543-20

Service Repair Kits

YPL101500		0.20 - 0.50 CSA
Cavities 1-6		
VDK500010	INSTRUCTION; REPAIR KIT	1
VDK500070	INSTRUCTION; EXTRACT TOOL	1
VDK500080	INSTRUCTION; EXTRACT TOOL	1
YMI000950	PRE-TERMINATED LEAD	1
YPQ000100	IDENTS (SMALL)	1
YQD000210	HEAT SHRINK SLEEVE	1
YRV000040	SPLICE (RED, CSA; 0.25-1.6)	1
YRW000390	WIRE STRIPPER	1
YRW500010	APPLICATOR	1

[VUB500150]

Description: Sensor-Height-Rear-LH
Location: Below LH rear wheelarch

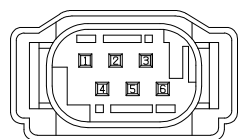
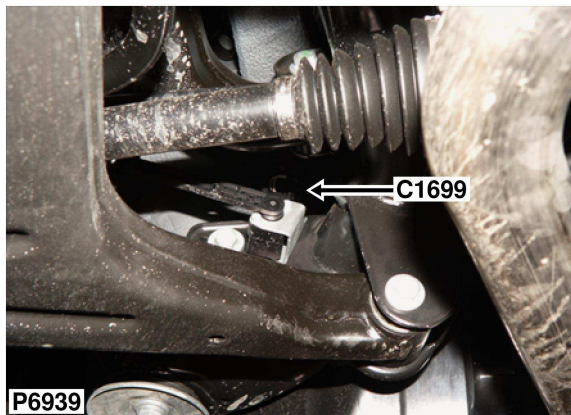

BLACK

Part No. YPC110680
Colour: BLACK
Gender: F
Type: MQS
No. of Ways: 6WY

Wire Chart

CAV	TERMINAL	CSA	COL	CCT	DESTN
1	YPL101500	0.35	WN	ALL	C0867-45
4	YPL101500	0.35	WS	ALL	C0867-27
5	YPL101500	0.35	WB	ALL	C0867-51

Service Repair Kits

YPL101500		0.20 - 0.50 CSA
Cavities 1,4,5		
VDK500010	INSTRUCTION; REPAIR KIT	1
VDK500070	INSTRUCTION; EXTRACT TOOL	1
VDK500080	INSTRUCTION; EXTRACT TOOL	1
YMI000950	PRE-TERMINATED LEAD	1
YPQ000100	IDENTS (SMALL)	1
YQD000210	HEAT SHRINK SLEEVE	1
YRV000040	SPLICE (RED, CSA; 0.25-1.6)	1
YRW000390	WIRE STRIPPER	1
YRW500010	APPLICATOR	1

[VUB500150]

Description: Main harness to SRS harness
Location: LH side of engine compartment

No photo
 Geen photo
 Pas de photo
 Kein foto
 Senza foto
 Sem fotografia
 No hay foto



Wire Chart

CAV	TERMINAL	CSA	COL	CCT	DESTN
1	YPL101880	MMH	N	ALL	C0256-49
2	YPL101880	MMH	NR	ALL	C0256-50

Service Repair Kits

YPL101880		0.20 - 0.50 CSA
Cavities 1,2		
VDK500010	INSTRUCTION; REPAIR KIT	1
VDK500070	INSTRUCTION; EXTRACT TOOL	1
VDK500080	INSTRUCTION; EXTRACT TOOL	1
YMI001080	PRE-TERMINATED LEAD	1
YPQ000100	IDENTS (SMALL)	1
YQD000210	HEAT SHRINK SLEEVE	1
YRV000040	SPLICE (RED, CSA; 0.25-1.6)	1
YRW000390	WIRE STRIPPER	1
YRW500010	APPLICATOR	1

[VUB500280]

Part No. YPC115230
Colour: YELLOW
Gender: F
Type: MQS
No. of Ways: 2WY

Description: Lamp-Door sill-Front-RH
Location: Behind RH side of fascia

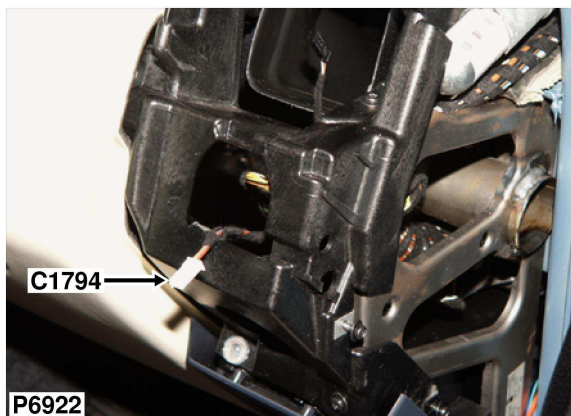

Part No. 8377066
Colour: NATURAL
Gender: F
Type: MQS
No. of Ways: 3WY

Wire Chart

CAV	TERMINAL	CSA	COL	CCT	DESTN
1	YPL101310	0.5	N	134	C0285-0
2	YPL101910	0.75	RU	134	C0295-0

Service Repair Kits

YPL101910		0.75 - 0.75 CSA
Cavities 1,2		
VDK500010	INSTRUCTION; REPAIR KIT	1
VDK500070	INSTRUCTION; EXTRACT TOOL	1
VDK500080	INSTRUCTION; EXTRACT TOOL	1
YMI000870	PRE-TERMINATED LEAD	1
YPQ000100	IDENTS (SMALL)	1
YRV000040	SPLICE (RED, CSA; 0.25-1.6)	1
YRW000390	WIRE STRIPPER	1
YRW500010	APPLICATOR	1
YRW500060	EXTRACT TOOL	1
YRW500070	EXTRACT TOOL	1

[VUB500080]

Description: Lamp-Door sill-Front-LH
Location: Behind LH side of fascia

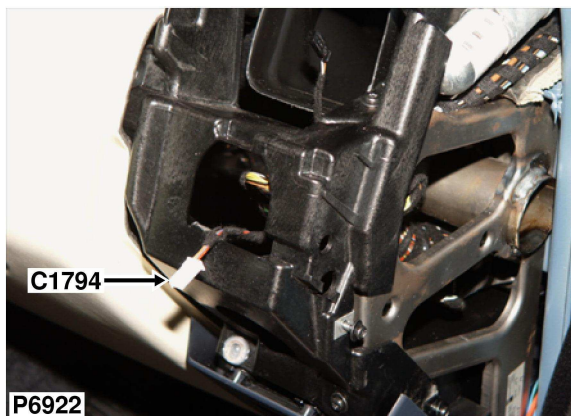

Part No. 8377066
Colour: NATURAL
Gender: F
Type: MQS
No. of Ways: 3WY

Wire Chart

CAV	TERMINAL	CSA	COL	CCT	DESTN
1	YPL101310	0.5	N	134	C0821-0
2	YPL101910	0.75	RU	134	C0295-0

Service Repair Kits

YPL101910		0.75 - 0.75 csa
Cavities 1,2		
VDK500010	INSTRUCTION; REPAIR KIT	1
VDK500070	INSTRUCTION; EXTRACT TOOL	1
VDK500080	INSTRUCTION; EXTRACT TOOL	1
YMI000870	PRE-TERMINATED LEAD	1
YPQ000100	IDENTS (SMALL)	1
YRV000040	SPLICE (RED, CSA; 0.25-1.6)	1
YRW000390	WIRE STRIPPER	1
YRW500010	APPLICATOR	1
YRW500060	EXTRACT TOOL	1
YRW500070	EXTRACT TOOL	1

[VUB500080]

Description: Switch-Steering column-Lighting

Location: Top of steering column

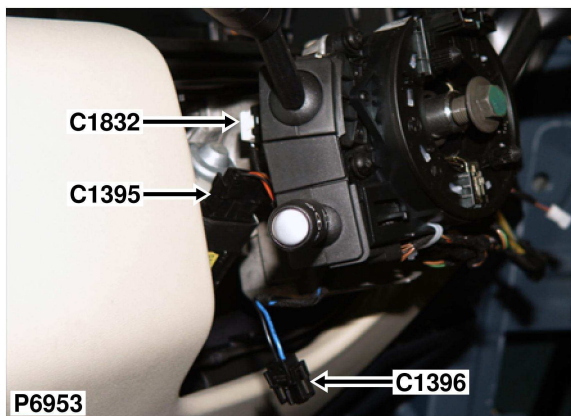

Wire Chart

CAV	TERMINAL	CSA	COL	CCT	DESTN
1	YPL101310	0.35	YR	ALL	C0234-5
7	YPL101310	0.35	U	ALL	C2040-50
9	YPL101310	0.35	W	ALL	C2040-30
10	YPL101310	0.5	NB	ALL	SJ X3361-

Service Repair Kits

YPL101310		0.20 - 0.50 CSA
Cavities 1,7,9,10		
VDK500010	INSTRUCTION; REPAIR KIT	1
VDK500070	INSTRUCTION; EXTRACT TOOL	1
VDK500080	INSTRUCTION; EXTRACT TOOL	1
YMI000870	PRE-TERMINATED LEAD	1
YPQ000100	IDENTS (SMALL)	1
YRV000040	SPLICE (RED, CSA; 0.25-1.6)	1
YRW000390	WIRE STRIPPER	1
YRW500010	APPLICATOR	1
YRW500060	EXTRACT TOOL	1
YRW500070	EXTRACT TOOL	1

[VUB500080]

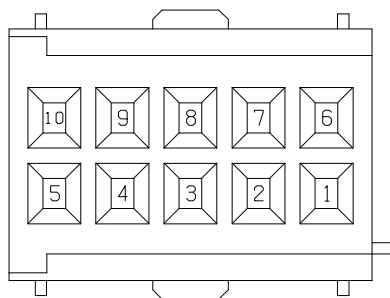

NATURAL

Part No. 6909002
Colour: NATURAL
Gender: F
Type: MQS
No. of Ways: 10WY

Description: Relay-Air injection pump
Location: Inside E-box

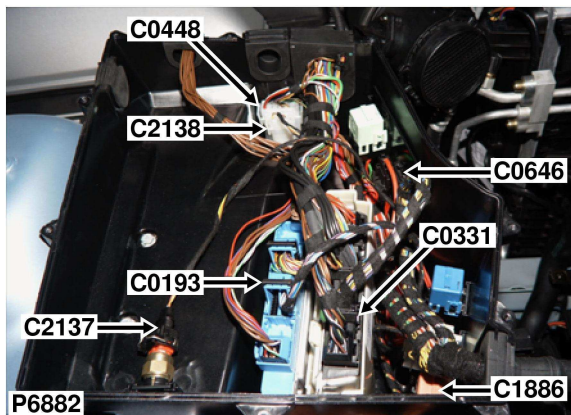

Wire Chart

CAV	TERMINAL	CSA	COL	CCT	DESTN
2	YPL102910	4.0	R	573	C0581-2
4	8377724	0.35	NU	573	C0331-3
5	YPL102890	0.5	N	573	C0285-0
6	YPL102910	4.0	BRY	573	C0879-2
8	YPL102890	0.75	RW	573	C0584-7

No repair kit
 Geen reparatiepakke
 Pas de nécessaire de réparation
 Kein Werkzeug
 Senza kit per le riparazioni
 Sem kit de reparação
 No hay kit de reparación

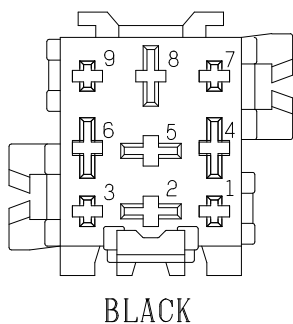

Part No. YPP100250
Colour: BLACK
Gender: F
Type: BASE - F4 RELAY
No. of Ways: 9WY

Description: Heater harness to main harness
Location: LH side of engine compartment

No photo
 Geen photo
 Pas de photo
 Kein foto
 Senza foto
 Sem fotografia
 No hay foto

Wire Chart

CAV	TERMINAL	CSA	COL	CCT	DESTN
1	YPJ100620	0.5	NB	20	C2326-1
2	YPJ100620	0.5	YN	20	C2326-2

No repair kit
 Geen reparatiepakke
 Pas de nécessaire de reparation
 Kein Werkzeug
 Senza kit per le riparazioni
 Sem kit de reparaçã
 No hay kit de reparaci3n

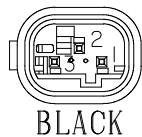

Part No. YPC111670
Colour: BLACK
Gender: M
Type: MQS
No. of Ways: 3WY

Description: PDC harness to main harness

Location: Rear of luggage compartment

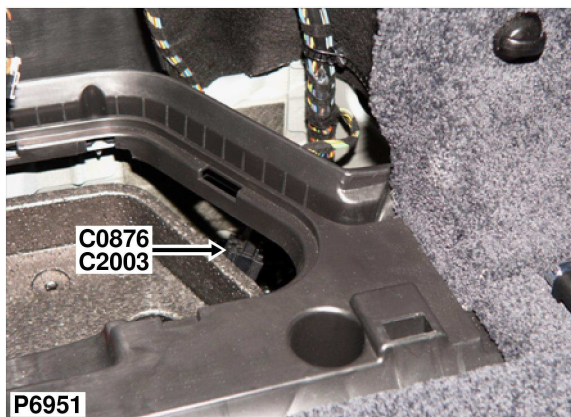

Wire Chart

CAV	TERMINAL	CSA	COL	CCT	DESTN
1	YPL101310	0.35	NB	171	C0964-3
2	YPL101310	0.35	NY	171	C0966-3
3	YPL101310	0.35	NW	171	C0963-3
4	YPL101310	0.35	GS	171	C0965-1
5	YPL101310	0.35	GN	171	C0964-1
6	YPL101310	0.35	GP	171	C0966-1

CAV	TERMINAL	CSA	COL	CCT	DESTN
7	YPL101310	0.35	NU	171	C0965-3
8	YPL101310	0.35	YB	171	C0965-2
9	YPL101310	0.35	YG	171	C0964-2
10	YPL101310	0.35	YN	171	C0966-2
11	YPL101310	0.35	YS	171	C0963-2
12	YPL101310	0.35	GB	171	C0963-1

Service Repair Kits

YPL101310		0.20 - 0.50 csa
Cavities 1-12		
VDK500010	INSTRUCTION; REPAIR KIT	1
VDK500070	INSTRUCTION; EXTRACT TOOL	1
VDK500080	INSTRUCTION; EXTRACT TOOL	1
YMI000870	PRE-TERMINATED LEAD	1
YPQ000100	IDENTS (SMALL)	1
YRV000040	SPLICE (RED, CSA; 0.25-1.6)	1
YRW000390	WIRE STRIPPER	1
YRW500010	APPLICATOR	1
YRW500060	EXTRACT TOOL	1
YRW500070	EXTRACT TOOL	1

[VUB500080]

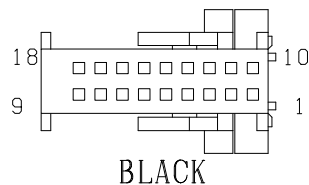

Part No. YPC111800
Colour: BLACK
Gender: F
Type: MQS
No. of Ways: 18WY

Description: Sensor-Anti-trap-Rear-RH
Location: Behind rear door trim panel

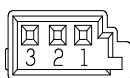
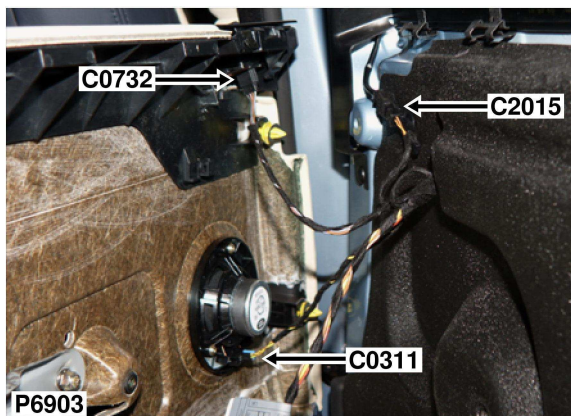

BLACK

Part No. 6905977
Colour: BLACK
Gender: M
Type: MQS
No. of Ways: 3WY

Wire Chart

CAV	TERMINAL	CSA	COL	CCT	DESTN
1	YPJ100830	0.35	N	247	SJ X834-
2	YPJ100830	0.35	NY	247	C0803-8

Service Repair Kits

YPJ100830		0.20 - 0.50 csa
Cavities 1,2		
VDK500010	INSTRUCTION; REPAIR KIT	1
VDK500070	INSTRUCTION; EXTRACT TOOL	1
VDK500080	INSTRUCTION; EXTRACT TOOL	1
YMI000990	PRE-TERMINATED LEAD	1
YPQ000100	IDENTS (SMALL)	1
YRV000040	SPLICE (RED, CSA; 0.25-1.6)	1
YRW000390	WIRE STRIPPER	1
YRW500010	APPLICATOR	1
YRW500060	EXTRACT TOOL	1
YRW500070	EXTRACT TOOL	1

[VUB500190]

Description: Module-Passenger door
Location: Behind passenger's door trim panel

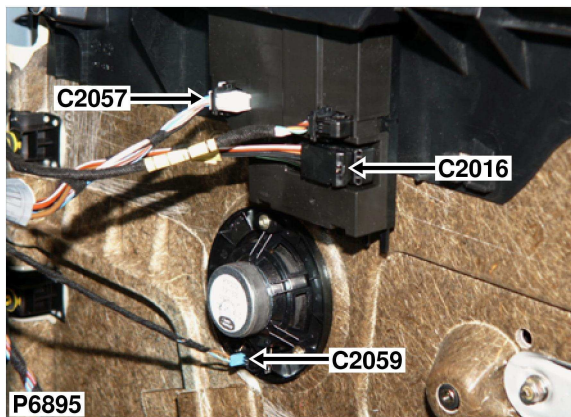

Wire Chart

CAV	TERMINAL	CSA	COL	CCT	DESTN
1	YPE100630	2.5	RW	40	C0322-27
2	YPE100630	2.5	N	247	SJ X891-
4	YPE100630	2.5	BG	247	C0741-1
5	YPE100630	2.5	BS	247	C0741-2

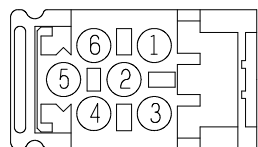

BLACK

Part No. 1387194
Colour: BLACK
Gender: F
Type: 2.5MM SYSTEM
No. of Ways: 6WY

No repair kit
 Geen reparatiepakke
 Pas de nécessaire de reparation
 Kein Werkzeug
 Senza kit per le riparazioni
 Sem kit de reparação
 No hay kit de reparación

Description: Module-Passenger door
Location: Behind passenger's door trim panel

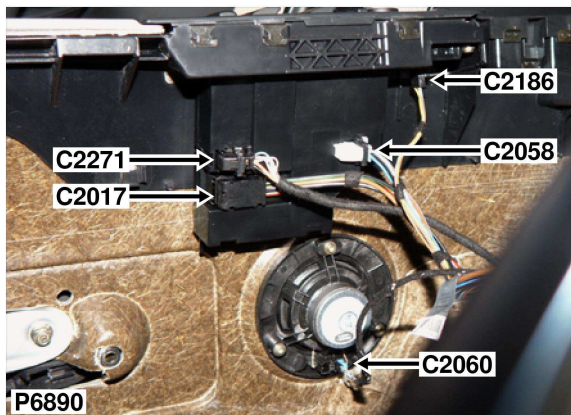

Wire Chart

CAV	TERMINAL	CSA	COL	CCT	DESTN
1	YPE100630	2.5	RP	40	C0336-27
2	YPE100630	2.5	N	247	SJ X849-
4	YPE100630	2.5	BG	247	C0740-1
5	YPE100630	2.5	BS	247	C0740-2

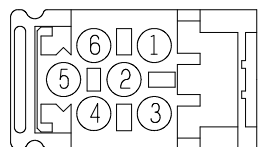

BLACK

Part No. 1387194
Colour: BLACK
Gender: F
Type: 2.5MM SYSTEM
No. of Ways: 6WY

No repair kit
 Geen reparatiepakke
 Pas de nécessaire de reparation
 Kein Werkzeug
 Senza kit per le riparazioni
 Sem kit de reparação
 No hay kit de reparación

Description: Fuse box-Rear
Location: Luggage compartment - RH side

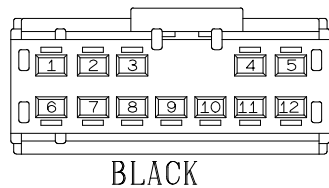
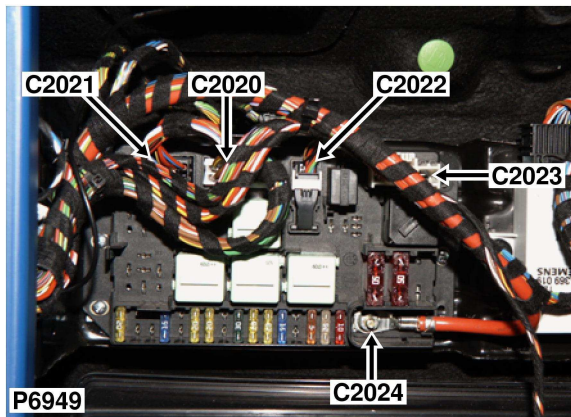

Wire Chart

CAV	TERMINAL	CSA	COL	CCT	DESTN
1	8384586	2.5	RU	394	C0473-4
2	8384586	2.5	RB	ALL	C1632-2
3	8384586	2.5	WU	ALL	C0114-1
4	8384586	2.5	WU	58	C0205-2
5	8384586	1.5	RBY	43	C0089-1

CAV	TERMINAL	CSA	COL	CCT	DESTN
7	8384586	1.5	RY	394	C0473-3
12	8384586	2.5	RG	43	C0868-6

Service Repair Kits

8384586		1.01 - 2.50 CSA
Cavities 1-5,7,12		
VDK500010	INSTRUCTION; REPAIR KIT	1
VDK500030	INSTRUCTION; EXTRACT TOOL	1
YMI500030	PRE-TERMINATED LEAD	1
YPQ000110	IDENTS (MEDIUM)	1
YRV000050	SPLICE (BLUE, CSA; 1.0-2.6)	1
YRW000390	WIRE STRIPPER	1
YRW500010	APPLICATOR	1
YRW500020	EXTRACT TOOL	1

[VUB500420]

Part No. 6906564
Colour: BLACK
Gender: F
Type: 2.8MM
No. of Ways: 12WY

Description: Fuse box-Rear
Location: Luggage compartment - RH side

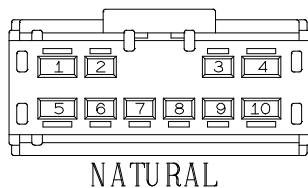
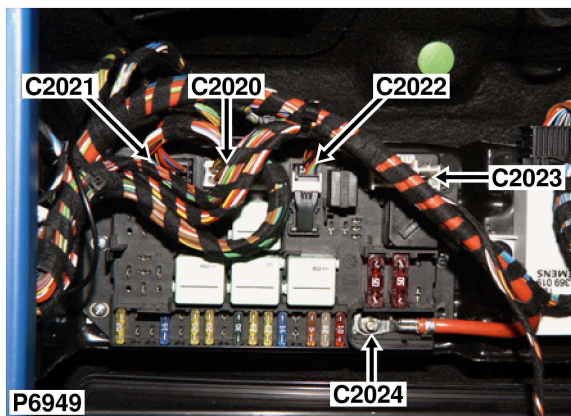

Wire Chart

CAV	TERMINAL	CSA	COL	CCT	DESTN
2	YPL102710	2.5	GU	19	C0839-2
3	YPL102710	1.5	RBV	575	C0089-1
4	6901664	2.5	RG	575	C0868-6
5	6901664	4.0	B	ALL	C0381-1

CAV	TERMINAL	CSA	COL	CCT	DESTN
6	YPL102710	1.5	GW	572	C0868-1
7	YPL102710	1.5	GN	572	C0868-2
9	YPL102710	2.5	RW	ALL	C0388-2
10	6901664	4.0	N	ALL	C0555-0

Service Repair Kits

YPL102710		1.01 - 2.50 CSA
Cavities 2,3,6,7,9		
VDK500010	INSTRUCTION; REPAIR KIT	1
VDK500050	INSTRUCTION; EXTRACT TOOL	1
YMI001010	PRE-TERMINATED LEAD	1
YPQ000110	IDENTS (MEDIUM)	1
YRV000050	SPLICE (BLUE, CSA; 1.0-2.6)	1
YRW000390	WIRE STRIPPER	1
YRW500010	APPLICATOR	1

[VUB500210]

6901664		2.50 - 4.00 CSA
Cavities 4,5,10		
VDK500010	INSTRUCTION; REPAIR KIT	1
VDK500040	INSTRUCTION; EXTRACT TOOL	1
YMI001030	PRE-TERMINATED LEAD	1
YPQ000120	IDENTS (LARGE)	1
YRV000060	SPLICE (YELLOW, CSA; 2.7-6.6)	1
YRW000390	WIRE STRIPPER	1
YRW500010	APPLICATOR	1
YRW500030	EXTRACT TOOL	1

[VUB500230]

Part No. 6901806
Colour: NATURAL
Gender: F
Type: 2.8 & 5.2 -UNSEALED
No. of Ways: 10WY

Description: Fuse box-Rear
Location: Luggage compartment - RH side

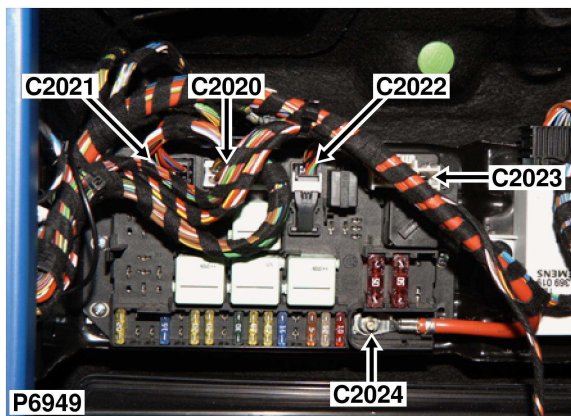

Wire Chart

CAV	TERMINAL	CSA	COL	CCT	DESTN
1	YPL101310	0.35	B	ALL	C0867-16
9	YPL101310	0.5	GY	394	C0473-2
10	YPL101310	0.5	GY	ALL	C0587-6
14	YPL101310	0.35	NY	ALL	C0661-22
15	YPL101910	0.75	UY	ALL	C0117-1
16	YPL101910	0.75	UW	ALL	C0117-2
17	YPL101910	0.75	RS	ALL	C0117-3

CAV	TERMINAL	CSA	COL	CCT	DESTN
21	YPL101310	0.5	RB	ALL	C0674-1
22	YPL101310	0.35	BP	ALL	C0331-10
23	YPL101910	0.75	RW	ALL	SJ X8066-
26	YPL101310	0.35	UN	ALL	C1629-7

Service Repair Kits

YPL101910		0.75 - 0.75 CSA
Cavities 1,9,10,14-17,21-23,26		
VDK500010	INSTRUCTION; REPAIR KIT	1
VDK500070	INSTRUCTION; EXTRACT TOOL	1
VDK500080	INSTRUCTION; EXTRACT TOOL	1
YMI000870	PRE-TERMINATED LEAD	1
YPQ000100	IDENTS (SMALL)	1
YRV000040	SPLICE (RED, CSA; 0.25-1.6)	1
YRW000390	WIRE STRIPPER	1
YRW500010	APPLICATOR	1
YRW500060	EXTRACT TOOL	1
YRW500070	EXTRACT TOOL	1

[VUB500080]

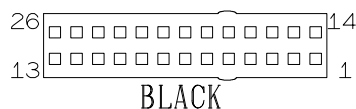

Part No. YPH900770
Colour: BLACK
Gender: F
Type: MQS
No. of Ways: 26WY

Description: Fuse box-Rear
Location: Luggage compartment - RH side

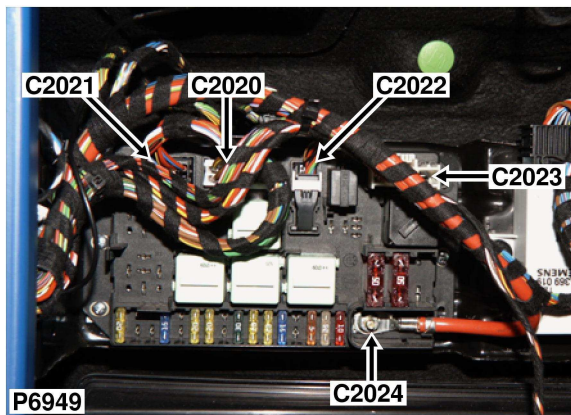

Wire Chart

CAV	TERMINAL	CSA	COL	CCT	DESTN
2	YPL104230	4.0	RY	ALL	C0873-1
3	YPL104230	4.0	RW	394	C0473-1



No repair kit
 Geen reparatiepakke
 Pas de nécessaire de reparation
 Kein Werkzeug
 Senza kit per le riparazioni
 Sem kit de reparaçao
 No hay kit de reparación

Part No. 6900557
Colour: NATURAL
Gender: F
Type: LSK 8
No. of Ways: 3WY

Description: Fuse box-Rear
Location: Luggage compartment - RH side

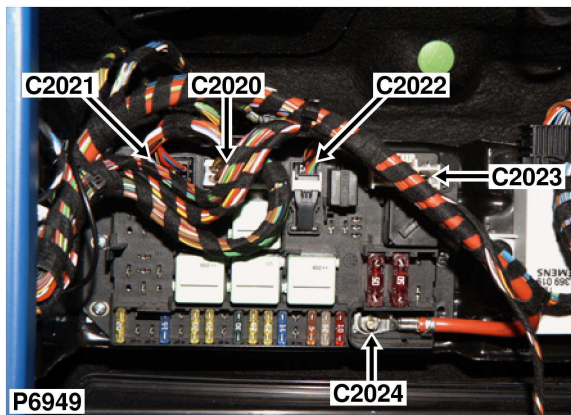

Wire Chart

CAV	TERMINAL	CSA	COL	CCT	DESTN
1	SEE DRAWING	16.0	R	ALL	C0588-1

No repair kit
 Geen reparatiepakke
 Pas de nécessaire de reparation
 Kein Werkzeug
 Senza kit per le riparazioni
 Sem kit de reparação
 No hay kit de reparación

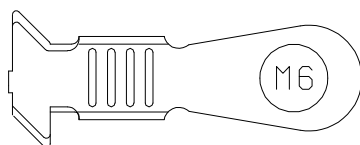

Part No. YPG101740
Colour: TIN PLATED
Gender: F
Type: STUD SIZE 6.0MM
No. of Ways: 1WY

Description: Sensor-Tyre-Front-LH
Location: Behind LH front wheel arch liner



Wire Chart

CAV	TERMINAL	CSA	COL	CCT	DESTN
1	YPL101500	MCCC	W	337	C1537-5
2	YPL101500	MCCC	G	337	C1537-21

Service Repair Kits

YPL101500		0.20 - 0.50 <small>CSA</small>
Cavities 1,2		
VDK500010	INSTRUCTION; REPAIR KIT	1
VDK500070	INSTRUCTION; EXTRACT TOOL	1
VDK500080	INSTRUCTION; EXTRACT TOOL	1
YMI000950	PRE-TERMINATED LEAD	1
YPQ000100	IDENTS (SMALL)	1
YQD000210	HEAT SHRINK SLEEVE	1
YRV000040	SPLICE (RED, CSA; 0.25-1.6)	1
YRW000390	WIRE STRIPPER	1
YRW500010	APPLICATOR	1

[VUB500150]



Part No. YPC116820
Colour: BLACK
Gender: F
Type: MQS
No. of Ways: 2WY

Description: Sensor-Tyre-Front-RH
Location: Behind RH front wheel arch liner

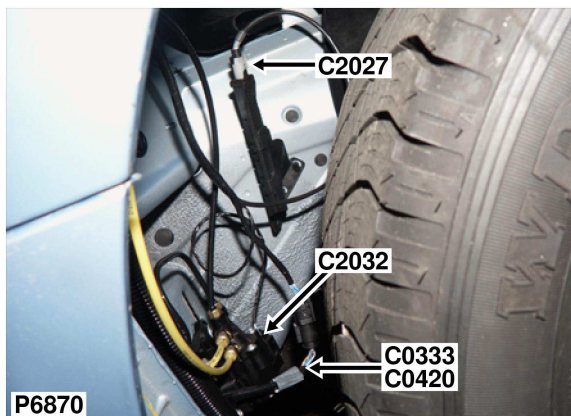

Wire Chart

CAV	TERMINAL	CSA	COL	CCT	DESTN
1	YPL101500	MCCA	W	337	C1537-7
2	YPL101500	MCCA	U	337	C1537-23

Service Repair Kits

YPL101500		0.20 - 0.50 CSA
Cavities 1,2		
VDK500010	INSTRUCTION; REPAIR KIT	1
VDK500070	INSTRUCTION; EXTRACT TOOL	1
VDK500080	INSTRUCTION; EXTRACT TOOL	1
YMI000950	PRE-TERMINATED LEAD	1
YPQ000100	IDENTS (SMALL)	1
YQD000210	HEAT SHRINK SLEEVE	1
YRV000040	SPLICE (RED, CSA; 0.25-1.6)	1
YRW000390	WIRE STRIPPER	1
YRW500010	APPLICATOR	1

[VUB500150]



Part No. YPC116820
Colour: BLACK
Gender: F
Type: MQS
No. of Ways: 2WY

Description: Sensor-Tyre-Rear-LH
Location: Below LH rear wheelarch

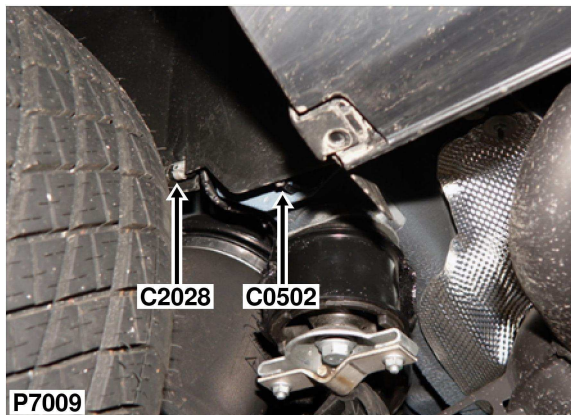

Wire Chart

CAV	TERMINAL	CSA	COL	CCT	DESTN
1	YPL101500	MCCE	W	337	C1537-8
2	YPL101500	MCCE	R	337	C1537-24

Service Repair Kits

YPL101500		0.20 - 0.50 CSA
Cavities 1,2		
VDK500010	INSTRUCTION; REPAIR KIT	1
VDK500070	INSTRUCTION; EXTRACT TOOL	1
VDK500080	INSTRUCTION; EXTRACT TOOL	1
YMI000950	PRE-TERMINATED LEAD	1
YPQ000100	IDENTS (SMALL)	1
YQD000210	HEAT SHRINK SLEEVE	1
YRV000040	SPLICE (RED, CSA; 0.25-1.6)	1
YRW000390	WIRE STRIPPER	1
YRW500010	APPLICATOR	1

[VUB500150]



Part No. YPC116820
Colour: BLACK
Gender: F
Type: MQS
No. of Ways: 2WY

Description: Sensor-Tyre-Rear-RH
Location: Below RH rear wheelarch



Wire Chart

CAV	TERMINAL	CSA	COL	CCT	DESTN
1	YPL101500	MCCD	W	337	C1537-10
2	YPL101500	MCCD	Y	337	C1537-26

Service Repair Kits

YPL101500		0.20 - 0.50 CSA
Cavities 1,2		
VDK500010	INSTRUCTION; REPAIR KIT	1
VDK500070	INSTRUCTION; EXTRACT TOOL	1
VDK500080	INSTRUCTION; EXTRACT TOOL	1
YMI000950	PRE-TERMINATED LEAD	1
YPQ000100	IDENTS (SMALL)	1
YQD000210	HEAT SHRINK SLEEVE	1
YRV000040	SPLICE (RED, CSA; 0.25-1.6)	1
YRW000390	WIRE STRIPPER	1
YRW500010	APPLICATOR	1

[VUB500150]

Part No. YPC116820
Colour: BLACK
Gender: F
Type: MQS
No. of Ways: 2WY

Description: ECU-Air suspension
Location: Behind LH side of fascia

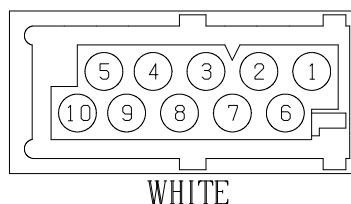
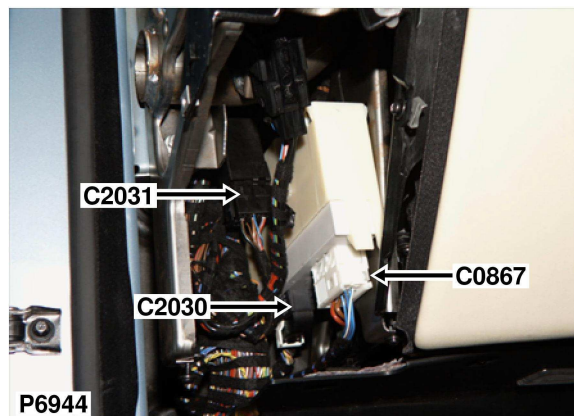

Wire Chart

CAV	TERMINAL	CSA	COL	CCT	DESTN
2	YPE10020	0.75	WU	ALL	C2032-2
3	YPE10020	0.75	UP	ALL	C2033-2
5	YPE100500	2.5	N	ALL	C0285-0

CAV	TERMINAL	CSA	COL	CCT	DESTN
7	YPE10020	0.75	UR	ALL	C2033-1
8	YPE10020	0.75	UN	ALL	C2032-1
10	YPE100500	2.5	RN	ALL	C0582-3

Service Repair Kits

YPE100500		1.01 - 2.50 CSA	
Cavities 5,10			
VDK500010	INSTRUCTION; REPAIR KIT	1	
VDK500030	INSTRUCTION; EXTRACT TOOL	1	
YMI000900	PRE-TERMINATED LEAD	1	
YPQ000110	IDENTS (MEDIUM)	1	
YRV000050	SPLICE (BLUE, CSA; 1.0-2.6)	1	
YRW000390	WIRE STRIPPER	1	
YRW500010	APPLICATOR	1	
[VUB500110]			

YPE10020		0.50 - 1.00 CSA	
Cavities 2,3,7,8			
VDK500010	INSTRUCTION; REPAIR KIT	1	
VDK500130	INSTRUCTION; EXTRACT TOOL	1	
YMI000860	PRE-TERMINATED LEAD	1	
YPQ000100	IDENTS (SMALL)	1	
YRV000040	SPLICE (RED, CSA; 0.25-1.6)	1	
YRW000390	WIRE STRIPPER	1	
YRW500010	APPLICATOR	1	
[VUB500070]			

Part No. YPC112630
Colour: NATURAL
Gender: F
Type: 2.5MM SYSTEM
No. of Ways: 10WY

Description: Relay-Headlamp wash/wipe
Location: Behind LH side of fascia

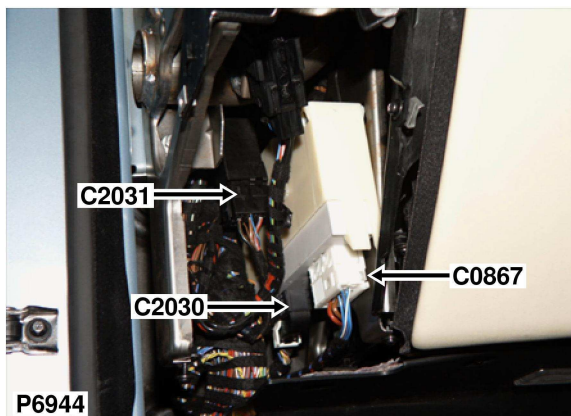

Wire Chart

CAV	TERMINAL	CSA	COL	CCT	DESTN
2	YPL102900	2.5	RS	279	C0288-0
4	8377724	0.35	NB	279	C0287-0
5	YPL102900	2.5	N	279	C0285-0
6	8377724	0.35	UB	279	C0661-17
8	YPL102900	2.5	BN	279	SJ X10087-

Service Repair Kits

YPL102900		1.50 - 2.50 CSA
Cavities 2,5,8		
VDK500010	INSTRUCTION; REPAIR KIT	1
VDK500110	INSTRUCTION; EXTRACT TOOL	1
YMI001120	PRE-TERMINATED LEAD	1
YPQ000110	IDENTS (MEDIUM)	1
YRV000050	SPLICE (BLUE, CSA; 1.0-2.6)	1
YRW000390	WIRE STRIPPER	1
YRW500010	APPLICATOR	1

[VUB500320]

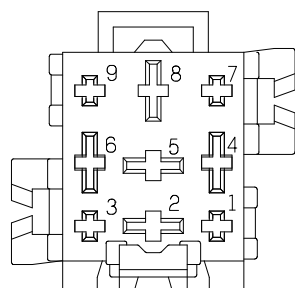

BLACK

Part No. 1389112
Colour: BLACK
Gender: F
Type: BASE - F4 RELAY
No. of Ways: 9WY

Description: Valve-Off-road-Front
Location: Behind RH front wheel arch liner

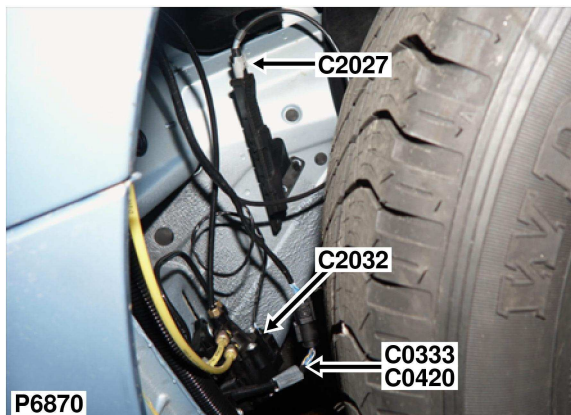

Wire Chart

CAV	TERMINAL	CSA	COL	CCT	DESTN
1	YPL102230	0.75	UN	ALL	C2030-8
2	YPL102230	0.75	WU	ALL	C2030-2

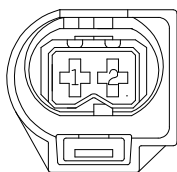

BLACK

Part No. YPC113410
Colour: BLACK
Gender: F
Type: SLK (VDA)
No. of Ways: 2WY

No repair kit
 Geen reparatiepakke
 Pas de nécessaire de réparation
 Kein Werkzeug
 Senza kit per le riparazioni
 Sem kit de reparaçã
 No hay kit de reparaci3n

Description: Valve-Off-road-Rear
Location: Below RH rear wheelarch

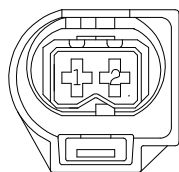
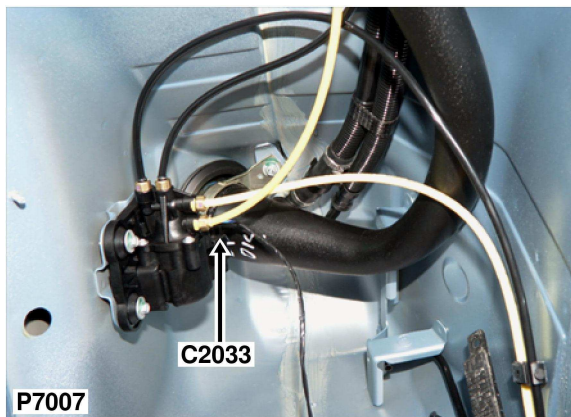

BLACK

Wire Chart

CAV	TERMINAL	CSA	COL	CCT	DESTN
1	YPL102230	0.75	UR	ALL	C2030-7
2	YPL102230	0.75	UP	ALL	C2030-3

No repair kit
 Geen reparatiepakke
 Pas de nécessaire de reparation
 Kein Werkzeug
 Senza kit per le riparazioni
 Sem kit de reparação
 No hay kit de reparaci3n

Part No. YPC113410
Colour: BLACK
Gender: F
Type: SLK (VDA)
No. of Ways: 2WY

Description: Valve-Water
Location: LH side of engine compartment

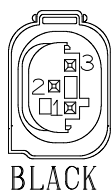
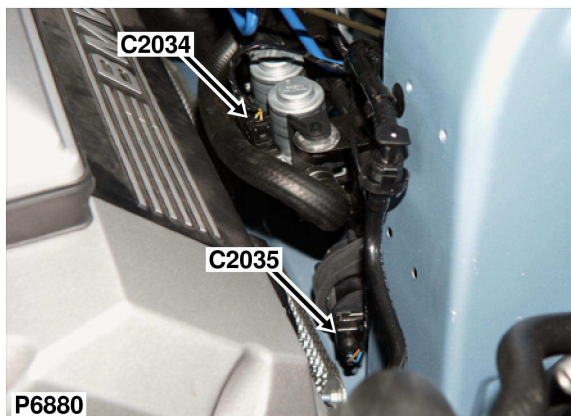

Wire Chart

CAV	TERMINAL	CSA	COL	CCT	DESTN
1	YPL101500	0.5	NB	ALL	C0554-0
2	YPL101500	0.5	YN	ALL	C1629-5
3	YPL101500	0.5	YP	19	C1629-6

Service Repair Kits

YPL101500		0.20 - 0.50 CSA
Cavities 1-3		
VDK500010	INSTRUCTION; REPAIR KIT	1
VDK500070	INSTRUCTION; EXTRACT TOOL	1
VDK500080	INSTRUCTION; EXTRACT TOOL	1
YMI000950	PRE-TERMINATED LEAD	1
YPQ000100	IDENTS (SMALL)	1
YQD000210	HEAT SHRINK SLEEVE	1
YRV000040	SPLICE (RED, CSA; 0.25-1.6)	1
YRW000390	WIRE STRIPPER	1
YRW500010	APPLICATOR	1

[VUB500150]

Part No. YPC906320
Colour: BLACK
Gender: F
Type: MQS
No. of Ways: 3WY

Description: Pump-Water
Location: LH side of engine compartment

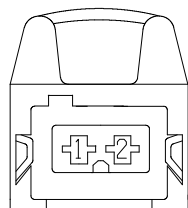
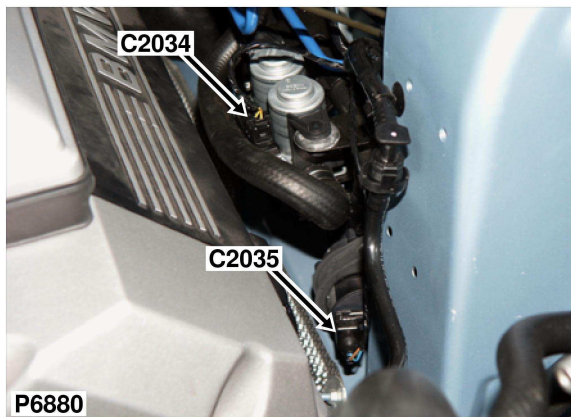

BLACK

Wire Chart

CAV	TERMINAL	CSA	COL	CCT	DESTN
1	YPL103300	0.75	N	ALL	C0551-0
2	1737771	0.5	UG	ALL	C1629-9

No repair kit

Geen reparatiepakke

Pas de nécessaire de reparation

Kein Werkzeug

Senza kit per le riparazioni

Sem kit de reparaçã

No hay kit de reparaci3n

Part No. 1732460
Colour: BLACK
Gender: F
Type: MINITIMER
No. of Ways: 2WY

Description: Switch-Pressure-ABS
Location: Rear LH side of engine compartment

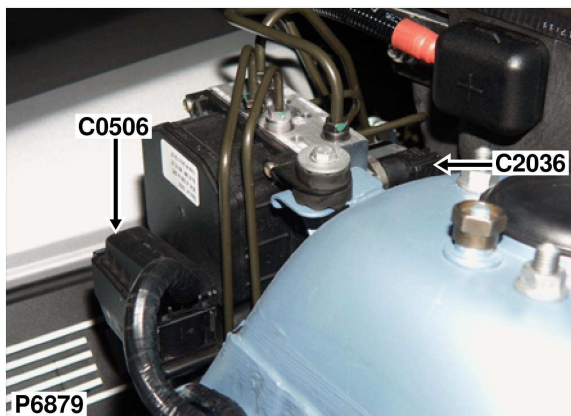

Wire Chart

CAV	TERMINAL	CSA	COL	CCT	DESTN
1	YPL101510	0.75	WU	ALL	C0506-25
2	YPL101510	0.75	UB	ALL	C0506-26
3	YPL101510	0.75	BP	ALL	C0506-42

Service Repair Kits

YPL101510		0.75 - 0.75 CSA
Cavities 1-3		
VDK500010	INSTRUCTION; REPAIR KIT	1
VDK500070	INSTRUCTION; EXTRACT TOOL	1
VDK500080	INSTRUCTION; EXTRACT TOOL	1
YMI000950	PRE-TERMINATED LEAD	1
YPQ000100	IDENTS (SMALL)	1
YQD000210	HEAT SHRINK SLEEVE	1
YRV000040	SPLICE (RED, CSA; 0.25-1.6)	1
YRW000390	WIRE STRIPPER	1
YRW500010	APPLICATOR	1

[VUB500150]

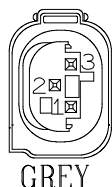

Part No. YPC906260
Colour: GREY
Gender: F
Type: MQS
No. of Ways: 3WY

Description: Valve-Non-return
Location: Rear of engine compartment

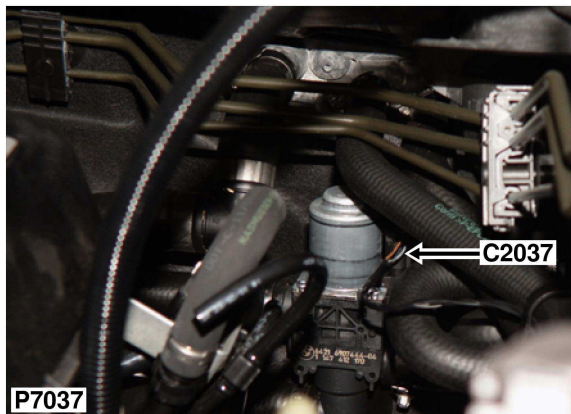

Wire Chart

CAV	TERMINAL	CSA	COL	CCT	DESTN
1	YPL101500	0.5	NB	97	C0554-0
2	YPL101500	0.5	SB	97	C1629-22

Service Repair Kits

YPL101500		0.20 - 0.50 csa
Cavities 1,2		
VDK500010	INSTRUCTION; REPAIR KIT	1
VDK500070	INSTRUCTION; EXTRACT TOOL	1
VDK500080	INSTRUCTION; EXTRACT TOOL	1
YMI000950	PRE-TERMINATED LEAD	1
YPQ000100	IDENTS (SMALL)	1
YQD000210	HEAT SHRINK SLEEVE	1
YRV000040	SPLICE (RED, CSA; 0.25-1.6)	1
YRW000390	WIRE STRIPPER	1
YRW500010	APPLICATOR	1

[VUB500150]



Part No. YPC116820
Colour: BLACK
Gender: F
Type: MQS
No. of Ways: 2WY

Description: Valve-Servotronic
Location: Behind RH headlamp

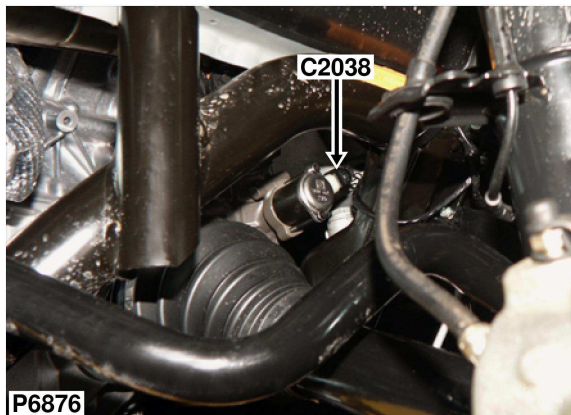

Wire Chart

CAV	TERMINAL	CSA	COL	CCT	DESTN
1	YPL101500	0.5	BW	ALL	C0662-9
2	YPL101500	0.5	BR	ALL	C0662-11

Service Repair Kits

YPL101500		0.20 - 0.50 CSA
Cavities 1,2		
VDK500010	INSTRUCTION; REPAIR KIT	1
VDK500070	INSTRUCTION; EXTRACT TOOL	1
VDK500080	INSTRUCTION; EXTRACT TOOL	1
YMI000950	PRE-TERMINATED LEAD	1
YPQ000100	IDENTS (SMALL)	1
YQD000210	HEAT SHRINK SLEEVE	1
YRV000040	SPLICE (RED, CSA; 0.25-1.6)	1
YRW000390	WIRE STRIPPER	1
YRW500010	APPLICATOR	1

[VUB500150]



Part No. YPC116830
Colour: GREY
Gender: F
Type: MQS
No. of Ways: 2WY

Description: Module-Lighting switch

Location: Base of RH 'A' post

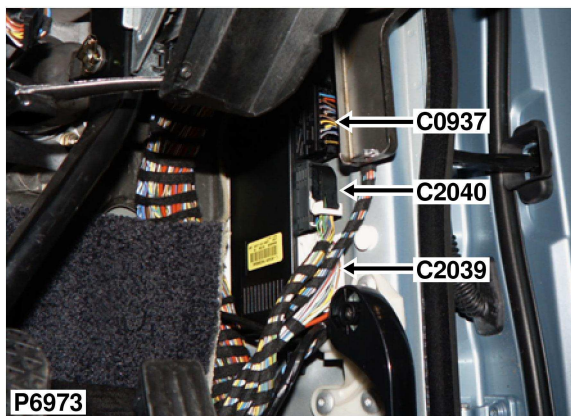

Wire Chart

CAV	TERMINAL	CSA	COL	CCT	DESTN
1	YPE100500	2.5	SR	ALL	C0286-0
2	YPE10020	0.5	N	ALL	C0553-0
3	YPE100500	2.5	WU	ALL	C0011-6
4	YPE10020	0.5	UY	ALL	C0013-2
6	YPE100500	1.5	WG	ALL	C0009-9
7	YPE10020	1.0	YR	ALL	C0514-2

CAV	TERMINAL	CSA	COL	CCT	DESTN
8	YPE100520	4.0	R	ALL	C0590-1
9	YPE10020	0.75	WY	ALL	SJ X428-
10	YPE10020	0.5	WB	574	SJ X13727-
11	YPE10020	0.75	UG	ALL	C0001-1
12	YPE10020	0.75	UN	394	SJ X185-
14	YPE10020	0.75	YB	ALL	C0121-3

Service Repair Kits

YPE100520		2.51 - 4.00 CSA
Cavities 8		
VDK500010	INSTRUCTION; REPAIR KIT	1
VDK500130	INSTRUCTION; EXTRACT TOOL	1
YMI000980	PRE-TERMINATED LEAD	1
YPQ000120	IDENTS (LARGE)	1
YRV000060	SPLICE (YELLOW, CSA; 2.7-6.6)	1
YRW000390	WIRE STRIPPER	1
YRW500010	APPLICATOR	1

[VUB500180]

YPE100500		1.01 - 2.50 CSA
Cavities 1,3,6		
VDK500010	INSTRUCTION; REPAIR KIT	1
VDK500030	INSTRUCTION; EXTRACT TOOL	1
YMI000900	PRE-TERMINATED LEAD	1
YPQ000110	IDENTS (MEDIUM)	1
YRV000050	SPLICE (BLUE, CSA; 1.0-2.6)	1
YRW000390	WIRE STRIPPER	1
YRW500010	APPLICATOR	1

[VUB500110]

YPE10020		0.50 - 1.00 CSA
Cavities 2,4,7,9-12,14		
VDK500010	INSTRUCTION; REPAIR KIT	1
VDK500130	INSTRUCTION; EXTRACT TOOL	1
YMI000860	PRE-TERMINATED LEAD	1
YPQ000100	IDENTS (SMALL)	1
YRV000040	SPLICE (RED, CSA; 0.25-1.6)	1
YRW000390	WIRE STRIPPER	1
YRW500010	APPLICATOR	1

[VUB500070]

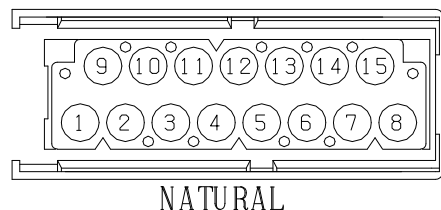

Part No. YPC112220
Colour: NATURAL
Gender: F
Type: 2.5MM SYSTEM
No. of Ways: 15WY

Description: Module-Lighting switch

Location: Base of RH 'A' post

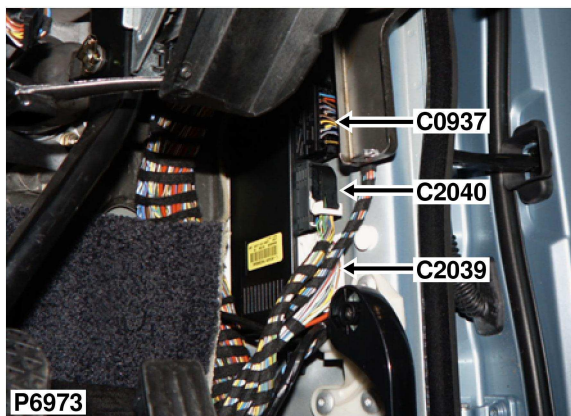

Wire Chart

CAV	TERMINAL	CSA	COL	CCT	DESTN
1	YPE100920	0.35	YG	ALL	C0041-1
7	YPE100920	0.35	NU	ALL	C0096-3
8	YPE100920	0.35	YW	ALL	C0041-9
10	YPE100920	0.35	NG	ALL	C0620-2
13	YPE100920	0.5	PY	ALL	C0587-23
15	YPE100920	0.35	SN	ALL	C0331-21
16	YPE100920	0.5	SB	ALL	C0041-3
17	YPE100920	0.5	SW	394	SJ X245-
18	YPE100920	0.5	SG	ALL	C0538-2
19	YPE100920	0.35	UN	ALL	C0096-4
24	YPE100920	0.35	NW	ALL	C0147-2
25	YPE100920	0.35	UR	ALL	SJ X181-
26	YPE100920	0.35	UY	148	C1604-3
27	YPE100920	0.5	YR	574	C1543-13
28	YPE100920	0.35	UY	ALL	C0835-6

CAV	TERMINAL	CSA	COL	CCT	DESTN
29	YPE100920	0.35	G	ALL	C0041-10
30	YPE100920	0.35	W	ALL	C1832-9
31	YPE100920	0.35	GS	ALL	C0587-11
33	YPE100920	0.35	Y	ALL	C0041-11
35	YPE100920	0.35	UNY	394	C0473-5
36	YPE100920	0.35	WSY	ALL	SJ X18226-
39	YPE100920	0.35	UY	386	C0698-1
39	YPE100920	0.35	UY	387	C0698-1
41	YPE100920	0.35	NGY	ALL	SJ X1123-
45	YPE100920	0.35	YB	ALL	C0041-8
47	YPE100920	0.35	YN	ALL	C0506-7
50	YPE100920	0.35	U	ALL	C1832-7
51	YPE100920	0.35	B	ALL	C0041-2
52	YPE100920	0.35	NB	ALL	C0041-7

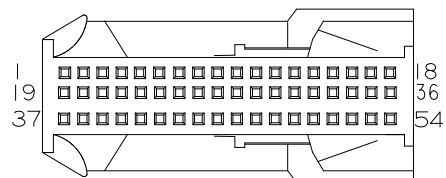

BLACK

Service Repair Kits

YPE100920		0.35 - 0.50 <small>CSA</small>
Cavities 1,7,8,10,13,15-19,24-31,33,35,36,39,41,45,47,50-52		
VDK500010	INSTRUCTION; REPAIR KIT	1
VDK500040	INSTRUCTION; EXTRACT TOOL	1
YMI001040	PRE-TERMINATED LEAD	1
YPO000100	IDENTS (SMALL)	1
YRV000040	SPLICE (RED, CSA; 0.25-1.6)	1
YRW000390	WIRE STRIPPER	1
YRW500010	APPLICATOR	1

[VUB500240]

Description: Heater-Cushion-Rear-LH
Location: Beneath rear seat

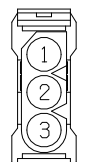
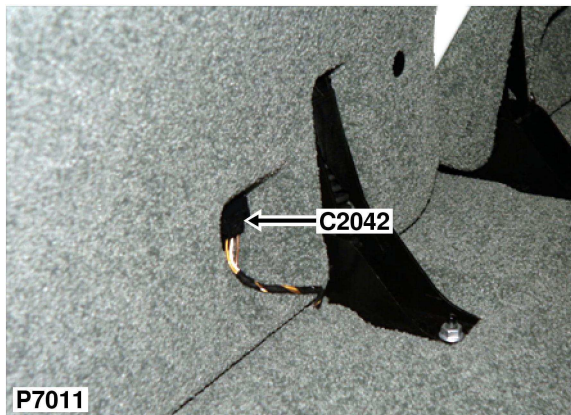

BLACK

Wire Chart

CAV	TERMINAL	CSA	COL	CCT	DESTN
1	YPE10020	0.5	YN	572	C0868-8
2	YPE10020	1.0	WY	572	C0868-3
3	YPE10020	1.0	N	572	C0553-0

Service Repair Kits

YPE10020		0.50 - 1.00 CSA
Cavities 1-3		
VDK500010	INSTRUCTION; REPAIR KIT	1
VDK500130	INSTRUCTION; EXTRACT TOOL	1
YMI000860	PRE-TERMINATED LEAD	1
YPQ000100	IDENTS (SMALL)	1
YRV000040	SPLICE (RED, CSA; 0.25-1.6)	1
YRW000390	WIRE STRIPPER	1
YRW500010	APPLICATOR	1
[VUB500070]		

Part No. YPC112530
Colour: BLACK
Gender: F
Type: 2.5MM SYSTEM
No. of Ways: 3WY

Description: Heater-Cushion-Rear-RH

Location: Beneath rear seat

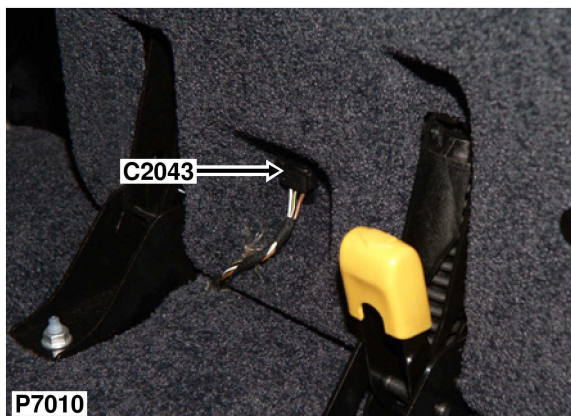

Wire Chart

CAV	TERMINAL	CSA	COL	CCT	DESTN
1	YPE10020	0.5	WN	572	C0868-9
2	YPE10020	1.0	BY	572	C0868-4
3	YPE10020	1.0	N	572	C0553-0

Service Repair Kits

YPE10020		0.50 - 1.00 CSA
Cavities 1-3		
VDK500010	INSTRUCTION; REPAIR KIT	1
VDK500130	INSTRUCTION; EXTRACT TOOL	1
YMI000860	PRE-TERMINATED LEAD	1
YPQ000100	IDENTS (SMALL)	1
YRV000040	SPLICE (RED, CSA; 0.25-1.6)	1
YRW000390	WIRE STRIPPER	1
YRW500010	APPLICATOR	1

[VUB500070]

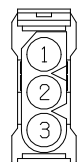

BLACK

Part No. YPC112530
Colour: BLACK
Gender: F
Type: 2.5MM SYSTEM
No. of Ways: 3WY

Description: Main harness to telephone harness

Location: Beneath centre console

No photo
 Geen photo
 Pas de photo
 Kein foto
 Senza foto
 Sem fotografia
 No hay foto

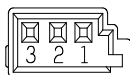

BLACK

Part No. 6905977
Colour: BLACK
Gender: M
Type: MQS
No. of Ways: 3WY

Wire Chart

CAV	TERMINAL	CSA	COL	CCT	DESTN
1	YPJ100830	MCCB	B	ALL	C1303-1
2	SCREEN	MCCB	SCR	ALL	C1303-3
3	YPJ100830	MCCB	Y	ALL	C1303-2

Service Repair Kits

YPJ100830		0.20 - 0.50 CSA
Cavities 1,3		
VDK500010	INSTRUCTION; REPAIR KIT	1
VDK500070	INSTRUCTION; EXTRACT TOOL	1
VDK500080	INSTRUCTION; EXTRACT TOOL	1
YMI000990	PRE-TERMINATED LEAD	1
YPQ000100	IDENTS (SMALL)	1
YRV000040	SPLICE (RED, CSA; 0.25-1.6)	1
YRW000390	WIRE STRIPPER	1
YRW500010	APPLICATOR	1
YRW500060	EXTRACT TOOL	1
YRW500070	EXTRACT TOOL	1

[VUB500190]

Description: Main harness to telephone harness

Location: Luggage compartment - LH side

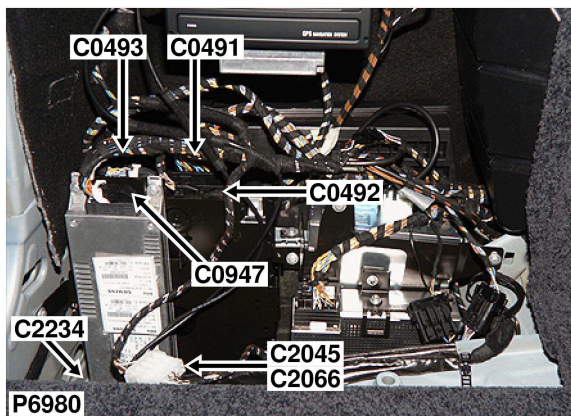

Wire Chart

CAV	TERMINAL	CSA	COL	CCT	DESTN
1	YPD10010	1.0	RY	ALL	C0583-8
2	YPD10010	0.75	PW	ALL	C0290-0
4	YPD100280	0.35	WSY	ALL	SJ X18226-
5	YPD10009	2.5	SR	ALL	SJ X1019-
7	YPD10010	1.0	NB	ALL	C0706-0

CAV	TERMINAL	CSA	COL	CCT	DESTN
8	YPD100280	0.35	WN	ALL	C0981-8
9	YPD10010	MAQC	BW	ALL	C0981-9
10	YPD10010	MAQC	BN	ALL	C0981-10
11	YPD100280	0.35	WG	ALL	C0981-11

Service Repair Kits

YPD10009		1.50 - 2.50 CSA
Cavities 5		
VDK500010	INSTRUCTION; REPAIR KIT	1
VDK500030	INSTRUCTION; EXTRACT TOOL	1
YMI001130	PRE-TERMINATED LEAD	1
YPQ000110	IDENTS (MEDIUM)	1
YRV000050	SPLICE (BLUE, CSA; 1.0-2.6)	1
YRW000390	WIRE STRIPPER	1
YRW500010	APPLICATOR	1

[VUB500330]

YPD100280		0.20 - 0.40 CSA
Cavities 1,2,4,7-11		
VDK500010	INSTRUCTION; REPAIR KIT	1
VDK500130	INSTRUCTION; EXTRACT TOOL	1
YMI000920	PRE-TERMINATED LEAD	1
YPQ000100	IDENTS (SMALL)	1
YRV000040	SPLICE (RED, CSA; 0.25-1.6)	1
YRW000390	WIRE STRIPPER	1
YRW500010	APPLICATOR	1
YRW500120	EXTRACT TOOL	1

[VUB500130]

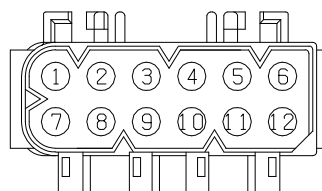

NATURAL

Part No. YPC112190
Colour: NATURAL
Gender: M
Type: 2.5MM SYSTEM
No. of Ways: 12WY

Description: Receiver-Fuel burning heater
Location: Luggage compartment - RH side

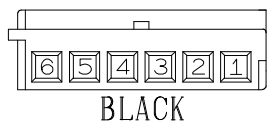
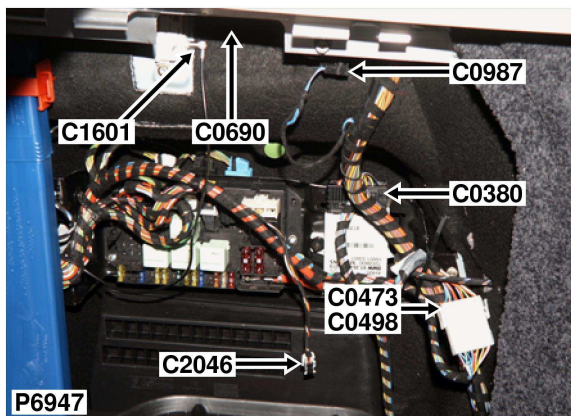

Wire Chart

CAV	TERMINAL	CSA	COL	CCT	DESTN
1	YPL101910	0.75	RY	97	C0582-7
3	YPL101310	0.35	WG	97	C0926-1
6	YPL101310	0.35	NB	97	C0706-0

Service Repair Kits

YPL101910		0.75 - 0.75 CSA
Cavities 1,3,6		
VDK500010	INSTRUCTION; REPAIR KIT	1
VDK500070	INSTRUCTION; EXTRACT TOOL	1
VDK500080	INSTRUCTION; EXTRACT TOOL	1
YMI000870	PRE-TERMINATED LEAD	1
YPQ000100	IDENTS (SMALL)	1
YRV000040	SPLICE (RED, CSA; 0.25-1.6)	1
YRW000390	WIRE STRIPPER	1
YRW500010	APPLICATOR	1
YRW500060	EXTRACT TOOL	1
YRW500070	EXTRACT TOOL	1

[VUB500080]

Part No. 6909052
Colour: BLACK
Gender: F
Type: MQS
No. of Ways: 6WY

Description: Lamp-Load space-RH
Location: Luggage compartment - RH side

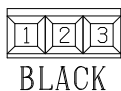
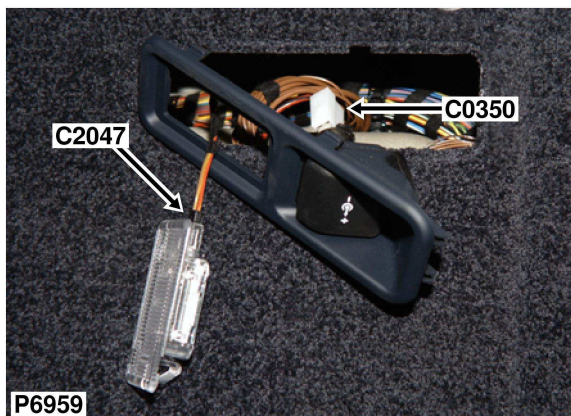

Part No. YPC117800
Colour: BLACK
Gender: F
Type: MQS
No. of Ways: 3WY

Wire Chart

CAV	TERMINAL	CSA	COL	CCT	DESTN
1	YPL101910	0.75	NY	ALL	SJ X18799-
3	YPL101910	0.75	RY	ALL	SJ X18121-

Service Repair Kits

YPL101910		0.75 - 0.75 CSA
Cavities 1,3		
VDK500010	INSTRUCTION; REPAIR KIT	1
VDK500070	INSTRUCTION; EXTRACT TOOL	1
VDK500080	INSTRUCTION; EXTRACT TOOL	1
YMI000870	PRE-TERMINATED LEAD	1
YPQ000100	IDENTS (SMALL)	1
YRV000040	SPLICE (RED, CSA; 0.25-1.6)	1
YRW000390	WIRE STRIPPER	1
YRW500010	APPLICATOR	1
YRW500060	EXTRACT TOOL	1
YRW500070	EXTRACT TOOL	1

[VUB500080]

Description: Heater-Wiper blade
Location: Behind LH side of fascia

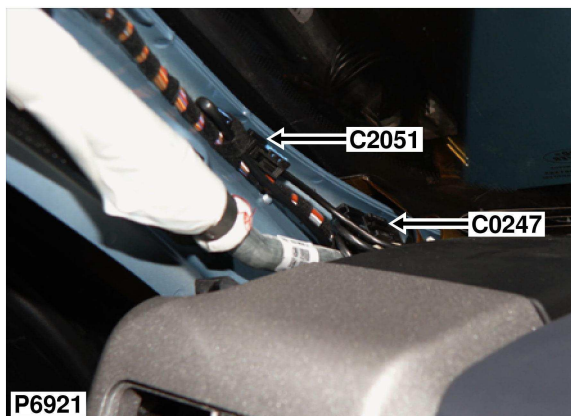

Wire Chart

CAV	TERMINAL	CSA	COL	CCT	DESTN
1	YPD10009	2.5	BG	ALL	SJ X1301-

Service Repair Kits

YPD10009		1.50 - 2.50 csa
Cavities 1		
VDK500010	INSTRUCTION; REPAIR KIT	1
VDK500030	INSTRUCTION; EXTRACT TOOL	1
YMI001130	PRE-TERMINATED LEAD	1
YPQ000110	IDENTS (MEDIUM)	1
YRV000050	SPLICE (BLUE, CSA; 1.0-2.6)	1
YRW000390	WIRE STRIPPER	1
YRW500010	APPLICATOR	1

[VUB500330]

Part No. YPC113940
Colour: BLACK
Gender: M
Type: 2.5MM SYSTEM
No. of Ways: 1WY

Description: Motor-CDL-Tailgate-Lower-RH
Location: RH side of taildoor, behind trim panel

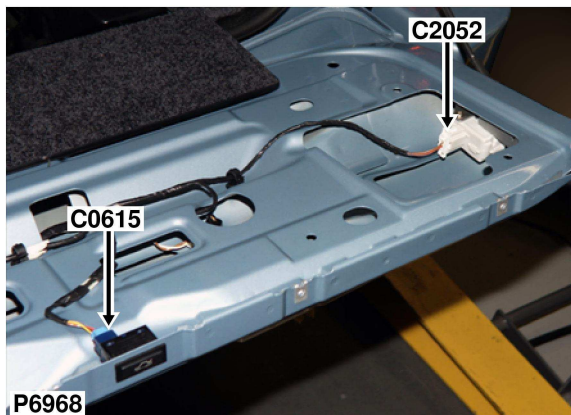

Wire Chart

CAV	TERMINAL	CSA	COL	CCT	DESTN
1	YPL102600	1.5	N	40	SJ X13276-
2	YPL102600	1.5	UY	40	C0384-1

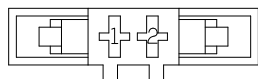

WHITE

No repair kit
 Geen reparatiepakke
 Pas de nécessaire de reparation
 Kein Werkzeug
 Senza kit per le riparazioni
 Sem kit de reparaçã
 No hay kit de reparaci3n

Part No.: YPC113630
Colour: WHITE
Gender: F
Type: JUNIOR POWER TIMER
No. of Ways: 2WY

Description: ECU-Interlock-Steering column

Location: Top of steering column

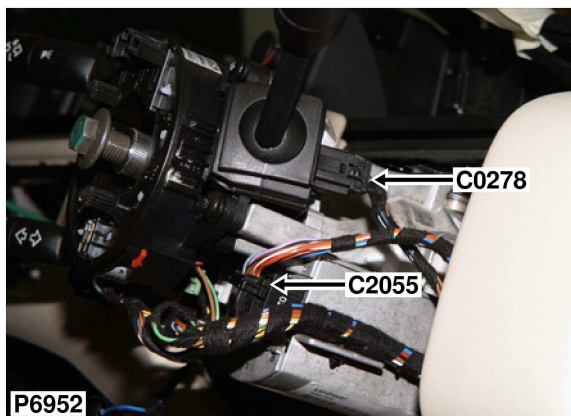

Wire Chart

CAV	TERMINAL	CSA	COL	CCT	DESTN
1	YPL101310	0.35	U	ALL	C0672-3
2	YPL101310	0.35	B	ALL	C0672-1
3	YPL101310	0.35	UB	ALL	SJ X197-
5	YPL101310	0.35	BU	ALL	C0059-6
6	YPL101310	0.35	S	ALL	C0672-2
7	YPL101910	0.75	RY	ALL	SJ X18316-
8	YPL101310	0.35	WRY	ALL	SJ X10116-

CAV	TERMINAL	CSA	COL	CCT	DESTN
9	YPL101310	0.35	NR	ALL	SJ X1101-
10	YPL101310	0.5	GB	ALL	C0587-4
11	YPL101310	0.5	PB	ALL	C0289-0
12	YPL101910	0.75	NB	ALL	SJ X3361-

Service Repair Kits

YPL101910		0.75 - 0.75 CSA
Cavities 1-3,5-12		
VDK500010	INSTRUCTION; REPAIR KIT	1
VDK500070	INSTRUCTION; EXTRACT TOOL	1
VDK500080	INSTRUCTION; EXTRACT TOOL	1
YMI000870	PRE-TERMINATED LEAD	1
YPQ000100	IDENTS (SMALL)	1
YRV000040	SPLICE (RED, CSA; 0.25-1.6)	1
YRW000390	WIRE STRIPPER	1
YRW500010	APPLICATOR	1
YRW500060	EXTRACT TOOL	1
YRW500070	EXTRACT TOOL	1

[VUB500080]

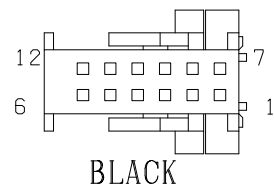

Part No. YPC111790
Colour: BLACK
Gender: F
Type: MQS
No. of Ways: 12WY

Description: Module-Passenger door
Location: Behind passenger's door trim panel

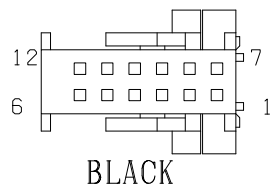
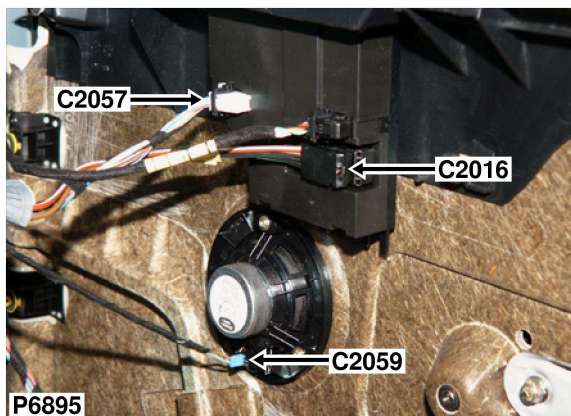

Wire Chart

CAV	TERMINAL	CSA	COL	CCT	DESTN
1	YPL101310	0.35	UR	247	C0322-23
2	YPL101310	0.5	SR	247	C0322-5
6	YPL101910	0.75	W	40	C1451-4
7	YPL101910	0.75	B	40	C1451-8

CAV	TERMINAL	CSA	COL	CCT	DESTN
8	YPL101310	0.35	SR	65	C2334-2
9	YPL101310	0.35	NR	247	C0600-2
11	YPL101310	0.5	NW	40	C1451-6
12	YPL101910	0.75	U	40	C1451-7

Service Repair Kits

YPL101910		0.75 - 0.75 CSA
Cavities 1,2,6-9,11,12		
VDK500010	INSTRUCTION; REPAIR KIT	1
VDK500070	INSTRUCTION; EXTRACT TOOL	1
VDK500080	INSTRUCTION; EXTRACT TOOL	1
YMI000870	PRE-TERMINATED LEAD	1
YPQ000100	IDENTS (SMALL)	1
YRV000040	SPLICE (RED, CSA; 0.25-1.6)	1
YRW000390	WIRE STRIPPER	1
YRW500010	APPLICATOR	1
YRW500060	EXTRACT TOOL	1
YRW500070	EXTRACT TOOL	1

[VUB500080]

Part No. YPC111790
Colour: BLACK
Gender: F
Type: MQS
No. of Ways: 12WY

Description: Module-Drivers door
Location: Behind driver's door trim panel

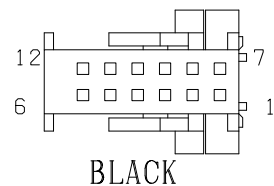
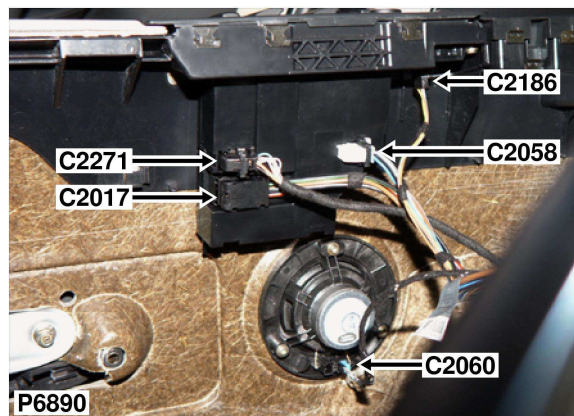

Wire Chart

CAV	TERMINAL	CSA	COL	CCT	DESTN
1	YPL101310	0.35	UR	247	C0336-23
2	YPL101310	0.35	SR	247	SJ X1720-
3	YPL101310	0.35	WB	40	C1449-3
4	YPL101310	0.35	UR	40	C1449-1
6	YPL101910	0.75	W	40	C1449-4

CAV	TERMINAL	CSA	COL	CCT	DESTN
7	YPL101910	0.75	B	40	C1449-8
8	YPL101310	0.35	SR	65	C2333-2
9	YPL101310	0.35	NR	247	C0599-2
11	YPL101310	0.35	NW	40	C1449-6
12	YPL101910	0.75	U	40	C1449-7

Service Repair Kits

YPL101910		0.75 - 0.75 CSA
Cavities 1-4,6-9,11,12		
VDK500010	INSTRUCTION; REPAIR KIT	1
VDK500070	INSTRUCTION; EXTRACT TOOL	1
VDK500080	INSTRUCTION; EXTRACT TOOL	1
YMI000870	PRE-TERMINATED LEAD	1
YPQ000100	IDENTS (SMALL)	1
YRV000040	SPLICE (RED, CSA; 0.25-1.6)	1
YRW000390	WIRE STRIPPER	1
YRW500010	APPLICATOR	1
YRW500060	EXTRACT TOOL	1
YRW500070	EXTRACT TOOL	1

[VUB500080]

Part No. YPC111790
Colour: BLACK
Gender: F
Type: MQS
No. of Ways: 12WY

Description: Speaker-Mid range-Front door-LH
Location: Behind passenger's door trim panel

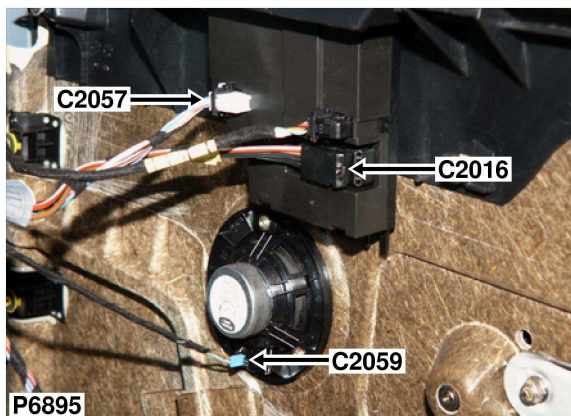

Wire Chart

CAV	TERMINAL	CSA	COL	CCT	DESTN
1	YPL101310	MMB	N	126	C0322-17
2	YPL101310	MMB	UY	126	C0322-16

Service Repair Kits

YPL101310		0.20 - 0.50 CSA
Cavities 1,2		
VDK500010	INSTRUCTION; REPAIR KIT	1
VDK500070	INSTRUCTION; EXTRACT TOOL	1
VDK500080	INSTRUCTION; EXTRACT TOOL	1
YMI000870	PRE-TERMINATED LEAD	1
YPQ000100	IDENTS (SMALL)	1
YRV000040	SPLICE (RED, CSA; 0.25-1.6)	1
YRW000390	WIRE STRIPPER	1
YRW500010	APPLICATOR	1
YRW500060	EXTRACT TOOL	1
YRW500070	EXTRACT TOOL	1

[VUB500080]

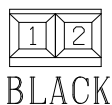

Part No. YPC111740
Colour: BLACK
Gender: F
Type: MQS
No. of Ways: 2WY

Description: Speaker-Mid range-Front door-RH

Location: Behind driver's door trim panel

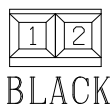
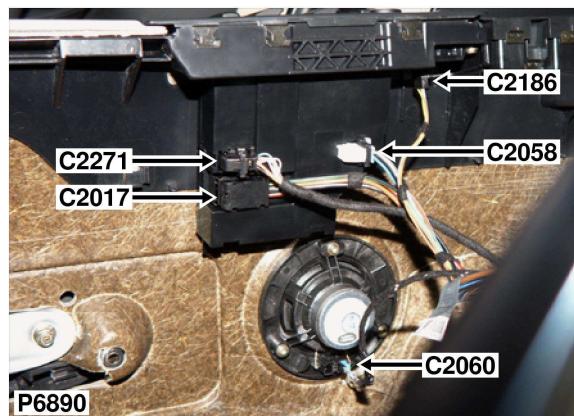

Wire Chart

CAV	TERMINAL	CSA	COL	CCT	DESTN
1	YPL101310	MMC	SN	126	C0336-17
2	YPL101310	MMC	SB	126	C0336-16

Service Repair Kits

YPL101310		0.20 - 0.50 csa
Cavities 1,2		
VDK500010	INSTRUCTION; REPAIR KIT	1
VDK500070	INSTRUCTION; EXTRACT TOOL	1
VDK500080	INSTRUCTION; EXTRACT TOOL	1
YMI000870	PRE-TERMINATED LEAD	1
YPQ000100	IDENTS (SMALL)	1
YRV000040	SPLICE (RED, CSA; 0.25-1.6)	1
YRW000390	WIRE STRIPPER	1
YRW500010	APPLICATOR	1
YRW500060	EXTRACT TOOL	1
YRW500070	EXTRACT TOOL	1

[VUB500080]

Part No. YPC111740
Colour: BLACK
Gender: F
Type: MQS
No. of Ways: 2WY

Description: Telephone harness to main harness

Location: Luggage compartment - LH side

No photo
 Geen photo
 Pas de photo
 Kein foto
 Senza foto
 Sem fotografia
 No hay foto

Wire Chart

CAV	TERMINAL	CSA	COL	CCT	DESTN
1	YPE10020	1.0	RY	507	SJ X1483-
2	YPE10020	0.75	PW	505	C0947-12
2	YPE10020	0.75	PW	508	SJ X229-
4	YPE100480	0.35	WSY	505	C0947-13
4	YPE100480	0.35	WSY	508	SJ X939-
5	YPE100500	2.5	SR	507	SJ X18056-
7	YPE10020	1.0	NB	507	SJ X3361-
8	YPE100480	0.35	WN	508	SJ X1293-
8	YPE100480	0.35	WN	505	C0947-29

CAV	TERMINAL	CSA	COL	CCT	DESTN
9	YPE10020	MAQB	BW	505	C0947-18
9	YPE10020	MAQA	BW	508	C2752-3
10	YPE10020	MAQB	BN	505	C0947-17
10	YPE10020	MAQA	BN	508	C2752-1
11	YPE100480	0.35	WG	505	C0947-47
11	YPE100480	0.35	WG	508	C2136-18

Service Repair Kits

YPE100480		0.20 - 0.40 CSA
Cavities 1,2,4,7-11		
VDK500010	INSTRUCTION; REPAIR KIT	1
VDK500130	INSTRUCTION; EXTRACT TOOL	1
YMI000860	PRE-TERMINATED LEAD	1
YPQ000100	IDENTS (SMALL)	1
YRV000040	SPLICE (RED, CSA; 0.25-1.6)	1
YRW000390	WIRE STRIPPER	1
YRW500010	APPLICATOR	1

[VUB500070]

YPE100500		1.01 - 2.50 CSA
Cavities 1,2,5,7,9-10		
VDK500010	INSTRUCTION; REPAIR KIT	1
VDK500030	INSTRUCTION; EXTRACT TOOL	1
YMI000900	PRE-TERMINATED LEAD	1
YPQ000110	IDENTS (MEDIUM)	1
YRV000050	SPLICE (BLUE, CSA; 1.0-2.6)	1
YRW000390	WIRE STRIPPER	1
YRW500010	APPLICATOR	1

[VUB500110]

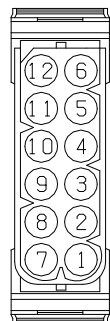

NATURAL

Part No. YPC112670
Colour: NATURAL
Gender: F
Type: 2.5MM SYSTEM
No. of Ways: 12WY

Description: Main harness to navigation harness

Location: Luggage compartment - LH side

No photo
 Geen photo
 Pas de photo
 Kein foto
 Senza foto
 Sem fotografia
 No hay foto

Wire Chart

CAV	TERMINAL	CSA	COL	CCT	DESTN
1	YPE10020	0.5	RG	568	C0899-10
1	YPE10020	0.75	RG	569	C0898-1
2	YPE10020	0.75	N	569	C0898-10
2	YPE10020	0.5	N	568	C0899-19
3	YPE10020	0.5	WSY	568	C0899-8
3	YPE10020	0.5	WSY	569	C0898-3
5	YPE10020	0.5	PW	568	C0899-9

CAV	TERMINAL	CSA	COL	CCT	DESTN
6	YPE10020	MMA	UN	568	C0899-18
6	YPE10020	MMB	UN	569	C0898-18
7	YPE10020	MMB	UR	569	C0898-9
7	YPE10020	MMA	UR	568	C0899-17

Service Repair Kits

YPE10020		0.50 - 1.00 CSA
Cavities 1-3,5-7		
VDK500010	INSTRUCTION; REPAIR KIT	1
VDK500130	INSTRUCTION; EXTRACT TOOL	1
YMI000860	PRE-TERMINATED LEAD	1
YPQ000100	IDENTS (SMALL)	1
YRV000040	SPLICE (RED, CSA; 0.25-1.6)	1
YRW000390	WIRE STRIPPER	1
YRW500010	APPLICATOR	1

[VUB500070]

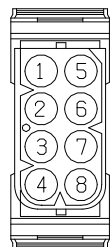

BLACK

Part No. YPC112390
Colour: BLACK
Gender: F
Type: 2.5MM SYSTEM
No. of Ways: 8WY

Description: Heater-Wiper blade
Location: Behind RH side of fascia

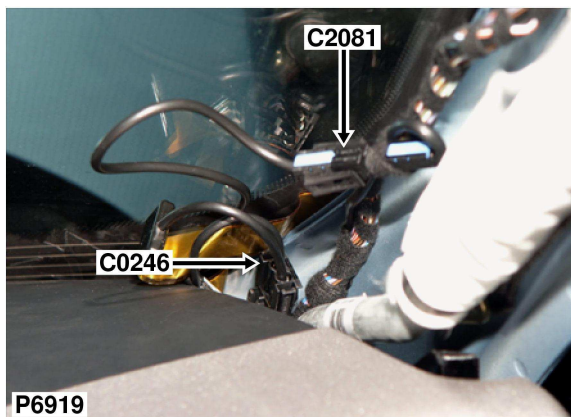

Wire Chart

CAV	TERMINAL	CSA	COL	CCT	DESTN
1	YPD10009	2.5	N	ALL	C0285-0

Service Repair Kits

YPD10009		1.50 - 2.50 csa
Cavities 1		
VDK500010	INSTRUCTION; REPAIR KIT	1
VDK500030	INSTRUCTION; EXTRACT TOOL	1
YMI001130	PRE-TERMINATED LEAD	1
YPQ000110	IDENTS (MEDIUM)	1
YRV000050	SPLICE (BLUE, CSA; 1.0-2.6)	1
YRW000390	WIRE STRIPPER	1
YRW500010	APPLICATOR	1

[VUB500330]

Part No. YPC113940
Colour: BLACK
Gender: M
Type: 2.5MM SYSTEM
No. of Ways: 1WY

Description: Navigation harness to main harness

Location: Luggage compartment - LH side

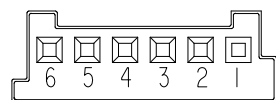
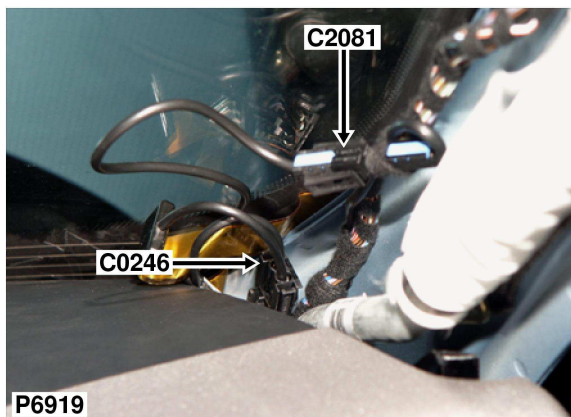

BLACK

Part No. YPC906200
Colour: BLACK
Gender: M
Type: MQS
No. of Ways: 6WY

Wire Chart

CAV	TERMINAL	CSA	COL	CCT	DESTN
1	YPJ100830	MCHB	SCRN	569	C0897-15
2	YPJ100830	MCHB	R	569	C0897-13
3	YPJ100830	MCHB	B	569	C0897-14
4	YPJ100830	MCHB	W	569	C0897-16
5	YPJ100830	MCHB	S	569	C0897-12

Service Repair Kits

YPJ100830		0.20 - 0.50 CSA
Cavities 1-5		
VDK500010	INSTRUCTION; REPAIR KIT	1
VDK500070	INSTRUCTION; EXTRACT TOOL	1
VDK500080	INSTRUCTION; EXTRACT TOOL	1
YMI000990	PRE-TERMINATED LEAD	1
YPQ000100	IDENTS (SMALL)	1
YRV000040	SPLICE (RED, CSA; 0.25-1.6)	1
YRW000390	WIRE STRIPPER	1
YRW500010	APPLICATOR	1
YRW500060	EXTRACT TOOL	1
YRW500070	EXTRACT TOOL	1

[VUB500190]

Description: Module-Voice recognition
Location: Luggage compartment - LH side

No photo
 Geen photo
 Pas de photo
 Kein foto
 Senza foto
 Sem fotografia
 No hay foto

Wire Chart

CAV	TERMINAL	CSA	COL	CCT	DESTN
1	YPE100890	0.75	RY	508	SJ X1483-
8	YPE100920	MCCC	NW	508	C1669-3
9	YPE100920	MCCC	W	508	C1669-1
10	YPE100920	MCCB	G	508	C0947-52
11	YPE100920	MCCB	YB	508	C0947-54
12	YPE100920	0.35	BN	508	C2752-2
13	YPE100920	0.35	BW	508	C2752-4
14	YPE100890	0.75	NB	508	SJ X3361-
18	YPE100920	0.35	WG	508	C2066-11

CAV	TERMINAL	CSA	COL	CCT	DESTN
21	YPE100920	0.35	WSY	508	SJ X939-
22	YPE100920	0.35	WN	508	SJ X1293-
23	YPE100920	0.5	YU	508	C0947-47
24	YPE100920	0.5	PW	508	SJ X229-
25	YPE100920	MCGA	UN	508	C0947-17
26	YPE100920	MCGA	UB	508	C0947-18

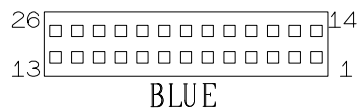

Service Repair Kits

YPE100890		0.75 - 0.75 csa
Cavities 1,8-14,18,21-26		
VDK500010	INSTRUCTION; REPAIR KIT	1
VDK500040	INSTRUCTION; EXTRACT TOOL	1
YMI001040	PRE-TERMINATED LEAD	1
YPQ000100	IDENTS (SMALL)	1
YRV000040	SPLICE (RED, CSA; 0.25-1.6)	1
YRW000390	WIRE STRIPPER	1
YRW500010	APPLICATOR	1

[VUB500240]

Part No. 8373606
Colour: BLUE
Gender: F
Type: ELO
No. of Ways: 26WY

Description: Sensor-Temperature-E-box
Location: Inside E-box

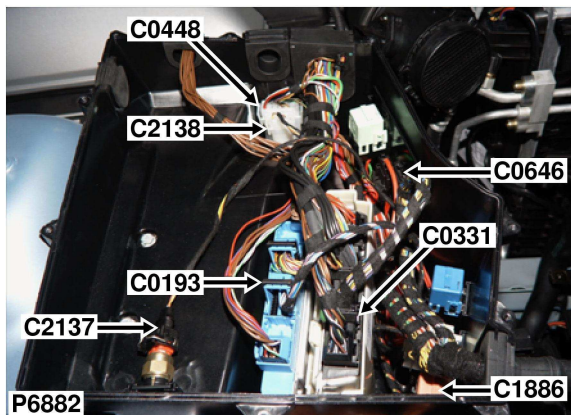

Wire Chart

CAV	TERMINAL	CSA	COL	CCT	DESTN
1	YPL103300	0.75	YU	ALL	C0646-3
2	YPL103300	0.75	RY	ALL	C0723-0

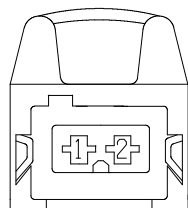

BLACK

No repair kit
 Geen reparatiepakke
 Pas de nécessaire de réparation
 Kein Werkzeug
 Senza kit per le riparazioni
 Sem kit de reparaçã
 No hay kit de reparaci3n

Part No. 1732460
Colour: BLACK
Gender: F
Type: MINITIMER
No. of Ways: 2WY

Description: Switch-Ride height-air suspension

Location: Behind driver's door trim panel

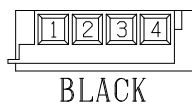
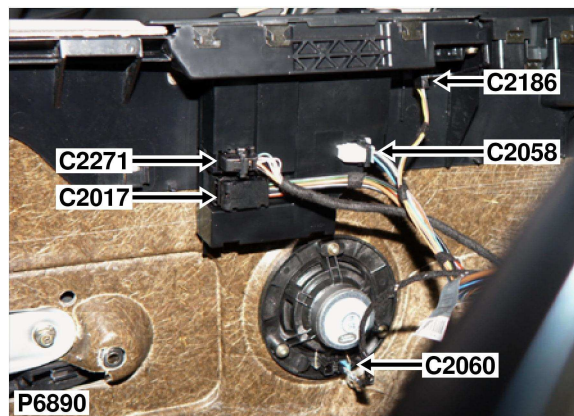

Wire Chart

CAV	TERMINAL	CSA	COL	CCT	DESTN
1	YPL101310	0.35	SR	16	SJ X1720-
2	YPL101310	0.5	N	16	SJ X850-
4	YPL101310	0.35	YG	16	C0336-1

Service Repair Kits

YPL101310		0.20 - 0.50 CSA
Cavities 1,2,4		
VDK500010	INSTRUCTION; REPAIR KIT	1
VDK500070	INSTRUCTION; EXTRACT TOOL	1
VDK500080	INSTRUCTION; EXTRACT TOOL	1
YMI000870	PRE-TERMINATED LEAD	1
YPQ000100	IDENTS (SMALL)	1
YRV000040	SPLICE (RED, CSA; 0.25-1.6)	1
YRW000390	WIRE STRIPPER	1
YRW500010	APPLICATOR	1
YRW500060	EXTRACT TOOL	1
YRW500070	EXTRACT TOOL	1

[VUB500080]

Part No. YPC117840
Colour: BLACK
Gender: F
Type: MQS
No. of Ways: 4WY

Description: Lamp-Puddle-Front
Location: Behind driver's door trim panel

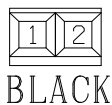
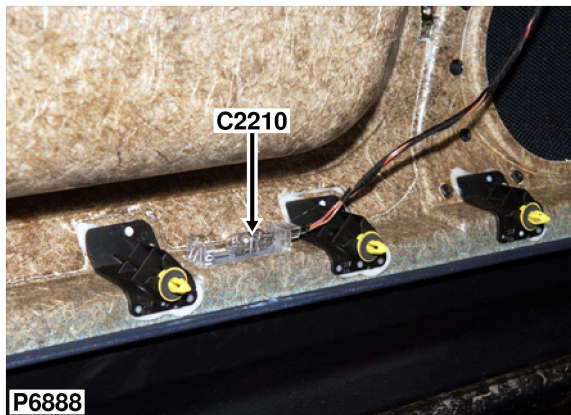

Wire Chart

CAV	TERMINAL	CSA	COL	CCT	DESTN
1	YPL101310	0.5	N	134	SJ X850-
2	YPL101910	0.75	RU	134	C0336-11

Service Repair Kits

YPL101910		0.75 - 0.75 CSA
Cavities 1,2		
VDK500010	INSTRUCTION; REPAIR KIT	1
VDK500070	INSTRUCTION; EXTRACT TOOL	1
VDK500080	INSTRUCTION; EXTRACT TOOL	1
YMI000870	PRE-TERMINATED LEAD	1
YPQ000100	IDENTS (SMALL)	1
YRV000040	SPLICE (RED, CSA; 0.25-1.6)	1
YRW000390	WIRE STRIPPER	1
YRW500010	APPLICATOR	1
YRW500060	EXTRACT TOOL	1
YRW500070	EXTRACT TOOL	1

[VUB500080]

Part No. YPC111740
Colour: BLACK
Gender: F
Type: MQS
No. of Ways: 2WY

Description: Lamp-Puddle-Front
Location: Behind passenger's door trim panel

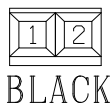
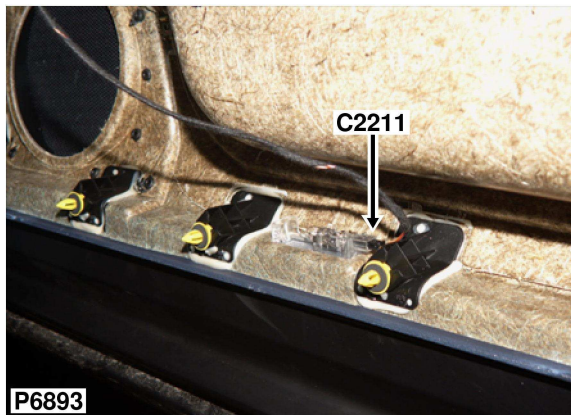

Wire Chart

CAV	TERMINAL	CSA	COL	CCT	DESTN
1	YPL101310	0.5	N	134	SJ X892-
2	YPL101910	0.75	RU	134	C0322-11

Service Repair Kits

YPL101910		0.75 - 0.75 CSA
Cavities 1,2		
VDK500010	INSTRUCTION; REPAIR KIT	1
VDK500070	INSTRUCTION; EXTRACT TOOL	1
VDK500080	INSTRUCTION; EXTRACT TOOL	1
YMI000870	PRE-TERMINATED LEAD	1
YPQ000100	IDENTS (SMALL)	1
YRV000040	SPLICE (RED, CSA; 0.25-1.6)	1
YRW000390	WIRE STRIPPER	1
YRW500010	APPLICATOR	1
YRW500060	EXTRACT TOOL	1
YRW500070	EXTRACT TOOL	1

[VUB500080]

Part No. YPC111740
Colour: BLACK
Gender: F
Type: MQS
No. of Ways: 2WY

Description: Lamp-Puddle-Rear
Location: Behind rear door trim panel

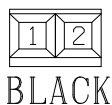
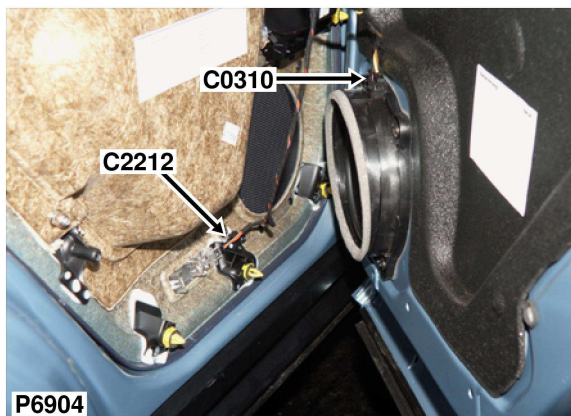

Part No. YPC111740
Colour: BLACK
Gender: F
Type: MQS
No. of Ways: 2WY

Wire Chart

CAV	TERMINAL	CSA	COL	CCT	DESTN
1	YPL101310	0.5	N	134	SJ X834-
2	YPL101910	0.75	RU	134	C0803-11

Service Repair Kits

YPL101910		0.75 - 0.75 csa
Cavities 1,2		
VDK500010	INSTRUCTION; REPAIR KIT	1
VDK500070	INSTRUCTION; EXTRACT TOOL	1
VDK500080	INSTRUCTION; EXTRACT TOOL	1
YMI000870	PRE-TERMINATED LEAD	1
YPO000100	IDENTS (SMALL)	1
YRV000040	SPLICE (RED, CSA; 0.25-1.6)	1
YRW000390	WIRE STRIPPER	1
YRW500010	APPLICATOR	1
YRW500060	EXTRACT TOOL	1
YRW500070	EXTRACT TOOL	1

[VUB500080]

Description: Module-Telephone
Location: Luggage compartment - LH side

No photo
Geen photo
Pas de photo
Kein foto
Senza foto
Sem fotografia
No hay foto

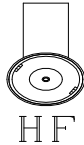

Wire Chart

CAV	TERMINAL	CSA	COL	CCT	DESTN
0	SCREEN	MBB	SCR	578	C2231-0
1	ASSEMBLY	MBB	T	578	C2231-1

No repair kit
Geen reparatiepakke
Pas de nécessaire de reparation
Kein Werkzeug
Senza kit per le riparazioni
Sem kit de reparaçao
No hay kit de reparación

Part No. 8383289
Colour: BLACK
Gender: M
Type: MINI UHF-RG58
No. of Ways: 1WY

Description: Antenna-Eject box
Location: Luggage compartment - LH side

No photo
Geen photo
Pas de photo
Kein foto
Senza foto
Sem fotografia
No hay foto



HIGH FREQUENCY

Wire Chart

CAV	TERMINAL	CSA	COL	CCT	DESTN
0	SCREEN	MBA	SCR	507	C2234-0
1	6909020	MBA	T	507	C2234-1

No repair kit
Geen reparatiepakke
Pas de nécessaire de reparation
Kein Werkzeug
Senza kit per le riparazioni
Sem kit de reparação
No hay kit de reparación

Part No. 6905818
Colour: BLACK
Gender: M
Type: HF
No. of Ways: 1WY

Description: Module-Telephone
Location: Luggage compartment - LH side

No photo
Geen photo
Pas de photo
Kein foto
Senza foto
Sem fotografia
No hay foto



HF-NATURAL

Part No. 6906016
Colour: BLACK
Gender: F
Type: HF
No. of Ways: 1WY

Wire Chart

CAV	TERMINAL	CSA	COL	CCT	DESTN
0	SCREEN	MBA	SCR	507	C2233-0
1	6909024	MBA	T	507	C2233-1

No repair kit
Geen reparatiepakke
Pas de nécessaire de reparation
Kein Werkzeug
Senza kit per le riparazioni
Sem kit de reparação
No hay kit de reparación

Description: Lamp-Ashtray
Location: Beneath centre console

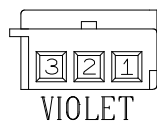
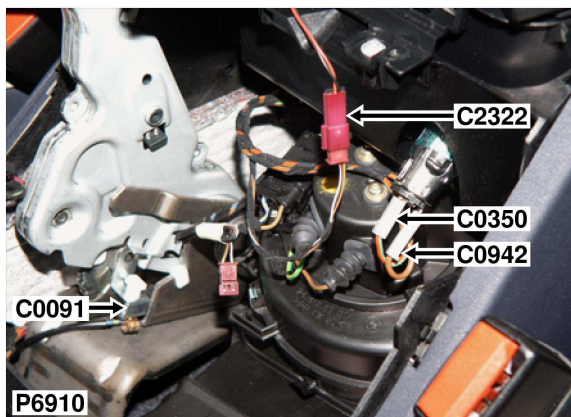

Part No. 8377070
Colour: VIOLET
Gender: F
Type: MQS
No. of Ways: 3WY

Wire Chart

CAV	TERMINAL	CSA	COL	CCT	DESTN
1	YPL101310	0.5	NB	43	SJ X3361-
2	YPL101310	0.35	SR	43	SJ X1720-

Service Repair Kits

YPL101310		0.20 - 0.50 csa
Cavities 1,2		
VDK500010	INSTRUCTION; REPAIR KIT	1
VDK500070	INSTRUCTION; EXTRACT TOOL	1
VDK500080	INSTRUCTION; EXTRACT TOOL	1
YMI000870	PRE-TERMINATED LEAD	1
YPQ000100	IDENTS (SMALL)	1
YRV000040	SPLICE (RED, CSA; 0.25-1.6)	1
YRW000390	WIRE STRIPPER	1
YRW500010	APPLICATOR	1
YRW500060	EXTRACT TOOL	1
YRW500070	EXTRACT TOOL	1

[VUB500080]

Description: Valve-Water
Location: LH side of engine compartment

No photo
 Geen photo
 Pas de photo
 Kein foto
 Senza foto
 Sem fotografia
 No hay foto



Wire Chart

CAV	TERMINAL	CSA	COL	CCT	DESTN
1	YPL101500	0.5	NB	20	C1898-1
2	YPL101500	0.5	YN	20	C1898-2

Service Repair Kits

YPL101500		0.20 - 0.50 CSA
Cavities 1,2		
VDK500010	INSTRUCTION; REPAIR KIT	1
VDK500070	INSTRUCTION; EXTRACT TOOL	1
VDK500080	INSTRUCTION; EXTRACT TOOL	1
YMI000950	PRE-TERMINATED LEAD	1
YPQ000100	IDENTS (SMALL)	1
YQD000210	HEAT SHRINK SLEEVE	1
YRV000040	SPLICE (RED, CSA; 0.25-1.6)	1
YRW000390	WIRE STRIPPER	1
YRW500010	APPLICATOR	1

[VUB500150]

Part No. YPC116820
Colour: BLACK
Gender: F
Type: MQS
No. of Ways: 2WY

Description: LED-Door
Location: Behind driver's door trim panel

No photo
 Geen photo
 Pas de photo
 Kein foto
 Senza foto
 Sem fotografia
 No hay foto

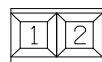

BLACK

Part No. YPC111740
Colour: BLACK
Gender: F
Type: MQS
No. of Ways: 2WY

Wire Chart

CAV	TERMINAL	CSA	COL	CCT	DESTN
1	YPL101310	0.35	N	65	SJ X850-
2	YPL101310	0.35	SR	65	C2058-8

Service Repair Kits

YPL101310		0.20 - 0.50 CSA
Cavities 1,2		
VDK500010	INSTRUCTION; REPAIR KIT	1
VDK500070	INSTRUCTION; EXTRACT TOOL	1
VDK500080	INSTRUCTION; EXTRACT TOOL	1
YMI000870	PRE-TERMINATED LEAD	1
YPO000100	IDENTS (SMALL)	1
YRV000040	SPLICE (RED, CSA; 0.25-1.6)	1
YRW000390	WIRE STRIPPER	1
YRW500010	APPLICATOR	1
YRW500060	EXTRACT TOOL	1
YRW500070	EXTRACT TOOL	1

[VUB500080]

Description: LED-Door
Location: Behind passenger's door trim panel

No photo
 Geen photo
 Pas de photo
 Kein foto
 Senza foto
 Sem fotografia
 No hay foto

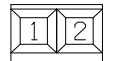

BLACK

Part No. YPC111740
Colour: BLACK
Gender: F
Type: MQS
No. of Ways: 2WY

Wire Chart

CAV	TERMINAL	CSA	COL	CCT	DESTN
1	YPL101310	0.35	N	65	SJ X892-
2	YPL101310	0.35	SR	65	C2057-8

Service Repair Kits

YPL101310		0.20 - 0.50 CSA
Cavities 1,2		
VDK500010	INSTRUCTION; REPAIR KIT	1
VDK500070	INSTRUCTION; EXTRACT TOOL	1
VDK500080	INSTRUCTION; EXTRACT TOOL	1
YMI000870	PRE-TERMINATED LEAD	1
YPQ000100	IDENTS (SMALL)	1
YRV000040	SPLICE (RED, CSA; 0.25-1.6)	1
YRW000390	WIRE STRIPPER	1
YRW500010	APPLICATOR	1
YRW500060	EXTRACT TOOL	1
YRW500070	EXTRACT TOOL	1

[VUB500080]

Description: LED-Door
Location: Behind rear door trim panel

No photo
 Geen photo
 Pas de photo
 Kein foto
 Senza foto
 Sem fotografia
 No hay foto

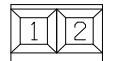

BLACK

Part No. YPC111740
Colour: BLACK
Gender: F
Type: MQS
No. of Ways: 2WY

Wire Chart

CAV	TERMINAL	CSA	COL	CCT	DESTN
1	YPL101310	0.35	N	65	SJ X834-
2	YPL101310	0.35	SR	65	SJ X1436-

Service Repair Kits

YPL101310		0.20 - 0.50 CSA
Cavities 1,2		
VDK500010	INSTRUCTION; REPAIR KIT	1
VDK500070	INSTRUCTION; EXTRACT TOOL	1
VDK500080	INSTRUCTION; EXTRACT TOOL	1
YMI000870	PRE-TERMINATED LEAD	1
YPO000100	IDENTS (SMALL)	1
YRV000040	SPLICE (RED, CSA; 0.25-1.6)	1
YRW000390	WIRE STRIPPER	1
YRW500010	APPLICATOR	1
YRW500060	EXTRACT TOOL	1
YRW500070	EXTRACT TOOL	1

[VUB500080]

Description: Sensor-Radiator outlet temperature
Location: Front of engine compartment RH side

No photo
Geen photo
Pas de photo
Kein foto
Senza foto
Sem fotografia
No hay foto

Wire Chart

CAV	TERMINAL	CSA	COL	CCT	DESTN
1	1737771	0.35	US	573	C0331-38
2	1737771	0.35	BS	573	C0331-39

No repair kit
Geen reparatiepakke
Pas de nécessaire de reparation
Kein Werkzeug
Senza kit per le riparazioni
Sem kit de reparação
No hay kit de reparación

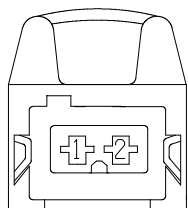

BLACK

Part No. 1732460
Colour: BLACK
Gender: F
Type: MINITIMER
No. of Ways: 2WY

Description: Clutch-Compressor-Air conditioning (A/C)
Location: Front of engine compartment RH side

No photo
 Geen photo
 Pas de photo
 Kein foto
 Senza foto
 Sem fotografia
 No hay foto

Wire Chart

CAV	TERMINAL	CSA	COL	CCT	DESTN
1	YPJ100620	0.5	BS	58	C1630-2

No repair kit
 Geen reparatiepakke
 Pas de nécessaire de reparation
 Kein Werkzeug
 Senza kit per le riparazioni
 Sem kit de reparação
 No hay kit de reparación

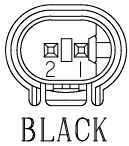

Part No. 8365385
Colour: BLACK
Gender: M
Type: MQS
No. of Ways: 2WY

Description: Clutch-Compressor-Air conditioning (A/C)

Location: Front of engine compartment RH side

No photo
 Geen photo
 Pas de photo
 Kein foto
 Senza foto
 Sem fotografia
 No hay foto

Wire Chart

CAV	TERMINAL	CSA	COL	CCT	DESTN
1	YPL101500	0.5	BS	1	C0127-1

Service Repair Kits

YPL101500		0.20 - 0.50 CSA
Cavities 1		
VDK500010	INSTRUCTION; REPAIR KIT	1
VDK500070	INSTRUCTION; EXTRACT TOOL	1
VDK500080	INSTRUCTION; EXTRACT TOOL	1
YMI000950	PRE-TERMINATED LEAD	1
YPQ000100	IDENTS (SMALL)	1
YQD000210	HEAT SHRINK SLEEVE	1
YRV000040	SPLICE (RED, CSA; 0.25-1.6)	1
YRW000390	WIRE STRIPPER	1
YRW500010	APPLICATOR	1

[VUB500150]



Part No. YPC116820
Colour: BLACK
Gender: F
Type: MQS
No. of Ways: 2WY

Description: Radio harness to main harness
Location: Luggage compartment - LH side

No photo
 Geen photo
 Pas de photo
 Kein foto
 Senza foto
 Sem fotografia
 No hay foto

Wire Chart

CAV	TERMINAL	CSA	COL	CCT	DESTN
1	YPD10010	MAQA	UG	589	C0144-1
2	YPD10010	MAQA	NO	589	C0144-6
3	YPD10010	MAQB	UO	589	C0144-5
4	YPD10010	MAQB	NO	589	C0144-10
6	YPD10010	0.5	NR	589	SJ X1101-

Service Repair Kits

YPD10010		0.50 - 1.00 CSA
Cavities 1-4,6		
VDK500010	INSTRUCTION; REPAIR KIT	1
VDK500130	INSTRUCTION; EXTRACT TOOL	1
YMI000920	PRE-TERMINATED LEAD	1
YPQ000100	IDENTS (SMALL)	1
YRV000040	SPLICE (RED, CSA; 0.25-1.6)	1
YRW000390	WIRE STRIPPER	1
YRW500010	APPLICATOR	1
YRW500120	EXTRACT TOOL	1

[VUB500130]

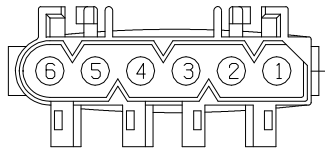

BLACK

Part No. YPC112110
Colour: BLACK
Gender: M
Type: 2.5MM SYSTEM
No. of Ways: 6WY

Description: Speaker-Surround-Rear-RH

Location: RH side of tail door

No photo
 Geen photo
 Pas de photo
 Kein foto
 Senza foto
 Sem fotografia
 No hay foto

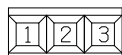

BLACK

Part No. YPC117800
Colour: BLACK
Gender: F
Type: MQS
No. of Ways: 3WY

Wire Chart

CAV	TERMINAL	CSA	COL	CCT	DESTN
1	YPL101910	MAQA	NO	ALL	C0385-6
2	YPL101910	MAQA	UG	ALL	C0385-1

Service Repair Kits

YPL101910		0.75 - 0.75 csa
Cavities 1,2		
VDK500010	INSTRUCTION; REPAIR KIT	1
VDK500070	INSTRUCTION; EXTRACT TOOL	1
VDK500080	INSTRUCTION; EXTRACT TOOL	1
YMI000870	PRE-TERMINATED LEAD	1
YPQ000100	IDENTS (SMALL)	1
YRV000040	SPLICE (RED, CSA; 0.25-1.6)	1
YRW000390	WIRE STRIPPER	1
YRW500010	APPLICATOR	1
YRW500060	EXTRACT TOOL	1
YRW500070	EXTRACT TOOL	1

[VUB500080]

Description: Speaker-Surround-Rear-LH
Location: LH side of taildoor

No photo
 Geen photo
 Pas de photo
 Kein foto
 Senza foto
 Sem fotografia
 No hay foto

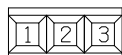

BLACK

Part No. YPC117800
Colour: BLACK
Gender: F
Type: MQS
No. of Ways: 3WY

Wire Chart

CAV	TERMINAL	CSA	COL	CCT	DESTN
1	YPL101910	MAQB	NO	ALL	C0385-10
2	YPL101910	MAQB	UO	ALL	C0385-5

Service Repair Kits

YPL101910		0.75 - 0.75 csa
Cavities 1,2		
VDK500010	INSTRUCTION; REPAIR KIT	1
VDK500070	INSTRUCTION; EXTRACT TOOL	1
VDK500080	INSTRUCTION; EXTRACT TOOL	1
YMI000870	PRE-TERMINATED LEAD	1
YPQ000100	IDENTS (SMALL)	1
YRV000040	SPLICE (RED, CSA; 0.25-1.6)	1
YRW000390	WIRE STRIPPER	1
YRW500010	APPLICATOR	1
YRW500060	EXTRACT TOOL	1
YRW500070	EXTRACT TOOL	1

[VUB500080]