



Electrical Library





FREELANDER 2004 MY ELECTRICAL LIBRARY

LRL0652ENG

Published by Land Rover

© Land Rover 2003

All rights reserved. No part of this publication may be reproduced, stored in a retrieval system or transmitted in any form, electronic, mechanical, recording or other means without prior written permission from Land Rover.

INTRODUCTION	1
ABOUT THIS DOCUMENT	1-1
ELECTRICAL PRECAUTIONS	1-3
HARNESS REPAIRS	1-5
ABBREVIATIONS	1-8
HOW TO USE THIS DOCUMENT	1-10
FAULT DIAGNOSIS	1-12
WIRE COLOUR CODES	1-13
FUSE DETAILS	2
ENGINE COMPARTMENT FUSE BOX	2-2
PASSENGER COMPARTMENT FUSE BOX	2-5
EARTH POINTS AND HEADERS	3
DESCRIPTION AND OPERATION	4
ANTI-THEFT ALARM AND CENTRAL DOOR LOCKING (CDL)	4-1
ENGINE IMMOBILISATION	4-9
WINDOWS – 3 DOOR	4-12
WINDOWS – 5 DOOR	4-14
WINDOWS – TAIL DOOR	4-19
SUNROOF	4-23
DOOR MIRRORS	4-25
FOLDING DOOR MIRRORS	4-28
HEATED SEATS	4-30
DIAGNOSTIC SOCKET	4-32
CENTRAL CONTROL UNIT (CCU)	4-33
CHARGING AND STARTING – Td4	4-34
CHARGING AND STARTING – K SERIES	4-38
CHARGING AND STARTING – KV6	4-42
CHARGING AND STARTING – KV6 (NORTH AMERICA)	4-46
CRUISE CONTROL – TD4 & KV6 (NORTH AMERICA)	4-50
CRUISE CONTROL – KV6	4-54
ELECTRONIC AUTOMATIC TRANSMISSION (EAT)	4-60
ANTI-LOCK BRAKING SYSTEM (ABS)	4-68
SUPPLEMENTARY RESTRAINT SYSTEM (SRS)	4-72
AIR CONDITIONING (A/C) – Td4	4-74
AIR CONDITIONING (A/C) – K SERIES AND KV6	4-78
AIR CONDITIONING (A/C) – KV6 (NORTH AMERICA)	4-82

CONTENTS

HEATER BLOWER	4-86
FUEL BURNING HEATER (FBH)	4-88
AIR BLAST TRANSMISSION COOLER	4-89
POSITIVE TEMPERATURE COEFFICIENT (PTC) HEATER	4-90
COOLING FANS	4-93
HEATED REAR WINDOW (HRW)	4-96
HEATED FRONT SCREEN (HFS)	4-98
WIPERS AND WASHERS	4-100
BRAKE AND REVERSE LAMPS	4-105
HEAD, SIDE AND TAIL LAMPS	4-107
HEAD, SIDE AND TAIL LAMPS – NAS	4-111
HEAD, SIDE AND TAIL LAMPS – CANADA	4-114
FOG LAMPS	4-117
DIRECTION INDICATOR/HAZARD WARNING LAMPS	4-120
INTERIOR LAMPS	4-122
INTERIOR ILLUMINATION	4-126
INSTRUMENTS	4-128
HORNS	4-132
REMOTE DISPLAY / CLOCK	4-133
CIGAR LIGHTER	4-134
ACCESSORY SOCKET	4-135
AUDIO SYSTEM	4-136
NAVIGATION SYSTEM	4-141
FUEL PUMP	4-146
ROTARY COUPLER	4-149
PARK DISTANCE CONTROL (PDC)	4-150

CONNECTOR	5
CIRCUIT REFERENCE NUMBERS	5-1

ABOUT THIS DOCUMENT

General

This document is intended to assist in diagnosing electrical faults, and should be used in conjunction with the Electrical Circuit Diagrams. The document is divided into the following sections.

1. **INTRODUCTION** – Includes Electrical Precautions, a list of Abbreviations and general information on how to use this document.
2. **FUSE DETAILS** – Provides details of location, rating in Amperes, and circuit(s) protected.
3. **EARTH POINTS AND HEADERS** – Provides details of earth points and earth headers, including a plan view of the vehicle to aid location.
4. **DESCRIPTION AND OPERATION** – Provides an explanation of how each of the systems operate.
5. **CIRCUIT REFERENCE NUMBERS** – Provides a list of circuit reference numbers against a model or feature to which they apply.
6. **CONNECTOR DETAIL** – Details of connectors including a location photograph, face view and pin-out table.

NOTE: Before starting electrical checks on the vehicle, ensure that relevant mechanical functions operate satisfactorily.

References

References to the LH or RH side given in this document are made when viewing the vehicle from the rear.

Operations covered in this document do not include reference to testing the vehicle after repair. It is essential that work is inspected and tested after completion and, if necessary, a road test of the vehicle is undertaken, particularly where safety related items are concerned.

CAUTION: Before undertaking any electrical work on a vehicle ALWAYS read the ELECTRICAL PRECAUTIONS.

INTRODUCTION

Battery Voltage

Open Circuit Voltage Test

Before commencing diagnosis of electrical problems, verify the condition of the battery is acceptable by using the open circuit voltage test.

1. Switch off all electrical loads on the vehicle.
2. Adjust digital multimeter to read dc volts on the appropriate scale.
3. Connect test probes across battery terminals ensuring that polarity is correct and record the voltage displayed.

A reading of 12.3 V or more is acceptable; any battery which reads less than this will need charging.

NOTE: If the vehicle has been used within a period of 8 hours prior to the test, surface charge must be removed from the battery by switching the headlamps on for approximately 30 seconds. Wait a further 60 seconds before checking the open circuit voltage.

Battery voltage is used as a known reference for ascertaining whether or not circuits are receiving sufficiently high voltage for components to function correctly. This reference is only a guide since most electronic circuits are designed to function over a wide range of voltages. In addition, consideration must be given to readings affected by voltage drop across certain components and fluctuations due to cable lengths.

ELECTRICAL PRECAUTIONS

General

The following guidelines are intended to ensure the safety of the operator whilst preventing damage to the electrical and electronic components fitted to the vehicle. Where necessary, specific precautions are detailed in the relevant sections of this document, reference of which should be made prior to commencing repair operations.

Equipment – Prior to commencing any test procedure on the vehicle, ensure that the relevant test equipment is working correctly and any harness or connections are in good condition. This particularly applies to mains lead or connections.

WARNING: Before commencing work on an ignition system, all high tension terminals, adaptors and diagnostic equipment for testing should be inspected to ensure that they are adequately insulated and shielded to prevent accidental personal contact and to minimise the risk of shock. Wearers of surgically implanted pacemaker devices should not work in close proximity to ignition circuits or diagnostic equipment.

Polarity – Never reverse connect the vehicle battery and always observe correct polarity when connecting test equipment.

High Voltage Circuits – Whenever disconnecting live ht circuits, always use insulated pliers and never allow the open end of the ht lead to come into contact with other components, particularly ECU's. Since high voltage spikes can occur on the terminals of the coil while the engine is running, exercise caution when measuring the voltage at these points.

Connectors and Harnesses – The engine compartment of a vehicle is a particularly hostile environment for electrical components and connectors. Always ensure these items are dry and oil free before disconnecting and connecting test equipment. Never force connectors apart either by using tools or by pulling on the wiring harness. Always ensure locking tabs are disengaged before removal and note orientation to enable correct reconnection. Ensure that any protective covers and substances are replaced if disturbed.

Before removing a faulty component, refer to the Workshop Manual for removal procedures. Ensure the ignition switch is turned to the 'OFF' position, the battery is disconnected (**see *Battery Disconnecting***) and any disconnected harnesses are supported to avoid any undue strain at the terminals. When replacing the component keep oily hands away from electrical connection areas and push connectors home until any locking tabs fully engage.

INTRODUCTION

Battery Disconnecting

Before disconnecting the battery, switch off all electrical equipment. If the radio is to be serviced, ensure the security code has been deactivated. When the battery is disconnected, certain data such as radio code and clock time will be lost.

CAUTION: To prevent damage to electrical components, ALWAYS disconnect the battery when working on the vehicle electrical systems. The earth lead must be disconnected first and reconnected last. Always ensure that battery leads are routed correctly and are not close to any potential chafing points.

Battery Charging

Recharge the battery out of the vehicle and keep the top well ventilated. While being charged or discharged, and for approximately fifteen minutes afterwards, batteries emit hydrogen gas. This gas is inflammable.

Always ensure any battery charging area is well ventilated and that every precaution is taken to avoid flames and sparks.

Disciplines

Switch off ignition prior to making any connection or disconnection in the system as electrical surge caused by disconnecting 'live' connections can damage electrical components.

Ensure hands and work surfaces are clean and free of grease, swarf, etc. as grease collects dirt which can cause tracking or high-resistance contacts.

When handling printed circuit boards, treat them as you would a disc – hold by the edges only; note that some electrical components are susceptible to body static.

Connectors should never be subjected to forced removal or refit, especially inter-board connectors. Damaged contacts will cause short-circuit and open-circuit conditions.

Prior to commencing testing, and periodically during testing, touch a good earth, i.e. cigar lighter socket, to discharge body static as some electrical components are vulnerable to static electricity.

Grease for Electrical Connectors

Some under bonnet and under body connectors are protected against corrosion by the application of a special grease during production. Should connectors of this type be disturbed, repaired, or replaced, a grease of this type, available under part number BAU 5811, should again be applied. Do not apply grease to any connectors that do not have grease applied as standard.

NOTE: The use of other greases must be avoided as they can migrate into relays, switches, etc. contaminating the contacts and leading to intermittent operation or failure.

HARNES REPAIRS

Introduction

Two Land Rover harness repair kits are available. Range Rover (LM) harness repairs can be carried out using repair kit LRT-86-010. Range Rover (LP), Discovery Series II, and Freelander (01MY onwards) are covered by Harness Repair Kit LRT-86-010/1.

The Harness Repair Kits contain the following components to enable the technician to carry out 'Right First Time' repairs:

- Crimping pliers.
- Wire cutter/stripping tool.
- Heat shrink tubing.
- Wire colour identification rings.
- Splice connectors.
- Pre-terminated leads (connector pins with 90mm wire 'pig tails').
- Connector housings.
- Connector pin extractor tools.

NOTE: Replacement connector housings and pre-terminated leads can be ordered from: SPX UK Ltd, Genoa House, Everdon Park, Daventry, Northants, NN11 5YJ. Tel: +44 (0)1327 303400

In order to carry out a repair, a suitable hot air gun and heat resistant blanket will also be required. These can be sourced locally.

The kits can be used to make repairs to all except the following:

- Any Media Orientated System Transport (MOST) network harnesses.
- Supplementary Restraint System (SRS) firing circuits.
- ABS wheel speed sensors with moulded connectors (Defender, Discovery Series II, and pre-02MY Freelanders only).
- Any wires with a Cross Sectional Area (CSA) of greater than 4.0mm.

If damage occurs in any of these areas, an overlay harness must be used.

WARNING: Repairs should only be carried out on wires that have been mechanically damaged, not electrically damaged (overheated/burned)

INTRODUCTION

Repair Guidelines

The Harness Repair Kit includes an illustrated instruction booklet. However, there are additional repair guidelines that should be adhered to.

Twisted Pairs

Twisted pairs of wires (CAN bus, ABS wiring, etc.) can be repaired as required. When repairing a twisted pair of wires do not unwind the existing wires any more than necessary. Before completing the repair, replicate as closely as possible the original twisting pattern on any new wiring.

Splice Connectors

Whenever a repair is required, the position of the splice connectors must be staggered as follows:

- Small (red) and medium (blue) splice connectors = 40mm stagger.
- Large (yellow) splice connectors = 50mm stagger.

This keeps the bulk of the repaired area to a minimum, ensuring all trim etc. can be refitted correctly after the repair has been effected.

NOTE: Do not make more than 5 repairs per connector. If more than 5 wires are damaged, a part harness must be used to carry out the repair.

Replacement Connectors

If a connector is damaged and needs replacing, use the tools contained in the Harness Repair Kit to relocate the wires into the replacement connector. Only relocate one wire at a time, ensuring it is fitted to the correct cavity in the new connector.

Gold Connector Pins

A number of connector pins on the vehicle are gold plated. When a repair is required, these must be replaced by gold connector pins. Do not replace gold connector pins with tin connector pins as this will lead to early failure of the electrical contact.

Sealed Terminals

A number of terminals on the vehicle are sealed. When a repair is required, these must be replaced by a sealed terminal. An unsealed terminal fitted in place of a sealed terminal will result in early failure of the electrical contact.

Repair Methods

The following process should be used when carrying out a repair:

CAUTION: Before starting any work, ensure the vehicle battery has been disconnected. Work must not start on the vehicle for a further ten minutes. This allows the SRS and Satellite Navigation systems time to de-energise.

1. Using the cutter/stripping tool, cut the wire to be repaired and strip the required amount of insulation from the wire.
2. Slide an appropriately sized heat shrink sleeve over the bare end wire for later fitment.
3. Remove the damaged connector pin from the connector housing using the appropriate extraction tools.
4. Select the correct connector pin pre-terminated lead and fit the appropriate wire colour identification rings.
5. Select the correct size of splice connector from the kit.
6. Using the crimping tool, crimp the splice connector to the harness bare end wire. The crimping tool contains three sets of jaws for crimping the splices. The jaw colours correspond to the splice connector colour.

CAUTION: The crimping tool jaws perform two different crimps simultaneously. One crimps the wire insulation, one crimps the bare wire. Ensure the splice connector is placed correctly in the crimping tool or the wire will be insufficiently crimped and a poor electrical contact may result.

7. Using the crimping tool, crimp the pre-terminated lead to the splice connector.
8. Slide the previously fitted heat shrink sleeve into position over the splice connector. Using the hot air gun to the manufacturers guidelines, apply heat evenly to the heat shrink tubing until it is tightly shrunk around the splice connector.

CAUTION: Place the asbestos blanket in a suitable position to avoid heat damage to adjacent components and trim.

CAUTION: Do not overheat the repair as degradation and subsequent failure of the connection may result.

9. Connect the repaired wire to the connector housing.
10. Repeat steps 1 to 9 for any further damaged wires.

INTRODUCTION

ABBREVIATIONS

General

A	Ampere
ABS	Anti-lock braking system
ac	Alternating current
A/C	Air Conditioning
ATF	Automatic transmission fluid
BUS	Databus
CAN	Controller area network
Cav	Cavity
Cct	Circuit
CCU	Central control unit
CDL	Central door locking
CHMSL	Centre high mounted stop lamp
Col	Colour
dc	Direct current
DCU	Diagnostic control unit
EAT	Electronic automatic transmission
EBD	Electronic braking force distribution
ECM	Engine control module
ECT	Engine coolant temperature
ECU	Electronic control unit
EKA	Emergency key access
ETC	Electronic traction control
F	Fuse
FL	Fusible link
HDC	Hill descent control
HFS	Heated front screen
HRW	Heated rear window
HT	High tension
ISO	International Organisation for Standardisation
LED	Light emitting diode
LH	Left hand
LHD	Left hand drive
MIL	Malfunction indicator lamp
MOST	Media Orientated System Transport
NAS	North American specification
PTC	Positive Temperature Co-efficient

PWM	Pulse width modulated
R	Relay
RF	Radio frequency
RH	Right hand
RHD	Right hand drive
ROW	Rest of world
SRS	Supplementary restraint system
V	Volt
VIN	Vehicle identification number
W	Watt

INTRODUCTION

HOW TO USE THIS DOCUMENT

Fuse Details

Contains information on fuse functions and values and should be used together with the power distribution circuit diagrams to establish which systems share a common power supply and to ensure that correct value fuses are fitted.

Earth Points and Headers

Shows a plan view of the vehicle with location of all earth points. Supporting photographs and connector detail information appear in the Connector section.

Description and Operation

Presented in the same order as the circuit diagrams in the Electrical Circuit Diagram folder, each of the descriptions contains a brief overview of the main system functions and includes reference to the appropriate wire colours. Always read this section before starting work on a system so that a good understanding of system functionality is obtained.

Connector Details

This section is effectively an index of every electrical connector on the vehicle, including headers and eyelets. A page is dedicated to each connector, with the information presented in a standard format. The connector number is displayed on each page header to ease reference. Connector information comprises:

- **Connector Number** – The assigned number, prefixed 'C'.
- **Connector Name** – Usually derived from the component to which the connection is made.
- **Male/Female** – If applicable, identifies the gender of the connector pins (NOT the housing) as Male or Female. Generally, connectors mating directly into a component have Female pins.
- **Colour** – If applicable, the colour of the connector housing is shown. NATURAL is used to describe connectors with a clear/translucent plastic finish.
- **Location Statement** – Used in conjunction with the photograph to determine the location of the connector.
- **Photograph** – Shows the location of the subject connector. In most cases the photograph will indicate the amount of trim removal necessary to reveal the connector. For convenience some photographs identify more than one connector.
- **Face View** – An outline of the connector housing, viewed from the front, showing pin numbers (if applicable).
- **Pin-out Table** – A three column table, detailing the colour and position of each wire in the connector:

Cav	Col	Cct
1	GR	ALL
2	B	ALL

1. **Cav:** The connector pin (cavity) number.
2. **Col:** The colour of wire populating the connector pin.
3. **Cct:** Identifies the model or feature which uses the wire. 'ALL' means applicable to all models in the range fitted with the feature or system in question. In instances where different models, features or systems require different colour wires to be fitted in a cavity, each instance of the cavity is included in the pin-out table.

NOTE: Wires may not be fitted to all cavities.

Example – 12 Pin Connector

Cav	Col	Cct
2	G	ALL
4	GW	8
4	GB	10
4	GR	12
5	LGB	ALL
6	GB	8
6	GW	10
6	GR	12
8	B	ALL

Where necessary, a table listing the circuit reference numbers against a description of the model or features which may or may not be fitted can be found at the beginning of the connector section. A sample of a typical table is shown below.

Cct	Model or Feature
1	3 Door
2	5 Door
3	LHD
4	RHD
5	Japanese vehicles only
6	NAS vehicles only
7	Australian vehicles only

INTRODUCTION

FAULT DIAGNOSIS

General

When diagnosing an electrical fault, follow the steps below:

1. Read the circuit description appropriate to the reported fault to ensure a good understanding of circuit operation.
2. Study the power distribution, fuse details and earth distribution diagrams and identify other circuits which share fuses and/or earth points. Check whether these circuits operate correctly.
3. Using the photographs contained in the Connector section, locate a point on the circuit (approximately half way between supply and earth) which is easily accessible.
4. Check that the pin-out details of the connector are correct and that the correct signals exist at the correct terminals.
5. Using the marker pen supplied (or other suitable non-permanent marker pen), mark the parts of the circuit you have verified.
6. Continue to the next point on the circuit which is easiest to access and repeat the above.
7. Continue with this approach until a fault is found, rectify the fault and then verify that the circuit operates correctly.

CAUTION: Never probe directly into the front face of a connector. This can damage the terminal and cause a failure. Always probe the back of a terminal, taking care not to damage the terminal or any seals.

Never probe wire insulation. On small diameter cables this can cut the conductors. It may also allow moisture into the cable, causing corrosion.

WIRE COLOUR CODES**General**

The following list contains wire colour codes used on the vehicle harness's.

Code	Colour
B	Black
G	Green
K	Pink
LG	Light green
N	Brown
O	Orange
P	Purple
R	Red
S	Slate (Grey)
T	Transparent
U	Blue
W	White
Y	Yellow

Introduction

Fuses are mounted in one of two fuse boxes. One fuse box is located in the LH rear side of the engine compartment, and the other is located behind the driver side cubby box.

The engine compartment fuse box contains three different types of fuse:

1. **Blade type fuse** – Small, pull out, male fuse, used to protect circuits from 5 A to 30 A.
2. **J-case fuse** – Square shaped, pull out, female fuse, used to protect circuits from 30 A to 60 A.
3. **Bolt down fuse** – Also known as a fusible link, used to protect circuits from 40 A to 150 A.

The passenger compartment fuse box contains blade type fuses only.

WARNING: Contained within the passenger compartment fuse box is the SRS fuse. This is identified on the fuse box cover by a yellow label. Do not carry out any work on the SRS system before reading the SRS warnings, cautions, and notes contained within the Introduction section of the Workshop manual.

FUSE DETAILS

ENGINE COMPARTMENT FUSE BOX

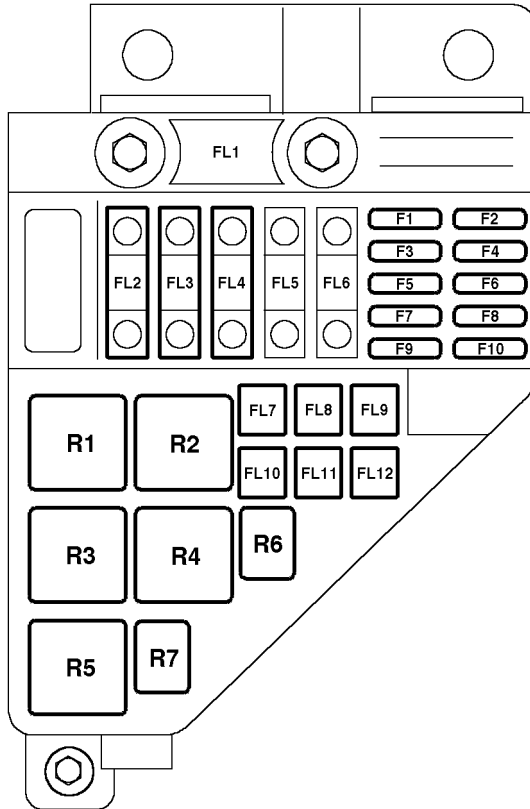

M86 5267

Relays (R)

1. Fuel pump relay.
2. Starter relay.
3. Not used on 04MY vehicles
4. Main ECM relay.
5. ECM relay (NAS only).
6. Horn relay.
7. A/C compressor clutch relay.

Link	Rating	Vehicle	Function
FL1	150 A	K1.8 & KV6	Alternator, FL2, FL7, FL10, fuse 5, fuse 8 and fuse 9 of the engine compartment fuse box.
FL2	60 A	All	Ignition switch.
FL3	60 A	All	Ignition switch.
FL4	80 A	All	CCU, HRW relay, window lift time-out relay, fuse 10, fuse 12, fuse 13, fuse 16, fuse 31, fuse 32, fuse 33, fuse 35, fuse 37 and fuse 38 of the passenger compartment fuse box.
FL5	80 A	A/C fitted	Cooling fan control unit
FL5	40 A	Non A/C	Cooling fan relay.
FL6	100 A	Td4	Glow plug relay.
FL7	40 A	All	Starter relay.
FL8	40 A	All	ABS ECU.
FL9	40 A	All	Main beam relay, and fuse 30 and 36 of the passenger compartment fuse box.
FL10	30 A	NAS	ECM relay.
FL11	40 A	All	ABS ECU.
FL12	40 A	All	Lighting switch.

Fuse	Rating	Vehicle	Function
F1	15 A	Td4	Glow plug relay, EGR modulator, airflow meter, fuel pressure sensor, camshaft sensor.
F1	15 A	K1.8	Purge control valve, rear HO2S
F1	15 A	KV6	VIS valves, CKP sensor, rear HO2S.
F1	15 A	NAS	VIS valves, CKP sensor, fuel leak detection pump.
F2	20 A	Td4	ECM.
F2	20 A	K1.8	ECM, fuel injectors, ignition coils.
F2	20 A	KV6	ECM, fuel injectors, ignition coils.
F2	20 A	NAS	ECM, ignition coils.
F3	15 A	K1.8	CMP sensor, front HO2S.
F3	15 A	KV6	CMP sensor, front HO2S.
F3	15 A	NAS	CMP sensor, front HO2S, air flow meter.
F4	15 A	Td4	Splice joint 51, A/C compressor clutch relay, E-Box temperature sensor, cooling fan control unit.
F4	15 A	K1.8	Splice joint 51, A/C compressor clutch relay, cooling fan control unit, cooling fan relay, E-box temperature sensor.

FUSE DETAILS

Fuse	Rating	Vehicle	Function
F4	15 A	KV6	Splice joint 51, A/C compressor clutch relay, cooling fan control unit, E-box temperature sensor.
F4	15 A	NAS	Splice joint 51, A/C compressor clutch relay, E-box temperature sensor.
F5	20 A	Td4 manual	Fuel burning heater (if fitted).
F5	20 A	Td4 Auto	Oil cooler fan (if fitted).
F5	20 A	K1.8, KV6 & NAS	ECM.
F6	15 A	All	Horn relay.
F7	15 A	All	Splice joint 12.
F8	30 A	All	Blower motor relay.
F9	10 A	All	A/C compressor clutch relay.
F10	20 A	All	Inertia switch.

PASSENGER COMPARTMENT FUSE BOX

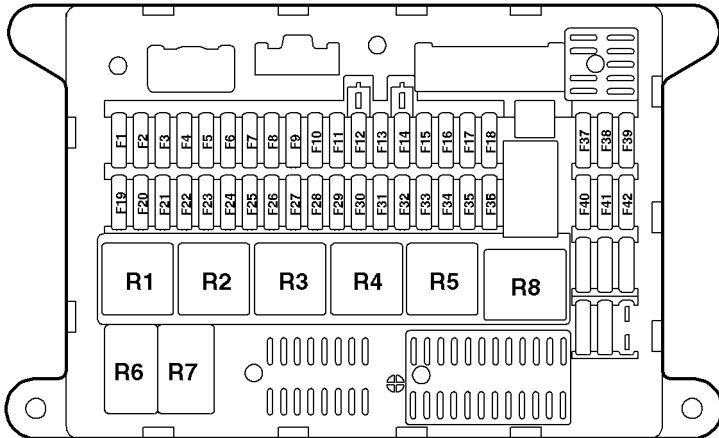

M86 6184

Relays (R)

1. Accessory socket
2. Time-out
3. Front fog lamp 1
4. Front fog lamp 2
5. Headlamp main beam
6. PTC heater
7. Not used
8. Flasher unit.

FUSE DETAILS

Fuse	Rating	Vehicle	Function
F1	20 A	All	windscreen wash/wipe switch, windscreen wiper motor, CCU.
F2	15 A	All	Reverse lamp relay, HDC relay, reverse lamp switch, brake pedal switch.
F3	15 A	All except Canada	Rear screen washer switch, splice joint 45.
F3	15 A	Canada	Rear screen washer switch, splice joint 45, daylight running relay.
F4	25 A	All	Blower motor switch.
F5	10 A	All	Splice joint 21.
F6	10 A	All	Header 292.
F7	10 A	All	LH headlamp (side lamp), trailer pick-up.
F8	25 A	3 door vehicles	Window lift ECU.
F8	25 A	5 door vehicles	Window lift switch pack.
F9	15 A	All	Cigar lighter.
F10	20 A	All	Accessory socket relay.
F11	20 A	All	Splice joint 44.
F12	15 A	High line ICE	Audio head unit.
F12	15 A	High line ICE with amplifier & Navigation	Splice joint 4.
F13	5 A	All	Engine immobilisation ECU.
F14	15 A	All	RH headlamp (main beam), instrument pack.
F15	10 A	All	Mirror switch.
F16	10 A	All	Rear interior lamp, illumination relay, header 285, header 1000.
F17	10 A	All except NAS	CCU, header 286, header 1000, splice joint 40.
F17	10 A	NAS	CCU, RH headlamp (side lamp), splice joint 40.
F18	15 A	All	CCU, Instrument pack, hazard warning switch.
F19	10 A	All	RH headlamp (dipped beam).
F20	10 A	All	LH headlamp (dipped beam).
F21	15 A	All	Sunroof switch.
F22	10 A	All	ECM.
F23	10 A	All	SRS DCU.
F24	5 A	All	PDC ECU.
F25	5 A	All	ABS ECU.
F26	20 A	All	HRW switch, HRW element.

Fuse	Rating	Vehicle	Function
F27	10 A	All	Splice joint 22.
F29	5 A	3 door vehicles	Passenger door window switch, driver door window switch.
F29	5 A	5 door vehicles	Passenger door window switch, window lift switch pack.
F30	15 A	All	Front fog lamp relay.
F31	20 A	All	Tail door window lift relay.
F32	25 A	5 door vehicles	LH rear window lift relays.
F33	25 A	5 door vehicles	RH rear window lift relays.
F34	15 A	All	LH headlamp (main beam).
F35	25 A	All	Front passenger window lift relays.
F36	10 A	All	Rear fog lamp relay.
F37	20 A	All	CCU (CDL).
F38	10 A	All	Rear wiper relay.
F39	10 A	All except NAS	Front fog lamp relay.
F41	10 A	All	Alternator.

EARTH POINTS AND HEADERS

General

The following illustration indicates the general position of each earth point and header on the vehicle. Refer to the **Connector** section for more information.

Refer to the **Circuit Diagrams** for details of electrical components and their associated earth points.

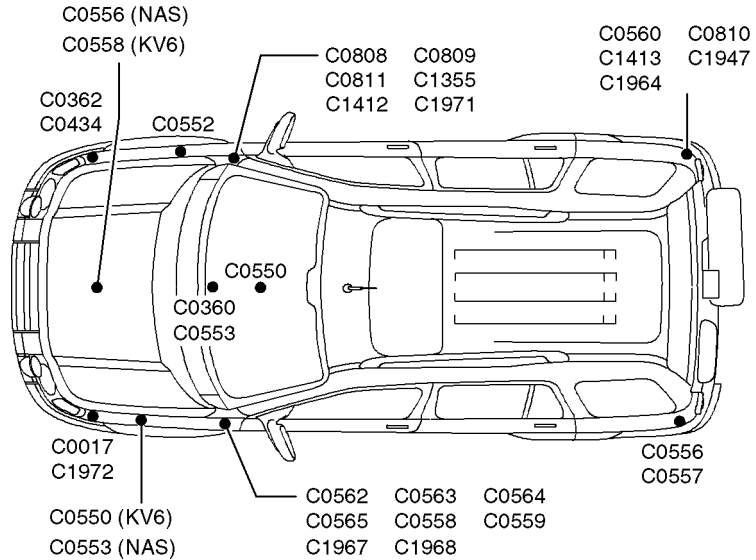

M86 6197

ANTI-THEFT ALARM AND CENTRAL DOOR LOCKING (CDL)

DESCRIPTION

General

The anti-theft alarm system is controlled by the Central Control Unit (CCU), which is mounted on the rear of the passenger compartment fuse box. The alarm can be armed and disarmed using the vehicle key or remote handset. The two main features of the alarm system are:

- Perimetric protection.
- Volumetric protection.

Perimetric Protection

Perimetric protection secures against intrusion through the bonnet, doors, tail door or roof. The CCU monitors the state of the hinged panels after the alarm system has been armed. If a panel is opened after the alarm has been armed, the alarm will be triggered.

Switches are incorporated into the door latch assemblies, the bonnet, and the tail door. Three door vehicles also have a 'roof on' switch, to inform the CCU if the hard back has been removed, or the soft back is opened.

Perimetric protection is initiated after a valid alarm request is received. If any panel is open when perimetric protection is activated (other than the roof), the alarm will enter a partially armed state.

Volumetric Protection

Volumetric protection provides protection for the vehicle interior. A volumetric sensor monitors the vehicle interior space and activates the alarm if unauthorised movement is detected. The volumetric sensor is located in a central position, behind the headlining.

A fifteen second delay is initiated after the alarm has been armed before signals from the volumetric sensor are interpreted as an intrusion. This precaution is included in the CCU software to avoid accidental or nuisance triggering of the alarm.

For a detailed description of the anti-theft alarm system, refer to the **Security** section of the System Description and Operation Workshop manual.

DESCRIPTION AND OPERATION

OPERATION

General

Feed from the positive battery terminal (C0192) is supplied to the horn relay, fuse 6, fuse 7, fuse 10, and fusible link 4 (C0632) on an R wire. All are located in the engine compartment fuse box. Fuse 10 (C0575) provides a constant battery feed to the inertia switch (C0123) on a G wire. Fuse 7 (C0576) provides a constant battery feed to the hazard warning relay located in the passenger compartment fuse box (C0580) on an NO wire.

Fusible link 4 (C0574) provides a constant battery feed to the CCU (C0593), fuse 14, and fuse 15 of the passenger compartment fuse box (C0581) on an NW wire. Fuse 15 provides a feed to the CCU (C0593). Fuse 14 (C0589) provides a feed to the alarm LED located in the instrument pack (C0230) and the transponder coil mounted around the ignition barrel (C0049) on P wires. Fuse 14 (C0580) also provides a feed to the diagnostic socket (C0040) and the roof on switch (3 door vehicles only) (C0497) on P wires.

Door Switches

In order for the perimeter alarm system to operate, the CCU monitors the condition of the door switches (including the tail door switch). The door switches are open circuit when the doors are closed. When the doors are opened, the switches close and an earth path is created. The CCU (C0428) is connected to the door switches as follows:

- To the driver door switch (C0441) on a PS then PW wire.
- To the passenger door switch (C0441) on a PW wire.
- To the LH rear door switch (C0442) on a PW wire.
- To the RH rear door switch (C0442) on a PW wire.
- To the tail door switch (C0616) on a BO wire.

NOTE: Both front and both rear door switches have the same connector number as they utilise the same harness.

The CCU treats the passenger door, and both rear doors as a single item. All door switches are earthed on B wires.

Bonnet Switch

In addition to the door switches, the CCU also monitors the condition of the bonnet switch. The bonnet switch is a normally open switch. When the bonnet is opened, the switch closes and an earth path is created.

The CCU (C0428) provides a feed to the bonnet switch (C0007) on an RP wire. The switch (C0007) is earthed on a B wire. By monitoring the state of the bonnet switch, the CCU can determine if the bonnet has been opened illegally and sound the alarm if necessary.

Roof On Switch (3 Door Vehicles Only)

The roof on switch (C0497) is located on the RH 'D' post, and is provided a constant battery feed by fuse 14 of the passenger compartment fuse box (C0580) on a P wire. The roof on switch is closed when the hard back is fitted, or the soft back is in the fitted position. In this instance, current flows across the switch (C0497) to the CCU (C0428) on a PY wire.

If the hard back is removed (or the soft back is folded down) the roof on switch becomes open circuit, and the feed to the CCU is removed. By monitoring the state of the roof on switch, the CCU can determine if the roof has been opened illegally and sound the alarm if necessary.

Anti-theft Alarm LED

Fuse 14 of the passenger compartment fuse box (C0589) provides a constant battery feed to the anti-theft alarm LED mounted in the instrument pack (C0230) on a P wire. The earth path for the LED (C0235) is controlled by the CCU (C0592) on a UK wire. By switching the earth path on and off, the CCU can control the flashing sequence of the LED.

Inertia Switch

Fuse 10 of the engine compartment fuse box (C0575) provides a constant battery feed to the inertia switch (C0123) on a G wire. The inertia switch is a normally closed switch. The inertia switch (C0123) is connected to the CCU (C0428) via the engine compartment fuse box by a GU then UG wire.

When the inertia switch is tripped the switch opens, cutting the voltage supply to the CCU. Sensing this, the CCU unlocks all doors and cuts the electrical supply to the fuel pump.

NOTE: The CCU will only unlock all doors if the ignition is switched on, and the anti-theft alarm isn't armed.

For more information on the fuel pump, refer to the relevant **Charging and Starting** section of this manual.

-  **CHARGING AND STARTING – Td4.**
-  **CHARGING AND STARTING – K SERIES.**
-  **CHARGING AND STARTING – KV6.**

DESCRIPTION AND OPERATION

Volumetric Sensor

The CCU (C0429) provides a feed to the volumetric sensor (C0358 on 3 door vehicles, C1896 on 5 door vehicles) on a WB wire. When the alarm is armed, the volumetric sensor (C0358 on 3 door vehicles, C1896 on 5 door vehicles) returns a signal feed back to the CCU (C0428) on an NB wire. If the sensor detects movement within the vehicle, it withdraws the signal feed to the CCU. Sensing this, the CCU will sound the alarm.

The CCU (C0429) also provides a gain setting signal to the volumetric sensor (C0358 on 3 door vehicles, C1896 on 5 door vehicles) on an SW wire. This enables the volumetric sensor to determine if it is looking at the interior of a 3 door vehicle or a 5 door vehicle and adjust its sensitivity accordingly.

The volumetric sensor (C0358 on 3 door vehicles, C1896 on 5 door vehicles) is earthed on a B wire.

Radio Frequency (RF) Receiver

The CCU (C0429) provides a feed to the RF receiver (C0359) on a Y wire. The RF receiver (C0359) provides a 12 V feed back to the CCU (C0428) on an S wire. When an RF signal is received from the remote handset, the receiver switches the feed back to the CCU between 12 V and 0 V at high frequency.

The RF receiver (C0359) is earthed on a B wire.

Central Door Locking Switches

A non-latching CDL rocker switch is located in each front door switch pack. When the lock half of either switch is pressed, current is able to flow from the CCU (C0428) to the switch (C0328) on a BN wire. Current flows across the closed switch contacts to earth on a B wire. The CCU will now lock all the doors.

NOTE: The alarm will not be armed when using the master lock switch.

When the unlock half of the switch is pressed, current is able to flow from the CCU (C0428) to the master lock switch (C0328) on a BK wire. Current flows across the closed switch contacts to earth on a B wire. The CCU will now unlock all the doors.

NOTE: Both CDL rocker switches have the same connector number as they utilise the same harness.

Door Lock Motors

When the CCU receives a request to lock or unlock the doors, it powers the door lock motors as follows:

Driver Door

To lock the driver door, the CCU (C0430) provides a feed to the driver door lock motor (C0441) on a K wire. The motor (C0441) is provided an earth path via the CCU (C0430) on an O wire. This enables the motor to drive the latch to the lock position.

To unlock the driver door, the CCU (C0430) provides a feed to the driver door lock motor (C0441) on an O wire. The motor (C0441) is provided an earth path via the CCU (C0430) on a K wire. This enables the motor to drive the latch to the unlock position.

Passenger Door

To lock the passenger door, the CCU (C0430) provides a feed to the passenger door lock motor (C0441) on a K wire. The motor (C0441) is provided an earth path via the CCU (C0430) on an O wire. This enables the motor to drive the latch to the lock position.

To unlock the passenger door, the CCU (C0430) provides a feed to the passenger door lock motor (C0441) on an O wire. The motor (C0441) is provided an earth path via the CCU (C0430) on a K wire. This enables the motor to drive the latch to the unlock position.

NOTE: The driver and passenger door lock motors have the same connector numbers as they utilise the same harness.

LH Rear Door

To lock the LH rear door, the CCU (C0430) provides a feed to the LH rear door lock motor (C0442) on a K wire. The motor (C0442) is provided an earth path via the CCU (C0430) on an O wire. This enables the motor to drive the latch to the lock position.

To unlock the LH rear door, the CCU (C0430) provides a feed to the LH rear door lock motor (C0442) on an O wire. The motor (C0442) is provided an earth path via the CCU (C0430) on a K wire. This enables the motor to drive the latch to the unlock position.

RH Rear Door

To lock the RH rear door, the CCU (C0430) provides a feed to the RH rear door lock motor (C0442) on a K wire. The motor (C0442) is provided an earth path via the CCU (C0430) on an O wire. This enables the motor to drive the latch to the lock position.

To unlock the RH rear door, the CCU (C0430) provides a feed to the RH rear door lock motor (C0442) on an O wire. The motor (C0442) is provided an earth path via the CCU (C0430) on a K wire. This enables the motor to drive the latch to the unlock position.

NOTE: The LH rear and RH rear door lock motors have the same connector numbers as they utilise the same harness.

DESCRIPTION AND OPERATION

Tail Door

Operation of the tail door latch mechanism is only possible when the vehicle is stationary or travelling at speeds lower than 3 mph (5 km/h). To allow the tail door latch to operate, the CCU (C0430) provides a single voltage pulse to the tail door motor (C0617) on a PU wire. The motor (C0617) is earthed on a B wire.

The CCU receives a road speed signal from the ABS ECU. If road speed rises above 3 mph (5 km/h), the CCU will not provide a voltage pulse to the tail door motor, inhibiting operation of the tail door latch mechanism.

Superlocking

Superlocking inhibits the use of the interior door handles in addition to driving the door lock motors to the lock position. When the CCU receives a request to superlock the doors, it supplies the following outputs in addition to those detailed above in the **Door Lock Motors** description.

NOTE: The vehicle will not start if the vehicle is superlocked. For more information, refer to the 'Engine Immobilisation' section of this manual.

ENGINE IMMOBILISATION.

Driver Door

To superlock the driver door, the CCU (C0430) provides a feed to the driver door superlock motor (C0441) on an NK wire. The superlock motor (C0441) is provided an earth path via the CCU (C0430) on an O wire. This powers the superlock motor to the lock position, inhibiting the interior door handle.

To unlock the driver door from the superlock condition, the CCU (C0430) provides a feed to the driver door lock motor and the superlock motor (C0441) on an O wire. The driver door lock motor and the superlock motor (C0441) are provided an earth path via the CCU (C0430) on a K wire. This powers both motors to the unlock position.

Passenger Door

To superlock the passenger door, the CCU (C0430) provides a feed to the passenger door superlock motor (C0441) on an NK wire. The superlock motor (C0441) is provided an earth path via the CCU (C0430) on an O wire. This powers the superlock motor to the lock position, inhibiting the interior door handle.

To unlock the passenger door from the superlock condition, the CCU (C0430) provides a feed to the passenger door lock motor and the superlock motor (C0441) on an O wire. The passenger door lock motor and the superlock motor (C0441) are provided an earth path via the CCU (C0430) on a K wire. This powers both motors to the unlock position.

LH Rear Door

To superlock the LH rear door, the CCU (C0430) provides a feed to the LH rear door superlock motor (C0442) on an NK wire. The superlock motor (C0442) is provided an earth path via the CCU (C0430) on an O wire. This powers the superlock motor to the lock position, inhibiting the interior door handle.

To unlock the LH rear door from the superlock condition, the CCU (C0430) provides a feed to the LH rear door lock motor and the superlock motor (C0442) on an O wire. The LH rear door lock motor and the superlock motor (C0442) are provided an earth path via the CCU (C0430) on a K wire. This powers both motors to the unlock position.

RH Rear Door

To superlock the RH rear door, the CCU (C0430) provides a feed to the RH rear door superlock motor (C0442) on an NK wire. The superlock motor (C0442) is provided an earth path via the CCU (C0430) on an O wire. This powers the superlock motor to the lock position, inhibiting the interior door handle.

To unlock the RH rear door from the superlock condition, the CCU (C0430) provides a feed to the RH rear door lock motor and the superlock motor (C0442) on an O wire. The RH rear door lock motor and the superlock motor (C0442) are provided an earth path via the CCU (C0430) on a K wire. This powers both motors to the unlock position.

Horns

If the anti-theft alarm is triggered, the CCU (C0430) provides an earth path for the horn relay coil (C0576) on a PY wire. The energised horn relay (C0570 & C0576) provides a feed to the LH (C0003) and RH (C0004) horns on PB wires. The horns are earthed on B wires.

By switching the earth path for the relay coil on and off, the CCU can control the operation of the horns.

DESCRIPTION AND OPERATION

Direction Indicator/Hazard Warning Lamps

If the anti-theft alarm is triggered, the CCU (C0593) provides an earth path for the hazard warning relay coil. The energised hazard warning relay provides a feed to the following:

- The LH rear direction indicator lamp (C0928) on a GR wire
- The RH rear direction indicator lamp (C0837) on a GW wire
- The LH front direction indicator lamp (C0009) on a GR wire
- The RH front direction indicator lamp (C0011) on a GW wire
- The trailer pick-up (C0499) on a GR and GW wire.

All are earthed on B wires, except the trailer pick-up which is earthed on a W then B wire.

By switching the earth path for the relay coil on and off, the CCU can control operation of the direction indicator lamps. For more information, refer to the ***Direction Indicator/Hazard Warning Lamps*** section of this manual.

 **DIRECTION INDICATOR/HAZARD WARNING LAMPS.**

ENGINE IMMOBILISATION

DESCRIPTION

General

The function of the engine immobilisation system is to prevent unauthorised starting of the vehicle. The system is controlled by the immobilisation ECU, which is located behind the centre of the fascia. Re-mobilisation is achieved via a transponder in the vehicle key, which is read by a transponder coil when the ignition switch is turned to the 'auxiliary' position. The transponder coil is mounted around the ignition barrel.

For a detailed description of the engine immobilisation system, refer to the **Security** section of the System Description and Operation Workshop manual.

OPERATION

General

Feed from the positive battery terminal (C0192) is supplied to fusible link 1, fusible link 3, and fusible link 4 of the engine compartment fuse box (C0632) on an R wire. Fusible link 4 (C0574) is connected to fuse 13 of the passenger compartment fuse box (C0587) by an NW wire. Fuse 13 (C0583) provides a constant battery feed to the immobilisation ECU (C0059) on a PN wire.

Fusible link 3 (C0571) is connected to the ignition switch (C0028) by an N wire. When the ignition switch is turned to the 'auxiliary' position, current flows across the switch (C0028) to fuse 27 of the passenger compartment fuse box (C0588) on a PS wire. Fuse 27 (C0580) provides an auxiliary ignition feed to the Central Control Unit (CCU) (C0430) on an LGW wire.

When the ignition switch is turned to the 'crank' position, current flows across the switch (C0028) to fuse 5 of the passenger compartment fuse box (C0588) on a WR wire. Fuse 5 (C0581) provides a feed to the immobilisation ECU (C0059) on a WR wire. The immobilisation ECU (C0059) is earthed via the passenger compartment fuse box (C0587) on a B wire.

DESCRIPTION AND OPERATION

Immobilisation ECU Inputs/Outputs

The immobilisation ECU receives inputs and outputs from a number of different components to ensure the right criteria are met before it will allow the engine to be started.

Transponder Coil

The transponder coil (C0049) mounted around the ignition barrel, and is connected to the engine immobilisation ECU (C0059) by KB and KG wires. Both connections between the immobilisation ECU and the transponder coil switch between both inputs and outputs. The transponder coil reads the vehicle identification information contained within the key transponder and relays it to the immobilisation ECU. The immobilisation ECU (C0059) then compares this information with the vehicle identification information received from the Central Control Unit (CCU) (C0429) on a G wire.

Central Control Unit (CCU)

The CCU (C0429) outputs a locking status signal to the immobilisation ECU (C0059) on a KN wire. If the vehicle has been superlocked or the anti-theft alarm system is armed, the immobilisation ECU issues a request for the CCU to remove both before it will allow the engine to be cranked.

NOTE: When the CCU receives a 'remove superlock' signal from the immobilisation ECU, it will unlock the driver door. Superlocking will be removed from the remaining doors if single point entry is selected.

For more information on superlocking and the anti-theft alarm system, refer to the ***Anti-theft Alarm and Central Door Locking (CDL)*** section of this manual.

ANTI-THEFT ALARM AND CENTRAL DOOR LOCKING (CDL).

The CCU also outputs an ignition status signal, informing the immobilisation ECU when the ignition switch has been turned to the 'ignition' position. The CCU (C0428) transmits this signal to the immobilisation ECU (C0059) on an ON wire.

Gearbox Solenoid (Automatic Vehicles Only)

When the gear selector lever is in the Park (P) or Neutral (N) position, the gearbox solenoid (C0244) provides a feed to the immobilisation ECU (C0059) on a W wire. If the selector lever is moved to any other position, the feed is removed and the immobilisation ECU will not allow the engine to be cranked.

Engine Control Module (ECM)

If the correct re-mobilisation code is received from the remote handset, the immobilisation ECU (C0059) transmits a rolling code to the ECM (C0331 on Td4 vehicles, C0913 on K Series vehicles, C0371 on KV6 vehicles) on a YR wire. The ECM (C0603 on Td4 vehicles, C0913 on K Series vehicles, C0371 on KV6 vehicles) will now energise the main relay by providing an earth path for the relay coil (C0576) on a WK wire.

Starter Relay

If the vehicle has been successfully re-mobilised, the immobilisation ECU (C0059) provides a feed to the starter relay coil (C0576) on an RW wire. The relay coil (C0576) is earthed on a B wire. The energised relay allows a feed from fusible link 7 to flow across the relay switch contacts (C0572) to the starter motor (C0179) on an NR wire (NR then B on Td4 vehicles). For more details of starter motor operation, refer to the ***Charging and Starting – Td4***, ***Charging and Starting – K Series*** or ***Charging and Starting – KV6*** sections of this manual.



CHARGING AND STARTING – Td4.



CHARGING AND STARTING – K SERIES.



CHARGING AND STARTING – KV6.

Diagnostic Socket

The diagnostic socket (C0040) is connected to the immobilisation ECU (C0059) by a K wire, enabling the immobilisation ECU to be interrogated by TestBook or T4.

DESCRIPTION AND OPERATION

WINDOWS – 3 DOOR

DESCRIPTION

General

The front electrically operated windows are opened and closed by using the non-latching switches mounted on each door trim casing. Both windows can also be controlled from the drivers door switch pack. The window lift system is controlled by the window lift ECU, which is located beneath the centre console, and will only operate when the ignition switch is in the 'ignition' position.

NOTE: When the ignition is switched off, the windows will still operate for approximately 40 seconds. This time out sequence will cease as soon as any of the doors are opened. This feature is not active on the tail door window.

OPERATION

General

Feed from the positive battery terminal is supplied to fusible link 3 and fusible link 4 of the engine compartment fuse box (C0632) on an R wire. Fusible link 4 (C0574) provides a constant battery feed to the following on an NW wire:

- Time out relay.
- Central Control Unit (CCU).
- Fuse 35.

All are located in the passenger compartment fuse box (C0587).

Fusible link 3 (C0571) is connected to the ignition switch (C0028) by an N wire. When the ignition switch is turned to the 'ignition' position, current flows across the switch (C0028) to fuse 18 of the passenger compartment fuse box (C0588) on a G wire. Fuse 18 provides an ignition feed to the CCU (C0593), which is mounted directly onto the rear of the passenger compartment fuse box.

Time Out Relay

Operation of the time out relay is controlled by the CCU (C0592). When energised, the time out relay provides a feed to fuse 8 and fuse 29, which are also located in the passenger compartment fuse box. Fuse 8 (C0585) provides a feed to the window lift ECU (C0341) on an SO wire. Fuse 29 (C0580) provides a feed to the following on RB wires:

- The drivers door window switch (C0242).
- The passenger door window switch (C0087).
- The drivers door mounted passenger window switch (C0321).

Drivers Window

If a request is made to lower the drivers door window, current flows across the window switch (C0242) to the window lift ECU (C0341) on an OU then OY wire. The window lift ECU (C0341) is now able to provide a feed to the window lift motor (C0326) on an R wire. Current flows through the motor windings (C0326) and back to the window lift ECU (C0341) on a U wire. An earth path is provided for the window lift motor by the window lift ECU (C0341) on a B wire.

If a request is made to raise the drivers door window, current flows across the window switch (C0242) to the window lift ECU (C0341) on an OR the OG wire. The window lift ECU (C0341) is now able to provide a feed to the window lift motor (C0326) on a U wire, Current flows through the motor windings (C0326) and back to the window lift ECU (C0341) on an R wire. An earth path is provided for the window lift motor by the window lift ECU (C0341) on a B wire.

Passenger Door Window

If a request is made to lower the passenger door window from the passenger door switch, current flows across the switch (C0087) to the 'FR Down' relay (C0586) on a U then OU wire. The 'FR Down' relay is located in the passenger compartment fuse box and is earthed (C0586) on a B wire.

The energised 'FR Down' relay (C0586) provides a battery feed from fuse 35 of the passenger compartment fuse box to the window lift motor (C0326) on an OR then R wire. Current flows through the motor windings (C0326) and is earthed via the de-energised 'FR Up' relay (C0586) on a U then OU wire.

If a request is made to raise the passenger door window from the passenger door switch, current flows across the switch (C0087) to the 'FR Up' relay (C0586) on an R then OR wire. The 'FR Up' relay is located in the passenger compartment fuse box and is earthed (C0586) on a B wire.

The energised 'FR Up' relay (C0586) provides a battery feed from fuse 35 of the passenger compartment fuse box to the window lift motor (C0326) on an OU then U wire. Current flows through the motor windings (C0326) and is earthed via the de-energised 'FR Down' relay (C0586) on an R then OR wire.

NOTE: Operation of the passenger door window is exactly the same as previous when using the drivers door mounted switch. Use the 'Passenger Door Window' description, replacing C0087 with C0321.

DESCRIPTION AND OPERATION

WINDOWS – 5 DOOR

DESCRIPTION

General

The front and rear electrically operated windows are opened and closed by using the non-latching switches mounted on each door trim casing. All windows can also be controlled from the drivers door switch pack when the ignition switch is in the 'ignition' position. The drivers door switch pack also contains the rear window inhibit switches.

NOTE: When the ignition is switched off, the windows will still operate for approximately 40 seconds. This time out sequence will cease as soon as any of the doors are opened. This feature is not active on the tail door window.

The window lift system is controlled by the window lift ECU, which is located within the drivers door switch pack.

OPERATION

General

Feed from the positive battery terminal (C0192) is supplied to fusible link 3 and fusible link 4 of the engine compartment fuse box (C0632) on an R wire. Fusible link 4 (C0574) provides a constant battery feed to the following on an NW wire:

- The time out relay.
- Fuse 32.
- Fuse 33.
- Fuse 35.
- The Central Control Unit (CCU).

All are located in the engine compartment fuse box (C0587).

Fusible link 3 (C0571) is connected to the ignition switch (C0028) by an N wire. When the ignition switch is turned to the 'ignition' position, current flows across the switch (C0028) to fuse 18 of the passenger compartment fuse box (C0588) on a G wire. Fuse 18 provides an ignition feed to the CCU (C0593).

Time Out Relay

The earth path for the time out relay coil is controlled by the CCU (C0592). When the CCU (C0593) receives an 'ignition on' feed from fuse 18 of the passenger compartment fuse box, it will energise the time out relay. The energised time out relay provides a feed to fuse 8 and fuse 29, which are also located in the passenger compartment fuse box.

If the ignition is switched off, the CCU withdraws the earth path for the timer relay coil after approximately 40 seconds. Similarly, if any of the doors are opened, the CCU will also remove the earth path for the timer relay coil.

Drivers Door Switch Pack

Operation of all four windows can be controlled by the drivers door switch pack. Fuse 29 of the passenger compartment fuse box (C0580) provides a feed to the drivers door switch pack (C0343) on an RB wire. Fuse 8 of the passenger compartment fuse box (C0585) provides a feed to the window lift ECU (C0081) on an SO wire. Both feeds are controlled by the time out relay.

Drivers Door Window

If a request is made to lower the drivers door window, a feed from fuse 8 of the passenger compartment fuse box (C0585) is provided to the window lift motor (C0326) by the window lift ECU (C0081) on an R wire. Current flow across the motor windings (C0326) and back to the window lift ECU (C0081) on a U wire. The drivers door switch pack (C0081) provides an earth path for the motor and the ECU on a B wire.

If a request is made to raise the drivers door window, a feed from fuse 8 of the passenger compartment fuse box (C0585) is provided to the window lift motor (C0326) by the window lift ECU (C0081) on a U wire. Current flow across the motor windings (C0326) and back to the window lift ECU (C0081) on an R wire. The drivers door switch pack (C0081) provides an earth path for the motor and the ECU on a B wire.

Front Passenger Window

If a request is made to lower the front passenger window from the drivers door switch pack, a feed from fuse 29 of the passenger compartment fuse box (C0580) is provided to the 'front down' relay (C0586) on an OU wire. The relay is located in the passenger compartment fuse box and is earthed (C0586) on a B wire.

The energised 'front down' relay (C0586) provides a battery feed from fuse 35 of the passenger compartment fuse box to the window lift motor (C0326) on an OR then R wire. Current flows across the motor windings (C0326) and back to the passenger compartment fuse box (C0586) on a U then OU wire. An earth path is provided for the motor via the de-energised 'front up' relay on a B wire.

DESCRIPTION AND OPERATION

If a request is made to raise the front passenger window from the drivers door switch pack, a feed from fuse 29 of the passenger compartment fuse box (C0580) is provided to the 'front up' relay (C0586) on an OR wire. The relay is located in the passenger compartment fuse box and is earthed (C0586) on a B wire.

The energised 'front up' relay (C0586) provides a battery feed from fuse 35 of the passenger compartment fuse box to the window lift motor (C0326) on an OU then U wire. Current flows across the motor windings (C0326) and back to the passenger compartment fuse box (C0586) on an R then OR wire. An earth path is provided for the motor via the de-energised 'front down' relay on a B wire.

RH Rear Window

If a request is made to lower the RH rear window from the drivers door switch pack, a feed from fuse 29 of the passenger compartment fuse box (C0580) is provided to the 'RR Down' relay (C0583) on a GU wire. The relay is located in the passenger compartment fuse box and is earthed (C0586) on a B wire.

The energised 'RR Down' relay (C0583) provides a battery feed from fuse 33 of the passenger compartment fuse box to the window lift motor (C0304) on a U wire. Current flows across the motor windings (C0304) and back to the passenger compartment fuse box (C0583) on an R wire. An earth path is provided for the motor via the de-energised 'RR Up' relay on a B wire.

If a request is made to raise the RH rear window from the drivers door switch pack, a feed from fuse 29 of the passenger compartment fuse box (C0580) is provided to the 'RR Up' relay (C0583) on a GR wire. The relay is located in the passenger compartment fuse box and is earthed (C0586) on a B wire.

The energised 'RR Up' relay (C0583) provides a battery feed from fuse 33 of the passenger compartment fuse box to the window lift motor (C0304) on an R wire. Current flows across the motor windings (C0304) and back to the passenger compartment fuse box (C0583) on a U wire. An earth path is provided for the motor via the de-energised 'RR Down' relay on a B wire.

LH Rear Window

If a request is made to lower the LH rear window from the drivers door switch pack, a feed from fuse 29 of the passenger compartment fuse box (C0580) is provided to the 'RL Down' relay (C2624) on a WU wire. The relay is located in the passenger compartment fuse box and is earthed (C0587) on a B wire.

The energised 'RL Down' relay (C2625) provides a battery feed from fuse 32 of the passenger compartment fuse box to the window lift motor (C0304) on a U wire. Current flows across the motor windings (C0304) and back to the passenger compartment fuse box (C2625) on an R wire. An earth path is provided for the motor via the de-energised 'RL Up' relay on a B wire.

If a request is made to raise the LH rear window from the drivers door switch pack, a feed from fuse 29 of the passenger compartment fuse box (C0580) is provided to the 'RL Up' relay (C2624) on a WR wire. The relay is located in the passenger compartment fuse box and is earthed (C0587) on a B wire.

The energised 'RL Up' relay (C2625) provides a battery feed from fuse 32 of the passenger compartment fuse box to the window lift motor (C0304) on an R wire. Current flows across the motor windings (C0304) and back to the passenger compartment fuse box (C2625) on a U wire. An earth path is provided for the motor via the de-energised 'RL Down' relay on a B wire.

NOTE: The RH and LH rear window lift motors have the same connector numbers as they utilise the same harness.

Rear Window Inhibit

Operation of the rear door mounted window switches is controlled by the rear window inhibit switch. Fuse 29 of the passenger compartment fuse box (C0580) provides a feed to the rear window inhibit switch (C0343) on an RB wire. When the switch is in the unlock position, current flows across the switch (C0343) to the LH and RH rear door mounted switches (C0732) on a pair of SG wires.

NOTE: The RH and LH rear door mounted window switches have the same connector numbers as they utilise the same harness.

DESCRIPTION AND OPERATION

Passenger Door Window Switch

Fuse 29 of the passenger compartment fuse box (C0580) provides a feed to the passenger door window switch (C0087) on an RB wire. If a request is made to lower the front passenger window, current flows across the switch (C0087) to the 'front down' relay (C0586) on a U then OU wire. The relay is located in the passenger compartment fuse box and is earthed (C0586) on a B wire. Operation of the front passenger window is then as described previously in the **Front Passenger Window** section.

If a request is made to raise the front passenger window, current flows across the switch (C0087) to the 'front up' relay (C0586) on an OR wire. The relay is located in the passenger compartment fuse box and is earthed (C0586) on a B wire. Operation of the front passenger window is then as described previously in the **Front Passenger Window** section.

RH Rear Door Window Switch

If a request is made to lower the RH rear window, current flows across the switch (C0732) to the 'RR Down' relay (C0583) on a WU then GU wire. The relay is located in the passenger compartment fuse box and is earthed (C0586) on a B wire. Operation of the RH rear window is then as described previously in the **RH Rear Window** section.

If a request is made to raise the RH rear window, current flows across the switch (C0732) to the 'RR Up' relay (C0583) on a WR then GR wire. The relay is located in the passenger compartment fuse box and is earthed (C0586) on a B wire. Operation of the RH rear window is then as described previously in the **RH Rear Window** section.

LH Rear Door Window Switch

If a request is made to lower the LH rear window, current flows across the switch (C0732) to the 'RL Down' relay (C2624) on a WU wire. The relay is located in the passenger compartment fuse box and is earthed (C0587) on a B wire. Operation of the LH rear window is then as described previously in the **LH Rear Window** section.

If a request is made to raise the LH rear window, current flows across the switch (C0732) to the 'RL Up' relay (C2624) on a WR wire. The relay is located in the passenger compartment fuse box and is earthed (C0587) on a B wire. Operation of the LH rear window is then as described previously in the **LH Rear Window** section.

WINDOWS – TAIL DOOR

DESCRIPTION

General

The tail door window is opened and closed by using the non-latching switch mounted on the rear of the centre console. Tail door window operation is controlled by the Central Control Unit (CCU), and will only operate when the ignition switch is in the 'ignition' position.

NOTE: The 40 second time out function (see above) does not operate on the tail door window. Tail door window operation will cease as soon as the ignition is switched off.

The tail door window can also be lowered using the remote handset. Pressing and holding the unlock button for approximately 2 seconds will inform the CCU to fully lower the tail door window. The tail door window can be raised by inserting the key in the tail door lock and turning it clockwise.

NOTE: If the key is released before the tail door window has reached the top of its travel, the CCU will lower the window back to the fully open position.

When the tail door handle is operated, a switch in the door handle informs the CCU to delay opening the door and to lower the window approximately 17 mm. This prevents the tail door from being opened with the window still engaged in the seal recess. When the tail door is closed, the CCU lifts the window to engage with the seal recess.

NOTE: When the tail door is open, the tail door window can only be lowered. The window will only raise once the tail door is closed.

If the rear wiper is operational, the tail door window will not lower until the wiper is on a downward stroke. When the window is in the lowered position, wiper operation will be suspended. On 3 door vehicles, the tail door window will be disabled if any of the following occur:

- The soft back is lowered.
- The soft back is removed.
- The hard back is removed.

DESCRIPTION AND OPERATION

Tail Door Window Calibration

When the CCU is changed from transit mode to a valid market mode, and after the vehicle battery has been disconnected, the tail door window must be calibrated to provide the CCU with a window position datum. When the CCU mode is changed to a valid market, or the battery reconnected, the CCU automatically begins the calibration process by energising the down contacts in the window lift relay module until the window lift motor stalls, to ensure the window is fully down. The calibration procedure is completed as follows:

1. Ensure the tail door is closed, the vehicle unlocked and the alarm disarmed.
2. On three door models, ensure the roof is on (hard back) or lowered and secured (soft back).
3. With the ignition on, use the console switch or the vehicle key in the tail door lock to raise the window until the motor stalls with the window fully closed.
4. Switch off the ignition.

NOTE: If the calibration procedure is unsuccessful, the CCU will sound a warning for approximately 0.8 seconds and fully lower the window.

OPERATION

General

Feed from the positive battery terminal (C0921) is supplied to fusible link 3 and fusible link 4 of the engine compartment fuse box (C0632) on an R wire. Fusible link 4 (C0574) provides a constant battery feed to fuse 16 and fuse 31 of the passenger compartment fuse box (C0587) on an N wire. Fusible link 4 also provides a constant battery feed to the Central Control Unit (CCU) (C0593). The CCU is mounted directly onto the rear of the passenger compartment fuse box.

Fusible link 3 (C0571) is connected to the ignition switch (C0028) by an N wire. When the ignition switch is in the 'ignition' position, current flows across the switch (C0028) to fuse 18 of the passenger compartment fuse box (C0588) on a G wire. Fuse 18 provides an ignition feed to the CCU (C0593).

Tail Door Wiper Motor

The CCU will not operate the tail door window if the rear wiper is operational. The CCU (C0428) monitors the condition of the rear wiper by providing a feed to the 'off screen' park switch (C0388) on an OB wire. The 'off screen' park switch is open circuit at all times except when the rear wiper is in the park position. When the wiper is in the park position, current flows across the switch contacts (C0388) to earth on a B wire. The CCU will only operate the tail door window when it registers this earth path.

The CCU (C0428) also monitors the position of the rear wiper by providing a feed to the 'on screen' switch (C0388) on an NG wire. The 'on' screen switch is open circuit at all times except when the rear wiper is at the top of its travel. At this point, the switch contacts close, and an earth path is created on a B wire.

NOTE: The rear wiper will not operate if the tail door glass has not been calibrated.

For more information on rear wiper operation, refer to the **Wipers and Washers** section of this manual.

WIPERS AND WASHERS.

Roof On Switch (3 Door Vehicles Only)

The roof on switch (C0497) is located on the RH 'D' post, and is provided a constant battery feed by fuse 16 of the passenger compartment fuse box (C0580) on a P wire. The roof on switch is closed when the hard back is fitted, or the soft back is in the fitted position. In this instance current flows across the switch (C0497) to the CCU (C0428) on a PY wire.

If the hard back is removed (or the soft back is folded down) the roof on switch becomes open circuit, and the feed to the CCU is removed. The CCU will now inhibit operation of the tail door window.

Tail Door Window Switch

The tail door window switch is located on the centre console. The CCU (C0428) provides feeds to the switch (C0354) on a BR wire and a BK wire. When the switch is moved to the down position, current supplied to the switch on the BR wire flows across the closed switch contacts to earth on a B wire. When the CCU registers this earth, it powers the tail door window down.

When the switch is moved to the up position, current supplied by the CCU on the BK wire flows across the closed switch contacts to earth on a B wire. When the CCU registers this earth, it powers the tail door window up.

Up

When up operation of the tail door window is requested, the CCU (C0429) provides a feed to the window lift relay module (C0043) on an RU wire. The relay module (C0043) is now able to provide a battery feed from fuse 31 of the passenger compartment fuse box (C2625) to the window motor (C0612) on a UB wire. Current flows across the motor windings (C0612) and back to the relay module (C0043) on a UG wire. The relay module (C0043) is earthed on a B wire.

DESCRIPTION AND OPERATION

Down

When down operation of the tail door window is requested, the CCU (C0429) provides a feed to the window lift relay module (C0043) on an RG wire. The relay module (C0043) is now able to provide a battery feed from fuse 31 of the passenger compartment fuse box (C2625) to the window motor (C0612) on a UG wire. Current flows across the motor windings (C0612) and back to the relay module (C0043) on a UB wire. The relay module (C0043) is earthed on a B wire.

Tail Door Window Motor

The CCU needs to know the position of the tail door window at all times (*see Description*). To do this, the CCU (C0429) provides a feed to a hall effect sensor located within the tail door window motor (C0612) on an SP wire. The sensor (C0612) is provided an earth by the CCU (C0430) on a KB wire. The hall effect sensor (C0612) provides a signal feed to the CCU (C0429) on an SR wire, informing it of the position of the tail door window.

Tail Door Open Switch

The CCU (C0428) monitors the condition of the tail door exterior handle by providing a feed to the tail door open switch (C0615) on an N wire. When the tail door handle is operated, current flows across the switch (C0615) to earth on a B wire. When the CCU registers this earth, it delays opening the tail door and lowers the tail door window approximately 17 mm.

The CCU (C0428) also monitors the condition of the tail door barrel switch (C0615) on a US wire. When the key is turned inside the barrel, current flows across the switch (C0615) to earth on a B wire. If the CCU registers a continuous earth path for approximately 2 seconds, it will lower the tail door glass.

SUNROOF

DESCRIPTION

General

An electrically operated sunroof is fitted to 5 door vehicles only. The sunroof will only operate when the ignition switch is in the 'ignition' position, and is controlled via a non-latching rocker switch mounted on the centre console.

When the upper half of the switch is pressed and held, the sunroof will move to its tilt position. When the lower half of the switch is pressed and held, the sunroof will return to its closed position. If the lower half of the switch is pressed and held while the sunroof is in its fully closed position, the sunroof will slide to its fully open position. The sunroof is closed by pressing the upper half of the switch.

OPERATION

General

Feed from the positive battery terminal (C0192) is supplied to fusible link 3 and fusible link 4 of the engine compartment fuse box (C0632) on an R wire. Fusible link 4 (C0574) provides a constant battery feed to the timer relay (C0587) on an NW wire. The auxiliary relay is located in the passenger compartment fuse box.

NOTE: The timer relay also controls operation of the heated seats.

Fusible link 3 (C0571) is connected to the ignition switch (C0028) by an N wire. When the ignition switch is turned to the 'ignition' position, current flows across the switch (C0028) to fuse 18 of the passenger compartment fuse box (C0588) on an NW wire. Fuse 18 provides an ignition feed to the Central Control Unit (CCU) (C0593). The CCU is mounted directly onto the rear of the passenger compartment fuse box.

When the CCU receives an ignition feed from fuse 18, it energises the timer relay by providing an earth path for the relay coil. The energised auxiliary relay provides a feed to fuse 21, which is also located in the passenger compartment fuse box. Fuse 21 (C0585) provides a feed to the sunroof switch (C0363) on an SR wire.

Open

When the bottom half of the sunroof switch is depressed (with the sunroof in the fully closed position), a feed is provided to the sunroof motor (C0614) from the switch (C0363) on a G wire. Current flows across the motor (C0614) and back to the switch (C0363) on an S wire. The switch (C0363) is earthed on a B wire. The motor will now power the sunroof back to the fully open position.

DESCRIPTION AND OPERATION

Close

When the top half of the sunroof switch is depressed (with the sunroof in the fully open position), a feed is provided to the sunroof motor (C0614) from the switch (C0363) on an S wire. Current flows across the motor (C0614) and back to the switch (C0363) on a G wire. The switch (C0363) is earthed on a B wire. The motor will now power the sunroof back to the fully closed position.

Tilt

When the top half of the sunroof switch is depressed (with the sunroof in the fully closed position), a feed is provided to the sunroof motor (C0614) from the switch (C0363) on an S wire. Current flows across the motor (C0614) and back to the switch (C0363) on a G wire. The switch (C0363) is earthed on a B wire. The motor will now power the sunroof to the tilt position.

When the bottom half of the switch is depressed (with the sunroof in the tilt position), a feed is provided to the sunroof motor (C0614) from the switch (C0363) on a G wire. Current flows across the motor (C0614) and back to the switch (C0363) on an S wire. The switch (C0363) is earthed on a B wire. The motor will now power the sunroof back to the fully closed position.

DOOR MIRRORS

DESCRIPTION

General

The electrically operated door mirrors are controlled via the multi-directional switch mounted on the fascia adjacent the instrument pack. Rotating the switch to the left, allows movement of the LH door mirror. A movement in the switch position will now be replicated by the LH door mirror. Rotating the switch to the right allows movement of the RH door mirror in the same way. The central switch position inhibits operation of both door mirrors.

Both mirrors also feature a heating element. The heating elements operate automatically when the ignition switch is in the 'ignition' position, and are not controllable by the driver.

OPERATION

General

Feed from the positive battery terminal (C0192) is supplied to fusible link 3 and fusible link 4 of the engine compartment fuse box (C0632) on an R wire. Fusible link 4 (C0574) provides a constant battery feed to the time-out relay (C0587) and the CCU (C0592) on an NW wire. The time-out relay is controlled by the CCU, which is mounted directly onto the rear of the passenger compartment fuse box. When energised, the time-out relay provides a feed to fuse 15, which is also located in the passenger compartment fuse box.

Fusible link 3 (C0571) is connected to the ignition switch (C0028) by an N wire. When the ignition switch is turned to the 'ignition' position, current flows across the switch (C0028) to fuse 3 of the passenger compartment fuse box (C0588) on an NW wire.

LH Door Mirror

Fuse 15 of the passenger compartment fuse box (C0589) provides a feed to the door mirror switch (C0066) on a G wire. When the door mirror switch is turned to the LH mirror position, it provides feeds and earth paths to the vertical and horizontal motors as follows:

Up

When the door mirror switch is moved upwards, it provides a feed to the LH vertical motor (C0319) on a BY then BP wire. Current flows across the motor (C0319) and back to the switch (C0066) on an SW wire. The switch (C0066) provides the motor an earth path on a B wire. The motor will move the mirror upwards until the switch is released, or it reaches the end of its travel.

DESCRIPTION AND OPERATION

Down

When the door mirror switch is moved downwards, it provides a feed to the LH vertical motor (C0319) on an SW wire. Current flows across the motor (C0319) and back to the switch (C0066) on a BP then BY wire. The switch (C0066) provides the motor an earth path on a B wire. The motor will move the mirror downwards until the switch is released, or it reaches the end of its travel.

Left

When the door mirror switch is moved to the left, it provides a feed to the LH horizontal mirror (C0319) on an SW wire. Current flows across the motor (C0319) and back to the switch (C0066) on a BN then BU wire. The switch (C0066) provides the motor an earth path on a B wire. The motor will move the mirror left until the switch is released, or it reaches the end of its travel.

Right

When the door mirror switch is moved to the right, it provides a feed to the LH horizontal mirror (C0319) on a BU then BN wire. Current flows across the motor (C0319) and back to the switch (C0066) on an SW wire. The switch (C0066) provides the motor an earth path on a B wire. The motor will move the mirror right until the switch is released, or it reaches the end of its travel.

RH Door Mirror

Fuse 15 of the passenger compartment fuse box (C0589) provides a feed to the door mirror switch (C0066) on a G wire. When the door mirror switch is turned to the RH mirror position, it provides feeds and earth paths to the vertical and horizontal motors as follows:

Up

When the door mirror switch is moved upwards, it provides a feed to the RH vertical motor (C0319) on a BP wire. Current flows across the motor (C0319) and back to the switch (C0066) on an SW wire. The switch (C0066) provides the motor an earth path on a B wire. The motor will move the mirror upwards until the switch is released, or it reaches the end of its travel.

Down

When the door mirror switch is moved downwards, it provides a feed to the RH vertical motor (C0319) on an SW wire. Current flows across the motor (C0319) and back to the switch (C0066) on a BP wire. The switch (C0066) provides the motor an earth path on a B wire. The motor will move the mirror downwards until the switch is released, or it reaches the end of its travel.

Left

When the door mirror switch is moved to the left, it provides a feed to the RH horizontal mirror (C0319) on an SW wire. Current flows across the motor (C0319) and back to the switch (C0066) on a BN wire. The switch (C0066) provides the motor an earth path on a B wire. The motor will move the mirror left until the switch is released, or it reaches the end of its travel.

Right

When the door mirror switch is moved to the right, it provides a feed to the RH horizontal mirror (C0319) on a BN wire. Current flows across the motor (C0319) and back to the switch (C0066) on an SW wire. The switch (C0066) provides the motor an earth path on a B wire. The motor will move the mirror right until the switch is released, or it reaches the end of its travel.

NOTE: Both the LH and RH door mirror motors have the same connector number as they utilise the same harness.

Door Mirror Heater Elements

Fuse 3 of the passenger compartment fuse box (C0581) provides an ignition feed to the LH and RH door mirror heater elements (C0319) on NG wires. The heater elements (C0319) are earthed on B wires.

NOTE: Both the LH and RH door mirror heater elements have the same connector number as they utilise the same harness.

DESCRIPTION AND OPERATION

FOLDING DOOR MIRRORS

DESCRIPTION

General

Certain markets are fitted with folding door mirrors. The door mirrors can be moved to their folded position by rotating the mirror switch to the centre position, then moving the switch downwards. Moving the switch downwards a second time returns the mirrors to their original position.

For more information on door mirror operation, refer to the ***Door Mirrors*** section of this manual.

DOOR MIRRORS.

OPERATION

General

Feed from the positive battery terminal (C0192) is supplied to fusible link 3 and fusible link 4 of the passenger compartment fuse box (C0632) on an R wire. Fusible link 4 (C0574) provides a feed to the time-out relay and fuse 16 of the passenger compartment fuse box (C0587) on an NW wire. Operation of the time-out relay is controlled by the Central Control Unit (CCU) (C0592).

Folding Mirror ECU

Fuse 16 of the passenger compartment fuse box (C0580) provides a constant battery feed to the folding mirror ECU (C0907) on a P then NS wire. The folding mirror ECU is located at the base of the passenger side 'A' post, and is earthed on a B wire.

The folding mirror ECU (C0907) monitors the condition of the door mirror switch (C0066) on a UB wire. When the switch is pressed, a momentary earth path is created on a B wire via the door mirror switch (C0066) and the passenger compartment fuse box (C0589 & C0587) on a B wire. When the folding mirror ECU senses this earth, it powers both folding mirror motors.

Door Mirrors

When the folding mirror ECU senses the door mirror switch has been pressed, it provides a feed to the LH folding mirror motor (C0444) on a Y then R wire, and the RH folding mirror motor (C0444) on a Y then B wire. Current flows across the motors (C0444) and back to the folding mirror ECU on a B then O wire (LH) and an R then O wire (RH).

DESCRIPTION AND OPERATION

When the folding mirror ECU senses the door mirror switch has been pressed for a second time, it provides a feed to the LH folding mirror motor (C0444) on an O then B wire, and the RH folding mirror motor (C0444) on an O then R wire. Current flows across the motors (C0444) and back to the folding mirror ECU on an R then Y wire (LH) and a B then Y wire (RH).

NOTE: The LH and RH door mirrors have the same connector numbers as they utilise the same harness.

DESCRIPTION AND OPERATION

HEATED SEATS

DESCRIPTION

General

The heated front seats are switched on and off by pressing either of the switches mounted on the centre console. The heated front seats are operated independently of each other. The switches also incorporate an illumination LED to show when the seat heaters are switched on.

OPERATION

General

Feed from the positive battery terminal (C0192) is supplied to fusible link 3 and fusible link 4 of the engine compartment fuse box (C0632) on an R wire. Fusible link 4 (C0574) is connected to the timer relay (C0587) by an NW wire. The earth path for the relay coil is controlled by the Central Control Unit (CCU) (C0592), which is mounted directly onto the rear of the passenger compartment fuse box.

Fusible link 3 (C0571) is connected to the ignition switch (C0028) by an N wire. When the ignition switch is turned to the 'ignition' position, current flows across the switch (C0028) to fuse 18 of the passenger compartment fuse box (C0588) on an OG wire. Fuse 18 provides an ignition feed to the CCU.

When the CCU receives an ignition feed, it energises the timer relay by providing an earth path for the relay coil. The energised timer relay provides a feed to fuse 11, which is also located in the passenger compartment fuse box.

Fuse 11 (C0585) provides a feed to the LH heated seat switch (C0249) and the RH heated seat switch (C0250) on N wires.

LH Seat

When the LH heated seat switch is pressed, current flows across the switch contacts (C0249) to the LH heated seat relay (C1221) on a US then R wire. Operation of the heated seat relay (C1221) is controlled by the temperature sensor on a G wire. The temperature sensor is a normally closed switch. Current flows across the switch to earth on a G then N then B wire.

When the temperature of the seat is within acceptable levels, the heated seat relay (C1221) provides a feed to the seat heater elements on an RW wire. The elements are wired in series and earthed on an N then B wire.

If the temperature sensor detects the temperature of the seat is too high, it cuts the earth path for the heated seat relay. This de-energises the relay until seat heat temperature decreases to acceptable levels.

RH Seat

When the RH heated seat switch is pressed, current flows across the switch contacts (C0250) to the RH heated seat relay (C1221) on a UK then R wire. Operation of the heated seat relay (C1221) is controlled by the temperature sensor on a G wire. The temperature sensor is a normally closed switch. Current flows across the switch to earth on a G then N then B wire.

When the temperature of the seat is within acceptable levels, the heated seat relay (C1221) provides a feed to the seat heater elements on an RW wire. The elements are wired in series and earthed on an N then B wire.

If the temperature sensor detects the temperature of the seat is too high, it cuts the earth path for the heated seat relay. This de-energises the relay until seat heat temperature decreases to acceptable levels.

DESCRIPTION AND OPERATION

DIAGNOSTIC SOCKET

DESCRIPTION

General

The diagnostic socket is located behind the centre console, and is accessible from the drivers footwell on NAS vehicles, or the passenger footwell on all other vehicle derivatives. The socket is compliant with SAE directive J1962 standard, and allows attachment of TestBook, T4, or any other suitable diagnostic software tool. It allows detailed fault diagnosis checks to be carried out on the vehicle via an ISO 9141 K Line.

OPERATION

General

Feed from the positive battery terminal (C0192) is supplied to fusible link 4 of the engine compartment fuse box (C0632) on an R wire. Fusible link 4 (C0574) is connected to fuse 16 of the passenger compartment fuse box (C0587) by an NW wire. Fuse 16 (C0580) provides a constant battery feed to the diagnostic socket (C0040) on a P wire.

The diagnostic socket is earthed on a pair of B wires.

The diagnostic socket (C0040) communicates with the following systems and components via the K line on K wires:

- The instrument pack (C0230).
- The Central Control Unit (CCU) (C0429).
- The SRS DCU (C0256).
- The cruise control ECU (KV6 ROW vehicles only) (C0239).
- The Electronic Automatic Transmission Electronic Control Unit (EAT ECU) (Td4 and KV6 vehicles only) (C0932).
- The Engine Control Module (ECM) (KV6 NAS vehicles only) (C0331).
- The Engine Control Module (ECM) (KV6 ROW vehicles only) (C0371).
- The ECM (K1.8 vehicles only) (C0913).
- The ECM (Td4 vehicles only) (C0603).
- The Fuel Burning Heater (FBH) (Td4 vehicles only) (C0925).

The diagnostic socket (C0040) also communicates with the immobilisation ECU (C0059) and the ABS ECU (C0501) via the DS-2 bus on a K wire.

CENTRAL CONTROL UNIT (CCU)

DESCRIPTION

General

For a full description of the CCU, refer to the **Control Units** section of the System Description and Operation Workshop manual.

OPERATION

General

For a full description of CCU operation, refer to the **Control Units** section of the System Description and Operation Workshop manual.

NOTE: The CCU is mounted directly onto the rear of the passenger compartment fuse box. As there is no harness connecting the passenger compartment fuse box to the CCU, connectors C0592 and C0593 are not shown in the 'Connector' section of this manual. For details on these connectors, refer to the 'Control Units' section of the System Description and Operation Workshop manual.

DESCRIPTION AND OPERATION

CHARGING AND STARTING – Td4

DESCRIPTION

Starting

The starting system on the vehicle comprises a 12 volt starter motor which drives the engine to start the combustion process. The starter converts electrical energy into mechanical power. The vehicle electrical system must be capable of supplying sufficient power to enable the engine to be cranked.

Charging

The charging system comprises a battery and an alternator. The battery must be of a sufficient capacity to operate the starter motor and operate various electrical systems in the vehicle. The alternator charges the battery when the engine is running and increases its output as demand on the battery increases.

The instrument pack incorporates a charge warning lamp which illuminates when there is no output or a low output from the alternator. For a detailed description of the charging and starting system, refer to the ***Engine Management Systems – EDC*** section of the System Description and Operation Workshop manual.

OPERATION

General

Feed from the positive battery terminal (C0192) is supplied to the main relay, fusible link 1, fusible link 3, fusible link 6, and fuse 10 (C0632) on an R wire. All are located in the engine compartment fuse box. The battery (C0192) also supplies a constant feed to the starter motor solenoid (C0631) on an R wire.

Fusible link 1 is connected in series with fusible link 7, which is also located in the engine compartment fuse box.

Fusible link 3 (C0571) is connected to the ignition switch (C0028) by an N wire. When the ignition switch is turned to the 'ignition' position, current flows across the switch (C0028) to fuse 18, fuse 22, and fuse 41 of the passenger compartment fuse box (C0588) on a G wire.

When the ignition switch is turned to the 'crank' position, current flows across the switch (C0028) to fuse 5 of the passenger compartment fuse box (C0588) on a WR wire.

Starting

Main Relay

The earth path for the main relay coil (C0576) is controlled by the Engine Control Module (ECM) (C0603) on a WK wire. The energised main relay provides a feed to fuse 1 which is also located in the engine compartment fuse box. Fuse 1 (C0576) provides a feed to the glow plug relay (C0215) on an RW wire.

For a detailed description of main relay operation, refer to the **Engine Management Systems – EDC** section of the System Description and Operation Workshop manual.

Inertia Switch

Fuse 10 of the engine compartment fuse box (C0575) provides a constant battery feed to the inertia switch (C0123) on a G wire. The inertia switch is a normally closed switch. If the inertia switch hasn't been tripped, current flows across the switch (C0123) to the fuel pump relay (C0575) on a GU wire.

The inertia switch (C0123) also provides a feed to the Central Control Unit (CCU) (C0428) on a GU wire. For more information on the CCU, refer to the **Control Units** section of the Workshop manual, and the **Anti-theft Alarm and Central Door Locking (CDL)** section of this manual.

 **ANTI-THEFT ALARM AND CENTRAL DOOR LOCKING (CDL).**

Fuel Pump Relay

The fuel pump relay coil receives a feed from the energised main relay. The earth path for the relay coil (C0575) is controlled by the ECM (C0331) on a BP wire. The ECM will energise the fuel pump relay when it receives an ignition feed from fuse 22 of the passenger compartment fuse box (C0580) on a W wire.

The energised fuel pump relay (C0572) provides a feed to the fuel pump (C0205) on a WP wire. The fuel pump (C0205) is earthed on a B wire.

Glow Plug Relay

Fuse 22 of the passenger compartment fuse box (C0580) provides an ignition feed to the ECM (C0603) on a W wire. If all criteria are met, the ECM (C0606) provides an earth path for the glow plug relay coil (C0215) on a BR wire.

Fusible link 6 of the engine compartment fuse box (C0577) provides a constant battery feed to the glow plug relay switch (C0215) on an NW wire. When the relay is energised, the switch contacts close, allowing the glow plug relay to provide a feed to the following:

- To glow plug number 1 (C0476) on a BG wire.
- To glow plug number 2 (C0477) on a BP wire.
- To glow plug number 3 (C0478) on a BY wire.
- To glow plug number 4 (C0479) on a BR wire.

For more details of glow plug operation, refer to the **Engine Management Systems – EDC** section of the Workshop manual.

DESCRIPTION AND OPERATION

Starter Relay

Fuse 5 of the passenger compartment fuse box (C0581) provides an ignition switch 'crank' feed to the immobilisation ECU (C0059) on a WR wire. If the vehicle has been successfully re-mobilised, the immobilisation ECU (C0059) provides a feed to the starter relay coil (C0576) on an RW wire. The starter relay is located in the engine compartment fuse box, and is earthed (C0576) on a B wire. A battery feed from fusible link 7 is now able to flow across the starter relay switch contacts (C0572) to the starter motor solenoid (C0178) on an NR then B wire.

For a detailed description of the immobilisation ECU, refer to the ***Engine Immobilisation*** section of this manual.

 **ENGINE IMMOBILISATION.**

Starter Motor and Starter Motor Solenoid

The starter motor solenoid coil (C0178) receives a feed from the energised starter motor relay (C0572) on an NR then B wire (*see above*). The energised starter motor solenoid allows a battery feed (C0178) to flow across the switch contacts and power the starter motor.

Central Control Unit (CCU)

The CCU (C0428) receives a feed from the inertia switch (C0123) on a GU wire. If this feed is removed due to the inertia switch being tripped, the CCU will unlock all of the doors. For more details of CCU operation, refer to the ***Control Units*** section of the Workshop manual. For more details of the Central Door Locking (CDL) system, refer to the ***Anti-theft Alarm and Central Door Locking (CDL)*** section of this manual.

 **ANTI-THEFT ALARM AND CENTRAL DOOR LOCKING (CDL).**

NOTE: The CCU will only unlock all doors if the ignition switch is in the 'ignition' position.

The CCU (C0429) also provides a signal feed to the immobilisation ECU (C0059) on a KN wire. This signal feed informs the immobilisation ECU to energise the starter relay. For a detailed description of the immobilisation ECU, refer to the ***Engine Immobilisation*** section of this manual.

 **ENGINE IMMOBILISATION.**

Charging

Alternator

The battery (C0192) provides a permanent feed to the alternator (C0183) via the starter motor (C0631) on an R then N wire. Fuse 41 of the passenger compartment fuse box (C0583) provides an ignition feed to the alternator (C0226) on a W then GN wire.

When the engine is turned over, the alternator (C0226) supplies the ECM (C0606) a Pulse Width Modulated (PWM) signal on a U wire. The ECM uses this PWM signal to calculate the electrical load on the alternator, and controls engine idle speed accordingly.

When the engine is started, the magnetised rotor within the stator windings generate 3 phase alternating current (ac) and voltage that rises rapidly with rotor speed. The field diodes in the rectifier pack convert the ac current into direct current (dc). Output current from the field diodes supplements the initial current flowing through the field windings. This causes an increase in the magnetic influence of the rotor, resulting in self-excitation of the alternator. The field current increases with rotor speed and thus increases the generated current and voltage until the alternator is fully excited. The alternator (C0183) charges the battery (C0192) by providing current on an N then R wire.

Ignition/No charge Warning Lamp

Fuse 18 of the passenger compartment fuse box (C0589) provides an ignition feed to the ignition/no charge warning lamp (C0233) on a G wire. Illumination of the warning lamp (C0233) is controlled by the ECM (C0331) on an NY wire.

DESCRIPTION AND OPERATION

CHARGING AND STARTING – K SERIES

DESCRIPTION

Starting

The starting system on the vehicle comprises a 12 volt starter motor which drives the engine to start the combustion process. The starter converts electrical energy into mechanical power. The vehicle electrical system must be capable of supplying sufficient power to enable the engine to be cranked.

Charging

The charging system comprises a battery and an alternator. The battery must be of a sufficient capacity to operate the starter motor and operate various electrical systems in the vehicle. The alternator charges the battery when the engine is running and increases its output as demand on the battery increases.

The instrument pack incorporates a charge warning lamp which illuminates when there is no output or a low output from the alternator. For a detailed description of the charging and starting system, refer to the ***Engine Management Systems – MEMS*** section of the System Description and Operation Workshop manual.

OPERATION

General

Feed from the positive battery terminal (C0192) is supplied to fusible link 1, fusible link 3, fuse 10 and the main relay (C0632) on an R wire. All are located within the engine compartment fuse box. The battery (C0192) also provides a feed to the starter motor solenoid (C0178) on an R wire.

Fusible link 1 is connected in series with fusible link 7, which is also located within the engine compartment fuse box.

Fusible link 3 (C0571) is connected to the ignition switch (C0028) by an N wire. When the ignition switch is turned to the 'ignition' position, current flows across the switch (C0028) to fuse 18, fuse 22, and fuse 41 of the passenger compartment fuse box (C0588) on a G wire.

When the ignition switch is turned to the 'crank' position, current flows across the switch (C0028) to fuse 5 of the passenger compartment fuse box (C0588) on a WR wire.

Starting

Main Relay

Fuse 22 of the passenger compartment fuse box (C0580) provides an ignition feed to the Engine Control Module (ECM) (C0913) on a W wire. When the ECM receives this feed, it energises the main relay by providing an earth path for the relay coil (C0576) on a WK wire. The energised main relay is now able to provide a feed to the fuel pump relay. The fuel pump relay is also located in the engine compartment fuse box.

For a detailed description of main relay operation, refer to the **Engine Management Systems – MEMS** section of the System Description and Operation Workshop manual.

Inertia Switch

Fuse 10 of the engine compartment fuse box (C0575) provides a constant battery feed to the inertia switch (C0123) on a G wire. The inertia switch is a normally closed switch. If the inertia switch hasn't been tripped, current flows across the switch (C0123) to the fuel pump relay (C0575) on a GU wire.

The inertia switch (C0123) also provides a feed to the Central Control Unit (CCU) (C0428) on a UG wire. For more information on the CCU, refer to the **Control Units** section of the Workshop manual, and the **Anti-theft Alarm and Central Door Locking (CDL)** section of this manual.

 **ANTI-THEFT ALARM AND CENTRAL DOOR LOCKING (CDL).**

Fuel Pump Relay

The fuel pump relay coil receives a feed from the energised main relay (*see above*). The earth path for the relay coil (C0575) is controlled by the ECM (C0913) on a BP wire. The ECM will energise the fuel pump relay when it receives an ignition feed from fuse 22 of the passenger compartment fuse box (C0581) on a W wire.

The energised fuel pump relay (C0572) provides a feed to the fuel pump (C0114) on a WP wire. The pump (C0114) is earthed on a B wire.

Starter Relay

Fuse 5 of the passenger compartment fuse box (C0581) provides an ignition switch 'crank' feed to the immobilisation ECU (C0059) on a WR wire. If the vehicle has been successfully re-mobilised, the immobilisation ECU (C0059) provides a feed to the starter relay coil (C0576) on a RW wire. The starter relay is located in the engine compartment fuse box, and is earthed (C0576) on a B wire. A battery feed from fusible link 7 is now able to flow across the starter relay switch contacts (C0572) to the starter motor solenoid (C0179) on an NR wire.

For a detailed description of the immobilisation ECU, refer to the **Engine Immobilisation** section of this manual.

 **ENGINE IMMOBILISATION.**

DESCRIPTION AND OPERATION

Starter Motor and Starter Motor Solenoid

The starter motor solenoid coil (C0179) receives a feed from the energised starter motor relay (C0572) on an NR wire (*see above*). The energised starter motor solenoid allows a battery feed (C0178) to flow across the switch contacts and power the starter motor.

Central Control Unit (CCU)

The CCU (C0428) receives a feed from the inertia switch (C0123) via the engine compartment fuse box (C0576) on a UG wire. If this feed is removed due to the inertia switch being tripped, the CCU will unlock all of the doors. For more details of the Central Door Locking (CDL) system, refer to the ***Anti-theft Alarm and Central Door Locking (CDL)*** section of this manual.

ANTI-THEFT ALARM AND CENTRAL DOOR LOCKING (CDL).

NOTE: The CCU will only unlock all doors if the ignition switch is in the 'ignition' position.

The CCU (C0429) also provides a signal feed to the immobilisation ECU (C0059) on a KN wire. This signal feed informs the immobilisation ECU to energise the starter relay. For a detailed description of the immobilisation ECU, refer to the ***Engine Immobilisation*** section of this manual.

ENGINE IMMOBILISATION.

Charging

Alternator

Fusible link 1 of the engine compartment fuse box (C0826) provides a constant battery feed to the alternator (C0183) on an R wire. Fuse 41 of the passenger compartment fuse box (C0583) provides an ignition feed to the alternator (C0185) on a W wire.

When the engine is started, the magnetised rotor within the stator windings generate 3 phase alternating current (ac) and voltage that rises rapidly with rotor speed. The field diodes in the rectifier pack convert the ac current into direct current (dc). Output current from the field diodes supplements the initial current flowing through the field windings. This causes an increase in the magnetic influence of the rotor, resulting in self-excitation of the alternator. The field current increases with rotor speed and thus increases the generated current and voltage until the alternator is fully excited.

When the engine is running, the alternator (C0185) supplies the ECM (C0914) with a Pulse Width Modulated (PWM) signal on a WR wire. The ECM uses the PWM signal to calculate electrical load on the alternator, and controls idle speed accordingly.

The alternator (C0183) charges the battery by providing current via fusible link 1 of the engine compartment fuse box (C0826 & C0632) to the battery positive terminal (C0192) on an R wire.

Ignition/No Charge Warning Lamp

Fuse 18 of the passenger compartment fuse box (C0589) provides an ignition feed to the ignition/no charge warning lamp (C0233) on a G wire. Current flows across the lamp (C0233) and is provided an earth path by the alternator (C0185) on an NY wire. The warning lamp will now illuminate.

When the alternator is charging, it provides a feed to the warning lamp (C0233) on the NY wire. Because the potential difference across the bulb is 0 V, the lamp will now extinguish.

DESCRIPTION AND OPERATION

CHARGING AND STARTING – KV6

DESCRIPTION

Starting

The starting system on the vehicle comprises a 12 volt starter motor which drives the engine to start the combustion process. The starter converts electrical energy into mechanical power. The vehicle electrical system must be capable of supplying sufficient power to enable the engine to be cranked.

Charging

The charging system comprises a battery and an alternator. The battery must be of a sufficient capacity to operate the starter motor and operate various electrical systems in the vehicle. The alternator charges the battery when the engine is running and increases its output as demand on the battery increases.

The instrument pack incorporates a charge warning lamp which illuminates when there is no output or a low output from the alternator. For a detailed description of the charging and starting system, refer to the ***Engine Management Systems – Siemens (All Except NAS)*** section of the System Description and Operation Workshop manual.

OPERATION

General

Feed from the positive battery terminal (C0192) is supplied to fusible link 1, fusible link 3, fuse 10, and the main relay (C0632) on an R wire. All are located in the engine compartment fuse box. The battery (C0192) also provides a feed to the starter motor solenoid (C0178) on an R wire.

Fusible link 1 is connected in series with fusible link 7, which is also located in the engine compartment fuse box.

Fusible link 3 (C0571) is connected to the ignition switch (C0028) by an N wire. When the ignition switch is turned to the 'ignition' position, current flows across the switch (C0028) to fuse 18, fuse 22, and fuse 41 of the passenger compartment fuse box (C0588) on a G wire.

When the ignition switch is turned to the 'crank' position, current flows across the switch (C0028) to fuse 5 of the passenger compartment fuse box (C0588) on a WR wire.

Starting

Main Relay

Fuse 22 of the passenger compartment fuse box (C0580) provides an ignition feed to the Engine Control Module (ECM) (C0371) on a W wire. When the ECM receives this feed, it energises the main relay by providing an earth path for the relay coil (C0578) on a WK wire. The energised main relay is now able to provide a feed to the fuel pump relay. The fuel pump relay is also located in the engine compartment fuse box.

Inertia Switch

Fuse 10 of the engine compartment fuse box (C0575) provides a constant battery feed to the inertia switch (C0123) on a G wire. The inertia switch is a normally closed switch. If the inertia switch hasn't been tripped, current flows across the switch (C0123) to the fuel pump relay (C0575) on a GU wire.

The inertia switch (C0123) also provides a feed to the Central Control Unit (CCU) (C0428) on a UG wire. For more information on the CCU, refer to the **Control Units** section of the Workshop manual, and the **Anti-theft Alarm and Central Door Locking (CDL)** section of this manual.

 **ANTI-THEFT ALARM AND CENTRAL DOOR LOCKING (CDL).**

Fuel Pump Relay

The fuel pump relay coil receives a feed from the energised main relay (*see above*). The earth path for the relay coil (C0575) is controlled by the ECM (C0371) on a BP wire. The ECM will energise the fuel pump relay when it receives an ignition feed from fuse 22 of the passenger compartment fuse box (C0580) on a W wire.

The energised fuel pump relay (C0572) provides a feed to the fuel pump (C0114) on a WP wire. The fuel pump (C0114) is earthed on a B wire.

Starter Relay

Fuse 5 of the passenger compartment fuse box (C0581) provides an ignition switch 'crank' feed to the immobilisation ECU (C0059) on a WR wire. If the vehicle has been successfully re-mobilised, the immobilisation ECU (C0059) provides a feed to the starter relay coil (C0576) on a RW wire. The starter relay is located in the engine compartment fuse box, and is earthed (C0576) on a B wire. A feed from fusible link 7 is now able to flow across the starter relay switch contacts (C0572) to the starter motor solenoid (C0179) on an NR wire.

For a detailed description of the immobilisation ECU, refer to the **Engine Immobilisation** section of this manual.

 **ENGINE IMMOBILISATION.**

DESCRIPTION AND OPERATION

Starter Motor and Starter Motor Solenoid

The starter motor solenoid coil (C0179) receives a feed from the energised starter relay (C0572) on an NR wire (*see above*). The energised starter motor solenoid allows a battery feed (C0178) to flow across the switch contacts and power the starter motor.

Central Control Unit (CCU)

The CCU (C0428) receives a feed from the inertia switch (C0123) via the engine compartment fuse box (C0576) on a UG wire. If this feed is removed due to the inertia switch being tripped, the CCU will unlock all of the doors. For more details of the Central Door Locking (CDL) system, refer to the ***Anti-theft Alarm and Central Door Locking (CDL)*** section of this manual.

ANTI-THEFT ALARM AND CENTRAL DOOR LOCKING (CDL).

NOTE: The CCU will only unlock all doors if the ignition switch is in the 'ignition' position.

The CCU (C0429) also provides a signal feed to the immobilisation ECU (C0059) on a KN wire. This signal feed informs the immobilisation ECU to energise the starter relay. For a detailed description of the immobilisation ECU, refer to the ***Engine Immobilisation*** section of this manual.

ENGINE IMMOBILISATION.

Charging

Alternator

Fusible link 1 of the engine compartment fuse box (C0826) provides a constant battery feed to the alternator (C0183) on an R wire. Fuse 41 of the passenger compartment fuse box (C0583) provides an ignition feed to the alternator (C0053) on a W wire.

When the engine is turned over, the alternator (C0053) supplies the ECM (C0371) with a Pulse Width Modulated (PWM) signal on a GK wire. The ECM uses this PWM signal to calculate the electrical load on the alternator, and controls engine idle speed accordingly.

When the engine is started, the magnetised rotor within the stator windings generate 3 phase alternating current (ac) and voltage that rises rapidly with rotor speed. The field diodes in the rectifier pack convert the ac current into direct current (dc). Output current from the field diodes supplements the initial current flowing through the field windings. This causes an increase in the magnetic influence of the rotor, resulting in self-excitation of the alternator. The field current increases with rotor speed and thus increases the generated current and voltage until the alternator is fully excited.

The alternator (C0183) charges the battery by providing current via fusible link 1 of the engine compartment fuse box (C0826 & C0632) to the battery positive terminal (C0192) on an R wire.

Ignition/No Charge Warning Lamp

Fuse 18 of the passenger compartment fuse box (C0589) provides an ignition feed to the ignition/no charge warning lamp (C0233) on a G wire. Current flows across the lamp (C0233) and is provided an earth path by the alternator (C0053) on an NY wire. The warning lamp will now illuminate.

When the alternator is charging, it provides a feed to the warning lamp (C0233) on the NY wire. Because the potential difference across the bulb is 0 V, the lamp will now extinguish.

DESCRIPTION AND OPERATION

CHARGING AND STARTING – KV6 (NORTH AMERICA)

DESCRIPTION

Starting

The starting system on the vehicle comprises a 12 volt starter motor which drives the engine to start the combustion process. The starter converts electrical energy into mechanical power. The vehicle electrical system must be capable of supplying sufficient power to enable the engine to be cranked.

Charging

The charging system comprises a battery and an alternator. The battery must be of a sufficient capacity to operate the starter motor and operate various electrical systems in the vehicle. The alternator charges the battery when the engine is running and increases its output as demand on the battery increases.

The instrument pack incorporates a charge warning lamp which illuminates when there is no output or a low output from the alternator. For a detailed description of the charging and starting system, refer to the ***Engine Management Systems – Siemens (NAS)*** section of the System Description and Operation Workshop manual.

OPERATION

General

Feed from the positive battery terminal (C0192) is supplied to fusible link 1, fusible link 3, fuse 10, and the main relay (C0632) on an R wire. All are located in the engine compartment fuse box. The battery (C0192) also provides a feed to the starter motor solenoid (C0178) on an R wire.

Fusible link 1 is connected in series with fusible link 7, which is also located in the engine compartment fuse box.

Fusible link 3 (C0571) is connected to the ignition switch (C0028) by an N wire. When the ignition switch is turned to the 'ignition' position, current flows across the switch (C0028) to fuse 18, fuse 22, and fuse 41 of the passenger compartment fuse box (C0588) on a G wire.

When the ignition switch is turned to the 'crank' position, current flows across the switch (C0028) to fuse 5 of the passenger compartment fuse box (C0588) on a WR wire.

Starting

Main Relay

Fuse 22 of the passenger compartment fuse box (C0580) provides an ignition feed to the Engine Control Module (ECM) (C0603) on a W wire. When the ECM receives this feed, it energises the main relay by providing an earth path for the relay coil (C0578) on an NG wire. The energised main relay is now able to provide a feed to the fuel pump relay. The fuel pump relay is also located in the engine compartment fuse box.

Inertia Switch

Fuse 10 of the engine compartment fuse box (C0575) provides a constant battery feed to the inertia switch (C0123) on a G wire. The inertia switch is a normally closed switch. If the inertia switch hasn't been tripped, current flows across the switch (C0123) to the fuel pump relay (C0575) on a GU wire.

The inertia switch (C0123) also provides a feed to the Central Control Unit (CCU) (C0428) on a UG wire. For more information on the CCU, refer to the **Control Units** section of the Workshop manual, and the **Anti-theft Alarm and Central Door Locking (CDL)** section of this manual.

 **ANTI-THEFT ALARM AND CENTRAL DOOR LOCKING (CDL).**

Fuel Pump Relay

The fuel pump relay coil receives a feed from the energised main relay (*see above*). The earth path for the relay coil (C0575) is controlled by the ECM (C0331) on a BP wire. The ECM will energise the fuel pump relay when it receives an ignition feed from fuse 22 of the passenger compartment fuse box (C0581) on a W wire.

The energised fuel pump relay (C0572) provides a feed to the fuel pump (C0114) on a WP wire. The fuel pump (C0114) is earthed on a B wire.

Starter Relay

Fuse 5 of the passenger compartment fuse box (C0581) provides an ignition switch 'crank' feed to the immobilisation ECU (C0059) on a WR wire. If the vehicle has been successfully re-mobilised, the immobilisation ECU (C0059) provides a feed to the starter relay coil (C0576) on a RW wire. The starter relay is located in the engine compartment fuse box, and is earthed (C0576) on a B wire. A feed from fusible link 7 is now able to flow across the starter relay switch contacts (C0572) to the starter motor solenoid (C0179) on an NR wire.

For a detailed description of the immobilisation ECU, refer to the **Engine Immobilisation** section of this manual.

 **ENGINE IMMOBILISATION.**

DESCRIPTION AND OPERATION

Starter Motor and Starter Motor Solenoid

The starter motor solenoid coil (C0179) receives a feed from the energised starter relay (C0572) on an NR wire (see above). The energised starter motor solenoid allows a battery feed (C0178) to flow across the switch contacts and power the starter motor.

Central Control Unit (CCU)

The CCU (C0428) receives a feed from the inertia switch (C0123) via the engine compartment fuse box (C0576) on a UG wire. If this feed is removed due to the inertia switch being tripped, the CCU will unlock all of the doors. For more details of the Central Door Locking (CDL) system, refer to the ***Anti-theft Alarm and Central Door Locking (CDL)*** section of this manual.

ANTI-THEFT ALARM AND CENTRAL DOOR LOCKING (CDL).

NOTE: The CCU will only unlock all doors if the ignition switch is in the 'ignition' position.

The CCU (C0429) also provides a signal feed to the immobilisation ECU (C0059) on a KN wire. This signal feed informs the immobilisation ECU to energise the starter relay. For a detailed description of the immobilisation ECU, refer to the ***Engine Immobilisation*** section of this manual.

ENGINE IMMOBILISATION.

Charging

Alternator

Fusible link 1 of the engine compartment fuse box (C0826) provides a constant battery feed to the alternator (C0183) on an R wire. Fuse 41 of the passenger compartment fuse box (C0583) provides an ignition feed to the alternator (C0053) on a W wire.

When the engine is turned over, the alternator (C0053) supplies the ECM (C0331) with a Pulse Width Modulated (PWM) signal on a GK wire. The ECM uses this PWM signal to calculate the electrical load on the alternator, and controls engine idle speed accordingly.

When the engine is started, the magnetised rotor within the stator windings generate 3 phase alternating current (ac) and voltage that rises rapidly with rotor speed. The field diodes in the rectifier pack convert the ac current into direct current (dc). Output current from the field diodes supplements the initial current flowing through the field windings. This causes an increase in the magnetic influence of the rotor, resulting in self-excitation of the alternator. The field current increases with rotor speed and thus increases the generated current and voltage until the alternator is fully excited.

The alternator (C0183) charges the battery by providing current via fusible link 1 of the engine compartment fuse box (C0826 & C0632) to the battery positive terminal (C0192) on an R wire.

Ignition/No Charge Warning Lamp

Fuse 18 of the passenger compartment fuse box (C0589) provides an ignition feed to the ignition/no charge warning lamp (C0233) on a G wire. Current flows across the lamp (C0233) and is provided an earth path by the alternator (C0053) on an NY wire. The warning lamp will now illuminate.

When the alternator is charging, it provides a feed to the warning lamp (C0233) on the NY wire. Because the potential difference across the bulb is 0 V, the lamp will now extinguish.

DESCRIPTION AND OPERATION

CRUISE CONTROL – TD4 & KV6 (NORTH AMERICA)

DESCRIPTION

General

Cruise control is switched on by pressing the cruise control master switch mounted on the drivers side of the fascia. The 'Set +' and 'Res' switches mounted on the steering wheel allow the driver to either set the vehicle speed as required or resume the last cruising speed set.

The cruise control system uses mechanical, electrical and vacuum operated devices to maintain vehicle speed at a setting selected by the driver. As vehicle speed changes due to changes in road gradients, so the cruise control ECU operates the cruise control pump, continually moving the cruise control actuator to maintain the set vehicle speed.

Should the driver wish to increase the speed of the vehicle, the 'Set +' switch should be pressed and held. The vehicle will accelerate until the switch is released. As the 'Set +' switch is released, the cruise control ECU will store the new cruise speed in its memory.

With cruise control switched on, it is possible to press the accelerator pedal and accelerate through the memorised set speed. When the accelerator is released, the cruise control ECU will automatically return the vehicle to its set speed.

Note: The cruise control system will only operate between speeds of 22 mph (35 kph) and 125 mph (201 kph).

Cruise control operation can be suspended by one of the following ways:

- By pressing the 'Res' switch.
- By pressing the brake pedal.
- The gearbox is placed in park, neutral, or reverse.
- Hill Descent Control (HDC) is active.
- Engine rev's are too high.

Under all these conditions, the cruise control set speed will be memorised. Cruise control operation can be resumed by pressing the 'Res' switch.

Cruise control operation can be cancelled in one of two ways:

- By pressing the cruise control master switch located on the drivers side of the fascia.
- By switching the ignition off.

In both these cases, the cruise control set speed will be lost.

Warning: Do not switch off the vehicle ignition unless the vehicle is stationary and the handbrake is applied.

OPERATION

General

Feed from the positive battery terminal (C0192) is supplied to the main relay, the horn relay, and fusible link 3 (C0632) on an R wire. All are located in the engine compartment fuse box.

The earth path for the main relay (C0578) is controlled by the ECM (C0604) on an NG wire. The energised main relay provides a feed to fuse 4, which is also located in the engine compartment fuse box. For more information on main relay operation, refer to the **Engine Management System – EDC** or **Engine Management System – Siemens (NAS)** section of the System Description and Operation Workshop manual.

Fusible link 3 (C0571) is connected to the ignition switch (C0028) by an N wire. When the ignition switch is turned to the 'ignition' position, current flows across the switch (C0028) to fuse 6 of the passenger compartment fuse box (C0588) on a G wire.

Cruise Control Master Switch

Cruise control is switched on and off by pressing the master switch mounted on the drivers side of the fascia. Fuse 6 of the passenger compartment fuse box (C0581) supplies the cruise control master switch (C0749) an ignition feed on a W then WK wire. When the switch is pressed, current flows across the switch contacts (C0749) to the cruise control interface unit (C0895) on a WY wire.

NOTE: When the cruise control system is switched off using the master switch, any stored road speed values will be lost.

Cruise Control Interface Unit

Fuse 4 of the engine compartment fuse box (C0575) provides a feed to the cruise control interface unit (C0895) on an NK wire. The interface unit (C0895) is earthed on a B wire. To enable it to control the cruise control system, the ECU receives a number of inputs from various sources as follows:

ABS ECU

The ABS ECU (C0501) provides a road speed signal to the cruise control interface unit (C0895) via the CAN-BUS on YN (Low) and YB (High) wires. For more information on the CAN-BUS road speed signal, refer to the **Communication Databuses** section of the System Description and Operation Workshop manual.

DESCRIPTION AND OPERATION

Set + Switch

A constant battery feed is supplied to the rotary coupler (C0082) via the horn relay (C0576) on a PY wire. Current flows across the rotary coupler (C1254) to the cruise control switches. The 'Set +' switch is a normally open, non-latching switch. When the switch is pulled forward, the switch contacts close. Current flows across the switch back to the rotary coupler. The rotary coupler (C0082) is connected to the cruise control interface unit (C0895) by an RW wire.

The interface unit (C0895) converts the signals received from the 'Set +' switch, and relays information to the Engine Control Module (ECM) (C0331) on an RG wire. The signal provided by the interface unit is a continuous, pulsed voltage, varying from approximately 6 V to 8 V. By measuring the frequency of the pulses, the ECM is able to control vehicle speed in accordance to requests from the 'Set +' switch.

Res switch

A constant battery feed is supplied to the rotary coupler (C0082) via the horn relay (C0576) on a PY wire. Current flows across the rotary coupler (C1254) to the cruise control switches. The 'Res' switch is a normally open, non-latching switch. When the switch is pulled forward, the switch contacts close. Current flows across the switch back to the rotary coupler. The rotary coupler (C0082) is connected to the cruise control interface unit (C0895) by a UW wire.

The interface unit (C0895) converts the signals received from the 'Res' switch, and relays information to the ECM (C0331) on an RG wire. The signal provided by the interface unit is a continuous, pulsed voltage, varying from approximately 6 V to 8 V. By measuring the frequency of the pulses, the ECM is able to control vehicle speed in accordance to requests from the 'Res' switch.

Brake Pedal Switch

Fuse 6 of the passenger compartment fuse box (C0581) provides an ignition feed to the hall effect brake pedal switch (C0652) on a W wire. The brake pedal switch (C0652) is earthed on a B wire.

When the brake pedal is in the rest position, only a nominal voltage (between approximately 0V and 2V) is supplied to the ECM (C0331) on GR and PG wires. When the brake pedal is pressed, this voltage rises to between approximately 6V and battery voltage. Sensing this increase, the ECM suspends cruise control operation.

Electronic Automatic Transmission (EAT) ECU

When cruise control is active, the cruise control interface unit (C0895) provides a feed to the EAT ECU (C0932) on a WU wire. When the EAT ECU receives this feed, it enters its cruise control mode. For more information on EAT operation, refer to the ***Electronic Automatic Transmission (EAT)*** section of this manual.

 **ELECTRONIC AUTOMATIC TRANSMISSION (EAT).**

Instrument Pack

When cruise control is operational, the cruise control interface unit (C0895) sends a 'cruise active' message to the instrument pack (C0230) via the CAN-BUS on YN (low) and YB (high) wires. This message is used to illuminate the cruise control lamp housed within the instrument pack.

DESCRIPTION AND OPERATION

CRUISE CONTROL – KV6

DESCRIPTION

General

Cruise control is switched on by pressing the cruise control master switch mounted on the drivers side of the fascia. The 'Set +' and 'Res' switches mounted on the steering wheel allow the driver to either set the vehicle speed as required or resume the last cruising speed set.

The cruise control system uses mechanical, electrical and vacuum operated devices to maintain vehicle speed at a setting selected by the driver. As vehicle speed changes due to changes in road gradients, so the cruise control ECU operates the cruise control pump, continually moving the cruise control actuator to maintain the set vehicle speed.

Should the driver wish to increase the speed of the vehicle, the 'Set +' switch should be pressed and held. The vehicle will accelerate until the switch is released. As the 'Set +' switch is released, the cruise control ECU will store the new cruise speed in its memory.

With cruise control switched on, it is possible to press the accelerator pedal and accelerate through the memorised set speed. When the accelerator is released, the cruise control ECU will automatically return the vehicle to its set speed.

Note: The cruise control system will only operate between speeds of 22 mph (35 km/h) and 125 mph (200 km/h).

Cruise control operation can be suspended by one of the following ways:

- By pressing the 'Res' switch.
- By pressing the brake pedal.
- The gearbox is placed in park, neutral, or reverse.
- Hill Descent Control (HDC) is active.
- Engine rev's are too high.

Under all these conditions, the cruise control set speed will be memorised. Cruise control operation can be resumed by pressing the 'Res' switch.

Cruise control operation can be cancelled in one of two ways:

- By pressing the cruise control master switch located on the drivers side of the fascia.
- By switching the ignition off.

In both these cases, the cruise control set speed will be lost.

Warning: Do not switch off the vehicle ignition unless the vehicle is stationary and the handbrake is applied.

OPERATION

General

Feed from the positive battery terminal (C0192) is supplied to the horn relay and fusible link 3 of the engine compartment fuse box (C0632) on an R wire. Fusible link 3 (C0571) is connected to the ignition switch (C0028) by an N wire. When the ignition switch is turned to the 'ignition' position, current flows across the switch (C0028) to fuse 6 of the passenger compartment fuse box (C0588) on a G wire. Fuse 6 (C0581) provides an ignition feed to the following:

- The cruise control master switch (C0749) on a W then WK wire.
- The cruise control interface unit (C0895) on a W wire (via header 292).
- The brake pedal sensor (C0652) on a W wire (via header 292).

The ignition switch (C0028) also provides a feed to fuse 2 of the passenger compartment fuse box (C0588) on an NW wire. Fuse 2 (C0581) provides an ignition feed to the brake pedal switch (C0075) on a G wire.

Cruise Control Master Switch

The cruise control master switch (C0749) is mounted in the drivers side of the fascia and is provided an ignition feed from fuse 35 of the passenger compartment fuse box (C0580) on a W then WK wire. When the switch is pressed, current flows across the switch contacts (C0749) to the cruise control interface unit (C1959) and the cruise control ECU (C0239) on WY wires.

NOTE: When the cruise control system is switched off using the master switch, any stored road speed values will be lost.

Cruise Control ECU

When cruise control is activated, the cruise control ECU (C0239) receives a feed from the cruise control master switch (C0749) on a WY wire. The ECU (C0239) is earthed on a B wire. To enable it to control the cruise control system, the ECU receives a number of inputs from various sources as follows:

ABS ECU

The ABS ECU (C0501) provides a pulsed wheel speed signal to the cruise control ECU (C0239) on a WO wire. The rate of pulses provided by the ABS ECU increases by 2.22 Hz for every mile per hour speed increase (approximately 8,000 pulses per mile travelled). This enables the cruise control ECU to calculate the road speed of the vehicle. If vehicle speed is outside the operating limits (see **Description**), the cruise control ECU will not activate the system.

NOTE: If the Cruise Control ECU fails to receive a pulsed wheel speed signal from the ABS modulator, cruise control will not operate.

For more information on ABS ECU operation, refer to the **Anti-lock Braking System (ABS)** section of this manual.



ANTI-LOCK BRAKING SYSTEM (ABS).

DESCRIPTION AND OPERATION

Set + Switch

The non latching Set + switch (C1254) is provided a feed via the horn relay (C0576) on a PY wire. When the switch is pulled back against spring pressure, the switch contacts close and a feed is provided to the cruise control ECU (C0239) via the rotary coupler (C0082) on a RW wire.

If cruise control is active, and the switch is operated for the first time, the cruise control ECU will store the current vehicle speed in its memory and maintain that speed.

NOTE: The cruise control ECU will only store and maintain the vehicle speed if it is within the operating limits given in the 'Description' section above.

If the switch is tapped a second time, the ECU will increase the vehicle speed by 1 mph. If the switch is pulled back and held against spring pressure, the vehicle will accelerate until the switch is released. The final vehicle speed in both instances will be stored in the cruise control ECU memory.

Res Switch

The non latching Res switch (C1254) is provided a feed via the horn relay (C0576) on a PY wire. When the switch is pulled back against spring pressure, the switch contacts close and a feed is provided to the cruise control ECU (C0239) via the rotary coupler (C0082) on a UW wire.

If the Res switch is pulled back against spring pressure, the cruise control ECU will alter vehicle speed to reflect the vehicle speed held within its memory. If the Res switch is pulled back for a second time, cruise control operation will be suspended

NOTE: If a road speed value is not held within the cruise control ECU memory, the ECU will not respond to the Res switch input. To enter a vehicle speed into the ECU memory, refer to the 'Set + Switch' section above.

Brake Pedal Sensor

The Hall effect brake pedal sensor (C0652) is provided an ignition feed (via header 292) from fuse 6 of the passenger compartment fuse box (C0581) on a W wire. The sensor (C0652) is earthed on a B wire. When the brake pedal is in its normal position, the sensor provides the cruise control interface unit (C0895) a low voltage (between approximately 0V and 2V) on a PG wire. When the brake pedal is pressed, this voltage rises to between approximately 6V and battery voltage. When the interface unit registers this rise in voltage, it suspends cruise control operation.

The brake pedal sensor (C0652) also provides a brake pedal status signal to the cruise control interface unit (C0895) on a GR wire.

Interface Unit

The interface unit (C0895) provides a feed to the cruise control ECU (C0239) on a PG wire if the following conditions exist:

- The cruise control master switch is depressed.
- The brake pedal is not depressed.
- HDC is not activated.
- The gear selector lever is not in the park, neutral, or reverse positions.
- Engine speed is below 6,496 rpm.

The cruise control ECU uses the feed provided by the interface unit to enable the cruise control pump. For more details on interface unit operation, refer to the **Interface Unit** section below.

Interface Unit

Fuse 6 of the passenger compartment fuse box (C0581) provides an ignition feed (via header 292) to the interface unit (C0895) on a W wire. The interface unit is earthed on a pair of B wires, and receives inputs from a number of different components as follows:

Cruise Control Master Switch

When the cruise control master switch is depressed, it provides a feed to the interface unit (C0895) on a WY wire.

Brake Pedal Sensor

When the brake pedal is in its normal position, the sensor (C0652) provides the interface unit (C0895) a low voltage (between approximately 0V and 2V) on GR and PG wires. When the brake pedal is pressed, this voltage rises to between approximately 6V and battery voltage.

Engine Control Module (ECM)

The ECM (C0371) provides a feed to the interface unit (C0895) on a BU wire if the following conditions exist:

- HDC is not activated.
- The gear selector lever is not in the park, neutral, or reverse positions.
- Engine speed is below 6,496 rpm.

For more information on the Siemens ECM, refer to the **Engine Management Systems – Siemens** section of the System Description and Operation Workshop manual.

DESCRIPTION AND OPERATION

Cruise Control Pump

When all conditions for cruise control activation have been met, the cruise control ECU (C0239) provides a feed to the cruise control pump motor (C0228) on a WU wire. The pump motor creates a vacuum in the pump actuator. For a detailed description of actuator operation, refer to the **Engine Management Systems – Siemens** section of the Workshop manual.

Current flow across the pump motor is controlled by the ECU (C0239) providing a varying Pulse Width Modulated (PWM) signal to the other side of the pump motor (C0228) on a BR wire. When the correct vehicle speed has been reached, the ECU (C0239) replaces the PWM feed with a continuous feed. As the potential difference across the pump motor is now 0V, the pump motor stops operating.

To maintain the vacuum in the actuator, both the control and dump valves are closed by the ECU. To close the valves, the ECU (C0239) provides a feed to the control and dump valves (C0228) on a WU wire. Current flows across the control valve (C0228) to the ECU (C0239) on a PY wire. Current flows across the dump valve (C0228) to the ECU (C0239) on a BR wire.

NOTE: Both the control valve and the dump valve are normally open valves.

When a decrease in speed is requested, the control valve is opened to reduce the depression within the actuator. This is done by the ECU (C0239) providing a PWM signal to the control valve (C0228) on a PY wire. When the correct speed has been achieved, the PWM signal is withdrawn.

When cruise is cancelled, the ECU (C0239) withdraws the feed to the dump valve (C0228) on a WU wire. The dump valve now opens, allowing atmospheric pressure into the actuator.

Brake Pedal Switch

As a safety feature, the dump valve is opened if the brake pedal is depressed. If cruise control is active and the brake pedal is pressed, the brake pedal switch (C0075) provides a feed to the dump valve (C0228) on a GP wire. As the potential difference across the valve is 0V, the valve opens allowing atmospheric pressure into the actuator.

Electronic Automatic Transmission (EAT) ECU

When all conditions for cruise control activation have been met, the cruise control ECU (C0239) provides a feed to the EAT ECU (C0932) on a WU wire. When the EAT ECU receives this feed, it enters its cruise control mode. For more information on EAT operation refer to the **Electronic Automatic Transmission (EAT)** section of this manual.

 **ELECTRONIC AUTOMATIC TRANSMISSION (EAT).**

Instrument Pack

When all conditions for cruise control activation have been met, the cruise control ECU (C0239) provides a feed to the cruise control LED mounted within the instrument pack (C0230) on a WU wire. The cruise control LED is provided an earth by the instrument pack (C0230) on a B wire.

Diagnostic Socket

The diagnostic socket (C0040) is connected to the cruise control ECU (C0239) by a K wire, enabling the ECU to be interrogated by TestBook or T4.

DESCRIPTION AND OPERATION

ELECTRONIC AUTOMATIC TRANSMISSION (EAT)

DESCRIPTION

General

The Jatco 5–speed automatic transmission fitted to Freelander is controlled by an Electronic Automatic Transmission Electronic Control Unit (EAT ECU). The EAT ECU is located inside the engine E-box, and receives information from the following sources to calculate when to operate the solenoid valves contained within the gearbox to enable quick, smooth, quiet gear changes;

- The Engine Control Module (ECM) via the CAN-BUS,
- The instrument pack via the CAN-BUS,
- The cruise control ECU,
- The automatic transmission selector,
- The brake pedal switch,
- The automatic gearbox sensors.

The Jatco automatic gearbox also has a number of different operating modes. When the ignition switch is first turned to the 'ignition' position, the gearbox will always revert to the 'Normal' mode. For a full description of the 5–speed automatic transmission, refer to the ***Automatic Gearbox – Jatco*** section of the System Description and Operation Workshop manual.

OPERATION

General

Feed from the positive battery terminal (C0192) is supplied to the main relay and fusible link 3 (C0632) on an R wire. Both are located in the engine compartment fuse box.

The battery also provides a feed to fusible link 4 of the engine compartment fuse box (C0632) on vehicles fitted with an instrument dimmer switch. For more information, refer to the ***Interior Lamps*** section of this manual.



INTERIOR LAMPS.

Operation of the main relay (C0576 on Td4 vehicles, C0578 on KV6 vehicles) is controlled by the Engine Control Module (ECM) (C0603 on Td4 vehicles, C0604 on KV6 NAS vehicles, C0371 on KV6 ROW vehicles) on a WK wire (NG on KV6 NAS vehicles). The energised main relay allows a battery feed to flow to fuse 4 of the engine compartment fuse box. Fuse 4 (C0575) provides a feed to the following:

- The Electronic Automatic Transmission Electronic Control Unit (EAT ECU) (C0932) on a pair of NK wires.
- The transmission selector (C0244) (vehicles without instrument dimmer only) on a NK then a NR wire.
- The illumination relay (C1976) (vehicles with instrument dimmer only) on a NK then a NR wire.
- The CommandShift switch (C0410) on a NK wire.

For further details of main relay operation, refer to the ***Engine Management – EDC***, ***Engine Management – Siemens (NAS)*** or ***Engine Management – Siemens (All Except NAS)*** section of the System Description and Operation Workshop manual.

Fusible link 3 (C0571) is connected to the ignition switch (C0028) by an N wire. When the ignition switch is turned to the 'ignition' position, current flows across the switch (C0028) to fuse 6 of the passenger compartment fuse box (C0588) on a G wire. Fuse 6 (C0581) provides an ignition feed to the transmission inhibit switch (C0244) on a W wire.

DESCRIPTION AND OPERATION

EAT ECU

The EAT ECU monitors the operation of the automatic gearbox via four sensors:

- The temperature of the automatic transmission fluid (ATF) is measured by the fluid temperature sensor. The fluid temperature sensor (C0243) receives a feed from the EAT ECU (C0932) on a WK wire. The temperature sensor return (C0243) to the EAT ECU (C0932) is via a KB wire. As the temperature of the ATF rises, so the resistance of the sensor decreases. The EAT ECU registers this drop in resistance and calculates the temperature of the ATF accordingly. For more information on the fluid temperature sensor, refer to the **Automatic Gearbox – Jatco** section of the System Description and Operation Workshop manual.
- Vehicle speed is measured by the vehicle speed sensor. The vehicle speed sensor (C0243) is connected to the EAT ECU (C0932) by a U wire. The speed sensor creates a sinusoidal waveform, with each positive phase of the waveform representing one tooth on the parking gear (19 per engine revolution). The EAT ECU uses this waveform to calculate vehicle speed. The sensor return (C0243) to the EAT ECU (C0932) is via a W then KB wire. For more information on the vehicle speed sensor, refer to the **Automatic Gearbox – Jatco** section of the System Description and Operation Workshop manual.
- Input shaft speed into the gearbox is measured by the turbine sensor. The turbine sensor (C0243) is connected to the EAT ECU (C0932) by an R wire. The turbine sensor creates a sinusoidal waveform, with 16 positive phases representing one input shaft revolution. The EAT ECU uses this signal along with a vehicle speed signal to calculate if the correct gear has been selected. The sensor return (C0243) to the EAT ECU (C0932) is via a U then KB wire. For more information on the turbine sensor, refer to the **Automatic Gearbox – Jatco** section of the System Description and Operation Workshop manual.
- The internal, or intermediate, transmission speed is measured by the intermediate sensor. The intermediate sensor (C0243) is connected to the EAT ECU (C0932) by an R wire. The intermediate sensor creates a sinusoidal waveform, with each positive phase of the waveform representing one tooth of the output gear (49 per revolution). The EAT ECU uses this signal to ensure the correct gear is engaged, and to monitor the amount of slip within the gearbox. The sensor return (C0243) to the EAT ECU (C0932) is via a B then KB wire. For more information on the intermediate sensor, refer to the **Automatic Gearbox – Jatco** section of the System Description and Operation Workshop manual.

Park

When park is selected, a main relay feed is able to flow from the transmission selector/inhibit switch (C0244) to the EAT ECU (C0932) and the selector indicator (C0675) on a KO wire. The 'P' symbol on the selector housing will now illuminate.

NOTE: On Canadian specification vehicles, a feed is also provided to the Central Control Unit (CCU) (C0593) on a KO wire. This input is used by the CCU to extinguish the daylight running lamps.

Reverse

When reverse gear is selected, a main relay feed is able to flow from the transmission selector/inhibit switch (C0244) to the reverse lamp relay (C2624) on an NG wire. The reverse lamp relay (C0935) is earthed on a B wire and controls operation of the reverse lamps. For more information on reverse lamp operation, refer to the **Brake and Reverse Lamps** section of this manual.

BRAKE AND REVERSE LAMPS.

A main relay feed is also supplied to the EAT ECU (C0932) and the selector indicator (C0675) on NG wires. The 'R' symbol on the selector housing will now illuminate.

If the vehicle is travelling forwards at greater than 6 mph (10 kph), the EAT ECU (C0932) provides a feed to the Low Coast solenoid (C0243) on a K wire. The Low Coast solenoid (C0243) is earthed via the EAT ECU (C0932) on an SB wire. When the Low Coast solenoid receives this feed, it drains the transmission fluid from the reverse clutch, thus preventing reverse gear from being selected.

Neutral

When neutral is selected, a main relay feed is able to flow from the transmission selector/inhibit switch (C0244) to the EAT ECU (C0932) and the selector indicator (C0675) on a WU wire. The 'N' symbol on the selector housing will now illuminate.

Drive

When drive is selected, a main relay feed is able to flow from the transmission selector/inhibit switch (C0244) to the EAT ECU (C0932) and the selector indicator (C0675) on a WB wire. The 'D' symbol on the selector housing will now illuminate.

When drive is selected, the EAT ECU (C0932) receives signals from the vehicle speed sensor (C0243) housed within the gearbox on a U wire. The sensor (C0243) is earthed via EAT ECU (C0932) on a W then KB wire. The EAT ECU (C0932) also receives a throttle pedal signal from the ECM (C0331 on Td4 and KV6 NAS vehicles, C0371 on KV6 ROW vehicles) via the CAN-BUS on YN (Low) and YB (High) wires. The EAT ECU uses this information to select the appropriate gear by operating the gearbox shift solenoids as follows:

DESCRIPTION AND OPERATION

1st Gear

To select first gear, shift solenoid B and shift solenoid C are operated. The EAT ECU (C0932) will provide a feed to shift solenoid B (C0243) on an O wire. Shift solenoid C (C0243) receives a feed from the EAT ECU (C0932) on an OU wire.

2nd Gear

To select second gear, shift solenoid A and shift solenoid B are operated. The EAT ECU (C0932) will provide a feed to shift solenoid A (C0243) on an R wire. Shift solenoid B (C0243) receives a feed from the EAT ECU (C0932) on an O wire.

3rd Gear

To select third gear, only shift solenoid B is operated. The EAT ECU (C0932) will provide a feed to shift solenoid B (C0243) on an O wire.

4th Gear

To select fourth gear, only shift solenoid C is operated. The EAT ECU (C0932) will provide a feed to shift solenoid C (C0243) on an OU wire.

5th Gear

To select fifth gear, shift solenoid A and shift solenoid C are operated. The EAT ECU (C0932) will provide a feed to shift solenoid A (C0243) on an R wire. Shift solenoid C (C0243) receives a feed from the EAT ECU (C0932) on an OU wire.

4

When 4 is selected, a main relay feed is able to flow from the transmission selector/inhibit switch (C0244) to the EAT ECU (C0932) and the selector indicator (C0675) on an RG wire. The '4' symbol on the selector housing will now illuminate.

When 4 is selected, only the lowest 4 gears will be operable. For more information, refer to the **Drive** section.

2

When 2 is selected, a main relay feed is able to flow from the transmission selector/inhibit switch (C0244) to the EAT ECU (C0932) and the selector indicator (C0675) on an OB wire. The '2' symbol on the selector housing will now illuminate.

When 2 is selected, only the lowest 2 gears will be operable. For more information, refer to the **Drive** section.

1

When 1 is selected, a main relay feed is able to flow from the transmission selector/inhibit switch (C0244) to the EAT ECU (C0932) and the selector indicator (C0675) on a GY wire. The '1' symbol on the selector housing will now illuminate.

When 1 is selected, only first gear will be operable. For more information, refer to the **Drive** section.

Mode Selection

Sport Mode

The selector lever (C0410) is provided a main relay feed via fuse 4 of the engine compartment fuse box (C0575) on an NK wire. When the lever is moved across to the 'S/M' position, the selector lever (C0410) provides a feed to the EAT ECU (C0932) on an LGK wire. The EAT ECU will now enter sport mode. In sport mode, the gearbox still operates as a conventional automatic transmission, but the unit becomes more responsive to driver demands. The selector lever (C0410) is earthed on a B wire.

The selector lever (C0410) also provides a feed to the selector indicator (C0675) on an LGK wire, illuminating the 'S/M' symbol on the selector housing.

Manual (CommandShift) Mode

When in sport mode, if the selector lever is moved to the '+' or '-' positions, the gearbox will automatically enter manual (CommandShift) mode. When the selector lever is moved to the '-' position, it provides a feed to the EAT ECU (C0932) on a GK wire. When the selector lever is moved to the '+' position, it provides a feed to the EAT ECU (C0932) on a GB wire. Manual gear changes can now be performed sequentially using the selector lever.

Cruise Control Mode – Td4 and NAS

The cruise control master switch is located on the drivers side of the fascia. When cruise control is activated, the cruise control interface unit (C0895) provides a feed to the EAT ECU (C0932) on a WU wire. In cruise control mode, the EAT ECU uses a dedicated gearshift map to control the gearbox and assist the cruise control ECU in maintaining the vehicle speed at the required level.

For more information on cruise control operation, refer to the ***Cruise Control – Td4 & KV6 (North America)*** section of this manual.

 **CRUISE CONTROL – TD4 & KV6 (NORTH AMERICA).**

Cruise Control Mode – KV6

The cruise control master switch is located on the drivers side of the fascia. When cruise control is activated, the cruise control ECU (C0239) provides a feed to the EAT ECU (C0932) on a WU wire. In cruise control mode, the EAT ECU uses a dedicated gearshift map to control the gearbox and assist the cruise control ECU in maintaining the vehicle speed at the required level.

For more information on cruise control operation, refer to the ***Cruise Control – KV6*** section of this manual.

 **CRUISE CONTROL – KV6.**

DESCRIPTION AND OPERATION

Hill Descent Control (HDC) Mode

In HDC mode, the EAT ECU applies engine braking to assist the ABS ECU in controlling the vehicles descent. HDC mode is activated if all of the following conditions exist:

- The gear selector lever is in position '1' or 'R'.
- The HDC switch is depressed.
- The throttle pedal is released.

The EAT ECU (C0932) communicates with the ABS ECU (C0501) via the CAN-BUS on YB (High) and YN (Low) wires. For more information on the CAN-BUS, refer to the **Communication Databases** section of the System Description and Operation Workshop manual.

Fluid Pressure Control

Fluid pressure within the automatic gearbox is controlled by the Line Pressure duty solenoid. When required, the EAT ECU (C0932) provides a Pulse Width Modulated (PWM) signal to the Line Pressure duty solenoid (C0243) on a Y wire. The solenoid (C0243) is earthed via the EAT ECU (C0932) on an SB wire. For more details on fluid pressure control, refer to the **Automatic Gearbox – Jatco** section of the System Description and Operation Workshop manual.

Torque Converter Lock-Up

When the gearbox is in 4th or 5th gear, and the EAT ECU registers a high vehicle speed combined with a small throttle angle, the EAT ECU will lock the torque converter. This will enable maximum power to be transmitted to the road wheels. When this occurs, the EAT ECU (C0932) provides a PWM signal to the Lock-Up duty solenoid (C0243) on a U wire. The solenoid (C0243) is earthed via the EAT ECU (C0932) on an SB wire. For more details on torque converter lock-up, refer to the **Automatic Gearbox – Jatco** section of the System Description and Operation Workshop manual.

Shift Interlock

When the ignition switch is in the 'ignition' position and the selector lever is in the 'Park', the EAT ECU (C0932) provides a feed to the shift interlock solenoid (C0268) on a GW wire locking the selector lever in the 'Park' position. When the brake pedal is pressed, the brake pedal switch (C0652) provides a feed to the EAT ECU (C0932) on a GR wire. Sensing the brake pedal has been pressed the EAT ECU withdraws the feed to the shift interlock solenoid, releasing the selector lever.

The shift interlock solenoid (C0268) is earthed on a B wire.

Diagnostic Socket

If the EAT ECU detects a failure in an associated component, a fault code will be stored in its memory. TestBook or T4 can be used via the diagnostic socket to retrieve these fault codes to identify the cause of the failure. The diagnostic socket (C0040) is connected to the EAT ECU (C0932) by a K wire.

DESCRIPTION AND OPERATION

ANTI-LOCK BRAKING SYSTEM (ABS)

DESCRIPTION

General

The ABS is a full time, four channel system that gives individual speed control to all four wheels to provide the vehicle with anti-lock braking (ABS), Electronic Traction Control (ETC), and Hill Descent Control (HDC). The systems are controlled by the ABS ECU, which is mounted on the rear of the ABS modulator. The ABS ECU also controls the front to rear brake balance by Electronic Braking force Distribution (EBD). This maximises vehicle stability under braking.

For a detailed description of ABS, ETC HDC, and EBD, refer to the **Brakes** section of the System Description and Operation Workshop manual.

The ABS modulator uses the CAN-BUS to communicate with other ECU's to enable it to control braking more efficiently. For more information on the CAN-BUS, refer to the **Communication Databases** section of the System Description and Operation Workshop manual.

OPERATION

General

Feed from the positive battery terminal (C0192) is supplied to fusible link 1, fusible link 3, fusible link 8, and fusible 11 (C0632) on an R wire. All are located in the engine compartment fuse box.

Fusible link 8 (C0574) and fusible link 11 (C0570) provide constant battery feeds to the ABS modulator (C0501) on NK and NR wires respectively. The ABS modulator (C0501) is earthed on a pair of B wires.

Fusible link 1 is connected in series with fusible link 2, which is also located in the engine compartment fuse box. Fusible link 2 (C0571) provides a feed to the ignition switch (C0028) on an NR wire. Fusible link 3 (C0571) also provides a feed to the ignition switch (C0028) on an N wire.

When the ignition switch is turned to the 'ignition' position, current flows across the switch (C0028) to fuse 2 of the passenger compartment fuse box (C0588) on an NW wire. When in the 'ignition' position, the ignition switch (C0028) also provides a feed to fuse 6 and fuse 25 of the passenger compartment fuse box (C0588) on a G wire.

Fuse 2 of the passenger compartment fuse box (C0581) provides an ignition feed to the brake pedal switch (C0075) on a G wire. Fuse 2 also provides a feed to the HDC relay and the reverse lamp relay, which are also located in the passenger compartment fuse box.

Fuse 25 (C0582) provides an ignition feed to the ABS ECU (C0501) on a W wire. Fuse 6 (C0581) provides an ignition feed to the HDC switch (C0878) on a W wire.

Wheel Speed Sensors

The ABS ECU (C0501) supplies a feed to all four wheel speed sensors as follows:

- To the LH front wheel speed sensor (C0516) on an R wire.
- To the RH front wheel speed sensor (C0517) on a Y wire.
- To the LH rear wheel speed sensor (C0502) on a G wire.
- To the RH rear wheel speed sensor (C0503) on a W wire.

The wheel speed sensors provide the ABS ECU with a square wave form signal. By measuring the frequency of the wave form, the ABS ECU can calculate the speed of the road wheel. The sensors provide the ABS ECU (C0501) with wheel speed signals as follows:

- From the LH front wheel speed sensor (C0516) on an RB wire.
- From the RH front wheel speed sensor (C0517) on a YB wire.
- From the LH rear wheel speed sensor (C0502) on a GB wire.
- From the RH rear wheel speed sensor (C0503) on a WB wire.

If the ABS ECU detects wheel deceleration is too great, it will initiate the ABS. If the ABS ECU detects that wheel speed is greater than vehicle speed, it will initiate ETC. If HDC is operational, the ABS ECU will control vehicle speed at 7 mph (11 km/h) by applying the brakes where necessary. For more information on ABS, ETC, and HDC, refer to the **Brakes** section of the System Description and Operation Workshop manual.

ABS ECU

Td4 – Manual Transmission

The ABS ECU (C0501) provides a road wheel speed signal to the Engine Control Module (ECM) (C0331) via the CAN BUS on YN (low) and YB (high) wires.

Td4 – Automatic Transmission

The ABS ECU (C0501) provides a road wheel speed signal to the Electronic Automatic Transmission Electronic Control Unit (EAT ECU) (C0932) via the CAN BUS on YN (low) and YB (high) wires.

K1.8

The ABS ECU (C0501) provides a road wheel speed signal to the Engine Control Module (ECM) (C0913) via the CAN BUS on YN (low) and YB (high) wires.

KV6

The ABS ECU (C0501) provides a road wheel speed signal to the EAT ECU (C0932) via the CAN BUS on YN (low) and YB (high) wires. This information is relayed to the ECM (C0371) via the CAN BUS on YN (low) and YB (high) wires.

For more information on the CAN BUS, refer to the **Communication Databases** section of the System Description and Operation Workshop manual.

The ABS ECU (C0501) also provides a pulsed road speed signal to the CCU (C0428) on a WO wire.

DESCRIPTION AND OPERATION

Brake Pedal Switch

The brake pedal switch is a double contact mechanical switch, mounted at the top of the brake pedal adjacent the brake pedal sensor. The switch (C0075) is provided an ignition feed from fuse 2 of the passenger compartment fuse box (C0582) on a G wire. When the brake pedal is at rest, the switch (C0075) provides a feed to the ABS ECU (C0501) on a GR wire. When the brake pedal is pressed, the switch (C0075) informs the ABS ECU (C0501) by providing a feed on a GP wire.

When the brake pedal is pressed, the switch (C0075) also provides a feed to the following on GP wires:

- The LH brake lamp (C0121).
- The RH brake lamp (C0125).
- The Centre High Mounted Stop Lamp (CHMSL) (C0613).
- The trailer pick-up (C0499) on a GP then R wire.

For more information on brake lamp operation, refer to the ***Brake and Reverse Lamps*** section of this manual.

 **BRAKE AND REVERSE LAMPS.**

Accelerometer

The accelerometer is mounted beneath the centre console adjacent the handbrake, and provides the ABS ECU additional information regarding vehicle motion. The ABS ECU (C0501) provides a feed to the accelerometer (C1220) on a Y wire. The sensor (C1220) returns a vehicle acceleration/deceleration signal to the ABS ECU (C0501) on an R wire.

The accelerometer (C1220) is provided an earth path via the ABS ECU (C0501) on a U wire.

Brake Fluid Level Switch

The ABS ECU (C0501) provides a feed to the brake fluid level switch (C0026) on a BW wire. The switch is closed when the correct amount of brake fluid is present in the brake fluid reservoir. The switch (C0026) is earthed on a B wire. If the brake fluid level drops below the recommended level, the switch contacts open. When the ABS ECU registers the switch opening, it informs the instrument pack (C0230) to illuminate the brake fluid warning lamp via the CAN-BUS on YN (low) and YB (high) wires.

For more information on warning lamp operation, refer to the ***Instruments*** section of this manual.

 **INSTRUMENTS.**

Hill Descent Control (HDC)

HDC Switch

The HDC switch (C0878) is mounted on the gear lever, and informs the ABS ECU (C0501) when HDC has been selected. When HDC is selected, the switch contacts close, and a feed is provided to the ABS ECU (C0501) on a PS wire. When the ABS ECU receives this feed, it energises the HDC relay.

NOTE: The ABS ECU will only initiate HDC if either 1st or reverse gear are selected, and brake temperature doesn't exceed 400 °C (752 °F).

1st Gear Switch (Manual Transmission)

The 1st gear switch (C0618) is mounted in the gearbox, and informs the ABS ECU (C0501) when 1st gear has been selected. The Instrument pack (C0230) provides a feed to the switch (C0618) on an RW wire (RW then GB on K1.8 vehicles). When 1st gear is selected, the instrument pack (C0230) informs the ABS ECU (C0501) via the CAN BUS on YN (low) and YB (high) wires. The switch (C0618) is earthed on a B wire.

HDC Relay

The HDC relay (C2624) is located in the passenger compartment fuse box, and is controlled by the ABS ECU (C0501) on a BR wire. When energised, the HDC relay (C2624) provides a feed to the following on GP wires:

- The ABS ECU (C0501).
- The LH brake lamp (C0121).
- The RH brake lamp (C0125).
- The CHMSL (C0613).
- The trailer pick-up (C0499) on GP then R wire.

Diagnostic Socket

The diagnostic socket (C0040) is connected to the ABS ECU (C0501) by a K wire, enabling the ABS ECU to be interrogated by TestBook or T4.

DESCRIPTION AND OPERATION

SUPPLEMENTARY RESTRAINT SYSTEM (SRS)

DESCRIPTION

General

The Supplementary Restraint System (SRS) is designed to work in conjunction with the vehicle seat belts. The main components of the system are:

- Driver Airbag – Mounted in the steering wheel to provide added protection for the driver during a frontal impact.
- Passenger airbag – Mounted in the fascia to provide added protection for the front seat passenger during a frontal impact.
- Seat Belt Pre-tensioners – Mounted on the inner edge of both front seats within the seat belt anchorage, to provide added protection during a front impact.
- Airbag Diagnostic Control Unit (DCU) – Mounted beneath the centre console, and used to detect crash conditions and control the SRS system.
- SRS LED – Mounted in the instrument pack, the LED acts as an indicator of system status.

NOTE: The airbag DCU illuminates the SRS LED for 5 seconds when the ignition switch is turned to the 'ignition' position to inform the driver the SRS LED is functioning correctly.

WARNING: Before starting work on the SRS system, refer to the safety precautions contained within the Workshop manual.

For a detailed description of the SRS system and safety precautions to carry out before starting work, refer to the System Description and Operation Workshop manual.

OPERATION

General

Feed from the positive battery terminal (C0192) is supplied to fusible link 3 of the engine compartment fuse box (C0632) on an R wire. Fusible link 3 (C0571) is connected to the ignition switch (C0028) by an N wire. When the ignition switch is turned to the 'ignition' position, current flows across the switch (C0028) to fuse 18, and fuse 23 of the passenger compartment fuse box (C0588) on a G wire.

Fuse 23 (C0580) provides an ignition feed to the airbag DCU (C0256) on a G wire. The DCU (C0256) is earthed on a B wire. Fuse 18 (C0589) provides an ignition feed to the SRS LED (C0233) on a G wire.

Driver Airbag

The airbag DCU (C0256) controls the feed to the driver airbag (C0545) via the rotary coupler (C0374) on a Y wire. The airbag DCU (C0256) controls the earth path for the driver airbag (C0545) via the rotary coupler (C0374) on an R wire.

Passenger Airbag

The airbag DCU (C0256) controls the feed to the passenger airbag (C0433) on a W wire. The earth path for the passenger airbag (C0433) is controlled by the airbag DCU (C0256) on a U wire.

Seat Belt Pre-tensioners

RH

The airbag DCU (C0256) controls the feed to the RH pre-tensioner (C0254) on an N wire. The earth path for the RH pre-tensioner (C0254) is controlled by the airbag DCU (C0256) on an NR wire.

LH

The airbag DCU (C0256) controls the feed to the LH pre-tensioner (C0252) on an O wire. The earth path for the LH pre-tensioner (C0252) is controlled by the airbag DCU (C0256) on an OU wire.

SRS LED

Fuse 18 of the passenger compartment fuse box (C0589) provides an ignition feed to the SRS LED (C0233) on a G wire. To illuminate the LED (C0233), an earth path is provided on a YR wire via the airbag DCU (C0256). To extinguish the LED, the airbag DCU withdraws the earth path.

Diagnostic Socket

The SRS system can be interrogated using TestBook or T4 via the diagnostic socket. The diagnostic socket (C0040) is connected to the airbag DCU (C0256) by a K wire.

DESCRIPTION AND OPERATION

AIR CONDITIONING (A/C) – Td4

DESCRIPTION

General

The air conditioning (A/C) system will only operate when the engine is running. The A/C system is switched on and off by pressing the switch mounted on the centre console. When the switch is pressed, an LED mounted within the switch illuminates to inform the driver the system is operational. For more information on LED operation, refer to the **Interior Illumination** section of this manual.

INTERIOR ILLUMINATION.

The position of the rotary heater control determines the amount of warm air from the heater matrix blended with cool air from the A/C evaporator, and hence the temperature of the air output from the heater ducts.

NOTE: The blower switch must be in at least position 1 for the A/C system to operate.

The A/C system is automatically switched on when either the screen or screen/feet positions are selected via the rotary distribution control knob.

NOTE: The A/C LED will not illuminate under these conditions.

For more information on heater operation, refer to the **Heater Blower** section of this manual.

HEATER BLOWER.

OPERATION

General

Feed from the positive battery terminal (C0192) is supplied to fusible link 5, fusible link 1 and the main relay (C0632) on an R wire. All are located within the engine compartment fuse box.

The earth path for the main relay coil (C0576) is controlled by the Engine Control Module (ECM) (C0603) on a WK wire. The energised main relay provides a feed to fuse 4, which is also located in the engine compartment fuse box. For more details on main relay operation, refer to the **Engine Management Systems – EDC** section of the System Description and Operation Workshop manual.

Fusible link 1 is connected in series with fusible link 2, fuse 8, and fuse 9 which are also located in the engine compartment fuse box. Fuse 8 (C0576) provides a constant battery feed to the heater blower relay (C0153) on a GN then GW wire. Fuse 9 provides a constant battery feed to the compressor clutch relay, which is also located in the engine compartment fuse box.

Fusible link 2 (C0571) is connected to the ignition switch (C0028) by an NR wire. When the ignition switch is turned to the 'ignition' position, current flows across the switch (C0028) to fuse 4 of the passenger compartment fuse box (C0588) on an SU wire. Fuse 4 (C0585) provides an ignition feed to the following on G then LGS wires:

- The blower motor switch (C0058).
- The fresh/recirculated air switch (C0750).
- The fresh/recirculated air motor (C0006).

A/C Master Switch

When the blower switch (C0058) is turned to position 1 or higher, it provides a feed to the A/C master switch (C0275) and the A/C microswitch (C2575) on SW then B wires. If A/C is requested, the switch (C0275) provides a feed to the instrument pack (C0233) via the microswitch (C2575) on a B then SK wire. When the instrument pack receives an A/C request from the switch, it informs the ECM (C0331) via the CAN BUS on YN (Low) and YB (High) wires.

The A/C master switch is mounted on the centre console, and is earthed (C0275) on a B wire.

For more information on the CAN BUS, refer to the **Communication Databases** section of the System Description and Operation Workshop manual.

A/C Microswitch

The A/C microswitch (C2575) is mounted on the rear of the heater distribution control knob, and switches the A/C on automatically when the screen or feet/screen position is selected. In this instance, the switch contacts close, allowing the blower motor switch (C0058) to provide a feed to the instrument pack (C0233) on an SW then SK wire, by-passing the A/C master switch.

Compressor

When the ECM (C0331) receives an A/C request signal via the CAN BUS, it will energise the A/C compressor clutch relay by providing an earth path for the relay coil (C0576) on a UB wire. A feed from fuse 9 of the engine compartment fuse box is now able to flow across the energised relay (C0575) to the compressor clutch (C0127) on an R wire.

DESCRIPTION AND OPERATION

Instrument Pack

The instrument pack (C0230) acts as a gateway, relaying CAN messages to and from different components throughout the vehicle as follows:

Pressure Sensor

The pressure sensor is located in the high pressure A/C line adjacent the compressor, and replaces the more traditional trinary pressure switch. The instrument pack (C0230) provides a 5 V reference voltage to the pressure sensor (C1257) on a UO wire. The pressure sensor (C1257) is provided an earth path via the instrument pack (C0230) on a PB wire.

The pressure sensor (C1257) provides the instrument pack (C0230) a signal feed on a UG wire. The value of this signal feed is dependent upon the pressure within the A/C system. This signal is relayed by the instrument pack (C0230) to the ECM (C0331) via the CAN-BUS on YB (High) and YN (Low) wires. The ECM uses this signal to determine the pressure within the A/C system, enabling it to carry out the following tasks:

- To provide a safety cut-out function if the pressure within the A/C system goes either too high or too low.
- To control the speed of the cooling and condenser fans via the cooling fan ECU.
- To help control engine idle speed.

Evaporator Temperature Sensor

The evaporator temperature sensor is used to ensure the evaporator doesn't freeze. The instrument pack (C0230) provides a feed to the evaporator temperature sensor (C0417) on a GO wire. The sensor (C0417) is earthed on a B wire. The instrument pack relays the temperature reading to the ECM (C0331) via the CAN BUS on YB (High) and YN (Low) wires.

NOTE: The ECM also uses the evaporator temperature sensor signal in conjunction with the pressure sensor signal to help control engine idle speed.

For more information on CAN messages, refer to the **Communication Databases** section of the System Description and Operation Workshop manual.

Cooling Fan Control Unit

Fusible link 5 of the engine compartment fuse box (C0573) provides a constant battery feed to the cooling fan control unit (C0208) on an NG wire. Fuse 4 of the engine compartment fuse box (C0575) provides a feed to the cooling control unit (C1680) on an NK wire when the main relay is energised (*see above*). The cooling control unit (C0208) is earthed on a B wire.

To control cooling fan and condenser fan speed, the ECM (C0331) provides the cooling fan control unit (C1680) a Pulse Width Modulated (PWM) signal on a UW wire. The frequency of the pulses supplied by the ECM determines the speed the cooling fan control unit will drive the cooling fan and condenser fan motors.

The cooling fan control unit interprets the PWM signal provided by the ECM as follows:

- If a PWM signal of between approximately 12 % and 87 % is received by the cooling fan control unit, it will not power the cooling fans.
- If a PWM signal of 87 % or over is received by the cooling fan control unit, it will provide a feed to the cooling fan (C0005) and condenser fan motors (C0280) on SU wires. An earth path is provided for the cooling fan (C0005) and condenser fan motors (C0280) by the cooling fan control unit (C2470) on a pair of PS wires.
- If a PWM signal of less than 12 % is received by the cooling fan control unit, it assumes a fault has occurred and powers the cooling and condenser fan motors as described above.
- If a continuous voltage is received by the cooling fan control unit, it assumes a fault has occurred and powers the cooling and condenser fan motors as described above.

Fresh/Recirculated Air

Fuse 4 of the passenger compartment fuse box (C0585) provides an ignition feed to the fresh/recirculated air motor (C0006) and the fresh/recirculated air switch (C0750) on G then LGS wires. When the switch is the normal (released) position, it provides an earth path for the motor (C0006) via a Y wire. The motor will open the recirculation flap, allowing the A/C system to use air drawn from outside the vehicle.

If the fresh/recirculated air switch is pressed, it provides an earth path for the motor (C0006) via a K wire. The motor will now close the recirculation flap, allowing the A/C system to use recirculated air. The switch is mounted on the centre console, adjacent the A/C master switch, and is earthed (C0750) on a B wire.

DESCRIPTION AND OPERATION

AIR CONDITIONING (A/C) – K SERIES AND KV6

DESCRIPTION

General

The air conditioning (A/C) system will only operate when the engine is running. The A/C system is switched on and off by pressing the switch mounted on the centre console. When the switch is pressed, an LED mounted within the switch illuminates to inform the driver the system is operational. For more information on LED operation, refer to the **Interior Illumination** section of this manual.

INTERIOR ILLUMINATION.

The position of the rotary heater control determines the amount of warm air from the heater matrix blended with cool air from the A/C evaporator, and hence the temperature of the air output from the heater ducts.

NOTE: The blower switch must be in at least position 1 for the A/C system to operate.

The A/C system is automatically switched on when either the screen or screen/feet positions are selected via the rotary distribution control knob.

NOTE: The A/C LED will not illuminate under these conditions.

For more information on heater operation, refer to the **Heater Blower** section of this manual.

HEATER BLOWER.

OPERATION

General

Feed from the positive battery terminal (C0192) is supplied to fusible link 1, fusible link 5, and the main relay (C0632) on an R wire. All are located within the engine compartment fuse box.

The earth path for the main relay coil (C0576 on K Series vehicles, C0578 on KV6 vehicles) is controlled by the Engine Control Module (ECM) (C0913 on K Series vehicles, C0371 on KV6 vehicles) on a WK wire. The energised main relay provides a feed to fuse 4, which is also located in the engine compartment fuse box. For more details on main relay operation, refer to the **Engine Management Systems – MEMS** or **Engine Management Systems – Siemens (All Except NAS)** section of the System Description and Operation Workshop manual.

Fusible link 1 is connected in series with fuse 8, fuse 9 and fusible link 2, which are also located in the engine compartment fuse box. Fuse 8 (C0576) provides a constant battery feed to the blower relay (C0153) on a GN then GW wire. Fuse 9 provides a constant battery feed to the compressor clutch relay, which is also located in the engine compartment fuse box.

Fusible link 2 (C0571) is connected to the ignition switch (C0028) by an NR wire. When the ignition switch is turned to the 'ignition' position, current flows across the switch to fuse 4 of the passenger compartment fuse box (C0588) on an SU wire. Fuse 4 (C0585) provides an ignition feed to following on G then LGS wires:

- The blower motor switch (C0058).
- The fresh/recirculated air switch (C0750).
- The fresh/recirculated air motor (C0006).

A/C Master Switch

When the blower switch (C0058) is turned to position 1 or higher, it provides a feed to the A/C master switch (C0275) and the A/C microswitch (C2575) on SW then B wires. If A/C is requested, the switch (C0275) provides a feed to the instrument pack (C0233) via the microswitch (C2575) on a B then SK wire. When the instrument pack receives an A/C request from the switch, it informs the ECM (C0913 K Series vehicles, C0371 on KV6 vehicles) via the CAN BUS on YN (Low) and YB (High) wires. The A/C master switch is mounted on the centre console, and is earthed (C0275) on a B wire.

For more information on CAN BUS operation, refer to the **Communication Databases** section of the System Description and Operation Workshop manual.

A/C Microswitch

The A/C microswitch (C2575) is mounted on the rear of the heater distribution control knob, and switches the A/C on automatically when the screen or feet/screen position is selected. In this instance the switch contacts close, allowing the blower motor switch (C0058) to provide a feed to the instrument pack (C0233) on an SW then SK wire, by-passing the A/C master switch.

Compressor

K1.8

When the ECM (C0913) receives an A/C request signal via the CAN BUS, it will energise the compressor clutch relay by providing an earth path for the relay coil (C0576) on a UB wire. A feed from fuse 9 of the engine compartment fuse box is now able to flow across the energised relay (C0578) to the compressor clutch (C0127) on an R wire.

KV6

When the ECM (C0371) receives an A/C request signal via the CAN BUS, it will energise the compressor clutch relay by providing an earth path for the relay coil (C0578) on a BR wire. A feed from fuse 9 of the engine compartment fuse box is now able to flow across the energised relay (C0575) to the compressor clutch (C0127) on an R wire.

DESCRIPTION AND OPERATION

Pressure Sensor

The pressure sensor is located in the high pressure A/C line adjacent the compressor, and replaces the more traditional trinary pressure switch. The ECM (C0913 on K Series vehicles, C0371 on KV6 vehicles) provides a 5 V reference voltage to the pressure sensor (C1257) on a UO wire. The pressure sensor (C1257) is provided an earth path by the ECM (C0913 on K Series vehicles, C0371 on KV6 vehicles) on a PB wire.

The pressure sensor (C1257) provides the ECM (C0913 on K Series vehicles, C0371 on KV6 vehicles) a signal feed on a UG wire. The value of this signal feed is dependent upon the pressure within the A/C system. The ECM uses this feed to determine the pressure within the A/C system, enabling it to carry out the following tasks:

- To provide a safety cut-out function if the pressure within the A/C system goes either too high or too low.
- To control the speed of the cooling and condenser fans via the cooling fan control unit.
- To help control engine idle speed.

Evaporator Temperature Sensor

The evaporator temperature sensor is used to ensure the evaporator doesn't freeze. The ECM (C0913 on K Series vehicles, C0371 on KV6 vehicles) provides a feed to the evaporator temperature sensor on a GO wire (GU on KV6 vehicles). The sensor is provided an earth path via the ECM (C0913 on K Series vehicles, C0371 on KV6 vehicles) on a BO wire (PB on KV6 vehicles).

NOTE: The ECM also uses the evaporator temperature sensor signal in conjunction with the pressure sensor signal to help control engine idle speed.

Cooling Fan Control Unit

Fusible link 5 of the engine compartment fuse box (C0573) provides a constant battery feed to the cooling fan control unit (C0208) on an NG wire. Fuse 4 of the engine compartment fuse box (C0575) provides a feed to the cooling fan control unit (C1680) on an NK wire when the main relay is energised. The cooling fan control unit (C0208) is earthed on a B wire.

To control cooling fan and condenser fan speed, the ECM (C0913 on K Series vehicles, C0371 on KV6 vehicles) provides the cooling fan control unit (C1680) a Pulse Width Modulated (PWM) signal on a UW wire (UR then UW on KV6 vehicles). The frequency of the pulses supplied by the ECM determines the speed the cooling fan control unit will drive the cooling fan and condenser fan motors.

The cooling fan control interprets the PWM signal provided by the ECM as follows:

- If a PWM signal of between approximately 12 % and 87 % is received by the cooling fan control unit , it will not power the cooling fans.
- If a PWM signal of 87 % or over is received by the cooling fan control unit, it will provide a feed to the cooling fan (C0005) and condenser fan motors (C0280) on SU wires. An earth path is provided for the cooling fan (C0005) and condenser fan motors (C0280) by the cooling fan control unit (C2470) on a pair of PS wires.
- If a PWM signal of less than 12 % is received by the cooling fan control unit, it assumes a fault has occurred and powers the cooling and condenser fan motors as described above.
- If a continuous voltage is received by the cooling fan control unit, it assumes a fault has occurred and powers the cooling and condenser fan motors as described above.

Fresh/Recirculated Air

Fuse 4 of the passenger compartment fuse box (C0585) provides an ignition feed to the fresh/recirculated air motor (C0006) and the fresh/recirculated air switch (C0750) on G then LGS wires. When the switch is the normal (released) position, it provides an earth path for the motor (C0006) via a Y wire. The motor will open the recirculation flap, allowing the A/C system to use air drawn from outside the vehicle.

If the fresh/recirculated air switch is pressed, it provides an earth path for the motor (C0006) via a K wire. The motor will now close the recirculation flap, allowing the A/C system to use recirculated air. The switch is mounted on the centre console, adjacent the A/C master switch, and is earthed (C0750) on a B wire.

DESCRIPTION AND OPERATION

AIR CONDITIONING (A/C) – KV6 (NORTH AMERICA)

DESCRIPTION

General

The air conditioning (A/C) system will only operate when the engine is running. The A/C system is switched on and off by pressing the switch mounted on the centre console. When the switch is pressed, an LED mounted within the switch illuminates to inform the driver the system is operational. For more information on LED operation, refer to the **Interior Illumination** section of this manual.

INTERIOR ILLUMINATION.

The position of the rotary heater control determines the amount of warm air from the heater matrix blended with cool air from the A/C evaporator, and hence the temperature of the air output from the heater ducts.

NOTE: The blower switch must be in at least position 1 for the A/C system to operate.

The A/C system is automatically switched on when either the screen or screen/feet positions are selected via the rotary distribution control knob.

NOTE: The A/C LED will not illuminate under these conditions.

For more information on heater operation, refer to the **Heater Blower** section of this manual.

HEATER BLOWER.

OPERATION

General

Feed from the positive battery terminal (C0192) is supplied to fusible link 1, fusible link 5, and the main relay (C0632) on an R wire. All are located within the engine compartment fuse box.

The earth path for the main relay coil (C0578) is controlled by the Engine Control Module (ECM) (C0604) on an NG wire. The energised main relay provides a feed to fuse 4, which is also located in the engine compartment fuse box. For more details on main relay operation, refer to the **Engine Management Systems – Siemens (NAS)** section of the System Description and Operation Workshop manual.

Fusible link 1 is connected in series with fuse 8, fuse 9 and fusible link 2, which are also located in the engine compartment fuse box. Fuse 8 (C0576) provides a constant battery feed to the blower relay (C0153) on a GN then GW wire. Fuse 9 provides a constant battery feed to the compressor clutch relay, which is also located in the engine compartment fuse box.

Fusible link 2 (C0571) is connected to the ignition switch (C0028) by an NR wire. When the ignition switch is turned to the 'ignition' position, current flows across the switch to fuse 4 of the passenger compartment fuse box (C0588) on an SU wire. Fuse 4 (C0585) provides an ignition feed to following on G then LGS wires:

- The blower motor switch (C0058).
- The fresh/recirculated air switch (C0750).
- The fresh/recirculated air motor (C0006).

A/C Master Switch

When the blower switch (C0058) is turned to position 1 or higher, it provides a feed to the A/C master switch (C0275) and the A/C microswitch (C2575) on SW then B wires. If A/C is requested, the switch (C0275) provides a feed to the instrument pack (C0233) via the microswitch (C2575) on a B then SK wire. When the instrument pack receives an A/C request from the switch, it informs the ECM (C0331) via the CAN BUS on YN (Low) and YB (High) wires.

The A/C master switch is mounted on the centre console, and is earthed (C0275) on a B wire.

For more information on CAN BUS operation, refer to the **Communication Databases** section of the System Description and Operation Workshop manual.

A/C Microswitch

The A/C microswitch (C2575) is mounted on the rear of the heater distribution control knob, and switches the A/C on automatically when the screen or feet/screen position is selected. In this instance the switch contacts close, allowing the blower motor switch (C0058) to provide a feed to the instrument pack (C0233) on an SW then SK wire, by-passing the A/C master switch.

Compressor

When the ECM (C0331) receives an A/C request signal via the CAN BUS, it will energise the compressor clutch relay by providing an earth path for the relay coil (C0576) on a UB wire. A feed from fuse 9 of the engine compartment fuse box is now able to flow across the energised relay (C0575) to the compressor clutch (C0127) on an R wire.

Instrument Pack

The instrument pack (C0230) acts as a gateway, relaying CAN messages to and from different components throughout the vehicle as follows:

DESCRIPTION AND OPERATION

Pressure Sensor

The pressure sensor is located in the high pressure A/C line adjacent the compressor, and replaces the more traditional trinary pressure switch. The instrument pack (C0230) provides a 5 V reference voltage to the pressure sensor (C1257) on a UO wire. The pressure sensor (C1257) is provided an earth path via the instrument pack (C0230) on a PB wire.

The pressure sensor (C1257) provides the instrument pack (C0230) a signal feed on a UG wire. The value of this signal feed is dependent upon the pressure within the A/C system. The instrument pack relays this information to the ECM via the CAN BUS. The ECM uses this to determine the pressure within the A/C system, enabling it to carry out the following tasks:

- To provide a safety cut-out function if the pressure within the A/C system goes either too high or too low.
- To control the speed of the cooling and condenser fans via the cooling fan control unit.
- To help control engine idle speed.

Evaporator Temperature Sensor

The evaporator temperature sensor is used to ensure the evaporator doesn't freeze. The instrument pack (C0230) provides a feed to the evaporator temperature sensor (C0417) on a GO wire. The sensor (C0417) is earthed on a B wire. The instrument pack relays evaporator temperature sensor status to the ECM via the CAN BUS.

NOTE: The ECM also uses the evaporator temperature sensor signal in conjunction with the pressure sensor signal to help control engine idle speed.

Cooling Fan Control Unit

Fusible link 5 of the engine compartment fuse box (C0573) provides a constant battery feed to the cooling fan control unit (C0208) on an NG wire. Fuse 4 of the engine compartment fuse box (C0575) provides a feed to the cooling fan control unit (C1680) on an NK wire when the main relay in energised (*see above*). The cooling fan control unit (C0208) is earthed on a B wire.

To control cooling fan and condenser fan speed, the ECM (C0331) provides the cooling fan control unit (C1680) a Pulse Width Modulated (PWM) signal on a UW wire. The frequency of the pulses supplied by the ECM determines the speed the cooling fan control unit will drive the cooling fan and condenser fan motors.

The cooling fan control unit interprets the PWM signal provided by the ECM as follows:

- If a PWM signal of between approximately 12 % and 87 % is received by the cooling fan control unit, it will not power the cooling fans.
- If a PWM signal of 87 % or over is received by the cooling fan control unit, it will provide a feed to the cooling fan (C0005) and condenser fan motors (C0280) on SU wires. An earth path is provided for the cooling fan (C0005) and condenser fan motors (C0280) by the cooling fan control unit (C2470) on a pair of PS wires.
- If a PWM signal of less than 12 % is received by the cooling fan control unit, it assumes a fault has occurred and powers the cooling and condenser fan motors as described above.
- If a continuous voltage is received by the cooling fan control unit, it assumes a fault has occurred and powers the cooling and condenser fan motors as described above.

Fresh/Recirculated Air

Fuse 4 of the passenger compartment fuse box (C0585) provides an ignition feed to the fresh/recirculated air motor (C0006) and the fresh/recirculated air switch (C0750) on G then LGS wires. When the switch is the normal (released) position, it provides an earth path for the motor (C0006) via a Y wire. The motor will open the recirculation flap, allowing the A/C system to use air drawn from outside the vehicle.

If the fresh/recirculated air switch is pressed, it provides an earth path for the motor (C0006) via a K wire. The motor will now close the recirculation flap, allowing the A/C system to use recirculated air. The switch is mounted on the centre console, adjacent the A/C master switch, and is earthed (C0750) on a B wire.

DESCRIPTION AND OPERATION

HEATER BLOWER

DESCRIPTION

General

The heater is operated from three rotary controls located in the centre console. Two of the controls operate the temperature and air flow distribution. The third control operates the four speed blower motor.

A resistor pack is mounted on the RH side of the heater unit. The resistor pack supplies reduced voltages to the blower motor for fan speed one, two, and three. Fan speed four drives the blower motor at full speed with a direct 12V supply.

The blower motor will only operate when the ignition switch is in the 'ignition' position.

OPERATION

General

Feed from the positive battery terminal (C0192) is supplied to fusible link 1 of the engine compartment fuse box (C0632) on an R wire. Fusible link 1 is connected in series with fuse 8 and fusible link 2, which are also located in the engine compartment fuse box.

Fusible link 2 (C0571) is connected to the ignition switch (C0028) by an NR wire. When the ignition switch is turned to the 'ignition' position, current flows across the switch (C0028) to fuse 4 of the passenger compartment fuse box (C0588) on an SU wire. Fuse 4 (C0585) provides an ignition feed to the following on G then LGS wires:

- The fresh/recirculated air motor (C0006).
- The fresh/recirculated air switch (C0750).
- The blower motor switch (C0058).

Blower Speed 1

If blower speed 1 is selected, current flows across the blower motor switch (C0058) to the resistor pack (C0425) on an RK wire. The resistor pack (C0425) is connected to the blower motor (C0056) by a GK then G wire. As current has to flow through the greatest value resistor, the blower motor operates at slow speed.

The blower motor (C0056) is earthed on a B wire.

Blower Speed 2

If blower speed 2 is selected, current flows across the blower motor switch (C0058) to the resistor pack (C0425) on an RY wire. The resistor pack (C0425) is connected to the blower motor (C0056) by a GK then G wire. As current has to flow through the medium value resistor, the blower motor operates at a slightly increased speed.

Blower Speed 3

If blower speed 3 is selected, current flows across the blower motor switch (C0058) to the resistor pack (C0425) on an RG wire. The resistor pack (C0425) is connected to the blower motor (C0056) by a GK then G wire. As current has to flow through the smallest value resistor, the blower motor operates at an increased speed.

Blower Speed 4

If blower speed 4 is selected, current flows across the blower motor switch (C0058) to the blower motor relay coil (C0153) on an RS wire. The relay coil (C0153) is earthed on a BS then B wire. The energised blower relay allows a feed from fuse 8 of the engine compartment fuse box (C0576) across the closed relay switch (C0153) directly to the blower motor (C0056) on a GR then G wire. As current by-passes the resistor pack, the blower motor operates at high speed.

Fresh/Recirculated Air

Fuse 4 of the passenger compartment fuse box (C0586) provides an ignition feed to the fresh/recirculated air motor (C0006) and the fresh/recirculated air switch (C0750) on G then LGS wires. When the switch is the normal (released) position, it provides an earth path for the motor (C0006) via a Y wire. The motor will open the recirculation flap, allowing the heater to use air drawn from outside the vehicle.

If the fresh/recirculated air switch is pressed, it provides an earth path for the motor (C0006) via a K wire. The motor will now close the recirculation flap, allowing the heater system to use recirculated air. The switch is mounted on the centre console and is earthed (C0750) on a B wire.

DESCRIPTION AND OPERATION

FUEL BURNING HEATER (FBH)

DESCRIPTION

General

A Fuel Burning Heater (FBH) is used to compensate for the lower operating temperatures of diesel engines by heating engine coolant before it enters the heater matrix. For a detailed description of FBH operation, refer to the ***Heating and Ventilation*** section of the System Description and Operation Workshop manual.

OPERATION

General

Feed from the positive battery terminal (C0192) is supplied to fusible link 1 of the engine compartment fuse box (C0632) on an R wire. Fusible link 1 is connected in series with fuse 5, which is also located in the engine compartment fuse box. Fuse 5 (C0576) provides a constant battery feed to the Fuel Burning Heater (FBH) (C0926) on a PN wire. The FBH (C0926) is earthed on a B wire.

When the engine is running, the alternator (C0226) provides the Engine Control Module (ECM) (C0606) a Pulse Width Modulated (PWM) signal on a U wire. When the ECM (C0331) receives this signal it provides a feed to the FBH temperature sensor (C0714) on an NY wire. The FBH temperature sensor measures ambient air temperature, and is a normally open switch.

If an ambient air temperature of below 5 °C is measured, the FBH temperature sensor closes. The ECM feed can now flow across the sensor (C0714) to the FBH (C0925) on an SG wire. On receiving this feed, the FBH will power the FBH pump.

The FBH (C0925) sends a PWM signal to the FBH pump (C0920) on a WU wire. By varying the frequency of the pulses, the FBH can control the pump to operate at one of three speeds. The pump (C0920) is earthed on a B wire.

Diagnostic Socket

The FBH can be interrogated using TestBook or T4 via the diagnostic socket. The diagnostic socket (C0040) is connected to the FBH (C0925) by a K wire.

AIR BLAST TRANSMISSION COOLER

DESCRIPTION

General

The air blast transmission cooler is located in the front LH wheel arch in place of the Fuel Burning Heater (FBH). The air blast cooler is only fitted to Td4 vehicles with automatic transmission in hot climate markets. For a detailed description of the air blast transmission cooler, refer to the ***Automatic Gearbox – Jatco*** section of the System Description and Operation workshop manual.

OPERATION

General

The air blast transmission cooler is fitted in place of the FBH and uses the FBH's electrical connections. Refer to the ***Fuel Burning Heater (FBH)*** section of this manual for operating details of the air blast cooler.

 **FUEL BURNING HEATER (FBH).**

The FBH circuit diagram can also be used when diagnosing possible faults with the air blast transmission cooler.

DESCRIPTION AND OPERATION

POSITIVE TEMPERATURE COEFFICIENT (PTC) HEATER

DESCRIPTION

General

The Positive Temperature Coefficient (PTC) heater replaces the Fuel Burning Heater (FBH) fitted to Td4 vehicles in markets of a moderate climate. The PTC heater, like the FBH, is an auxiliary heating system that compensates for the relatively low coolant temperature inherent in the diesel engine.

The PTC heater is an electrical heating element installed in the heater assembly on the downstream side of the heater matrix. For a more detailed description of PTC heater operation, refer to the **Heating and Ventilation** section of the System Description and Operation Workshop manual.

NOTE: Cold climate specification vehicles still maintain the FBH.

OPERATION

General

Feed from the positive battery terminal (C0192) is supplied to fusible link 1 and fuse 10 of the engine compartment (C0632) on an R wire. Fuse 10 (C0575) provides a constant battery feed to the inertia switch (C0123) on a G wire. The inertia switch is a normally closed switch. If the inertia switch hasn't been tripped, current flows across the switch to the fuel pump relay (C0575) on a GU wire.

Fusible link 1 is connected in series with fusible link 2, which is also located in the engine compartment fuse box. Fusible link 2 (C0571) is connected to the ignition switch (C0028) by an NR wire. When the ignition switch is turned to the 'ignition' position, current flows across the switch (C0028) to fuse 4 of the passenger compartment fuse box (C0588) on an SU wire. Fuse 4 (C0585) provides an ignition feed to the blower motor switch (C0058) on a G then LGS wire.

The battery (C0192) also provides a feed to fusible link 1 (C1875) located in the fuse holder on an R wire. Fusible link 1 (C1875) provides a constant battery feed to PTC relay 2 (C0157) on an N wire.

PTC Switch

If the rotary blower motor switch is turned to position 1 or higher, current from fuse 4 of the passenger compartment fuse box (C0585) flows across the switch (C0058) to the PTC switch (C0422) on an SW wire. The PTC switch is mounted on the rear of the rotary temperature control switch. When the temperature control switch is in the cold to warm position (i.e. less than approximately 1 o'clock), the PTC switch contacts are open. If the temperature control switch is turned to the warm to hot position (i.e. approximately 1 o'clock and above) the PTC switch contacts close. This allows current to flow from the PTC switch (C0422) to PTC relay 1 (C2624) on a GW wire.

PTC Relays

Operation of the PTC heater is controlled by two relays. PTC relay 1 is the control relay and is located in the passenger compartment fuse box. PTC relay 2 is the power relay and is mounted on the engine bulkhead, behind the engine compartment fuse box.

PTC Relay 1

The coil of PTC relay 1 (C2624) receives a feed from the PTC switch (C0422) on a GW wire. The relay coil (C0587) is earthed on a B wire. When energised, PTC relay 1 (C0154) provides an earth path for PTC relay 2 (C0157) on a G then GY wire.

PTC Relay 2

The coil of PTC relay 2 (C0157) receives a feed from the fuel pump relay (C0572) on a WP then GR wire. When PTC relay 1 is energised, it provides an earth path for the relay coil of PTC relay 2 on a GY wire. This allows a battery feed from fusible link 1 (C1875), located in the fuse holder, to flow across the closed relay switch contacts to fuse 1, fuse 2, and fuse 3 (C1876) on B wires. All are located in the fuse holder.

For more information on fuel pump relay operation, refer to the **Fuel Pump** section of this manual.

FUEL PUMP.

PTC Heater

The PTC heater is powered via three fuses located in an additional fuse holder. The fuse holder is mounted on the side of the E-box. Fuses 1, 2, and 3 (C1876) are provided a feed by the energised PTC relay 2 (C0157) on B wires, and power the PTC heater elements as follows:

- Fuse 1 is connected to PTC heater element 3 (C1879) by a BP wire.
- Fuse 2 is connected to PTC heater element 2 (C1877) by a BN wire.
- Fuse 3 is connected to PTC heater element 3 (C1878) by a BG wire.

DESCRIPTION AND OPERATION

Engine Control Module (ECM)

On vehicles fitted with manual transmission, a feed is provided to the ECM (C0331) on a GY wire when the PTC heater is operational. This signal feed informs the ECM to raise the engine idle speed.

COOLING FANS

DESCRIPTION

K Series

K Series vehicles are fitted with a single cooling fan, which is mounted on the rear face of the radiator. Operation of the single speed cooling fan is controlled by the Engine Control Module (ECM) via the cooling fan relay.

NOTE: Vehicles fitted with Air Conditioning (A/C) are also fitted with a condenser fan and a cooling fan control unit. For more information, refer to the 'Air Conditioning (A/C) – K Series and KV6' section of this manual.

AIR CONDITIONING (A/C) – K SERIES AND KV6.

The cooling fan will also operate after the ignition has been switched off to control rising engine bay temperatures after the engine has stopped running.

KV6 and Td4

KV6 and Td4 vehicles are fitted with a fan to control the temperature within the E-box. If the temperature within the E-box reaches 35 °C (95 °F), the fan operates until the temperature drops to 27 °C (80 °F).

For information on cooling fan operation, refer to the ***Air Conditioning (A/C) – Td4***, ***Air Conditioning (A/C) – K Series and KV6***, or ***Air Conditioning (A/C) – KV6 (North America)*** section of this manual.

AIR CONDITIONING (A/C) – Td4.

AIR CONDITIONING (A/C) – K SERIES AND KV6.

AIR CONDITIONING (A/C) – KV6 (NORTH AMERICA).

OPERATION

Td4

Feed from the positive battery terminal (C0192) is supplied to fusible link 1 and the main relay (C0632) on an R wire. Both are located in the engine compartment fuse box. Operation of the main relay (C0576) is controlled by the Engine Control Module (ECM) (C0603) on a WK wire. The energised main relay provides a feed to fuse 4, which is also located in the engine compartment fuse box.

Fusible link 1 is connected in series with fusible link 7. Fusible link 7 provides a constant battery feed to the starter relay, which is also located in the engine compartment fuse box. Operation of the starter relay (C0576) is controlled by the ECM (C0059) on an RW wire. The relay coil (C0576) is earthed on a B wire. The energised starter relay (C0572) provides a feed to the E-box fan (C0646) on an NR wire.

DESCRIPTION AND OPERATION

E-box Fan

Fuse 4 of the engine compartment fuse box (C0575) provides a feed to the E-box temperature sensor (C1258) on an NK wire. The temperature sensor is a thermostatic switch. When the temperature within the E-box reaches 35 °C (95 °F) the switch contact close. Current flows across the switch contacts (C1258) to the E-box fan (C0646) on an NK wire. The E-box fan (C0646) is earthed on a B wire.

When the temperature within the E-box drops to 27 °C (80 °F), the switch contacts within the sensor open, cutting the feed to the E-box fan.

K Series

Feed from the positive battery terminal (C0192) is supplied to fusible link 5, and the main relay on an R wire. Both are located in the engine compartment fuse box. Fusible link 5 (C0573) provides a constant battery feed to the cooling fan relay (C0019) on an SU wire.

Operation of the main relay (C0576) is controlled by the ECM (C0913) on a WK wire. When energised, the main relay provides a feed to fuse 4, which is also located in the engine compartment fuse box. Fuse 4 (C0575) is connected to the cooling fan relay (C0019) by an NK wire.

Engine Coolant Temperature (ECT) Sensor

The ECM monitors Engine Coolant Temperature (ECT) via the ECT sensor. The ECM (C0914) provides a feed to the ECT sensor (C0169) on a KG wire. As ECT rises, the resistance of the sensor falls. By measuring the voltage returned from the ECT sensor (C0169) on a KB wire, the ECM (C0914) can determine ECT.

Cooling Fan

When the ECM (C0913) registers a temperature of 102 °C (215 °F) via the ECT sensor, it energises the cooling fan relay by providing an earth path for the relay coil (C0019) on a UR wire. The energised cooling fan relay (C0019) provides a feed to the cooling fan motor (C0005) on an NR wire. The cooling fan motor (C0005) is earthed on a B wire.

KV6

Feed from the positive battery terminal (C0192) is supplied to fusible link 3 and the main relay (C0632) on an R wire. Both are located in the engine compartment fuse box. Operation of the main relay (C0578) is controlled by the ECM (C0604 on KV6 NAS vehicles, C0371 on KV6 ROW vehicles) on a WK wire (NG on KV6 NAS vehicles). The energised main relay provides a feed to fuse 4, which is also located in the engine compartment fuse box.

Fusible link 3 (C0571) is connected to the ignition switch (C0028) by an N wire. When the ignition switch is turned to the 'ignition' position, current flows across the switch (C0028) to fuse 5 of the passenger compartment fuse box (C0588) on a WR wire. Fuse 5 (C0581) provides an ignition feed to the E-box fan (C0646) on a WR wire.

E-box Fan

Fuse 4 of the engine compartment fuse box (C0575) provides a feed to the E-box temperature sensor (C1258) on an NK wire. The temperature sensor is a thermostatic switch. When the temperature within the E-box reaches 35 °C (95 °F) the switch contact close. Current flows across the switch contacts (C1258) to the E-box fan (C0646) on an NK wire. The E-box fan (C0646) is earthed on a B wire.

When the temperature within the E-box drops to 27 °C (80 °F), the switch contacts within the sensor open, cutting the feed to the E-box fan.

DESCRIPTION AND OPERATION

HEATED REAR WINDOW (HRW)

DESCRIPTION

General

The HRW comprises eleven metallic strips bonded to the inside surface of the tail door glass to form an element. The metallic strips terminate in two larger strips at the bottom of the glass. Two connectors bonded to the terminations provide attachment of the supply and earth connections.

The HRW is controlled by the Central Control Unit (CCU) via a non latching switch mounted on the centre console. The switch has an illumination LED to show when the HRW is operational. The switch is also illuminated by a separate bulb when the side or headlamps are switched on. For more information on switch illumination, refer to the **Interior Illumination** section of this manual.

INTERIOR ILLUMINATION.

The CCU will only operate the HRW when all of the following conditions are met:

- The HRW switch is pressed.
- The engine is running.
- The tail door window is closed.
- The roof is fitted (3 door models only).

NOTE: The HRW will not operate if the tail door window has not been calibrated. For more information on tail door window calibration, refer to the Windows section of this manual.

WINDOWS – 5 DOOR.

The CCU will switch the HRW off automatically after approximately 15 minutes.

OPERATION

General

Feed from the positive battery terminal (C0192) is supplied to fusible link 3 and fusible link 4 of the engine compartment fuse box (C0632) on an R wire. Fusible link 4 (C0574) provides a constant battery feed to the HRW relay and fuse 16 of the passenger compartment fuse box (C0587) on an NW wire.

NOTE: Only 3 door vehicles utilise fuse 16 for HRW operation.

The earth path for the HRW coil is controlled by the CCU (C0592), which is connected directly into the rear of the passenger compartment fuse box. The CCU will only provide an earth path for the relay coil if the ignition is switched on, and the engine is running.

Fusible link 3 (C0571) is connected to the ignition switch (C0028) by an N wire. When the ignition switch is turned to the 'ignition' position, current flows across the switch (C0028) to fuse 18 of the passenger compartment fuse box (C0588) on a G wire. Fuse 18 provides an ignition feed to the CCU (C0593).

When the CCU receives an ignition feed, it provides a feed to the HRW switch (C0072) on a GY wire. When the switch is pressed, current flows across the switch contacts (C0072) to earth on a B wire. The first of two electrical switches within the CCU will now close.

When the ignition is switched on, the CCU (C0592) also provides a feed to the oil pressure switch (C0187) via the passenger compartment fuse box (C0581) on an NW then WN wire. The oil pressure switch contacts are closed when there is no oil pressure. When the engine is started, the rise in oil pressure causes the switch contacts to open. When the switch contacts open, the second electrical switch within the CCU closes.

When both electrical switches within the CCU are closed, the CCU (C0592) provides an earth path for the HRW relay coil. The energised HRW relay provides a feed to fuse 26, which is also located in the passenger compartment fuse box. Fuse 26 (C0583) provides a feed to the HRW element (C0381) on an N wire. The HRW element (C0382) is earthed on a B wire. Fuse 26 (C0583) also provides a feed to the switch illumination LED (C0072) on an NG wire. The LED (C0072) is earthed on a B wire.

The CCU will de-energise the HRW relay by removing its earth path after approximately 15 minutes has elapsed, or if the ignition is switched off.

Tail Door Window Lift

The HRW will not operate if the tail door glass is not in the fully closed position. If the tail door window is opened while the HRW is operational, the CCU suspends the feed to the HRW element by de-energising the HRW relay. The CCU (C0428) monitors the condition of the tail door window via the tail door window switch (C0354) on BR and BK wires. The switch (C0354) is earthed on a B wire.

For more information on tail door window operation, refer to the **Windows** section of this manual.

 **WINDOWS – 5 DOOR.**

Roof On Switch (3 Door Vehicles Only)

Fuse 16 of the passenger compartment fuse box (C0580) provides a constant battery feed to the roof on switch (C0497) on a P wire. The roof on switch is closed when the hard back is fitted, or the soft back is in the fitted position. In this instance, current flows across the switch (C0497) to the CCU (C0428) on a PY wire. If the hard back is removed (or the soft back is folded down) the roof on switch becomes open circuit, and the feed to the CCU is removed. The CCU will now inhibit operation of the HRW.

DESCRIPTION AND OPERATION

HEATED FRONT SCREEN (HFS)

DESCRIPTION

General

The Heated Front Screen (HFS) consists of two heater elements which are embedded into the LH and RH sides of the windscreen. Two connectors at the base of the windscreen provide the power feed and an integral earth for each of the heater elements.

Operation of the HFS is controlled by the CCU and a non latching switch on the centre console. The switch contains an LED which illuminates while the HFS is on. The CCU de-energises the HFS relay after approximately 5 minutes, when the switch is pressed again or if the engine stops.

OPERATION

General

Feed from the positive battery terminal (C0192) is supplied to fusible link 3 of the engine compartment fuse box (C0632) on an R wire and the Heated Front Screen (HFS) relay (C0994) on an N wire.

Fusible link 3 (C0571) provides a constant battery feed to the ignition switch (C0028) on an N wire. When the ignition switch is turned to the 'ignition' position, current flows across the switch (C0028) to fuse 18 of the passenger compartment fuse box (C0588) on a G wire. Fuse 18 provides an ignition feed to the CCU (C0593), which is mounted on the rear of the passenger compartment fuse box. The CCU (C0593) is earthed via the passenger compartment fuse box (C0587) on a B wire.

HFS Relay

The battery (C0192) provides a constant battery feed to the HFS relay coil (C0994) on an N wire. The earth path for the relay coil (C0994) is controlled by the CCU (C0429) on an SB wire.

The CCU will only provide an earth path for the HFS relay coil if all of the following are present:

- The ignition is on.
- The engine is running.
- The HFS switch is pressed.

The CCU (C0592) monitors the condition of the oil pressure switch (C0187) on a WN wire. The oil pressure switch contacts are closed when there is no oil pressure. When the engine is started, the rise in oil pressure causes the switch contacts to open.

HFS Switch

The CCU (C0429) monitors the condition of the HFS switch (C0131) by providing a feed on a KO wire. When the switch is pressed the CCU senses the momentary earth path, and (providing all other conditions are met) energises the HFS relay. The switch (C0131) is earthed on a B wire.

HFS Elements

The energised HFS relay (C0994) provides a feed to fuse A and fuse B (C1860) on a pair of NW wires. Fuse A (C1860) provides a feed to the LH screen element (C0247) on a PS wire. Fuse B (C1860) provides a feed to the RH screen element (C0246) on a PW wire.

The energised HFS relay (C0994) also provides a feed to fuse C (C1860) on an NW wire. Fuse C (C1860) provides a feed to the HFS switch tell-tale LED (C0131) on a PK wire. The LED (C0131) is earthed on a B wire.

DESCRIPTION AND OPERATION

WIPERS AND WASHERS

DESCRIPTION

Front

Wipers

Operation of the windscreen wipers is controlled by the Central Control Unit (CCU). There are four modes of wiper operation. These are selectable from the RH column stalk when the ignition switch is in the 'ignition' position.

NOTE: Windscreen wiper operation is temporarily suspended while the engine is cranking.

The modes of windscreen wiper operation are:

- Slow wipe.
- Fast wipe.
- Intermittent wipe.
- Flick wipe.

Washers

The windscreen washer jets are controlled by the CCU and are operated by pulling the RH column stalk back against spring pressure. When the washer jets are operated, the windscreen wipers will start operating at slow speed after a delay of approximately 0.6 seconds. The wipers will continue to operate at slow speed until approximately 2 seconds after the RH wiper stalk is released.

Rear

Wiper

The rear wiper is switched on and off by pressing the switch mounted on the centre of the fascia. The rear wiper is controlled by the Central Control Unit (CCU) and will only operate when the ignition switch is in the 'ignition' position.

NOTE: Rear wiper operation will NOT be suspended while the engine is cranking.

The rear wiper will stop operating and return to its park position if any of the following occur:

- The tail door is opened.
- The tail door window is opened.
- The roof is removed (3 door vehicles only).

If the windscreen wipers are in operation and reverse gear is selected, the rear wiper will automatically operate at slow speed, irrespective of rear wiper switch position. The rear wiper will stop operating when reverse gear is de-selected.

Washer

The rear washer is operated by pressing the non-latching switch mounted on the centre of the fascia. The washer will operate until the switch is released.

The rear wiper will start operating at slow speed as soon as the washer switch is depressed, and will continue to operate at slow speed for approximately 6 seconds after the switch is released.

OPERATION

Front

General

Feed from the positive battery terminal (C0192) is supplied to fusible link 3 of the engine compartment fuse box (C0632) on an R wire. Fusible link 3 (C0571) is connected to the ignition switch (C0028) by an N wire. When the ignition switch is turned to the 'ignition' position, current flows across the switch (C0028) to fuse 8 (C0588) on a G wire, and fuse 1 (C0588) on an NW wire. Both are located in the passenger compartment fuse box.

Fuse 8 and fuse 1 (C0593) both provide an ignition feed to the front wiper relay contained within the Central Control Unit (CCU). The CCU (C0593) is earthed via the passenger compartment fuse box (C0587) on a B wire.

Intermittent Wipe

Fuse 1 of the passenger compartment fuse box (C0581) provides an ignition feed to the wiper switch (C0035) on an LG wire, and the variable wipe potentiometer (C0320) on a GY wire. When the wiper switch is moved to the intermittent wipe position, current flows across the switch (C0035) to the CCU (C0428) on a G wire.

The variable wipe potentiometer has 5 pre-set positions. The potentiometer (C0320) is connected to the CCU (C0429) by a WK wire. The voltage supplied to the CCU by the potentiometer is dependent upon its position. The CCU is able to determine the amount of delay to apply to the wipers by measuring the voltage provided on the WK wire.

When the CCU receives a feed from the intermittent wipe switch and the potentiometer, it provides an intermittent feed back to the wiper switch (C0035) on a LGK wire. The wiper switch (C0035) is connected to the wiper motor (C0030) by a ULG wire. Current flows across the motor slow speed windings and is earthed (C0030) on a B wire.

Slow Wipe

Fuse 1 of the passenger compartment fuse box (C0581) provides an ignition feed to the wiper switch (C0035) on a G wire. When the wiper switch is moved to the slow wipe position, current flows across the switch (C0035) to the wiper motor (C0030) on a ULG wire. Current flows across the motor slow speed windings and is earthed (C0030) on a B wire.

DESCRIPTION AND OPERATION

Fast Wipe

Fuse 1 of the passenger compartment fuse box (C0581) provides an ignition feed to the wiper switch (C0035) on a G wire. When the wiper switch is moved to the fast wipe position, current flows across the switch (C0035) to the wiper motor (C0030) on a RG wire. Current flows across the motor fast speed windings and is earthed (C0030) on a B wire.

Park

Fuse 1 of the passenger compartment fuse box (C0581) provides an ignition feed to the wiper motor park switch (C0030) on an LG wire. The park switch is closed with the wipers in any position other than the park position.

When the wipers are turned off, current flows across the park switch (C0030) to the CCU (C0430) on an NLG wire. The CCU (C0430) is connected to the wiper switch (C0035) by an LGK wire. The wiper switch (C0035) provides a feed to the wiper motor (C0040) on a ULG wire. Current flows across the motor slow speed windings and is earthed (C0030) on a B wire. When the wipers reach the park position, the switch contacts open and power to the wiper motor is cut.

Washers

Fuse 1 of the passenger compartment fuse box (C0581) provides an ignition feed to the washer switch (C0035) on an LG wire. When the RH column stalk is pulled back against spring pressure, current flows across the switch (C0035) to the washer pump (C0008) on a LGB wire. The washer pump (C0008) is earthed on a B wire.

The washer switch (C0035) also provides a feed to the CCU (C0428) on an LGB wire. When the CCU receives this feed, it initiates its programmed wash/wipe function.

Rear

General

Feed from the positive battery terminal (C0192) is provided to fusible link 3, and fusible link 4 of the engine compartment fuse box (C0632) on an R wire. Fusible link 4 (C0574) is connected to fuse 38 and fuse 16 of the passenger compartment fuse box (C0587) by an NW wire. Fuse 38 (C0583) provides a constant battery feed to the rear wiper relay (C0124) on a PR wire. Fuse 16 (C0580) provides a constant battery feed to the 'Roof On' switch (C0497) on a P wire.

Fusible link 3 (C0571) is connected to the ignition switch (C0028) by an N wire. When the ignition switch is turned to the 'ignition' position, current flows across the switch (C0028) to fuse 3 of the passenger compartment fuse box (C0588) on an NW wire. The ignition switch (C0028) also provides a feed to fuse 18 of the passenger compartment fuse box (C0588) on a G wire.

Wiper

The CCU (C0592) monitors the condition of the wiper switch (C0079) by providing a feed via the passenger compartment fuse box (C0589) on an RG wire. When the switch is pressed, current flows across the switch contacts (C0079) to earth on a B wire. When the CCU registers this earth, it provides a feed to the rear wiper relay (C0124) on a YB wire. The rear wiper relay contains two independent relays; a forward relay and a reverse relay.

The energised forward relay (C0124) is now able to provide a feed to the wiper motor (C0388) on a GR wire. Current flows across the motor windings (C0388) and back to the rear wiper relay (C0124) on a G wire.

To move the wiper back, the CCU (C0429) removes the feed to the wiper relay on a YB wire and provides a feed on a YW wire. This feed energises the reverse relay, which is earthed on a B wire.

The energised reverse relay (C0124) is now able to provide a feed to the wiper motor (C0388) on a G wire. Current flows across the motor windings (C0388) and back to the rear wiper relay (C0124) on a GR wire.

Off-Screen Park

The CCU (C0428) monitors the off-screen park function of the rear wiper (C0388) by providing a signal feed on OB and NG wires. For more information on the off-screen park function, refer to the **Wipers and Washers** section of the Workshop manual.

Tail Door Window Lift

The rear wiper will not operate if the tail door glass is not in the fully closed position. If the tail door window is open. The CCU (C0428) monitors the condition of the tail door window via the tail door window switch (C0354) on BR and BK wires. The switch (C0354) is earthed on a B wire.

For more information on tail door window operation, refer to the **Windows** section of this manual.



WINDOWS – 5 DOOR.

Washer

Fuse 3 of the passenger compartment fuse box (C0589) provides an ignition feed to the washer switch (C0073) on a GY wire. When the switch is depressed, current flows across the switch contacts (C0073) to the rear washer pump relay (C2624) and the CCU (C0428) on GB wires. The rear washer pump relay is located in the passenger compartment fuse box and is earthed (C2624) on a B wire.

When the CCU receives this feed, it initiates its programmed wash/wipe function, and provides a feed to the rear wiper relay (C0124) on a YB wire. The rear wiper relay operates the rear wiper as described above.

DESCRIPTION AND OPERATION

The rear wiper relay (C0124) also provides a feed to the rear washer pump relay (C2624) on a GR wire. The energised washer pump relay (C2624) provides a feed to the washer pump (C0021) on a GB wire. The pump (C0021) is earthed on a B wire.

Tail Door Switch

The CCU (C0428) monitors the condition of the tail door switch (C0616) by providing a feed on a BO wire. The tail door switch is open circuit when the tail door is closed. When the tail door is opened, the switch contacts close and an earth path is created on a B wire. Sensing this earth path, the CCU suspends operation of the rear wiper.

Roof On Switch (3 Door Vehicles Only)

Fuse 16 of the passenger compartment fuse box (C0580) provides a constant battery feed to the roof on switch (C0497) on a P wire. The roof on switch is closed when the hard back is fitted, or the soft back is in the fitted position. In this instance, current flows across the switch (C0497) to the CCU (C0428) on a PY wire.

If the hard back is removed (or the soft back is folded down) the roof on switch becomes open circuit, and the feed to the CCU is removed. When the CCU registers this, it suspends operation of the rear wiper.

BRAKE AND REVERSE LAMPS

DESCRIPTION

Brake Lamps

Three brake lamps are fitted to the rear of the vehicle. Two brake lamps are mounted above the rear bumper, and share a dual filament bulb with the tail lamps. A third, high mounted tail lamp is housed within a casting mounted on the tail door above the spare wheel.

NOTE: NAS vehicles are also fitted with a second pair of brake lamp bulbs. These operate in conjunction with the normal brake lamp bulbs. These secondary bulbs are also used as fog lamps. For more information of fog lamp operation, refer to the 'Fog Lamps' section of this manual.

FOG LAMPS.

The brake lamps are operated by the brake pedal switch, which is mounted on the pedal box, and will only operate when the ignition switch is in the 'ignition' position.

The brake lamps will also operate without operation of the brake pedal. If Hill Descent Control (HDC) is engaged, ABS ECU will operate the brake lamps, responding from signals from the ABS modulator.

For more details of HDC, refer to the **Brakes** section of the Workshop manual. For more information on ABS operation, refer to the **Anti-lock Braking System (ABS)** section of this manual.

ANTI-LOCK BRAKING SYSTEM (ABS).

Reverse Lamps

The reverse lamps are incorporated into the tail lamp units, and will only operate when the ignition switch is in the 'ignition' position, and reverse gear is selected.

OPERATION

General

Feed from the positive battery terminal (C0192) is supplied to fusible link 3 of the engine compartment fuse box (C0632) on an R wire. Fusible link 3 (C0571) is connected to the ignition switch (C0028) by an N wire. When the ignition switch is turned to the 'ignition' position, current flows across the switch (C0028) to fuse 2 of the passenger compartment fuse box (C0588) on an NW wire.

DESCRIPTION AND OPERATION

Fuse 2 provides an ignition feed to the reverse lamp relay, which is also located in the passenger compartment fuse box. Fuse 2 (C0581) also provides an ignition feed to the brake pedal switch (C0075), and the reverse lamp switch (C0163) on G wires.

NOTE: The reverse lamp switch is fitted to manual transmission vehicles only. The reverse lamp relay is fitted to automatic transmission vehicles only.

Brake Lamps

The brake pedal switch (C0075) is provided an ignition feed from fuse 2 of the passenger compartment fuse box (C0581) on a G wire. When the brake pedal is pressed, current flows across the switch (C0075) to the following on GP wires:

- The RH brake lamp (C0125).
- The LH brake lamp (C0121).
- The Centre High Mounted Stop Lamp (CHMSL) (C0613).
- The trailer pick-up (C0499) (GP then R wire).
- The ABS ECU (C0501).

All brake lamps are earthed on a B wire. The trailer pick-up is earthed on a W then B wire

NOTE: The brake pedal switch (C0075) provides a second feed to the ABS ECU on a GR wire. For more information on ABS operation, refer to the 'Anti-lock Braking System (ABS)' section of this manual.

ANTI-LOCK BRAKING SYSTEM (ABS).

Reverse Lamps

Manual Transmission

Fuse 2 of the passenger compartment fuse box (C0581) provides an ignition feed to the reverse lamp switch (C0163) on a G wire. When reverse gear is selected, current flows across the switch (C0166 on K1.8 vehicles, C0163 on Td4 vehicles) to the RH (C0455) and LH (C0472) reverse lamps on GN wires. Both lamps are earthed on B wires.

Automatic Transmission

Fuse 2 of the passenger compartment fuse box (C0580) provides an ignition feed to the reverse lamp relay (C0935) on a G wire. When reverse gear is selected, the Electronic Automatic Transmission (EAT) ECU (C0932) provides a feed to the reverse lamp relay coil (C2624) on an NG wire. The relay coil (C0587) is earthed on a B wire. The energised reverse lamp relay (C2624) is now able to provide a feed to the RH (C0455) and LH (C0472) reverse lamps on GN wires. Both lamps are earthed on B wires.

For more information on EAT operation, refer to the **Electronic Automatic Transmission (EAT)** section of this manual.

ELECTRONIC AUTOMATIC TRANSMISSION (EAT).

HEAD, SIDE AND TAIL LAMPS

DESCRIPTION

General

The headlamp assemblies each contain a side lamp bulb and a dual filament headlamp bulb. The tail lamps and rear number plate lamp operate together with the side lamps and headlamps, and share a dual filament bulb with the brake lamps. The rear number plate lamp is incorporated into the tail door handle.

The side and headlamps are controlled via the lighting switch, which is mounted on the end of the LH column switch. Turning the switch to its first position will illuminate the side lamps. Turning the switch to its second position will illuminate the headlamps. The headlamps can be switched between full and dipped beam by pulling the column switch back against (and past) spring pressure. When the headlamps are switched on, a blue warning lamp illuminates within the instrument pack.

If the side or headlamps are switched on, the ignition is switched off, and the driver door is opened, the Central Control Unit (CCU) will sound a 2 KHz sounder. The sounder is integral within the CCU, and informs the driver the lights have been left on inadvertently.

Headlamp Levelling

To prevent dazzling oncoming road users, the headlamps can be adjusted to compensate for the effect of different load on headlamp vertical alignment. Headlamp levelling is controlled via a four position switch mounted below the instrument pack. The switch operates a levelling motor on each headlamp when the lighting switch is in either the side or headlamp position.

The switch is marked with four positions, which should be used under the following conditions:

- 0 – Driver, or driver and front seat passenger only (no luggage).
- 1 – Driver and three passengers (no luggage).
- 2 – Driver, three passengers and full luggage compartment.
- 3 – Driver only, full luggage compartment.

DESCRIPTION AND OPERATION

OPERATION

General

Feed from the positive battery terminal (C0192) is supplied to fusible link 3, fusible link 9 and fusible link 12 of the engine compartment fuse box (C0632) on an R wire. Fusible link 12 (C0570) provides a constant battery feed to the lighting switch (C0041) on a UN wire. A second constant battery feed is provided by fusible link 12 (C0575) to the lighting switch (C0041) on an RN wire.

Fusible link 9 (C0570) provides a constant battery feed to the headlamp main/dipped beam relay (C0587) on an N wire. The headlamp main/dipped beam relay is located in the passenger compartment fuse box.

Fusible link 3 (C0571) is connected to the ignition switch (C0028) by an N wire. When the ignition switch is turned to the 'ignition' position, current flows across the switch (C0028) to fuse 18 of the passenger compartment fuse box (C0588) on a G wire. Fuse 18 provides an ignition feed to the Central Control Unit (CCU) (C0593), which is mounted directly onto the rear of the passenger compartment fuse box.

Side Lamps

When the lighting switch is turned to the side lamp position, current flows across the switch (C0041) to fuse 7 and fuse 17 of the passenger compartment fuse box (C0587) on an R wire. Fuse 17 (C0580) provides a feed to the following on RO wires:

- RH side lamp (C0011).
- RH tail lamp (C0125).
- Rear number plate lamp (C0138).
- Trailer pick-up (C0499) (RO then B wire).

Fuse 7 (C0581) provides a feed to the following on RB wires:

- LH headlamp (C0009).
- LH tail lamp (C0121).
- The trailer pick-up (C0499) (RB then N wire).

All are earthed on B wires except the trailer pick-up, which is earthed on a W then B wire.

Headlamps

Dipped Beam

When the lighting switch is turned to the headlamp position, current flows across the switch (C0041) to fuse 19 and fuse 20 of the passenger compartment fuse box (C0587) on a UO wire. Fuse 19 (C0581) provides a feed to the RH dipped beam bulb (C0011) on a UB wire. Fuse 20 (C0581) provides a feed to the LH dipped beam bulb (C0009) on a UK wire. Both are earthed on B wires.

Main Beam

When the lighting switch is turned to the headlamp position, and pulled back to the main beam position, current flows across the switch (C0041) to the main/dipped beam relay coil (C0586) on a UW wire. The main/dipped beam relay coil is located within the passenger compartment fuse box (C0587) and is earthed on a B wire.

The energised main/dipped beam relay allows a feed from fusible link 9 of the engine compartment fuse box (C0570) to provide a feed to fuse 14 and fuse 34 of the passenger compartment fuse box. Fuse 14 (C0584) provides a feed to the RH headlamp main beam bulb (C0011) on a UG wire. Fuse 14 (C0589) also provides a feed to the warning lamp located within the instrument pack (C0233) on a UG wire. Both are earthed on B wires.

Fuse 34 (C0587) provides a feed to the LH main beam bulb (C0009) on a US wire. The bulb (C0009) is earthed on a B wire.

Headlamp Flash

When the LH column switch is pulled back (but not past) spring pressure, the headlamps operate in exactly the same way as described in the ***Main Beam*** section until the switch is released.

CCU

When the lighting switch is turned to the main beam position, current flows across the switch (C0041) to the CCU (C0428) on an OU wire. The CCU also monitors the condition of the driver door switch (C0441) on a PS then PW wire, and the ignition switch. If the driver door switch is closed and the ignition switch in the 'off' position, the CCU will power its integral 2 KHz sounder.

For more information on the driver door switch, refer to the ***Anti-theft Alarm and Central Door Locking (CDL)*** section of this manual.



ANTI-THEFT ALARM AND CENTRAL DOOR LOCKING (CDL).

DESCRIPTION AND OPERATION

Headlamp Levelling

When the lighting switch is turned to the side or headlamp position, current flows across the switch (C0041) to fuse 7 of the passenger compartment fuse box (C0587) on an R wire. Fuse 7 (C0589) provides a feed to the headlamp levelling switch (C0093) on an RB wire. The switch (C0093) is earthed on a B wire.

The headlamp levelling switch has four pre-set positions. At each of the four switch positions, the contacts in the switch connect to a different resistance value to provide one of four different output voltages.

RH Motor

The headlamp levelling switch (C0093) is connected to the RH headlamp levelling motor (C0070) by a UB wire. By comparing the voltage provided by the switch against a feed provided by fuse 17 of the passenger compartment fuse box (C0582) on an RO wire, the motor moves the headlamp to the required position. The motor is earthed on a B wire.

LH Motor

The headlamp levelling switch (C0093) is connected to the LH headlamp levelling motor (C0071) by a UB wire. By comparing the voltage provided by the switch against a feed provided by fuse 7 of the passenger compartment fuse box (C0582) on an RB wire, the motor moves the headlamp to the required position. The motor (C0071) is earthed on a B wire.

HEAD, SIDE AND TAIL LAMPS – NAS

DESCRIPTION

General

The headlamp assemblies each contain a side lamp bulb and a dual filament headlamp bulb. The tail lamps and rear number plate lamp operate together with the side lamps and headlamps, and share a dual filament bulb with the brake lamps. Additional tail lamps are also incorporated within the E-post mounted lamp cluster. The rear number plate lamp is incorporated into the tail door handle.

The side and headlamps are controlled via the lighting switch, which is mounted on the end of the LH column switch. Turning the switch to its first position will illuminate the side lamps. Turning the switch to its second position will illuminate the headlamps. The headlamps can be switched between full and dipped beam by pulling the column switch back against (and past) spring pressure. When the headlamps are switched on, a blue warning lamp illuminates within the instrument pack.

If the side or headlamps are switched on, the ignition is switched off, and the driver door is opened, the Central Control Unit (CCU) will sound a 2 KHz sounder. The sounder is integral within the CCU, and informs the driver the lights have been left on inadvertently.

OPERATION

General

Feed from the positive battery terminal (C0192) is supplied to fusible link 3, fusible link 9 and fusible link 12 of the engine compartment fuse box (C0632) on an R wire. Fusible link 12 (C0570) provides a constant battery feed to the lighting switch (C0041) on a UN wire. A second constant battery feed is provided by fusible link 12 (C0575) to the lighting switch (C0041) on an RN wire.

Fusible link 9 (C0570) provides a constant battery feed to the headlamp main/dipped beam relay (C0587) on an N wire. The headlamp main/dipped beam relay is located in the passenger compartment fuse box.

Fusible link 3 (C0571) is connected to the ignition switch (C0028) by an N wire. When the ignition switch is turned to the 'ignition' position, current flows across the switch (C0028) to fuse 18 of the passenger compartment fuse box (C0588) on a G wire. Fuse 18 provides an ignition feed to the Central Control Unit (CCU) (C0593), which is mounted directly onto the rear of the passenger compartment fuse box.

DESCRIPTION AND OPERATION

Side Lamps

When the lighting switch is turned to the side lamp position, current flows across the switch (C0041) to fuse 7 and fuse 17 of the passenger compartment fuse box (C0587) on an R wire. Fuse 17 (C0580) provides a feed to the following on RO wires:

- RH side lamp (C0011).
- E-post mounted RH tail lamp (C0489).
- Bumper mounted RH tail lamp (C0125).
- Rear number plate lamp (C0138).
- Trailer pick-up (C0499) (RO then B wire).

Fuse 7 (C0581) provides a feed to the following on RB wires:

- LH headlamp (C0009).
- E-post mounted LH tail lamp (C0490).
- Bumper mounted LH tail lamp (C0121).
- The trailer pick-up (C0499) (RB then N wire).

All are earthed on B wires except the trailer pick-up, which is earthed on a W then B wire.

Headlamps

Dipped Beam

When the lighting switch is turned to the headlamp position, current flows across the switch (C0041) to fuse 19 and fuse 20 of the passenger compartment fuse box (C0587) on a UO wire. Fuse 19 (C0581) provides a feed to the RH dipped beam bulb (C0011) on a UB wire. Fuse 20 (C0581) provides a feed to the LH dipped beam bulb (C0009) on a UK wire. Both are earthed on B wires.

Main Beam

When the lighting switch is turned to the headlamp position, and pulled back to the main beam position, current flows across the switch (C0041) to the main/dipped beam relay coil (C0586) on a UW wire. The main/dipped beam relay coil is located within the passenger compartment fuse box (C0587) and is earthed on a B wire.

The energised main/dipped beam relay allows a feed from fusible link 9 of the engine compartment fuse box (C0570) to provide a feed to fuse 14 and fuse 34 of the passenger compartment fuse box. Fuse 14 (C0584) provides a feed to the RH headlamp main beam bulb (C0011) on a UG wire. Fuse 14 (C0589) also provides a feed to the warning lamp located within the instrument pack (C0233) on a UG wire. Both are earthed on B wires.

Fuse 34 (C0587) provides a feed to the LH main beam bulb (C0009) on a US wire. The bulb (C0009) is earthed on a B wire.

Headlamp Flash

When the LH column switch is pulled back (but not past) spring pressure, the headlamps operate in exactly the same way as described in the ***Main Beam*** section until the switch is released.

CCU

When the lighting switch is turned to the main beam position, current flows across the switch (C0041) to the CCU (C0428) on an OU wire. The CCU also monitors the condition of the driver door switch (C0441) on a PS then PW wire, and the ignition switch. If the driver door switch is closed and the ignition switch in the 'off' position, the CCU will power its integral 2 KHz sounder.

For more information on the driver door switch, refer to the ***Anti-theft Alarm and Central Door Locking (CDL)*** section of this manual.



ANTI-THEFT ALARM AND CENTRAL DOOR LOCKING (CDL).

DESCRIPTION AND OPERATION

HEAD, SIDE AND TAIL LAMPS – CANADA

DESCRIPTION

General

Daylight running lamps are fitted to Canadian specification vehicles only. The following lamps will operate when the engine is running, irrespective of lighting switch position.

NOTE: Daylight running lamps are extinguished when the vehicle is in 'Park'.

- Headlamps (dipped beam only)
- Side lamps
- Tail lamps
- Side marker lamps
- Number plate lamps.

NOTE: Instrument illumination is not operational until the lighting switch is moved to the side or headlamp position.

OPERATION

General

Feed from the positive battery terminal (C0192) is supplied to fusible link 3, fusible link 9, and fusible link 12 (C0632) on an R wire. Fusible link 12 (C0575) provides a constant battery feed to the lighting switch (C0041) and the daylight running relay (C0212) on an RN wire. A second constant battery feed is provided by fusible link 12 (C0570) to the lighting switch (C0041) and the daylight running relay (C0212) on a UN wire.

Fusible link 9 (C0570) provides a constant battery feed to the headlamp main/dipped beam relay (C0587) on an N wire. The headlamp main/dipped beam relay is located in the passenger compartment fuse box.

Fusible link 3 (C0571) is connected to the ignition switch (C0028) by an N wire. When the ignition switch is turned to the 'ignition' position, current flows across the switch (C0028) to fuse 3 of the passenger compartment fuse box (C0588) on an NW wire. Fuse 3 (C0581) provides an ignition feed to the daylight running relay (C0212) on a GR wire.

The ignition switch (C0028) also provides a feed to fuse 18 of the passenger compartment fuse box (C0588) on a G wire. Fuse 18 provides an ignition feed to the Central Control Unit (CCU) (C0593), which is mounted directly onto the rear of the passenger compartment fuse box.

Side Lamps

When the lighting switch is turned to the side lamp position, current flows across the switch (C0041) to the daylight running relay (C0212) on an RW wire. Current flows through the daylight running relay (C0212) to fuse 7 and fuse 17 of the passenger compartment fuse box (C0587) on an R wire. Fuse 17 (C0580) provides a feed to the following on RO wires:

- The RH side lamp (C0011).
- The bumper mounted RH tail lamp (C0125).
- The E-post mounted RH tail lamp (C0489).
- The rear number plate lamp (C0138).
- The trailer pick-up (C0499) (RO then B wire).

All are earthed on B wires except the trailer pick-up, which is earthed on a W then B wire.

Fuse 7 (C0581) provides a feed to the following on RB wires:

- The LH side lamp (C0009).
- The bumper mounted LH tail lamp (C0121).
- The E-post mounted LH tail lamp (C0490).
- The trailer pick-up (C0499) (RB then N wire).

All are earthed on B wires except the trailer pick-up, which is earthed on a W then B wire.

Headlamps

Dipped Beam

When the lighting switch is turned to the headlamp position, current flows across the switch (C0041) to the daylight running relay (C0212) on a UG wire. Current flows through the relay (C0212) to fuse 19 and fuse 20 of the passenger compartment fuse box (C0587) on a UO wire. Fuse 19 (C0581) provides a feed to the RH dipped beam bulb (C0011) on a UB wire. Fuse 20 (C0581) provides a feed to the LH dipped beam bulb (C0009) on a UK wire. Both are earthed on B wires.

Main Beam

When the lighting switch is turned to the headlamp position, and pulled back to the main beam position, current flows across the switch (C0041) to the main/dipped beam relay coil (C0586) on a UW wire. The main/dipped beam relay coil is located within the passenger compartment fuse box (C0587) and is earthed on a B wire.

The energised main/dipped beam relay allows a feed from fusible link 9 of the engine compartment fuse box (C0570) to provide a feed to fuse 14 and fuse 34 of the passenger compartment fuse box. Fuse 14 (C0584) provides a feed to the RH headlamp main beam bulb (C0011) on a UG wire. Fuse 14 (C0589) also provides a feed to the warning lamp located within the instrument pack (C0233) on a UG wire. Both are earthed on B wires.

Fuse 34 (C0587) provides a feed to the RH main beam bulb (C0009) on a US wire. The bulb (C0009) is earthed on a B wire.

DESCRIPTION AND OPERATION

Headlamp Flash

When the LH column switch is pulled back (but not past) spring pressure, the headlamps operate in exactly the same way as described in the '*Main Beam*' section until the switch is released.

CCU

When the lighting switch is turned to the main beam position, current flows across the switch (C0041) to the CCU (C0428) on a UG wire. The CCU also monitors the condition of the driver door switch (C0441) on a PS then PW wire, and the ignition switch. If the driver door switch is closed and the ignition switch in the 'off' position, the CCU will power its integral 2 KHz sounder.

For more information on the driver door switch, refer to the ***Anti-theft Alarm and Central Door Locking (CDL)*** section of this manual.

 **ANTI-THEFT ALARM AND CENTRAL DOOR LOCKING (CDL).**

Daylight Running Lamps

The daylight running lamps will be operational if the following conditions are met:

- The ignition switch is in the 'ignition' position.
- The engine is running.
- The automatic transmission isn't in 'Park'.
- The lighting switch isn't in the 'Headlamp' position.

The CCU (C0593) is provided an ignition feed via fuse 18 of the passenger compartment fuse box, and registers if the engine is running via the oil pressure switch. The CCU (C0592) provides a feed to the oil pressure switch (C0187) on a WN wire. The oil pressure switch contacts are closed when there is no oil pressure. When the engine is started, the rise in oil pressure causes the switch contacts to open.

If 'Park' is selected, the automatic transmission selector (C0244) provides a feed to the CCU (C0593) on a KO wire. For more information on automatic transmission operation, refer to the ***Electronic Automatic Transmission (EAT)*** section of this manual.

 **ELECTRONIC AUTOMATIC TRANSMISSION (EAT).**

The CCU (C0428) monitors the condition of the lighting switch (C0041) via a UG wire. A feed will only be provided to the CCU when the lighting switch is turned to the 'Headlamp' position.

If all of these conditions are met, the CCU (C0593) provides an earth path for the daylight running relay (C0212) on an RG wire. This allows a battery feed from fusible link 12 of the engine compartment fuse box (C0570) to flow through the relay (C0212) and power the headlamp dipped beam bulbs as described previously.

FOG LAMPS

DESCRIPTION

General

The rear fog lamps are incorporated within the light clusters mounted on the E post. The front fog lamps are mounted on either side of the bumper. The front fog lamps are operated by pressing the latching switch mounted in the centre of the fascia. The rear fog lamps are operated by pressing the adjacent non-latching switch. Both switches contain a tell-tale LED to inform the driver the fog lamps are operational.

The fog lamps will only operate if the following conditions exist:

BRAKE AND REVERSE LAMPS.

- The ignition switch is turned to the 'ignition' position.
- The lighting switch is in the side or headlamp position.
- The relevant fascia mounted switch is pressed.

NOTE: The front fog lamps on NAS vehicles will not illuminate while headlamp main beam is operational.

OPERATION

Front

General

Feed from the positive battery terminal (C0192) is supplied to fusible link 3, fusible link 9 and fusible link 12 of the engine compartment fuse box (C0632) on an R wire. Fusible link 9 (C0570) provides a constant battery feed to the main/dipped beam relay (NAS vehicles only) and fuse 30 of the passenger compartment fuse box (C0587) on an N wire.

Fusible link 3 (C0571) is connected to the ignition switch (C0028) by an N wire. When the ignition switch is tuned to the 'ignition' position, current flows across the switch (C0028) to the front fog lamp relay coil (C0588) on a G wire. The relay is located in the passenger compartment fuse box and is earthed (C0589) on a B wire.

Fusible link 12 (C0575) is connected to the lighting switch (C0041) by an RN wire. Fusible link 12 (C0570) also provides a feed to the lighting switch (C0041) on a UN wire.

Lighting Switch

When the lighting switch is turned to the side lamp position, current flows across the switch (C0041) to fuse 39 of the passenger compartment fuse box (C0587) on an R wire. Fuse 39 (C0580) provides a feed to the front fog lamp relay (C2624) on an R wire.

DESCRIPTION AND OPERATION

Lighting Switch – NAS

When the lighting switch is turned to the headlamp position, current flows across the switch (C0041) to fuse 28 of the passenger compartment fuse box (C0587) on a UO wire. Fuse 28 (C0582) provides a feed to the front fog lamp relay (C2624) on an R wire.

Fog Lamp Relays and Switch

Two front fog lamp relays, relay 3 and relay 4, are located in the passenger compartment fuse box. Relay 4 is energised when the ignition switch is turned to the 'ignition' position. If side or headlamps are selected, the energised relay 4 provides a feed to the coil of relay 3. The earth path for relay 3 (C0589) is controlled via the fog lamp switch (C0065) on an R wire.

When the fog lamp switch is pressed, current flows across the switch (C0065) to earth on a B wire. This will energise relay 3, which supplies a feed from fuse 30 of the passenger compartment fuse box to the LH (C0514) and RH (C0513) fog lamps on UP wires. Both lamps are earthed on B wires.

Fog Lamp Relays and Switch – NAS

Two front fog lamp relays, relay 3 and relay 4, are located in the passenger compartment fuse box. Relay 4 is energised when the ignition switch is turned to the 'ignition' position. If headlamps are selected, the energised relay 4 provides a feed to the coil of relay 3. The earth path for relay 3 (C0589) is controlled via the fog lamp switch (C0065) on an R wire.

When the fog lamp switch is pressed, current flows across the switch (C0065) to fuse 42 of the passenger compartment fuse box (C0589) on a B wire. Fuse 42 is connected to the main/dipped beam relay, which is also located in the passenger compartment fuse box.

If dipped beam has been selected, the main/dipped beam relay is de-energised and provides an earth path (C0587) on a B wire. This will energise relay 3, which supplies a feed from fuse 30 of the passenger compartment fuse box to the LH (C0514) and RH (C0513) fog lamps on UP wires. Both lamps are earthed on B wires.

If main beam has been selected, the lighting switch (C0041) provides a feed to the main/dipped beam relay (C0588) on a UO wire. The relay is earthed (C0587) on a B wire. The main/dipped beam relay is now energised and cuts off the electrical supply to fog lamp relay 3, extinguishing the fog lamps.

Rear

Feed from the positive battery terminal (C0192) is supplied to fusible link 3, fusible link 9, and fusible link 12 of the engine compartment fuse box (C0632) on an R wire. Fusible link 9 (C0570) provides a constant battery feed to fuse 36 of the passenger compartment fuse box (C0587) on an N wire. Fuse 36 is connected to the rear fog lamp relay, which is also located in the passenger compartment fuse box.

Fusible link 3 (C0571) is connected to the ignition switch (C0028) by an N wire. When the ignition switch is turned to the 'ignition' position, current flows across the switch (C0028) to the rear fog lamp relay and fuse 18 of the passenger compartment fuse box (C0588) on a G wire. Fuse 18 provides an ignition feed to the Central Control Unit (CCU) (C0593), which is mounted directly onto the rear of the passenger compartment fuse box.

The earth path for the fog lamp relay coil is controlled by the CCU (C0593). The CCU (C0592) monitors the condition of the rear fog lamp switch (C0064) by providing a feed via the passenger compartment fuse box (C0589) on a RY wire. When the switch is pressed, a momentary earth path is created on a B wire.

The CCU also monitors the condition of the lighting switch. Fusible link 12 (C0570) provides a constant battery feed to the lighting switch (C0041) on a UN wire. When the lighting switch is turned to the side or headlamp position, current flows across the switch (C0041) to the CCU (C0428) on an OU wire. The CCU will now energise the rear fog lamp relay.

The energised rear fog lamp relay (C0588) provides a feed to both the LH fog lamp (C0490 on NAS vehicles, C0515 on all other vehicles), and the RH fog lamp (C0489 on NAS vehicles, C0512 on all other vehicles) on RY wires. The relay also provides a feed to the trailer pick-up (C0499) on a RY then U wire. The fog lamps are earthed on B wires.

DESCRIPTION AND OPERATION

DIRECTION INDICATOR/HAZARD WARNING LAMPS

DESCRIPTION

General

The direction indicator lamps are controlled via the LH column switch. The lamps will only operate when the ignition switch is in the 'ignition' position.

The hazard warning lamps are switched on and off by pressing the hazard warning switch mounted on the centre of the fascia. Hazard warning lamp operation is not dependant upon ignition switch position.

OPERATION

Direction Indicator Lamps

Feed from the positive battery terminal (C0192) is supplied to fusible link 3 of the engine compartment fuse box (C0632) on an R wire. Fusible link 3 (C0571) is connected to the ignition switch (C0028) by an N wire. When the ignition switch is turned to the 'ignition' position, current flows across the switch (C0028) to fuse 18 of the passenger compartment fuse box (C0588) on a G wire. Fuse 18 (C0582) provides an ignition feed to the hazard warning switch (C0096) on a G wire. Current flows across the switch (C0096) to the flasher unit (C2624) on an LGK wire. The flasher unit is located in the passenger compartment fuse box and is earthed (C0587) on a B wire. The energised flasher unit (C0580) provides a feed to the indicator switch (C0036) on an LGN wire.

LH Turn

When the direction indicator switch is moved to the LH turn position, current flows across the switch (C0036) to the following:

- The LH front direction indicator lamp (C0009) on a GR wire.
- The LH side repeater (C0013) on a GR wire.
- The LH rear direction indicator lamp (C0928) on a GR wire.
- The instrument pack (C0233) on a GR wire.
- The trailer pick-up (C0499) on a GR then Y wire.

All are earthed on B wires, except the trailer pick-up (W then B wire).

RH Turn

When the direction indicator switch is moved to the RH turn position, current flows across the switch (C0036) to the following:

- The RH front direction indicator lamp (C0011) on a GW wire.
- The RH side repeater (C0012) on a GW wire.
- The RH rear direction indicator lamp (C0837) on a GW wire.
- The instrument pack (C0233) on a GW wire.
- The trailer pick-up (C0499) on a GW then G wire.

All are earthed on B wires, except the trailer pick-up (W then B wire).

Hazard Warning Lamps

Feed from the positive battery terminal (C0192) is supplied to fusible link 4 and fuse 7 of the engine compartment fuse box (C0632) on an R wire. Fusible link 4 (C0574) provides a constant battery feed to the Central Control Unit (CCU) (C0593) on an NW wire.

Fuse 7 of the engine compartment fuse box (C0576) provides a constant battery feed to the hazard warning switch (C0096) on an NO wire. When the hazard warning switch is pressed, current flows across the switch (C0096) to the flasher unit (C0580) on an LGK wire. The flasher unit (C0587) is earthed on a B wire. The energised flasher unit (C0580) returns a feed back to the hazard warning switch (C0096) on an LGN wire. The hazard warning switch (C0096) is now able to provide feeds to both the LH and RH direction indicator circuits simultaneously on GR and GW wires respectively.

NOTE: Freelander vehicles no longer contain a dedicated hazard warning lamp within the instrument pack. When hazard warning lamp operation is requested, the LH and RH direction indicator warning lamps will flash simultaneously.

Fuse 7 of the engine compartment fuse box (C0576) also provides a constant battery feed to the hazard warning relay (C0580) on an NO wire. The earth path for the hazard warning relay is controlled by the CCU (C0593). For more details on hazard warning relay and CCU operation, refer to the **Electrics** section of the System Description and Operation Workshop manual, and the **Anti-theft Alarm and Central Door Locking (CDL)** section of this manual.



ANTI-THEFT ALARM AND CENTRAL DOOR LOCKING (CDL).

DESCRIPTION AND OPERATION

INTERIOR LAMPS

DESCRIPTION

3 Door

The interior lamp is mounted in the centre of the headlining, and is controlled by the Central Control Unit (CCU) via a three position switch. With the switch in the centre position, the lamp will illuminate as soon as either door is opened. The interior lamp will fade out when any of the following occur:

- Approximately 15 seconds after the last door is closed.
- When the ignition switch is turned to the 'ignition' position.
- When the vehicle is locked using either the remote handset or the key.
- After approximately 10 minutes if a door is left open.

With the switch in the forward 'ON' position, the lamp will remain illuminated irrespective of door status. With the switch in the rear 'OFF' position, the lamp will remain extinguished irrespective of door status.

Additional interior illumination is provided by a glove box lamp, and a load space lamp. The load space lamp will illuminate when the tail door is opened.

5 Door

The front and rear interior lamps are mounted in the headlining, and are controlled by the Central Control Unit (CCU). Both interior lamps will illuminate when any door is opened. The lamps will fade out when any of the following occur:

- Approximately 15 seconds after the last door is closed.
- When the ignition switch is turned to the 'ignition' position.
- When the vehicle is locked using either the remote handset or the key.
- After approximately 10 minutes if a door is left open.

The front interior lamp can also be switched on and off manually by pressing the central switch mounted on the lamp unit. Also incorporated into the front interior lamp unit are two map reading lamps. These can be switched on and off by pressing the appropriate switch on either side of the lamp unit. The rear interior lamp can also be switched on and off manually, by pressing the switch mounted on the rear lamp assembly.

Additional interior illumination is provided by a glove box lamp, and a load space lamp. The load space lamp will illuminate when the tail door is opened.

OPERATION

General

Feed from the positive battery terminal (C0192) is supplied to fusible link 3, fusible link 4 and fusible link 12 of the engine compartment fuse box (C0632) on an R wire. Fusible link 12 (C0575) provides a constant battery feed to the lighting switch (C0041) on an RN wire. Fusible link 4 (C0574) provides a constant battery feed to fuse 16 of the passenger compartment fuse box (C0587) on an NW wire.

Fusible link 3 (C0571) is connected to the ignition switch (C0028) by an N wire. When the ignition switch is turned to the 'ignition' position, current flows across the switch (C0028) to fuse 18 of the passenger compartment fuse box (C0588) on a G wire. Fuse 18 provides an ignition feed to the Central Control Unit (CCU) (C0593), which is mounted directly to the rear of the passenger compartment fuse box.

Central Control Unit (CCU)

The CCU monitors the condition of the door switches as follows:

- The driver door switch (C0441) on a PS then PW wire.
- The front passenger door switch (C0441) on a PW wire.
- The LH rear passenger door switch (C0442) on a PW wire (5 door vehicles only).
- The RH rear passenger door switch (C0442) on a PW wire (5 door vehicles only).

NOTE: Both front door switches and both rear door switches have the same connector numbers as they utilise the same harness's.

All the above are normally open switches. If a door is opened, the switch contacts close and an earth path is created. When the CCU senses an earth path, it illuminates the interior lamp(s). All the above are earthed on B wires.

The CCU (C0428) also monitors the condition of the tail door switch (C0616) on a BO wire. When the tail door is opened, an earth path is created. The CCU will now illuminate the load space lamp (*see 'Load Space Lamp'*).

For more information on CCU operation, refer to the **Control Units** section of the System Description and Operation Workshop manual.

DESCRIPTION AND OPERATION

Illumination Relay

Vehicles fitted with an instrument dimmer switch are also fitted with an illumination relay. Fuse 16 of the passenger compartment fuse box (C0589) provides a constant battery feed to the illumination relay (C1976) on a pair of P wires. The earth path for the relay coil (C1976) is controlled by the CCU (C0592) on a BR wire.

The CCU (C0593) provides an earth path for the relay coil when it receives a 'key in' signal from the transponder coil (C0049) on a PW wire. The energised illumination relay (C1976) provides a feed to the automatic transmission selector (C0244) on an NR wire.

NOTE: If an instrument dimmer is not fitted, the feed to the automatic transmission selector (C0244) is provided by fuse 4 of the engine compartment fuse box via header 285.

For more information on instrument dimmer operation, refer to the **Interior Illumination** section of this manual.

INTERIOR ILLUMINATION.

Interior Lamp(s)

3 Door

Fuse 16 of the passenger compartment fuse box (C0580) provides a constant battery feed to the interior lamp (C0357) on a P wire. When the interior lamp switch is in the normal (central) position, the earth path for the lamp (C0357) is controlled by the CCU (C0593) via the passenger compartment fuse box (C0580) on a PW wire. The CCU will illuminate the interior lamp if it senses any of the doors are open (*see 'Central Control Unit – CCU'*).

When the switch is moved to the 'ON' position, current flows across the bulb to earth via the lamp fixings. This results in the lamp being illuminated irrespective of the condition of the door switches.

When the switch is moved to the 'OFF' position, the circuit is broken. This results in the lamp being extinguished irrespective of the condition of the door switches.

5 Door

Fuse 16 of the passenger compartment fuse box (C0580) provides a constant battery feed to the front interior lamp (C0355) on a P wire. When the interior lamp switch is in the normal position, the earth path for the lamp (C0355) is controlled by the CCU (C0593) via the passenger compartment fuse box (C0582) on a PW wire. The CCU will illuminate the interior lamp if it senses any of the doors are open (*see 'Central Control Unit – CCU'*).

When the switch is pressed, current flows across the bulb (C0355) to earth on a B wire. This results in the lamp being illuminated irrespective of the condition of the door switches.

Fuse 16 (C0580) also provides a constant battery feed to the rear interior lamp (C0356) on a P wire. When the interior lamp switch is in the normal position, the earth path for the lamp (C0356) is controlled by the CCU (C0593) via the passenger compartment fuse box (C0582) on a PW wire. The CCU will illuminate the interior lamp if it senses any of the doors are open (see *'Central Control Unit – CCU'*).

When the switch is pressed, current flows across the bulb (C0356) to earth on a B wire. This results in the lamp being illuminated irrespective of the condition of the door switches.

Map Reading Lamps (5 Door Vehicles Only)

Fuse 16 of the passenger compartment fuse box (C0580) provides a constant battery feed to both the LH and RH map reading lamp switches (C0355) on a P wire. When either of the switches are pressed, current is able to flow across the switch to the map reading lamp bulb. Both bulbs are earthed via the lamp fixings.

Load Space Lamp

Fuse 16 of the passenger compartment fuse box (C0583) provides a constant battery feed to the load space lamp (C0119) on a P wire. The earth path for the load space lamp (C0120) is controlled by the CCU (C0593) via the passenger compartment fuse box (C0582) on a PW wire. The CCU will illuminate the interior lamp if it senses the tail door is open (see *'Central Control Unit – CCU'*).

Glove Box Lamp

Fusible link 12 of the engine compartment fuse box (C0575) provides a constant battery feed to the lighting switch (C0041) on an RN wire. When the lighting switch is turned to the side or headlamp position, current flows across the switch to fuse 17 of the passenger compartment fuse box (C0587) on an R wire. Fuse 17 (C0589) provides a feed to the glove box lamp (C0227) on an RO wire.

The earth path for the glove box lamp (C0235) is controlled by the glove box switch (C0238) on a BR wire. When the glove box is opened, the switch closes and an earth path is created via the passenger compartment fuse box (C0587) on a B wire.

Vanity Mirrors

Fuse 16 of the passenger compartment fuse box (C0580) provides a constant battery feed to the LH (C0760 on 3 door vehicles, C0737 on 5 door vehicles) and RH (C0736) vanity mirror lamps on P wires. The lamps are earthed on B wires.

DESCRIPTION AND OPERATION

INTERIOR ILLUMINATION

DESCRIPTION

General

Interior illumination provides background lighting for the instrument pack and control switch graphics. Interior illumination operates when the lighting switch is turned to the side or headlamp position, irrespective of ignition switch position.

OPERATION

General

Feed from the positive battery terminal (C0192) is supplied to fusible link 12 and fusible link 4 of the engine compartment fuse box (C0632) on an R wire. Fusible link 4 (C0574) is connected to the timer relay (C0587) by an NW wire. The timer relay is located in the passenger compartment fuse box, and is controlled by the Central Control Unit (CCU) (C0592).

When energised, the timer relay provides a feed to fuse 29 of the passenger compartment fuse box. Fuse 29 (C0580) is connected to the window lift switch pack (C0343) by an RB wire. The switch pack (C0081) is earthed on a B wire.

Fusible link 12 (C0575) is connected to the lighting switch (C0041) by an RN wire. When the lighting switch is turned to the side or headlamp position, current flows across the switch (C0041) to fuse 17 of the passenger compartment fuse box (C0587) on an R wire.

Fuse 17 (C0580) provides a feed to the following on RO wires:

- The cruise control master switch (C0749).
- The hazard warning switch (C0096).
- The Heated Rear Window (HRW) switch (C0072).
- The front LH window switch (C0321).
- The front RH window switch (C0242).
- The Hill Descent Control (HDC) switch (C0878).
- The tail door window switch (C0354).
- The Central Door Locking (CDL) switch (C0328).
- The LH seat switch (C0249).
- The RH seat switch (C0250).
- The LH rear window switch (C0732) (5 door vehicles only).
- The RH rear window switch (C0732) (5 door vehicles only).
- The sunroof switch (C0363).
- The cigar lighter (C0074).
- The audio head unit (C0098).
- The satellite navigation head unit (C0921).
- The heater controls (C0051).
- The air conditioning (a/c) switch pack (C0275).
- The fresh/recirculated air switch (C0750).
- The Heated Front Screen (HFS) switch (C0131).
- The passenger door window switch (C0087).
- The PDC switch (C0404).

All the above are earthed on B wires.

Fuse 17 (C0589) also provides a feed to the following on RO wires:

- The instrument pack (C0233).
- The rear fog lamp switch (C0064).
- The front fog lamp switch (C0065).
- The clock (C0232).
- The rear screen washer switch (C0073).
- The rear screen wiper switch (C0079).

All the above are earthed on B wires.

Instrument Dimmer (Canadian Vehicles Only)

The instrument dimmer is a rotary potentiometer mounted on the fascia below the instrument pack. When the lighting switch is turned to the side or headlamp position, current flows across the switch (C0041) to fuse C (C1875) on an RW wire. Fuse C (C1875) is connected to the instrument dimmer (C0201) by an RB wire. The dimmer (C0201) provides a feed to all the switches and controls mentioned previously on RO wires.

The switch (C0201) also contains a tell-tale LED, which is earthed on a B wire.

DESCRIPTION AND OPERATION

INSTRUMENTS

DESCRIPTION

General

The instrument pack is a totally electronic controlled device receiving electrical signals from sender units, and CAN messages from the Engine Control Module (ECM), the ABS ECU, the Electronic Automatic Transmission Electronic Control Unit (EAT ECU) and the cruise control interface unit (Td4 vehicles only). The instrument pack transposes these via a microprocessor into analogue gauge read out and warning lamp illumination.

The warning lamps illuminate in one of four colours, which indicate the level of importance of the warning as follows:

- Red = Warning.
- Yellow = Caution.
- Green = System operative.
- Blue = Headlamp main beam operative.

For a detailed description of the instrument pack, refer to the ***Instruments*** section of the System Description and Operation Workshop manual.

OPERATION

General

Feed from the positive battery terminal (C0192) is supplied to the following (C0632) on an R wire:

- Fuse 7
- Fusible link 12
- Fusible link 9
- Fusible link 4
- Fusible link 3

Fuse 7 (C0576) provides a constant battery feed to the hazard warning relay located in the passenger compartment fuse box (C0580) on an NO wire.

Fusible link 12 (C0575) provides a constant battery feed to the lighting switch (C0041) on an RN wire.

Fusible link 9 (C0570) is connected to the main/dipped beam relay located in the passenger compartment fuse box (C0587) by an N wire.

Fusible link 4 (C0574) is connected to fuse 16 of the passenger compartment fuse box (C0587) by an NW wire. Fuse 16 (C0589) provides a constant battery feed to the instrument pack (C0230) on a P wire.

Fusible link 3 (C0571) is connected to the ignition switch (C0028) by an N wire. When the ignition switch is turned to the 'ignition' position, current flows across the switch (C0028) to fuse 18 of the passenger compartment fuse box (C0588) on a G wire. Fuse 18 (C0589) provides an ignition feed to the instrument pack (C0233) on a G wire.

The warning lamps contained within the instrument operate as follows:

- The LH direction indicator warning lamp (C0233) receives a feed from the hazard warning lamp relay (C0589) on a GR wire. The lamp is earthed on a B wire.
- The RH direction indicator warning lamp (C0233) receives a feed from the hazard warning lamp relay (C0589) on a GW wire. The lamp is earthed on a B wire.
- The main beam warning lamp (C0233) receives a feed from the main/dipped beam relay via fuse 14 of the passenger compartment fuse box (C0589) on a UG wire. The lamp is earthed on a B wire.
- The glow plug warning lamp receives a constant battery feed from fuse 16 of the passenger compartment fuse box (C0589) on a P wire. Illumination of the lamp is controlled by the Engine Control Module (ECM) (C0331) via the CAN-BUS on YN (Low) and YB (High) wires. This signal is delivered to the instrument pack via the ABS ECU (C0501).
- The seat belt warning lamp receives an ignition feed from fuse 18 of the passenger compartment fuse box (C0589) on a G wire. Illumination of the lamp is controlled by the Central Control Unit (CCU) (C0593) via the passenger compartment fuse box (C0589) on an RP wire.

NOTE: The seat belt warning lamp is not operational in all markets.

- The SRS warning lamp receives an ignition feed from fuse 18 of the passenger compartment fuse box (C0589) on a G wire. Illumination of the lamp is controlled by the airbag DCU (C0256) on a YR wire.
- The ABS warning lamp receives a constant battery feed from fuse 16 of the passenger compartment fuse box (C0589) on a P wire. Illumination of the lamp is controlled by the ABS ECU (C0501) via the CAN-BUS on YN (Low) and YB (High) wires.
- The door open warning lamp receives an ignition feed from fuse 18 of the passenger compartment fuse box (C0589) on a G wire. Illumination of the lamp is controlled by the CCU (C0593) via the passenger compartment fuse box (C0589) on a PB wire.
- The Hill Descent Control (HDC) warning lamp receives a constant battery feed from fuse 16 of the passenger compartment fuse box (C0589) on a P wire. Illumination of the lamp is controlled by the ABS ECU (C0501) via the CAN-BUS on YN (Low) and YB (High) wires.
- The Hill Descent Control (HDC) information lamp receives a constant battery feed from fuse 16 of the passenger compartment fuse box (C0589) on a P wire. Illumination of the lamp is controlled by the ABS ECU (C0501) via the CAN-BUS on YN (Low) and YB (High) wires.

DESCRIPTION AND OPERATION

- The handbrake/low brake fluid warning lamp receives a constant battery feed from fuse 16 of the passenger compartment fuse box (C0589) on a P wire. Illumination of the lamp is controlled by the handbrake switch (C0091) on a BW wire. When the handbrake is applied, the switch contacts close and an earth path is created, illuminating the lamp. Illumination of the lamp is also controlled by the ABS ECU (C0501) via the CAN BUS on YN (Low) and YB (High) wires. If the warning lamp is illuminated while the handbrake is released, urgent attention is required to the braking system.
- The low oil pressure warning lamp receives an ignition feed from fuse 18 of the passenger compartment fuse box (C0589) on a G wire. Illumination of the lamp is controlled by the oil pressure switch (C0187) on a WN wire (WN then NG on Td4 vehicles).
- The ignition/no charge warning lamp receives an ignition feed from fuse 18 of the passenger compartment fuse box (C0589) on a G wire. Illumination of the lamp is controlled by the ECM (C0331) on Td4 vehicles, and the alternator (C0053) on K1.8 and KV6 vehicles.
- The anti-theft alarm LED receives a constant battery feed from fuse 16 of the passenger compartment fuse box (C0589) on a P wire. Illumination of the lamp is controlled by the CCU (C0592) via the passenger compartment fuse box (C0589) on a UK wire.
- The overspeed warning lamp receives a constant battery feed from fuse 16 of the passenger compartment fuse box (C0589) on a P wire. Illumination of the lamp is controlled by the ABS ECU (C0501) via the CAN-BUS on YN (Low) and YB (High) wires.

NOTE: The overspeed warning lamp is not operational in all markets.

- The cruise control warning lamp receives a constant battery feed from fuse 16 of the passenger compartment fuse box (C0589) on a P wire. On KV6 vehicles, illumination of the warning lamp is controlled by the cruise control ECU (C0239) on a WU wire. On Td4 vehicles, illumination of the warning lamp is controlled by the cruise control interface unit (C1959) via the CAN-BUS on YN (Low) and YB (High) wires.

NOTE: The list of CAN-BUS connections is by no means exhaustive. For more details, refer to the 'Communication Databases' and 'Instruments' sections of the System Description and Operation Workshop manual.

Speedometer

The speedometer is driven by a CAN message from the Engine Control Module (ECM) on YN (Low) and YB (High) wires. For more information on speedometer operation, refer to the **Instruments** section of the System Description and Operation Workshop manual.

Tachometer

The tachometer is driven by a CAN message from the Engine Control Module (ECM) on YN (Low) and YB (High) wires. For more information on tachometer operation, refer to the **Instruments** section of the System Description and Operation Workshop manual.

Engine Coolant Temperature Gauge

The Engine Coolant Temperature (ECT) gauge is driven by a CAN message from the Engine Control Module (ECM) on YN (Low) and YB (High) wires. For more information on ECT gauge operation, refer to the **Instruments** section of the System Description and Operation Workshop manual.

Fuel Gauge

The instrument pack (C0230) provides a feed to the fuel tank sender (C0114) on a GB wire. The sender is located within the fuel tank and is earthed on a B wire. The sender is a float operated rotary potentiometer, which provides a variable resistance to earth for the output from the instrument pack.

For more information on fuel gauge operation, refer to the **Instruments** section of the System Description and Operation Workshop manual.

DESCRIPTION AND OPERATION

HORNS

DESCRIPTION

General

Two vehicle horns are fitted, one below each headlamp on either side of the engine bay. One horn emits a high tone, the other a low tone. The horns are operated by pressing either of the two buttons located on the steering wheel.

The horn circuit is fed directly from the battery and operates independently of the ignition circuits. The horns are also used as an audible warning if the anti-theft alarm system is triggered. For more information on anti-theft alarm operation, refer to the ***Anti-theft Alarm and Central Door Locking (CDL)*** section of this manual.

 **ANTI-THEFT ALARM AND CENTRAL DOOR LOCKING (CDL).**

OPERATION

Horns

Feed from the positive battery terminal (C0192) is supplied to fusible link 4, fuse 6, and the horn relay coil (C0632) on an R wire. All are located in the engine compartment fuse box. The horn relay coil (C0576) is connected to the horn switches (C1254) via the rotary coupler (C0082) by a PY then P wire. The horn switches are normally open switches. When either of the horn switches are depressed, the switch contacts close and an earth path is created via the rotary coupler (C0082) on a B wire.

The horn relay (C0576) is now energised, and is able to provide a feed from fuse 6 to the LH horn (C0003) on a PB wire. The horn relay (C0570) also provides a feed to the RH horn (C0004) on a PB wire. Both horns are earthed on B wires.

Alarm Trigger

Fusible link 4 (C0574) provides a constant battery feed to the Central Control Unit (CCU) (C0593) via the passenger compartment fuse box (C0587) on an NW wire. If the alarm is triggered, the CCU (C0430) provides an earth path for the relay coil (C0576) on a PY wire. The horns relay is now able to provide a feed to the horns as described above.

By pulsing the earth path for the horn relay on and off, the CCU is able to control operation of the horns. For more information on alarm operation, refer to the ***Anti-theft Alarm and Central Door Locking (CDL)*** section of this manual.

 **ANTI-THEFT ALARM AND CENTRAL DOOR LOCKING (CDL).**

REMOTE DISPLAY / CLOCK

DESCRIPTION

General

The remote display/clock is mounted in the centre of the fascia. The time displayed on the clock can be adjusted using the 'H' and 'M' buttons mounted in the clock bezel. The clock will also display radio/cassette information. For more details on audio system operation, refer to the relevant **Audio System** section of this manual.

 **AUDIO SYSTEM.**

 **NAVIGATION SYSTEM.**

OPERATION

General

Feed from the positive battery terminal (C0192) is supplied to fusible link 1, fusible link 4, and fusible link 12 of the engine compartment fuse box (C0632) on an R wire. Fusible link 4 (C0574) is connected to fuse 14 of the passenger compartment fuse box (C0587) by an NW wire. Fuse 14 (C0589) provides a constant battery feed to the remote display/clock (C0241) on a P wire. The remote display/clock (C0241) is earthed on a B wire.

Fusible link 1 is connected in series with fusible link 2, which is also located in the engine compartment fuse box. Fusible link 2 (C0571) provides a constant battery feed to the ignition switch (C0028) on an NR wire. When the ignition switch is turned to the 'ignition' position, current flows across the switch (C0028) to fuse 11 of the passenger compartment fuse box (C0588) on a PS wire. Fuse 11 (C0580) provides an ignition feed to the remote display/clock (C0241) on a LGW wire. When the remote display/clock receives this feed, it will illuminate.

Fusible link 12 (C0575) provides a constant battery feed to the lighting switch (C0041) on an RN wire. When the lighting switch is turned to the side or headlamp position, current flows across the switch (C0041) to fuse 16 of the passenger compartment fuse box (C0587) on an R wire. Fuse 16 (C0589) is connected to the remote/display/clock by an RO wire. When the remote display/clock receives this feed, it dims its illumination.

DESCRIPTION AND OPERATION

CIGAR LIGHTER

DESCRIPTION

General

The cigar lighter is located in the centre console, and will only operate when the ignition switch is in the 'auxiliary' or 'ignition' position. When the cigar lighter element is pushed into its holder, power is automatically switched through its locking clips to the heater coil. As current passes through the heating coil, the element will heat up to the point where the locking clips expand and release the cigar lighter element.

OPERATION

General

Feed from the positive battery terminal (C0192) is supplied to fusible link 1 of the engine compartment fuse box (C0632) on an R wire. Fusible link 1 is connected in series with fusible link 2, which is also located in the engine compartment fuse box.

Fusible link 2 (C0571) is connected to the ignition switch (C0028) by an NR wire. When the ignition switch is turned to the 'auxiliary' position, current flows across the switch (C0028) to fuse 9 of the passenger compartment fuse box (C0588) on a PS wire.

Fuse 9 (C0585) provides a feed to the cigar lighter (C0089) on a PR wire. When the cigar lighter element is pushed into the cigar lighter, an earth path is created (C0089) on a B wire. When the element reaches the correct temperature and is ejected, the circuit is broken.

ACCESSORY SOCKET

DESCRIPTION

General

The accessory socket is located at the rear of the centre console. It supplies battery voltage to any approved Land Rover accessory when the ignition switch is in either the 'auxiliary' or 'ignition' position.

CAUTION: The cigar lighter should NOT be used for accessory power or damage may result.

OPERATION

General

Feed from the positive battery terminal (C0192) is supplied to fusible link 1 and fusible link 4 of the engine compartment fuse box (C0632) on an R wire. Fusible link 4 (C0574) is connected to fuse 10 of the passenger compartment fuse box (C0587) by an NW wire.

Fusible link 1 is connected in series with fusible link 2, which is also located in the engine compartment fuse box. Fusible link 2 (C0571) is connected to the ignition switch (C0028) by an NR wire. When the ignition switch is turned to the 'auxiliary' position, current flows across the switch (C0028) to the accessory socket relay (C0588) on a PS wire. The accessory socket relay is located in the passenger compartment fuse box, and is earthed (C0587) on a B wire.

The energised accessory socket relay allows a feed from fuse 10 to flow across the relay switch contacts (C0584) to the accessory socket (C0350) on a PN wire. The accessory socket (C0350) is earthed on a B wire.

DESCRIPTION AND OPERATION

AUDIO SYSTEM

DESCRIPTION

General

The audio system features a centre console mounted radio and front loading single CD player. Depending on the specification of the vehicle, the CD player will be capable of holding either a single CD, or in the case of higher specification vehicles, up to 6 CD's.

Higher specification vehicles are also fitted with a power amplifier and sub-woofer. For more information on audio system features and functionality, refer to the ***In-Car Entertainment*** handbook.

NOTE: The supporting circuit diagram shows the mid-range audio system fitted with optional Harmon Kardon speakers. A system fitted with standard speakers will not have a power amplifier or rear high range speakers fitted. The connector numbers applied to the high range speakers differ between the two speaker systems. For more information, refer to the 'Speakers – Standard' and 'Speakers – Harmon Kardon' sections.

OPERATION

General

Feed from the positive battery terminal (C0192) is supplied to fusible link 1 and fusible link 4 of the engine compartment fuse box (C0632) on an R wire. Fusible link 4 (C0574) is connected to fuse 12 of the passenger compartment fuse box (C0587) by an NW wire. Fuse 12 (C0584) provides a constant battery feed to the head unit (C0098) on a P wire (P then PK if fitted with a power amplifier) and the power amplifier (C0491) on a P then PK wire.

Fusible link 1 is connected in series with fusible link 2, which is also located in the engine compartment fuse box. Fusible link 2 (C0571) is connected to the ignition switch (C0028) by an NR wire. When the ignition switch is turned to the 'auxiliary' position, current flows across the switch (C0028) to fuse 27 of the passenger compartment fuse box (C0588) on a PS wire. Fuse 27 (C0580) provides an auxiliary ignition feed to the head unit (C0098) on an LGW wire.

The head unit (C0098) and the power amplifier (C0491) are both earthed on B wires.

Speakers – Standard

The head unit (C0098) is connected to the speakers as follows:

NOTE: The LH and RH speakers share the same connector numbers as they utilise the same door harness.

- A positive signal is provided by the head unit to the RH front mid-range speaker (C0369) on an OK wire. The RH front mid-range speaker (C0369) is provided a negative signal by the head unit (C0092) on an OB wire.
- A positive signal is provided by the head unit to the RH front high range speaker (C0531) on an OK wire. The RH front high range speaker (C0530) is provided a negative signal by the head unit (C0092) on an OB wire.
- A positive signal is provided by the head unit to the LH front mid-range speaker (C0369) on a YK then OK wire. The LH front mid-range speaker (C0369) is provided a negative signal by the head unit (C0092) on a YB then OB wire.
- A positive signal is provided by the head unit to the LH front high range speaker (C0531) on a YK then OK wire. The LH front high range speaker (C0530) is provided a negative signal by the head unit (C0092) on a YB then OB wire.
- A positive signal is provided by the head unit to the RH rear mid-range speaker (C0445) on a UK wire. The RH rear mid-range speaker (C0445) is provided a negative signal by the head unit (C0092) on a UB wire.
- A positive signal is provided by the head unit to the LH rear mid-range speaker (C0445) on an SK then UK wire. The LH rear mid-range speaker (C0445) is provided a negative signal by the head unit (C0092) on an SB then UB wire.

NOTE: It is essential that all speakers are connected correctly. A speaker connected incorrectly will be out of phase with the remaining speakers, causing a deterioration of sound quality.

DESCRIPTION AND OPERATION

Speakers – Harmon Kardon

The head unit (C0098) is connected to the power amplifier (C0491) as follows:

- A positive signal is provided by the head unit to the power amplifier on a BG wire. This signal is used by the power amplifier for the RH rear speakers.
- A negative signal is provided by the head unit to the power amplifier on a BO wire. This signal is used by the power amplifier for the RH rear speakers.
- A positive signal is provided by the head unit to the power amplifier on a BP wire. This signal is used by the power amplifier for the RH front speakers.
- A negative signal is provided by the head unit to the power amplifier on a BU wire. This signal is used by the power amplifier for the RH front speakers.
- A positive signal is provided by the head unit to the power amplifier on a BW wire. This signal is used by the power amplifier for the LH front speakers.
- A negative signal is provided by the head unit to the power amplifier on a BS wire. This signal is used by the power amplifier for the LH front speakers.
- A positive signal is provided by the head unit to the power amplifier on a BN wire. This signal is used by the power amplifier for the LH rear speakers.
- A negative signal is provided by the head unit to the power amplifier on a BR wire. This signal is used by the power amplifier for the LH rear speakers.

The power amplifier (C0491) receives inputs from the head unit (C0098) and relays them to the speakers as follows:

NOTE: The LH and RH speakers share the same connector numbers as they utilise the same door harness.

- A positive signal is provided by the power amplifier to the RH front mid-range speaker (C1577) on an OK wire. The RH front mid-range speaker (C1577) is provided a negative signal by the power amplifier (C0491) on an OB wire.
- A positive signal is provided by the power amplifier to the RH front high range speaker (C0680) on an OK wire. The RH front high range speaker (C0680) is provided a negative signal by the power amplifier (C0491) on an OB wire.
- A positive signal is provided by the power amplifier to the LH front mid-range speaker (C1577) on a YK then OK wire. The LH front mid-range speaker (C1577) is provided a negative signal by the power amplifier (C0491) on a YB then OB wire.
- A positive signal is provided by the power amplifier to the LH front high range speaker (C0680) on a YK then OK wire. The LH front high range speaker (C0680) is provided a negative signal by the power amplifier (C0491) on a YB then OB wire.
- A positive signal is provided by the power amplifier to the RH rear mid-range speaker (C1428) on a UK wire. The RH rear mid-range speaker (C1428) is provided a negative signal by the power amplifier (C0491) on a UB wire.
- A positive signal is provided by the power amplifier to the RH rear high range speaker (C0679) on a UK wire. The RH rear high range speaker (C0679) is provided a negative signal by the power amplifier (C0491) on a UB wire.
- A positive signal is provided by the power amplifier to the LH rear mid-range speaker (C1428) on an SK then UK wire. The LH rear mid-range speaker (C1428) is provided a negative signal by the power amplifier (C0491) on an SB then UB wire.
- A positive signal is provided by the power amplifier to the LH rear high range speaker (C0679) on an SK then UK wire. The LH rear high range speaker (C0679) is provided a negative signal by the power amplifier (C0491) on an SB then UB wire.

NOTE: It is essential that all speakers are connected correctly. A speaker connected incorrectly will be out of phase with the remaining speakers, causing a deterioration of sound quality.

Remote Audio Controls

The head unit (C0098) provides a feed via the rotary coupler (C0082) to the remote audio controls (C1254) on a BR wire. The remote audio controls contain a number of normally open switches and resistors. When either of the controls are moved, one of the switches closes and a voltage is returned to the head unit (C0098) on a BW wire. The value of the voltage returned to the head unit is dependent upon which way the controls are moved (and how many resistors are brought into the circuit). By measuring this returned voltage, the head unit determines which function has been requested.

DESCRIPTION AND OPERATION

Speed Dependent Volume Control

The ABS ECU (C0501) provides a road speed signal to the power amplifier (C0491) (if fitted) and the head unit (C0098) on a WO wire. This signal is used to raise or lower the volume level from the speakers as road speed changes.

NAVIGATION SYSTEM

DESCRIPTION

General

The satellite navigation head unit is located in the centre console, and also incorporates a radio and a front loading single CD player. Some vehicles are also fitted with a CD autochanger.

The system operates when the ignition switch is turned to the 'auxiliary' position. For more information on audio system features and functionality, refer to the **Audio and Navigation System** handbook. For detailed information on satellite navigation operation, refer to the **Navigation System** section of the System Description and Operation Workshop manual.

NOTE: The supporting circuit diagram shows the Navigation system fitted with optional Harmon Kardon speakers. A system fitted with standard speakers will not have a power amplifier or rear high range speakers fitted. The connector numbers applied to the high range speakers differ between the two speaker systems. For more information, refer to the 'Speakers – Standard' and 'Speakers – Harmon Kardon' sections.

OPERATION

General

Feed from the positive battery terminal (C0192) is supplied to fusible link 1 and fusible link 4 of the engine compartment fuse box (C0632) on an R wire. Fusible link 4 (C0574) is connected to fuse 12 of the passenger compartment fuse box (C0587) by an NW wire. Fuse 12 (C0584) provides a constant battery feed to the following on P then PK wires:

- The head unit (C0921)
- The CD autochanger (C0941)
- The power amplifier (C0491).

Fusible link 1 is connected in series with fusible link 2, which is also located in the engine compartment fuse box. Fusible link 2 (C0571) is connected to the ignition switch (C0028) by an NR wire. When the ignition switch is turned to the 'auxiliary' position, current flows across the switch (C0028) to fuse 27 of the passenger compartment fuse box (C0588) on a PS wire. Fuse 27 (C0580) provides an auxiliary ignition feed to the head unit (C0921) and the remote interface unit (C1897) on LGW wires.

The head unit (C0921), CD autochanger (C0941), power amplifier (C0491), and the remote interface unit (C1897) are all earthed on B wires.

DESCRIPTION AND OPERATION

Speakers – Harmon Kardon

The head unit (C0092) is connected to the power amplifier (C0491) as follows:

- A positive signal is provided by the head unit to the power amplifier on a BG wire. This signal is used by the power amplifier for the RH rear speakers.
- A negative signal is provided by the head unit to the power amplifier on a BO wire. This signal is used by the power amplifier for the RH rear speakers.
- A positive signal is provided by the head unit to the power amplifier on a BP wire. This signal is used by the power amplifier for the RH front speakers.
- A negative signal is provided by the head unit to the power amplifier on a BU wire. This signal is used by the power amplifier for the RH front speakers.
- A positive signal is provided by the head unit to the power amplifier on a BW wire. This signal is used by the power amplifier for the LH front speakers.
- A negative signal is provided by the head unit to the power amplifier on a BS wire. This signal is used by the power amplifier for the LH front speakers.
- A positive signal is provided by the head unit to the power amplifier on a BN wire. This signal is used by the power amplifier for the LH rear speakers.
- A negative signal is provided by the head unit to the power amplifier on a BR wire. This signal is used by the power amplifier for the LH rear speakers.

The power amplifier (C0491) receives inputs from the head unit (C0092) and relays them to the speakers as follows:

NOTE: The LH and RH speakers share the same connector numbers as they utilise the same door harness.

- A positive signal is provided by the power amplifier to the RH front mid-range speaker (C1577) on an OK wire. The RH front mid-range speaker (C1577) is provided a negative signal by the power amplifier (C0491) on an OB wire.
- A positive signal is provided by the power amplifier to the RH front high range speaker (C0680) on an OK wire. The RH front high range speaker (C0680) is provided a negative signal by the power amplifier (C0491) on an OB wire.
- A positive signal is provided by the power amplifier to the LH front mid-range speaker (C1577) on a YK then OK wire. The LH front mid-range speaker (C1577) is provided a negative signal by the power amplifier (C0491) on a YB then OB wire.
- A positive signal is provided by the power amplifier to the LH front high range speaker (C0680) on a YK then OK wire. The LH front high range speaker (C0680) is provided a negative signal by the power amplifier (C0491) on a YB then OB wire.
- A positive signal is provided by the power amplifier to the RH rear mid-range speaker (C1428) on a UK wire. The RH rear mid-range speaker (C1428) is provided a negative signal by the power amplifier (C0491) on a UB wire.
- A positive signal is provided by the power amplifier to the RH rear high range speaker (C0679) on a UK wire. The RH rear high range speaker (C0679) is provided a negative signal by the power amplifier (C0491) on a UB wire.
- A positive signal is provided by the power amplifier to the LH rear mid-range speaker (C1428) on an SK then UK wire. The LH rear mid-range speaker (C1428) is provided a negative signal by the power amplifier (C0491) on an SB then UB wire.
- A positive signal is provided by the power amplifier to the LH rear high range speaker (C0679) on an SK then UK wire. The LH rear high range speaker (C0679) is provided a negative signal by the power amplifier (C0491) on an SB then UB wire.

NOTE: It is essential that all speakers are connected correctly. A speaker connected incorrectly will be out of phase with the remaining speakers, causing a deterioration of sound quality.

DESCRIPTION AND OPERATION

Speakers – Standard

The head unit (C0092) is connected to the speakers as follows:

- A positive signal is provided to the RH front mid-range speaker (C1577) on an OK wire. The RH front mid-range speaker (C1577) is provided a negative signal by the head unit (C0092) on an OB wire.
- A positive signal is provided to the RH high range speaker (C0680) on an OK wire. The RH high range speaker (C0680) is provided a negative signal by the head unit (C0092) on an OB wire.
- A positive signal is provided to the LH front mid-range speaker (C1577) on a YK then OK wire. The LH front mid-range speaker (C1577) is provided a negative signal by the head unit (C0092) on a YB then OB wire.
- A positive signal is provided to the LH front high range speaker (C0680) on a YK then OK wire. The LH front high range speaker (C0680) is provided a negative signal by the head unit (C0092) on a YB then OB wire.
- A positive signal is provided to the RH rear mid-range speaker (C1428) on a UK wire. The RH rear mid-range speaker (C1428) is provided a negative signal by the head unit (C0092) on a UB wire.
- A positive signal is provided to the LH rear mid-range speaker (C1428) on an SK then UK wire. The RH rear mid-range speaker (C1428) is provided a negative signal by the head unit (C0092) on an SB then UB wire.

NOTE: The LH and RH front speakers and the LH and RH rear speakers share the same connector numbers as they utilise the same door harness.

NOTE: It is essential that all speakers are connected correctly. A speaker connected incorrectly will be out of phase with the remaining speakers, causing a deterioration of sound quality.

Remote Interface Unit

The remote interface unit (C1897) is provided an ignition feed via fuse 27 of the passenger compartment fuse box (C0580) on an LGW wire. The interface unit enables the head unit to communicate with the remote audio controls, and is earthed on a B wire.

The interface unit (C1897) communicates with the head unit (C0922) and the CD autochanger (if fitted) (C0941) via the Instrument (I) bus on a K wire.

Remote Audio Controls

The remote interface unit (C1897) provides a feed via the rotary coupler (C0082) to the remote audio controls (C1254) on a BR wire. The remote audio controls contain a number of normally open switches and resistors. When either of the controls are moved, one of the switches closes and a voltage is returned to the interface unit (C1897) on a BW wire. The value of the voltage returned to the interface unit is dependent upon which way the controls are moved (and how many resistors are brought into the circuit). By measuring this returned voltage, the interface unit determines which function has been requested. The interface unit (C1897) converts this input into an Instrument (I) bus protocol message which it outputs to the head unit on a K wire. If a CD autochanger is fitted, this message is also relayed to the CD autochanger (C0941) on a K wire.

Speed Dependent Volume Control

The ABS ECU (C0501) provides a road speed signal to the power amplifier (C0491) on a WO wire. The amplifier uses this signal to raise or lower the volume level from the speakers as road speed changes.

CD Autochanger

The CD autochanger (C0941) is provided a constant battery feed via fuse 12 of the passenger compartment fuse box (C0584) on a P wire. The autochanger (C0941) is earthed on a pair of B wires.

The CD autochanger (C0941) provides the following signals to the head unit (C0983):

- A LH speaker positive signal on a KB wire.
- A LH speaker negative signal on a BK then B wire.
- A RH speaker positive signal on a YB wire.
- A RH speaker negative signal on a BY wire then B wire.

Navigation Inputs

The ABS ECU (C0501) provides a road speed signal to the Central Control Unit (CCU) (C0428) and the head unit (C0921) on a pair of WO wires. A reverse gear signal is provided by the reverse gear switch (C0166 on K1.8 vehicles, C0163 on Td4 manual vehicles) or the reverse lamp relay (C2624) on automatic transmission vehicles on a pair of GN wires.

For detailed information on satellite navigation operation, refer to the **Navigation System** section of the System Description and Operation Workshop manual.

DESCRIPTION AND OPERATION

FUEL PUMP

DESCRIPTION

Td4

The fuel system on Td4 vehicles features a single fuel pump. The low pressure pump is mounted in the RH rear wheel arch, and delivers diesel fuel to the high pressure FIP. For more information on the Td4 fuel system, refer to the **Fuel Delivery System – Td4** section of the System Description and Operation Workshop manual.

K Series and KV6

The electric fuel pump is mounted in the plastic fuel tank, and supplies fuel at a constant pressure to the fuel rail via a filter. The fuel rail distributes fuel equally to each of the four injectors. The system also incorporates a spill return line, which returns any unused fuel back to the tank.

For more information on the K Series and KV6 fuel systems, refer to the **Fuel Delivery System – K Series 1.8** and **Fuel Delivery System – K Series KV6** sections of the System Description and Operation Workshop manual.

OPERATION

Td4

General

Feed from the positive battery terminal (C0192) is supplied to fusible link 3, fuse 10, and the main relay (C0632) on an R wire. All are located in the engine compartment fuse box. Operation of the main relay (C0576) is controlled by the Engine Control Module (ECM) (C0603) on a WK wire. For more information on main relay operation, refer to the **Engine Management Systems – EDC** section of the System Description and Operation Workshop manual.

Fuse 10 (C0575) provides a constant battery feed to the inertia switch (C0123) on a G wire. Fusible link 3 (C0571) provides a constant battery feed to the ignition switch (C0028) on an N wire. When the ignition switch is turned to the 'ignition' position, current flows across the switch (C0028) to fuse 22 of the passenger compartment fuse box (C0588) on a G wire. Fuse 22 (C0580) provides an ignition feed to the ECM (C0603) on a W wire.

Inertia Switch

Fuse 10 of the engine compartment fuse box (C0575) provides a constant battery feed to the inertia switch (C0123) on a G wire. The inertia switch is a normally closed switch. If the inertia switch hasn't been tripped, current flows across the switch (C0123) to the fuel pump relay (C0575) on a GU wire.

The inertia switch (C0123) also provides a feed to the Central Control Unit (CCU) (C0428) on a GU then UG wire. For more information on the CCU, refer to the **Control Units** section of the System Description and Operation Workshop manual, and the **Anti-theft Alarm and Central Door Locking (CDL)** section of this manual.

 **ANTI-THEFT ALARM AND CENTRAL DOOR LOCKING (CDL).**

Fuel Pump Relay

The fuel pump relay coil (C0730) receives a feed from the energised main relay, which is also located in the engine compartment fuse box. The earth path for the relay coil (C0575) is controlled by the ECM (C0331) on a BP wire. The energised fuel pump relay enables a feed from fuse 10 of the engine compartment fuse box (C0575) to flow across the relay switch contacts (C0572) to the low pressure fuel pump (C0205) on a WP wire. The pump (C0205) is earthed on a B wire.

K Series and KV6

General

Feed from the positive battery terminal (C0192) is supplied to fusible link 3, fuse 10, and the main relay (C0632) on an R wire. All are located in the engine compartment fuse box. Operation of the main relay (C0576 on K Series vehicles, C0578 on KV6 vehicles) is controlled by the Engine Control Module (ECM) (C0913 on K Series vehicles, C0604 on KV6 NAS vehicles, C0371 on KV6 ROW vehicles) on a WK wire (NG on KV6 NAS vehicles). For more information on main relay operation, refer to the **Engine Management Systems – MEMS** or **Engine Management Systems – Siemens** section of the System Description and Operation Workshop manual.

Fuse 10 (C0575) provides a constant battery feed to the inertia switch (C0123) on a G wire. Fusible link 3 (C0571) provides a constant battery feed to the ignition switch (C0028) on an N wire. When the ignition switch is turned to the 'ignition' position, current flows across the switch (C0028) to fuse 22 of the passenger compartment fuse box (C0588) on a G wire. Fuse 22 (C0581) provides an ignition feed to the ECM (C0913 on K Series vehicles, C0603 on KV6 NAS vehicles, C0371 on KV6 ROW vehicles) on a W wire.

Inertia Switch

Fuse 10 of the engine compartment fuse box (C0575) provides a constant battery feed to the inertia switch (C0123) on a G wire. The inertia switch is a normally closed switch. If the inertia switch hasn't been tripped, current flows across the switch (C0123) to the fuel pump relay located in the engine compartment fuse box (C0575) on a GU wire.

The inertia switch (C0123) also provides a feed to the Central Control Unit (CCU) (C0428) on a GU then UG wire. For more information on the CCU, refer to the **Control Units** section of the System Description and Operation Workshop manual, and the **Anti-theft Alarm and Central Door Locking (CDL)** section of this manual.

 **ANTI-THEFT ALARM AND CENTRAL DOOR LOCKING (CDL).**

DESCRIPTION AND OPERATION

Fuel Pump Relay

The fuel pump relay coil receives a feed from the energised main relay. The earth path for the relay coil (C0575) is controlled by the ECM (C0913 on K Series vehicles, C0331 on KV6 NAS vehicles, C0371 on KV6 vehicles) on a BP wire. The ECM will energise the fuel pump relay when it receives an ignition feed from fuse 6 of the passenger compartment fuse box (C0581) on a W wire.

The energised fuel pump relay (C0572) provides a feed to the fuel pump (C0114) on a WP wire. The pump (C0114) is earthed on a B wire.

ROTARY COUPLER

DESCRIPTION

General

The rotary coupler is a rotating link harness, acting as a bridge between the electrical circuits contained within the steering wheel and the steering column. It relays signals for the following systems:

- Horns.
- Audio system.
- Driver airbag.
- Cruise control.

WARNING: Before carrying out any work on the rotary coupler, refer to the warning information given in the Service Procedures Workshop manual.

OPERATION

General

For more information on horn operation, refer to the ***Horns*** section of this manual.

 **HORNS.**

For more information on audio system operation, refer to the relevant ***Audio System*** section of this manual.

 **AUDIO SYSTEM.**

 **NAVIGATION SYSTEM.**

For more information on driver airbag operation, refer to the ***Supplementary Restraint Systems (SRS)*** section of this manual.

 **SUPPLEMENTARY RESTRAINT SYSTEM (SRS).**

For more information on cruise control operation, refer to the relevant ***Cruise Control*** section of this manual.

 **CRUISE CONTROL – TD4 & KV6 (NORTH AMERICA).**

 **CRUISE CONTROL – KV6.**

DESCRIPTION AND OPERATION

PARK DISTANCE CONTROL (PDC)

DESCRIPTION

General

Park Distance Control (PDC) provides an audible warning to the driver when any obstacles are in the path of the vehicle during reverse parking manoeuvres. The system consists of:

- Four ultrasonic sensors mounted in the rear bumper.
- An ECU mounted on the RH side of the luggage compartment.
- A sounder mounted on the RH side of the luggage compartment.
- A non-latching master switch mounted in the rear of the centre console.

The non-latching master switch also contains a tell-tale LED to inform the driver the system is operational. When the system is activated, a confirmation tone is emitted as further confirmation the system is operational. The system is only operational when reverse gear is selected and the master switch is pressed (LED illuminated).

OPERATION

General

Feed from the positive battery terminal (C0192) is supplied to fusible link 3 of the engine compartment fuse box (C0632) on an R wire. Fusible link 3 (C0571) is connected to the ignition switch (C0028) by an N wire.

When the ignition switch is turned to the 'ignition' position, current flows across the switch (C0028) to fuse 2 of the passenger compartment fuse box (C0588) on an NW wire. Fuse 2 provides an ignition feed to the reverse lamp switch (C0163) on a G wire (manual transmission vehicles only) or the reverse lamp relay (automatic transmission vehicles only), which is located within the passenger compartment fuse box.

When in the 'ignition' position, the ignition switch (C0028) also provides a feed to fuse 24 of the passenger compartment fuse box (C0588) on a G wire. Fuse 24 (C2624) provides an ignition feed to the PDC ECU (C0958) on an LGO wire.

PDC ECU

The PDC ECU will only initiate PDC if reverse gear is selected and the PDC switch is pressed. The PDC ECU monitors driver requests as follows:

PDC Switch

The PDC ECU (C0958) monitors the condition of the non-latching PDC switch (C0404) by providing a feed on a BS wire. When the switch is pressed, a momentary earth is created on a B wire.

Reverse Lamp Switch – Manual Transmission Only

Fuse 2 of the passenger compartment fuse box (C0581) provides an ignition feed to the reverse lamp switch (C0163) on a G wire. When reverse gear is selected, current flows across the switch (C0163 on Td4 vehicles, C0166 on K1.8 vehicles) to the PDC ECU (C0958) on a GN wire.

Reverse Lamp Relay – Automatic Transmission Only

The Electronic Automatic Transmission (EAT) ECU (C0932) monitors the condition of the transmission selector/inhibit switch (C0268) by providing a feed on a GW wire. When reverse gear is selected, the switch contacts close and an earth path is created on a B wire. Sensing this, the EAT ECU (C0932) provides a feed to the reverse lamp relay coil (C2624) on an NG wire. The relay coil (C0587) is earthed on a B wire.

The energised reverse lamp relay (C2624) now provides a feed to the PDC ECU (C0958) on a GN wire.

PDC Sensors

The PDC ECU provides two different signals to the four PDC sensors. The 'transmit' signal commands the PDC sensors to emit an ultrasonic 'burst'. This is followed by a 'receive' signal, which switches the PDC sensors to listening mode. In this mode, the sensors are able to receive an ultrasonic echo. This process is repeated every 100ms.

The PDC ECU (C0957) is connected to the four PDC sensors as follows:

RH Outer Sensor

The PDC ECU provides signal feeds to the RH outer sensor (C0966) on a WG then W wire. An earth path is provided for the sensor by the PDC ECU on a B then BG wire. The PDC sensor outputs a pulsed signal to the PDC ECU on an O wire, which the ECU translates into a distance reading.

RH Inner Sensor

The PDC ECU provides signal feeds to the RH inner sensor (C0965) on a WG then W wire. An earth path is provided for the sensor by the PDC ECU on a B then BG wire. The PDC sensor outputs a pulsed signal to the PDC ECU on a Y wire, which the ECU translates into a distance reading.

LH Inner Sensor

The PDC ECU provides signal feeds to the LH inner sensor (C0964) on a WG then W wire. An earth path is provided for the sensor by the PDC ECU on a B then BG wire. The PDC sensor outputs a pulsed signal to the PDC ECU on a U wire, which the ECU translates into a distance reading.

DESCRIPTION AND OPERATION

LH Outer Sensor

The PDC ECU provides signal feeds to the LH outer sensor (C0963) on a WG then W wire. An earth path is provided for the sensor by the PDC ECU on a B then BG wire. The PDC sensor outputs a pulsed signal to the PDC ECU on a G wire, which the ECU translates into a distance reading.

PDC Switch Illumination

When all conditions for PDC operation have been met, the PDC ECU (C0958) provides a feed to the PDC switch illumination LED (C0404) on an RS wire. The LED (C0404) is earthed on a B wire. The PDC ECU will remove the feed to the switch if reverse gear is de-selected, or the PDC switch is pressed for a second time.

PDC Sounder

The PDC ECU converts the signals received from the PDC sensors into an audible signal via the PDC speaker. The PDC ECU (C0958) provides a positive signal to the speaker (C0987) on a K wire and a negative signal on an N wire.

CIRCUIT REFERENCE NUMBERS**CONNECTOR APPLICABILITY****General**

The following table lists the circuit reference numbers against a description of the model or feature to which they apply.

This information should be used in conjunction with the connector pin-out tables on the following pages to determine the wire configuration of the vehicle being worked on.

Cct	Model or Feature
1	All vehicles
2	LHD
3	RHD
4	NAS
5	3 door vehicles
6	5 door vehicles
7	Folding door mirrors
8	Low-line audio system
9	Mid-line audio system
10	Mid-line audio system with amplifier
11	Mid-line audio system with CD autochanger
12	Navigation system
13	Navigation system with CD autochanger
14	CD autochanger
15	Australian vehicles only
16	KV6
17	Td4
18	K1.8
19	Instrument dimmer
20	No instrument dimmer
21	Sunroof
22	FBH
23	Automatic transmission
24	Manual transmission
25	Canadian vehicles only
26	Td4 and NAS
27	KV6 with cruise control
28	KV6 and Td4
29	All except NAS

CONNECTOR

30	K1.8 and KV6
31	Headlamp levelling
32	K1.8 with air conditioning
33	Td4 with cruise control
34	K1.8 with air conditioning, Td4 and KV6
35	Heated seats
36	Td4 manual transmission
37	Td4 automatic transmission
38	Japanese vehicles only
39	PDC
40	Pre-04MY vehicles only
41	Remote ICE controls with amplifier
42	Td4 with air conditioning
43	Folding door mirrors and heated seats

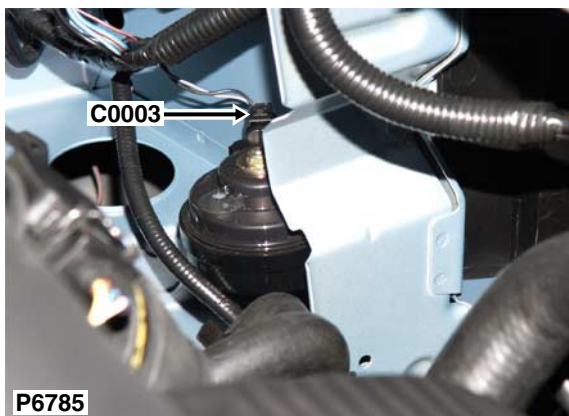

Cav	Col	Cct
1	PB	ALL
2	B	ALL

Description: *Horn-LH*

Location: *Front LH side of engine compartment*

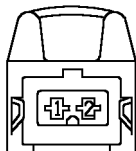

YPC114900

Colour: *BLACK*

Gender: *Female*



Cav	Col	Cct
1	PB	ALL
2	B	ALL

Description: *Horn-RH*

Location: *Front RH side of engine compartment*

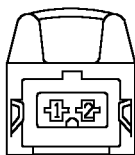

YPC114900

Colour: *BLACK*

Gender: *Female*

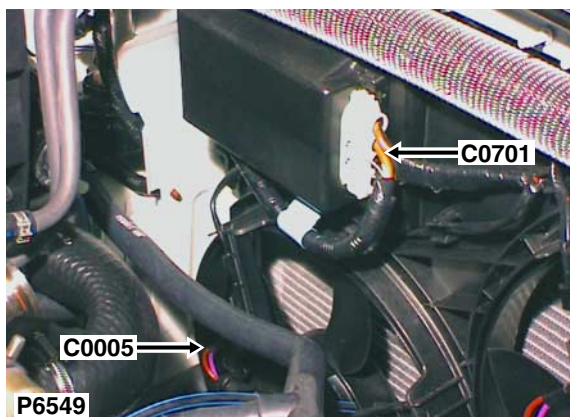

Cav	Col	Cct
A	NR	18
B	B	18

Description: *Motor-Cooling fan-1*

Location: *Front LH side of engine compartment*

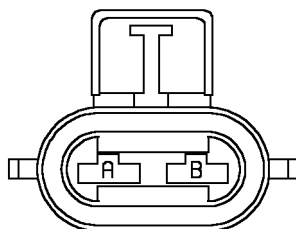

YPC10348

Colour: *BLACK*

Gender: *Female*

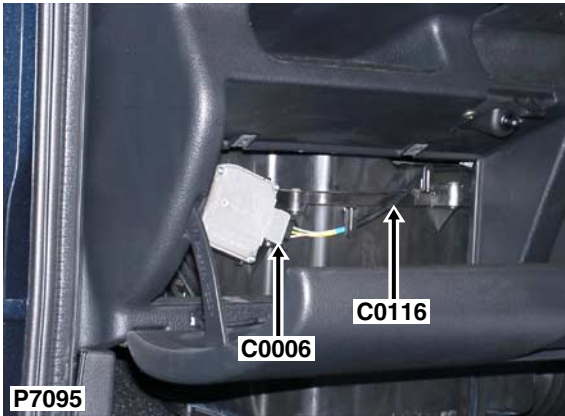

Cav	Col	Cct
1	K	ALL
1	Y	ALL
2	K	ALL
2	Y	ALL
3	LGS	ALL

Description: *Motor-Recirculated air*

Location: *Behind glovebox*

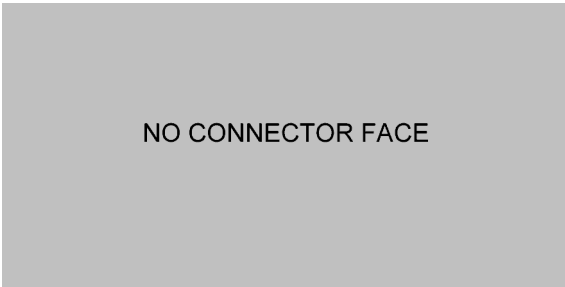

Colour: *BLACK*

Gender: *Female*

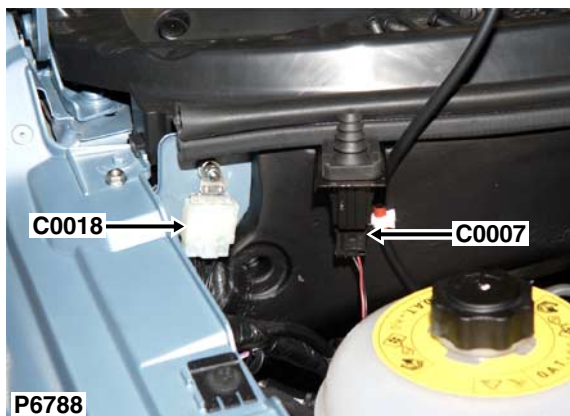

Cav	Col	Cct
1	RP	ALL
2	B	ALL

Description: *Switch-Bonnet*

Location: *Rear of engine compartment*

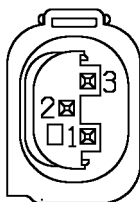

YPC116850

Colour: *BLACK*

Gender: *Female*

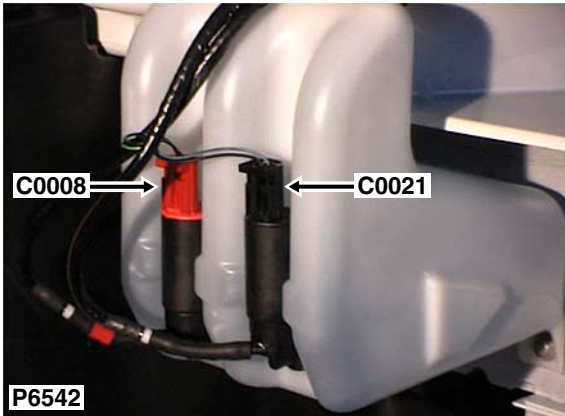

Cav	Col	Cct
1	LGB	ALL
2	B	ALL

Description: *Pump-Washer-Windscreen*
Location: *Behind RH side of front bumper*

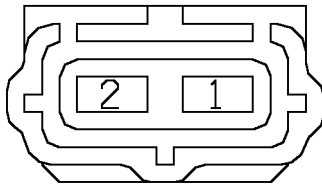

YPC10131

Colour: *RED*
Gender: *Female*

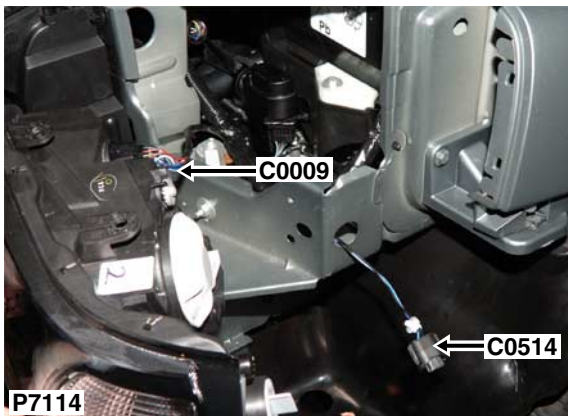

P7114

Description: *Headlamp-LH*Location: *Front LH side of engine compartment*

Cav	Col	Cct
1	B	ALL
2	RB	ALL
3	GR	ALL
4	RB	ALL
5	UB	ALL
6	B	ALL
7	US	ALL
8	UK	ALL
9	B	ALL

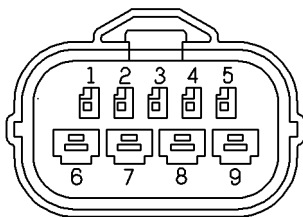

YPC115380

Colour: *BLACK*Gender: *Female*

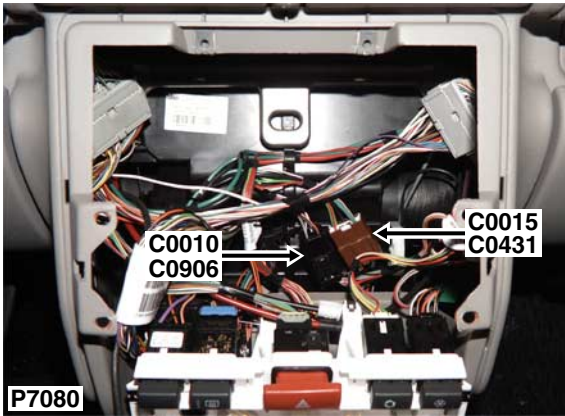

Cav	Col	Cct
1	B	ALL
1	BO	ALL
3	LGS	ALL
4	RO	ALL
5	SW	ALL
6	SK	ALL

Description: Heater harness to air conditioning (A/C) harness

Location: Behind centre console

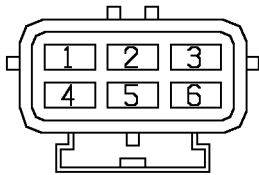

YPC10057

Colour: BLACK

Gender: Male



Description: *Headlamp-RH*

Location: *Front RH side of engine compartment*

Cav	Col	Cct
1	B	ALL
2	RO	ALL
3	GW	ALL
4	RO	ALL
5	UB	ALL
6	B	ALL
7	UG	ALL
8	UB	ALL
9	B	ALL

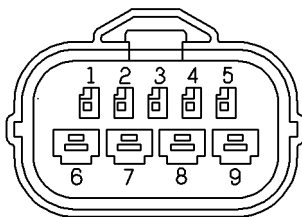

YPC115380

Colour: *BLACK*

Gender: *Female*



Cav	Col	Cct
1	GW	ALL
2	B	ALL

Description: *Lamp-Side repeater-Front-RH*

Location: *Behind RH side repeater lamp*

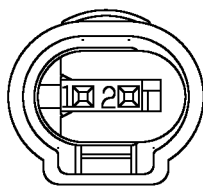

YPC116820

Colour: *BLACK*

Gender: *Female*



Cav	Col	Cct
1	GR	ALL
2	B	ALL

Description: *Lamp-Side repeater-Front-LH*

Location: *Behind LH side repeater lamp*

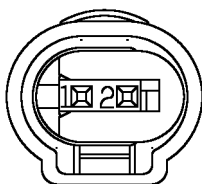

YPC116820

Colour: *BLACK*

Gender: *Female*

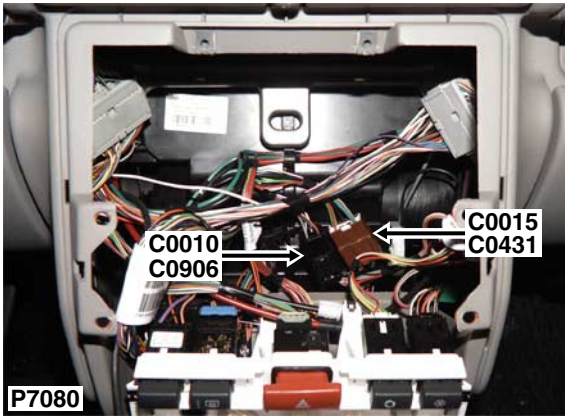

Cav	Col	Cct
1	GW	ALL
2	RO	ALL
3	SK	ALL
4	B	ALL
5	LGS	ALL

Description: *Heater harness to main harness*

Location: *Behind centre console*

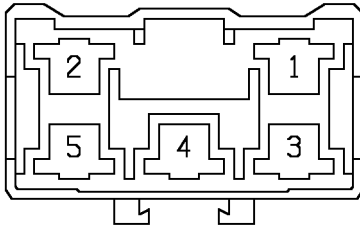

YPC10463

Colour: *BROWN*

Gender: *Male*

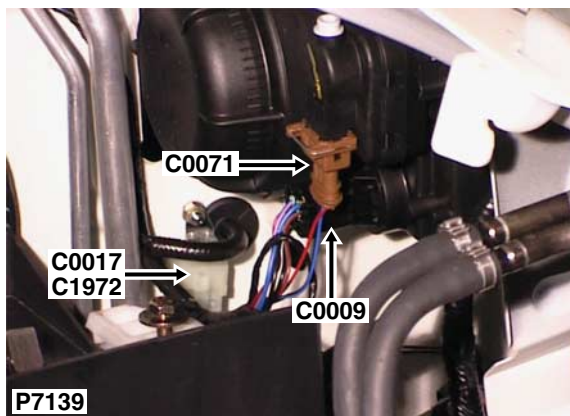

Cav	Col	Cct
1	B	ALL
2	B	ALL
3	B	ALL
4	B	ALL
5	B	17
6	B	ALL

Description: *Header -Earth*

Location: *Lower LH front of engine compartment*

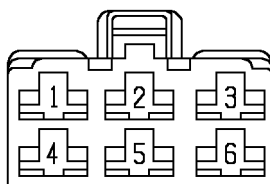

YPC10004

Colour: *NATURAL*

Gender: *Female*

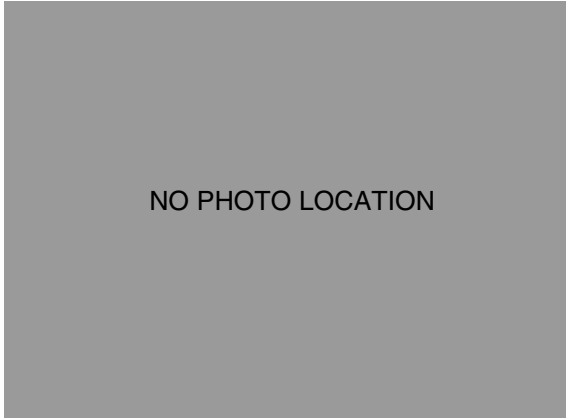

Cav	Col	Cct
2	SU	18
4	NK	18
6	UR	18
8	NR	18

Description: *Relay-Cooling fan*

Location: *Rear LH side of engine compartment*

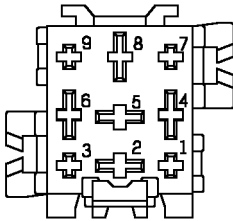

YPP100200

Colour: *BLACK*

Gender: *Female*

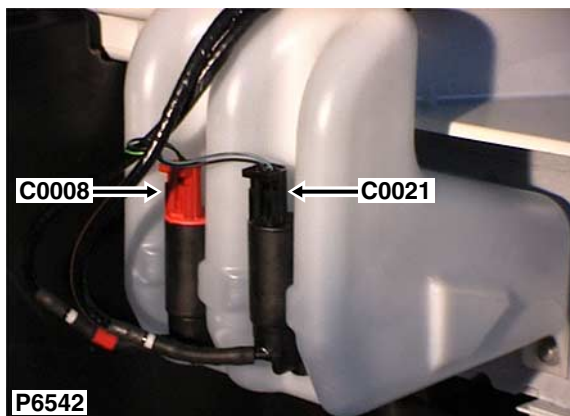

Cav	Col	Cct
1	GB	ALL
2	B	ALL

Description: *Pump-Washer-Rear screen*

Location: *Behind RH side of front bumper*

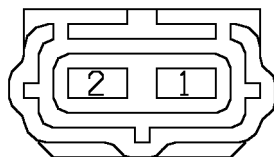

YPC10070

Colour: *BLACK*

Gender: *Female*

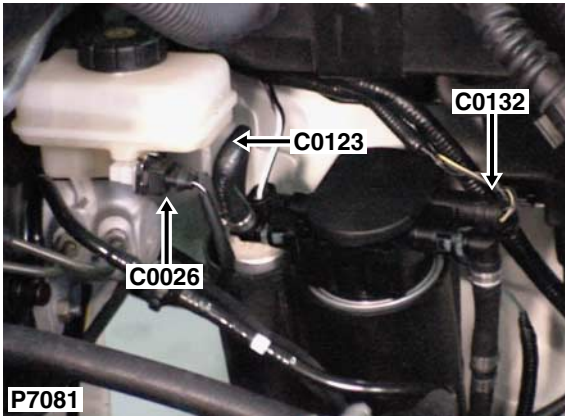

P7081

Description: *Switch-Brake fluid level*

Location: *Rear of engine compartment - driver's side*

Cav	Col	Cct
1	B	ALL
2	BW	ALL

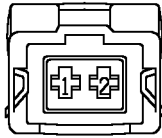

YPC107790

Colour: *BLACK*

Gender: *Female*

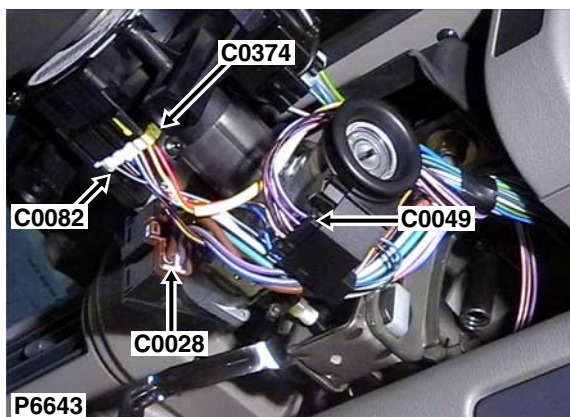

Cav	Col	Cct
1	N	ALL
2	NW	ALL
3	NR	ALL
4	WR	ALL
5	G	ALL
6	SU	ALL
7	PS	ALL

Description: *Switch-Ignition*

Location: *Underside of steering column*

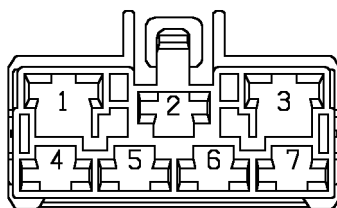

YPC10480

Colour: *BROWN*

Gender: *Female*

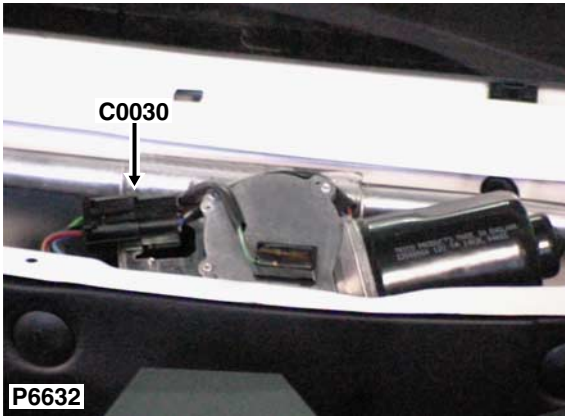

Cav	Col	Cct
1	LG	ALL
2	B	ALL
3	RG	ALL
4	NLG	ALL
5	ULG	ALL

Description: *Motor-Wiper-Windscreen*

Location: *Beneath driver side of air intake plenum*

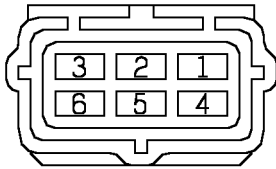

YPC10064

Colour: *BLACK*

Gender: *Female*

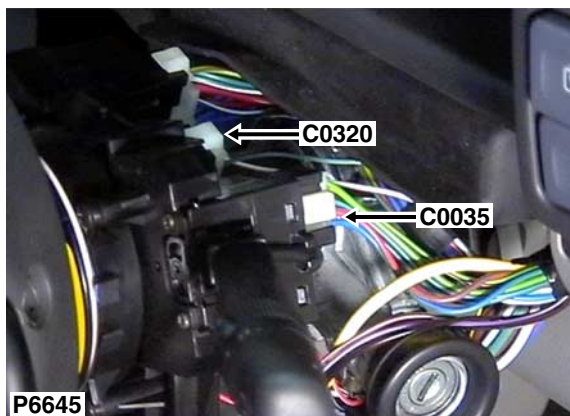

Cav	Col	Cct
1	LG	ALL
2	G	ALL
3	RG	ALL
4	ULG	ALL
5	G	ALL
7	LGK	ALL
8	LGB	ALL

Description: *Switch-Wiper-Front*

Location: *RH side of steering column*

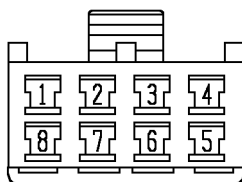

YPC10006

Colour: *NATURAL*

Gender: *Female*

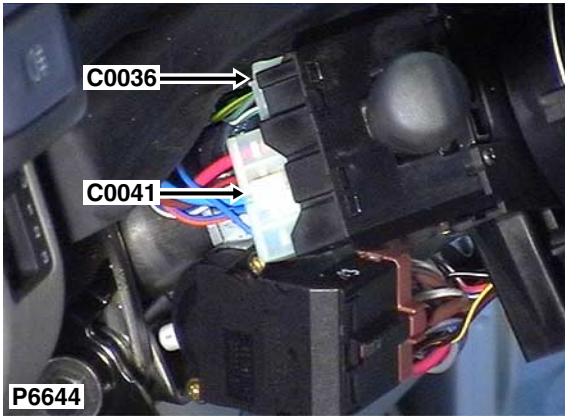

Cav	Col	Cct
1	GR	ALL
2	LGN	ALL
4	GW	ALL

Description: *Switch-Direction indicator*
 Location: *LH side of steering column*

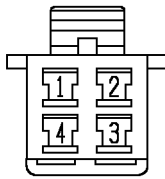

YPC10002

Colour: *NATURAL*
 Gender: *Female*

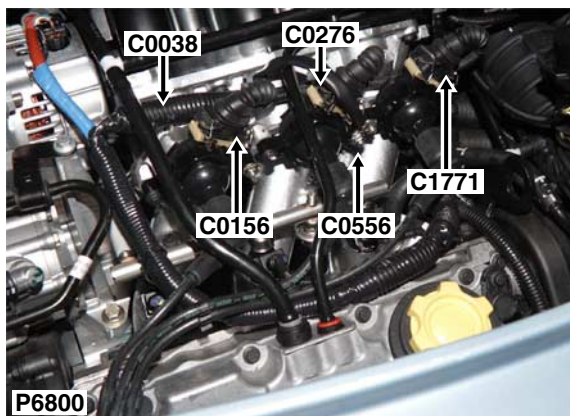

Cav	Col	Cct
1	B	ALL
2	B	ALL

Description: *Resistor*

Location: *Top of engine*

NO CONNECTOR FACE

Colour: *TIN-PLATE*

Gender:

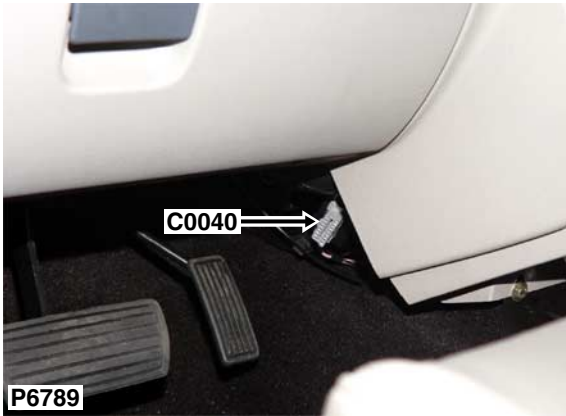

Cav	Col	Cct
4	B	ALL
5	B	ALL
7	K	ALL
13	K	ALL
16	P	ALL

Description: *Diagnostic socket*

Location: *Beneath centre console LH side*

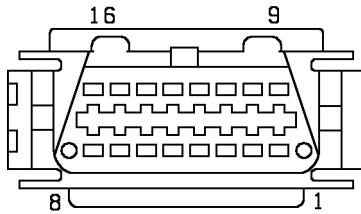

YPC107910

Colour: *GREY*

Gender: *Female*

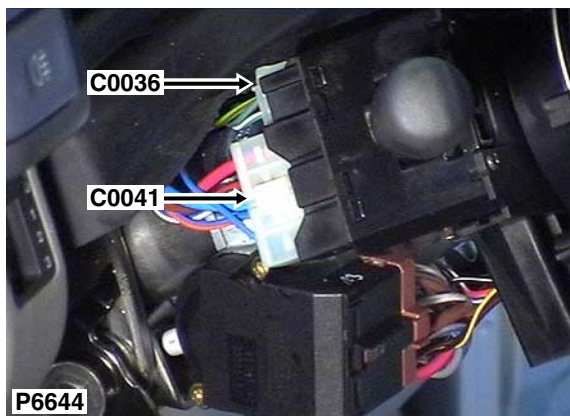

Description: *Switch-Lighting*

Location: *LH side of steering column*

Cav	Col	Cct
1	UO	ALL
1	UG	25
3	RN	ALL
4	R	ALL
4	RW	25
5	UW	ALL
6	UN	ALL

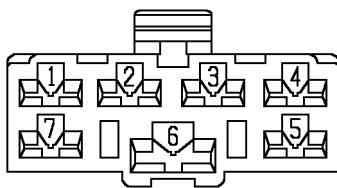

YPC10008

Colour: *NATURAL*

Gender: *Female*

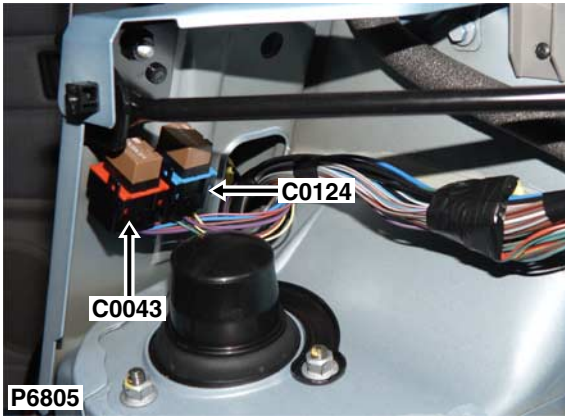

Cav	Col	Cct
1	RU	ALL
2	PN	ALL
4	B	ALL
6	UB	ALL
7	RG	ALL
9	UG	ALL

Description: *Relay-Lift-Tail door window*

Location: *Luggage compartment - RH side*

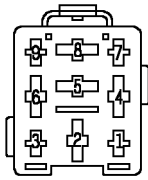

YPP10001

Colour: *BLACK*

Gender: *Female*

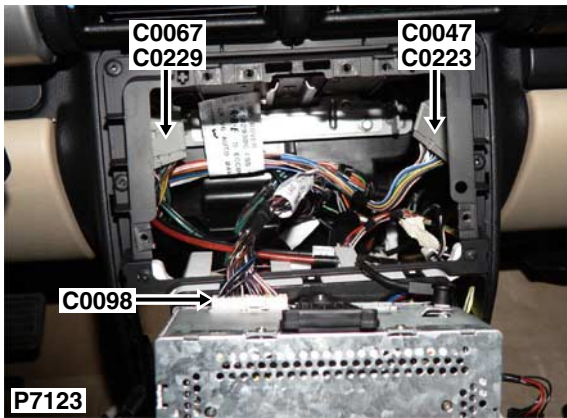

Description: *Main harness to fascia harness*
 Location: *Behind centre console*

Cav	Col	Cct
1	NR	ALL
2	SK	ALL
3	GB	ALL
4	RO	ALL
4	RW	ALL
5	GN	ALL
6	K	ALL
7	NY	ALL
8	YR	ALL
9	WR	ALL
10	SO	4
11	NK	23
12	YN	ALL
13	YB	ALL
14	BY	ALL
15	BP	ALL
16	SW	ALL
17	BN	ALL
18	BU	ALL
19	S	ALL
20	Y	ALL
21	UB	ALL
22	PW	ALL

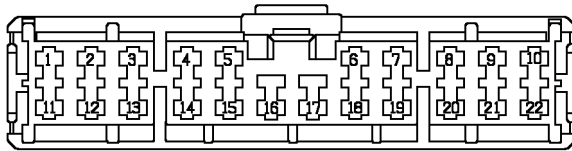

YPC108200

Colour: *LIGHT GREY*
 Gender: *Female*

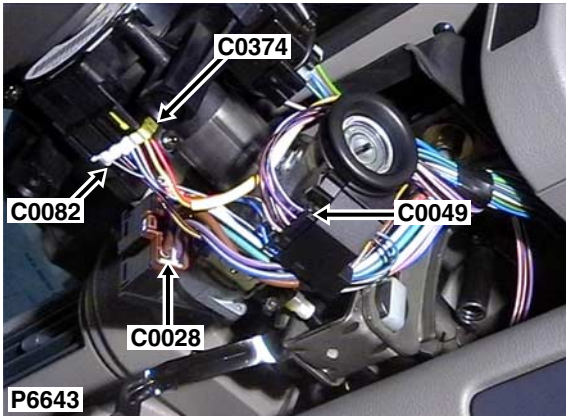

Cav	Col	Cct
1	PW	ALL
3	P	ALL
5	KB	ALL
6	B	ALL
7	KG	ALL
8	BR	ALL

Description: *Coil-Transponder*

Location: *RH side of steering column*

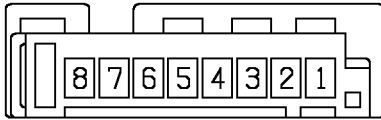

YPC117320

Colour: *BLACK*

Gender: *Female*

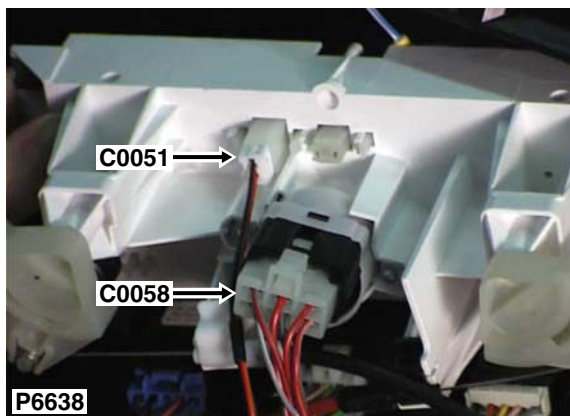

Cav	Col	Cct
1	BO	ALL
2	RO	ALL

Description: *Heater switch illumination*

Location: *Behind centre console*

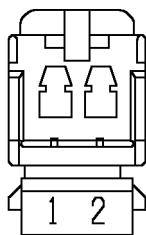

YPC10246

Colour: *WHITE*

Gender: *Female*

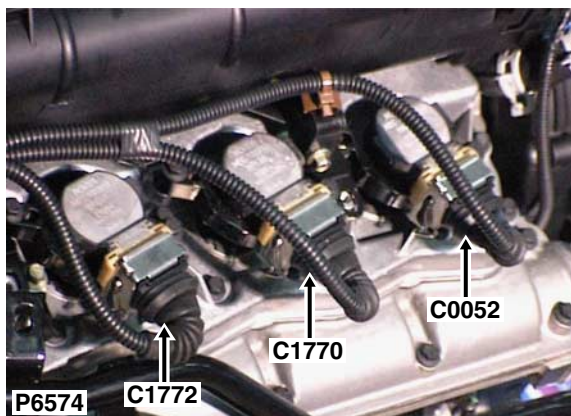

Cav	Col	Cct
1	BG	ALL
2	B	ALL
3	NK	ALL

Description: *Ignition coil-2 - KV6*

Location: *Top of engine*

NO CONNECTOR FACE

Colour: *BLACK*

Gender: *Female*

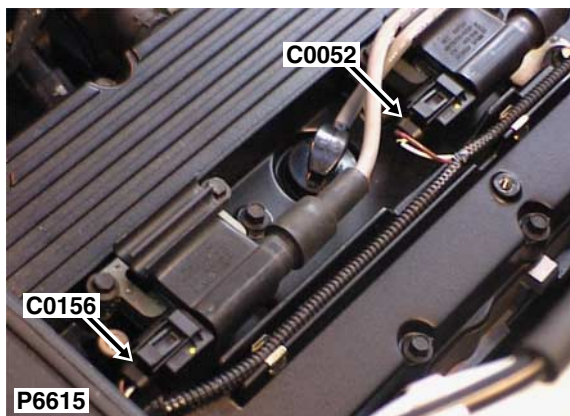

Cav	Col	Cct
1	NK	ALL
2	WB	ALL

Description: *Ignition coil-2 - K1.8*

Location: *Top of engine*

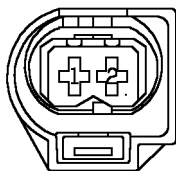

YPC113410

Colour: *BLACK*

Gender: *Female*

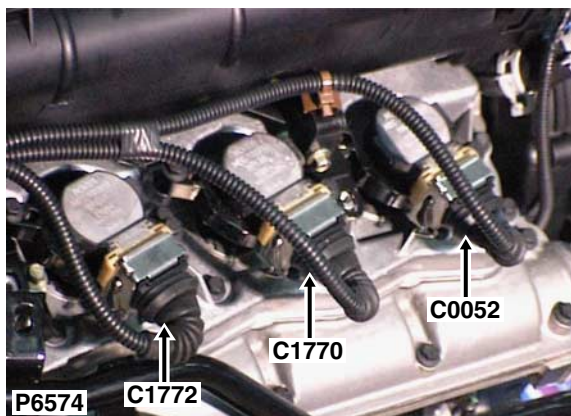

Cav	Col	Cct
1	BG	ALL
2	B	ALL
3	NK	ALL

Description: *Ignition coil-2 - KV6*

Location: *Top of engine*

NO CONNECTOR FACE

Colour: *BLACK*

Gender: *Female*

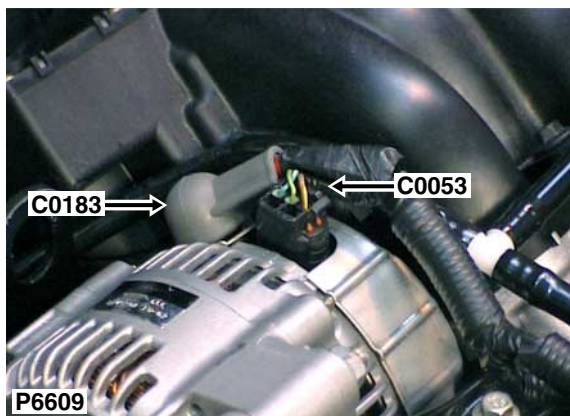

Cav	Col	Cct
1	NY	ALL
2	W	ALL
3	GK	ALL

Description: *Control-Alternator - KV6*

Location: *Top of engine*

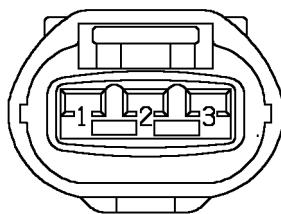

YPC10604

Colour: *BLACK*

Gender: *Female*

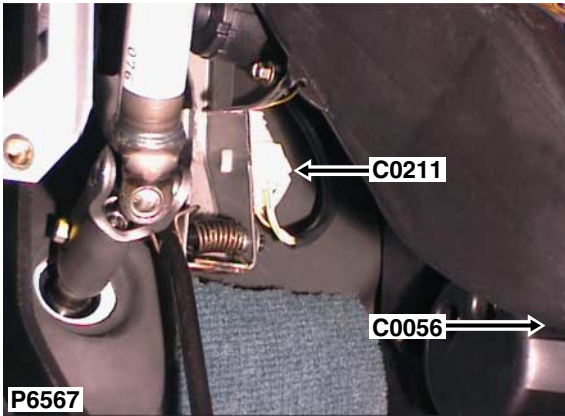

Cav	Col	Cct
1	G	ALL
2	B	ALL

Description: *Motor-Blower*

Location: *Behind centre console*

NO CONNECTOR FACE

Colour:

Gender:

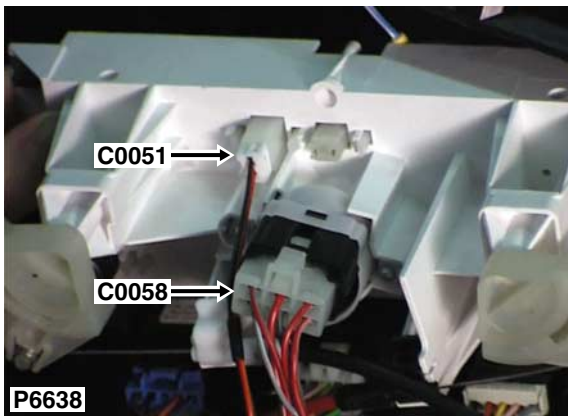

Description: *Switch-Blower motor*

Location: *Behind centre console*

Cav	Col	Cct
1	RY	ALL
2	RG	ALL
3	RS	ALL
4	RK	ALL
5	LGS	ALL
6	SW	ALL

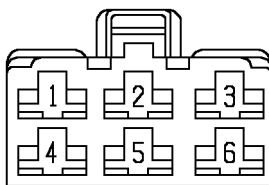

YPC10004

Colour: *NATURAL*

Gender: *Female*

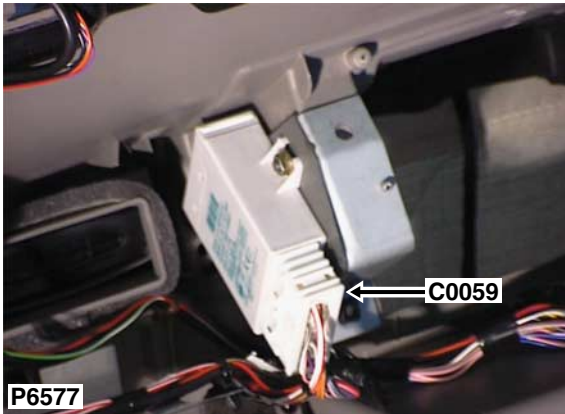

Description: *ECU-Engine Immobilisation*

Location: *Behind centre of fascia*

Cav	Col	Cct
1	B	ALL
2	PN	ALL
3	W	ALL
4	K	ALL
5	WB	ALL
7	RW	ALL
8	WR	ALL
9	G	ALL
10	KB	ALL
11	KG	ALL
13	KN	ALL
14	YR	ALL
15	ON	ALL

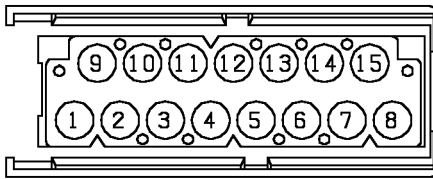

YPC112220

Colour: *NATURAL*

Gender: *Female*



Cav	Col	Cct
1	RY	ALL
2	RO	ALL
4	B	ALL
5	RY	ALL

Description: *Switch-Fog guard lamp-Rear*

Location: *Behind centre of fascia*

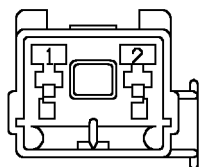

YPC10526

Colour: *GREEN*

Gender: *Female*



P7108

Description: *Switch-Fog lamp-Front*

Location: *Behind centre of fascia*

Cav	Col	Cct
1	R	ALL
2	RO	ALL
4	B	ALL
5	UP	ALL

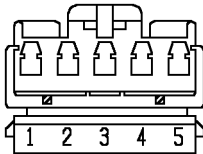

YPC10523

Colour: *BLACK*

Gender: *Female*

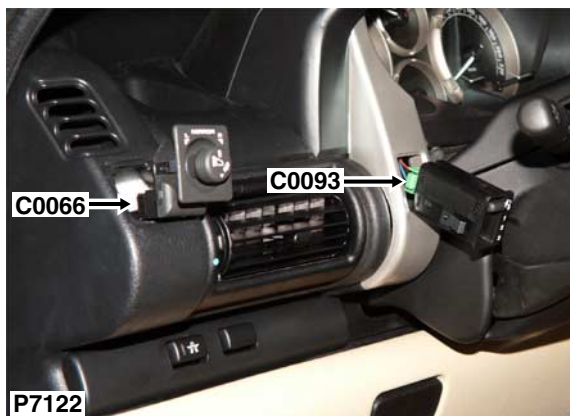

Description: *Switch-Mirror*

Location: *Behind driver side of fascia*

Cav	Col	Cct
1	BY	ALL
2	BP	ALL
3	SW	ALL
4	B	ALL
5	BN	ALL
6	G	ALL
7	BU	ALL
8	UB	29

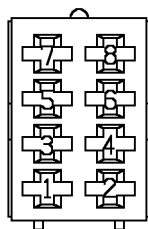

ADU9122

Colour: *BLACK*

Gender: *Female*

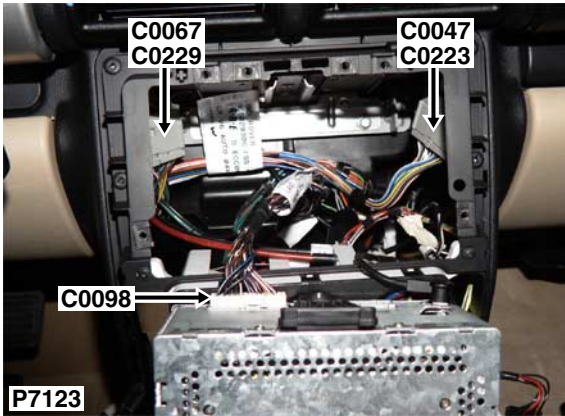

Description: *Main harness to fascia harness*
 Location: *Behind centre console*

Cav	Col	Cct
1	PB	ALL
2	UO	ALL
3	UG	ALL
4	UB	ALL
4	RO	4
5	WU	16
5	GO	ALL
6	PN	ALL
7	W	ALL
8	GB	ALL
9	RW	ALL
10	WR	ALL
11	G	ALL
12	KN	ALL
13	YR	ALL
14	ON	ALL
15	BR	ALL
16	B	ALL
17	K	ALL
18	LGW	ALL
19	UP	ALL
20	RY	ALL

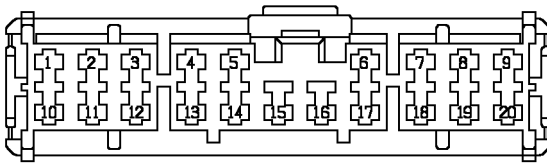

YPC10498

Colour: *LIGHT GREY*
 Gender: *Female*

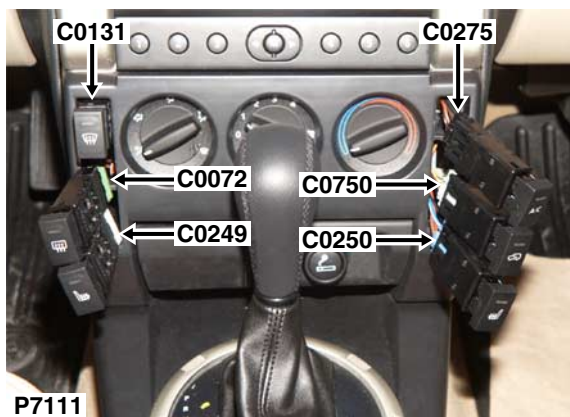

Cav	Col	Cct
1	GY	ALL
2	RO	ALL
4	B	ALL
5	NG	ALL

Description: *Switch-Heated rear screen*

Location: *Behind centre console*

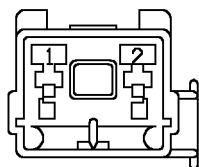

YPC10526

Colour: *GREEN*

Gender: *Female*



P7108

Description: *Switch-Washer-Rear screen*

Location: *Behind centre of fascia*

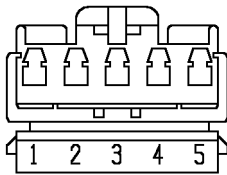

YPC10524

Colour: *WHITE*

Gender: *Female*

Cav	Col	Cct
1	GY	ALL
2	B	ALL
4	GB	ALL
5	RO	ALL

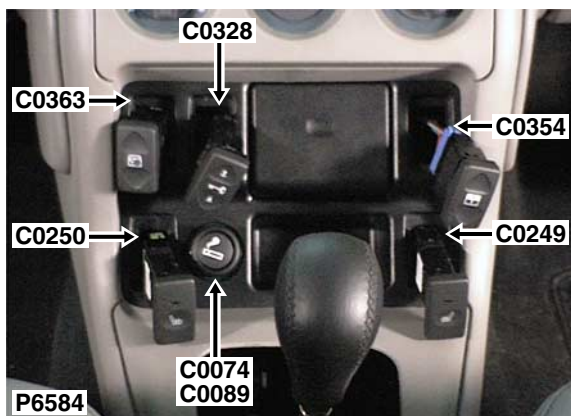

Cav	Col	Cct
1	RO	ALL

Description: *Cigar lighter illumination*

Location: *Behind centre console*

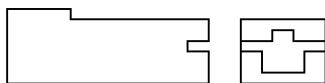

YPC10395

Colour: *WHITE*

Gender: *Female*

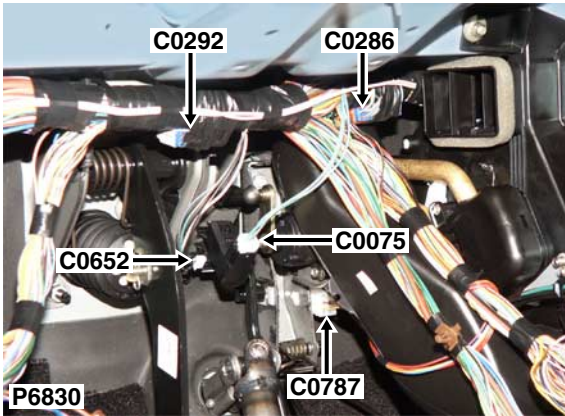

Cav	Col	Cct
1	G	ALL
2	GR	ALL
3	GP	ALL

Description: *Switch-Brake pedal*

Location: *Driver's footwell*

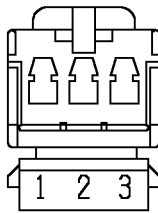

YPC10227

Colour: *WHITE*

Gender: *Female*



Description: *Switch-Wiper-Rear*

Location: *Behind centre of fascia*

Cav	Col	Cct
1	RG	ALL
2	RO	ALL
4	B	ALL

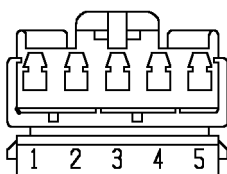

YPC10525

Colour: *BLUE*
 Gender: *Female*

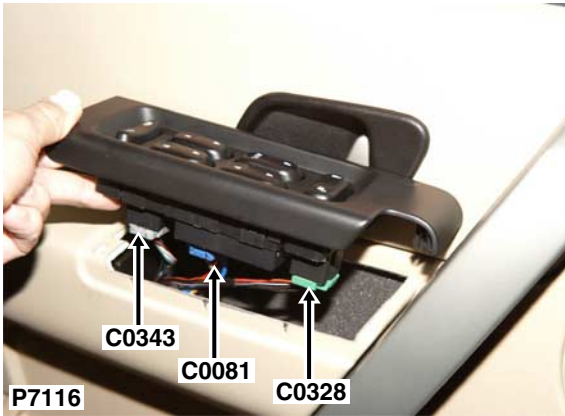

Description: *Switch pack-Window lift*
 Location: *Behind driver door switch pack*

Cav	Col	Cct
1	RO	2
1	OU	3
2	SO	2
2	OR	3
3	OU	2
3	SO	3
4	OR	2
4	RO	3
5	U	3
6	B	2
6	R	3
7	R	2
7	B	3
8	U	2

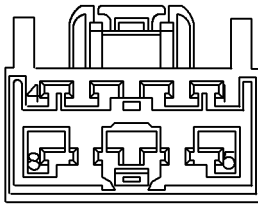

YPC901000

Colour: *BLUE*
 Gender: *Female*

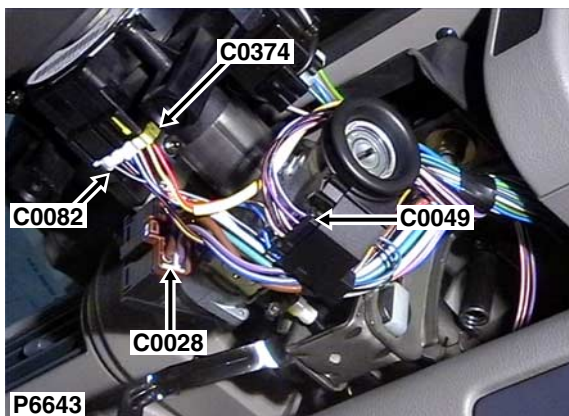

Description: *Rotary coupler*

Location: *Underside of steering column*

Cav	Col	Cct
1	RW	ALL
2	UW	ALL
3	PY	ALL
4	B	ALL
5	BR	ALL
6	BW	ALL

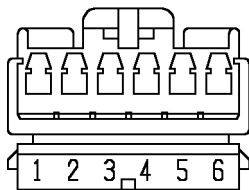

YPC10270

Colour: *WHITE*

Gender: *Female*

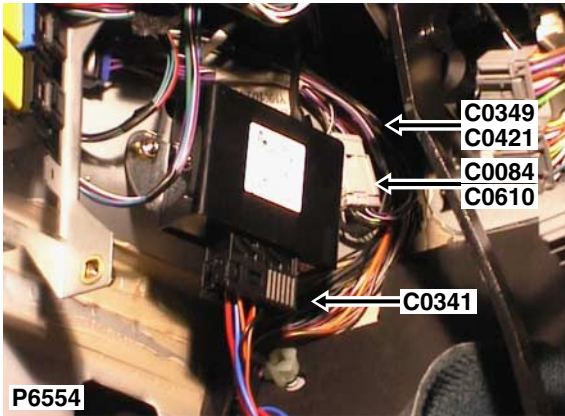

Cav	Col	Cct
1	P	ALL
2	PW	ALL
3	B	ALL
4	G	ALL
5	S	ALL
6	WB	ALL
7	NB	ALL
8	SW	ALL

Description: *Main harness to roof harness*
 Location: *Behind driver side of fascia*

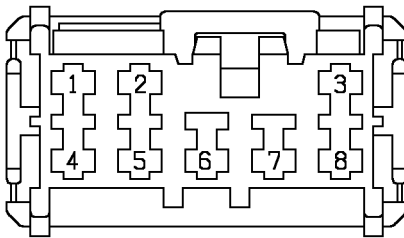

YPC10492

Colour: *LIGHT GREY*
 Gender: *Female*

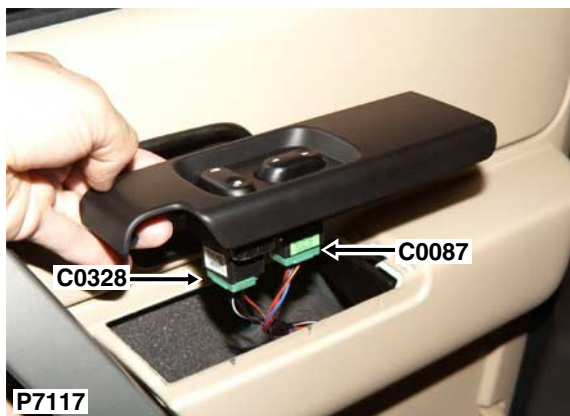

Cav	Col	Cct
1	B	1
3	U	1
4	RB	1
5	RO	1
7	R	1

Description: *Switch-Window-Passenger door*
 Location: *Behind passenger door switch pack*

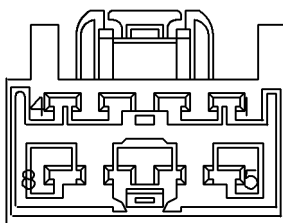

YPC901060

Colour: *GREEN*
 Gender: *Female*

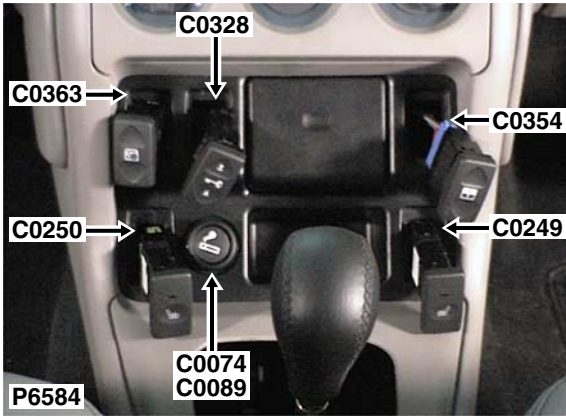

Cav	Col	Cct
1	B	ALL
2	PR	ALL

Description: *Cigar lighter*

Location: *Behind centre console*

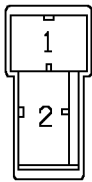

AFU3199

Colour: *BLACK*

Gender: *Female*

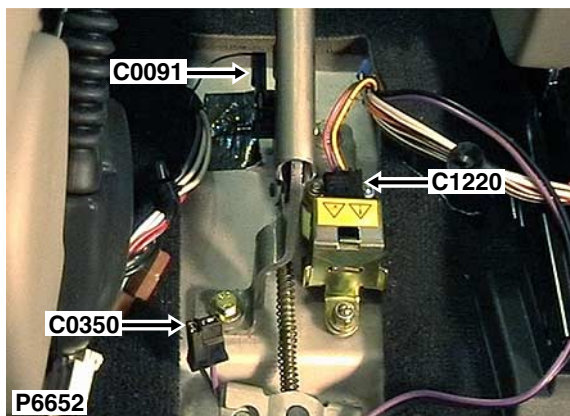

Cav	Col	Cct
1	BW	ALL

Description: *Switch-Handbrake*

Location: *Beneath centre console*



AAU1010

Colour: *BLACK*

Gender: *Female*

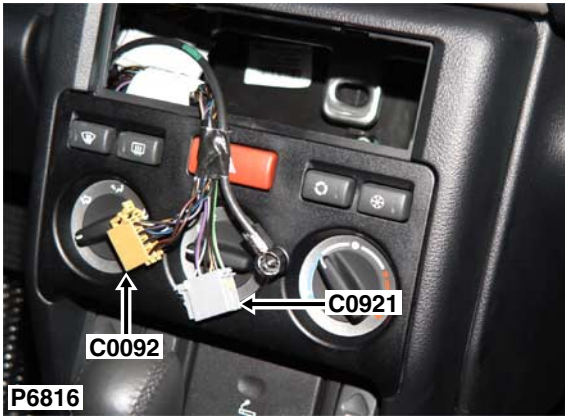

Description: *Head Unit-Audio System*
 Location: *Behind centre console*

Cav	Col	Cct
1	UK	9
1	BG	ALL
2	UB	9
2	BO	ALL
3	OK	9
3	BP	ALL
4	OB	9
4	BU	ALL
5	YK	9
5	BW	ALL
6	YB	9
6	BS	ALL
7	SK	9
7	BN	ALL
8	SB	9
8	BR	ALL

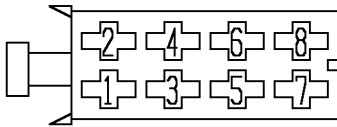

YPC10191

Colour: *BROWN*
 Gender: *Female*

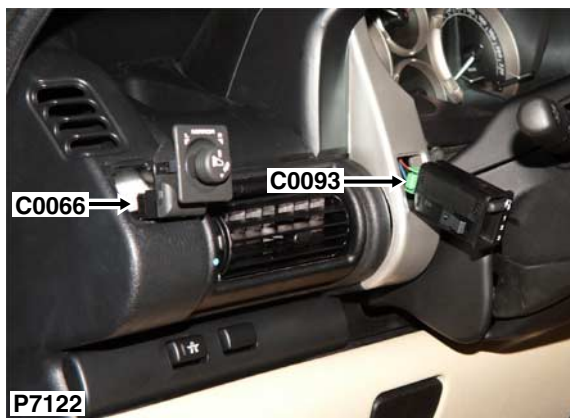

Cav	Col	Cct
1	UB	ALL
3	B	ALL
5	RB	ALL

Description: *Switch-Headlamp levelling*
 Location: *Behind driver side of fascia*

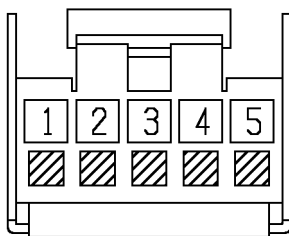

YPC10182

Colour: *GREEN*
 Gender: *Female*



P7108

Description: *Switch-Hazard warning*

Location: *Behind centre of fascia*

Cav	Col	Cct
1	LGK	ALL
2	G	ALL
3	NO	ALL
4	LGN	ALL
5	GR	ALL
6	GW	ALL
7	RO	ALL
8	B	ALL

NO CONNECTOR FACE

Colour:

Gender:

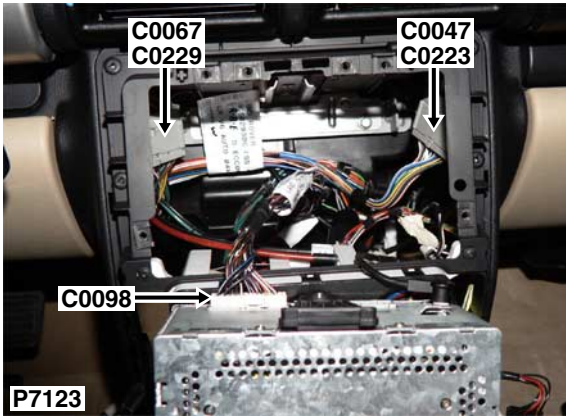

Description: *Head Unit-Audio System*
 Location: *Behind centre console*

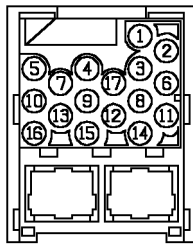

YPC115120

Colour: *BLACK*
 Gender: *Female*

Cav	Col	Cct
1	P	1
1	PK	1
1	YK	8
2	LGW	1
2	OK	8
3	RO	1
3	SK	8
4	B	ALL
5	PY	1
5	LGW	8
6	UK	8
7	WRY	14
8	YK	1
8	BW	1
8	YB	8
9	BN	1
9	SK	1
9	P	ALL
10	UK	1
10	BG	1
10	BW	8
11	OK	1
11	BP	1
11	OB	8
12	BU	1
12	OB	1
12	SB	8
13	B	ALL
13	RO	8
14	WO	ALL
14	UB	8
15	B	ALL
17	B	ALL
17	BR	8
18	BR	1
19	BW	1
21	BS	1

Cav	Col	Cct
21	YB	1
22	SB	1
22	BR	1
23	BO	1
23	UB	1
24	B	ALL

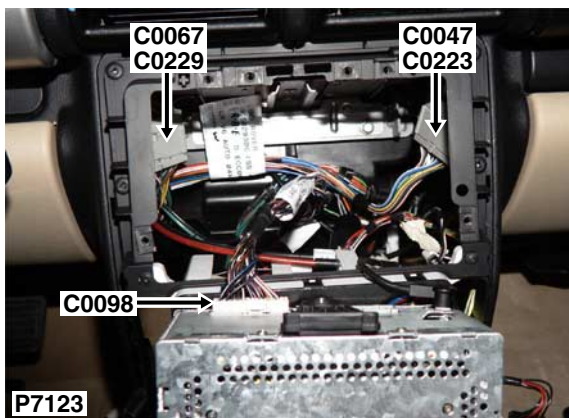

Description: *Head Unit-Audio System*
 Location: *Behind centre console*

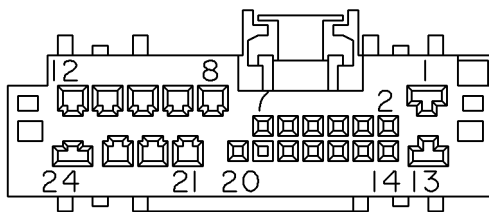

YPC500400

Colour: *GREY*
 Gender: *Female*

Cav	Col	Cct
1	P	1
1	PK	1
1	YK	8
2	LGW	1
2	OK	8
3	RO	1
3	SK	8
4	B	ALL
5	PY	1
5	LGW	8
6	UK	8
7	WRY	14
8	YK	1
8	BW	1
8	YB	8
9	BN	1
9	SK	1
9	P	ALL
10	UK	1
10	BG	1
10	BW	8
11	OK	1
11	BP	1
11	OB	8
12	BU	1
12	OB	1
12	SB	8
13	B	ALL
13	RO	8
14	WO	ALL
14	UB	8
15	B	ALL
17	B	ALL
17	BR	8
18	BR	1
19	BW	1
21	BS	1

Cav	Col	Cct
21	YB	1
22	SB	1
22	BR	1
23	BO	1
23	UB	1
24	B	ALL

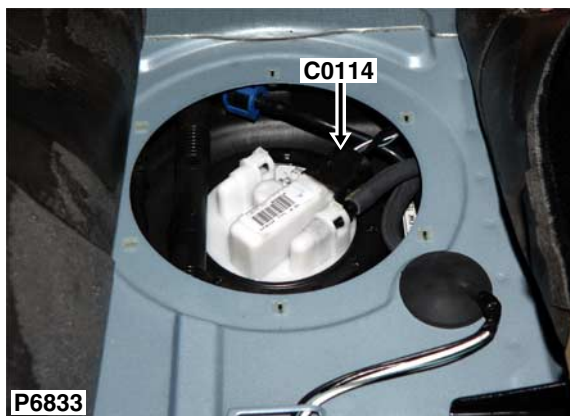

Description: *Unit-Fuel Tank*

Location: *Beneath rear seat*

Cav	Col	Cct
1	B	ALL
2	GB	ALL
3	B	30
4	WP	30

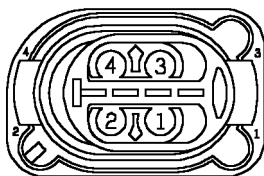

YPC110200

Colour: *BLACK*

Gender: *Female*

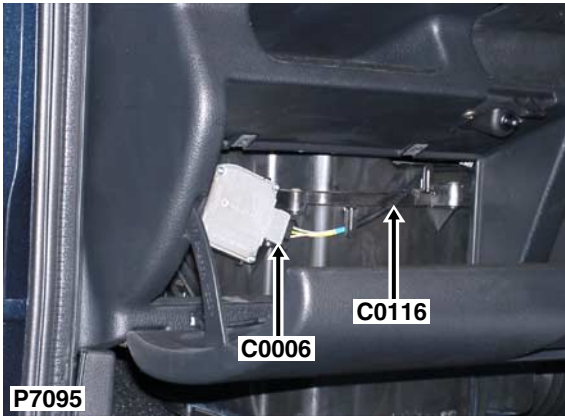

Cav	Col	Cct
1	K	ALL
2	K	ALL

Description: *Diode*

Location: *Behind glovebox*

NO CONNECTOR FACE

Colour:

Gender:

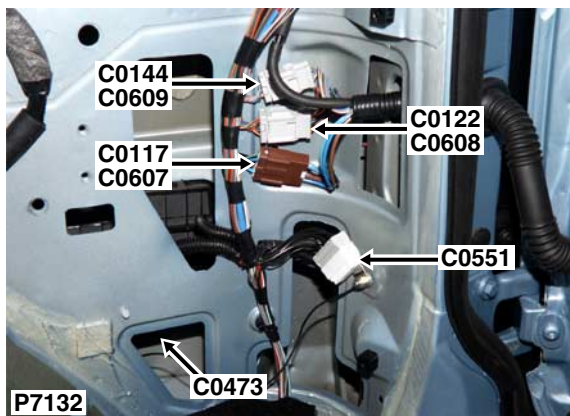

Cav	Col	Cct
1	UB	ALL
2	UG	ALL
3	N	ALL
4	B	ALL
5	G	ALL

Description: *Main harness to tail door harness*

Location: *Rear of luggage compartment - RH side*

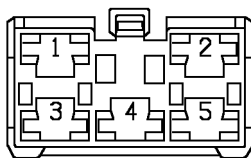

YPC10462

Colour: *BROWN*

Gender: *Female*

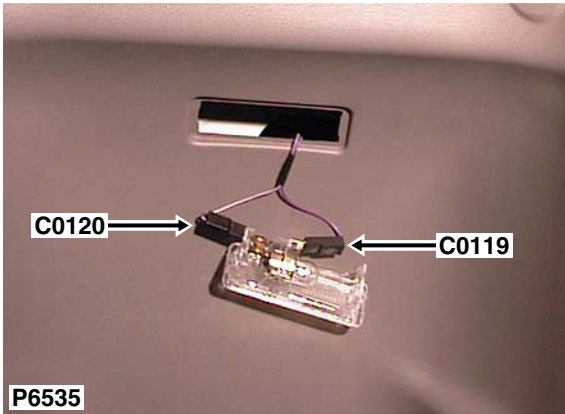

Cav	Col	Cct
1	P	ALL

Description: *Lamp-Load space*

Location: *Luggage compartment - RH side*

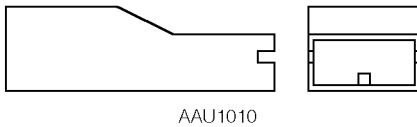

Colour: *BLACK*
Gender: *Female*

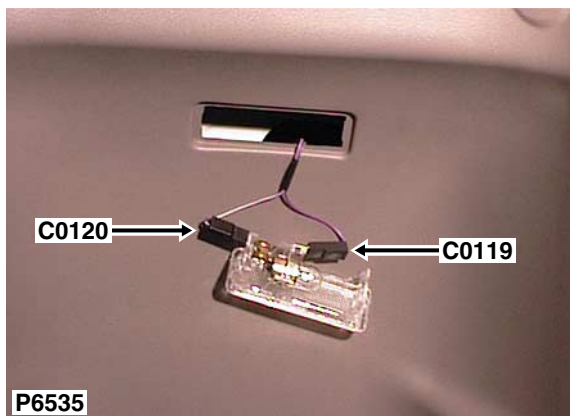

Cav	Col	Cct
1	PW	ALL

Description: *Lamp-Load space*

Location: *Luggage compartment - RH side*



AAU1010

Colour: *BLACK*

Gender: *Female*



Description: *Lamp-Tail-LH*

Location: *LH rear of vehicle*

NO CONNECTOR FACE

Colour: *BLACK*

Gender: *Female*

Cav	Col	Cct
1	RB	ALL
2	GP	ALL
3	B	ALL

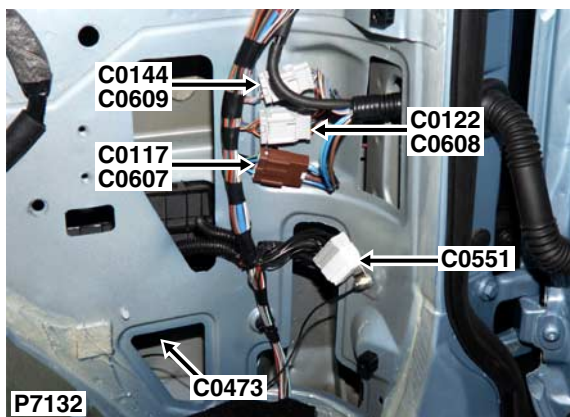

Cav	Col	Cct
1	ON	ALL
2	BO	ALL
3	RO	ALL
4	PU	ALL
5	GP	ALL
6	B	ALL
7	GR	ALL
8	OB	ALL

Description: *Main harness to tail door harness*

Location: *Rear of luggage compartment - RH side*

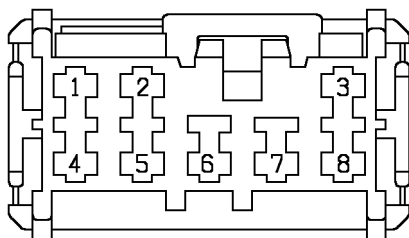

YPC10492

Colour: *LIGHT GREY*

Gender: *Female*

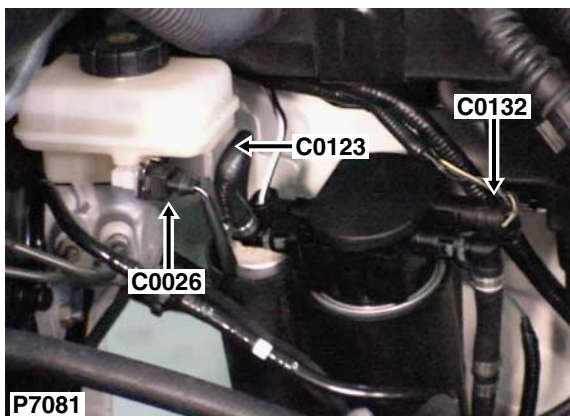

Cav	Col	Cct
1	G	ALL
3	GU	ALL

Description: *Switch-Inertia*

Location: *Rear LH side of engine compartment*

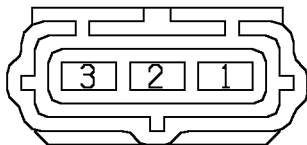

YPC10068

Colour: *BLACK*

Gender: *Female*

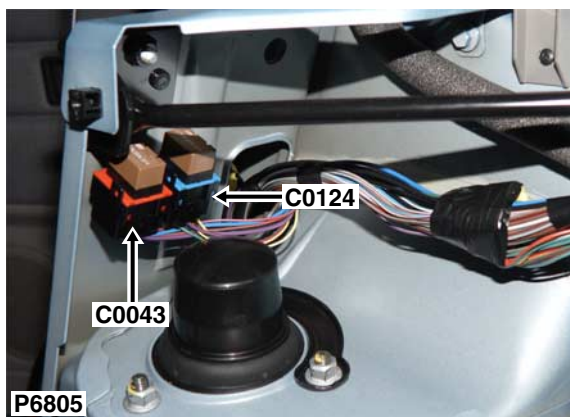

Description: *Relay-Rear wiper*

Location: *Luggage compartment - RH side*

Cav	Col	Cct
1	YW	ALL
2	PR	ALL
4	B	ALL
6	G	ALL
7	YB	ALL
9	GR	ALL

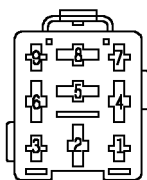

YPP10001

Colour: *BLACK*

Gender: *Female*

**P7105**Description: *Lamp-Tail-RH*Location: *RH rear of vehicle*

Cav	Col	Cct
1	RO	ALL
2	GP	ALL
3	B	ALL

NO CONNECTOR FACE

Colour: *BLACK*Gender: *Female*

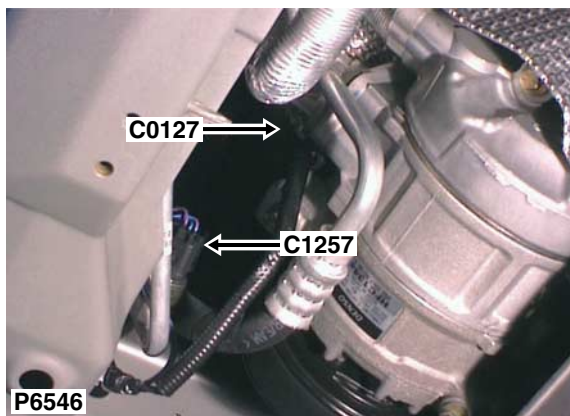

Cav	Col	Cct
1	R	28

Description: *Clutch-Compressor-Air conditioning (A/C) - Td4 & KV6*
Location: *Lower front of engine - RH side*

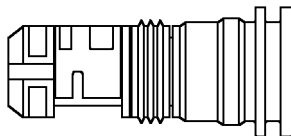
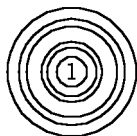

YPC110230

Colour: *BLACK*
Gender: *Female*

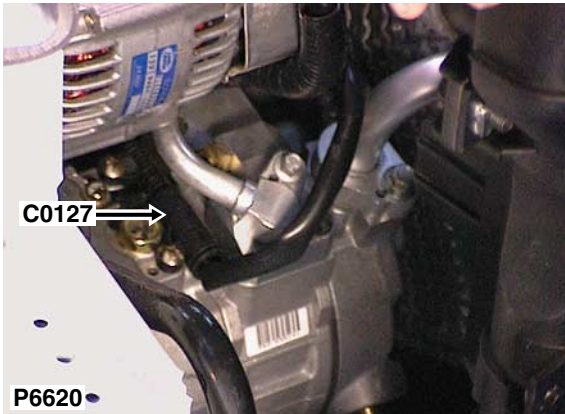

Cav	Col	Cct
1	R	ALL

Description: *Clutch-Compressor-Air conditioning (A/C) - K1.8*

Location: *Lower front of engine - RH side*

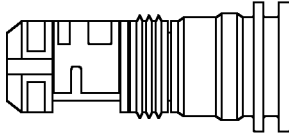
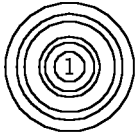

YPC110230

Colour: *BLACK*

Gender: *Female*

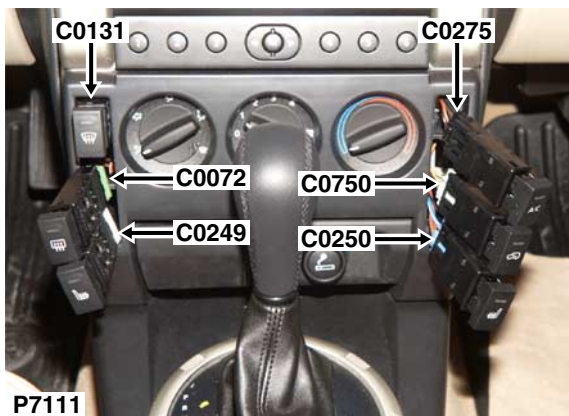

Description: *Switch-Heated front screen*

Location: *Behind centre console*

Cav	Col	Cct
1	KO	28
2	RO	28
4	B	28
5	PK	28

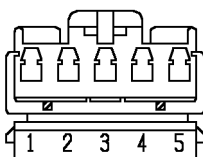

YPC10523

Colour: *BLACK*

Gender: *Female*

C0132

CONNECTOR DETAILS

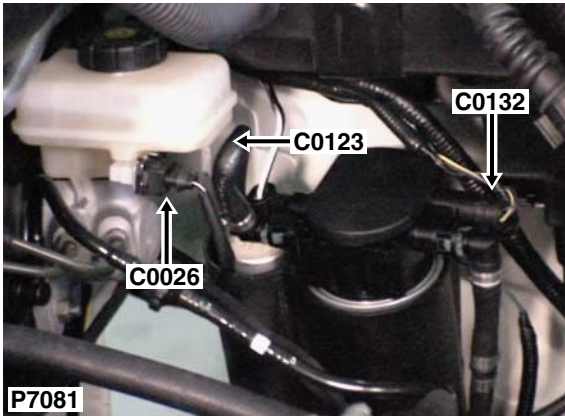

Cav	Col	Cct
1	PG	17
2	BG	17
3	GS	17

Description: *Sensor-Low fuel pressure*

Location: *Rear LH side of engine compartment*

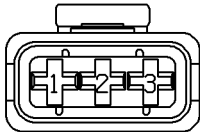

YPC110140

Colour: *BLACK*

Gender: *Female*

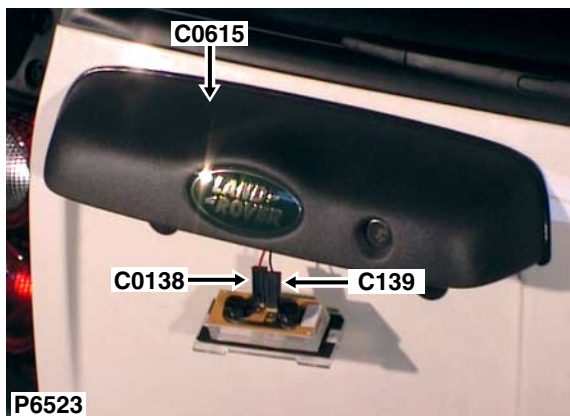

Cav	Col	Cct
1	RO	ALL

Description: *Lamp-Number plate*

Location: *Behind number plate lamp*

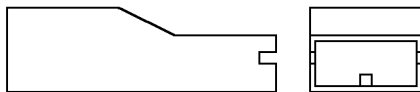

AAU1010

Colour: *BLACK*

Gender: *Female*

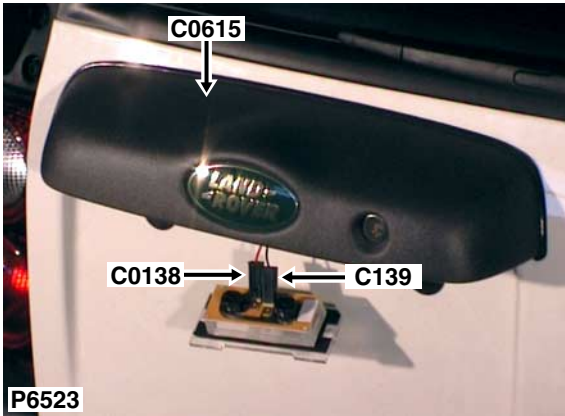

Cav	Col	Cct
1	B	1
2	B	1

Description: *Lamp-Number plate*

Location: *Behind number plate lamp*

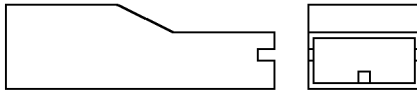

AAU1010

Colour: *BLACK*

Gender: *Female*

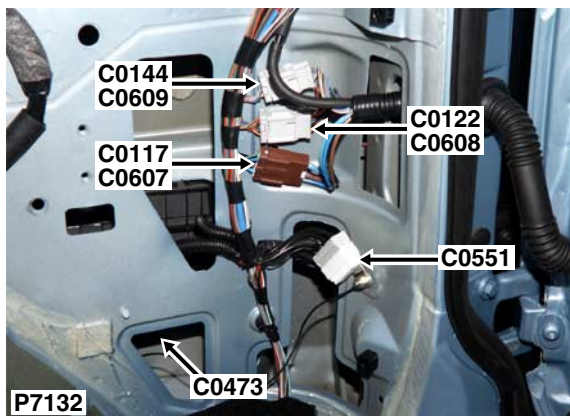

Cav	Col	Cct
1	KB	ALL
3	SR	ALL
4	SP	ALL
5	US	ALL
6	NG	ALL

Description: *Main harness to tail door harness*

Location: *Rear of luggage compartment - RH side*

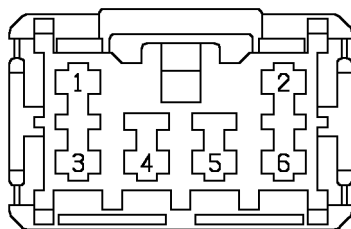

YPC10634

Colour: *LIGHT GREY*

Gender: *Female*

C0149

CONNECTOR DETAILS

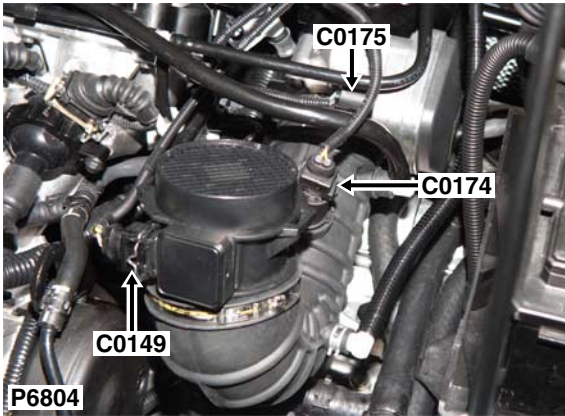

Cav	Col	Cct
1	YW	ALL
2	GW	ALL
3	YG	ALL

Description: *Sensor-Mass air flow (MAF) - NAS*

Location: *LH side of engine compartment*

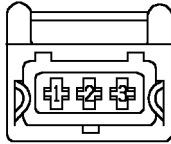

YPC114930

Colour: *BLACK*

Gender: *Female*

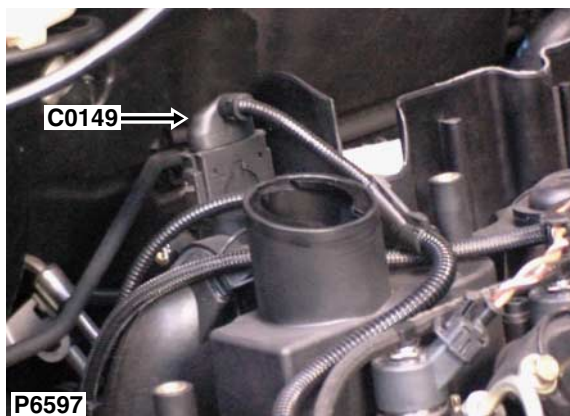

Cav	Col	Cct
1	UW	ALL
2	RW	ALL
3	B	ALL
4	RY	ALL
5	Y	ALL

Description: *Sensor-Mass air flow (MAF) - Td4*

Location: *Top of engine*

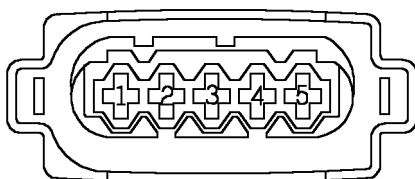

YPC113350

Colour: *BLACK*

Gender: *Female*

C0150

CONNECTOR DETAILS



Cav	Col	Cct
1	LGS	ALL
2	BK	ALL
3	BO	ALL
4	BK	ALL

Description: *Sensor-Knock (KS) - KV6*

Location: *Rear LH side of engine*

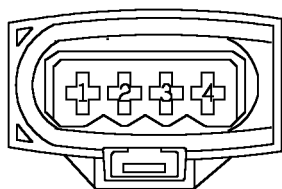

YPC113840

Colour: *BLACK*

Gender: *Female*



Cav	Col	Cct
1	NU	ALL
2	BO	ALL

Description: *Purge control valve - K1.8*

Location: *Rear LH side of engine compartment*

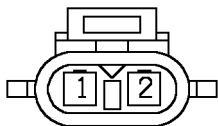

YPC117890

Colour: *BLACK*

Gender: *Female*

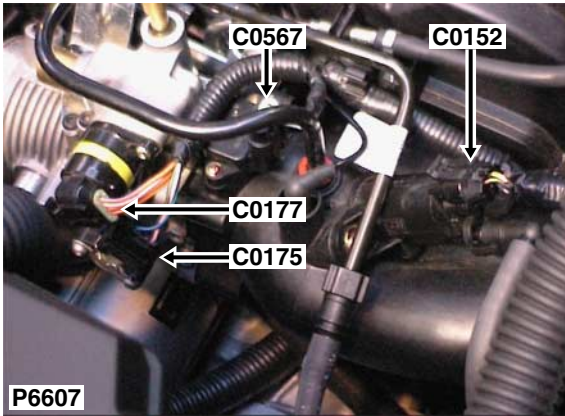

Cav	Col	Cct
1	YU	ALL
2	BO	ALL

Description: *Purge control valve - KV6*

Location: *Top of engine*

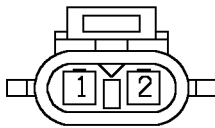

YPC117890

Colour: *BLACK*

Gender: *Female*

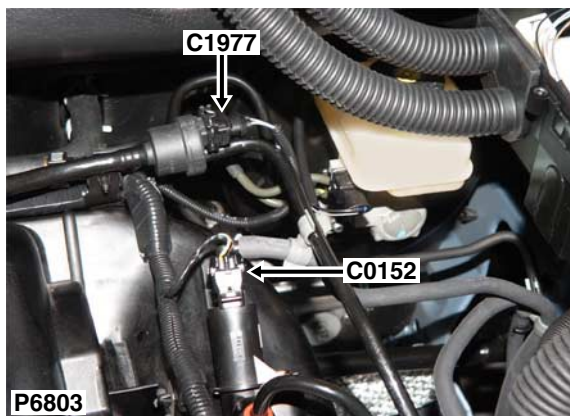

Cav	Col	Cct
1	YU	ALL
2	BO	ALL

Description: *Purge control valve - NAS*
Location: *Rear of engine compartment*

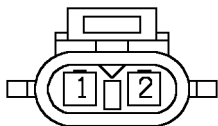

YPC117890

Colour: *BLACK*
Gender: *Female*

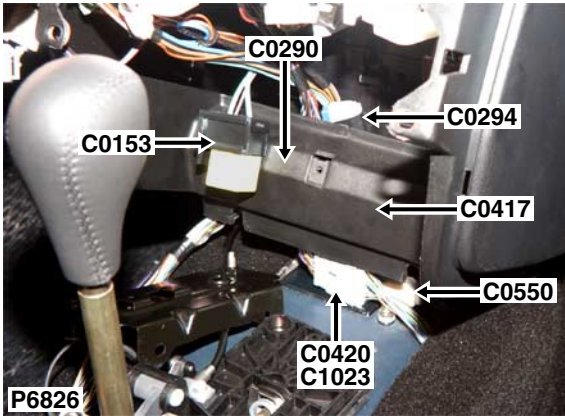

Cav	Col	Cct
30	GW	ALL
85	BS	ALL
86	RS	ALL
87	GR	ALL

Description: *Relay-Blower*

Location: *Behind centre console*

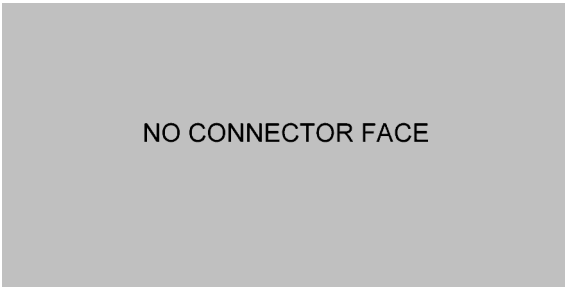

Colour:

Gender:

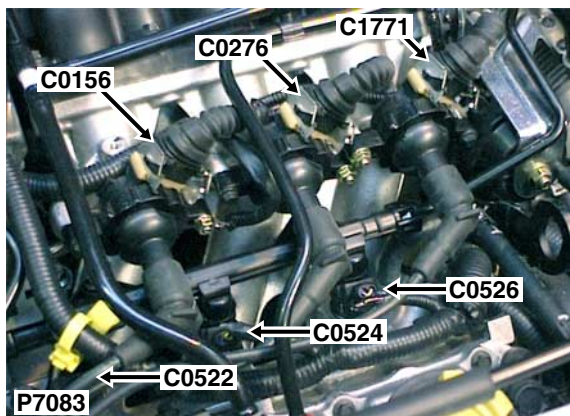

Cav	Col	Cct
1	BR	ALL
2	B	ALL
3	NK	ALL

Description: *Ignition coil-1 - KV6*

Location: *Top of engine*

NO CONNECTOR FACE

Colour: *BLACK*

Gender: *Female*

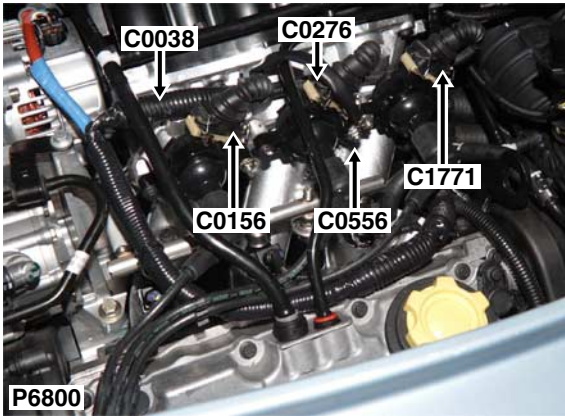

Cav	Col	Cct
1	BR	ALL
2	B	ALL
3	NK	ALL

Description: *Ignition coil-1 - NAS*

Location: *Top of engine*

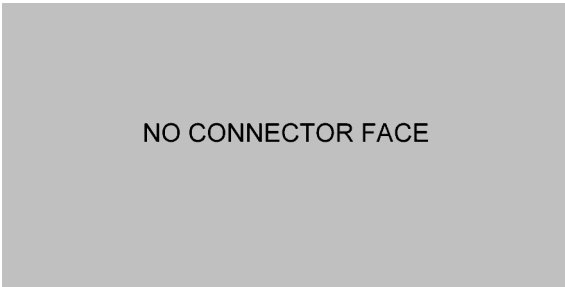

Colour: *BLACK*

Gender: *Female*

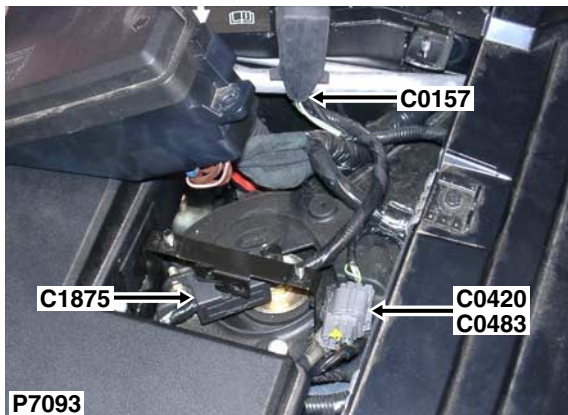

Cav	Col	Cct
1	N	ALL
2	GY	ALL
3	B	ALL
4	WP	ALL

Description: *Relay-PTC 2*

Location: *Rear LH side of engine compartment*

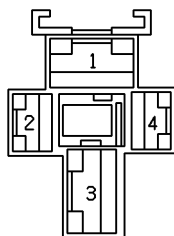

YPP10005

Colour: *BLACK*

Gender: *Female*

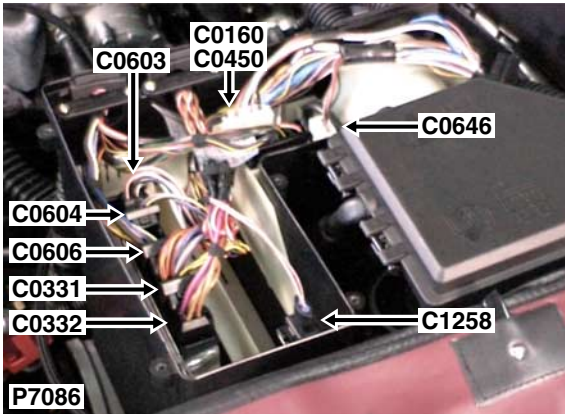

Description: *Engine harness to main harness*

Location: *Inside E-box*

Cav	Col	Cct
1	B	ALL
2	BR	ALL
3	BY	ALL
6	GN	ALL
8	BP	ALL
9	BG	ALL
11	BR	ALL
12	RW	ALL



YPC112660

Colour: *BLACK*

Gender: *Female*

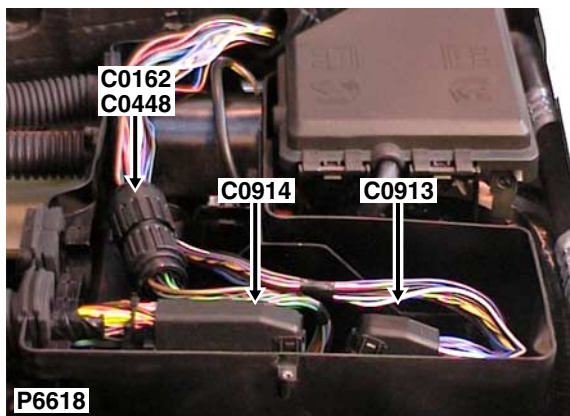

Cav	Col	Cct
1	G	ALL
2	GN	ALL
3	GB	ALL
4	B	ALL
5	KB	ALL
6	LGS	ALL
7	GU	ALL
8	GO	ALL
9	BO	ALL
12	NR	ALL

Description: *Engine harness to main harness - K1.8*

Location: *Inside E-box*

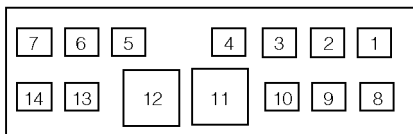

YPC115760

Colour: *LIGHT GREY*

Gender: *Male*



Description: *Engine harness to main harness - KV6*

Location: *Inside E-box*

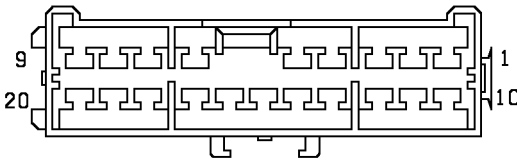

YPC10548

Colour: *LIGHT GREY*

Gender: *Male*

Cav	Col	Cct
1	PB	ALL
2	UO	ALL
3	UG	ALL
4	GU	ALL
5	OY	ALL
6	BG	ALL
7	YR	ALL
8	Y	ALL
9	UW	ALL
10	U	ALL
11	R	ALL
12	YB	ALL
13	YN	ALL
14	K	ALL
15	BU	ALL
16	BP	ALL
17	UR	ALL
18	WO	ALL
19	UY	ALL
20	W	ALL

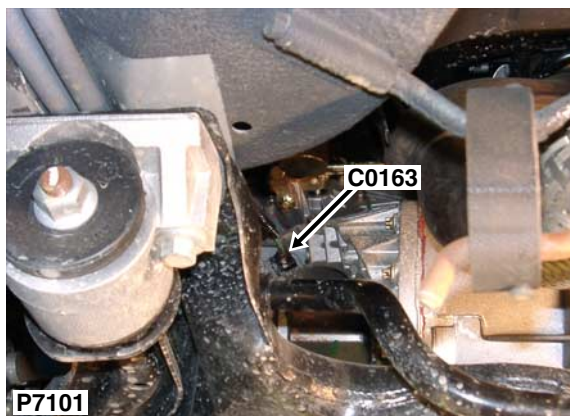

Cav	Col	Cct
1	GN	ALL
2	G	ALL

Description: *Switch-Reverse - Td4*

Location: *Gearbox - Rear*

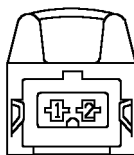

YPC114900

Colour: *BLACK*

Gender: *Female*

C0163

CONNECTOR DETAILS

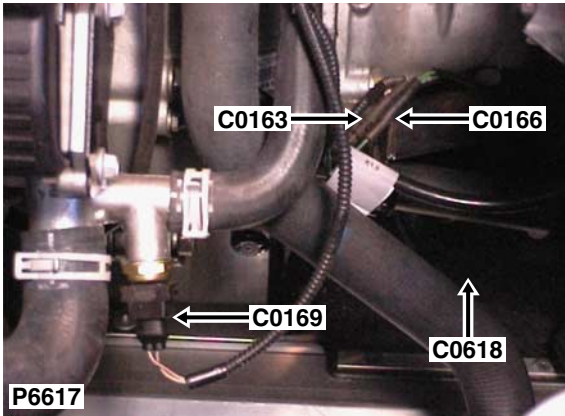

Cav	Col	Cct
1	G	ALL

Description: *Switch-Reverse - K1.8*

Location: *Above gearbox*

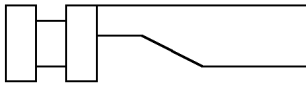

AFU3629

Colour: *BLACK*

Gender: *Female*

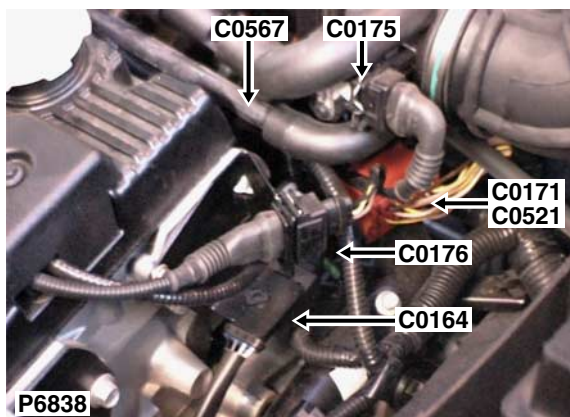

Cav	Col	Cct
1	KB	ALL
2	LGS	ALL
3	BU	ALL
4	NU	ALL

Description: *Sensor-Heated oxygen (HO2S)-Front - K1.8*

Location: *RH side of engine compartment*

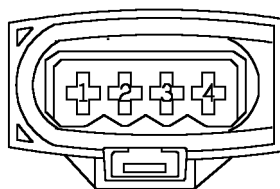

YPC113840

Colour: *BLACK*

Gender: *Female*

C0164

CONNECTOR DETAILS

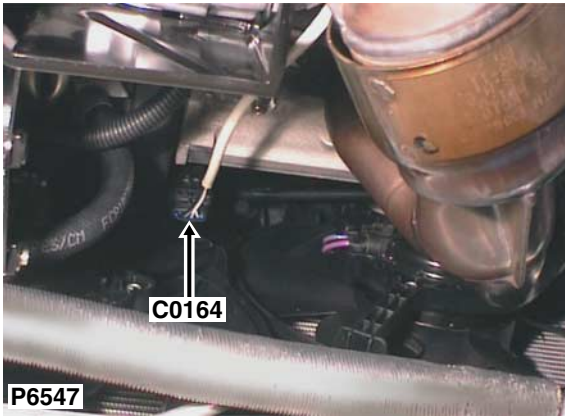

Cav	Col	Cct
1	UY	ALL
2	BG	ALL
3	UN	ALL
4	YG	ALL

Description: *Sensor-Heated oxygen (HO2S)-Front - KV6*

Location: *Front of engine - centre*

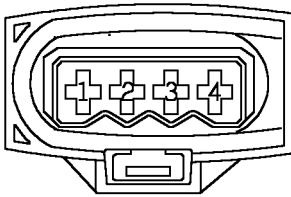

YPC114880

Colour: *BLACK*

Gender: *Female*

Cav	Col	Cct
1	GN	ALL

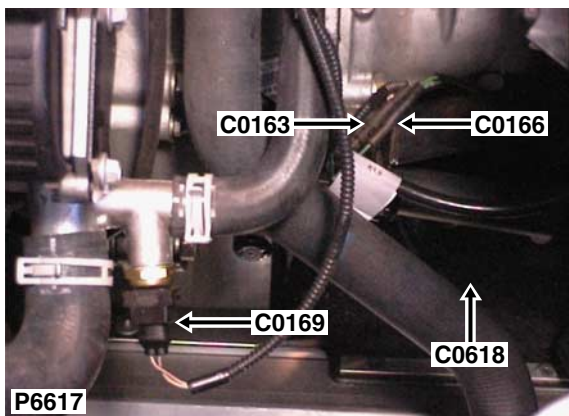

Description: *Switch-Reverse*

Location: *Above gearbox*

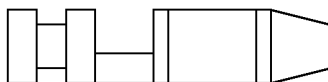

AFU3630

Colour: *BLACK*

Gender: *Male*

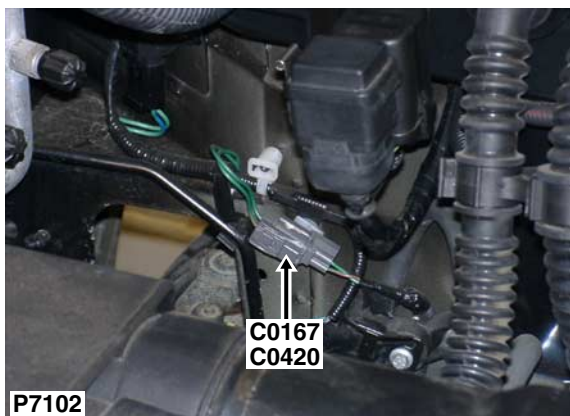

Cav	Col	Cct
1	GN	36
2	G	36

Description: *Link harness to main harness*

Location: *Beneath engine compartment fusebox*

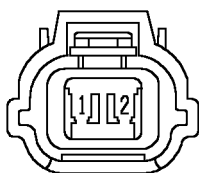

YPC10180

Colour: *GREY*

Gender: *Female*

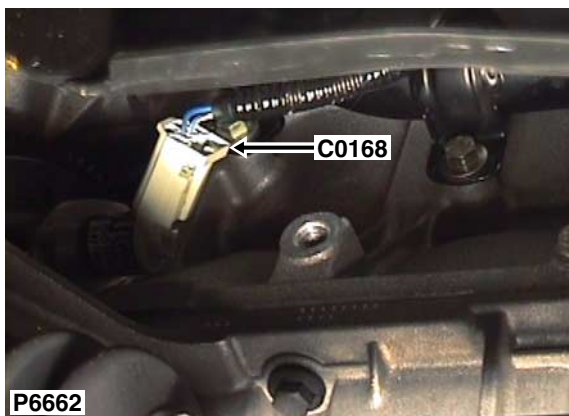

Cav	Col	Cct
1	B	ALL
2	NB	ALL

Description: *Sensor-Crankshaft position (CKP) - K1.8*

Location: *Centre rear of engine*

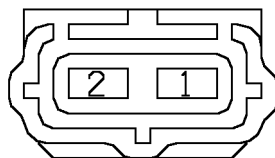

YPC10187

Colour: *WHITE*

Gender: *Female*

Cav	Col	Cct
1	GU	4
2	UG	4

NO PHOTO LOCATION

Description: *Sensor-Thermostat monitoring - NAS*

Location: *Front of engine compartment - centre*

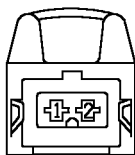

YPC114900

Colour: *BLACK*

Gender: *Female*

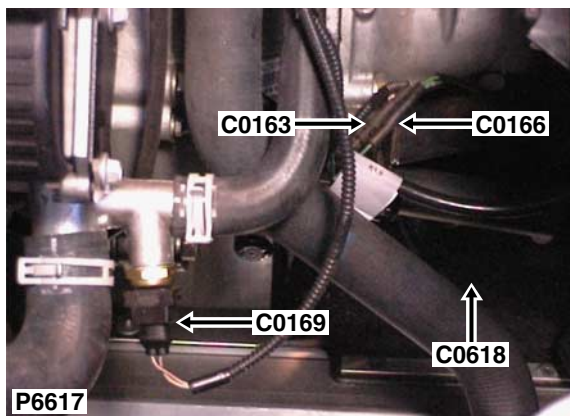

Cav	Col	Cct
1	KB	ALL
2	KG	ALL

Description: *Sensor-Engine coolant temperature (ECT) - K1.8*

Location: *Above gearbox*

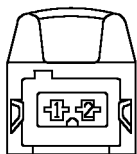

YPC114920

Colour: *BLACK*

Gender: *Female*

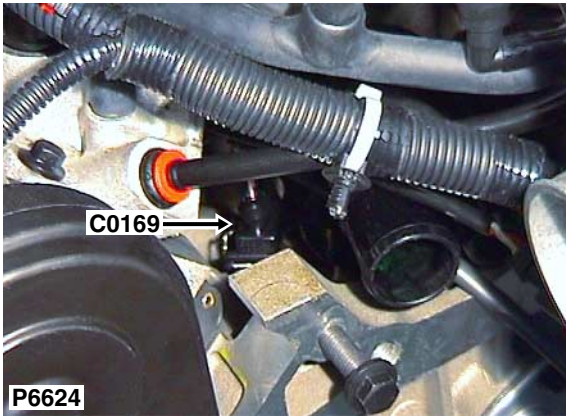

Cav	Col	Cct
1	KB	ALL
2	KG	ALL

Description: *Sensor-Engine coolant temperature (ECT) - KV6*
Location: *Front of engine - centre*

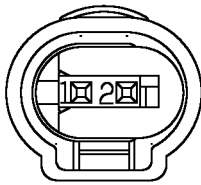

YPC116820

Colour: *BLACK*
Gender: *Female*

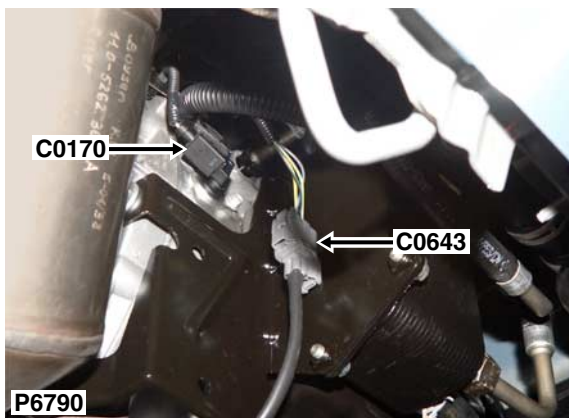

Cav	Col	Cct
1	BS	ALL
2	WU	ALL
3	YU	ALL

Description: *Sensor-Crankshaft position (CKP) - KV6*

Location: *Rear LH side of engine*

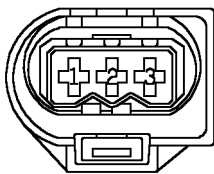

YPC113380

Colour: *BLACK*

Gender: *Female*

C0171

CONNECTOR DETAILS

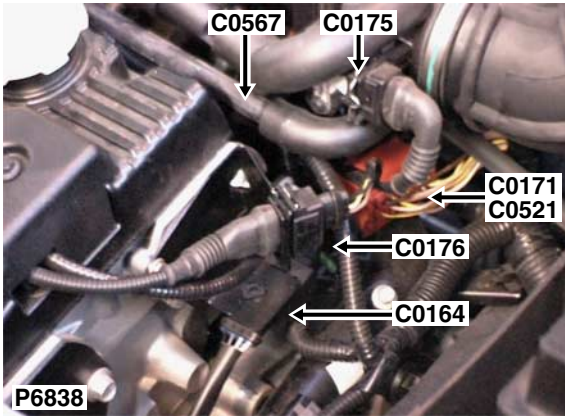

Description: *Engine harness to injector harness - K1.8*

Location: *Rear LH side of engine*

Cav	Col	Cct
1	NK	ALL
2	YU	ALL
6	YG	ALL
7	YR	ALL
8	KB	ALL
9	YW	ALL
10	YN	ALL
11	NK	ALL
12	YP	ALL
13	RG	ALL
15	WB	ALL
16	WO	ALL

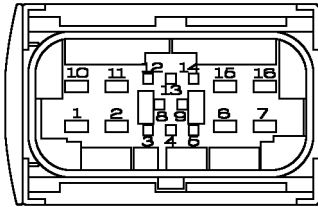

YPC116590

Colour: *BLACK*

Gender: *Female*

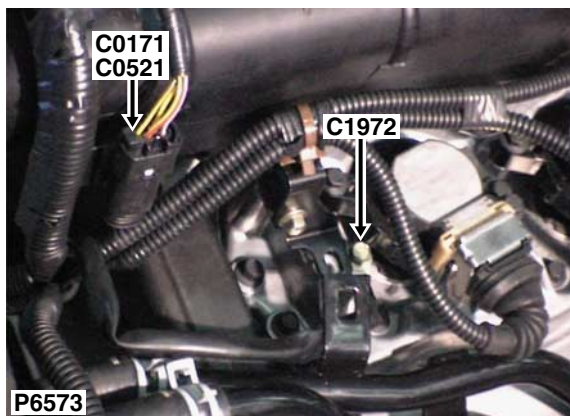

Cav	Col	Cct
1	YN	ALL
2	YR	ALL
3	YG	ALL
4	NK	ALL

Description: *Engine harness to injector harness - KV6*

Location: *Top of engine*

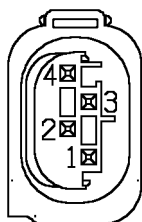

YPC117050

Colour: *BLACK*

Gender: *Female*



Cav	Col	Cct
1	YN	ALL
2	YR	ALL
3	YG	ALL
4	NK	ALL

Description: *Engine harness to injector harness - NAS*

Location: *Top of engine*

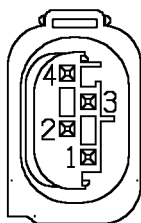

YPC117050

Colour: *BLACK*

Gender: *Female*

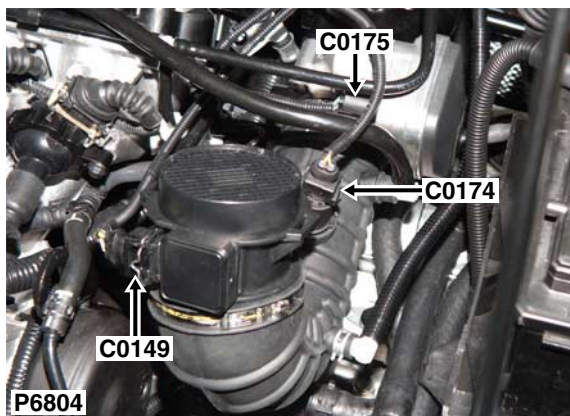

Cav	Col	Cct
1	OG	ALL
2	OS	ALL

Description: *Sensor-Inlet air temperature (IAT) - NAS*

Location: *LH side of engine compartment*

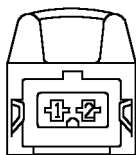

YPC114900

Colour: *BLACK*

Gender: *Female*



Description: *Sensor-Throttle position (TP) - Td4*
Location: *Behind driver side of fascia*

Cav	Col	Cct
1	NRB	ALL
2	RN	ALL
3	YRB	ALL
4	RU	ALL
5	URB	ALL
6	RY	ALL

NO CONNECTOR FACE

Colour: *BLACK*
Gender: *Female*

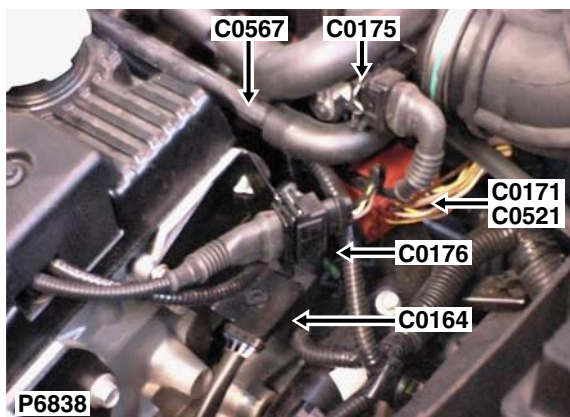

Cav	Col	Cct
1	KP	ALL
2	GY	ALL
3	KB	ALL

Description: *Sensor-Throttle position (TP) - K1.8*

Location: *Top of engine*

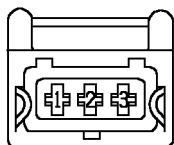

YPC114930

Colour: *BLACK*

Gender: *Female*

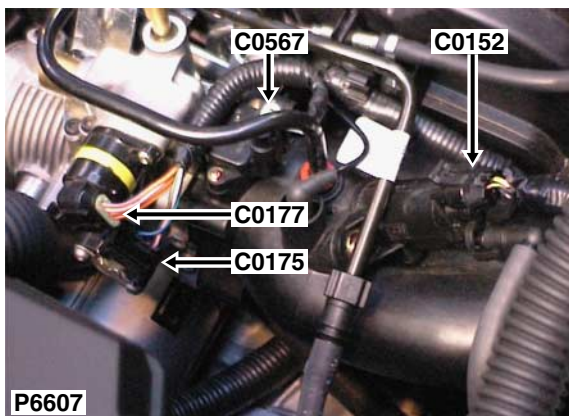

Cav	Col	Cct
1	GU	ALL
2	BLG	ALL
3	KB	ALL

Description: *Sensor-Throttle position (TP) - KV6*

Location: *Top of engine*

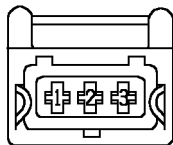

YPC114930

Colour: *BLACK*

Gender: *Female*

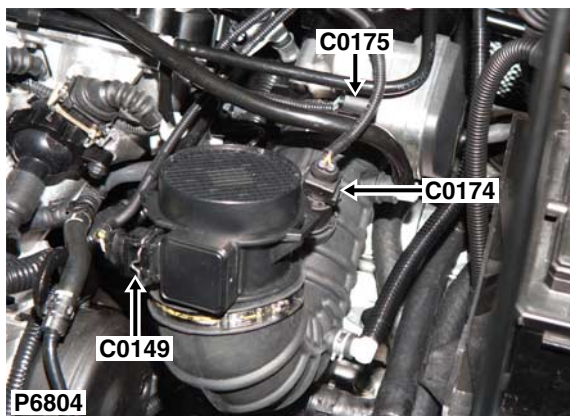

Cav	Col	Cct
1	NP	ALL
2	NW	ALL
3	NB	ALL
4	NU	ALL
5	GW	ALL
6	NG	ALL

Description: *Sensor-Throttle position (TP) - NAS*

Location: *LH side of engine compartment*

NO CONNECTOR FACE

Colour: *BLACK*

Gender: *Female*

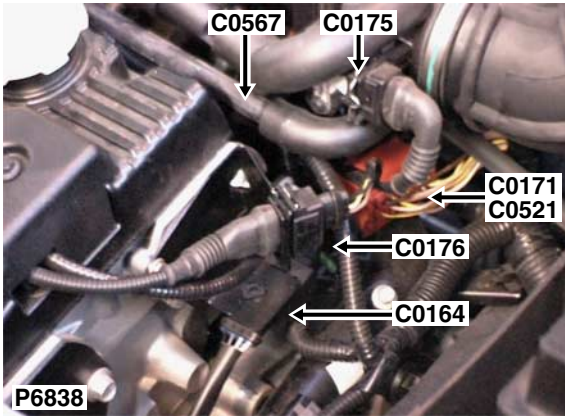

Cav	Col	Cct
1	NU	ALL
2	YP	ALL
3	BS	ALL

Description: *Sensor-Camshaft position (CMP) - K1.8*

Location: *Top of engine*

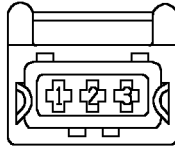

YPC114950

Colour: *BLACK*

Gender: *Female*

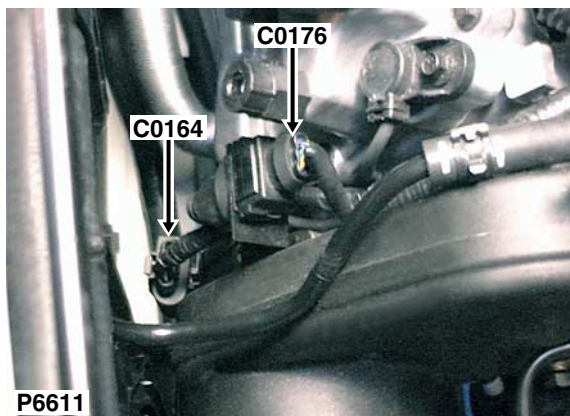

Cav	Col	Cct
1	YG	ALL
2	UG	ALL
3	BS	ALL

Description: *Sensor-Camshaft position (CMP) - KV6*
Location: *Top of engine*

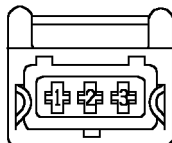

YPC114930

Colour: *BLACK*
Gender: *Female*

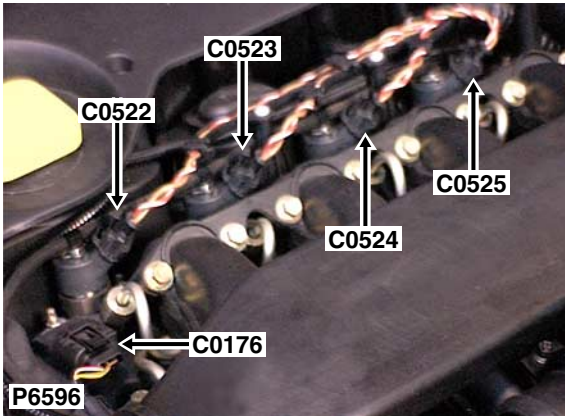

Cav	Col	Cct
1	RW	ALL
2	Y	ALL
3	N	ALL

Description: *Sensor-Camshaft position (CMP) - Td4*

Location: *Top of engine*

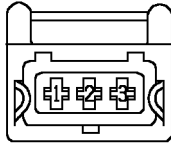

YPC114930

Colour: *BLACK*

Gender: *Female*

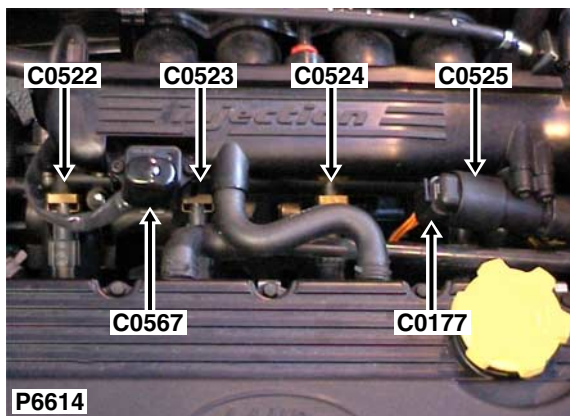

Description: *Idle air control valve (IACV) - K1.8*

Location: *Top of engine*

Cav	Col	Cct
A	KU	ALL
B	OG	ALL
C	OS	ALL
D	OU	ALL

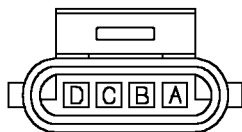

YPC117430

Colour: *BLACK*

Gender: *Female*

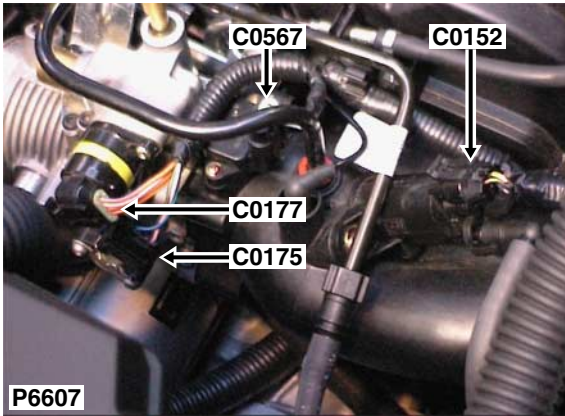

Cav	Col	Cct
A	OG	ALL
B	OS	ALL
C	KU	ALL
D	OU	ALL

Description: *Idle air control valve (IACV) - KV6*

Location: *Top of engine*

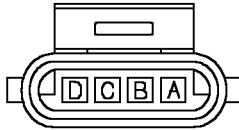

YPC117430

Colour: *BLACK*

Gender: *Female*

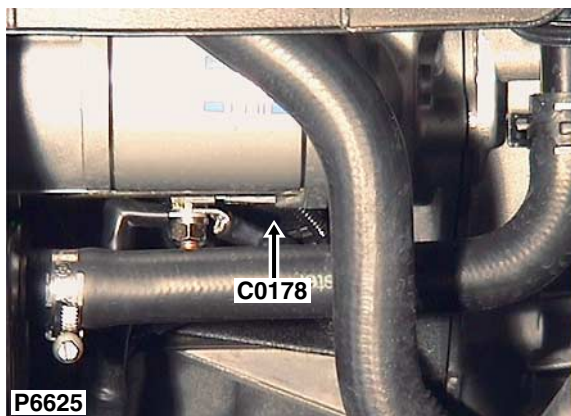

Cav	Col	Cct
1	B	ALL

Description: *Starter motor - Td4*

Location: *Front of engine - centre*

NO CONNECTOR FACE

Colour:

Gender:

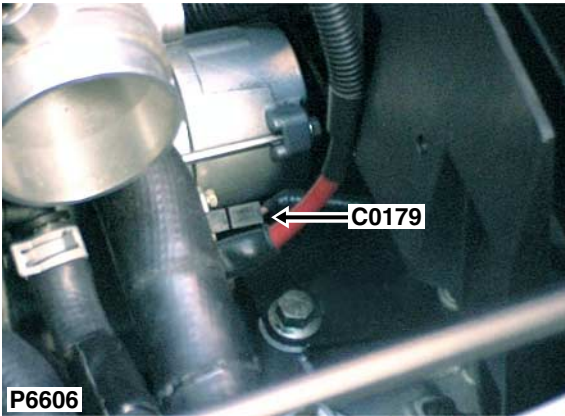

Cav	Col	Cct
1	NR	16

Description: *Solenoid-Starter motor - KV6*
Location: *Above gearbox*

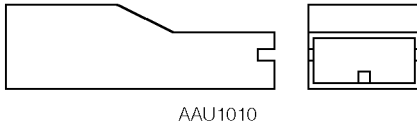

Colour: *BLACK*
Gender: *Female*

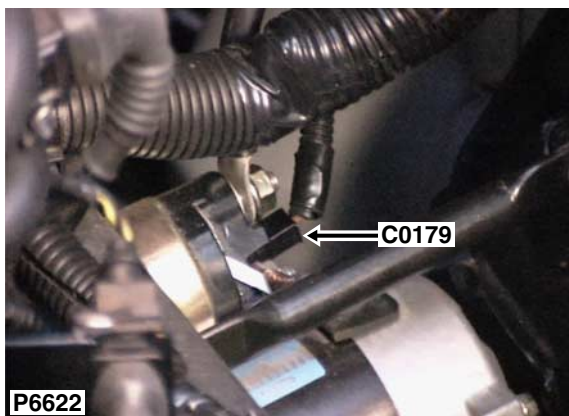

Cav	Col	Cct
1	NR	ALL

Description: *Solenoid-Starter motor - K1.8*

Location: *Above gearbox*



AAU1010

Colour: *BLACK*

Gender: *Female*

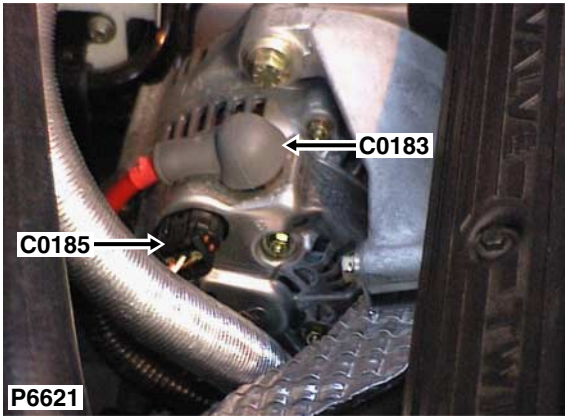

Cav	Col	Cct
1	R	ALL

Description: *Power-Alternator - K1.8*
Location: *Front of engine - centre*



Colour:
Gender:

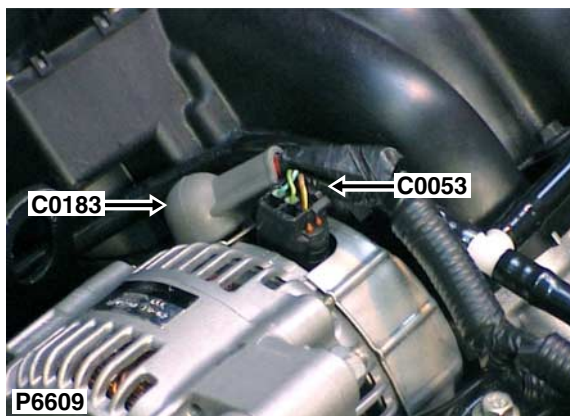

Cav	Col	Cct
1	R	ALL

Description: *Power-Alternator - KV6*

Location: *Top of engine*

NO CONNECTOR FACE

Colour:

Gender:

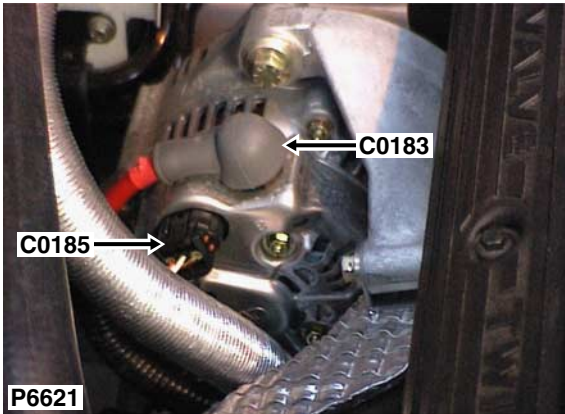

Cav	Col	Cct
1	NY	ALL
2	W	ALL
3	WR	ALL

Description: *Warning lamp-Ignition/no charge - K1.8*
Location: *Front of engine - centre*

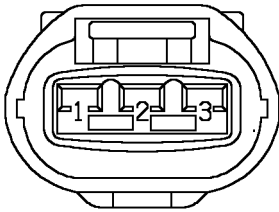

YPC10604

Colour: *BLACK*
Gender: *Female*

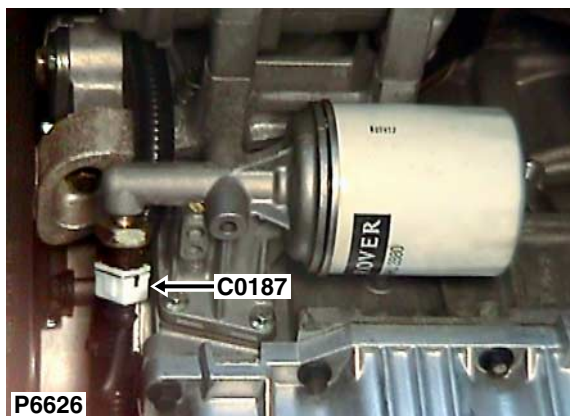

Cav	Col	Cct
1	WN	ALL

Description: *Switch-Oil pressure - K1.8*

Location: *Lower front of engine - RH side*

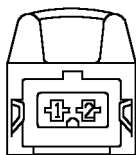

YPC114900

Colour: *BLACK*

Gender: *Female*

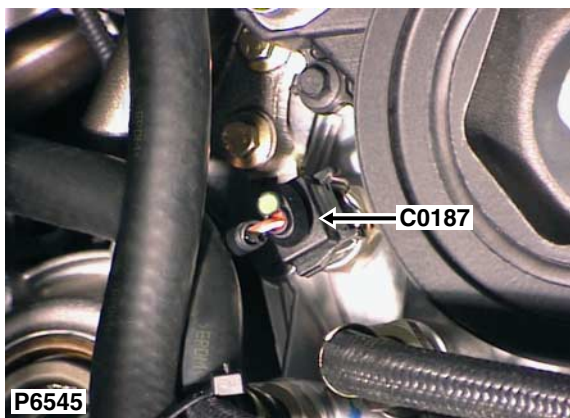

Cav	Col	Cct
1	WN	ALL

Description: *Switch-Oil pressure - KV6*

Location: *Bottom of engine - RH side*

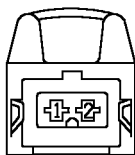

YPC114900

Colour: *BLACK*

Gender: *Female*

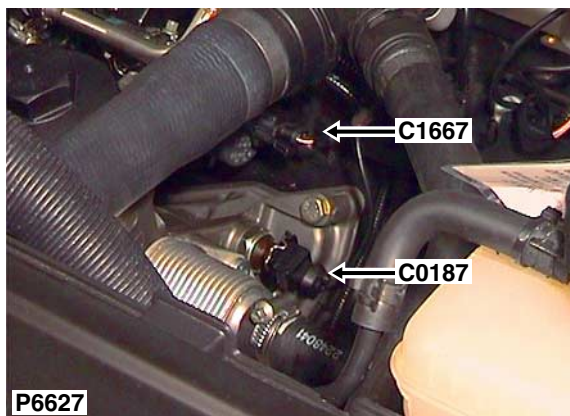

Cav	Col	Cct
1	NG	ALL

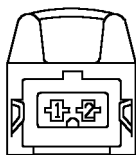
P6627Description: *Switch-Oil pressure - Td4*Location: *Front of engine - centre*

YPC114900

Colour: *BLACK*Gender: *Female*

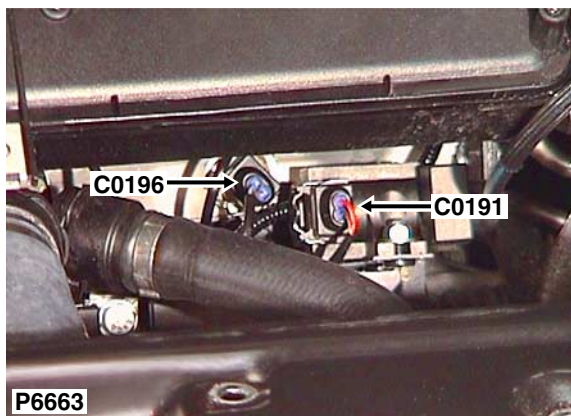

Cav	Col	Cct
1	RW	ALL
2	NS	ALL

Description: *Solenoid-EGR - Td4*
 Location: *Front of engine - centre*

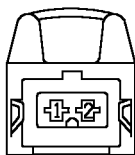

YPC114900

Colour: *BLACK*
 Gender: *Female*

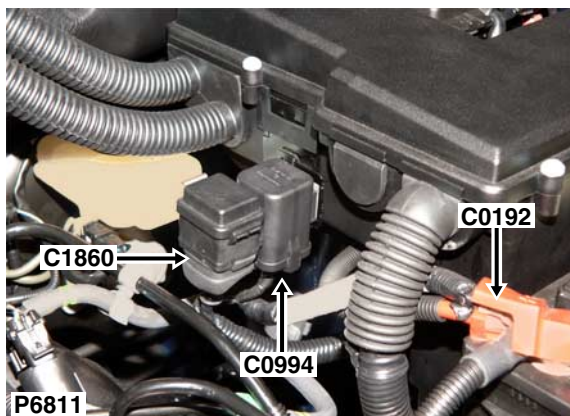

Cav	Col	Cct
1	N	ALL

Description: *Battery*

Location: *Front LH side of engine compartment*

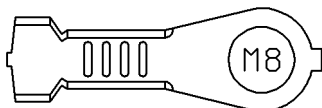

YPG10016

Colour: *TIN-PLATE*

Gender: *Female*

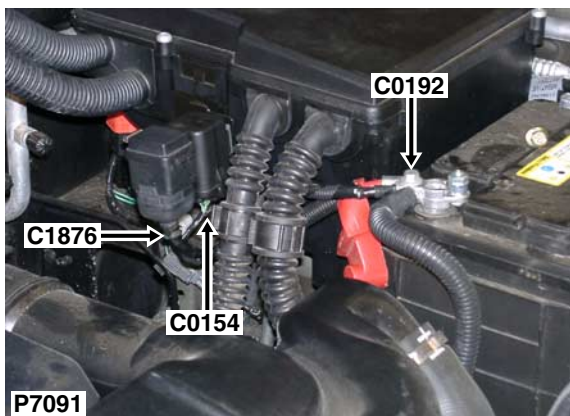

Cav	Col	Cct
1	R	ALL

Description: *Battery*

Location: *Front LH side of engine compartment*

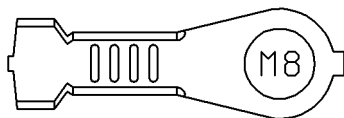

YPG10018

Colour: *TIN-PLATE*

Gender: *Female*

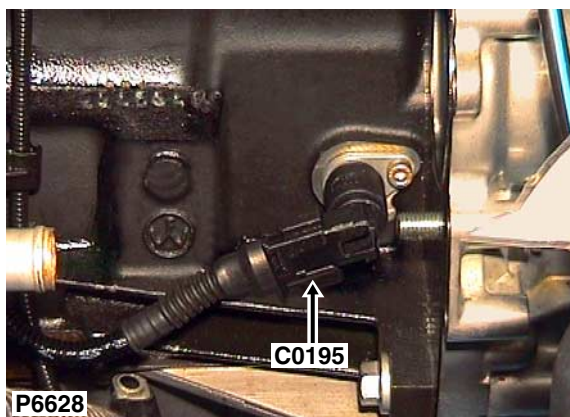

Cav	Col	Cct
1	B	ALL
2	Y	ALL

Description: *Sensor-Engine speed*

Location: *Front of engine - centre*

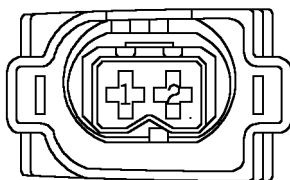

YPC113400

Colour: *BLACK*

Gender: *Female*

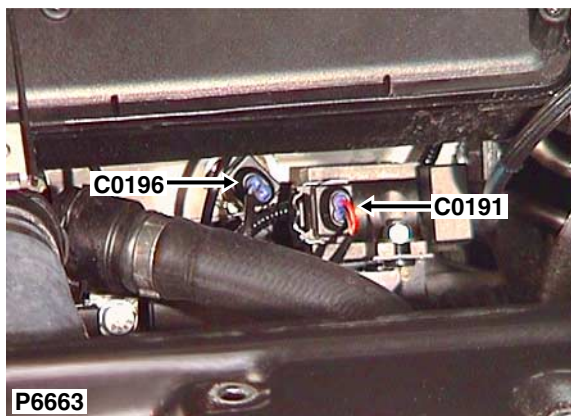

Cav	Col	Cct
1	SU	ALL
2	NG	ALL

Description: *Sensor-Engine coolant temperature (ECT)*

Location: *Front of engine - centre*

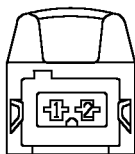

YPC114920

Colour: *BLACK*

Gender: *Female*

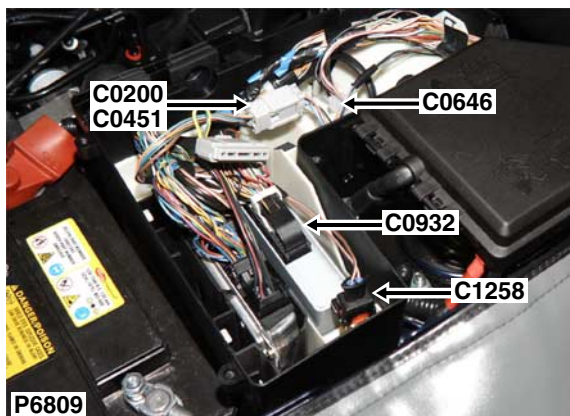

Cav	Col	Cct
1	NK	ALL
2	BG	ALL
3	OU	ALL
4	GK	ALL
5	UK	ALL

Description: *Engine harness to main harness*

Location: *Inside E-box*

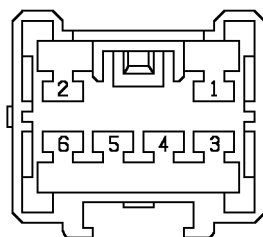

YPC10500

Colour: *LIGHT GREY*

Gender: *Male*



Cav	Col	Cct
1	B	ALL
2	RB	ALL
3	RO	ALL

Description: *Dimmer-Instrument illumination*
 Location: *Behind driver side of fascia*

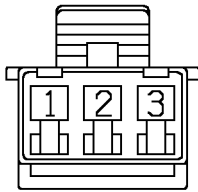

AFU3760

Colour: *NATURAL*
 Gender: *Female*

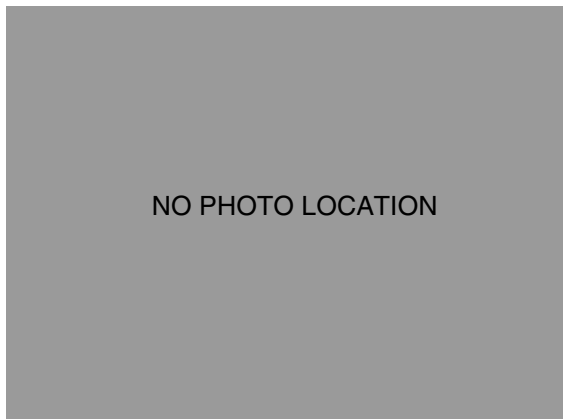

Cav	Col	Cct
1	B	22
2	WP	17

Description: *Pump-Fuel*

Location: *Below RH rear wheelarch*

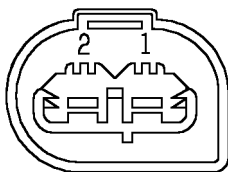

YPC115060

Colour: *BLACK*

Gender: *Female*

Cav	Col	Cct
1	B	22

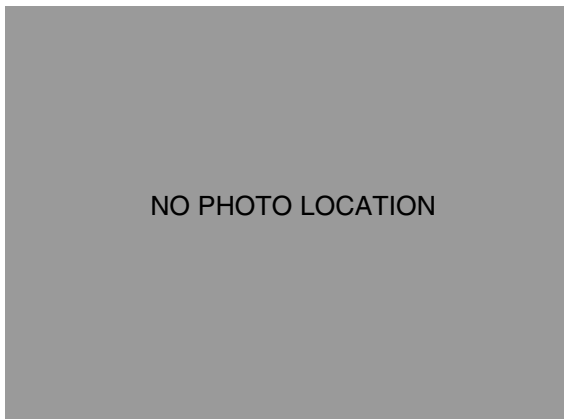

Description: *Pump-Fuel*

Location: *Below RH rear wheelarch*



AAU1010

Colour: *BLACK*

Gender: *Female*

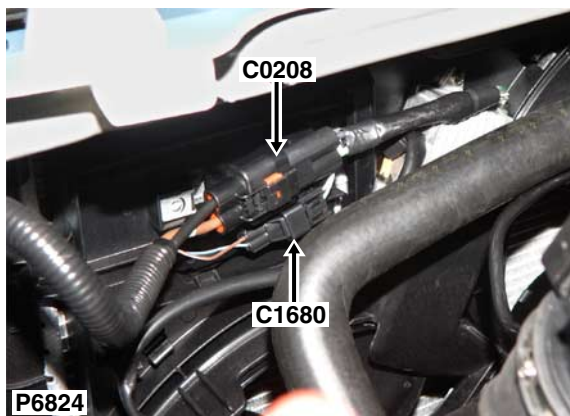

Cav	Col	Cct
1	NG	34
2	B	34

Description: *Control Unit-Cooling Fan*

Location: *Front of engine compartment - centre*

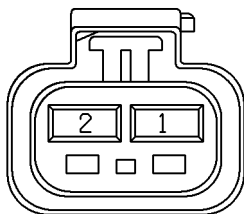

YPC500040

Colour: *BLACK*

Gender: *Female*

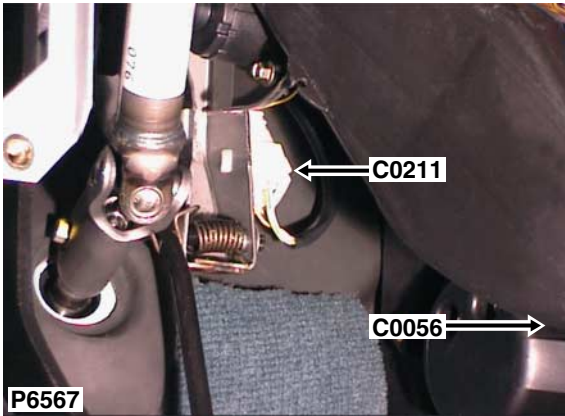

Cav	Col	Cct
1	W	30
2	B	30
4	UY	ALL

Description: *Switch-Throttle pedal*
 Location: *Driver's footwell*

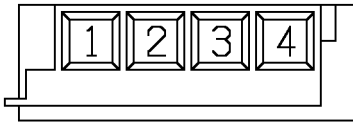

YPC117850

Colour: *NATURAL*
 Gender: *Female*

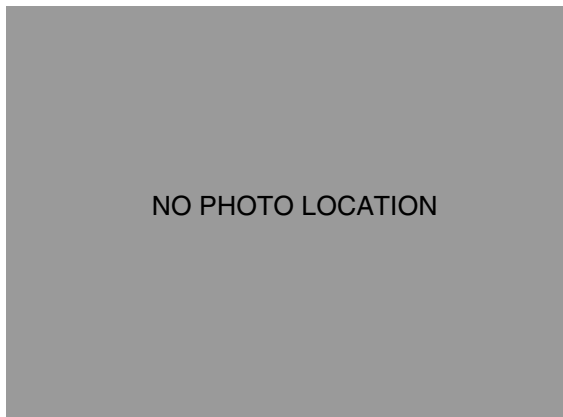

Cav	Col	Cct
1	UO	25
2	UN	25
3	GR	25
4	UG	25
5	RG	25
6	R	25
7	RN	25
8	B	25
9	RW	25
10	UO	25

Description: *Relay-Daylight running*

Location: *Behind passenger compartment fusebox cover*

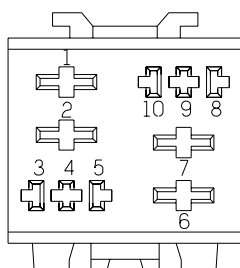

Colour: *BLACK*

Gender: *Female*

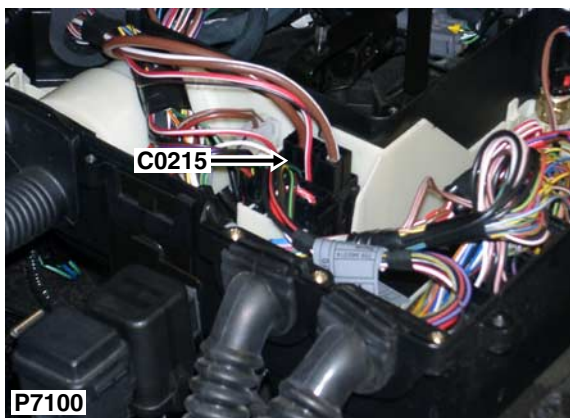

Cav	Col	Cct
1	RW	17
2	BR	17
3	NW	17
4	N	17

Description: *Relay-Glow plug*

Location: *Inside E-box*

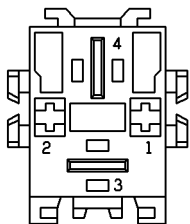

YPP100220

Colour: *BLACK*

Gender: *Female*

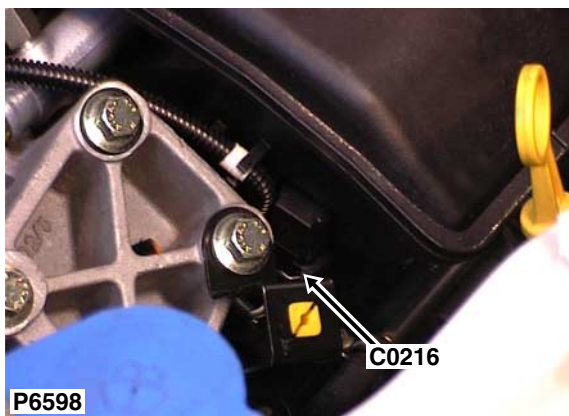

Cav	Col	Cct
1	UY	ALL
2	NG	ALL
3	W	ALL

Description: *Sensor-Boost pressure*

Location: *Top of engine*

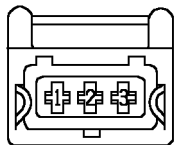

YPC114930

Colour: *BLACK*

Gender: *Female*

Cav	Col	Cct
1	KB	ALL
2	GO	ALL

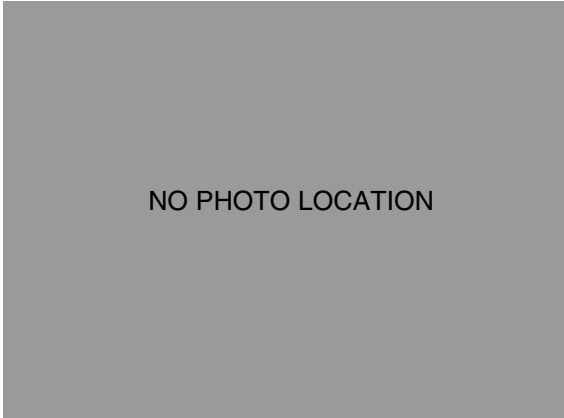

Description: *Switch-Oil temperature*
Location: *Front of engine - centre*

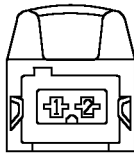

YPC114920

Colour: *BLACK*
Gender: *Female*

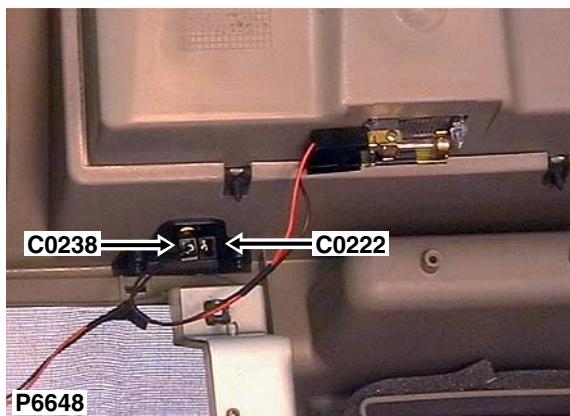

Cav	Col	Cct
1	B	ALL

Description: *Switch-Glove box*

Location: *Behind passenger side of fascia*

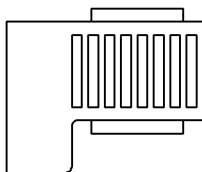

YPC10510

Colour: *BLACK*

Gender: *Female*

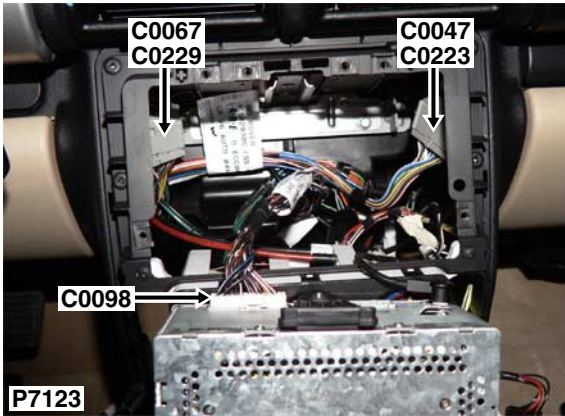

Description: *Fascia harness to main harness*

Location: *Behind centre console*

Cav	Col	Cct
1	NK	20
1	NR	23
2	SK	ALL
3	GB	ALL
4	RW	ALL
4	RB	4
5	GN	ALL
6	K	ALL
7	NY	ALL
8	YR	ALL
9	WR	ALL
10	SO	ALL
11	NK	ALL
12	YN	ALL
13	YB	ALL
14	BY	ALL
15	BP	ALL
16	SW	ALL
17	BN	ALL
18	BU	ALL
19	S	ALL
20	Y	ALL
21	UB	29
22	PW	ALL

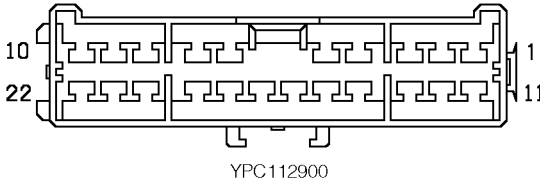

Colour: *LIGHT GREY*

Gender: *Male*

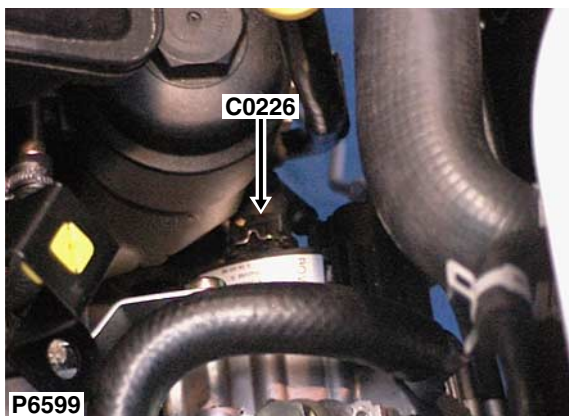

Cav	Col	Cct
1	GN	ALL
2	U	ALL

Description: *Alternator/generator*

Location: *Front RH side of engine*

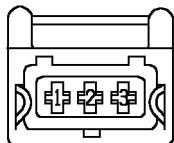

YPC114930

Colour: *BLACK*

Gender: *Female*

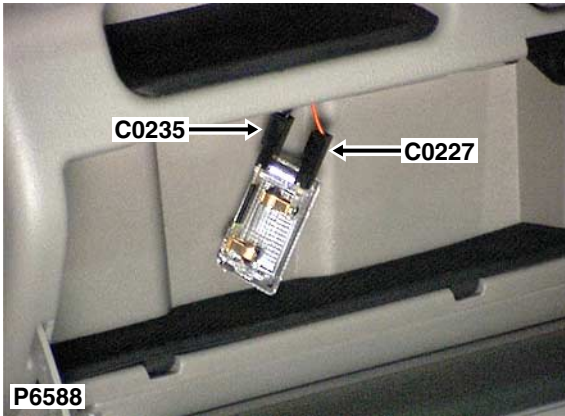

Cav	Col	Cct
1	RO	ALL

Description: *Lamp-Glove box*

Location: *Glovebox - inside*

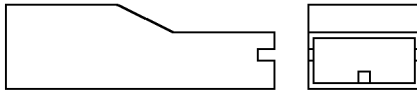

AAU1010

Colour: *BLACK*

Gender: *Female*

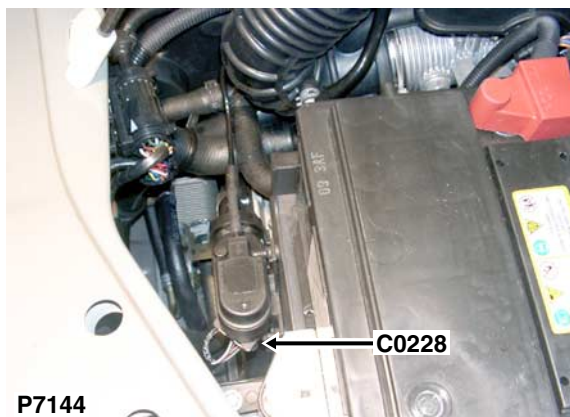

Cav	Col	Cct
2	GP	16
3	PY	16
4	BR	16
5	WU	16

P7144

Description: *Pump-Cruise control*

Location: *Lower LH front of engine compartment*

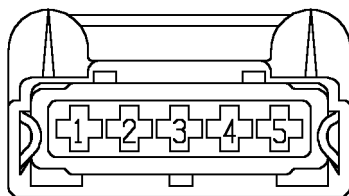

YPC107840

Colour: *BLACK*

Gender: *Female*

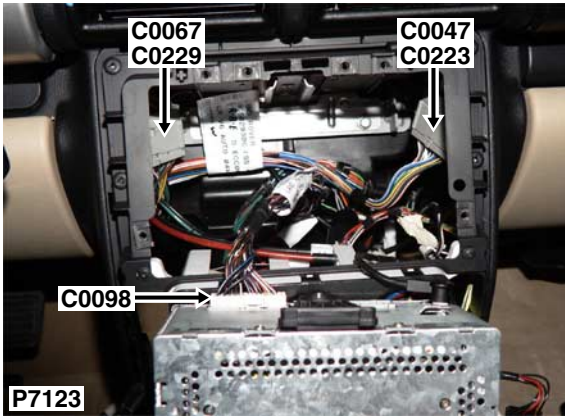

Description: *Fascia harness to main harness*
 Location: *Behind centre console*

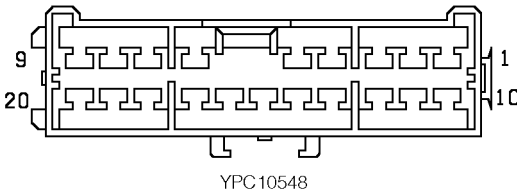

Colour: *LIGHT GREY*
 Gender: *Male*

Cav	Col	Cct
1	PB	ALL
2	UO	ALL
3	UG	ALL
4	UB	ALL
4	RO	4
5	GO	ALL
5	WU	27
6	PN	ALL
7	W	ALL
8	GB	ALL
9	RW	ALL
10	WR	ALL
11	G	ALL
12	KN	ALL
13	YR	ALL
14	ON	ALL
15	BR	ALL
16	B	ALL
17	K	ALL
18	LGW	ALL
19	UP	ALL
20	RY	ALL

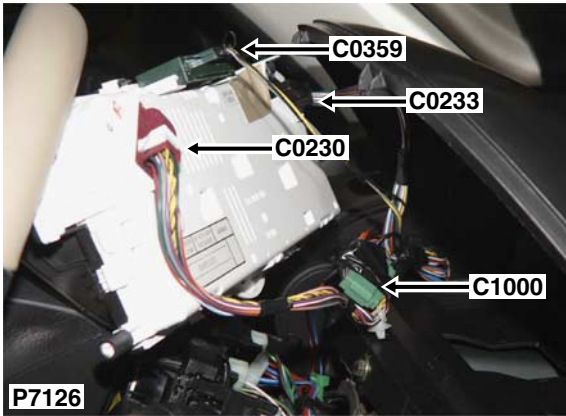

Description: *Instrument Pack*
 Location: *Behind instrument pack*

Cav	Col	Cct
1	RP	ALL
3	RW	ALL
4	WB	ALL
5	WU	27
10	PB	ALL
11	K	ALL
12	YB	ALL
15	GP	ALL
17	UO	ALL
18	SO	ALL
20	GO	ALL
21	GB	ALL
22	UG	ALL
23	P	ALL
24	B	ALL
25	YN	ALL

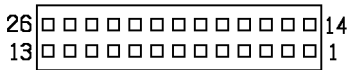

YPC114350

Colour: *GREY*
 Gender: *Female*

C0232

CONNECTOR DETAILS



Cav	Col	Cct
1	P	29
2	B	ALL
3	LGW	ALL
4	RO	ALL
4	RB	15
8	P	4

Description: *Clock-Digital*

Location: *Behind centre of fascia*

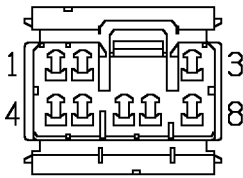

YPC10186

Colour: *WHITE*

Gender: *Female*

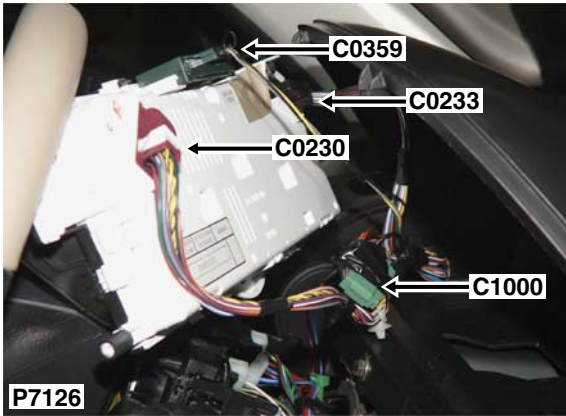

Description: *Instrument Pack*
 Location: *Behind instrument pack*

Cav	Col	Cct
1	PB	ALL
4	BW	ALL
5	B	ALL
6	RO	ALL
7	B	ALL
8	G	ALL
9	WR	ALL
10	NY	ALL
11	YR	ALL
12	WN	ALL
13	SK	ALL
14	GN	ALL
15	UK	ALL
16	GR	ALL
17	UG	ALL
18	GW	ALL

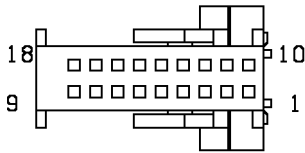

YPC111800

Colour: *BLACK*
 Gender: *Female*

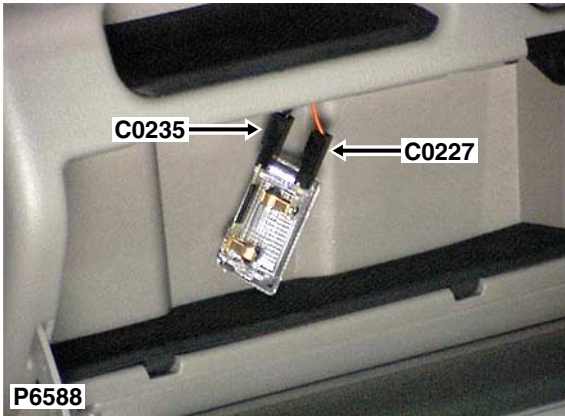

Cav	Col	Cct
1	BR	ALL

Description: *Lamp-Glove box*

Location: *Glovebox - inside*

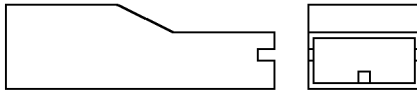

AAU1010

Colour: *BLACK*

Gender: *Female*

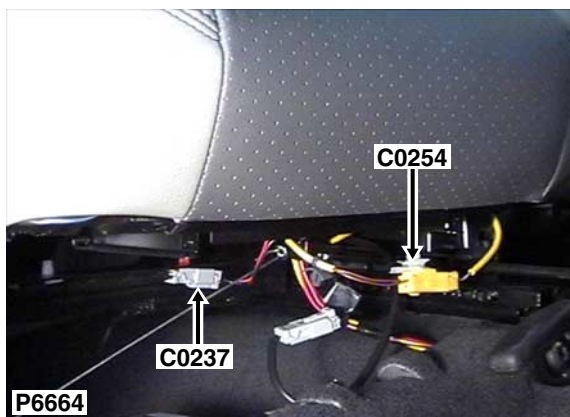

Cav	Col	Cct
1	B	34
2	UK	34

Description: *Heated seat-RH*
Location: *Beneath RH seat*

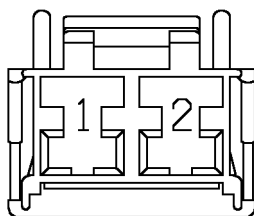

YPC10427

Colour: *LIGHT GREY*
Gender: *Female*

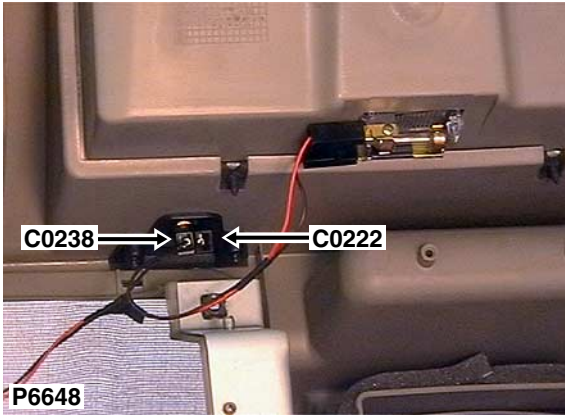

Cav	Col	Cct
1	BR	ALL

Description: *Switch-Glove box*

Location: *Behind passenger side of fascia*

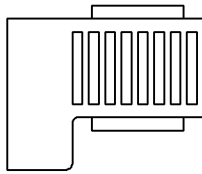

YPC10510

Colour: *BLACK*

Gender: *Female*

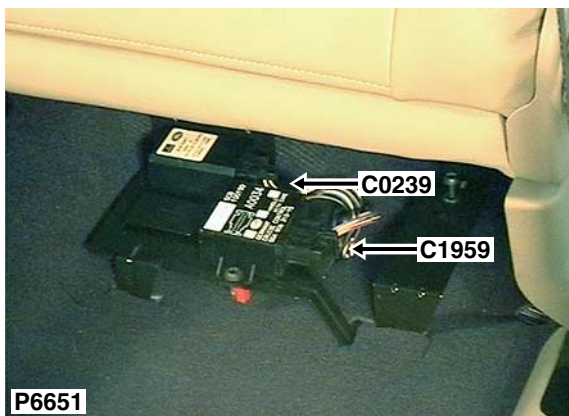

Description: *ECU-Cruise control*

Location: *Beneath RH seat*

Cav	Col	Cct
1	PG	16
2	UW	16
4	RW	16
5	GP	16
7	BR	16
8	WY	16
11	WU	16
15	WO	16
16	K	16
17	PY	16
18	B	16

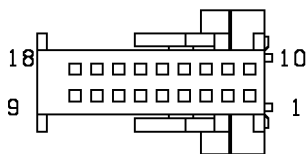

YPC111800

Colour: *BLACK*

Gender: *Female*

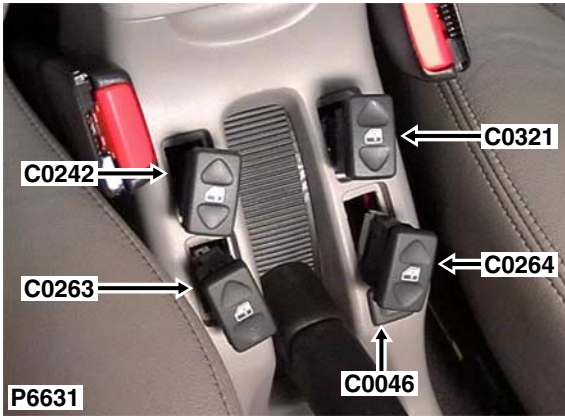

Cav	Col	Cct
1	B	5
2	SO	5
3	OU	5
3	OY	5
4	OG	5
4	OR	5
6	RO	5

Description: *Switch-Window-Front-RH - 3 Door*

Location: *In rear of centre console*

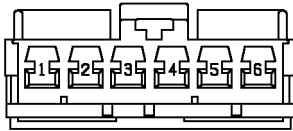

YPC113220

Colour: *WHITE*

Gender: *Female*

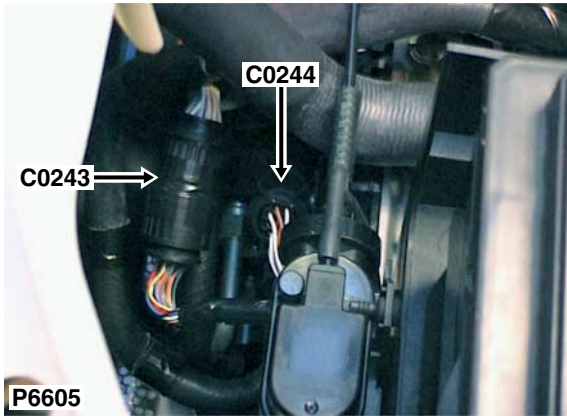

Description: *Solenoid-Gearbox*
 Location: *Front LH side of engine compartment*

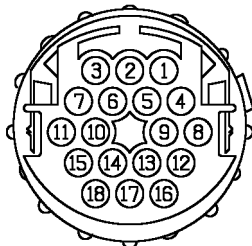

YPC117420

Colour: *BLACK*
 Gender: *Female*

Cav	Col	Cct
SCR	SCR	ALL
1	U	ALL
2	R	ALL
3	B	ALL
4	R	ALL
5	W	ALL
6	U	ALL
7	WK	ALL
8	KB	ALL
9	R	ALL
10	O	ALL
11	OU	ALL
12	K	ALL
13	GR	ALL
14	OG	ALL
15	Y	ALL
16	GP	ALL
17	U	ALL
18	SB	ALL

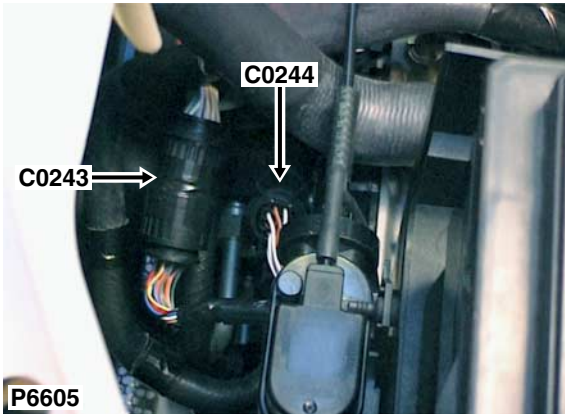

Cav	Col	Cct
1	WB	ALL
2	WU	ALL
3	OB	ALL
4	RG	ALL
5	GY	ALL
6	W	ALL
7	NG	ALL
8	NR	ALL
9	KO	ALL
10	W	ALL

Description: *Selector-Automatic transmission*

Location: *Front LH side of engine compartment*

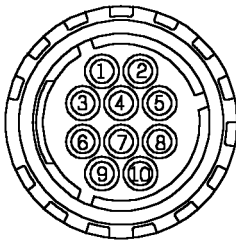

YPC114480

Colour: *BLACK*

Gender: *Female*



Cav	Col	Cct
1	PW	ALL

Description: *Heated screen-Front*

Location: *Behind RH side of fascia*

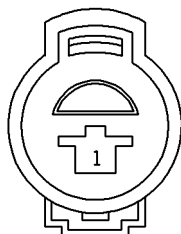

AFU3347

Colour: *NATURAL*

Gender: *Male*



Cav	Col	Cct
1	PS	ALL

Description: *Heated screen-Front*

Location: *Behind LH side of fascia*

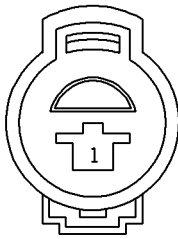

AFU3347

Colour: *NATURAL*

Gender: *Male*

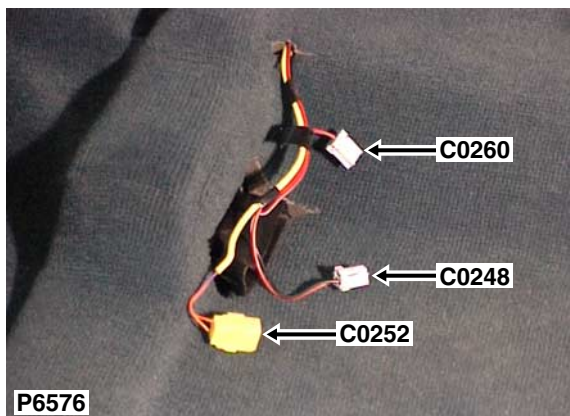

Cav	Col	Cct
1	B	34
2	US	34

Description: *Heated seat-LH*
Location: *Beneath LH seat*

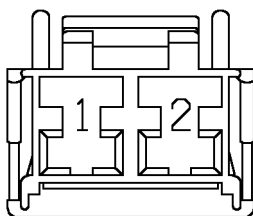

YPC10427

Colour: *LIGHT GREY*
Gender: *Female*

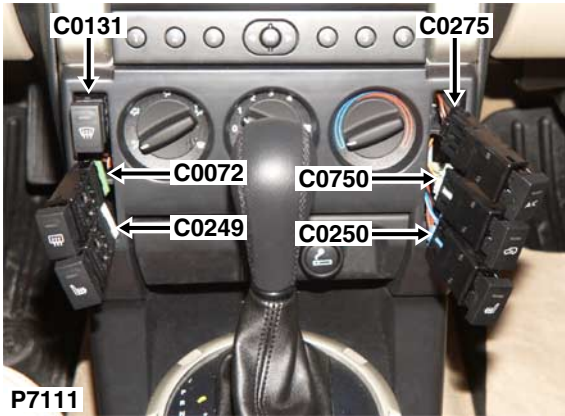

P7111
 Description: *Switch-Heater-Seat-RH*
 Location: *Behind centre console*

Cav	Col	Cct
1	N	ALL
2	RO	34
4	US	34
5	B	34

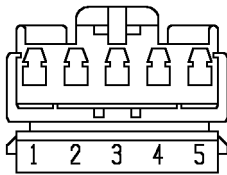

YPC10524

Colour: *WHITE*
 Gender: *Female*

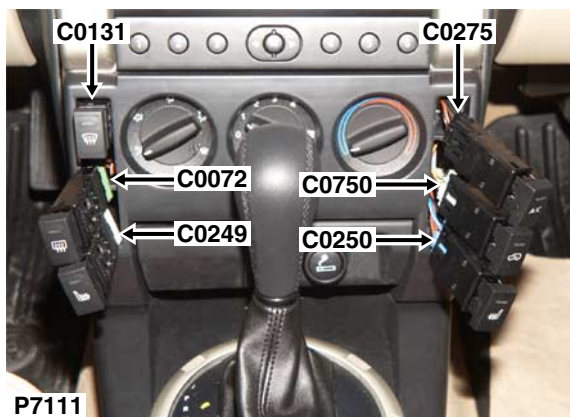

Cav	Col	Cct
1	N	ALL
2	RO	34
4	UK	34
5	B	34

Description: *Switch-Heater-Seat-LH*

Location: *Behind centre console*

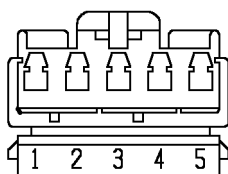

YPC10525

Colour: *BLUE*
 Gender: *Female*

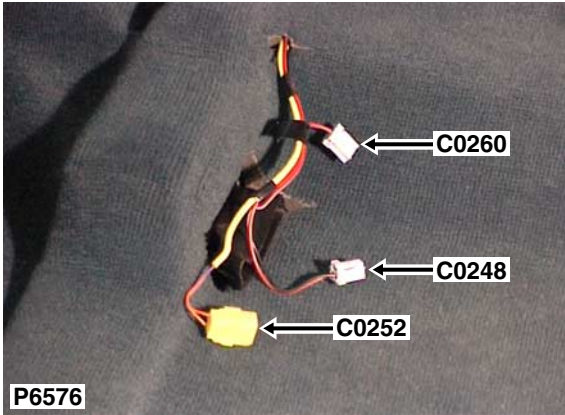

Cav	Col	Cct
1	O	ALL
2	OU	ALL

Description: *Pre-tensioner-LH*
Location: *Beneath LH seat*

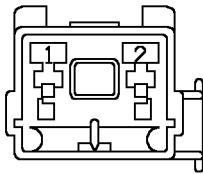

YPC108810

Colour: *YELLOW*
Gender: *Male*

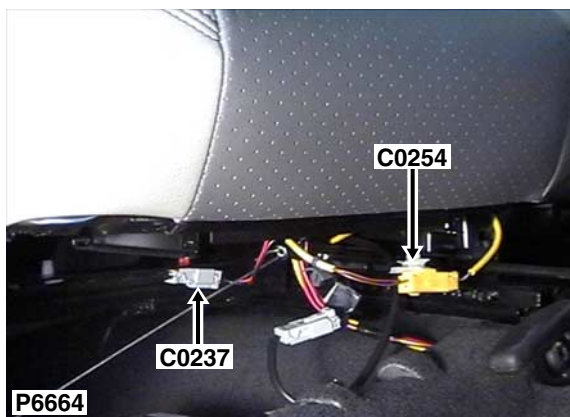

Cav	Col	Cct
1	N	ALL
2	NR	ALL

Description: *Pre-tensioner-RH*
Location: *Beneath RH seat*

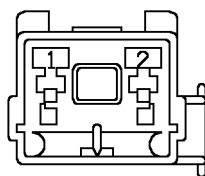

YPC108810

Colour: *YELLOW*
Gender: *Male*

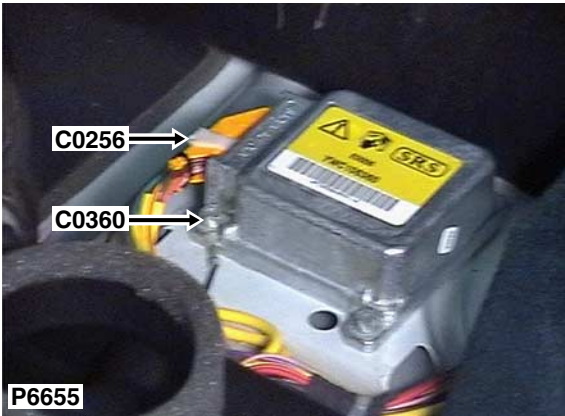

Description: *DCU-Airbag*

Location: *Behind centre console*

Cav	Col	Cct
26	G	ALL
27	YR	ALL
28	B	ALL
29	R	ALL
30	Y	ALL
31	W	ALL
32	U	ALL
33	O	ALL
34	OU	ALL
35	N	ALL
36	NR	ALL
54	K	ALL

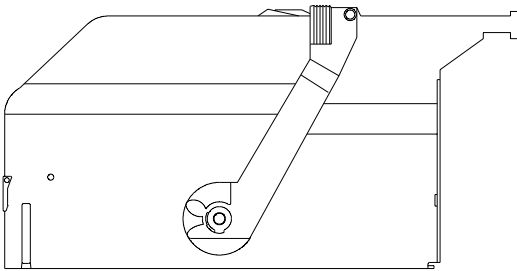

Colour: *ORANGE*

Gender: *Female*

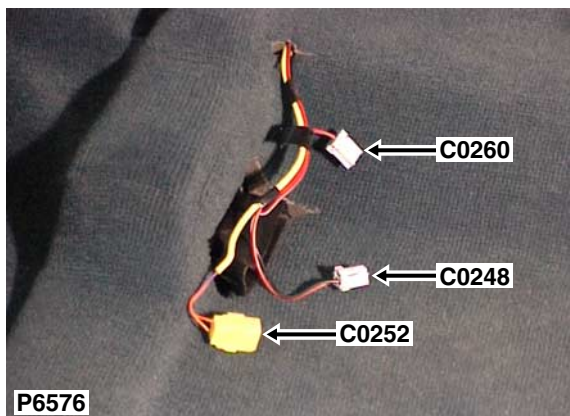

Cav	Col	Cct
1	B	ALL
2	RW	ALL

Description: *Switch-Seat belt*

Location: *Beneath front seat*

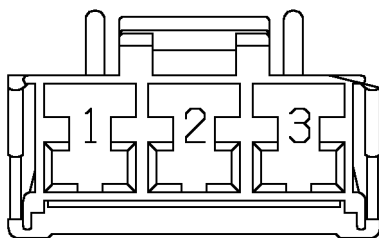

YPC10488

Colour: *LIGHT GREY*

Gender: *Female*

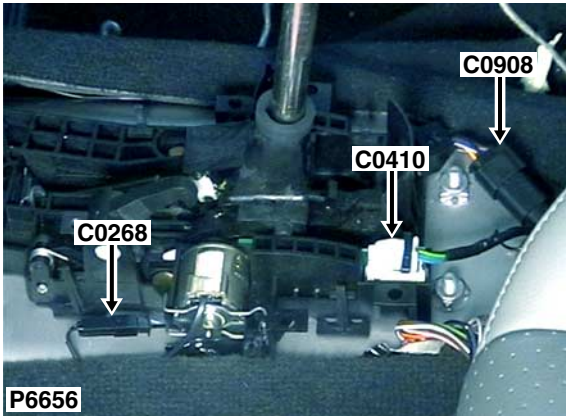

Cav	Col	Cct
1	GW	23
3	B	23

Description: *Solenoid-Shift-Interlock*
Location: *Beneath centre console*

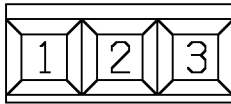

YPC117800

Colour: *BLACK*
Gender: *Female*

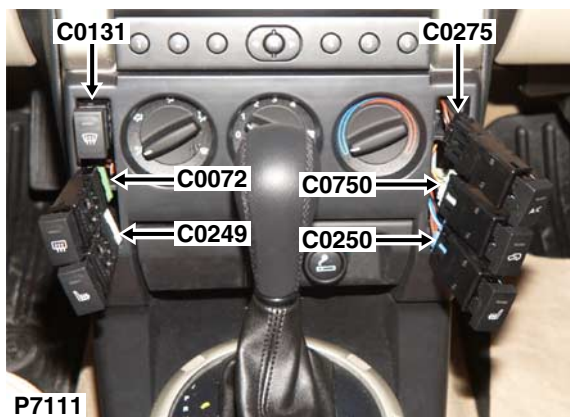

Description: *Switch pack-Air conditioning (A/C)*

Location: *Behind centre console*

Cav	Col	Cct
1	B	ALL
2	BO	ALL
3	RO	ALL
4	B	ALL
5	B	ALL
5	BO	ALL

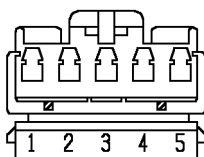

YPC10523

Colour: *BLACK*

Gender: *Female*

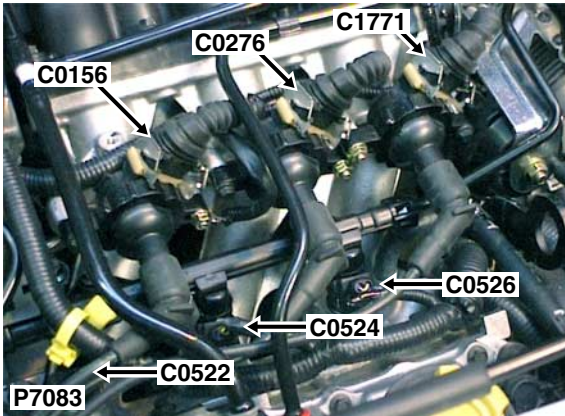

Cav	Col	Cct
1	BW	ALL
2	B	ALL
3	NK	ALL

Description: *Ignition coil-3 - KV6*

Location: *Top of engine*

NO CONNECTOR FACE

Colour: *BLACK*

Gender: *Female*

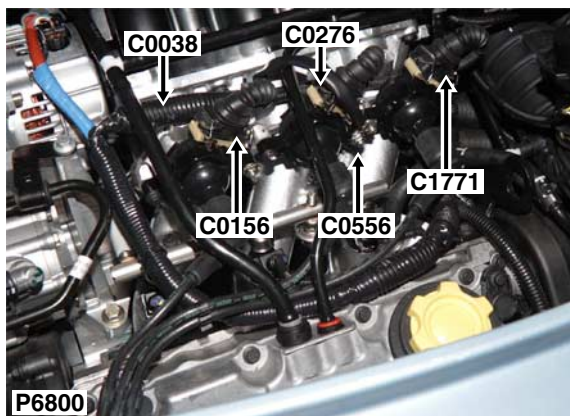

Description: *Ignition coil-3 - NAS*

Location: *Top of engine*

Cav	Col	Cct
1	BW	ALL
2	B	ALL
3	NK	ALL

NO CONNECTOR FACE

Colour: *BLACK*

Gender: *Female*

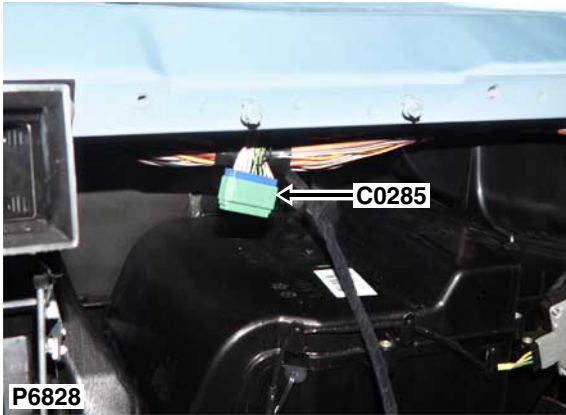

Description: *Header*

Location: *Behind centre of fascia*

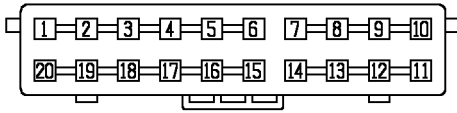

YQC10005

Colour: *BLUE*

Gender: *Female*

Cav	Col	Cct
1	GR	28
2	GR	ALL
3	GR	23
4	NK	23
5	NK	26
6	NK	23
7	P	ALL
8	P	ALL
9	P	ALL
10	NS	ALL
11	WO	ALL
12	WO	ALL
13	WO	16
14	WO	ALL
15	B	ALL
16	B	ALL
17	B	ALL
18	B	3
19	B	28
20	B	3

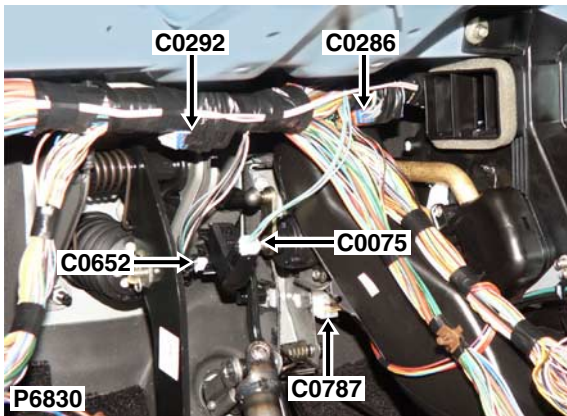

Description: *Header*

Location: *Behind LH side of fascia*

Cav	Col	Cct
1	WR	ALL
2	WR	16
3	GN	ALL
4	RO	ALL
5	RO	ALL
5	RB	3
6	GP	ALL
7	GP	16
9	GN	ALL
10	GN	ALL
11	RO	2
11	RB	3
12	RO	ALL
13	GP	16
14	GP	ALL

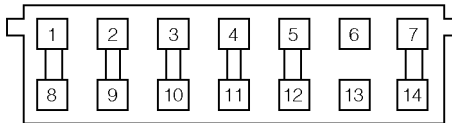

YQC101050

Colour: *BLUE*

Gender: *Female*

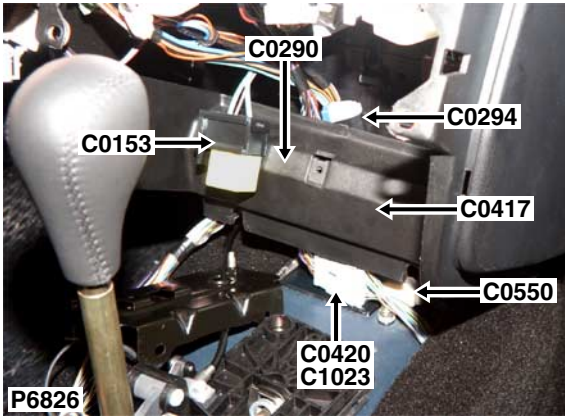

Description: *Header*

Location: *Behind centre console*

Cav	Col	Cct
1	RO	ALL
2	RO	ALL
3	RO	ALL
4	RO	6
5	RO	34
6	RO	34
7	RO	28
8	RO	ALL
13	RO	ALL
14	RO	ALL
15	RO	6
16	RO	ALL
17	RO	ALL
18	RO	ALL
19	RO	ALL
20	RO	ALL

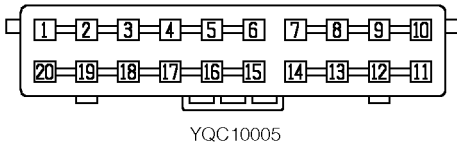

Colour: *BLUE*
 Gender: *Female*

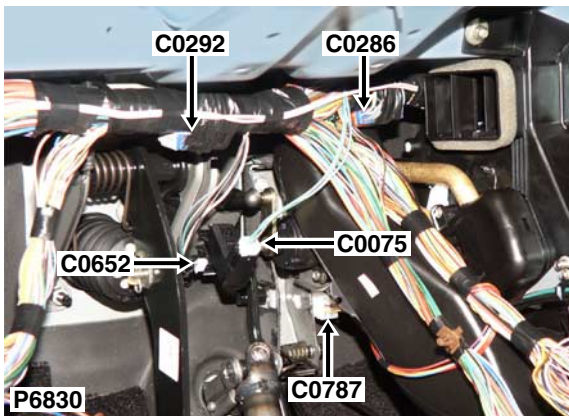

Description: *Header*

Location: *Behind LH side of fascia*

Cav	Col	Cct
1	K	ALL
2	K	ALL
3	K	ALL
5	K	ALL
6	K	ALL
7	K	ALL
8	K	23
9	NG	ALL
10	NG	23
11	NG	23
12	NG	23
13	W	ALL
14	W	16
15	W	28
16	W	ALL
17	W	4
18	W	ALL
19	W	23
20	W	ALL

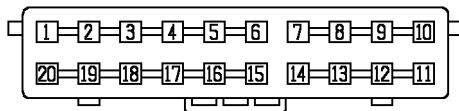

YQC10005

Colour: *BLUE*

Gender: *Female*

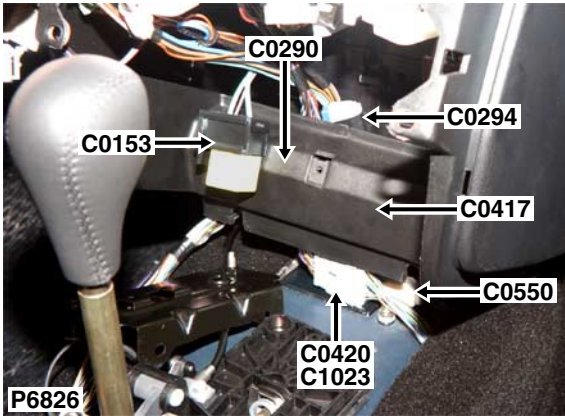

Description: *Header*

Location: *Behind centre console*

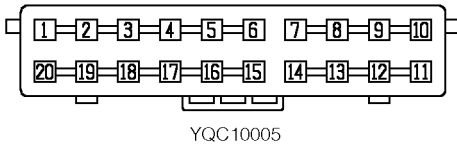

Colour: *BLUE*
 Gender: *Female*

Cav	Col	Cct
1	B	ALL
2	B	ALL
3	B	26
4	B	ALL
5	B	ALL
6	B	ALL
7	B	ALL
8	B	34
9	B	34
10	B	34
11	B	34
12	B	34
13	B	34
14	B	28
15	B	ALL
16	B	ALL
17	B	23
18	B	ALL
19	B	ALL
20	B	ALL

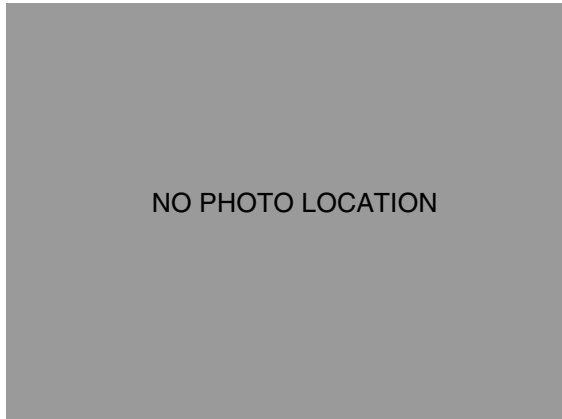

Description: *Header - NAS*

Location: *Inside E-box*

Cav	Col	Cct
2	YG	ALL
4	YG	ALL
5	YG	ALL
6	YG	ALL
7	YG	ALL
8	YG	ALL
9	YG	ALL
10	YG	ALL
11	YG	ALL
13	NK	ALL
14	NK	ALL
15	NK	ALL
16	NK	ALL
17	NK	ALL
18	NK	ALL
19	NK	ALL

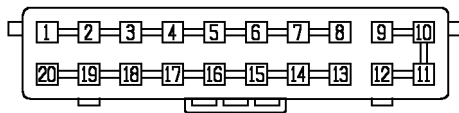

YQC10002

Colour: *GREY*

Gender: *Female*

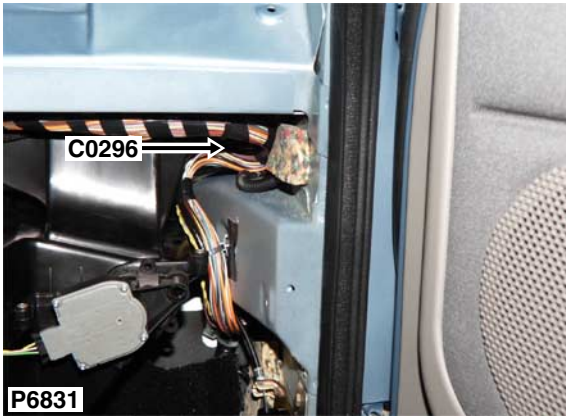

Cav	Col	Cct
1	YN	26
2	YN	ALL
3	YB	26
8	YN	26
9	YB	ALL
10	YB	26

Description: *Header*

Location: *Behind RH side of fascia*

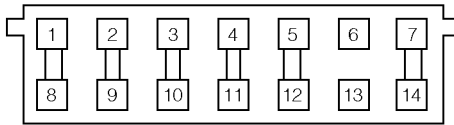

YQC101050

Colour: *BLUE*

Gender: *Female*

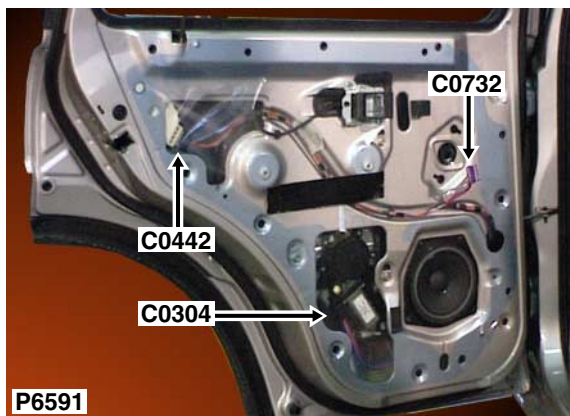

Cav	Col	Cct
1	R	ALL
2	U	ALL

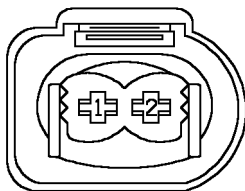
P6591Description: *Motor-Window-Rear*Location: *Behind rear door trim panel*

YPC116370

Colour: *BLACK*Gender: *Female*

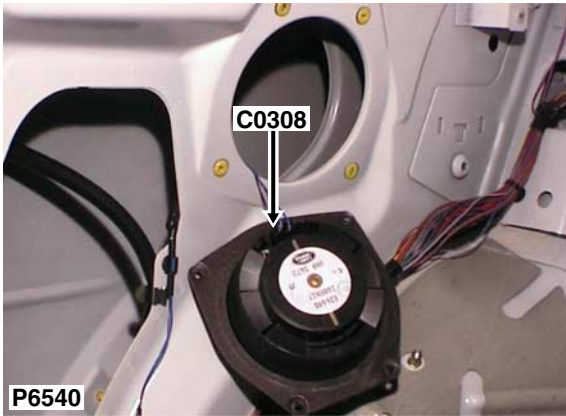

Cav	Col	Cct
1	UB	5
2	UK	5

Description: *Speaker-Rear-RH*

Location: *Behind RH rear speaker*

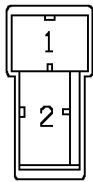

AFU3199

Colour: *BLACK*

Gender: *Female*

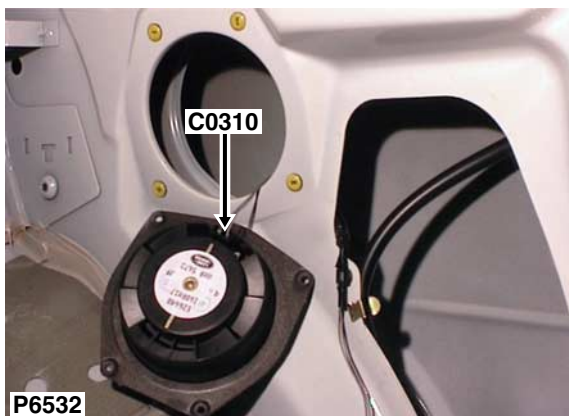

Cav	Col	Cct
1	SB	5
2	SK	5

Description: *Speaker-Rear-LH*

Location: *Behind LH rear speaker*

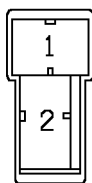

AFU3199

Colour: *BLACK*

Gender: *Female*

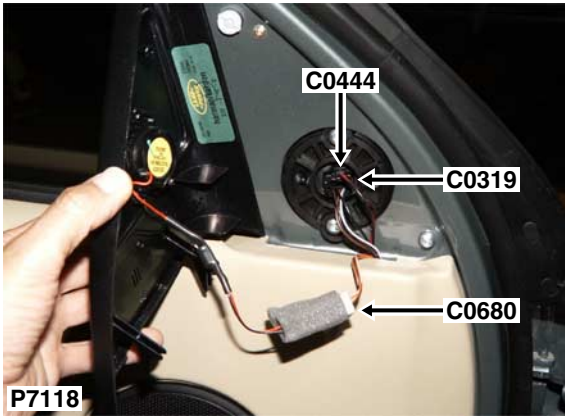

Cav	Col	Cct
1	BP	ALL
2	SW	ALL
3	NG	ALL
4	B	ALL
5	BN	ALL

Description: *Mirror-Door - 3 Door*

Location: *Behind front door trim panel*

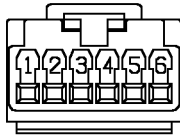

YPC107610

Colour: *BLACK*

Gender: *Female*

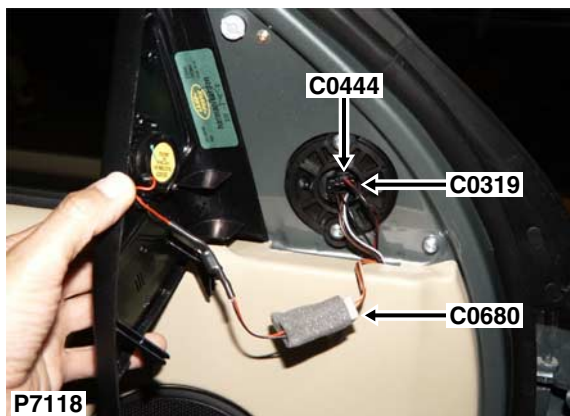

Cav	Col	Cct
1	BP	ALL
2	SW	ALL
3	NG	ALL
4	B	ALL
5	BN	ALL

Description: *Mirror-Door - 5 Door*

Location: *Behind front door trim panel*

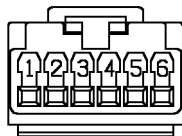

YPC107610

Colour: *BLACK*

Gender: *Female*

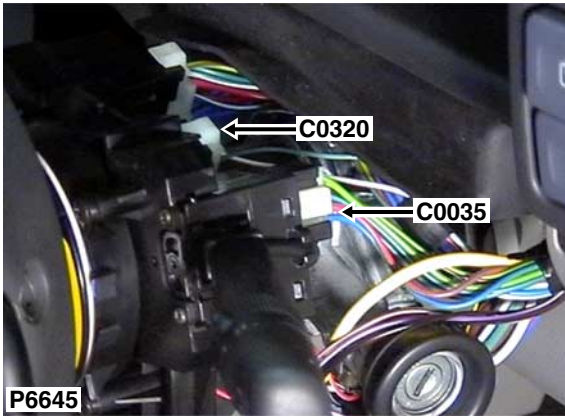

Cav	Col	Cct
4	WK	ALL
6	GY	ALL

Description: *Switch-Wiper-Front*

Location: *RH side of steering column*

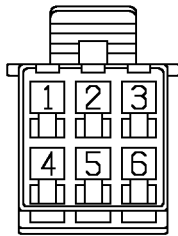

YPC10038

Colour: *NATURAL*

Gender: *Female*



Cav	Col	Cct
1	B	5
2	RG	5
3	OY	5
3	U	5
4	R	5
4	OG	5
6	RO	5

Description: *Switch-Window-Front-LH - 3 Door*

Location: *In rear of centre console*

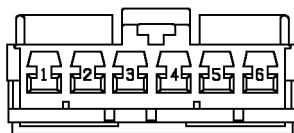

YPC113220

Colour: *WHITE*

Gender: *Female*

C0326

CONNECTOR DETAILS

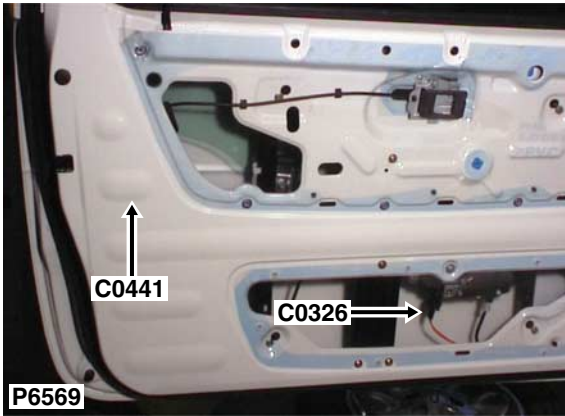

Cav	Col	Cct
1	R	ALL
2	U	ALL

Description: *Motor-Window-Front - 3 Door*

Location: *Behind front door trim panel*

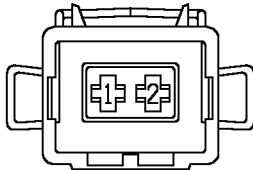

YPC108740

Colour: *BLACK*

Gender: *Female*

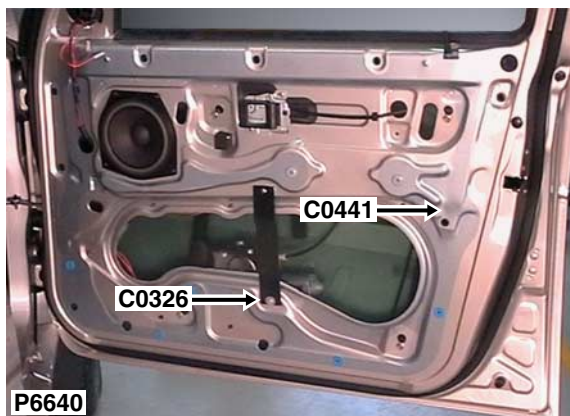

Cav	Col	Cct
1	R	ALL
2	U	ALL

Description: *Motor-Window-Front - 5 Door*

Location: *Behind front door trim panel*

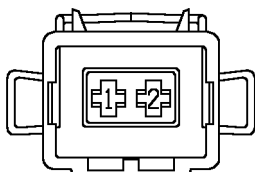

YPC108740

Colour: *BLACK*

Gender: *Female*

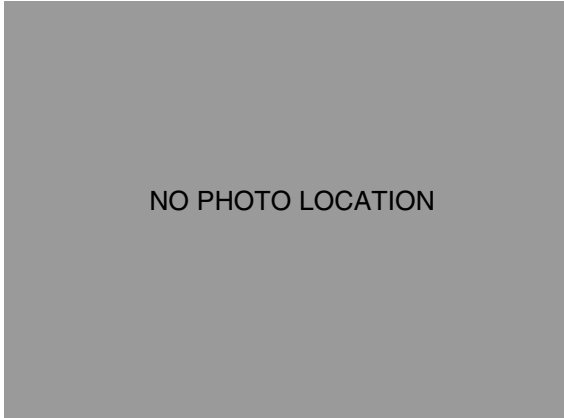

Cav	Col	Cct
1	B	5
2	BK	5
3	BK	5
4	BN	ALL
6	RO	5

Description: *Switch-Central door locking - 3 Door*
Location: *In rear of centre console*

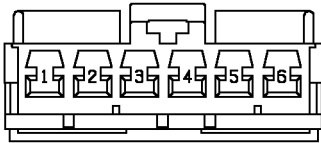

YPC113230

Colour: *BLACK*
Gender: *Female*

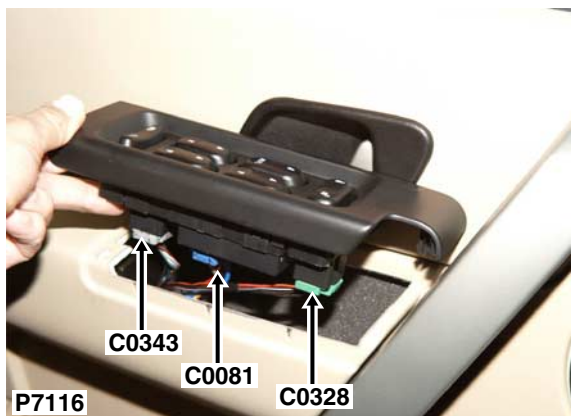

Cav	Col	Cct
1	B	ALL
3	BK	ALL
4	B	ALL
5	RO	ALL
7	BN	ALL

Description: *Switch-Central door locking - 5 Door*
 Location: *Behind front door trim panel*

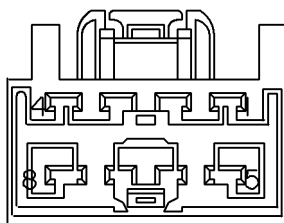

YPC901060

Colour: *GREEN*
 Gender: *Female*

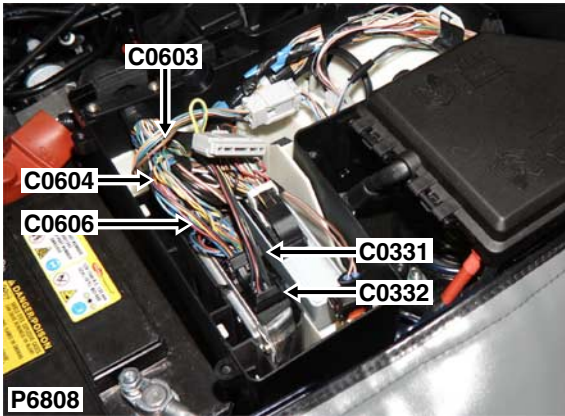

Description: *Engine control module (ECM)*

Location: *Inside E-box*

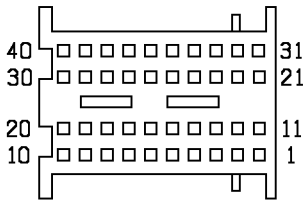

YPH100430

Colour: *BLACK*

Gender: *Female*

Cav	Col	Cct
1	NY	17
4	UW	26
7	RU	ALL
8	YRB	ALL
9	RN	ALL
10	BP	ALL
11	WN	17
12	URB	ALL
13	RY	ALL
14	NRB	ALL
20	G	4
21	GK	4
22	WO	26
23	OU	4
23	GR	36
24	PG	ALL
27	RG	26
28	GR	26
29	UB	26
30	U	4
31	GY	17
32	K	4
33	YR	ALL
34	UK	4
36	YB	ALL
37	YN	ALL
38	GU	4
39	UG	4

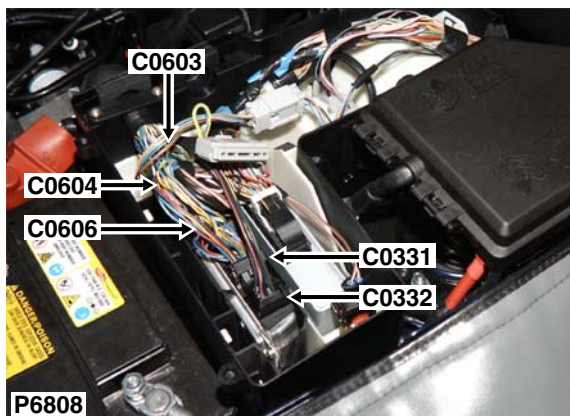

Description: *Engine control module (ECM)*

Location: *Inside E-box*

Cav	Col	Cct
1	BP	ALL
2	BW	ALL
3	BR	ALL
5	B	ALL
6	B	ALL
7	BY	ALL
8	BU	ALL
9	BG	ALL

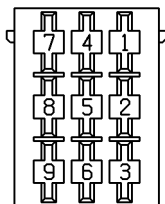

YPC112950

Colour: *GREY*

Gender: *Female*

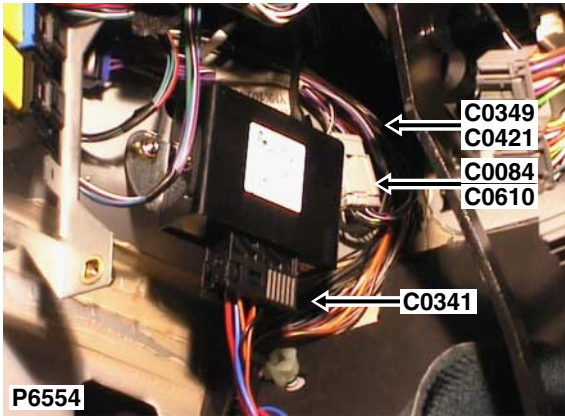

Cav	Col	Cct
2	OY	5
4	OG	5
5	B	5
6	RG	5
6	SO	5
7	U	5
9	R	5

Description: *ECU-Window lift*

Location: *Behind driver side of fascia*

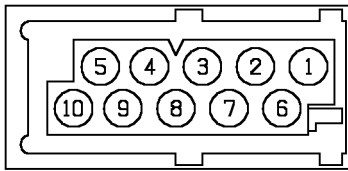

YPC112620

Colour: *BLACK*

Gender: *Female*

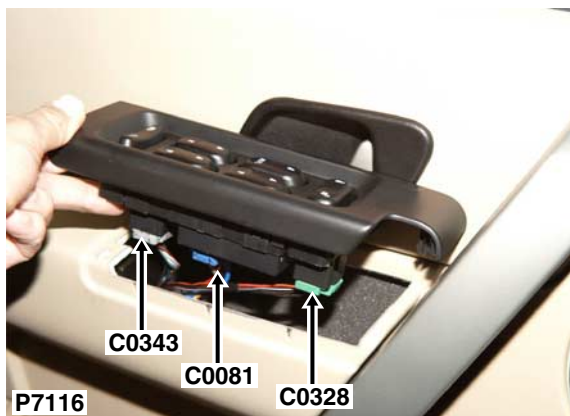

Description: *Switch-Window-Driver door*

Location: *Behind driver door switch pack*

Cav	Col	Cct
1	RB	2
1	WU	3
2	GU	2
2	WR	3
3	GR	2
3	RB	3
4	SG	2
4	GR	3
5	WR	2
5	GU	3
6	WU	2
6	SG	3

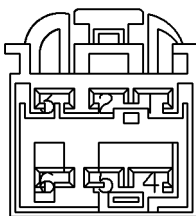

YPC500590

Colour: *LIGHT GREY*

Gender: *Female*

C0350

CONNECTOR DETAILS

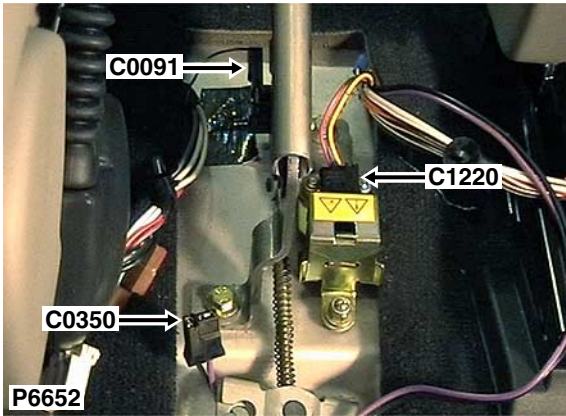

Cav	Col	Cct
1	B	ALL
2	PN	ALL

Description: *Socket-Accessory*

Location: *Beneath centre console*

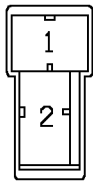

AFU3199

Colour: *BLACK*

Gender: *Female*

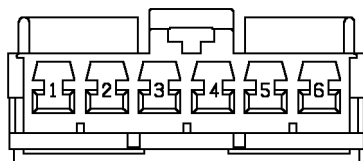

Cav	Col	Cct
1	B	ALL
3	BR	ALL
4	BK	ALL
6	RO	ALL

P7109Description: *Switch-Window-Tail door*Location: *In rear of centre console*

YPC113200

Colour: *GREEN*Gender: *Female*

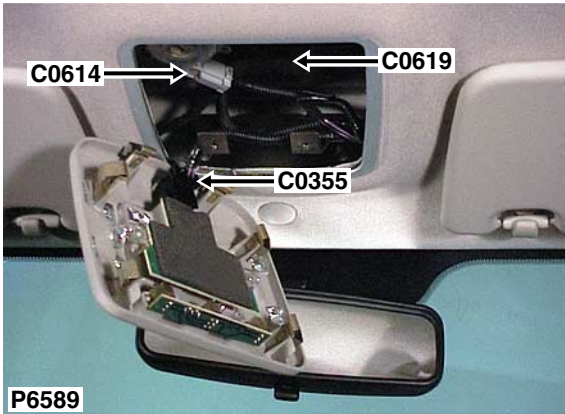

Cav	Col	Cct
1	B	ALL
3	P	ALL
4	PW	6

Description: *Lamp-Interior-Front*

Location: *Front of headlining in the centre*

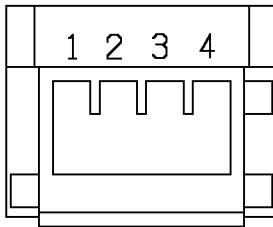

AFU3648

Colour: *BLACK*

Gender: *Female*

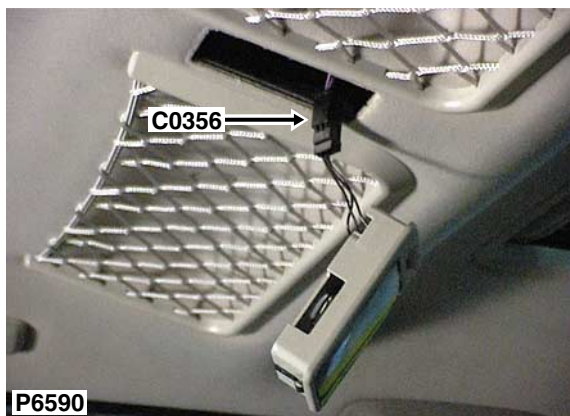

Cav	Col	Cct
1	P	ALL
2	PW	6
3	B	ALL

Description: *Lamp-Interior-Rear*

Location: *Behind centre headlining*

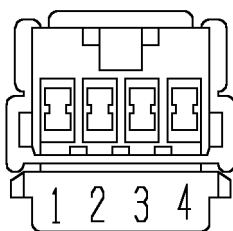

YPC10247

Colour: *BLACK*

Gender: *Female*

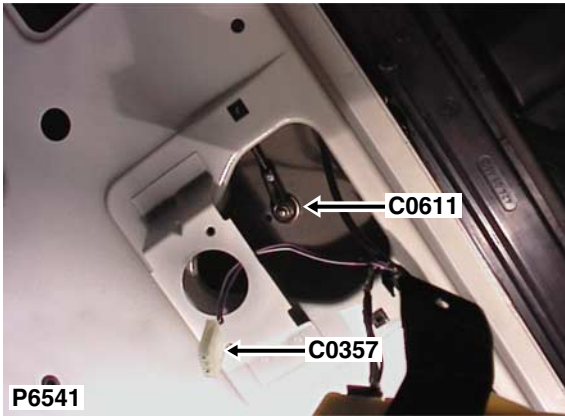

Cav	Col	Cct
1	PW	5
3	P	ALL

Description: *Unit-Lamp-Interior*
 Location: *Behind centre headlining*



YPC10026

Colour: *NATURAL*
 Gender: *Female*

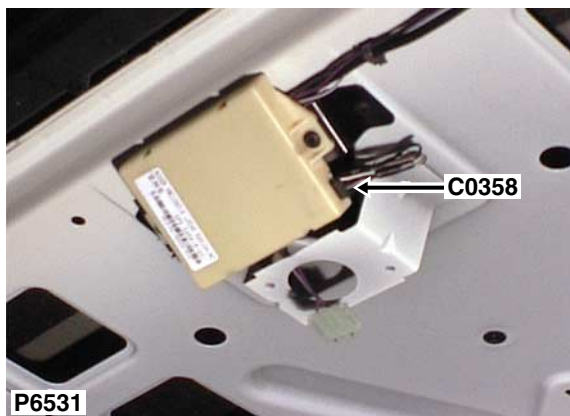

Description: *Sensor-Volumetric*

Location: *Behind centre headlining*

Cav	Col	Cct
1	WB	5
2	NB	5
3	SW	5
4	B	5

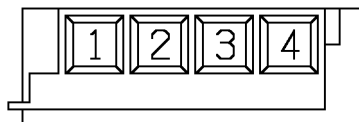

YPC117840

Colour: *BLACK*

Gender: *Female*

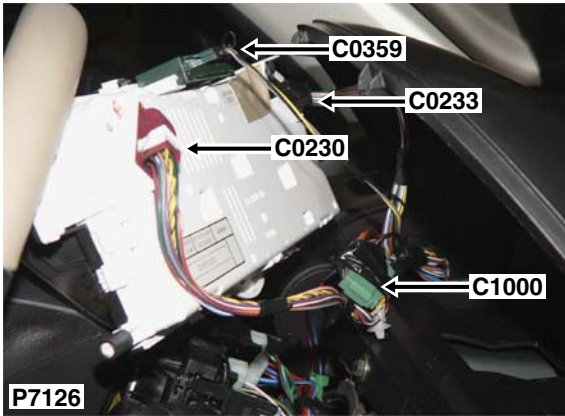

Cav	Col	Cct
1	S	ALL
2	B	ALL
3	Y	ALL
4	B	ALL

Description: *Receiver-Radio frequency (RF)*
 Location: *Behind instrument pack*

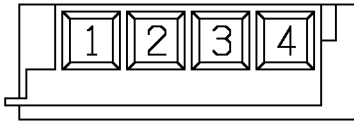

YPC117840

Colour: *BLACK*
 Gender: *Female*

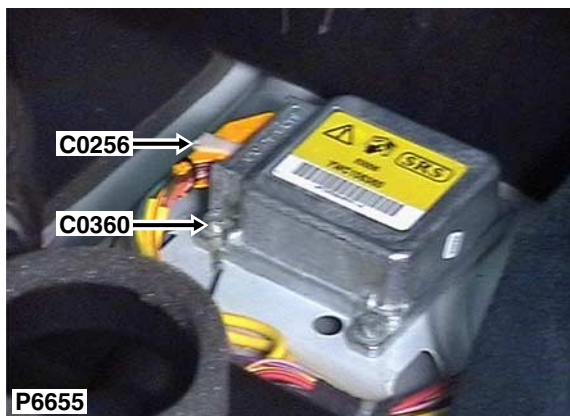

Cav	Col	Cct
1	B	ALL

Description: *Earth-SRS*

Location: *Behind centre console*

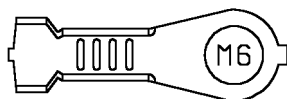

YPG10003

Colour: *TIN-PLATE*

Gender: *Female*



Cav	Col	Cct
1	B	ALL

Description: *Earth-ABS*

Location: *Front RH side of engine compartment*

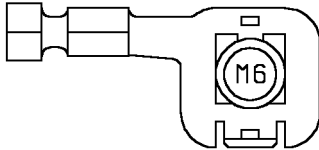

YPG 10050

Colour: *TIN-PLATE*

Gender: *Female*

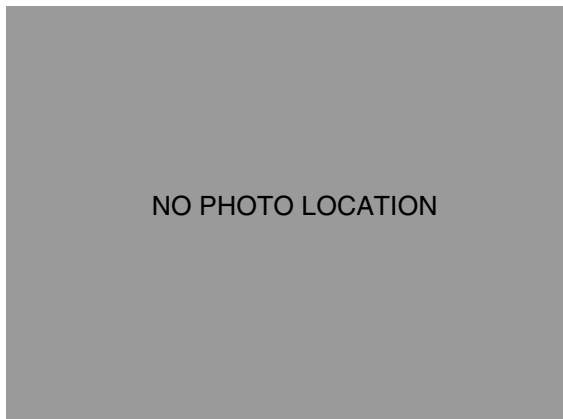

Cav	Col	Cct
1	B	6
2	SR	ALL
3	S	ALL
4	G	ALL
6	RO	6

Description: *Switch-Sunroof*

Location: *In rear of centre console*

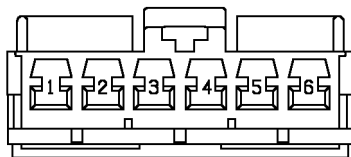

YPC113210

Colour: *BLUE*

Gender: *Female*

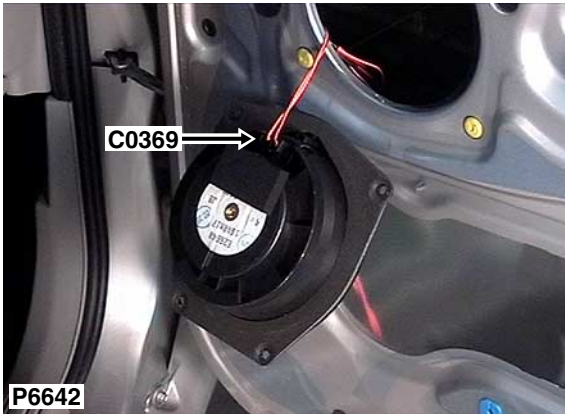

Cav	Col	Cct
1	OB	8
2	OK	8

Description: *Speakers-Front - 3 Door*

Location: *Behind front door trim panel*

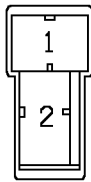

AFU3199

Colour: *BLACK*

Gender: *Female*

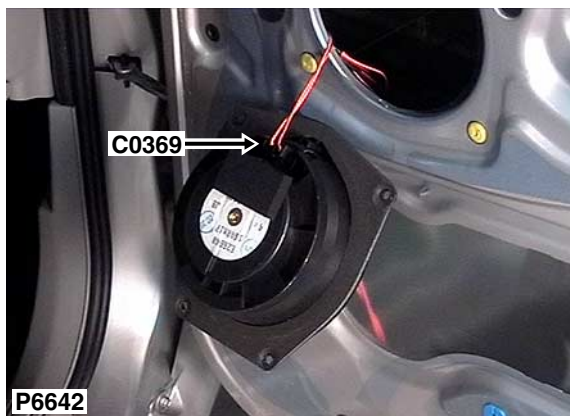

Cav	Col	Cct
1	OB	8
2	OK	8

Description: *Speakers-Front - 5 Door*
Location: *Behind front door trim panel*

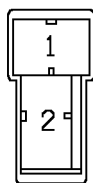

AFU3199

Colour: *BLACK*
Gender: *Female*

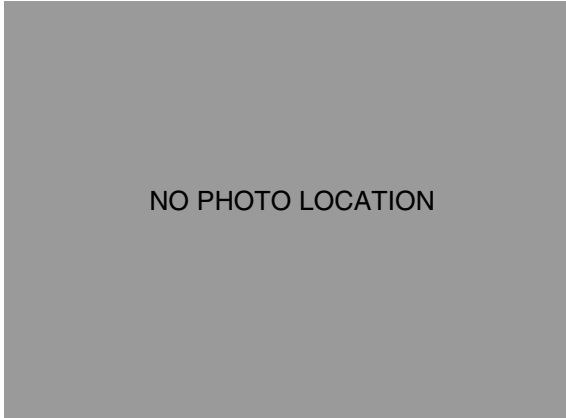

Cav	Col	Cct
1	GY	ALL
2	BG	ALL
3	GN	ALL
4	YG	ALL

Description: *Sensor-Heated oxygen (H02S)*

Location: *Centre rear of engine*

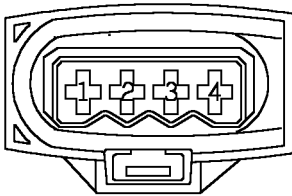

YPC114880

Colour: *BLACK*

Gender: *Female*

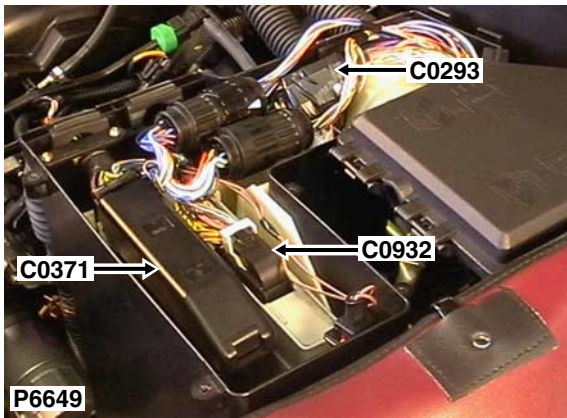

Description: *Engine control module (ECM)*
 Location: *Inside E-box*

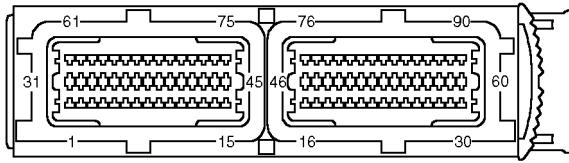

YPC114110

Colour: *BLACK*
 Gender: *Female*

Cav	Col	Cct
1	BY	ALL
2	BW	ALL
3	B	ALL
4	BO	ALL
5	Y	ALL
6	U	ALL
7	WK	ALL
8	SB	ALL
9	BP	ALL
10	BU	ALL
12	BS	ALL
13	GY	ALL
14	UY	ALL
15	KB	ALL
16	OY	ALL
17	UG	ALL
18	BS	ALL
19	BS	ALL
20	BO	ALL
21	WO	ALL
23	UK	ALL
27	YB	ALL
28	B	ALL
29	W	ALL
30	NP	ALL
31	BU	ALL
32	BP	ALL
33	B	ALL
34	UN	ALL
35	UW	ALL
36	GN	ALL
38	OY	ALL
42	KU	ALL
44	BLG	ALL
45	KG	ALL
46	GU	ALL
47	KO	ALL

Cav	Col	Cct
48	R	ALL
49	UY	ALL
50	LGS	ALL
51	GK	ALL
52	YR	ALL
53	PB	ALL
54	WU	ALL
56	K	ALL
57	YN	ALL
58	YR	ALL
59	YN	ALL
60	Y	ALL
61	BR	ALL
62	BG	ALL
63	B	ALL
64	BR	ALL
66	NK	ALL
67	B	ALL
69	UR	ALL
70	OU	ALL
71	OG	ALL
72	OS	ALL
73	GW	ALL
74	GU	ALL
75	KB	ALL
76	BG	ALL
77	BG	ALL
78	YW	ALL
80	BK	ALL
81	UO	ALL
82	UG	ALL
84	OU	ALL
85	BS	ALL
88	YU	ALL
89	YP	ALL
90	YG	ALL

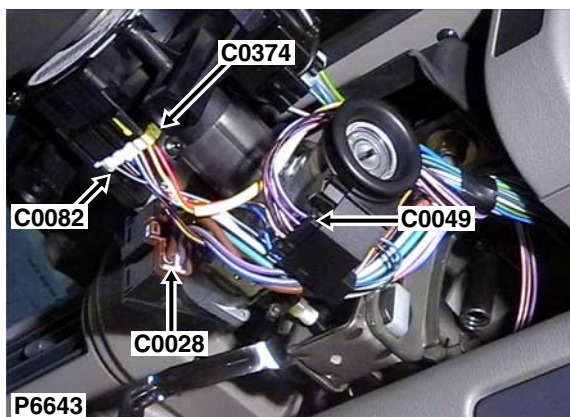

Cav	Col	Cct
1	R	ALL
2	Y	ALL

Description: *Rotary coupler*

Location: *Underside of steering column*

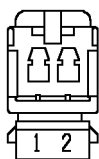

YPC106880

Colour: *YELLOW*

Gender: *Female*

C0381

CONNECTOR DETAILS

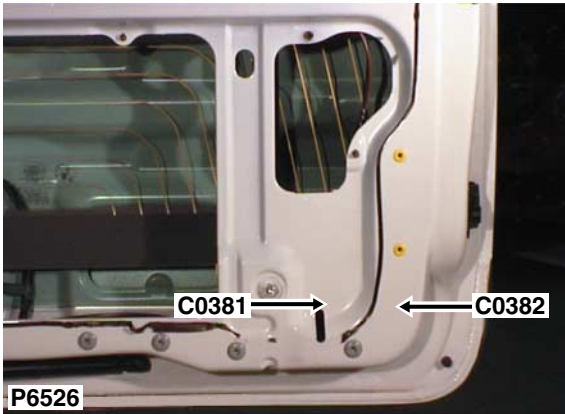

Cav	Col	Cct
1	N	1

Description: *Heated rear window (HRW)*

Location: *LH side of taildoor*

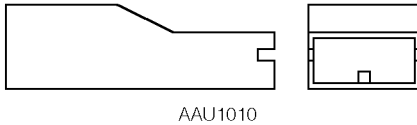

AAU1010

Colour: *BLACK*

Gender: *Female*

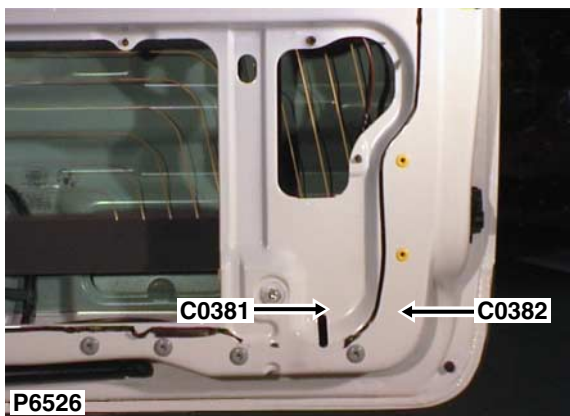

Cav	Col	Cct
1	B	1

Description: *Heated rear window (HRW)*
 Location: *LH side of taildoor*

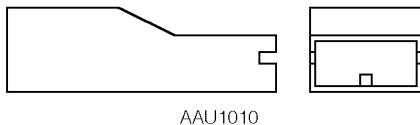

AAU1010

Colour: *BLACK*
 Gender: *Female*

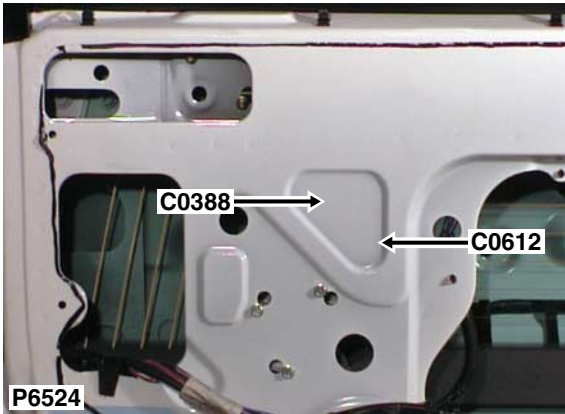

Cav	Col	Cct
1	GR	1
2	G	1
3	NG	1
4	OB	1
5	B	1

Description: *Motor-Wiper-Rear screen*

Location: *Centre of taildoor, behind trim panel*

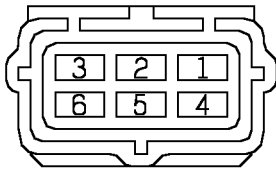

YPC10064

Colour: *BLACK*

Gender: *Female*

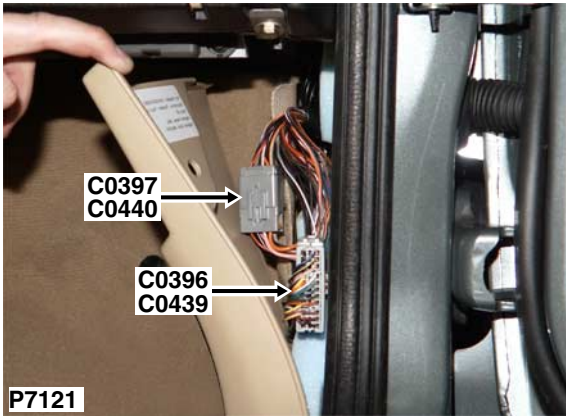

Description: *Main harness to door harness*
 Location: *Base of passenger side 'A' post*

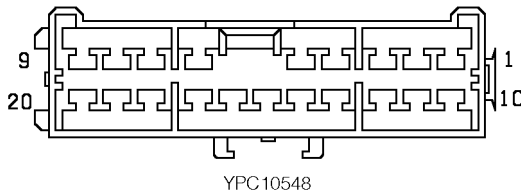

Colour: *LIGHT GREY*
 Gender: *Male*

Cav	Col	Cct
1	BR	3
2	BK	3
3	PS	3
3	PW	ALL
4	O	ALL
5	Y	ALL
6	OB	ALL
7	OK	ALL
8	SW	ALL
9	NG	ALL
10	BN	ALL
11	BP	ALL
12	WR	6
13	WU	6
14	SG	6
15	OR	6
15	GU	6
16	GR	6
16	OU	6
17	B	6
17	OR	6
18	OU	6
18	RO	6
19	RB	6
20	BN	6

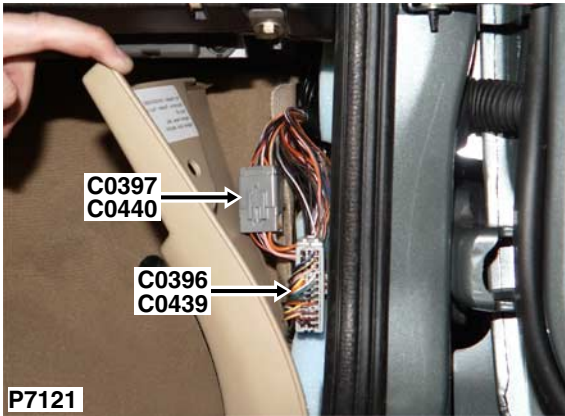

Description: *Main harness to door harness*
 Location: *Base of passenger side 'A' post*

Cav	Col	Cct
1	OR	ALL
1	R	5
1	SO	6
2	OU	ALL
2	U	5
2	B	6
3	NK	ALL
4	B	ALL
5	O	ALL
6	K	ALL
7	BK	6
8	RO	6

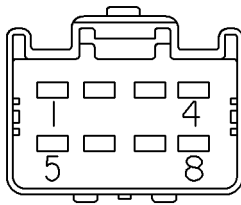

YPC900860

Colour: *LIGHT GREY*
 Gender: *Male*

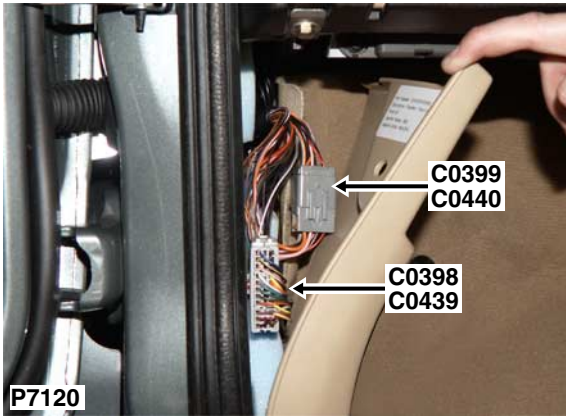

Description: *Main harness to door harness*
 Location: *Base of passenger side 'A' post*

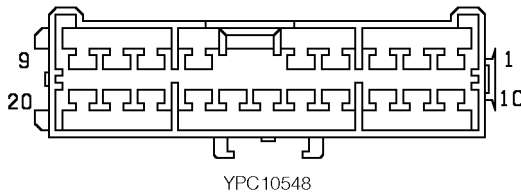

Colour: *LIGHT GREY*
 Gender: *Male*

Cav	Col	Cct
1	BR	2
2	BK	2
3	PS	2
3	PW	ALL
4	Y	ALL
5	O	ALL
6	YB	ALL
7	YK	ALL
8	SW	ALL
9	NG	ALL
10	BU	ALL
11	BY	ALL
12	WR	6
13	WU	6
14	SG	6
15	GU	6
15	OR	6
16	GR	6
16	OU	6
17	OR	6
17	B	6
18	OU	6
18	RO	6
19	RB	6
20	BN	6

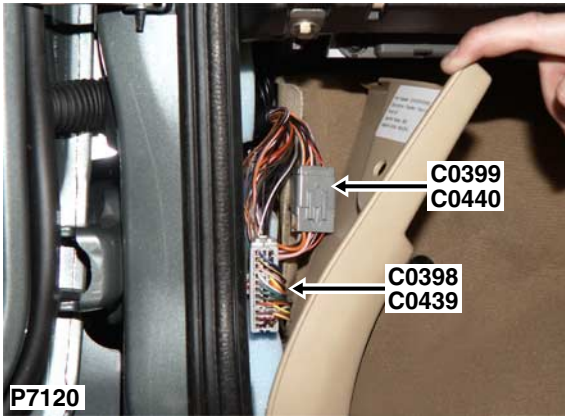

Description: *Main harness to door harness*

Location: *Base of passenger side 'A' post*

Cav	Col	Cct
1	R	5
1	SO	6
1	OR	6
2	U	5
2	B	6
2	OU	6
3	NK	ALL
4	B	ALL
5	O	ALL
6	K	ALL
7	BK	6
8	RO	6

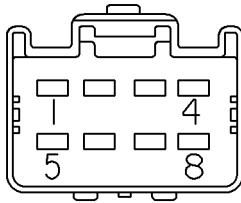

YPC900860

Colour: *LIGHT GREY*

Gender: *Male*



Cav	Col	Cct
1	S	ALL
2	RO	ALL
4	B	ALL
5	RS	ALL

Description: *Switch-PDC*

Location: *In rear of centre console*

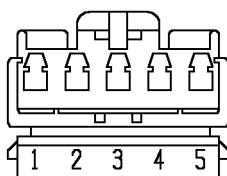

YPC10524

Colour: *WHITE*

Gender: *Female*

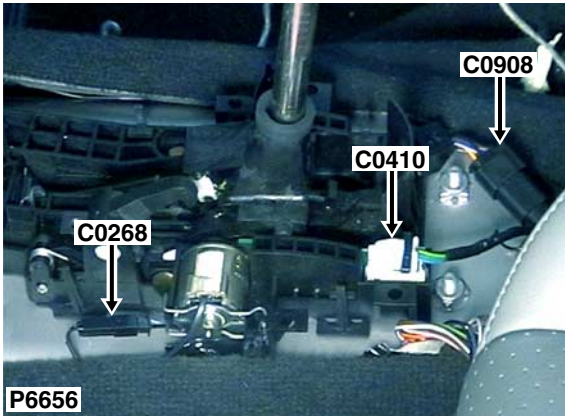

Description: *Switch-CommandShift*
 Location: *Beneath centre console*

Cav	Col	Cct
1	NK	23
2	B	23
7	GB	23
8	GK	23
9	LGK	23

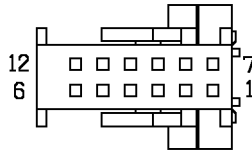

YPC111790

Colour: *BLACK*
 Gender: *Female*

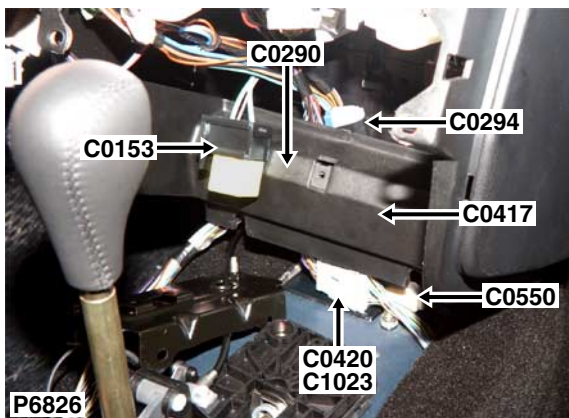

Cav	Col	Cct
1	GU	16
1	GO	ALL
2	PB	16
2	B	26
2	BO	32

Description: *Sensor-Evaporator*
 Location: *Behind centre console*

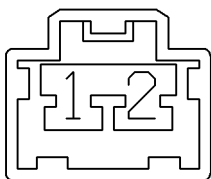

YPC10601

Colour: *LIGHT GREY*
 Gender: *Male*

C0420

CONNECTOR DETAILS

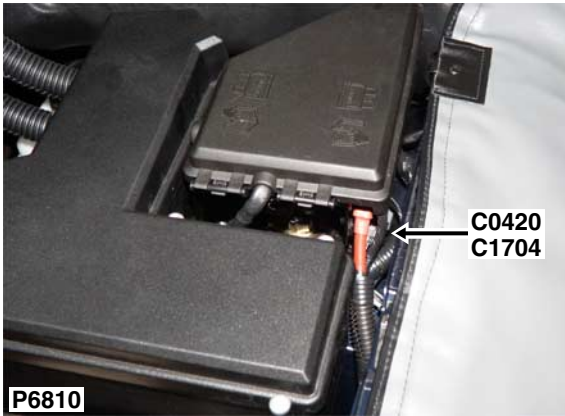

Cav	Col	Cct
1	SB	ALL
2	PG	ALL

Description: *Heated front screen harness to main harness*
Location: *LH side of engine compartment*

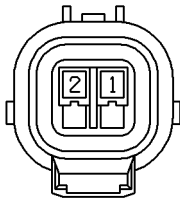

YPC10184

Colour: *GREY*
Gender: *Male*

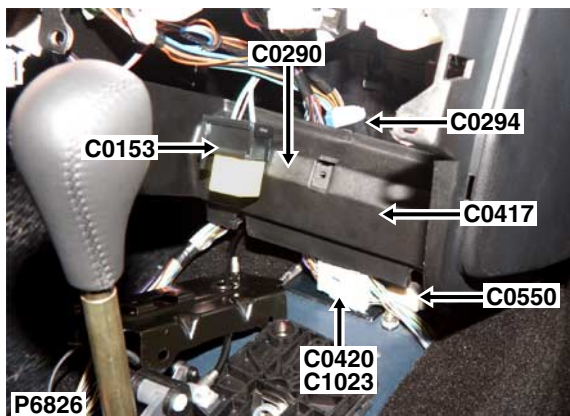

Cav	Col	Cct
1	UB	ALL
2	UK	ALL

Description: *Audio system harness to main harness - High line*

Location: *Behind centre console*

NO CONNECTOR FACE

Colour: *NATURAL*

Gender: *Male*

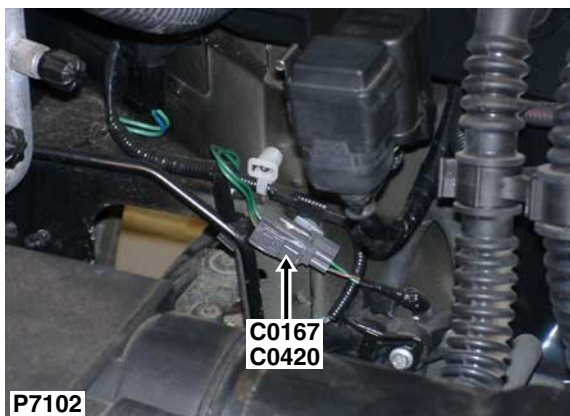

P7102

Description: *Link harness to main harness - Td4*

Location: *Beneath engine compartment fusebox*

Cav	Col	Cct
1	GN	ALL
2	G	ALL

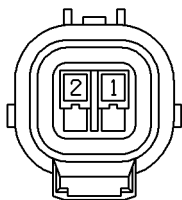

YPC10184

Colour: *GREY*

Gender: *Male*

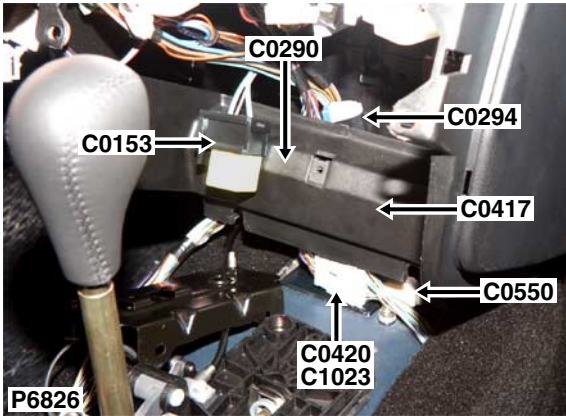

Description: *Audio system harness to main harness - Low line*
 Location: *Behind centre console*

Cav	Col	Cct
1	YK	ALL
2	OK	ALL
3	SK	ALL
4	LGW	ALL
5	UK	ALL
6	YB	ALL
7	P	ALL
7	PK	ALL
8	BW	ALL
9	OB	ALL
10	SB	ALL
11	RO	ALL
12	UB	ALL
13	B	ALL
14	BR	ALL
15	WO	ALL
16	GN	12
17	SB	ALL
18	SN	ALL
19	SW	ALL
20	SR	ALL

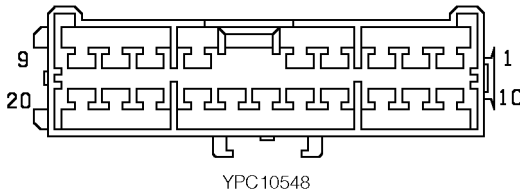

Colour: *LIGHT GREY*
 Gender: *Male*

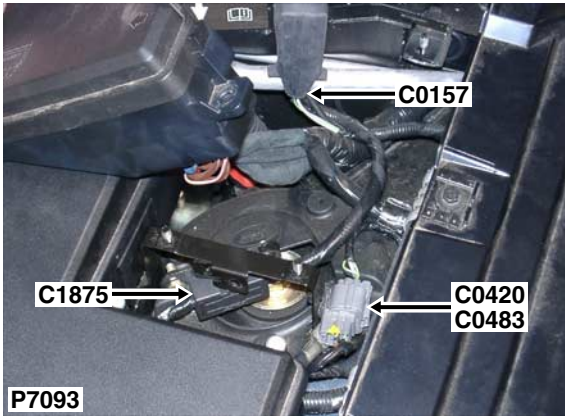

Cav	Col	Cct
1	GY	40
2	WP	40
3	GY	40
4	B	40
5	GW	40

Description: *PTC heater harness to main harness*
 Location: *Beneath engine compartment fusebox*

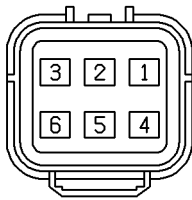

YPC106620

Colour: *GREY*
 Gender: *Male*

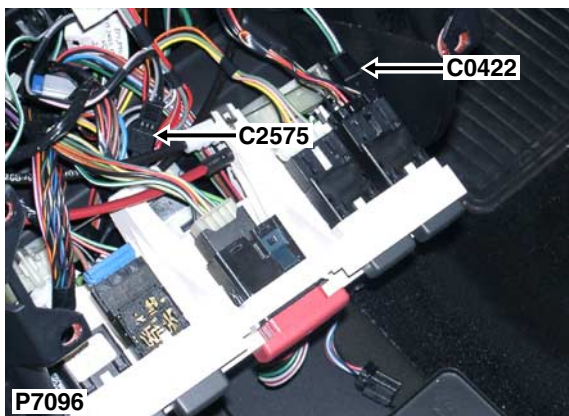

Cav	Col	Cct
1	SW	ALL
2	GW	ALL

Description: *Switch-Thermostatic*

Location: *Behind centre console*

NO CONNECTOR FACE

Colour:

Gender:



Cav	Col	Cct
1	GK	ALL
2	RY	ALL
3	RK	ALL
4	RG	ALL

Description: *Resistor pack*

Location: *Behind centre of fascia*

NO CONNECTOR FACE

Colour:

Gender:

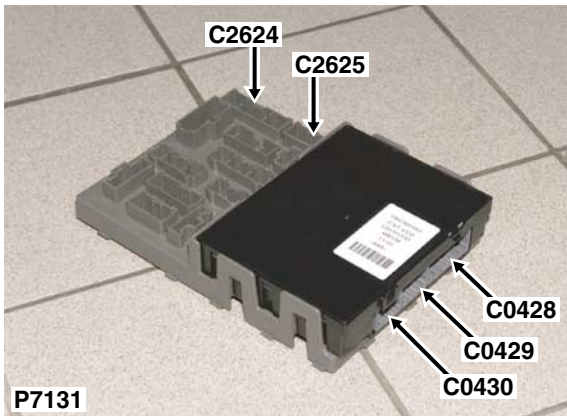

Description: *Central Control Unit (CCU)*
 Location: *Behind passenger compartment fusebox*

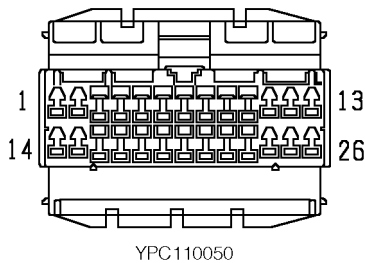

Colour: *GREY*
 Gender: *Female*

Cav	Col	Cct
1	GB	ALL
2	LGB	ALL
3	G	ALL
4	GN	ALL
5	NG	ALL
6	NB	ALL
7	BR	ALL
8	BK	ALL
9	RW	ALL
10	BR	ALL
11	BK	ALL
12	US	ALL
13	PY	5
14	ON	ALL
15	OU	ALL
15	UO	4
15	UG	25
16	UG	ALL
17	OB	ALL
18	ON	ALL
19	BK	ALL
20	BN	ALL
21	PW	ALL
22	RP	ALL
23	BO	ALL
24	PS	ALL
25	WO	ALL
26	S	ALL

C0429

CONNECTOR DETAILS

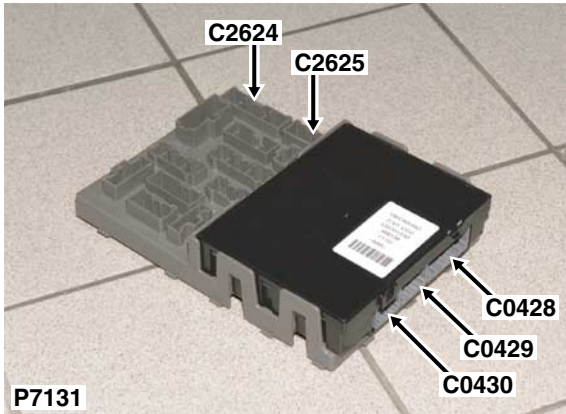

Description: *Central Control Unit (CCU)*

Location: *Behind passenger compartment fusebox*

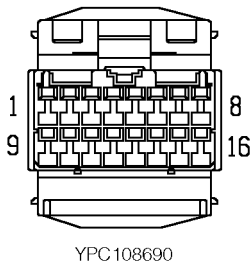

Colour: *LIGHT GREY*

Gender: *Female*

Cav	Col	Cct
1	RG	ALL
2	WB	ALL
3	RU	ALL
4	YW	ALL
5	YB	ALL
6	WK	ALL
7	G	ALL
8	SW	ALL
9	Y	ALL
10	SB	28
11	KO	28
12	SP	ALL
13	SR	ALL
14	K	ALL
15	KN	ALL
16	GY	ALL

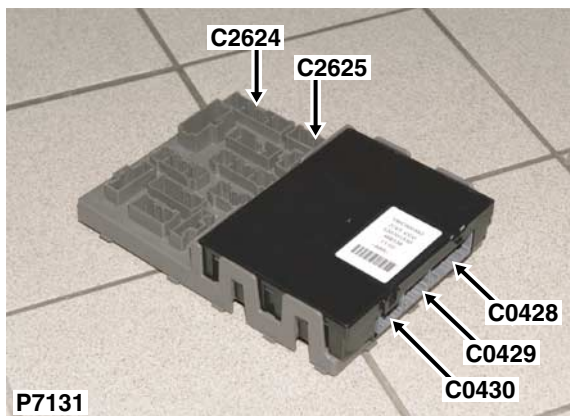

Cav	Col	Cct
1	NLG	ALL
2	PU	ALL
3	NK	ALL
4	K	ALL
5	PY	ALL
6	LGW	ALL
7	O	ALL
8	LGK	ALL
9	K	ALL
10	KB	ALL

Description: *Central Control Unit (CCU)*

Location: *Behind passenger compartment fusebox*

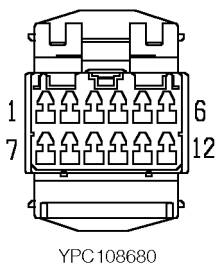

Colour: *LIGHT GREY*

Gender: *Female*

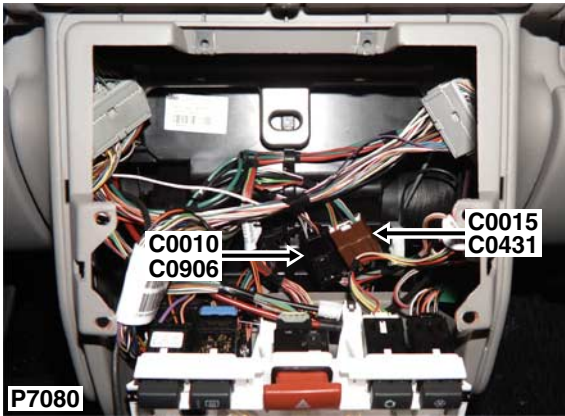

Cav	Col	Cct
1	GN	ALL
2	RO	ALL
3	SK	ALL
4	B	ALL
5	G	ALL

Description: *Main harness to heater harness*

Location: *Behind centre console*

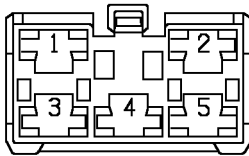

YPC10462

Colour: *BROWN*

Gender: *Female*



Cav	Col	Cct
1	W	ALL
2	U	ALL

Description: *Air bag-Passenger*

Location: *Behind passenger's airbag module*

NO CONNECTOR FACE

Colour:

Gender:

C0434

CONNECTOR DETAILS



Cav	Col	Cct
1	B	ALL

Description: *Earth-ABS modulator*

Location: *Front RH side of engine compartment*

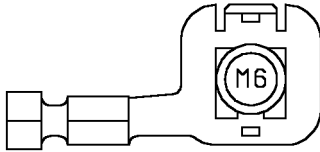

YPG10051

Colour: *TIN-PLATE*

Gender: *Female*

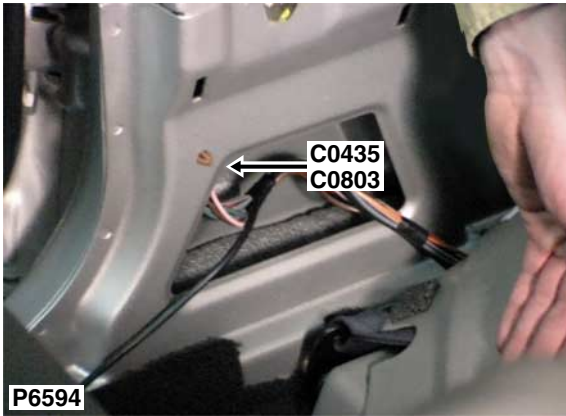

Description: *Main harness to door harness*
 Location: *Base of 'B' post LH side*

Cav	Col	Cct
1	SB	6
2	SK	6
3	B	6
4	O	6
5	B	6
6	K	6
7	PW	6
8	NK	6
9	WR	6
10	WU	6
11	R	6
12	U	6
13	SG	6
14	RO	6

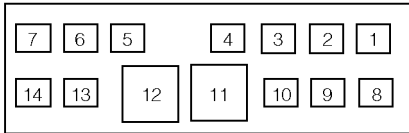

YPC115760

Colour: *LIGHT GREY*
 Gender: *Male*

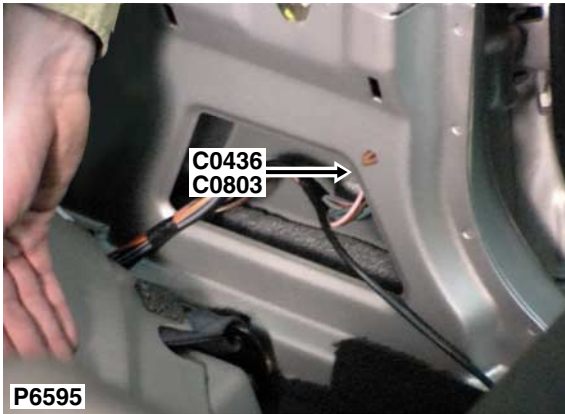

Description: *Main harness to door harness*

Location: *Base of 'B' post RH side*

Cav	Col	Cct
1	UB	6
2	UK	6
3	B	6
4	O	6
5	B	6
6	K	6
7	PW	6
8	NK	6
9	GR	6
10	GU	6
11	R	6
12	U	6
13	SG	6
14	RO	6

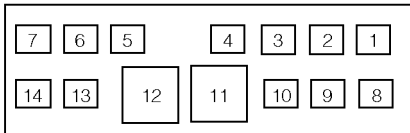

YPC115760

Colour: *LIGHT GREY*

Gender: *Male*

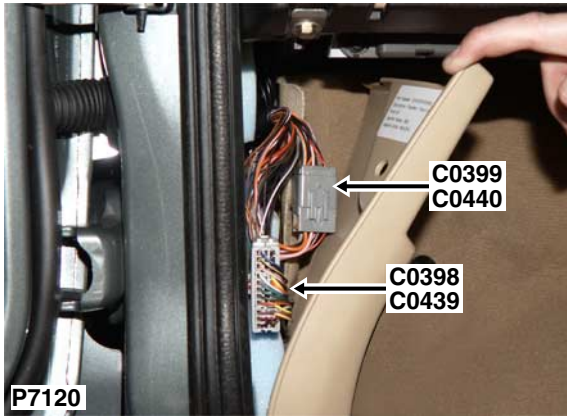

Description: *Door harness to main harness - 3 Door*

Location: *Base of driver side 'A' post*

Cav	Col	Cct
1	BR	ALL
2	BK	ALL
3	PW	ALL
4	R	7
5	B	7
6	OB	ALL
7	OK	ALL
8	SW	ALL
9	NG	ALL
10	BN	ALL
11	BP	ALL

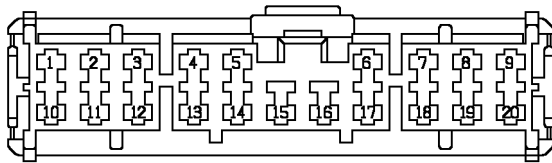

YPC10498

Colour: *LIGHT GREY*

Gender: *Female*

C0439

CONNECTOR DETAILS

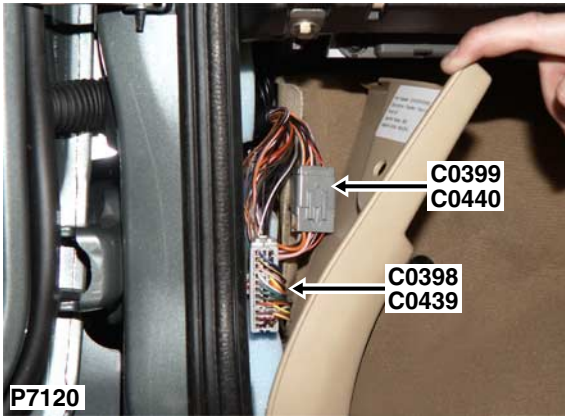

Description: Door harness to main harness - 5 Door
 Location: Base of driver side 'A' post

Cav	Col	Cct
1	BR	ALL
2	BK	ALL
3	PW	ALL
4	R	7
5	B	7
6	OB	ALL
7	OK	ALL
8	SW	ALL
9	NG	ALL
10	BN	ALL
11	BP	ALL
12	WR	ALL
13	WU	ALL
14	SG	ALL
15	R	1
15	GU	ALL
16	U	1
16	GR	ALL
17	B	1
17	OR	ALL
18	RO	1
18	OU	ALL
19	RB	ALL
20	BN	ALL

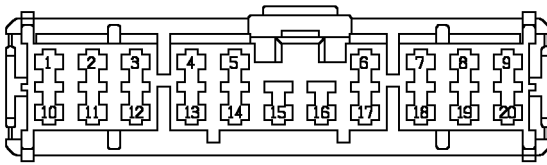

YPC10498

Colour: LIGHT GREY
 Gender: Female

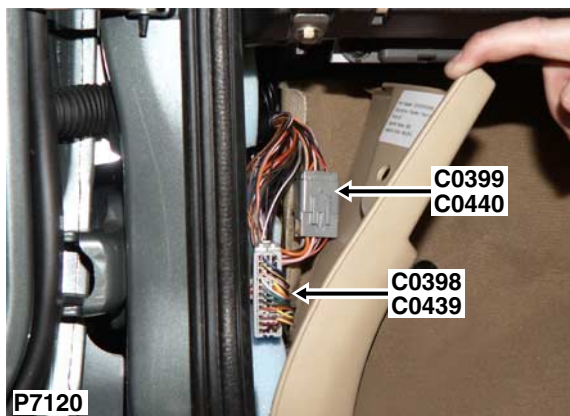

Description: *Door harness to main harness - 3 Door*

Location: *Base of driver side 'A' post*

Cav	Col	Cct
1	R	ALL
2	U	ALL
3	NK	ALL
4	B	ALL
5	O	ALL
6	K	ALL

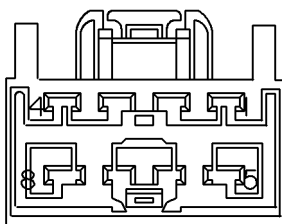

YPC900220

Colour: *LIGHT GREY*

Gender: *Female*

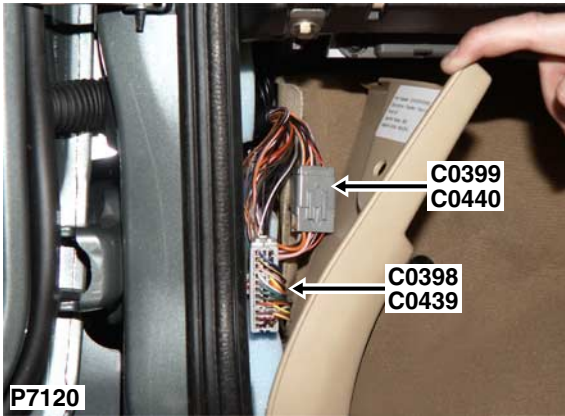

Description: *Door harness to main harness - 5 Door*

Location: *Base of driver side 'A' post*

Cav	Col	Cct
1	R	1
1	SO	ALL
2	U	1
2	B	ALL
3	NK	ALL
4	B	ALL
5	O	ALL
6	K	ALL
7	BK	ALL
8	RO	ALL

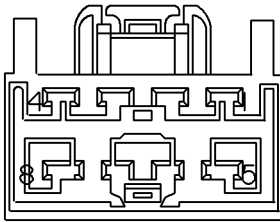

YPC900220

Colour: *LIGHT GREY*

Gender: *Female*

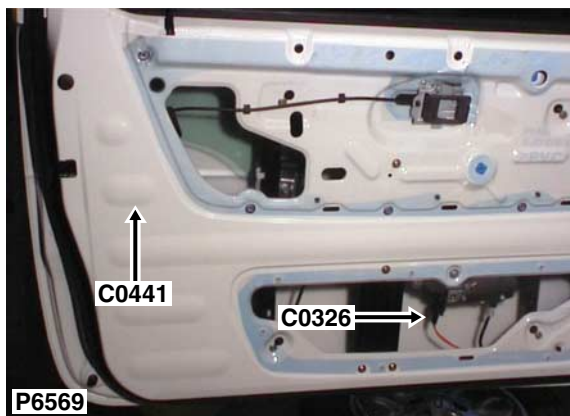

Cav	Col	Cct
1	BK	ALL
3	BR	ALL
4	K	ALL
5	B	ALL
6	PW	ALL
7	O	ALL
8	NK	ALL

Description: *Motor-Door lock-Front - 3 Door*

Location: *Behind front door trim panel*

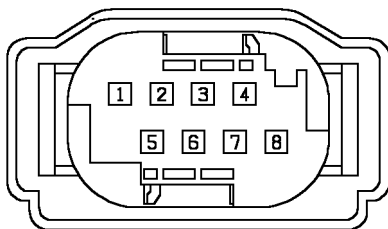

YPC108040

Colour: *BLACK*

Gender: *Female*

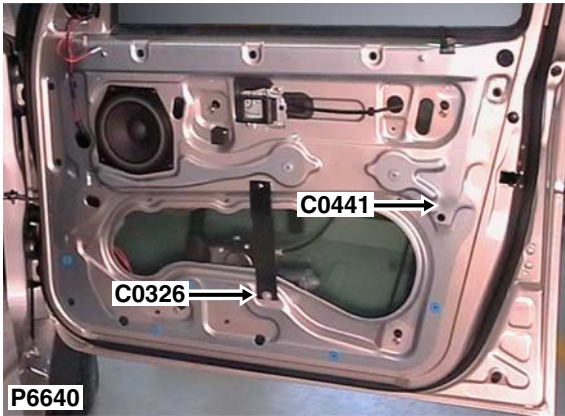

Cav	Col	Cct
1	BK	ALL
3	BR	ALL
4	K	ALL
5	B	ALL
6	PW	ALL
7	O	ALL
8	NK	ALL

Description: *Motor-Door lock-Front - 5 Door*

Location: *Behind front door trim panel*

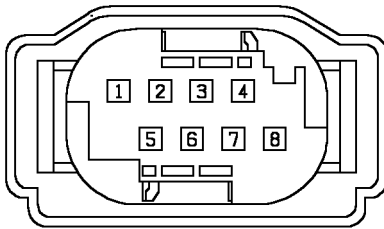

YPC108040

Colour: *BLACK*

Gender: *Female*

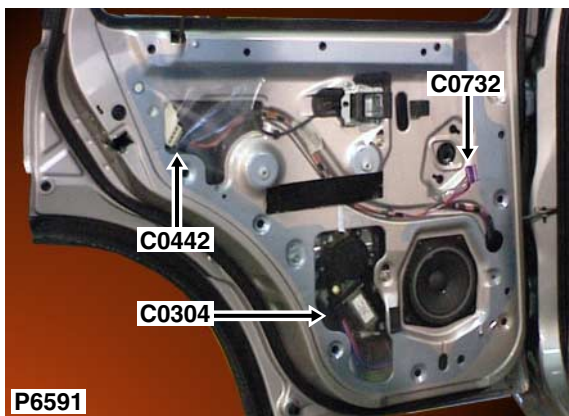

Cav	Col	Cct
4	K	ALL
5	B	ALL
6	PW	ALL
7	O	ALL
8	NK	ALL

P6591

Description: *Motor-Door lock-Rear*

Location: *Behind rear door trim panel*

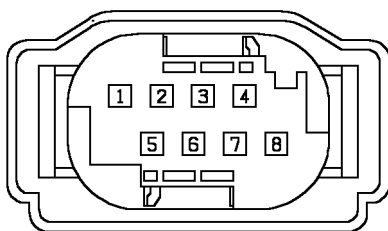

YPC108040

Colour: *BLACK*

Gender: *Female*

C0444

CONNECTOR DETAILS

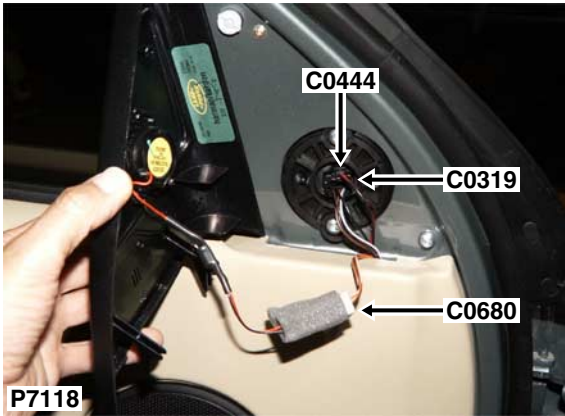

Cav	Col	Cct
1	R	7
2	B	7

Description: *Mirror-Door - 3 Door*

Location: *Behind front door trim panel*

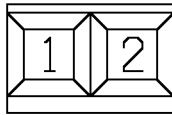

YPC111740

Colour: *BLACK*

Gender: *Female*

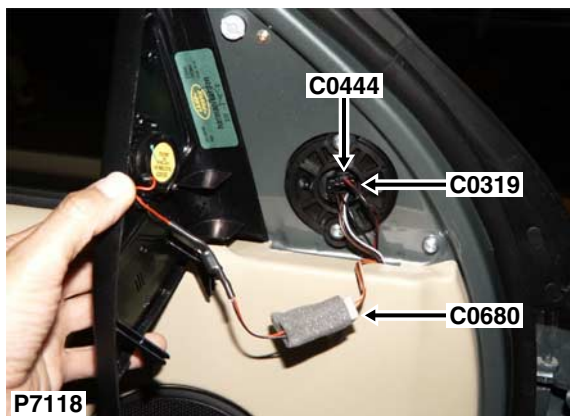

Cav	Col	Cct
1	R	7
2	B	7

Description: *Mirror-Door - 5 Door*

Location: *Behind front door trim panel*

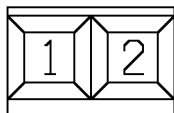

YPC111740

Colour: *BLACK*

Gender: *Female*

C0445

CONNECTOR DETAILS

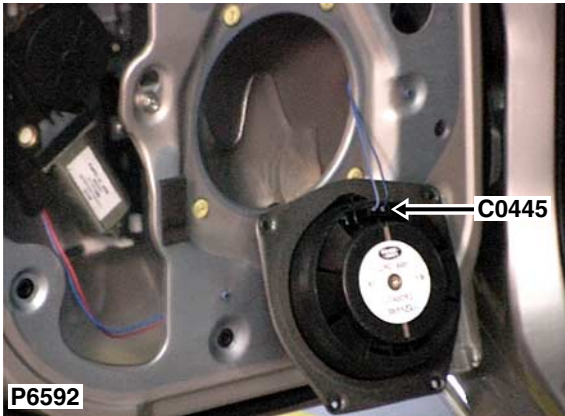

Cav	Col	Cct
1	UB	ALL
2	UK	ALL

Description: *Speakers-Rear - High line*
Location: *Behind rear door trim panel*

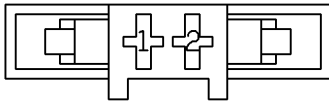

YPC113640

Colour: *BLACK*
Gender: *Female*

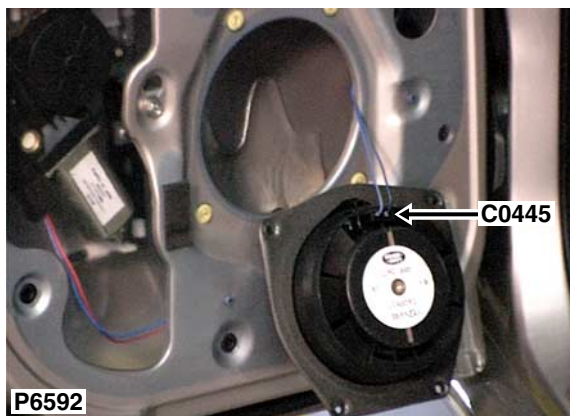

Cav	Col	Cct
1	UB	8
2	UK	8

Description: *Speakers-Rear - Low line*
Location: *Behind rear door trim panel*

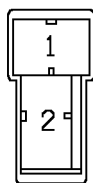

AFU3199

Colour: *BLACK*
Gender: *Female*

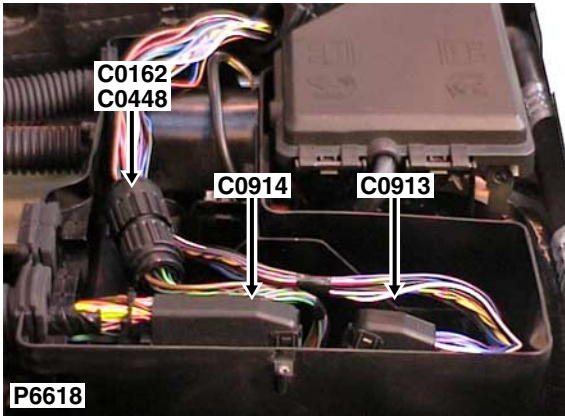

Cav	Col	Cct
1	G	18
2	GN	18
3	RW	18
4	B	18
5	KB	18
6	LGS	18
7	GU	18
8	GO	32
9	BO	32
12	NR	18

Description: *Main harness to engine harness*

Location: *Inside E-box*

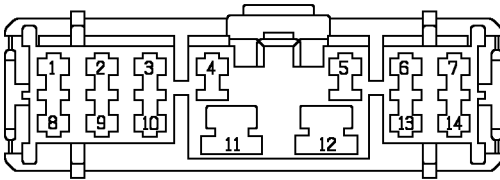

YPC10627

Colour: *LIGHT GREY*

Gender: *Female*

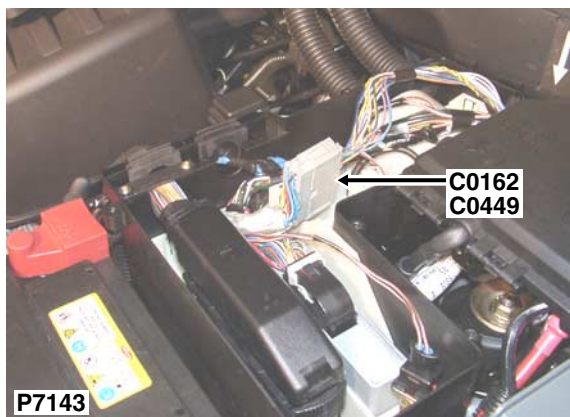

Description: *Main harness to engine harness*
 Location: *Inside E-box*

Cav	Col	Cct
1	PB	16
2	UO	16
3	UG	16
4	GU	16
5	OY	16
6	BG	16
7	YR	16
9	UW	16
12	YB	16
13	YN	16
14	K	16
15	BU	16
16	BP	16
17	UW	16
18	WO	16
19	UY	16
20	W	16

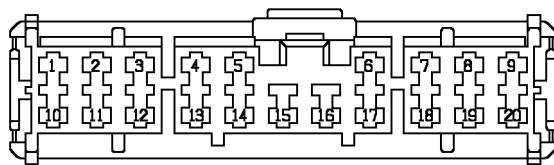

YPC10498

Colour: *LIGHT GREY*
 Gender: *Female*

C0450

CONNECTOR DETAILS

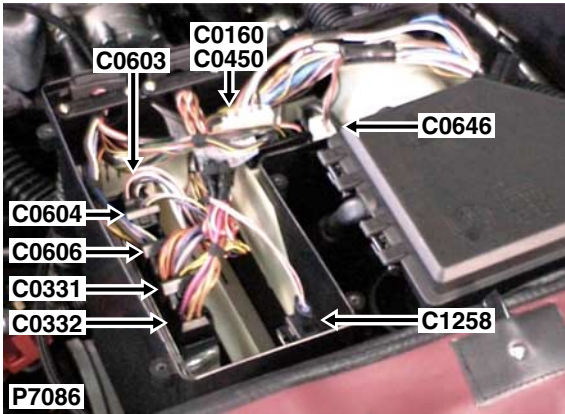

Description: *Main harness to engine harness*

Location: *Inside E-box*

Cav	Col	Cct
1	NR	17
2	BY	17
3	BR	17
6	W	17
8	BP	17
9	BG	17
11	BR	17
12	RW	17

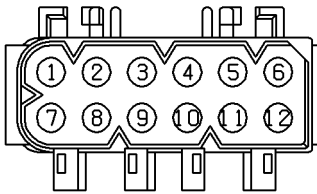

YPC112180

Colour: *BLACK*

Gender: *Male*

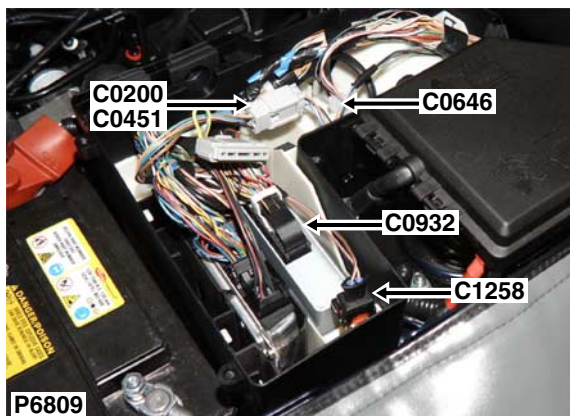

Cav	Col	Cct
1	NK	4
2	BG	4
3	OU	4
4	GK	4
5	UK	4

Description: *Main harness to engine harness*

Location: *Inside E-box*

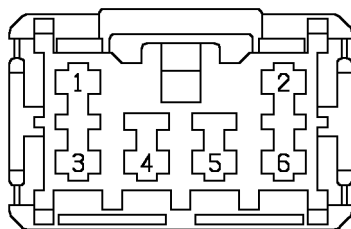

YPC10634

Colour: *LIGHT GREY*

Gender: *Female*

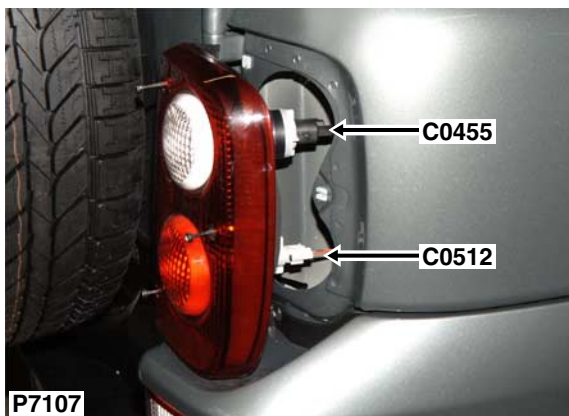

Cav	Col	Cct
1	B	ALL
2	GN	ALL

P7107

Description: *Lamp-Reverse-RH*

Location: *RH rear of vehicle*

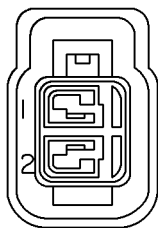

YPC500750

Colour: *BLACK*

Gender: *Female*

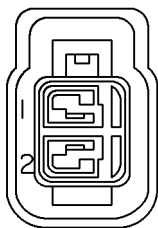

Cav	Col	Cct
1	B	ALL
2	GN	ALL

P7106Description: *Lamp-Reverse-LH*Location: *LH rear of vehicle*

YPC500750

Colour: *BLACK*Gender: *Female*

C0473

CONNECTOR DETAILS

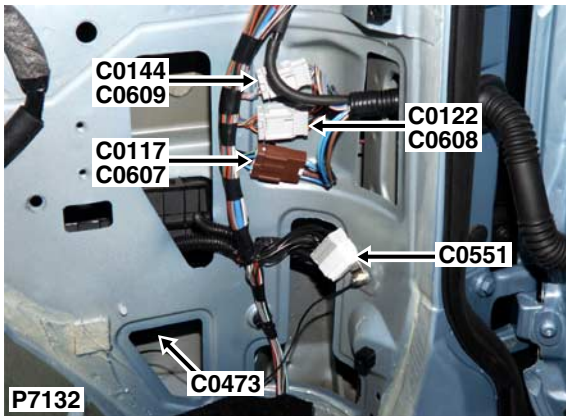

Cav	Col	Cct
1	GR	ALL
2	RY	ALL
3	GW	ALL
4	B	ALL
5	RB	ALL
6	GP	ALL
7	RO	ALL

Description: *Main harness to trailer harness*

Location: *Rear of luggage compartment - RH side*

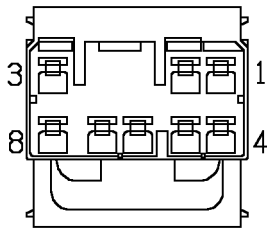

YPC10185

Colour: *WHITE*

Gender: *Male*

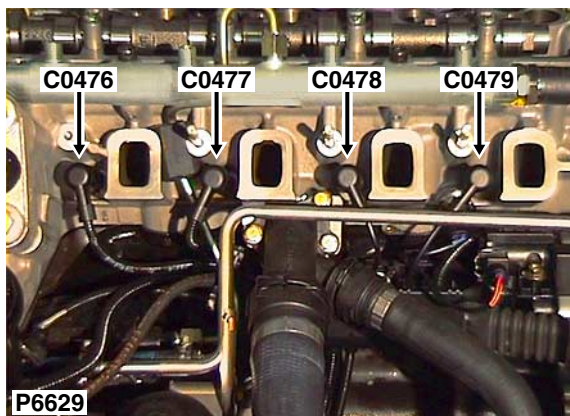

Cav	Col	Cct
1	BG	ALL

Description: *Glow plug*

Location: *Top of engine*

NO CONNECTOR FACE

Colour: *BLACK*

Gender: *Female*

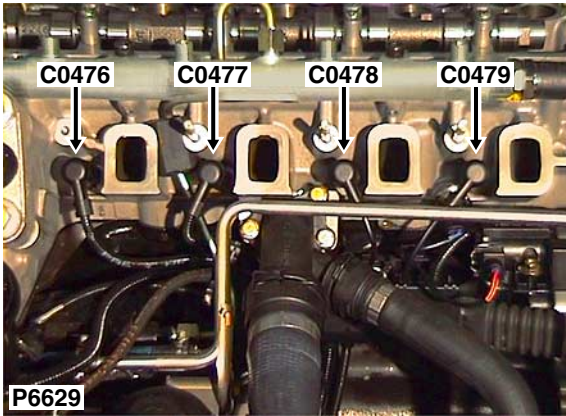

Cav	Col	Cct
1	BP	ALL

Description: *Glow plug*

Location: *Top of engine*

NO CONNECTOR FACE

Colour: *BLACK*

Gender: *Female*

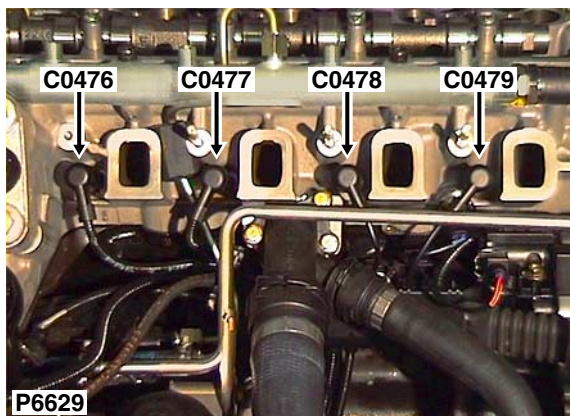

Cav	Col	Cct
1	BY	ALL

Description: *Glow plug*

Location: *Top of engine*

NO CONNECTOR FACE

Colour: *BLACK*

Gender: *Female*

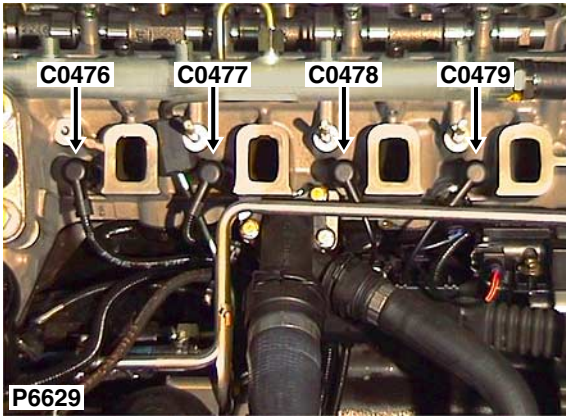

Cav	Col	Cct
1	BR	ALL

Description: *Glow plug*

Location: *Top of engine*

NO CONNECTOR FACE

Colour: *BLACK*

Gender: *Female*

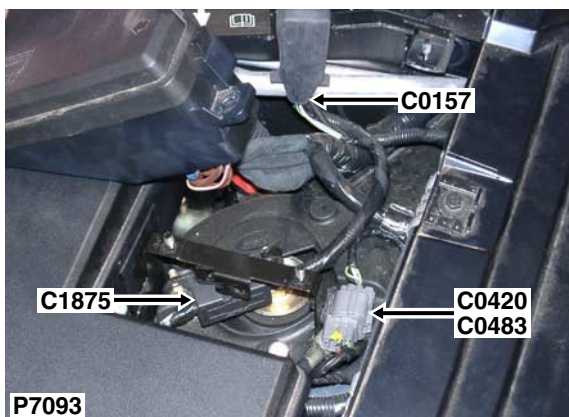

Cav	Col	Cct
1	GY	17
2	WP	17

Description: *Main harness to PTC heater harness*
Location: *Beneath engine compartment fusebox*

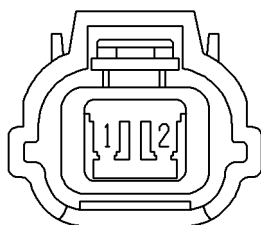

YPC10360

Colour: *ORANGE*
Gender: *Female*

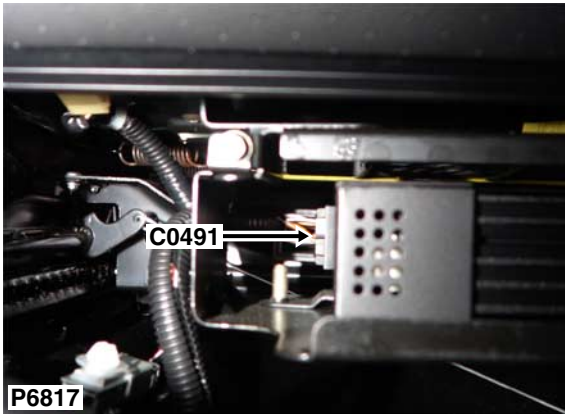

Description: *Amplifier-Power-ICE*
 Location: *Beneath driver's seat*

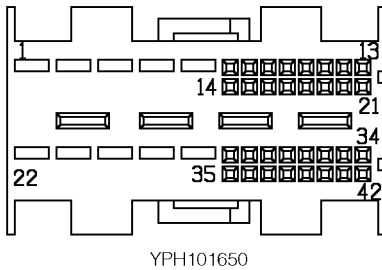

Colour: *BLACK*
 Gender: *Female*

Cav	Col	Cct
1	SB	ALL
2	SN	ALL
3	YB	ALL
4	YK	ALL
5	PK	ALL
8	BG	ALL
9	BP	ALL
10	PY	ALL
13	UK	ALL
15	PY	ALL
16	BO	ALL
17	BU	ALL
20	WO	ALL
21	UB	ALL
22	OB	ALL
23	OK	ALL
24	SW	ALL
25	SR	ALL
26	B	ALL
29	BR	ALL
30	BS	ALL
31	SK	ALL
32	SB	ALL
37	BN	ALL
38	BW	ALL



Cav	Col	Cct
1	PY	5
2	P	5

Description: *Switch-Roof on*

Location: *RH 'D' post*

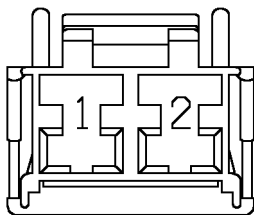

YPC10427

Colour: *LIGHT GREY*

Gender: *Female*

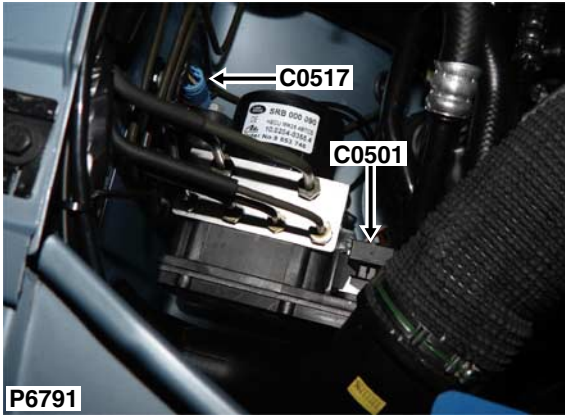

Description: *Modulator-ABS*

Location: *Front RH side of engine compartment*



Colour: *BLACK*

Gender: *Female*

Cav	Col	Cct
1	NK	ALL
2	K	ALL
4	W	ALL
6	PS	ALL
9	BW	ALL
11	YB	ALL
13	YN	ALL
15	YN	ALL
16	B	ALL
24	U	ALL
26	Y	ALL
32	NR	ALL
33	YB	ALL
34	Y	ALL
35	BR	ALL
36	G	ALL
37	GB	ALL
38	GP	ALL
39	WO	ALL
40	R	ALL
41	GR	ALL
42	WB	ALL
43	W	ALL
44	YB	ALL
45	R	ALL
46	RB	ALL
47	B	ALL



Cav	Col	Cct
1	G	ALL
2	GB	ALL

Description: *Sensor-ABS-Rear-LH*
Location: *Below LH rear wheelarch*

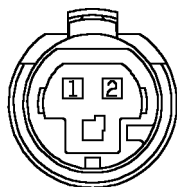

YPC110510

Colour: *BLUE*
Gender: *Female*

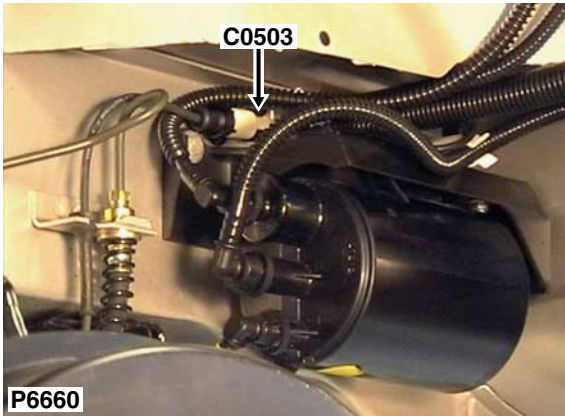

Cav	Col	Cct
1	W	ALL
2	WB	ALL

Description: *Sensor-ABS-Rear-RH*
Location: *Below RH rear wheelarch*

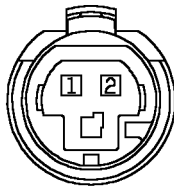

YPC110510

Colour: *BLUE*
Gender: *Female*

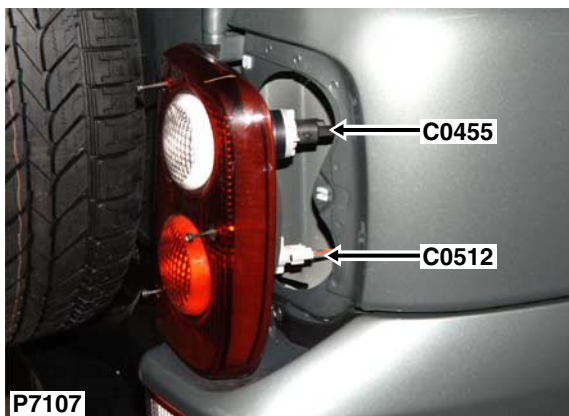

Description: *Lamp-Fog guard-Rear-RH*

Location: *RH rear of vehicle*

Cav	Col	Cct
1	B	ALL
2	RY	ALL

NO CONNECTOR FACE

Colour:

Gender:



Cav	Col	Cct
1	UP	ALL
2	B	ALL

Description: *Lamp-Fog-Front-RH*

Location: *Behind RH side of front bumper*

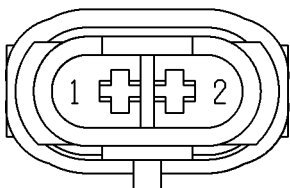

YPC000340

Colour: *BLACK*

Gender: *Female*

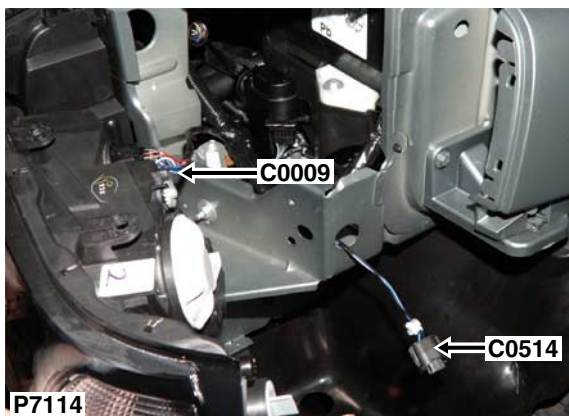

Cav	Col	Cct
1	UP	ALL
2	B	ALL

Description: *Lamp-Fog-Front-LH*

Location: *Behind LH side of front bumper*

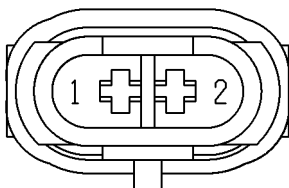

YPC000340

Colour: *BLACK*

Gender: *Female*

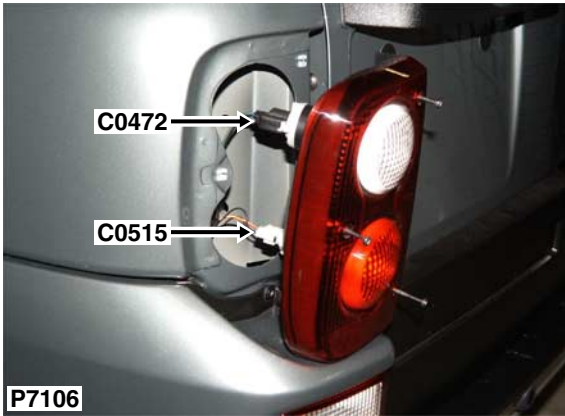

Cav	Col	Cct
1	B	ALL
2	RY	ALL

Description: *Lamp-Fog guard-Rear-LH*

Location: *LH rear of vehicle*

NO CONNECTOR FACE

Colour:

Gender:

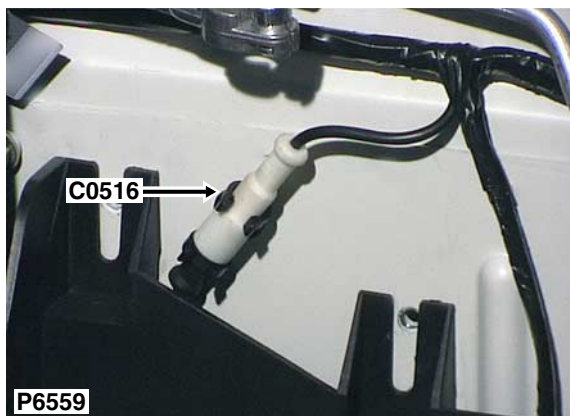

Cav	Col	Cct
1	R	ALL
2	RB	ALL

Description: *Sensor-ABS-Front-LH*

Location: *Lower LH front of engine compartment*

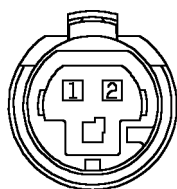

YPC110510

Colour: *BLUE*
Gender: *Female*

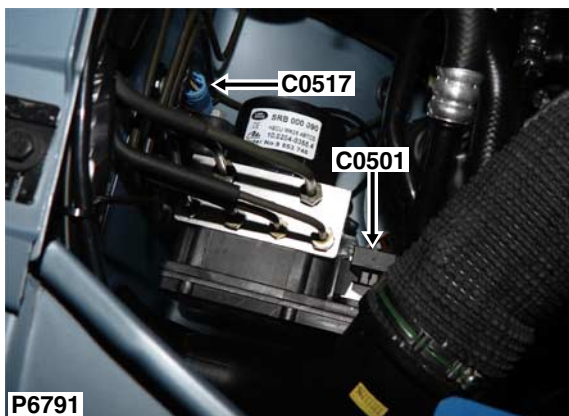

P6791

Description: *Sensor-ABS-Front-RH*

Location: *Front RH side of engine compartment*

Cav	Col	Cct
1	Y	ALL
2	YB	ALL

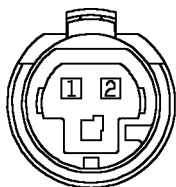

YPC110510

Colour: *BLUE*

Gender: *Female*

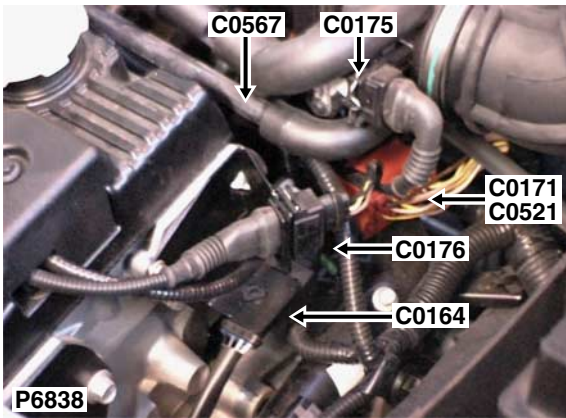

Description: *Injector harness to engine harness - K1.8*
 Location: *Top of engine*

Cav	Col	Cct
1	NK	ALL
2	YU	ALL
6	YG	ALL
7	YR	ALL
8	KB	ALL
9	YW	ALL
10	YN	ALL
11	NK	ALL
12	YP	ALL
13	RG	ALL
15	WB	ALL
16	WO	ALL

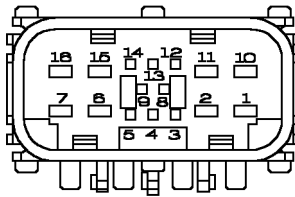

YPC116610

Colour: *BLACK*
 Gender: *Male*



Cav	Col	Cct
1	YN	ALL
2	YR	ALL
3	YG	ALL
4	NK	ALL

Description: *Injector harness to engine harness - KV6*

Location: *Top of engine*

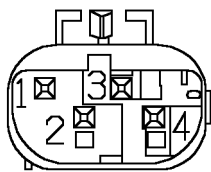

YPC110750

Colour: *BLACK*

Gender: *Male*

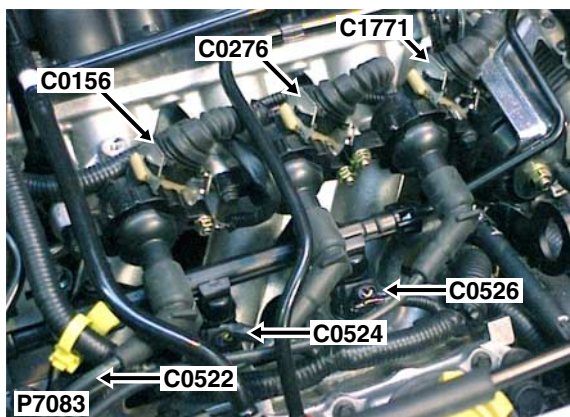

Cav	Col	Cct
1	NK	ALL
2	Y	ALL

Description: *Fuel injector-No.1 - KV6*

Location: *Top of engine*

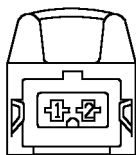

YPC114900

Colour: *BLACK*

Gender: *Female*

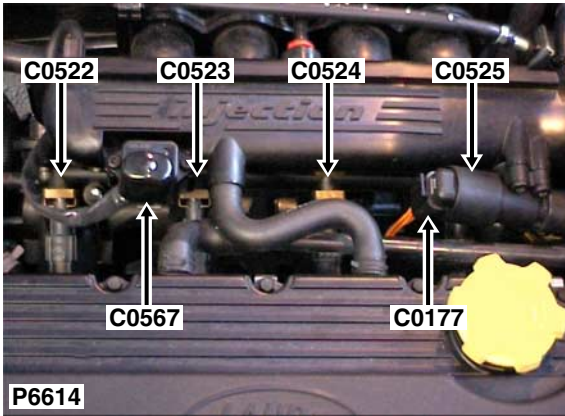

Cav	Col	Cct
1	NK	ALL
2	YU	ALL

Description: *Fuel injector-No.1 - K1.8*

Location: *Top of engine*

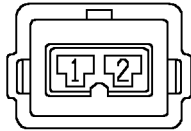

YPC115270

Colour: *BLACK*

Gender: *Female*



Cav	Col	Cct
1	NK	ALL
2	Y	ALL

Description: *Fuel injector-No.1 - NAS*

Location: *Top of engine*

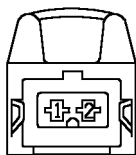

YPC114900

Colour: *BLACK*

Gender: *Female*

C0523

CONNECTOR DETAILS

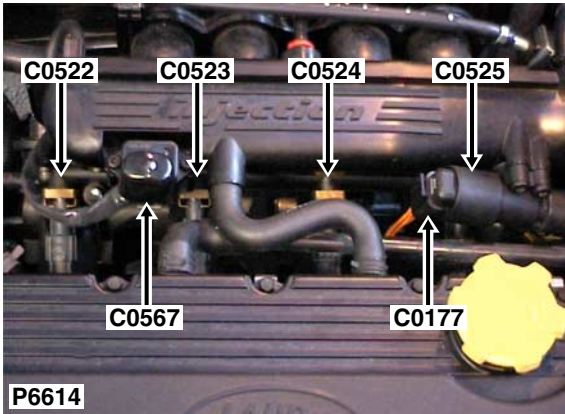

Cav	Col	Cct
1	NK	ALL
2	YG	ALL

Description: *Fuel injector-No.2 - K1.8*

Location: *Top of engine*

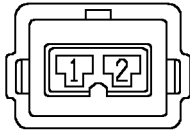

YPC115270

Colour: *BLACK*

Gender: *Female*

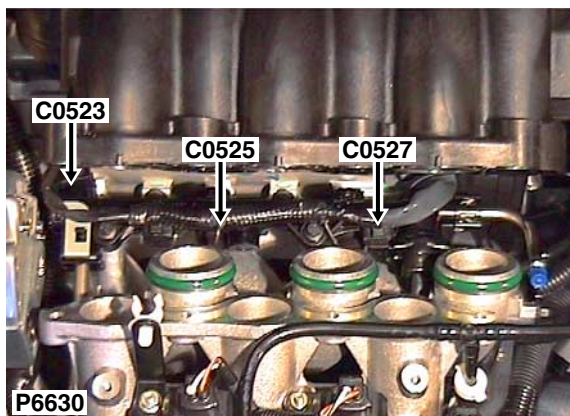

Cav	Col	Cct
1	NK	ALL
2	YN	ALL

Description: *Fuel injector-No.2 - KV6*

Location: *Top of engine*

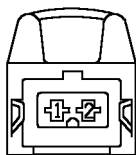

YPC114900

Colour: *BLACK*

Gender: *Female*

C0524

CONNECTOR DETAILS

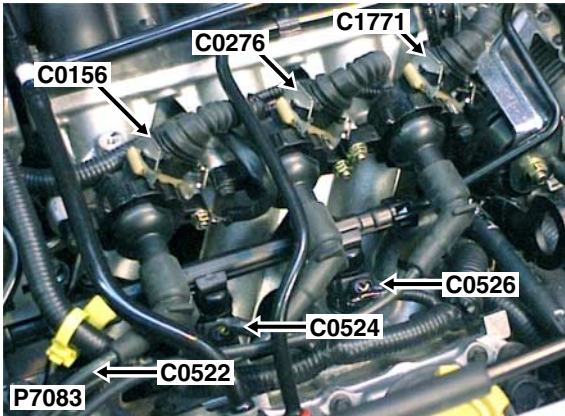

Cav	Col	Cct
1	NK	ALL
2	YU	ALL

Description: *Fuel injector-No.3 - KV6*

Location: *Top of engine*

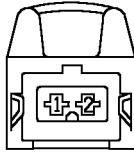

YPC114900

Colour: *BLACK*

Gender: *Female*

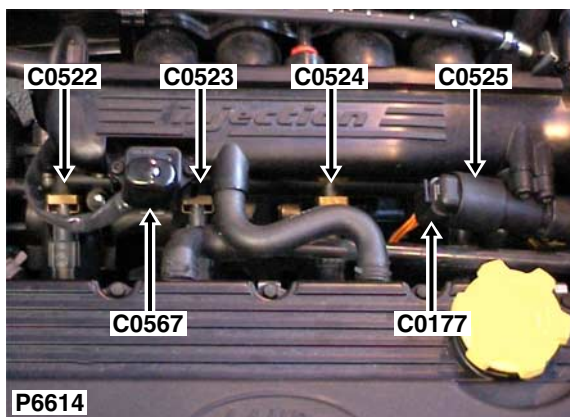

Cav	Col	Cct
1	NK	ALL
2	YR	ALL

Description: *Fuel injector-No.3 - K1.8*

Location: *Top of engine*

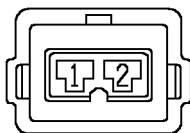

YPC115270

Colour: *BLACK*

Gender: *Female*



Description: *Fuel injector-No.3 - NAS*

Location: *Top of engine*

Cav	Col	Cct
1	NK	ALL
2	YU	ALL

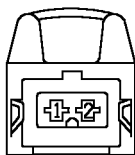

YPC114900

Colour: *BLACK*

Gender: *Female*

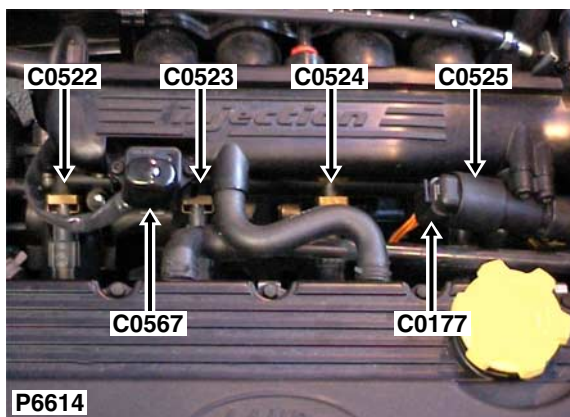

Cav	Col	Cct
1	NK	ALL
2	YN	ALL

Description: *Fuel injector-No.4 - K1.8*

Location: *Top of engine*

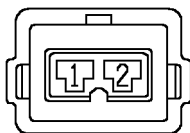

YPC115270

Colour: *BLACK*

Gender: *Female*

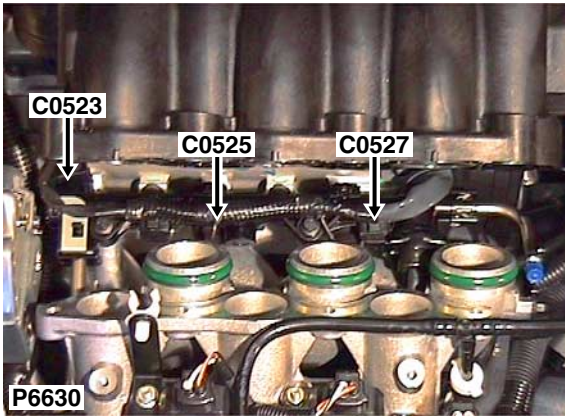

Cav	Col	Cct
1	NK	ALL
2	YR	ALL

Description: *Fuel injector-No.4 - KV6*

Location: *Top of engine*

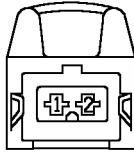

YPC114900

Colour: *BLACK*

Gender: *Female*

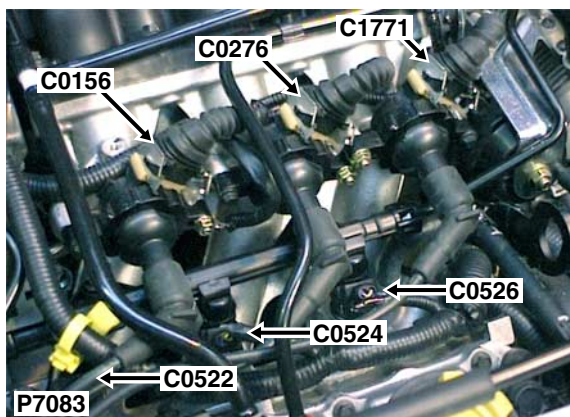

Cav	Col	Cct
1	NK	ALL
2	YP	ALL

Description: *Fuel injector-No.5 - KV6*

Location: *Top of engine*

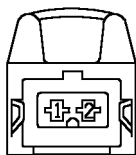

YPC114900

Colour: *BLACK*

Gender: *Female*



Cav	Col	Cct
1	NK	ALL
2	YP	ALL

Description: *Fuel injector-No.5 - NAS*
Location: *Top of engine*

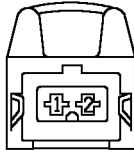

YPC114900

Colour: *BLACK*
Gender: *Female*

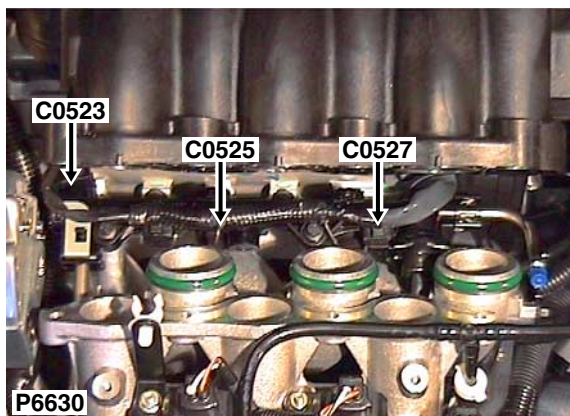

Cav	Col	Cct
1	NK	ALL
2	YG	ALL

Description: *Fuel injector-No.6 - KV6*

Location: *Top of engine*

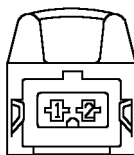

YPC114900

Colour: *BLACK*

Gender: *Female*

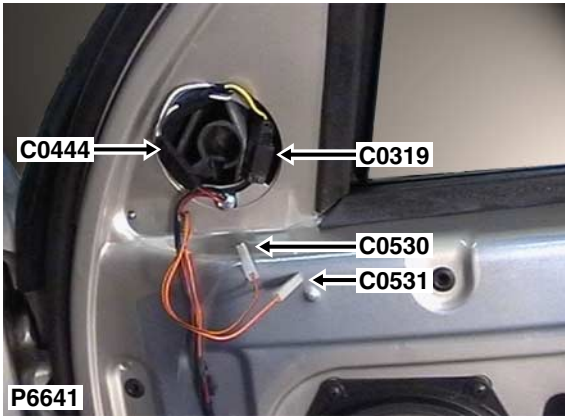

Cav	Col	Cct
2	UK	ALL
3	UB	ALL

Description: *Speakers-High Range - High line*
 Location: *Behind front door trim panel*

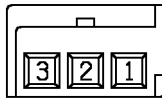

YPC117810

Colour: *WHITE*
 Gender: *Female*

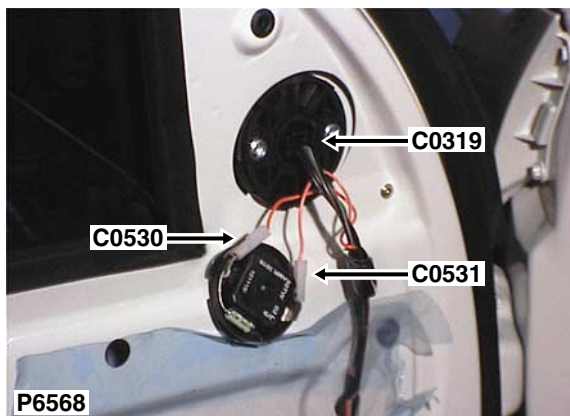

Cav	Col	Cct
1	OB	8

Description: *Speakers-High Range - 3 Door*

Location: *Behind front door trim panel*



YPC113020

Colour: *NATURAL*

Gender: *Female*

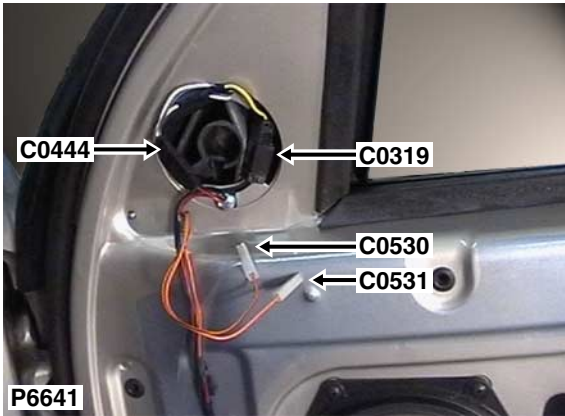

Cav	Col	Cct
1	OB	8

Description: *Speakers-High Range - Low line*
 Location: *Behind front door trim panel*



YPC113020

Colour: *NATURAL*
 Gender: *Female*

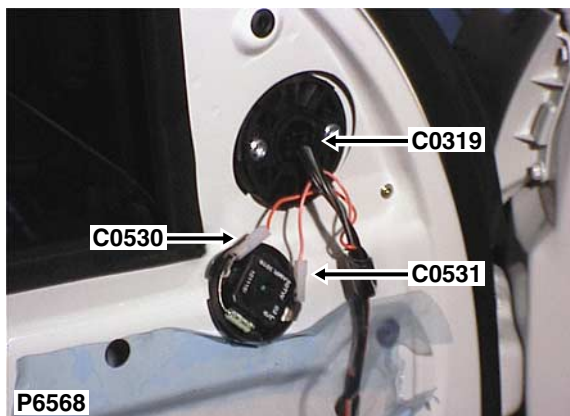

Cav	Col	Cct
1	OK	8

Description: *Speakers-High Range - 3 Door*

Location: *Behind front door trim panel*



YPC113010

Colour: *NATURAL*

Gender: *Female*

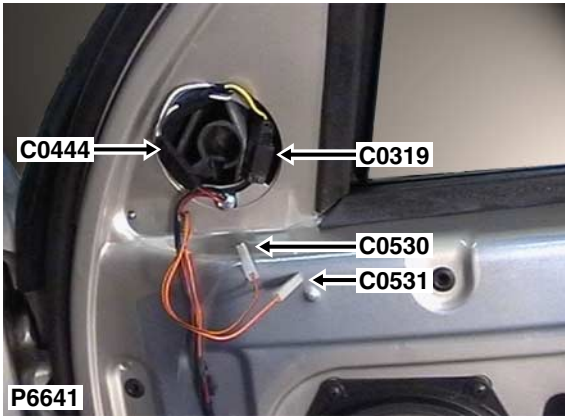

Cav	Col	Cct
1	OK	8

Description: *Speakers-High Range - 5 Door*

Location: *Behind front door trim panel*



YPC113010

Colour: *NATURAL*

Gender: *Female*

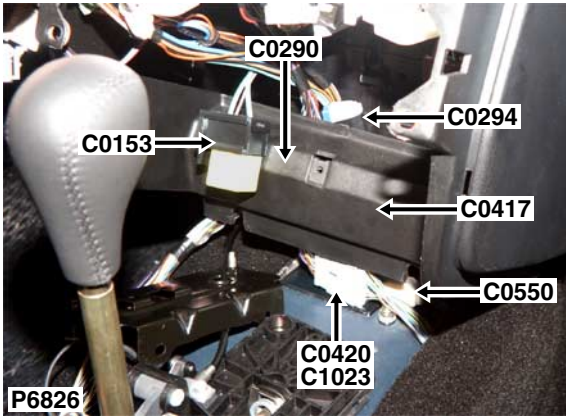

Cav	Col	Cct
1	B	6
2	B	6
3	B	6
4	B	6
5	B	6
7	B	6
8	B	6
9	B	6
10	B	6

Description: *Header -Earth*

Location: *Behind centre console*

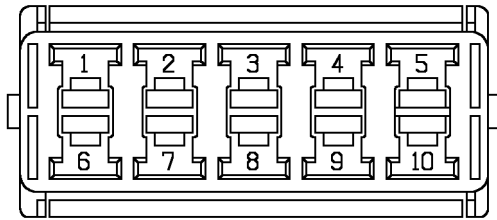

YPC10611

Colour: *LIGHT GREY*

Gender: *Female*

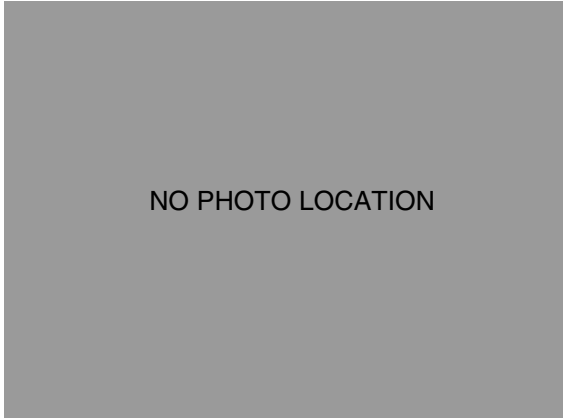

Cav	Col	Cct
1	B	ALL
2	B	ALL
3	B	ALL
4	B	ALL
5	B	ALL
6	B	ALL
7	B	ALL
8	B	ALL
9	B	ALL

Description: *Header -Earth - KV6*

Location: *LH side of engine compartment*

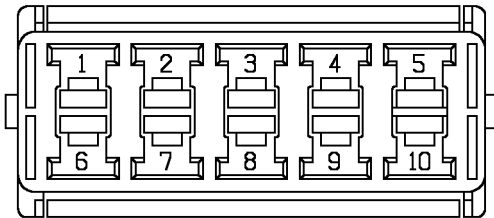

YPC10611

Colour: *LIGHT GREY*

Gender: *Female*

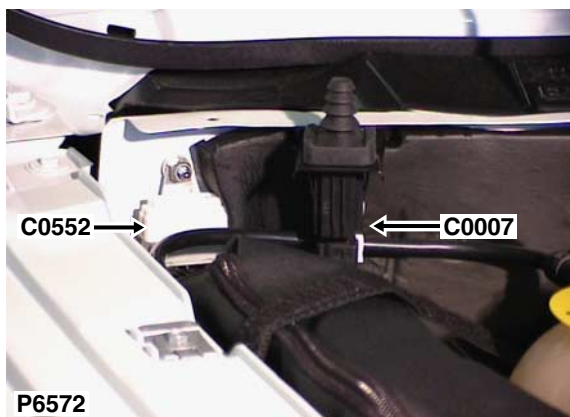

Cav	Col	Cct
1	B	ALL
2	B	ALL
3	B	ALL
4	B	ALL
5	B	ALL
6	B	ALL

Description: *Header -Earth*

Location: *RH side of engine compartment*

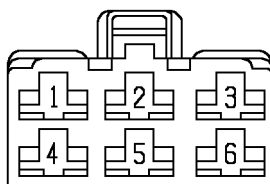

YPC10004

Colour: *NATURAL*

Gender: *Female*

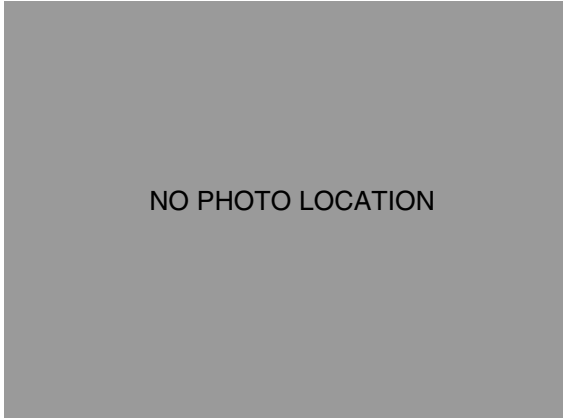

Cav	Col	Cct
1	B	5
2	B	5
3	B	5
4	B	5
5	B	5

Description: *Header -Earth - 3 Door*

Location: *Behind centre console*

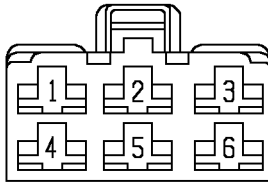

YPC10004

Colour: *NATURAL*

Gender: *Female*

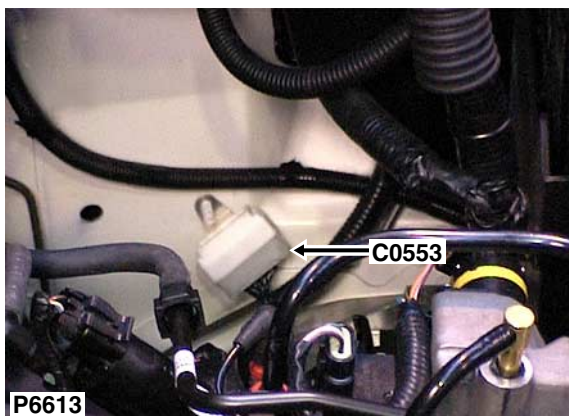

Cav	Col	Cct
1	B	ALL
2	B	ALL
3	B	ALL
4	B	ALL

Description: *Header -Earth - NAS*

Location: *Beneath engine compartment fusebox*

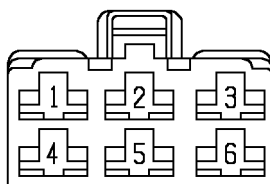

YPC10004

Colour: *NATURAL*

Gender: *Female*



Cav	Col	Cct
1	B	ALL

Description: *Earth - 3 Door*

Location: *Rear of luggage compartment - LH side*

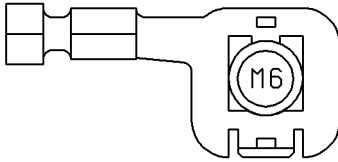

YPG10052

Colour: *TIN-PLATE*

Gender: *Female*

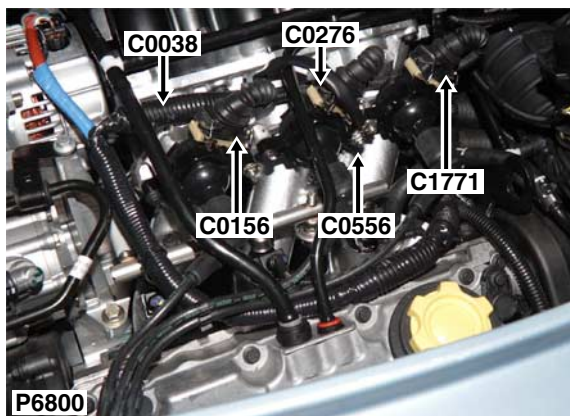

Cav	Col	Cct
1	B	ALL

Description: *Earth - NAS*

Location: *Top of engine*

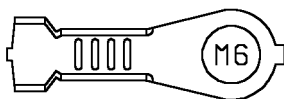

YPG10014

Colour: *TIN-PLATE*

Gender: *Female*



Cav	Col	Cct
1	B	ALL

Description: *Earth*

Location: *Rear of luggage compartment - LH side*

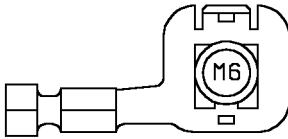

YPG 10053

Colour: *TIN-PLATE*

Gender: *Female*

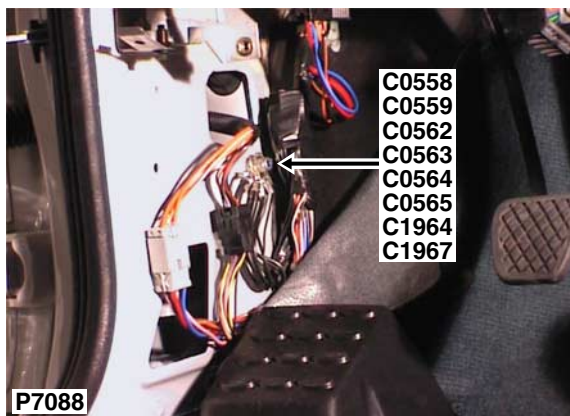

Cav	Col	Cct
1	B	26

Description: *Earth - Td4 & NAS KV6*

Location: *Base of driver side 'A' post*

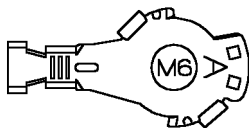

YPG101400

Colour: *TIN-PLATE*

Gender: *Female*

Cav	Col	Cct
1	B	ALL

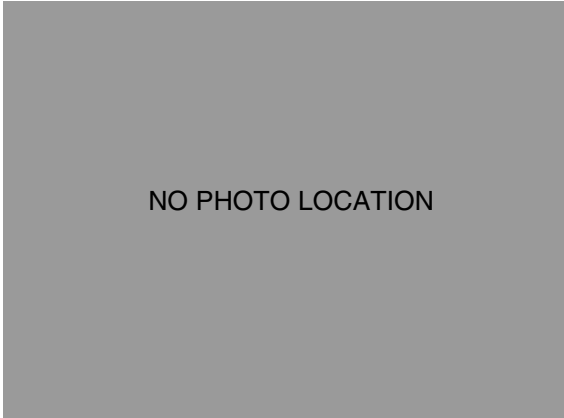

Description: *Earth - KV6*

Location: *Top of engine*

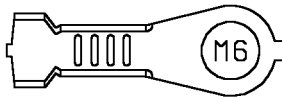

YPG10014

Colour: *TIN-PLATE*

Gender: *Female*

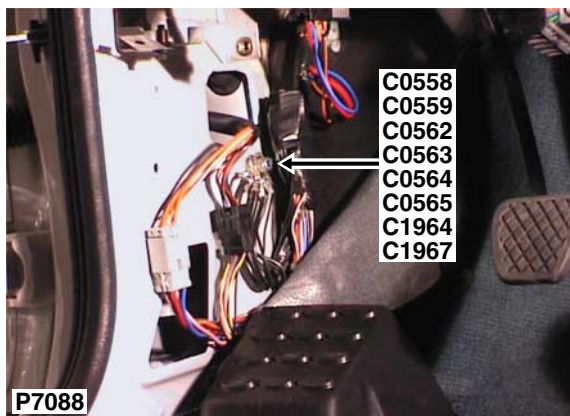

Cav	Col	Cct
1	B	18

Description: *Earth*

Location: *Base of LH 'A' post*

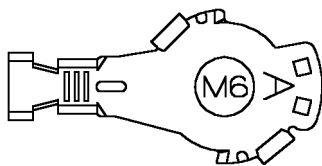

YPG101390

Colour: *TIN-PLATE*

Gender: *Female*

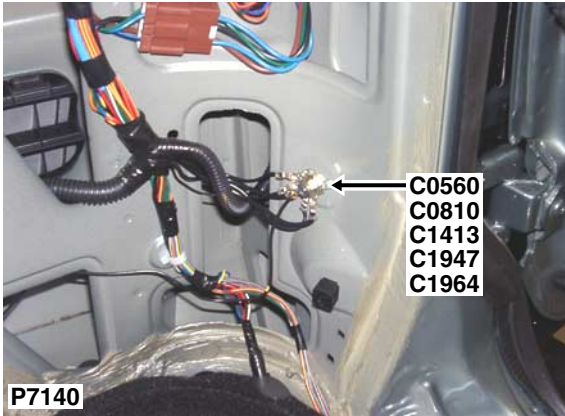

Cav	Col	Cct
1	B	ALL

Description: *Earth*

Location: *Luggage compartment - RH side*

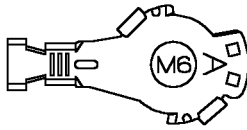

YPG101400

Colour: *TIN-PLATE*

Gender: *Female*

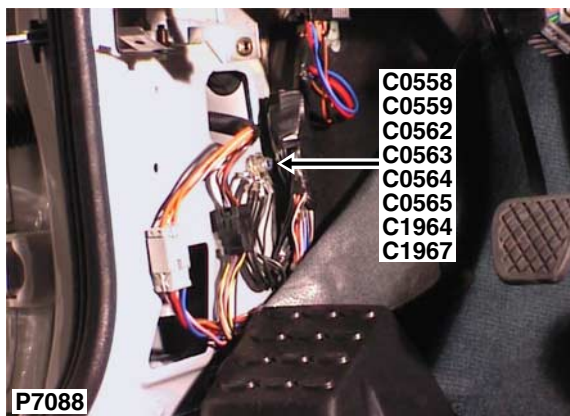

Cav	Col	Cct
1	B	ALL

Description: *Earth*

Location: *Base of LH 'A' post*

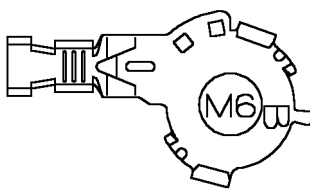

YPG101410

Colour: *TIN-PLATE*

Gender: *Female*

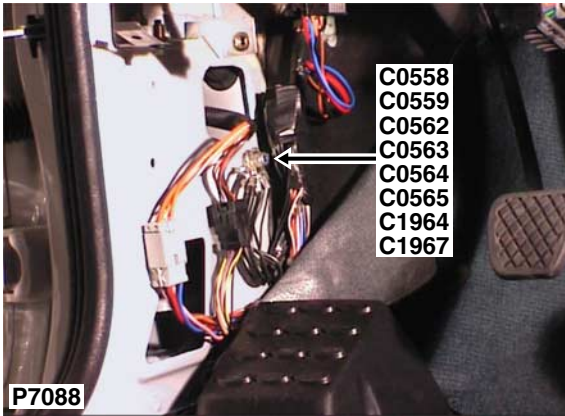

Cav	Col	Cct
1	B	ALL

Description: *Earth*

Location: *Base of LH 'A' post*

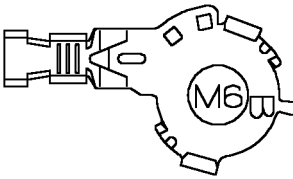

YPC101420

Colour: *TIN-PLATE*

Gender: *Female*

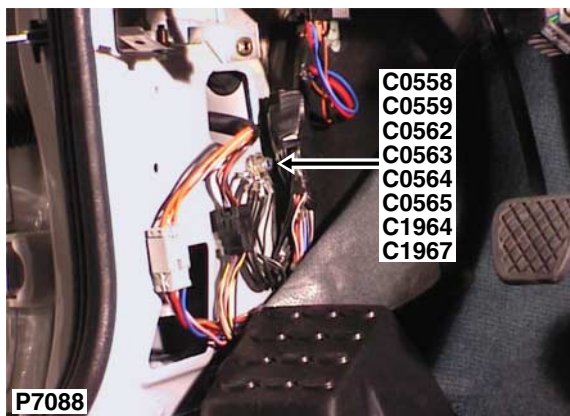

Cav	Col	Cct
1	B	ALL

Description: *Earth*

Location: *Base of LH 'A' post*

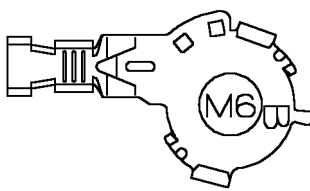

YPG101410

Colour: *TIN-PLATE*

Gender: *Female*

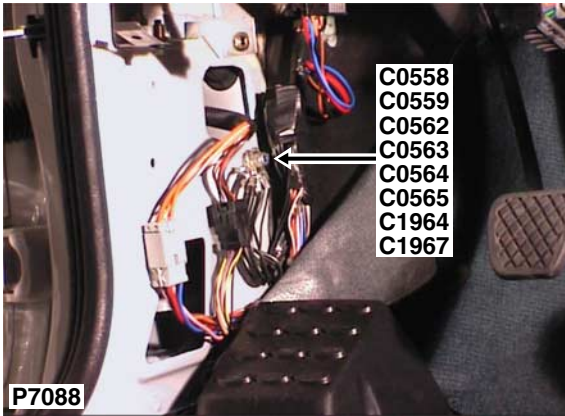

Cav	Col	Cct
1	B	ALL

Description: *Earth*

Location: *Base of LH 'A' post*

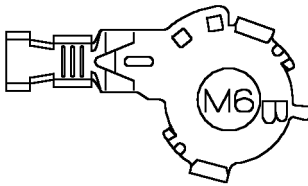

YPG101410

Colour: *TIN-PLATE*

Gender: *Female*

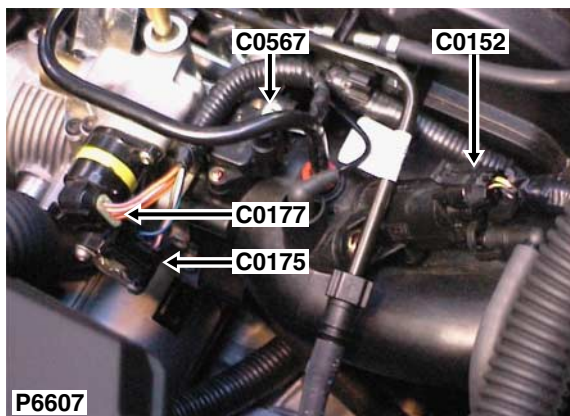

Cav	Col	Cct
A	BS	ALL
B	KO	ALL
C	YW	ALL
D	GW	ALL

Description: *Sensor-Inlet Air Temperature (IAT) and Manifold Absolute Pressure (MAP)*

Location: *Top of engine*

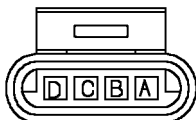

YPC117460

Colour: *BLACK*

Gender: *Female*

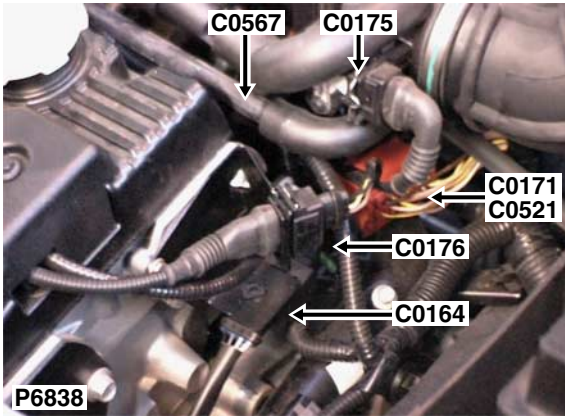

Cav	Col	Cct
A	KB	ALL
B	YW	ALL
C	YP	ALL
D	RG	ALL

Description: *Sensor-Inlet Air Temperature (IAT) and Manifold Absolute Pressure (MAP) - K1.8*

Location: *Top of engine*

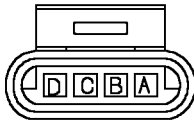

YPC117460

Colour: *BLACK*

Gender: *Female*

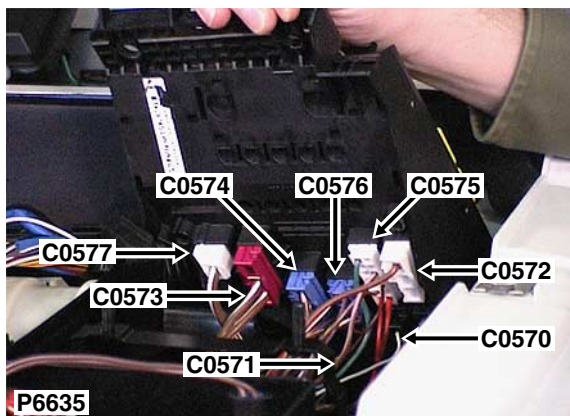

Description: *Fuse box-Engine compartment*

Location: *Beneath engine compartment fusebox*

Cav	Col	Cct
1	NK	ALL
2	N	ALL
3	NR	ALL
5	UN	ALL
6	PB	ALL

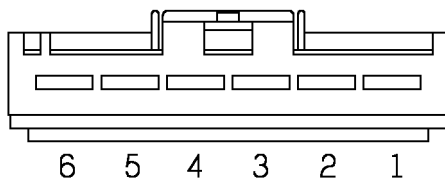

YPC115260

Colour: *BLACK*

Gender: *Female*

C0571

CONNECTOR DETAILS

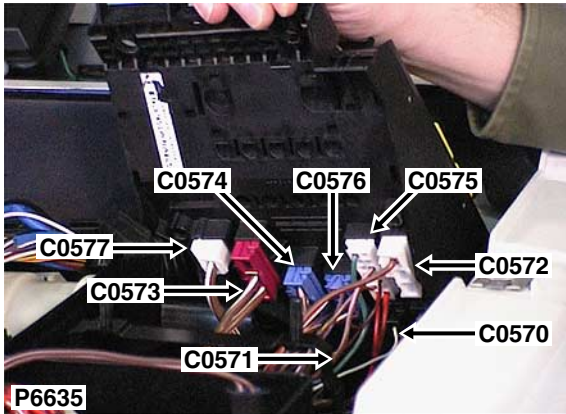

Cav	Col	Cct
1	W	4
2	NR	ALL
3	N	ALL

Description: *Fuse box-Engine compartment*

Location: *Beneath engine compartment fusebox*

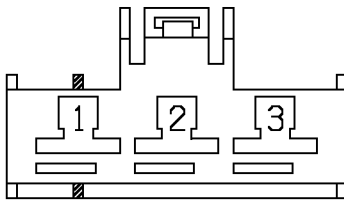

YPC115390

Colour: *BLACK*

Gender: *Female*

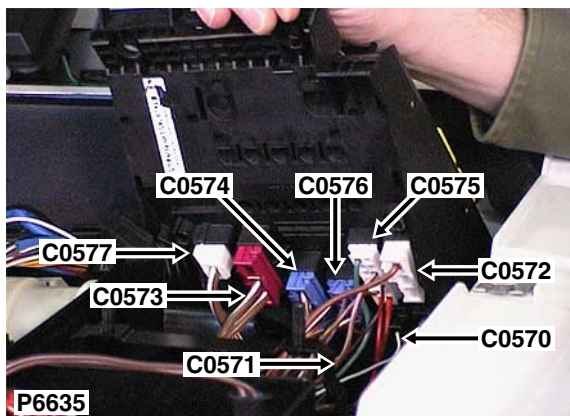

Cav	Col	Cct
1	NR	ALL
2	NK	4
3	WP	ALL

Description: *Fuse box-Engine compartment*

Location: *Beneath engine compartment fusebox*

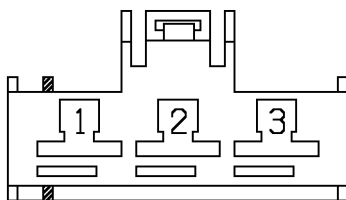

YPC115400

Colour: *NATURAL*

Gender: *Female*

C0573

CONNECTOR DETAILS

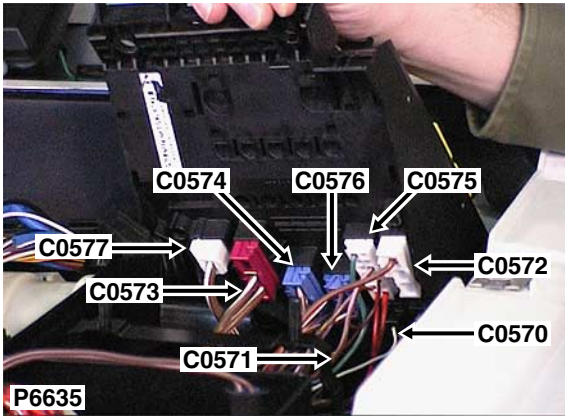

Cav	Col	Cct
2	NG	34
3	SU	18
3	NG	34

Description: *Fuse box-Engine compartment*

Location: *Beneath engine compartment fusebox*

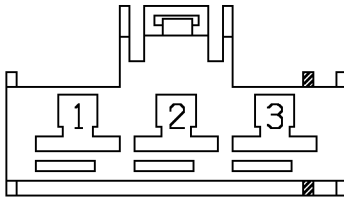

YPC115420

Colour: *PURPLE*

Gender: *Female*

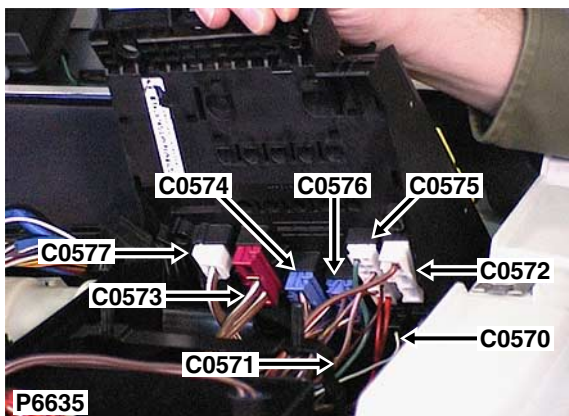

Cav	Col	Cct
1	NK	ALL
2	NW	ALL

Description: *Fuse box-Engine compartment*

Location: *Beneath engine compartment fusebox*

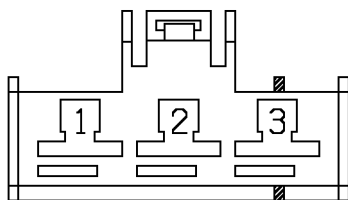

YPC115410

Colour: *BLUE*

Gender: *Female*

C0575

CONNECTOR DETAILS

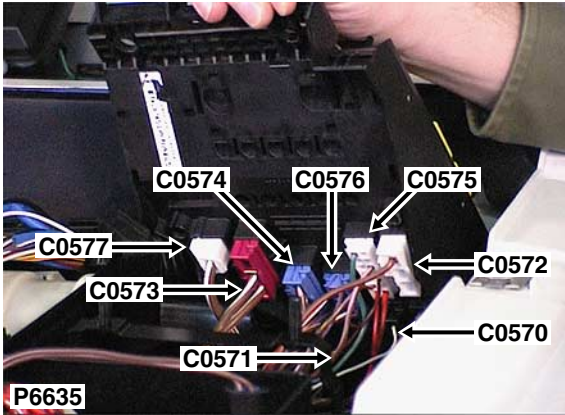

Description: Fuse box-Engine compartment

Location: Beneath engine compartment fusebox

Cav	Col	Cct
1	G	ALL
2	GU	ALL
3	W	30
4	NK	ALL
5	R	28
6	NY	30
7	WN	30
8	NK	23
9	BP	ALL
12	RN	ALL

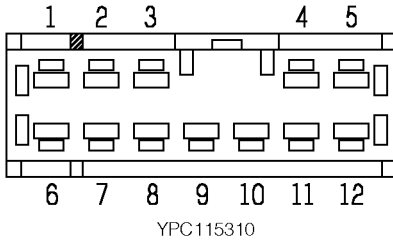

Colour: NATURAL

Gender: Female

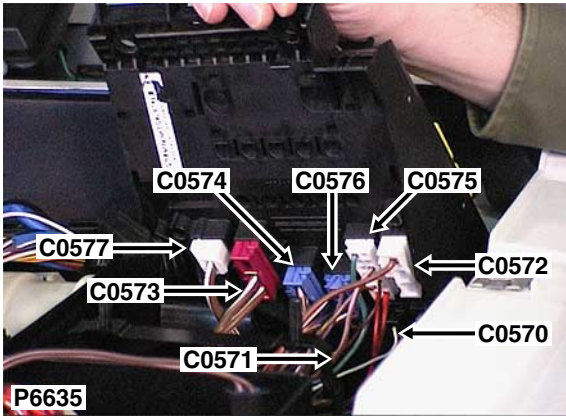

Description: *Fuse box-Engine compartment*
 Location: *Beneath engine compartment fusebox*

Cav	Col	Cct
1	RW	ALL
2	UG	ALL
3	GN	ALL
4	PY	ALL
5	B	4
6	NG	ALL
6	PN	17
7	B	ALL
8	PB	ALL
9	WK	ALL
10	NK	ALL
10	RW	17
11	UB	ALL
12	NO	ALL

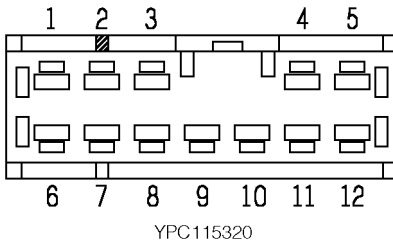

Colour: *BLUE*
 Gender: *Female*

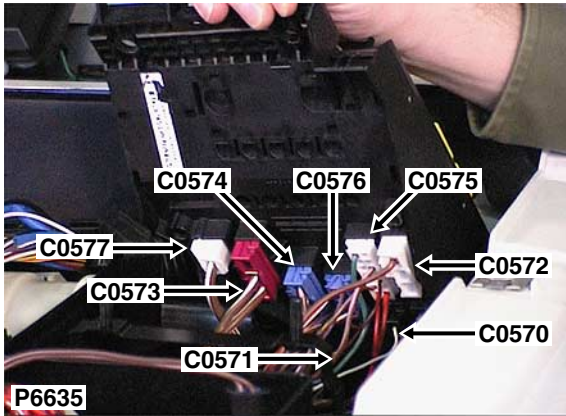

Cav	Col	Cct
1	NW	17

Description: *Fuse box-Engine compartment*

Location: *Beneath engine compartment fusebox*

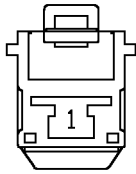

YPC109810

Colour: *WHITE*

Gender: *Female*

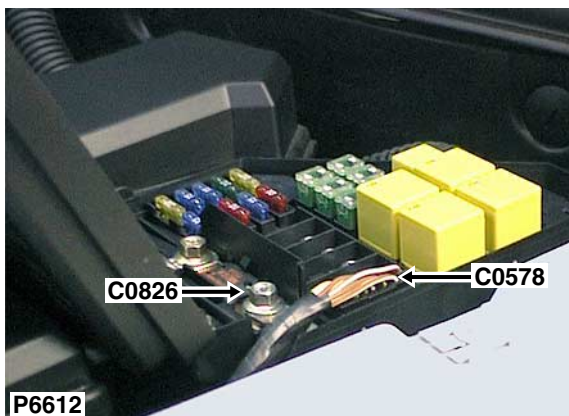

Description: *Fuse box-Engine compartment - K1.8*

Location: *Rear LH side of engine compartment*

Cav	Col	Cct
1	NK	ALL
2	NK	ALL
5	NU	ALL
6	R	ALL
7	WN	ALL
8	NY	ALL
10	W	ALL
11	NU	ALL

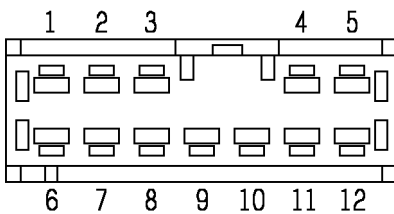

YPC115300

Colour: *BLACK*

Gender: *Female*

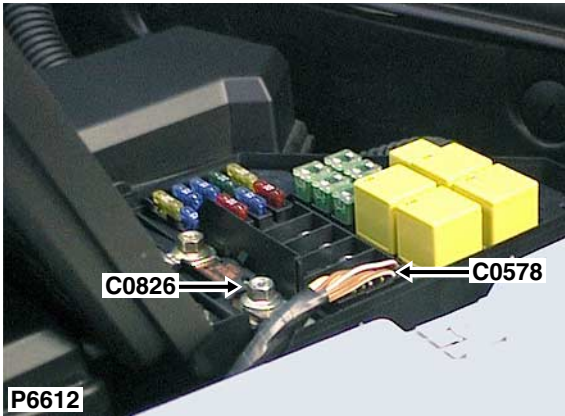

Cav	Col	Cct
1	NK	ALL
2	NK	ALL
3	NP	ALL
5	YU	ALL
7	WN	ALL
8	NY	ALL
9	WK	ALL
10	W	ALL
11	YG	ALL
12	BR	ALL

Description: Fuse box-Engine compartment - KV6

Location: Rear LH side of engine compartment

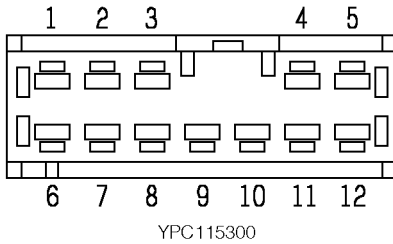

Colour: BLACK

Gender: Female

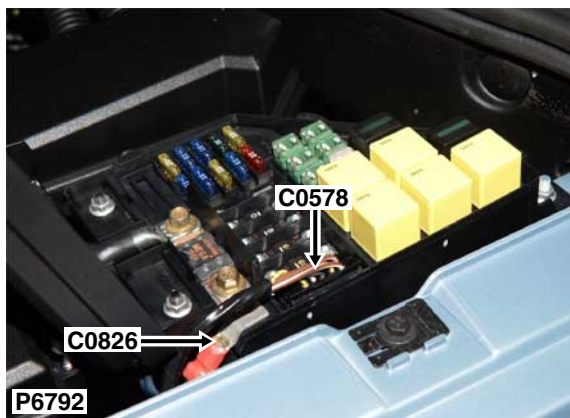

Cav	Col	Cct
2	NK	ALL
5	YU	ALL
7	WN	ALL
8	NY	ALL
9	NG	ALL
10	W	ALL
11	YG	ALL

Description: *Fuse box-Engine compartment - NAS*

Location: *Rear LH side of engine compartment*

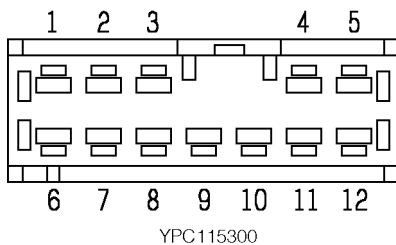

Colour: *BLACK*

Gender: *Female*

C0580

CONNECTOR DETAILS

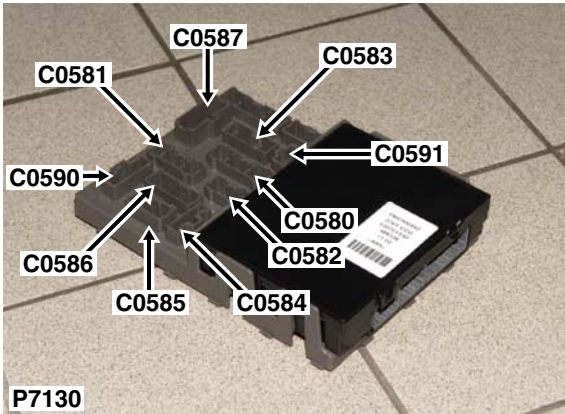

Description: *Fuse box-Passenger compartment*

Location: *Behind passenger compartment fusebox*

Cav	Col	Cct
1	WN	ALL
2	RO	ALL
3	RO	ALL
4	GR	ALL
5	P	ALL
6	R	ALL
7	LGN	ALL
8	G	ALL
9	NO	ALL
10	GR	ALL
11	GR	ALL
12	GR	ALL
13	BW	ALL
14	P	ALL
15	RB	ALL
16	LGW	ALL
17	LGN	ALL
18	W	ALL

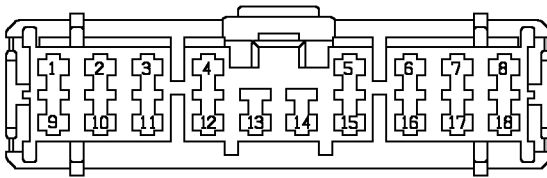

YPC10539

Colour: *LIGHT GREY*

Gender: *Female*

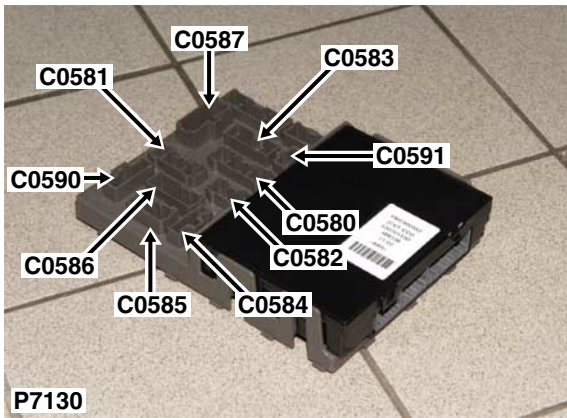

Description: *Fuse box-Passenger compartment*
 Location: *Behind passenger compartment fusebox*

Cav	Col	Cct
1	GR	25
2	RB	ALL
3	RB	ALL
4	W	ALL
5	UB	ALL
6	UK	ALL
7	NG	ALL
8	LG	ALL
9	GY	ALL
10	G	ALL
11	LG	ALL
12	G	ALL
13	G	ALL
14	WR	ALL

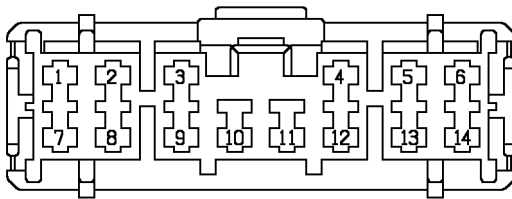

YPC10495

Colour: *LIGHT GREY*
 Gender: *Female*

C0582

CONNECTOR DETAILS

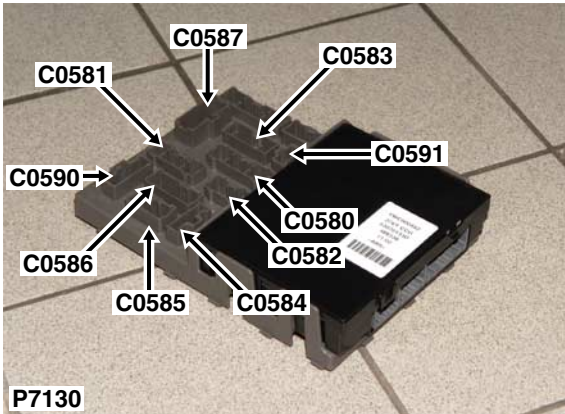

Cav	Col	Cct
1	PW	ALL
2	GW	ALL
3	GW	ALL
4	RG	25
5	G	ALL
6	GW	ALL
7	GW	ALL
8	KO	25
9	R	4
10	W	ALL

Description: *Fuse box-Passenger compartment*

Location: *Behind passenger compartment fusebox*

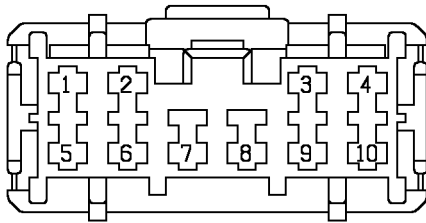

YPC10534

Colour: *LIGHT GREY*

Gender: *Female*

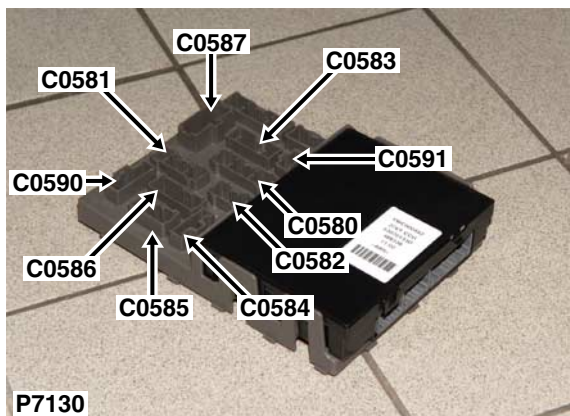

Cav	Col	Cct
1	W	ALL
2	UO	ALL
3	U	6
4	N	ALL
5	GU	6
6	PN	ALL
7	NG	ALL
8	PR	ALL
9	R	6
10	GR	6

Description: Fuse box-Passenger compartment

Location: Behind passenger compartment fusebox

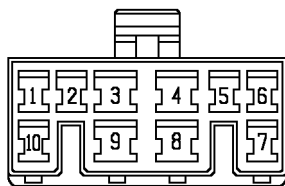

YPC10048

Colour: NATURAL

Gender: Female

C0584

CONNECTOR DETAILS

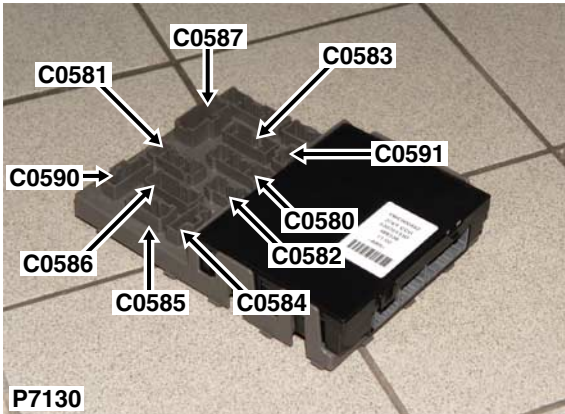

Cav	Col	Cct
1	P	ALL
2	UG	ALL
3	PN	ALL

Description: Fuse box-Passenger compartment

Location: Behind passenger compartment fusebox

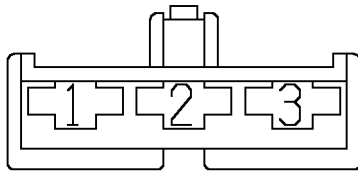

YPC10579

Colour: BROWN

Gender: Female

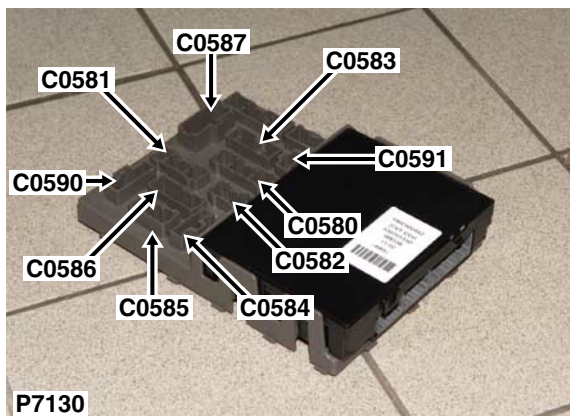

Cav	Col	Cct
1	N	ALL
2	SR	ALL
3	PR	ALL
4	SO	ALL
4	RG	5
5	G	ALL

Description: *Fuse box-Passenger compartment*

Location: *Behind passenger compartment fusebox*

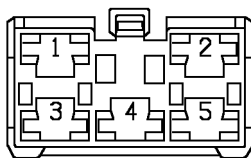

YPC10462

Colour: *BROWN*

Gender: *Female*

C0586

CONNECTOR DETAILS

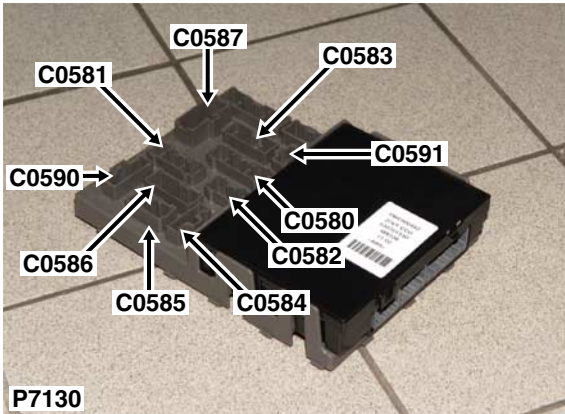

Cav	Col	Cct
1	OR	6
2	UW	ALL
3	OU	6
4	RG	5
4	SO	5
4	OU	6
5	RY	ALL
6	RB	5
6	OR	6
7	B	ALL

Description: Fuse box-Passenger compartment

Location: Behind passenger compartment fusebox

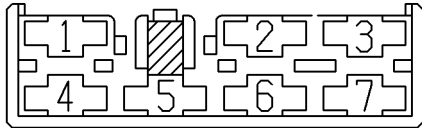

YPC10473

Colour: *BROWN*

Gender: *Female*

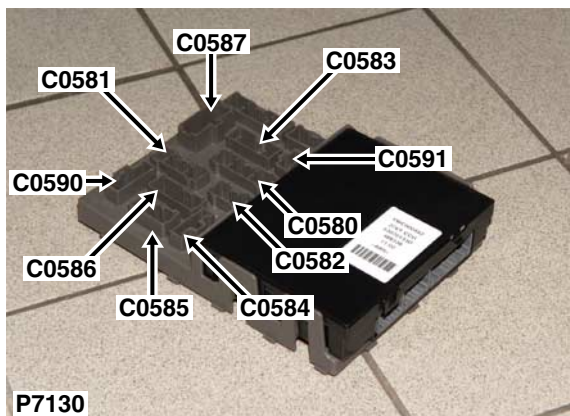

Description: *Fuse box-Passenger compartment*

Location: *Behind passenger compartment fusebox*

Cav	Col	Cct
1	NW	ALL
2	B	ALL
3	N	ALL
5	R	ALL
7	UO	ALL

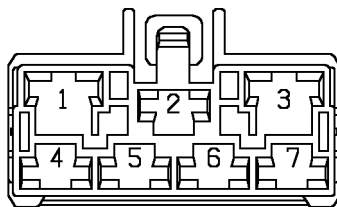

YPC10480

Colour: *BROWN*

Gender: *Female*

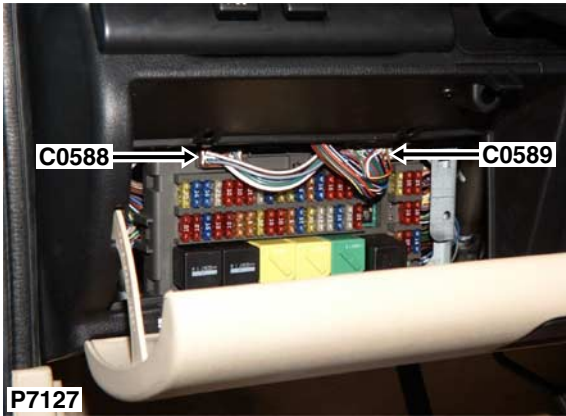

Cav	Col	Cct
1	PS	ALL
2	NW	ALL
3	G	ALL
4	WR	ALL
5	SU	ALL

Description: Fuse box-Passenger compartment

Location: Behind passenger compartment fusebox cover

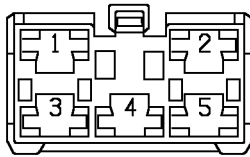

YPC10462

Colour: *BROWN*

Gender: *Female*

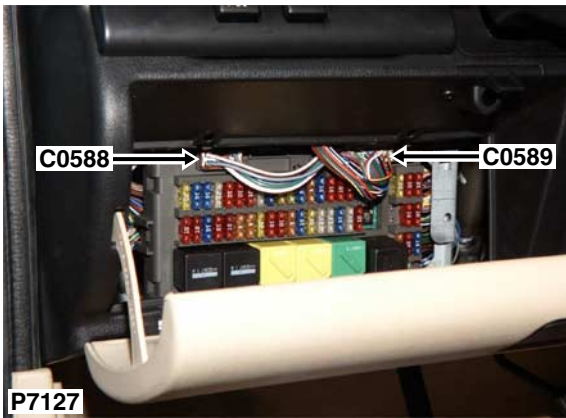

Description: *Fuse box-Passenger compartment*
 Location: *Behind passenger compartment fusebox cover*

Cav	Col	Cct
1	RY	ALL
2	WN	ALL
3	RG	ALL
4	UK	ALL
5	PB	ALL
6	GY	ALL
7	RP	ALL
8	GP	ALL
9	RB	ALL
10	GR	ALL
11	R	ALL
12	B	ALL
13	B	4
14	G	ALL
15	GW	ALL
16	BW	ALL
17	RB	15
17	RO	20
18	P	ALL
19	G	ALL
20	UG	ALL

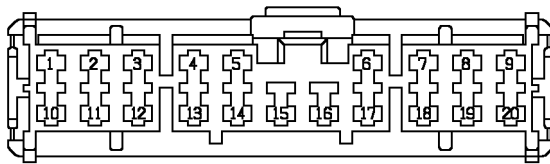

YPC10498

Colour: *LIGHT GREY*
 Gender: *Female*

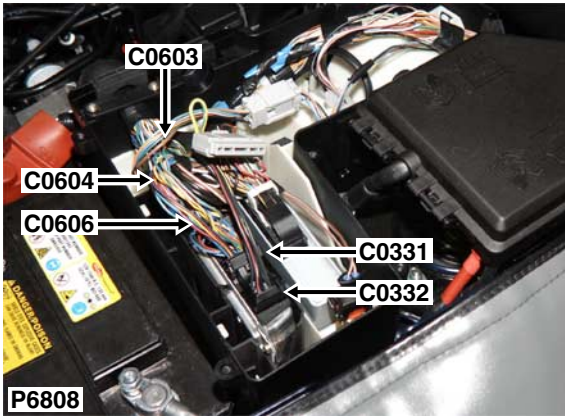

Description: *Engine control module (ECM)*

Location: *Inside E-box*

Cav	Col	Cct
1	W	4
1	NK	17
3	K	17
4	B	26
5	B	26
6	B	26
7	NG	4
7	W	17
8	NK	ALL
9	NK	4
9	WK	17

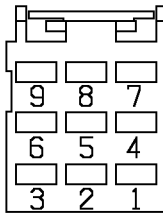

YPC108920

Colour: *BLACK*

Gender: *Female*

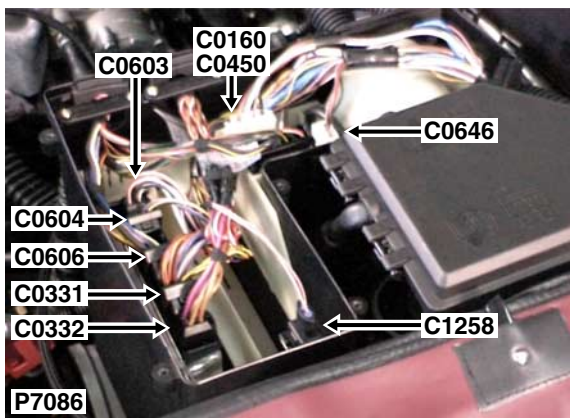

Cav	Col	Cct
9	PG	17
10	BG	17
17	GS	17

Description: *Engine control module (ECM) - Td4*
 Location: *Inside E-box*

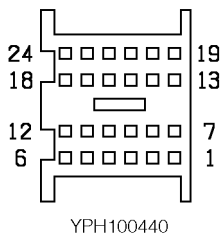

Colour: *BLACK*
 Gender: *Female*

C0604

CONNECTOR DETAILS

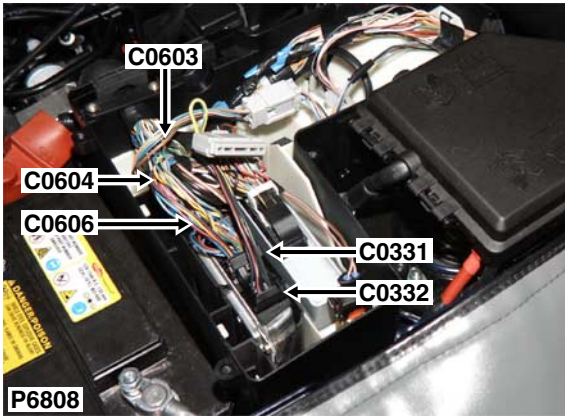

Description: *Engine control module (ECM) - NAS*
Location: *Inside E-box*

Cav	Col	Cct
1	UY	ALL
7	GY	ALL
13	GY	ALL
14	UN	ALL
15	GN	ALL
16	UN	ALL
18	GN	ALL
19	UY	ALL
20	BG	ALL
21	BG	ALL
22	BG	ALL
23	NG	ALL
24	BG	ALL

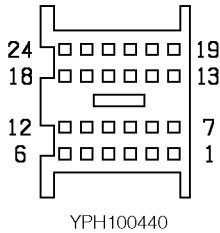

Colour: *BLACK*
Gender: *Female*

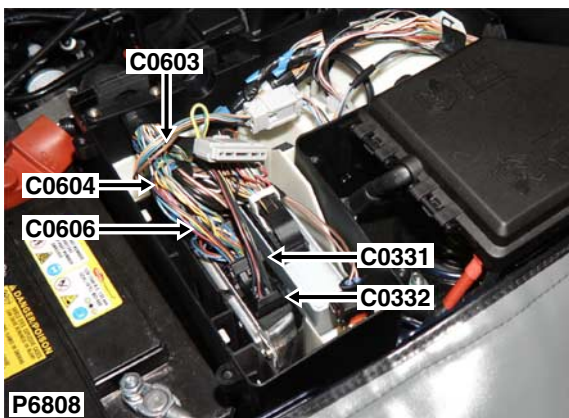

Description: *Engine control module (ECM) - NAS*
 Location: *Inside E-box*

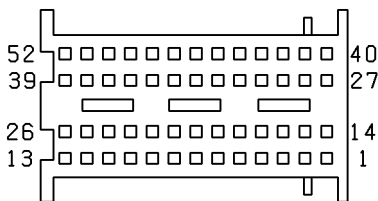

YPH100450

Colour: *BLACK*
 Gender: *Female*

Cav	Col	Cct
1	GW	ALL
5	UG	ALL
7	NW	ALL
8	WU	ALL
10	NU	ALL
11	SB	ALL
17	YW	ALL
18	BS	ALL
19	NP	ALL
20	NG	ALL
21	BS	ALL
22	OG	ALL
23	OS	ALL
24	KB	ALL
25	KG	ALL
29	BO	ALL
30	BK	ALL
31	LGS	ALL
32	BK	ALL
33	Y	ALL
34	YU	ALL
35	YP	ALL
36	YN	ALL
37	YG	ALL
38	YR	ALL
42	BO	ALL
43	NB	ALL
44	GW	ALL
48	B	ALL
49	BG	ALL
51	BG	ALL

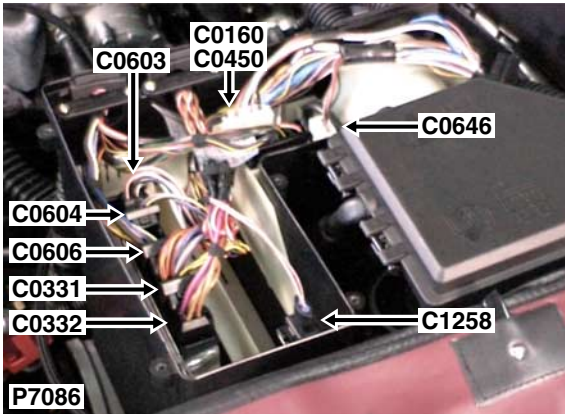

Description: *Engine control module (ECM) - Td4*

Location: *Inside E-box*

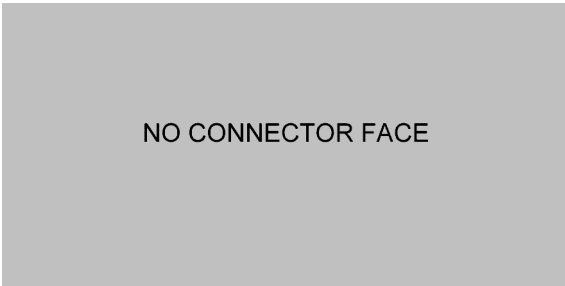

Colour: *BLACK*

Gender: *Female*

Cav	Col	Cct
1	RY	ALL
2	Y	ALL
3	B	ALL
4	Y	ALL
6	B	ALL
10	NS	ALL
12	BR	ALL
14	W	ALL
15	UY	ALL
16	NG	ALL
17	N	ALL
19	SCR	ALL
20	NG	ALL
23	NW	ALL
28	SU	ALL
29	UW	ALL
31	Y	ALL
32	NG	ALL
33	UB	ALL
35	WY	ALL
38	NU	ALL
41	NG	ALL
50	U	ALL

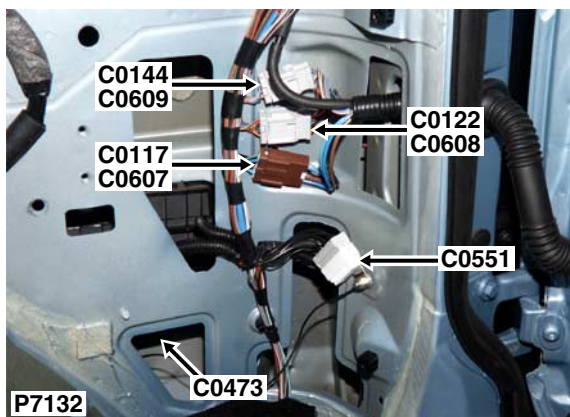

Cav	Col	Cct
1	UB	1
2	UG	1
3	N	1
4	B	1
5	G	1

Description: Tail door harness to main harness

Location: Rear of luggage compartment - RH side

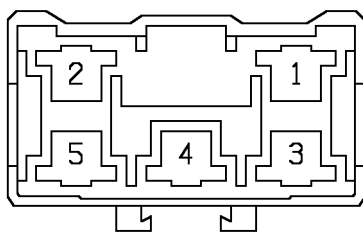

YPC10463

Colour: BROWN

Gender: Male

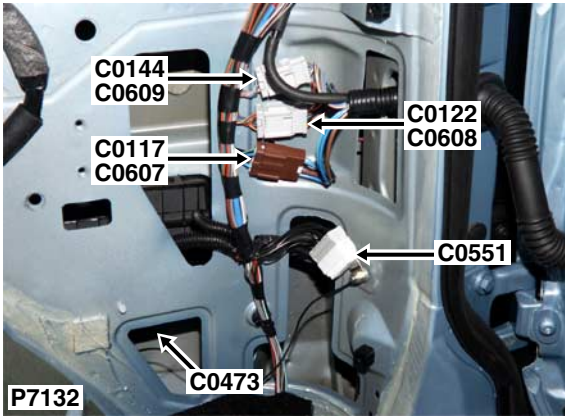

Cav	Col	Cct
1	ON	ALL
2	BO	ALL
3	RO	ALL
4	PU	ALL
5	GP	1
6	B	1
7	GR	1
8	OB	1

Description: *Tail door harness to main harness*

Location: *Rear of luggage compartment - RH side*

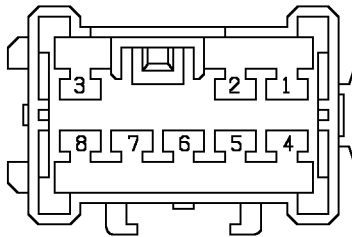

YPC10591

Colour: *LIGHT GREY*

Gender: *Male*

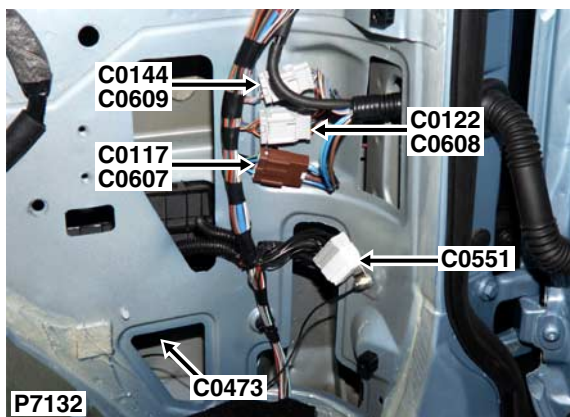

Cav	Col	Cct
1	KB	1
3	SR	1
4	SP	1
5	US	1
6	NG	1

Description: *Tail door harness to main harness*

Location: *Rear of luggage compartment - RH side*

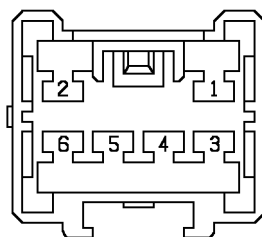

YPC10500

Colour: *LIGHT GREY*

Gender: *Male*

C0610

CONNECTOR DETAILS

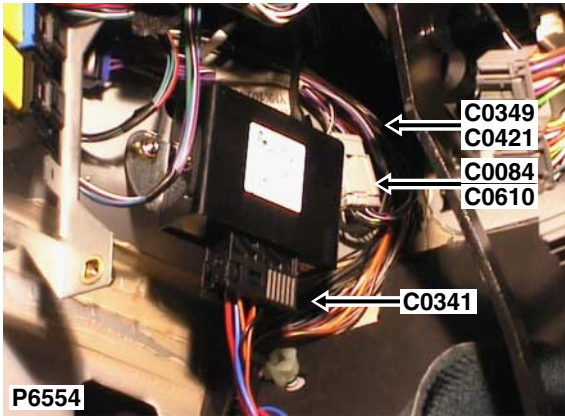

Cav	Col	Cct
1	P	ALL
2	PW	ALL
3	B	ALL
4	G	6
5	S	6
6	WB	ALL
7	NB	ALL
8	SW	ALL

Description: *Roof harness to main harness*

Location: *Behind driver side of fascia*

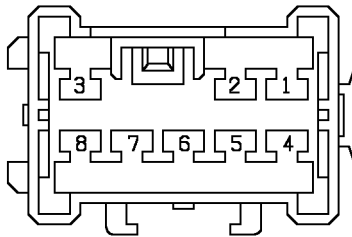

YPC10591

Colour: *LIGHT GREY*

Gender: *Male*

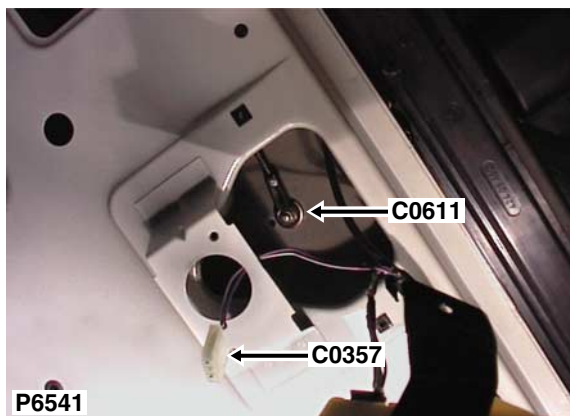

Cav	Col	Cct
1	B	5
2	SCR	5

Description: *Aerial*

Location: *Behind centre headlining*

NO CONNECTOR FACE

Colour:

Gender:

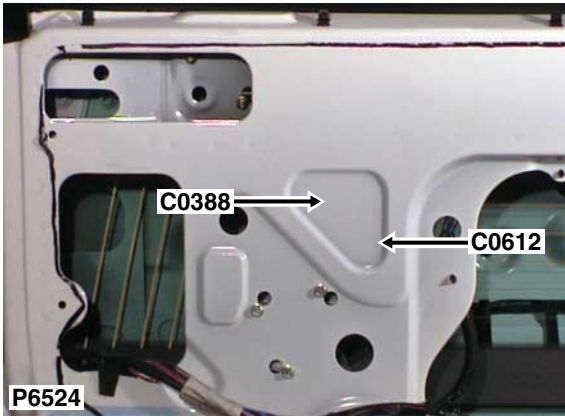

Cav	Col	Cct
1	KB	1
3	UG	1
4	SP	1
5	SR	1
6	UB	1

Description: *Motor-Window-Tail door*

Location: *Centre of taildoor, behind trim panel*

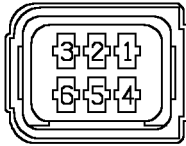

YPC115110

Colour: *BLACK*

Gender: *Female*



Description: *Lamp-brake-high mounted*

Location: *Behind lamp*

Cav	Col	Cct
1	B	1
2	GP	1

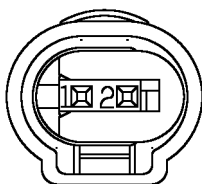

YPC116820

Colour: *BLACK*

Gender: *Female*

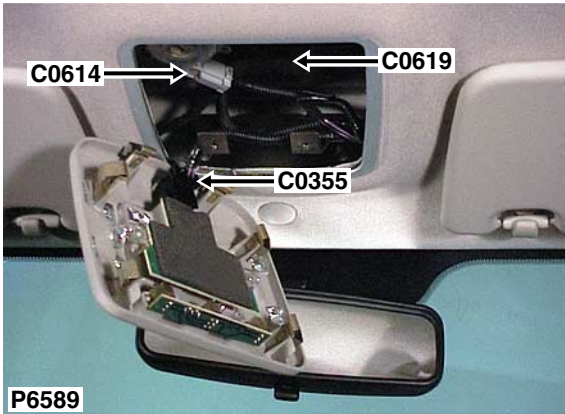

Cav	Col	Cct
1	S	6
2	G	6

Description: *Motor-Sunroof*

Location: *Front of headlining in the centre*

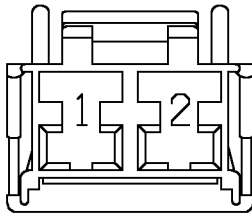

YPC10427

Colour: *LIGHT GREY*

Gender: *Female*

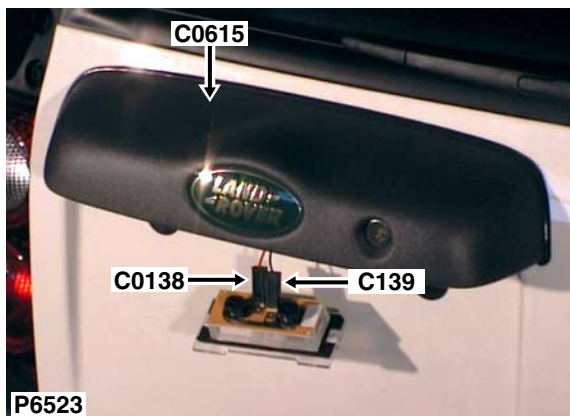

Description: *Switch-Tail door open*

Location: *Behind number plate lamp*

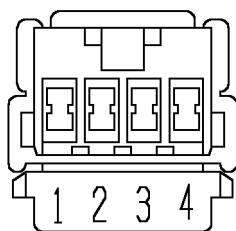

YPC10247

Colour: *BLACK*

Gender: *Female*

Cav	Col	Cct
1	B	1
2	ON	ALL
3	US	1

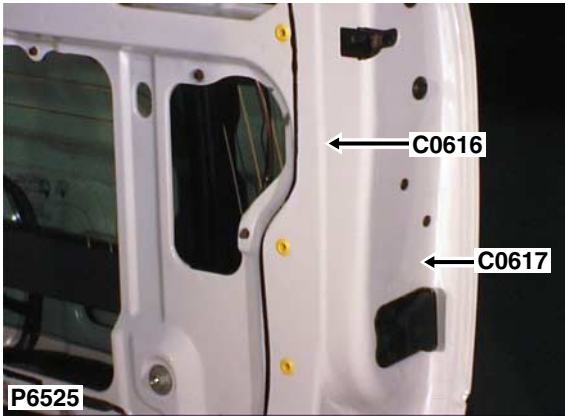

Cav	Col	Cct
1	B	1
2	BO	ALL

Description: *Switch-Boot/tail door*
Location: *LH side of taildoor*

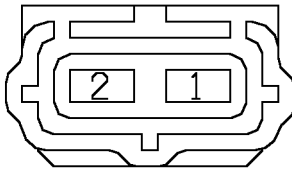

YPC10208

Colour: *BLUE*
Gender: *Female*

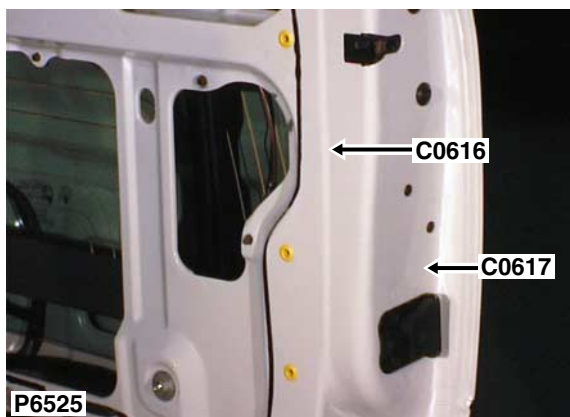

Cav	Col	Cct
1	PU	ALL
2	B	1

Description: *Motor-Lock-Tail door*

Location: *LH side of taildoor*

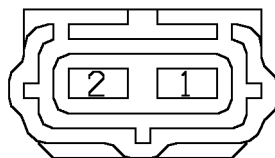

YPC10187

Colour: *WHITE*

Gender: *Female*

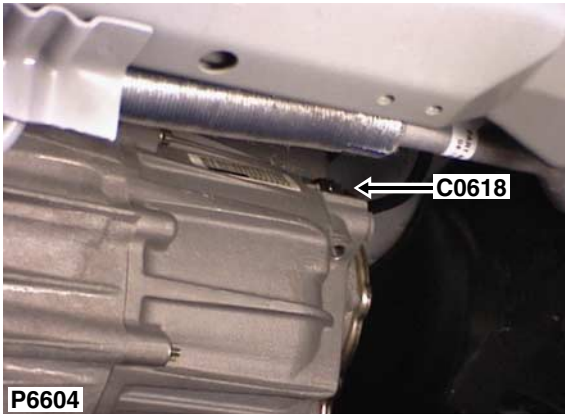

Cav	Col	Cct
1	RW	ALL
2	B	ALL

Description: *Switch-Hill descent (1st gear) - Td4*
Location: *Gearbox - Rear*

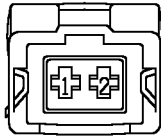

YPC107790

Colour: *BLACK*
Gender: *Female*

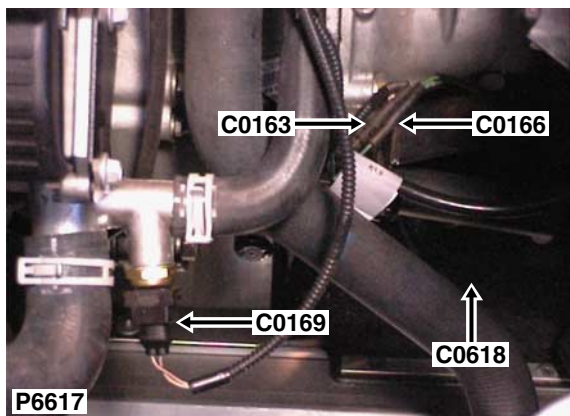

Cav	Col	Cct
1	GB	ALL
2	B	ALL

Description: *Switch-Hill descent (1st gear) - K1.8*
Location: *Gearbox - front*

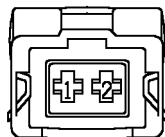

YPC107790

Colour: *BLACK*
Gender: *Female*

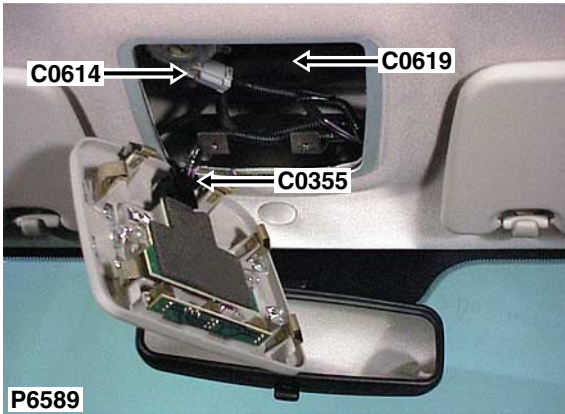

Cav	Col	Cct
1	B	6
2	SCR	6

Description: *Aerial*

Location: *Front of headlining in the centre*

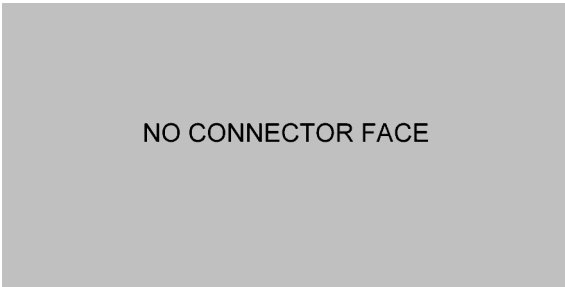

Colour:

Gender:

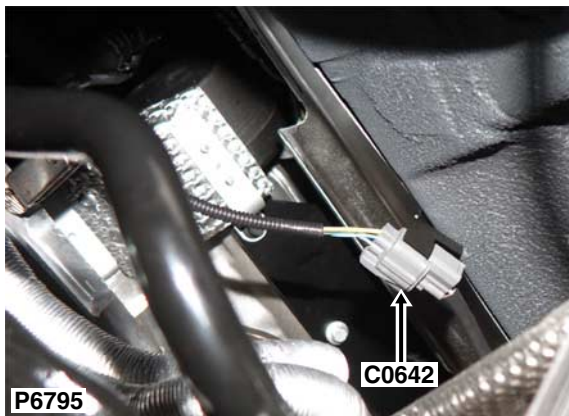

Cav	Col	Cct
1	BG	ALL
2	GN	ALL
3	YG	ALL
4	UY	ALL

Description: *Sensor-Oxygen-Even-Post catalyst - NAS*
 Location: *Lower RH rear of engine compartment*

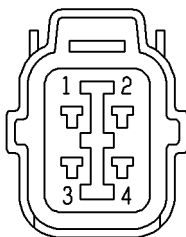

YPC10470

Colour: *GREY*
 Gender: *Female*

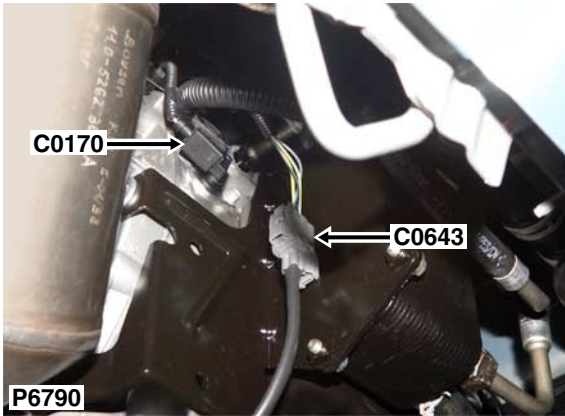

Cav	Col	Cct
1	BG	ALL
2	UN	ALL
3	YG	ALL
4	GY	ALL

Description: *Sensor-Oxygen-Odd-Post catalyst - NAS*
 Location: *Centre rear of engine*

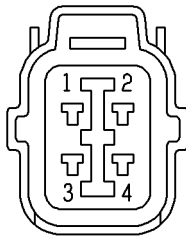

YPC10470

Colour: *GREY*
 Gender: *Female*

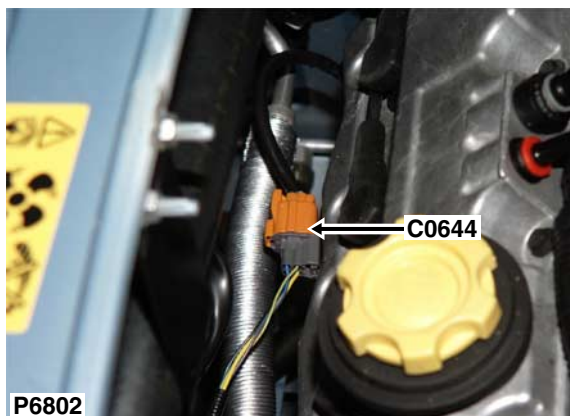

Cav	Col	Cct
1	BG	ALL
2	UN	ALL
3	YG	ALL
4	UY	ALL

Description: *Sensor-Oxygen-Odd-Pre-catalyst - NAS*
Location: *Front of engine compartment - centre*

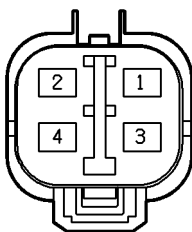

YPC113730

Colour: *ORANGE*
Gender: *Male*

C0645

CONNECTOR DETAILS

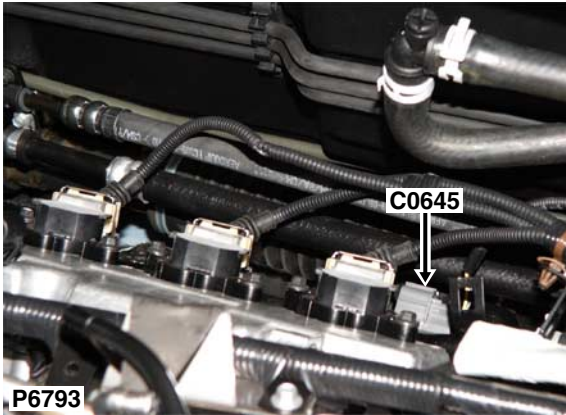

Cav	Col	Cct
1	BG	ALL
2	GN	ALL
3	YG	ALL
4	GY	ALL

Description: *Sensor-Oxygen-Even-Pre-catalyst - NAS*
Location: *Centre rear of engine*

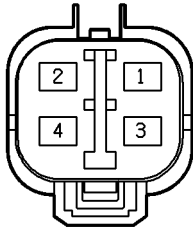

YPC113730

Colour: *ORANGE*
Gender: *Male*

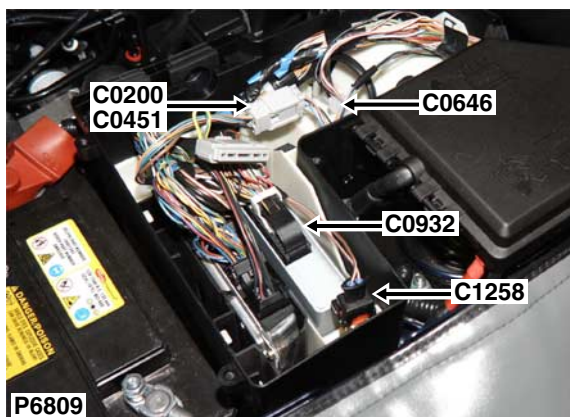

Cav	Col	Cct
1	B	28
2	WR	16
2	NR	17
3	NK	28

Description: *Fan-E-box*

Location: *Inside E-box*

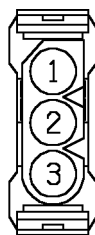

YPC112540

Colour: *NATURAL*

Gender: *Female*

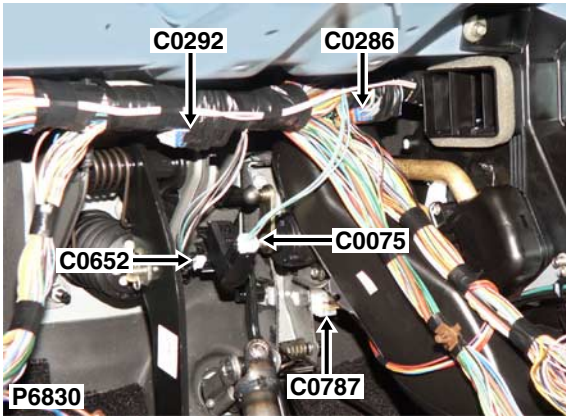

Cav	Col	Cct
1	W	28
2	B	28
3	GR	28
4	PG	ALL

Description: *Sensor-Brake pedal*

Location: *Driver's footwell*

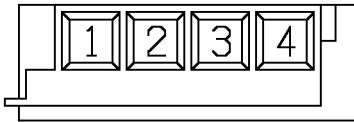

YPC117850

Colour: *NATURAL*

Gender: *Female*

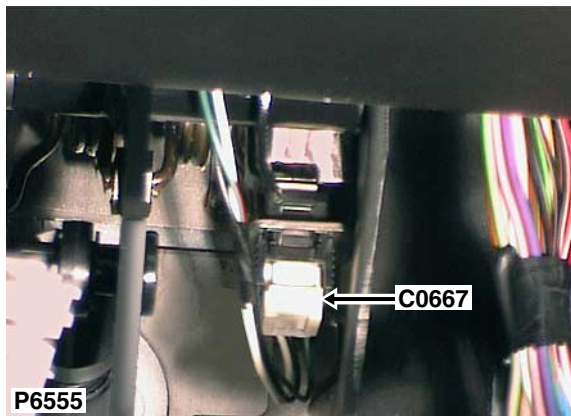

Cav	Col	Cct
1	W	36
2	B	36
4	GR	36

Description: *Switch-Clutch pedal*

Location: *Driver's footwell*

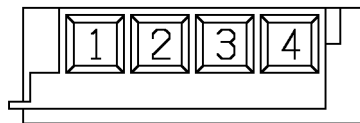

YPC117850

Colour: *NATURAL*

Gender: *Female*

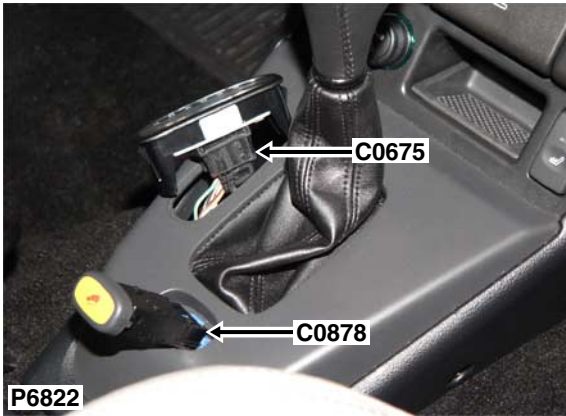

Description: *Selector-Automatic transmission*
 Location: *Beneath centre console*

Cav	Col	Cct
1	OB	ALL
2	GY	ALL
3	LGK	23
4	B	23
5	RO	ALL
7	RG	ALL
8	WB	ALL
9	RO	ALL
9	RW	25
10	WU	ALL
11	NG	23
12	KO	ALL

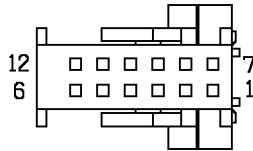

YPC111790

Colour: *BLACK*
 Gender: *Female*

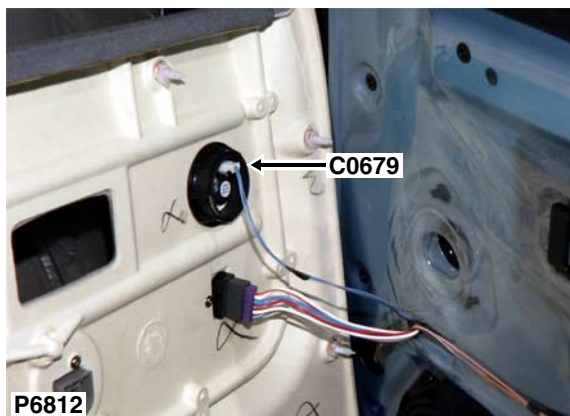

Cav	Col	Cct
2	UK	9
3	UB	9

Description: *Speakers-High Range*

Location: *Behind rear door trim panel*

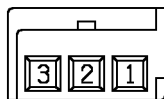

YPC117810

Colour: *WHITE*

Gender: *Female*

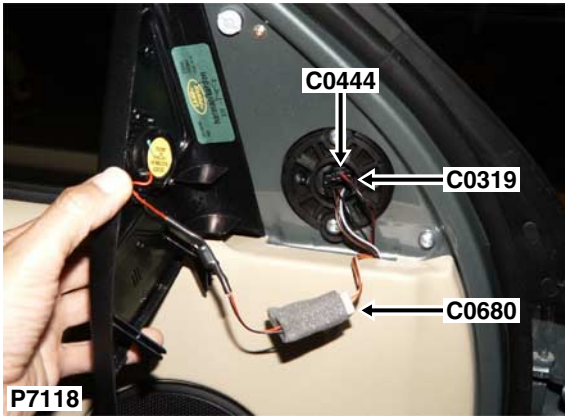

Cav	Col	Cct
1	OB	9
2	OK	9

Description: *Speakers-High Range - 3 Door*
 Location: *Behind front door trim panel*

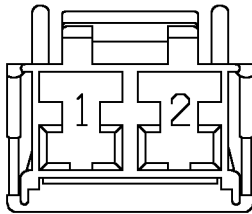

YPC10427

Colour: *LIGHT GREY*
 Gender: *Female*

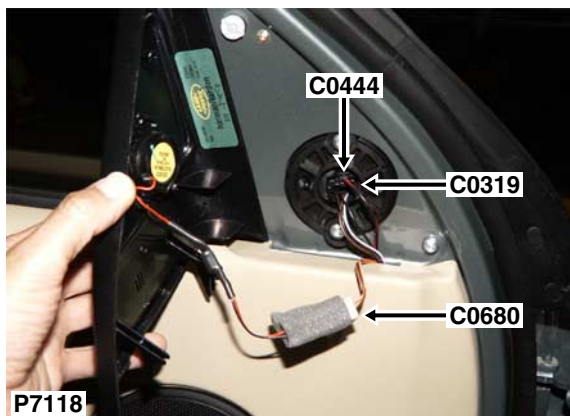

Cav	Col	Cct
1	OB	9
2	OK	9

Description: *Speakers-High Range - 5 Door*

Location: *Behind front door trim panel*

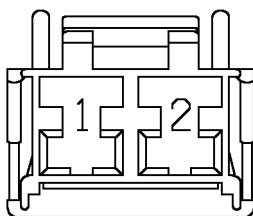

YPC10427

Colour: *LIGHT GREY*

Gender: *Female*

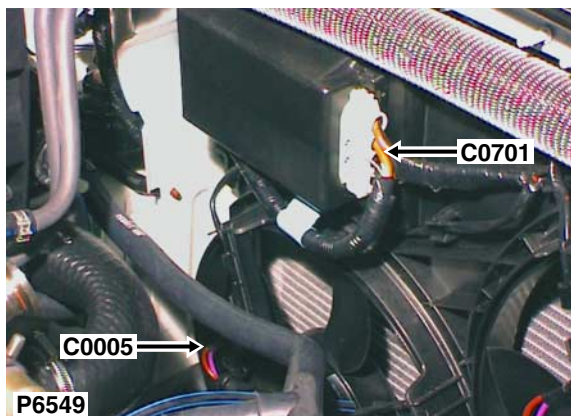

Cav	Col	Cct
1	U	ALL
2	W	ALL
3	GW	ALL
4	B	ALL

Description: *Control Unit-Cooling Fan*

Location: *Front of engine compartment - centre*

NO CONNECTOR FACE

Colour:

Gender:

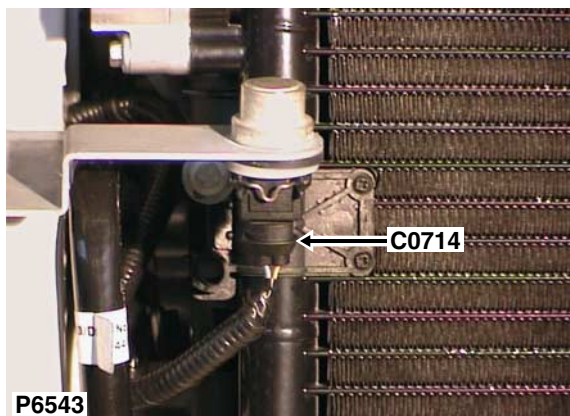

Cav	Col	Cct
1	NY	17
2	SG	17

Description: *Sensor-Air temperature-Fuel burning heater*
Location: *Behind centre of bumper*

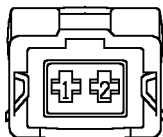

YPC107790

Colour: *BLACK*
Gender: *Female*

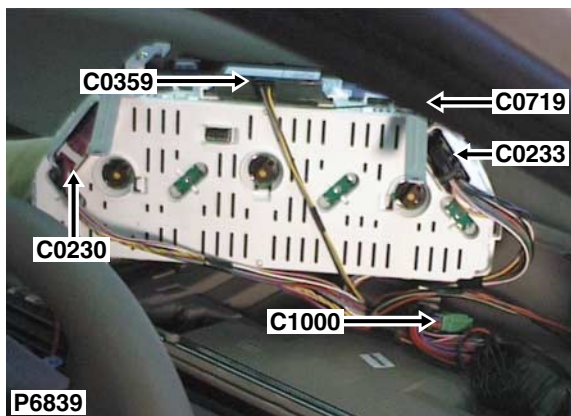

Cav	Col	Cct
1	B	ALL

Description: *Receiver-Radio frequency (RF)*

Location: *Behind instrument pack*

NO CONNECTOR FACE

Colour:
Gender:

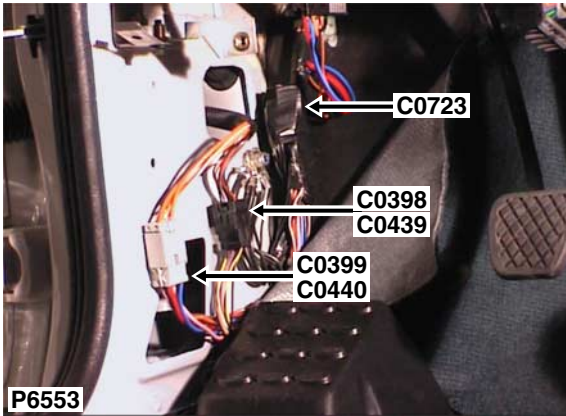

Description: *Header*

Location: *Base of driver side 'A' post*

Cav	Col	Cct
1	B	2
2	B	2
3	B	28
5	B	2
6	B	2
8	B	2
13	B	2
14	B	ALL
15	B	18
16	B	28
17	B	ALL
18	B	23
19	B	2
20	B	2

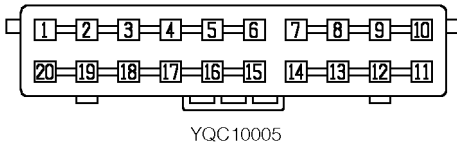

Colour: *BLUE*
 Gender: *Female*



Description: *Switch-Window-Rear*

Location: *Behind rear door trim panel*

Cav	Col	Cct
1	B	ALL
3	WU	ALL
4	SG	ALL
5	RO	ALL
7	WR	ALL

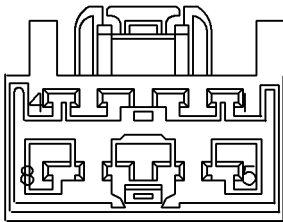

YPC901060

Colour: *GREEN*

Gender: *Female*

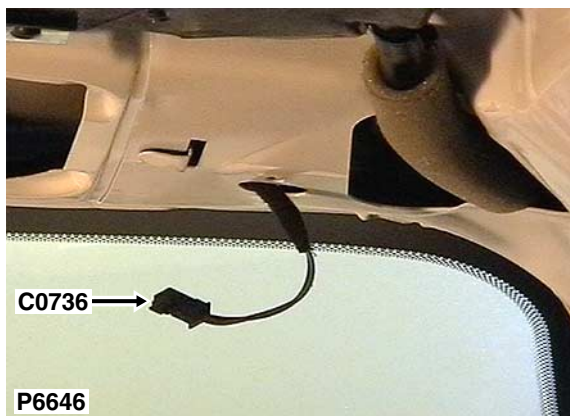

Cav	Col	Cct
1	P	ALL
2	B	ALL

Description: *Mirror-Vanity-RH*

Location: *Headlining - front RH side*

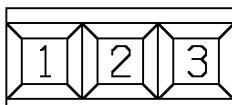

YPC117800

Colour: *BLACK*

Gender: *Female*

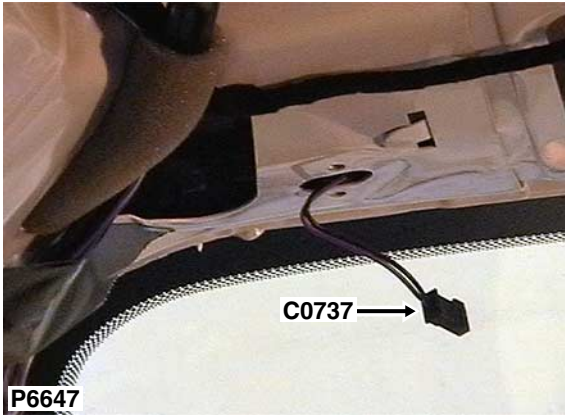

Cav	Col	Cct
1	P	6
2	B	6

Description: *Mirror-Vanity-LH*

Location: *Headlining - front LH side*

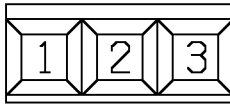

YPC117800

Colour: *BLACK*

Gender: *Female*

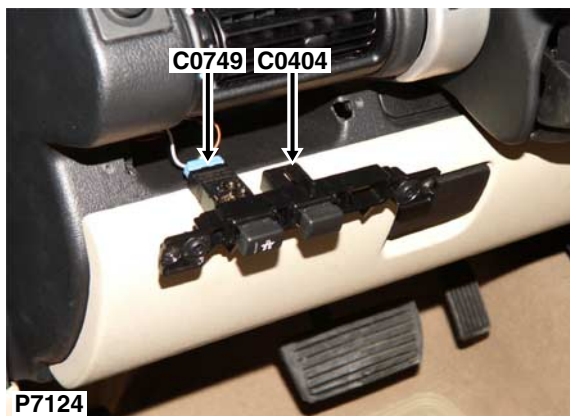

Description: *Switch-Cruise control*

Location: *Behind driver side of fascia*

Cav	Col	Cct
1	W	ALL
2	RO	ALL
4	WY	ALL
5	B	ALL

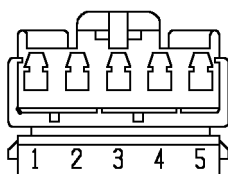

YPC10525

Colour: *BLUE*
Gender: *Female*

C0750

CONNECTOR DETAILS

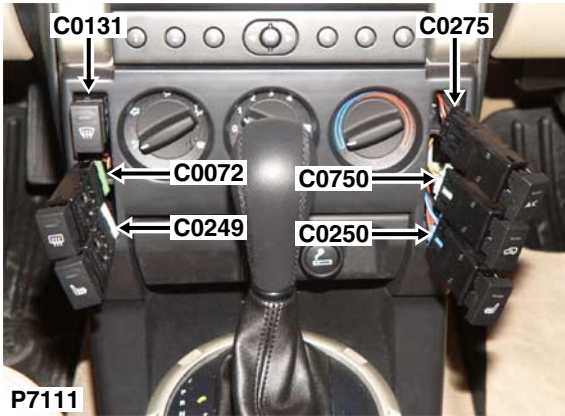

Description: *Switch-Fresh/recirculated air*
Location: *Behind centre console*

Cav	Col	Cct
1	B	ALL
2	RO	ALL
3	Y	ALL
4	K	ALL
5	LGS	ALL

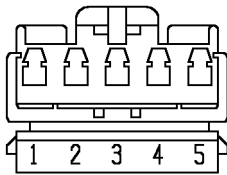

YPC10524

Colour: *WHITE*
Gender: *Female*

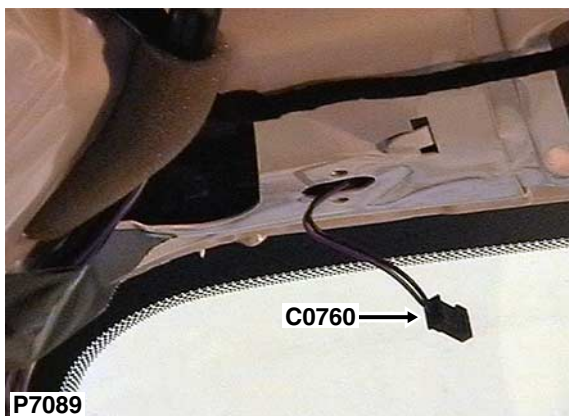

Cav	Col	Cct
1	P	5
2	B	5

Description: *Mirror-Vanity-LH - Japan*
Location: *Headlining - front LH side*

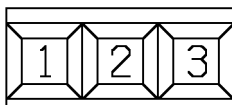

YPC117800

Colour: *BLACK*
Gender: *Female*

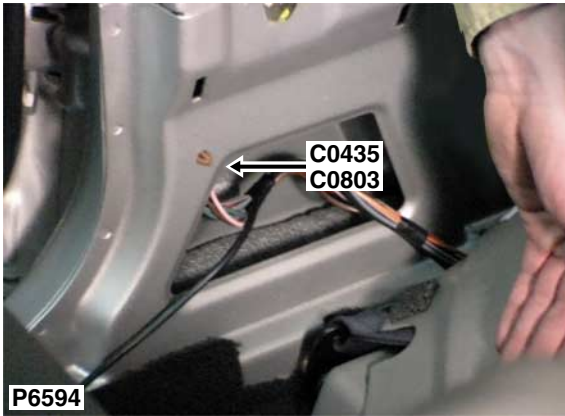

Description: *Door harness to main harness - 5 Door*

Location: *Base of 'B' post LH side*

Cav	Col	Cct
1	UB	ALL
2	UK	ALL
3	B	ALL
4	O	ALL
5	B	ALL
6	K	ALL
7	PW	ALL
8	NK	ALL
9	WR	ALL
10	WU	ALL
11	R	ALL
12	U	ALL
13	SG	ALL
14	RO	ALL

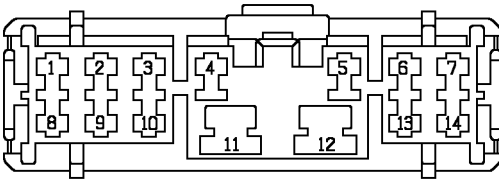

YPC10627

Colour: *LIGHT GREY*

Gender: *Female*

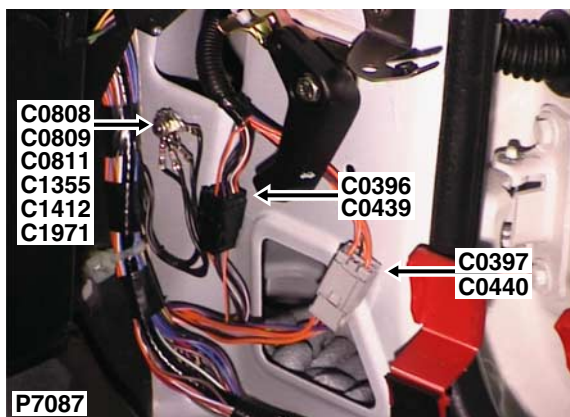

Cav	Col	Cct
1	B	ALL

Description: *Earth*

Location: *Base of RH 'A' post*

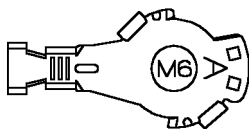

YPG101400

Colour: *TIN-PLATE*

Gender: *Female*

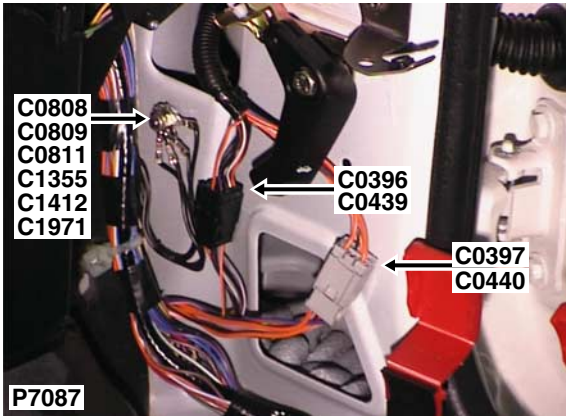

Cav	Col	Cct
1	B	30

Description: *Earth*

Location: *Base of RH 'A' post*

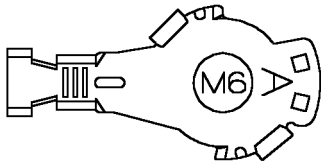

YPG101390

Colour: *TIN-PLATE*

Gender: *Female*

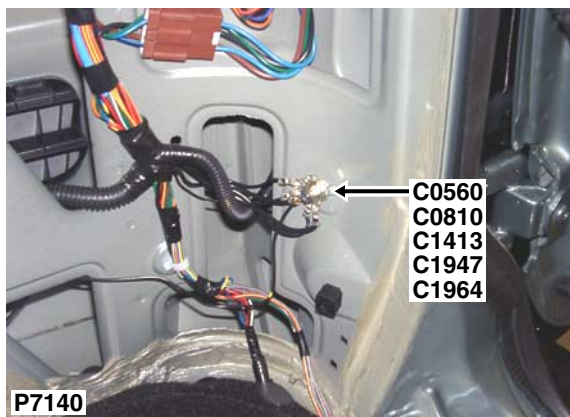

Cav	Col	Cct
1	B	ALL

Description: *Earth*

Location: *Luggage compartment - RH side*

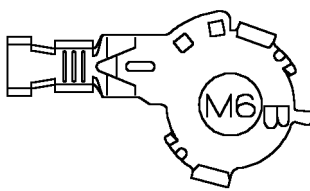

YPG101410

Colour: *TIN-PLATE*

Gender: *Female*

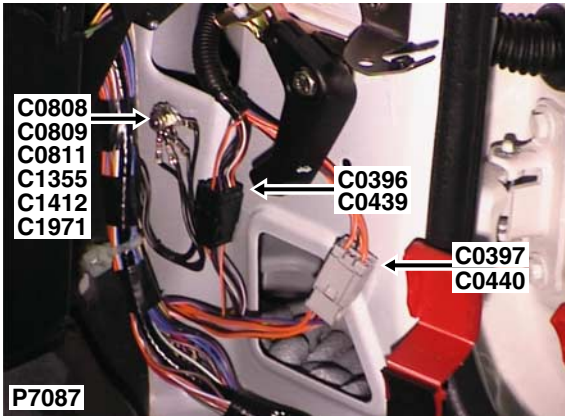

Cav	Col	Cct
1	B	ALL

Description: *Earth*

Location: *Base of RH 'A' post*

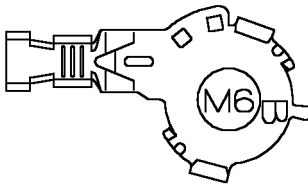

YPG101410

Colour: *TIN-PLATE*

Gender: *Female*

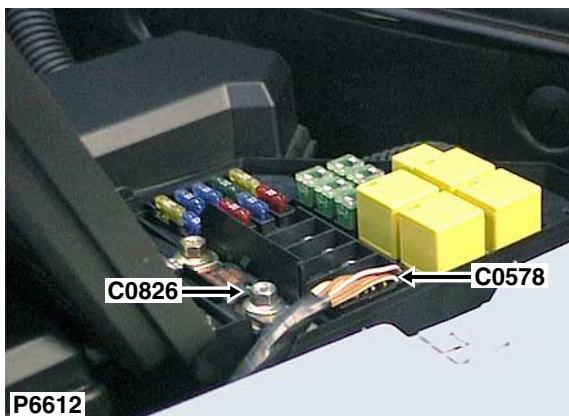

Cav	Col	Cct
1	R	ALL

Description: *Fuse box-Engine compartment - K1.8*

Location: *Rear LH side of engine compartment*

NO CONNECTOR FACE

Colour:

Gender:

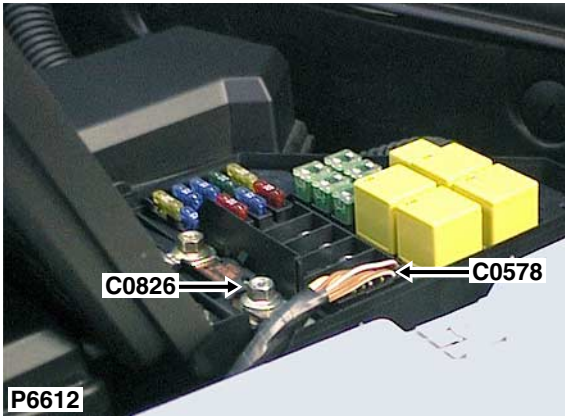

Cav	Col	Cct
1	R	ALL

Description: *Fuse box-Engine compartment - KV6*
Location: *Rear LH side of engine compartment*

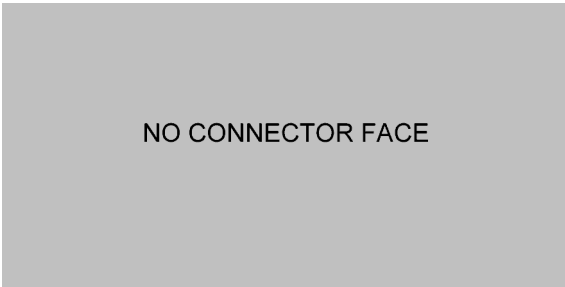

Colour:
Gender:

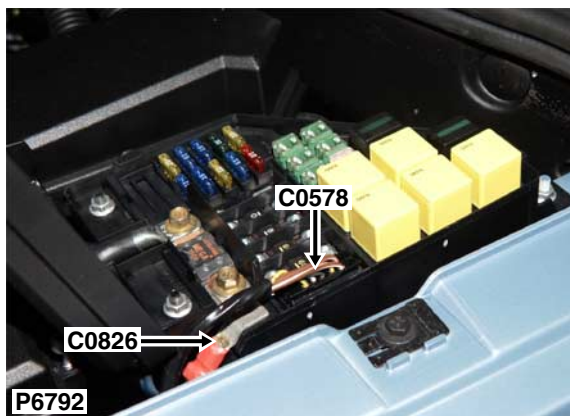

Cav	Col	Cct
1	R	ALL

Description: *Fuse box-Engine compartment - NAS*

Location: *Rear LH side of engine compartment*

NO CONNECTOR FACE

Colour:

Gender:

C0834

CONNECTOR DETAILS

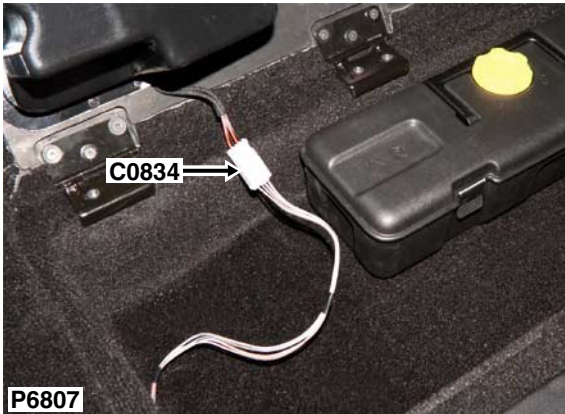

Cav	Col	Cct
1	SR	ALL
2	SW	ALL
3	SN	ALL
4	SB	ALL

Description: *Sub-woofer*

Location: *Luggage compartment lid*

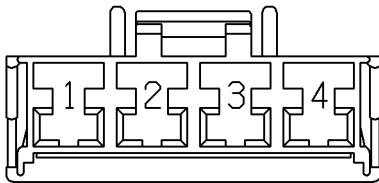

YPC10490

Colour: *LIGHT GREY*

Gender: *Female*

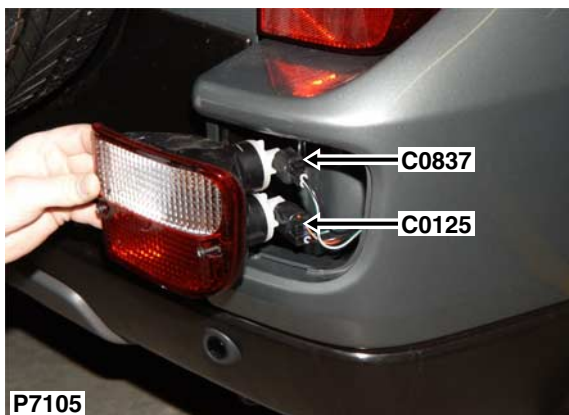

Cav	Col	Cct
1	B	ALL
2	GW	ALL

P7105

Description: *Lamp-Direction indicator/hazard warning-Rear-RH*

Location: *RH rear of vehicle*

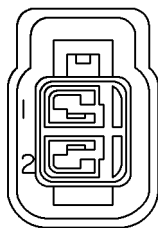

YPC500750

Colour: *BLACK*

Gender: *Female*



Cav	Col	Cct
1	G	4
2	BG	4
3	U	4
4	NK	4

Description: *Unit-Leak detection*

Location: *Below RH rear wheelarch*

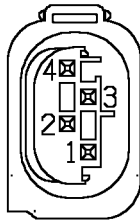

YPC117050

Colour: *BLACK*

Gender: *Female*



Cav	Col	Cct
1	W	ALL
2	RO	ALL
4	PS	ALL
5	B	ALL

Description: *Switch-Hill descent*

Location: *Beneath centre console*

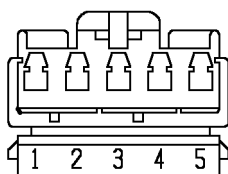

YPC10525

Colour: *BLUE*
Gender: *Female*



Cav	Col	Cct
1	SO	4
2	B	4

Description: *Sensor-Ambient air temperature*
Location: *Behind LH side of front bumper*

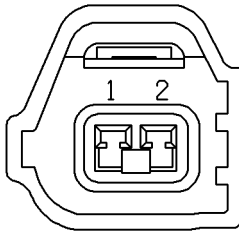

YPC108190

Colour: *BLACK*
Gender: *Female*

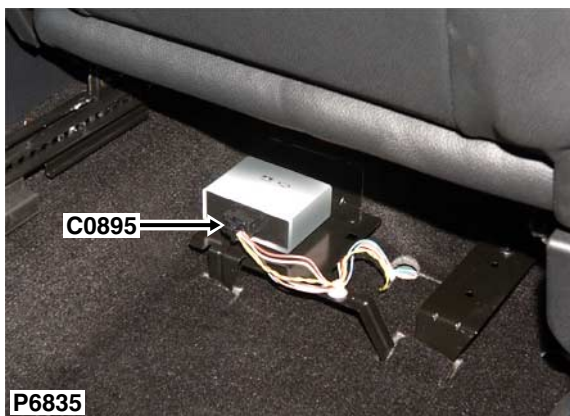

Description: *Relay-Cruise control*
 Location: *Beneath driver's seat*

Cav	Col	Cct
1	B	ALL
2	RG	26
3	RW	ALL
4	PG	16
4	UW	ALL
5	BU	16
5	YN	26
6	GR	16
6	YB	26
7	WY	ALL
8	W	16
8	NK	26
9	PG	16
9	WU	26
11	B	16
12	WY	16

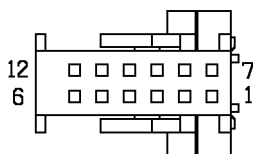

YPC111790

Colour: *BLACK*
 Gender: *Female*

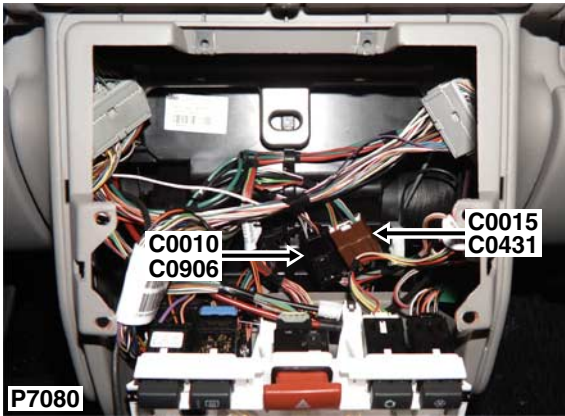

Cav	Col	Cct
1	B	ALL
3	LGS	ALL
4	RO	ALL
5	SW	ALL
6	SK	ALL

Description: *Air conditioning (A/C) harness to heater harness*

Location: *Behind centre console*

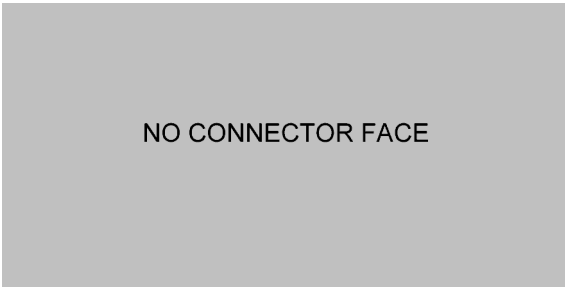

Colour: *YELLOW*

Gender: *Female*

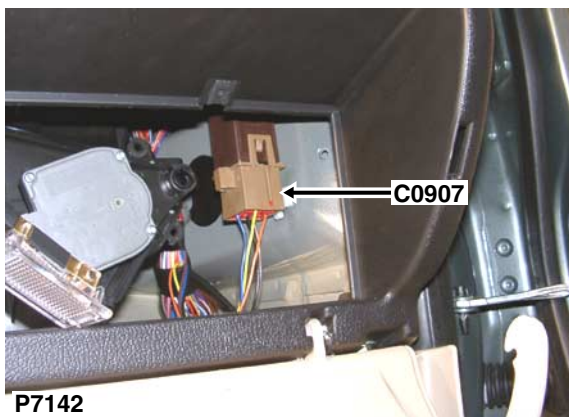

Cav	Col	Cct
1	O	ALL
2	UB	ALL
3	Y	ALL
4	NS	ALL
5	B	ALL

Description: *Relay-Folding door mirrors*

Location: *Base of passenger side 'A' post*

NO CONNECTOR FACE

Colour:

Gender: *Female*

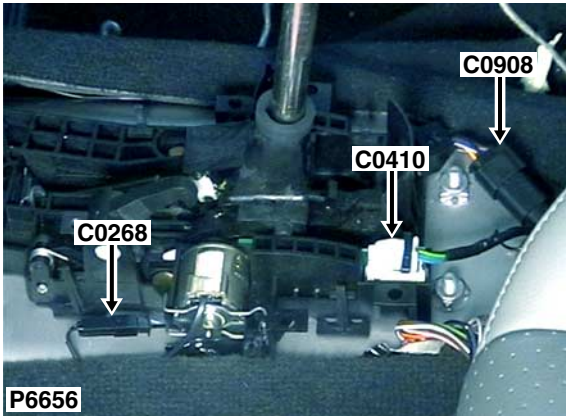

Description: *Sensor-Heated oxygen (HO2S)-Rear*
 Location: *Beneath centre console*

Cav	Col	Cct
1	OY	16
1	KB	18
2	BG	16
2	LGS	18
3	UW	16
3	GU	18
4	NK	30

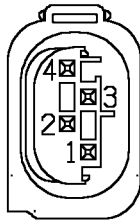

YPC117050

Colour: *BLACK*
 Gender: *Female*

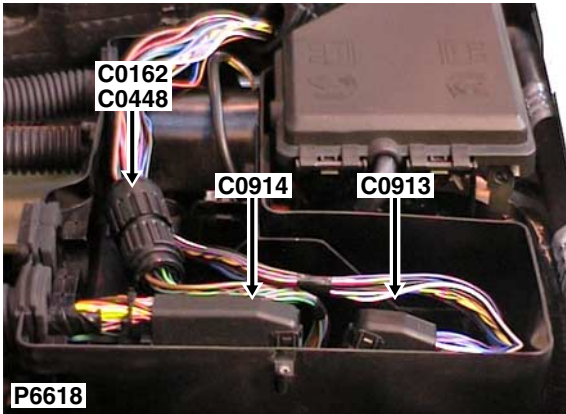

Description: *Engine harness to main harness*

Location: *Inside E-box*

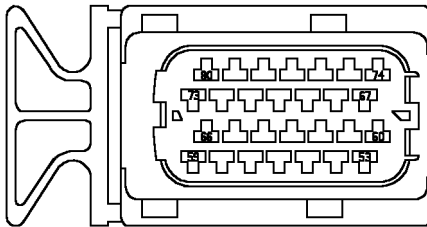

YPC114540

Colour: *BLACK*

Gender: *Female*

Cav	Col	Cct
53	UB	18
54	WK	18
57	UO	32
58	K	18
59	B	18
61	W	18
65	YB	18
66	B	18
67	UR	18
67	UW	32
68	BP	18
70	UG	32
71	PB	32
72	YR	18
73	B	18
77	UY	18
79	YN	18
80	NG	18

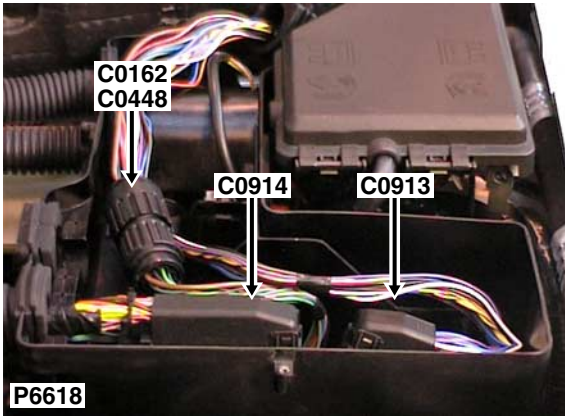

Description: *Engine control module (ECM)*
 Location: *Inside E-box*

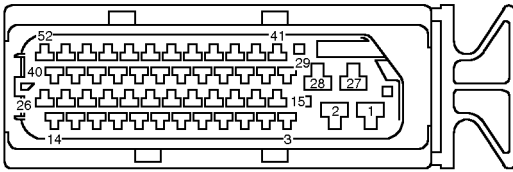

YPC114550

Colour: *BLACK*
 Gender: *Female*

Cav	Col	Cct
1	BU	ALL
3	KB	ALL
4	NB	ALL
6	KB	ALL
7	KB	ALL
8	YP	ALL
13	OS	ALL
14	YR	ALL
15	KB	ALL
16	YP	ALL
19	NK	ALL
20	GY	ALL
24	OU	ALL
25	YU	ALL
26	WB	ALL
27	GU	ALL
29	LGS	ALL
30	B	ALL
31	KB	ALL
32	GO	ALL
33	KG	ALL
34	KB	ALL
35	WR	ALL
37	GO	ALL
38	BO	ALL
39	OG	ALL
40	YN	ALL
41	LGS	ALL
42	BS	ALL
44	YW	ALL
45	RG	ALL
46	KP	ALL
47	BO	ALL
50	KU	ALL
51	YG	ALL
52	WO	ALL

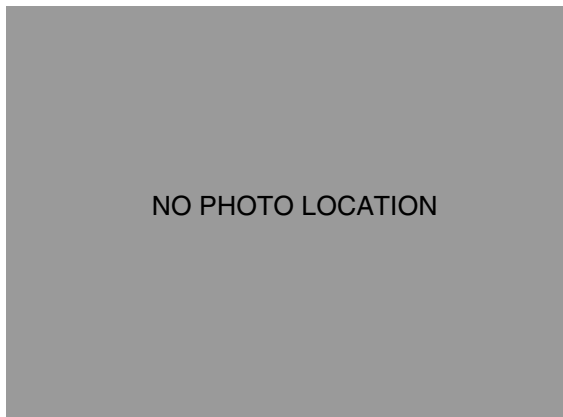

Cav	Col	Cct
1	WU	17
2	B	22

Description: *Pump-Fuel burning heater (FBH)*

Location: *Below RH rear wheelarch*

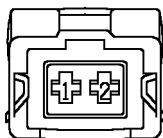

YPC107790

Colour: *BLACK*

Gender: *Female*

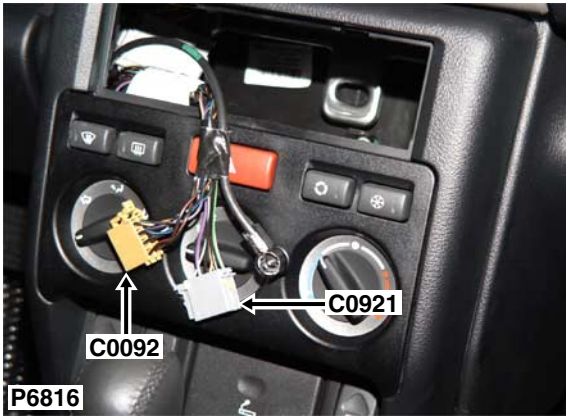

Cav	Col	Cct
1	WO	12
2	BW	ALL
2	GN	12
3	BR	ALL
4	P	9
4	PK	ALL
5	PY	ALL
6	RO	ALL
7	LGW	ALL
8	B	ALL

Description: *Head Unit-Audio System*

Location: *Behind centre console*

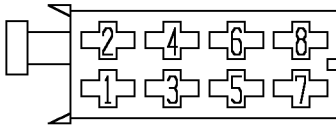

YPC10190

Colour: *GREY*
 Gender: *Female*

Cav	Col	Cct
12	K	ALL

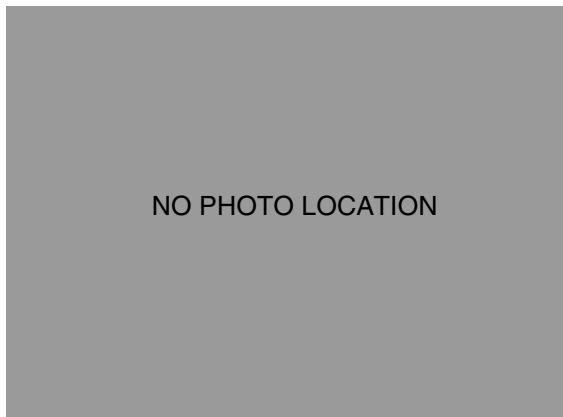

Description: *Head Unit-Audio System*

Location: *Behind centre console*

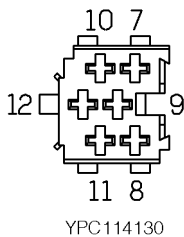

Colour: *GREEN*

Gender: *Female*

C0925

CONNECTOR DETAILS

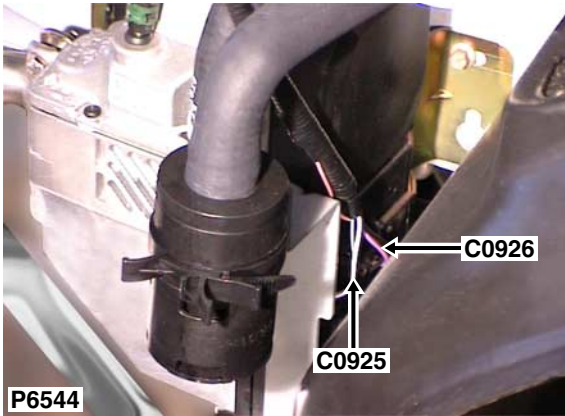

Cav	Col	Cct
2	K	17
3	SG	17
6	WU	17

Description: *Heater-Fuel burning*

Location: *Behind LH side of front bumper*

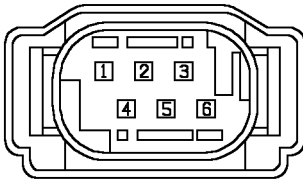

YPC110680

Colour: *BLACK*

Gender: *Female*

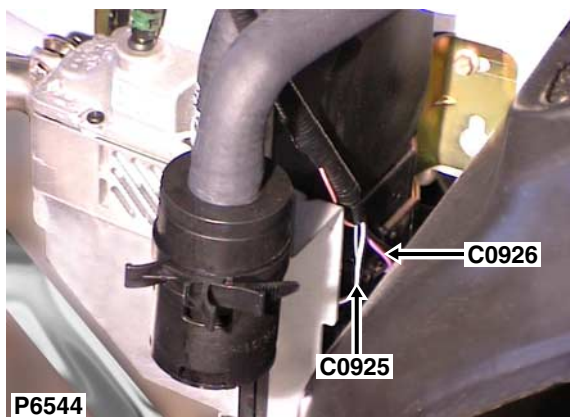

Cav	Col	Cct
1	PN	17
2	B	17

Description: *Heater-Fuel burning*

Location: *Behind LH side of front bumper*

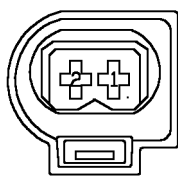

YPC115080

Colour: *BLACK*

Gender: *Female*

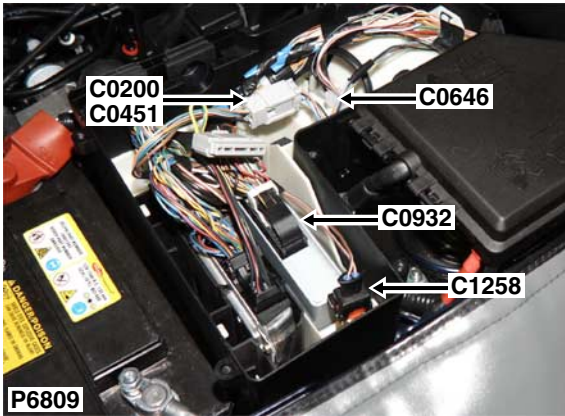

Description: *ECU-Electronic automatic transmission*
 Location: *Inside E-box*

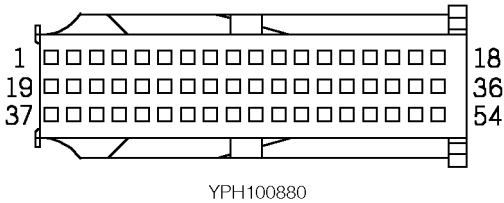

Colour: *BLACK*
 Gender: *Female*

Cav	Col	Cct
1	K	23
3	GP	ALL
4	GR	ALL
5	U	ALL
7	OB	ALL
8	GY	ALL
9	B	23
10	OG	ALL
12	YN	ALL
13	YN	23
14	O	ALL
15	R	ALL
16	U	ALL
17	SB	ALL
18	Y	ALL
19	GB	23
20	KB	ALL
21	R	ALL
24	R	ALL
25	WU	ALL
26	NG	23
27	WB	ALL
30	KO	ALL
33	YB	ALL
34	YB	23
36	NK	23
37	GK	23
38	B	23
39	WK	ALL
41	LGK	23
43	GR	23
45	RG	ALL
49	WU	ALL
50	GW	23
52	OU	ALL
53	K	ALL
54	NK	23

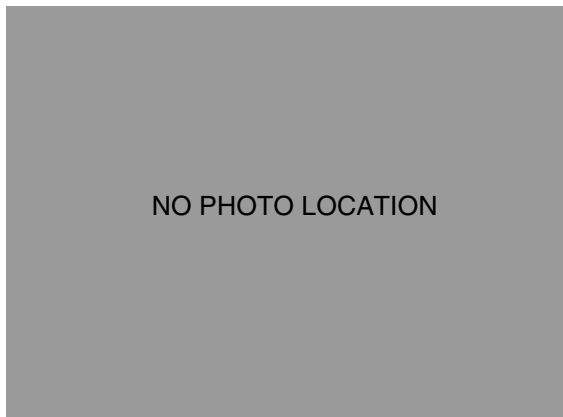

Cav	Col	Cct
1	YB	ALL
2	BY	ALL
3	B	ALL
5	K	13
5	WRY	14
6	KB	ALL
7	BK	ALL
8	B	ALL
10	PK	13
10	P	14

Description: *CD auto changer*

Location: *Beneath driver's seat*

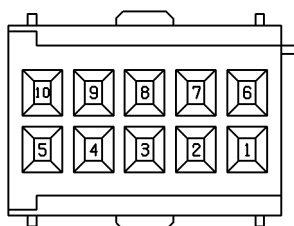

6909000

Colour: *BLACK*

Gender: *Female*

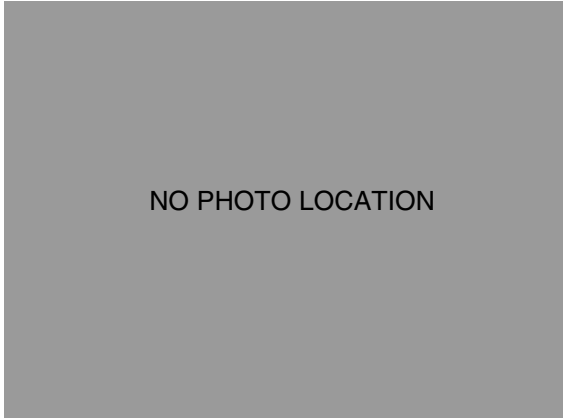

Cav	Col	Cct
1	B	12
2	SCR	12
3	B	12
4	SCR	12

Description: *Reciever-Navigation - 5 Door*

Location: *Front of headlining in the centre*

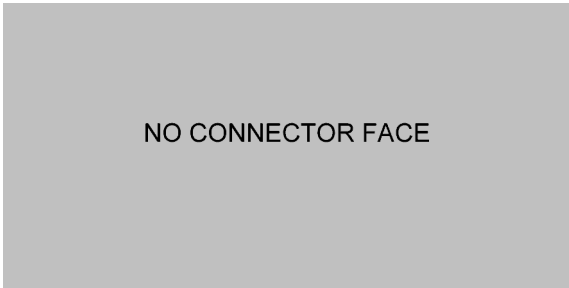

Colour:

Gender:

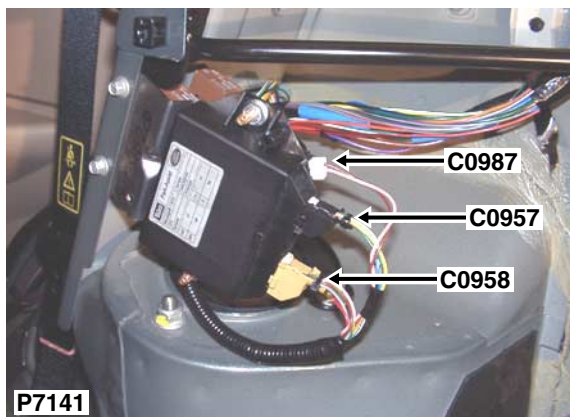

Cav	Col	Cct
2	Y	ALL
3	U	ALL
4	O	ALL
5	G	ALL
8	BG	ALL
10	WG	ALL

Description: *ECU-PDC*

Location: *Luggage compartment - RH side*

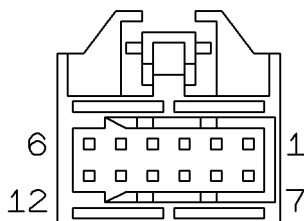

YPC800750

Colour: *WHITE*

Gender:

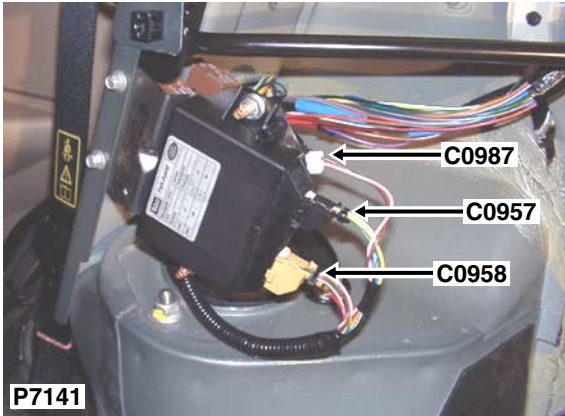

Cav	Col	Cct
1	LGO	ALL
2	N	ALL
4	S	ALL
6	GN	ALL
8	B	ALL
10	K	ALL
13	RS	ALL

Description: *ECU-PDC*

Location: *Luggage compartment - RH side*

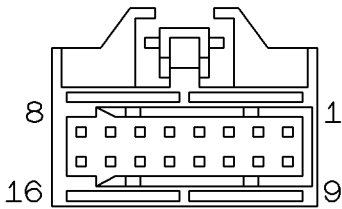

YPC800740

Colour: *WHITE*

Gender: *Female*

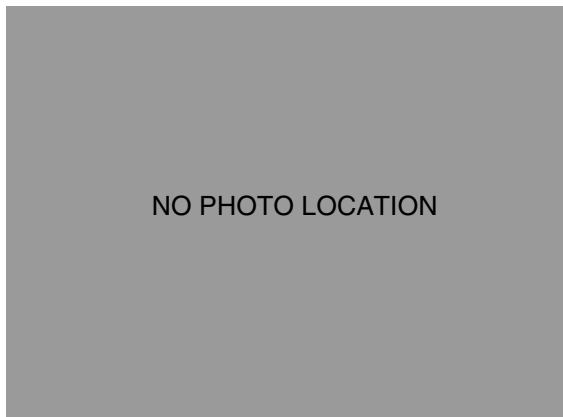

Cav	Col	Cct
1	B	12
2	SCR	12
3	B	12
4	SCR	12

Description: *Reciever-Navigation - 3 Door*

Location: *Behind centre headlining*

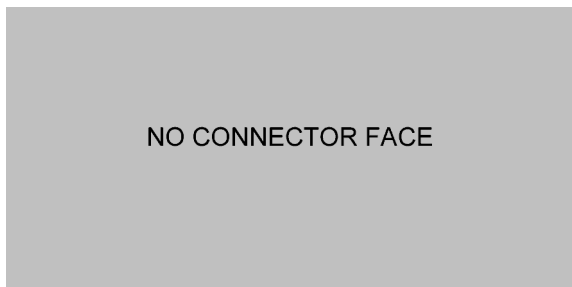

Colour:

Gender:

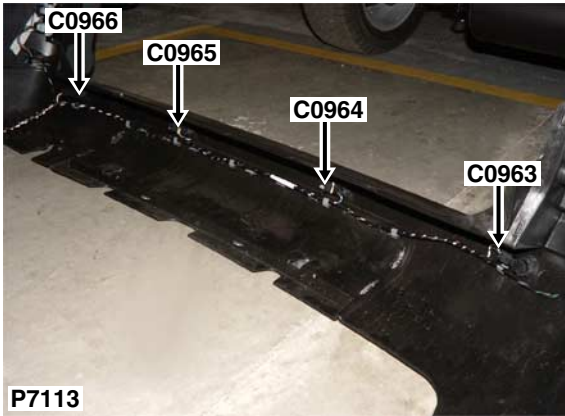

Cav	Col	Cct
1	W	39
2	G	39
3	B	39

Description: *Sensor-PDC-Outer-Rear-LH*
 Location: *Behind LH side of rear bumper*

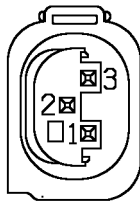

YPC116850

Colour: *BLACK*
 Gender: *Female*

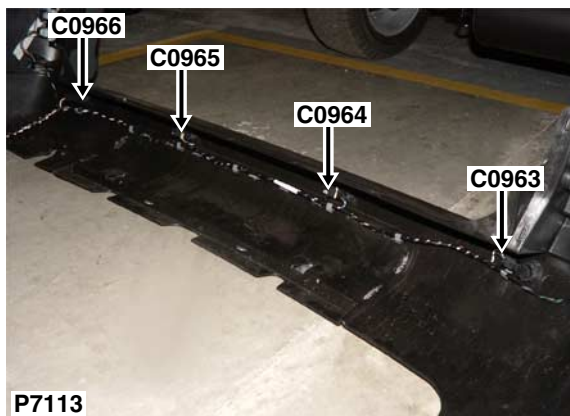

Cav	Col	Cct
1	W	39
2	U	39
3	B	39

Description: *Sensor-PDC-Inner-Rear-LH*

Location: *Behind LH side of rear bumper*

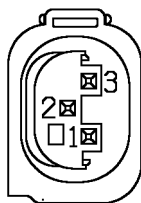

YPC116850

Colour: *BLACK*

Gender: *Female*

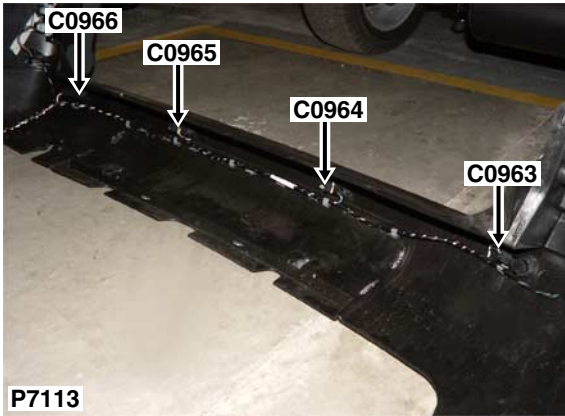

P7113

Description: *Sensor-PDC-Inner-Rear-RH*

Location: *Behind RH side of rear bumper*

Cav	Col	Cct
1	W	39
2	Y	39
3	B	39

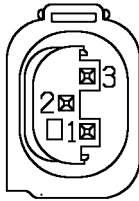

YPC116850

Colour: *BLACK*

Gender: *Female*

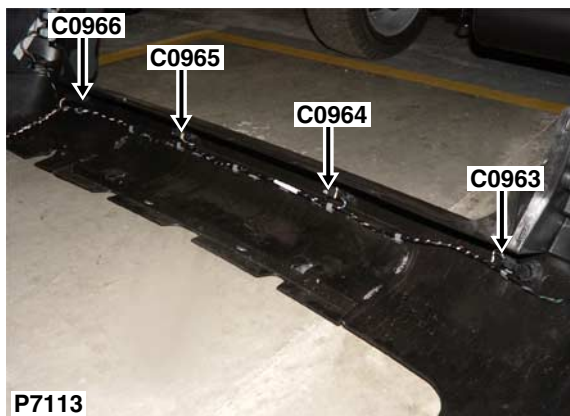

Cav	Col	Cct
1	W	39
2	O	39
3	B	39

Description: *Sensor-PDC-Outer-Rear-RH*
Location: *Behind RH side of rear bumper*

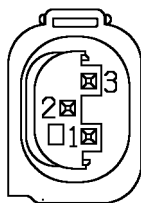

YPC116850

Colour: *BLACK*
Gender: *Female*

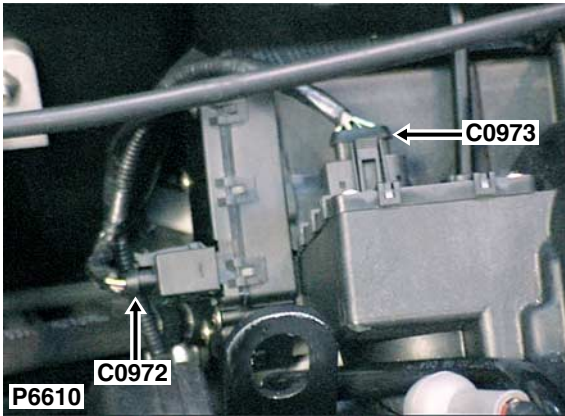

Cav	Col	Cct
1	SB	ALL
2	OU	ALL
3	B	ALL
4	YU	ALL

Description: *Valve-Balance-1 - KV6*

Location: *Top of engine*

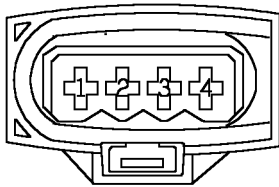

YPC113840

Colour: *BLACK*

Gender: *Female*

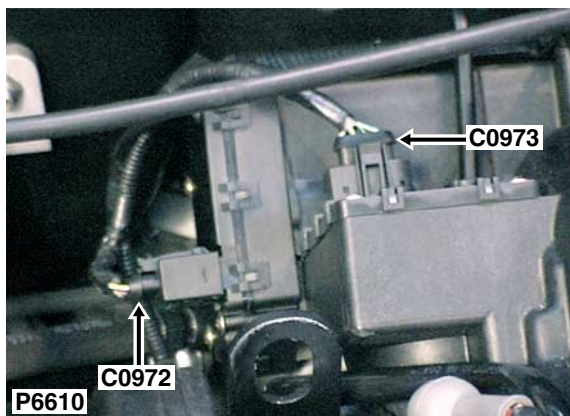

Cav	Col	Cct
1	SB	ALL
2	OU	ALL
3	B	ALL
4	YU	ALL

Description: *Valve-Balance-1 - NAS*

Location: *Top of engine*

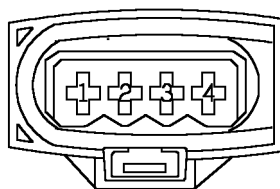

YPC113840

Colour: *BLACK*

Gender: *Female*

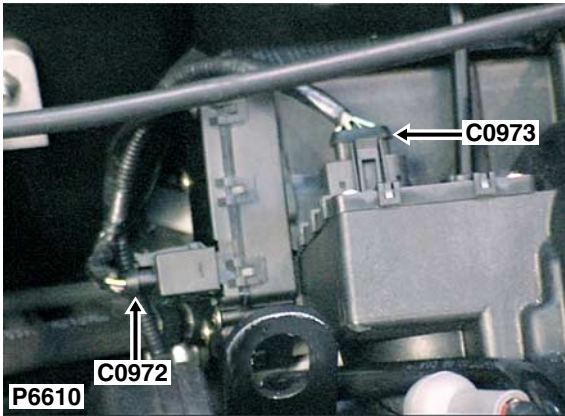

Cav	Col	Cct
1	OY	ALL
2	B	ALL
3	YU	ALL
4	UK	ALL

Description: *Valve-Butterfly - KV6*

Location: *Top of engine*

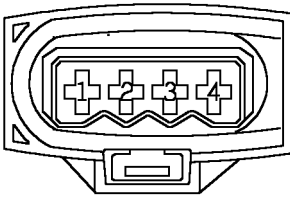

YPC114880

Colour: *BLACK*

Gender: *Female*

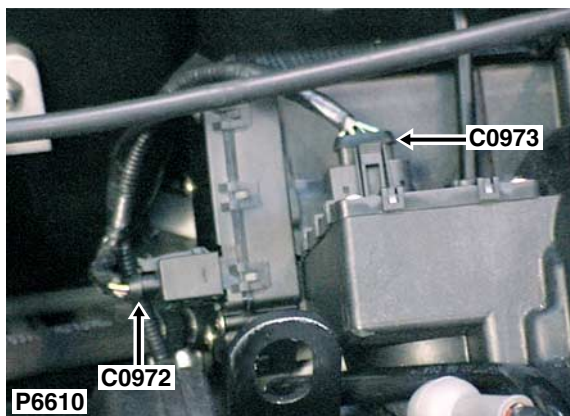

Description: *Valve-Butterfly - NAS*

Location: *Top of engine*

Cav	Col	Cct
1	BG	ALL
2	B	ALL
3	YU	ALL
4	UK	ALL

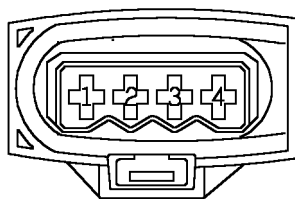

YPC114880

Colour: *BLACK*

Gender: *Female*

Cav	Col	Cct
18	B	13
19	KB	13
20	YB	13

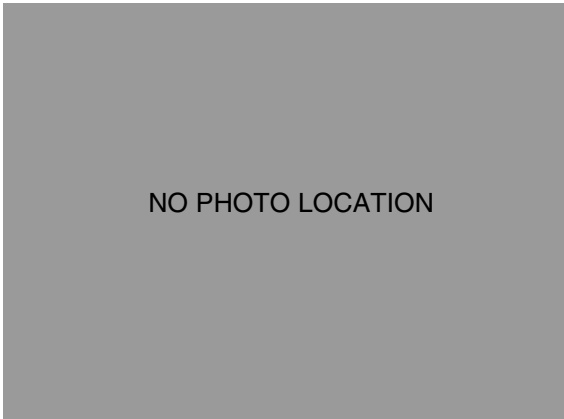

Description: *Head Unit-Audio System*
Location: *Behind centre console*

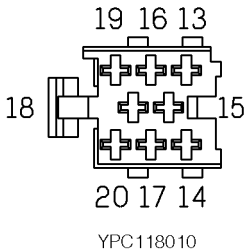

Colour: *BLACK*
Gender: *Female*

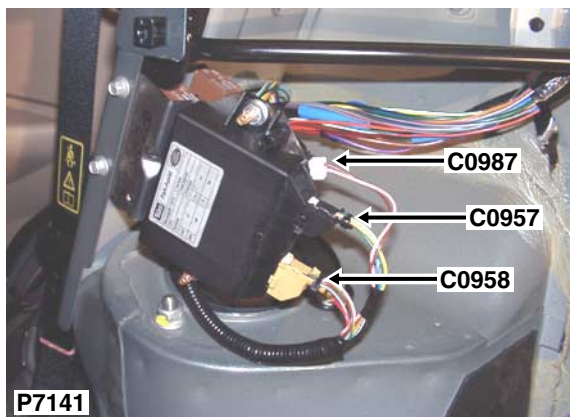

Description: *Speaker-PDC*

Location: *Luggage compartment - RH side*

Cav	Col	Cct
1	K	ALL
2	N	ALL

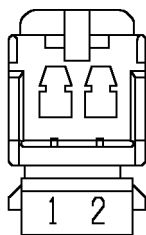

YPC10246

Colour: *WHITE*

Gender: *Female*

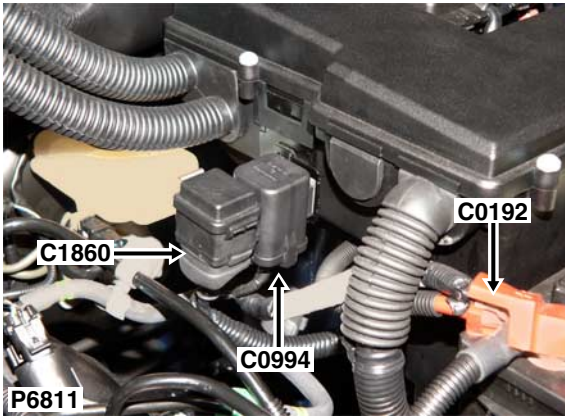

Cav	Col	Cct
1	N	ALL
2	N	ALL
3	SB	ALL
4	NW	ALL

Description: *Relay-Heated front screen*

Location: *Rear LH side of engine compartment*

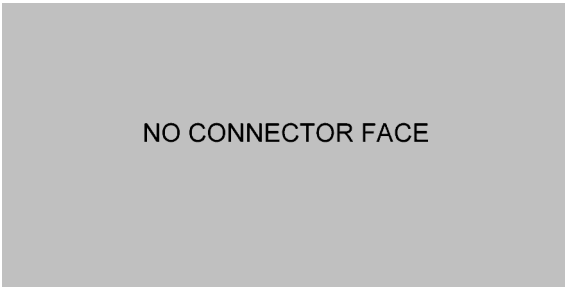

Colour:

Gender:

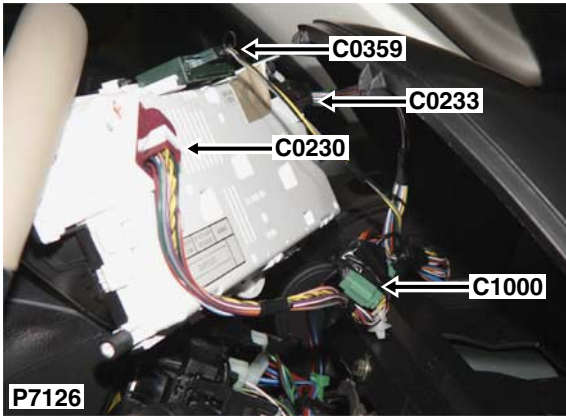

Description: *Header*
 Location: *Behind instrument pack*

Cav	Col	Cct
1	P	ALL
2	P	ALL
3	P	ALL
4	P	ALL
5	RB	15
6	RB	15
7	RB	15
9	RO	ALL
10	RO	ALL
11	RO	ALL
12	RO	ALL
13	B	ALL
14	B	ALL
15	B	ALL
16	B	ALL
17	B	ALL
18	B	ALL
20	B	ALL

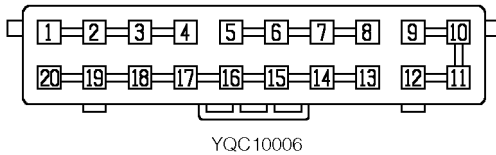

Colour: *GREEN*
 Gender: *Female*

C1023

CONNECTOR DETAILS

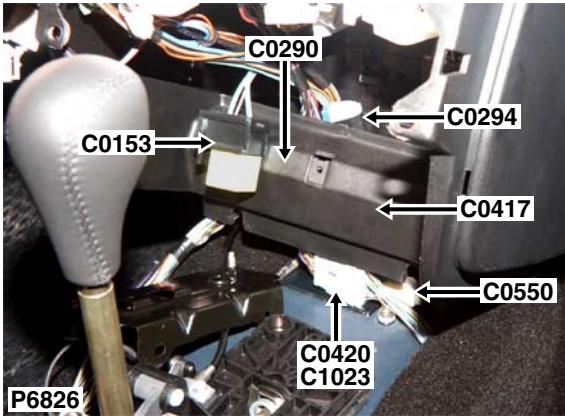

Description: *Main harness to audio system harness*

Location: *Behind centre console*

Cav	Col	Cct
1	YK	ALL
2	OK	ALL
3	SK	ALL
4	LGW	ALL
5	UK	ALL
6	YB	ALL
7	P	ALL
8	BW	ALL
9	OB	ALL
10	SB	ALL
11	RO	ALL
12	UB	ALL
13	B	ALL
14	BR	ALL
15	WO	ALL
16	GN	ALL
17	SB	ALL
18	SN	ALL
19	SW	ALL
20	SR	ALL

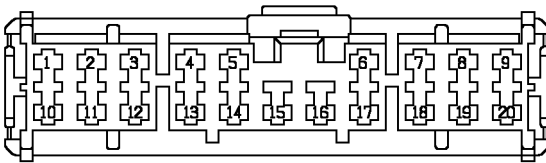

YPC10498

Colour: *LIGHT GREY*

Gender: *Female*

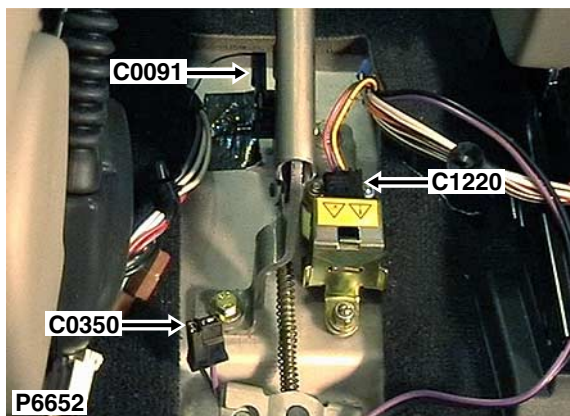

Cav	Col	Cct
1	R	ALL
2	U	ALL
3	Y	ALL

Description: *Accelerometer*

Location: *Beneath centre console*

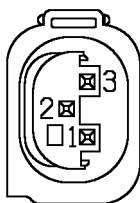

YPC116860

Colour: *GREY*

Gender: *Female*

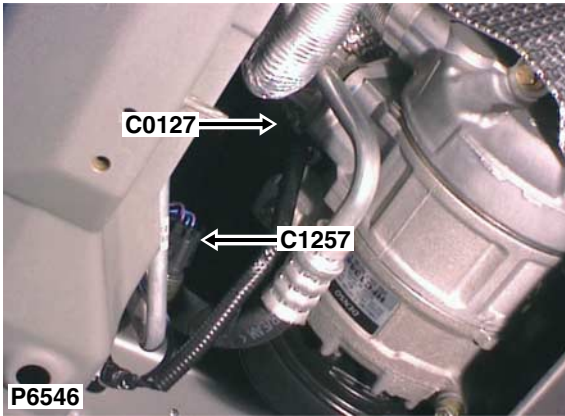

Cav	Col	Cct
1	PB	ALL
2	UG	ALL
3	UO	ALL

Description: *Switch-Dual pressure*

Location: *Lower RH front of engine compartment*

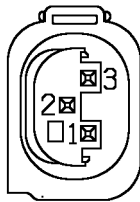

YPC116850

Colour: *BLACK*

Gender: *Female*

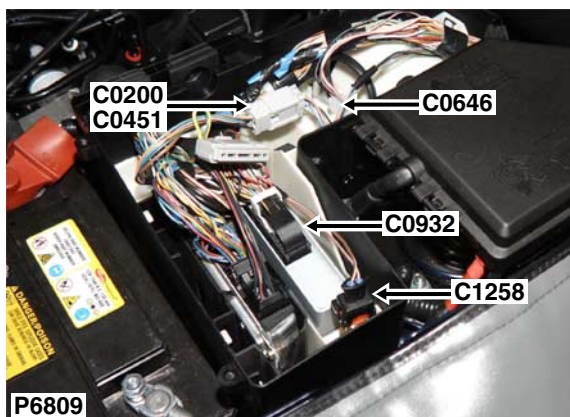

Cav	Col	Cct
1	NK	28
2	NK	28

Description: *Sensor-Temperature-E-box*

Location: *Inside E-box*

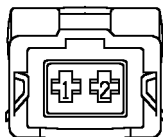

YPC107790

Colour: *BLACK*

Gender: *Female*



Cav	Col	Cct
1	KB	14
2	YB	14
3	B	14
6	BK	14
7	BY	14

Description: *Head Unit-Audio System*
 Location: *Behind centre console*

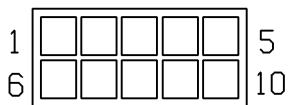

YPC111780

Colour: *BLACK*
 Gender: *Female*

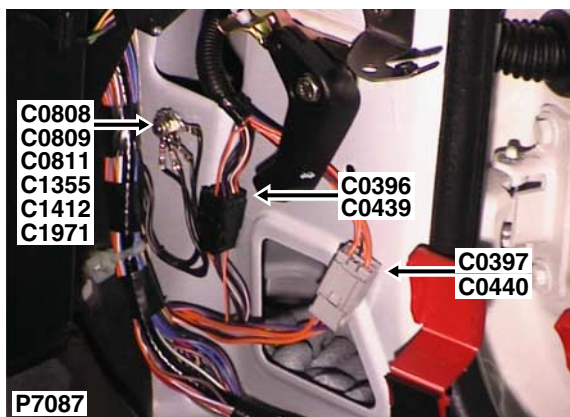

Cav	Col	Cct
1	B	ALL

Description: *Earth*

Location: *Base of RH 'A' post*

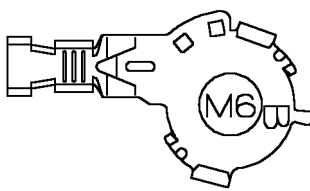

YPG101410

Colour: *TIN-PLATE*

Gender: *Female*

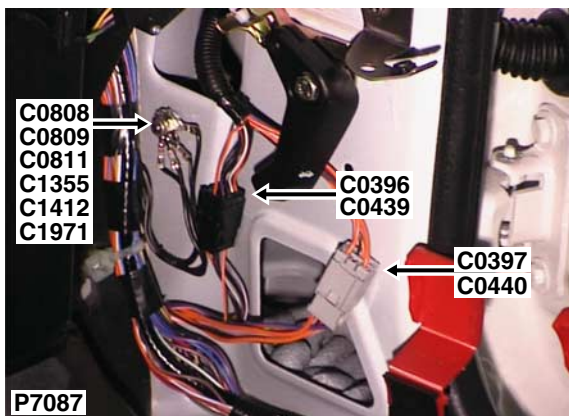

Cav	Col	Cct
1	B	ALL

Description: *Earth*

Location: *Base of RH 'A' post*

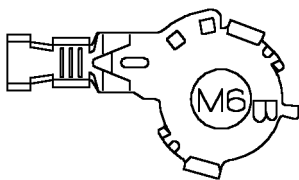

YPC101420

Colour: *TIN-PLATE*

Gender: *Female*

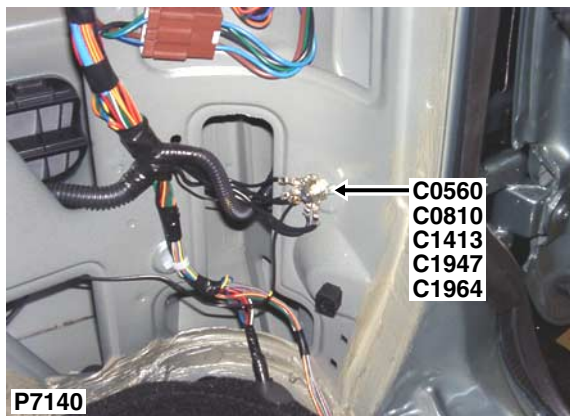

Cav	Col	Cct
1	B	ALL

Description: *Earth*

Location: *Rear of luggage compartment - RH side*

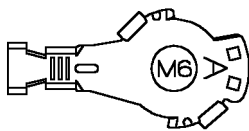

YPG101400

Colour: *TIN-PLATE*

Gender: *Female*

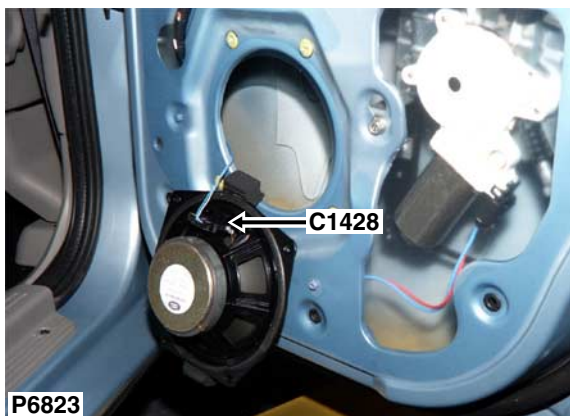

Cav	Col	Cct
1	UB	9
2	UK	9

Description: *Speakers-Rear*

Location: *Behind rear door trim panel*

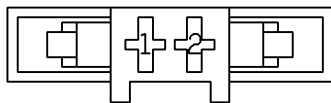

YPC113640

Colour: *BLACK*

Gender: *Female*

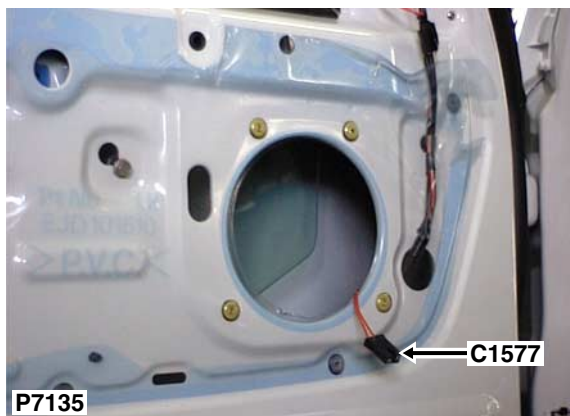

Cav	Col	Cct
1	OB	9
2	OK	9

Description: *Speakers-Front - 3 Door*
Location: *Behind front door trim panel*

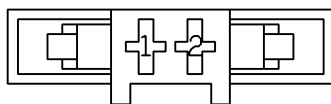

Colour: *BLACK*
Gender: *Female*



P7119

Description: *Speakers-Front - 5 Door*

Location: *Behind front door trim panel*

Cav	Col	Cct
1	OB	9
2	OK	9

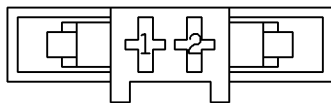

YPC113640

Colour: *BLACK*

Gender: *Female*

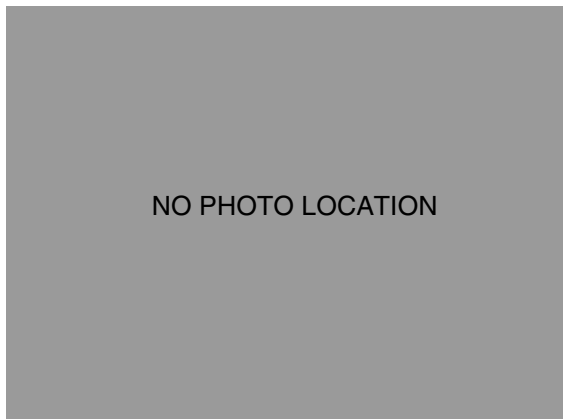

Cav	Col	Cct
1	B	12
2	SCR	12

Description: *Receiver-Global Positioning System (GPS)*

Location: *Behind centre console*

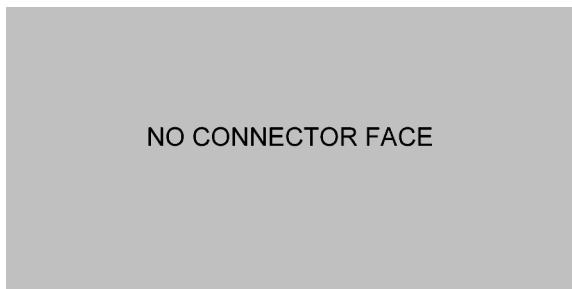

Colour:

Gender:

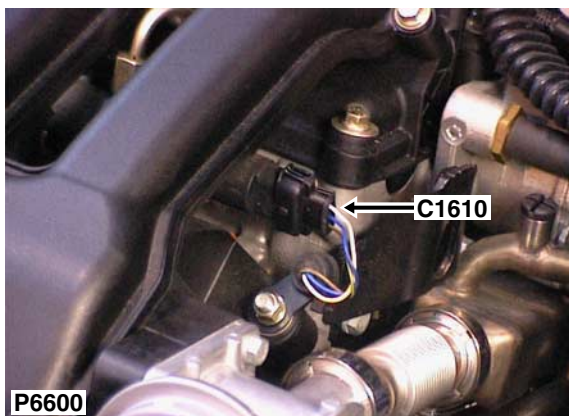

Cav	Col	Cct
1	NG	ALL
2	UB	ALL
3	WY	ALL

Description: *Sensor-Pressure-Fuel rail*

Location: *Top of engine*

NO CONNECTOR FACE

Colour:

Gender:

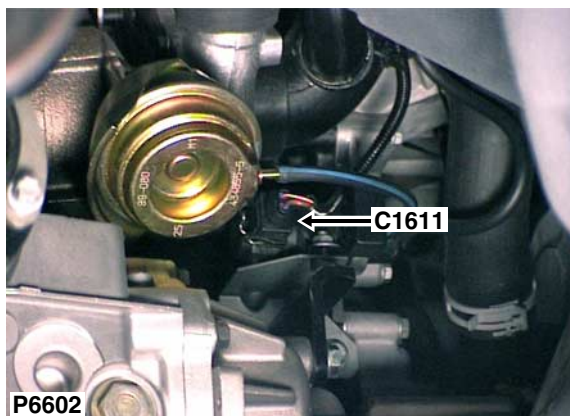

Cav	Col	Cct
1	RW	ALL
2	NW	ALL

Description: *Solenoid valve-Boost Control*
Location: *Lower rear of engine - RH side*

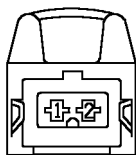

YPC114900

Colour: *BLACK*
Gender: *Female*

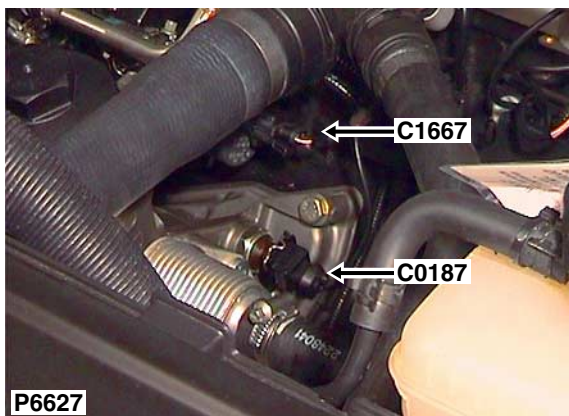

Cav	Col	Cct
1	RW	ALL
2	NU	ALL

Description: *Regulator-Fuel pressure*

Location: *Front of engine - centre*

NO CONNECTOR FACE

Colour:

Gender:

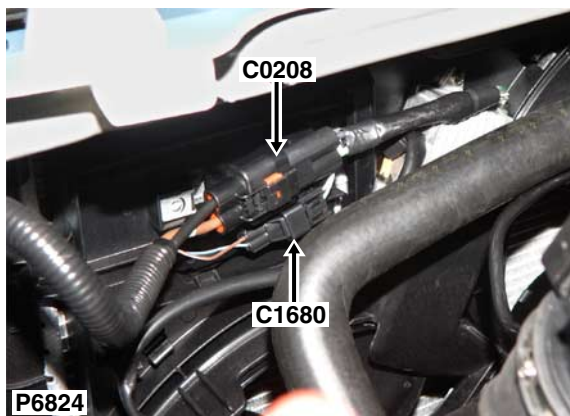

Cav	Col	Cct
1	UW	ALL
2	NK	ALL

Description: *Control Unit-Cooling Fan*

Location: *Front of engine compartment - centre*

NO CONNECTOR FACE

Colour: *BLACK*

Gender: *Male*

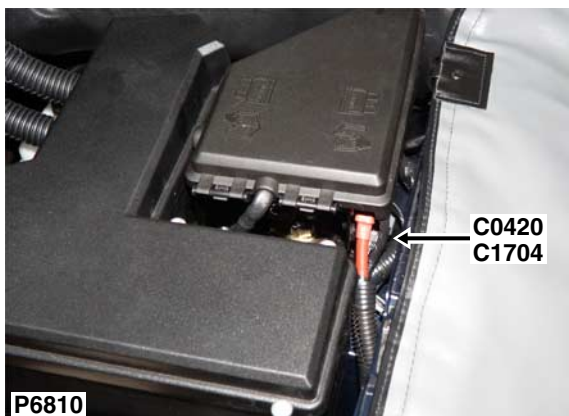

Cav	Col	Cct
1	SB	28
2	PK	28

Description: *Main harness to heated front screen harness*
 Location: *Rear LH side of engine compartment*

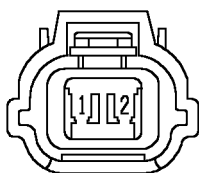

YPC10180

Colour: *GREY*
 Gender: *Female*

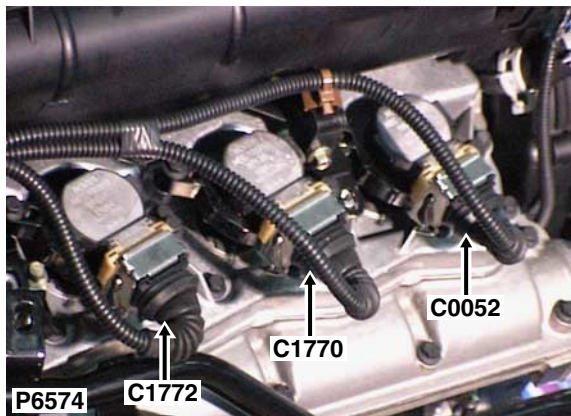

Cav	Col	Cct
1	BY	ALL
2	B	ALL
3	NK	ALL

Description: *Ignition coil-4 - KV6*

Location: *Top of engine*

NO CONNECTOR FACE

Colour: *BLACK*

Gender: *Female*

C1770

CONNECTOR DETAILS

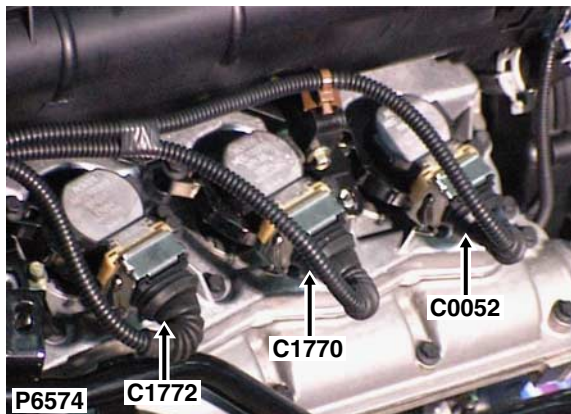

Cav	Col	Cct
1	BY	ALL
2	B	ALL
3	NK	ALL

Description: *Ignition coil-4 - NAS*

Location: *Top of engine*

NO CONNECTOR FACE

Colour: *BLACK*

Gender: *Female*

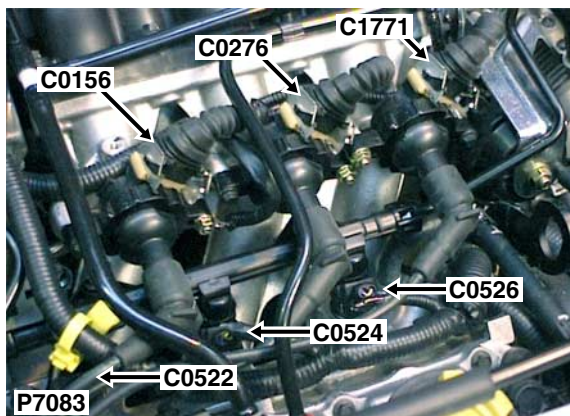

Description: *Ignition coil-5 - KV6*

Location: *Top of engine*

Cav	Col	Cct
1	BP	ALL
2	B	ALL
3	NK	ALL

NO CONNECTOR FACE

Colour: *BLACK*

Gender: *Female*

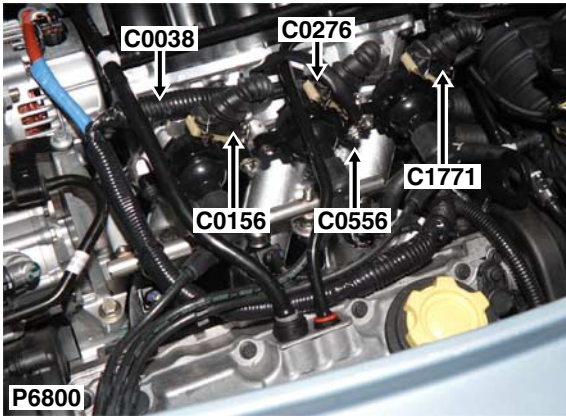

Cav	Col	Cct
1	BP	ALL
2	B	ALL
3	NK	ALL

Description: *Ignition coil-5 - NAS*

Location: *Top of engine*

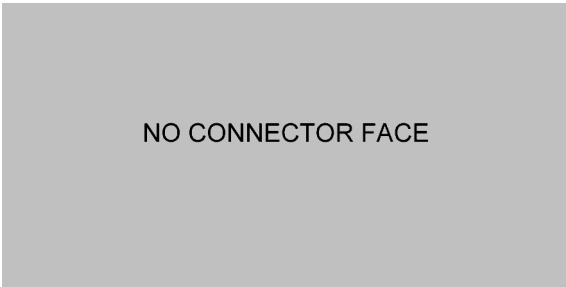

Colour: *BLACK*

Gender: *Female*

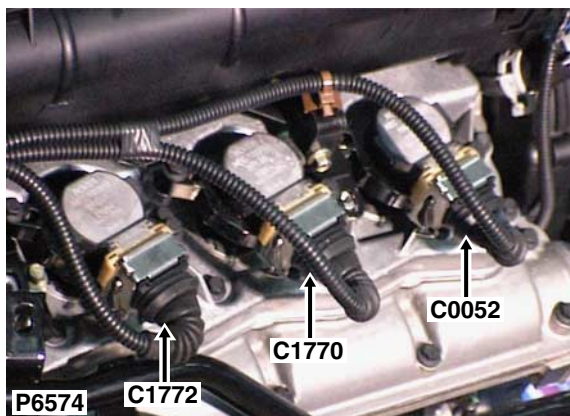

Cav	Col	Cct
1	BU	ALL
2	B	ALL
3	NK	ALL

Description: *Ignition coil-6 - KV6*

Location: *Top of engine*

NO CONNECTOR FACE

Colour: *BLACK*

Gender: *Female*

C1772

CONNECTOR DETAILS

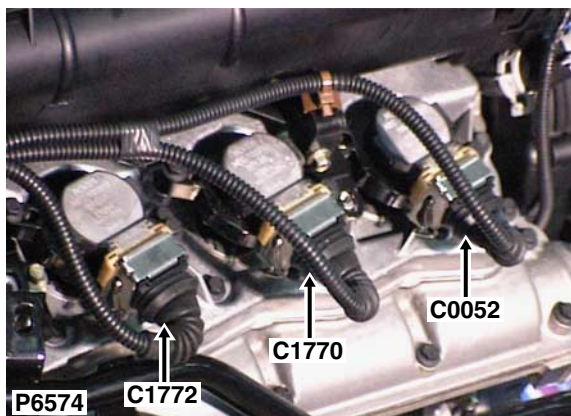

Cav	Col	Cct
1	BU	ALL
2	B	ALL
3	NK	ALL

Description: *Ignition coil-6 - NAS*

Location: *Top of engine*

NO CONNECTOR FACE

Colour: *BLACK*

Gender: *Female*

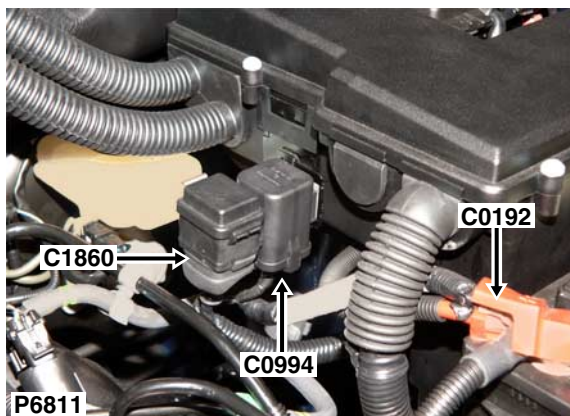

Description: *Holder-Fuse*

Location: *Rear LH side of engine compartment*

Cav	Col	Cct
1A	NW	ALL
2A	NW	ALL
3A	NW	ALL
1B	PS	ALL
2B	PW	ALL
3B	PG	ALL

NO CONNECTOR FACE

Colour:

Gender:

Cav	Col	Cct
1	RW	25
2	RO	25

NO PHOTO LOCATION

Description: *Holder-Fuse - Canada*

Location: *Behind passenger compartment fusebox cover*

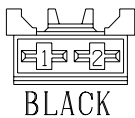

Colour: *BLACK*

Gender: *Female*

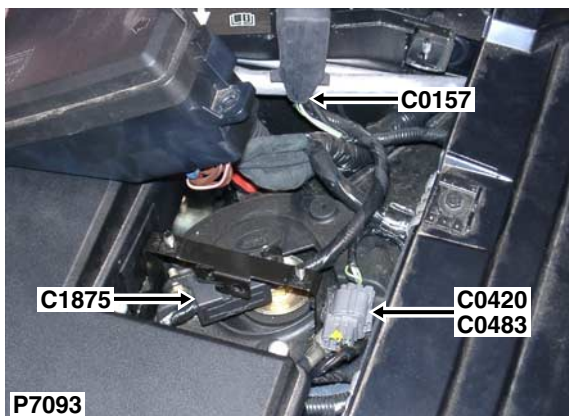

Cav	Col	Cct
1	R	ALL
2	N	ALL

Description: *Holder-Fuse - Td4*

Location: *Beneath engine compartment fusebox*

NO CONNECTOR FACE

Colour: *BLACK*

Gender: *Female*

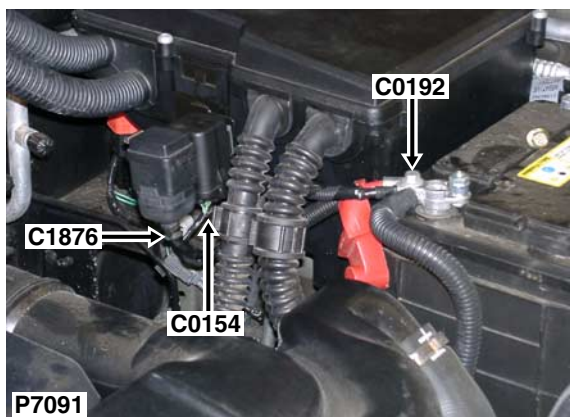

Description: *Holder-Fuse*

Location: *LH side of engine compartment*

NO CONNECTOR FACE

Colour:

Gender:

Cav	Col	Cct
1A	B	ALL
2A	B	ALL
3A	B	ALL
1B	BP	ALL
2B	BN	ALL
3B	BG	ALL

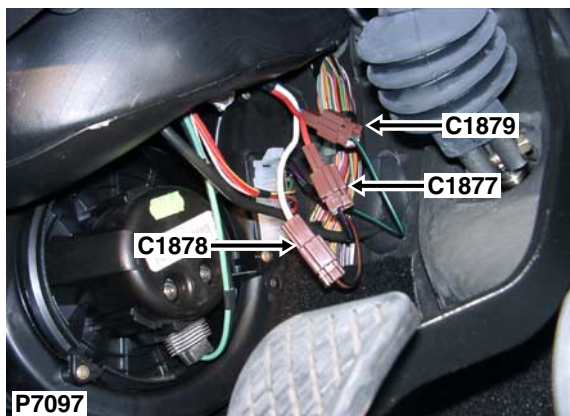

Cav	Col	Cct
1	BN	ALL

Description: *Heater-PTC*

Location: *Behind centre of fascia*

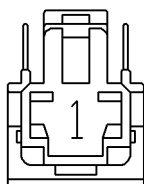

YPC10577

Colour: *BROWN*

Gender: *Female*

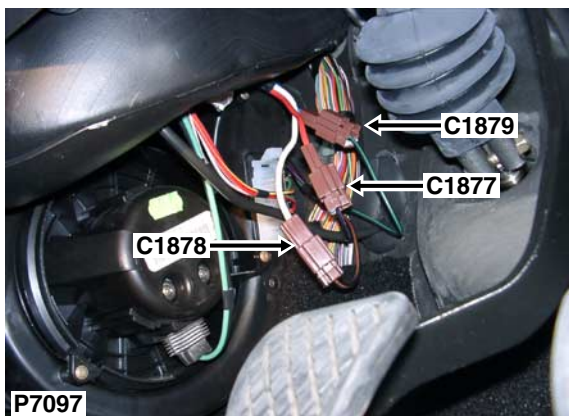

Cav	Col	Cct
1	BG	ALL

Description: *Heater-PTC*

Location: *Behind centre of fascia*

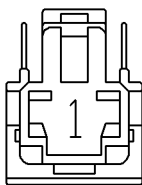

YPC10577

Colour: *BROWN*

Gender: *Female*

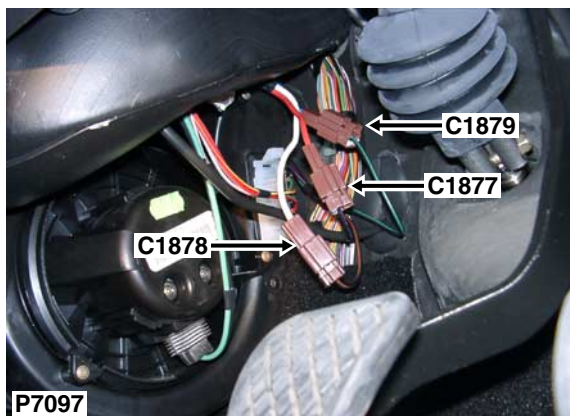

Cav	Col	Cct
1	BP	ALL

Description: *Heater-PTC*

Location: *Behind centre of fascia*

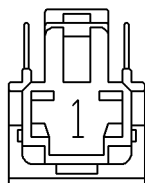

YPC10577

Colour: *BROWN*

Gender: *Female*

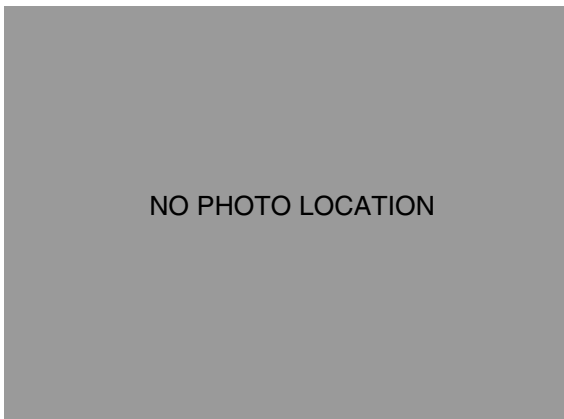

Cav	Col	Cct
1	WB	6
2	NB	6
3	SW	6
4	B	6

Description: *Sensor-Volumetric*

Location: *Behind centre headlining*

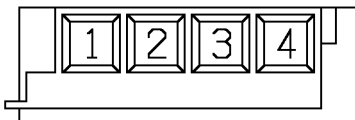

YPC117840

Colour: *BLACK*

Gender: *Female*

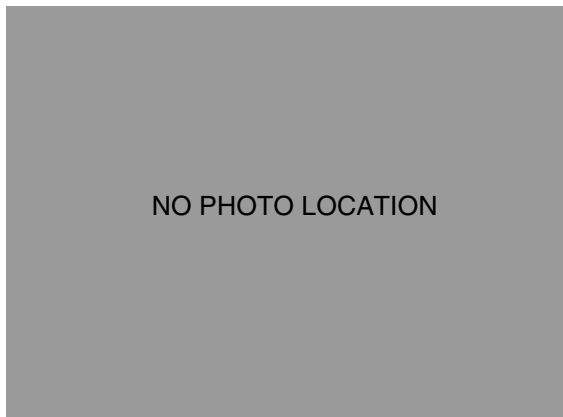

Cav	Col	Cct
1	LGW	12
2	BR	41
3	K	ALL
5	BW	41
6	B	ALL

Description: *Module-ICE interface*

Location: *Behind centre console*

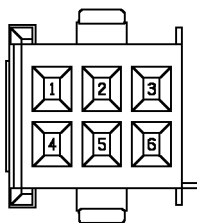

YPC115290

Colour: *BLACK*

Gender: *Female*

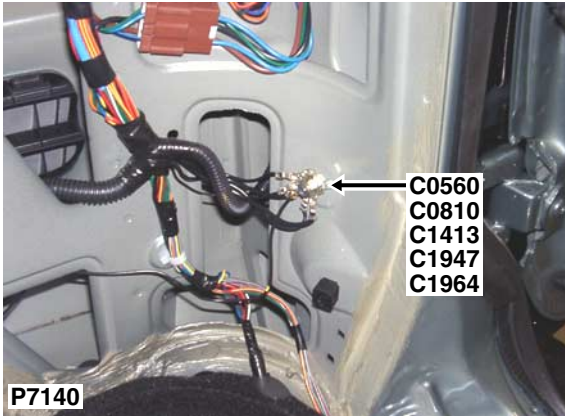

Cav	Col	Cct
1	B	ALL

Description: *Earth*

Location: *Rear of luggage compartment - RH side*

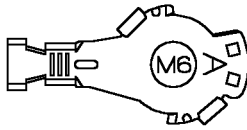

YPG101400

Colour: *TIN-PLATE*

Gender: *Female*

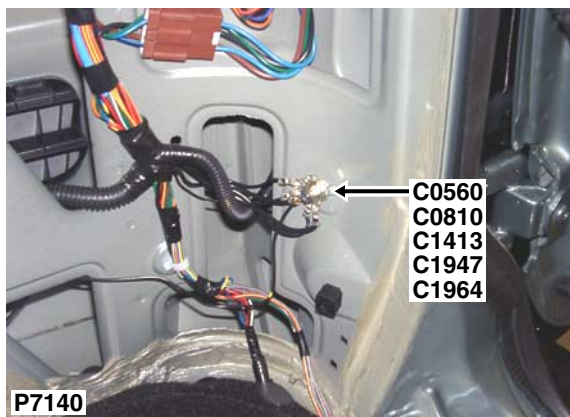

Cav	Col	Cct
1	B	ALL

Description: *Earth*

Location: *Rear of luggage compartment - RH side*

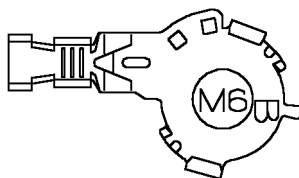

YPC101420

Colour: *TIN-PLATE*

Gender: *Female*

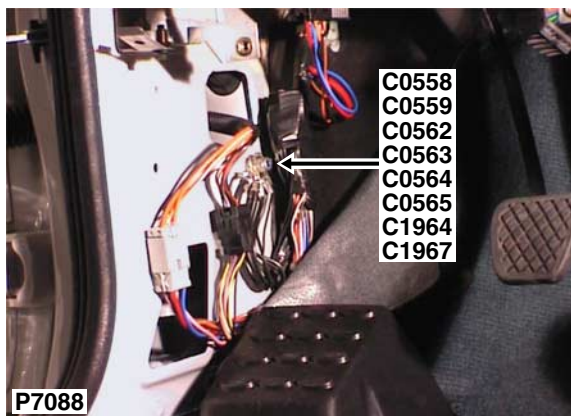

Cav	Col	Cct
1	B	ALL

Description: *Earth*

Location: *Base of LH 'A' post*

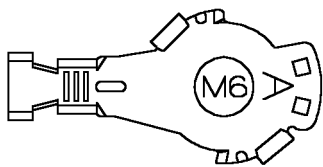

YPG101390

Colour: *TIN-PLATE*

Gender: *Female*

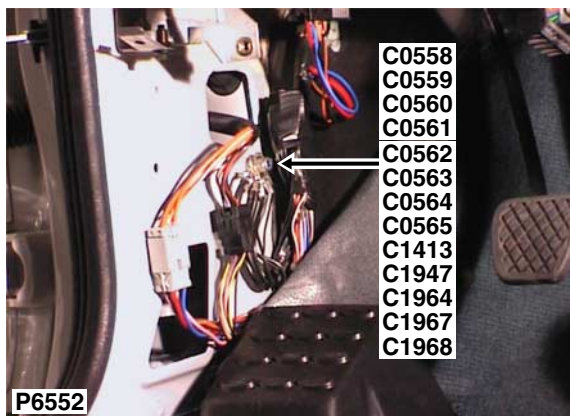

Cav	Col	Cct
1	B	ALL

Description: *Earth*

Location: *Base of LH 'A' post*

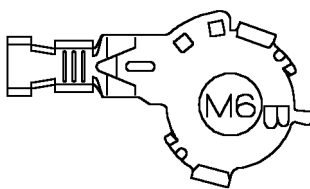

YPG101410

Colour: *TIN-PLATE*

Gender: *Female*

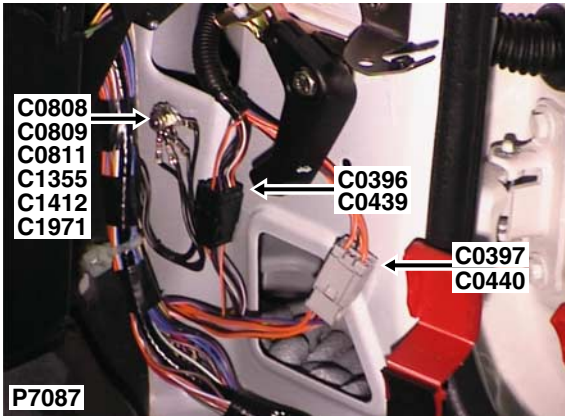

Cav	Col	Cct
1	B	ALL

Description: *Earth*

Location: *Base of RH 'A' post*

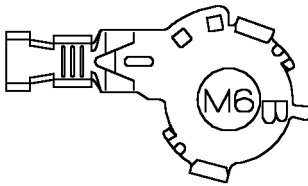

YPG101410

Colour: *TIN-PLATE*

Gender: *Female*

Cav	Col	Cct
1	B	34

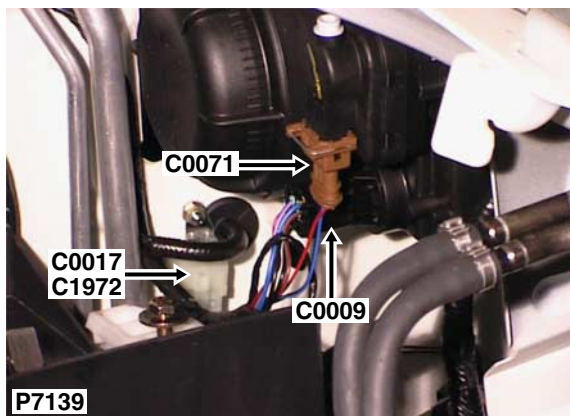

Description: *Earth*

Location: *Lower LH front of engine compartment*

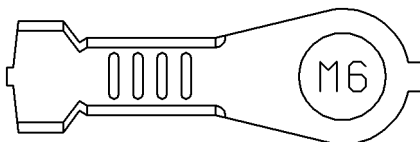

YPG100740

Colour: *BRASS*

Gender: *Female*



Cav	Col	Cct
2	NR	23
4	P	23
5	NK	23
6	BR	23
8	P	23

Description: *Relay-Illumination*

Location: *Behind RH side of fascia*

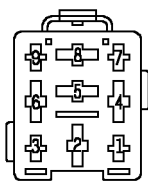

YPP10001

Colour: *BLACK*

Gender: *Female*

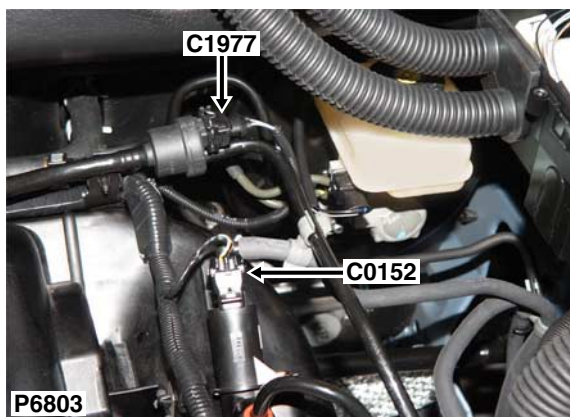

Cav	Col	Cct
1	BS	ALL
2	YU	ALL

Description: *Vacuum enhance*

Location: *Rear of engine compartment*

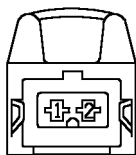

YPC114900

Colour: *BLACK*

Gender: *Female*

C2403

CONNECTOR DETAILS

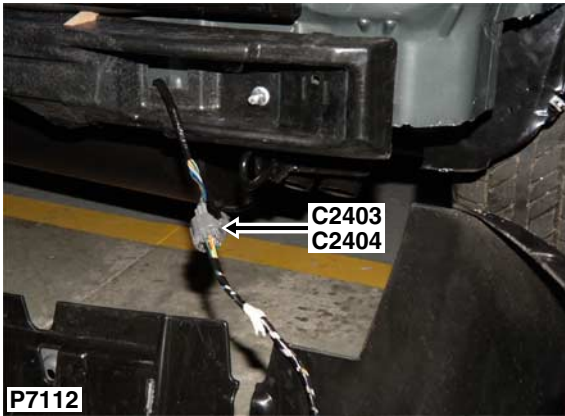

Description: *Main harness to PDC harness*
Location: *Behind RH side of rear bumper*

Cav	Col	Cct
1	B	ALL
2	GW	ALL
3	RO	ALL
4	GR	ALL
5	RB	ALL
6	GP	ALL
7	WG	ALL
8	O	ALL
9	Y	ALL
10	U	ALL
11	G	ALL
12	BG	ALL

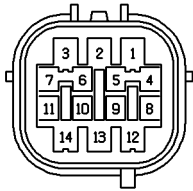

YPC10469

Colour: *GREY*
Gender: *Male*

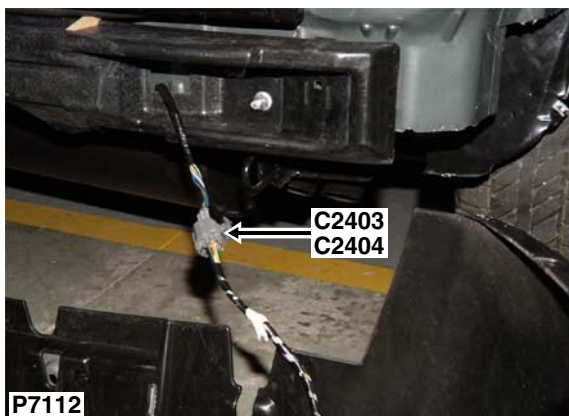

Description: *PDC harness to main harness*

Location: *Behind RH side of rear bumper*

Cav	Col	Cct
1	B	ALL
2	GW	ALL
3	RO	ALL
4	GR	ALL
5	RB	ALL
6	GP	ALL
7	W	39
8	O	39
9	Y	39
10	U	39
11	G	39
12	B	39

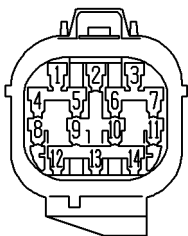

YPC10549

Colour: *GREY*

Gender: *Female*

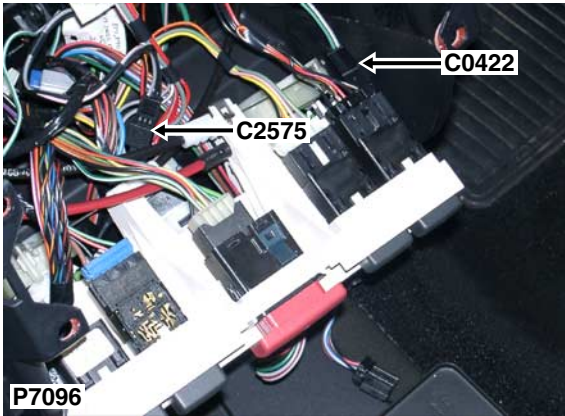

Description: *Micro switch*

Location: *Behind centre console*

Cav	Col	Cct
1	SK	ALL
2	B	ALL
3	B	ALL

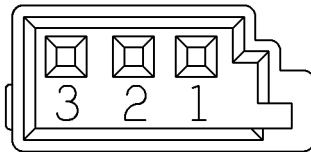

6905977

Colour:

Gender:

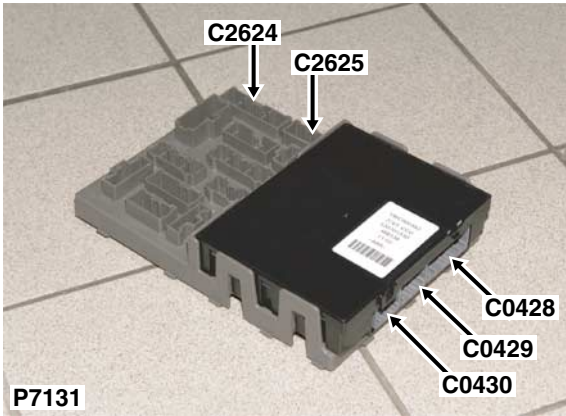

Description: *Fuse box-Passenger compartment*
 Location: *Behind passenger compartment fusebox*

Cav	Col	Cct
1	LGK	ALL
2	BR	ALL
3	GP	ALL
4	NG	23
5	GN	23
6	LGO	ALL
7	GB	ALL
8	GR	ALL
9	GB	ALL
10	BR	ALL
11	UP	ALL
12	R	ALL
13	RS	ALL
15	WR	6
16	WU	6
18	OU	ALL
19	GY	17
20	GW	17

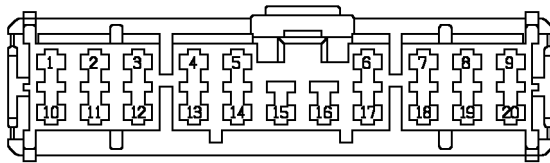

YPC10498

Colour: *LIGHT GREY*
 Gender: *Female*

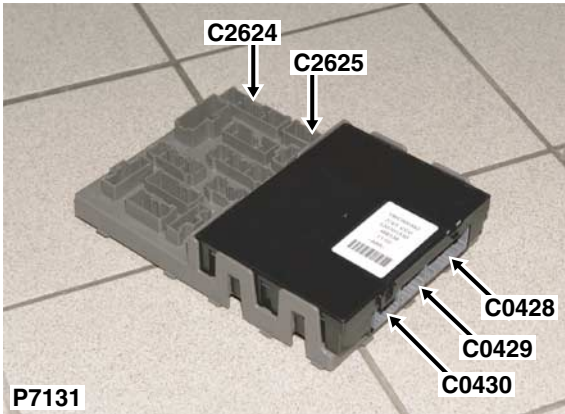

P7131

Cav	Col	Cct
1	U	6
2	US	ALL
3	PN	ALL
5	R	6

Description: *Fuse box-Passenger compartment*

Location: *Behind passenger compartment fusebox*

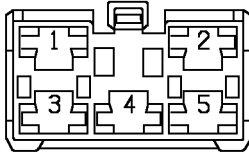

YPC10462

Colour: *BROWN*

Gender: *Female*