

# Audio and Navigation System





## Audio & Navigation System

### IMPORTANT

Some features described in this manual may not be available in all countries. Where this is the case, these features will not be available in the display.

Publication Part No. LRL 0475NAS

© Land Rover 2001

All rights reserved. No part of this publication may be reproduced, stored in a retrieval system or transmitted in any form, electronic, mechanical, recording or other means without prior written permission from Land Rover.



As part of Land Rover environmental policy, this publication is printed on paper made from chlorine free pulp.

# Contents

---

Control panel.....	3
Anti-theft system.....	6
General operation.....	10
Radio operation.....	14
CD operation.....	28
CD autochanger.....	34
Navigation operation.....	36
User menu.....	72

# Remote Controls

## RADIO REMOTE CONTROLS \*

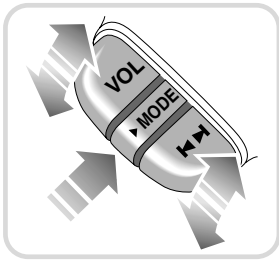
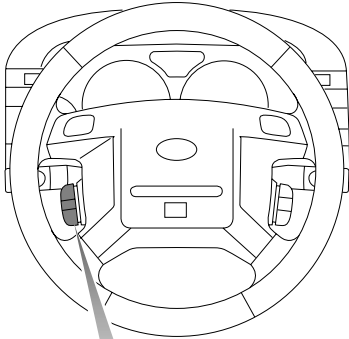

H3550

### Volume control

**VOL** Lift or press to increase or decrease the volume.

### Mode select control

**MODE** Press to change between radio mode, navigation mode and CD mode. The unit will only change to CD mode if an audio CD has been loaded into the unit or CD autochanger\*.

### Search control

 Lift or press to select the next or previous radio station on the selected waveband.

In CD mode, lift the control to move to the next track on the disc, or press to return to the start of the current track.

Operate the control repeatedly, or hold the control to move forward or back through several tracks at a time.

\* If fitted.

# Control panel

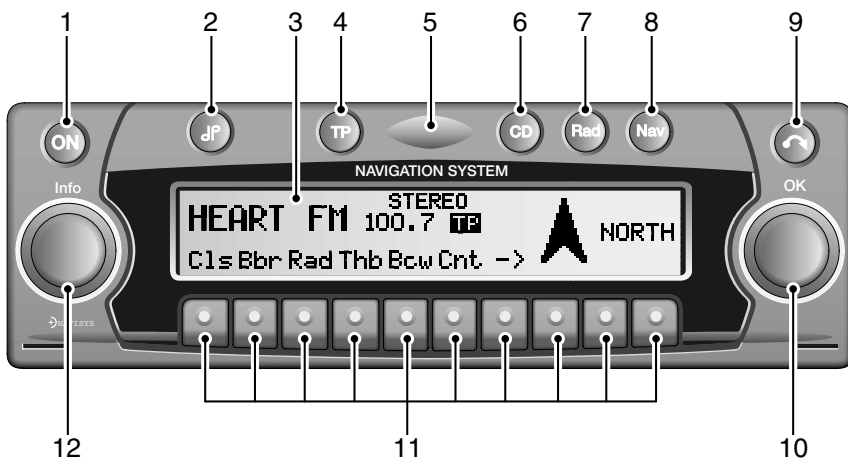

ICE 1242

## CONTROL PANEL

- 1. On/Off**  
Press to switch ON. The display shows 'LAND ROVER'
- 2. Tone button**  
Press to activate the tone menu.
- 3. Display**
- 4. Traffic programme button**  
Press to activate the TP menu.
- 5. Security light**
- 6. CD mode selection button**  
Press to select CD mode, if a music CD is already in the slot or in the CD autochanger.
- 7. Radio mode selection button**  
Press to select radio mode. While in radio mode, press to select radio menu.
- 8. Navigation mode selection button**  
Press to select main navigation mode. While in navigation mode, press to select navigation menu.
- 9. Display/CD eject button**  
Press briefly to fold display panel forwards.  
Press and hold to eject a CD.
- 10. Right rotary control**  
Turn to select a menu item, press to confirm selection.
- 11. Multifunction buttons**
- 12. Left rotary control**  
Press to display information, rotate to adjust the volume.

# Anti-theft system

---

ENTERING THE CODE NUMBER .....	6
REMOVING THE PORTABLE PANEL .....	7
INSERTING THE PORTABLE PANEL .....	8

# Anti-theft system

---

## ENTERING THE CODE NUMBER

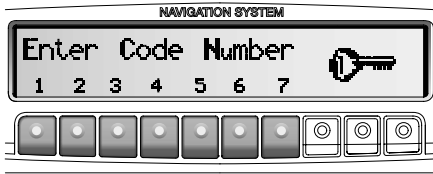

ICE 0285

If the unit is disconnected from the power supply, it is theft-protected upon reconnection. After switching on via the 'ON' button, 'Enter Code Number' is displayed.

The five-digit code must then be entered using the multifunction buttons 1 - 7.

Example: Code number 15372 (the code number can be found on your SECURITY CARD).

Enter code number using the multifunction buttons. The unit automatically switches on when the fifth digit is entered and all other digits have been entered correctly.

If an incorrect code number is entered, 'CODE' is displayed again.

After entering an incorrect code three times 'WAIT' is displayed for approximately 60 minutes.

**NOTE:** *The disabling period functions only whilst the unit is switched on.*

# Anti-theft system

## REMOVING THE PORTABLE PANEL

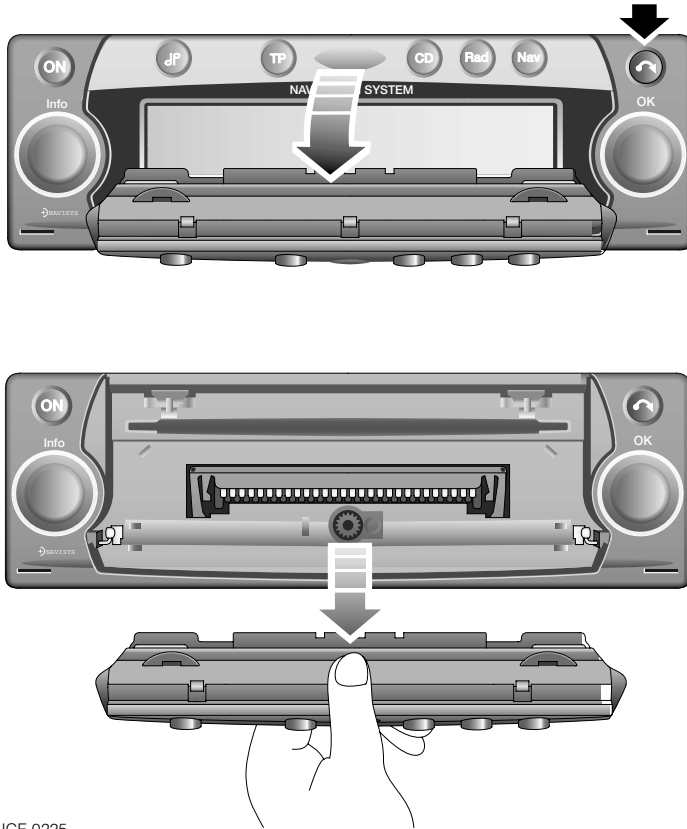

ICE 0225

As an effective anti-theft device, the portable panel can be removed from the unit.

Press the 'CD Eject' button briefly (storage medium remains in the unit). The display folds forwards to reveal the CD slot.

The portable component can then be pulled out.

The volume is limited to a maximum value after the display panel has been folded down. After 20 seconds an audible signal indicates that the display panel is still folded down and the unit then switches off.

**NOTE:** For safety reasons, do not leave the portable panel open when driving. Do not touch the metal contacts on the portable panel or on the radio.



# Anti-theft system

---

## **INSERTING THE PORTABLE PANEL**

Insert the portable panel in the lower left catch and then engage it in the lower right catch. Next, fold up the portable panel and engage it in the upper catches.

Alternately, position portable panel directly over all four catches and press in firmly to engage.

For correct functioning, ensure that the portable panel is firmly engaged in all four catches.

If a new portable panel or one from another unit is utilised, the code number must be entered in order to activate the unit.

# General operation

---

SWITCH ON/OFF .....	10
ADJUSTING THE VOLUME .....	10
ACTIVATING THE TONE MENU .....	10
Bass setting .....	10
Treble setting .....	10
Fader setting .....	10
Balance setting .....	11
Linear setting .....	11
SWITCHING LOUDNESS ON/OFF .....	11

# General operation

## SWITCH ON/OFF

Press the 'ON' button.

Additional options for switching on / off:

Via ignition: In order to switch on via the ignition, the unit must have been switched off previously via the ignition.

With the ignition switched off, the unit can also be switched on via the ON button. The unit switches off automatically after 1 hour.

To deactivate the unit, either switch off the ignition or press the 'ON' button.

## ADJUSTING THE VOLUME

Turn the left rotary adjustment control. The volume is increased or decreased.

## ACTIVATING THE TONE MENU

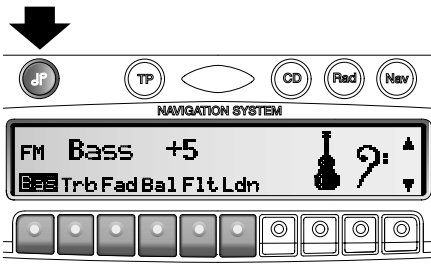

ICE 0242

Press the 'TONE' button and the tone menu is activated.

The following functions can be requested:

Bas (Bass)

Trb (Treble)

Bal (Balance)

Fad (Fader)

Flt (Linear setting)

Ldn (Loudness)

Select function by pressing the required multifunction button.

Set desired level with right rotary control and press to confirm. (Level set will remain in memory).

Settings for the bass, treble, fader, balance and loudness are stored separately for MW, LW, SW, FM and for traffic announcements, navigation, CD and CDC operation.

## Bass setting



Press the 'TONE' button and then the multifunction button 'Bas'. Set the desired bass level using the right rotary control.

ICE 0226

## Treble setting

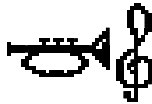

Press the 'TONE' button and then the multifunction button 'Trb'. Set the desired treble level using the right rotary control.

ICE 0227

## Fader setting

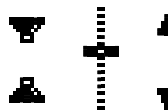

Press the 'TONE' button and then the multifunction button 'Fad'. Use the right rotary control for the desired fader setting.

ICE 0228

# General operation

---

## Balance setting

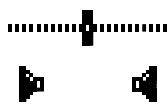

ICE 0229

Press the 'TONE' button and then the multifunction button 'Bal'. Set the desired balance level using the right rotary control.

## Linear setting

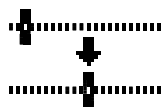

ICE 0231

Briefly press the 'Tone' button.

Press the multifunction button 'Flt' (Tone flat is displayed).

By pressing the multifunction button 'Flt' again the tone settings for the currently selected signal source (e.g. FM) are set to an average value.

## SWITCHING LOUDNESS ON/OFF

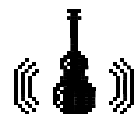

ICE 0230

Press the 'Tone' button and then the multifunction button 'Ldn'. Using the multifunction button 'Ldn', you can select either loudness on (ON) or loudness off (OFF).

Loudness is switched off in MW, LW and SW wavebands.



# Radio operation

---

RDS SYSTEM . . . . .	14
DAS Seek Qual. plane . . . . .	14
DAS Seek Name plane . . . . .	14
Station RDS plane . . . . .	14
Stations Fix plane. . . . .	14
SWITCHING ON THE RADIO. . . . .	14
ACTIVATING THE RADIO MENU . . . . .	14
Selecting the FM waveband . . . . .	14
Selecting the AM waveband . . . . .	15
Setting options for frequency selection . . . . .	15
DYNAMIC AUTOSTORE (FM DAS) . . . . .	16
FM DAS transmitter search . . . . .	16
MW, LW, SW transmitter search . . . . .	16
Scan search . . . . .	17
PTY (PROGRAMME TYPE) . . . . .	18
Programme type selection . . . . .	18
Switching PTY display on/off. . . . .	18
SELECTING/STORING FREQUENCIES . . . . .	19
FM frequencies . . . . .	19
Storing. . . . .	19
AM, LW, SW frequencies. . . . .	19
AM, LW autostore . . . . .	19
MANUAL TUNING. . . . .	20
FM fine tuning . . . . .	20
AM, LW, SW . . . . .	20
REGIONALISATION . . . . .	21
Switching regionalisation on/off . . . . .	22
Switching frequency display on/off . . . . .	22
Switching radio text display on/off. . . . .	22
TRAFFIC PROGRAMME (TP) . . . . .	23
Activating/quitting the TP menu. . . . .	23
Switching on Tp. . . . .	23
Setting/deleting direct programming . . . . .	24
Switching off TP . . . . .	24
Switching mute function on/off . . . . .	24
Interrupting TP announcements . . . . .	25
TP announcement volume . . . . .	25

# Radio operation

## RDS SYSTEM

This car radio is capable of receiving RDS signals (RDS = Radio Data System) in the VHF range.

RDS is a technique which enables the transmission of inaudible additional information in the VHF broadcasting range. This means that the transmitter broadcasts information which can be evaluated by the car radio.

## DAS Seek Qual. plane

In the 'DAS Seek Qual' plane, all receivable and identifiable RDS programmes are alphabetically arranged in a list according to quality. The dynamic autostore, search and scan search functions fall back upon this list.

## DAS Seek Name plane

In the 'DAS Seek Name' plane, all receivable and identifiable RDS programmes are alphabetically arranged in a list according to name. The dynamic autostore, search and scan search functions fall back upon this list.

## Station RDS plane

In the 'Stations RDS' plane, only identified RDS stations can be stored. The unit constantly switches to the best receivable transmission frequency for the station. During the search on 'Stations RDS' the unit only stops at identifiable stations.

## Stations Fix plane

In the 'Stations Fix' plane, frequencies can be assigned to the station buttons. RDS evaluation does not take place. The search on 'Stations Fix' is applicable to FM manual tuning only.

## SWITCHING ON THE RADIO

Press the 'RAD' button to select radio mode. The radio is set to the previously selected waveband.

## ACTIVATING THE RADIO MENU

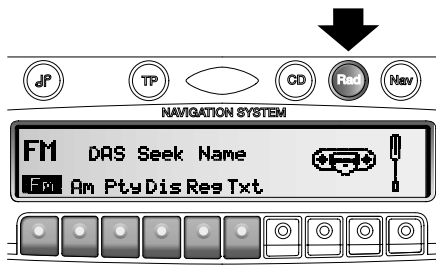

ICE 1243

To select the radio menu, press the "Rad" button again.

The radio menu is switched on and displayed. The unit switches back to radio mode if no button is pressed within the next 8 seconds.

## Selecting the FM waveband

In radio menu mode, press the 'FM' multifunction button.

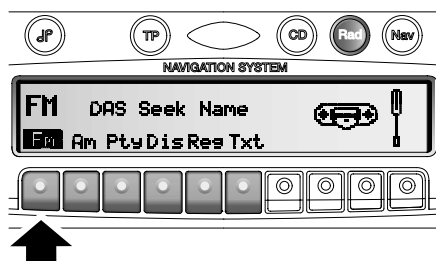

ICE 1244

The last selected frequency and graphics are displayed.

# Radio operation

By pressing the 'FM' multifunction button repeatedly, the graphics: 'DAS, Seek Qual', 'DAS Seek Name', 'Stations RDS' and 'Stations Fix' can be selected.

## Selecting the AM waveband

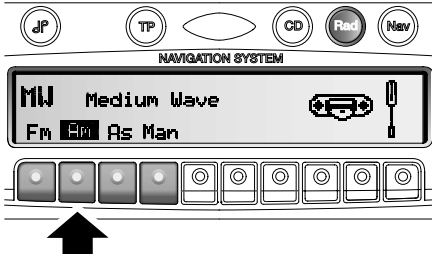

ICE 0234

In the radio menu, press the 'AM' multifunction button.

The last selected waveband and frequency are set.

To select the wavebands MW (Medium Wave), LW (Long Wave) and SW (Short Wave), press the multifunction button 'AM' repeatedly until the required waveband is selected.

## Setting options for frequency selection

The desired transmitter can be selected via dynamic autostore (FM), autostore (MW, LW), frequency search, manual tuning and station buttons.



# Radio operation

## DYNAMIC AUTOSTORE (FM DAS)

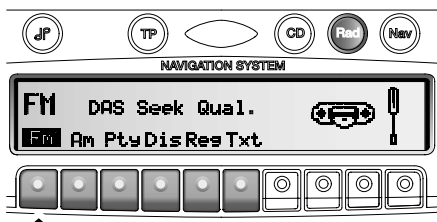

ICE 1245

In radio menu mode, press the 'FM' multifunction button repeatedly until 'DAS Seek Qual' or 'DAS Seek Name' is displayed.

After 8 seconds, the screen will display the receivable frequencies according to the setting via the multifunction buttons.

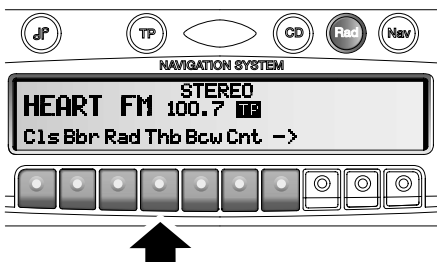

ICE 1246

If programmes broadcast by the transmitter you are tuned to have previously been stored, the last stored programme entry will be automatically selected.

Set the desired frequency by pressing the button directly below the abbreviated station designation.

If the selected transmitter broadcasts several programmes/regional programmes, a submenu is automatically displayed for 8 seconds, allowing further selection if so desired.

The multifunction button → indicates that the button can be pressed for displaying and selecting additional transmitters.

When using the unit for the first time, or following interruption of the power supply, allow a brief waiting period so that the receiver can evaluate the transmitter signals.

The display will appear incrementally as the evaluation progresses.

### FM DAS transmitter search

Turn the rotary selection control to the left/right. The radio displays the receivable and identified transmitters in descending/ascending order.

### MW, LW, SW transmitter search

In the desired waveband (MW, LW, SW), turn the rotary selection control the left/right. The radio searches for reception frequencies in descending/ ascending order of frequency.

# Radio operation

---

## Scan search

First select the desired waveband (FM, MW, LW, SW) then press the rotary selection control. SC is displayed before the automatic frequency search is started.

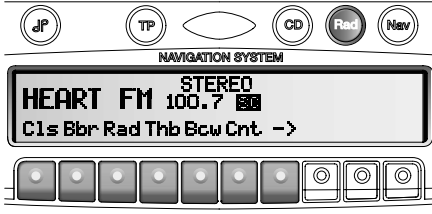

ICE 1247

The first run is performed on an insensitive plane, all further runs on a sensitive plane.

Receivable frequencies can be heard for 8 seconds before the search facility moves onto the next frequency.

Press the rotary selection control if the received programme should be retained.

**NOTE:** For FM DAS the scan search is performed in alphabetical order.

# Radio operation

## PTY (PROGRAMME TYPE)

Specific types of programme, such as e.g. sport, pop music, classical music etc., can be selected using the PTY function. The PTY is broadcast by the RDS transmitter, provided that the transmitter is equipped with this function. The selected transmitter programme type can be displayed or a search for a specific PTY transmitter can be performed.

Examples of programme types are:

NEWS	News services
POP M	Pop music
AFFAIRS	Politics and current affairs
ROCK M	Rock music
INFO	Special word programme
SCIENCE	Science
EDUCATE	Learning and further education
LIGHT M	Light music
DRAMA	Radio plays and literature
CLASSICS	Classical music
CULTURE	Culture, church and society
EASY M	Easy listening
VARIED	Light entertainment
SPORT	Sport
OTHER M	Special music programmes
WEATHER	Weather report
FINANCE	Financial information
CHILDRG	Children's programmes
SOCIAL	Social reports
RELIGION	Religious reports
PHONE IN	Interviews
TRAVEL	Travel reports
LEISURE	Leisure reports
JAZZ	Jazz music
COUNTRY	Country music
NATION M	National folk music
OLDIES	Oldies
DOCUMENT	Documentaries
NO PTY	No PTY

## Programme type selection

In radio menu mode, press the 'Pty' multifunction button then, using the multifunction button 'Pty', select the programme type.

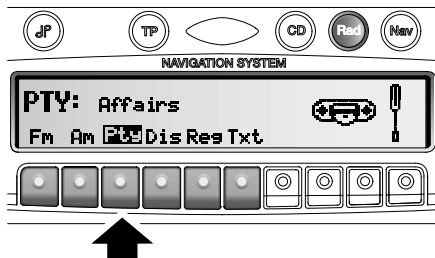

ICE 1249

The extent of programme types is limited to those available through local transmitters.

Once PTY is operational, only those transmitters that are equipped with PTY can be selected in FM DAS mode.

By selecting 'NO PTY', all transmitters will be re-displayed in FM DAS mode.

## Switching PTY display on/off

Select radio menu. Using the multifunction button 'Dis' select either PTY (PTY display switched on) or Frequenc (PTY display switched off).

# Radio operation

## SELECTING/STORING FREQUENCIES

### FM frequencies

Select radio menu.

Use repeated pressings of the multifunction button 'FM', 'Stations RDS' or 'Stations Fix'.

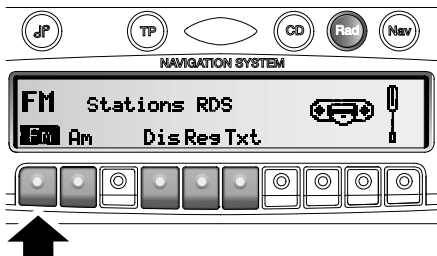

ICE 0239

Press 'Rad' to display the frequency display graphic.

### Storing

Twelve frequencies or programmes can be stored per waveband.

To store a selection, first tune to the desired station. Choose a multifunction button on which to store your selection (1-6 or 7-12) and press until a signal tone sounds

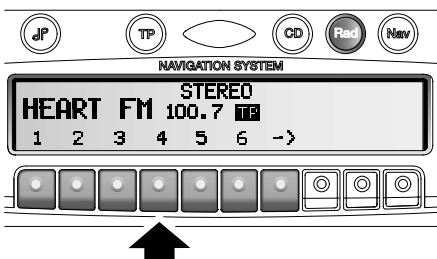

ICE 1250

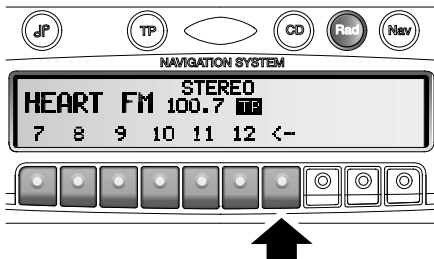

ICE 1251

The station is now stored and can be accessed again by pressing the same button. Buttons 7-12 can be accessed by pressing the -> button. Return to buttons 1 - 6 by pressing the <- button.

### AM, LW, SW frequencies

First select the AM waveband using the 'AM' multifunction button.

Follow the same procedure as for storing FM frequencies.

### AM, LW autostore

First select the desired waveband, then press the 'Rad' button.

Press the 'As' multifunction button repeatedly until 'Autostore on' is displayed.

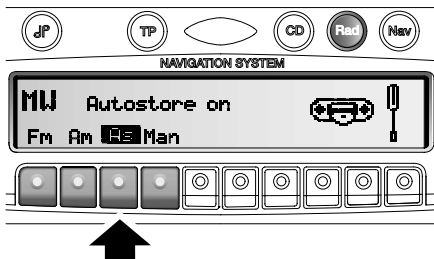

ICE 0245

# Radio operation

Press the 'As' multifunction button and hold until 'Seek Autostore' is displayed

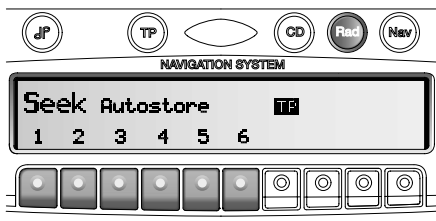

ICE 0246

The 6 strongest frequencies available will be stored under the station buttons in order of quality.

In order to quit autostore storage, press the multifunction button 'As' (Off). The radio will return to the station button graphics.

## MANUAL TUNING

### FM fine tuning

First select the radio menu, and then use the multifunction button 'FM' to select 'Stations Fix'.

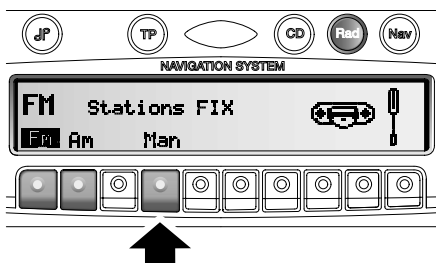

ICE 0247

Press the 'Man' multifunction button twice.

On the display, active manual tuning is indicated by 'MAN'.

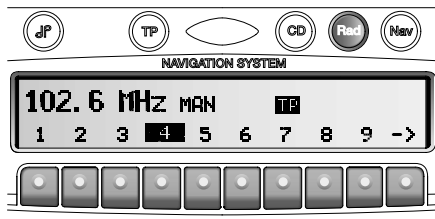

ICE 0248

Turn the rotary selection control to adjust fine tuning manually (100 kHz tuning steps are performed).

Stations can be stored in the manner previously described.

After a short delay and without turning the rotary selection control, 'MAN' disappears and manual tuning will switch off.

### AM, LW, SW

First select the desired waveband, then press the 'Rad' button.

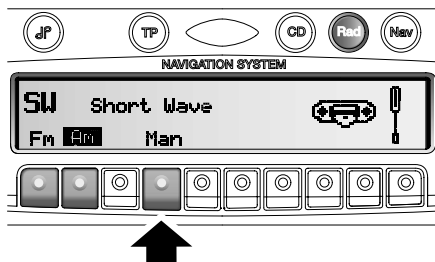

ICE 0249

Press the 'Man' multifunction button twice. On the display, active manual tuning is indicated by 'MAN'.

# Radio operation

Turn the rotary selection control to adjust fine tuning manually. (Tuning steps of 9kHz in MW, 3 kHz in LW or 5kHz in SW are performed).

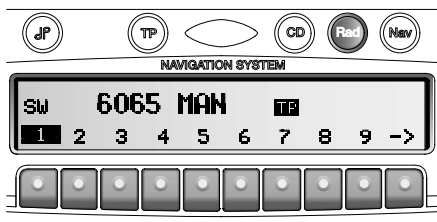

ICE 0250

Stations can be stored in the manner previously described.

After a short delay and without turning the rotary selection control, 'MAN' disappears and manual tuning will switch off.

## REGIONALISATION

The RDS diversity function is independent of region. If the RDS diversity function should switch among various regional programmes with diverse broadcast contents, the special regional sub-programme must be selected directly.

A transmitter must first be selected in order to see if it broadcasts more than one regional programme.

Transmitters with additional regional transmitters are identified by a star (e.g. 4\*).

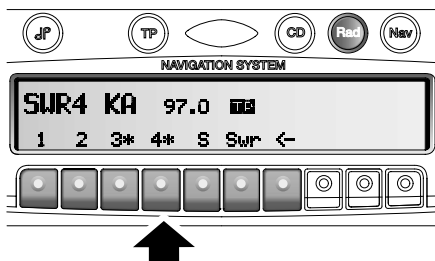

ICE 0251

Upon selection of one of these transmitters (e.g. 4\*) all receivable regional sub-programmes for this transmitter will be displayed. Then select the desired regional sub-programme

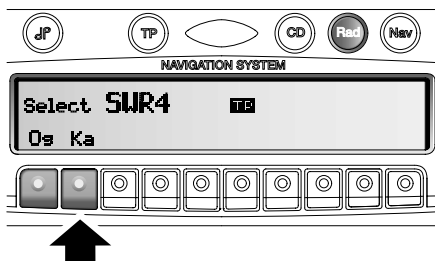

ICE 0252

If, despite RDS diversity function, the reception quality of a regional sub-programme is inferior, bear in mind that regional sub-programmes are transmitted for the most part over only a few frequencies. If the unit remains tuned to frequencies with better reception quality, there will be less drift.

# Radio operation

## Switching regionalisation on/off

Select radio menu mode

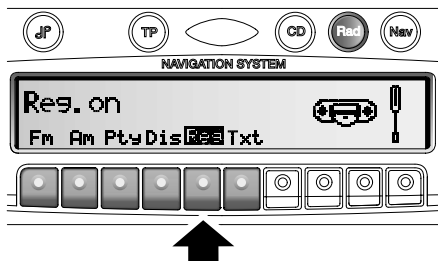

ICE 1252

Using the multifunction button switch the regionalisation on or off.

## Switching frequency display on/off

Select radio menu mode

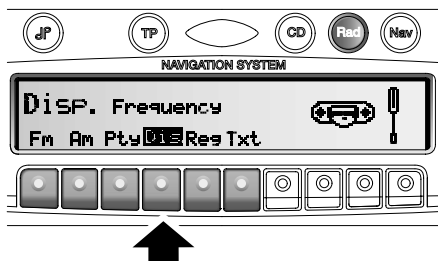

ICE 1253

Using the 'Dis' multifunction button select either Frequency (frequency display switched on) or PTY (frequency display switched off).

## Switching radio text display on/off

Select FM radio menu mode. Using the multifunction button switch on radio text.

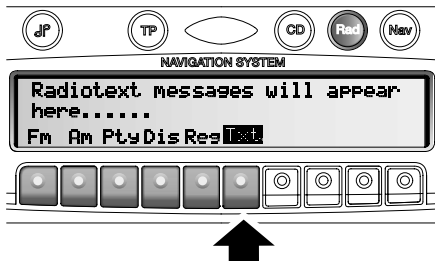

ICE 1254

The car radio filters information from a transmitter and displays it in the form of radio text.

Radio text cannot be displayed unless the selected transmitter also transmits radio text. Unfavourable reception conditions, including interference, can garble or even block a radio text display.

In order to quit radio text, press the 'Rad' button.

**NOTE:** Since information transmitted via radio text display varies constantly, we recommend tuning in the radio text only when the vehicle is stationary to avoid unnecessary distraction for the driver. This is a necessary precaution for accident prevention.

# Radio operation

## TRAFFIC PROGRAMME (TP)

If an RDS diversity transmitter transmits TP announcements you can have CD, CDC/AUX, MW, LW and SW operation interrupted and the transmitted TP announcements switched through. Moreover, you can listen to one FM transmitter while having TP announcements switched through that are transmitted by another FM transmitter.

There are two ways to select a TP transmitter:

- automatic tracking
- direct programming

Automatic tracking transmits TP bulletins over the FM transmitter currently being received. If the selected FM transmitter reception is of poor quality or cannot function as a TP transmitter, the unit applies specified criteria to search for a new TP transmitter.

Direct programming enables a TP transmitter to be programmed that is not the FM transmitter being received.

For example, an FM transmitter can be received while TP announcements transmitted by another FM transmitter are switched through.

If the programmed TP transmitter reception is poor, the unit switches to automatic tracking until the programmed TP transmitter is receivable.

If an RDS transmitter is equipped with a traffic programme, this is indicated on the display by TP.

An inverse TP appears on the display to indicate that the traffic programme is active.

## Activating/quitting the TP menu

**Activating:** Press the 'TP' button (traffic announcements cannot be transmitted). Press the 'Tp' multifunction button.

**Quitting:** Press the 'TP' button or the TP menu will be automatically terminated after 8 seconds without actuation.

## Switching on Tp

In all modes and wavebands, automatic tracking can be switched on by pressing the 'TP' button for more than 2 seconds. An inverse 'TP' symbol will be displayed on the screen

To switch on automatic tracking in the TP menu, press the 'TP' multifunction button until 'TP on' is displayed.

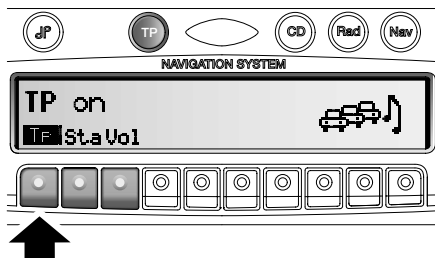

ICE 1255

**Attention:** If a TP transmitter has already been programmed directly, it will once again be selected as a TP transmitter.



# Radio operation

## Setting/deleting direct programming

Activate the TP menu.

**Setting:** Press the 'Sta' multifunction button.

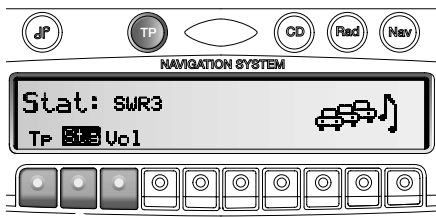

ICE 1256

Using the rotary selection control, select the desired TP transmitter. After a short delay and without actuation, the selected transmitter is accepted.

**Deleting:** Press the 'Sta' multifunction button.

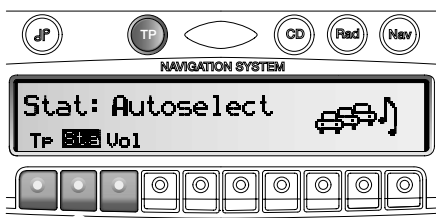

ICE 1257

Using the rotary selection control, select 'Autoselect' and press to confirm. After a short delay and without actuation, the direct programming is deleted.

Quit the TP menu.

## Switching off TP

In all modes and wavebands, TP can be switched off by pressing the 'Tp' button for more than 2 seconds. The display changes from the inverse symbol to 'TP'.

To switch off TP in the TP menu, press multifunction button 'Tp' repeatedly until 'TP off' is displayed.

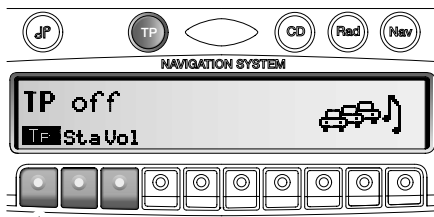

ICE 1258

TP is switched off after returning to normal display.

## Switching mute function on/off

After selection of a TP or EON transmitter, the mute function can be activated by briefly pressing the 'TP' button.

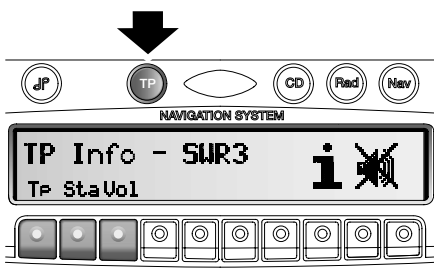

ICE 1259

Thereafter, only traffic announcements and navigation announcements can be switched through. After again pressing the 'TP' button, muting is cancelled.

# Radio operation

## Interrupting TP announcements

During a TP announcement, briefly press the 'TP' button. The announcement currently broadcast will be interrupted and the system will automatically return to the previously selected mode.

## TP announcement volume

Activate the TP menu. Press the 'Vol' multifunction button.

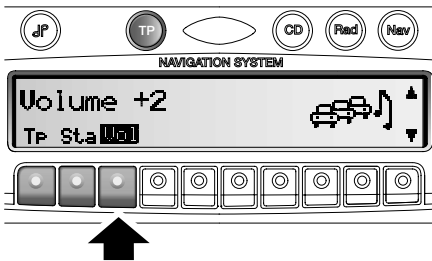

ICE 1279

Using the rotary selection control, four different settings (0 - 3) can be selected. This means that the volume can be raised to a fixed value according to the setting.

- Setting 0: no volume increase
- Setting 1: slight volume increase
- Setting 2: medium volume increase
- Setting 3: large volume increase



# CD operation

---

CONTROL PANEL .....	28
CARING FOR YOUR COMPACT DISCS .....	29
INSERTING/EJECTING CD's .....	30
COMPACT DISC PLAYER CONTROLS .....	31
Track skip - forwards/backwards .....	31
Scan search .....	31
Fast forward/rewind .....	31
Random play .....	31
Repeating a track .....	32
Number of tracks and total playing time .....	32
TEMPERATURE PROTECTION CIRCUIT .....	32

# CD operation

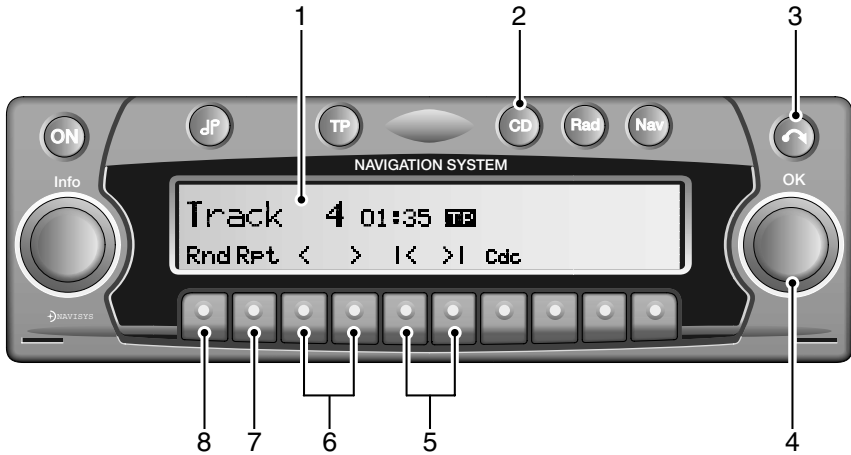

ICE 0224

## CONTROL PANEL

- 1. Display**
- 2. CD mode selection button**  
Press to select CD mode if a music CD is already in the slot or 'NAV CD' is displayed if a navigation CD is in the slot or the changer unit is loaded with CD's.
- 3. Display/Eject button**  
Briefly press to fold display forwards. Press and hold to eject a CD.
- 4. Rotary selection control**  
Turn to select options.
- 5. Track skip multifunction buttons**
- 6. Fast forward and rewind multifunction buttons**
- 7. Track repeat button**
- 8. Random play multifunction button**

# CD operation

## CARING FOR YOUR COMPACT DISCS

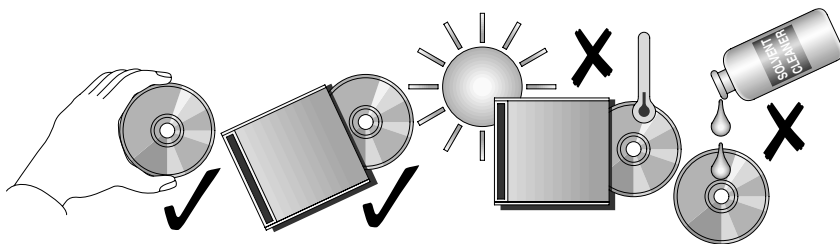

ICE 0022

Sound interruptions may occur if the CD is dirty. In order to ensure optimum tone quality, please note the following:

- Always touch the CD at the edges only. Keep the disc clean and never touch the surface.
- Never stick anything to the CD.
- Protect the CDs against direct sunlight and from heat sources such as heaters etc.
- Before playing, clean the CD with a commercially available cleaning cloth, wiping from the center outwards. Solvents such as petrol, thinners or other commercially available cleaners and anti-static sprays must not be used.

To move to CD mode from any other mode, press the CD button. If a CD is already in the player the display will show 'Cdc' above the relevant multi-function button, the last selected track number and play will commence from the position at which it was left before switching off. If a multi-changer unit is employed 'Scd' will be displayed above the multi function button; please see 'CD changer operation'.

**NOTE:** A temperature protection circuit is a feature of this unit. It is utilised to protect the laser diode against overheating. When the unit activates the feature, 'Temp' is displayed for 8 seconds and the unit switches to radio mode. After a short cooling phase the single CD mode can be used again, however, if the temperature is still too high, the unit will again switch to radio mode.

# CD operation

## INSERTING/EJECTING CD's

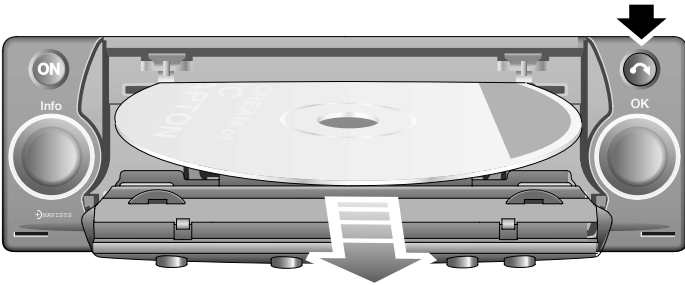
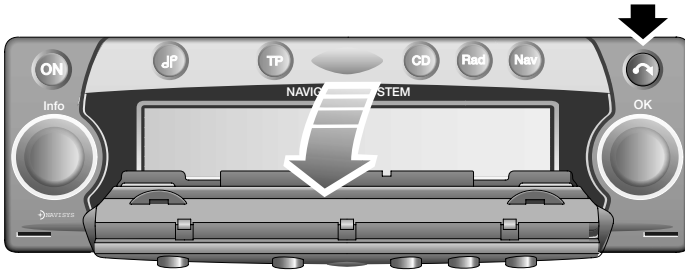

ICE 0244

Press and hold the 'Display/eject' button; the display folds downwards and the CD slot becomes visible. Press the 'Display/eject' button again to eject a loaded CD. Insert a disc into the CD slot with the printed side upwards. The unit will pull in the CD automatically and begin to play the disc from the first track. Fold the display up again. After playing the last track, the unit automatically begins to play the first track of the CD again.

**NOTE:** The CD is not ejected when the unit is switched off but remains in the CD slot.

If the CD is ejected but not removed, after a brief delay the unit will return the CD into the slot.

# CD operation

## COMPACT DISC PLAYER CONTROLS

### Track skip - forwards/backwards

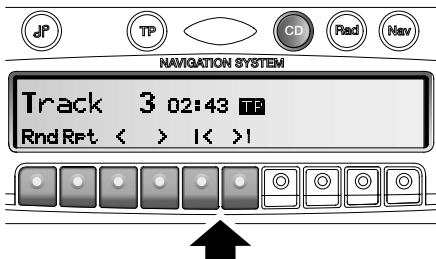

ICE 0262

Briefly press the appropriate multifunction 'skip' button to move to the beginning of the next track, or return to the start of the current track. Press the buttons repeatedly to skip several tracks.

### Scan search

Press the right rotary control, SC appears on the display.

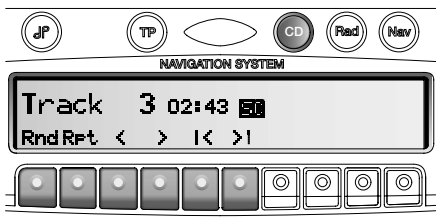

ICE 0263

The unit will now continue scanning CD tracks, playing the first 10 seconds of each track until the right rotary control is pressed again.

### Fast forward/rewind

Press and hold the forward multifunction button to activate audible fast forward. Release the button to terminate the action. Fast rewind operates in the same manner using the rewind multifunction button.

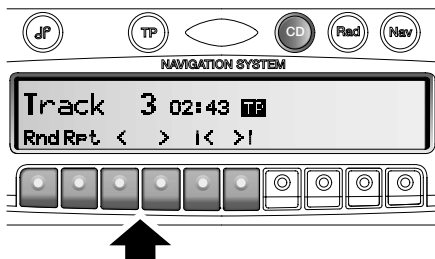

ICE 0264

Fast forward / rewind is terminated by releasing the multifunction button.

### Random play

Briefly press the 'Rnd' multifunction button to activate random play. 'Rnd' is inversely displayed and tracks on the CD are now played in random order.

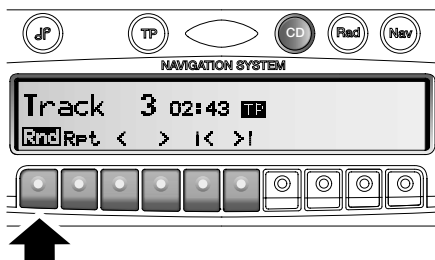

ICE 0265

A second press of the 'Rnd' button will deactivate random play.



# CD operation

## Repeating a track

Briefly press the 'Rpt' multifunction button. 'Rpt' is displayed inversely and the currently selected CD track will be repeated until the 'Rpt' button is pressed again.

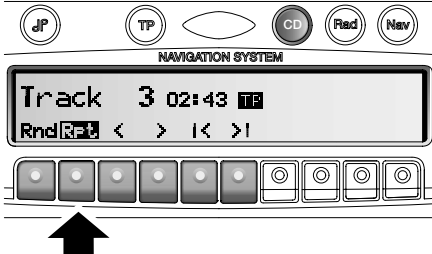

ICE 0266

## Number of tracks and total playing time

In CD mode, press the 'CD' button. Press the 'Trk' multifunction button to briefly display the elapsed time for the tracks already played.

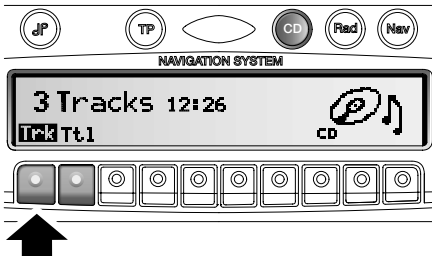

ICE 0267

Press the 'Ttl' multifunction button to briefly display the total playing time of the current CD.

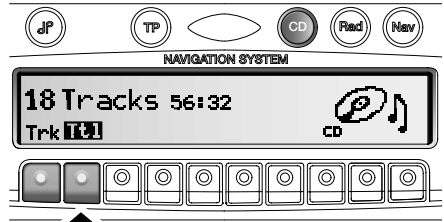

ICE 0268

## TEMPERATURE PROTECTION CIRCUIT

A temperature protection circuit is utilised in this unit in order to protect the laser diode against overheating.

When the protection circuit is requested 'CD Temp' is displayed for 8 seconds and the unit switches to radio operation. The single CD operation can be requested again after a short cooling phase. However, if the temperature is still too high, the unit again switches back to the previously selected signal source.

# CD autochanger

---

CD CHANGER OPERATION .....	34
Operational readiness of a CD changer .....	34
CD magazine - load unload .....	34
Playing CD's in the loaded magazine. ....	34

# CD autochanger

## CD CHANGER OPERATION

**NOTE:** Do not insert the Navigation CD into the CD changer magazine.

### Operational readiness of a CD changer

If a CD changer is connected to the unit, it is ready for use when loaded with at least one CD.

### CD magazine - load unload

To remove the CD magazine, open the sliding cover on the changer and press the eject button. The magazine is ejected and can be removed. Please note the imprint on the magazine before inserting CD's. To ensure the fastest possible CD change, load the magazine from compartment 1 onwards. After loading the magazine into the changer close the sliding cover. All further operations are performed via the unit in CD mode.

**NOTE:** Incorrectly inserted CD's will not play.

## Playing CD's in the loaded magazine

If you are already in CD mode, press the 'Cdc' multifunction button to switch to CD changer operation. To move to CD mode from any other mode, press the CD button. If a Navigation CD is in the single CD head unit, the CD changer will play as default and the display will show 'Scd' above the relevant multi function button. If no CD is already in the player the CD changer menu will be active and again the display will show 'Scd' above the relevant multi function button.

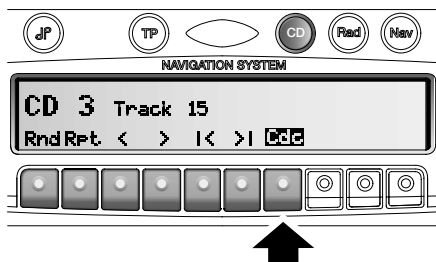

ICE 0269

The last selected CD and track number will be displayed and CD play will commence from the position at which it was left before switching off.

Loaded CDs can be selected by turning the right rotary control. 'Loading CD X' is displayed during the selection time. The magazine compartment number or the name of the CD and the number of the current track on the selected CD are then displayed. If the selected magazine compartment is empty (e.g. compartment 2), 'NO CD 2' is displayed briefly. After playing the last track of a CD, the next CD is automatically selected and played. The functions; Track skip, Scan search, Fast forward, Number of tracks and total playing time and Random play all operate in the same manner as for CD mode.

# Navigation operation

---

SAFETY WARNINGS.....	36	Starting route guidance to a stopover ..	52
SATELLITE NAVIGATION .....	37	Deleting a stopover .....	52
Safety instructions.....	37	Stopover reached .....	53
Digitised area.....	38	TRAFFIC JAM FUNCTION.....	53
Navigation CD's.....	38	Entering the length of a traffic jam ....	53
GENERAL NOTES.....	39	Delete block .....	54
Confirm warning .....	40	CANCELLING ROUTE GUIDANCE.....	54
Selecting navigation .....	40	NOTES ON ROUTE GUIDANCE.....	54
Main navigation menu.....	41	INFORMATION DURING ROUTE GUIDANCE	57
ENTERING A DESTINATION.....	41	Requesting journey duration and distance	
Updating software .....	42	travelled .....	58
Entering the location .....	42	Displaying the route settings.....	58
Entering a street name.....	44	Requesting current time .....	59
Entering the destination center .....	45	Requesting current position .....	59
ROUTE MENU .....	47	Requesting the street list .....	60
Entering the house number for the		Destination memory .....	60
destination street.....	47	SPECIAL DESTINATIONS.....	61
Select the intersection for the destination		Selecting NATIONWIDE.....	65
street .....	48	SYSTEM SETTINGS.....	66
Selecting the route settings.....	48	Setting the time.....	66
Storing a specified destination in the		Saving your position .....	67
destination memory.....	50	Requesting the position .....	68
Deleting stored destinations .....	50	Setting the language .....	68
Destination memory full .....	51	Animations .....	68
ROUTE GUIDANCE CALCULATION.....	51	Switching announcement of the estimated	
Recalculating the route .....	51	time of arrival on/off .....	69
STOPOVER.....	51	Setting the measuring unit .....	69
Entering a stopover .....	51		

# Navigation operation

---

## **SAFETY WARNINGS**

### Danger of accident

- through operation of the navigation unit when driving, e.g. entering destination,
  - the destination must only be entered when the vehicle is stationary.
  - use of the navigation unit is only permitted if traffic conditions are suitable and you are absolutely sure that no risk, obstruction or inconvenience will be incurred to you, your passengers or other road users.
- through non-observance of Road Traffic Regulations,
  - the requirements of the Road Traffic Regulations retain their validity. It is possible that inaccurate or incorrect instructions are given due to altered traffic routes, e.g. due to road works or deviating data. The actual road signs and traffic regulations must therefore always be observed.
- through misuse of the unit
  - the navigation system serves solely as an aid to navigation. In particular, the navigation system cannot be used as an aid to orientation when visibility is poor. The volume of the car radio/navigation system must be adjusted so that external noise is still audible.
  - switch off the unit immediately if a fault occurs (e.g. emission of smoke or odours).

# Navigation operation

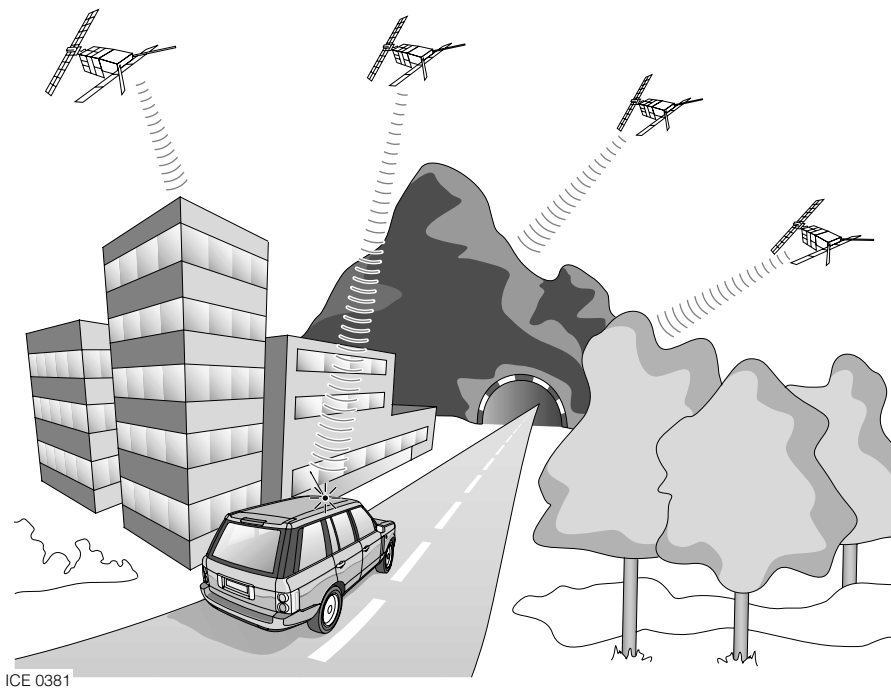

## SATELLITE NAVIGATION

The satellite navigation system fitted to your vehicle uses the Global Positioning System (GPS). This works in conjunction with direction and speed sensors incorporated in the vehicle's electronic systems, to continually monitor its position. The navigation computer then integrates this data with the information stored on the navigation CD, enabling you to plan and follow a route map to your desired destination. This is particularly useful if you are travelling to or through unfamiliar territory.

There are 24 GPS satellites in orbit (at a height of 21,000 km) around the earth. The GPS navigation system will pick up and utilise any available signals to plot your position. To accurately determine the position of the vehicle, the GPS receiver needs to be able to pick up the signals from at least four satellites.

Obstacles such as tall buildings, tunnels and mountains can sometimes shield a vehicle from satellite signals, which may cause a temporary interruption to the operation of the navigation system. However, the vehicle's direction and speed sensors will minimise any adverse effect on the operation of the navigation system, if this should occur. Normal operation will resume once the obstruction has been passed.

### Safety instructions

The requirements of the Road Traffic Regulations (RTR) apply.

Observation of traffic signs and local traffic regulations always takes priority.

Traffic guidance is restricted to passenger vehicles. Special driving recommendations and regulations for other vehicles (e.g. commercial vehicles) are not taken into account. The destination must only be entered when the vehicle is stationary.

# Navigation operation

## Digitised area

The navigation system can only provide information and guidance for the area covered by the navigation CD - ensure that you are using the latest version of the correct CD for your country.

**NOTE:** *Navigation CD's are updated approximately every 12 months. Your Navigation CD contains operating software. Later CD versions may update the operating software.*

The navigation CD provided contains a digitised street map. Highways, federal and regional roads, as well as district roads are detailed in this street map. Larger cities and boroughs are completely covered. The regional and unclassified roads or access roads and the town center for smaller towns and boroughs are included.

One way streets, pedestrian zones, turn bans and other traffic regulations are taken into account as far as possible. There may be discrepancies between the data on the navigation CD and the actual local situation, due to permanent changes to road systems and their traffic regulations.

Under normal operating conditions, the navigation system requires approximately 8 seconds to confirm the vehicle's position using the satellites. If the vehicle battery has been disconnected, or if the vehicle has been transported to a new location on another vehicle (e.g. by trailer or train), the navigation system will require approximately 1 minute to identify the new position.

## Navigation CD's

Your Navigation unit is supplied with two navigation CD's. One contains data for the western half of the USA, the other contains data for the eastern half.

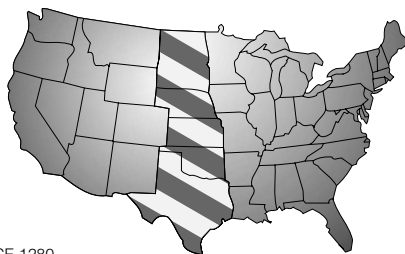

ICE 1280

Data for North Dakota, South Dakota, Nebraska, Kansas, Oklahoma and Texas are contained on both CD's. The cross over area is indicated in the illustration.

# Navigation operation

---

## GENERAL NOTES

- Depending on the last used system mode, a disclaimer may be displayed. Before any navigation information can be displayed the disclaimer must be confirmed by the user by pressing the right rotary control.
- Radio or CD operation continues during navigation operation.
- The distance to be covered before the next announcement and the estimated time of arrival are always displayed at the right of the display.
- The unit can be switched to radio mode when route guidance is in operation by pressing the 'Rad' button. Press the 'CD' button to switch to CD mode.  
The navigation menu is automatically displayed when navigation announcements are given.
- When entering the address, only those letters, digits and symbols which are relevant for the address are displayed. The entries are automatically completed. Spaces (e.g. in Long Lawton) must be entered using the underline symbol. Letters, numbers and symbols can be selected via the multifunction buttons 1 to 9. The individual symbols can be selected by pressing the relevant multifunction buttons repeatedly. Selection can also be made using the right rotary control.
- 'Nav' quits the current menu and displays the previous menu.
- The route is recalculated by the system if deviation from the route is made
- Press the left rotary control to hear the current navigation announcement.
- During the navigation announcement, adjustment can be made to the volume using the left rotary control and to the tone by pressing the Tone button.
- By briefly pressing the left rotary control additional information can be requested during route guidance or the current position when route guidance is not active. See "Information during route guidance".
- The current navigation announcement is interrupted by pressing the left rotary control.
- If the right rotary control is pressed for longer than 2 seconds during a navigation announcement, the navigation announcement switches off and route guidance continues via display only.  
By briefly pressing the left rotary control the navigation announcements are switched on again.
- The scroll marks ▲ and ▼ indicate a selection list which can be scrolled through using the right rotary control. Each entry in the list shown in capital letters can be selected by pressing the right rotary control.



# Navigation operation

## Confirm warning

Before you can use the navigation system, a warning appears.

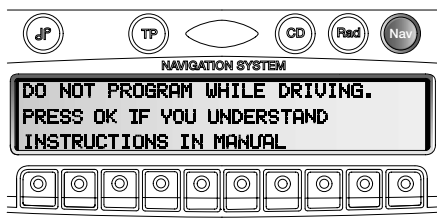

ICE 1283

If you confirm the receipt of this warning you state that you have read and understood the user guide and that you are aware of the dangers connected to the use of this navigation equipment.

## Selecting navigation

Press the 'Nav' multifunction button.

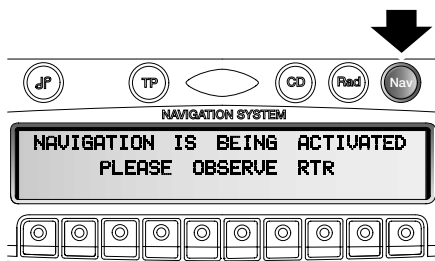

ICE 0275

The main navigation menu appears after this display.

**NOTE:** The navigation CD must be loaded when starting navigation operation for the first time. If navigation system has not yet been calibrated, a calibration journey is prompted.

A navigation CD with the data for the destination must be inserted to start the route calculation. During the calculation, the prompt CD flashes on the display. Once the calculation has been completed, the prompt CD extinguishes, the navigation CD can be removed and an audio CD can be inserted.

When entering destinations, driving off should be delayed until the prompt CD disappears.

# Navigation operation

## Main navigation menu

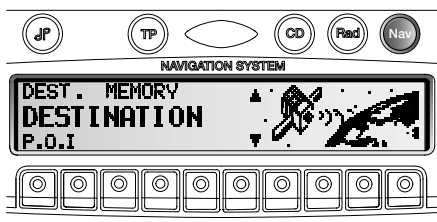

ICE 0276

Selection from:

- DESTINATION
- DEST. MEMORY
- P. O. I.
- LAST DESTINATIONS

can be made by turning the right rotary control and confirmed by pressing the right rotary control.

- **DESTINATION**  
accesses the entry menu for the destination.
- **DEST. MEMORY**  
contains destinations which have been stored previously
- **P.O.I.**  
Menu for the selection of special local and inter-regional destinations and special destinations nearby. Special destinations are e.g. gas stations, airports, hospitals etc.
- **LAST DESTINATIONS**  
A list of the last 50 destinations is displayed. The desired destination can be selected using the right rotary control. Before confirming with the right rotary control, details of the destination can be requested by pressing the left rotary control. Stopovers are not stored as last destinations.

## ENTERING A DESTINATION

Select **DESTINATION** in the main navigation menu using the right rotary control and press to confirm.

The navigation data for the USA is stored on two CD's (see **Navigation CD's**).

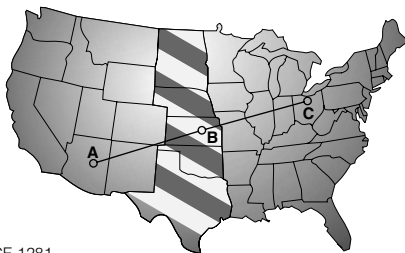

ICE 1281

When you need to enter a route from a place contained on the USA West CD (A) to a destination stored on the USA East CD (C), you will need to enter an intermediary destination (B) in one of the following states; North Dakota, South Dakota, Nebraska, Kansas, Oklahoma or Texas. Once you have reached the intermediary destination, or once you reach one of the aforementioned states, you may switch CD's and enter your final destination (C).

**NOTE:** When switching CD's, the vehicle should be stationary with the ignition turned on.

# Navigation operation

## Updating software

Each navigation CD you use has its own software included and the navigation unit reads and downloads that software whenever you insert a different CD.

When a different CD is inserted into the unit you will be prompted to select EXECUTE UPDATE using the right rotary control and press to confirm.

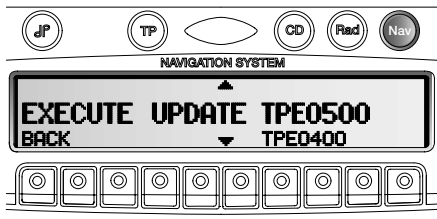

ICE 1282

The system now checks radio and navigation software and loads all data required for further navigation. The display will show a progress bar. After a short delay the system restarts the navigation software and you will need to confirm the warning message.

## Entering the location

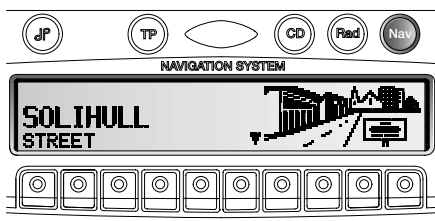

ICE 1211

The last location entered is displayed. If you want to enter a destination in the displayed location, you can select STREET or CENTER immediately. If your destination lies in another location, select the location using the right rotary control and press to confirm.

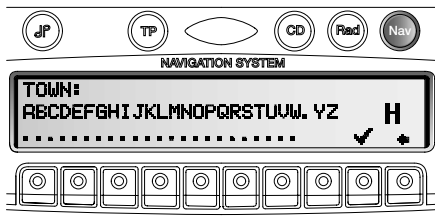

ICE 1212

Select the letters one after the other by turning the right rotary control and press to confirm.

The enlarged selected letter appears at the right of the display.

Using the multifunction button  the last confirmed letter is deleted.

The complete entry is deleted if the multifunction button  is pressed for more than 2 seconds.

# Navigation operation

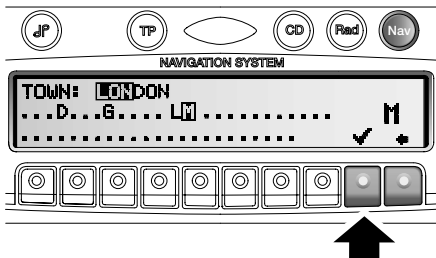

ICE 0290

Letters which are already entered are displayed inversely. The unit offers only the possible remaining letters for selection. If no other entries are available, the unit completes the place-name automatically.

To accept the entry, press and hold the right rotary control for more than 2 seconds or select the small tick and briefly press the right rotary control.

If the complete place-name was previously entered or was automatically completed, the program switches to either place-distinguishing list or to street or center entry.

In a situation where the entry name is linked to various locations throughout the country, a sub menu will display these locations with state and county details. Use the rotary control to select the desired location. The program will switch to either a place distinguishing list or to street or center entry.

If no streets and only the center can be selected in the location entered, the program switches directly to route menu.

If an incomplete location entry was confirmed, the place selection list is displayed.

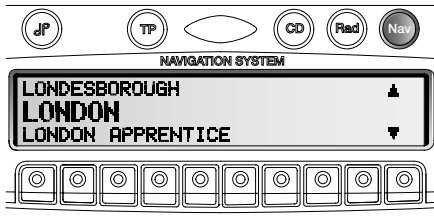

ICE 0292

The place nearest to the entry appears in capital letters in the place selection list.

The scroll marks indicate that more places are available for selection in alphabetical order.

Select by turning and confirm by pressing the right rotary control.

If the entry is unequivocal, the program switches to street or center entry. If no streets and only the center can be selected in the location entered, the program switches directly to route menu

The place-distinguishing list is displayed if the selection is ambiguous.

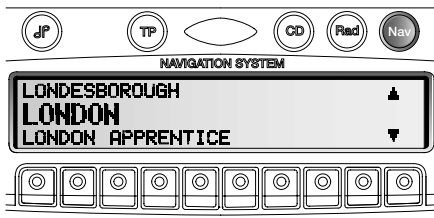

ICE 0292

Select the required place using the right rotary control and press to confirm.

The program switches to street or center entry

If no streets and only the center can be selected in the location entered, the program switches directly to route menu.

# Navigation operation

## Entering a street name

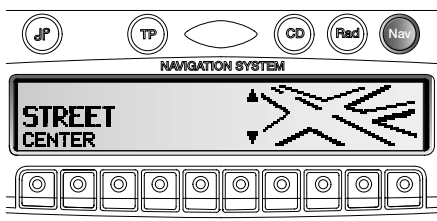



ICE 1213

Using the right rotary control, select STREET and press to confirm. At this point one of two methods can be used to find a street.

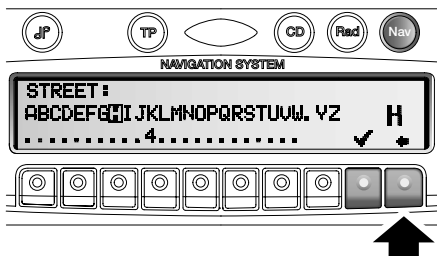
1. Select the first 2 or 3 letters of the street name, one after the other, by turning the right rotary control and pressing to confirm. When confirming the second or third letter, press and hold the control for more than 2 seconds. An alphabetical street list is displayed. Scroll the list to find the desired street name and then press to confirm selection.



ICE 1214

2. Select the letters one after the other by turning the right rotary control and press to confirm. The enlarged selected letter appears at the right of the display. Using the multifunction button  the last confirmed letter is deleted. The complete entry is deleted if the multifunction button  is pressed for more than 2 seconds.

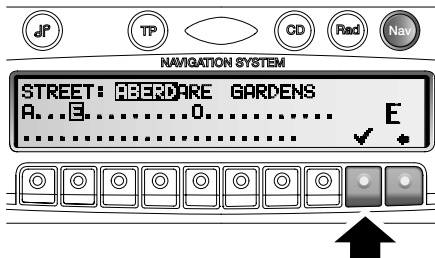

ICE 1215

Letters which are already entered are displayed inversely. The unit offers only the possible remaining letters for selection.

If no other entries are available, the unit completes the street name.

To accept the entry, press and hold the right rotary control for more than 2 seconds or select the small tick and briefly press the right rotary control.

If the complete street-name was previously entered or was automatically completed, the program switches to either street-distinguishing list or to route menu.

If an incomplete location entry was confirmed, the street selection list is displayed.

*NOTE: Street names with added direction information, eg. South Ford Street, are changed in the database to the streetname and a suffix so South Ford Street is displayed as Ford St S. If a search for 'Ford' reveals more than one Ford Street, each entry is displayed with a directional suffix like 'Ford St N, Ford St S' etc.*

# Navigation operation

## Entering the destination center

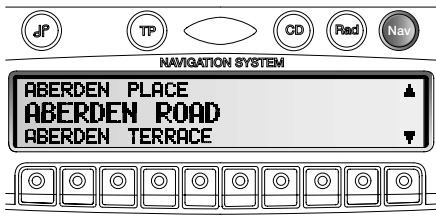

ICE 0296

The street nearest to the entry appears in capital letters in the street selection list.

The scroll marks indicate that more streets are available for selection in alphabetical order. Select the street by turning the right rotary control and press to confirm.

If the entry is unequivocal, the program switches to route menu.

The street distinguishing list is displayed if the selection is ambiguous.

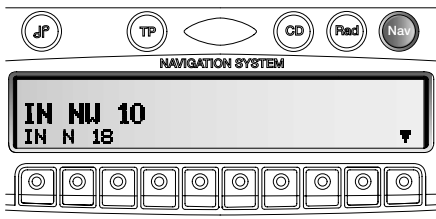

ICE 0297

Select the required place using the right rotary control and press to confirm.

The program switches to route menu.

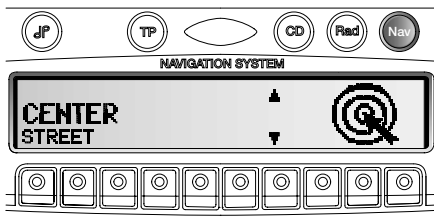

ICE 1216

Using the right rotary control, select center and press to confirm.

If the place selected only has one center, the program switches immediately to route menu.

If the number of centers is less than 10, the center list is displayed.

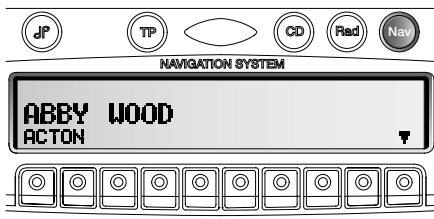

ICE 0299

Select the center by turning the right rotary control and press to confirm.

If the number of centers is greater than 9, the programme switches to center entry.

# Navigation operation

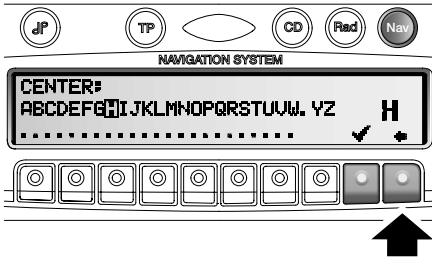

ICE 1217

Select the letters one after the other by turning the right rotary control and press to confirm. The enlarged selected letter appears at the right of the display.

Using the multifunction button ← the last confirmed letter is deleted.

The complete entry is deleted if the multifunction button ← is pressed for more than 2 seconds.

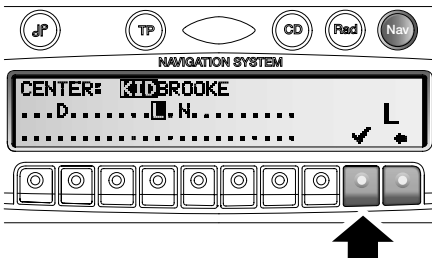

ICE 1218

Letters which are already entered are displayed inversely. The unit offers only the possible remaining letters for selection. If no other entries are available, the unit completes the center-name.

To accept the entry, press and hold the right rotary control for more than 2 seconds or select the small tick and briefly press the right rotary control.

If the complete center-name was previously entered or was automatically completed, the program switches to route menu.

The program switches to the center list if the selection is ambiguous.

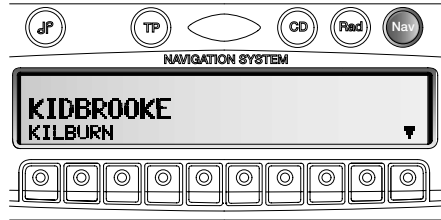

ICE 0302

The center nearest to the entry appears in capital letters in the center list.

The scroll mark indicates that more centers are available for selection in alphabetical order. Select the center by turning the right rotary control and press to confirm.

The program switches to the route menu.

**NOTE:** A list of possible centers is displayed immediately pressing the right rotary control for more than 2 seconds without having selected any letters.

# Navigation operation

## ROUTE MENU

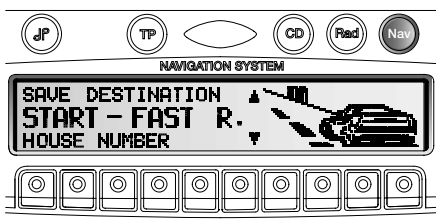

ICE 0303

Selection from

- SAVE DESTINATION
- START-FAST R., START-SHORT R.
- HOUSE NUMBER
- CROSSING
- ROUTE SETTING

can be made by turning, and confirmed by pressing the right rotary control.

- SAVE DESTINATION  
accesses the entry menu for the destination memory.
- START-FAST R., START-SHORT R.  
starts route guidance. Simultaneously, a prompt appears indicating the currently selected route option (-SHORT R. for a short route, -FAST R. for a fast route).
- HOUSE NUMBER  
The house number in the specified destination road can be entered here. This function is only available if this information is stored on the navigation CD.
- CROSSING  
An intersecting road can be defined as the destination here. This function is only available if this information is stored on the navigation CD.
- ROUTE SETTINGS  
Specifications such as FAST route, short route, motorway, ferries and toll roads can be selected here.

## Entering the house number for the destination street

Using the right rotary control select HOUSE NUMBER in the route menu and press to confirm.

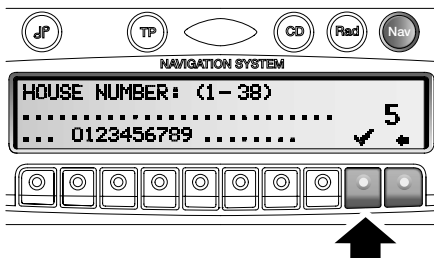

ICE 0304

Using the right rotary control, enter the house number for the destination street and press for more than 2 seconds to confirm the entry. To confirm, the small tick can also be selected and the right rotary control briefly pressed. Due to the system characteristics, route guidance continues only in the area of the house number specified.

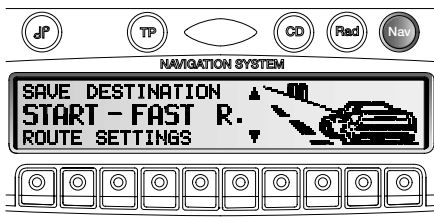

ICE 0305

Select START- to start route guidance.

Select SAVE DESTINATION to jump to the destination memory menu.

Select ROUTE SETTINGS to access the possible route settings.

Select by turning the right rotary control and press to confirm the selection



# Navigation operation

## Select the intersection for the destination street

Using the right rotary control, select CROSSING in the route menu and press to confirm.

Select the intersection for the destination street by turning the right rotary control and press to confirm the selection.

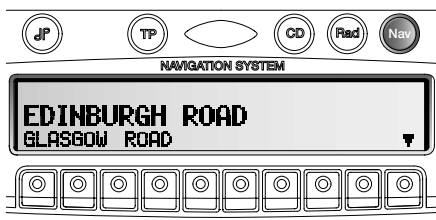

ICE 0306

Select START- to start route guidance.

Select SAVE DESTINATION to jump to the destination memory menu.

Select ROUTE SETTINGS to access the possible route settings.

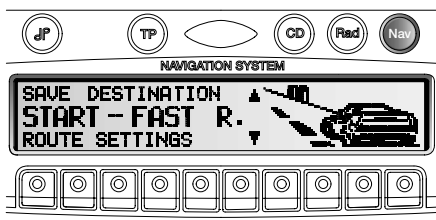

ICE 0305

Select by turning the right rotary control and press to confirm the selection.

## Selecting the route settings

Using the right rotary control, select ROUTE SETTINGS in the route menu and press to confirm.

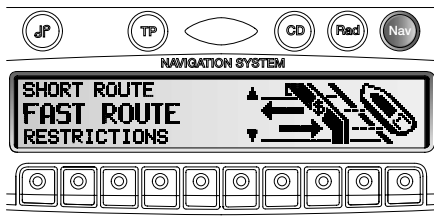

ICE 0307

- **FAST ROUTE (WITH HIGHWAY)**  
If selected, the programme calculates the shortest possible journey time.
- **FAST ROUTE (WITHOUT HIGHWAY)**  
Fastest route without using a highway.
- **SHORT ROUTE (WITH HIGHWAY)**  
If selected, the programme calculates the shortest possible distance and may use highway as short route.
- **SHORT ROUTE (WITHOUT HIGHWAY)**  
May use single track roads so caution is needed when towing a large trailer.

**NOTE:** The setting "SHORT ROUTE" is often recommended for larger cities or conurbations.

# Navigation operation

- RESTRICTIONS

Provides options for avoiding highways, ferries or toll roads.

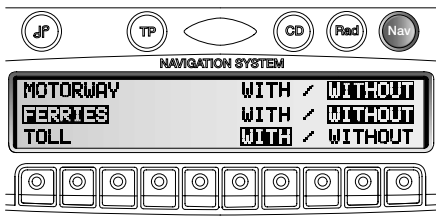

ICE 1219

Selection can be made by turning the right rotary control, and settings can be changed by pressing the right rotary control.

Press the control for more than 2 seconds to accept all settings and quit the menu.

**NOTE:** Routes without highways can only be calculated for short distances (up to 120 miles).

**NOTE:** It is possible that routes without the use of interstate highways may not be calculable. In this case you will receive a message

# Navigation operation

## Storing a specified destination in the destination memory

It is not absolutely necessary to store a destination in the destination memory for route guidance. It saves repeated manual entry, if the destination is required at a later date.

Select SAVE DESTINATION in the route menu and press the right rotary control to confirm.

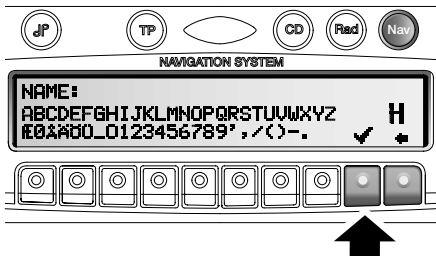

ICE 0309

Any name of your choice consisting of up to 14 characters can be entered for the specified destination and then automatically only be stored in the destination memory after pressing the right rotary control for more than 2 seconds.

To store, the small tick can also be selected and the right rotary control briefly pressed. If you do not wish to enter a name of your choice, press and hold the right rotary control for more than 2 seconds to store the address as previously entered in the destination memory.

The last destination entered can be filed at any position by turning the right rotary control. The memory position is confirmed by briefly pressing the right rotary control.

A total of 50 destinations can be stored.

**NOTE:** Do not save your home address as 'HOME'. Should your vehicle be stolen with your keys, for example, the thief could easily find your home address and be guided there by your navigation system.

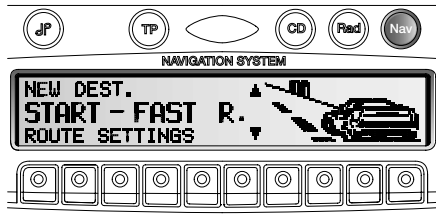

ICE 0310

For final storage in the destination memory, either route guidance must be started or the program must be switched to a new destination entry by selection of NEW DEST.

## Deleting stored destinations

Select destination memory.

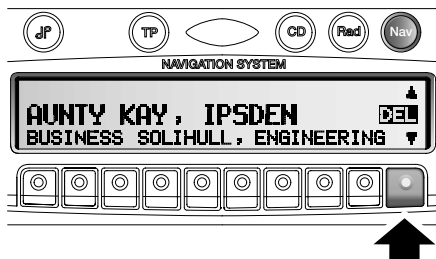

ICE 0311

Select the destination to be deleted using the right rotary control and press the 'Del' multifunction button.

# Navigation operation

## Destination memory full

This occurs when the destination memory is full.

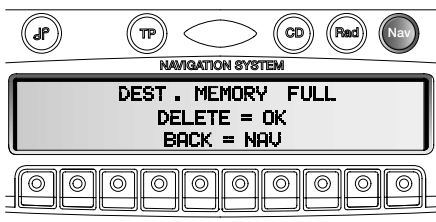

ICE 0312

Select either DELETE (to jump to the destination memory in order to delete a destination) or BACK (to cancel saving).

## ROUTE GUIDANCE CALCULATION

The message "Calculating route" indicates that the distance is being calculated, which may take several seconds.

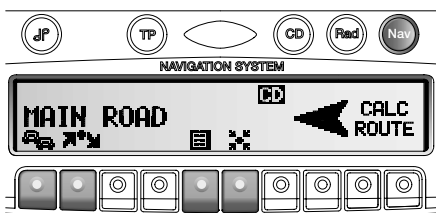

ICE 1260

After the first route guidance announcement, the prompt CD flashes on the display until the route has been completely calculated. When entering a destination, driving off should be delayed until CD no longer flashes.

## Recalculating the route

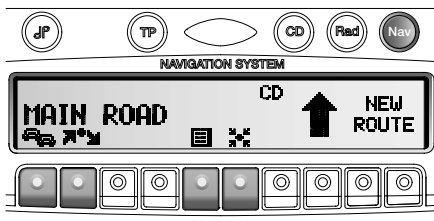

ICE 1261

If the current route is not followed due to road blocks, diversions, unintentional driving in the wrong direction or failing to observe the recommendations, the system immediately calculates a new route. During this recalculation, NEW ROUTE is displayed.

## STOPOVER

This function enables a stopover to be entered when route guidance is active.

## Entering a stopover

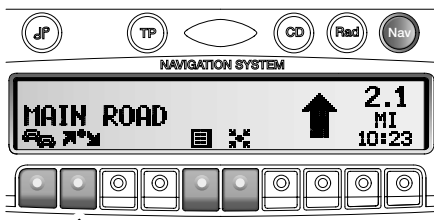

ICE 1262

Press the multifunction button .

# Navigation operation

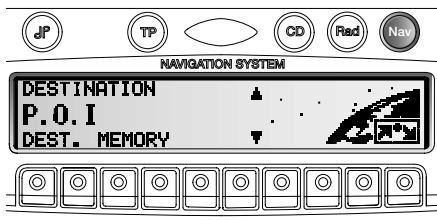

ICE 0316

Using the right rotary control, make a selection and press to confirm.

- **DEST. MEMORY**  
select the stopover from the destination memory.
- **DESTINATION**  
enables the selection of special destinations as stopovers via NEARBY DESTINATION, NEARBY and TOWN, e.g. gas stations or airports.

## Starting route guidance to a stopover

To start route guidance to the stopover, press the right rotary control.

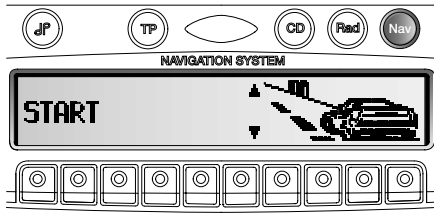

ICE 0317

The route is calculated and route guidance begins.

**NOTE:** The  symbol is displayed inversely during route guidance to a stopover.

## Deleting a stopover

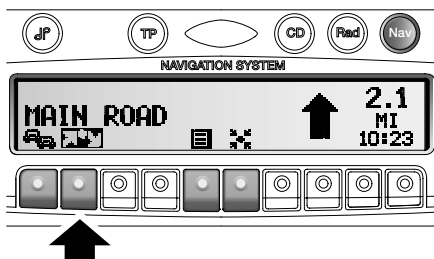

ICE 1263

Press the multifunction button .

# Navigation operation

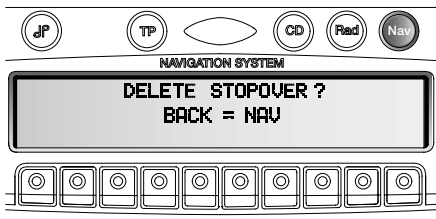

ICE 0319

To delete the stopover, press the right rotary control within 8 seconds.

## Stopover reached

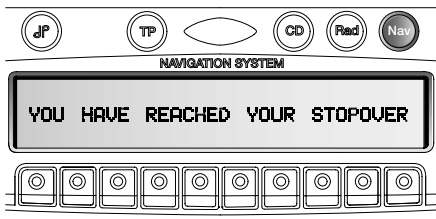

ICE 0320

Route guidance to the final destination automatically starts following the message "YOU HAVE REACHED YOUR STOPOVER"

## TRAFFIC JAM FUNCTION

This function allows you to block the approaching route sections as from the next junction and calculate a bypass route when a traffic jam or road block is directly ahead.

## Entering the length of a traffic jam

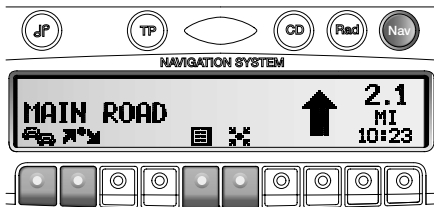

ICE 1264

Press the multifunction button .

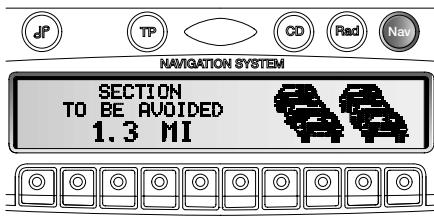

ICE 0322

Using the right rotary control, select the length of the traffic jam and press to confirm.

# Navigation operation

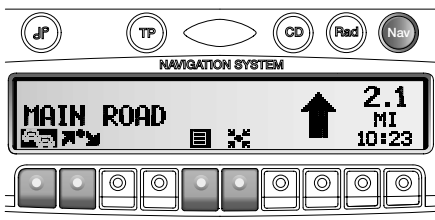

ICE 1265

 is displayed inversely and the route is recalculated.

## Delete block

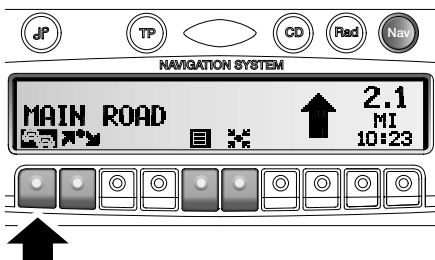

ICE 1266

Press the multifunction button 

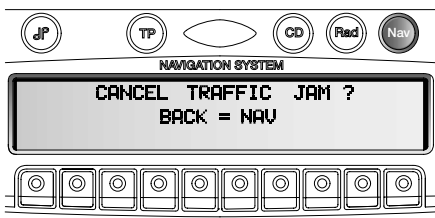

ICE 0325

To delete a block, press the right rotary control within 8 seconds.

## CANCELLING ROUTE GUIDANCE

Press the 'Nav' button

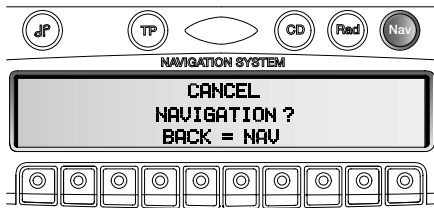

ICE 0326

Route guidance is cancelled by pressing the right rotary control within 8 seconds, otherwise, route guidance continues.

## NOTES ON ROUTE GUIDANCE

After entering the destination (address), the system calculates the route and announces: "We can start now".

The driving recommendations are given by voice messages and displays on the screen.

By pressing the left rotary control the current driving recommendation can be repeated.

If the route to be travelled is not clear, e.g. at an intersection where a change in direction is not specified, the direction of travel can be displayed by pressing the right rotary control.

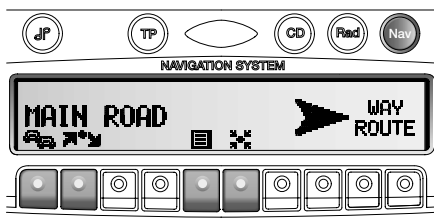

ICE 1267

Please follow the direction indicated by the arrow.

# Navigation operation

The display appears for 8 seconds after pressing the right rotary control.

**Danger! If a driving recommendation contradicts the applicable Road Traffic Regulations (RTR), the RTR is always valid!**

For clarification, there follows a selection of examples of possible driving recommendations:

- “Please perform a U-turn if possible”.

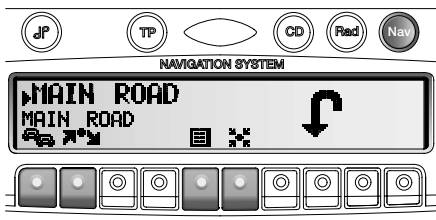

ICE 1220

You are driving in the wrong direction and should turn back at the earliest opportunity.

- Please turn right after 1/4 mile”.

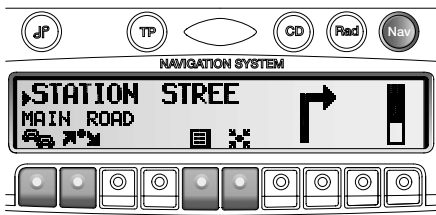

ICE 1268

The arrow indicator  points to the next street into which you should turn. The name of the street is displayed.

The progress bar on the right illustrates the distance and the black part decreases as you approach the intersection.

- “Please follow the road”.

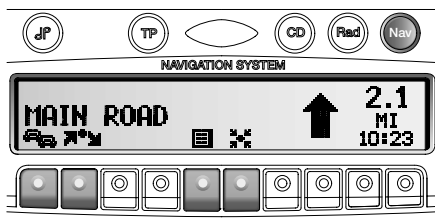

ICE 1269

This display tells you that you should follow the course of the road.

- “Prepare to turn left” or “Please move into the left-hand lane”.

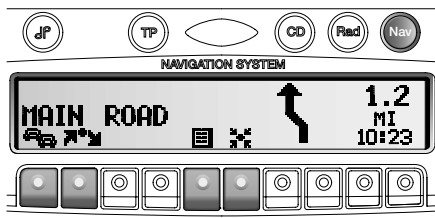

ICE 1270

This recommendation prepares you for the next turning to be taken

However, “move into the left-hand lane” does not mean that you should do so immediately!

**NOTE:** At junctions and traffic circles, only the end of the street which is to be passed is displayed.



# Navigation operation

- “Please leave the traffic circle at the third exit on the right”.

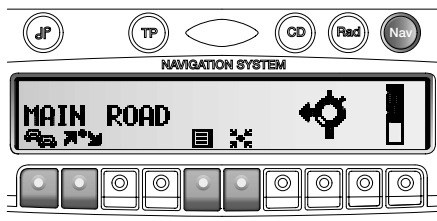

ICE 1221

This display shows you which exit (marked with the arrow) you must take at the traffic circle.

- “Now drive straight ahead”

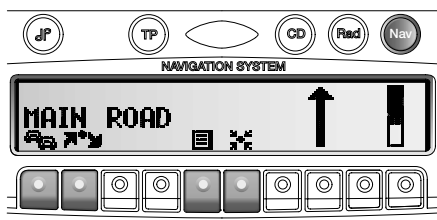

ICE 1271

At this point, you must drive straight ahead.

- “Please follow the direction arrows”.

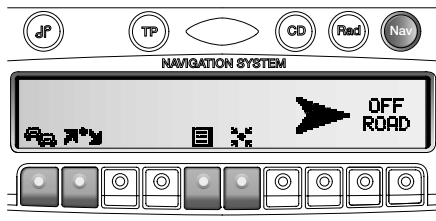

ICE 1272

This display tells you that you are in a non-digitised street (e.g. car park, garage), which is not included in the digital street map. The arrow indicates the direction of the destination as the crow flies.

- “Keep right after 2 miles”.

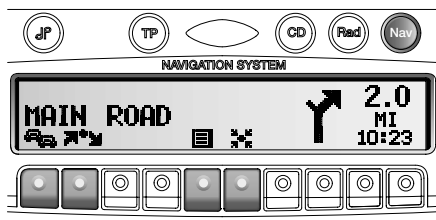

ICE 1273

Keeping to the right means that the road forks and you should follow the relevant direction.

# Navigation operation

- “You have reached your destination”.

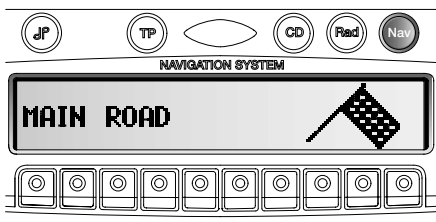

ICE 0336

The destination specified is reached and route guidance is terminated.

## INFORMATION DURING ROUTE GUIDANCE

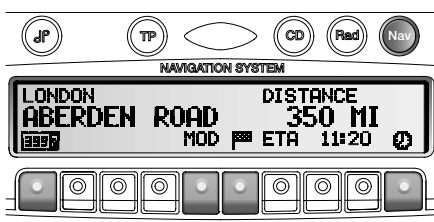

ICE 0337

Press the left rotary control.

The destination, the distance and the estimated time of arrival are displayed.

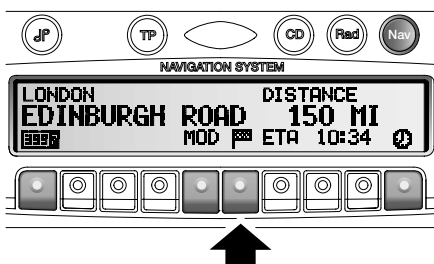

ICE 0338

If a stopover has been specified, the stopover, the distance and estimated time of arrival are displayed.

The main destination can be displayed via the multifunction button .

Press the multifunction button on the far left to display;

Time travelled  
Average speed  
Distance travelled

To return to route guidance, press the left rotary control again or wait for 8 seconds.

# Navigation operation

## Requesting journey duration and distance travelled

During route guidance, press the left rotary control.

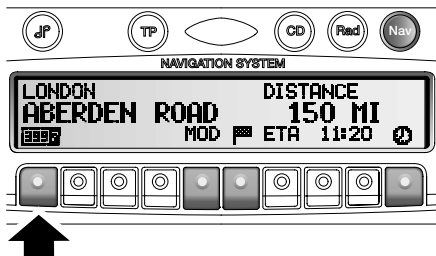

ICE 0926

Press the multifunction button .

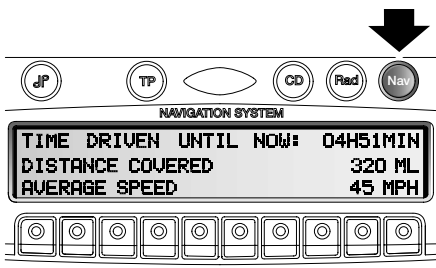

ICE 1222

The journey duration, distance travelled and the average speed are displayed. Pressing the right rotary control or the 'Nav' button, returns to the route guidance display.

The information for journey duration, distance travelled and the average speed can be requested as previously described, provided that the destination flag waves after the destination has been reached.

**NOTE:** The destination flag graphic is only active if ANIMATIONS are turned on. See SYSTEM SETTINGS - Animations.

## Displaying the route settings

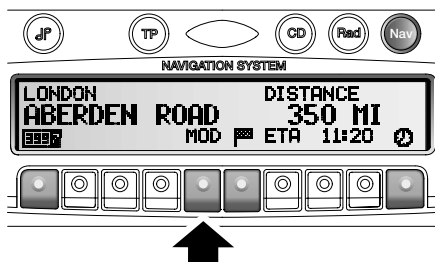

ICE 0339

During route guidance, press the left rotary control. Press the 'Mod' multifunction button.

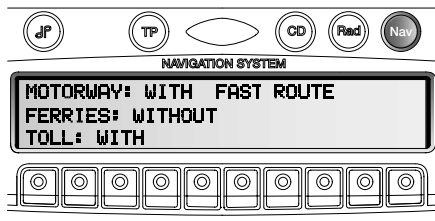

ICE 0340

The route settings are displayed.

After 8 seconds, the system returns to the route guidance display.

# Navigation operation

## Requesting current time

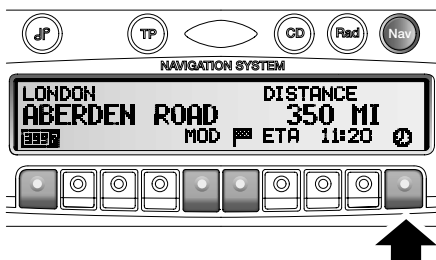

ICE 0341

During route guidance, press the left rotary control. Press the  multifunction button.

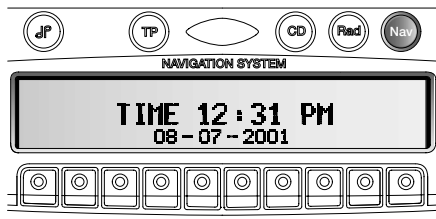

ICE 0342

The current time is displayed. After 8 seconds, the system returns to the route guidance display.

## Requesting current position

During route guidance, the current position can be requested.

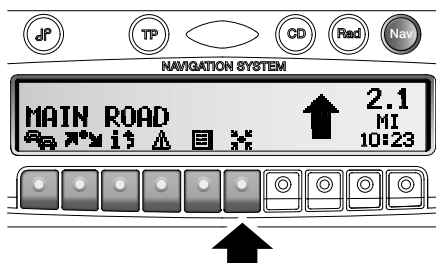

ICE 0343

Press the multifunction button .

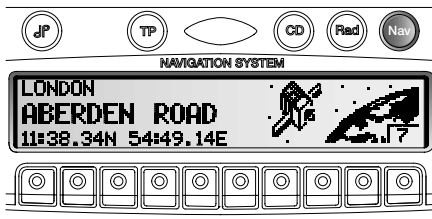

ICE 0344

The current position with road name (if available), degrees of longitude and latitude and the number of satellites received are displayed.

By pressing the right rotary control, the program returns to the route guidance display

The current position can be requested even when route guidance is not active by pressing the left rotary control.

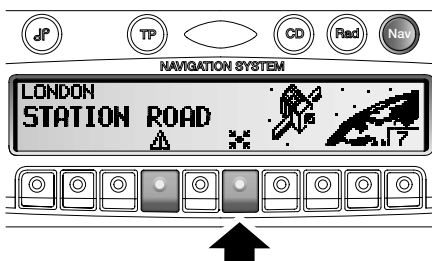

ICE 0928

Press the multifunction button .

# Navigation operation

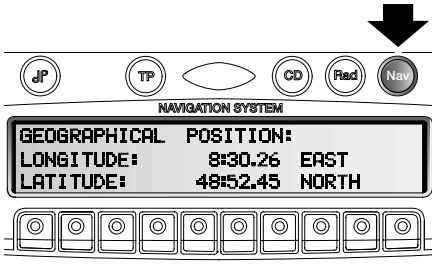

ICE 0929

The geographic position is displayed. Pressing the right rotary control or the 'Nav' button returns to the information menu.

## Requesting the street list

During route guidance, the planned route list can be requested.

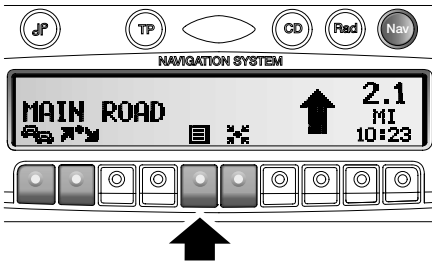

ICE 1274

Press the multifunction button .

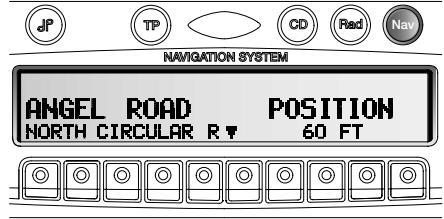

ICE 1223

The current street and the street names up to the destination are displayed. The route list can be scrolled by turning the right rotary control.

By pressing the right rotary control, the program returns to the route guidance display.

**NOTE:** After destination entry, there is a short delay until the route list is created. If the vehicle is "off road" at the moment of destination entry, the route list cannot be created until a stored road is reached.

## Destination memory

Using the right rotary control, select DEST. MEMORY in the main navigation menu and press to confirm.

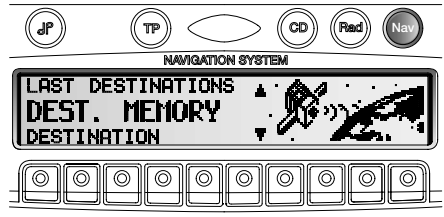

ICE 0347

The destination memory contains personally stored destinations. Once stored, manual entry of the destination is no longer necessary.

# Navigation operation

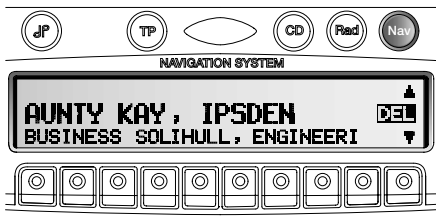

ICE 0348

Select the destination using the right rotary control and press to confirm.

Then start route guidance.

## SPECIAL DESTINATIONS

Menu for selecting special destinations from a specified list.

Special destinations are e. g. gas stations, airports, hospitals etc.

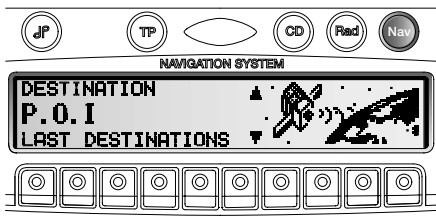

ICE 0349

Using the right rotary control, select P. O. I. from the main navigation menu and press to confirm.

Points of Interest, NEARBY DESTINATION/NEARBY.

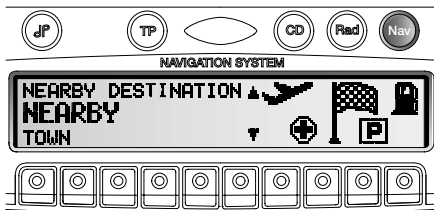

ICE 1224

Special destinations in the current surrounding area of the vehicle or special destinations near the destination can be selected. Using the right rotary control, make a selection and press to confirm.

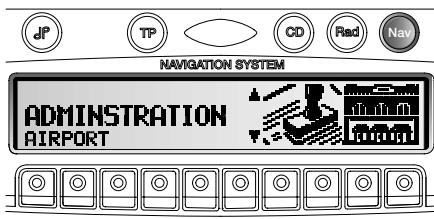

ICE 0351

Using the right rotary control select a category and press to confirm.

# Navigation operation

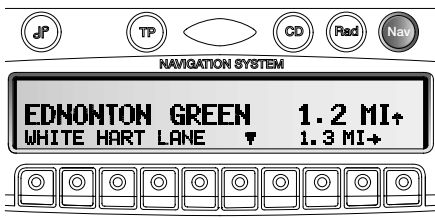

ICE 0352

Destinations are listed according to proximity. The figures in miles relate to the direct distance (as the crow flies) between the special destination and the current location.

The arrows following the distance information indicate the distance as the crow flies to the relevant special destination (e.g. ↑ special destination lies in the direction of travel, ↓ special destination lies in the opposite direction to that of travel).

Select the desired destination using the right rotary control.

By pressing the left rotary control, information selected destination is listed (e.g. a hospital).

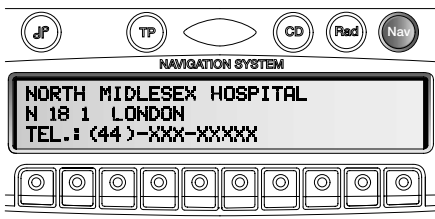

ICE 0353

Confirm the selection using the right rotary control.

The system jumps to the route menu.

**NOTE:** If you select the category **RESTAURANT**, another sub menu appears.

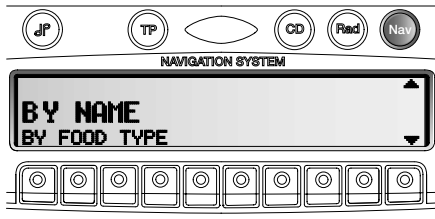

ICE 1284

If you select by **BY NAME**, all available restaurants will be displayed in a scroll list. If there are more than 9 items in the list, you will be prompted to enter text.

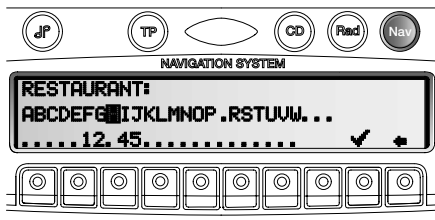

ICE 1285

Enter the restaurant name and confirm. Confirm your choice in the selection list by pressing the right rotary control.

If you select **BY FOOD TYPE**, the display will show a list of different ethnic foods e.g. Chinese.

# Navigation operation

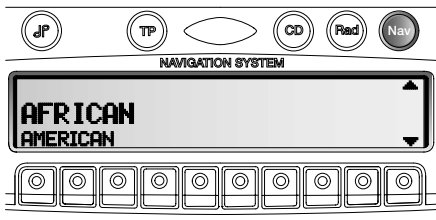

ICE 1286

Select the desired category and confirm by pressing the right rotary control. If there is more than one choice in the category selected, the display will show the available restaurants. Make your selection and confirm to start navigation.

- **Points of Interest. TOWN/NATIONWIDE**  
Special destinations contained in the navigation CD can be selected.

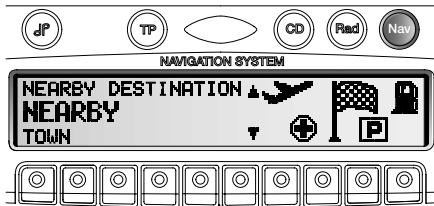

ICE 1224

Using the right rotary control, select TOWN and press to confirm.

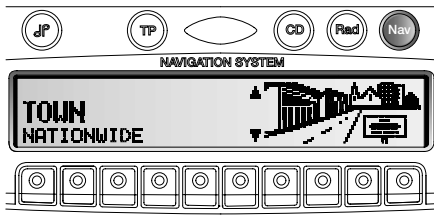

ICE 1225

Using the right rotary control, select either TOWN or NATIONWIDE and press to confirm.



# Navigation operation

## Selecting TOWN

Using the right rotary control, select TOWN and press to confirm

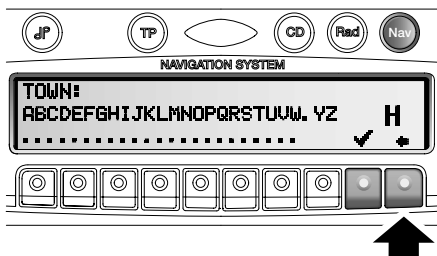

ICE 0289

Using the selection process described in 'Entering the location', select the town and press to confirm.

Then select the town from the town selection list using the right rotary control and press again to confirm.

Special destinations for the selected town are displayed.

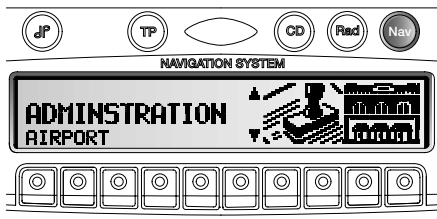

ICE 0351

Using the right rotary control, select a category and press to confirm.

A list with special destinations is displayed or if there are more than 9 entries in the list, you will be requested to enter text.

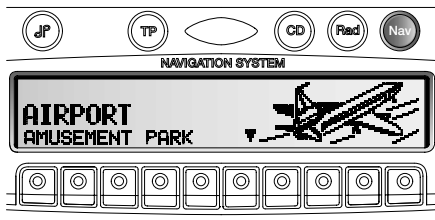

ICE 1226

Enter the special destination and confirm by pressing the right rotary control.

The system jumps to the route menu.

**NOTE:** A list of possible special destinations is displayed by pressing the right rotary control for more than 2 seconds without having selected any letters.

# Navigation operation

## Selecting NATIONWIDE

**NOTE:** A list of possible special destinations is displayed by pressing the right rotary control for more than 2 seconds without having selected any letters.

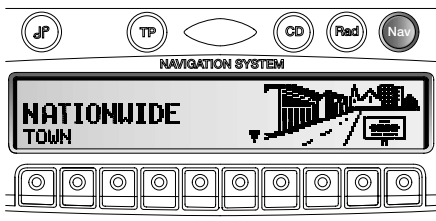

ICE 1227

Using the right rotary control, select NATIONWIDE and press to confirm.

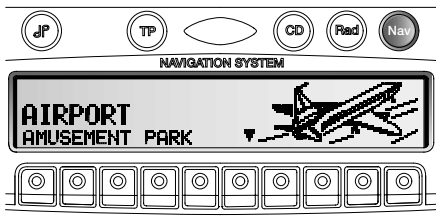

ICE 1226

A list with special destinations is displayed or if there are more than 9 entries in the list, you will be requested to enter text.

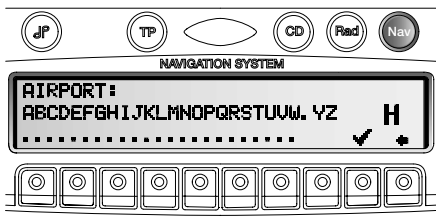

ICE 1228

Enter the special destination and confirm by pressing the right rotary control.

The system jumps to the route menu.

# Navigation operation

## SYSTEM SETTINGS

In the main navigation menu, press and hold the 'Nav' button.

The system settings menu is requested.

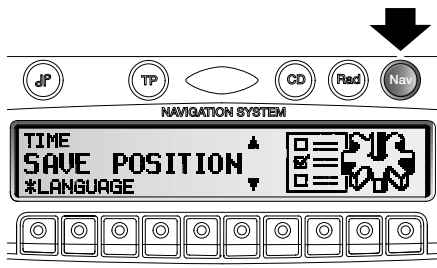

ICE 1287

Selection from

- TIME
- SAVE POSITION
- \* LANGUAGE
- ANIMATIONS
- MEASURING UNIT
- ANNOUNCEMENT ETA

can be made by turning the rotary control and then confirmed with a press of the control.

- TIME  
The internal system clock can be set to local time.
- SAVE POSITION  
The current position can be saved and stored in the destination memory.
- \*LANGUAGE  
Language setting for the navigation system.
- ANIMATIONS  
The display animations can be switched on or off.

- MEASURING UNIT

The display units can be changed from metres to feet.

- ANNOUNCEMENT ETA

Announcement of the estimated time of arrival can be switched on / off.

## Setting the time

In order to calculate the estimated time of arrival, it is necessary to set the GMT time transmitted from satellites to the current time zone.

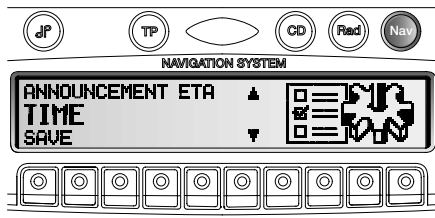

ICE 1288

With the right rotary control select TIME in the system settings menu and press to confirm.

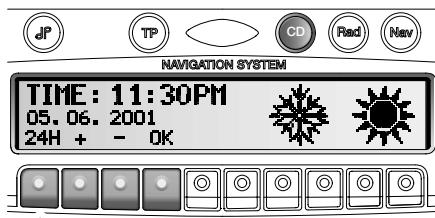

ICE 0359

Using the multifunction button the time can be changed from the 24 hour to the 12 hour display

# Navigation operation

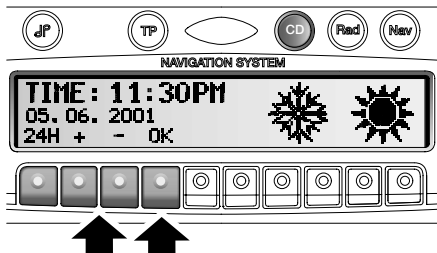

ICE 0360

Using the multifunction buttons + or - the time is adjusted by half an hour.

By pressing the right rotary control or the multifunction button 'OK' the time set is accepted. The program returns to the system settings menu.

## Saving your position

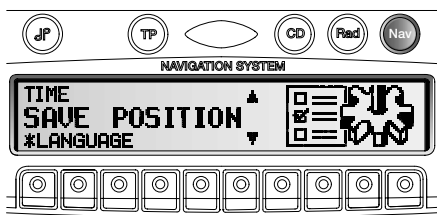

ICE 1289

Select SAVE POSITION in the system settings menu and confirm.

The current co-ordinates (degrees of longitude and latitude) are displayed.

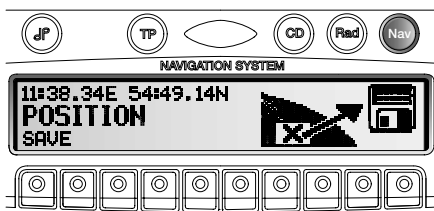

ICE 0362

Confirm again by pressing the right rotary control.

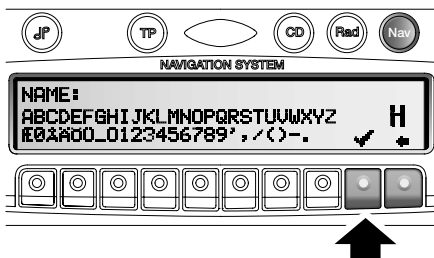

ICE 0309

Enter the name of the position.

Press the right rotary control for more than 2 seconds to confirm the name entered.

Alternatively, select the small tick and then briefly press the right rotary control.

The destination memory is automatically requested.

Select the desired position in the destination memory using the right rotary control and press to confirm.

# Navigation operation

## Requesting the position

Request the destination memory and select destination using the right rotary control.

If the position is outside a digitised area, the driver is guided to the digitised route nearest to the destination. The announcement “Your destination is nearby” is given. The direction of the arrows must be followed in order to reach the destination.

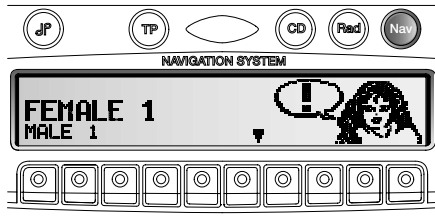

ICE 1277

## Setting the language

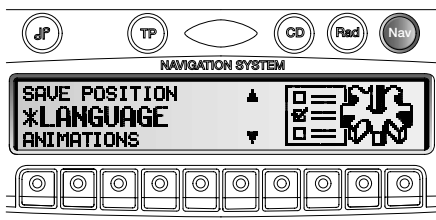

ICE 1276

Select \*LANGUAGE in the system settings menu and confirm.

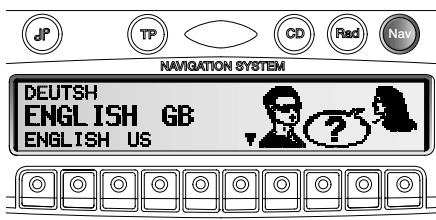

ICE 0366

Select the language using the right rotary control. The language selection is accepted by pressing the control and the language is installed.

You can choose either a male or a female voice for certain languages.

Select the voice using the right rotary control. The voice is accepted and installed by pressing the control.

The system returns to the system settings menu after installation.

**NOTE:** In every language, the menu entry LANGUAGE is preceded an asterisk (\*) i.e. \*LANGUAGE. This enables you to recognise the menu entry in the System Settings no matter what the previously set language is.

## Animations

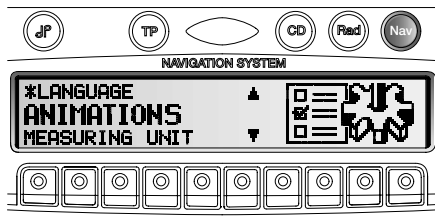

ICE 1278

Select ANIMATIONS in the system settings menu and confirm.

# Navigation operation

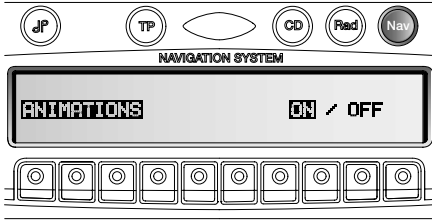

ICE 0369

It is possible to select between animations ON and OFF by briefly pressing the right rotary control.

Press and hold the right rotary control to accept the setting.

The system returns to the system settings menu.

## Switching announcement of the estimated time of arrival on/off

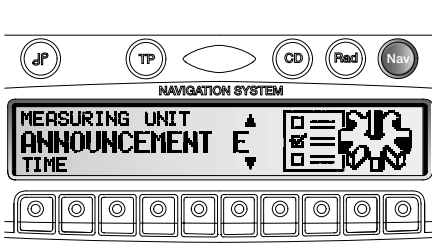

ICE 1290

Select ANNOUNCEMENT ETA in the system settings menu and confirm.

**ETA** stands for **Estimated Time of Arrival**.

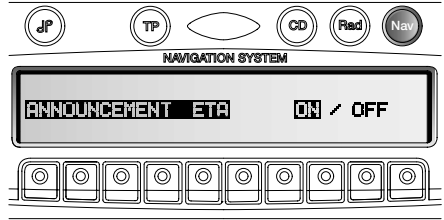

ICE 0371

It is possible to select between announcement ETA ON and OFF by briefly pressing the right rotary control.

Press and hold the right rotary control to accept the setting.

The system returns to the system settings menu.

## Setting the measuring unit

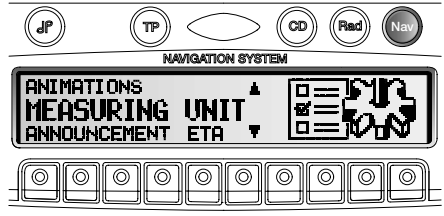

ICE 0372

Select MEASURING UNIT in the system settings menu and confirm.

# Navigation operation

---

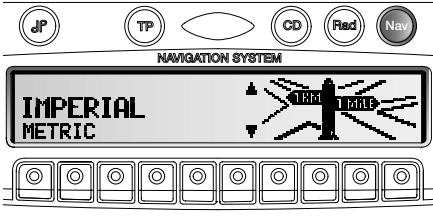

ICE 0373

Select the measuring unit using the right rotary control. The measuring unit is accepted by pressing the control.

The system returns to the system settings menu.

**NOTE:** *METRIC* indicates calculation in metres.  
*IMPERIAL* indicates calculation in feet.

# User menu

---

REQUESTING/QUITTING THE USER MENU . . . . .	76
GAL setting . . . . .	76
LED setting . . . . .	77
Setting reception optimization (M/S) . . . . .	77
Setting navigation announcements (Nav) . . . . .	78
Compass display . . . . .	78
Signal tone volume . . . . .	79
MALFUNCTION RESET . . . . .	79



# User menu

## REQUESTING/QUITTING THE USER MENU

The user menu is requested by pressing the 'Tone' button for more than 2 seconds.

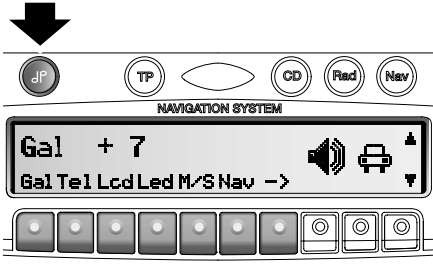

ICE 0277

After requesting the user menu, the following basic settings can be selected on two planes according to your personal preference.

The planes can be accessed by pressing the -> and <- multifunction button.

First plane:

Gal speed-dependent volume control  
Tel telephone characteristics  
Led LED setting  
M/S reception optimization setting

Second plane:

Nav navigation announcement setting  
Aux aux input setting  
CMP compass display setting  
Bev signal tone volume setting

Press the 'Nav' button again to quit the user menu.

## GAL setting

GAL is a radio control circuit, which automatically adjusts the car radio volume according to vehicle speed. This results in compensation of the driving noise produced at higher speeds.

Request the user menu. Press the 'Gal' multifunction button. Using the right rotary control, select between '0' and '+15'.

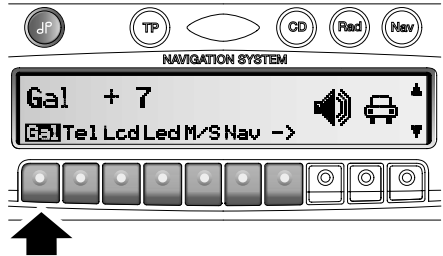

ICE 0278

With the GAL setting, the start of volume adjustment can be specified according to vehicle speed.

The setting is stored automatically.

Explanation:

0 no volume increase  
+ 1 volume is increased at low speed  
+15 volume is increased at a higher speed

# User menu

## LED setting

The flashing of the LED (flashes when unit is switched off) can be switched on or off using this function.

Request the user menu. By pressing the multifunction button 'Led', select either 'blinking' (LED on) or 'off' (LED off).

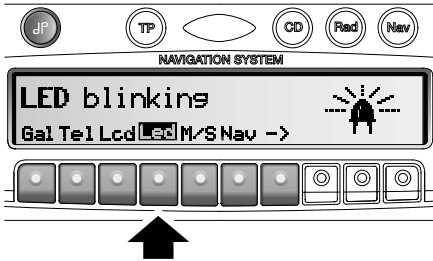

ICE 0281

The setting is stored automatically.

## Setting reception optimization (M/S)

Two different reception optimization settings can be selected in order to suppress reception-dependent interference and reflections.

Request the user menu. By pressing the multifunction button 'M/S', select either 'Stereo', 'Mono' or 'Auto'.

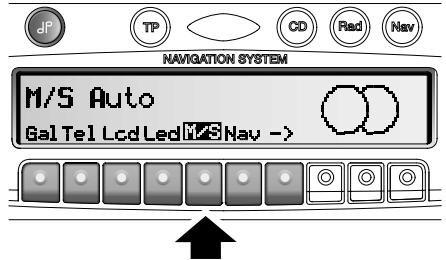

ICE 0280

**Auto:** Setting for normal operation - i.e., the system switches from stereo to mono and back, depending upon reception location (provides the optimum setting for almost all reception areas).

**Stereo:** Setting for exceptional reception conditions - i.e. the unit is constantly set to stereo.

**Mono:** Setting for reception conditions in which reflections constantly occur - i.e., the unit is set constantly to mono.

The setting is effective immediately and is also retained on switching off.

# User menu

## Setting navigation announcements (Nav)

With this function you can select how you wish to hear navigation announcements.

For selection, request user menu then press the -> multifunction button. Using the multifunction button 'Nav', select either 'only', 'mixed' or 'independ'.

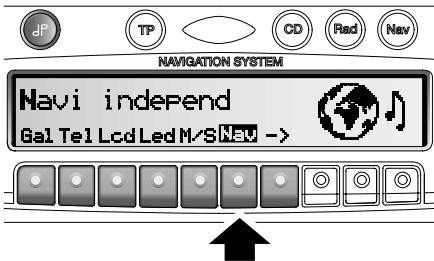

ICE 0282

The setting is stored automatically.

**only:** The audio source currently being listened to is switched off and only navigation announcements are heard.

**mixed:** The volume level of the audio source currently being listened to is decreased. The navigation announcement is set to the same volume level as the previously heard audio source, but still adjustable within a range of +/-6 dB. If the audio source volume is then changed, the navigation announcement volume is adjusted accordingly.

**independ:** The audio source being listened to and the navigation announcement can be set to various levels.

Land Rover suggest that 'independ' be set for best all-round performance.

## Compass display

If route guidance is not active, it is possible to display a compass on the right side of the display.

For selection, request user menu then press the -> multifunction button.

Using the multifunction button 'Cmp', select either 'Show compass' (compass is displayed) or 'Hide compass' (compass is not displayed).

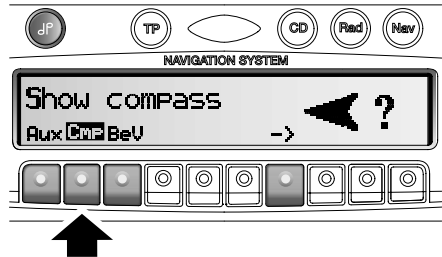

ICE 0283

If the compass display is switched off, 9 multifunction buttons are assigned transmitter abbreviations in FM - DAS mode (route guidance not active).

The setting is stored automatically.

# User menu

## Signal tone volume

The volume of signal tones (e.g. storage confirmation) can be set using this function.

For selection, request user menu then press the -> multifunction button. Press the 'BeV' multifunction button. Using the right rotary control, select between '0' (quiet) and '+5' (loud).

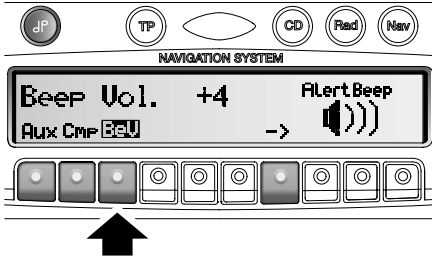

ICE 0284

The setting is stored automatically.

## MALFUNCTION RESET

If a malfunction of the unit should occur, such that the unit is no longer capable of operation, or is defective in some other way, a restart of the unit software (reset) can be triggered.

In order to trigger a reset, press the '1' and the '3' multifunction buttons and the 'TP' button simultaneously. The navigation CD must be inserted after a reset of the unit.

# User menu

---

# Index

## C

Caring for your CD's	29
CD changer operation	34
magazine load/unload	34
operational readiness	34
playing CD's in the loaded magazine	34
CD player controls	31
fast forward/rewind	31
number of tracks and total playing time	32
random play	31
repeating a track	32
scan search	31
track skip - forwards/backwards	31

## D

Disclaimer confirmation	40
Dynamic autostore	16
FM DAS transmitter search	16
MW, LW, SW transmitter search	16
scan search	17

## E

Entering a destination	41
entering a road name	44
entering the destination centre	45
entering the location	42
Entering the code number	6

## G

General operation	
activating the tone menu	10
adjusting the volume	10
balance setting	11
bass setting	10
fader setting	10
linear setting	11
switch on/off	10
switching loudness on/off	11
treble setting	10

## I

Information during route guidance	57
destination memory	60
displaying the route settings	58
request current time	59
requesting current position	59
requesting the road list	60
Inserting/ejecting CD's	30

## M

Malfunction reset	75
-------------------	----

## N

Navigation	
general notes	39
main navigation menu	41
selecting	40
Navigation operation	
safety instructions	36

## P

Portable panel	
inserting	8
removing	7
Programme type selection	18
switching PTY display on/off	18
PTY Programme type	18

## R

Radio operation	
activating the radio menu	14
manual tuning	20
selecting the AM waveband	15
selecting the FM waveband	14
selecting/storing frequencies	19
setting options for frequency selection	15
switching on the radio	14
Radio/cassette player	
remote controls	3
RDS system	14
Regionalisation	21
switching frequency display on/off	22
switching regionalisation on/off	22
Remote controls (radio)	3
Requesting journey duration and distance travelled	58

# Index

---

Route guidance		Traffic jam function	
cancelling	54	delete block	54
notes	54	entering the length of a traffic jam	53
Route guidance calculation	51	Traffic programme (TP)	23
recalculating the route	51	activating/quitting the TP menu	23
Route menu	47	interrupting TP announcements	25
deleting stored destinations	50	setting automatic tracking	23
destination memory full	51	setting/deleting direct programming	24
entering the house number for the destination		switching mute function on/off	24
road	47	switching off TP	24
select the intersection for the destination road		TP announcement volume	25
48			
selecting the route settings	48	<b>U</b>	
storing a specified destination	50	Updating software	42
		User menu	
<b>S</b>		compass display	74
Satellite navigation	37	GAL setting	72
digitised area	38	LED setting	73
safety instructions	37	requesting/quitting the user menu	72
Selecting/storing FM frequencies		setting navigation announcements	74
AM, LW autostore	19	setting reception optimization	73
AM, LW, SW manual tuning	20	signal tone volume	75
FM manual fine tuning	20		
selecting/storing AM, LW, SW frequencies	19		
storing	19		
Special destinations	61		
Stopover	51		
deleting a stopover	52		
entering a stopover	51		
starting route guidance to a stopover	52		
stopover reached	53		
Switching radio text display on/off	22		
System settings	66		
animations	68		
requesting the position	68		
saving the position	67		
setting the language	68		
setting the measuring unit	69		
setting the time	66		
switching announcement of the ETA on/off	69		
<b>T</b>			
Temperature protection	32		
Traffic jam function	53		