

RANGE ROVER



Electrical troubleshooting manual



AMENDMENT INSTRUCTION SHEET



RANGE ROVER ELECTRICAL TROUBLESHOOTING MANUAL

Publication Number LRL0086ENG - 6th Edition

Amendment Number: **LP004.98**

Date: **07/98**

To ensure that this manual is kept up to date and that a record of amendments to this manual is available, an Amendment Instruction Sheet will be issued with each set of revised pages.

- The Title page of the Manual is re-issued, and the Part No. has been raised to the next edition. Except for the Contents pages, all revised and new pages have the issue date at the foot of each page, together with an indication of whether the pages are revised or new.
- This Amendment Instruction Sheet must be inserted at the front of the manual to indicate that the amendment has been incorporated. Do not discard previous Amendment Instruction sheets.
- Your manual is only complete to this issue providing all prior Amendments are included.
- The filing instructions give section and page numbers affected. Additional pages or complete new sections may be issued, insert the pages as instructed.

FILING INSTRUCTIONS

Section	Discard Existing Pages	Insert New Pages	Reason for Amendment
Introduction	Title Page	Title Page	Part number raised to next edition.
A6 - Diesel	Page 5	Page 5	Link to EGR system added.
A6 - Diesel	Page 9	Page 9	Link from MAF sensor added.
A6 - Diesel	Page 13	Page 13, 15	EGR system information added.
E2 - Warnings and Indicators	Page 9	Page 9	Wire colour corrected at C257-9
E6 - Radio (Low Line)	Page 3	Page 3	New radio ground point added.
E6 - Radio (Mid Line)	Page 5	Page 5	New radio ground point added.
E6 - Radio (High Line)	Page 8	Page 8	New radio ground point added.
M4 - Memory Seats (Left)	Page 2	Page 2	Left memory seat switch detail corrected.
M4 - Memory Seats (Right)	Page 8	Page 8	Right memory seat switch detail corrected.
Y5 - Ground Distribution	Page 10, 18, 21	Page 10, 18, 21	Ground point information modified.
Z4 Component Location Table	Entire Section	Entire Section	Table modified.
Z5 - Component Location Views	Page 43	Page 43	Gearbox position switch connector changed.
Z5 - Component Location Views	Page 71	Page 71	Location views of EGR components added.
Z6 - Connector Views	Page 65, 71, 79, 81	Page 65, 71, 79, 81	Connector face views changed.

AMENDMENT INSTRUCTION SHEET



RANGE ROVER ELECTRICAL TROUBLESHOOTING MANUAL

Publication Number LRL0086ENG - 5th Edition

Amendment Number: **LP002.98**

Date: **02/98**

To ensure that this manual is kept up to date and that a record of amendments to this manual is available, an Amendment Instruction Sheet will be issued with each set of revised pages.

- The Title page of the Manual is re-issued, and the Part No. has been raised to the next edition. Except for the Contents pages, all revised and new pages have the issue date at the foot of each page, together with an indication of whether the pages are revised or new.
- This Amendment Instruction Sheet must be inserted at the front of the manual to indicate that the amendment has been incorporated. Do not discard previous Amendment Instruction sheets.
- Your manual is only complete to this issue providing all prior Amendments are included.
- The filing instructions give section and page numbers affected. Additional pages or complete new sections may be issued, insert the pages as instructed.

FILING INSTRUCTIONS

Section	Discard Existing Pages	Insert New Pages	Reason for Amendment
Introduction	Title Page	Title Page	Part number raised to next edition.
B5 - Cruise Control (Diesel)	Page 9	Page 9	Fuel pump assembly K196 added.
B5 - Cruise Control (Diesel)	Page 11	Page 11	Fuel pump assembly K196 deleted, transfer box ECU Z256 added.
K4 - Heating and Ventilation (With A/C)	Pages 1 and 9	Pages 1 and 9	Ambient sensor information revised.
Y2 - Fuse Details	Page 7	Page 7	Home link connector X325 added.
Y5 - Ground Distribution	Page 15	Page 15	Home link connector X325 added.
Z4 - Component Location Table	Complete section	Complete section	Section updated.
Z5 - Component Location Views	Pages 18, 21, 23, 46, 71	Pages 18, 21, 23, 46, 71	New picture on view 70; effectivity information added for C204 on view 81; effectivity information added for C104 on view 92; identification of C583 and C586 corrected on view 183; new views 283 and 284 added.
Z6 - Connector Views	Pages 2, 28, 62	Pages 2, 28, 62	Variants of C104 and C204 added; C384 added.
Z9 - Index	Complete section	Complete section	Section updated.

RANGE ROVER

From Model Year 97

Contents

Section	Title
i	Introduction
A1	Sequential Multiport Fuel Injection (SFI-V8)
A6	Diesel
B1	Starting and Charging
B5	Cruise Control
B6	Transfer Gearbox
B7	Automatic Gearbox
C1	Ignition and Shift Interlock
D1	Anti-Lock Brake System
D3	Data Link Connector
E1	Instruments
E2	Warnings and Indicators
E5	Horns
E6	Radio
F5	Wash/Wipe
F6	Heated Front Screen
F9	Heated Rear Screen
G1	Electrochromic Rear View Mirror
H1	Headlamps
H4	Side Lamps
H5	Stop Lamps
H6	Direction Indicator Lamps
H7	Reversing Lamps
H9	Fog Guard Lamps
J1	Interior Lamps
J2	Cigar Lighter/Clock
K3	Heating and Ventilation (without A/C)
K4	Heating and Ventilation (with A/C)
L1	Power Windows
L4	Sunroof
M1	Power Seats
M3	Power Mirrors
M4	Memory Seats
M6	Heated Seats
M7	Memory Mirrors
P1	Trailer Auxiliary Socket
S1	Air Suspension
S3	Security/Central Locking
Y1	Power Distribution
Y2	Fuse Details
Y5	Ground Distribution
Z4	Component Location Table
Z5	Component Location Views
Z6	Connector Views
Z8	Harness Routing
Z9	Index

Publication Part No. LRL 0086 ENG (6th Edition)
Published by Rover Technical Communication
© 1998 Rover Group Limited



CIRCUIT DIAGRAMS

- Circuit diagrams are arranged so that current flow is from the top of the diagram (current source) to the bottom of the diagram (ground).
- Only those components that work together in the circuit are shown. If only part of a component is used in the circuit, then only that part of the component is shown.
- Remember:

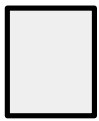

Entire component

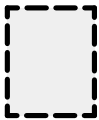

Part of a component

TERMINAL NUMBER**DESIGNATION**

50	Battery voltage: Ignition Switch in position III
30	Battery voltage: supplied constantly
15	Battery voltage: Ignition Switch in position II or III
R	Battery voltage: Ignition Switch in positions I, II
31	Ground

See Introduction (i) for additional circuit diagram symbols.

DIAGNOSIS

- If the diagram is accompanied by text:
 - Read the Circuit Operation before proceeding with the electrical diagnosis.
 - Read the Troubleshooting Hints before performing the System Diagnosis.
 - Tests follow the System Diagnosis
 - When performing the System Diagnosis, be certain that all components disconnected in previous steps are reconnected unless otherwise directed.



Component is disconnected.
Backprobe harness connector



Component is connected.
Backprobe harness connector

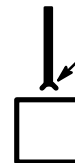

Component is disconnected.
Probe component



Component is disconnected.
Probe harness connector



Probe in-line connector

INTRODUCTION

This manual is intended for use by trained Land Rover technicians as an aid to diagnosing electrical concerns.

This manual is organized into sections, with most sections containing circuit diagrams. Each section has a unique alpha–numeric code that will normally remain the same from year to year. For example, the Headlights circuit is in Section H1, with the first page of the section numbered H1–1. The following pages of this section will be numbered H1–2, H1–3, H1–4, etc. The manual does not contain any information concerning removal, refit or overhaul of electrical components or harnesses. These details are contained in the Workshop Manual. The following information forms the basis of the troubleshooting routines:

- Circuit Diagrams
- System Diagnosis Flow Charts
- Component Location Table
- Component Locations Views

Additional information, such as Circuit Operation, is also contained in the manual to aid in your understanding of how the different circuits operate.

DESCRIPTION OF MANUAL

Circuit Operation And Diagram

The Circuit Operation information at the beginning of the section will give you an overview of how the circuit works.

The Circuit Diagrams should always be your starting point in using this Electrical Troubleshooting Manual. The diagram shows the electrical current paths when a circuit is operating properly. It is essential to understand how a circuit should work before trying to figure out why it doesn't. Diagrams are shown with the Ignition Switch in the OFF position and other switches in the OFF or 'at rest' position.

Notes are provided after certain switches to clarify switch positions. Abbreviations found in the notes are explained in the Abbreviation Table found in the SYMBOLS section of this chapter.

Circuit Diagrams (schematics) break the entire electrical system into individual circuits. Electrical components that work together are shown together.

Each diagram is arranged so current flows from positive, at the top of the page, to ground, at the

bottom of the page. The 'power' labels at the top of a fuse show when the Battery, Main Light Switch, or Ignition Switch supplies power to that fuse.

Wires that connect to another circuit are shown with an arrowhead pointing in the direction of current flow. The name of the circuit that shares the wiring is provided for reference.

Wire Colour charts are no longer provided on each circuit page. One chart is provided in the SYMBOLS section of this chapter.

'See Fuse Details' means there are more connections to other circuits that are not shown. All such shared circuits are shown on the Fuse Details diagrams. 'See Ground Distribution' means there are more shared ground circuits which are shown on the Ground Distribution diagrams.

No attempt is made on the diagrams to represent components and wiring as they physically appear on the car. For example, a long length of wire is treated no differently in a diagram from one which is only a few centimeters long. The number of cavities for each connector is listed in the Component Location Table rather than illustrated. Similarly, switches and other components are shown as simply as possible, with regard to function only.

Power Distribution

The Power Distribution diagrams are found in Section Y1. These diagrams show how voltage is supplied from the positive Battery terminal to the various circuits in the vehicle.

The individual Circuit Diagrams begin with a fuse or the Ignition Switch. Power Distribution shows the wiring from the Battery to the Fuse Boxes, the Ignition Switch, the Main Lighting Switch, and any circuit fuses not located in a Fuse Box.

Fuse Details

The Fuse Details diagrams are found in Section Y2. These diagrams show all the wiring between each fuse in the Fuse Boxes and the components connected to the output of the fuse. The Fuse Details diagrams are extremely helpful in locating a short circuit that causes a fuse to blow. These diagrams also aid in troubleshooting an inoperative circuit by showing a second circuit using the same fuse. If the second circuit works, then the fuse and certain wires of the inoperative circuit are good.

Ground Distribution

The Ground Distribution diagrams are found in Section Y5. These diagrams show which components share each ground point. This information can often be a time-saver when troubleshooting a poor ground.

For example, if the Fuel Pump does not run, you may suspect an open in its circuit to ground. However, if the Number Plate Lamps work, and they share the same ground point as the Fuel Pump, you know that the ground and the wire up to the common splice are good. You have learned this just by inspecting the diagram and knowing the vehicle's symptoms.

Connector Views

Connector Views are provided in section Z6. All connectors with 2 terminals or more will be shown. Pin-out tables with the appropriate wire colours will also be shown.

Component Location Table

A Component Location Table can be found in Section Z4. Except for the location of obvious components like the Left Headlight, the table lists the location of every component, connector and ground point depicted in the Circuit Diagrams. The table also gives references to Component Location Views located in Section Z5 and cross references to Workshop Manual remove and refit procedure sections. The number of cavities in each connector and the connector colour is also listed. Wires may not be used in all connector cavities.

TROUBLESHOOTING TECHNIQUE

The following five-step troubleshooting procedure is recommended.

(1) Verify the Problem

Check the operation of the circuit to be sure you understand the problem. Do not begin disassembly or testing until you have narrowed down the possible causes.

(2) Analyze the Circuit Diagram (schematic)

Analyze the diagram. Check circuits that share the wiring with the problem circuit. The names of shared circuits are often given on each Circuit Diagram to aid troubleshooting. Shared power and ground circuits can be found in the Power and Ground Distribution sections. Try to operate the shared circuits. If these circuits work, then the shared wiring is OK. The cause must be within the wiring used only by the problem circuit. If several circuits fail at the same time, chances are the power (fuse) or ground circuit is faulty.

(3) Find the Cause

- Narrow down the possible causes.
- Before you replace a component, check power, signal, and ground wires at the component harness connector.

(4) Repair the Problem

Once the specific problem is identified, make the repair. Be sure to use the correct tools and safe procedures.

(5) Check the Repair

Check the operation of the repaired circuit in all modes to make sure you fixed the entire problem. If the problem was a blown fuse, be sure to test all of the circuits on that fuse. Make sure no new problems are present.

digital multimeter. Never use a test light on circuits that contain solid-state devices. Damage to the device may result.

On circuits without solid-state devices, a test light may be used to check for voltage. A test light is made up of a 12-volt bulb with a pair of leads attached. After grounding one lead, touch the other lead to various points along the circuit where voltage should be present. The bulb will come on if the voltage at the point being tested is greater than 5 volts.

Self-powered Test Light and Ohmmeter

Use a self-powered test light or ohmmeter to check for continuity. The ohmmeter shows how much resistance there is between two points along a circuit. Low resistance means good continuity.

TEST EQUIPMENT

Where applicable, Land Rover recommended testers should be used.

Voltmeter and Test Light

Use a voltmeter or test light to check for voltage. While a test light shows whether or not voltage is present, a voltmeter indicates how much voltage there is.

CAUTION: A number of circuits include solid-state devices. Voltages in these circuits should be tested only with a 10-megohm or higher impedance

CAUTION: Never use a self-powered test light on circuits that contain solid-state devices. Damage to these devices may result.

Diodes and solid-state devices in a circuit can make an ohmmeter give a false reading. To find out if a component is affecting a measurement, take one reading, reverse the leads, and take a second reading. If the readings differ, the component is affecting the measurement.

Circuits that contain solid-state devices should only be tested with a 10-megohm or higher impedance digital multimeter.

A self-powered test light consists of a light bulb, Battery and two leads. If the leads are touched together, the bulb will go on.

A self-powered test light is only used on an unpowered circuit. First, disconnect the battery or remove the fuse that feeds the circuit you are working on. Select two points along the circuit through which there should be continuity. Connect one lead of the self-powered test light to each point. If there is continuity, the test light's circuit will be completed and the bulb will go on.

Fused Jumper Wire

Use a fused jumper wire to bypass an open circuit. A fuse jumper wire is made up of an in-line fuse holder connected to a set of test leads. Never use a jumper wire across any load. This direct battery short will blow the fuse.

The following symbol represents a fused jumper:

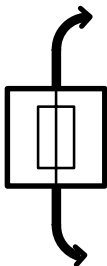

SYMBOLS

The abbreviations and symbols explained here are used throughout the manual; it is necessary to know what they mean in order to use the diagrams effectively.

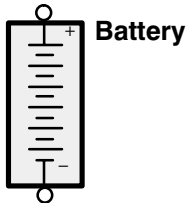

Battery

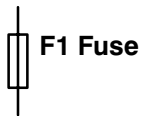

F1 Fuse



MF2 Maxi-Fuse®

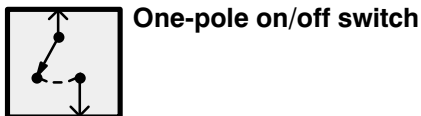

One-pole on/off switch

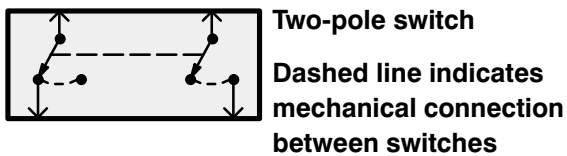

Two-pole switch

Dashed line indicates mechanical connection between switches



Multiple Position Switch

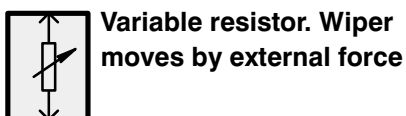

Variable resistor. Wiper moves by external force

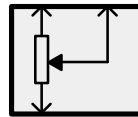

Potentiometer. Wiper moves by external force

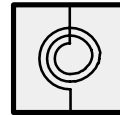

Steering Column Rotary Coupler



Diode. Current flows in direction of arrow only



LED



Bulb



Electronic or Solid State device

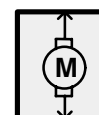

Permanent magnet motor (one speed)

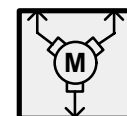

Permanent magnet motor (two speed)

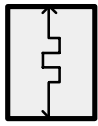

Heating Element



Antenna



Loudspeaker or horn

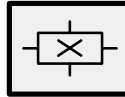

Hall Effect Sensor

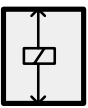

Coil

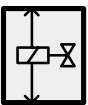

Solenoid



Relay

Switch is drawn into the closed position when current flows through coil

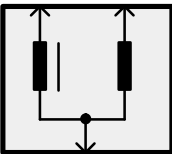

Ignition Coil

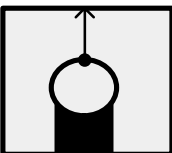

Steering Column
Horn Brush/
Slip Ring

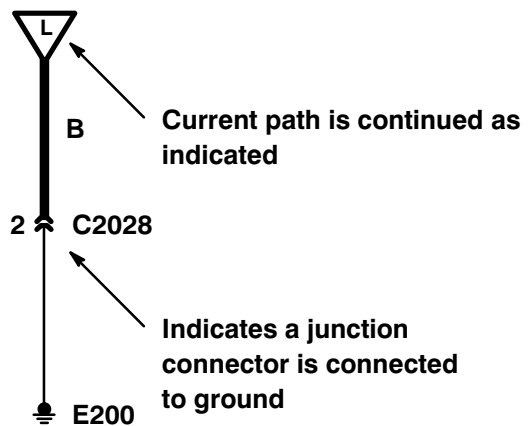
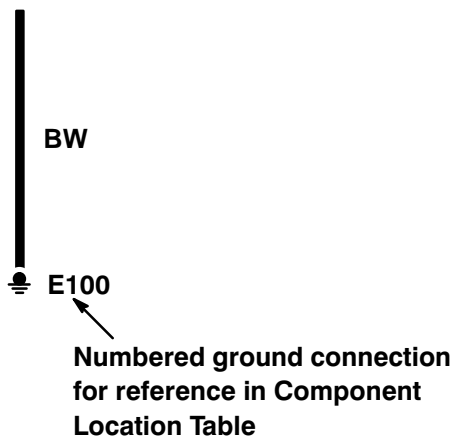
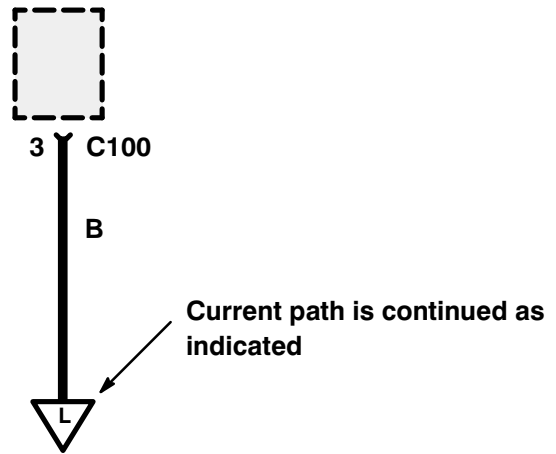
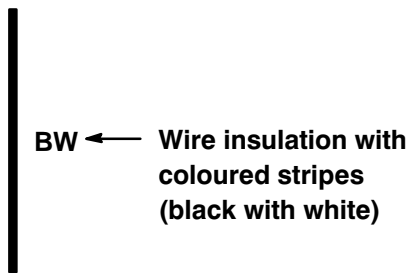
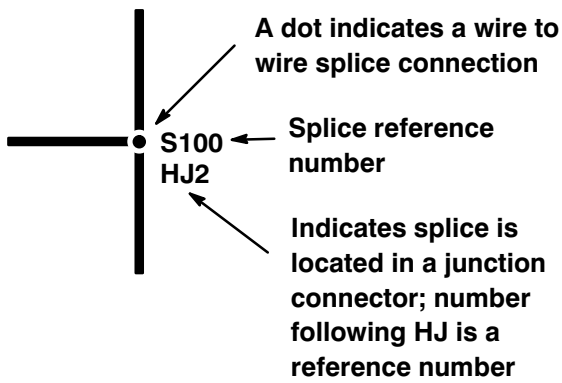
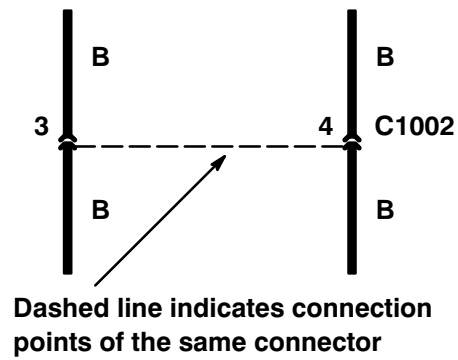
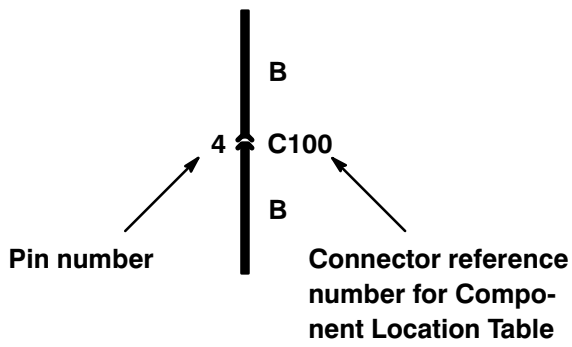

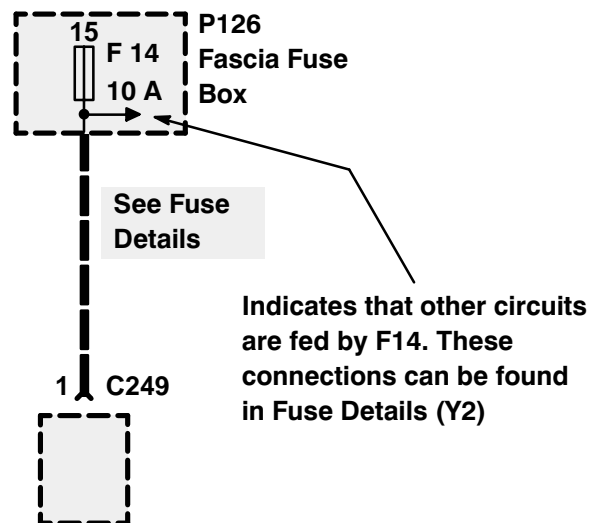
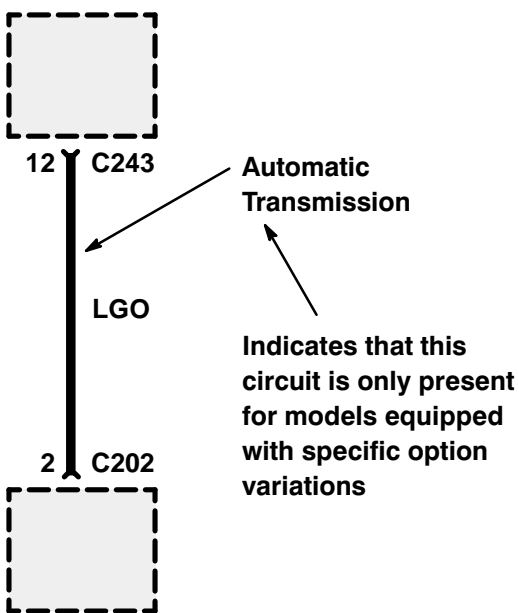
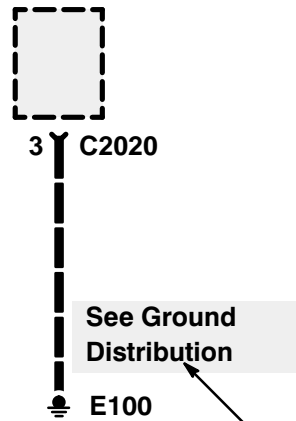
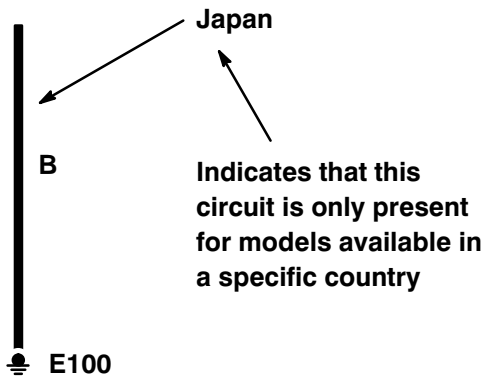
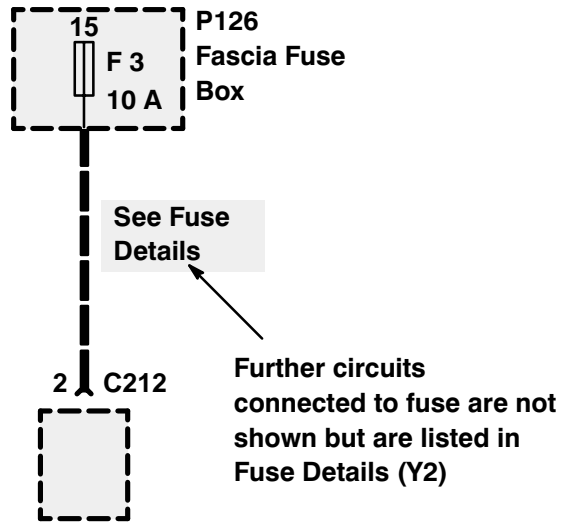
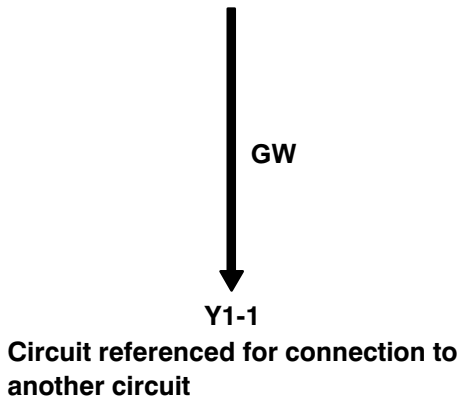

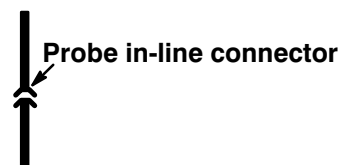
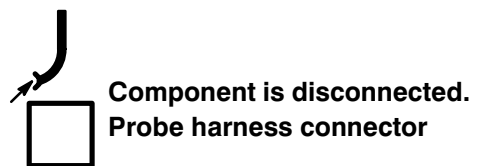
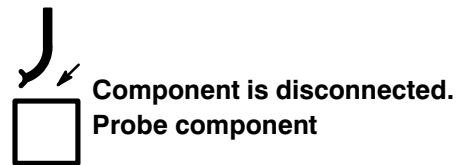
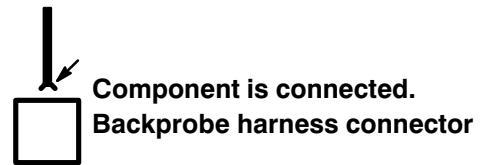
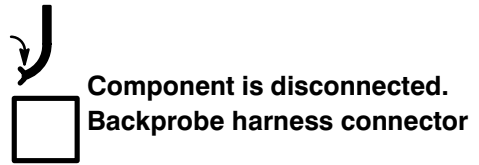
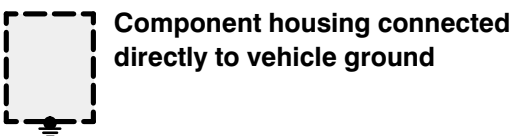
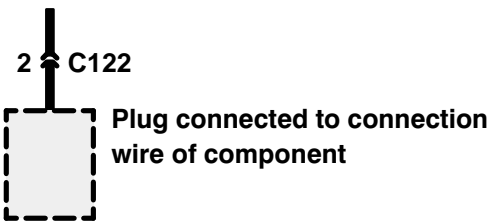
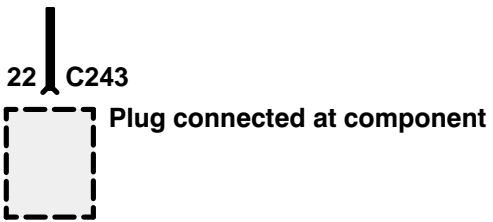
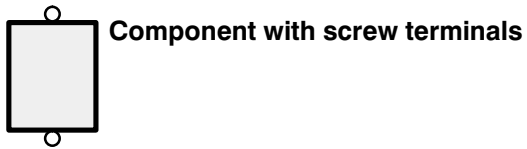
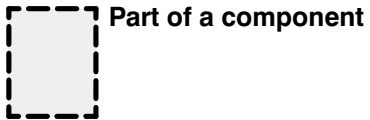

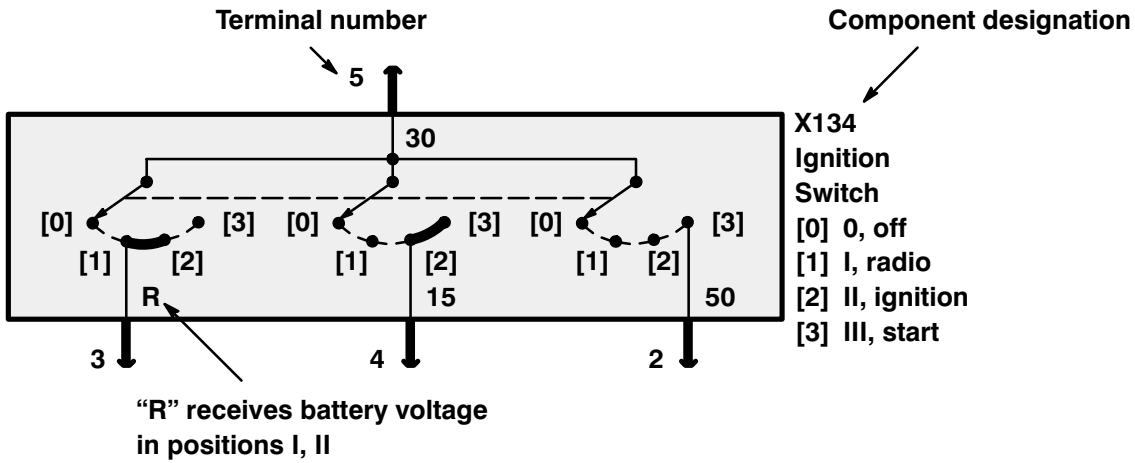

Terminal number	Designation
50	Battery voltage: Ignition Switch in position III
30	Battery voltage: supplied constantly
15	Battery voltage: Ignition Switch in position II or III
R	Battery voltage: Ignition Switch in positions I, II
31	Ground

Terminal number	Designation
X	Switched battery voltage through the ignition load relay or accessory relay; ignition switch is in position I or II.
49	Flasher unit input
49a	Flasher unit output
50	Start
56a	High beam
56b	Low beam
56d	Headlamp flash
58	Side lamps
85	End of relay coil
86	Start of relay coil
87	Relay contact
87a	Relay contact

Definition of Vehicle Component Codes

All components are identified by a letter followed by an arbitrary number assigned to the component. The letter assigned to the component indicates the type of component.

B	Bulbs, Heated Screens, Mirror Demisters, Cigar Lighters, and Heated Washer Jets
K	Relays, Solenoids, Speakers, and Resistors
M	Motors
P	Fuse Boxes and Fusible Links
X	Switches and Sensors
Z	Electronic Control Units, Modules, Shields, Diodes, and Capacitors

Wire Colours

All wires are identified by letters which indicate a certain colour. Wire colour and size will only be shown once if it does not change throughout the circuit. The following chart explains the wire colour abbreviations.

Wire Colour Chart

B - Black	P - Purple
G - Green	R - Red
K - Pink	S - Grey
L - Light	U - Blue
N - Brown	W - White
O - Orange	Y - Yellow

Previous and Next Arrows

Schematic pages which follow another schematic page of the same chapter will have an arrow in the upper left hand corner. There is no arrow on the first schematic page of a chapter. Schematic pages which are followed by another schematic page will have an arrow in the lower right hand corner. If the page is the last page of the chapter, there will be a square instead of an arrow.

Page Qualifiers

Schematic pages which are specific to certain model, option or country variations will have a small "Qualifier" after the Previous Arrow in the upper left hand corner. For example, a section might contain pages specific to petrol engines and some pages specific to diesel engines. "Petrol" will be shown in the upper left hand corner of petrol specific pages, and "Diesel" will be shown in the upper left hand corner of diesel specific pages.

Circuit Qualifiers

Certain abbreviations are used throughout the Electrical Troubleshooting Manual as circuit qualifiers. The following list explains all abbreviations used as qualifiers in the Circuit Diagrams.

ABS	Anti-Lock Braking System
CPU	Central Processing Unit
LHD	Lefthand Drive
RHD	Righthand Drive
LWB	Long Wheel Base
SWB	Short Wheel Base
NAS	North American Countries
MFI-V8	Multiport Fuel Injection (MFI-V8)
A/C	Air Conditioning
SFI-V8	Sequential Multiport Fuel Injection (SFI-V8)

Switch Positions

Certain abbreviations are used throughout the Electrical Troubleshooting Manual as Switch Position notes. The following list explains all abbreviations used as Switch Position notes in the Circuit Diagrams.

< 100°	Less than 100°
> 100°	More than 100°

Connectors, Grounds, and Splices are identified by a letter followed by a number. Connectors are identified by C, grounds by E, and splices by S. The numbers assigned to the connectors, grounds, and splices no longer correspond to its location in the vehicle. Connectors, grounds, and splices have been numbered according to which harness the connector, ground, or splice is located on. The following table illustrates the appropriate numbers for each harness.

Connector, Ground, and Splice Identification by Harness

100–199	Underbonnet Harness
200–299	Fascia Harness (LHD and RHD)
300–349	Right Body Harness
350–399	Left Body Harness
400–499	Airbag Harness
500–549	Petrol Engine Harness
550–569	Transmission Harness
570–599	Diesel Engine Harness
600–699	Console Harness
700–749	Rear Door Harness
750–799	Front Door Harness
800–849	Lower Tailgate Harness
850–899	Upper Tailgate Harness
900–949	Composite Seat Harness
950–999	Left and Right Seat Harness
SUFFIX	
A	For Different Option Variations
B	For Different Option Variations
L	Left Side of Vehicle only
R	Right Side of Vehicle only
P	Petrol Engine only
D	Diesel Engine only

CIRCUIT OPERATION

Sensors

Engine Fuel Temperature Sensor (X128)

This is a resistive sensor, located on the fuel rail and measuring the temperature of the rail rather than the fuel. The signal is used to increase the injection pulse times when undergoing hot restarts. When the fuel is hot, vaporisation occurs in the rail and a "bubble" could form within the injectors. Increasing the pulse times flushes the "bubbles" away and cools the fuel rail with fuel from the tank.

Knock Sensors (X309, X310)

The knock sensor is a "Piezo-electric accelerometer," i.e. it produces an output voltage proportional to mechanical vibration produced by the engine. The Engine Control Module (ECM) (Z132) receives the signal, filters out any noise and calculates if the engine is knocking. Due to the cam and crank signals supplying information regarding the position of the engine in its cycle, the ECM (Z132) can work out exactly which cylinder is knocking and retards the ignition on that particular cylinder until the knock disappears. It then advances the ignition again to find the optimum ignition point for that cylinder for those conditions (i.e. fuel type, air temperature etc.). The ECM (Z132) will be able to adjust cylinder timing for knock simultaneously, so that all eight cylinders could have different advance angles at the same time.

Coolant Temperature Sensor (X126)

A temperature dependant resistive metal component is the major constituent of this sensor, i.e. the resistance of the metal strip varies quite considerably with temperature. The coolant sensor signal is vital to correct engine operation, as the injected fuel quantity is dependant upon the engine temperature, i.e. richer mixture at low temperatures.

Intake Air Temperature Sensor (X311)

This is a resistive sensor, i.e. the change in resistance is related to change in air temperature. The signal from the Intake Air Temperature Sensor (X311) is used to retard the ignition timing if the air temperature rises above 55°C.

Crankshaft Position Sensor (X250)

The Crankshaft Position Sensor (X250) is a very important sensor, as the signal it produces tells the ECM (Z132) that the engine is turning, how fast it is turning and at which stage the engine is at in the

cycle. The crank signal is the basis of the fuel injection and coil firing times.

Camshaft Position Sensor (Z262)

This is a Hall Effect sensor producing one pulse for every two revolutions. The Signal is used in two areas: Injector timing corrections for fully sequential fuelling and active knock control.

Camshaft operation is essential to continue normal ignition, i.e. actuate the fuel injectors in the normal sequential order, timing the injection correctly with respect to top dead centre. In this way the sequential fuelling will either be correct, or one engine revolution out of synchronisation.

Mass Air Flow Sensor (X105)

The sensing element of a Mass Air Flow Sensor (X105) is a "hot wire anemometer" consisting of two wires; one heated, one not. The air flows across the wires, cooling the hot wire and thereby altering its resistance. The ECM (Z132) measures this change in resistance and so calculates the amount of air flowing into the engine.

If the Mass Air Flow Sensor (X105) fails, the engine will start and then die as the engine reaches 550 rpm before the ECM (Z132) looks for the Mass Air Flow Sensor (X105) signal.

Throttle Position Sensor (X171)

This sensor is a variable resistor. The signal informs the ECM (Z132) of the actual position of the throttle plate. Failure of the Throttle Position Sensor (X171) will result in poor idle and lack of throttle response. If the Throttle Position Sensor (X171) fails in the "closed" mode, then the engine will only rev up to 1740 rpm when the ECM (Z132) will initiate "over run fuel cut-off".

Heated Oxygen Sensors (X139, X160, X289, X290)

The heated oxygen sensor consists of a titanium metal sensor surrounded by a gas-permeable ceramic coating. Oxygen in the exhaust gas diffuses through the ceramic coating on the sensor and reacts with the titanium wire, altering the resistance of that wire. From this change in resistance, the ECM (Z132) can calculate the percentage of oxygen in the exhaust gas and adjust the injected fuel quantity that as to achieve the correct air/fuel ratio. This reduces the emissions of Carbon Monoxide (CO), Hydrocarbons (HC) and oxides of Nitrogen (NOX) to acceptable levels.

Presently, two heated oxygen sensors are used, one in each exhaust down pipe just before the catalyst.

In the event of sensor failure, the system will default to "open loop". Operation and fuelling will be calculated using signals from the remaining ECM inputs. The fault is indicated by illumination of the malfunction indicator lamp (MIL). ECM diagnostics also uses heated oxygen sensors to detect catalyst damage, misfire and fuel system faults.

North American vehicles have two extra heated oxygen sensors mounted one after each catalyst. These are used to determine whether the catalysts are operating efficiently.

Idle Air Control Valve (M112)

The Idle Air Control Valve (M112) controls the idle speed of the engine by moving the plunger a set distance, known as a step. Fully open is zero steps and fully closed is 180 steps. The motor moves each step by sequentially changing the polarity to each of the two coils.

Ignition Coils (Z261)

The ignition system on the petrol engine consists of a “DIS” format, a Direct Ignition System, comprising of four double ended coils operating on the “wasted spark” technique. The circuit to each coil is completed via switching within the ECM (Z132), allowing the coil to charge up and then fire. It produces sparks in two cylinders simultaneously, one cylinder on the compression stroke and one on the exhaust stroke. Due to relatively easy ionisation of the fuel/air mixture in the cylinder under compression, the coil will dissipate more energy in that cylinder than the other, so very little energy is wasted in the system.

Failure of a coil will result in lack of sparks in two cylinders (coil 1 feeds cylinders 1/6, coil 2 feeds cylinders 5/8, coil 3 feeds cylinders 4/7 and coil 4 feeds cylinders 2/3). This results in a misfire.

Injector/Injectors

The fuel injection system used is a “sequential multi-point” system (SFI) i.e. one injector for each cylinder (compared to “single point” injection or throttle body injection which uses one injector only). A fuel injector consists of a small solenoid which is activated by the ECM (Z132), allowing fuel to pass into the combustion chamber. Due to the fuel pressure in the rail and the shape of the injector orifice, the fuel squirts into the cylinder in a fine spray to aid combustion.

Relays

The engine management system uses four relays:
 – Starter motor, ECM (Z132) power supply (main relay), ignition and fuel pump, all located within the fusebox.

Main Relay

This relay supplies the power feed to the ECM (Z132) with a tap off to feed the fuel injectors and air flow meter. This relay is controlled by the ECM (Z132) itself, so that the ECM (Z132) remains powered up after the ignition is removed and the ECM (Z132) can record all temperature readings and motorise the Idle Air Control Valve (M112) to the fully open position. This is known as the “ECM (Z132) power down routine”. Failure of this relay will cause the ECM (Z132) to not be switched on, resulting in absence of fuel and spark and therefore a failed start.

Ignition Relay

This relay is ignition key controlled and supplies a feed to the coils, evaporative emission canister purge valve and heated oxygen sensor. When the ignition key is turned off, supply to the coils is cut immediately.

Starter Motor Relay

This relay is also ignition key controlled and is activated with the key in the ignition III position only. Releasing the key after cranking cuts supply to the relay and switches off the starter motor.

Fuel Pump Relay

This relay is fed from the ignition relay and controlled by the ECM (Z132). It is pulled in on ignition II position to prime the fuel system. If the key remains in the ignition II position, then the relay falls out after a few seconds, precisely when determined by the ECM (Z132).

Engine Control Module (ECM) (Z132)

If the ECM (Z132) itself is not working, the entire engine management system will cease to operate: no fuel, sparks, tacho reading, etc.

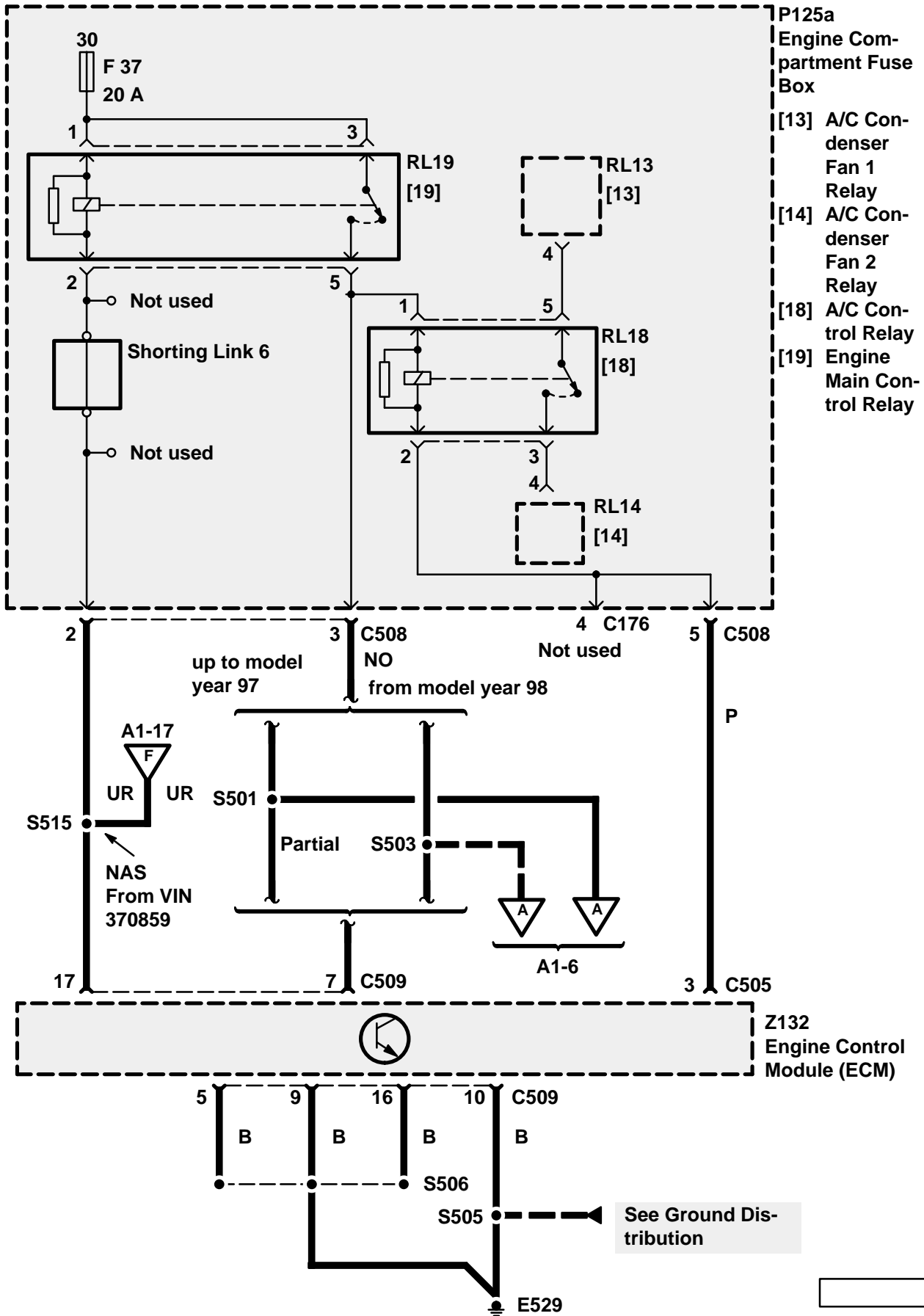

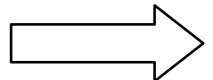
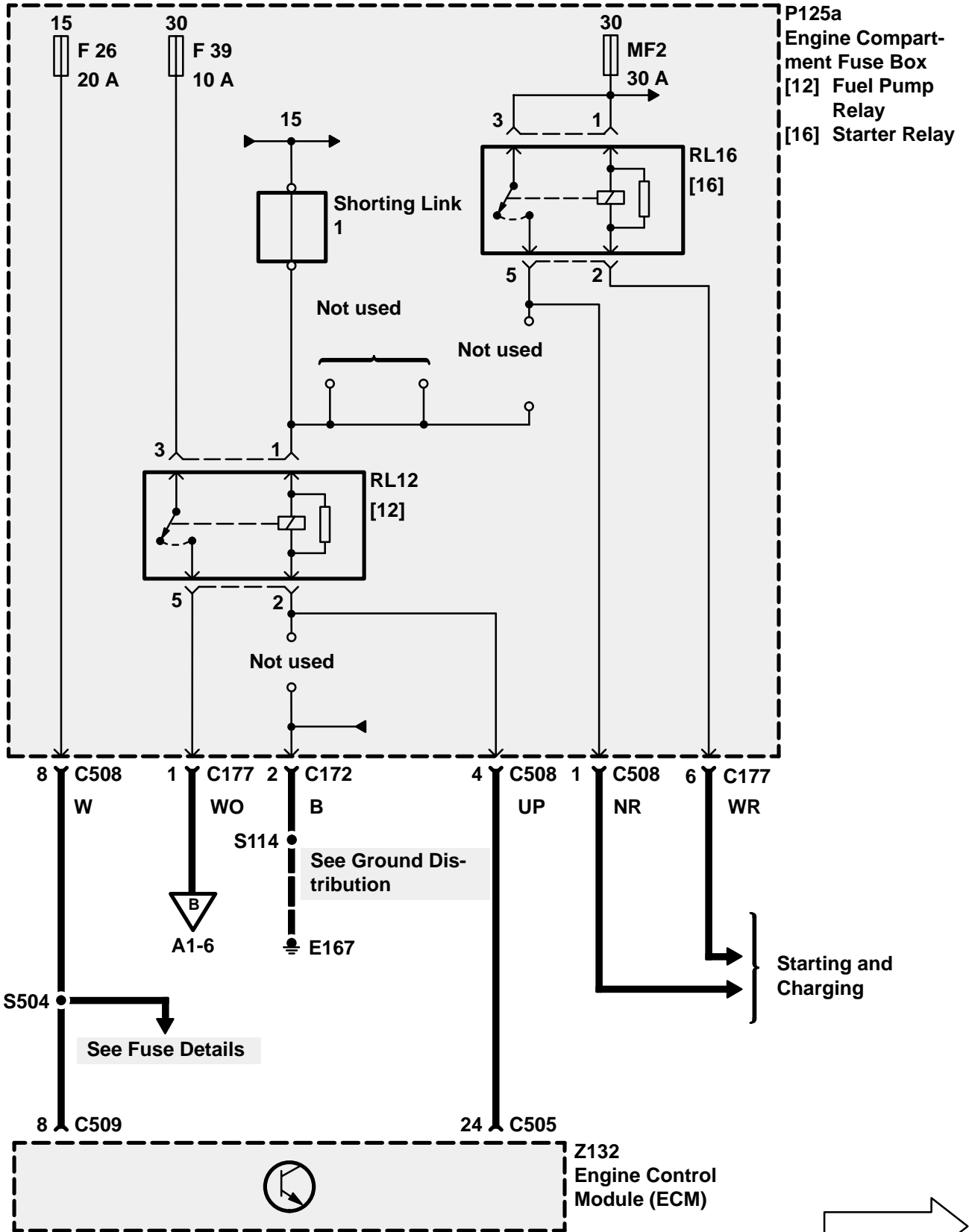
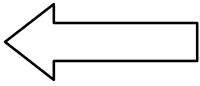

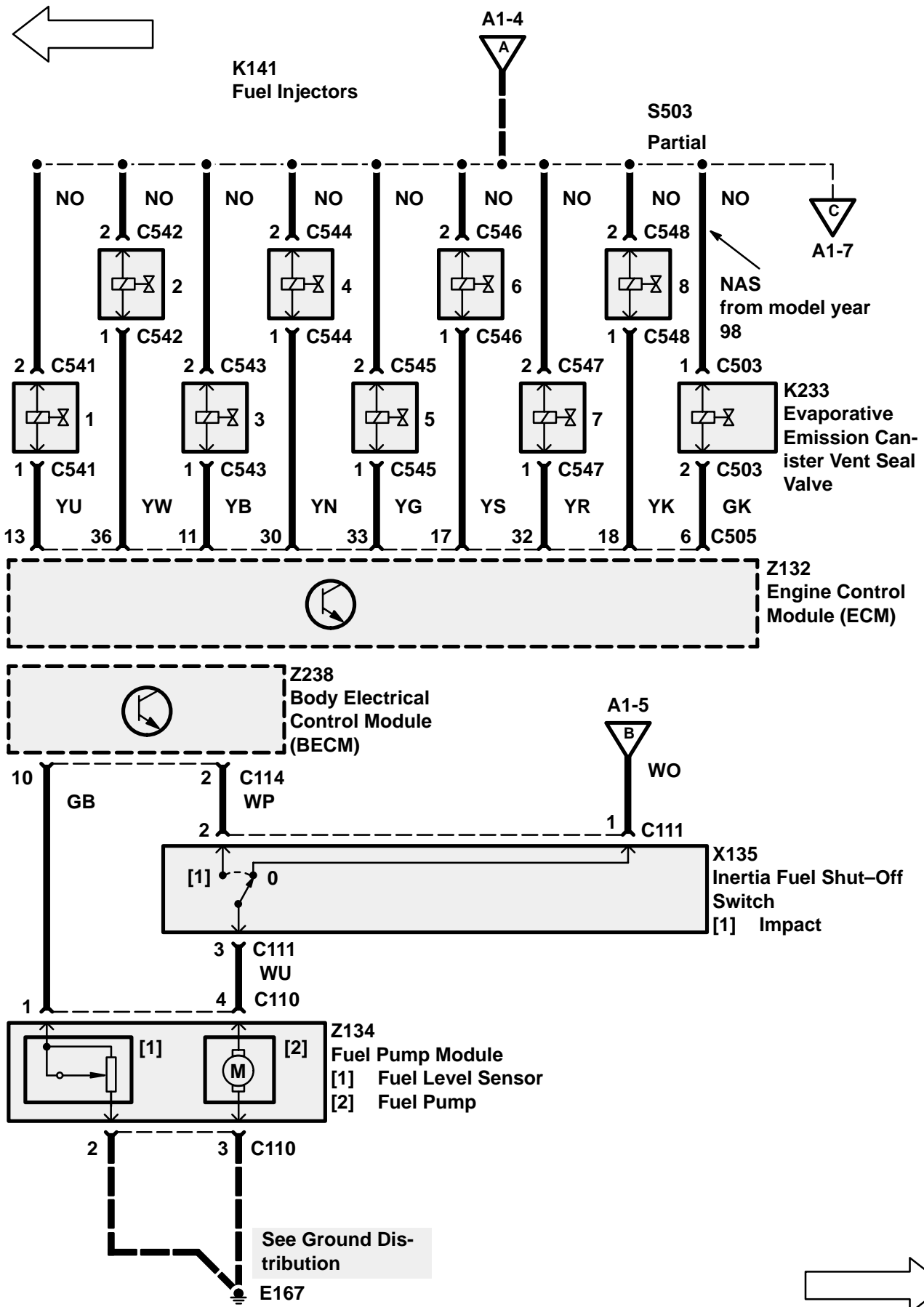

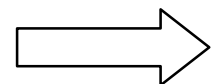
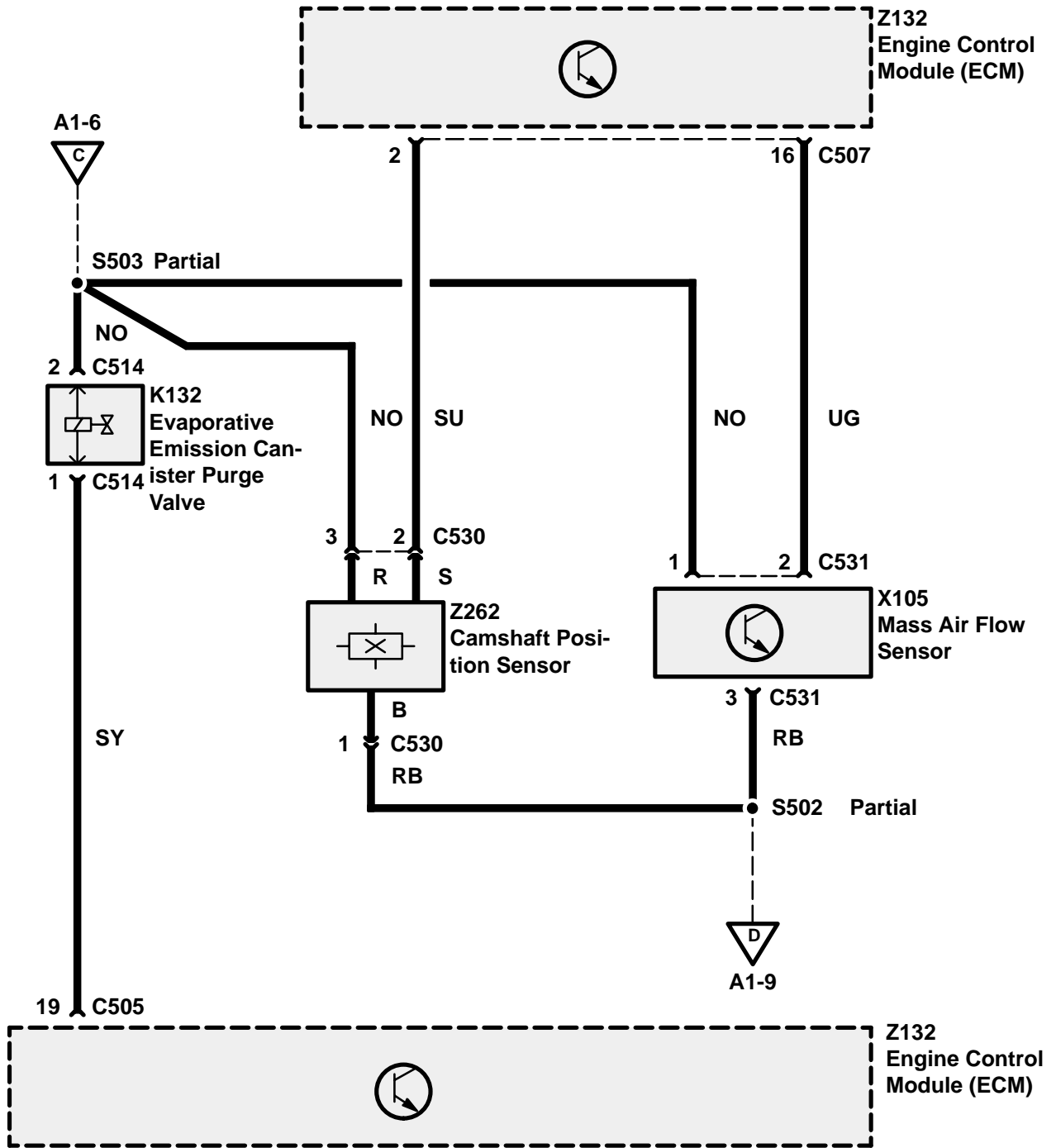
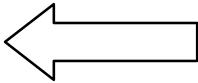

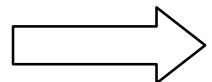
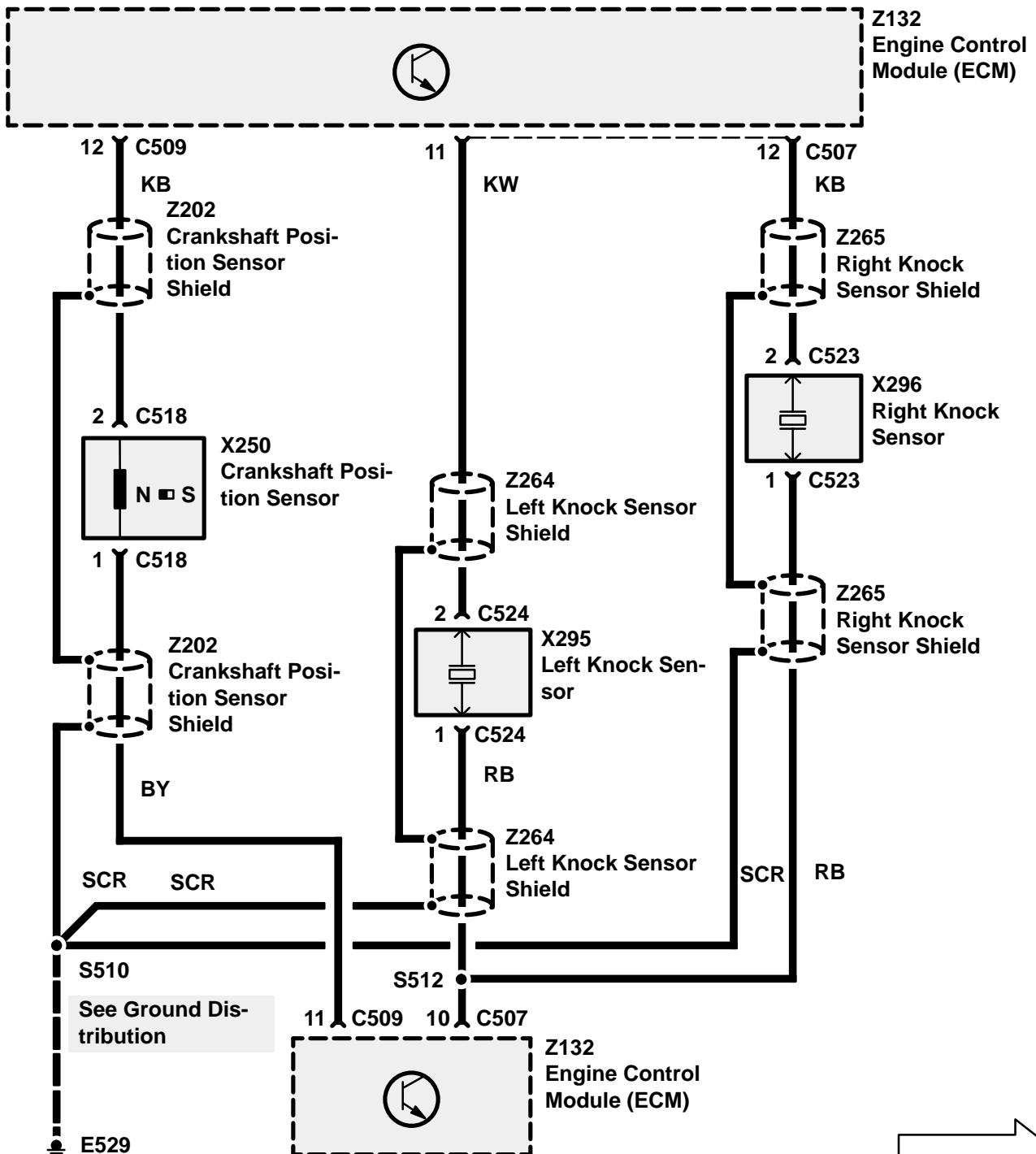
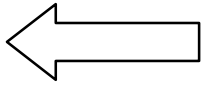

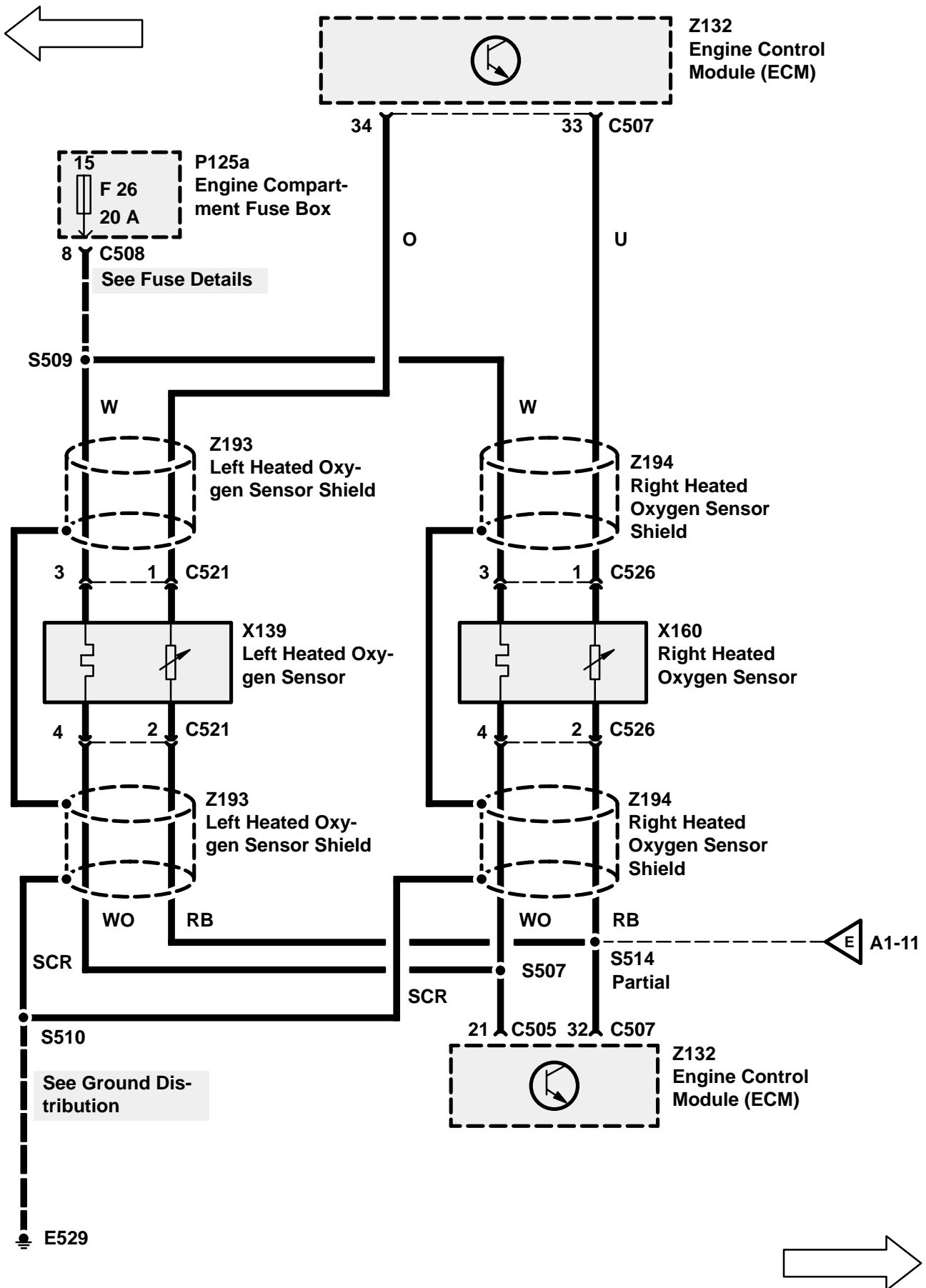

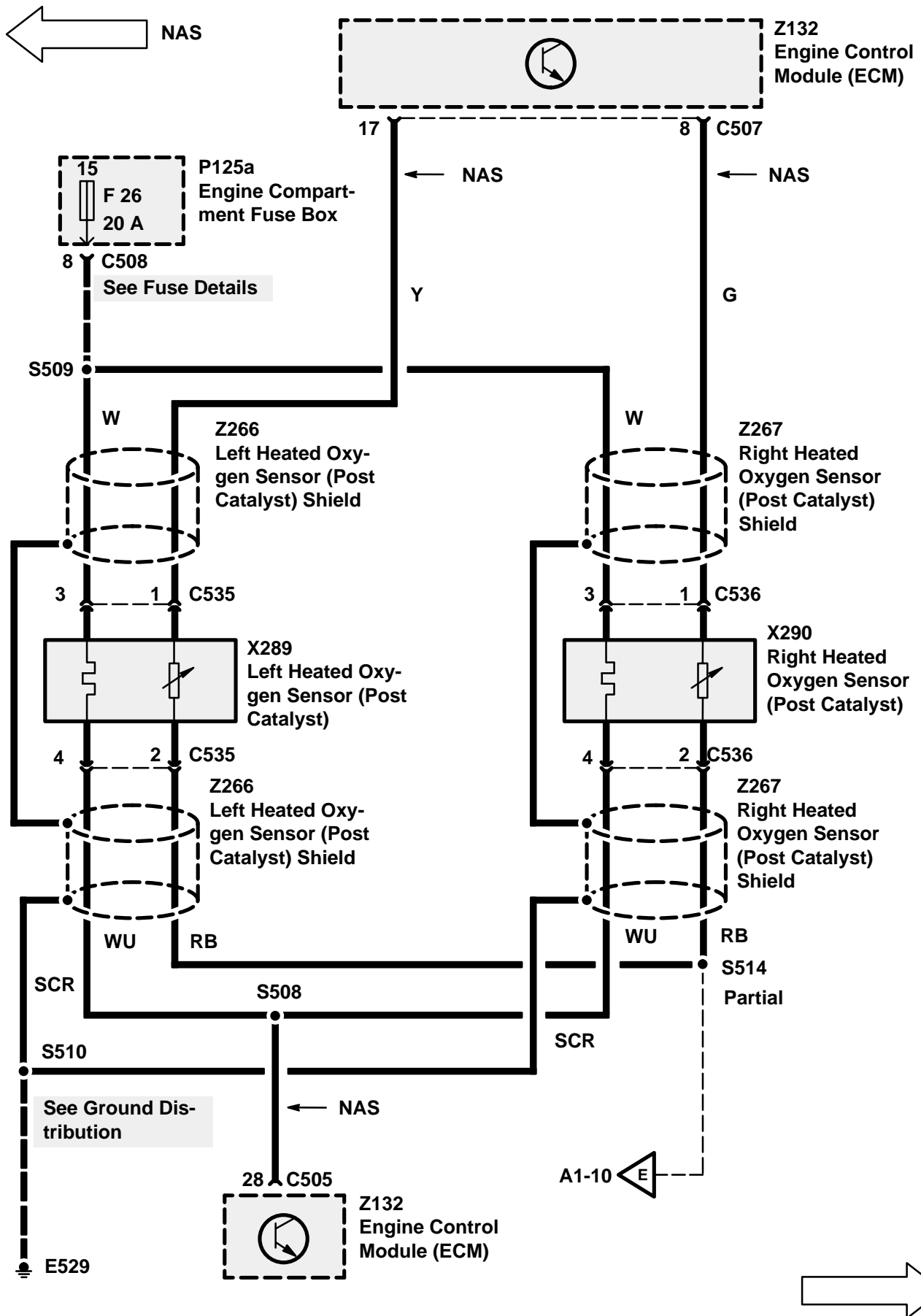

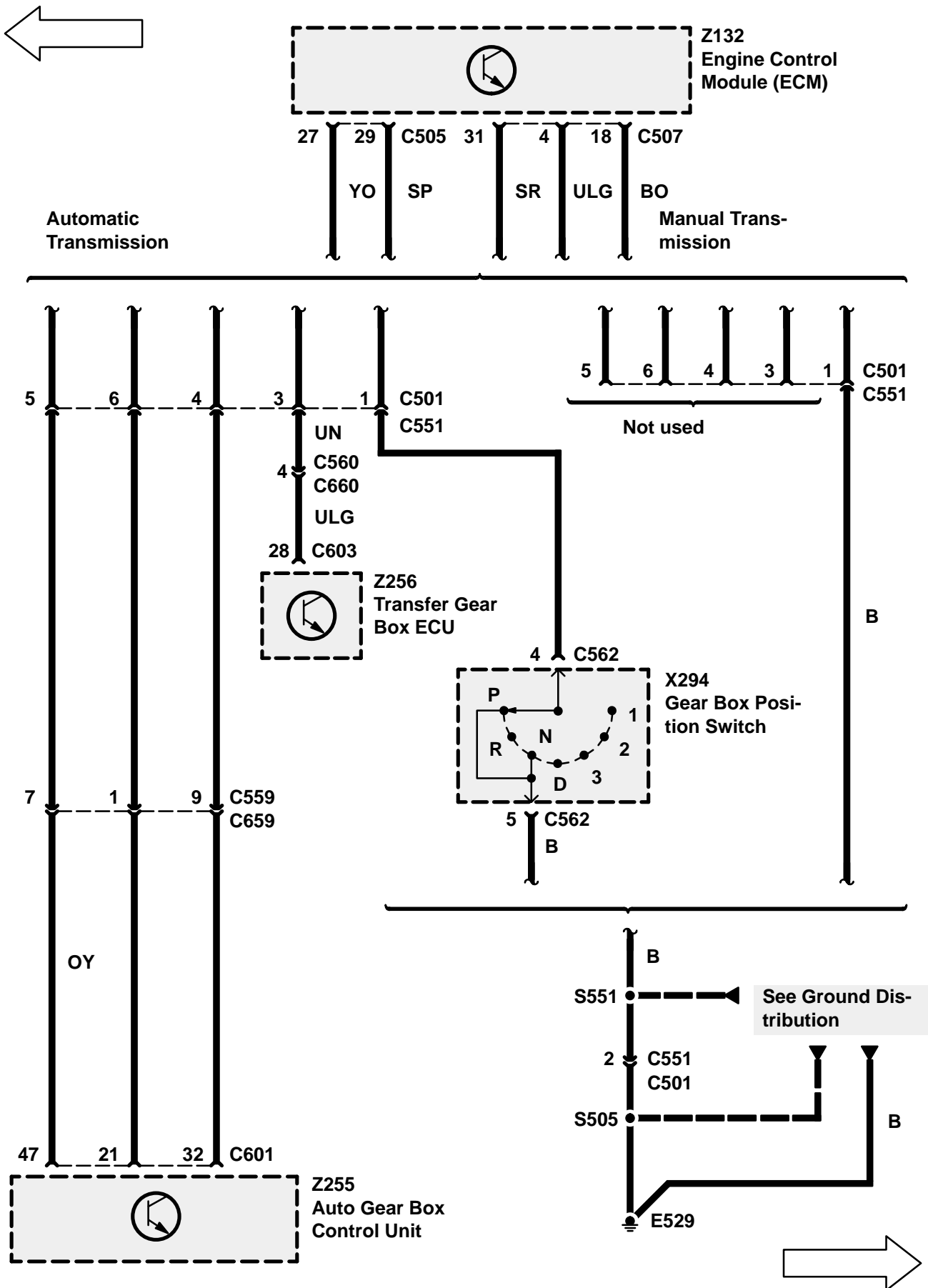

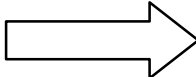
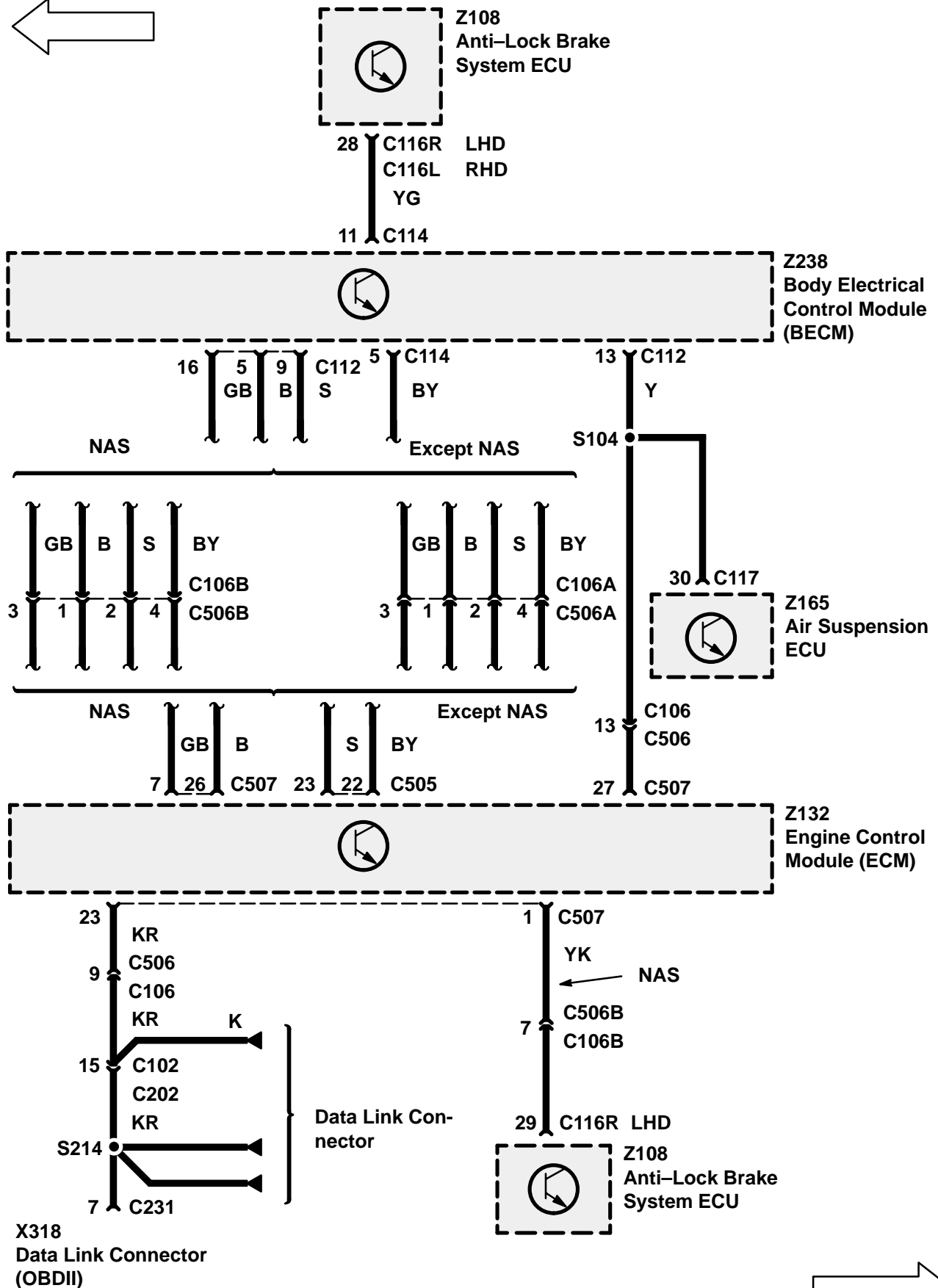
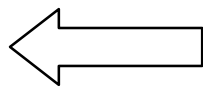

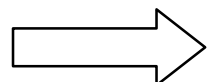
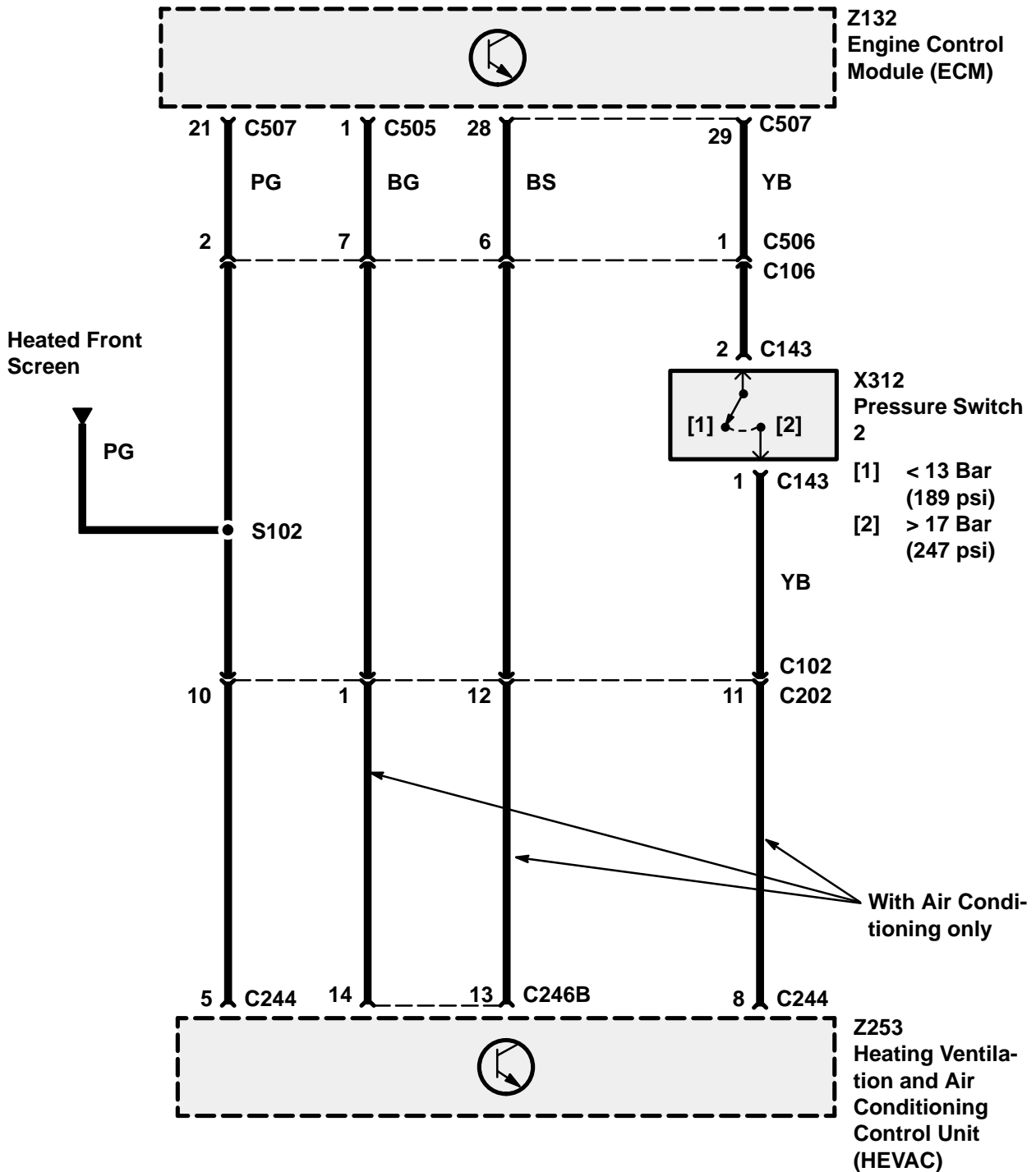
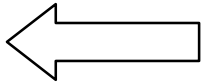

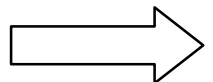
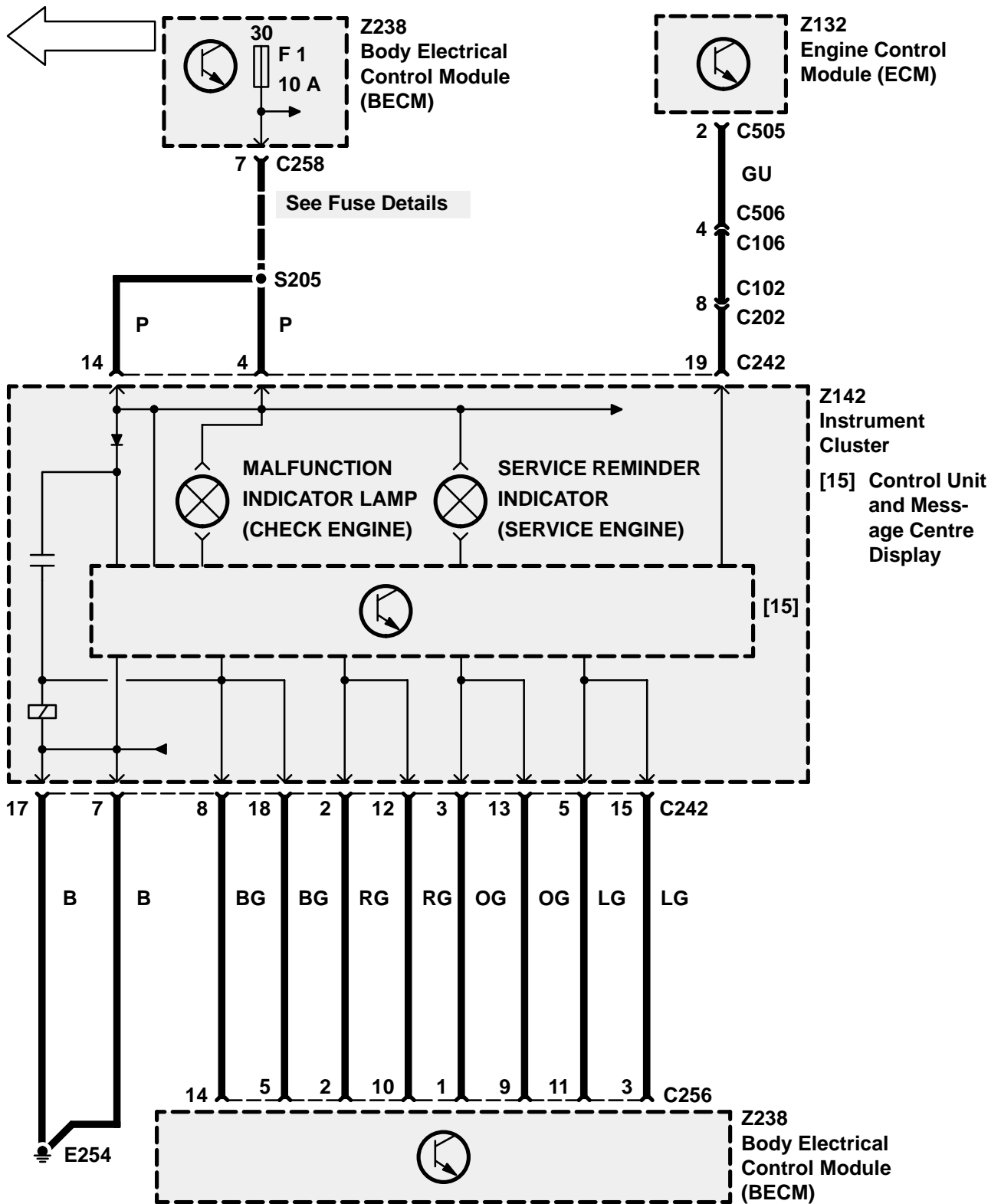

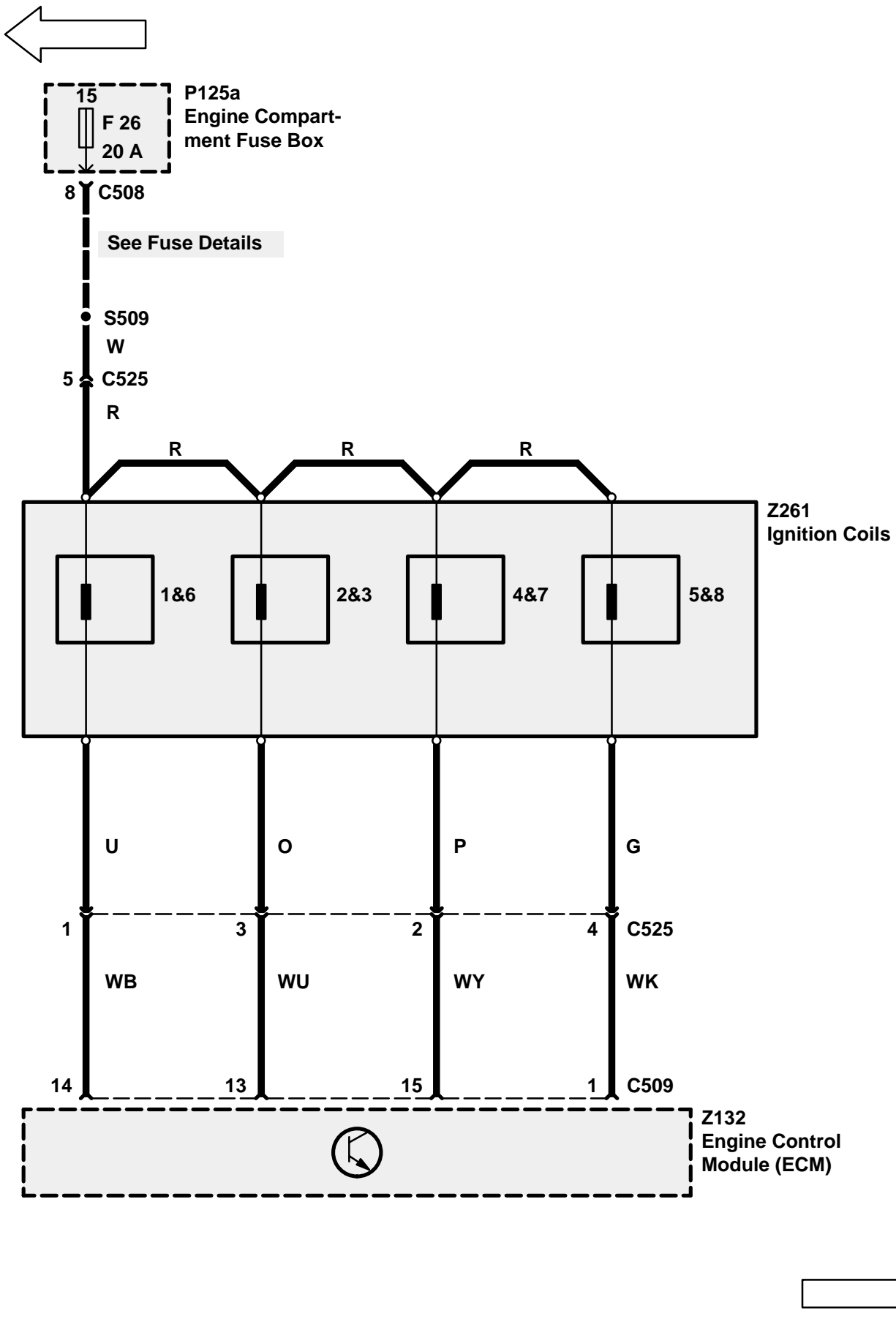

← NAS
From VIN 370859

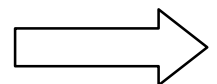
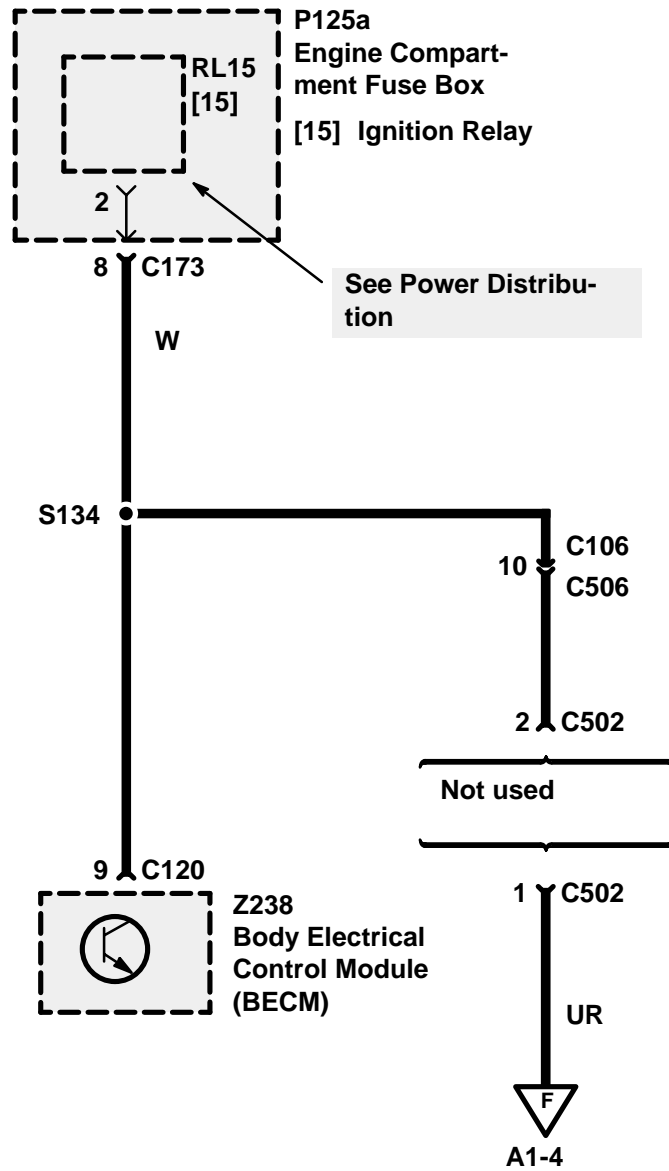

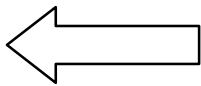

NAS
from model year
98

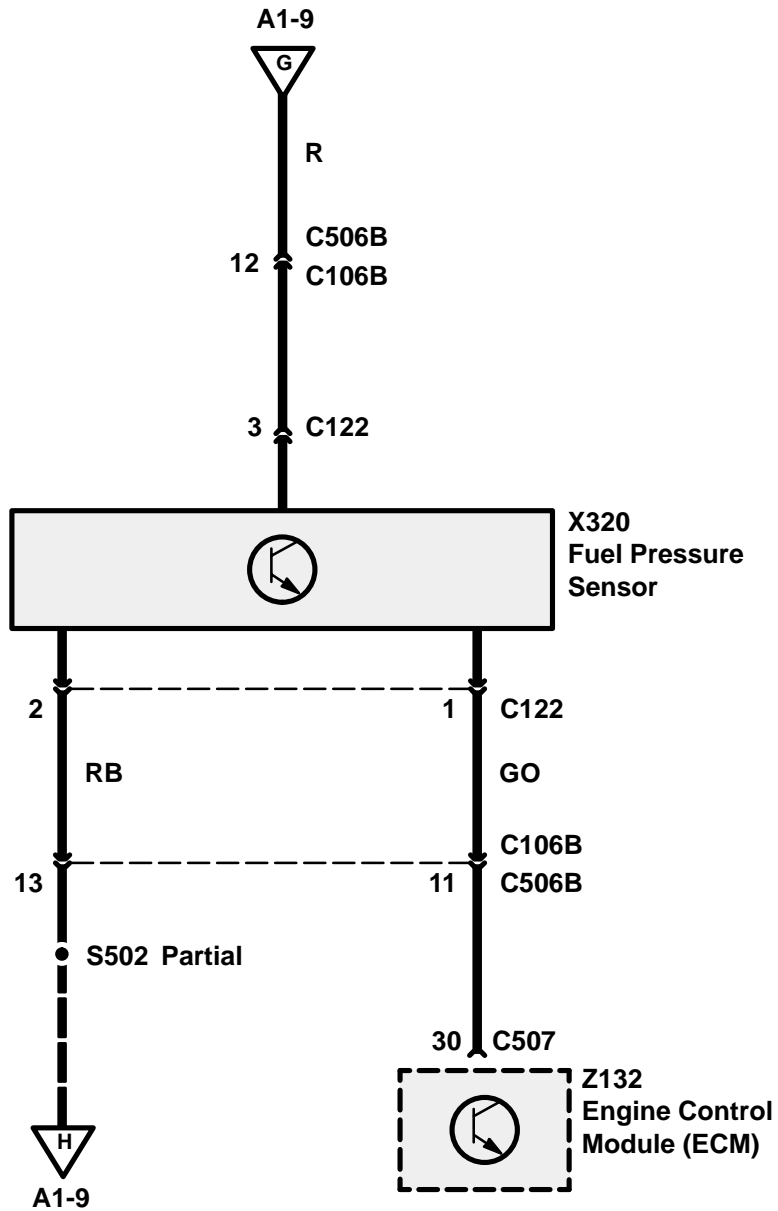

CIRCUIT OPERATION

Sensors

Engine Speed Sensor (X255)

The engine speed signal is crucial to the system, as the information from the sensor is used in virtually all of the strategies within the 'DDE' (Digital Diesel Electronics) and its Engine Control Module (ECM) (Z132). Through this sensor, the ECM (Z132) knows if the engine is turning, how fast it is turning and approximately where the engine is in its cycle. The sensor is of the 'Hall effect' type, which sends out a pulse to the ECM (Z132) every time a 'tooth' is sensed on the flywheel (the flywheel has six 'teeth'). If the sensor fails, then the warning lamp is activated and the ECM (Z132) enters a 'limp home' mode where the ECM (Z132) looks at the signal from the needle lift sensor in one of the injectors. The needle lift sensor gives one pulse per injection, i.e. one pulse per twelve engine speed sensor pulses. The response of the ECM (Z132) to changes in engine parameters will, therefore, be considerably slower, and a higher idle speed is initiated to try to compensate at low engine speeds.

Needle Lift Sensor (X318)

The engine has six diesel fuel injectors, one of which has a sensing element at the tip which informs the ECM (Z132) exactly when the injector fires (the 'beginning of injection' signal). The ECM (Z132) uses this to correct the injection timing and also to back up the engine speed signal in case that sensor fails. If this sensor fails, the warning lamp will switch on and the vehicle will enter 'limp home' mode with reduced engine power/performance and lack of throttle response (as there is a lack of feedback on the injection timing).

Engine Coolant Temperature Sensor (X126)

This sensor is a 'thermistor' (a temperature dependent resistor) where the voltage output varies in proportion to coolant temperature. The ECM (Z132) uses this information in many strategies, i.e. to correct the injected fuel quantity and timing (especially during cold starts), length of glow plug timing, etc. The sensor is located in the top of the engine block. In case of a failure, the warning lamp is not activated and the ECM (Z132) selects a substitute value of 50°C for glow plug and ignition timing and uses the fuel temperature to correct the fuel quantity, glow plug timing will not be correct, possibly resulting in long crank times in cold weather

as well as slight fuelling effects. These symptoms may not be noticeable.

Air Temperature Sensor (X311)

This sensor is another thermistor, located in the inlet manifold, just after the intercooler, and measures the actual temperature of the turbo booster air entering the engine. To calculate the maximum amount of injected fuel allowed, the ECM (Z132) needs to know the volume of air flowing into the engine. Normally a bulky, heavy and expensive air flow meter is necessary, but the ECM (Z132) can calculate the air flow from the air temperature and air pressure, so eliminating the need for an air flow meter. If the air temperature sensor fails, a substitute value of 30°C is used, so by producing an incorrect air flow reading and a reduction in engine power.

Boost Pressure Sensor

The boost pressure sensor signal is used in conjunction with the air temperature signal to calculate volume air flow into the engine. The sensor is located on the rear bulkhead, with the pressure tap just after the charge air cooler. If the sensor fails, a substitute value of 490 hPa is used by the ECM (Z132), producing a reduction in power due to a fuel quantity limiting to 21mg/stroke.

Throttle Position Sensor (X171)

The DDE system is a 'Drive by Wire' system i.e. the throttle pedal does not directly control a throttle disc or the amount of fuel injected into the engine, but accelerator movements or 'drivers request' are sensed and the information is passed to the ECM (Z132). The ECM (Z132) calculates the maximum allowable fuel quantity from the air flow into the engine, engine speed, temperature, etc. It also includes information from strategies such as smoke limitation, active surge damping, automatic gear change, fuel reduction, etc. to calculate the final figure. When driving, if the 'drivers request' signal is smaller than the maximum allowable quantity, then the requested quantity is injected. However, if the requested quantity is greater than the maximum allowable, then the latter quantity is injected rather than the driver's demand. Therefore the Throttle Position Sensor (X171) is very important to the system. It is located within the cab, close to the pedal assembly itself. The unit consists of a potentiometer and has three outputs:

1. Throttle Position – pin 37 ECM (Z132)

The sensor outputs the pedal position to the ECM (Z132), which uses the information as described above.

2. Idle Position Switch – pin 25 ECM (Z132).

The sensor has a separate idle position switch which informs the ECM (Z132) of the pedal status in the form of a simple on/off signal. This information is used by the ECM (Z132) to implement 'idle speed control' and other strategies i.e. 'overrun fuel shut-off'.

3. Kick Down Switch.

This switch is currently not used.

Fuel Temperature Sensor

A thermistor is also located inside the injection pump. The fuel temperature sensor signal is used to adjust the quantity of injected fuel, especially during temperature extremes. The signal is also used to back up the Engine Coolant Temperature Sensor (X126). If this sensor fails, the ECM (Z132) uses a

substitute value of 60°C and only slight effects on fuelling may possibly be noted.

Fuel Quantity Feedback Sensor

Located within the injection pump, this sensor sends the ECM (Z132) information regarding the actual quantity of fuel injected. Failure of the sensor or corrupted signals will illuminate the warning lamp and cause the engine to stall or not start. A second check, a plausibility check against the needle lift sensor, also takes place.

Fuel Quantity Actuator

Once again located within the injection pump, this is a moving magnet actuator, failure of which will cause the engine to stall or not start as the ECM (Z132) will activate the Fuel Shut–Off Solenoid (K111).

Injection Timing (Solenoid Valve Injection Timing Device (K229))

This is another actuator within the injection pump. The ECM (Z132) receives a signal from the needle lift sensor and attempts to correct the injection timing accordingly. If a change does not occur, then the ECM (Z132) assumes a fault exists, activates the warning lamp and reduces the quantity of injected fuel.

Fuel Shut–Off Solenoid (K111)

The Fuel Shut–Off Solenoid (K111) shuts the engine down if the ECM (Z132) detects a major fault. Failure of the valve itself does not activate the warning lamp, although if a short circuit occurs, the engine will shut down.

Cruise Control

Due to the DDE system being 'drive by wire', a cruise control feature is supplied in the ECM (Z132) itself. Activation is via the steering wheel switches to a converter box and on a single line to the ECM (Z132). Failure of the signal results in cruise control not working.

Brake Switches

The ECM (Z132) has two brake inputs, each of opposite polarity. Comparison of the polarity states provides the ECM (Z132) with a brake sense (i.e. if switch 1 high and switch 2 low going to switch 1 low and switch 2 high) and so cancels cruise control. If both switches are the same polarity, the ECM (Z132) senses a fault and does not allow cruise control.

Vehicle Speed Signal

The ECM (Z132) takes this signal from the Anti–Lock Brake System ECU (Z108) and uses the information for cruise control and 'active surge damping'. Failure of the signal results in cruise disallowed and temporary lack of surge damping (i.e. hard acceleration will cause the vehicle to surge slightly). After 10 sec. a substitute value of 150 km/h

is used. Surging will reduce so as to be hardly noticeable.

Theft Alarm

The ECM (Z132) has a simple on/off input regarding the theft alarm. The ECM (Z132) will not allow the engine to start once activated and will kill the engine if activated up to 300 RPM (programmable). Over 300 RPM, the engine is unaffected.

Relays

The DDE engine management system on the diesel vehicles uses four relays:

ECM (Z132) power supply (main relay), glow plug relay, starter motor relay and fuel pump relay. Two are located in the fuse box and two in the ECM (Z132) box behind the battery.

Main Relay

Located in the ECM (Z132) box, this relay supplies the power feed to the ECM (Z132). It is controlled via the Ignition Switch (X274) in position II.

Glow Plug Relay (Z135)

The Glow Plug Relay (Z135) takes a feed directly from the battery and, on initialisation via the ECM (Z132), supplies current to each of the six glow plugs (one per cylinder) to aid cold starting. The glow time is controlled via the ECM (Z132) which also monitors the relay and illuminates the glow plug indicator lamp for the duration of the glow time. This relay is relatively large and is located with the main relay next to the ECM (Z132).

Starter Motor Relay

This relay is also ignition key controlled, activated with the key in the ignition III position only. Releasing the key after cranking cuts supply to the relay and switches off the starter motor.

Fuel Pump Relay

The fuel pump relay is pulled in when the starter motor is activated, the earth path provided by the alternator output. When the engine is running, the starter motor is deactivated, supplying an earth path while the generator supplies a feed i.e. a polarity reversal.

ECM (Z132)

If the ECM (Z132) itself is not working, the entire engine management system will cease to operate, i.e. no fuel, tachometer reading, etc.

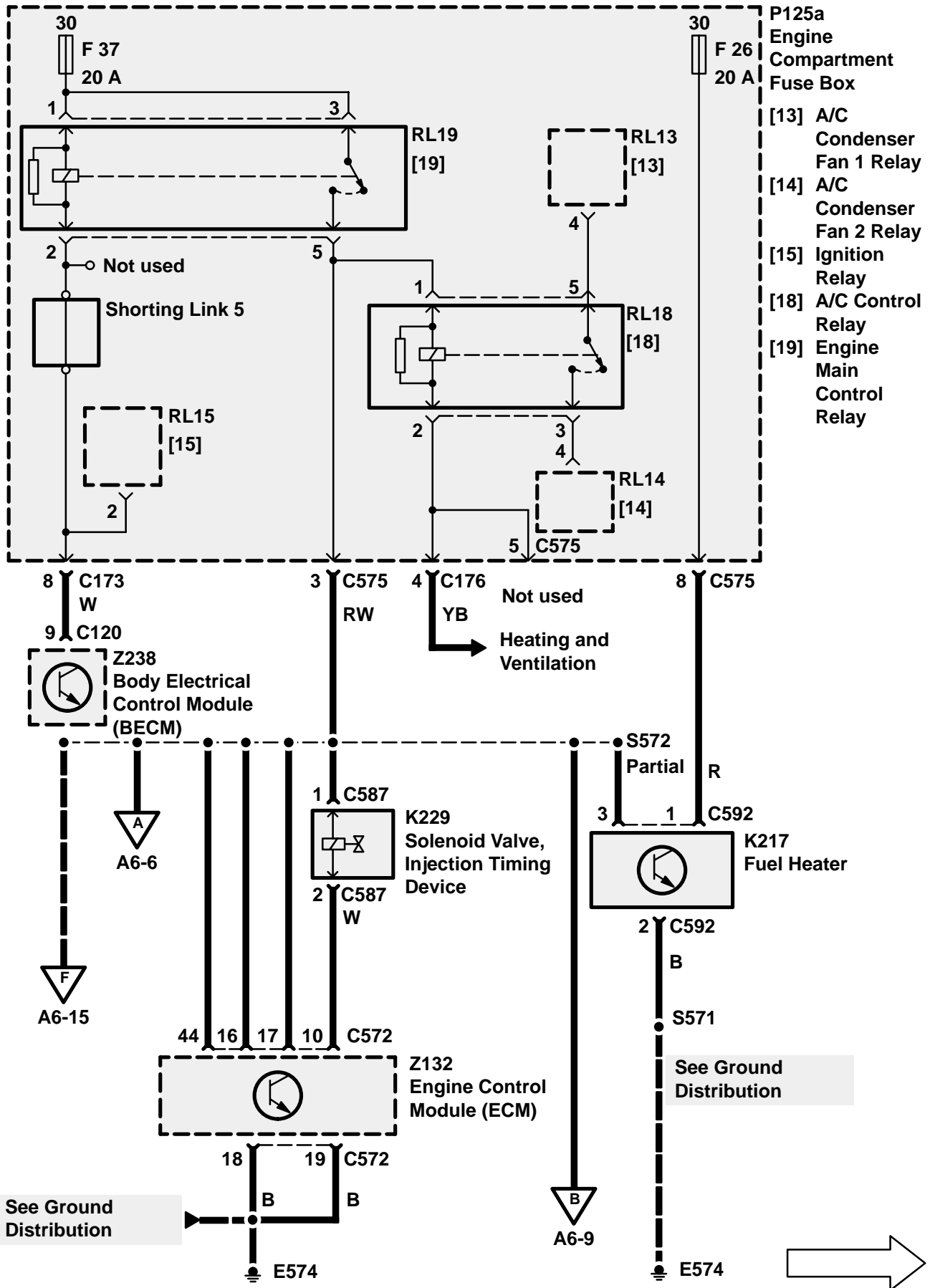

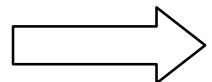
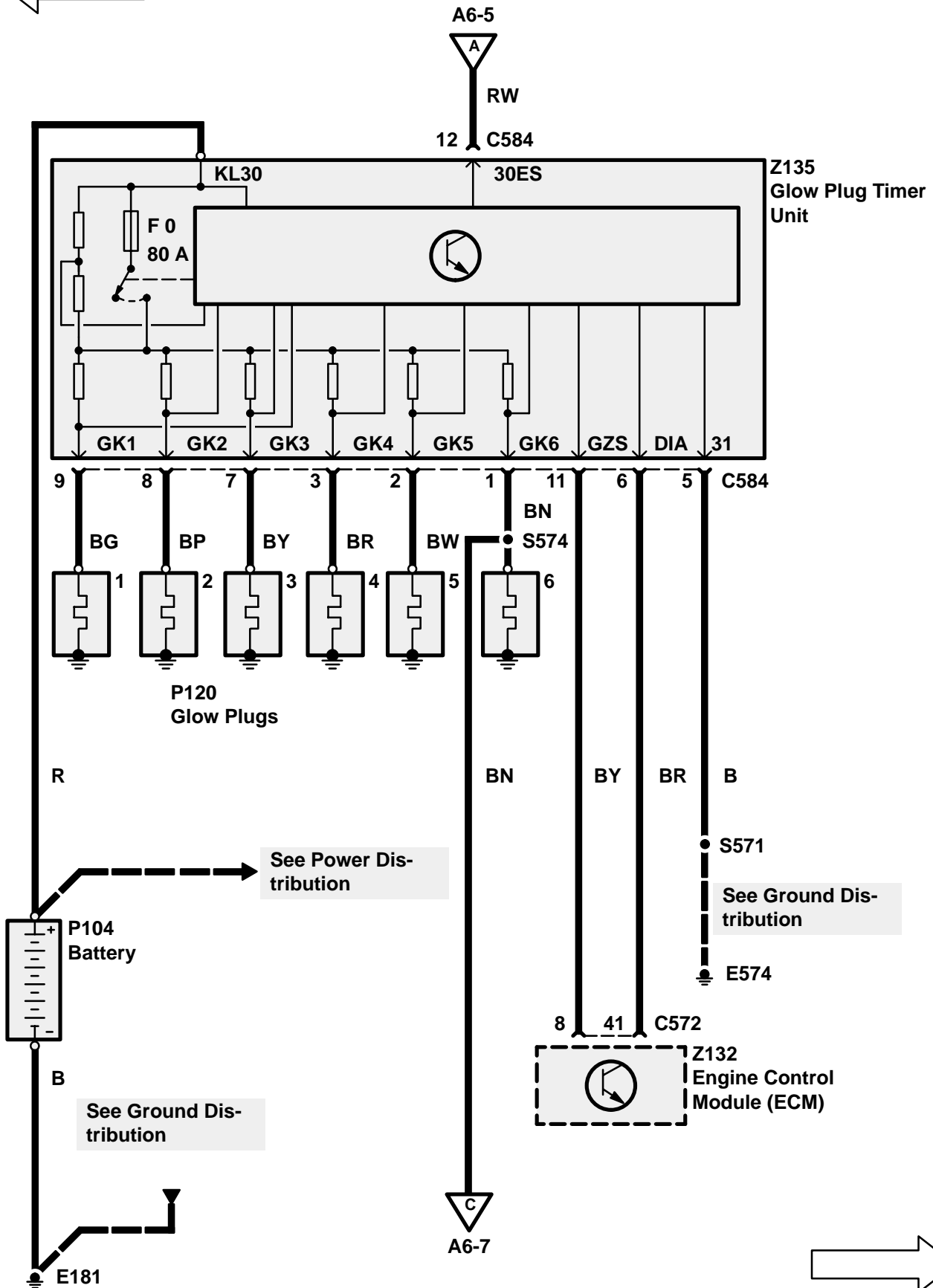
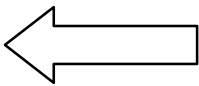

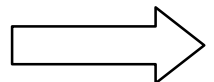
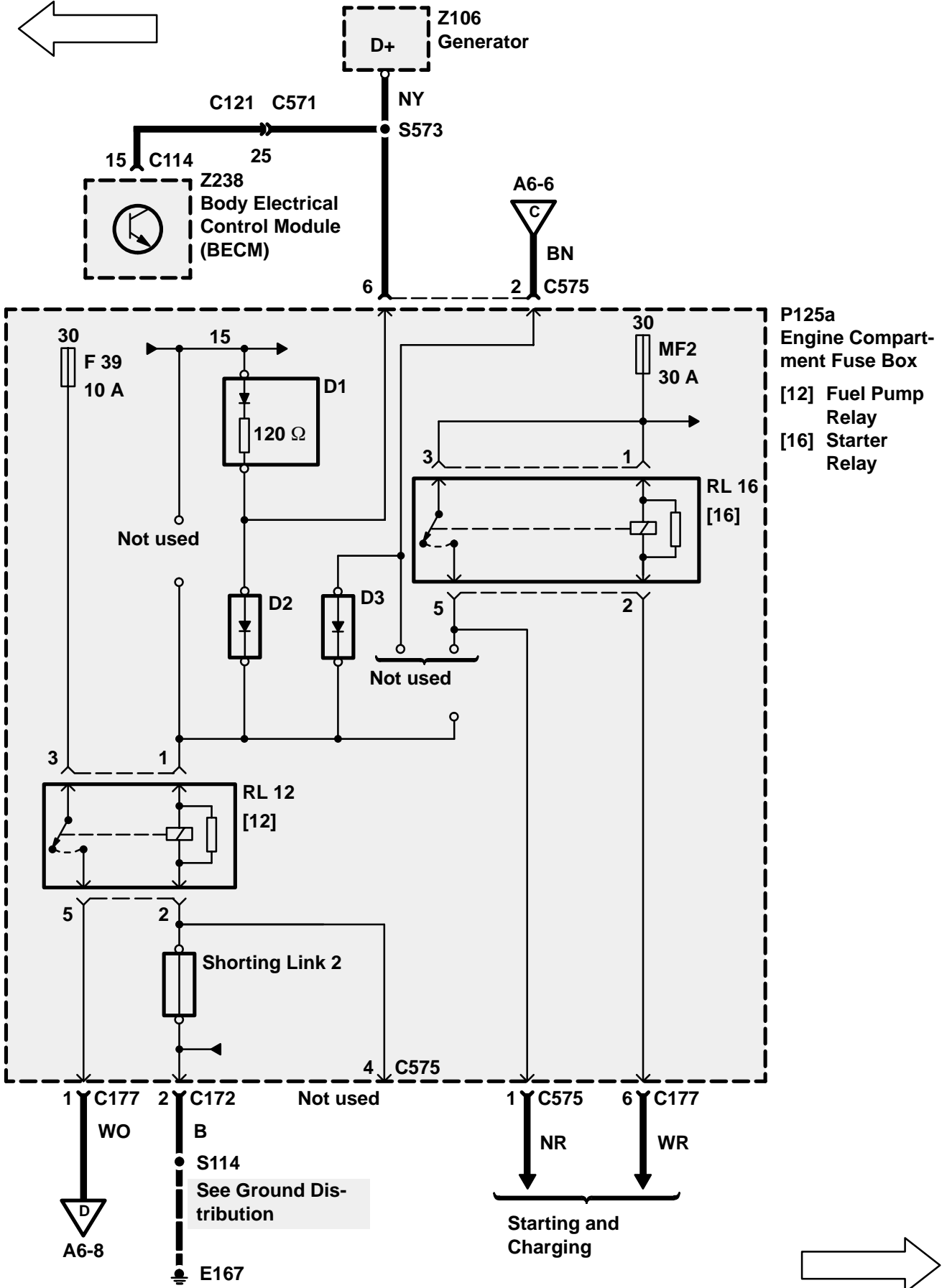
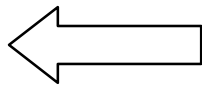

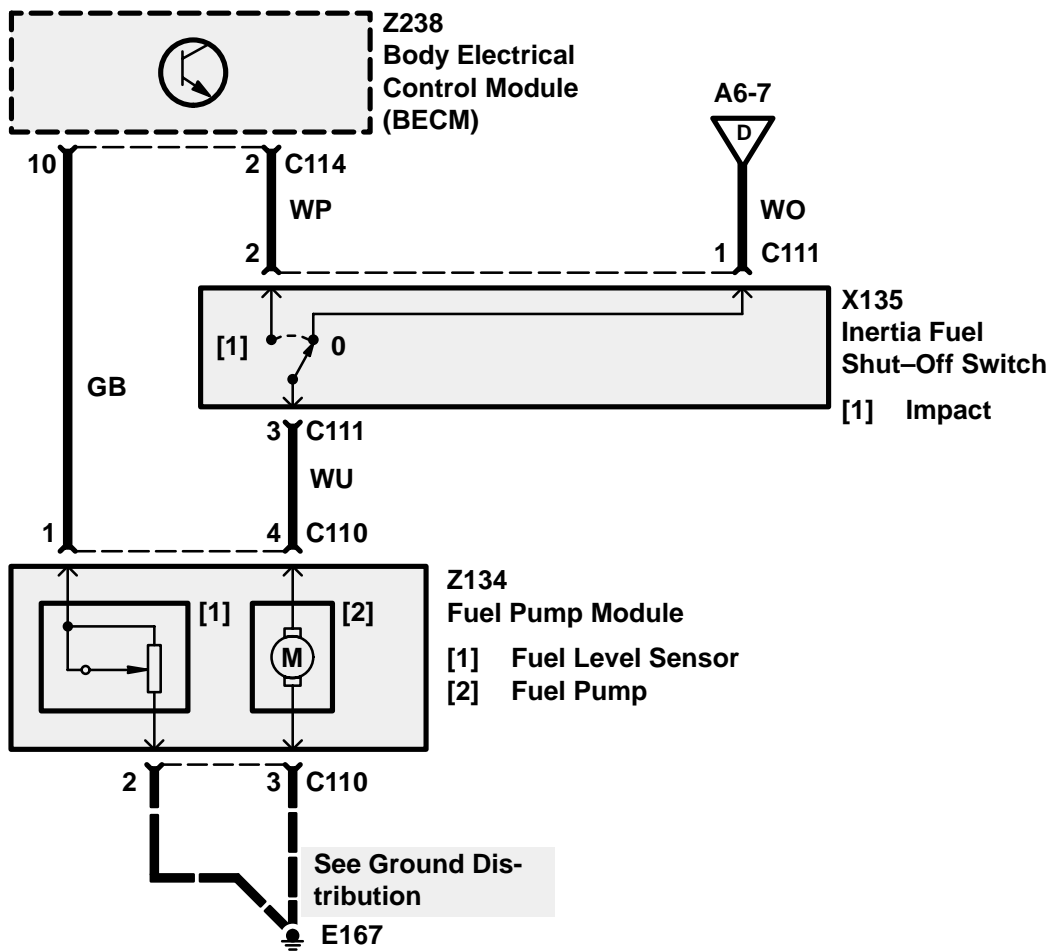
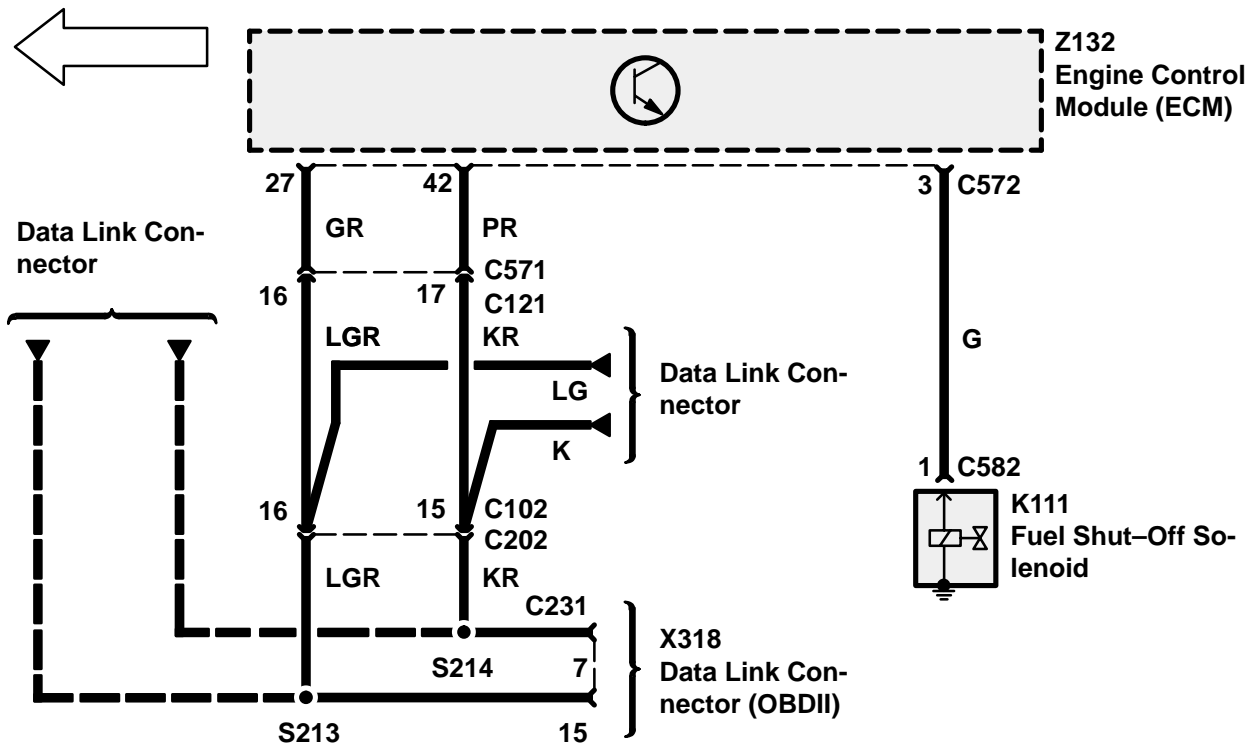

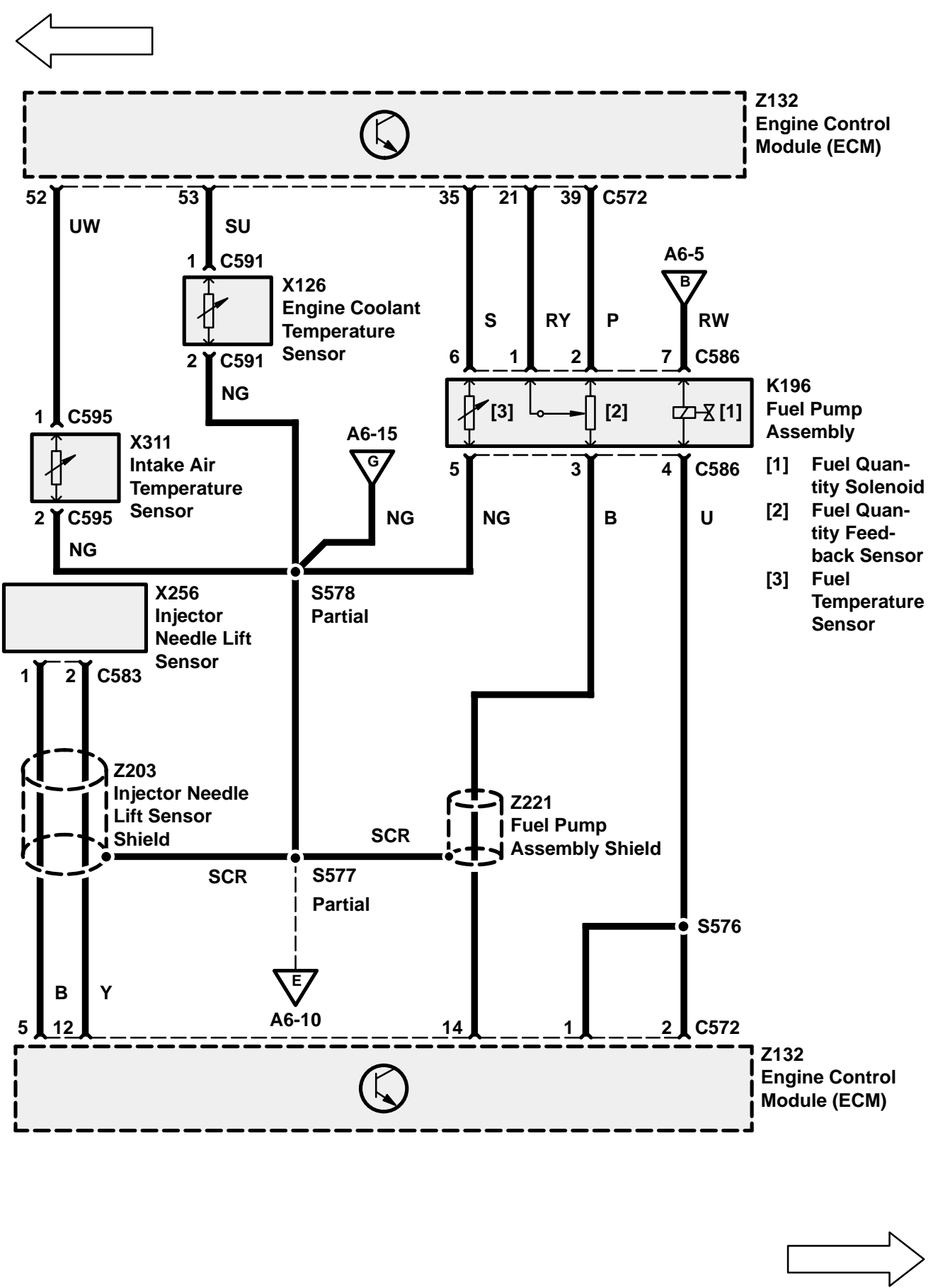

Z132
Engine Control
Module (ECM)

K196
Fuel Pump
Assembly

- [1] Fuel Quantity Solenoid
- [2] Fuel Quantity Feedback Sensor
- [3] Fuel Temperature Sensor

Z132
Engine Control
Module (ECM)

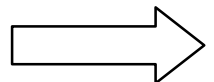
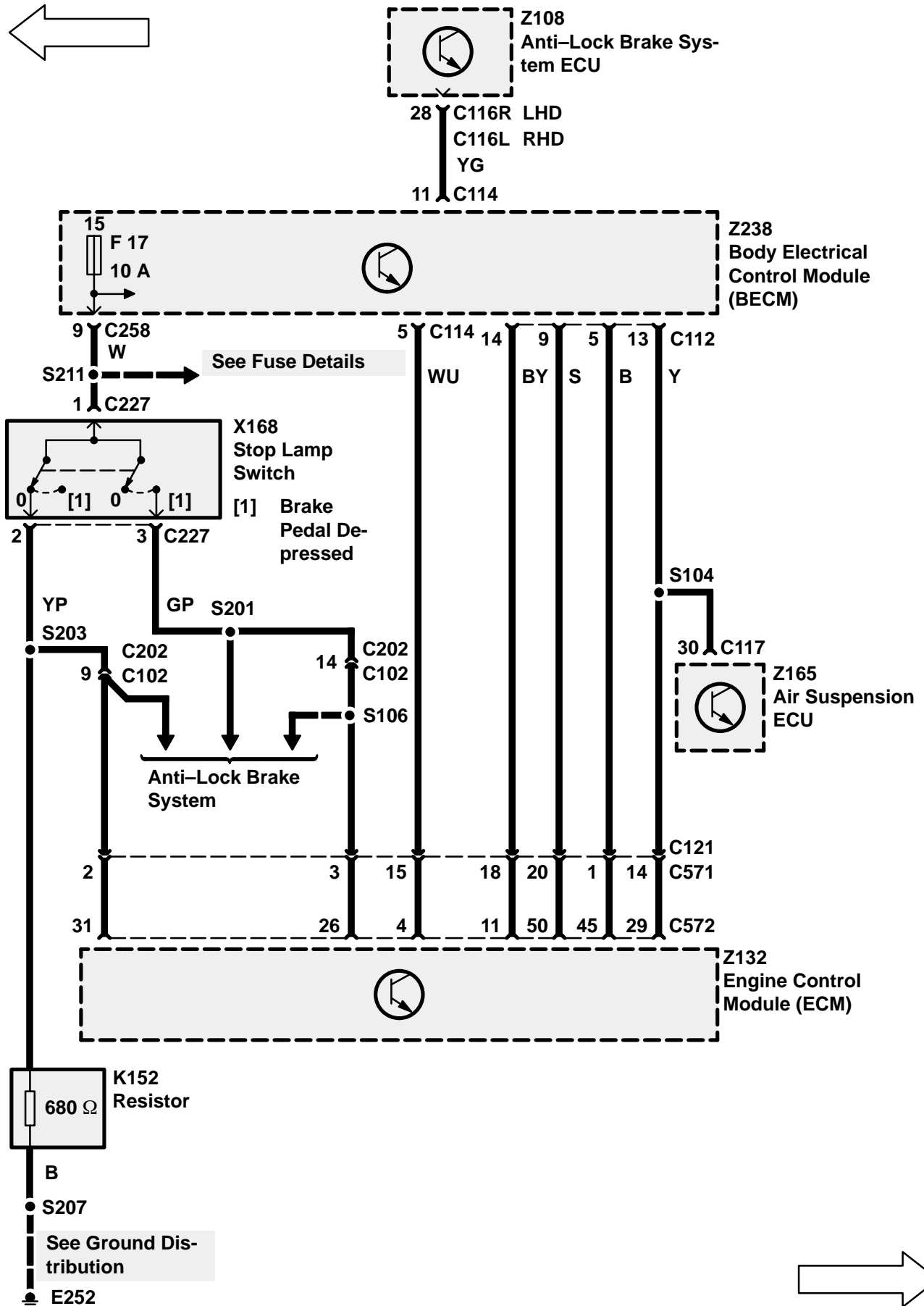
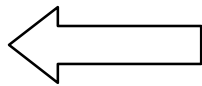

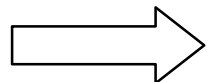
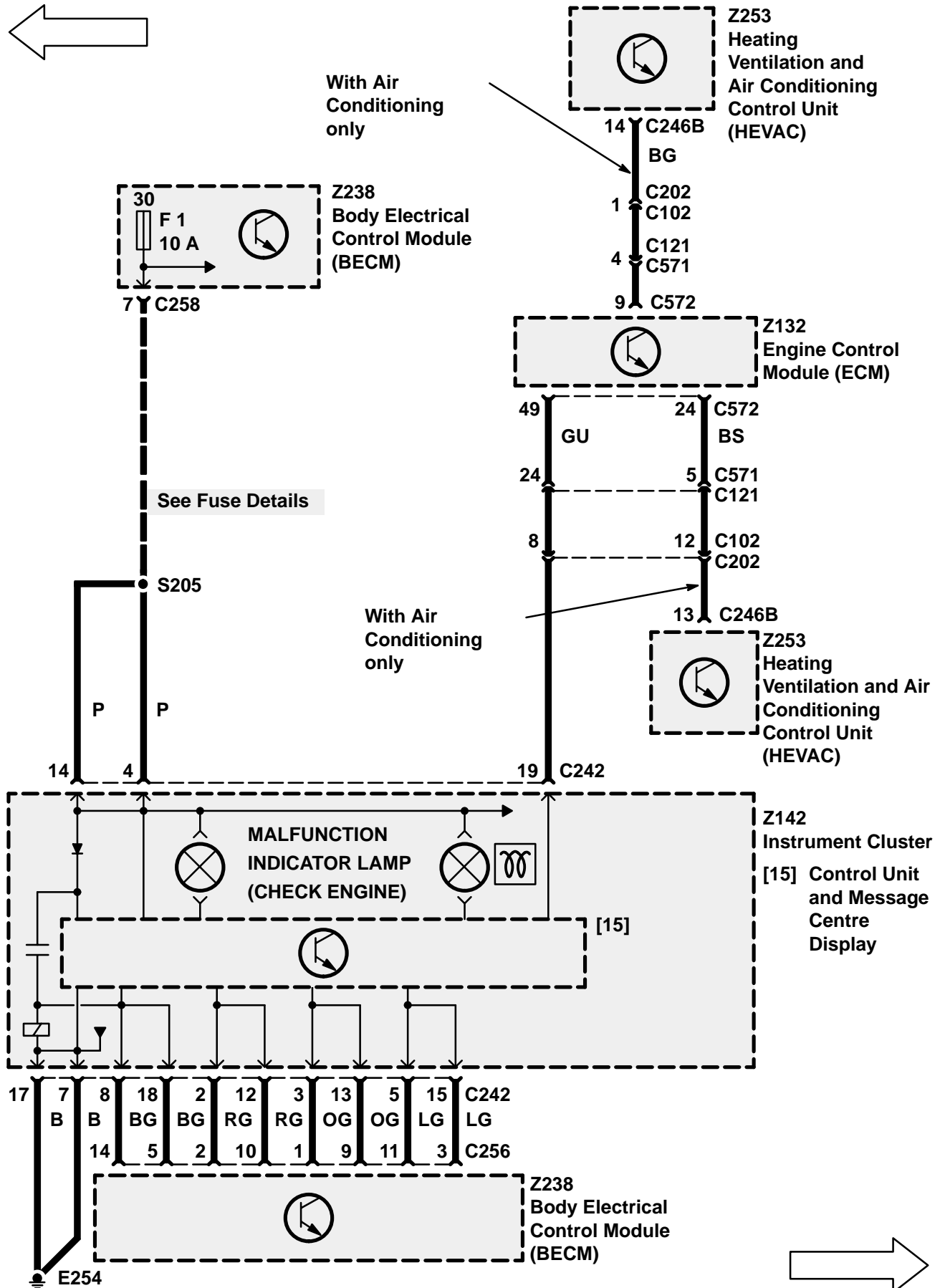
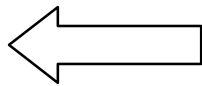

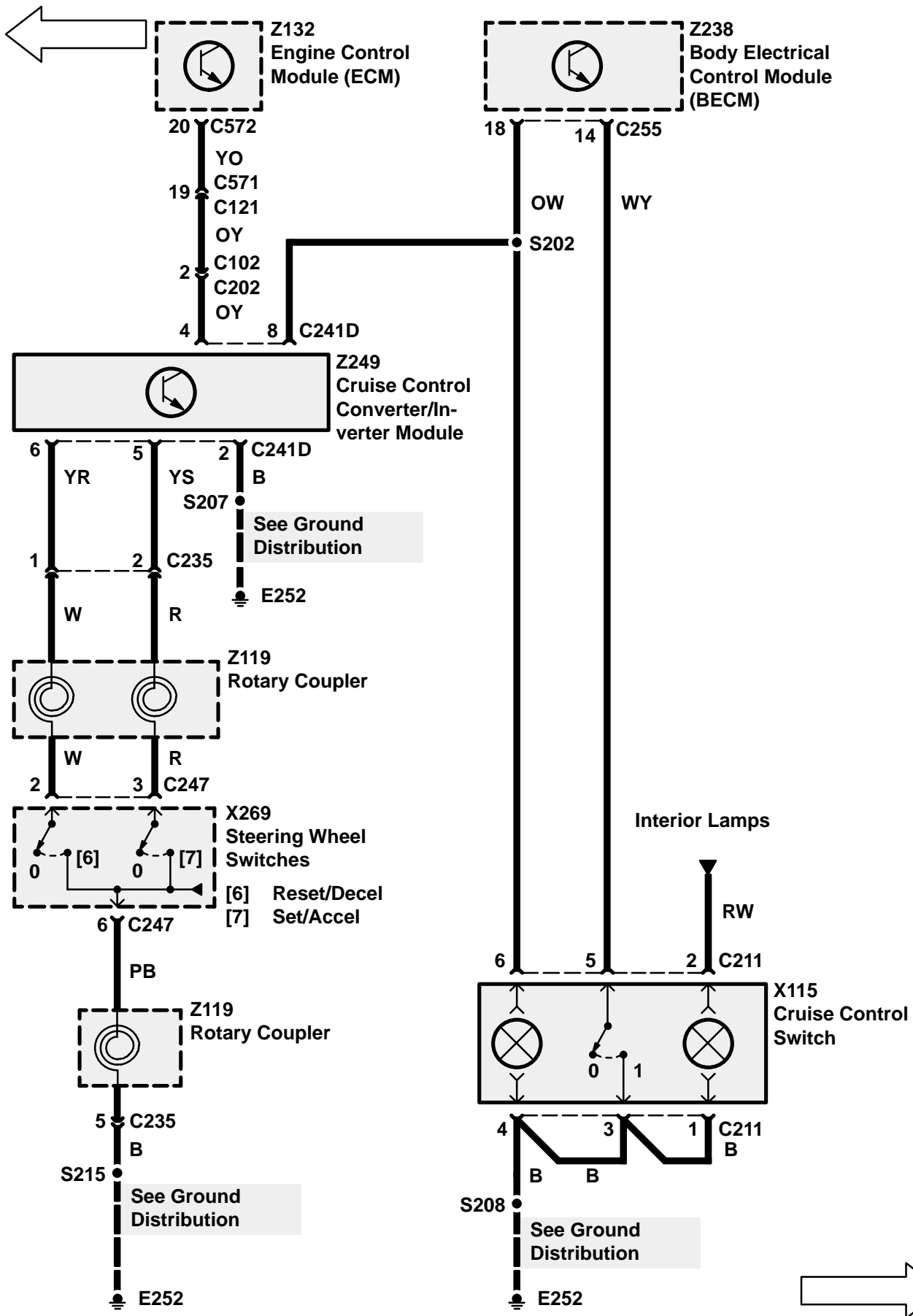

← From Model 98.5

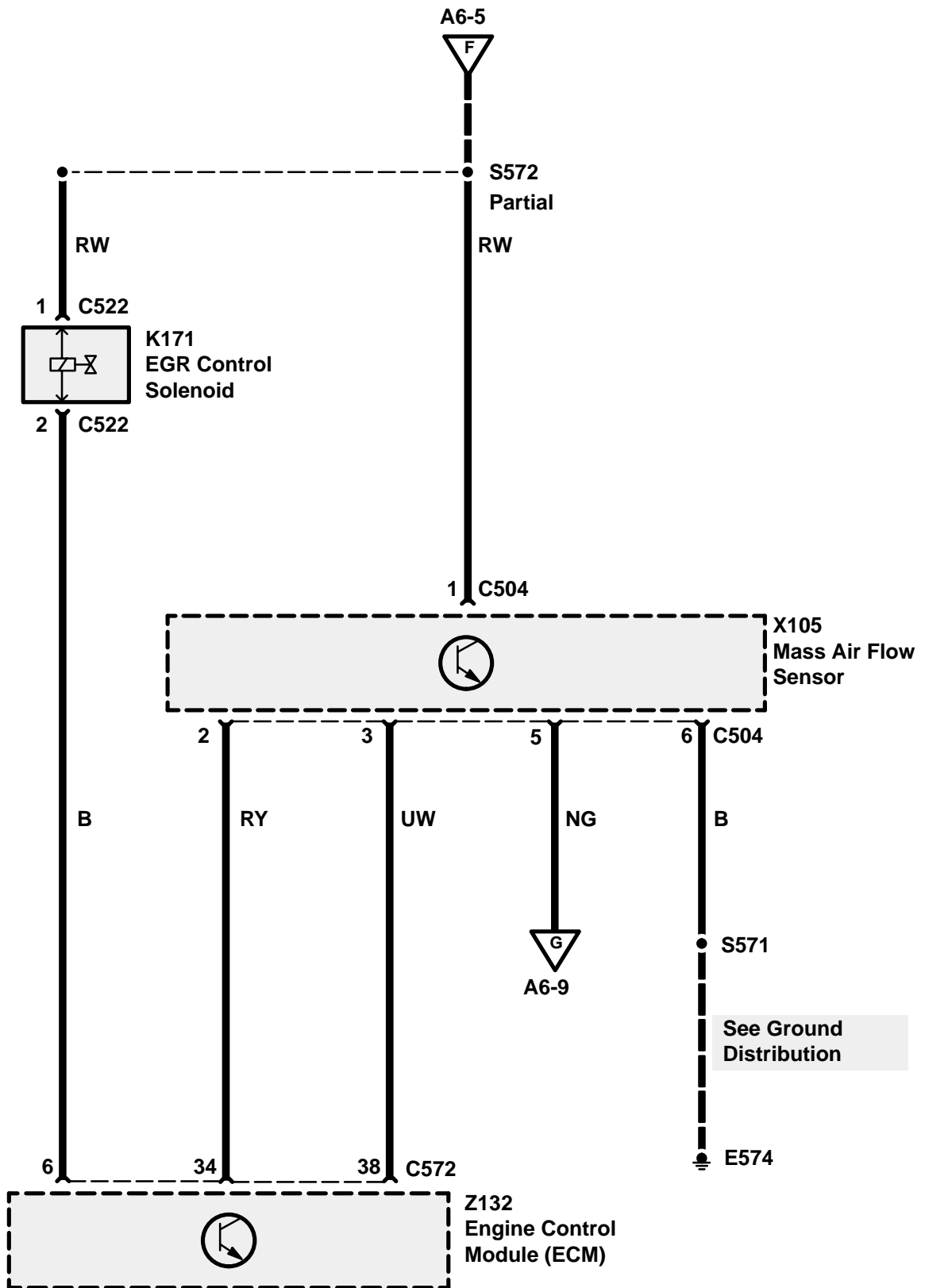

CIRCUIT OPERATION

Starting System

When the Ignition Switch (X274) is switched to position III, the BeCM (Z238) grounds the starter solenoid relay inside the Engine Compartment Fuse Box (P125) which then energizes, applying battery voltage to the Starter Solenoid (K136) and Starter (M134).

Charging System

When the Ignition Switch (X274) is in position II, the BeCM (Z238) turns the charge warning light on via the datalink connection to the Instrument Pack (Z142)

When the Generator (Z106) starts to produce power, the BeCM (Z238) gets an input signal on Pin 15 and turns off the charge warning light.

For the Diesel engine this signal is also used as an input signal for the fuel pump relay inside the Engine Compartment Fusebox (P125) to make sure that the Fuel Pump (M109) is only supplied with power when the engine is running.

If the Generator (Z106) fails to produce power, the charge warning light remains illuminated.

Petrol

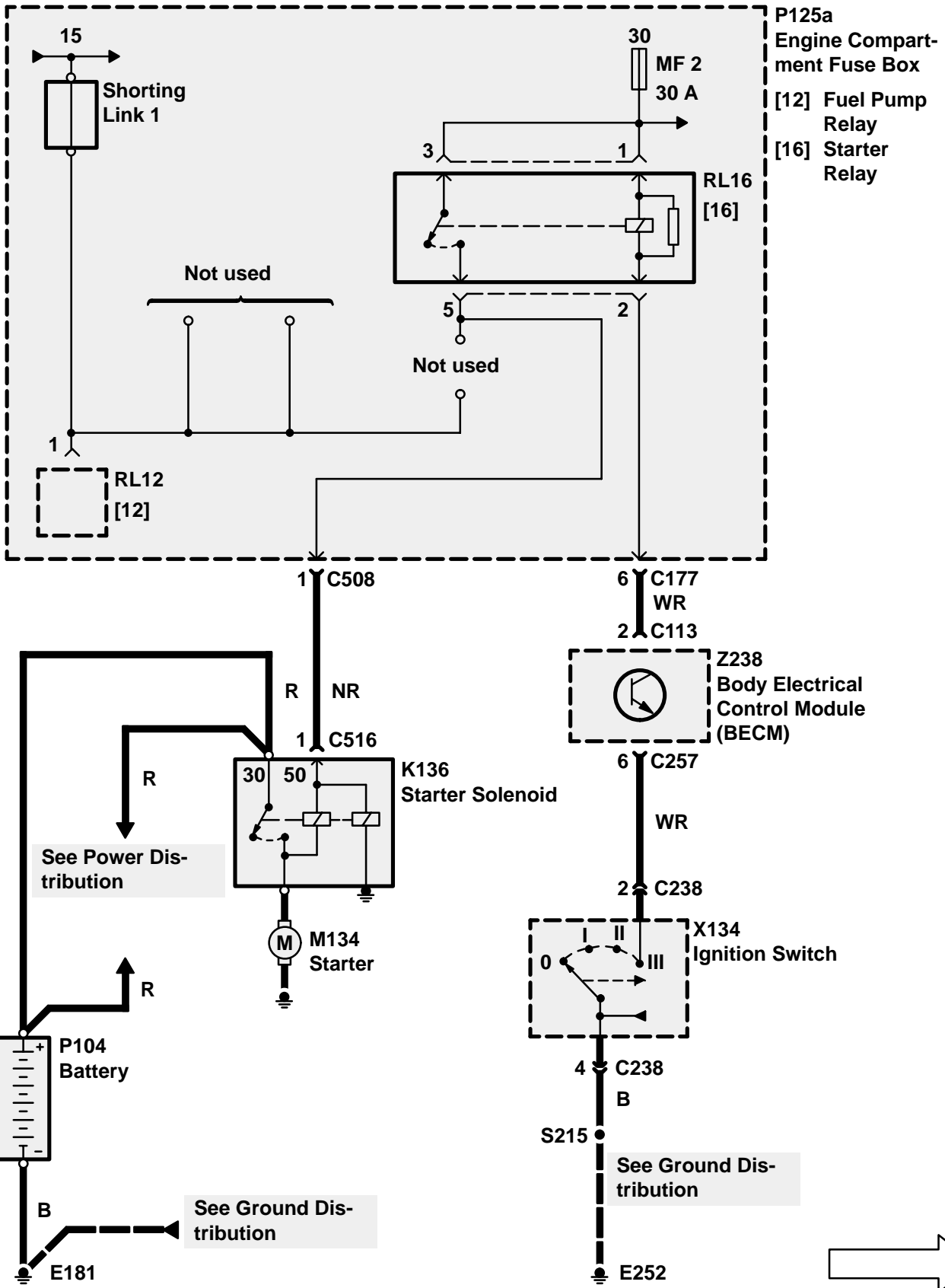

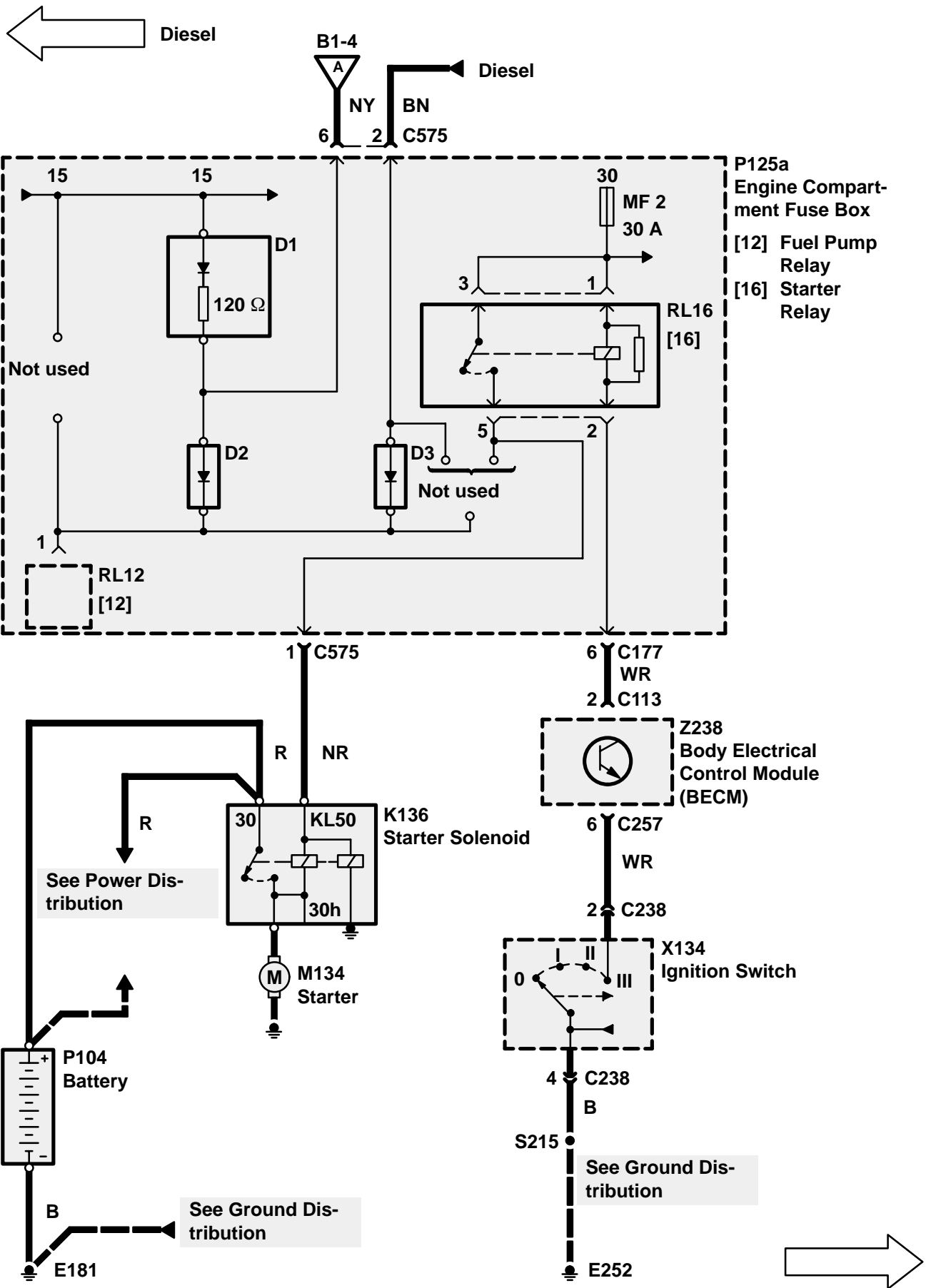

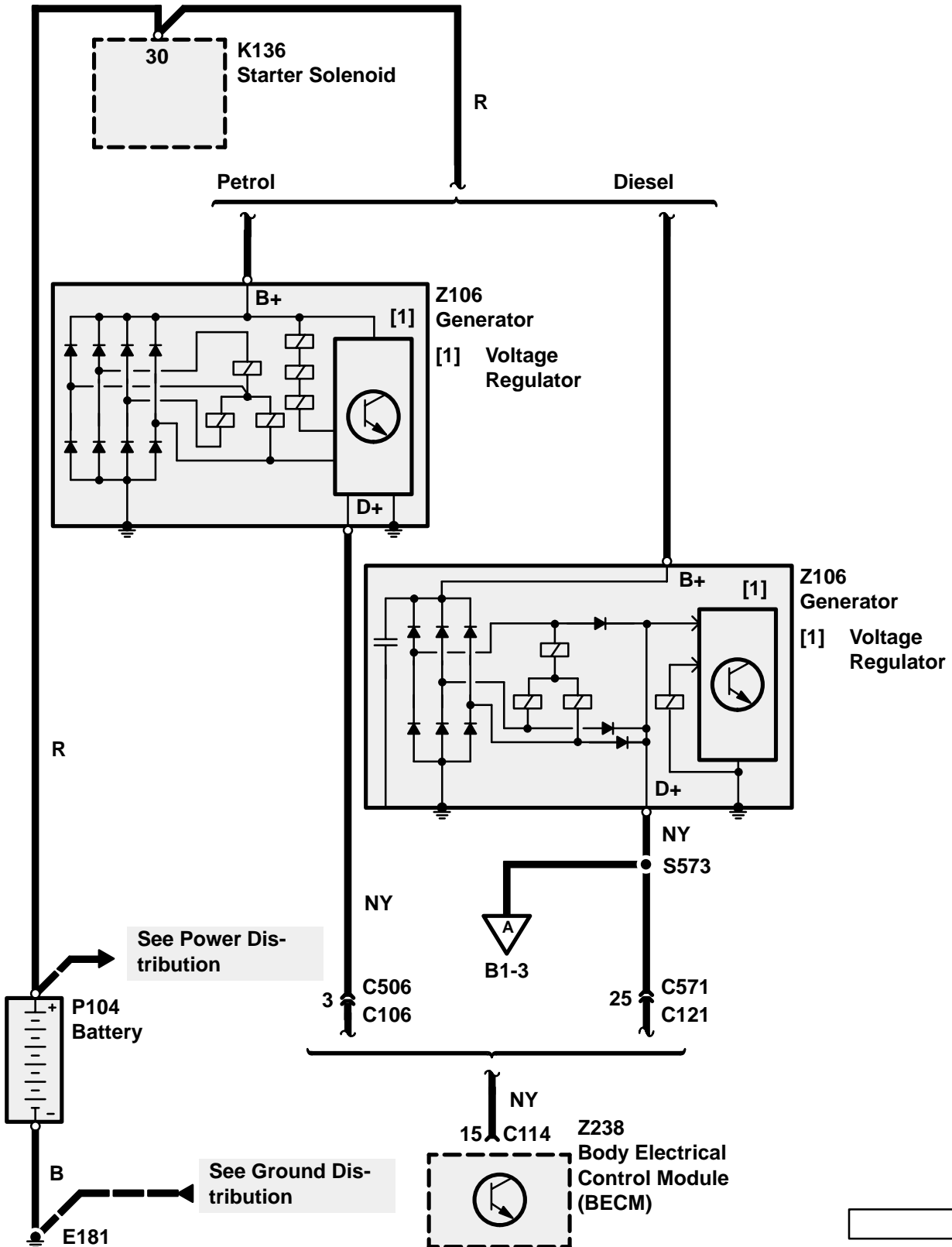
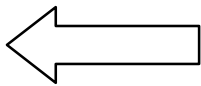

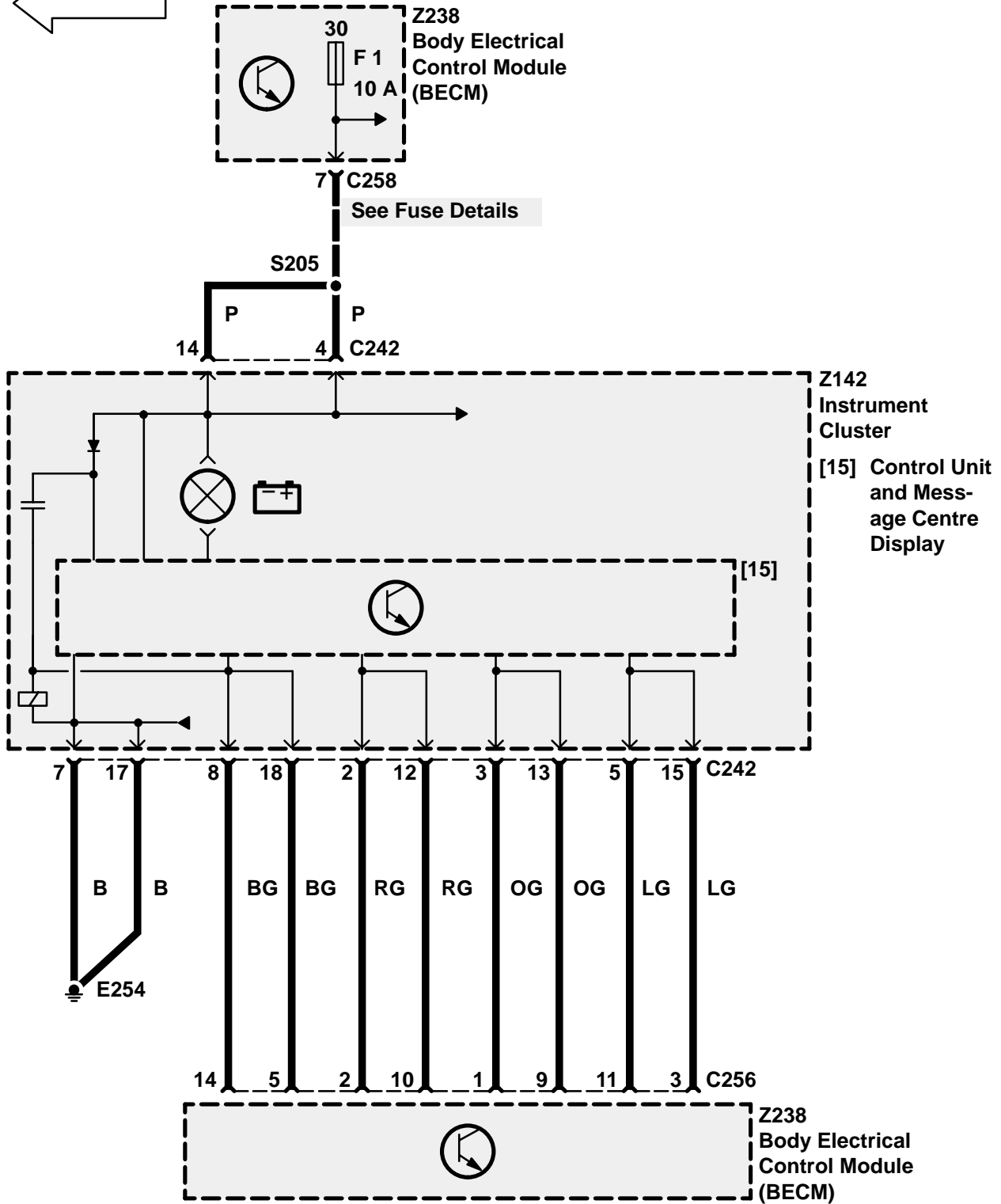
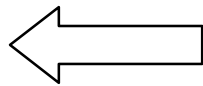

TROUBLESHOOTING HINTS

4. If the charge warning light does not light with the engine off and the Ignition Switch (X274) in position II, check the bulb. If ok, check BeCM (Z238), Instrument Pack (Z142) and the datalink between them.

SYSTEM DIAGNOSIS

5. If the Starter Solenoid (K136) does not click and the engine does not crank, do Test A.

6. If the Starter Solenoid (K136) clicks but the engine does not crank or cranks slowly, do Test B.

7. If the charge warning light stays lit with the engine running, and the Generator (Z106) is ok, do Test C.

Test A

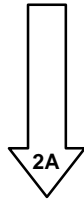
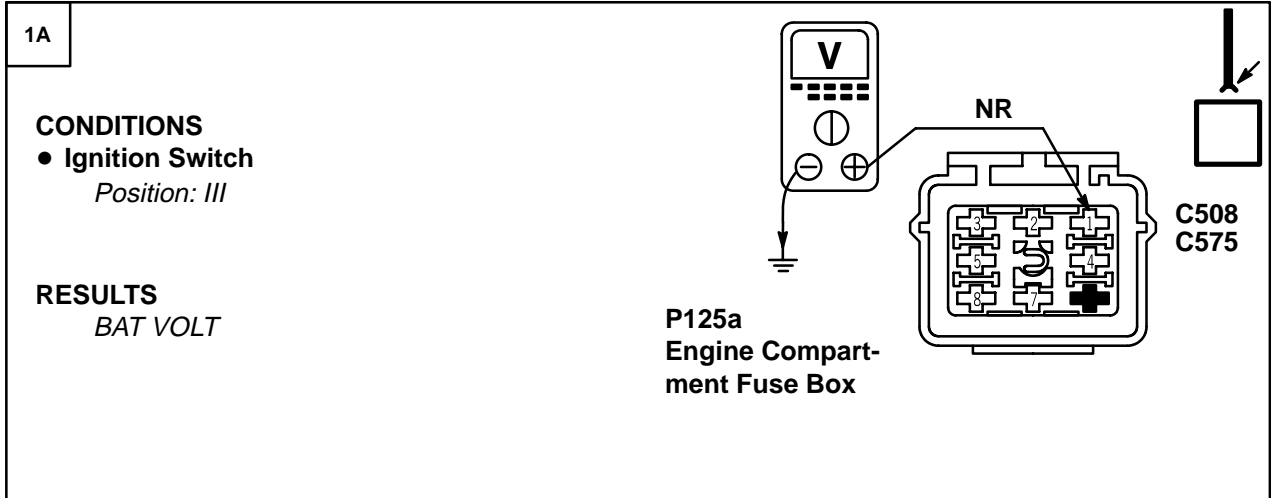

- PROBLEM CAUSE**
- NR Wire
 - Starter Solenoid

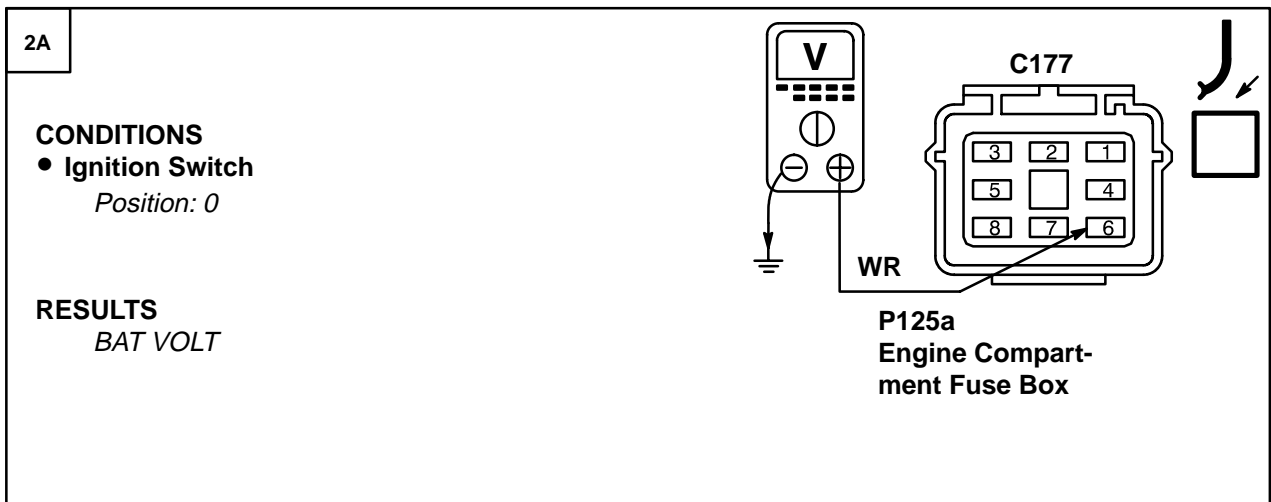

- PROBLEM CAUSE**
- Engine Compartment Fuse Box
 - Starter Solenoid Relay

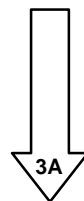

2A

3A

CONDITIONS

- Ignition Switch
Position: 0

RESULTS
BAT VOLT

Z238
Body Electrical
Control Module
(BECM)



PROBLEM CAUSE
- WR Wire



PROBLEM CAUSE
- Body Electrical Control Module (BECM)

- Ignition Switch

- WR Wire
- B Wire

Test B

1B

CONDITIONS

- Ignition Switch
Position: III

RESULTS
Less than 0.5V

M134
Starter



PROBLEM CAUSE
- R Wire
- Battery Terminal Connection
- Starter Solenoid (K136) terminal connection

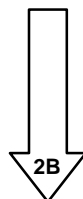

1B

2B

CONDITIONS

- Ignition Switch
Position: III

RESULTS
Less than 0.5V



PROBLEM CAUSE

- B Wire
- Ground Connections
- Battery Terminal Connection



PROBLEM CAUSE

- Starter
- Starter Solenoid

Test C

1C

CONDITIONS

- Ignition Switch
Position: II
- Engine running

RESULTS
BAT VOLT



PROBLEM CAUSE

- NY Wire



PROBLEM CAUSE

- Body Electrical Control Module (BECM)
- Instrument Cluster

CIRCUIT OPERATION

Petrol Engine

For vehicles equipped with a manual transmission, cruise control can only be activated when the Cruise Control Switch (X115) is depressed, the transfer gear box is in Hi range, and the clutch pedal is not depressed. Also, the BeCM (Z238) will deactivate cruise control if the engine rpm rises above $5000 \pm 10\%$, due to the possibility of selecting gears manually without the use of the clutch.

For vehicles equipped with an automatic transmission, cruise control can only be activated when the Cruise Control Switch (X115) is depressed, the transfer gear box is in Hi range, and the transmission is in one of the forward gears.

With the Cruise Control Switch (X115) on, a ground signal is applied to C255/Pin 14 of the BeCM (Z238). The BeCM (Z238) then supplies signal voltage via its Pin 18 to the Converter/Inverter (Z249), to Pin 10 of the Cruise Control ECU (Z121) and to the "Operation" bulb of the Cruise Control Switch (X115). The transfer gearbox Hi range status from the Transfer Gear Box ECU (Z256) is applied to C626/Pin 3 of the BeCM (Z238). The X, Y, and Z switch status (PRND321 position information) from the gearbox position switch is applied to C626/Pins 8, 9, and 18 of the BeCM (Z238). The clutch pedal position input is applied to C255/Pin 4 and the engine speed input C112/Pin 9 of the BeCM (Z238). When the transfer gearbox is in Hi range, a forward gear is selected and the Cruise Control Switch (X115) is on, the BeCM (Z238) supplies voltage via C258/Pin 1 and the Brake Switch Vent Valve (X112) to the Cruise Control ECU (Z121) Pin 9, which then "knows" that cruise control can be operated.

When cruise control is activated and a cruise speed is set, the Cruise Control ECU (Z121) applies voltage through the OU wire and ground through the OR wire to operate the Cruise Control Vacuum Pump (M103) motor. The Cruise Control ECU (Z121) applies ground through the OK wire to close the normally open solenoid valve in the pump. The pump applies vacuum to the actuator.

SET/ACCEL

To set a cruise speed, the Cruise Control Switch (X115) must be on and vehicle speed must exceed 28 mph (45 km/h). When the SET/ACCEL Switch is depressed under these conditions, the Converter/Inverter (Z249) is supplied with a ground

signal. This signal is "converted" to a voltage signal and is transmitted via the SY wire to the Cruise Control ECU (Z121) terminal 3, causing the vacuum pump to operate. When the SET/ACCEL Switch is released, the signal is removed from terminal 3, signalling the ECU to set the speed.

RES/DECEL

When the RES/DECEL Switch is depressed, a signal is applied via the RY wire to terminal 4 of the Cruise Control ECU (Z121). This tells the ECU (Z121) to disengage the system and the vehicle slows down. When the switch is depressed a second time, the signal is again applied to the ECU (Z121) and the vehicle returns to the previously set speed.

Speed Input

Terminal 11 of the Cruise Control ECU (Z121) receives the Vehicle Speed output signal from the BeCM (Z238) through the Y or YR wire. The BeCM (Z238) receives the vehicle speed signal from the Anti-lock Brake System ECU (Z108). The signal is a pulsing voltage and its frequency changes with vehicle speed.

System Disable

The cruise control system can be disabled in one of four ways:

8. The Cruise Control Switch (X115) is put in the 0 position, removing the BeCM (Z238) power from the Cruise Control ECU (Z121) and vacuum pump, and erasing the set speed memory.
9. The RES/DECEL Switch is depressed, signalling the Cruise Control ECU (Z121) via the Inverter/Converter (Z249) to disengage the system.
10. The brake pedal is depressed and a vacuum valve in the Switch Vent Valve opens (X112). This vents vacuum to the actuator valve and releases the throttle.
11. The Voltage applied to the Cruise Control ECU (Z121) terminal 9 is interrupted, causing the Cruise Control ECU (Z121) to turn off the vacuum pump and de-energize the vacuum solenoid valve. This voltage path is interrupted when:
 - The brake pedal is depressed. With the brake pedal depressed, the Brake Switch Vent Valve (X112) moves to position 1 and the circuit is interrupted.
 - The transfer gear box is not in Hi range.
 - The vehicle speed does not exceed 28 mph (45 km/h).
 - The vehicle is not in a forward gear (P, R, or N) (Automatic Transmission).
 - The clutch pedal is depressed (Manual Transmission).
 - The engine rpm rises above $5000 \pm 10\%$ (Manual Transmission).

The BeCM (Z238), which monitors these signals, will then remove power from C255/Pin 18.

Diesel Engine

For vehicles equipped with a manual transmission, cruise control can only be activated when the Cruise Control Switch (X115) is depressed and the clutch pedal is not depressed. The Diesel Engine Control Module (Z132) will not allow the engine to overspeed if a cruise control speed is requested that is beyond the capability of the engines speed range.

For vehicles equipped with an automatic transmission, cruise control can only be activated when the Cruise Control Switch (X115) is depressed, the transfer gear box is in Hi range, and the transmission is in one of the forward gears.

With the Cruise Control Switch (X115) on, a ground signal is applied to C255/Pin 14 of the BeCM (Z238). The X, Y, and Z switch status (PRND321 position information) from the gearbox position switch is applied to C626/Pins 8, 9, and 18 of the BeCM (Z238). The clutch pedal position input is applied to C255/Pin 4 and the engine speed input is applied to C112/Pin 9 of the BeCM (Z238). The BeCM (Z238) then supplies voltage, via its Pin 18 to the Inverter/Converter (Z249) and to the "Operation" bulb of the Cruise Control Switch (X115).

The Cruise Control Converter/Inverter Module (Z249) supplies the Engine Control Module (Z132) via its pin 4 with a voltage signal to "switch on" the cruise circuit. For the Diesel Engine, the Engine Control Module (Z132) controls the cruise circuit as the Cruise Control ECU (Z121) does for the Petrol Engine. The Engine Control Module (Z132) is also responsible for the acceleration/deceleration of the vehicle.

SET/ACCEL

To set a cruise speed, the Cruise Control Switch (X115) must be on and vehicle speed must exceed 28 mph (45 km/h). When the SET/ACCEL Switch is depressed under these conditions, the Inverter/Converter (Z249) is supplied with a ground signal. This signal is transmitted via the OY wire to the Engine Control Module (ECM) (Z132) causing the vehicle to accelerate. When the SET/ACCEL Switch is released, the signal is removed signalling the Engine Control Module (ECM) (Z132) to set the speed.

RES

When the RES Switch is depressed, a signal is applied to the ECM (Z132) and the vehicle will return to the previously set speed.

Speed Input

The BeCM (Z238) receives the vehicle speed signal from the Anti-lock Brake System ECU (Z108). The BeCM (Z238) then provides the vehicle speed signal to the Engine Control Module (ECM) (Z132). This signal is a pulsing voltage and its frequency changes with the vehicle speed.

System Disable

The cruise control system can be disabled in two ways:

1. The Cruise Control Switch (X115) is put in the 0 position, causing the BeCM (Z238) to remove power from the Engine Control Module (ECM) (Z132) and erasing the set speed memory.
2. The Voltage applied via the Inverter/Converter (Z249) to the Engine Control Module (ECM) (Z132) terminal 20 is interrupted, causing the Engine Control Module (ECM) (Z132) to disengage the system. This voltage path is interrupted when :
 - The brake pedal is depressed. The Engine Control Module (ECM) (Z132) has two Stop Lamp Switch (X168) inputs, each of opposite polarity. The ECM (Z132) compares the polarity states to determine when the brake pedal has been depressed.
 - The vehicle speed does not exceed 28mph (45 km/h).
 - The vehicle is not in a forward gear (P, R, or N) (Automatic Transmission).

- The clutch pedal is depressed (Manual Transmission).

The BeCM (Z238), which monitors these signals, will then remove power from C255/Pin 18.

Road Test

CAUTION: DO NOT ENGAGE CRUISE CONTROL WHEN VEHICLE IS BEING USED IN LOW TRANSFER GEARS.

WARNING: The use of cruise control is not recommended on winding, snow covered or slippery roads, or in heavy traffic conditions where constant speed cannot be maintained.

1. Start the engine and depress the Cruise Control Switch (X115) to activate the cruise control system. Accelerate to approximately 30 mph (50 km/h) and press the SET/ACCEL Switch. Immediately release the switch and remove foot from the accelerator pedal. The vehicle should maintain the speed at which the SET/ACCEL Switch was pressed.
2. Press the SET/ACCEL Switch and hold at that position. The vehicle should accelerate smoothly until the switch is released. The vehicle should now maintain the new speed at which the SET/ACCEL Switch was released.
3. Press the RES/DECEL Switch while the vehicle is in the cruise control mode. The cruise control should disengage. Slow to approximately 35 mph (55km/h) and press the RES/DECEL Switch. Immediately release the switch and remove foot from the accelerator. The vehicle should smoothly accelerate to the previously set speed. Increase speed using the accelerator pedal. Releasing the pedal should return the vehicle to the previously set speed.
4. Depressing the brake pedal should immediately disengage the cruise control system and return the vehicle to driver's control at accelerator pedal. Press the RES/DECEL Switch and the vehicle should accelerate to the previously set speed without operation of the accelerator pedal.
5. Press the RES/DECEL Switch and allow the vehicle to decelerate to below 26 mph (42 km/h). Press the RES/DECEL Switch and remove foot from the accelerator pedal. The vehicle should smoothly adjust to the previously memorized speed.
6. Press the SET/ACCEL Switch below 28 mph (45km/h) and the cruise control system should remain disengaged. Accelerate the vehicle above 28 mph (45 km/h), press the RES/DECEL Switch and remove foot from the accelerator pedal. The vehicle should smoothly adjust to the previously memorized speed.
7. Pressing the Cruise Control Switch (X115) should immediately disengage the cruise control

system and erase the previously set speed from Cruise Control ECU (Z121)/Engine Control Module (ECM) (Z132) memory.

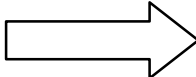
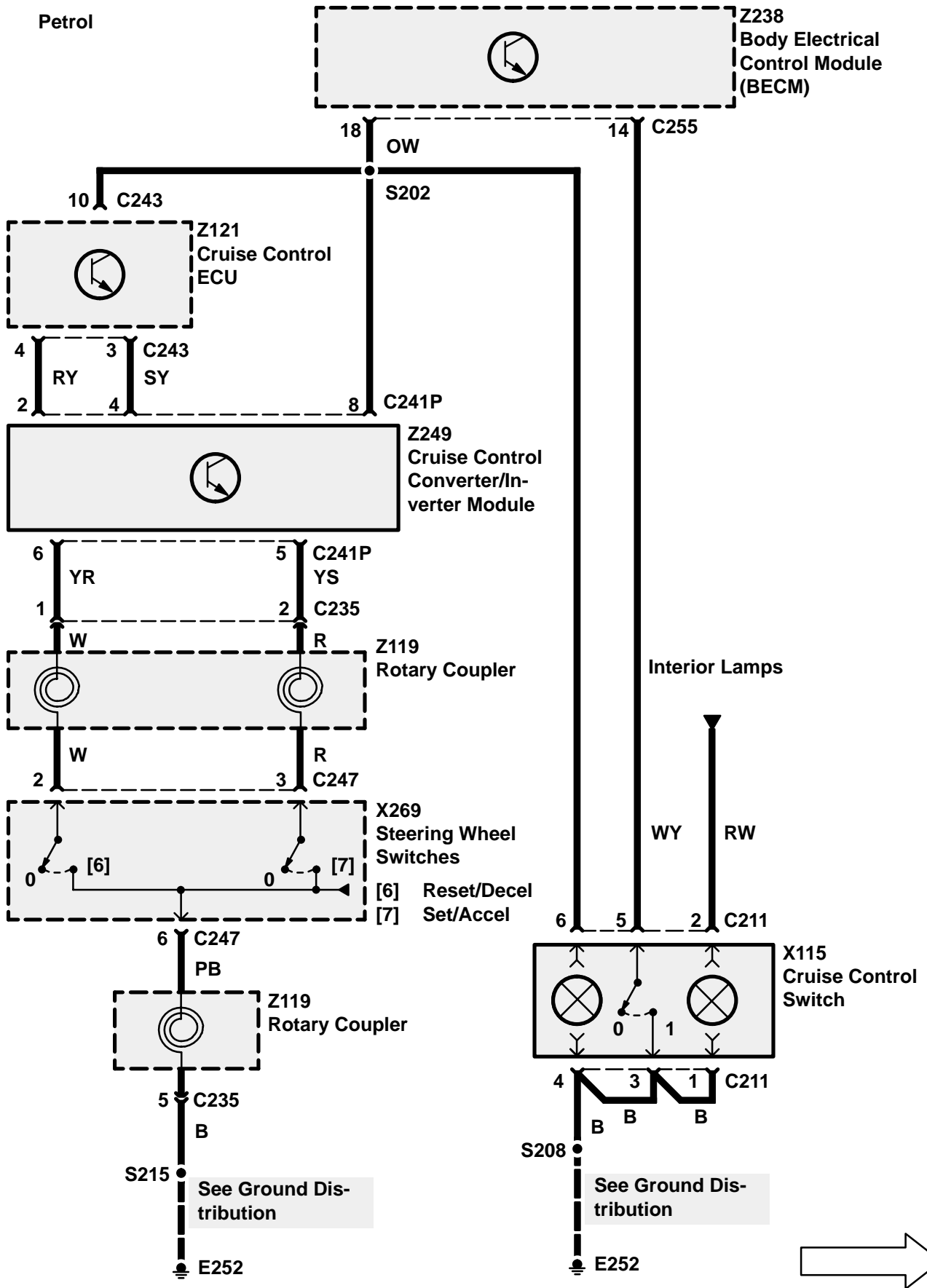

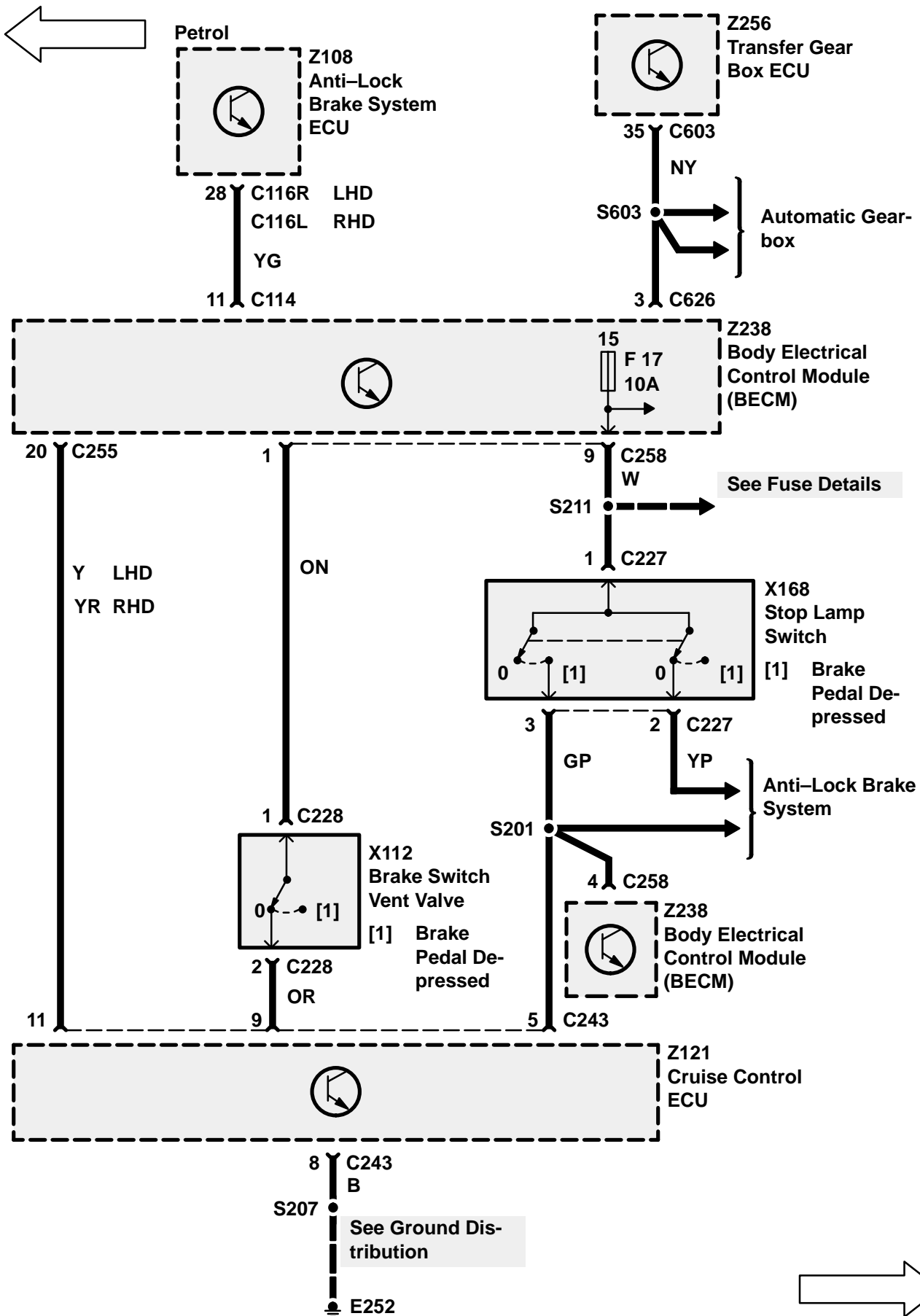

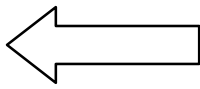

Petrol

	X	Y	Z
P	0	1	1
R	0	0	1
N	1	0	1
D	1	0	0
3	0	0	0
2	0	1	0
1	1	1	0
Z*	1	1	1

1 = Switch Open

0 = Switch Closed

* = Fault

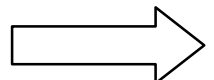
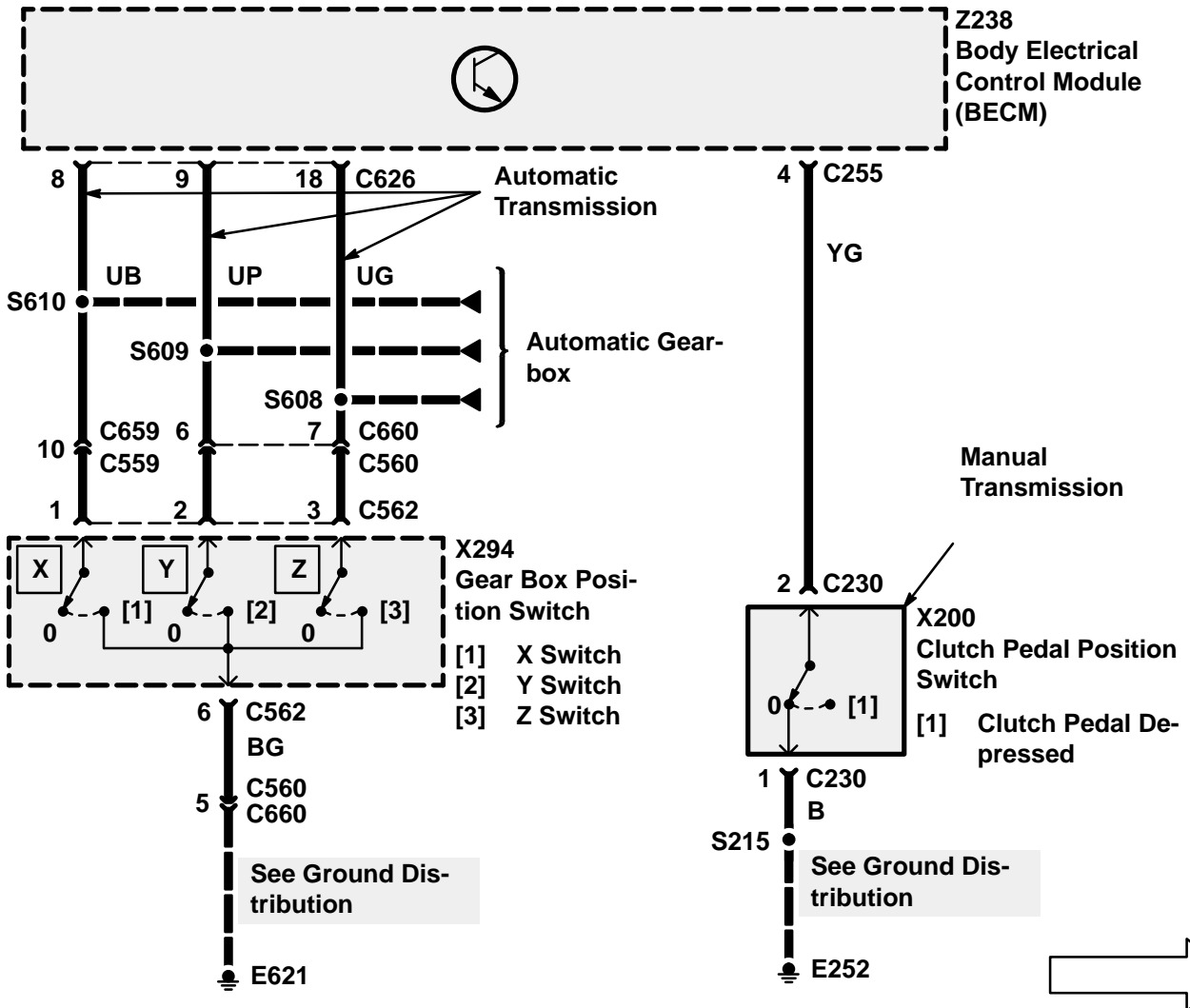
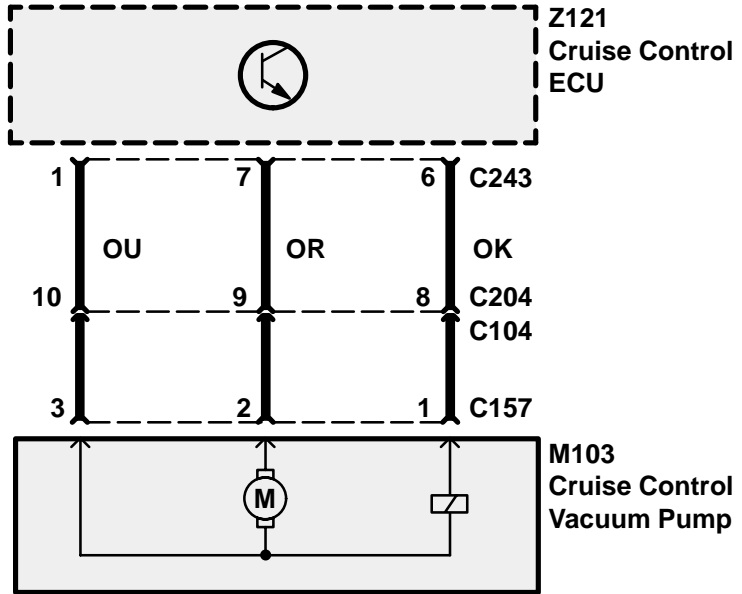

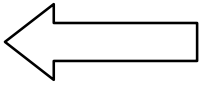
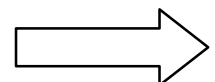
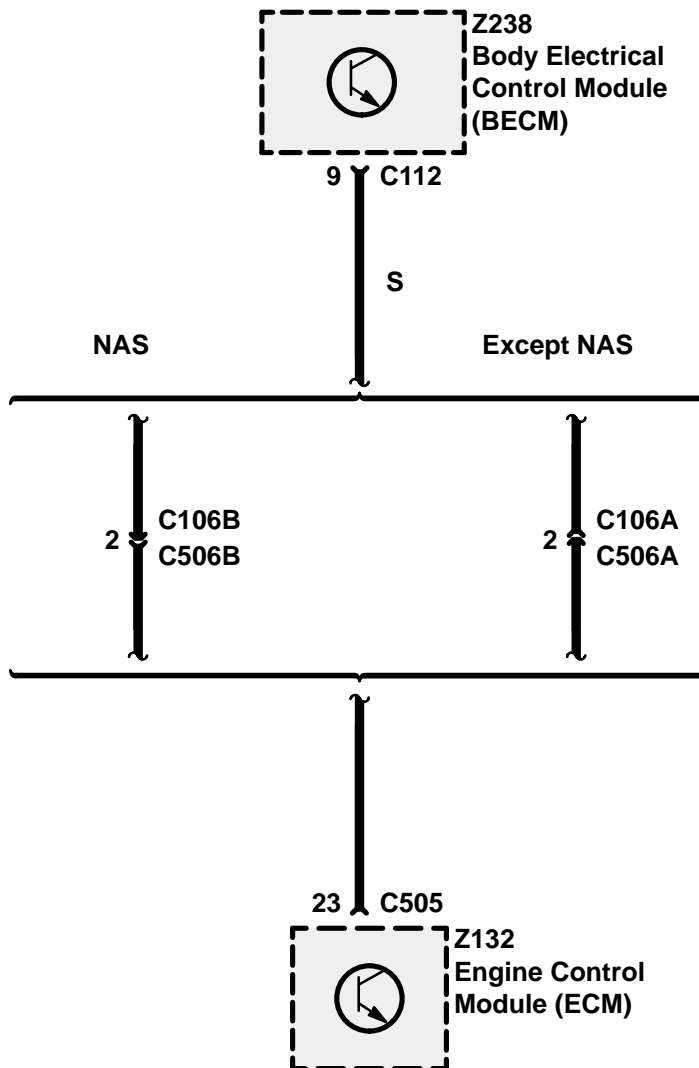
**Petrol**

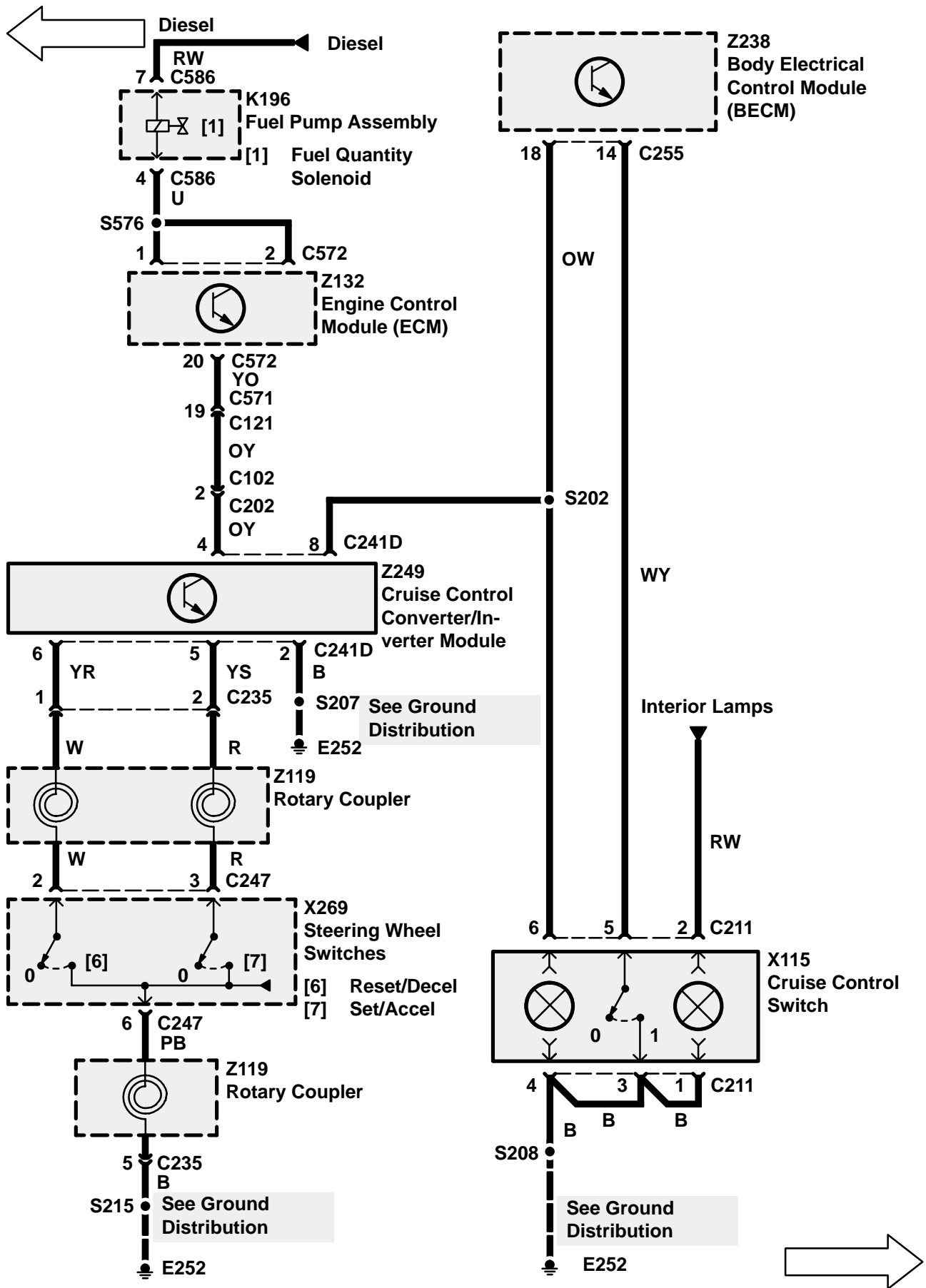

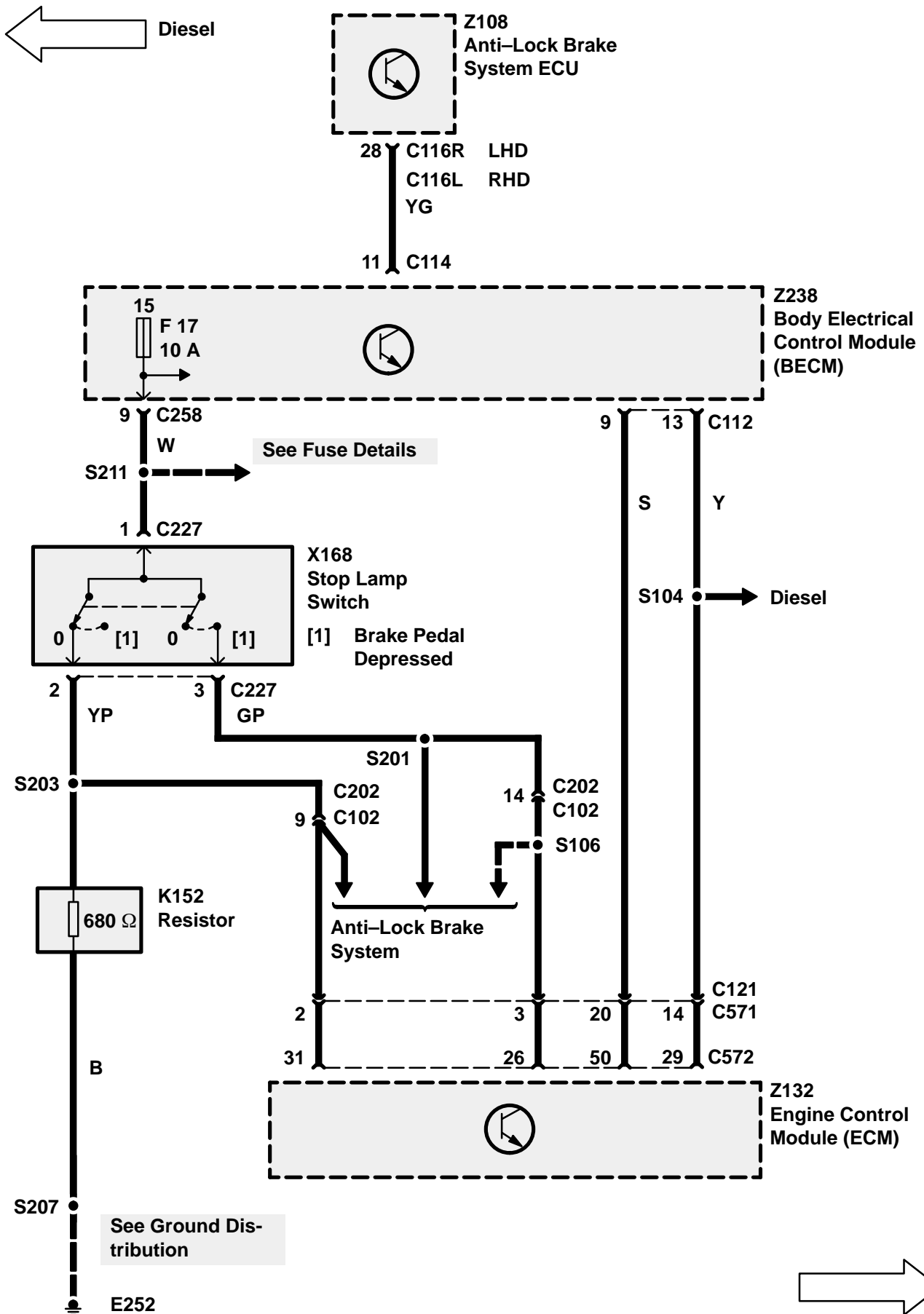

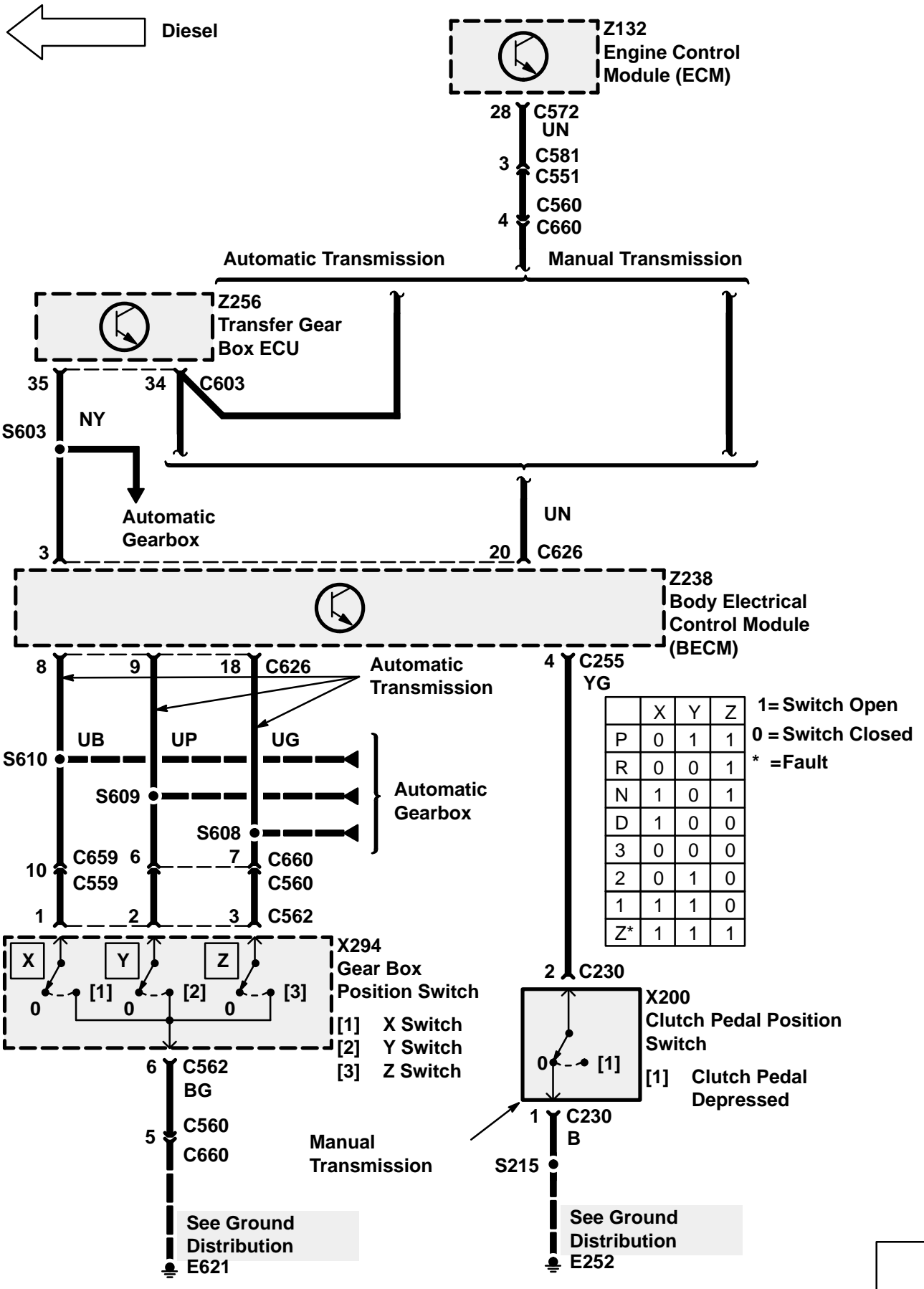

TROUBLESHOOTING HINTS

8. If the interior lights operate but the cruise control switch light does not illuminate, check the bulb, B wire and RW wire. If the cruise control system operates but the cruise control switch light does not illuminate, check bulb and OW wire.
9. Inspect vacuum hoses for kinks and restrictions.
10. Inspect actuator linkage for restrictions and adjustment.
11. Check the following two input signals to the BeCM (Z238): Signal from Clutch Pedal Position Switch (X200) for vehicles equipped with a manual transmission, or the X, Y, and Z switch signals from the Gearbox Position Switch (X294) for vehicles equipped with an automatic transmission.
12. For vehicles equipped with a Petrol Engine, check the following input signal to the BeCM (Z238): Transfer box in Hi range signal from Transfer Gear Box ECU (Z256).
13. For vehicles equipped with a Diesel engine, check the Stop Lamp Switch (X168) inputs to the Engine Control Module (ECM) (Z132).
14. Note: For vehicles equipped with a manual transmission, cruise control can only be activated when the Cruise Control Switch (X115) is depressed, the transfer gear box is in Hi range (Petrol only), and the clutch pedal is not depressed. Also, the BeCM (Z238) will deactivate cruise control if the engine rpm rises above 5000 +/- 10 percent, due to the possibility of selecting manual without the use of the clutch (Petrol only). For vehicles equipped with an automatic transmission, cruise control can only be activated when the Cruise Control Switch (X115) is depressed, the transfer gear box is in Hi range (Petrol only), and the transmission is in one of the forward gears. The Transfer Gear Box ECU (Z256) provides the BeCM (Z238) with transfer gear box Hi range status. The Transfer Gear Box Position Switch (X294) provides the BeCM (Z238) with X, Y, Z switch status (PRND321 position information).

SYSTEM DIAGNOSIS

1. If the cruise control system does not operate correctly and the vehicle is equipped with a Petrol Engine, do Test A.

2. If the cruise control system does not operate correctly and the vehicle is equipped with a Diesel Engine, do Test E.

Test A

1A

CONDITIONS

- Ignition Switch
Position: II
- Cruise Control Switch
On

RESULTS
Within 1.5V of battery voltage

Z121
Cruise Control
ECU

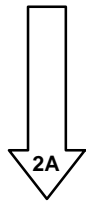

GO TO TEST B

2A

CONDITIONS

- Ignition Switch
Position: 0

RESULTS
Less than 1 ohm

Z121
Cruise Control
ECU



PROBLEM CAUSE
- B Wire

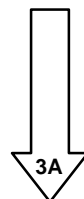

2A

3A

Z238
Body Electrical Control Module (BECM)

CONDITIONS

- Ignition Switch
Position: 0
- Cruise Control Switch

On

RESULTS
Less than 1 ohm



PROBLEM CAUSE

- WY Wire
- B Wire
- Cruise Control Switch



PROBLEM CAUSE

- OW Wire
- Body Electrical Control Module (BECM)

Test B

1B

Z249
Cruise Control Converter/Inverter Module

CONDITIONS

- Ignition Switch
Position: II
- Cruise Control Switch
On
- Transfer Box
Hi Range
- Gear Selector
Forward Gear
- Clutch Pedal
Released

RESULTS
BAT VOLT



PROBLEM CAUSE

- OW Wire

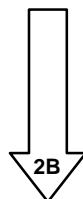

1B

2B

Z121
Cruise Control ECU

CONDITIONS

- Ignition Switch
Position: II
- Cruise Control Switch
On

RESULTS

- Steering Wheel Switches
RES/DECEL Switch

<i>On</i>	=	<i>BAT VOLT</i>
<i>Off</i>	=	<i>0V</i>

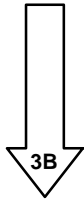

GO TO TEST C

3B

Z249
Cruise Control Converter/Inverter Module

CONDITIONS

- Ignition Switch
Position: 0

RESULTS

- Steering Wheel Switches
RES/DECEL Switch

<i>On</i>	=	<i>Less than 1 ohm</i>
<i>Off</i>	=	<i>More than 10K ohms</i>



PROBLEM CAUSE

- YR, W Wire
- B, PB Wire
- Steering Wheel Switches

- Rotary Coupler



PROBLEM CAUSE

- Cruise Control Converter/Inverter Module

Test C

1C

CONDITIONS

- Ignition Switch
Position: II
- Cruise Control Switch
On

RESULTS

- Steering Wheel Switches
SET/ACCEL Switch

<i>On</i>	=	<i>BAT VOLT</i>
<i>Off</i>	=	<i>0 V</i>

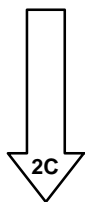

GO TO TEST D

2C

CONDITIONS

- Ignition Switch
Position: 0

RESULTS

- Steering Wheel Switches
SET/ACCEL Switch

<i>On</i>	=	<i>Less than 1 ohm</i>
<i>Off</i>	=	<i>More than 10K ohms</i>



PROBLEM CAUSE

- YS,R Wire
- Rotary Coupler



PROBLEM CAUSE

- Cruise Control Converter/Inverter Module

- Steering Wheel Switches

Test D

1D

CONDITIONS

- Ignition Switch
Position: II

RESULTS

- Brake Pedal

<i>Depressed</i>	=	<i>BAT VOLT</i>
<i>Released</i>	=	<i>0 V</i>

PROBLEM CAUSE

- GP Wire
- W Wire
- Stop Lamp Switch

2D

CONDITIONS

- Ignition Switch
Position: II
- Cruise Control Switch
On
- Transfer Box
Hi Range
- Gear Selector
Forward Gear

RESULTS

- Brake Pedal

<i>Depressed</i>	=	<i>0 V</i>
<i>Released</i>	=	<i>BAT VOLT</i>

PROBLEM CAUSE

- OR, ON Wire
- Brake Switch Vent Valve
- Body Electrical Control Module (BECM)

2D

3D

CONDITIONS

- Ignition Switch
Position: II
- Turn a drive wheel by hand

RESULTS

- = 5V with ignition position II
- = 2.5V approx. with wheels turning



PROBLEM CAUSE

- Y, YR Wire
- Body Electrical Control Module (BECM)

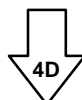

4D

CONDITIONS

- Ignition Switch
Position: II
- Cruise Control Switch
On
- Transfer Gearbox
Hi Range
- Gear Selector
Forward Gear
- Brake Pedal
Released

RESULTS

- Cruise Control Vacuum Pump
Operates



PROBLEM CAUSE

- OU, OR Wire
- Cruise Control Vacuum Pump



4D

5D

CONDITIONS

- Ignition Switch
Position: II
- Cruise Control Switch

On
- Transfer Gearbox
Hi Range
- Gear Selector
Forward Gear
- Brake Pedal
Released

RESULTS

- Cruise Control Vacuum Pump

Operates
Valve Closes
Throttle Opens Wide

Z121
Cruise Control ECU



PROBLEM CAUSE

- OK Wire
- Cruise Control Vacuum Pump



PROBLEM CAUSE

- Cruise Control ECU

Test E

1E

CONDITIONS

- Ignition Switch
Position: II
- Cruise Control Switch

On
- Gear Selector
Forward Gear
- Clutch Pedal
Released

RESULTS

BAT VOLT

Z249
Cruise Control Converter/Inverter Module

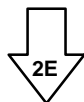

GO TO TEST F

1E

2E

CONDITIONS

- Ignition Switch
Position: 0

RESULTS

- Less than 1 ohm

Z249
Cruise Control Converter/Inverter Module



PROBLEM CAUSE
- B Wire

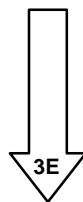

3E

CONDITIONS

- Ignition Switch
Position: 0
- Cruise Control Switch

On

RESULTS

- Less than 1 ohm

Z238
Body Electrical Control Module (BECM)



PROBLEM CAUSE
- WY Wire
- B Wire
- Cruise Control Switch



PROBLEM CAUSE
- OW Wire
- Body Electrical Control Module (BECM)

Test F

1F

C572

Z132 Engine Control Module (ECM)

GP

CONDITIONS

- Ignition Switch
Position: II

RESULTS

- Brake Pedal
Depressed = *BAT VOLT*
Released = *0 V*

OK PROBLEM CAUSE

- GB Wire
- Stop Lamp Switch

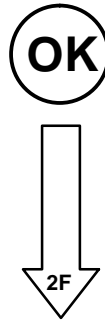

2F

C572

Z132 Engine Control Module (ECM)

YP

CONDITIONS

- Ignition Switch
Position: II

RESULTS

- Brake Pedal
Depressed = *0 V*
Released = *BAT VOLT*

OK PROBLEM CAUSE

- YP Wire
- Stop Lamp Switch

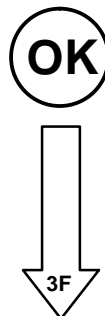

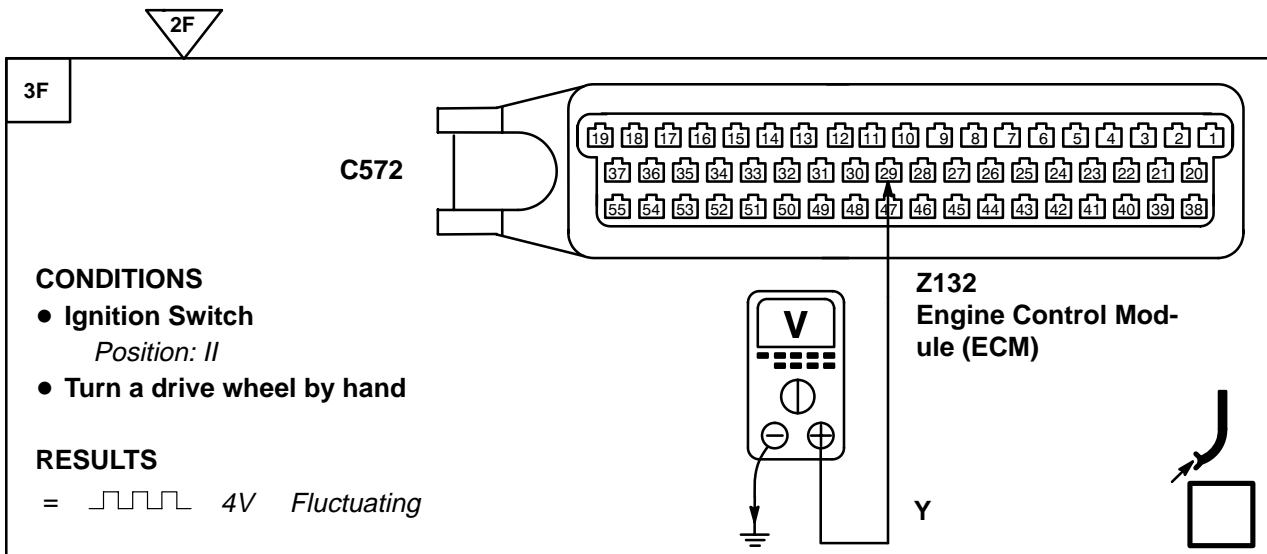

PROBLEM CAUSE

- Y, YG Wire
- Body Electrical Control Module (BECM)

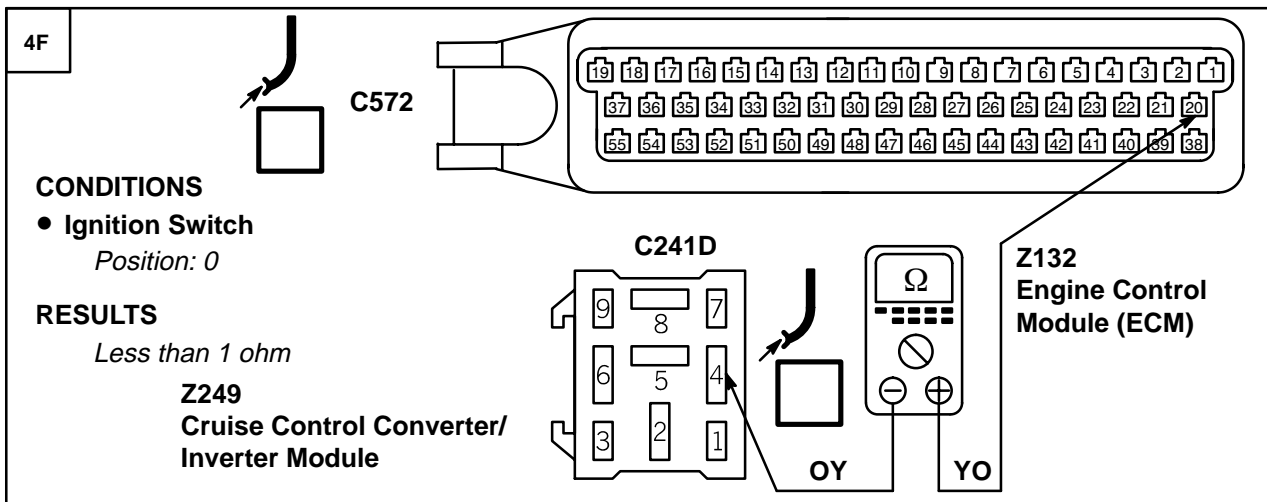
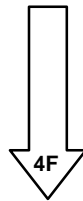

PROBLEM CAUSE

- OY, YO Wire

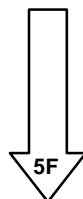

4F

5F

Z249
Cruise Control Converter/Inverter Module

CONDITIONS

- Ignition Switch
Position: 0

RESULTS

- Steering Wheel Switches
RES/DECEL Switch

<i>On</i>	=	<i>Less than 1 ohm</i>
<i>Off</i>	=	<i>More than 10K ohms</i>



PROBLEM CAUSE

- YR, W Wire
- B, PB Wire
- Rotary Coupler

- Steering Wheel Switches

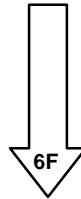

6F

Z249
Cruise Control Converter/Inverter Module

CONDITIONS

- Ignition Switch
Position: 0

RESULTS

- Steering Wheel Switches
SET/ACCEL Switch

<i>On</i>	=	<i>Less than 1 ohm</i>
<i>Off</i>	=	<i>More than 10K ohms</i>



PROBLEM CAUSE

- YS, R Wire
- Rotary Coupler

- Steering Wheel Switches



PROBLEM CAUSE

- Cruise Control Converter/ Inverter Module

- Body Electrical Control Module (BECM)

CIRCUIT OPERATION

Interface to transfer motor inside Transfer Box (X313)

The Transmission Gearbox Control Unit (Z256) has a seven wire interface to the Transfer Motor inside the Transfer Box (X313), consisting of the four motor position switches, the ground for the switches and the drives to move the motor one way or the other.

Motor Position Switches—pins 17, 32, 33, 7

The Transmission Gearbox Control Unit (Z256) reads the position of the motor in the form of a binary Gray Code.

So the Transmission Gearbox Control Unit (Z256) can find out in which gear the Transfer Box (X313) is in and where the motor should move to, to engage the desired range. If the Transfer Box (X313) moves outside the normal modes (e.g. Left of High) then the Transmission Gearbox Control Unit (Z256) can move the motor back to the correct position.

Motor Position Switch ground—pin 19

The switches on the transfer box motor are referenced to pin 19, i.e. if there is a problem with the harness to pin 19 then the Transmission Gearbox Control Unit (Z256) will not be able to assess where the transfer motor is and so will not move the motor.

Motor drive Clockwise (pins 25, 26) and Counter Clockwise (pins 1, 2)

The Transmission Gearbox Control Unit (Z256) receives signals from the motor position switches, the drivers request, the vehicle speed and the transmission neutral signal and, when the parameters are correct, powers the motor from one mode to another via the motor drives. This is actually a single wire interface for each direction which is split down to two wires at the Transmission Gearbox Control Unit (Z256) to help pass the current through two pins rather than one. If there is a problem with either the motor drives or the harness, then the motor will not move and a range change will not be possible.

Vehicle Speed Sensor—pins 13, 30

The Transmission Gearbox Control Unit (Z256) senses how fast the vehicle is travelling, compares this speed to the value stored in the memory and decides if a range change is allowed. Presently the shift speeds are set at 5 mph High to Low and Low to High on vehicles with an automatic transmission

and 15 mph Low to High on vehicles with a manual transmission.

Interface to BeCM (Z238)

High, Low and Neutral Status Lamps—pins 35, 14, 36

The Transmission Gearbox Control Unit (Z256) informs the BeCM (Z238), which informs the Instrument Pack (Z142), about the range the vehicle is in via three status lamps.

When a range change is requested, the desired range will flash up on the display (i.e. "HIGH") and continue flashing until the range change is achieved. When complete, the range message will switch to constant and be displayed for a few seconds.

If a range change is requested and not all of the conditions are satisfied then the desired range message will flash and continue flashing until all of the parameters are satisfied or the request is removed.

If the transfer box neutral is selected then, after a five second safety delay, the Transfer Box (X313) moves to neutral and the display shows "NEUTRAL".

The High and Low status lamp signals also pass information to the H-Gate and the Auto Gear Box Control Unit (Z255).

Interface to Engine Control Module (ECM) (Z132)

On North American Specification (NAS) vehicles, the inability of the Transfer Gear Box ECU (Z256) to move into the High range is flagged over the fault output line. A fault will also be flagged in the event of a speed sensor failure or incorrect transfer motor position information. The Malfunction Indicator Lamp (MIL) will illuminate if a fault is recorded on two successive journeys.

Neutral Switch (X308) or Clutch Switch—pin 34

A shift between ranges is possible when the transmission is in neutral. The Transmission Gearbox Control Unit (Z256) senses this via a Park/Neutral Switch (X308) on automatic transmission vehicles and via either a clutch switch or a lever neutral switch on manual transmission vehicles. This signal is passed via the BeCM (Z238).

Interface to “H–Gate”—pin 35, 15 (automatic transmission only)

The H–Gate gets the range information via a High and Low status signal from the output of the Transmission Gearbox Control Unit (Z256); e.g. when the vehicle is in High then the High side of the “H” is illuminated. When a range change to Low is requested, the Low side of the “H” starts to flash whilst the High side stays constant. When Low range is obtained then the flashing light on the Low side changes to constant and the High side light goes off.

If a range change is requested and not all of the conditions are satisfied, then the current range will stay illuminated and the desired range will flash and continue flashing until all of the parameters are satisfied or the request is removed.

If the gear lever is placed in the neutral position for the gearbox and the transfer box then, after a five second safety delay, the transfer box moves to neutral and the lights on both side of the “H” are extinguished.

Interface to Auto Gear Box Control Unit (Z255) – pin 35

The High/Low signal to the Auto Gear Box Control Unit (Z255) comes from the High range status lamp. If the Auto Gear Box Control Unit (Z255) does not receive the range information, then an incorrect gear change mode could be selected, i.e. Manual rather than Sport in High range and vice versa in Low range. Also, the shift strategy is different between the Economy modes of High and Low and so poor shift quality could result.

Automatic Selector Park Interlock

When the gear selector lever is in the park position, the shift interlock solenoid is deenergized and prevents the selector from being moved to another gear. To free the selector, the Ignition Switch (X134) must be in position II and the brake pedal must be depressed.

Current is then supplied to the solenoid through the PR wire via fuse 13. The solenoid is grounded using the B wire to the console ground E621.

The solenoid is now energised, freeing the selector. The solenoid is energised continuously whilst the selector lever is in any position other than park and the Ignition Switch (X134) is in position II.

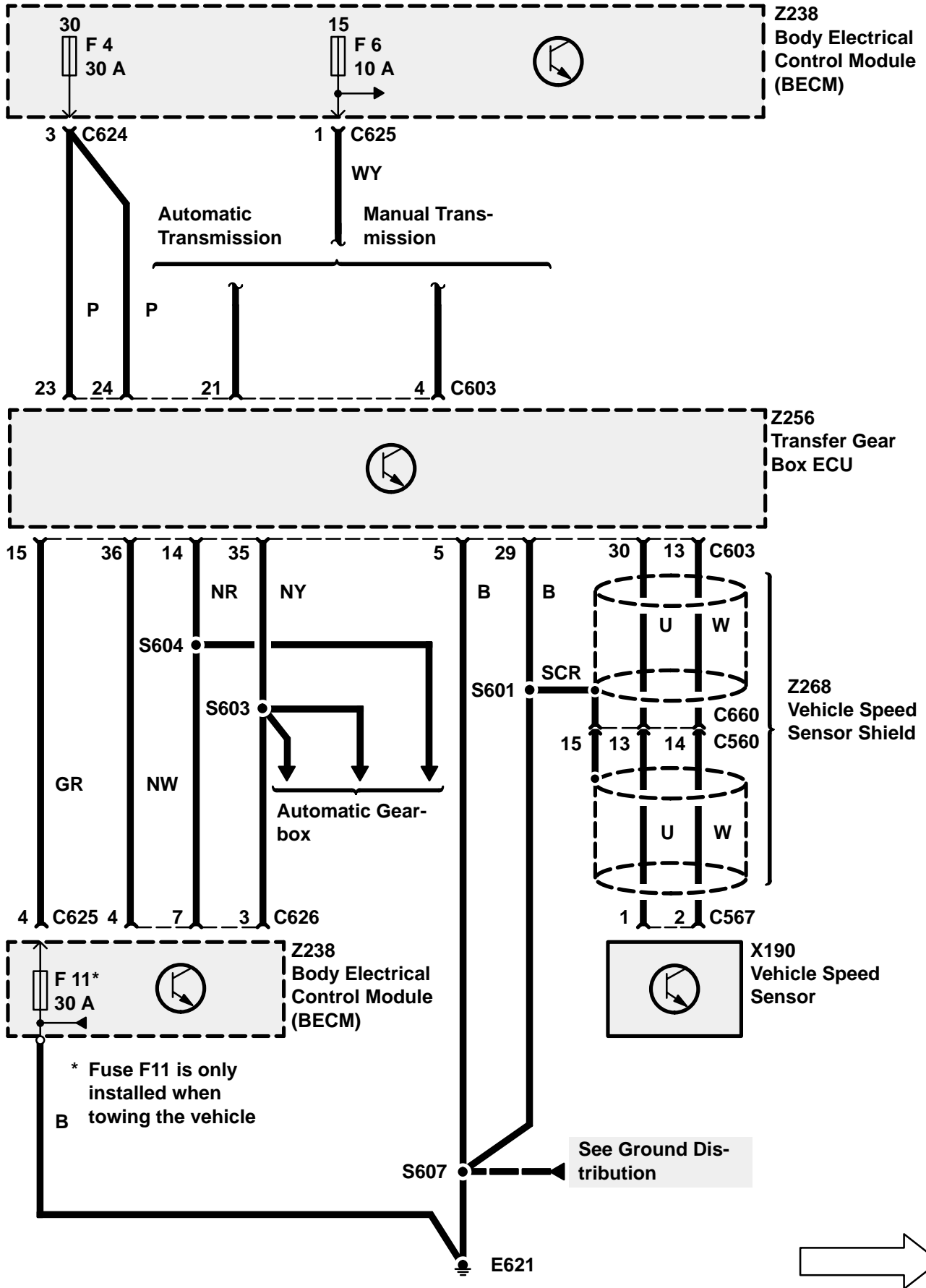

← Manual Transmission

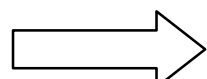
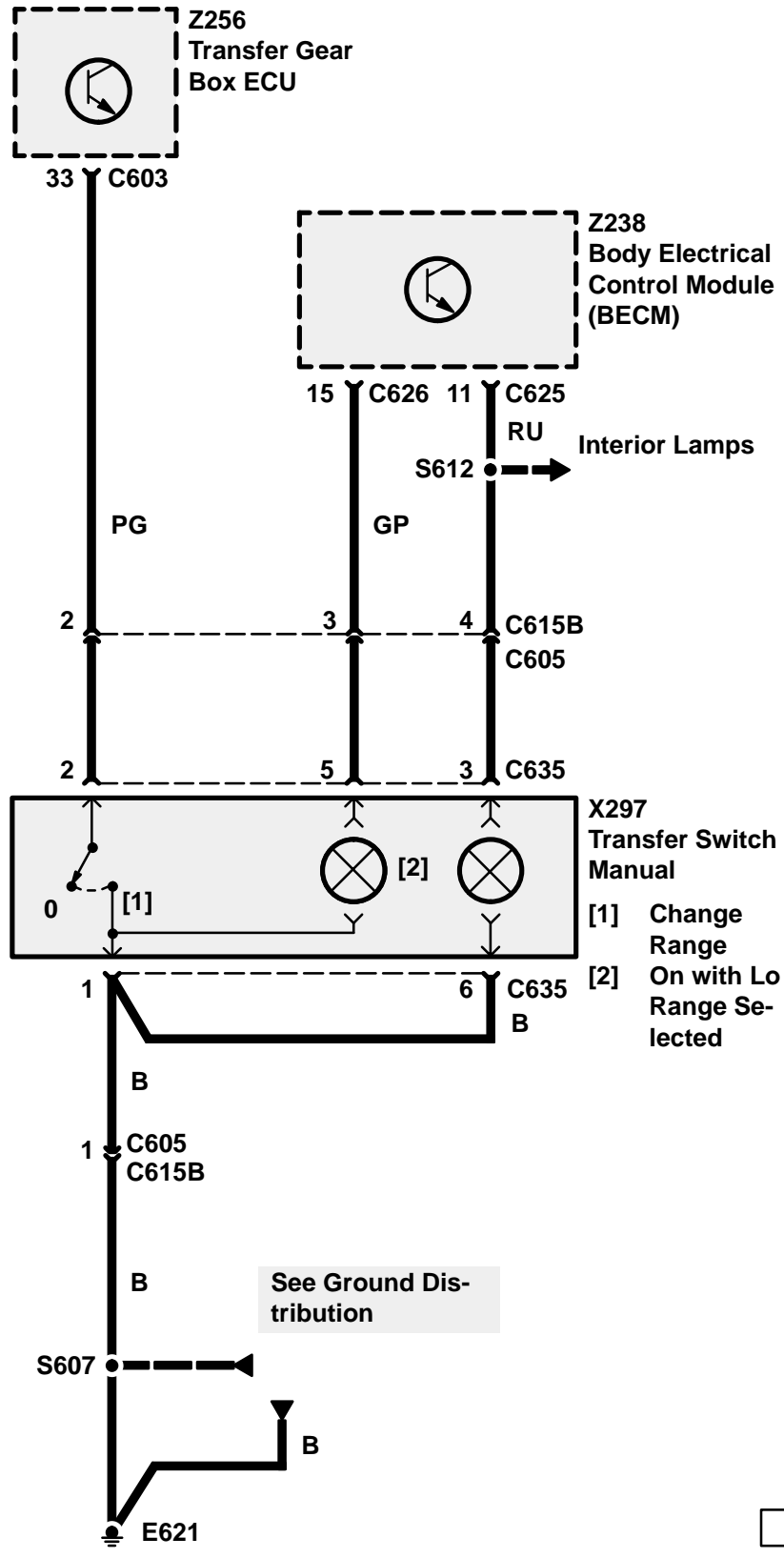

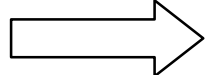
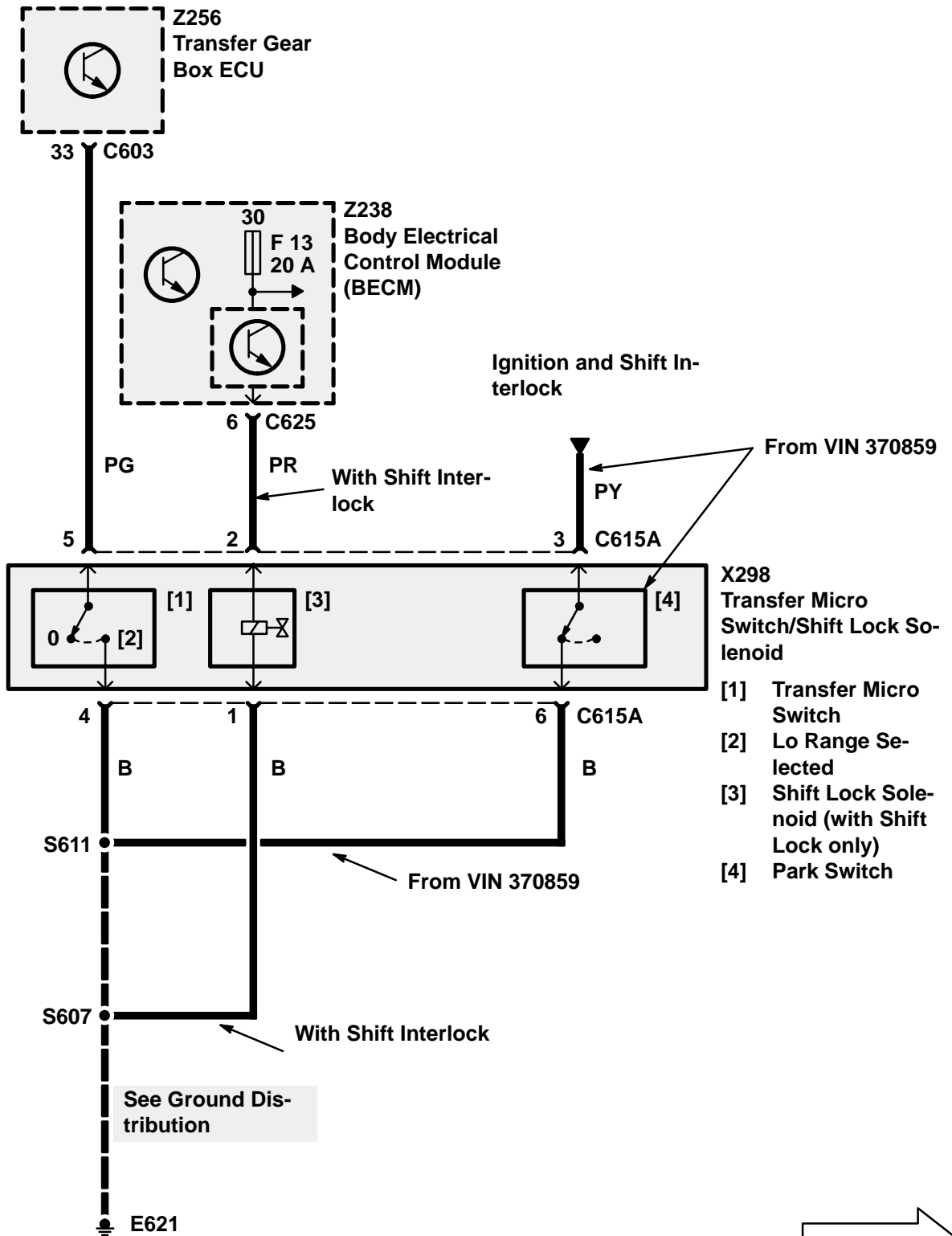

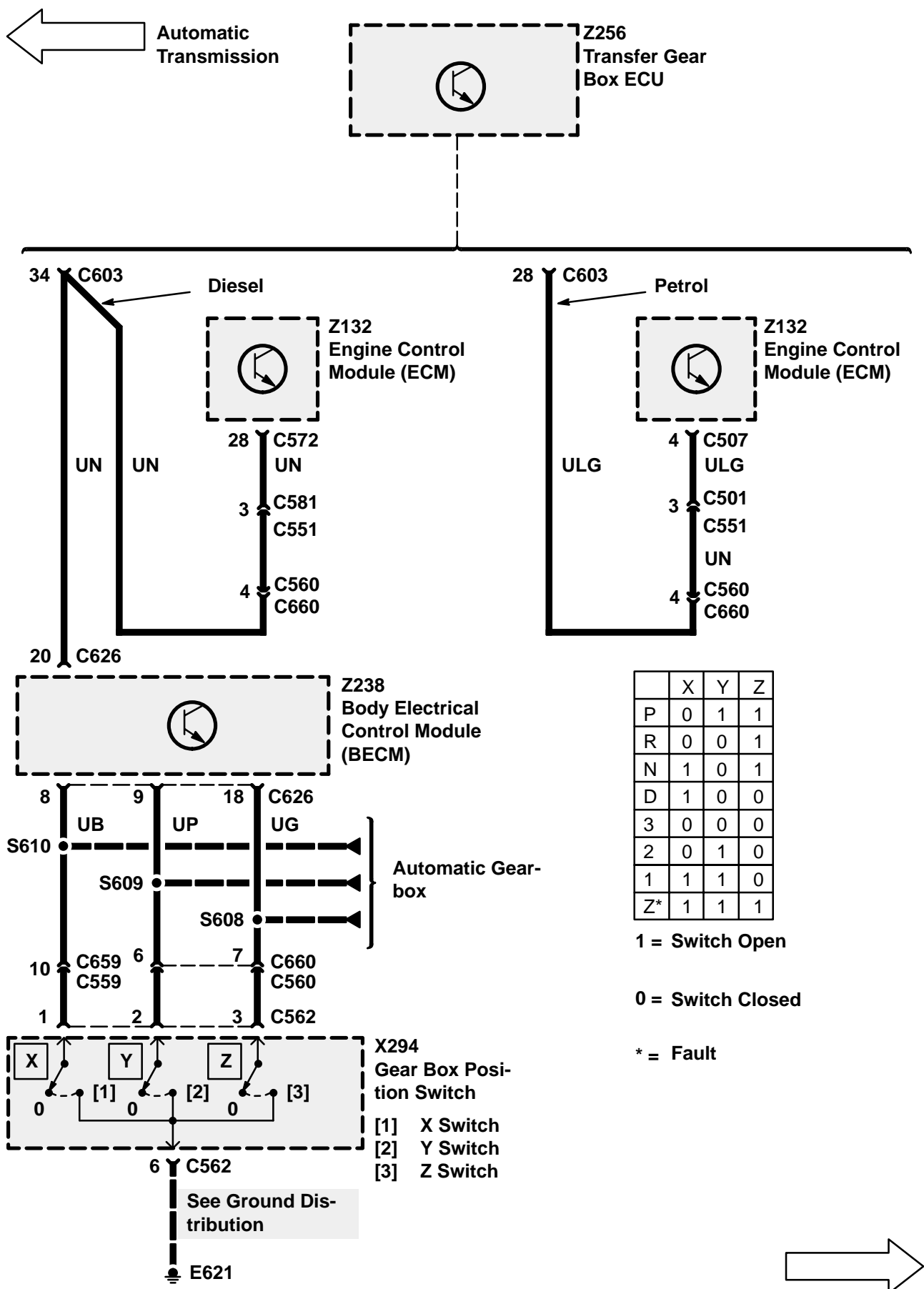

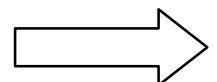
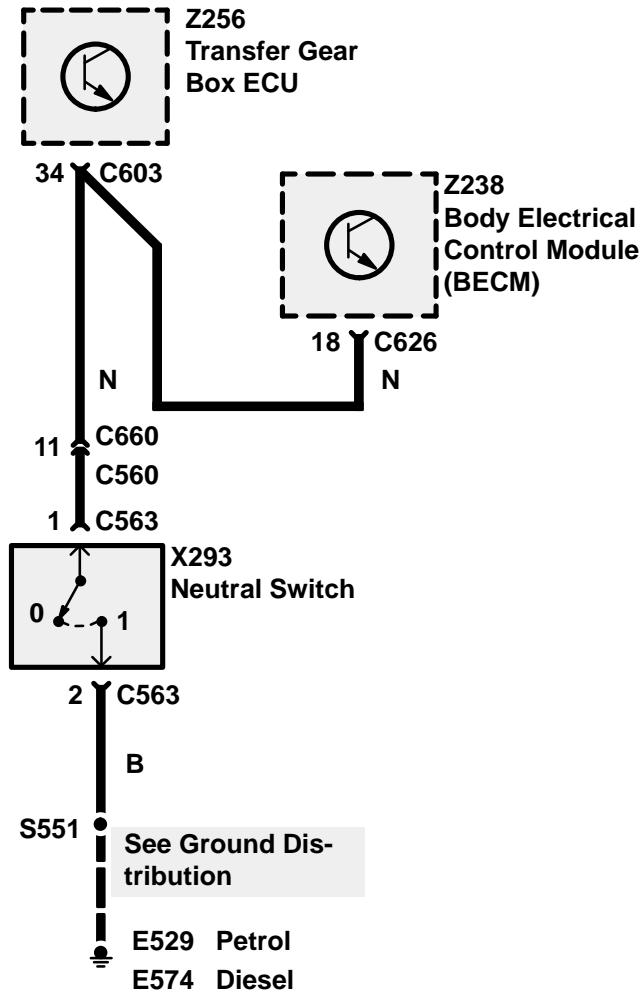

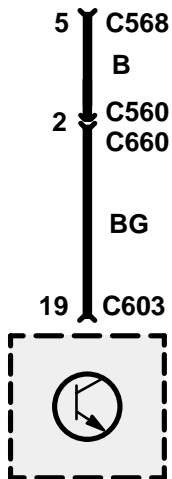
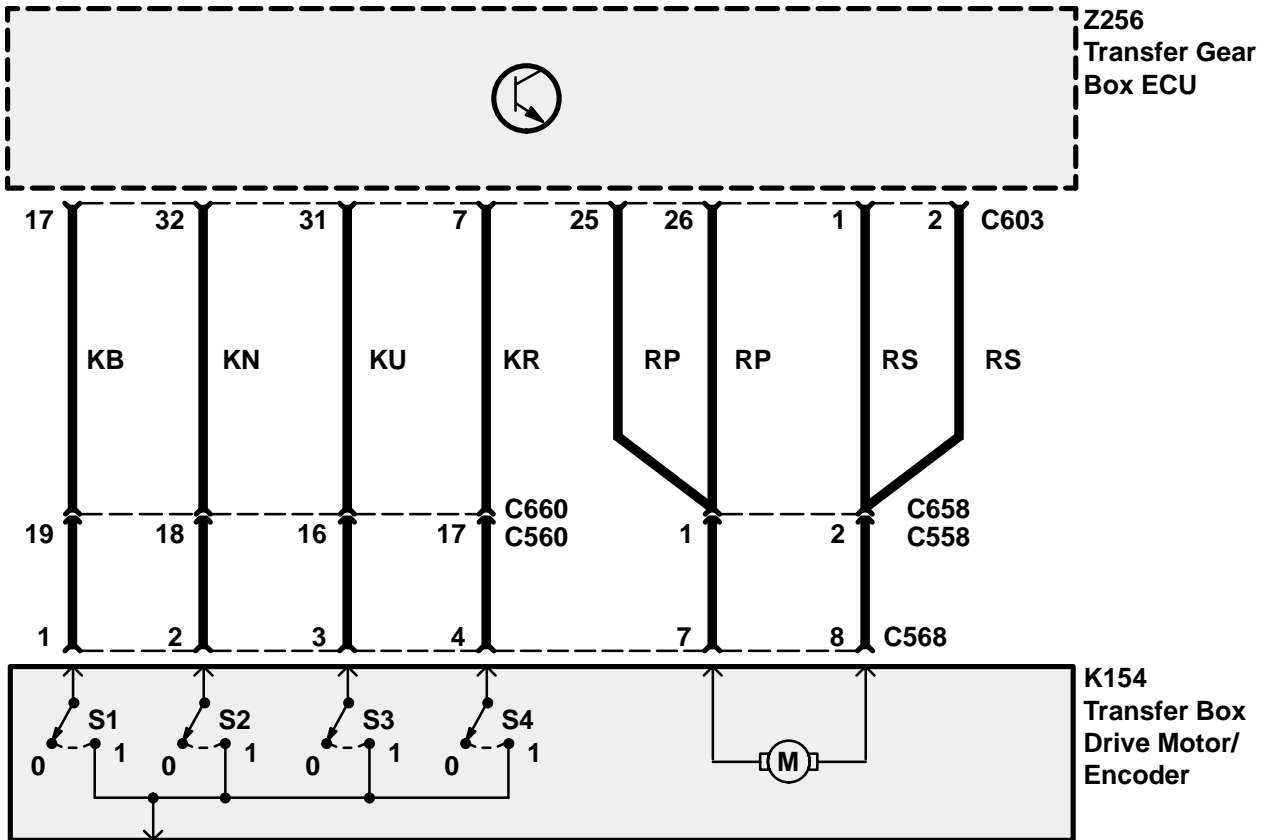
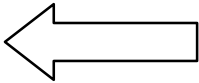

	S1	S2	S3	S4
Left Stop	1	1	1	0
Left of Hi Mode	1	0	1	0
Hi Mode	0	0	1	0
Right of Hi Mode	0	0	0	0
Zone 1	1	0	0	0
Neutral Mode	1	0	0	1
Zone 2	0	0	0	1
Lo Mode	0	1	0	1
Right Stop	0	1	0	0

1 = Switch Open

0 = Switch Closed



CIRCUIT OPERATION

Economy, Sport and Manual Modes

The Auto Gear Box Control Unit (Z255) has various different driving modes available, with Economy being selected automatically on start up. When the vehicle is in High range, Sport mode can be selected. This will make the gear change much more sensitive to throttle movement, thereby shifting down earlier and holding onto lower gears longer than the Economy mode equivalent. If the vehicle is in Low range, then Manual mode can be selected. This will make the gear box change into the selected gear as quickly as possible and hold on to that gear at all speeds, i.e. if "3" is selected, then the gear box will not shift down to "2" or "1" as the vehicle slows down. It will only change gear to prevent the vehicle from stalling.

Interface to Petrol Engine Control Module (ECM) (Z132)

The Auto Gear Box Control Unit (Z255) takes the engine torque, engine speed and throttle angle signals from the ECM, calculates which gear is required, outputs to the solenoid valves and sends a torque reduction signal back to the ECM, thereby retarding the ignition point on each of the cylinders and so giving a reduction in engine power during gear changes that result in a smooth change.

The engine torque is received by the Auto Gear Box Control Unit (Z255) on its pin 21, the engine speed on pin 3 and the throttle angle on pin 47. The torque reduction signal is sent to the ECM from the Auto Gear Box Control Unit (Z255) via its pin 32.

Interface to Diesel Engine Control Module (ECM) (Z132)

The functionality of the interface is similar to the petrol interface, except for the format of the signal.

Interface to Auto Gear Box Control Unit (Z255)

Gear position Switch–pins 14, 33, 50

The gear position switch is mounted on the side of the gearbox and contains five internal switches, although only 3 are connected to the Auto Gear Box Control Unit (Z255) via pins 50, 14, and 33. By analysing the status of these 3 switches, the Auto Gear Box Control Unit (Z255) calculates which gear the vehicle is in.

If a fault occurs with the switch, then the Auto Gear Box Control Unit (Z255) may try to put the gearbox into a different gear than the driver's request.

Solenoid Valves–pins 5, 6, 19, 24, 42

The Auto Gear Box Control Unit (Z255) has control over 4 solenoid valves: MV1, MV2, torque converter lock up and pressure regulator. These are all supplied via pin 19, which is activated via a relay in the Auto Gear Box Control Unit (Z255) itself.

MV1 – pin 5, MV2 – pin 24:

When the driver selects "D"rive, then the Auto Gear Box Control Unit (Z255) controls the gear selection by the use of the two solenoid valves. If a fault occurs with one or both of the valves, then a different gear than the one selected will result.

If the Auto Gear Box Control Unit (Z255) defaults the gearbox, then the common supply to all the solenoid valves is removed and the gearbox mechanically shifts either to third gear, if the vehicle is stationary, or fourth, if moving.

MV2 is also used to prevent the driver from selecting reverse when the vehicle is moving forward at more than 8 km/h and from disengaging reverse at reverse speeds greater than 6 km/h. This is known as "Reverse Safety" and will not be available if MV2 is non-operational and/or the gearbox has defaulted.

Torque Converter Lock-Up Solenoid – pin 42:

The torque converter slips to allow smooth operation of the gearbox. Lock-Up occurs when the vehicle reaches a speed of 45MPH or above in either third or fourth gears.

Pressure Regulator Solenoid – pin 6:

The gear shift quality is controlled by modulating the pressure regulator, which is controlled by the Auto Gear Box Control Unit (Z255). The solenoid is energised closed, such that if a failure occurs, then the regulator allows default gear change.

Output Shaft Speed Sensor – pins 2, 38, 20

The automatic gearbox system incorporates an output shaft speed sensor which is input to the Auto Gear Box Control Unit (Z255) on pins 2 and 38 with a screen over the cable attached to pin 20. It is important that this signal is screened correctly.

MES 1 and 2 – pins 16, 31

The two Manual/Economy/Sport (MES) lines indicate to the BeCM (Z238) which mode has been selected or if a fault within the transmission has occurred.

Interface to Transmission Gearbox Control Unit (Z256)

–High/Low Range Signal – pin 46

The High/Low signal is used by the Auto Gear Box Control Unit (Z255) to select the correct mode on application of the "MES" switch. Also, the gear shift points and strategies are very different in the different ranges.

Interface to "H-Gate" – pin 29

The "H"-Gate sensor module (Z254) displays selected gear information from the Gear Box Position Switch (X294), ratio information from the Transmission Gearbox Control Unit (Z256) and mode information from the gear box Auto Gear Box Control Unit (Z255). The H-Gate receives an ignition 2 signal on the W wire. This is fed via fuse 6. It is grounded to the console ground E621 via the B wire.

Information on the selected gear (PRNDL) is received from the Gear Box Position Switch (X294) on wires UB, UP, UG. These three lines also go to

the Auto Gear Box Control Unit (Z255) and the BeCM (Z238).

Information on the gear box mode (sport or manual) is received on the YG wire and the YR wire. These two lines also go to the BeCM (Z238).

The Transmission Gearbox Control Unit (Z256) high status is received on the NY wire. The low status is received on the NR wire. These two lines also go the Transmission Gearbox Control Unit (Z256) and the BeCM (Z238).

The illumination signal is on the RU wire.

The mode request is on the UO wire. This is sent from the H-gate Sensor Module (Z254) to the Auto Gear Box Control Unit (Z255). The line is activated and deactivated by pressing the momentary action MODE button. The line is active at all times.

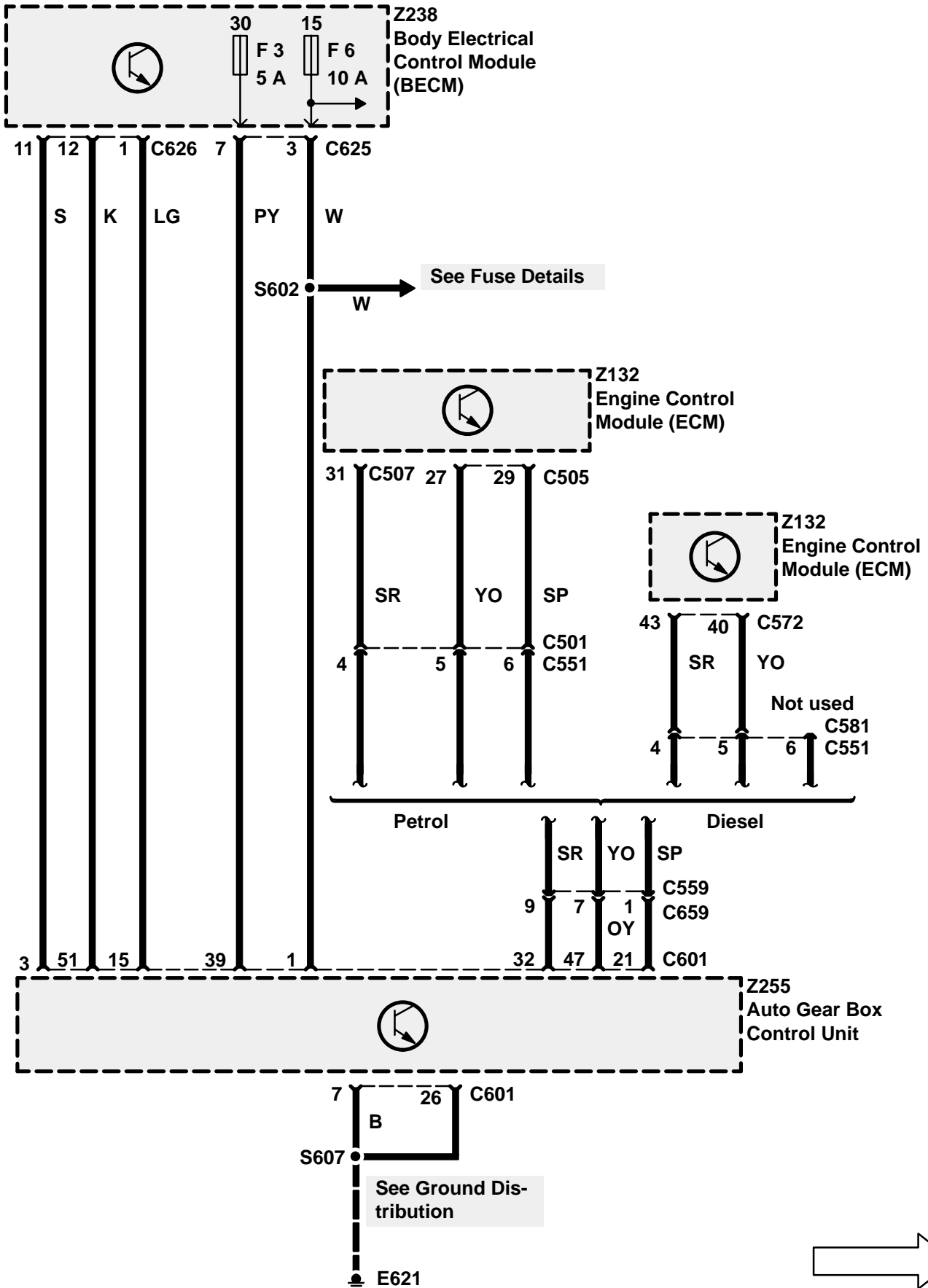

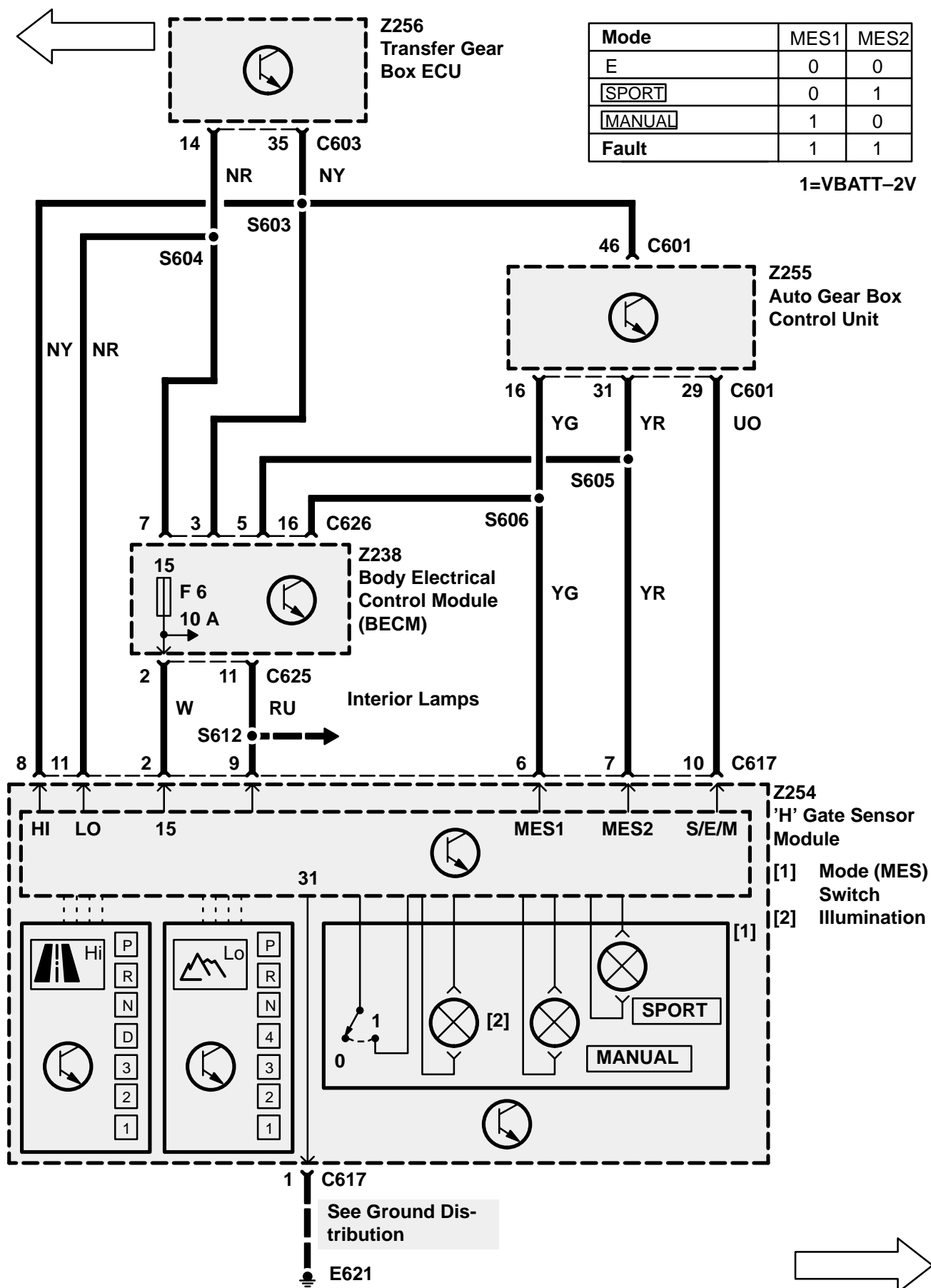

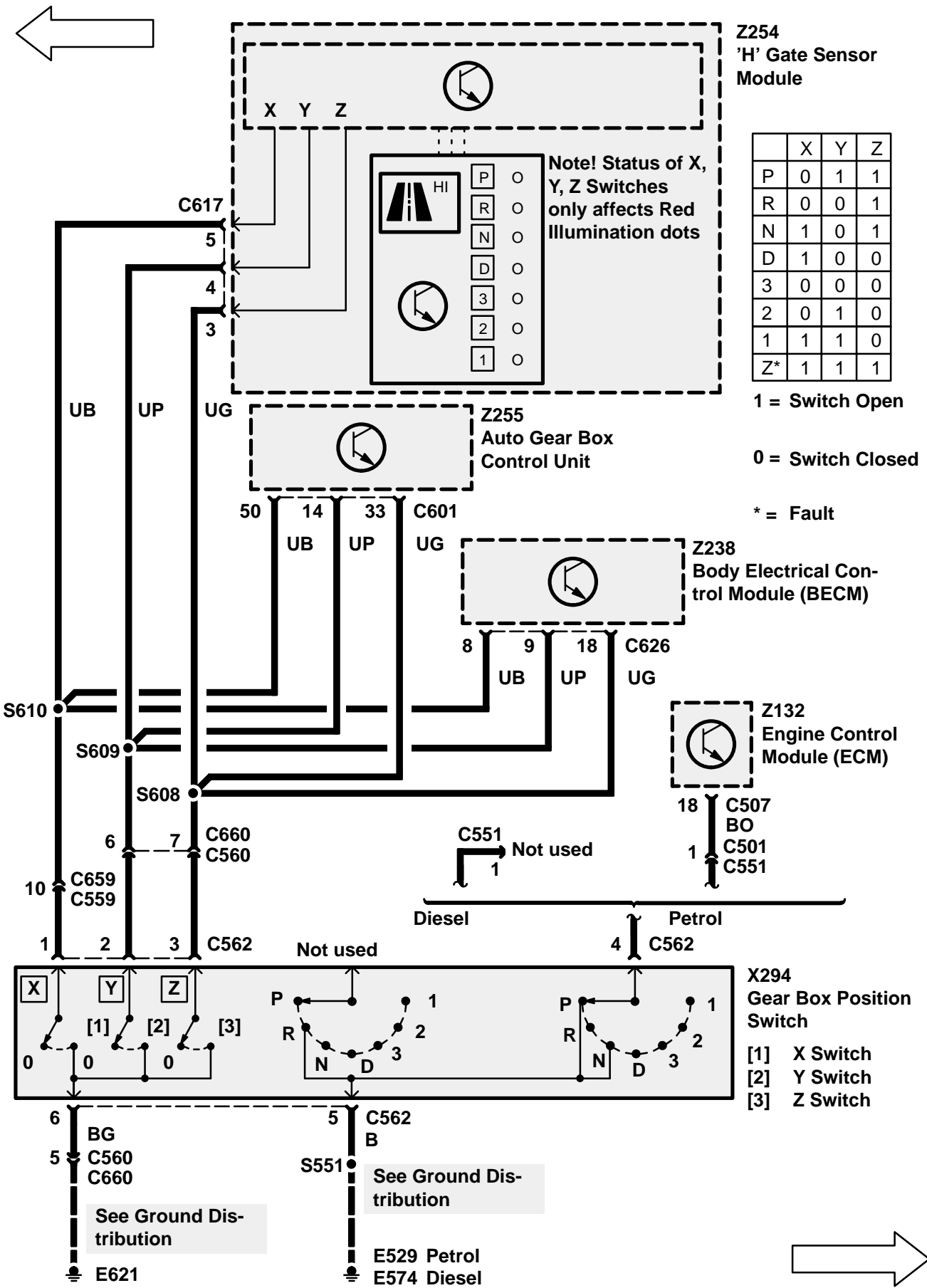

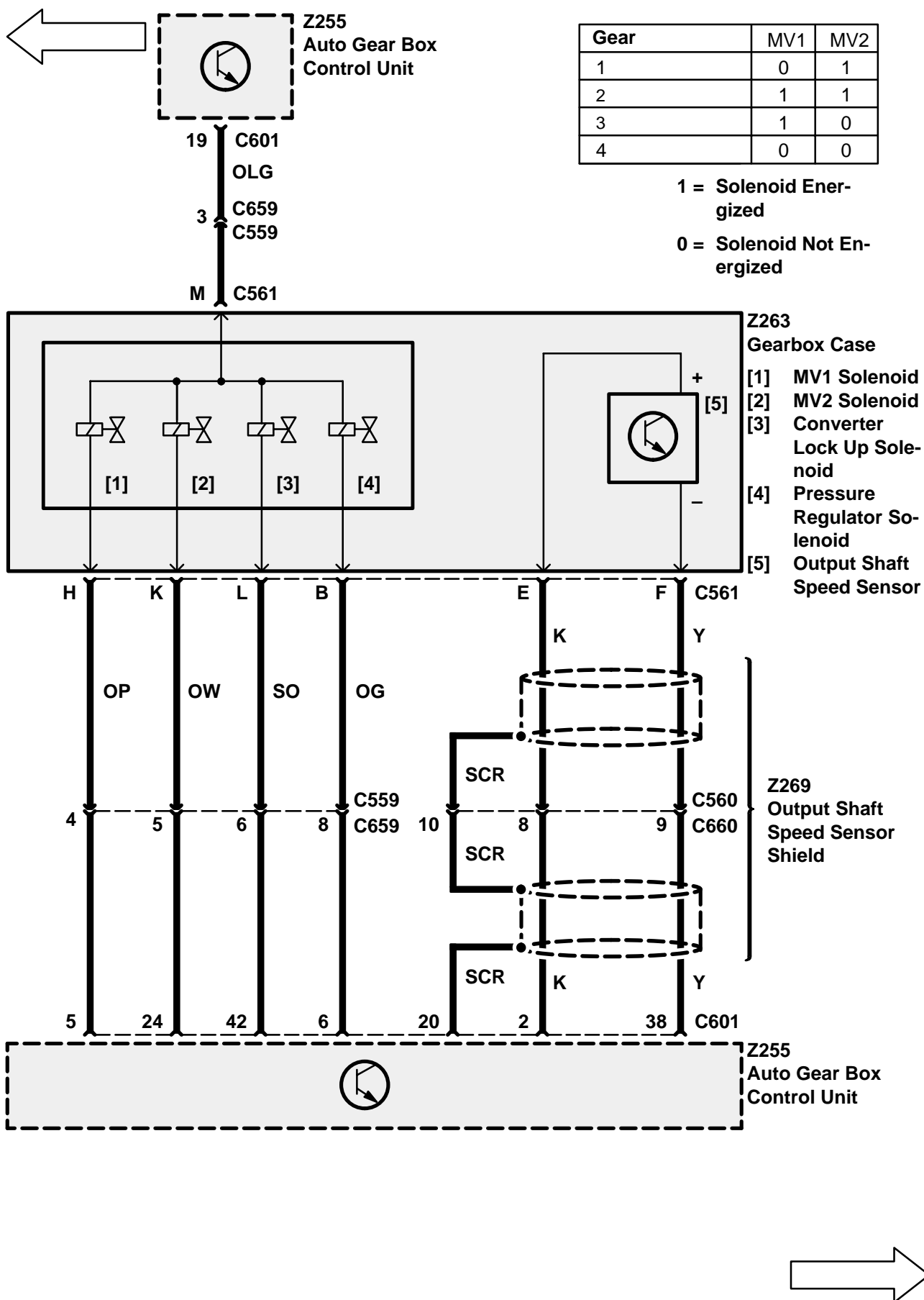

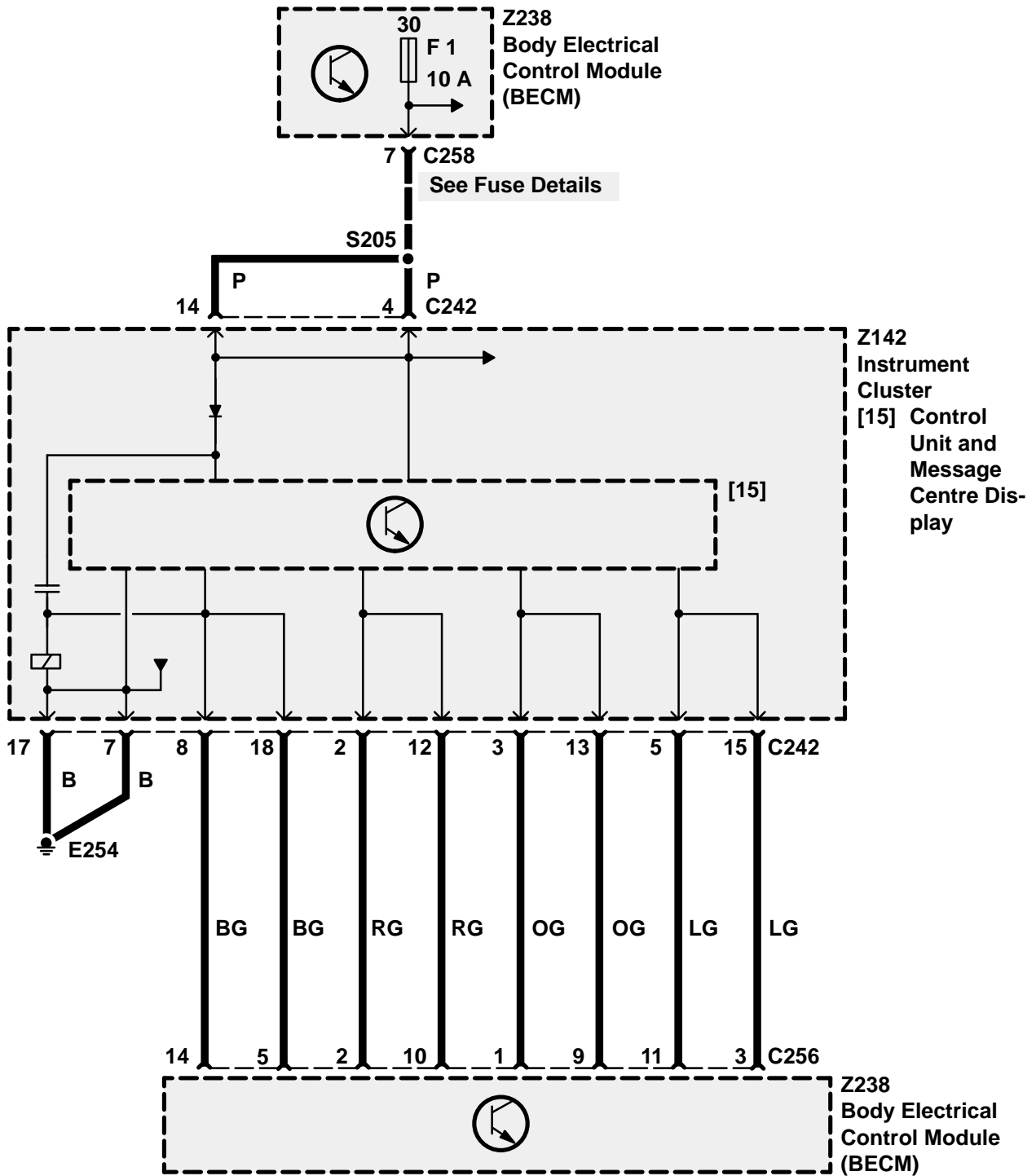
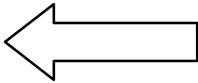

Circuit Operation

Selector Interlock

The Gear Selector Lever may only be moved out of the Park position when the ignition is on and the brake pedal is depressed. The Shift Lock Solenoid shall be energised continuously whilst the Ignition is on and the Gear Selector Lever is in a position other than Park or Neutral.

Ignition Key Interlock

The Ignition Key Lock Solenoid shall at all times prevent removal of the Key from the Ignition Switch unless the Gear Selector Lever is in the Park position.

For vehicles from VIN 370859 the Ignition Key Lock Solenoid (K191) is feed from Fuse 29.

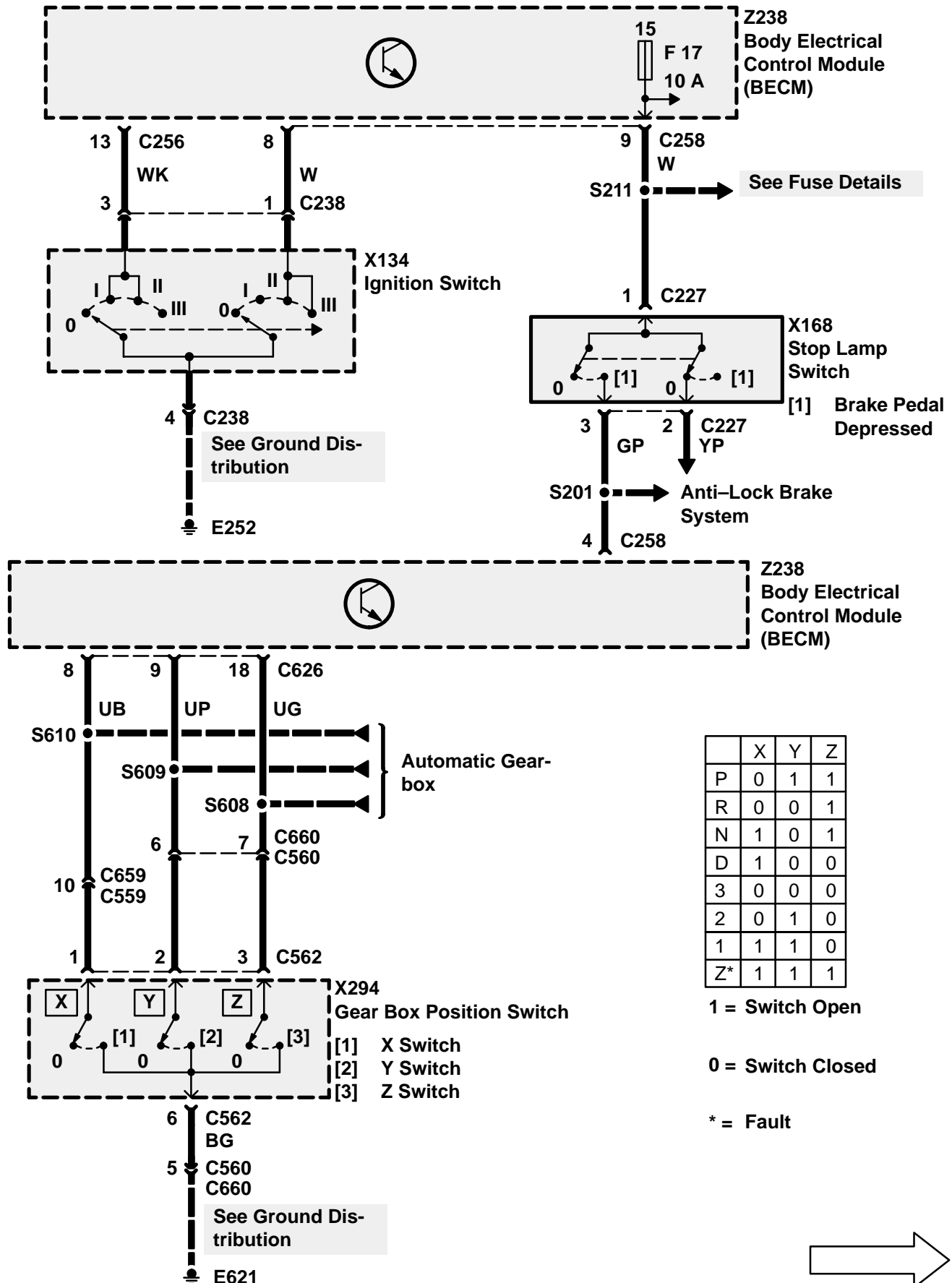

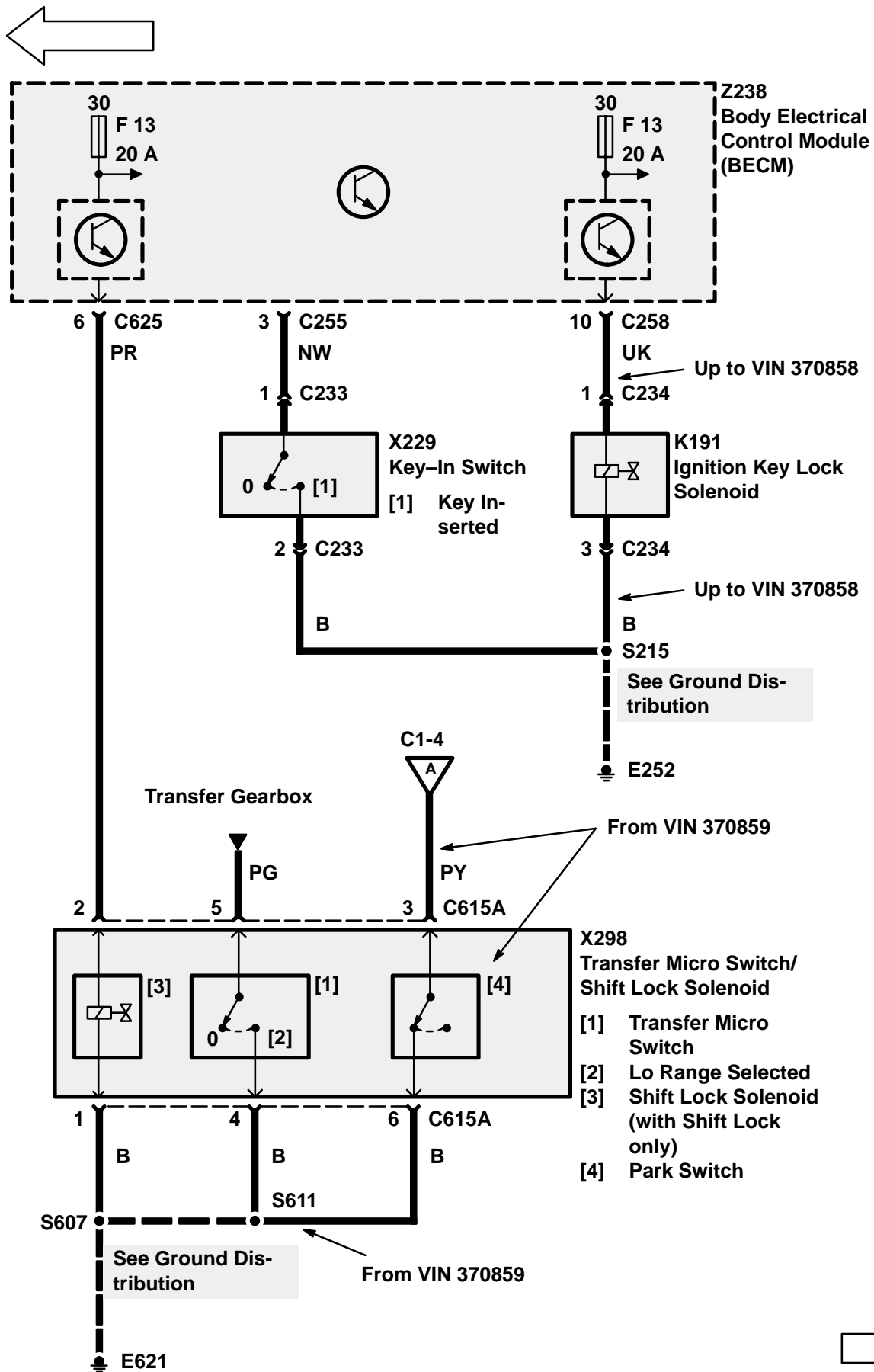

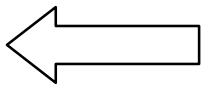

From VIN 370859

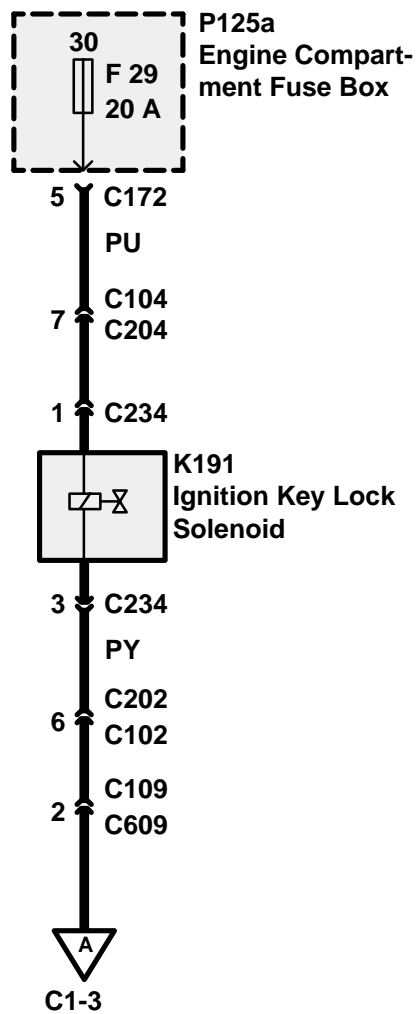

CIRCUIT OPERATION

The Anti-Lock Brake System prevents wheel lockup during braking. This enables the driver to maintain vehicle stability and 'steerability' while braking.

The Electronic Traction Control System aids traction when a rear wheel spins or loses traction. The system works by applying the brake to the spinning rear wheel. The braking action allows more torque to be transferred and applied to the non-spinning rear wheel.

Anti-Lock Brake System ECU (Z108)

The Anti-Lock Brake System ECU (Z108) is a computer that controls ABS system operation by consistently monitoring the vehicle's 4 wheel speeds when the ignition is in position II. If an impending wheel lock up is detected during this monitoring, the Anti-Lock Brake ECU (Z108) will apply voltage to the various inlet and outlet valve solenoids contained in the ABS Booster Unit (Z103). Operation of the solenoid valves regulates the pressure applied to each wheel brake calliper and therefore prevents wheel lock-up.

Electronic Traction Control (ETC) is an extension to the Anti-Lock Brake System ECU. In addition to monitoring the rear wheel speeds for lockup, the Anti-Lock Brake System ECU also monitors wheel speed for traction control. When rear wheel slip is detected (one wheel spinning faster than the other), the Anti-Lock System ECU will apply the brake to the spinning wheel, causing additional torque to be applied to the non-spinning wheel.

The Anti-Lock Brake System ECU applies the brake by operating various inlet and outlet solenoid valves in the ABS Booster.

The ETC warning light will be on for up to 60 seconds while the system is active, and the message TRACTION is displayed. After 60 seconds of ETC operation, the ETC warning light will begin to flash to inform the driver that the system has been shut down to allow the brakes to cool. Also the message TRACTION OVERHEAT is displayed.

If the ETC warning light stays on continuously for more than 60 seconds, a fault in the system is indicated. The message TRACTION FAILURE is also displayed.

The Anti-Lock Brake System ECU (Z108) also has diagnostic capabilities that allow it to detect faults that may impair the system's efficiency. If a fault

occurs, the ECU informs the operator of a problem by illuminating the ABS or the ETC warning light. The ECU also illuminates the warning light when the ignition is first placed in position II. The ABS warning light will remain illuminated until the ECU completes a self check of the system. When the ECU sees all wheels reach a speed of 7 km/h (5 mph), the self check is completed and the ABS warning light turns off. If a fault is detected during the self check, the ABS or the ETC warning light will remain on and a fault code will be stored in memory to aid in servicing the system. When an ABS fault has been detected, the message ABS FAULT may also display.

The fault code can be retrieved using a diagnostic tester.

ABS Booster Unit (Z103)

The ABS Booster Unit (Z103) contains 2 isolation solenoid valves and 4 pairs of solenoid control valves which are grounded through the harness. When the ETC is fitted, the booster unit also contains an additional 2 solenoid valves. The pairs of solenoid control valves each include a fluid pressure inlet and outlet valves that control ABS braking to one wheel.

The Anti-Lock Brake System ECU (Z108) operates these valves by applying battery voltage to them. The valves are designed to decrease, hold or increase pressure to retain wheel rotation and optimum braking.

The 2 isolation valves consist of 2 solenoid valves that control fluid inlet and outlet. Their function is to disconnect or isolate the master cylinder from the servo cylinder and to connect the servo cylinder to the reservoir return during ABS functions.

Wheel Speed Sensors (X137, X140, X158, X161)

A wheel speed sensor is located at each wheel. The speed sensors generate an AC voltage signal as a toothed ring rotates past the stationary sensor pickup. The Anti-Lock Brake System ECU (Z108) calculates the wheel speed by measuring the frequency of the AC voltage signal generated by the sensors.

ABS Hydraulic Pump (M102)

The hydraulic boost for the system is provided by the ABS Hydraulic Pump (M102), which is controlled by the ABS Pump Relay (K102) and the ABS Pressure Switch Unit (Z104).

The Pressure Switch unit incorporates three electro-mechanical switches. The first operates the pump, two more illuminate the low pressure condition and signal that ABS and ETC functions should be curtailed. The Hydraulic Pump includes a hydraulic accumulator and non-return valve, as well as a pressure relief valve to protect the system.

When low pressure occurs in the brake system, a switch in the pressure switch unit closes to ground the coil of the pump relay. The pump relay now energizes and applies battery voltage from the fuse to the hydraulic pump through the closed relay contacts. The hydraulic pump runs to increase pressure in the hydraulic accumulator. When sufficient pressure is developed in the system, the pressure switch opens to de-energize the pump relay and to turn off the hydraulic pump.

ABS Warning Lamp

The Anti-Lock Brake System ECU (Z108) sends signals to the BeCM which then controls the illumination of the ABS warning lamp. The BeCM also controls the display of the system messages.

Solenoid Valve Relay

This is energized by the ABS ECU and sends voltage back to the part of the same ECU which controls the solenoid valves in the booster. When the ABS ECU detects a fault that requires a complete system shutdown, the relay is de-energized.

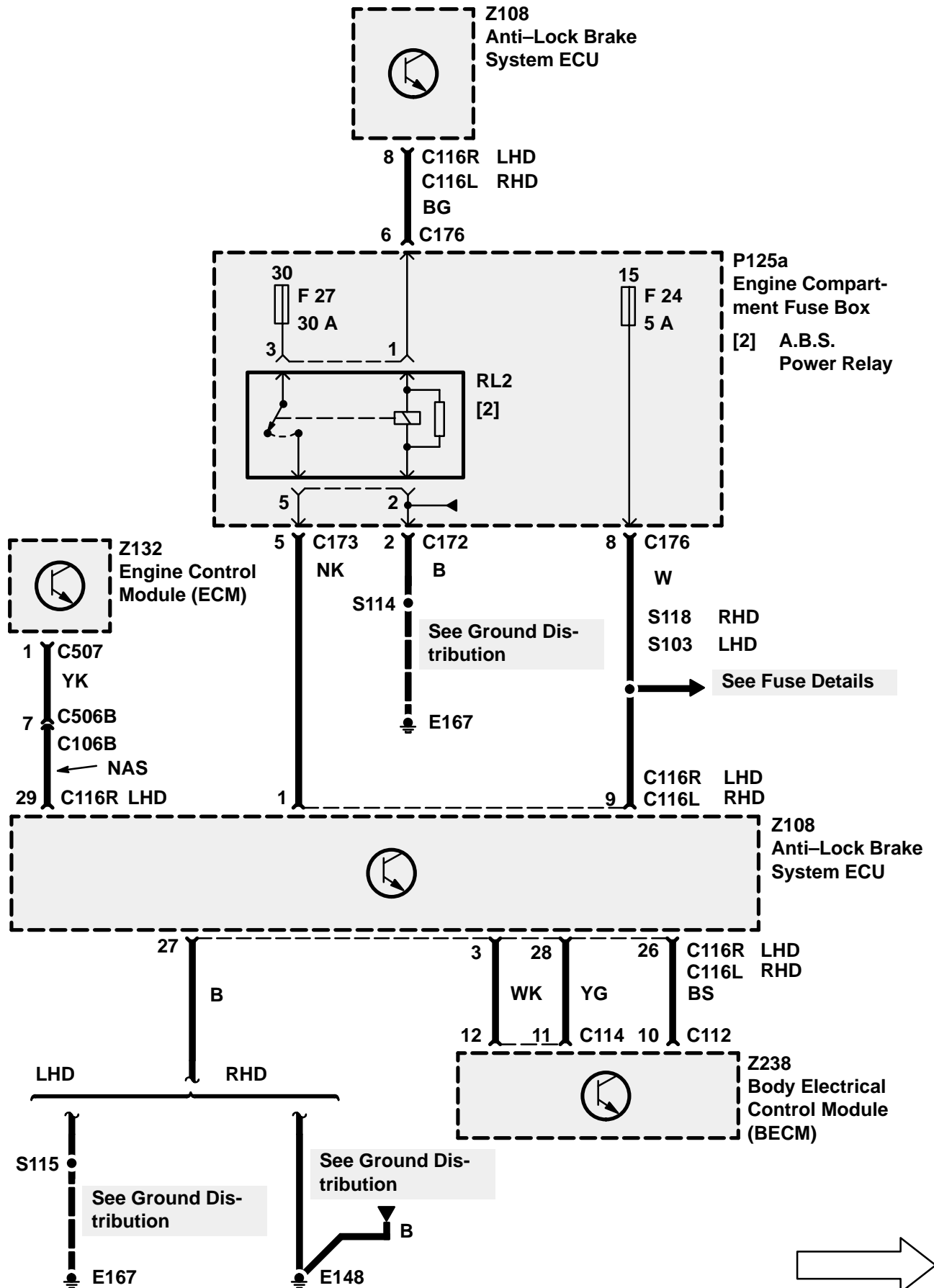

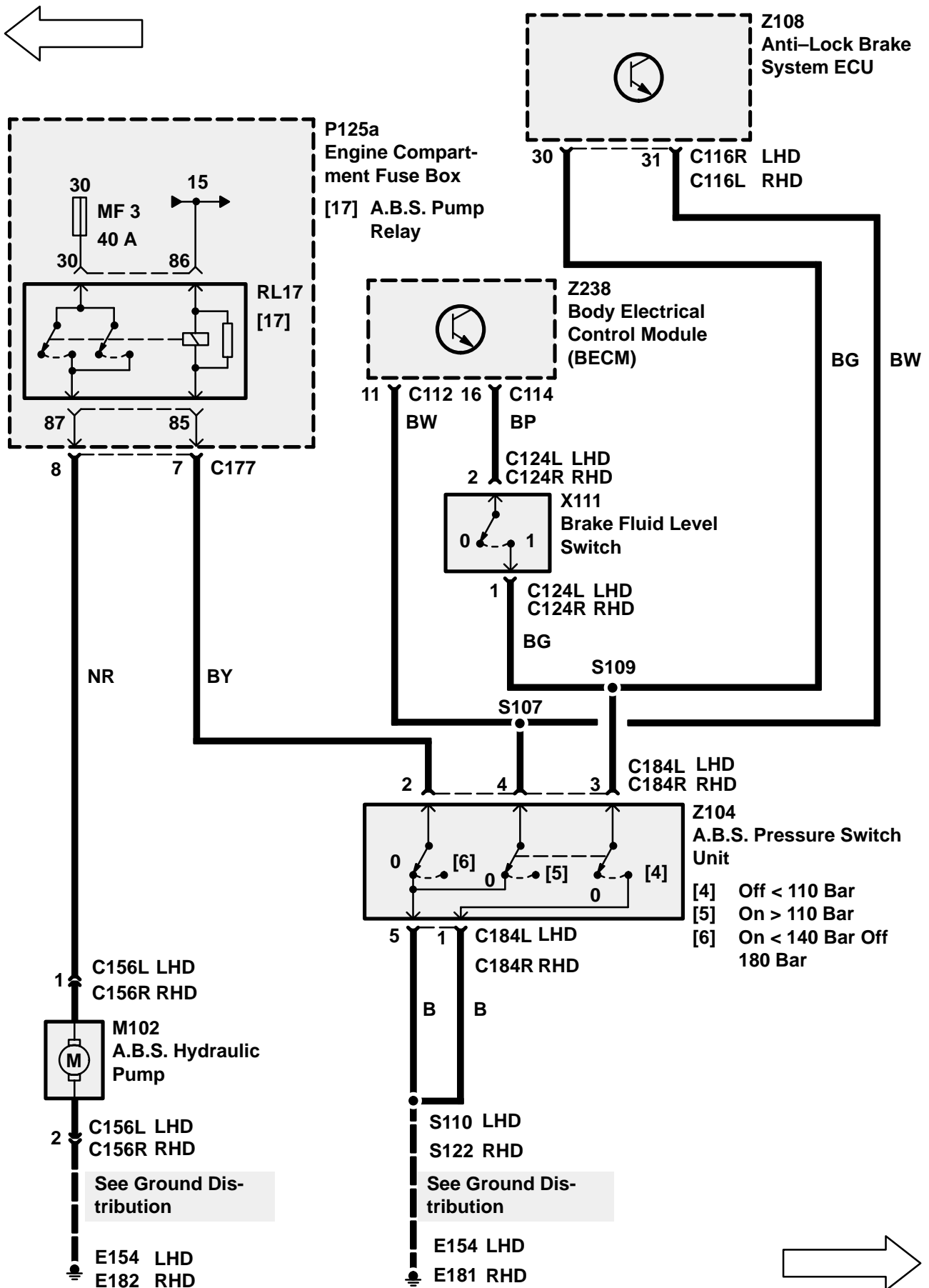

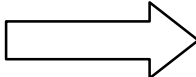
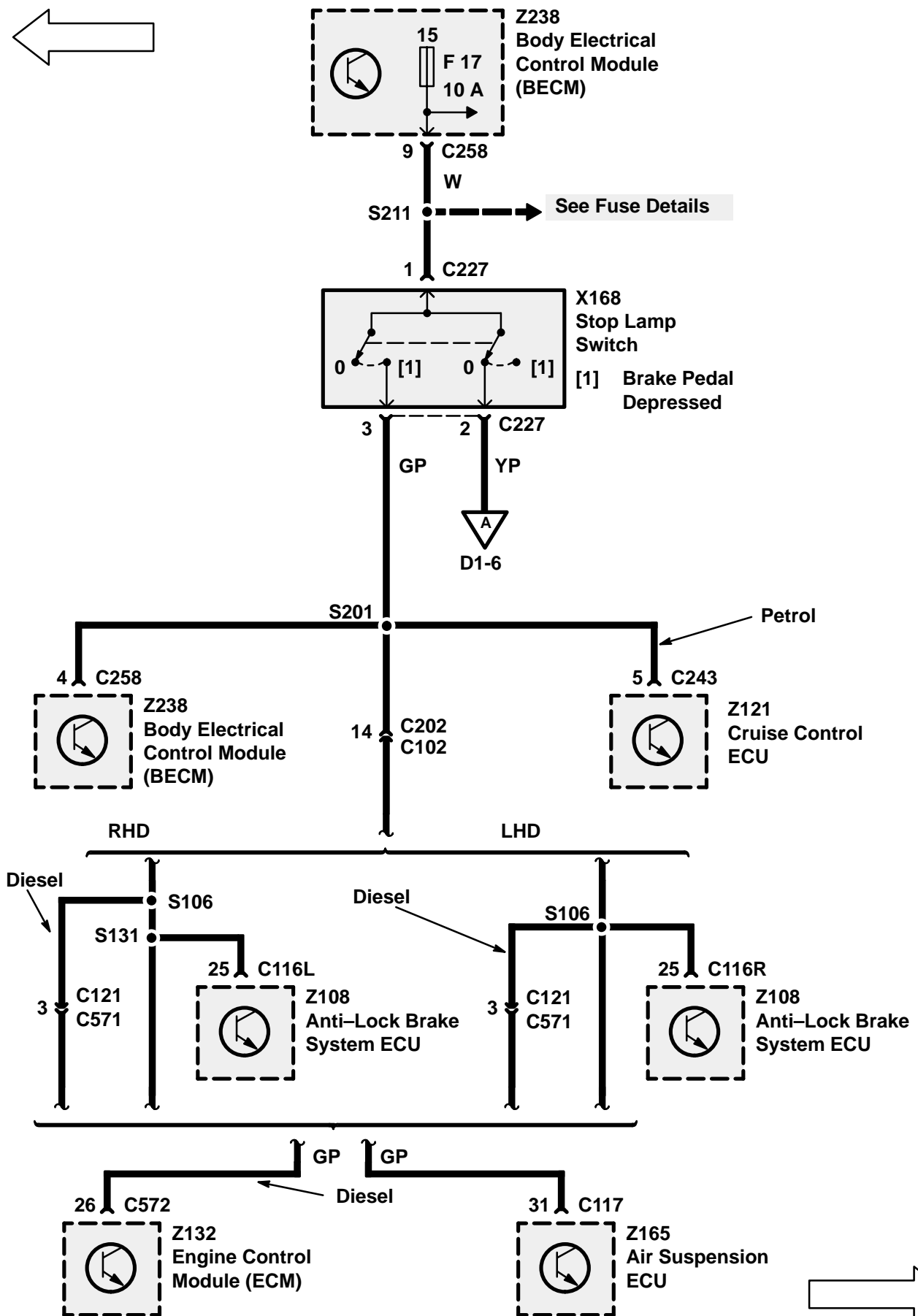
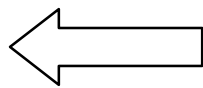

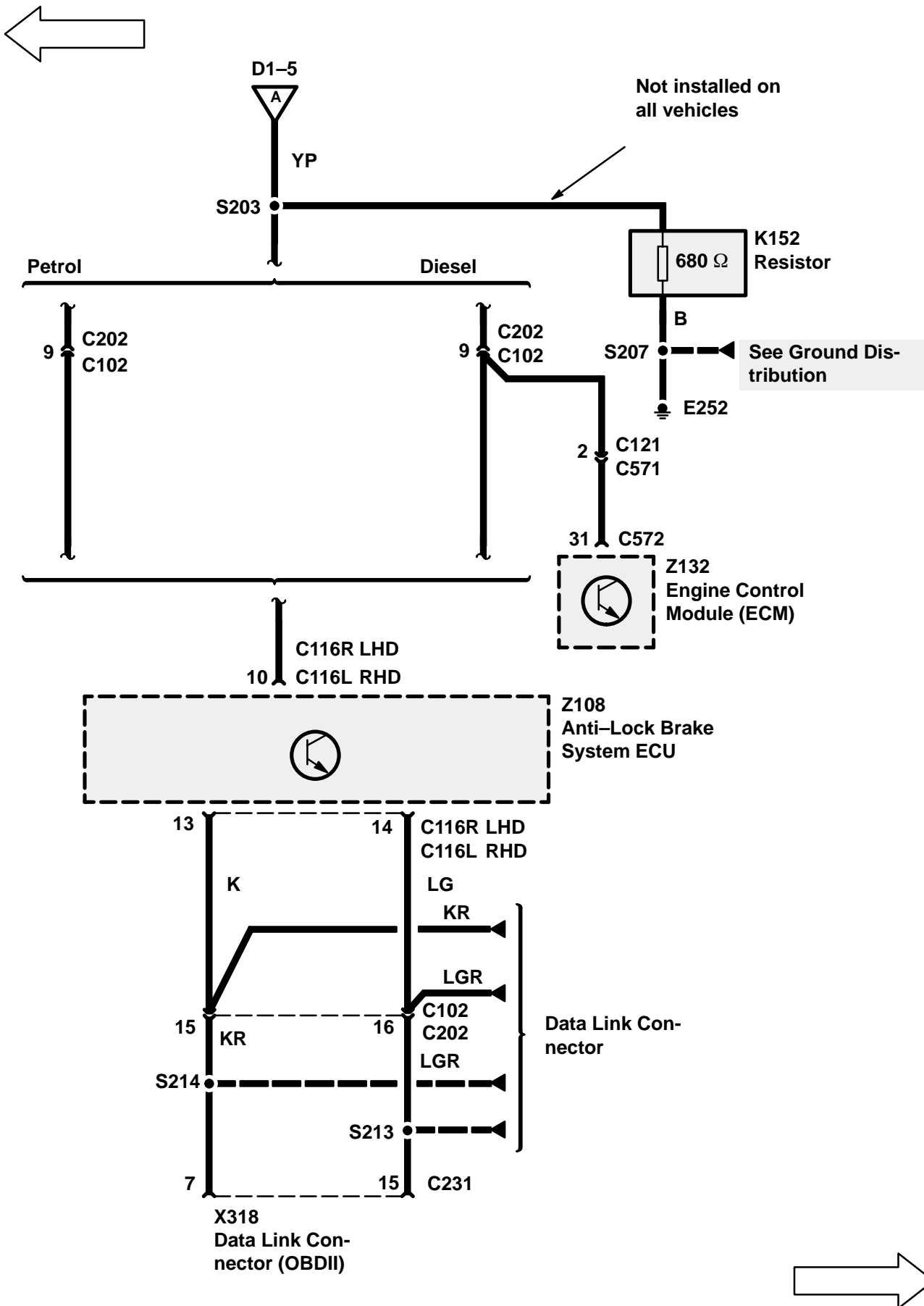

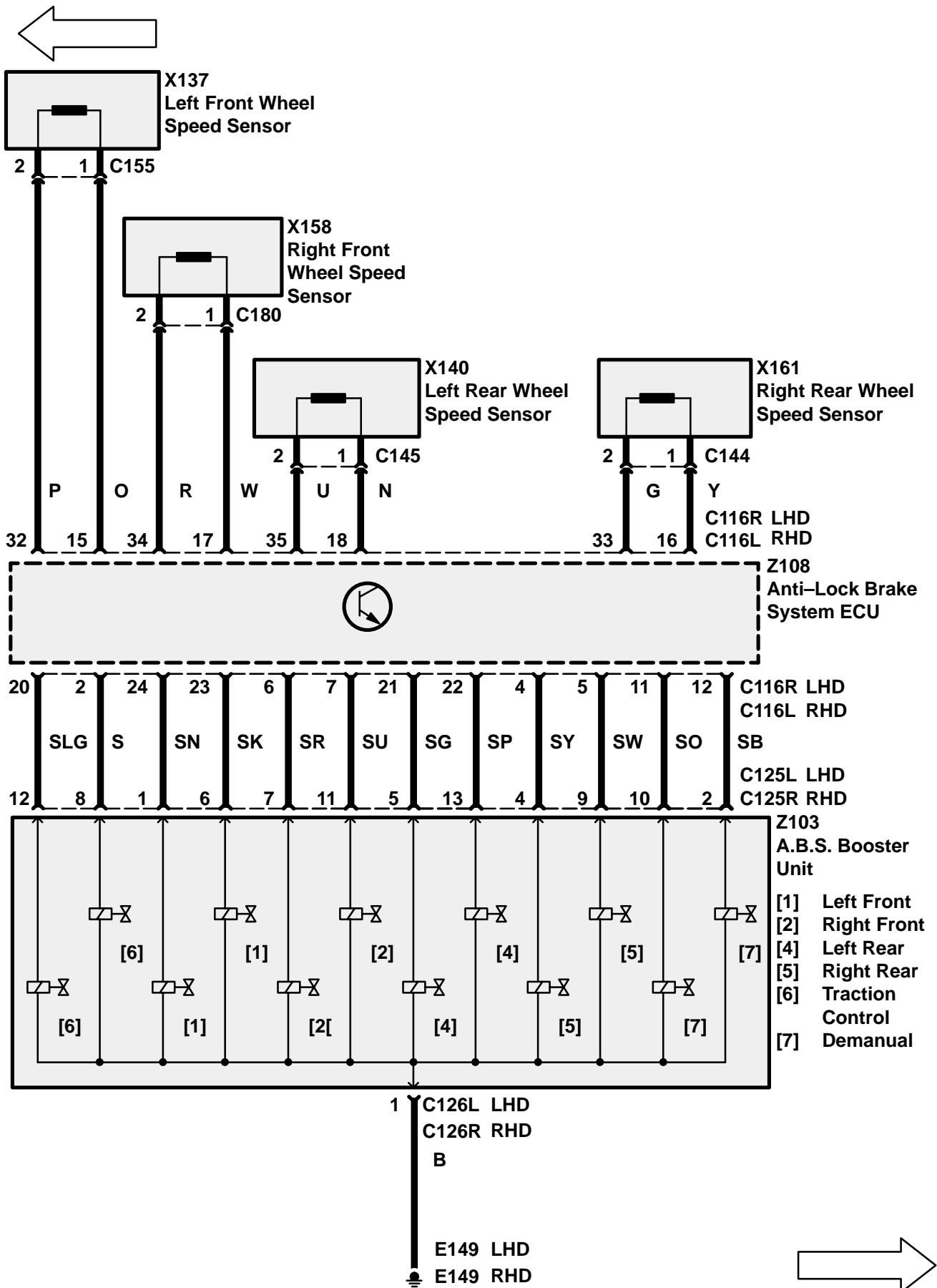

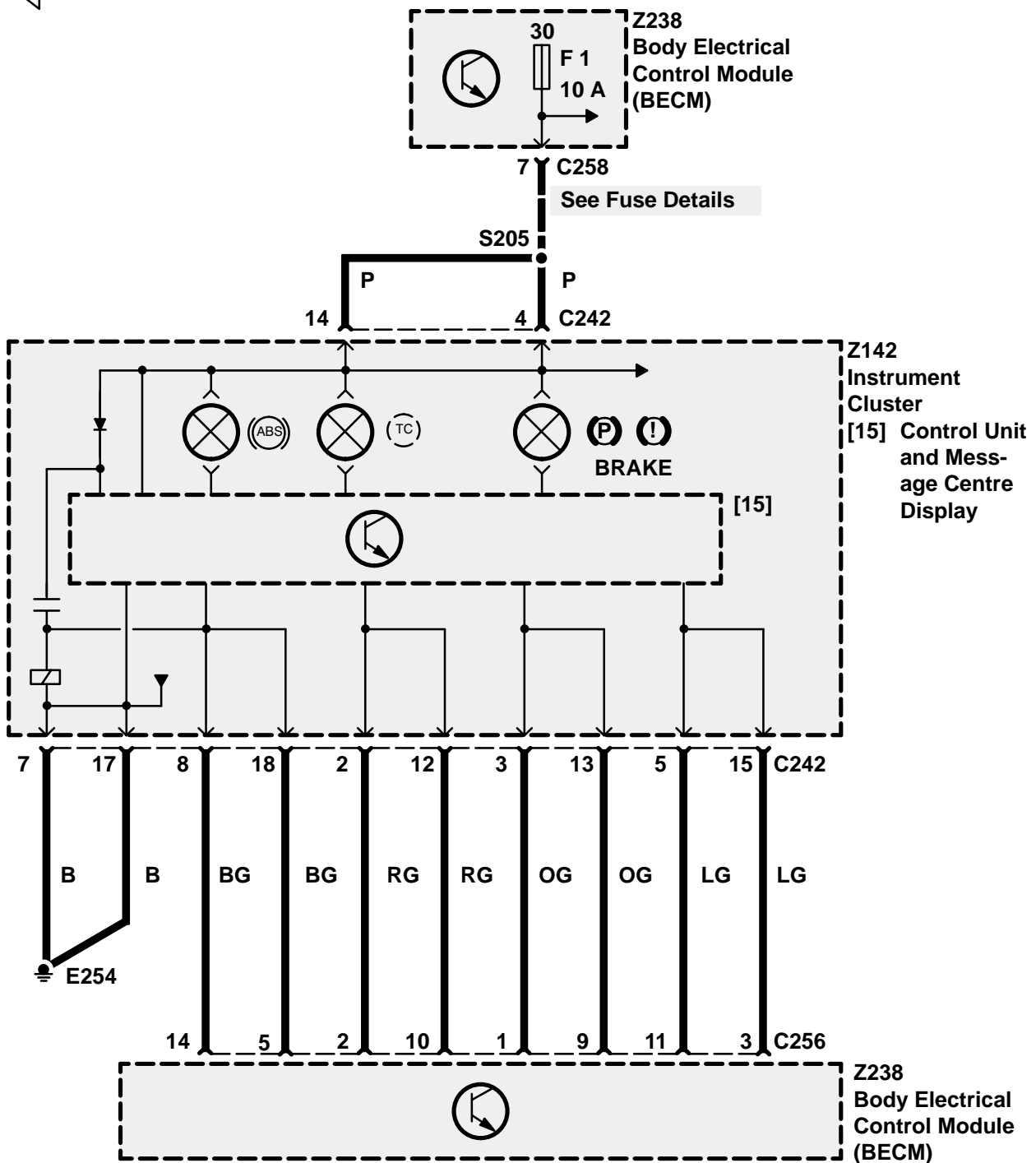
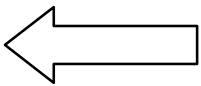

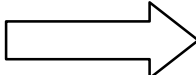
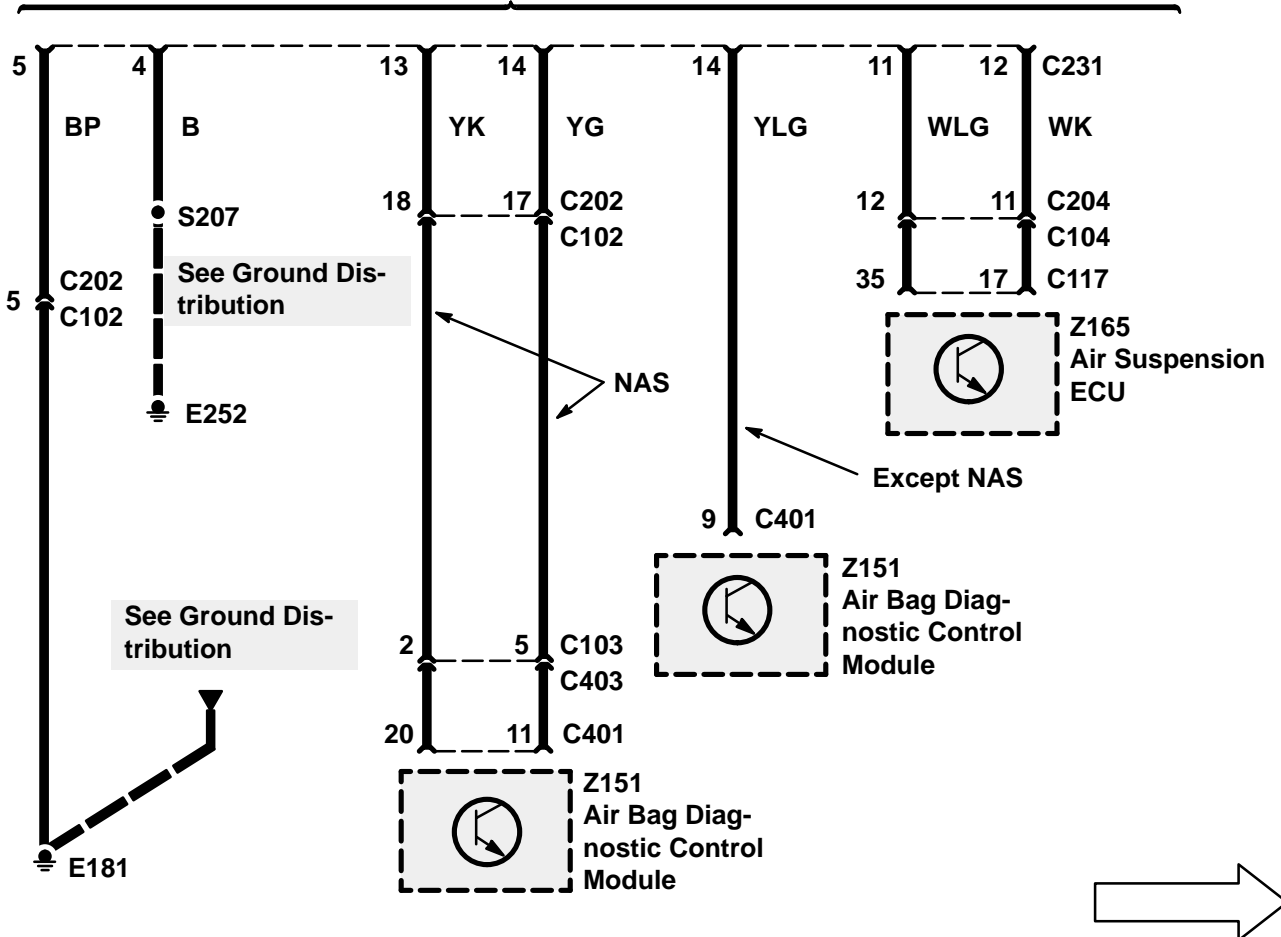
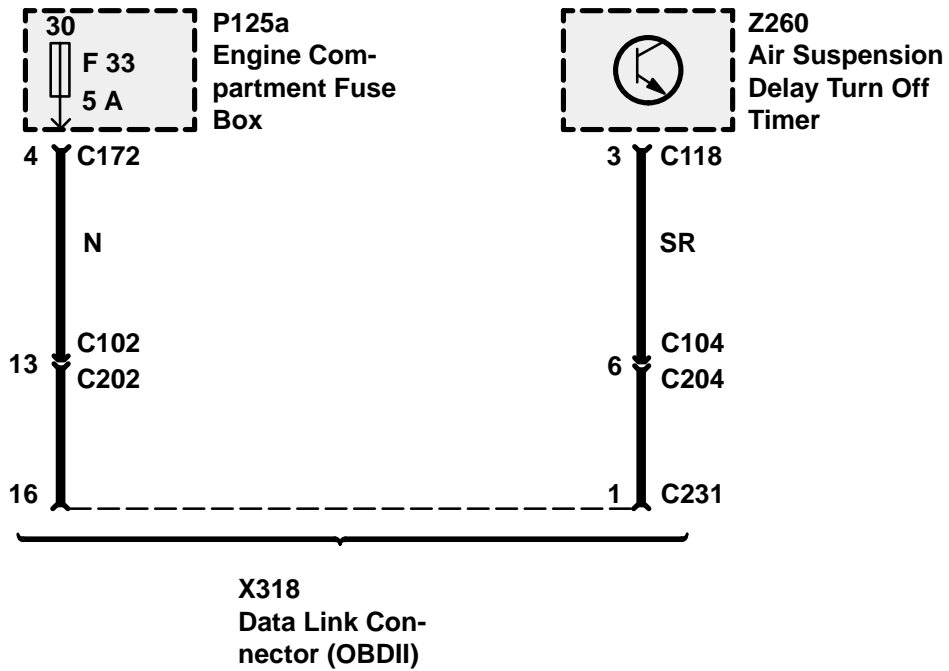

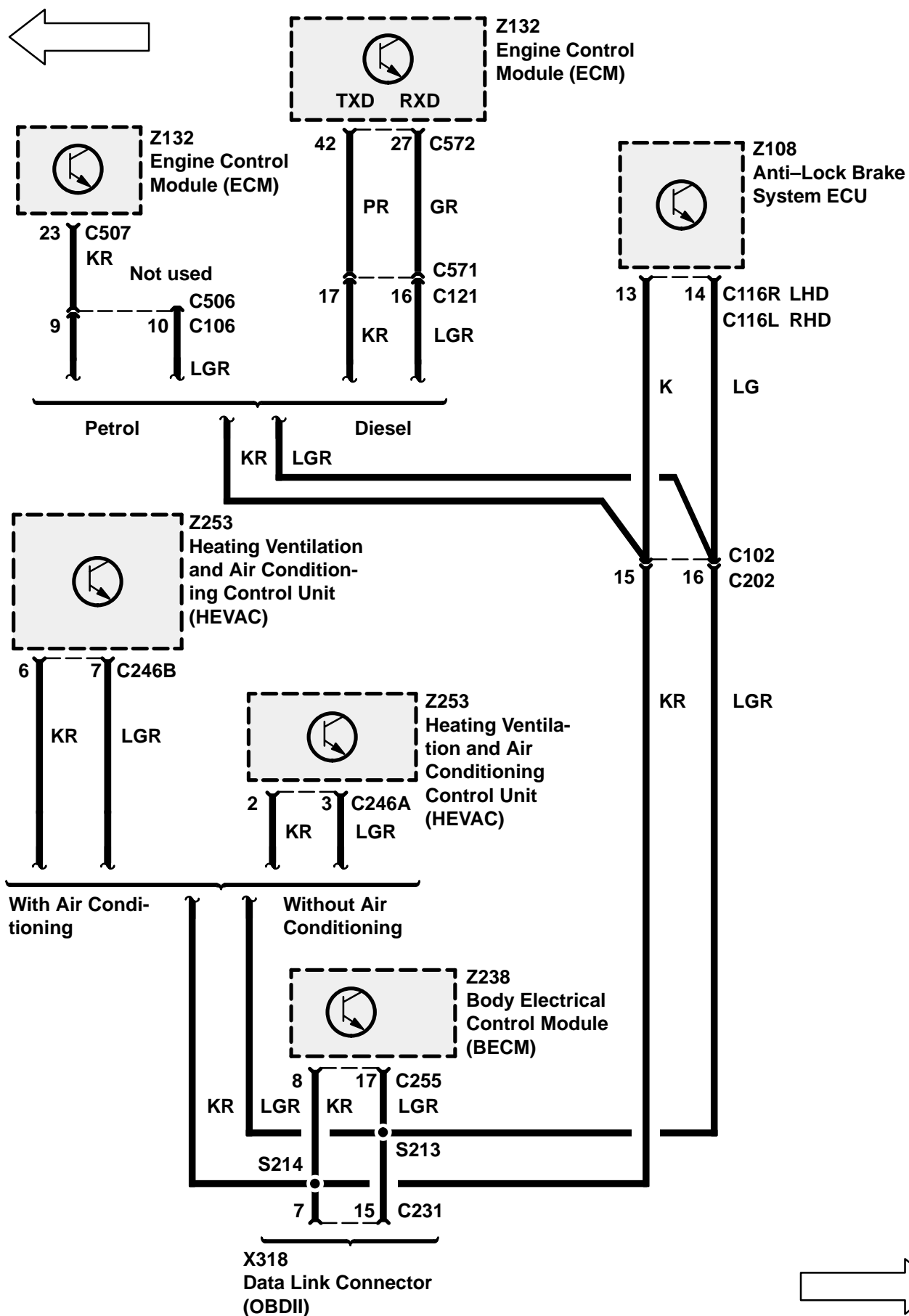

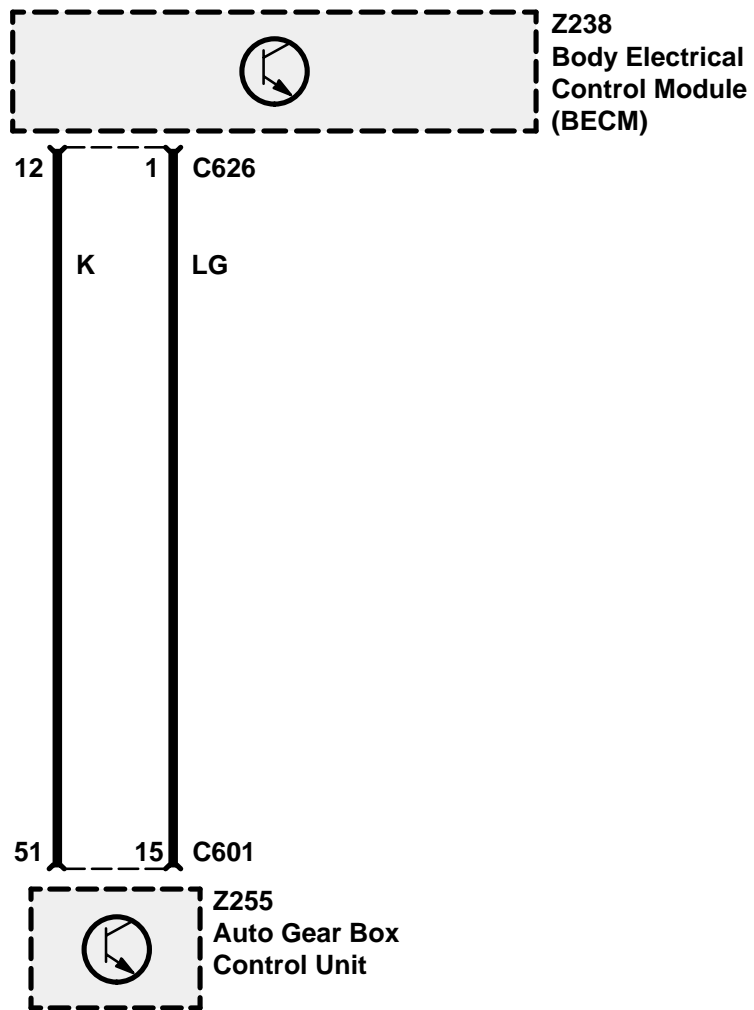
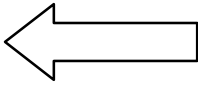

CIRCUIT OPERATION

Engine Coolant Temperature Gauge

The engine coolant temperature gauge sensor has the capability to sense from -40°C to $+130^{\circ}\text{C}$. Petrol and Diesel resistance values are different.

Both Petrol and Diesel sensors are interfaced to the Instrument Cluster (Z142) via the BeCM (Z238). The resistance value then being represented by an A/D data transfer generating the required angular deflection on this gauge. [A/D = Analog to Digital]

Fuel Gauge

When the fuel tank level is low ("E"), the resistance value of the gauge sensor is 270Ω for petrol and diesel engines. As the fuel level increases, the resistance of the sensor decreases. When the fuel tank is full, the resistance value of the sensor for petrol engines is 19Ω and for diesel engines 25.8Ω . When the fuel gauge sensors resistance value increases to 175Ω (9 liters/2.25 US gallons), the low fuel warning light will illuminate to warn of the fuel status. Both Petrol and Diesel sensors are interfaced to the Instrument Cluster (Z142) via the BeCM (Z238). The resistance values then being represented by an A/D data transfer generating the required angular deflection on the gauge.

Speedometer

The signal to activate the gauge is originated at the ABS wheel sensors, transmitted to the ABS ECU (Z108) which then puts out a usable signal to the Instrument Cluster (Z142) of 8000 pulses per mile or 4972 pulses per kilometer. The signal is also transmitted to other ECU's, such as the Engine Control Module (ECM) (Z132) and the Cruise Control ECU (Z121).

Tachometer

The tachometer will display the engine speed in R.P.M. It will derive the engine speed from the engine speed pulse train transmitted from the Engine Control Module (ECM) (Z132).

The pulse rate for petrol engines will be 4 pulses per engine revolution.

The pulse rate for diesel engines will be 3 pulses per engine revolution.

Audible Warning

Receipt of an audible warning request signal from a vehicle parameter/message condition shall cause the BeCM (Z238) to generate the required number of warning tones. The actuator sounder unit is located at the rear of the Instrument Cluster (Z142).

See message listing for categories/priority and levels of audible warnings.

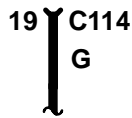
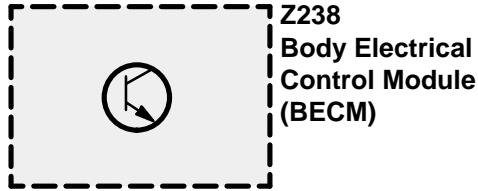
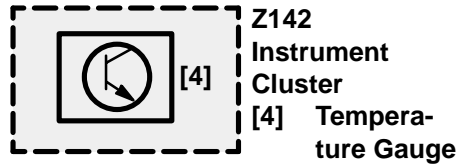
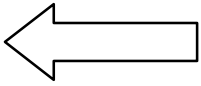

Petrol

Diesel

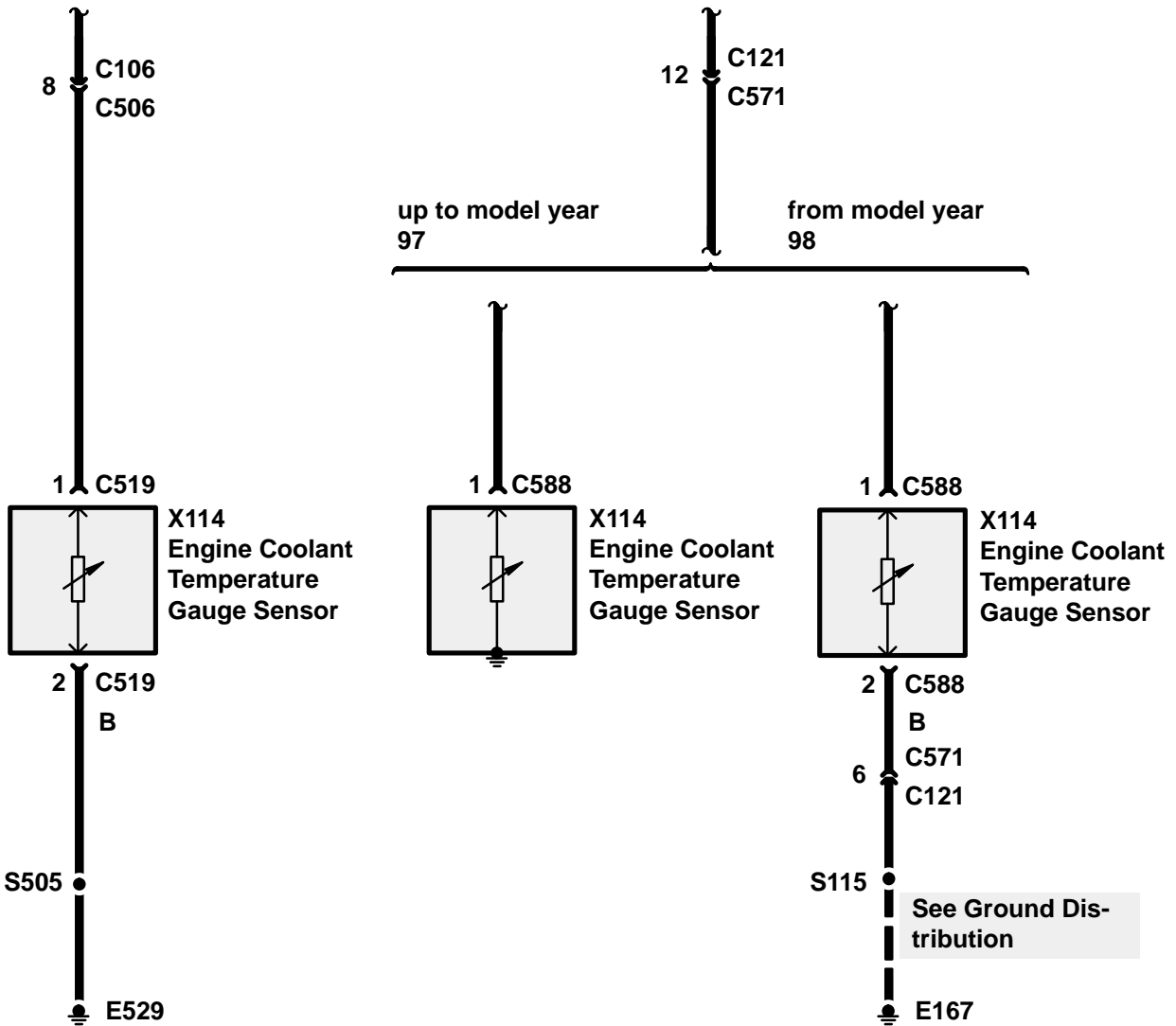

CIRCUIT OPERATION

All warning Indicators are controlled by Data sent to the Instrument Cluster (Z142) from the Body Electrical Control Module (BeCM) (Z238). All data is transmitted via the serial data lines. The BeCM (Z238) will provide data based upon input from various sensors.

Some warning lights may also be accompanied by a message which will appear in the message centre display on the instrument pack.

Service Reminder Indicator (SERVICE ENGINE)

Illuminates briefly (for 3 seconds) as a bulb check when the Ignition switch is turned to position II.

Illuminates continuously when the vehicle reaches 50,000 miles (80,500 km) approx.

Low Fuel Warning Indicator

Illuminates briefly (for 4 seconds) as a bulb check when the Ignition Switch is turned to position II.

When the fuel gauge sensors resistance value increases to 175Ω (9 liters/2.25 US gallons, the low fuel warning light will illuminate to warn of the fuel status. Both Petrol and Diesel sensors are interfaced to the Instrument Cluster (Z142) via the BeCM (Z238).

High Temperature Warning Indicator

Illuminates briefly (for 4 seconds) as a bulb check when the Ignition switch is turned to position II.

The engine coolant temperature gauge sensor has the capability to sense from -40°C to $+130^{\circ}\text{C}$. Petrol and Diesel resistance valves are different.

Both Petrol and Diesel sensors are interfaced to the Instrument Cluster (Z142) via the BeCM (Z238).

Malfunction Indicator Lamp (CHECK ENGINE)

Illuminates briefly when the Ignition Switch is turned to position II as a bulb check and extinguishes when the engine is running. Illumination at any other times indicates an engine fault.

Both Petrol and Diesel Engine Control Modules (Z132) are interfaced to the Instrument Cluster (Z142) via the BeCM (Z238).

Oil Pressure Warning Indicator

Illuminates as a bulb check when the Ignition switch is turned to position II, and extinguishes when the engine is running.

The Oil Pressure Switch (X149) is closed with Low Oil Pressure.

Both Petrol and Diesel switches are interfaced to the Instrument Cluster (Z142) via the BeCM (Z238).

ABS Warning Indicator

This light illuminates for approximately 1 second when the Ignition switch is turned to position II, and then briefly extinguishes before coming on again. The warning indicator will then remain illuminated until the vehicle is driven above approximately 5 mph (7 km/h). If the light does not extinguish or illuminates again then a fault has occurred with the ABS system.

If the light remains illuminated once a speed of 5 mph (7km/h) has been reached, or subsequently illuminates whilst driving, a fault has been detected by the self-monitoring system. The message centre will display 'ABS FAULT'.

The ABS System is interfaced to the Instrument Cluster (Z142) via the BeCM (Z238).

ETC Warning Indicator (TC)

Illuminates for 3 seconds after the Ignition switch is turned on and the ABS and traction control systems have completed their self-checks.

Whilst driving, the TC light will illuminate (for a minimum of 2 seconds) whenever traction control is active; the light extinguishing as soon as traction control ceases. The light flashing (for at least 10 seconds) indicates that the system has been over-used; it will be available again once the system components have cooled.

If the light illuminates continuously, a fault with the system is indicated.

The ABS System is interfaced to the Instrument Cluster (Z142) via the BeCM (Z238).

Brake Warning Indicator

Illuminates for 3 seconds as a bulb check when the Ignition switch is turned to position II and also illuminates when the handbrake is applied and the Ignition switch is in position II.

The light should extinguish when the handbrake is fully released or after the bulb check if the handbrake is off. If the light illuminates whilst driving, a fault is indicated.

NOTE: If the vehicle has been standing for some time, it may take up to 40 seconds before the light extinguishes (in this case, ABS and TC warning lights will also be illuminated).

The Brake System and Handbrake Switch (X191) are interfaced to the Instrument Cluster (Z142) via the BeCM (Z238).

Cruise Active Indicator

When the Cruise Control System has been activated the indicator will be illuminated. The Cruise System is interfaced to the Instrument Cluster (Z142) via the BeCM (Z238).

Charge Warning Indicator

Illuminates as a bulb check when the Ignition switch is turned to position II and extinguishes when the engine is running and the Generator (Z106) is producing normal power. If the Generator (Z106) is not producing normal power or the Generator (Z106) stops turning the indicator will illuminate.

Both Petrol and Diesel Generators (Z106) are interfaced to the Instrument Cluster (Z142) via the BeCM (Z238).

Fasten Seat Belt Indicator

Illuminates for 6 seconds when the Ignition switch is turned to position II. When the driver's seat belt is buckled, the indicator turns off.

The Driver's Seat Belt Switch (X120) is interfaced to the Instrument Cluster (Z142) via the BeCM (Z238).

Air Suspension Indicator

Illuminates as a bulb check when the Ignition switch is turned to position II and remains illuminated until 2 seconds after the engine has started.

In addition, the light will illuminate whilst driving whenever 'High' or 'Extended' ride heights are selected, and also if a fault with the air suspension system is detected.

The air suspension system is interfaced to the Instrument Cluster (Z142) via the BeCM (Z238).

Lights "ON" Indicator

This light illuminates when the sidelights and/or headlights are switched on. It will not illuminate when parking lights or headlight delay are in operation.

The Main Light Switch is interfaced to the Instrument Cluster (Z142) via the BeCM (Z238).

Direction Indicators

The left or right warning indicator flashes in time with the corresponding left or right direction indicator lamps whenever they are operated. A warning indicator flashing twice the normal speed indicates that a direction indicator lamp bulb has failed (the message centre will indicate which bulb is faulty). If a trailer is connected and a rear indicator lamp bulb fails then the message will not be displayed. When the hazard switch is pressed, both warning indicators will illuminate in conjunction with the indicator lamps.

The Direction Indicator switches are interfaced to the Instrument Cluster (Z142) via the BeCM (Z238).

Main Beam Indicator

This indicator illuminates whenever the main beam headlights are on.

The Main Beam Switch is interfaced to the Instrument Cluster (Z142) via the BeCM (Z238).

Trailer Indicator

This indicator is only operative when a trailer is connected to the vehicle via a multi-pin socket. The indicator flashes in conjunction with the vehicle direction indicator lamps, thus confirming that the trailer indicator lamps are operating correctly. In the event of a failure of a trailer direction indicator lamp, the warning indicator will not illuminate.

The Trailer Auxilliary Socket is interfaced to the Instrument Cluster (Z142) via the BeCM (Z238).

Glow Plug Indicator

This indicator illuminates when the Engine Control Module (Z132) activates the Glow Plug Timer Unit (Z135).

The Engine Control Module (Z132) is interfaced to the Instrument Cluster (Z142) via the BeCM (Z238).

Catalyst Warning Indicator (Japan Only)

This indicator illuminates when a fault in the catalyst system is detected.

The Catalyst Overheat Sensors (X299, X300) and the Catalyst Amplifier (X301) are interfaced to the Instrument Cluster (Z142) via the BeCM (Z238).

Audible Warning

Receipt of an audible warning request signal from a vehicle parameter/message condition shall cause the BeCM (Z238) to generate the required number of warning tones. The actuator sounder unit is located at the rear of the Instrument Cluster (Z142).

See message listing for categories/priority and levels of audible warnings.

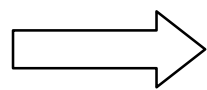
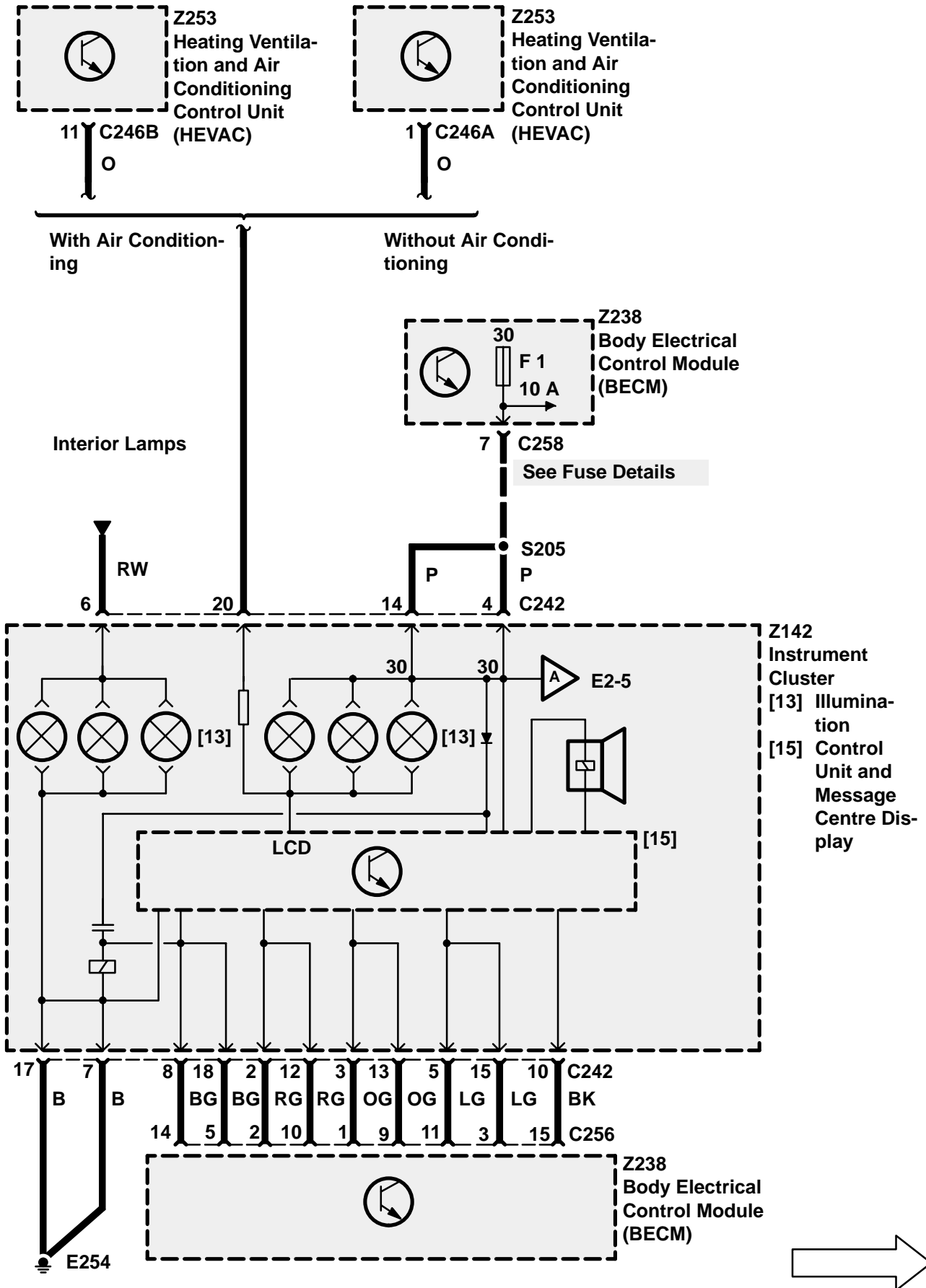

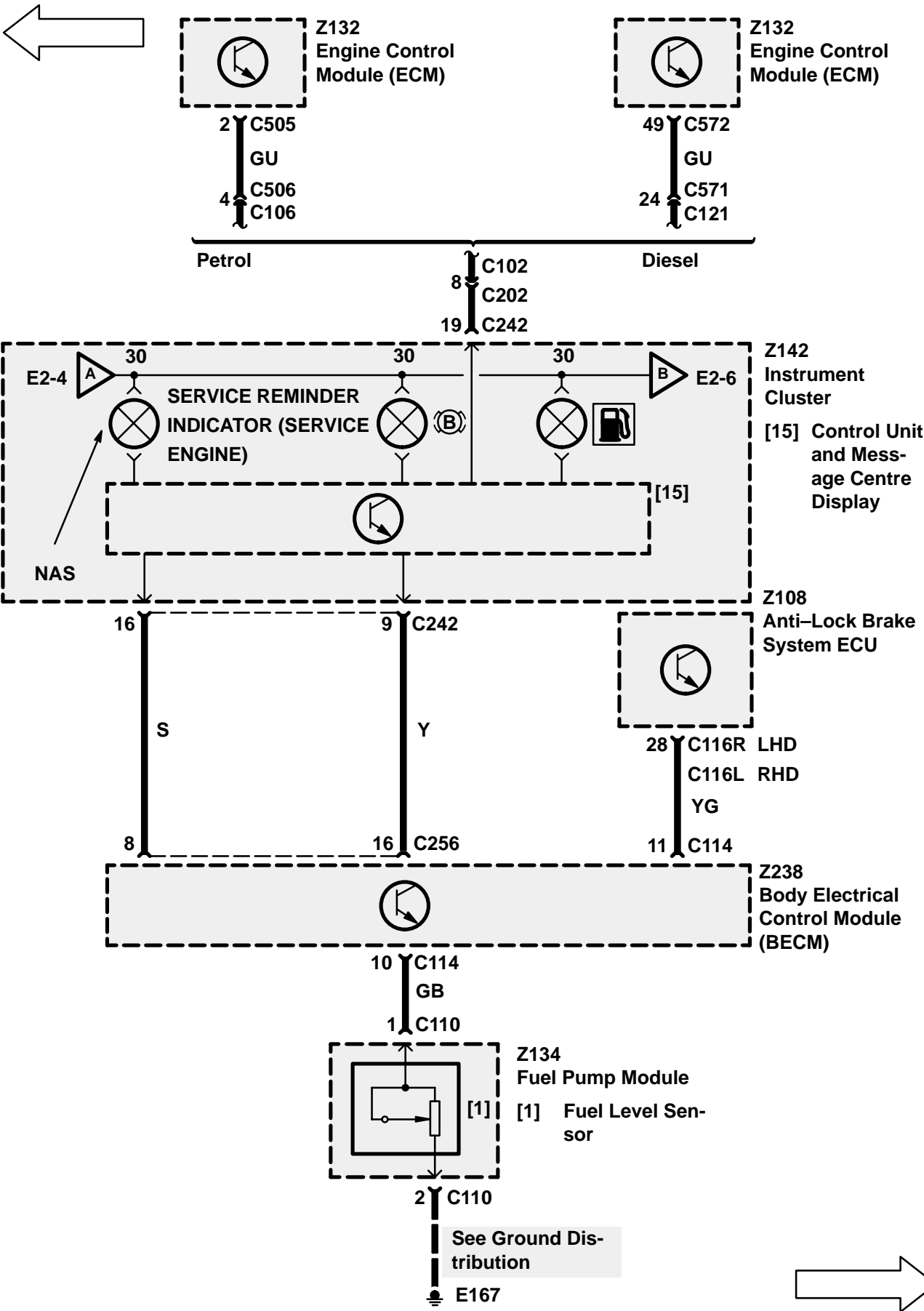

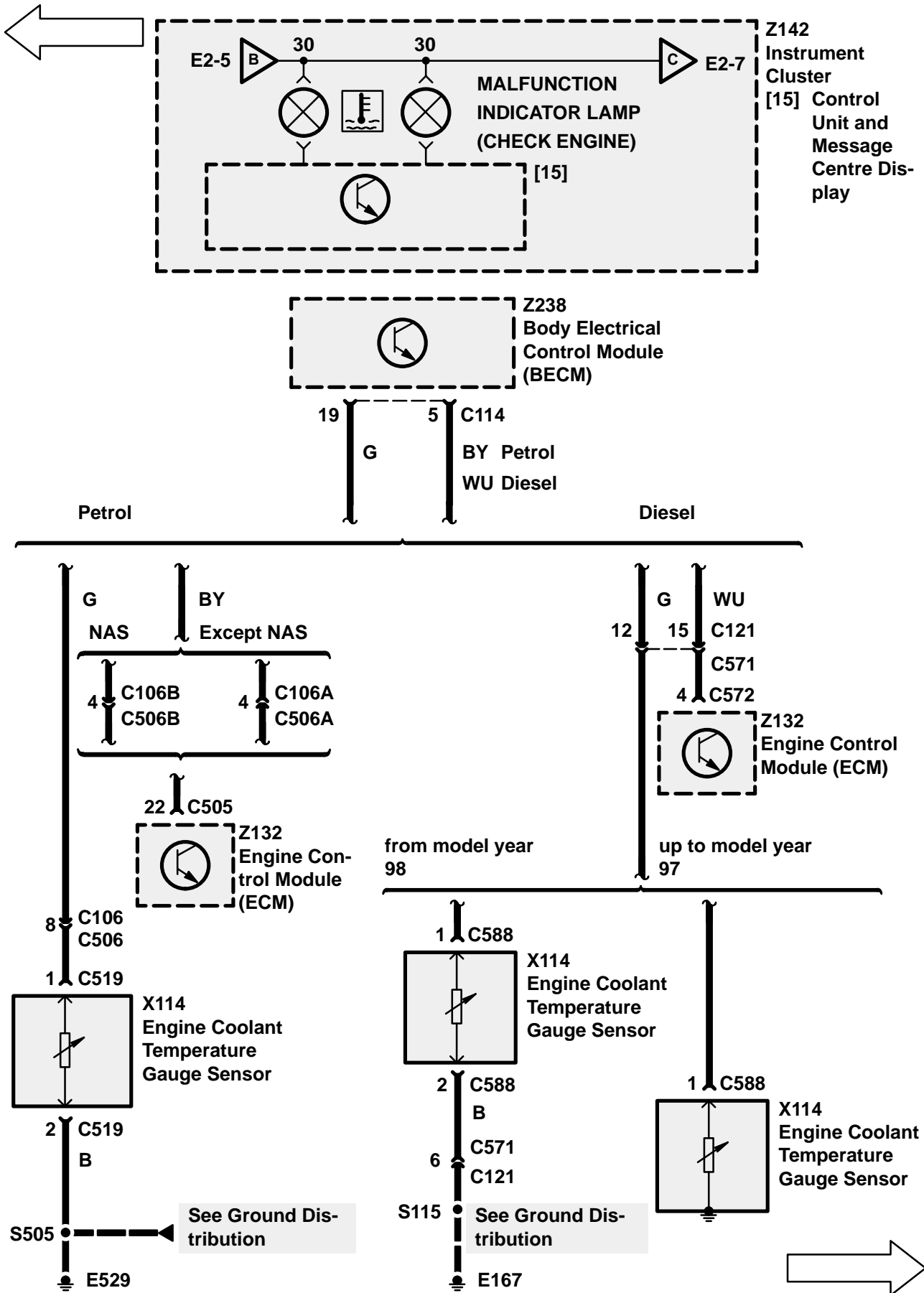

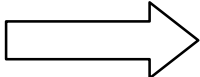
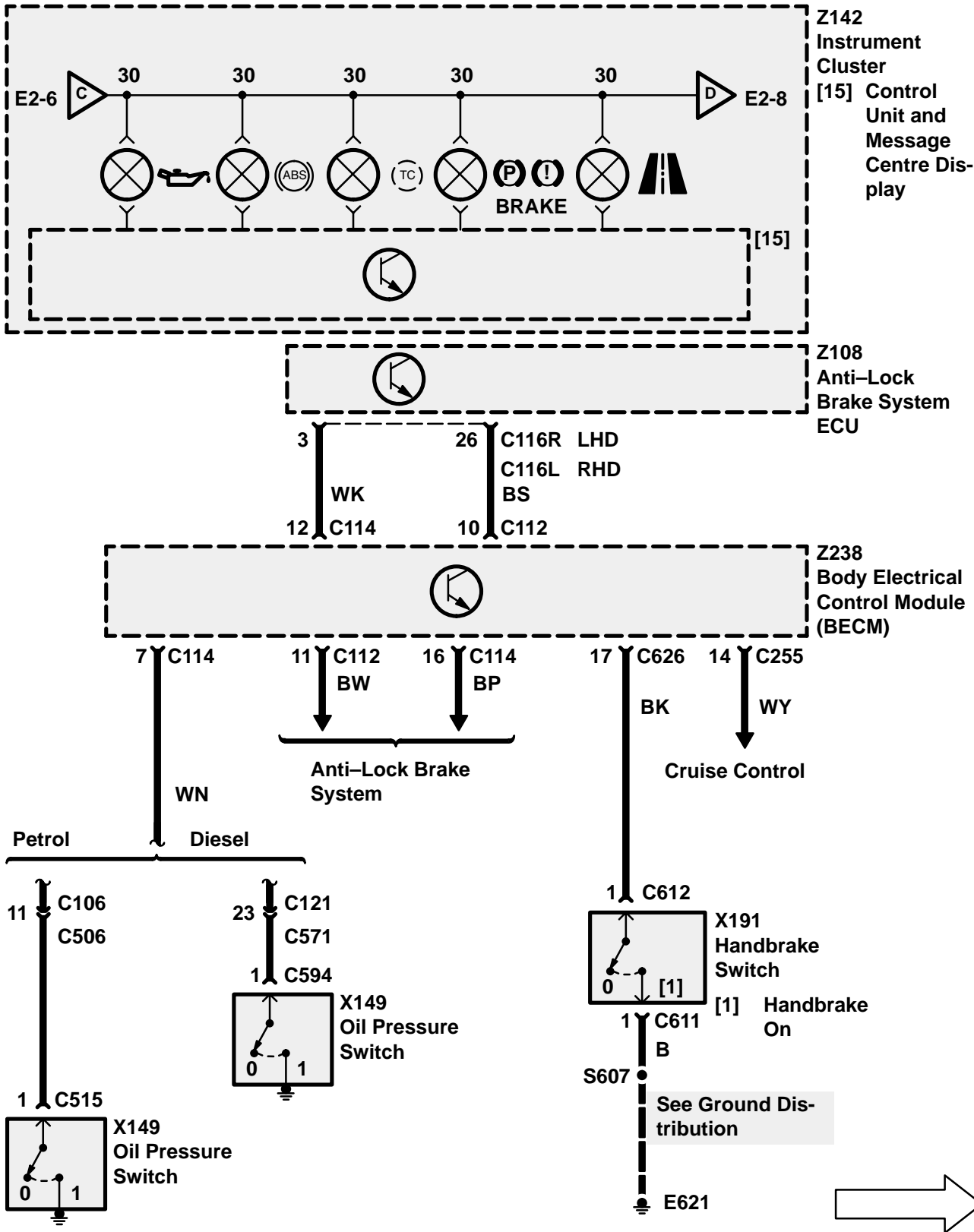
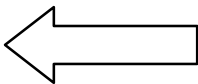

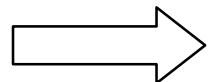
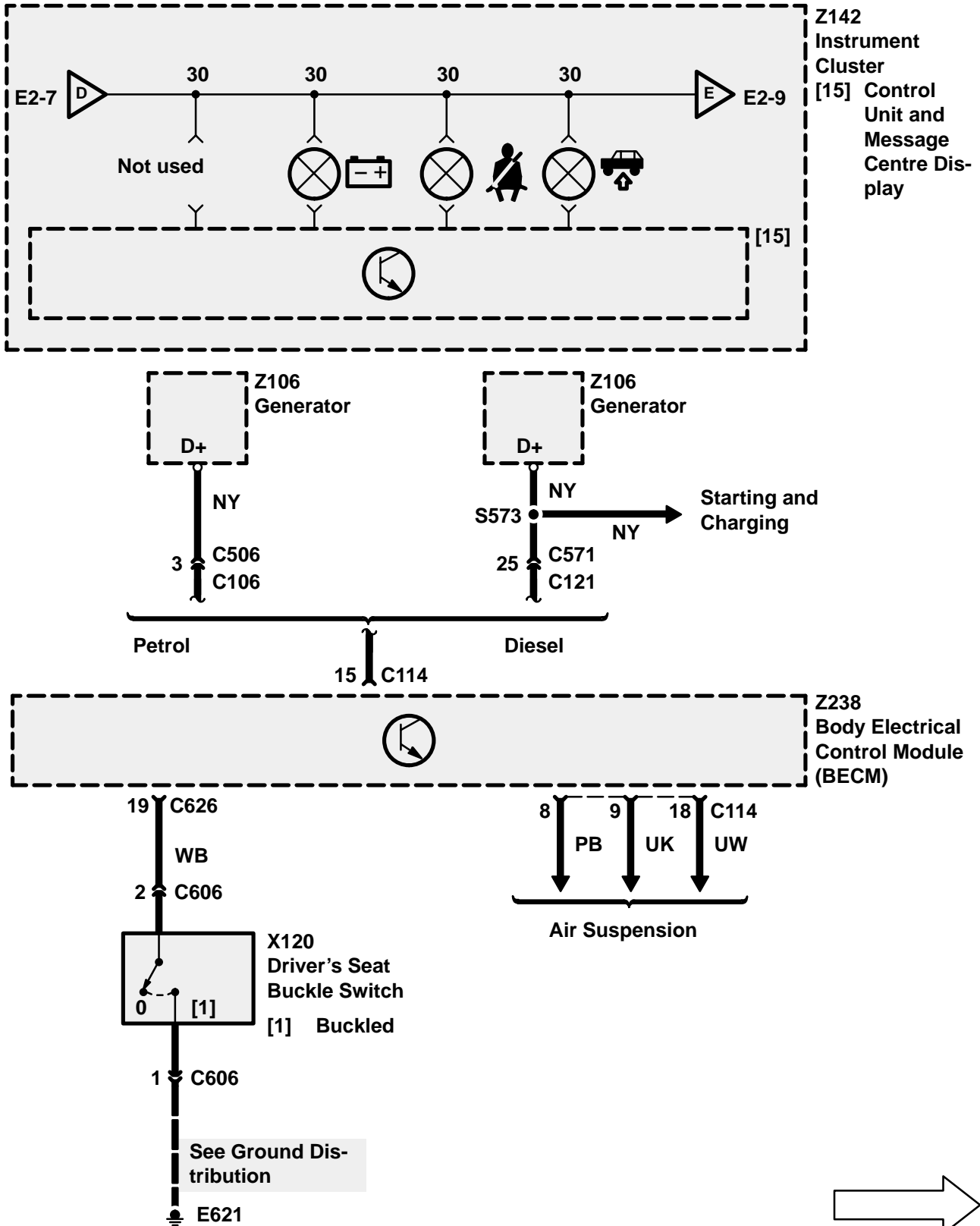
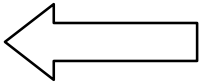

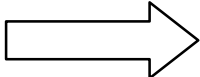
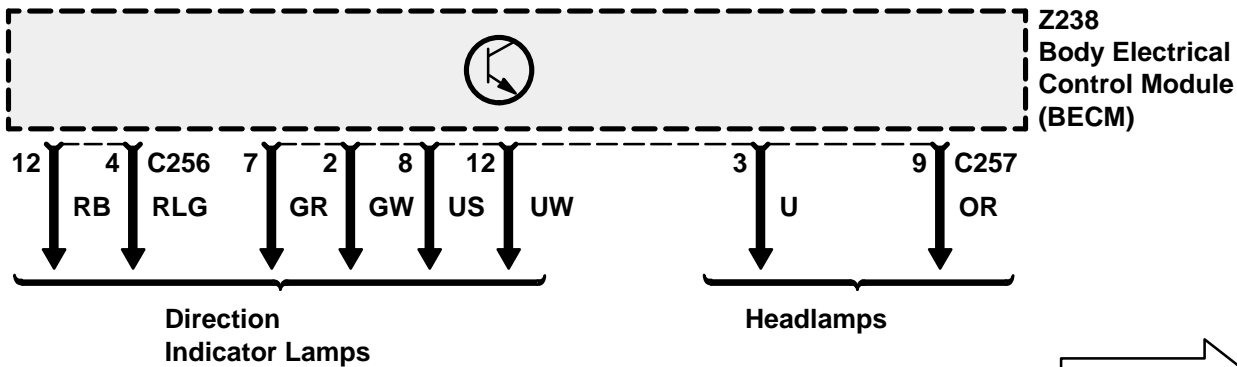
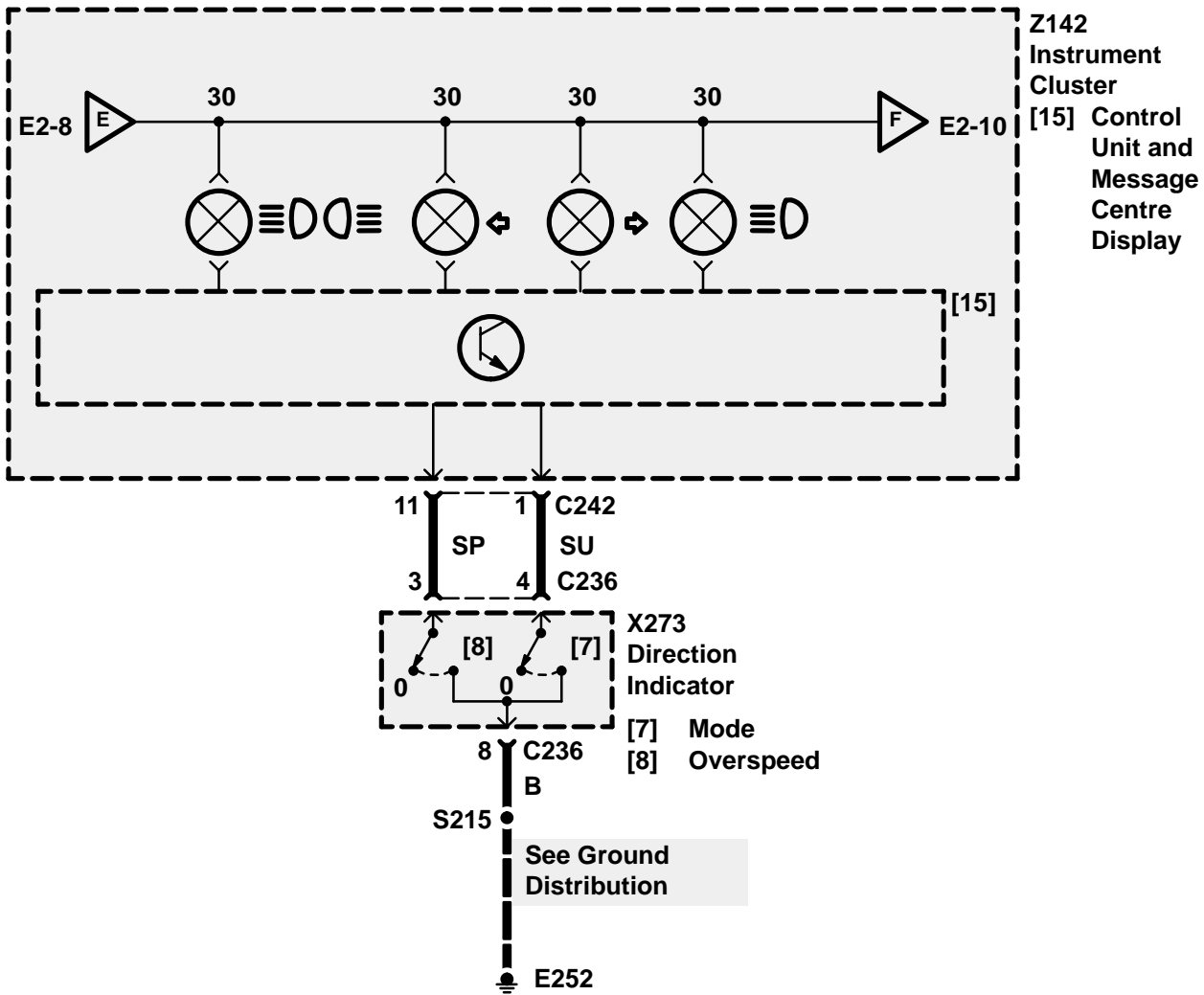
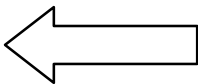

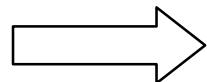
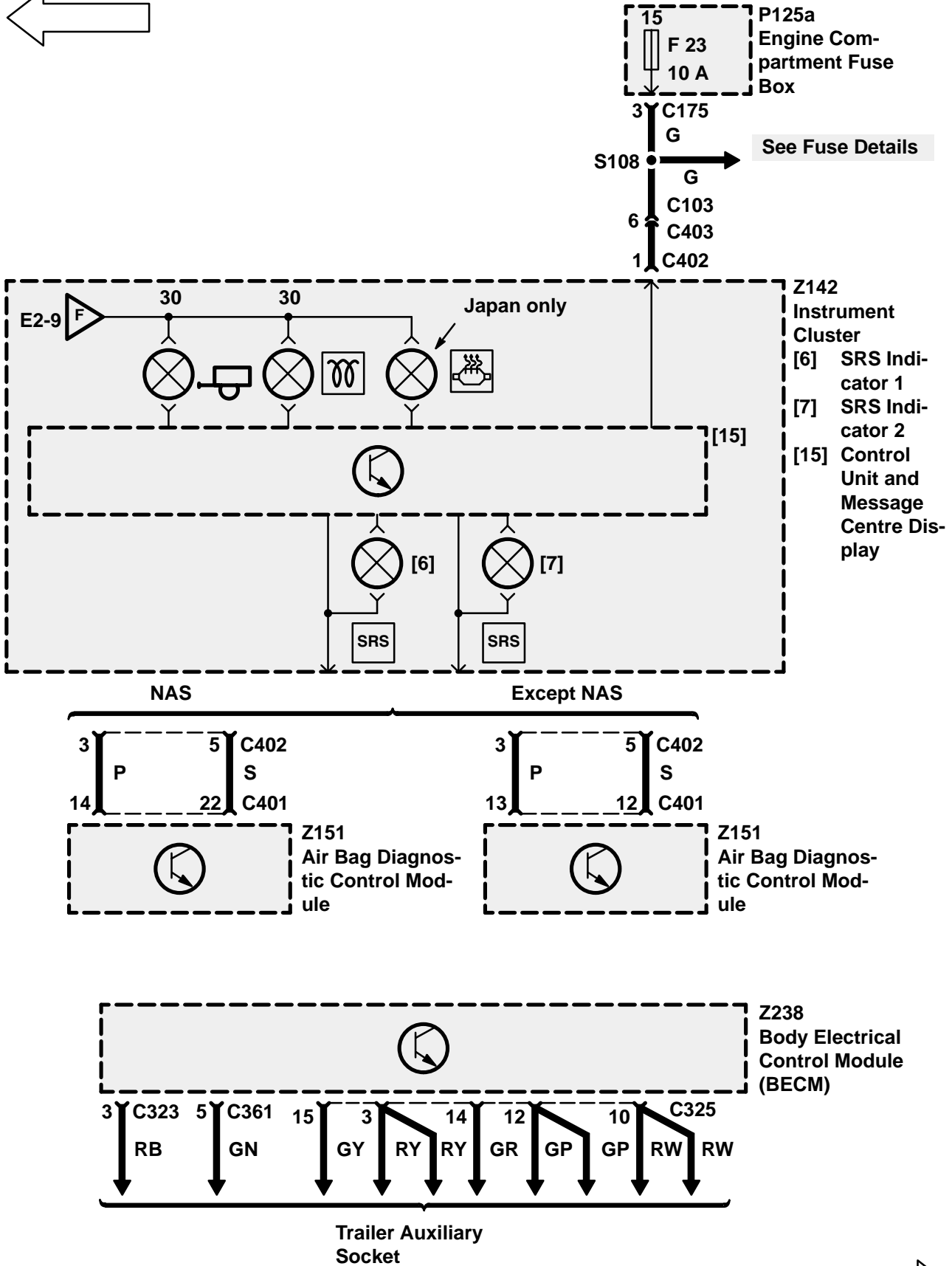
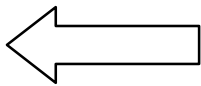

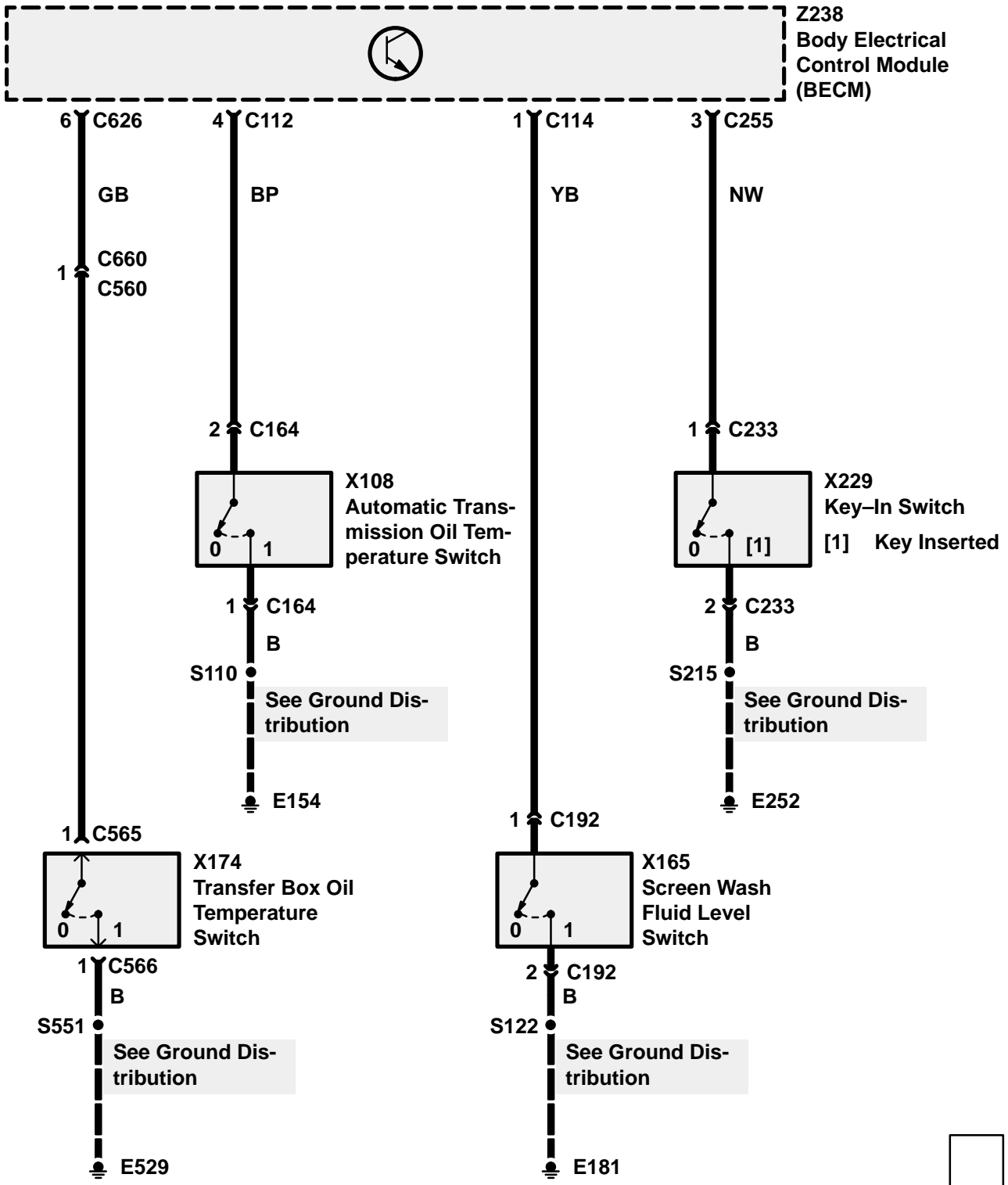
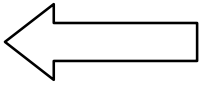

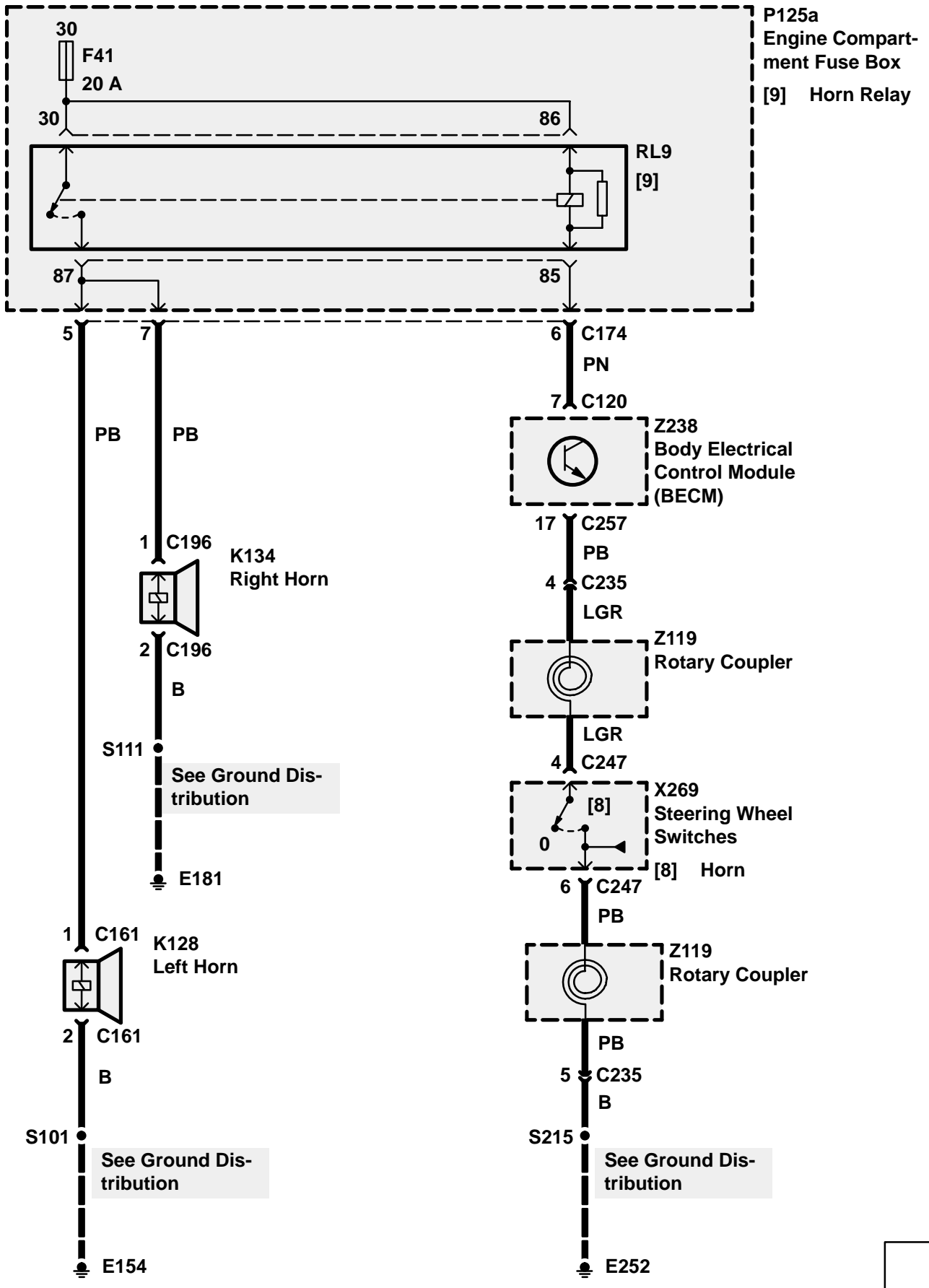

CIRCUIT OPERATION

Battery Voltage is provided to the radio at all times through the P wire. In addition to the anti-theft feature, this input voltage keeps the preset station memory alive. Whenever battery power to the unit is lost, the anti-theft code must be entered and the preset stations must be reprogrammed.

When the Radio (Z111) and the ignition are turned on, the voltage signal through the WK wire to the control head 'wakes up' the unit. The Radio (Z111) plays, the LCD display comes on and the control buttons illuminate. On some models, when the park lamps or headlamps are turned on, a voltage signal is sent through the RW wire to dim the LCD display and control buttons for night driving.

Radio (Z111) signals are received via a coaxial cable from the side screens and antenna amplifiers. The amplifiers filter and boost the signal from the side screen, using power supplied on WO wires, whenever the Ignition Switch (X274) is in position I or II.

The CD Changer (Z114) is permanently supplied with power through the P wire via the radio and a DIN cable.

For the new Range Rover, three levels of factory-fitted in-car entertainment are available.

The mid/low line radio has the following features: Electronically tuned AM/FM cassette radio (Z111), RH antenna amplifier (Z178) for AM/FM signals and 6, 8 or 10 speakers.

The high line (NAS/JAPAN) radio has the following features: Electronically tuned AM/FM cassette radio (Z111), RH antenna amplifier (Z178) for AM/FM signals, LH antenna amplifier (Z177) for FM signals only, 4 door speaker amplifiers (Z241, Z242, Z245, Z246), a subwoofer amplifier (Z176), a CD changer (Z114) and 10 speakers plus a subwoofer speaker (K146).

Subwoofer

The subwoofer amplifies frequencies between 20 and 150 Hz to give an enhanced bass sound.

Subwoofer Amplifier

The Subwoofer (K146) is supplied with power and ground from the Subwoofer Amplifier (Z176) via two separate channels which consist of 4 BW/B wires. The subwoofer amplifier (Z176) is permanently

supplied with power on the P wire, but it is only switched on when the radio supplies a signal on the SB wire.

Speaker Amplifier

The Speaker Amplifiers (Z241, Z242, Z245, Z246) are situated in the 4 doors and are supplied with permanent power via the P wire. They are switched on when the radio sends a signal on the SB wire. The speaker amplifiers (Z241, Z242, Z245, Z246) have one channel for the bass speakers (K202, K203, K209, K220) and a second for the midrange speakers (K200, K201, K2111, K212) and tweeter speakers (K197, K198) (front doors only). The tweeter incorporates a capacitor to filter the signals.

Side Screen Antenna

The antenna is printed into the rear side screen. For NAS and Japan, the element is fitted in both rear side screens. This is referred to as a diversity antenna system. Other markets have a single element in the right hand screen only. Diversity reception means that as vehicle movement results in loss of signal due to reflections from buildings (known as multipath distortion), the radio will switch to the antenna receiving the strongest signal. This results in less interference and better stereo performance.

Antenna Amplifier

Antenna amplifiers are in the LH and RH side of the luggage compartment behind trim panel. The FM and AM amplifier would be located on the right hand side, and the FM only amplifier is located on the left hand side.

Speakers

Trim level 1/2 – The low/midline radio is equipped with 6, 8 or 10 speakers fitted in the doors. The midrange speakers (K200, K201, K211, K212) are filtered by capacitors in the wires (K239, K240, K247, K248) and the tweeter speakers (K197, K198) filter the signals by built-in capacitors.

Trim level 3 – the high line is equipped with 10 speakers like the trim level 1/2, but they all receive power and ground via 4 additional speaker amplifiers. The signals for the tweeter speakers (K197, K198) are filtered by their internal capacitors, similar to the mid/low line tweeters.

Low Line Radio

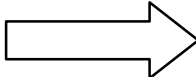
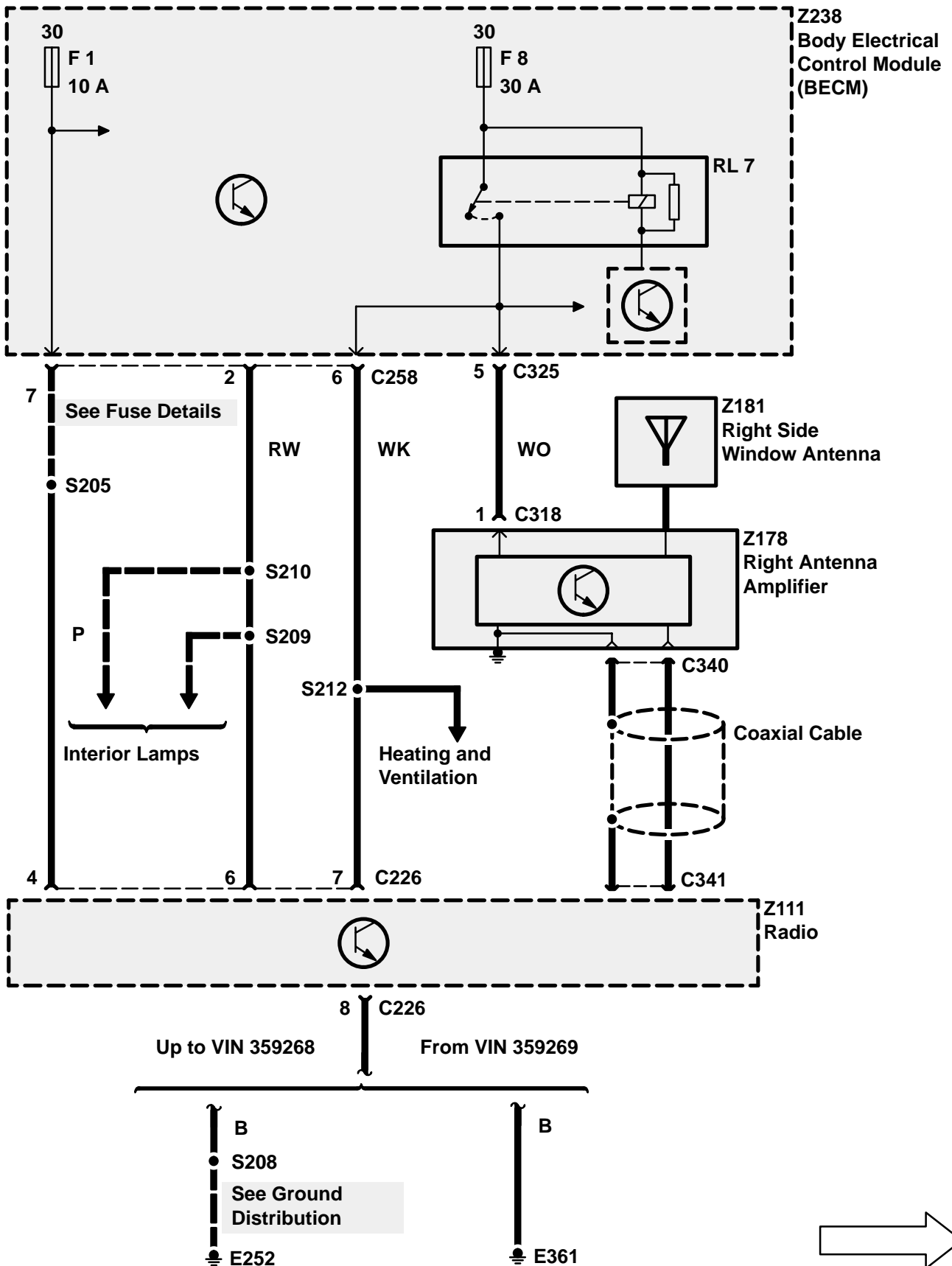

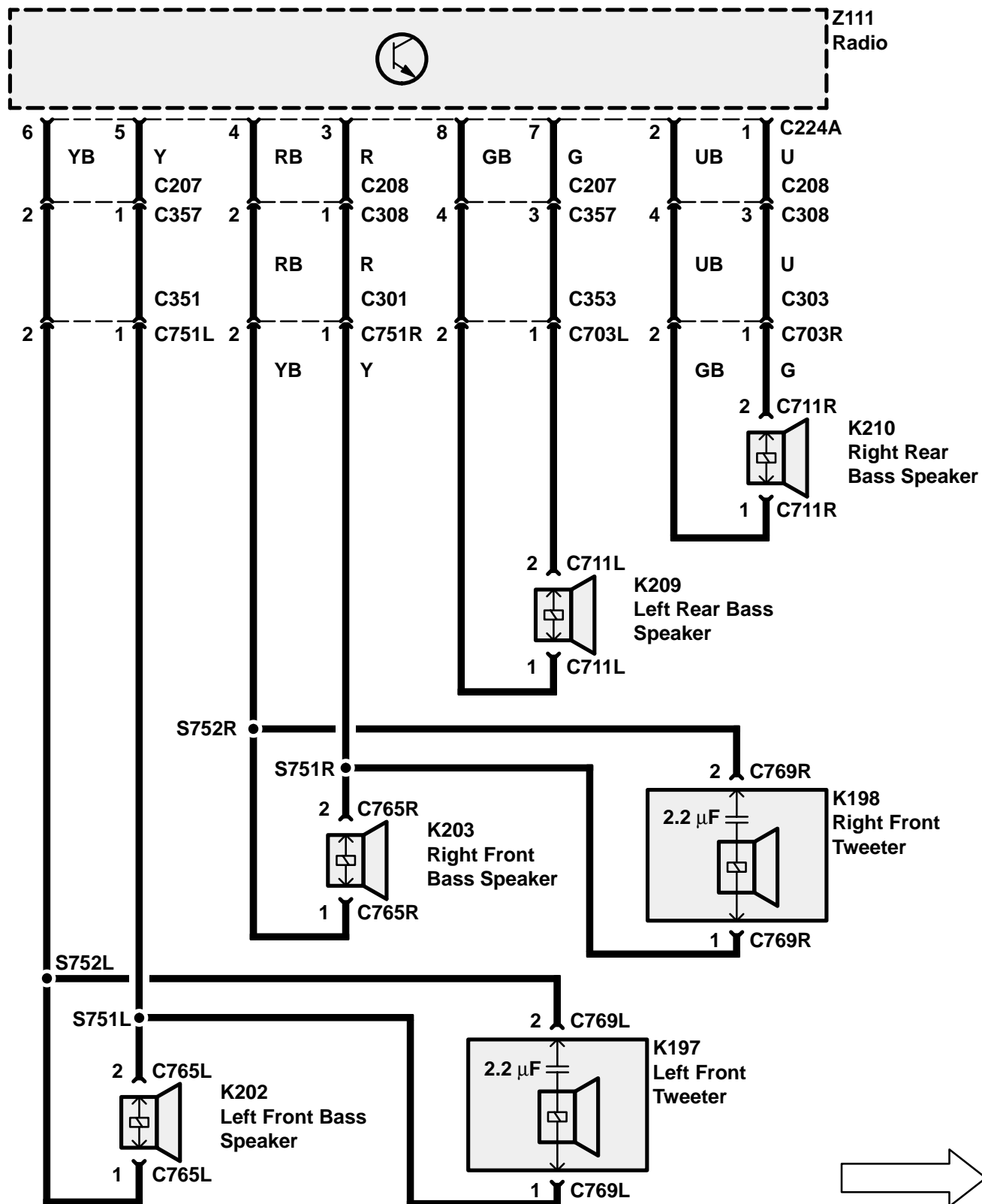
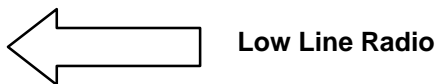

← Mid Line Radio

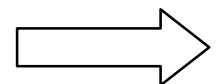
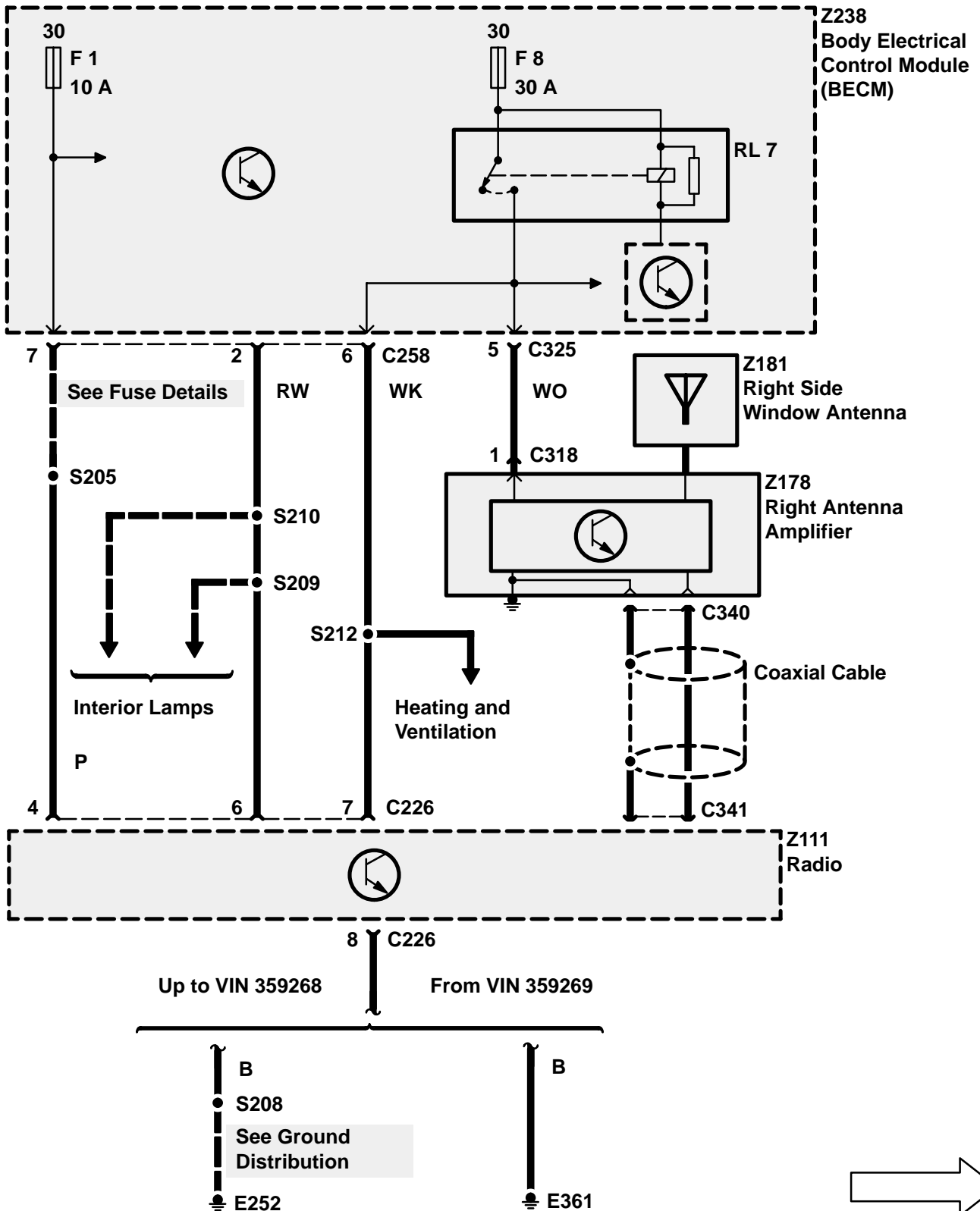

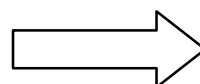
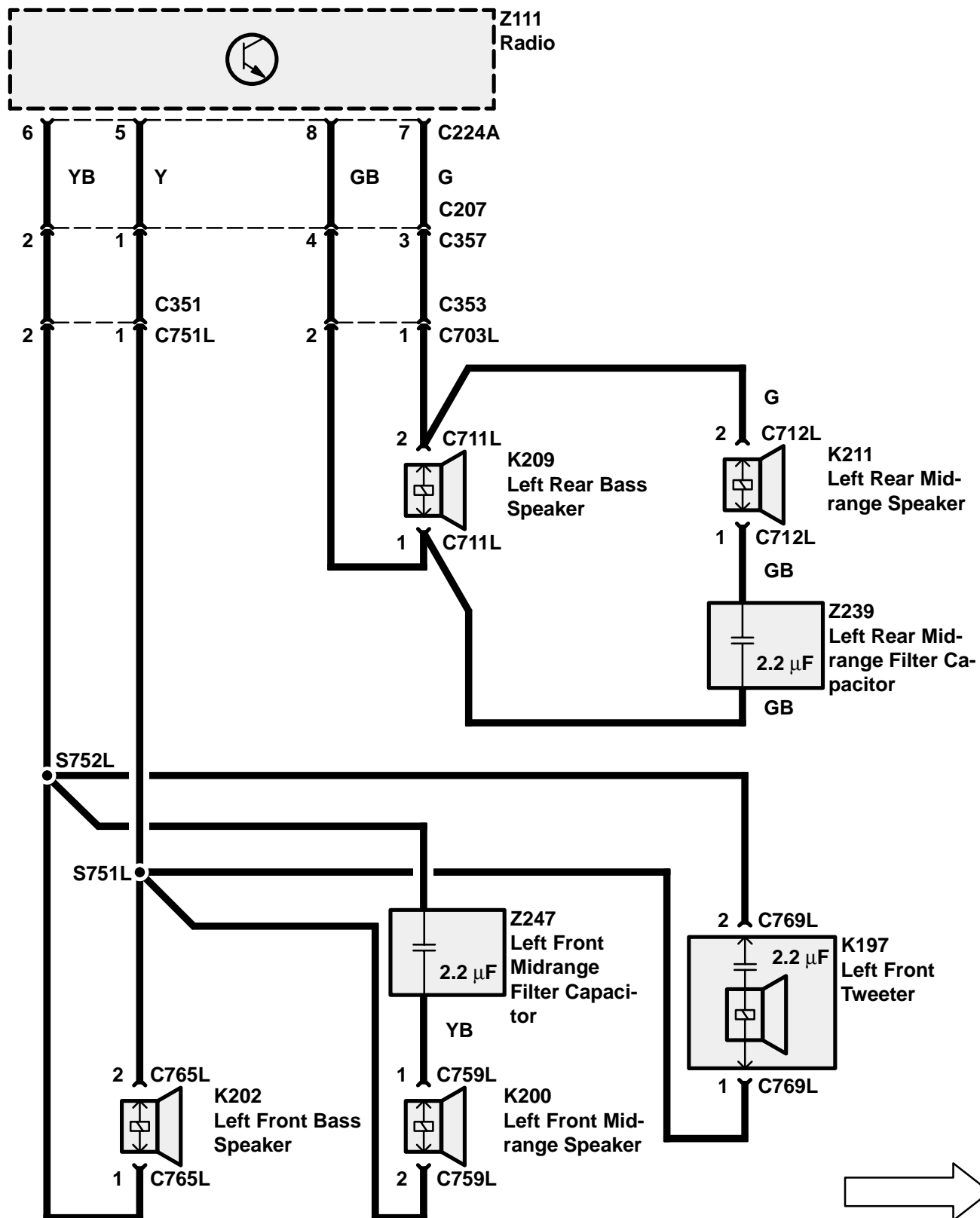

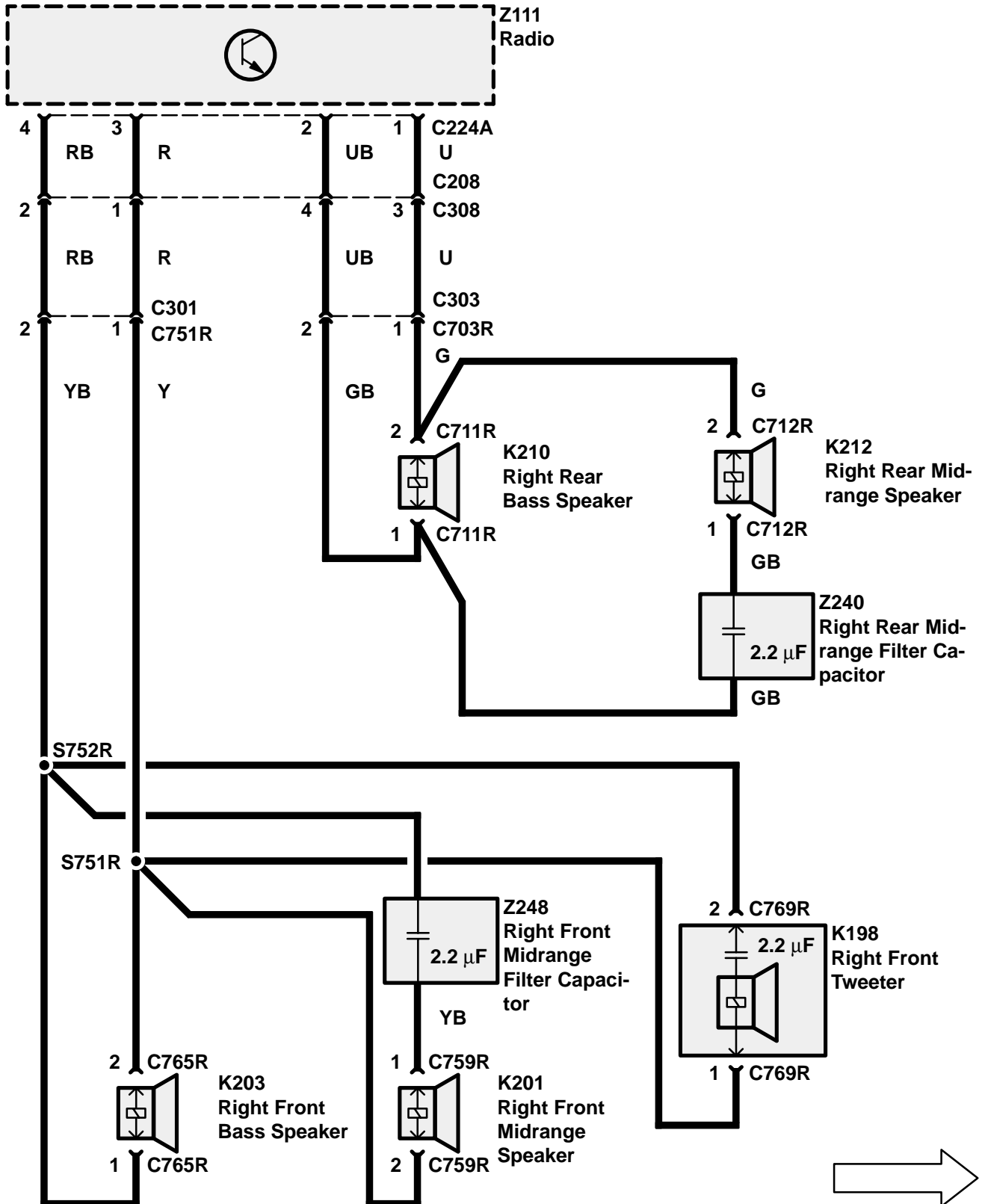

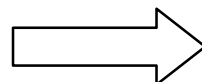
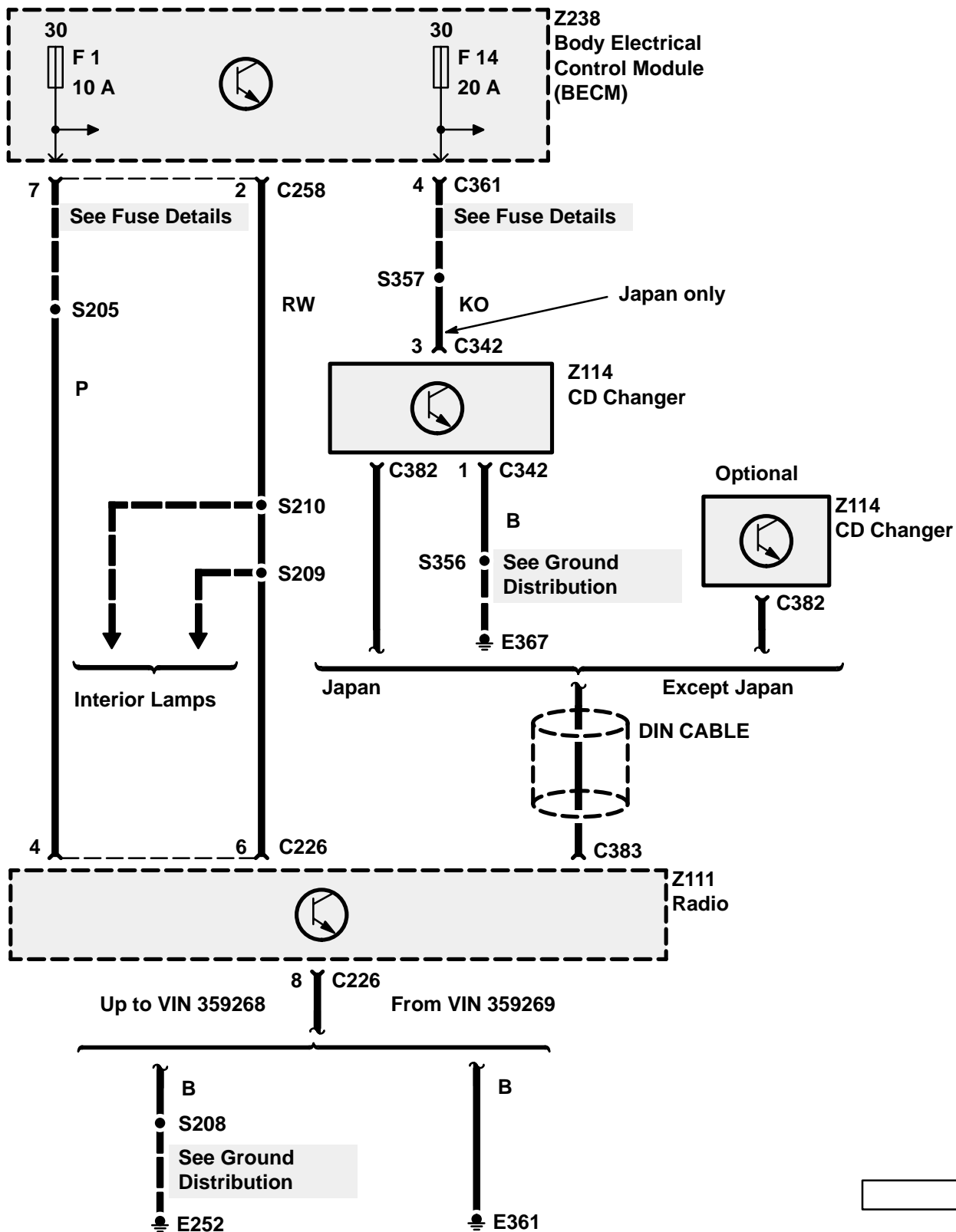
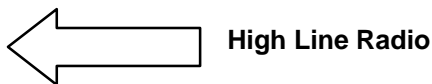

← High Line Radio

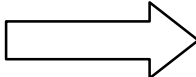
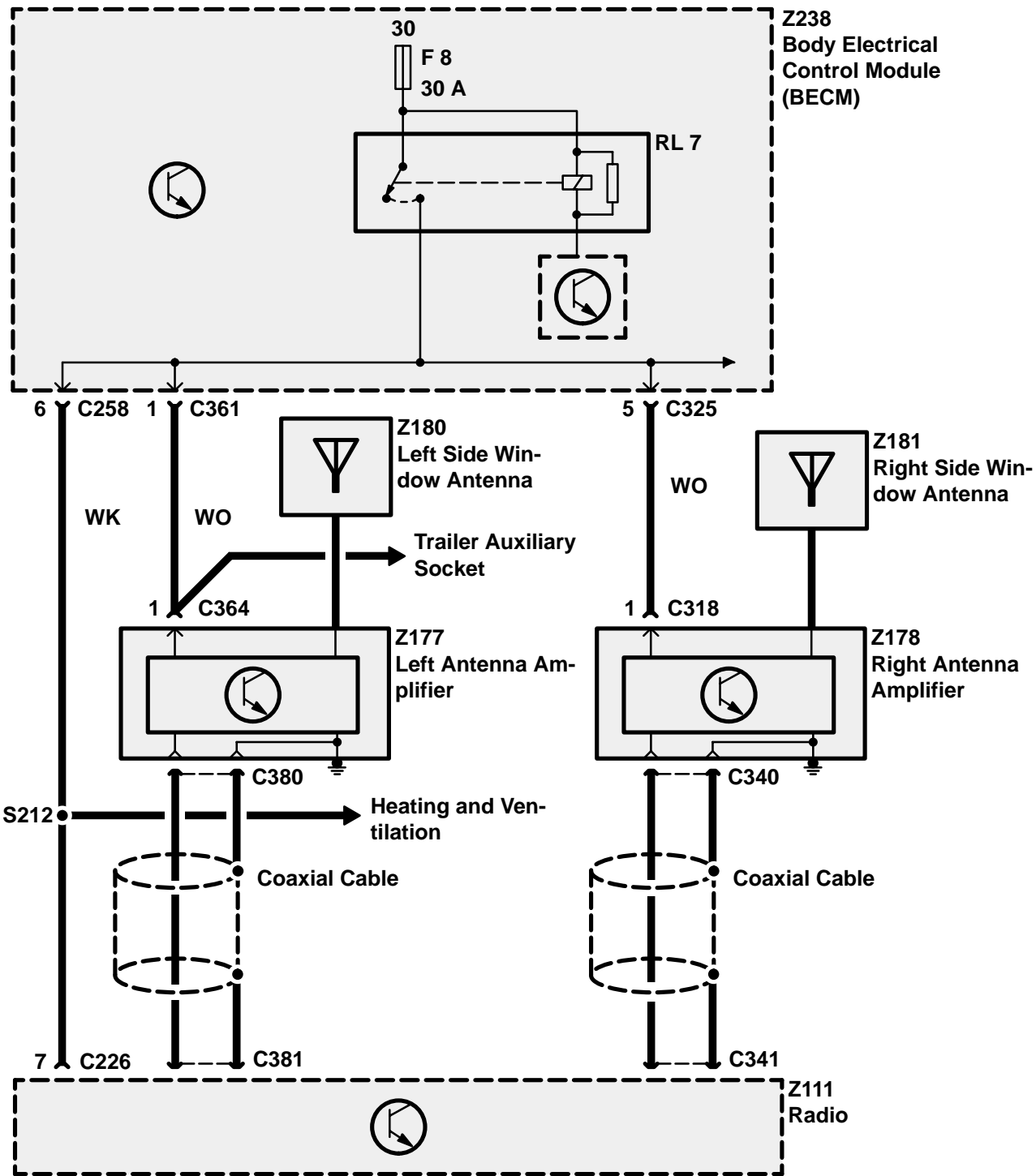

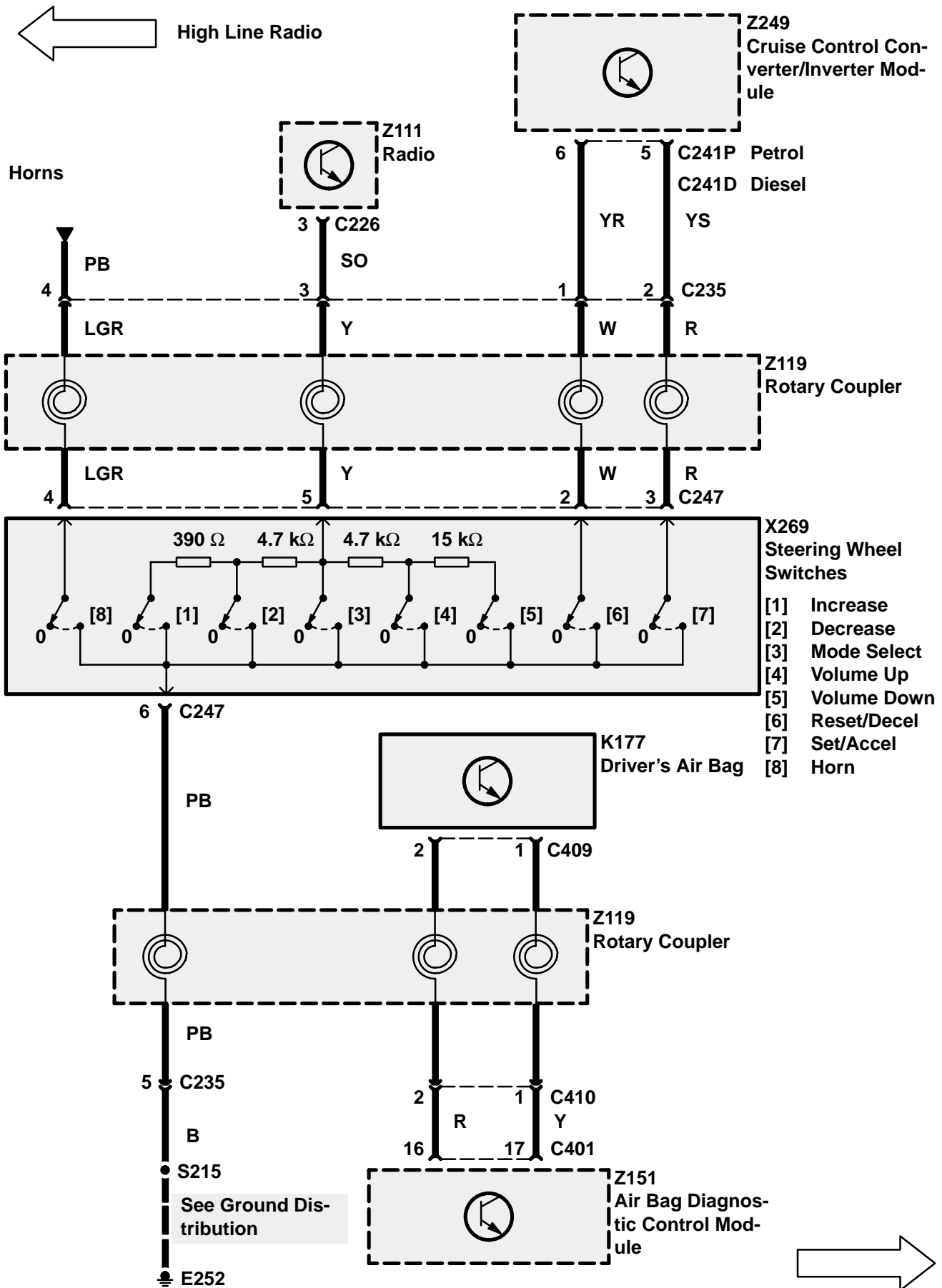

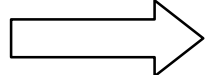
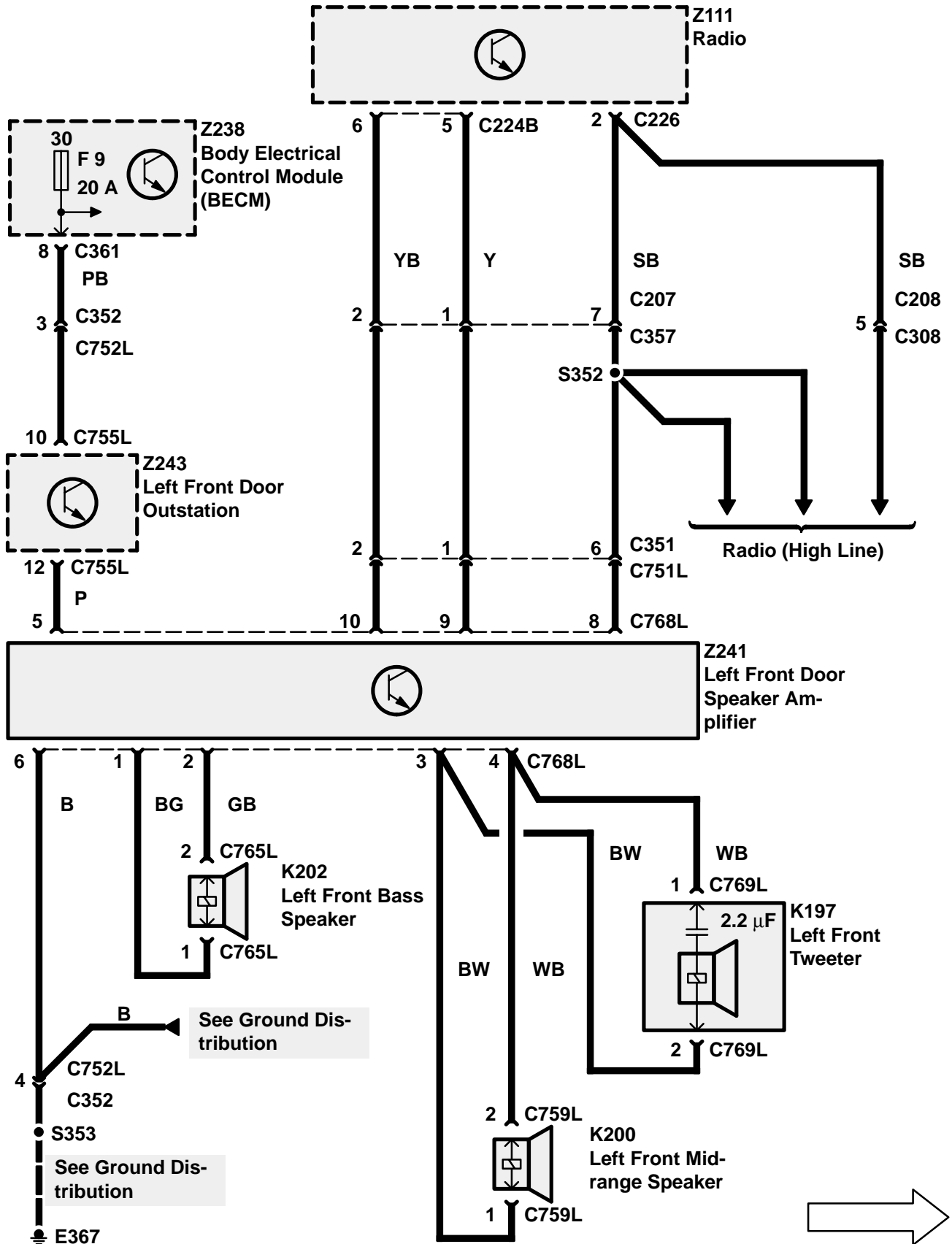

← High Line Radio

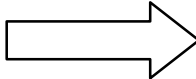
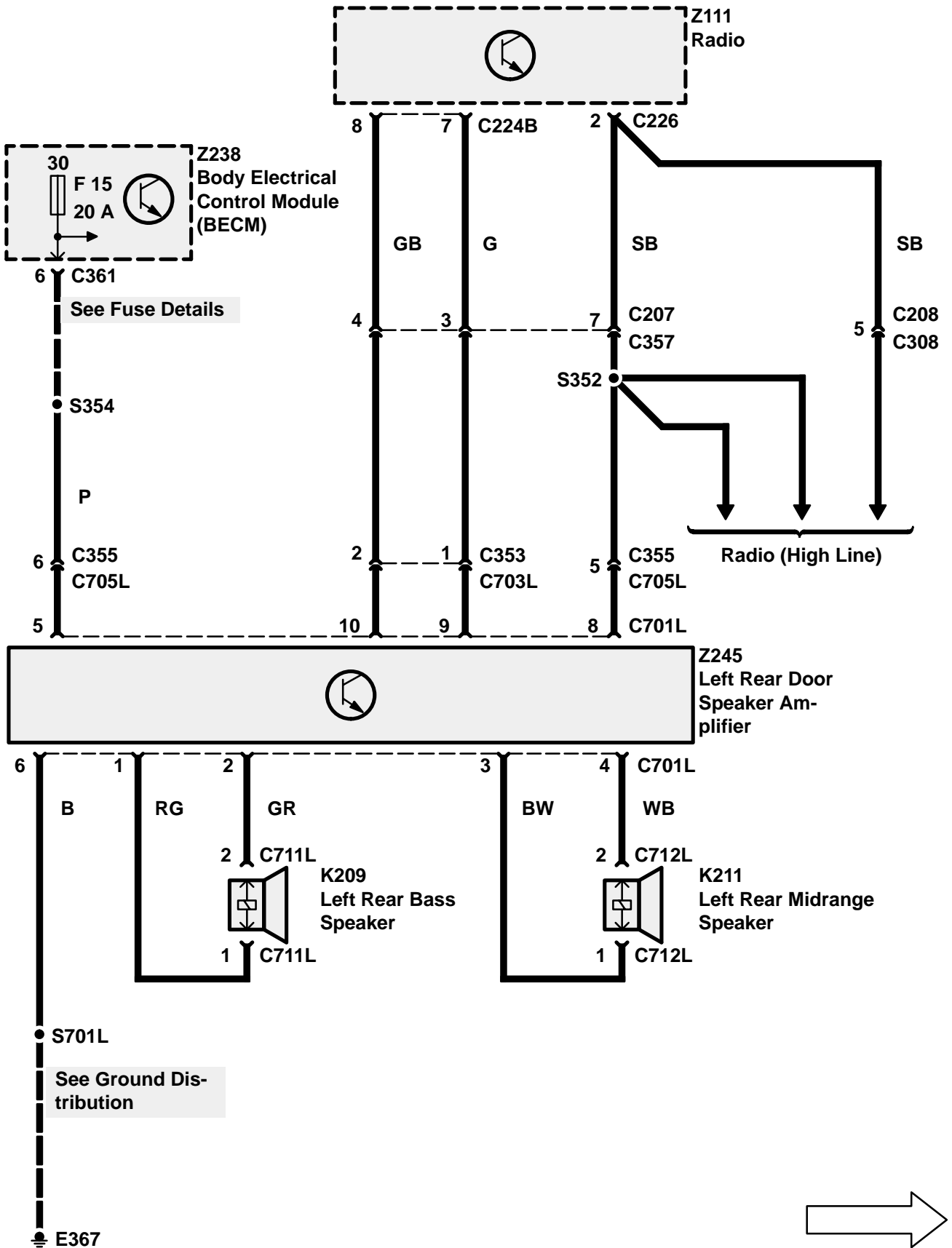

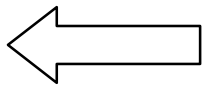

High Line Radio

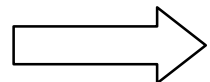
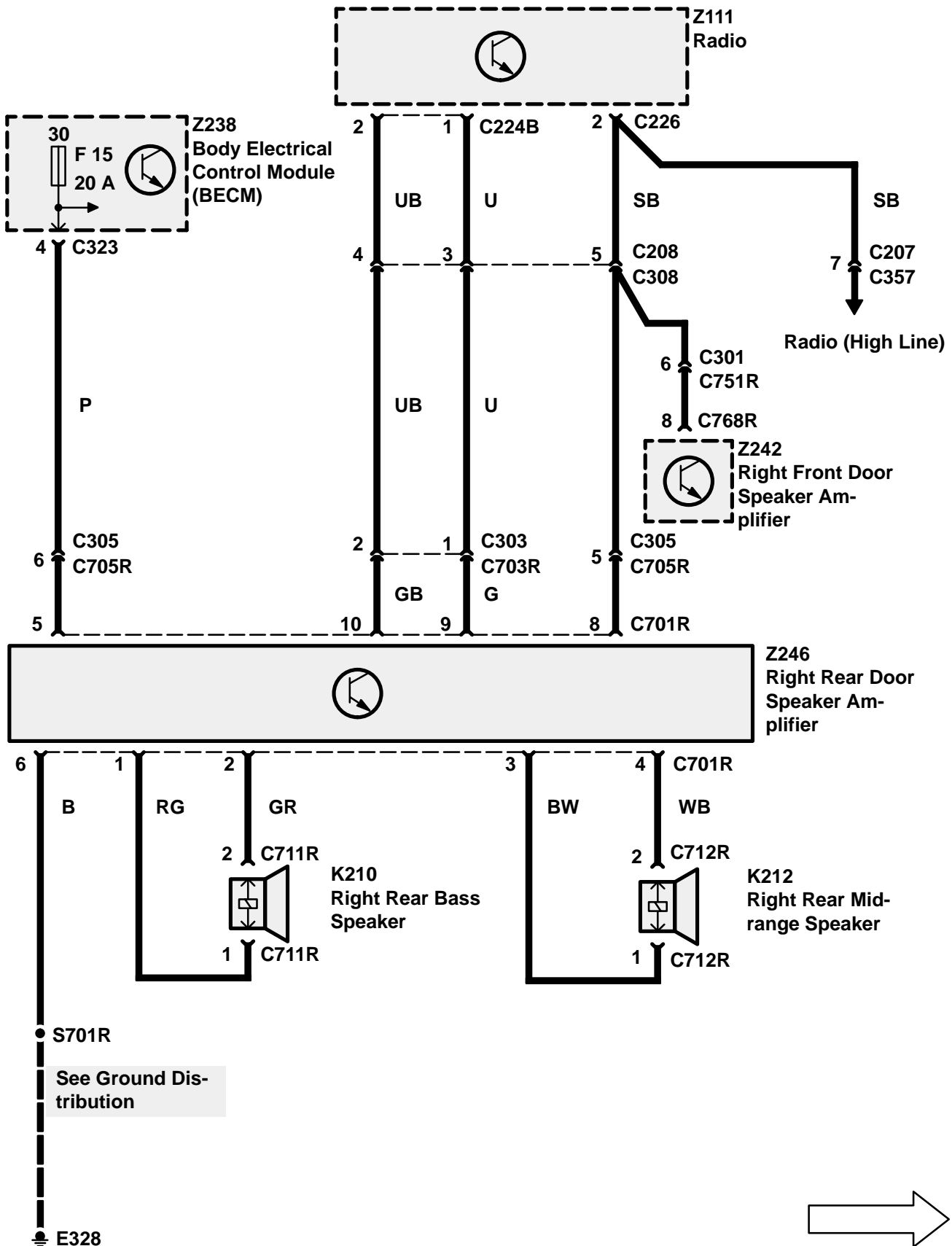

← High Line Radio

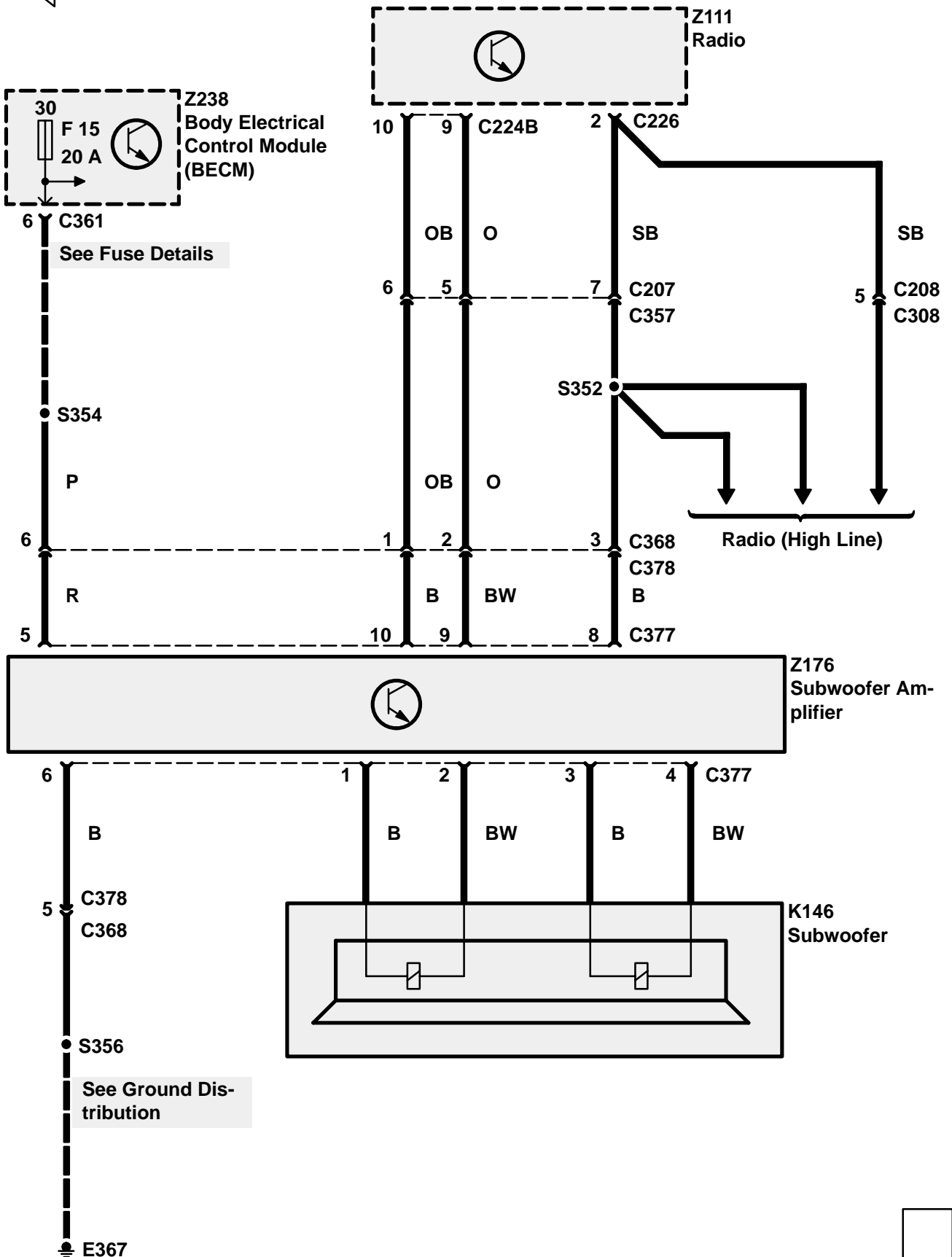

TROUBLESHOOTING HINTS

3. Check fuses F1, F8, F9, F14 and F15 of BeCM (Z238).
4. Check that Radio (Z111) connectors and coaxial cable are tight and properly connected.
5. For proper Radio (Z111) noise diagnosis, take the vehicle outside where signals are strong. Close the hood and keep away from metal buildings or other sources of Radio interference.
6. If Radio (Z111) noise is excessive when an accessory is on, install a radio noise suppression capacitor to the power lead of the accessory.
7. If Radio (Z111) noise is excessive at all times, check antenna wiring, side screen antennas and antenna amplifiers. If OK, check speaker plugs, spark plug wiring and wiring close to the ignition system which could transmit noise to the Radio (Z111) wiring.
8. If only the CD Changer (Z114) does not operate, check DIN cable. If OK, check Radio and CD Changer (Z114).
9. If the Radio (Z111) is inoperative and displays either CODE (low line) or CODE IN (all others), follow the instructions below.

Security Code Instructions

Low Line (PRC7613)

Obtain the 4 digit security code from the customer's security card or, if they have lost it, from the manufacturer.

1. Press the preset 1 button once.
2. Using the arrow up and arrow down buttons, change the – to show the first digit of the code.
3. Press the preset 1 once.
4. Repeat steps 2 and 3 for digits 2, 3 and 4.
5. When the preset 1 button is pressed after the fourth digit, operation should be restored.

If the wrong code is entered, the word WAIT will appear. Do not switch off. Wait until CODE appears, then try again. The time delay will increase each time an incorrect code is entered.

All others (PRC7617, PRC7618, AMR2672)

Obtain the four digit security code from the customer's security card or from the manufacturer.

Enter the code using the preset buttons (1 to 6). When the final digit is entered, the radio should return to full operation.

If the wrong code has been entered, the display will show the number just entered, instead of the frequency. This must be cleared by pressing and holding the BAND button for 5 seconds. The display will then revert to CODE IN, and the code should be entered.

If the wrong code is entered more than THREE times in succession, the code can no longer be entered. Units PRC7617 and PRC7618 will show —. When this clears, input the correct code. Unit AMR2672 will allow the code to be entered, but will not respond even if the code is correct. If this happens, leave the set switched on for at least one hour without touching any controls. After waiting this time period, try again.

SYSTEM DIAGNOSIS

1. If Radio (Z111) does not operate at all, do Test A.
2. If Radio scans past all frequencies when in seek mode and hiss is present over most stations, do Test B.
3. If VF display does not dim when headlamps or park lamps are turned on, do Test C.
4. If one or more speakers do not operate, do Test D.
5. If the Subwoofer (K146) does not operate, do Test E.
6. If all right rear door speakers do not operate, do Test F.
7. If all left rear door speakers do not operate, do Test G.
8. If all left front door speakers do not operate, do Test H.
9. If all right front door speakers do not operate, do Test I.
10. If none of the steering wheel switches to the radio operate, do Test J.

Test A

1A

CONDITIONS

- Ignition Switch
Position: I

RESULTS

BAT VOLT

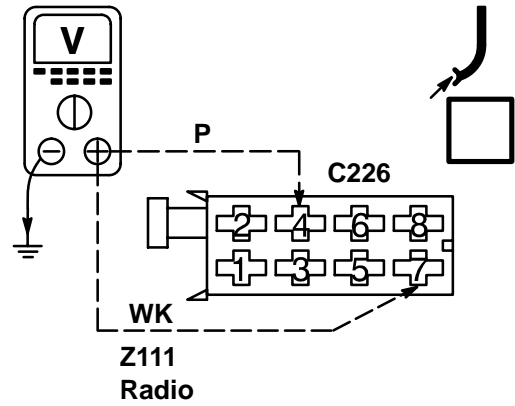

PROBLEM CAUSE

- P Wire
- WK Wire
- Fuse F1
- Body Electrical Control Module (BECM)

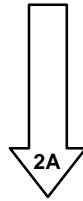

2A

CONDITIONS

- Ignition Switch
Position: I

RESULTS

BAT VOLT

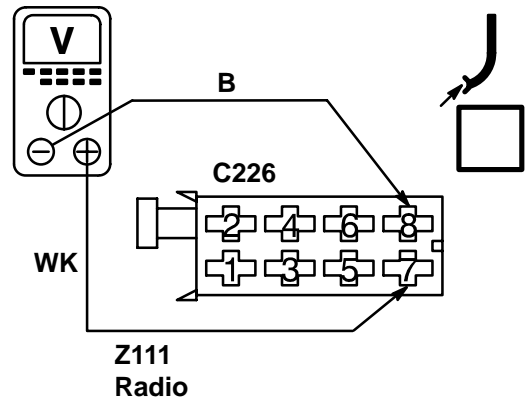

PROBLEM CAUSE

- B Wire



PROBLEM CAUSE

- Radio

Test B

1B

CONDITIONS

- Ignition Switch
Position: I

RESULTS
BAT VOLT



- PROBLEM CAUSE**
- WO Wire
 - Fuse F8
 - Body Electrical Control Module (BECM)



- PROBLEM CAUSE**
- Coaxial Cable
 - Radio
 - Antenna Amplifier(s)

Test C

1C

CONDITIONS

- Ignition Switch
Position: II
- Headlamps
On

RESULTS
BAT VOLT



- PROBLEM CAUSE**
- RW Wire
 - Body Electrical Control Module (BECM)



- PROBLEM CAUSE**
- Radio

Test D

1D

CONDITIONS

- Connect for less than 1 second
- Connect at suspect connector

RESULTS

Speaker 'pops'

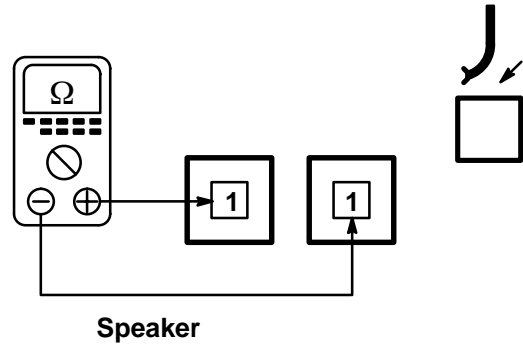

Speaker



PROBLEM CAUSE
- Speaker



PROBLEM CAUSE
- Speaker Wiring
Low Line Radio and Mid Line Radio:
- Radio
High Line Radio:
- Amplifier

Test E

1E

CONDITIONS

- Ignition Switch
Position: I

RESULTS

BAT VOLT

**Z176
Subwoofer Amplifier**

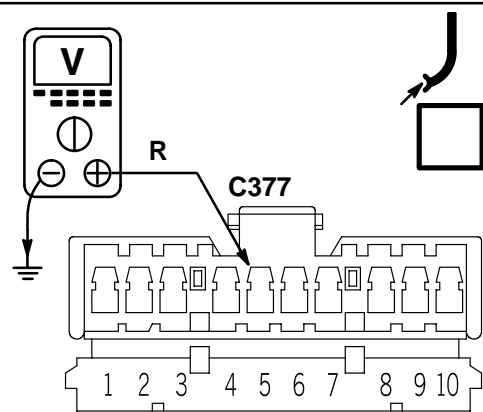

PROBLEM CAUSE
- R, P Wire
- Fuse F15
- Body Electrical Control Module (BECM)

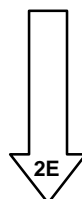

1E

2E

CONDITIONS

- Ignition Switch
Position: II
- Radio
On

RESULTS
BAT VOLT

Z176
Subwoofer Amplifier

~~OK~~ PROBLEM CAUSE
- B, SB Wire

OK

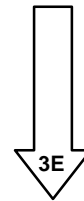

3E

CONDITIONS

- Ignition Switch
Position: 0

RESULTS
Less than 1 ohm

Z176
Subwoofer Amplifier

~~OK~~ PROBLEM CAUSE
- B Wire

OK

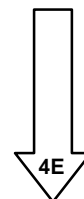

3E

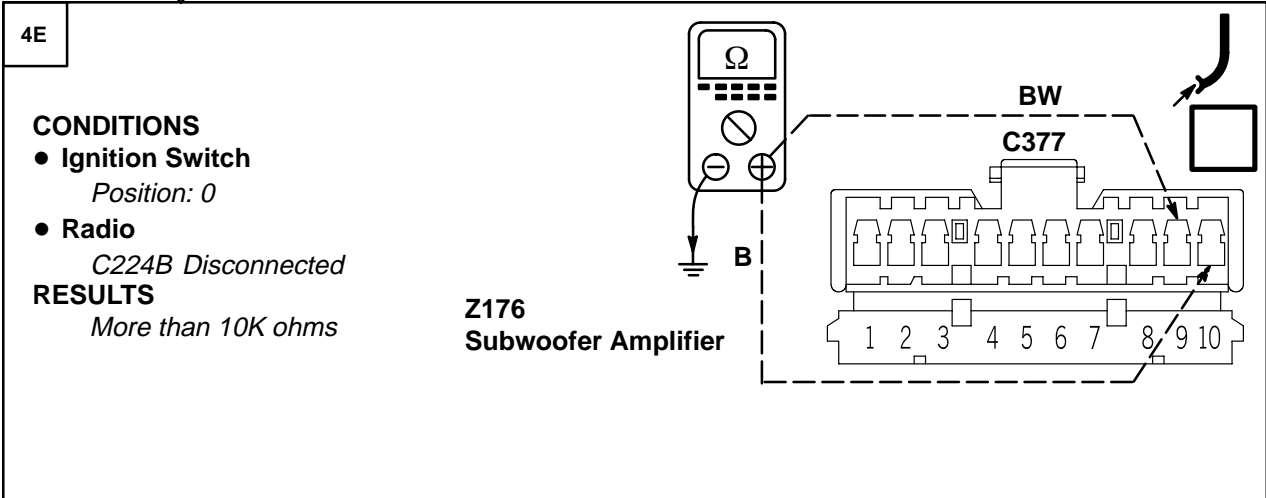

PROBLEM CAUSE

- BW, O Wire
- B, OB Wire

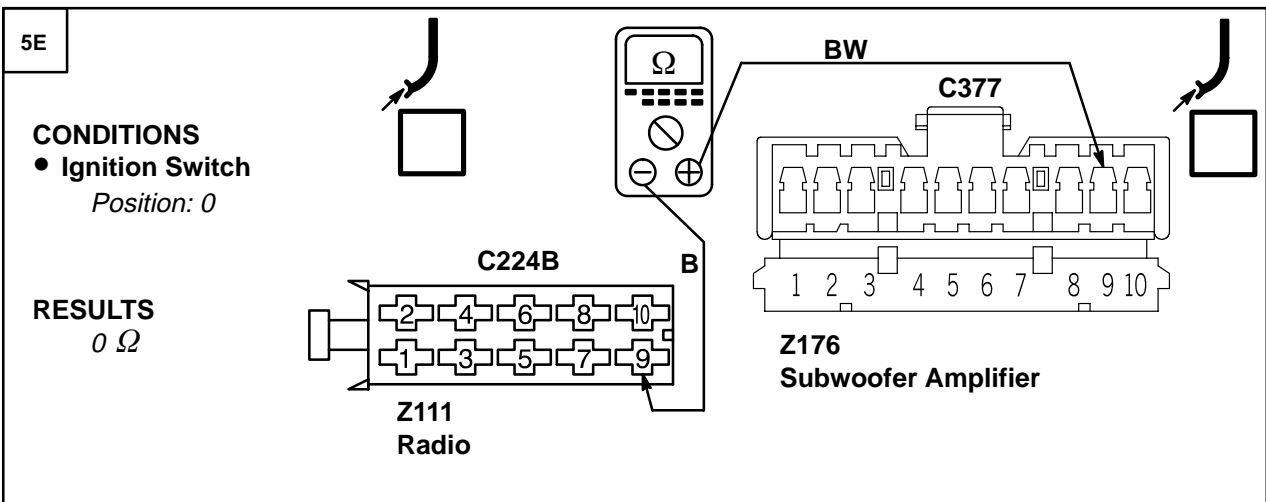
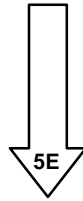

PROBLEM CAUSE

- BW, O Wire

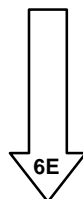

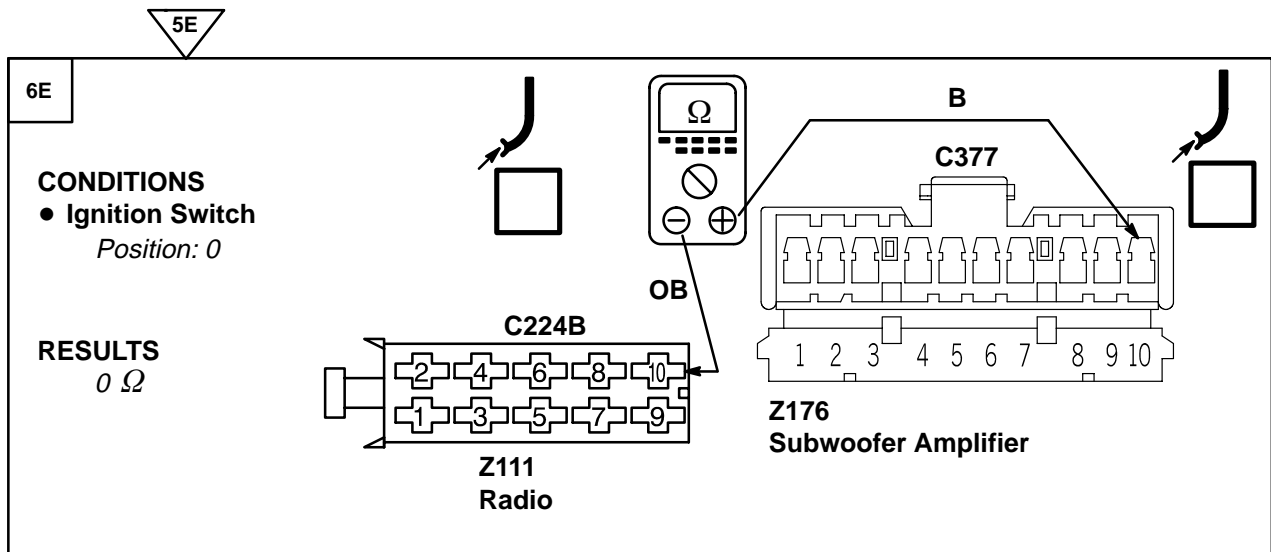

~~OK~~ **PROBLEM CAUSE**
- B, OB Wire

OK

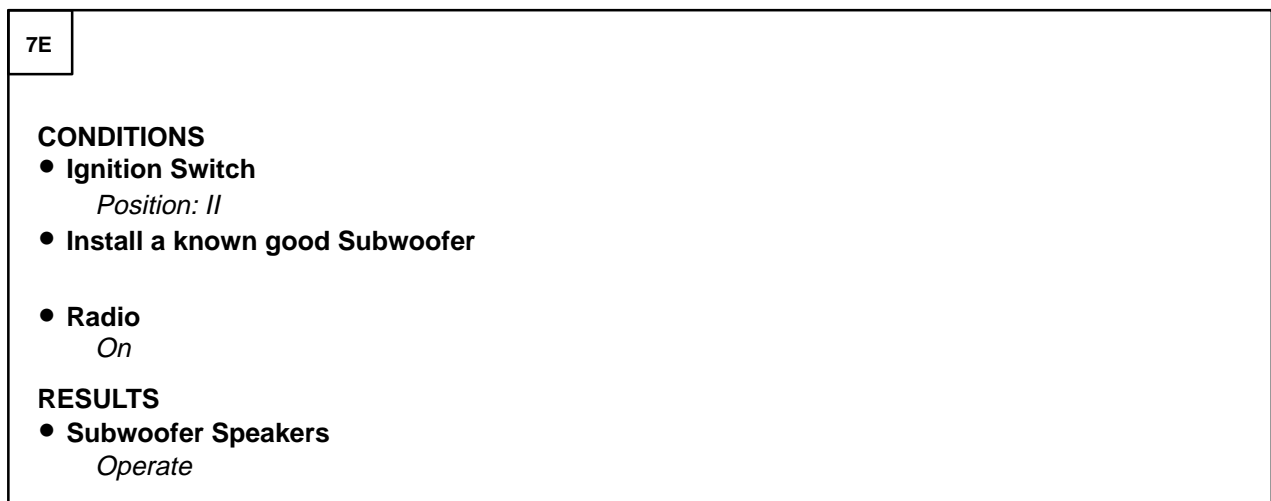
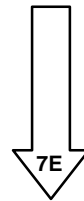

~~OK~~ **PROBLEM CAUSE**
- Radio
- Subwoofer Amplifier

OK **PROBLEM CAUSE**
- Subwoofer

Test F

1F

CONDITIONS

- Ignition Switch
Position: I
- Radio
On

RESULTS
BAT VOLT

Z246
Right Rear Door Speaker Amplifier



PROBLEM CAUSE

- P, SB Wire
- Fuse F15
- Body Electrical Control Module (BECM)

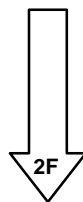

2F

CONDITIONS

- Ignition Switch
Position: 0

RESULTS
Less than 1 ohm

Z246
Right Rear Door Speaker Amplifier



PROBLEM CAUSE

- B Wire

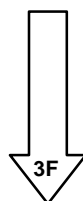

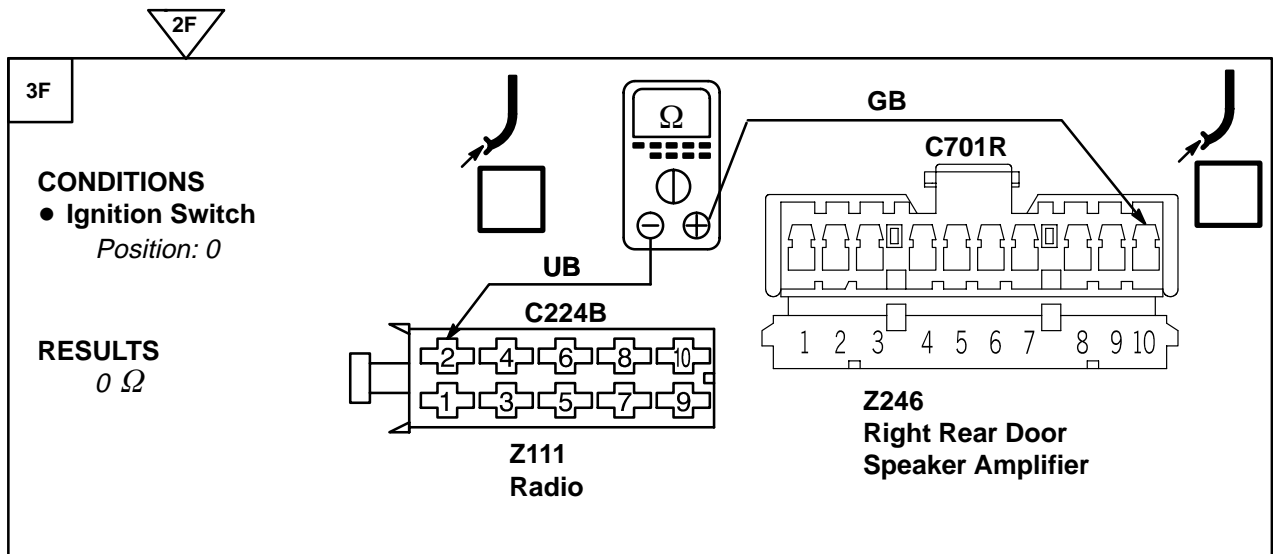

~~OK~~ **PROBLEM CAUSE**
- UB, GB Wire

OK

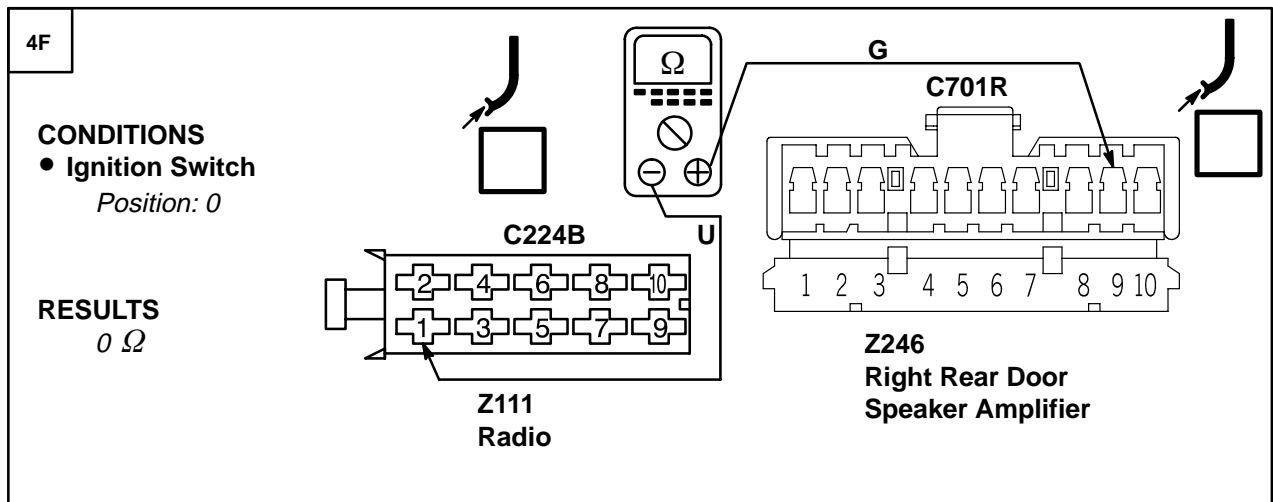
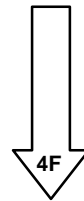

~~OK~~ **PROBLEM CAUSE**
- U, G Wire

OK **PROBLEM CAUSE**
- Radio
- Right Rear Door
Speaker Amplifier

Test G

1G

CONDITIONS

- Ignition Switch
Position: I
- Radio
On

RESULTS
BAT VOLT

Z245
Left Rear Door
Speaker Amplifier



PROBLEM CAUSE

- P, SB Wire
- Fuse F15
- Body Electrical Control Module (BECM)

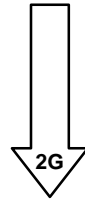

2G

CONDITIONS

- Ignition Switch
Position: 0

RESULTS
Less than 1 ohm

Z245
Left Rear Door
Speaker Amplifier



PROBLEM CAUSE

- B Wire

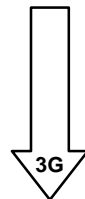

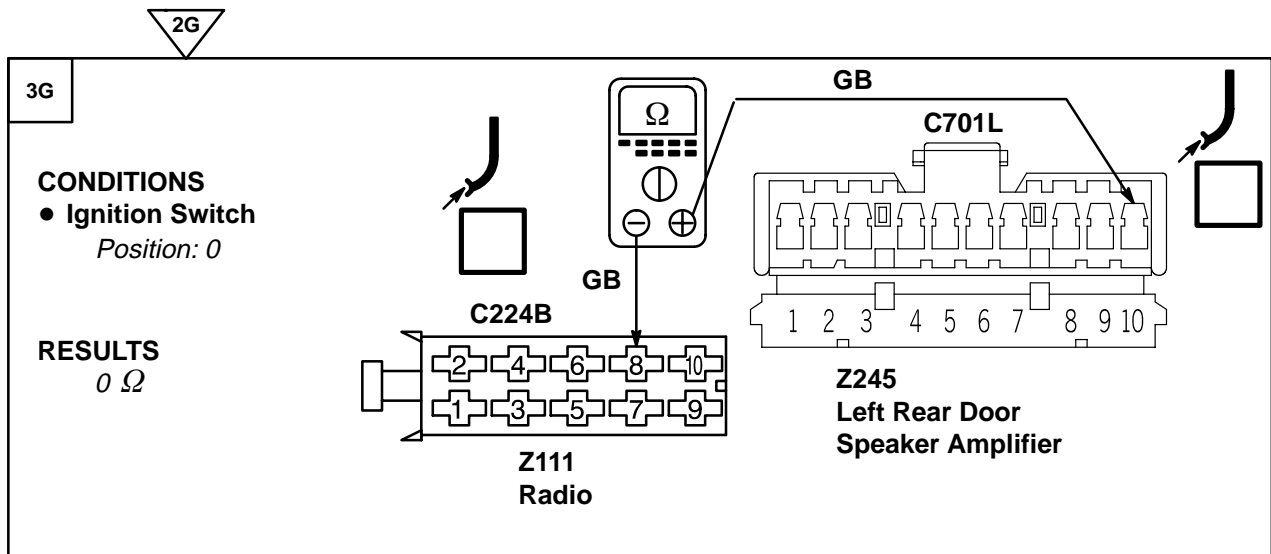

~~OK~~ PROBLEM CAUSE
- GB Wire

OK

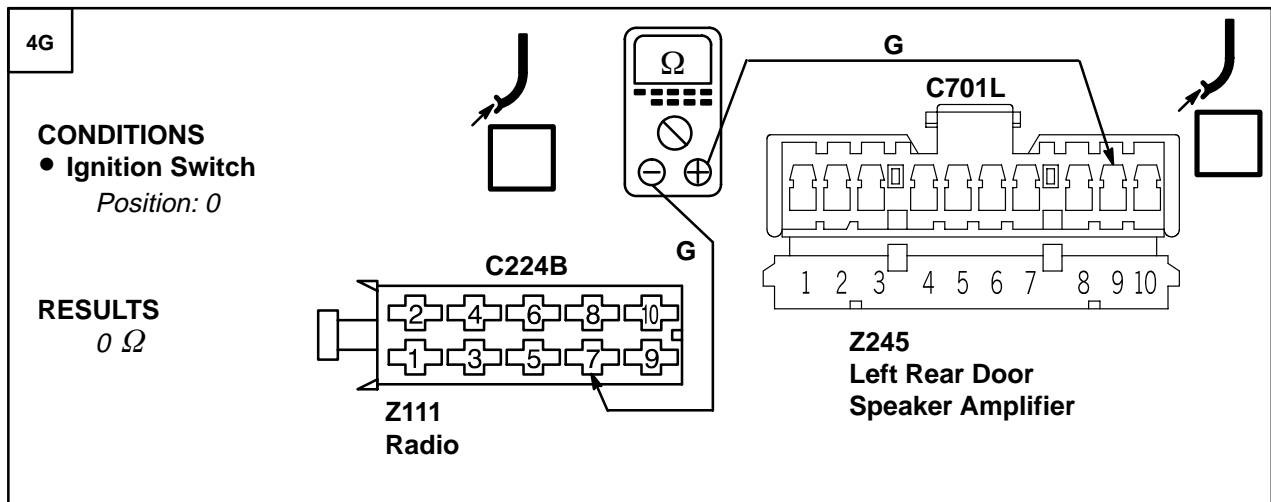
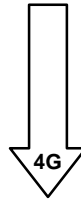

~~OK~~ PROBLEM CAUSE
- G Wire

OK PROBLEM CAUSE
- Radio
- Left Rear Door
Speaker Amplifier

Test H

1H

CONDITIONS

- Ignition Switch
Position: I
- Radio
On

RESULTS

BAT VOLT

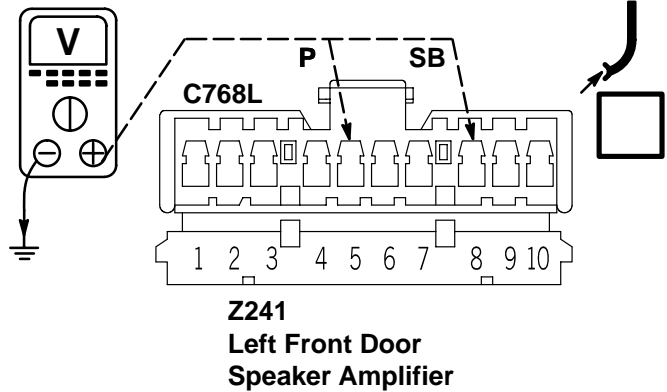

PROBLEM CAUSE

- P, PB, SB Wire
- Fuse F9
- Left Front Door Outstation

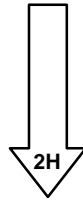

2H

CONDITIONS

- Ignition Switch
Position: 0

RESULTS

Less than 1 ohm

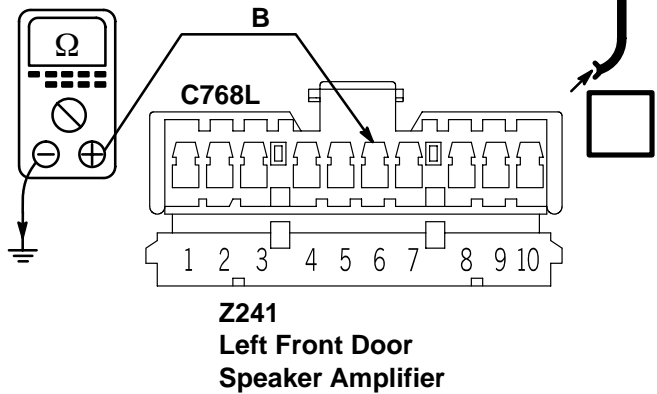

PROBLEM CAUSE

- B Wire

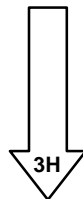

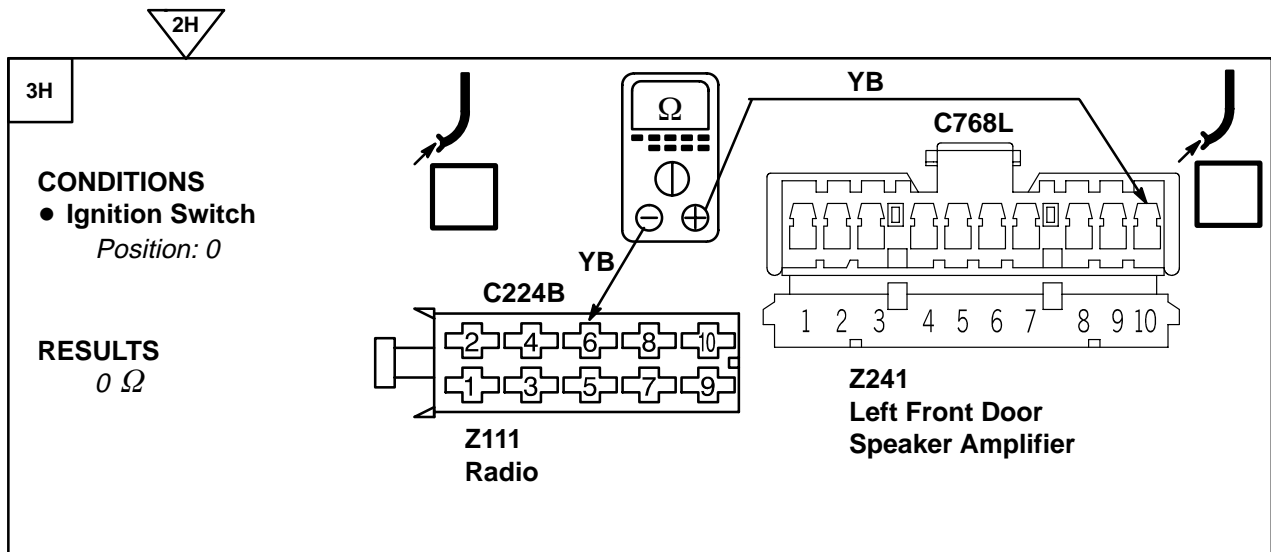

~~OK~~ PROBLEM CAUSE
- YB Wire

OK

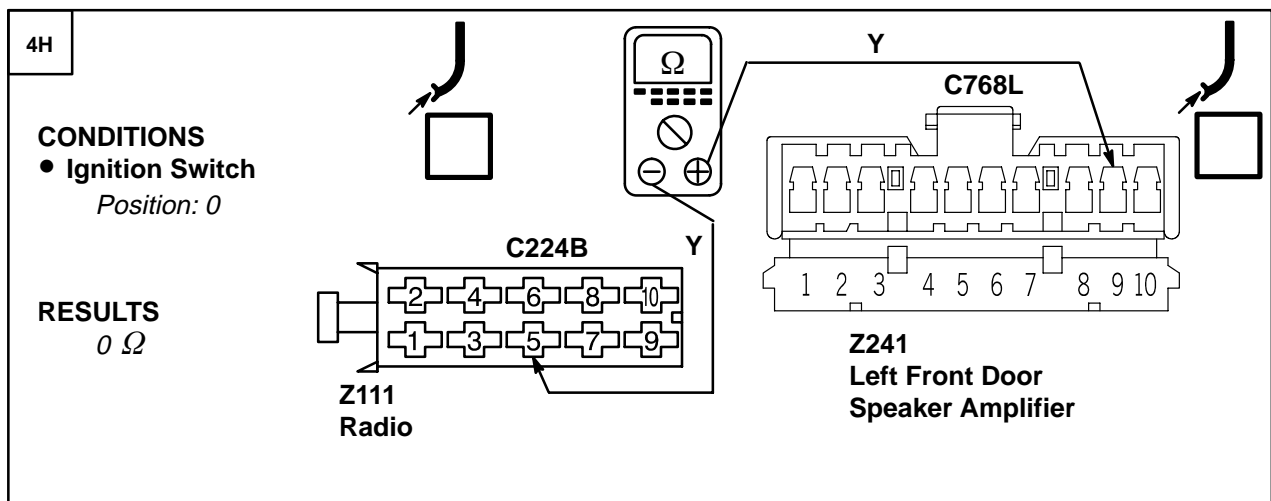
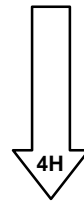

~~OK~~ PROBLEM CAUSE
- Y Wire

OK PROBLEM CAUSE
- Radio
- Left Front Door
Speaker Amplifier

Test I

11

CONDITIONS

- Ignition Switch
Position: I
- Radio
On

RESULTS
BAT VOLT

Z242
Right Front Door
Speaker Amplifier



PROBLEM CAUSE

- P, PB, SB Wire
- Fuse F9
- Right Front Door Outstation

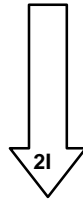

21

CONDITIONS

- Ignition Switch
Position: 0

RESULTS
Less than 1 ohm

Z242
Right Front Door
Speaker Amplifier



PROBLEM CAUSE

- B Wire

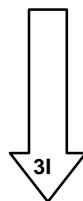

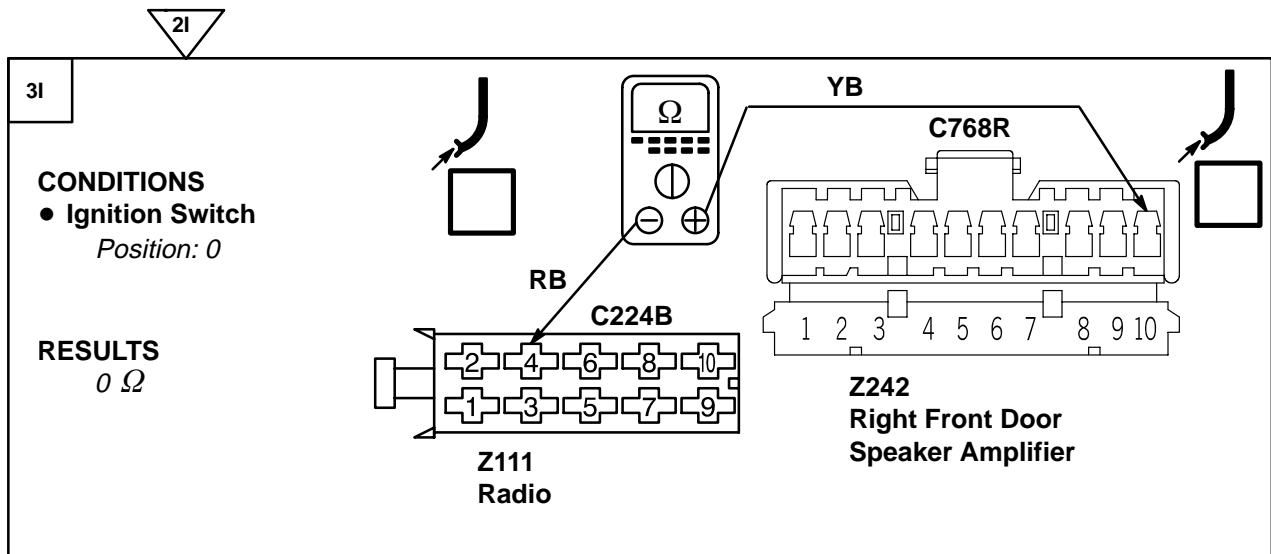

~~OK~~ PROBLEM CAUSE
- RB, YB Wire

OK

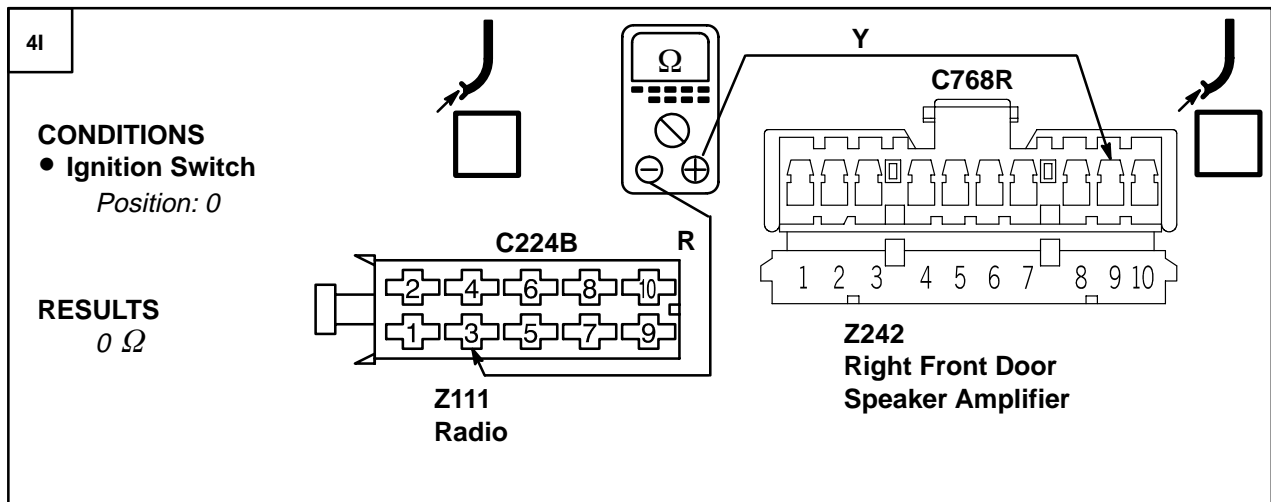
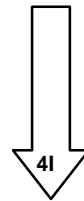

~~OK~~ PROBLEM CAUSE
- R, Y Wire

OK PROBLEM CAUSE
- Radio
- Right Front Door
Speaker Amplifier

Test J

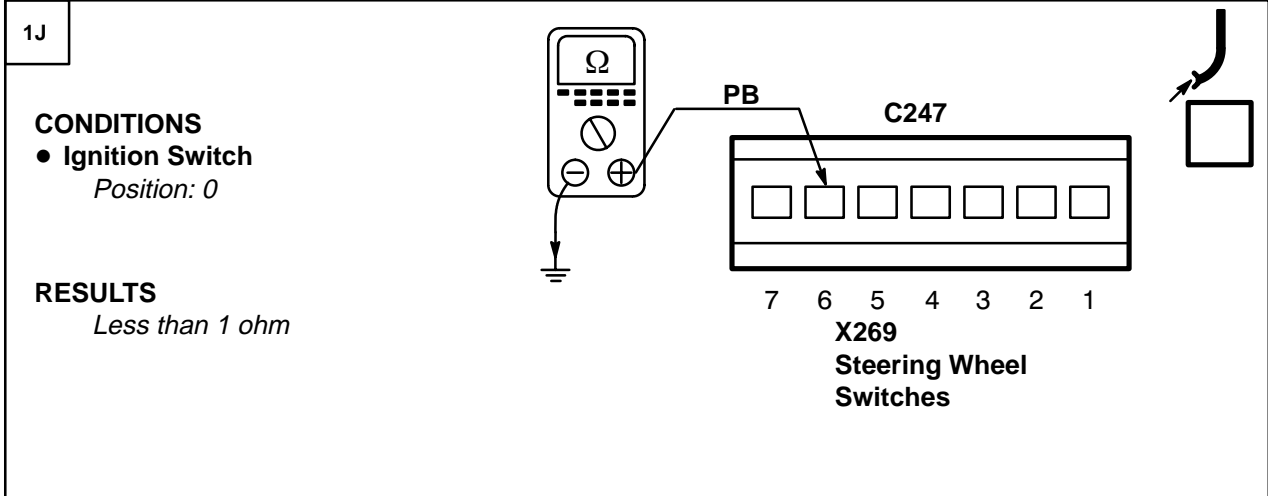

PROBLEM CAUSE

- PB, B Wire
- Rotary Coupler

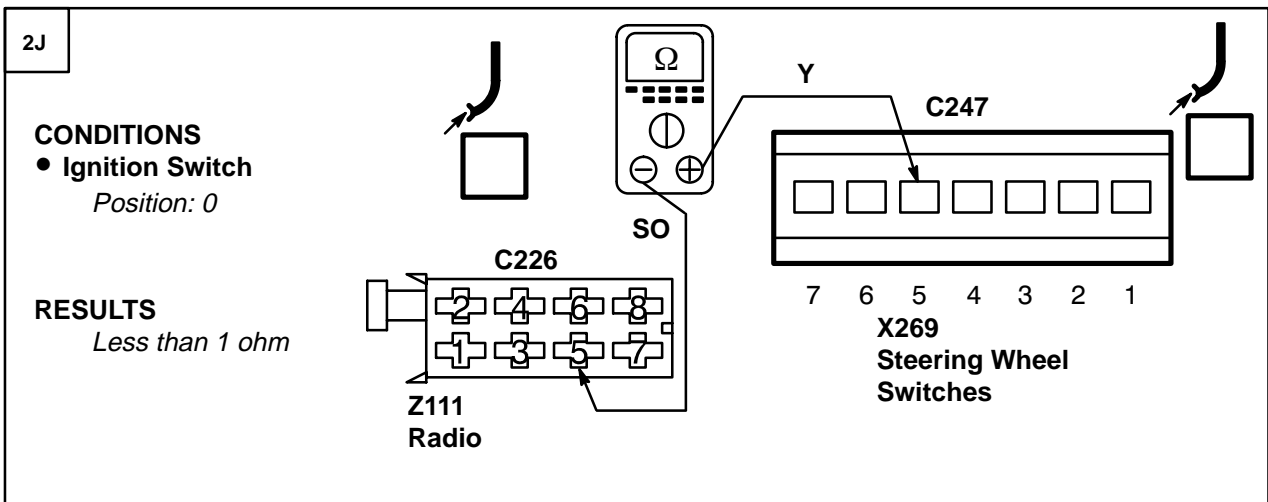
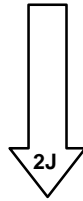

PROBLEM CAUSE

- SO Wire
- Y Wire
- Rotary Coupler



PROBLEM CAUSE

- Radio
- Steering Wheel
Switches

CIRCUIT OPERATION

Front Wipers

The front wipers will only operate with auxiliary or ignition on, except when auxiliary and ignition are both turned off, the wipers will continue to operate until they reach the park position. If the engine is cranked while the wipers are on, then the wiper operation will be suspended until cranking is released.

Flick Wipe Operation

When the flick wipe switch is operated, the wiper will operate in the slow wipe mode until the switch is released.

Intermittent Operation

When the wiper control stalk is moved to the intermittent position, the wipers will perform one wipe of the screen at slow speed and then wait for N seconds before doing another wipe etc. The value of N is determined by the position of the wipe delay potentiometer. When the potentiometer is in the far left position the time delay is 2 seconds. Each movement of the potentiometer to the right doubles the time delay, up to a maximum of 32 seconds.

Slow Speed Operation

When the wiper control stalk is moved to the slow position, the wipers will operate continuously at slow speed.

Fast Speed Operation

When the wiper control stalk is moved to the fast position, the wipers will start operating at fast speed immediately and will continue to do so until fast speed is switched off.

Front Screen Programmed Wash/Wipe

If the wash/wipe switch is operated, the front screen wash motor will operate for 1.5 seconds or for the duration the switch is held on, whichever is the longer.

The slow front wipe will be operated for 0.5 seconds after the switch is closed and will continue to operate until three full wipes have been completed after the wash motor has ceased its operation.

Rear Wiper

Intermittent Operation

When the rear wiper stalk is moved to the "on" position, then the rear wiper will perform two complete wipes and stop in the park position. After

that, its operation will vary depending on the selected mode of the front wipers.

Reverse Gear Wiping

If reverse gear is selected while auxiliary or ignition is on and a front wiper function is selected, then the rear wiper will operate as well.

If reverse gear is selected while the front wipers are off (or performing a wash/wipe cycle) then the rear wiper will operate in the mode indicated by the rear wiper switch.

Rear Screen Programmed Wash/Wipe

If the rear wash/wipe switch is operated, the rear screen wash motor will operate for 1.5 seconds or for as long as the switch is held on, whichever is the longer. The rear wipe will be operated 0.5 seconds after the switch closed and will continue to operate until three full wipes have been completed after the washer motor has ceased its operation.

Wiper Operation With Speed Dependency On

If the vehicle has speed dependent wipers, the wiper adapts its speed to the vehicle speed.

The speed barrier, where the wipers move between a faster or slower operation, is 2 mph.

Headlight Wash/Wipe

If the headlight switch is in the on position, the first and every alternate operation of the front screen wash switch will activate the headlight wash/wipe motor, which will operate for 2 seconds, regardless of the length of time the switch is pressed.

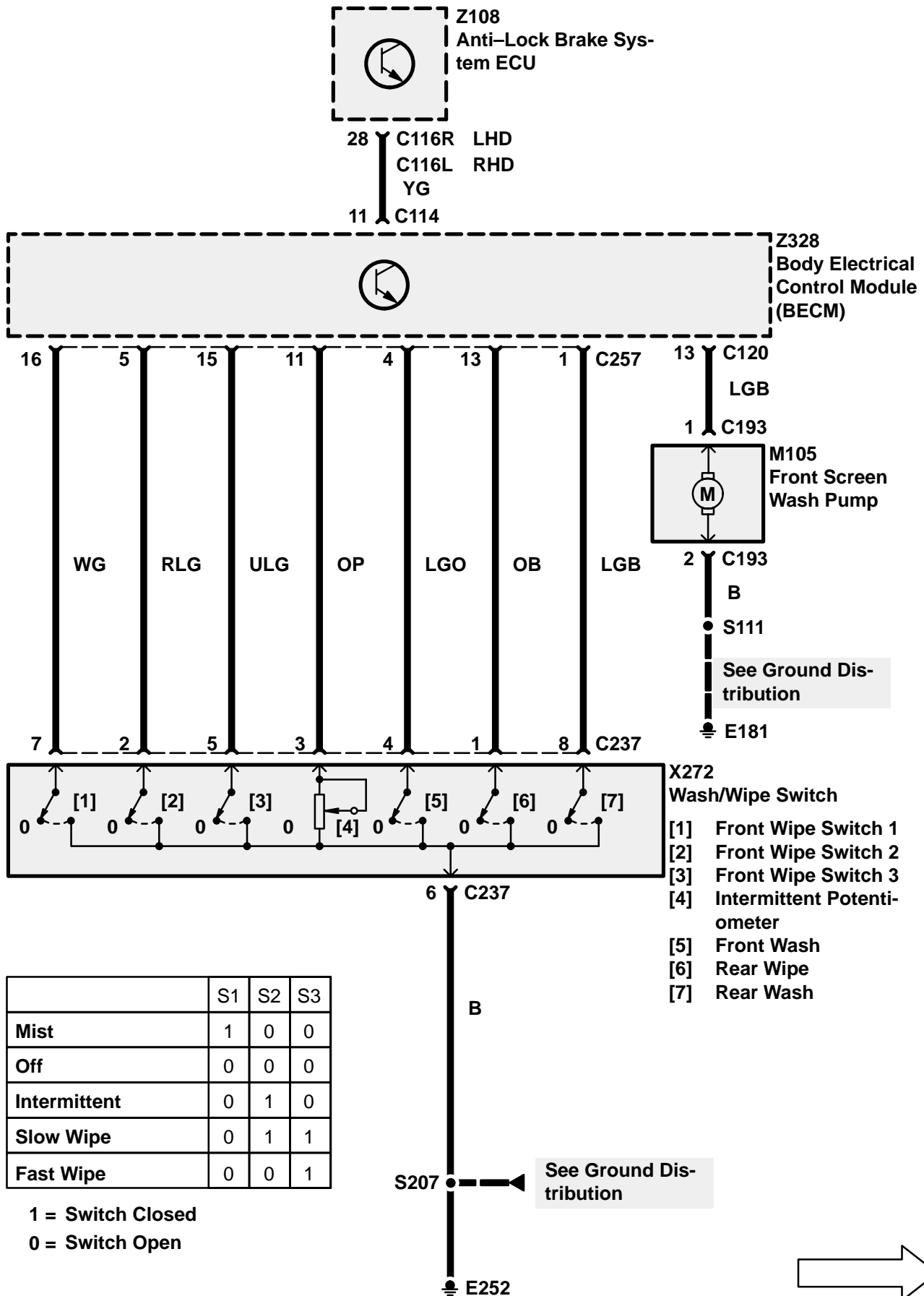

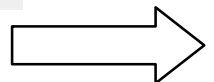
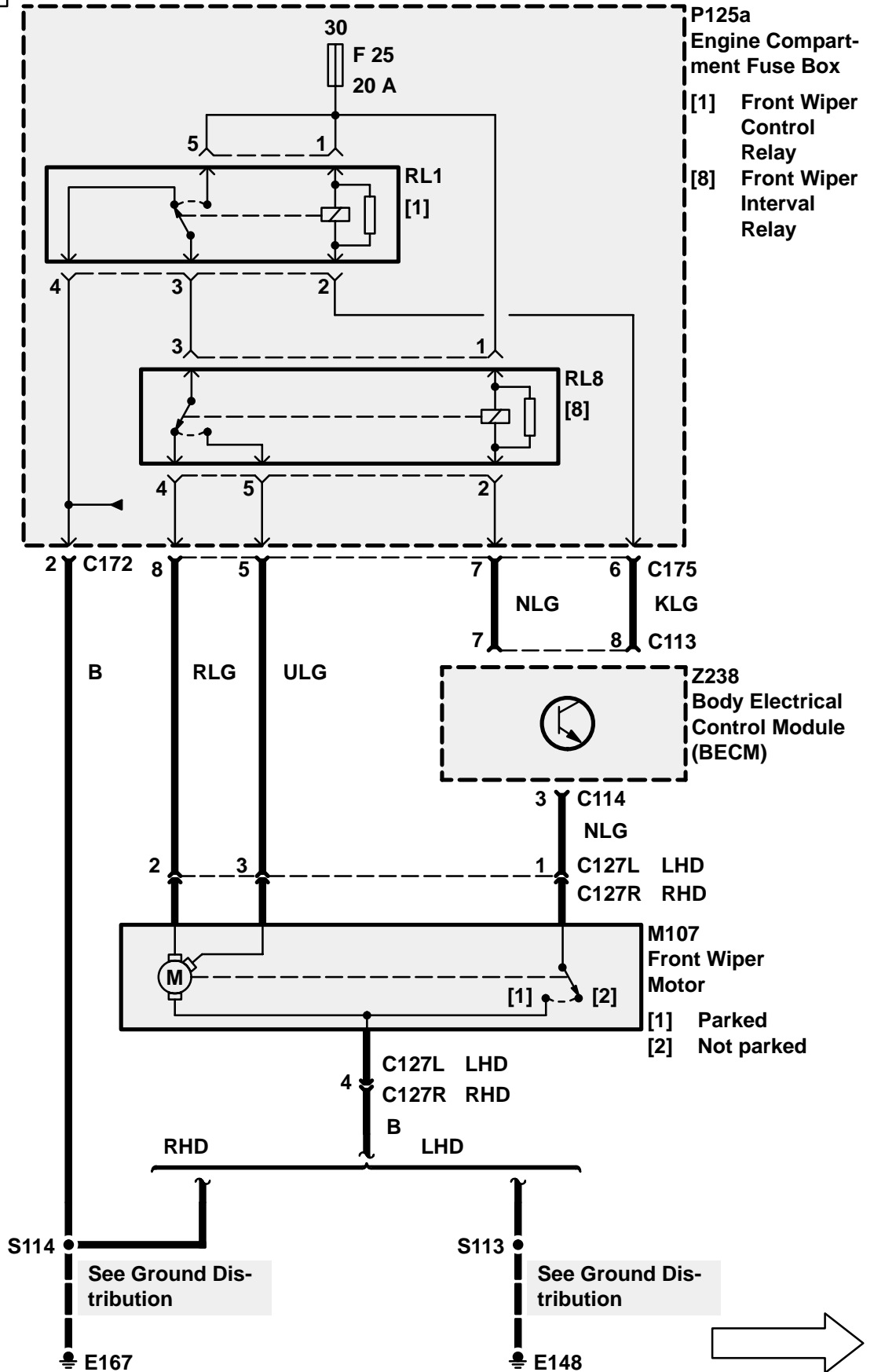
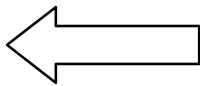

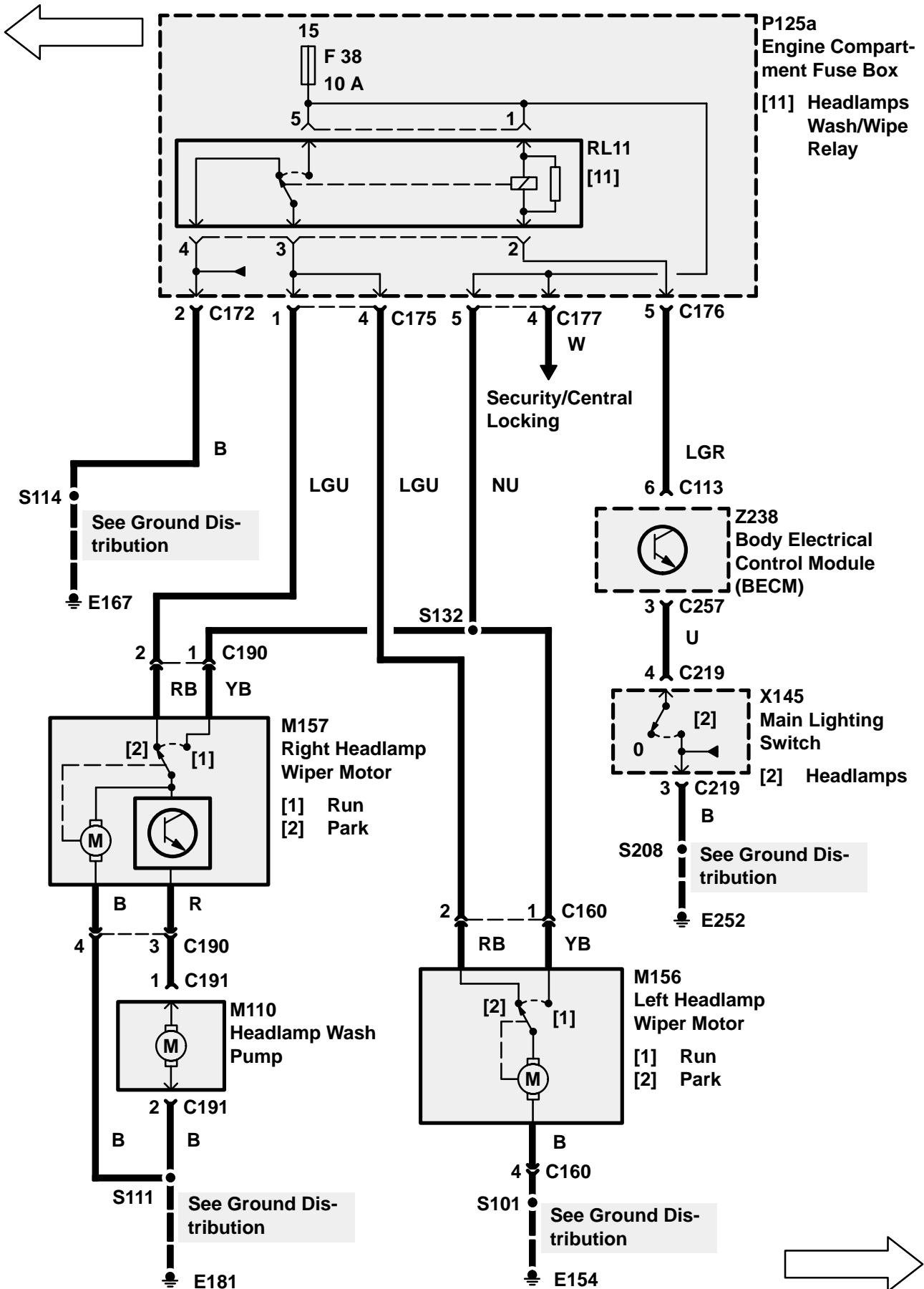

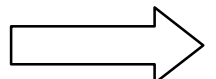
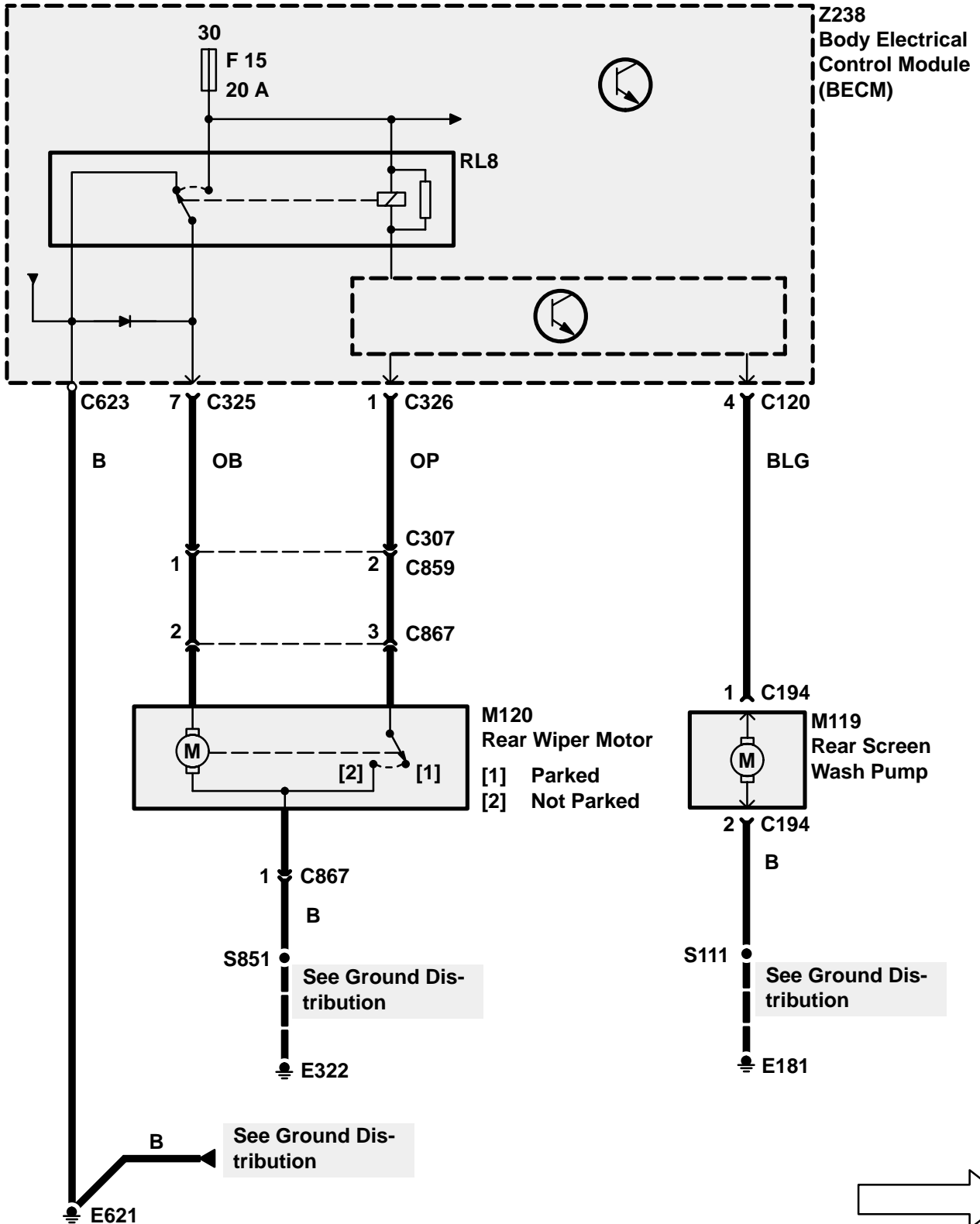
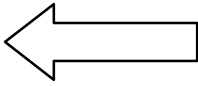

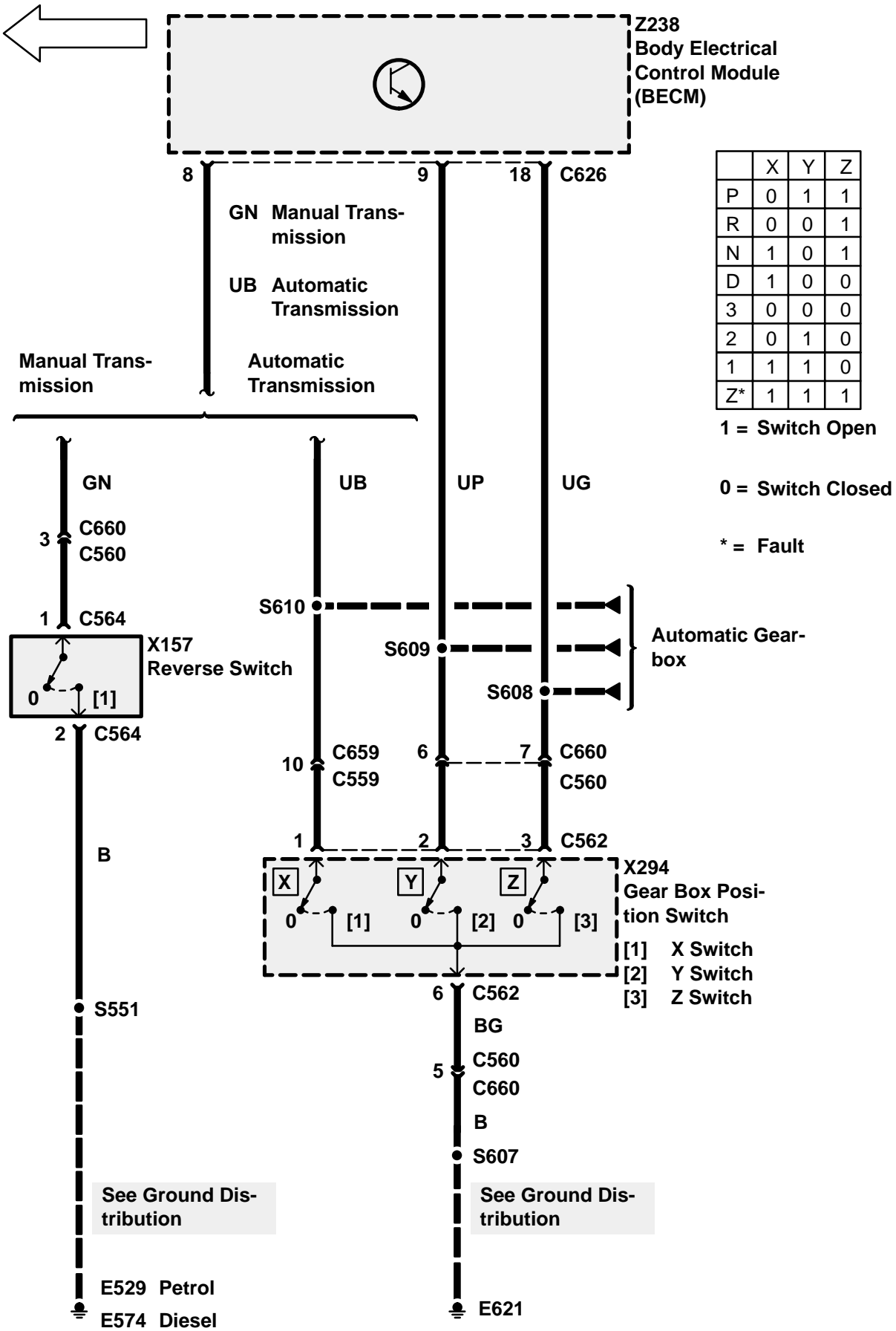

CIRCUIT OPERATION

This operates only with the engine running, which is determined by the HEVAC panel. In the off state, the signal is at 12 volts. When the Heated Front Windscreen is activated, the signal is switched to 0 volts. This provides the ground required for relay 5 to be pulled in, as there is an ignition feed on the other side of the coil provided by relay 15. This relay energises one half of the heated screen elements.

Once relay 5 has been energised, a 12 volt signal is provided to the coil of relay 4. The other side of the coil is connected directly to ground, thereby energising the relay and switching on the other half of the elements.

There is also a feed spliced from the harness which provides the petrol Engine Control Module with a signal that tells the unit there will be a large electrical load turned on/off.

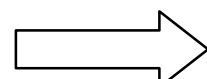
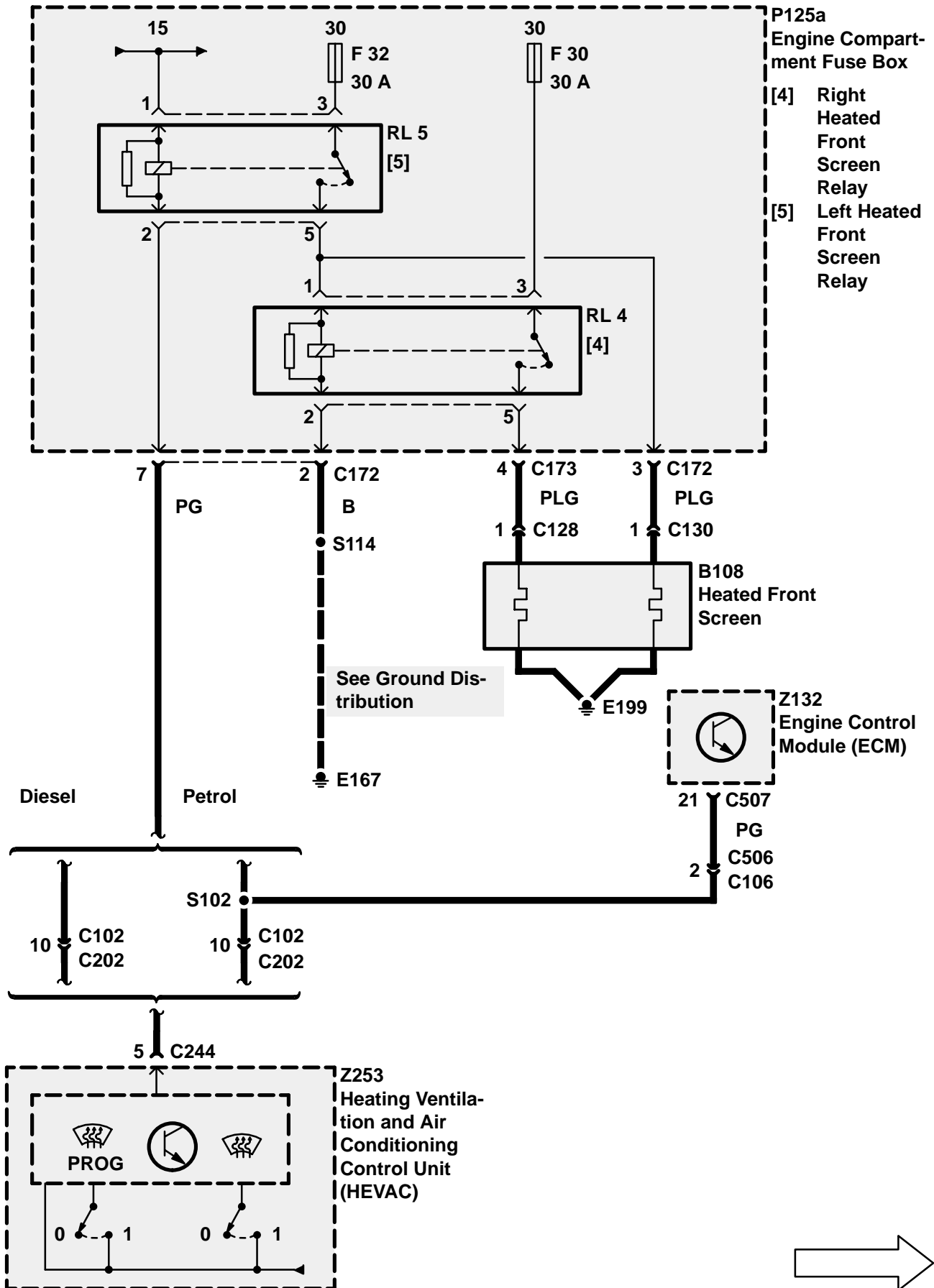

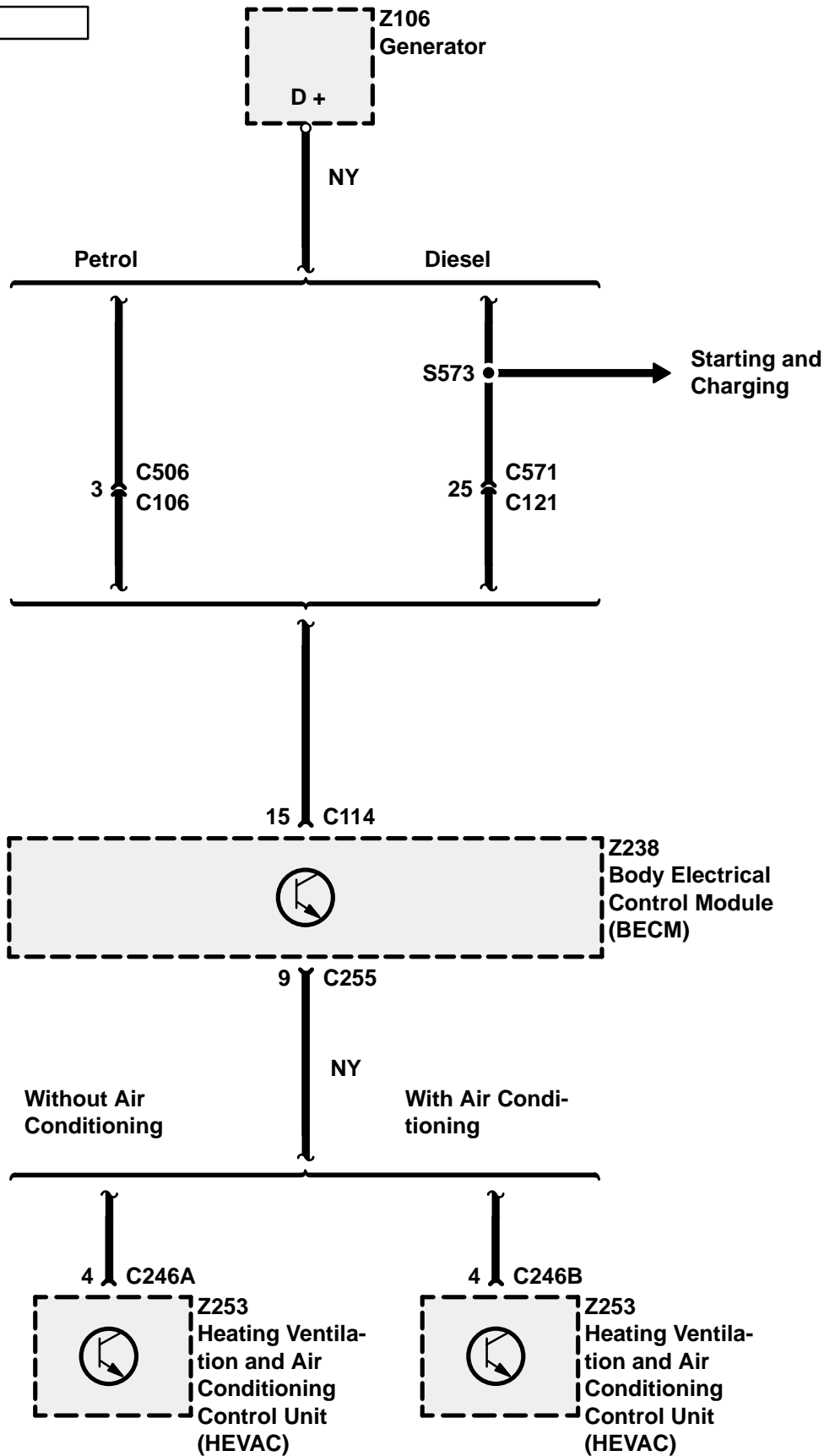
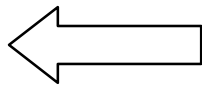

CIRCUIT OPERATION

The rear screen heater will reflect the state of the heated rear screen input from the HEVAC unit at any time while the BeCM (Z238) is in the active mode. This signal is normally 12V and 0V when active (Active Low).

The HEVAC unit will control all timing functions related to the rear screen heater.

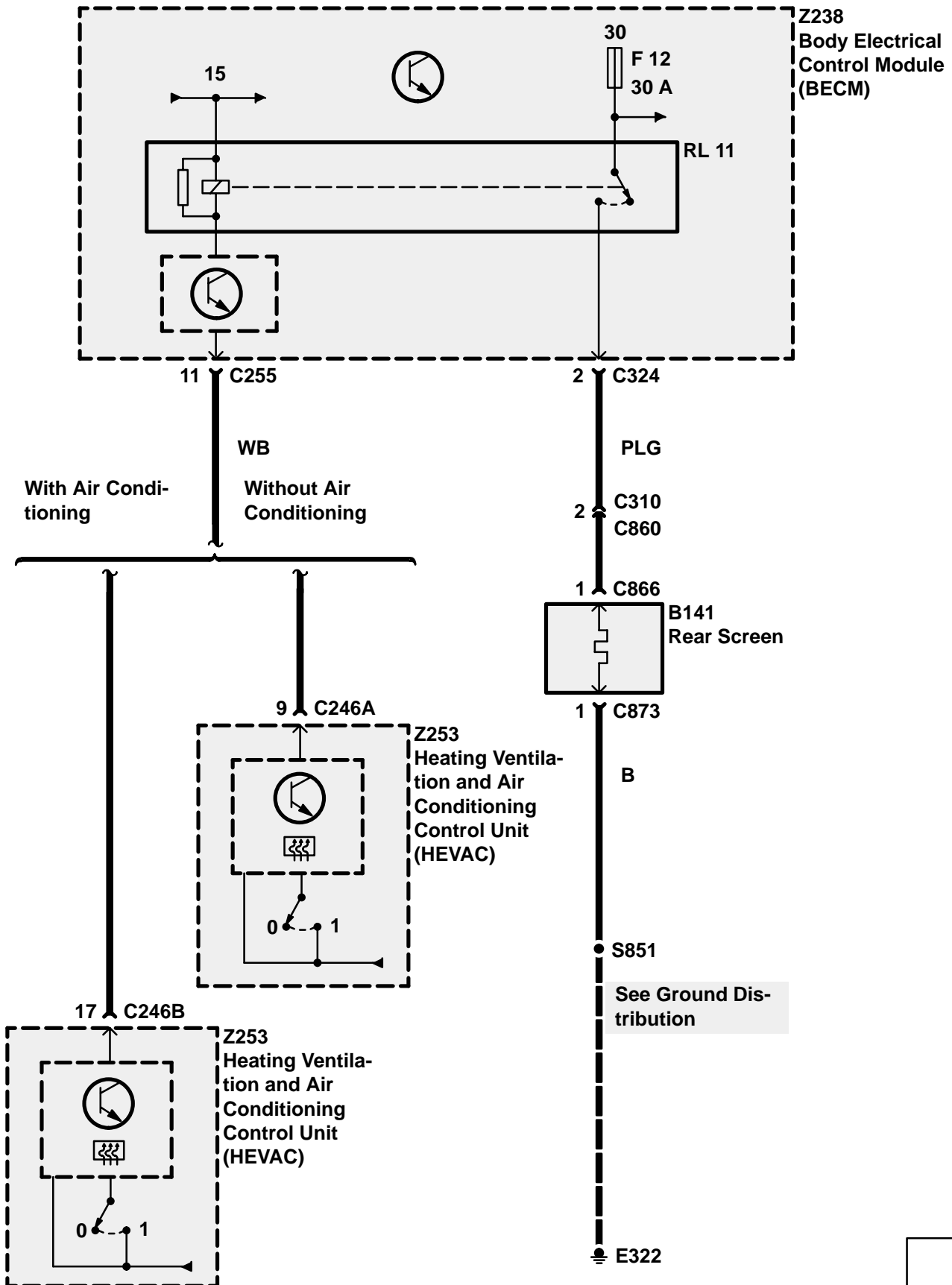

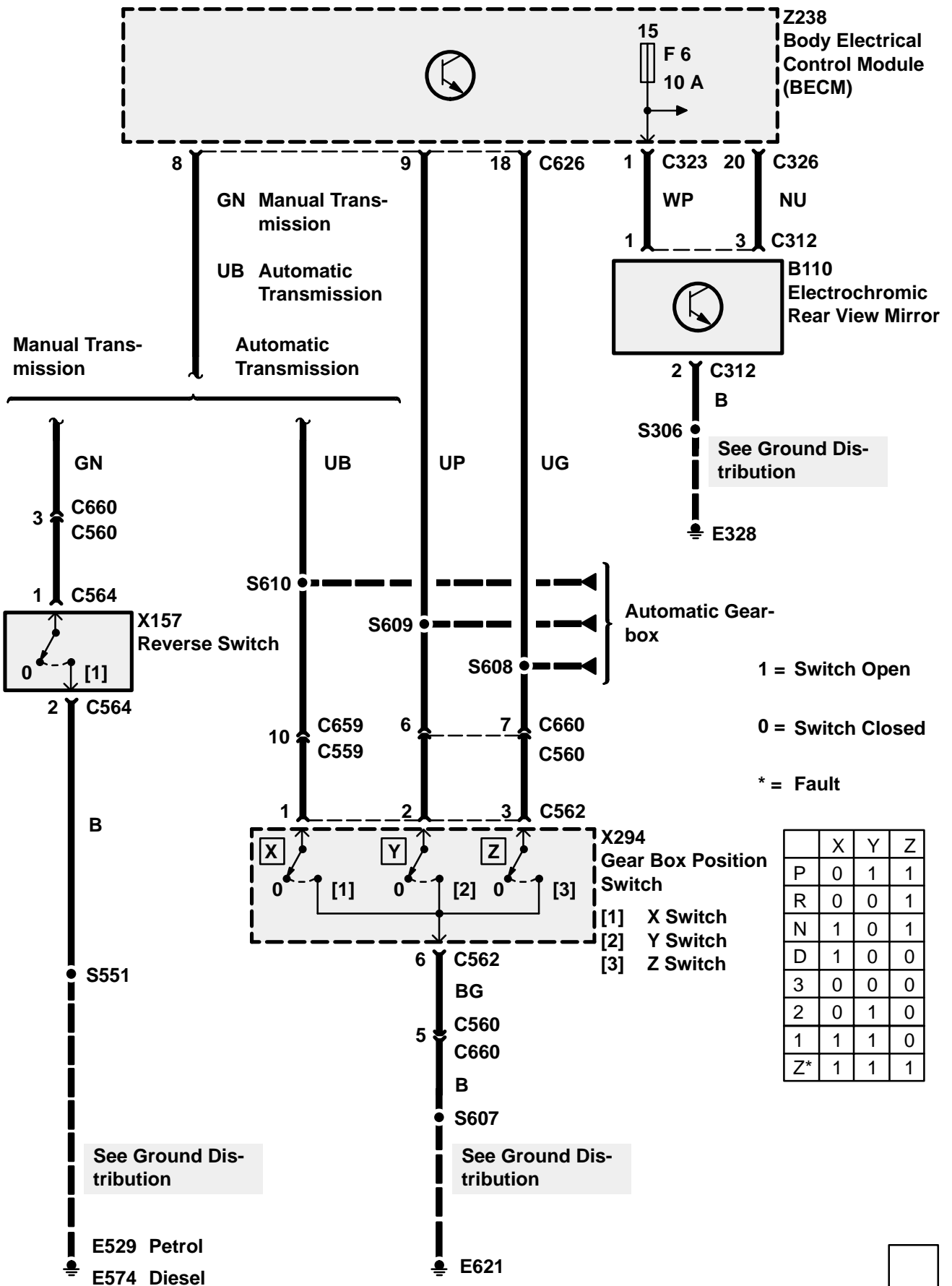

CIRCUIT OPERATION

Dipped Beam Headlamps

Operation of the headlamp switch will activate the LH and RH dipped beam headlamps, regardless of the state of the ignition switch.

Headlamp Delay

The term "headlamp" used throughout this section is assumed to be either dipped beam or main beam, as selected by the main beam changeover switch. This switch will continue to function for the duration of the delay period.

The headlamps will operate when the headlamp switch is set to the headlamp position, regardless of the status of the ignition switch.

If the ignition switch is turned off and the key removed whilst the headlamps are on, and the headlamp switch is subsequently turned off with a dwell of less than 1 second in the side lamp position, then a 25 second headlamp delay will be initiated.

If the ignition switch is turned off and the key removed while the headlamps are on and the headlamp switch is subsequently turned to the side lamp position for greater than 1 second then the headlamps will be switched off and parking lamps will remain on until the headlamp switch is turned off, or turned back to the headlamp position.

The headlamp delay may be cancelled immediately at any time while it's active (master lighting switch in the off position) by the following actions:

- Insertion of the ignition key or selection of auxiliary /ignition (all exterior lamps will be extinguished).
- Turning the headlamp switch to the side lamp position. In this case the exterior lamps will immediately revert to parking lamps mode.
- Turning the headlamp switch to the headlamps position. In this case the headlamps and normal side lamps (i.e. not parking lamps) will be active.

Main Beam/Side lamp Warning lamps

The main beam warning lamp will be activated whenever the main beam lamps are on, regardless of the state of the ignition switch. The side lamp warning lamp will be active whenever the side lamp switch is on and the side lamps are operating in side lamp mode, but not when the key is removed and the parking lamp mode is on.

Main Beam Headlamps

The main beam change over switch has a momentary action, which will cause the headlamps to switch between dipped and main beam on each operation.

Operation of the main beam changeover switch, while the dipped beam headlamps are activated and the front fog lamps are inactive, will cause the dipped beam lamps to be extinguished and both main beam 1 and main beam 2 lamps to be illuminated.

Operation of the main beam changeover switch, while both dipped beam and front fog lamps are active, will cause the dipped beam lamps to be extinguished and the main beam 1 lamps to be illuminated.

Daytime Running lamps

This feature is a requirement for vehicles for the Canadian, Norwegian, Swedish and Finnish markets.

On these vehicles, with the engine running, daytime running loads will be active regardless of the state of any switches.

This feature will in no way effect the operation of any of the other lighting systems.

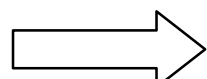
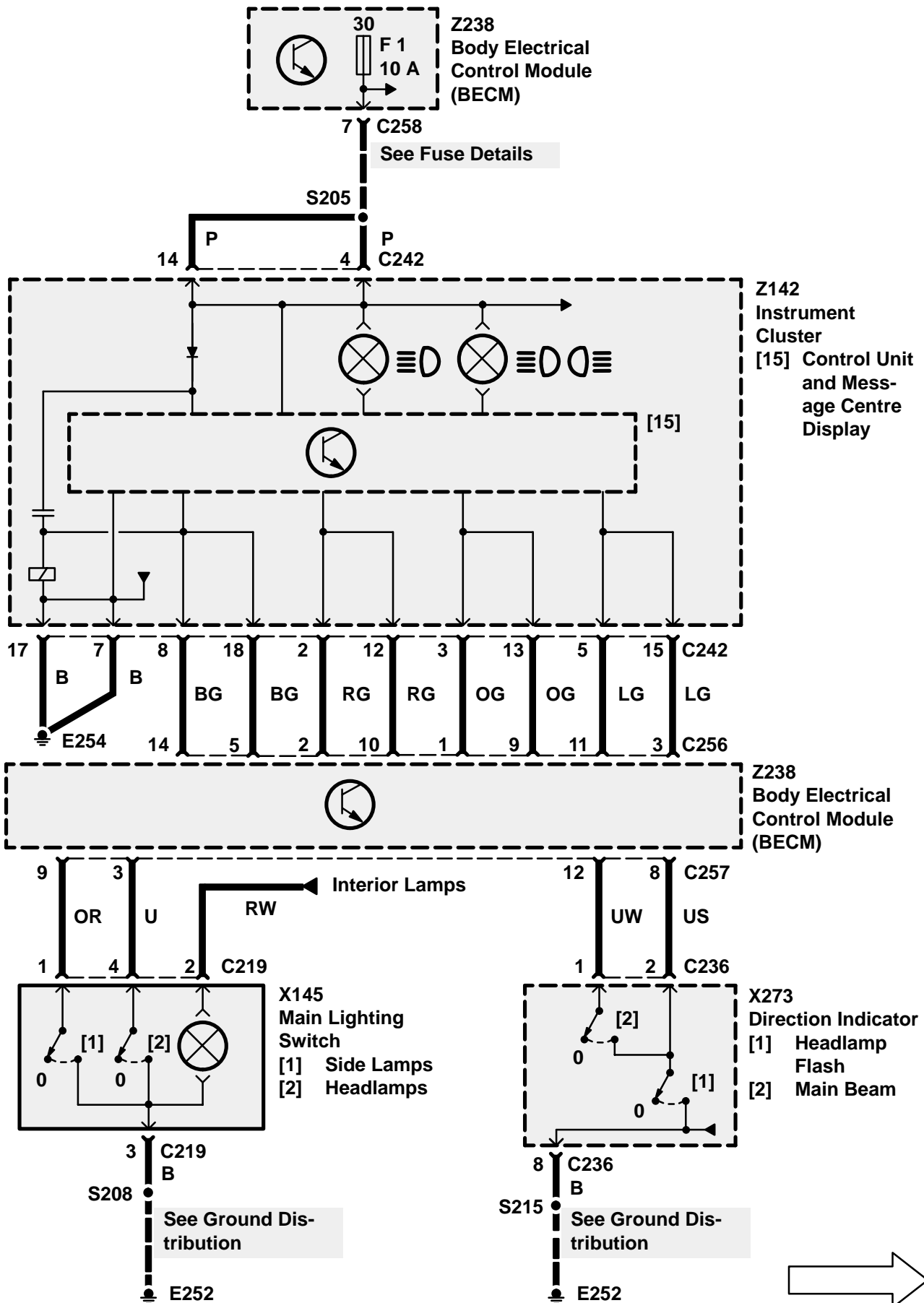

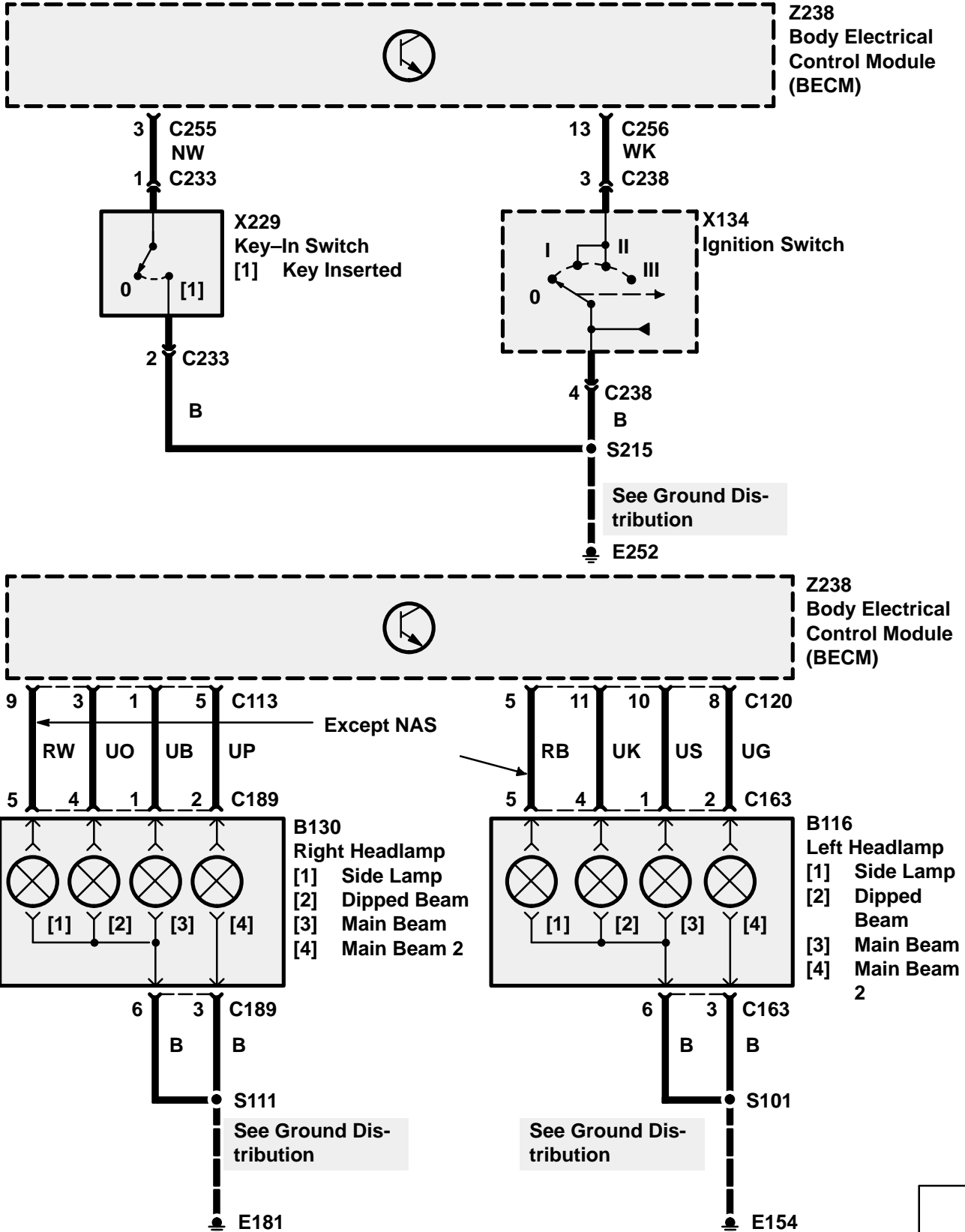
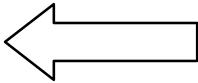

CIRCUIT OPERATION

Side lamps:

Activation of the side lamp switch, when the ignition key is in, when the ignition is on, or when the head lamp switch is on, will result in the operation of the following; front LH and RH side lamps, rear LH and RH side lamps, number plate lamps, lamps on warning lamp and the rear door switch pack illumination.

The following lamps will also operate through the activation of the side lamp switch:

Clock, fascia switch pack, console switch pack, gear select assembly, instrument pack, front cigar lighter, Hevac panel switches and I.C.E. (remote telephone dial, when fitted).

Parking lamps:

With the ignition and auxiliary off, the key out and the headlamp switch in the side lamp position, the parking lamps will be activated according to the position of the direction indicator switch as follows:

- If the indicator switch is in the central position, then all the side lamps will be on.
- If the indicator switch is in the RH position, then the front right and rear right side lamps will be on.
- If the indicator switch is in the LH position, then the front left and rear left side lamps will be on.

If the headlamp switch is set to the headlamp position, then normal side lamps will operate in conjunction with the headlamps.

Side lamp Warning lamps:

The side lamp warning lamp will be active whenever the side lamp switch is on and the side lamps are operating in side lamp mode, but not when the key is removed and the parking lamp mode is on.

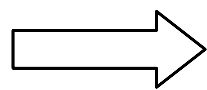
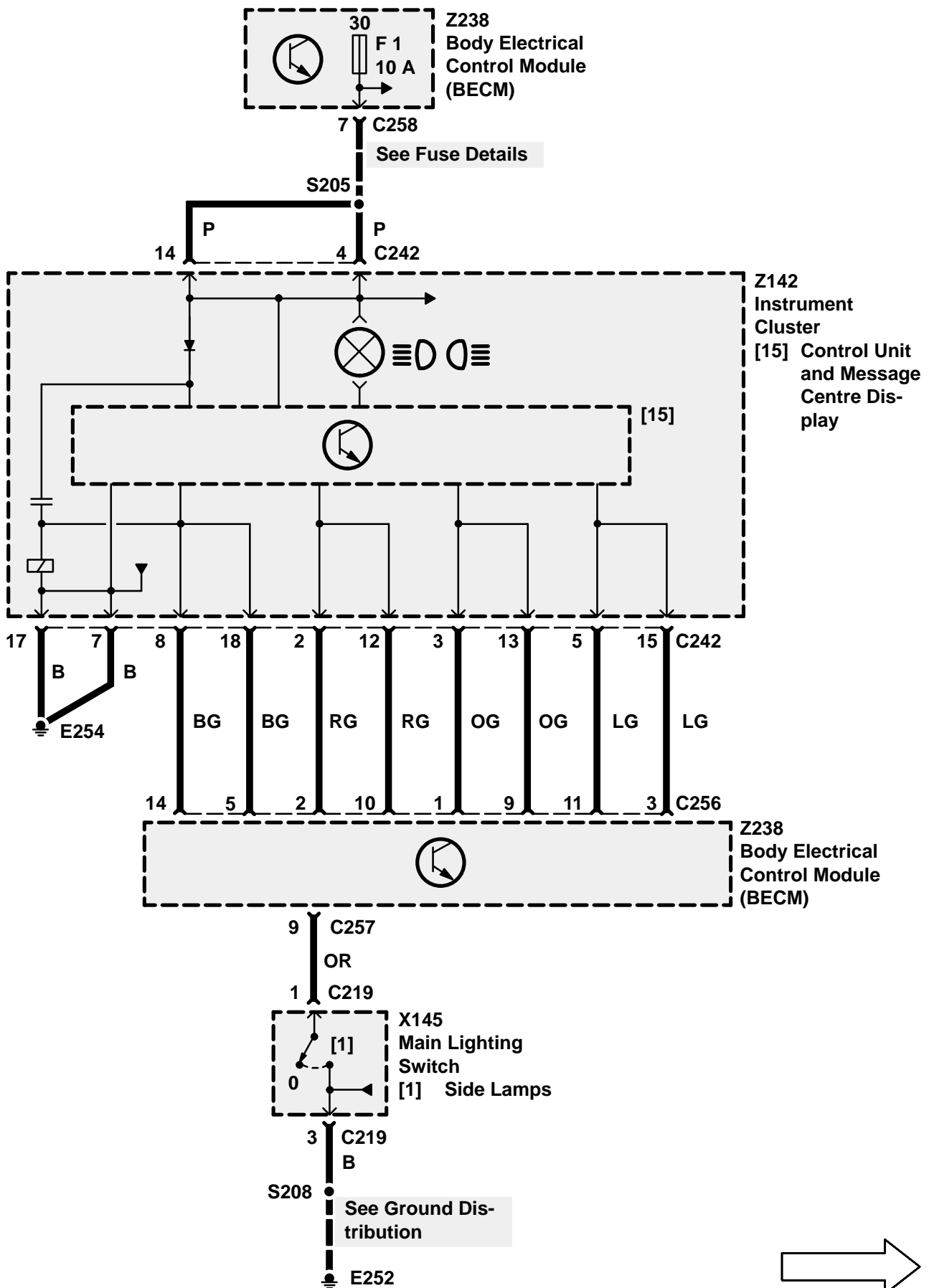

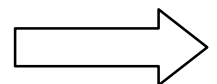
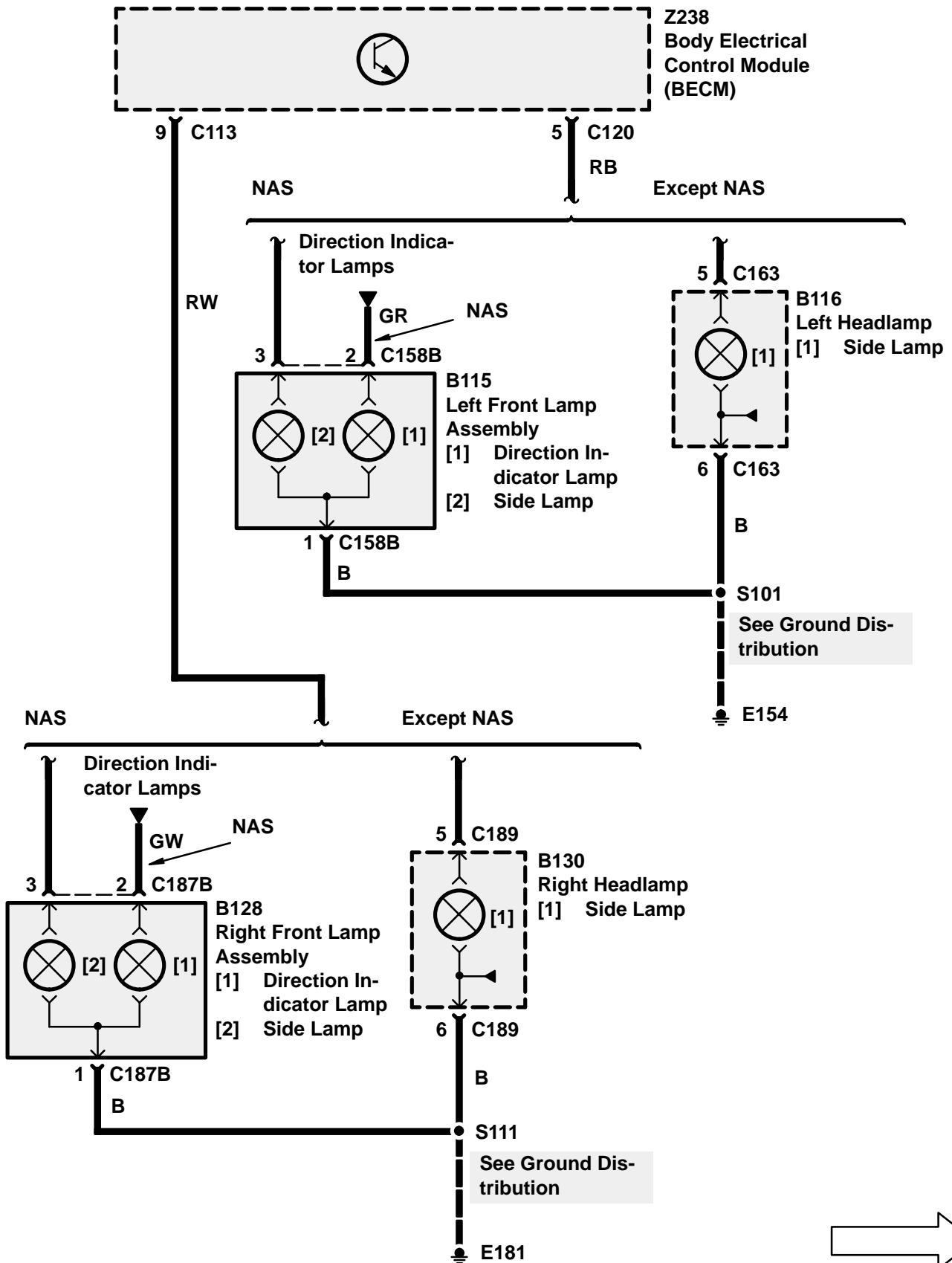
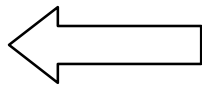

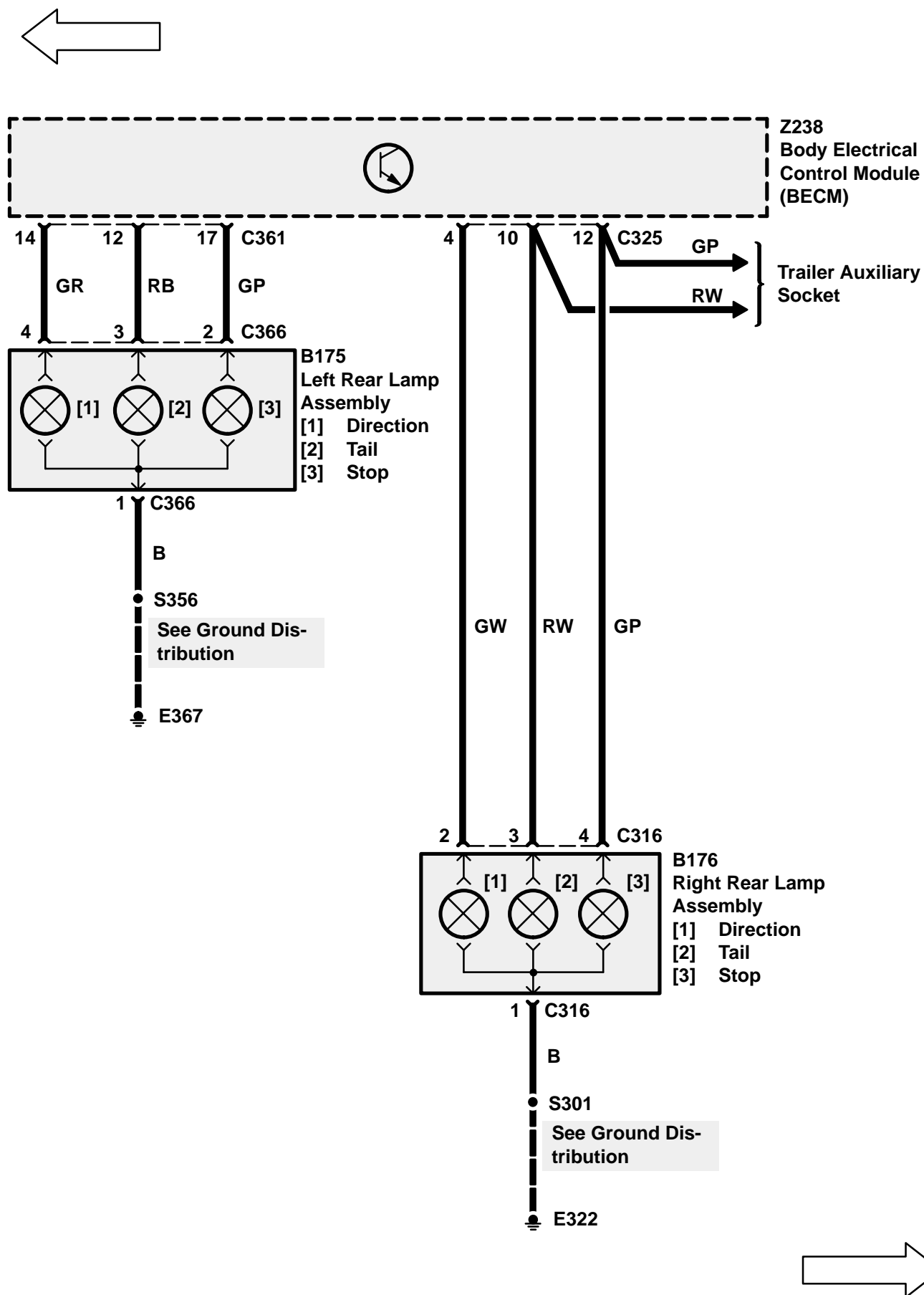

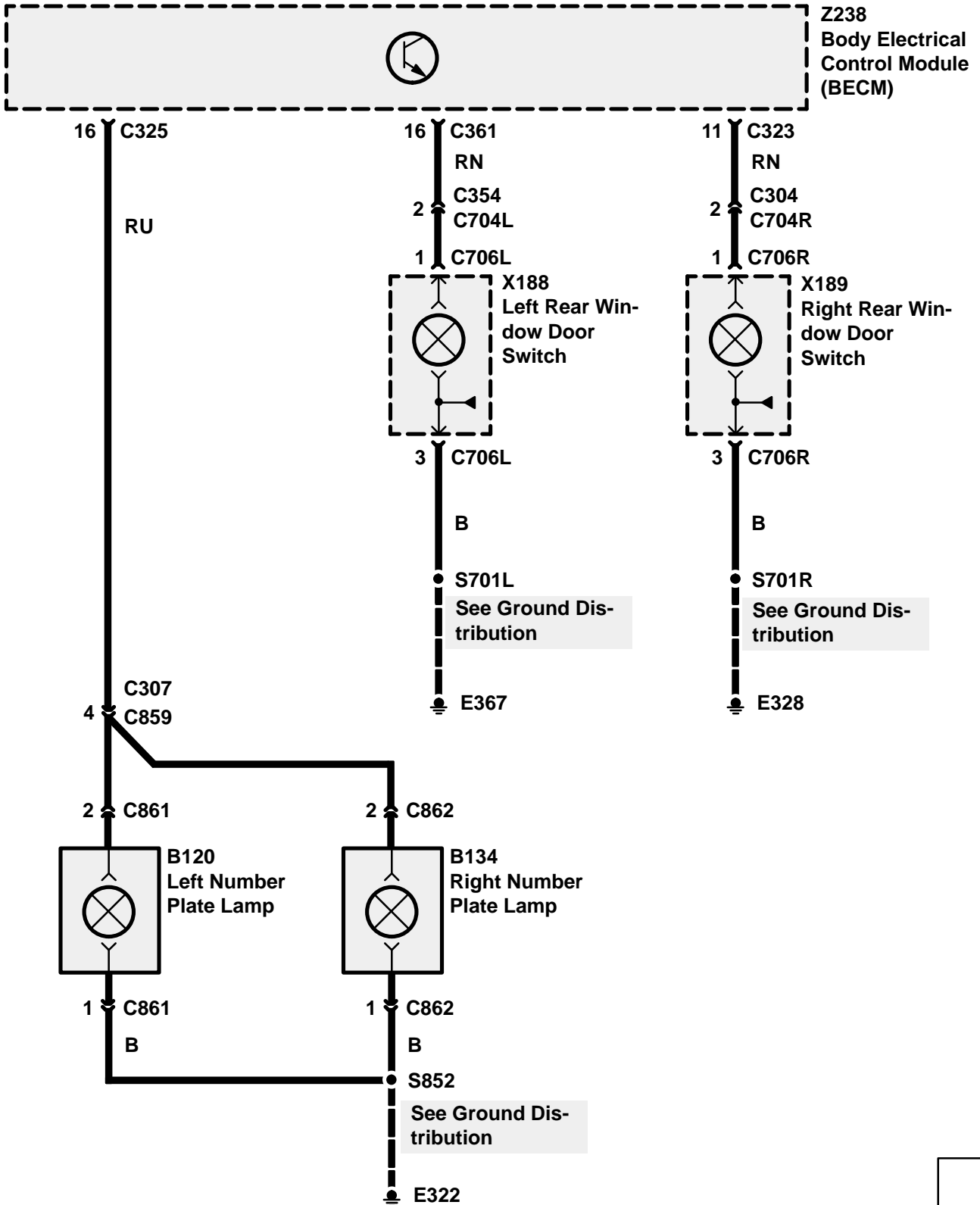
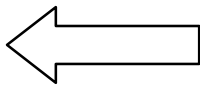

CIRCUIT OPERATION

Brake lamps

The brake lamps (including the high mounted stop lamp when fitted), are operated when the brake switch is closed, provided the ignition is switched on.

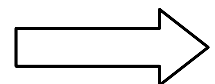
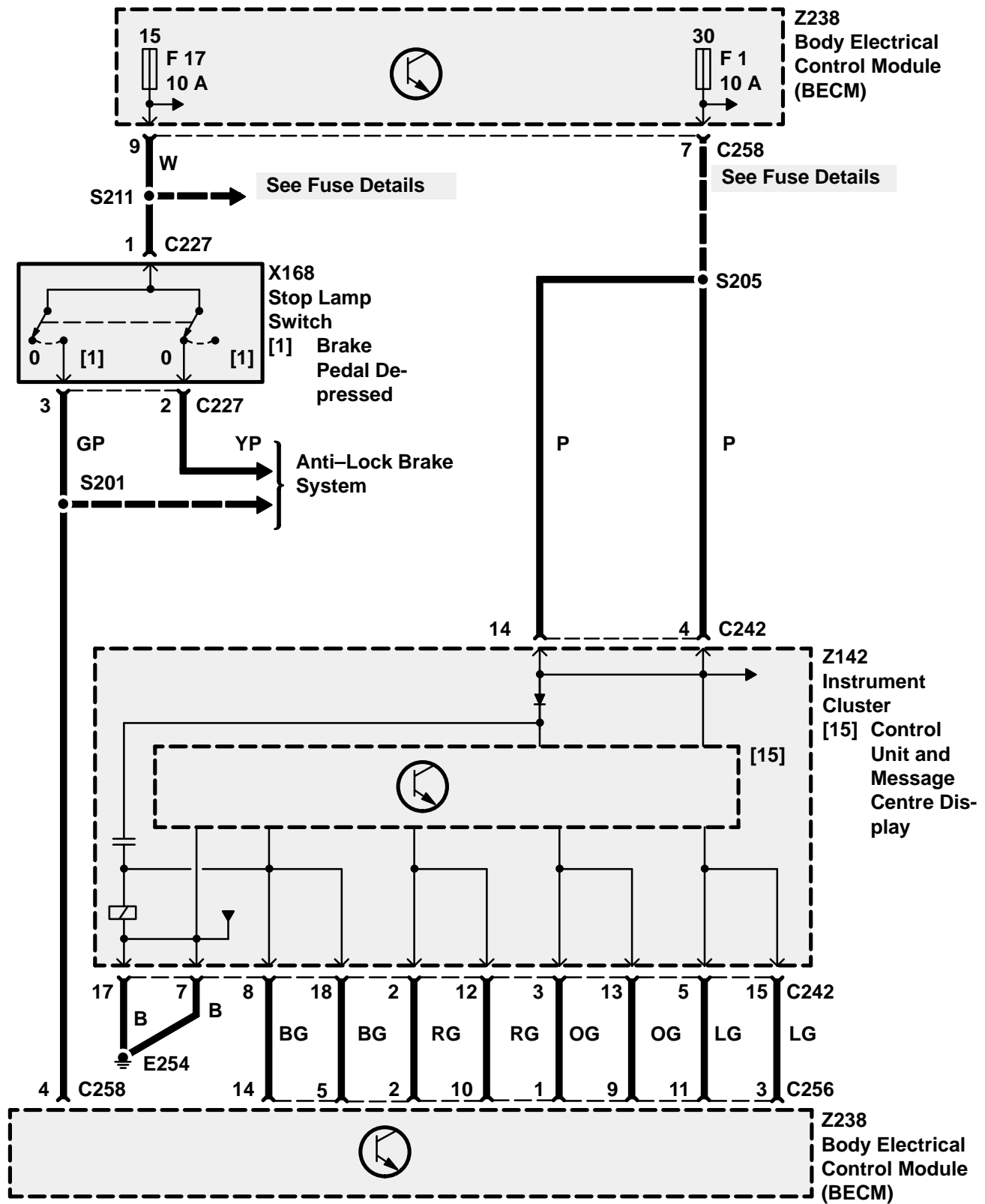

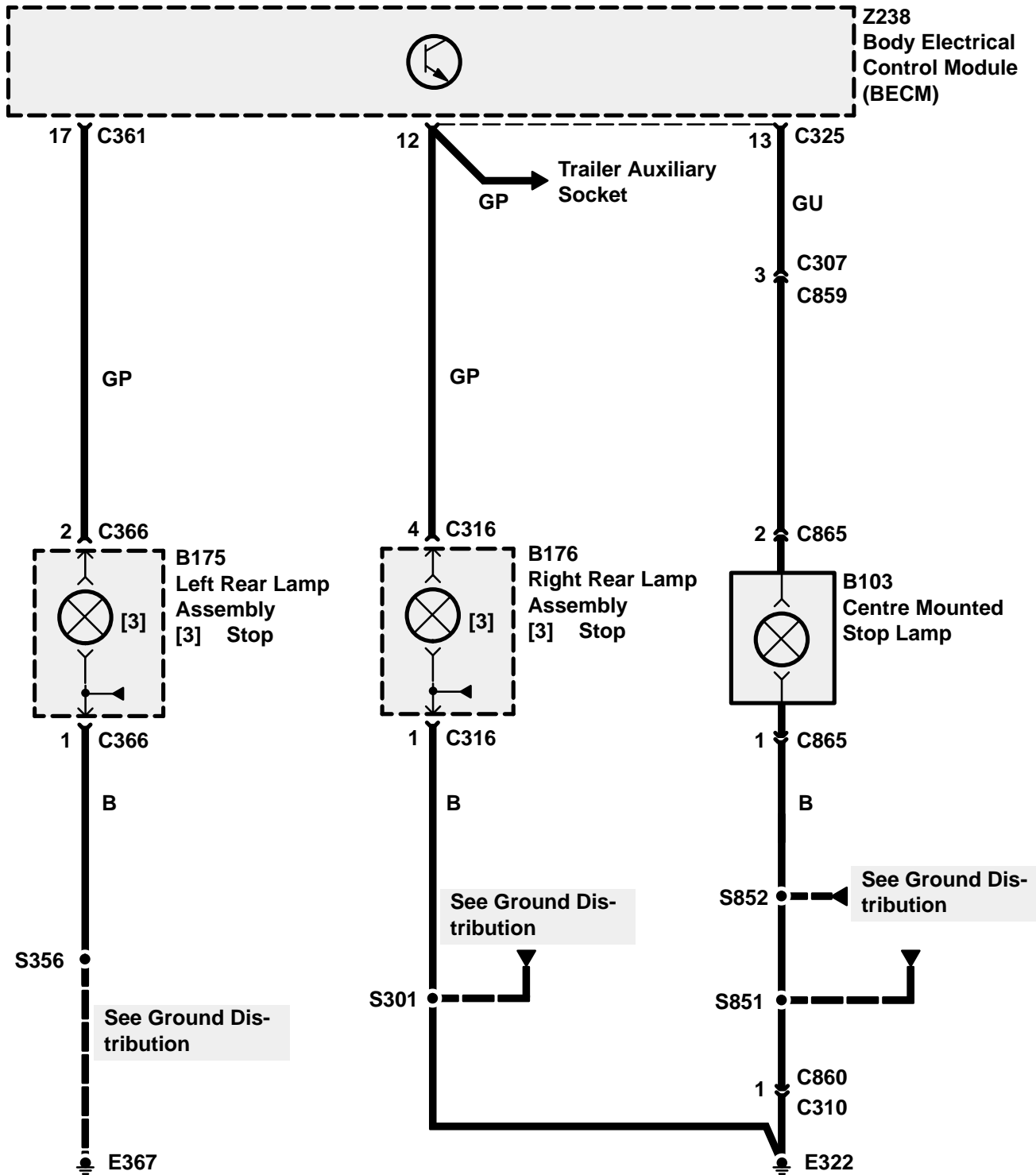
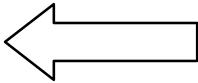

CIRCUIT OPERATION**Hazard lamps**

When the hazard warning switch is operated, all indicator bulbs, side repeaters and the hazard switch illumination bulb will operate at the specified rate, regardless of the ignition switch position. The indicator warning lamps within the instrument pack will also operate under this condition.

If the inertia switch is operated and the ignition is on, all indicator bulbs, side repeaters, warning lamps and the hazard switch bulb will flash at the specified rate.

In addition to the operation of the indicator bulbs there will be an audible tick generated by the BeCM, timed to match the bulb illumination in the instrument pack.

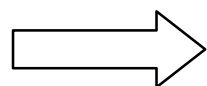
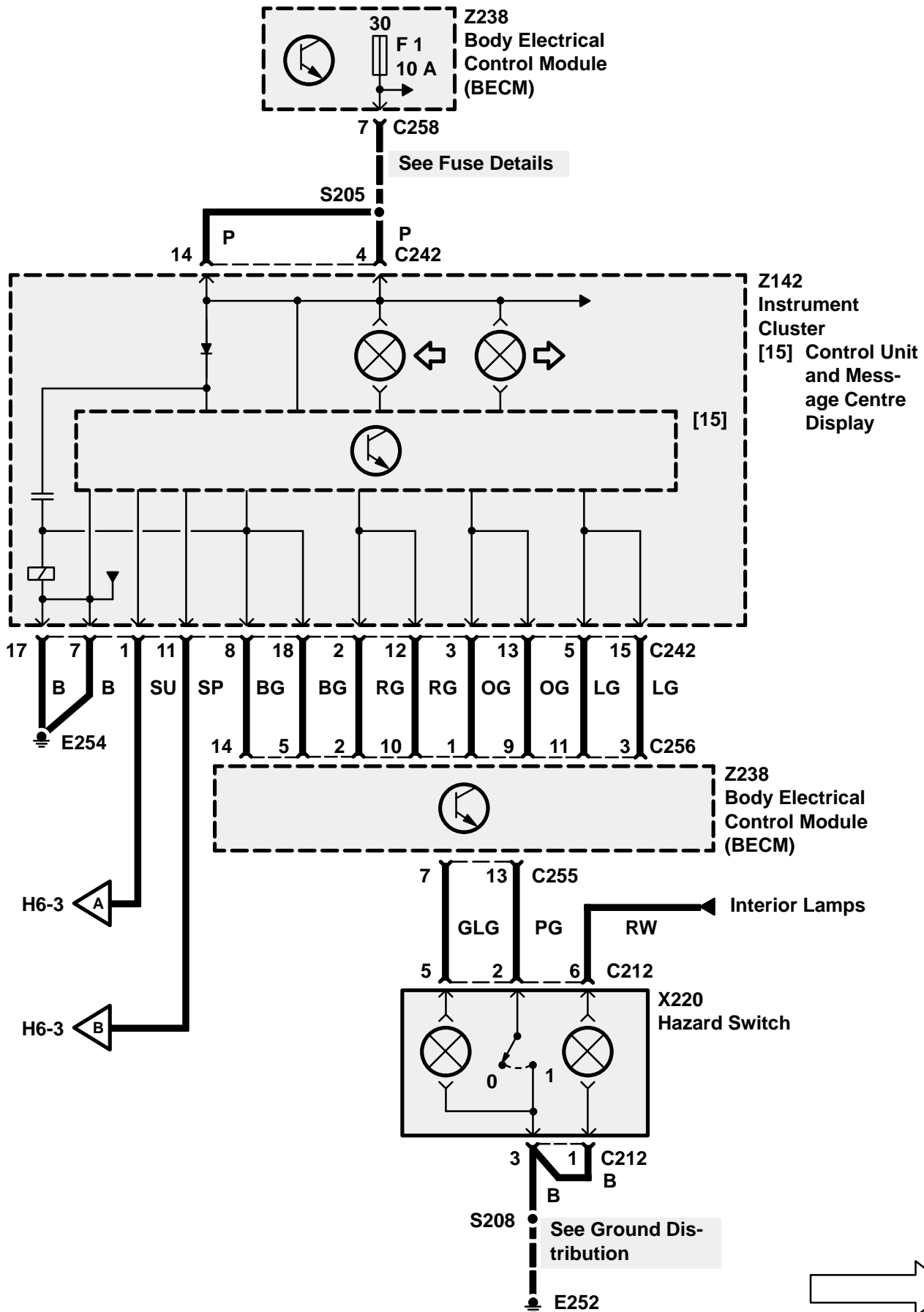

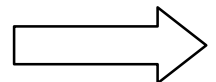
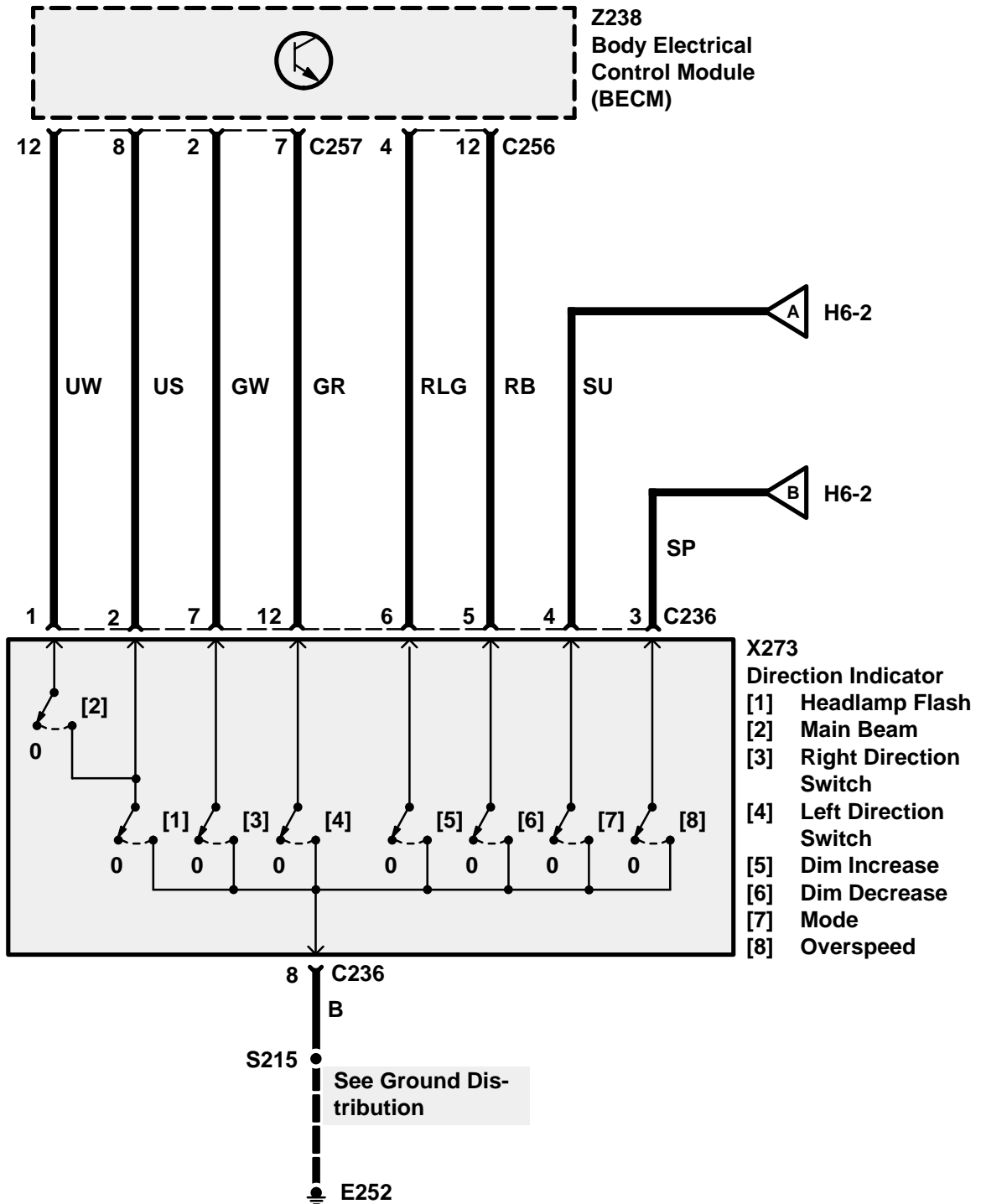
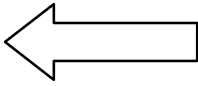

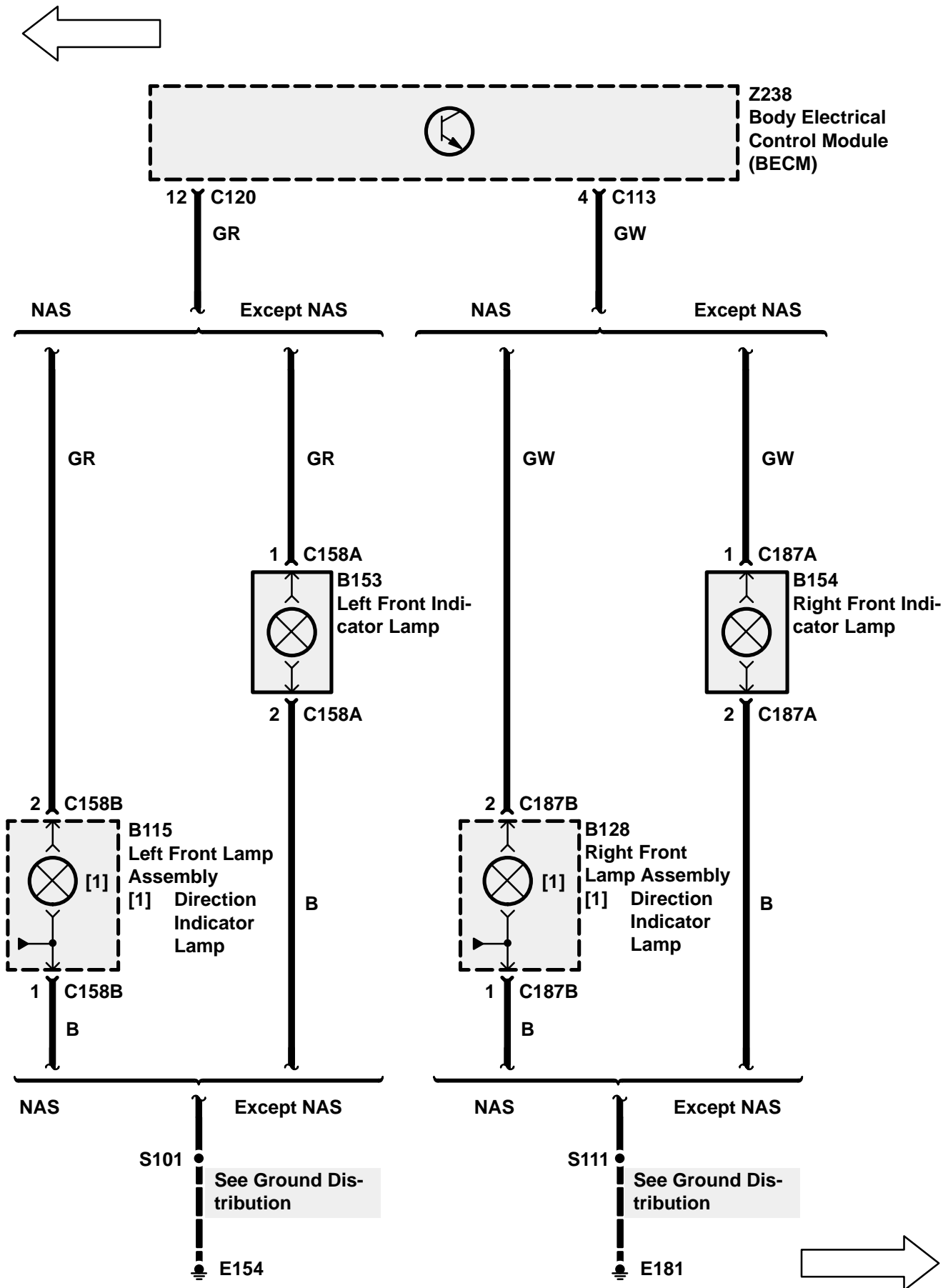

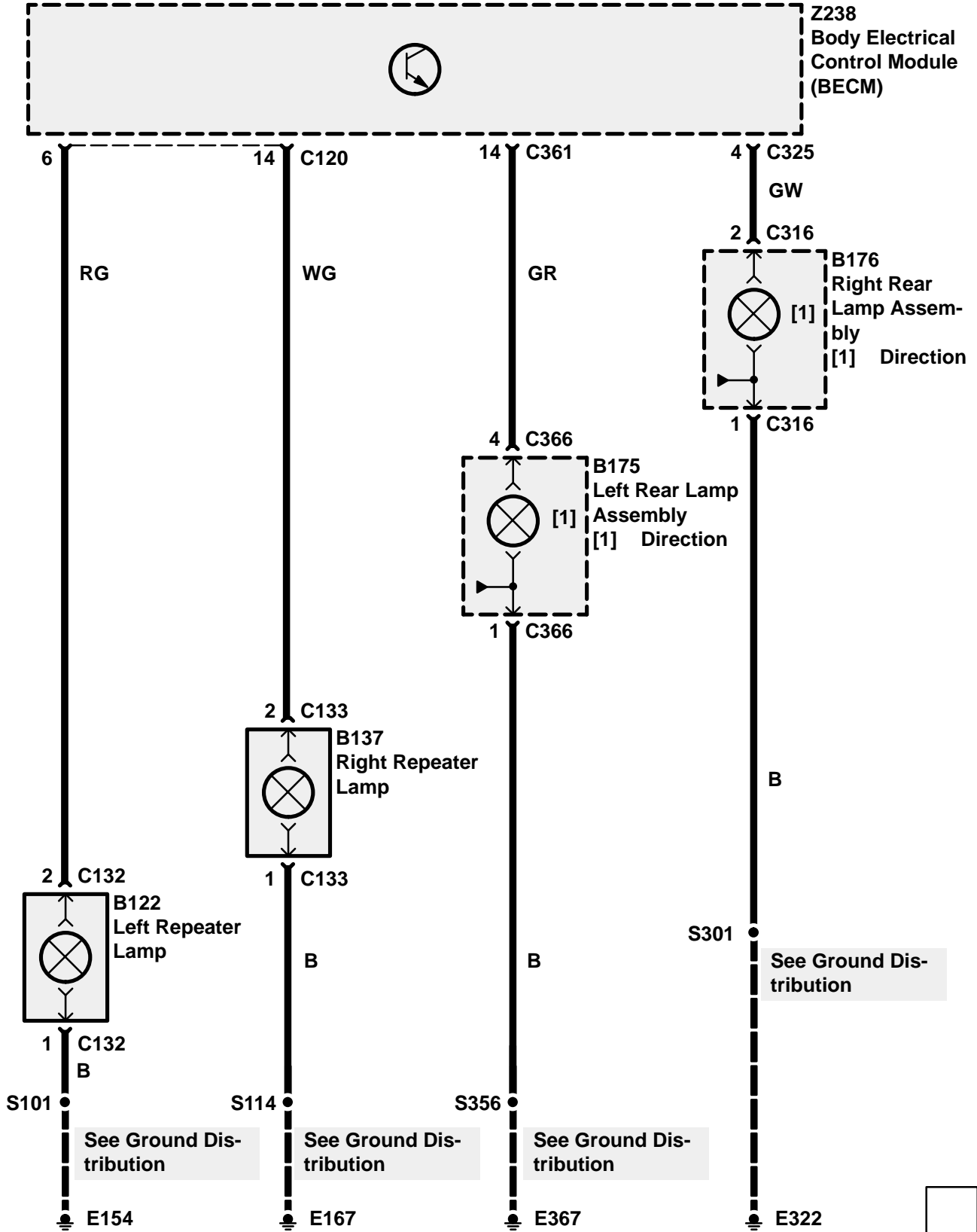
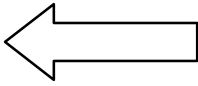

CIRCUIT OPERATION

Reversing lamps:

With the ignition on and the gear selector lever moved to the reverse position both reverse lamps will activate.

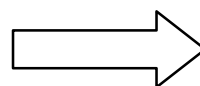
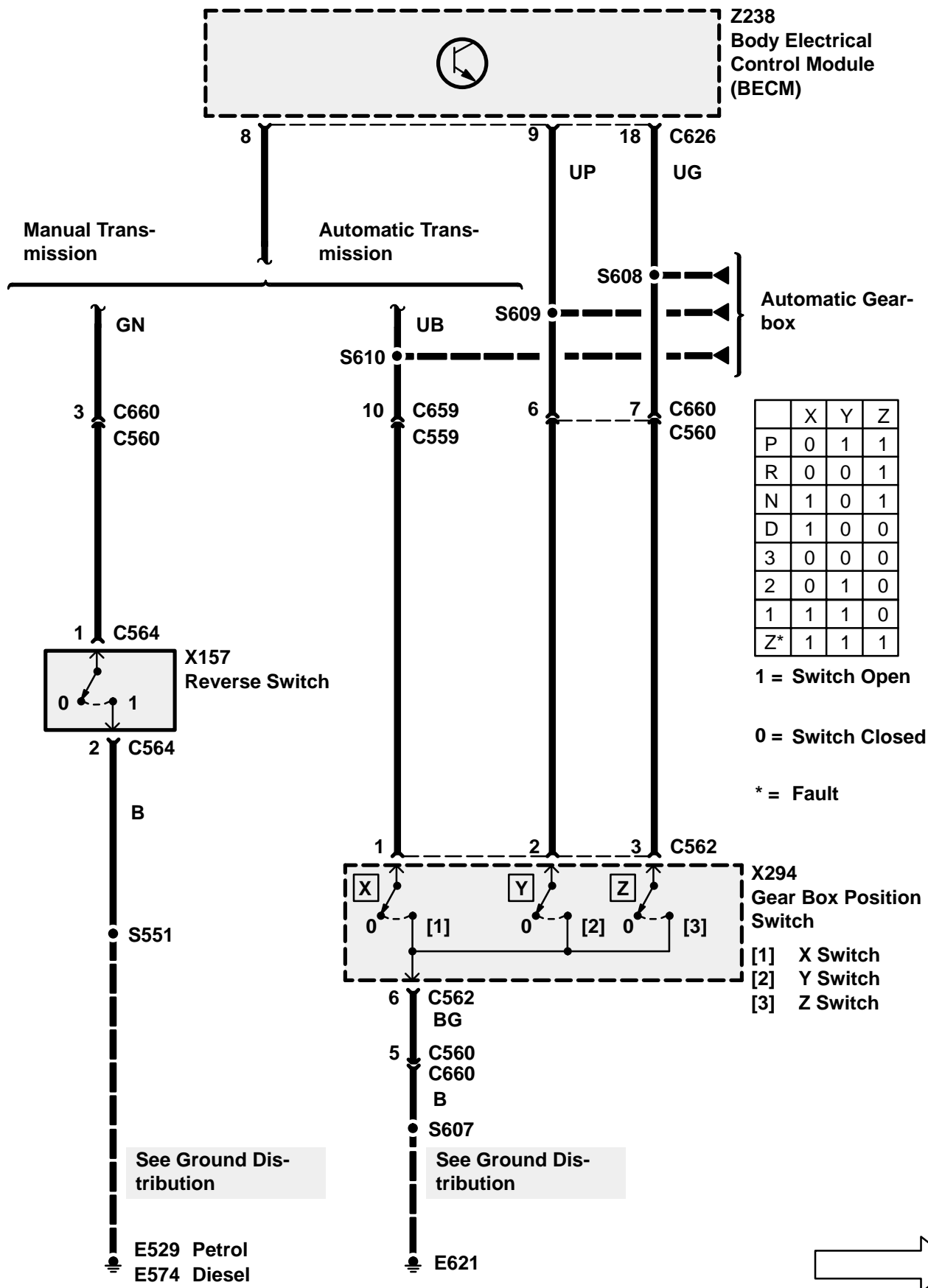

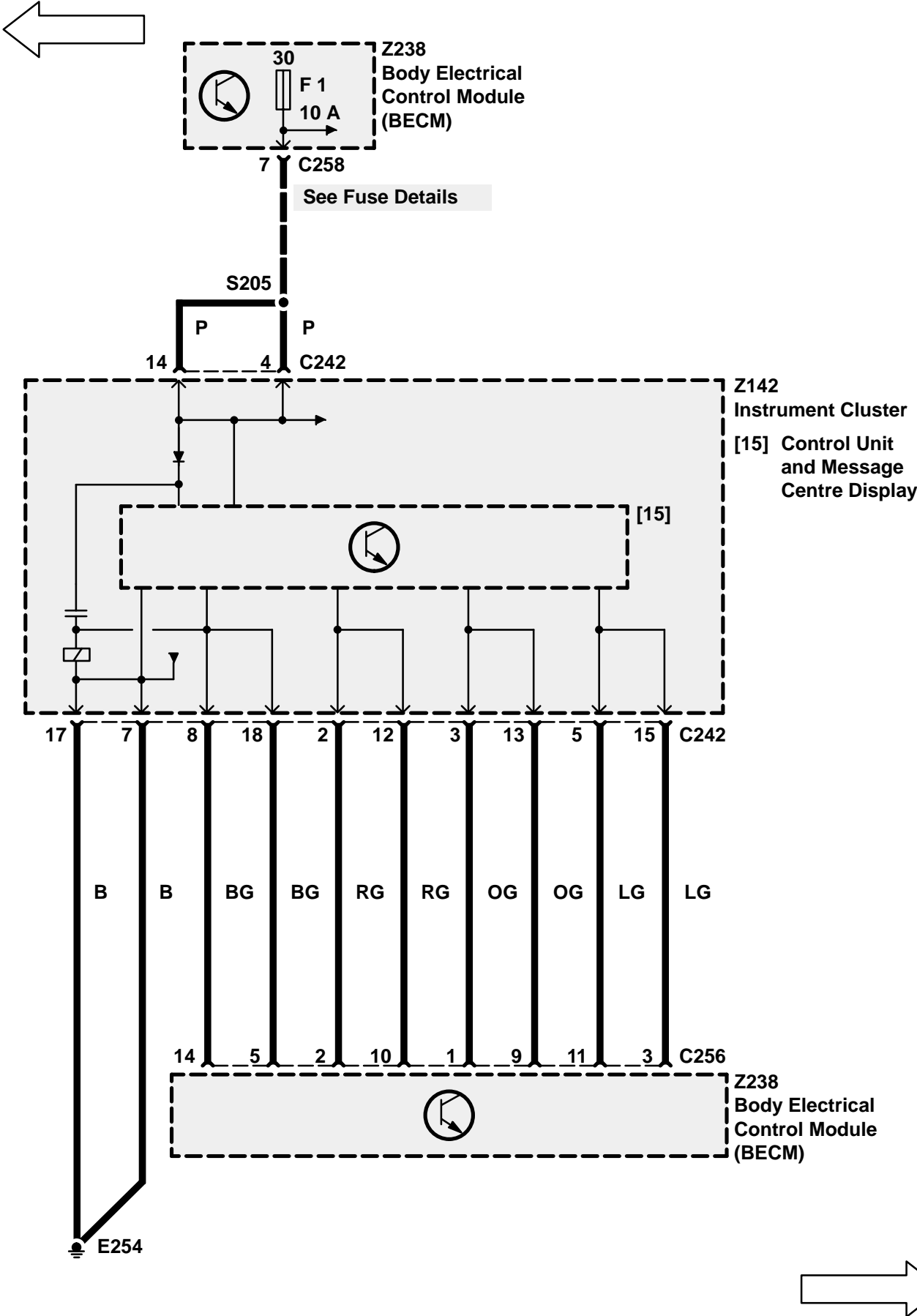

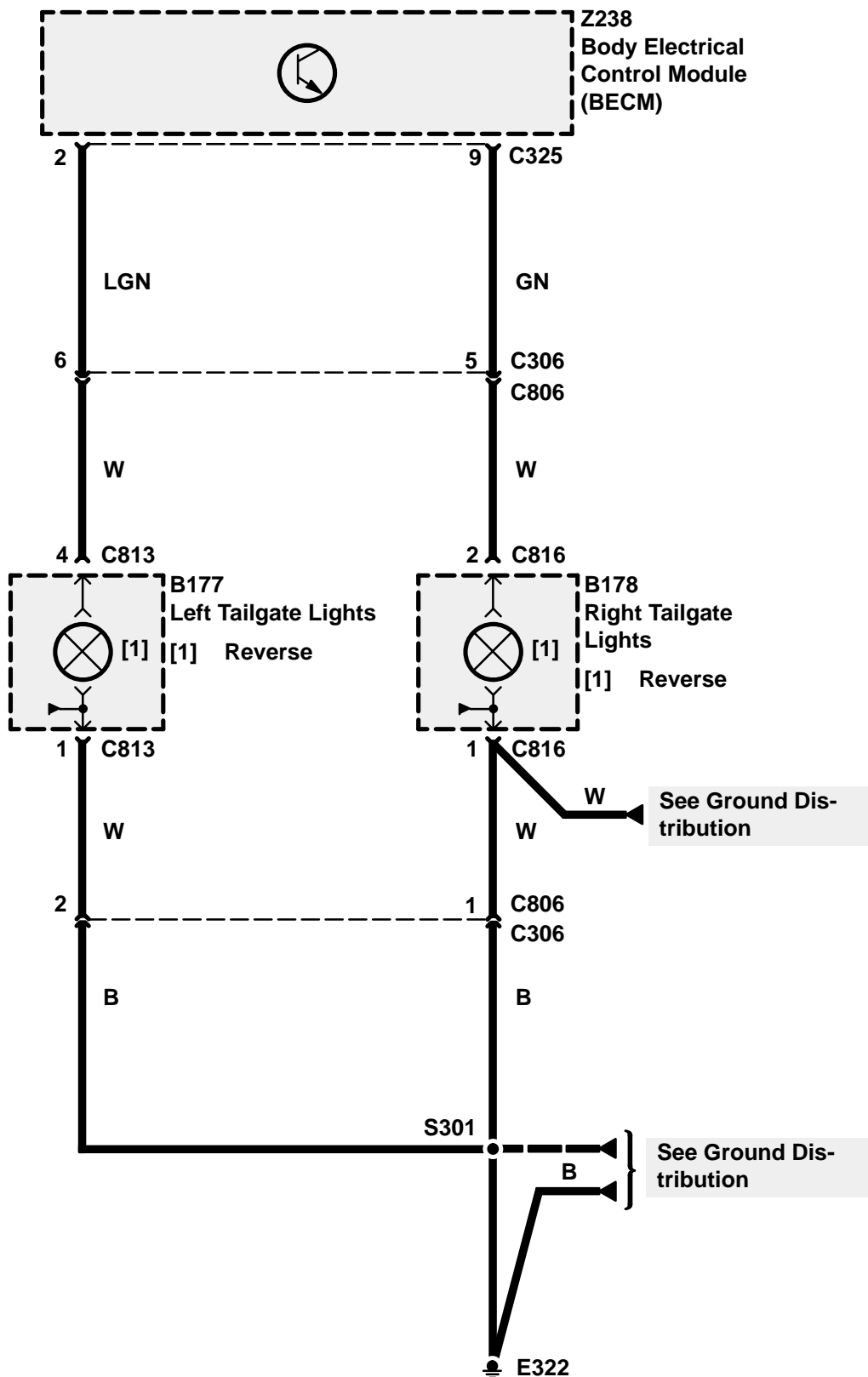
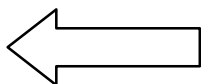

CIRCUIT OPERATION

Front Fog lamps

With the ignition switch and side lamp or headlamp switch on, a momentary operation of the front fog lamp switch will activate the front fog lamps. A further momentary operation of the fog lamp switch, or switching off of the headlamps/side lamps or ignition, will cause the front fog lamps to be extinguished. N.B. The front fog lamps will always be inactive when the ignition is turned on.

Rear Fog lamps

With the ignition on, the headlamp switch on or front fog lamps on, a momentary operation of the rear fog lamp switch will activate the rear fog lamps. Operation of the rear fog lamps will also activate a bulb within the fog lamp switch. A further momentary operation of the fog lamp switch, switching off the headlamps and front fog lamps, or switching off the ignition, will cause the rear fog lamps to switch off. N.B. The rear fog lamps will always be inactive when the ignition is turned on.

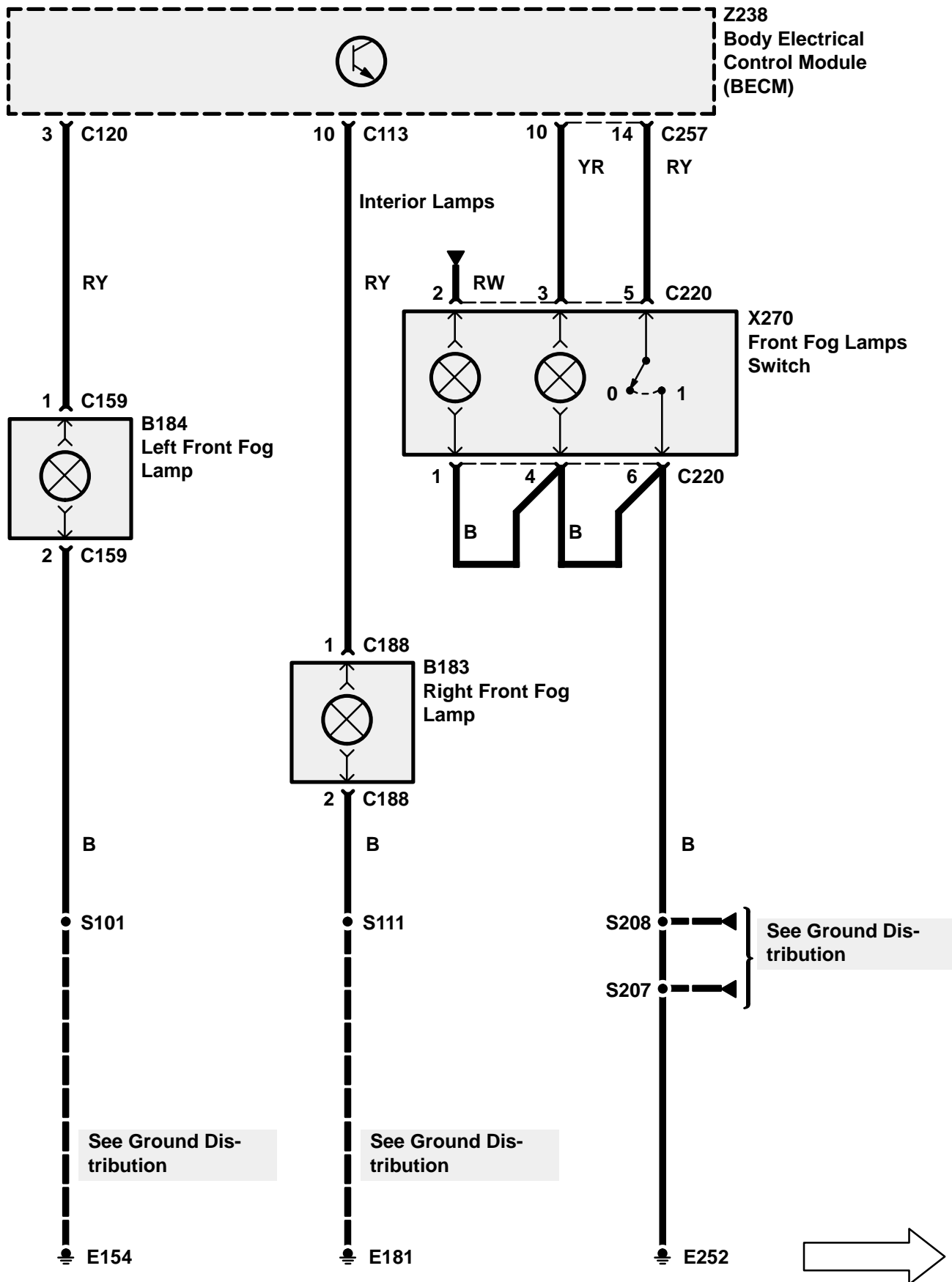

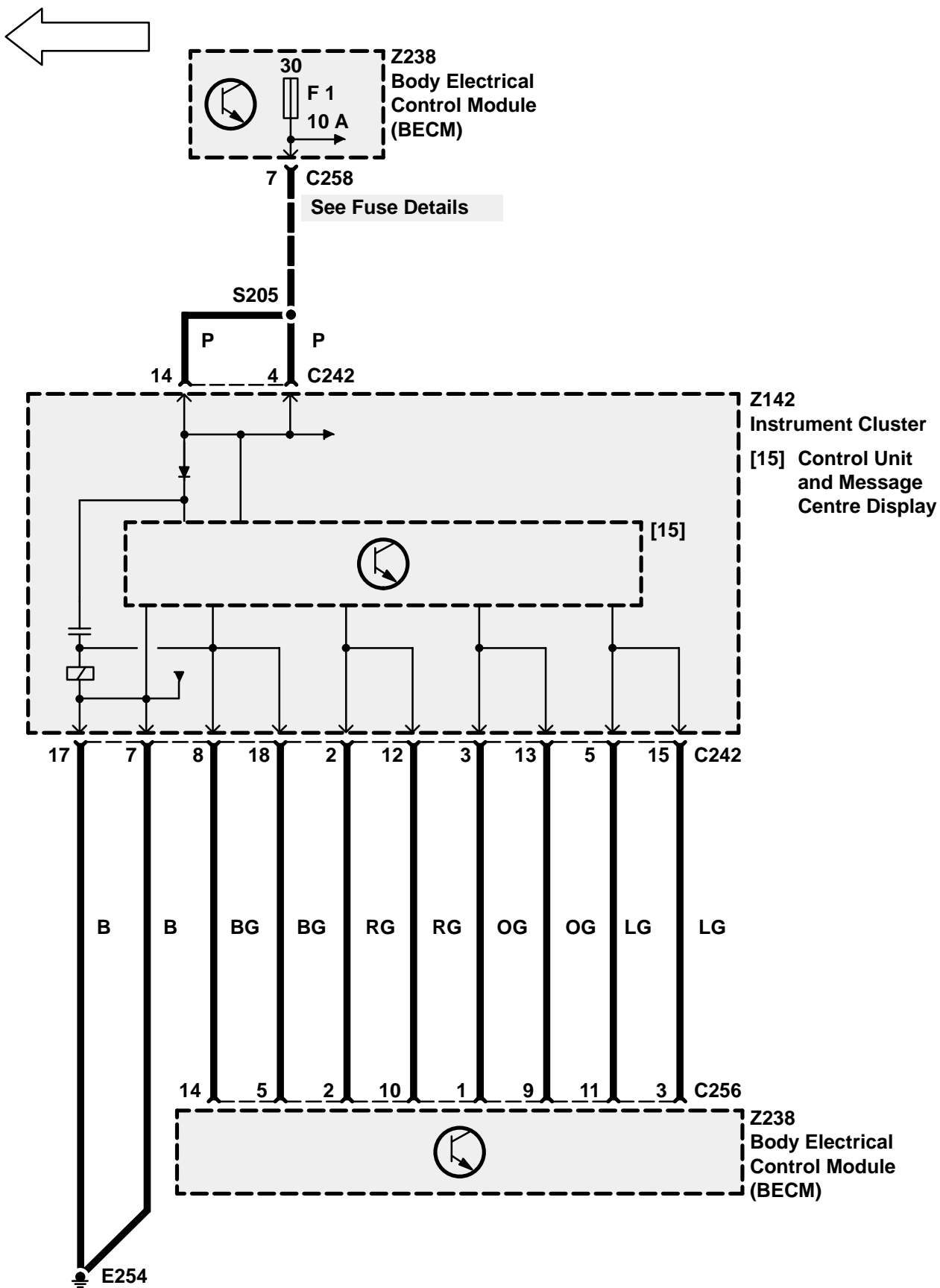

CIRCUIT OPERATION

Courtesy lamps

Automatic courtesy lamp facility enabled

With the tailgate or any of the four doors opened the illumination level of the following lamps will fade on over a period of approximately 0.5 seconds:

- front courtesy lamp
- rear left courtesy lamp
- rear right courtesy lamp
- load space lamps
- front left footwell lamp
- front right footwell lamp
- ignition ring illumination
- rear right footwell lamp
- rear left footwell lamp

If any door is left open, the lamps will fade out after a time of approximately 10 minutes. During the 10 minute time out, if any other door is opened the timer will be reset.

If all doors are closed prior to the end of this 10 minute period then all specified lamps will fade out after a delay of 15 seconds.

If the ignition is switched on before the end of the 15 second time out period, the specified lamps will begin to fade out after a delay of 1 second.

If the ignition is then switched off and no door opened, the 15 second time out of the lamps will not be resumed.

If an unlock signal is received from the remote key, or if a key unlock is received from either of the front doors while all the doors are closed, then the courtesy lamps will fade to on in 0.5 seconds and begin a 15 second time out period.

If any of the doors or the tailgate are opened during this delay, then the time out period will be restarted.

If all the doors are closed and a lock signal is received from the remote key or either of the front door CDL switches while the courtesy lamps are in their 15 second time out period, then the time delay will be cancelled and the lamps immediately faded out.

Automatic courtesy lamp facility disabled

Whenever the main courtesy lamp switch is operated for greater than 2 seconds, the automatic courtesy lamp feature will switch between the enabled and disabled mode upon release of the switch. At the

same time an "Int lamps off"/"Int lamps auto" message will be displayed on the instrument pack. This extended switch operation will also extinguish the courtesy lamps if the button has been depressed for 2 seconds, causing the system to switch from the automatic to disabled mode, but otherwise will have no effect on their state. While the automatic courtesy lamp facility is disabled, the courtesy lamps may only be switched on and off by momentary activation of the main courtesy lamp switch. The change of lamp state will occur on release of the switch.

Panel Dimmer:

Operation of the panel dimmer switch, with the side lamps on, will alter the level of panel illumination between approximately 6 and 94%. Depressing the switch momentarily will cause the illumination to increase or decrease to the next level. Holding the switch closed will cause the illumination to ramp towards fully on or fully off.

The illumination level selected will be stored in the BeCM's non-volatile memory whenever the driver's seat store sequence is completed successfully, provided the side lamp switch is on. If the side lamp switch is not on and a successful memory store sequence is completed, then the previously stored illumination level will remain unchanged.

Puddle lamps

With any door open and the automatic courtesy lamp feature enabled, the puddle lamp within the relevant door will be illuminated, either until the door is closed or a time period of approximately 10 minutes has elapsed. If any puddle lamp is on, momentary operation of the courtesy lamp master switch will extinguish all puddle lamps on release of the switch.

Further operation of the switch or reopening a door (if automatic courtesy lamps are enabled) will again activate the puddle lamps for those doors that are open. If the courtesy lamp switch is held on for longer than 2 seconds, the automatic operation of the puddle lamps from the door open switches will switch between enabled and disabled.

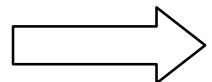
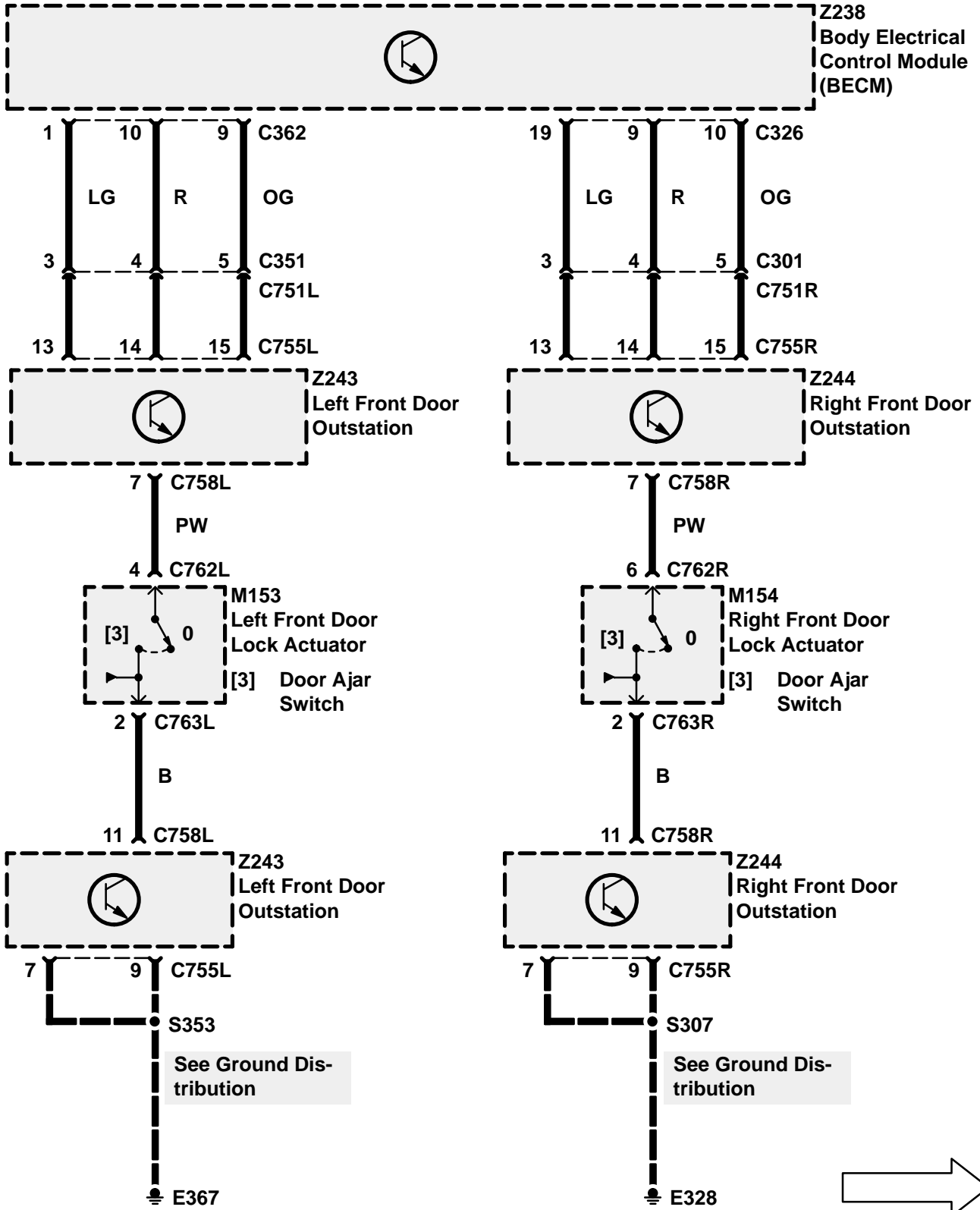
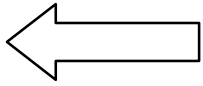

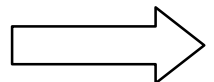
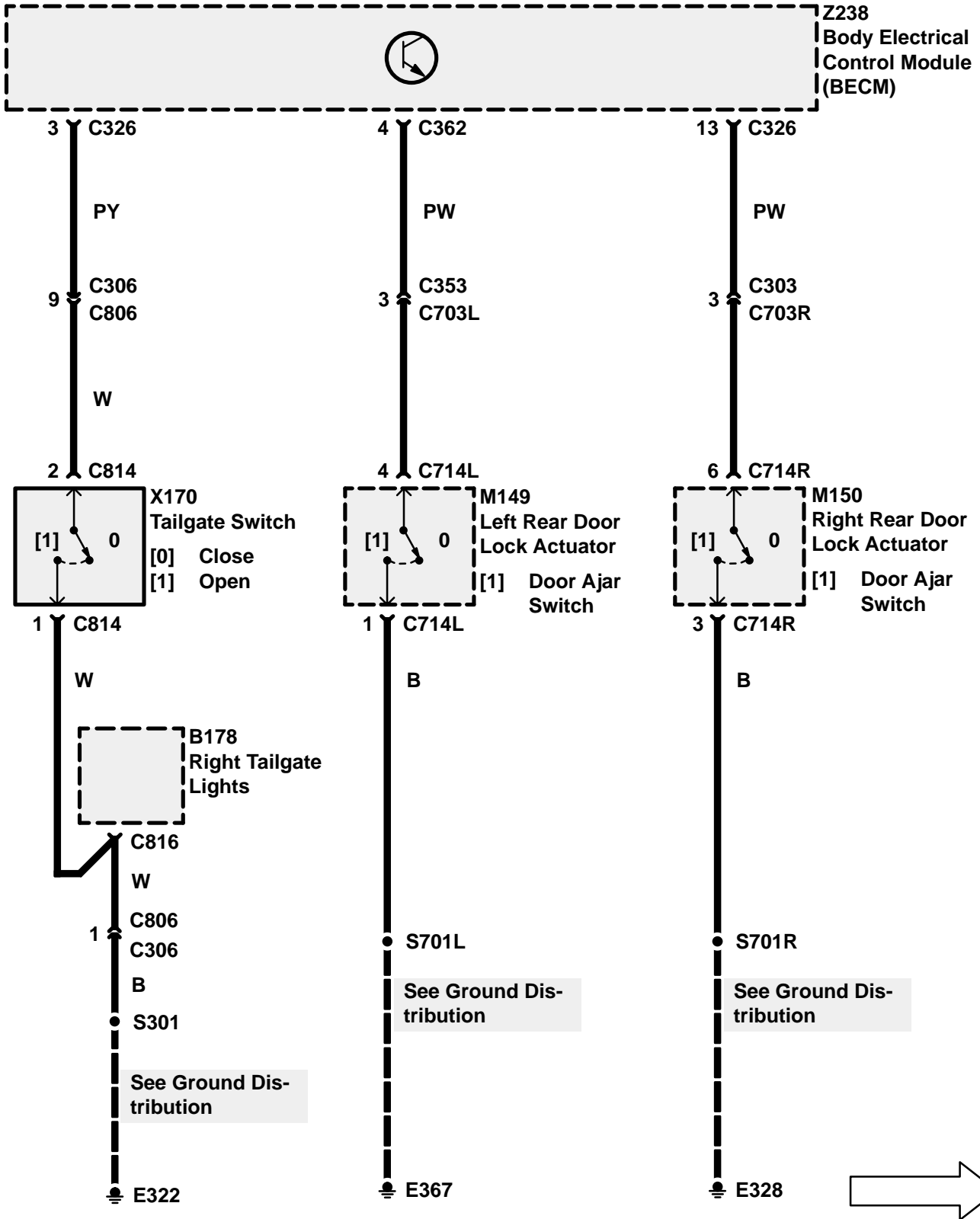
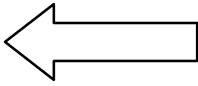

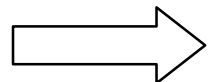
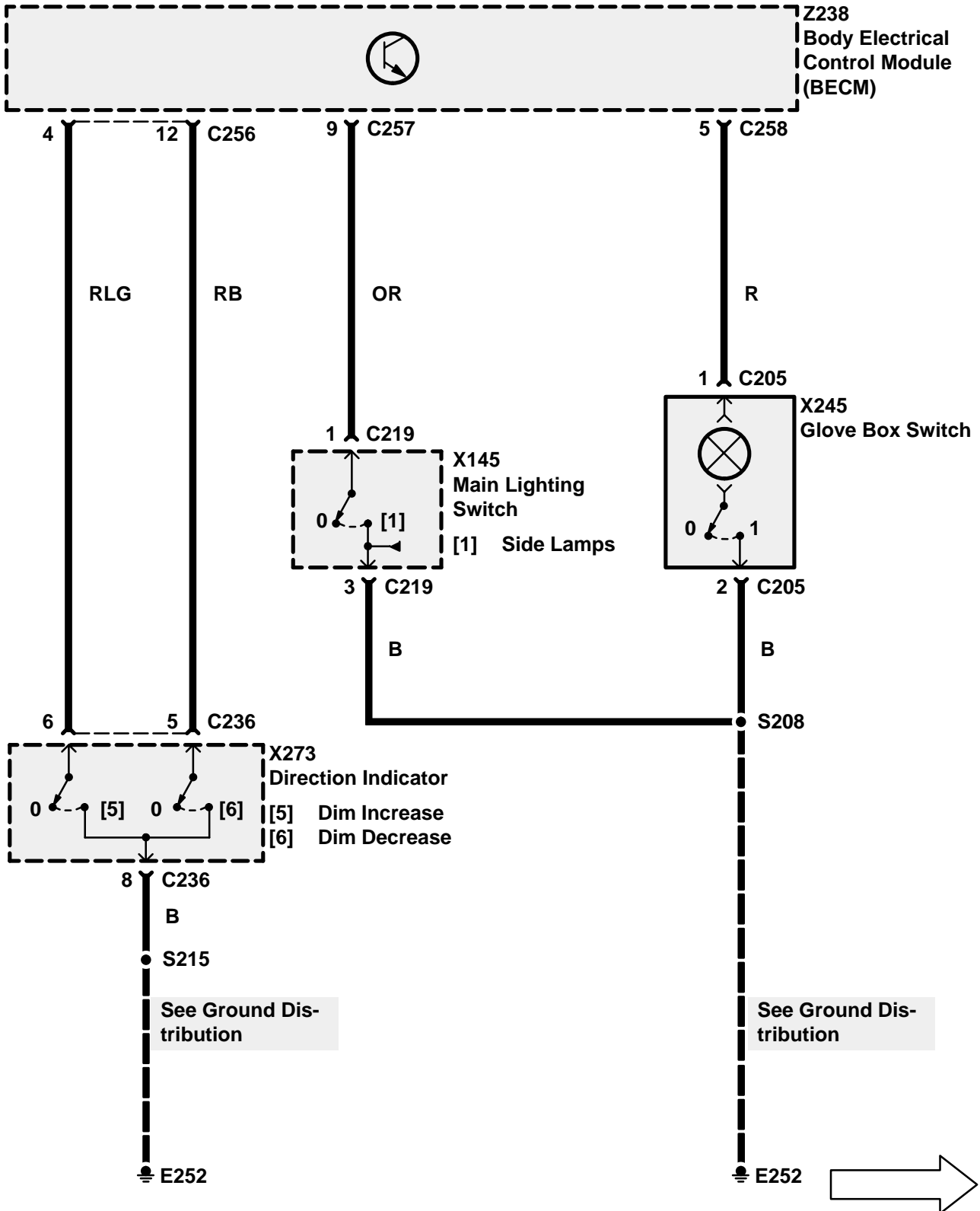
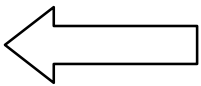

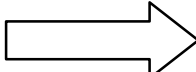
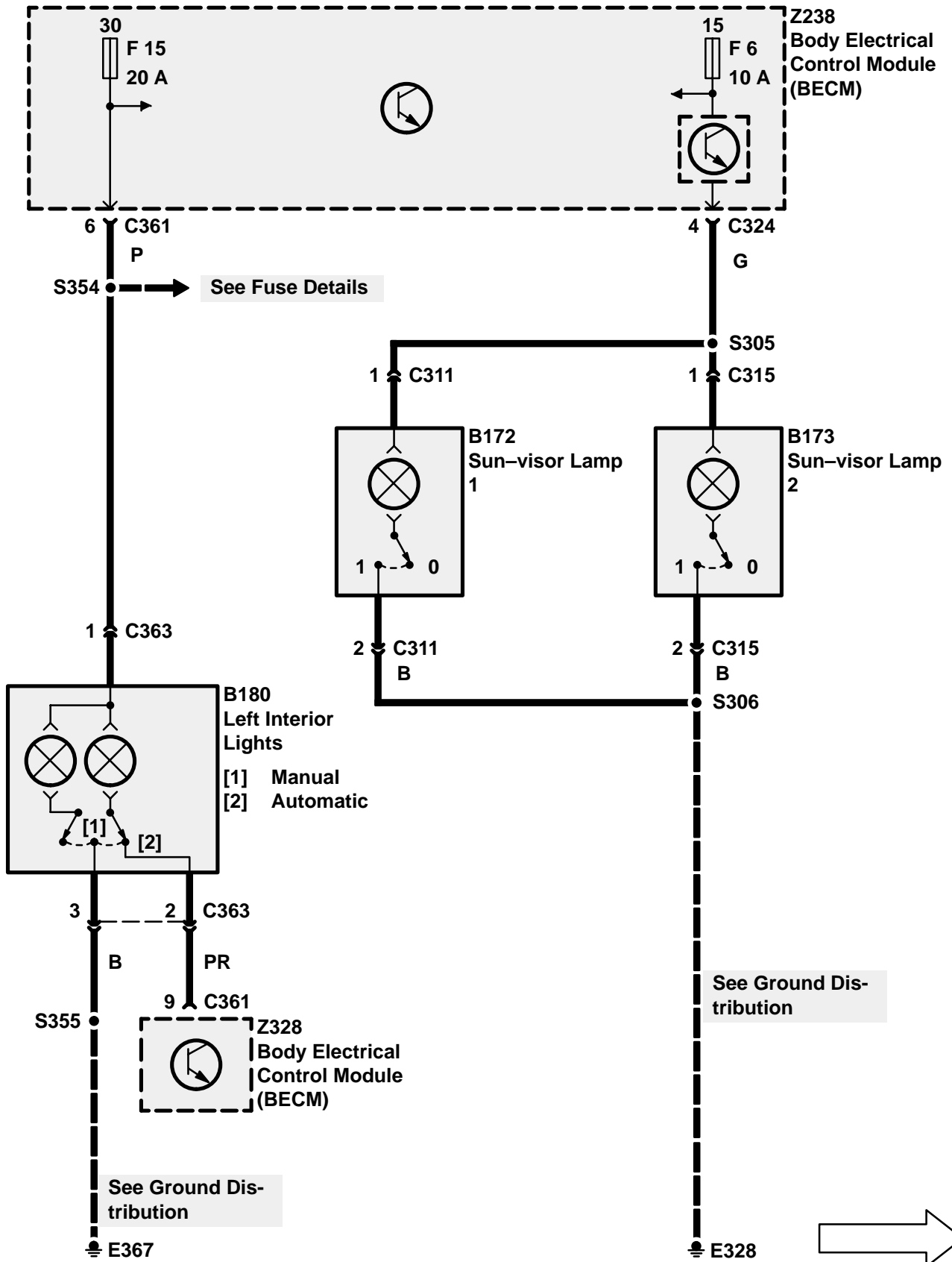
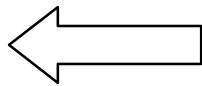

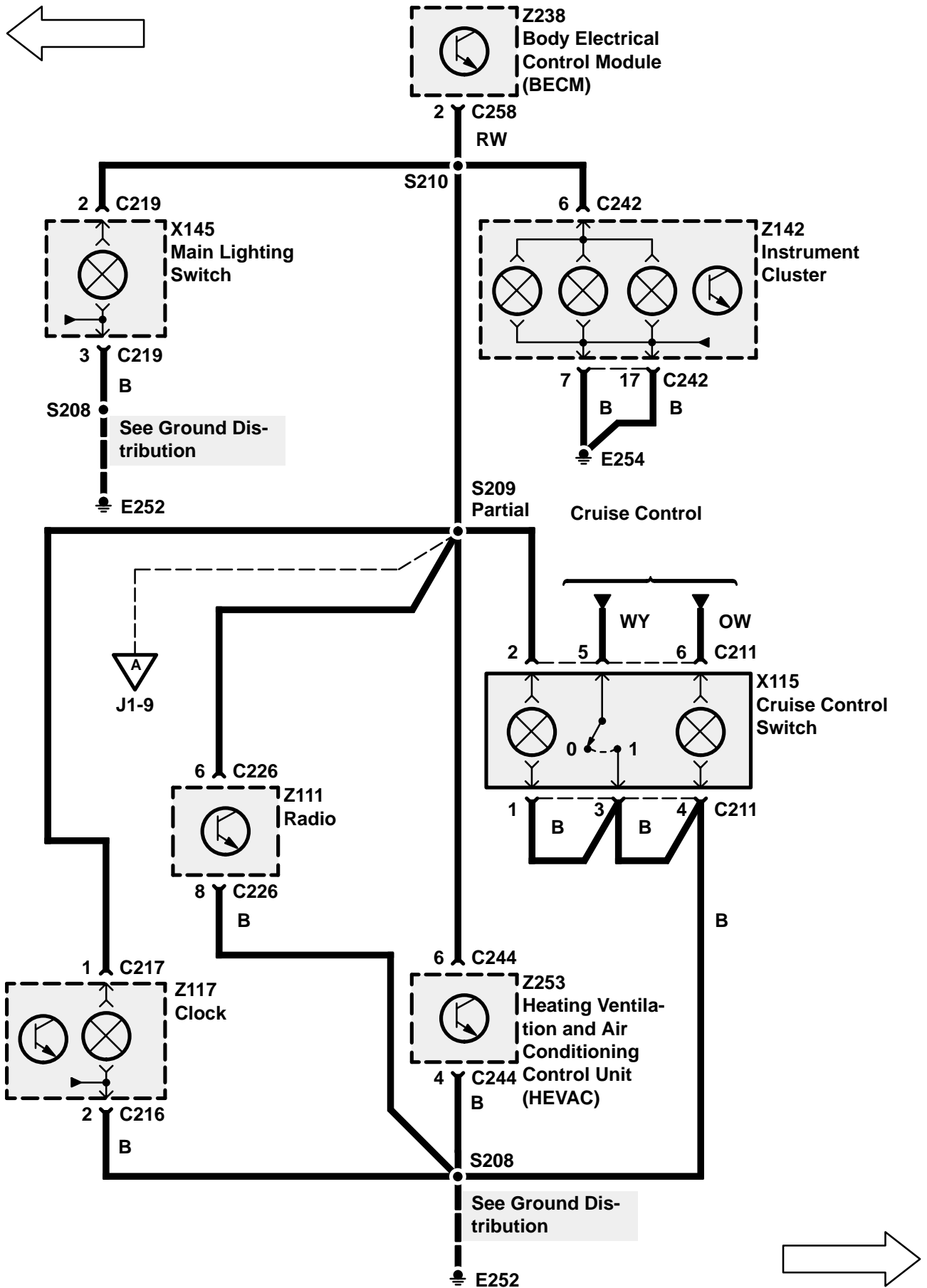

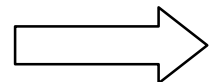
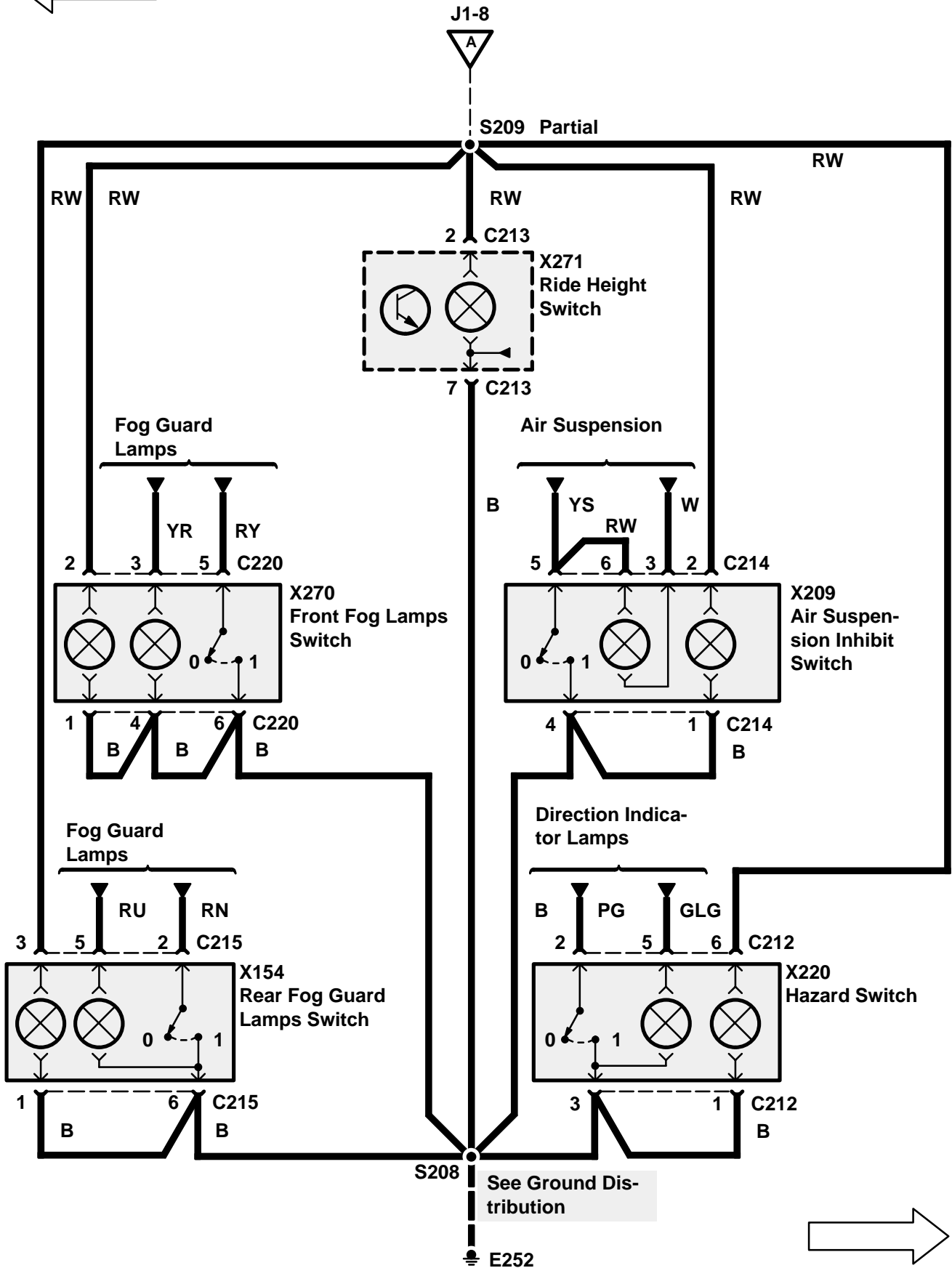
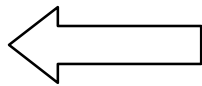

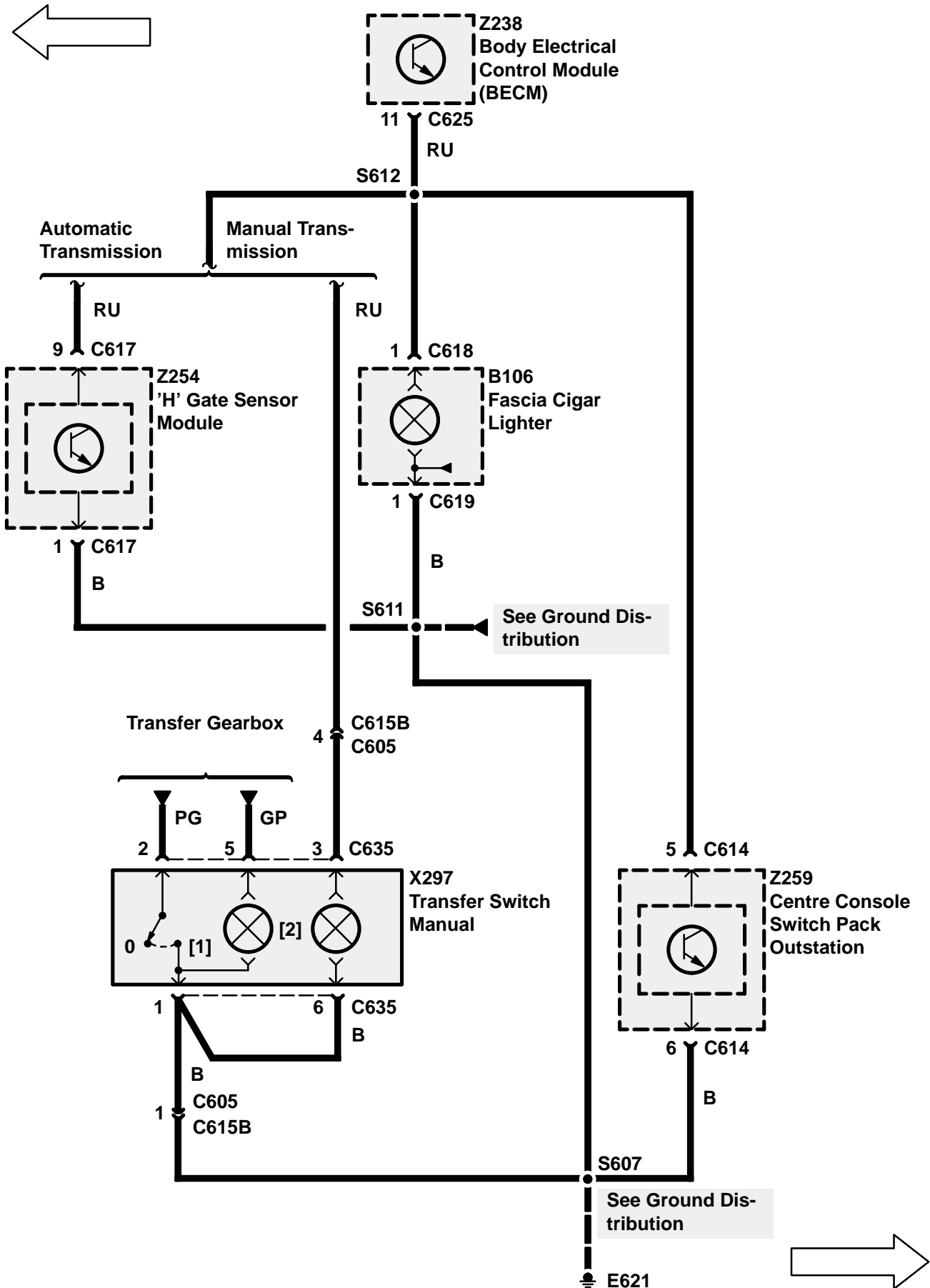

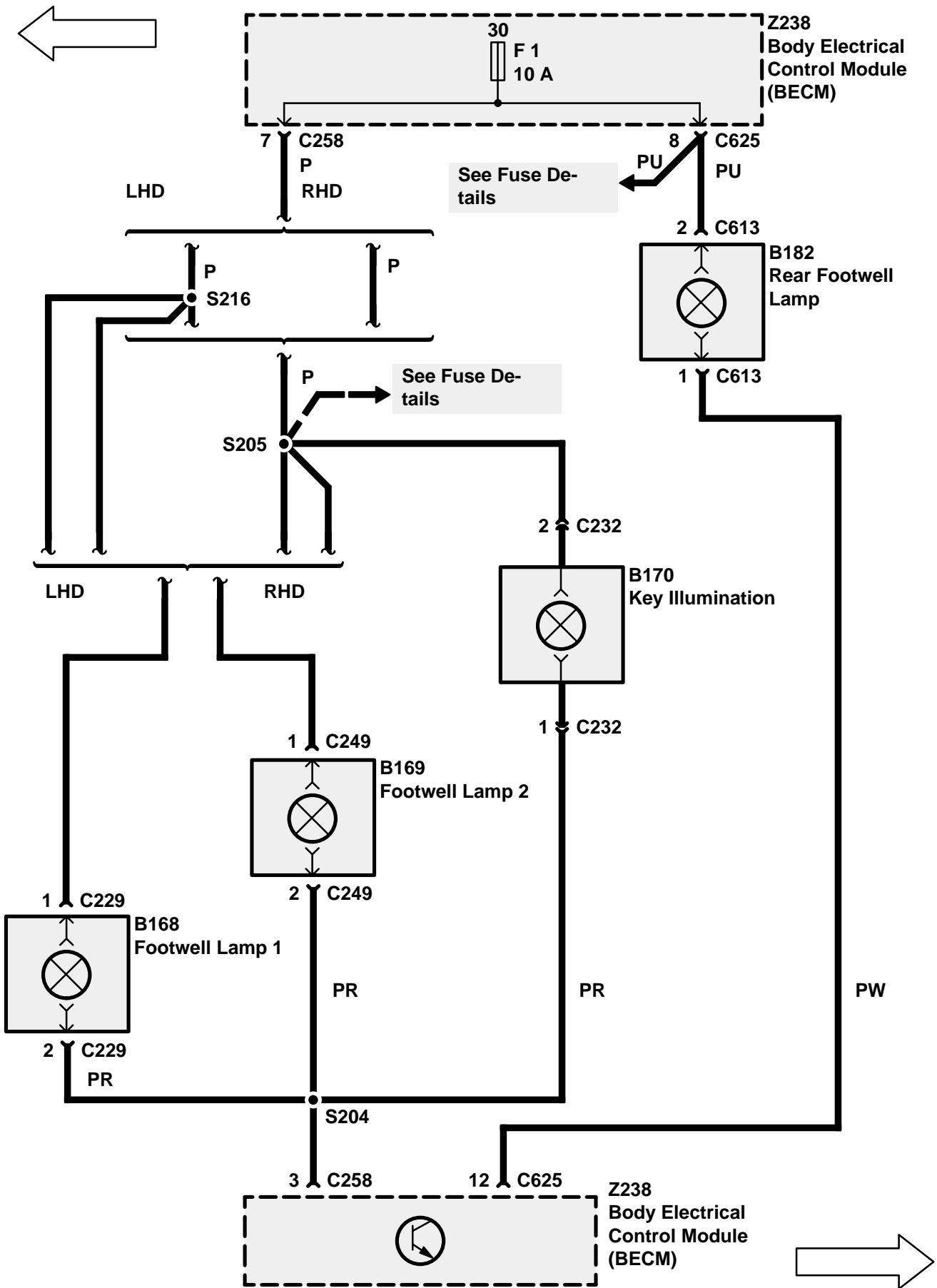

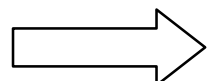
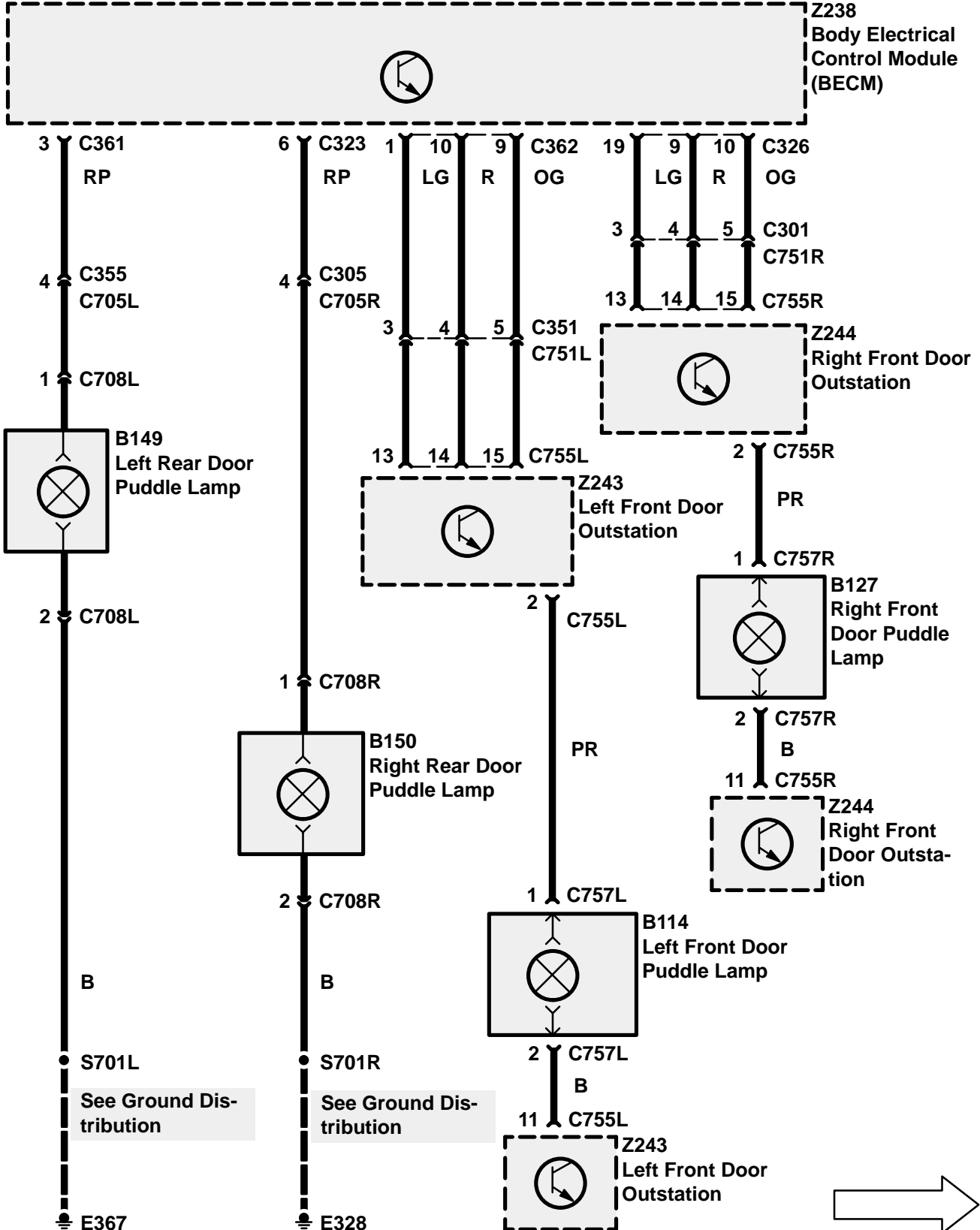
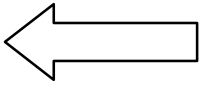

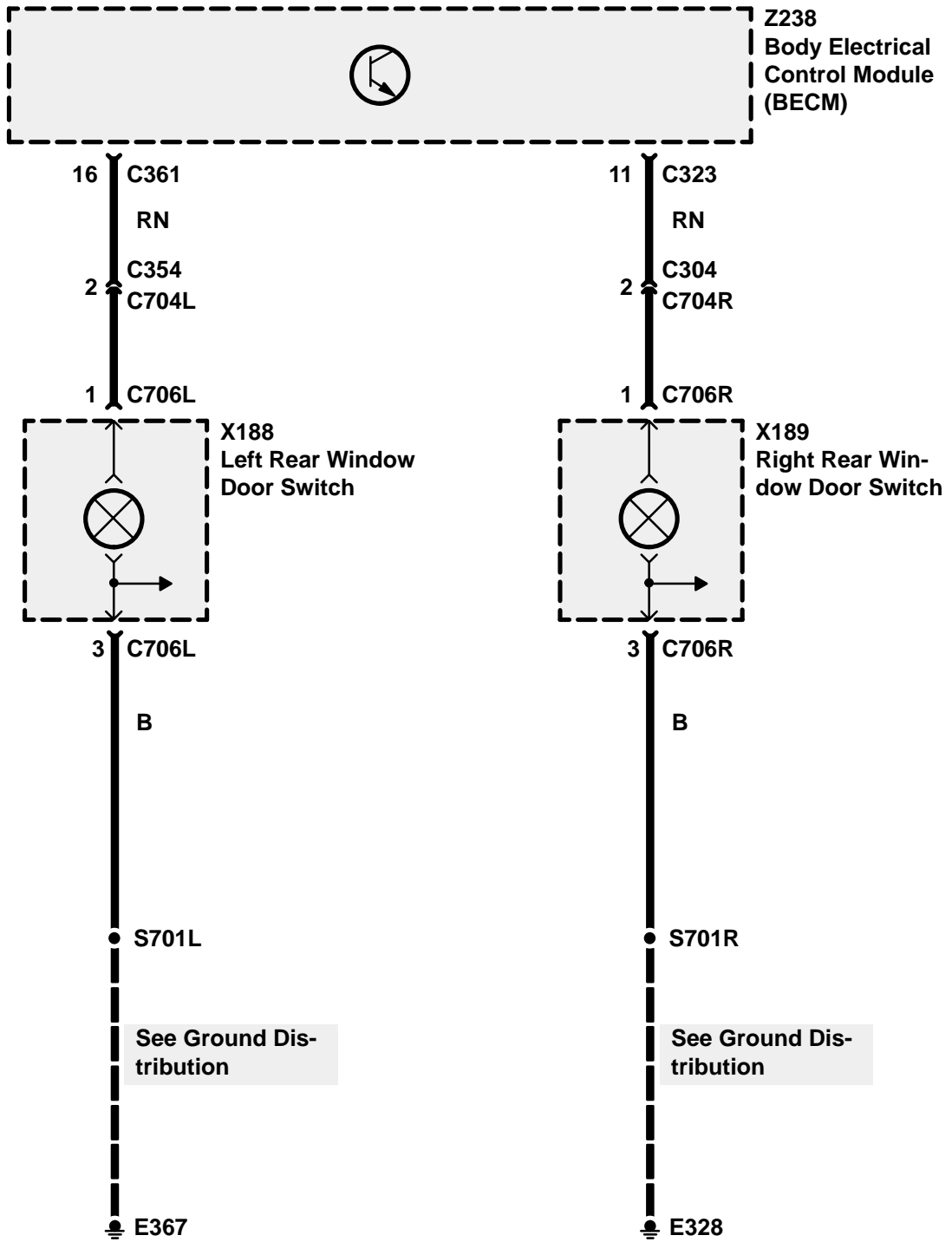
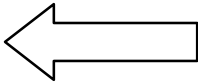

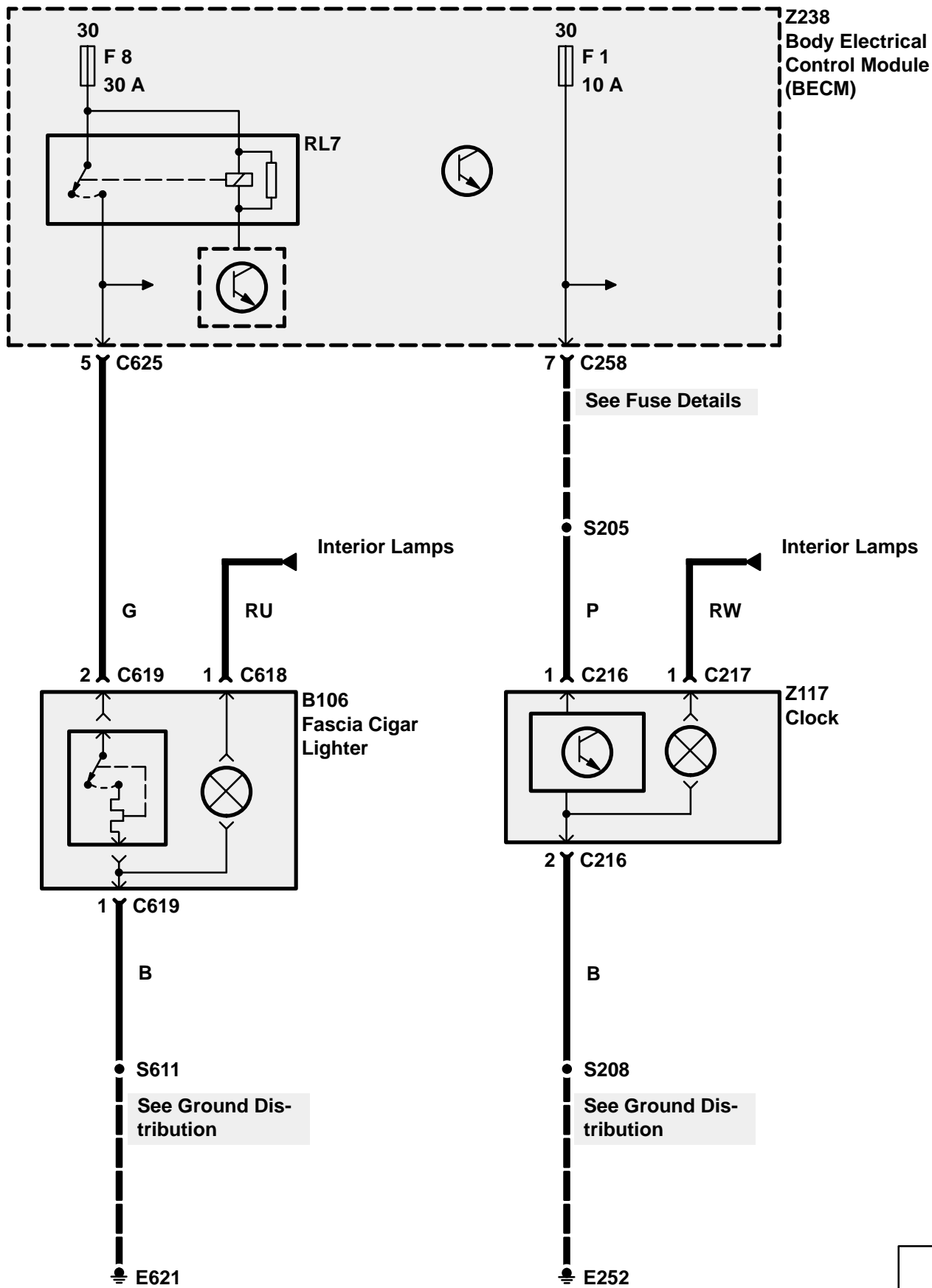

CIRCUIT OPERATION

Ignition position 1 (Accessories)

This feed is obtained from the BeCM via fuse 8 and is shared with the Radio, Front cigar lighter, Aerial amplifier and car phone (if fitted). The Ignition 1 is essential to the control panel as it provides power to the ECU although no functions or display on the LCD are possible.

Ignition position 2

This feed is obtained from the BeCM via fuse 17.

Battery feed

This feed is obtained from the fuse box via fuse 42.

Ground Connection

This feed runs down to a spliced joint, joining the main earth run down to fascia earth point 1.

Dimmer Line

This Pulse Width Modulated signal is provided by the BeCM.

LCD Dimmer line

This line is a input to the HEVAC and the signal is a inverse Pulse Width Modulated signal which is determined by the instrument pack.

Alternator Charge signal

This signal is given to the HEVAC ECU to inform it that the engine is running. This signal is active low.

Diagnostic K line

This line is used to communicate with the diagnostic equipment (TESTBOOK) and is normally held at 12V when not active

Left/Right Recirculation motors

These motors control the flaps on the blower motor modules. The flaps should be in one of two positions, either fully open or fully closed.

Left/Right Blower modules

The blowers have a permanent 12V feed to them. The speed of the motors is determined by the control lines which go to the motors. The motors also provide a voltage feedback to the HEVAC ECU to determine the actual voltage at the motors but also to show if there are any faults.

Left/Right Blend and Distribution Motors

These motors are controlled by the HEVAC ECU which provides power to the motors, which in turn report back their actual positions to the HEVAC ECU.

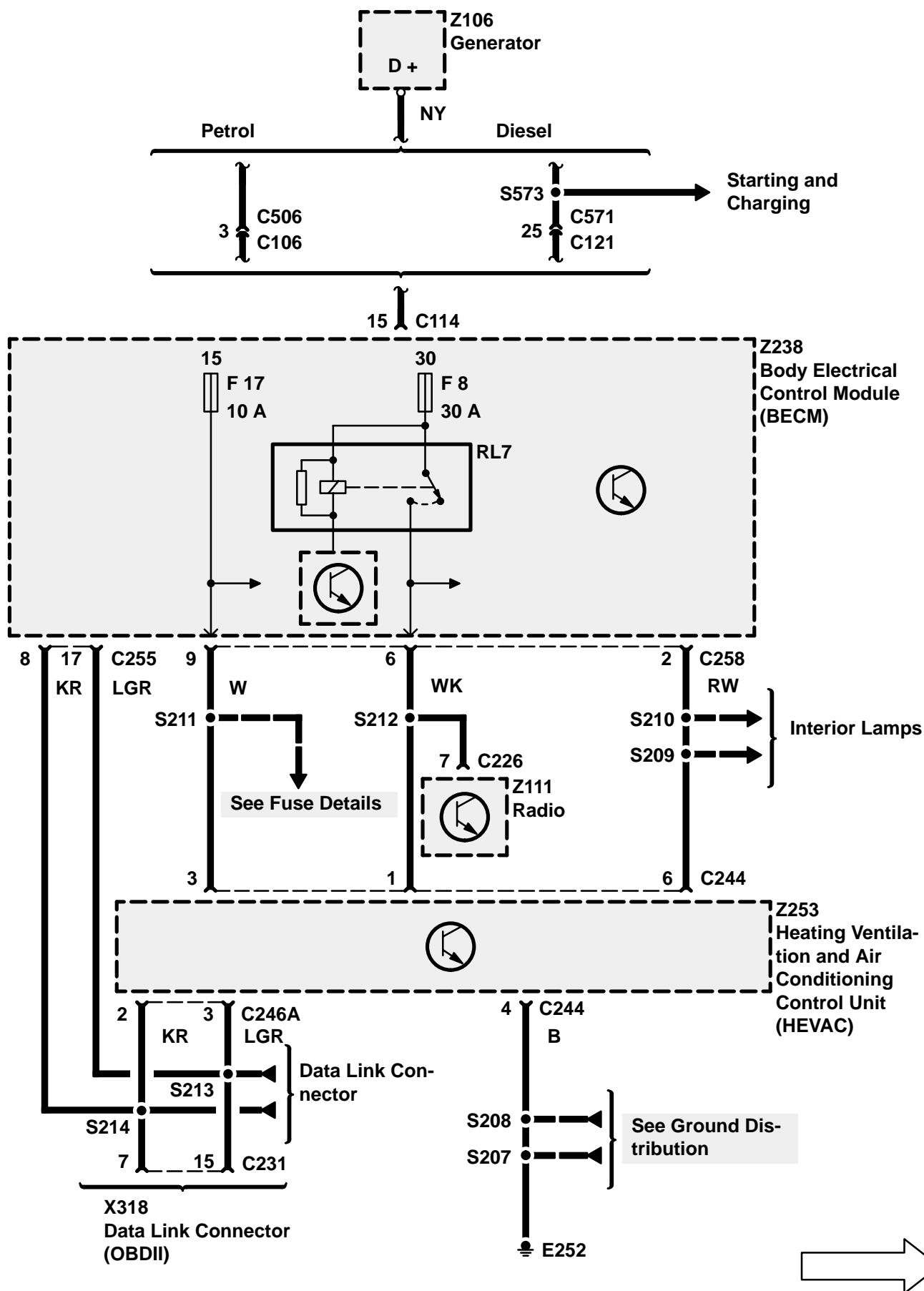

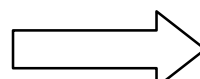
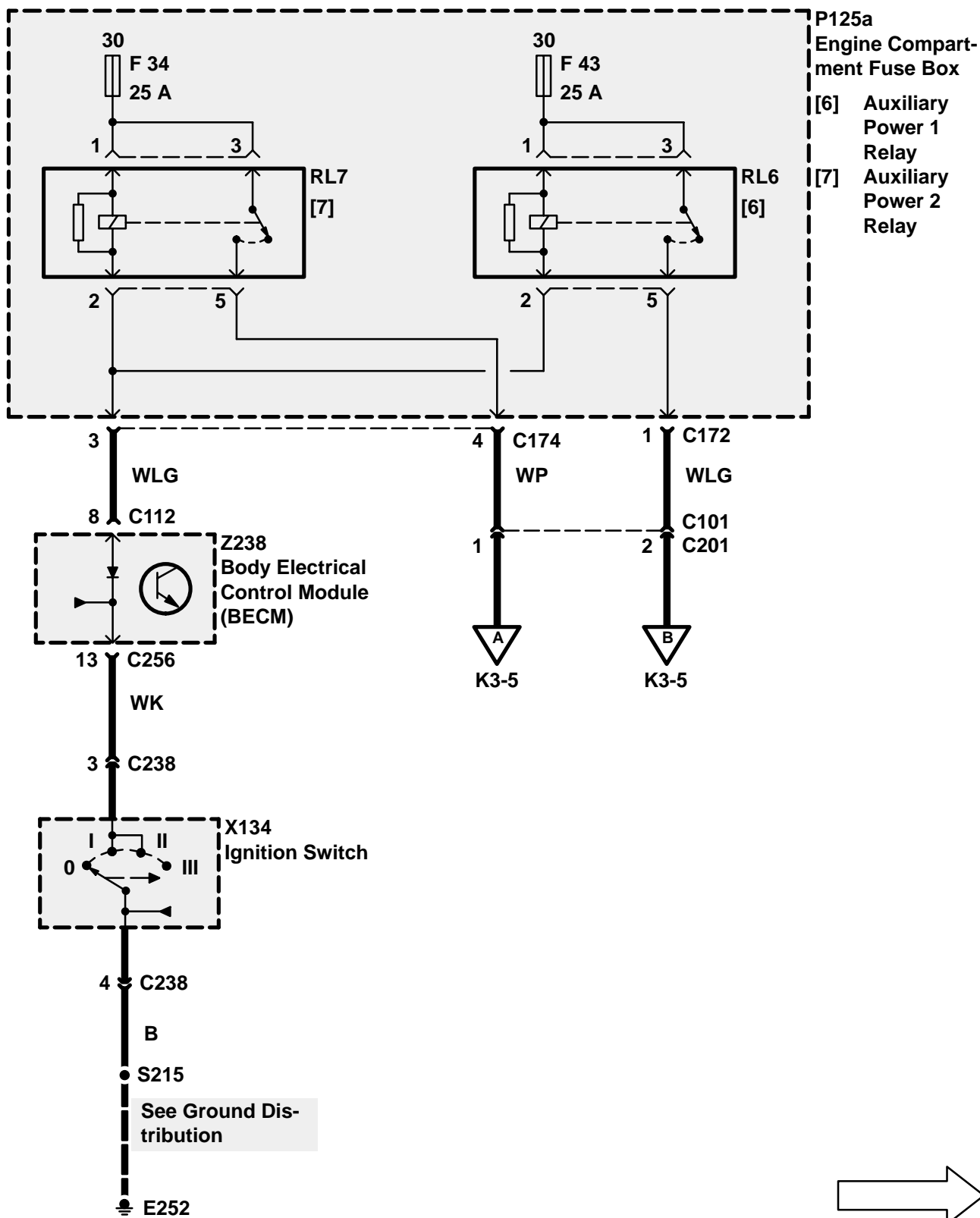
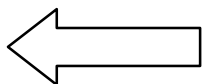

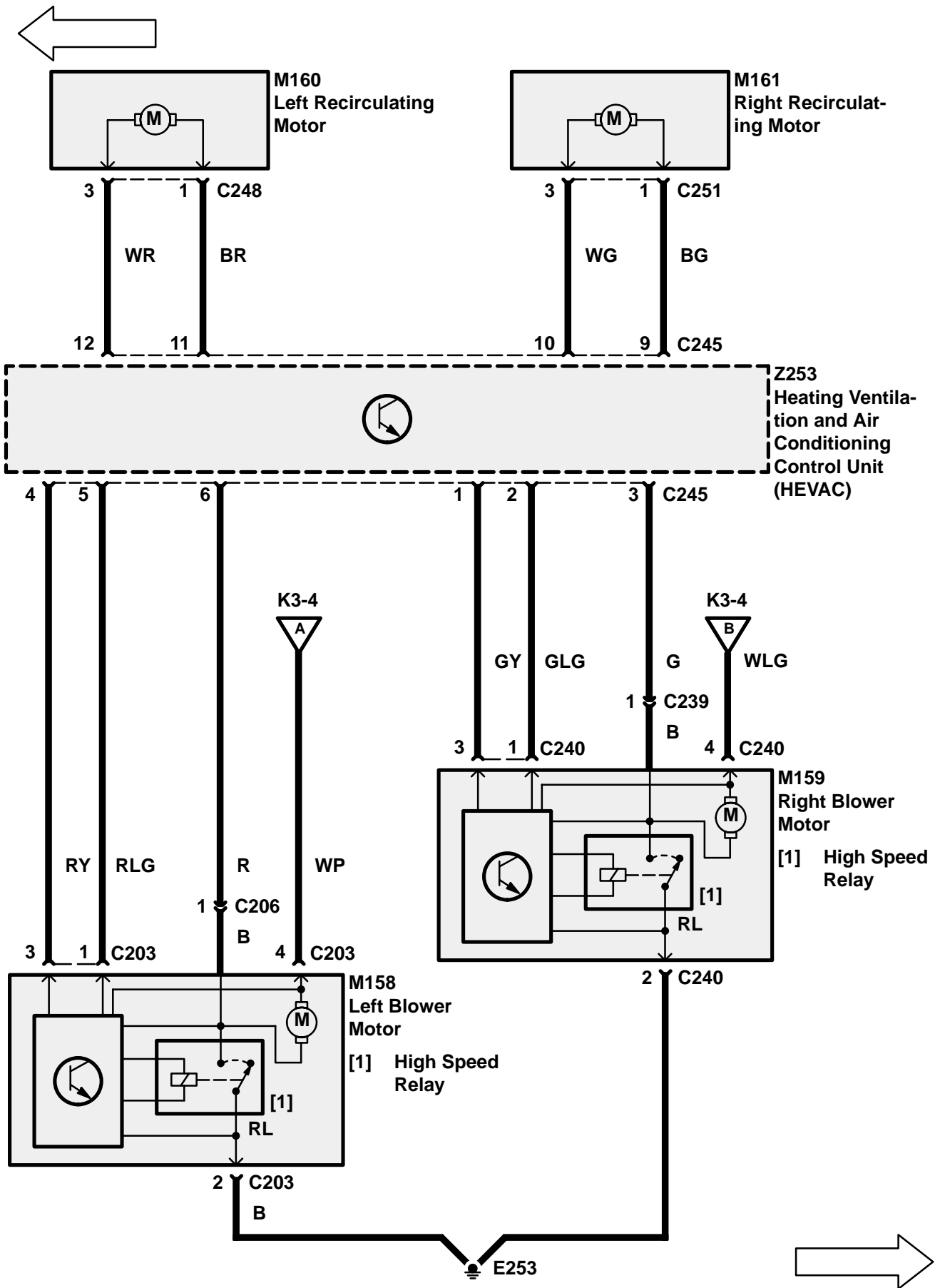

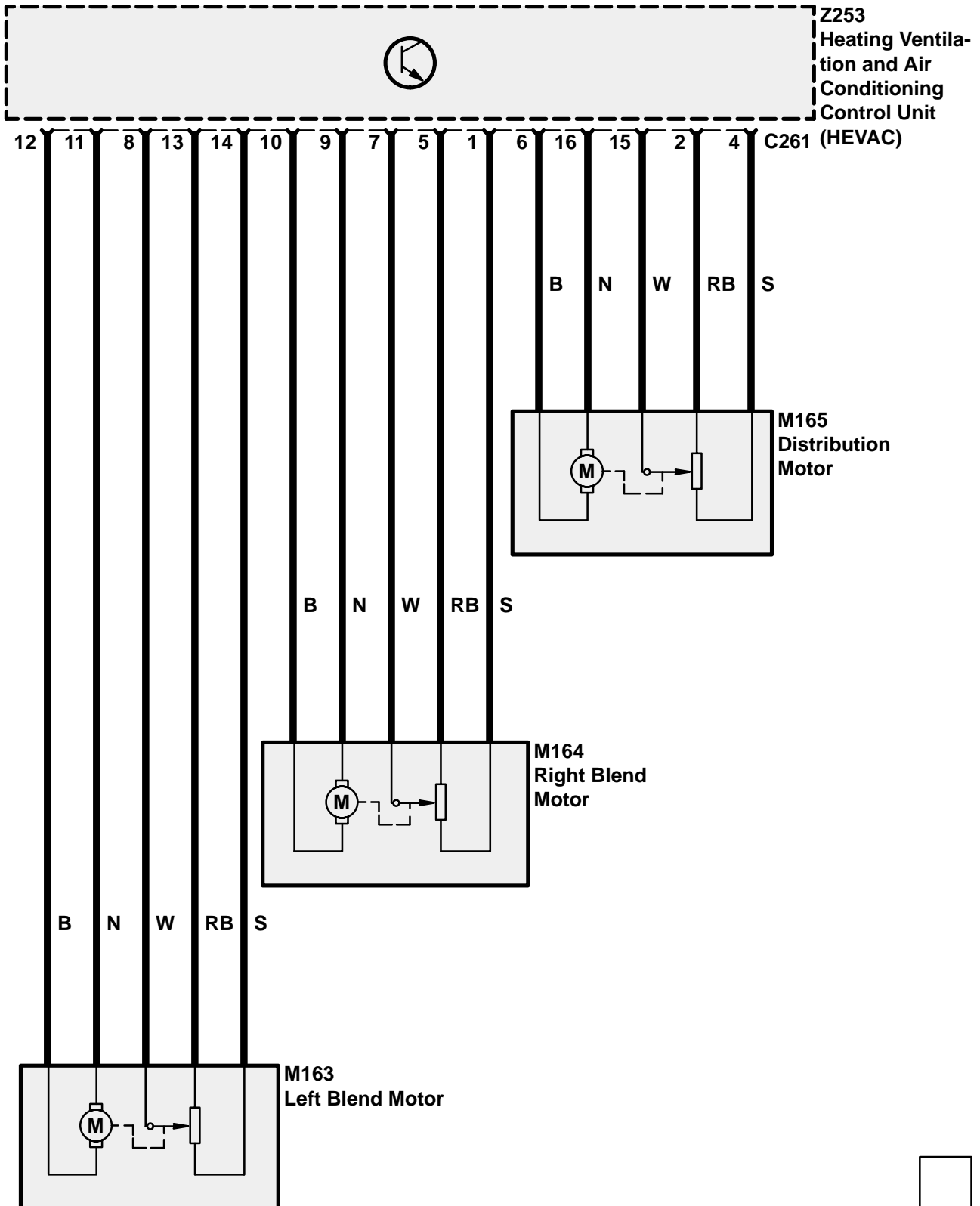
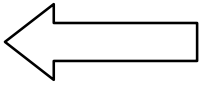

CIRCUIT OPERATION

Ignition position 1 (Accessories)

This feed is obtained from the BeCM via fuse 8 and is shared with the Radio, Front cigar lighter, Aerial amplifier and car phone (if fitted). The Ignition 1 is essential to the control panel as it provides power to the ECU although no functions or display on the LCD are possible.

Ignition position 2

This feed is obtained from the BeCM via fuse 17.

Battery feed

This feed is obtained from the fuse box via fuse 42.

Ground Connection

This feed runs down to a spliced joint, joining the main earth run down to fascia earth point 1.

Dimmer Line

This Pulse Width Modulated signal is provided by the BeCM.

LCD Dimmer line

This line is a input to the HEVAC and the signal is a inverse Pulse Width Modulated signal which is determined by the instrument pack.

Compressor Clutch

The clutch line provides a 12 volt power feed to the compressor clutch via pressure switch 1.

Condenser Fans

The HEVAC panel provides a signal normally at 12 volts for "off" condition and 0 volts for the "on" condition, which in the case of petrol vehicles is fed into the ECM and diesel vehicles directly onto the coil of relay 18. In line is the Air-Conditioning pressure switch 2, which turns the fans on/off.

When relay 18 is energised, it provides connection between relays 13 and 14 (fan 1 and 2) in series or parallel with each other. This is dependent upon the state of the air-conditioning pressure switch 1.

For the petrol option, when the signal enters the ECM, the ECM will switch the output on/off to the fusebox. The ECM will switch the output on sometimes for engine cooling reasons even though the engine has been turned off.

Aspirator

There are two parts of this sensor, one of which is a fan which draws cabin air onto the temperature sensor. The temperature sensor then sends the signal back to the HEVAC ECU.

Ambient Sensor

This sensor measures the temperature of the external air flow into the vehicle.

For vehicles with VIN's up to 381430:

The ambient temperature sensor is located behind the drivers side of the fascia.

For vehicles with VIN's from 381431:

The ambient temperature sensor is located behind the LH side of the vehicle in front of the condenser. The revised location improves the response time of the sensor. The new HEVAC software will not update the ambient temperature sensor readings unless the vehicle is travelling over approximately 15 mph (25 km/h). The HEVAC software will therefore not automatically correct temperature readings when a faulty ambient temperature sensor is renewed.

Temperature	Resistance (Ohms)
-20° C (-4° F)	94.5 K
-10° C (14° F)	54.3 K
0° C (32° F)	32.1 K
10° C (50° F)	19.7 K
20° C (68° F)	12.5 K
30° C (86° F)	8.1 K
40° C (104° F)	5.4 K

Heater Core Sensor

This sensor measures the engine coolant temperature within the fascia area.

Evaporator Sensor

This sensor is located within the evaporator unit and, by providing feedback to the HEVAC ECU, prevents it from freezing.

Alternator Charge signal

This signal is given to the HEVAC ECU to inform it that the engine is running. This signal is active low.

Diagnostic K line

This line is used to communicate with the diagnostic equipment (TESTBOOK) and is normally held at 12V when not active.

Road Speed

This signal is fed into the HEVAC ECU.

Solar Sensor

This sensor provides the HEVAC ECU with the power of the sun's solar load and allows the system to compensate accordingly.

A/C Request

This signal is active low and sends a request to the ECM to switch on the air-conditioning system.

A/C Grant

This signal is active low and sends a signal to the HEVAC ECU to acknowledge the request signal and that it is ready for the load to be switched on by the HEVAC system.

Pressure switch 1 (Trinary switch)

This switch is in parallel with two components, the condenser fans and the compressor clutch which are both normally short circuit. If the pressure is too high or too low, the switch will open and cut the feed to the clutch to prevent damage to the system. With the third setting, at a specific pressure the switch is shorted and changes the condenser fan mode from series to parallel.

Pressure switch 2 (Single switch)

The switch is normally open circuit. At a specific pressure, the switch is shorted and allows the condenser fans to turn on.

Left/Right Recirculation motors

These motors control the flaps on the blower motor modules. The flaps should be in one of two positions, either fully open or fully closed.

Left/Right Blower modules

The blowers have a permanent 12V feed to them. The speed of the motors is determined by the control lines which go to the motors. The motors also provide a voltage feedback to the HEVAC ECU to determine the actual voltage at the motors but also to show if there are any faults.

Left/Right Blend and Distribution Motors

These motors are controlled by the HEVAC ECU which provides power to the motors, which in turn report back their actual positions to the HEVAC ECU.

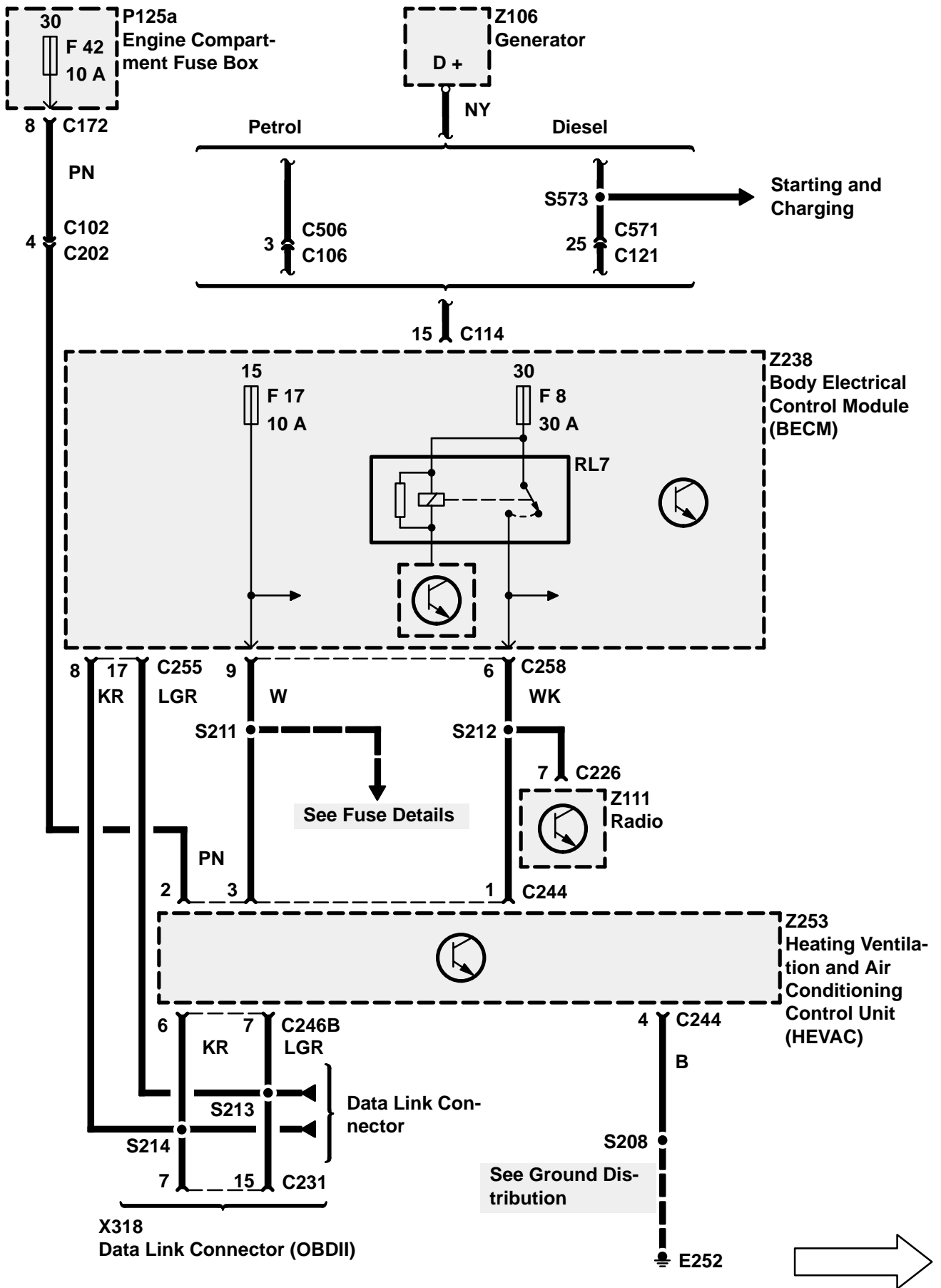

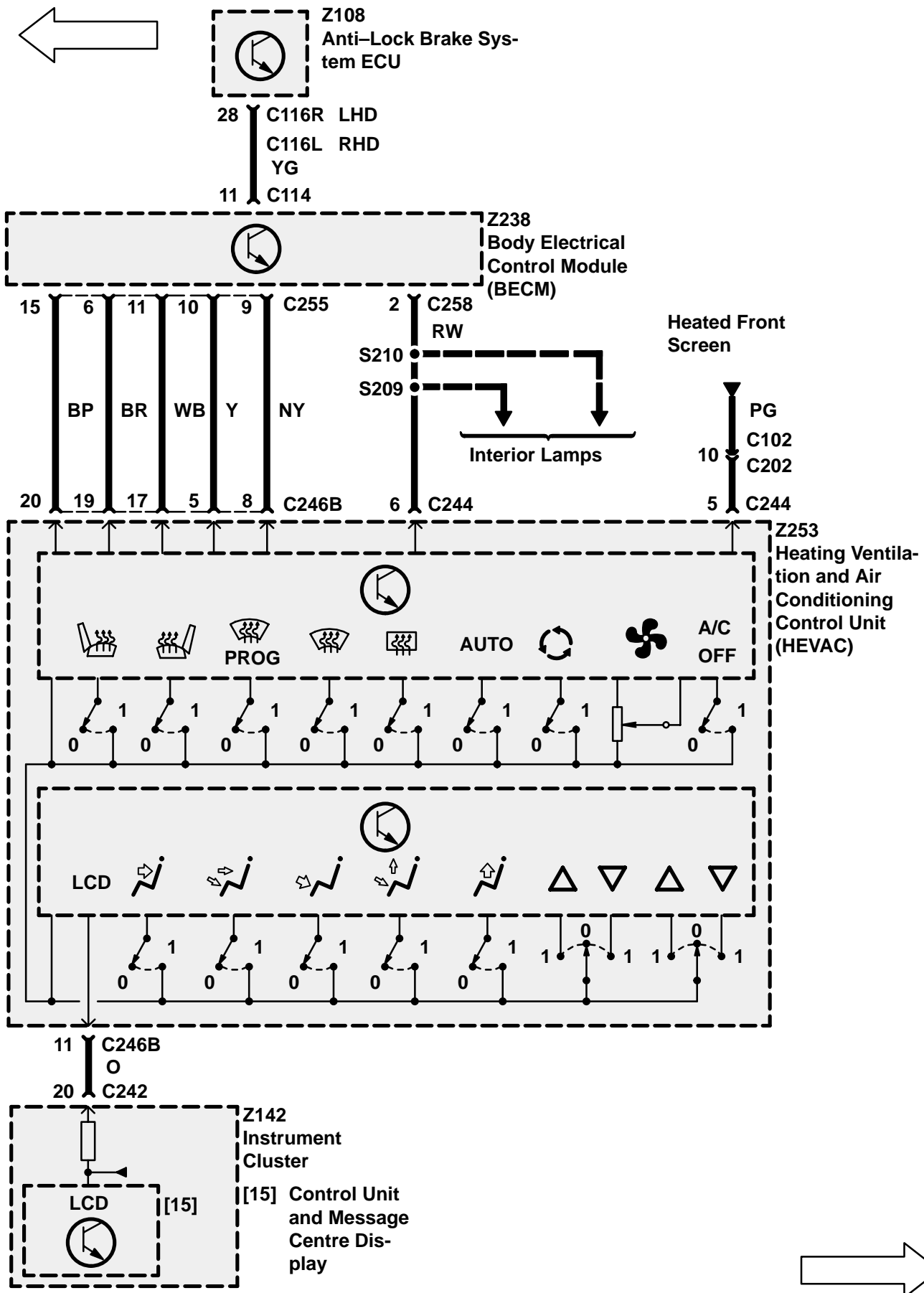

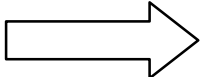
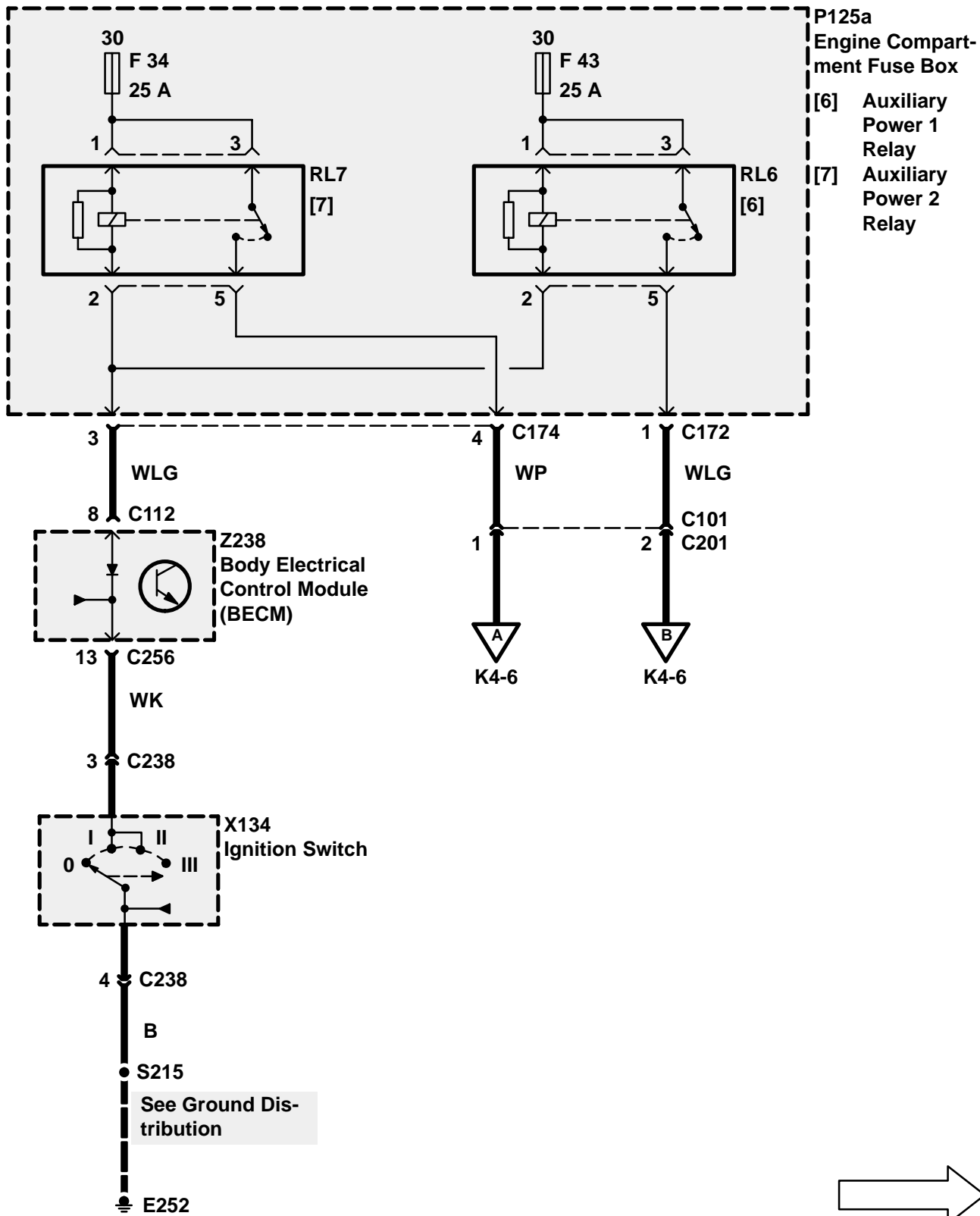
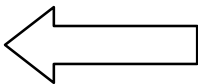

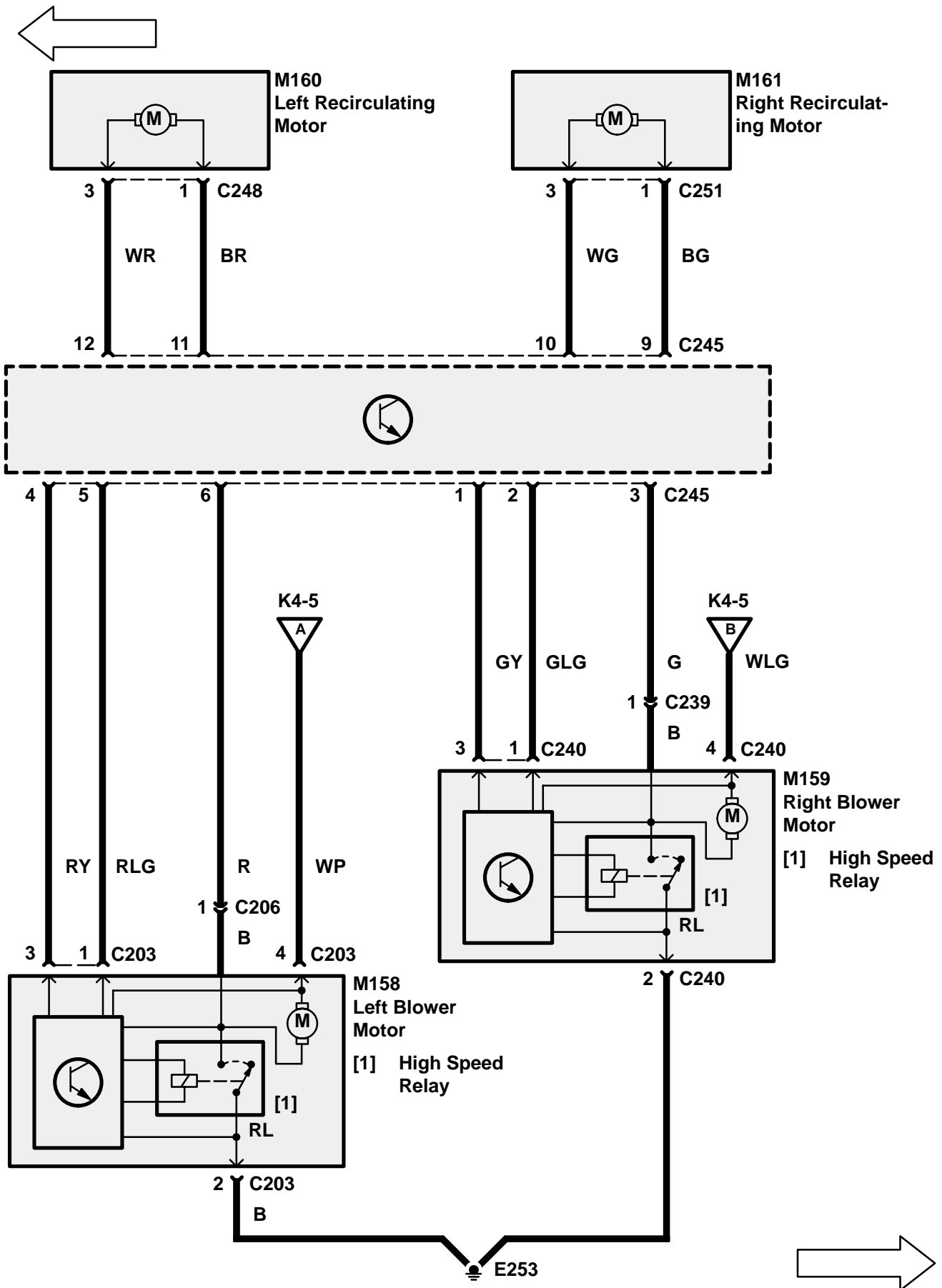

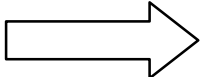
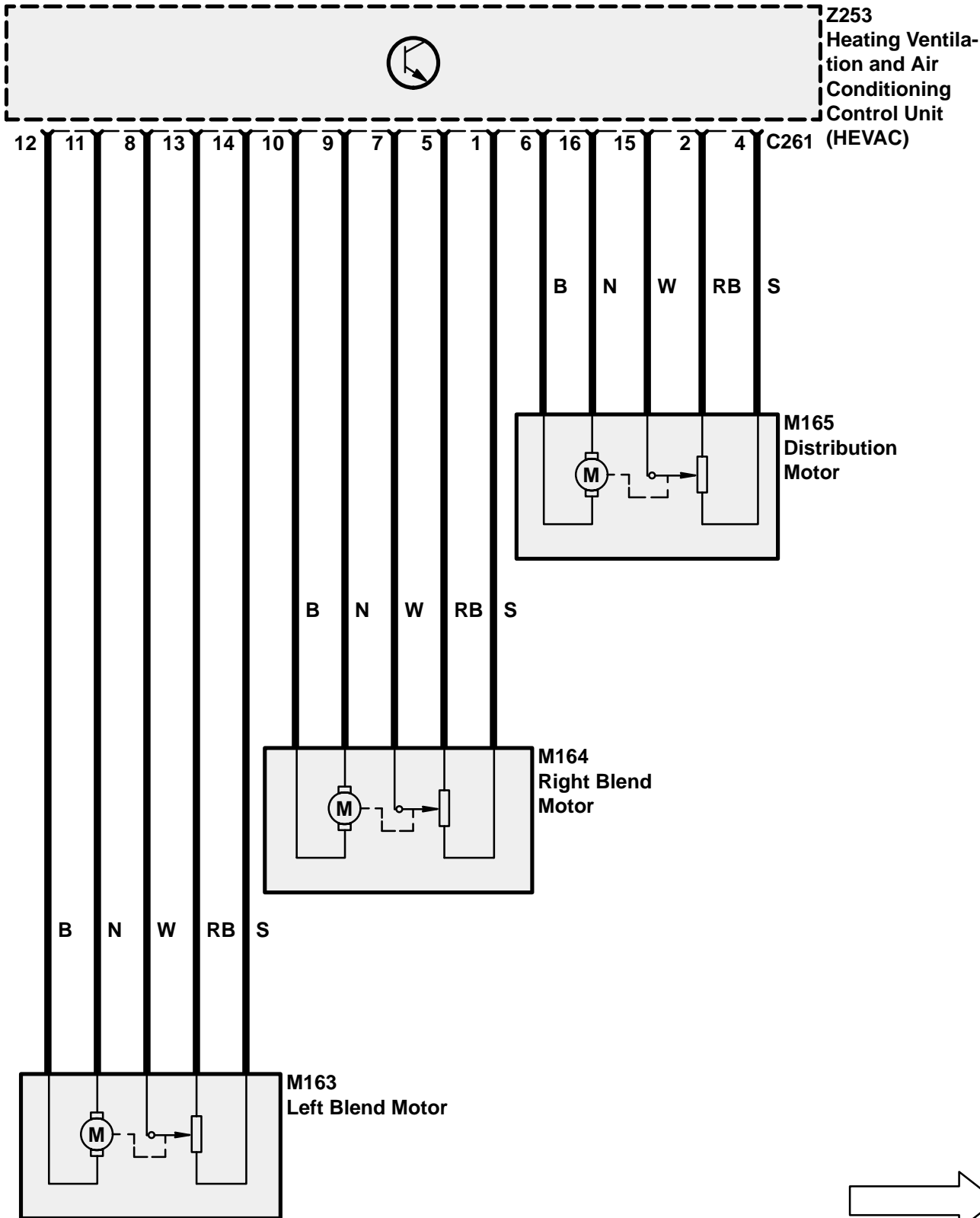
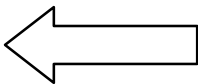

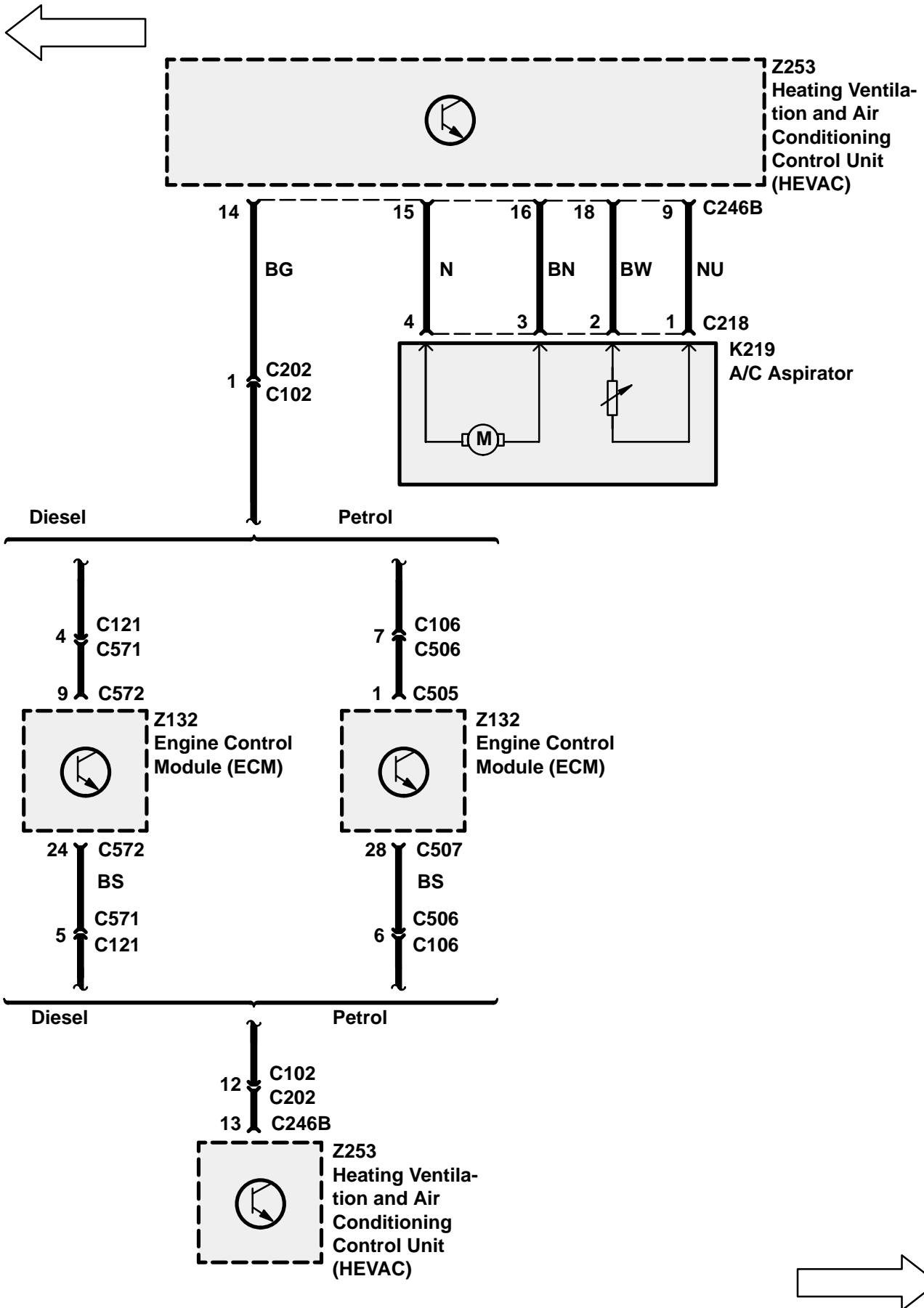

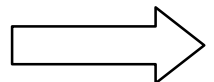
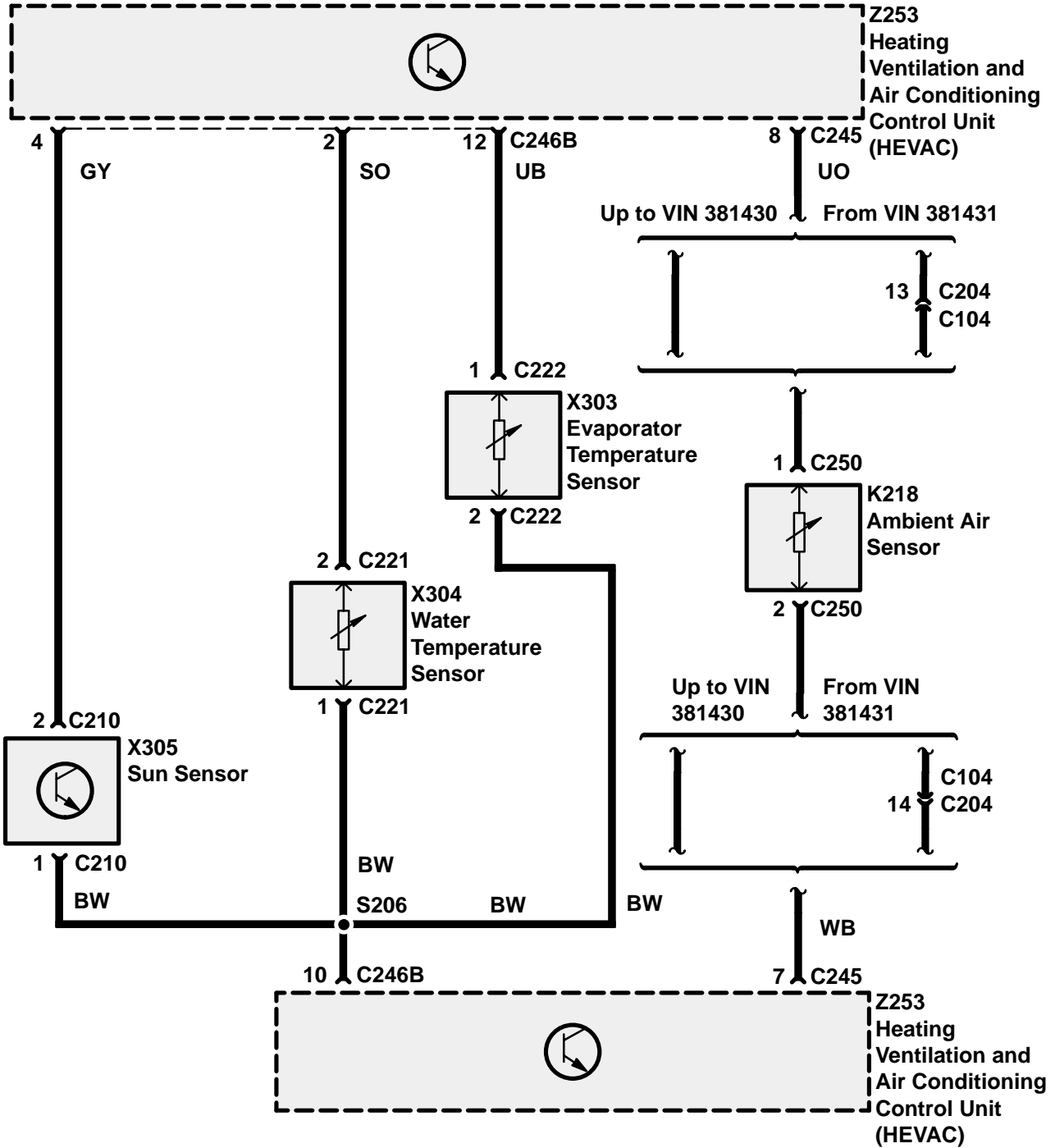
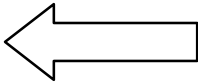

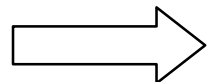
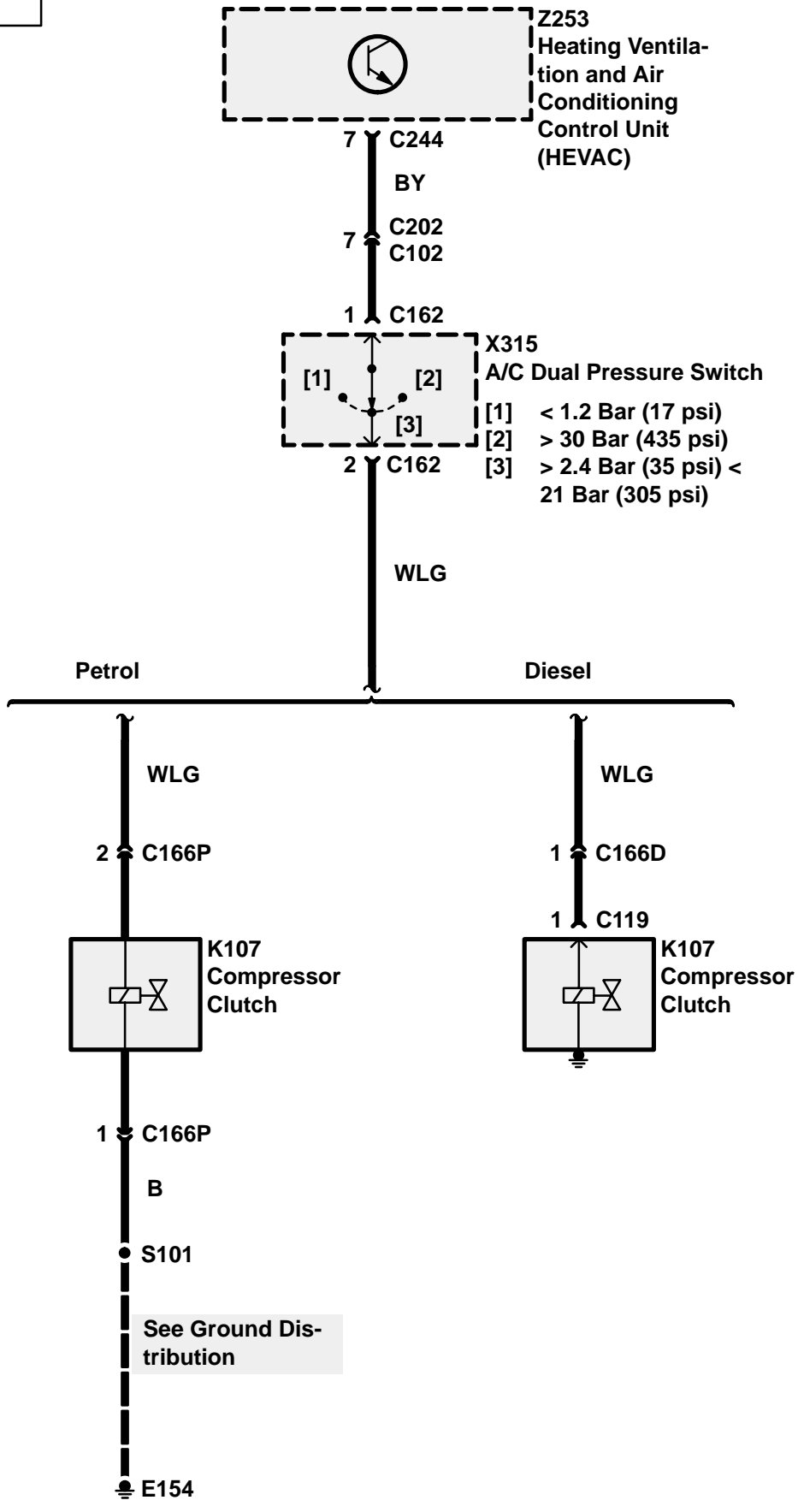
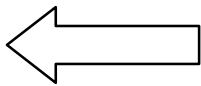

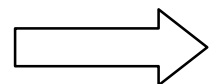
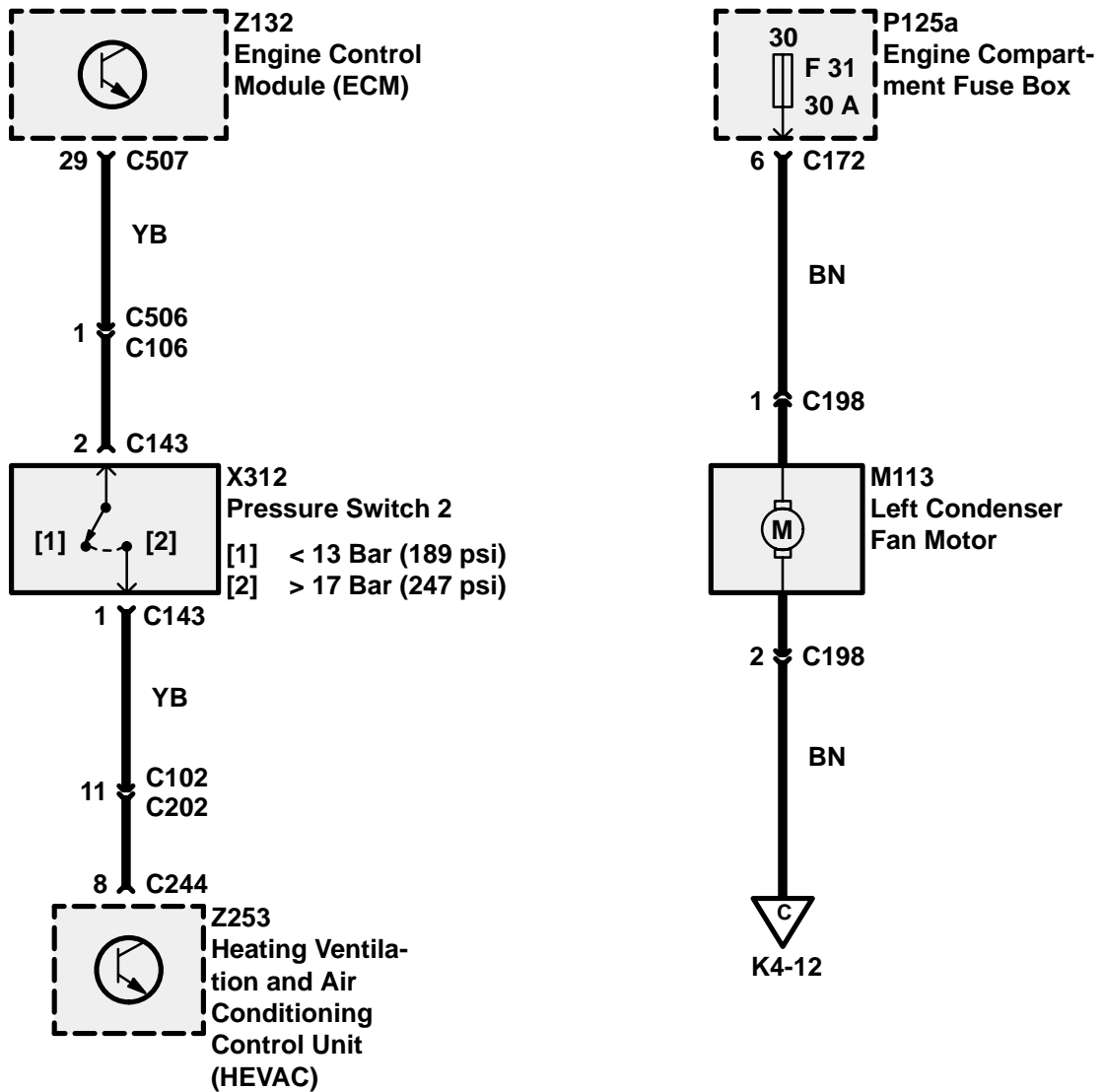
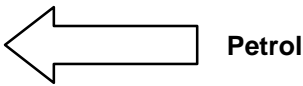

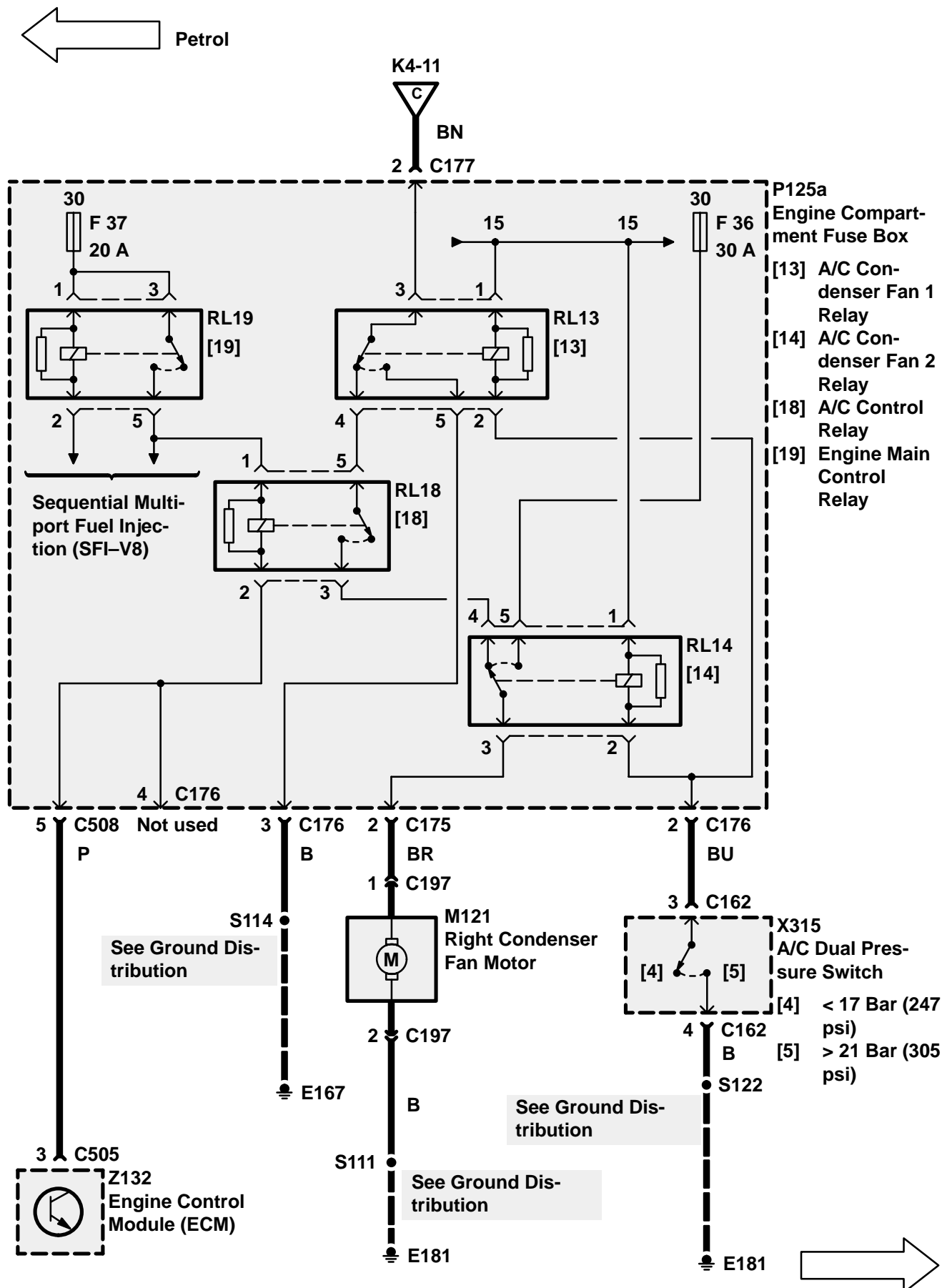

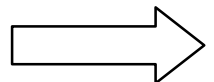
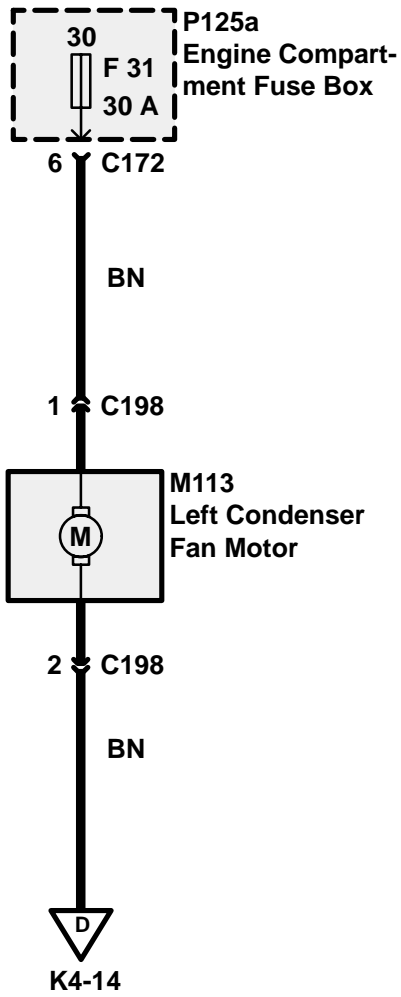
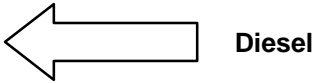

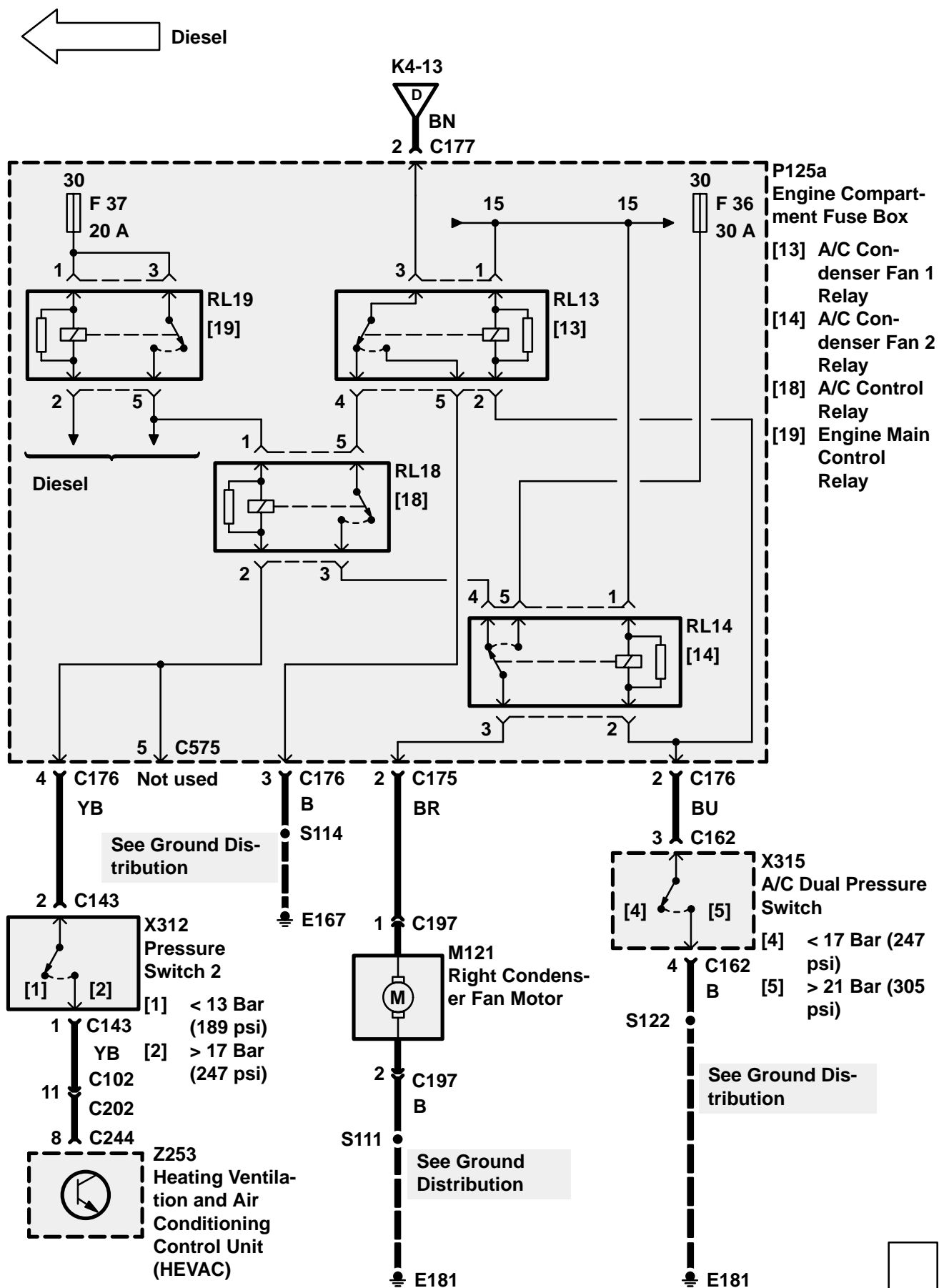

CIRCUIT OPERATION

The window lift system will provide one touch or inch mode on all windows and will have the anti-trap function (when initialised) on close.

Initialised window operation.

Selection of any* aperture switch, in either direction, for less than 0.4 seconds shall initiate the "one touch" mode of operation. That aperture will be driven in the direction selected until a trap (obstruction) is detected (close only) or the motor stalls. This mode will be cancelled by the operation of the associated switch in the opposite direction. If the associated aperture switch is operated in the opposite direction then the window will be driven in that direction according to the requirements for one touch/inch mode operation.

* Rear window one touch up is a programmable feature.

Selection of any aperture switch for greater than 0.4 seconds will cause that aperture to operate in the "inch mode". The aperture will move in the selected direction until a trap (obstruction) is detected (close only), the limit of travel is reached or the switch is released.

All windows will operate independently from each other and may operate in parallel. In case of conflict between switches, those in the centre console switch pack will have priority.

The window lift system will only be active under the following conditions:

a) while auxiliary is on, ie, the window system will not be active during crank. Any one touch operations will be cancelled when ignition 1 turns off during crank.

b) for the first 45 seconds after auxiliary has been switched off, the one touch up and down functions will not be available during this time period. If, during the above 45 second time period, the drivers door is opened, the window system will remain active for a further 45 seconds from the door opening or until the door is closed again, whichever is sooner. If during either of the 45 second time periods a door lock signal is received, then the timer will be cancelled and therefore the window lift system will no longer be active.

The rear windows can be prevented from being operated from their local switch by the rear inhibit switch in the centre console. In the event of a centre console serial link failure being detected, the local rear window switches will default to inhibited.

Operation of the driver's window down switch will cause the drivers window to move in the down direction until the switch is released (unless in the one touch mode), the up switch is operated, or until a stall condition is detected (i.e. the window is fully open).

Operation of the drivers window up switch will cause the window to operate in the close direction until the switch is released (unless in the one touch mode), the window down switch is operated, a trap condition is detected, or until the motor stalls (i.e. the window is fully closed).

Market Deviations:

a) USA/Canada/Germany:

The system will only be active when the auxiliary (ignition 1) is on, or for the time between switching the auxiliary feed off and opening either of the front doors, but not exceeding 45 seconds.

b) Australia: One touch operation will only be available for the drivers window.

c) Germany: The back off distance from a trap condition will be 200mm.

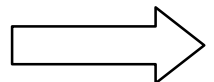
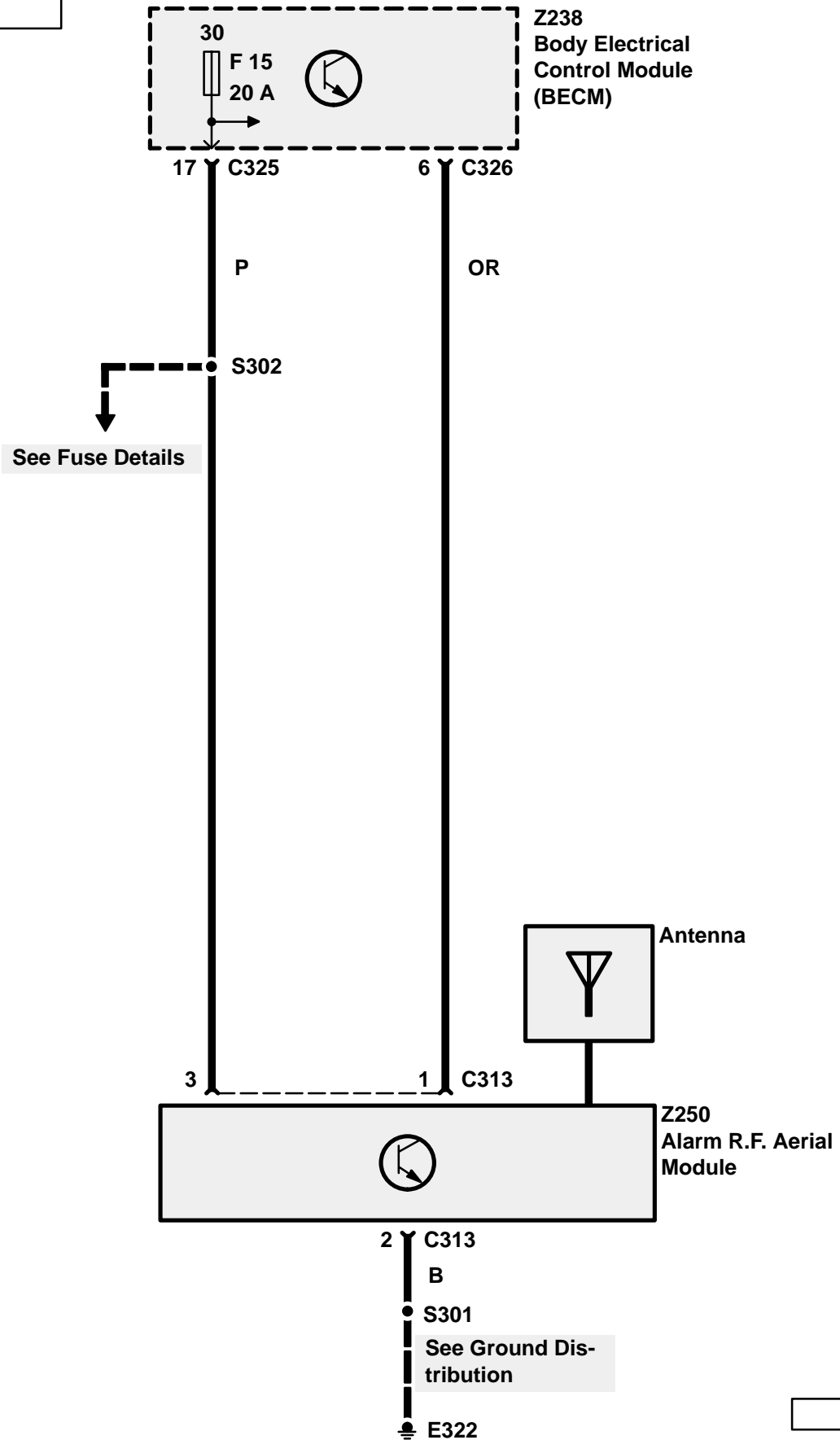
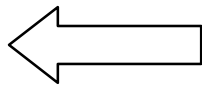

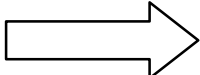
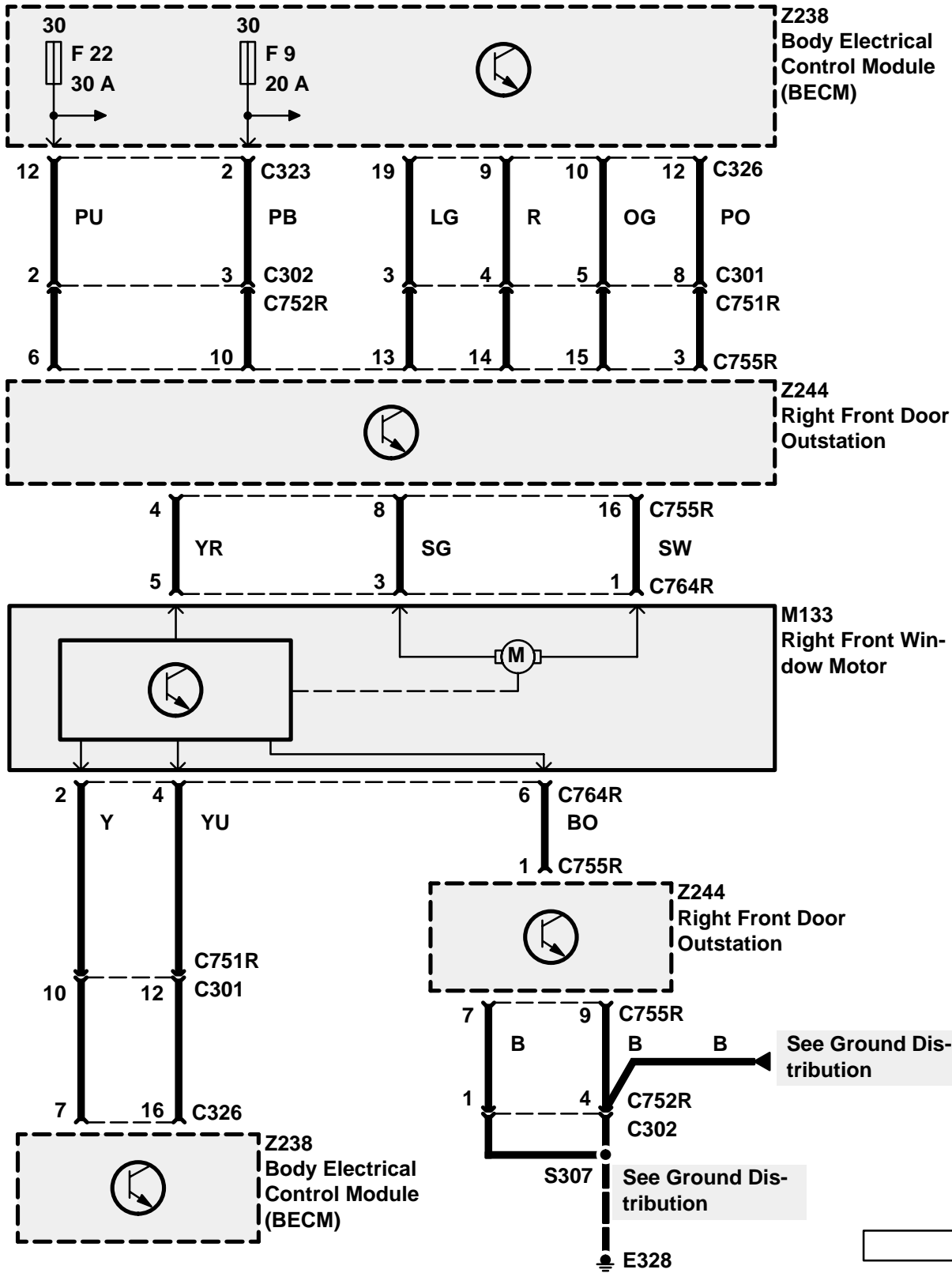
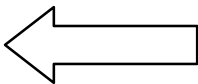

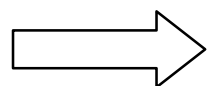
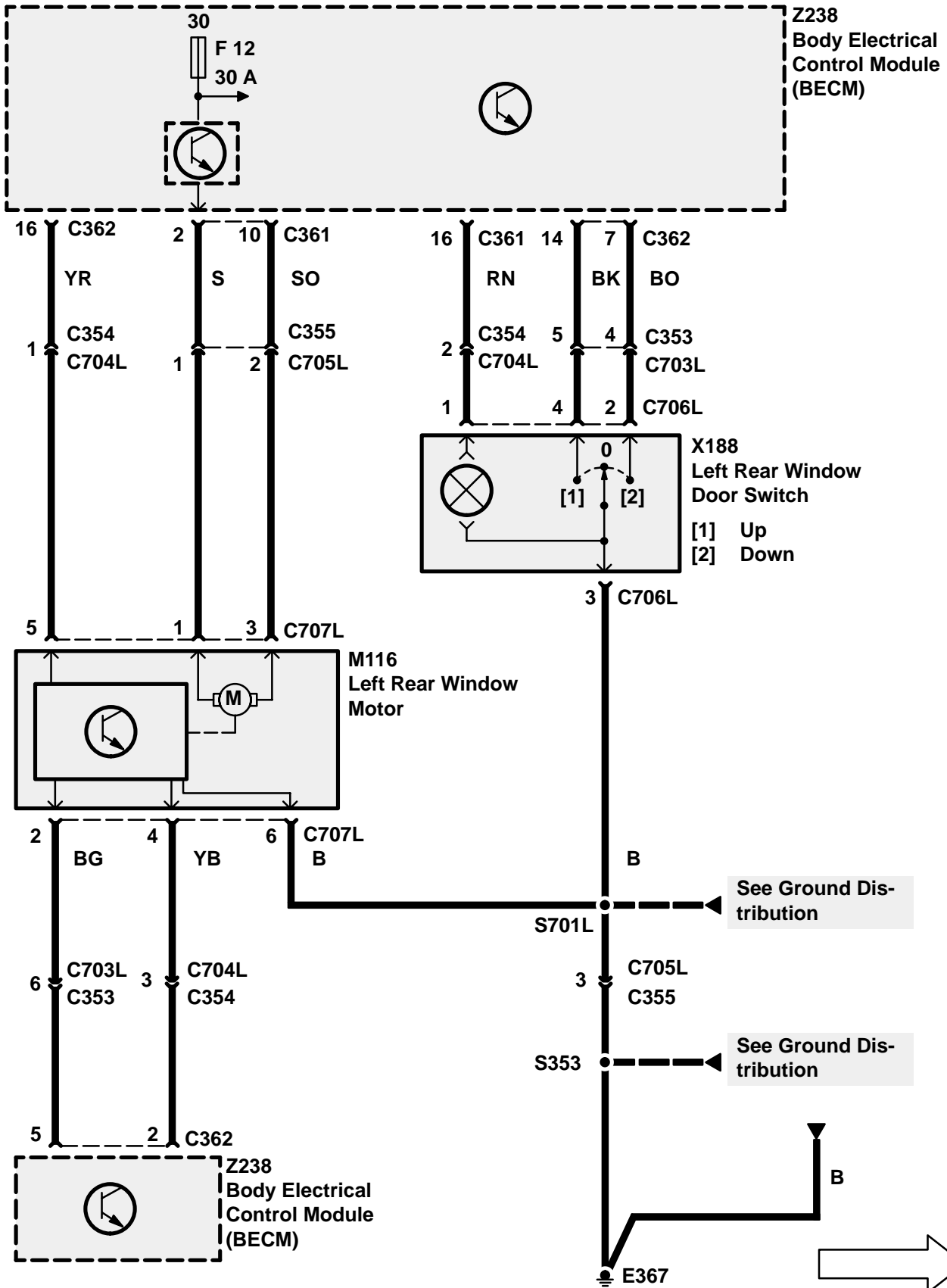
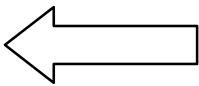

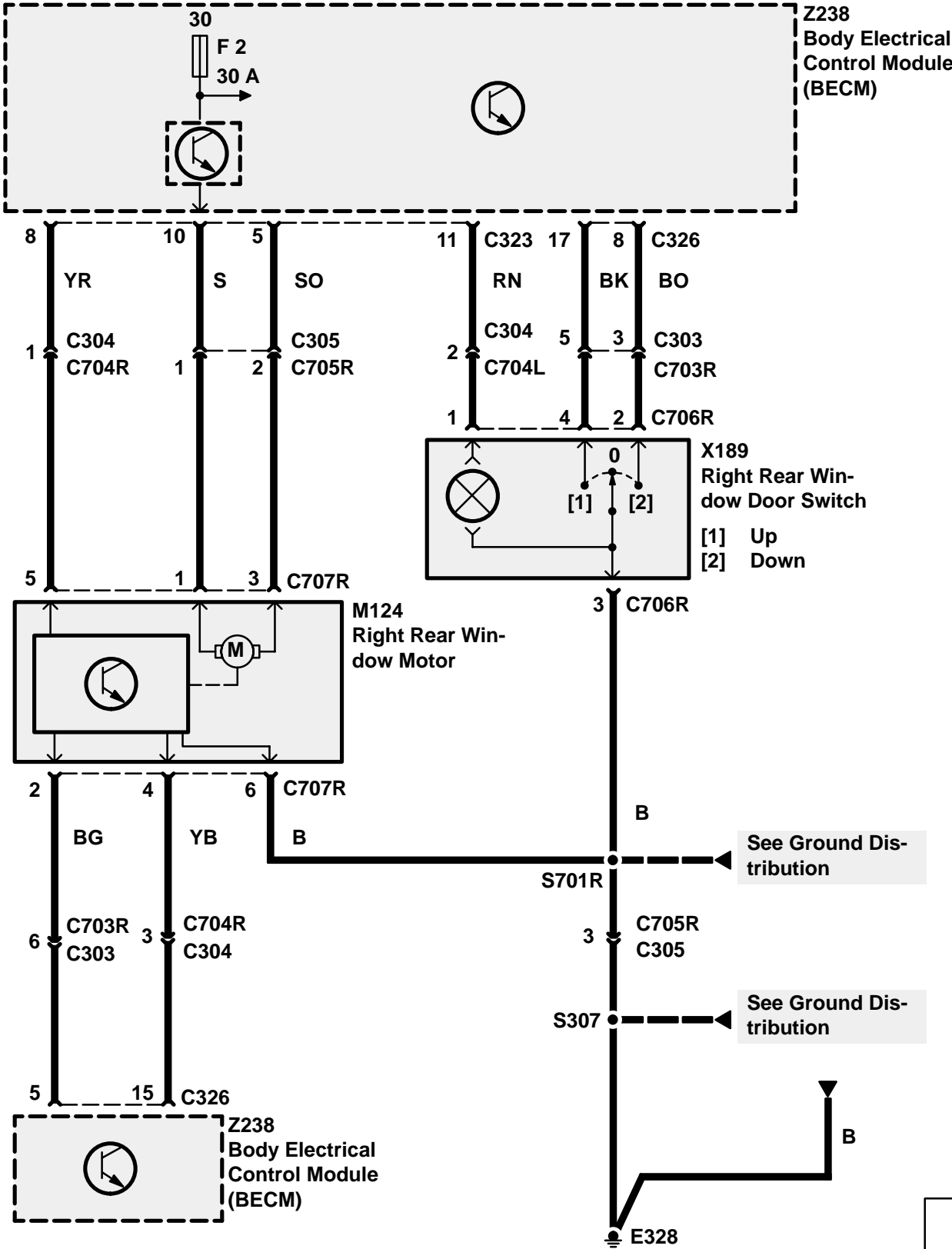
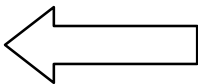

CIRCUIT OPERATION

The sunroof can operate in either slide or tilt mode. To change from one mode to the other, the sunroof must be in the closed position, the switch released and then repressed.

The sunroof functions will be active if the ignition is selected or for the first 45 seconds after it has been switched off provided that no door lock signal is received, in which case the timer will be cancelled.

The sunroof slide function will operate in one of two modes: one touch, or dead man's handle. One touch mode is initiated when the sunroof switch is operated for less than 400ms, dead man's handle mode is initiated when the sunroof switch is operated for 400ms or more. Further operation of either sunroof switch during the one shot mode will cause the sunroof to stop operation.

The sunroof tilt function will operate in deadman's handle mode only.

There will be trap detection on sunroof close and on tilt close, but not on opening operations.

If a trap is detected whilst the sunroof is closing from the slide position, then the sunroof will back off 20cm or until the motor stalls. If a trap is detected whilst the sunroof is closing from the tilt position then the sunroof will back off to the fully tilt open position.

These conditions will also activate a message on the instrument pack which will be accompanied by three audible beeps.

With the sunroof in the closed or partially tilted open position, operation of the sunroof forward switch will cause the roof to operate in the tilt open direction. This will continue until the switch is released, or until a stall condition is detected.

If the sunroof back switch is operated while the sunroof is in the tilt open position, the roof will operate in the tilt close direction. This will continue until the switch is released, a trap is detected or until the sunroof is in the closed position.

If the sunroof back switch is operated with the sunroof in the closed or partially open position, the sunroof will operate in the open direction. This movement will continue until the switch is released (unless in the one touch mode), the sunroof forward switch is operated, or a stall condition is detected.

With the sunroof in an open position, operation of the sunroof forward switch will cause the sunroof to operate in the close direction. This will continue until the switch is released (unless in the one touch mode), the sunroof back switch is operated, a trap is

detected, or until the sunroof is in the fully closed position.

The heated rear window will be inhibited for the duration of any sunroof operation.

Market Deviations:

USA/Canada: the system will only be active when the auxiliary or ignition feeds are on, or for the time between switching the ignition feed off and opening either of the front doors.

Australia: the system will only be active when the ignition switch is in the auxiliary, the ignition or the crank position, or for 45 seconds after the key is removed from the ignition switch.

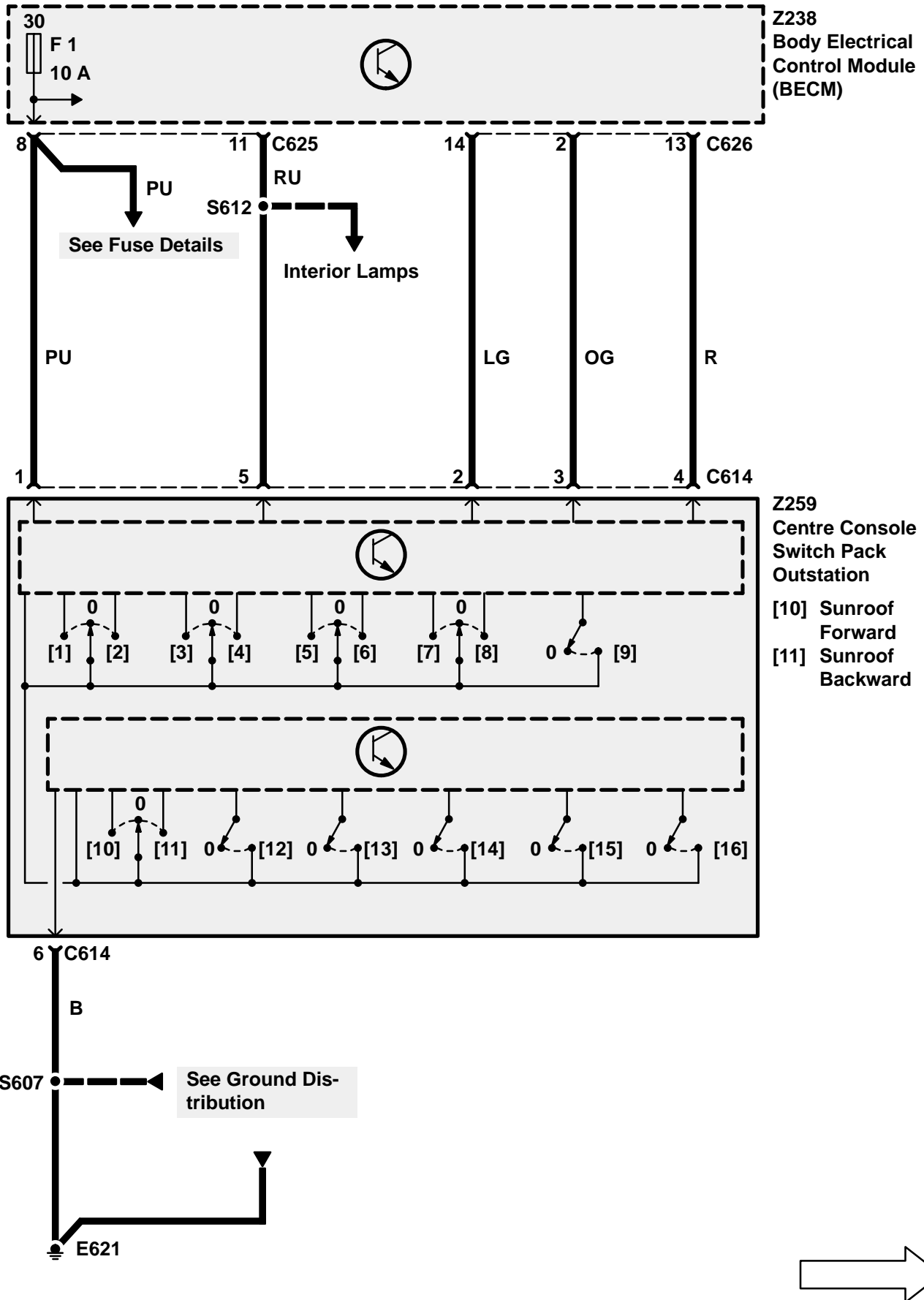

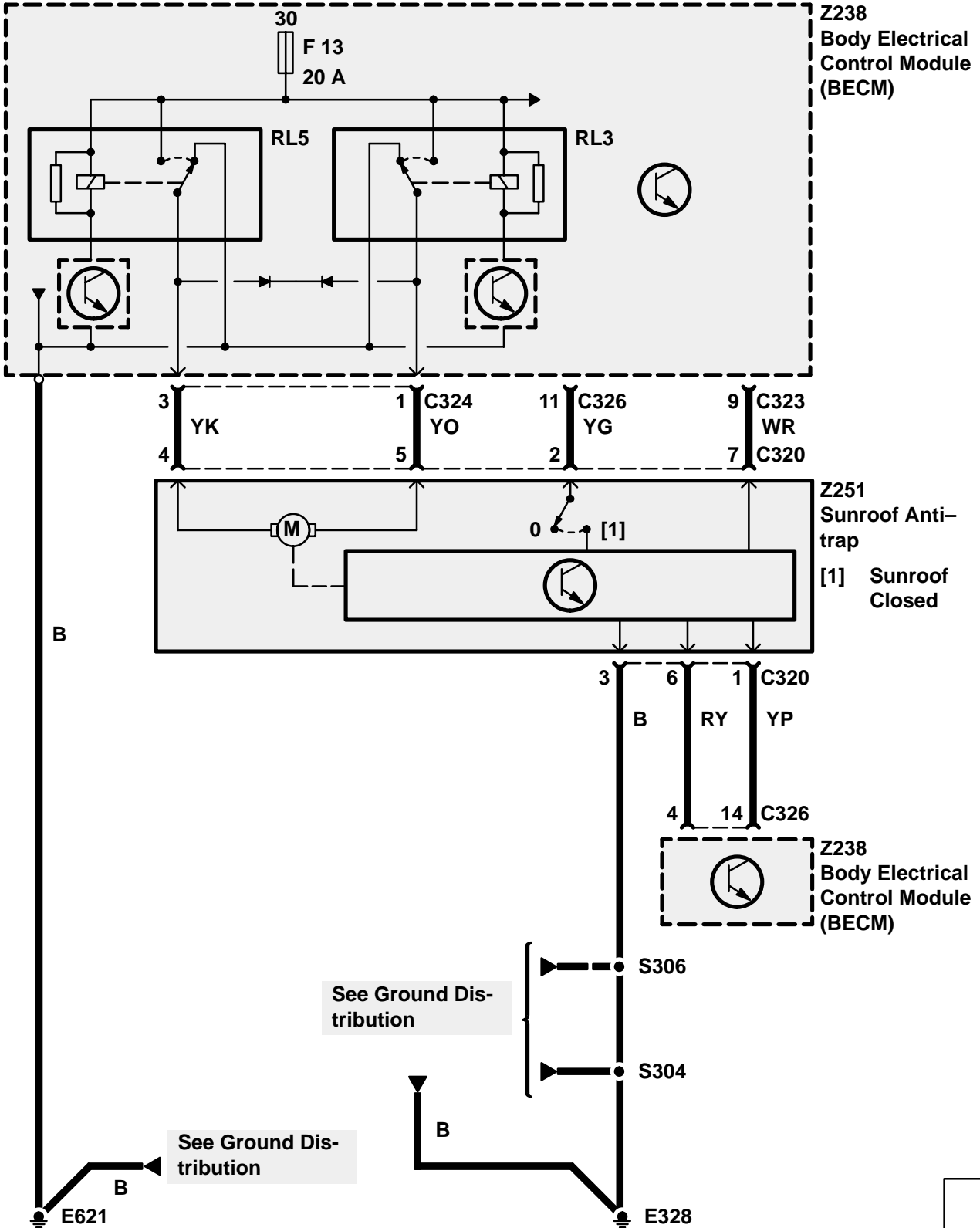
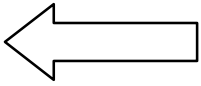

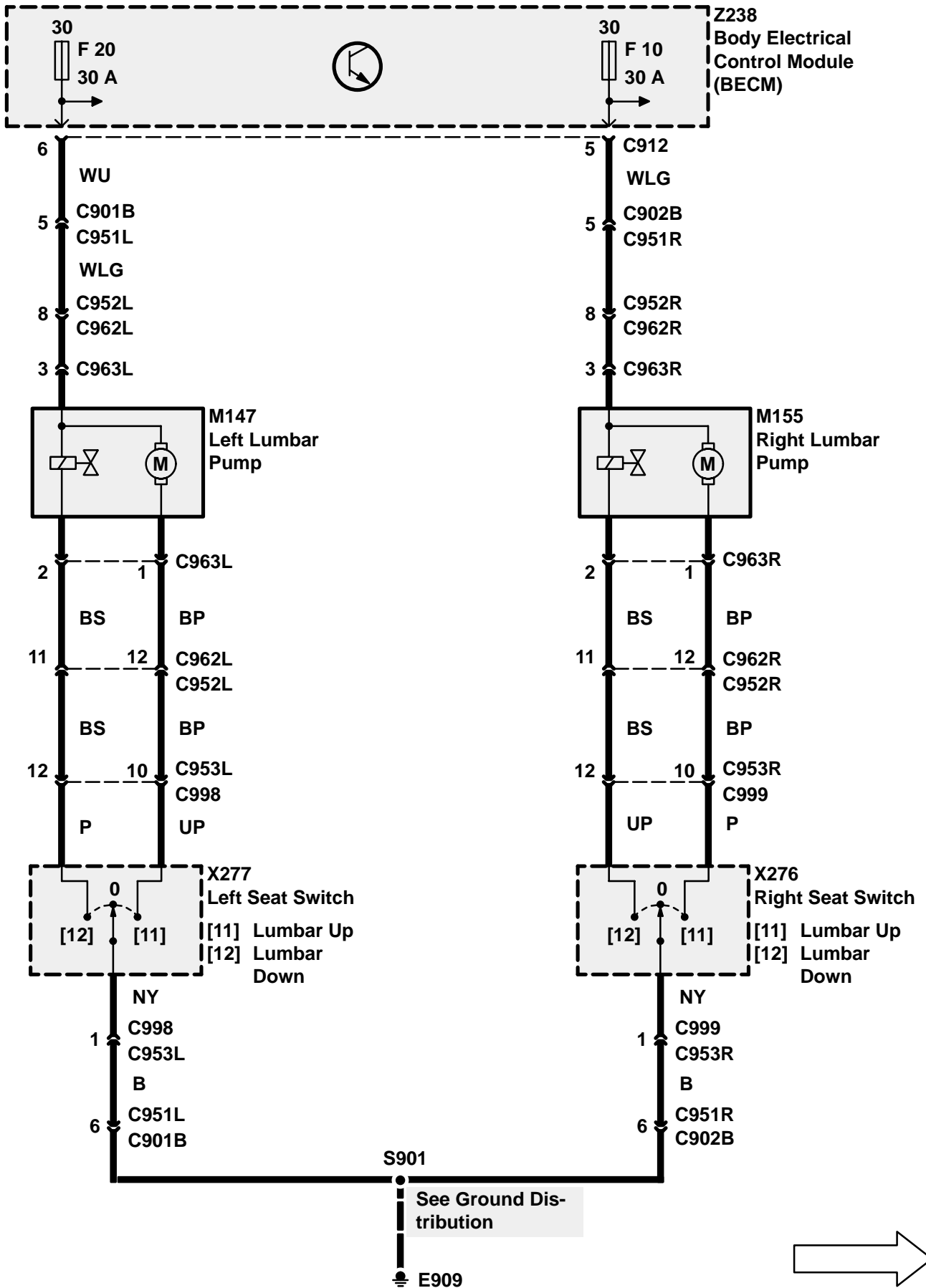

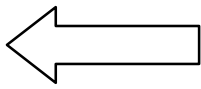

Power Seats
(Left)

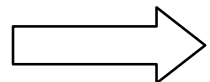
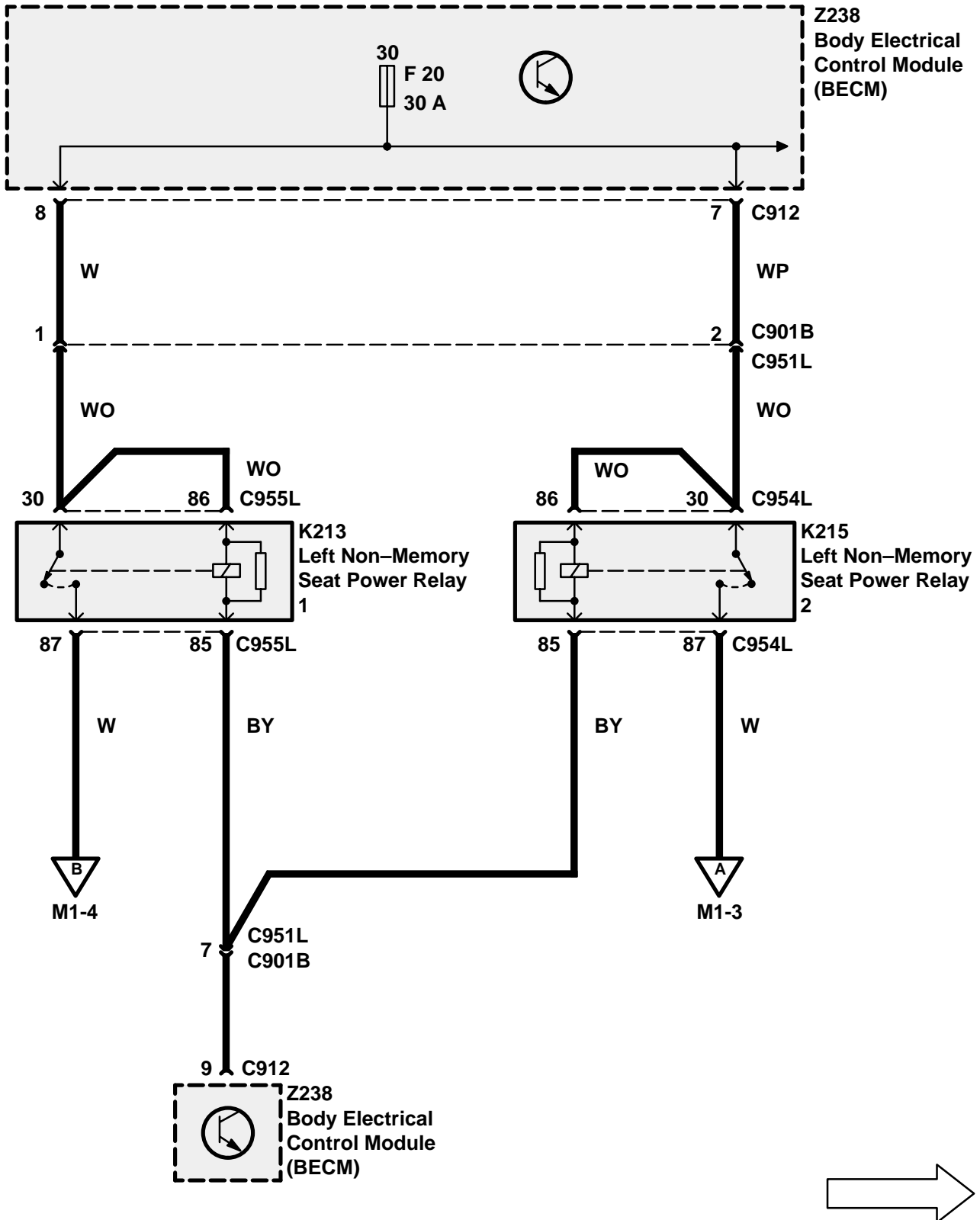

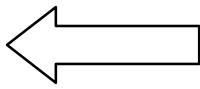

Power Seats
(Left)

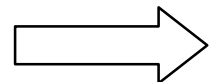
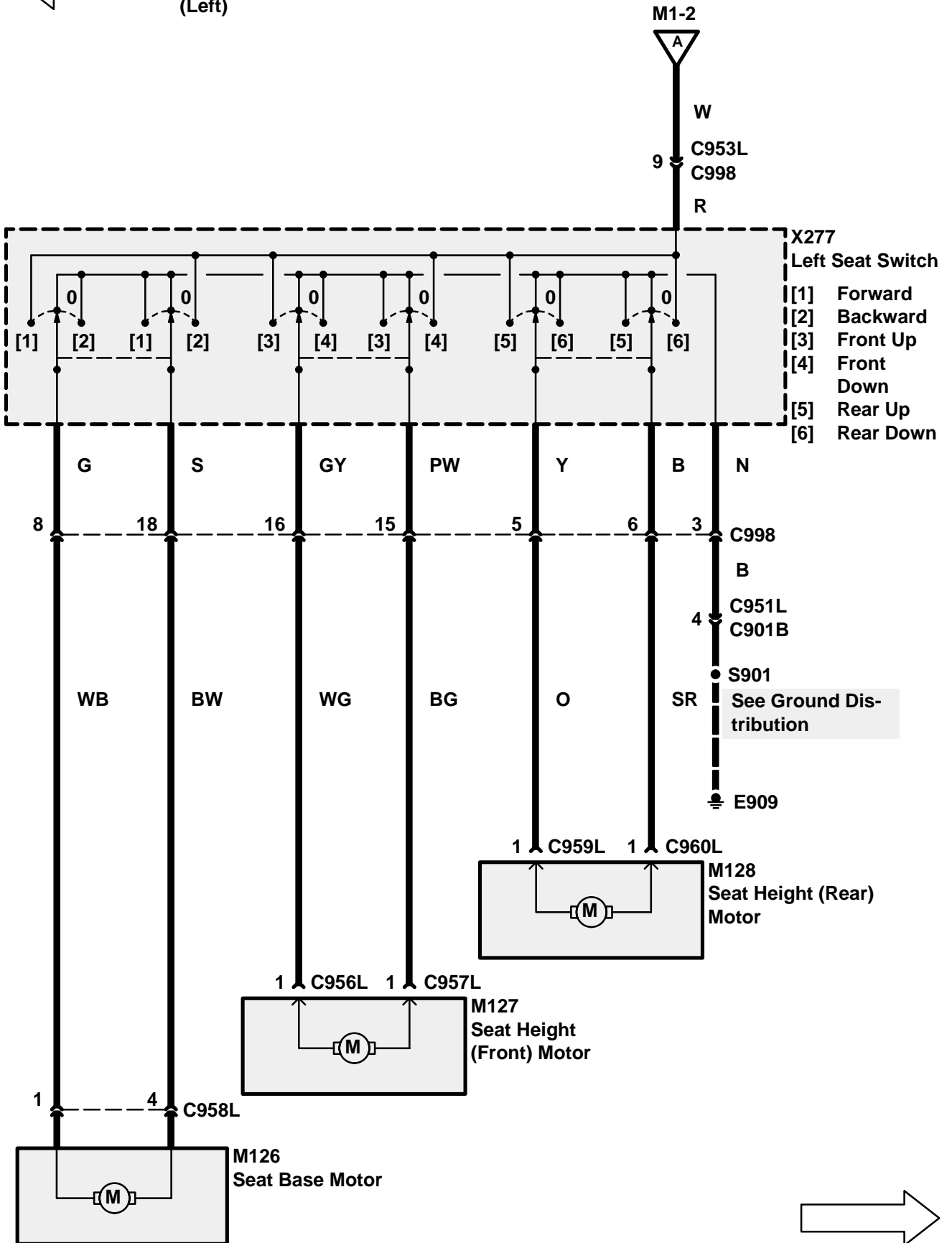

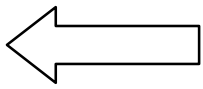

Power Seats
(Left)

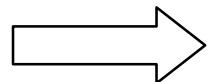
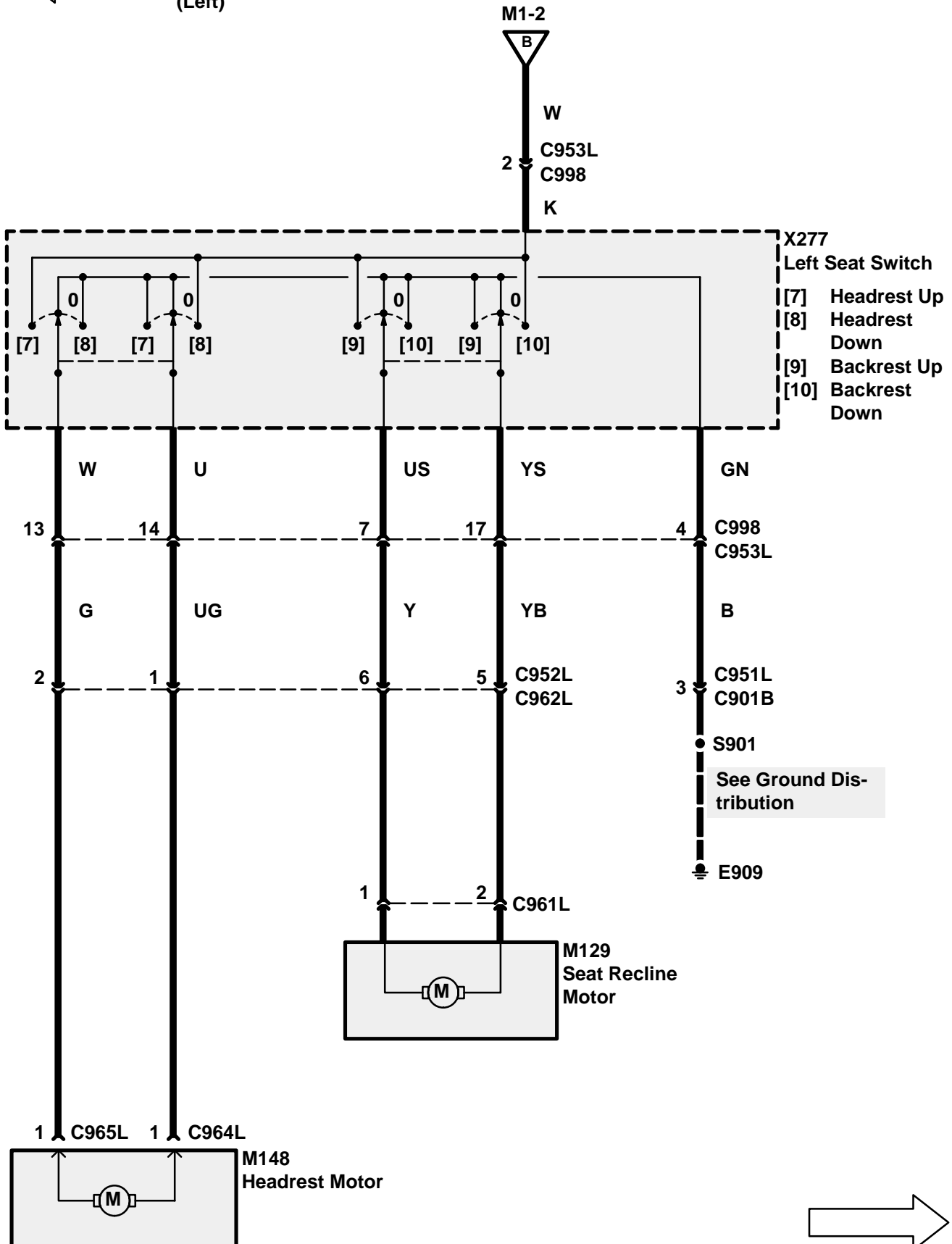

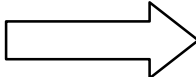
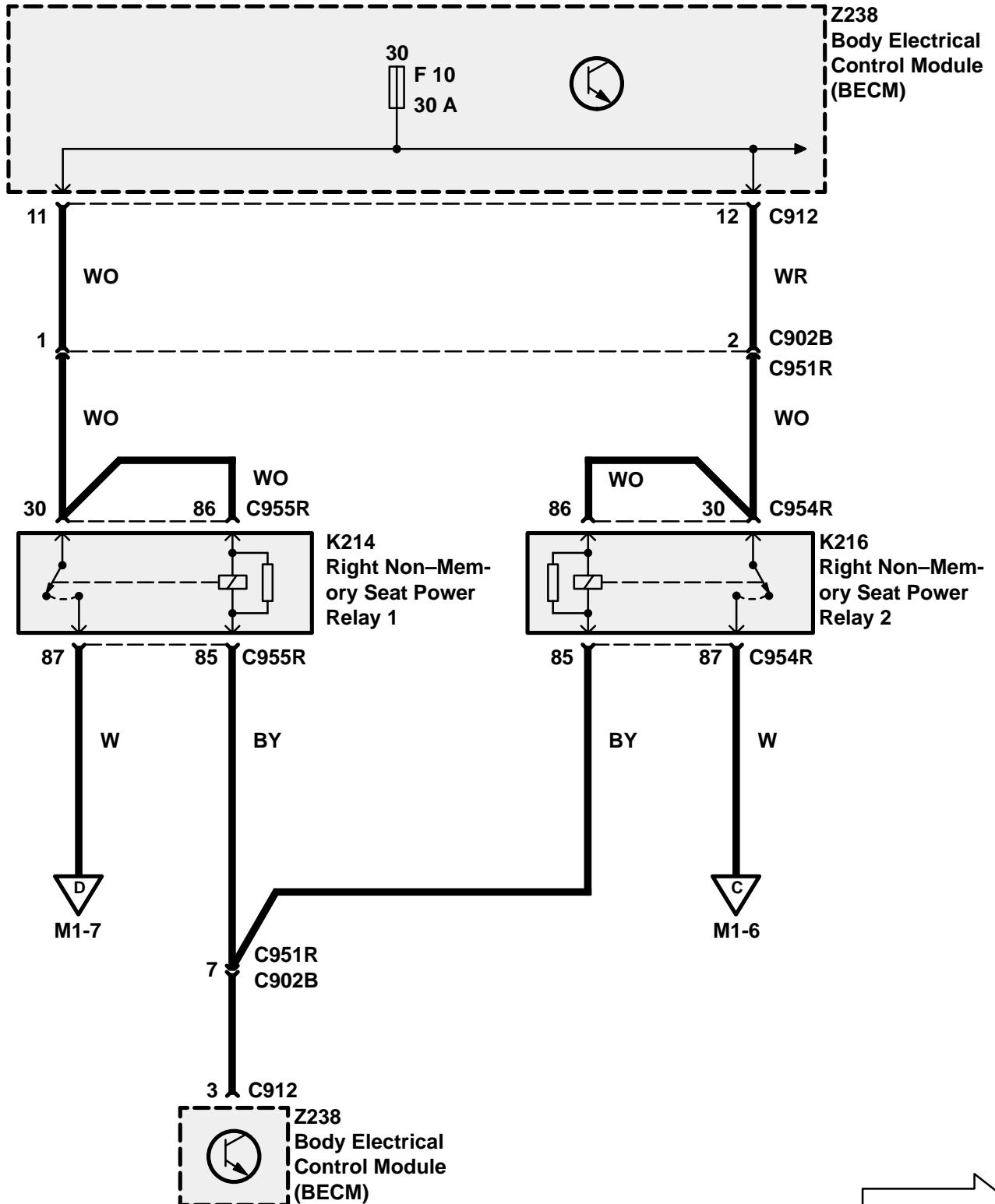
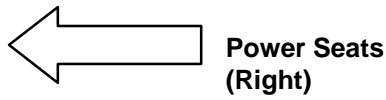

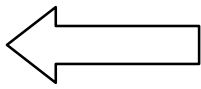

Power Seats
(Right)

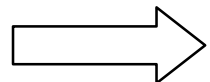
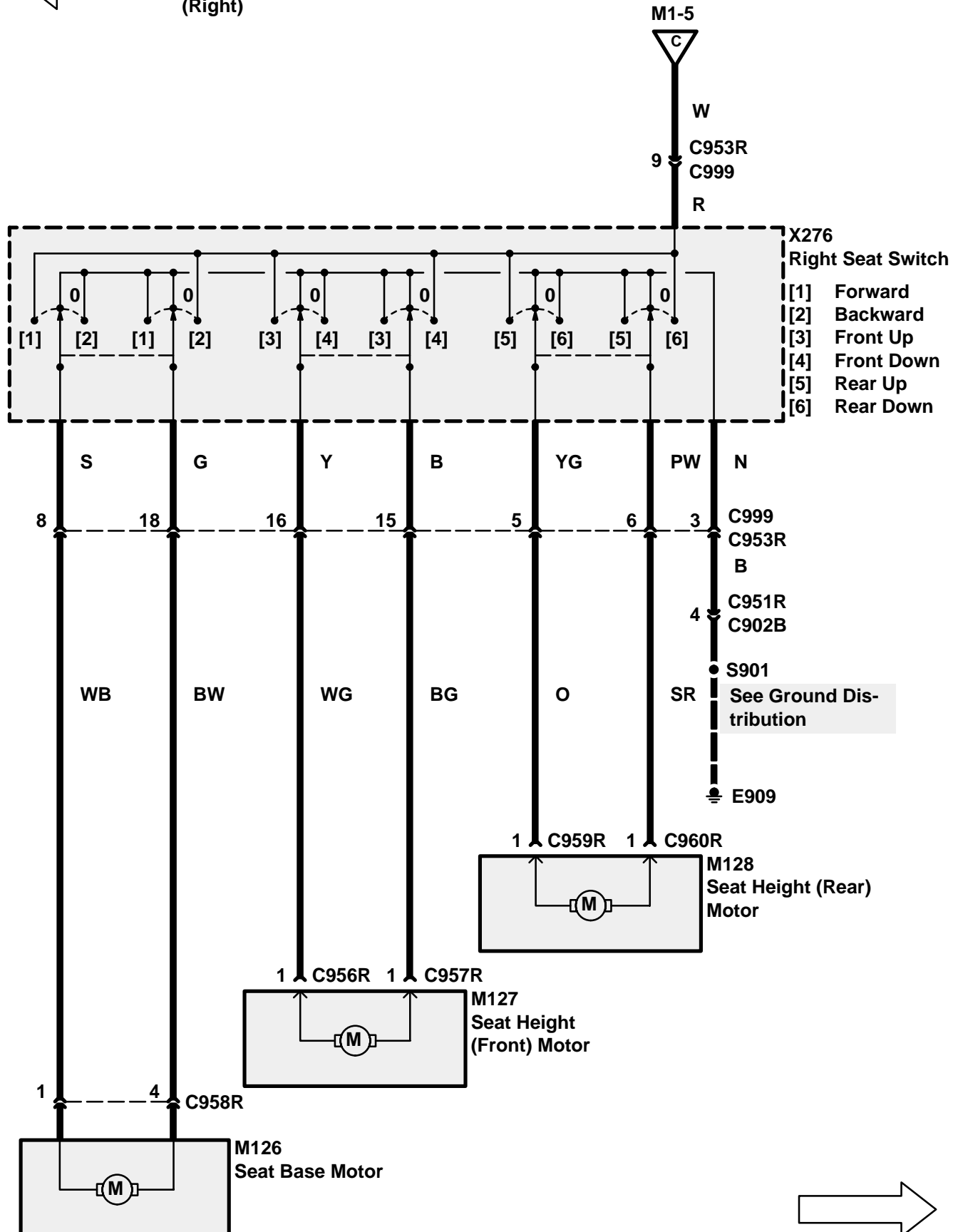

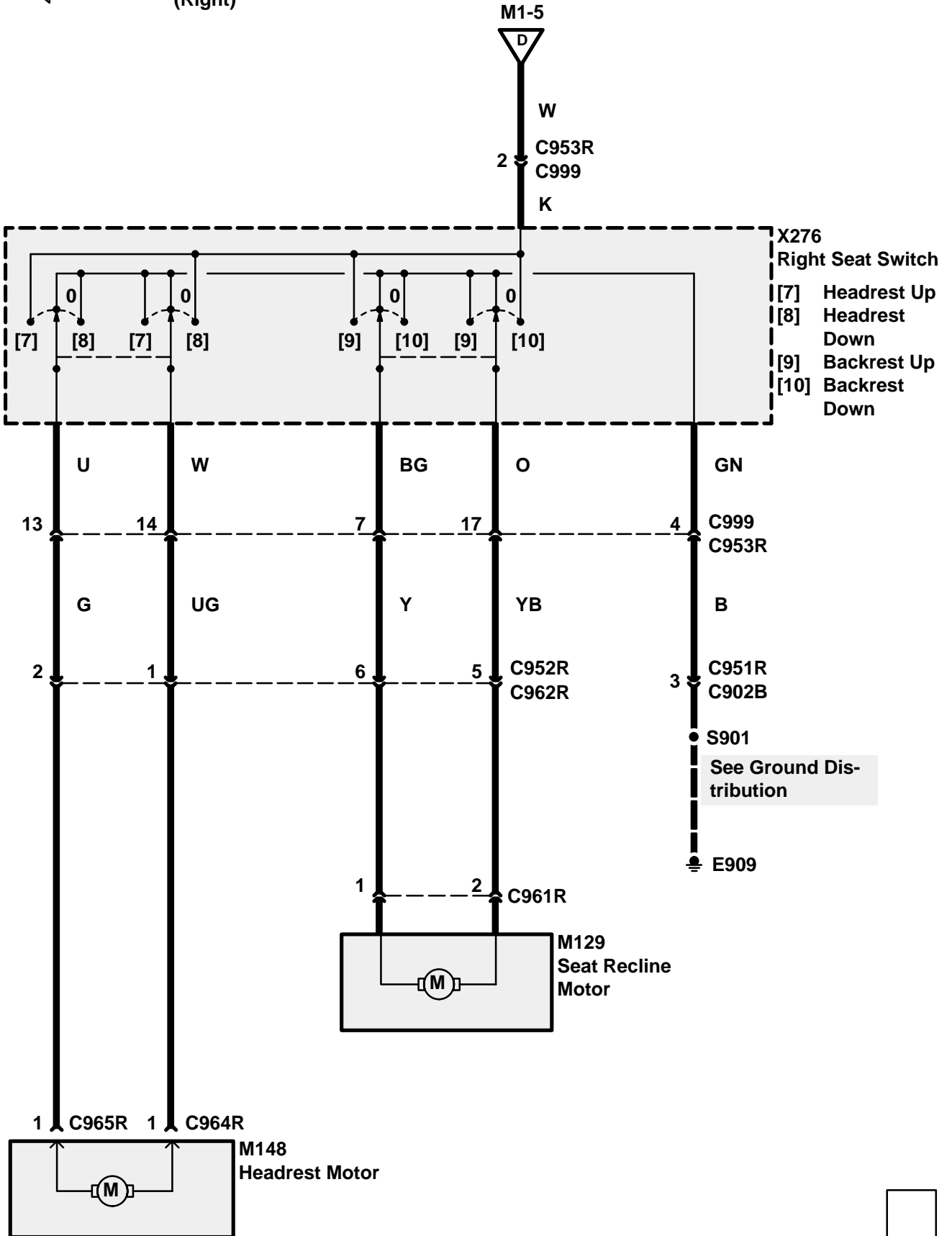
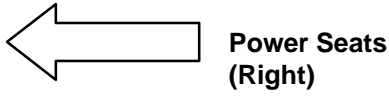

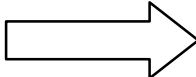
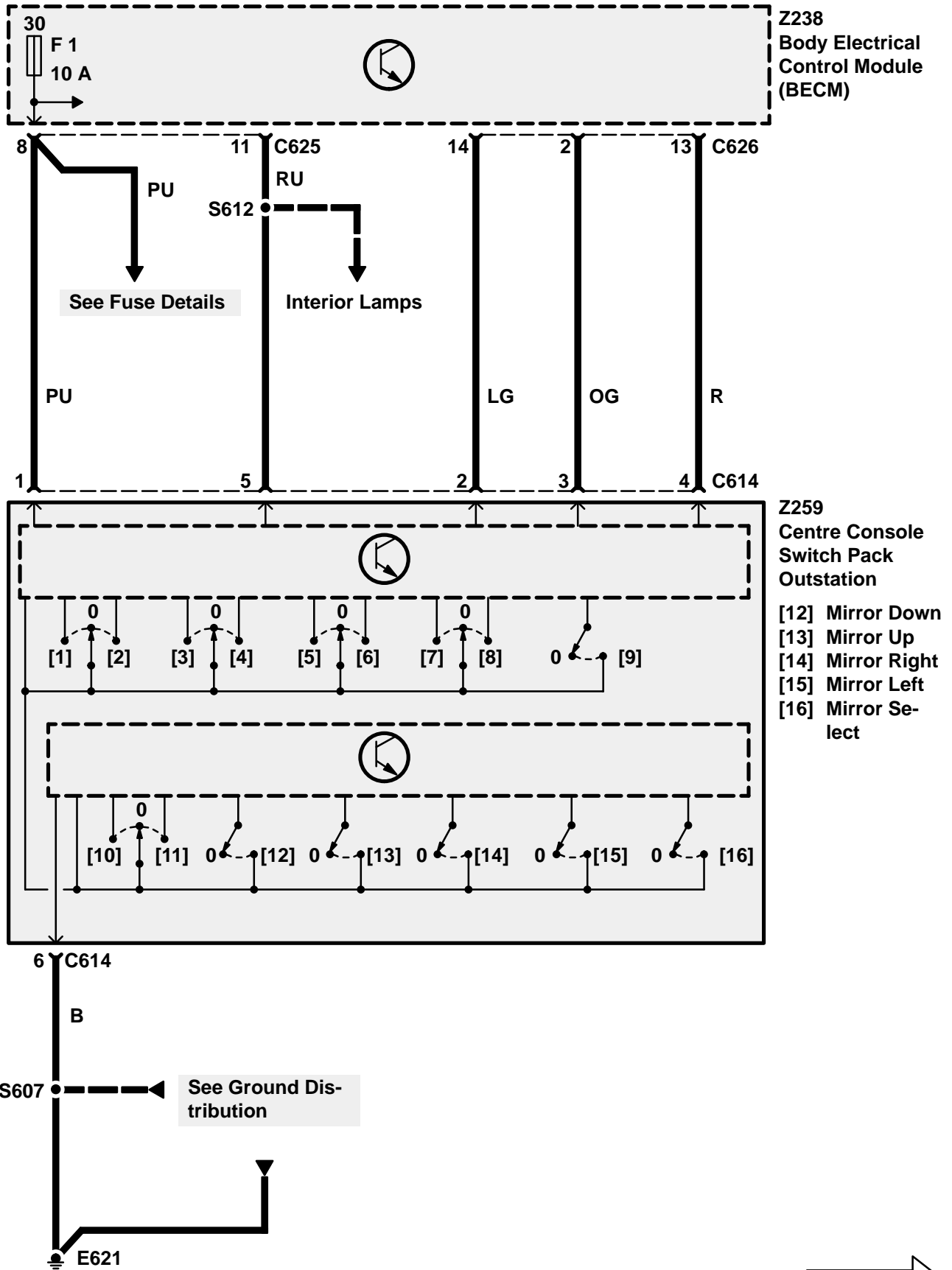

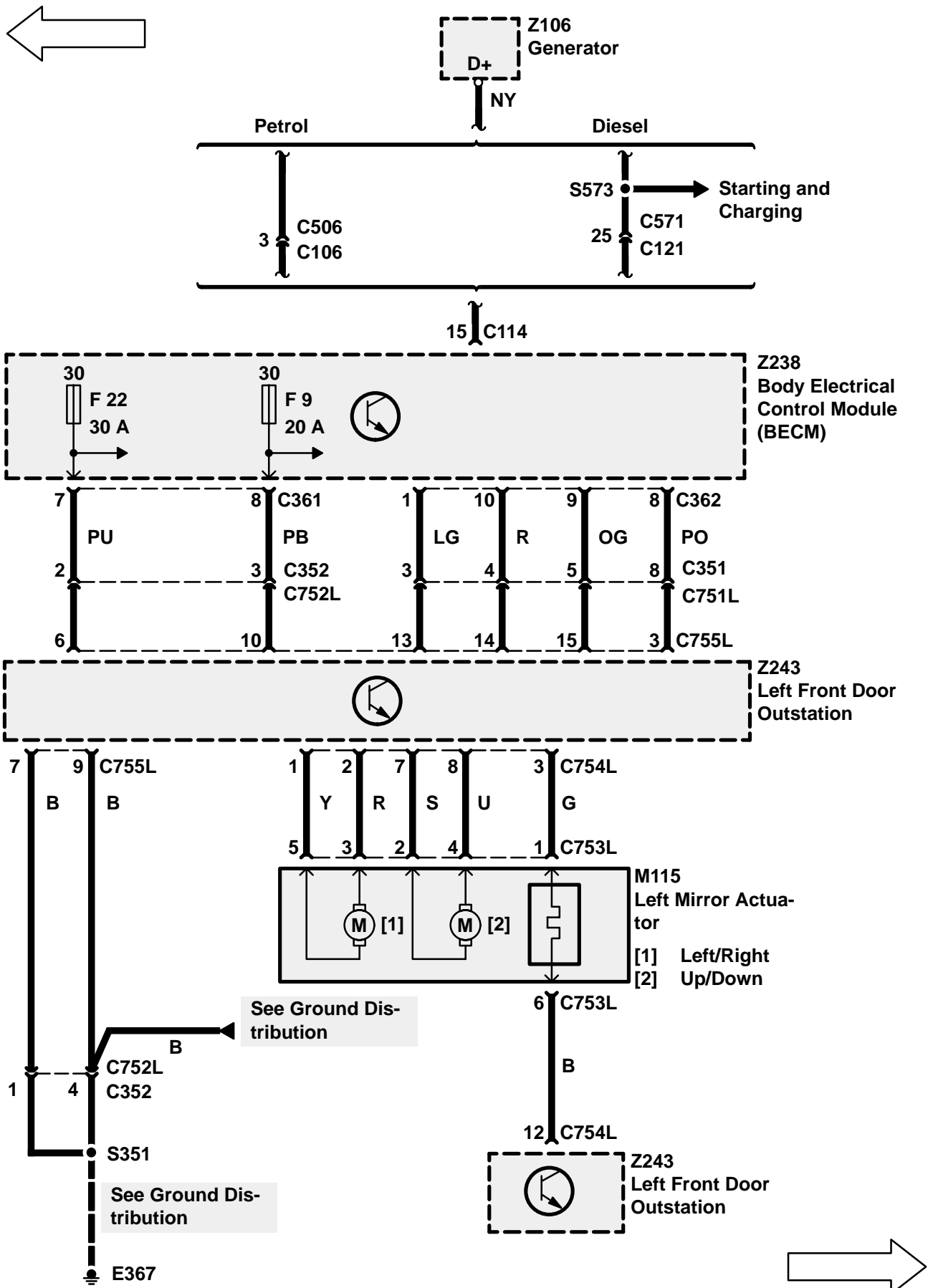

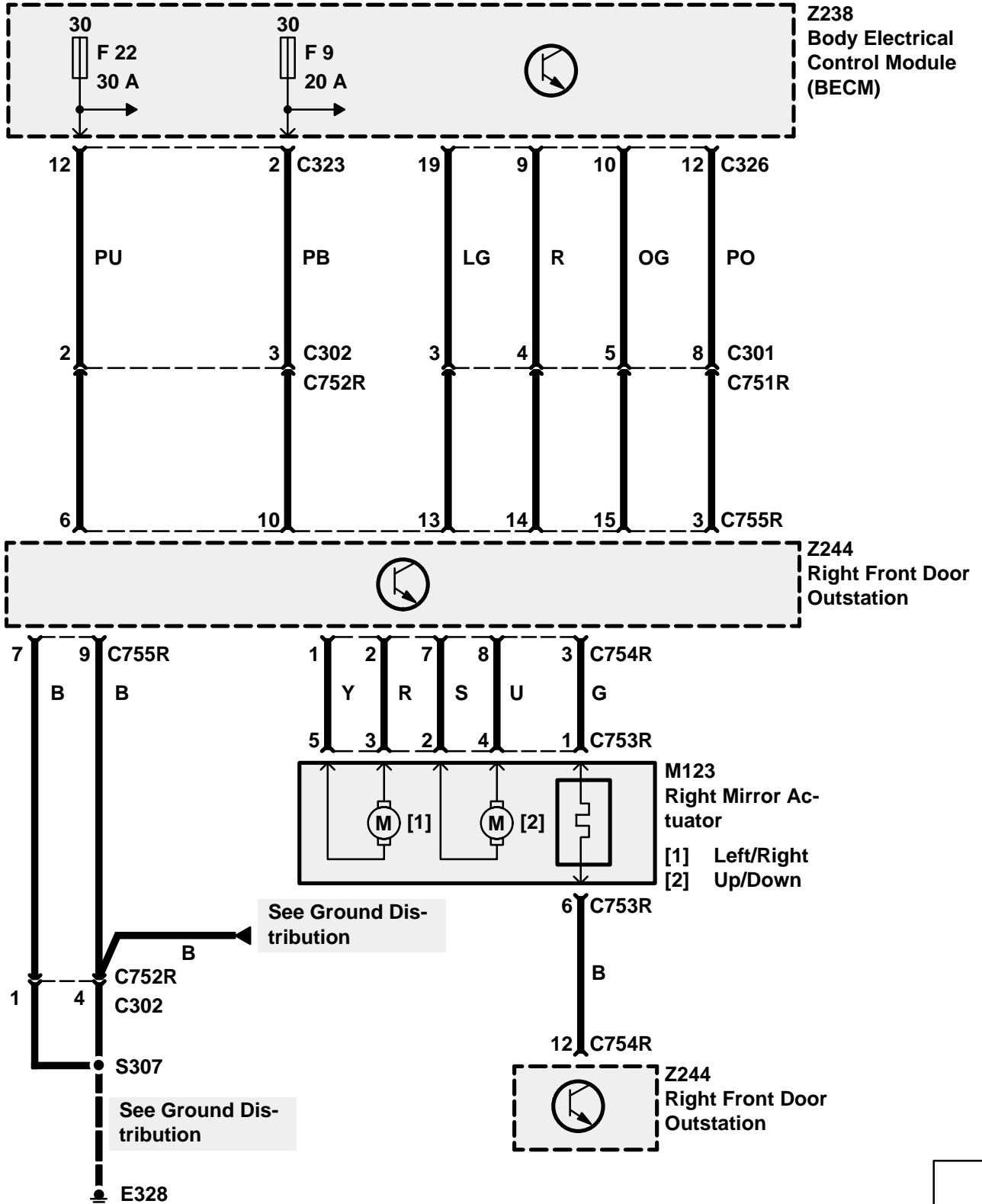
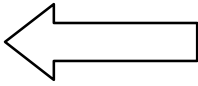

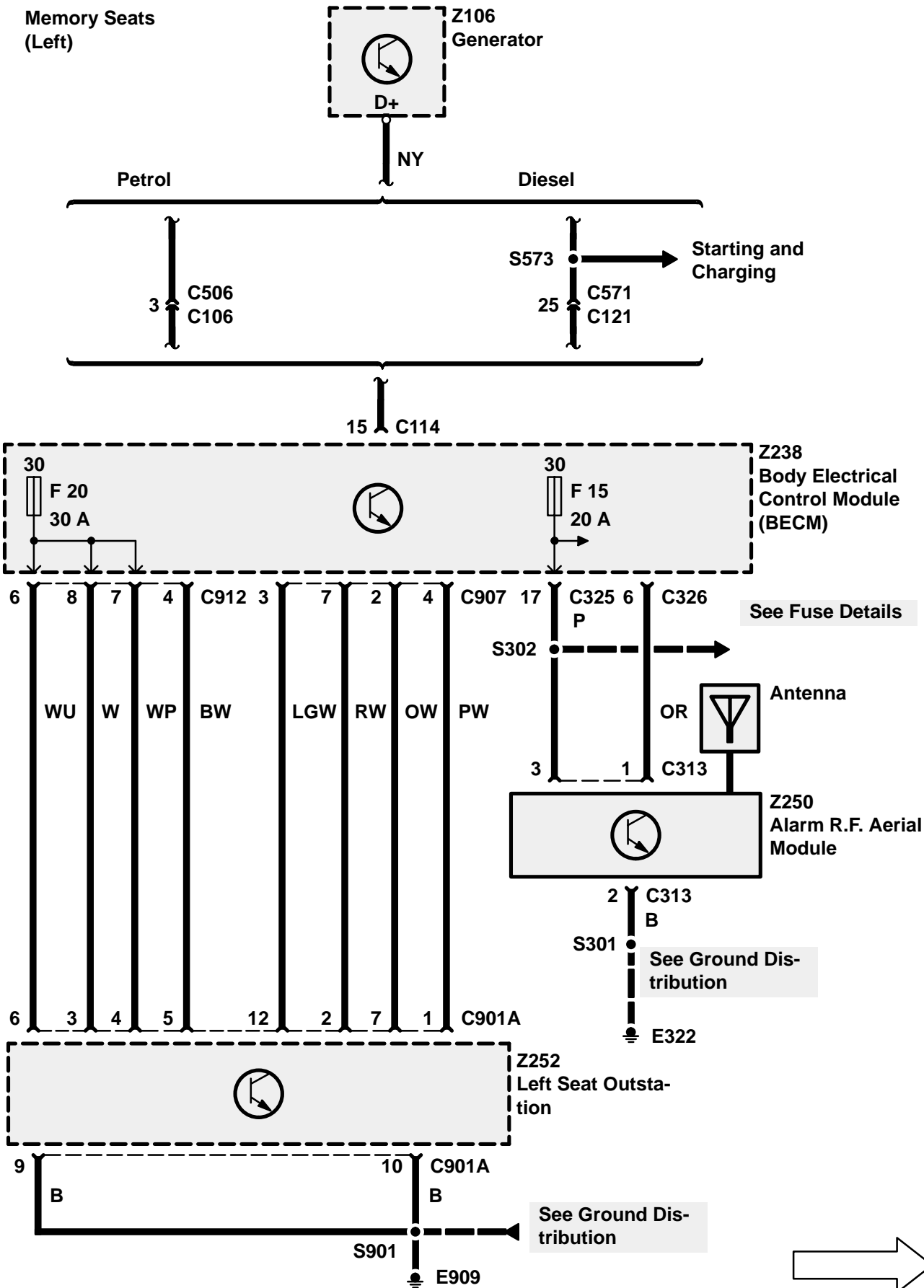

M4

MEMORY SEATS (LEFT)

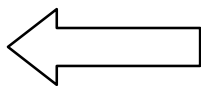

Memory Seats (Left)

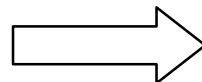
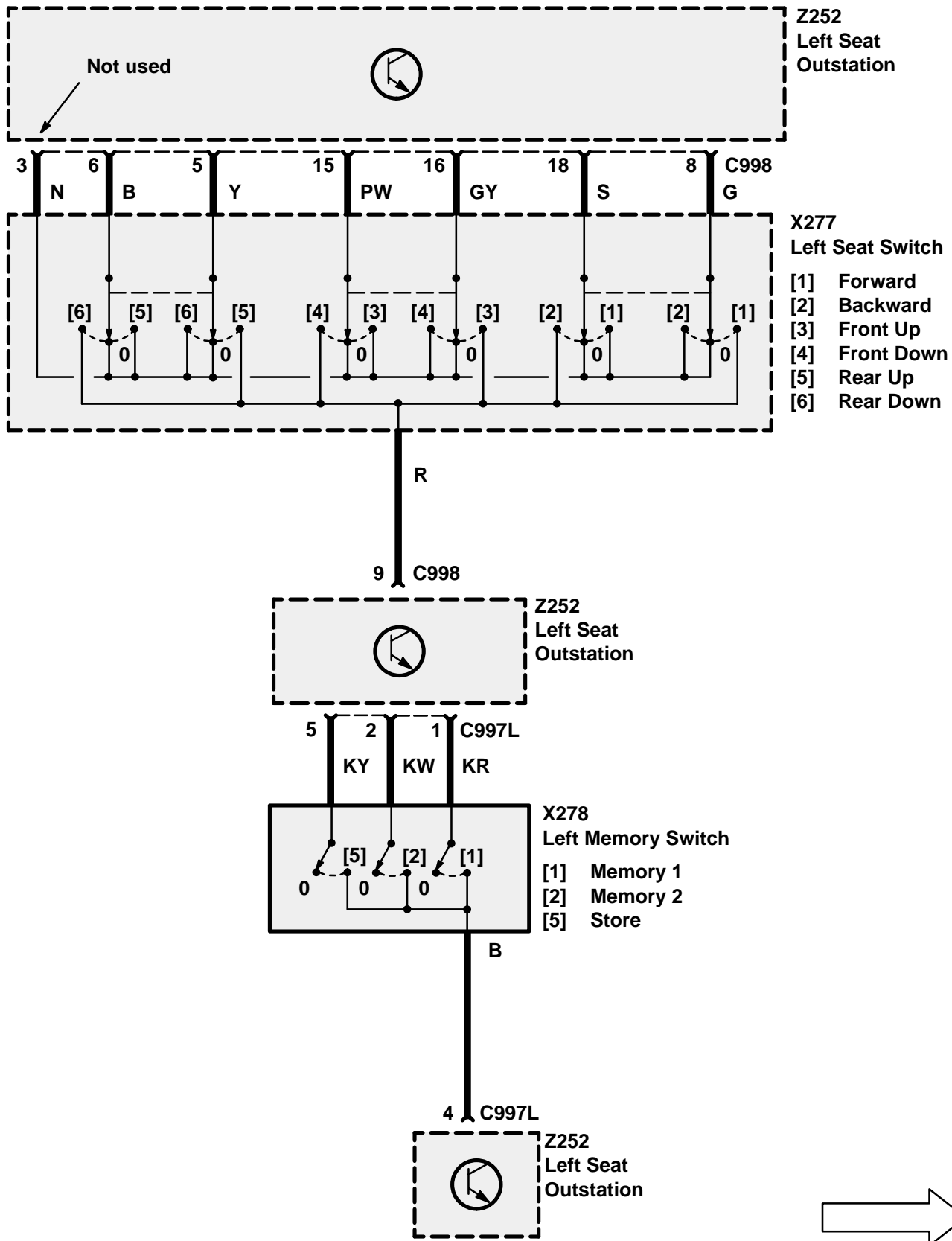

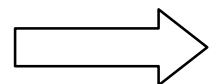
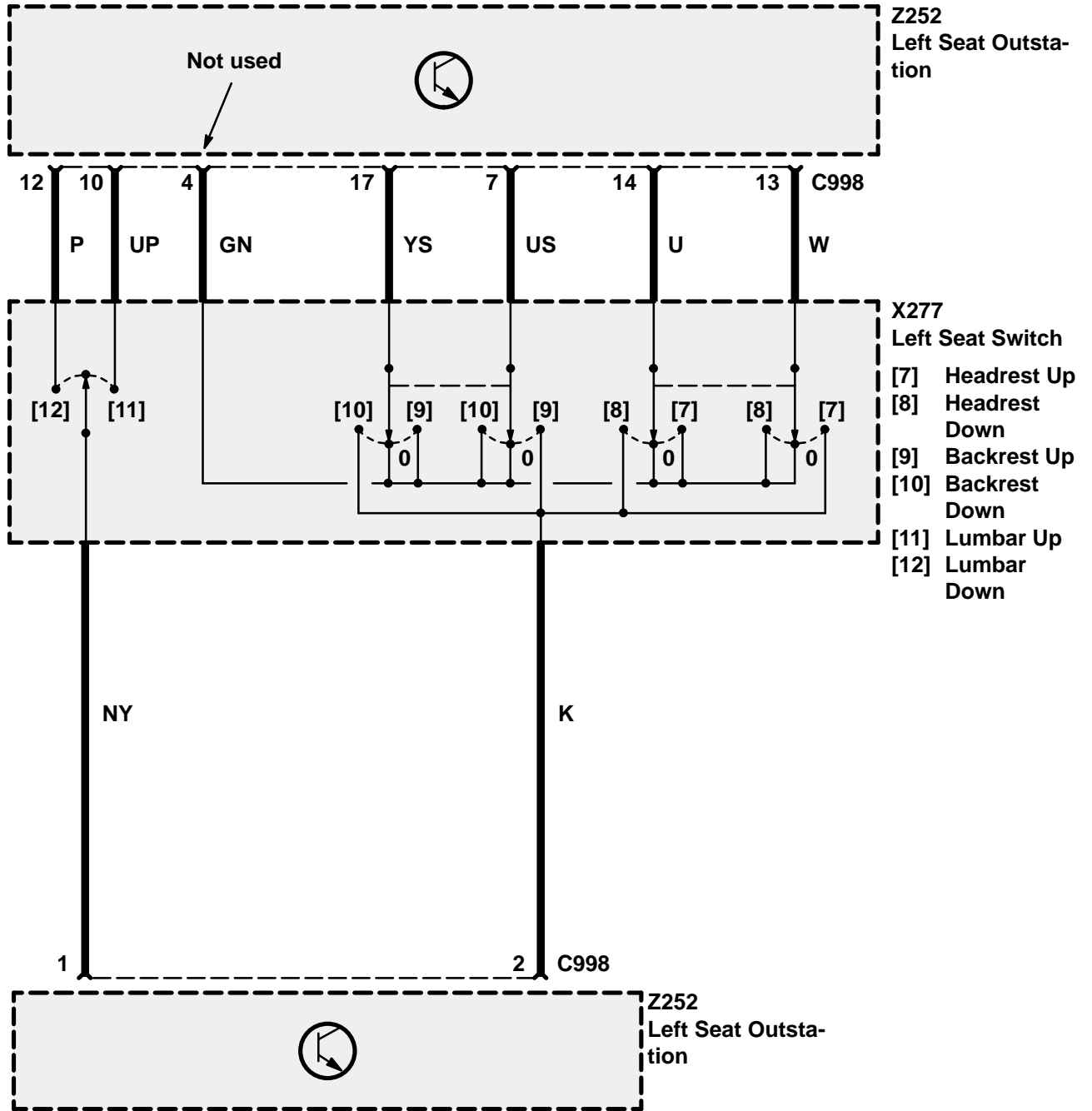

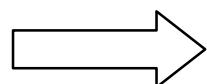
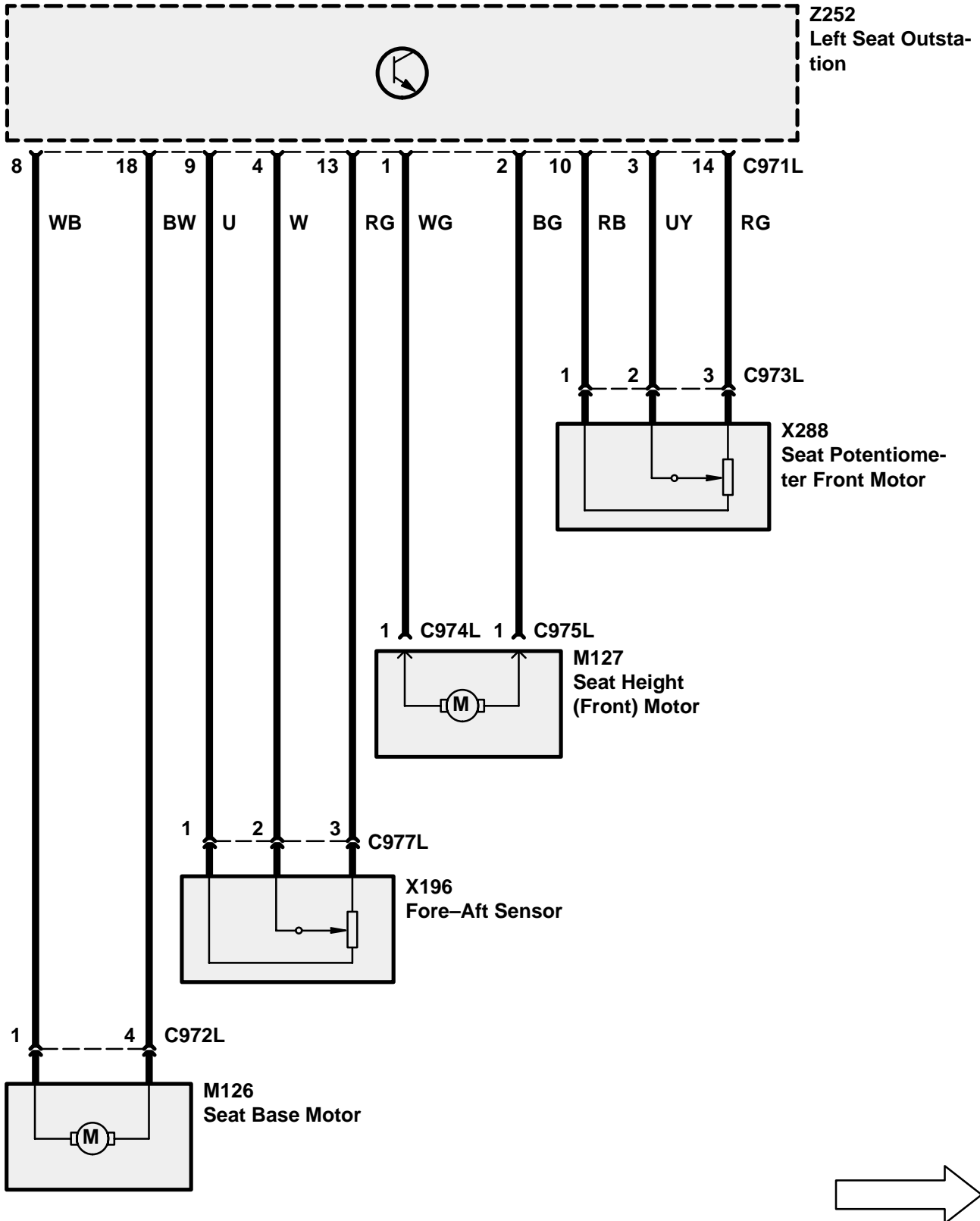

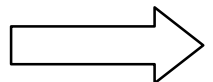
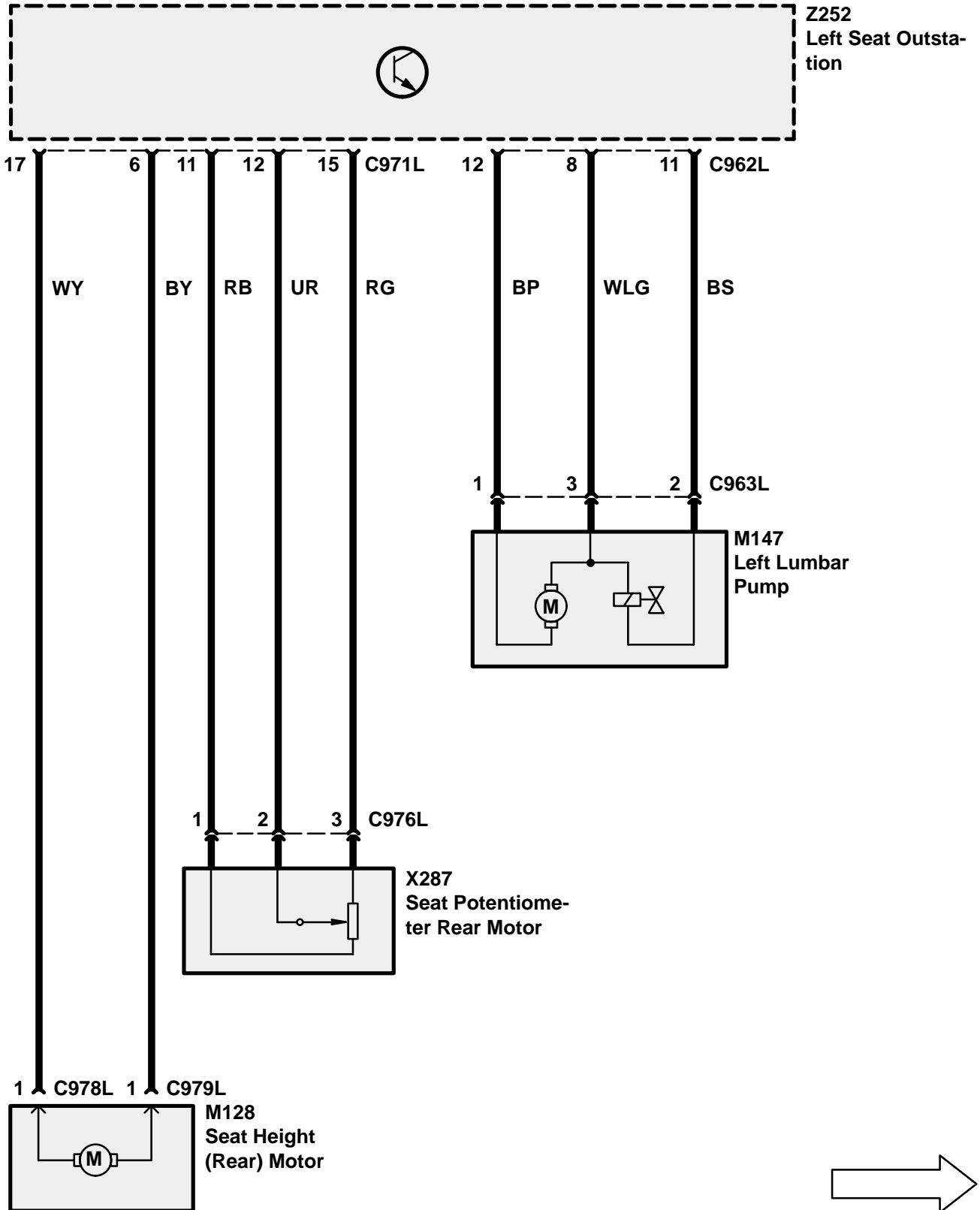

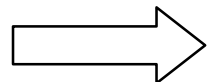
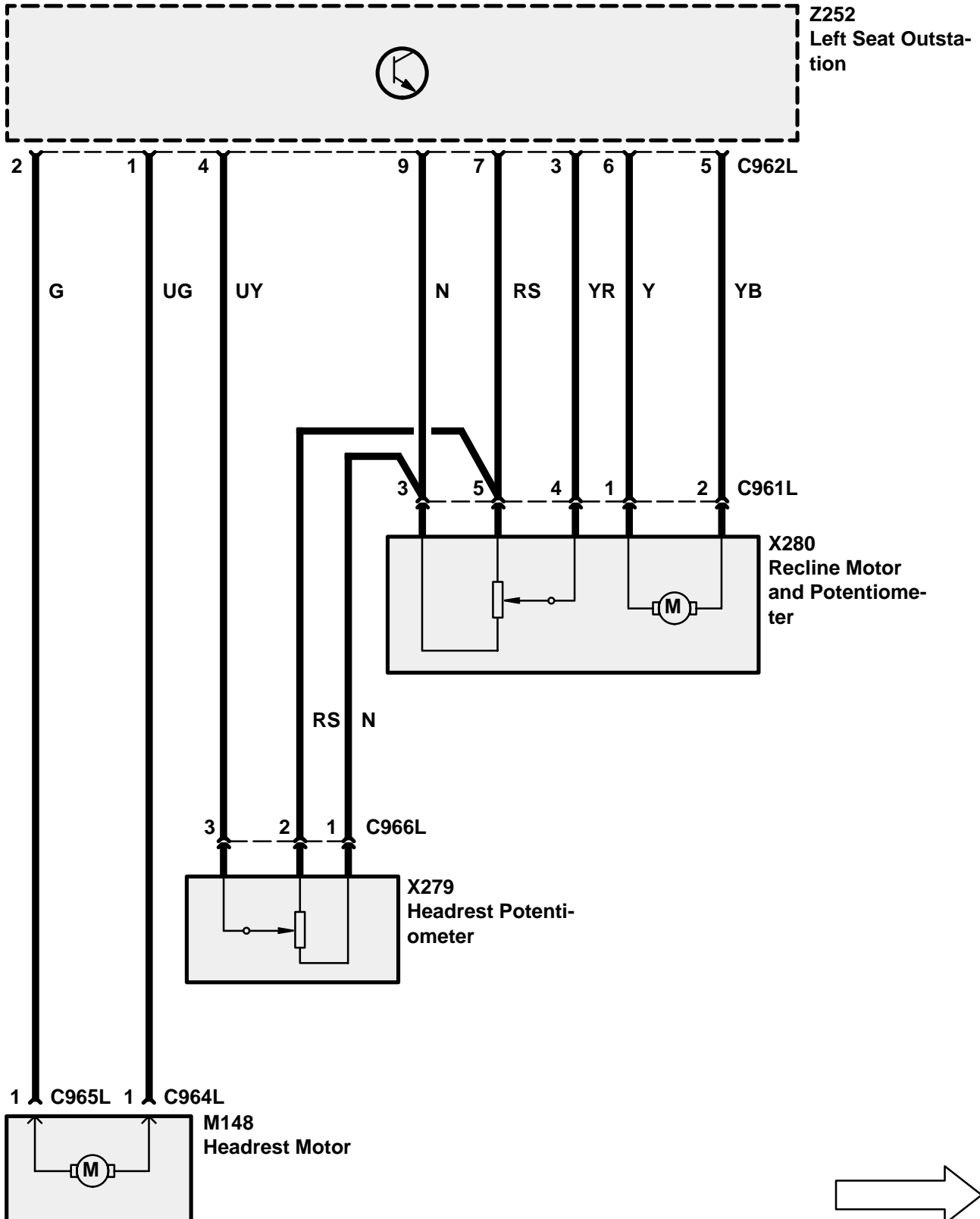

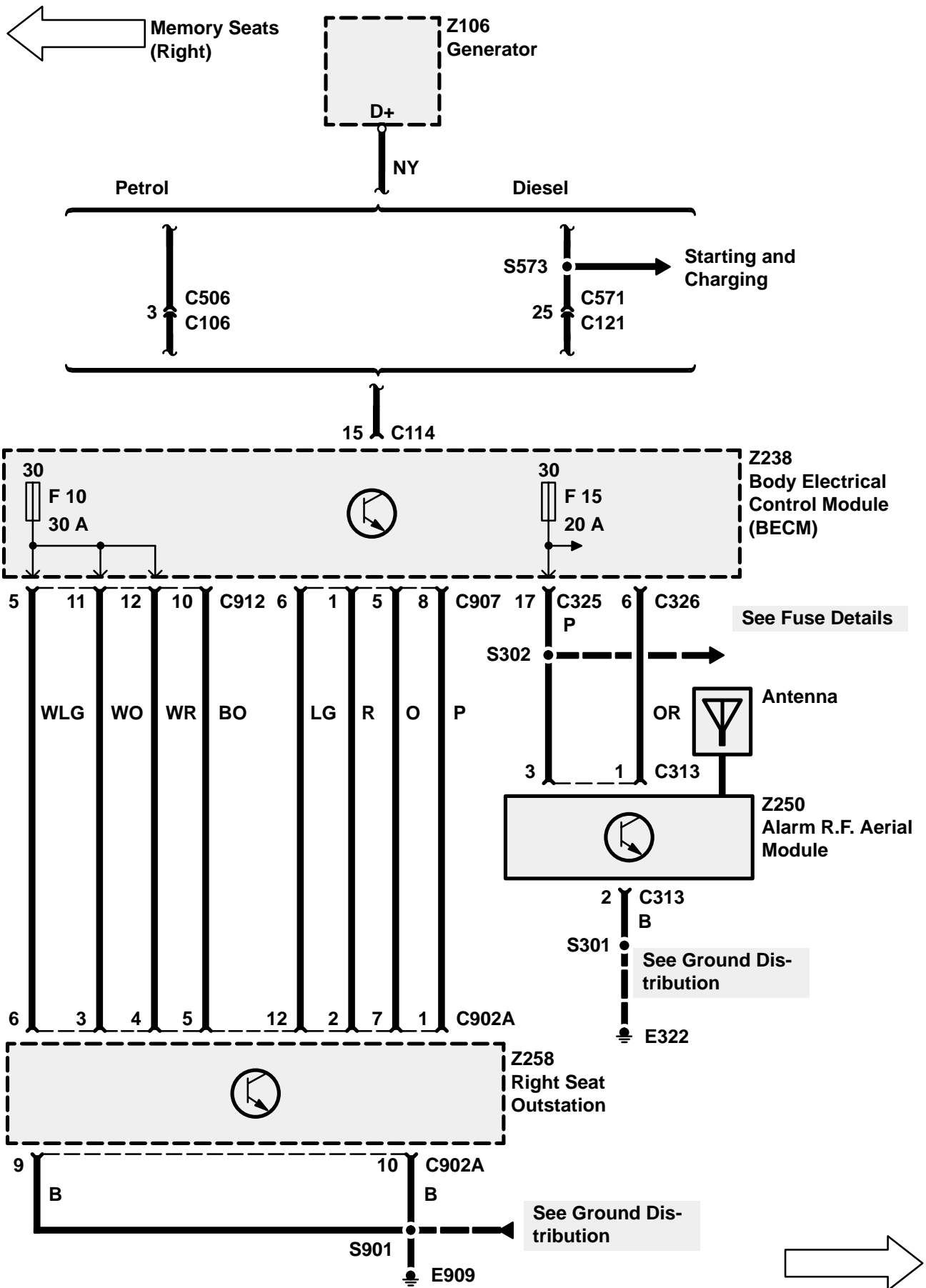

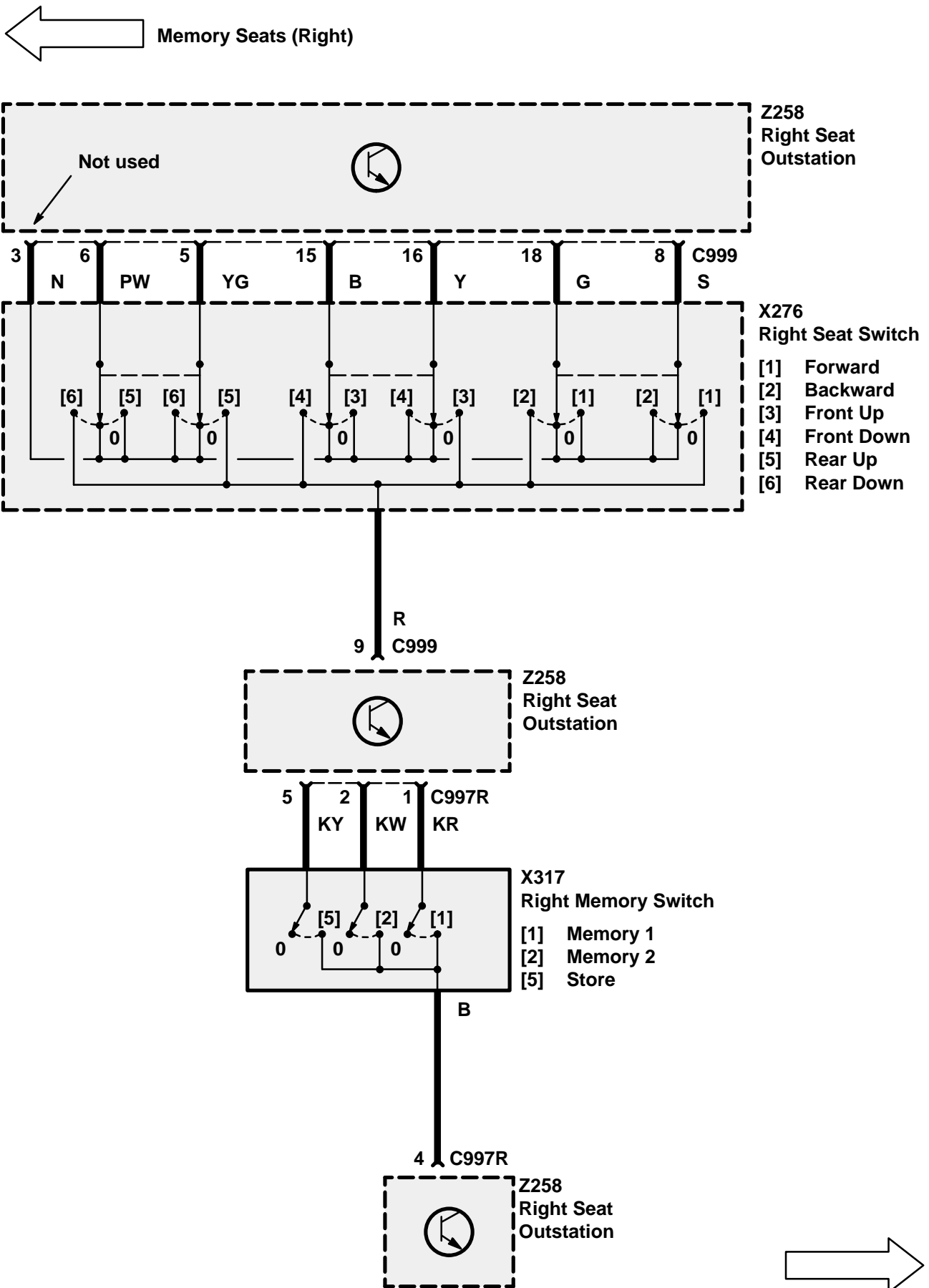

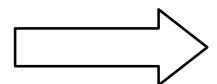
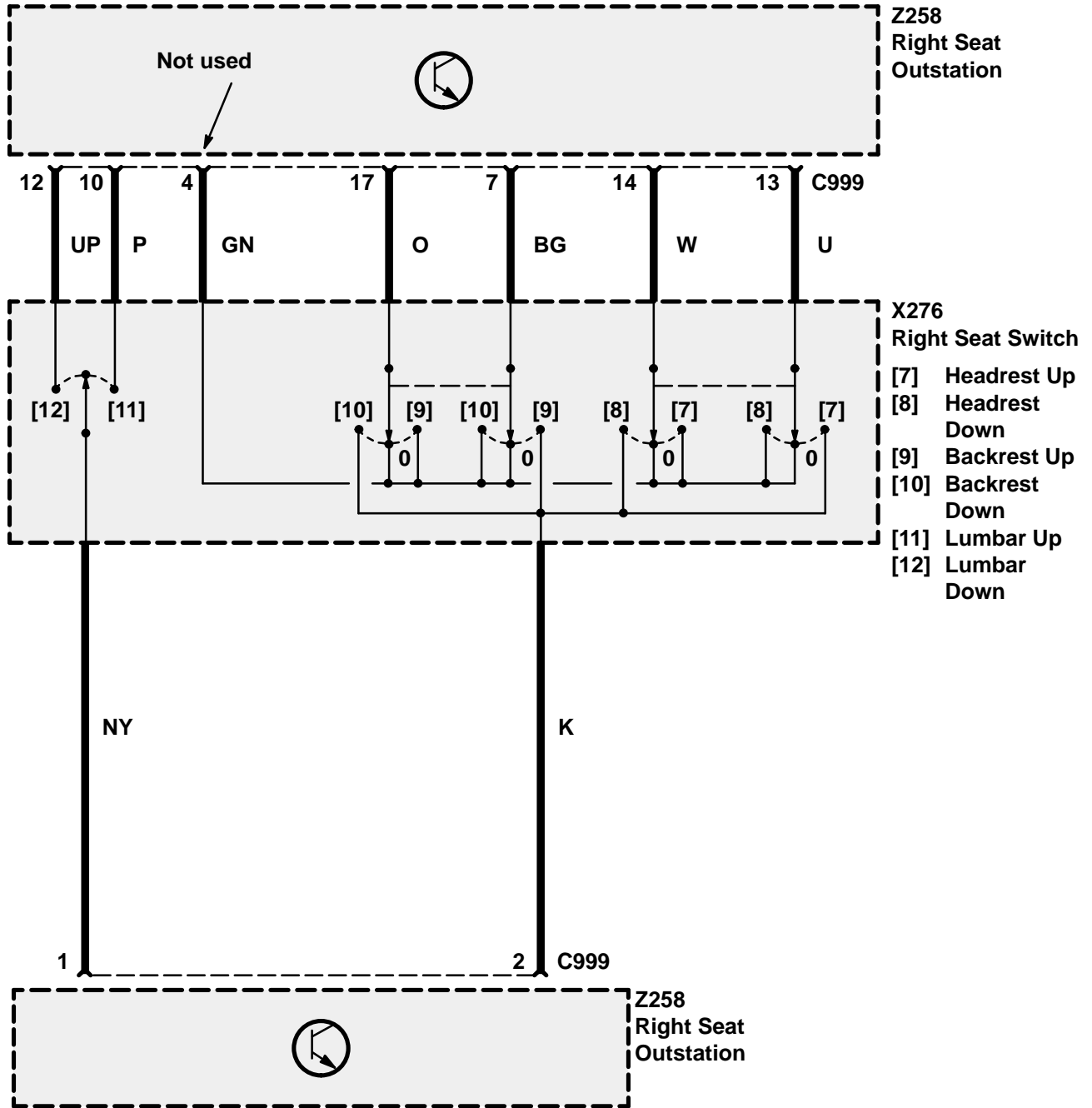
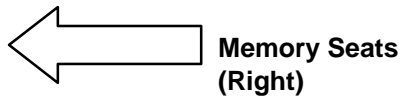

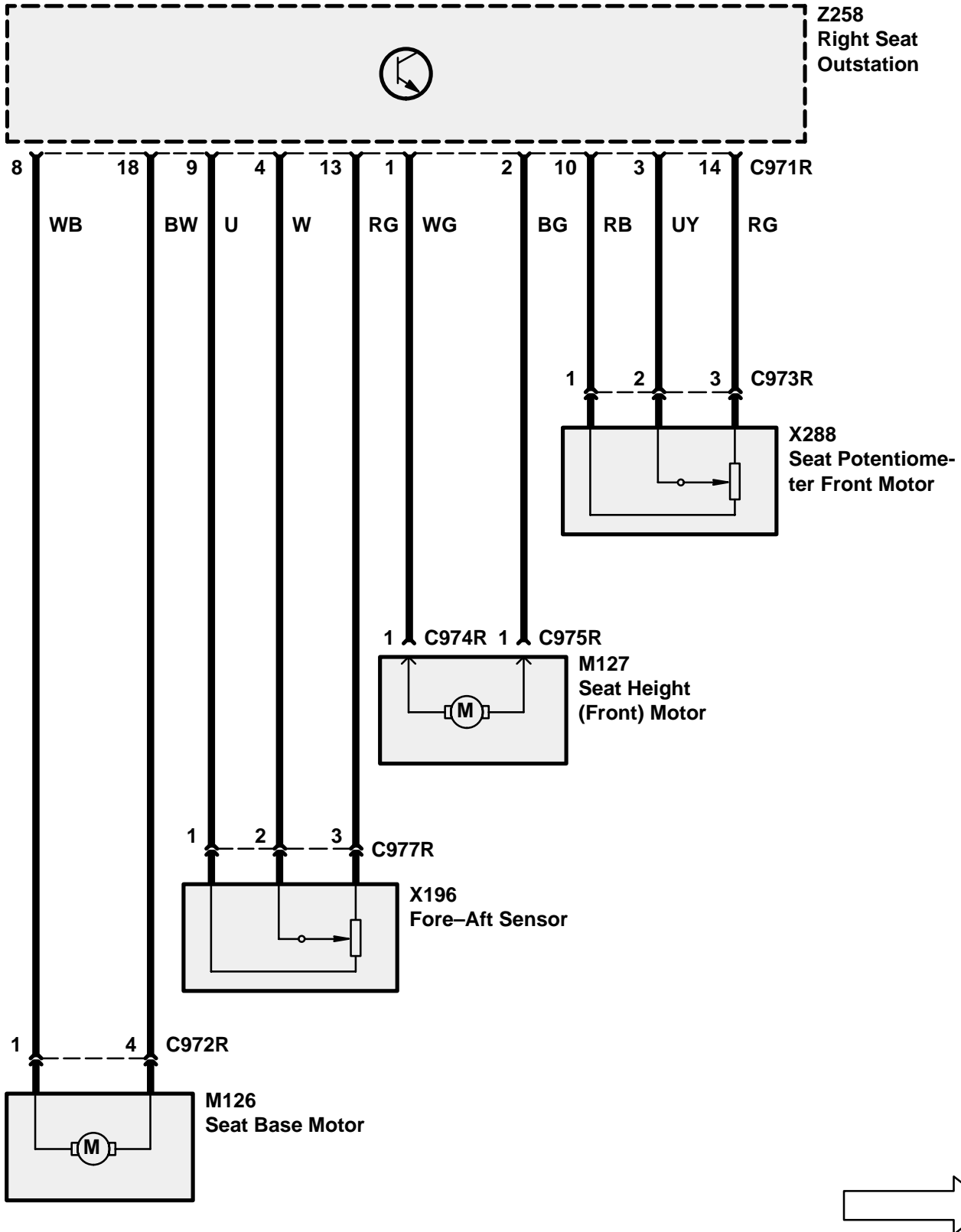

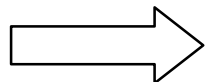
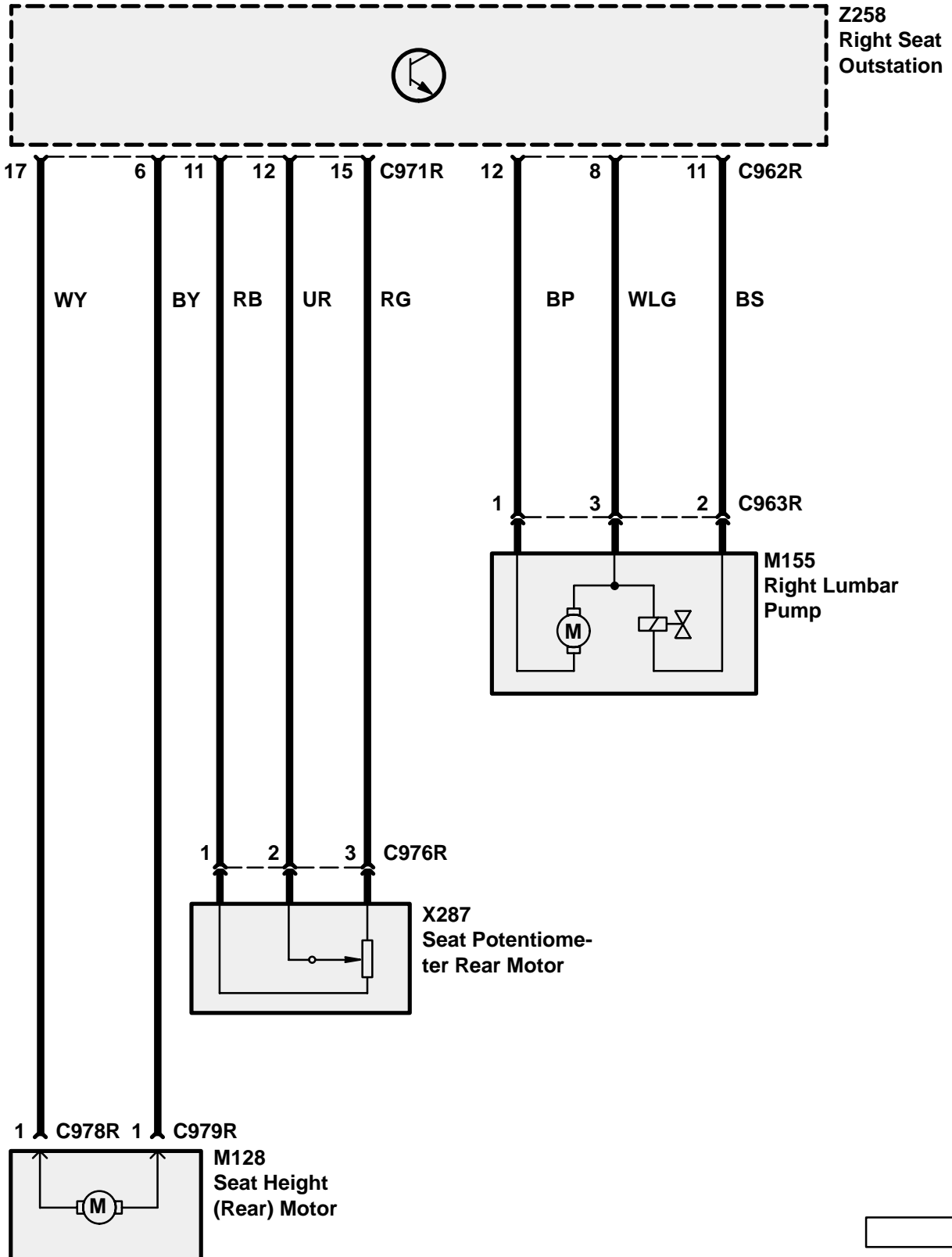

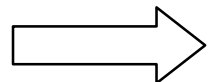
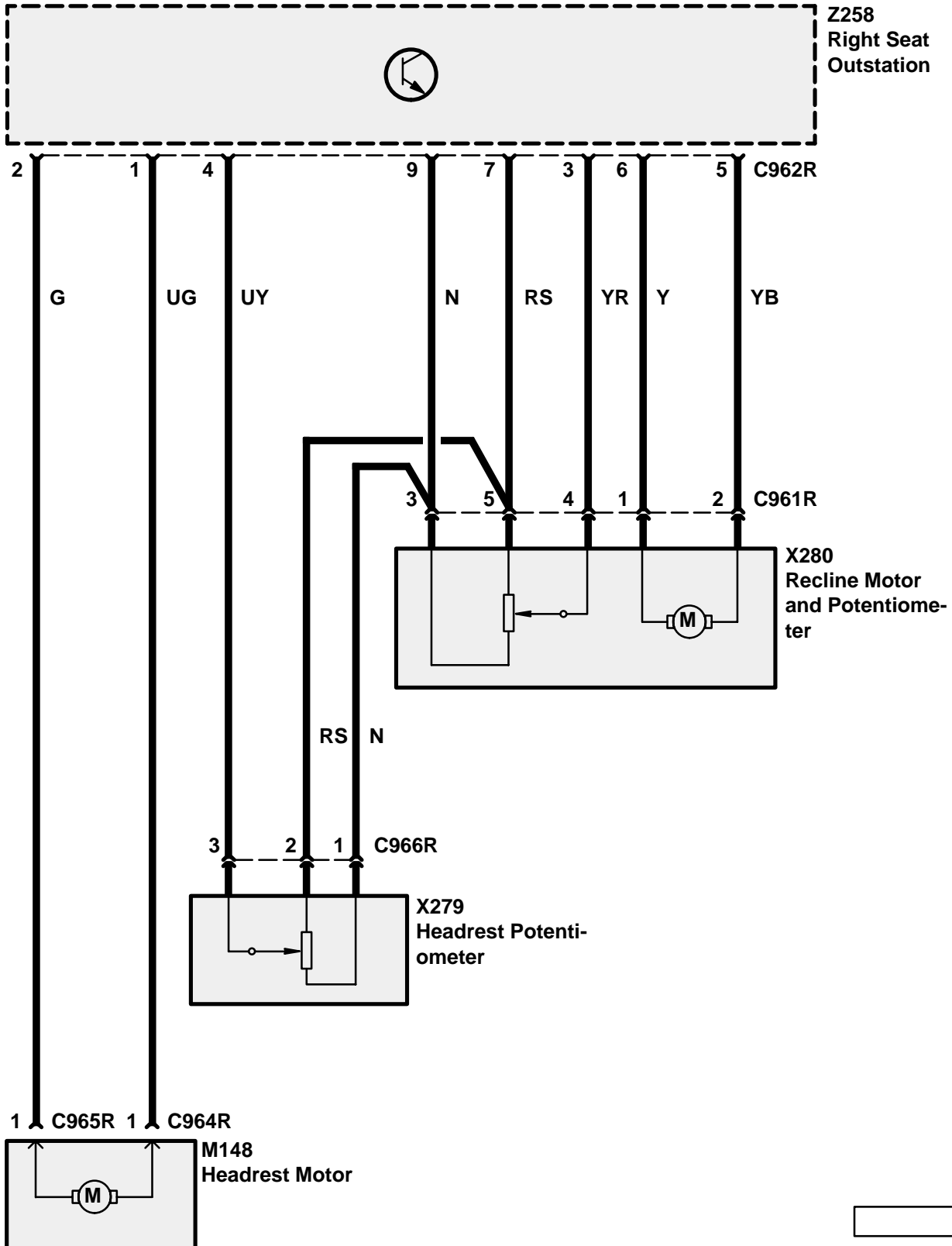

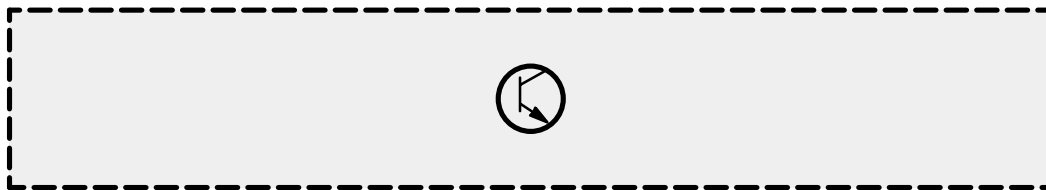
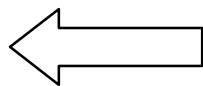

Z238
Body Electrical
Control Module
(BECM)

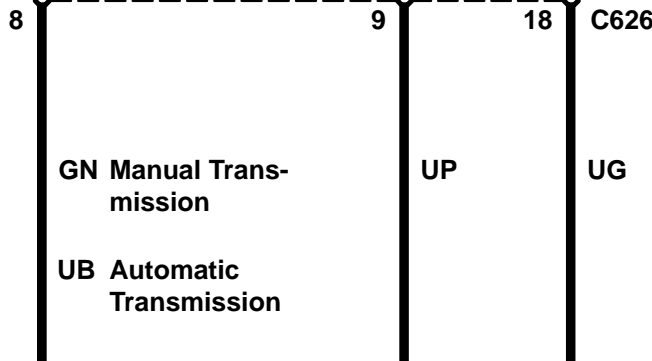

P	X	Y	Z
P	0	1	1
R	0	0	1
N	1	0	1
D	1	0	0
3	0	0	0
2	0	1	0
1	1	1	0
Z*	1	1	1

1 = Switch Open

0 = Switch Closed

* = Fault

Manual Trans-
mission

Automatic
Transmission

Automatic Gear-
box

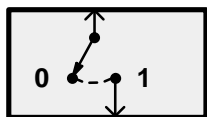

X157
Reverse Switch

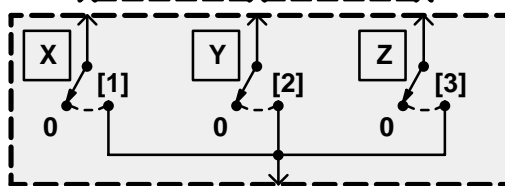

X294
Gear Box Posi-
tion Switch

- [1] X Switch
- [2] Y Switch
- [3] Z Switch

See Ground Dis-
tribution

See Ground Dis-
tribution



CIRCUIT OPERATION

Driver and passenger seat heaters are PTC regulated. Heated seat activation requests and timing functions are generated by the Hevac ECU while the Ignition Switch (X274) is in position II. The BeCM (Z238) provides power switching only for this function. In the case of both rear windows and the sunroof being operated at the same time or an uninitialised rear window or sunroof function being operated, the seat heaters will be inhibited to maintain current demand within a safe operating area.

The signals are sent from the HEVAC ECU to the BeCM (Z238) and are active low. Therefore the lines are normally held at 12V.

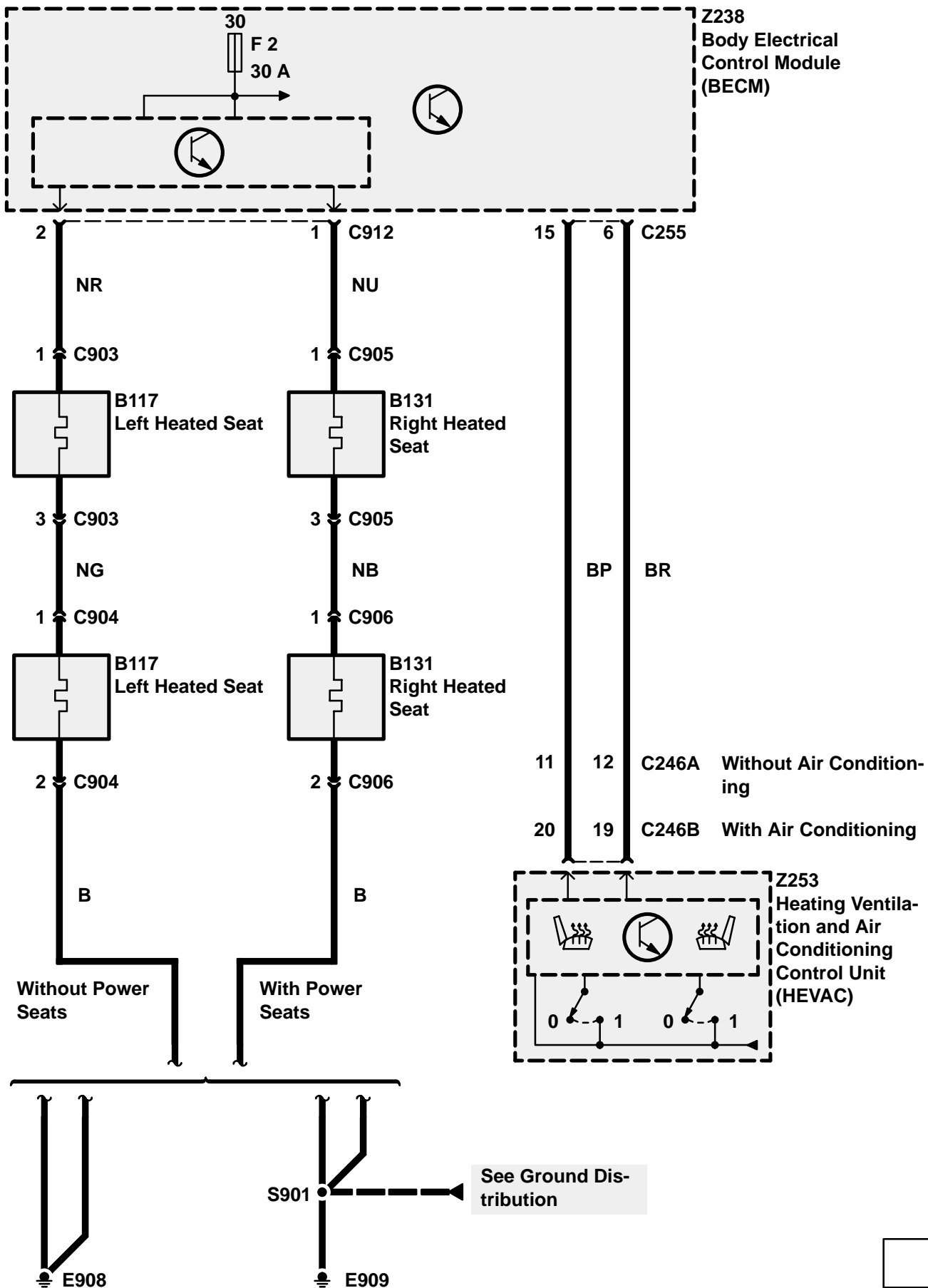

CIRCUIT OPERATION

General

The following combinations of seat and mirror adjustment method will be available:

11. Memory driver's seat, memory passenger seat and memory mirrors.
12. Memory driver's seat, electric passenger's seat and memory mirrors.
13. Mechanically adjusted driver's and passenger's seats, electric mirrors.

The memory mirror system will store the horizontal and vertical position of each mirror. Storage and recall functions will be controlled by the driver's memory seat control switches, each seat memory position having a mirror memory position associated with it.

Memory mirror enable and one touch enable will occur under the same conditions as memory seat enable and one touch enable .

Reverse dip position

Reverse mirror dipping will be enabled when the presence of a driver's side seat memory outstation is detected.

If a driver's seat memory store sequence is executed whilst auxiliary is selected and the transmission is in reverse, then the stored mirror position will be the position that the mirrors will dip to when reverse gear is next selected and that memory number is currently recalled. To protect against accidental setting, the mirror position will only be stored if it has been altered since reverse was selected and a message on the instrument pack will inform the driver that the mirror position has been stored.

The function may be toggled on and off by holding the memory store button for at least 2 seconds whilst in reverse gear with auxiliary or ignition selected.

Successful toggling of the function will be accompanied by the message "Mirror dip on"/"Mirror dip off" as described in the message parameter table.

Successful toggling of the function will result in the mirrors moving immediately to the dipped/undipped position as appropriate.

Storing a new reverse dip position will automatically toggle the function on.

Vehicles fitted with automatic transmission will have a 0.5 sec delay following the selection of reverse gear prior to the mirror dip position being recalled.

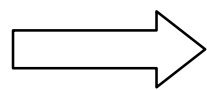
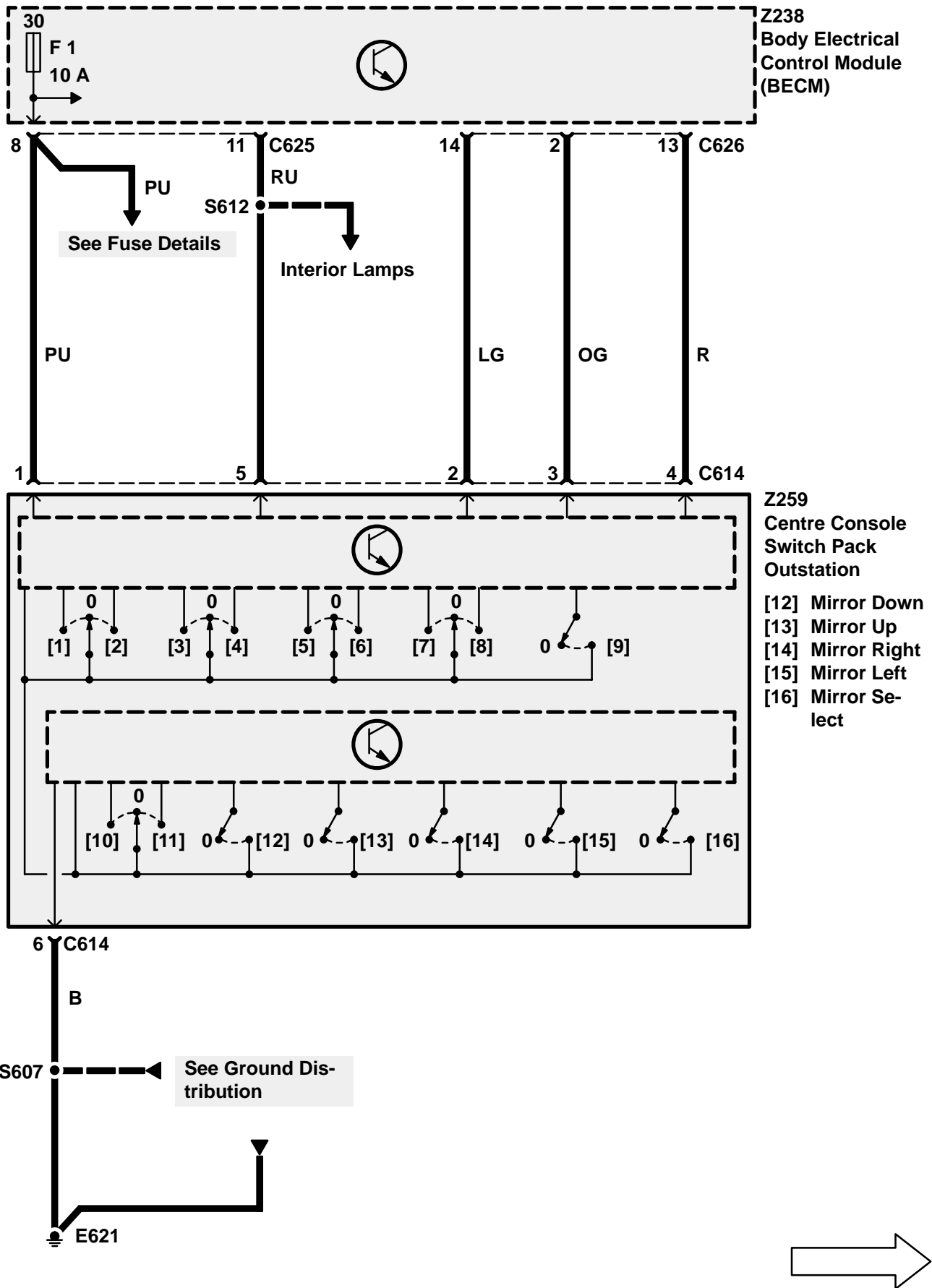

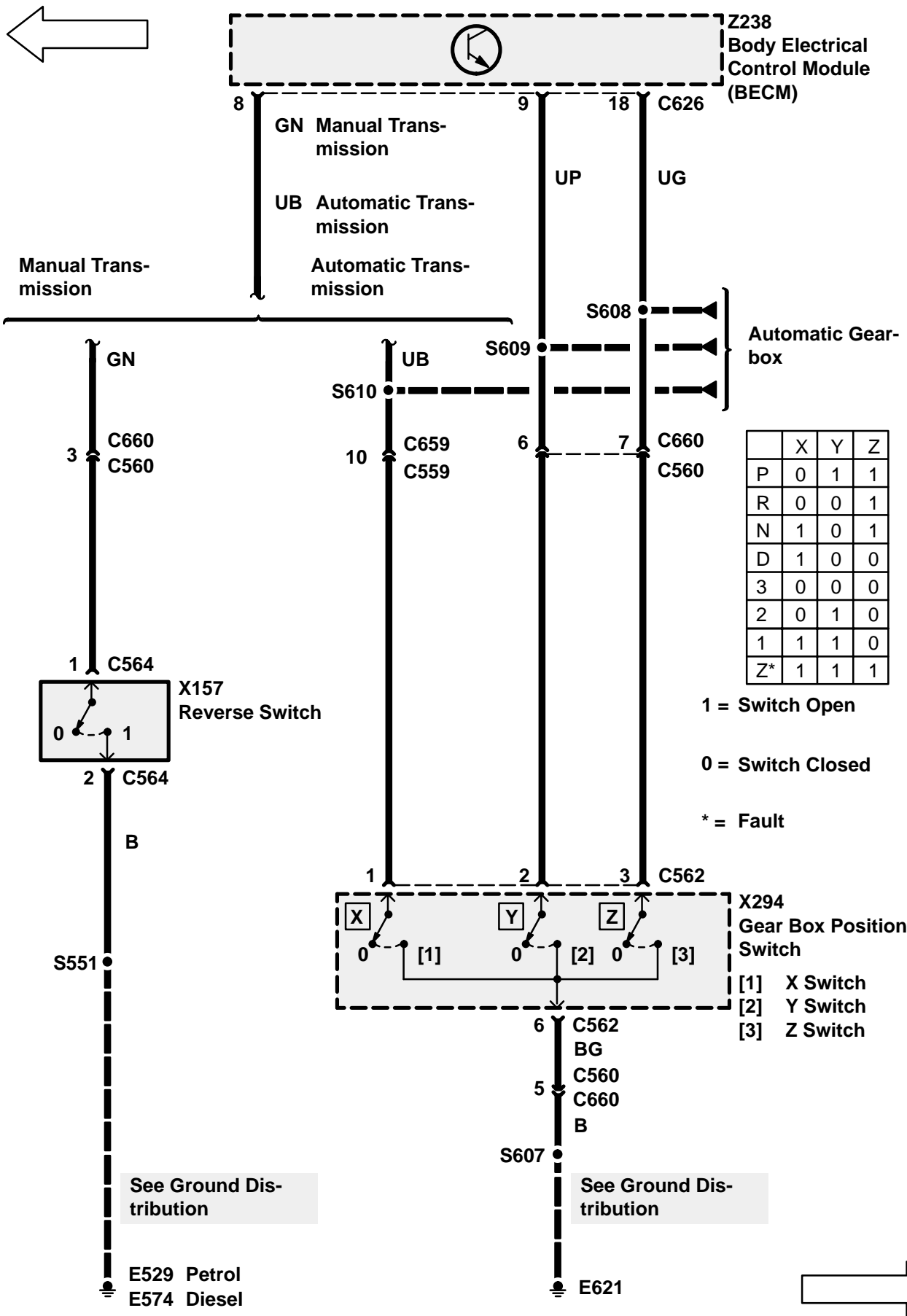

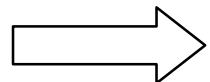
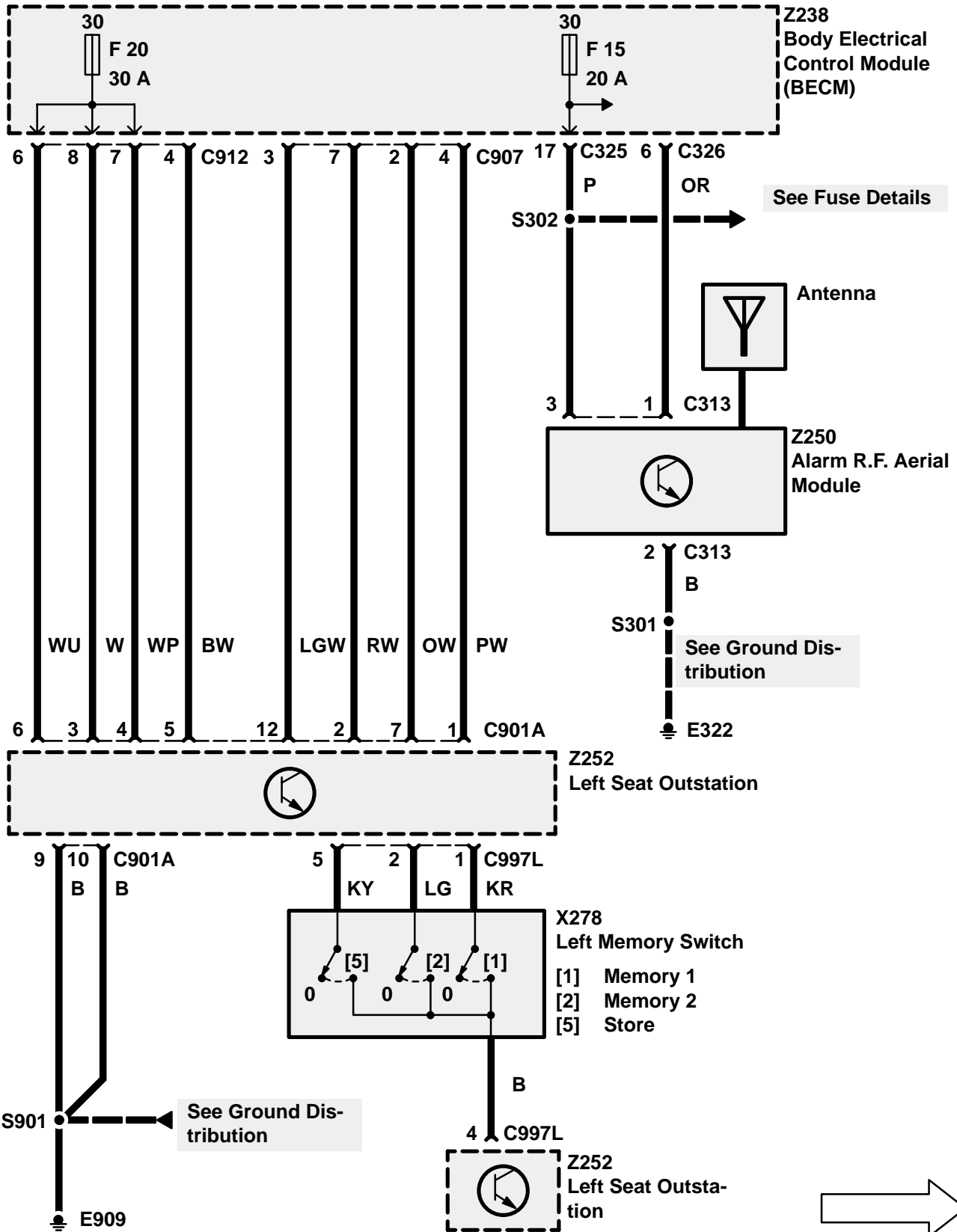
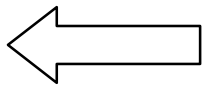

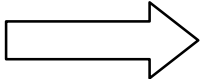
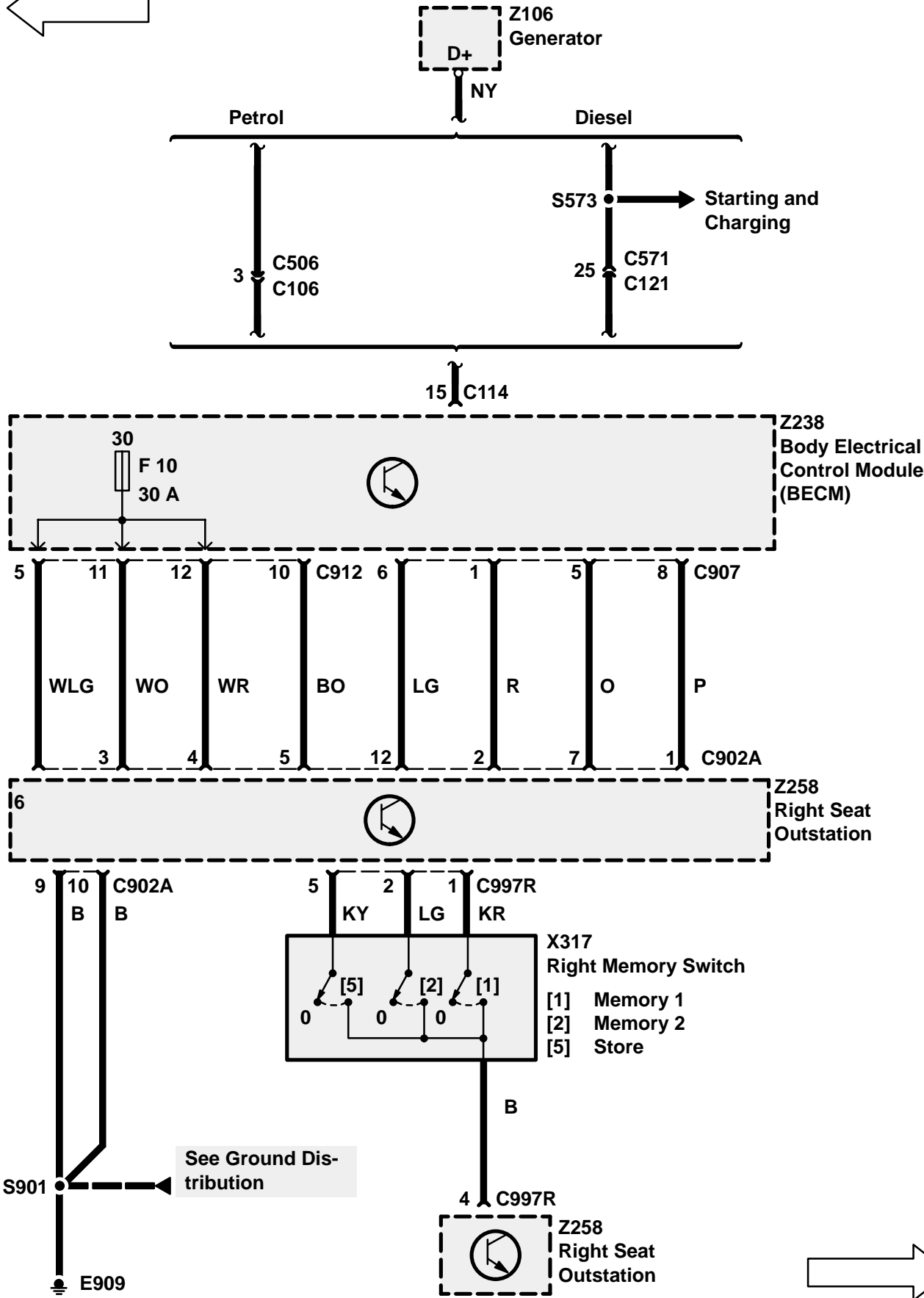
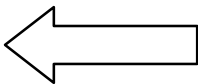

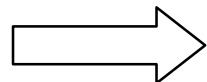
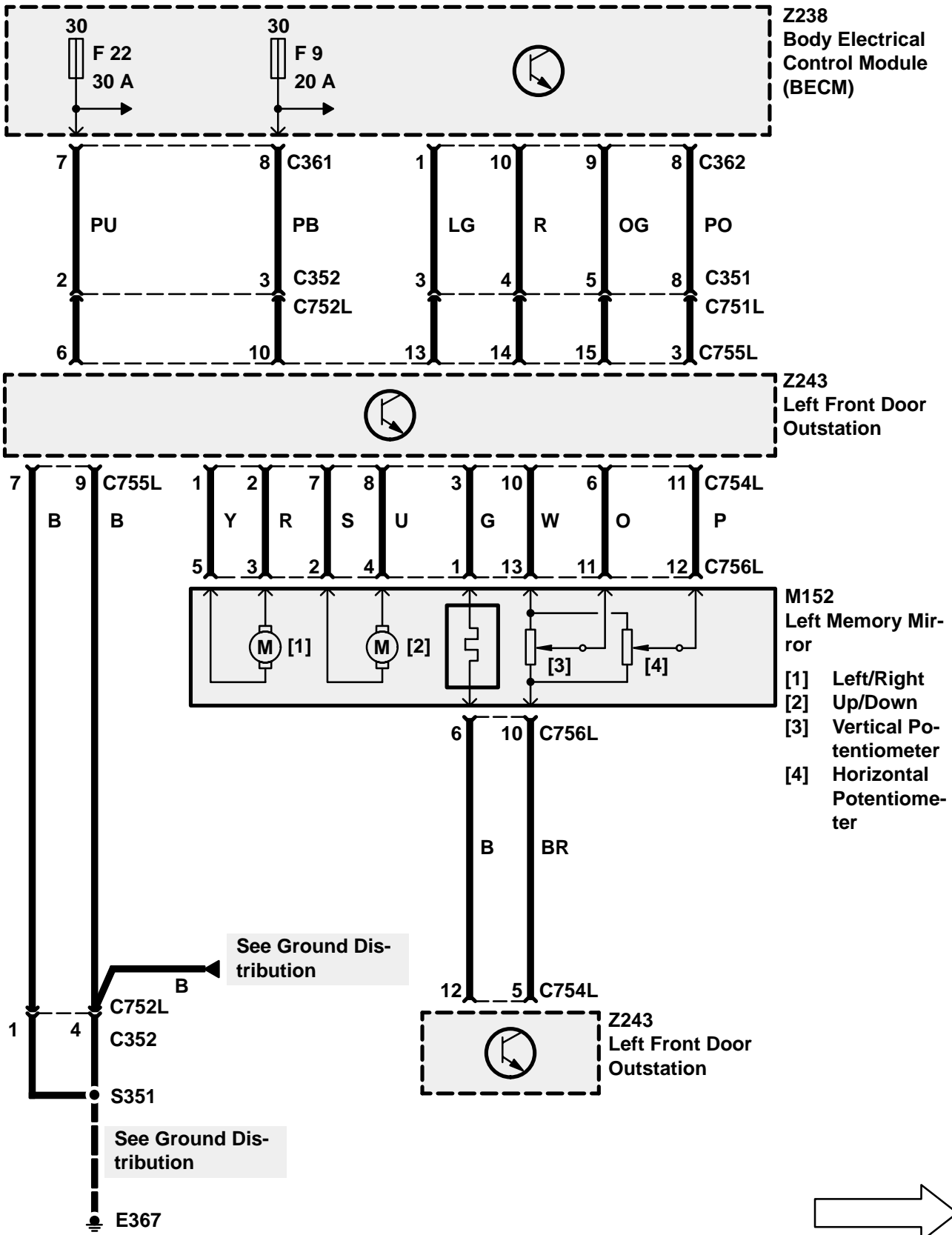
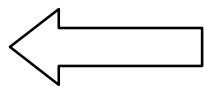

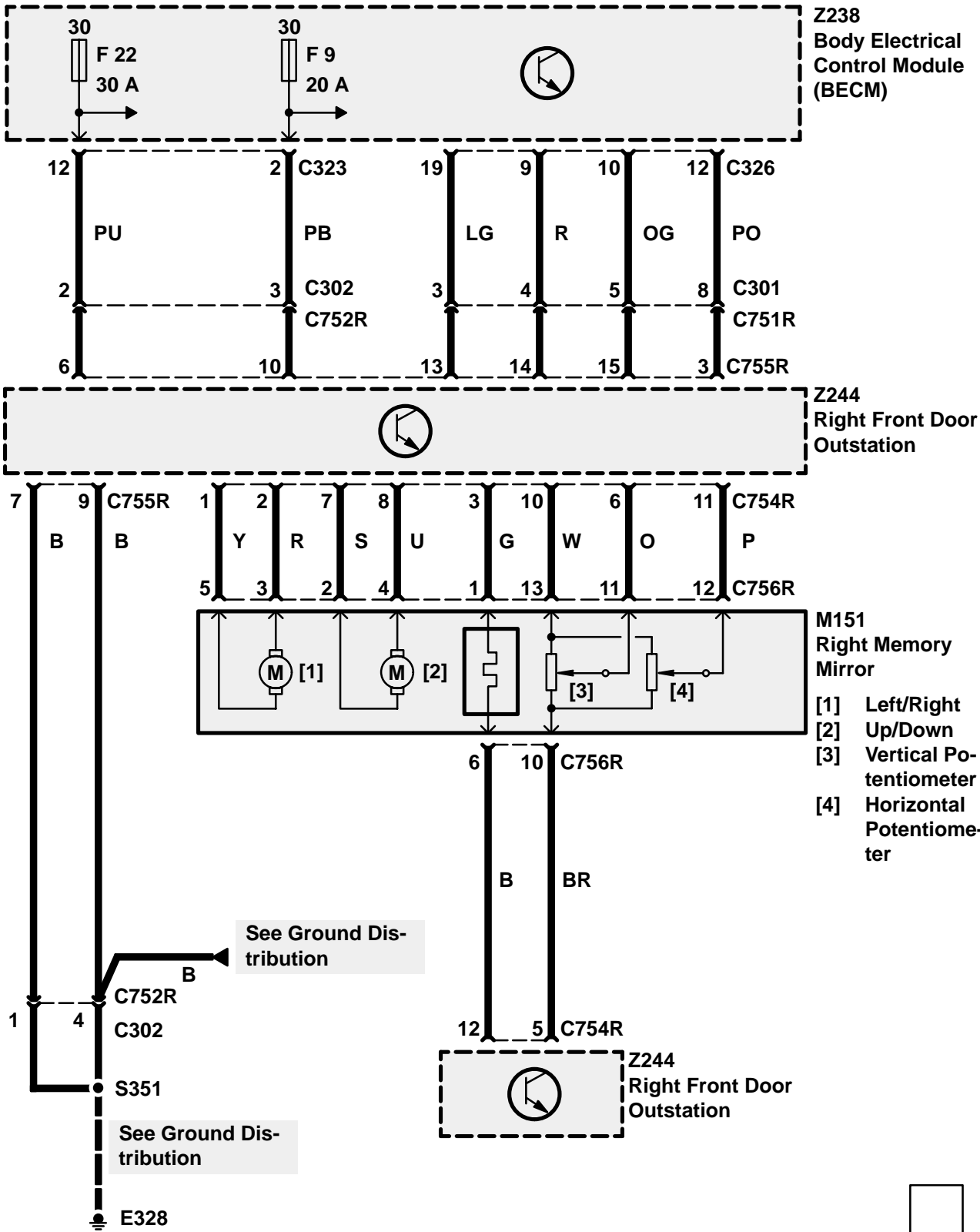
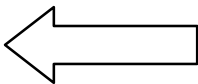

CIRCUIT OPERATION

Accommodation within the system has been made for the addition of a trailer lighting system to consist of 2 side lamps, 2 fog lamps, 2 reverse lamps, 2 brake lamps, 1 LH indicator and 1 RH indicator.

In addition to these loads, there is also a provision for a 10 amp battery feed to the trailer.

Bulb Failure Diagnosis With Trailer

The diagnosis of external bulb failures will be modified by the presence of a trailer as follows:

Brake lamps

- Diagnosis of the RH vehicle and trailer lamps will only detect a failure of all the filaments.
- Diagnosis of the LH vehicle brake light is unaffected.

Rear side lamps

- Diagnosis of the LH rear side lamps will only detect the failure of both the vehicle filament and the trailer filament.
- Diagnosis of the RH rear side lamps will only detect the failure of both the vehicle filament and the trailer filament.

Reverse lamps

- Diagnosis of the RH vehicle reverse light and the LH and RH trailer reverse lamps will only detect failure of all of the filaments.
- Diagnosis of the LH vehicle reverse light is unaffected.

Fog lamps

- Diagnosis of the RH vehicle rear fog light and the LH and RH trailer fog lamps will only detect failure of all of the filaments.
- Diagnosis of the LH vehicle rear fog light is unaffected.

Direction indicators

The indicator warning lamp and trailer warning lamp will diagnose the status of the vehicle's rear filaments, and trailer direction indicator filaments according to the following table:

Indicator w/l	Trailer w/l	Vehicle filament	Trailer filament
Flash	Flash	Good	Good
Flash	Extinguished	Good	Fail/not fitted
Flash	Flash	Fail	Good
Flash w/ double rate	Extinguished	Fail	Fail/not fitted

In the case of hazard light operation with trailer lamps fitted, the failure of a trailer direction indicator light will cause the trailer warning light to flash at double rate, while the direction indicator light will flash at the "standard" rate.

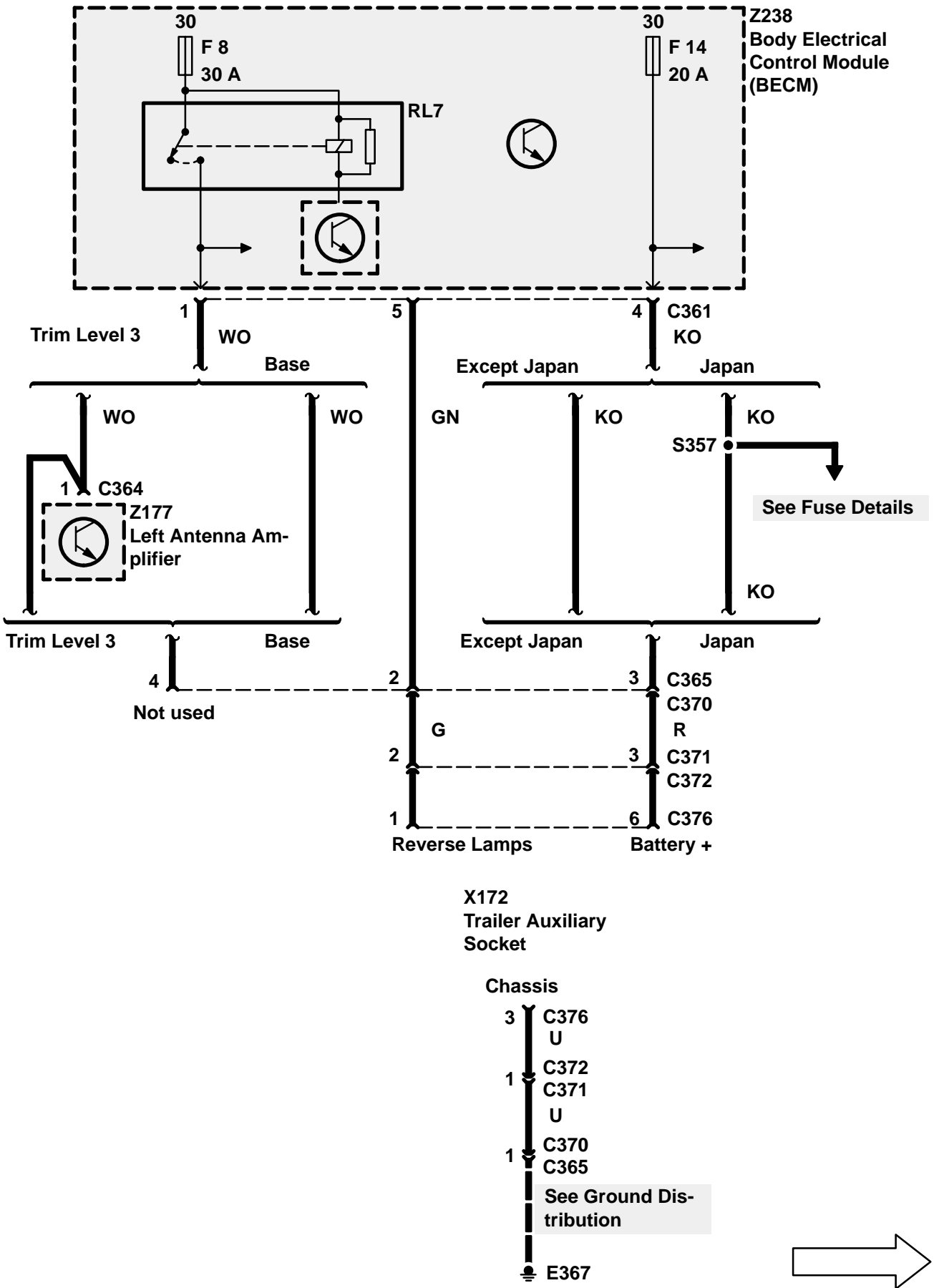

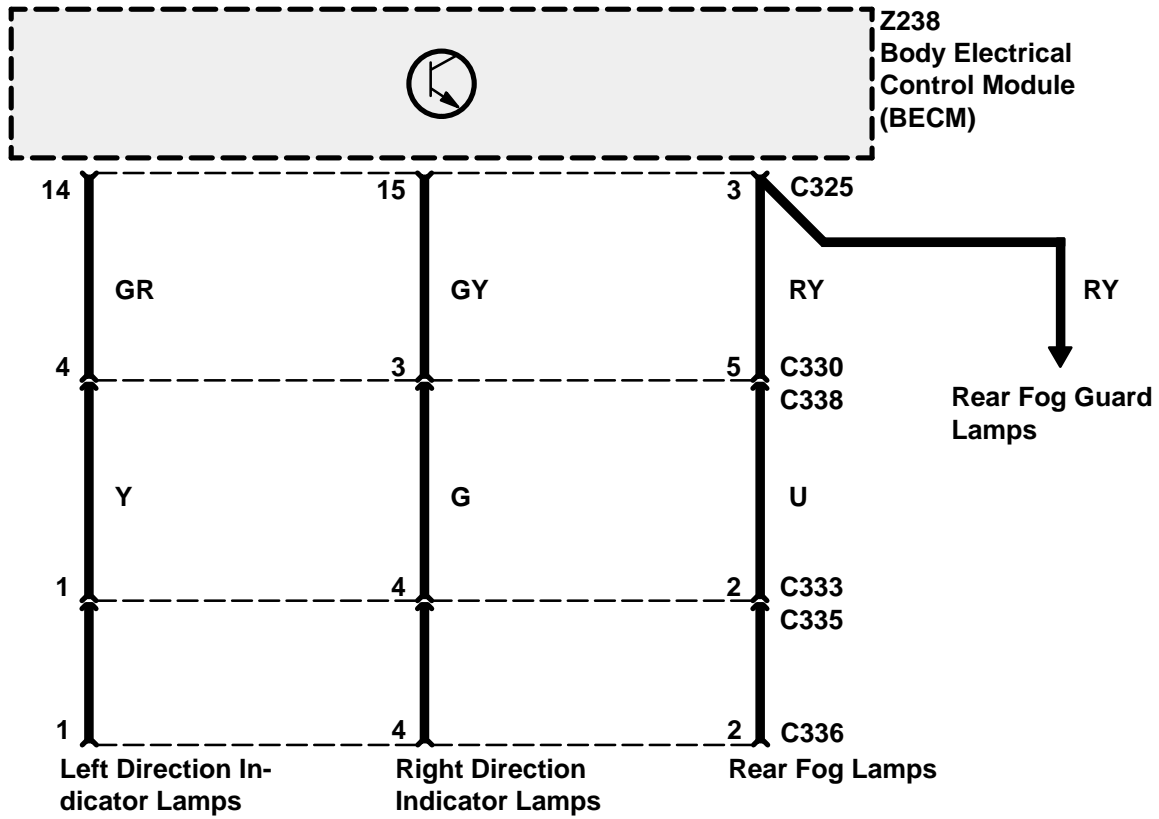
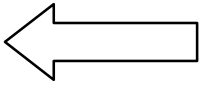

X286 Trailer Main Socket

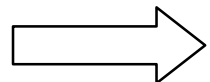
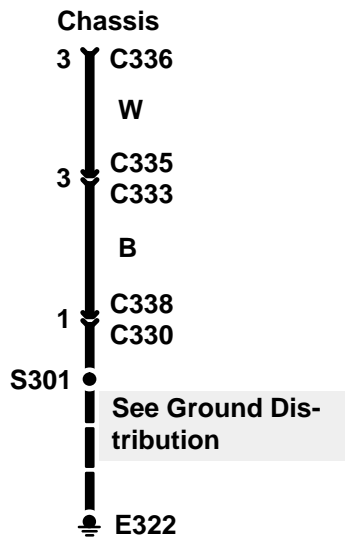

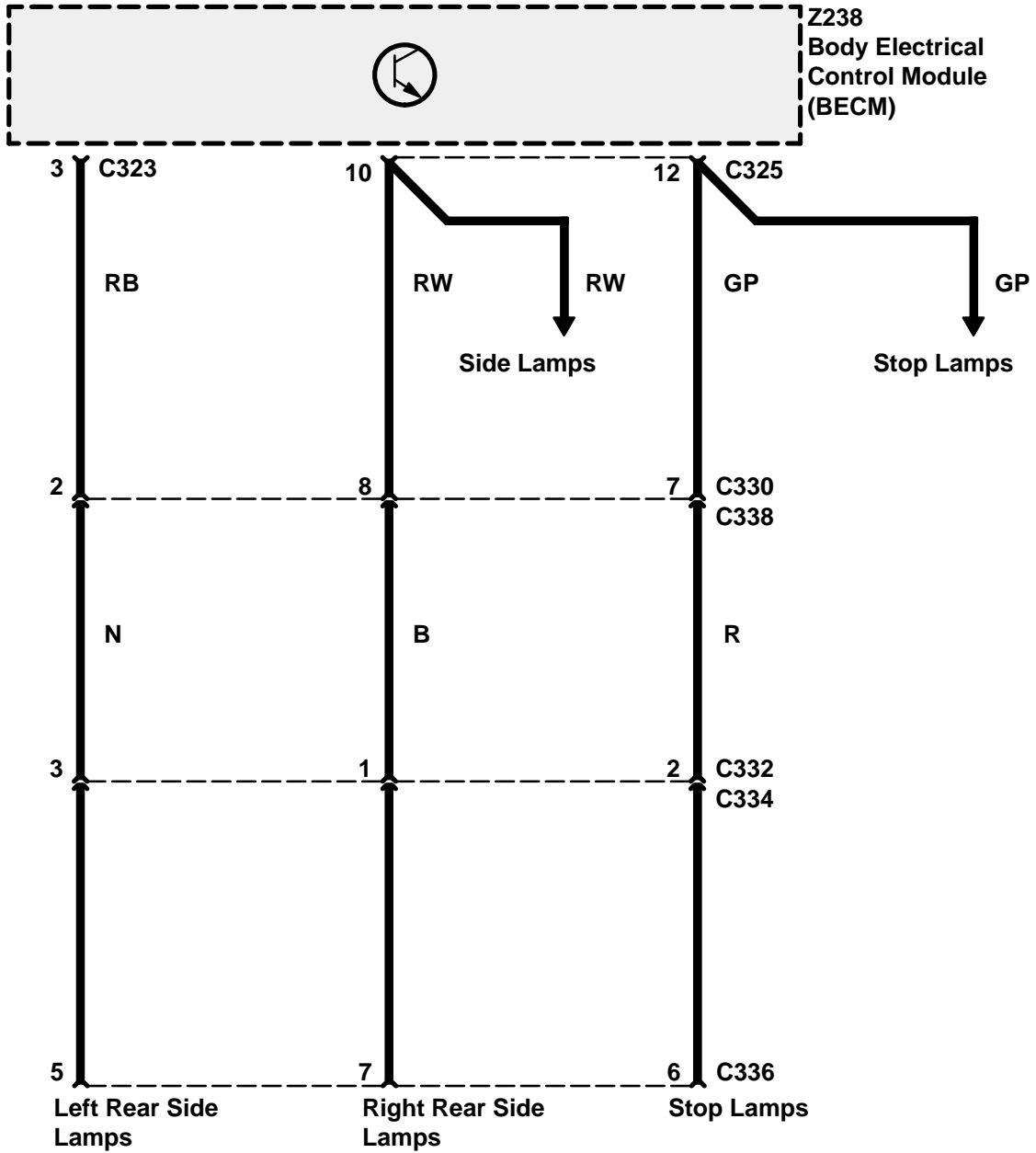
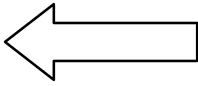

X286
Trailer Main
Socket

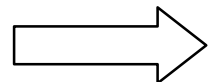

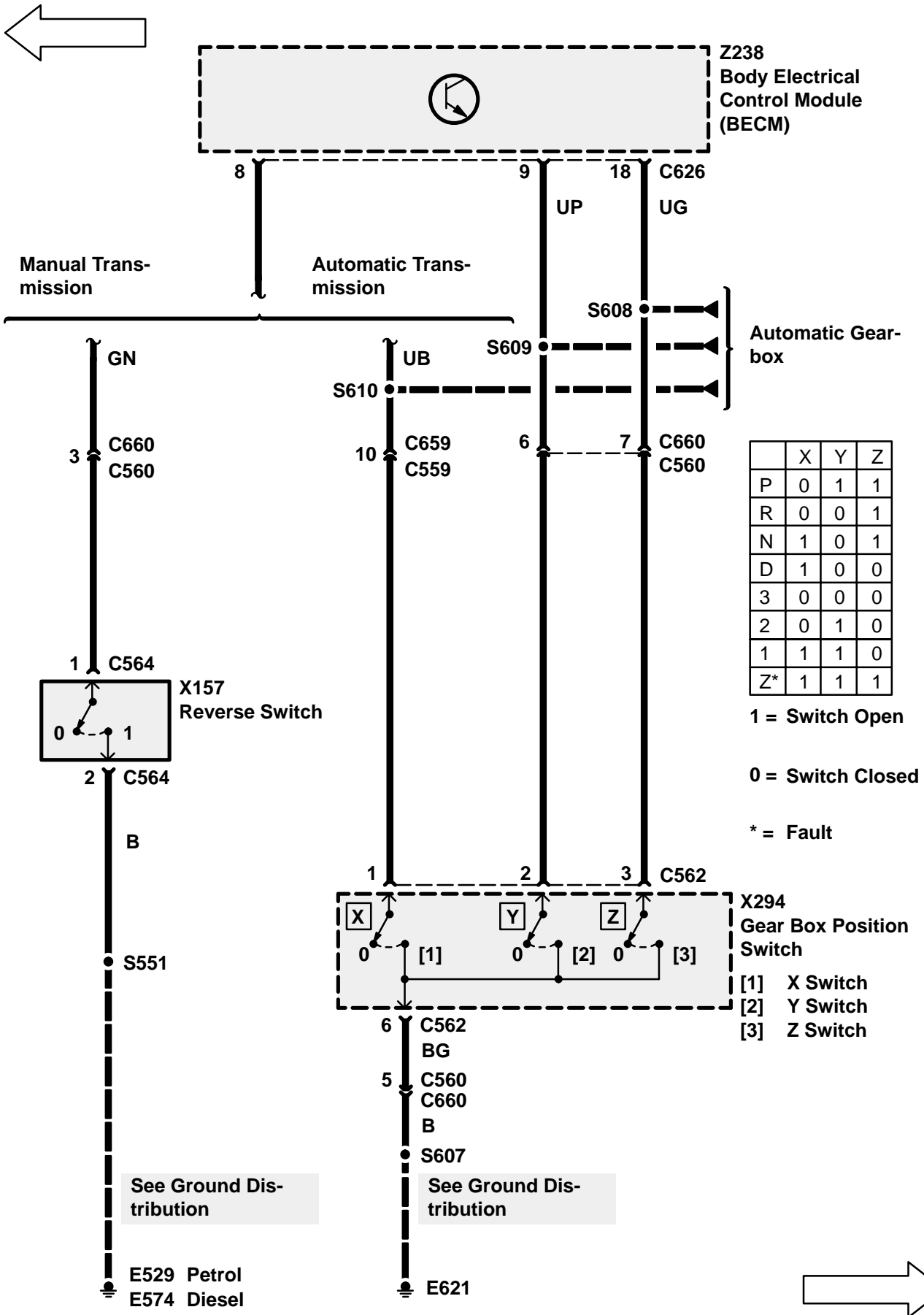

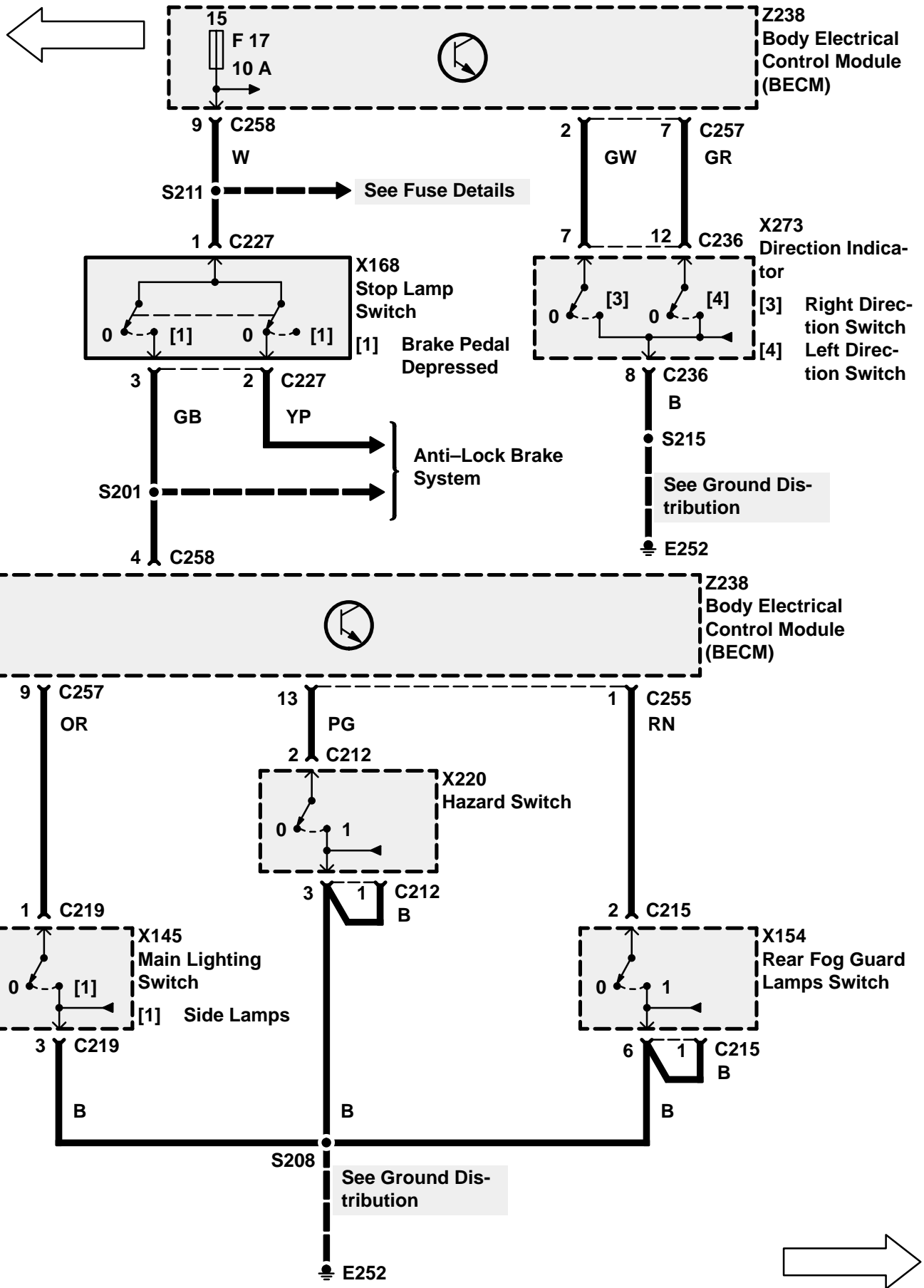

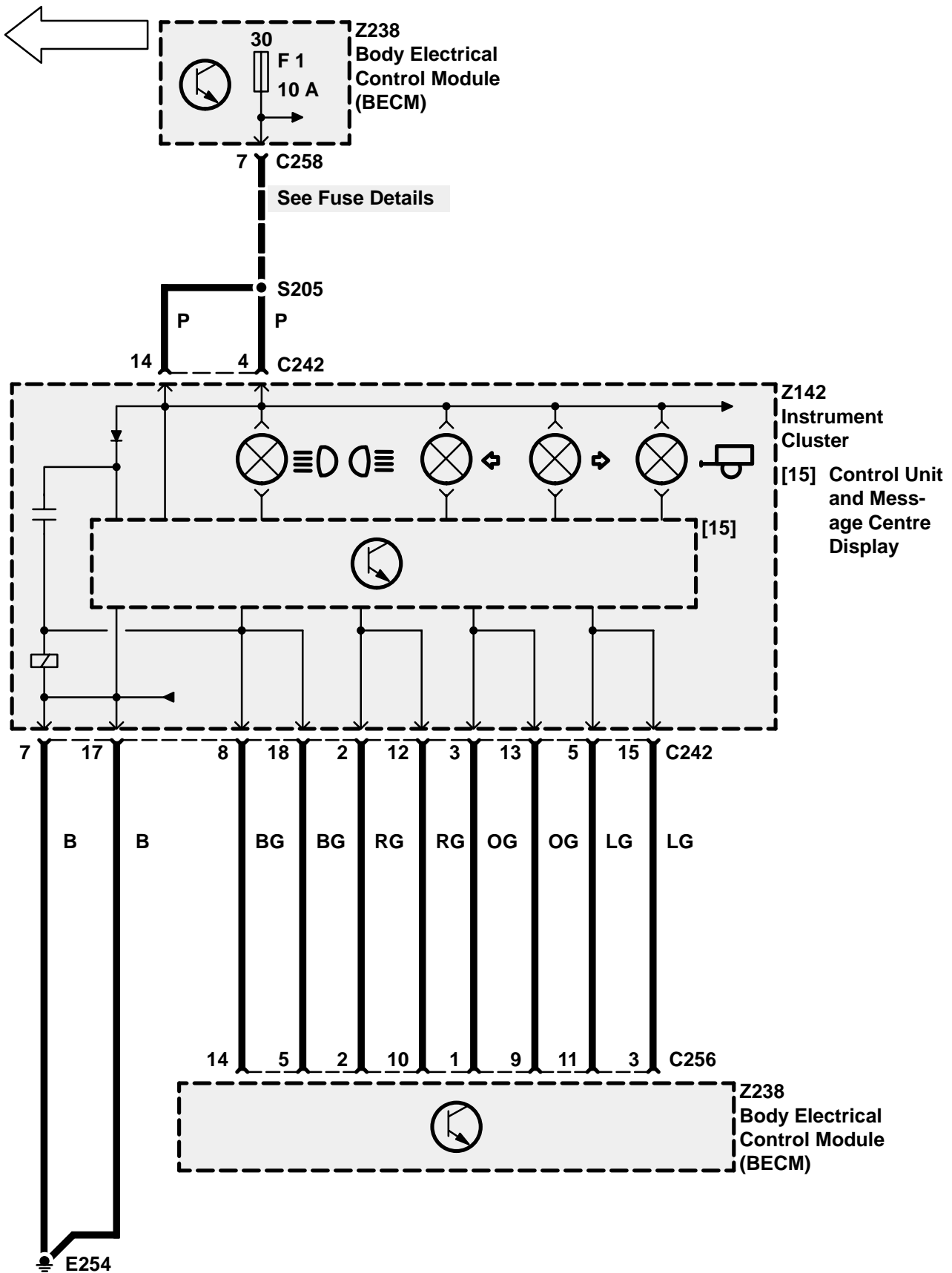

CIRCUIT OPERATION

The Electronic Air Suspension (EAS) is designed to maintain the selected vehicle height under varying loads. This is achieved by adjusting the quantity of air within the air springs located next to each wheel. It should be noted that the system is not intended to control the roll or dive of the vehicle whilst cornering or braking. The accuracy of height control achieved is sufficient to ensure that no additional driver controlled means of adjusting the headlamp beam is required to compensate for different vehicle loading conditions.

The system can operate in any one of five heights or modes: Access, Low Profile, Standard Profile, High Profile and Extended Profile. All heights with the exception of Extended Profile can be selected by the driver using the ride height switches on the fascia. When **Inhibit** is selected (indicated by the **Inhibit** switch tell-tale lamp being illuminated), automatic height changes between Standard and Low Profile are disabled; it is recommended that Standard Profile **Inhibit** mode is selected whenever a trailer is being towed.

The ride height of the vehicle is displayed to the driver by the LEDs in the ride height display adjacent to the ride height switches on the fascia. The LED for the current ride height is continuously illuminated whenever the engine is running. When a height change is taking place, the LED for the new target height flashes and the LED for the old height remains continuously illuminated until the new target height is reached whereupon the old height LED is extinguished and the new height LED is continuously illuminated.

It should be noted that if any of the side doors or the tailgate are open when the vehicle speed is less than 5 mph (8 km/h), all height changes are suspended until the doors and tailgate are closed. If a door has been open for more than 30 seconds, then the system will need "reminding" of the new height after the door has been closed. This condition is indicated by the LEDs for the old and new heights both being continuously illuminated.

Application of the footbrake also causes any height changes to be suspended whilst it is pressed. If the footbrake has been applied continuously for more than 3 minutes, then height changes are allowed to resume.

The ride height of the vehicle is correctly maintained only whilst the engine is running. To compensate for any changes in load after parking (e.g. driver or passengers getting out), the EAS system will lower

the vehicle to the height of the lowest corner after the last door is closed. Furthermore, if the vehicle should develop a lean due to temperature effects or air leakage whilst parked, the EAS system is automatically re-powered every few hours to allow limited corrections to the height to be achieved.

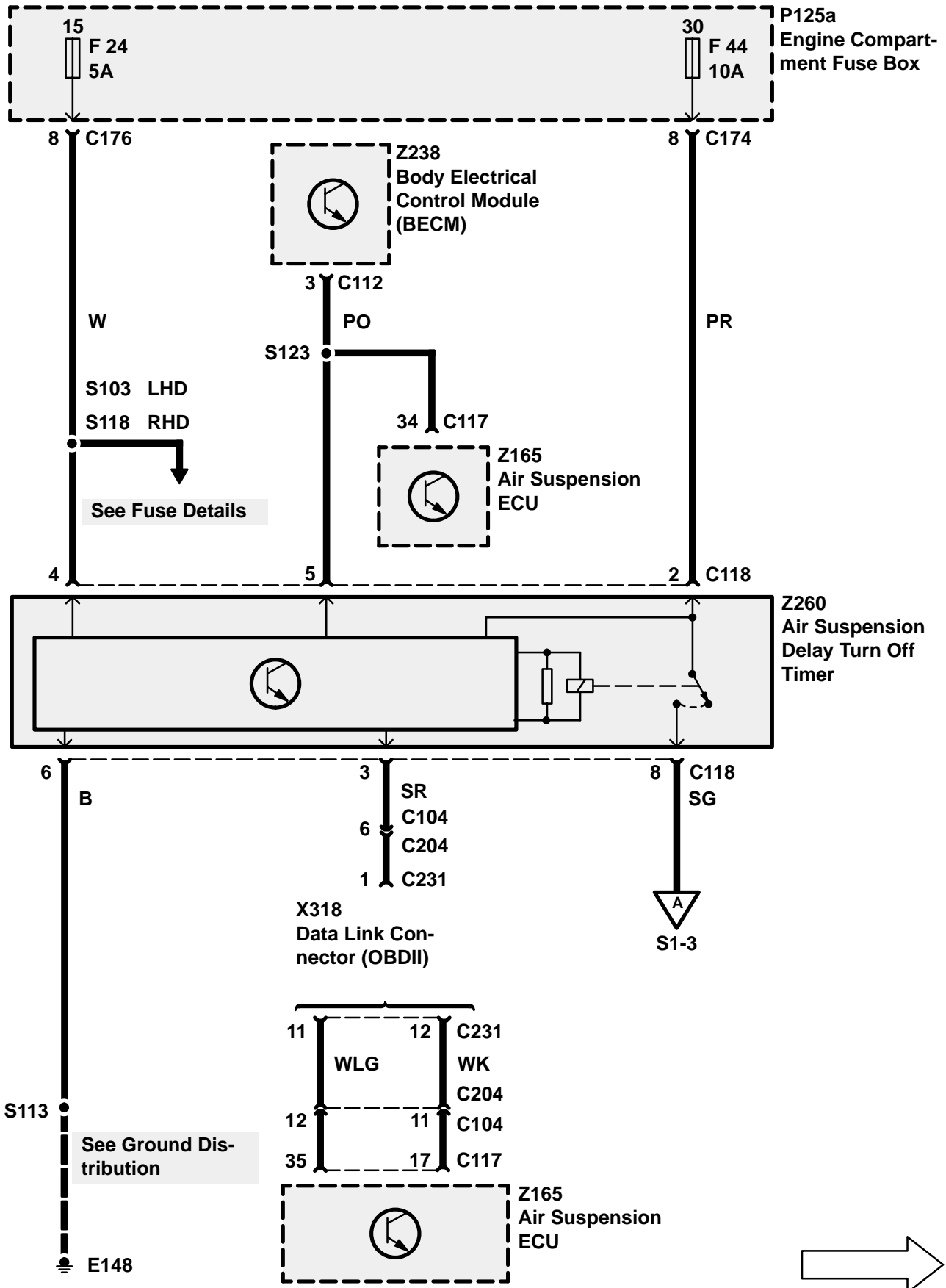

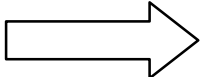
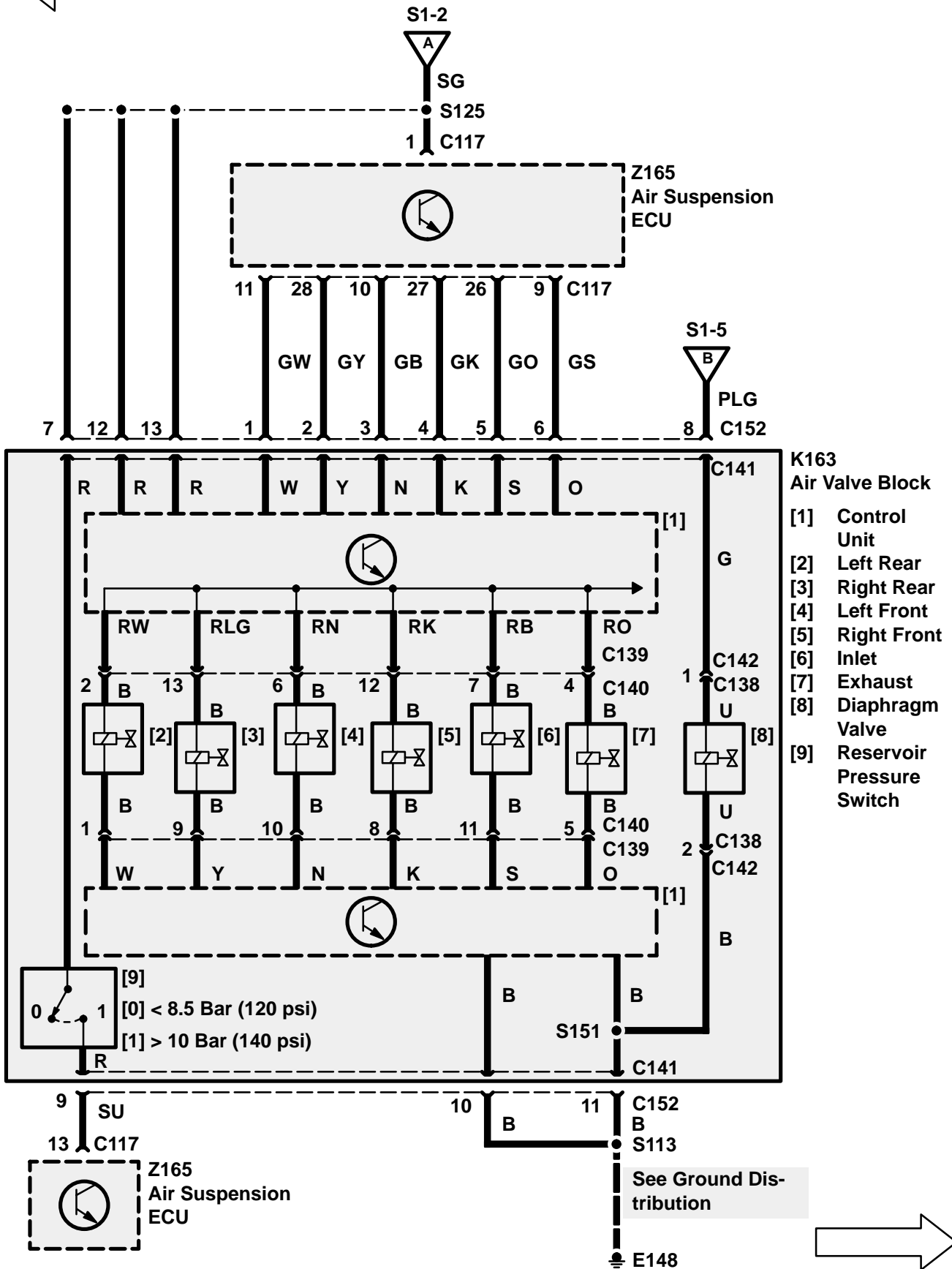
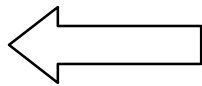

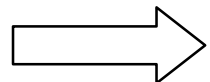
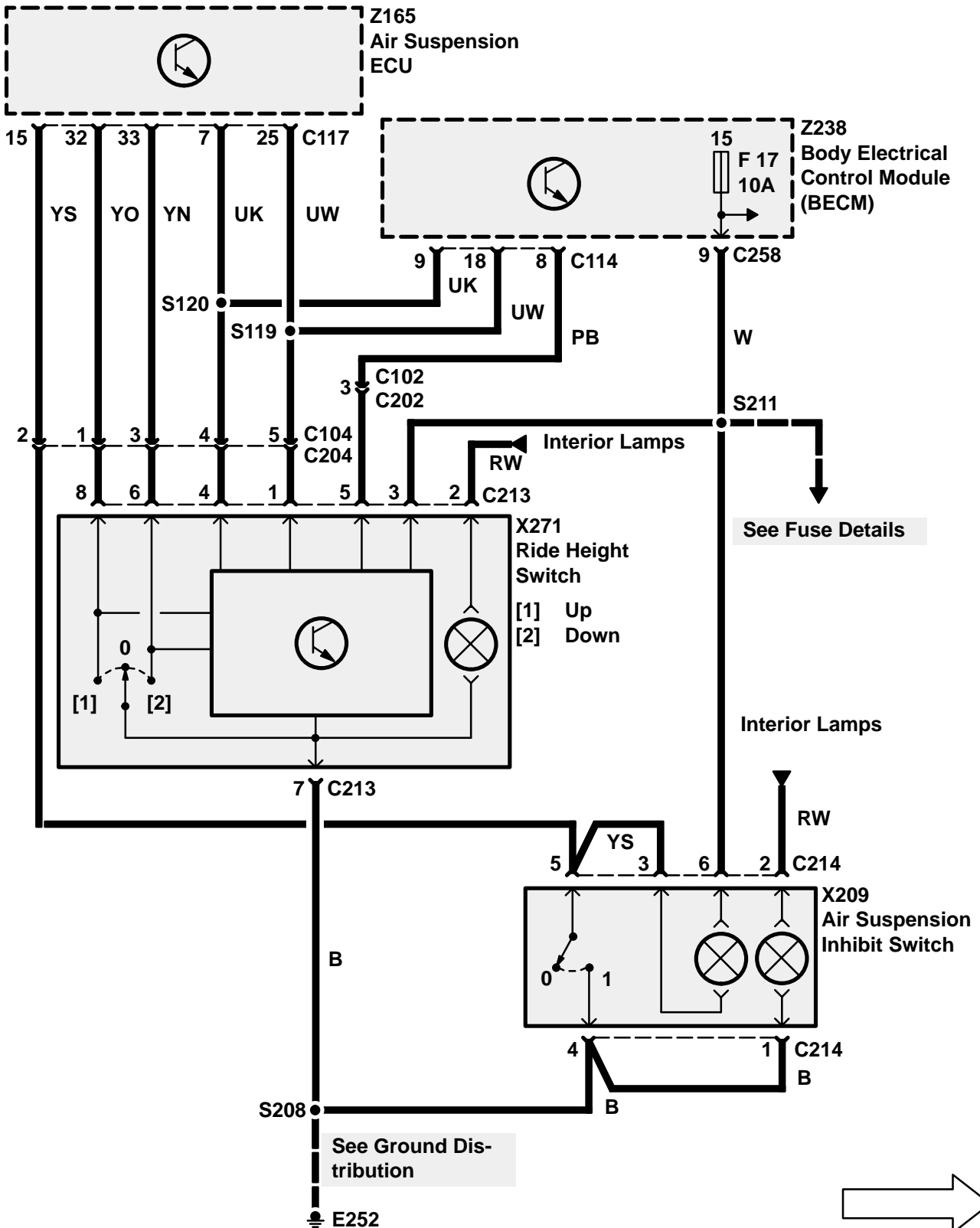
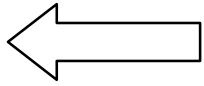

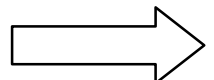
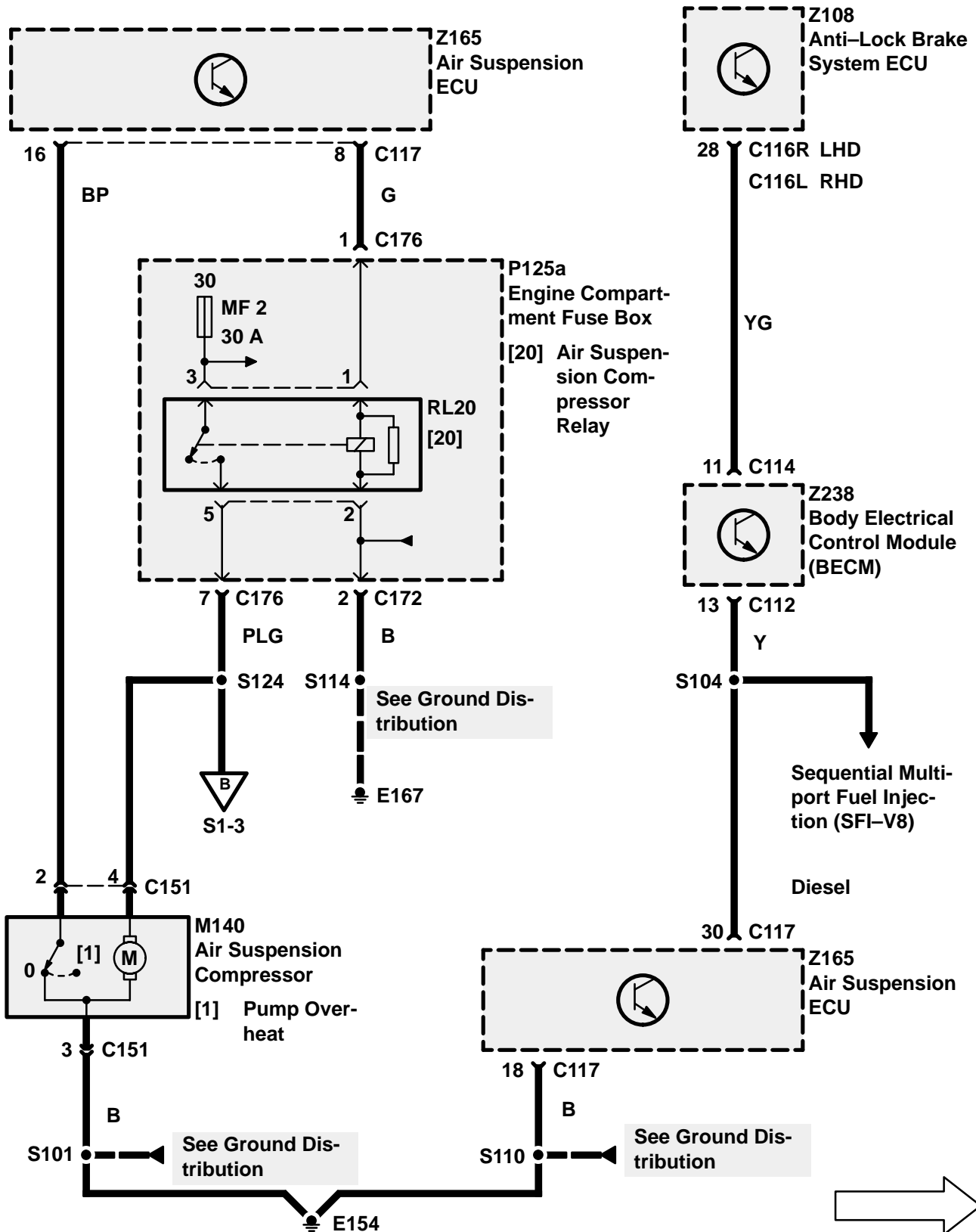
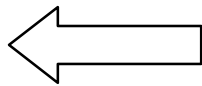

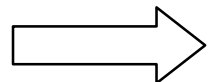
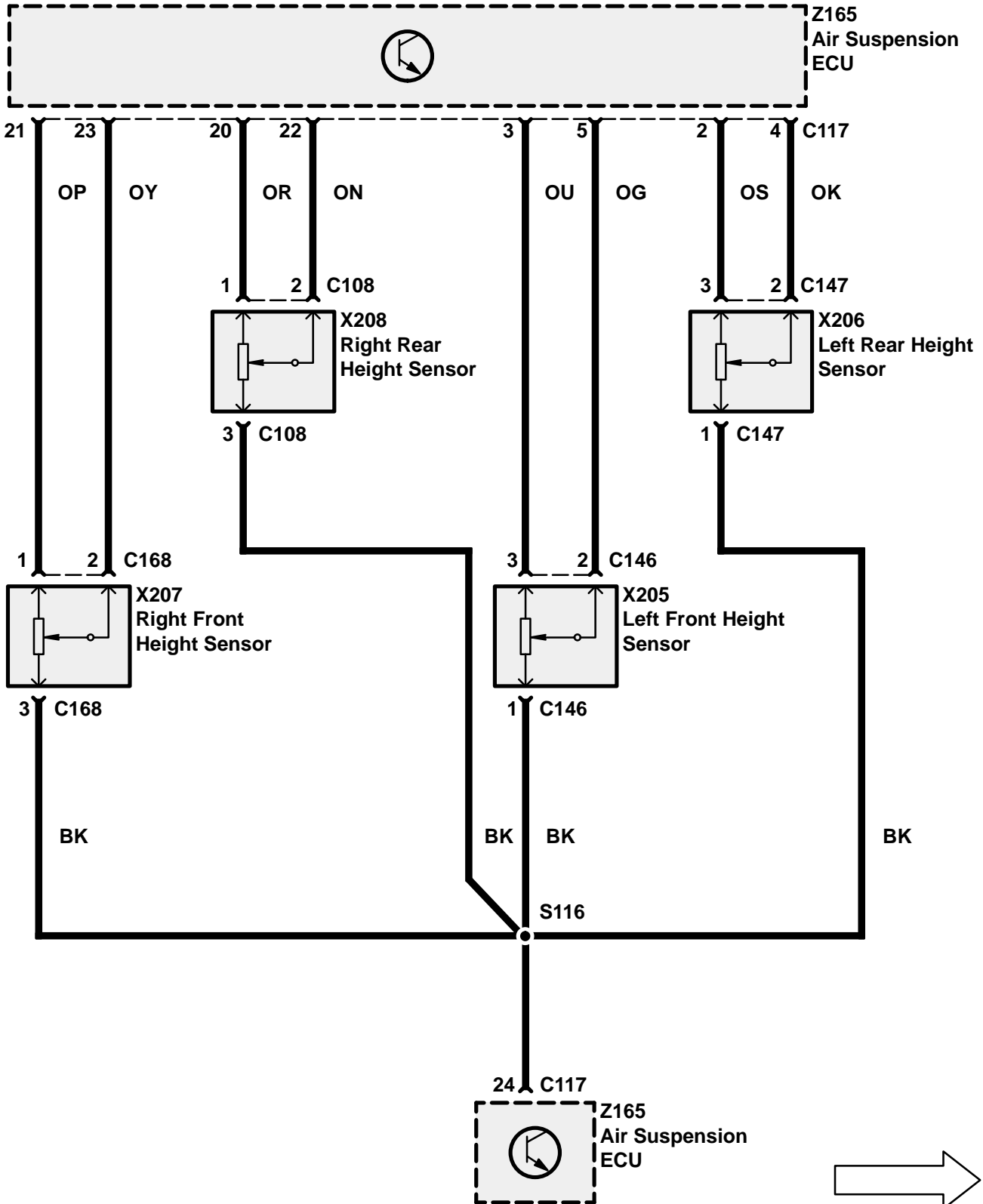
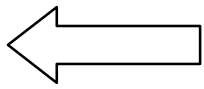

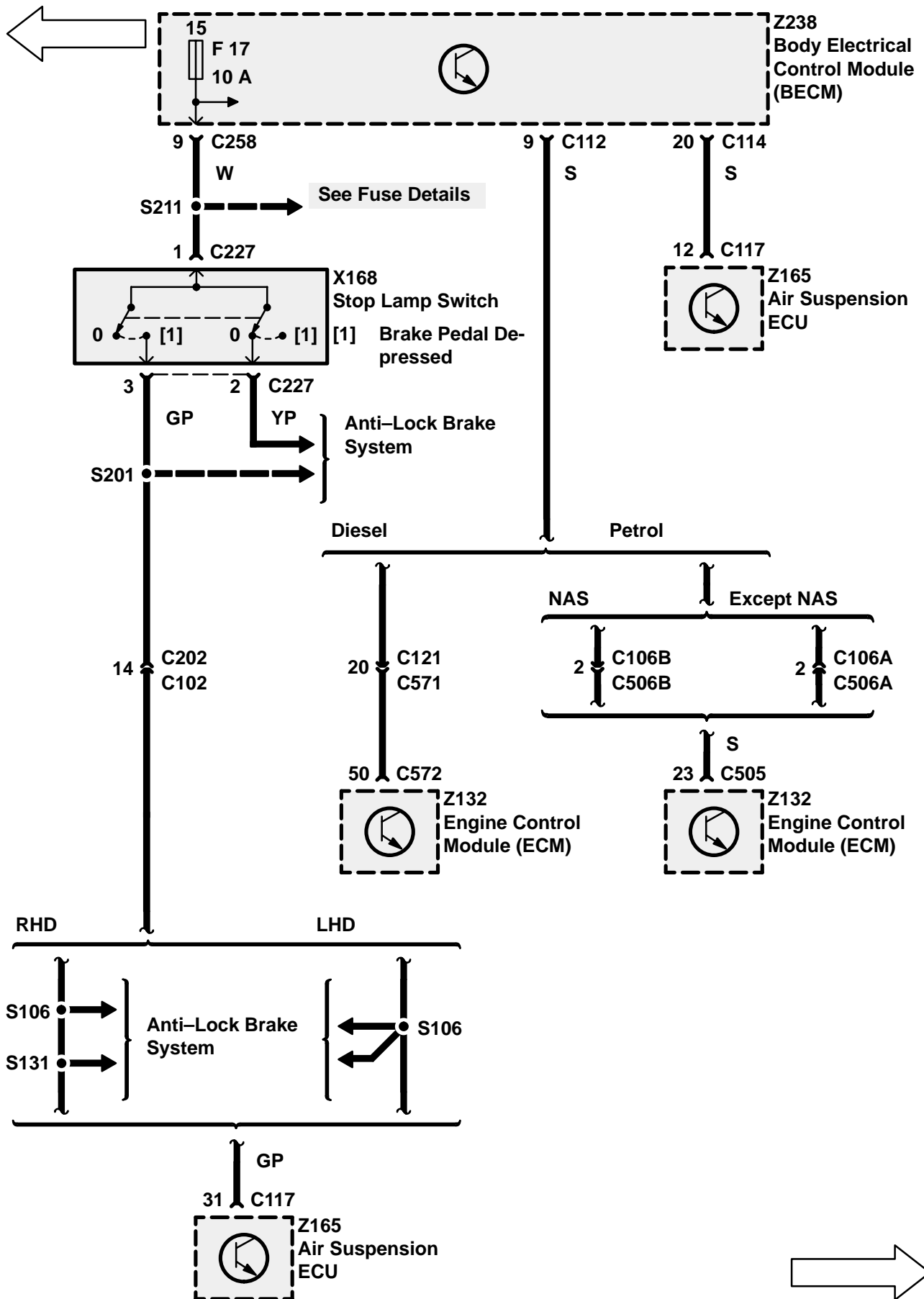

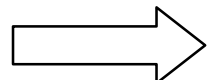
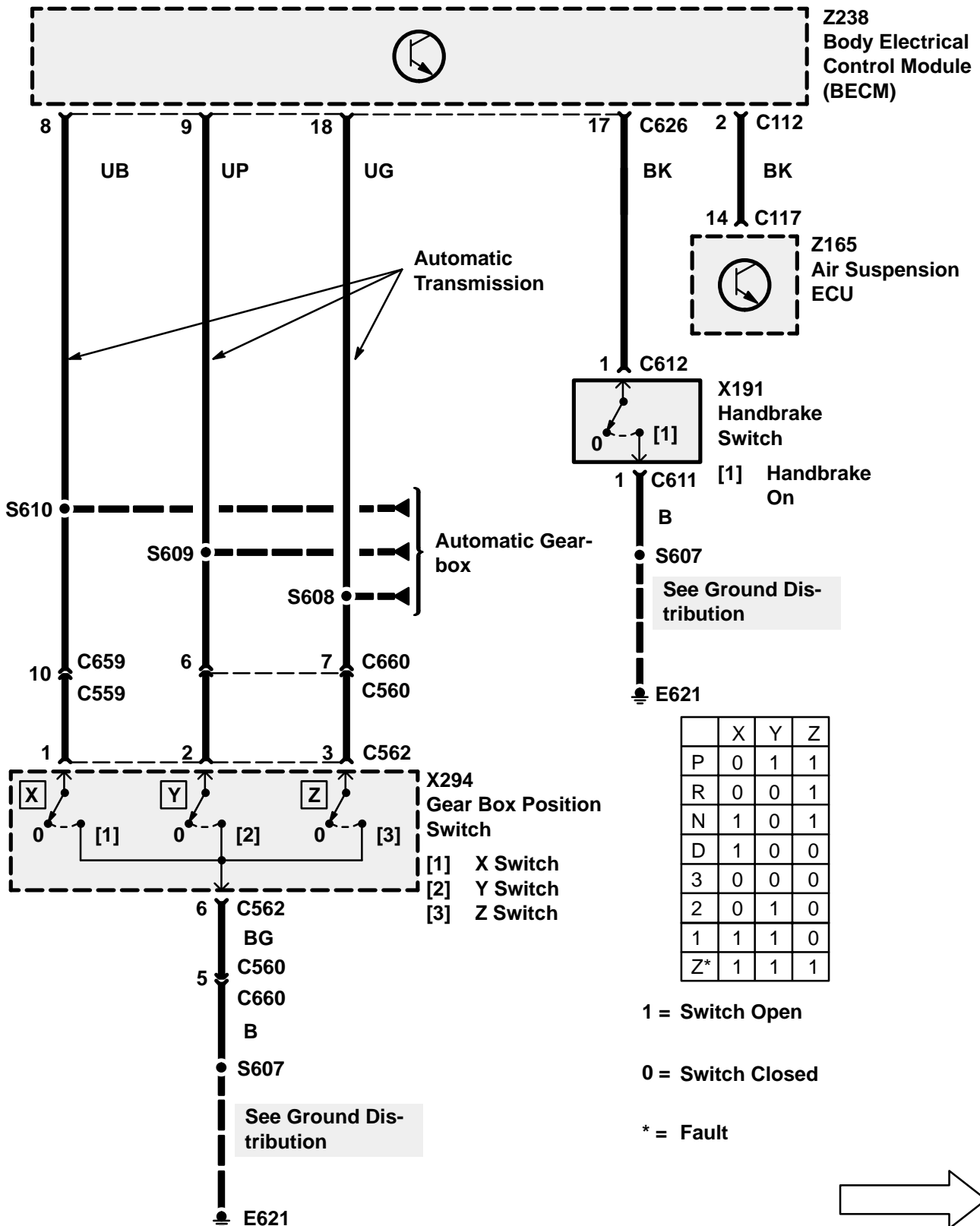
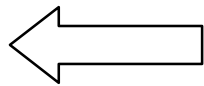

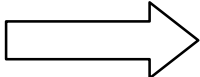
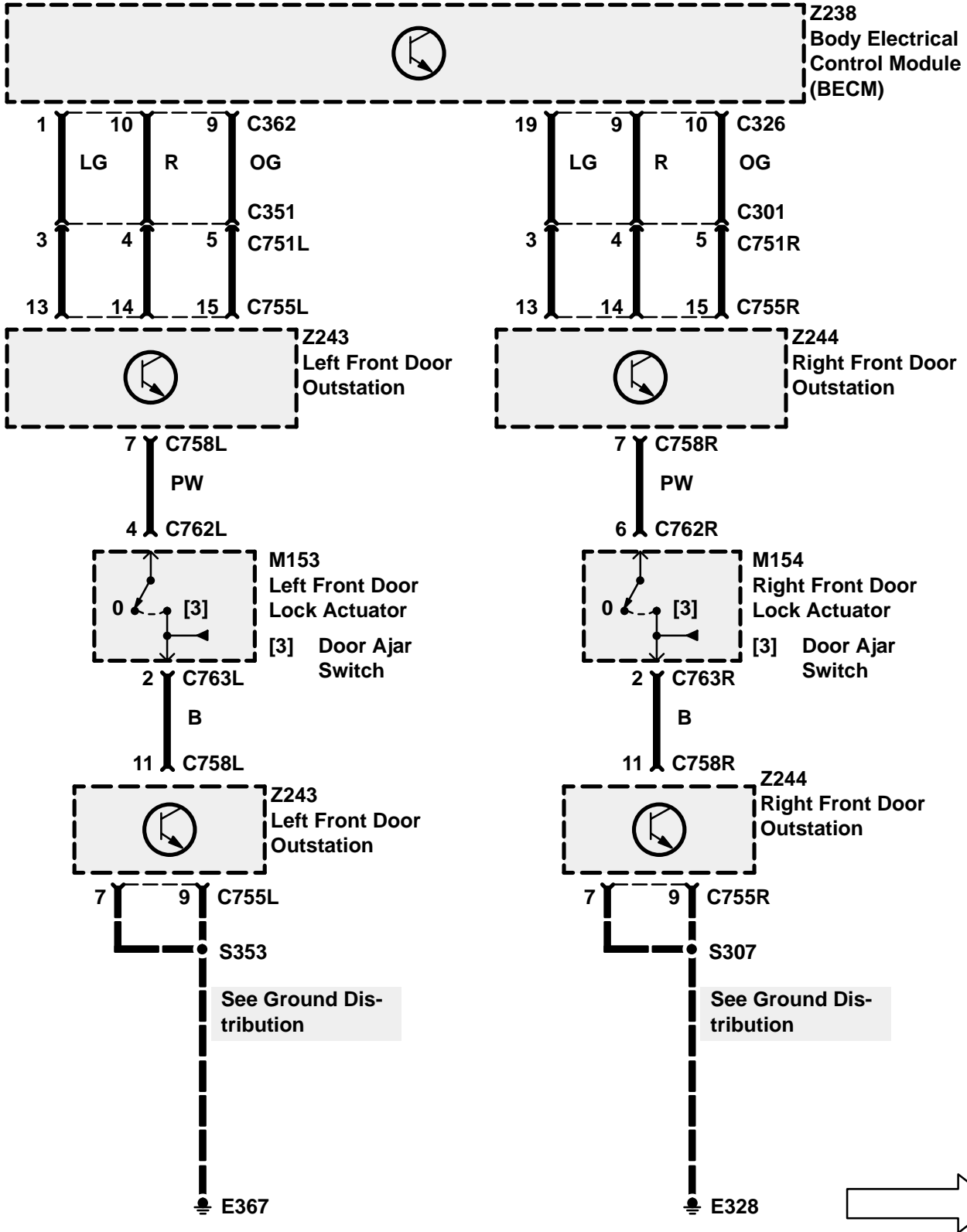
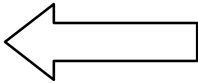

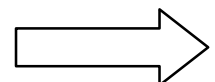
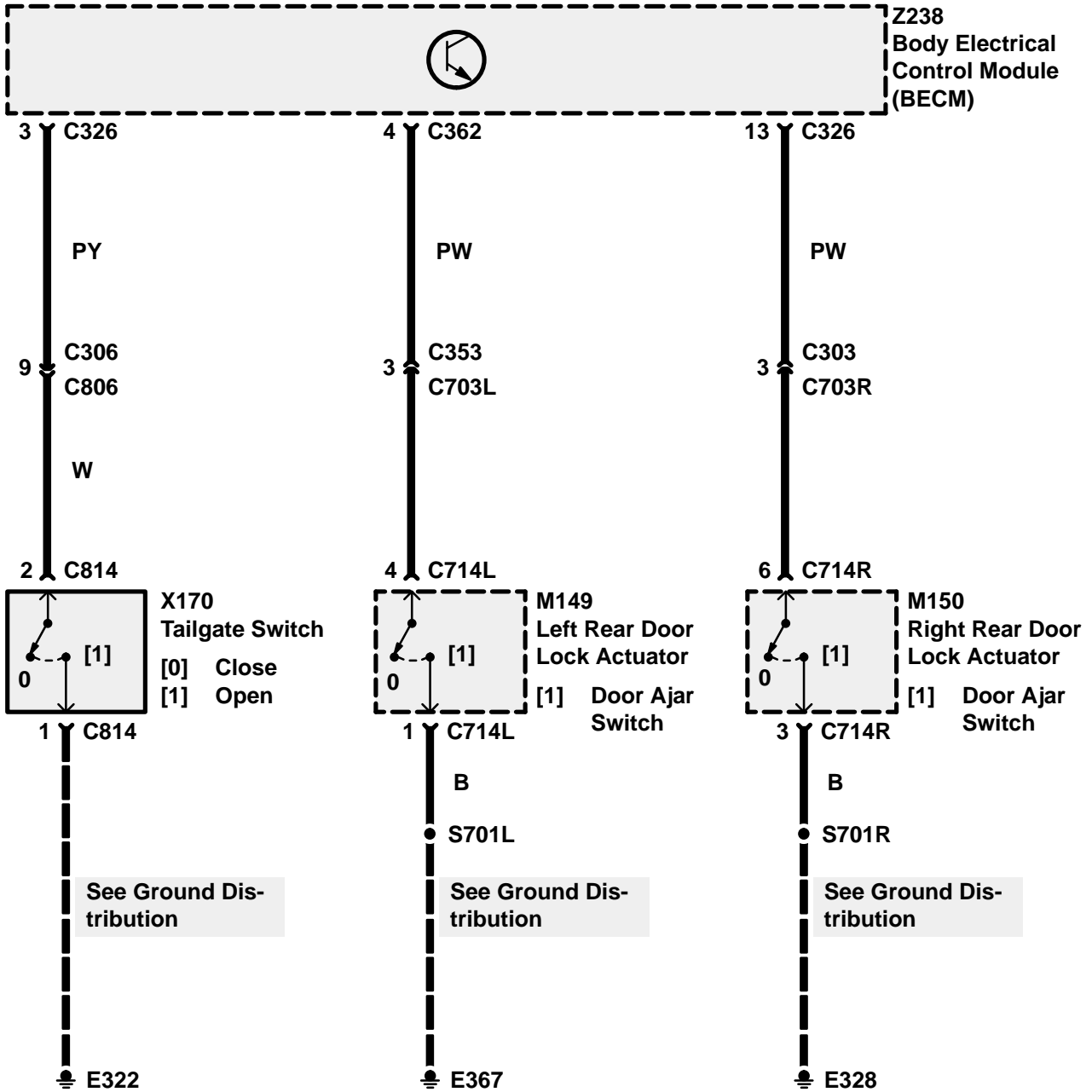
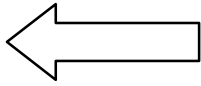

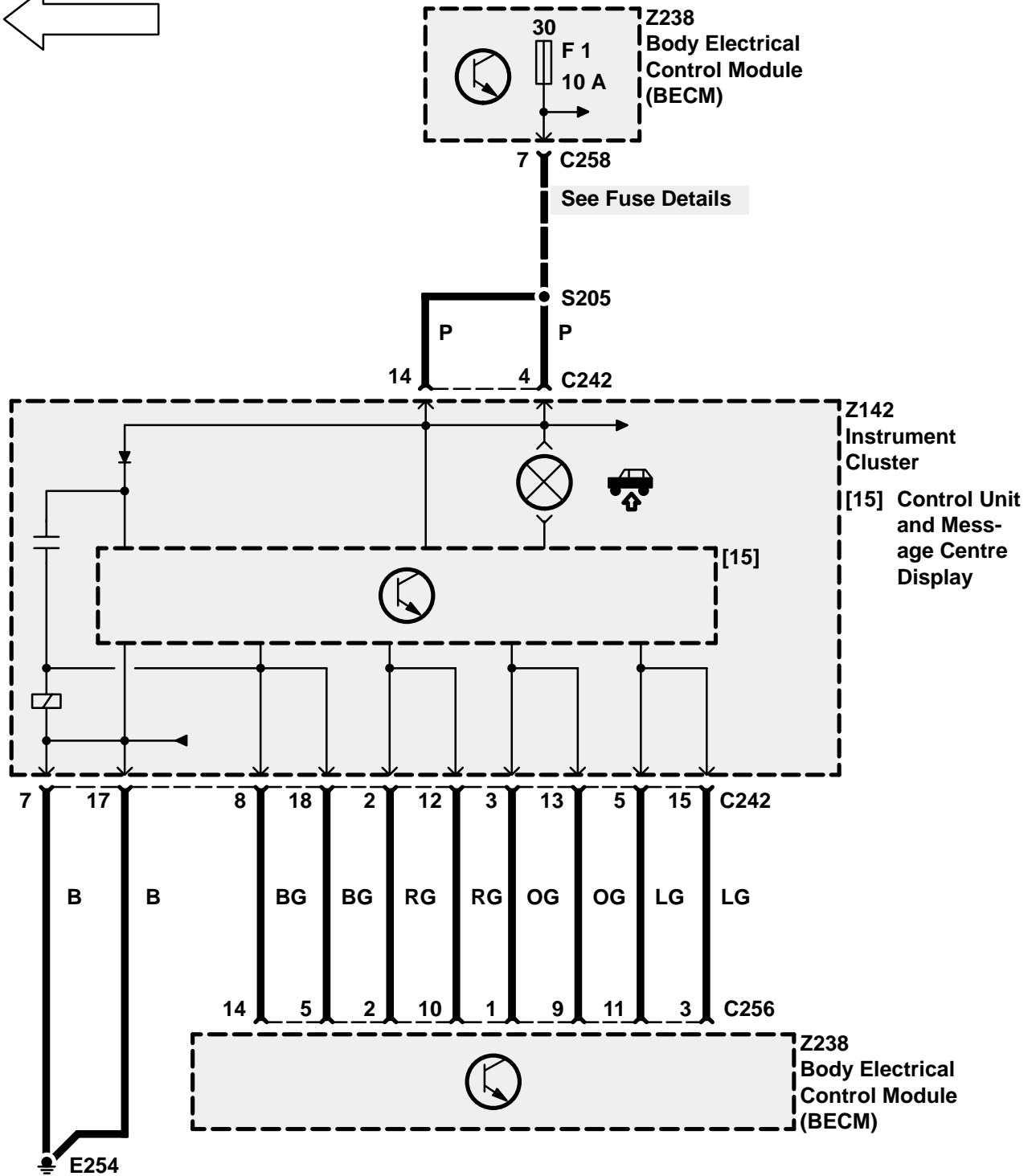
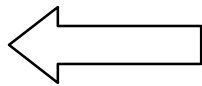

CIRCUIT OPERATION

Basic Overview – Central Door Locking

All new Range Rover models feature Central Door Locking.

All four doors and the tailgate can be locked and unlocked through operation of the central locking system, which can be operated by:

- Pressing down, or lifting up, either of the front door sill buttons.
- Turning the key clockwise (to lock), or turning the key anti-clockwise (to unlock), with the key in the drivers door lock.
- Pressing the “lock” button, or pressing the “unlock” button, on the remote handset.

The new Range Rover is also equipped with a “Superlocking” feature. When the vehicle is “Superlocked”, it is impossible to unlock any of the doors from inside the vehicle by lifting any of the sill buttons.

Basic Overview – Alarm

All new Range Rovers are equipped with a sophisticated integrated security system.

The alarm system offers the following forms of protection:

- Perimetric protection against unauthorised opening of any of the hinged “slam” panels.
- Engine crank inhibit against unauthorised engine crank.
- Electronic engine immobilisation against unauthorised engine start.
- Volumetric protection against intrusion into the passenger compartment.

Basic Overview – Lazy Locking

An additional feature of the new Range Rover’s security system is Lazy Locking.

Lazy Locking enables the driver to close any open glass panel (window or sunroof) from outside the car using either the key or the remote handset.

Lazy Locking can be carried out either when locking or super locking the vehicle, or when the vehicle is already in a locked state.

N.B. Activation of a lazy locking sequence will be dependent on market requirements.

General

The vehicle locking and security system comprises the following components:

- “C” type latches on the passenger doors incorporating central door locking, superlocking and slam locking facilities.
- An external key barrel on the driver’s door, allowing central door locking, superlocking and unlocking, with mechanical override via key (excluding superlocking) in the event of a power failure.
- Separately controlled central door locking actuators on tailgate and fuel filler flap.
- Ultrasonic movement detector, located over the LH “B” post.
- Passive Immobilisation Coil (Z270) (Not on all vehicles).
- Under bonnet mounted alarm klaxon (Not on all vehicles).
- Battery Backed Up Alarm Sounder (Z272) (Not on all vehicles).
- Radio Frequency remote key allowing locking, superlocking, unlocking and lazy locking.
- Inertia switch allowing unlocking in the event of a crash.
- Security LED to indicate the “alarm active” state.

Remote Handset Operation

The handset has two buttons, lock/superlock and unlock. The operation is as follows:

- Lock – single press of lock button.
- Superlock – double press of lock button (within 1 second).
- Unlock – single press of unlock button from either locked or superlocked.
- Lazy lock – press and hold lock button for more than 1 second.
- (NB Hold on second press if superlock required as well.)
- Lazy Seats – press unlock button for more than 1 second.
- (NB This will unlock as well.)

Locking operation

There are six different ways to lock a new Range Rover. These are:

• Sill Locking

Depressing either of the front door sill buttons while both front doors are closed will result in all the doors and the tailgate locking, and the vehicle entering a sill locked state.

In this state the alarm remains inactive (provides no protection), with no LED flash.

Sill locking can be achieved independently of key-in and ignition switch status.

• Slam Locking:

Depressing either of the front door sill buttons with either front door open, will result in all the doors and the tailgate locking and the vehicle entering a slam locked state.

Following a slam locking operation, the alarm will enter the perimetric mode, engine crank will be disabled and electronic engine immobilisation will be activated.

Attempting to slam lock the vehicle with either the key in the ignition, or the ignition on, will cause unlocking of all the doors.

• Key Locking

A single turn of the key towards the front of the vehicle will result in all the doors and tailgate locking.

The alarm will enter the perimetric mode, engine crank will be disabled and electronic engine immobilisation will be activated.

• Key Superlocking

A double turn of the key in a clockwise direction (i.e. towards the front of the vehicle) within 2 seconds, provided the doors, tailgate and bonnet are closed, will result in all the doors being superlocked.

The alarm will enter the perimetric mode, engine crank will be disabled and electronic engine immobilisation will be activated.

• Remote Locking

A single press of the lock button on the remote handset will result in all the doors and the tailgate locking.

The alarm will enter the perimetric mode, engine crank will be disabled and electronic engine immobilisation will be activated.

• Remote Superlocking

A double press of the lock button on the remote handset within 2 seconds, provided the doors, tailgate and bonnet are closed, will result in all the doors being superlocked (subject to ultrasonic look around – see Ultrasonic Sensor).

Providing all the windows are closed, the perimetric and volumetric alarm will be set. If all the windows are not closed, then only the perimetric alarm will be set.

Engine crank will be disabled and electronic engine immobilisation will be activated.

Lazy Locking

Lazy locking can be carried out when either locking or superlocking, or when the vehicle is already in a locked state, by either holding the key turned to the lock position or by holding the remote handset lock button pressed for more than one second.

This will cause all the open windows to start closing simultaneously. Closure of the windows will be followed by closure of the sunroof.

Dependent upon market requirements, lazy locking will either operate in one-shot mode, or in dead man's handle mode.

- In one-shot mode, the windows and sunroof will continue to close even after the key has been released from the lock position, or the lock button on the remote handset has been released.
- In dead man's handle mode, closure of the windows and sunroof will only continue for as long as the key is held to the lock position, or the lock button is pressed on the remote handset. In this case, failure of any of the apertures to be fully closed upon release of the key/button will result in a mislock.

Mislock

A mislock condition is indicated by either two short "beeps" from the alarm sounder, or by three short flashes of the courtesy lights, depending on the market legislation.

Partial Arming Of The Perimetric Alarm

If the perimetric alarm is armed with one (or more) of the doors, or the tailgate, or the bonnet open, then the remaining panels are all protected by the alarm. If any of the open panels are subsequently closed, then they too will be protected by the alarm.

Security LED

The security LED has two functions:

- Firstly for the initial ten seconds after a lock request, it provides visual confirmation of the lock status.
- Secondly, after this confirmation period, it acts as a deterrent to any theft attempt, (flashing at a slower rate).

Volumetric Protection

Volumetric protection, (protection of the vehicle's interior), is provided by an **Ultrasonic Sensor** and an **Ultrasonic detector**.

If the vehicle has been successfully superlocked with the key, then provided all the windows are closed, a

single press on the remote transmitter lock button will activate the ultrasonics. There is a 5 second settling period before movement can be detected.

Audible/Visual Warnings

When an intrusion is detected, the Alarm Sounder (Z171) will sound and visual indicators will flash. The output from the sounder is either pulsed or a continuous tone, depending on market legislation. If the output is pulsed, then its status will be synchronised with that of the visual indicators.

The lamps used for external visual indication are dependent upon market legislation, but will be either Hazards, or Side and Tail, or Dip and Tail.

Two different types of Alarm Sounders are available:

1. Normal Alarm Klaxon (Alarm Sounder (Z171))
2. Battery Backed Up Alarm Sounder (Z272)

The Battery Backed Up Alarm Sounder (Z272) is an alarm sounder which contains its own internal battery. When the ignition is on, the internal battery is charged via an ignition feed. If either the connector is removed or the wires to it are cut, then the sounder will sound for 4.5 minutes.

To disconnect the Battery Backed Up Alarm Sounder (Z272):

- Turn Ignition On (Pos. II).
- Turn Ignition Off.
- Disconnect within 17 seconds.

To silence if triggered:

- Connect.
- Disarm Alarm.
- Turn Ignition On (Pos. II).

Alarm Triggering

The perimetric alarm will be triggered by any of the doors opening, the tailgate opening, the bonnet opening, the ignition key being inserted, the ignition being turned on, or the inertia switch being tripped.

The volumetric alarm will be triggered by any movement within the passenger compartment.

The alarm will be triggered a maximum of three times during any set/unset period. Any further triggers after this will be ignored.

ENGINE IMMOBILISATION FUNCTION

The engine will be immobilised whenever the alarm is armed or the alarm enters the Passive Immobilisation mode (regardless of whether or not the theft alarm is armed). There are two methods of Engine Immobilisation featured:

1. Engine Crank Disable
2. Electronic Engine Immobilisation

The electronic engine immobilisation is controlled jointly by the engine management system's Electronic Control Module and the BeCM.

If a crank signal is detected when the engine is immobilised, the "Engine Immobilised" message will be transmitted to the instrument pack, and it will not be possible to start the engine.

Engine Immobilisation (Petrol)

The BeCM mobilises the engine by transmitting an engine mobilise code to the ECM. The code is not sent when the engine is immobilised.

Engine Immobilisation (Diesel)

The electronic engine immobilisation feature fitted to the diesel engine derivatives is different to the system fitted to the petrol versions.

The BeCM mobilises the engine by holding the engine mobilise output high. The output will be low when the engine is immobilised.

Passive Immobilisation

The following conditions will passively immobilise the vehicle:

- 30 seconds after ignition has been turned off and the driver's door has been opened.
- 30 seconds after ignition has been turned off, the key removed, and the driver's door has been opened.
- 10 minutes after ignition has been turned off and the key removed (without opening the driver's door).
- The handset becomes desynchronised (or with an improperly functioning handset).

The vehicle can be mobilised by any of the following methods:

- Turn the ignition on (The handset must be functioning properly and within close proximity to the key!)
- Press unlock button on the handset
- Enter EKA code

NOTE: The vehicle will remain immobilised by attempting to turn the ignition on with the handset detached from the key ring (or with an improperly functioning handset).

If the handset becomes desynchronised (or is functioning improperly), the engine will be passively immobilised. If an attempt is made to start the engine, the message "Engine Disabled, Press Remote" will be displayed on the message centre. To mobilise the engine the EKA code must be entered and the handset (when functioning properly) resynchronised.

Passive Immobilisation Coil (Z270)

A magnetic field is generated by the passive Immobilisation Coil (Z270) contained in the steering column. This field excites a receiving coil in the handset causing it to transmit a mobilisation signal to the BeCM. If the BeCM does not receive this signal from the handset, the vehicle will remain immobilised.

Handset Transmitter Resynchronisation

The Theft Alarm Unit (Z163) will remain synchronised with the handset unless:

- The handset's batteries have been removed.
- The vehicle's battery has been disconnected.

NOTE: All handsets must be resynchronised when the vehicle's battery has been disconnected.

A handset may be resynchronised by performing a key lock, or unlock, on either front door within 30 seconds of performing a remote lock, superlock, or unlock function. The BeCM uses the change of state of the CDL Switch to initiate resynchronisation.

Emergency Key Access (EKA)

EKA is used to disarm the theft alarm and mobilise the vehicle in the event of a handset failure. This is possible through a series of locks and unlocks with the key in the driver's door lock cylinder. With the vehicle locked and the alarm armed, turn the key the required number of times according to the following sequence:

1. To enter the first digit, turn the key the required number of times to the unlock position.
2. To enter the second digit, turn the key the required number of times to the lock position.
3. To enter the third digit, turn the key the required number of times to the unlock position.
4. To enter the fourth digit, turn the key the required number of times to the lock position.
5. Turn the key to the unlock position to unlock the doors, disarm the alarm, and mobilise the vehicle.

NOTE: The key must be fully turned to the rest and lock/unlock position each time.

After 5 wrong attempts, you must wait 10 minutes.

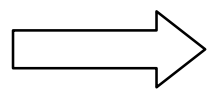
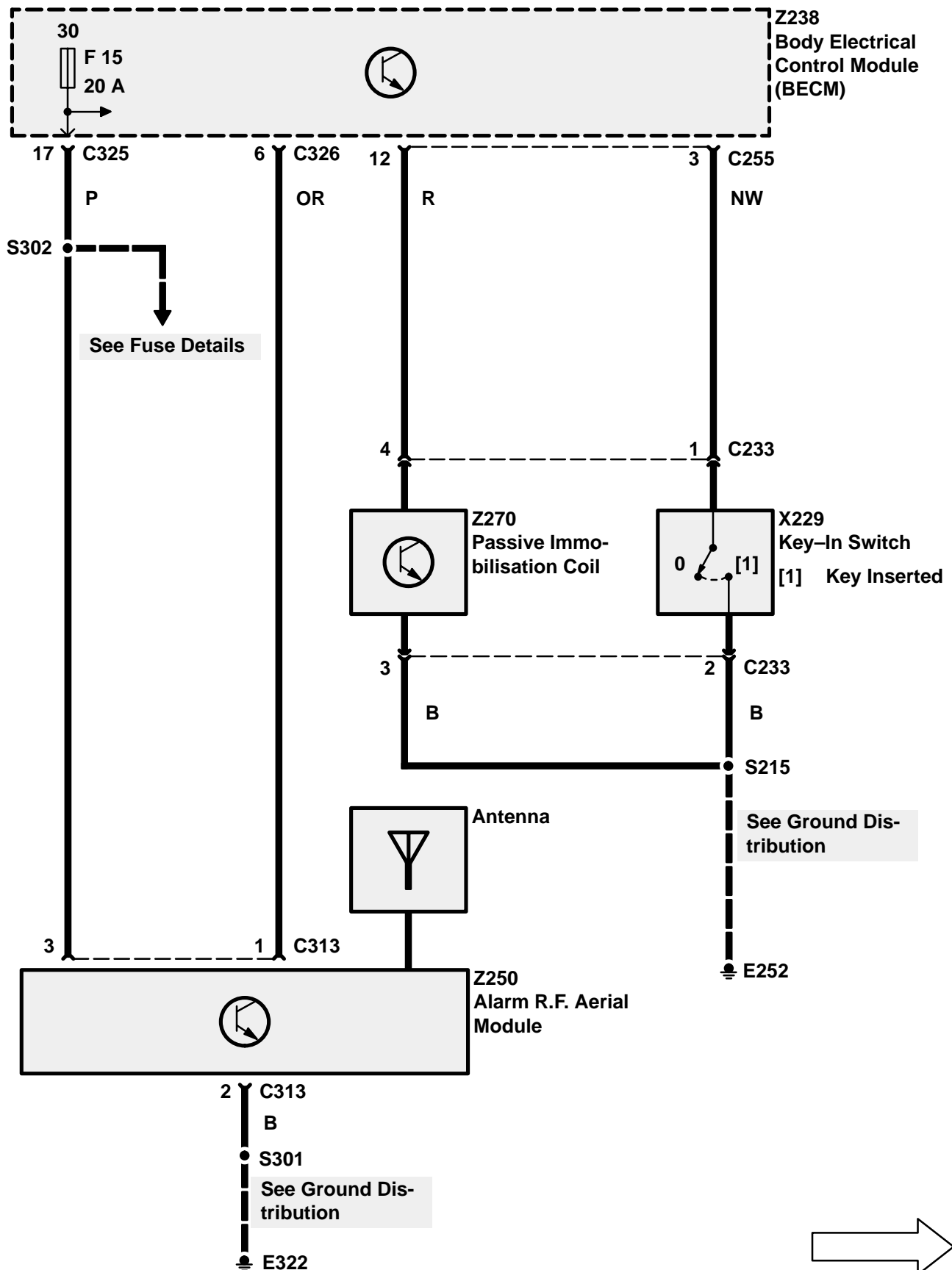

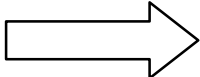
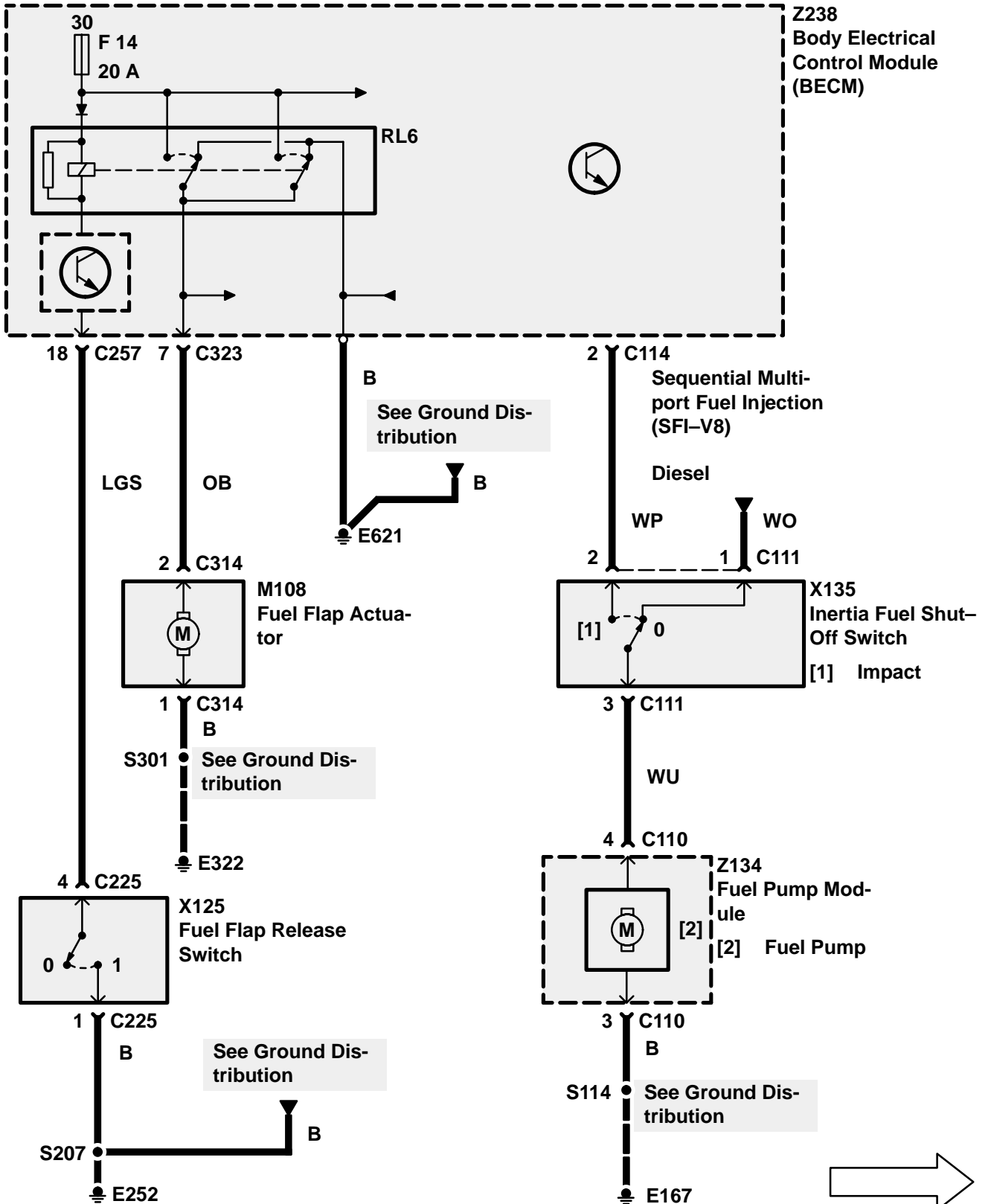
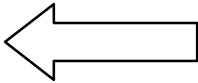

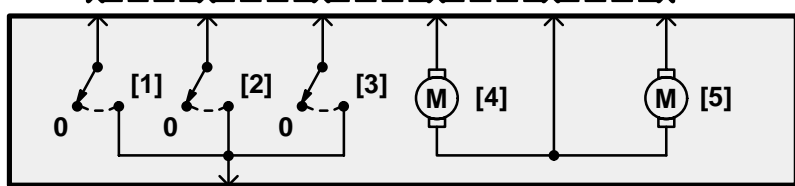
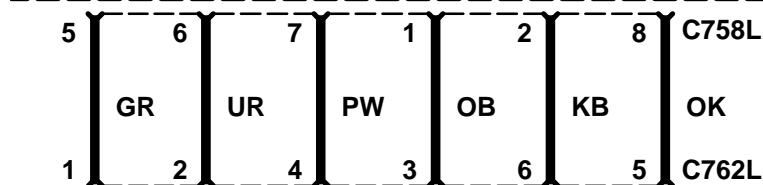
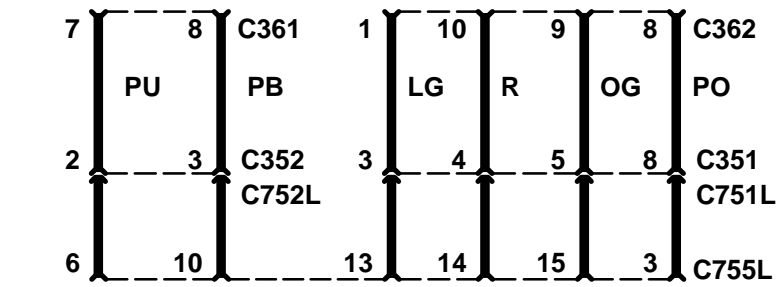
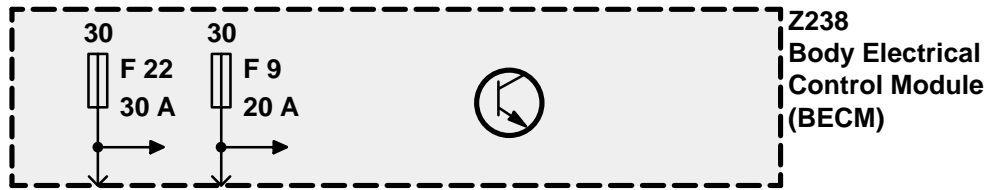
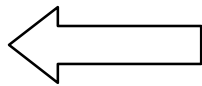

- [1] C.D.L Switch
- [2] Key Switch
- [3] Door Ajar Switch
- [4] C.D.L. Motor
- [5] Superlock

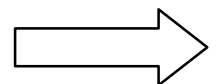
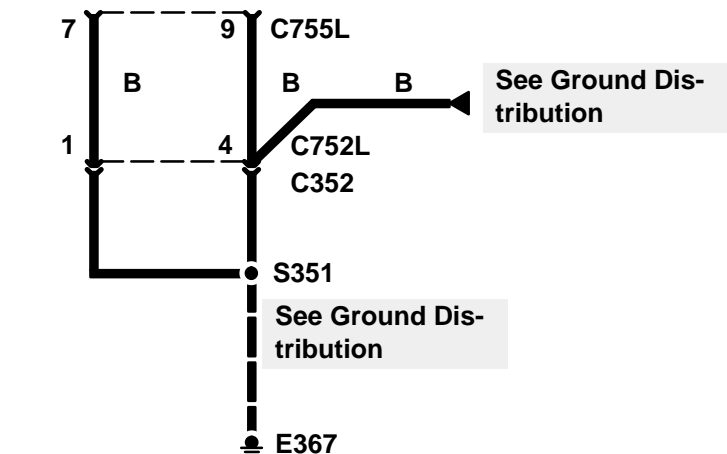
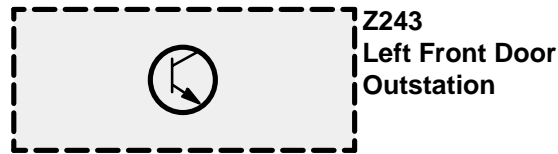
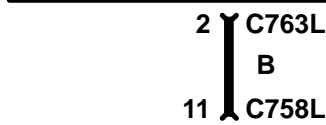

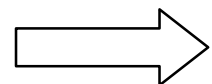
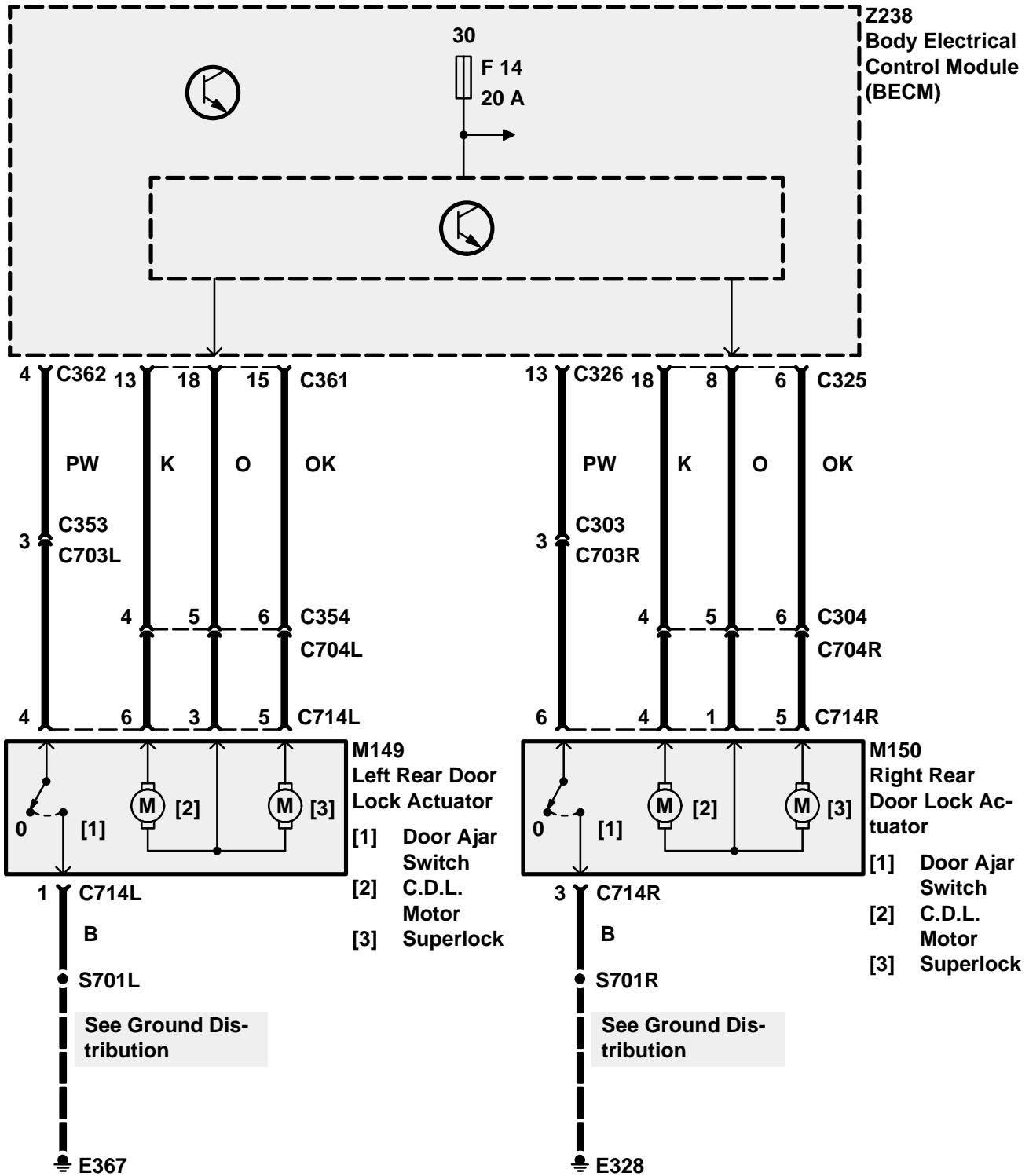
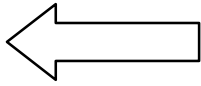

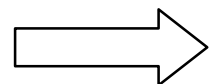
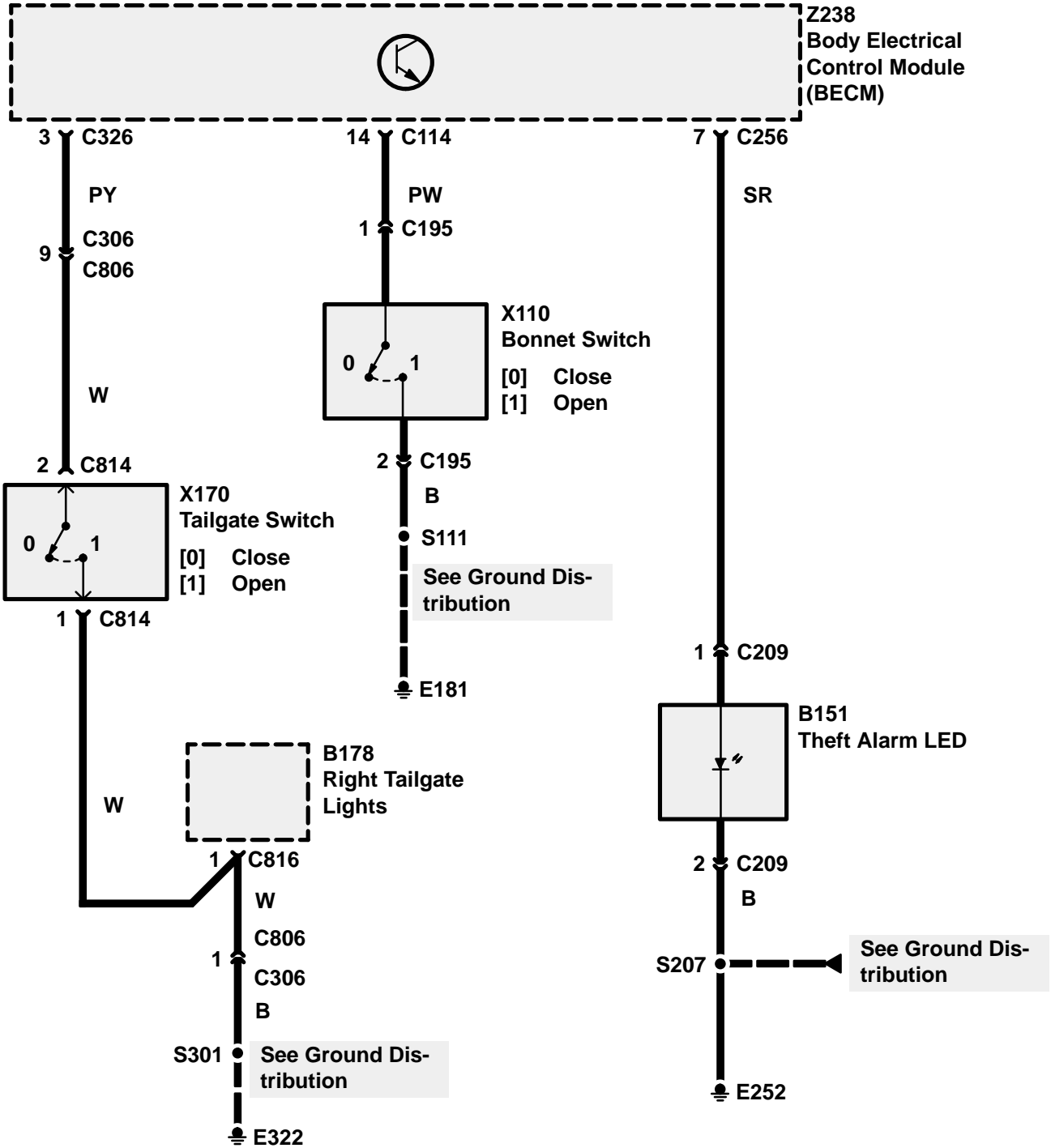
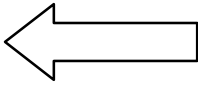

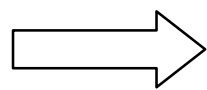
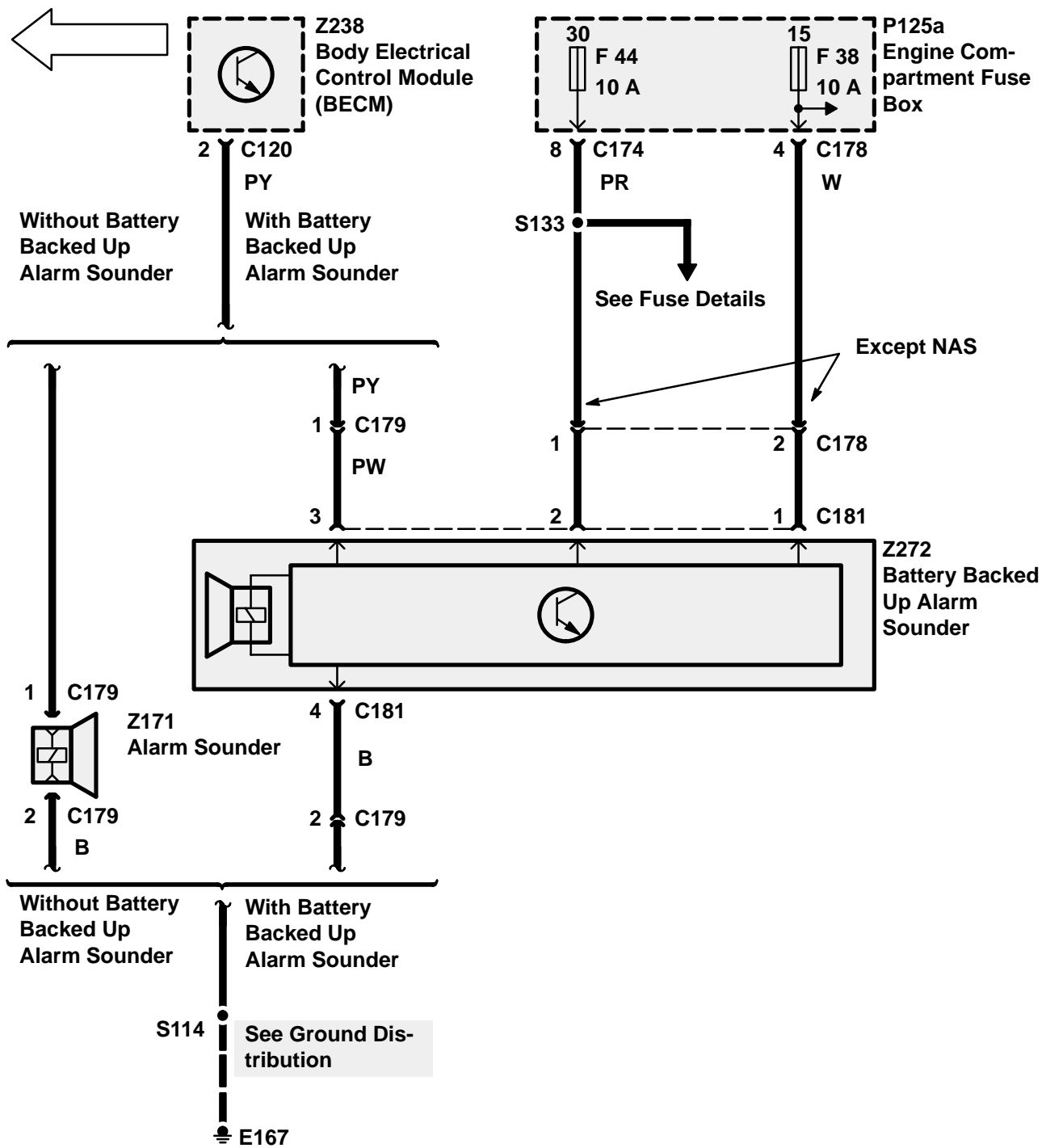

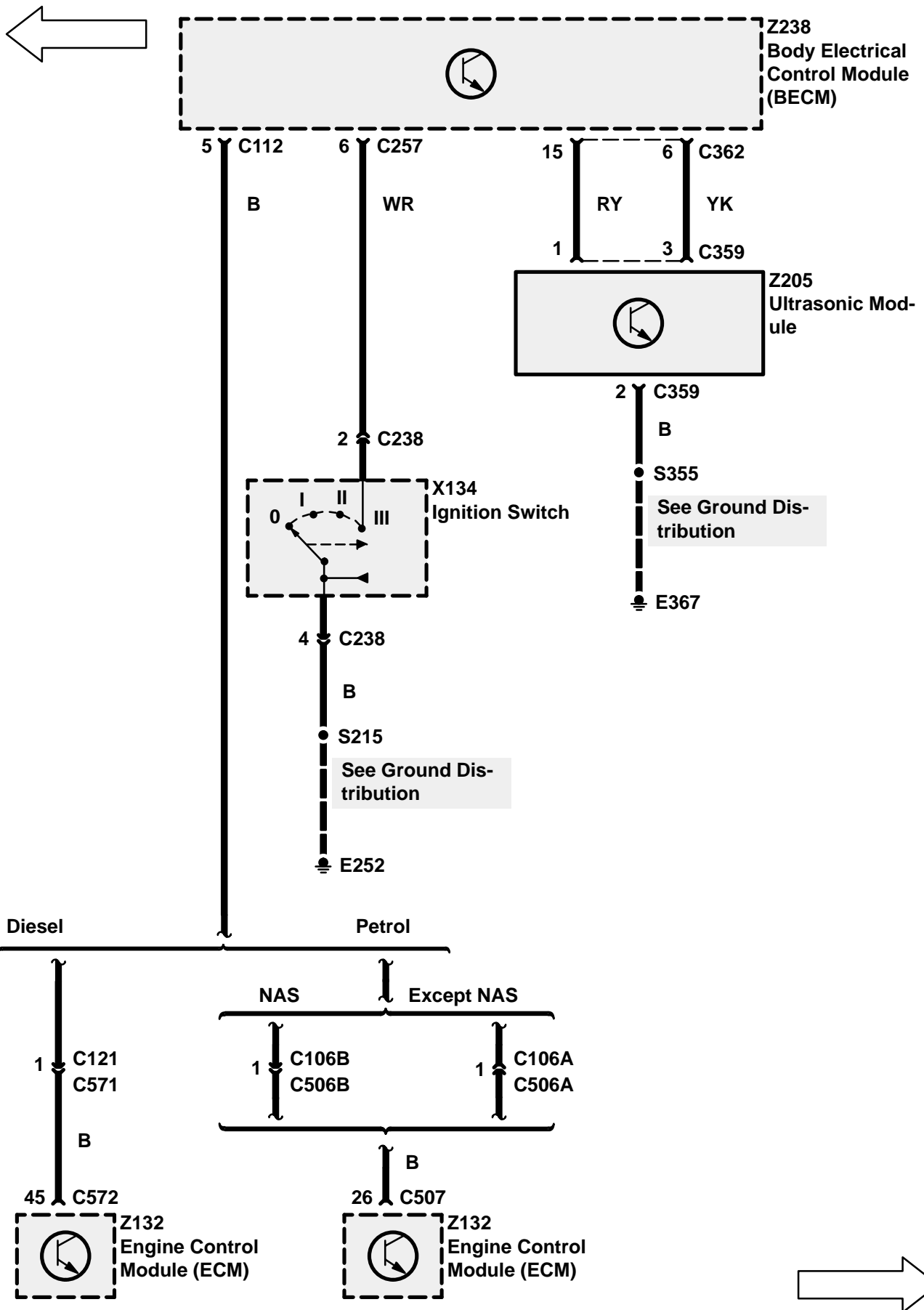

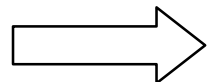
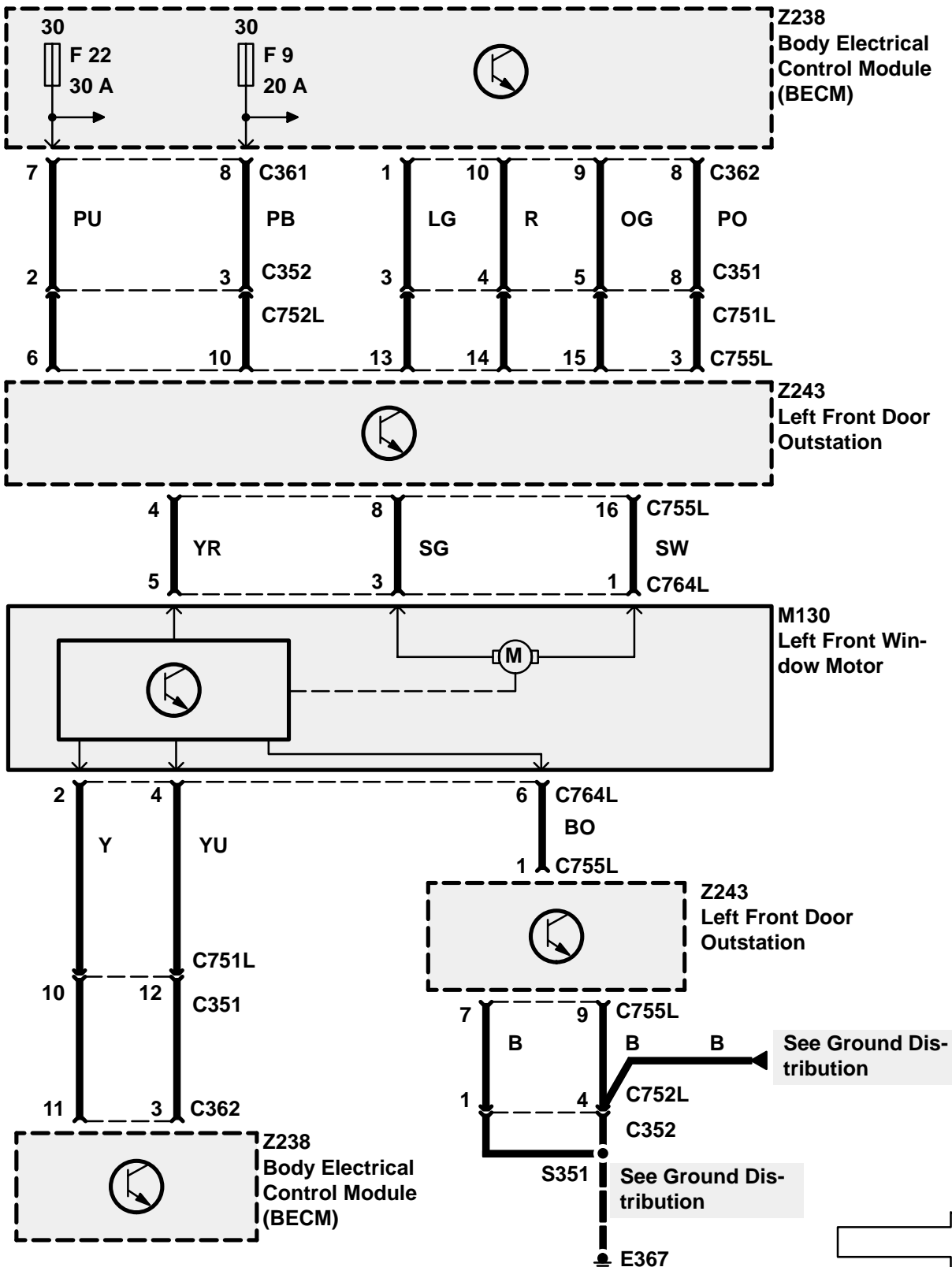
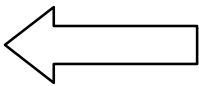

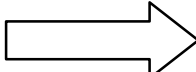
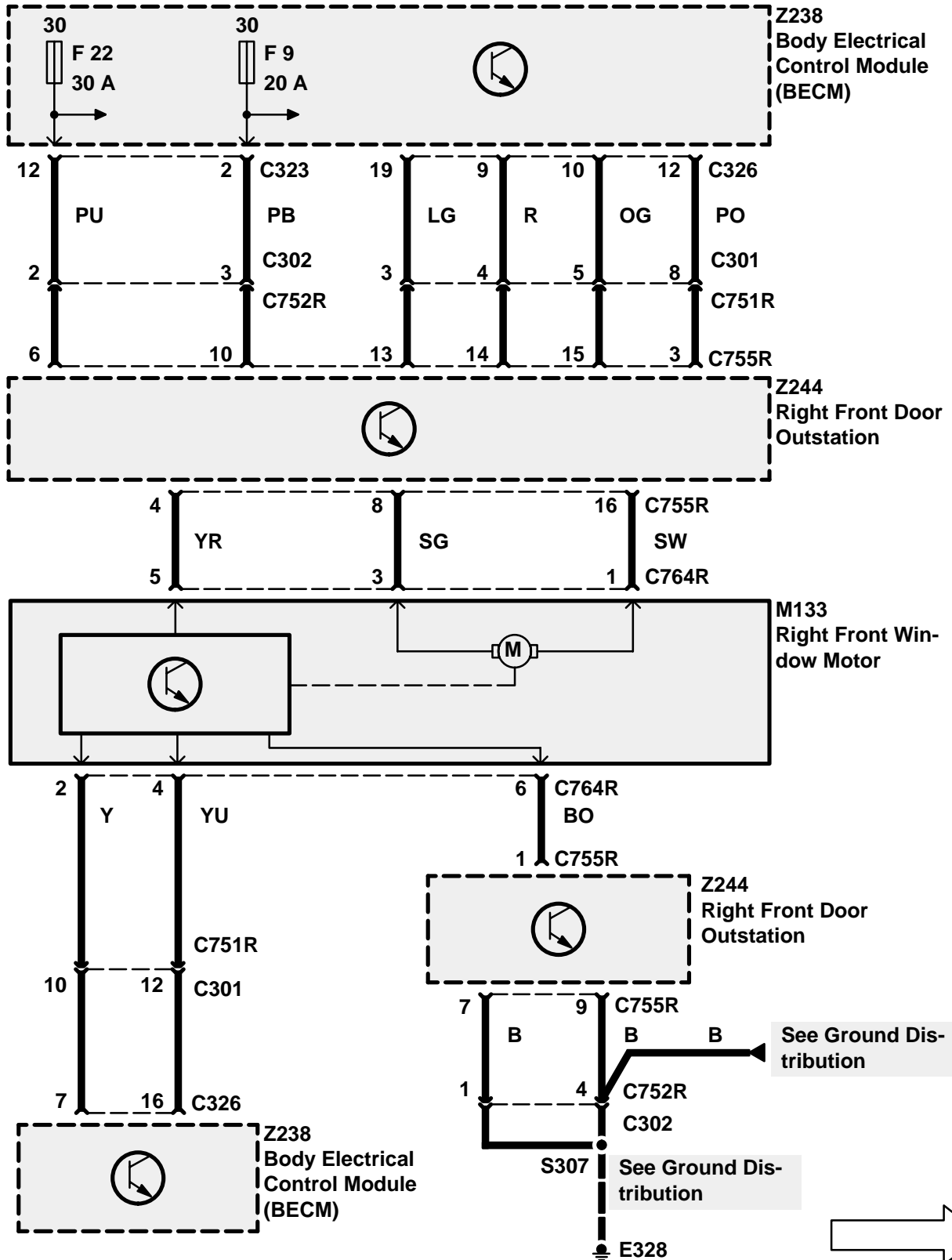
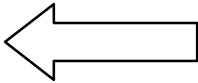

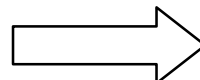
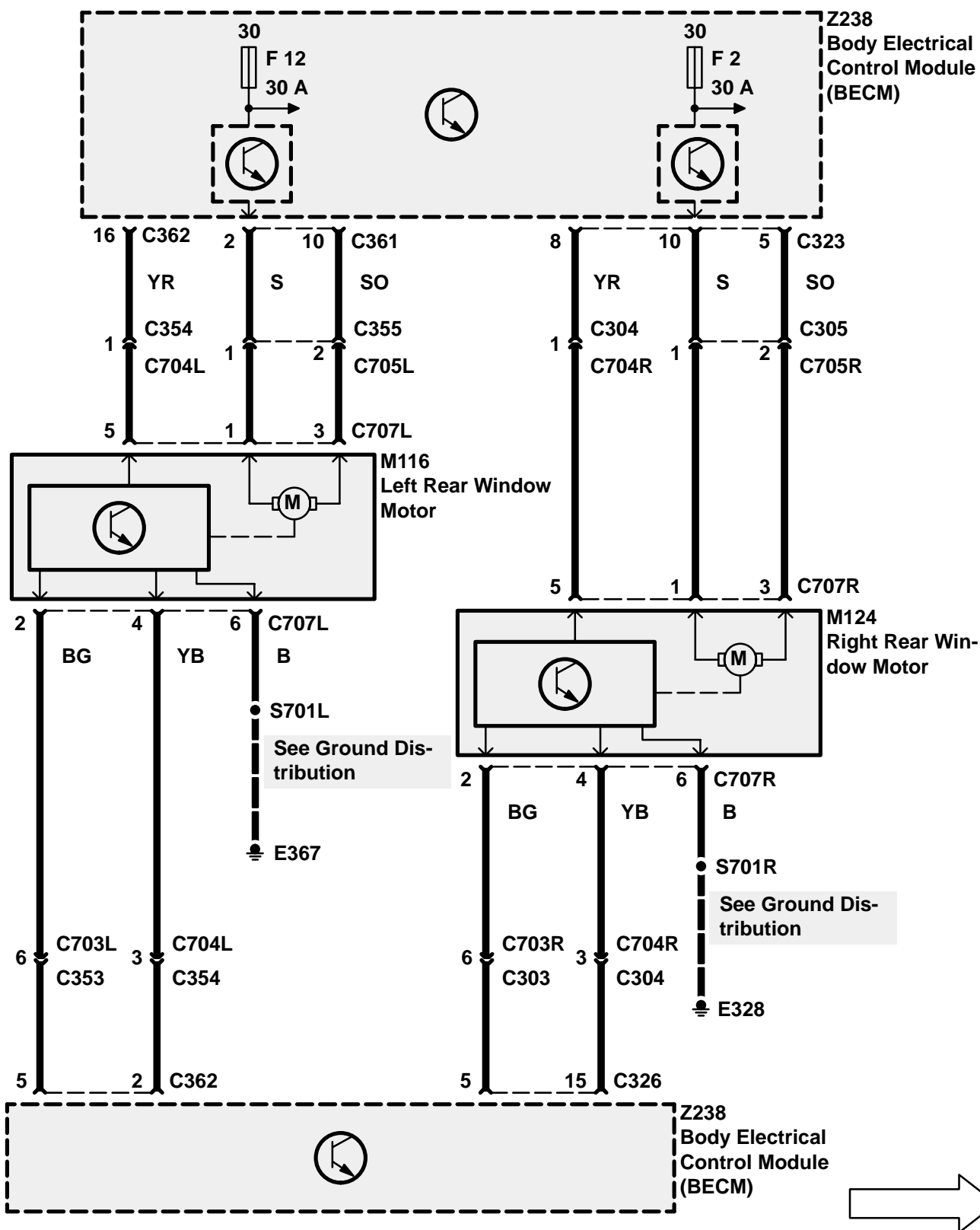
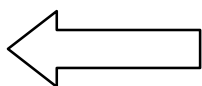

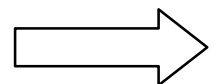
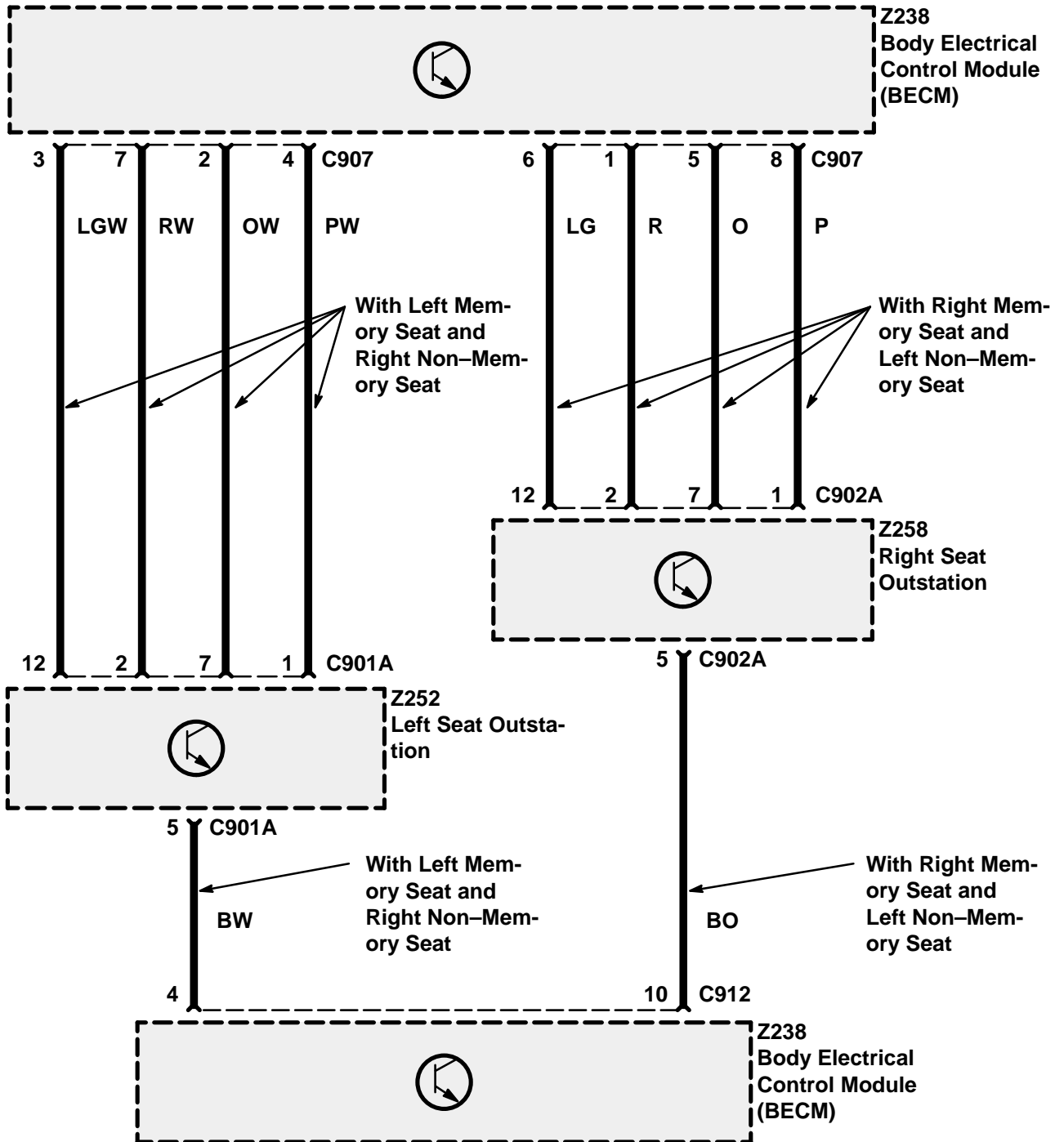
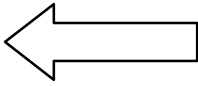

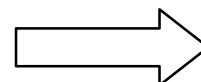
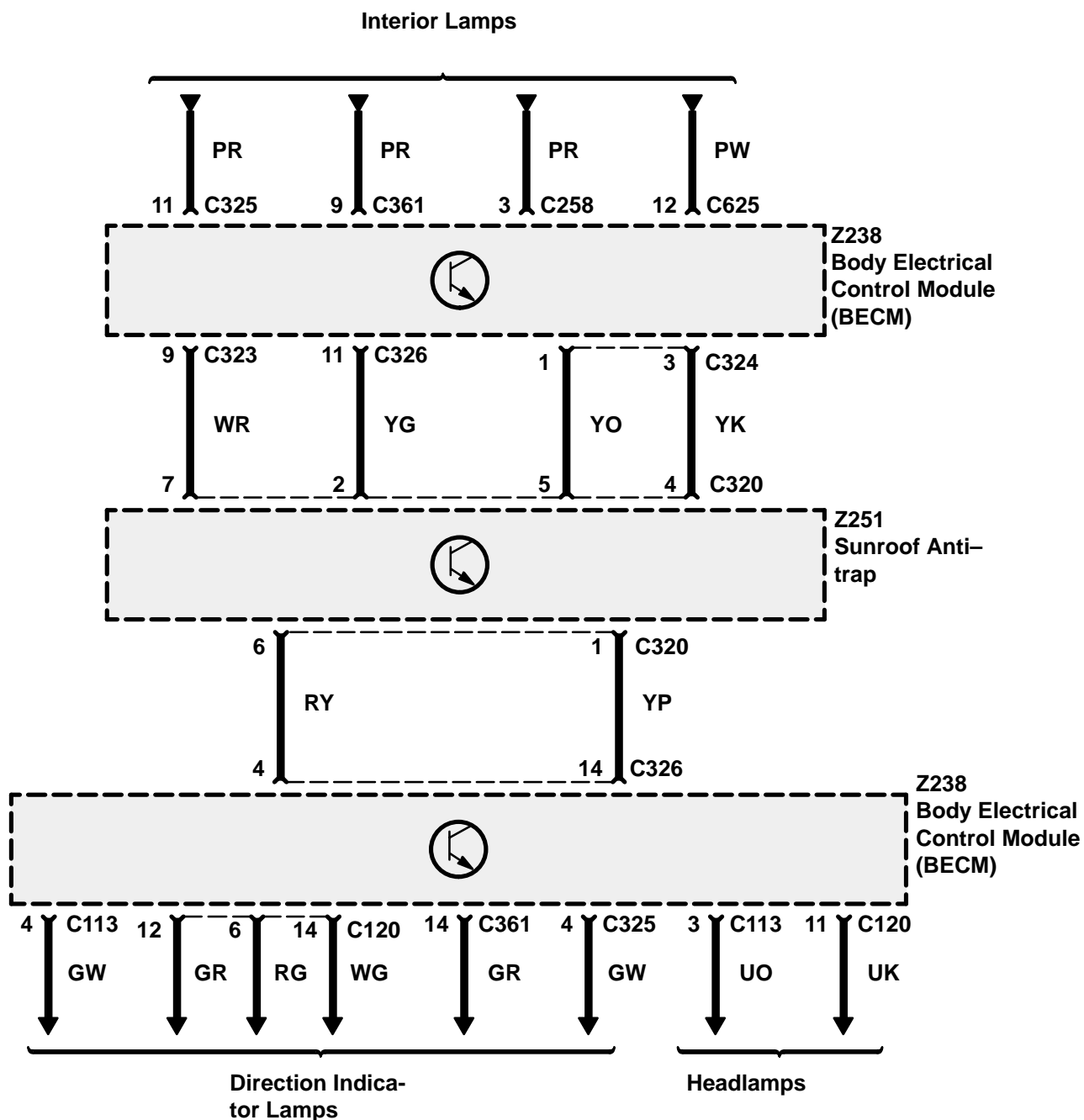
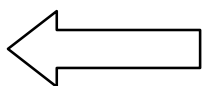

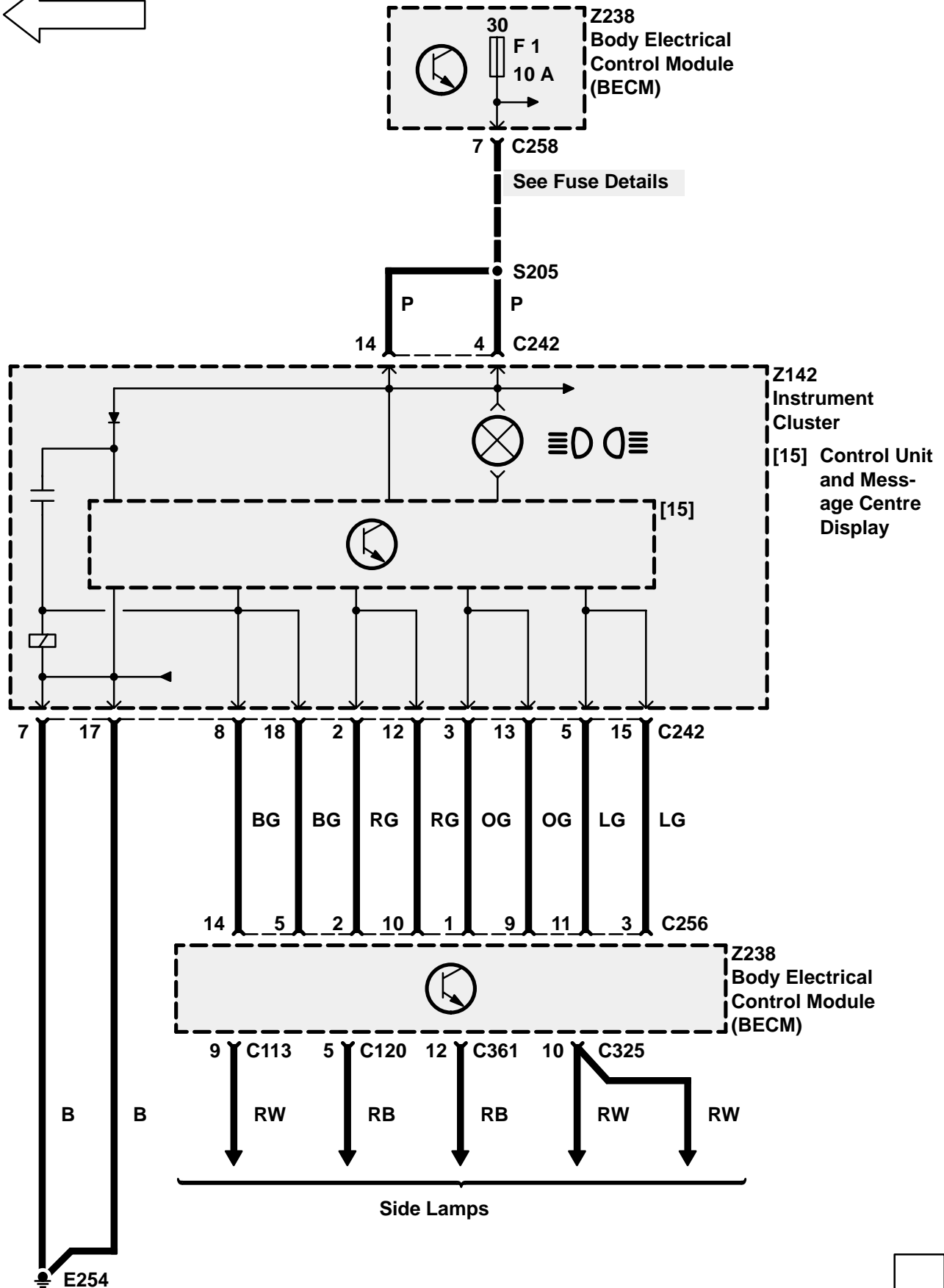
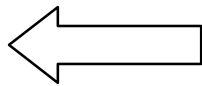

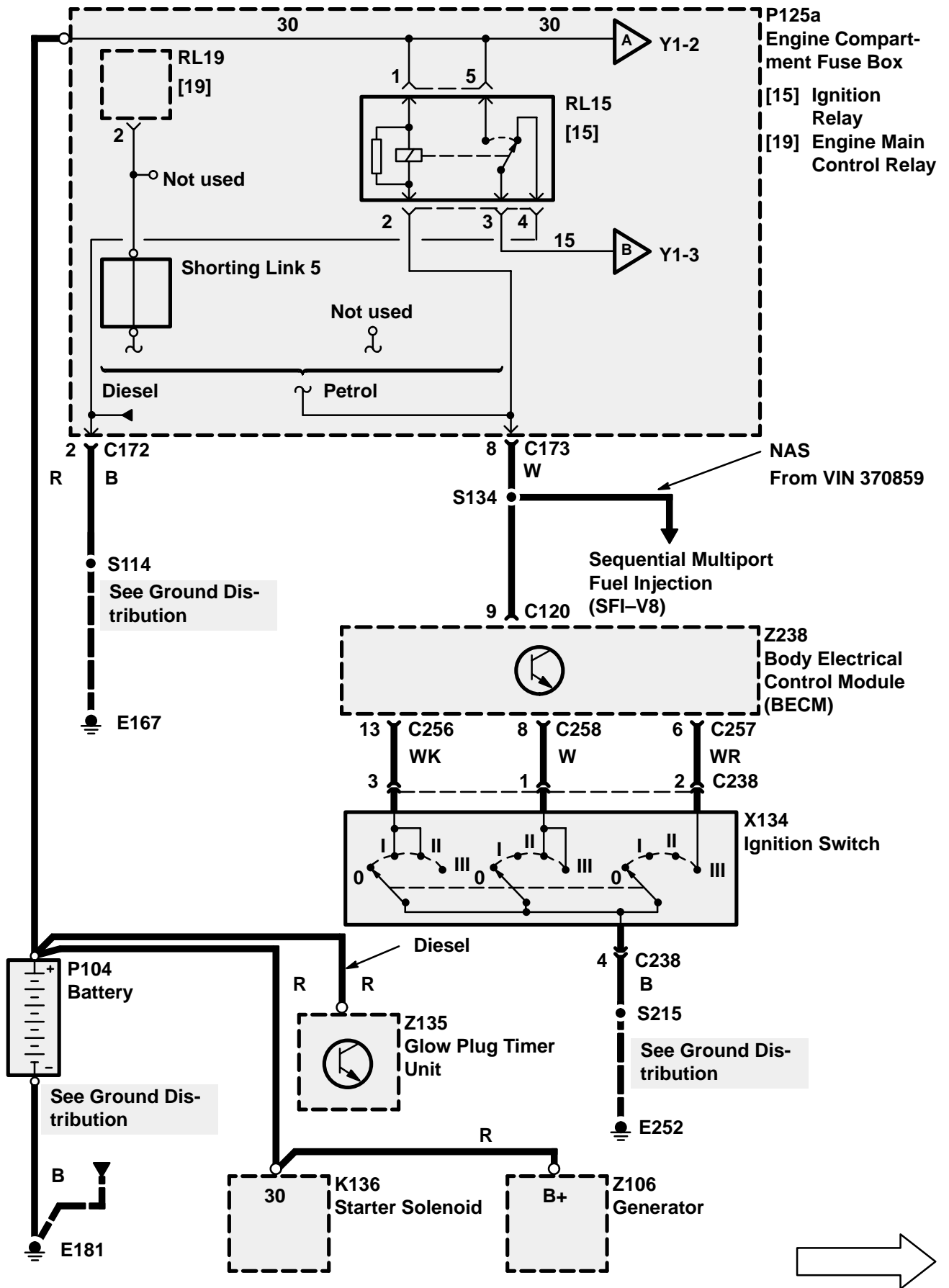

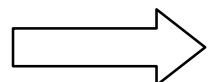
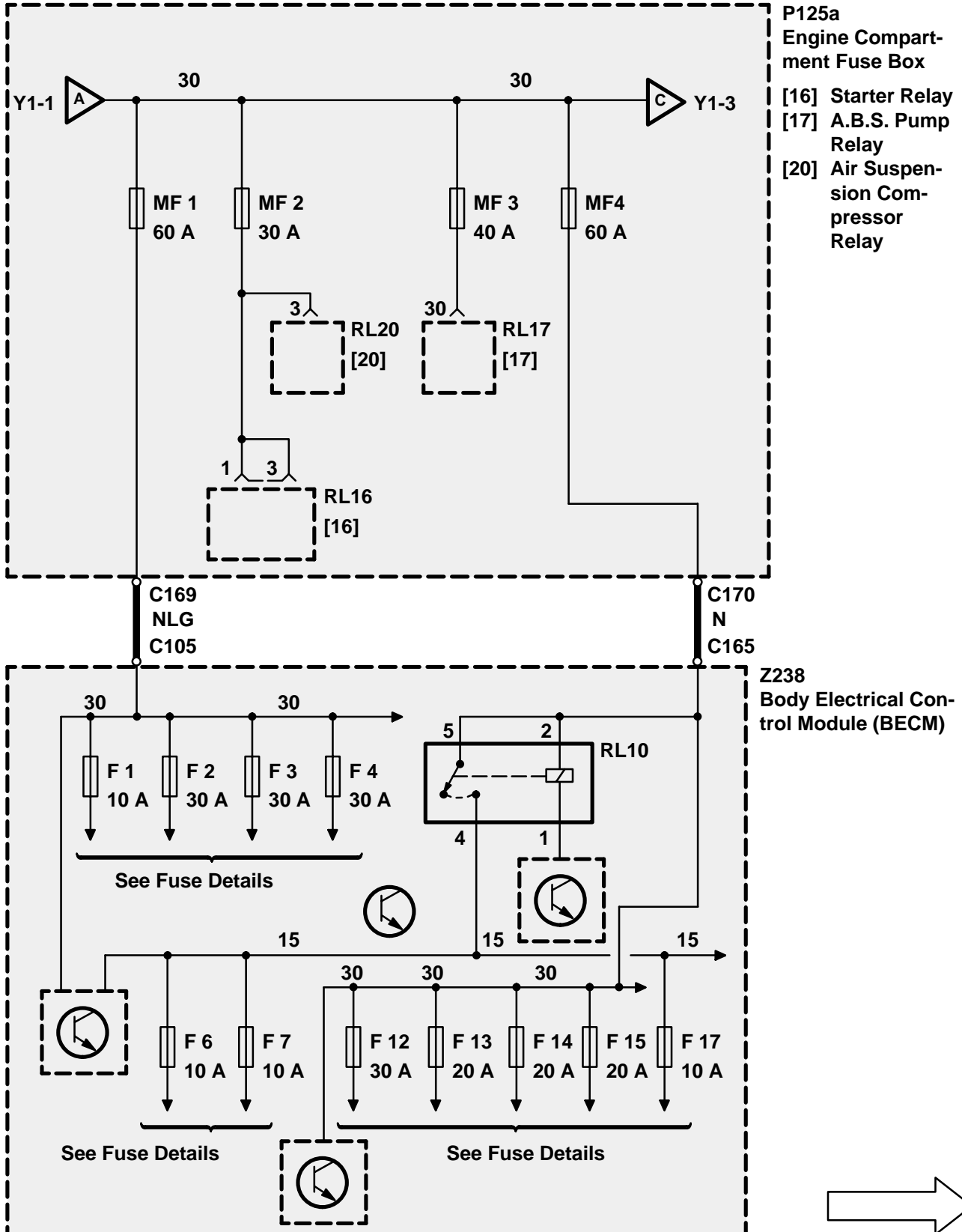
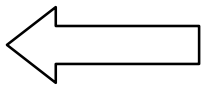

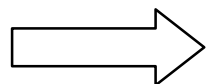
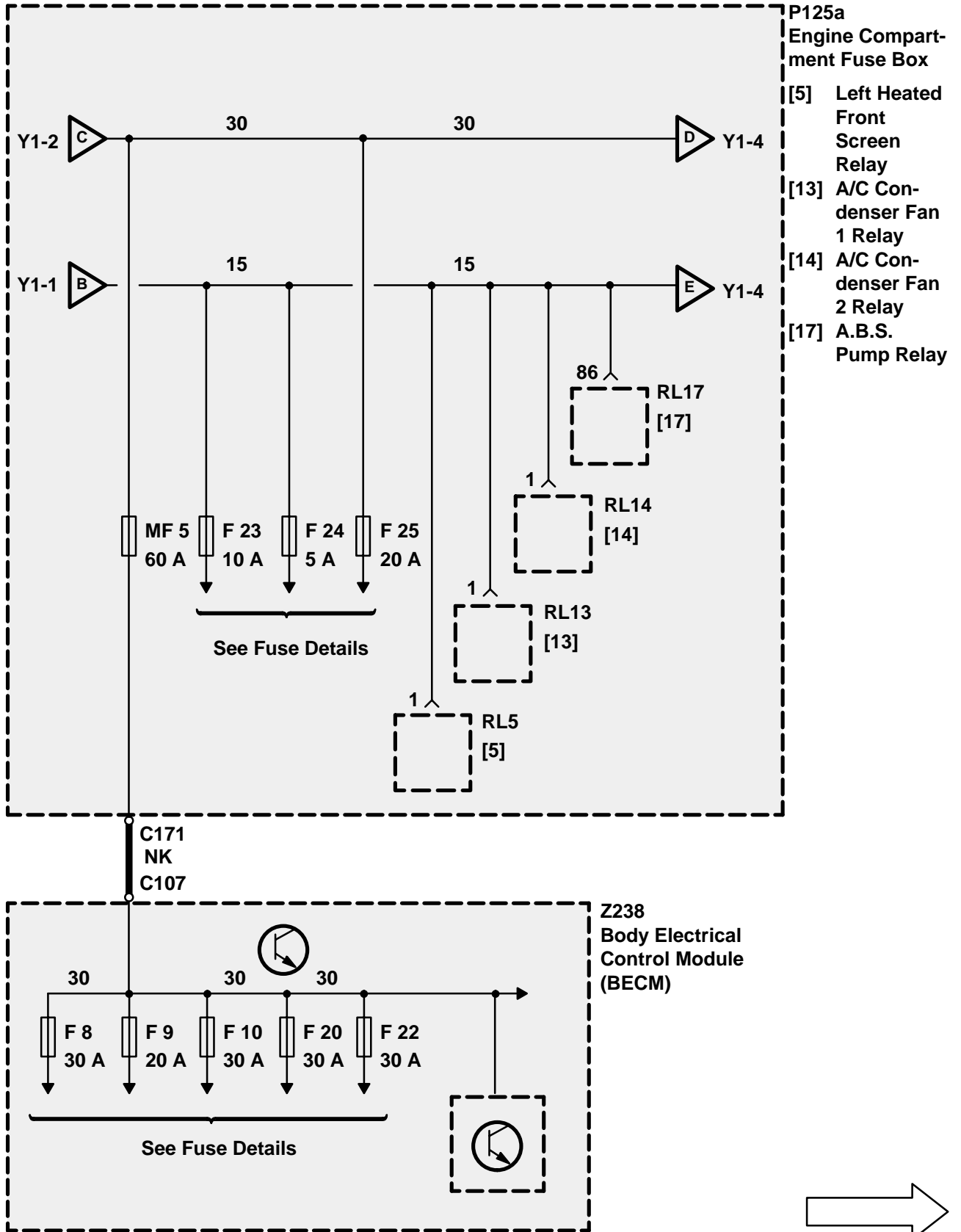
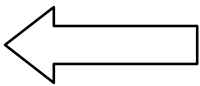

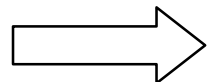
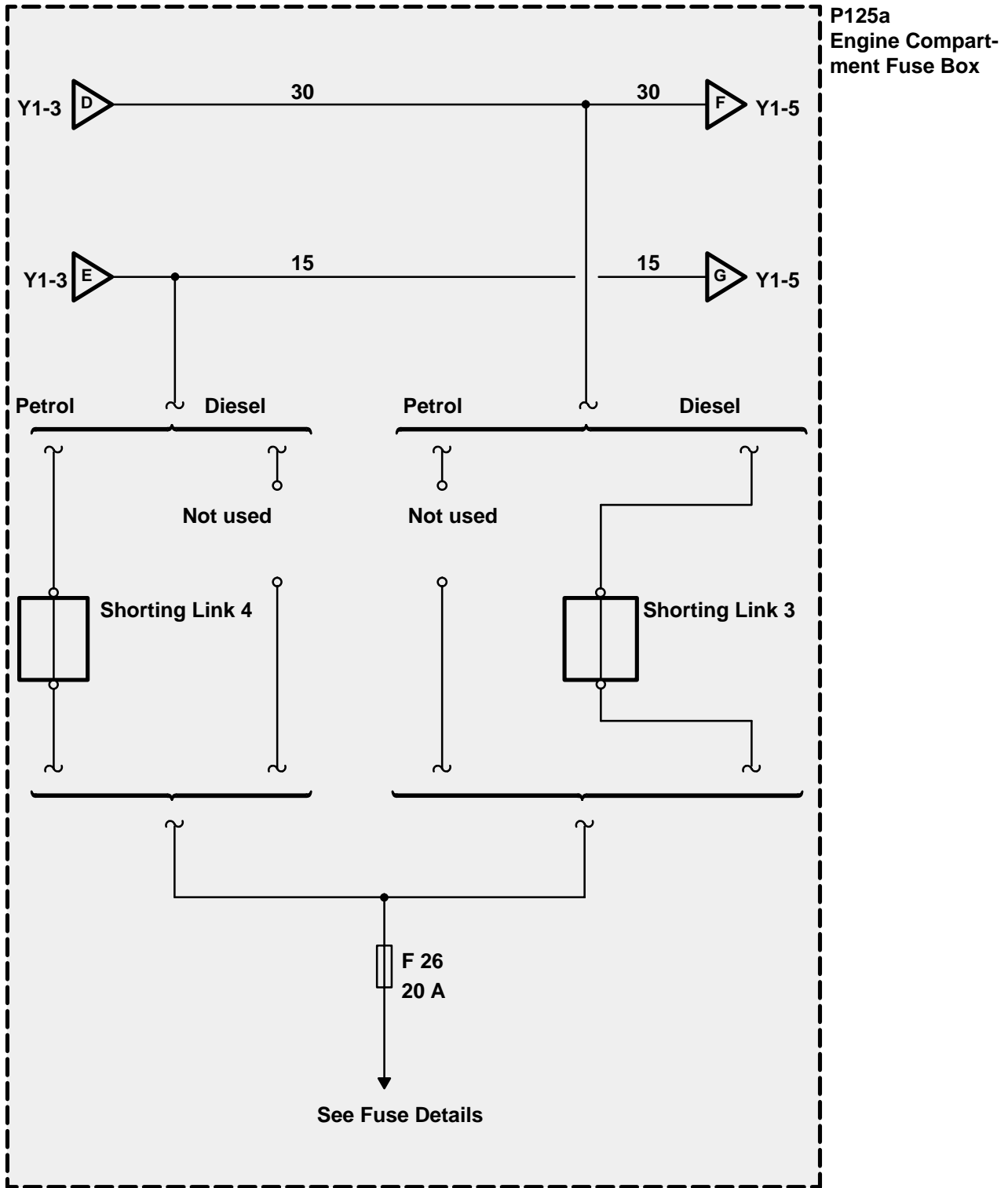
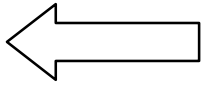

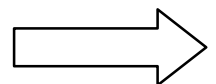
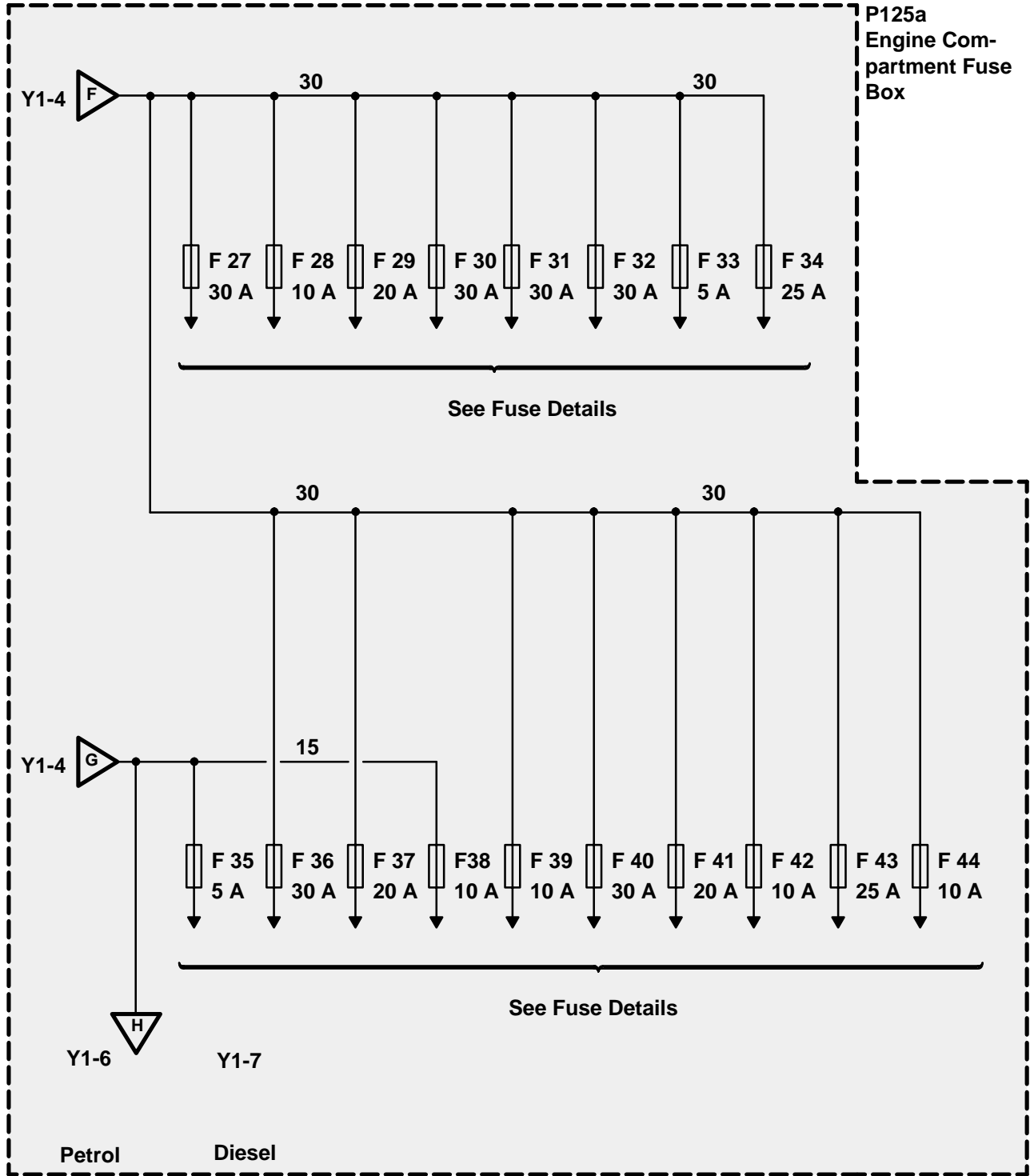
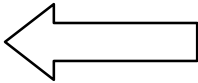

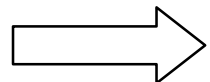
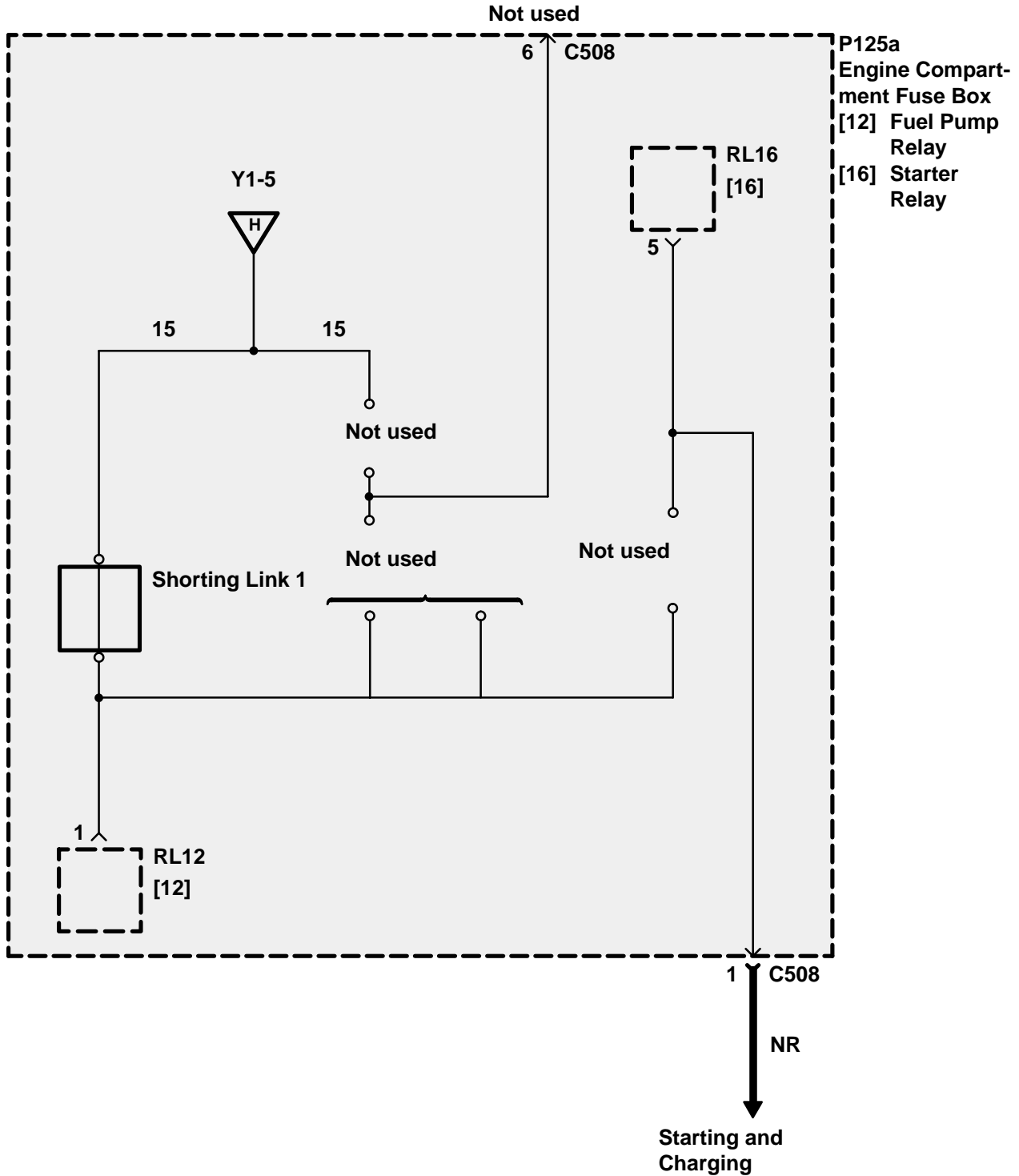
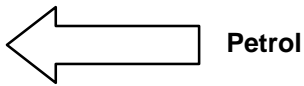

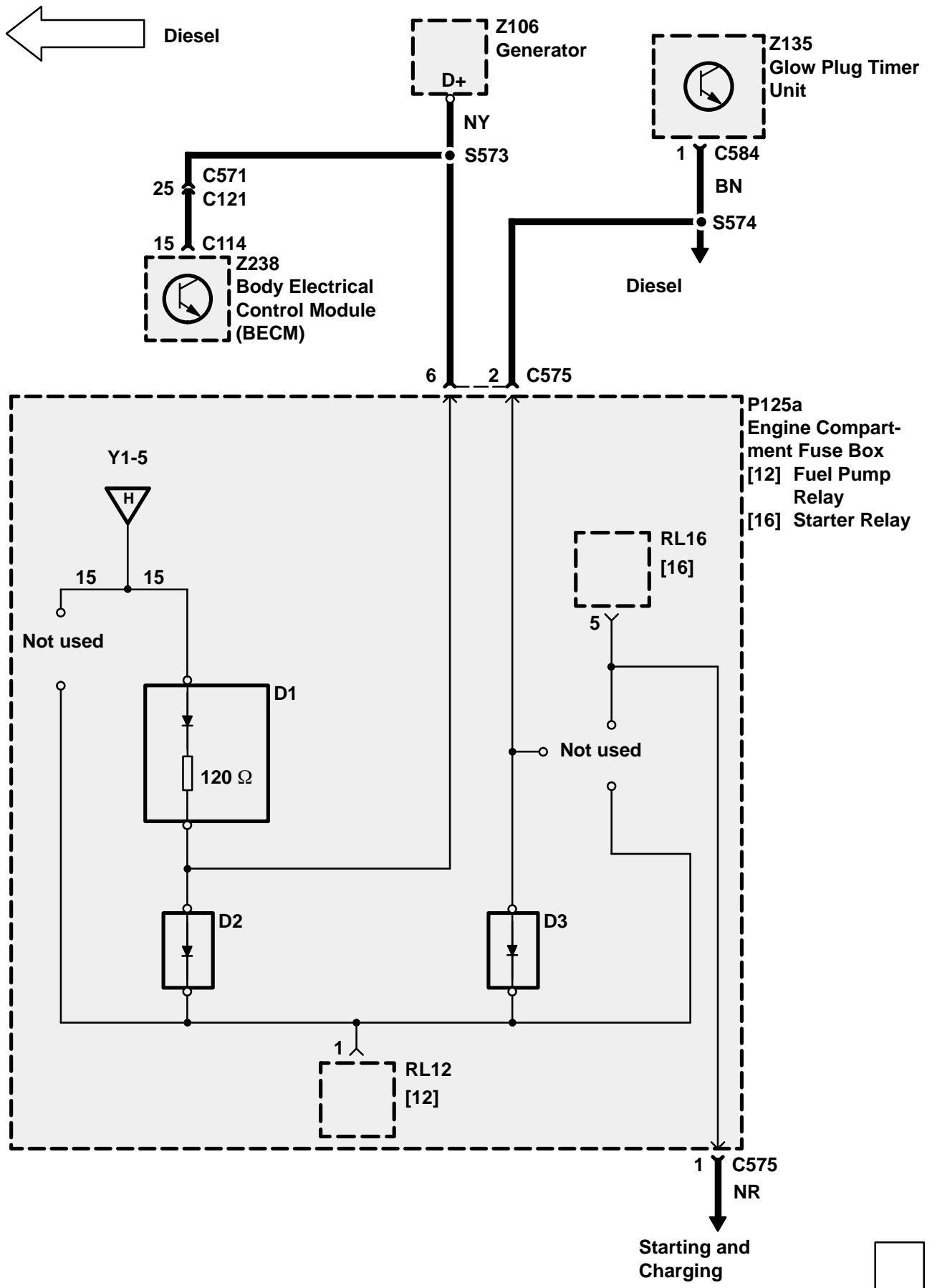

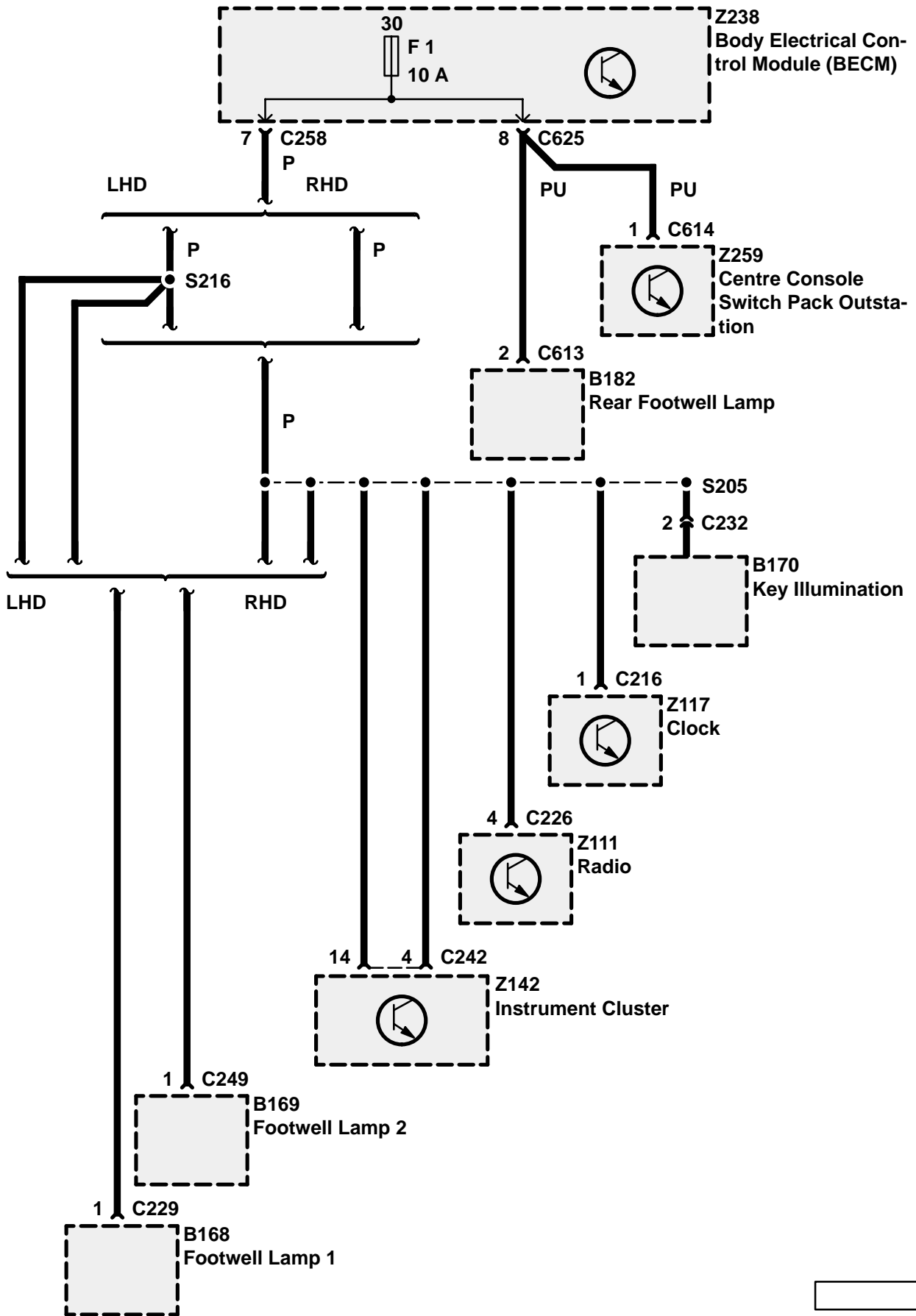

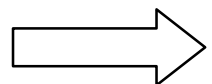
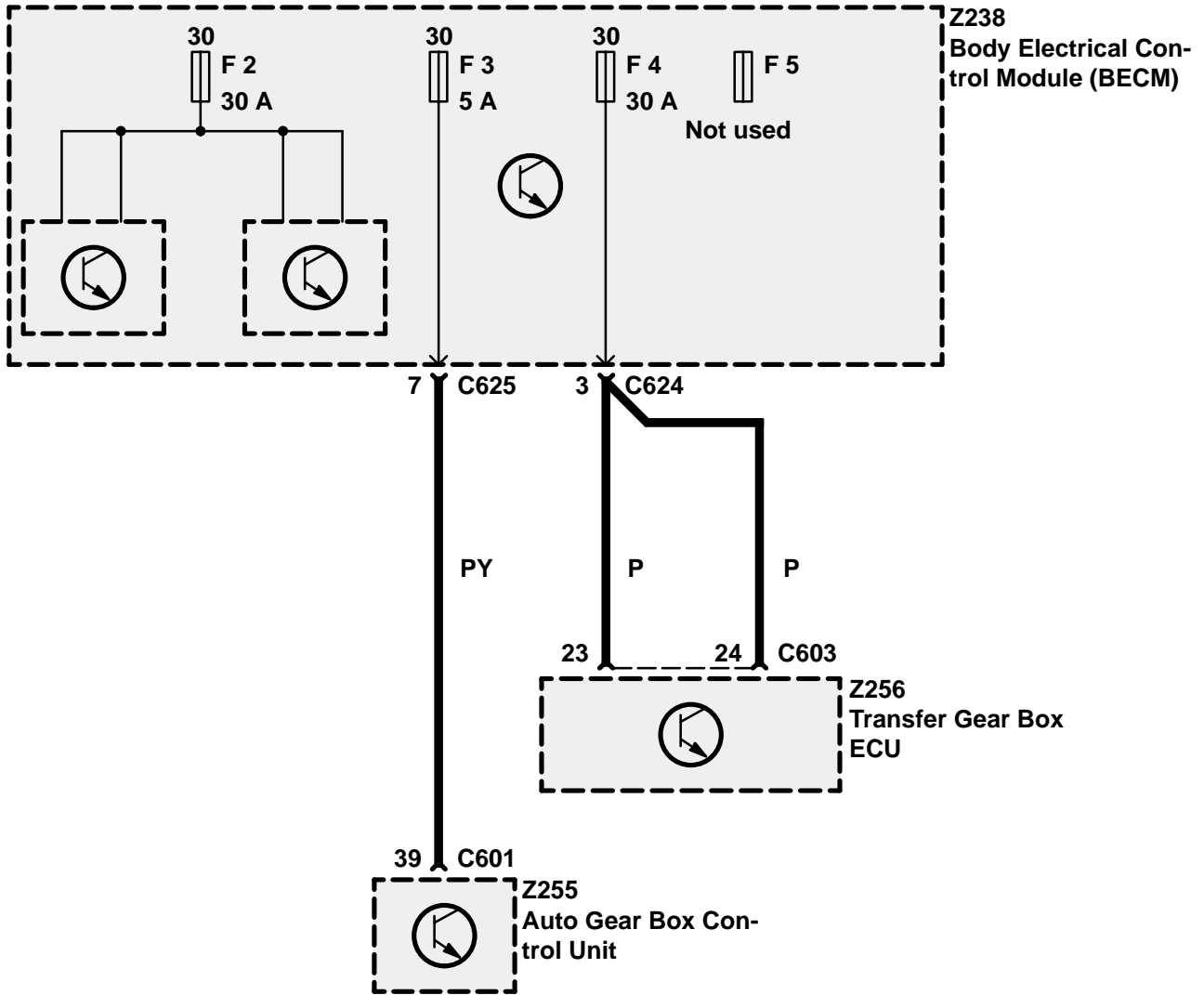
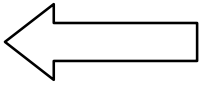

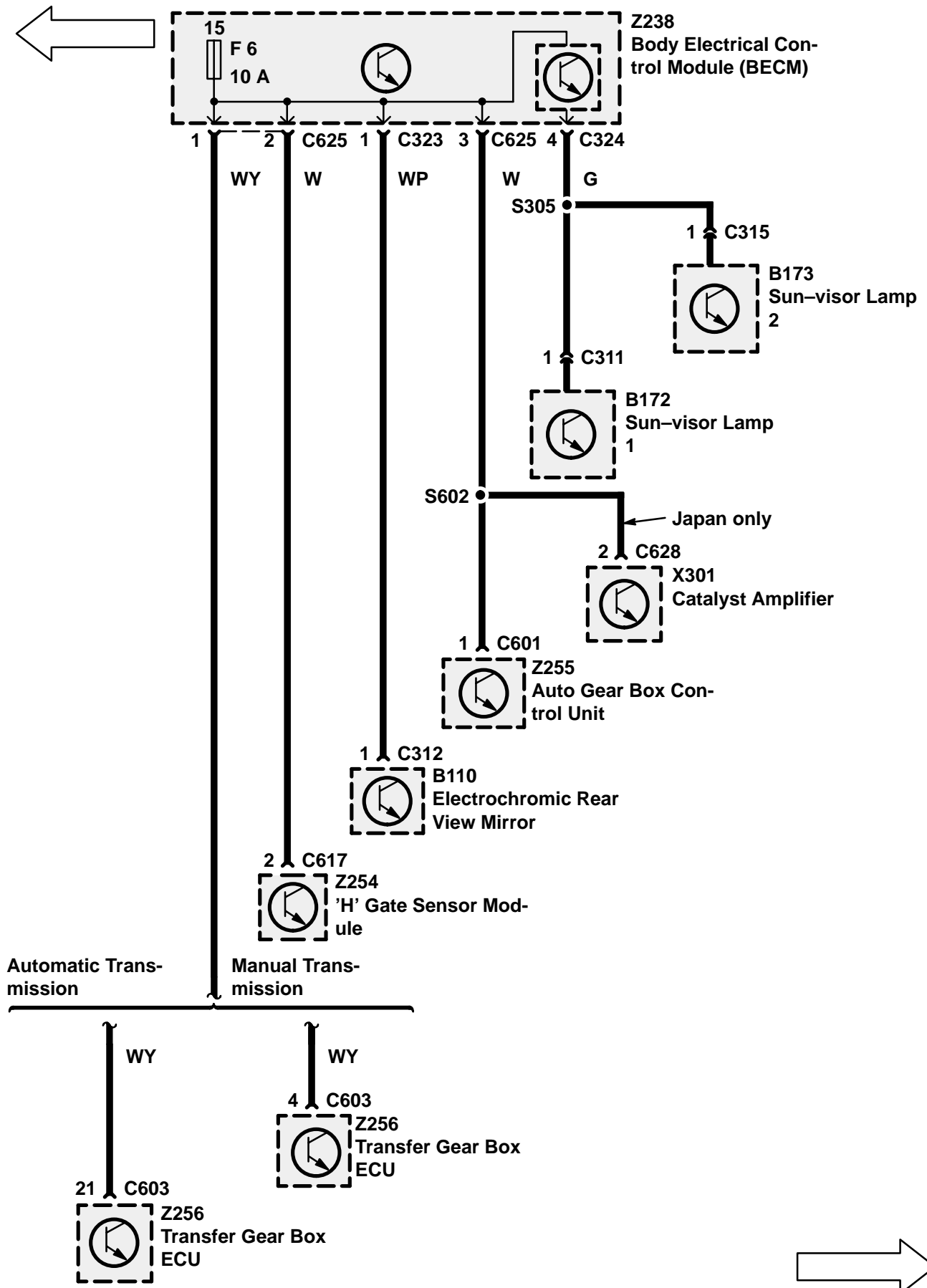

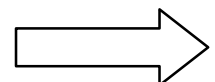
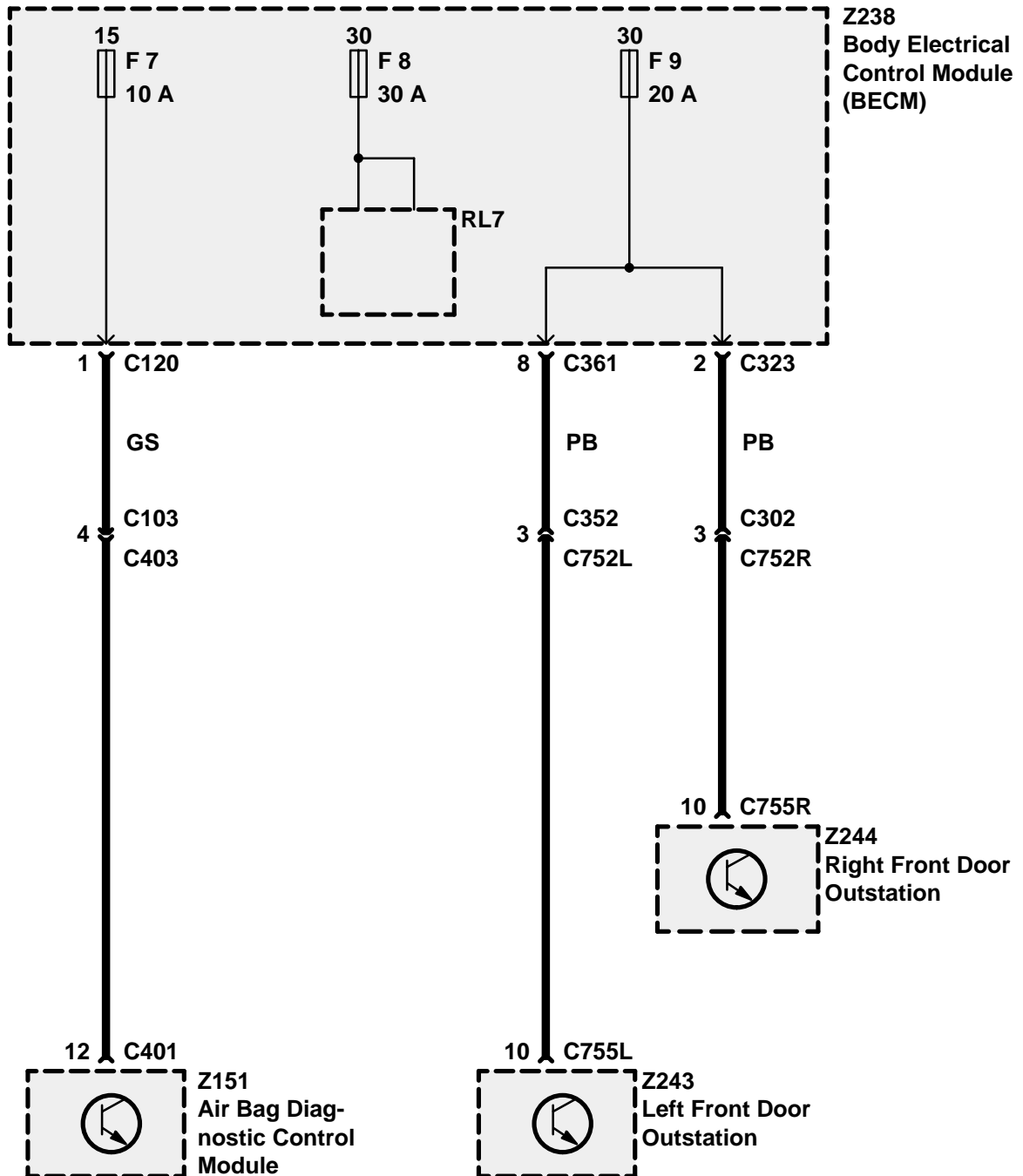
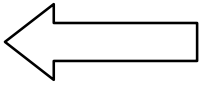

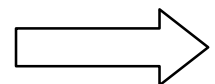
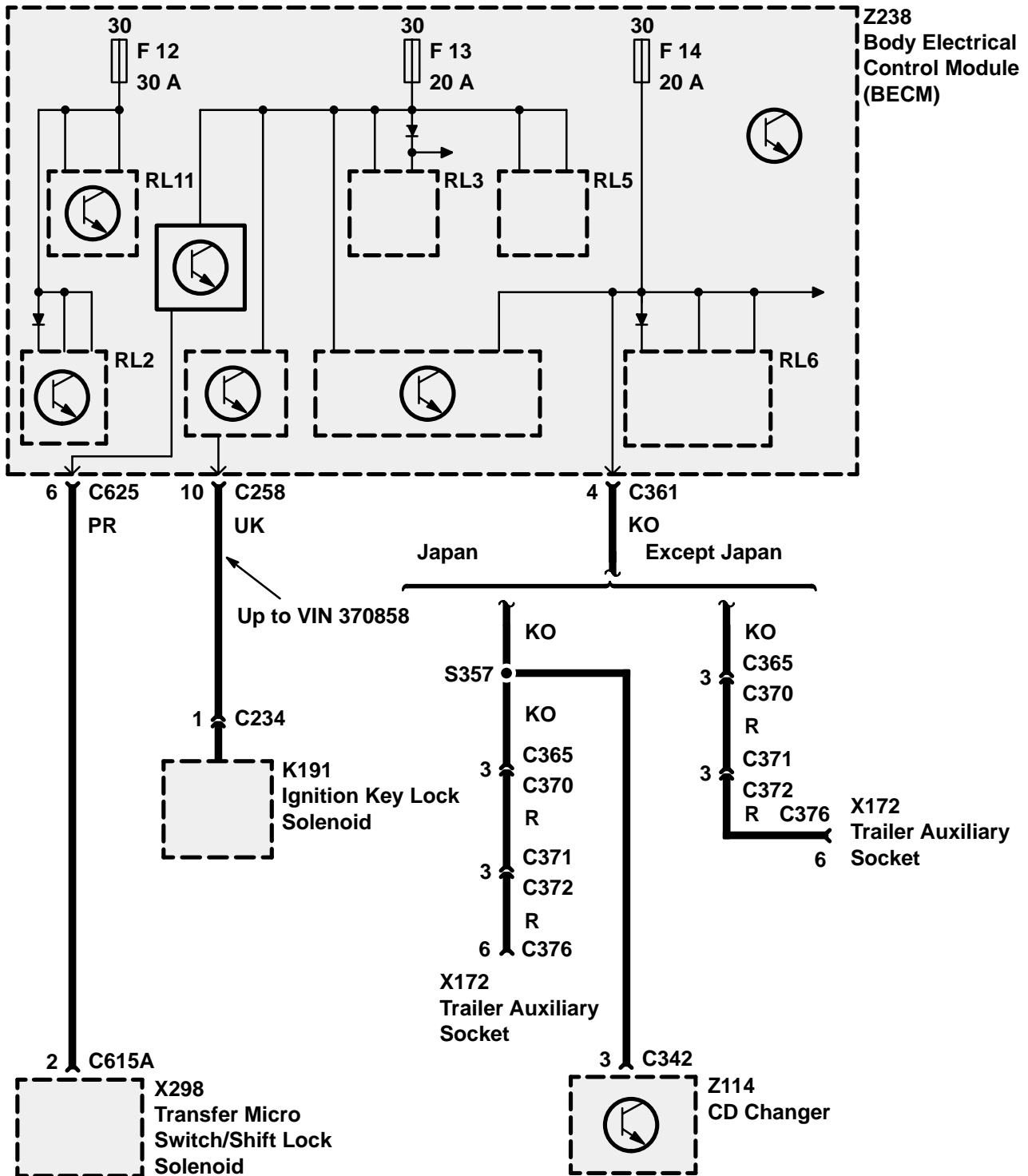
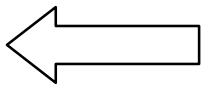

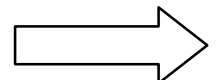
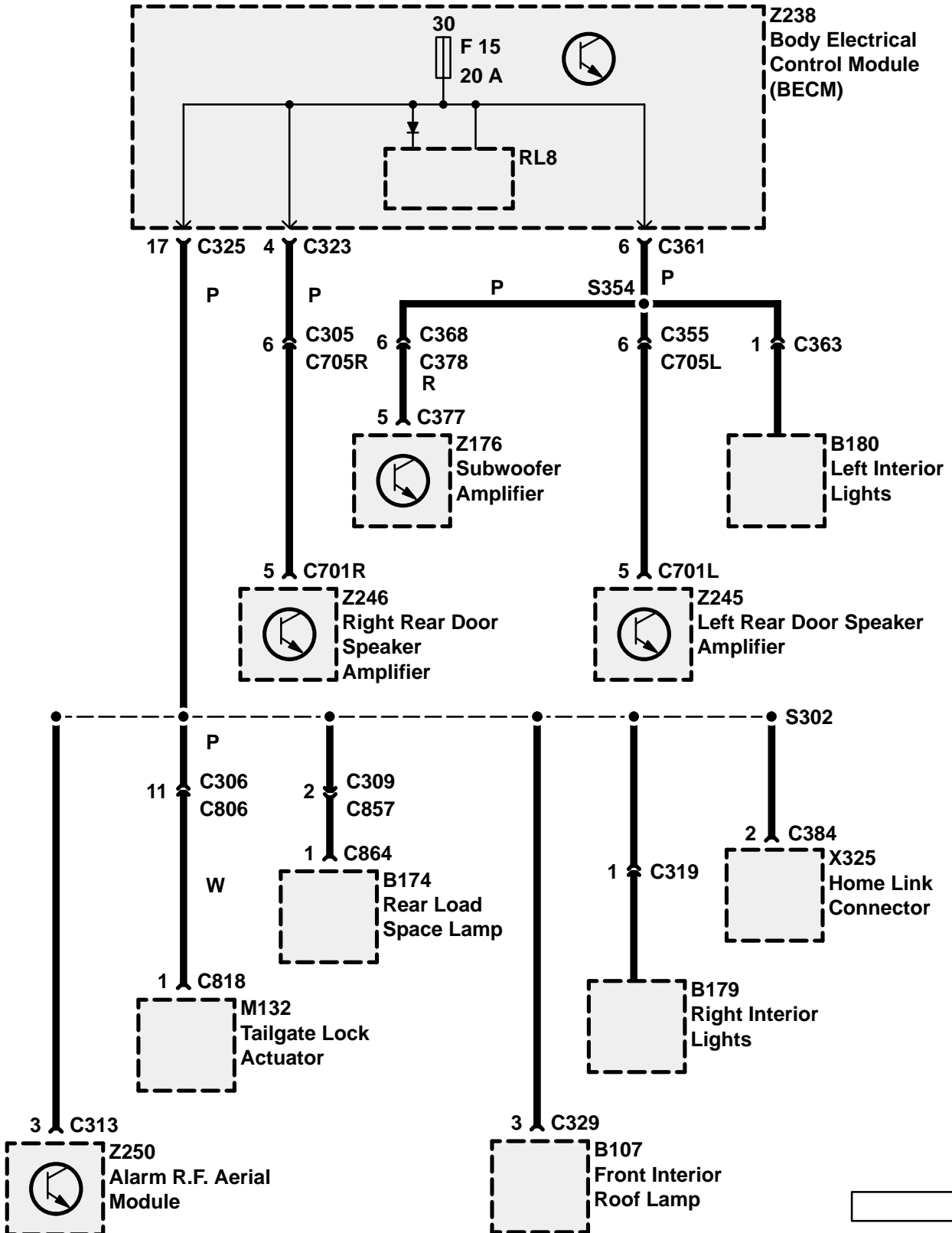
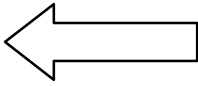

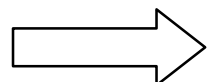
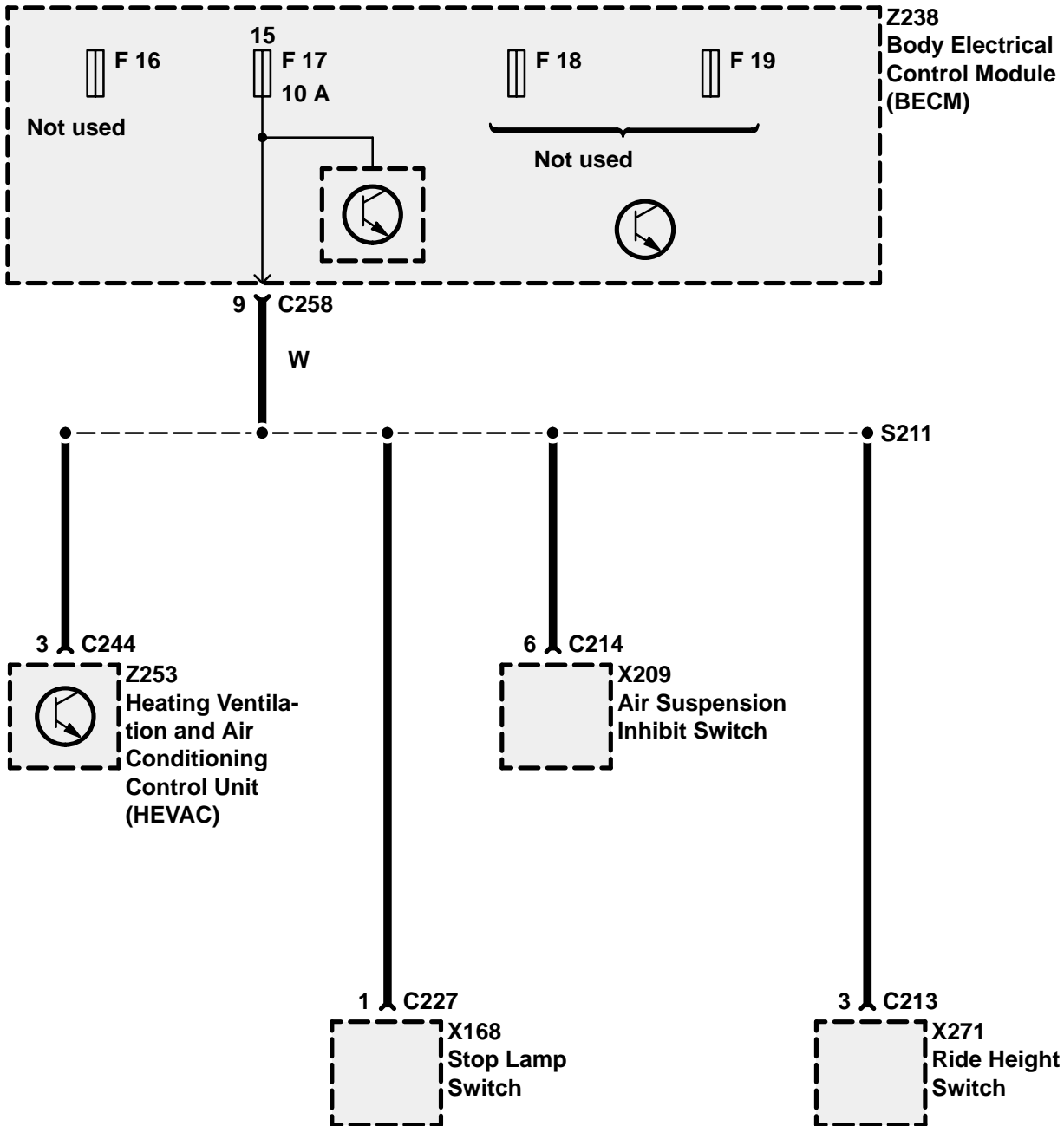
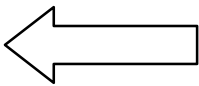

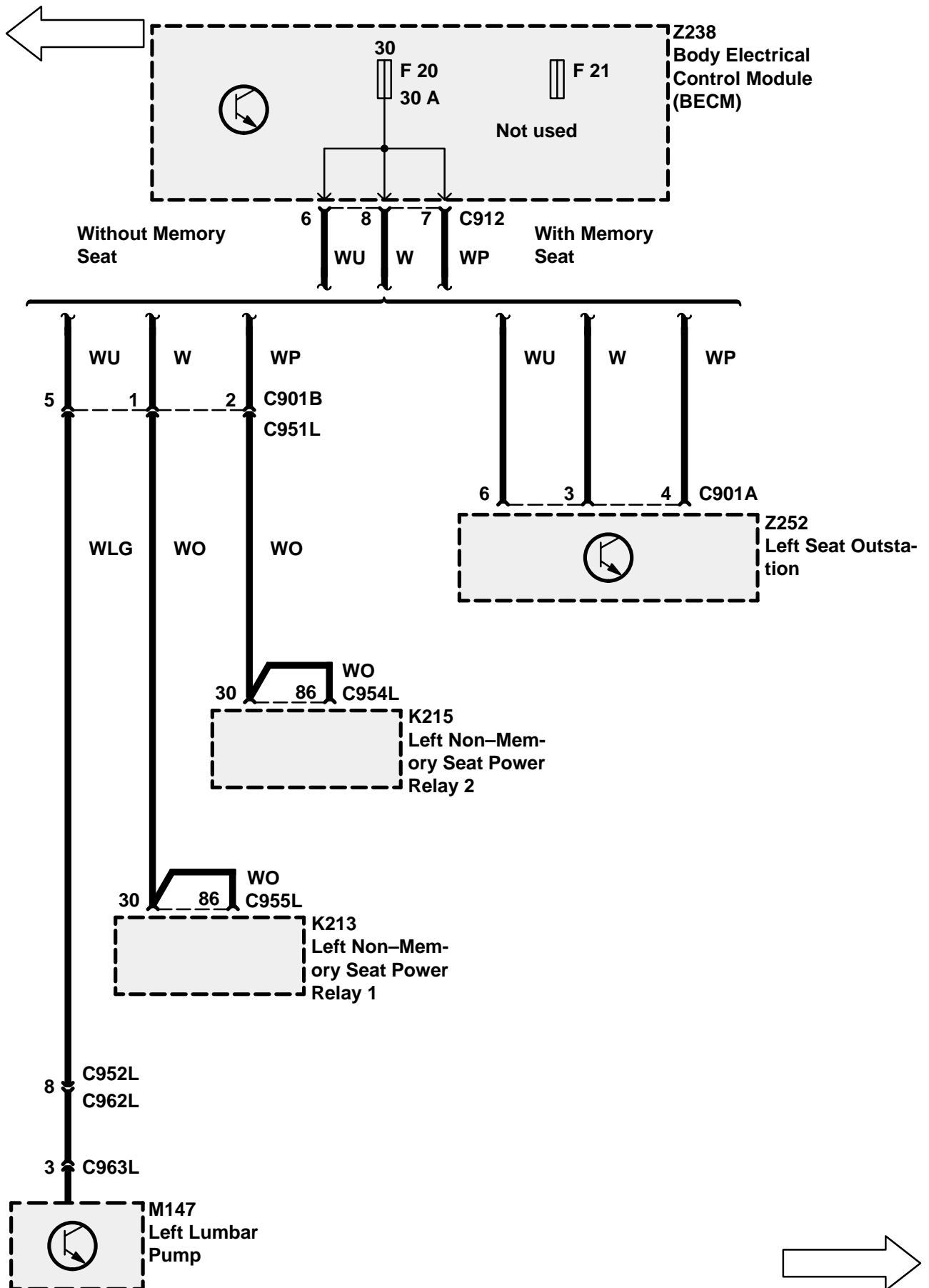

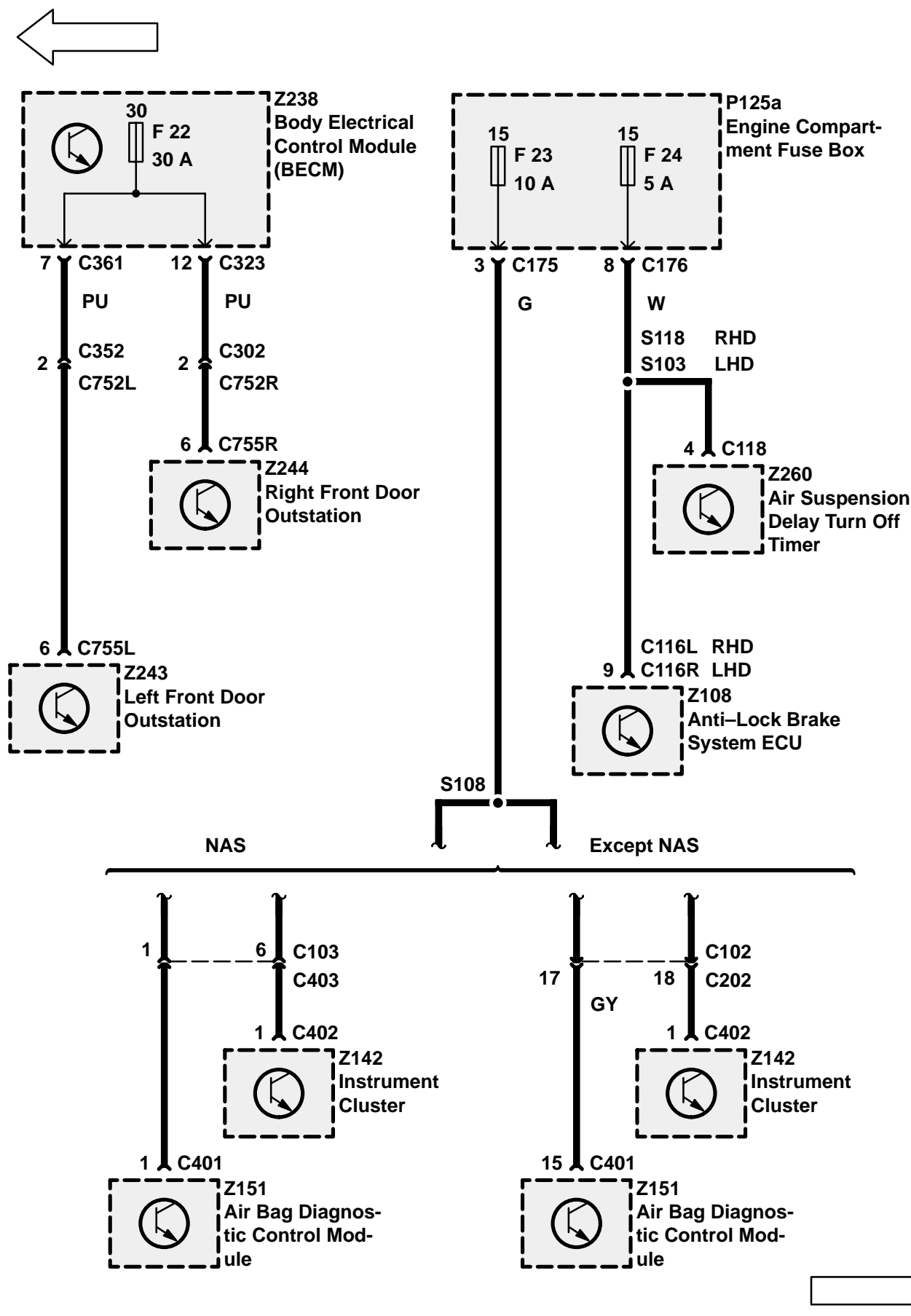

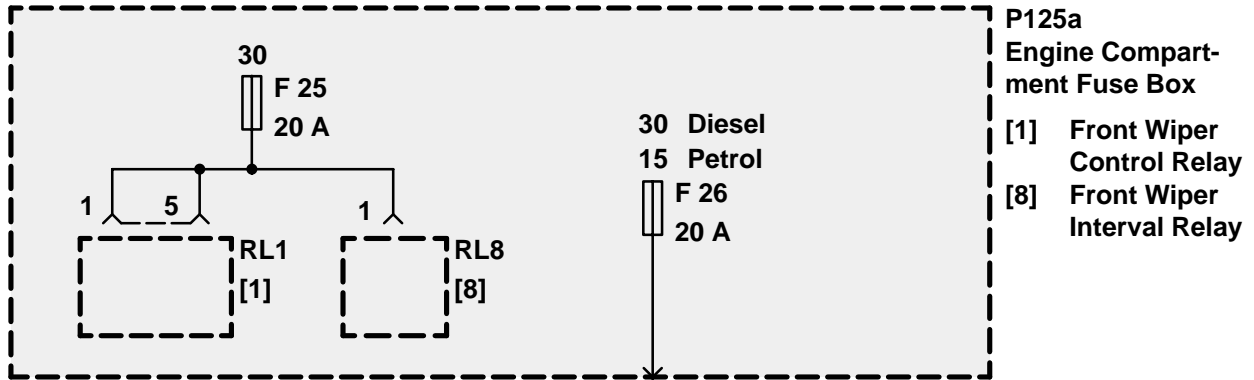
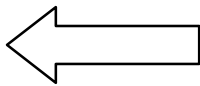

Petrol

Diesel

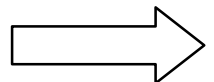
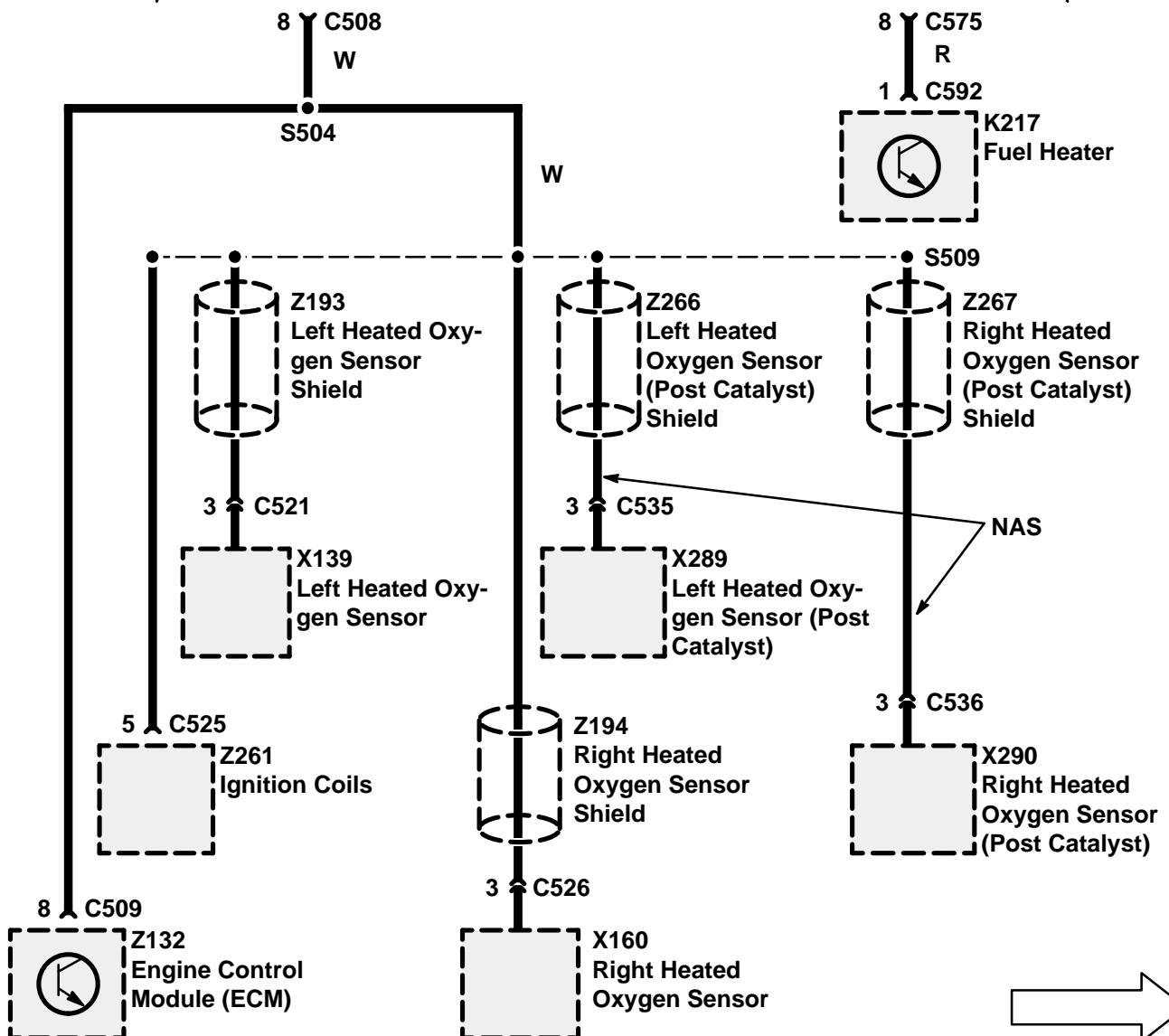

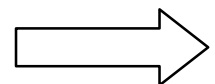
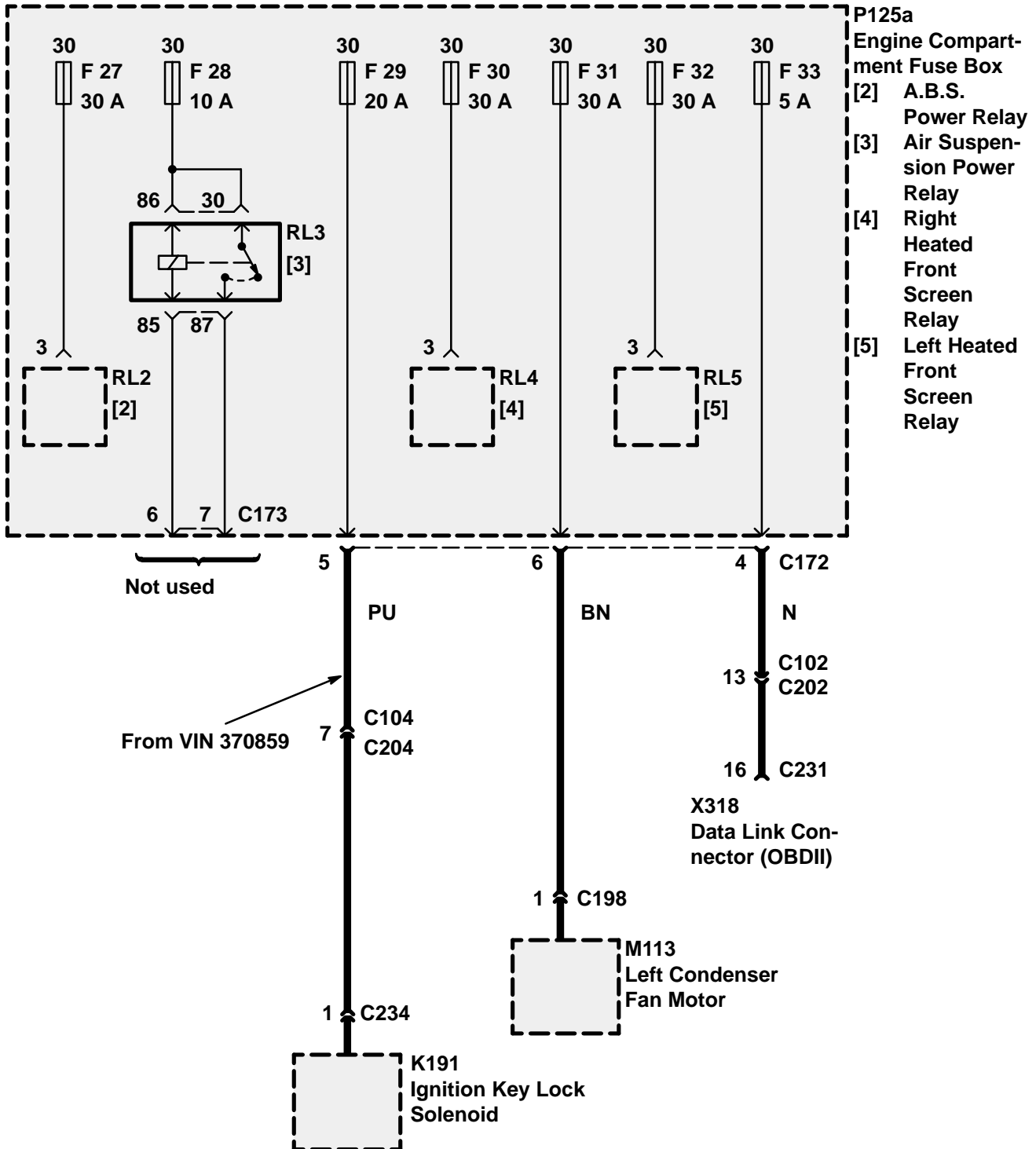
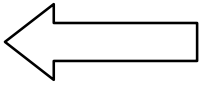

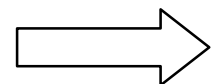
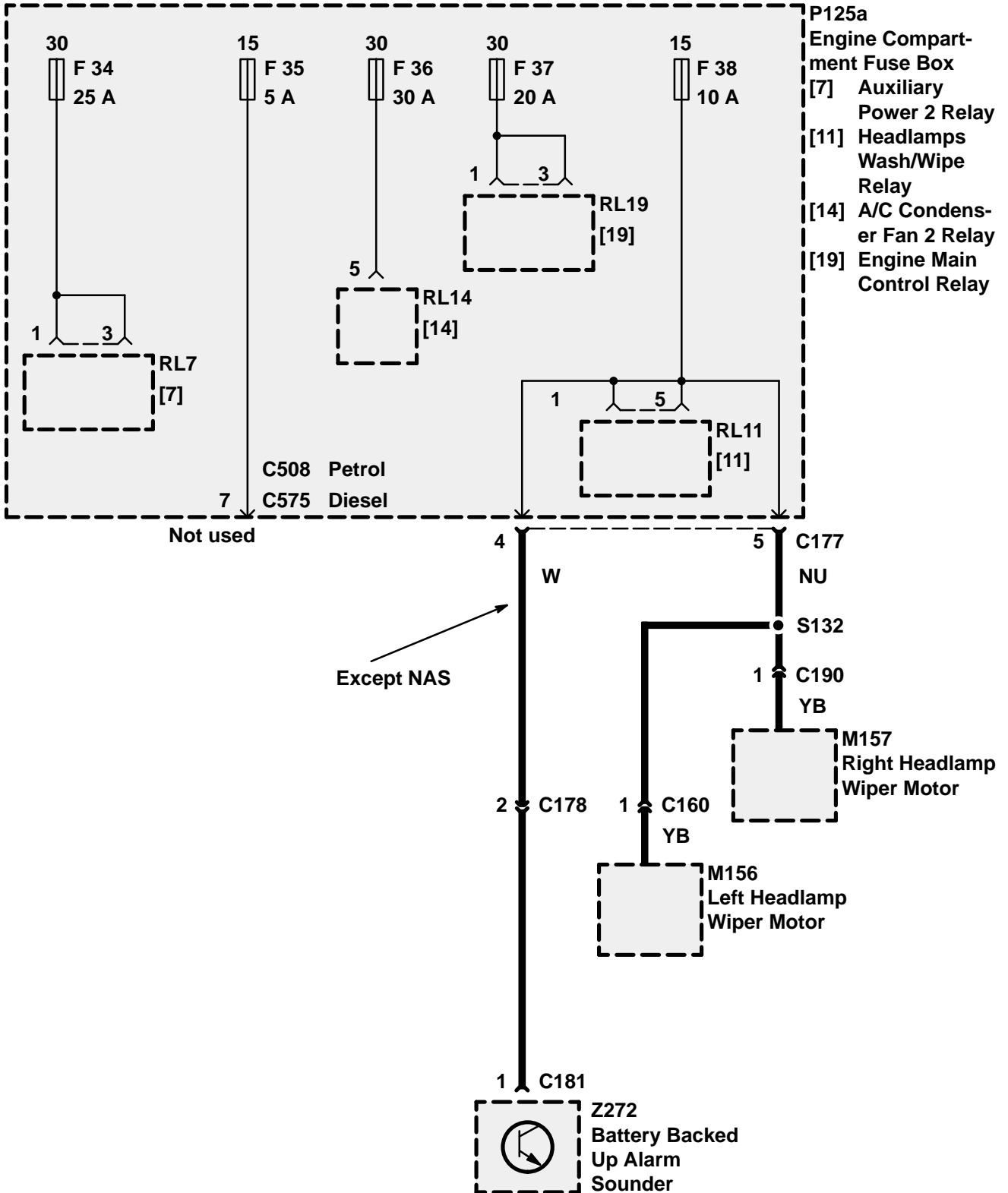
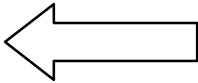

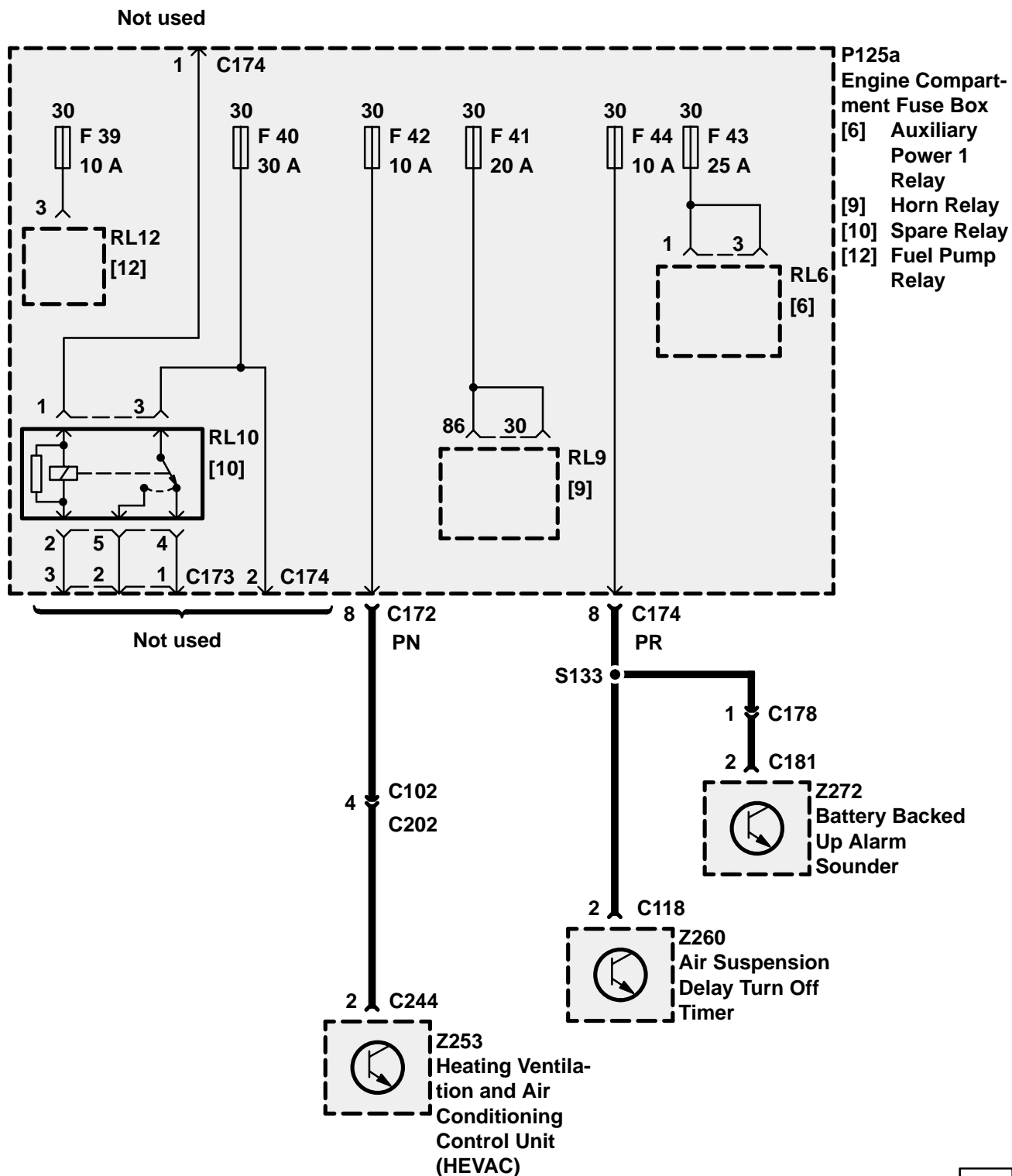
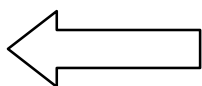

GROUND AND SPLICE INDEX

Ground	Page	Splice	Page
E100	Y5-7, 8	S351	Y5-18
E135	Y5-2	S353	Y5-18
E148	Y5-2	S355	Y5-17
E149	Y5-2	S356	Y5-17
E154	Y5-3, 4	S505	Y5-20
E167	Y5-5, 6	S506	Y5-20
E181	Y5-7, 8	S510	Y5-19
E182	Y5-4	S551 (Diesel)	Y5-21
E252	Y5-9, 10, 11	S551 (Petrol)	Y5-20
E253	Y5-12	S552	Y5-23
E254	Y5-12	S571	Y5-21
E322	Y5-13, 14	S601	Y5-22
E328	Y5-15, 16	S607	Y5-22, 23
E367	Y5-17, 18	S611	Y5-22
E412	Y5-18	S701L	Y5-18
E500	Y5-7, 8	S701R	Y5-16
E529	Y5-19, 20	S851	Y5-14
E574	Y5-21	S852	Y5-14
E621	Y5-22, 23	S901	Y5-24
E908	Y5-24		
E909	Y5-24		
Splice	Page		
S101	Y5-3		
S110	Y5-4		
S111	Y5-7, 8		
S113	Y5-2		
S114	Y5-6		
S115	Y5-6		
S122	Y5-8		
S207	Y5-11, 12		
S208	Y5-10, 11		
S215	Y5-9		
S301	Y5-13		
S304	Y5-15		
S306	Y5-15		
S307	Y5-16		

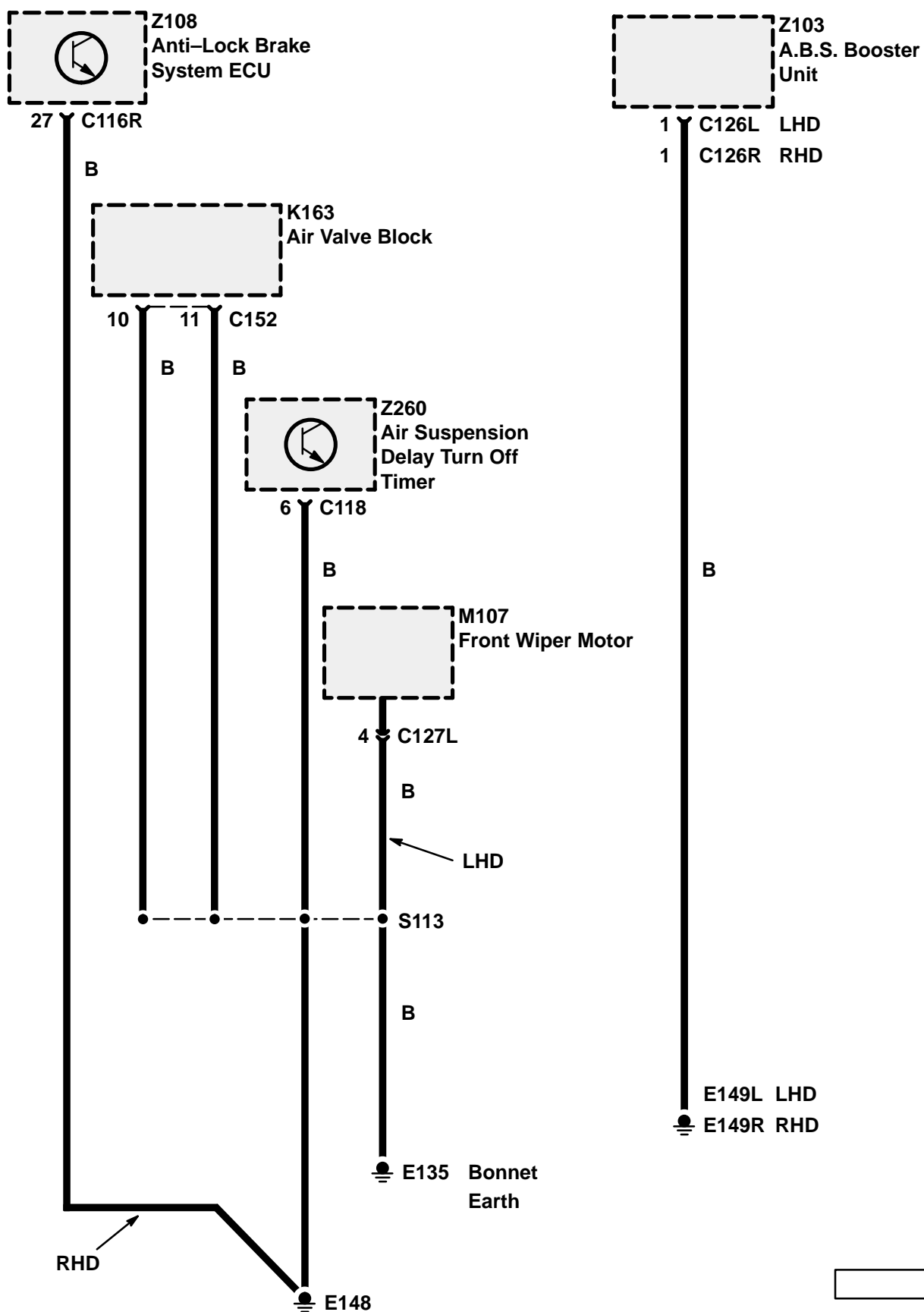

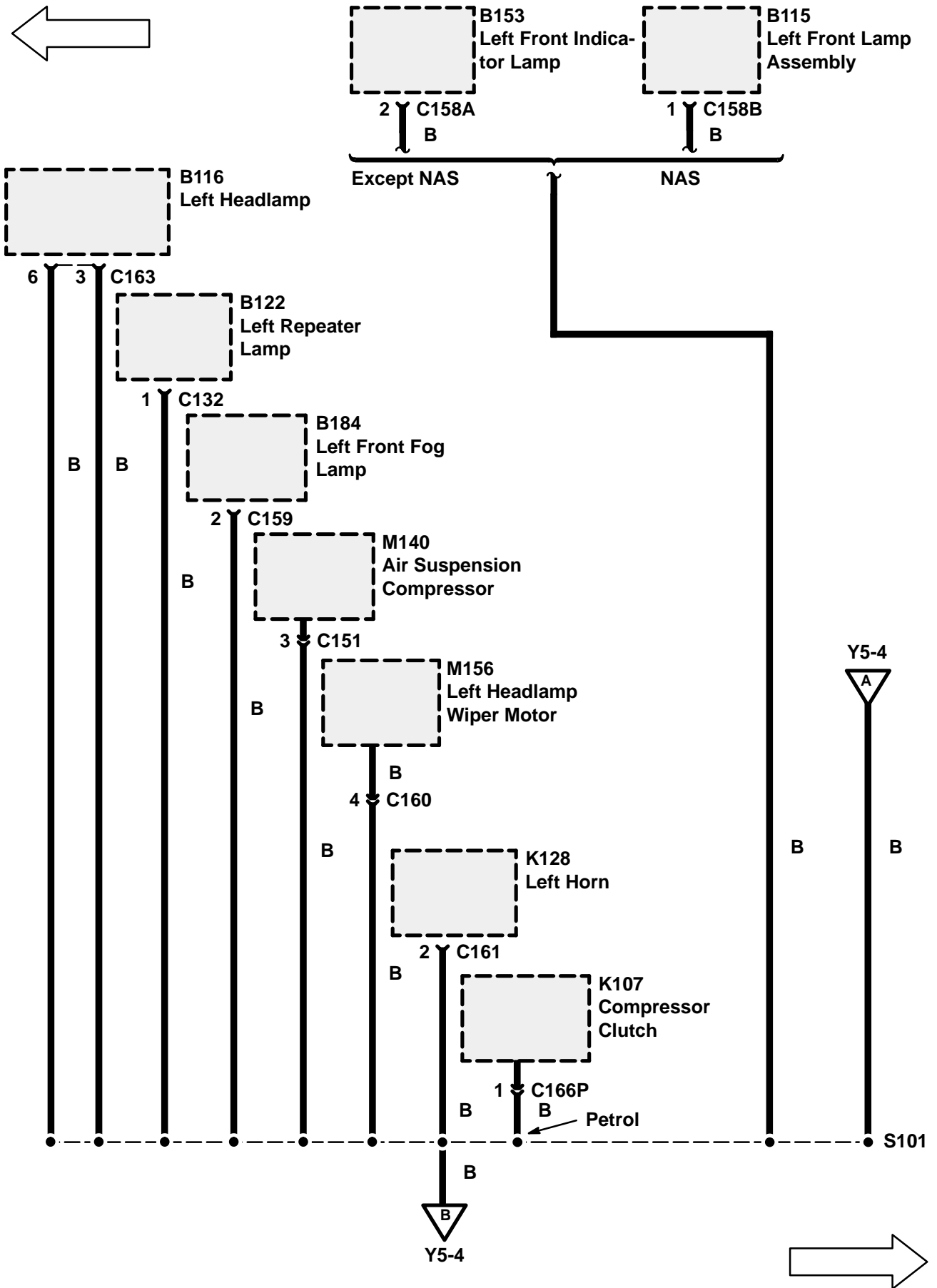

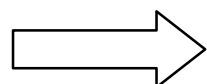
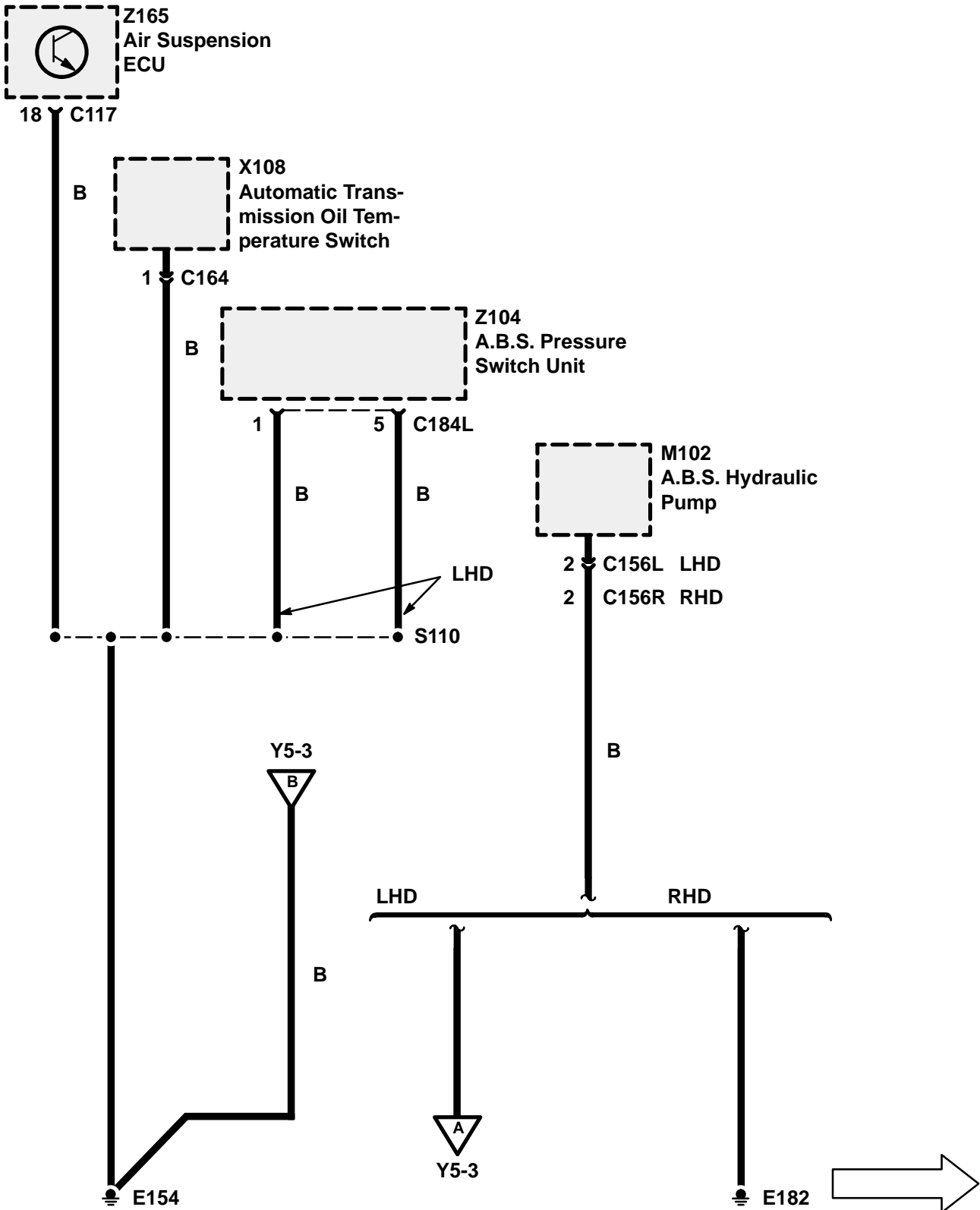
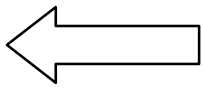

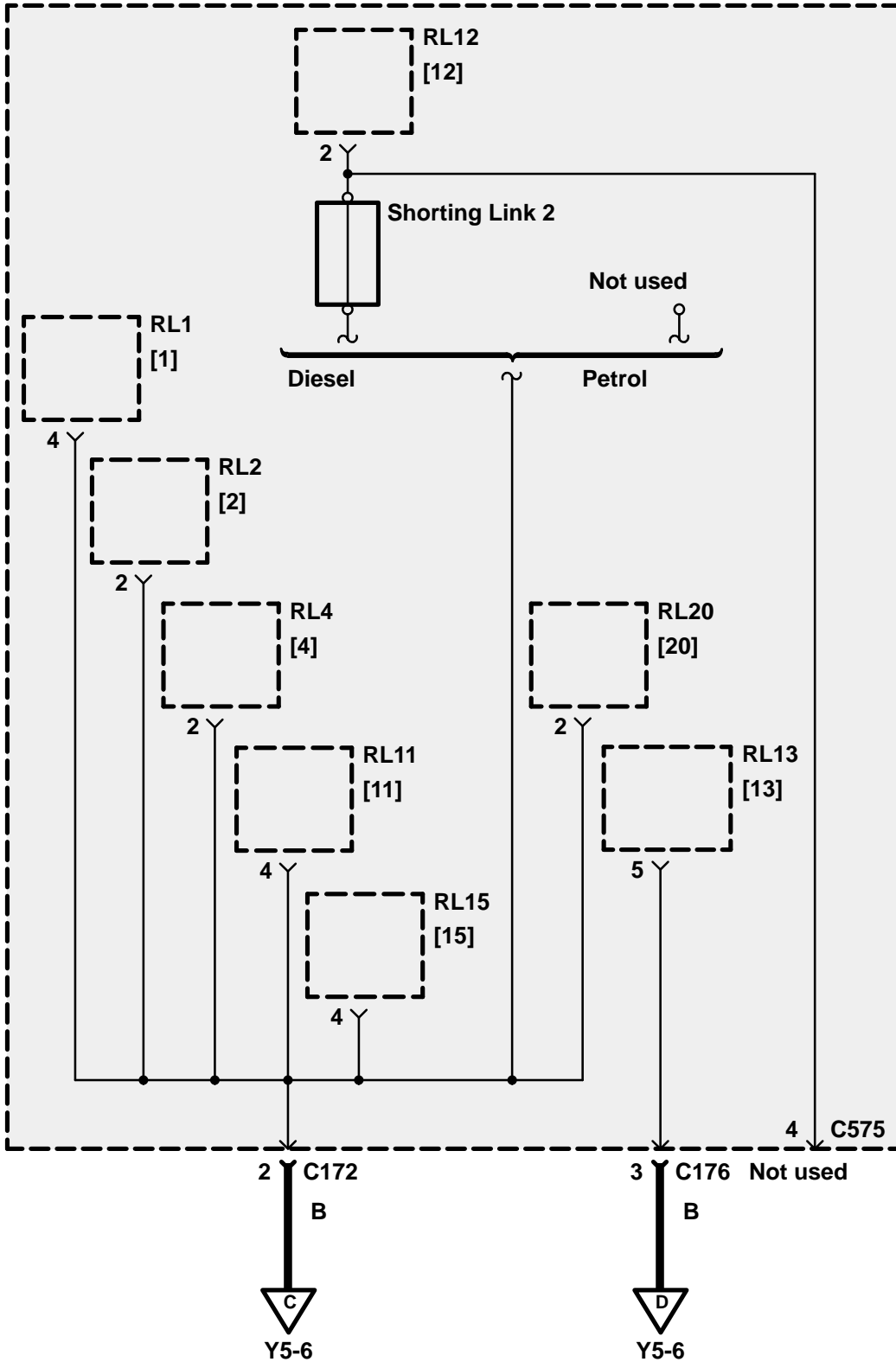
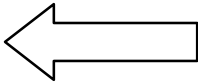

- P125a**
Engine Compartment Fuse Box
- [1] Front Wiper Control Relay
 - [2] A.B.S. Power Relay
 - [4] Right Heated Front Screen Relay
 - [11] Headlamps Wash/Wipe Relay
 - [12] Fuel Pump Relay
 - [13] A/C Condenser Fan 1 Relay
 - [15] Ignition Relay
 - [20] Air Suspension Compressor Relay

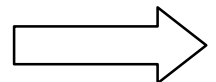

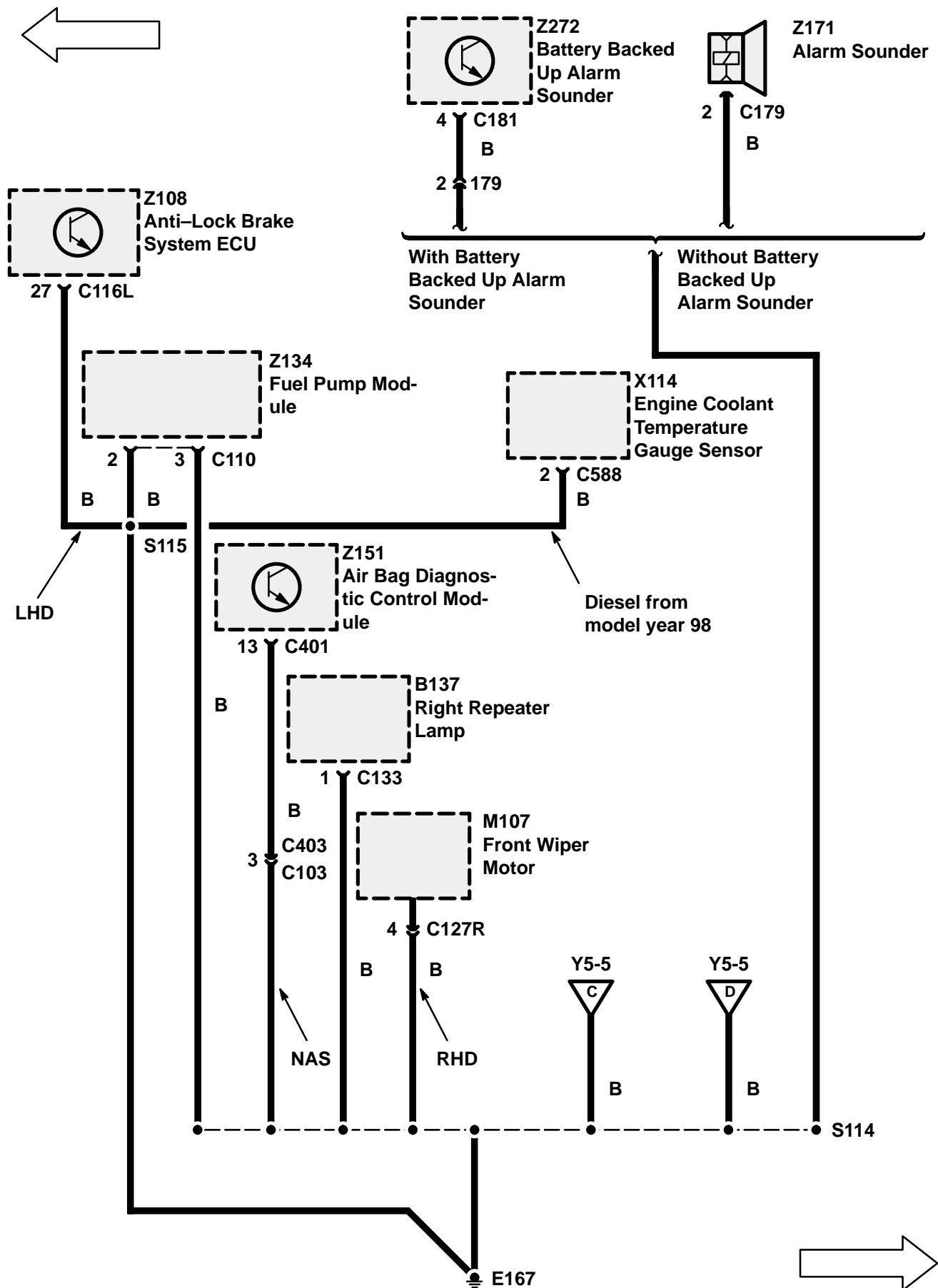

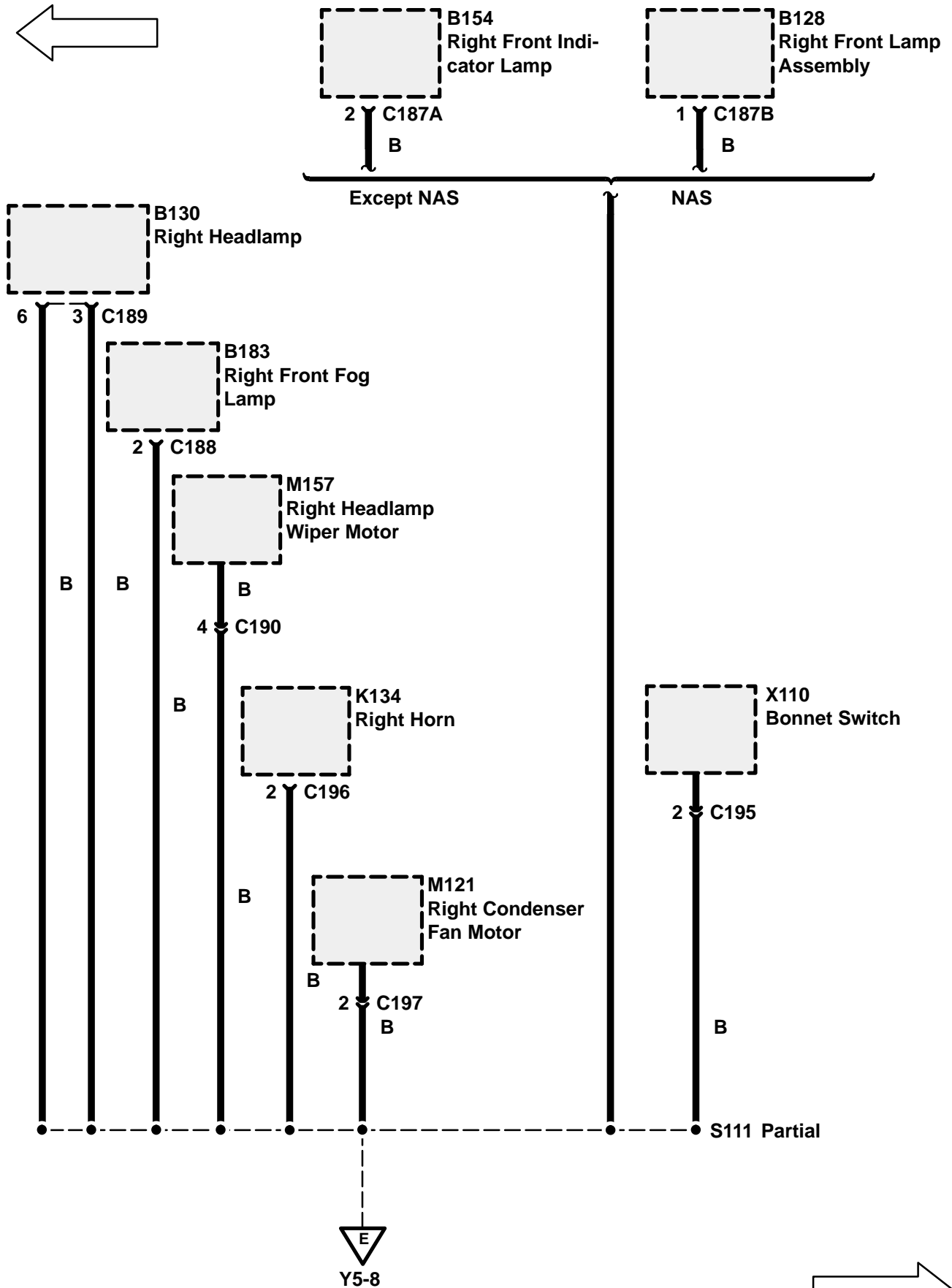
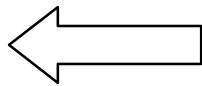

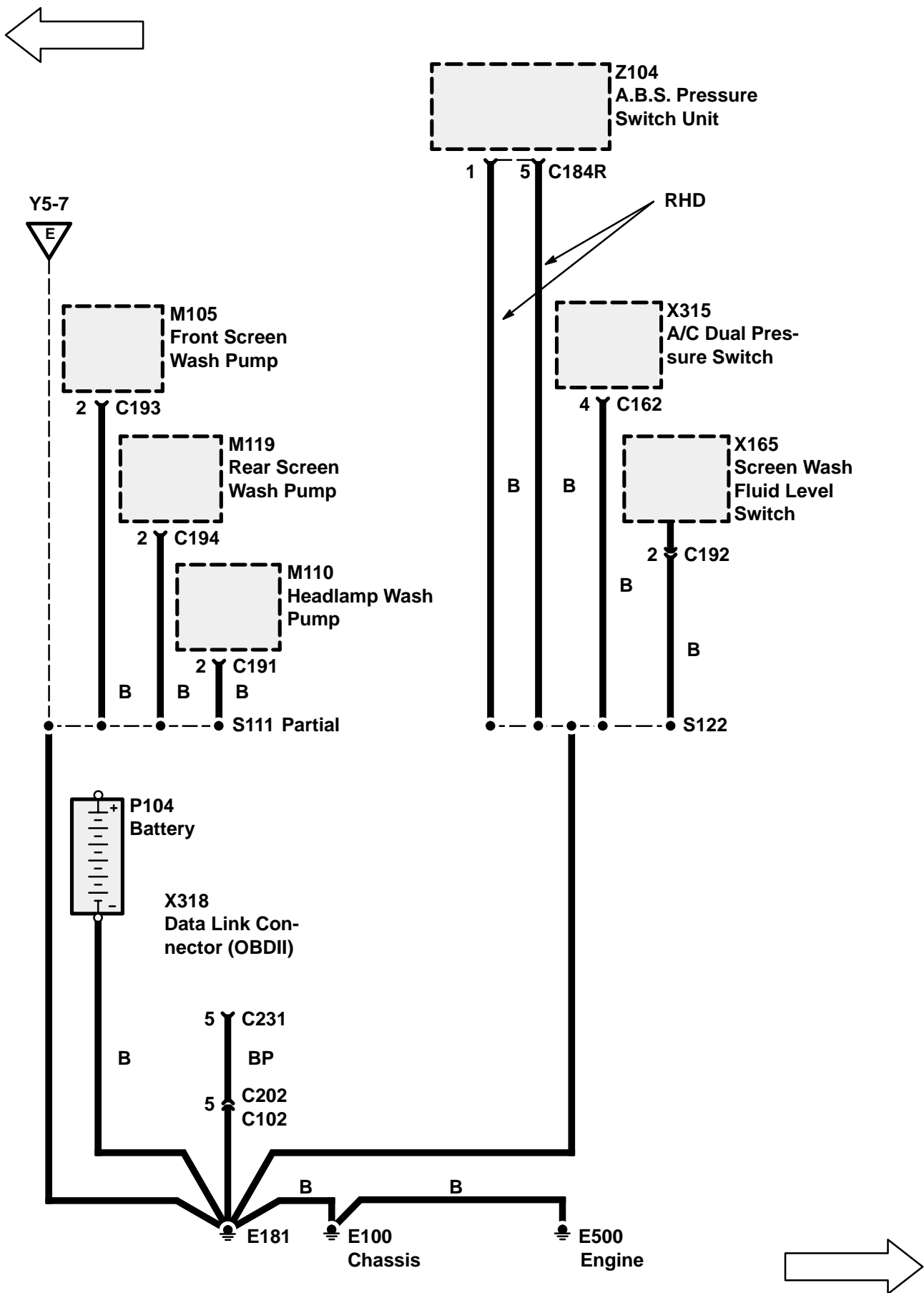

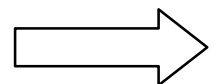
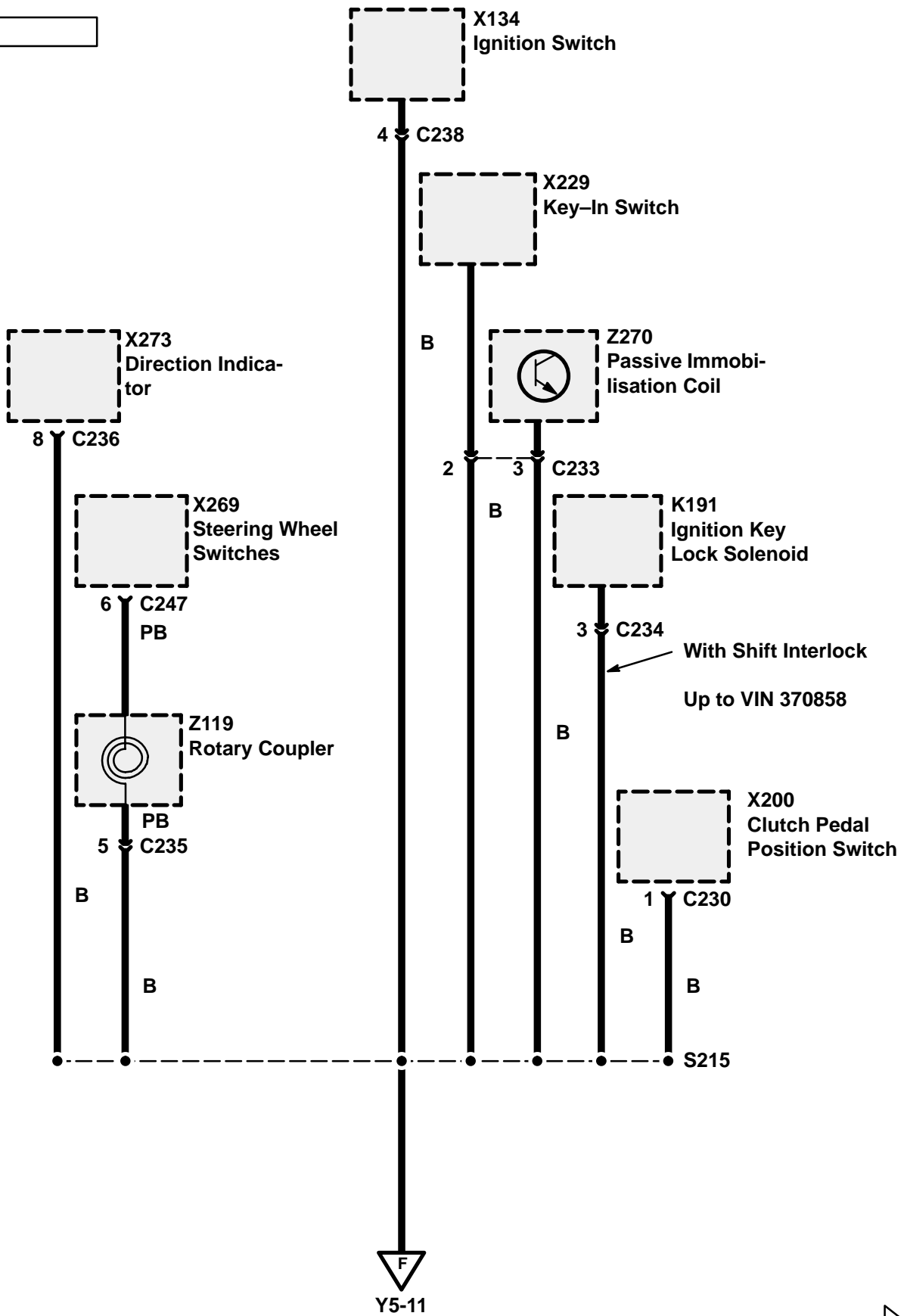
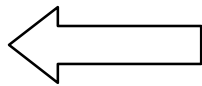

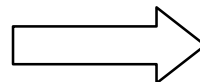
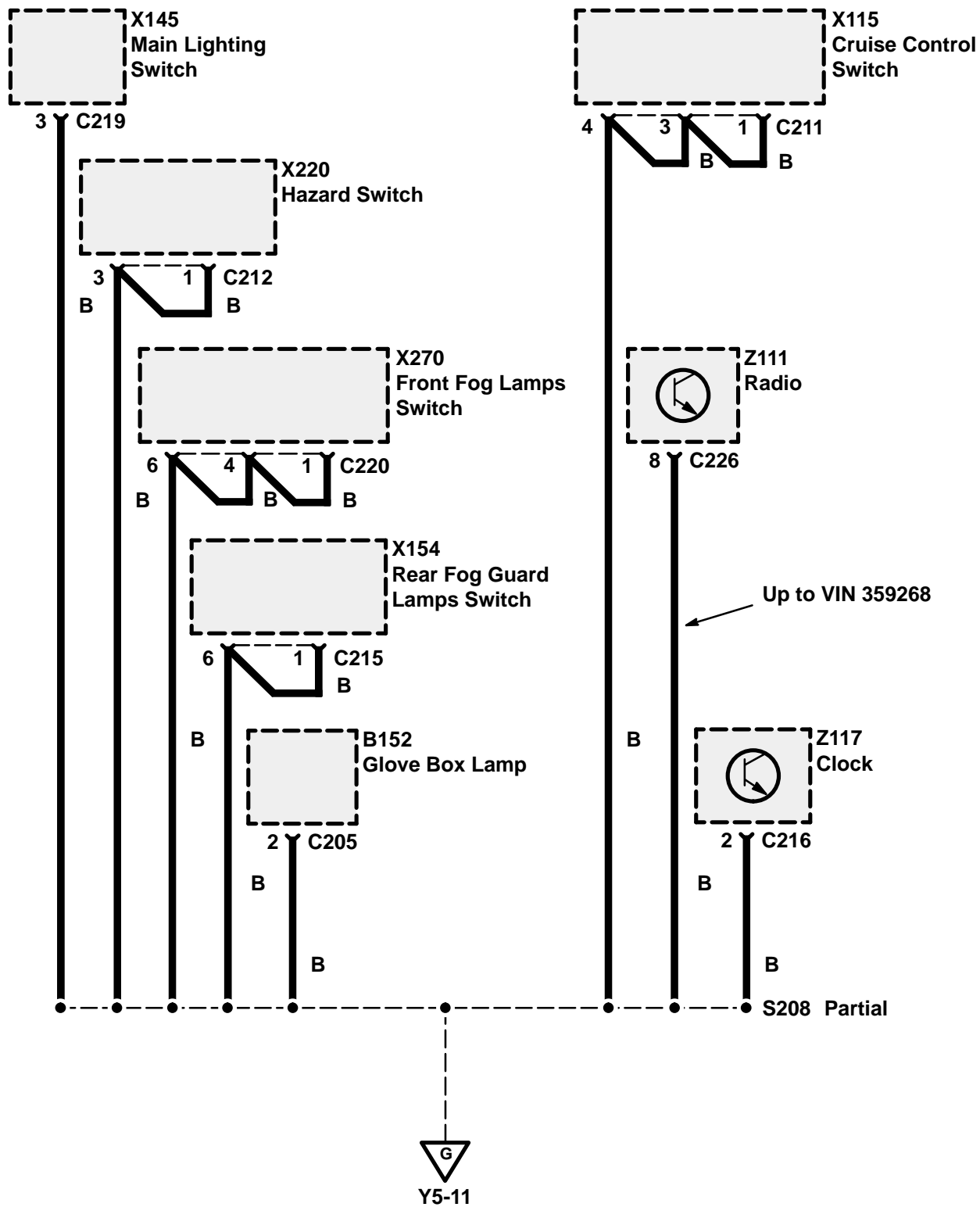
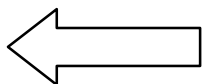

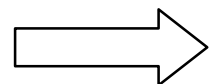
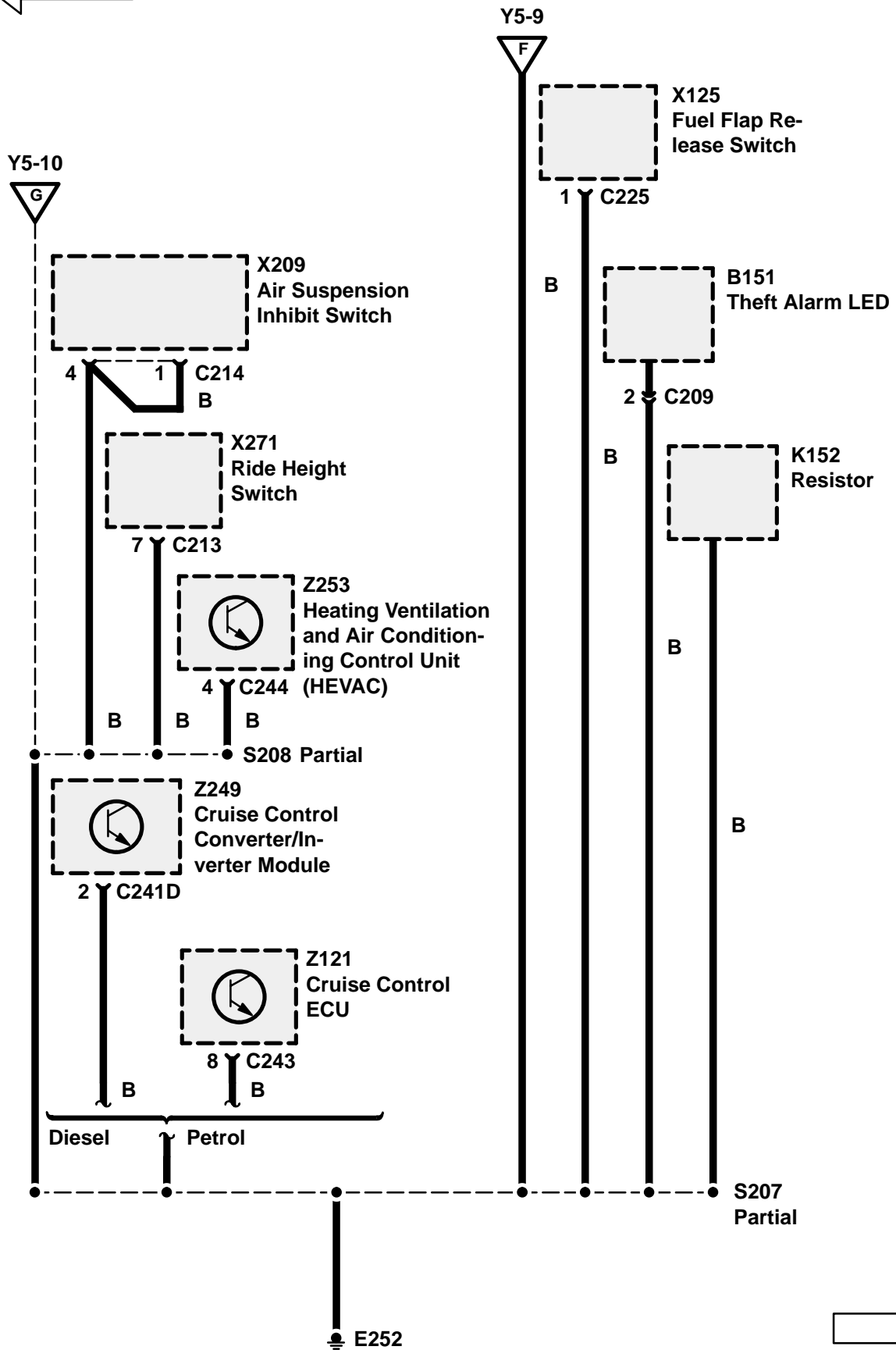
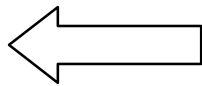

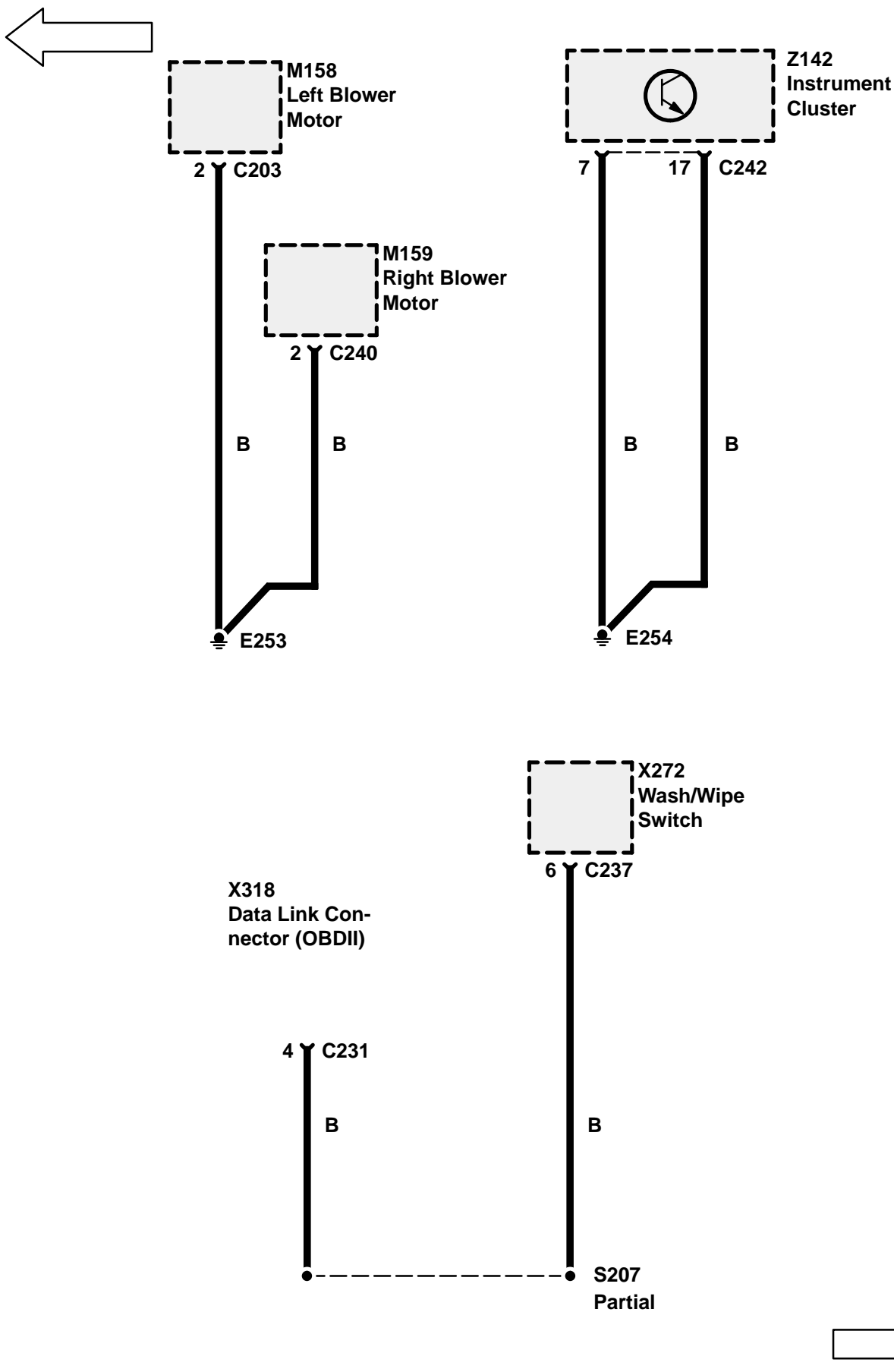

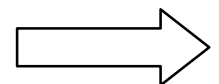
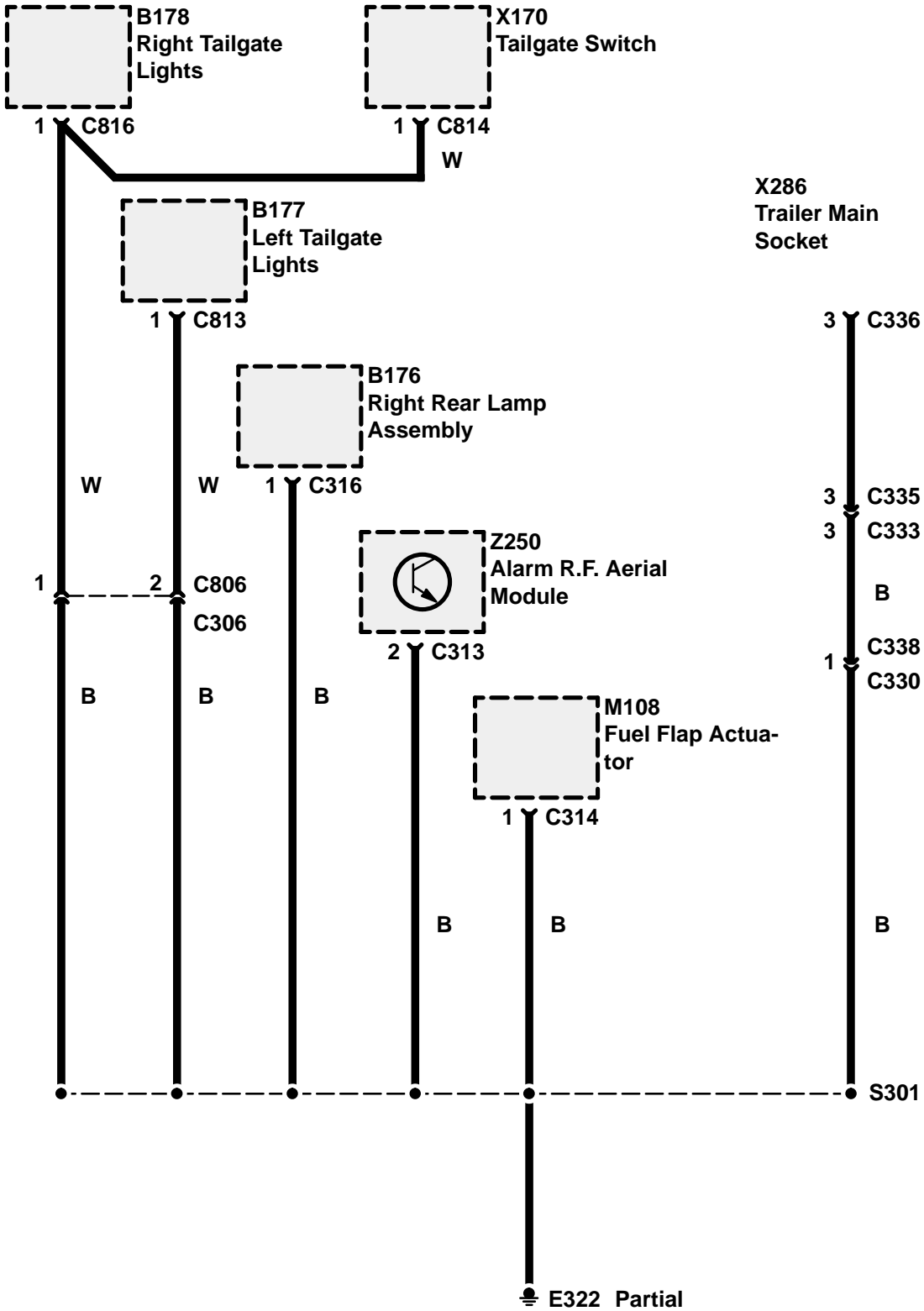
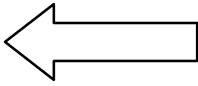

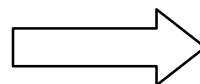
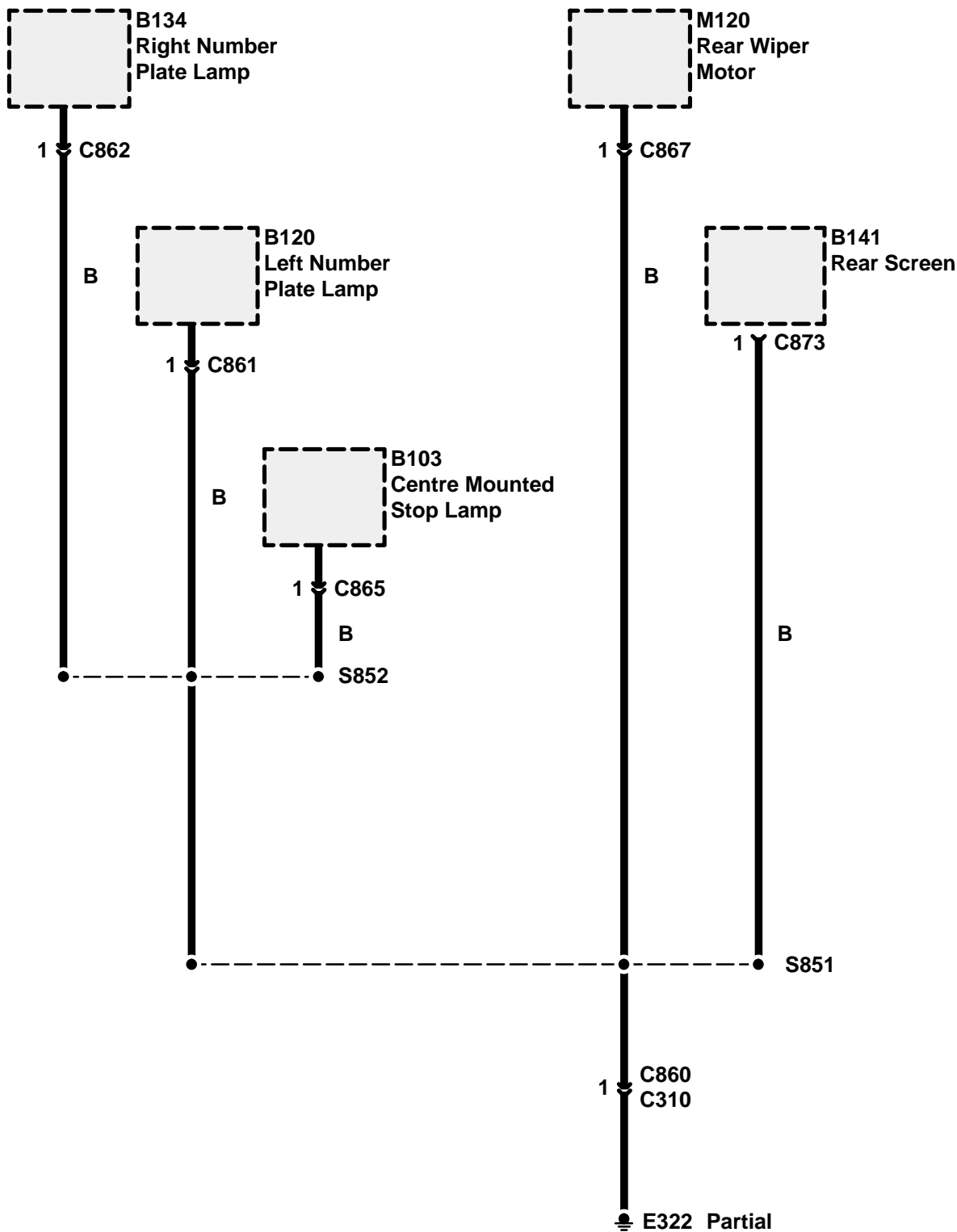
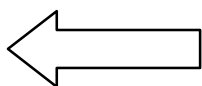

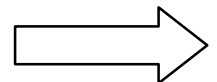
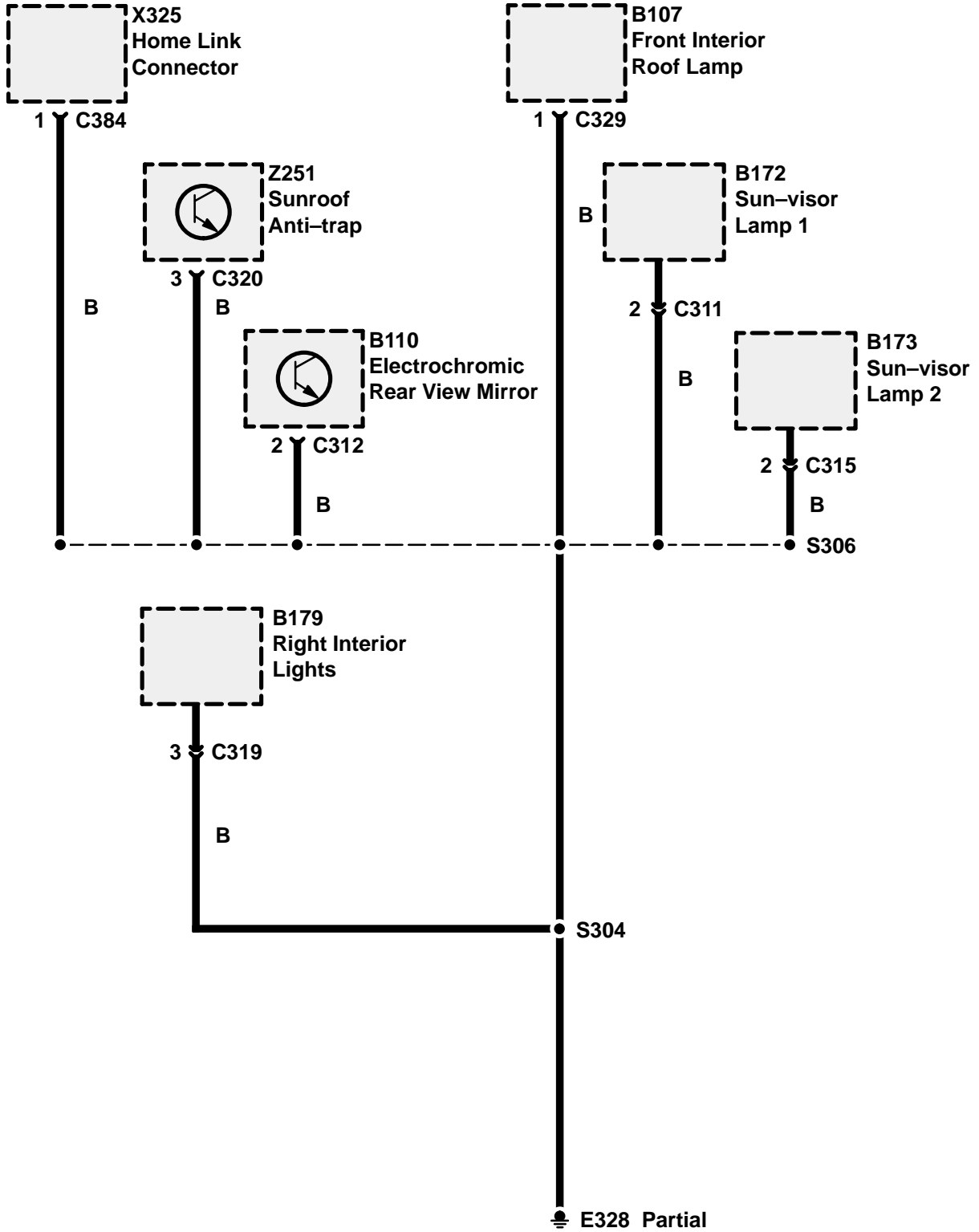
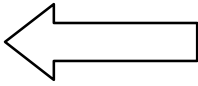

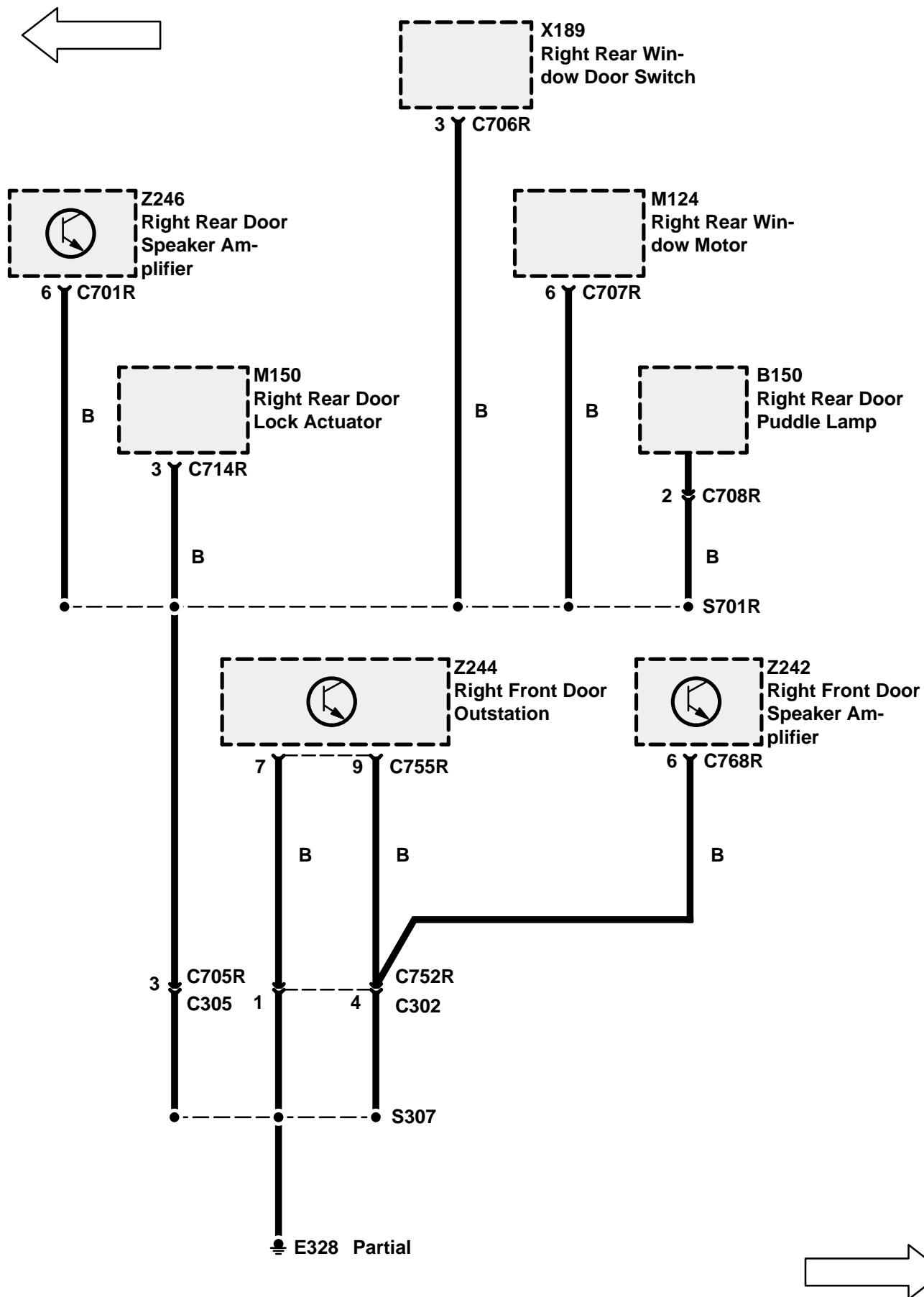

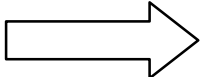
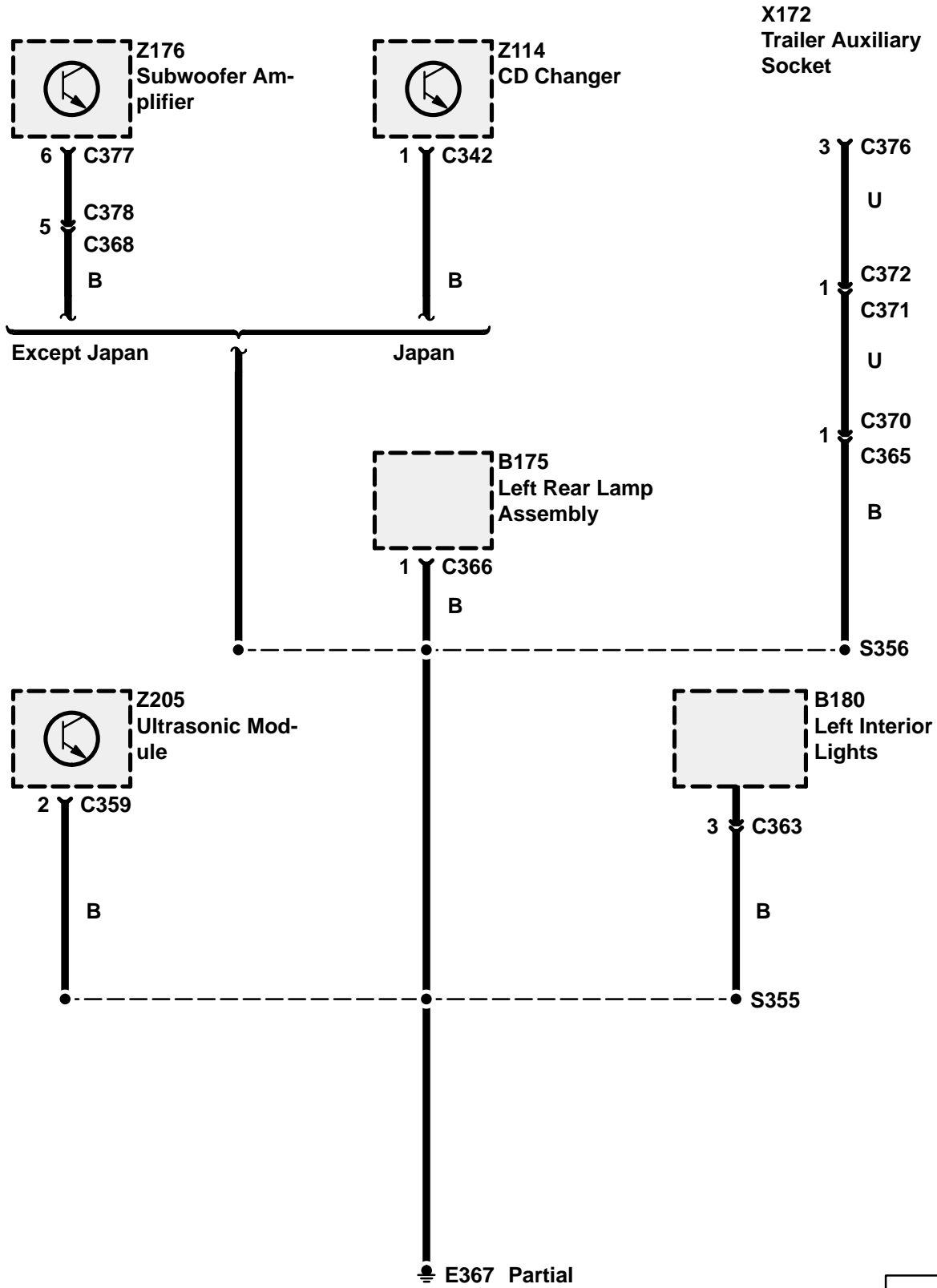
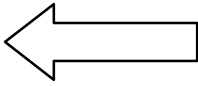

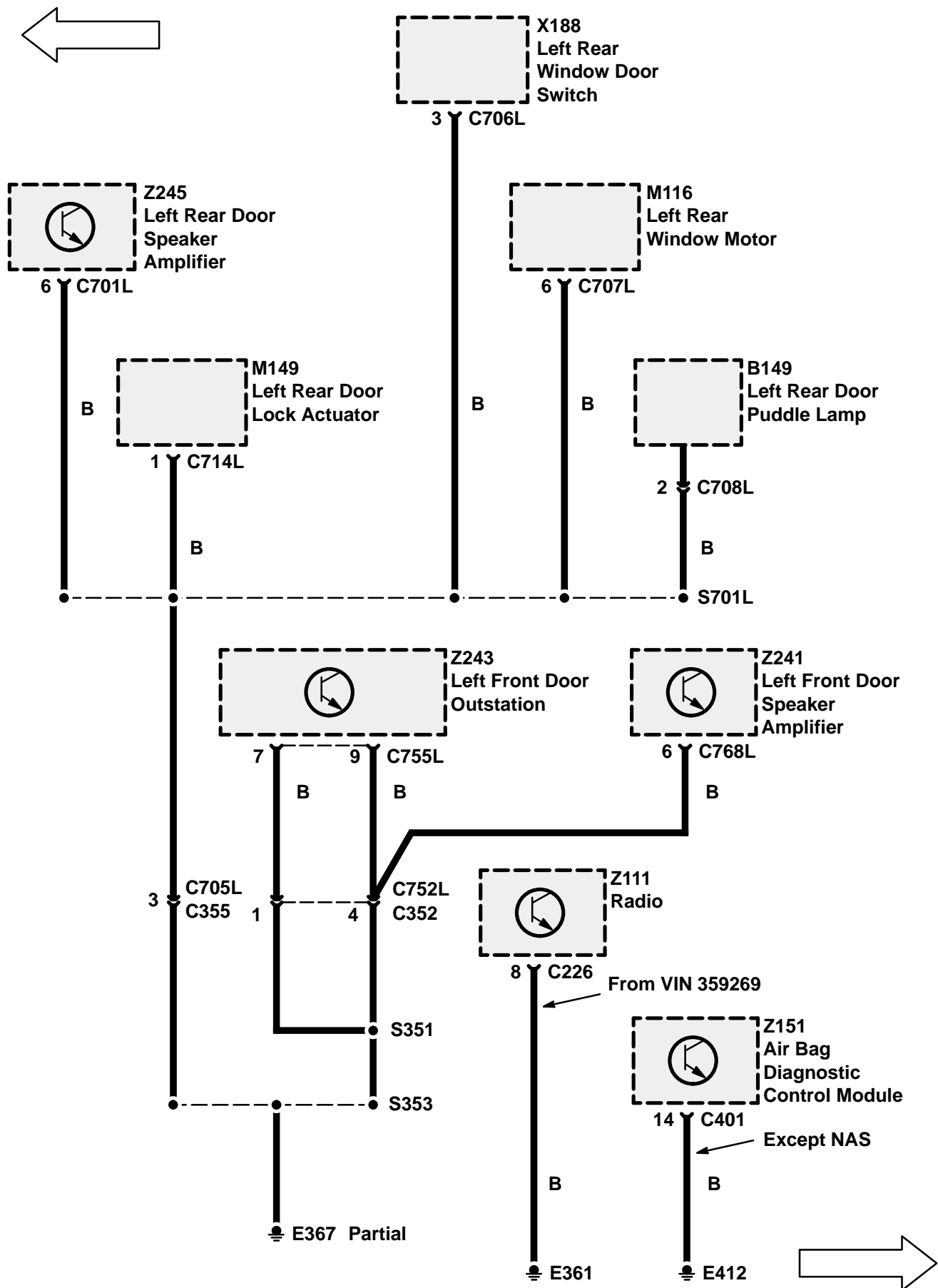

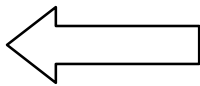

Petrol

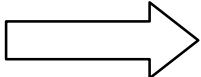
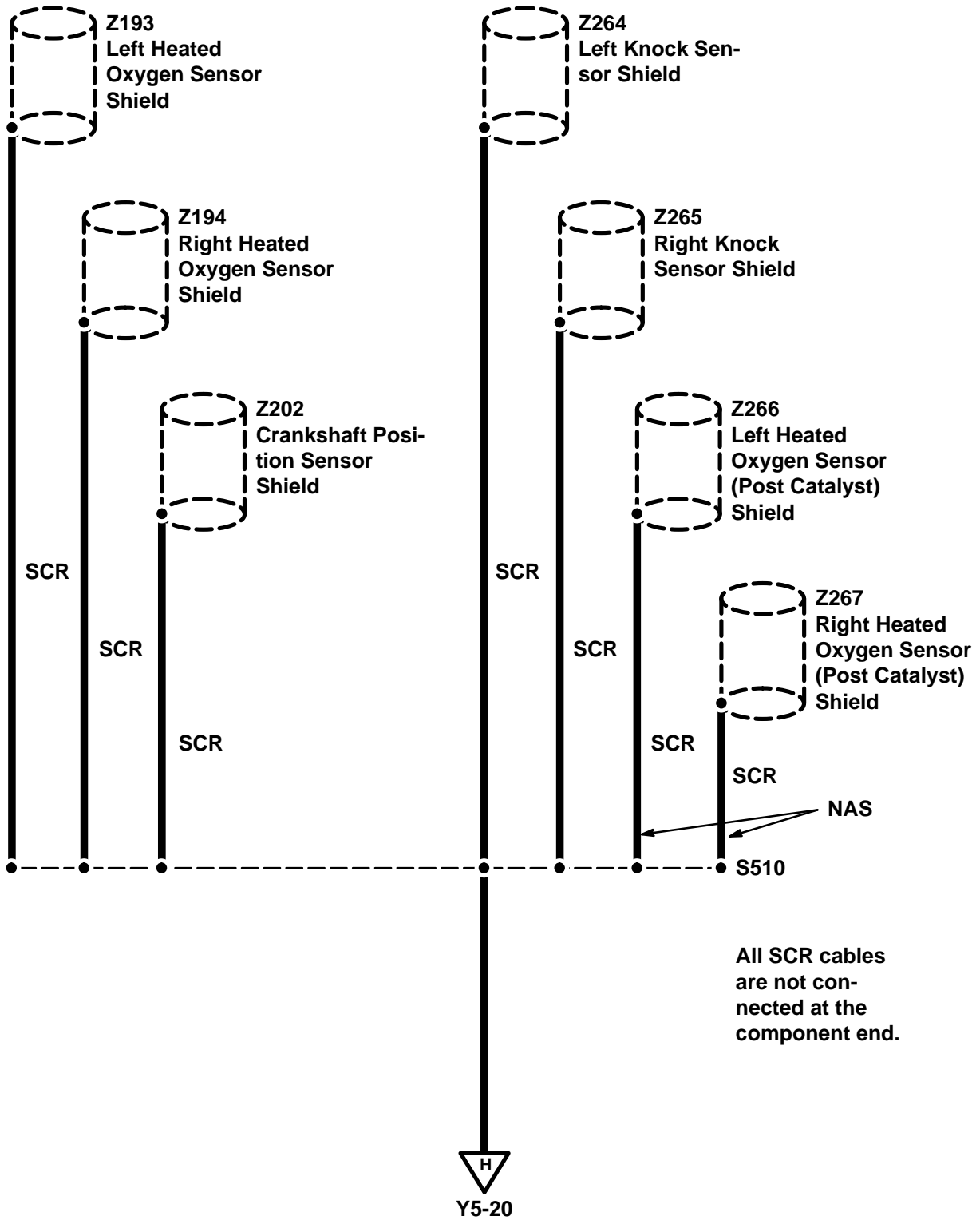

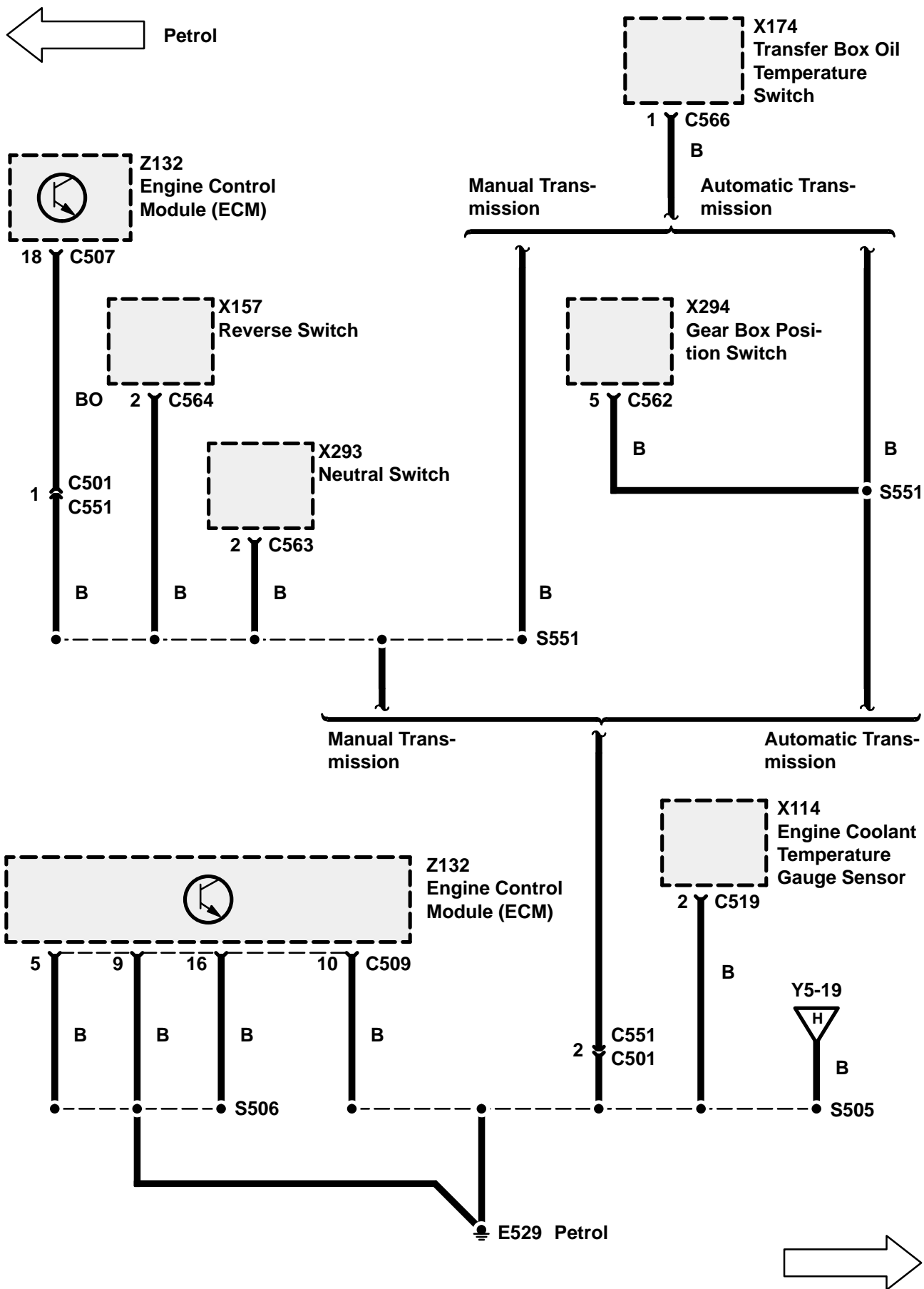

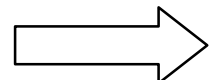
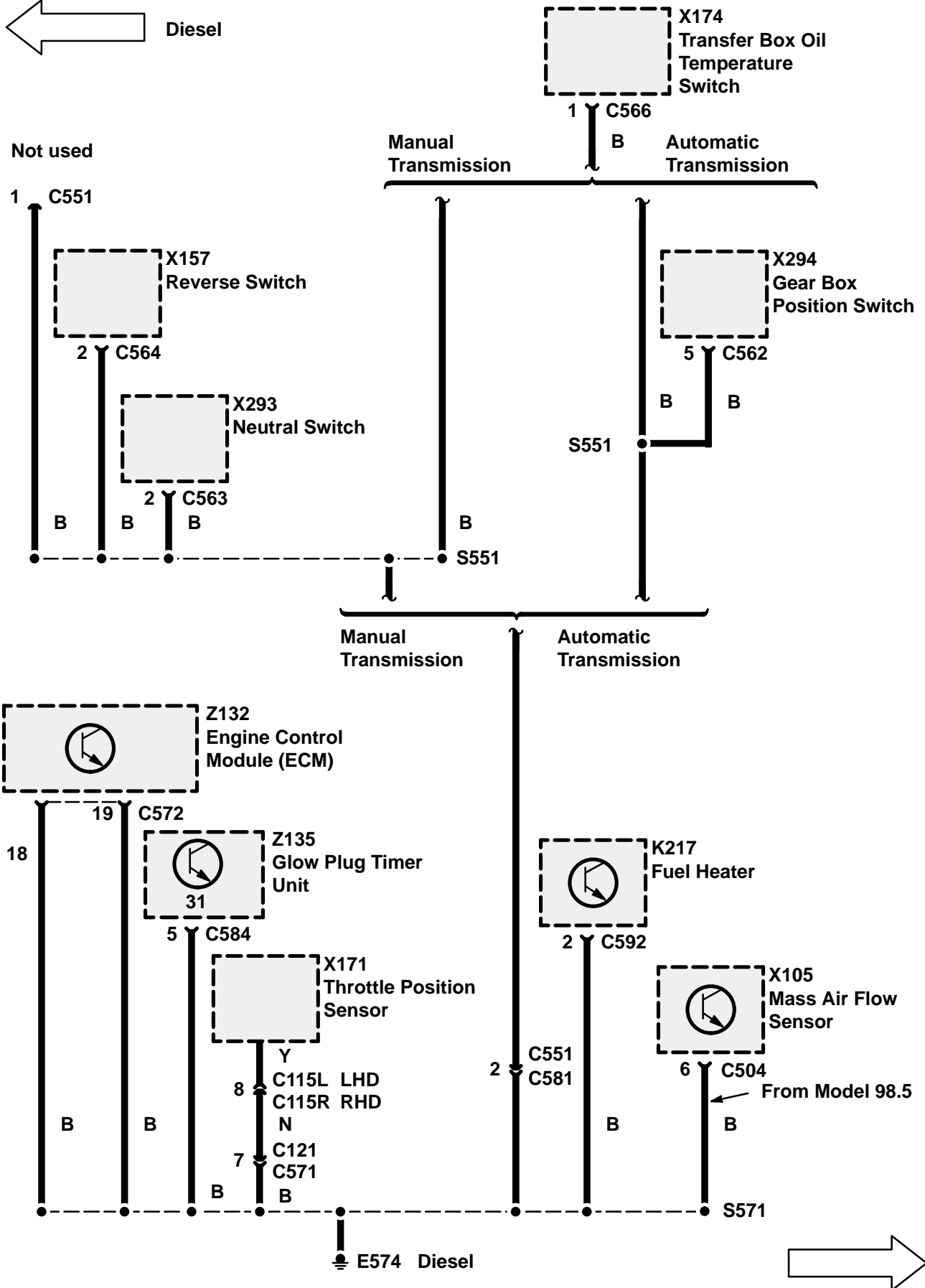
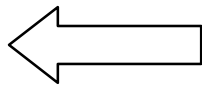

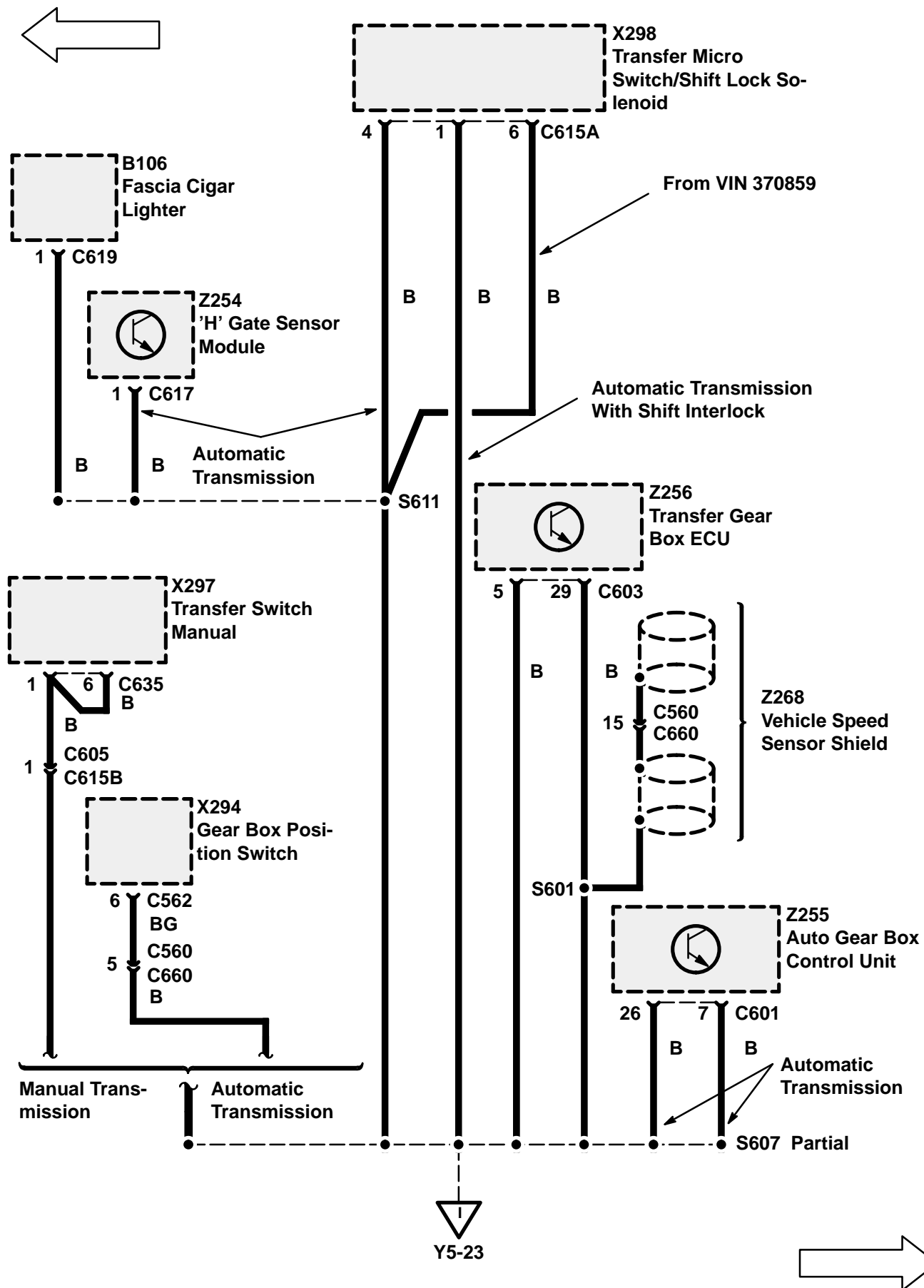

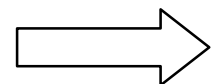
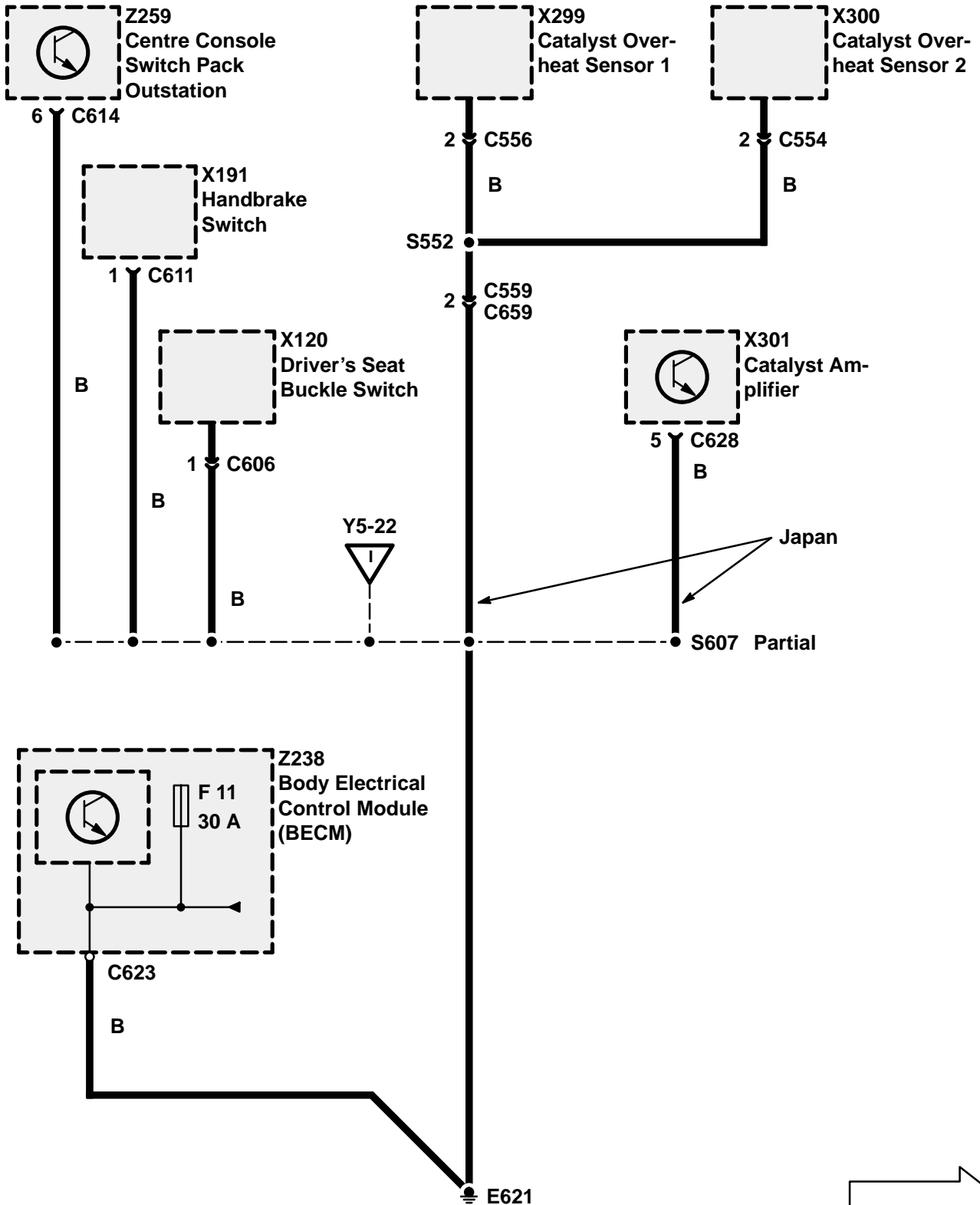
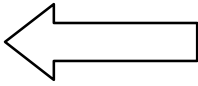

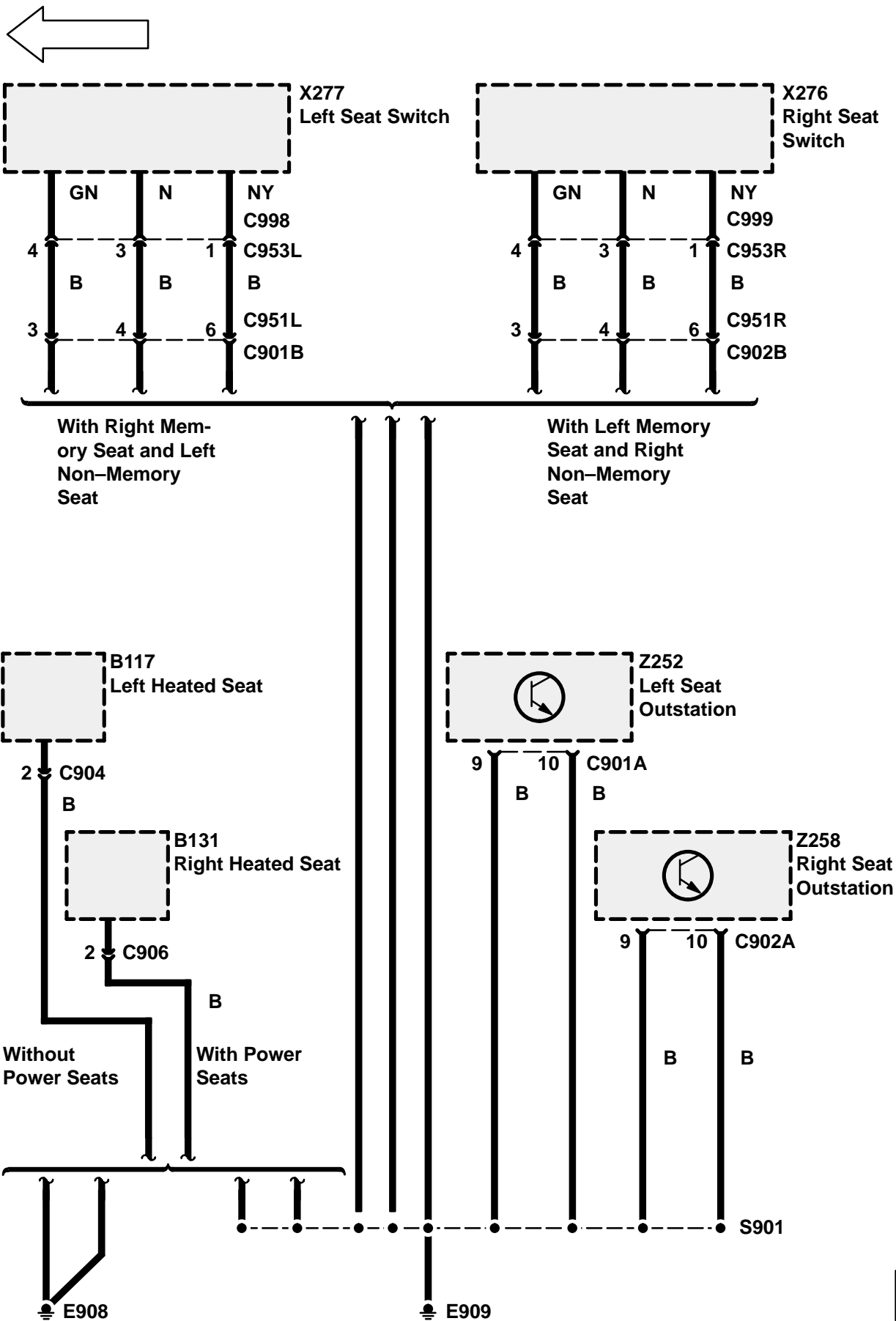

Component	Location	Manual	View
A/C Aspirator (K219)	centre of fascia	82	63
A/C Dual Pressure Switch (X315)	behind LH side of front bumper	82	15
A.B.S. Booster Unit (Z103)	driver's side of engine compartment	70	8
A.B.S. Hydraulic Pump (M102)	driver's side of engine compartment	70	39
A.B.S. Pressure Switch Unit (Z104)	driver's side of engine compartment	70	39
Air Bag Diagnostic Control Module (Z151)	beneath centre console	76	84
Air Suspension Compressor (M140)	LH rear of engine compartment	60	40
Air Suspension Delay Turn Off Timer (Z260)	beneath LH front seat	60	2
Air Suspension ECU (Z165)	beneath LH front seat	60	2
Air Suspension Inhibit Switch (X209)	centre of fascia	60	97
Air Valve Block (K163)	LH side of engine compartment	60	40
Air Bag Diagnostic Connector (X226)	passenger's footwell	76	
Alarm R.F. Aerial Module (Z250)	RH side of luggage compartment	86	112
Alarm Sounder (Z171)	RH side of engine compartment	86	29
Ambient Air Sensor (K218) (Up to VIN 381430)	behind driver's side of fascia (lower dash panel removed)	82	72
Ambient Air Sensor (K218) (From VIN 381431)	LH front of vehicle in front of condenser	82	283
Anti-Lock Brake System ECU (Z108)	beneath fascia on passenger's side of bulkhead	70	12
Auto Gear Box Control Unit (Z255)	beneath LH front seat	44	2
Auto Gear Box Control Unit (Z255)	beneath LH front seat	44	195
Automatic Transmission Oil Temperature Switch (X108)	LH front of engine compartment	44	
Battery (P104)	RH front of engine compartment	86	178
Battery Backed Up Alarm Sounder (Z272)	RH side of engine compartment	86	277
Body Electrical Control Module (BECM) (Z238)	beneath RH front seat	76	10
Bonnet Switch (X110)	RH front of engine compartment near Right Horn	86	21
Boost Pressure Sensor (X253)	LH rear of engine compartment	19	184
Brake Fluid Level Switch (X111)	driver's side of engine compartment	70	7
Brake Switch Vent Valve (X112)	behind driver's side of fascia on brake pedal support	70	68
Camshaft Position Sensor (Z262)	LH front of engine	18	
Catalyst Amplifier (X301)	beneath LH front seat	18	

Component	Location	Manual	View
Catalyst Overheat Sensor 1 (X299)	beneath vehicle on left catalyst	18	
Catalyst Overheat Sensor 2 (X300)	beneath vehicle on right catalyst	18	
CD Changer (Z114)	LH rear of luggage compartment	86	107
Centre Console Switch Pack Outstation (Z259)	in centre console	86	202
Centre Mounted Stop Lamp (B103)	lower centre of rear screen	86	261
Clock (Z117)	centre of fascia	88	63
Clutch Pedal Position Switch (X200) (Diesel)	behind driver's side of fascia (lower dash panel removed)	18	70
Clutch Pedal Position Switch (X200) (Petrol)	behind driver's side of fascia (lower dash panel removed)	18	71
Compressor Clutch (K107) (Diesel)	RH front of engine	82	99
Compressor Clutch (K107) (Petrol)	LH front of engine	82	34
Crankshaft Position Sensor (X250)	LH rear of engine	18	146
Cruise Control Converter/Inverter Module (Z249) (Diesel)	behind RH side of fascia right of steering column	19	77
Cruise Control Converter/Inverter Module (Z249) (Petrol)	behind RH side of fascia right of steering column	19	76
Cruise Control ECU (Z121)	behind RH side of fascia right of steering column	19	75
Cruise Control Switch (X115)	centre of fascia	19	62
Cruise Control Vacuum Pump (M103)	LH rear corner of engine compartment	19	255
Data Link Connectors (X127)	passenger's footwell	86	57
Diaphragm Valve (K220)	LH side of engine compartment	60	
Diaphragm Valve (X302)	LH side of engine compartment	60	
Direction Indicator (X273)	left of steering column	86	79
Distribution Motor (M165)	beneath centre of fascia	82	
Driver's Air Bag (K177)	driver's side on steering wheel	76	100
Driver's Seat Buckle Switch (X120)	inside driver's seat belt buckle assembly	86	196
EGR Control Solenoid (K171) (From Model 98.5)	front LH wing in front of bulkhead	86	286
Electrochromic Rear View Mirror (B110)	top centre of front screen	76	117
Engine Compartment Fuse Box (P125a)	RH side of engine compartment	86	22
Engine Control Module (ECM) (Z132) (Diesel)	RH side of engine compartment behind battery	18	174
Engine Control Module (ECM) (Z132) (Petrol)	RH side of engine compartment	18	151
Engine Coolant Temperature Gauge Sensor (X114) (Diesel)	LH side of engine	88	179
Engine Coolant Temperature Gauge Sensor (X114) (Petrol)	LH side of engine	88	150

Component	Location	Manual	View
Engine Coolant Temperature Sensor (X126) (Diesel)	LH side of engine	18	182
Engine Coolant Temperature Sensor (X126) (Petrol)	LH side of engine	18	150
Engine Fuel Temperature Sensor (X128)	LH side of engine	18	149
Engine Speed Sensor (X255)	lower LH rear of engine	18	186
Evaporative Emission Canister Purge Valve (K132)	LH side of engine compartment	17	159
Evaporative Emission Canister Vent Seal Valve (K233) (NAS) (From Model Year 98)	LH rear corner of engine compartment	86	280
Evaporator Temperature Sensor (X303)	RH side of heater evaporator unit	82	60
Fascia Cigar Lighter (B106)	in centre console	86	192
Footwell Lamp 1 (B168)	passenger's footwell	86	58
Footwell Lamp 2 (B169)	driver's footwell	86	
Fore-Aft Sensor (X196)	underside of respective front seat	78	
Front Fog Lamps Switch (X270)	centre of fascia	86	61
Front Interior Roof Lamp (B107)	front centre of roof	86	115
Front Screen Wash Pump (M105)	behind RH side of front bumper	84	14
Front Wiper Motor (M107)	LH rear corner of engine compartment	84	33
Fuel Flap Actuator (M108)	RH side of luggage compartment	86	113
Fuel Flap Release Switch (X125)	top LH side of fascia	86	74
Fuel Heater (K217)	LH rear of engine compartment	19	184
Fuel Injectors (K141) (Petrol)	top of engine	19	143
Fuel Pressure Sensor (X320) (NAS) (From Model Year 98)	top of fuel tank	19	282
Fuel Pump Assembly (K196) (Diesel)	LH side of engine	19	183
Fuel Pump Module (Z134)	top of fuel tank	19	43
Fuel Shut-Off Solenoid (K111)	LH side of engine	19	190
Gearbox Case (Z263)	LH side of transmission	44	171
Gear Box Position Switch (X294)	LH side of transmission	44	172
Generator (Z106) (Diesel)	LH front of engine	86	185
Generator (Z106) (Petrol)	top RH side of engine	86	148
Glove Box Lamp (B152)	behind glovebox	86	59
Glow Plug Timer Unit (Z135)	RH front of engine compartment behind battery	19	175
Glow Plugs (P120)	LH side of engine	19	181
'H' Gate Sensor Module (Z254)	in centre console	44	194
Handbrake Switch (X191)	beneath centre console on handbrake lever	70	193
Hazard Switch (X220)	centre of fascia	86	62

Component	Location	Manual	View
Headlamp Wash Pump (M110)	behind RH side of front bumper	84	14
Headrest Motor (M148)	RH side of seat squab frame	78	249
Headrest Potentiometer (X279)	RH side of seat squab frame	78	250
Heating Ventilation and Air Conditioning Control Unit (HEVAC) (Z253)	centre of fascia	80	65
Home Link Connector (X325)	front centre of roof	86	284
Idle Air Control Valve (M112)	LH side of engine	18	165
Ignition Coils (Z261)	centre rear of engine compartment	86	167
Ignition Key Lock Solenoid (K191)	right of steering column	86	95
Ignition Switch (X134)	left side of steering column	86	105
Inertia Fuel Shut-Off Switch (X135)	behind RH footwell trim panel	19	13
Injector Needle Lift Sensor (X256)	LH side of engine	18	183
Instrument Cluster (Z142)	driver's side of fascia	88	80
Intake Air Temperature Sensor (X311) (Diesel)	top LH side of engine on intake manifold	18	180
Intake Air Temperature Sensor (X311) (Petrol)	LH side of engine compartment on air cleaner	18	160
Key Illumination (B170)	right of steering column	86	89
Key-In Switch (X229)	right of steering column	86	89
Left Antenna Amplifier (Z177)	LH side of luggage compartment behind trim panel	86	134
Left Blend Motor (M163)	beneath centre of fascia	82	
Left Blower Motor (M158)	behind driver's side of fascia (lower dash panel removed)	80	88
Left Condenser Fan Motor (M113)	behind front grille	82	16
Left Front Bass Speaker (K202)	front door trim panel – lower	86	217
Left Front Door Lock Actuator (M153)	in top rear of LH front door	76	214
Left Front Door Outstation (Z243)	behind front door trim panel	86	221
Left Front Door Puddle Lamp (B114)	underside of front door	86	262
Left Front Door Speaker Amplifier (Z241)	behind front door trim panel	86	218
Left Front Fog Lamp (B184)	behind LH side of front bumper	86	19
Left Front Height Sensor (X205)	beneath LH side of vehicle on chassis	60	47
Left Front Indicator Lamp (B153)	LH front of vehicle	86	51
Left Front Indicator Lamp (B153)	LH front of vehicle	86	51
Left Front Lamp Assembly (B115)	LH front of vehicle	86	35

Component	Location	Manual	View
Left Front Midrange Filter Capacitor (Z247)	behind front door trim panel in Left Front Midrange Speaker top centre of engine	86	
Left Front Midrange Speaker (K200)	front door trim panel – centre	86	220
Left Front Tweeter (K197)	front door cheater panel	86	213
Left Front Wheel Speed Sensor (X137)	behind LH front wheel	70	101
Left Front Window Motor (M130)	behind front door trim panel	86	216
Left Headlamp (B116)	LH front of vehicle	86	35
Left Headlamp Wiper Motor (M156)	LH front of vehicle	84	35
Left Heated Oxygen Sensor (X139)	on left exhaust downpipe	18	263
Left Heated Oxygen Sensor (Post Catalyst) (X289)	on left intermediate pipe	18	259
Left Horn (K128)	LH front of engine compartment	86	38
Left Interior Lights (B180)	LH centre of headlining	86	131
Left Knock Sensor (X295)	lower LH side of engine	18	155
Left Lumbar Pump (M147)	RH side of seat squab frame	78	251
Left Memory Mirror (M152)	LH front door	76	264
Left Memory Switch (X278)	on side of respective front seat	78	268
Left Mirror Actuator (M115)	LH front door	76	
Left Non-Memory Seat Power Relay 1 (K213)	underside of LH front seat	78	241
Left Non-Memory Seat Power Relay 2 (K215)	underside of LH front seat	78	241
Left Number Plate Lamp (B120)	rear of vehicle, on tailgate	86	234
Left Rear Bass Speaker (K209)	rear door trim panel – lower	86	212
Left Rear Door Lock Actuator (M149)	in top of LH rear door	76	205
Left Rear Door Puddle Lamp (B149)	underside of rear door	86	265
Left Rear Door Speaker Amplifier (Z245)	behind rear door trim panel	86	209
Left Rear Height Sensor (X206)	beneath LH side of vehicle on chassis	60	45
Left Rear Lamp Assembly (B175)	LH rear of vehicle	86	135
Left Rear Midrange Filter Capacitor (Z239)	behind rear door trim panel in Left Rear Midrange Speaker top centre of engine	86	
Left Rear Midrange Speaker (K211)	rear door trim panel – centre	86	208
Left Rear Wheel Speed Sensor (X140)	behind LH rear wheel	70	102
Left Rear Window Door Switch (X188)	rear door trim panel	86	206
Left Rear Window Motor (M116)	behind rear door trim panel	84	207

Component	Location	Manual	View
Left Recirculating Motor (M160) (Diesel)	behind driver's side of fascia (lower dash panel removed)	80	70
Left Recirculating Motor (M160) (Petrol)	behind driver's side of fascia (lower dash panel removed)	80	71
Left Repeater Lamp (B122)	LH front side of vehicle	86	6
Left Seat Switch (X277)	at LH side of LH front seat	78	266
Left Seat Outstation (Z252)	underside of LH front seat	78	248
Left Tailgate Lights(B177)	LH rear of vehicle	86	228
Main Lighting Switch (X145)	centre of fascia	86	61
Mass Air Flow Sensor (X105) (Petrol)	LH side of engine compartment	18	159
Mass Air Flow Sensor (X105) (Diesel) (From Model 98.5)	LH side of engine compartment	86	287
N/S Crash Sensor (X227)	LH front of engine compartment	76	87
Neutral Switch (X293)	LH side of transmission	37	173
O/S Crash Sensor (X228)	RH front of engine compartment	76	86
Oil Pressure Switch (X149) (Diesel)	lower LH side of engine	12	276
Oil Pressure Switch (X149) (Petrol)	lower RH side of engine	12	158
Passenger's Air Bag (K178)	top of fascia, passenger's side	76	85
Passive Immobilisation Coil (Z270)	underside of steering column	86	
Pressure Switch 2 (X312)	behind LH side of front bumper	82	15
Radio (Z111)	centre of fascia	86	64
Rear Fog Guard Lamps Switch (X154)	centre of fascia	86	61
Rear Footwell Lamp (B182)	beneath cubby box liner rear of	86	203
Rear Load Space Lamp (B174)	rear of luggage compartment	86	
Rear Screen (B141)	rear of vehicle	76	230
Rear Screen Wash Pump (M119)	behind RH side of front bumper	84	14
Rear Wiper Motor (M120)	top centre of front screen behind trim panel	84	229
Recline Motor and Potentiometer (X280)	LH side of seat squab frame	78	247
Resistor (K152)	behind driver's side of fascia	86	69
Reverse Switch (X157)	behind LH footwell trim panel	37	173
Ride Height Switch (X271)	centre of fascia	60	94
Right Antenna Amplifier (Z178)	RH side of luggage compartment behind trim panel	86	114
Right Blend Motor (M164)	beneath centre of fascia	82	
Right Blower Motor (M159)	behind RH side of fascia (lower dash panel removed)	80	257
Right Condenser Fan Motor (M121)	behind front grille	82	16
Right Front Bass Speaker (K203)	front door trim panel – lower	86	217

Component	Location	Manual	View
Right Front Door Lock Actuator (M154)	in top rear of RH front door	86	214
Right Front Door Outstation (Z244)	behind front door trim panel	86	219
Right Front Door Puddle Lamp (B127)	underside of front door	86	262
Right Front Door Speaker Amplifier (Z242)	behind front door trim panel	86	218
Right Front Fog Lamp (B183)	behind RH side of front bumper	86	18
Right Front Height Sensor (X207)	beneath RH side of vehicle on chassis	60	46
Right Front Indicator Lamp (B154)	RH front of vehicle	86	52
Right Front Indicator Lamp (B154)	RH front of vehicle	86	52
Right Front Lamp Assembly (B128)	RH front of vehicle	86	273
Right Front Midrange Filter Capacitor (Z248)	behind front door trim panel in Right Front Midrange Speaker harness	86	
Right Front Midrange Speaker (K201)	front door trim panel – centre	86	220
Right Front Tweeter (K198)	front door cheater panel	86	213
Right Front Wheel Speed Sensor (X158)	behind RH front wheel	70	103
Right Front Window Motor (M133)	behind front door trim panel	86	216
Right Headlamp (B130)	RH front of vehicle	86	273
Right Headlamp Wiper Motor (M157)	RH front of vehicle	84	273
Right Heated Oxygen Sensor (X160)	on right exhaust downpipe	18	267
Right Heated Oxygen Sensor (Post Catalyst) (X290)	on right exhaust intermediate pipe	18	260
Right Horn (K134)	RH front of engine compartment	86	21
Right Interior Lights (B179)	RH centre of headlining	86	120
Right Knock Sensor (X296)	lower RH side of engine	18	156
Right Lumbar Pump (M155)	RH side of seat squab frame	78	251
Right Memory Mirror (M151)	RH front door	76	270
Right Memory Switch (X317)	on side of respective front seat	78	268
Right Mirror Actuator (M123)	RH front door	76	
Right Non–Memory Seat Power Relay 1 (K214)	underside of RH front seat	78	246
Right Non–Memory Seat Power Relay 2 (K216)	underside of RH front seat	78	246
Right Number Plate Lamp (B134)	rear of vehicle, on tailgate	86	234
Right Rear Bass Speaker (K210)	rear door trim panel – lower	86	212
Right Rear Door Lock Actuator (M150)	in top of RH rear door	76	205

Component	Location	Manual	View
Right Rear Door Puddle Lamp (B150)	underside of rear door	86	265
Right Rear Door Speaker Amplifier (Z246)	behind rear door trim panel	86	209
Right Rear Height Sensor (X208)	beneath RH side of vehicle on chassis	60	44
Right Rear Lamp Assembly (B176)	RH rear of vehicle	86	123
Right Rear Midrange Filter Capacitor (Z240)	behind rear door trim panel in Right Rear Midrange Speaker harness	86	
Right Rear Midrange Speaker (K212)	rear door trim panel – centre	86	208
Right Rear Wheel Speed Sensor (X161)	behind RH rear wheel	60	104
Right Rear Window Door Switch (X189)	rear door trim panel	86	206
Right Rear Window Motor (M124)	behind rear door trim panel	86	207
Right Recirculating Motor (M161)	behind passenger's side of fascia (lower dash panel removed)	80	257
Right Repeater Lamp (B137)	RH front side of vehicle	86	5
Right Seat Switch (X276)	at RH side of RH front seat	86	266
Right Seat Outstation (Z258)	underside of RH front seat	78	248
Right Tailgate Lights (B178)	RH rear of vehicle	86	224
Rotary Coupler (Z119)	top of steering column	86	105
Screen Wash Fluid Level Switch (X165)	behind RH side of front bumper	84	
Seat Base Motor (M126) (With Memory)	underside of respective front seat	78	
Seat Base Motor (M126) (Without Memory)	underside of respective front seat	78	243
Seat Height (Front) Motor (M127) (With Memory)	underside of respective front seat	78	271
Seat Height (Front) Motor (M127) (Without Memory)	underside of respective front seat	78	244
Seat Height (Rear) Motor (M128) (With Memory)	underside of respective front seat	78	272
Seat Height (Rear) Motor (M128) (Without Memory)	underside of respective front seat	78	245
Seat Potentiometer Front Motor (X288)	underside of respective front seat	78	252
Seat Potentiometer Rear Motor (X287)	underside of respective front seat	78	253
Seat Recline Motor (M129)	underside of respective front seat	78	
Solenoid Valve, Injection Timing Device (K229)	LH front of engine	19	185
Starter (M134) (Diesel)	lower LH rear of engine	86	187
Starter (M134) (Petrol)	lower RH rear of engine	86	157
Starter Solenoid (K136) (Diesel)	lower LH rear of engine	86	187

Component	Location	Manual	View
Starter Solenoid (K136) (Petrol)	lower RH rear of engine	86	157
Steering Wheel Switches (X269)	on steering wheel	86	100
Stop Lamp Switch (X168) ...	behind driver's side of fascia on brake pedal support	86	274
Subwoofer (K146)	LH side of luggage compartment	86	269
Subwoofer Amplifier (Z176) ..	LH rear of luggage compartment	86	269
Sun Sensor (X305)	top centre of fascia	82	66
Sun-visor Lamp 1 (B172) ...	RH front of roof	86	118
Sun-visor Lamp 2 (B173) ...	LH front of roof	86	119
Sunroof Anti-trap (Z251)	front centre of roof	76	116
Sunroof Motor (M131)	front centre of roof	76	116
Tailgate Lock Actuator (M132)	centre of tailgate	86	227
Tailgate Switch (X170)	centre of tailgate	86	226
Tailgate Unlock Switch (X275)	centre of tailgate behind trim panel	86	225
Theft Alarm LED (B151)	top centre of fascia	86	67
Throttle Position Sensor (X171) (Diesel)	behind driver's side of fascia on brake pedal support	18	32
Throttle Position Sensor (X171) (Petrol)	LH side of engine	18	165
Trailer Auxiliary Socket (X172)	beneath centre rear of vehicle	86	126
Trailer Main Socket (X286) ..	beneath centre rear of vehicle	86	126
Transfer Box Solenoid (K154)	on transfer box rear of	41	169
Transfer Box Oil Temperature Switch (X174)	on transfer box rear of	41	168
Transfer Micro Switch/Shift Lock Solenoid (X298) (Automatic Transmission) ...	beneath centre console	41	194
Transfer Switch Manual (X297) (Manual Transmission)	centre of fascia	41	201
Transfer Gear Box ECU (Z256)	beneath LH front seat	41	2
Ultrasonic Module (Z205)	top of LH B-post	86	132
Vehicle Speed Sensor (X190)	on transfer box rear of	41	170
Wash/Wipe Switch (X272) ...	right of steering column	84	78
Water Temperature Sensor (X304)	RH side of heater evaporator unit	82	60
Connector	Location		View
C100 (E100)	RH side of engine on chassis		93
C101 (2-B)	behind RH footwell trim panel		13
C102 (18-W)	behind RH footwell trim panel		13
C103 (6-R)	behind RH footwell trim panel		13
C104 (12-W) (Up to VIN 381430)	behind LH footwell trim panel		92
C104 (14-W) (From VIN 381431)	behind LH footwell trim panel		92

Connector	Location	View
C105 (T105)	RH front of engine compartment beneath Engine Compartment Fuse Box	96
C106 (13-B)	RH rear of engine compartment beneath coolant expansion tank	23
C106A (4-B)	RH rear of engine compartment beneath coolant expansion tank	50
C106B (13-B)	RH rear of engine compartment beneath coolant expansion tank	23
C107 (T107)	RH front of engine compartment beneath Engine Compartment Fuse Box	96
C108 (3-B)	beneath RH rear of vehicle to Right Rear Height Sensor	44
C109 (2-W)	beneath RH front seat near Body Electrical Control Module (BECM)	
C110 (4-B)	top of fuel tank on Fuel Pump Module	43
C111 (3-B)	behind RH footwell trim panel on Inertia Fuel Shut-Off Switch	13
C112 (16-G)	beneath RH front seat on Body Electrical Control Module (BECM)	11
C113 (10-Y)	beneath RH front seat on Body Electrical Control Module (BECM)	11
C114 (20-G)	beneath RH front seat on Body Electrical Control Module (BECM)	11
C115L (8-G)	behind driver's side of fascia to Throttle Position Sensor	32
C115R (8-G)	behind driver's side of fascia to Throttle Position Sensor	32
C116L (35-B)	passenger's side of bulkhead on Anti-Lock Brake System ECU	12
C116R (35-B)	passenger's side of bulkhead on Anti-Lock Brake System ECU	12
C117 (35-B)	beneath LH front seat on Air Suspension ECU	2
C118 (9-B)	beneath LH front seat on Air Suspension Delay Turn Off Timer	2
C119 (1-)	RH front of engine on Compressor Clutch	
C120 (14-Y)	beneath RH front seat on Body Electrical Control Module (BECM)	11
C121 (25-B)	rear of engine compartment	48
C122 (3-B) (NAS) (From Model 98.5)	top of fuel tank on Fuel Pressure Sensor	282
C124L (2-B)	driver's side of engine compartment on Brake Fluid Level Switch	7
C124R (2-B)	driver's side of engine compartment on Brake Fluid Level Switch	7
C125L (13-B)	driver's side of engine compartment on A.B.S. Booster Unit	8
C125R (13-B)	driver's side of engine compartment on A.B.S. Booster Unit	3
C126L (1-W)	driver's side of engine compartment on A.B.S. Booster Unit	8
C126R (1-W)	driver's side of engine compartment on A.B.S. Booster Unit	3
C127L (4-B)	RH rear corner of engine compartment to Front Wiper Motor	33
C127R (4-B)	LH rear corner of engine compartment to Front Wiper Motor	256
C128 (1-W)	lower RH side of windscreen to Heated Front Screen	42
C130 (1-W)	lower LH side of windscreen to Heated Front Screen	41
C132 (2-B)	LH front side of vehicle on Left Repeater Lamp	6
C133 (2-B)	RH front side of vehicle on Right Repeater Lamp	5
C135 (E135)	under LH rear of bonnet	1
C138 (2-B)	LH side of engine compartment on Air Valve Block	91
C139 (13-B)	LH side of engine compartment on Air Valve Block	90
C140 (13-B)	LH side of engine compartment on Air Valve Block	90
C141 (13-B)	LH side of engine compartment on Air Valve Block	91
C142 (2-B)	LH side of engine compartment on Air Valve Block	91
C143 (2-B)	behind LH side of front bumper on Pressure Switch 2	15
C144 (2-)	beneath LH rear of vehicle to Right Rear Wheel Speed Sensor	9
C145 (2-)	beneath LH rear of vehicle to Left Rear Wheel Speed Sensor	9
C146 (3-B)	beneath LH front of vehicle to Left Front Height Sensor	47
C147 (3-B)	beneath LH rear of vehicle to Left Rear Height Sensor	45
C148 (E148)	LH rear of engine compartment near Air Valve Block	27
C149L (E149L)	LH rear of engine compartment near Air Valve Block	27
C149R (E149R)	RH rear of engine compartment near Engine Compartment Fuse Box	20
C151 (4-B)	LH rear of engine compartment to Air Suspension Compressor	40
C152 (13-B)	LH rear of engine compartment on Air Valve Block	40

Connector	Location	View
C154 (E154)	LH front of engine compartment	26
C155 (2-)	LH front of engine compartment to Left Front Wheel Speed Sensor	25
C156L (2-W)	driver's side of engine compartment on A.B.S. Hydraulic Pump	39
C156R (2-W)	driver's side of engine compartment on A.B.S. Hydraulic Pump	4
C157 (3-S)	LH rear corner of engine compartment on Cruise Control Vacuum Pump	255
C158A (2-B)	LH front of vehicle on Left Front Indicator Lamp	51
C158B (3-B)	LH front of vehicle on Left Front Lamp Assembly	36
C159 (2-W)	behind LH side of front bumper on Left Front Fog Lamp	19
C160 (4-B)	LH front of vehicle on Left Headlamp Wiper Motor	35
C161 (2-B)	LH front corner of engine compartment near Left Front Lamp Assembly on Left Horn	38
C162 (4-B)	behind LH side of front bumper on A/C Dual Pressure Switch	15
C163 (6-B)	LH front of vehicle on Left Headlamp	37
C164 (2-U)	LH front of engine compartment to Automatic Transmission Oil Temperature Switch	24
C165 (T165)	RH front of engine compartment beneath Engine Compartment Fuse Box	96
C166D (2-U)	rear of engine compartment near A.B.S. Booster Unit	49
C166P (2-W)	LH front of engine to Compressor Clutch	34
C167 (E167)	RH rear of engine compartment near Engine Compartment Fuse Box	20
C168 (3-B)	beneath RH front of vehicle to Right Front Height Sensor	46
C169 (T169)	beneath RH front seat on Body Electrical Control Module (BECM)	10
C170 (T170)	beneath RH front seat on Body Electrical Control Module (BECM)	10
C171 (T171)	beneath RH front seat on Body Electrical Control Module (BECM)	10
C172 (8-Y)	RH front of engine compartment beneath Engine Compartment Fuse Box	22
C173 (8-P)	RH front of engine compartment beneath Engine Compartment Fuse Box	22
C174 (8-U)	RH front of engine compartment beneath Engine Compartment Fuse Box	22
C175 (8-G)	RH front of engine compartment beneath Engine Compartment Fuse Box	22
C176 (8-N)	RH front of engine compartment beneath Engine Compartment Fuse Box	98
C177 (8-S)	RH front of engine compartment beneath Engine Compartment Fuse Box	98
C178 (2-W)	RH side of engine compartment	278
C179 (2-B) (With Battery Backed Up Alarm Sounder)	RH side of engine compartment	277
C179 (2-B) (Without Battery Backed Up Alarm Sounder)	RH side of engine compartment on Alarm Sounder	29
C180 (2-)	RH front of engine compartment to Right Front Wheel Speed Sensor	28
C181 (4-B)	RH side of engine compartment on Battery Backed Up Alarm Sounder	277
C182 (E182)	RH side of engine compartment	54
C184L (5-B)	driver's side of engine compartment on A.B.S. Pressure Switch Unit	39
C184R (5-B)	driver's side of engine compartment on A.B.S. Pressure Switch Unit	4
C187A (2-B)	RH front of vehicle on Right Front Indicator Lamp	52
C187B (3-B)	RH front of vehicle on Right Front Lamp Assembly	30
C188 (2-W)	behind RH side of front bumper on Right Front Fog Lamp	18
C189 (6-B)	RH front of engine compartment on Right Headlamp	21
C190 (4-B)	RH front of engine compartment on Right Headlamp Wiper Motor	31
C191 (2-W)	behind RH side of front bumper on Headlamp Wash Pump	14

Connector	Location	View
C192 (2-U)	behind RH side of front bumper near Battery to Screen Wash Fluid Level Switch	17
C193 (2-R)	behind RH side of front bumper on Front Screen Wash Pump	14
C194 (2-B)	behind RH side of front bumper on Rear Screen Wash Pump	14
C195 (2-B)	RH front of engine compartment near Right Horn to Bonnet Switch	21
C196 (2-B)	RH front of engine compartment on Right Horn	21
C197 (2-B)	behind front grille to Right Condenser Fan Motor	16
C198 (2-B)	behind front grille to Left Condenser Fan Motor	16
C199 (E199)	centre rear of engine compartment	53
C201 (2-B)	behind RH footwell trim panel	55
C202 (18-W)	behind RH footwell trim panel	55
C203 (4-N)	behind LH side of fascia on Left Blower Motor	88
C204 (12-W) (Up to VIN 381430)	behind LH footwell trim panel	81
C204 (14-W) (From VIN 381431)	behind LH footwell trim panel	81
C205 (2-W)	behind passenger's side of fascia on Glove Box Lamp	59
C206 (1-B)	behind LH side of fascia on Left Blower Motor	73
C207 (8-W)	behind LH footwell trim panel	81
C208 (6-W)	behind RH footwell trim panel	55
C209 (2-G)	top centre of fascia to Theft Alarm LED	67
C210 (2-B)	top centre of fascia on Sun Sensor	66
C211 (6-W)	behind centre of fascia on Cruise Control Switch	62
C212 (6-W)	behind centre of fascia on Hazard Switch	62
C213 (8-B)	behind centre of fascia on Ride Height Switch	94
C214 (6-W)	behind centre of fascia on Air Suspension Inhibit Switch	97
C215 (6-W)	behind centre of fascia on Rear Fog Guard Lamps Switch	61
C216 (2-B)	behind centre of fascia on Clock	63
C217 (1-B)	behind centre of fascia on Clock	63
C218 (4-B)	behind centre of fascia on A/C Aspirator	63
C219 (4-W)	behind centre of fascia on Main Lighting Switch	61
C220 (6-W)	behind centre of fascia on Front Fog Lamps Switch	61
C221 (2-U)	RH side of heater evaporator unit on Water Temperature Sensor	60
C222 (2-B)	RH side of heater evaporator unit on Evaporator Temperature Sensor	60
C224A (8-N)	behind radio	64
C224B (10-R)	behind radio	64
C225 (5-B)	left of steering column on Fuel Flap Release Switch	74
C226 (8-S)	behind radio	64
C227 (3-W)	behind driver's side of fascia on Stop Lamp Switch	68
C228 (2-W)	behind driver's side of fascia on Brake Switch Vent Valve	68
C229 (2-W)	passenger's footwell to Footwell Lamp 1	58
C230 (2-W) (Diesel)	behind driver's side of fascia on Clutch Pedal Position Switch	70
C230 (2-W) (Petrol)	behind driver's side of fascia on Clutch Pedal Position Switch	71
C231 (16-S)	passenger's footwell on Data Link Connectors	57
C232 (2-B)	right of steering column to Key Illumination	89
C233 (3-W)	right of steering column to Key-In Switch	89
C234 (3-W)	right of steering column to Ignition Key Lock Solenoid	95
C235 (6-W)	right of steering column to Rotary Coupler	78
C236 (12-B)	left of steering column on Direction Indicator	79
C237 (8-B)	right of steering column on Wash/Wipe Switch	78
C238 (4-W)	right of steering column to Ignition Switch	78
C239 (1-B)	passenger's side of bulkhead on Right Blower Motor	257
C240 (4-N)	passenger's side of bulkhead on Right Blower Motor	257

Connector	Location	View
C241D (9-B)	behind driver's side of fascia on Cruise Control Converter/Inverter Module	77
C241P (9-B)	behind driver's side of fascia on Cruise Control Converter/Inverter Module	76
C242 (20-B)	behind driver's side of fascia on Instrument Cluster	80
C243 (15-B)	behind driver's side of fascia on Cruise Control ECU	75
C244 (8-W)	behind centre of fascia on Heating Ventilation and Air Conditioning Control Unit (HEVAC)	65
C245 (12-B)	behind centre of fascia on Heating Ventilation and Air Conditioning Control Unit (HEVAC)	65
C246A (12-G)	behind centre of fascia on Heating Ventilation and Air Conditioning Control Unit (HEVAC)	65
C246B (20-B)	behind centre of fascia on Heating Ventilation and Air Conditioning Control Unit (HEVAC)	65
C247 (7-P)	top of steering column to Steering Wheel Switches	100
C248 (3-W) (Diesel)	behind LH side of fascia on Left Recirculating Motor	70
C248 (3-W) (Petrol)	behind LH side of fascia on Left Recirculating Motor	71
C249 (2-W)	behind LH side of fascia on Footwell Lamp 2	
C250 (2-B) (Up to VIN 381430)	behind driver's side of fascia on Ambient Air Sensor	72
C250 (2-B) (From VIN 381431)	LH front of vehicle in front of condenser on Ambient Air Sensor	283
C251 (3-W)	passenger's side of bulkhead on Right Recirculating Motor	257
C252 (E252)	behind RH footwell trim panel	56
C253 (E253)	behind RH footwell trim panel	56
C254 (E254)	behind RH footwell trim panel	56
C255 (20-W)	beneath RH front seat on Body Electrical Control Module (BECM)	82
C256 (16-W)	beneath RH front seat on Body Electrical Control Module (BECM)	82
C257 (20-Y)	beneath RH front seat on Body Electrical Control Module (BECM)	82
C258 (10-W)	beneath RH front seat on Body Electrical Control Module (BECM)	83
C259 (12-B)	behind centre of fascia	
C260 (20-B)	behind centre of fascia	
C261	behind centre of fascia on Heating Ventilation and Air Conditioning Control Unit (HEVAC)	
C301 (12-B)	front of RH front door jamb	109
C302 (4-W)	front of RH front door jamb	109
C303 (6-W)	in lower part of RH B-post	121
C304 (6-S)	in lower part of RH B-post	121
C305 (6-Y)	in lower part of RH B-post	121
C306 (12-B)	RH side of luggage compartment	114
C307 (4-W)	rear of vehicle, on tailgate	122
C308 (6-W)	behind RH footwell trim panel	110
C309 (2-W)	rear of vehicle, on tailgate	122
C310 (2-B)	rear of vehicle, on tailgate	122
C311 (2-B)	RH front of roof to Sun-visor Lamp 1	118
C312 (5-B)	top centre of front screen on Electrochromic Rear View Mirror	117
C313 (3-W)	RH side of luggage compartment on Alarm R.F. Aerial Module	112
C314 (2-W)	RH side of luggage compartment on Fuel Flap Actuator	113
C315 (2-B)	LH front of roof to Sun-visor Lamp 2	119
C316 (4-G)	RH rear of vehicle on Right Rear Lamp Assembly	123
C318 (1-B)	RH side of luggage compartment on Right Antenna Amplifier	114
C319 (4-B)	RH centre of headlining to Right Interior Lights	120
C320 (8-W)	front centre of roof on Sunroof Anti-trap	116

Connector	Location	View
C322 (E322)	RH side of luggage compartment	112
C323 (12-S)	beneath RH front seat on Body Electrical Control Module (BECM)	111
C324 (4-W)	beneath RH front seat on Body Electrical Control Module (BECM)	111
C325 (18-S)	beneath RH front seat on Body Electrical Control Module (BECM)	111
C326 (20-U)	beneath RH front seat on Body Electrical Control Module (BECM)	127
C328 (E328)	RH side of luggage compartment	112
C329 (4-B)	front centre of roof on Front Interior Roof Lamp	115
C330 (6-W)	RH rear of vehicle	124
C332 (3-B)	beneath RH rear of vehicle	125
C333 (4-B)	beneath RH rear of vehicle	125
C334 (3-B)	beneath RH rear of vehicle	125
C335 (4-B)	beneath RH rear of vehicle	125
C336 (7-B)	beneath rear of vehicle on Trailer Connector	126
C338 (8-W)	RH rear of vehicle	124
C340 (1-B)	RH side of luggage compartment on Right Antenna Amplifier	114
C341 (1-B)	beneath centre of fascia on Radio	108
C342 (3-W)	LH side of luggage compartment on CD Changer	
C351 (12-B)	front of LH front door jamb	128
C352 (4-W)	front of LH front door jamb	128
C353 (6-W)	in lower part of LH B-post	129
C354 (6-S)	in lower part of LH B-post	129
C355 (6-Y)	in lower part of LH B-post	129
C357 (8-W)	behind LH footwell trim panel	138
C359 (4-B)	top of LH B-post on Ultrasonic Module	132
C361 (18-W)	beneath RH front seat on Body Electrical Control Module (BECM)	137
C362 (16-B)	beneath RH front seat on Body Electrical Control Module (BECM)	136
C363 (4-B)	LH centre of headlining to Left Interior Lights	131
C364 (1-B)	LH side of luggage compartment on Left Antenna Amplifier	134
C365 (4-W)	LH rear of luggage compartment	135
C366 (4-G)	LH rear of luggage compartment on Left Rear Lamp Assembly	135
C367 (E367)	LH side of luggage compartment	133
C368 (6-W)	LH side of luggage compartment to Subwoofer	130
C370 (4-W)	LH rear of luggage compartment	139
C371 (3-B)	beneath LH rear of vehicle	140
C372 (3-B)	beneath LH rear of vehicle	140
C376 (7-B)	beneath centre rear of vehicle on Trailer Auxiliary Socket	141
C377 (10-W)	LH side of luggage compartment on Subwoofer Amplifier	106
C378 (6-W)	LH side of luggage compartment to Subwoofer	106
C380 (1-B)	LH side of luggage compartment on Left Antenna Amplifier	134
C381 (1-B)	beneath centre of fascia on Radio	108
C382 (12-B)	LH side of luggage compartment on CD Changer	107
C383 (12-B)	beneath centre of fascia on Radio	108
C384 (2-B)	front centre of roof on Home Link Connector	284
C401 (29-R)	beneath centre console on Air Bag Diagnostic Control Module	84
C401 (30-Y)	beneath centre console on Air Bag Diagnostic Control Module	84
C402 (5-LTU)	behind driver's side of fascia on Instrument Cluster	80
C403 (6-R)	behind RH footwell trim panel	55
C404 (2-R)	top of fascia, passenger's side on Passenger's Air Bag	85
C405 (3-Y)	LH front of engine compartment on N/S Crash Sensor	87
C406 (3-Y)	RH front of engine compartment on O/S Crash Sensor	86
C409 (2-R)	behind driver's side of fascia on Driver's Air Bag	70
C410 (2-)	top of steering column to Rotary Coupler	

Connector	Location	View
C500 (E500)	RH front of engine	164
C501 (6-B)	top rear of engine	145
C502 (2-W) (NAS) (From VIN 370859)	RH side of engine compartment	281
C503 (2-R) (NAS) (From Model 98.5)	LH rear corner of engine compartment on Evaporative Emission Canister Vent Seal Valve	280
C504 (6-B) (From Model 98.5)	LH side of engine compartment on Mass Air Flow Sensor	287
C505 (36-B)	RH side of engine compartment on Engine Control Module (ECM)	151
C506 (13-B)	RH rear of engine compartment beneath coolant expansion tank	153
C506A (4-B)	RH rear of engine compartment beneath coolant expansion tank	153
C506B (13-B)	RH rear of engine compartment beneath coolant expansion tank	163
C507 (36-R)	RH side of engine compartment on Engine Control Module (ECM)	151
C508 (8-K)	RH side of engine compartment on Engine Compartment Fuse Box	152
C509 (18-B)	RH side of engine compartment on Engine Control Module (ECM)	151
C510 (4-B)	LH side of engine on Idle Air Control Valve	165
C511 (2-N)	LH side of engine on Engine Coolant Temperature Sensor	150
C512 (2-S)	LH side of engine on Engine Fuel Temperature Sensor	149
C513 (2-B)	LH side of engine compartment on air cleaner on Intake Air Temperature Sensor	160
C514 (2-B)	LH side of engine compartment on Evaporative Emission Canister Purge Valve	159
C515 (1-B)	lower RH side of engine on Oil Pressure Switch	158
C516 (1-B)	lower RH rear of engine on Starter Solenoid	157
C517 (T517)	top RH side of engine on Generator	148
C518 (2-W)	LH rear of engine on Crankshaft Position Sensor	146
C519 (1-G)	LH side of engine on Engine Coolant Temperature Gauge Sensor	150
C520 (3-B)	LH side of engine to Throttle Position Sensor	165
C521 (4-B)	lower LH side of engine to Left Heated Oxygen Sensor	155
C522 (2-B) (From Model 98.5)	front LH wing in front of bulkhead on EGR Control Solenoid	286
C523 (2-S)	lower RH side of engine on Right Knock Sensor	156
C524 (2-B)	lower LH side of engine on Left Knock Sensor	155
C525 (5-B)	LH rear of engine on Ignition Coils	144
C526 (4-B)	lower RH side of engine to Right Heated Oxygen Sensor	156
C527 (T527)	top RH side of engine on Generator	148
C528 (T528)	lower RH rear of engine on Starter Solenoid	157
C529 (E529)	RH side of engine compartment	152
C530 (3-B)	front centre of engine to Camshaft Position Sensor	154
C531 (3-B)	LH side of engine compartment on Mass Air Flow Sensor	159
C535 (4-B)	beneath LH side of vehicle to Left Heated Oxygen Sensor (Post Catalyst)	161
C536 (4-B)	beneath RH side of vehicle to Right Heated Oxygen Sensor (Post Catalyst)	162
C541 (3-B)	top LH side of engine on Fuel Injector	142
C542 (2-B)	top RH side of engine on Fuel Injector	147
C543 (2-B)	top LH side of engine on Fuel Injector	142
C544 (2-B)	top RH side of engine on Fuel Injector	147
C545 (2-B)	top LH side of engine on Fuel Injector	142
C546 (2-B)	top RH side of engine on Fuel Injector	147
C547 (2-B)	LH rear of engine on Fuel Injector	143
Connector	Location	View

Connector	Location	View
C548 (2-B)	top RH side of engine on Fuel Injector	147
C551 (6-B)	centre rear of engine compartment	167
C554 (2-B)	beneath centre of vehicle to Catalyst Overheat Sensor 2	
C556 (2-B)	beneath centre of vehicle to Catalyst Overheat Sensor 1	
C558 (2-B)	beneath centre console	166
C559 (10-W)	beneath centre console	166
C560 (20-B)	beneath centre console	166
C561 (14-B)	beneath centre of vehicle on Gearbox Case	171
C562 (6-B) (Up to VIN 387824)	LH side of transmission on Gear Box Position Switch	172
C562 (6-S) (From VIN 387825)	LH side of transmission on Gear Box Position Switch	174
C563 (2-B)	LH side of transmission on Neutral Switch	173
C564 (2-B)	LH side of transmission on Reverse Switch	173
C565 (1-B)	beneath centre of vehicle on transfer box rear of on Transfer Box Oil Temperature Switch	168
C566 (1-B)	beneath centre of vehicle on transfer box rear of	168
C567 (2-B)	beneath centre of vehicle on Vehicle Speed Sensor	170
C568 (8-B)	beneath centre of vehicle on Transfer Box Solenoid	169
C570 (T570)	lower LH rear of engine on Starter	187
C571 (25-B)	RH rear of engine compartment beneath coolant expansion tank	176
C572 (55-B)	RH front of engine compartment behind battery on Engine Control Module (ECM)	174
C574 (E574)	RH side of engine compartment near Engine Compartment Fuse Box	177
C575 (8-B)	RH side of engine compartment beneath Engine Compartment Fuse Box	177
C576 (T576)	LH side of engine on Glow Plugs	181
C577 (T577)	LH side of engine on Glow Plugs	181
C578 (T578)	LH side of engine on Glow Plugs	181
C579(T579)	RH front of engine compartment on Battery	178
C580 (T580)	lower LH rear of engine on Starter Solenoid	187
C581 (6-B)	LH side of engine	188
C582 (1-)	LH side of engine on Fuel Shut-Off Solenoid	
C583 (2-W)	LH side of engine on Injector Needle Lift Sensor	183
C584 (12-B)	RH front of engine compartment behind battery on Glow Plug Timer Unit	175
C585 (T585)	RH front of engine compartment behind battery on Glow Plug Timer Unit	175
C586 (7-B)	LH side of engine on Fuel Pump Assembly	183
C587 (2-B)	LH front of engine on Solenoid Valve, Injection Timing Device	185
C588 (2-B)	LH side of engine on Engine Coolant Temperature Gauge Sensor	179
C589 (2-B)	LH rear of engine to Engine Speed Sensor	186
C590 (3-B)	LH rear of engine compartment on Boost Pressure Sensor	184
C591 (2-B)	LH side of engine on Engine Coolant Temperature Sensor	182
C592 (3-B)	LH rear of engine compartment on Fuel Heater	184
C594 (2-B)	lower LH side of engine on Oil Pressure Switch	276
C595 (2-B)	LH side of engine on Intake Air Temperature Sensor	180
C596 (T596)	LH side of engine on Glow Plugs	189
C597 (T597)	LH side of engine on Glow Plugs	189
C598 (T598)	LH side of engine on Glow Plugs	189
C599 (T599)	LH front of engine on Generator	185
C601 (55-B)	beneath LH front seat on Auto Gear Box Control Unit	195
C603 (36-B)	beneath LH front seat on Transfer Gear Box ECU	195

Connector	Location	View
C605 (4-W)	behind centre of fascia to Transfer Switch Manual	
C606 (2-W)	inside driver's seat belt buckle assembly	196
C609 (2-W)	beneath RH front seat near Body Electrical Control Module (BECM)	
C611 (1-B)	beneath centre console on Handbrake Switch	193
C612 (1-B)	beneath centre console on Handbrake Switch	193
C613 (2-W)	beneath cubby box liner on Rear Footwell Lamp	191
C614 (8-U)	beneath centre console on Centre Console Switch Pack Outstation	202
C615A (6-W)	beneath centre console on Transfer Micro Switch/Shift Lock Solenoid	194
C615B (4-W)	behind centre of fascia to Transfer Switch Manual	
C617 (12-B)	beneath centre console on 'H' Gate Sensor Module	204
C618 (1-W)	beneath centre console on Fascia Cigar Lighter	192
C619 (2-B)	beneath centre console on Fascia Cigar Lighter	192
C621 (E621)	beneath RH front seat on Body Electrical Control Module (BECM)	200
C623 (T623)	beneath RH front seat on Body Electrical Control Module (BECM)	200
C624 (4-W)	beneath RH front seat on Body Electrical Control Module (BECM)	198
C625 (12-W)	beneath RH front seat on Body Electrical Control Module (BECM)	198
C626 (20-B)	beneath RH front seat on Body Electrical Control Module (BECM)	199
C628 (6-W)	beneath LH front seat on Catalyst Amplifier	
C635 (6-W)	behind centre of fascia on Transfer Switch Manual	201
C658 (2-B)	beneath centre console	197
C659 (10-W)	beneath centre console	197
C660 (20-B)	beneath centre console	197
C701L (10-W)	respective rear door on Left Rear Door Speaker Amplifier	209
C701R (10-W)	respective rear door on Right Rear Door Speaker Amplifier	209
C703L (6-W)	behind rear door trim panel	211
C703R (6-W)	behind rear door trim panel	211
C704L (6-S)	behind rear door trim panel	211
C704R (6-S)	behind rear door trim panel	211
C705L (6-Y)	behind rear door trim panel	211
C705R (6-Y)	behind rear door trim panel	211
C706L (4-W)	respective rear door on Left Rear Window Door Switch	206
C706R (4-W)	respective rear door on Right Rear Window Door Switch	206
C707L (6-B)	respective rear door on Left Rear Window Motor	207
C707R (6-W)	respective rear door on Right Rear Window Motor	207
C708L (2-B)	behind rear door trim panel to Left Rear Door Puddle Lamp	210
C708R (2-B)	behind rear door trim panel to Right Rear Door Puddle Lamp	210
C711L (2-B)	respective rear door on Left Rear Bass Speaker	212
C711R (2-B)	respective rear door on Right Rear Bass Speaker	212
C712L (2-B)	respective rear door on Left Rear Midrange Speaker	208
C712R (2-B)	respective rear door on Right Rear Midrange Speaker	208
C713L	respective rear door	205
C713R	respective rear door	205
C714L (6-B)	inside respective rear door on Left Rear Door Lock Actuator	205
C714R (6-W)	inside respective rear door on Right Rear Door Lock Actuator	205
C751L (12-B)	front of LH front door jamb	222
C751R (12-B)	front of RH front door jamb	222
C752L (4-W)	front of LH front door jamb	222
C752R (4-W)	front of RH front door jamb	222
C753L (6-B)	respective front door on Left Mirror Actuator	213
C753R (6-B)	respective front door on Right Mirror Actuator	213
C754L (12-B)	inside respective front door on Left Front Door Outstation	221
C754R (12-B)	inside respective front door on Right Front Door Outstation	219

Connector	Location	View
C755L (16-B)	inside respective front door on Left Front Door Outstation	221
C755R (16-B)	inside respective front door on Right Front Door Outstation	219
C756L (13-B)	respective front door on Left Memory Mirror	213
C756R (13-B)	respective front door on Right Memory Mirror	213
C757L (2-B)	behind front door trim panel on Left Front Door Puddle Lamp	215
C757R (2-B)	behind front door trim panel on Right Front Door Puddle Lamp	215
C758L (20-B)	inside respective front door on Left Front Door Outstation	221
C758R (20-B)	inside respective front door on Right Front Door Outstation	219
C759L (2-B)	behind front door trim panel on Left Front Midrange Speaker	220
C759R (2-B)	behind front door trim panel on Right Front Midrange Speaker	220
C762L (6-B)	inside respective front door on Left Front Door Lock Actuator	214
C762R (6-W)	inside respective front door on Right Front Door Lock Actuator	214
C763L (2-B)	inside respective front door on Left Front Door Lock Actuator	214
C763R (2-B)	inside respective front door on Right Front Door Lock Actuator	214
C764L (6-B)	respective front door on Left Front Window Motor	216
C764R (6-W)	respective front door on Right Front Window Motor	216
C765L (2-B)	respective front door on Left Front Bass Speaker	217
C765R (2-B)	respective front door on Right Front Bass Speaker	217
C768L (10-W)	respective front door on Left Front Door Speaker Amplifier	218
C768R (10-W)	respective front door on Left Front Door Speaker Amplifier	218
C769L (2-B)	respective front door on Left Front Tweeter	213
C769R (2-B)	respective front door on Right Front Tweeter	213
C806 (10-B)	RH rear of luggage compartment	223
C813 (4-G)	LH side of tailgate on Left Tailgate Lights	228
C814 (2-B)	centre of tailgate on Tailgate Switch	226
C815 (3-B)	centre of tailgate RH rear of luggage compartment Tailgate Unlock Switch	225
C816 (4-G)	RH side of tailgate on Right Tailgate Lights	224
C818 (2-B)	centre of tailgate on Tailgate Lock Actuator	227
C857 (4-W)	centre rear of roof	232
C859 (2-W)	centre rear of roof	232
C860 (2-B)	centre rear of roof	232
C861 (2-B)	centre of tailgate to Left Number Plate Lamp	234
C862 (2-B)	centre of tailgate to Right Number Plate Lamp	234
C863 (1-B)	centre of tailgate on Rear Load Space Lamp	235
C864 (1-B)	centre of tailgate on Rear Load Space Lamp	235
C865 (2-W)	centre of tailgate to Centre Mounted Stop Lamp	233
C867 (3-B)	top centre of rear screen to Rear Wiper Motor	229
C868 (1-B)	LH side of tailgate on Rear Screen	230
C873 (1-B)	RH side of tailgate on Rear Screen	231
C901A (12-S)	beneath LH front seat on Left Seat Outstation	240
C901B (8-W)	beneath LH front seat	240
C902A (12-S)	beneath RH front seat on Right Seat Outstation	236
C902B (8-W)	beneath RH front seat	236
C903 (3-W)	beneath LH front seat to Left Heated Seat	240
C904 (2-W)	beneath LH front seat to Left Heated Seat	240
C905 (3-W)	beneath RH front seat to Right Heated Seat	236
C906 (2-W)	beneath RH front seat to Right Heated Seat	236
C907 (8-B)	beneath RH front seat on Body Electrical Control Module (BECM)	239
C908 (E908)	beneath RH front seat near Body Electrical Control Module (BECM)	238
C909 (E909)	beneath RH front seat near Body Electrical Control Module (BECM)	238
C912 (12-G)	beneath RH front seat on Body Electrical Control Module (BECM)	237

Connector	Location	View
C951L (8-W)	underside of respective front seat	242
C951R (8-W)	underside of respective front seat	242
C952L (12-W)	underside of respective front seat	242
C952R (12-W)	underside of respective front seat	242
C953L (18-W)	underside of respective front seat	242
C953R (18-W)	underside of respective front seat	242
C954L (5-B)	underside of LH front seat on Left Non-Memory Seat Power Relay 2	241
C954R (5-B)	underside of RH front seat on Right Non-Memory Seat Power Relay 2	246
C955L (5-B)	underside of LH front seat on Left Non-Memory Seat Power Relay 1	241
C955R (5-B)	underside of RH front seat on Right Non-Memory Seat Power Relay 1	246
C956L (1-R)	underside of respective front seat on Seat Height (Front) Motor	244
C956R (1-R)	underside of respective front seat on Seat Height (Front) Motor	244
C957L (1-B)	underside of respective front seat on Seat Height (Front) Motor	244
C957R (1-B)	underside of respective front seat on Seat Height (Front) Motor	244
C958L (4-W)	underside of respective front seat to Seat Base Motor	243
C958R (4-W)	underside of respective front seat to Seat Base Motor	243
C959L (1-B)	underside of respective front seat on Seat Height (Rear) Motor	245
C959R (1-B)	underside of respective front seat on Seat Height (Rear) Motor	245
C960L (1-R)	underside of respective front seat on Seat Height (Rear) Motor	245
C960R (1-R)	underside of respective front seat on Seat Height (Rear) Motor	245
C961L (6-W) (With Memory)	underside of respective front seat to Recline Motor and Potentiometer	247
C961L (6-W) (Without Memory)	underside of respective front seat to Seat Recline Motor	
C961R (6-W) (With Memory)	underside of respective front seat to Recline Motor and Potentiometer	247
C961R (6-W) (Without Memory)	underside of respective front seat to Seat Recline Motor	
C962L (12-G) (With Memory)	underside of respective front seat on Left Seat Outstation	248
C962L (12-W) (Without Memory)	underside of respective front seat	
C962R (12-G) (With Memory)	underside of respective front seat on Right Seat Outstation	248
C962R (12-G) (Without Memory)	underside of respective front seat	
C963L (4-W)	underside of respective front seat to Left Lumbar Pump	249
C963R (4-W)	underside of respective front seat to Right Lumbar Pump	249
C964L (1-R)	underside of respective front seat on Headrest Motor	250
C964R (1-R)	underside of respective front seat on Headrest Motor	250
C965L (1-B)	underside of respective front seat on Headrest Motor	250
C965R (1-B)	underside of respective front seat on Headrest Motor	250
C966L (3-W)	underside of respective front seat to Headrest Potentiometer	249
C966R (3-W)	underside of respective front seat to Headrest Potentiometer	249
C971L (18-W)	underside of respective front seat	254
C971R (18-W)	underside of respective front seat on Left Seat Outstation	254
C972L (4-W)	underside of respective front seat to Seat Base Motor	271
C972R (4-W)	underside of respective front seat to Seat Base Motor	271
C973L (3-W)	underside of respective front seat to Seat Potentiometer Front Motor	252
C973R (3-W)	underside of respective front seat to Seat Potentiometer Front Motor	252
C974L (1-R)	underside of respective front seat on Seat Height (Front) Motor	252
C974R (1-R)	underside of respective front seat on Seat Height (Front) Motor	252
C975L (1-B)	underside of respective front seat on Seat Height (Front) Motor	252
C975R (1-B)	underside of respective front seat on Seat Height (Front) Motor	252

Connector	Location	View
C976L (3-W)	underside of respective front seat on Seat Potentiometer Rear Motor	253
C976R (3-W)	underside of respective front seat to Seat Potentiometer Rear Motor	253
C977L (4-W)	underside of respective front seat to Fore-Aft Sensor	272
C977R (4-W)	underside of respective front seat to Fore-Aft Sensor	272
C978L (1-B)	underside of respective front seat	253
C978R (1-B)	underside of respective front seat on Seat Height (Rear) Motor	253
C979L (1-R)	underside of respective front seat	253
C979R (1-R)	underside of respective front seat on Seat Height (Rear) Motor	253
C997L	underside of respective front seat on Left Seat Outstation	272
C997R	underside of respective front seat on Right Seat Outstation	272
C998 (With Memory)	underside of respective front seat on Left Seat Outstation	272
C998 (Without Memory)	underside of respective front seat to Left Seat Switch	
C999 (With Memory)	underside of respective front seat on Right Seat Outstation	272
Ground	Location	View
E100	RH side of engine	93
E135	under LH rear of bonnet	1
E148	LH rear of engine compartment	27
E149L	LH rear of engine compartment	27
E149R	RH rear of engine compartment	20
E154	LH front of engine compartment	26
E167	RH rear of engine compartment	20
E181	RH side of engine compartment	54
E182	RH side of engine compartment	54
E199	centre rear of engine compartment	53
E252	behind RH footwell trim panel	56
E253	behind RH footwell trim panel	56
E254	behind RH footwell trim panel	56
E322	RH side of luggage compartment	112
E328	RH side of luggage compartment	112
E361 (From VIN 359269)	in front of centre console behind heater and A/C control panel	285
E367	LH side of luggage compartment	133
E412	behind RH footwell trim panel	
E500	RH front of engine	164
E529	RH side of engine compartment	279
E574	RH side of engine compartment	279
E621	beneath RH front seat	200
E908	beneath RH front seat	238
E909	beneath RH front seat	238

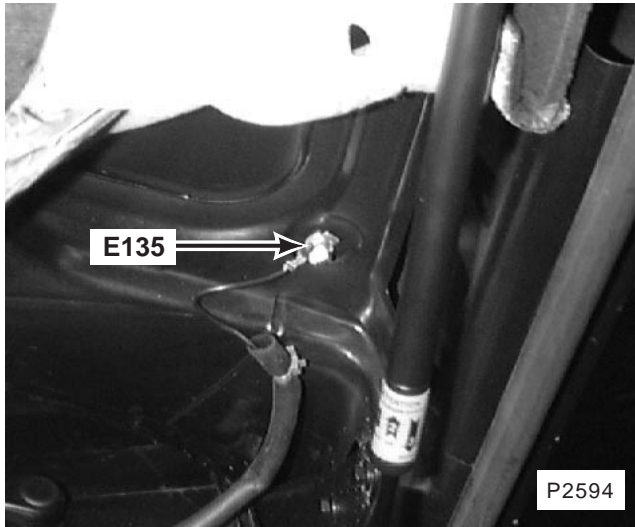

1. under LH rear of bonnet
E135

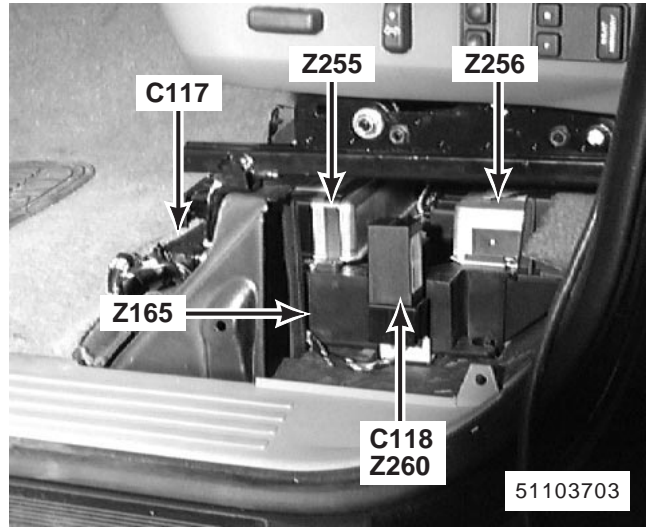

2. beneath LH front seat
Z260 Air Suspension Delay Turn Off Timer
Z165 Air Suspension ECU
Z255 Auto Gear Box Control Unit
Z256 Transfer Gear Box ECU
C117 (35-B)
C118 (9-B)

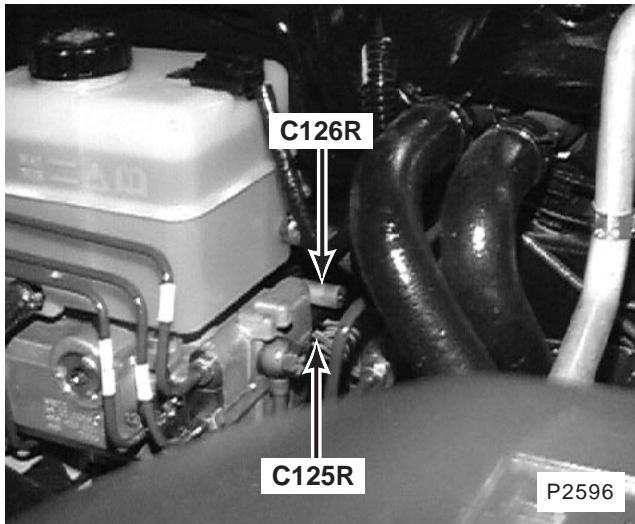

3. driver's side of engine compartment
C125R (13-B)
C126R (1-W)

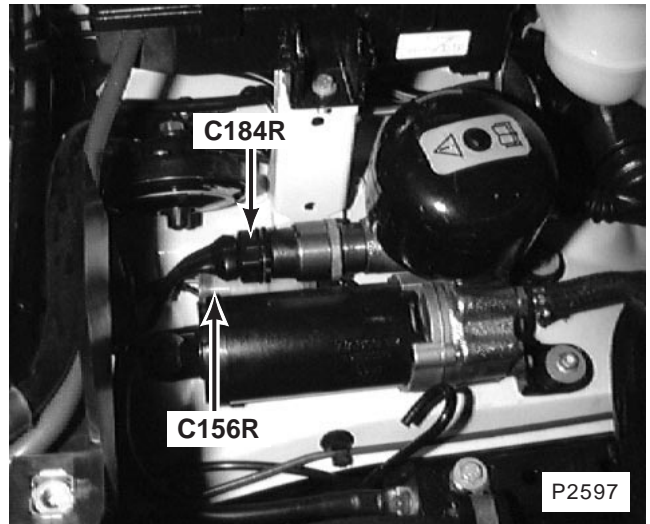

4. RH side of engine compartment
C156R (2-W)
C184R (5-B)

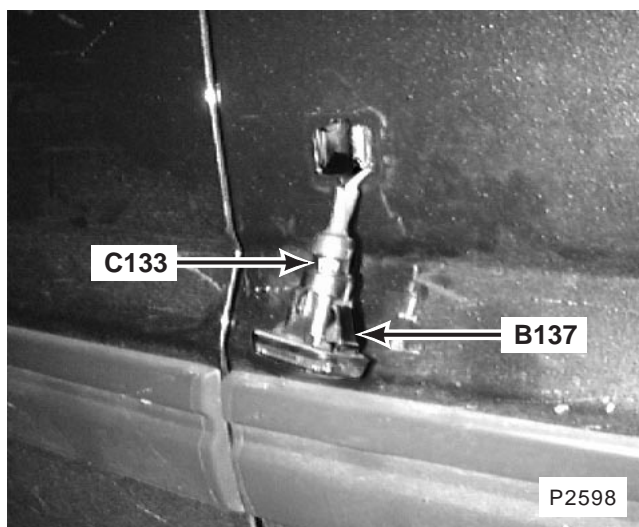

5. RH front side of vehicle
B137 Right Repeater Lamp
C133 (2-B)

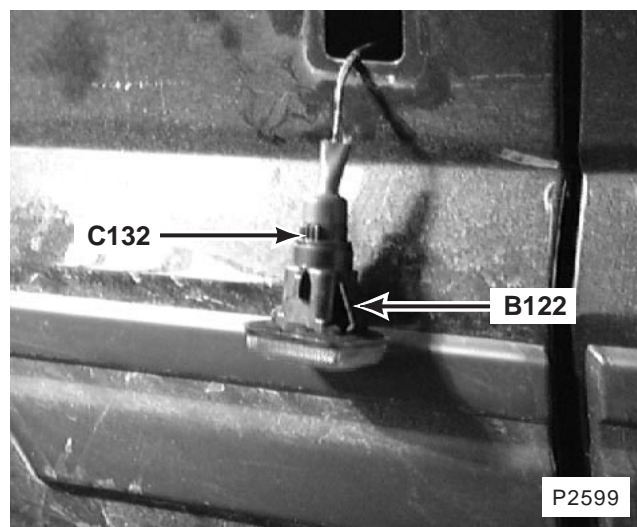

6. LH front side of vehicle
B122 Left Repeater Lamp
C132 (2-B)

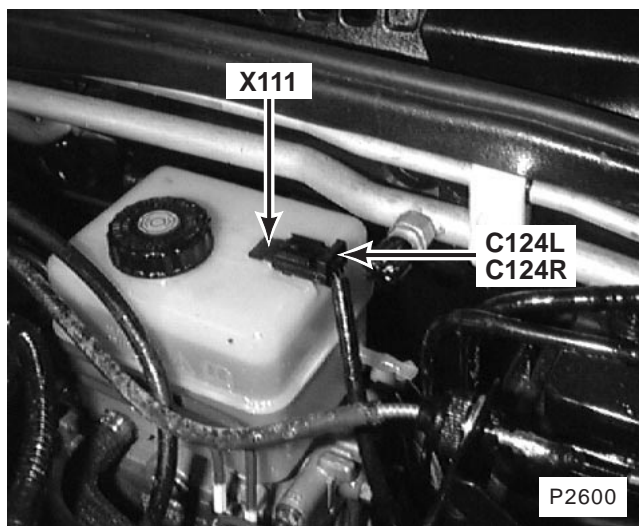

7. driver's side of engine compartment
X111 Brake Fluid Level Switch
C124L (2-B)
C124R (2-B)

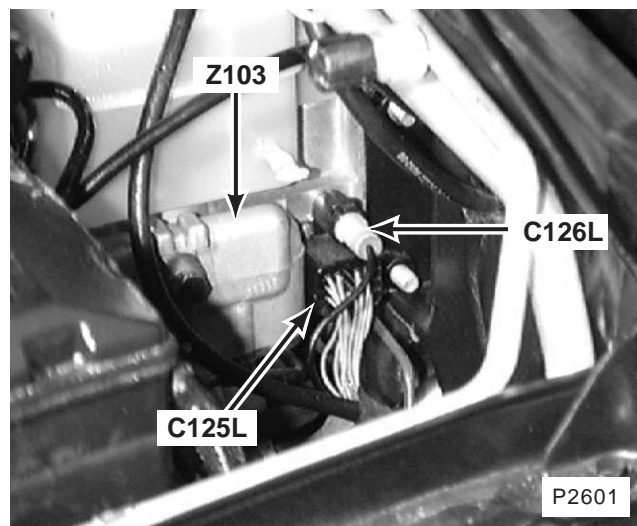

8. driver's side of engine compartment
Z103 A.B.S. Booster Unit
C125L (13-B)
C126L (1-W)

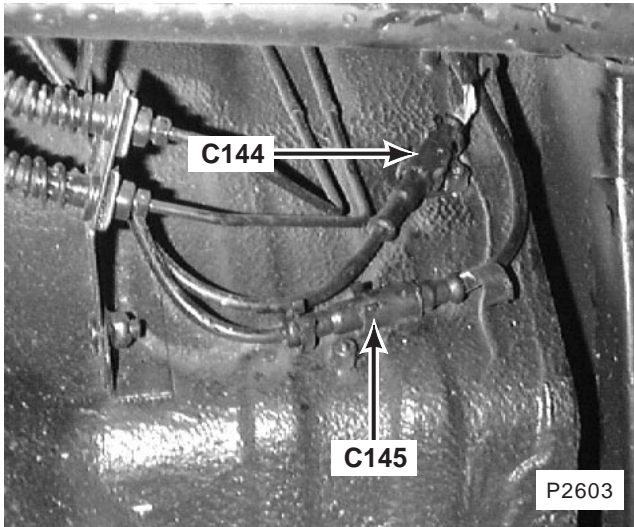

9. beneath LH rear of vehicle
 C144 (2-)
 C145 (2-)

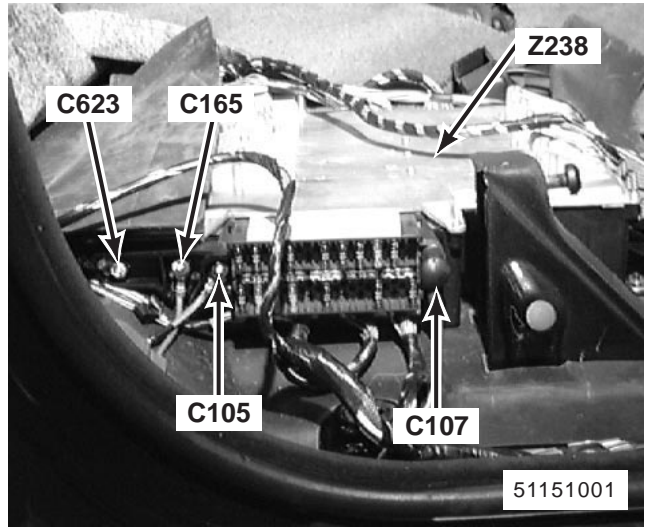

10. beneath RH front seat
 Z238 Body Electrical Control Module (BECM)
 C105
 C107
 C165
 C623

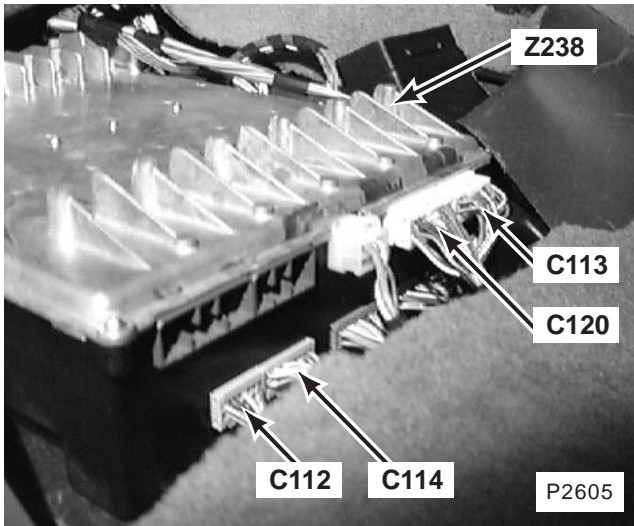

11. beneath RH front seat
 Z238 Body Electrical Control Module (BECM)
 C112 (16-G)
 C113 (10-Y)
 C114 (20-G)
 C120 (14-Y)

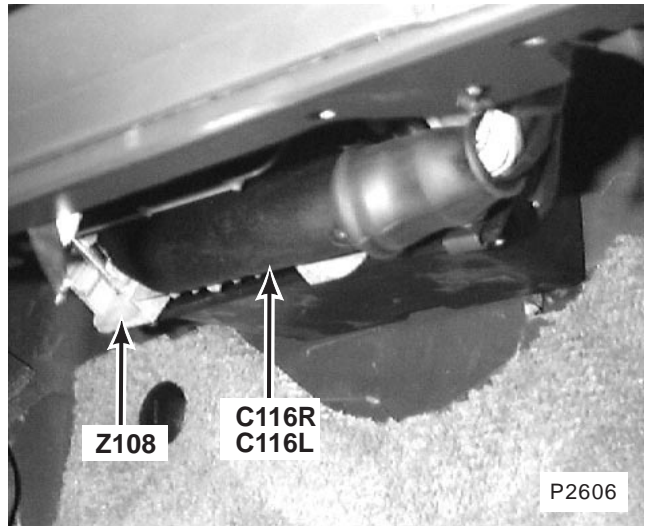

12. beneath fascia on passenger's side of bulk-head
 Z108 Anti-Lock Brake System ECU
 C116R (35-B)
 C116L (35-B)

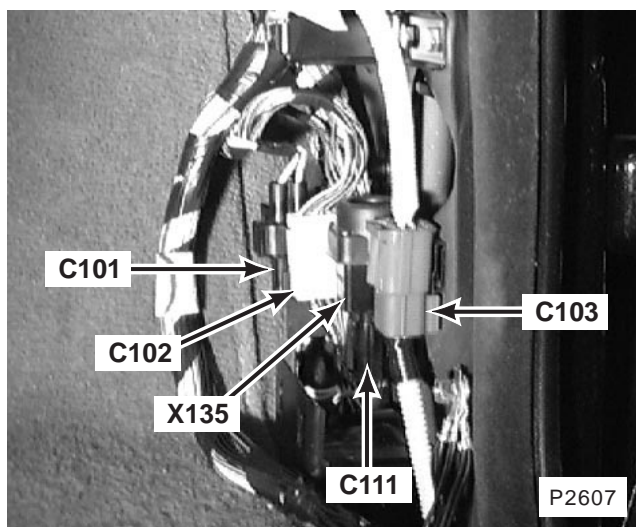

13. behind RH footwell trim panel
 X135 Inertia Fuel Shut-Off Switch
 C101 (2-B)
 C102 (18-W)
 C103 (6-R)
 C111 (3-B)

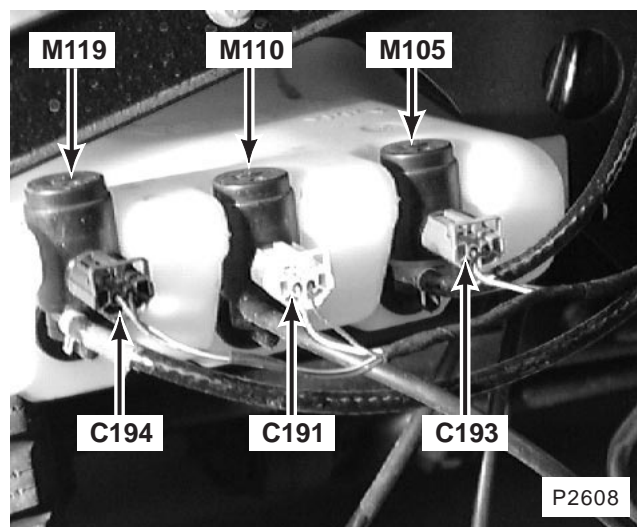

14. behind RH side of front bumper
 M105 Front Screen Wash Pump
 M110 Headlamp Wash Pump
 M119 Rear Screen Wash Pump
 C191 (2-W)
 C193 (2-R)
 C194 (2-B)

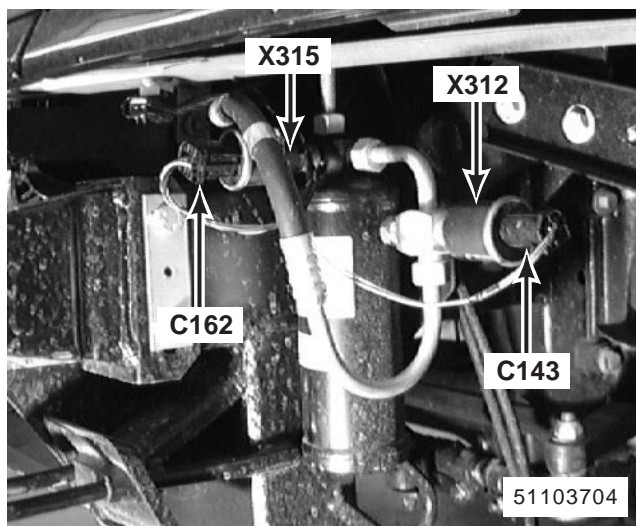

15. behind LH side of front bumper
 X315 A/C Dual Pressure Switch
 X312 Pressure Switch 2
 C143 (2-B)
 C162 (4-B)

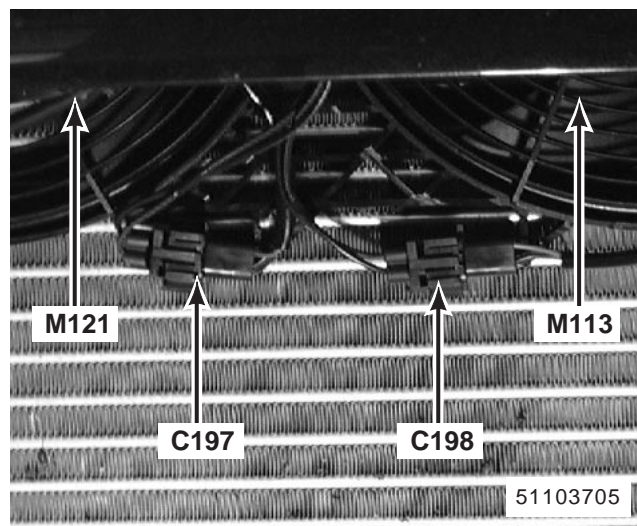

16. behind front grille
 M113 Left Condenser Fan Motor
 M121 Right Condenser Fan Motor
 C197 (2-B)
 C198 (2-B)

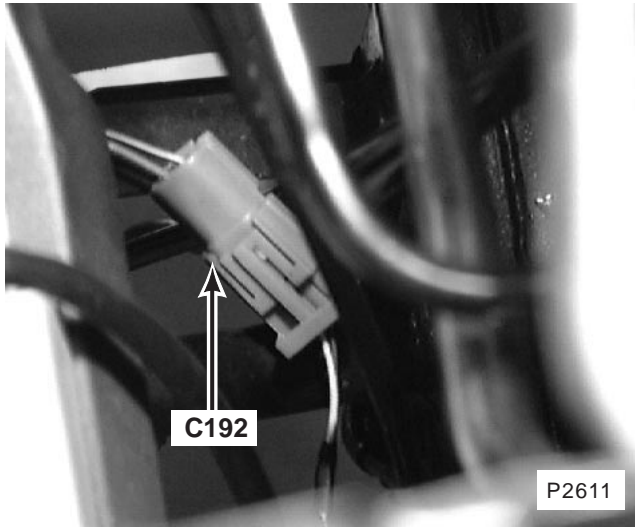

17. behind RH side of front bumper
C192 (2-U)

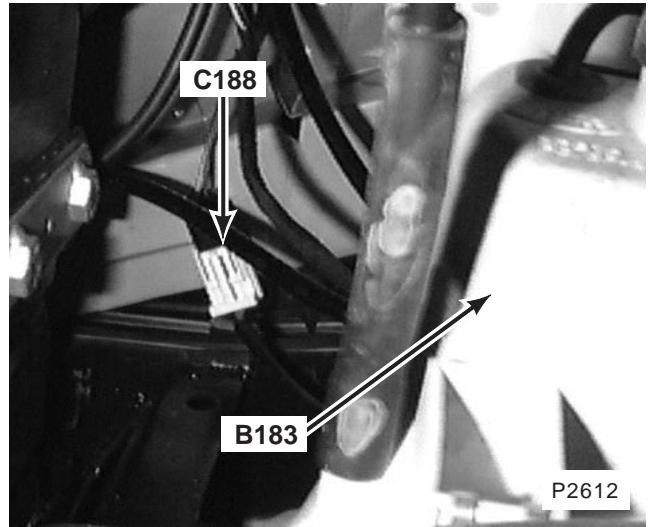

18. behind RH side of front bumper
B183 Right Front Fog Lamp
C188 (2-W)

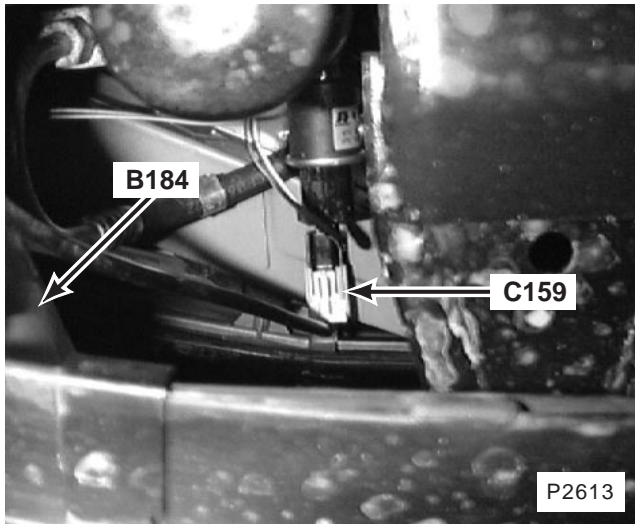

19. behind LH side of front bumper
B184 Left Front Fog Lamp
C159 (2-W)

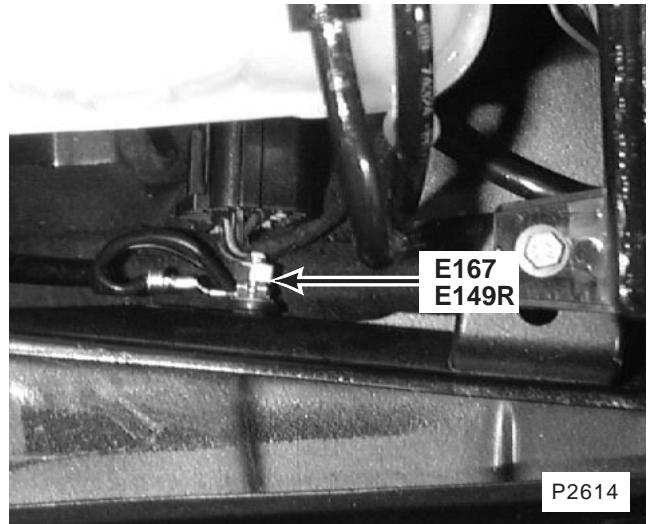

20. RH rear of engine compartment
E149R
E167

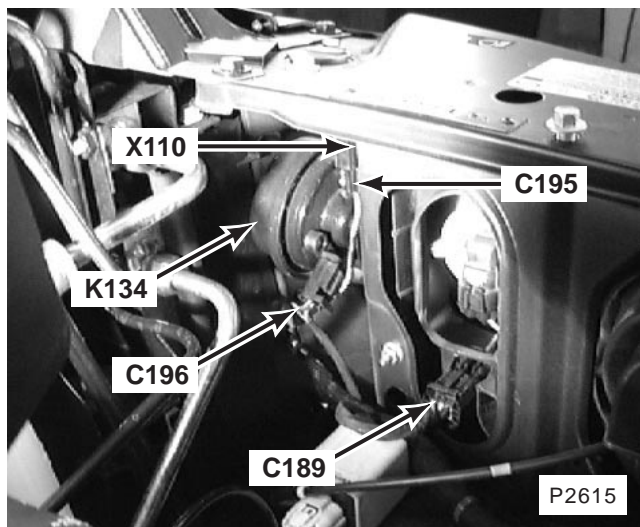

21. RH front of engine compartment
 K134 Right Horn
 X110 Bonnet Switch
 C189 (6-B)
 C195 (2-B)
 C196 (2-B)

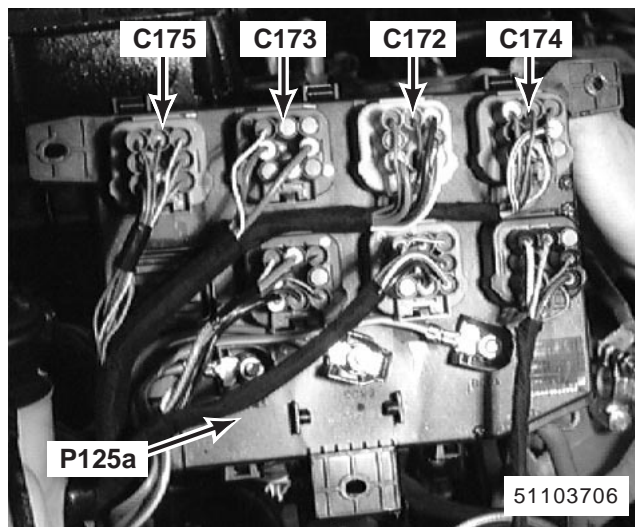

22. RH side of engine compartment
 P125a Engine Compartment Fuse Box
 C172 (8-Y)
 C173 (8-P)
 C174 (8-U)
 C175 (8-G)

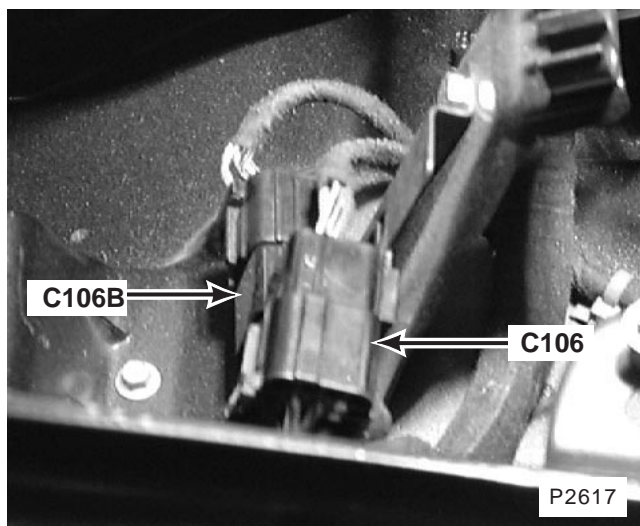

23. RH rear of engine compartment beneath coolant expansion tank
 C106 (13-B)
 C106B (13-B)

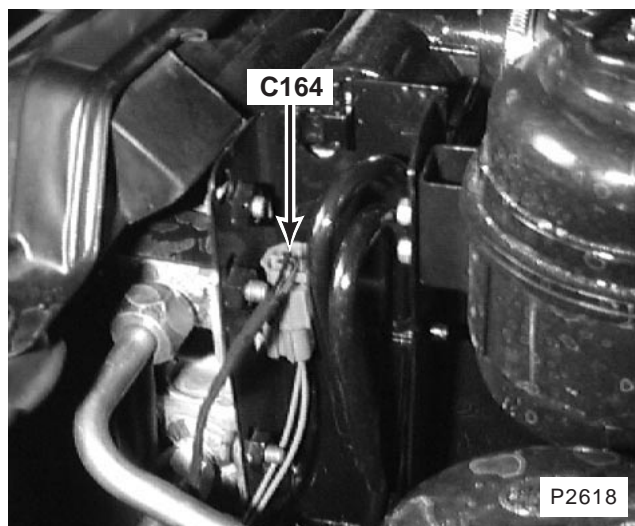

24. LH front of engine compartment
 C164 (2-U)

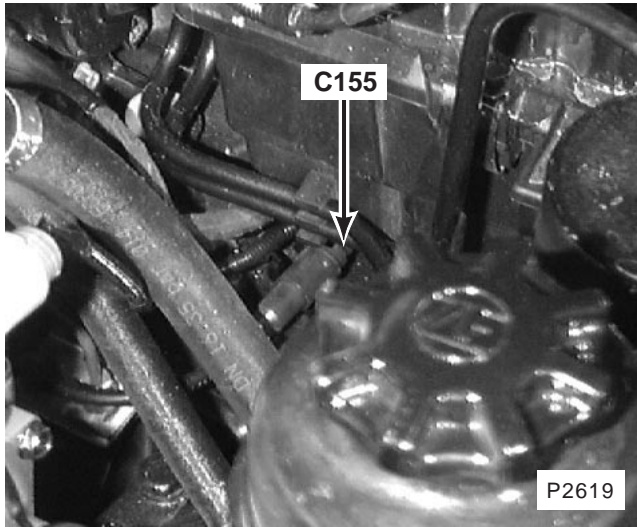

25. LH front of engine compartment
C155 (2-)

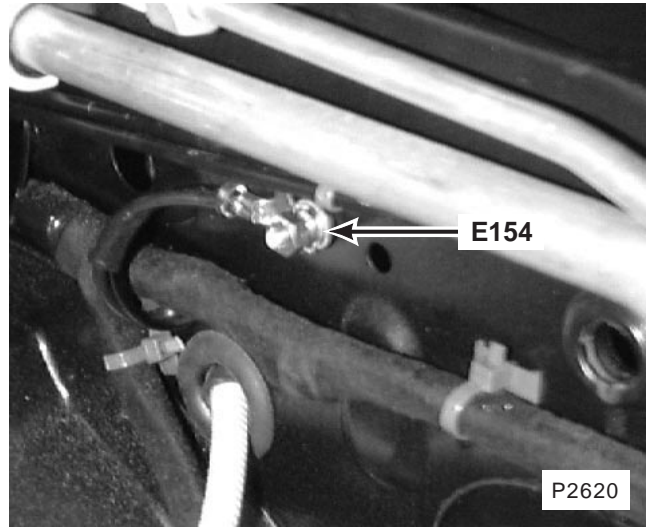

26. LH front of engine compartment
E154

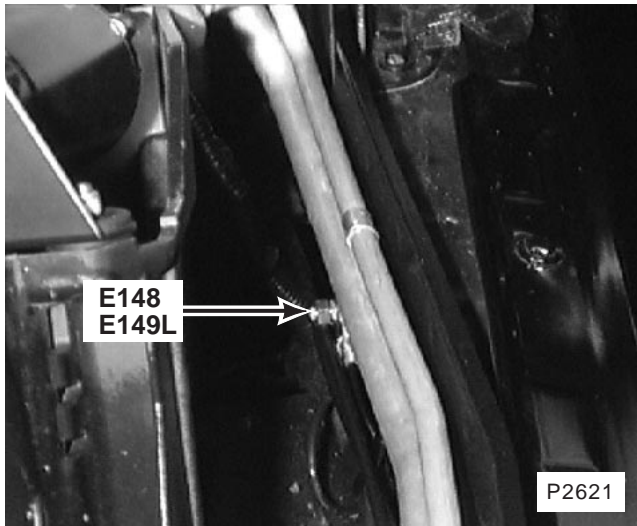

27. LH rear of engine compartment
E148
E149L

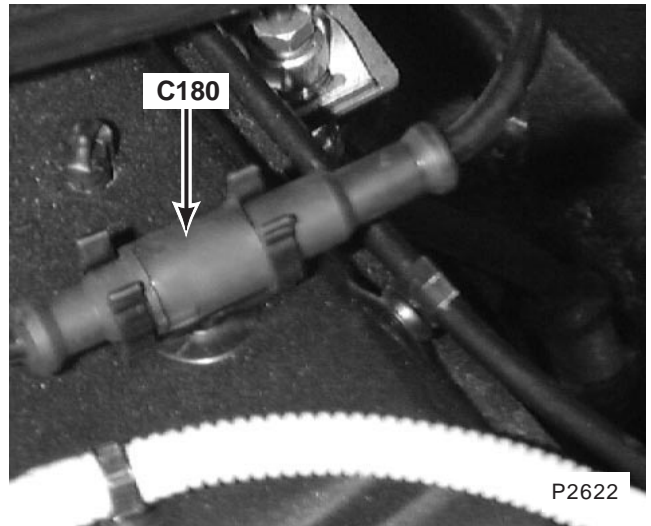

28. RH front of engine compartment
C180 (2-)

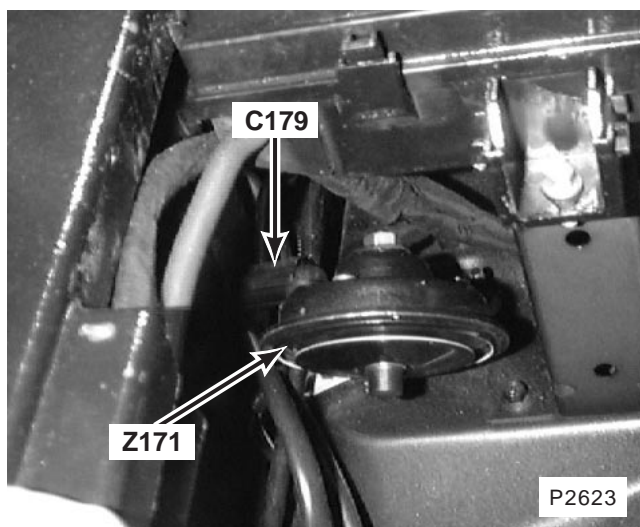

29. RH side of engine compartment
Z171 Alarm Sounder
C179 (2-B)

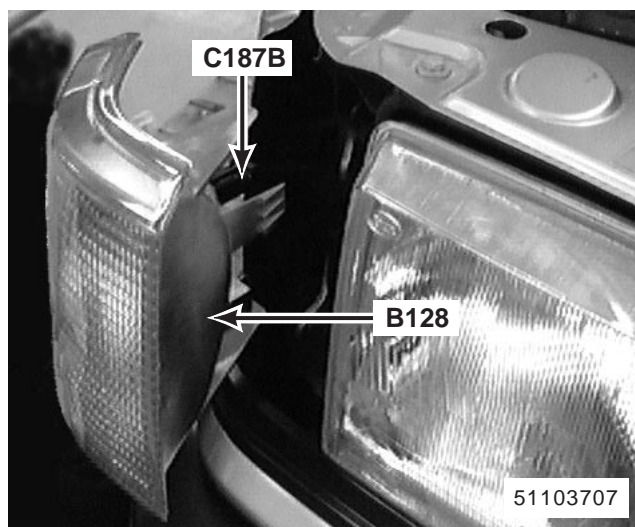

30. RH front of vehicle (LH similar)
B128 Right Front Lamp Assembly
C187B (3-B)

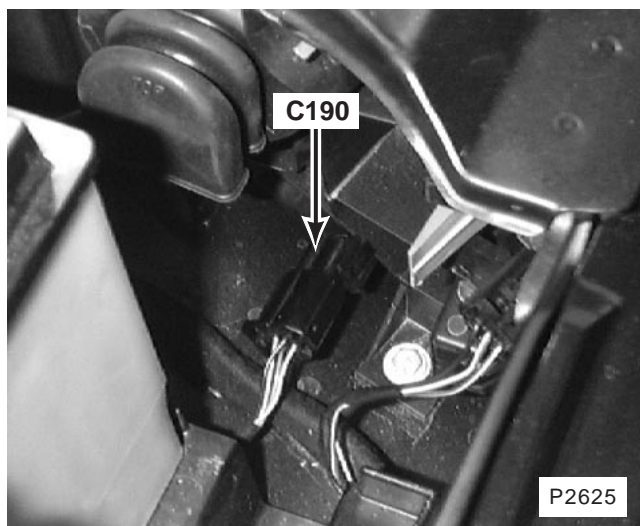

31. RH front of engine compartment
C190 (4-B)

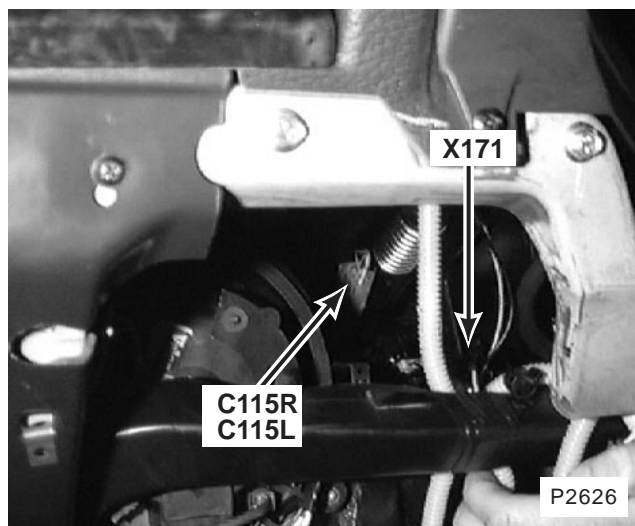

32. behind driver's side of fascia on brake pedal support
X171 Throttle Position Sensor
C115R (8-G)
C115L (8-G)

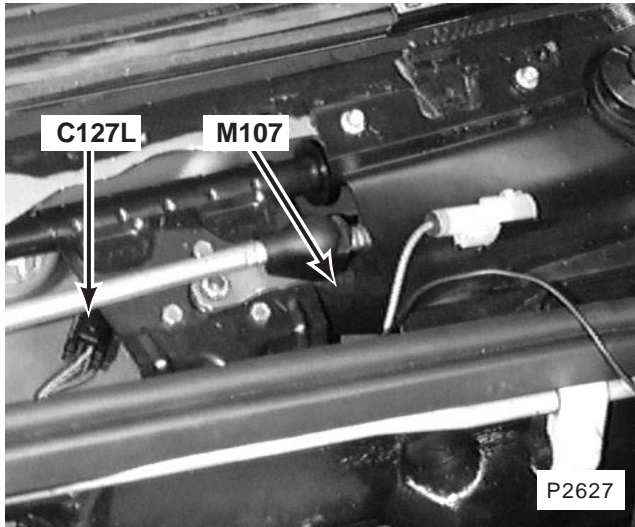

33. LH rear corner of engine compartment (RH similar)
 M107 Front Wiper Motor
 C127L (4-B)

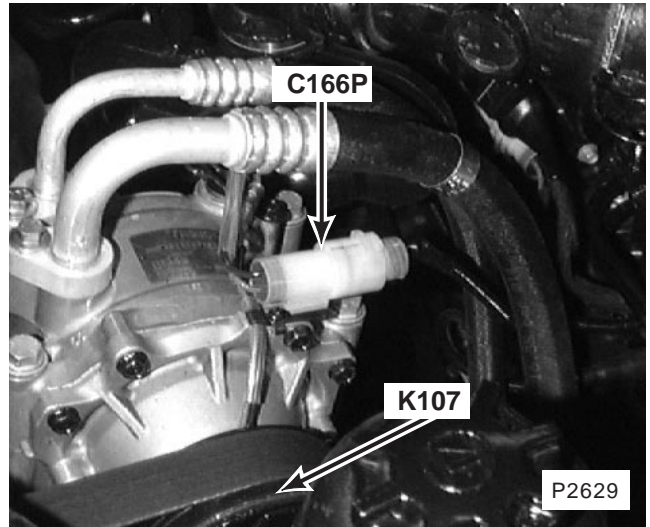

34. LH front of engine
 K107 Compressor Clutch
 C166P (2-W)

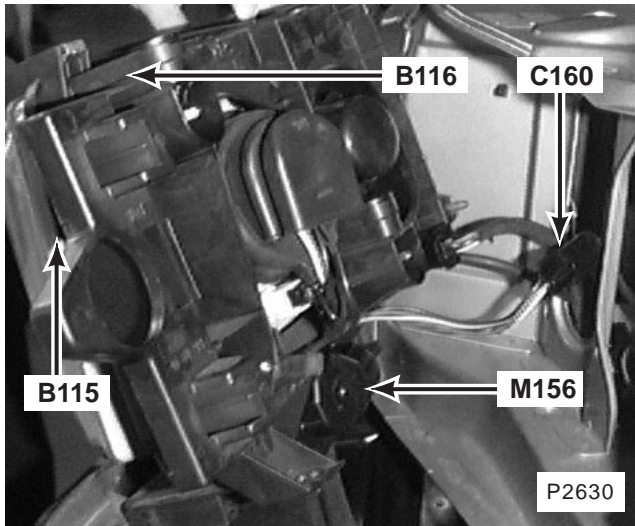

35. LH front of vehicle (RH similar)
 B115 Left Front Lamp Assembly
 B116 Left Headlamp
 M156 Left Headlamp Wiper Motor
 C160 (4-B)

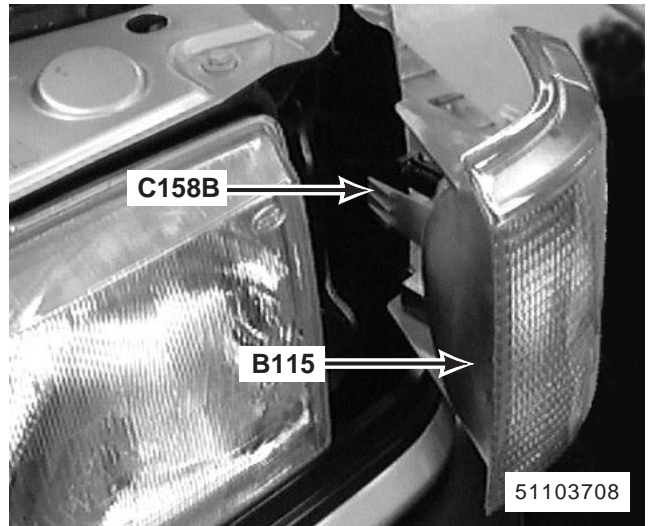

36. LH front of vehicle
 B115 Left Front Lamp Assembly
 C158B (3-B)

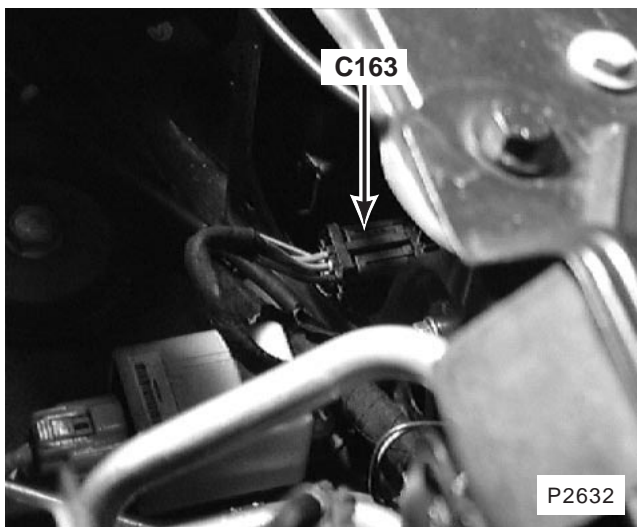

37. LH front of vehicle
C163 (6-B)

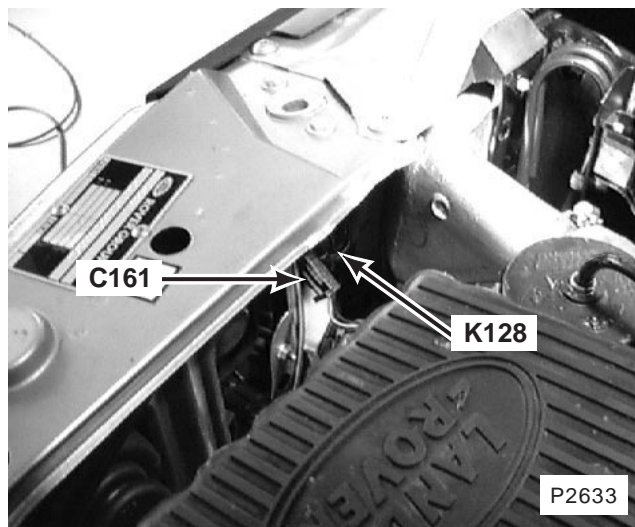

38. LH front of vehicle
K128 Left Horn
C161 (2-B)

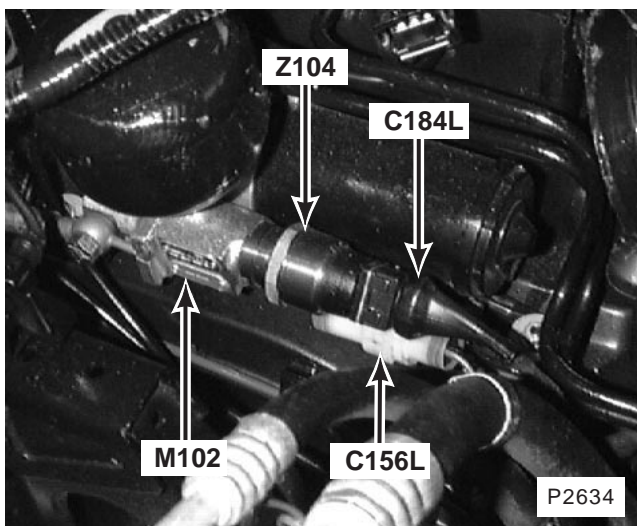

39. driver's side of engine compartment (LHD)
M102 A.B.S. Hydraulic Pump
Z104 A.B.S. Pressure Switch Unit
C156L (2-W)
C184L (5-B)

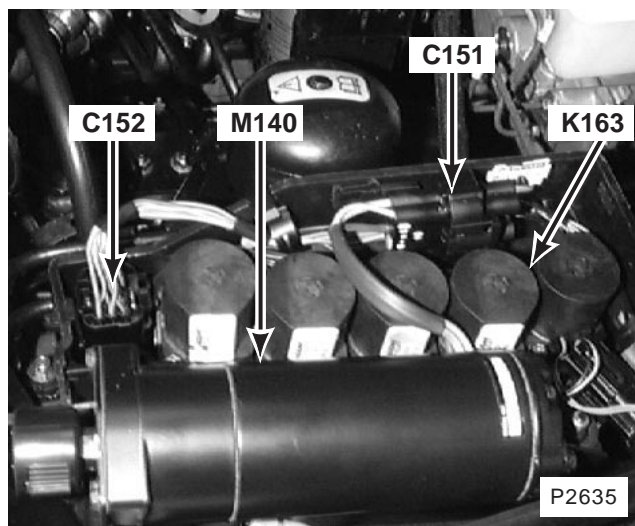

40. LH rear of engine compartment
K163 Air Valve Block
M140 Air Suspension Compressor
C151 (4-B)
C152 (13-B)

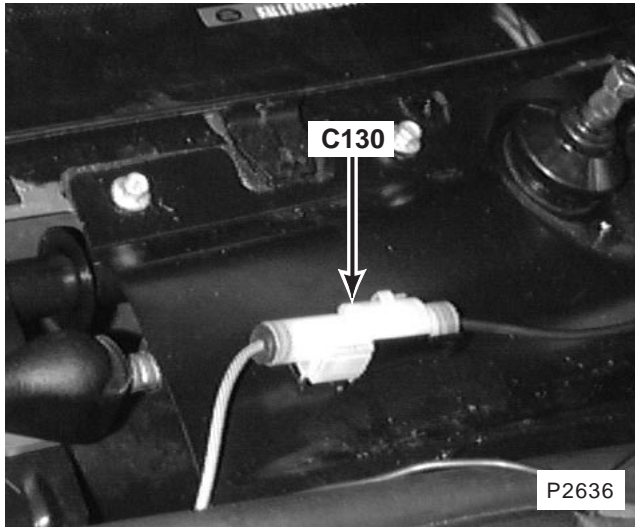

41. lower LH side of windscreen
C130 (1-W)

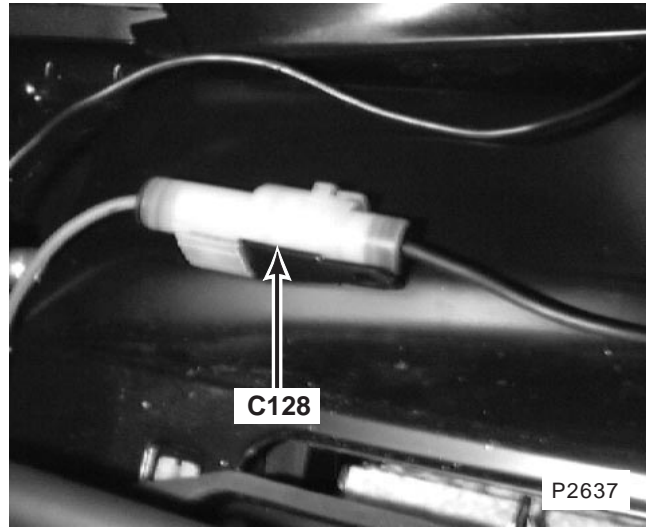

42. lower RH side of windscreen
C128 (1-W)

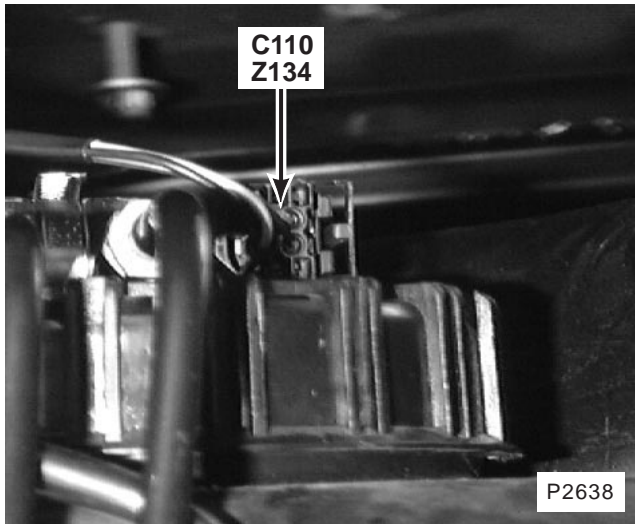

43. top of fuel tank
Z134 Fuel Pump Module
C110 (4-B)

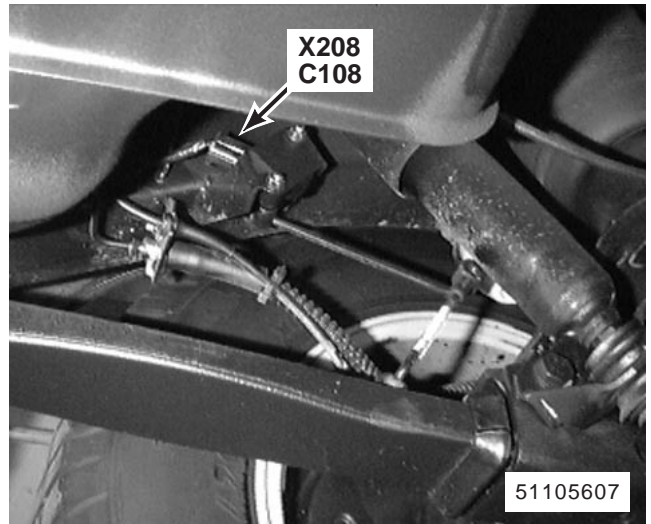

44. beneath RH rear of vehicle
X208 Right Rear Height Sensor
C108 (3-B)

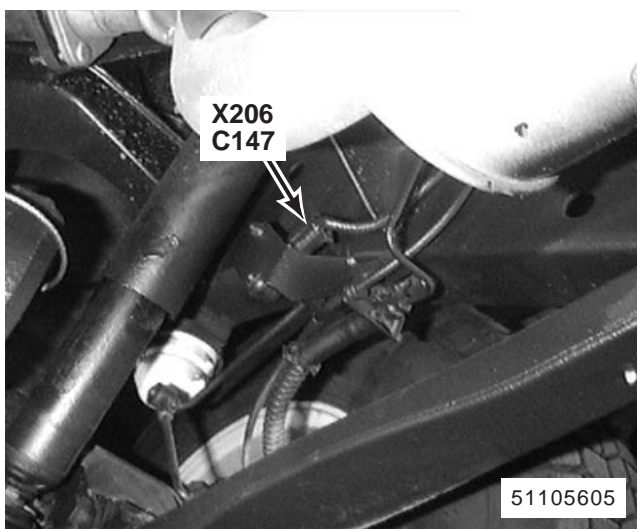

45. beneath LH rear of vehicle
X206 Left Rear Height Sensor
C147 (3-B)



46. beneath RH side of vehicle
X207 Right Front Height Sensor
C168 (3-B)



47. beneath RH side of vehicle
X205 Left Front Height Sensor
C146 (3-B)

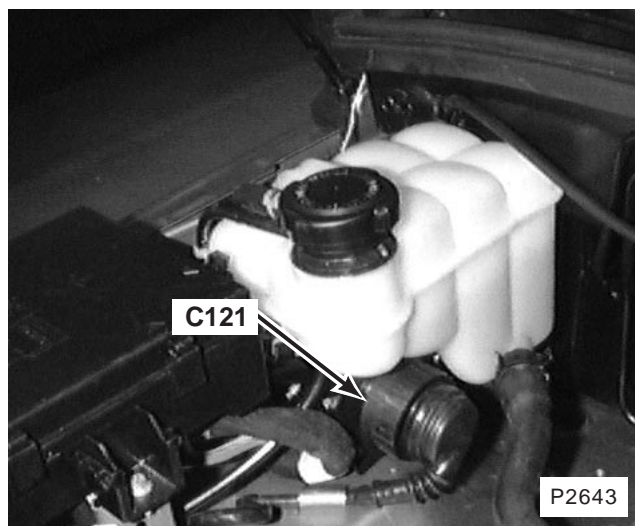

48. rear of engine compartment
C121 (25-B)

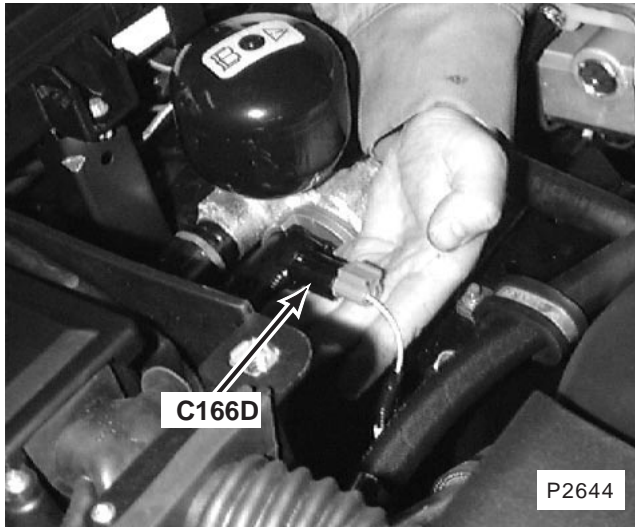

49. rear of engine compartment
C166D (2-U)

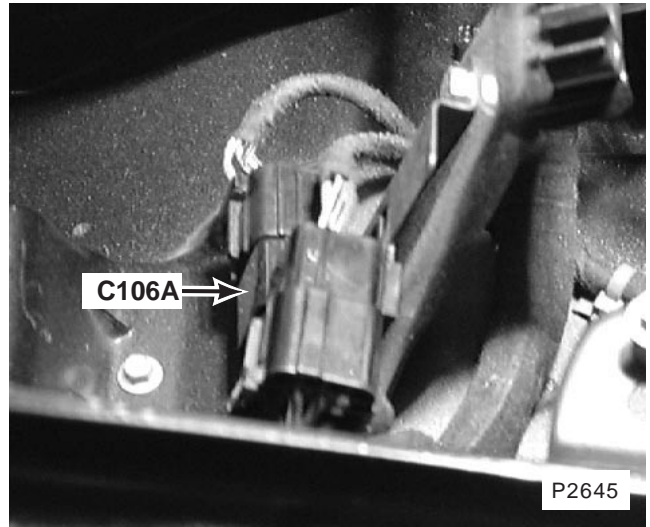

50. RH rear of engine compartment beneath
coolant expansion tank
C106A (4-B)

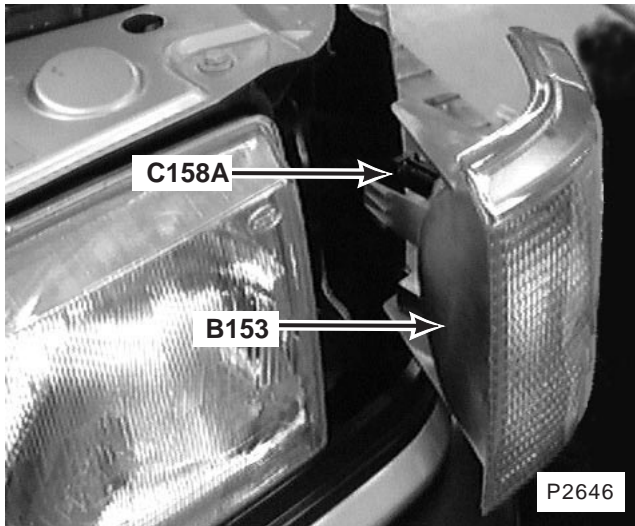

51. LH front of vehicle (LH similar)
B153 Left Front Indicator Lamp
C158A (2-B)

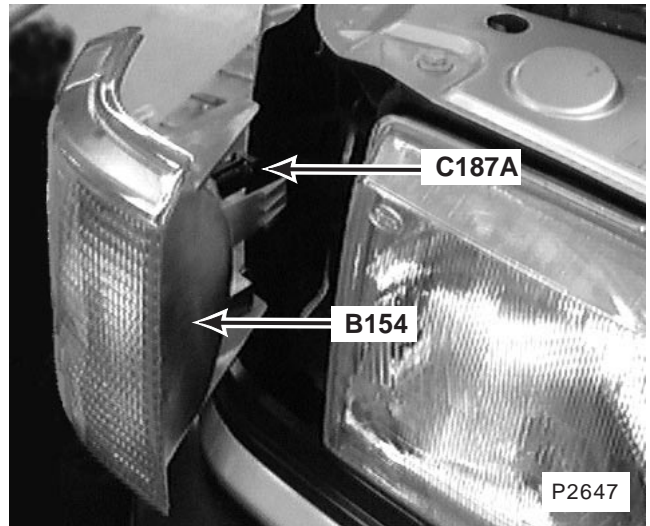

52. RH front of vehicle (LH similar)
B154 Right Front Indicator Lamp
C187A (2-B)

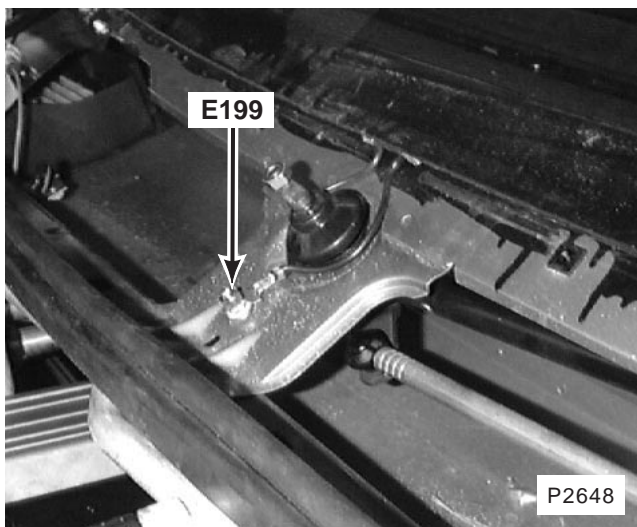

53. centre rear of engine compartment
E199

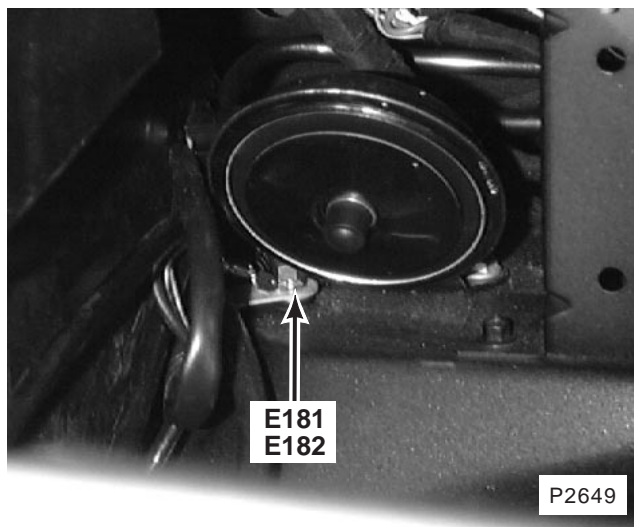

54. RH side of engine compartment
E181
E182

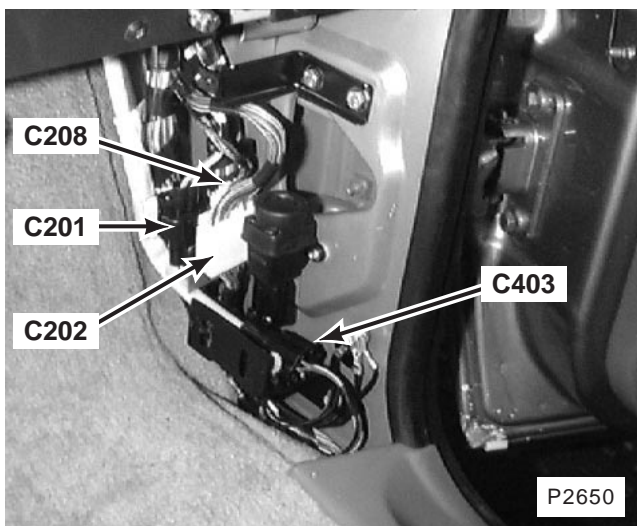

55. behind RH footwell trim panel
C201 (2-B)
C202 (18-W)
C208 (6-W)
C403 (6-R)

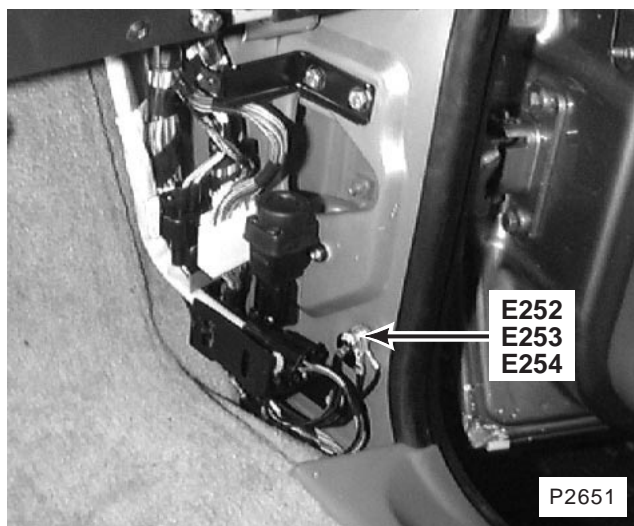

56. behind RH footwell trim panel
E252
E253
E254

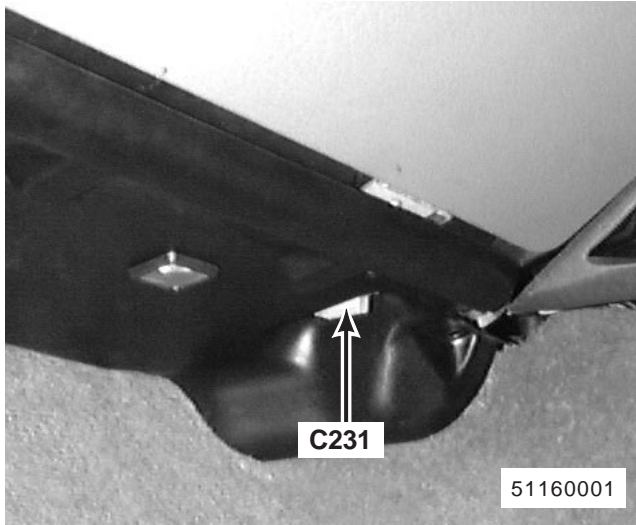

57. passenger's footwell
X318 Data Link Connector (OBDII)
C231 (16-S)

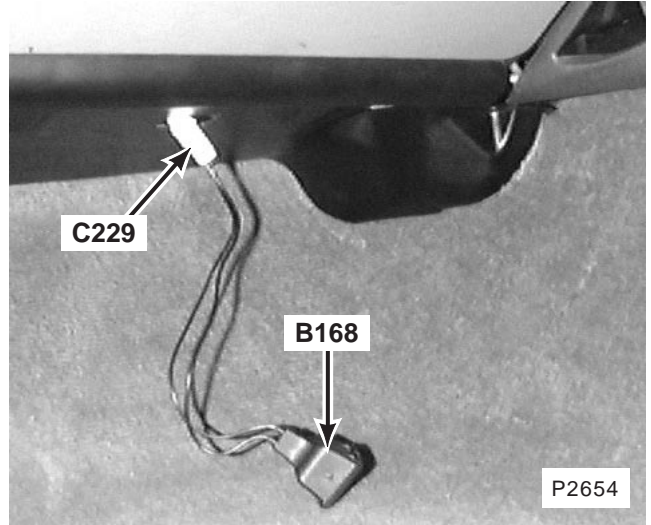

58. passenger's footwell
B168 Footwell Lamp 1
C229 (2-W)

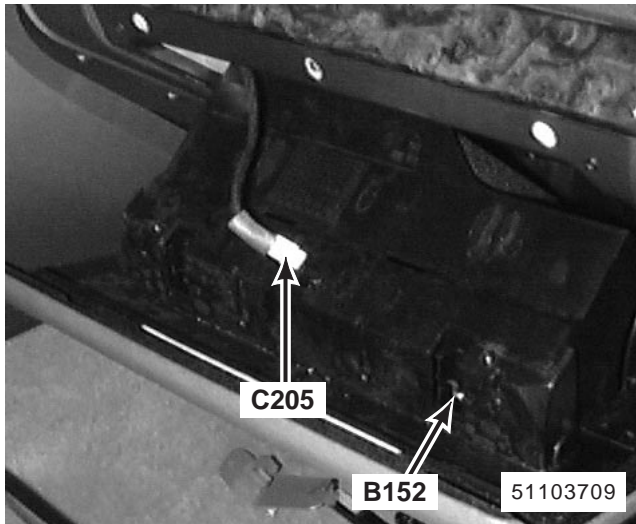

59. behind glovebox
B152 Glove Box Lamp
C205 (2-W)

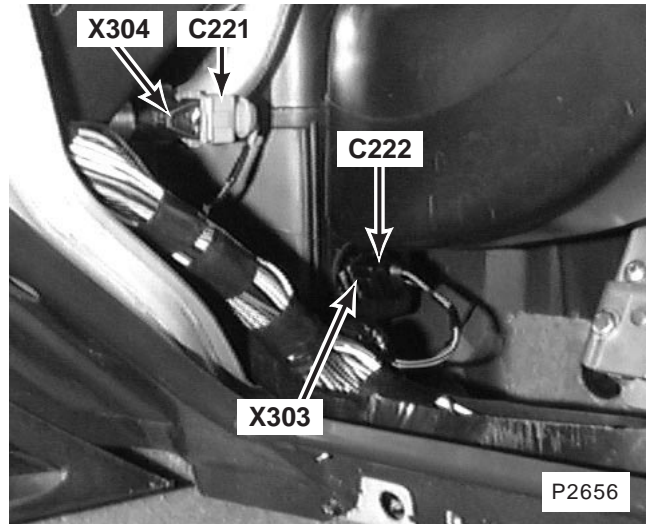

60. RH side of heater evaporator unit
X303 Evaporator Temperature Sensor
X304 Water Temperature Sensor
C221 (2-U)
C222 (2-B)

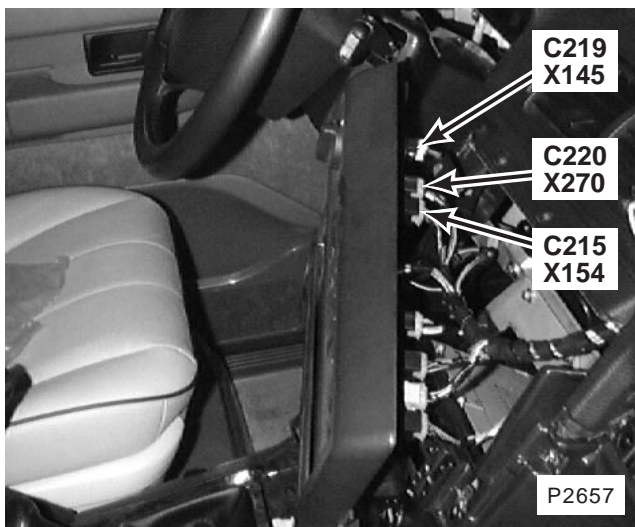

61. centre of fascia
 X145 Main Lighting Switch
 X154 Rear Fog Guard Lamps Switch
 X270 Front Fog Lamps Switch
 C215 (6-Y)
 C220 (6-U)
 C219 (4-W)

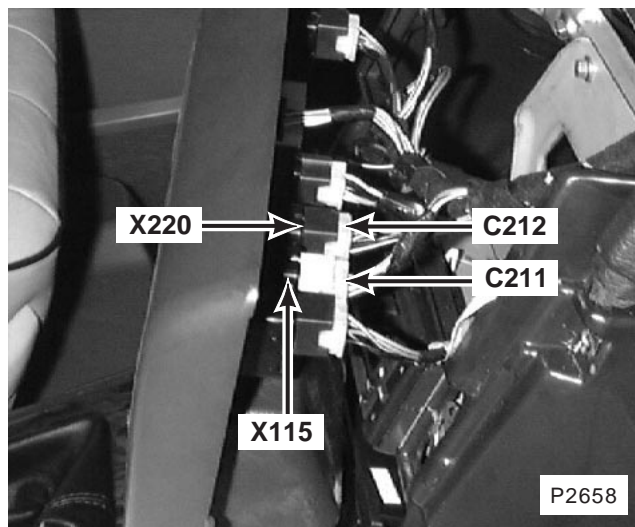

62. centre of fascia
 X115 Cruise Control Switch
 X220 Hazard Switch
 C211 (6-G)
 C212 (6-R)

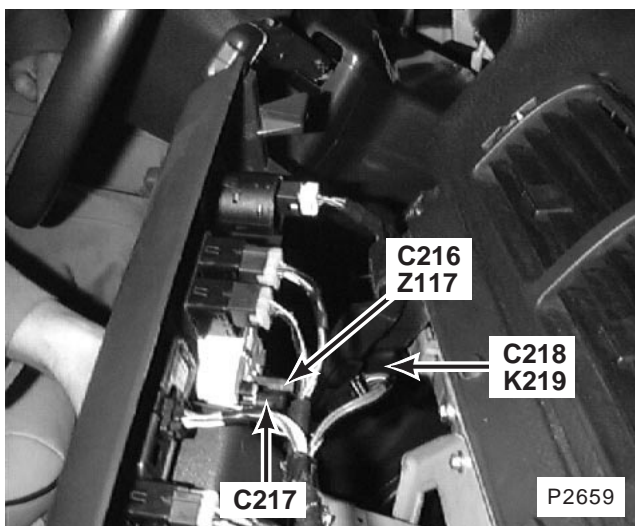

63. centre of fascia
 K219 A/C Aspirator
 Z117 Clock
 C216 (2-B)
 C217 (1-B)
 C218 (4-B)

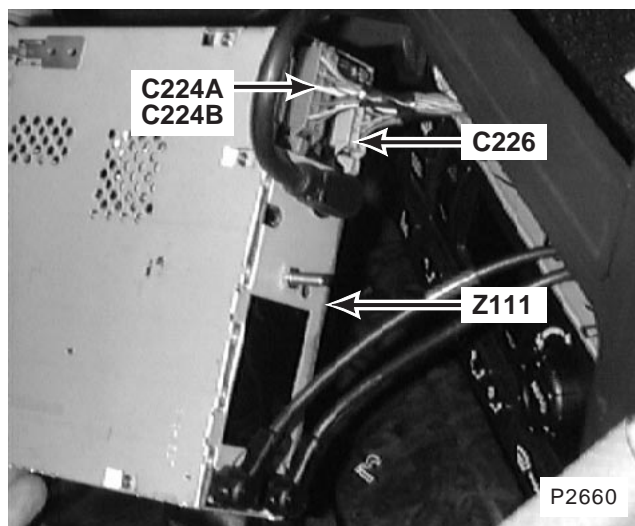

64. centre of fascia
 Z111 Radio
 C224A (8-N)
 C224B (10-R)
 C226 (8-S)

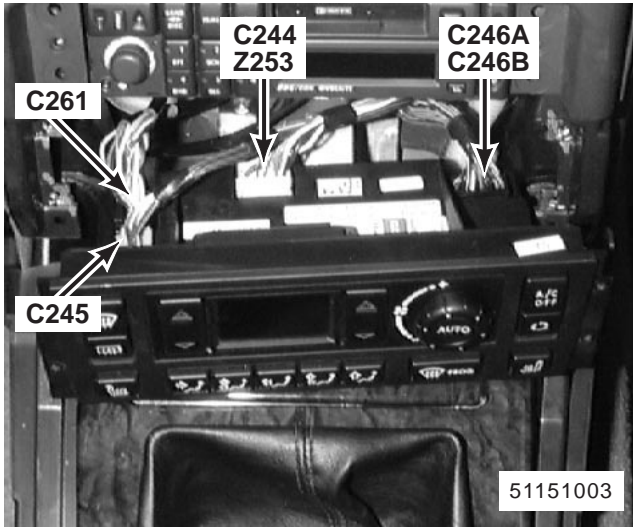

65. centre of fascia
 Z253 Heating Ventilation and Air Conditioning Control Unit (HEVAC)
 C244 (8-W)
 C245 (12-B)
 C246B (20-B)
 C246A (12-G)
 C261 (16-B)

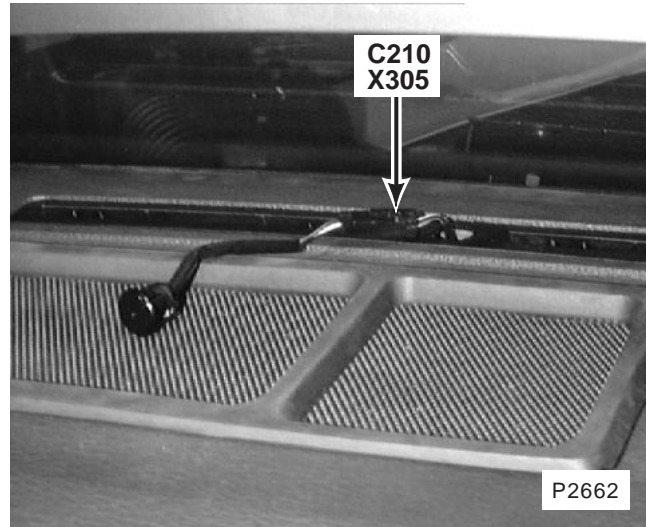

66. top centre of fascia
 X305 Sun Sensor
 C210 (2-B)

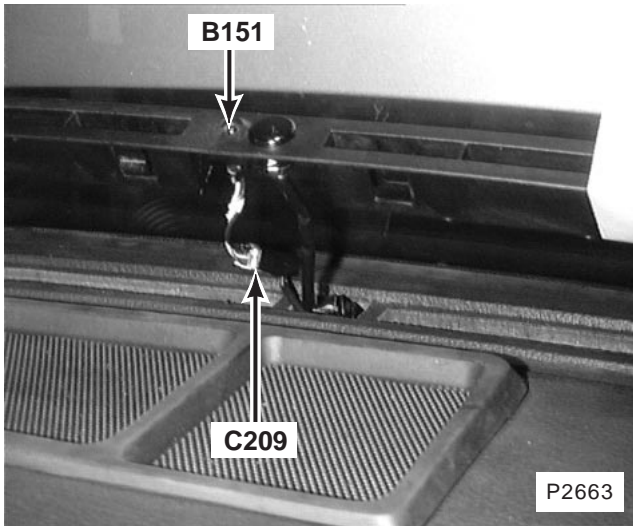

67. top centre of fascia
 B151 Theft Alarm LED
 C209 (2-G)

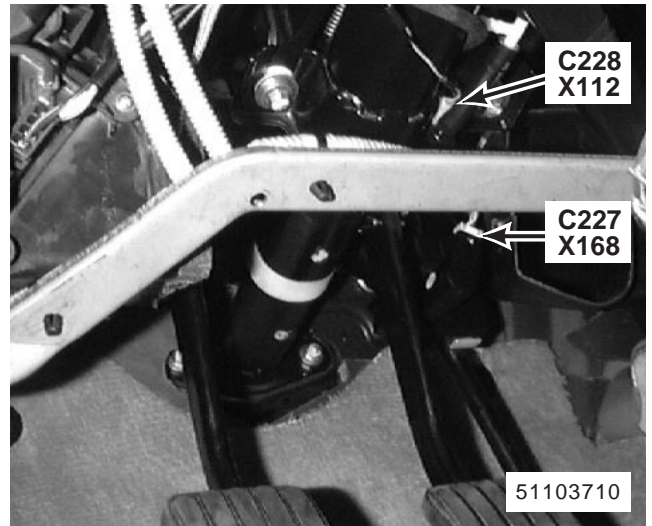

68. behind driver's side of fascia on brake pedal support
 X112 Brake Switch Vent Valve
 X118 Right Front Door Switch
 C227 (3-W)
 C228 (2-W)

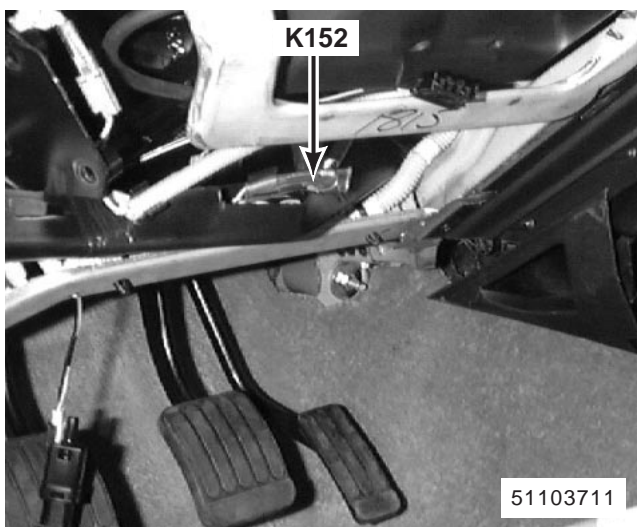

69. driver's side beneath fascia
K152 Resistor

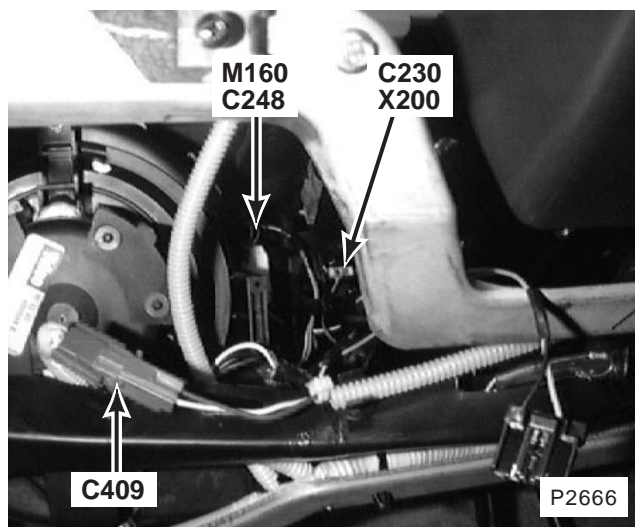

70. behind driver's side of fascia (lower dash panel removed)
M160 Left Recirculating Motor
X200 Clutch Pedal Position Switch
C230 (2-W)
C248 (3-W)
C409 (2-R)

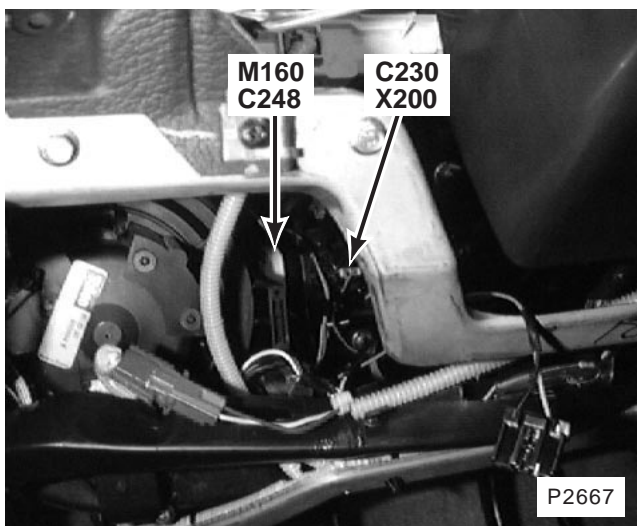

71. behind driver's side of fascia (lower dash panel removed)
M160 Left Recirculating Motor
X200 Clutch Pedal Position Switch
C230 (2-W)
C248 (3-W)

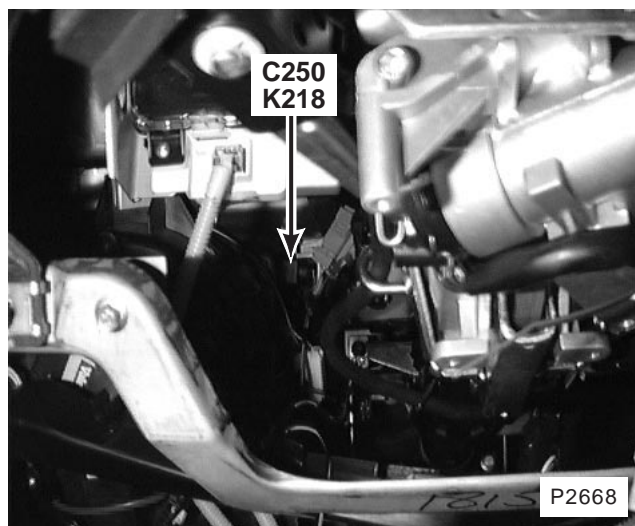

72. behind driver's side of fascia (lower dash panel removed) Up to VIN 381430
K218 Ambient Air Sensor
C250 (2-B)



73. behind driver's side of fascia (lower dash panel removed)
C206 (1-B)

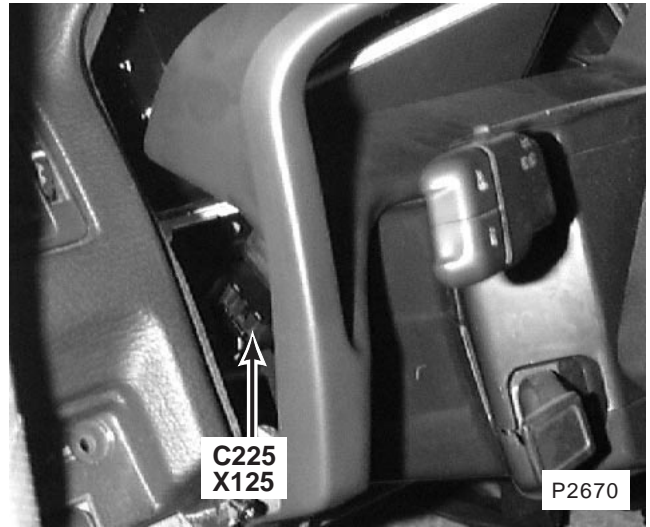

74. top LH side of fascia
X125 Fuel Flap Release Switch
C225 (5-B)

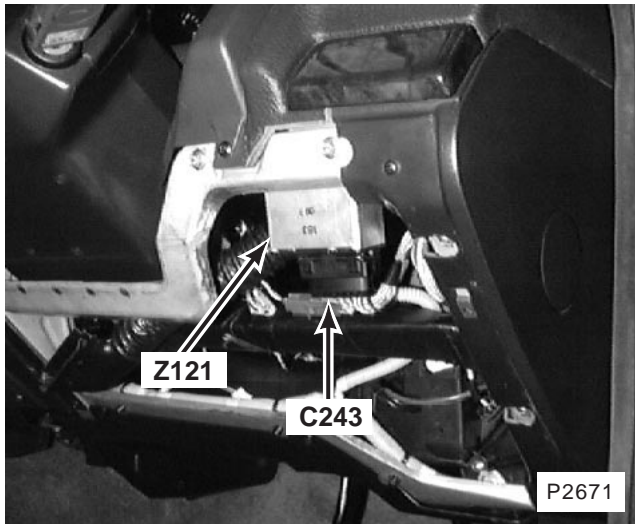

75. behind RH side of fascia right of steering column
Z121 Cruise Control ECU
C243 (15-B)

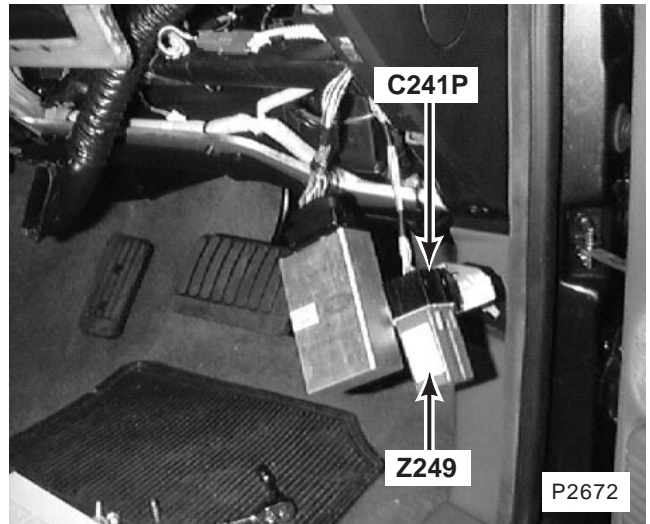

76. behind RH side of fascia right of steering column
Z249 Cruise Control Converter/Inverter Module
C241 (9-B)

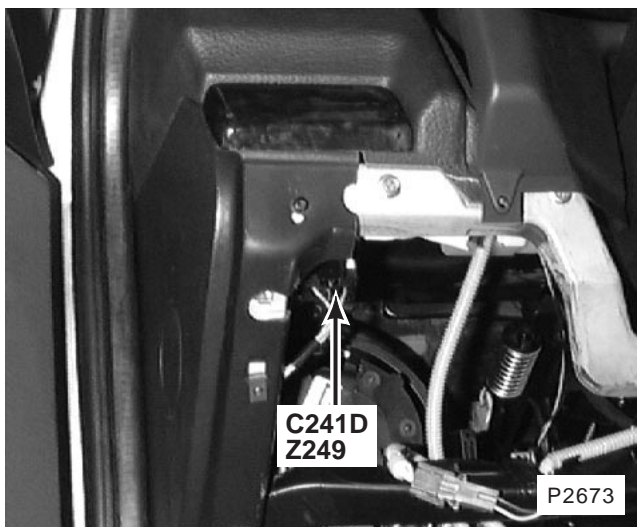

77. behind driver's side of fascia
Z249 Cruise Control Converter/Inverter Module
C241D (9-B)

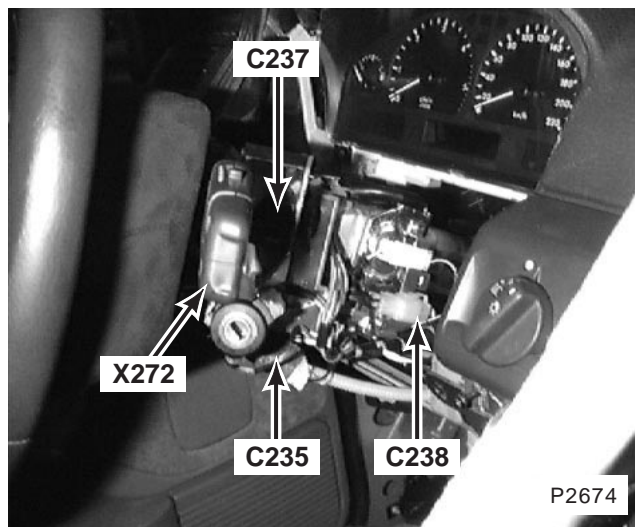

78. right of steering column
X272 Wash/Wipe Switch
C235 (6-W)
C237 (8-B)
C238 (4-W)

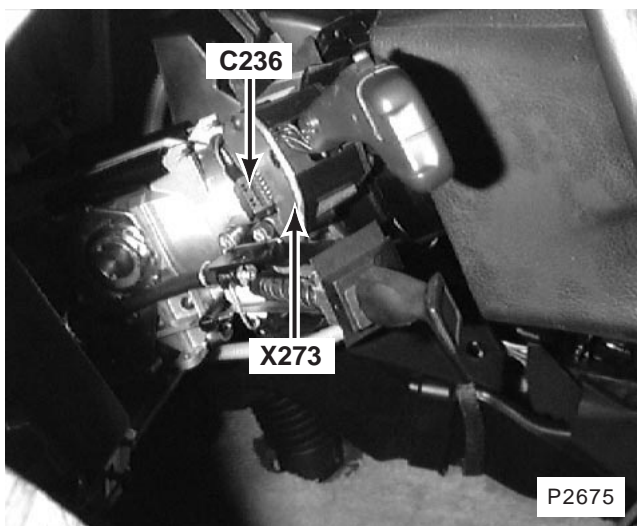

79. left of steering column
X273 Direction Indicator
C236 (12-B)

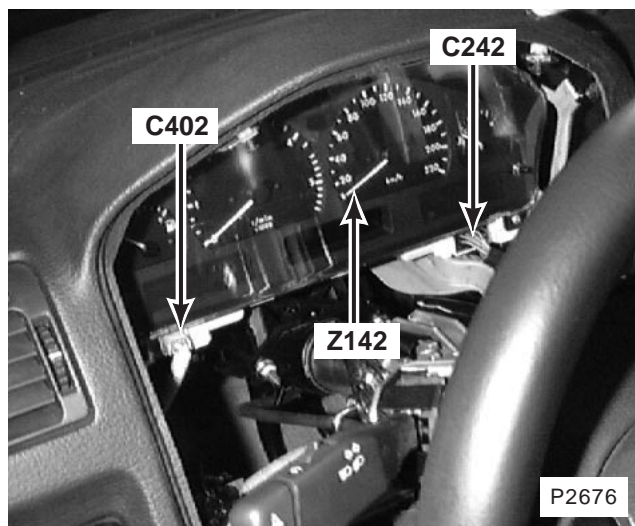

80. driver's side of fascia
Z142 Instrument Cluster
C242 (20-B)
C402 (5-LTU)

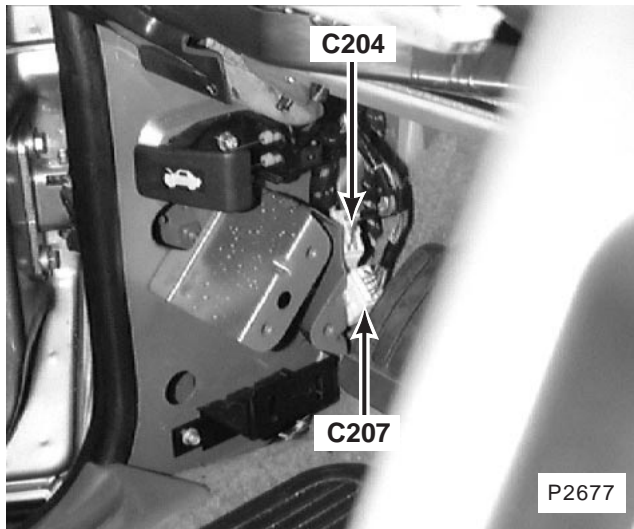

81. behind LH footwell trim panel
 C204 (12-W) Up to VIN 381430
 C204 (14-W) From VIN 381431
 C207 (8-W)

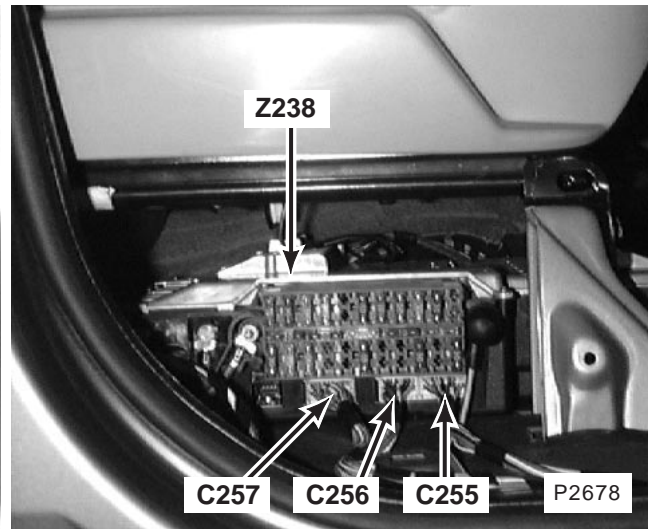

82. beneath RH front seat (trim removed)
 Z238 Body Electrical Control Module (BECM)
 C255 (20-W)
 C256 (16-W)
 C257 (20-Y)

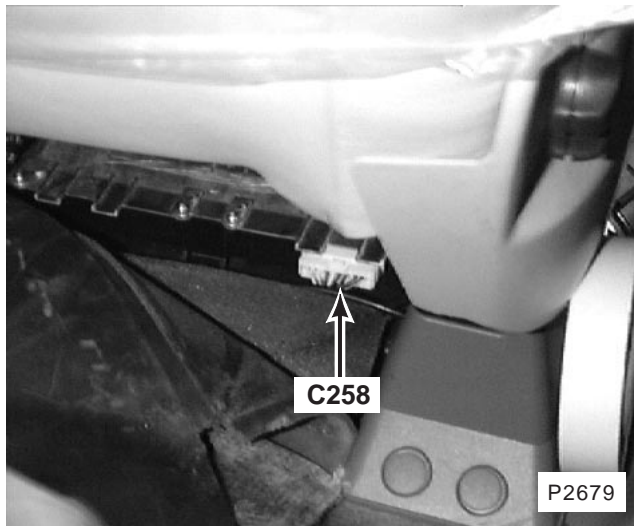

83. rear of beneath RH front seat
 C258 (10-W)

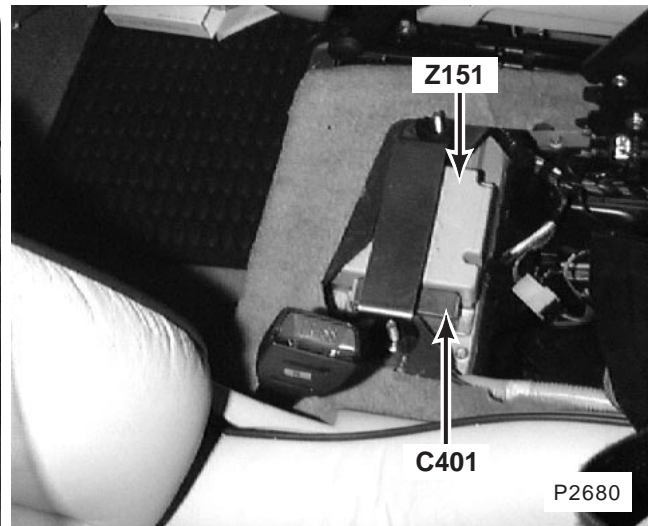

84. beneath centre console
 Z151 Air Bag Diagnostic Control Module
 C401 (29-R) NAS
 C401 (30-Y) Except NAS

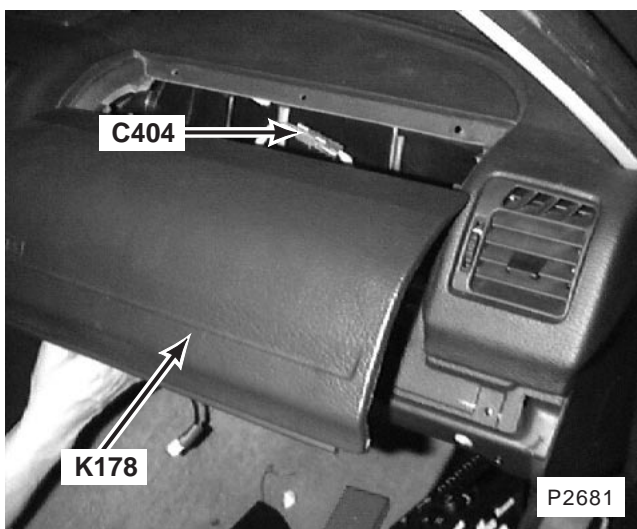

85. top of fascia, passenger's side
K178 Passenger's Air Bag
C404 (2-R)

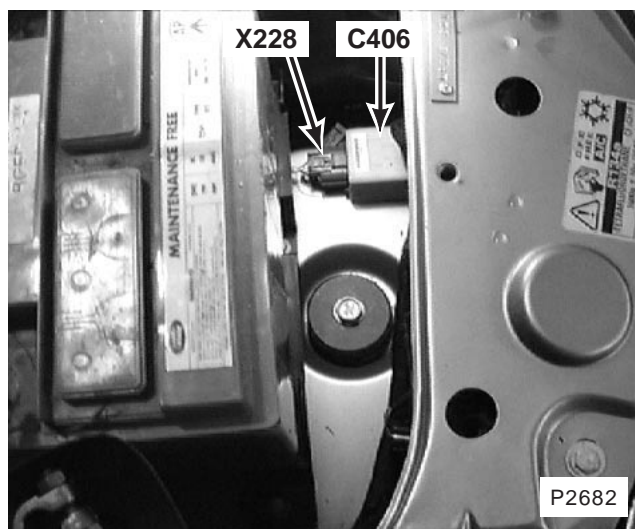

86. RH front of engine compartment
X228 O/S Crash Sensor
C406 (3-Y)

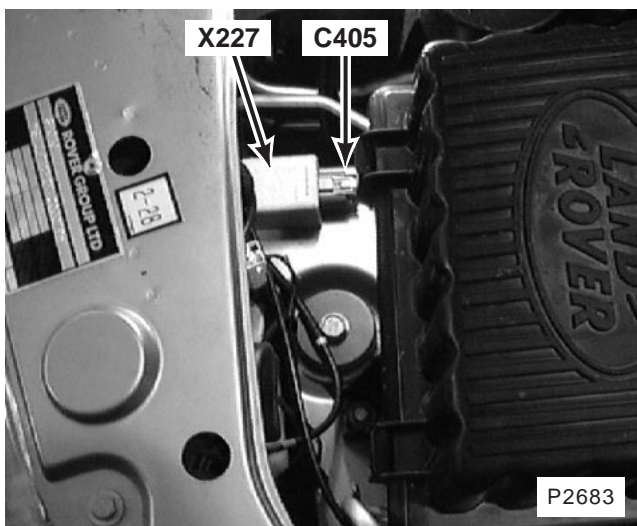

87. LH front of engine compartment
X227 N/S Crash Sensor
C405 (3-Y)

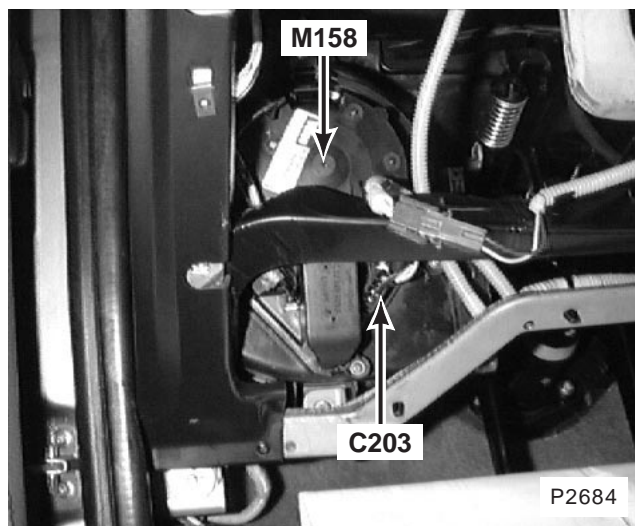

88. behind driver's side of fascia (lower dash panel removed)
M158 Left Blower Motor
C203 (4-N)

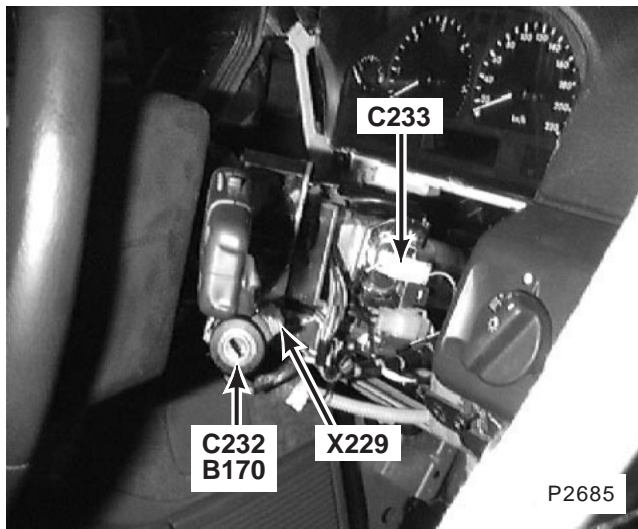

P2685

89. right of steering column
 B170 Key Illumination
 X229 Key-In Switch
 C232 (2-B)
 C233 (4-W)

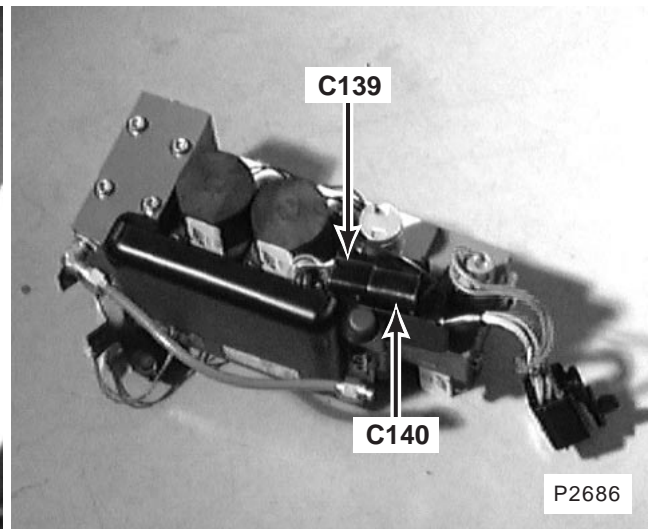

P2686

90. LH side of engine compartment
 C139 (13-B)
 C140 (13-B)

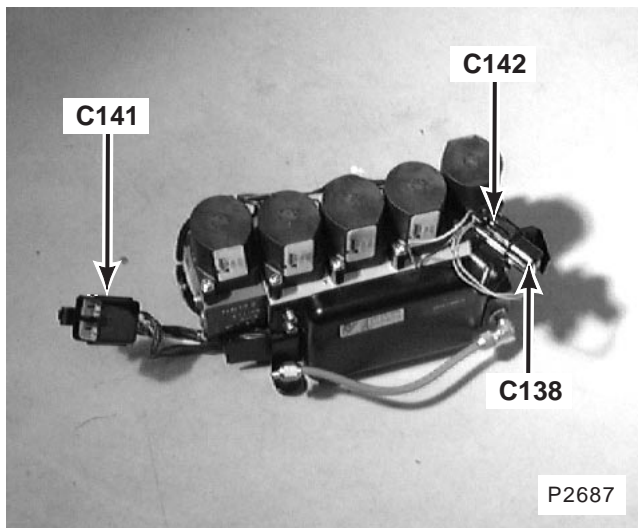

P2687

91. LH side of engine compartment
 C138 (2-B)
 C141 (13-B)
 C142 (2-B)



P2688

92. behind LH footwell trim panel
 C104 (12-W) Up to VIN 381430
 C104 (14-W) From VIN 381431

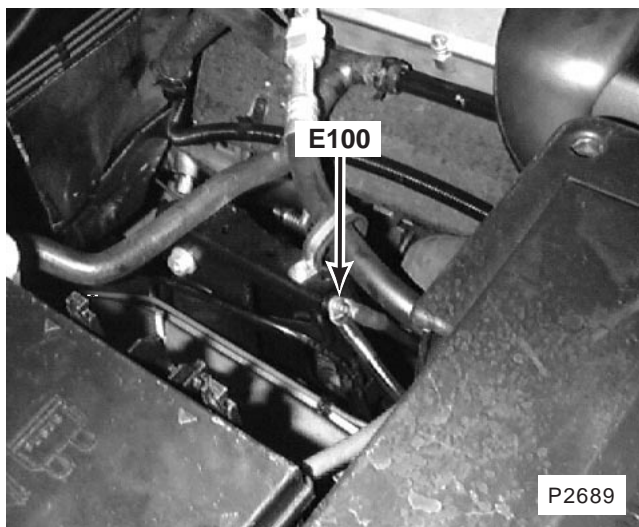

93. RH side of engine
E100

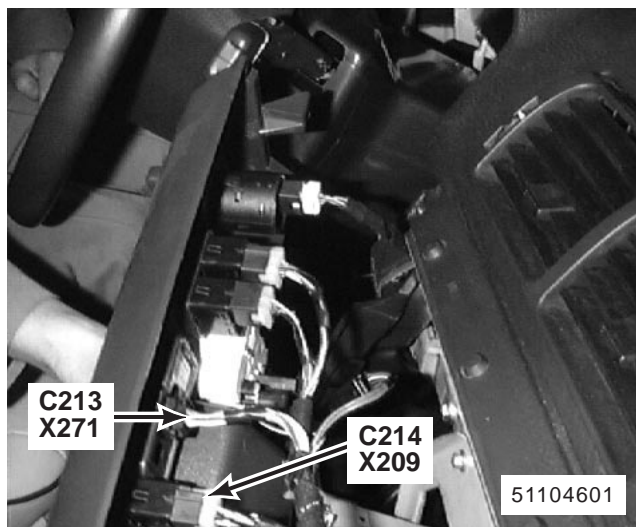

94. centre of fascia
X271 Ride Height Switch
X209 Air Suspension Inhibit Switch
C213 (8-B)
C214 (6-B)

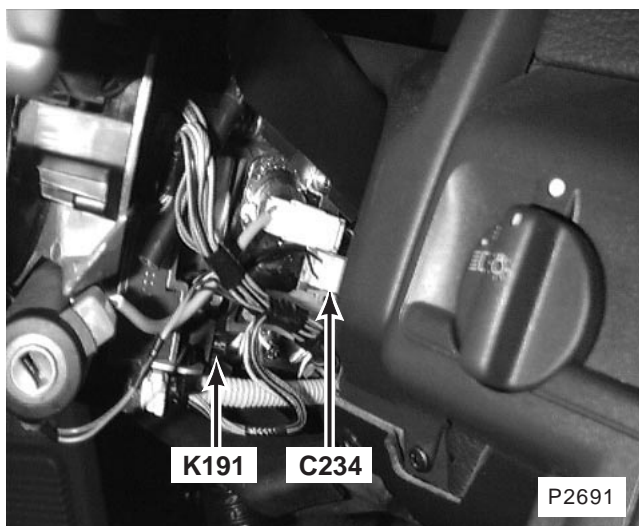

95. right of steering column
K191 Ignition Key Lock Solenoid
C234 (3-W)

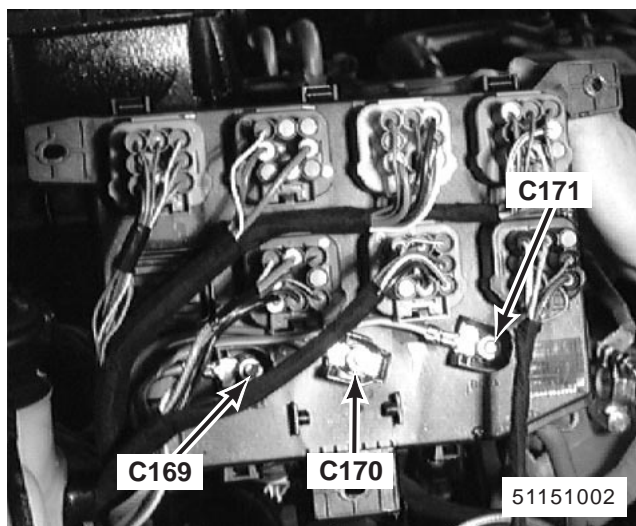

96. RH side of engine compartment
C169
C170
C171

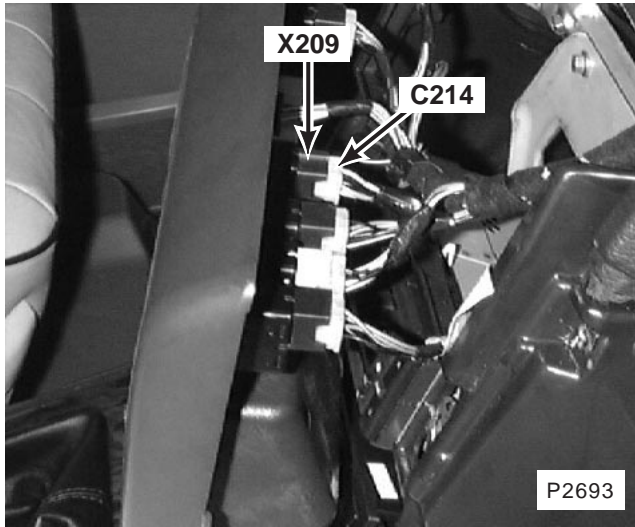

97. centre of fascia
 X209 Air Suspension Inhibit Switch
 C214 (6-B)

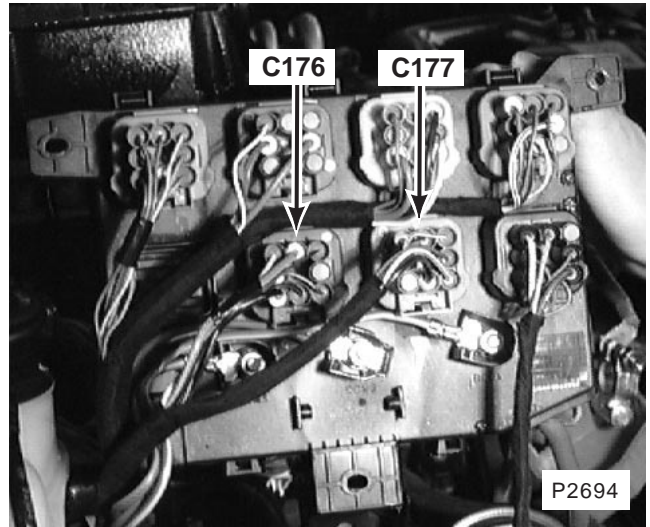

98. RH side of engine compartment
 C176 (8-N)
 C177 (8-S)

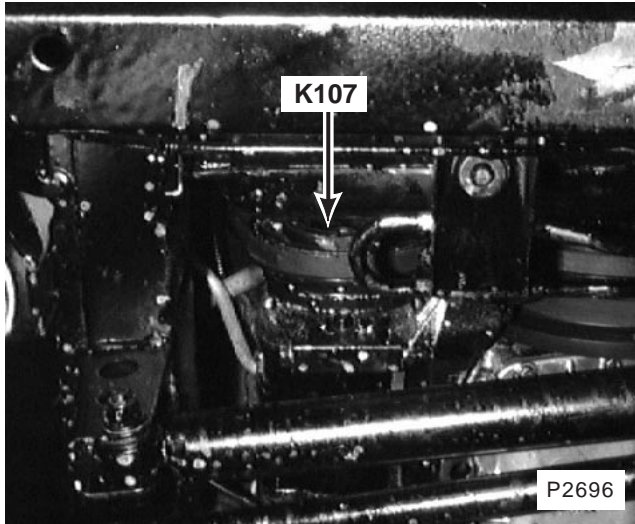

99. RH front of engine
 K107 Compressor Clutch

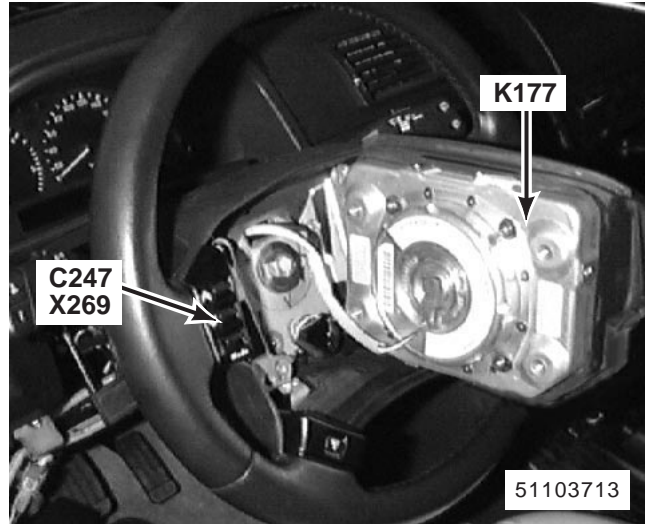

100. on steering wheel
 K177 Driver's Air Bag
 X269 Steering Wheel Switches
 C247 (7-P)

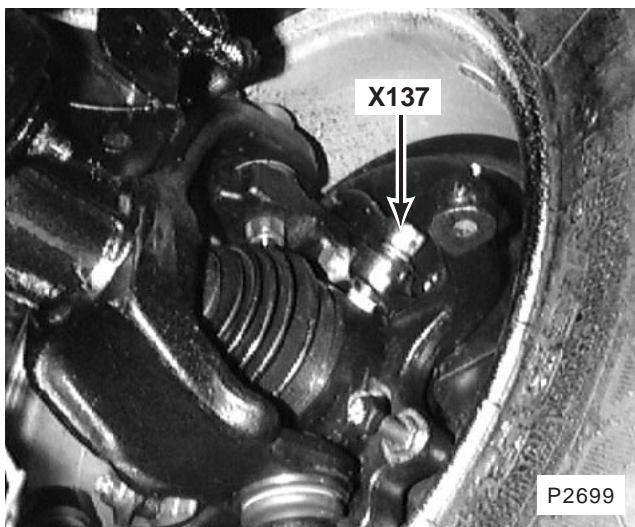

101. behind LH front wheel
X137 Left Front Wheel Speed Sensor

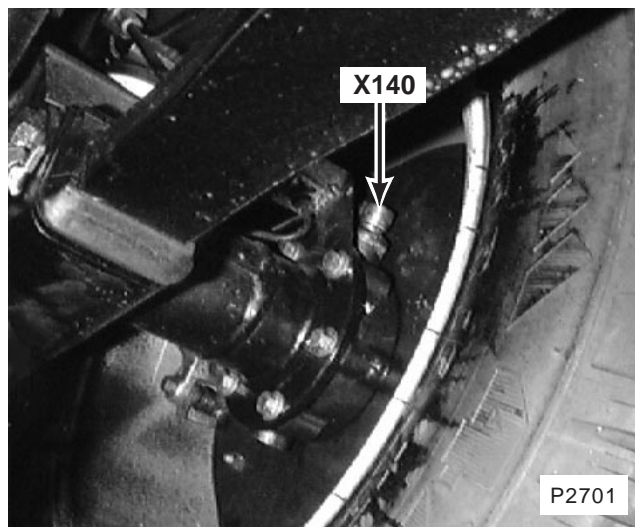

102. behind LH rear wheel
X140 Left Rear Wheel Speed Sensor

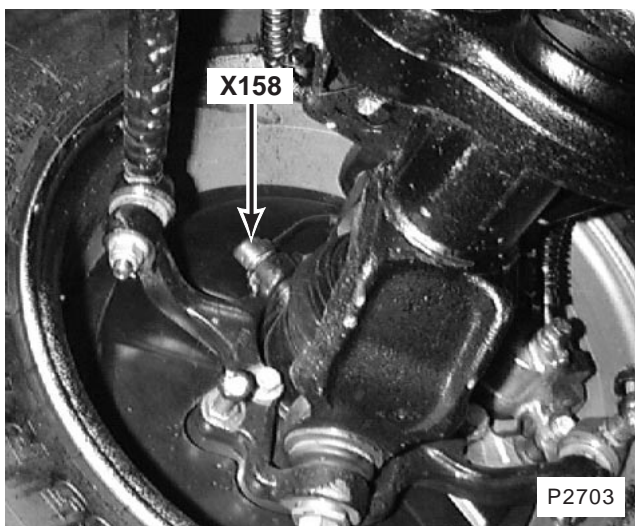

103. behind RH front wheel
X158 Right Front Wheel Speed Sensor

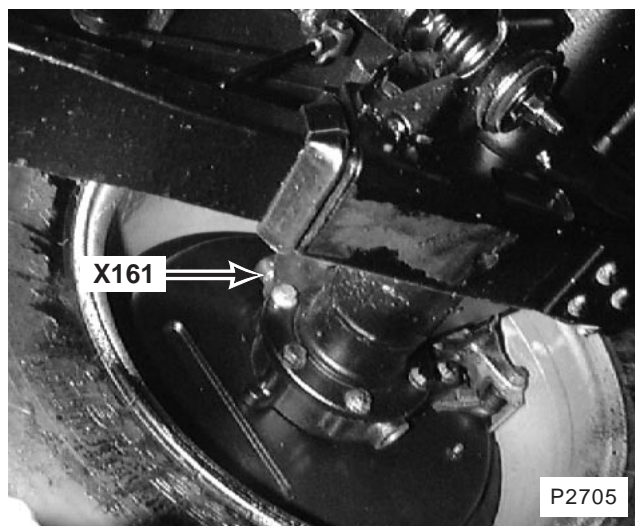

104. behind RH rear wheel
X161 Right Rear Wheel Speed Sensor

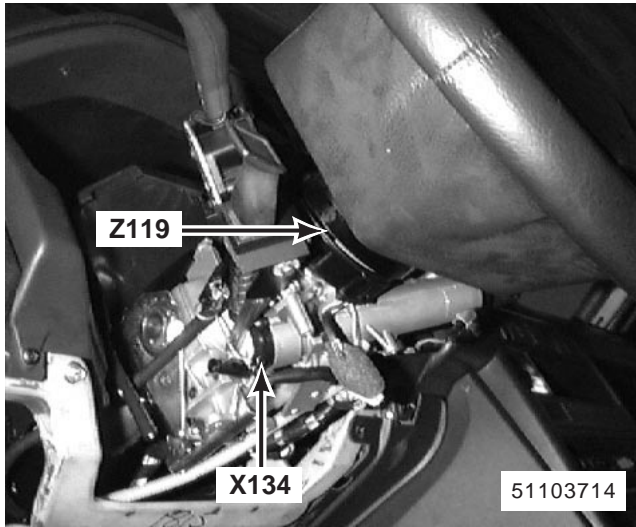

105. top of steering column left side of steering column
 X134 Ignition Switch
 Z119 Rotary Coupler

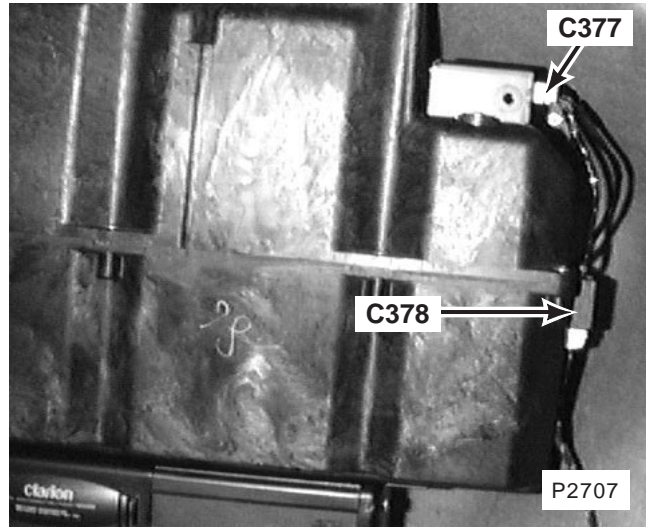

106. LH side of luggage compartment
 C377 (10-W)
 C378 (6-W)

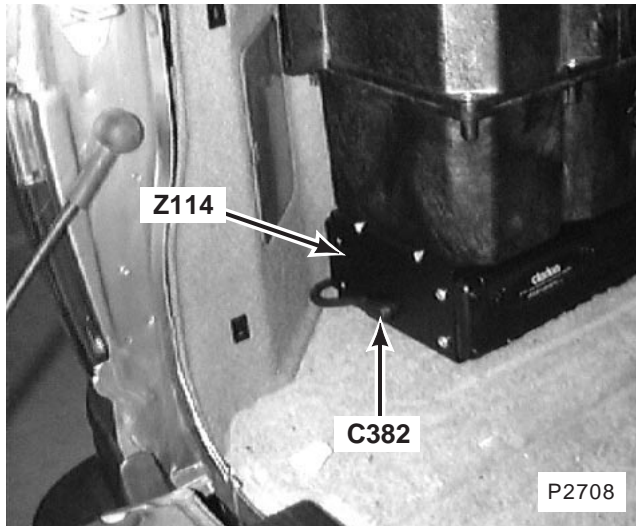

107. LH rear of luggage compartment
 Z114 CD Changer
 C382 (12-B)

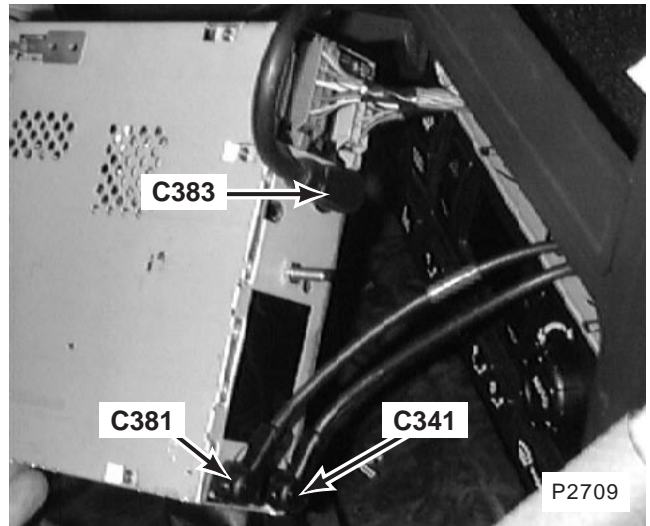

108. centre of fascia
 C341 (1-B)
 C381 (1-B)
 C383 (12-B)

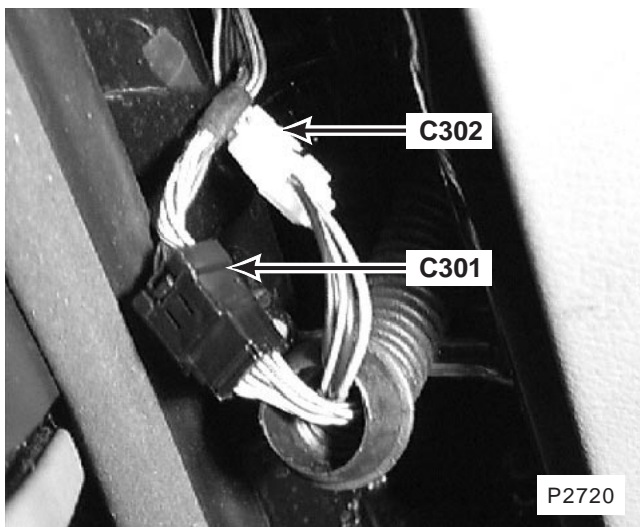

109. front of RH front door jamb (LH similar)
C301 (12-B)
C302 (4-W)



110. behind RH footwell trim panel
C308 (6-W)

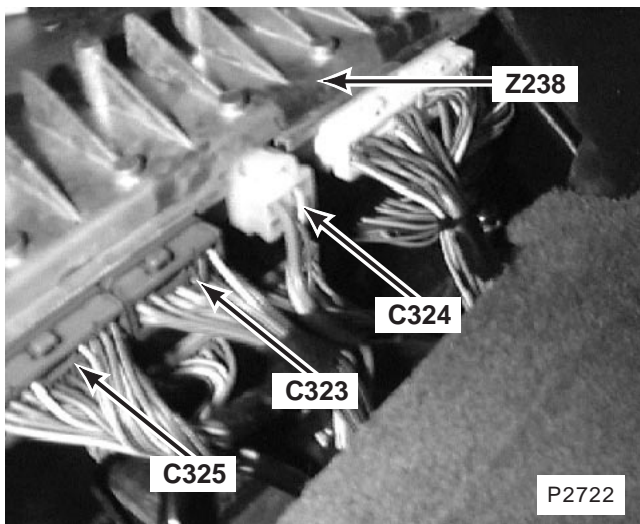

111. beneath RH front seat
Z238 Body Electrical Control Module (BECM)
C323 (12-S)
C324 (4-W)
C325 (18-S)

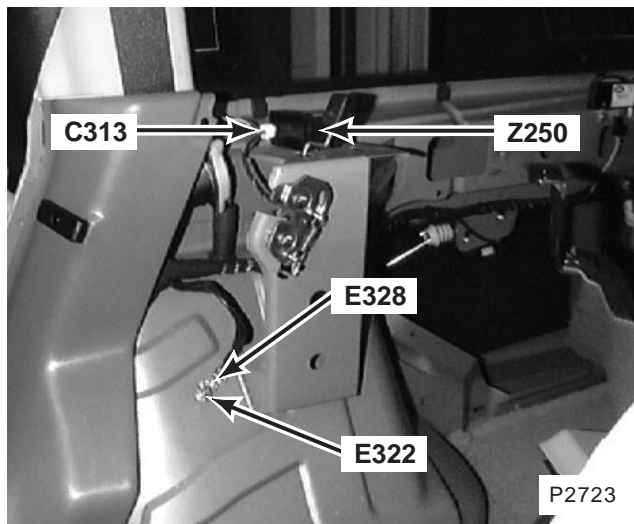

112. RH side of luggage compartment behind trim panel
Z250 Alarm R.F. Aerial Module
C313 (3-W)
E322
E328

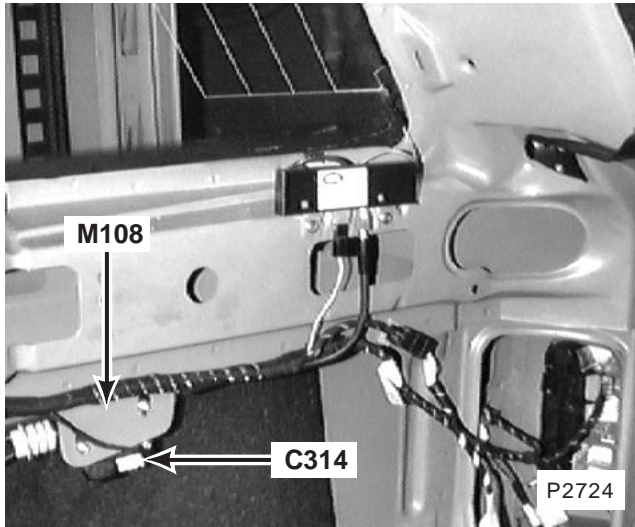

113. RH side of luggage compartment behind trim panel
 M108 Fuel Flap Actuator
 C314 (2-W)

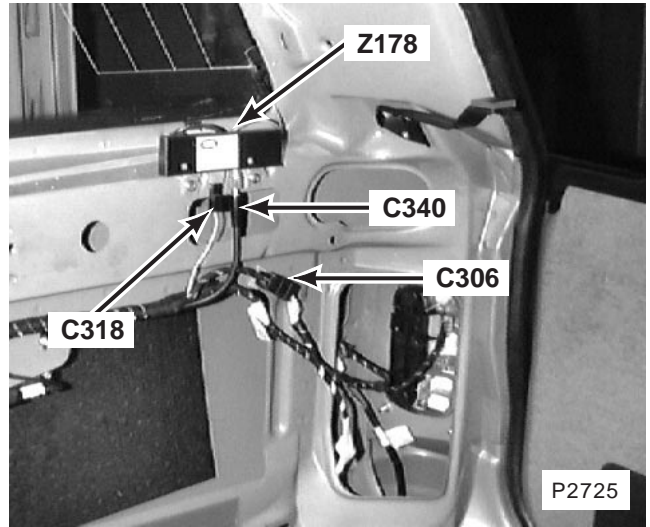

114. RH side of luggage compartment behind trim panel
 Z178 Right Antenna Amplifier
 C306 (12-B)
 C318 (1-B)
 C340 (1-B)

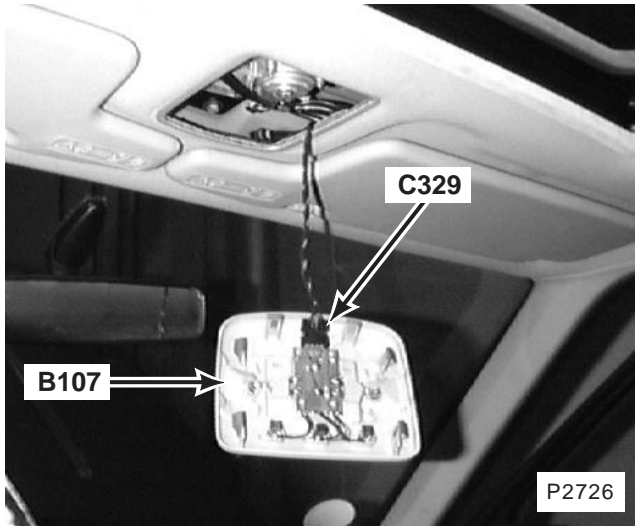

115. front centre of roof
 B107 Front Interior Roof Lamp
 C329 (4-B)

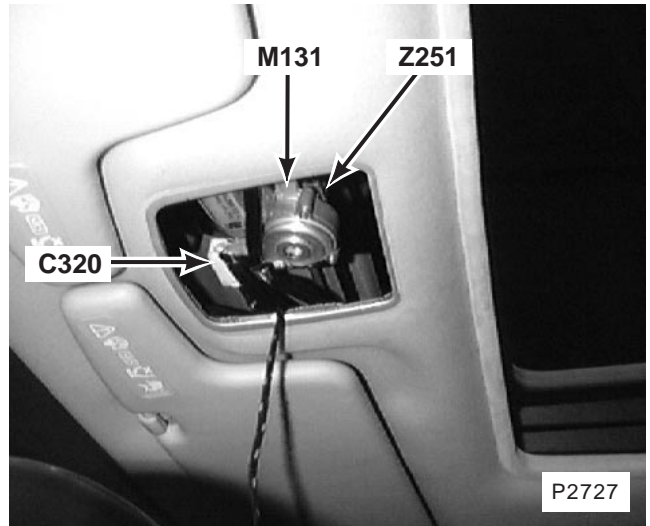

116. front centre of roof
 M131 Sunroof Motor
 Z251 Sunroof Anti-trap
 C320 (8-W)

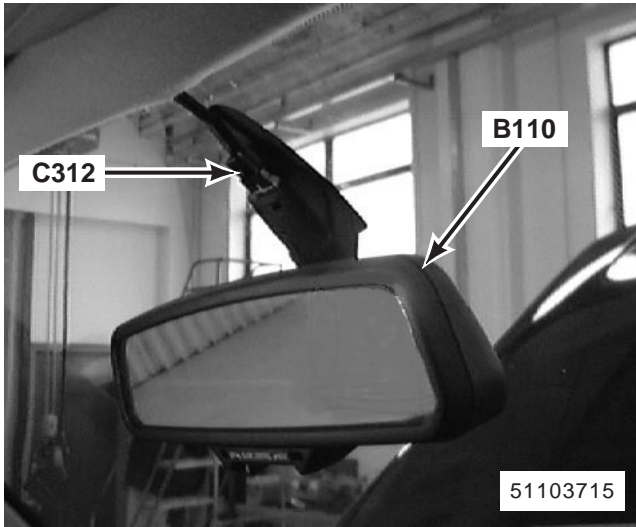

117. top centre of front screen
 B110 Electrochromic Rear View Mirror
 C312 (5-B)

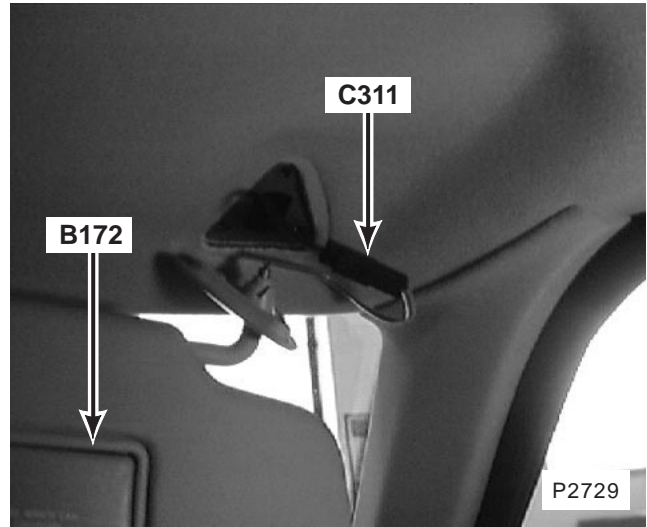

118. RH front of roof
 B172 Sun-visor Lamp 1
 C311 (2-B)

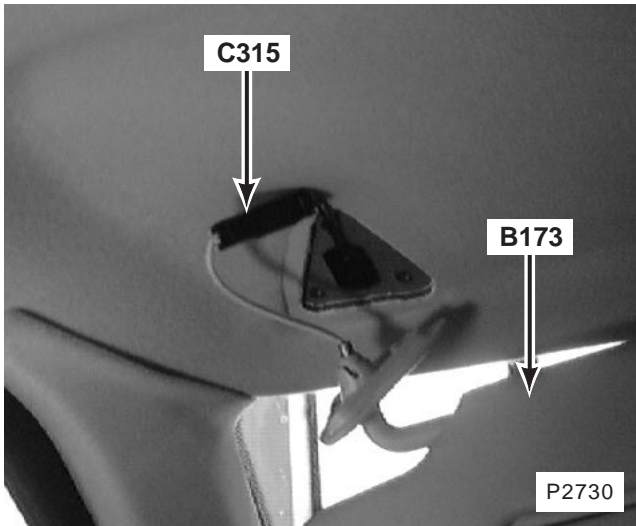

119. LH front of roof
 B173 Sun-visor Lamp 2
 C315 (2-B)

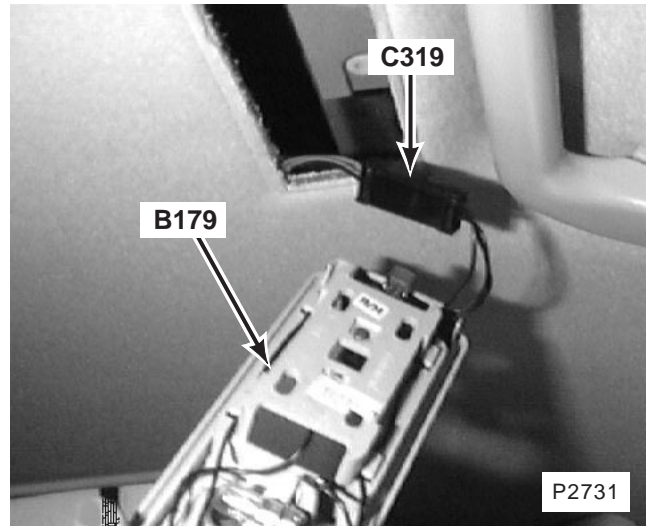

120. RH centre of headlining
 B179 Right Interior Lights
 C319 (4-B)

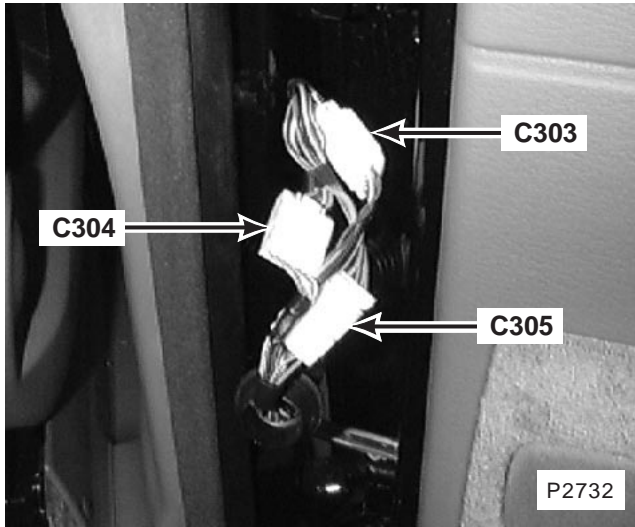

121. in lower part of RH B-post
 C303 (6-W)
 C304 (6-S)
 C305 (6-Y)

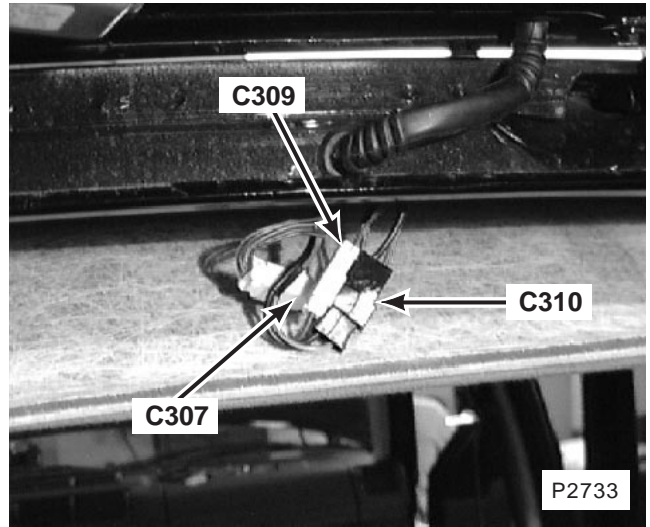

122. centre rear of roof, (trim removed)
 C307 (4-W)
 C309 (2-W)
 C310 (2-B)

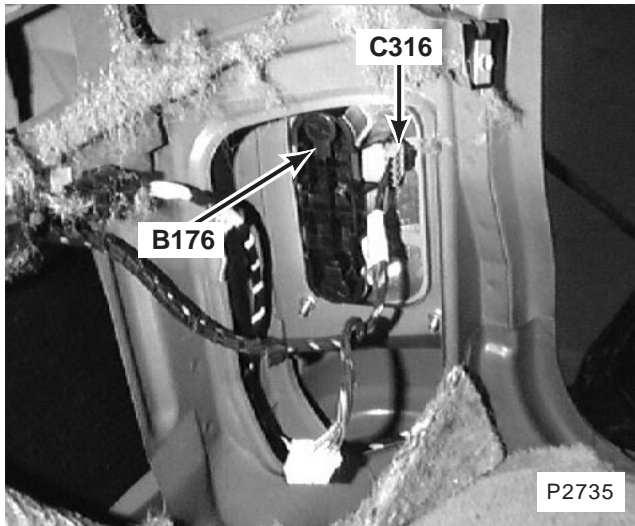

123. RH rear of vehicle
 B176 Right Rear Lamp Assembly
 C316 (4-G)

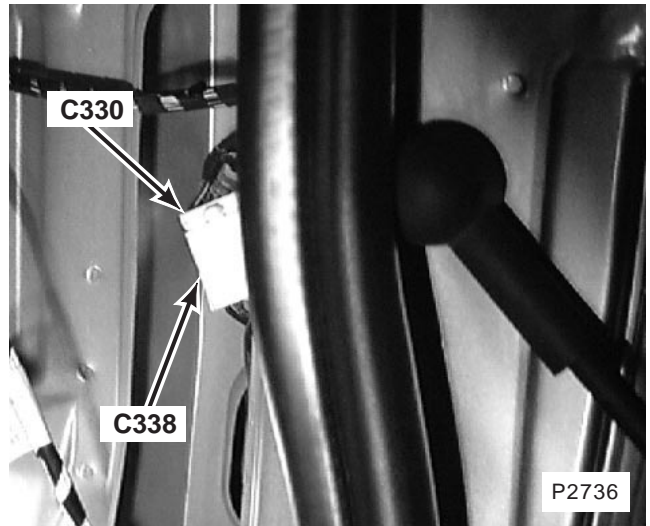

124. RH rear of vehicle
 C330 (6-W)
 C338 (8-W)

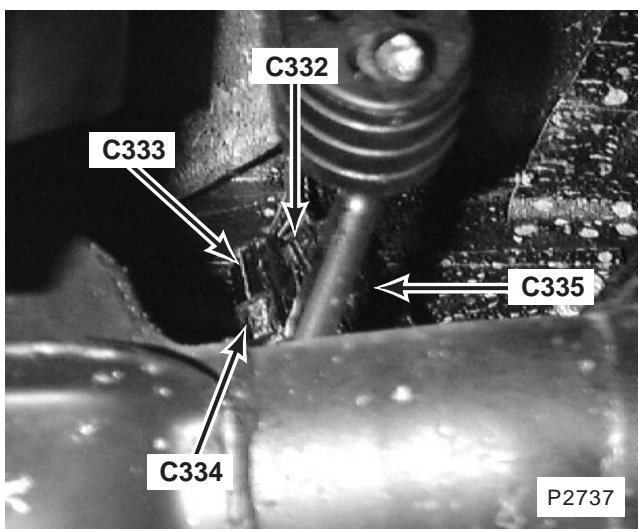

125. RH rear of vehicle
 C332 (3-B)
 C333 (4-B)
 C334 (3-B)
 C335 (4-B)

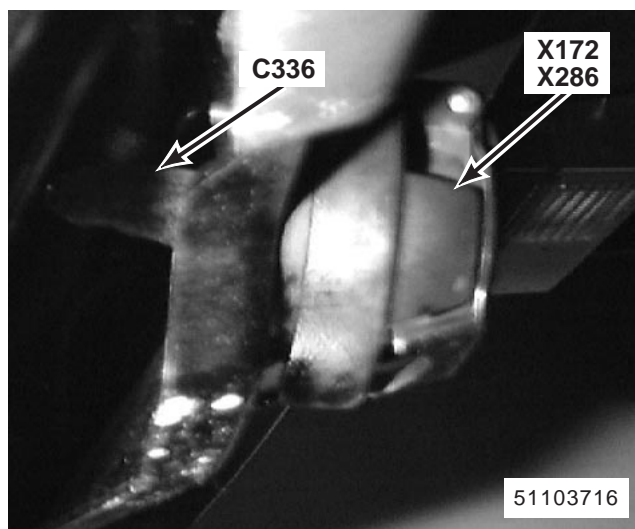

126. beneath rear of vehicle
 X172 Trailer Auxiliary Socket
 X286 Trailer Main Socket
 C336 (7-B)

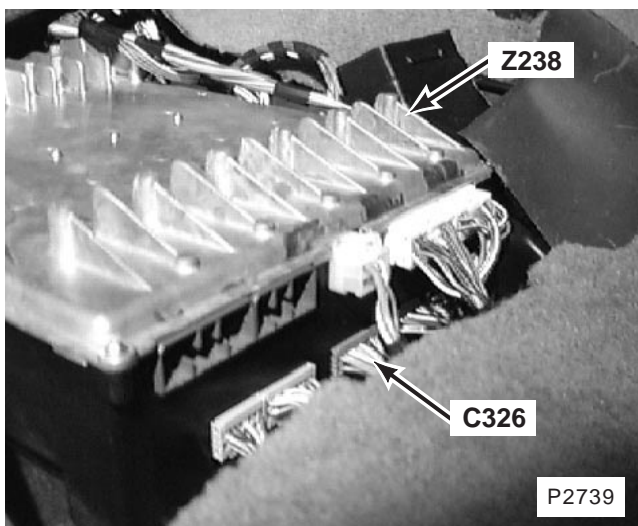

127. beneath RH front seat
 Z238 Body Electrical Control Module (BECM)
 C326 (20-U)

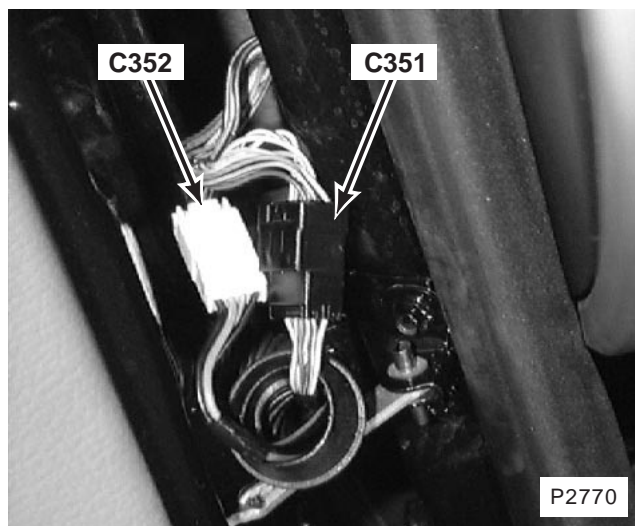

128. LH A-post
 C351 (12-B)
 C352 (4-W)

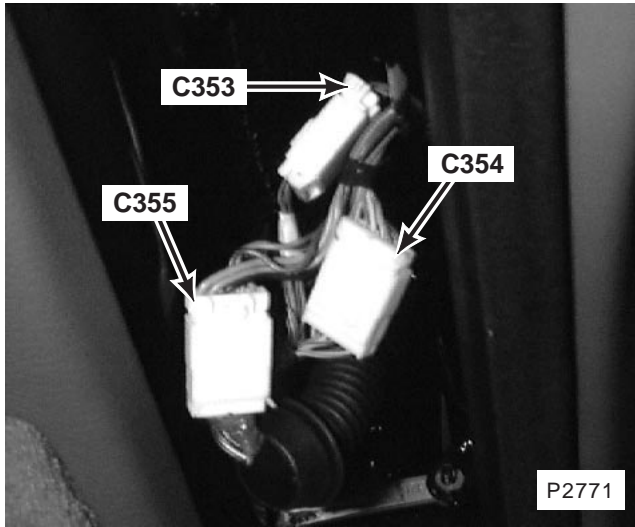

129. in lower part of LH B-post
 C353 (6-W)
 C354 (6-S)
 C355 (6-Y)

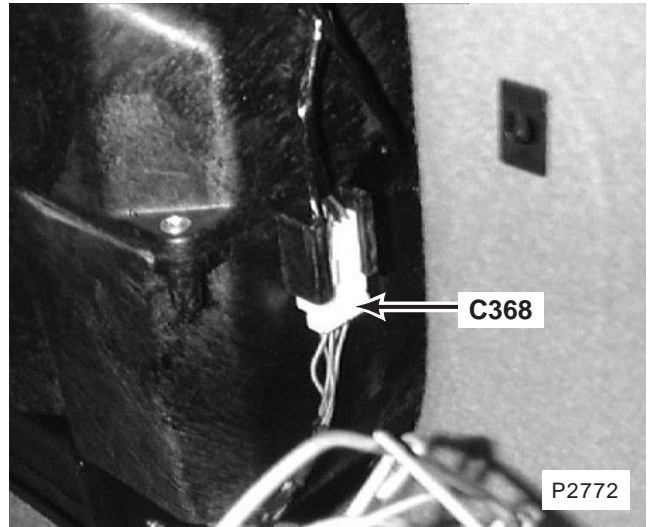

130. LH side of luggage compartment
 C368 (6-W)

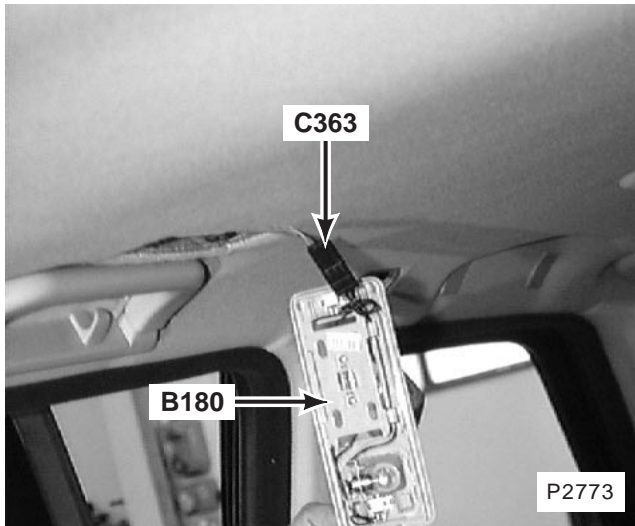

131. LH centre of headlining
 B180 Left Interior Lights
 C363 (4-B)

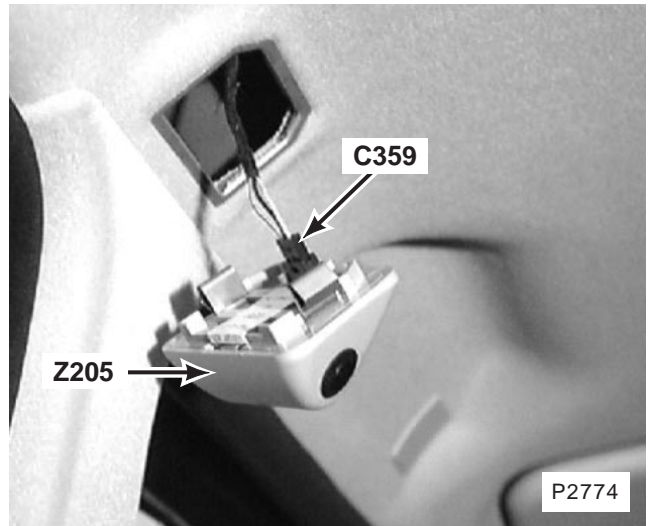

132. top of LH B-post
 Z205 Ultrasonic Module
 C359 (4-B)

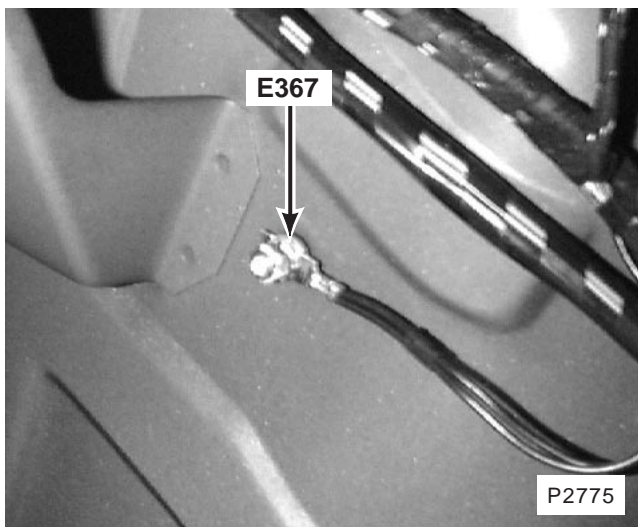

133. LH side of luggage compartment
E367

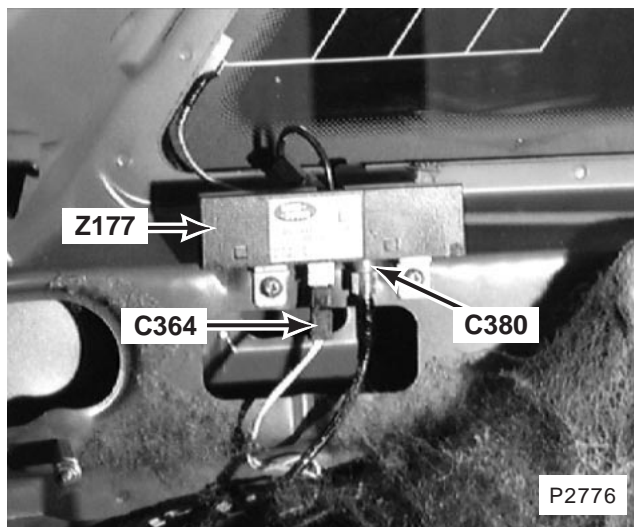

134. LH side of luggage compartment behind trim panel
Z177 Left Antenna Amplifier
C364 (1-B)
C380 (1-B)

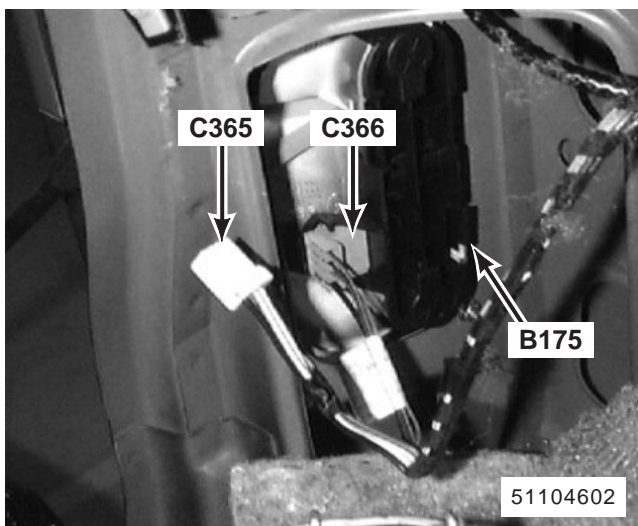

135. LH rear of luggage compartment
B175 Left Rear Lamp Assembly
C365 (4-W)
C366 (4-G)

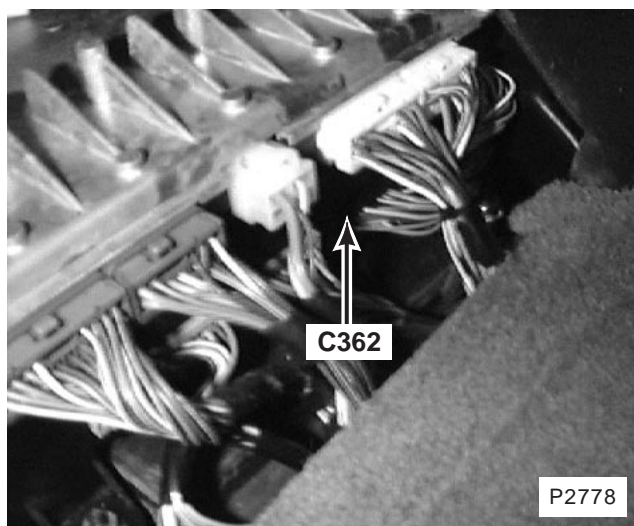

136. beneath RH front seat
C362 (16-B)

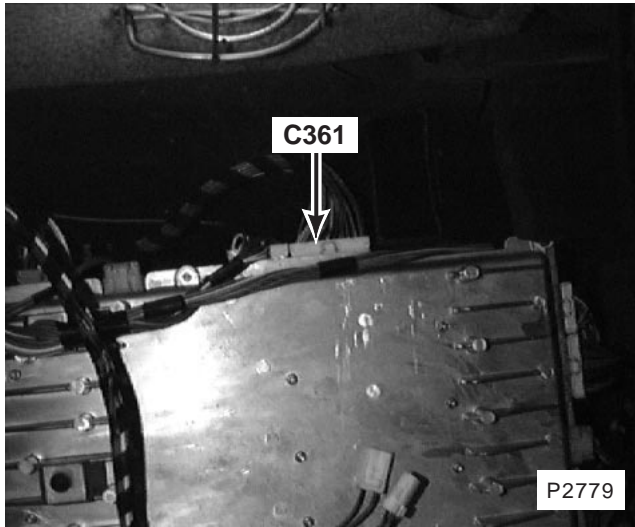

137. beneath RH front seat
C361 (18-W)

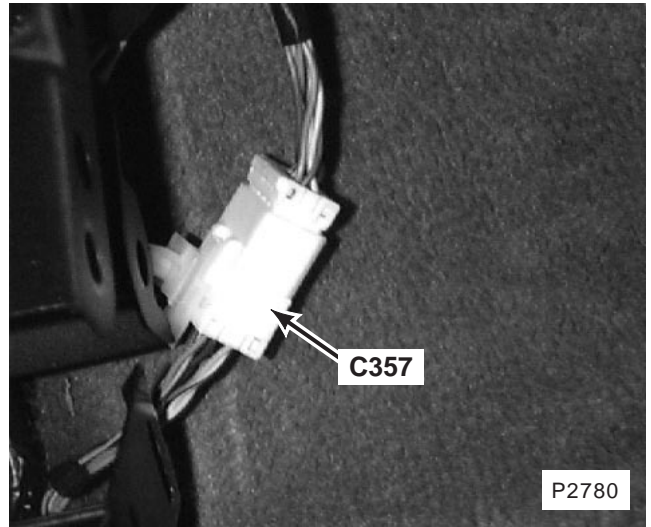

138. behind LH footwell trim panel (trim removed)
C357 (8-W)

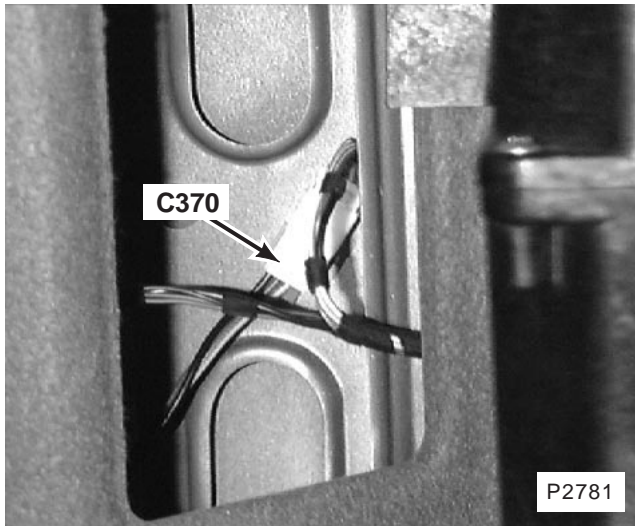

139. LH side of luggage compartment behind trim
C370 (4-W)

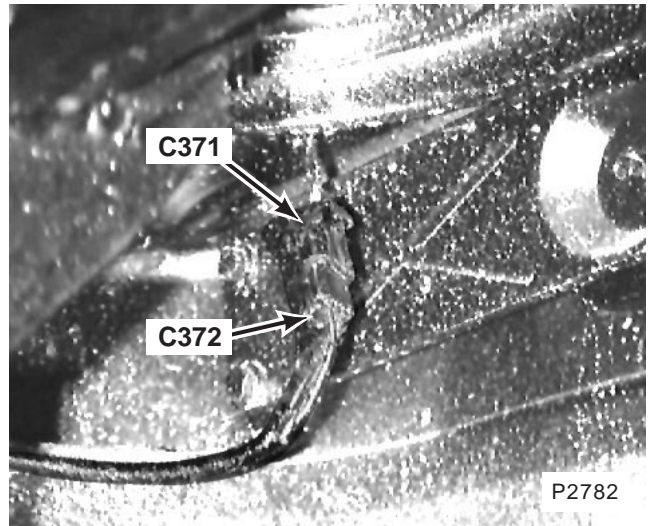

140. beneath LH rear of vehicle
C371 (3-B)
C372 (3-B)

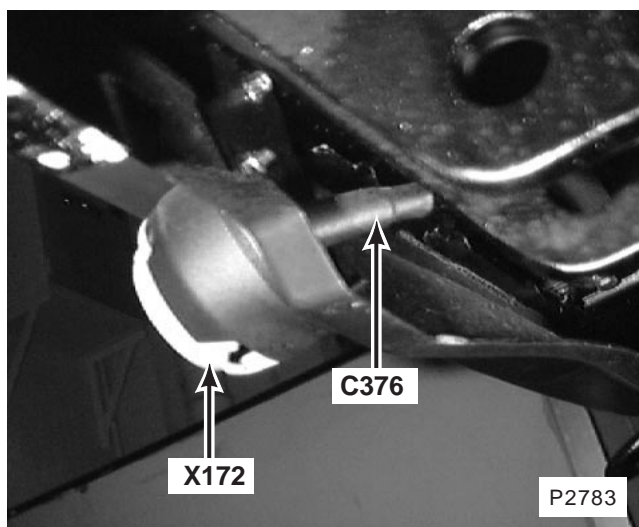

141. beneath centre rear of vehicle
X172 Trailer Auxiliary Socket
C376 (7-B)

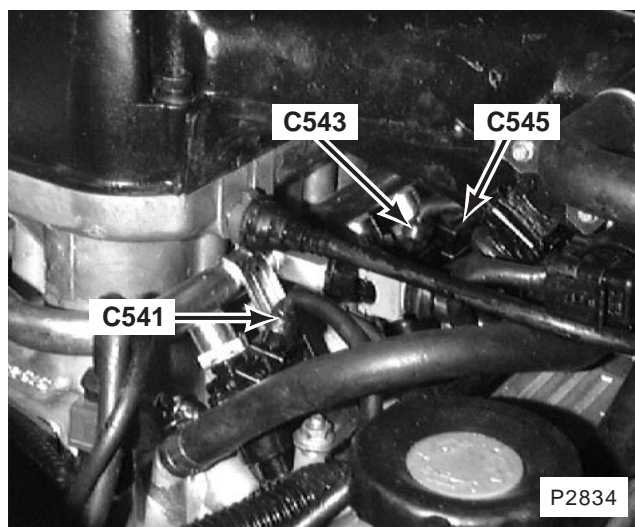

142. top LH side of engine
C541 (3-B)
C543 (2-B)
C545 (2-B)

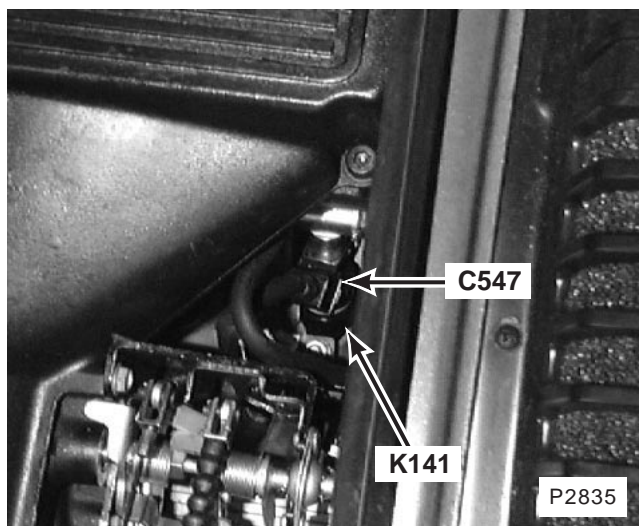

143. LH rear of engine
K141 Fuel Injectors
C547 (2-B)

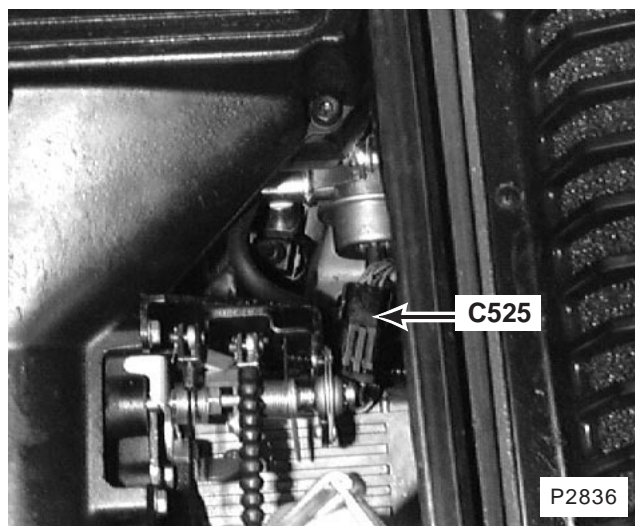

144. LH rear of engine
C525 (5-B)

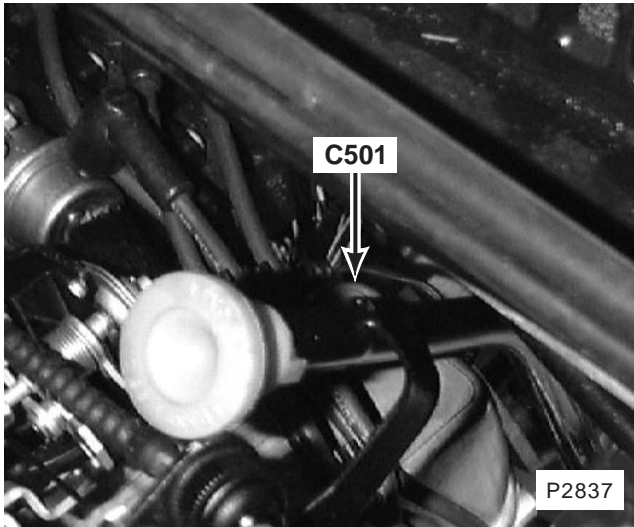

145. top rear of engine
C501 (6-B)

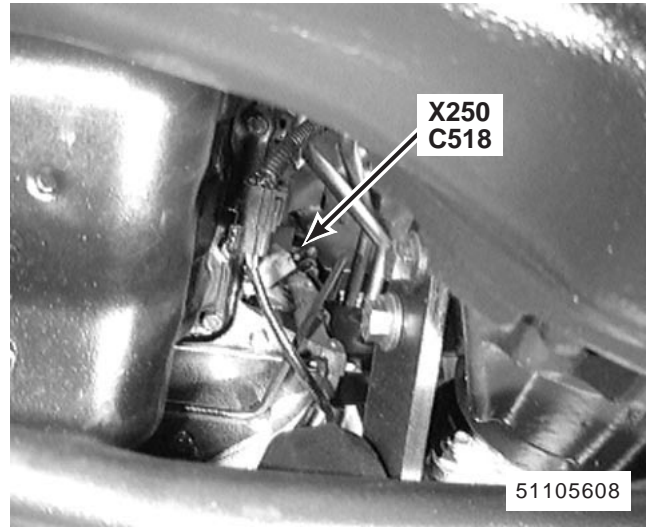

146. LH rear of engine
X250 Crankshaft Position Sensor
C518 (2-W)

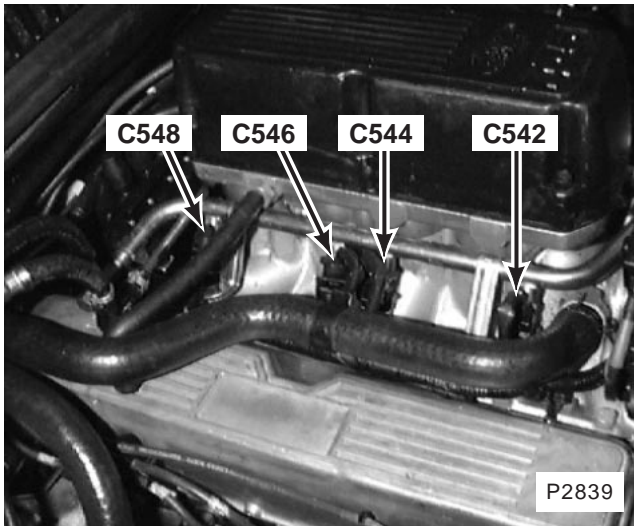

147. top RH side of engine
C542 (2-B)
C544 (2-B)
C546 (2-B)
C548 (2-B)

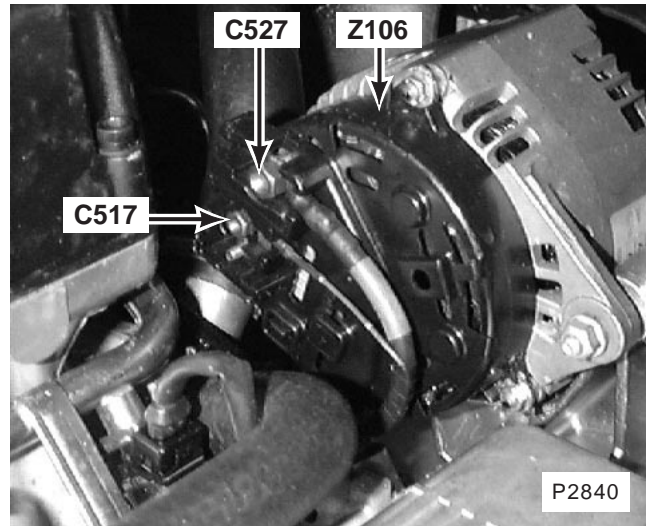

148. top RH side of engine
Z106 Generator
C517
C527

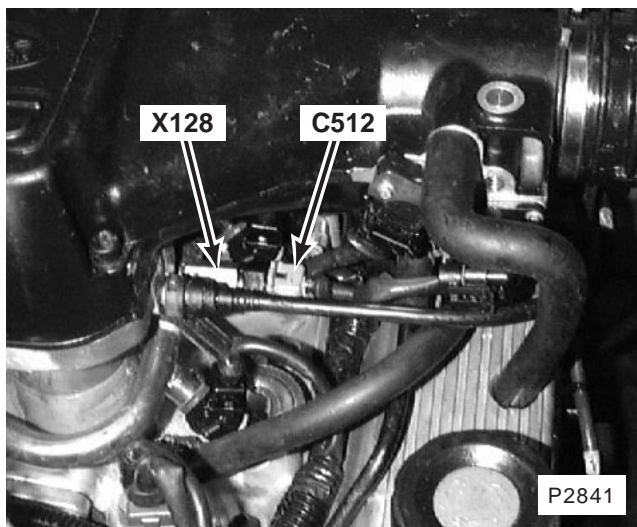

149. LH side of engine
 X128 Engine Fuel Temperature Sensor
 C512 (2-S)

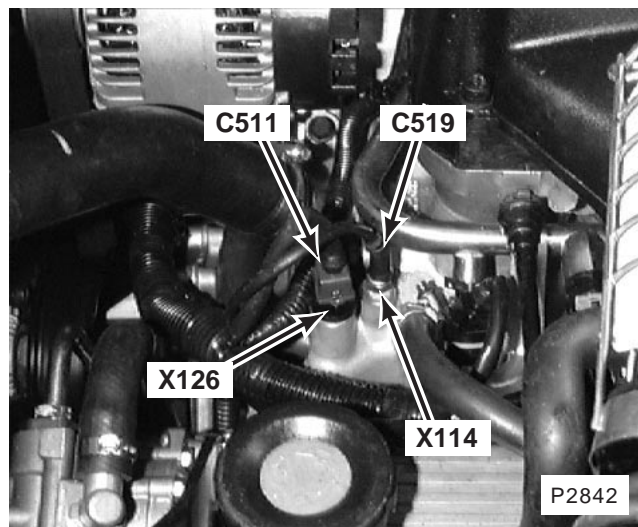

150. LH side of engine
 X114 Engine Coolant Temperature Gauge Sensor
 X126 Engine Coolant Temperature Sensor
 C511 (2-N)
 C519 (2-G)

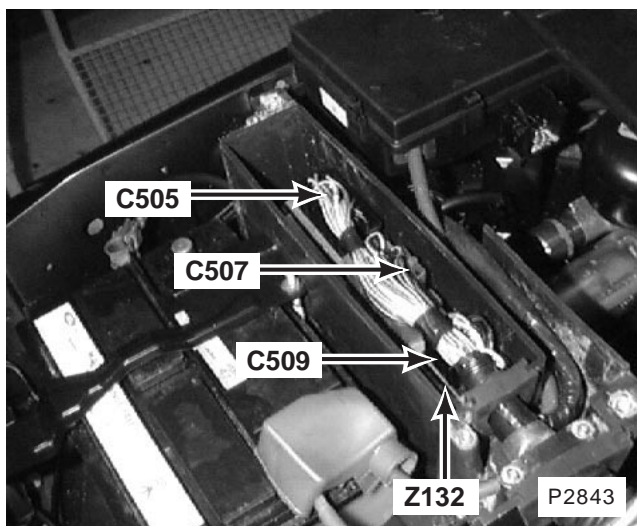

151. RH front of engine compartment behind battery
 Z132 Engine Control Module (ECM)
 C505 (36-B)
 C507 (36-R)
 C509 (18-B)

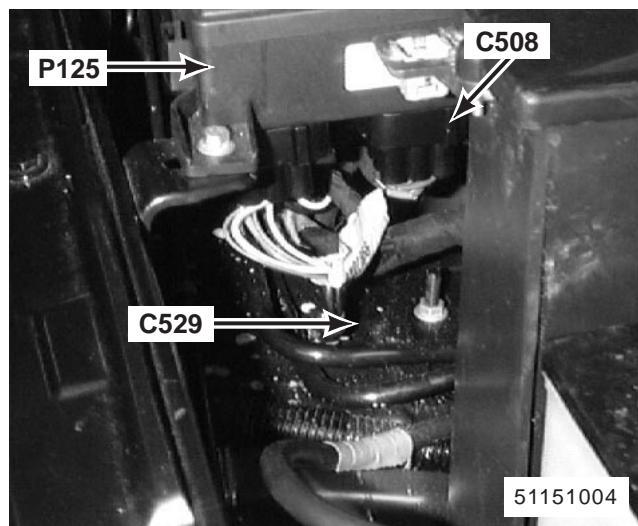

152. RH front of engine compartment
 P125 Engine Compartment Fuse Box
 C508 (8-K)
 C529

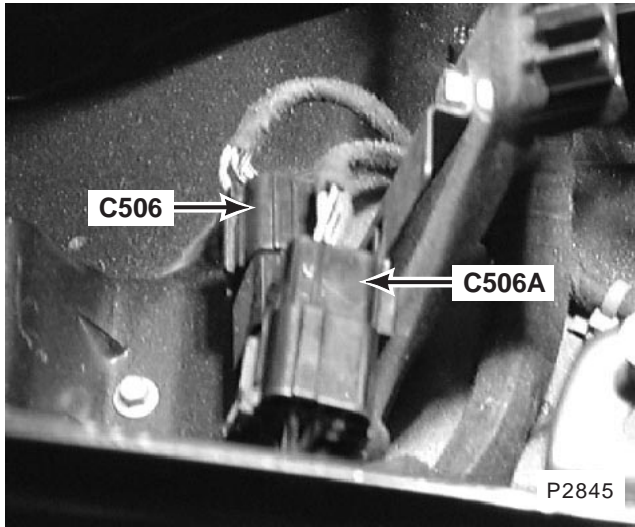

153. RH rear of engine compartment beneath coolant expansion tank
C506 (13-B)
C506A (4-B)

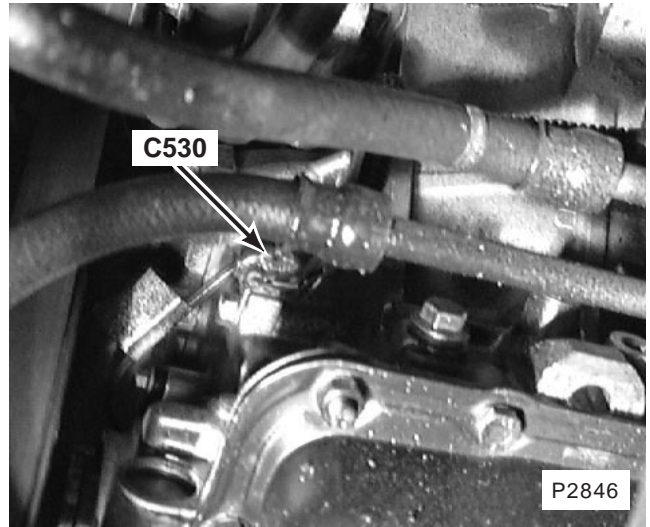

154. front centre of engine
C530 (3-B)

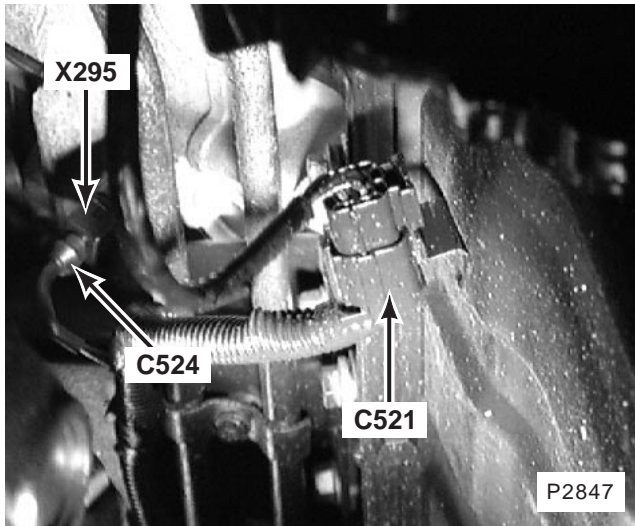

155. lower LH side of engine
X295 Left Knock Sensor
C521 (4-B)
C524 (2-B)

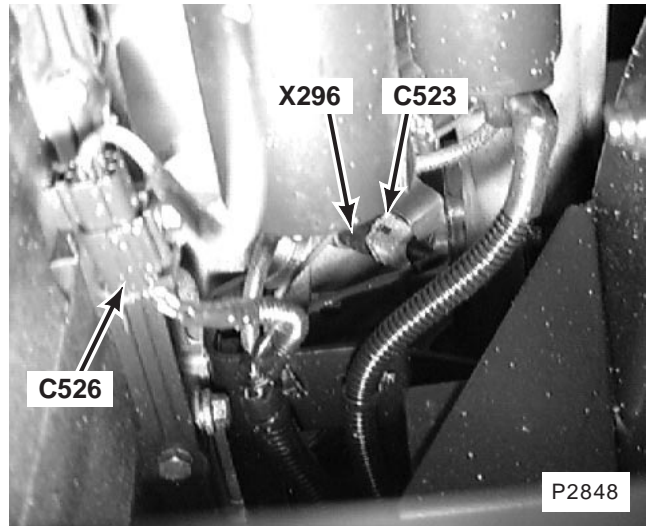

156. lower RH side of engine
X296 Right Knock Sensor
C523 (2-S)
C526 (4-B)

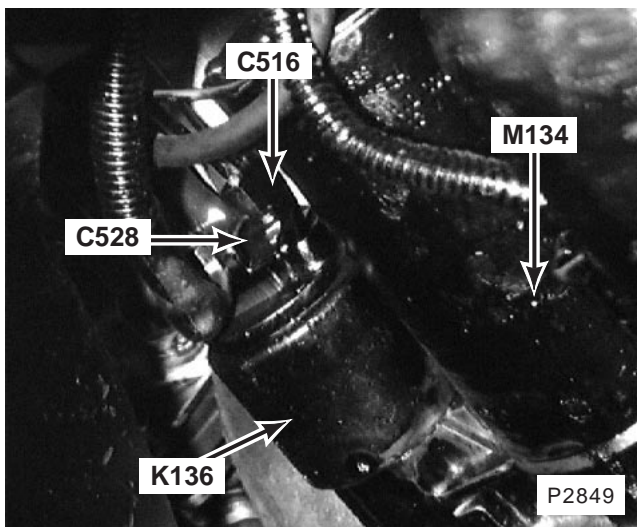

157. lower RH rear of engine
 K136 Starter Solenoid
 M134 Starter
 C516 (1-B)
 C528

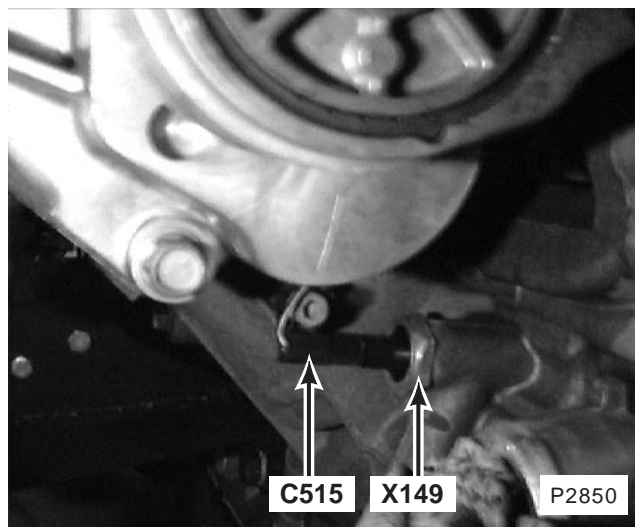

158. lower RH side of engine
 X149 Oil Pressure Switch
 C515 (1-B)

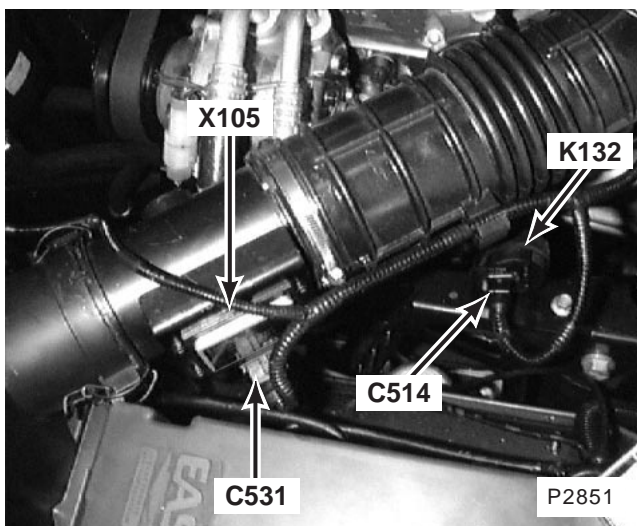

159. LH side of engine compartment
 K132 Evaporative Emission Canister Purge Valve
 X105 Mass Air Flow Sensor
 C514 (2-B)
 C531 (3-B)

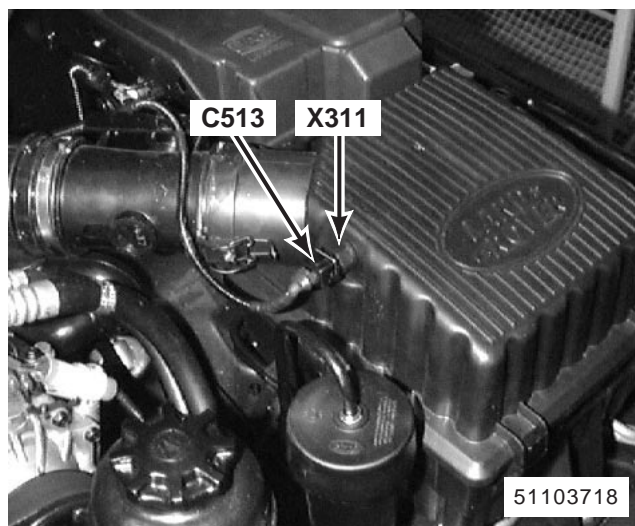

160. LH side of engine compartment on air cleaner
 X311 Intake Air Temperature Sensor
 C513 (2-B)

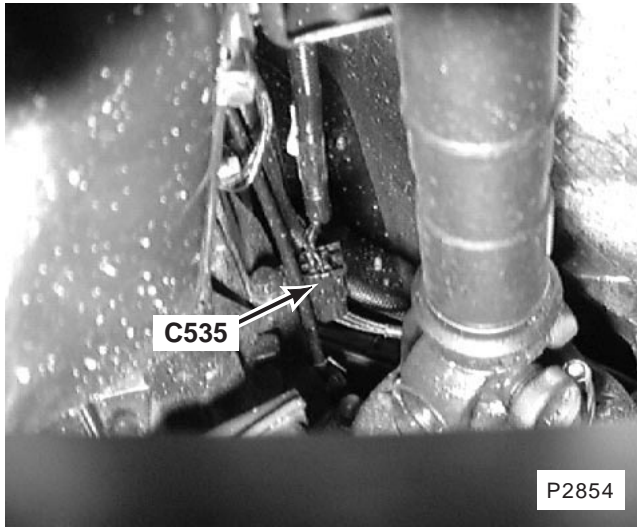

161. beneath LH side of vehicle
C535 (4-B)

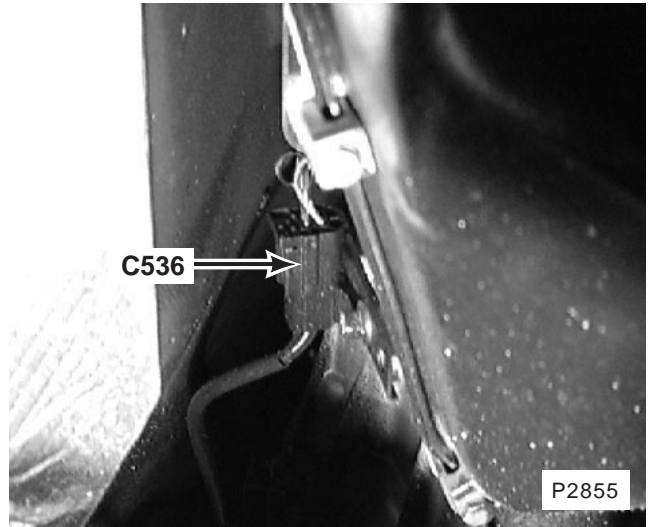

162. beneath RH side of vehicle
C536 (4-B)

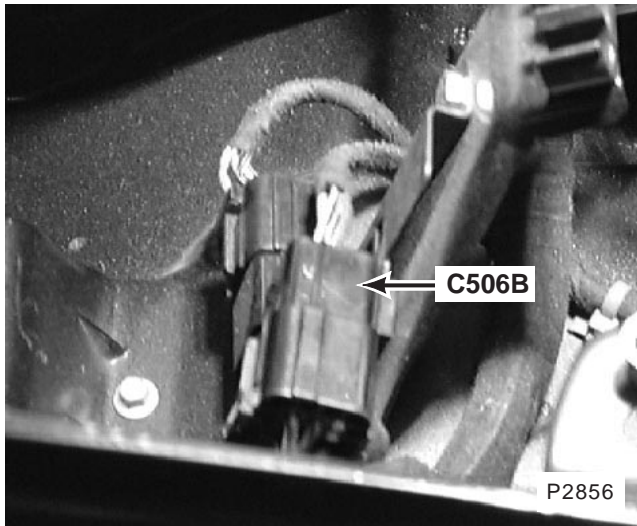

163. RH rear of engine compartment beneath
coolant expansion tank
C506B (13-B)

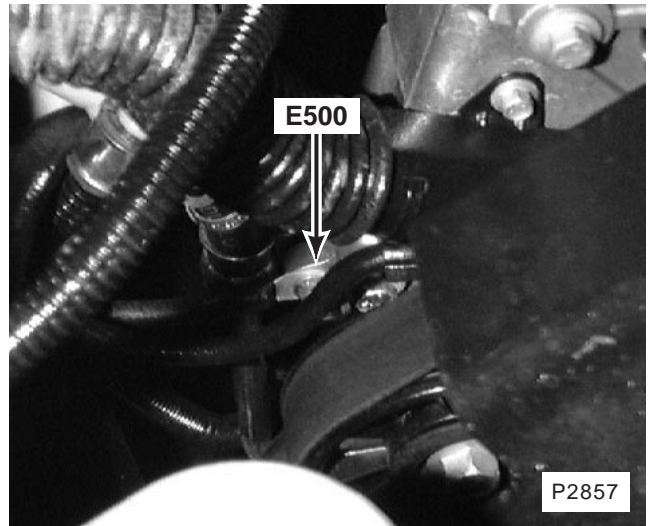

164. RH front of engine
E500

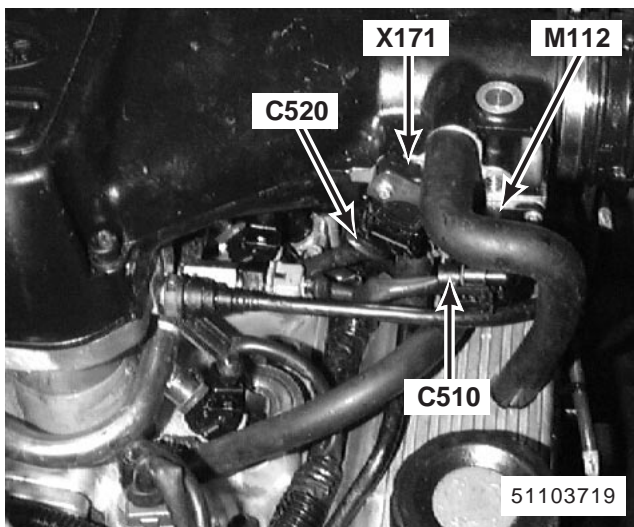

165. LH side of engine
 X171 Throttle Position Sensor
 M112 Idle Air Control Valve
 C510 (4-B)
 C520 (3-B)

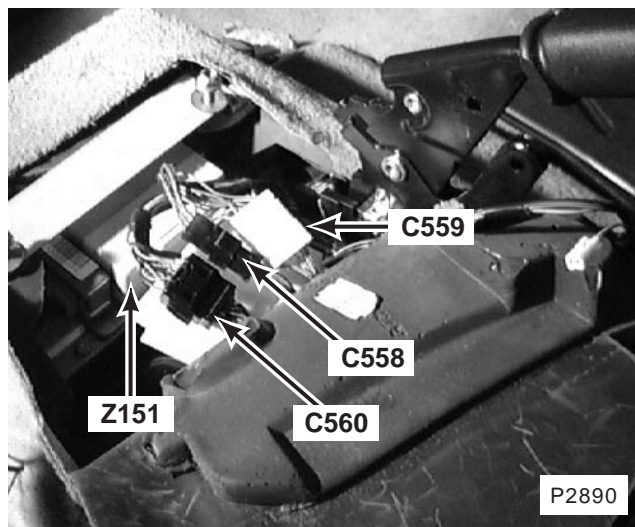

166. beneath centre console
 Z151 Air Bag Diagnostic Control Module
 C558 (2-B)
 C559 (10-W)
 C560 (20-B)

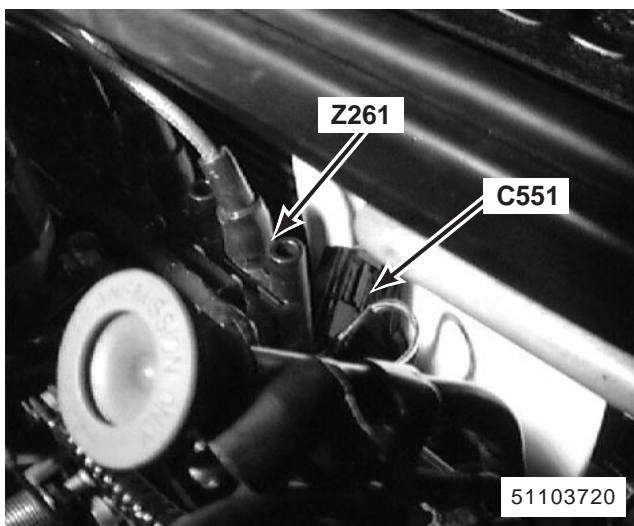

167. centre rear of engine compartment
 Z261 Ignition Coils
 C551 (6-B)

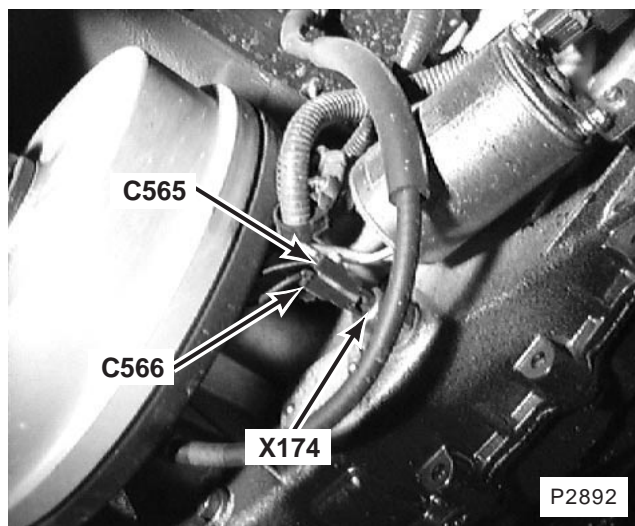

168. on transfer box rear of
 X174 Transfer Box Oil Temperature Switch
 C565 (1-B)
 C566 (1-B)

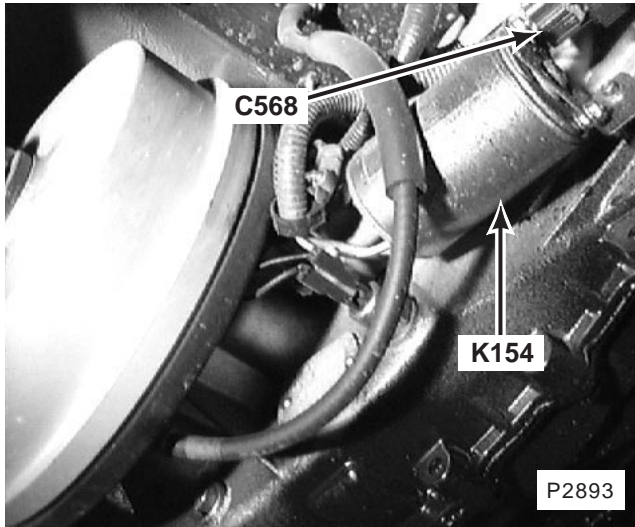

169. on transfer box rear of
K154 Transfer Box Solenoid
C568 (8-B)

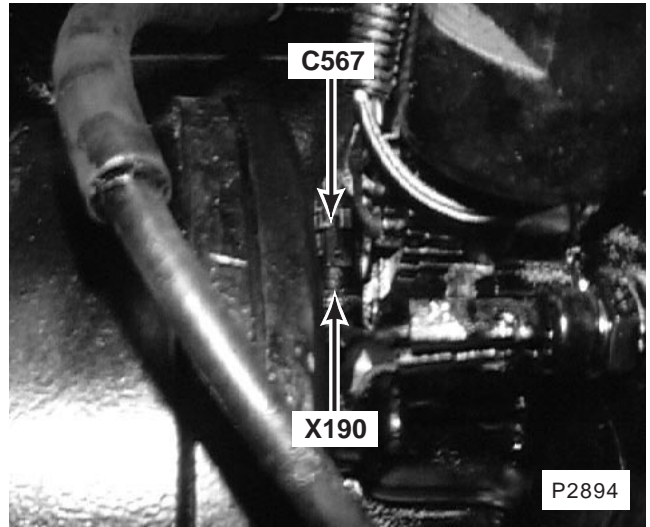

170. on transfer box rear of
X190 Vehicle Speed Sensor
C567 (2-B)

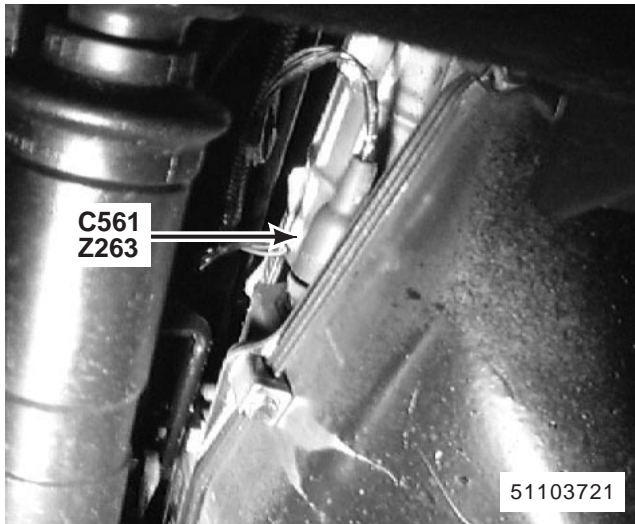

171. beneath centre of vehicle LH rear of engine
Z263 Gearbox Case
C561 (14-B)

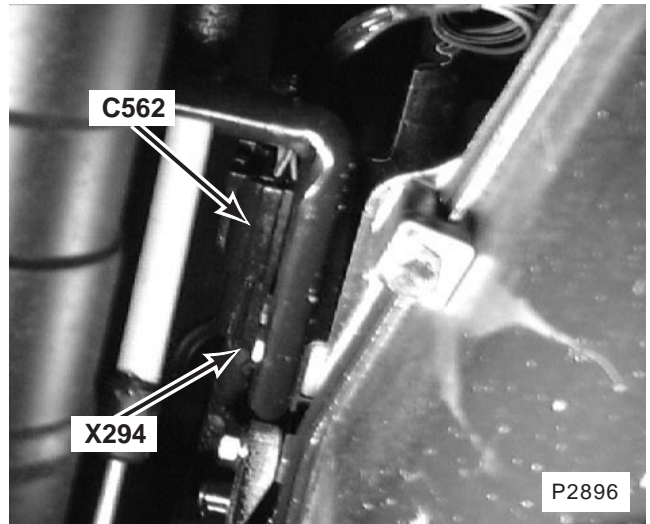

172. LH side of transmission
X294 Gear Box Position Switch
C562 (6-B) (Up to VIN 387824)
C562 (6-S) (From VIN 387825)

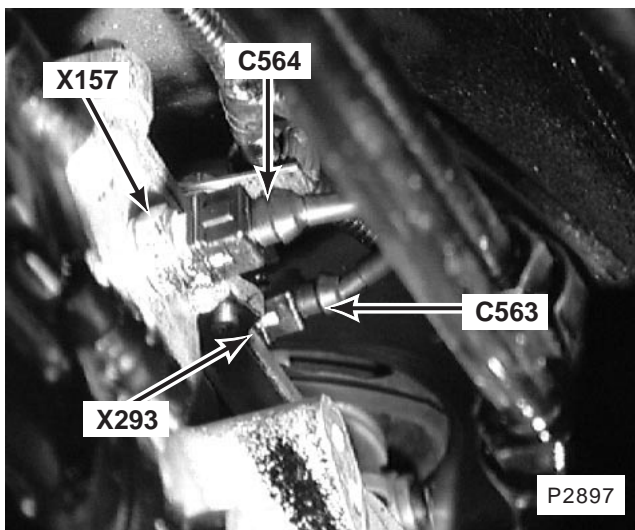

173. LH side of transmission
 X157 Reverse Switch
 X293 Neutral Switch
 C563 (2-B)
 C564 (2-B)

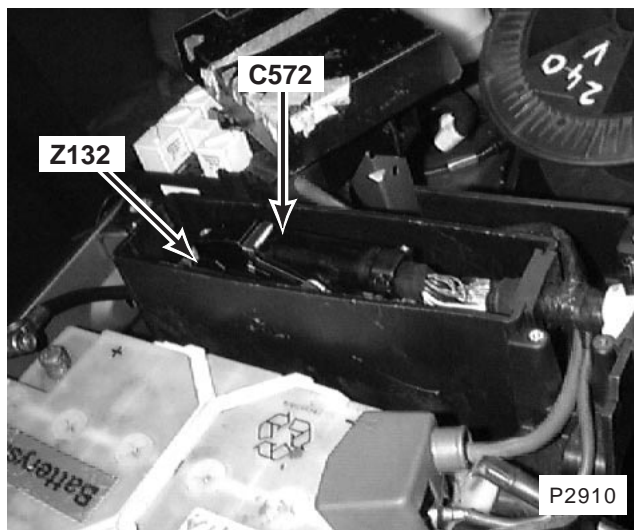

174. RH front of engine compartment behind battery
 Z132 Engine Control Module (ECM)
 C572 (55-B)

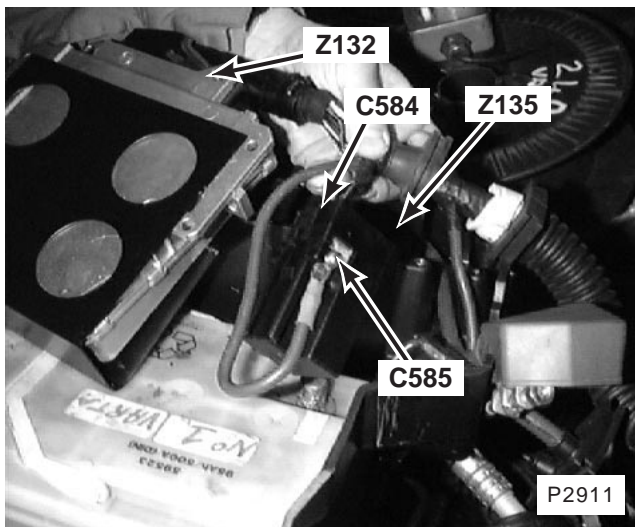

175. RH front of engine compartment behind battery
 Z132 Engine Control Module (ECM)
 Z135 Glow Plug Timer Unit
 C584 (12-B)
 C585 (1-)

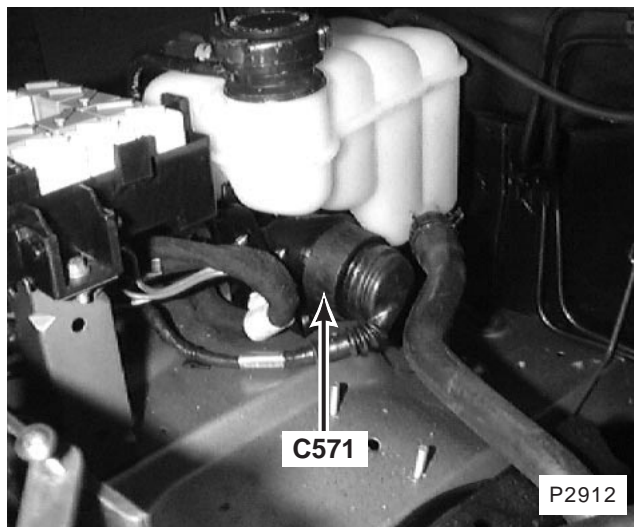

176. RH rear of engine compartment
 C571 (25-B)

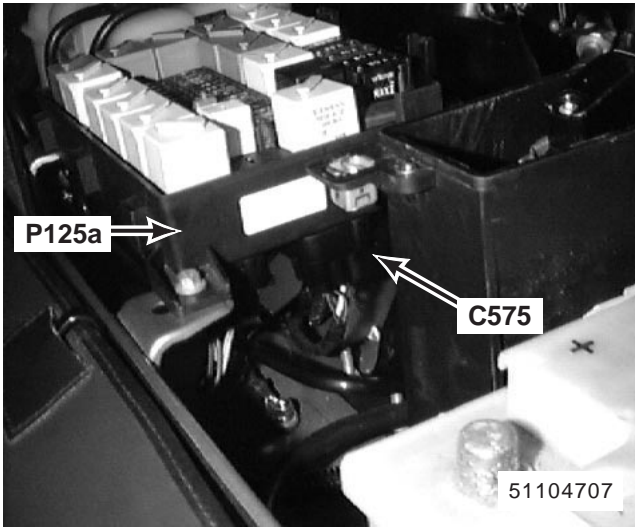

177. RH side of engine compartment
 P125a Engine Compartment Fuse Box
 C575 (8-B)

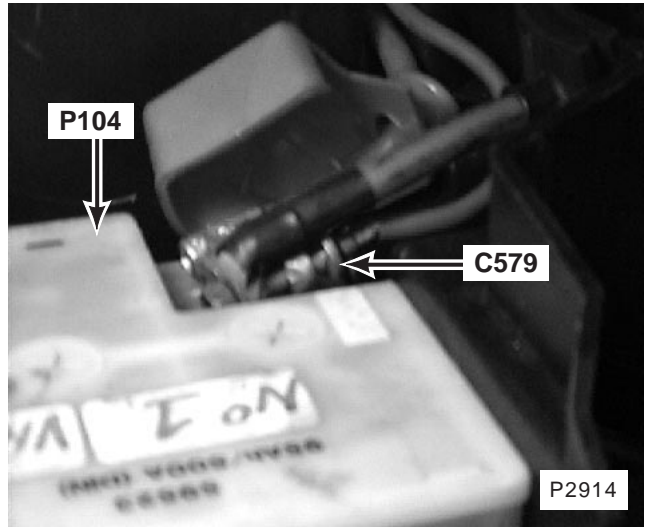

178. RH front of engine compartment
 P104 Battery
 C579

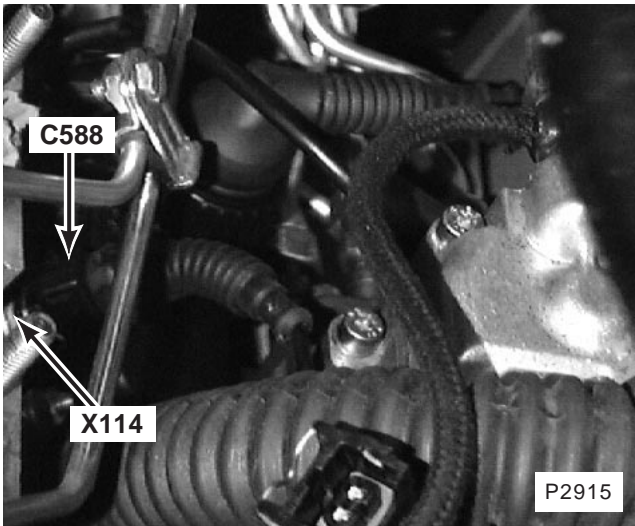

179. LH side of engine
 X114 Engine Coolant Temperature Gauge Sensor
 C588 (2-B)

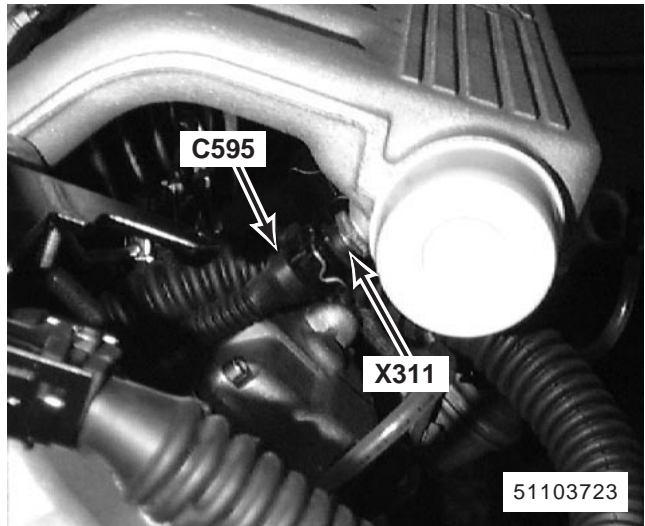

180. LH side of engine
 X311 Intake Air Temperature Sensor
 C595 (2-B)

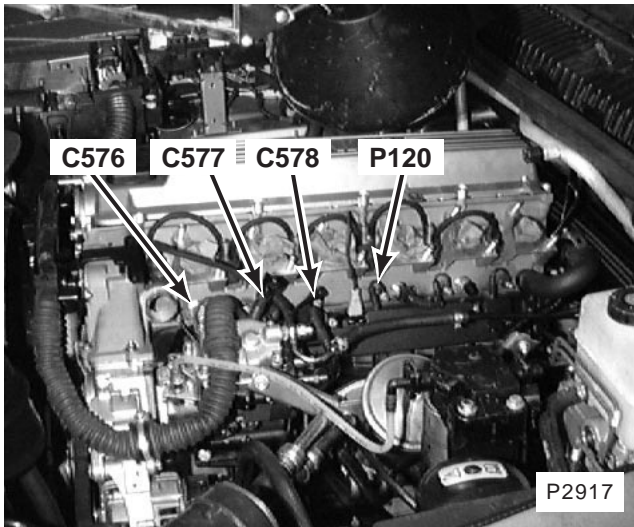

181. LH side of engine

P120 Glow Plugs

C576 (1 -)

C577 (1 -)

C578 (1 -)

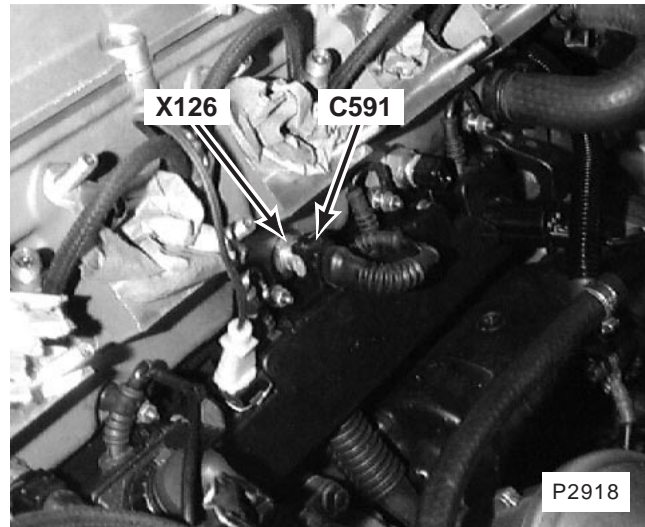

182. LH side of engine

X126 Engine Coolant Temperature Sensor

C591 (2-B)

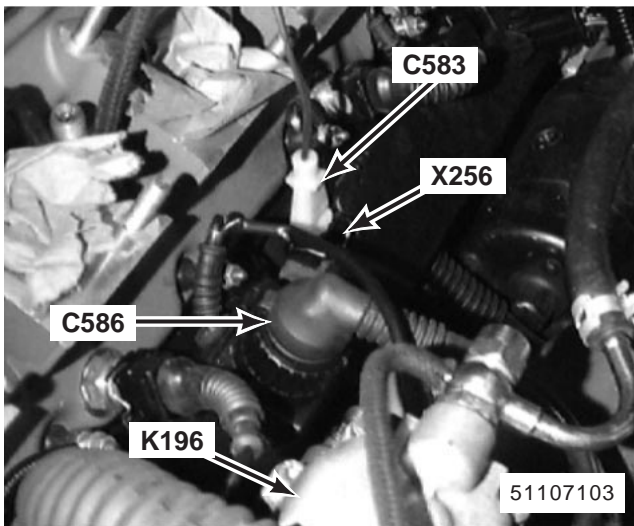

183. LH side of engine

K196 Fuel Pump Assembly

X256 Injector Needle Lift Sensor

C583 (2-W)

C586 (7-B)

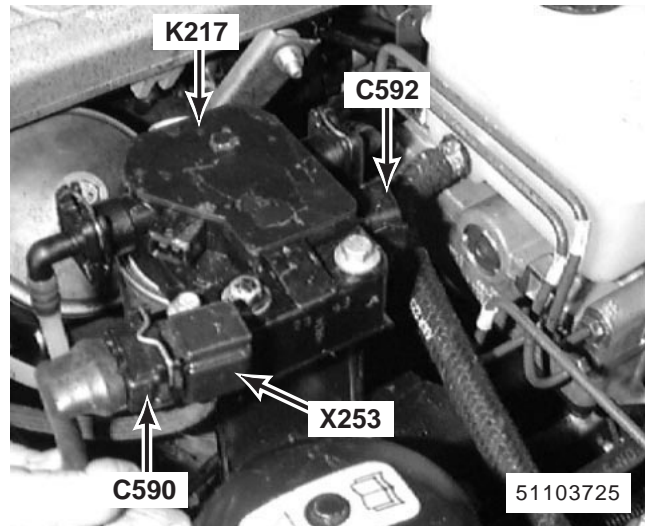

184. LH rear of engine compartment

K217 Fuel Heater

X253 Boost Pressure Sensor

C590 (3-B)

C592 (3-B)

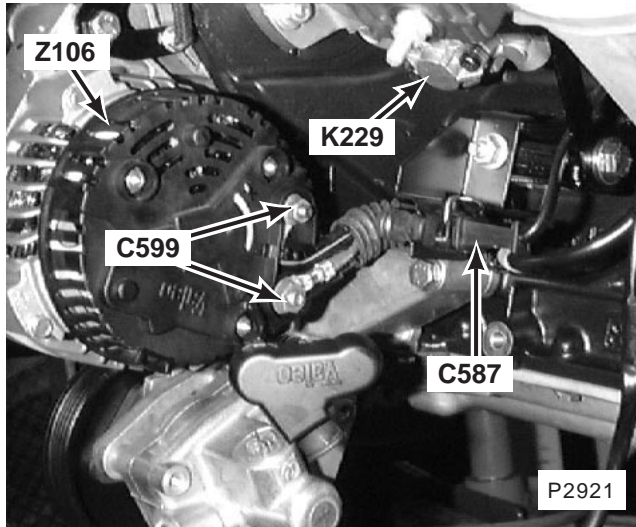

185. LH front of engine
 K229 Solenoid Valve, Injection Timing Device
 Z106 Generator
 C587 (2-B)
 C599

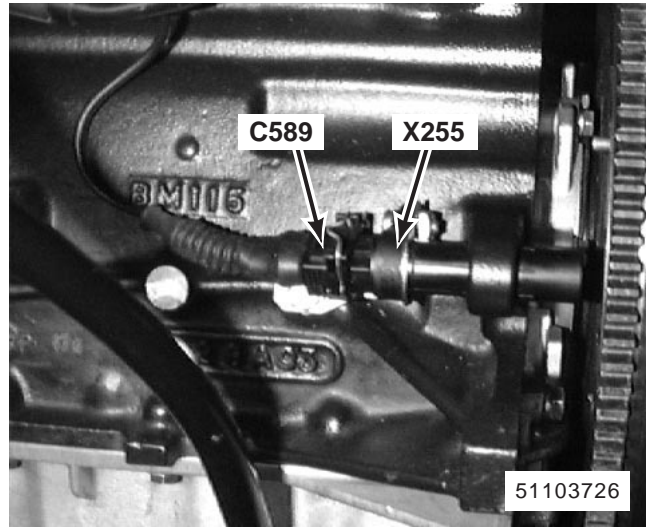

186. LH rear of engine
 X255 Engine Speed Sensor
 C589 (2-B)

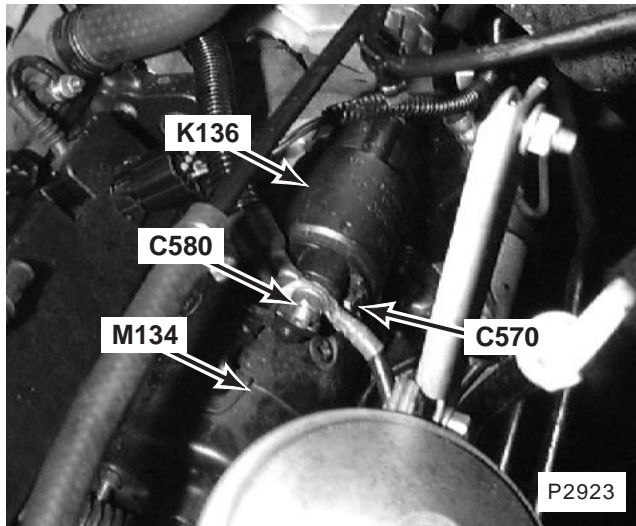

187. lower LH rear of engine
 K136 Starter Solenoid
 M134 Starter
 C570
 C580

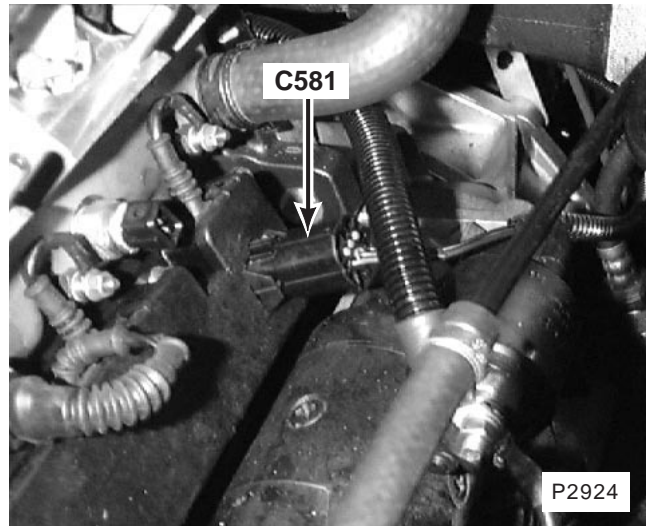

188. LH side of engine
 C581 (6-B)

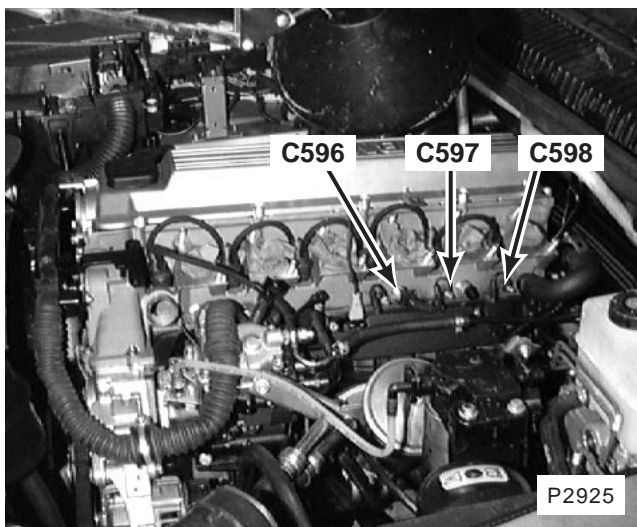

189. LH side of engine

C596 (1 -)

C597 (1 -)

C598 (1 -)

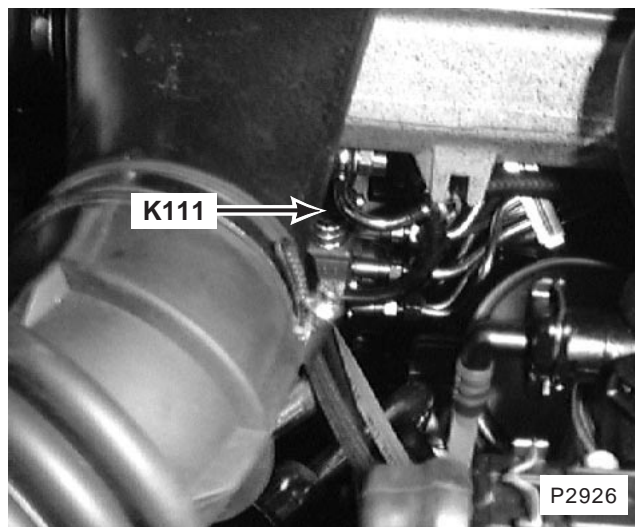

190. LH side of engine

K111 Fuel Shut-Off Solenoid

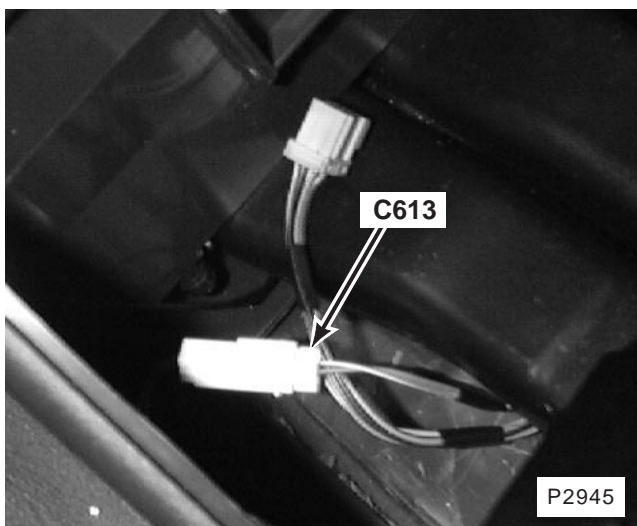

191. beneath cubby box liner

C613 (2-W)

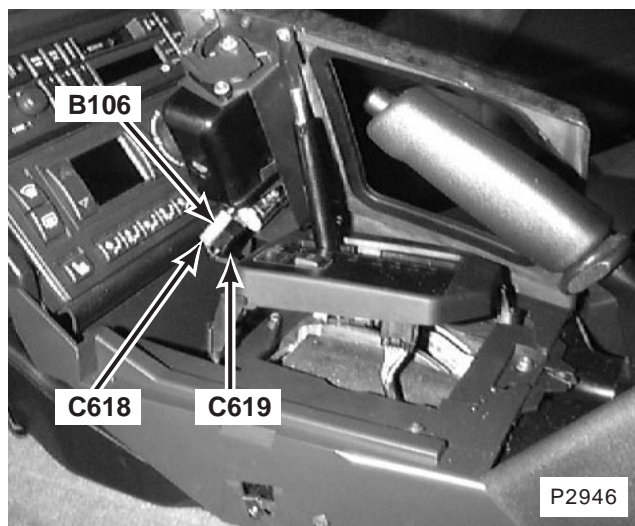

192. in centre console

B106 Fascia Cigar Lighter

C618 (1-W)

C619 (2-B)

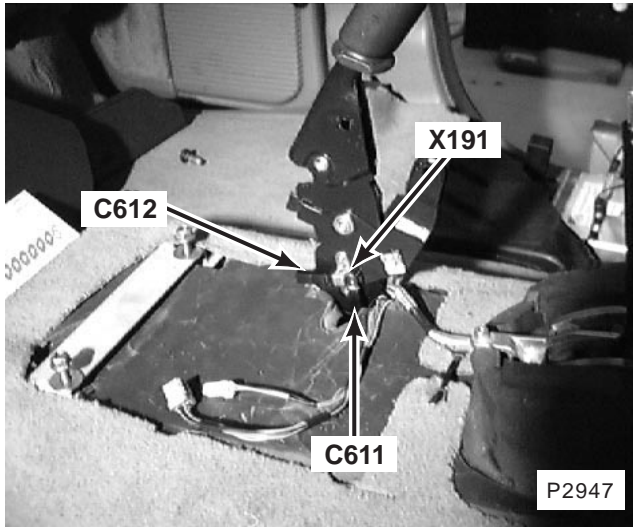

193. beneath centre console on handbrake lever
 X191 Handbrake Switch
 C611 (1-B)
 C612 (1-B)

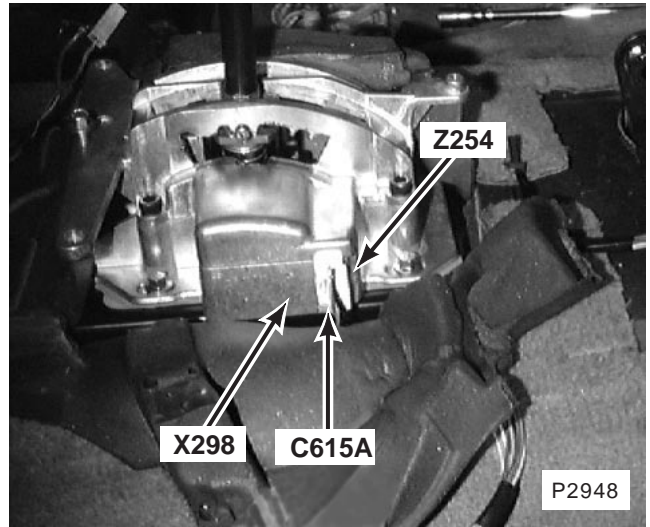

194. beneath centre console
 X298 Transfer Micro Switch/Shift Lock Solenoid
 Z254 'H' Gate Sensor Module
 C615A (6-W)

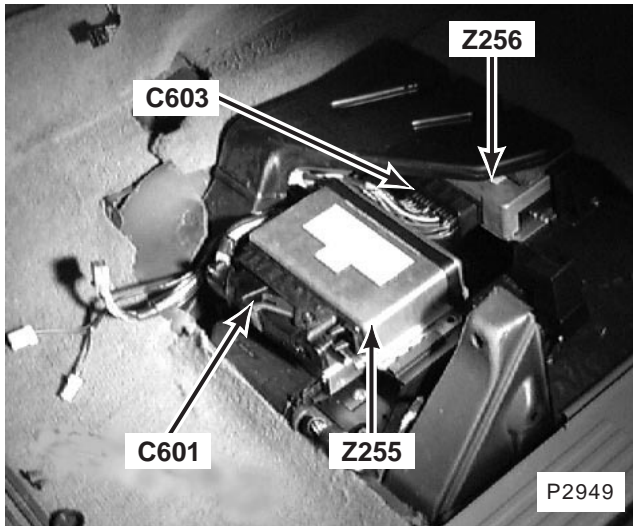

195. beneath LH front seat
 Z255 Auto Gear Box Control Unit
 Z256 Transfer Gear Box ECU
 C601 (55-B)
 C603 (36-B)

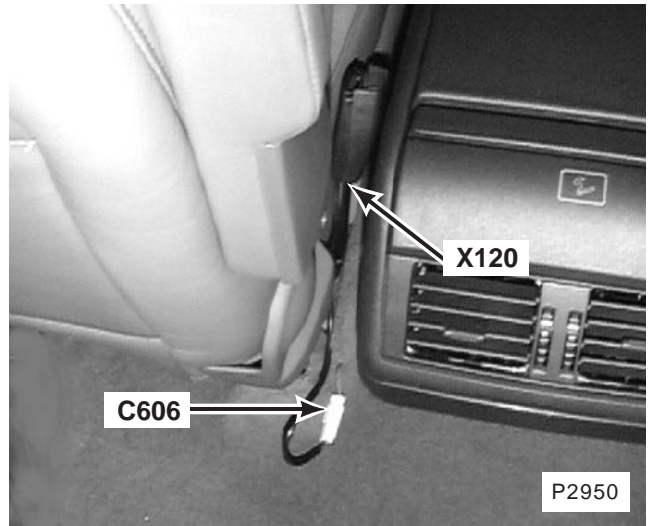

196. inside driver's seat belt buckle assembly
 X120 Driver's Seat Buckle Switch
 C606 (2-W)

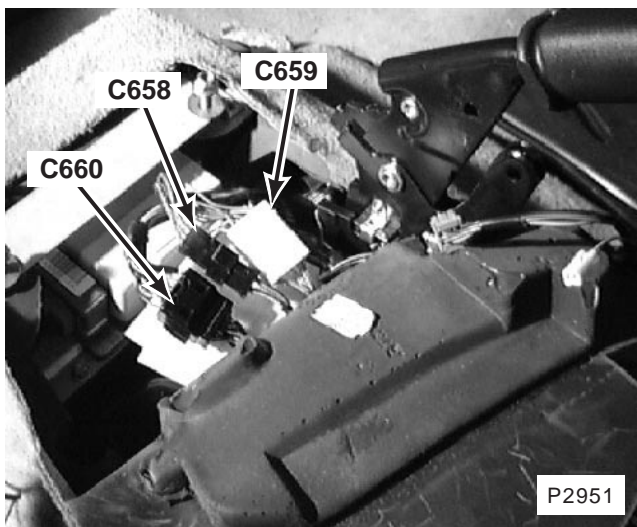

197. beneath centre console
 C658 (2-B)
 C659 (10-W)
 C660 (20-B)

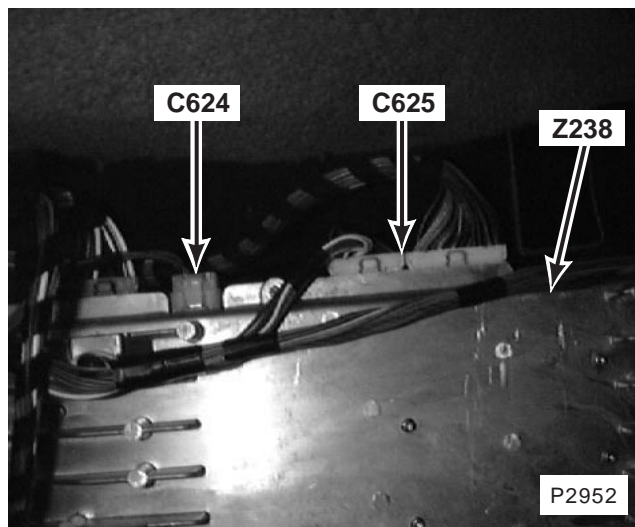

198. beneath RH front seat
 Z238 Body Electrical Control Module (BECM)
 C624 (4-W)
 C625 (12-W)

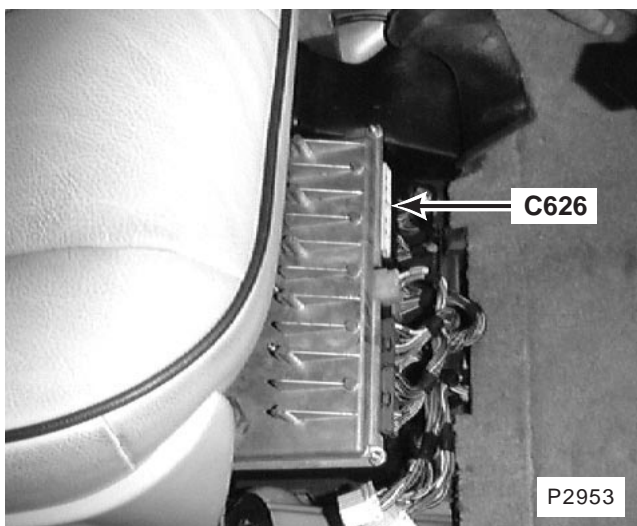

199. beneath RH front seat
 C626 (20-B)

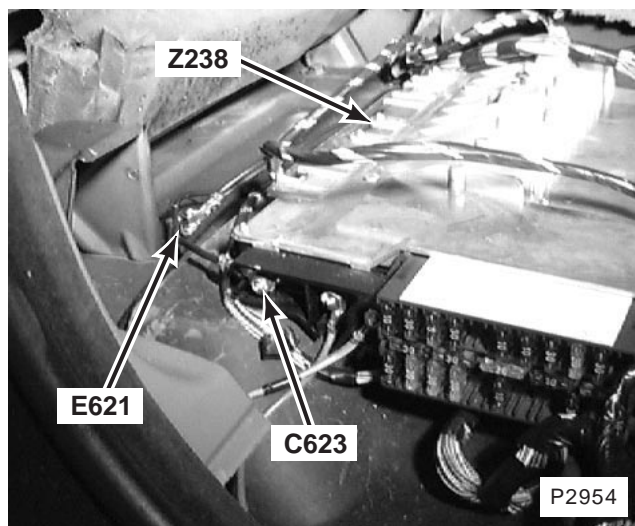

200. beneath RH front seat
 Z238 Body Electrical Control Module (BECM)
 C623
 E621

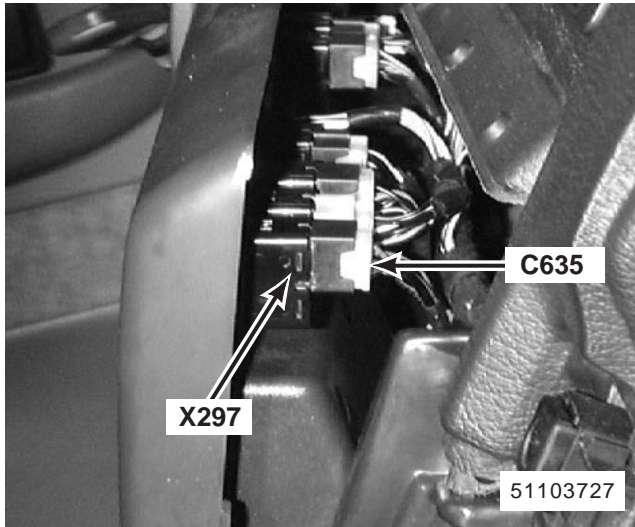

201. behind centre of fascia
X297 Transfer Switch Manual
C635 (6-W)

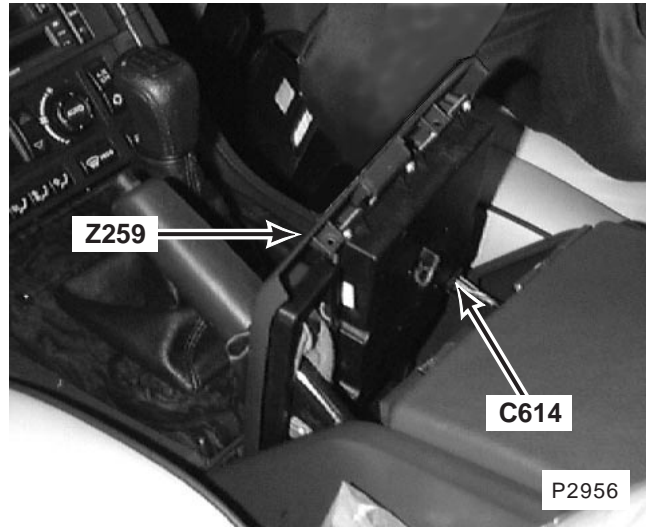

202. in centre console
Z259 Centre Console Switch Pack Outstation
C614 (8-U)



203. in centre console rear of
B182 Rear Footwell Lamp

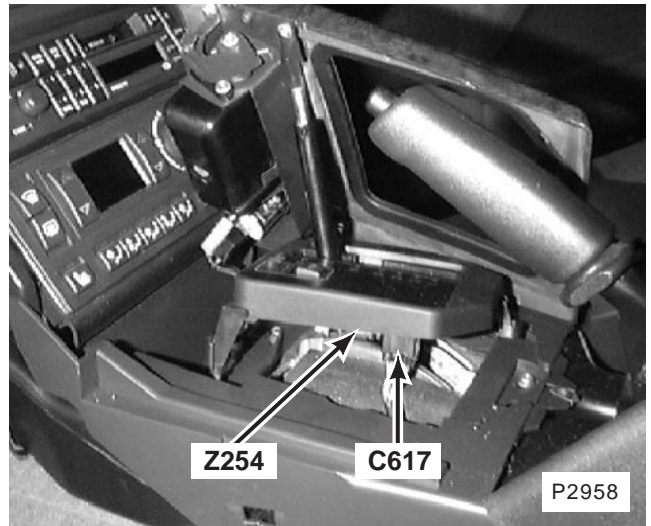

204. beneath centre console
Z254 'H' Gate Sensor Module
C617 (12-B)

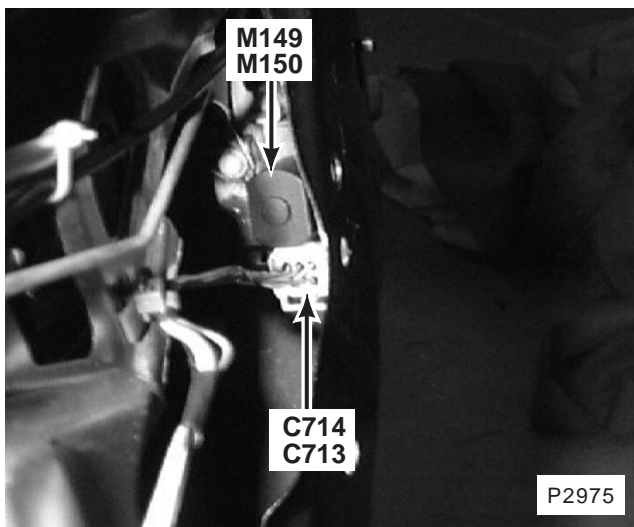

205. respective rear door (trim removed)
 M149 Left Rear Door Lock Actuator
 M150 Right Rear Door Lock Actuator
 C713
 C714L (6-B)
 C714R (6-W)

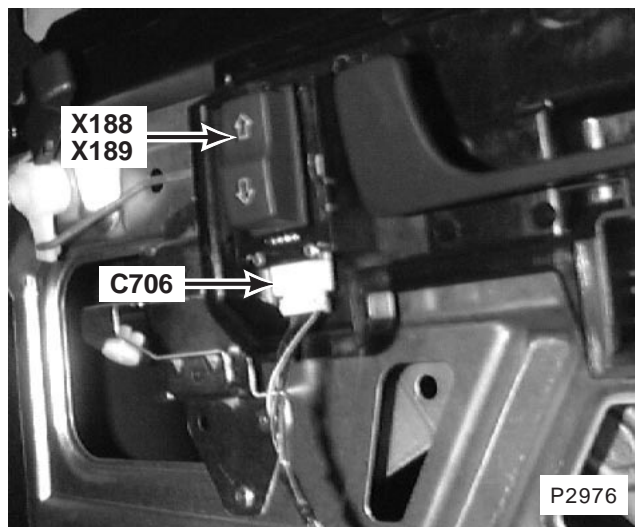

206. respective rear door (trim removed)
 X188 Left Rear Window Door Switch
 X189 Right Rear Window Door Switch
 C706 (4-W)

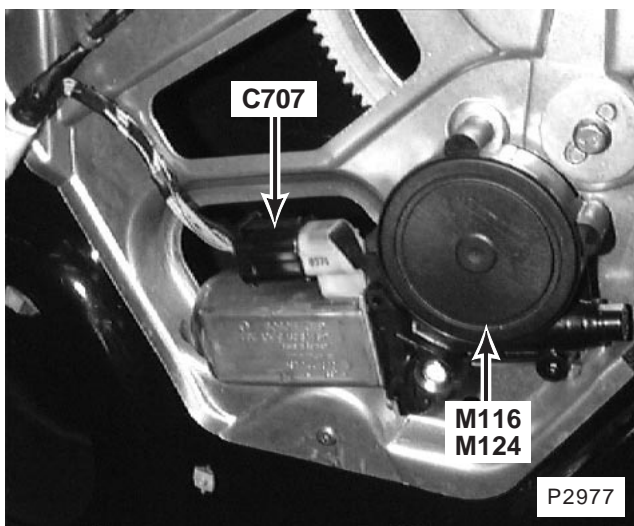

207. behind rear door trim panel
 M116 Left Rear Window Motor
 M124 Right Rear Window Motor
 C707L (6-B)
 C707R (6-W)

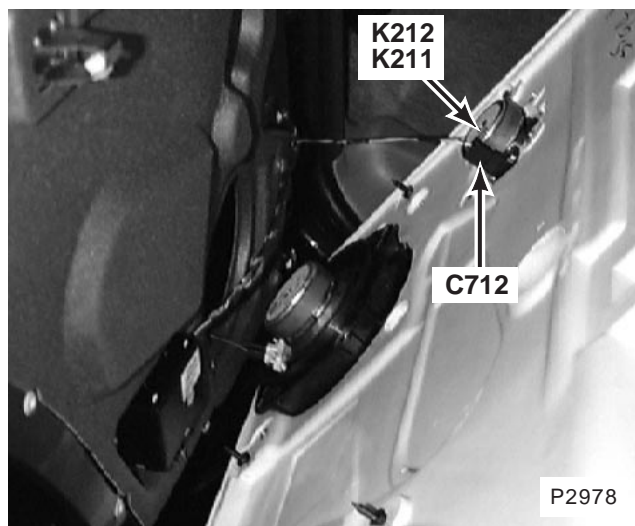

208. respective rear door (trim removed)
 K211 Left Rear Midrange Speaker
 K212 Right Rear Midrange Speaker
 C712 (2-B)

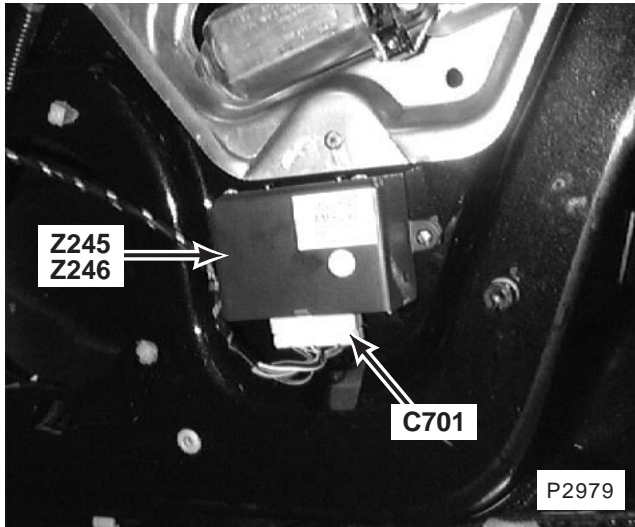

209. behind rear door trim panel
 Z245 Left Rear Door Speaker Amplifier
 Z246 Right Rear Door Speaker Amplifier
 C701 (10-W)

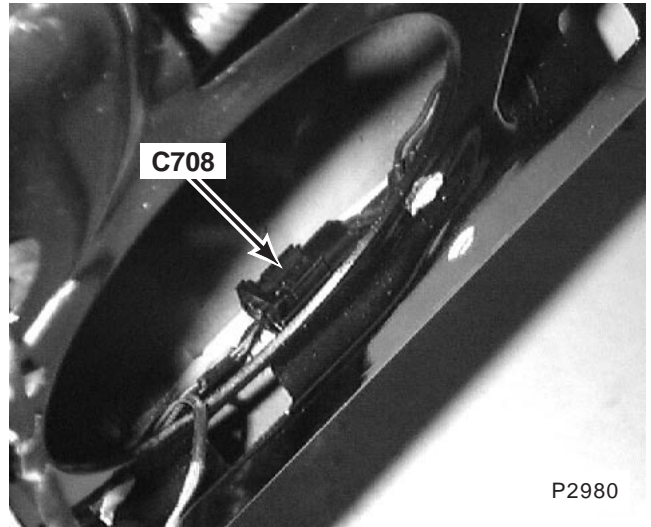

210. behind rear door trim panel
 C708 (2-B)

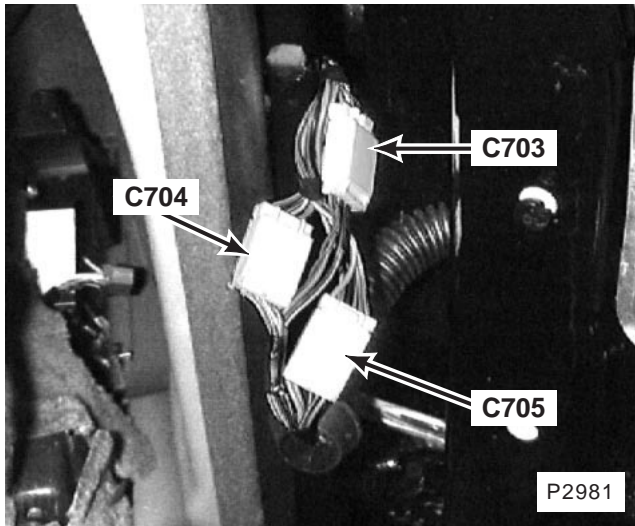

211. behind rear door trim panel
 C703 (6-W)
 C704 (6-S)
 C705 (6-Y)

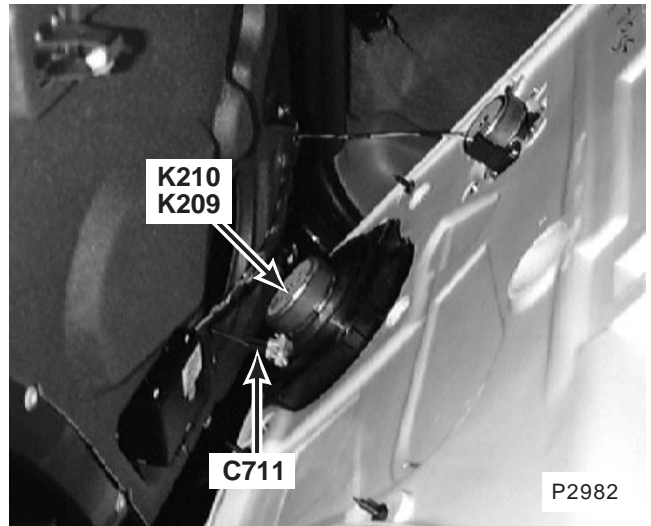

212. respective rear door (trim removed)
 K209 Left Rear Bass Speaker
 K210 Right Rear Bass Speaker
 C711 (2-B)

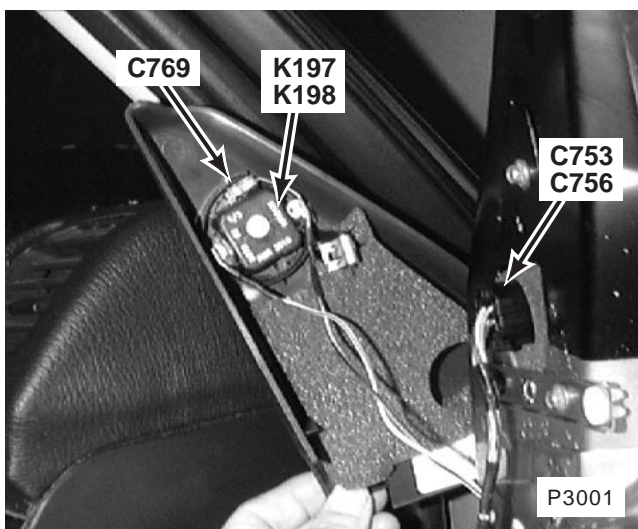

213. respective front door (trim removed)
 K197 Left Front Tweeter
 K198 Right Front Tweeter
 C753 (6-B)
 C756 (13-B)
 C769 (2-B)

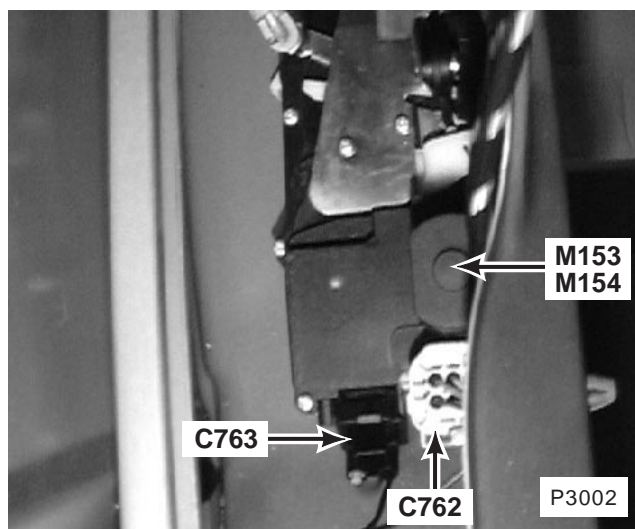

214. respective front door (trim removed)
 M153 Left Front Door Lock Actuator
 M154 Right Front Door Lock Actuator
 C762L (6-B)
 C762R (6-W)
 C763 (2-B)

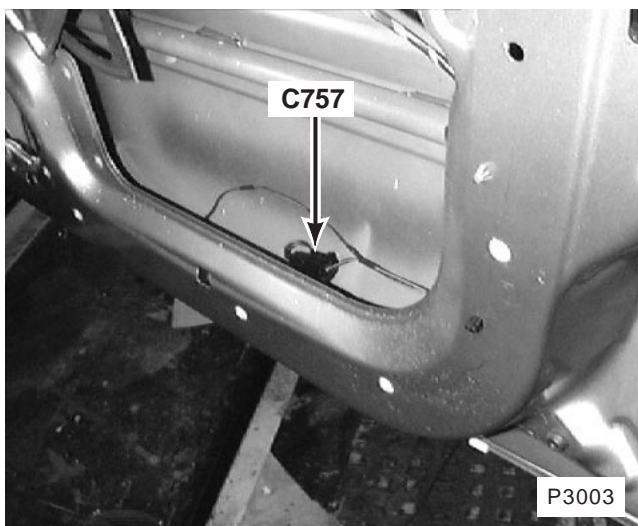

215. behind front door trim panel
 C757 (2-B)

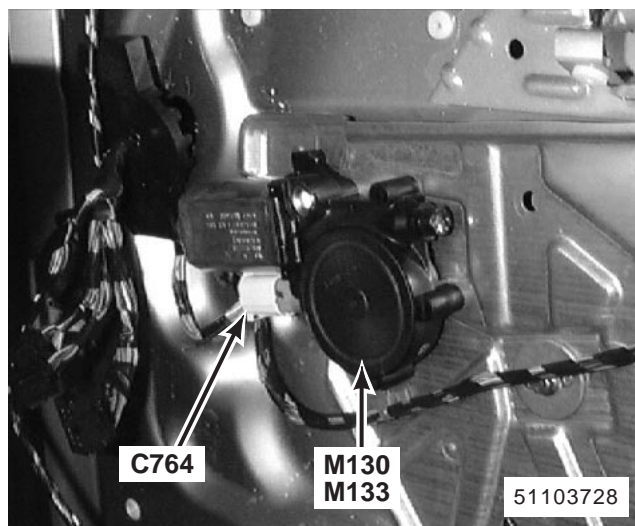

216. respective front door (trim removed)
 M133 Right Front Window Motor
 M130 Left Front Window Motor
 C764L (6-B)
 C764R (6-W)

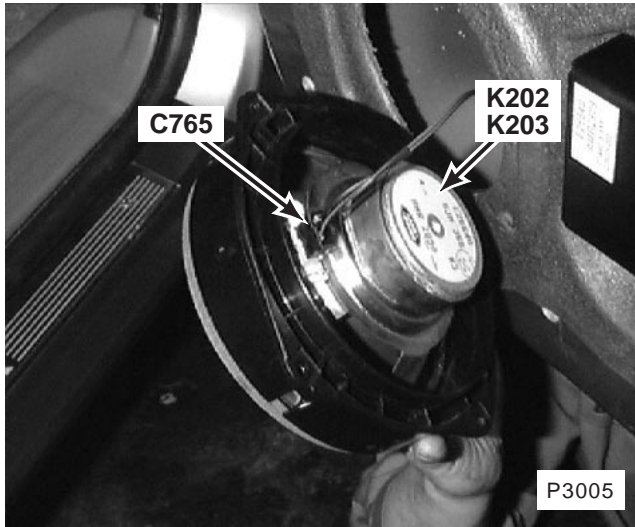

217. respective front door (trim removed)
 K202 Left Front Bass Speaker
 K203 Right Front Bass Speaker
 C765 (2-B)

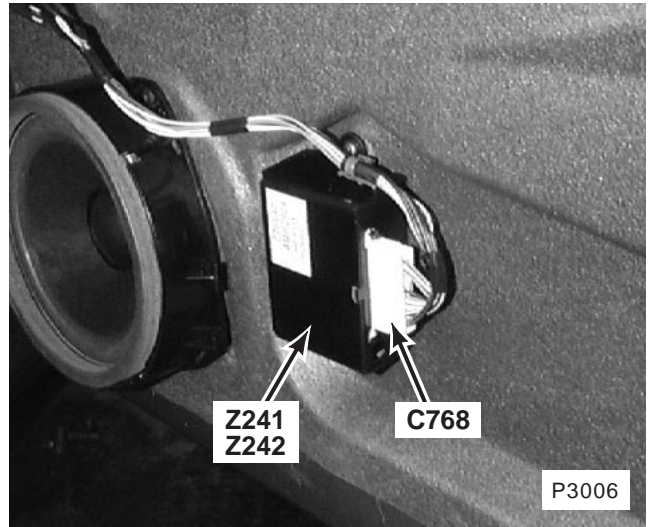

218. respective front door (trim removed)
 Z241 Left Front Door Speaker Amplifier
 Z242 Right Front Door Speaker Amplifier
 C768 (10-W)

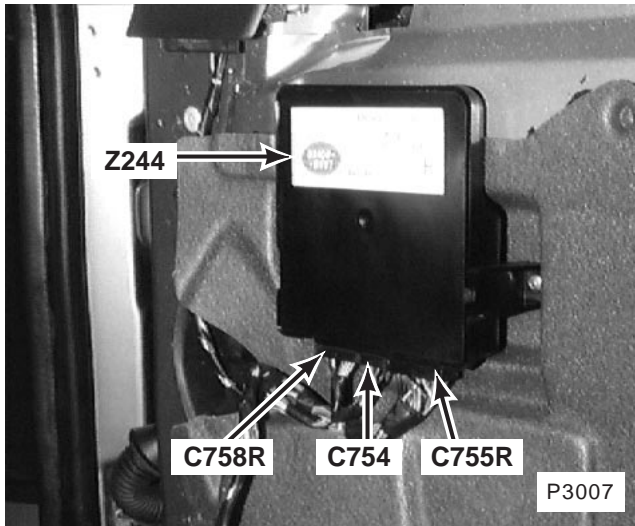

219. LH front door (trim removed)
 Z244 Right Front Door Outstation
 C754R (12-B)
 C755R (16-B)
 C758R (20-B)

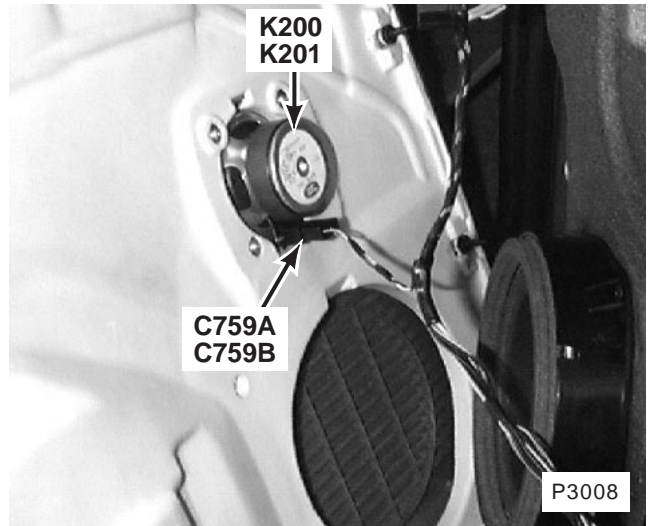

220. behind front door trim panel
 K200 Left Front Midrange Speaker
 K201 Right Front Midrange Speaker
 C759 (2-B)

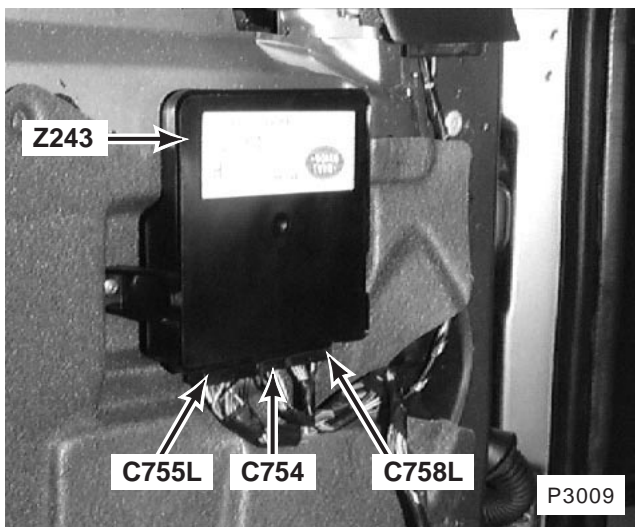

221. RH front door (trim removed)
 Z243 Left Front Door Outstation
 C754L (12-B)
 C755L (16-B)
 C758L (20-B)

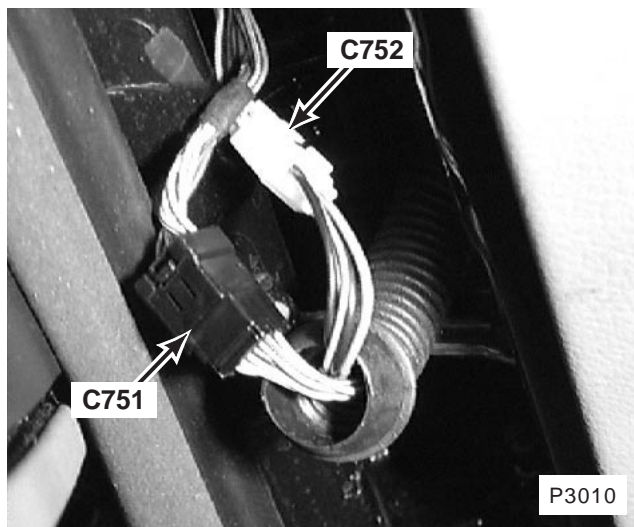

222. front of RH front door jamb (LH similar)
 C751 (12-B)
 C752 (4-W)

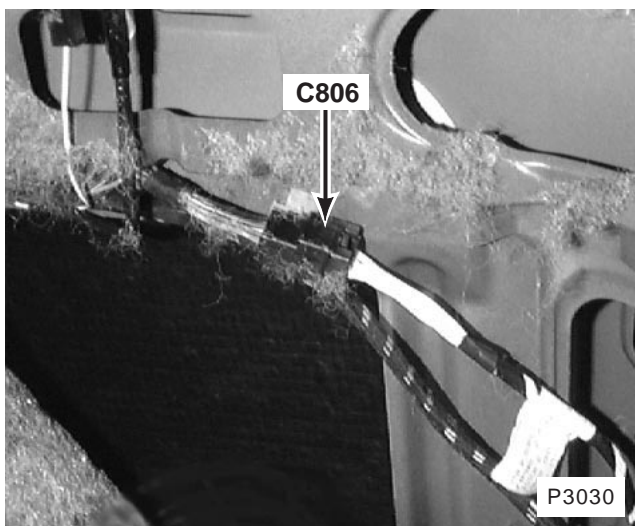

223. RH rear of luggage compartment (trim removed)
 C806 (10-B)

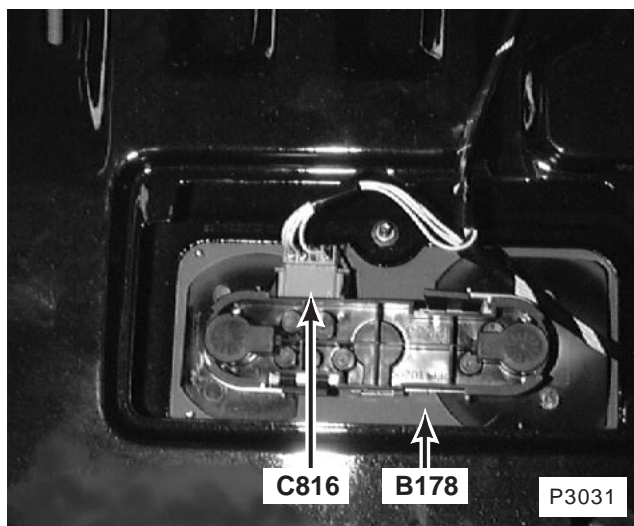

224. RH side of tailgate (trim removed)
 B178 Right Tailgate Lights
 C816 (4-G)

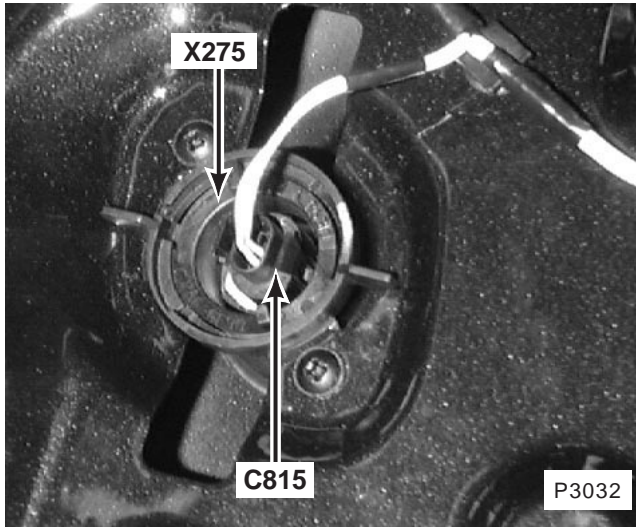

225. centre of tailgate behind trim panel
 X275 Tailgate Unlock Switch
 C815 (3-B)

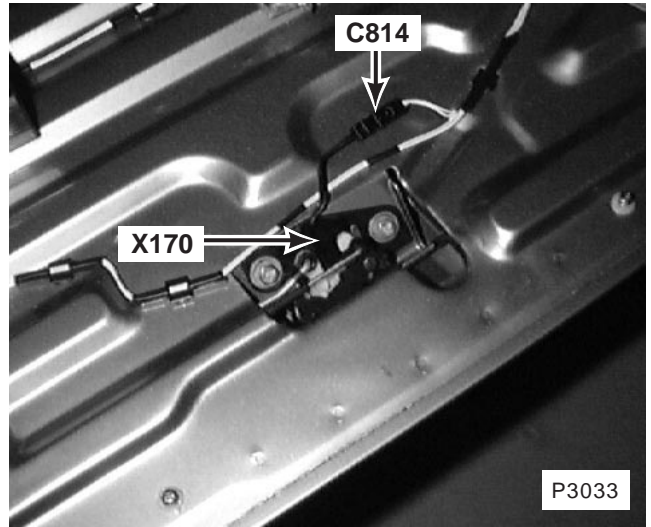

226. centre of tailgate (trim removed)
 X170 Tailgate Switch
 C814 (2-B)

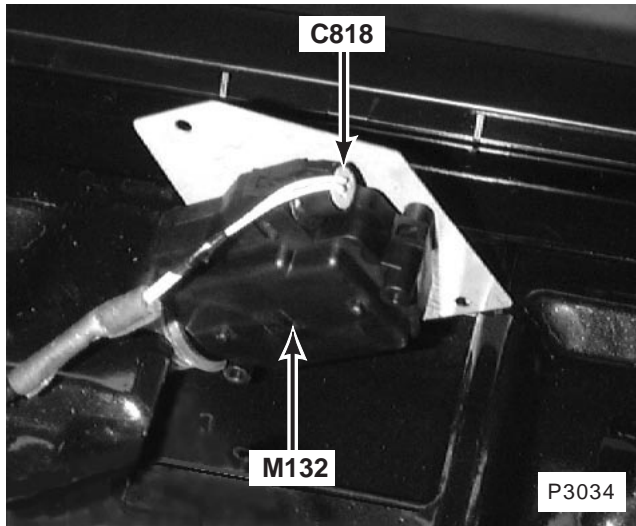

227. centre of tailgate (trim removed)
 M132 Tailgate Lock Actuator
 C818 (2-B)

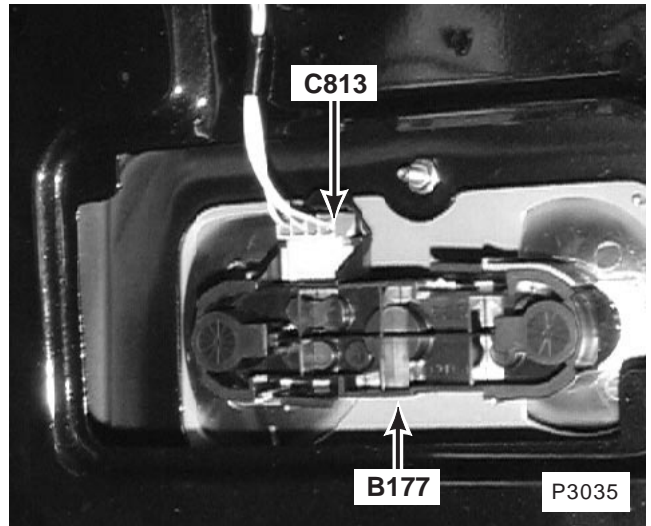

228. LH side of tailgate
 B177 Left Tailgate Lights
 C813 (4-G)

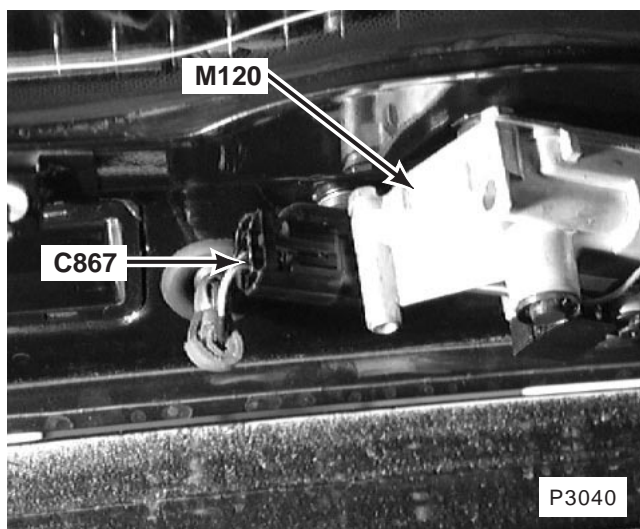

229. top centre of front screen behind trim panel
 M120 Rear Wiper Motor
 C867 (3-B)

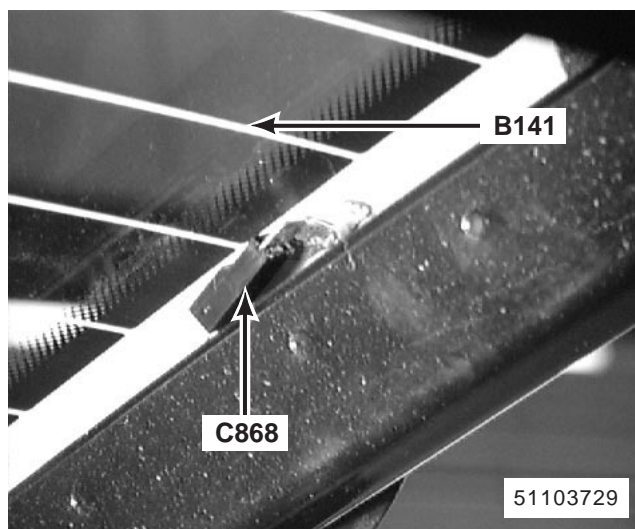

230. LH side of tailgate
 B141 Rear Screen
 C868 (1-B)

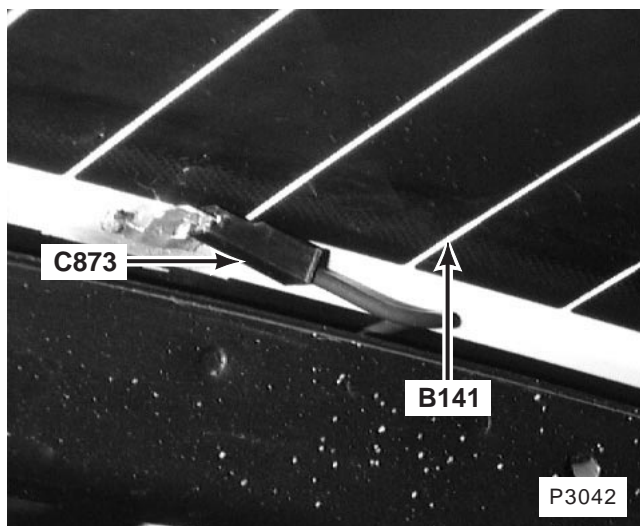

231. RH side of tailgate
 B141 Rear Screen
 C873 (1-B)

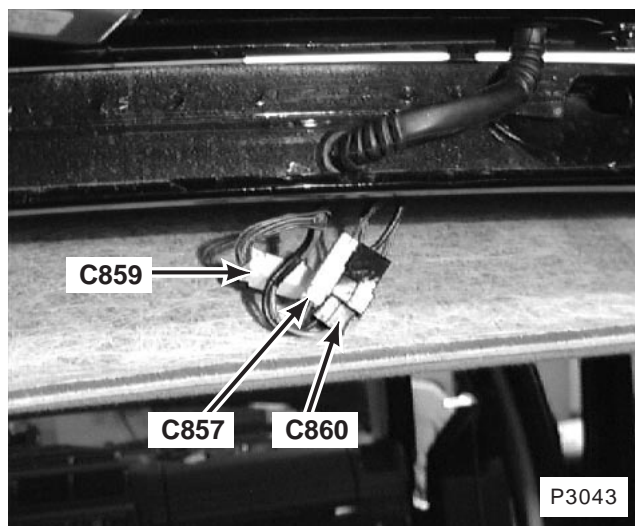

232. centre rear of roof (trim removed)
 C857 (4-W)
 C859 (2-W)
 C860 (2-B)

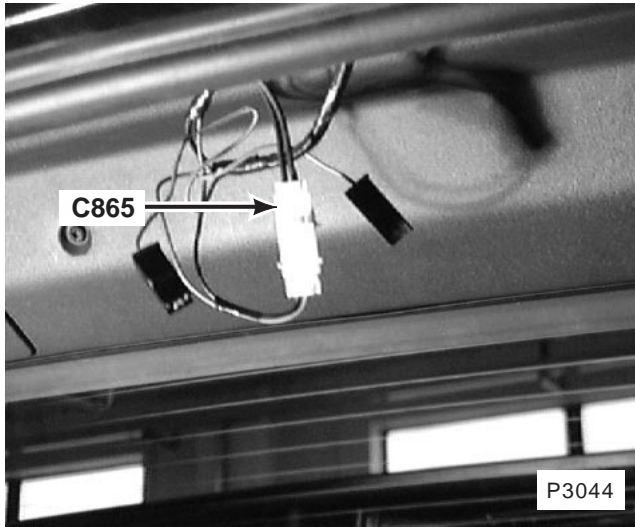

233. centre of tailgate (trim removed)
C865 (2-W)

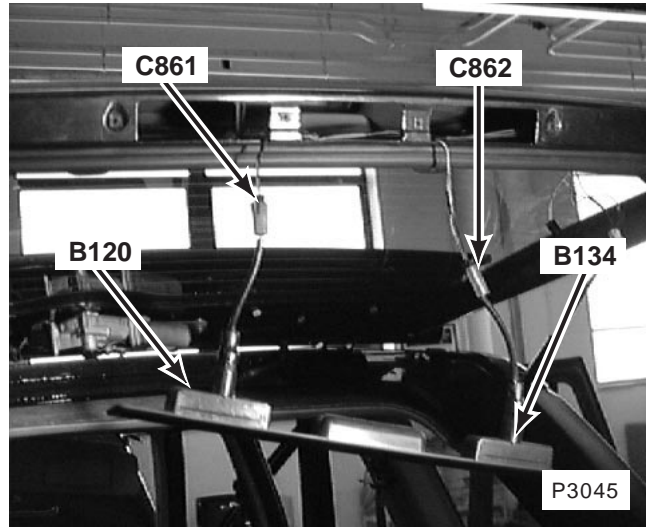

234. centre of tailgate (trim removed)
B120 Left Number Plate Lamp
B134 Right Number Plate Lamp
C861 (2-B)
C862 (2-B)

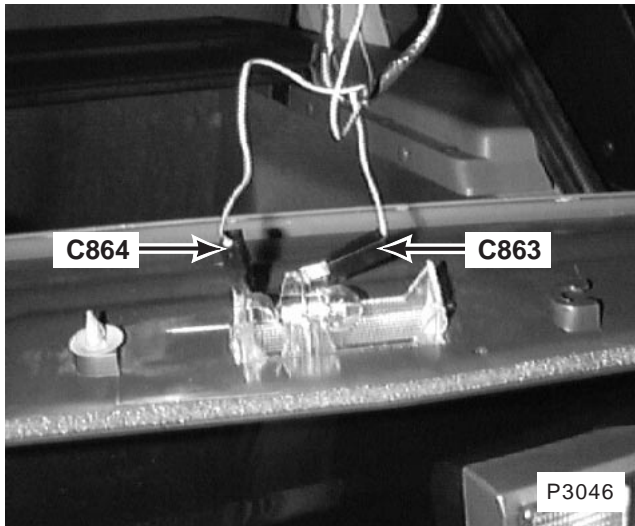

235. centre of tailgate (trim removed)
C863 (1-B)
C864 (1-B)

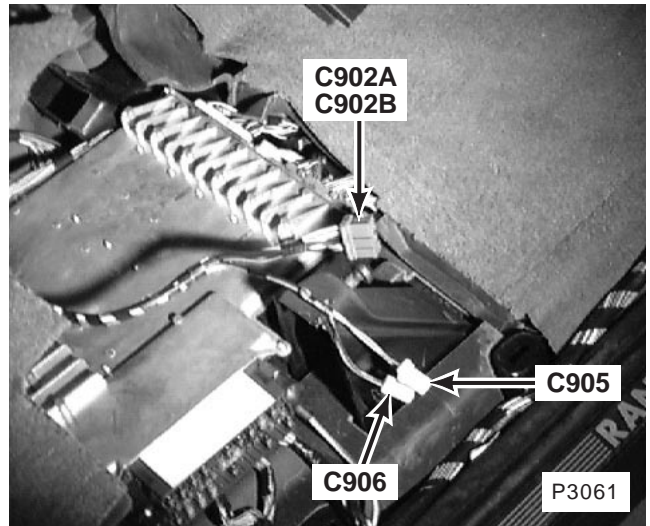

236. beneath RH front seat
C902A (12-S)
C902B (8-W)
C905 (3-S)
C906 (2-S)

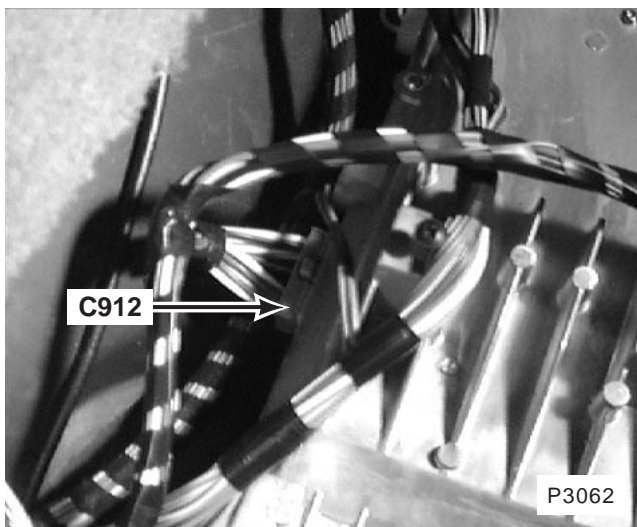

237. beneath RH front seat
C912 (12-G)

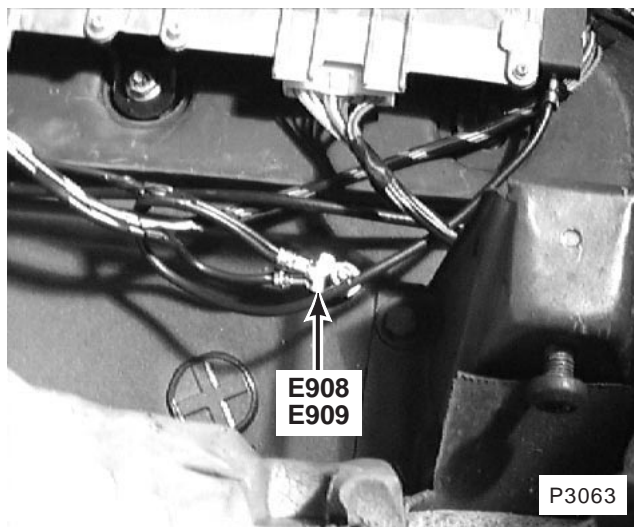

238. beneath LH front seat
E908
E909

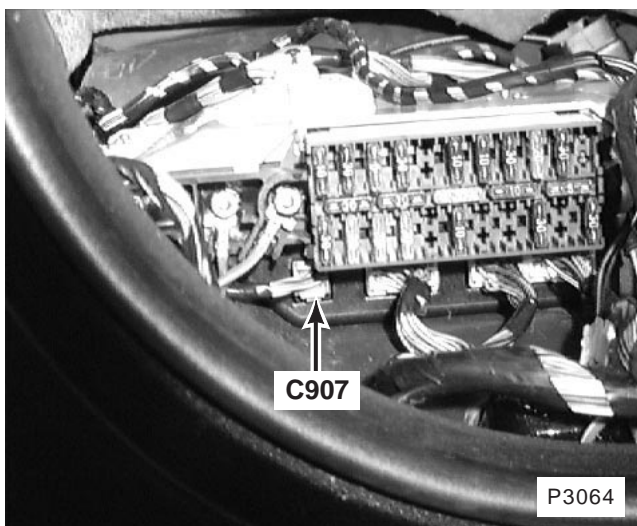

239. beneath RH front seat
C907 (8-B)

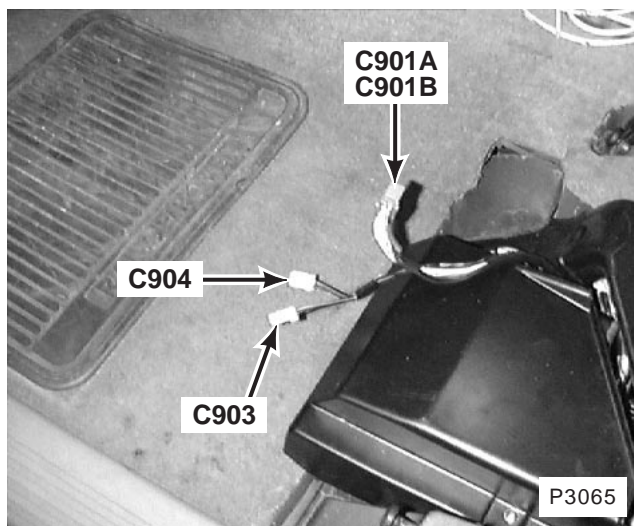

240. beneath LH front seat
C901A (12-S)
C901B (8-W)
C903 (3-W)
C904 (2-W)

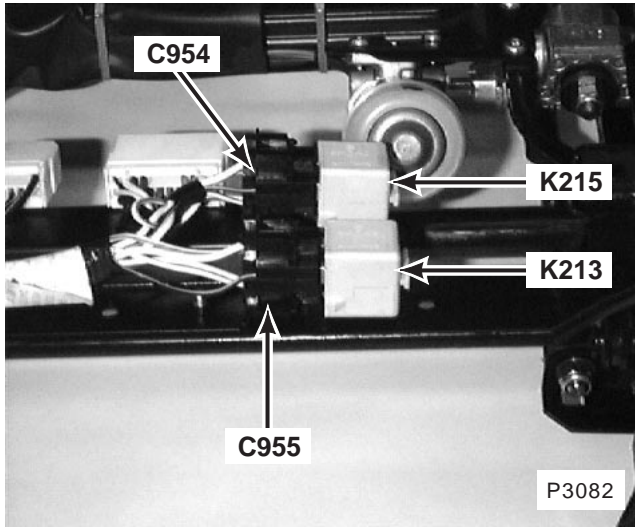

241. underside of LH front seat
 K213 Left Non-Memory Seat Power Relay 1
 K215 Left Non-Memory Seat Power Relay 2
 C954L (5-B)
 C955L (5-B)

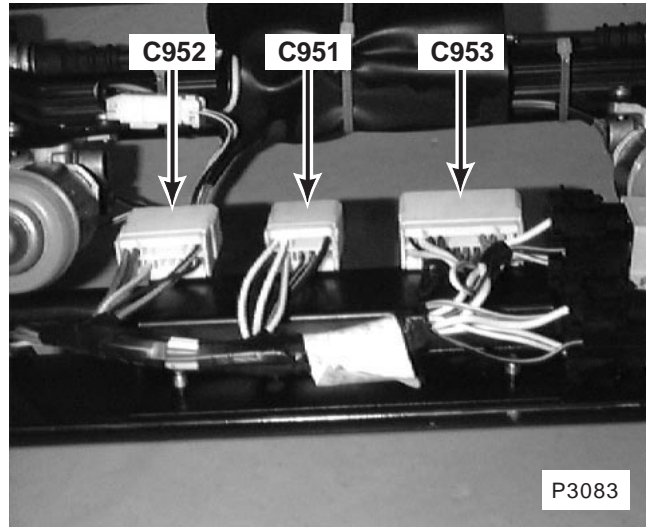

242. underside of LH front seat (RH similar)
 C951 (8-W)
 C952 (12-W)
 C953 (18-W)

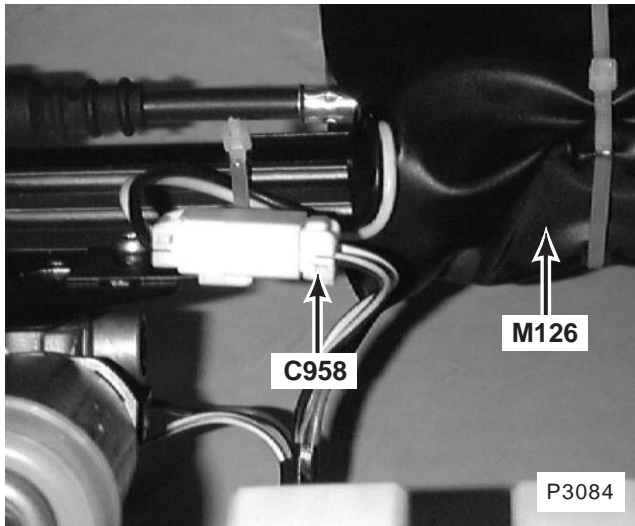

243. underside of LH front seat (RH similar)
 M126 Seat Base Motor
 C958 (4-W)

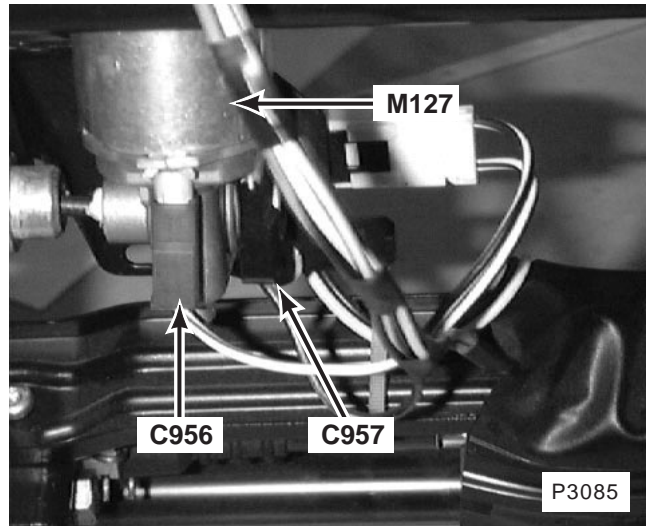

244. underside of LH front seat (RH similar)
 M127 Seat Height (Front) Motor
 C956 (1-R)
 C957 (1-B)

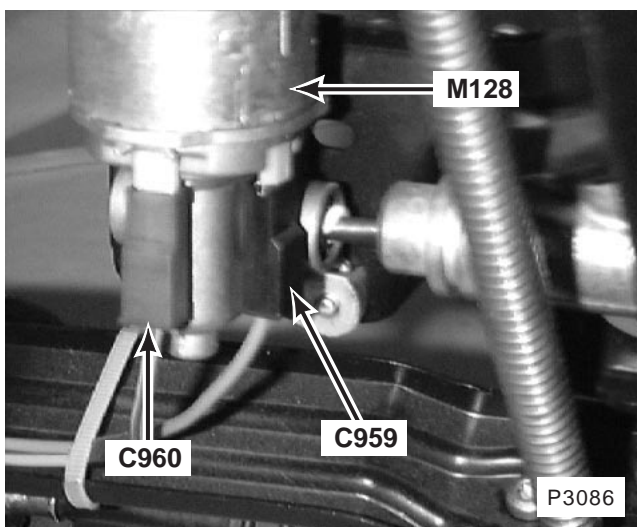

245. underside of LH front seat (RH similar)
Without Memory
M128 Seat Height (Rear) Motor
C959 (1-B)
C960 (1-R)

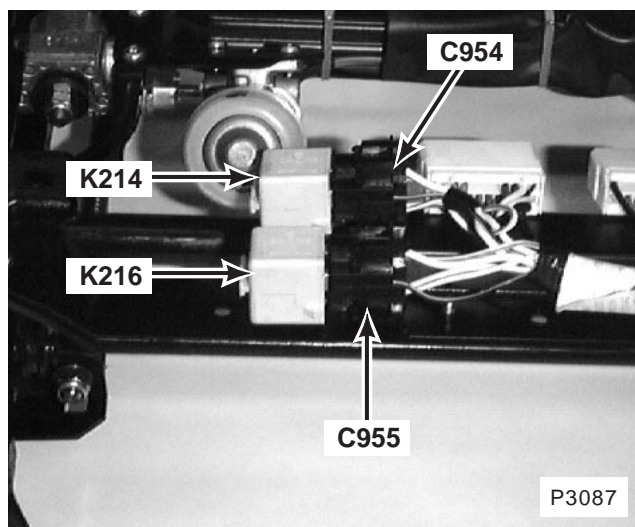

246. underside of RH front seat
K214 Right Non-Memory Seat Power Relay 1
K216 Right Non-Memory Seat Power Relay 2
C954R (5-B)
C955R (5-B)

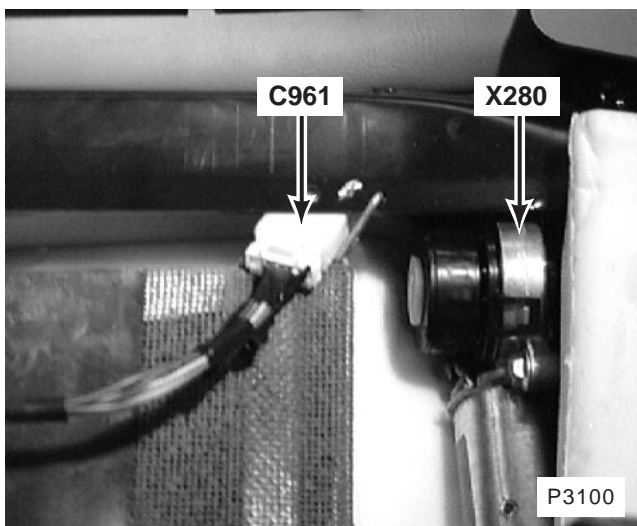

247. underside of LH front seat (RH similar)
X280 Recline Motor and Potentiometer
C961 (6-W)

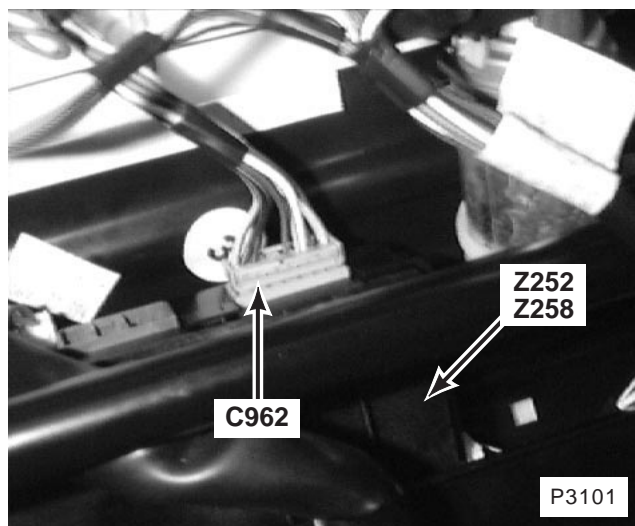

248. underside of respective front seat
Z252 Left Seat Outstation
Z258 Right Seat Outstation
C962 (12-W)

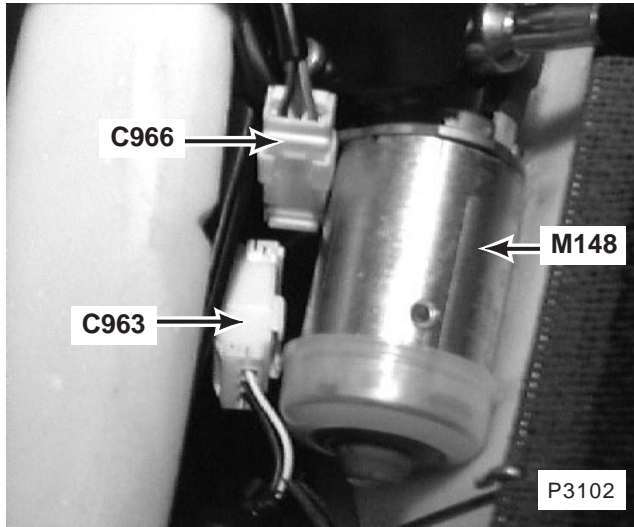

249. underside of LH front seat (RH similar)
 M148 Headrest Motor
 C963 (4-W)
 C966 (3-W)

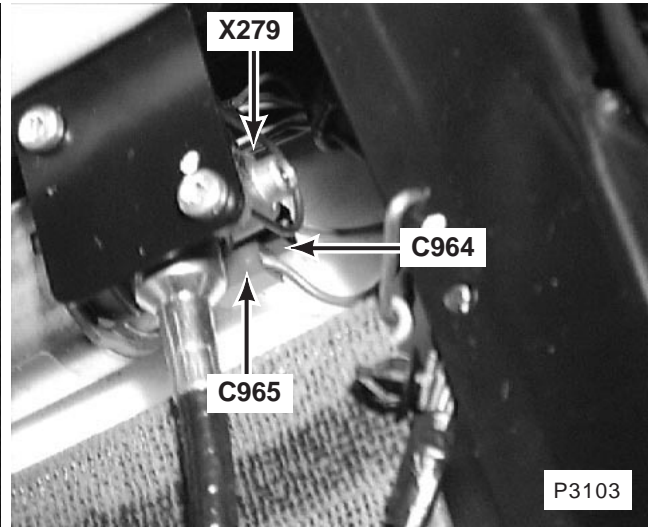

250. RH side of seat squab frame
 X279 Headrest Potentiometer
 C964 (1-R)
 C965 (1-B)

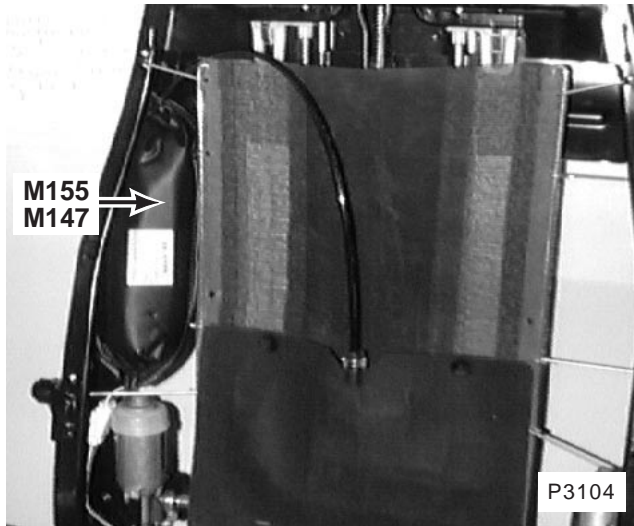

251. RH side of seat squab frame
 M147 Left Lumbar Pump
 M155 Right Lumbar Pump

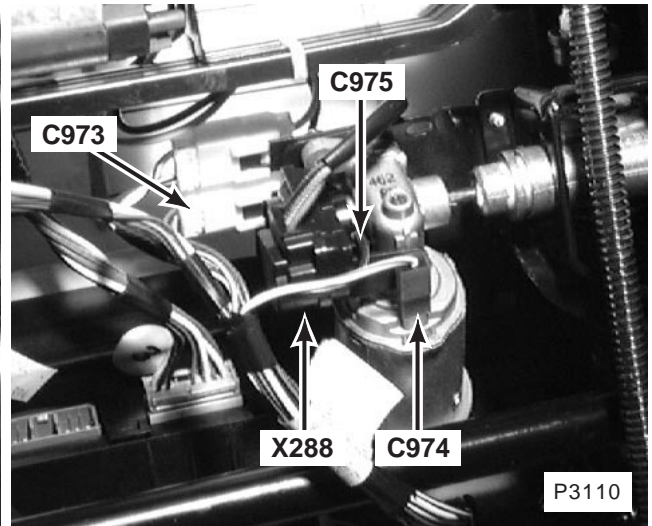

252. underside of respective front seat
 X288 Seat Potentiometer Front Motor
 C973 (3-W)
 C974 (1-R)
 C975 (1-B)

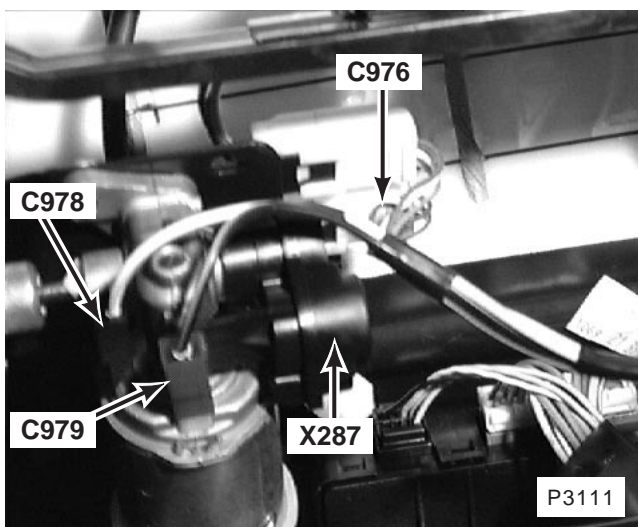

253. underside of respective front seat
 X287 Seat Potentiometer Rear Motor
 C976 (3-W)
 C978 (1-B)
 C979 (1-R)

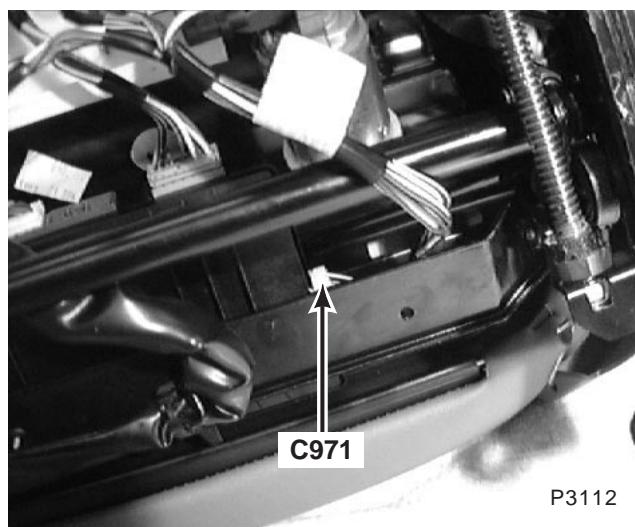

254. underside of respective front seat
 C971 (18-W)

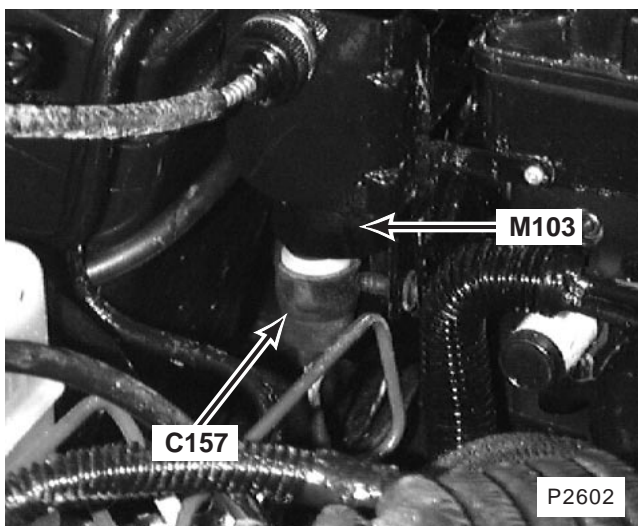

255. LH rear corner of engine compartment
 M103 Cruise Control Vacuum Pump
 C157 (3-S)

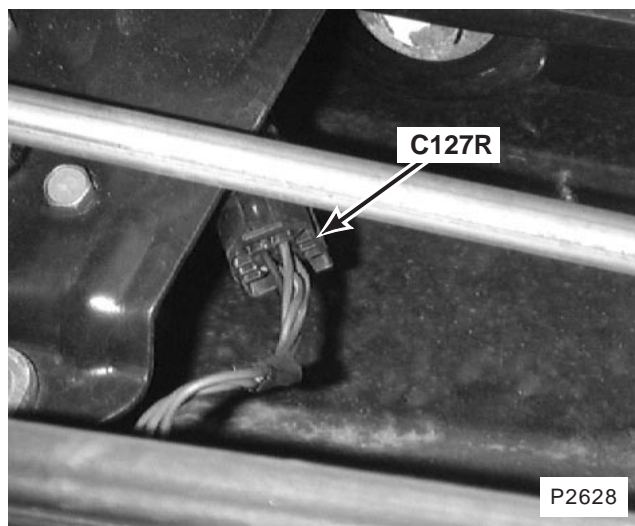

256. RH side of engine compartment rear of
 C127R (4-B)

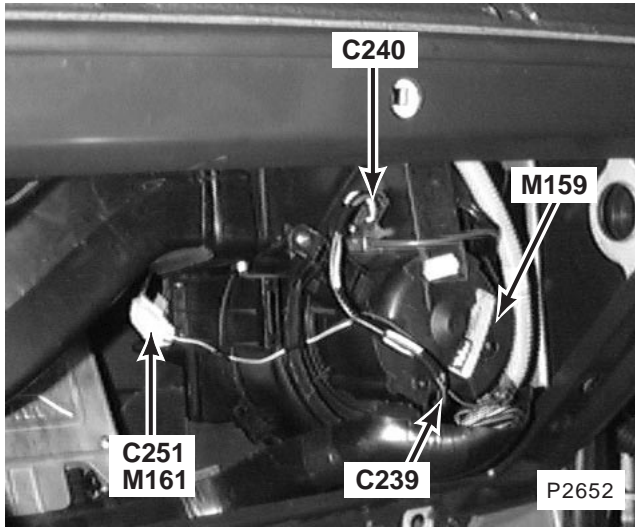

257. (lower dash panel removed) behind passenger's side of fascia

- M159 Right Blower Motor
- M161 Right Recirculating Motor
- C239 (1-B)
- C240 (4-N)
- C251 (3-W)

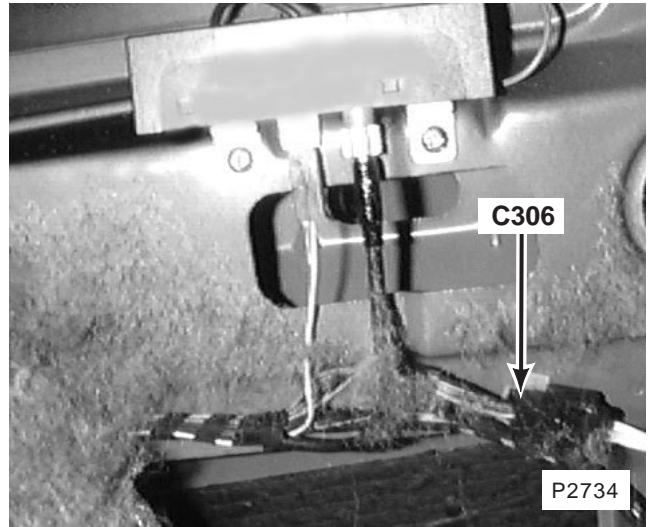

258. RH rear of luggage compartment (trim removed)

- C306 (12-B)

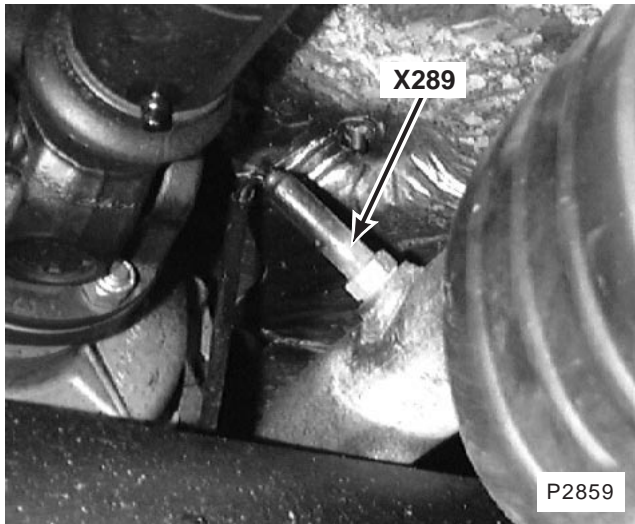

259. on left intermediate pipe

- X289 Left Heated Oxygen Sensor (Post Catalyst)

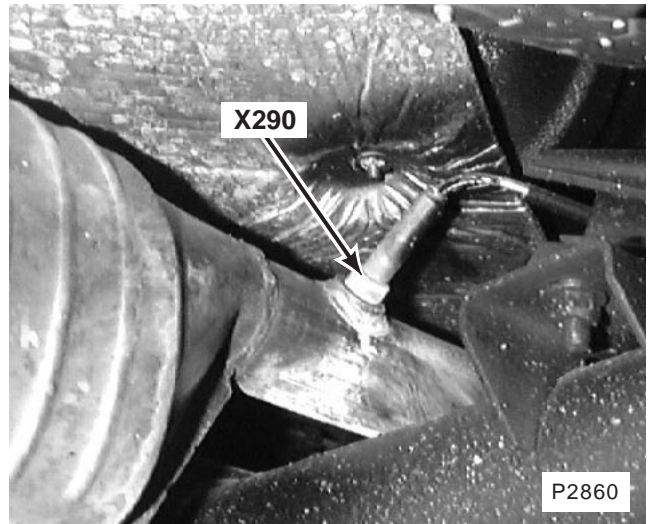

260. on right exhaust intermediate pipe

- X290 Right Heated Oxygen Sensor (Post Catalyst)

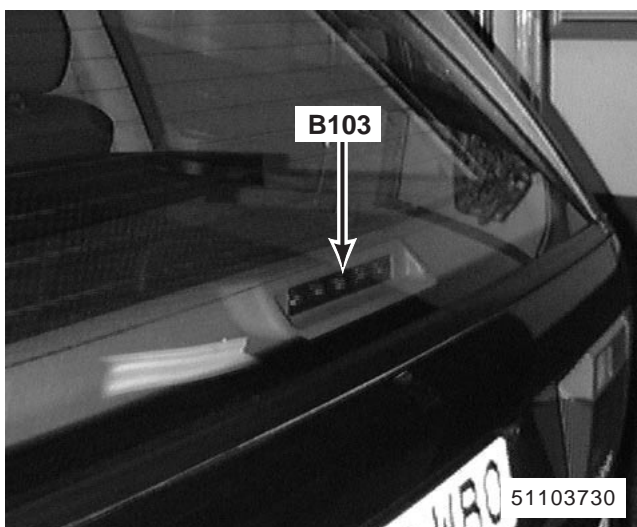

261. lower centre of rear screen
B103 Centre Mounted Stop Lamp

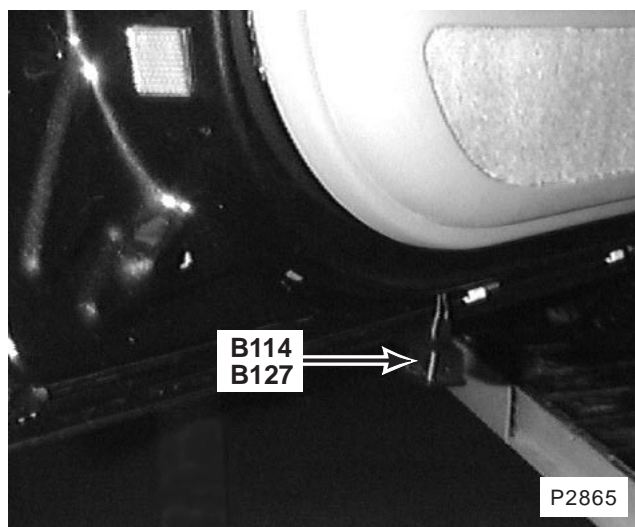

262. underside of front door
B114 Left Front Door Puddle Lamp
B127 Right Front Door Puddle Lamp

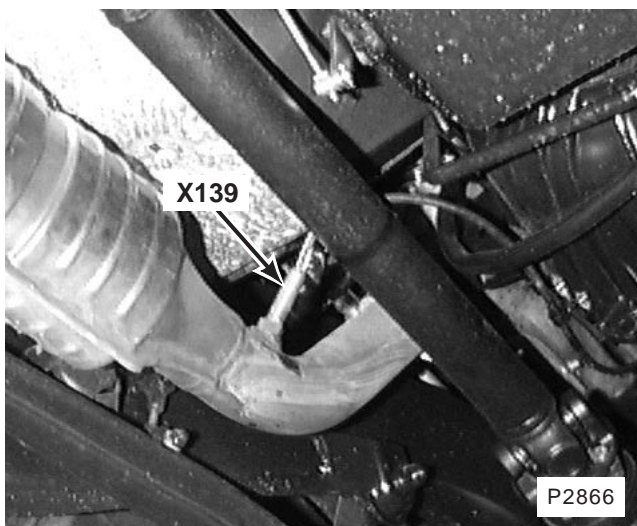

263. on left exhaust downpipe
X139 Left Heated Oxygen Sensor

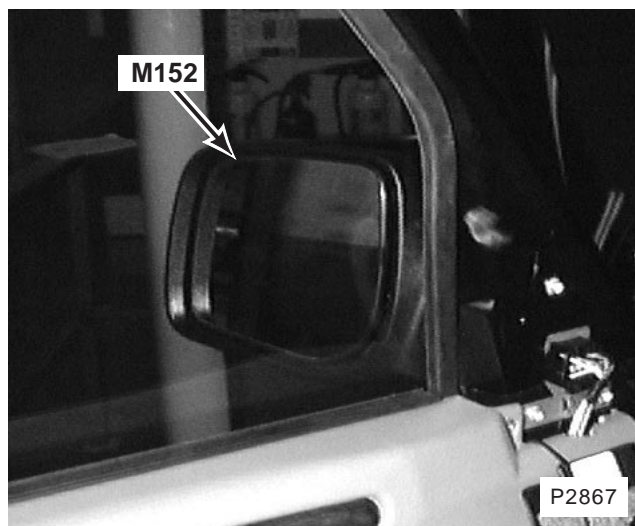

264. LH front door
M152 Left Memory Mirror

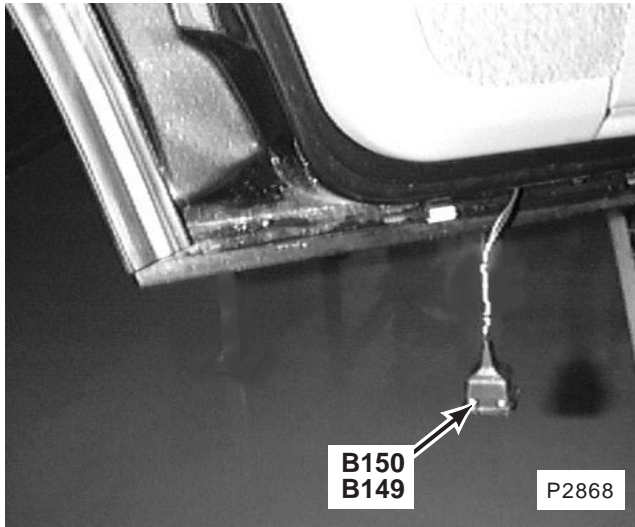

265. underside of rear door
 B149 Left Rear Door Puddle Lamp
 B150 Right Rear Door Puddle Lamp

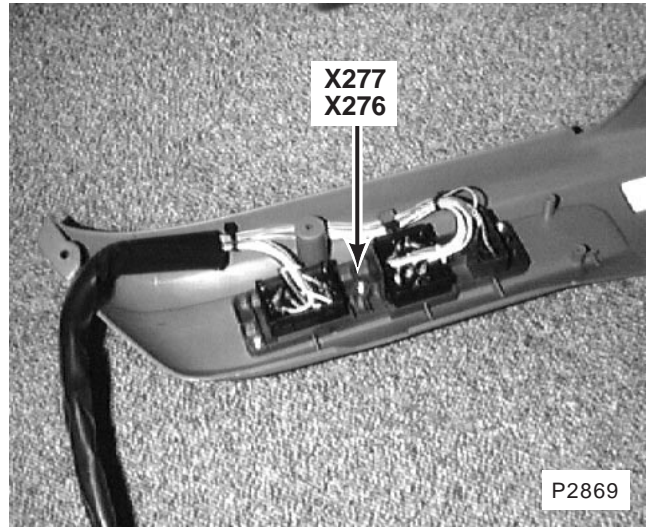

266. at LH side of LH front seat (RH similar)
 X276 Right Seat Switch
 X277 Left Seat Switch

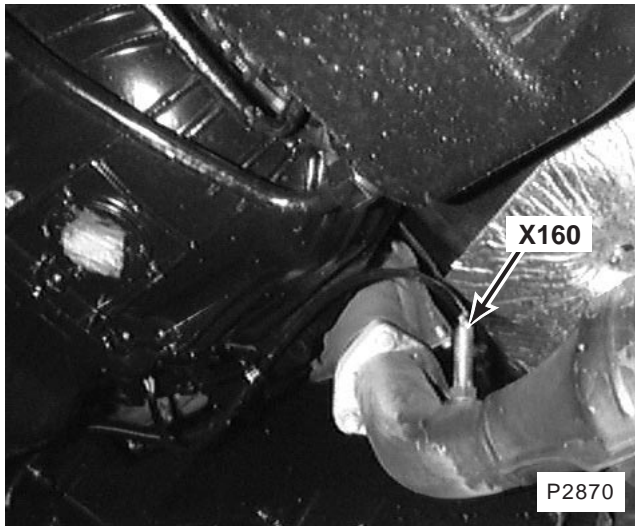

267. on right exhaust downpipe
 X160 Right Heated Oxygen Sensor

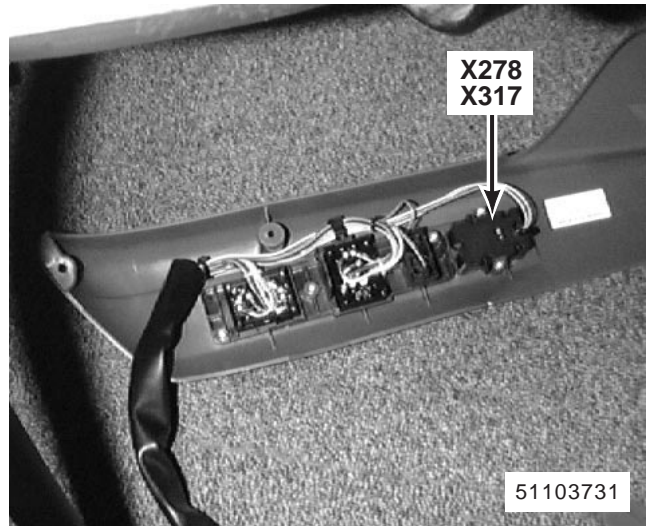

268. on side of respective front seat
 X278 Left Memory Switch
 X317 Right Memory Switch

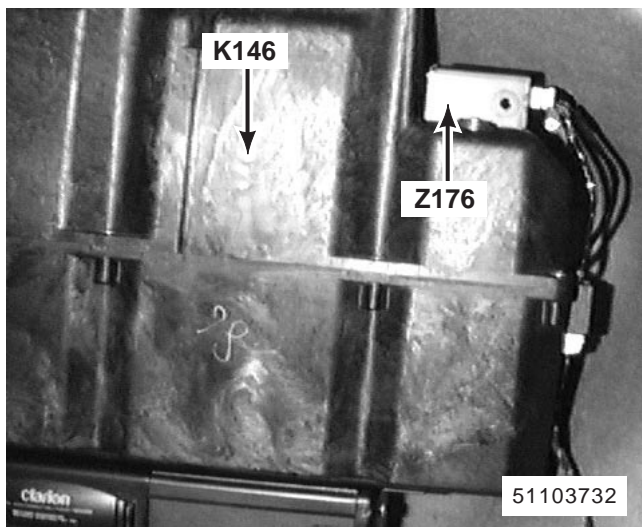

269. LH rear of luggage compartment
 K146 Subwoofer
 Z176 Subwoofer Amplifier

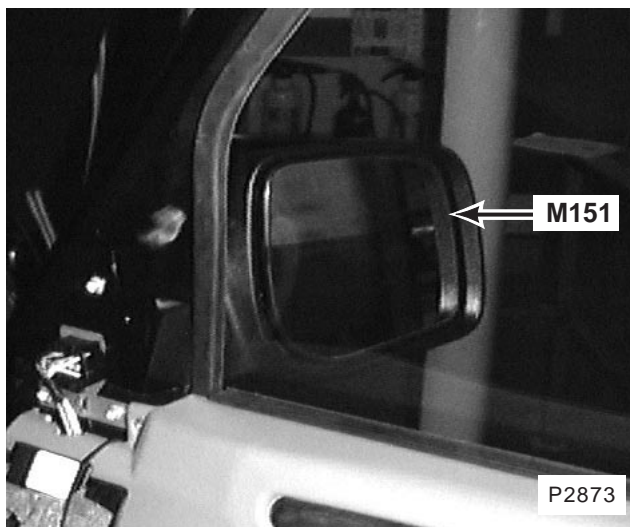

270. RH front door
 M151 Right Memory Mirror

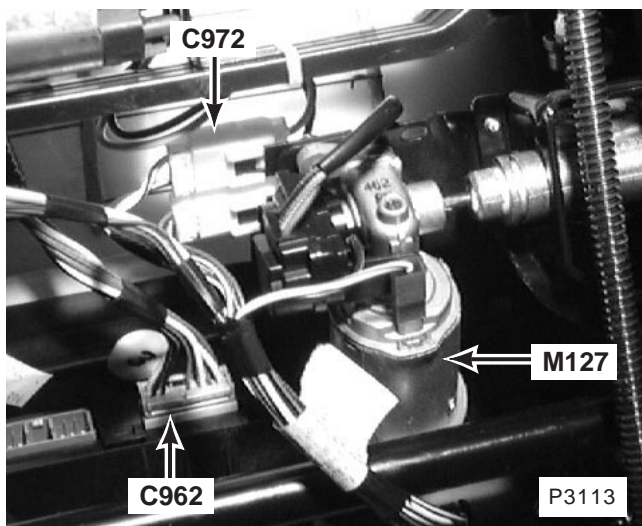

271. underside of respective front seat With Memory
 M127 Seat Height (Front) Motor
 C962 (12-W)
 C972 (4-W)

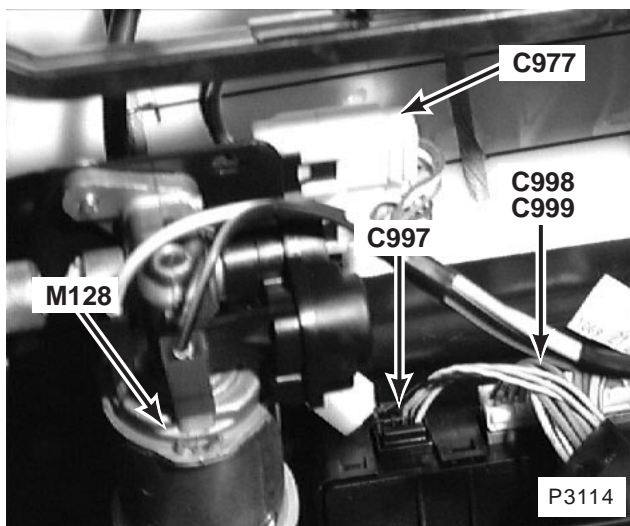

272. underside of respective front seat
 M128 Seat Height (Rear) Motor
 C977 (4-W)
 C997
 C998
 C999

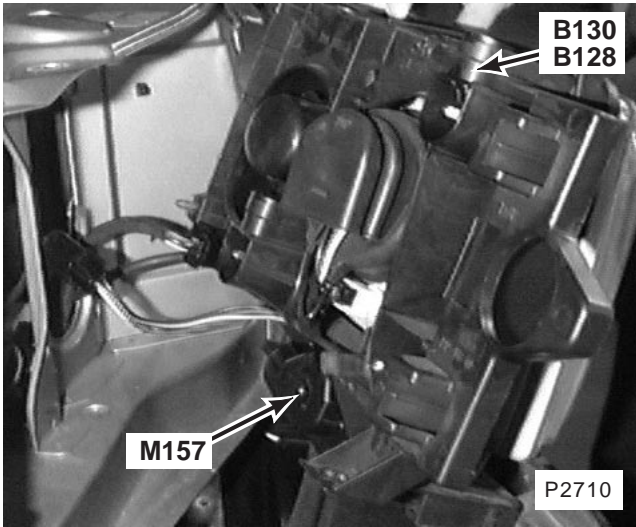

273. RH front of vehicle
 B128 Right Front Lamp Assembly
 B130 Right Headlamp
 M157 Right Headlamp Wiper Motor

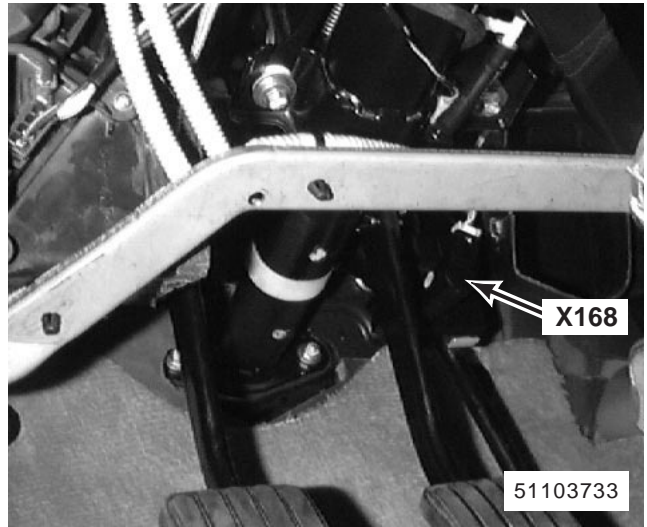

274. behind driver's side of fascia on brake pedal support
 X168 Stop Lamp Switch

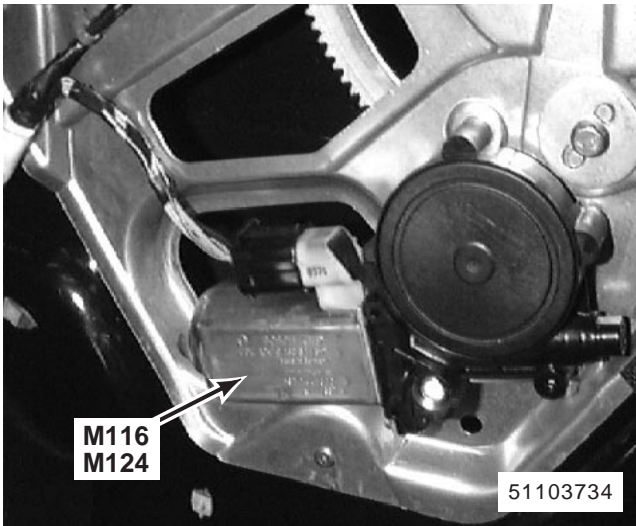

275. behind rear door trim panel
 M116 Left Rear Window Motor
 M124 Right Rear Window Motor

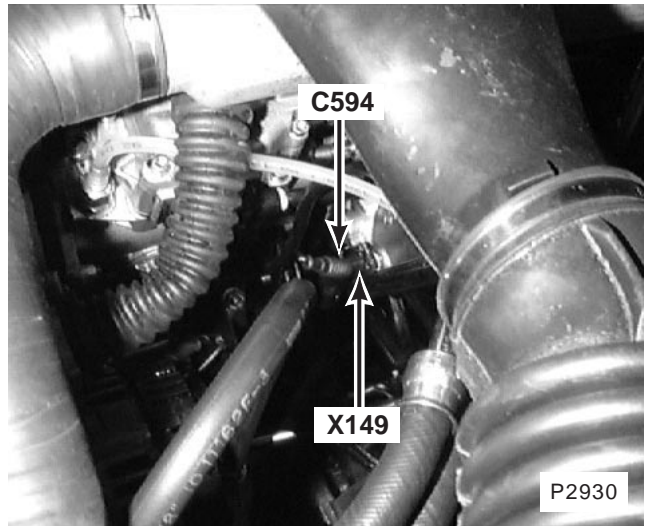

276. lower LH side of engine, on
 X149 Oil Pressure Switch
 C594 (2-B)

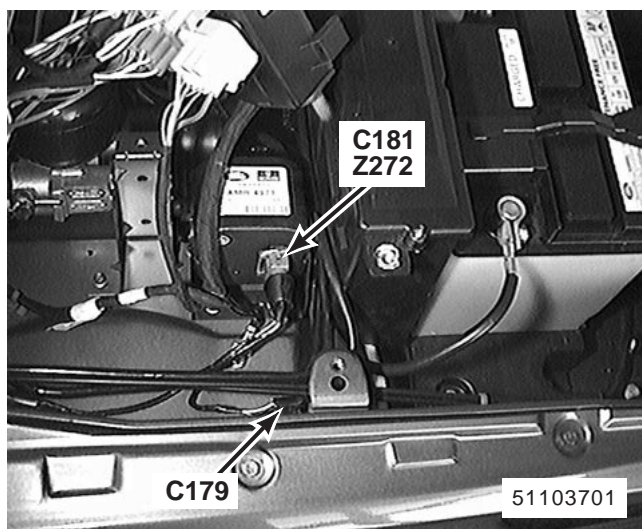

277. RH side of engine compartment
 Z272 Battery Backed Up Alarm Sounder
 C179 (2-B)
 C181 (4-B)

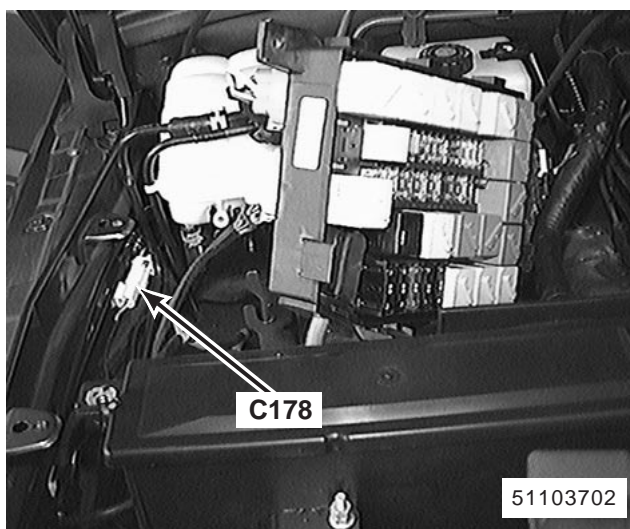

278. RH side of engine compartment
 C178 (2-W)

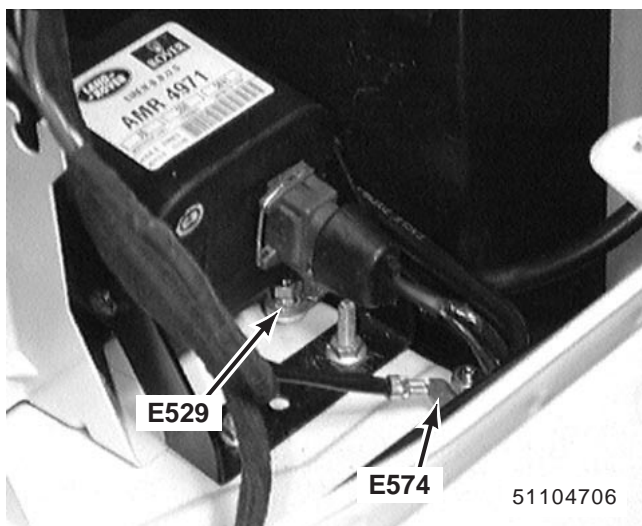

279. RH side of engine compartment
 E529
 E574



280. LH rear corner of engine compartment
 K233 Evaporative Emission Canister Vent Seal Valve
 C503 (2-R)



281. RH side of engine compartment
C502 (2-W)

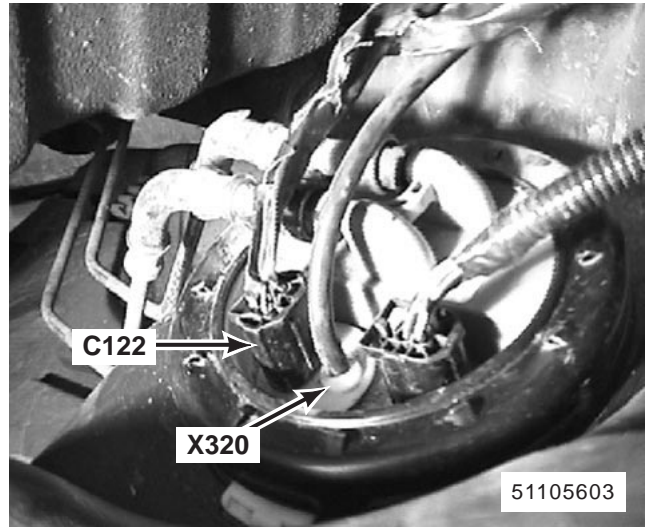

282. top of fuel tank
X320 Fuel Pressure Sensor
C122 (3-B)

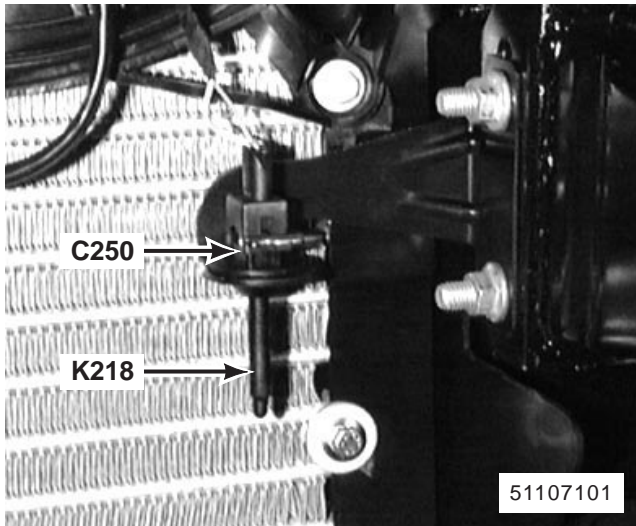

283. LH front of vehicle in front of condenser
(From VIN 381431)
K218 Ambient Air Sensor
C250 (2-B)

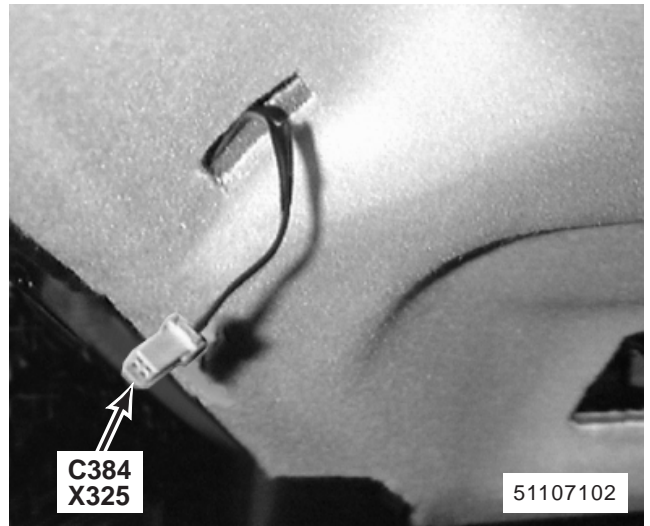

284. front centre of roof
X325 Home Link Connector
C384 (2-G)

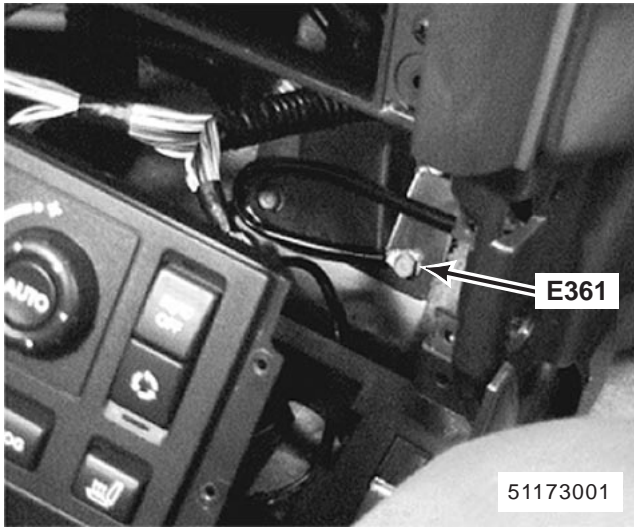

285. in front of centre console (From VIN 359269)
E361

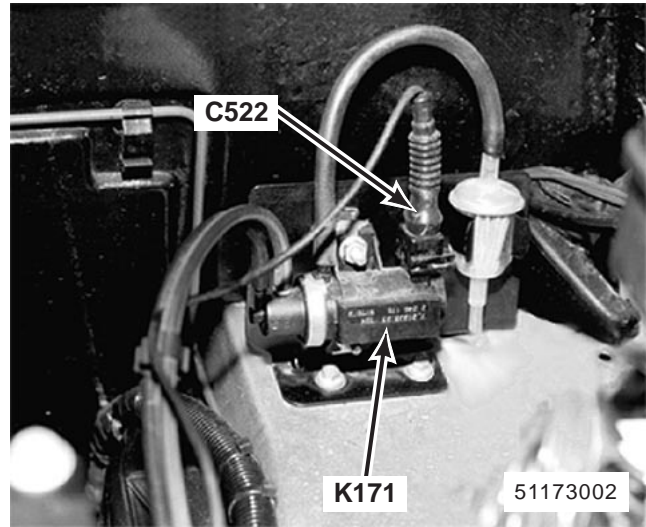

286. front LH wing in front of bulkhead (From Model 98.5)
K171 EGR Control Solenoid
C522 (2-B)

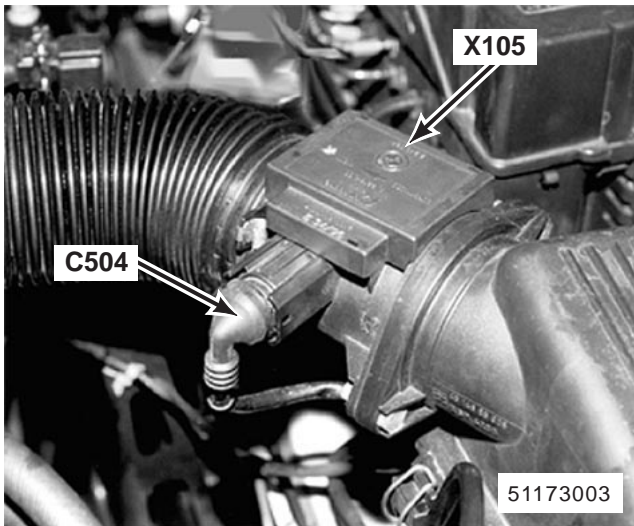

287. LH side of engine compartment (From Model 98.5)
X105 Mass Air Flow Sensor
C504 (6-B)

C101

(2 - B)

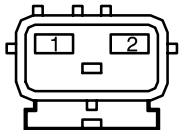

1	WP
2	WLG

CA3C0101

C102

(18 - W)

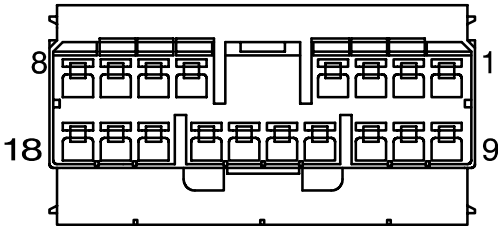

1	BG	10	PG
2	OY	11	YB
3	PB	12	BS
4	PN	13	N
5	BP	14	GP
6	PY	15	KR,K
7	BY	16	LGR,LG
8	GU	17	YG,G
9	YP	18	YK,G

CA3C0102

C103

(6 - R)

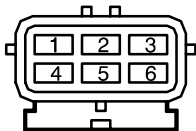

1	G
2	YK
3	B
4	GS
5	YG
6	G

CA3C0103

C104

(12 - W)

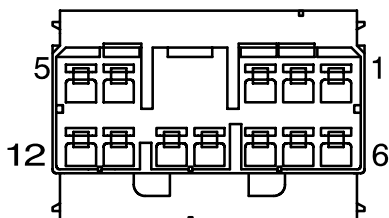

1	YO	7	PU
2	YS	8	OK
3	YN	9	OR
4	UK	10	OU
5	UW	11	WK
6	SR	12	WLG

CA3C0104

C106

(13 - B)

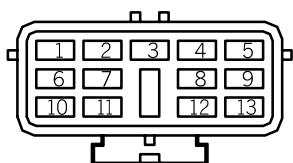

1	YB	8	G
2	PG	9	KR
3	NY	10	W
4	GU	11	WN
5		12	
6	BS	13	Y
7	BG		

CA3C0106

C106A

(4 - B)

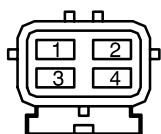

1	B
2	S
3	GB
4	BY

CA3C106A

C106B

(13 - B) 

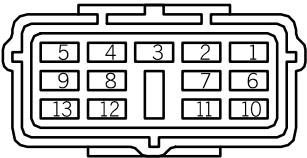

1	B	8	
2	S	9	
3	GB	10	
4	BY	11	GO
5		12	R
6		13	RB
7	YK		

CA3C106B

C108

(3 - B) 

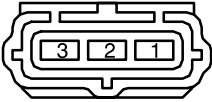

1	OR
2	ON
3	BK

CA3C0108

C109

(2 - W) 

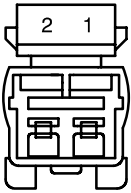

1	BY
2	PY

CA3C0109

C110

(4 - B) 

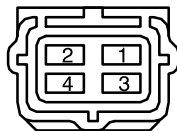

1	GB
2	B
3	B
4	WU

CA3C0110

C111

(3 - B) 

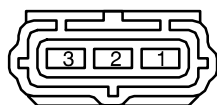

1	W0
2	WP
3	WU

CA3C0111

C112

(16 - G) 

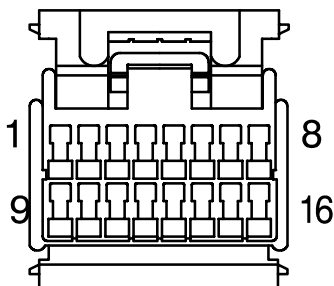

1		9	S
2	BK	10	BS
3	PO	11	BW
4	BP	12	
5	B	13	Y
6		14	BY
7		15	
8	WLG	16	GB

CA3C0112

C113

(10 - Y) 

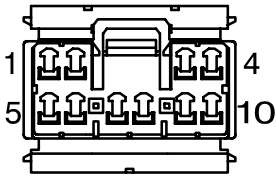

1	UB	6	LGR
2	WR	7	NLG
3	UO	8	KLG
4	GW	9	RW
5	UP	10	RY

CA3C0113

C114

(20 - G) 

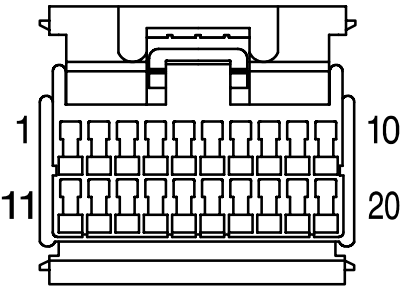

1	YB	11	YG
2	WP	12	WK
3	NLG	13	
4		14	PW
5	BY(P),WU(D)	15	NY
6		16	BP
7	WN	17	
8	PB	18	UW
9	UK	19	G
10	GB	20	S

CA3C0114

C115

(8 - G) 

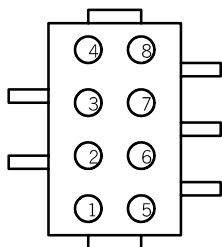

1	W	5	SW
2	YS	6	
3		7	
4	NG	8	N

CA3C0115

C116

(35 - B) 

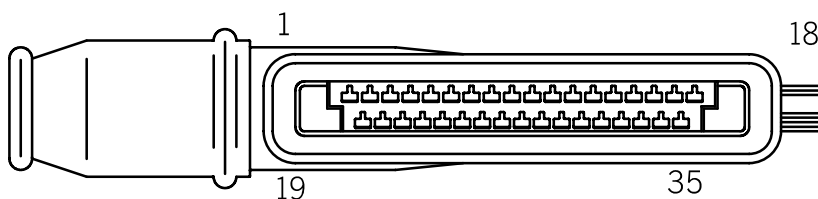

1	NK	10	YP	19		28	YG
2	S	11	SO	20	SLG	29	YK
3	WK	12	SB	21	SG	30	BG
4	SY	13	K	22	SP	31	BW
5	SW	14	LG	23	SK	32	P
6	SR	15	O	24	SN	33	G
7	SU	16	Y	25	GP	34	R
8	BG	17	W	26	BS	35	U
9	W	18	N	27	B		

CA3C0116

C117

(35 - B) 

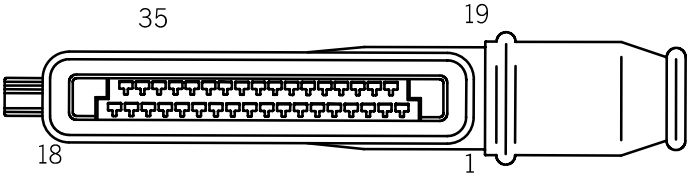

1	SG	10	GB	19		28	GY
2	OS	11	GW	20	OR	29	
3	OU	12	S	21	OP	30	Y
4	OK	13	SU	22	ON	31	GP
5	OG	14	BK	23	OY	32	YO
6		15	YS	24	BK	33	YN
7	UK	16	BP	25	UW	34	PO
8	G	17	WK	26	GO	35	WLG
9	GS	18	B	27	GK		

CA3C0117

C118

(9 - B) 

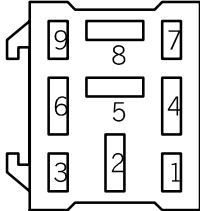

1		6	B
2	PR	7	
3	SR	8	SG
4	W	9	
5	PO		

CA3C0118

C120

(14 - Y) 

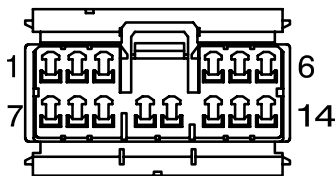

1	GS	8	UG
2	PY	9	W
3	RY	10	US
4	BLG	11	UK
5	RB	12	GR
6	RG	13	LGB
7	PN	14	WG

CA3C0120

C121

(25 - B) 

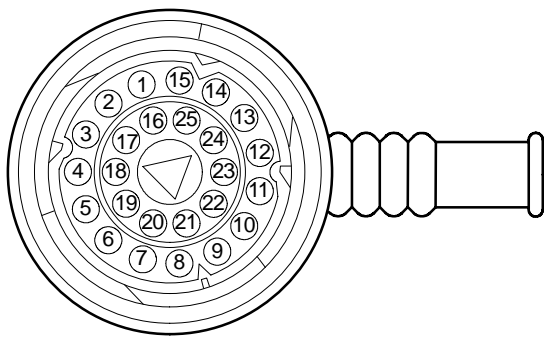

1		10	SW	19	OY
2	YP	11	NG	20	S
3	GP	12	G	21	
4	BG	13		22	
5	BS	14	Y	23	WN
6	B	15	WU	24	GU
7	N	16	LGR	25	NY
8	W	17	KR		
9	YS	18	BY		

CA3C0121

C122

(3 - B) 

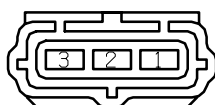

1	GO
2	RB
3	R

CA3C0122

C124

(2 - B) 

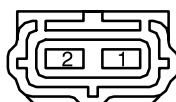

1	BG
2	BP

CA3C0124

C125

(13 - B)

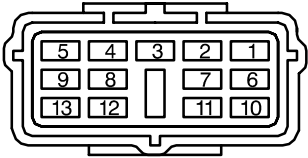

1	SN	8	S
2	SB	9	SW
3		10	SO
4	SY	11	SU
5	SG	12	SLG
6	SK	13	SP
7	SR		

CA3C0125

C127

(4 - B)

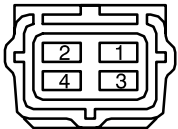

1	NLG
2	RLG
3	ULG
4	B

CA3C0127

C132

(2 - B)

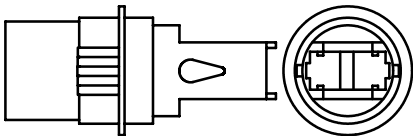

1	B
2	RG

AFU3698

C133

(2 - B) 

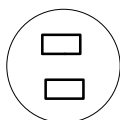

1	B
2	WG

CA3C0133

C138

(2 - B) 

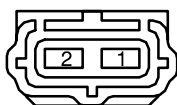

1	U
2	B

CA3C0138

C139

(13 - B) 

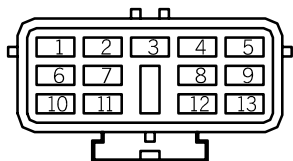

1	W	8	K
2	RW	9	Y
3	-	10	N
4	RO	11	S
5	O	12	RK
6	RN	13	RLG
7	RB		

CA3C0139

C140

(13 - B) 

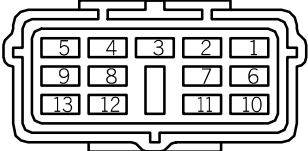

1	B	8	B
2	B	9	B
3		10	B
4	B	11	B
5	B	12	B
6	B	13	B
7	B		

CA3C0140

C141

(13 - B) 

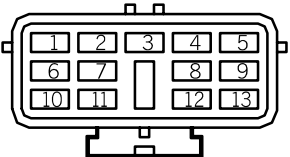

1	W	8	G
2	Y	9	R
3	N	10	B
4	K	11	B
5	G	12	R
6	O	13	R
7	R		

CA3C0141

C142

(2 - B) 

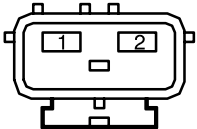

1	G
2	B

CA3C0142

C143

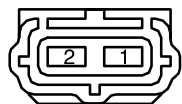

(2 - B) 

1	YB
2	YB

CA3C0143

C144

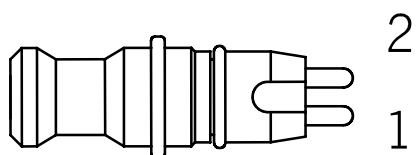

(2 -) 

1	Y
2	G

CA3C0144

C145

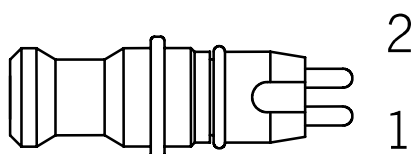

(2 -) 

1	N
2	U

CA3C0145

C146

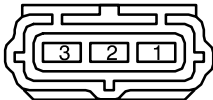

(3 - B) 

1	OU
2	OG
3	BK

CA3C0146

C147

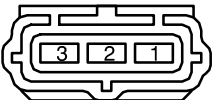

(3 - B) 

1	OS
2	OK
3	BK

CA3C0147

C151

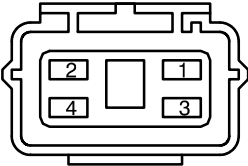

(4 - B) 

1	
2	BP
3	B
4	PLG

CA3C0151

C152

(13 - B) 

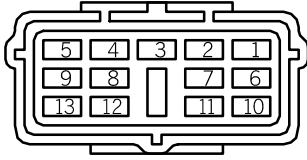

1	GW	8	PLG
2	GY	9	SU
3	GB	10	B
4	GK	11	B
5	GO	12	SG
6	GS	13	SG
7	SG		

CA3C0152

C155

(2 -) 

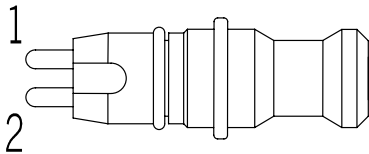

1	0
2	P

CA3C0155

C156

(2 - W) 

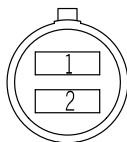

1	NR
2	B

CA3C0156

C157

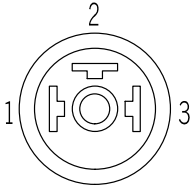



(3 - S) 

1	OK
2	OR
3	OU

CA3C0157

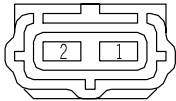
C158A



(2 - B) 

1	GR
2	B

CA3C158A

C158B

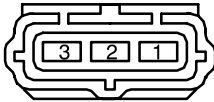

(3 - B) 

1	B
2	GR
3	RB

CA3C158B

C159

(2 - W) 

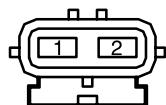

1	RY
2	B

CA3C0159

C160

(4 - B) 

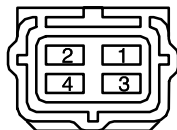

1	NU
2	LGU
3	
4	B

CA3C0160

C161

(2 - B) 

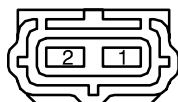

1	PB
2	B

CA3C0161

C162

(4 - B) 

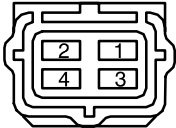

1	BY
2	WLG
3	BU
4	B

CA3C0162

C163

(6 - B) 

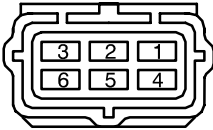

1	US
2	UG
3	B
4	UK
5	RB
6	B

CA3C0163

C164

(2 - U) 

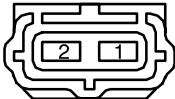

1	B
2	BP

CA3C0164

C166D

(2 - U) 

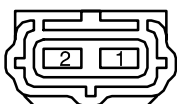

1	WLG
2	

CA3C166D

C166P

(2 - W) 



1	B
2	WLG

CA3C166P

C168

(3 - B) 

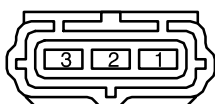

1	OP
2	OY
3	BK

CA3C0168

C172

(8 - Y) 

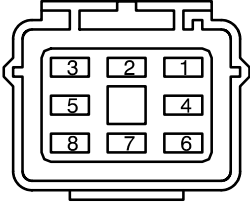

1	WLG	5	PU
2	B	6	BN
3	PLG	7	PG
4	N	8	PN

CA3C0172

C173

(8 - P) 

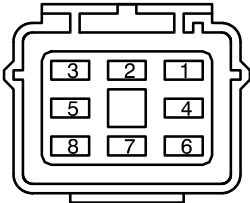

1		5	NK
2		6	
3		7	
4	PLG	8	W

CA3C0173

C174

(8 - U) 

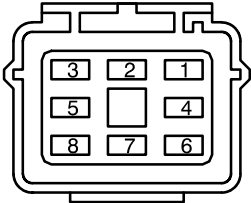

1		5	PB
2		6	PN
3	WLG	7	PB
4	WP	8	PR

CA3C0174

C175

(8 - G) 

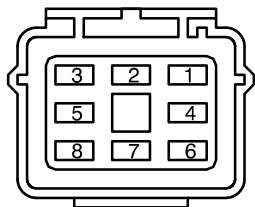

1	LGU	5	ULG
2	BR	6	KLG
3	G	7	NLG
4	LGU	8	RLG

CA3C0175

C176

(8 - N) 

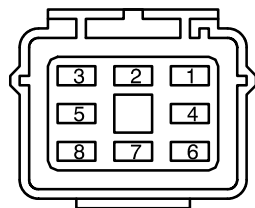

1	G	5	LGR
2	BU	6	BG
3	B	7	PLG
4	YB	8	W

CA3C0176

C177

(8 - S) 

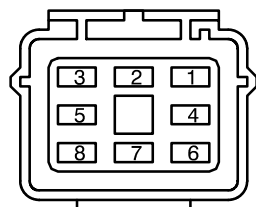

1	WO	5	NU
2	BN	6	WR
3		7	BY
4	NU	8	NR

CA3C0177

C178

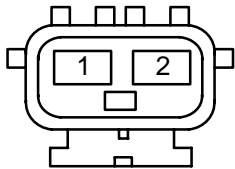

(2-W)



1	PR
2	W

C178

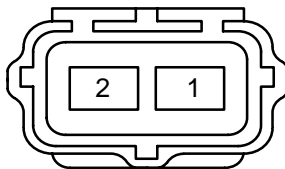

(2-W)



1	PR
2	W

CA3C0178

C179

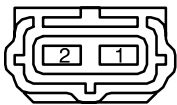

(2 - B)



1	PY
2	B

C179

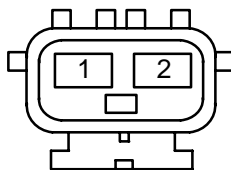

(2 - B)



1	PW
2	B

CA3C0179

C180

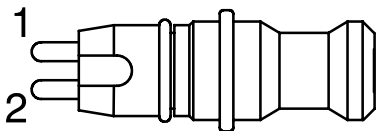

(2 -)



1	W
2	R

CA3C0180

C181

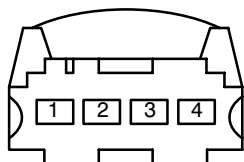



(4-N) 

1	W
2	PR
3	PW
4	B

CA3C0181

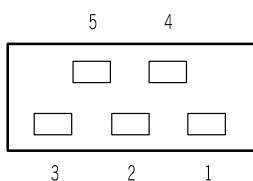
C184L





(5 - B) 

1	B
2	BY
3	BG
4	BW
5	B

CA3C0184

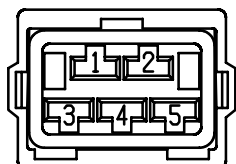
C184R



(5 - B) 

1	B
2	BY
3	BG
4	BW
5	B

YPC10351

C187A

(2 - B) 

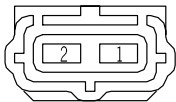

1	GW
2	B

CA3C187A

C187B

(3 - B) 

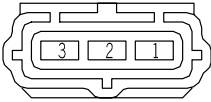

1	B
2	GW
3	RW

CA3C187B

C188

(2 - W) 

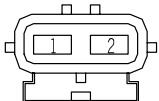

1	RY
2	B

CA3C0188

C189

(6 - B) 

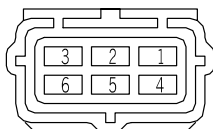

1	UB
2	UP
3	B
4	UO
5	RW
6	B

CA3C0189

C190

(4 - B) 

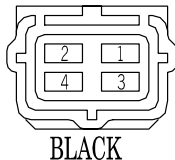

1	NU
2	LGU
3	LG
4	B

CA3C0190

C191

(2 - W) 

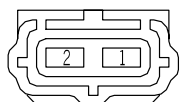

1	LG
2	B

CA3C0191

C192

(2 - U) 

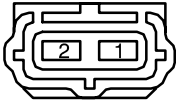

1	YB
2	B

CA3C0192

C193

(2 - R) 

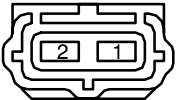

1	LGB
2	B

CA3C0193

C194

(2 - B) 

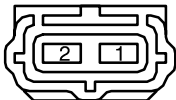

1	BLG
2	B

CA3C0194

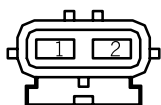
C195(2 - B) 

1	PW
2	B

CA3C0195

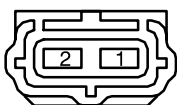
C196(2 - B) 

1	PB
2	B

CA3C0196

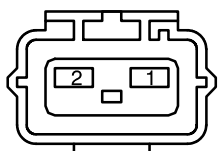
C197(2 - B) 

1	BR
2	B

CA3C0197

C198

(2 - B) 

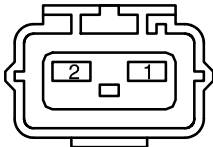

1	BN
2	BN

CA3C0198

C201

(2 - B) 

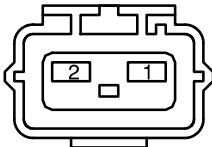

1	WP
2	WLG

CA3C0201

C202

(18 - W) 

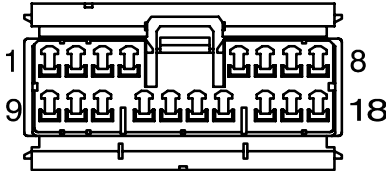

1	BG	10	PG
2	OY	11	YB
3	PB	12	BS
4	PN	13	N
5	BP	14	GP
6	PY	15	KR
7	BY	16	LGR
8	GU	17	YG
9	YP	18	G

CA3C0202

C203

(4 - N) 

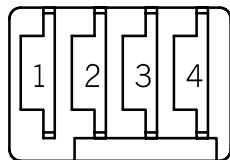

1	RLG
2	B
3	RY
4	WP

CA3C0203

C204

(12 - W) 

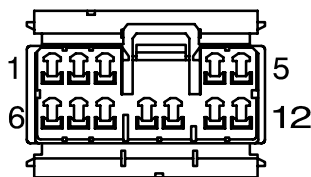

1	Y0	7	PU
2	YS	8	OK
3	YN	9	OR
4	UK	10	OU
5	UW	11	WK
6	SR	12	WLG

CA3C0204

C205

(2 - W) 

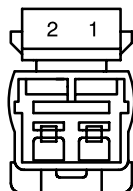

1	R
2	B

CA3C0205

C207

(8 - W) 

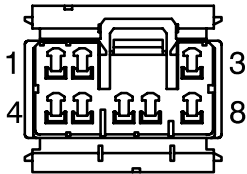

1	Y	5	O
2	YB	6	OB
3	G	7	SB
4	GB	8	

CA3C0207

C208

(6 - W) 

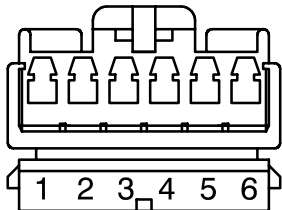

1	R	4	UB
2	RB	5	SB
3	U	6	

CA3C0208

C209

(2 - G) 

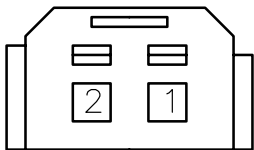

1	SR
2	B

CA3C0209

C210

(2 - B) 

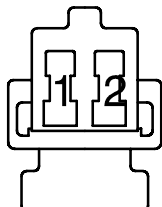

1	BW
2	GY

CA3C0210

C211

(6 - W) 

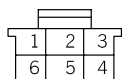

1	B	4	B,B
2	RW	5	WY
3	B,B	6	OW

CA3C0211

C212

(6 - W) 

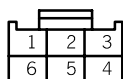

1	B	4	
2	PG	5	GLG
3	B,B	6	RW

CA3C0212

C213

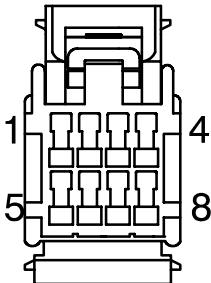

(8 - B)

1	UW	5	PB
2	RW	6	YN
3	W	7	B
4	UK	8	YO

CA3C0213

C214

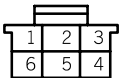

(6 - W)

1	B	4	B,B
2	RW	5	YS,YS
3	YS	6	W

CA3C0214

C215

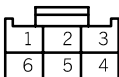

(6 - W)

1	B	4	
2	RN	5	RU
3	RW	6	B,B

CA3C0215

C216

(2 - B)

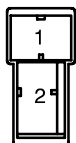

1	P
2	B

CA3C0216

C218

(4 - B) 

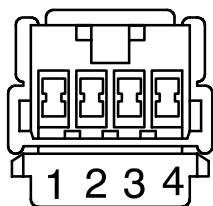

1	NU
2	BW
3	BN
4	N

CA3C0218

C219

(4 - W) 

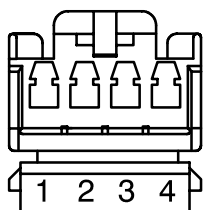

1	OR
2	RW
3	B
4	U

CA3C0219

C220

(6 - W) 

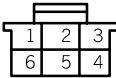

1	B	4	B,B
2	RW	5	RY
3	YR	6	B,B

CA3C0220

C221

(2 - U) 

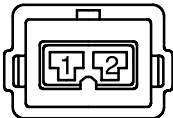

1	BW
2	SO

CA3C0221

C222

(2 - B) 

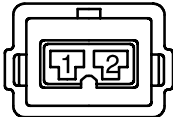

1	UB
2	BW

CA3C0222

C224A

(8 - N) 

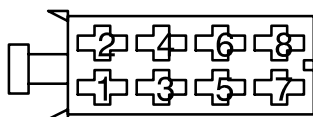

1	U	5	Y
2	UB	6	YB
3	R	7	G
4	RB	8	GB

CA3C224A

C224B

(10 - R) 

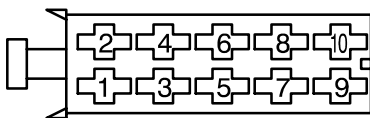

1	U	6	YB
2	UB	7	G
3	R	8	GB
4	RB	9	O
5	Y	10	OB

CA3C224B

C225

(5 - B) 

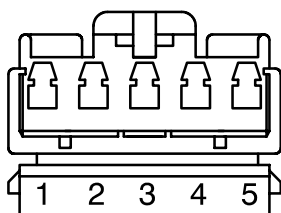

1	B
2	
3	
4	LGS
5	

CA3C0225

C226

(8 - S) 

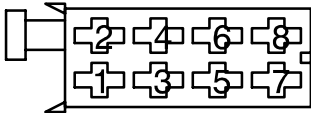

1		5	
2	SB	6	RW
3	SO	7	WK
4	P	8	B

CA3C0226

C227

(3 - W) 

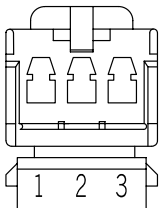

1	W
2	YP
3	GP

CA3C0227

C228

(2 - W) 

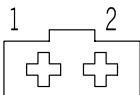

1	ON
2	OR

CA3C0228

C229

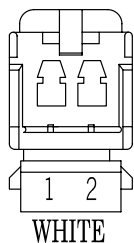

(2 - W)

1	P
2	PR

CA3C0229

C230

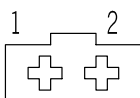

(2 - W)

1	B
2	YG

CA3C0230

C231

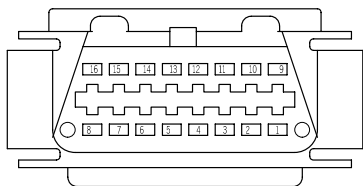

(16 - S)

1	SR	10	
2		11	WLG
3		12	WK
4	B	13	YK
5	BP	13	
6		14	YLG
7	KR	14	YG
8		15	LGR
9		16	N

CA3C0231

C232





(2 - B) 

1	PR
2	P

CA3C0232

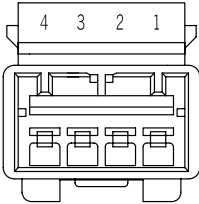
C233





(4 - W) 

1	NW
2	B
3	B
4	R

CA3C0233

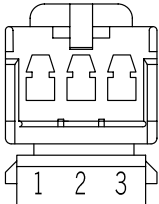
C234



(3 - W) 

1	UK
2	
3	B

CA3C0234

C235

(6 - W) 

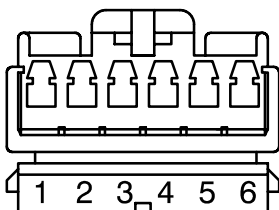

1	YR	4	PB
2	YS	5	B
3	SO	6	

CA3C0235

C236

(12 - B) 

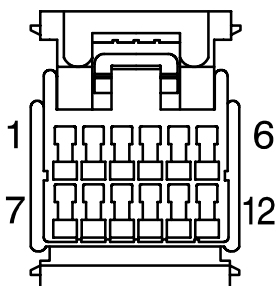

1	UW	7	GW
2	US	8	B
3	SP	9	
4	SU	10	
5	RB	11	
6	RLG	12	GR

CA3C0236

C237

(8 - B) 

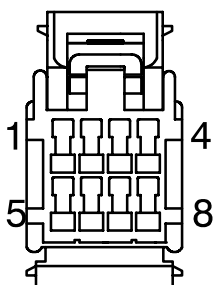

1	OB	5	ULG
2	RLG	6	B
3	OP	7	WG
4	LGO	8	LGB

CA3C0237

C238

(4 - W) 

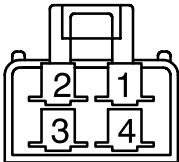

1	W
2	WR
3	WK
4	B

CA3C0238

C240

(4 - N) 

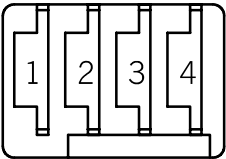

1	GLG
2	B
3	GY
4	WLG

CA3C0240

C241P

(9 - B) 

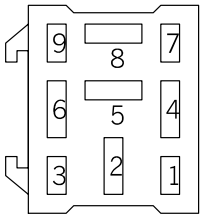

1		6	YR
2	RY	7	
3		8	OW
4	SY	9	
5	YS		

CA3C241P

C241D

(9 - B) 

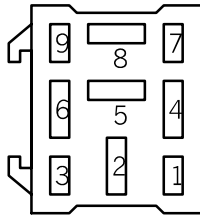

1		6	YR
2	B	7	
3		8	OW
4	OY	9	
5	YS		

CA3C241D

C242

(20 - B) 

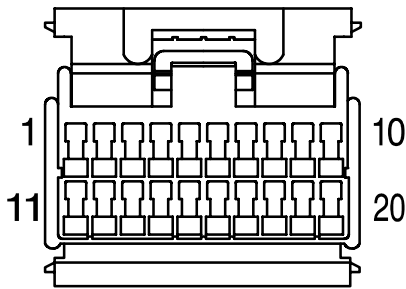

1	SU	11	SP
2	RG	12	RG
3	OG	13	OG
4	P	14	P
5	LG	15	LG
6	RW	16	S
7	B	17	B
8	BG	18	BG
9	Y	19	GU
10	BK	20	O

CA3C0242

C243

(15 - B) 

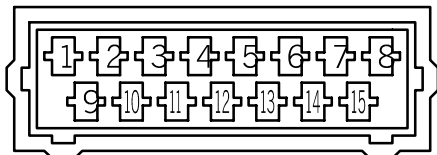

1	OU	9	OR
2		10	OW
3	SY	11	Y
4	RY	12	
5	GP	13	
6	OK	14	
7	OR	15	
8	B		

CA3C0243

C244

(8 - W) 

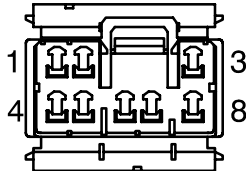

1	WK	5	PG
2	PN	6	RW
3	W	7	BY
4	B	8	YB

CA3C0244

C245

(12 - B) 

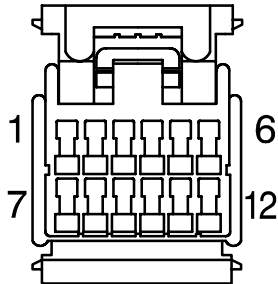

1	GY	7	WB
2	GLG	8	UO
3	G	9	BG
4	RY	10	WG
5	RLG	11	BR
6	R	12	WR

CA3C0245

C246A

(12 - G) 

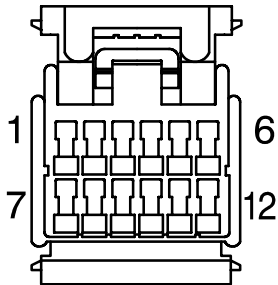

1	O	7	
2	KR	8	
3	LGR	9	WB
4	NY	10	
5		11	BP
6		12	BR

CA3C246A

C246B

(20 - B) 

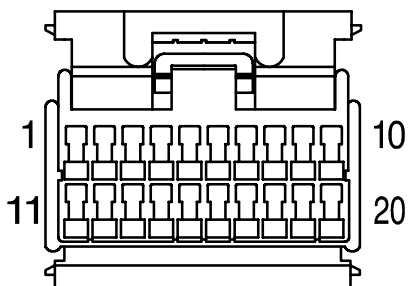

1		11	O
2	SO	12	UB
3		13	BS
4	GY	14	BG
5	Y	15	N
6	KR	16	BN
7	LGR	17	WB
8	NY	18	BW
9	NU	19	BR
10	BW	20	BP

CA3C246B

C247

(7 - W) 

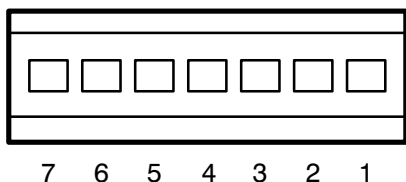

1	PB	5	YB
2	W	6	PB
3	R	7	PB
4	GR		

CA3C0247

C248

(3 - W) 

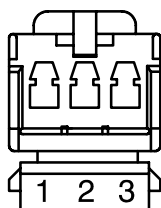

1	BR
2	
3	WR

CA3C0248

C249

(2 - W) 

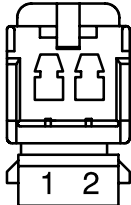

1	P
2	PR

CA3C0249

C250

(2 - B) 

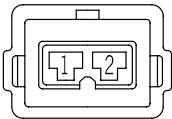

1	U0
2	WB

CA3C0250

C251

(3 - W) 

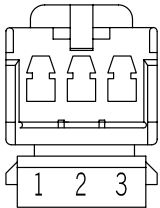

1	BG
2	
3	WG

CA3C0251

C255

(20 - W) 

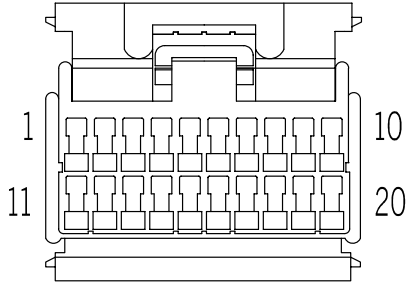

1	RN	11	WB
2		12	
3	NW	13	PG
4	YG	14	WY
5		15	BP
6	BR	16	
7	GLG	17	LGR
8	KR	18	OW
9	NY	19	
10	Y	20	Y

CA3C0255

C256

(16 - W) 

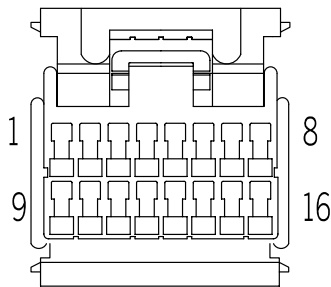

1	OG	9	OG
2	RG	10	RG
3	LG	11	LG
4	RLG	12	RB
5	BG	13	WK
6	RU	14	BG
7	SR	15	BK
8	S	16	Y

CA3C0256

C257

(20 - Y) 

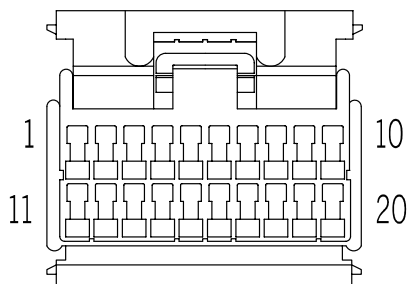

1	LGB	11	OP
2	GW	12	UW
3	U	13	OB
4	LGO	14	RY
5	RLG	15	ULG
6	WR	16	WG
7	GR	17	PB
8	US	18	LGS
9	OR	19	
10	YR	20	

CA3C0257

C258

(10 - W) 

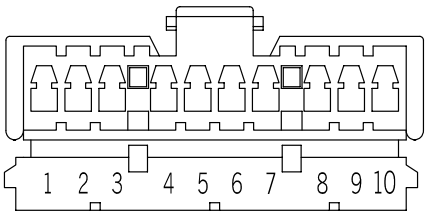

1	ON	6	WK
2	RW	7	P
3	PR	8	W
4	GP	9	W
5	R	10	UK

CA3C0258

C259

(12 - B) 

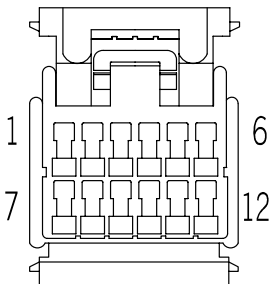

1	0	7	
2	KR	8	
3	LGR	9	WB
4	NY	10	
5		11	BP
6		12	BR

CA3C0259

C260

(20 - B) 

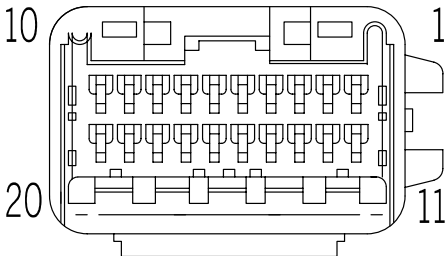

1		11	0
2		12	
3		13	
4		14	
5		15	
6	KR	16	
7	LGR	17	WB
8	NY	18	
9		19	BR
10		20	BP

CA3C0260

C301

(12 - B) 

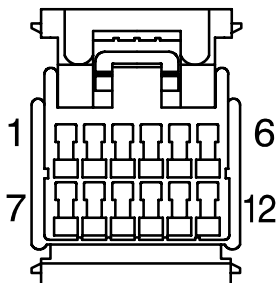

1	R	7	
2	RB	8	PO
3	LG	9	GR
4	R	10	Y
5	OG	11	
6	SB	12	YU

CA3C0301

C302

(4 - W) 

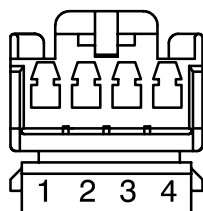

1	B
2	PU
3	PB
4	B

CA3C0302

C303

(6 - W) 

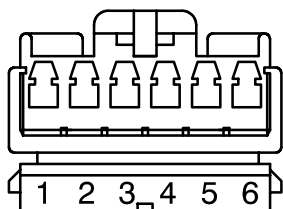

1	U
2	UB
3	PW
4	BO
5	BK
6	BG

CA3C0303

C304

(6 - S) 

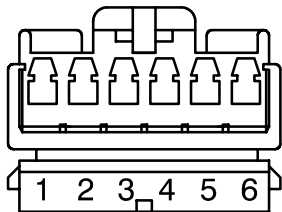

1	YR
2	RN
3	YB
4	K
5	O
6	OK

CA3C0304

C305

(6 - Y) 

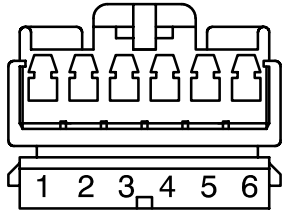

1	S
2	SO
3	B
4	RP
5	SB
6	P

CA3C0305

C306

(12 - B) 

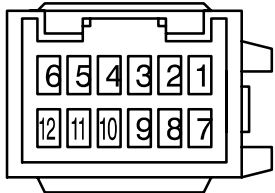

1	B	7	
2	B	8	
3	RY	9	PY
4	RY	10	GR
5	GN	11	P
6	LGN	12	

CA3C0306

C307

(4 - W) 

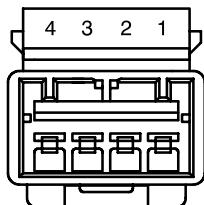

1	OB
2	OP
3	GU
4	RU

CA3C0307

C308

(6 - W) 

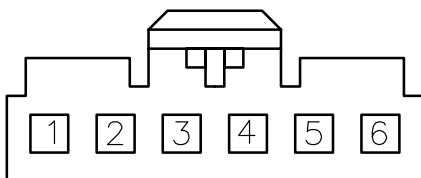

1	R
2	RB
3	U
4	UB
5	SB,SB
6	

CA3C0308

C309

(2 - W) 

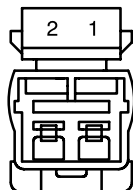

1	PR
2	P

CA3C0309

C310

(2 - B) 

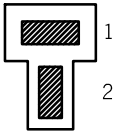

1	B
2	PLG

CA3C0310

C311

(2 - B) 

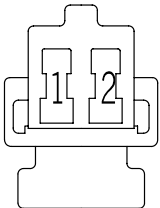

1	G
2	B

CA3C0311

C312

(5 - B) 

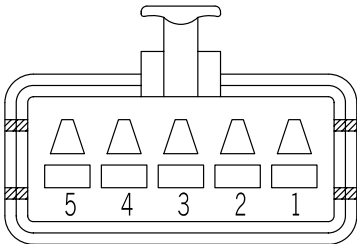

1	WP
2	B
3	NU
4	
5	

CA3C0312

C313

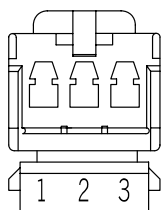



(3 - W) 

1	OR
2	B
3	P

CA3C0313

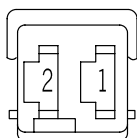
C314



(2 - W) 

1	B
2	OB

CA3C0314

C315

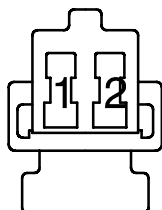

(2 - B) 

1	G
2	B

CA3C0315

C316

(4 - G) 

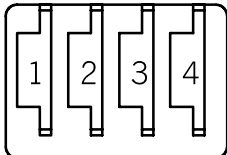

1	B
2	GW
3	RW
4	GP

CA3C0316

C319

(4 - B) 

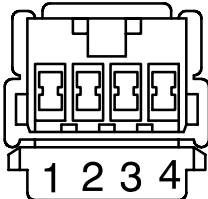

1	P
2	PR
3	B
4	

CA3C0319

C320

(8 - W) 

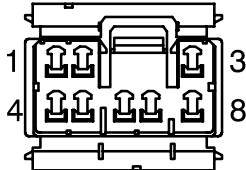

1	YP	5	YO
2	YG	6	RY
3	B	7	WR
4	YK	8	

CA3C0320

C323

(12 - S) 

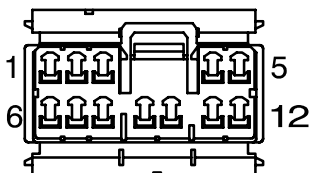

1	WP	7	OB
2	PB	8	YR
3	RB	9	WR
4	P	10	S
5	SO	11	RN
6	RP	12	PU

CA3C0323

C324

(4 - W) 

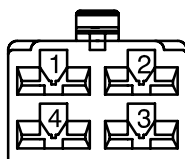

1	YO
2	PLG
3	YK
4	G

CA3C0324

C325

(18 - S) 

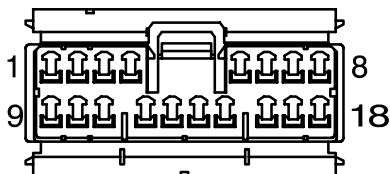

1	RY	10	RW,RW
2	LGN	11	PR
3	RY,RY	12	GP,GP
4	GW	13	GU
5	WO	14	GR
6	OK	15	GY
7	OB	16	RU
8	O	17	P
9	GN	18	K

CA3C0325

C326

(20 - U) 

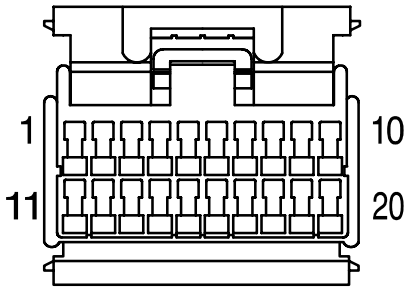

1	OP	11	YG
2	BP	12	PO
3	PY	13	PW
4	RY	14	YP
5	BG	15	YB
6	OR	16	YU
7	Y	17	BK
8	BO	18	
9	R	19	LG
10	OG	20	NU

CA3C0326

C329

(4 - B) 

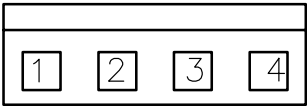

1	B
2	PR
3	P
4	PB

CA3C0329

C330

(6 - W) 

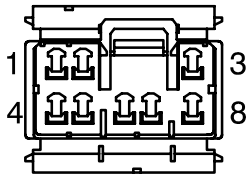

1	B
2	RB
3	GY
4	GR
5	RY
6	
7	GP
8	RW

CA3C0330

C332

(3 - B) 

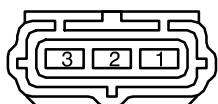

1	B
2	R
3	N

CA3C0332

C333

(4 - B) 

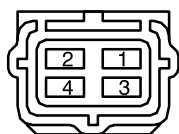

1	Y
2	U
3	B
4	G

CA3C0333

C334

(3 - B) 

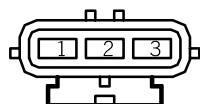

1	B
2	R
3	N

CA3C0334

C335

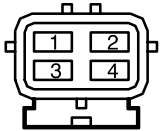

(4 - B)

1	Y
2	U
3	B
4	G

CA3C0335

C336

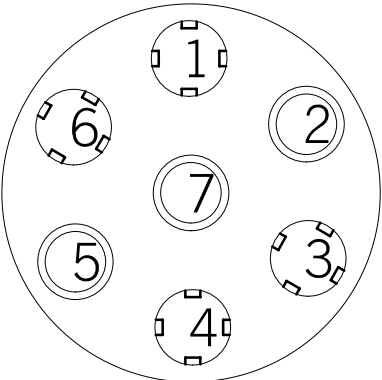

(7 - B)

1	Y
2	U
3	W
4	G
5	N
6	R
7	B

CA3C0336

C338

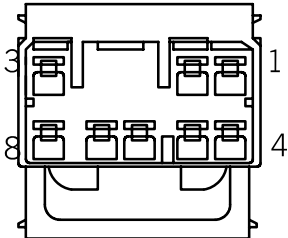

(8 - W)

1	B
2	N
3	G
4	Y
5	U
6	
7	R
8	B

CA3C0338

C351

(12 - B) 

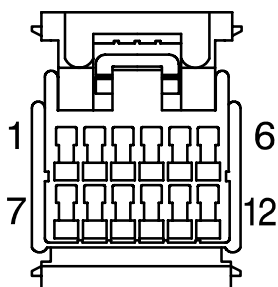

1	Y	7	
2	YB	8	PO
3	LG	9	
4	R	10	Y
5	OG	11	
6	SB	12	YU

CA3C0351

C352

(4 - W) 

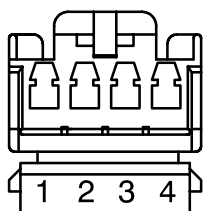

1	B
2	PU
3	PB
4	B

CA3C0352

C353

(6 - W) 

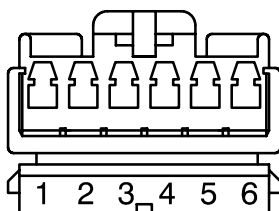

1	G
2	GB
3	PW
4	BO
5	BK
6	BG

CA3C0353

C354

(6 - S) 

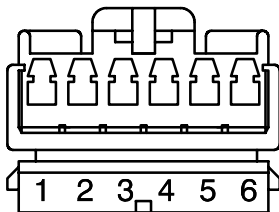

1	YR
2	RN
3	YB
4	K
5	O
6	OK

CA3C0354

C355

(6 - Y) 

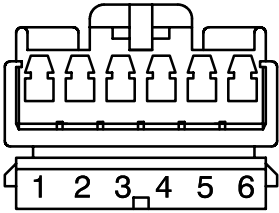

1	S
2	SO
3	B
4	RP
5	SB
6	P

CA3C0355

C356

(4 - W) 

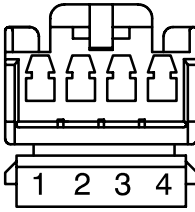

1	B
2	GN
3	KO
4	WO

CA3C0356

C357

(8 - W) 

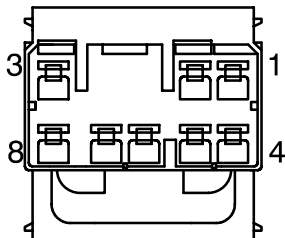

1	Y	5	O
2	YB	6	OB
3	G	7	SB
4	GB	8	

CA3C0357

C359

(4 - B) 

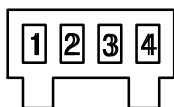

1	RY
2	B
3	YK
4	

CA3C0359

C361

(18 - W) 

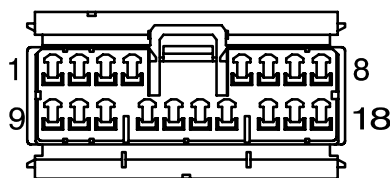

1	WO	10	SO
2	S	11	
3	RP	12	RB
4	KO	13	K
5	GN	14	GR
6	P	15	OK
7	PU	16	RN
8	PB	17	GP
9	PR	18	O

CA3C0361

C362

(16 - B) 

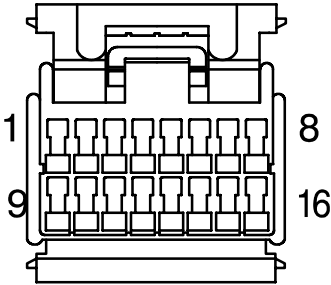

1	LG	9	OG
2	YB	10	R
3	YU	11	Y
4	PW	12	
5	BG	13	
6	YK	14	BK
7	BO	15	RY
8	PO	16	YR

CA3C0362

C363

(4 - B) 

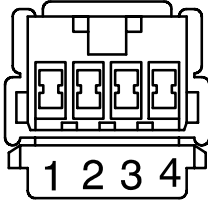

1	P
2	PR
3	B
4	

CA3C0363

C366

(4 - G) 

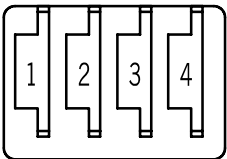

1	P
2	GP
3	RB
4	GR

CA3C0366

C368

(6 - W) 

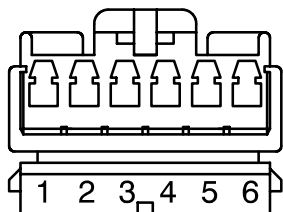

1	OB
2	O
3	SB
4	
5	B
6	P

CA3C0368

C370

(4 - W) 

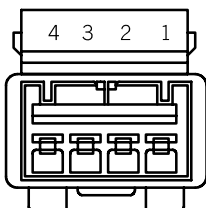

1	U
2	G
3	R
4	

CA3C0370

C371

(3 - B) 

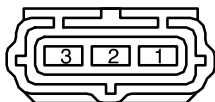

1	U
2	G
3	R

CA3C0371

C372

(3 - B) 

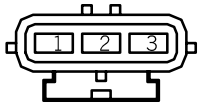

1	U
2	G
3	R

CA3C0372

C376

(7 - B) 

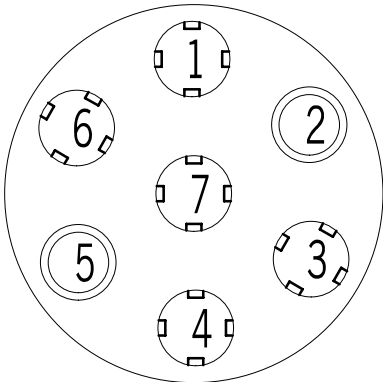

1	G
2	
3	U
4	
5	
6	R
7	

CA3C0368

C377

(10 - W) 

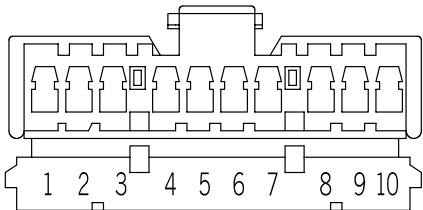

1	B	6	B
2	BW	7	
3	B	8	B
4	BW	9	BW
5	R	10	B

CA3C0377

C384

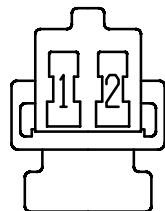

(2 - G) 

1	B
2	P

C401

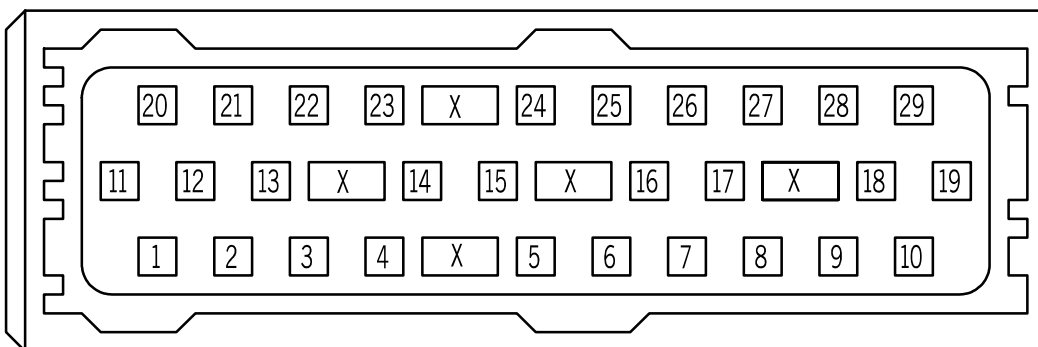

(29 - R) 

1	G	11	YLG	21	
2		12	GS	22	S
3		13	B	23	NW
4	WN	14	P	24	NW
5	WN	15	W	25	
6		16	U	26	BU
7	GU	17	Y	27	BW
8	RU	18	R	28	
9	GW	19		29	
10	RW	20	YK		

CA3C0401

C401

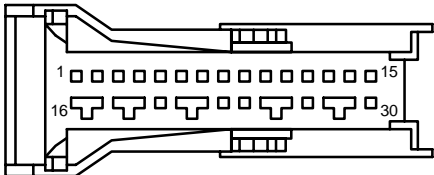

(30 - Y)



1	R	16
2	Y	17
3	U	18
4	W	19
5		20
6		21
7		22
8		23
9	YLG	24
10		25
11		26
12	S	27
13	P	28
14	B	29
15	GY	30

R300001

C402

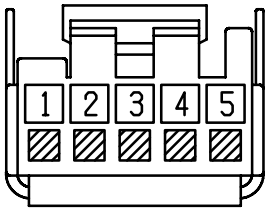

(5 - LTU)



1	G
2	
3	P
4	
5	S

CA3C0402

C403

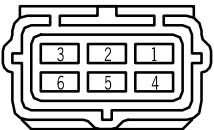

(6 - R)



1	G
2	YK
3	B
4	GS
5	YLG
6	G

CA3C0403

C404

(2 - R) 

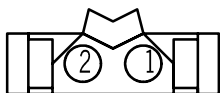

1	U
2	W

CA3C0404

C405

(3 - Y) 

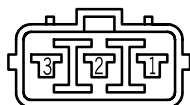

1	BU
2	GU
3	RU

CA3C0405

C406

(3 - Y) 

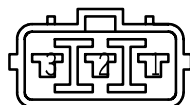

1	BW
2	GW
3	RW

CA3C0406

C409

(2 - R) 

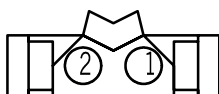

1	R
2	Y

CA3C0409

C501

(6 - B) 

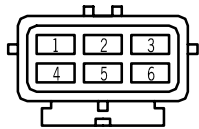

1	BO
2	B
3	ULG
4	SR
5	YO
6	SP

CA3C0501

C502

(2 - W) 

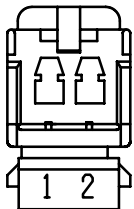

1	UR
2	W

CA2C0502

C503

(2 - R) 

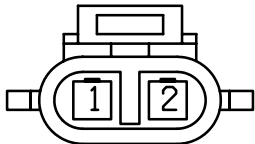

1	NO
2	GK

CA2C0503

C504 From Model 98.5

(6 - B) 

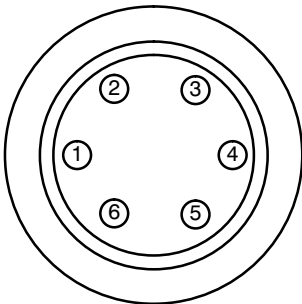

1	RW
2	RY
3	UW
4	
5	NG
6	B

C505

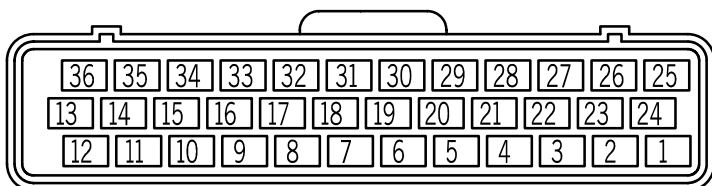

(36 - B)



1	BG	10		19	SY	28	WU
2	GU	11	YB	20		29	SP
3	P	12		21	WO	30	YN
4		13	YU	22	BY	31	
5		14		23	S	32	YR
6	GK	15	US	24	UP	33	YG
7		16	RG	25		34	GW
8		17	YS	26		35	OR
9		18	YK	27	YO	36	YW

CA3C0505

C506

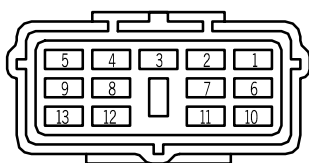

(13 - B)



1	YB	8	G
2	PG	9	KR
3	NY	10	W
4	GU	11	WN
5		12	
6	BS	13	Y
7	BG		

CA3C0506

C506A

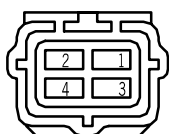

(4 - B)



1	B
2	S
3	GB
4	BY

CA3C506A

C506B

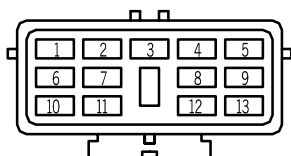

(13 - B)



1	B	8	
2	S	9	
3	GB	10	
4	BY	11	GO
5		12	R
6		13	RB
7	YK		

CA3C506B

C507

(36 - R) 

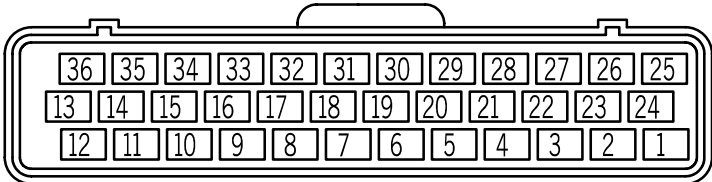

1	YK	10	RB	19		28	BS
2	SU	11	KW	20		29	YB
3		12	KB	21	PG	30	GO
4	ULG	13	SLG	22		31	SR
5		14	G	23	KR	32	RB
6		15	YLG	24		33	U
7	GB	16	UG	25		34	O
8	G	17	Y	26	B	35	SW
9		18	BO	27	Y	36	RB

CA3C0507

C508

(8 - K) 

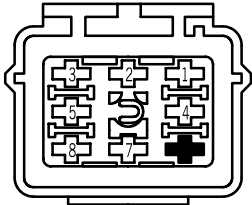

1	NR
2	UR
3	NO
4	UP
5	P
6	
7	
8	W

CA3C0508

C509

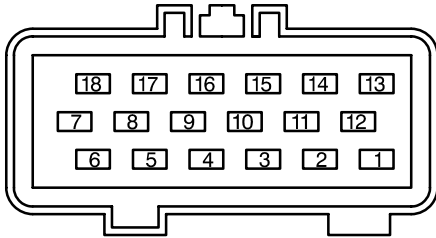

(18 - B)



1	WK	10	B
2		11	BY
3		12	KB
4	R	13	WU
5	B	14	WB
6		15	WY
7	NO	16	B
8	W	17	UR
9	B	18	

CA3C0509

C510

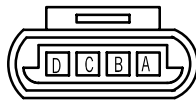

(4 - B)



A	OR
B	RG
C	GW
D	US

CA3C0510

C511

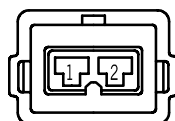

(2 - N)



1	RB
2	G

CA3C0511

C512

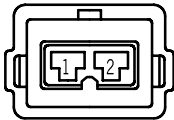

(2 - S) 

1	RB
2	SW

CA3C0512

C513

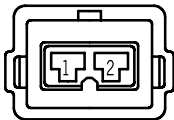

(2 - B) 

1	RB
2	SLG

CA3C0513

C514

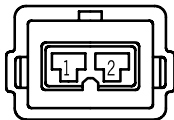

(2 - B) 

1	SY
2	NO

CA3C0514

C518

(2 - W) 

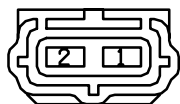

1	BY
2	KB
SCR	

YPC10070

C519

(2 - G) 

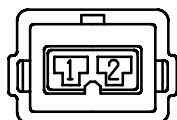

1	G
2	B

YPC10070

C520

(3 - B) 

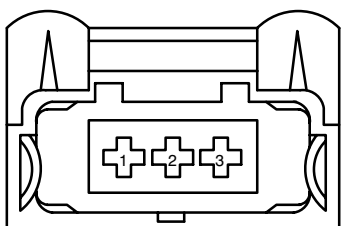

1	R
2	YLG
3	RB

CA3C0520

C521

(4 - B) 

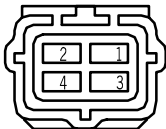

1	O
2	RB
3	W
4	WO
SCR	

CA3C0521

C522 From Model 98.5

(2 - B) 

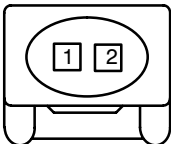

1	RW
2	B

CA3C0522

C523

(2 - S) 

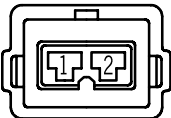

1	RB
2	KB
SCR	

CA3C0523

C524

(2 - B) 

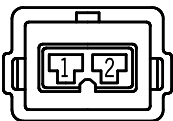

1	RB
2	KW
SCR	

CA3C0524

C525

(5 - B) 

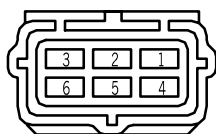

1	WB
2	WY
3	WU
4	WK
5	W
6	

CA3C0525

C526

(4 - B) 

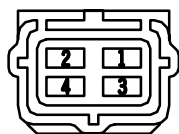

1	U
2	RB
3	W
4	WO
SCR	

CA3C0526

C530

(3 - B) 

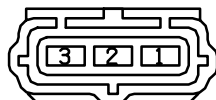

1	RB
2	SU
3	NO

YPC10067

C531

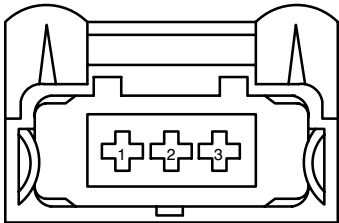

(3 - B)

1	NO
2	UG
3	RB

YPC10512

C535

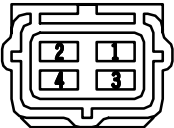

(4 - B)

1	Y
2	RB
3	W
4	WU
SCR	

CA3C0535

C536

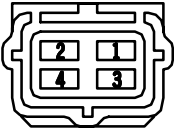



(4 - B)

1	G
2	RB
3	W
4	WU
SCR	

CA3C0536

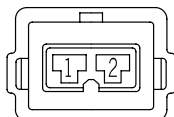
C541





(3 - B) 

1	YU
2	NO

CA3C0541

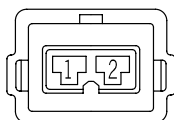
C542





(2 - B) 

1	YW
2	NO

CA3C0542

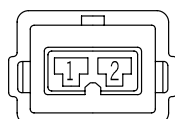
C543





(2 - B) 

1	YB
2	NO

CA3C0543

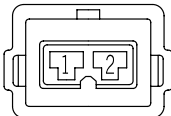
C544





(2 - B) 

1	YN
2	NO

CA3C0544

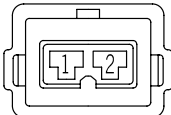
C545





(2 - B) 

1	YG
2	NO

CA3C0545

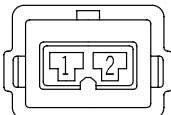
C546



(2 - B) 

1	YS
2	NO

CA3C0546

C547

(2 - B) 

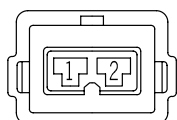

1	YR
2	NO

CA3C0547

C548

(2 - B) 

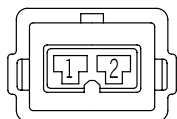

1	YK
2	NO

CA3C0548

C551

(6 - B) 

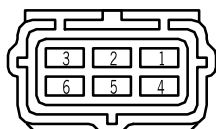

1	BO,B
2	B
3	UN
4	SR
5	YO
6	SP

CA3C0551

C554

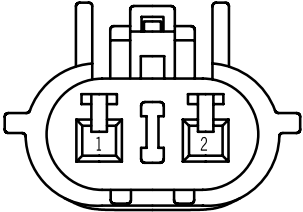

(2 - B) 

1	SB
2	B

CA3C0554

C556

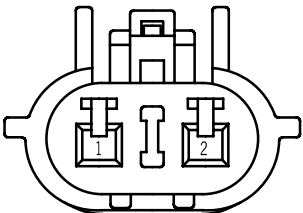

(2 - B) 

1	SN
2	B

CA3C0556

C558

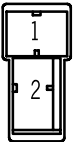

(2 - B) 

1	RP
2	RS

CA3C0558

C559

(10 - W) 

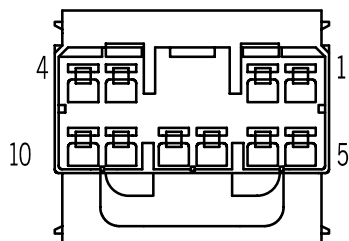

1	SP	6	SO
2	B	7	YO
3	OLG	8	OG
4	OP	9	SR
5	OW	10	UB

CA3C0559

C560

(20 - B) 

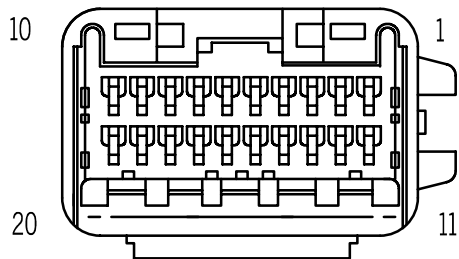

1	GB	11	N
2	B	12	SB
3	GN	13	U
4	UN	14	W
5	BG	15	SCR
6	UP	16	KU
7	UG	17	KR
8	K	18	KN
9	Y	19	KB
10	SCR	20	

CA3C0560

C561

(14 - B) 

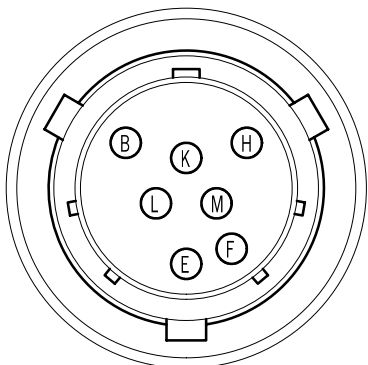

B	OG
E	K
F	Y
H	OP
K	OW
L	SO
M	OLG
SCR	

CA3C0561

C562 Up to VIN 387824

(6 - B) 

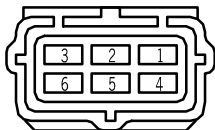

1	UB
2	UP
3	UG
4	BO
5	B
6	BG

CA3C0562

C562 From VIN 387825



1	UB
2	UP
3	UG
4	BO
5	B
6	BG

C563

(2 - B) 

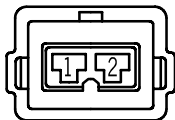

1	N
2	B

CA3C0563

C564

(2 - B) 

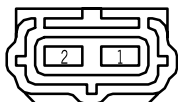

1	GN
2	B

CA3C0564

C567

(2 - B) 



1	U
2	W
SCR	

CA3C0567

C568

(8 - B) 

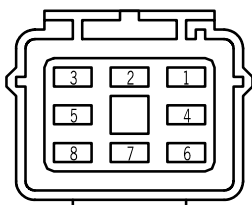

1	KB
2	KN
3	KU
4	KR
5	B
6	
7	RP
8	RS

CA3C0568

C571

(25 - B) 

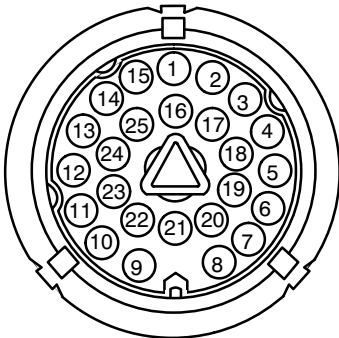

1		10	SW	19	OY
2	YP	11	NG	20	S
3	GP	12	G	21	
4	BG	13		22	
5	BS	14	Y	23	WN
6	B	15	WU	24	GU
7	N	16	LGR	25	NY
8	W	17	KR		
9	YS	18	BY		

CA3C0571

C572

(55 - B) 

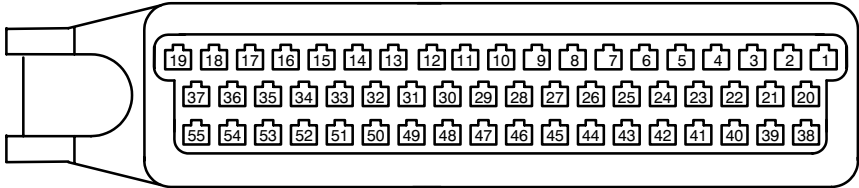

1	U	15		29	Y	43	SR
2	U	16	RW	30		44	RW
3	G	17	RW	31	YP	45	B
4	WU	18	B	32		46	
5	B	19	B	33	YS	47	B
6	NG	20	YO	34	RY	48	
7		21	RY	35	S	49	GU
8	BY	22		36		50	S
9	BG	23		37	W	51	W
10	W	24	BS	38	UW	52	UW
11	BY	25	SW	39	P	53	SU
12	Y	26	GP	40	YO	54	UY
13	NG	27	GR	41	BR	55	
14	B	28	UN	42	PR		

CA3C0572

C575

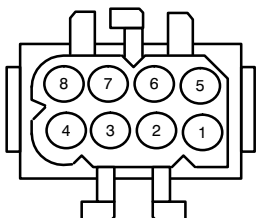

(8 - B)

1	NR
2	BN
3	RW
4	
5	
6	NY
7	
8	R

CA3C0575

C581

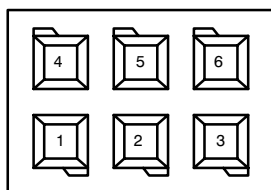

(6 - B)

1	
2	B
3	UN
4	SR
5	YO
6	

CA3C0581

C583

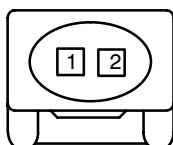

(2 - W)

1	B
2	Y

CA3C0583

C584

(12 - B) 

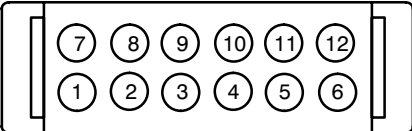

1	BN	7	BY
2	BW	8	BP
3	BR	9	BG
4		10	
5	B	11	BY
6	BR	12	RW

CA3C0584

C586

(7 - B) 

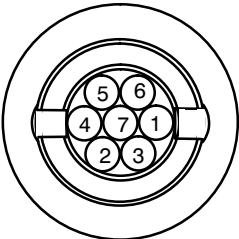

1	RY
2	B
3	P
4	U
5	NG
6	S
7	RW

CA3C0586

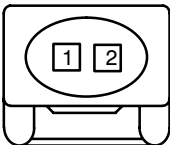

C587

(2 - B) 



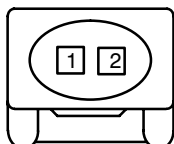

1	RW
2	B

CA3C0587

C588(2-B) 

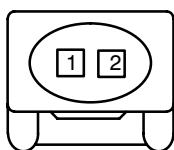

1	G
2	B

CA3C0588

C589(2-B) 

1	B
2	Y

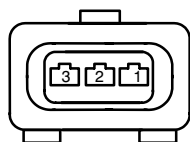
CA3C0589

C590(3-B) 

1	UY
2	NG
3	W

CA3C0590

C591

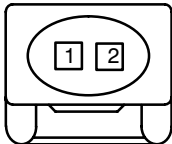

(2-B) 

1	SU
2	NG

CA3C0591

C592

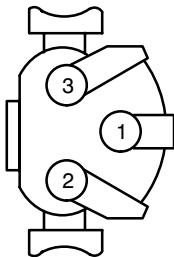



(3-B) 

1	R
2	B
3	RW

CA3C0592

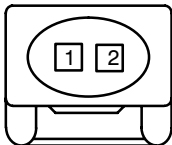
C594



(2-B) 

1	WN
2	

CA3C0594

C595

(2 - B) 

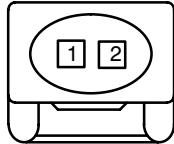

1	UW
2	NG

CA3C0595

C601

(55 - B) 

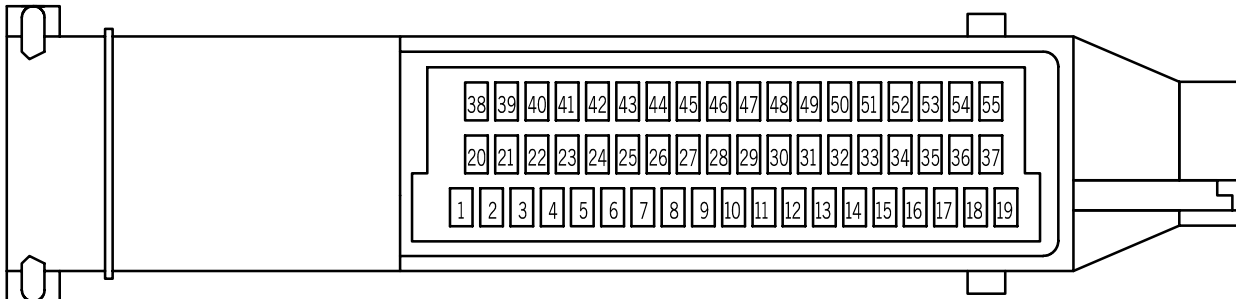

1	W	15	LG	29	UO	43	
2	OK	16	YG	30		44	
3	S	17		31	YR	45	
4		18		32	SR	46	NY
5	OP	19	OLG	33	UG	47	OY
6	OG	20	SCR	34		48	
7	B	21	SP	35		49	
8		22		36		50	UB
9		23		37		51	K
10		24	OW	38	Y	52	
11		25		39	PY	53	
12		26	B	40		54	
13		27		41		55	
14	UP	28		42	SO	56	

CA3C0601

C603

(36 - B)

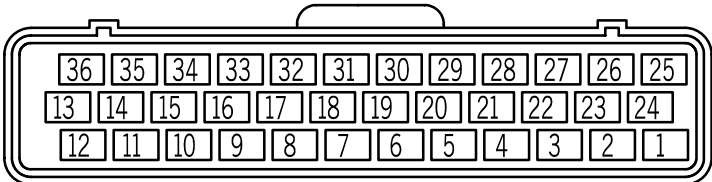

1	RS	10		19	BG	29	B
2	RS	11		20		30	U
3		12		21	WY	31	KU
4	WY	13	R	22		32	KN
5	B	14	NR	23	P	33	PG
6		15	GR	24	P	34	UN,UN
7	KR	16		25	RP	34	N,N
8		17	KB	26	RP	34	UN
9		18		27		35	NY
				28	ULG	36	NW

CA3C0603

C605

(4 - W)

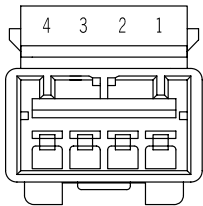

1	B
2	PG
3	GP
4	RU

CA3C0605

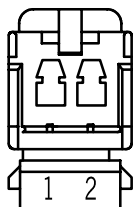
C606

(2 - W)



1	B
2	WB

CA3C0606

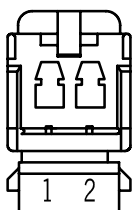
C609

(2 - W)



1	BY
2	PY

CA3C0609

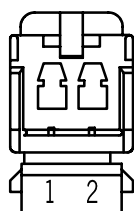
C613

(2 - W)



1	PW
2	PU

CA3C0613

C614

(8 - U) 

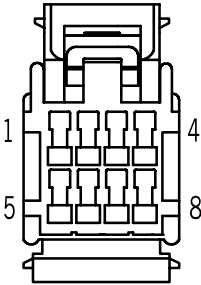

1	PU
2	LG
3	OG
4	R
5	RU
6	B
7	
8	

CA3C0614

C615A

(6 - W) 

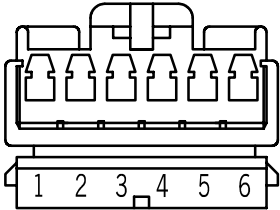

1	B
2	PR
3	PY
4	B
5	PG
6	B

CA3C615A

C615B

(4 - W) 

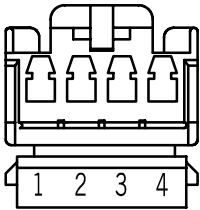

1	B
2	PG
3	GP
4	RU

CA3C615B

C617

(12 - B) 

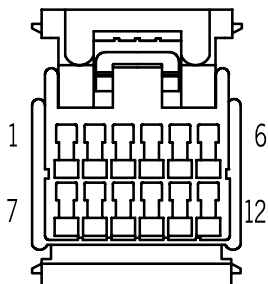

1	B	7	YR
2	W	8	NY
3	UG	9	RU
4	UP	10	UO
5	UB	11	NR
6	YG	12	

CA3C0617

C619

(2 - B) 

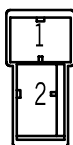

1	B
2	G

CA3C0619

C624

(4 - W) 

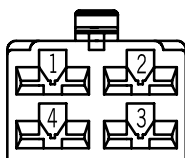

1	
2	
3	P,P
4	

CA3C0624

C625

(12 - W)

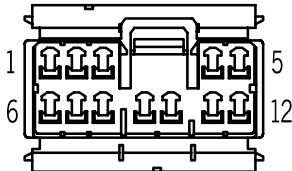

1	WY	7	PY
2	W	8	PU,PU
3	W	9	
4	GR	10	
5	G	11	RU
6	PR	12	PW

CA3C0625

C626

(20 - B)

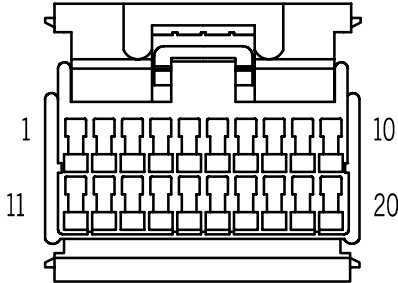

1	LG	11	S
2	OG	12	K
3	NY	13	R
4	NW	14	LG
5	YR	15	GP
6	GB	16	YG
7	NR	17	BK
8	UB	18	UG
8	GN	18	N
9	UP	19	WB
10	BY	20	UN

CA3C0626

C628

(6 - W)

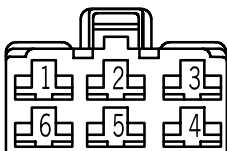

1	
2	W
3	SN
4	BY
5	B
6	SB

CA3C0628

C635

(6 - W)

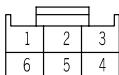

1	B,B	4	
2	PG	5	GP
3	RU	6	B

CA3C0635

C658

(2 - B)

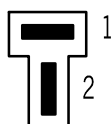

1	RP,RP
2	RS,RS

CA3C0658

C659

(10 - W) 

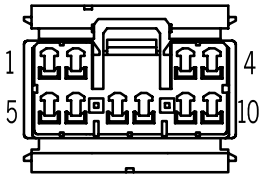

1	SP	6	SO
2	B	7	OY
3	OLG	8	OG
4	OP	9	SR
5	OW	10	UB

CA3C0659

C660

(20 - B) 

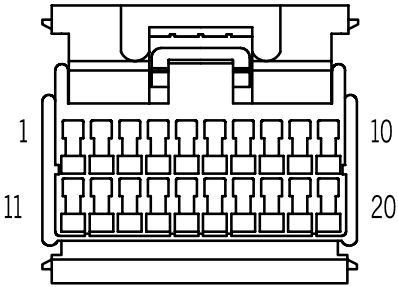

1	GB	10	SCR
2	BG	11	N
3	SN	12	SB
3	GN	13	U
4	UN	14	R
4	ULG	15	SCR
5	B	16	KU
6	UP	17	KR
7	UG	18	KN
8	OK	19	KB
9	OB	20	

CA3C0660

C701

(10 - W) 

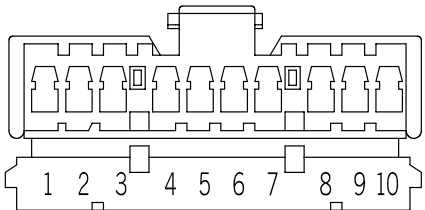

1	RG	6	B
2	GR	7	
3	BW	8	SB
4	WB	9	G
5	P	10	GB

CA3C0701

C703

(6 - W) 

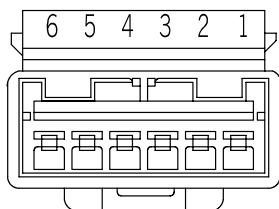

1	G
2	GB
3	PW
4	BO
5	BK
6	BG

CA3C0703

C704

(6 - S) 

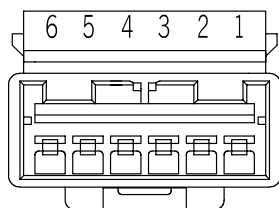

1	YR
2	RN
3	YB
4	K
5	O
6	OK

CA3C0704

C705

(6 - Y) 

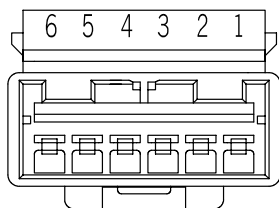

1	S
2	SO
3	B
4	RP
5	SB
6	P

CA3C0705

C706

(4 - W) 

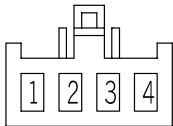

1	RN
2	BO
3	B
4	BK

CA3C0706

C707L

(6 - B) 

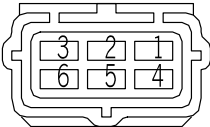

1	S
2	BG
3	SO
4	YB
5	YR
6	B

CA3C707L

C707R

(6 - W) 

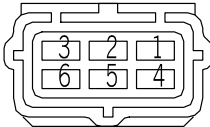

1	S
2	BG
3	SO
4	YB
5	YR
6	B

CA3C707R

C708

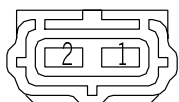

(2 - B)



1	RP
2	B

CA3C0708

C711

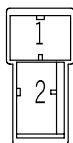

(2 - B)



1	RG,GB
2	G,GR

CA3C0711

C712

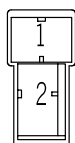

(2 - B)



1	BW,GB
2	G,WB

CA3C0712

C714R

(6 - W)

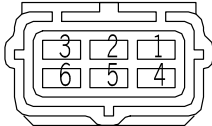

1	B,O
2	
3	O,B
4	PW,K
5	OK
6	K,PW

CA3C714R

C714L

(6 - B)

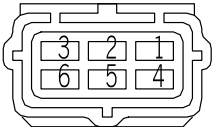

1	B,O
2	
3	O,B
4	PW,K
5	OK
6	K,PW

CA3C714L

C751

(12 - B)

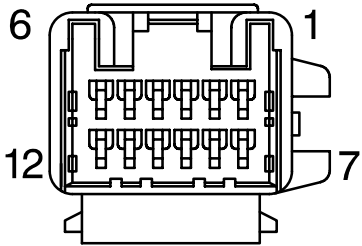

1	Y	7	
2	YB	8	PO
3	LG	9	GR
4	R	10	Y
5	OG	11	
6	SB	12	YU

CA3C0751

C752

(4 - W) 

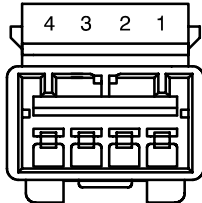

1	B
2	PU
3	PB
4	B,B

CA3C0752

C753

(6 - B) 

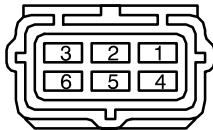

1	G
2	S
3	R
4	U
5	Y
6	B

CA3C0753

C754

(12 - B) 

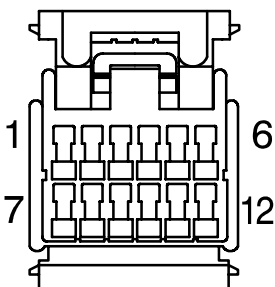

1	Y	7	S
2	R	8	U
3	G	9	
4		10	W
5	BR	11	P
6	O	12	B

CA3C0754

C755L

(16 - B) 

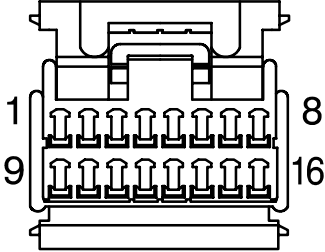

1	B0	9	B
2	PR	10	PB
3	PO	11	B
4	YR	12	P
5		13	LG
6	PU	14	R
7	B	15	OG
8	SG	16	SW

CA3C755L

C755R

(16 - B) 

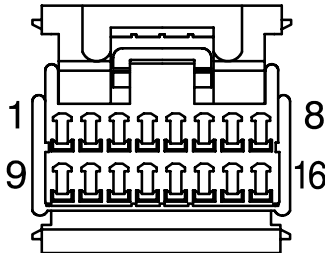

1	B0	9	B
2	PR	10	PB
3	PO	11	B
4	YR	12	P
5		13	LG
6	PU	14	R
7	B	15	OG
8	SG	16	SW

CA3C755R

C756

(12 - B) 

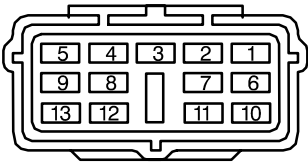

1	G	8	
2	S	9	
3	R	10	BR
4	U	11	O
5	Y	12	P
6	B	13	W
7			

CA3C0756

C757

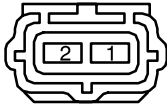



(2 - B) 

1	PR
2	B

CA3C0757

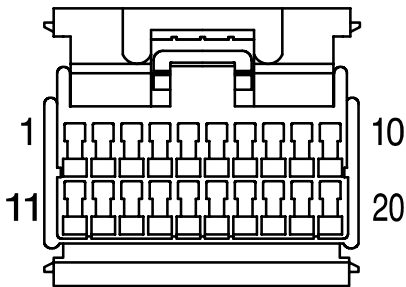
C758L





(20 - B) 

1	OB	11	B
2	KB	12	
3		13	
4		14	
5	GR	15	
6	UR	16	
7	PW	17	
8	OK	18	
9		19	
10		20	

CA3C758L

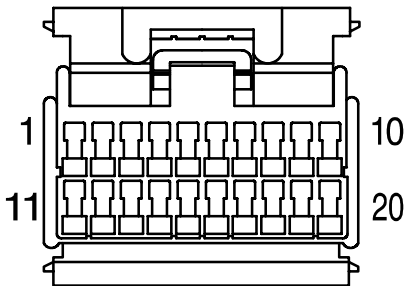
C758R





(20 - B) 

1	OB	11	B
2	KB	12	
3		13	
4		14	
5	GR	15	
6	UR	16	
7	PW	17	
8	OK	18	
9		19	
10		20	

CA3C758R

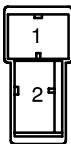
C759A





(2 - B) 

1	BW
2	WB

CA3C759A

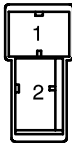
C759B



(2 - B) 

1	YB
2	Y

CA3C759B

C762R

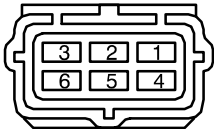

(6 - W) 

1	OB
2	UR
3	GR
4	KB
5	OK
6	PW

CA3C762R

C762L

(6 - B) 

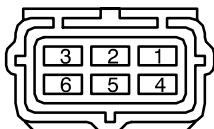

1	GR
2	UR
3	OB
4	PW
5	OK
6	KB

CA3C762L

C763

(2 - B) 

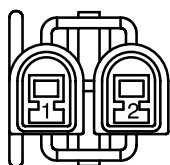

1	
2	B

CA3C0763

C764R

(6 - W) 

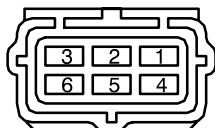

1	SW
2	Y
3	SG
4	YU
5	YR
6	BO

CA3C764R

C764L

(6 - B)

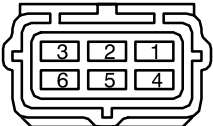

1	SW
2	Y
3	SG
4	YU
5	YR
6	BO

CA3C764L

C765

(2 - B)

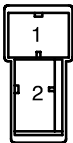

1	YB,BG
2	Y,GB

CA3C0765

C768

(10 - W)

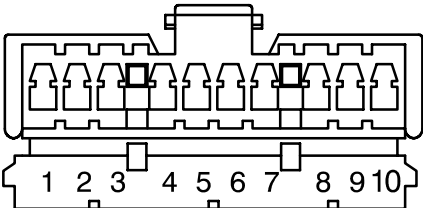

1	BG	6	B
2	GB	7	
3	BW,BW	8	SB
4	WB,WB	9	Y
5	P	10	YB

CA3C0768

C769



(2 - B) 

1	Y,WB
2	YB,BW

CA3C0769

C806

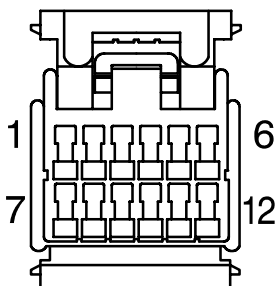

(10 - B) 

1	W	7	
2	W	8	
3	W	9	W
4	W	10	W
5	W	11	W
6	W	12	

CA3C0806

C813

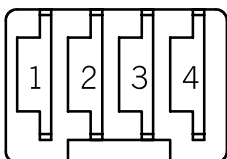

(4 - G) 

1	W
2	W
3	
4	W

CA3C0813

C814

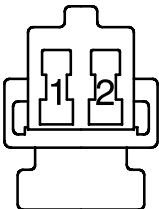

(2 - B) 

1	W
2	W

CA3C0814

C815

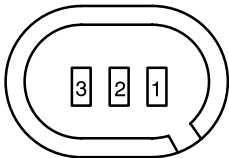

(3 - B) 

1	W
2	W
3	

CA3C0815

C816

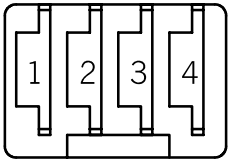

(4 - G) 

1	W
2	W
3	
4	W

CA3C0816

C818

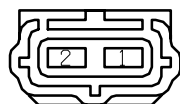

(2 - B) 

1	W
2	W

CA3C0818

C857

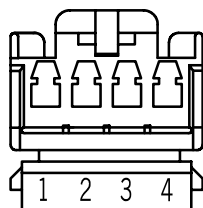

(4 - W) 

1	OB
2	OP
3	GU
4	RU,RU

CA3C0857

C859

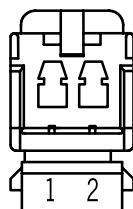

(2 - W) 

1	PR
2	P

CA3C0859

C860

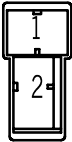

(2 - B) 

1	B
2	PLG

CA3C0860

C861

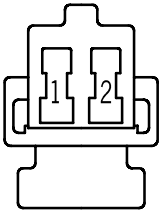

(2 - B) 

1	B
2	RU

CA3C0861

C862

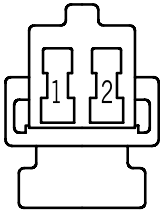



(2 - B) 

1	B
2	RU

CA3C0862

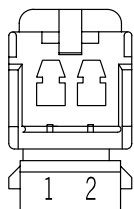
C865





(2 - W) 

1	B
2	GU

CA3C0865

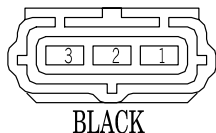
C867





(3 - B) 

1	B
2	OB
3	OP

CA3C0867

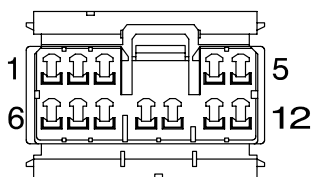
C901A



(12 - S) 

1	PW	7	OW
2	RW	8	
3	W	9	B
4	WP	10	B
5	BW	11	
6	WU	12	LGW

CA3C901A

C901B

(8 - W) 

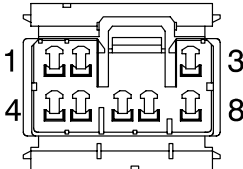

1	W	5	WU
2	WP	6	B
3	B	7	BY
4	B	8	

CA3C901B

C902A

(12 - S) 

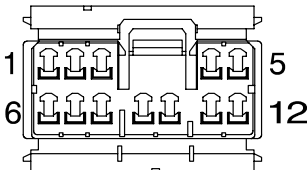

1	P	7	O
2	R	8	
3	WO	9	B
4	WR	10	B
5	BO	11	
6	WLG	12	LG

CA3C902A

C902B

(8 - W) 

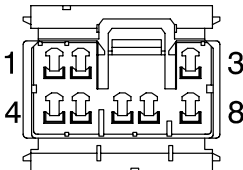

1	WO	5	WLG
2	WR	6	B
3	B	7	BY
4	B	8	

CA3C902B

C903

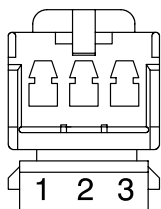



(3 - W) 

1	NR
2	
3	NG

CA3C0903

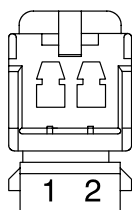
C904





(2 - W) 

1	NG
2	B

CA3C0904

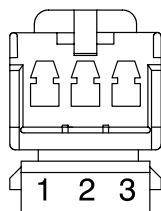
C905



(3 - W) 

1	NU
2	
3	NB

CA3C0905

C906

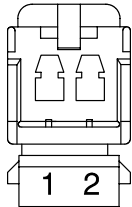

(2 - W)

1	NB
2	B

CA3C0906

C907

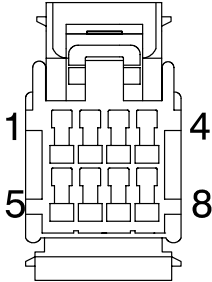

(8 - B)

1	R	5	O
2	OW	6	LG
3	LGW	7	RW
4	PW	8	P

CA3C0907

C912

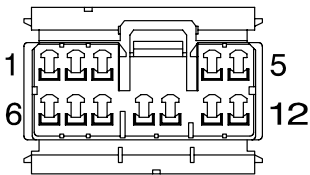

(12 - G)

1	NU	7	WP
2	NR	8	W
3	BY	9	BY
4	BW	10	BO
5	WLG	11	WO
6	WU	12	WR

CA3C0912

C951

(8 - W) 

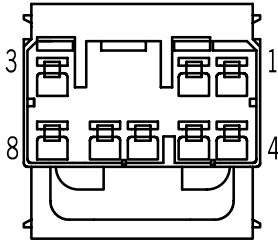

1	WO	5	WLG
2	WO	6	B
3	B	7	BY,BY
4	B	8	

CA3C0951

C952

(12 - W) 

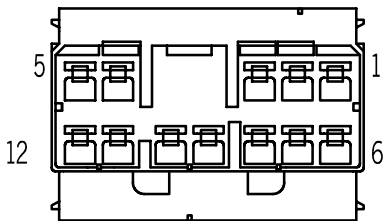

1	UG	7	
2	G	8	WLG
3		9	
4		10	
5	YB	11	BS
6	Y	12	BP

CA3C0952

C953

(18 - W) 

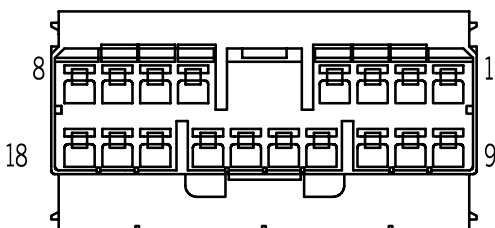

1	B	10	BP
2	W	11	
3	B	12	BS
4	B	13	G
5	O	14	UG
6	SR	15	BG
7	Y	16	WG
8	WB	17	YB
9	W	18	BW

CA3C0953

C954

(5 - B)

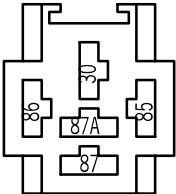

30	WO,WO
85	BY
86	WO
87	W
87A	

CA3C0954

C955

(5 - B)

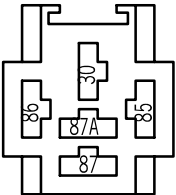

30	WO,WO
85	BY
86	WO
87	W
87A	

CA3C0955

C958

(4 - W)

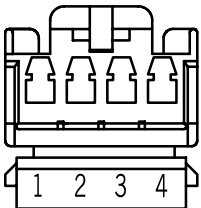

1	WB
2	
3	
4	BW

CA3C0958

C961

(6 - W) 

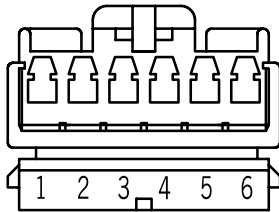

1	Y
2	YB
3	N,N
4	YR
5	RS,RS
6	

CA3C0961

C962

(12 - W) 

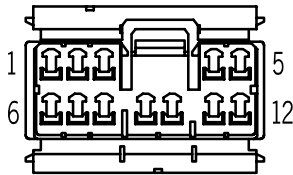

1	UG	7	RS
2	G	8	WLG
3	YR	9	N
4	UY	10	
5	YB	11	BS
6	Y	12	BP

CA3C0962

C963

(4 - W) 

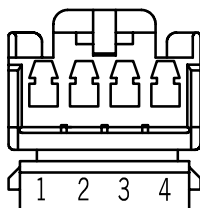

1	BP
2	BS
3	WLG
4	

CA3C0963

C966

(3 - W) 

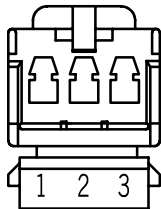

1	N
2	RS
3	UY

CA3C0966

C971

(18 - W) 

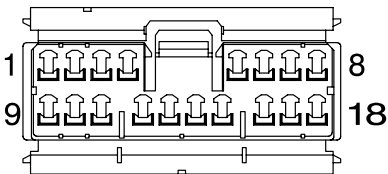

1	WG	10	RB
2	BG	11	RB
3	UY	12	UR
4	W	13	RG
5		14	RG
6	BY	15	RG
7		16	
8	WB	17	WY
9	U	18	BW

CA3C0971

C972

(4 - W) 

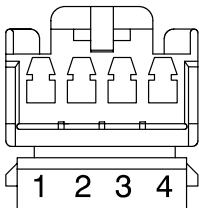

1	WB
2	
3	
4	BW

CA3C0972

C973

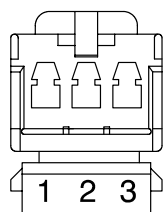



(3 - W) 

1	RG
2	UY
3	RG

CA3C0973

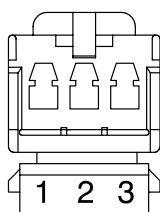
C976





(3 - W) 

1	RG
2	UR
3	RG

CA3C0976

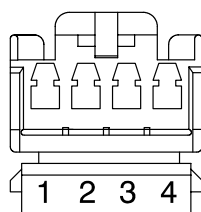
C977



(4 - W) 

1	U
2	W
3	RG
4	

CA3C0977

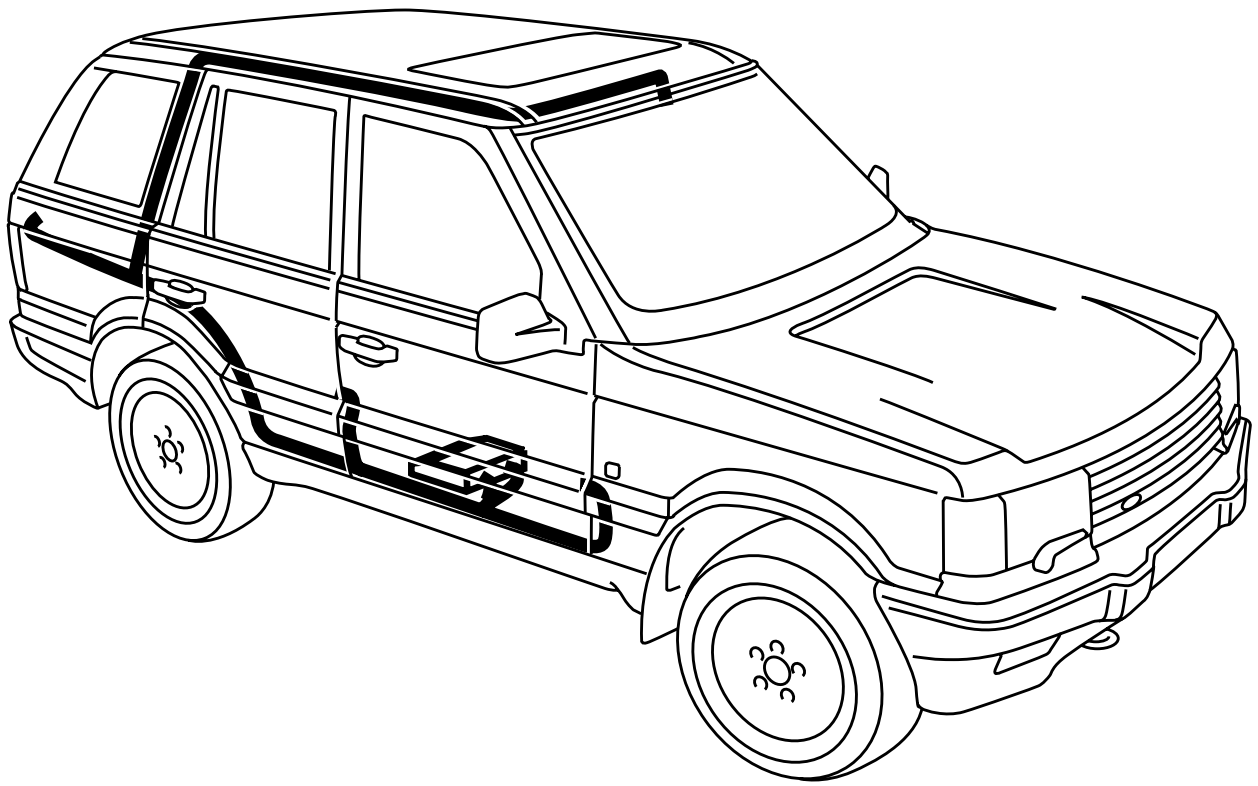

RH Body Wire Harness

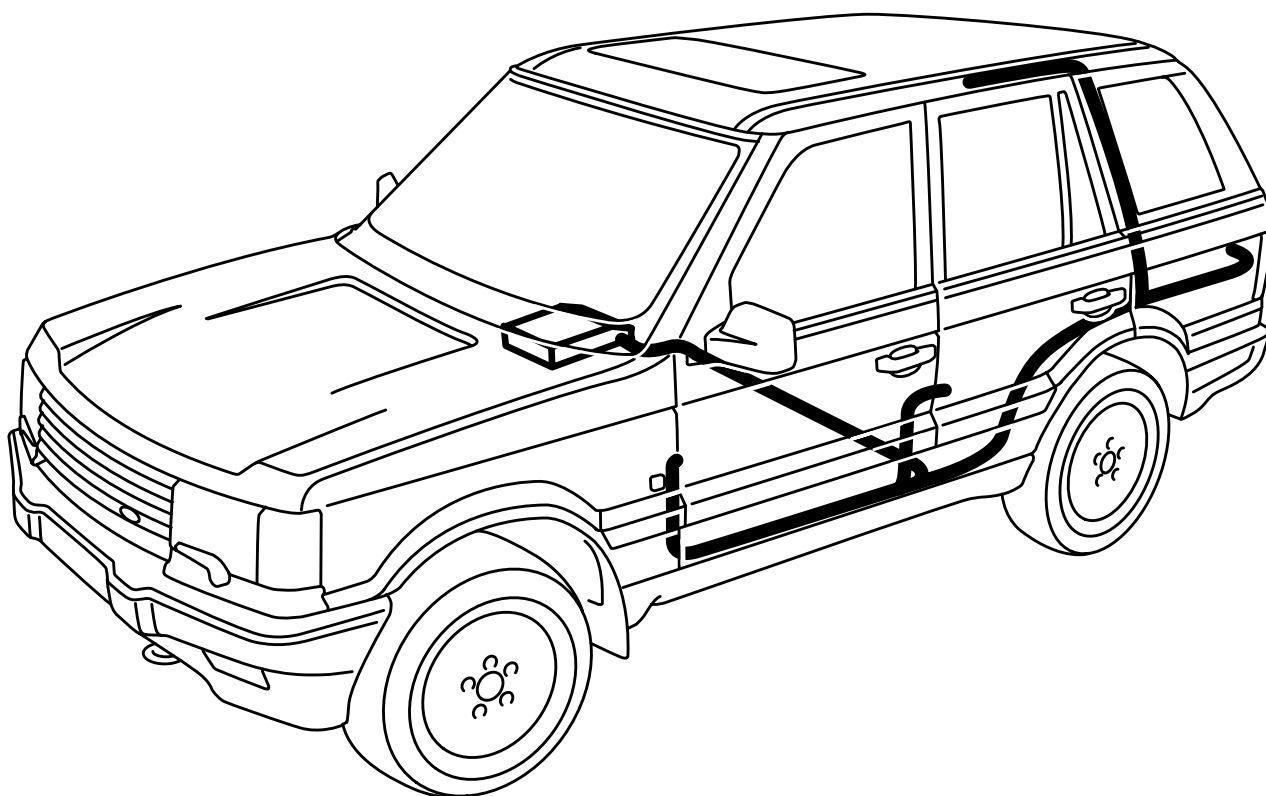

LH Body Wire Harness

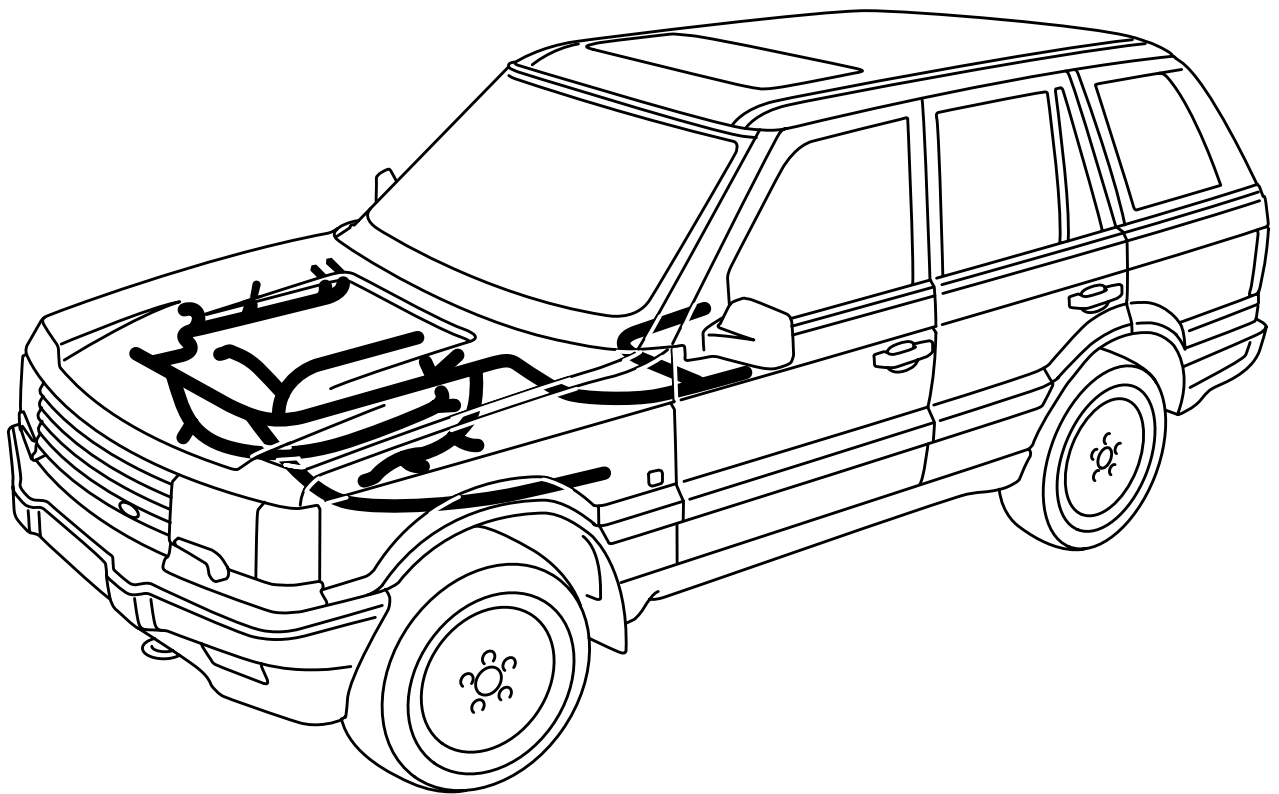

Engine Wire Harness Except NAS

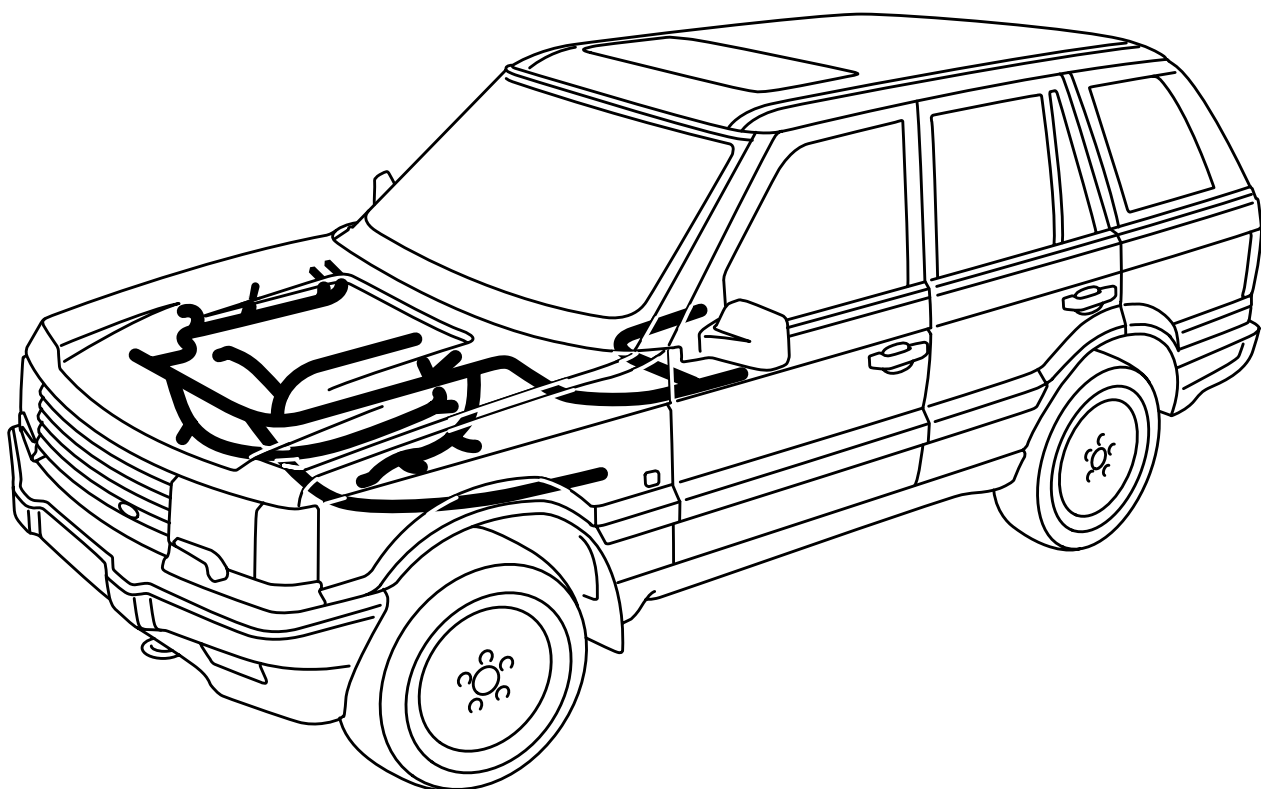

Engine Wire Harness NAS

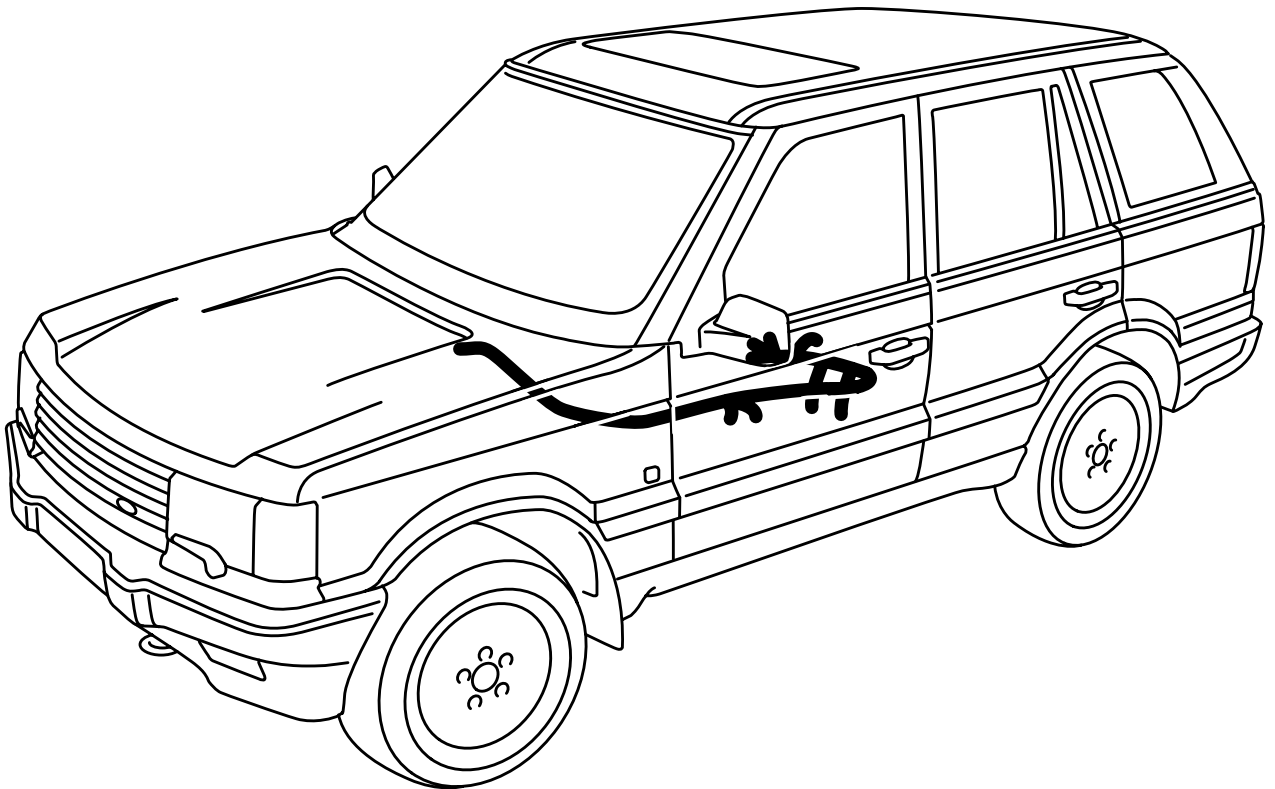

Manual Transmission Harness

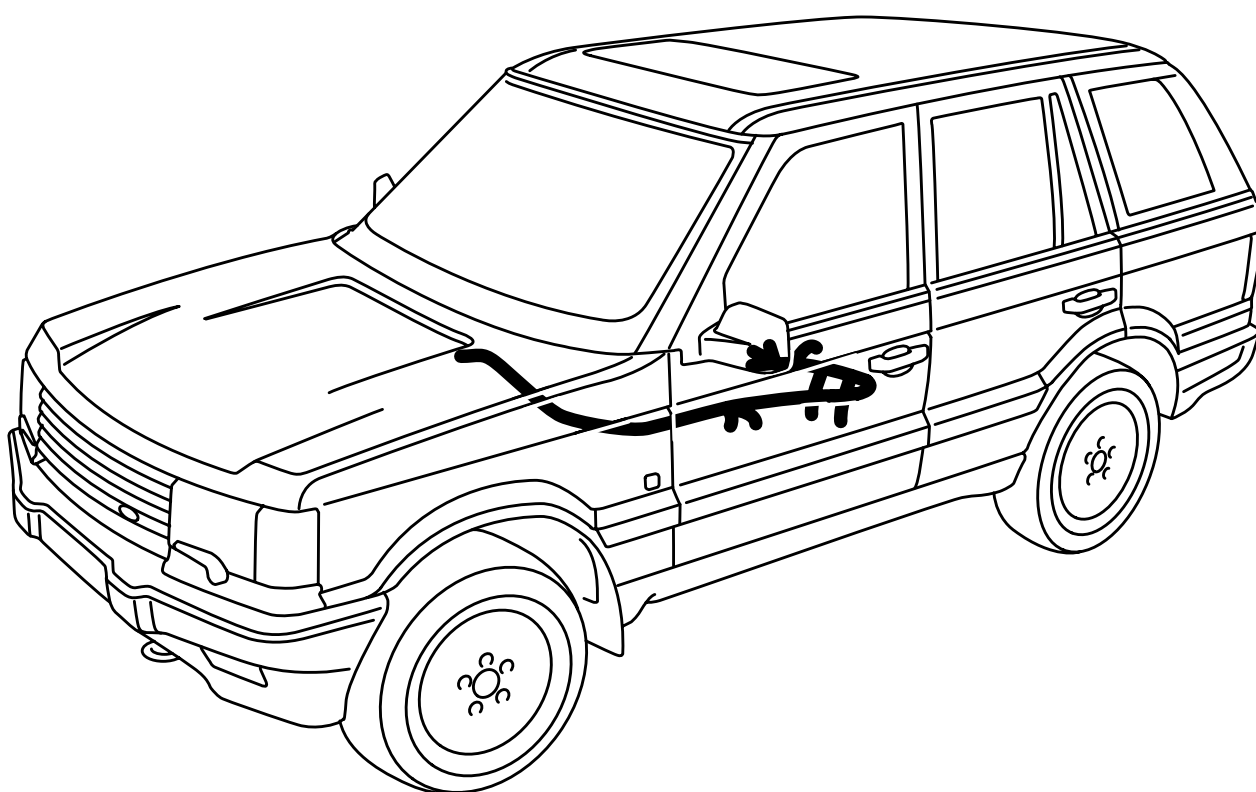

Automatic Transmission Harness

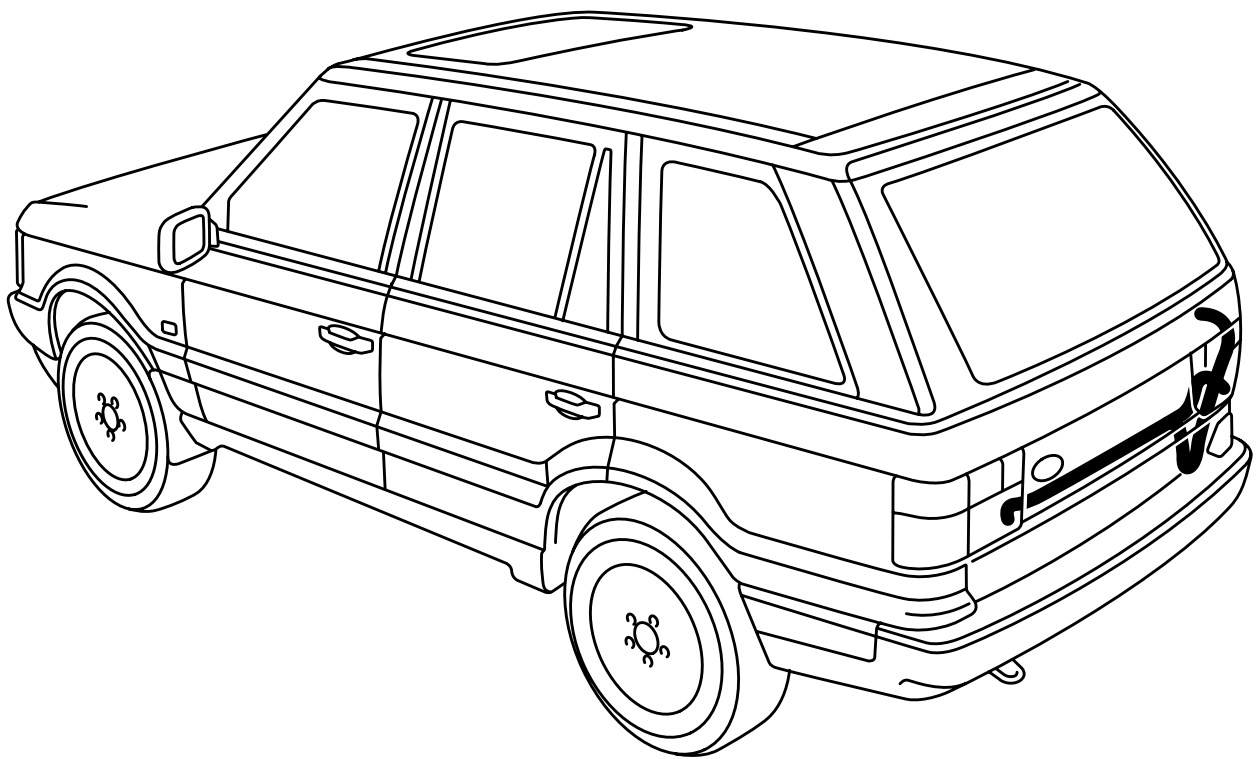

Lower Tailgate Harness

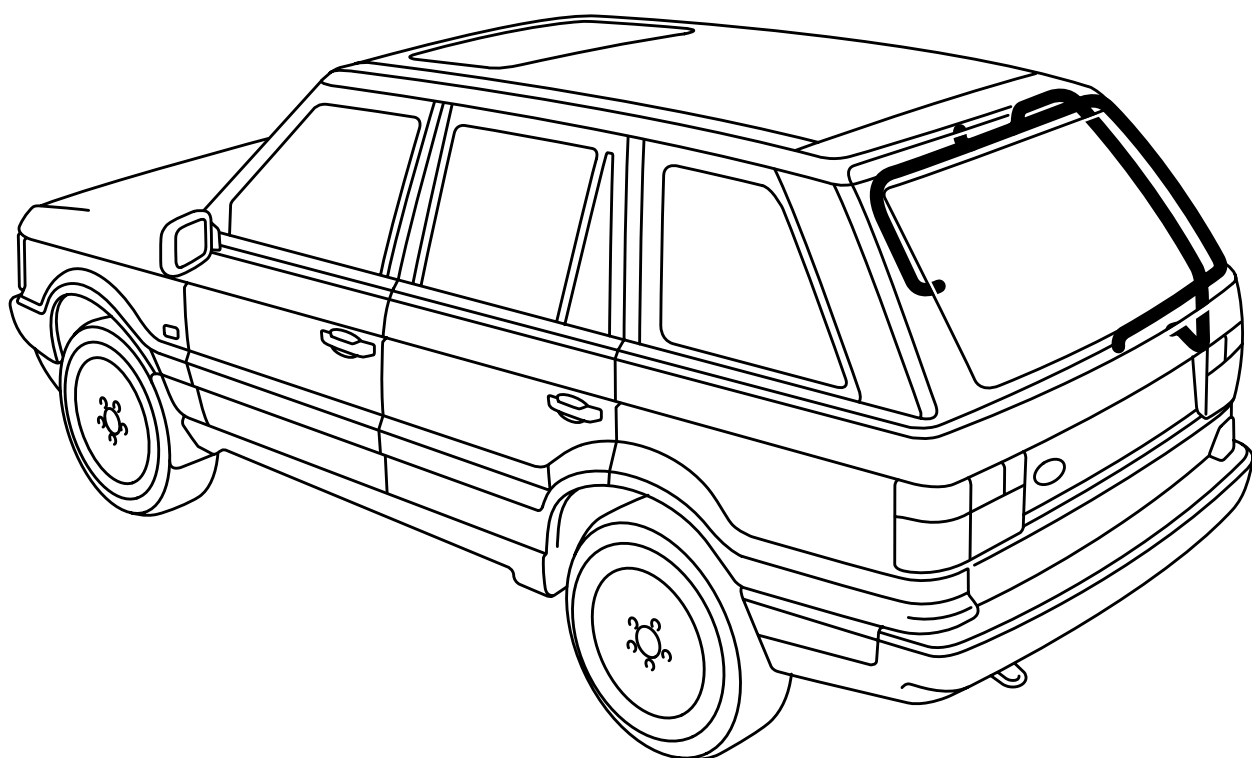

Upper Tailgate Harness

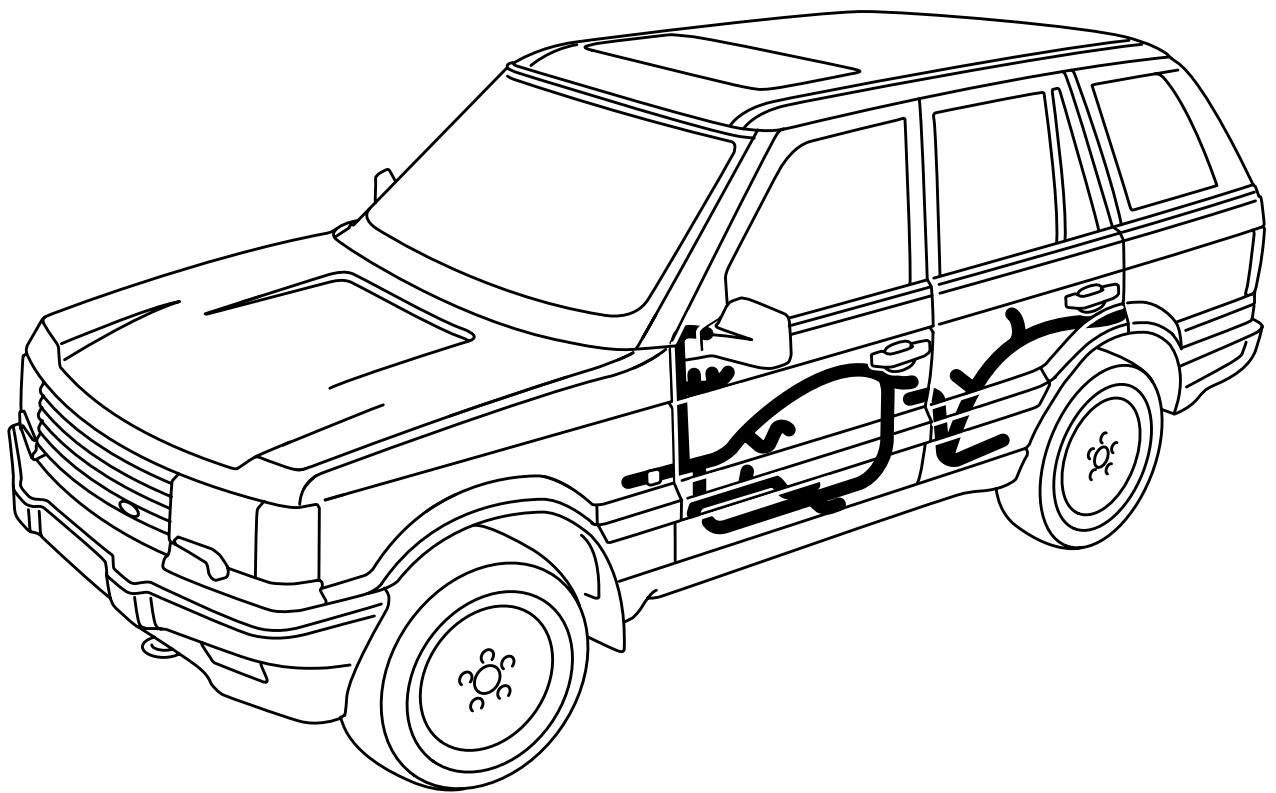

Front and Rear Door Harness

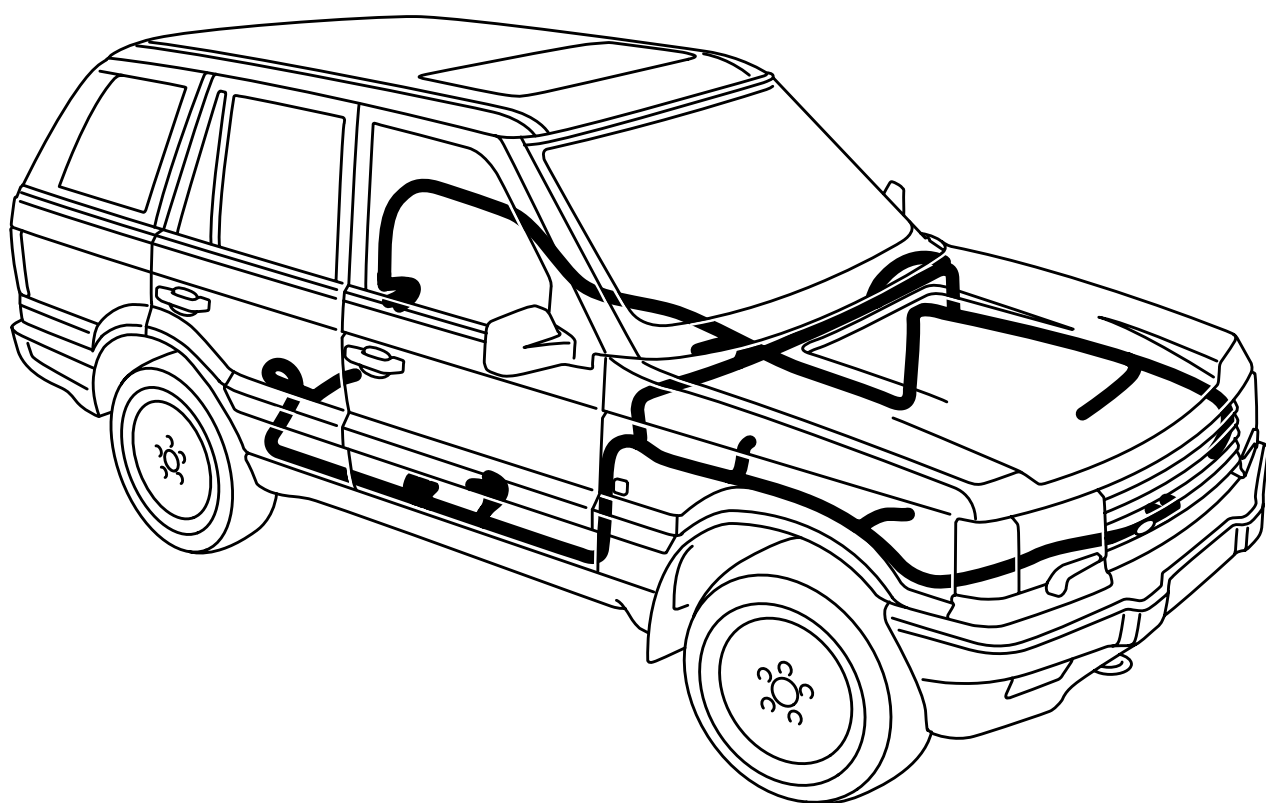

Under-bonnet Harness

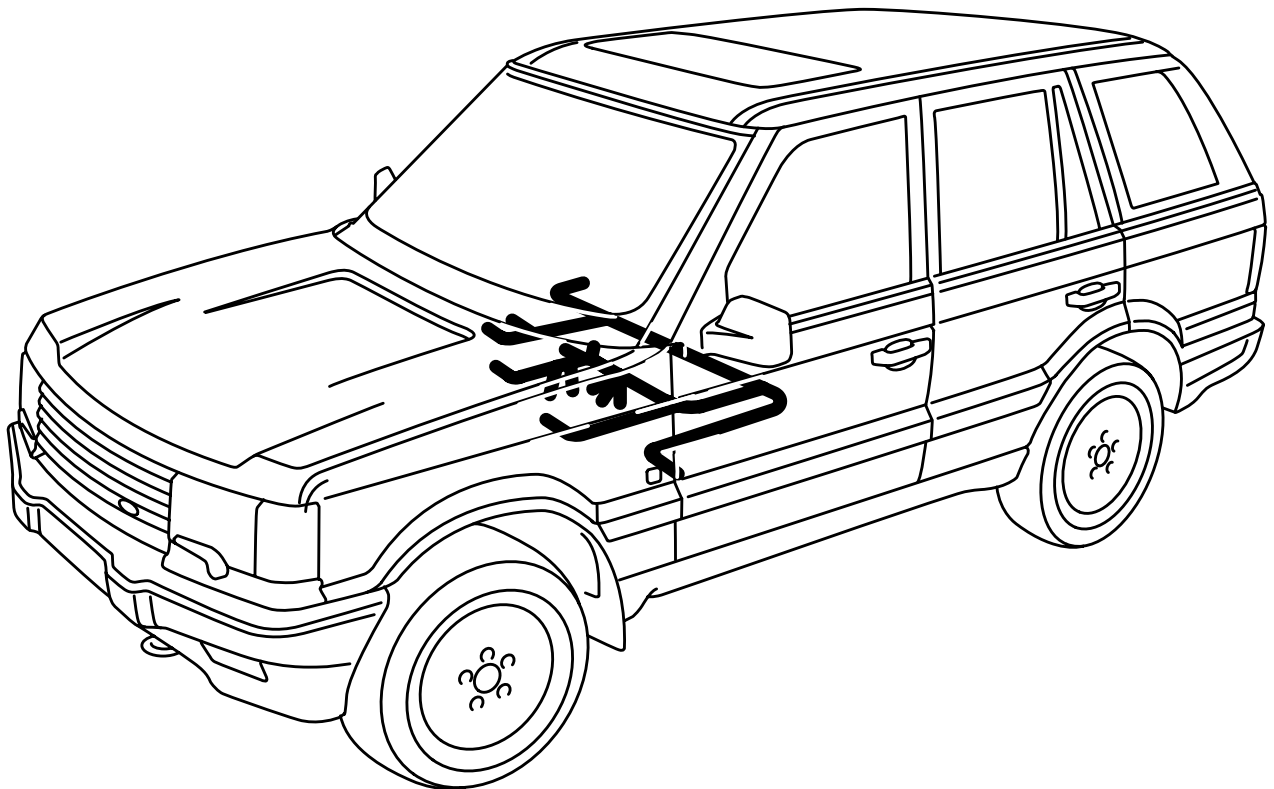

Centre Console Harness