



**In-Car Entertainment**



---

The audio equipment fitted to your vehicle has been carefully chosen to add to your motoring enjoyment.

Whether you drive for business, or purely for pleasure, we want you to enjoy using your audio equipment, so please take a little time to read these instructions and find out how to get the very best In-Car Entertainment!

---



As part of Land Rover's environmental policy, this publication is printed on paper made from chlorine free pulp.



# In-Car Entertainment

---

## Contents

<i>Sound controls</i> .....	2
<i>Radio controls</i> .....	4
<i>Cassette player</i> .....	5
<i>Compact disc player</i> .....	7
<i>Radio tuning</i> .....	9
<i>Weather band</i> .....	9
<i>Radio pre-set buttons</i> .....	10
<i>Auto-store</i> .....	11
<i>Radio data system</i> .....	12
<i>Programme type (PTY)</i> .....	13
<i>Digital sound processing (if fitted)</i> .....	14
<i>Radio reception</i> .....	15
<i>Care of cassette player and tapes</i> .....	16
<i>Compact disc changer unit</i> .....	17
<i>Caring for compact discs</i> .....	18
<i>Security code</i> .....	19

---

# Sound Controls



ICE0113

2

## SOUND CONTROLS

### 1. On/off and volume control

Press to switch on (display shows 'RANGE ROVER', followed briefly by 'CODE'). Press again to switch off.

Rotate steadily to right or left to adjust the volume.

The volume can also be adjusted using the remote switches on the steering wheel (see 'Owner's handbook').

**NOTE:** The volume level will automatically increase or decrease according to the vehicle road speed, thereby combating any additional road or wind noise that may be experienced.

**NOTE:** If you have a car telephone with a mute signal output connected to the stereo system, radio, tape or CD play automatically mutes when the telephone is in use.

### 2. Audio selection button

Press one or more times to select bass, treble, balance, fader and on some models, subwoofer control and digital sound processing (DSP). The audio system display confirms selection.

**NOTE:** The subwoofer control and DSP settings, and their associated displays, operate only if the audio unit is fitted with these options.

#### Bass:

Press once, then rotate volume control to left or right to reduce or increase bass response. Display shows:

'BASS - 9' = minimum bass

'BASS 0' = normal bass

'BASS + 9' = maximum bass

#### Treble:

Press twice, then rotate volume control to left or right to reduce or increase treble response. Display shows:

'TREB - 9' = minimum treble

'TREB 0' = normal treble

'TREB + 9' = maximum treble

# Sound Controls

---

## Subwoofer (if fitted):

Press three times, then rotate volume control left or right to reduce or increase subwoofer response. Display shows:

'SUB WFR - 9' = minimum response

'SUB WFR 0' = normal response

'SUB WFR + 9' = maximum response

Press the button again to return to volume control.

**NOTE:** *The subwoofer control will operate only with the optional subwoofer unit.*

## Balance:

Press four times, then rotate volume control to left or right to adjust balance between left and right speakers. Display shows:

'BAL R 9' = max sound from RIGHT

'BAL 0' = equal balance

'BAL L 9' = max sound from LEFT

## Fader:

Press five times, then rotate volume control to left or right to adjust balance between front and rear speakers. Display shows:

'FAD F 9' = max sound from FRONT

'FAD 0' = equal balance

'FAD R 9' = max sound from REAR

## Digital Sound Processing - DSP (if fitted):

Press six times, then rotate volume control to select from the following:

'DSP OFF'

'DSP SPATIAL'

'DSP DRIVER'

The sound quality will change to reflect the option displayed. When the desired option has been chosen, to select, wait for 5 seconds with that choice displayed. For further information about DSP modes, see 'Digital Sound Processing' later in this book.

**NOTE:** *After 5 seconds without further adjustment, audio mode deselected and reverts to volume control with the audio mode adjustments stored as the settings.*

<b>IMPORTANT</b>
------------------

*This unit is equipped with a 20 minute time-out function. This enables the unit to be switched on and then used for up to 20 minutes after the vehicle starter switch has been turned to position '0', even if the key is removed. This means that if a passenger is to be left in the vehicle, music can be listened to, without the security risk of leaving the keys in the starter switch. At the end of the 20 minutes, the unit will switch off automatically.*

---

# Radio Controls

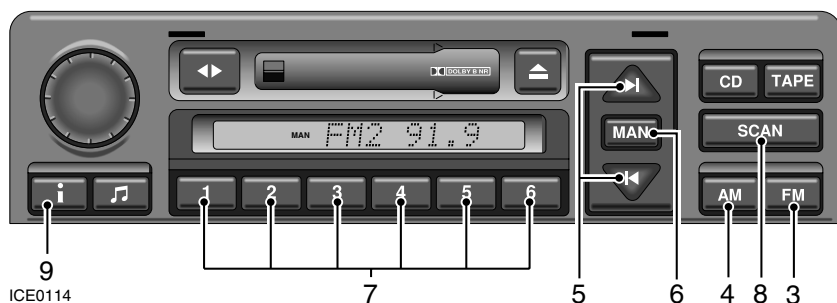

## RADIO CONTROLS

### 3. FM waveband selector

Press briefly to select FM frequencies. There are two FM bands (FM1 and FM2). Both have the same tuning range, and each one can be used to store six frequencies on the pre-set buttons.

Press and hold to activate auto-store (on FM2 only - see 'Auto-store').

### 4. AM waveband selector

Press briefly to select one of the three AM bands (AM1, AM2 and WB). Both AM wavebands can be used to store six stations on the pre-set buttons. For more information on 'WB' mode, see 'Weather band'.

Press and hold to activate auto-store (on AM2 only - see 'Auto-store').

### 5. Tuning buttons

Briefly press either button to search (manually or automatically) up or down the frequency range (see 'Radio tuning').

### 6. Manual tuning selector

Press to select manual tuning mode ('MAN' is displayed) - use in conjunction with the tuning buttons (see 'Radio tuning'). Press again to return to automatic tuning.

**NOTE:** The frequency can also be adjusted by using the remote switches on the steering wheel (see 'Owner's handbook').

### 7. Radio pre-set buttons (1-6)

Use to store up to 6 radio stations on the FM and AM wavebands.

Press briefly to select a stored frequency.

Press and hold (until radio bleeps) to store a frequency on a pre-set (see 'Pre-set buttons').

### 8. Scan mode button

Press the button to scan through all frequencies on the chosen waveband (5 seconds of each frequency will be played). Press again to cancel the scan.

### 9. Programme type (PTY)

Press to activate PTY mode. Use the tuning buttons (5) to select the desired category, then press the PTY button again to find a station broadcasting the selected programme type (see 'Programme type').

# Cassette Player

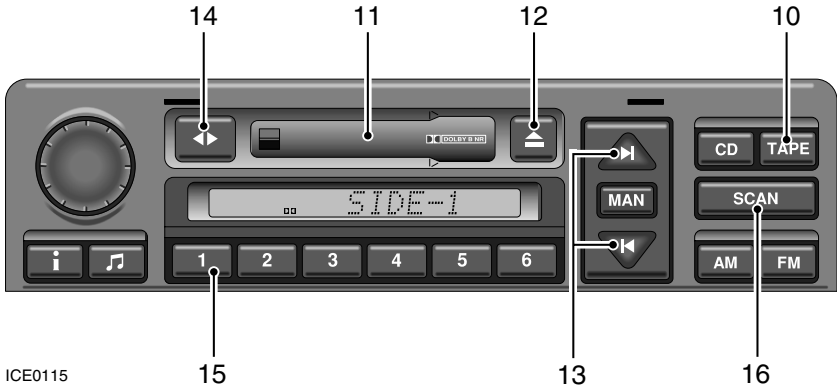

## CASSETTE PLAYER CONTROLS

### 10. Tape mode selector

Press to select tape play (display shows 'SIDE-1' or 'SIDE-2').

If the set is switched off during tape play, the cassette remains in stand-by mode. Play resumes when the set is switched on again.

### 11. Cassette compartment

Insert the tape with the open side to the right and push in gently. The radio mutes and tape play starts immediately.

**NOTE:** At the end of either side of the tape, play will automatically continue in the opposite direction.

### 12. Cassette eject button

Press to eject the tape (display shows 'TAPE EJECT'). The unit returns to radio mode, selecting the waveband and frequency last in use.

**NOTE:** If the tape is ejected when the set is in radio or CD mode, sound briefly mutes.

### 13. Tape search controls

#### Fast forward/rewind:

Press the manual mode button ('MAN'), then press and hold (for at least 1 second) the appropriate search button ('TAPE FFWD' or 'TAPE REW') (appear in the display). The tape will fast forward/rewind until the search button is pressed again.

#### Skip:

With the unit in automatic mode, press the appropriate search button to skip to either the beginning of the next track, or the beginning of the current track ('SEEK', and chevrons indicating direction, appear in the display). Press the button repeatedly to skip forwards or backwards through more than one track.

**NOTE:** The skip function may not find spaces between tracks of less than three seconds duration, and may also be confused by excessive background noise, very soft musical passages and intermittent pauses in music or speech.

**NOTE:** Skip and mode selection can be operated using the remote switches on the steering wheel (see 'Owner's handbook').

# Cassette Player

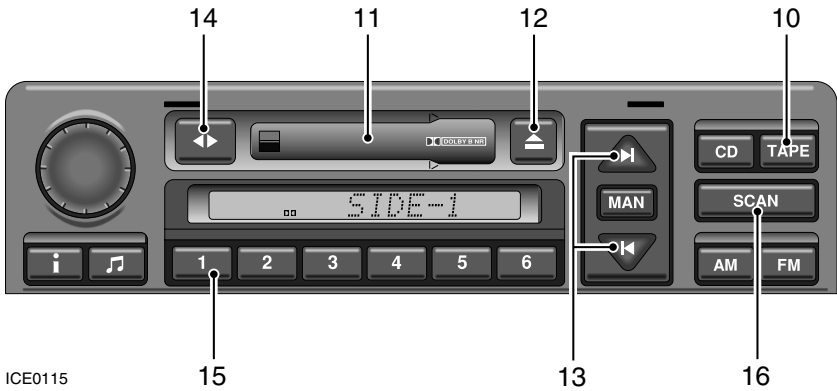

## 14. Tape reverse

Press to play the opposite side of the tape.

## 15. Dolby B noise reduction \*

Press pre-set 1 when playing tapes recorded using the Dolby B NR system (display shows 'DD').

## 16. Tape scan button

Press the SCAN button to listen to the first 10 seconds of each track on the tape (both sides). The display shows 'TAPE SCAN'. The scan continues until the button is pressed again or until another function is selected.

\* Noise reduction manufactured under license. Dolby and the double 'D' symbol are trade marks of Dolby Laboratories Licensing Corporation.



# Compact Disc Player

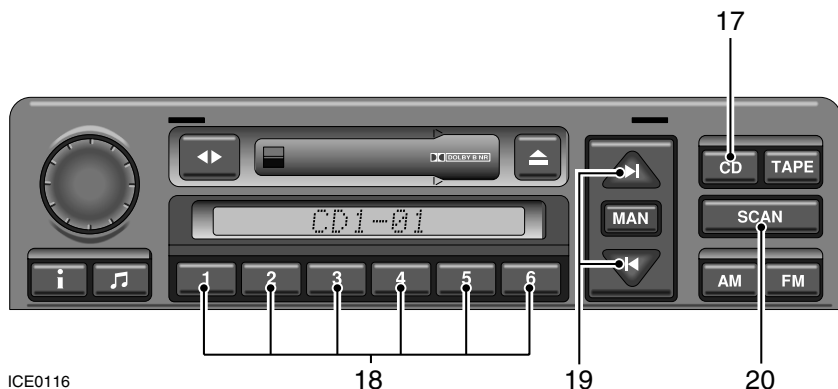

ICE0116

18

19

20

## COMPACT DISC PLAYER CONTROLS

(if fitted)

### 17. CD mode selector

Press to select CD player mode. Playback starts from the point on the disc at which play last stopped, or from the start of the first disc if the magazine is newly inserted. The display shows disc number ('CD1') and track number ('01'). If no magazine has been inserted into the autochanger, 'NO MAGAZINE' is displayed.

At the end of each disc, playback automatically continues with the next disc (missing discs are skipped if less than six have been loaded).

**NOTE:** If a disc has been inserted into the magazine upside down, 'CD ERROR' is displayed.

### 18. Disc selection buttons (1-6)

Press the appropriate button to select the desired disc. If an empty compartment is selected, the display shows 'NO DISC' and the next available disc is selected instead.

**NOTE:** Skip and mode selection can be operated using the remote switches on the steering wheel (see 'Owner's handbook').

**NOTE:** The compact disc player controls will operate only with the optional CD changer unit.

# Compact Disc Player

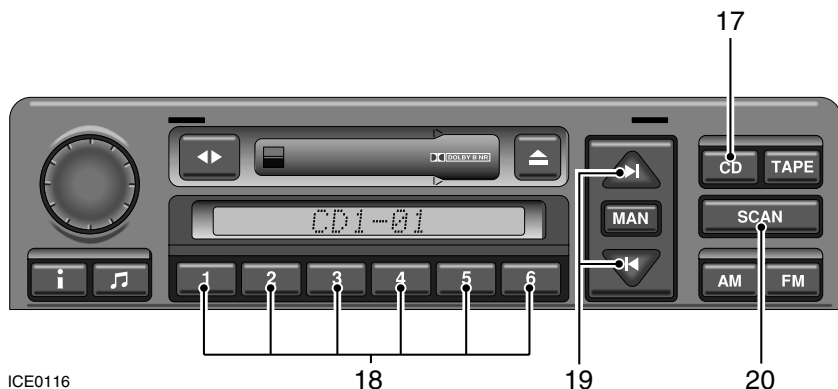

## 19. Track search buttons

### Skip:

Press the appropriate button to skip to the beginning of the next, or back to the beginning of the current track (the display shows disc and track numbers). Press the backward search button twice to skip to the beginning of the previous track. If the button is pressed and held, the CD player continues to skip tracks (forwards or backwards) until the button is released.

### Search:

Press the Manual mode button ('MAN'), then press and hold the appropriate search button to move forward or backward (display shows 'FFWD' or 'FREW') through the track at a greatly increased play speed (volume reduces).

## 20. Scan mode button (SCAN)

Press the SCAN button to listen to the first 10 seconds of every track on the selected disc. 'SCAN' appears in the display, along with the numbers of the disc and the scanned track. The scan continues until the button is pressed again or until another function is selected.

Press and hold the button for approximately 2 seconds (until the set bleeps) to activate the random play mode ('RND' and the disc and track number are displayed). This allows any track from any loaded disc to be played at random.

# Radio Tuning

## RADIO TUNING

If you know the frequency of the radio station you are seeking, or you need to select a radio station that is too weak to be found by automatic tuning, use manual tuning, as follows:

Select the desired waveband (FM or AM), then press the 'MAN' button (6). By briefly pressing either tuning button (5), the frequency changes (either up or down) in steps of 0.1 MHz for FM, or 1 kHz for AM.

### Fast manual tuning

By keeping either manual tuning button depressed, the waveband is scanned rapidly (up or down) until the button is released.

### Automatic tuning

Select the required waveband (FM or AM), then briefly press one of the tuning buttons (5) - ('SEEK' along with the chosen waveband appear in the display).

The radio automatically searches the frequency range (either up or down depending upon which button is pressed) looking for a station of acceptable strength. The search then stops unless you choose to continue by pressing the tuning button again.

The search can be stopped at any time by pressing any pre-set button.

### Weather band

Press the AM button (4) up to three times until 'WB' appears in the display. The radio will automatically search for the strongest national weather station signal in the area.

If the radio is unable to find a sufficiently strong weather information signal, it will continue to search ('NO WB' appears in the display) until a strong enough signal is found. To leave WB mode and return to radio/cassette or CD play, press the appropriate AM, FM, TAPE or CD mode button.

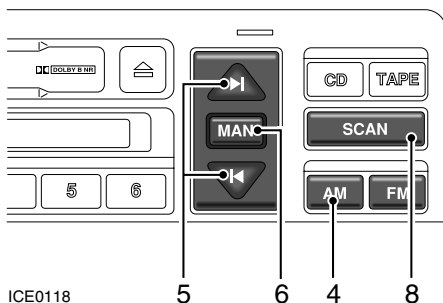

ICE0118

### Waveband scan

Select the desired waveband (FM or AM) and press the SCAN button (8). The radio scans through the waveband, seeking stations of acceptable strength (the waveband, frequency and 'SC' are displayed). The radio stops at each one it finds and plays that station for 5 seconds, the radio then mutes and scans for the next station.

To stop the scan, press the button again - the radio commences playing the station at which the scan was stopped.

**NOTE:** If you have a car telephone with a mute signal output connected to the radio, the radio automatically mutes when the telephone is in use.

### MONO/STEREO

Whenever the FM waveband is selected, the radio automatically reproduces stereo sound, provided a suitable signal is available. However, if a signal becomes too weak for good stereo reception, only mono sound is produced until the signal strengthens sufficiently for stereo sound reproduction.

# Radio Pre-sets

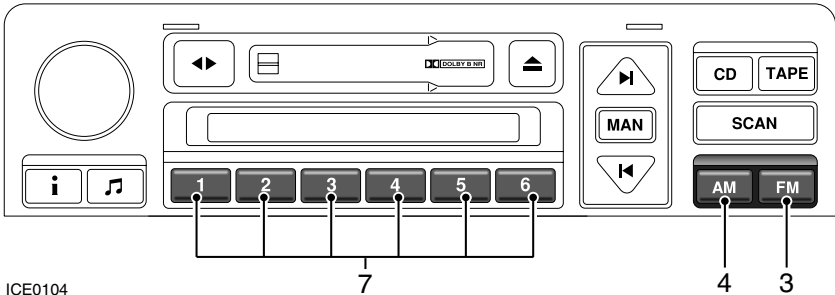

ICE0104

## RADIO PRE-SET BUTTONS

The six pre-set buttons (7) can be used to manually store up to twelve FM stations (six each on FM1 and FM2) and twelve AM stations (six each on AM1 and AM2). The pre-sets are programmed as follows:

### Programming the pre-sets

- Select the required waveband (FM1, FM2, AM1 or AM2).
- Tune to the desired frequency using either automatic or manual tuning.
- Press and hold one of the pre-set buttons until a bleep sounds. The frequency is now stored (the display shows the waveband and frequency or name of the station to which you have tuned).

***NOTE:** Once the pre-sets have been programmed, they will be retained by the unit until they are re-programmed or until the battery is disconnected.*

### Operating the pre-sets

Once the pre-set buttons have been programmed, operation is simple; select the desired waveband, then press the pre-set button of your choice.

# Auto-store

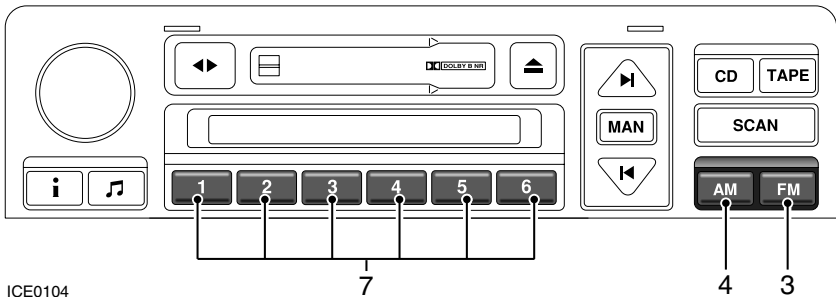

## AUTO-STORE

Auto-store enables you to rapidly tune and store the strongest FM and AM radio signals in a single operation. This facility is particularly useful if you are in an unfamiliar area and have little knowledge of local transmitter frequencies.

### Programming auto-store

Press and hold the appropriate waveband selection button (3 or 4) until a bleep sounds (the radio mutes and the display shows either 'FM AUTOSTORE' or 'AM AUTOSTORE').

Auto-store scans the waveband to find the six strongest frequencies and then stores them on either the FM2 or AM2 pre-set buttons in order of signal strength.

**NOTE:** Auto-store overwrites any stations already stored on the FM2 or AM2 pre-set buttons.

Radio play resumes when the operation is complete.

**NOTE:** If auto-store is unable to find six strong stations, the remaining pre-set buttons remain blank.

### Operating auto-store

To tune to one of the auto-store frequencies, select FM2 or AM2, then press the pre-set button of your choice; the frequency or radio station name appears on the display.

# Radio Data System

---

## RADIO DATA SYSTEM (RDS)

This radio is equipped with RDS (Radio Data System). RDS operates on the FM waveband and enables the radio to receive other information in addition to radio signals, including:

- *the programme service name* (this enables the set to display the radio station name instead of the frequency).
- *programme type selection* (allows choice of listening by one of 15 programme types rather than by radio station name).
- *an alarm announcement system* (this enables the set to give priority to emergency information; eg. a very serious accident or natural disaster). All other audio functions will be overridden ('ALERT' appears in the display).

### Receiving RDS stations

The radio is automatically in the RDS mode whenever the FM waveband is selected.

Whenever an RDS radio station is received, the radio station name illuminates in the display.

**NOTE:** *This facility can be deactivated or reactivated by your dealer.*

**NOTE:** *Not all FM radio stations broadcast RDS. If a non-RDS station is received the RDS features described previously will not be available.*

### Local radio stations

Reception of most local radio stations is intentionally limited to a comparatively small area around the transmitter.

# Programme Type

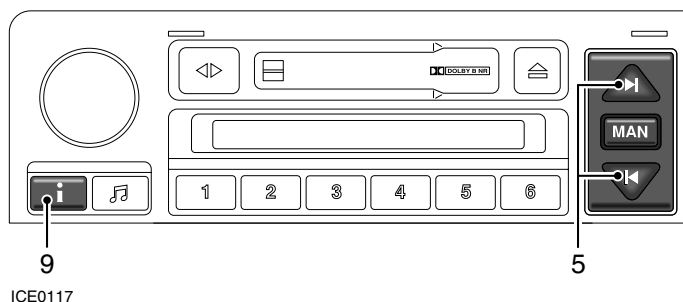

ICE0117

## PROGRAMME TYPE (PTY)

PTY is a service whereby RDS compatible radio stations are able to transmit a signal which identifies the programme content. Your radio is able to receive and decipher this signal, thereby enabling you to select a programme category, which will then be given priority over other broadcasts.

For example, if you want to listen to classical music, select the 'CLASSICAL' category and the set will automatically search for and broadcast a station transmitting the 'CLASSICAL' PTY code.

### Operating PTY

Select your chosen PTY category as follows:

- Press the Programme type button (9); the current PTY category will appear in the display (eg. 'COUNTRY').
- To change the category, scroll up or down through the list of 22 options using the tuning buttons (5).
- Press the Programme type button again - the radio will search through the waveband for a station broadcasting the selected PTY code.

In some circumstances (depending on the time of day, popularity of programme choice, etc), the set may not be able to immediately locate a radio station broadcasting the chosen PTY code - the display will show 'NO PTY' and return to the original station.

The 22 categories available for selection are as follows.

1. 'NEWS'
2. 'INFORM'
3. 'SPORTS'
4. 'TALK'
5. 'ROCK'
6. 'CLASSIC ROCK'
7. 'ADULT HIT'
8. 'SOFT ROCK'
9. 'TOP 40'
10. 'COUNTRY'
11. 'OLDIES'
12. 'SOFT'
13. 'NOSTALGIA'
14. 'JAZZ'
15. 'CLASSICAL'
16. 'R & B'
17. 'SOFT R&B'
18. 'LANGUAGE'
19. 'REL MUSIC' - (religious music)
20. 'REL TALK' - (religious talk)
21. 'PERSONALITY'
22. 'PUBLIC'

# Digital Sound Processing

---

## DIGITAL SOUND PROCESSING (DSP)

(if fitted)

To improve overall sound quality and the ability of the audio system to negate the effects of adverse road and travelling conditions on audio reception, some vehicles are fitted with DSP. In addition, DSP provides 'intelligent' interaction with other vehicle equipment, such as the navigation system and telephone.

### Audio quality

#### Driver adjustable features

Press the audio selection button 6 times to access the DPS menu. Rotate the volume control to select the desired option:

'DSP OFF' - Select to cancel all DPS features.

'DSP SPATIAL' - Select to optimise treble and bass responses, adding width, height and imaging to the standard audio signal, to give a more dynamic output for all occupants of the vehicle.

'DSP DRIVER' - Concentrates the field of sound across the width of the vehicle in the area between the driver and the windscreen. Select when only the driver is in the vehicle.

**NOTE:** After 5 seconds without further adjustment, the option displayed is selected and the display reverts to normal.

#### Automatic features

'Speed dependent volume and sound equalisation' - The volume and sound equalisation levels will automatically adjust to compensate for road noise.

'Speed & volume dependent compression' - The audio system takes into account road speed and any quiet audio passages, to improve volume and sound quality.

'Dynamic headroom management system' - The audio system monitors both the input and the output for the amplifier, thereby optimising its performance to ensure maximum output with minimal background 'noise'.

### Audio interaction

With the audio system switched on, the digital amplifier is able to prioritise any output to, or information for, the driver in order of importance, whilst minimising any inconvenience to other occupants.

#### Navigation messages

The audio system output to the front speakers is muted and the navigation system uses these speakers to relay messages to the driver. Audio output to the rear speakers is unaffected.

#### Telephone calls

The audio system output to the front speakers is muted and the telephone call is received through these speakers. Audio output to the rear speakers is unaffected.

#### Navigation messages & telephone calls

If both a navigation message and a telephone call are received at the same time, audio system output to all speakers is muted. The navigation message will be relayed to the driver through the rear speakers, and the telephone call will be received through the front.

If the audio system is not turned on and both a navigation message and a telephone call are received at the same time, the configuration will be as above, but the volume levels will be as set independently in the respective navigation and telephone modes.

**NOTE:** When the navigation message or phone call is complete, the audio output reverts to its previous level

#### Emergency announcements

If the Radio Data System receives an emergency announcement, all other audio output is overridden - including the navigation system and telephone (see 'Radio data system (RDS)'). 'ALERT' appears in the display for the duration of the announcement.



# Radio Reception

**Distortion, interference and lack of signal clarity, are often attributed to a fault in the radio - this is rarely the case.**

Problems of this kind are usually caused by phenomena such as atmospheric conditions, signal strength, hilly terrain, tall buildings, bridges and even electrical interference from power lines.

**Please remember:** A car radio receives signals while the vehicle is in motion (unlike a domestic set) - constantly changing direction and moving away from, or nearer to, the transmitter whilst negotiating terrain with widely differing reception characteristics. Some interference is to be expected from time to time.

FM transmitters can only broadcast over a limited range and good, clear signals will only be received in the immediate area of the transmitter. When travelling, it may be

necessary to re-tune the radio from time to time, to offset the effects of moving from one transmitter area to another.

The broadcast range for good stereo reception (usually within a 30 to 40 mile radius of the transmitter) is noticeably less than it is for mono.

FM Signals (like light waves) travel in a straight line, so large obstacles, such as tall buildings, can shield the car from the signal causing distortion or loss of reception (known as dead spots).

Distortion can also occur if FM signals received directly from the transmitter mix with signals which have been reflected by obstructions such as mountains, hills and tall buildings (this is known as multi-path distortion).

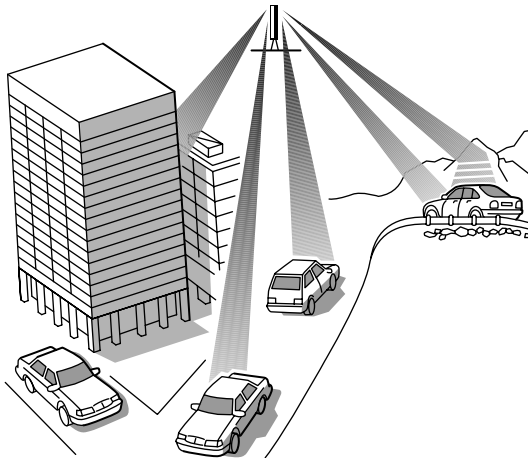

ICE 0052

# Care of Cassette Player and Tapes

---

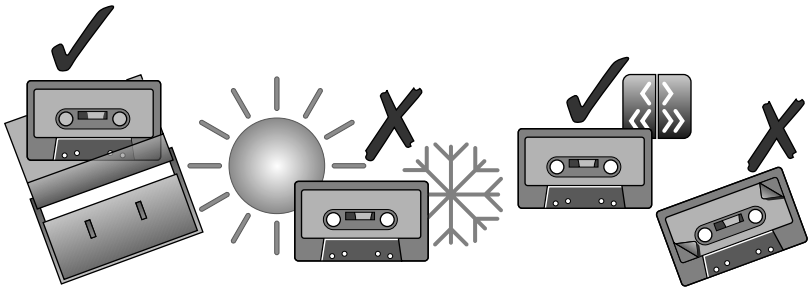

ICE 0054

Use only good quality tapes with a maximum capacity of ninety minutes (C90). Check that both spools rotate freely and remove any loose turns at the start of the tape by winding one spool with a pen or pencil.

## Cassette player

In use, the tape head accumulates dust and contamination, gradually impairing sound reproduction and, in extreme cases, reducing volume too. To combat contamination, clean the tape head periodically (after approximately every 20 hours playing time) by passing a wet type cleaning cassette through the player.

**NOTE:** *Because your cassette player is fitted with auto reverse, the cleaning cassette must be played in both directions.*

The tape will require more frequent cleaning in winter, as contamination is greater in conditions of low temperature and increased humidity. However, the use of good quality tapes, keeps the build up to a minimum.

## Cassette tapes

- Always store cassettes in their boxes when not in use.
- Never leave cassettes in the vehicle during extremes of temperature. In particular, do not leave tapes in direct sunlight as they may warp and become unuseable, or jam the tape player mechanism.
- Fast forward, or rewind tapes every 8 to 10 plays to prevent them from becoming too tightly wound.
- Ensure that labels attached to the cassette are glued firmly in place.
- DO NOT leave tapes in the cassette player for more than a few hours in very cold or humid conditions - the oxides on the tape surface may contaminate the cassette player mechanism.

**NOTE:** *After continuous playing, cassettes may become hot to touch. This is normal and will not harm good quality tape.*

# CD Autochanger & Discs

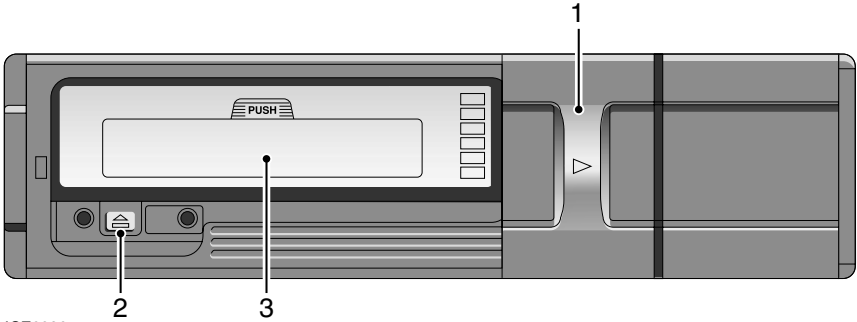

ICE0096

## COMPACT DISC CHANGER UNIT (if fitted)

The CD autochanger is located on the left hand side of the luggage compartment.

### Removing/inserting the magazine

Fully open the sliding cover (1) to insert or remove the magazine. Keep the cover closed at all other times to prevent dust and dirt from entering the changer unit.

Press the button (2) to eject the magazine.

Insert the magazine (3) in the direction of the arrow marked on the magazine casing and push it fully into the changer. Finally, close the sliding cover.

### Loading & unloading the magazine

Holding the magazine as shown (arrow uppermost), remove each CD tray in turn.

Place a disc (label side uppermost) onto each tray - holding ONLY the outside edge and centre hole of the disc. Load only one disc in each tray. Correctly align the tray with the parallel slots on each side of the magazine and slide the tray into the magazine.

To unload the magazine, hold the magazine with the arrow uppermost, pull out each tray in turn, holding the tray securely so as not to drop the disc. Unload one disc at a time and handle only the edge and centre of the disc.

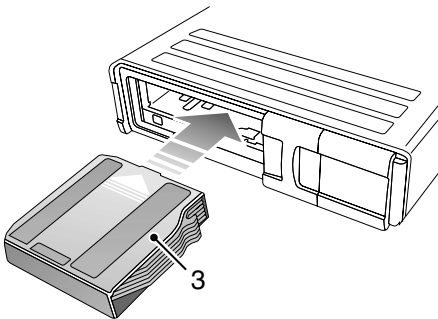

ICE0097

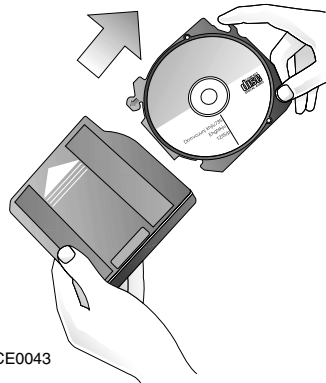

ICE0043

# Caring for Compact Discs

## IMPORTANT

- Use standard 12cm CDs only.
- DO NOT use irregularly shaped or damaged CDs - these may damage the compact disc changer.
- 8cm CD singles must NOT be used, even if a CD adaptor is fitted.
- The CD autochanger should not be used in temperatures outside the range  $-10^{\circ}\text{C}$  to  $+60^{\circ}\text{C}$ .
- In the unlikely event that the CD autochanger overheats, 'CD OVER TEMP' will be displayed - change to radio or tape mode until the unit has cooled.
- The CD autochanger should only be used as described - any other application or method of use could result in the user being exposed to invisible laser radiation exceeding the limit of laser class 1.

**NOTE:** Additional magazines can be obtained from a Land Rover dealer.

## CARING FOR COMPACT DISCS

Dirt, dust, condensation and heat can damage discs. Always observe the following precautions:

**NEVER** touch the horizontal playing surface (the unlabelled side) of a disc! Handle discs by holding the outer edges, or the edge of the central hole and the outer edge, between finger and thumb.

**ALWAYS** return discs to their boxes after use (dirt detracts from the sound quality).

**NEVER** leave the disc or the box exposed to excessive heat or direct sunlight!

**NEVER** use a solvent or abrasive cleaner! Dust or dirt should be removed from the playing surface by wiping with a clean, dry, lint-free cloth always wipe in a straight line from the centre to the edge of the disc!

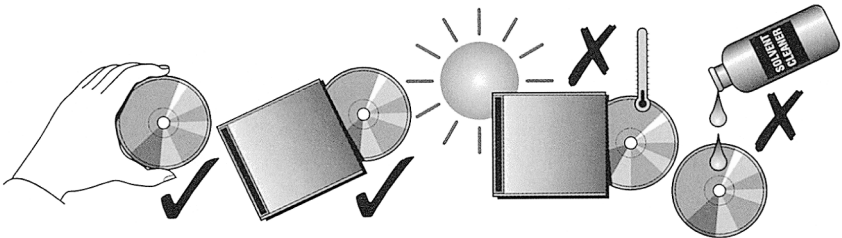

ICE 0022

# Security Code

---

## SECURITY CODE INFORMATION

**NOTE:** *Your vehicle was delivered with the security code disabled, if you wish to have the code activated, consult your Land Rover dealer.*

To reduce the risk of theft, Range Rover radio/cassette and CD players are programmed with a four digit security code. Once activated, this code prevents the unit from functioning if it is illegally removed from the vehicle. There are 10,000 different codes - making your radio equipment valueless to a thief unless he has the correct one. In addition, each unit is further protected by a time delay penalty system that effectively defies even the most systematic attempt to break the code.

**NOTE:** *If an incorrect code is entered, a one minute time delay is imposed before a second code can be attempted. Each time a wrong code is entered, the time delay doubles (2 min, 4 min, 8 min, etc.) making theft a very unattractive proposition.*

The vehicle was supplied with a Security Information card. This card contains a record of the four digit security code, as well as the unit's unique serial number. The serial number is also stamped into the metal side of the unit and, in the event of theft, would confirm proof of ownership.

It is VERY IMPORTANT that you keep a safe record of the security code and heed the following advice:

- NEVER keep a record of the security code in the vehicle.
- PLEASE stick the security warning stickers where the potential thief is sure to see them, but where they do not impede your vision of traffic and pedestrians.
- If you lose your code number, contact the nearest Land Rover dealer, who will be able to obtain this information for you.

# Security Code

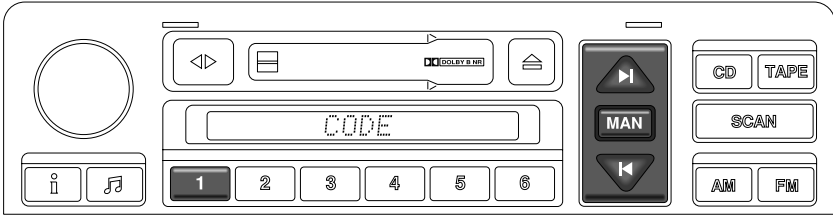

ICE0106

## ENTERING THE SECURITY CODE

If the code has not already been entered, or power to the set has been interrupted, the code **MUST** be entered before the set will operate. Enter the code as follows:

- Switch on the radio ('CODE' appears in the display). Press pre-set button 1.
- Press either the up or down tuning button (highlighted in illustration) until the first digit of the security code appears in the display. Press pre-set 1 to store the first digit in the unit's memory.
- Use either tuning button to select the second digit of the code (correct digit appears in the display). Press pre-set 1 to store the second digit.
- Select the third digit, again using the tuning buttons (until the correct digit is displayed). Press pre-set 1 to store the third digit.
- Select the final digit (the display now shows the full four digit code). Press pre-set 1 to store the final digit.

If the correct code has been selected, a two-tone bleep sounds and the radio will operate.

**NOTE:** If an incorrect code has been entered, the first time delay period commences. During the delay period, 'WAIT' appears in the display - **DO NOT** switch off. At the end of the delay period, 'CODE' reappears in the display and you can then enter the correct code. Remember; the time delay period doubles each time an incorrect code is entered.