

SERVICE MANUAL

NISSAN PATROL

MODEL
60 SERIES



NISSAN MOTOR CO., LTD.
TOKYO, JAPAN

SERVICE MANUAL

NISSAN PATROL MODEL 60 SERIES



NISSAN MOTOR CO., LTD.

TOKYO, JAPAN

GROUP INDEX	
Title	Page
GENERAL	1
EXPLANATION OF DIFFERENCES BETWEEN VARIOUS MODELS OF 60 SERIES	17
ENGINE	29
CLUTCH	35
TRANSMISSION	45
TRANSFER CASE	65
PROPELLER SHAFT AND UNIVERSAL JOINTS	87
FRONT SUSPENSION	93
FRONT AXLE	101
REAR SUSPENSION	141
REAR AXLE (MODEL 60 AND 660)	147
REAR AXLE (MODEL 660H)	157
BRAKES	171
STEERING SYSTEM	189
WHEELS AND TIRES	201
ELECTRICAL SYSTEM	209

FOREWORD

The information in this Service Manual covers a brief description of construction, and through data on operation, care, specifications, and overhaul of the Nissan Patrol Model 60.

This Manual should be kept in a place handy for quick reference. Properly used, you will be able to better service Nissan Patrol, building an enviable reputation for outstanding service in your locality.

It is emphasised that only genuine Nissan Spare Parts should be used as replacements.

A "Service News Reference" memoranda space has been provided at the end of each section so you may note any additional service information received during the current period following publication of the Manual. Certain helpful service information will be given as "Service Bulletin" and "Service Journal".

GENERAL

1. MAJOR SPECIFICATION

MODEL

Model	80
Year	1960
Kind of vehicle	4-wheel-drive
Name of vehicle	Nissan Patrol
Maker.....	Nissan Motor Co., Ltd.
Location	Yokohama, Japan

CAR DIMENSIONS

Overall length (approx. mm).....	3770
Overall width (approx. mm)	1693
Overall height (approx. mm)	1980
Wheel base (mm)	2200
Tread-Front (mm)	1386
-rear (mm)	1404
Road clearance (mm)	222
Rear Floor height at rear end (no load mm)	725
Rear overhang (mm)	730 (Rear axle center to rear end of body)

CAR WEIGHT

Weight of B chassis (kg)	1310
Distribution - Front (kg)	814
- Rear (kg)	496
Weight of vehicle (kg)	1565
Distribution - Front (kg)	825
- Rear (kg)	740
Height of gravitational center (mm)	640
Maximum over turn angle	
- Right (deg.)	47°
- Left (deg.)	47°
Maximum pay load (kg)	400 kg
Seating capacity	
- with load (persons)	2
- without load (persons)	6
Gross vehicle weight with load (kg)	2075
Distribution-Front (kg)	845
-Rear (kg)	1230

PERFORMANCE

Maximum speed (km/hr)	117
Fuel consumption (km/ltr)	9.0
(on paved road)	
Grade ability (sin θ)	0.6
Minimum turning radius (m)	5.5
Brake stopping distance (m)	14.0
(at 50 km/hr)	

ENGINE

Model	P
Cylinder number and arrangement	6 cylinder, in-line
Cycle	4 cycle
Valve arrangement	1 type over head valve
Bore x stroke (mm)	85.7 x 114.3 (3-3/8x4-1/2 ins)
Total piston displacement (cc)	3,956 (242 cu.ins.)
Compression ratio	7:6
Max. power/rpm	145 hp/3800rpm.
Max. torque/rpm	235ft-lbs/2000 r.p.m.
Length x width x height(mm) (without transmission)	(S.A.E.rating) 904 x 671 x 938
Weight (kg) (without transmission)...	295
Firing order	1-5-3-6-2-4

IGNITION SYSTEM

Ignition system	12V battery and coil
Ignition timing	10deg. B.T.D.C.
Ignition coil	Hitachi CIZ-01
Distributor	Hitachi D617-01
Automatic advance	Centrifugal and vacuum type
Spark plugs	NGK B-54E or B-6E (14 mm)
Spark plug gap	0.6 - 0.7 mm

FUEL SYSTEM

Carburetor	Hitachi VC-42-4A
Fuel tank capacity	50 ltr (13 U.S gal)
Fuel strainer	Glass bowl type
Fuel pump	Mechanical diaphragm type
Air cleaner	Oil bath type

LUBRICATION SYSTEM

Lubrication method	Pressure-feed and splash lubrication
Oil pump	Gear type
Oil filter	Filter-paper, by-pass type
Oil capacity	6.7 ltr (1.8 U.S gal)

COOLING SYSTEM

Cooling method	Water-cooling, forced circula- tion
Radiator	Fin and tube, pressurised type
Cooling water capacity	17.5 ltr. (4.6 U.S. gal)
Water pump	Centrifugal type, belt driven
Thermostat	Bellows type

BATTERY

Model	25MC
Voltage	12 V
Capacity	60 AH (20 hr rate)
Terminal grounded	positive

GENERATOR

Model Hitachi G 115-11
Generating system Shunt winding
Voltage 12V
Capacity 200W
Voltage-current regulator Hitachi carbon-pile type

STARTER MOTOR

Model Hitachi
Voltage and power 12 V. 1.4 hp

CLUTCH

Type Dry single-plate type
Operating system Mechanical
Facing Dimension (mm) 275 x 175 - 3.5 mm

TRANSMISSION

Type Three forward speeds and one reverse, synchromesh on 2nd and top gear, water protect type

Gear ratio	T/M	Aux. Trans.	Range
1st speed	2.900:1	High	Low
2nd "	1.562:1	1 : 1	2.264 : 1
3rd "	1.000:1		
Reverse	3.015:1		
Oil capacity Transmission	2 ltr. (0.52 U.S gal)		
Oil capacity Auxiliary transmission	3.4 ltr. (0.90 U.S. gal)		

PROPELLER SHAFT

Type Steel bar and steel tube
Universal joint Spicer type

REAR AXLE

Type Semi-floating
Gear ratio 4.10 (41T:10T)
Drive system Hypoid bevel gear
Oil capacity 1.2 ltr. (0.32 U.S gal)

STEERING SYSTEM

Gear mechanism Worm and roller
Gear ratio 23.6:1
Steering angle-inside 28°
-outside..... 25°32'

FRONT AXLE

Type Tracta joint type
Toe-in 3 - 4 mm
Camber 1°30'
Caster 1°30'
Knuckle flange inclination..... 7°30'

BRAKE SYSTEM

Type Foot brake Hydraulic, internal expansion
2-shoes type.
Drum dia 11.5"
Hand brake Mechanical, external clamping
type
Drum dia 5.9 in.

SPRING AND SHOCK ABSORBERS

Front springs Parallel semi-elliptic leaf
springs
Dimension and number of leaves 1100 x 70 x 6.5mm-3
1100 x 60 x 6.0mm-1
Rear springs Parallel semi-elliptic leaf
springs
Dimensions and number of leaves 1300 x 70 x 7.5 mm - 5
Shock absorbers
Type Telescopic, double acting
front & rear.
Stabilizer Torsion bar type, front and
rear

FRAME

Type Pressed steel box section
ladder type all parts welded.

WHEELS

Type Steel disc

TIRES

Type - Front 6.50-16-6P
- Rear 6.50-16-6P
Max. load, long distance
driving
Air pressure ... Front ... 22 lbs/sq.in 24 lbs/sq.in.
Rear 30 lbs/sq.in 36 lbs/sq.in.

P.T.O-device (optional)... Power to front, center or rear

CAUTION: Refer to the paragraph "EXPLANATION OF DIFFERENCES
BETWEEN MODEL 60 AND G60H"

2. IDENTIFICATION NUMBER

The manufacturers chassis serial number is stamped on the right frame side member at the front end, and the engine serial number is stamped on the right side of the cylinder block, front lower corner.

Both of the above serial numbers are stamped on a name plate at engine room side of dash panel under hood.



Location of chassis serial number stamped

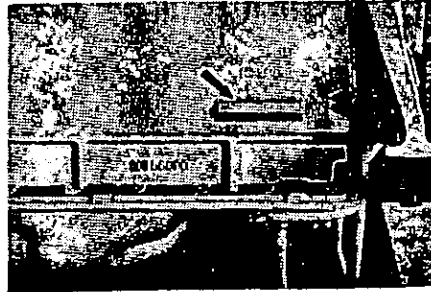

Location of engine serial number stamped

3. GENERAL LUBRICATION

(3-1) UNIT CAPACITIES

Engine	6.7 ltr. (1.8 U.S. Gal.)
Transmission	2.0 ltr. (0.52 U.S. Gal.)
Transfer case	3.4 ltr. (0.90 U.S. Gal.)
Front axle	1.2 ltr. (0.31 U.S. Gal.)
Rear axle	1.2 ltr. (0.31 U.S. Gal.)

The selection of the proper lubricant and its correct application at regular intervals does much to increase the life and operation of all moving parts of the vehicle. Consequently it is important that the correct grade of oil or grease, as noted in the following descriptions, be used.

(3-2) ENGINE LUBRICATION

Proper selection of the oil to be used will add much to the performance, reliability, economy and long life of the engine.

(A) OIL PRESSURE GAUGE

When starting a cold engine, it will be noted that the oil gauge on the instrument panel registers a high oil pressure. As the engine warms up, the pressure will drop until it reaches a point where changes to higher speeds will raise the pressure very little, if at all.

If the oil pressure registers abnormally high after the engine is thoroughly warmed up, an inspection should be made to ascertain if the oil lines and passages are "plugged" up.

(B) LUBRICATION

The oil should be selected to give the best performance under the climatic and driving conditions, in the territory in which the vehicle is driven.

When the crankcase is drained and refilled, the oil should be selected, not on the basis of the existing temperature at the time of the change, but on the lowest or highest temperature anticipated for the period during the oil is to be used.

The grades best suited for use in an engine at the various temperatures are shown in the following table.

Temperature	Under 10°F -12°C	10°F—90°F -12°C—32°C	Over 90°F 32°C
Grade of oil	SAE 10W MS	SAE 20W/20 MS	SAE 30 MS

(C) MAINTAINING OIL LEVEL

The oil level gauge is marked "MAX" and "MIN". The oil level should be maintained between these two lines; neither going above the "MAX" line nor under the "MIN." line.

Check the oil level frequently and add oil when necessary. Always be sure the crankcase is full before starting on a long drive.

(D) WHEN TO CHANGE ENGINE OIL

Some oils have been greatly improved, driving conditions have changed, and improvements in engines have greatly lengthened the life of good lubricating oils. However, to insure continuation of best performance, low maintenance cost and long engine life, it is necessary to change the engine oil whenever it becomes contaminated with harmful foreign materials. Under normal driving conditions draining the

crankcase and replacing with fresh oil every 3,000 Km (2,000 Miles) is recommended. Under the adverse driving conditions described in the following paragraphs, it may become necessary to change the engine oil more frequently.

Driving over dusty roads or through dust storms introduces abrasive material into the engine. Carburetor Air Cleaners decrease the amount of dust that may enter the crankcase. The frequency of changing depends upon severity of dust conditions and no definite draining periods can be recommended.

Short runs in cold weather, such as city driving, do not permit thorough warming up of the engine and water may accumulate in the crankcase from condensation of moisture produced by the burning of gasoline. Water, in the crankcase, may freeze and interfere with proper oil circulation. It also promotes rusting and may cause clogging of oil screens and passages. Under normal driving conditions this water is removed in the form of vapor by the crankcase ventilator. But if water accumulates, due to short runs in cold weather, it should be removed by the changing the engine oil as frequently as may be required.

It is always advisable to drain the engine oil only after the engine has become thoroughly warmed up or reached normal operating temperature. The benefit of draining is, to large extent, lost if the crankcase is drained when the engine is cold, as some of the suspended foreign material will cling to the sides of the oil pan and will not drain out readily with the cold, slower moving oil.

(E) CRANKCASE DILUTION

A phase of engine oil deterioration, probably the most serious of all, is that of crankcase dilution.

By crankcase dilution, we mean a thinning of the oil due to certain portions of the gasoline leaking past the pistons and rings and mixing with the oil.

Leakage of gasoline, or gasoline vapors, into the oil reservoir mostly occurs during the "warming up" period when the gasoline is not thoroughly vaporized and burned.

(F) AUTOMATIC CONTROL DEVICES TO MINIMIZE CRANKCASE DILUTION

The Nissan Model "P" engine is equipped with automatic devices which aid greatly in minimizing the danger of crankcase dilution.

Rapid warming up of the engine is aided by the thermostatic water temperature control, which automatically prevents circulation of the

water in the cooling system until it reaches a pre-determined temperature.

Thermostatic heat control on the exhaust manifold which during the warming up period, automatically directs the hot exhaust gases against the center of the intake manifold, greatly aids the proper vaporization of the gasoline.

The down-draft carburetor is an aid to easy starting, thereby minimizing the use of the choke. Sparing use of the choke reduces danger of raw, or unvaporized, gasoline entering the combustion chamber and leaking into the oil pan or crankcase.

An efficient crankcase ventilating system drives off gasoline and other vapors and aids in the evaporation of the raw gasoline and water which may find its way into the oil pan or crankcase.

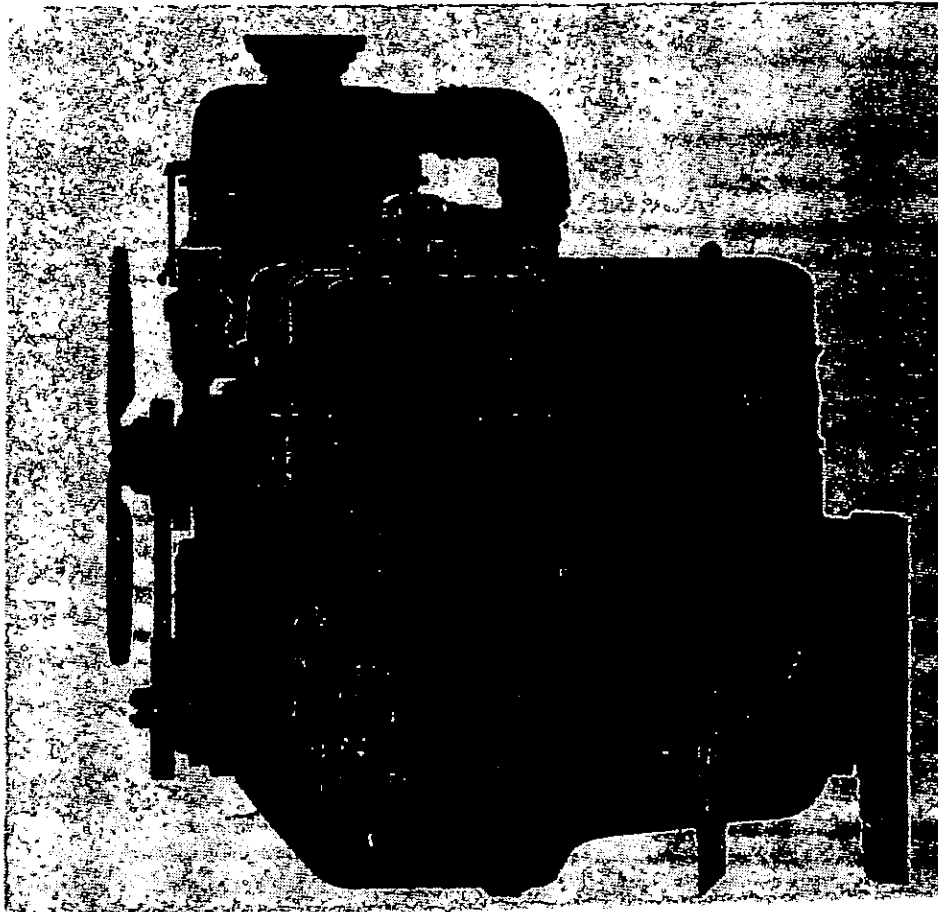

Crankcase Ventilation

(G) CONTROL BY OWNER UNDER NORMAL CONDITIONS

Ordinarily the above automatic control devices will minimize, or eliminate, the danger of crankcase dilution.

However, there are abnormal conditions of service when the owner must aid in the control of crankcase dilution.

Short runs in cold weather, such as city driving, do not permit the thorough warming up of the engine nor the efficient operation of automatic control devices. It is recommended that the oil be changed more often when the car is subject to this type of operation.

The car should be kept in good mechanical condition. Poor mechanical condition of the engine, such as scored cylinders, poor ring fit, "sloppy" or loose pistons, faulty valves, poor ignition and incomplete combustion will increase dilution. A good grade of gasoline should be used. Poor gasoline which contain portions hard to ignite and slow to burn will increase crankcase dilution.

(H) WATER IN CRANKCASE

Serious lubrication troubles may result in cold weather by an accumulation of water in the oil pan. This condition is, as a rule, little understood by the car owner. To demonstrate the chief cause of water in the oil pan, hold a piece of cold metal near the end of the exhaust pipe of the engine and note the rapid condensation and collection of drops of water on it. The exhaust gases are charged with water vapor and the moment these gases strike a cold surface, will condense, forming drops of water.

A slight amount of these gases passes the pistons and rings, even under the most favorable conditions, and causes the formation of water in the oil pan, in a greater or less degree, until the engine becomes warm. When the engine becomes thoroughly warm, the crankcase and oil pan will longer act as a condenser and all of these gases will pass out through the crankcase ventilator system.

Short runs in cold weather, such as city driving, will aggravate this water-forming condition.

(I) CORROSION

Practically all present-day gasolines contain a small amount of sulphur which, in the state in which it is found, is harmless; but this sulphur on burning, forms certain gases, a small portion of which is likely to leak past the pistons and rings and reacting with water, when present in the oil pan, form very corrosive acids. The more sulphur in the gasoline, the greater the danger from this

type of corrosion. This is a condition which can not wholly be avoided, but it may be reduced to a minimum by proper care of the engine.

As long as the gases and the internal walls of the crankcase are hot enough to keep water vapor from condensing, no harm will result; but when an engine is run in low temperatures, moisture will collect and unite with the gases formed by combustion: thus, acid will be formed and is likely to cause serious etching or pitting. This etching, pitting or corrosion, when using gasoline containing considerable sulphur, manifests itself in excessively rapid wear on piston pins, camshaft bearings and other moving parts of the engine, oftentimes causing the owner to blame the car manufacturer or lubricating oil when in reality the trouble may be traced back to the character of gasoline used, or the condition of the engine. such as excessive blowbys or improper carburetor adjustment.

(J) WATER PUMP LUBRICATION

Every 600 Km (or 400 miles), supply water pump grease to the bearing. But remember that lubrication to this part should be rather moderate than to other parts. Otherwise, the drain hole for the leaked cooling water will be clogged. That is why it is requested keenly to lubricate water pump periodically.

Wipe off the excessive grease around the nipple to avoid slip of the fan belt.

(K) STARTING MOTOR AND GENERATOR LUBRICATION

Every 600 Km (or 400 miles), lubricate the starting motor and generator by putting a few drops of light oil, or engine oil, in the oil cup.

(L) CLUTCH RELEASE BEARING LUBRICATION

The clutch release bearing is of the thrust ball bearing type and is lubricated at the time of manufacture. The bearing requires no further lubrication.

(M) DISTRIBUTOR LUBRICATION

The ignition distributor is equipped with a grease cup. Fill this cup with chassis lubricant, or equivalent soft, smooth grease and turn one or two turns down every 600 Km (or 400 miles).

To lubricate the rotor and the cam surface; apply one or two drops of light machine oil on the felt under the rotor, and also on the cam surface lubricate with cup grease which should not be over-saturated.

(3-3) FRONT AXLE, REAR AXLE AND TRANSMISSION LUBRICATION

(A) LUBRICANTS FOR AXLES AND TRANSMISSION

The axles and transmission, as delivered from the factory, are filled with SAE MP90 as the "Year-around" lubricant.

However, when extremely low temperatures are encountered for long periods of time during winter months, SAE MP80 grade may be used.

And also, during the summer months, or when the weather is extremely warm or the vehicle is the subject to other severe working conditions, a heavier grade of lubricant, such as SAE MP140, may be used in axles and transmission.

The following table shows the recommended oil grade in different temperature.

Temperature	Under 10°F -12°C	10 F — 90°F -12 C — 32°C	Over 90°F 32°C
Gear oil	SAE 80 MP	SAE 90 MP	SAE 140 MP

"MP" - multi purpose

(B) LUBRICANT ADDITIONS

The lubricant level in the axle and transmission case should be checked periodically.

It is recommended that any additions required to bring up the lubricant level, be made using the same type lubricant as in the housing or case.

The level of the lubricant under normal temperature should be just to the bottom of the filler plug opening.

(C) LUBRICANT CHANGES

While seasonal changes of the lubricant are not required, it is recommended that the housing and case be drained and refilled with the recommended lubricant at least twice a year, or every 10,000 Km (or 6,000 miles).

It may be necessary and desirable to drain axles and transmission in the vehicles in subject to severe service more frequently than recommended above.

CAUTION: Use a light flushing oil to flush out the housings when draining. Do not use water, steam, kerosene, gasoline, alcohol, ETC.

(3-4) UNIVERSAL JOINT LUBRICATION

The universal joint of front and rear propeller shaft is of the needle bearing type equipped with the lubrication fittings and should be lubricated with chassis grease recommended in the table which is shown at the end of this information.

The lubrication should be done every 600 Km (or 400 miles).

(3-5) FRONT WHEEL LUBRICATION

It is necessary to remove the wheels and drive flanges to lubricate the ball bearings which is used on front axle.

The bearing assemblies should be cleaned, and the bearing ball retainer packed with a high melting point front wheel bearing grease recommended in the following table.

In mounting the front wheels, great care must be taken to properly adjust the bearings, an operation that requires mechanical skill, which is described in the Front Axle Section.

The lubrication to the front wheel bearing is required at least twice a year, or every 10,000 Km (or 6,000 miles).

(3-6) REAR WHEEL LUBRICATION

It is requested to remove rear axle shaft and hub to lubricate the rear wheel bearings.

In mounting the rear axle, great care should be taken to properly treat the oil seals. The lips of oil seal should be coated with bearing grease.

The bearing should be lubricated at least twice a year, or 10,000 Km (or 6,000 miles) with a high melting point bearing grease recommended in the following table.

(3-7) SPRING SHACKLES

The spring shackles on Nissan Patrol are equipped with lubrication fittings, and should be lubricated with the chassis grease recommended in following table, every 600 Km (or 400 miles).

On the front eye of front and rear spring, rubber bushings must not be lubricated or sprayed with oil.

(3-8) STEERING GEAR LUBRICATION

The steering gear is filled at the factory with a all-season lubricant. Seasonal change of this lubricant is unnecessary and the housing should not be drained. Whenever required, additions should be made using a lubricant which, at low temperature, is fluid and will not "channel" or cause "hard steering" and which will provide satisfactory lubrication under extreme summer conditions.

It is recommended that the same grade of gear oil which is used on axles and transmission, should be used on steering gear.
(according to the temperature)

(3-9) BRAKE AND CLUTCH PEDAL LUBRICATION

The pedals should be lubricated with a few drops of light motor oil, every 1,000 Km (or 600 miles)

(3-10) CHASSIS LUBRICATION

For the chassis lubrication, consult the lubrication instruction. That shows the points to be lubricated and how often the lubricant should be supplied.

The recommended lubricants are shown in the following tables.

RECOMMENDED LUBRICANTS

Recommended Lub. Oil Classification	Nippon Oil	Standard Vacuum Oil	Shell Oil	Castrol	Gulf Oil	California Standard Oil
Engine oil	Elephant Motor Oil	Mobile Oil or Mobile Special	Shellx 100 Multi- grade	Castrolite	Gulf Price HD	R.P.M. Motor Oil H P
Gear Oil	MP 90	Mobilube G x 90	Spirax 90 E P	Castrol Hypoy	Multipur- pos Gear- lube 90	Universal Gearlube 90
Chassis Grease	Chassis Grease No.0	Mobile Grease No.2	Retinax A or C	Castro- lease Cl	Gulflex A	Marfak No.0 or 1
Universal Joint Grease	Chassis Grease No.0	Mobile Grease MP	Retinax A or C	Castro- lease Unijoint	Gulflex A	Marfak No.0 or 1
Wheel Bearing Grease	Wheel bear. Grease No.2	Mobile Grease No.5	Retinax H	Castro- lease Heavy	Gulflex A	Marfak No.2 HD

Oil Viscosity which is recommended for various temperature

Temperature	F	Under 10°	10----90°	Over 90°
	C	Under -12°	-12----32°	Over 32°
Engine oil		SAE 10W MS	SAE 20W/20 MS	SAE 30 MS
Gear oil		SAE 80 MP	SAE 90 MP	SAE 140 MP

REMARKS: MS - Motor Service
MP - Multi Purpose

LUBRICATION INSTRUCTION (CHASSIS)

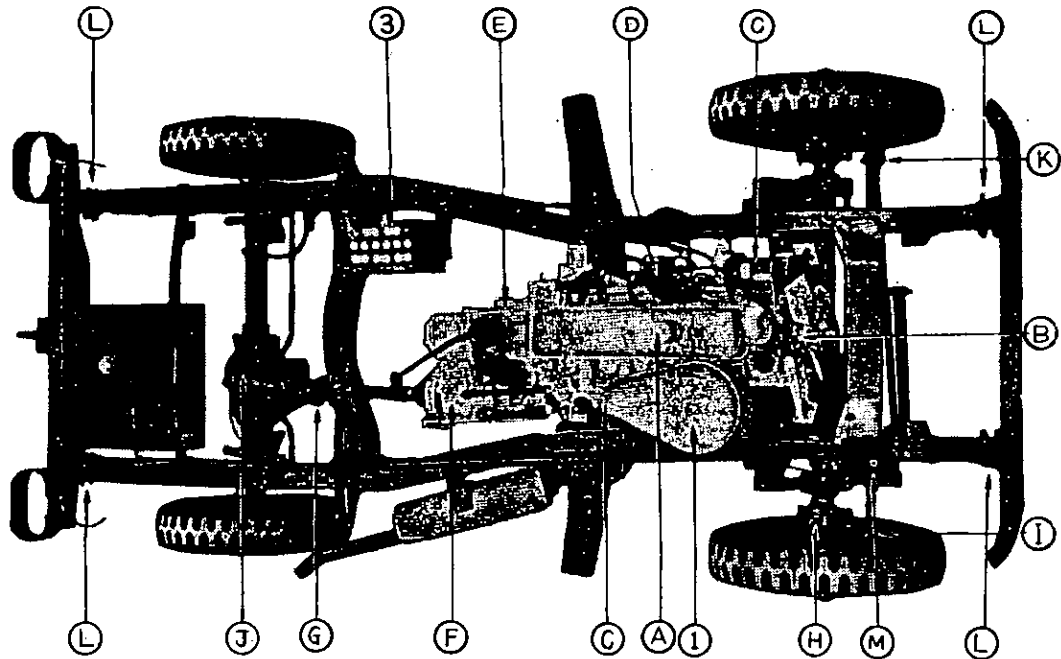

	Description	Lubricant	every	every	every	every
			600 Km	1,500 Km	3,000 Km	10,000 Km
Lubrication	A Engine oil (drain and refill 6.7 ltr).....	motor oil				○
	B Water pump bearings (lubricate slight)	Water pump grease	○			
	C Starter motor, Generator (feed 2-3 drops of oil).....	motor oil	○			
	D Distributer (lubricate shaft)	— + —	○			
	Clutch and brake pedal (lubricate)	light motor oil				
	Clutch release yoke shaft (lubricate)	chassis grease		○		
	E Transmission (drain and refill 2 ltr)	gear oil				
	F Transfer (3.4 ltr).....	— + —				○
	G Propeller shaft (lubricate joints)	chassis grease	○			
	H Knuckle flange bearing (lubricate)	bearing grease	○			
	I Tie rod (lubricate end of rod)	chassis grease	○			
	J Front and rear axle differential case (drain and refill 1.2 ltr each)	gear oil				○
	K Drag link (lubricate joint)	chassis grease	○			
L Spring shackle	— + —	○				
M Steering gear box (check level)	gear oil	○				
Fluid	1 Air cleaner (drain and refill)	motor oil			○	
	2 Radiator (clean)			○		
	3 Battery (check and top up)	distilled water	○			

CAUTION: The air cleaner used under dusty condition, must be drained and refilled more often than above-mentioned.

EXPLANATION OF DIFFERENCES BETWEEN VARIOUS MODELS OF 60 SERIES

1. EXPLANATION OF MODEL NUMBERS

This manual is described based upon the construction of model 60 which is the standard model of 60 series. However, there are many variations in model 60 series, and it is essential to understand that the model itself, the meaning of model numbers, and the differences between these various models, in order to give proper service to the vehicle, and to give the proper order of spare parts. The following table will give you the rough idia as to these questions.

Model No.	Description
60	Standard model wheel base: 2,200 mm carrying capacity: 2 persons + 400 Kg Four wheel drive
G60	Long wheel base: 2,500 mm carrying capacity: 2 persons + 400 Kg Four wheel drive
G60H	Long wheel base: 2,500 mm Carrying capacity: 2 persons + 750 Kg Four wheel drive
N60	Short wheel base: 2,200 mm Carrying capacity: 2 persons + 400 Kg Two wheel drive

If the vehicle is of the left hand drive type, its model number must have "L" on the head of the model number, such as L60, LH60, LG60H and LN60.

Another letters on the head of model numbers, such as "D", "W", "V", "K" and "F", indicate the type of body. "D" means the seat arrangement is different from the standard one. "W" means the station wagon type. "V" means the delivery van type. "K" means the hard top model. "F" means the fire engine model.

2. MAJOR DIFFERENCE BETWEEN MODEL 60, G60, AND G60H

(2-1) DIFFERENCE BETWEEN 60 AND G60

The differences between model 60 and G60 are, as you noticed already, come from the difference of the wheel base.

The long frame is used on model G60, and the wiring harness of chassis wiring, the rear propeller shaft, the body itself and the relative small parts are different from model 60.

(2-2) DIFFERENCE BETWEEN MODEL 60 AND G60H

Model G60 is designed as a heavy duty vehicle basing upon the chassis of model G60. The differences between model 60 and G60H are come from the difference of wheel base and from the difference of carrying capacity.

In order to carry heavier load than model 60 does, following systems are specially designed for model 60. As to the different parts of G60H that originated the long wheel base, refer to the parts catalogues, because these parts are exactly the same as model G60 with on exception of rear propeller shaft.

The different type of rear axle housing, axles, differential gears and relative parts are used on the G60H. Many of these parts are interchangeable with model B140, which is 1-3/4 tonner conventional truck called "NISSAN JUNIOR".

The wheels and tires are also different from model 60. Accordingly, the speedometer gear setting is different.

The rear brake drums and wheel cylinders are also different from model 60.

The front and rear springs are specially designed for model G60H. The relative front and rear suspension parts are different from model 60.

The parts numbers of these different parts are illustrated in the following "comparison list of major chassis parts, between 60 and G60H".

Please read carefully through this manual, thinking of these difference. And remember each paragraphs of this manual are described based upon model 60, with some exception.

COMPARISON LIST OF MAJOR SPECIFICATIONS

	60	660	G60H
CAR DIMENTIONS			
Overall length	3770 mm (148.5 in.)	4070 mm (160.0 in.)	4070 mm (160.0 in.)
Overall width	1693 mm (66.5 in.)	1693 mm (66.5 in.)	1693 mm (66.5 in.)
Overall height	1980 mm (78.0 in.)	1980 mm (78.0 in.)	2015 mm (79.3 in.)
Wheel base	2200 mm (86.6 in.)	2500 mm (98.4 in.)	2500 mm (98.4 in.)
Tread--front	1382 mm (54.4 in.)	1382 mm (54.4 in.)	1382 mm (54.4 in.)
--rear	1400 mm (55.1 in.)	1400 mm (55.1 in.)	1400 mm (55.1 in.)
Road clearance	222 mm (8.8 in.)	213 mm (8.4 in.)	223 mm (8.8 in.)
Rear floor height at rear end	720 mm (28.3 in.)	720 mm (28.3 in.)	755 mm (29.7 in.)

CAR WEIGHT			
Vehicle weight	1570 Kg (3461 lbs)	1595 Kg (3516 lbs)	1650 Kg (3638 lbs)
Distribution--front	825 Kg (1819 lbs)	865 Kg (1907 lbs)	875 Kg (1929 lbs)
--rear	745 Kg (1642 lbs)	730 Kg (1609 lbs)	775 Kg (1709 lbs)
Gross vehicle weight	2080 Kg (4586 lbs)	2105 Kg (4641 lbs)	2510 Kg (5534 lbs)
Distribution--front	845 Kg (1863 lbs)	920 Kg (2028 lbs)	935 Kg (2061 lbs)
--rear	1235 Kg (2723 lbs)	1185 Kg (2613 lbs)	1575 Kg (3473 lbs)

SEATING & CARGO CAPACITY	6 -- 7 persons	8 -- 9 persons	8 -- 9 persons
	or	or	or
	2 persons + 400 Kg	2 persons + 400 Kg	2 persons + 750 Kg

PERFORMANCE			
Maximum speed	120 KPH (75 MPH)	120 KPH (75 MPH)	120 KPH (75 MPH)
Maximum grade ability (Sin θ)	0.625	0.625	0.625
Minimum turning radius	5.5 m (18 feet)	6.2 m (20 feet)	6.2 m (20 feet)
Brake stopping distance (at 50 KPH)	14.0 m (45.9 feet)	14.0 m (45.9 feet)	14.5 m (47.6 feet)
Maximum over turn angle--right	47 degree	47 degree	47 degree
--left	47 degree	47 degree	47 degree

MODEL 60 GENERAL VIEW

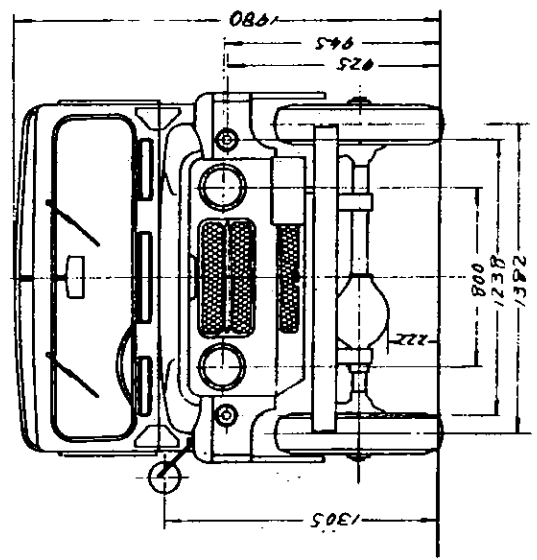
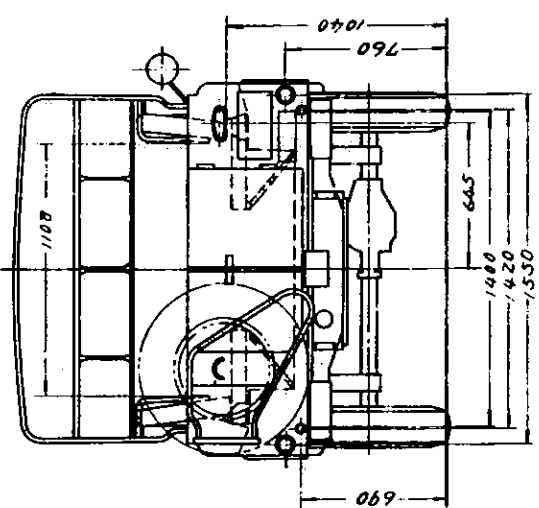
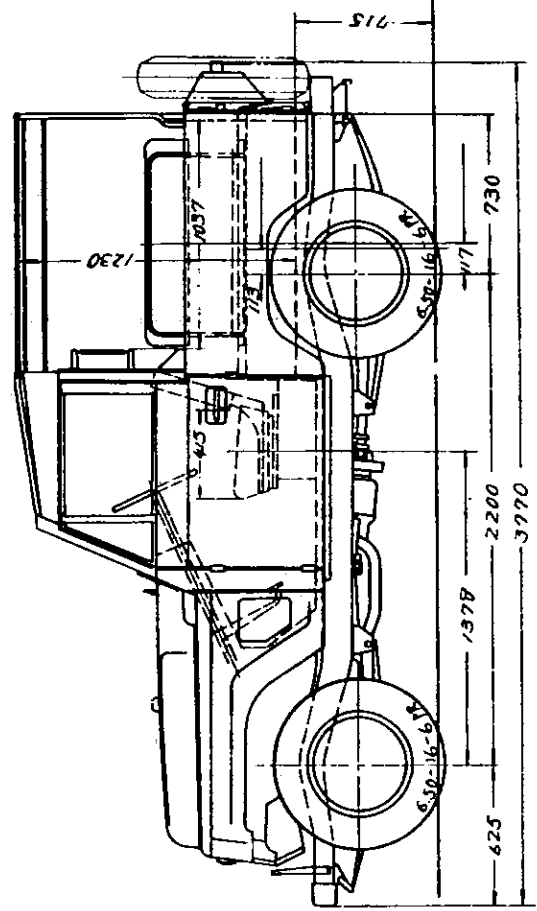
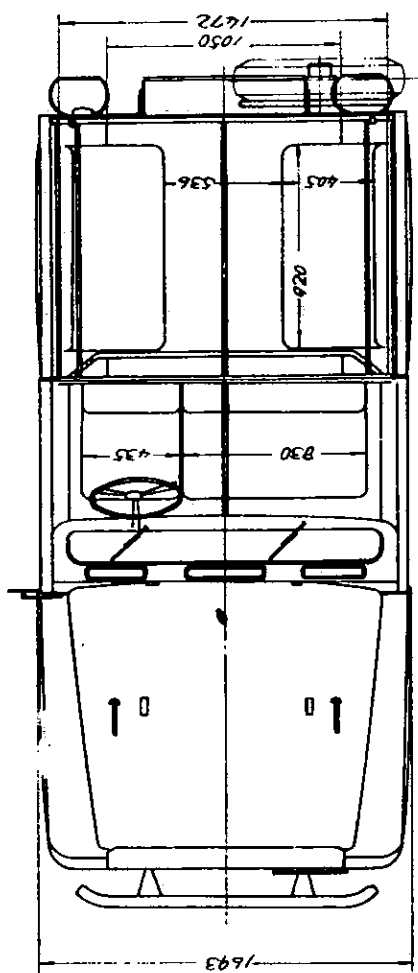

MODEL G60 GENERAL VIEW

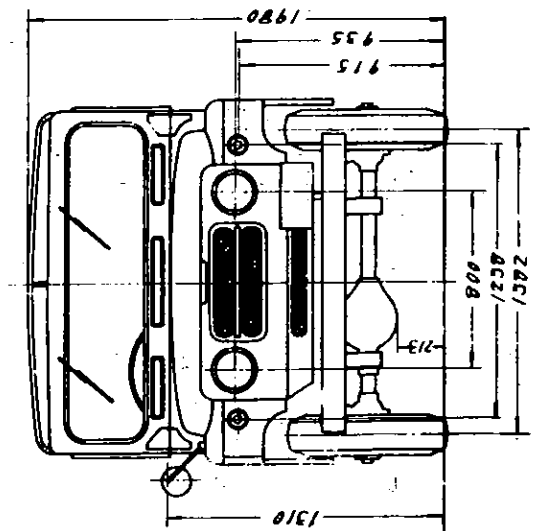
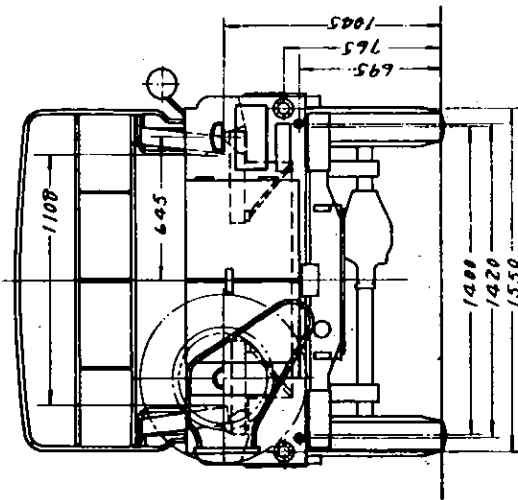
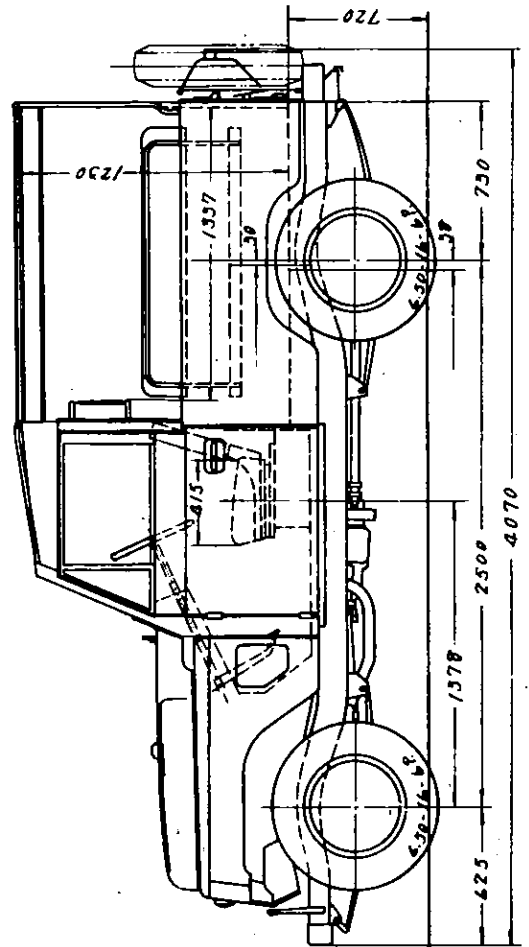
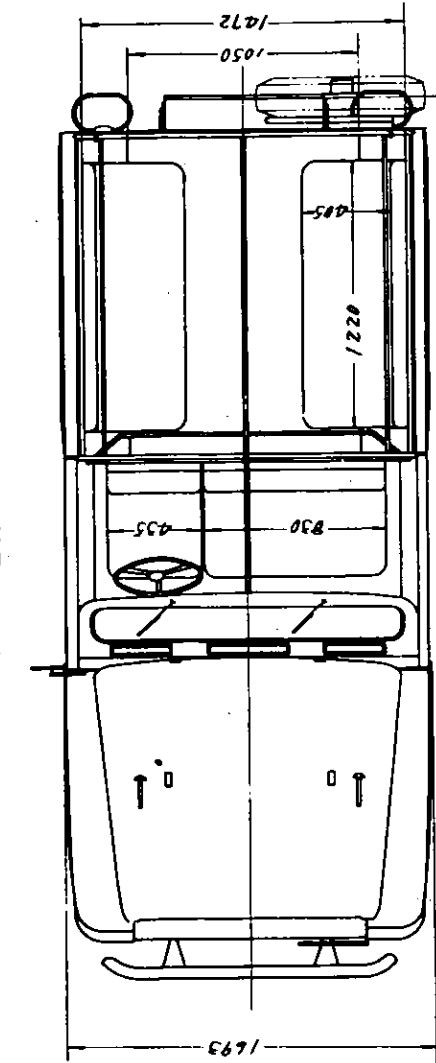

MODEL G60H GENERAL VIEW

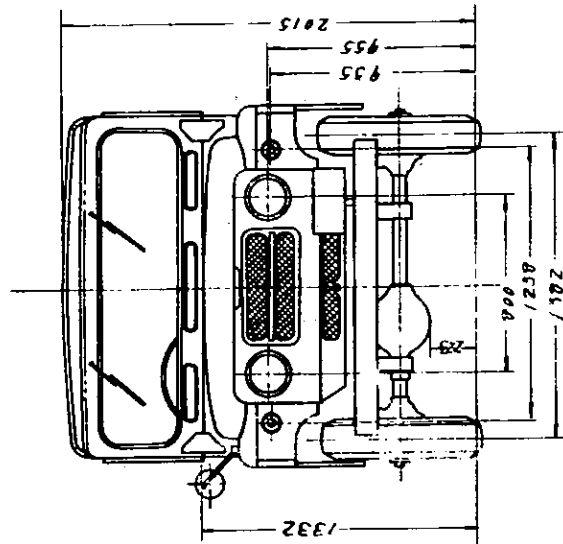
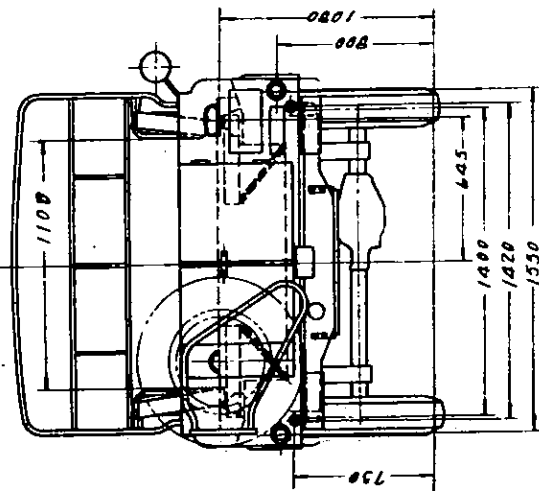
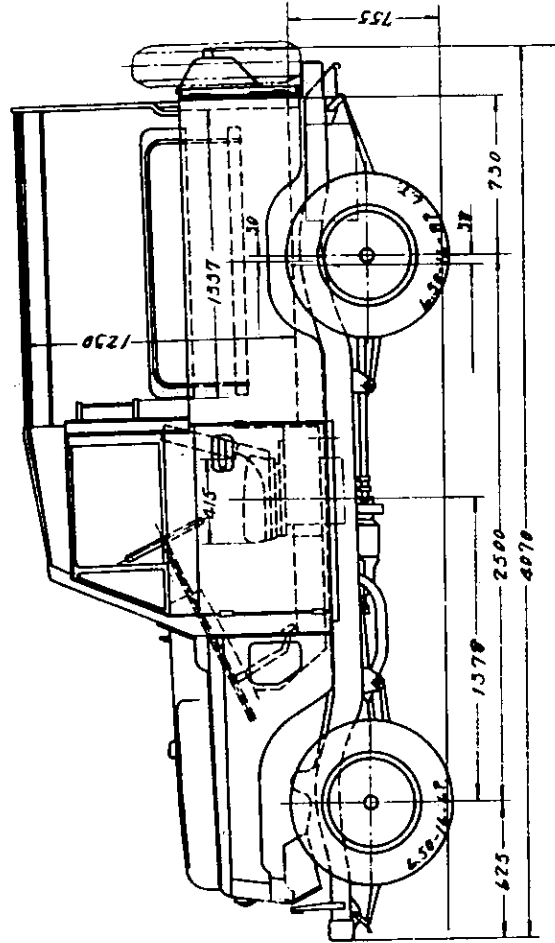
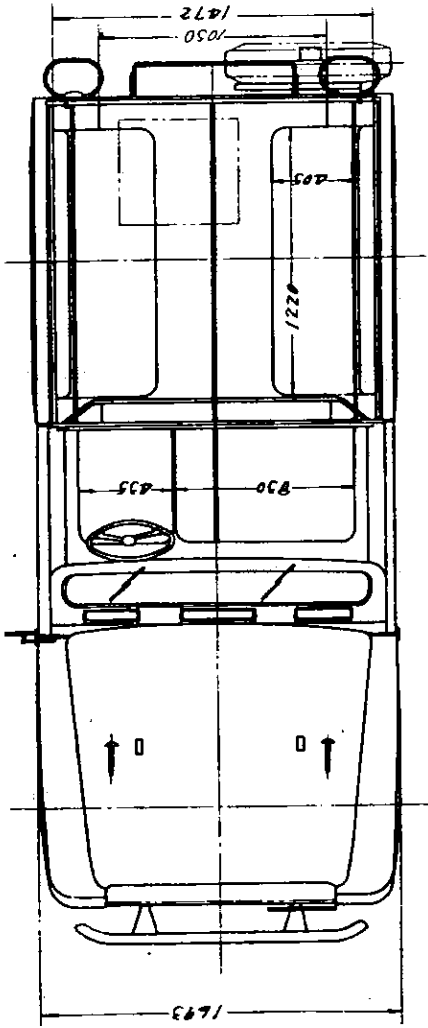

**COMPARISON LIST OF MAJOR CHASSIS
PARTS BETWEEN MODEL 60
AND G60H**

PARTS NUMBER		PARTS NAME
60	G60H	
32700-44000	32700-44300	Set, Gear & pinion speedometer
32701-44000	32701-44000	Gear, speedometer (5 teeth)
32703-44000 (15T)	32703-44300 (14T)	Pinion, drive, speedometer
(1) 37320-44000	37320-44300	Set-Propeller shaft with joint, rear
37300-44000	37300-44300	Ass'y-Prop. shaft, rear
43010-44000	43010-44300	Complete-Housing, rear axle
43068-32200	43068-30100	Spacer, oil seal, rear axle
38212-01300	38212-95960	Oil seal, rear axle shaft
43081-32201	43081-30100	Cage, bearing, rear axle
43083-32201	43083-30100	Bolt, serration
40227-32200	43223-30100	Oil seal, rear axle bearing
38164-44000	38164-44300	Rear axle shaft, R.H.
43217-32000	43217-30100	Packing, grease catcher, rear axle
43216-32200	43216-30100	Grease catcher, rear axle shaft
38175-44000	38175-44300	Shaft, rear axle, L.H.
43070-44000	43070-30100	Spacer, rear axle bearing
38440-25660	40211-50000	Taper roller bearing, rear axle
38441-25660	40213-50000	Cone, taper roller bearing
38442-25660	40214-50000	Cup, taper roller bearing
40207-44000	43207-30100	Brake drum, rear
44010-44000	44010-44300	Brake disc ass'y, R.H.
44023-44000	44023-44300	Brake disc ass'y, L.H.
44100-44000 (1")	44100-44300 (1-1/8")	Wheel cylinder ass'y, rear
44100-44001	44100-44301	Wheel cylinder ass'y, rear (for tropic)
41124-30100	44112-44300	Cup, wheel cyl. rear
41124-30101	44112-44301	Cup, wheel cyl. rear (for tropic)
44135-31400	44135-30100	Boot, rear wheel cylinder
44126-31400	44126-30100	Spring lock, rear wheel cyl. boot

PARTS NUMBER		PARTS NAME
60	G60H	
(2) 38300-44000	38300-44300	Ass'y-Gear carrier & gear
38310-44000	38310-30100	Ass'y-Gear carrier
38420-44000	38421-30100	Case, differential
38423-40000	38423-30100	Side gear, diff. bevel
(3) 38424-85060	38424-30100	Thrust washer, diff, side gear
or		
38424-44460		
38425-40000	38425-30100	Pinion mate, diff.
(4) 38426-45460	38426-30100	Washer, thrust, pinion mate
or		
38426-85060		
38427-44000	38427-30100	Shaft, pinion mate
None	38430-30100	Block, thrust
None	38431-30100	Spacer, thrust block
None	38428-30100	Pin, pinion mate shaft, lock
38101-44000	38101-44300	Gear drive, hypoid (41T)
38102-44000	38102-30100	Bolt, drive gear
38103-44000	38103-30100	Lock washer, drive gear bolt
38112-44000	38112-44300	Pinion, drive, hypoid (10T)
40215-50000	38120-30100	Bearing, drive pinion
38127-45460	38153-30100	Shim, drive pinion adjusting
38128-45460	38154-30100	Shim, drive pinion adjusting
38133-45460	38155-30100	Shim, drive pinion adjusting
38144-45460	38156-30100	Shim, drive pinion adjusting
38154-45460	38127-45460	Shim, bearing adjusting, pinion
38155-45460	38128-45460	Shim, pinion bearing adjusting,
38156-45460	38133-45460	Shim, pinion bearing adjusting,
None	38134-45460	Shim, pinion bearing adjusting
38163-44000	38163-30901	Spacer, drive pinion bearing
38191-44000	38191-30100	Spacer, oil seal, pinion
38189-44000	38189-30901	Oil seal, drive pinion
38210-44000	38211-30901	Flange, companion
38215-44000	38215-30901	Washer, plain drive pinion nut
38216-44000	38215-30901	Nut, drive pinion
38440-42101	40211-50000	Side bearing, differential case
None	38316-30100	Nut, adjust, diff. case
38129-42100	None	Shim, adjusting, diff. side bearing
38130-42100	None	Shim, adjusting, diff. side bearing
38131-42100	None	Shim, adjusting, diff. side bearing
38132-42100	None	Shim, adjusting, diff. side bearing

PARTS NUMBER		PARTS NAME
60	G80H	
(5) None	38319-30100	Finger, lock, diff. adjust nut
40513-44000	None	Cover, gear carrier
40515-44000	None	Gasket, cover, gear carrier
None	38320-30100	Gasket, gear carrier
9-31112	43027-04100	Drain plug
40535-41400	38322-55100	Ventilator plug
43219-44000	43219-30100	Shim, rear axle case end
43220-44000	43220-30100	Shim, rear axle case end
43221-44000	43221-30100	Shim, rear axle case end
43219-32200	43222-30100	Shim, rear axle case end
43084-32200	43084-30100	Nut, rear axle shaft bearing lock
43069-32200	43069-30100	Washer, lock, rear axle bearing
54010-44000	54010-44300	Front spring ass'y
54011-44000	54011-44300	Leaf, front spring No.1
54012-44000	54012-44300	Leaf, front spring No.2
54013-44000	54013-44300	Leaf, front spring No.3
None	54014-44300	Leaf, front spring No.4
None	54015-44300	Leaf, front spring No.5
55045-07200	55045-00900	Rubber bushing, front spring
54026-44000	None	Spacer, front spring center
55010-44000	55010-44300	Rear spring assembly
55011-44000	55011-44300	Leaf, rear spring No.1
55012-44000	55012-44300	Leaf, rear spring No.2
55013-44000	55013-44300	Leaf, rear spring No.3
55014-44000	55014-44300	Leaf, rear spring No.4
55015-44000	55015-44300	Leaf, rear spring No.5
None	55016-44300	Leaf, rear spring No.6
None	55017-44300	Leaf, rear spring No.7
None	55018-44300	Leaf, rear spring No.8
None	55287-44300	Plate, clip, rear spring R.H.
None	55297-44300	Plate, clip, rear spring L.H.
55054-44000	55054-44300	Ass'y, seat, rear spring R.H.
55055-44000	55055-44300	Ass'y, seat, rear spring L.H.
55247-44000	55247-44300	Clip, rear spring
None	55246-44300	Clip, rear spring, inner side R.H.
55240-44000 (2 pcs)	55240-44000 (1 pc.)	Ass'y bumper bound

PARTS NUMBER		PARTS NAME
60	G60H	
None	55240-44300	Ass'y bumper bound R.H. (1 pc.)
56247-44000	56247-44300	Bolt, connecting, rear stabilizer
56271-44000	56271-44300	Bracket, shock-ab. axle side R.H.

REMARKS:

- (1) Parts number of the propeller shaft for model G60, not for G60H, is as follows.

37320-44500 Set-Propeller shaft with joint, rear
37300-44500 Ass'y prop. shaft, rear

Remember the prop. shaft of G60 is not same as model 60 or G60H.

- (2) Gear carrier assembly of model 60 is welded on the rear axle housing. Accordingly, 38300-44000 and 38310-44000 are not provided for sale.
- (3) 38424-85060 and 38424-44460 are provided for select assembly.
- (4) 38426-45460 and 38426-44000 are provided for select assembly.
- (5) Gear carrier cover of model G60H is welded on the rear axle housing assembly.
- (6) The correct parts name are, sometimes, different from the name that is mentioned above. This difference came from the fact that the part which is designed as a another part of different model, is used.
For example, the differential case side bearing of model G60H (40211-50000) is originally designed as a front wheel bearing of another type of vehicle. Therefore, that's correct name is "Bearing, front wheel outer."
However, the representative name is used in this comparison list for the convenience.
- (7) As to the difference of the tires, refer to the section "WHEEL AND TIRES" of this manual.

ENGINE

1. INSTRUCTION

The engine used in Nissan Patrol Model 60 is a straight six-cylinder over head valve type. The model of the engine is "P".

The detail of the specification of this engine and service operations are given in the service manual of "Nissan Engine, Model P" which has been published independently.

However, the necessary data of this engine is given in the top of this Manual.

2. REMOVE ENGINE ASSEMBLY FROM CHASSIS

To remove the engine from the chassis, follow the undermentioned operations.

- (2-1) Drain the radiator and cylinder block. Open the hood as wide as possible. Place some rag between the hood and the windshield, in order to prevent any damage on the paint.
- (2-2) Disconnect head lamp, and parking lamp at the junction block.
- (2-3) Disconnect the main harness which is fitted on the left hand hood ledge, and connected the voltage regulator and junction block.

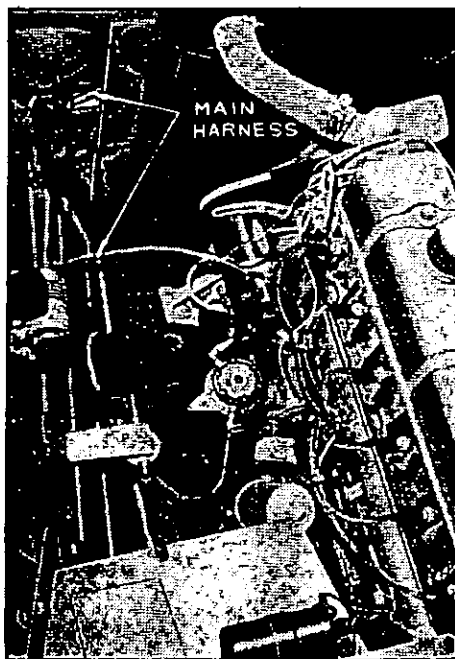

- (2-4) Remove the upper and lower radiator hose connections.
- (2-5) Remove the bolts and the nuts that secure the radiator to the left and right fenders. Then, lift off the radiator shell and radiator as an assembly.

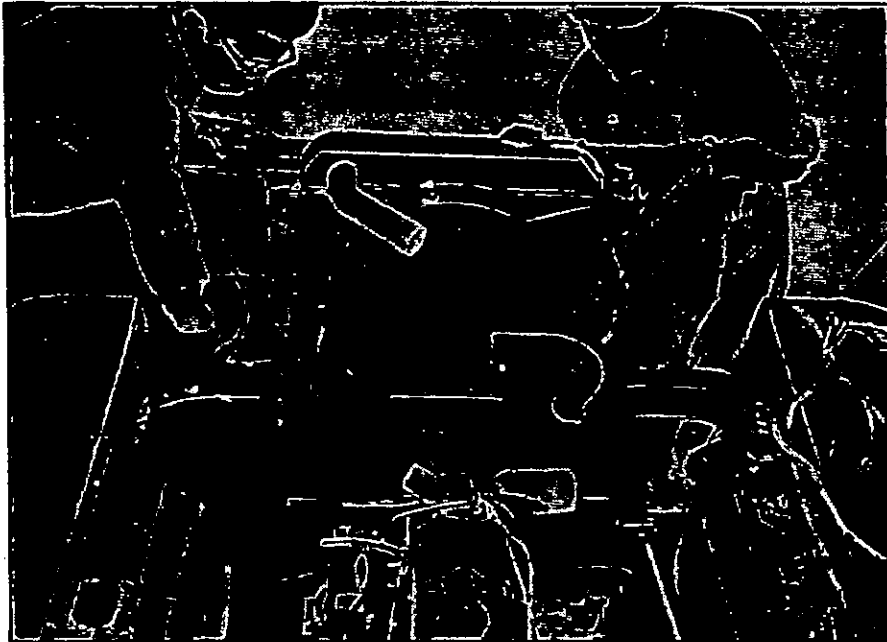

Removing radiator shell and radiator

- (2-6) Disconnect the primary wire from the distributor and high tension cord from the coil.
- (2-7) Disconnect the gasoline line from the fuel pump. Disconnect the throttle and choke controls from the carburetor.
- (2-8) Disconnect the exhaust pipe from the exhaust manifold.
- (2-9) Remove the transmission cover from the board. Take off the control lever of the transmission, the lever of the side brake, the high low control lever of the transfer-case, the front drive control lever of the transfer-case and cover of these levers from the transmission and transfer-case.
- (2-10) Disconnect the clutch operating linkage at the clutch cross shaft.

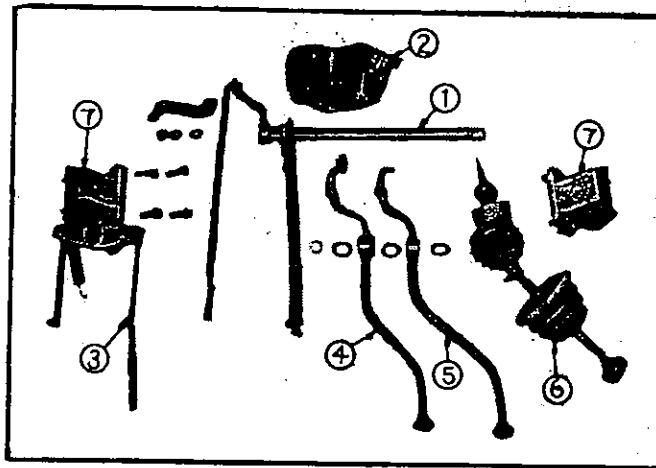

- (1) Hand Brake linkage.
- (2) Cover
- (3) Clutch Control Linkage
- (4) T/F Case Lever
- (5) T/F Case Lever
- (6) Change Speed Gear (T/Mission)
- (7) Rear Engine Mount

Remove these parts from engine supporting engine with garage jack.

- (2-11) Remove the bolts and nuts that secure the universal joint of the front and rear propeller shaft at the end of transfer-case.
- (2-12) Remove the engine rear suspension on the both side. Use the support underneath of the engine.
- (2-13) Remove the front engine support on the both side.

- (2-14) Attach a chain hoist, raise the engine clear of its mountings, then pull it forward. Again raise the engine sufficiently to clear the frame front cross member. The chassis may then be rolled back to clear the engine.



Raising engine

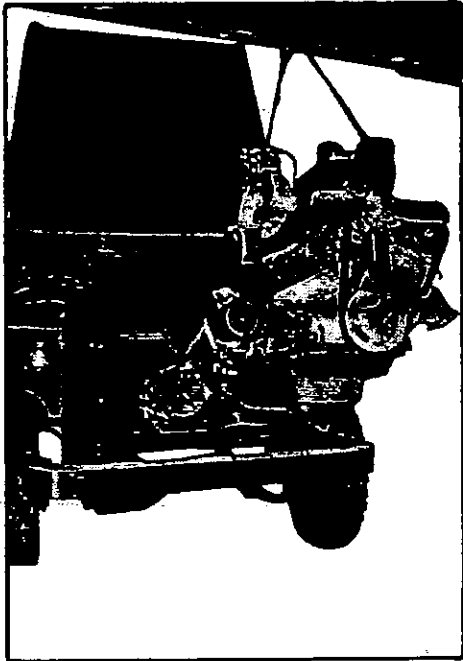

Rolling chassis back.

To replace the engine in the chassis the removal operations are just reversed.

Further service operations of the engine should be referred the "Service Manual of the Nissan Engine Model P"

CLUTCH

1. CONSTRUCTION AND DATA

(1-1) CONSTRUCTION

The clutch of the Nissan Patrol is of single dry disc type and is composed of parts as illustrated in instruction drawing. It embodies a mechanism which is known as centrifugal weight pressure system. This mechanism helps increase plate pressure as the speeds of the engine increases. It makes reduced spring pressure possible so that clutch is easier to operate at idling speeds.

(1-2) DATA

Type	Single dry disc plate, with centrifugal governer weight.
Pressure plate	
Diameter	276 mm (10.875 in.)
Thickness	15 mm (0.595 in.)
Clutch disc	
Facing number	2
Facing material	Woven asbestos
Facing diameter	275 mm (10.827 in.)
Facing thickness	3.6 mm (0.138 in.)
Total thickness	10.6 mm (0.417 in.) - (free thickness)
Facing area	353.5 cm ² x 2
Pressure spring	
Free length	61 mm (2.405 in.)
Tension	81 Kg when the length is 39.7 mm
Height of release lever	63.5 ± 0.5 mm (2-½ in.) (Measured up to flywheel surface)
	Difference between each levers should not to exceed 0.2 mm (0.008 in.)
Release bearing	Oil less ball bearing
Play of clutch pedal	1 — 1¼ in.
Height of clutch pedal	210 ± 5 mm from the toe board (8.22 in.)
Travel of clutch pedal	180 ± 4 mm
Type of pilot bearing	Oilite bearing

2. ADJUSTMENT AND REPAIR

(2-1) REMOVE THE CLUTCH ASSEMBLY

Remove the transmission assembly first. Remove the clutch housing cover. Remove clutch withdrawal lever, shaft and release bearing. Remove the screws that secure the clutch assembly to the flywheel. Clutch assembly and clutch disc can be taken off through the bottom of the clutch housing. Care should be taken so that all the screws are loosened evenly, instead of removing one after another, so that the tension of the six pressure springs may be gradually and evenly relieved. Otherwise, the screws may be damaged by the springing tension.

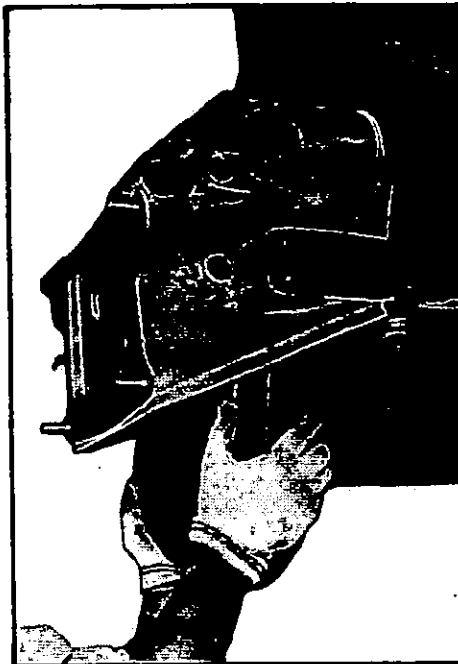

(2-2) ADJUSTMENT OF CLUTCH PEDAL HEIGHT AND PLAY

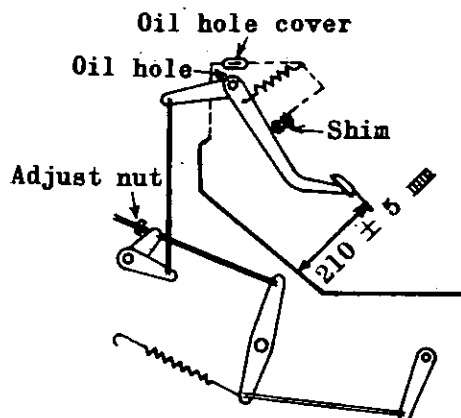

Keep the height of the clutch pedal from the toe board 210 mm (8.22 in.). To make this adjustment, adjust the thickness of the shim fitted in the stopper of the pedal.

To adjust the play of the clutch pedal, adjust the length of the intermediate rod. The play can be increased by means of screwing out the adjust nut of the intermediate rod. If the adjust nut is screwed in, the play will be decreased. Proper adjustment is a pedal play of 1 — 1½ in., before the clutch starts to engage.

Wear of clutch facing will lessen the pedal play, and if not adjusted in due to time, clutch slippage or insufficient clutch engagement will result.

An excessive play will make clutch disengagement difficult.

(2-3) CLUTCH TROUBLES AND THEIR REMEDIES

(A) SLIPPAGE OF CLUTCH

When clutch fails to fully transmit the power of engine, usually the clutch is slipping. A slight slippage is often unnoticed, but if you find any one or combination of the following phenomena, you are warned against a poor clutch.

- (i) Poor pick-up and speed.
- (ii) Larger fuel consumption.
- (iii) Overheating of engine.
- (iv) Truck speed does not pick up as much as engine speed is accelerated.
- (v) Poor performance in climbing hill, and a detestable smell at the same time.

In those cases, check up to find out if these conditions exist in the clutch.

- (i) No play or free movement of the pedal.
- (ii) Broken or fatigued clutch springs.
- (iii) Uneven wear or groove in clutch pressure plate.
- (iv) Worn, or hardened, or greasy clutch facing.
- (v) Worn surface of the flywheel.

For remedy of (i) follow the instruction as shown in the caption "ADJUSTMENT OF CLUTCH PEDAL HEIGHT AND PLAY".

If this adjustment does not give satisfactory result, the trouble must be lying in either one or combination of (ii) to (v) and proper step has to be taken as instructed in the caption "DISASSEMBLING AND REPAIRING OF CLUTCH"

(B) POOR DISENGAGEMENT OF CLUTCH

This will happen when;

- (i) There is too much play of clutch pedal.
- (ii) Clutch release yoke end is excessively worn.
- (iii) Friction surface of the release bearing sleeve to the release yoke is worn.
- (iv) Clutch release lever is bent or damaged.

- (v) Clutch disc assembly is out of alignment.
- (vi) Main drive gear shaft is stuck to pilot bushing due to excessive heat.
- (vii) Clutch disc hub is sticking to main drive gear shaft at the spline.

For remedy of (i) refer to item of "ADJUSTMENT OF CLUTCH PEDAL HEIGHT AND PLAY" for correct adjustment. If this adjustment does not cure the trouble, the trouble can be located in either one or combination of the items (ii) to (vii). Repair instruction for these items are given in caption "DISASSEMBLING AND REPAIRING OF CLUTCH".

(C) TRUCK JERKS WHEN STARTED

If the truck jerks at the time when clutch is being gradually engaged, the trouble is usually caused by friction surfaces of the clutch facing having been hardened like mirror, or having been smeared with grease or oil. Or else, it may be due to uneven height of the clutch release lever. Refer to "DISASSEMBLING AND REPAIRING OF CLUTCH" for removal of the trouble.

(2-4) DISASSEMBLING AND REPAIRING OF CLUTCH

To remove clutch cover from the pressure plate, place the cover assembly under a press and hold the cover under pressure so that the pressure springs will not throw up the cover. Then remove three screws, and relieve gradually the pressure of the press. Now the cover will come off.

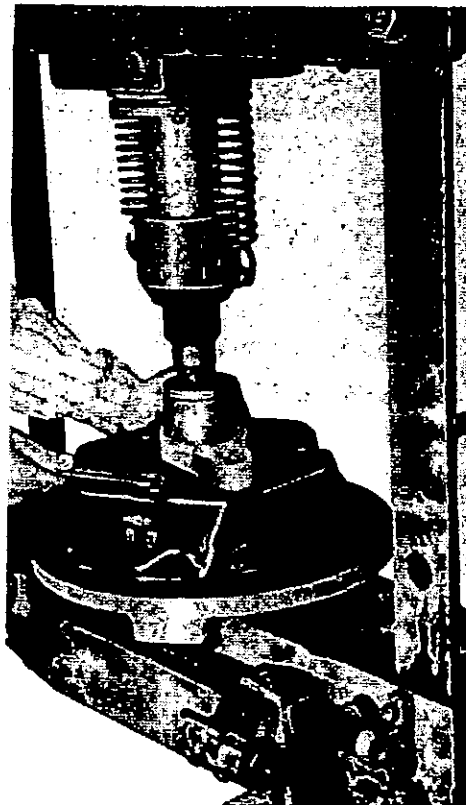

Press the pressure springs

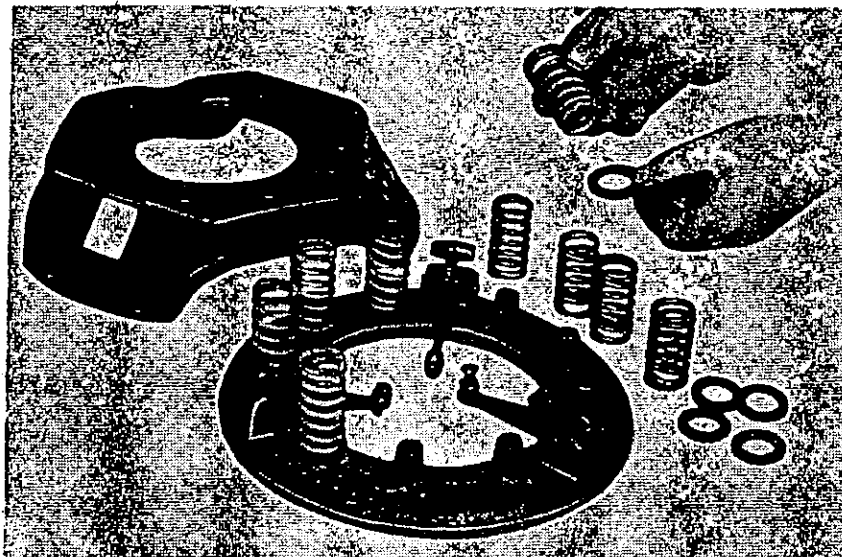

Removement of clutch cover

A careful inspection should be made on the component parts of the clutch and necessary remedy should be made on any defective one.

(A) BACK LASH BETWEEN MAIN DRIVE GEAR AND CLUTCH DISC

If there is more than 0.020 inch backlash between the main drive gear shaft and the spline of the clutch disc, replace them with new parts.

(B) WORN CLUTCH FACING AND LOOSE RIVETS

If the facing is worn down flush to the brass rivet, or if the facing is scarred or hardened, reline the plate with new facings. If the rivet holes are enlarged and facing is not securely in place, it is also advisable to reline with new facings.

(C) CLUTCH FACING SMEARED WITH LUBRICANT

If the clutch facing is found smeared with grease or oil, it indicates either the release bearing has been damaged, or else transmission lubricant is leaking. Remove these troubles first and then take care of the facings, by cleaning the faces with gasoline, or by replacing with new facings if they are worn or hardened.

(D) WARPAGE OF CLUTCH DISC

Check the clutch disc for warpage by means of a tester as illustrated in figure right hand. Wabbling disc will give poor performance.

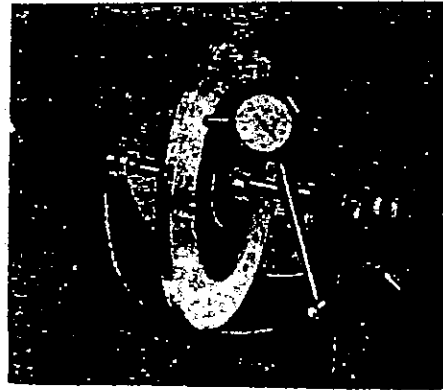

Check of clutch Disc warpage

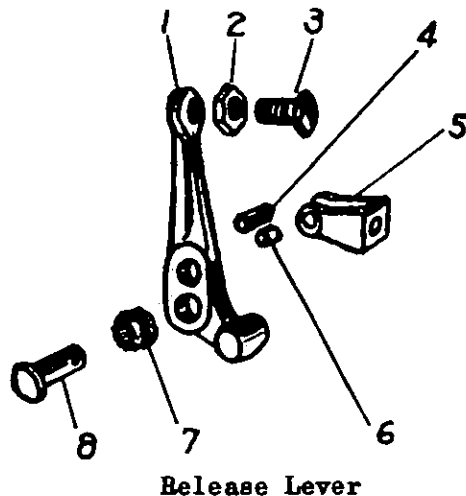

1. Release Lever
2. Lock Nut
3. Adjusting Nut
4. Release Yoke Pin
5. Release Lever Yoke
6. Release Yoke Roller
7. Needle Bearing
8. Release Lever Pin

If the wabbling is beyond the limit of 0.014 inch at the circumference, a new disc must be used.

(E) CHECK THE RELEASE LEVER NEEDLE BEARING

Check the wear at release lever pin and needle bearing, and at release yoke pin and roller. Excessive wear at these points will result in poor engagement of the clutch. Replace any of the worn parts with new ones. In making replacement, the release lever can be removed from the pressure plate by removing the cotter and then the lever pin. Care should be taken so that needle rollers will not become missing they are nineteen in number.

(F) CHECK THE SURFACE OF FLYWHEEL AND PRESSURE PLATE

Check the friction surfaces of both flywheel and pressure plate. These surfaces must be flat and smooth. Any scar, groove, or uneven wear must be treated with fine emery for mirror finish, or if necessary, must be worked on a leath. In either case of treatments, never remove the stock more than 1/16 inch deep.

If more stock has to be shaved off, it is advisable a new part is replaced.

By the way, when the pressure plate surface is shaved, supplement the reduced thickness with a washer of corresponding thickness inserted between release lever yoke and clutch cover.

(G) CHECK THE CLUTCH SPRING

The clutch spring tension has a direct bearing on the efficiency of the power transmission, and a very careful check-up is necessary. First, check each one of the nine springs for absence of any crack, and see that they have proper free length of which difference must be within 1/8 inch one another. Next, put each spring on a tester as illustrated in figure and compress the spring to a height of 39.7 mm (1-9/16 in.). If the reading of pressure gauge is less than 180-190 pounds, the spring is fatigued, and a new spring should be used.

Such a spring as will have a crack, or a free length difference of more than 1/8 inch, or a pressure difference of more than 10 pounds from other springs should be replaced with a new one.

The spring insulator washers are subject to wear, as they are constantly under pressure of the spring. Worn or damaged washers will effect the spring tension. Such washers should be replaced with new ones.

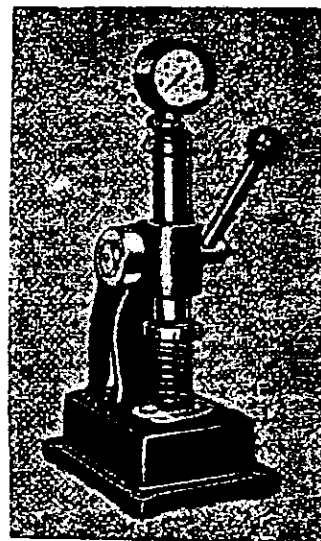

Spring Tester

(H) CHECK THE CLUTCH PILOT BUSHING

If the main drive gear shaft is loose in the bushing more than 0.005 inch, it will have bad effect on the clutch and transmission. A new bushing should be used.

(I) CHECK THE HEIGHT OF THE RELEASE LEVER

When the clutch is re-installed to the flywheel, be sure to check the height of the release levers.

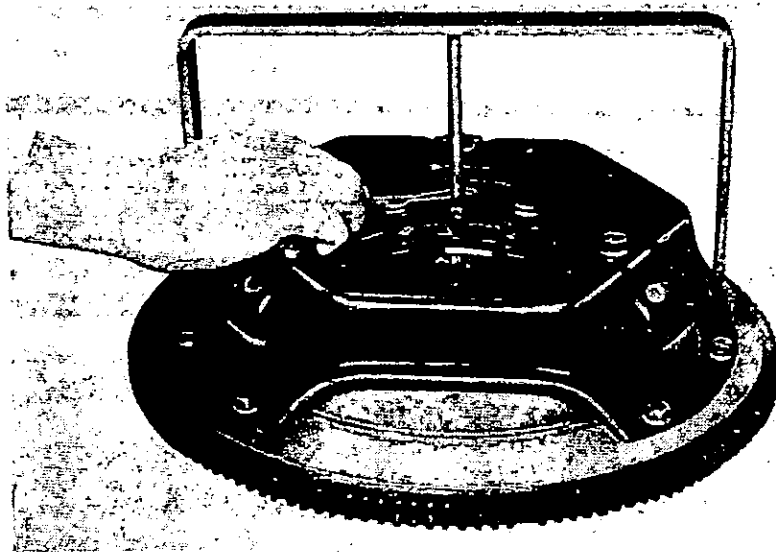

Measurement of Release Lever Adjusting Screw Height

If all the foregoing adjustment and repairs are properly made, and if the thickness of the clutch disc plate is 0.47 inch, the height of the release lever measured by a gauge as illustrated in figure, should be $2\frac{1}{2}$ in. above the face of the flywheel.

The height difference from other lever should not to exceed more than 0.2 mm (0.008 in.)

(J) CHECK CLUTCH RELEASE BEARING AND SLEEVE

First, thoroughly clean and give a few drops of oil to the bearing and then check it for free and silent rotation. Any noise or drag is a result of worn, corroded or deformed races or balls of the bearing. Use of such a bearing will produce noises in truck operation, and will result in premature wear of the head of clutch release lever adjusting screw. A new bearing should be installed, for satisfactory truck operation. Also, the release bearing sleeve is apt to wear on the side it contacts the release yoke. Wear on this part will result in poor disengagement of the clutch, so a new part should be installed if worn excessively.

To assemble the clutch unit to the flywheel, be sure the pressure plate assembly is strictly in alignment with the flywheel, making it sure that the centers of both units are on the same line.

To obtain the alignment, it is usually done by the use of a piloting device. If, however, such a device is not at hand, make one from a main drive gear shaft, cutting off the gear of the shaft.

Install this shaft to the clutch disc hub and insert the end of the shaft to the pilot bushing in the center of the flywheel. Thus placing the flywheel and the clutch pressure plate on the same center line, proceed to fasten the latter unit to the flywheel.

(K) CHECK AGAIN AFTER ASSEMBLING

- (i) First, with the engine running, depress the clutch pedal as far as it goes. Try to shift the transmission gear shift lever into various gears. The shifting will be made easily and quietly if the clutch is properly assembled.
- (ii) Pull the emergency brake, and with the truck standing, speed up the engine. Depress the clutch pedal, and throw the shift lever into the low gear position.

Then, gradually engage the clutch, and see if the engine stalls.

If the clutch is satisfactorily repaired, there is no clashing noise of the gears in the former test, and the engine will stall in the latter case.

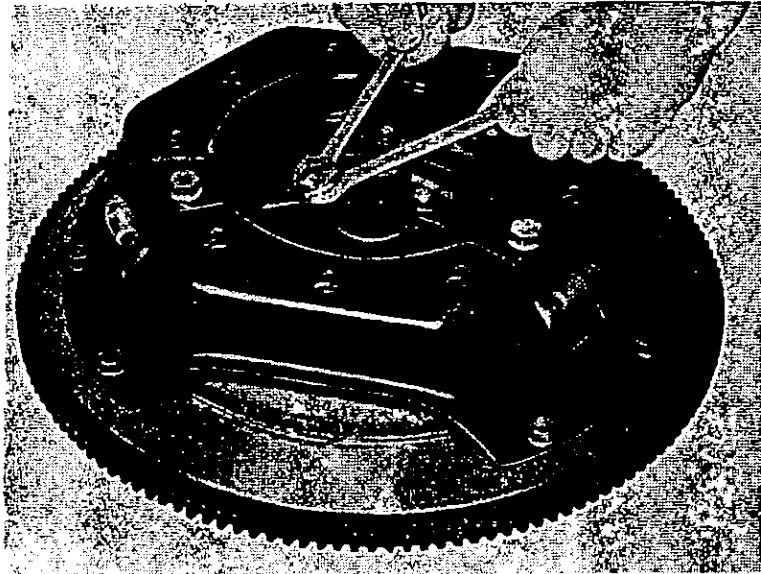

Setting Adjusting Nut

INSTRUCTION DRAWING CLUTCH ASSEMBLY MODEL 60

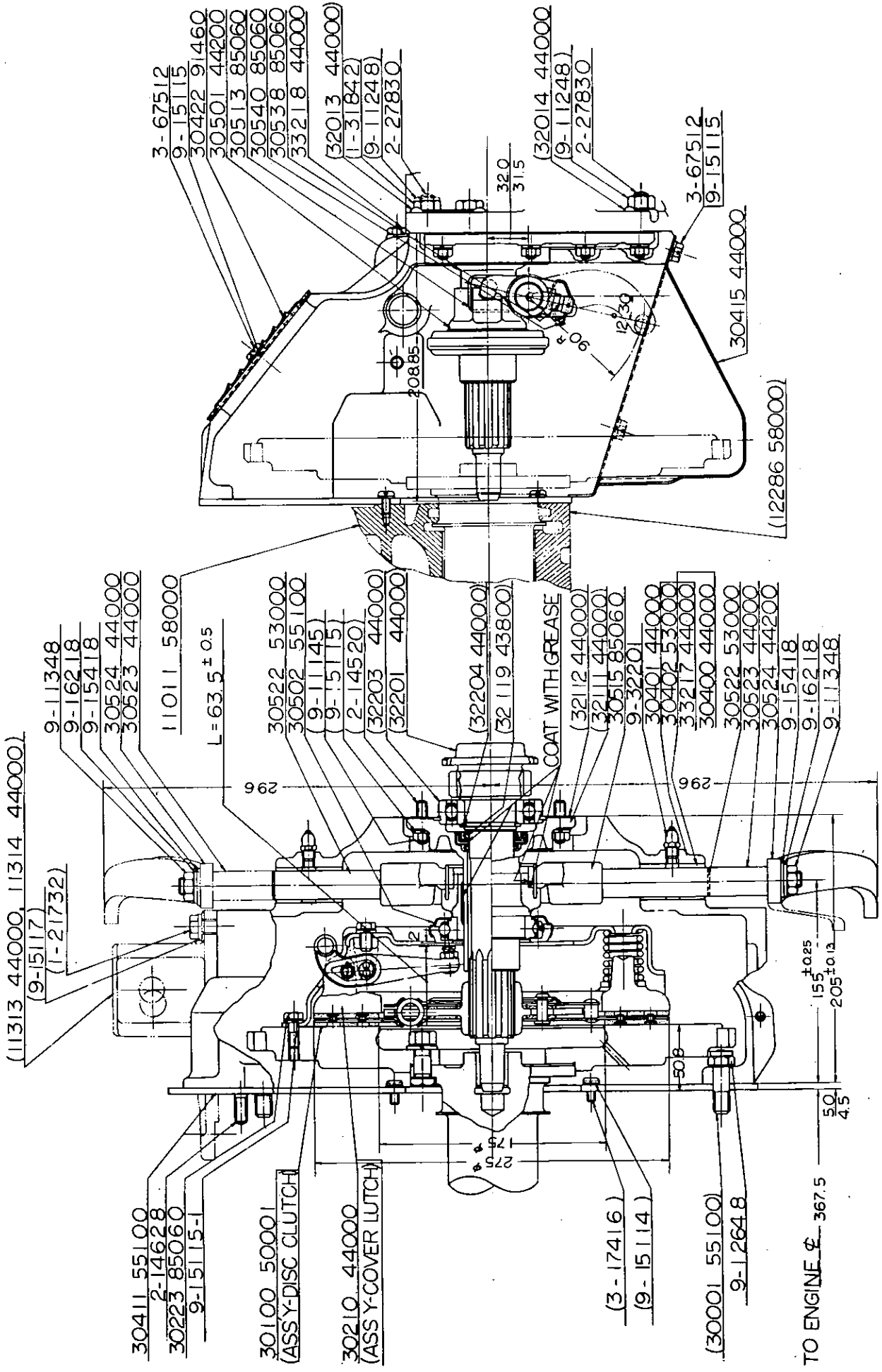

TRANSMISSION

1. DESCRIPTION AND DATA

(1-1) DESCRIPTION

The transmission is of the 3-speed type with synchronized second and high speed gears. The transmission and transfer case as a unit is assembled to the clutch housing. The gearshift lever is incorporated in the gearshift cover.

(1-2) DATA

Type	Synchro-meshed on 2nd and 3rd gear
Gear ratio	
1st	2.900
2nd	1.562
3rd	1.000
Rev.	4.015
Gear tooth number	
Main drive gear	15
Main shaft 2nd gear	21
Main shaft 1st gear	27
Counter drive gear	29
Counter 2nd gear	26
Counter 1st gear	18
Counter reverse gear	13
Reverse idler gear	15
Outer diameter of Reverse idler shaft	18.979 - 19.000 mm (0.7472 - 0.7480 in.)
Back lash of various gears	0.075 - 0.125 mm (0.03 - 0.05 in.)
Pilot bearing of main shaft	Needle roller bearing
Diameter x length x number	30 x 28 x 24 mm
Bushing of main shaft 2nd gear	
inner diameter	31.975 - 32.000 mm (1.2589 - 1.2598 in.)
outer diameter	38.040 - 38.050 mm (1.4976 - 1.4980 in.)
Thickness of thrust washer for main shaft 2nd gear available	3.860 - 3.900 mm (0.1520 - 0.1535 in.) 3.910 - 3.950 mm (0.1539 - 0.1555 in.) 3.960 - 4.000 mm (0.1559 - 0.1575 in.)
End play of main shaft 2nd speed gear	0.067 - 0.133 mm (0.003 - 0.016 in.)

Synchronizer spring	
Free length	12.7 mm (1/2 in.)
Outer diameter	6.7 mm (0.2638 in.)
Wire diameter	0.8 mm (0.031 in.)
Tension	1.8 - 2.3 kg when 8 mm (0.315 in.) in length
Locating ball of synchronizer	
Outer diameter	7.144 mm (0.2813 in.)
Bearings (outer dia. x Inner dia. x width)	
Main drive gear bearing	80 x 40 x 18
Main drive shaft rear bearing	80 x 35 x 21
Counter shaft front bearing	52 x 25 x 15 (type NU205)
Counter shaft rear bearing	62 x 25 x 17 (type 6305ZR)
Oil capacity	2 ltr. (0.52 U.S. Gal.)

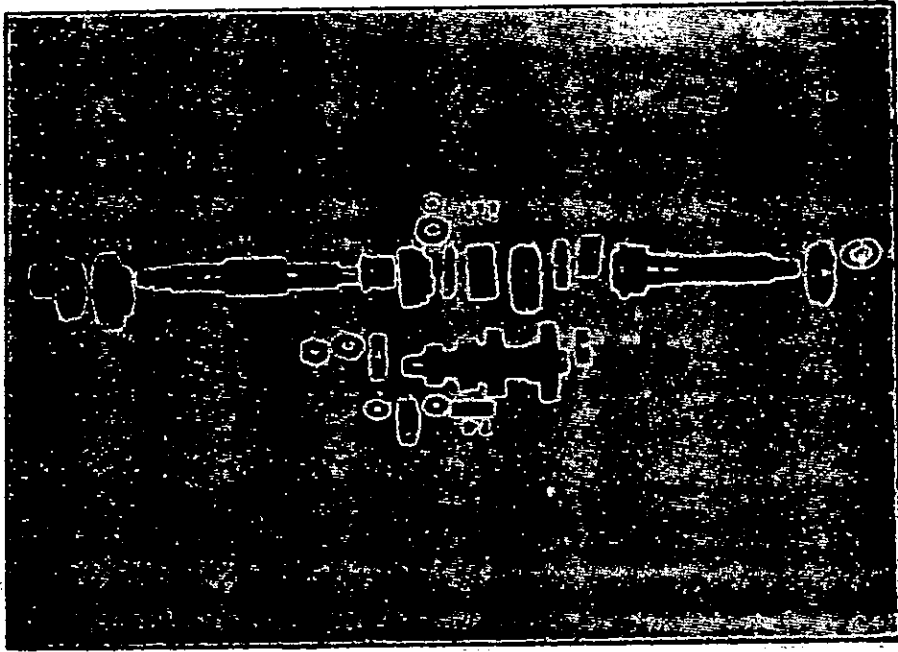

Constructive diagram of Transmission.

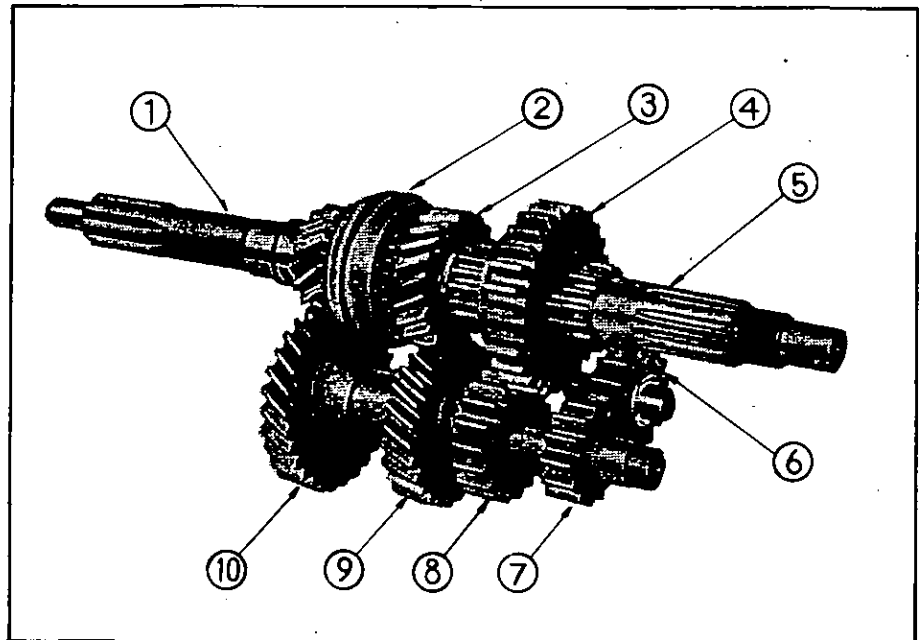

Gear train of transmission

- 1) Main drive gear
- 2) 2nd and top synchronizer
- 3) Main shaft 2nd gear
- 4) Main shaft low gear
- 5) Main drive shaft
- 6) Reverse idler gear
- 7) Counter reverse gear
- 8) Counter low gear
- 9) Counter 2nd gear
- 10) Counter shaft drive gear

2. TRANSMISSION DISASSEMBLY

(2-1) REMOVE TRANSMISSION FROM TRANSFER CASE

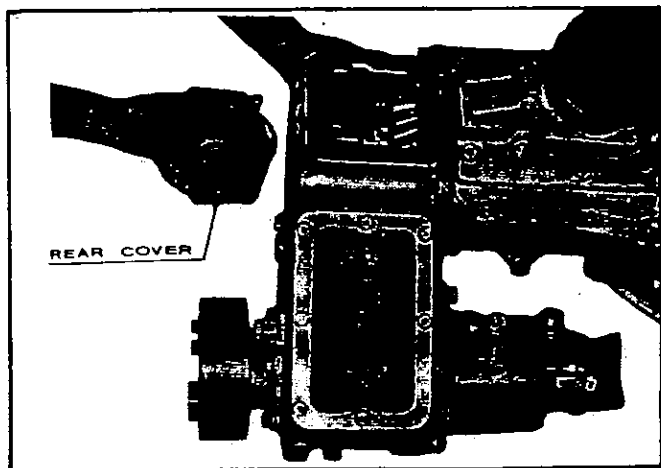

Removing rear cover of transfer case

Drain the oil from the transmission and transfer case. Remove the rear cover from the transfer case. Remove the castellated nut and flat washer that secure the drive gear on the transmission mainshaft and remove the drive gear from the transmission mainshaft, use a suitable puller, if necessary. Remove the four cap screws and one nut that secure the transfer case to transmission. Slide transfer case out rearward.

(2-2) REMOVE GEARSHIFT COVER

Remove the six cap screws that secure the gearshift cover to the transmission. Lift the cover from transmission.

(2-3) REMOVE MAIN DRIVE GEAR RETAINER

Remove the seven nuts and lock washer from the bearing retainer. Slide the bearing retainer and oil seal off the main drive gear.

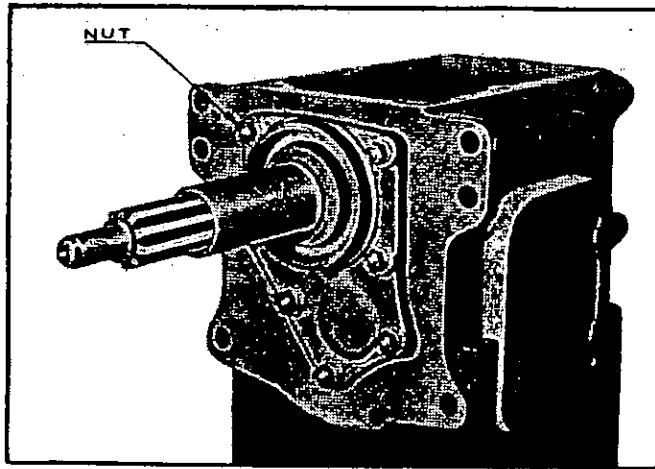

Removing bearing retainer

(2-4) REMOVE COUNTER SHAFT REAR BEARING

Bend the lip of the lock plate and unscrew the nut. Drive the counter gear assembly rearward $1/8$ inch from front, just enough so a pulley can be hooked on the bearing snap ring. Pull out the bearing.

(2-5) REMOVE MAINSHAFT REAR BEARING

Drive out main shaft rearward just enough to hook the bearing with puller. Remove the rear bearing and slide out the mainshaft partly toward rear and then take out from the top of case.

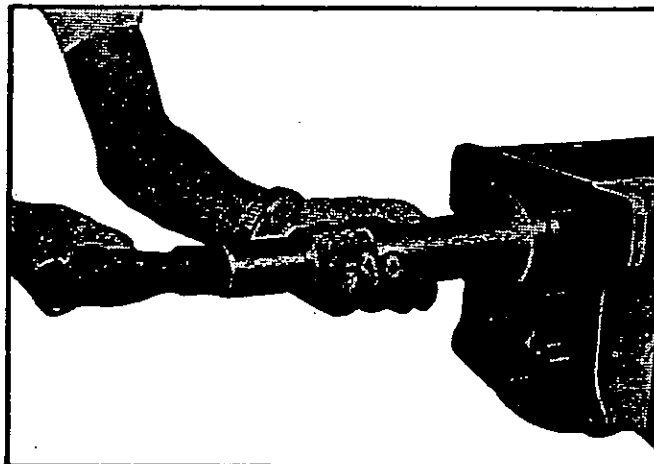

Driving out main shaft rearward.

(2-6) REMOVE DRIVE GEAR

Remove the drive gear snap ring and drive the drive gear in with mallet until free, then pull out from case. Drive bearing out from inside.

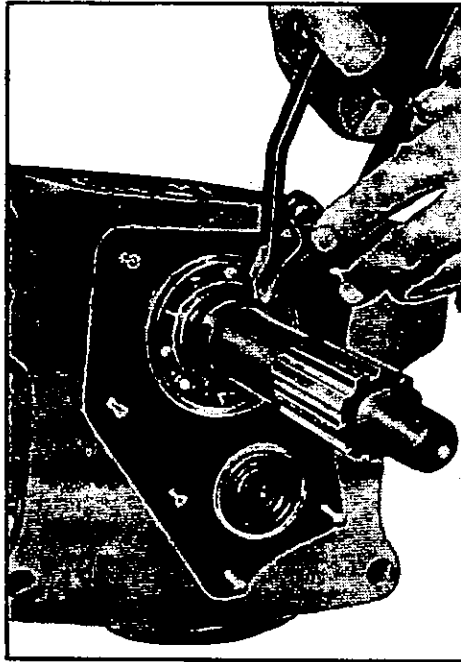

Removing the snap ring

(2-7) REMOVE THE COUNTER SHAFT

Tap the countershaft from front and remove countershaft and washer from top.

(2-8) REMOVE COUNTERSHAFT FRONT BEARING

Remove the countershaft front bearing by driving in the outer race with suitable driver.

(2-9) REMOVE REVERSE IDLER GEAR AND SHAFT

Bend the lock plate and remove the cap screw which locks the reverse idler shaft. Remove the idler shaft with drift, and take out the idler gear and thrust washer.

3. CLEANING, INSPECTION, AND REPAIR

(3-1) CLEANING

Wash all parts thoroughly in cleaning solvent until all trace of old lubricant has been removed. Oil the bearings immediately after cleaning to prevent corrosion of the highly polish surfaces.

(3-2) INSPECTION AND REPAIR

(A) TRANSMISSION CASE ASSEMBLY

Inspect the case and gearshift cover for cracks or damaged of any kind. Cracked or damaged units must be replaced.

(B) MAIN DRIVE GEAR

Replace the main drive gear if the following conditions are apparent: Broken teeth or excessive wear; pitted or twisted shaft; discolored bearing surfaces due to overheating. Small nicks can be honed and the polish with a fine stone.

(C) MAINSHAFT

A mainshaft excessively worn, or with pitted or discolored bearing surfaces due to overheating, must be replaced.

(D) FIRST AND REVERSE GEAR

A first and reverse gear with excessively worn teeth or splines, or with broken or chipped teeth must be replaced. Slide the gears onto the mainshaft. If the backlash between gear and the shaft exceeds 0.125 mm (0.005 inch), either the gear or the shaft, or both, must be replaced. A gear with small nicks can be honed and then polished with a fine stone.

(E) SECOND GEAR

A second gear with excessively worn, broken, or chipped teeth, or scored bearing surface must be replaced. Measure the inside diameter of the gear. If more than 38.175 mm (1.503 inches) the gear or bushing or main shaft must be replaced. If the outer diameter of 2nd gear bushing less than 38.00 mm (1.495 in.) or was worned excessively, it must be replaced. If the pin which prevents the bushing from turning was loosen, replace bushing and pin together.

Small nicks can be honed and then polished with a fine stone.

(F) SECOND GEAR BUSHING REPLACEMENT

The second gear bushing is press fitted on the mainshaft. To remove bushing first remove snap ring and thrust washer. Slide second gear out, take out the pin which prevents the bushing from turning. Drive out the bushing with drift. To install new bushing use arbor press with suitable driver.

(G) COUNTER GEAR

Replace excessively worn gears, and gears with broken or chipped teeth, or with pitted or discolored bearing surface due to overheating.

Bearings with loose or discolored balls or roller, or with pitted or cracked races must be replaced.

(H) REVERSE IDLE GEAR

A gear with excessively worn or broken teeth, or with a scored bearing surface must be replaced. Small nicks can be honed and then polished with a fine stone. Measure the inside diameter of the idle gear bushing. If more than 19.00 mm (0.7480 inch), the bushing must be replaced.

(I) IDLE GEAR BUSHING REPLACEMENT

Place the idler gear in an arbor press and, with a suitable driver, press the bushing out of the gear. Use a suitable drive to press a new bushing in the idle gear. Ream the bushing from 19.040 mm (0.7496 inch), to 19.073 mm (0.7509 inch).

(J) IDLE GEAR SHAFT

Ridged, scored, or excessively worn, shafts must be replaced. On idle gear shaft measuring under 18.879 mm (0.7432 inch) must be replaced.

(K) SYNCHRONIZER

Blocking ring with worn, broken or nicked teeth, must be discarded. Hubs and spline with excessively worn splines must be replaced. Weak, deflected or cracked, check ball spring must be replaced.

(L) MAIN DRIVE GEAR ROLLERS

Needle bearing rollers with flat spots, pitted, or discolored surfaces must be replaced. Measure the diameter of each roller. If less than 2.99 mm (0.117 inch), the roller must be replaced.

(M) SHIFT LEVER

Replace the gear shift lever if the pivot-ball is excessively worn. Replace the pivot-ball pin if it is loose or excessively worn. Replace the shift lever spring, if it is cracked.

4. ASSEMBLY

CAUTION-

Dip or coat with transmission lubricant, all gears, bearings shafts and thrust washers before assembly.

(4-1) INSTALL IDLE GEAR

Hold the idle gear in place in the case with the cone end of the hub toward the front, with thrust washers at each sides, and push the idle gear shaft into the case. Align the set screw hole and insert the set screw with lock plate. Tighten the screw and bend up the edge of the lock plate against the hex. head of the cap screw.

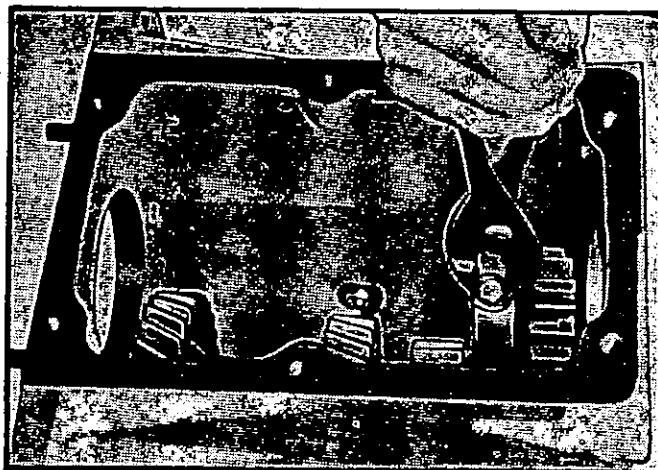

Bending up the lock plate of set screw.

(4-2) INSTALL COUNTER GEAR

Lay the countershaft gear in the case with the large gear toward the front.

(4-3) INSTALL MAINSHAFT ASSEMBLY

(A) SUBASSEMBLY SECOND GEAR

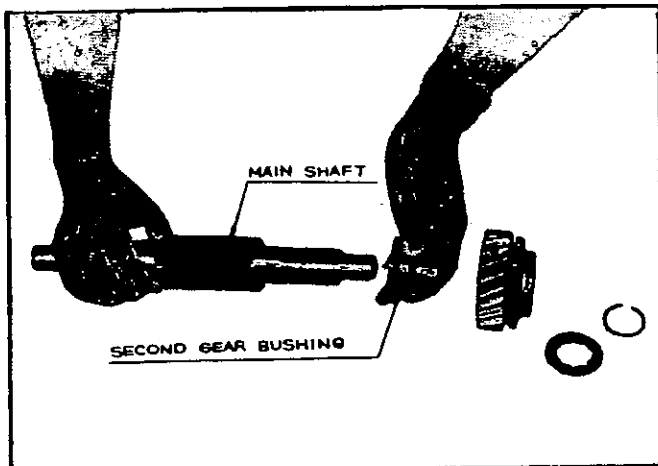

Replacing second gear bushing

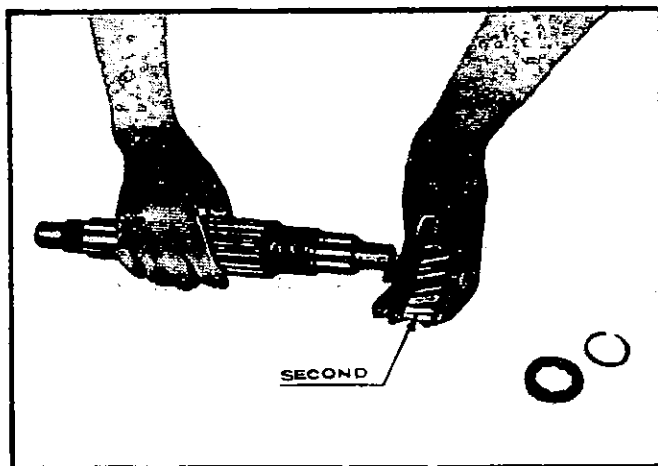

Replacing second gear

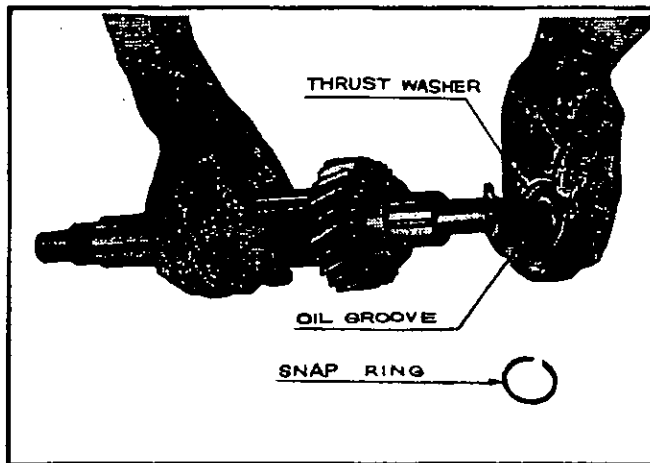

Replacing thrust washer

Drive in the second gear bushing on the mainshaft with suitable driver. Insert the lock pin in the bushing hole. Slide the second speed gear onto the mainshaft with tapered end of the gear toward the front. Slide in the thrust washer. Three of thickness of washers are available for adjusting the gear end play. Insert snap locking ring into the groove on the main shaft. The second gear must have an end play of from 0.067 mm (0.0026 inch) to 0.133 mm (0.005 inch). The second gear bushing itself must have no end play. Slide the first and reverse gear onto the shaft, with the shifter fork channel toward the front.

(B) SUBASSEMBLY SYNCHRONIZER

Special guides are available to facilitate the reassembling of the three balls and springs into the synchronizers. The guide is slipped over the synchronizer hub, the 3 holes in guide and the 3 holes of the hub must coincide. A spring and ball are then placed in position, depress the balls and insert the lock plates in the three grooves.

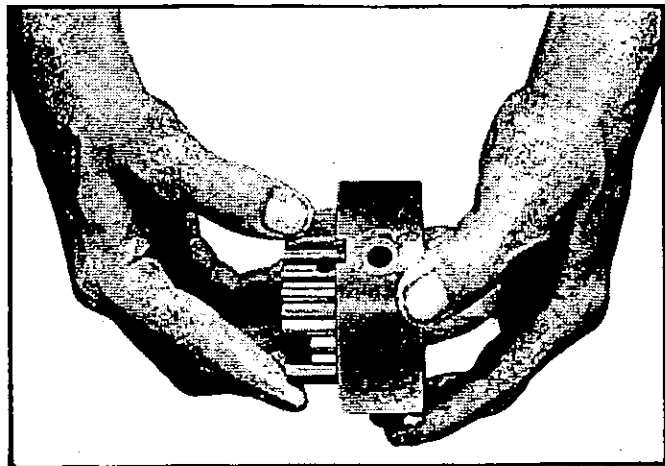

Sliding guide onto the hub.

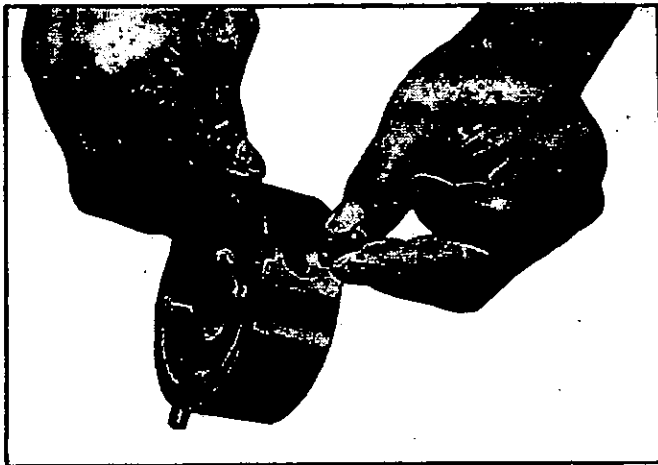

Replacing the spring and ball.

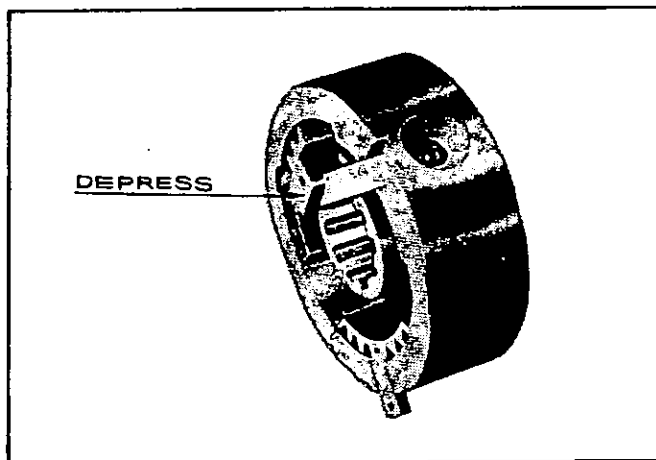

Depressing the plate of guide

The guide is then pushed further along the synchronizer splines (1/3), followed by the coupling sleeve. As the coupling sleeve replaces the guide, the balls find their correct location in the coupling sleeve groove. It should be noted that the synchronizer hub has a much greater depth of flange on one side, and on reassembly to mainshaft this should be towards the rear of the case.

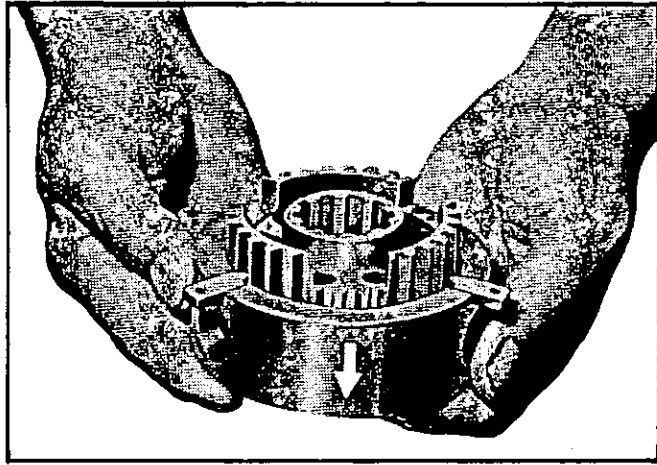

Push the guide downward.

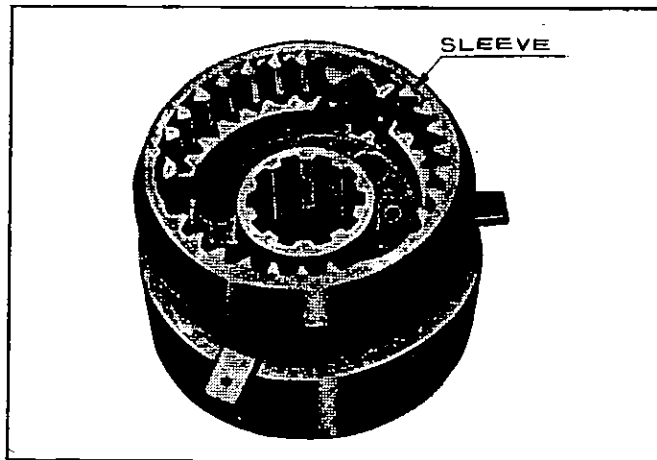

Replace the sleeve on the guide

In addition the internal splines must be correctly located to allow the baulking ring to pass through the machined grooves between the teeth.

Place the baulking rings in both sides of the hub, the pointed ends of the baulking ring lugs must face inwards to the synchronizers.

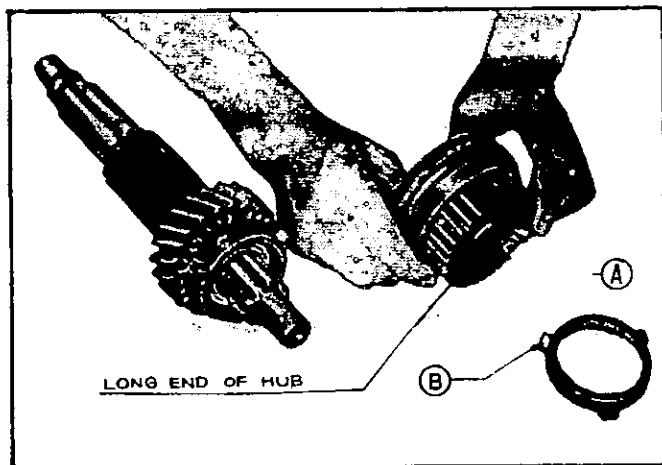

Ⓐ Must correspond to Ⓑ

Slide the synchronizer onto the mainshaft with the long end of the hub toward the front.

(C) INSTALL MAINSHAFT ASSEMBLY IN CASE

Carefully insert the mainshaft in the case through the top opening of the case. Place dummy bearing in upper bearing hole and lock with special plate. Insert the front end of mainshaft into the dummy bearing, drive in the rear bearing with suitable driver. Take off the front dummy bearing end drive in the main deive gear assy.

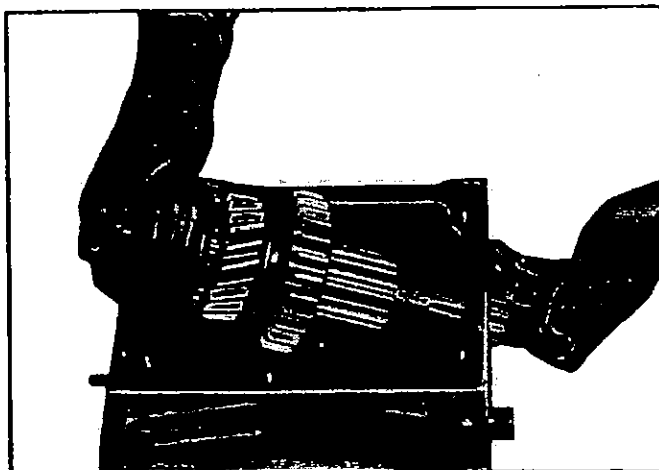

Installing mainshaft assembly

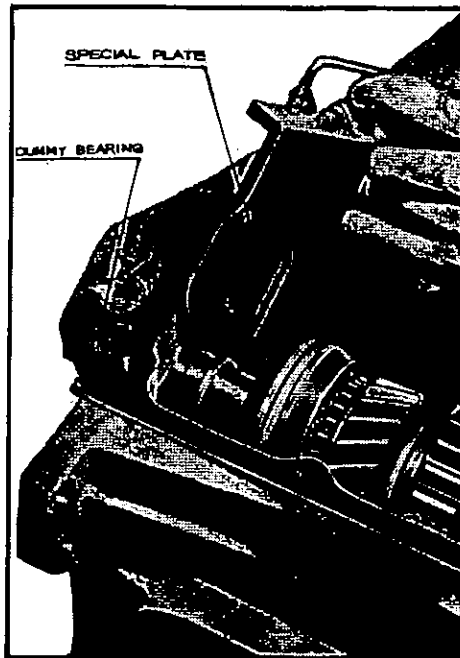

Holding mainshaft assembly

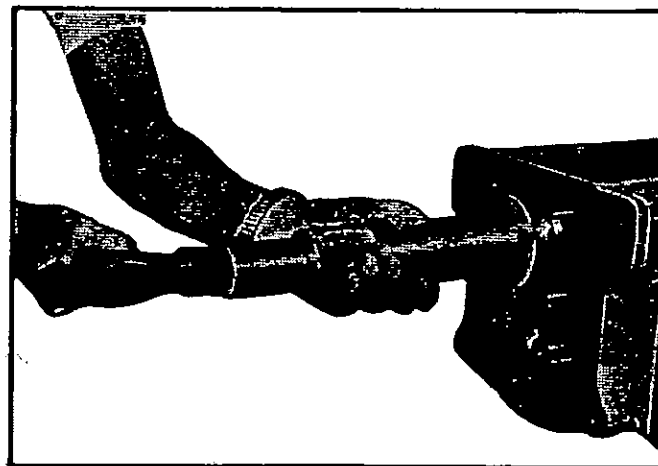

Driving main drive gear in.

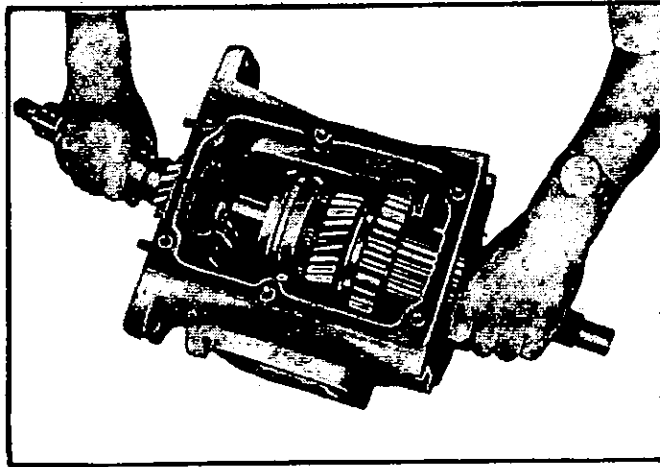

Installing main drive gear

(D) INSTALL COUNTERSHAFT

Raise countershaft gear assembly with hand thru power-take-off hole. Insert front washer and drive in roller bearing. Place the rear ball bearing on the countershaft and drive in with suitable driver. Install washer and screw in the nut. Tighten the nut securely and bend the ears of the lock washer over the nut.

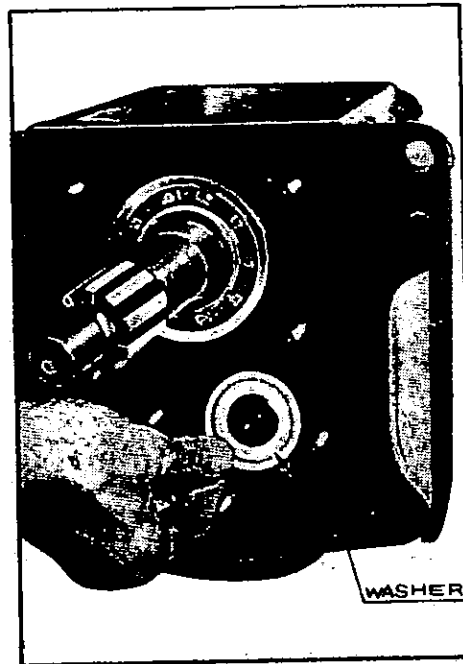

Inserting front washer

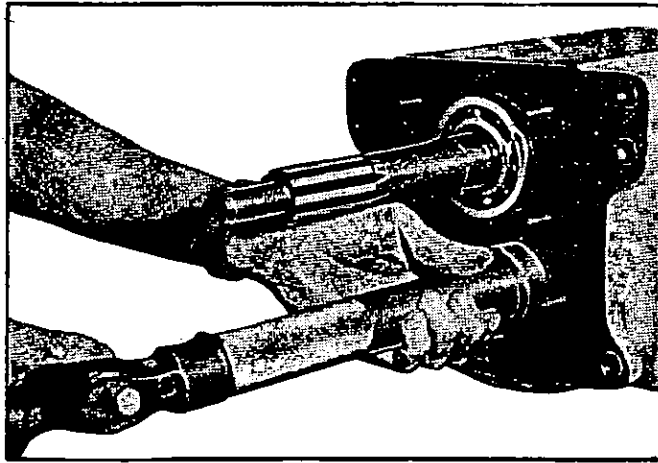

Driving roller bearing in

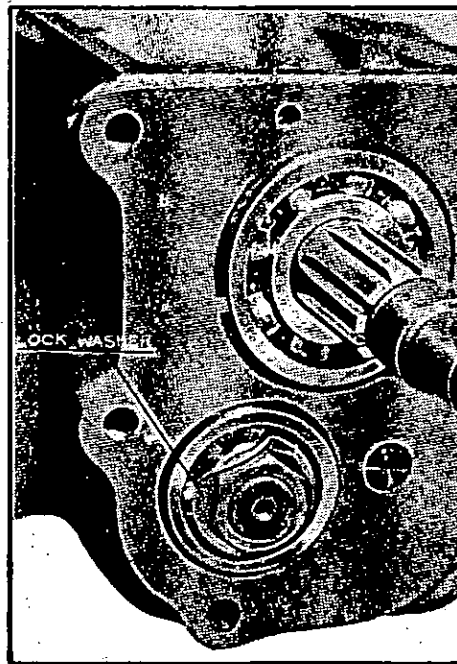

Bending the eare of the lock washer

(E) ASSEMBLE FRONT BEARING RETAINER

Coat main drive gear with oil where oil seal contacts. Assemble the main drive gear bearing retainer and gasket to the case and tighten the nuts securely.

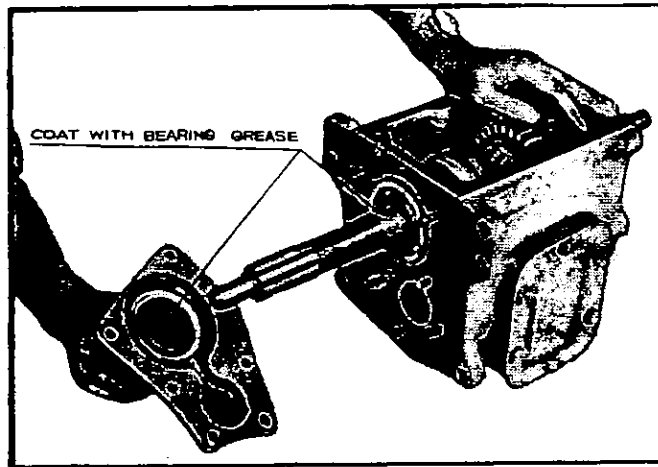

Fitting front bearing retainer.

(F) INSTALL GEAR SHIFT COVER

Install the cover assembly and gasket to the transmission case, making sure that the shifter forks enter the shifter fork grooves in the gears.



Transmission assembly

TRANSFER CASE

1. DESCRIPTION AND DATA

(1-1) DESCRIPTION

The transfer case is located at the rear of the transmission. The transfer case is essentially a 2-speed transmission, which provides two gear ratios and a means of distributing the power from the transmission to the two axles.

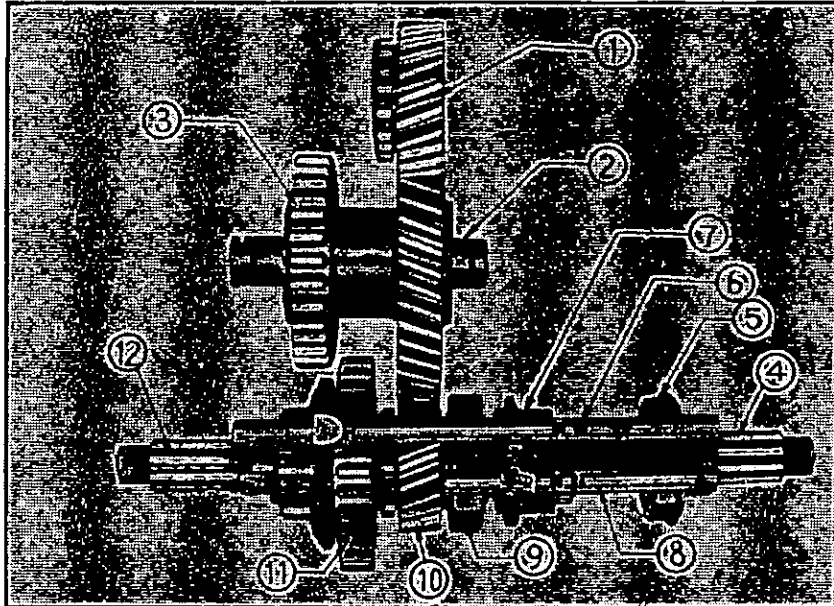

- 1) Main gear
- 2) Counter shaft
- 3) Counter shaft gear
- 4) Front drive shaft
- 5) Front bearing
- 6) High & low shift rod
- 7) Front drive sleeve
- 8) Front drive shift rod
- 9) Front bearing of rear drive shaft
- 10) High speed gear
- 11) Low speed gear
- 12) Rear drive shaft

Gear train of transfer case

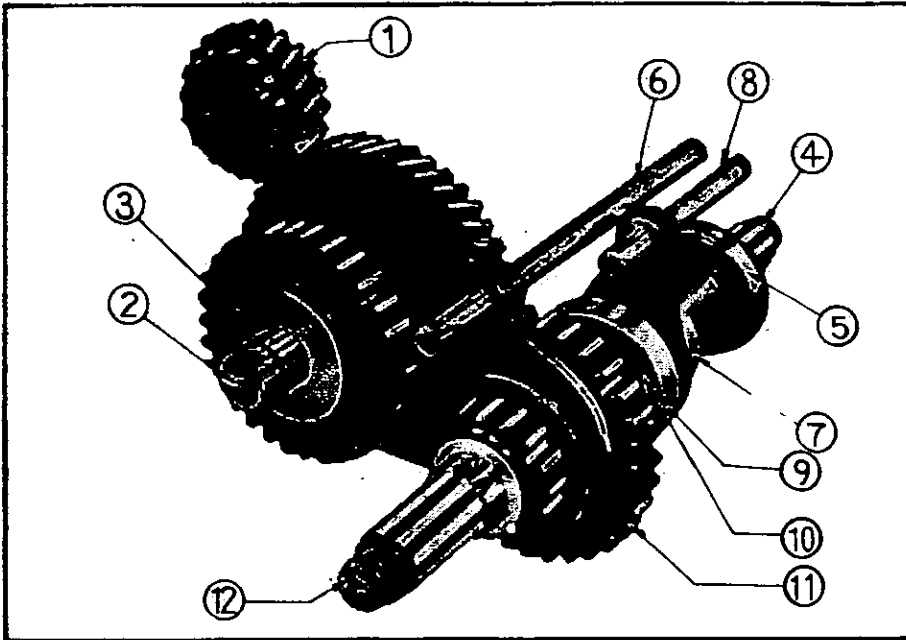

- 1) Main gear
- 2) Counter shaft
- 3) Counter shaft gear
- 4) Front drive shaft
- 5) Front bearing
- 6) High & low shift rod
- 7) Front drive sleeve
- 8) Front drive shift rod
- 9) Front bearing of rear drive shaft
- 10) High speed gear
- 11) Low speed gear
- 12) Rear drive shaft

Gear train of transfer case

(1-2) DATA

Gear ratio				
high			1.000	
low			2.264	
Combined gear ratio with transmission				
T/mission ratio		T/fer case position	Combined gear ratio	order
1st	2.900	low	6.564	1
		high	2.900	3
2nd	1.562	low	3.535	2
		high	1.562	5
3rd	1.000	low	2.264	4
		high	1.000	6
Rev.	4.015	low	9.089	
		high	4.015	
Gear teeth number				
Main shaft gear			21	
Counter gear front			46	
Counter gear rear			30	
high speed gear			21	
low speed gear			31	
Thickness of thrust washer				
for rear drive shaft			3.88 - 3.92 mm	
			(0.1528 - 0.1543 in.)	
for counter gear			3.43 - 3.47 mm	
			(0.1350 - 0.1366 in.)	
Bearings (outer dia. x Inner dia.				
x Width)				
Pilot bearing for main drive shaft			35x22x25 mm (type SJ2225)	
Rear drive shaft bearing front			90x40x23 (type 6308)	
Rear drive shaft bearing rear			90x40x23 (type 6308NR)	
Front drive shaft bearing			80x35x21 (type 6307NB)	
Pilot bearing for front drive shaft			25x18x22 (type 18V2522)	
Oil capacity			3.4 ltr. (0.90 U.S. Gal.)	
Back lash on various gears			0.102 - 0.152 mm	
			(0.004-0.006 in.)	
Front drive shaft pilot end diameter			17.989 - 18.000 mm	
			(0.7082 - 0.7087 in.)	
Counter shaft outer diameter			31.734 - 31.000 mm.	
			(1.2494 - 1.2205 in.)	

2. REMOVAL FROM VEHICLE

(2-1) REMOVE PROPELLER SHAFT

Disconnect the front and rear propeller shaft at the transfer case.

(2-2) REMOVE HAND BRAKE ROD, SHIFTER ROD AND SPEEDOMETER CABLE

Remove the clevis pin that secures the hand brake rod at the brake on the transfer case. Remove the clevis pins that secure the shifter rods. Disconnect the speedometer cable.

(2-3) REMOVE REAR COVER

Remove the six cap screws that secure the rear cover to the transfer case.

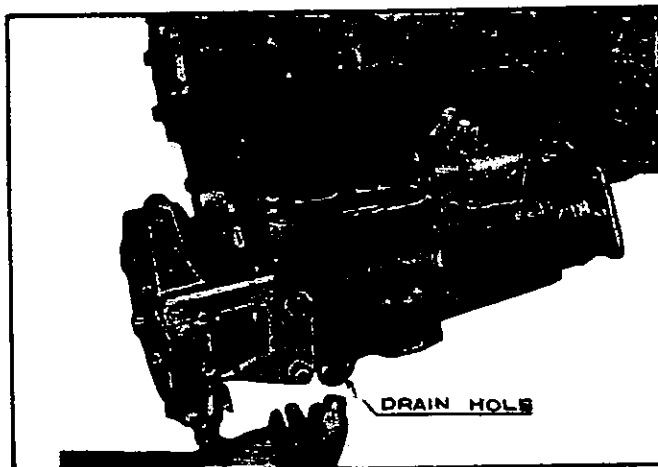

Drain gear oil.
Removing hand brake linkage.

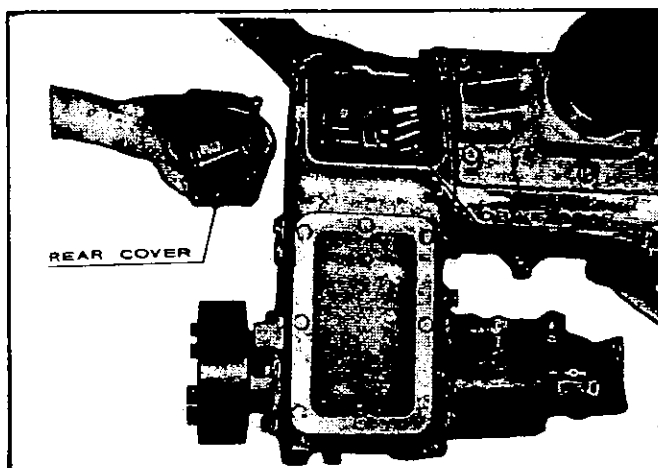

Removing rear cover

(2-4) REMOVE MAINSHAFT GEAR

Through the opening at the rear of the transfer case, remove the nut that secures the mainshaft gear to the transmission mainshaft. Remove the flat washer and mainshaft gear.

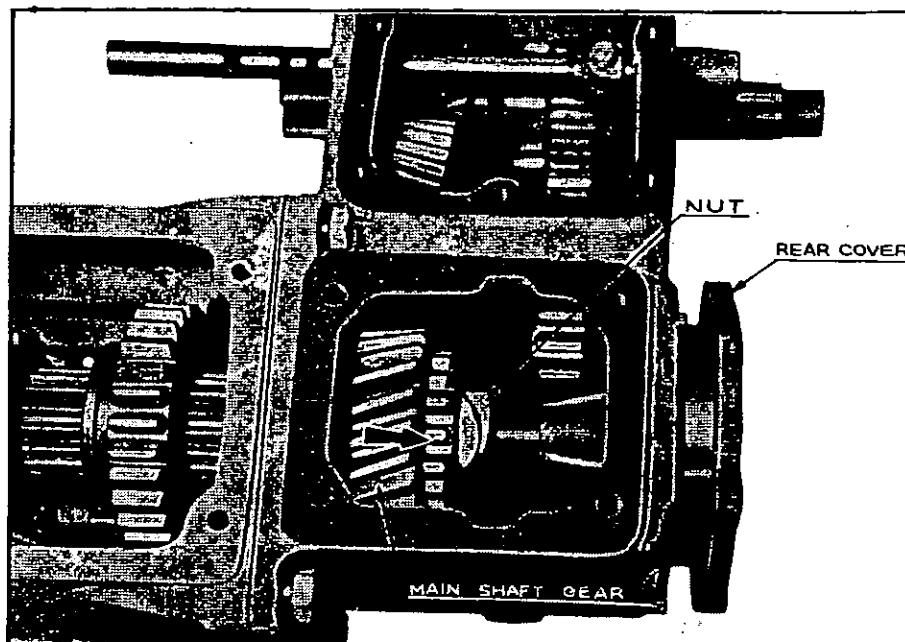

Removing main shaft gear

(2-5) REMOVE TRANSFER CASE FROM TRANSMISSION

Place a jack under the transfer case. Remove the five cap screws that secure the transfer case to the transmission. Move the transfer case straight back until the transmission mainshaft is out of the transfer case. Remove the transfer case.

3. DISASSEMBLY

(3-1) REMOVE BRAKE BAND AND DRUM

Remove the five anchor screws from the brake band anchor brackets. Remove the brake band assembly. Remove the castellated nut that secures the universal joint flange to the output shaft. Pull out the joint flange, if it is tight use puller to remove flange.

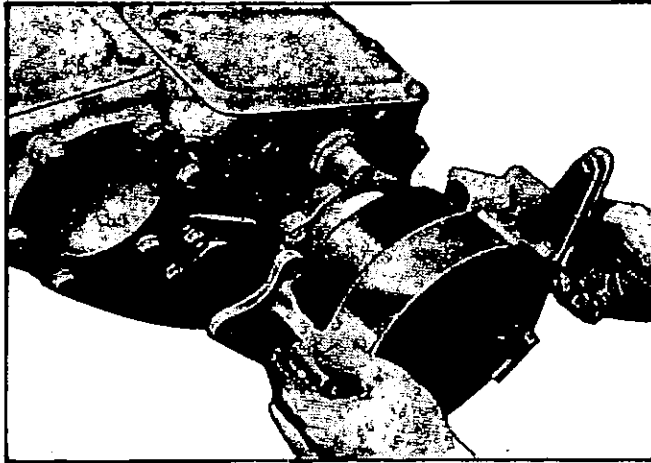

Removing brake band

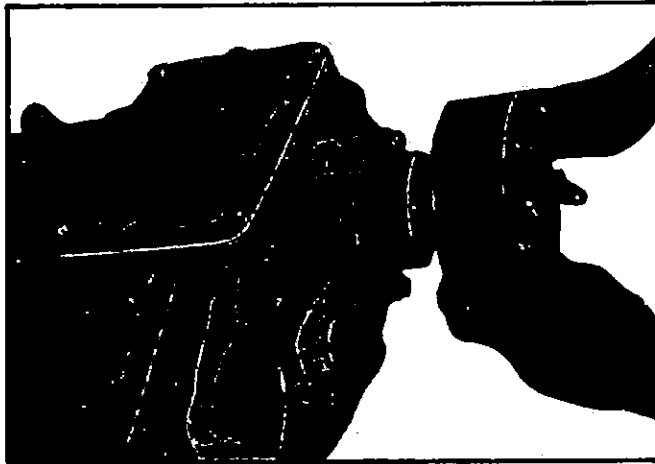

Removing brake drum

(3-2) REMOVE TOP COVERS

Remove the twelve cap screws that secure the two top covers and remove the two covers.

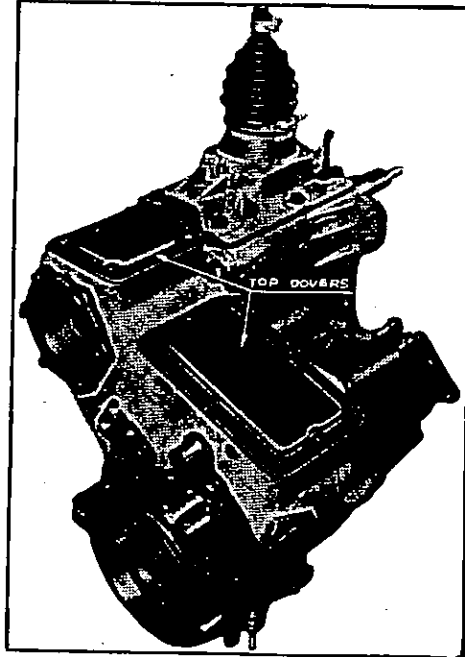

(3-3) REMOVE FRONT JOINT FLANGE AND BEARING RETAINER

Remove the castellated nut that secure the front joint flange. Remove the joint flange with mullet, if it is very tight use puller to remove flange.

Remove the five cap screws that secure the front bearing retainer. Remove the bearing retainer.

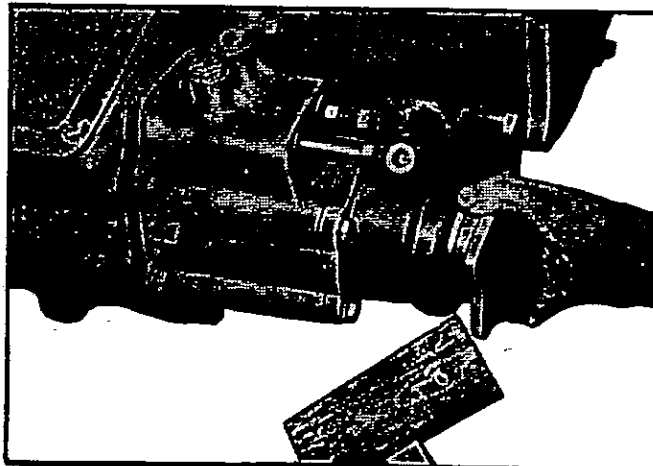

Removing front joint flange.

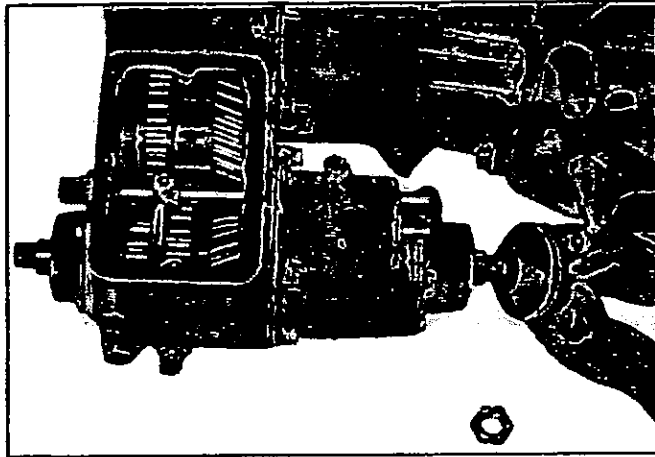

Remove front drive flange

(3-4) REMOVE FRONT DRIVE SHAFT BEARING RETAINER

Remove the five cap screws that secure retainer to cover.
Remove retainer out from cover.

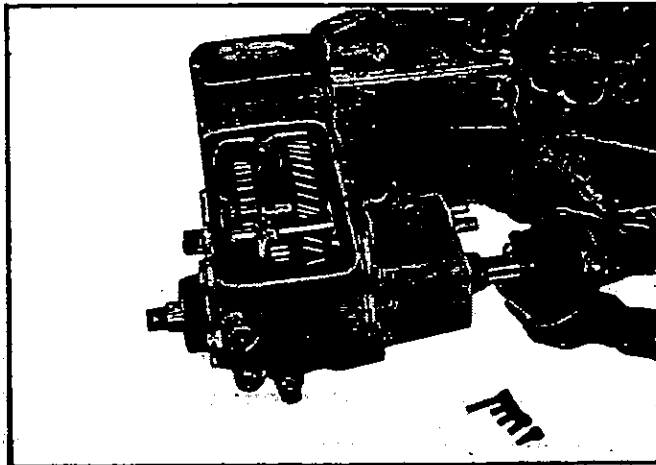

Removing bearing retainer

(3-5) REMOVE CHECK BALLS AND SPRINGS

Remove the two spring plugs from the front cover. Remove the
two springs and the two check balls.

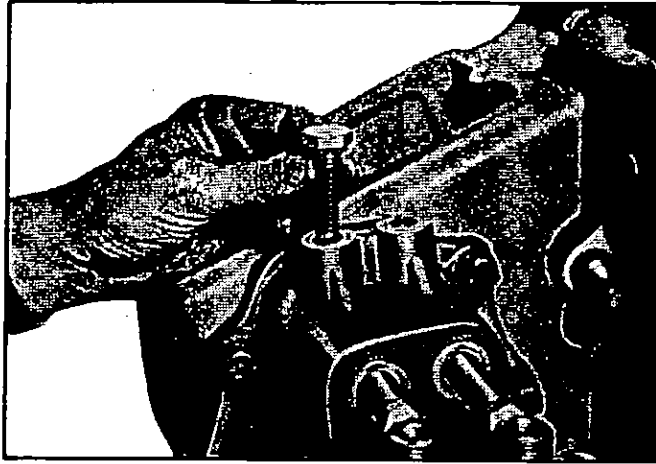

Removing check ball and spring

(3-6) REMOVE THE SHIFTER ROD EYELET

Undo the two check nuts and remove the two shifter rod eyelet from the rods.

(3-7) REMOVE THE FRONT COVER

Remove the six cap screws and slide the front cover out carefully. Leave the one shifter rods in place.

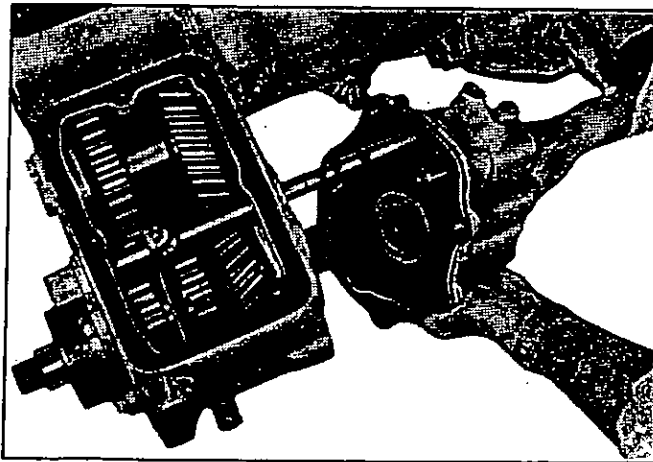

Removing front cover

(3-8) REMOVE FRONT DRIVE SHIFT ROD WITH FORK

Remove the front drive shift rod with fork and the front drive sleeve. Remove the front drive needle roller bearing.

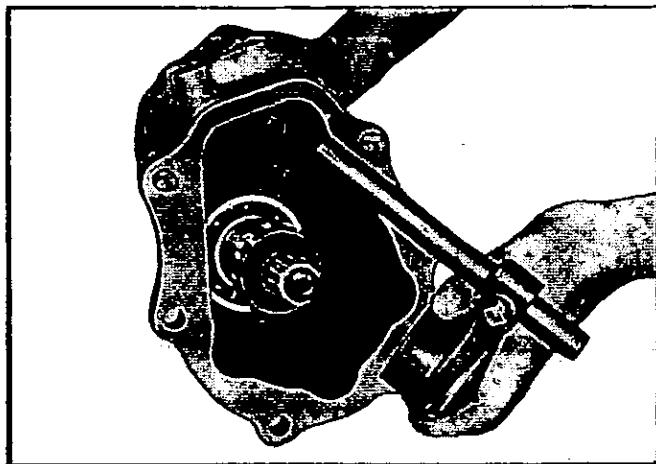

Removing front drive shift rod

(3-9) REMOVE HIGH AND LOW SHIFT ROD

Remove the set screw that secures the shifter fork to the high and low speed shifter rod. Slide the shifter rod out of the fork and case. Remove fork from case.

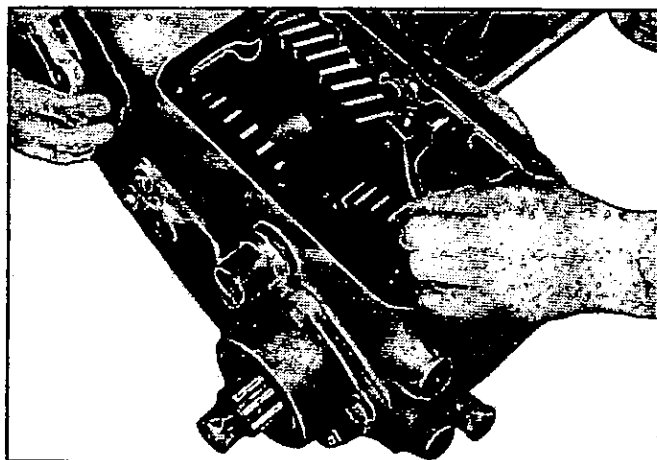

Removing high and low shift rod

(3-10) REMOVE COUNTER SHAFT AND GEAR

Remove the cap screw that secures the lock plate. Remove the lock plate. Drive the counter shaft out with suitable drift. Remove the counter gear, two thrust washers, and roller bearings from the top of the transfer case.

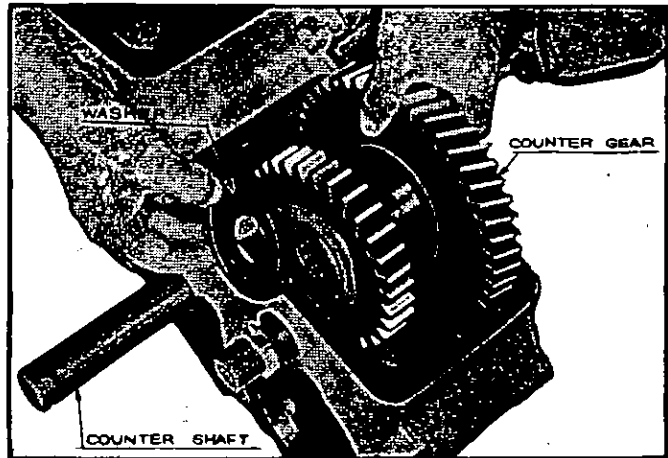

Removing counter gear

(3-11) REMOVE DRIVE SHAFT

Remove drive shaft rear bearing with a suitable puller, or press drive shaft out toward front with an arbor press. Remove the low speed gear from the top of the transfer case. Drive the rear bearing out from case with suitable driver, if drive shaft was pressed out by arbor press.

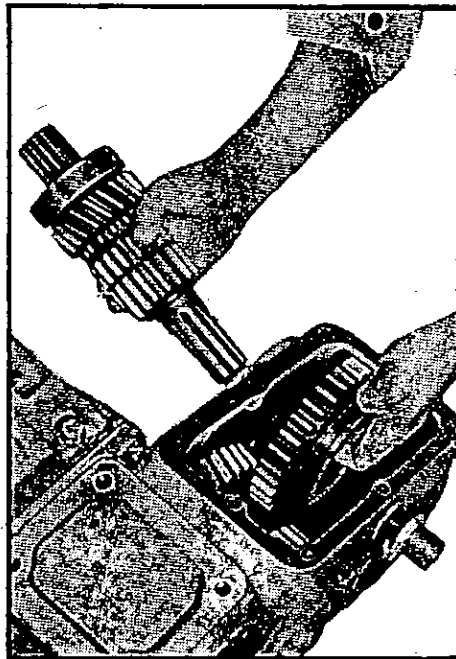

Removing drive shaft

(3-12) DISASSEMBLE DRIVE SHAFT

Remove snap ring from the drive shaft that secures the front bearing. Remove the spacer washer and the ball bearing with suitable puller. Remove the thrust washer and the high speed gear from the drive shaft.

4. CLEANING, INSPECTION, AND REPAIR

(4-1) CLEANING

Cleaning all parts thoroughly in cleaning solvent. Clean the bearings by rotating them while immersed in cleaning solvent until all trace of lubricant has been removed. Oil the bearings immediately to prevent corrosion of the highly polished surface.

(4-2) INSPECTION

(A) TRANSFER CASE ASSEMBLY

Inspect the transfer case housing for cracks or damage of any kind. Inspect the top and rear cover for bent or damaged condition. Replace all gaskets for covers and retainers.

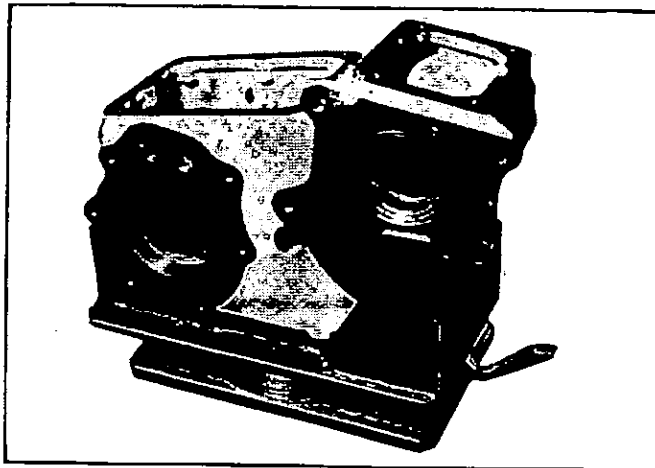

Transfer case

(B) FRONT DRIVE SHAFT BEARING COVER ASSEMBLY

(i) Front drive shaft bearing cover.

Replace the front bearing cover, if it is cracked or damaged. Shift rod oil seals must be replaced.

(ii) Front wheel drive shift rod and fork.

Replace the front wheel drive shift rod, if bent or damaged. Replace the fork if it has stripped set screw threads, if it is cracked, or worn, or has bent forks.

(iii) Front drive shaft and sleeve

Replace the front drive shaft if the splines or gear teeth are chipped or worn, if the gear has any teeth missing. Check the diameter of the pilot end of the drive shaft. If the diameter is less than 17.000 mm. 0.6693 in. replace the drive shaft. Replace the drive sleeve, if it is worn or has any broken teeth.

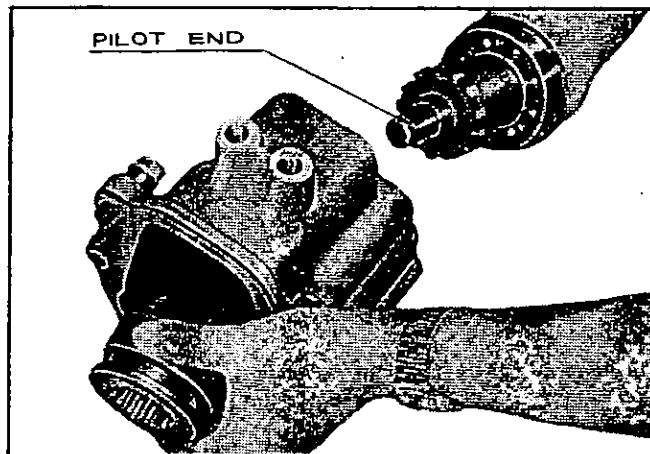

Removing front drive shaft

(iv) Shaft bearing

Ball bearings with loose or discolored balls or with pitted or cracked races must be replaced.

(v) Speedometer

Replace the speedometer drive gear if it is worn or has damaged teeth.

(C) COUNTER GEAR ASSEMBLY

Replace the counter gear if excessively worn, or if any teeth are damaged. Check thickness of the thrust washers. If the thrust washers are less than 3.33 mm. (0.1311 inch), replace them. If the surface of thrust washer was excessively worn, replace them. Check the diameter of the counter gear shaft. If the diameter is less than 31.73 mm. (0.1249 inch), replace the counter gear shaft. Replace the roller bearing, if the rollers are scored or have flat spots.

(D) REAR DRIVE SHAFT BEARING RETAINER ASSEMBLY

Replace the drive shaft bearing retainer if cracked or damaged. Replace the oil seal in the bearing retainer. Replace the brake drum if it is cracked or excessively worn. Replace the universal joint flange, if the splines are worn.

(E) DRIVE SHAFT ASSEMBLY

Replace the drive shaft if the splines are worn. Small nicks can be removed by honing and then polishing with a fine stone. Replace the front drive sleeve gear if it is worn, or has any damaged teeth. Replace the slow speed sliding gear, if it is worn or has damaged teeth. Measure the thickness of the thrust washer. If the thrust washer thickness is less than 3.6 mm (0.142 inch), replace it. Or if the surface of thrust washer is worn excessively, replace it. Replace the roller bearings if they are scored or have flat spots.

(F) HIGH AND LOW SPEED DRIVE SHIFTER FORK ASSEMBLY

Check the fork for stripped set screw threads, cracked or bent fork. Replace if in any of these conditions. Replace the shifter rod if it is bent.

(G) DRIVE SHAFT BEARING RETAINER OIL SEAL REPLACEMENT

Drive the old oil seal out of the bearing retainer, using a suitable driver. Drive the oil seals out, working from the inside of the retainer. To install a new oil seal, use a driver the size of the oil seal and drive the new seal in the bearing retainer.

5. ASSEMBLY

(5-1) ASSEMBLE REAR DRIVE SHAFT

Push the rear bearing on the drive shaft. Set the low speed sliding gear in the transfer case, channel side toward rear. Insert the drive shaft in the transfer case and through the gear. Insert dummy bearing at the front side to center the drive shaft. Drive in the rear bearing and drive shaft assembly. Paste rear retainer gasket on case. Place rear bearing drive shaft spacer on shaft, chamber side toward bearing. Install the oil seal in the rear bearing cap. Install bearing cap on the transfer case. Tighten the five cap screws evenly to prevent cracking the drive shaft bearing cap. Coat oil seal with grease. Insert the universal joint flange.

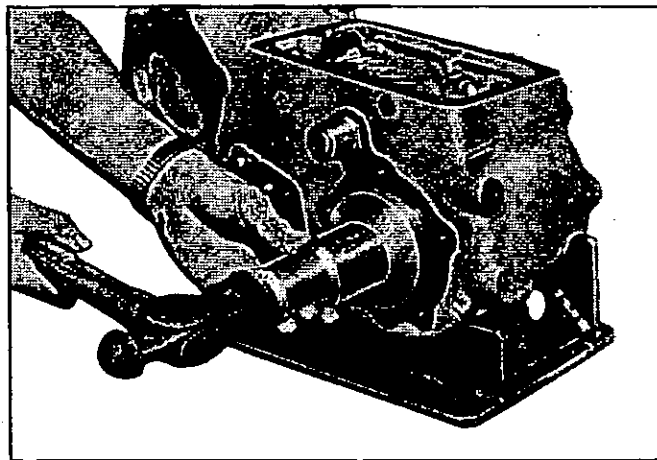

Driving rear drive shaft in

spacer on the drive shaft. Insert the snap ring in the groove of the drive shaft.

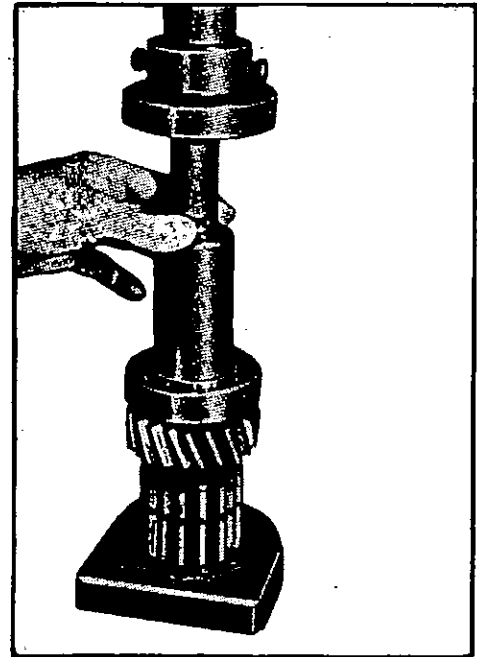

Press in bearing

Install the rear universal joint flange on the drive shaft and tighten securely with nut. Insert cotter pin. Remove the dummy bearing from the front side of drive shaft. Slide the high speed gear onto the drive shaft, small gear toward rear. Insert the thrust washer, face the gooved side toward the gear. Drive in the front bearing with a suitable driver. Install the bearing

(5-2) INSTALL COUNTER GEAR

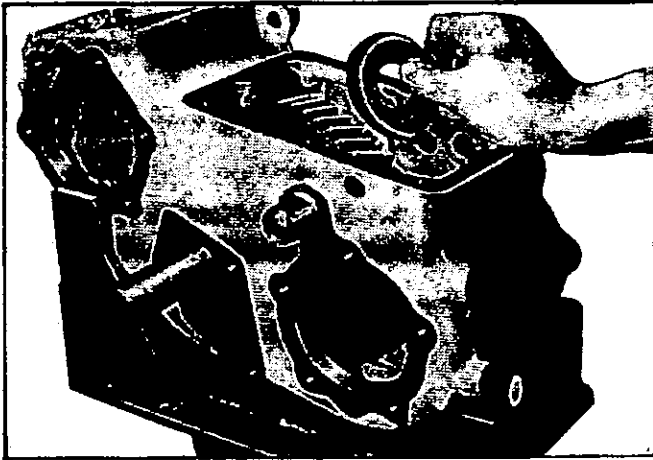

Replacing counter gear washer

Place rear "O" ring on shaft. Place the counter gear in the transfer case, large gear toward the front. Insert the front thrust washer and drive the shaft in. Drive the shaft out to the front side far enough to place "O" ring on the shaft. Drive the shaft back in and install the lock plate that secures the counter gear shaft to the transfer case.

Insert the roller bearings in the counter gear, place the spacer between the two roller bearings. Place the rear thrust washer in the transfer case, with the side having the oil groove facing, toward the counter gear. Apply grease to the thrust washer to hold it in position, if necessary, drive in shaft for enough to hold the washer. Insert guide into the counter gear.

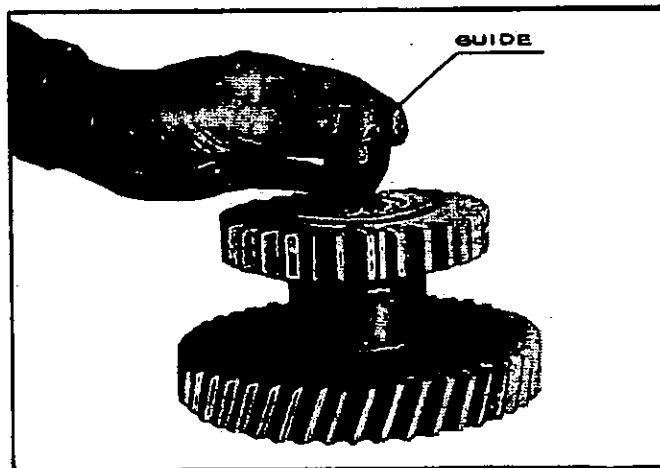

Replacing bearing into the counter gear



Fitting "O" ring

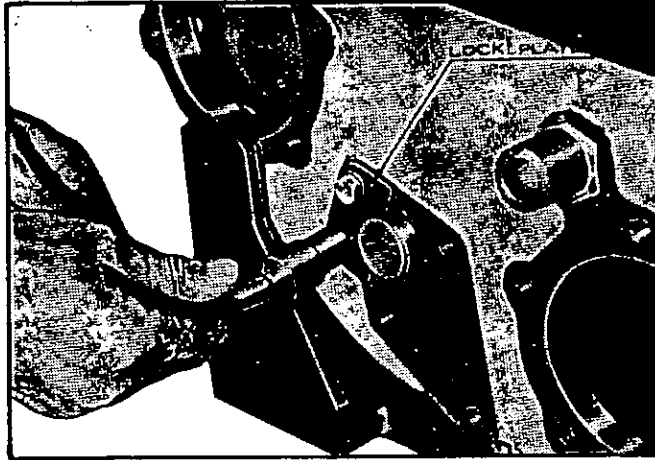

Locking counter shaft

(5-3) INSTALL SHIFTER RODS

Place the low drive shifter fork in the transfer case. Insert the high and low shifter shaft in the transfer case and shifter fork. Install the shifter fork set screw that secures the fork to the shifter shaft. Secure the set screw with lock wire.

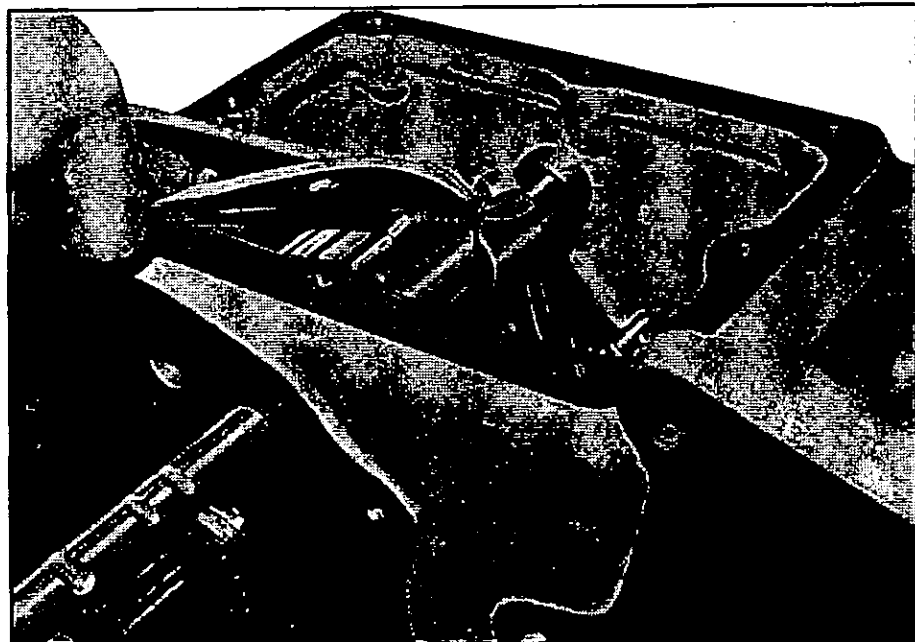

Locking with wire

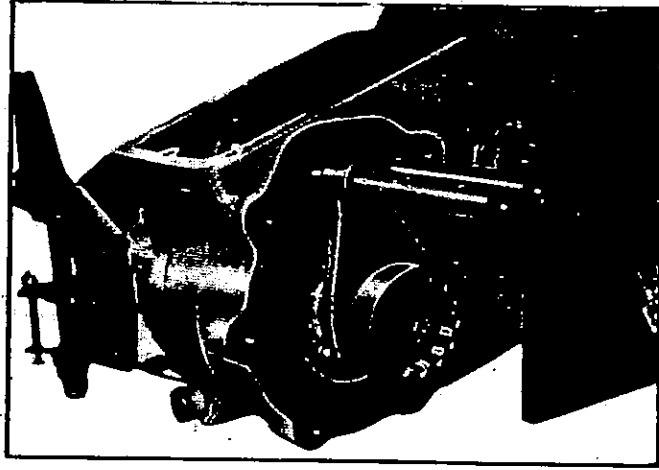

Fitting front drive sleeve and rod.

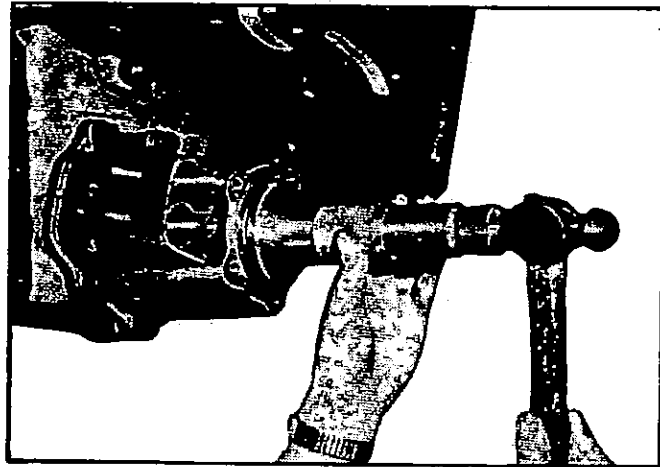

Driving bearing in.

Slide the front drive shifter fork on the shifter shaft. Install the set screw in the shift fork and secure with a lock wire. Place the front wheel drive shifter fork in position on the front drive sleeve gear. Insert the shift rod into the hole in the transfer case, place the front drive sleeve on the drive shaft. Insert needle roller bearings in drive shaft.

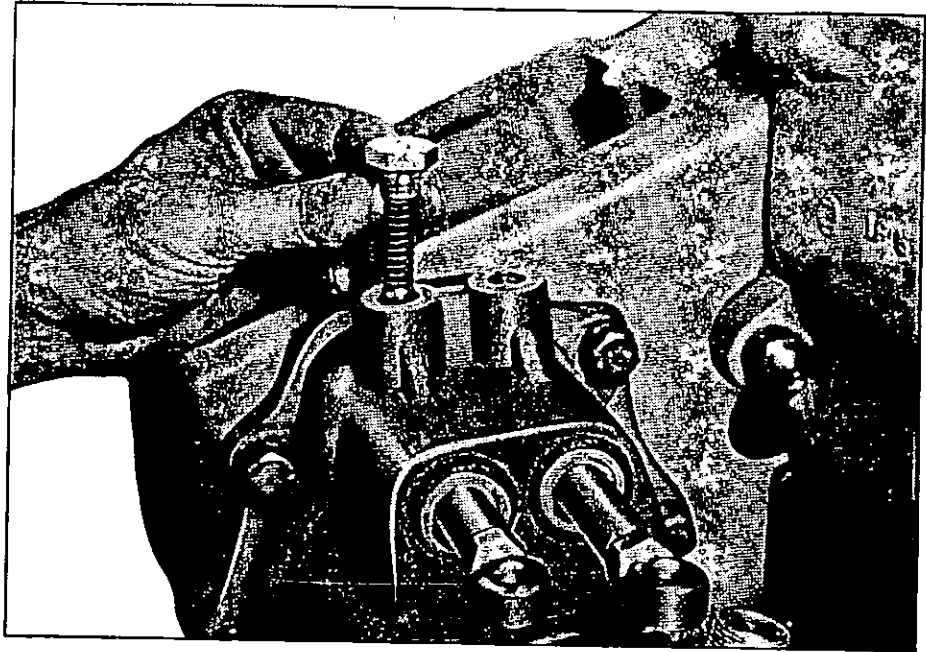

Replacing poppet ball and spring

(5-4) INSTALL FRONT COVER

Place a new gasket in position on the transfer case. Install the front transfer case cover. Tighten the six cap screws evenly to prevent cracking the cover. Drive in the front drive shaft and bearing assembly with a suitable driver. Install the shifter rod poppet ball, poppet spring and poppet plug in the two holes.

(5-5) INSTALL FRONT BEARING RETAINER ASSEMBLY

Slide the speedometer drive gear on the front drive shaft. Place a new gasket on the front cover and install the retainer with five cap screws. Coat the oil seal lip with chassis grease (NCS1). Install the front universal joint flange on the front drive shaft, and install nut. Tighten the nut securely and insert cotter pin.

(5-6) INSTALL TOP COVERS TO TRANSFER CASE

Install a new gasket in position on the transfer case. Place the covers on the transfer case. Install the cap screws that secure the covers to the transfer case.

(5-7) INSTALL HAND BRAKE BAND ASSEMBLY TO CASE

Place the brake band assembly on the brake drum. Install the cap screws that secure the brake band anchor to the transfer case. Brake band must be adjusted after installation to vehicle. Refer to the paragraph "BRAKE ADJUSTMENT"

6. INSTALLATION

(6-1) RAISE TRANSFER CASE

Raise the transfer case and line up the transfer case with the transmission. Place a new gasket on the transmission. Slide transfer case forward, install the four cap screws and one nut that secures the transfer case to transmission.

(6-2) INSTALL MAINSHAFT GEAR

Insert the spacer and mainshaft gear, small gear toward rear, on the mainshaft. Install the lock washer and nut that secure the mainshaft gear on the transmission mainshaft. Tighten the nut securely and bend the lip of the lock washer. Place a new gasket and the rear cover with roller bearing on the transfer case. Install the cap screws that secure the cover to the case.

(6-3) CONNECT HAND BRAKE, SHIFT ROD AND SPEEDOMETER CABLE

Install the clevis pin that secures the hand brake rod to the brake band and shifter lever arms to shifter rods. Install the speedometer cable to the transfer case at the top of the front drive shaft cover.

(6-4) INSTALL PROPELLER SHAFT

Connect the front and rear propeller shaft to the transfer case. Fill the transfer case with specified oil to the proper level. Adjust the hand brake band.

Temperature	F	Under 10°	10° - 90°	Over 90°
	C	Under -12°	-12° - 32°	Over 32°
Oil SAE		MP 80	MP 90	MP 140

TRANSFER CASE ASSEMBLY MODEL 60

SECTION B-B

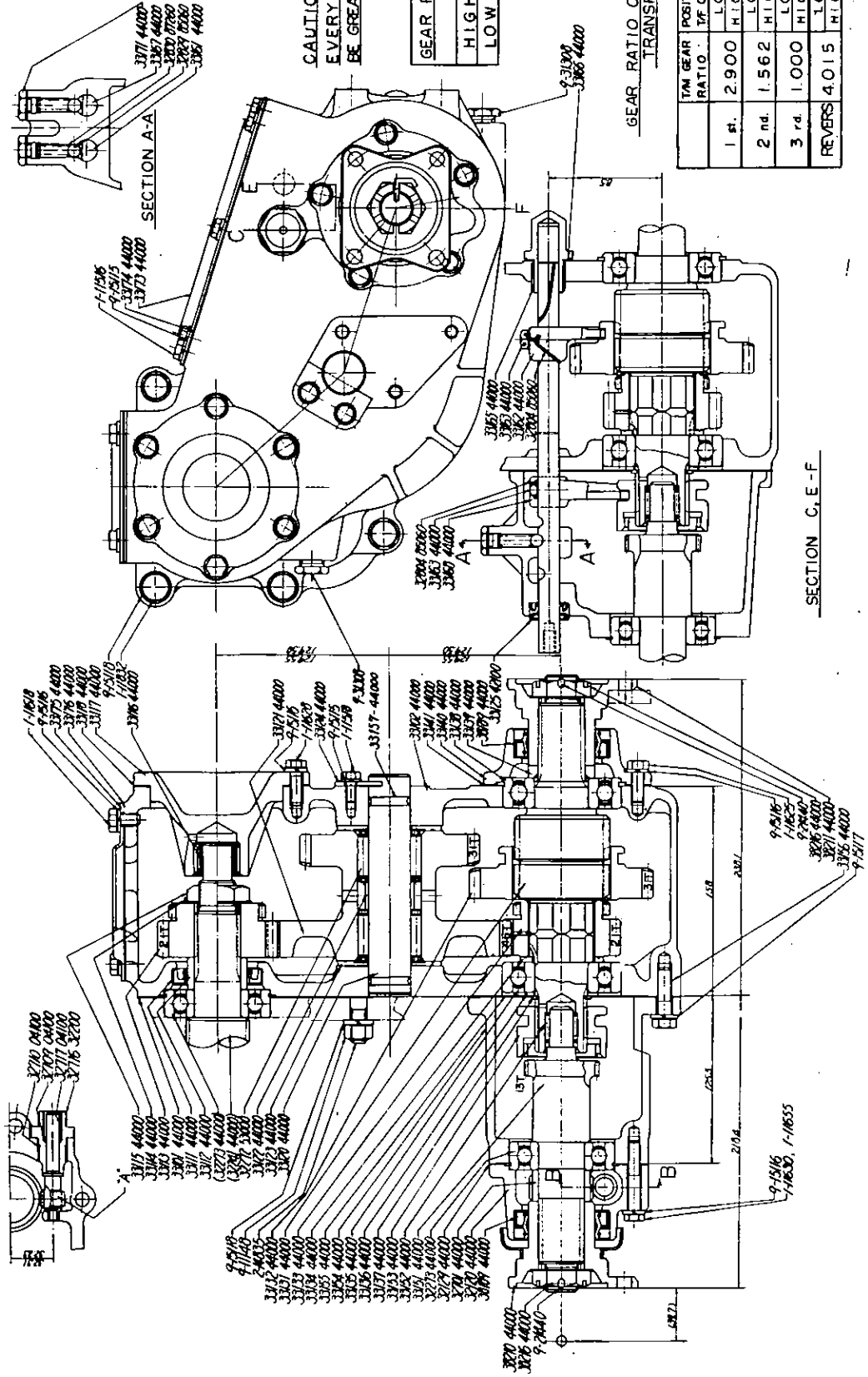

CAUTION
EVERY OIL SEAL LIP MUST
BE GREASED WHEN ASSEMBLED

GEAR RATIO OF TRANSFER CASE	
HIGH	1.000
LOW	2.264

GEAR RATIO OF TRANSMISSION WITH
TRANSFER CASE

TAN GEAR POSITION	POSITION OF CASE	COMBINED RATIO	ORDER OF RATIO
1 st.	LOW	6.564	1
	HIGH	2.900	3
2 nd.	LOW	3.535	2
	HIGH	1.562	5
3 rd.	LOW	2.264	4
	HIGH	1.000	6
REVERS	LOW	9.089	1
	HIGH	4.015	2

PROPELLER SHAFT AND UNIVERSAL JOINTS

1. DESCRIPTION AND DATA

(1-1) DESCRIPTION

The power from the transfer case is carried through two propeller shafts. One shaft runs from the front of the transfer case to the front axle, and a second propeller shaft runs from the rear of the transfer case to the rear axle. Each is equipped with two universal joints. All four universal joints are of the needle bearing type. The front and rear yoke of each universal joint is machined to receive the bearings. The bearings are pressed into the yokes and locked by snap rings.

Each journal (trunnion) is drilled and fed by a central lubrication fitting for lubricating the bearings. On the side opposite the lubrication fitting, a relief valve is mounted. This valve is adjusted to "pop" at from 40-80 lbs. pressure, thereby preventing overlubrication or damage to the journal bearing seals.

A lubrication fitting is mounted on the sleeve yoke to lubricate the splines. A plug is staked into the forward end of the splined opening to retain the lubricant. A small hole is drilled in the center of this plug to relieve trapped air. The rear end of the splined opening is sealed by dust cover, the end of dust cover is sealed by cork packing contained in a retainer cap which screws on the end of dust cover.

The splined slip joint at one end of each shafts allows for variations in distance between the transfer case and the axle units due to spring actions. Solid yoke type of universal joints are used.

(1-2) DATA

Length x Out. dia x Inn. Dia.	length shows between joint and joint.
Front	566 x 45 x 38 mm
Rear	457 x 45 x 38 mm
Type of Joint	Cross spider type
Outer diameter of journal	17.272 — 17.285 mm (0.6800 - 0.6805 in.)
Needle roller	
Outer diameter	3.165 — 3.175 mm (0.1246 - 0.1250 in.)
Dynamic balance of propeller shaft with Joint assembly	Not exceed 36 gr-cm.
Tightening torque of fix bolt	6-7 kg-m (43 - 51 ft-lbs.)

2. REMOVAL

FRONT & REAR PROPELLER SHAFT: Remove the four nuts that secure the universal joints flange yoke to the flange at both ends of propeller shaft. Remove the propeller shaft which ever worked on.

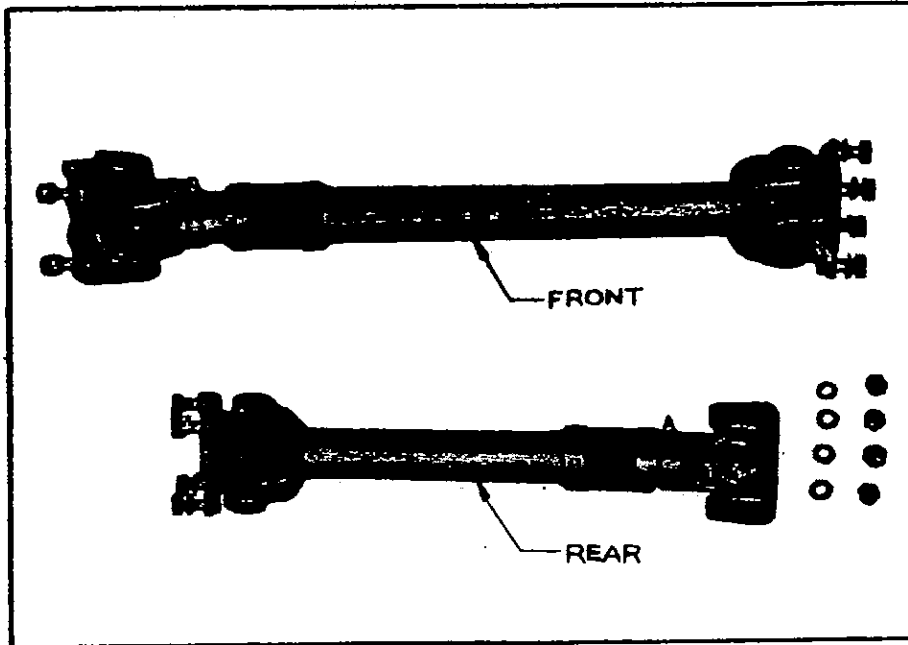

3. DISASSEMBLY

(3-1) FRONT AND REAR PROPELLER SHAFT

(A) REMOVE SNAP RINGS FROM YOKE

Place the propeller shaft in a vise. Remove the snap rings the secure the journal bearings in the yoke flange with a pair of pliers. If the snap ring does not snap out of the groove, tap the end of the bearing lightly. This will relieve the pressure against the snap ring.

(B) REMOVE SPIDER FROM THE YOKE

Drive lightly on the end of the journal bearing until the opposite bearing is pushed out of the yoke flange. Turn the assembly over in the vise and drive the first spider bearing back out of its lug by

driving on the exposed end of the spider. Use a brass drift with a flat face about 1/32 inch smaller in diameter than the hole in the yoke, otherwise there is danger of damaging the spider bearing. Repeat the operation for the other two bearings, then lift out the journal, sliding to one side and tilting over the top of the yoke.

(C) REMOVE SLEEVE YOKE FROM SHAFT

Slide the sleeve yoke off the drive shaft. Remove the dust cap and seal.

(3-2) CLEANING, INSPECTION, AND REPAIR

Clean all parts thoroughly with cleaning solvent. Inspect the drive shafts for cracks broken welds, scored journal bearing, surfaces, or bent shafts. Parts with any of these faults must be replaced. Inspect the sleeve yoke for worn splines, worn bearing surfaces and bearings and plugged lubricant fittings. Check diameter of the machined surface of the journal. If the diameter is less than 17,172 mm (0.676 in.) replace the journal. Replace all grease seals regardless of their condition.

4. ASSEMBLY

(4-1) SHAFT AND SLEEVE YOKE

Place the propeller shaft in a bench vise. Place a new seal in the cap and slide the dust cap on the sleeve yoke. Slide the sleeve yoke on the shaft splines, being sure that the yoke on the shaft is in the same angle as the yoke at the opposite end of the propeller shaft. Screw the dust cap on the dust cover securely.

NOTE Coat oil seal with lubricant.

(4-2) REAR PROPELLER SHAFT

Install Spider in Yoke Flange. Insert the journal into the yoke flange. Tap the journal bearing approximately 1/4 inch into the yoke flange, using a brass drift approximately 1/32 inch smaller than the hole in the yoke. Tap the other bearing into the opposite end of the yoke flange until the bearing is in line with the snap ring grooves. With a pair of pliers, install the snap rings on both ends of the yoke flange. Insert the flange assembly in the sleeve yoke. Tap the bearing approximately 1/4 inch into the yoke. Place the other bearing into the opposite end of the yoke, and tap this bearing into the yoke until the bearing is in line with the snap ring groove. Install the snap rings on both ends of the yoke.

NOTE - Coat the inside of the bearings with chassis grease before install to journal.

5. INSTALLATION

Be sure to place the propeller shaft with the splined end toward the transfer case. Install the four nuts that secure the joint flange at both ends of propeller shaft and tight securely. Lubricate the propeller shaft with specified lubricant.

PROPELLER SHAFT ASSEMBLY MODEL 60

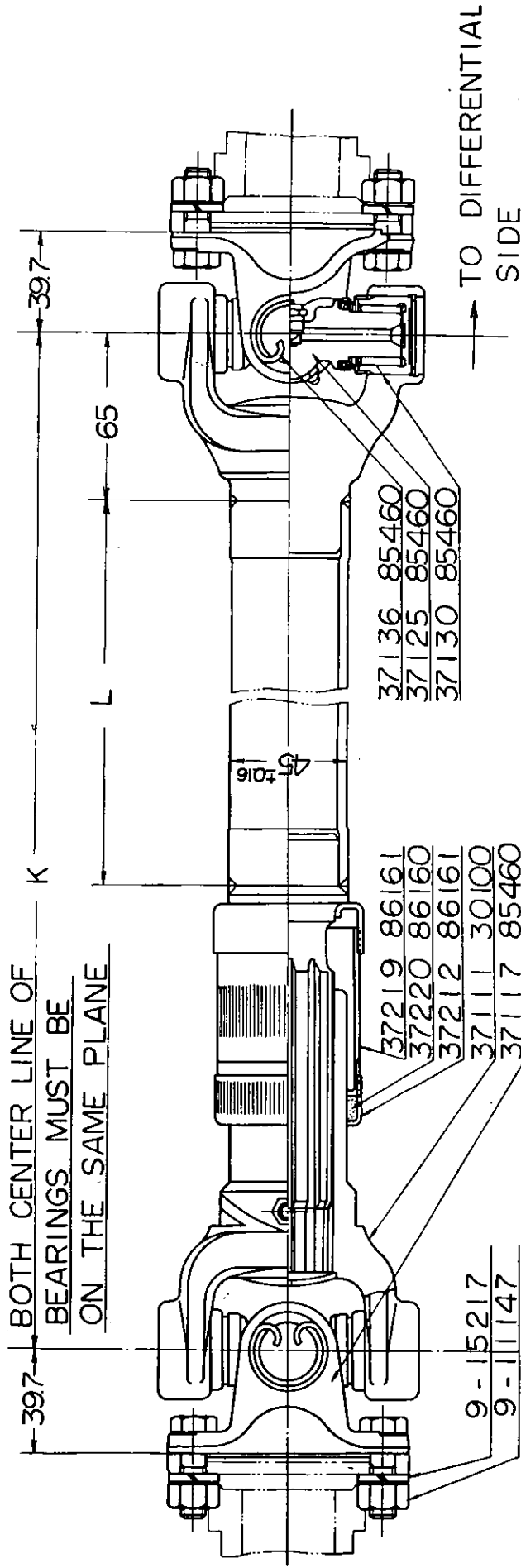

PARTS NO.	K	L	REMARKS
37210 -44000	566mm	321 + δ	FRONT : FOR MODEL 60
37300 -44000	457mm	212 + δ	REAR : " "
37300 -44300	687.5mm	442.5 + δ	REAR : " G60H
37300 -44500	752.5mm	507.5 + δ	REAR : " G60

FRONT SUSPENSION

1. CONSTRUCTION AND DATA

(1-1) DESCRIPTION

The front suspension of Nissan Patrol consists of front springs, front shock absorbers, stabilizer, rebound stoppers, rubber bumpers and torque arrester, and is shown in the drawing.

(1-2) DATA

FRONT SPRING	
Type	Parallel semi-elliptic leaf spring with grooved section
Thickness x Width x Span-Number	for Model 60 & G60 6.5 x 70 x 1.100-3 6.5 x 60 x 1.100-1 for Model G60H 6.5 x 70 x 1.100-5
Spring constant	Model 60 & G602.90 kg/mm Model G60H3.86 kg/mm
Camber when loaded	Model 60 & G6053 mm Model G60H47 mm
Bushing	Steel bushing used on front shackles. Silentblock type rubber bushing used on rear spring eyes.
SHOCK ABSORBERS	Telescopic, double acting.
STABILIZER	Torsion bar type, outer diameter of torsion bar - 20 mm

2. FRONT SPRINGS

The front springs on the Nissan Patrol are of a low camber and low spring rate type. The advantage of this type spring is that the rebound or throw is much less giving a smooth ride. The second leaf is wrapped around the main eye for safety. A special steel bushing with bolt type is used at the shackles of front spring.

The rear end of the front springs on the Nissan Patrol are mounted in a bond rubber bushings. The bushing consist of an internal steel tube and a tubular outer retainer, to which a rubber bushing is molded and securely bonded. These rubber bushings require no lubrication and no attention other than to keep the bolt

drawn up snugly. Before installation coat the bushing securing with a very thin coat of grease, to protect it from freezing by corrosion.

To remove and replace bushing in the eye, a special press or arbor press with a drift is necessary.

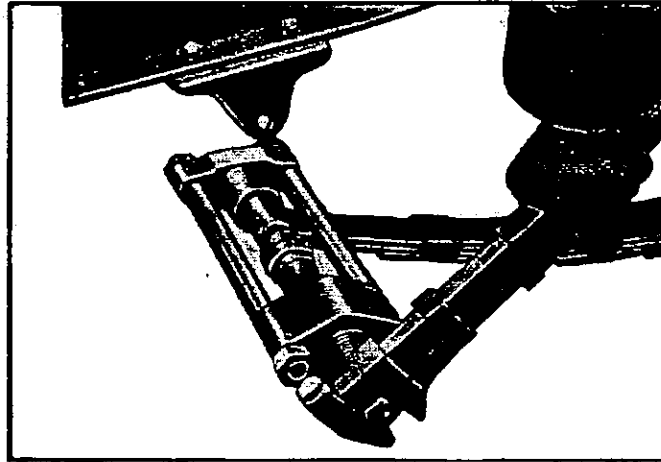

Special press

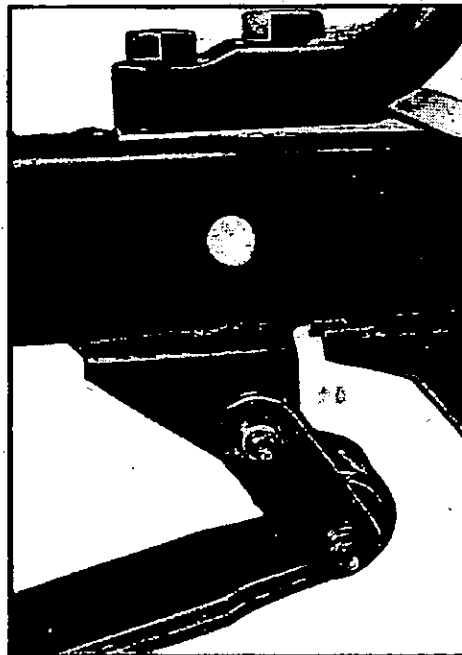

Front spring front shackle

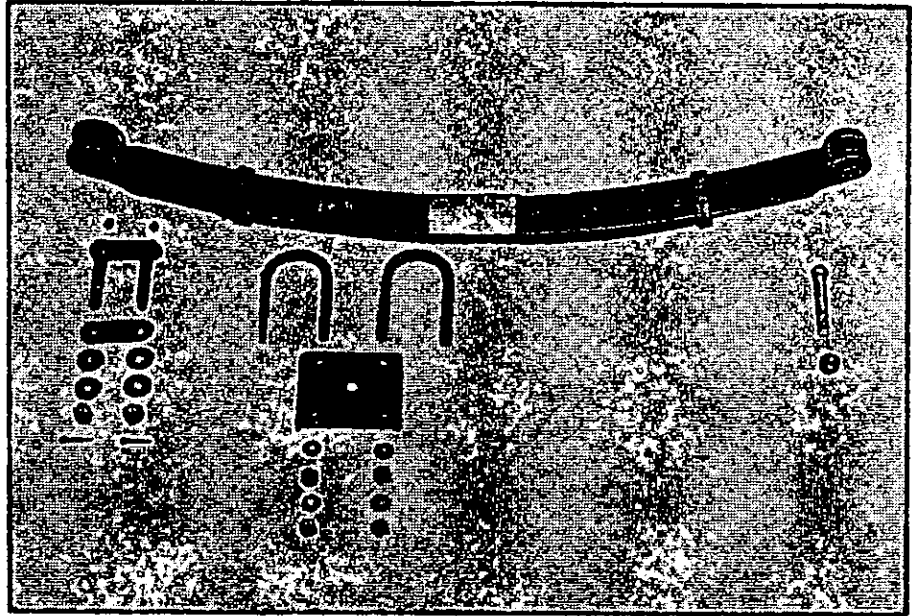

Front spring parts

The great cares should be paid for tightening the nuts up of the spring eyes and shackles. Namely, the springs must be loaded when they are tightened up, to prevent to give unnecessary initial deflection to the rubber bushings of the springs.

It is recommended that the weight of the vehicle is on the vehicle, in order to give correct load to the springs. To be sure whether or not the correct load has been keeping, check the buffer clearance (between the rubber bumper and the axle). If that clearance is 46 mm (1.81 in.), the springs are loaded with correct weight.

The tightening torque of the spring eye nut is 6.2 — 6.9 Kg-m (45 — 50 ft-lbs).

The nuts on the front spring shackles should be tightened up by the following method.

- (1) Tighten nut up as tight as possible.
- (2) Back off the nut a quarter turn.
- (3) If the slot in the nut and the cotter pin hole line up, insert the cotter pin. If not, back the nut off until the slot and the hole are in line, and then insert the

cotter pin.

The tightening torque of the nut that secure the spring clip U-bolt, should be 6.9 — 8.3 kg-m (50 — 60 ft-lbs).

3. FRONT SHOCK ABSORBERS

The front shock absorbers on the Nissan Patrol are of the none-adjustable type, and the double acting type. That is why no further maintenance will be needed.

Replace the shock absorber if the leakage of fluid is found, or the dumping force is decreased.

The same shock absorbers are used on the rear suspension of this model.

4. FRONT STABILIZER

The stabilizer used in the Nissan Patrol is of the torsion bar type with rubber bushing on the mounting.

Check the torsion bar for the crack or any other fault. If any, replace it.

Replace the rubber bushing, if it is worn.

Check every nuts that secure the stabilizer and connecting rods to the axle and frame, at least every 10,000 Km (6,000 miles).

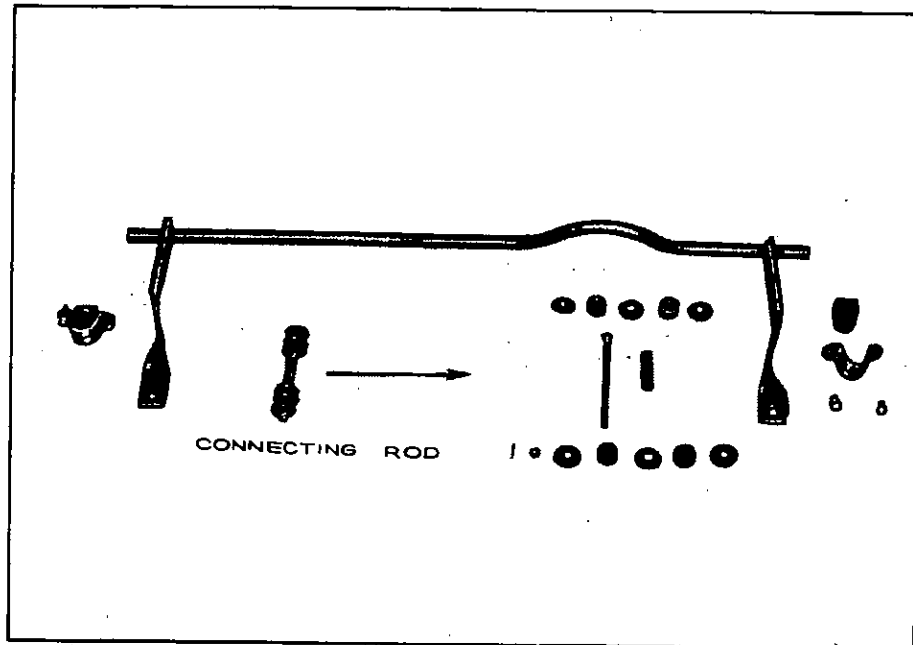

Front stabilizer parts

5. FRONT REBOUND STOPPER

The front rebound stopper of the Nissan Patrol are mounted between front axle and the bracket which is welded on the inner side rail of the frame, with rubber bushings. This rebound stopper bolt is designed so as to be strong enough to receive big tension in rebounding.

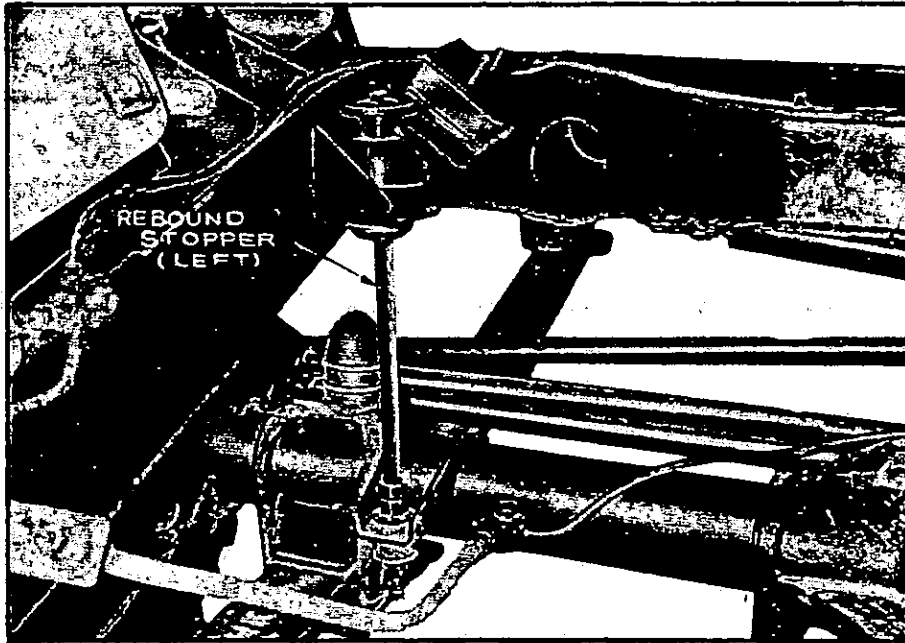

Rebound stopper L.H.

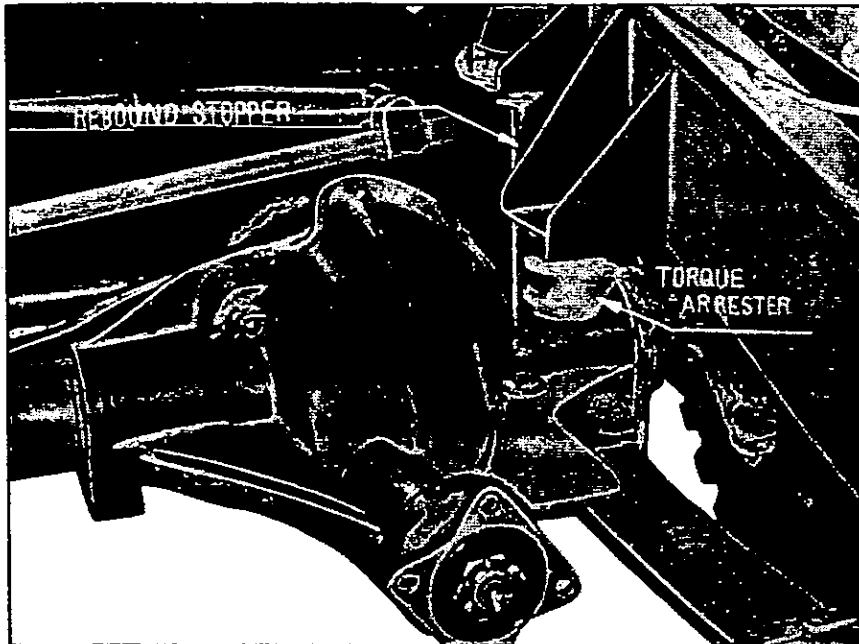

Rebound stopper R.H. and torque arrester.

In order to avoid any damage on the shock absorbers and springs as well, the length of the rebound stopper should be adjusted carefully. If the bottom end of the screwed parts of the stopper is 12 mm (0.47 in.) far from the bottom surface of the nut, the rebound stroke will be kept in correct measurement. Correct stroke is 85 mm (3.34 in.). Adjust the length of the screwed part of the rod, if necessary to maintain the rebound stroke. However it must not be less than 5 mm (0.2 in.).

Every 10,000 Km (6,000 miles), check the nuts, rebound bumper and rubber bushings. Replace these rubbers, if necessary.

6. TORQUE ARRESTER

The Nissan Patrol is equipped with a torque arrester on its right hand side rail of the frame.

The front spring of the Nissan Patrol is so soft in order to get comfortable riding during the driving, that the rear axle housing can be turned its rear end up when the vehicle is braked during the running. If this movement is kept free, the universal joint of the propeller shaft will have so big angle that disturbs the smooth rotation of the propeller shaft and cause the uncomfortable riding and the damage of the propeller shaft as well.

The torque arrester of the Nissan Patrol prevents this movement and keep the housing of the rear axle in its normal position, providing the good riding even when the car is going to be braked or running.

Check the rubber deformation of the torque arrester, at least every 5,000 Km (3,000 miles).

FRONT AXLE

1. DESCRIPTION AND DATA

(1-1) DESCRIPTION

The front axle assembly is a front wheel driving unit, with specially designed spindle housings, and has a conventional type differential with hypoid drive gears. The differential parts are interchangeable with those of the rear axle. The axle shafts are of the full-floating type. The differential is mounted in the housing similar to the rear axle, except that the drive pinion shaft is toward the rear instead of the front and to the right of the center of the axle. Tracta type universal joints have been used.

(1-2) DATA

Type	Full floating Tracta joint type
Front wheel alignment	
Tread	1382 mm (54.4 in.)
Camber	1°30'
Swivel pin angle	7°30'
Toe in	3 — 4 mm (0.12 — 0.16 in.)
Caster	1°30'
Driving method	Hypoid bevel gear
Gear ratio	4.1 : 1
Number of teeth	
Ring gear	41
Drive gear	10
Differential gear type	Straight bevel gear
Number of teeth	Side gear 16 Pinion mate 10
Standard position to install drive pinion:	
Distance from center of drive gear to pinion head	70.36 mm (2.7706 in.)
Preload of drive pinion	11 — 14 kg-cm (without oil seal and ring gear)
Tightening torque	
Drive pinion nut	25 — 30 kg-cm (180 — 217 ft-lbs.)
Drive gear fix bolts for diff. case	7.5 — 9.0 kg-m (55 — 65 ft-lbs.)
Differential case bolt	7.5 — 9.0 kg-m (55 — 65 ft-lbs.)
Side bearing cap bolt	10 — 11 kg-m (72 — 80 ft-lbs.)

Upper and lower cap for muckle flange	1.9 — 2.1 kg-m (14 — 15 ft-lbs.)
Back lash	
Ring gear and drive pinion	0.13 — 0.18 mm (0.005 — 0.007 in.)
Diff. side gear and pinion mate	0.006 — 0.008 in.
Bearings	
Inner wheel bearing	Out. dia. x Inn. dia. x width 85x45x20.75 mm Type taper roller JIS 30209
Outer wheel bearing	73.025x41.275x16.7 mm Type; taper roller Timken 18590/18520
Swivel lower bearing	52x20x16.25 mm Type taper roller JIS 30304
Standard Oil and capacity Differential housing	SAE MP-90 1.2 ltr. (0.31 U.S. Gal)

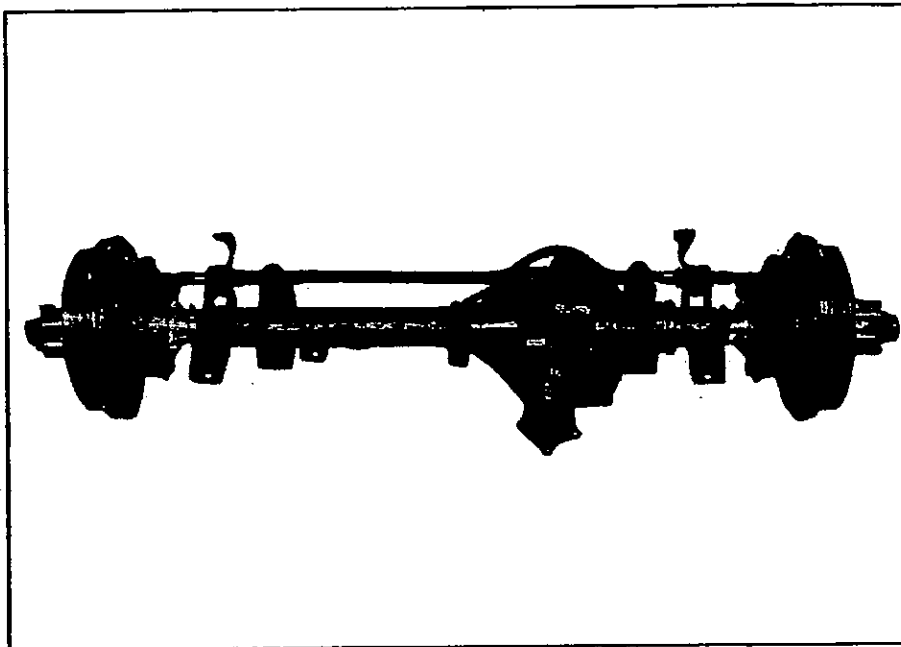

Front axle assembly

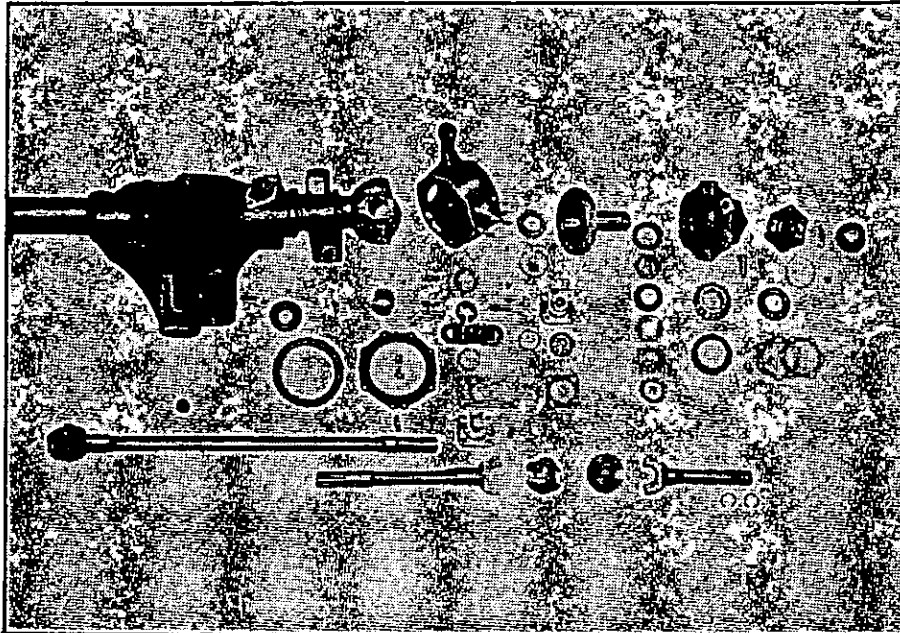

Front axle knuckle flange and shaft parts

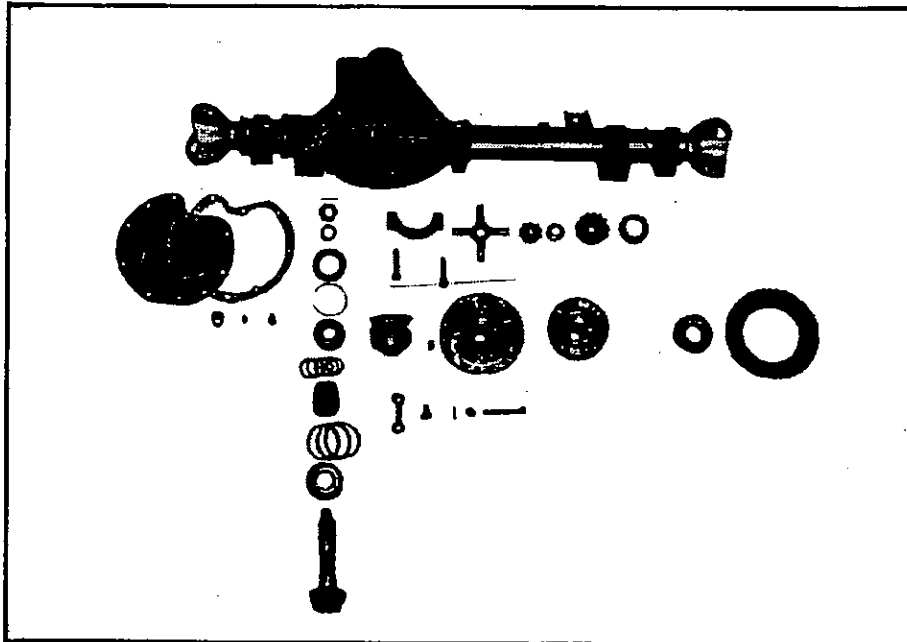

Front axle differential gear parts

2. REMOVAL

(2-1) PRELIMINARY WORK

Remove the drain plug at the differential housing and drain the gear oil. Raise the vehicle until the weight is off the front springs.

(2-2) DISCONNECT SHOCKABSORBERS, DRAG LINKS, STABILIZERS, BRAKE AND REBOUND STOPPER.

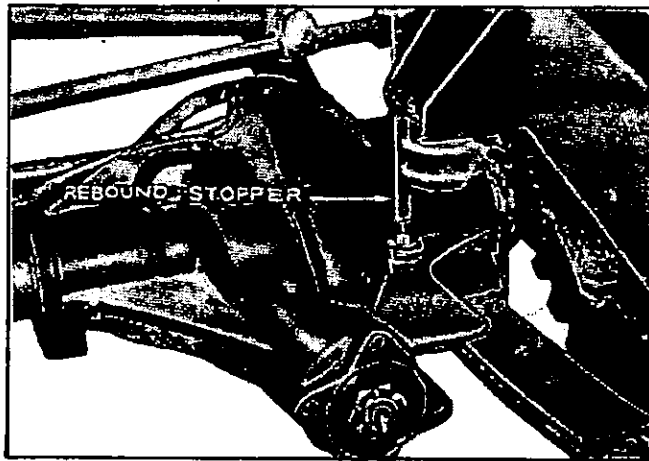

Rebound Stopper.

Remove the nuts, washer and grommet that secure both front shock absorbers. Remove the drag link plug at the steering arm and remove the drag link. Remove four cap screws that secure the stabilizer bar and remove the stabilizer bar. Disconnect the center brake hose. Remove nut that secure steering damper. Remove washer, rubber bushing and steering damper.

(2-3) DISCONNECT FRONT PROPELLER SHAFT AND SPRING U-BOLTS.

Disconnect the front propeller shaft at the front axle. Remove the eight nuts from the two studs and three U-bolts that secure the spring seat plates. Remove the spring seat plate and U-bolts.

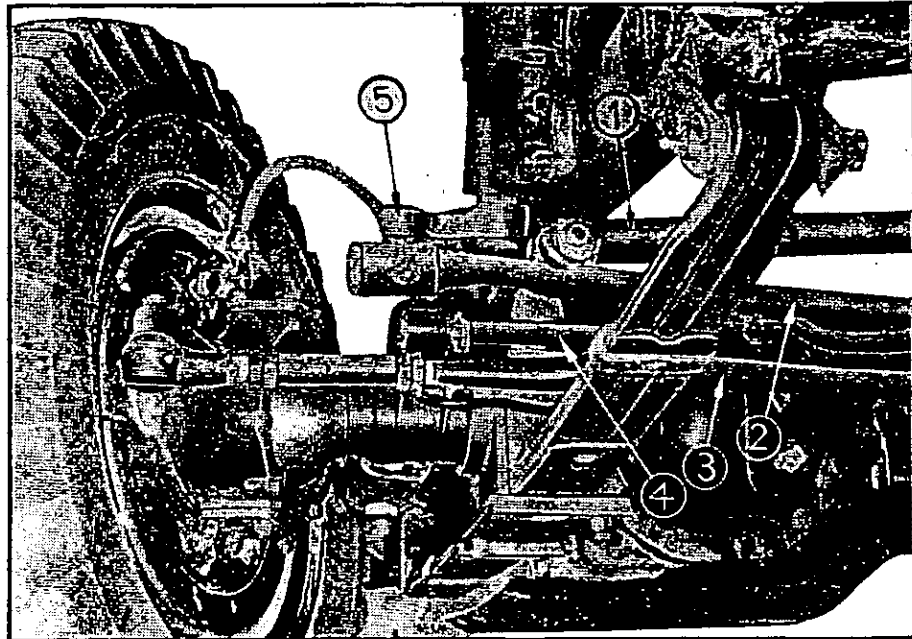

- | | |
|---------------------|----------------|
| (1) Steering dumper | (4) Stabilizer |
| (2) Drag link | (5) Pitman arm |
| (3) Tie rod | |

Disconnect those parts

(2-4) REMOVE FRONT SHACKLE

Remove the front shackle nuts and remove the shackle from both front springs and drop the forward end of the spring to the floor. Roll the front axle assembly from the vehicle.

3. DISASSEMBLY

(3-1) REMOVE WHEELS

Place the front axle assembly on two blocks. Remove the six nuts that secure wheels to the brake drum. Remove the wheels.

(3-2) REMOVE AXLE SHAFT ASSEMBLY

Using a screw driver, pry the hub cap off the drive flange. Remove the snap ring in axle shaft groove. Install the puller on

drive flange end. Remove the drive flange. Bend the ear of the lock washer off the bearing lock nut. Remove the bearing lock nut, lock washer, and bearing adjustment nut, using wheel bearing

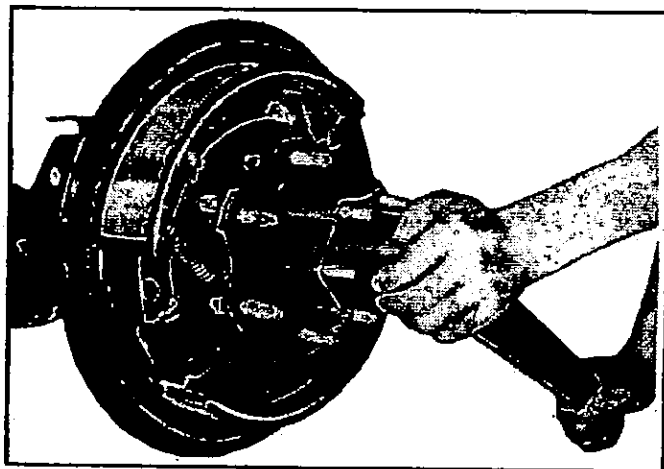

Remove bearing lock nut

adjust nut wrench. Slide the brake drum and hub assembly, including the wheel bearings, off the spindle. Disconnect the hydraulic brake hose. Remove the six nuts that secure the brake plate to the spindle housing. Remove the brake plate from the spindle. Slide the spindle off the axle shaft. The axle shaft can now be removed from the housing. Use the same procedure to disassemble the other end of the front axle.

(3-3) AXLE SHAFT DISASSEMBLY (TRACTA JOINT)

Remove the outer portion of the axle shaft and the outer portion of the universal joint from the axle housing. Pull the inner portion of the axle shaft and the inner portion of the universal joint out of the housing.

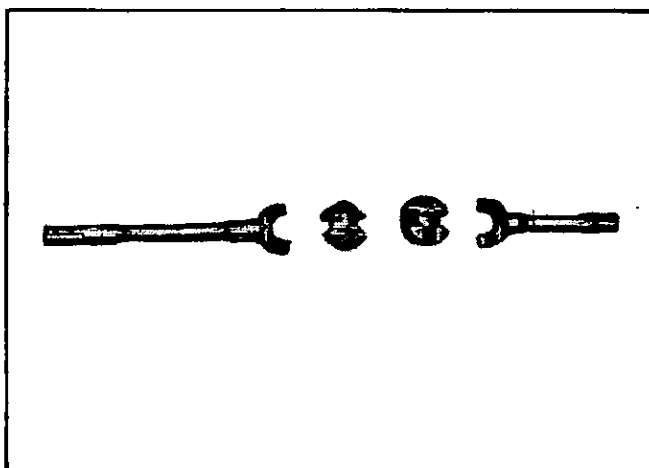

Front axle shaft

(3-4) REMOVE SPINDLE HOUSING

Remove the castellated nut that secures the tie rod ends to the two spindle arms and remove the tie rod. Remove the four nuts that secure knuckle flange upper cap and remove the knuckle flange upper cap, spring disc, and bearing cone. Remove the four nuts that secure the lower bearing cap to the knuckle flange and remove the lower cap and pin assembly. Remove the eight cap screws that secure the knuckle flange oil seal retainer to the knuckle flange. Remove the knuckle flange from the axle housing. Use the same procedure for disassembling the other knuckle flange.

(3-5) REMOVE DIFFERENTIAL

Remove the twelve plain nuts and lock washers that secure the differential cover to the differential housing. Remove the differential cover and gasket. Remove the two cap screws from the bearings cap at each end of the differential gears and remove the caps. Remove the differential gear assy from the housing, using a pry bar, if necessary. Reinstall the bearing caps in the housing, noting the marking to assure their being installed in their correct location.

NOTE - Stamp marks on bearing caps and housing, if there are no markings.

(3-6) DISASSEMBLE DIFFERENTIAL

(A) REMOVE DIFFERENTIAL PINION GEARS AND SIDE GEARS

To disassemble the differential, check and make sure the case halves are marked. So it may be reassembled in the same position. Remove four bolts by removing the cotters and castellated nuts. Lift off the case cover and remove the four pinion mate and two side gears with thrust washers.

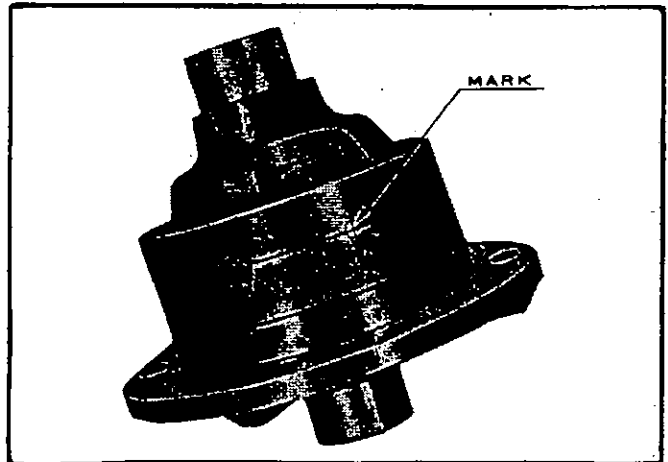

Mark on the case

(8) REMOVE RING GEAR FROM CASE

Bend the ears of the lock plates off the cap screws. Remove the cap screws that secure the ring gear to the case, and remove the ring gear.

Pull side bearings of diff. case out with suitable puller.

(3-7) REMOVE DRIVE PINION

Remove the nut and flat washer that secure the universal joint flange to the drive pinion. Install puller to the joint flange and remove the flange. Using a brass drift and hammer, drive the drive pinion out of the axle housing. Remove the shims and spacer from the drive pinion, noting the thickness of the shims removed from the pinion.



Flange fix nut

4. CLEANING, INSPECTION AND REPAIR

(4-1) CLEANING

Clean all parts in clean gasoline or cleaning solvent. Rotate the bearings while immersed in the cleaning solvent until all trace of lubricant has been removed. Oil the bearings to prevent corrosion of the highly polished surface unless they are to be used immediately.

(4-2) INSPECTION AND REPAIR

(A) AXLE HOUSING

Replace or repair the axle housing if it is bent or has any broken welds or cracks. Drive pinion bearing cups that are pitted, corroded or discolored due to overheating must be replaced. Knuckle flange, bearing cups that are pitted or corroded must be replaced. Replace the oil seals in axle housing regardless of their conditions. Check differential cover for crack and damage of threads in the filler plug hole, also check for missing or damage breather valve. Measure the inside diameter of the bushing at each end of the housing. If the bushing is worn to more than 35.3 mm (1.350 inch), replace the bushing.

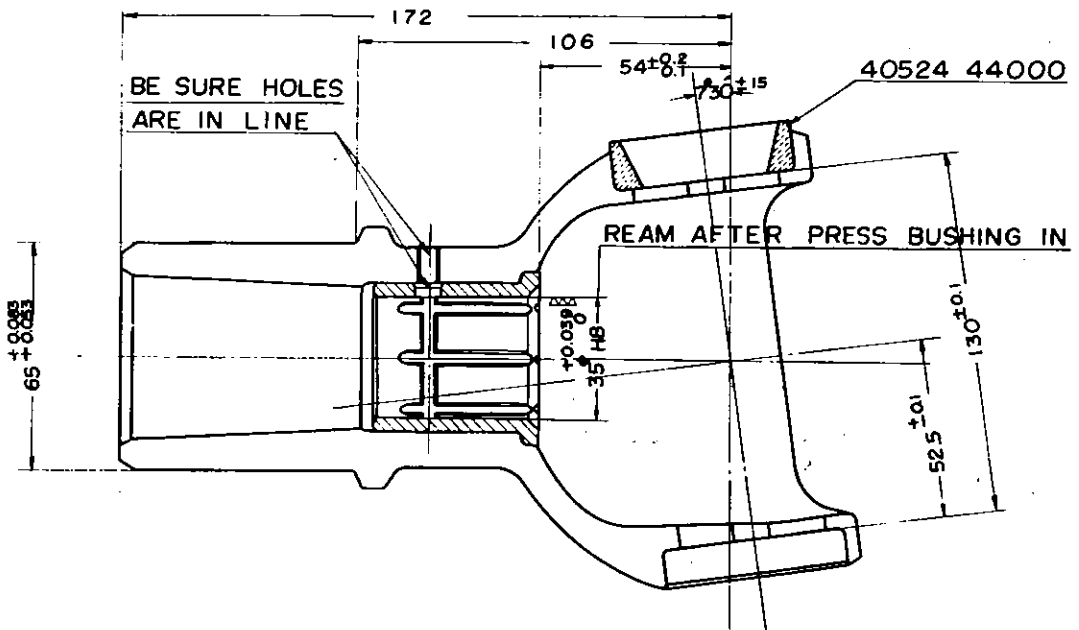

Housing end bushing

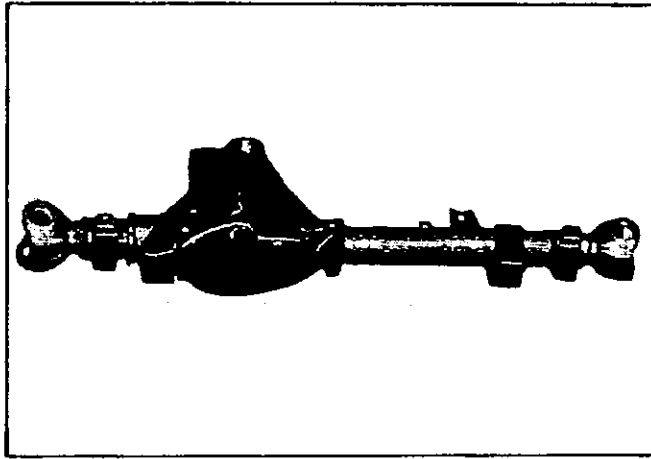

Rear axle housing

(B) DRIVE PINION BEARING CUP REPLACEMENT

Remove the inner and outer bearing cups, using standard puller, noting the thickness of the shims when removing the inner bearing cup. To install new bearing cups, use brass drift and hammer. Place the original thickness of shims behind the inner bearing cup and tap the bearing cups lightly around the entire circumference until flush with the shoulder in the axle housing.

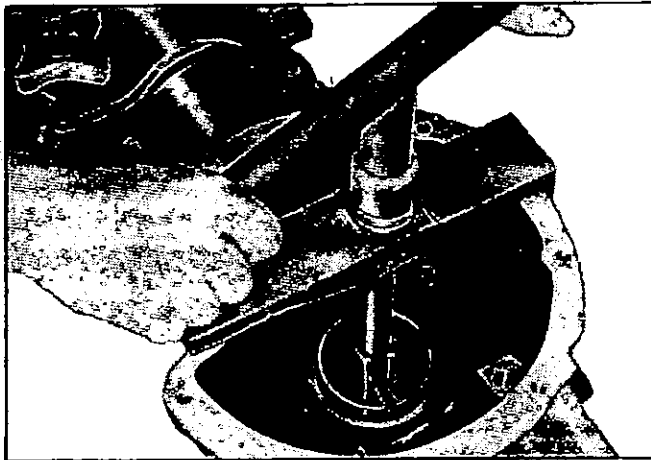

Removing inner bearing cup

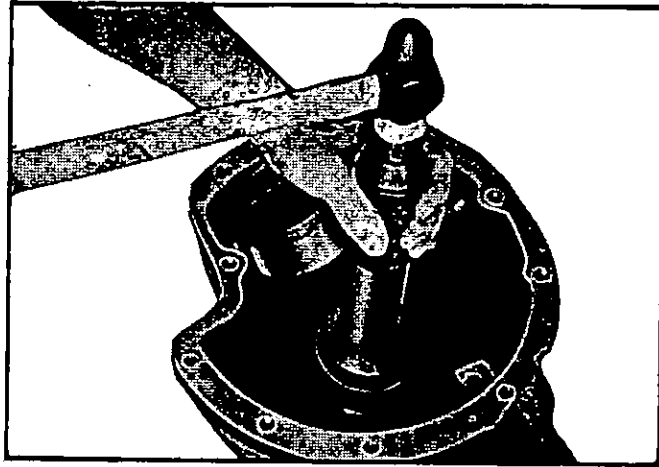

Installing inner bearing cup

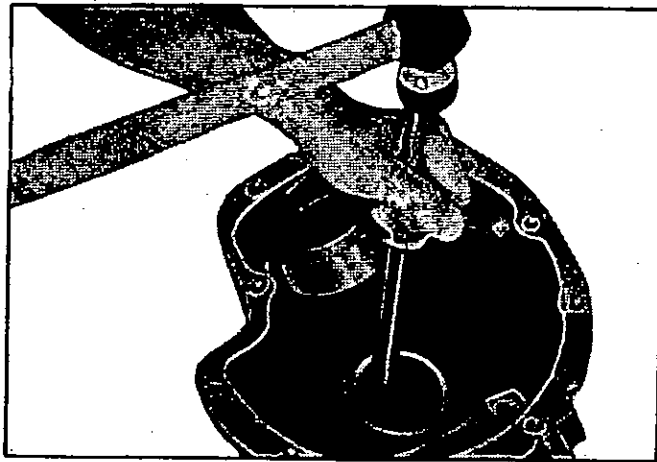

Removing outer bearing cup

(C) KNUCKLE FLANGE BEARING CUP REPLACEMENT

Working through one of the bearing cups, tap the opposite bearing cup out of the axle housing, using a brass drift and hammer

To install new bearing cups, place the bearing cup in position and tap the cup lightly until it seats in the axle housing.

Installing knuckle
flange bearing cup

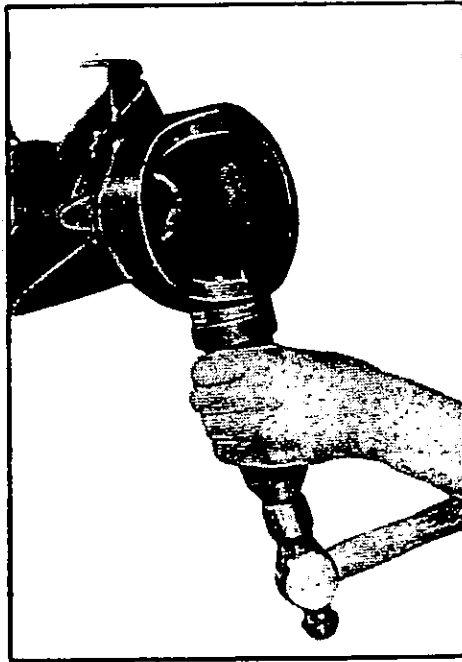

(D) OIL SEAL REPLACEMENT

To remove the inner axle oil seal use the oil seal remover and to install the inner oil seal, use the oil seal replacer and tap the oil seal in the inner end of the axle housing.

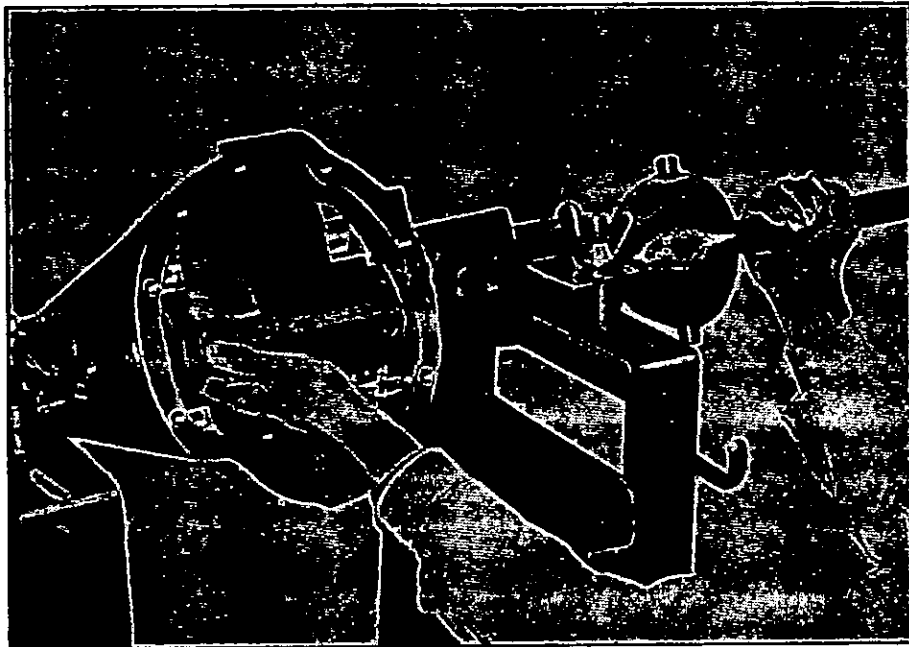

Replacing new oil seal

(E) AXLE HOUSING BUSHING REPLACEMENT

Remove the bushing from the outer end of the axle bushing, using a standard puller. To install a new bushing, place the bushing in position in the axle housing (align the grease hole) and using a suitable driver, drive the bushing in the housing until it seats.

(F) DRIVE PINION ASSEMBLY

Roller bearings that are pitted, corroded or discolored due to overheating must be replaced. Replace the pinion if it has worn or broken teeth. The differential ring gear and the drive pinion assembly are furnished only in matched sets and if either is found damaged, both must be replaced. Small nicks can be removed from the pinion gear with a fine stone.

(G) DIFFERENTIAL ASSEMBLY

Replace any gear that is excessively worn or has any broken teeth. Replace the differential pinion gears, if the inside diameter is worn. Replace the differential pinion shaft if the diameter is worn. Replace the axle shaft gears if the outside diameter of the hub is worn. Replace the differential pinion gear and axle shaft gear thrust washers if the thickness worn Roller bearings and races that are pitted, corroded or discolored due to overheating must be replaced. All shims that were damaged during disassembly must be replaced.

(H) TRACTA UNIVERSAL JOINTS AND SHAFT

Replace the inner portion or the outer portion of the axle shafts, if they are bent or have worn splines. Replace the inner portion or the outer portion of the universal joints, if they are cracked or excessively worn. Small nicks or scratches can be removed with a fine stone.

(I) TIE ROD

Replace the tie rod if bent or damaged. Replace the tie rod ends if the sockets are loose.

To remove the tie rod ends loosen the lock nuts at both ends of the tie rod and screw out the tie rod ends. To install tie rod ends, place the lock nut on the tie rod end, then screw in the tie rod ends into the tie rod. The amount screwed in must be same for both ends.

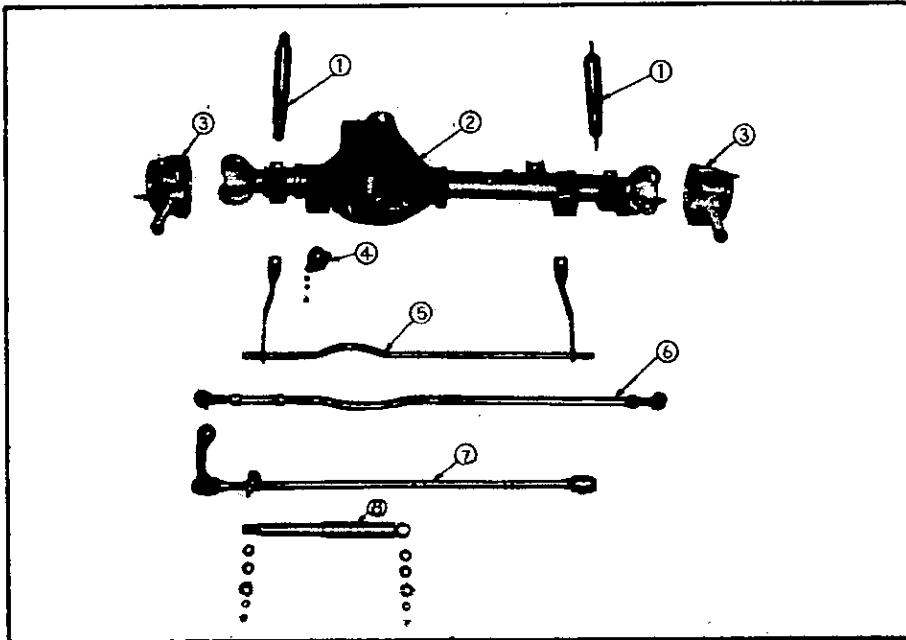

- | | |
|------------------------|---------------------|
| (1) Shock absorber | (5) Stabilizer |
| (2) Front axle housing | (6) Tie rod |
| (3) Knuckle flange | (7) Drag link |
| (4) Torque arrester | (8) Steering dumper |

(J) KNUCKLE FLANGE BEARING CAP

Replace the upper bearing pin, cone and cup if they are worn, pitted or corroded. Replace the lower knuckle flange bearing cap pin, bearing and cup if they are worn, pitted or corroded or discolored due to overheating.

Place the knuckle flange cap in a press and with a suitable driver, press out the bearing pin. To install a new pin, use a suitable drive and press the pin in until it seats.

(K) KNUCKLE FLANGE AND SPINDLE

Replace the knuckle flange if it is cracked. If the studs on the knuckle flange are bent, broken or damaged, replace them. Replace the spindle if it has damaged threads or grooved bearing surfaces. Roller bearings that are pitted, corroded or discolored must be replaced.

Indent the end of the broken stud exactly in the center with a center punch. Drill approximately two thirds through the broken stud, using a small drill, then follow up with a larger drill (the size of the drill depending on the size of the stud to be removed). The drill selected, however, must leave a wall thicker than the depth of the threads. Select an extractor of the proper size. Insert it into the drilled hole and screw out the remaining part of the broken stud. To install a new stud, use a standard stud driver and drive all studs until no threads show at the bottom of the stud. If the stud is too tight or too loose in the stud hole, select another stud.

5. ASSEMBLY

(5-1) INSTALL INNER BEARING ON PINION

Press the inner bearing on the pinion, using an arbor press. Make sure the bearing is seated against the shoulder of the pinion gear when installed.

Press the rear (inner) bearing cup in the housing with proper thickness of shims. Press in the front bearing cup.

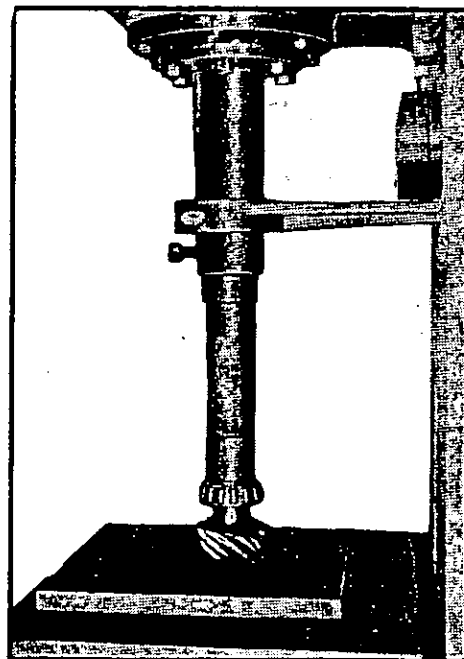

(5-2) ADJUST PINION IN HOUSING

If the original ring gear and pinion are being used in the original carrier, use the original shim packs at each bearing. If a new pinion or differential carrier is installed, note the markings

on the end of the pinion gear and differential carrier to obtain the correct thickness of shimming to be used for correct setting of gears. The marking figure signify thousandth of a inch.

Place the pinion in the differential housing. Install the depth gauge to check the setting from the back face of the pinion to the center line of the differential case bearing. The standard setting is 70.36 mm (2,7706 in.) If the setting mark on the pinion head is (+) 2, the correct setting distance is 70.36 mm plus 0.002 inch. If the setting mark is (-)2 the correct setting distance is 70.36 mm minus 0.002 inch. Adjustment is made by adding or removing shims under inner bearing cup. And add another shim 0.002 inch in each case, in order to give preload on bearing.

(5-3) INSTALL OUTER BEARING ON PINION

After the correct pinion setting has been obtained, install spacer and the original amount of shims on the pinion. Install the outer bearing on the pinion.

(5-4) PRE-LOAD ADJUSTMENT OR DRIVE PINION BEARING

Place the universal joint, companion flange on the pinion and, while holding the flange from turning, tighten the nut to a torque load of 25 - 30 kg-m (180 - 215 ft-lbs.)

Check the pinion bearing pre-load with a spring scale and heavy cord wrapped around the companion flange (oil seal contact surface). Pull on the spring scale. The torque required to rotate the pinion is 11 - 14 kg-cm. If not within these limits, add or remove shims from behind the front bearing to obtain the proper pre-load.

After the correct adjustment is obtained, again remove the universal joint flange and install a new oil seal (well soaked) on the pinion. Reinstall the universal joint flange. Install nut and cotter pin. Check the pinion hight again to be sure.

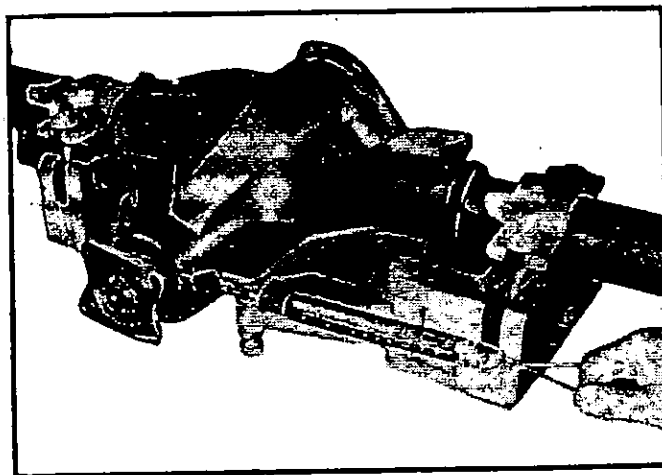

Checking pinion pre-load

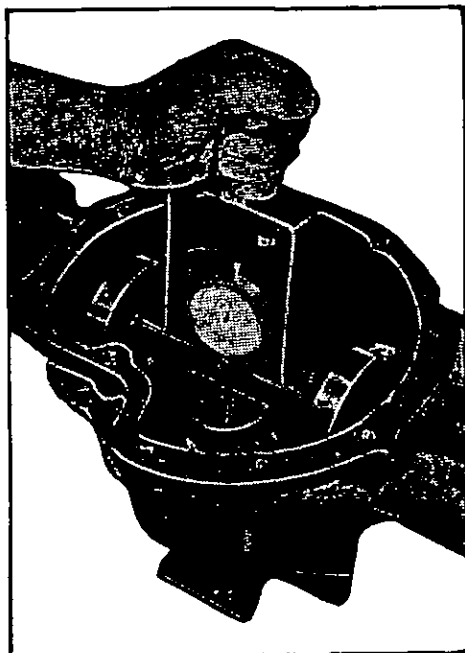

Measuring pinion height

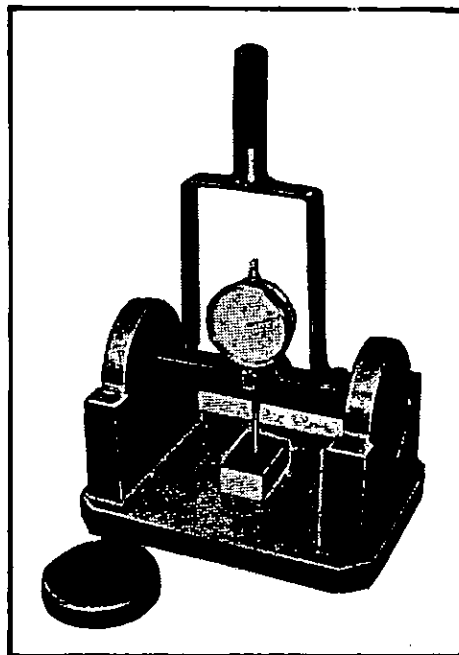

Pinion alignment gauge

(5-5) INSTALL GEARS IN DIFFERENTIAL CASE

Place the ring gear side half of the differential case on bench and assemble side gear with thrust washer in it. Do not forget to lubricate gears and thrust washers before installation. Install differential main shaft (spider) with pinions and thrust washers in differential case. Install the second side gear and thrust washer on top of pinion. Assemble the other half of the case, being sure to line up the marks on the case halves. Drive the four bolts from the small side of the case, install nuts and tighten the nuts to a

torque load of 6.9 - 9 kgm. (50 - 65 ft-lbs.) Check differential side gear back lash, clearance must be within 0.003 - 0.010 inches. If it is out of these limit the thrust washers or gears must be changed. If it is correct secure the nuts with cotter pins.

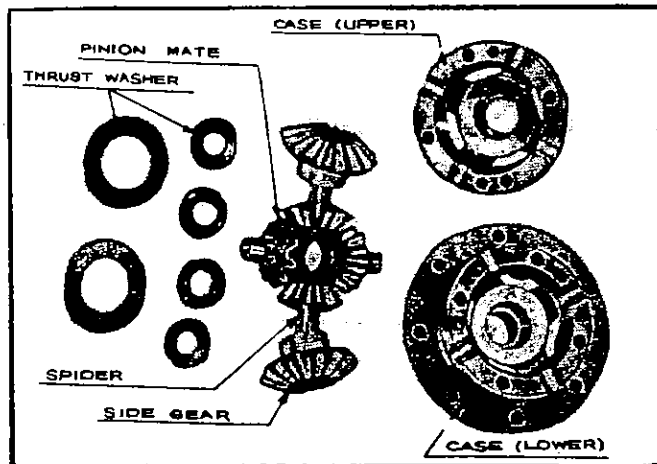

Differential gear parts

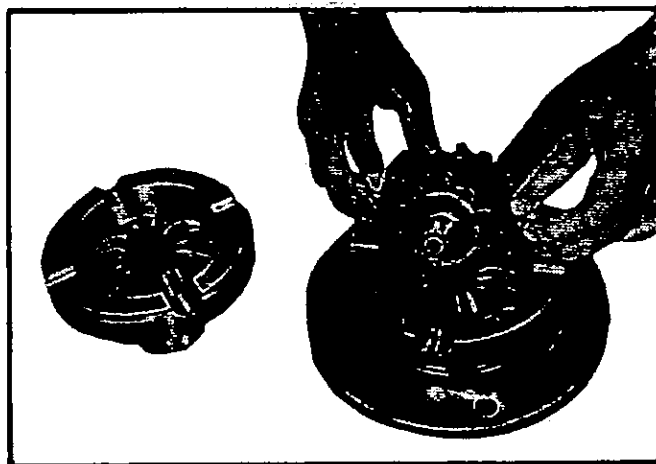

Assembling differential gears

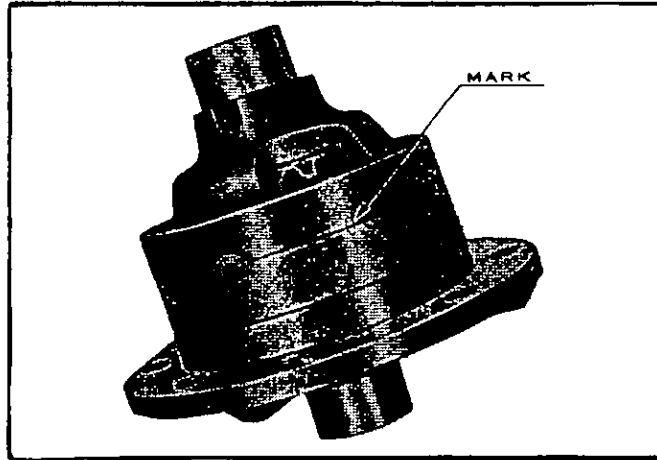

Be sure to line up the marks

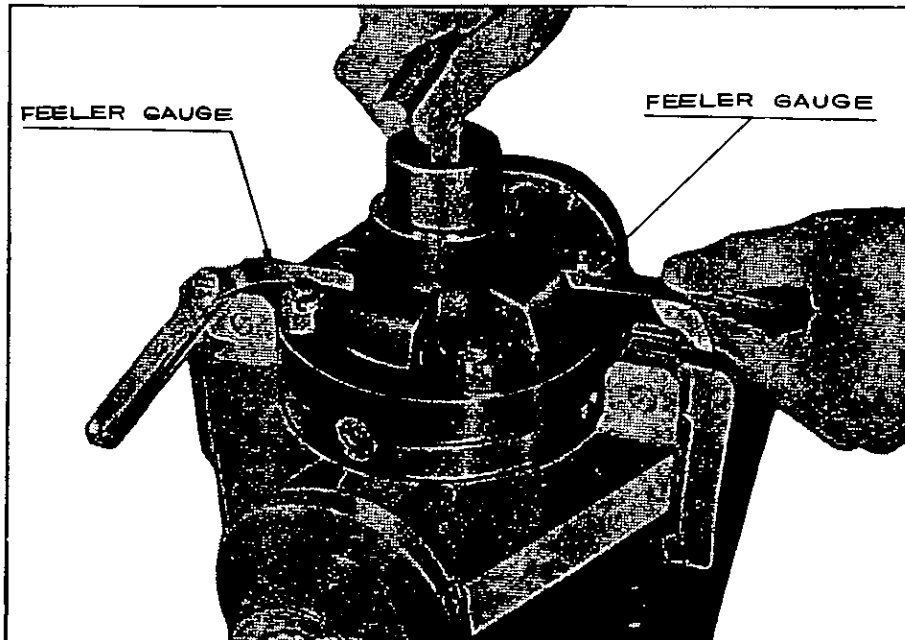

Checking back lash.

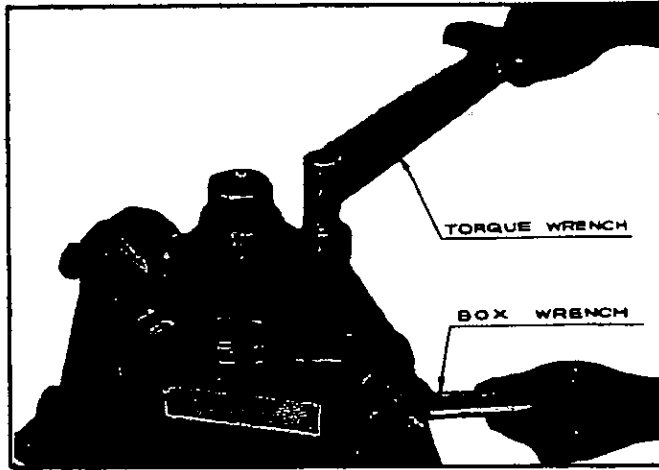

Securing differential case bolts

(5-8) INSTALL DIFFERENTIAL RING GEAR

Place the differential ring gear in position on the case. Install the lock plates and cap screws that secure the ring gear to the case, tighten the cap screws to a torque load of 4.4 - 5.8 kg-m (32 - 42 ft.lbs.). Bend the ears of the lock plates on the cap screws.

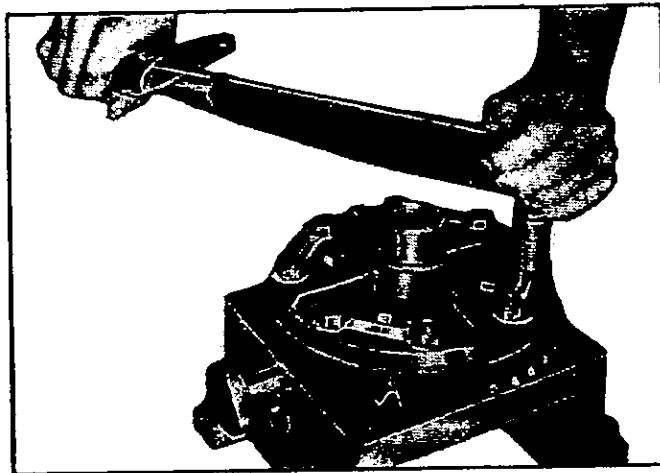

Installing ring gear

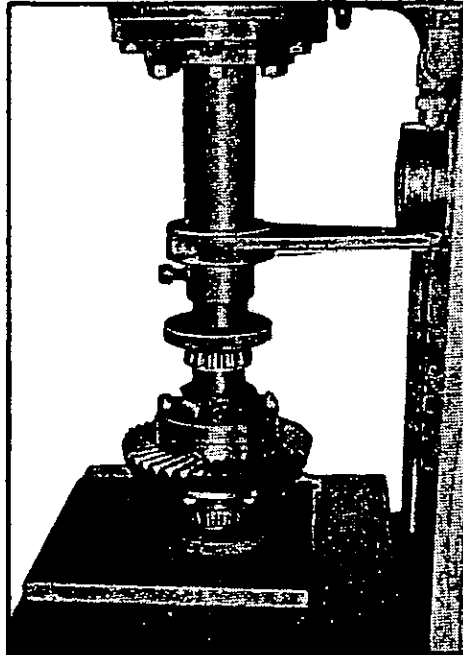

Installing bearings on diff. case

(5-7) INSTALL ROLLER BEARING ON CASE

If all the original parts have been used in the differential assembly, add the same thickness of shims as original used and press the roller bearings on the case, then with subparagraph h, below. If the original parts are not being used or if the original shim thickness is not known, use shims as table 1, or install the roller bearings on the case without shims, and proceed with paragraph i, below.

Part No.	Thickness	Pcs.*
38129 - 42100	0.08	6
38130 - 42100	0.13	8
38131 - 42100	0.25	4
38132 - 42100	0.76	2

NOTE: Numbers of pcs. shows for 1 unit, not for one side of housing,

Table 1

(5-8) INSTALL DIFFERENTIAL ASSEMBLY IN HOUSING

Place the bearing cups on the roller bearing. Tilt the bearing

cups in order to start the assembly in the housing. Tap the bearing cups lightly until the assembly is seated firmly in the housing. Install the two bearing caps so the numbers on the caps and the housing face the same way and match in every way as shown in. If the differential assembly being used is not the original in the axle, proceed with subparagraph (5-9), below.

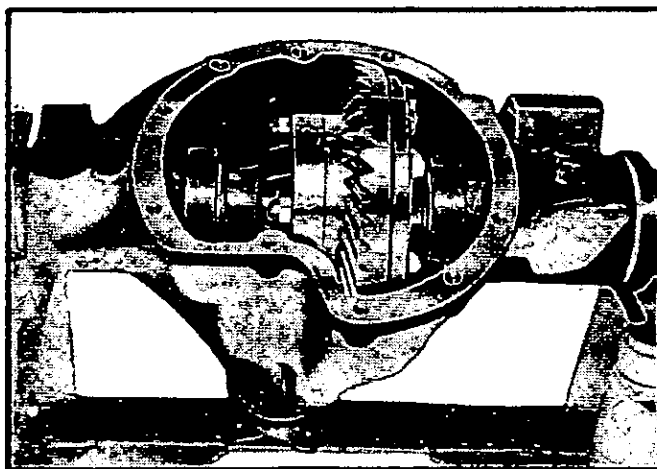

Installing diff. case assembly

(5-9) ADJUST DIFFERENTIAL ASSEMBLY

Place the bearing cups on the differential assembly without any shim and place the assembly in the housing. Slide the assembly to one side of the housing. Check the clearance between the bearing cup and differential housing with a feeler gauge. After this clearance has been determined, add 0.002" to the left bearing and 0.01" to the right bearing.

This will give the thickness of shims required for proper bearing adjustment. Remove the differential assembly from the housing. Remove the bearings from the differential case. Install the amount of shims determined above in equal amounts on each side of the case and install the bearings back on the case. Tilt the bearing cups and place the differential in the housing. Tap the bearing cups lightly until the assembly is seated firmly in the housing. Install the two bearing caps so the numbers on the caps and the housing face the same way, and match in every way. Tighten the four cap bolts to a torque load of 8.6 - 10 kg-m (62 - 72 ft-lbs.) and wire lock on the bolts.

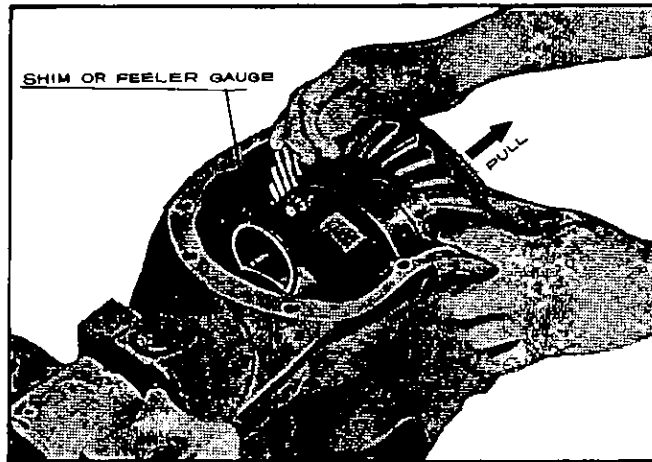

Measuring thickness of shims

(5-10) CHECK BACKLASH

Install a dial indicator on the differential housing so that the indicator contact is resting on the surface of a ring gear tooth as shown. Rotate the ring gear back and forth to determine the backlash. If the backlash is less than 0.005 inch or more than 0.007 inch, remove the differential from the housing and remove the bearings from the differential case. If the backlash is less than 0.005 inch, the ring gear must be moved away from the pinion. This is accomplished by moving shims equal to the error in backlash from one side of the case and adding them to the other side. Install the bearings on the case. Install differential in housing and recheck the backlash.



(5-11) CHECK RING GEAR RUN-OUT

Install a dial indicator on the differential housing so that the indicator contact is resting on the flat side of the ring gear.

Turn the pinion drive flange by hand to determine the run-out on the ring gear. The run-out should not exceed 0.0025 inch. If the run-out is more than 0.0025 inch, remove the ring gear from the differential case. Check the surface of the differential case and the ring gear for chips or small nicks, which might have occurred during the assembly of the differential. If any small nicks are found, remove them with a fine stone, also check the flange on the differential case for being sprung. Reinstall the differential assembly in the housing and recheck the ring gear run-out.

(5-12) GEAR TOOTH CONTACT PATTERN

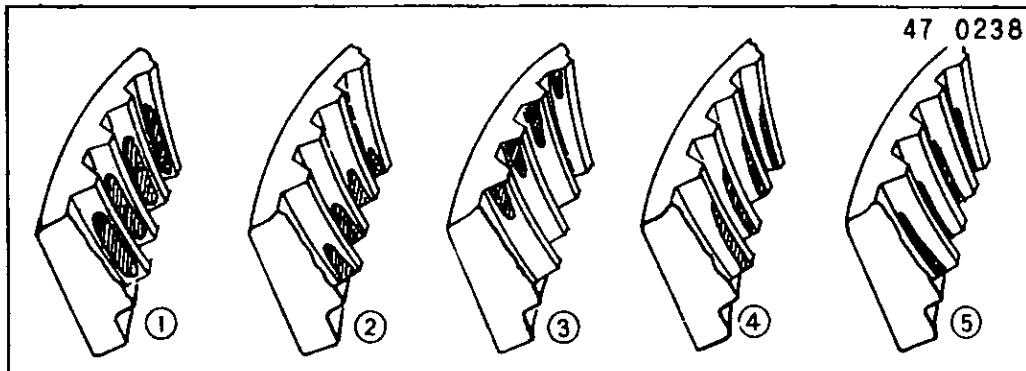

- (1) Correct tooth contact
- (2) Short toe contact - Move ring gear away from pinion
- (3) Short heel contact - Move ring gear toward pinion
- (4) Contact too high and narrow, Pinion should be moved toward center of axle.
- (5) Contact too low and narrow, Pinion should be moved away from center of axle.

Allowable variations in the carrier or drive pinion may cause the pinion to be too far in or out even when shimmed properly. Thus, the tooth contact must be tested and corrected as necessary or the gear may be noisy.

Paint the ring gear teeth with a light coating of red lead, or white lead or prussion blue. Revolve the gears and observe the contact, referring to the illustrations shown in for this operation.

(5-13) INSTALL DIFFERENTIAL COVER

Place a new gasket and the differential cover in place on the axle housing. Install the ten cap screws that secure the cover to the housing.

(5-14) INSTALL SPINDLE HOUSING

Dip the knuckle flange lower taper roller bearing in grease. Install the oil seal "O" ring on the lower cap. Press in the grease. Install the oil seal "O" ring on the lower cap. Press in the greased taper roller bearing on to the pin in lower cap.

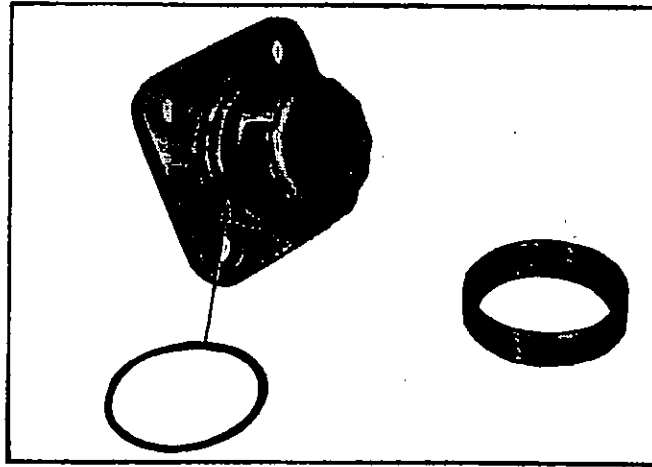

"O"ring and bearing cup.

Install standard thickness of shims according to table two. Place the knuckle flange on the axle housing with the steering arm to the front of vehicle. Install the lower bearing cap assembly on the knuckle flange and install the four nuts that secure the cap to the knuckle flange. Install the oil seal "O" ring on the upper cap. Insert spring-disc and bearing cone, align grease hole of pin and cone. Install upper bearing cap assembly without shim to knuckle flange.

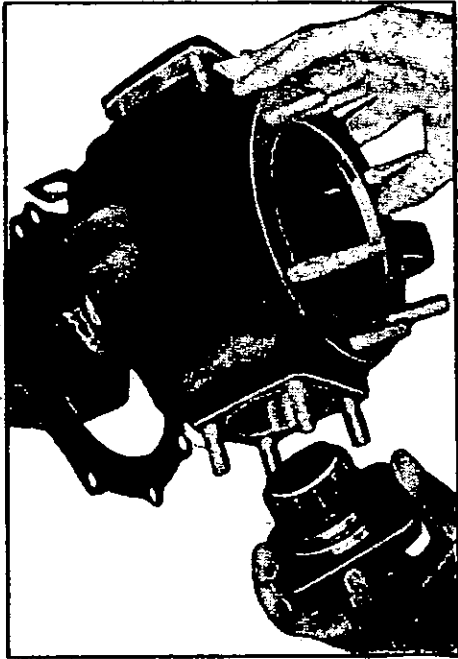

Installing
lower cap

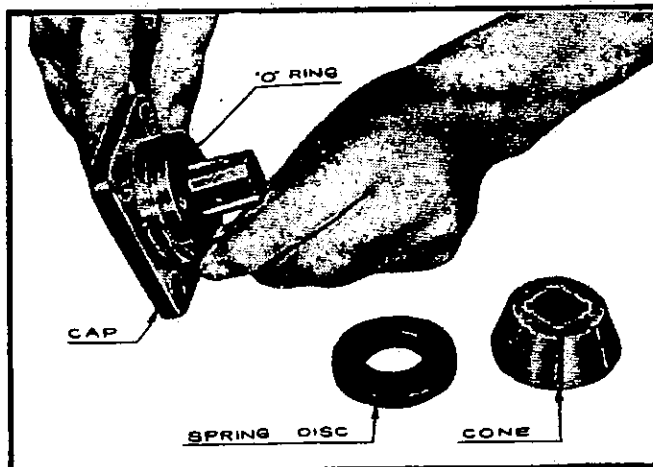

Assembling upper cap.

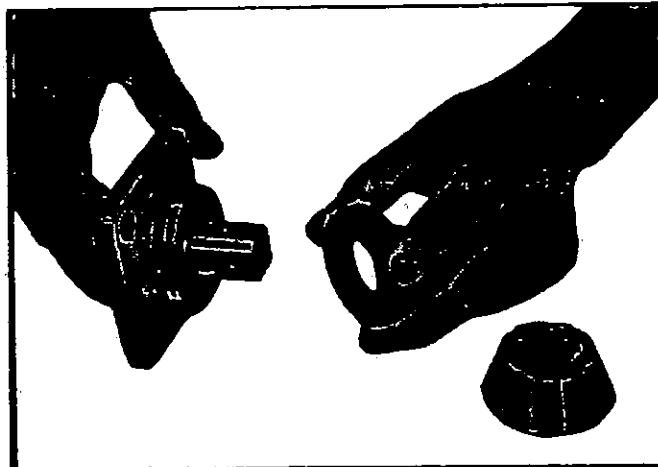

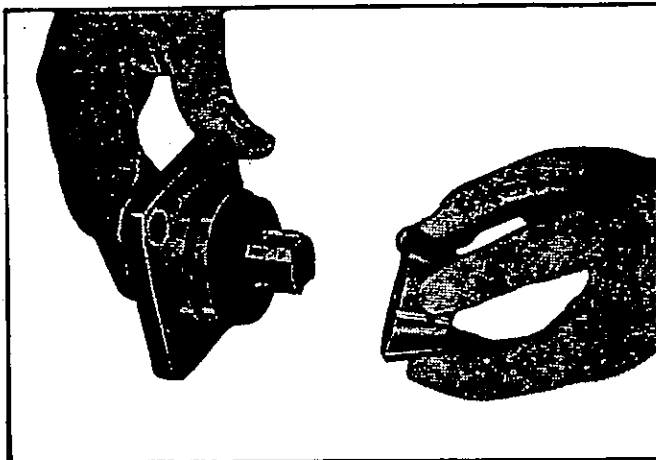

Assembling upper cap

Tighten equally the four nuts that secure the cap until the bearing cone does not turn when the knuckle flange is turned back and forth. Check the clearance between cap and knuckle flange with feeler gauge.

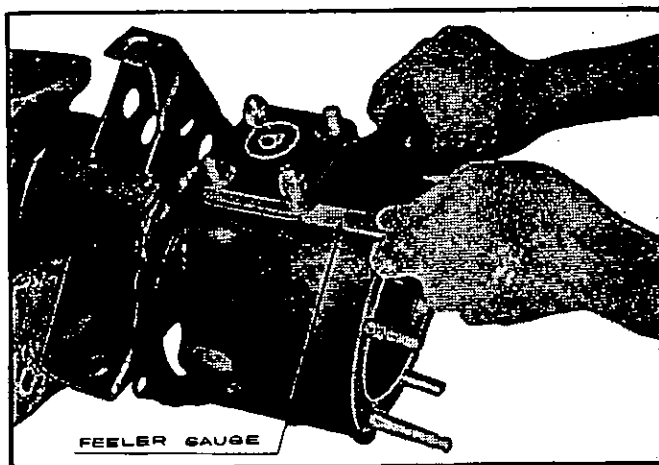

Measuring thickness of shims

After this clearance Ⓢ has been determined, add 0.4 mm (0.016 inch). This will give the thickness of shims required for the upper bearing adjustment. Tightening torque for the bearing cap nuts is 1.9 - 2.1 Kg-m. (14 - 15 ft-lbs.). The torque load for turning the knuckle flange at the edge of the steering knuckle arm is 9 - 10 kg (20 - 22 lbs). Add, or remove, shims to upper bearing cap until the correct tension is obtained.

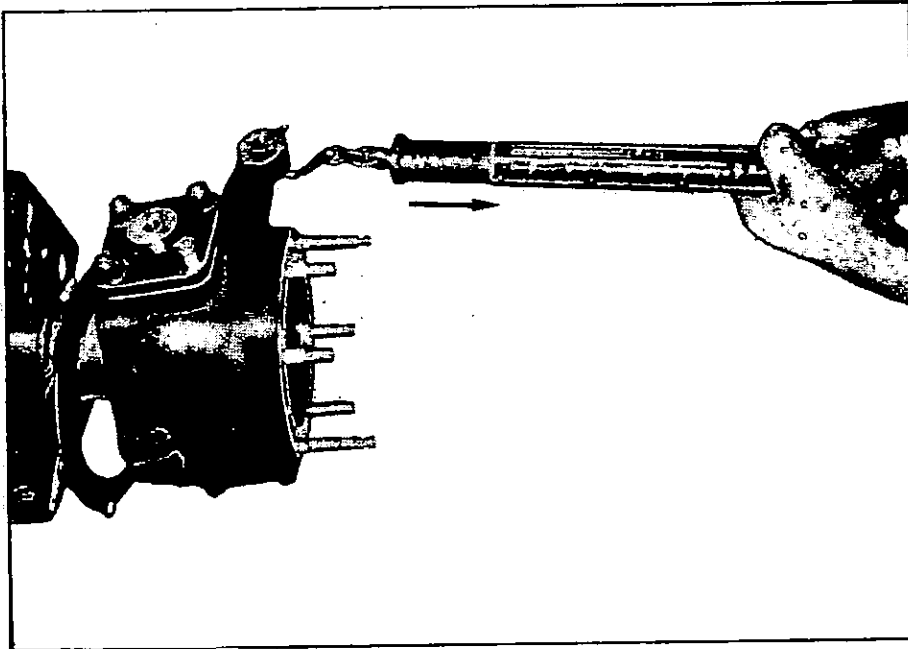

Checking knuckle flange turning torque

TABLE 2

BEARING WIDTH mm.	16.0-16.1	16.1-16.2	16.2-16.3	16.3-16.4	16.4-16.5
SHIM PART NO.					
40605-44000 (0.127 mm)			1	1	2
40606-44000 (0.075 mm)		1	1	2	2
Total		1	2	3	4

Lower bearing cap Standard shim thickness.

See the instruction drawing of front axle assembly.

(5-15) INSTALL SPINDLE HOUSING OIL SEAL

Place the oil seal on the knuckle flange. Install the 6 cap screws that secure the oil seal guard to the knuckle flange.

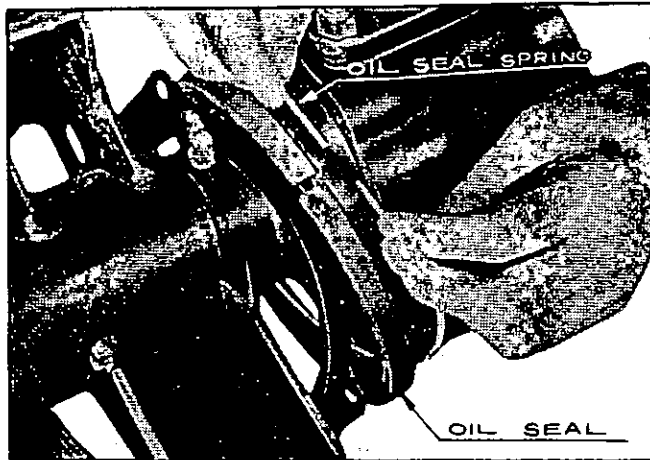

Installing oil seal and its spring.
Connect both ends of oil seal and spring.

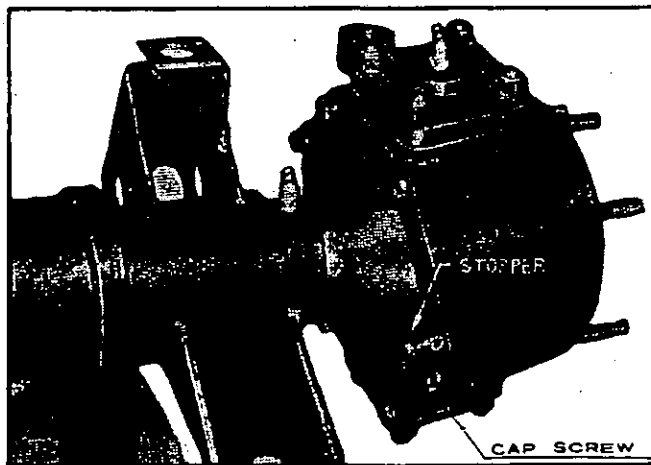

Installing oil seal guard.

(5-16) ASSEMBLE AXLE SHAFTS AND TRACTA JOINT

Lubricate with chassis grease all bearing surface of shafts and joints. Slide the inner portion of the axle shaft and the inner portion of the universal joint into the axle housing. Turn the axle shaft so as to line up the splines of the axle shaft with the axle

shaft gear in the differential. Slide the outer portion of the universal joint on the outer portion of the axle shaft. Line up the slots of the two universal joints and slide the outer axle shaft in place on the axle.

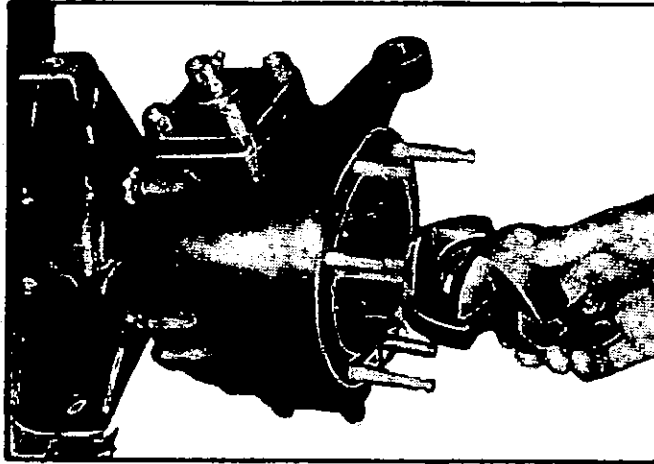

Installing inner axle shaft and joint

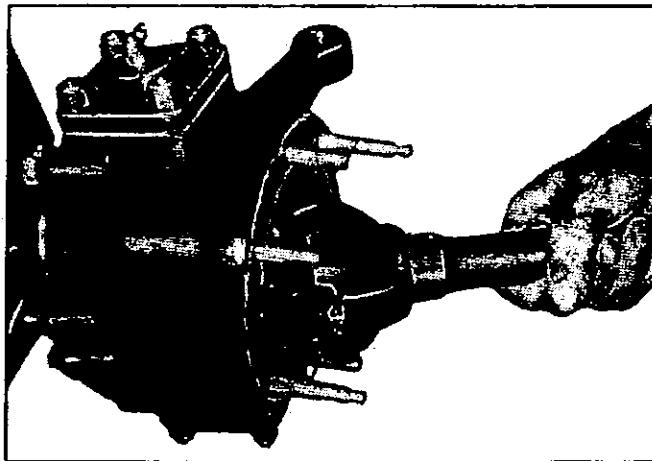

Installing outer joint and shaft.

(5-17) INSTALL SPINDLE AND BRAKE PLATE

Pack roller bearing with specified bearing grease and place in spindle. Secure in place with locking ring. Place the spindle on the spindle housing. Place the brake plate on the spindle with the oil drain hole toward the bottom. Place the grease catcher on the spindle, line up the oil drain hole of grease cotcher and brake plate. Install the six lock washers and nuts.

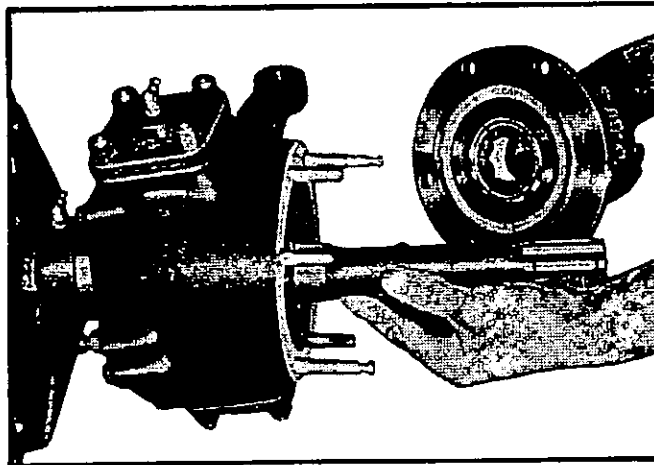

Installing front spindle

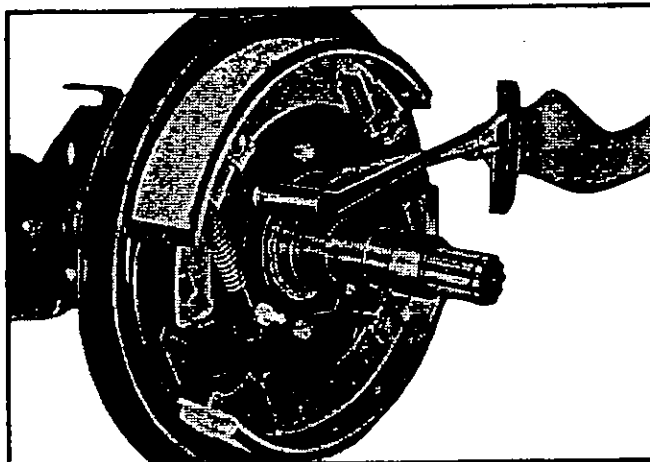

Fixing brake disc and front spindle.

(5-18) INSTALL HUB AND DRUM

Install spindle collar, coat surface where oil seal contact, with very thin layer of grease (KWB). Pack the wheel bearings with the specified lubricant. Insert the hub and brake drum on the spindle with the inner wheel bearing and oil seal in the hub. Insert outer wheel bearing and the thrust washer on the spindle and install the bearing adjusting nut. Tighten the adjusting nut until the brake drum binds when turned, then back off the adjusting nut one-eighth turn. This will give the correct wheel bearing adjust-

ment. Install the lock washer and lock nut on the spindle. Bend the ears of the lock washers over the nut. Hub turning torque must be within 15 - 45 kg-cm. (1 - 3 ft.lbs.)

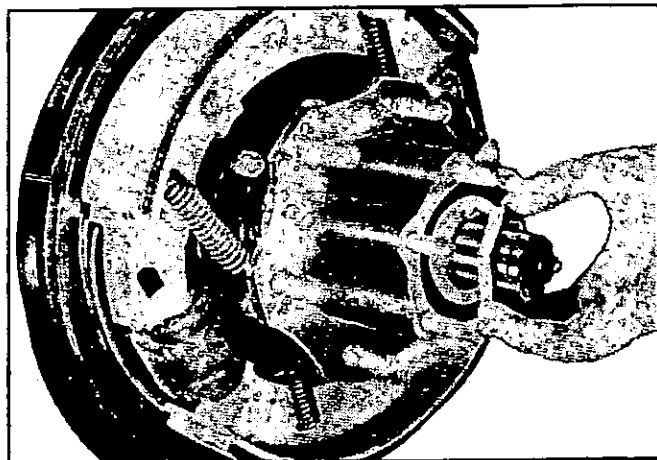

Installing wheel bearing nut

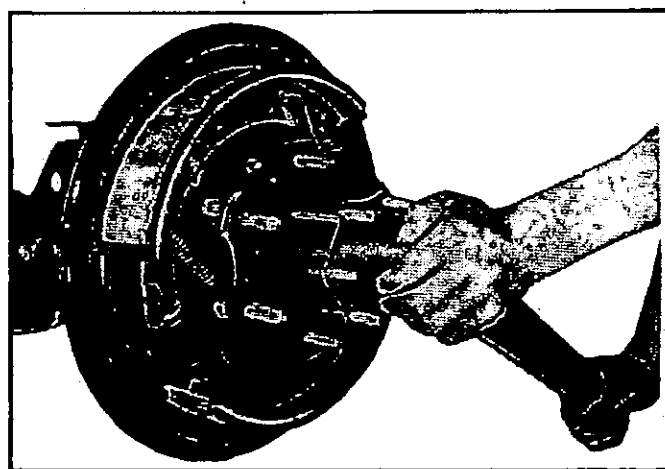

Tightening bearing nut

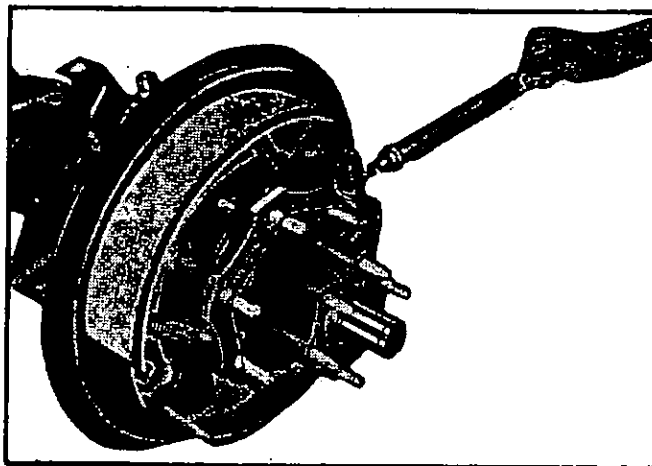

Measuring turning torque of hub.

(5-19) HUB AND SPINDLE ALIGNMENT

Place the straight edge or steel rule on spindle and measure the space between hub and straight edge with a feeler gage or shims to determine the thickness of shims to be installed.

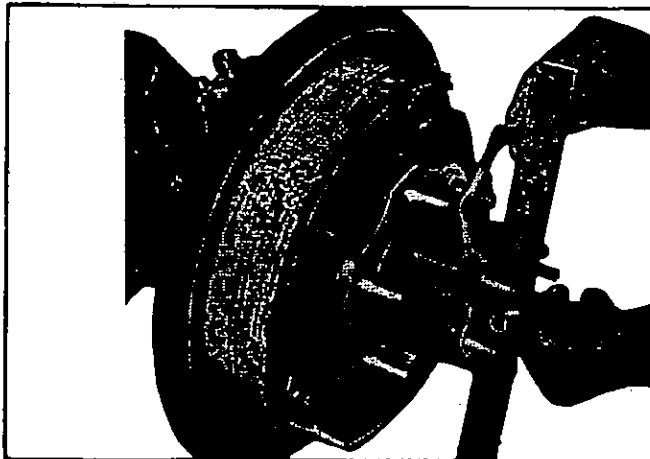

Measuring space between hub and spindle.

(5-20) DRIVE FLANGE INSTALLATION

Insert inner snap ring on the axle shaft groove. Place the required thickness of shims on the and secure the drive flange with six nuts and three lock plates. Bend the ears of lock plates after tightening the nuts to the torque wrench setting of 3.5 - 3.8 kg-m (25 - 27.5 ft. lbs.). Insert outer snap ring on axle shaft groove.

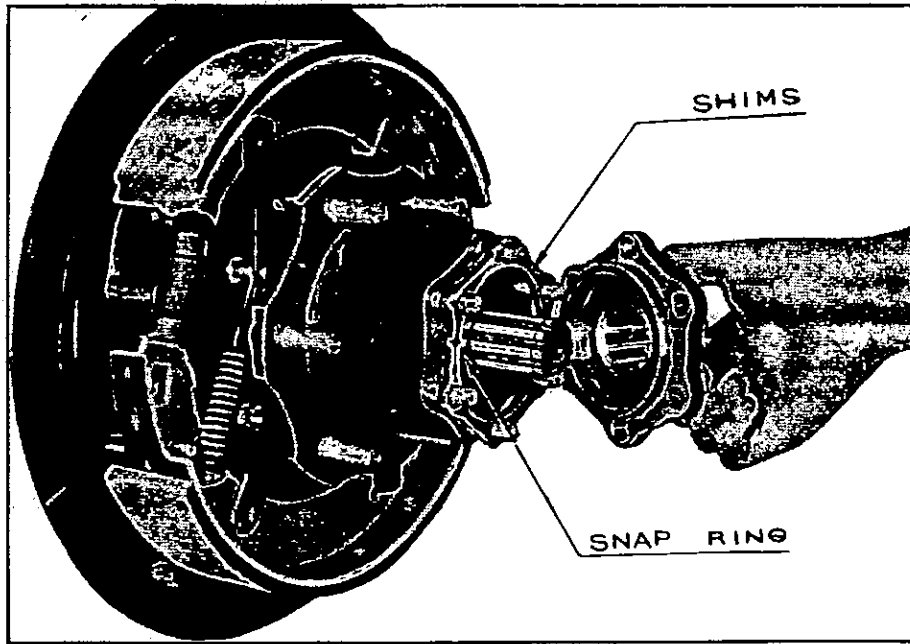

Installing drive flange

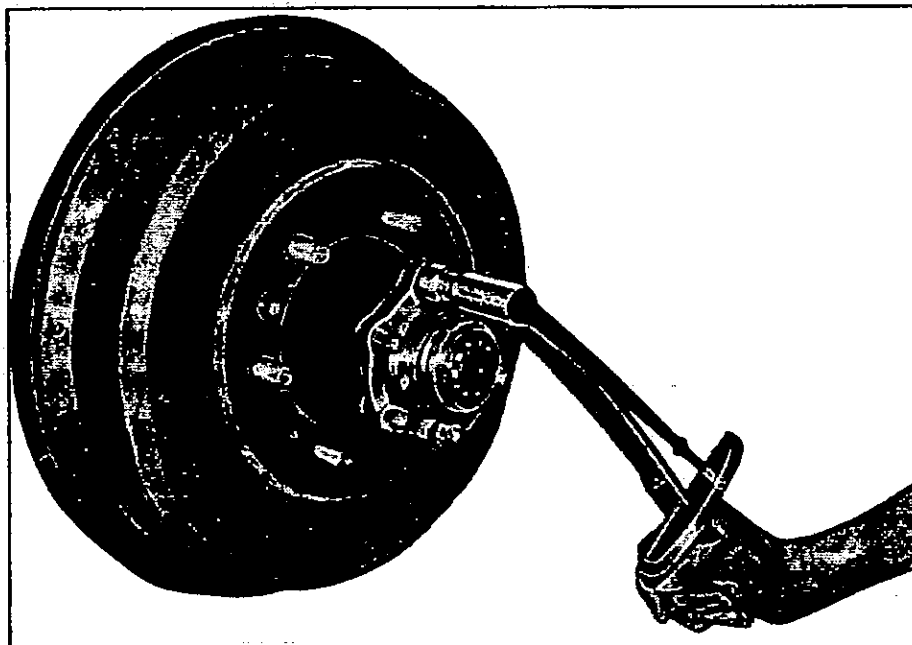

Tightening drive flange nut.

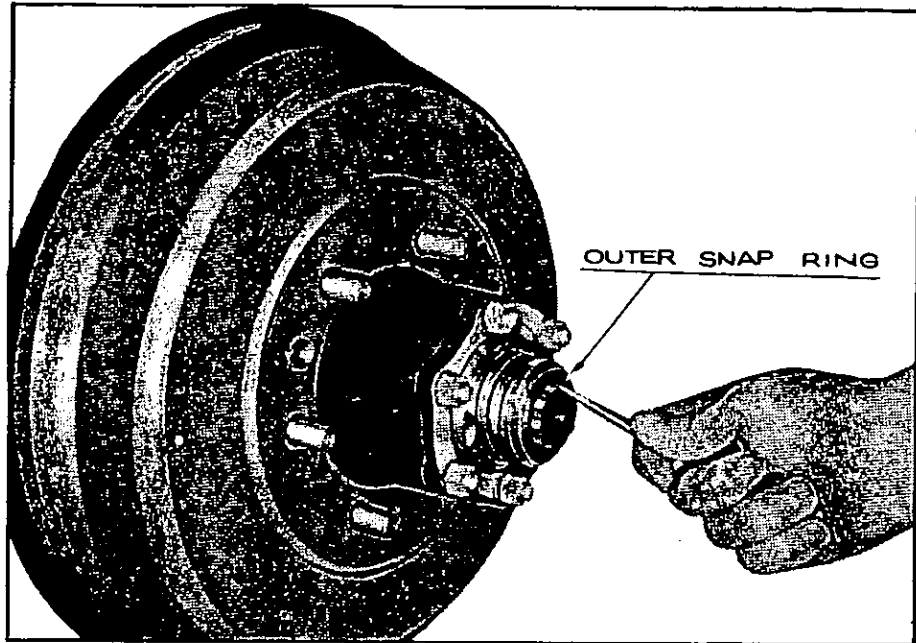

Inserting outer snap ring

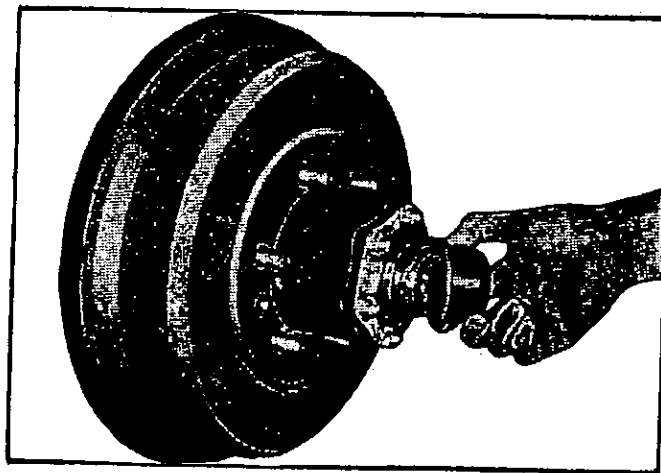

Installing flange cap.

(5-21) INSTALL TIE RODS

Insert the ends of tie rods in the spindle arms. Be sure the dust seal and covers are on the tie rods. Install the castellated nuts that secure the tie rods to the spindle arms.

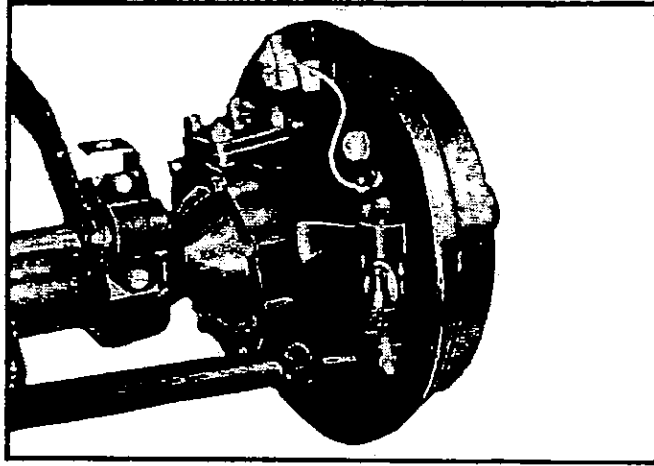

Installing tie rod

6. INSTALLATION

(6-1) PRELIMINARY WORK

Place a hydraulic jack under the front axle assembly. Roll the assembly under the vehicle. Raise the assembly until the front springs can be raised and secured to the spring shackles. Lower the jack to allow the axle assembly to rest on the springs.

(6-2) INSTALL SPRING U-BOLTS

Place the spring U-bolts in position on the axle housing. Install the spring seat plates on the U-bolts at the both side of the axle. Install the nuts that secure the spring seat to the U-bolts.

(6-3) INSTALL SHOCK ABSORBERS AND TORSION BAR

Insert rubber bushing on each side of each shock absorber plate. Install special washer, castellated nut and cotter pin. Install torsion bar, insert rubber bushing, special washer, and tighten with castellated nut. Lock the nut with cotter pin from turning.

(6-4) INSTALL - STEERING DAMPER, REBOUND STOPPER

Insert a rubber bushing in the eyes of steering damper eye and assemble to the drag link.

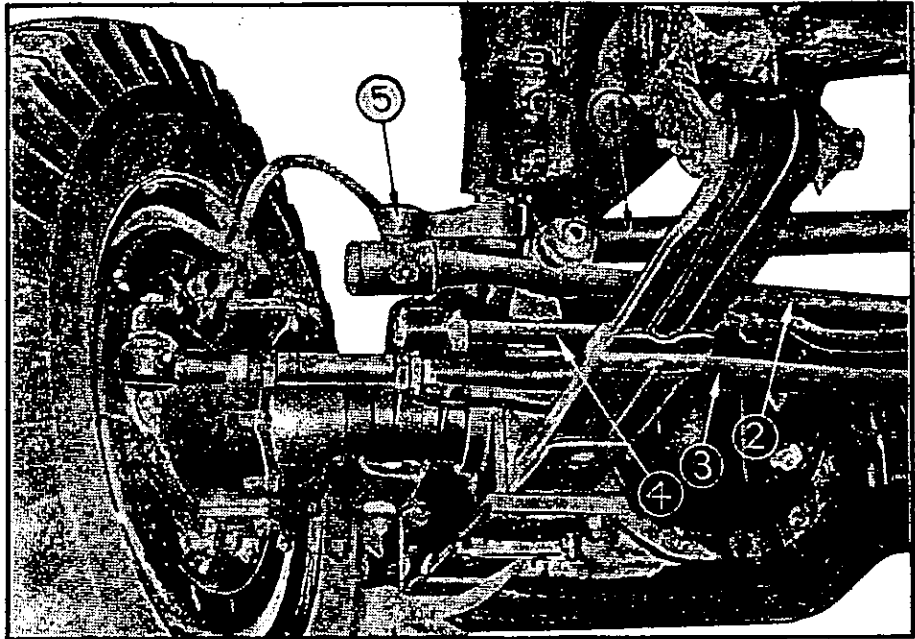

- (1) Steering dumper
- (2) Drag link
- (3) Tie rod

- (4) Stabilizer
- (5) Pitman arm

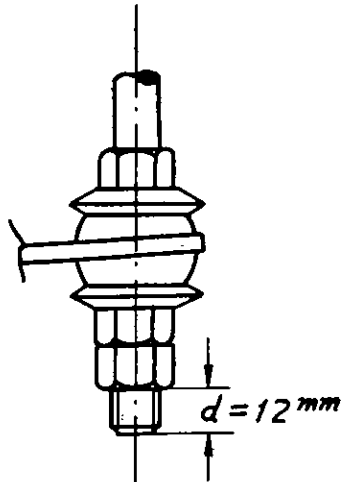

Insert rubber bushing on the rebound stopper rods and assemble to the bracket at both end of the axle. Tighten the nuts until the distance from end of rod to top of check nut is 12 mm (15/32 in.). The rebound stroke is 85 mm. (3-11/32 in.). Distance should not be less than 5 mm (13/64 in.).

(8-5) INSTALL PROPELLER SHAFT, DRAG LINK, AND WHEELS.

Install the propeller shaft to the front axle. Place the drag

link in the ball on the steering arm. Install the drag link plug on the drag link. Install the cotter pin in the drag link plug. Install the wheels.

(6-6) LUBRICATE

Fill the differential to proper level with specified oil. Apply specified grease in each spindle housing and to all fittings. Bleed the hydraulic brake system.

7. WHEEL ALIGNMENT

(7-1) CASTER AND CAMBER

The caster and camber is established at the time of manufacture and cannot be altered by any adjustment.

(7-2) TOE-IN ADJUSTMENT

After the front axle is assembled, lubricated and brakes bled, remove the blocks and lower the vehicle on ground. Pull the vehicle straight forward at least three feet to remove the backlash and place the telescoping wheel aligning gauge between the wheels in front of the axle so that the chains (must be the same length) on both ends of the gauge are barely touching the floor. Set the scale so the pointer registers zero. Pull the vehicle forward until the gauge is brought to a position back of the axle with both chains barely touching the floor. The reading at this point will be the amount of toe-in or toe-out. Adjust the tie rod adjuster until toe-in of 3 - 4 mm (0.012 - 0.016 in.) is obtained. Recheck the toe-in after making the adjustment. Tighten the tie rod adjuster lock nut.

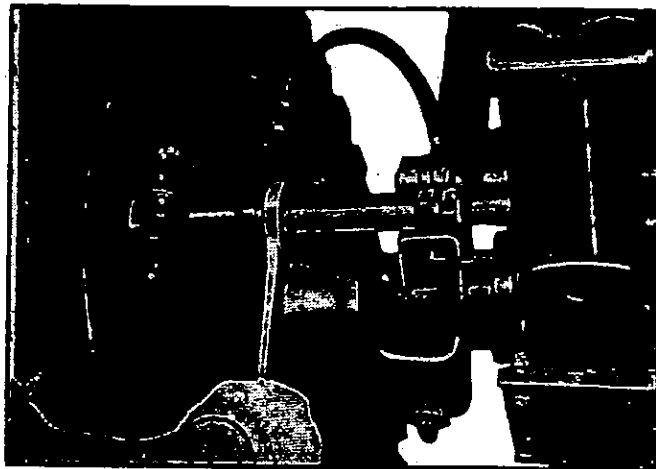

Adjusting toe-in.

GEAR CARRIER ASSEMBLY WITH GEAR MODEL 60

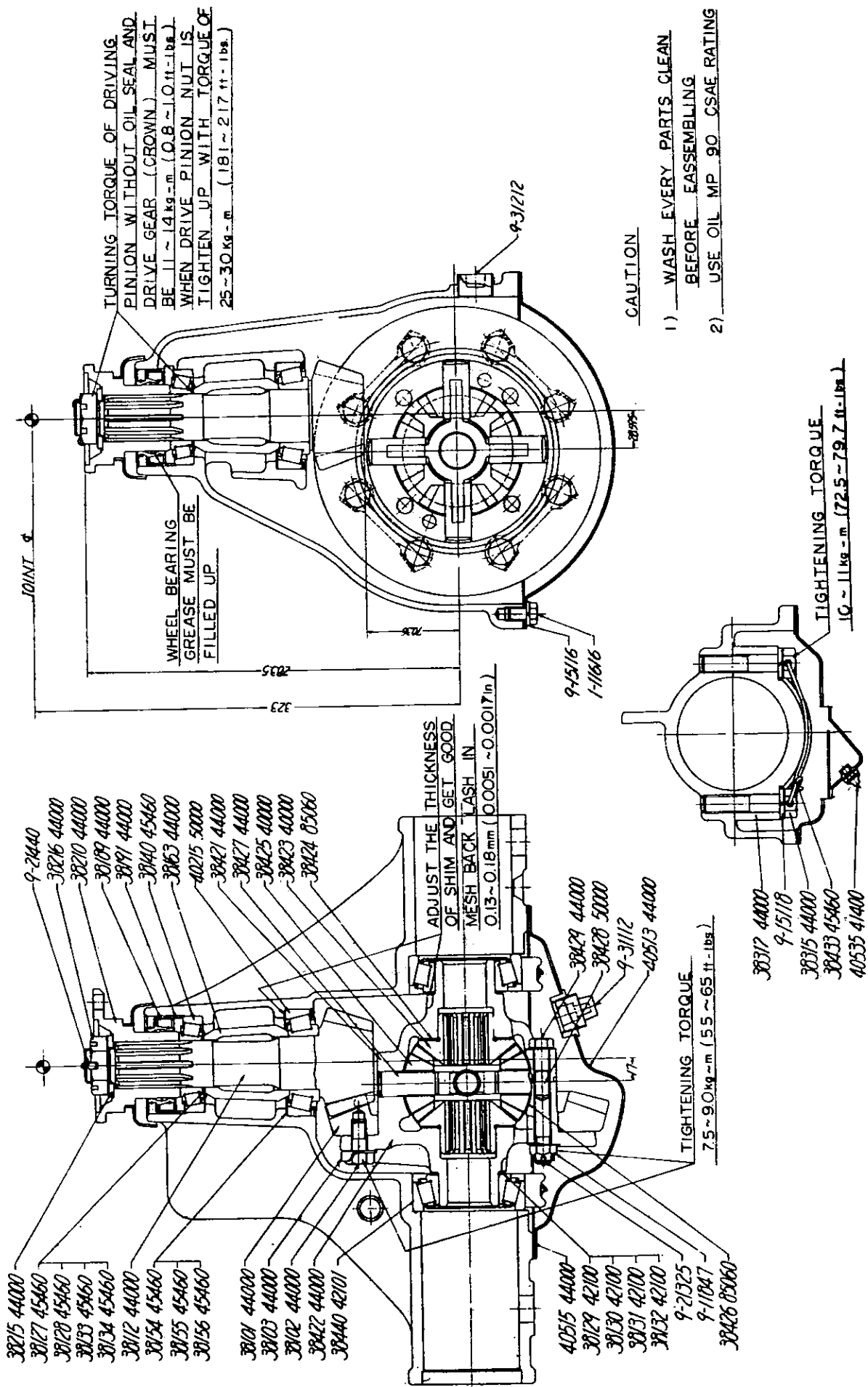

REAR SUSPENSION

1. CONSTRUCTION AND DATA

(1-1) CONSTRUCTION

The rear suspension of the Nissan Patrol consists of rear springs, rear shock absorbers, stabilizer, rebound stopper on the frame, and torque arresters on the frame. Refer to the instruction drawing.

(1-2) DATA

REAR SPRING	
Type	Parallel semi-elliptic leaf spring with grooved section
Thickness x Width x Span-Number	for Model 60 & G60 7.5 x 70 x 1,300-5 for Model G60H 8 x 70 x 1,300-1 7.5 x 70 x 1,300-7
Spring constant	Model 60 & G60 3.42 kg/mm Model G60H 6.18 kg/mm
Camber when loaded	Model 60 & G60 41 mm Model G60H 48 mm
Bushing	Silentbloc type rubber bushing on front eyes. Steel bushing on rear spring shackles.
SHOCK ABSORBERS	Telescopic, double acting
STABILIZER	Torsion bar type, outer diameter of torsion bar - 20 mm

2. REAR SPRING

The rear spring of the Nissan Patrol are of a low camber and low spring rate type. The advantage of this spring is that the rebound or the throw is much less giving a smooth ride. The torque arrester which is fixed on the frame, just rearwards of the spring eye, is provide to work as a spring helper when vehicle is loaded. Namely, after the surface of the spring attached the bottom face of the torque arrester, the arrester acts as a kind of rubber spring, making the combind spring rate with rear spring higher than the rate of rear spring alone. Thus, the rear spring of the Nissan Patrol will give smooth ride when it is not loaded, and give the enough hardness in order to carry the load when it is loaded.

The second leaf of the rear spring is wrapped around the main eye for the safety. A special steel bushing with bolt type is used at the shackles of rear spring. The front end of the rear springs are mounted in a bond rubber bushings. The bushing consist of an internal steel tube and tubular outer retainer, to which a rubber bushing is molded and securely bonded. These rubber bushings require no lubrication and no attention other than to keep the bolt drawn up snugly. Before installation coat the bushing securing with a very thin coat of grease, to protect it from freezing by corrosion.

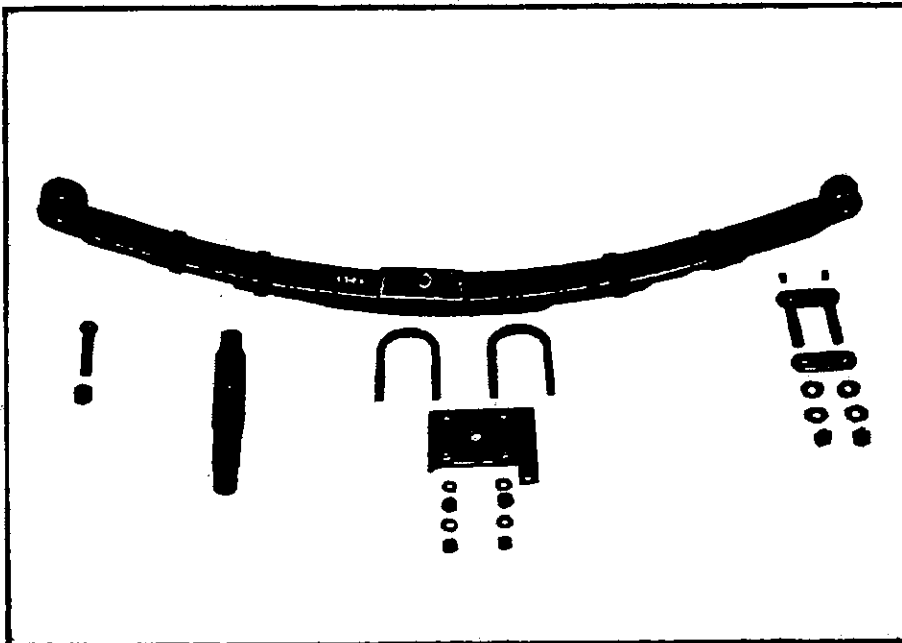

Rear suspension parts for model 60 & G60

It must be remembered that the rear springs should be loaded when the nuts of spring front eyes and shackles of the rear spring are tightened, as well as the front spring.

To be sure loaded correctly or not, check the buffer clearance between the torque arrester and main leaf of the spring. If that clearance is 13 mm (0.515 in.), the springs are loaded with a correct weight.

The tightening torque of the spring eye (rubber bushings) is 6.2 — 6.9 kg-m (45 — 50 ft-lbs.).

The nuts on the rear shackles should be tightened up by the following method.

- (1) Tighten nut up as tight as possible.
- (2) Back off the nut a quarter turn.
- (3) If the slot in the nut and the cotter pin hole line up, insert the cotter pin. If not, back the nut off until the slot and the hole are in line, and then insert the cotter pin.

The tightening torque of the nut that secure the spring clip U-bolt, should be 6.9 --- 8.3 kg-m (50 --- 60 ft-lbs).

3. REAR SHOCK ABSORBERS

The rear shock absorbers used on the Nissan Patrol are of the none-adjustable type, and the double acting type. That is why, no further maintenance will be needed.

Replace the shock absorber if the leakage of the fluid is recognized, or the dumping force is decreased.

The same shock absorbers are used on the front suspension of this vehicle.

4. REAR STABILIZER

The stabilizer used on the Nissan Patrol is of the torsion bar type with rubber bushing on the mounting.

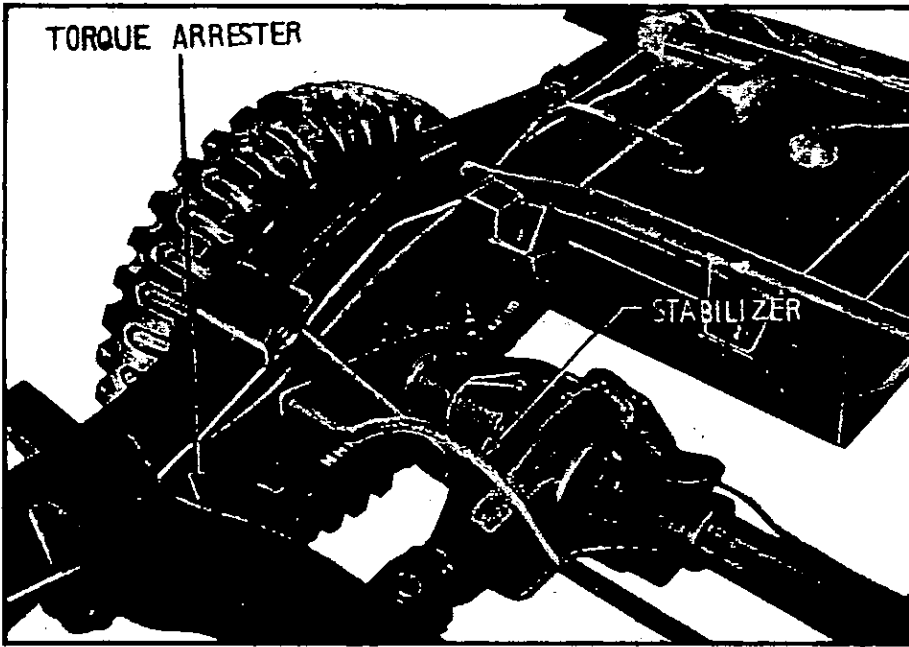

Rear suspension

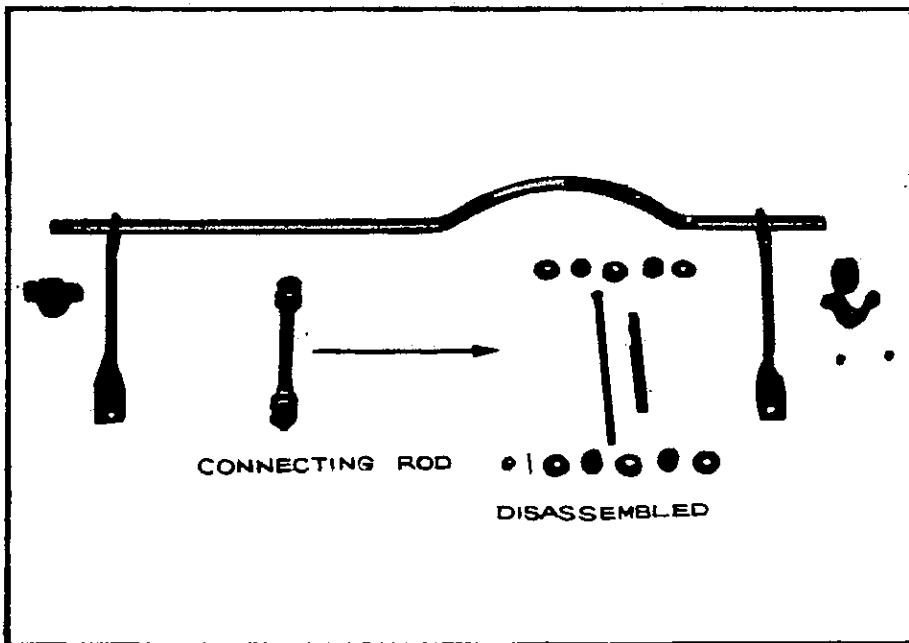

Rear stabilizer

Replace the torsion bar, if the crack or any other fault is found.
Replace the rubber bushing, if it is worn.
Checking must be done at least every 10,000 Km (6,000 miles).

5. TORQUE ARRESTER

The Nissan Patrol is equipped with a pair of the torque arresters on its bottom face of the side rail near the spring brackets.

These torque arrester have the two purposes. Namely, one is to prevent the movement of the rear axle housing when the vehicle is going to start. Another purpose is to act as a kind of rubber spring when the springs are over loaded. Thus, springs can be designed as a low spring rate one providing good ride with less weight on the vehicle, and providing enough carrying capacity with torque arresters, with much weight on it.

The buffer clearance between the torque arrester and the surface of the springs should be 13 mm (0.515 in.) when it is loaded with normal load.

Check the deformation of the torque arrester at least every 5,000 Km (3,000 miles). Replace it, if it is deformed excessively.

INSTRUCTION DRAWING OF REAR SUSPENSION MODEL 60

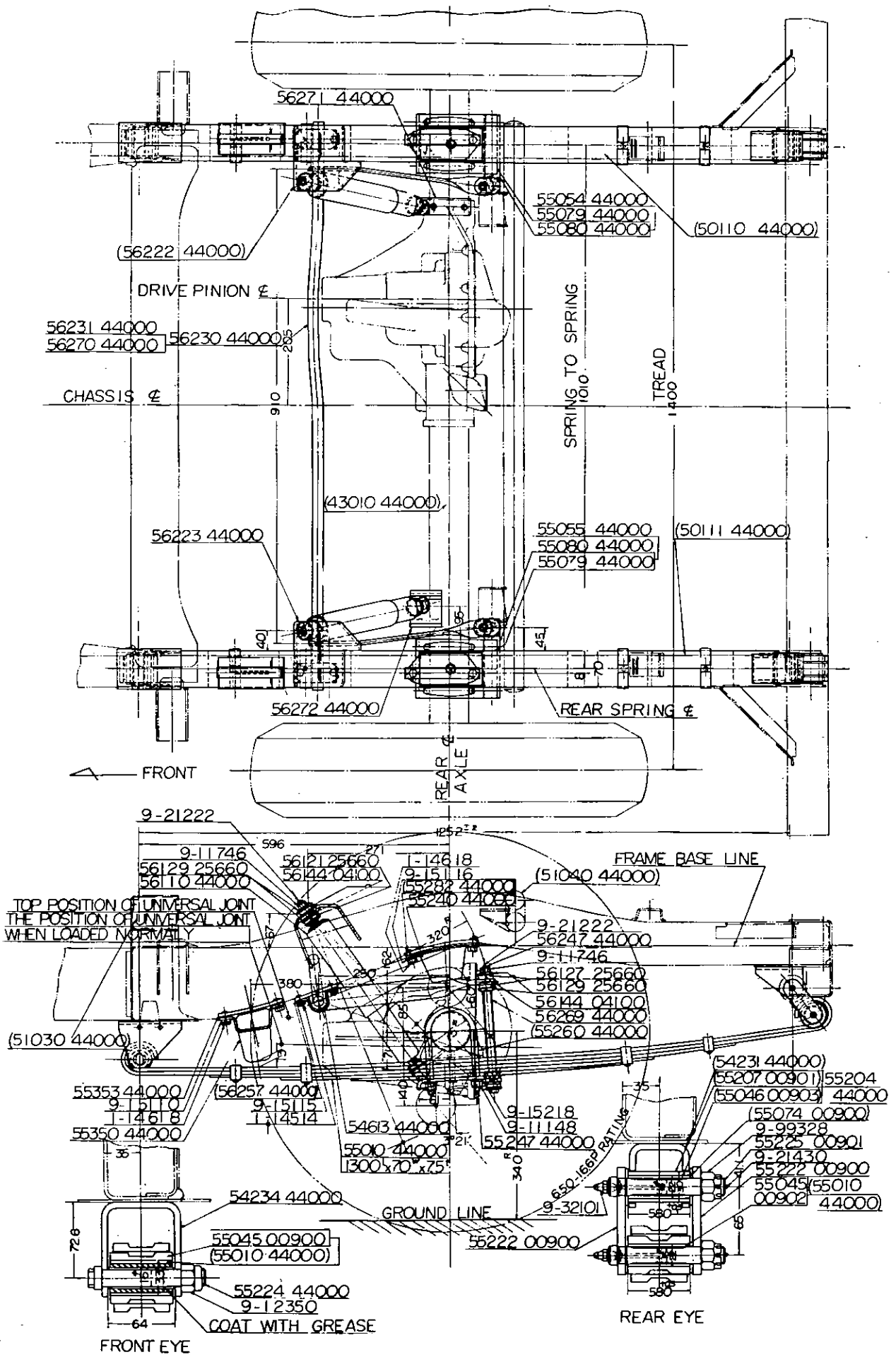

REAR AXLE (MODEL 60 AND G60)

1. DESCRIPTION AND DATA

(1-1) DESCRIPTION

The rear axle of the Nissan Patrol model 60 and G60, is of the semi-floating type with conventional type differential and hypoid drive gears. The differential parts are interchangeable with those of the front axle. The differential is mounted in the housing similar to the front axle, except that the drive pinion is toward the front instead of the rear.

For the model G60H (heavy duty type model), the special rear axle is designed. The rear axle housing, the rear axle shaft, the differential gear carrier assembly and relative parts are quite different from model 60 and G60.

(1-2) DATA

Type	Semi-floating
Tread	1,400 mm (55.15 in.)
Driving method	Hypoid bevel gear
Gear ratio	4.1 : 1
Number of teeth	
Ring gear	41
Drive pinion	10
Rear axle shaft bearing	
Type	Taper roller, JIS 30208
Out. Dia. x Inn. dia. x	
Width	80 x 40 x 20
End play of rear axle shaft	0.05 -- 0.15 mm (0.002 -- 0.006 in.)
Torque wrench setting	
Axle shaft bearing	
lock nut	12 Kg-m (157 ft-lbs)
Bearing cage bolt	1.5--2.0 Kg-m (21--28 ft-lbs.)
Rear axle shaft adjust	
shims available	0.076 mm (0.003 in.) 0.127 mm (0.005 in.) 0.254 mm (0.010 in.) 0.762 mm (0.030 in.)
Recommended oil and capacity	SAE MP-90 1.2 ltr (0.31 U.S. Gal)

As to the differential gears, refer to the paragraph "FRONT AXLE".

2. REMOVAL

(2-1) PRELIMINARY WORK

Remove the drain plug at the differential housing and drain the gear oil. Raise the vehicle until the weight is off the rear axle supporting the frame.

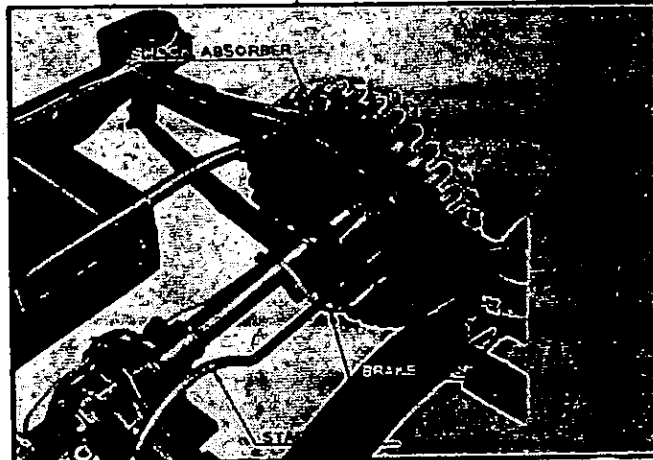

Disconnect these parts

(2-2) DISCONNECT SHOCK ABSORBERS, STABILIZER AND BRAKE HOSE

Remove the nuts, washer and grommet that secure the rear shock absorbers. Remove Nuts, washers and grommets that secure the stabilizer. Remove the shock absorbers and stabilizer. Remove the brake hose from the connector on the rear axle.

(2-3) DISCONNECT REAR PROPELLER SHAFT AND SPRING U-BOLTS

Disconnect the rear propeller shaft at the rear axle. Remove the eight nuts from the four spring clip bolts that secure the spring seat plates. Remove the spring seat plate and U-bolts (spring clip bolts).

(2-4) REMOVE REAR SPRING SHACKLES

Remove the rear spring shackle nuts and remove the shackles from both rear springs. Drop the rearward end of the springs to the floor. Roll the rear axle assembly from the vehicle.

3. DISASSEMBLY

(3-1) REMOVE WHEELS

Remove the six nuts that secure wheels to the brake drum. Remove the wheels.

(3-2) REMOVE AXLE SHAFT ASSEMBLY

Remove the screws that secure the brake drum to the rear axle. Remove the brake drum from the axle shaft. Back the four nuts off that secure the rear axle shaft bearing cage and brake disc to the rear axle housing. Remove the rear axle shaft with brake disc from the axle housing.

Remove the lock plate and back the bearing lock nut off with special tee-wrench. Remove the wheel bearing and spacer from the axle shaft. Remove the brake disc with the rear axle bearing cage from the rear axle shaft.

Press out the four serrated bolts that hold the brake disc and the bearing cage, and remove the bearing cage from the brake disc. Remove the outer race of the bearing and the outer oil seal from the bearing cage, using suitable puller.

Remove the inner oil seal from the end of the rear axle housing with suitable puller.

(3-3) REMOVE DIFFERENTIAL

As to the removal, inspection, repair and re-assembly, refer to the paragraph "FRONT AXLE". The parts and these operations are exactly the same as front axle differential parts.

4. CLEANING, INSPECTION, AND REPAIR

(4-1) CLEANING

Clean the all parts thoroughly in the cleaning solvent, until all trace of lubricant has been removed. Oil the bearings to prevent corrosion of the highly polished surface.

(4-2) AXLE HOUSING

Replace or repair the axle housing if it is bent or has any broken welds or cracked.

(4-3) REAR AXLE SHAFT

Replace the rear axle shaft if it is bent or twisted or has any damaged tooth of the spline. If the parts of the rear axle, on which the inner lase of the bearing is fitted, has any coloured surface, replace the axle and bearing together.

(4-4) WHEEL BEARING

The bearings that are pitted, corrded or discolored due to over-heating must be replaced.

(4-5) OIL SEAL

Replace the oil seals which are fitted originally, even though they do not look like they are damaged.

Never use the old oil seal in reassembling operation again.

5. ASSEMBLY

(5-1) BEARING CAGE ASSEMBLY

Press the new oil seal into the bearing cage with suitable drift and press.

Press the bearing cup into the bearing cage.

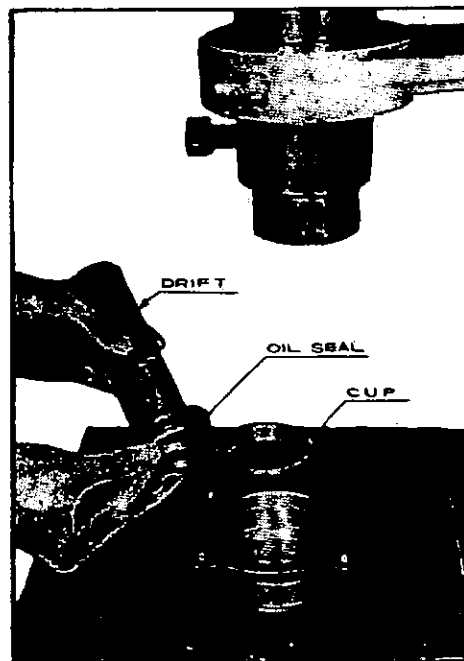

Press oil seal and bearing cup in

(5-2) ASSEMBLE BRAKE DISC AND CAGE

Place the bearing cage and brake disc on the suitable press. Press the four serrated bolts in through both brake disc and cage.

(5-3) ASSEMBLE BEARING CAGE AND SHAFT

Put the rear axle shaft through the brake disc assembly. Place the bearing spacer into the bearing cage.

Fit the wheel bearing to the axle shaft, and drive the bearing in using the special hammer.

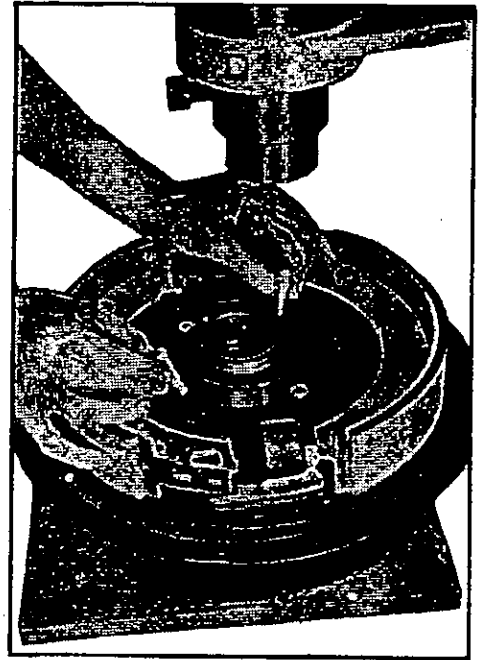

Press serrated bolt in

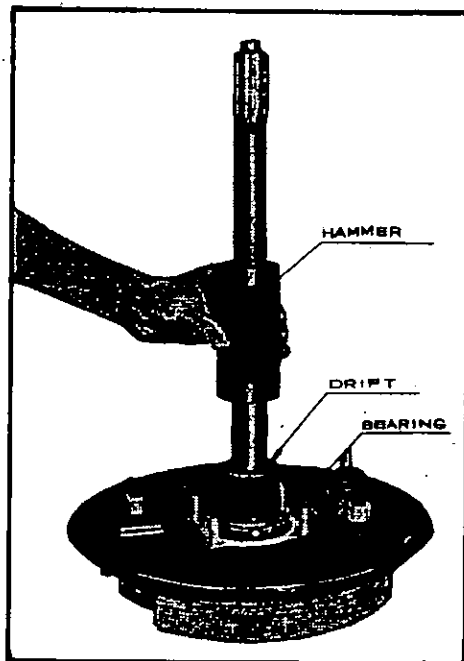

Place bearing spacer

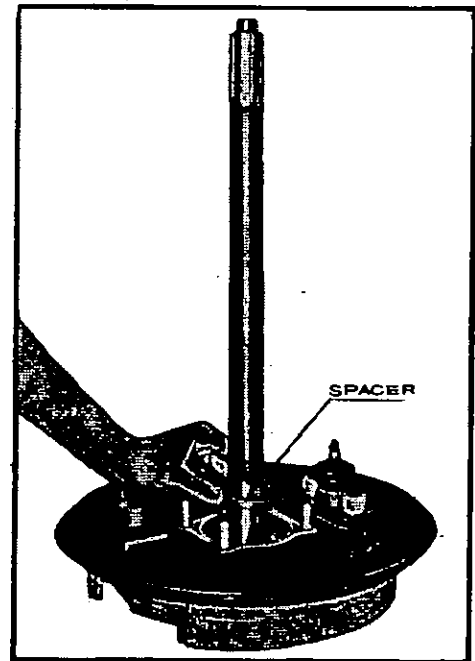

Place the bearing

Place the bearing lock nut and its lock plate, then, tighten the nut up. The tightening torque is 12 Kg-m (157 ft-lbs). Crock the lock plate so that the lock nut is locked securely.

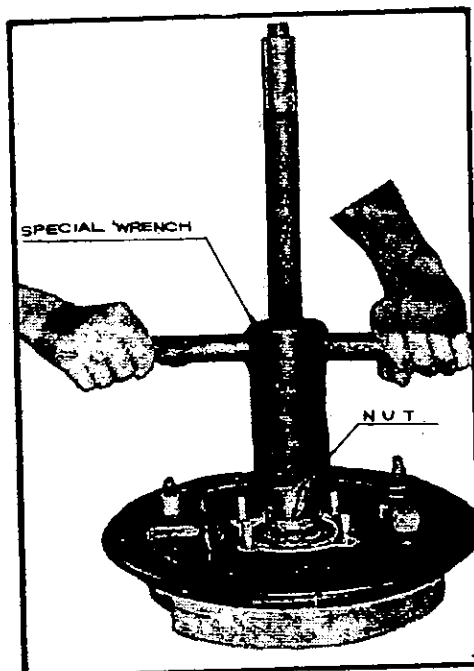

Tightening lock nut.

(5-4) ASSEMBLE AXLE ASSEMBLY TO THE HOUSING

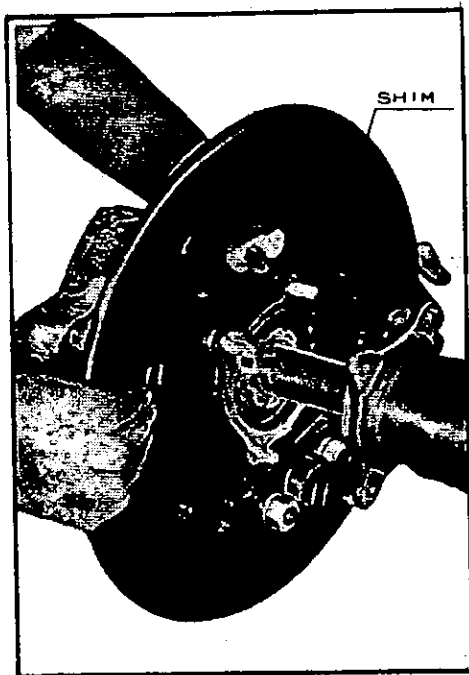

Place the rear axle adjust shims 1.495 mm (0.059 in.) in total thickness on the bearing cage of one rear axle assembly. Replace the rear axle assembly to the rear axle housing. Secure the four nuts that hold the cage to the housing. Tightening torque is 1.5—2.0 Kg-m (21—28 ft-lbs).

Replace rear axle shaft

Place another rear axle assembly without adjust shims, and tighten the two bearing cage nut temporarily.. Measure the clearance between the bearing cage and the end of the axle housing, using feeler gauge. Say this value as A.

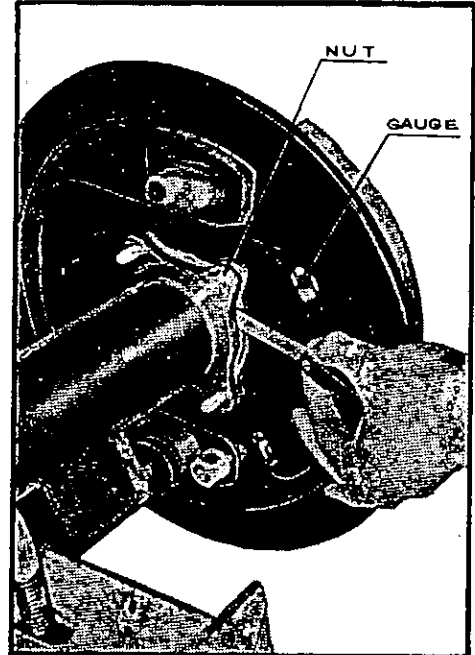

Measure thickness of adjust shims

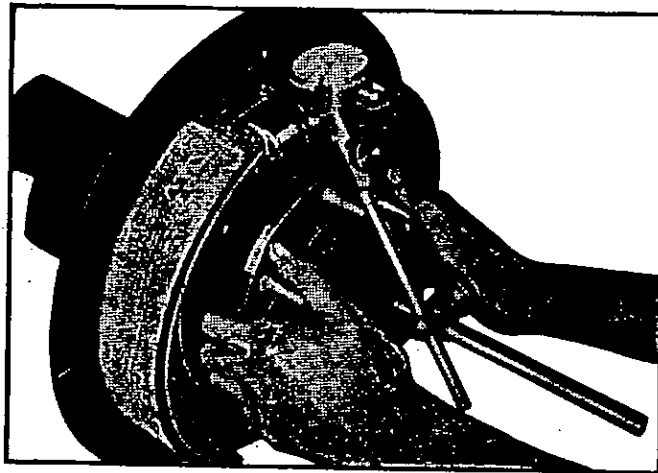

Measure end play of rear axle

Remove the nuts that was tightened temporarily. Remove the rear axle shaft assembly from the housing. Place the rear axle adjust shims (A-0.1 mm) in total thickness, onto the rear axle bearing cage. Replace the rear axle with adjusting shims, this time, and tighten the four nuts up.

Place a dial indicator onto the rear axle shaft flange, and measure the end play of the rear axle shaft. The end play of the rear axle shaft must be in 0.05 -- 0.15 mm (0.002 -- 0.006 in.). If not, adjust the thickness of the adjusting shims on the later axle shaft so that the end play is in the standard value. Record the total thickness of the adjusting shims each time when the thickness is changed. Because the total thickness of both axle must not differ more than 1.0 mm (0.04 in.). If the difference exceeds more than 1.0 mm, adjust the thickness of the shims which is fitted on the former axle. And then, repeat the same operations in checking the end play and adjusting the total thickness of later axle.

6. INSTALLATION

(6-1) PRELIMINARY WORK

Fill the lubricant into the differential housing. Place a hydraulic jack under the rear axle assembly. Roll the assembly under the vehicle, Raise the assembly until the rear springs can be raised and secured to the spring shackles. Lower the jack to allow the axle assembly to rest on the springs.

(6-2) INSTALL SPRING U-BOLTS

Place the spring U-bolts in position on the axle housing. Install the spring seat plates on the U-bolts at the both side of the axle. Install the nuts that secure the spring seat to the U-bolts.

(6-3) INSTALL SHOCK ABSORBERS

Insert the rubber bushings on each side of each shock absorber plate. Install the special washer, castellated nut and cotter pin. Install the torsion bar, insert rubber bushing, special washer, and tighten with castellated nut. Lock the nut with cotter pin from the turning.

(6-4) INSTALL PROPELLER SHAFT AND CONNECT BRAKE HOSE

Install the propeller shaft to the rear axle.

Connect the brake hose to the connector on the rear axle. Bleed the air which is in the brake hydraulic system.

REAR AXLE ASSEMBLY MODEL 60

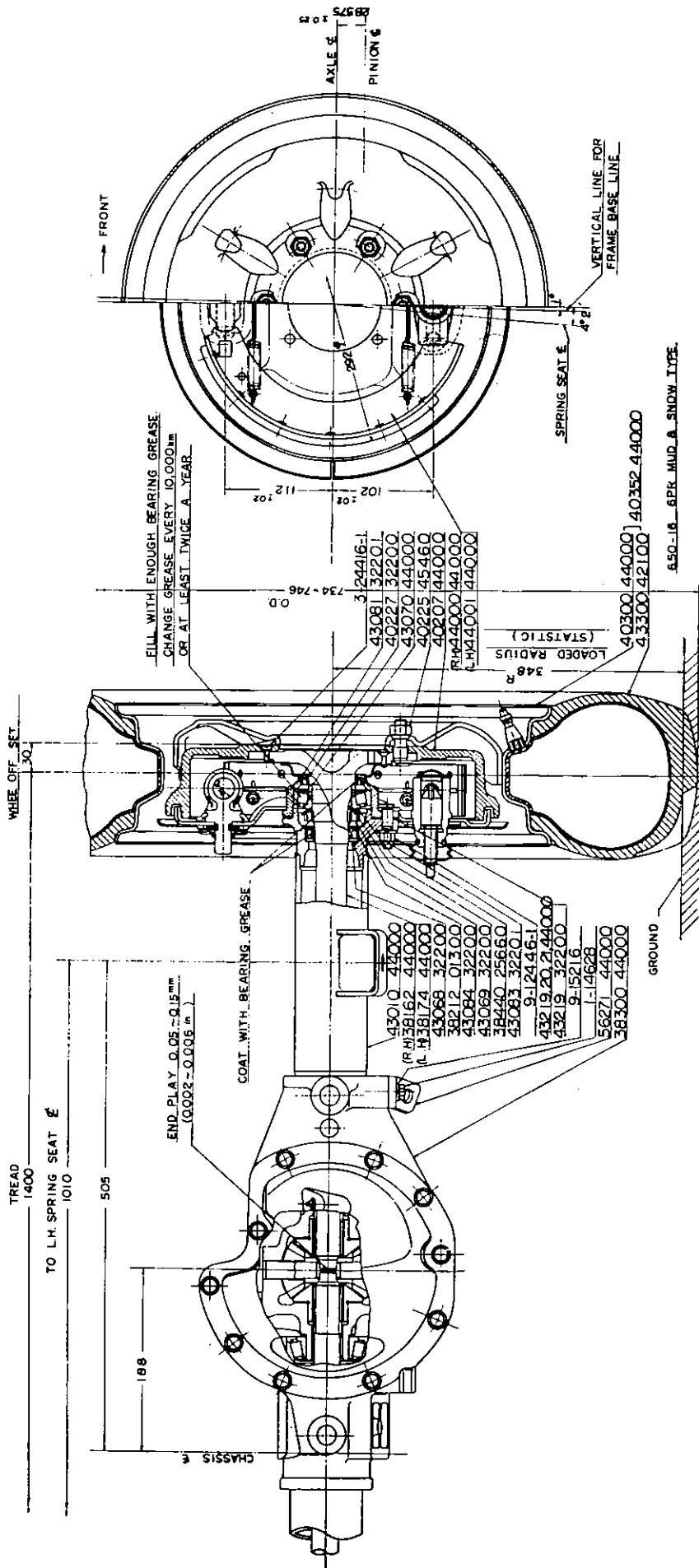

REAR AXLE (MODEL G60H)

1. DESCRIPTION AND DATA

(1-1) DESCRIPTION

The rear axle of the Nissan Patrol model G60H (heavy duty type) is of the semi-floating type with conventional differential gears and hypoid gears.

In comparison with the rear axle of model 60 and G60, the following parts are different.

The axle housing is made out of the pressed steel plate in the form of banjo, and for its light weight, with its rear cover being welded.

The gear carrier is made out of strong malleable cast iron and the differential gear assembly is so constructed as to make easy dismantling and the adjustment of each gear. The gear carrier is separable from the rear axle housing instead of the welded gear carrier of model 60 and G60.

The rear axle is made of special steel of highly strength, therefore model G60H can carry heavier weight than model 60 and G60 does, co-operating with its pressed banjo type axle housing and strong differential gears.

Inside the housing, the drive pinion drives the bevel gear which is closely connected with the differential gear case. The each two pinion mates and side gears are fixed in this case and locked each other. The pinion mate with the pinion shaft which is supported by the gear case, while the side gear, which is supported as to function freely inside the gear case, is connected with the spline at the top end of rear axle shaft.

The particular point in the construction of differential gears of model G60H, is the existence of the thrust block. The thrust block and its spacer are located in the center of the differential case by supporting pinion mate shaft. The block is designed so that the thrust force on the both rear axle shafts is supported by this, while the both rear axle shafts themselves support the thrust force in the case of model 60 and G60. The differential case of model G60H is constructed as a mono-block, while the case of model 60 has the separable construction to two pieces.

(1-2) DATA

Type	Semi floating type
Driving method:	Hypoid bevel gear
Gear ratio:	4.100
Number of teeth:	
Ring gear	41
Drive pinion	10
Pinion nut tightening torque	120-180 ft.lbs.
Pre-load for pinion bearings	12-15 kg-cm (10.4-13 in-lbs.)
Pinion gear adj. shim thickness:	
	0.003 in.
	0.005 in.
	0.010 in.
	0.030 in.
Pre-load adj. shim thickness	
	0.003 in.
	0.005 in.
	0.010 in.
	0.030 in.
Standard position to install drive pinion:	
Distance from center of drive gear to pinion head	82.55 mm (3.25 ins.)
Tightening torque for drive gear cap screws	55-65 ft.lbs.
Drive gear backside run-out	Not to exceed 0.076 mm (0.003 in.)
Side gear number of teeth	16
Side gear thrust washer thickness	1.55 mm (0.063 in.)
Pinion mate number of teeth	10
Pinion mate thrust washer thickness	1.55 mm (0.063 in.)
Pinion mate and side gear back lash	0.006-0.008 in.
Ring gear and pinion gear back lash	0.006-0.008 in.
Pre-load of side bearings	Tight adjusting nut until bearing cap stopper distance is: 262.9-262.85 mm 10.348-10.350 ins.
Torque wrench setting:	
Pinion nut	120-180 ft.lbs.
Side bearing cap bolts	80 - 90 ft.lbs.
Standard oil & capacity	Hypoid gear oil 2.5 ltr. 0.66 US gal.
Wheel bearings	Taper roller bearing
Dimensions	100 x 55 x 26.75 mm (3.937 x 2.165 x 1.053 in.)
End play of rear axle shaft	0.05-0.10 mm (0.002-0.004 in.)

Thickness of adjusting shims:	0.030 in.
	0.010 in.
	0.005 in.
	0.003 in.

2. DISASSEMBLY

As to the removal of the rear axle assembly from the chassis, and the removal of the rear axle shaft, the operations are, in principle, exactly the same as model 60 and G60. Therefore, the only differential gear carrier removal is described in this paragraph.

(2-1) REMOVE REAR AXLE SHAFT AND PROPELLER SHAFT

Drain the oil from the gear carrier assembly. Pull out the both axle from the rear axle assembly completely or pull out the shaft at least 4 inches. Then, remove the propeller shaft from the companion flange of the gear carrier.

(2-2) REMOVE GEAR CARRIER ASSEMBLY

Remove the twelve nuts that secure the carrier assembly to the axle housing. Dismount forward the carrier assembly from the axle housing. Place the garage jack, if necessary.

(2-3) REMOVE DIFFERENTIAL CASE ASSEMBLY

Take off the side bearing caps of the carrier and lever out the differential gear case and bearing. Such as dismount the differential side bearing, the side bearing puller is adopted and pull out the bearing. The puller should be handled with care in catching the edge of bearing inner race which is hard to hook. Both bearings of the right and the left, should be arranged separately.

(2-4) REMOVE RING GEAR

Slacken the differential case set screws after bent back the lock washer and pull out the ring gear, in this time loosen the set screws in a diagonal line considering to keep the gear from bending.

(2-5) REMOVE PINION MATES AND SIDE GEARS

The pinion mate shaft should be pulled out by striking out the pinion mate shaft locking pin which is fixed on the differential case from left side (from the ring gear fixed side) to the right, before pulling out the pinion, side gear and the thrust washer. The gears as well as thrust washers should be arranged separately as left and right, front and rear.

(2-6) REMOVE DRIVE PINION

Remove the flange nut using drive pinion flange wrench (BT4449) and box wrench. Pull out the companion flange with suitable puller.

Remove the drive pinion from the gear carrier by striking out lightly to the backwards the front end (at the side of the companion flange) of drive pinion with the drift of soft metal. Thus, the pinion would be taken out together with the inner race of rear bearing and roller, distance piece and the adjusting shims.

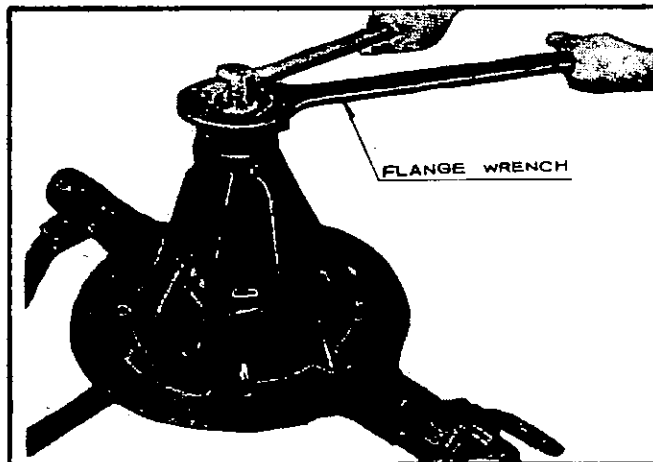

Remove flange nut

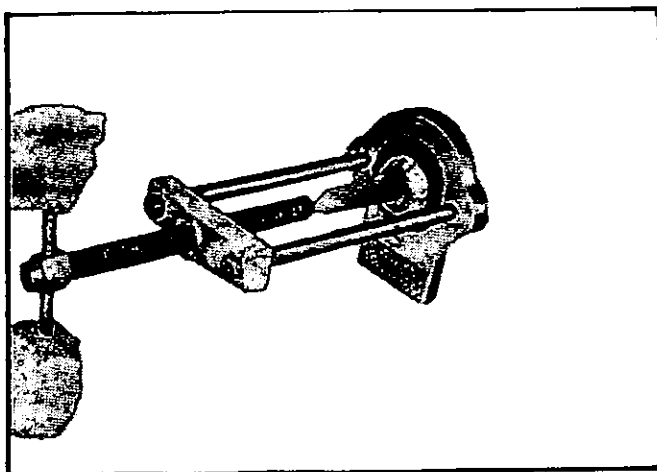

Remove rear bearing

The oil seal, outer race of front and rear bearing, pinion adjusting shims are remained into the carrier. Pull out the rear inner race from the drive pinion. The special tool (AT-4712) drive pinion rear bearing inner race replacer and (BT-4454) adapter should be employed in this case, and it is easy to handle with the vice fixing one end of replacer.

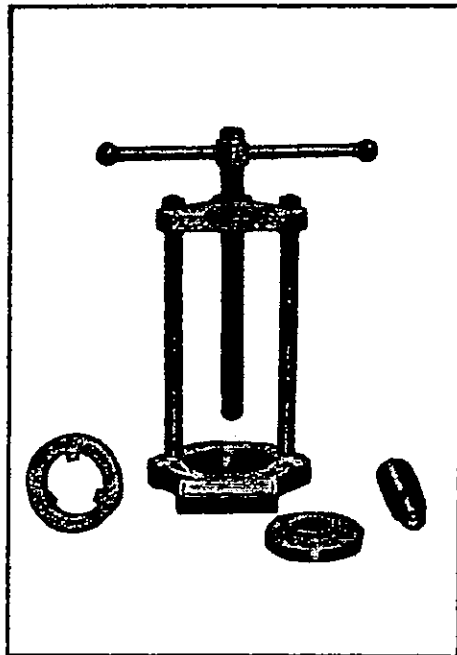

Drive pinion rear bearing
inner race replacer

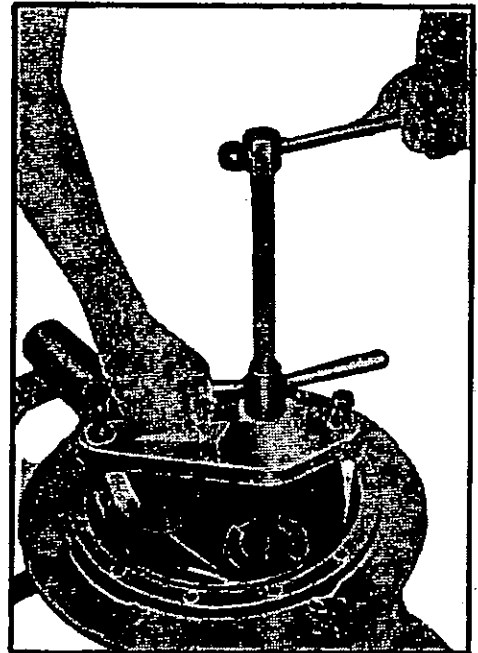

Remove rear bearing
outer race.

Pull out front bearing outer race and oil seal of pinion gear by drift, and the oil seal should be replaced with new one, and removed the rear and front bearing outer race by using service tool (BT-4450) which is drive pinion front and rear bearing outer race replacer.

3. INSPECTION AND CHECKING

(3-1) BEARINGS

Inspect all bearing cups, races and rollers for scoring, chipping or excessive wear. Inspect large end of rollers for wear. This is where is most evident on taper roller bearing.

Drive pinion front & rear
bearing outer race replacer

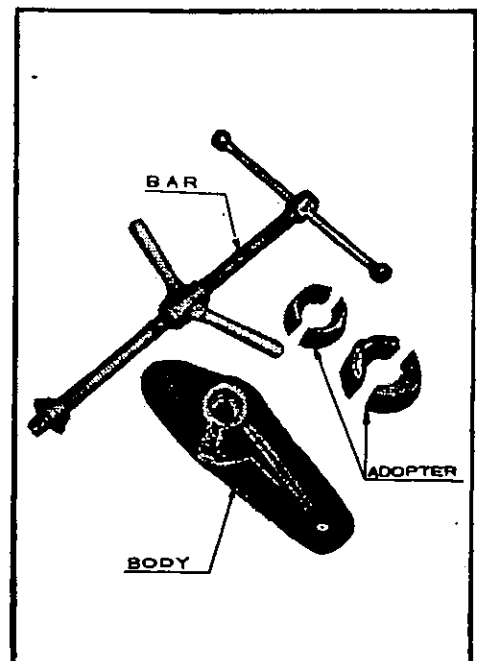

(3-2) OIL SEAL

Inspect oil seals for evidence of wear or any damage. However, it is recommended to replace them with new one whenever the drive pinion is disassembled.

(3-3) DRIVE PINION AND RING GEAR

Inspect pinion splines and flange for evidence of excessive wear. Inspect ring gear and pinion teeth for scoring, cracking or chipping. Inspect the gear tooth contact bearings.

(3-4) DIFFERENTIAL CASE AND GEARS

Inspect differential case for cracks or scores on side gear and pinion mate thrust faces. Check fit of differential side gears in case. Check fit of side gears and axle shaft splines. Inspect differential pinion shaft for scoring or evidence of excessive wear.

(3-5) GEAR CARRIER

Inspect differential carrier for cracks or cross threads on differential bearing cups and bosses.

(3-6) ALIGNMENT OF RING GEAR TO DIFF. CASE

At the stage when the ring gear is assembled with differential case assembly, the alignment of the ring gear should be tested. Place the differential case with side bearings and ring gear onto the gear carrier. Best the complete assembly on its place by striking lightly by soft metal hammer. Place the leg of the dial indicator onto the surface of the ring gear, and rotate the ring gear. If the fluctuation of dial gauge reading is more than 0.076 mm (0.003 in.), the ring gear and differential case should be repaired or replaced together.

(3-7) GEAR TOOTH CONTACT PATTERN

It is very important that tooth contact be tested before carrier assembly is installed. Allowable variations in the carrier or rear pinion may cause pinion to be too far in or out even when shimmed correctly. Thus, tooth contact must be tested and corrected as necessary or the gears may be noisy. This test may be performed as follows with the carrier assembly mounted in the holding fixture.

Thoroughly clean the ring gear and drive pinion teeth and paint ring gear teeth lightly with red lead and oil of suitable consistency to produce a contact pattern.

The large end of the teeth is called the "heel" and the small end the "toe". Also, the top of the tooth, which is the part above the pitch line, is called the "face", while the part below the pitch line is called the "flank". The space between the meshed teeth is referred to as "back lash".

As to the tooth contact pattern and its remedies, refer to the paragraph "FRONT AXLE".

4. ASSEMBLE DIFFERENTIAL GEAR AND CARRIER ASSEMBLY

(4-1) ASSEMBLE DIFFERENTIAL GEAR

Place the pinion mates and side gears in the differential gear case. Every parts should be cleaned and oiled with new gear oil, then, the pinion mates, side gears and thrust washers should be assembled by the inspection and selection before pushing the pinion mates shaft into the pinion mates. Inspection should be made again in the clearance of back lash.

Strike the pinion shaft locking pin into the differential case, from the right side of the case (opposite side of drive gear) and must be fixed by setting well, and by striking around the hole of it so that the pin should not be loosen or come out.

(4-2) ASSEMBLE RING GEAR

Fix the ring gear with the differential case. The ring gear as well as the drive pinion should be well inspected or they must be replaced as a set whenever the replacement is required. Otherwise, the proper tooth contact pattern would not be given after assembling is completed.

In mounting in the case, the fitting surface of the gear and case must be thoroughly cleaned and fixed with set screws and lock washers. Bend the lock washers. In tightening up the screws, it should be set and supported by vice or any other setting tools so as not to damage it and screw up in a diagonal line with a wrench which fit correctly with the head of the screw. The standard screwing torque is 55 ft-lbs to 65 ft-lbs, at this time, the screw head should lightly be striken by a quarter pound hammer.

(4-3) ASSEMBLE BEARINGS

Mount the side bearing on the differential case. Press in the both side of the bearings by using the drift, or by using suitable press.

(4-4) ASSEMBLE PINION TO CARRIER.

Fit the bearing outer race to the gear carrier by using the drive pinion front and rear outer race replacer.

Refit the pinion head shim, if the original shim is damaged or not available, select the shim from 0.030 in., 0.010 in., 0.005 in. and 0.003 in.

Fit the front bearing outer race to the gear carrier by using the replacer.

Fit the inner race of the rear bearing to the pinion shaft by using drive pinion rear bearing inner race replacer or suitable machine, and fit the inner race of the front bearing.

Fit the drive pinion to the gear carrier.

(4-5) ADJUST PINION PRE-LOAD

Assemble the drive pinion bearing and shims to the gear carrier, fit the oil seal and companion flange. Tighten the flange nut gradually to a torque wrench reading of 120 — 180 ft-lbs., checking pre-load at intervals to ensure that it is 12—15 Kg-cm (10.4—13.0 in.-lbs). If the pre-load is too great, more shims must be added, if too small the thickness of the shim must be decreased.

(4-6) ADJUST DRIVE PINION HEIGHT

To adjust the position of the drive pinion, the service tool BT-4447, drive pinion alignment gauge, is to be applied.

The standard height of the drive pinion is 82.55 mm (3.25 in.) from the center of the carrier bearing. Set both sides of the alignment gauge closely to the position of the

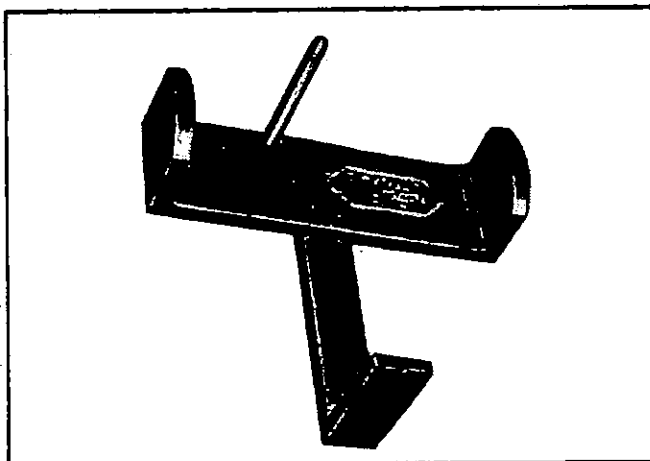

Drive pinion alignment gauge

bearing, and insert the feeler gauge between the extreme end of the gauge bar and the pinion head. The height of the gauge has been made 10/1,000 inch less than the regular dimension. Therefore, provided that the pinion head mark reads 0 and the gap measured 10/1,000 inch, the pinion can be regarded as fixed at the correct position. When it is necessary to adjust the pinion height and also pinion rear bearing outer race from the carrier and adjust it by adding or reducing the adjust shims. For example, when the mark shown 2, apply the feeler gauge with thickness, $10+2 = 12$, that is 12/1,000 inch.

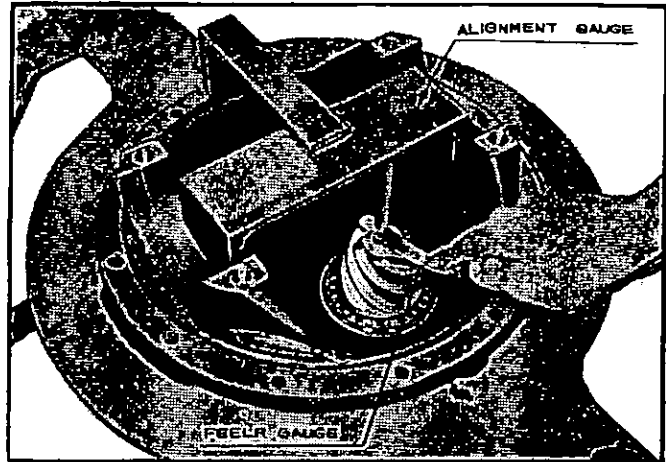

Measure pinion height

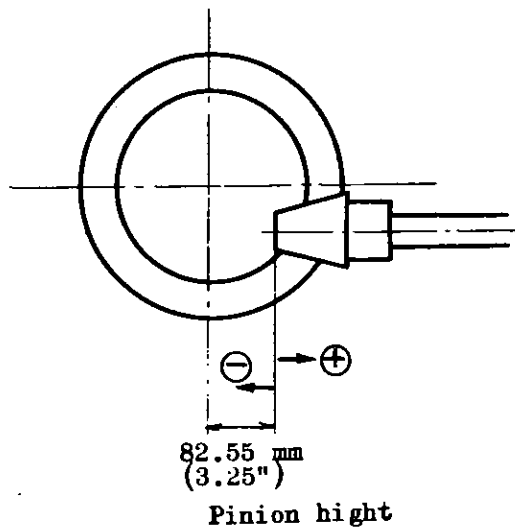

(4-7) ADJUST SIDE BEARING PRE-LOAD AND BACK LASH

Place the differential case assembly onto the gear carrier. Replace the side bearing cap of the carrier on the carrier. Tighten up the bearing cap bolts with tightening torque 80—90 ft-lbs.

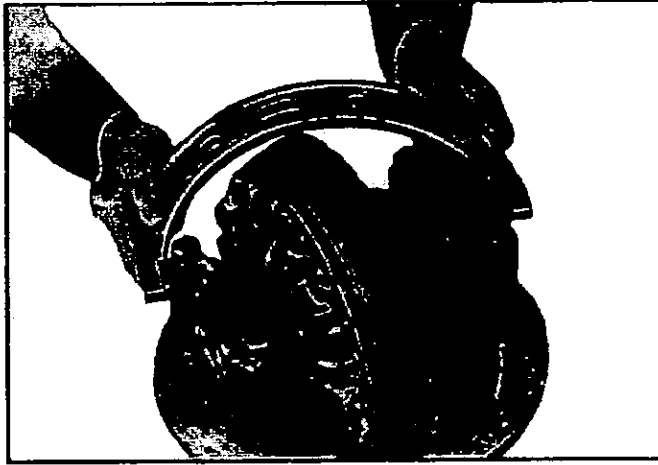

Measuring side bearing cap distance

The differential case assembly can be moved by tightening or backing off the side bearing adjusting nut. At first, adjust the back lash of drive pinion and ring gear by means of moving differential case toward right or left hand as necessary. The back lash should be in 0.006—0.008 inch.

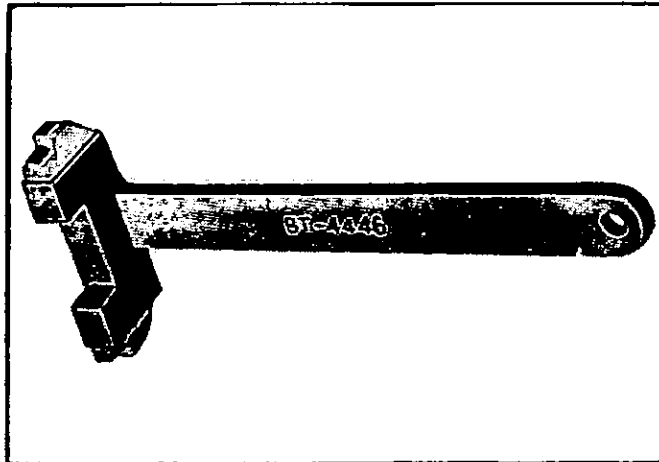

Adjusting nut wrench

After correct back lash has been settled, in another words the correct position of differential case has been got, the pre-load of side bearings should be given by tightening the side bearing caps in. When the bearing adjust nut is turn in, the pre-load of the bearings will be increased and the distance between the measuring surface of the both bearing caps, will be increased. Because, the caps and carrier will be deformed by the stress which is given by tightening torque of the adjusting nut.

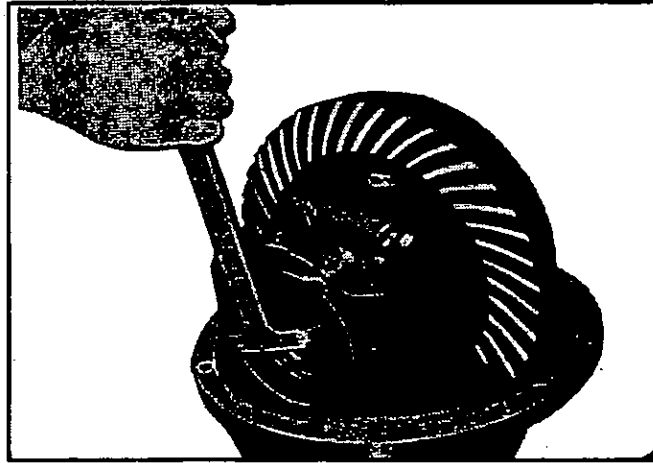

Adjusting side bearing nut

The value of the pre-load, thus, can be measured by the distance of the both bearing caps.

To give the correct pre-load to the bearings, turn the both bearings in evenly. The distance of the both caps should be 262.85—262.90 mm (10.348—10.350 in.) in diameter.

5. ASSEMBLE REAR AXLE SHAFT AND MOUNT TO CHASSIS

As to these operation, refer to the paragraph "REAR AXLE MODEL 60 AND G60", because the construction and operations are identical with those models.

REAR AXLE MODEL G60H

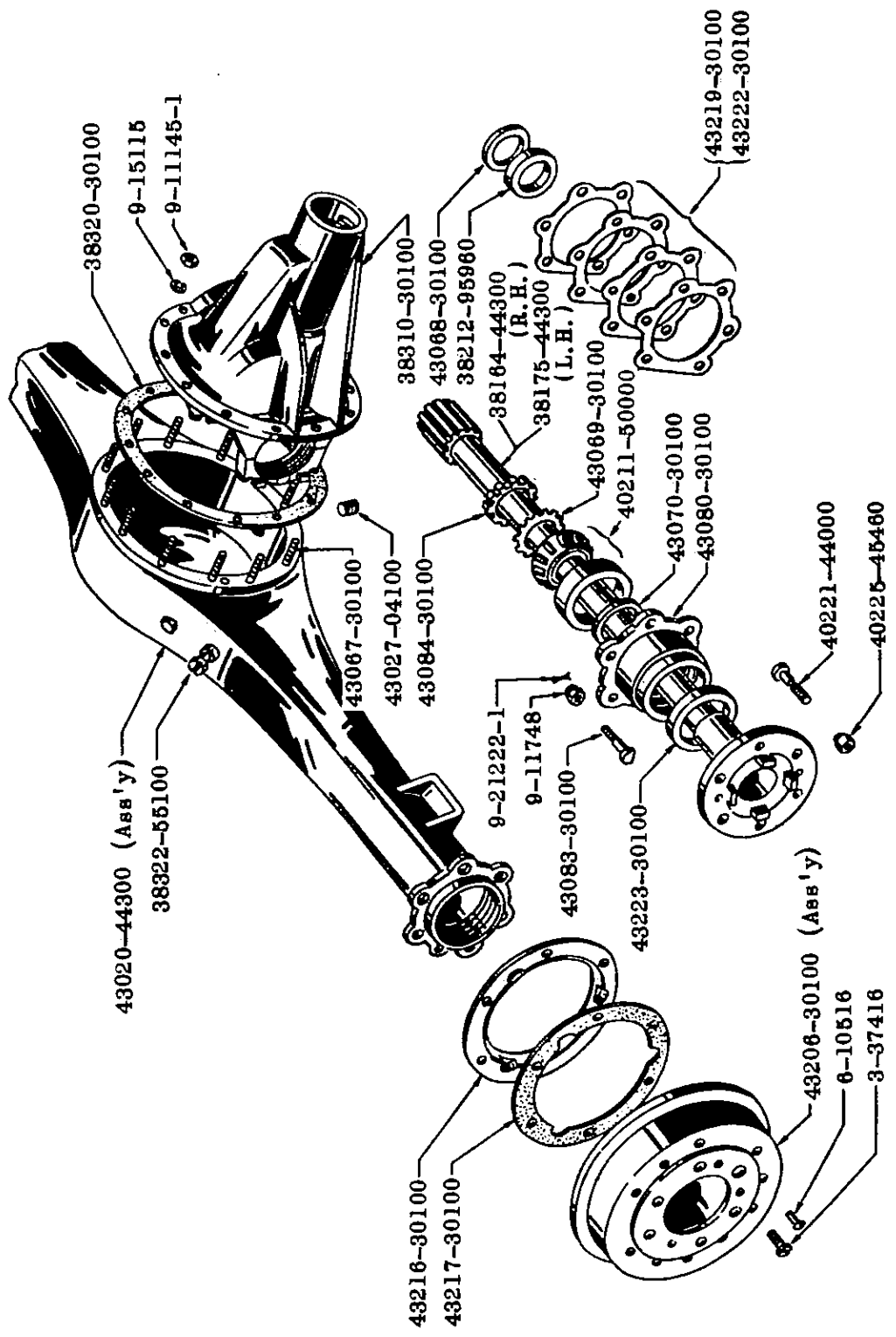

REAR AXLE MODEL G60H

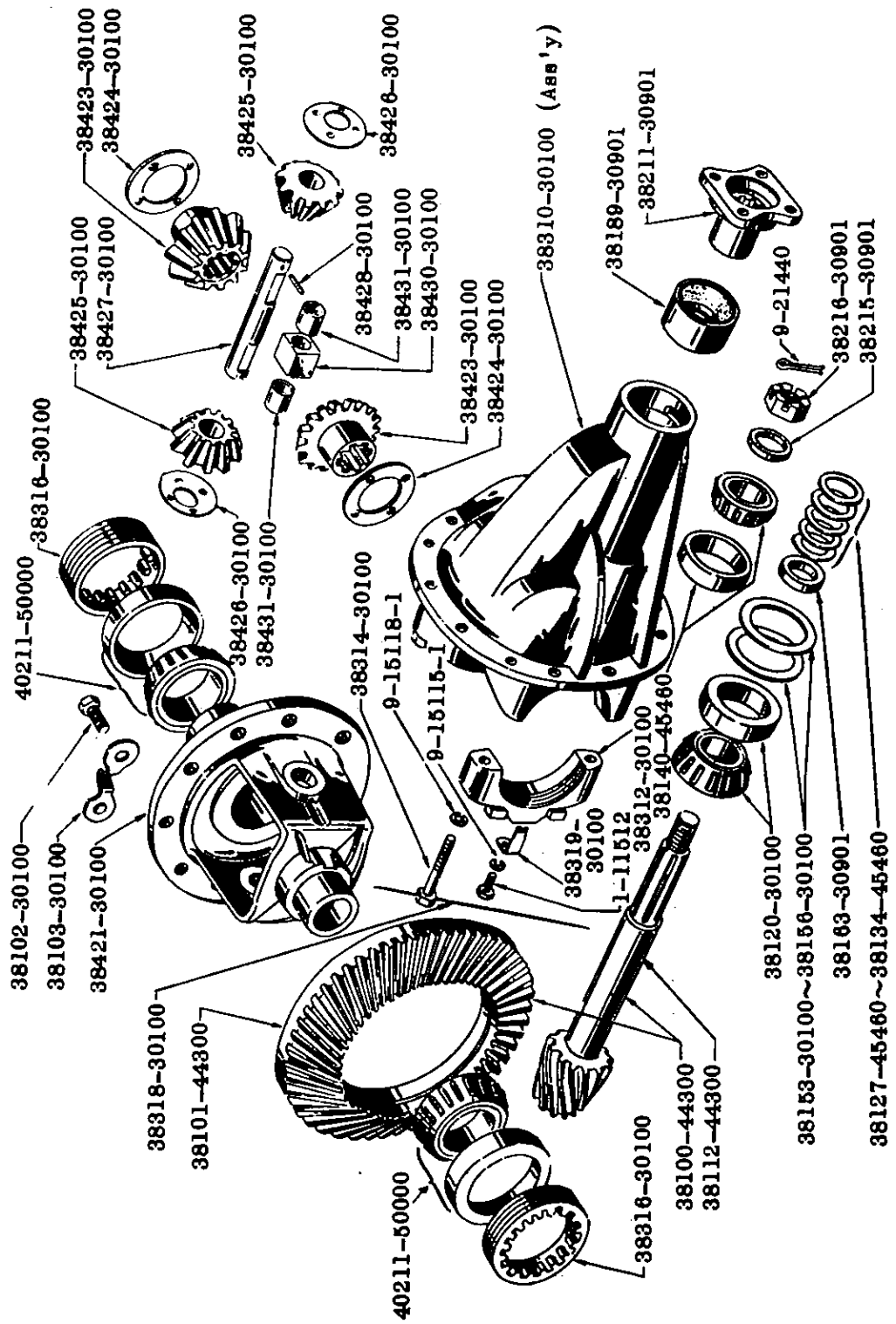

BRAKES

1. DESCRIPTION AND DATA

(1-1) DESCRIPTION

The brakes on all four wheels are hydraulically operated by foot pedal application, directly coupled to a master cylinder in which the hydraulic pressure of the brake operating fluid is originated. A supply tank cast integrally with the master cylinder provides a reservoir by which the fluid is replenished, and a pipe line consisting of tube, flexible hose and connectors, interconnect the master cylinder and the wheel cylinders.

The pressure generated in the master cylinder by application with the foot pedal is transmitted with equal and undiminished force to all wheel cylinders simultaneously. This moves the pistons outwards, which in turn expand the brake shoes thus producing automatic equalisation, and efficiency in direct proportion to the effort supplied at the pedal.

When the pedal is released the brake shoe springs return the shoes which then return the wheel cylinder pistons, and therefore the fluid back into the pipe lines and master cylinder.

An independent mechanical linkage actuated by a hand brake lever (or parking brake lever), located at the center of the floor board, operates the brake drum mounted at the rear end of the transfer case by external contracting band.

The front brakes are of the two leading shoe type with sliding shoes which ensure automatic centralisation of the brake shoe in operation.

The rear brakes are of the leading trailing type with sliding cylinder and sliding shoes.

Refer to the instruction drawing of the front and rear axle, of the brake piping, and of the pedal arrangement.

(1-2) DATA

Type	Hydraulic, two leading shoe for front, leading trailing for rear.	
Pedal free movement	$\frac{1}{2}$ — $\frac{3}{4}$ in.	
Drum diameter (inner)	292 mm (11 $\frac{1}{2}$ in.)	
Lining (front and rear)		
material	Special woven	
width	55 mm (2.16 in.)	
length	302 mm (11.9 in.)	
thickness	6.8 mm (0.268 in.)	
Total friction area	2020 cm ²	
Master cylinder inside diameter	25.4 mm (1 in.)	
Wheel cylinder inside diameter	model 60 and G60	model G60-H
front	25.4 mm (1 in.)	25.4 mm (1 in.)
rear	25.4 mm (1 in.)	28.57 mm (1-1/8 in.)
Hand brake type	mechanical, external contracted brake band at the end of the transfer case.	
drum diameter	150 mm (5.9 in.)	
lining		
material	woven	
length	220.5 mm (8.69 in.)	
width	45 mm (1.77 in.)	
thickness	6.3 mm (2.47 in.)	
friction area	198.5 cm ²	
Clearance between drum and brake lining	0.7 — 0.8 mm (0.028 — 0.032 in.)	

2. REPAIRING OF THE BRAKES

(2-1) MASTER CYLINDER

The master cylinder of the Nissan Patrol consists of a body with a polished, finished bore, and reservoir with a cap. The inner assembly is made up of the push rod, piston stopper stopper lock, piston, piston primary cup, piston secondary cup, retainer and ring of piston cup, valve, and valve seat. The open end of the cylinder

BRAKE MASTER CYLINDER ASSEMBLY MODEL 60

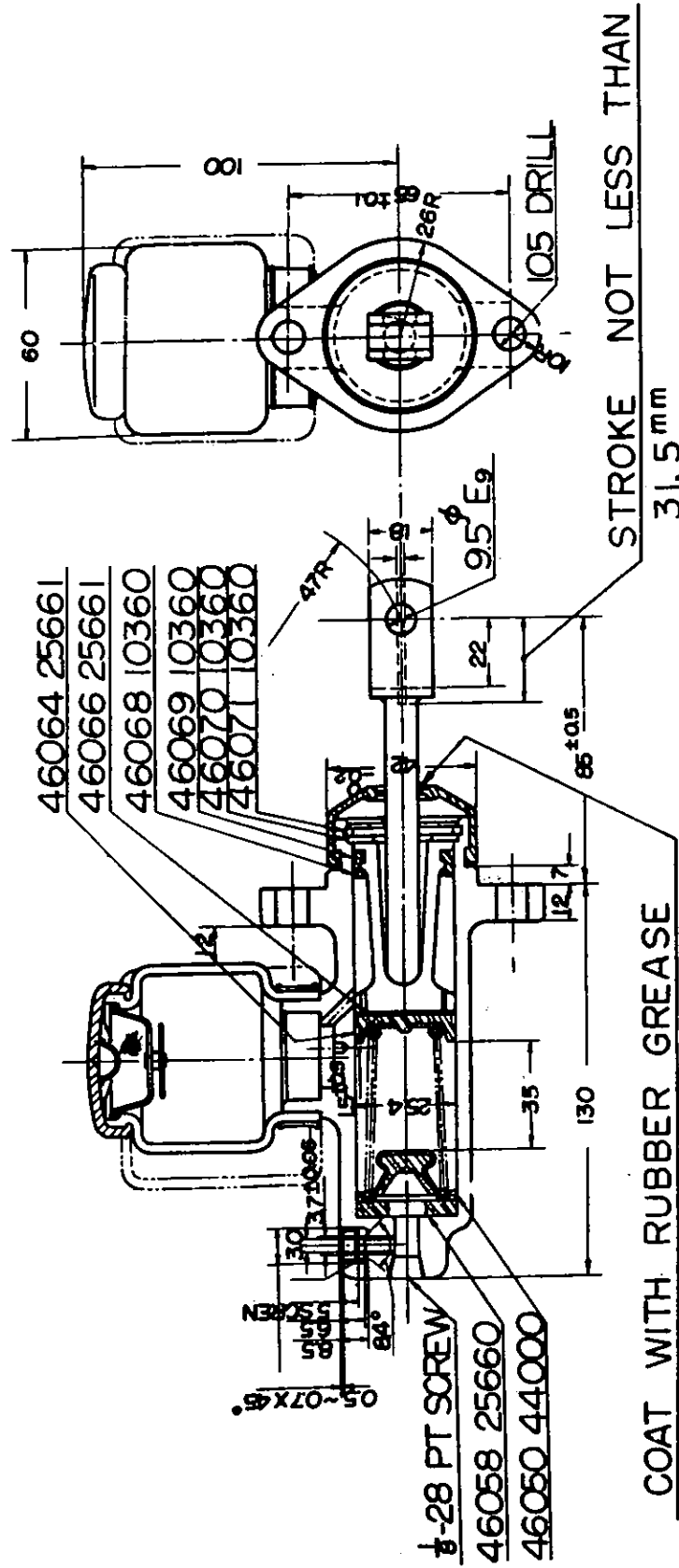
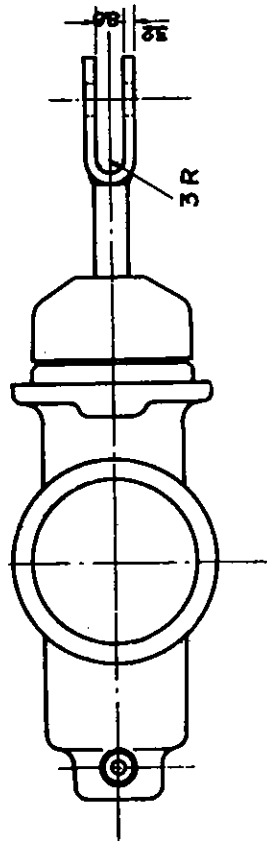

is protected by a rubber dust cover.

A. REMOVE THE MASTER CYLINDER

To remove the master cylinder from dash board, take off the cotter pin that penetrate the clevis pin at the end of push rod. Remove the clevis pin that connects the push rod and pedal. Back the nut off that secure the master cylinder to the dash board. Care should be taken to check the thickness of the shim which is fitted between master cylinder and the dash board panel. Disconnect the piping from the master cylinder. Then the master cylinder assembly can be withdrawn from the vehicle.

Remove the filler cap and drain the fluid out. Pull back the rubber dust cover and remove the stopper lock with a pair of long-nosed pliers. The push rod and the piston stopper can be removed. When the push rod has been removed the piston with the secondary piston cup will be exposed, therefore remove the piston assembly complete. The assembly can be separated by lifting the secondary cup ring over the shouldered end of the piston.

Give the shock slightly at the front end of the body where the pressure tube was connected, using the wooden mullet. Then the primary piston cup, its retainer, return spring, valve and valve seat will be come out gradually.

Examine every parts carefully, especially the cups, for wear or distortion and replace with new parts where necessary.

B. ASSEMBLING THE BRAKE MASTER CYLINDER

Replace the valve seat at the bottom of the body. Replace the valve assembly so that the large end is correctly seated on the valve seat. Put the new primary piston cup on the piston return spring assuring the projection of the cup is centered in the hole of the piston return spring. Replace the piston return spring and primary cup into the cylinder. Replace the primary cup retainer on the primary cup.

Replace the secondary piston cup on the piston rear end with new part. Replace the piston assembly into the cylinder. Put the stopper on the piston and press the piston into the cylinder. Replace the stopper lock, pressing the piston assembly, and fix the stopper. If rubber grease of good quality is available, coat the primary and secondary piston cup with it before assembling in order to get smooth sliding between the cups and cilinder wall.

Replace the push rod and dust cover. Secure the unit by means of two nuts on the flange and re-fit the pressure pipe into the cylinder.

Within the car, line up the push rod fork with its corresponding hole in the brake pedal arm and push through the clevis pin. Put the cotter pin through the clevis pin hole. Adjust the pedal height and pedal free movement (pedal play) by means of the following paragraph.

If no further maintenance to the brake system is necessary, it must be remembered to bleed the system.

(2-2) FRONT BRAKES

(A) CONSTRUCTION

The front brakes are operated by two wheel cylinders situated diametrically opposite each other on the inside of the brake disc and connected by means of two pressure tube and connector on the outside.

Each wheel cylinder consists of a light alloy body containing a piston, piston cup, spring and dust cover. Each shoe is located in the slot of one wheel cylinder and expanded by the piston of the other with the leading edges of both shoes making initial contact with the drum.

The shoes are allowed to slide and centralise during the actual braking operation which distributes the braking force equally over the lining area ensuring high efficiency and even lining wear.

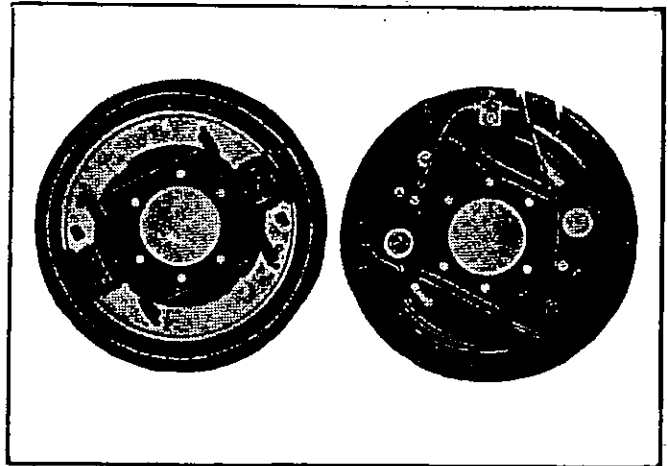

Front brake assembly

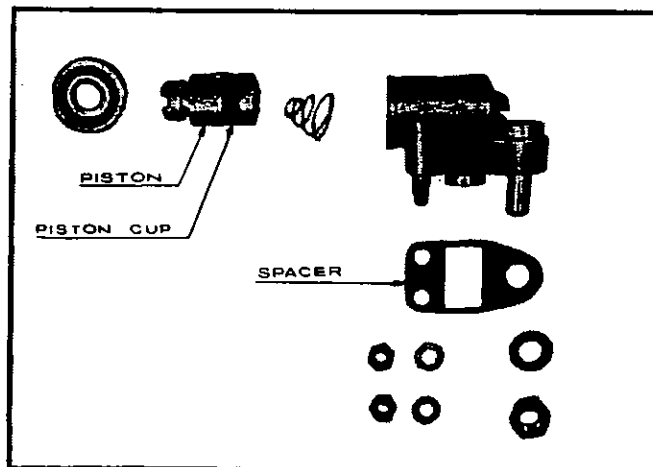

Front wheel cylinder

Adjustment for lining wear is by means of two knurled snail cam adjusters, each operating against a peg at the actuating end of each shoes. Both adjusters turn clock wise to expand the shoes.

The brake shoes rest on the seat fixed inside of the brake

disc, and are held in position by two return springs for each shoe which pass from the hole the web to the bolt located on the brake disc.

(B) FITTING REPLACEMENT BRAKE SHOES

Always fit "Nissan Genuine Shoes" as a replacement. These have the correct type of lining and are accurately ground to size which ensures a fast and easy bed-in the drums.

When fitting replacement shoes, fit a new set of shoe return springs.

The following instructions, if carefully carried out in sequence, should present no difficulty to either owner or mechanic.

- (i) Jack up the car and remove the road wheels and brake drums.
- (ii) Lift one shoe out of the abutment slot of one wheel cylinder, then release from the piston slot of the other. (it will be found quite simple to remove the shoe return springs). To prevent the wheel cylinder piston from expanding it is advisable to place a rubber band round each cylinder. Repeat with the second shoe.
- (iii) Clean down the brake disc, check wheel cylinders for leaks and freedom of motion.
- (iv) Check adjusters for easy working and turn back (anti-clockwise) to full "off" position. Lubricate where necessary with rubber grease of good quality, if available.
- (v) Smear the tips of the rest the operating and abutment ends of the new shoes with rubber grease of good quality. Keep all grease off the linings on new replacement shoes



Remove the road wheel and drum.

and do not handle more than necessary.

CAUTION: Never use the ordinary chassis grease for the brakes.

(vi) Fit the new return springs to the new shoes. Place the short hooked end of the spring through the hole in the shoe web and the long end to the bolt located on the brake disc. Each shoe can be replaced independently, but it is advisable to replace the upper shoe first.

(vii) Make sure the drums are clean and free from grease, etc., then re-fit.

(viii) Adjust the brakes as described later on.

(ix) Re-fit the road wheels and lower the car to the ground.

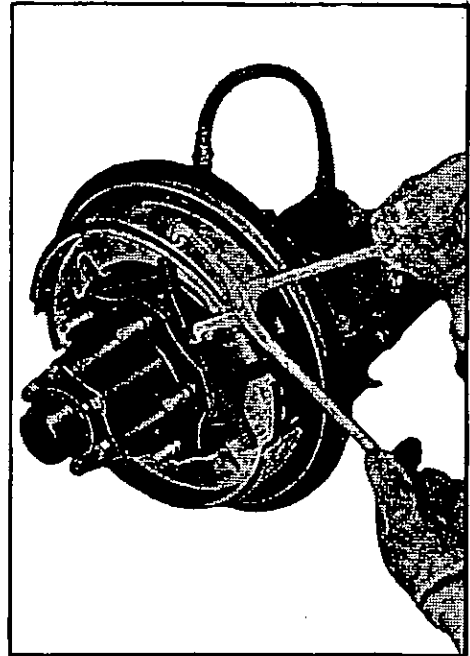

Replacing the return spring

(C) EXAMINATION OF THE WHEEL CYLINDER

The front wheel cylinder can be removed by means of three nuts that secure the wheel cylinder to the brake disc. Do not forget to remove the pressure tube from the wheel cylinder before remove the three nuts.

Examine all parts, especially the cup of the piston for wear or distortion and replace with new parts, if necessary.

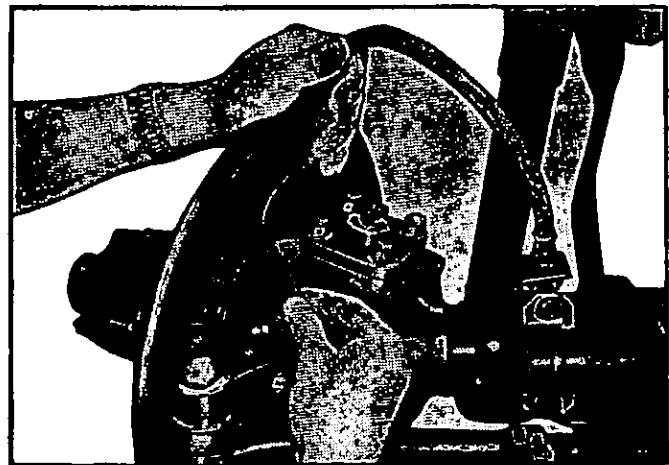

Removeing the pressure tube

To be sure the spacer of the wheel cylinder is in correct position, then replace the wheel cylinder.

Do not confuse the left hand wheel cylinder and right hand one.

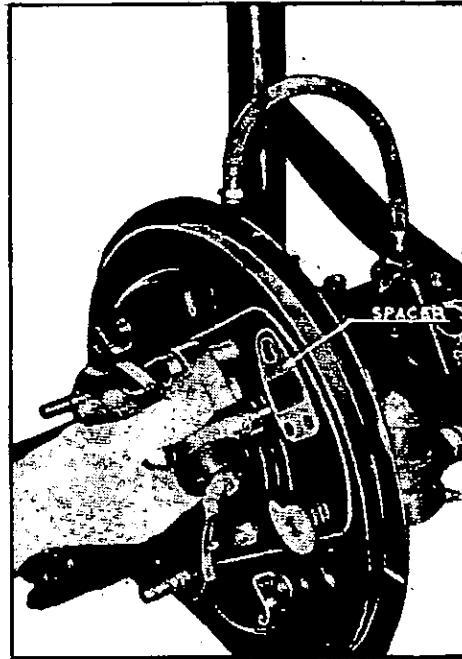

Replacing the wheel cylinder

(D) ADJUSTING THE LINING CLEARANCE

A separate snail cam adjuster is provided for each shoe. Jack up the car until the wheel to be adjusted clear of the ground, then fully release both the hexagon head adjuster bolts on the out side of the disc by turning anti-clock wise with an open-ended spanner.

Turn one of the adjuster bolt clockwise until the brake shoe concerned touches the brake drum, then release the adjuster until the shoe is just free of the drum. Repeat the whole procedure for the second front wheel.

It is advisable to adjust the rear brakes in the same time, as described latter on.

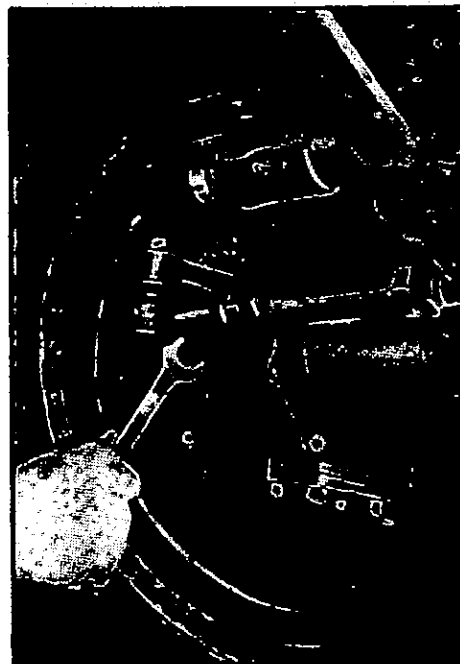

Adjusting the brake lining clearance

(2-3) REAR BRAKES

(A) DESCRIPTION

The rear brake shoes are not fixed but are allowed to slide and centralise with the same effect as in the front brakes. They are hydraulically operated by a single wheel cylinder. At the cylinder end the leading shoe is located in a slot in the position while the trailing shoe rests in a slot formed in the cylinder body. At the adjuster end they rest in slots in the adjuster links.

Both shoes are supported by dimples formed in the brake disc and are held in position by two springs from shoe to shoe.

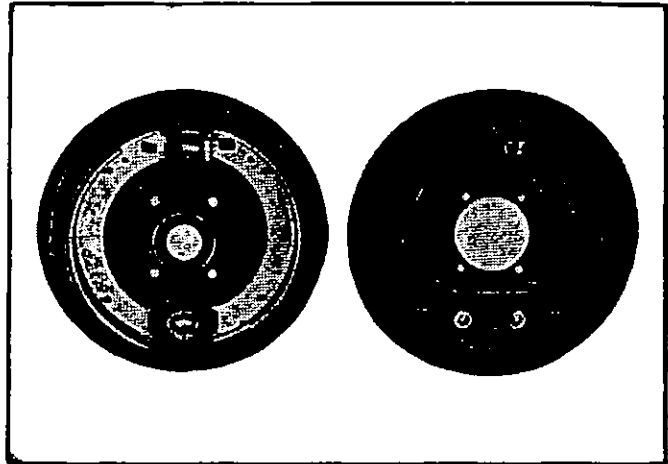

Rear brake assembly

The wheel cylinder consists of a light alloy die casting into the end of which moves a piston, with cup, in a highly finished bore. Into the other end of the housing is machined a slot to carry the trailing shoe. The cylinder is attached to the brake disc by a spring clip allowing it to slide laterally.

Adjustment for lining wear is made by the brake shoe adjuster.

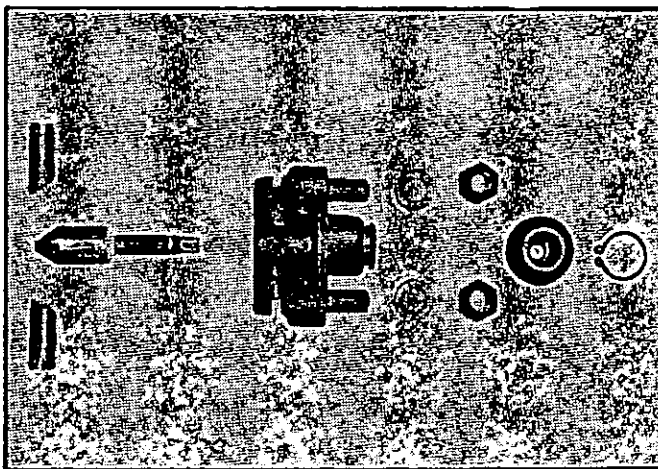

Rear brake shoe adjuster.

This has a steel housing which is spigoted and bolted firmly to the inside of the brake disc. The housing carries two opposed steel links, the outer end slotted to carry the shoes, and the inclined inner faces bearing on inclined faces of the hardened steel wedge. The wedge has a finely threaded spindle with a square end, enabling a spanner to be used for adjustment pur-

poses, which project on the outside of the brake disc. By rotating the wedge in a clockwise direction, the links are forced apart and the fulcrum of the brake shoes expanded.

When the brake is applied the piston, under the influence of the hydraulic pressure, moves shoe and the body reacts by sliding on the brake disc to operate the trailing shoe.

(B) REFITTING REPLACEMENT BRAKE SHOES

- (i) Jack up the car and remove the road wheels and brake drums.
- (ii) Lift one of the shoe out of the slots in the adjuster link and wheel cylinder piston.
- (iii) Clean down the brake disc, check wheel cylinder for leaks and freedom of motion.
- (iv) Check adjuster for easy working and turn back until "off" position. Lubricate where necessary with rubber grease of good quality, if available.
- (v) Smear the tips of the dimples, the operating and abutment ends of the new shoes with rubber grease of good quality. Keep all grease off the linings on new replacement shoes and do not handle more than necessary.
- (vi) Fit the two new shoe return springs to the new shoes from shoe to shoe and between shoe web and brake disc. Locate one shoe in the adjuster link and wheel cylinder piston slots, then prise over the opposite shoe into the its relative position.
- (vii) Make sure the drums are clean and free from grease, etc., then re-fit.

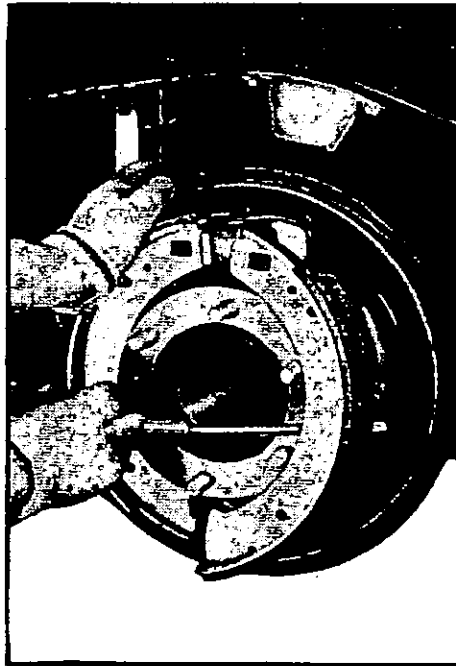

Removing rear brake shoes

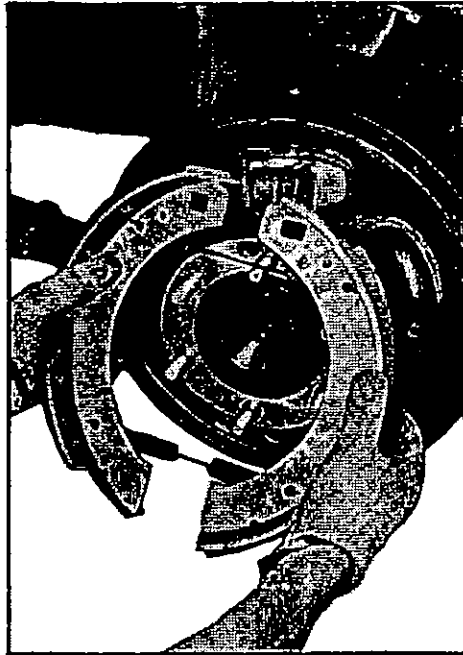

Fitting two return springs

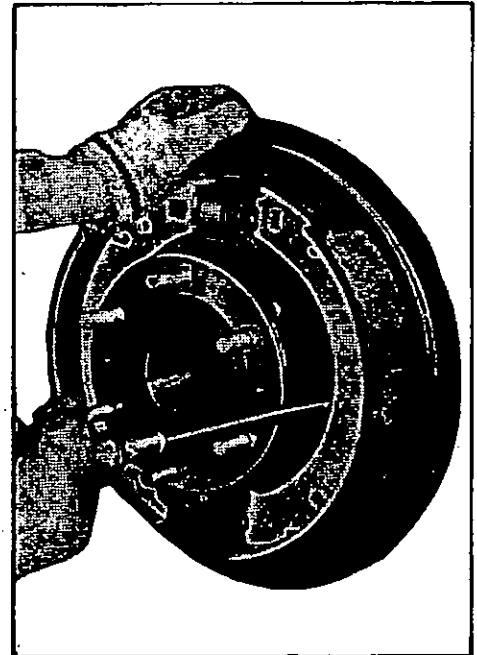

Replacing the shoes

(viii) Adjust the brakes as described later on.

(ix) Re-fit the road wheels and lower the car to the ground.

(C) EXAMINATION OF THE WHEEL CYLINDER

The rear wheel cylinder is attached to the disc by a spring clip allowing it to slide laterally. After taking brake shoes off, disconnect the pressure tube from the wheel cylinder. Take off the spring clip of the wheel cylinder. Slide the shims off which are fitted between wheel cylinder and the out side of the brake disc. Then, it can be removed.

Examine all parts carefully, especially the piston cup for wear and distortion and replace with new parts where necessary.

When the wheel cylinder is

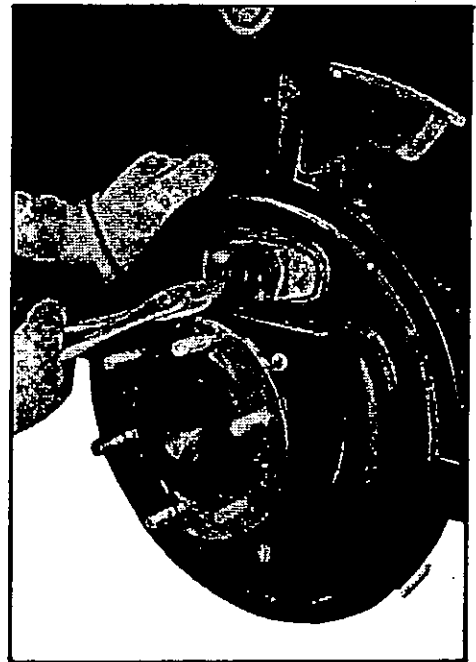

Taking off the spring clip

replaced, check the cylinder so that it can slide smoothly on the brake disc. Apply small quantity of grease on the brake disc and fitting face of the wheel cylinder, if necessary, to be sure the movement of wheel cylinder keep free.

(D) REMOVING OF ADJUSTER

The rear brake adjuster is attached by means of two nuts to the brake disc. To remove the adjuster, take the clip off which secure the rubber dust cover of the adjuster. Remove the dust cover. Back the nuts off that secure the adjuster to the brake disc.

Check every parts carefully, especially two steel links and the wedge for wear. If the inclined faces of links and wedge are worn, replace them with new parts. Replace wedge with new part, if the square end of the threaded spindle worn.

(E) ADJUSTMENT THE LINING CLEARANCE

One common adjuster is provided for both shoes and the adjustment of both rear wheels is identical.

Jack up the car until the wheel to be adjusted clear of the ground, then turn the square end of the adjuster on the out side of each rear brake disc in clockwise direction until a resistance felt. Slacken two clicks when the drum should rotate freely.

Immediately after fitting replacement shoes it is advisable to slacken one further click to allow for possible lining expansion, reverting to normal adjustment afterwards.

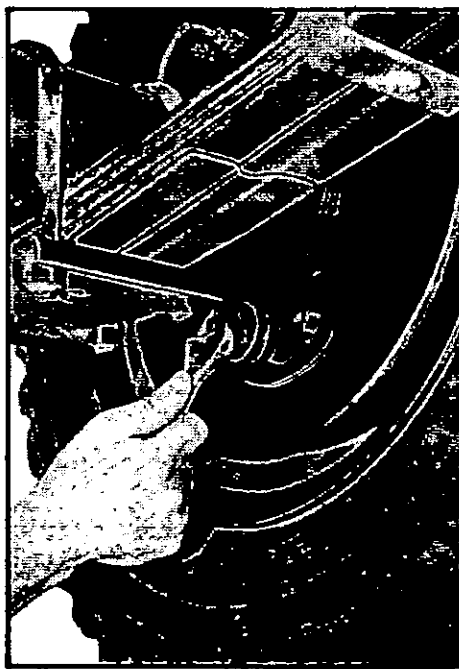

Adjusting the rear lining clearance

(2-4) GENERAL MAINTENANCE

(A) REPLENISHMENT OF HYDRAULIC FLUID

Inspect the supply tank at regular intervals and maintain at about three-quarters full by the addition of brake fluid of good quality.

Great care should be exercised when adding brake fluid, to prevent dirt or foreign matter entering the system.

(B) BLEEDING THE HYDRAULIC SYSTEM

Bleeding is necessary any time a portion of the hydraulic system has been disconnected, or if the level of the brake fluid has been allowed to fall so low that air has entered the master cylinder.

With all the hydraulic connections secure and the supply tank topped up with the fluid, remove the rubber cap from the L.H. rear bleed nipple and fit the bleed tube over the bleed nipple, immersing the free end of the tube in a clean jar containing a little brake fluid.

Unscrew the bleed nipple about three-quarters of a turn and then operate the brake pedal with a slow full stroke until the fluid entering jar is completely free of air bubbles. Then, during a down-stroke of the brake pedal, tighten the screw sufficiently to seat the ball, remove bleed tube and replace the bleed nipple dust cap.

CAUTION: Under no circumstances must excessive force be used when tightening the bleed screws.

This process must now be repeated for each bleed screw at each of the three remaining brake discs, finishing at the wheel nearest the master cylinder. Always keep a careful check on the supply tank during bleeding, since it is most important that a full level is maintained.

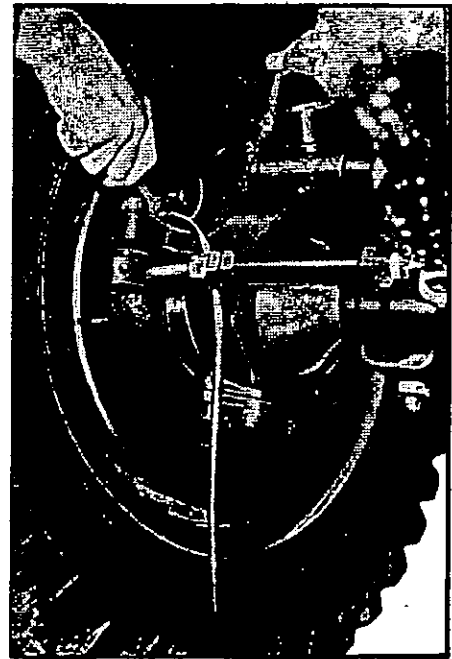

Bleeding the system

Should air reach the master cylinder from the supply tank, the whole of the bleeding operation must be repeated.

After bleeding, top up the supply tank to its correct level of approximately three-quarters full.

Never use the fluid that has just been bled from a brake system for topping up the supply tank, as this brake fluid may be to some extent aerated. Such fluid must be allowed to stand for at least twenty-four hours before it is used again. This will allow the air in the fluid time to disperse.

Great cleanliness is essential when dealing with any part of the hydraulic system, and especially so where the brake fluid is concerned. Dirty fluid must never be added to the system.

It is advisable to turn all the brake shoe adjusters to their full "off" position before bleeding. After bleeding adjust brakes as described.

(C) GENERAL ADVICE

- (i) Always exercise extreme cleanliness when dealing with any part of the hydraulic system.
- (ii) Always take care not to scratch the highly polished surface of cylinder bores or pistons.
- (iii) Always use clean brake fluid of excellent quality or alcohol for cleaning internal parts of the hydraulic system. On no account should petrol or paraffin be allowed to contact these parts.
- (iv) Always examine all rubber cups carefully when overhauling hydraulic system and replace with Genuine Nissan Spares any which show the least sign of wear or damage.
- (v) Always use the rubber grease of excellent quality for packing rubber boots and dust covers and lubricating parts likely to contact any rubber components. Never use ordinal chassis grease nor bearing grease for these purpose.
- (vi) If it is suspected that incorrect fluid have been used All Rubber Cups in the master cylinder and wheel cylinders must be changed after the components and pipelines have been thoroughly flushed and cleaned out with alcohol or clean brake fluid. Never use petrol or paraffin for this purpose.

If incorrect fluid has been in the system for any length of time it is advisable to replace the high pressure hoses.

(2-5) ADJUSTMENT OF CENTER BRAKE

The center brake (or sometimes called hand brake, parking brake or emergency brake) of the Nissan Patrol is of the external contracting band type.

The clearance between drum and lining should be adjusted by means of anchor adjusting screw, adjusting nut and bracket bolt. The brake lining must have 0.7—0.8 mm (0.027—0.032 in.) clearance evenly on drum.

The upper half of lining is adjusted by the adjusting nut and lower half of the lining is adjusted by the bracket screw.

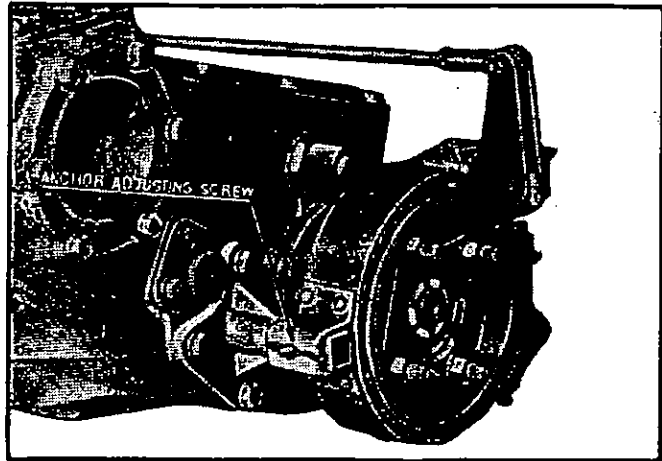

Lock anchor adjusting screw by the lock wire and lock the adjusting nut and bracket screw by means of lock nut.

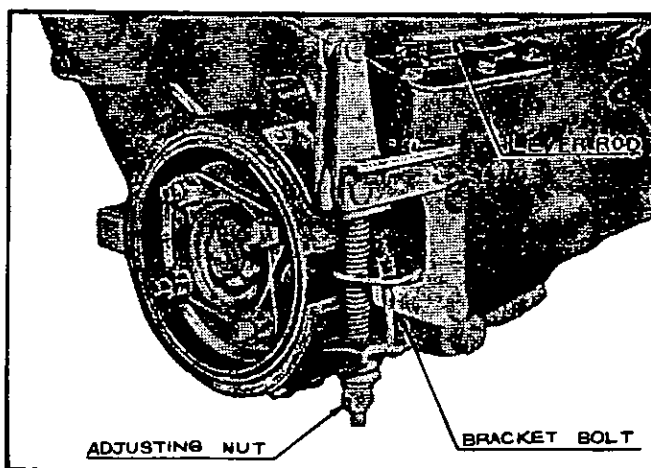

After adjusting brake lining clearance, adjust the length of the lever rod so that the bottom of the cam can be seated on the bracket correctly.

Replace the lining, if it is worn excessively, or hardened.

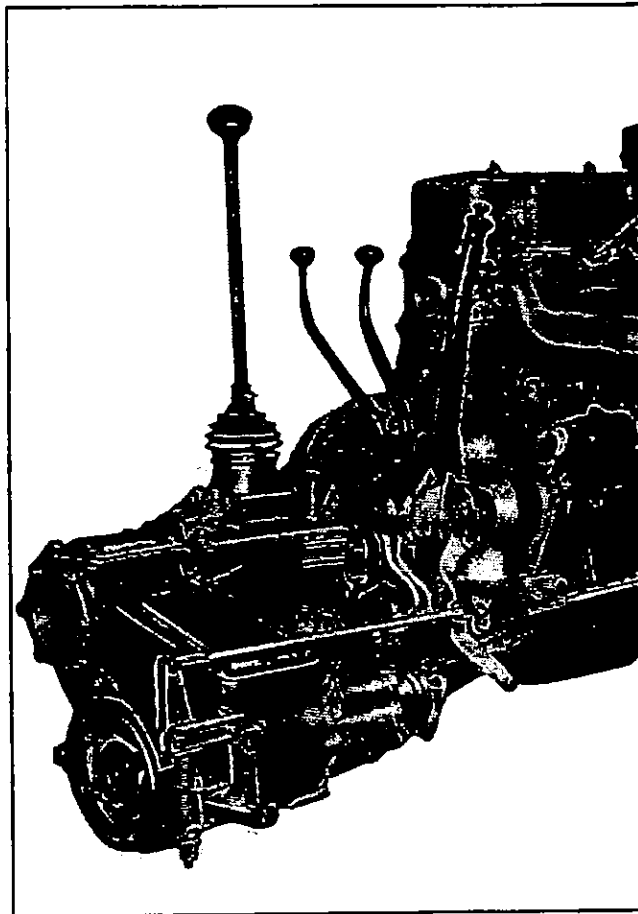

Center brake linkage

INSTRUCTION DRAWING CENTER BRAKE MODEL 60

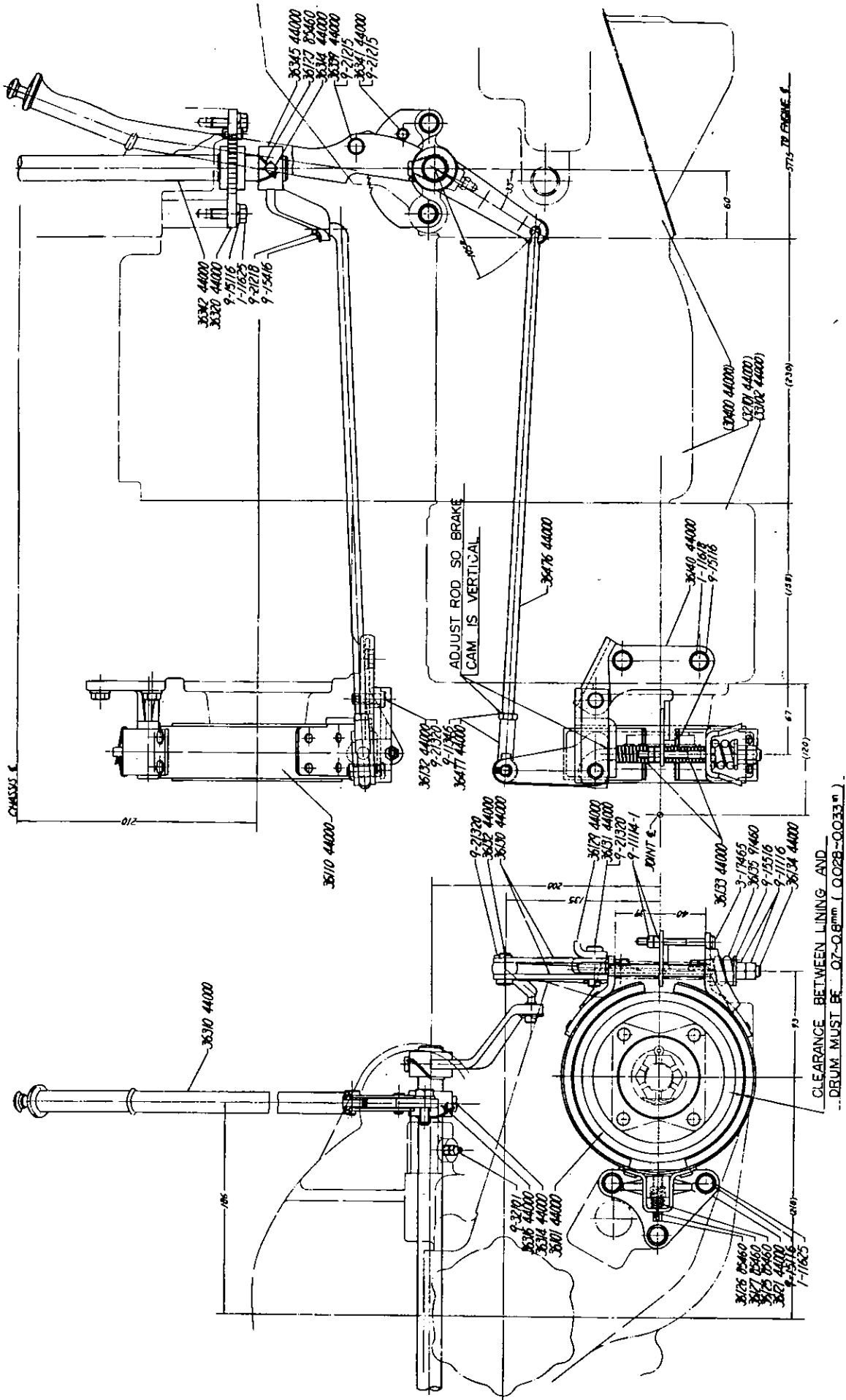

STEERING SYSTEM

1. DESCRIPTION AND DATA

(1-1) DESCRIPTION

The steering system of the Nissan Patrol consists of the steering gear assembly, pitman arm (gear arm), transverse drag link, tie rod, tie rod socket and steering dumper assembly, providing both easy steering on the rough road and stability at high speeds driving.

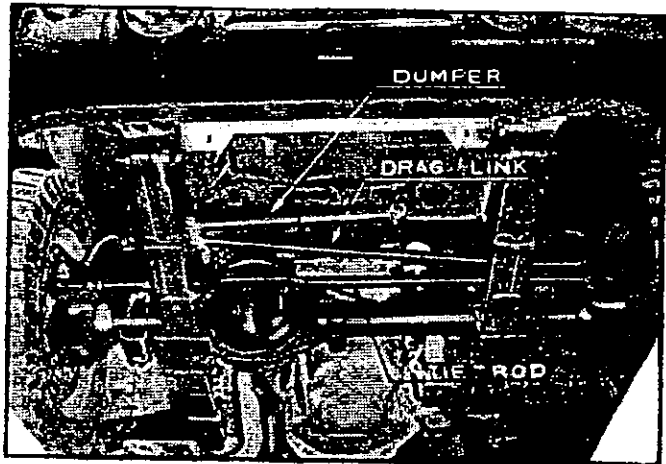

Tie rod, drag link and steering dumper

(1-2) DATA

Type	Two teeth semi-external mesh hindlley worm
Gear ratio	23.6 to 1
Steering angle	
inner	28°
outer	25°32'
Center distance	65 mm (2.559 in.)
Worm gear bearing adjust shims:	
Thickness available	0.762 mm (0.030 in.) one for standard
	0.254 mm (0.010 in.) one
	0.127 mm (0.005 in.) one
	0.050 mm (0.002 in.) three
Roller shaft adjust snims:	
Thickness available	1.6 mm (0.063 in.) two for standard
	0.25 mm (0.0099 in.) one
	0.125 mm (0.005 in.) two
	0.075 mm (0.003 in.) four
Worm shaft turning torque	0.15 — 0.25 kg (0.33 — 0.55 lbs) at steering wheel rim without roller shaft

Back lash worm and roller	0.3 — 0.8 Kg (0.66 — 1.76 lbs.) at steering wheel rim after assembled completely with roller shaft.
	0 — 0.1 mm (0 — 0.004 in.) at end pitman arm, and at mid-position of wheel turns.
	Back lash must not to exceed 4 mm (0.158 in.) at any position of wheel turns.
	The difference of back lash between right end and left end of the wheel turns, must not to exceed 1.5 mm (0.06 in.)
Torque wrench setting for:	
Pitman arm nut	15 Kg-m (110 ft-lbs.)
Flange bolts	2.5 Kg-m (18 ft-lbs.)
Housing cover bolts	2.5 Kg-m (18 ft-lbs.)
Roller shaft cover bolts	2.5 Kg-m (18 ft-lbs.)
Housing bracket bolts	9 Kg-m (66 ft-lbs.)
Diameter of steering wheel	410 mm (16.14 in.)
Lubricant capacity	0.5 ltr. (0.132 U.S. Gal.)
Steering dumper dumping force	75 Kg at 0.3 m/sec.

2. STEERING GEAR ASSEMBLY

(2-1) DESCRIPTION

The steering gear used in the Nissan Patrol is of the two teeth semi-external mesh hindley worm type. The sector roller rotates on two row of needle roller bearings. The gear ratio is 23.6 to 1.

The sector shaft rotates in two long bushings, one in the housing side and one in the cover, having oil groove for adequate lubrication. The upper worm taper roller bearing is mounted in the gear housing, assuring accurate alignment. The worm shaft is aligned at the top by vinyle-rubber bushing. Shims are placed in between the steering column jacket and housing for corect setting of steering worm. Shims are also placed in between the lower cover and steering housing for worm bearing adjustment.

The steering gear roller shaft is serrated for attachment of the pitman arm, the steering wheel is serrated for attachment of the worm and shaft assembly. The steering wheel is 410 mm (16.14 in.)

in diameter.

(2-2) DISASSEMBLY

(A) REMOVE PITMAN ARM

Remove the nut and lock washer that hold the pitman arm on the roller sector shaft assembly. Pull the pitman arm off the roller shaft assembly with a suitable puller.

(B) REMOVE ROLLER SHAFT ASSEMBLY

Remove the four cap screws that secure the roller shaft cover to the housing and remove the roller shaft cover and rubber "O" ring. Slide the roller shaft assembly from the housing.

(C) REMOVE FRONT COVER

Remove the four cap screws that secure the front housing cover and shims to the housing. Slide the front housing cover, shims and "O" ring off the worm and shaft assembly.

(D) REMOVE STEERING GEAR WORM BEARING

Tap the top end of the worm and shaft assembly with mallet until the front bearing cup out of the housing. Remove the front bearing cup off the housing. Remove the four cap screws that secure the steering column jacket to the housing, and slide the jacket, shims and "O" ring off the housing. Slide the worm and shaft assembly off the housing. Remove the upper and lower bearing with suitable puller, if necessary.

(2-3) INSPECTION

Clean all parts thoroughly in cleaning solvent. Replace a housing assembly or roller shaft cover that is cracked or damaged. Replace the inner and outer bushings in the housing if worn larger than 32.30 mm (1.272 in.) inside diameter.

Replace a roller shaft assembly that has flat spots on the roller surface or that has chipped roller. Replace roller shaft assembly if the end play of roller is excessive. Replace the roller shaft if the shaft measures less than 31.875 mm (1.255 in.) at the bearing surface. Replace the worm and shaft assembly if the worm is excessively worn, ridged, scored or chipped. Replace a worn, pitted, or cracked worm upper and lower bearing cup. Replace a broken or damaged horn wire. Replace a steering column jacket that is bent or damaged. Replace the whole assembly if it

is damaged. Replace upper and lower bearing if it is damaged, or excessively worn. Replace a steering column jacket bushing that is excessively worn or with damaged horn wire.

(2-4) ASSEMBLY

(A) REPLACE NEW OIL SEAL

Drive the new oil seal into the housing. Coat the lip of the oil seal with grease.

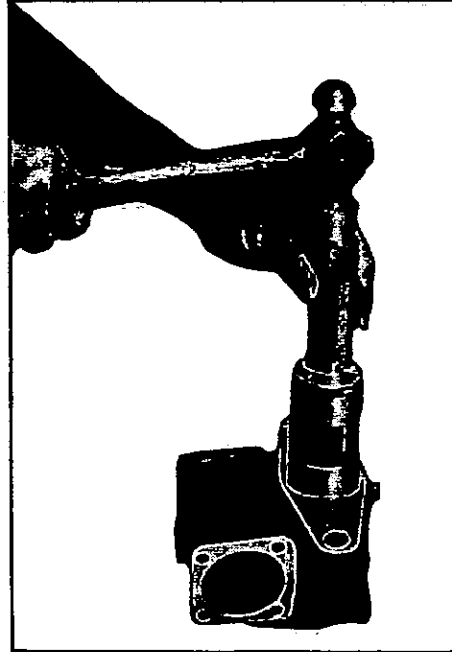

Oil seal fitting

b) PLACE UPPER BEARING CUP

Drive the upper bearing cup into the housing with suitable driver.

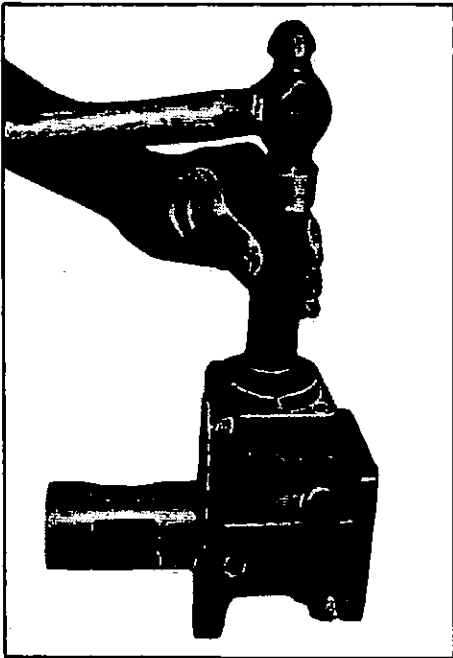

Fitting upper bearing cup

(C) ASSEMBLE COLUMN JACKET TO THE HOUSING

Place the column jacket on the housing with "O" ring, "O" ring seat and adjusting shims of standard thickness. As to the thickness of the adjusting shims, refer to the "DATA" and paragraph "ADJUSTMENT OF WORM BEARING PRE-LOAD". Care should be taken in selecting of the "O" ring. Refer to the paragraph "SELECTING "O" RING".

Tighten the four cap screws that secure the jacket to the housing.

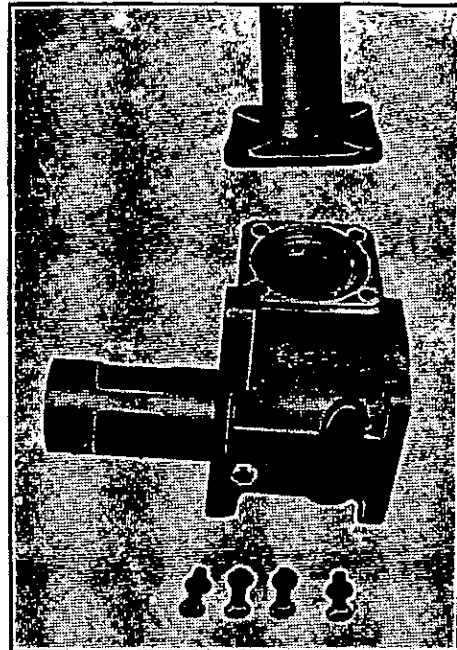

Assembling column jacket

(D) ASSEMBLE BEARINGS TO THE WORM SHAFT

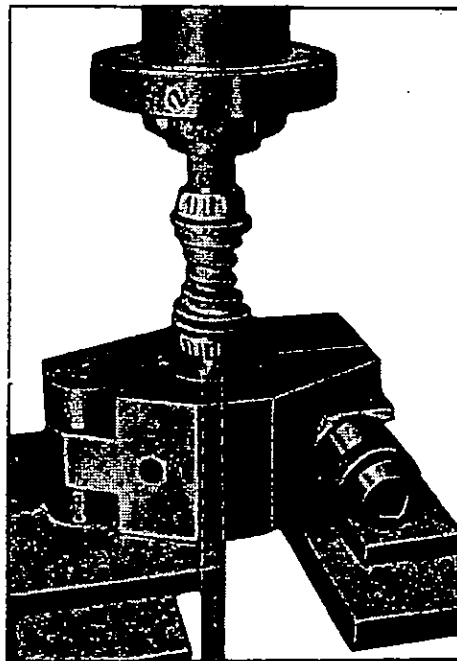

Pressing bearing in

Press the upper and lower bearings into the steering column with a press.

(E) INSTALL WORM AND SHAFT ASSEMBLY IN HOUSING

Slide the worm and shaft assembly into the housing. Drive the lower bearing cup into the housing. Place the "O" ring, "O" ring seat, worm adjusting shims of standard thickness and front housing cover on the housing. Tighten the four cap screws that secure the cover to the housing. Tightening torque of these screws is 2.5 Kg-m (18 ft-lbs.)

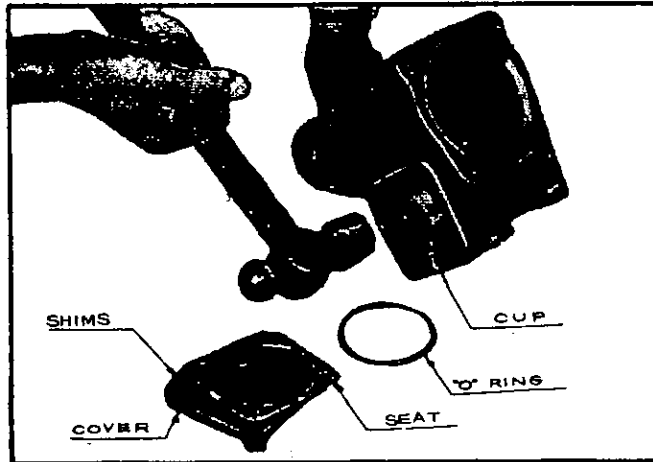

Driving the front bearing cup

(F) ADJUSTMENT OF WORM BEARING PRE-LOAD

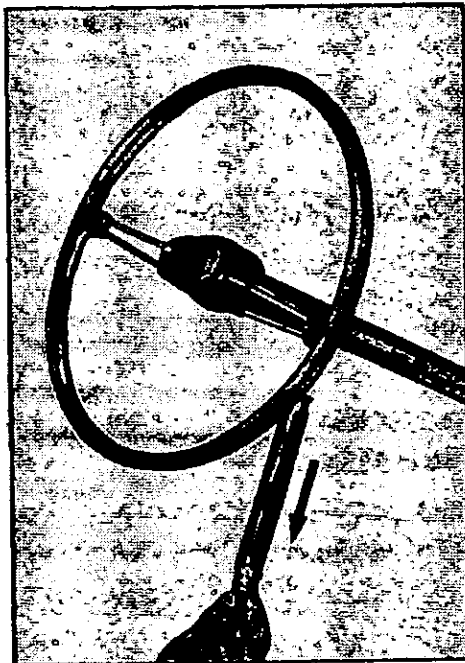

Measuring of the turning torque

To check the upper and lower bearing preload, measure the turning torque of the worm shaft. This torque should be in 0.15 — 0.25 Kg (0.33 — 0.55 lbs) at steering wheel rim. (Turn the steering wheel three or four times before measuring the torque.) If not, adjust the thickness of the worm adjust shims so that the turning torque is in above mentioned value, decreasing or increasing the numbers of the shims. During this operation, the thickness of both upper and lower shims should be nearly the same as other side.

(G) INSTALL ROLLER SHAFT ASSEMBLY

Install the roller shaft assembly into the housing with thrust washer and roller shaft adjust shims of standard thickness.

Install the roller shaft cover assembly onto the housing with "O" ring. Tighten the four cap screws that secure the cover to the housing. Torque wrench setting is 2.5 Kg-m (18 ft-lbs).

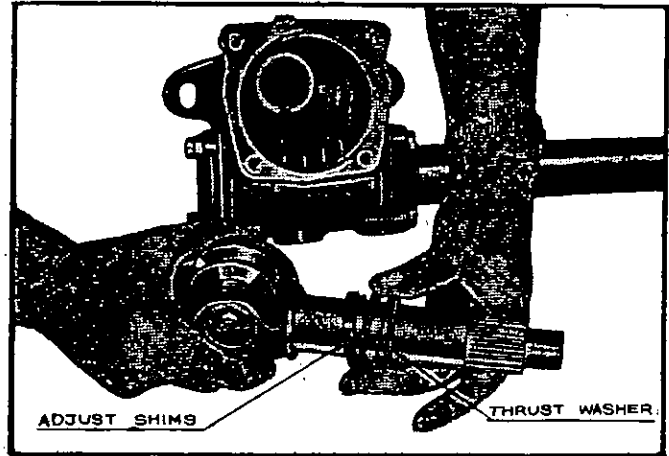

Roller shaft and adjust shims

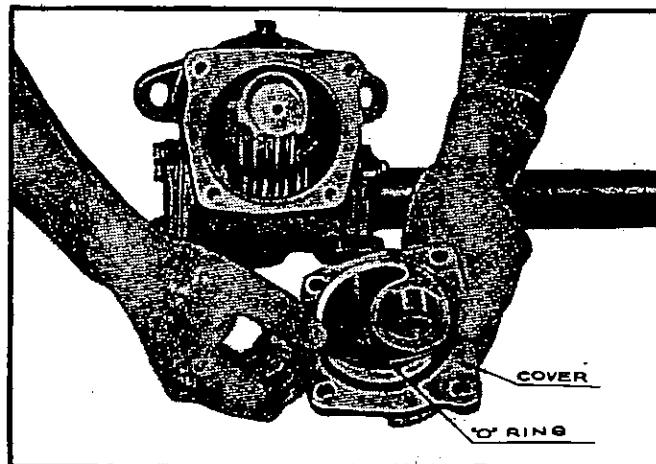

Installing roller shaft cover

(H) CORRECTION WORM SHAFT SETTING

Check the back lash of the worm and roller at the end of the pitman arm. The back lash should be minimum at the center or mid-position of wheel turning as illustrated in the figure, with solid line and should have the same value in both

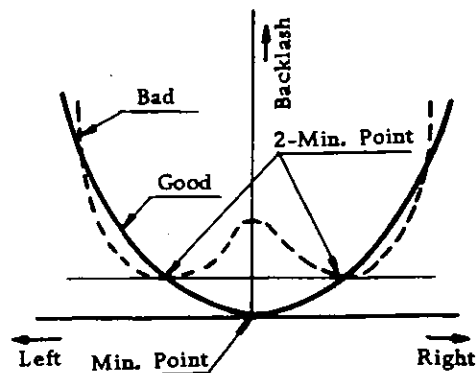

right and left end of turns.

If the back lash has the two minimum points, as illustrated in figure with broken line, it means the relative position of worm and roller in axial direction of worm shaft, is not correct. In this case, adjust the position of the worm gear by means of transferring worm adjust shim from upper flange to lower cover, or reversely, until the correct alignment can be got. Never change the total thickness of the whole shims.

(I) SELECTING "O" RING

Care should be used in selecting the "O" ring for the both upper and lower flange of the steering housing, in order to prevent oil leakage.

After the setting of worm gear is corrected as described in paragraph H), measure the total thickness of the worm adjusting shims and seat of both side of the housing, one by one. Then, select the suitable "O" ring according to the following table.

Total thickness of shim and seat together at one side	"O" ring to be used (Part number)
Less than 1.9 mm (0.075 in.)	48035-44000
1.9 — 2.7 mm (0.075 — 0.106 in.)	48035-44001 (standard)
More than 2.7 mm (0.106 in.)	48035-44002

(J) ADJUST BACK LASH

Turn the roller shaft adjust screw in clockwise, until the inside flange of screw is attached the end of roller shaft. Then back the screw off just enough the roller shaft can be rotated smoothly. Check the back lash at the end of the pitman arm. The back lash should be in 0 — 0.1 mm (0—0.004 in.) at mid-position (or center) of the wheel turns. No back lash more than 4 mm (0.158 in.) should be allowed at any position of

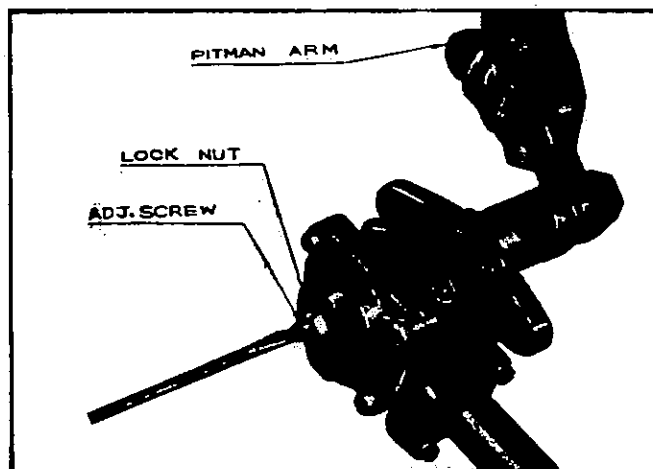

Adjusting the back lash

wheel turns. Also, the difference of the back lash between right end and left end of the wheel turns, should not to exceed 1.5 mm (0.06 in.)

Check the turning torque of the worm shaft again. In this stage, the torque should be in 0.3 — 0.8 Kg (0.66 — 1.76 lbs) at the steering wheel rim.

(K) INSTALL PITMAN ARM

Install pitman arm to the roller shaft. Tightening torque of the nut that secure the pitman arm to the roller shaft is 15 Kg-m (110 ft-lbs). This operation can be worked after the steering gear assembly is re-installed on chassis.

(L) REPLENISH GEAR OIL

Replenish the gear oil recommended. The capacity of gear housing is 0.5 ltr. (0.132 U.S.Gal.)

3. STEERING DUMPER

The steering system of the Nissan Patrol is equipped with a steering dumper between drag link and the front cross member of the frame.

The dumper is of the none-adjustable type, therefore no further maintenance should be necessary.

If the oil leakage is founded or dumping force of the dumper is founded less than 75 Kg at 0.3 m/sec., replace it to assure the stability in high speeds drive, to keep comfortable feeling on steering wheel, to relieve the kick back from rough road to the steering wheel and to prevent the happening of shimmy.

4. RETIGHTEN STEERING LINKAGE BOLTS AND NUTS

It is strongly recommended to retighten every bolts and nuts on the steering system after the vehicle have done first 3,000 Km (2,000 miles) with suggested torque wrench settings.

WHEELS AND TIRES

1. INFLATION PRESSURES

Maintaining the correct inflation pressures is one of the most important elements of tire care. The inflation pressure recommended for the Nissan Patrol is carefully worked out as the best pressure to give an efficient balance of the following factors of good car performance: comfortable ride, stability, steering ease, even tread wear, tire cord life and immunity from blowouts.

It is recommended that tires in ordinary use be checked for proper pressure once each week. This will result in added tire life as 2 pounds pressure will normally be lost in a week of ordinary driving. Cars operated at high speeds or in more than ordinary severe service should have the tire checked at more frequent intervals.

2. TESTING FOR TIRE NOISE

The determination of whether tires are causing the noise complained of is relatively simple. The car should be driven at various speeds and note taken of the effect of part throttle, sudden acceleration, and deceleration on the noise condition, as axle and exhaust noises show definite variations under these conditions, while tire noise will remain constant. Tire noise, is, however, most pronounced at speeds of approximately twenty or thirty miles per hour.

The tire noise may be further checked by driving the car over smooth pavements or dirt roads (not gravel) with the tires at normal pressure and again over the same stretch of road when the tires have been inflated to fifty pounds pressure. If the noise for which the test is being made is caused by tires, it will noticeably decrease when the tire pressure is increased, whereas, rear axle noise should show no change in volume as a result of changes in tire pressure.

If, on inspection, the tires on the front wheels are found to be creating most of the noise, the alignment of the front wheels should be checked, as excessive tire noise result from low tire pressure, incorrect alignment or from uneven tire wear.

3. CORRECTION OF IRREGULAR TIRE WEAR

Since irregular tire wear due to some action which causes certain places on a tire to wear more than others, the remedy is

naturally to correct the condition causing wear. However, after the adjusting have been made, it is wise to interchange the tires to equalize the future normal wear which will occur.

Tires may be alternated several ways to even up irregular wear. However, the following method is the simplest and, in most cases, the most satisfactory.

Wheels should be changed without dismounting the tires, right front to spare, spare to right rear, right rear to left front, and the left rear to right front.

4. TIRE BALANCE

Original equipment tires and tubes are marked at source, so that the light portion of the casing is counterbalanced by the heavy portion of tube.

Due to irregularities in tread wear, caused by sudden brake applications, misalignment, low inflation pressure, or tube and casing repairs, a casing and tube assembly can lose its original balance. If a disturbance is felt in the steering wheel due to the action of the front wheels, the first items to check are pressures and the balance of the tire and wheel assembly.

Wheel balance is the equal distribution of the weight of the wheel and tire assembly around the axis of rotation. There are two ways in which every wheel must be balanced—statically and dynamically.

(4-1) STATIC BALANCE

Static balance (sometimes called still balance) is the equal distribution of the weight of the wheel and tire assembly about the axis of rotation in such a manner that the assembly has no tendency to rotate by itself, regardless of its position. For example: A wheel with a chunk of dirt on the rim will always rotate by itself until the heavy side is at the bottom. Any wheel with a heavy side like this is statically out of balance. Static unbalance of a wheel causes a hopping or pounding action (up and down) which frequently leads to wheel flutter and quite often to wheel "tramp".

(4-2) DYNAMIC BALANCE

Dynamic balance (sometimes called running balance) means that the wheel must be in static balance and also run smoothly at all speeds on an axis which runs through the center line of the wheel and tire, and is perpendicular to the axis of rotation. To explain the

principle of dynamic balance, let us first consider what happens when we swing a weight attached to a string. If we start to swing this weight slowly, it is apparent that the weight swings in a sharp angle with reference to the axis of rotation (the hand). If the speed is increased, the weight climbs until the weight mass is right angles to the axis of rotation. Now, let us apply this principle to a spinning wheel.

By referring to the figure shown right hand, it can be seen that when a wheel and tire assembly is in static balance, the sum of the weight of sections A and B is equal to the sum of the weight of sections C and D: or, in other words, the weight is equally distributed about the axis of rotation. This figure is a drawing of a wheel that is in static balance because the shaded heavy point B is balanced by the shaded heavy point C.

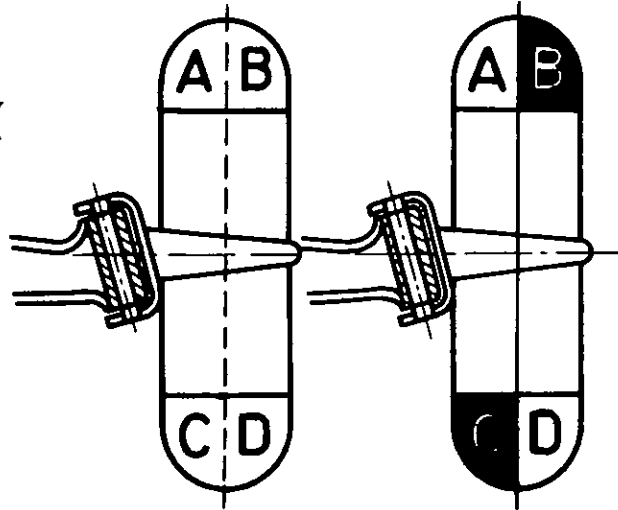

(Wheel in static balance)

However, it can be seen that with reference to the center line, section A is lighter than section B, and that section D is lighter than section C.

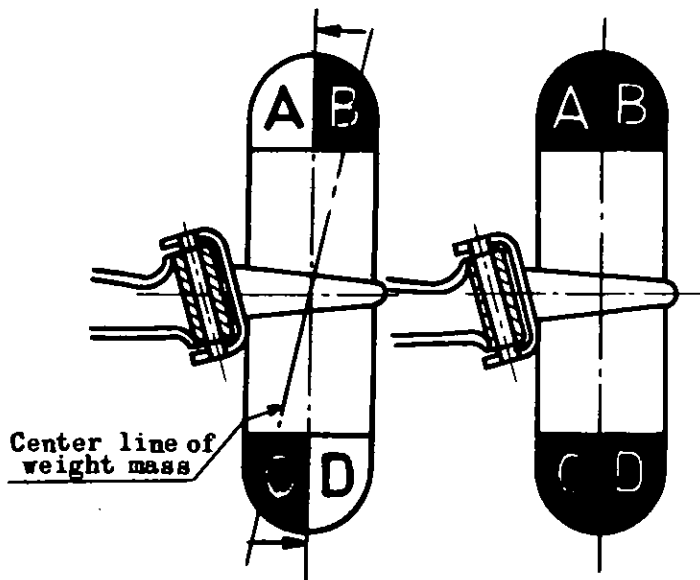

(Wheel in Static and Dynamic Balance)

When we start to spin this wheel (as in the figure left) the center line of the weight masses B and C tries to get at right angles to the axis of rotation, just as the weight on the string tried to get at right angles to its axis of rotation (the hand). This tendency to get at right angles exerts a force on the wheel (as shown by the arrows). This force, in turn, tends to move the center line of the wheel,

and, in so doing, distorts the axis of rotation.

When the wheel has turned 180°, the forces exerted by the heavy sections B and C now tend to move the center line of the wheel in the opposite direction. In other words, the wheel tries to rock first in one direction, then in the other.

The result of the movement of these unbalanced forces causes the wheel to wobble or shimmy, and the condition becomes more violent with increased speeds.

To correct this condition we must add weight to sections A and D so they will be equal to the weight of sections B and C. Notice that this addition of weight now distributes the total weight evenly about both the axis of rotation and the center of the wheel as seen in figure (with shaded four parts A, B, C and D). Therefore, this wheel is now both statically and dynamically balanced.

Wheel must be both statically and dynamically balanced to give maximum steering ease and stability at speeds where unbalance becomes noticeable. The wheels must be statically balanced before they can be balanced dynamically. To demonstrate the balancing of a wheel assembly we will use a combination static and dynamic wheel balancer.

Before the wheel assembly is balanced, the wheel and tire must be clean and free from all foreign matter. The tires should be tube. Bent wheels that have a run-out of over 3/16" should either be replaced or straightened before being balanced.

(4-3) DYNAMIC BALANCE ON THE NISSAN PATROL

The wheel assembly of the Nissan Patrol is balanced at the factory. However, due to the wear of the tire or run-out of the wheel, it may be caused to lose the wheel balance naturally.

It is recommended to check the balance (both static and dynamic) periodically.

The counter weight which is used in order to balance the wheel assembly, must be in various size such as 10 gr (0.35 oz.) 20 gr (0.70 oz.) and so on. In using these various kind of counter weights, wheel assembly will be balanced better.

5. TIRES AVAILABLE ON THE NISSAN PATROL

(5-1) SIZE OF WHEEL

The wheel disc of the Nissan Patrol is of the pressed steel disc

type. The thickness of the steel plate is 4.5 mm. The size of the rim is 4.50E x 16. The wheel to which the wheel cap can be fixed, is available as an optional part.

(5-2) TIRE SIZE AND INFLATED PRESSURE

For the Nissan Patrol, the following tires are available.

Model	Tire Size	Air pressure	
		front	rear
60, G60	Front 6.50-16-6PR Rear "	(1) 1.5 Kg/cm ² (22 lbs/in ²)	2.1 Kg/cm ² (30 lbs/in ²)
G60H	Front 6.50-16-6PRLT Rear 6.50-16-8PRLT	1.7 Kg/cm ² (24 lbs/in ²)	4.2 Kg/cm ² (60 lbs/in ²)
(2) 60, G60 (3) G60H	Front 7.00-16-6PRLT Rear "	1.2 Kg/cm ² (18 lbs/in ²)	1.5 Kg/cm ² (22 lbs/in ²)



REMARKS:

- (1) In the case of using the Nissan Patrol Model 60 and G60 with full load, and for the long distance drive, the tire pressure should be 1.7 Kg/cm² (24 lbs/in²) for Front, 2.5 Kg/cm² (36 lbs/in²) for Rear to minimize tire wear and save the fuel consumption.
- (2) It is recommended to use the tire 7.00-16-6PRLT for sandy area. But, the carrying capacity of the vehicle is limited not to exceed 200 Kg (440 lbs) maximum.
- (3) The standard model is model 60. G60 means the long wheel base one. G60H means the one for the heavy duty, with long wheel base.

(5-3) TIRE PATTERNS

It is very important to select the correct tire patterns for the conditions in which the vehicle is used. If the grip tire (for mud and snow type) is used for the driving on the high way and with low air pressure, it may cause the irregular wear of the tire tread and excessive tire noise. On the contract, if the tire with passenger type tread pattern is used on the rough road such as on the mud and snow road, it is obvious that the traction force in the mud is not sufficient enough.

Therefore, the Nissan Patrol has been provided to be used with various type of the tire shown in the following table. It is strongly recommended to change tire pattern, if the pattern of the tire which is fitted on the vehicle is not suitable for the local driving condition, or if the local condition is changed. The following table gives various tire patterns available on the Nissan Patrol.

TYPE OF TREAD PATTERN	FOR	TIRE SIZE	PARTS NO.	REMARKS
	The vehicle used on the rough road. Mud and Snow type	6.50-16-6PR	43300-42100 (grip tire)	Standard for 60, G60, L60 and LG60.
		6.50-16-6PR	40310-43301 (lug tire)	Standard for model G60H and LG60H front.
		6.50-16-8PRLT	43300-42200 (lug tire)	Standard for model G60H and LG60H rear.
	On and off type. For the vehicle used on the rough road and high way.	6.50-16-6PR	40310-44002	Optional parts for model 60, G60 L60 and LG60
	The vehicle used on the high way.	6.50-16-6PR	40310-44000	Optional parts for model 60, G60 L60 and LG60
		6.50-16-6PR	40310-44300 (light truck tire)	Optional parts for model G60H and LG60H front.
		6.50-16-8PRLT	43310-44300 (light truck tire)	Optional parts for model G60H and LG60H rear.
		7.00-16-6PRLT	40310-44200 (light truck tire)	Optional parts for all model used in sandy area such as desert.

BODY AND FRAME

1. BODY

(1-1) TARPAULIN BOW ASSEMBLY

The body of the Nissan Patrol is usually delivered from factory with packed tarpaulin and tarpaulin bow. Following steps should be taken to assemble tarpaulin and its bow to the body.

(A) PLACE WINDSHIELD GLASS FRAME ASSEMBLY

Mount front windshield onto the cowl assembly. Fix windshield assembly to the cowl with three spring washers and cap screws. Rubber shim should be inserted between hinge plate and panel of cowl.

In case of above mentioned operation, care should be used to check that the bottom surface of the windshield frame is correctly seated on the rubber strip, as shown in the figure. Both part A and B should contact to the rubber strip firmly to prevent the water coming into the inside. This fitting position can be adjusted by means of adjusting the relative position of windshield frame and its hinges, as shown in figure. It is also possible to adjust the relative position of the hinges and cowl assembly according to the same method.

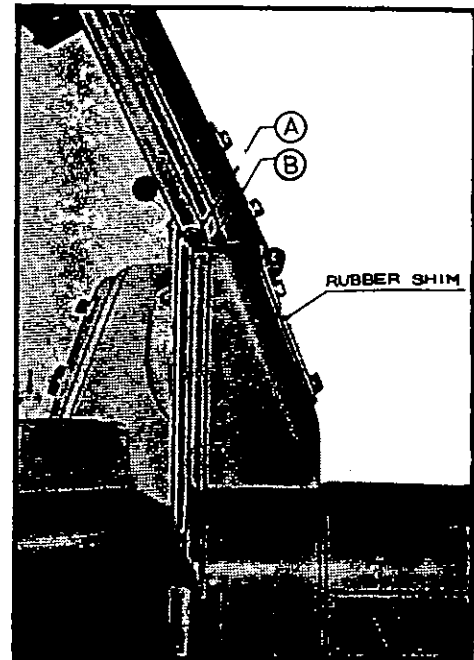

Replacing windshield

Before fixing the inside hooks, connect the wire of the wiper motor through the hole on the cowl, and check the sag of the wire. Then, fix the wind shield by means of the inside hook.

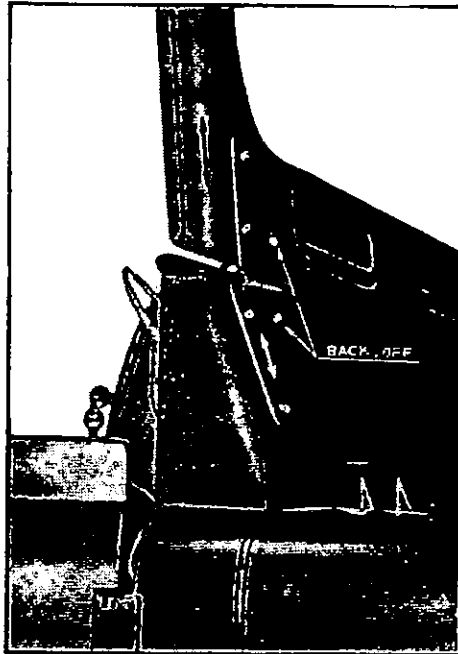

Adjusting the position of windshield.

(B) PLACING REAR BOW AND REAR GUARD BARS

Place rear bow and rear guard bars to the channel of the rear body and rear end of the wheel house. Be sure every junction has rubber shim in its position.

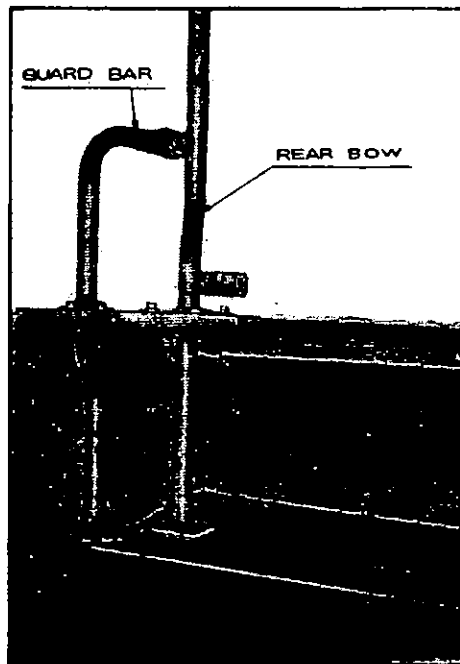

Replacing rear bow and rear guard bar.

(C) PLACE CENTER PILLAR, SEAT BRACKET AND SEAT BACK SUPPORT

Place the center pillar by means of five cap screws and one nut which secure the center pillar to the top channel of the rear body.

Fit the rear seat back support to the channel and wheel house by means of eight cap screws.

Install the seat bracket on the wheel house.

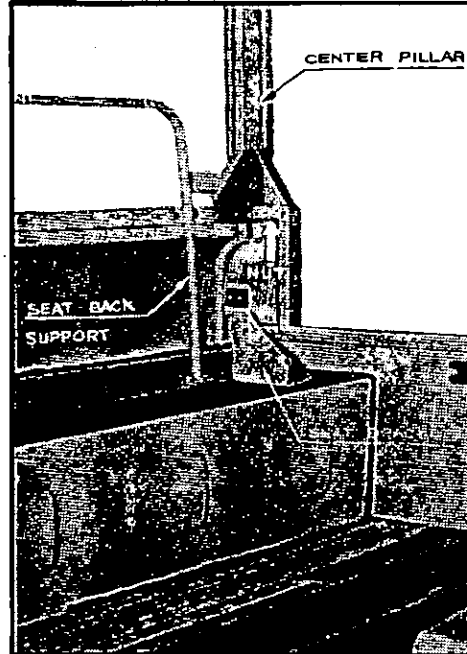

Replacing center pillar, etc.

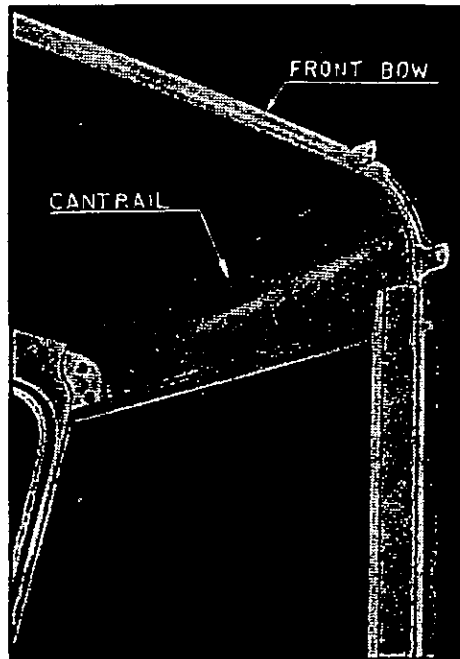

Replacing cantrail and front bow.

(D) PLACE CANTRAIL AND FRONT BOW

Paste two rubber seat on the cantrail, then fix the front end of the cantrail to the windshield frame by means of two screws. (Right and left side)

Place the front bow on the center pillar, and secure with four bolts and nuts to the center pillar, securing the rear end of the rail together.

(E) PLACE FRONT CENTER BOW AND THREE CENTER BOWS

Place front center bow between windshield frame and the center of the front bow. Place three center bows between front bow and rear bow. Another two bows should be placed when the side curtain is installed on the vehicle, because they are designed as the upper curtain stopper, acting the center bow as well.

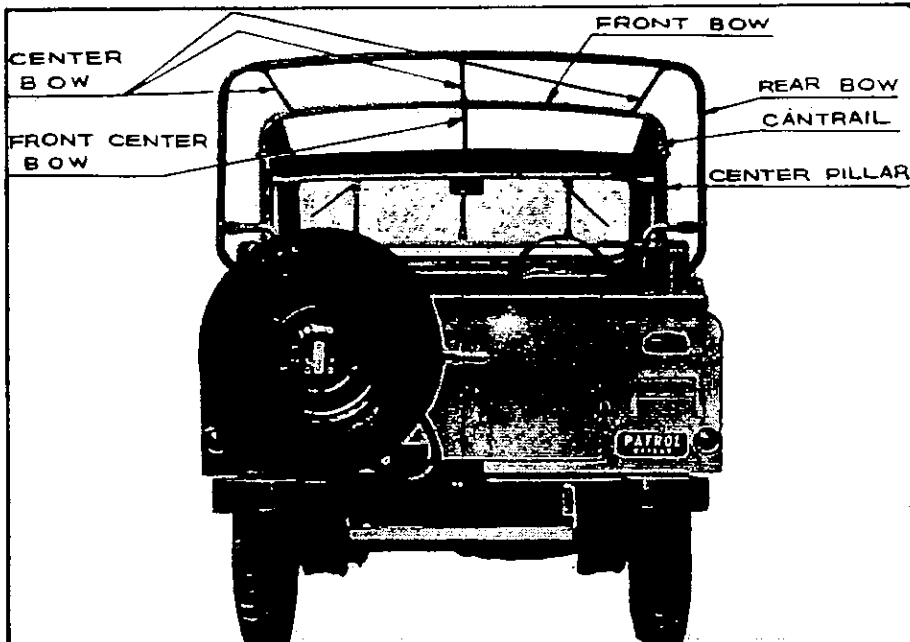

Tarpaulin bows

The rubber shims must be inserted between center bow and front or rear bow at each junction, as illustrated in figure.

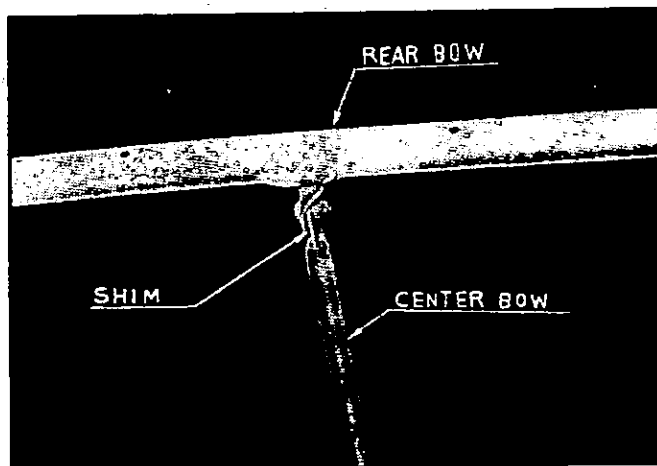

Junction of bows

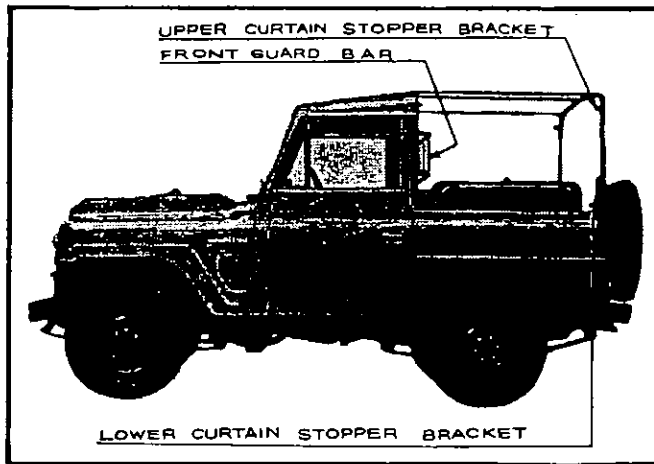

Side view of tarpaulin bows

REMARK:

The front guard bar is available as a optional parts.

(1-2) FITTING TARPAULIN

(A) FITTING SIDE CURTAIN

Insert the center bow into the upper part of the curtain which is left as a upper stopper of the curtain during operation (1-1)--E). Secure both end of the bow to front and rear bow, with bolts, nuts, plain washers, spring washers and rubber shims.

Insert the lower curtain stopper, into the bottom of the curtain. Fix the lower curtain stopper to front and rear bow with bolts, nuts, plain washers, spring washers and rubber shims.

(B) FITTING TARPAULIN

Fit the top end of curtain into the groove which is welded on the top of the windshield frame. Fit the side of the curtain into the groove which is welded on the cantrail. (Right hand and left hand.)

Fix the curtain with side curtain and rear curtain by means of the snaps and clamps.

(1-3) FRONT DOOR

(A) FRONT DOOR FITTING

The front door of Nissan Patrol is installed with two hinges onto door hinge pillar. Each hinge is secured by means of four cap screws, as illustrated in figure.

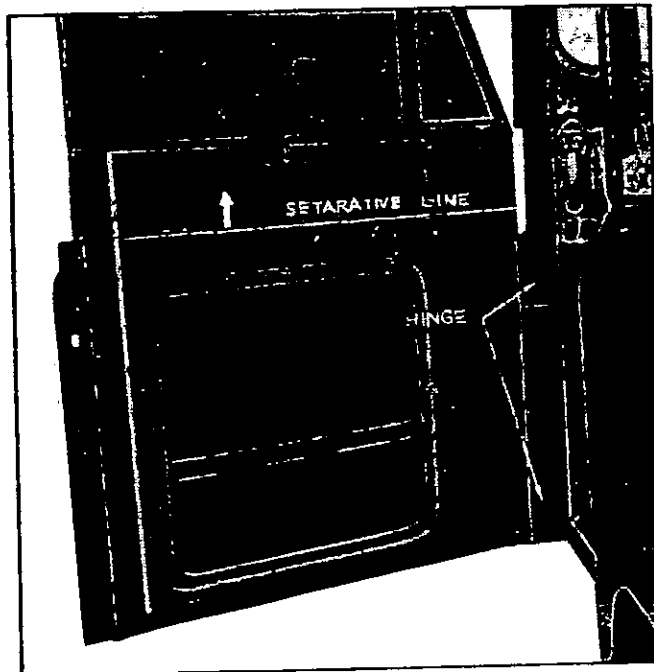

Front door (left hand)

(B) FRONT DOOR REMOVING

The front door of the Nissan Patrol is of the detachable type from the body as an assembly, and also the door sash (or upper part of door) can be divided from door assembly.

In order to remove the door assembly from the body, following steps should be taken.

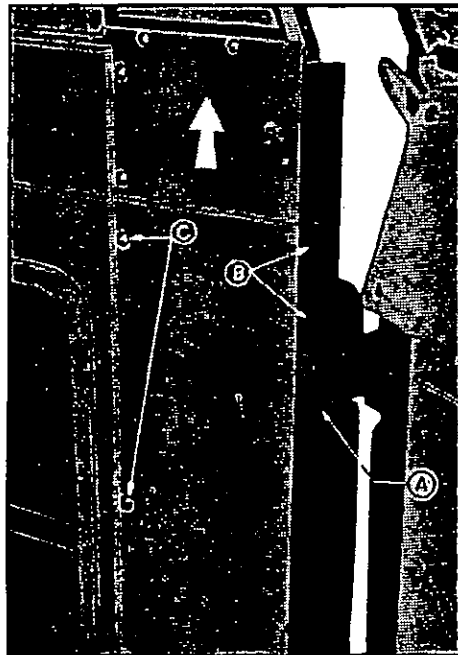
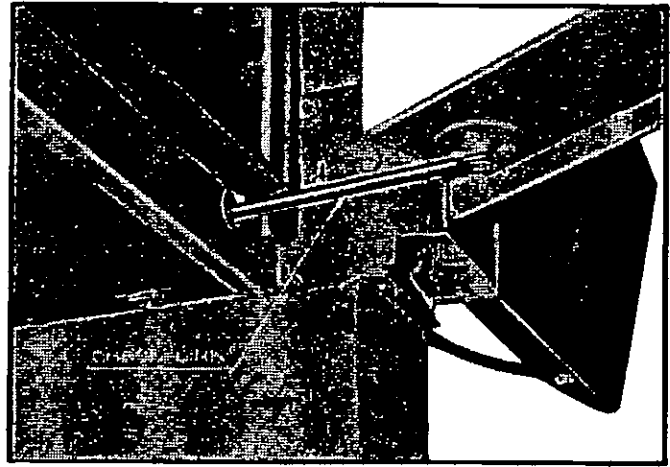

Check link of front door

- i) Remove the door check link from door.
- ii) Back the screws (A) off which secure the door hinges to door, as illustrated in figure.

Then, door can be removed.

To remove the door sash assembly from door, following steps should be taken.

- i) Back the two cap screws (B) off that secure the door sash to the front end of the door.
- ii) Back two screws (C) off that secure the door sash to the door panel.
- iii) Back two cap screws (D) off that secure the door sash to the rear end of the door panel.
- iv) Raise the door sash up as an assembly.

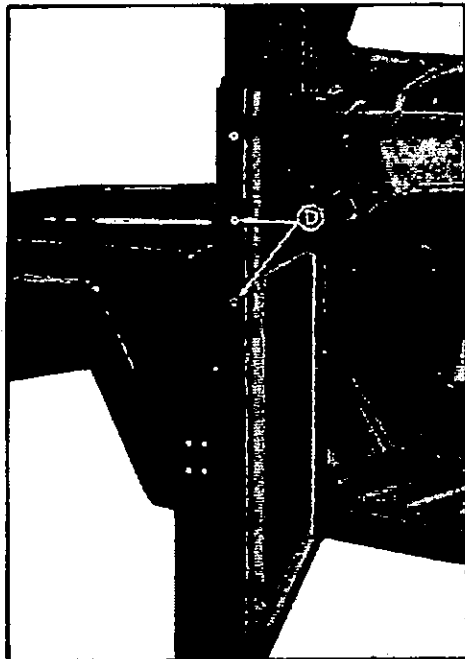

(C) ADJUSTMENT OF THE DOOR CLEARANCE

Whenever the door is installed, the adjustment of the door clearance is necessary.

Adjust the clearance evenly at the front, rear and top part of the door assembly.

Insert some adjust shim between body mounting bracket and frame, if necessary.

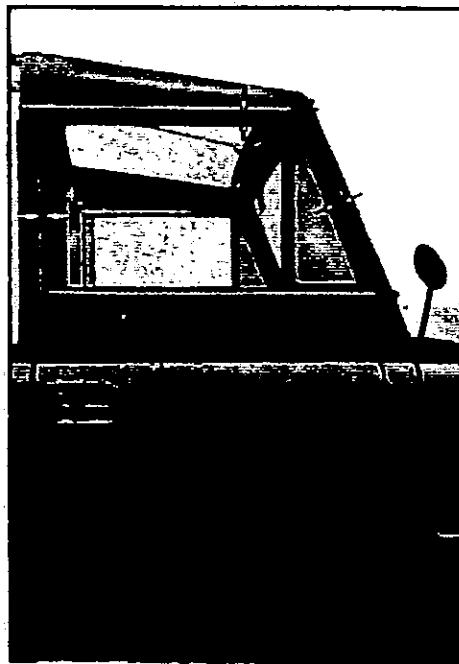

Door clearance

(1-4) HOOD ADJUSTMENT

The two adjustments are required on the hood. One is to adjust the relative position of hood lock dovetail and its female, in order to close hood properly. This adjustment is done by means of loosening the screws that secure the hood lock dovetail and its female to the hood, panel and radiator shell, and of moving the dovetail and its female.

Another adjustment is to make the clearance evenly between the hood panel and cowl assembly and fender. This operation can be worked by changing the relative position of hood panel and its hinges, and also by changing the relative position of hood hinges and cowl assembly.

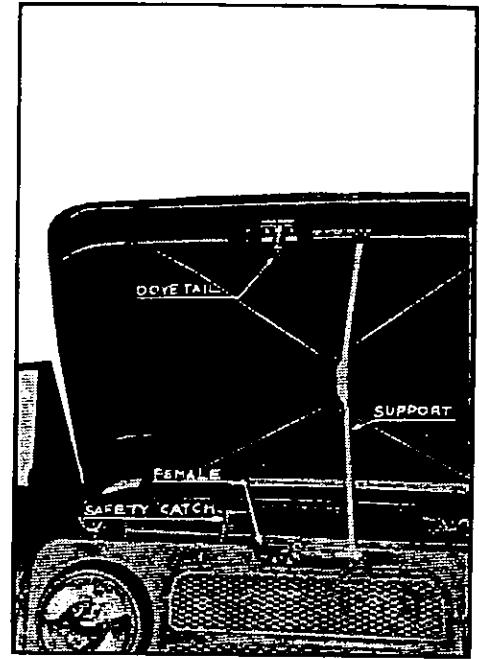

Hood support and hood lock dovetail.

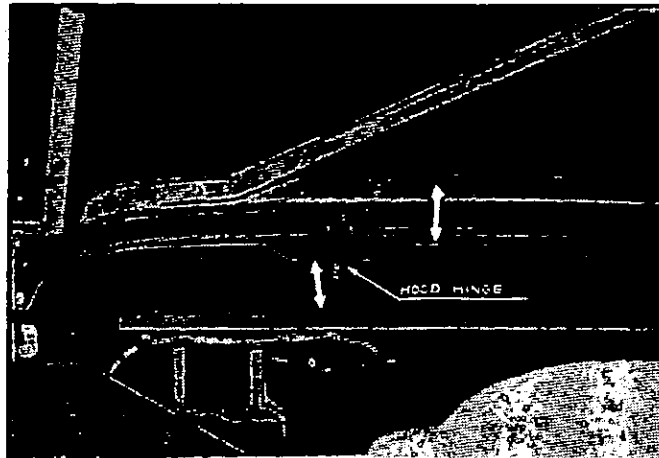

Hood hinge

(1-5) FENDER AND RADIATOR SHELL

Those parts, such as right and left fenders, hood ledges, and radiator shell are bolted firmly each other and to the cowl assembly. Therefore, it is very easy to remove radiator shell or fender, if necessary.

Following pictures show the bolts and cap screws that secure those parts each other.

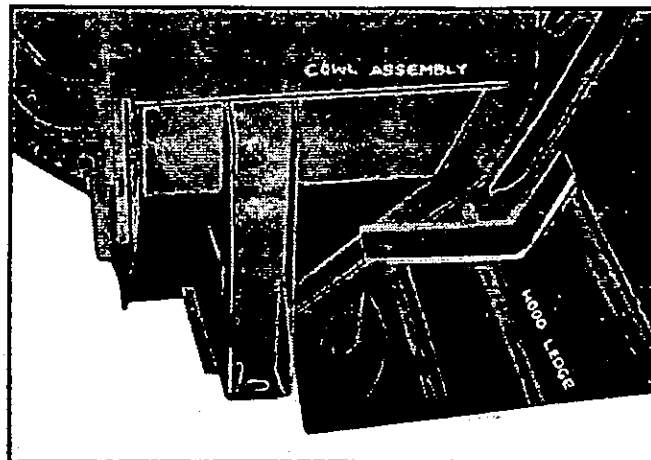
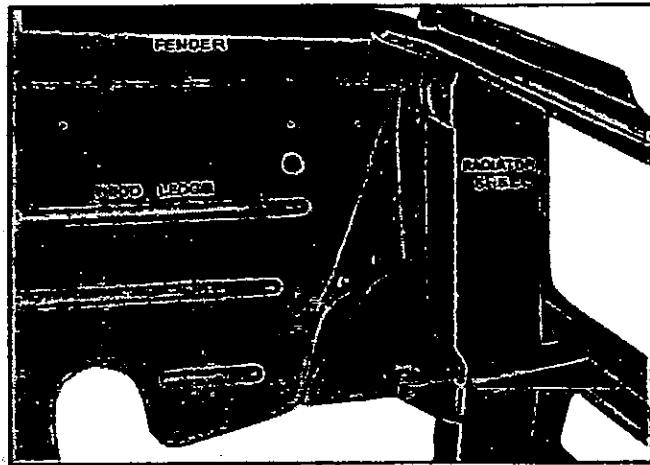

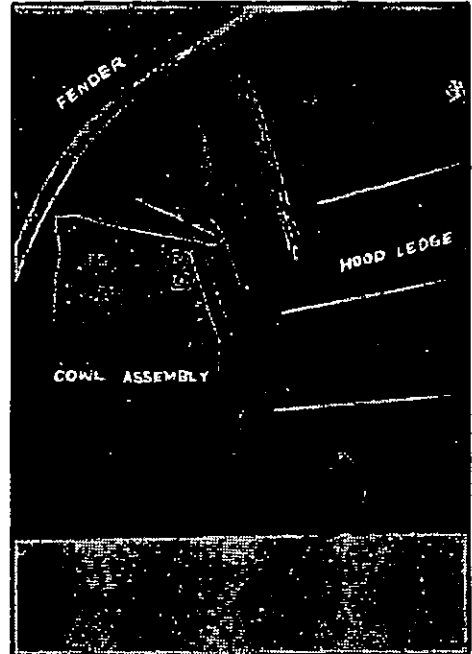

Underneath the fender

(1-6) INSTRUMENT PANEL

The instrument panel (or cluster lid) of the Nissan Patrol is provided with removing very easily, as illustrated in the following picture, cluster lid and glove box are installed by means of the set screws which is cromed beautifully.

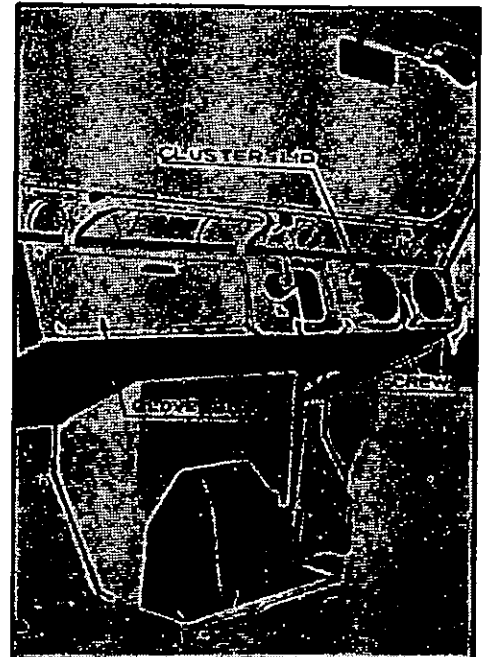

Cluster lid and glove box

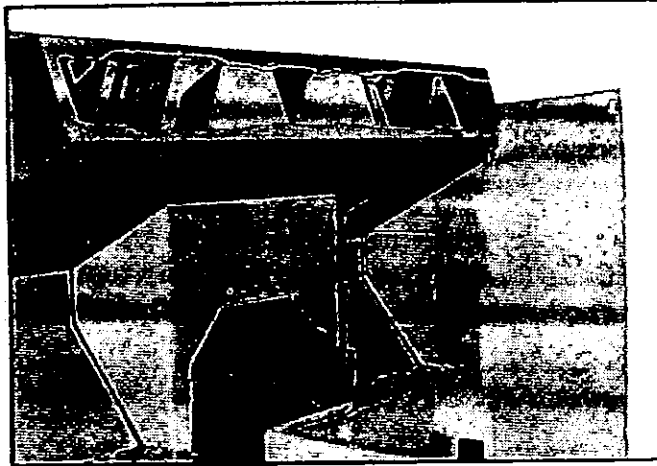

Inside of the instrument panel

(1-7) BODY MOUNTING

The body assembly of the Nissan Patrol is mounted with five point of each side of the body. Every mounting bracket is provided with the duck belt and the steel adjusting shims, if necessary. Following pictures show the mounting brackets undeneath the floor.

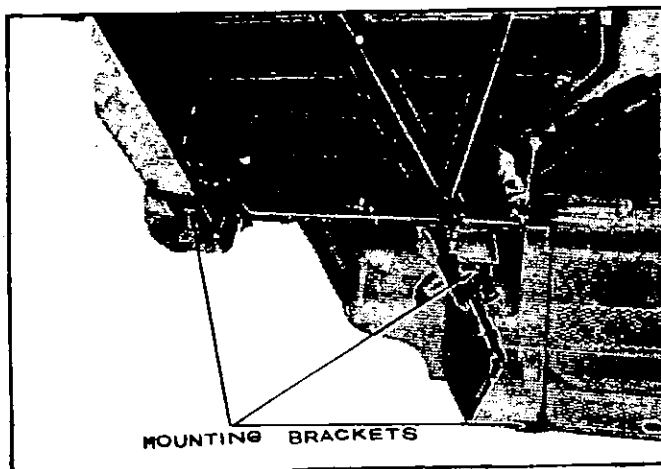

Underneath the front part of the body

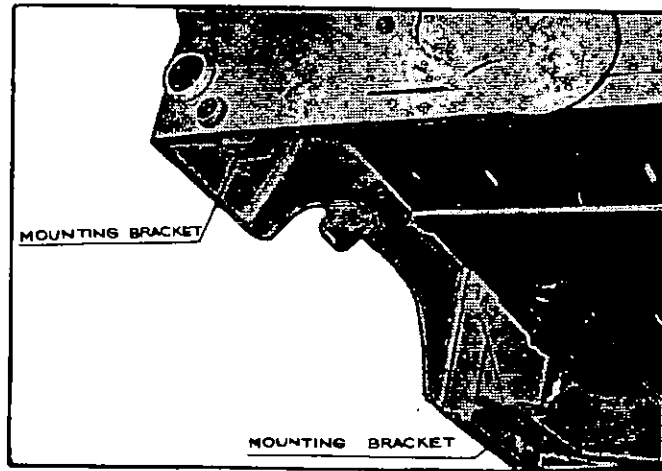

Underneath the rear part of the body

2. FRAME

The frame of the Nissan Patrol is of the all welded ladder type, and of the box section type. The rigidity of the frame is excessively high because of its construction. Therefore, the body is able to have simple and separable construction. Refer to the instruction drawing of frame.

INSTRUCTION DRAWING WINDSHIELD MODEL 60

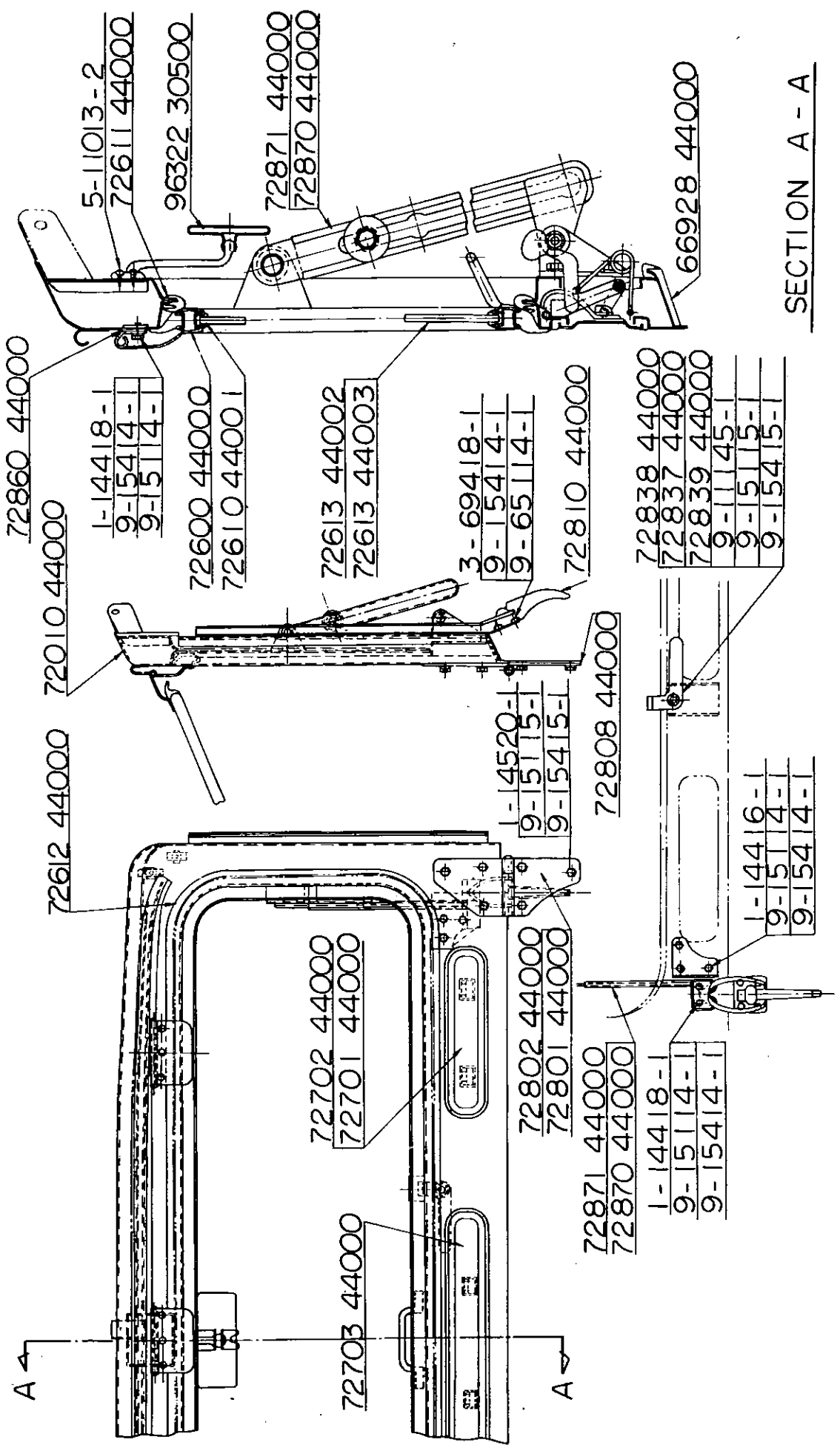

SECTION A - A

