

NISSAN PATROL

REFERENCE DOCUMENT

By AKSNISS

www.patrol4x4.com/forum/

Version: 2.2

CONTENTS

INTRODUCTION	5
ZD 30 SPECIFIC (Mostly)	6
Engine Protection.....	6
Spares.....	8
After/During an Engine Rebuild.....	9
Reliability	10
Test If Your Vehicle Is Affected By Over Boost - How To	12
How I Tested My Own Vehicle.....	12
In Summary.....	13
ELECTRICALS	15
Air Bag(s) System - Disabling.....	15
ECU Fault Codes - GU	16
Manual Extraction.....	16
Fault Code Table	16
Clearing Fault Codes.....	18
Key in ignition alarm	19
Spot Light Wiring Diagram.....	20
Stereo Wiring Diagrams.....	21
MAINTENANCE	22
Maintaining Your Tyres.....	22
Tyre Inflation	22
Checking Tyre Tread.....	22
Wear On Both Edges: UNDER INFLATION	22
Wear In Centre: OVER INFLATION	22
Cups or Dips in the tread: WORN PARTS.....	22
Sawtooth edges: MISALIGNMENT.....	22
Tyre Balancing.....	23
Vehicle Alignment.....	23
Tyre Rotation	23
Repairing Tyres.....	23
MECHANICAL	24
5th Gear Failure GU	24
Belt Tensioners ZD30.....	25
Exhaust Gas Reticulation System (EGR).....	26
EGR Blocking - How To.....	28
Principle	28
Tools.....	28
Disassembling	29
To reassemble	29
EGR Technical Diagram	30
Earthing Issues.....	31
Flat Mirror on GU4 (non convex)	32
Free Wheeling Hub Diagrams- Manual.....	33
Keyless Remote - Reprogramming	34
Oil Catch Can - How To Make Your Own and Install.....	35
How to do it.....	35
Bits required and costs.....	41
Installation	41
Oil Pressure Gauge Sendor Install	44
Introduction.....	44
What you will need	45

Nissan Patrol Reference Document

How to do it.....	45
Rear Brake Force Less Due To Lift Kit - Brake Proportioning Valve	48
What Is It - A Technical Explanation	48
What Is It - A Plain English Explanation	48
Putting The Above Technical Jargon Simply.....	49
How To Do And Examples	49
Cracked Rear Chassis.....	52
Speedo Correction	53
Introduction.....	53
How Do You Fix Your Speedo Being Out?.....	53
Steering Castor Correction - After Lift	57
Which Kit	57
Technical Explanation.....	57
Other Tyre Wear- Simple Explanations	58
Sway Bar Extension Bracket Kit - After Lift	59
VNT Screw Adjustment.....	61
TRIMS, MOULDINGS ETC.....	63
Bubbling Dash.....	63
Drivers Seat Movement - GU	64
Pollen Filter Kit	65
Trims - Silver Plastic on Doors and Dash.....	66
WHITE PAPERS, BULLETINS AND PRODUCT TESTING.....	67
Air Filter Test Report - Spicers ISO 5011 Duramax.....	67
Scope.....	67
ISO 5011 Test	67
Capacity and Efficiency	67
Flow Restriction.....	67
Filter Efficiency	68
Accumulative Capacity.....	68
Accumulative Gain.....	69
Initial Restriction.....	69
Dirt Passed Versus Total Test Time	70
Dust Loading	70
Restriction to Flow.....	71
Test Data Tables	71
The Story Behind The Test.....	75
Chip Tuning or Performance Modules or Electronic Tuning Devices.....	77
What Are They.....	77
Diesel Tuning Devices	77
Chips And Computers - How Do They Go About Improving Performance?	78
Basic Basic Basic Universal Fuel Increase Units....and Cheap To Manufacture	78
Basic Basic....Multi Point Fuel Adjustment	79
Desirable Fuel Mapping.....	79
Independent Injection Timing.....	80
Engine Durability	81
Programming, Numbers, Data - The Stuff That Goes Into a Computer.....	82
Conclusions.....	83
Differentials (Diffs).....	84
What Are They.....	84
A Standard (Open) Differential	84
Traction-Adding Devices	84
Whats A Locking Differential Or Locker	85
Intercoolers.....	87
What Are They.....	87
Air To Air Intercoolers.....	87

Nissan Patrol Reference Document

Front Mounting An Intercooler?	88
Air-To-Liquid Intercoolers	88
Mass Airflow Sensor (MAF).....	89
What Is It	89
Hot Wire Sensor	89
How To Remove	90
Nissan Bulletin On ZD30 Engine Oil - Sept 2004.....	91
PCV Valve	92
Explanation.....	92
History	92
PCV System.....	93
Operation.....	93
Trailer Wiring Diagrams.....	95
Turbo Tech 101 (Basic) By Garrett	96
Tyre Terminology	102
All Terrain Tires	102
Mud Terrain Tyres.....	102
Bias-Ply Tyres and Radial Tyres.....	102
Radial	103
Reading a Tire	104
Light Truck Sidewall Designations.....	106
Tire Components	106
Winch Considerations	109
Major Considerations	109
Other Considerations	110
Winch Components.....	110
Winch Solenoid	112
Wheel Terminology	113
A few terms	113
Why Synthetic Oils Are Superior.....	115
Engine Oil Basics	115
What Is Lubricating Oil?	115
There Are Four Different Types of Motor Oil Base Stocks	115
And There Are a Variety of Additives	115
Let's Look at Conventional (Mineral) Oil.....	116
Hydroprocessed Oil	116
Severe Hydroprocessed Oil	116
Semi-Synthetics.....	116
Synthetics	116
Base Oils Summary.....	117
So What Does This All Mean?	117
There Is a Clear Difference in Motor Oil Protection and Performance.....	118
GLOSSARY	119

Nissan Patrol Reference Document

INTRODUCTION

The contents of this document has been compiled from input by the research performed by myself, input by members of the Patrol4x4 forum Web site (whether they know it or not), people with mechanical qualifications, technical white papers, other official company literature, industry experts who modify four wheel drives for a living and the French Patrol forum who created the original EGR blocking documentation translated to English by a forum member.

All information contained in this document is my opinion and many works I have performed on my own vehicle during the testing.

IF YOU CARRY OUT OR PERFORM ANY MODIFICATIONS TO YOUR VEHICLE THEN YOU DO SO AT YOUR OWN RISK.

This document started as a ZD30 issue document but has since grown to be more of a reference document. It will be forever growing and check back now and then for the current version.

Most articles do not specifically relate to the ZD30 and can be applied to other vehicles also.

Nissan Patrol Reference Document

ZD 30 SPECIFIC (MOSTLY)

ENGINE PROTECTION

In order to look after your engine there are a few things you can do, it is all pretty simple really, the best way to keep your engine running optimally is to keep an eye on it and use products that can better protect it, a basic list is as follows;

- ☑ **Snorkel** - Probably the most important item for any diesel engine. On a Patrol the air intake comes from inside the left hand (passenger) side guard. As you drive the dust that is stirred up from the front tyre is sucked up into the guard and into the filter thereby blocking it quickly. Diesels do not like water and if it gets into your engine it can be a rebuild or replacement, if you are lucky it may just be a clean out. Water can not be compressed so it will lock the engine and all that pressure needs to go somewhere so it usually breaks something internal.
- ☑ **Boost gauge** - This will help you identify any over boost issues.
- ☑ **EGT gauge** - Will help you to keep an eye on the all important temperature of your exhaust. The higher the EGT readings the more fuel your engine is burning and the hotter it will run. A hotter than normal engine may display that your MAF has gone faulty.
- ☑ **Turbo timer** - get a turbo timer installed regardless of what the dealers may tell you. Letting your engine idle to cool down a hot turbo is beneficial. I personally know of someone who did not and after blowing his 2nd turbo decided to get one. Mind you this was after his father, a Diesel mechanic, had been telling him for about 2 years to get one. He was an avid beach driver and all the extra load from sand driving had the turbo nice and hot. What happens is the oil solidifies in the lubrication channels in the turbo and affects the flow of oil as they become partially blocked, the extra heat can also weaken the bearings. See other points below as they can relate to this point.
- ☑ **Synthetic Oil** - Use synthetic oil in the engine it has higher heat tolerances, does not degrade like mostly mineral based oils and has added properties that can stop the soot etc from sticking to the inside of you engine, this will help with the 10,000 klm extended oil change interval. Also make sure you use the right viscosity, check your handbook as it does differ for each model. In a GU4 the handbook states to use 5-30w weighted oil in all temperature ranges and to only use something else if not available. In 2004 Nissan released a bulletin stating which oil to use in the models that were around and prior to the time of issue, *a full version is in this document*. Just as a side note, I have not found one dealer that uses the official Nissan specified semi-synthetic oil; they generally use whatever they buy in bulk for most other vehicles.
- ☑ **Oil level** - Never over fill the oil in your engine, always make sure it is at the correct level by starting the engine then switching it off and letting stand for 5 or more minutes, check again. If you over fill the return line from the turbo can be covered and therefore not drain properly, as the engine block is pressurised when in use it can slow down the flow of oil out of the turbo thereby not allowing sufficient fresh cooler oil to provide the lubrication and cooling. In the models that have had their dipsticks modified/shortened (2000-2001) it is easier to over fill so be careful. Over filling also means more oil gets sucked through the breather into the intake. That oil can damage the turbo, add to the sooting up of the manifold and adds to the fuel going in. Also due to the extra fuel (engine oil) goes into the cylinder via the intake instead of being injected it can burn well in advance of the actual fuel being injected which can further increase EGT's.
- ☑ **Fuel** - Just like the old commercial said, for those who have been around for a while, "oils ain't oils". The same applies to fuel, not all fuels are created equal. Use a reputable service station that is attached to a bigger fuel company and you should be right. To give you a few examples, when I bought my ZD30 I used to buy my fuel from an independent service station about 1 klm up the road, where I used to fill up my Subaru. When driving down the coast I would not bother driving at 110 as the engine was that

Nissan Patrol Reference Document

much loader that I had to turn up the radio, not owning a Diesel before I thought this was normal. When I was at my destination I filled the tank with Mobil diesel. Within about 30 klms the engine was noticeably quieter and smoother running, the fuel economy stayed the same. The same happened recently, June 07, I filled up at a well know supermarket service station because the fuel light was on and half way in the red (received vehicle back from dealer in this state), I was desperate. As the dealer had my car for a few weeks I could not figure out what they done to it, I pulled the batteries and re-set the ECU, still the same. Then I remembered the independent fuel quality. I waited until the tank was almost empty then went back to my usual big named service station, problem solved. I again, after about 30klms, had a quiet and smooth running vehicle. There was some mention that if you use BP Diesel that you can get more mileage from your vehicle, I have found this too, I get an extra 30-40 klms per tank.

- ☑ **Thermal fan** - Install a thermal fan to keep the intercooler cool. An 8 inch fan kit can be obtained for as little as \$90.00. An issue with most of these vehicles is that when a bull bar or bonnet protector is installed the air flow is disrupted and very little to no air is funneled through the bonnet scoop.



8 inch fan mounted on engine cover

You can test this by spraying water on the bonnet until it beads and going for a drive, do it on a day with no wind. On my vehicle the water on top of the bonnet and scoop started moving at 90 klms p/h. Therefore under this speed no airflow, when four wheel driving you are generally moving slowly so unless you have a constant airflow the intercooler may heat up considerably, the engine heat also contributes (hot air rises). A 7" fan will do

the trick also, it does not need to be a large amount of airflow, just get the air moving through it. My 8" fan under extreme driving or towing keeps the intercooler lukewarm to the touch. I have installed a switch so I can choose when to have it on.

- ☑ **Oil Catch Can** - An oil catch can's purpose is to catch oil and water blow-by gasses that can eventually create a carbon and oil sludge build-up in the air intake. Or put simply, air and oil mist is routed back from the engine crankcase into the intake manifold. Over time this will make your manifold, air filter, air flow sensor etc dirty. A catch can separates the oil from the air before it reaches the intake manifold keeping it nice and clean. I had an air filter in for some 20,000 klms and I swapped for a new one, the old one I stored in a plastic bag, when I removed it from the bag there was a small puddle of oil. *See PCV Valve section.*

This picture is of my air filter after 10,000 klms. What it shows is the oil mist that has been blown back has soaked into the paper element and caused the dust to stick.

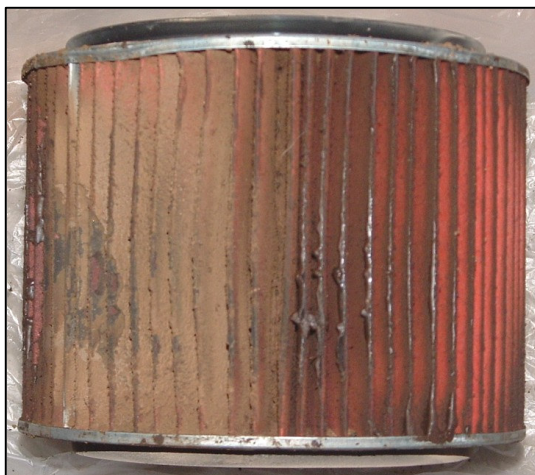

This element has in fact already been tapped out (a bit too hard you can see the dented metal edges) as best it can but the dust remains intact. The wet looking "mud" is actually oil not water, after a week of sitting in the shed it was still nice and moist, if it was water it would have dried.

Remember that you should not use a compressor to clean a paper element unless absolutely necessary (you don't have a spare), see air filters below.

Nissan Patrol Reference Document

- ☑ **Filters** - *Always, and I mean always, only ever use the original Nissan filters.* The engine is designed around them.
 - **Air Filters** - I change my air filter every 10,000 klms. Never use an air gun to blow out your filter, if you have too (in case you don't have a spare) lightly blow the compressed air from inside out only. Using an air gun only weakens the fibers and can cause small holes that can allow fine dust particles through fouling the MAF and getting into the engine. Tap the metal upper or lower on something but not hard enough to cause dents or it may not seal properly. Slightly dirty filters can filter better than a clean one. Changing from standard can also change the airflow more than expected by your MAF sensor. The genuine filter goes back in with the thicker rubber ring down and flexible seal up.



Aftermarket Filter



Genuine Nissan Filter

Notice that the Aftermarket filter, although built strongly, has a tighter paper weave. Both the Repco and Valvoline filters are made like this. Now you may think that this will filter better but in fact it just means that the filter can block faster in dusty conditions. The tighter weave also reduces the amount/volume of air passing through the filter to the engine. Diesels like air and plenty of it to run smoothly. The Nissan filter, with its more open weave, is designed with the airflow required by the engine in mind.

- **Oil Filter** - Well you should know by now that the ZD30 does not use a standard oil filter like just about every other vehicle. As I have my EGR blocked and hardly any soot now gets into the engine I only change mine every 10,000 klms, prior to the EGR blocking I would change the oil and filter every 5,000.
- **Fuel Filter** - I change my fuel filter every 20,000 even though the book will state 40,000. Our fuel quality here can vary greatly depending on where you buy it, particularly in the outback. A partially blocked fuel filter will affect the flow of fuel to the pump and can make the engine feel underpowered and sluggish. Also changing more often will protect that all important *expensive* fuel pump from unnecessary wear and tear. It is a cheaper option to change more often than spending thousands for a repair or replacement.

SPARES

Some spares you should consider keeping on hand besides the usual radiator hoses, fuel, air, oil filters etc;

- ☑ **MAF sensor** - This sensor is the key to ensuring your engine is getting the right amount of fuel. If it goes faulty you will see the EGTs go high and stay there. A faulty MAF has the potential to over fuel your engine which has the potential to burn out the pistons or crack the head etc. Make sure you get the right part as the MAFs are not the same for all models.
- ☑ **MAF sensor screwdriver** - The sensor uses a special security Torx screwdriver, you can buy these anywhere so keep one in the glove box for when you will need it, on mine it is a T20 size and a set of 8 different sizes cost about \$14.

Nissan Patrol Reference Document

- ☑ **Oil Pressure Switch** - For \$20 from a Nissan dealer (\$7 from SuperCheap Autos) it is good insurance in case one goes faulty. Basically if the engine thinks there is no oil pressure then the ECU will switch off the engine and not allow you to restart until it thinks there is the right amount of pressure again. The oil pressure switch can be unscrewed with a 26mm spanner. The oil pressure switch is just that a switch, it is either on or off, it is not able to sense how much oil pressure there is.

AFTER/DURING AN ENGINE REBUILD

Tip from GQ Banger

If you ever rebuild a ZD30 make sure that you send your injector pump to a reliable diesel service & have your injector pump recalibrated.

Bosch had released a revised injector pump mapping. It does not require a full overhaul, just needs to be set up on their test bench to be remapped.

All the vehicles that I have heard of having repeat failures have never had this done. The reprogramming slightly reduces the fuel quantity delivered at peak torque to keep the combustion temps down. The vehicles that I know of that have had this done have never had a repeat repair.

Nissan Patrol Reference Document

RELIABILITY

You will hear a lot of talk on the web and other places regarding the reliability of the ZD30 engine. These engines are built pretty tough and can handle a lot as long as they are looked after.

There are quite a few differing opinions on what causes the ZD30 engine to fault after performing certain modifications, namely;

- adding a larger exhaust (2.5 - 3.0 Inch), and/or
- blocking the EGR, and/or,
- Installing a Diesel performance chip.

It needed to be put in one document for all to read and discuss and argue certain points etc. I have also included a piece on what I think the reasons for the ZD30 early model failures are.

I have now configured my vehicle as explained within these pages and the vehicle is now running as it was when new.

I had the added benefit of not going out and adding every mod required straight away, I had the vehicle for approximately 6 months even before installing a snorkel, and 18 months prior to adding the first series of performance modifications, a 3" exhaust, aftermarket performance chip and blocked EGR.

During my testing I did not get so far as to re-install my standard exhaust as it was deemed not necessary. From two reliable independent sources in the industry (and no I will not name them) I have been told a particular boost level in a certain circumstance is required as the measure of how the system should be performing. The French author of the original EGR blocking document also had similar information, although that document never mentioned what the boost should be, just how to stop the over boost error from occurring using a method of feel. Their document also did not consider a larger exhaust or any other modification, it was assumed that the vehicle was still stock standard.

There is a great deal of interest and argument on what is the cause of the ZD30 blown engine issue, but since most blown engines seem to crack pistons 3 and 4, and it tends to affect the older 2000 - mid 2002 models only, it seems to be one of engine design at that time.

It seems that the 2000 to 2001 model engine block was not designed with enough oil channels or they were inadequate so the lower cylinder walls were not receiving enough lubrication. This may have caused additional heat and may have contributed to the engine blow up issues we hear of today. Also these versions did not have enough oil capacity in the sump so when driving hard all the oil ended up in the top of the engine with the sump virtually running dry. Nissan had a fix for the lack of oil capacity and shortened the dip stick on older models to increase the capacity when being filled.

Nissans fix for the blown engines was an engine overhaul kit (part number MK101 VC128AU which breaks into 12 individual part numbers and water connector 14075 VC100) which replaced the engine block with a new one as well as new pistons etc. As this kit was available it seems there was an issue identified. Although you will never find a vehicle manufacturer going public on any major fault, the engines were repaired on an as required basis.

Here goes, now I am going to get a lot of argument on this one, why does the ZD30 engine have the above issues? simply, **because most people modify the engines away from how they were originally designed**. This is not as dramatic as it sounds but modifying the engine does change its characteristics. For instance, did you know that if you put a 2.5" or 3.0" exhaust on your vehicle, from the turbo back, it will cause the engine to over boost when highway driving? Hence get a boost gauge fitted **before** you start modifying!

Nissan Patrol Reference Document

How does the ZD30 work? With the testing I have performed these are my basic observations;

- The engine has a Variable Geometry/Nozzle Turbocharger (VGT/VNT) also known by lots of other names; check the glossary under VGT for more of an explanation. The VGT is controlled by the ECU that decides, via sensors attached to your engine and throttle, what it is going to do with turbo boost.
- It also checks the load on the engine to determine if it needs to give a bit more to keep the power at its optimum level.
- If you need more power, like going up a hill, it will reduce boost and give you more fuel.
- If you are coasting at a regular speed down the highway, for economy reasons (I think), it will give you less fuel but up the boost to ensure your power is kept to a maximum.
- While in the above state, it might as well make sure your emissions are within legal requirements so it will adjust the EGR and give a bit more boost to keep the engine combustion and temperatures lower.

If you take all of the above into consideration, most people seem to report that the engine goes bang when out for a drive along the highway, may be either towing or under some other load, on a flat bit of road doing 100, 110, 120 etc. This is the ideal state for a ZD30 to do some emission control and fuel saving. The faulty MAF that is mentioned quite a bit around the place is a good place to start.

So here goes, and again, let the arguments begin. The following is my opinion on why these engines go bang;

- While cruising at 100 klms or more a ZD30 will go into maximum boost as determined by the length of the VNT screw on the turbo.
- While in that state the EGR is opened fully to let as much hot exhaust gas back into the engine to meet emission controls.
- You have a dirty or failed MAF that decides that there is heaps of air flowing from your filter box so it decides to give you more fuel, therefore over heating and fuelling the upper cylinder walls and piston.
- Your Patrol engine is now starting to feel the heat as the lower part of the engine is getting super heated due to added friction from not enough volume of oil and possible lower engine lubrication design, therefore it too gets hot and starts breaking down.

I have been advised that the most likely reason pistons 3 and 4 crack is the rear pistons on most motors run hotter than the front ones. When you push a motor to the max it is often the rear pistons that fail.

The above itself is enough to stress the engine and have pistons 3 and 4 crack, and it may need to be happening over a period of time, there is nothing anywhere that states it happens all at once, it may be little by little.

The final clincher is that you have installed a nice big exhaust to get the gas out quicker and make the turbo spool quicker thereby getting rid of some of that low down lag and make it more drivable, did you re-adjust the VNT to compensate? Over boost anyone!

Simple formula;

Cruise on highway = More boost = EGR fully open = Too much exhaust heat = Faulty MAF = Too much fuel = Very hot engine internals = Exhaust or EGR modifications = More boost = BANG at weakest and hottest point.

Nissan Patrol Reference Document

TEST IF YOUR VEHICLE IS AFFECTED BY OVER BOOST - How To

To test if your vehicle is having the over boost issue carry out the following test;

- Find a nice flat piece of highway where you can coast the vehicle at a set speed without changing speed or RPM while driving i.e. moving your foot up and down on the accelerator.
- Get the vehicle to around 100-110 klms, not your corrected version for bigger tyres etc. This is dependant on your vehicle; a manual GU4 sits around 2600 RPM at about this speed. Drop gears but keep in a higher gear so that slight foot movements are minimally registered. 4th or 5th gears are preferred.
- The important thing is to keep the vehicle at around 2600-2700 RPM.
- Coast at this for as long as you can and see if you can feel an engine twitch (bit like being hit by a slight side wind, can take anywhere between 20-60 seconds) or if you have a boost gauge watch the boost go to its maximum level and feel for the same twitch.
- If you feel a twitch great, don't take your foot off the accelerator, as doing this resets the ECU and it will happily adjust itself and lose the error. Slowly accelerate and if your foot goes all the way to the floor with no acceleration you have just experienced a Nissan boost safety feature, by design.
- If you have a boost gauge, on mine the boost dropped to 15PSI for about a second then to 10PSi, then to 4PSI and stayed there with no acceleration possible, foot to the floor staying at speed.
- If you don't feel a twitch keep coasting for about a minute then slowly accelerate if your foot goes all the way to the floor with no acceleration you have the issue.

This Nissan designed feature is to make sure your engine does not stay at boost for long periods of time therefore causing damage to the engine, it is an over boost safety feature that **does not** throw an engine management code.

HOW I TESTED MY OWN VEHICLE

All testing was carried out on my manual Nissan Patrol Y61 ZD30TD 2005 GU4 model, build date is June 2005, 3" mandrel bent exhaust with ceramic coated dump pipe, hi-flow CAT and vortex muffler. I also had access to 2 other 2005 model GU4 experiencing the same issues after EGR blocking, both with 3" exhausts. It seems that the GU4's may not be as tolerant of modifications as the Series 3, could be different ECU's, more boost, new ECU code introduced, could be many variables?

When increasing your exhaust diameter, thereby improving gas flow, or blocking the EGR and redirecting the additional exhaust gas flow toward the turbo it will cause the turbo to spin faster thereby giving better low down performance and faster Turbo spool up which can greatly reduce Turbo lag, and is seen as a plus for drivability, *but this also increases boost.*

In the below I used the above method to test, I also tested each phase over a number of days with a mixture of highway and around town driving. I was advised by two independent sources that by performing the test method above my maximum boost should have been around 10-11 PSI so this is what I set the boost around (I could not find a standard same year unmodified vehicle with boost gauge to test on).

- EGR unblocked, tested, boost was too high at around 18 PSI, so it errored as expected.
- Screwed the VNT 3/4 a turn to drop the boost to around 10-11 PSI, tested, at this point of the test the vehicle was far more drivable even revved quicker to the higher RPMs (3500-4000) than it had for quite a while. The engine did not work as hard and gear

Nissan Patrol Reference Document

changes were smoother. After driving for a short period the boost would “creep up” by a PSI or two and settle around 13-14 PSI.

- I then blocked the EGR and turned the VNT a further 1/4 a turn, tested, noticed the boost back up around 16 PSI. So blocking the EGR increased the boost by about 5-6 PSI. Driving around town between gear changes it felt like there was a restriction in the engine so when you changed gears the RPM dropped quite quickly and made changing gears jerky.
- I then turned the VNT again so that it is now 1 1/4 turn in total and the boost is now normally back around 10-11 PSI. The vehicle is far more drivable at this level and it still has plenty of pulling power down the highway. What it did was cause a type of power band at around 2000 RPM that would make the car take off when you hit the accelerator for overtaking etc and the boost stayed low. It is very easy too start at 2000 RPM and get the car to over 4000RPM easily without feeling any engine restriction. However one slight side affect was the loss of some, not much but noticeable, torque down lower. The owners of some cars I have adjusted want to leave it this way and not re-adjust as I have done below. If you drive a car set up like this you would understand why, you can be cruising at 100 klms and put your foot down to overtake and the car just takes off, even while you are towing, with no over boosting of the engine.
- After the above testing, and a few months, I re-installed my Steinbauer Diesel performance chip. What this did was change the way the fuel is delivered to the engine and gave it more pulling power down low. One of the side effects of installing a chip is that it will make the engine run slightly hotter the more the chip is turned up the more fuel, so the hotter it gets. This can also be detrimental to your engine if you do not keep an eye on it.
- Now here’s a catch, the turbo is also responsible for cooling the combustion temperatures in the engine. So I simply re-adjusted the turbo VNT screw back 1/8th of a turn to slightly increase the boost to around 14 PSI while cruising on the highway. The VNT screw is now set at 1 1/8 of a turn in total. This had the effect of dropping the temperatures by approx 25 deg C, and gave me back some lower down torque. The engine now has a more even power band right through the RPM range. BUT guess what, while cruising down the highway the engine now over boost errors as it did previously.
- So final adjustment was to turn the screw back to its 1 1/4 setting to stop the over boost error. So you can see that only a slight 3-4mm turn of the screw can have such an effect.

After each test I reset the ECU by disconnecting the battery(s) for 20 minutes. Make sure you save your trip meter reading or you will lose them. This reset allows the vehicle to start back at factory defaults and re-learn its engine set up accordingly. As a matter of course I will do this every time my vehicle has been serviced at a dealer and it always performs smoother and quieter than when I receive it.

IN SUMMARY

Even performing the above adjustments does not limit your maximum boost to 10-11 PSI. Remember that at all times your boost and fuel are being determined by the ECU and it will decide how much boost you are going to get when you need it.

When I drive around town and accelerate down the street I still get boost readings up to and over 20 PSI with the occasional higher spike just like normal, as I should as it is a design characteristic of the Turbo (see Glossary on VGT).

What the above does is bring the mechanical/vacuum controlled boost VNT actuator setting down to its normal designed threshold so that while coasting along the highway you don’t over boost your engine and cause other issues along the way, like a leaky intercooler due to higher

Nissan Patrol Reference Document

than normal boosts over long periods of time, or a blown engine because your MAF has failed and the over boost just helps it fail that much sooner.

The best way to protect your engine is as a separate section in the document. So get to it, give your engine a test and see if it happens.

Just remember, these are a great engine and Nissan to its credit has been trying to engineer out any issues over time, in my own opinion, with the mix of power and economy and the fact that it needs to pull a 2500 kg vehicle around it does a great job.

If you modify your exhaust, block the EGR or both you will cause the engine to over boost, it may not boost high enough to throw a code, or even to error all the time, but it definitely will be boosting higher than designed.

ELECTRICALS

AIR BAG(S) SYSTEM - DISABLING

Thanks to TUFFGU & GQ

Always disable the air bag system when working on steering components.

Disabling the air bag system is simply a matter of turning the ignition off, disconnecting both Negative and Positive battery terminals in that order, and wait at least 3 minutes. During this time it is still possible for the air bag(s) to deploy, therefore work should not be commenced on the air bag system for at least 3 minutes.

Use extreme caution when working around the air bag system. When carrying a live air bag assembly, always carry it with the trim cover facing away from you.

When storing the air assembly on a bench, always store it with the trim cover facing up and avoid placing anything near, or on the assembly.

Note: If the steering column or steering gear has been disconnected for any reason make sure that the steering gear and then the Clock Spring are centered to avoid damage to the fine ribbon wire inside.

Nissan Patrol Reference Document

ECU FAULT CODES - GU

Adapted from forum post by TUFFGU & GQ

MANUAL EXTRACTION

1. Switch ignition ON.
2. Confirm the Check Engine Lamp illuminates.
 1. (The system will be in Diagnostic Test Mode I.)
 2. Bridge Diagnostic Connector terminals 1 and 8.
 3. Confirm the Check Engine Lamp extinguishes.
 4. Wait at least two seconds.
 5. Disconnect the bridge between Diagnostic Connector terminals 1 and 8.
 6. (The system will be in Diagnostic Test Mode II.)
 7. Read Fault Codes as flashes of the Check Engine Lamp.

Read the codes by counting the number of flashes of the Check Engine warning lamp. The code numbers are displayed as sets separated by a 2.1 second pause. Each set comprises a series of 0.6 second flashes, a 0.9 second pause and a further series of 0.3 second flashes. The first set represents the first 2 digits of the code and the second set represents the last 2 digits.

Example 1 - Code 0102 (Air Flow sensor) would be shown as one 0.6 second flash, a 0.9 second pause and two 0.3 second flashes.

Example 2 - Code 1004 (Injection Pump fuel cut out system) would be shown as ten 0.6 second flashes, a 0.9 second pause and four 0.3 second flashes.

Note: To cease retrieving codes or to read codes again, turn the ignition off and wait at least ten seconds before restarting the above procedure if necessary.

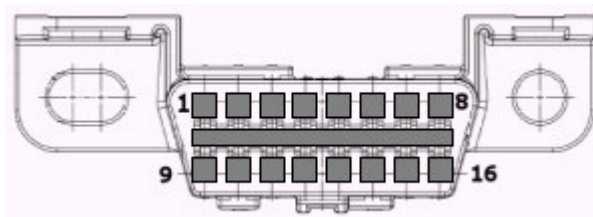

Nissan Plugs are usually white

Do not switch ignition off during this procedure or the system returns to Diagnostic Test Mode I.

FAULT CODE TABLE

Code # Circuit and Status

0102 Mass Air Flow Sensor
Circuit, Sensor or ECM failure

0103 Engine Coolant Temperature Sensor
(excessively high or low voltage at ECM)
Circuit, Sensor or ECM failure

0104 Vehicle Speed Sensor
(signal not sent when vehicle is in motion)

Nissan Patrol Reference Document

Circuit, Sensor or ECM failure

0203 Accelerator Position Switch (incorrect signal sent to ECM)
Accelerator Position Switch fault or ECM failure

0208 Overheating Fault
Cooling Fan system failure, Engine coolant re-filling procedure not followed,
Cooling system faulty, Engine lubrication problem

0301 ECM 2, failure (calculation function is malfunctioning)
Internal IC failure

0402 Fuel Temperature Sensor
(incorrect signal for fuel temperature received)
Refer to Injection Pump Control Unit
Circuit, Sensor or ECM failure

0403 Accelerator Position Sensor
(out of range signal received from sensor or switch assembly)
Circuit malfunction, Accelerator Position Sensor failure,
Accelerator Pedal Dual Contact Position Switch failure, ECM failure

0406 INT/AIR volume (excessively high signal from Mass Air Flow Sensor)
Air Duct, Charge Air cooler, Variable Nozzle Turbo Charger Control System,
Variable Nozzle Turbo Charger, Mass Air Flow Sensor failure, Circuit malfunction

0407 Crankshaft Position Sensor
Circuit, Sensor or ECM failure

0502 Battery voltage (excessively high voltage sent to battery)
Incorrect jump starting, Battery, Alternator, ECM

0504 Automatic Transmission Communication Line
(ECM receives incorrect voltage from Transmission ECM)
Circuit malfunction, Automatic Transmission ECM

0505 No faults detected
Monitored circuits are operating normally

0701 Camshaft Position Sensor
(incorrect signal from the Injection Pump Control Unit)
Refer to Injection Pump Control Unit
Circuit malfunction, Injection Pump Control Unit

0702 Top Dead Centre Pulse Signal
(incorrect signal from the Injection Pump Control Unit)

Refer to Injection Pump Control Unit
Circuit malfunction, Injection Pump Control Unit

0703 Pump Communication Line
(incorrect signal from the Injection Pump Control Unit)
Refer to Injection Pump Control Unit
Circuit malfunction, Injection Pump Control Unit

0704 Spill Valve Circuit

Nissan Patrol Reference Document

Circuit malfunction, Injection Pump Control Unit

0705 Pump Control Module

Circuit malfunction, Injection Pump Control Unit failure

0706 Spill Valve

Circuit malfunction, Spill Valve, Injection Pump Control Unit

0707 Fuel Injection Timing Control System

Circuit malfunction, Injection Pump Control Unit failure, Poor fuel quality

0802 Barometric Pressure Sensor (built into the ECM)

Internal circuit malfunction, ECM failure

0804 ECM internal input signal processing function malfunctioning

ECM failure

0807 Brake Light Switch

Circuit malfunction, Switch failure

0901 ECM Failure (calculation function is malfunctioning)

Internal IC failure

0902 ECM Relay (incorrect voltage received by the ECM from the relay)

Main Relay malfunction, Circuit malfunction

0903 ECM Internal input signal processing function malfunctioning

ECM failure

0905 Turbo Pressure

Circuit malfunction, Charge Air Pressure Sensor failure

1003 EGR Volume Control Valve

Circuit malfunction, EGR Volume Control Valve failure

1004 Fuel Cut System

Circuit malfunction, Injection Pump Control Unit failure, ECM failure

1401 to

1408 Nissan Anti Theft System

Refer to Anti Theft system information

CLEARING FAULT CODES

1. After reading the fault codes as described, reconnect the wire bridging terminals 8 (IGN) and 1 (CHK) while the ignition is still on.

2. Wait at least two seconds and then remove the wire bridging the terminals. Any stored codes should now be erased.

Note: Fault codes are also erased if the battery is disconnected for more than 24 hours.

3. Road test the vehicle and check that there are no fault codes stored.

Nissan Patrol Reference Document

KEY IN IGNITION ALARM

Adapted from forum post by TUFFGU & GQ

This is so simple to do!

1. Remove steering column shroud

- 3 screws.
- Remove key surround.
- With a small screwdriver, gently force the two shroud sections apart.

Insert the screwdriver where the two (2) stalks enter the shroud. Only the bottom section of shroud has to be removed fully.

2. On top of the key cylinder 2 wires exit with black tube wrap, going to a white (4.2 li) or brown (3.0 li) plug. This plugs into a socket which is wrapped in foam around the black wiring loom. JUST UNPLUG IT!

3. Replace the shroud.

4. Enjoy the silence.

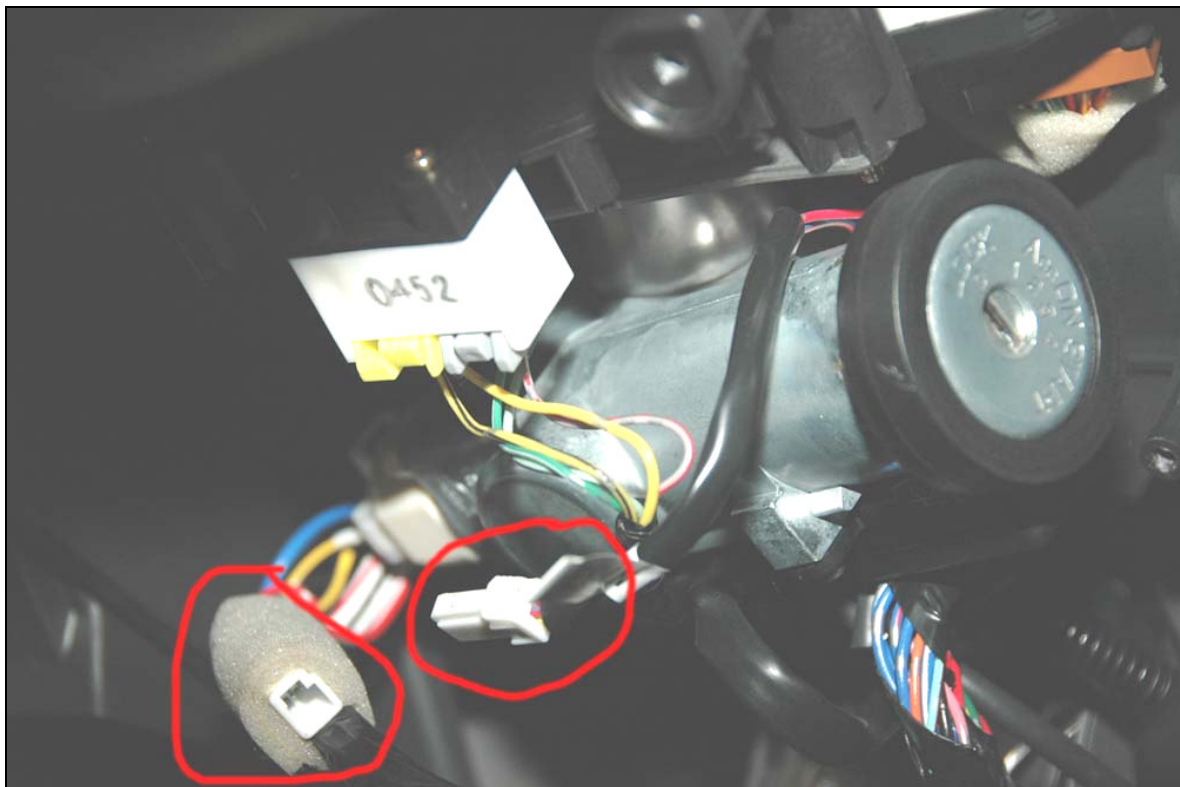
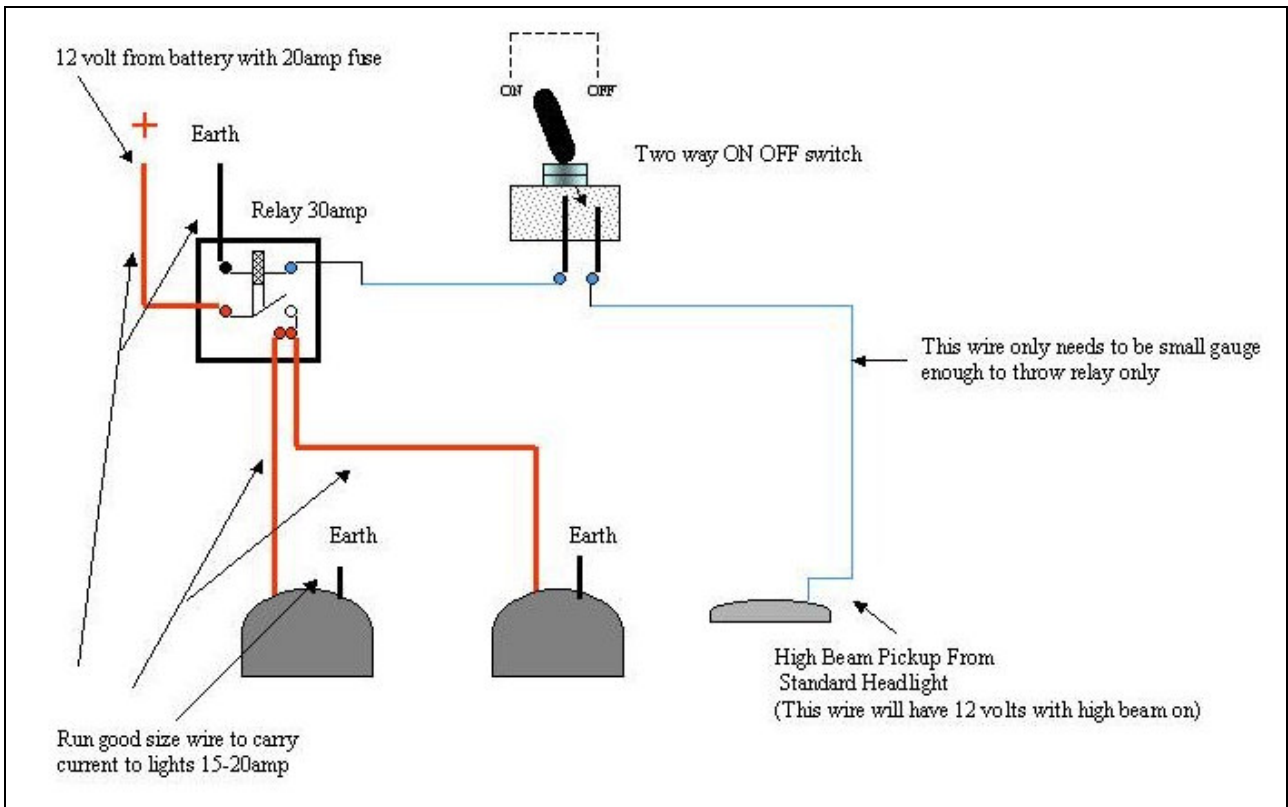

DIAGRAM OF 4.2 LITRE CONNECTOR THAT HAS BEEN UNPLUGGED

Nissan Patrol Reference Document

SPOT LIGHT WIRING DIAGRAM

Thanks BIGGQ



Nissan Patrol Reference Document

STEREO WIRING DIAGRAMS

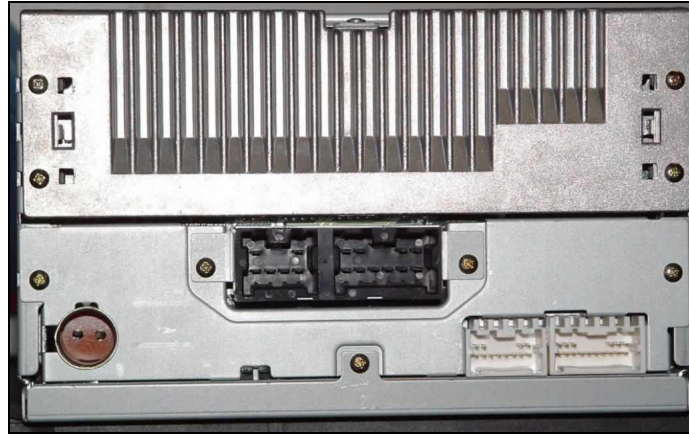

Rear view of Nissan stereo from a 2005 model Patrol

Up To 1985-1994



Pin	What It Is	Typical Nissan In Dash Wire Color	Typical New Radio Equivalent Wire Color
A	+12 Volt Ignition Wire	Blue	Red
B		<i>Do Not Use</i>	
C	Ground Wire	metal brackets on radio	Black
D		<i>Do Not Use</i>	
E	+12 Volt Battery Wire	Red w/ Black Stripe	Yellow
F	Right Front Speaker (+)	Brown	Gray
G	Left Front Speaker (+)	Blue w/ White Stripe	White
H	Power Antenna Turn On		Blue
I	Right Front Speaker (-)	Brown w/ White Stripe	Gray w/ Black Stripe
J	Left Front Speaker (-)	Blue w/ Yellow Stripe	White w/ Black Stripe
K	Right Rear Speaker (+)	Blue	Purple
L	Left Rear Speaker (+)	Red	Green
M	Factory Amp Turn On	Lite Green	Blue Power Antenna Wire
N	Right Rear Speaker (-)	Pink	Purple w/ Black Stripe
O	Left Rear Speaker (-)	Dark Green	Green w/ Black Stripe
P		<i>Do Not Use</i>	

1995 And Newer

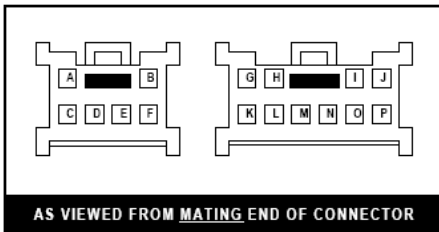

Pin	What It Is	Typical Nissan In Dash Wire Color	Typical New Radio Equivalent Wire Color
A	Right Rear Speaker (+)	Gray	Purple
B	Amplifier Turn On Wire		Blue or Blue w/ White
C	Right Rear Speaker (-)	Gray w/ Red Stripe	Purple w/ Black Stripe
D	Left Rear Speaker (+)	Orange	Green
E	Left Rear Speaker (-)	Black w/ Pink Stripe	Green w/ Black Stripe
F	Amp Ground Wire	(connect this wire to the radios ground wire)	
G	+12 Volt Ignition Wire	Blue	Red
H		<i>Do Not Use</i>	
I	Right Front Speaker (+)	Brown	Gray
J	Left Front Speaker (+)	Purple	White
K	Ground Wire (if available)	metal brackets on radio	Black
L		<i>Do Not Use</i>	
M	+12 Volt Battery Wire	Pink	Yellow
N	Power Antenna Wire		Blue
O	Right Front Speaker (-)	Brown w/ White Stripe	Gray w/ Black Stripe
P	Left Front Speaker (-)	Green w/ Yellow Stripe	White w/ Black Stripe

Note: using an optional snap on wire harness adapter will simplify the wiring. Most snap on wire harness adapters have already converted and color coded the wires from the auto makers in dash wire harness to match typical aftermarket radio wire colors.

** The wire colors listed in the chart above are typical for these vehicles during these years but may not be the exact colors for this vehicle. This is another reason to use a snap on wire harness adapter. **

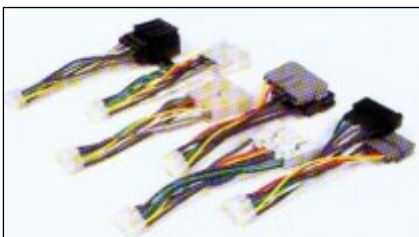

As I replaced my original Nissan stereo with an Alpine unit an adapter was required. There are a few companies out there who make pre wired adapters to go from your Nissan wiring loom to a compatible connector for the back of your new stereo. Just keep this in mind. Most good stereo shops and installers can get these for you.

MAINTENANCE

MAINTAINING YOUR TYRES

TYRE INFLATION

Proper tyre inflation is a key ingredient in driving safety and long tyre life. It is wise to check your tyre's inflation at least once a month with an accurate tyre pressure gauge. Continuous loss of inflation pressure is an indication of a possible tyre/wheel assembly problem; consult your tyre professional immediately if you encounter this situation. Be sure to check the pressure while the tyres are cold, and have not been used recently. If you drive even a mile this will cause your tyre pressure to increase and give you an inaccurate reading.

CHECKING TYRE TREAD

All passenger, light truck, and medium commercial tyres have tread wear indicator bars moulded into the tread. These bars are located at the bottoms of the tread grooves in several locations around the tyre, and when the tyre is worn to the point where any of them become visibly flush with the adjacent tread ribs, it is time to replace the tyre. Proper tread depth is essential for proper tyre performance. If you notice a loss or change in wet traction, you may not have enough tread left on your tyres. Once the tread depth reaches 2-3 mm it must be replaced.

WEAR ON BOTH EDGES: UNDER INFLATION

If a tyre looks like this, it may be under inflated. The worst enemy a tyre can have is too little inflation pressure. Under inflation reduces tread life through increased tread wear on the outside edges (or shoulders) of the tyre. It also generates excessive heat which reduces tyre durability. Finally, it reduces fuel economy through increased rolling resistance (soft tyres makes your vehicle work harder). Check your tyres regularly for proper inflation. Abnormal tyre wear may also be due to misalignment or mechanical problems.

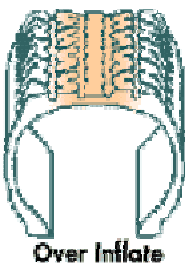
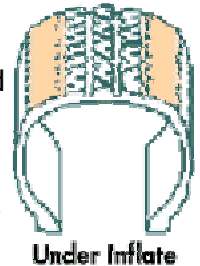

WEAR IN CENTRE: OVER INFLATION

When a tyre is over inflated, the centre of the tread bears most of the load and wears out faster than the outside edges. Uneven wear reduces the useful life of a tyre. Check your tyres regularly for proper inflation. Abnormal tyre wear may also be due to misalignment or mechanical problems.

CUPS OR DIPS IN THE TREAD: WORN PARTS

Cupping (also called dipping or scalloping) is most common on front tyres, though rear tyres can cup as well. It may be a sign that wheels are out of balance or that suspension or steering system parts are worn out.

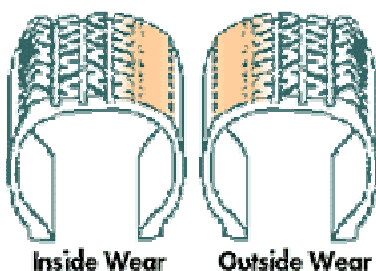
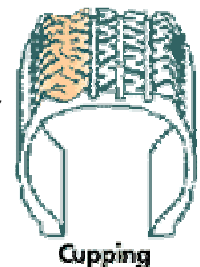

SAWTOOTH EDGES: MISALIGNMENT

Do the edges of the tread take on a sawtooth or feathered appearance? This is caused by erratic scrubbing against the road. The solution is toe-in or toe-out alignment correction.

Nissan Patrol Reference Document

TYRE BALANCING

Unbalanced tyres cause vibration, which can lead to driver fatigue, premature/irregular tyre wear, and unnecessary wear to your vehicle's suspension. Your tyres should be balanced when they are mounted on wheels for the first time or when they are remounted after repair. Tyre balance should be checked at the first sign of a vibration or shimmy.

VEHICLE ALIGNMENT

A vehicle is properly aligned when all suspension and steering components are sound and when the tyre and wheel assemblies are running straight and true. If you notice uneven tread wear this could be due to a misalignment and must be serviced by a professional.

TYRE ROTATION

While many people are capable of rotating their own tyres, it is quick and easy to let a professional do it for you. Your vehicle's owner's manual will specify the proper rotation pattern and schedule for your vehicle. If there is no specific schedule specified a good rule of thumb is to rotate your tyres every 5,000 to 10,000 kilometres'.

REPAIRING TYRES

Tyre repairs should be made by a trained tyre professional. Proper repair procedure will include dismounting the tyre from the wheel for a thorough inspection to check for damage, and the use of a patch and plug to repair any punctures that fall within the limits and guidelines for repair.

Nissan Patrol Reference Document

MECHANICAL

5TH GEAR FAILURE GU

From Outer Limits - raptorthumper

I thought I would post pics of the new parts available for GU 5 speed boxes, that are much stronger. I believe both series 1 and 2 GU's are affected. No more failed 5th gears.

Parts are available from Nissan for \$513 approx but you can get a better price if you have a good relationship with dealer. Nissan acknowledge the problem.

I have heard any between 1999 and end of 2002 may be prone to this. I think it is not so much a manufacturing defect than a design issue. These boxes have been around since the early 4.2's and those engines only had about 250nm of torque. The 3.0 has around 350nm and so do the turbo 4.2's, so they have a lot more ability to twist the splines in overdrive and this seems to be what is happening. The later boxes have a longer spline for the 5th gear. Just my thoughts.

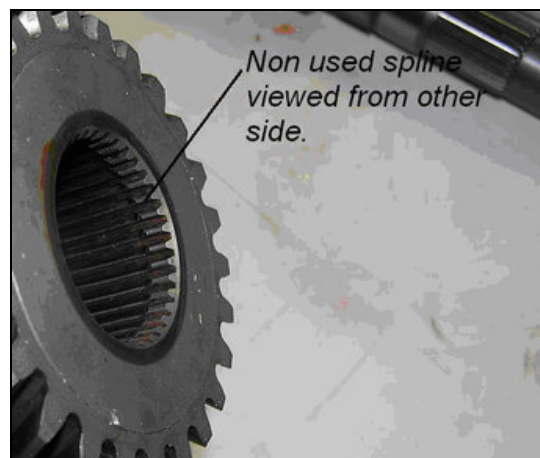
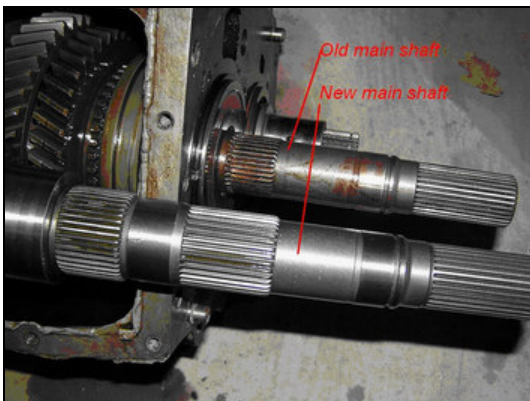

Nissan Patrol Reference Document

BELT TENSIONERS ZD30

By dirty wheels

Like all belt tensioners mine was a bit noisy after over 200,000K on the truck. I was less than impressed with the \$ required by Mr Nissan for the 'genuine' replacement.

So if you're a ZD30 owner here is how to replace the tensioner bearing for \$45.00. NB Mr Nissan.

Remove the belt by loosening the tensioner as per the workshop manual.

Remove the tensioner from the truck (two bolts)

Dismantle the tensioner arrangement (1 bolt)

Place tensioner pulley and mounting in a vice and remove the bearing axle. This requires a special torque spanner. Mine cost \$25.00. (1st outlay)

Press the noisy bearing out of the pulley. I used 2 sockets of the right size and just a decent bench vice.

Buy the correct bearing.

Here is the catch as most bearings are the wrong depth, but NTN bearing number WC87503 is the OE article and cost \$20.00 (second outlay).

Once you give them the NTN number most parts places can source these bearings.

Press the new bearing into the pulley. Re assemble the whole tensioner. install the belt correctly, radiator shrouds etc etc.

and VOILA!! no more belt tensioner noise for \$45.00 and a Saturday morning's work.

Nissan Patrol Reference Document

EXHAUST GAS RETICULATION SYSTEM (EGR)

This document also explains how to block the EGR on the ZD30 engine (thanks to the French again) only I have translated into plain English to make it a little easier. Why block the EGR, for these reasons (I'm sure there are more);

- Less heat into the engine (may save those pistons number 3 & 4),
- Far less soot to block up the intake (a couple of members from the Patrol forum had posted the below pictures of their blockages, according to a Nissan mechanic by 85,000 klms it is already too late),



In case you can not read the text it states;
“Carbon buildup (totally blocked, soot with toasty oil @ 85,000 klms)”

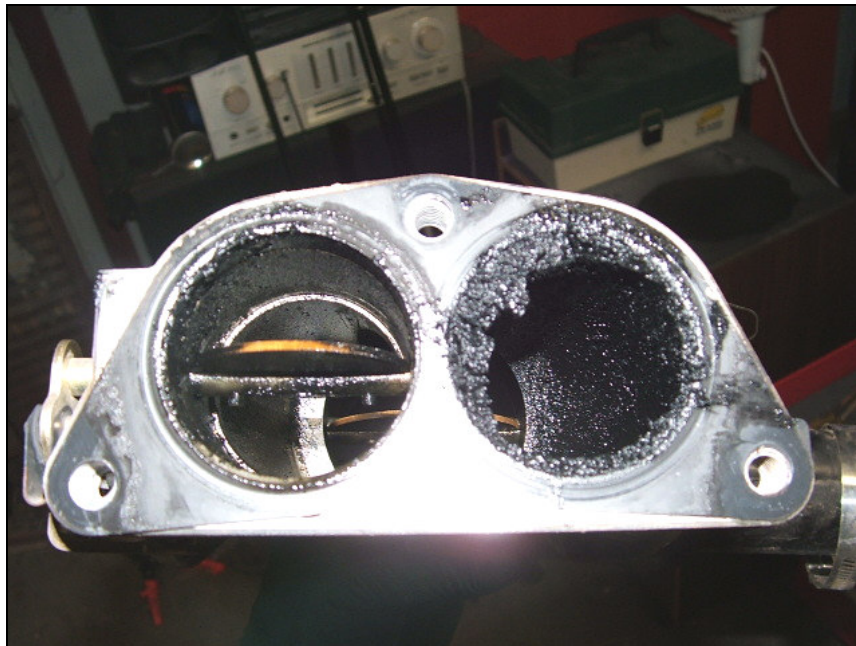

Another picture of an intake from a forum member who decided to do his glow plugs, he wasn't expecting this I don't think.

Nissan Patrol Reference Document

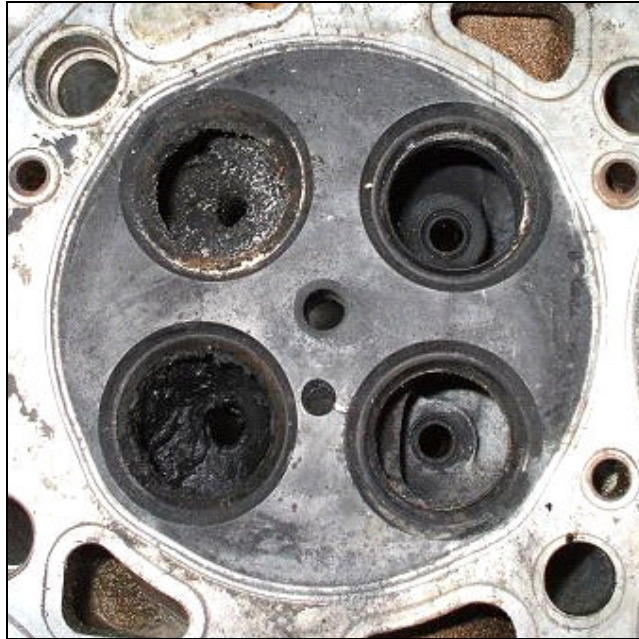

A picture of a cylinder head from a forum member (GUHOON) notice how carboned up the two left ports are.

- Less soot into the engine means cleaner oil, after 7,500 klms my oil only has a slight dark tinge, not totally black and sooted like before. This will save the engine and turbo from abrasion fouling and pre-mature wear, as the soot needs to stick somewhere, and
- No pre burnt exhaust gas means better combustion and less black smoke out of the exhaust.

What you will find is that after you block the EGR your exhaust gases will seem hotter than before because some of that super heated exhaust gas is not being redirected back into the engine, it is going where it should, out of the exhaust pipe. If you have an EGT gauge the exhaust temperatures may increase by around 50c.

The newer ZD30CRD engine has a EGR cooler (looks like its borrowed from a 4.2 Diesel 2005 model and up) just like the European models (why remove it for Australia?) where the gas first flows through a heat exchange device to cool the gases some what before being forced into the engine. Although it does this it is still introducing spent exhaust gases into the engine, all the Diesel mechanics I have spoken too agree that the EGRs on Diesel engines should all be blocked as the EGR is simply there for emissions control not engine performance and longevity. Be aware that it may be illegal to block the EGR in your country, state or territory.

There have been cases where the EGR valve gets locked/jammed open and the EGR gases are constantly flowing into the engine rather than being metered by the ECU, not a good thing.

And I have been told by a Nissan representative and performance exhaust specialist that fits Diesel performance modules that sometimes they will have a strange problem with getting one of these engines running smoothly so they block the EGR to fix.

Nissan Patrol Reference Document

EGR BLOCKING - How To

PRINCIPLE

To insert the plate you will need to loosen 3 x 12 mm bolts (2 on the upper intake, 1 on the lower EGR support bracket (Ecroû de 12) and remove 2 x 14 mm bolts on the lower EGR tube (Ecroû de 14) as shown below.

Then the adjustment screw that controls the turbo vanes, hereby called the VNT screw, to open to their maximum will need to be adjusted to stop the engine from producing too much boost. Keep referring to the below diagram while you are doing the work. For a full technical diagram of the EGR go to the end of this section.

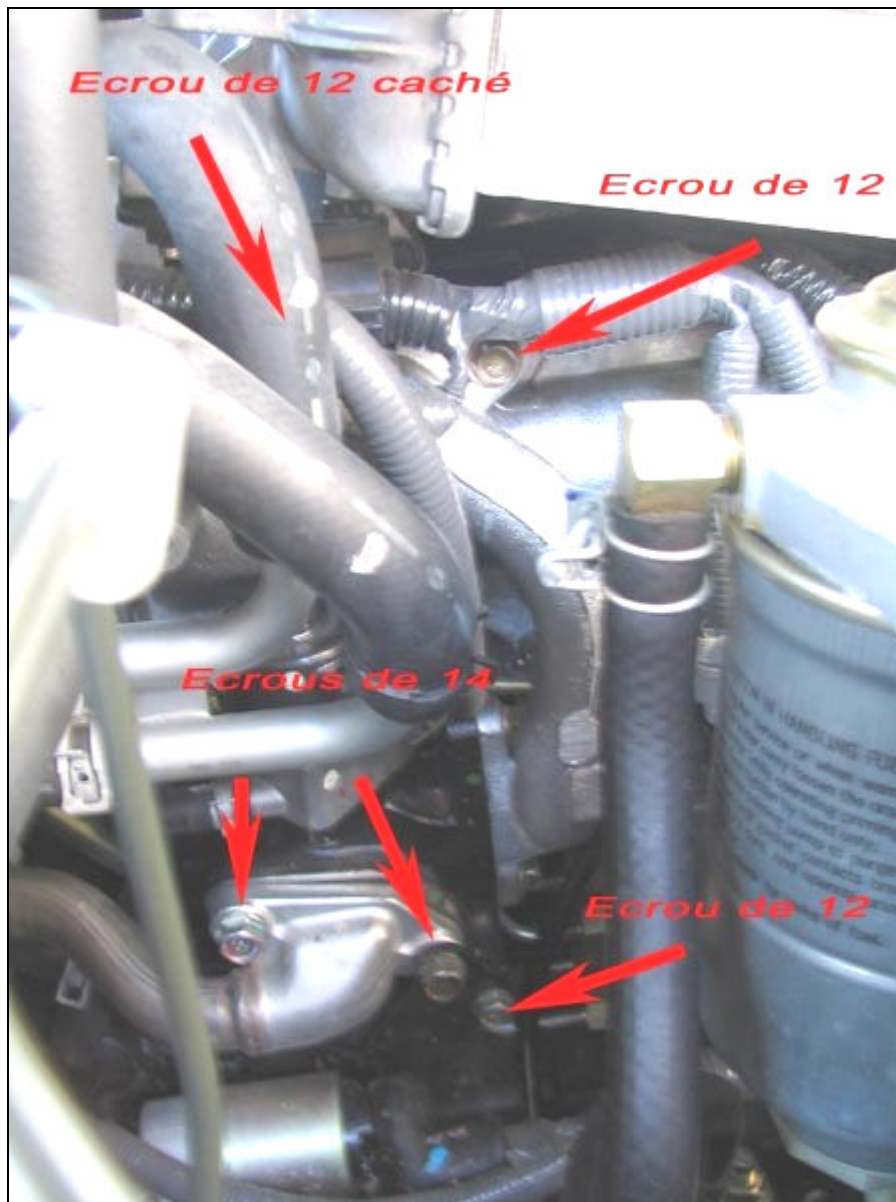

TOOLS

1. Ratchet spanner
 - a. Extension bar from 10 to 20 cm
 - b. Sockets 12 and 14 mm
2. Torque wrench or hand
3. A sheet of mild steel 1-2 + mm thick
4. Tin/metal cutters or a small grinding machine

Nissan Patrol Reference Document

5. 8 and 10mm ring spanners
6. 2.5mm crochet hook or similar. I used a small screw driver

DISASSEMBLING

1. Let the engine cool, that EGR pipe and turbo gets very hot.
2. Remove the intercooler/engine cover for more visibility (you can do without removing but you will see better without it).
3. Loosen the upper bolts (12 mm) without removing them completely, half way out is OK.
4. Loosen the lower 12 mm bolt that is connected to the right hand 14mm bolt bracket, about half way out.
5. Completely unscrew the 14 mm screws (Ecrous de 14) and remove. Make sure you notice which bolt goes where, one is slightly longer (right side).
6. Move the valve housing by moving it back, there is a copper gasket in there, remove the gasket
7. Use the gasket as a template to make the blocking plate.
8. The thinner the plate the better as it will end up with a flusher seal when installed.

TO REASSEMBLE

1. Install the plate and reinsert the 14 mm bolts. The longer bolt goes in the right hand hole.

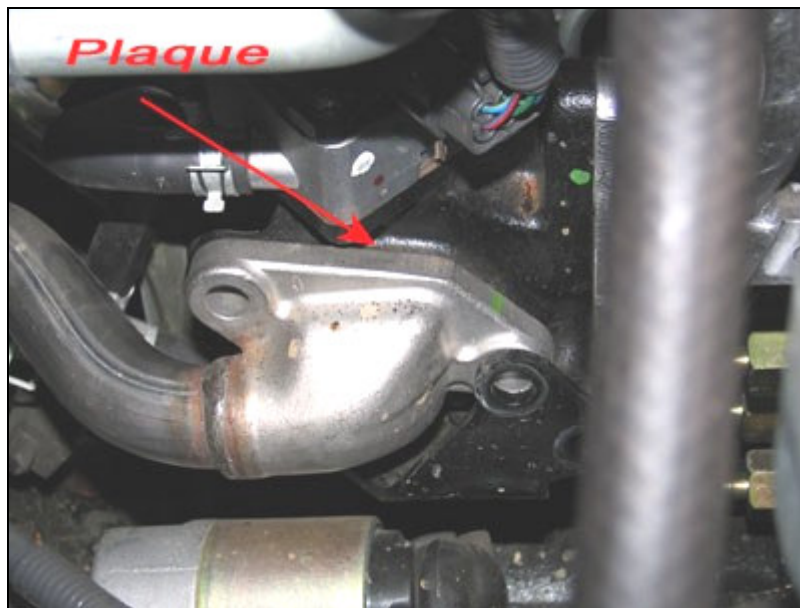

2. Finger tighten the bolts until they are all the way in.
3. Tighten both the upper 12 mm bolts to 2,5 - 2,9 n.m of torque.
4. Tighten the lower 12 mm bolt to 2,5 - 2,9 n.m of torque.
5. Tighten both the 14 mm bolts to 5,2 - 5,9 n.m torque.
6. The plate is now fixed and the EGR is blocked just before the EGR valve which is placed slightly above the port. The valve will happily open and close as it is told by the ECU.

Make sure you check out the section on testing for over boost issues, this should be done immediately after you block the EGR. If you have the issue go to the VNT adjustment section to fix.

Nissan Patrol Reference Document

EGR TECHNICAL DIAGRAM

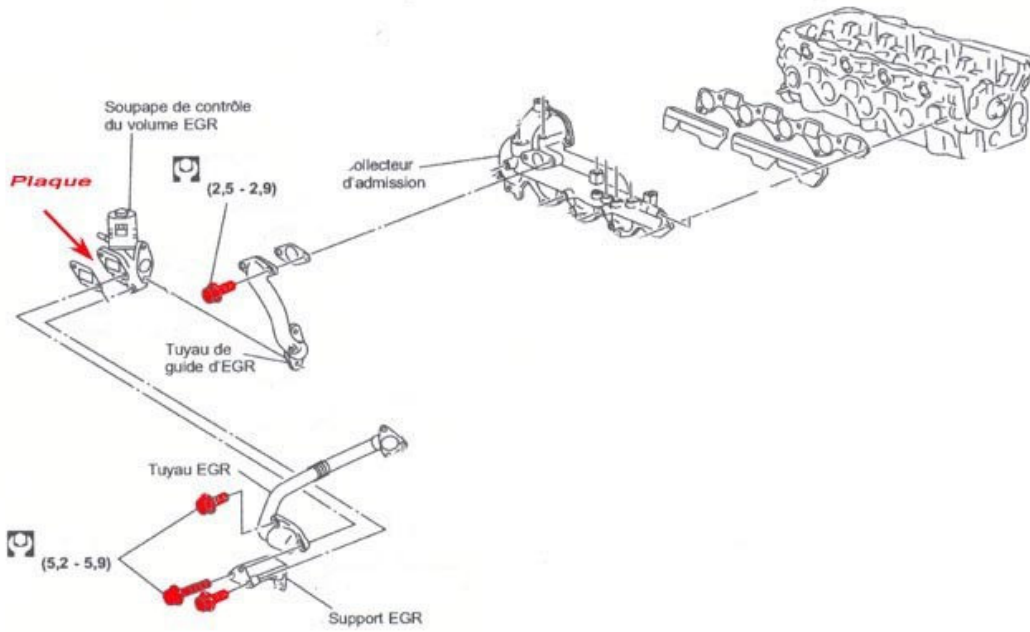

Nissan Patrol Reference Document

EARTHING ISSUES

Most of us with ZD3.0's will notice that you can start getting electrical problems over the years. In my case it was within the first 6 months when the cruise control started resetting itself.

There are a multitude of problems that can be fixed with this additional strap. With GU4 2005 model the Nissan dealers will put an additional earthing strap from the body of the vehicle to the chassis. Unfortunately my dealer did not remove the rust proofing bitumen first so it never had a good contact to the metal chassis.

Earthing straps pre made with connectors already crimped can be obtained from just about any auto store. They range in cost from \$10 - \$20 so it's a cheap fix.

Has been known to fix the following issues, but is not limited to;

- Cruise control reset
- Keyless remote not working properly or at all
- Sub tank light coming on for no reason
- Radio reception greatly improved
- Dimming head lights when motor slows down
- Instrument cluster issues

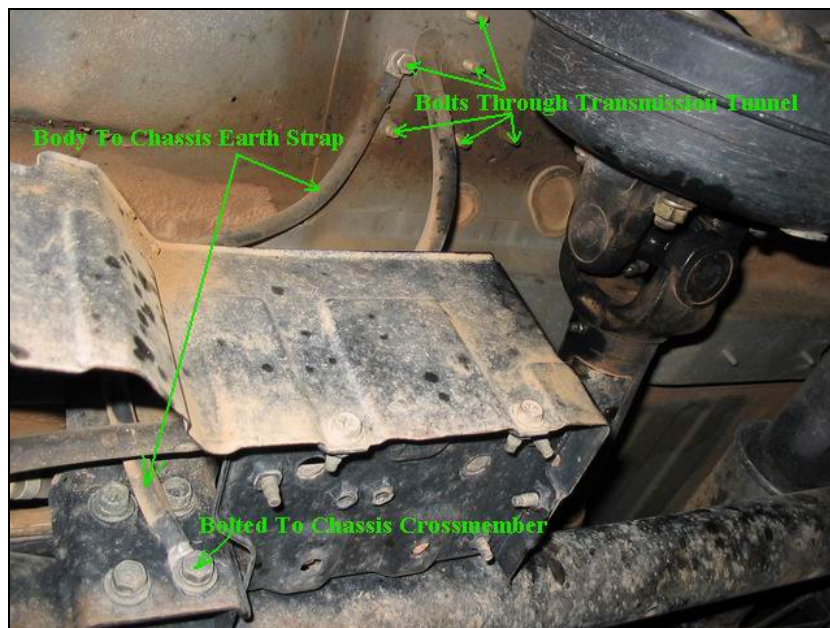

Heres one a forum member (chaz) did earlier

The ZD3.0 is particularly sensitive to current drawer so you should always clean your battery terminals. Some think its because it has more electronics than the 4.2.

Nissan Patrol Reference Document

FLAT MIRROR ON GU4 (NON CONVEX)

By nrb1748 & Fatcatsam

I had problems when towing our caravan with the conflicting images from the standard (convex) mirror and the flat towing mirror.

I had mine changed to the flat mirror by my local Nissan Dealer so I can't assist with difficulty. Cost was about \$60. The Part No. is 96365-VB111 drivers side flat glass from a series 1, 2, 3, but it is interchangeable with the series 4, 5 even though it is not listed as such.

I still have the original mirror and there are a couple of plastic clips on the back of the mirror towards the bottom that possibly clip into a frame.

If you turn the mirror all the way in, you can see the internals of the mirror.

You have to slide a flathead screwdriver to release the lock; the mirror will slide upwards and out.

Most probably easier to get your nissan dealer to change it.

Nissan Patrol Reference Document

FREE WHEELING HUB DIAGRAMS- MANUAL

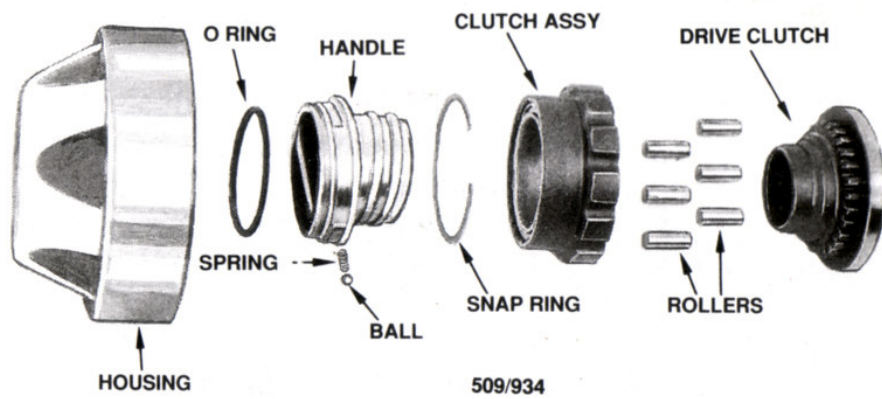

Manual free wheeling hub components.

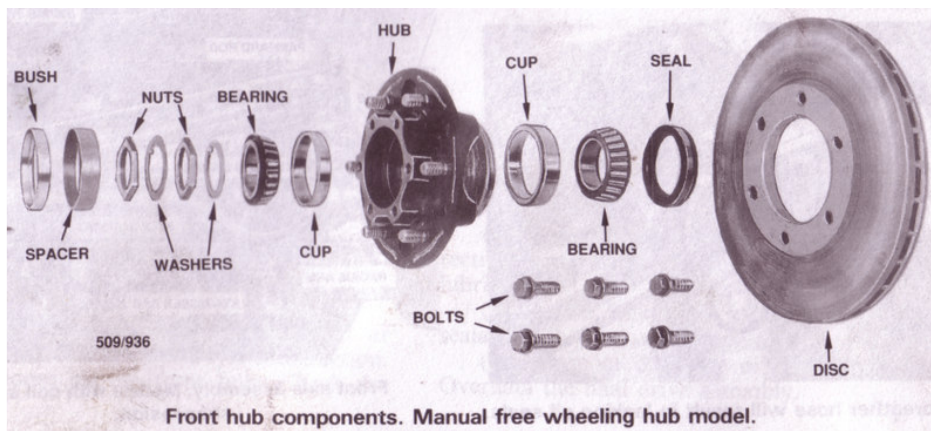

Front hub components. Manual free wheeling hub model.

Nissan Patrol Reference Document

KEYLESS REMOTE - REPROGRAMMING

Heres how it's done:

1. Get in your vehicle and close all the doors.
2. Using your drivers lock button, lock all doors.
3. After doors are locked take your ignition key and insert it and remove it from ignition switch approximately 6 times within a 10 second period a reasonably quick way. Make sure the key is all the way out before inserting again.
4. The hazard lights should flash and the doors will unlock.
5. Re-lock the doors using the drivers lock button.
6. Put the key in ignition switch and turn to the on position. Do not start the engine or you will have to start again.
7. When in the on position hit the lock button on the remote, one time, the hazard lights should flash.
8. Turn the ignition off and remove the key, open the drivers door and close, then test the key.

Note: You will have to reprogram all your remotes at once, if you do not your old remotes will not work. If you have other remotes press their buttons within 7 seconds of the first one.

Nissan Patrol Reference Document

OIL CATCH CAN - HOW TO MAKE YOUR OWN AND INSTALL

Well there has been a lot of talk about whether to install a catch can or not. In the maintenance section you will see a piece on this so yes I think it is required and so I have made one myself.

The initial design had an oil level tube in it but I saw this as unnecessary and just another place to seal and be a possible cause for leaks. I intend draining it every 5000klms anyway so there should be hardly any oil in it, I estimate approx. 100ml.

Why make it I hear you say? Simple, I could not find one to buy that I considered having a suitable baffle to catch as much oil mist as possible. The only other option was to make one. All up after I managed to work out a design and buy all the bits, taking my time, it only took 1.5 hours to finish this includes the time to paint it. It is also cheap when you add up the costs.



HOW TO DO IT



Most of the bits I needed and used (full list at end of section)

Firstly I cut a piece of PVC pipe down to a length of 200mm (20cm), As I was building the can I found this to be too long and shortened to 150mm (15cm) which seems to be the ideal length. At this size and the baffle I used can hold approx. 250ml of oil before reaching the bottom of the baffle. So you will notice that the pipe suddenly gets shorter at one point during the build.



After cutting to length I sanded the tube and end caps ready for painting. Is much easier to do before assembling.

Nissan Patrol Reference Document

I then cut the baffle to size. The Filter I bought was an oil compatible one that is of an open foam design. Open foam meaning that if you hold it up to the light you can see light through it. I cut the filter to allow the biggest possible baffle surface area.



After cutting the foam I glued one of the end caps on using the pipe glue and drilled a hole to accept the drain plug. At this point I also trimmed the pipe down to 150mm.



I then, using high temp gasket silicon, screwed and glued the brass oil drain sleeve into the hole. As the plastic is quite thick it seals very well and the threaded plug cut its own thread through the pipe.



Nissan Patrol Reference Document

While the glues were setting I then moved onto the remaining end cap to drill the holes for the in and out pipes. To do this I simply put an off cut piece of PVC pipe into the end cap and drilled from the inside out. That way the thickness of the PVC pipe is taken into account and will not obstruct the holes. I then tested the fit for the connectors and allowed each fitting to cut its own tread through the hole.



Then it was time to look at the baffle. Use an off cut of pipe to gauge how large a curve you would need to allow the out fitting to clear the baffle separator.



Then cut a piece of pipe to that curve and made sure it was the same length as the baffle foam.



Nissan Patrol Reference Document

Trim the baffle foam to be around the shape of the baffle separator, to do this I used the pipe that I cut the baffle separator from. I did this so the foam seated itself properly around the baffle separator so there would be no gap down either side to suck the oil mist past the foam.



Test the whole arrangement to make sure it will fit OK and seals well prior to glueing.



Then glue the baffle separator and foam in using the silicon. With the foam I simply wiped a fair bit of the silicon about finger thickness wide down where the top of the arch is and on each side. I then compressed the foam pushed it in and allowed it to expand on to the silicon. Also I pushed the foam in so there was a gap at the top giving more foam surface area for the oil mist to initially condense on to (picture of this further down).



Nissan Patrol Reference Document

Time to test the clearance. I put the end cap on and made sure that the fittings would clear and not fowl the baffle separator.



Now time to assemble. After smothering the top of the can with plenty of silicon, to make sure it has a good internal seal, I pressed the end cap on and wiped off any extra silicon pushed out around the edges (because paint does not stick to silicon all that well).



Nissan Patrol Reference Document

Now what? Time to finish the last bits. I engraved each connector with a marker, as in an I (In) and O (Out). I then used araldite to glue the connectors in place. I did this as the top connectors will need to hold the weight of the hoses possible vibrating up and down and the araldite gives a nice firm resin base to seal and stick the connector down. I did not screw the fittings all the way down either; I allowed the height of a few threads to give more surface area for the araldite to stick.



Then it was simply time to use some Teflon based sealing compound to seal in the drain plug.



Nissan Patrol Reference Document

Last and the most important were to paint and let all the glues etc dry for a few days. I chose black gloss paint for mine, simply because I already had it for my sliders, and I didn't want to draw any attention to it when installed under the bonnet. Black just makes it look like any other Nissan bit.



BITS REQUIRED AND COSTS

2	Brass Elbows from Enzed	20.13
1	Brass drain sleeve and plug (had already came with pyro gauge and boost pipe).	0.00
1	1mtr length of 65mm PVC pipe (shortest I could buy)	11.00
2	65mm End Caps	9.50
1	1.5mt Length of heater hose	13.99
1	Uni-Filter RF 405 Safari Snorkel Pod filter.	7.92
1	High pressure pipe glue (not really needed if you have some oil proof silicon).	5.50
	Total:	68.04

The silicon and Teflon sealer I had already and you only use a very small amount.

INSTALLATION

Installation is pretty straight forward. You need to make sure that the catch can is secured to something solid that will stop it from vibrating backwards and forwards. I installed mine where the locker compressor is installed at the back right hand side of the engine bay.

There is an existing bracket holding other bits on. I used a straight piece of steel and drilled some holes to make a secure anchor. The holes I drilled lined up with the holes already on that bracket; I used a few washers to lift the steel from the Nissan bracket so that the clamps had room to pass through. I then used 2 x 52-75mm clamps to hold it on to the steel (you can see the white barcode label on the clamp in the picture below).

Nissan Patrol Reference Document

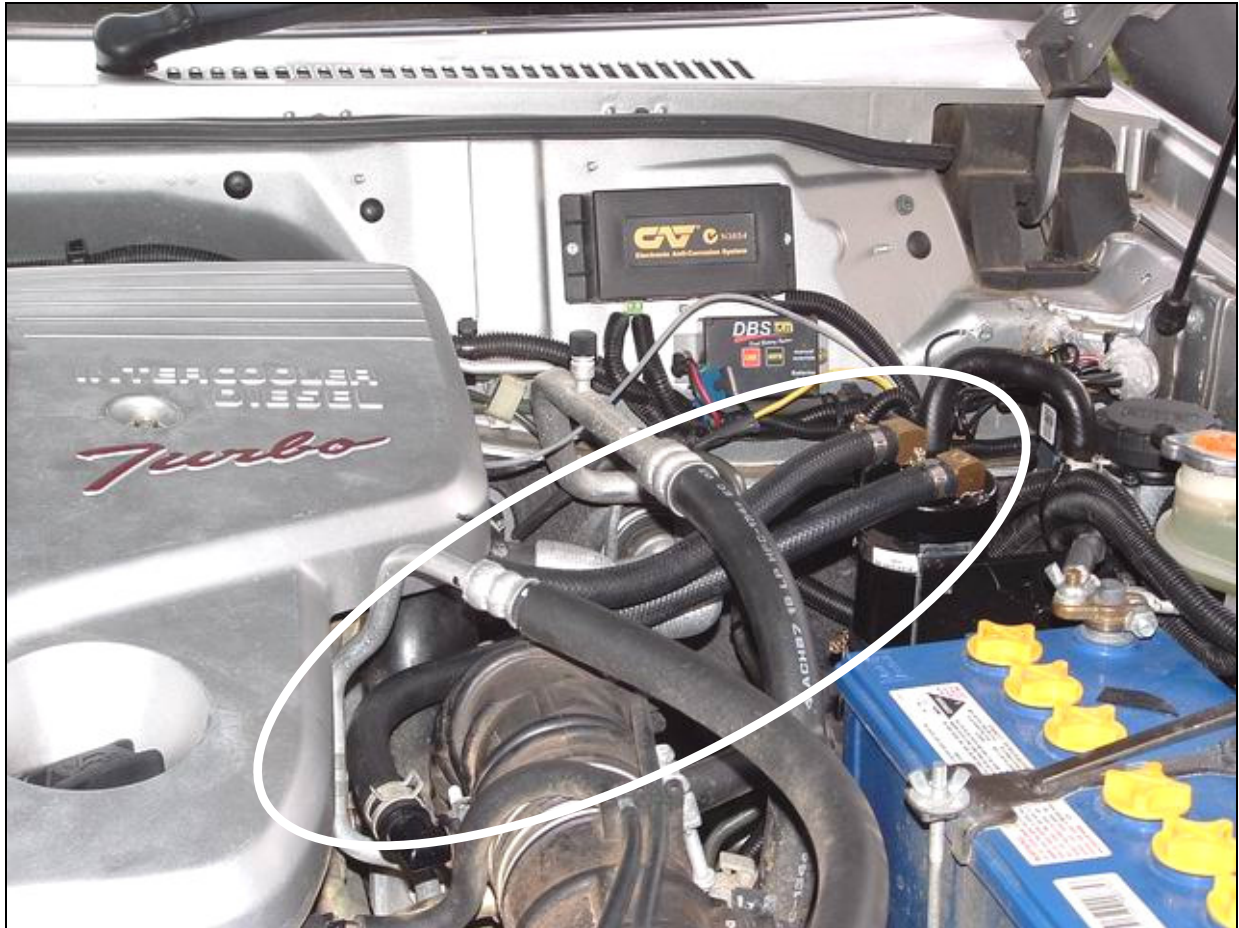

Here's the completed picture with the job circled

When connecting the hoses I removed the restrictor from the Nissan hose and installed it into the inlet hose, its there for a reason so use it.



Nissan Patrol Reference Document

When connecting the hose make sure that once the engine cover is back on it does not touch. The plastic cover vibrates a fair bit and can eventually “saw” its way through the hose.



The following pictures are some before and after shots of the install.



Before



After



After from left hand side

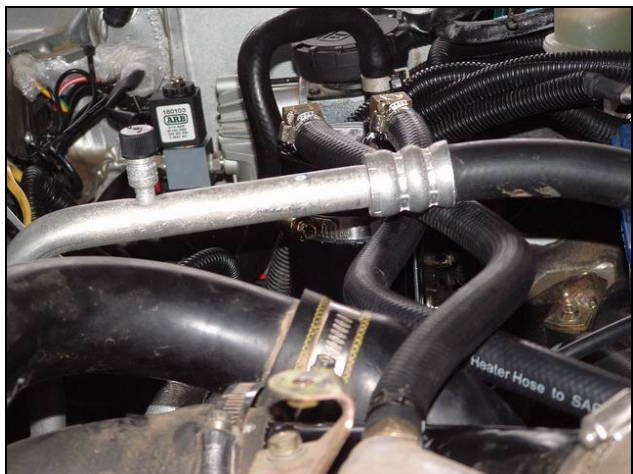

After from right hand side

Nissan Patrol Reference Document

OIL PRESSURE GAUGE SENDOR INSTALL

INTRODUCTION

This section explains how I installed an autometer electrical oil pressure sender to my ZD30 motor.

On a “newer” ZD30 there are 2 oil pressure sensors, one on the Right Hand (RH) side of the engine and another on the Left Hand (LH) side of the engine directly under the turbo. The one on the LH side may be hard to see as it has a heat shield covering it. It is actually easier to see by lying under the car and looking up at the turbo from underneath with a light.

Nissan released a bulletin on the 7 August 2003 advising that from now on there are 2 oil pressure switches on the Y61 ZD30DDTi motors. They changed the numbering so that the switches were now called oil pressure switches 1 (low) and 2 (high).

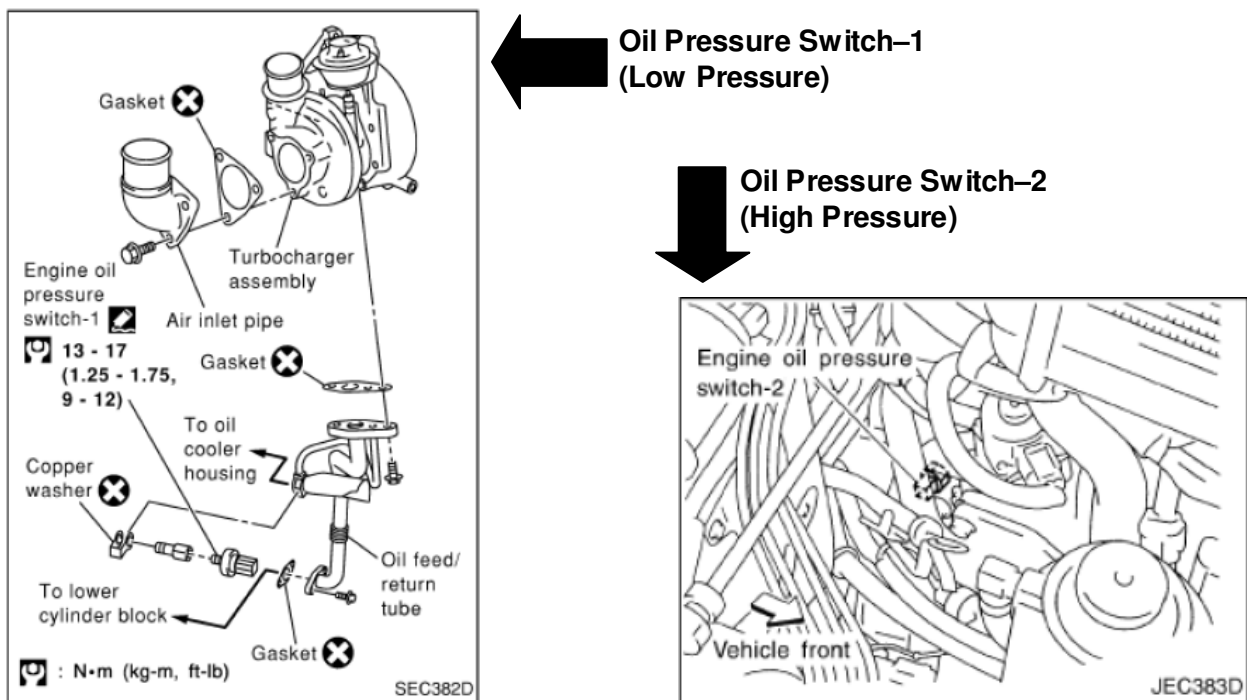

On my engine (Y61 2005 ZD30) it was not practical to use the high pressure switch location due to the very limited space available and the difficulty in getting to the switch. Upon discussion with the Nissan mechanics I was advised that they use the low pressure switch location to test oil pressure with their special gauge tool, so this is the location that I used.

The below table displays the oil pressure you should be reading at certain RPM once the oil has warmed up in the engine. Although I have my sender attached to the low oil pressure location my pressure gauge reads exactly as displayed in that table. As you can see, over 4000 RPM the oil pressure is over 100PSI, I have a 100PSI gauge so mine stops reading over this point which is OK for me as I rarely rev that high when driving and the gauge will still tell me if I have oil pressure or not.

Engine speed rpm	Approximate discharge pressure kPa (bar, kg/cm ² , psi)
Idle speed	More than 147 (1.47, 1.5, 21)
2,000	More than 539 (5.39, 5.5, 78)
4,000	More than 736 (7.36, 7.5, 107)

Oil Pressure at RPM

Nissan Patrol Reference Document

WHAT YOU WILL NEED

Firstly you will need a couple of bits and pieces to complete the job. I used:

- Teflon pink plumbing tape. The pink is the better quality and can be rated to have a heat tolerance just over 300 C.
- 26mm ring spanner to unscrew the oil pressure switch. Buy a cheapie from somewhere as I had to cut the handle down to 100mm in length as a full sized handle did not have enough clearance to turn properly. At least then you will have a custom oil pressure switch ring spanner tool. It **MUST** be a ring ended spanner as there is not enough clearance between the switch and heat shield to use the open end.

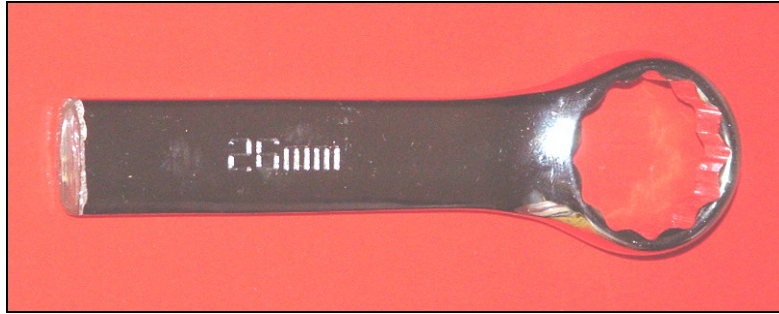

- Brass/steel adaptor that has a 1/8th NPT threads (this is what the oil pressure switch has, and my oil pressure sender had the same thread) I bought a brass adaptor from Enzed, Stock Code No.: 1/8 MRO-S described as a Male Run Tee 1/8 NPT. The picture below shows how you need 1 x male and 2 x female threads in the adaptor; a T adaptor will not fit.

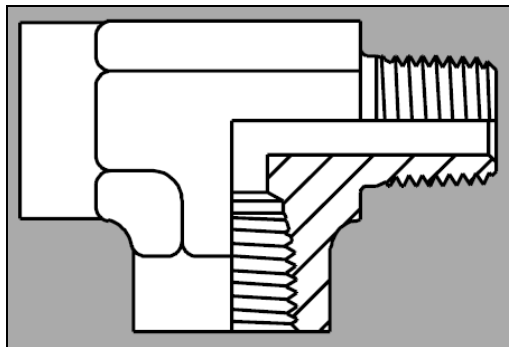

- A small mirror so that you can hold it down underneath and see what you are looking for and make sure there are no leaks etc. A make-up mirror is a good size.
- Patience is the most important thing. Just about the whole install is done via “feel” as you can not really see what you are doing.

How TO DO IT

Firstly, let the engine cool. I did mine first thing in the morning so the engine cooled down overnight and the oil had a chance to run back down into the sump.

Feel under the turbo and use the mirror for the oil pressure switch; get familiar with where the heat shield is and how the oil pressure switch is screwed horizontally into the block.

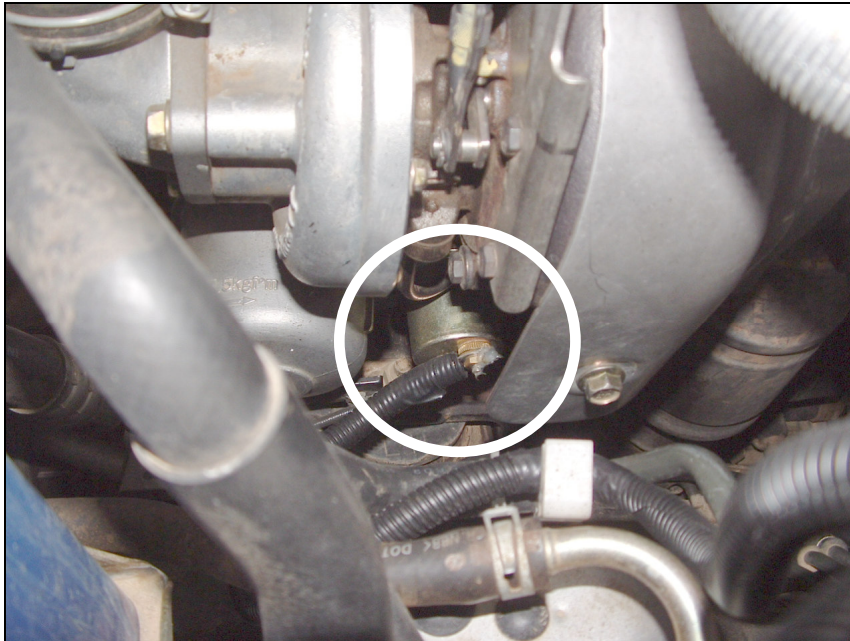

In this picture you can see the end of my oil pressure sender
this is the position of pressure switch 1.

There is a rubber boot that covers the end of the switch, you will need to pull/peel this back so you can get to the electrical clip. The clip if you feel the end has a slightly raised edge on one side, if you push this down it will release the clip and you can then pull it straight away from the switch. There is only a single wire that is attached.

Once the switch is disconnected then use your 26mm oil pressure switch tool (aka ring spanner end) to place it around the switch and turn the usual direction to unscrew. It may take a few goes to get it loose as the heat shield half circles over the switch so you can only turn a little at a time, and usually there is either some liquid sealer or Teflon tape on there already so it may be a bit tight to start with. When it is loose enough just use your fingers to finish unscrewing.

As my adapter is already installed here is a picture of one and what went where.

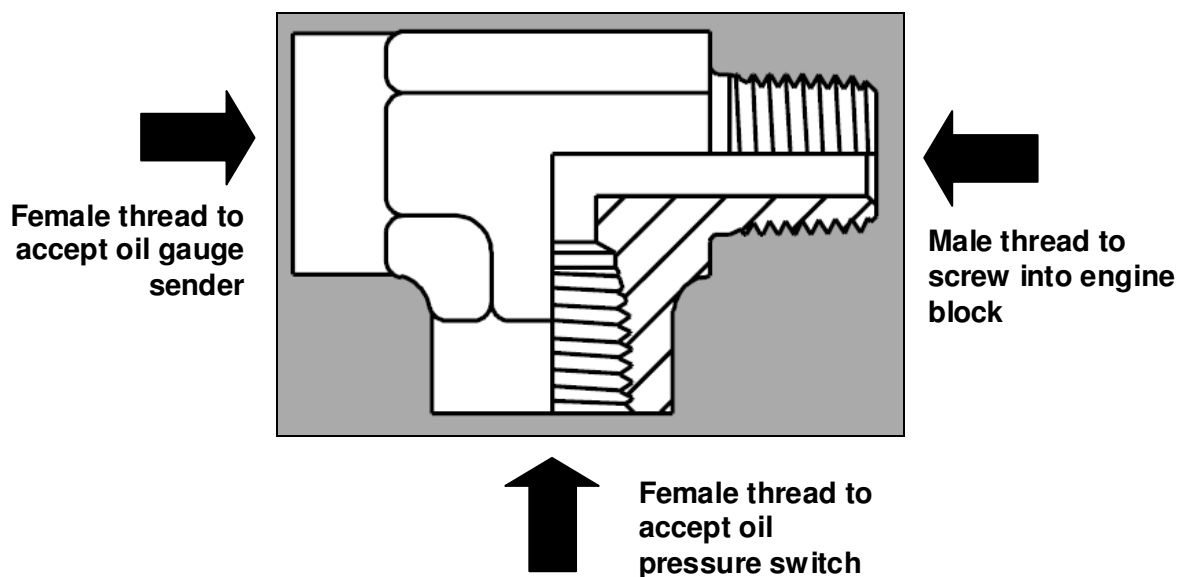

The reason the oil pressure sender is directly horizontal with the adapter is simply a size issue. The sender is much larger than the oil pressure switch and it only fitted this way on my vehicle;

Nissan Patrol Reference Document

the oil pressure switch being smaller was installed vertically under the adapter where there was room.

Now, wrap some Teflon sealer (tape or liquid sealer, I used tape) around the oil gauge sender thread and screw into the adapter so that it is nice and tight.

Then, wrap some Teflon tape around the male thread on the adapter and screw it into the motor so that when tight the remaining female thread is pointing downwards. This may take a few goes to get the amount of Teflon tape to tightness right. Also the adapter I used was square in shape so I could use an open ended spanner on an angle to tighten the adapter properly into the block. If you have an issue getting it right, remove the gauge sender and install the adapter first. If you do this make sure that when you tighten up the sender unit it does not turn the adapter a little further thereby misaligning the downward facing oil pressure switch thread.

Wrap some Teflon tape around the oil pressure switch and screw into place, use your oil pressure tool to tighten.

Note: The threads being a NPT type design mean they are very fine, so you may think that you have screwed it a fair way in when there may be plenty of thread to go. Use the mirror to check every now and then to be sure.

Once all is in and firmly tightened re-connect the oil pressure switch connector and push the rubber boot back over the connector. You may have to lengthen the wire just a bit, on mine there was plenty of play to just pull it through a little bit more.

Now after the oil pressure switch is connected (the engine won't start if it is not) start the engine and use the mirror to look for leaks. If there are none you just need to connect the gauge wire to the sender and you are done.

Nissan Patrol Reference Document

REAR BRAKE FORCE LESS DUE TO LIFT KIT - BRAKE PROPORTIONING VALVE

If you have lifted your GU Nissan Patrol it is better to re-align the rear Brake Proportioning Valve (BPV) control arm. Most people don't do it.

WHAT IS IT - A TECHNICAL EXPLANATION

A load sensing proportioning valve system for the hydraulic brake system of passenger cars and the like for varying the amount of brake fluid pressure and thus the braking torque at the rear brakes of a passenger car.

The system includes a load sensor oriented between a suspension component, such as a supporting spring, and the vehicle frame or body and includes a cavity for incompressible fluid. A variation in load will vary the volume of the cavity for providing increased pressure and volumetric flow of an incompressible fluid from the cavity to a proportioning valve incorporated into the hydraulic brake lines extending from the master cylinder, to the rear brakes of a passenger car for regulating the proportioning valve to vary the braking pressure and thus braking torque to the rear wheels. This reduces or eliminates premature rear wheel locking when applying brakes of a lightly loaded vehicle and to maintain adequate braking force for the same vehicle when heavily loaded.

A flexible line interconnects the load sensor and the proportioning valve to compensate for relative movement between the vehicle frame and suspension system and the proportioning valve includes an actuator in the form of an actuating piston, engageable with the proportioning piston in the proportioning valve to regulate the movement of the proportioning piston and thus regulate the proportioning valve in response to variations in load applied to the rear suspension components of the vehicle.

WHAT IS IT - A PLAIN ENGLISH EXPLANATION

To reduce hydraulic pressure to the rear brakes so the rear brakes don't lock up when the brakes are applied, a "proportioning valve" is required. This valve helps compensate for the differences in weight distribution front-to-rear as well as the forward weight shift that occurs when the brakes are applied.

What we're really talking about here is "brake balance" or "brake bias", which is the difference in the amount of hydraulic pressure channelled to the front and rear brakes. The front brakes on most rear-wheel-drive vehicles normally handle about 60-70 percent of the brake load. But on front-wheel-drive cars and minivans, as well as RWD and 4WD pickups and SUVs, the percentage handled by the front brakes can be as much as 90 percent of the load.

Consequently, the front brakes need a higher percentage of the total hydraulic force that's applied to keep all four brakes properly balanced.

If the front-to-rear brake force isn't balanced correctly by the proportioning valve, the rear brakes will receive too much brake force, causing them to lock up and skid when the brakes are applied. The other reason for using a proportioning valve to reduce hydraulic pressure to the rear brakes has to do with the design of the brakes themselves. When hydraulic pressure is applied to the wheel cylinder inside a drum brake, the shoes are pushed outward against the drum. When the shoes make contact, the rotation of the drum tries to drag them along. But since the shoes are anchored in place, the drum pulls the shoes up tighter only against itself. Because of this, drum brakes that are "self-energising" require little additional pedal effort once the brakes are applied. Disc brakes, on the other hand, are not self-energising. It takes increased pedal effort to squeeze the pads against the rotor.

Some vehicles have load sensing proportioning valves that change rear brake metering to compensate for changes in vehicle loading and weight shifts that occur during braking. This type of proportioning valve has an adjustable linkage that connects to the rear suspension or axle. As

Nissan Patrol Reference Document

the vehicle is loaded, ride height decreases and pressure to the rear brakes is increased. This type of proportioning valve can be found on many minivans, 4WDs and even some passenger cars.

Load sensing proportioning valves usually are adjustable, and must be adjusted correctly if they are to properly balance the rear brakes to the vehicle's load. The valve linkage is adjusted with the suspension at its normal height (wheels on the ground) and the vehicle unloaded. The adjustment bracket or linkage is then adjusted according to the vehicle manufacturer's instructions, which typically involves adjusting the linkage to a certain position or height.

Load-sensing proportioning valves are also calibrated to work with stock springs. Any suspension modifications that increase the load-carrying capability (installing helper springs, or overload or air-assist shocks, for example) may adversely affect the operation of this type of proportioning valve. Modifications that make the suspension stiffer reduce the amount of deflection in the suspension when the vehicle is loaded, which prevents the proportioning valve from increasing rear brake effort as much as it normally would. A defective proportioning valve, or one that is not properly adjusted, can also upset brake balance. If the rear brakes on a vehicle seem to be overly aggressive (too much pressure to the rear brakes), or the vehicle seems to take too long to stop (not enough pressure to the rear brakes), the problem may be a bad proportioning valve. Proportioning valves can be tested by installing a pair of hydraulic gauges (one on each side of the valve) to see if the valve reduces pressure as it should.

On some late-model vehicles, the mechanical proportioning valve has been replaced by "electronic" brake proportioning through the ABS system. By sensing wheel speeds, the ABS system reduces pressure to the rear brakes as needed when the brakes are applied.

PUTTING THE ABOVE TECHNICAL JARGON SIMPLY

So putting the above simply, it makes sure that the right amount of brake fluid pressure is being directed to the rear brakes when you need it most, like carrying a load. If you modify the height of the vehicle then you will have to modify the BPV bracket to suit. If you do not have the skills to make a bracket yourself, Snake Racing sell them, take a look at <http://www.snakeracing.com.au/>, click on the  button and search on "brake bracket". They are between \$22 and \$28 each.

HOW TO DO AND EXAMPLES

Always make the bracket the same height as your lift, I measured from the centre of the bottom hole 2" (50 mm) as I have a 2" lift. The idea is to make sure that the spring re-aligns itself at an almost 45 degree angle to the BPV lever. On a GU 4 this does not sit level as some may mention. I checked a stock standard GU4 prior to adjusting mine. On other models it may be different so find a standard un-lifted vehicle, climb in underneath and take a look to be doubly sure.

Once fitted you do not need as much force on the pedal. Under hard braking it is much more controlled and has less nose dive as it is not just up to the front brakes to slow you down now.

DO NOT touch the allen head screw on the valve these are pre-set from the factory. The spring needs to measure between 175mm and 178mm end to end of the spring not just the coils.

Some will tell you that the spring is self adjusting, meaning that when you lift the vehicle the spring will stay at the correct length, this in fact it actually does with a 2" lift. What changes is the ability of the spring to provide the correct tension at the correct angle. As for higher lifts check out the picture in this section of a GU4 that has a 5" lift, the spring is almost vertical to the BPV lever.

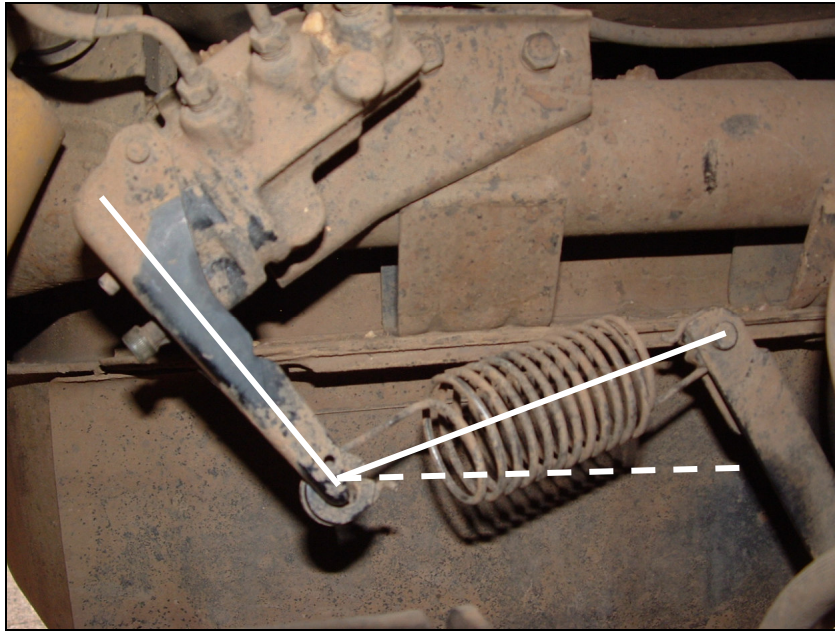

After correction the spring is closer to a 90 degree angle (full line)
As opposed to where it was prior to the bracket being fitted (dashed line)



Home made bracket (2" lift), any piece of spare/scrap steel will do.



The two pictures above are from a stock standard GU4, you can see clearly how the spring is almost at a 45 degree angle to the BPV lever.

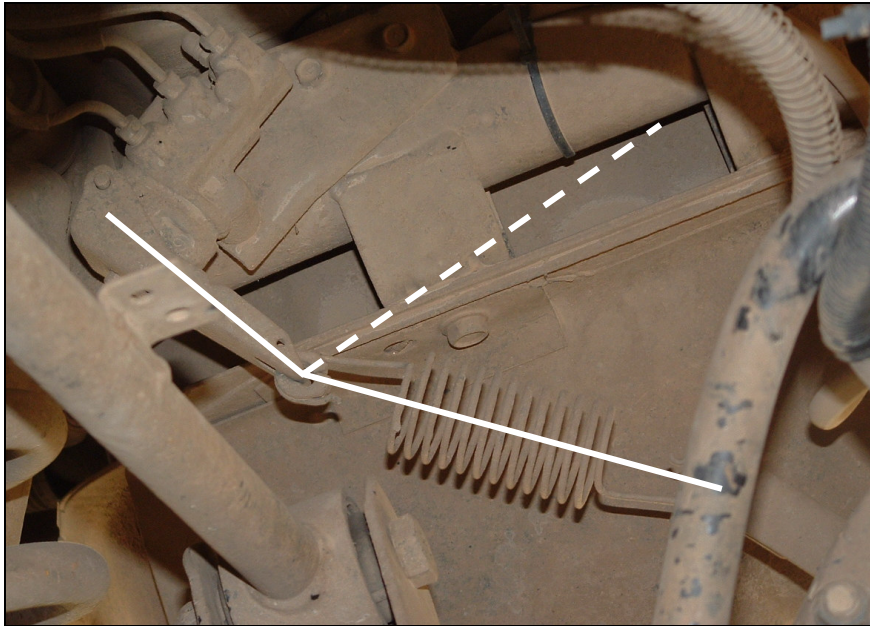

This picture is of a GU4 that has had a 5" lift, full line shows you how far out it really is. Dashed line shows you where it should be.

Nissan Patrol Reference Document

CRACKED REAR CHASSIS

Some forum members found they have ended up with a cracked or broken upper spring mounts on their coil spring rear suspension or cracked chassis near the mount.

This can occur if the vehicle is used to carry heavy loads or has heavy duty coil springs.

There are kits available like the one here that can reinforce that will assist in stopping the cracking from occurring. They are available from any good 4WD retailer.

Now some not so pretty sights;



Aftermarket chassis mounting bracket

Nissan Patrol Reference Document

SPEEDO CORRECTION

INTRODUCTION

Well as some of us already know once you add bigger tyres to your vehicle your speedometer (speedo) will be out. This is due to the rolling diameter of the tyres being bigger so the same RPM on your engine actually propels the vehicle forward faster.

Before we go any further lets have a quick look at how the speedo actually works. There are 3 main parts; Speedo in the dash; Sender unit in the transfer case; gear in the transfer case.

Speedometer in dash

The speedometer is electronic and is calibrated at the factory before shipping. This is due to the different tyre sizes and settings required for different countries. Each country will get a different setup. By the way don't ever shock and knock out the calibration I have been told that the head unit will need to be sent back to Japan for the re-calibration. This I know as a dealer shocked mine and with 33" tyres on my vehicle, which should be about 8 klms out at 100 klms, it is in fact now 16 klms out. The speedo accepts the pulses from the sender unit and moves the needle accordingly.

Sender in transfer case

The sender unit is the bit that sends the pulses up to the speedometer. This sender only has two (2) wires that are directly connected to the back of the speedo.

Speedo gear

Really the most crucial element as this gear and how many teeth it has can greatly affect the speedos accuracy. There is an additional gear inside the transfer case that connects to the gear on the sender unit. After I had some reduction gears installed the mechanic made a fundamental error in how they re-installed the internal gear and it caused my speedo to jump all over the place at lower speeds. To fix they had to remove my drive shaft and open the back of the transfer case again.

HOW DO YOU FIX YOUR SPEEDO BEING OUT?

There are 2 main methods; change the gear to have a different number of teeth; or, as in my case, I made up an electronic speedo correction device I bought in kit form from Jaycar for \$50. Apparently these kits are very useful for truckers who can use it to get around the speed limiting devices in their trucks.

Changing the gear

Changing the gear is the easiest way of correcting the issue, although it won't allow you to adjust the speedo for different size tyres, like play ones (you will need electronic adjustment for that). below are some part numbers from Nissan, if you ask they will probably tell you they don't exist, so give them the numbers yourself.

Thanks go to MarcusParcus who created the following for the forum.

I changed my standard tyres to 275/70/17's and this caused the speedo to read under by 6%.

I investigated fitting an electronic switch to convert the signal but having had a Jeep before and changing tyres and gears a few times I wanted to correct the problem at the SOURCE and not the dash display.

After almost NINE months I finally found the part numbers and a big thanks go to Wayne at Blackburn Nissan 4x4 for getting this for me.

The standard pinion speedometer gear on a 3.0L GU Manual has 17 teeth and in my case my speedo is reading 6% below the actual speed.

Nissan Patrol Reference Document

So to calculate the correct gear:

Standard Gear = 17 Teeth

Speedo Error = 6% Below

6% of 17 = 1.02

Number of teeth Required = 16 (17-1)

Of course if your speedo is reading higher then the actual speed then you need to add teeth.

The following part numbers for a ZD3.0 are needed to order the correct gear:

32743-VB015 15 Teeth

32743-VB016 16 Teeth

32743-74P17 17 Teeth

32743-74P18 18 Teeth

Cost approx \$50.

Again - Thanks to Blackburn Nissan 4x4 for this information.

To install the gear:

I have documented the steps in a series of pictures below.

1) Locate the pinion speedo gear Housing - just next to the Handbrake Drum at the rear of the gearbox.



2) Using a 10mm socket - remove the screw on the side of the housing and slowly pull the housing out. Warning - you will lose about a cup of gear oil so place a bucket under the gear box. Don't worry - it will run out and stop after about 10 seconds.

Nissan Patrol Reference Document

3) Remove the old gear (Black in Picture). The gear is held on by a C-Clip which uses tiny holes. I just used a screw driver to remove it.

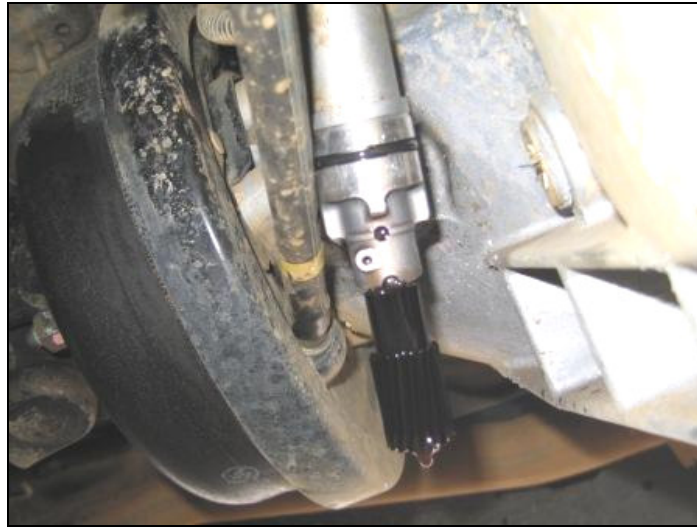

4) Put the new gear on the spindle (Yellow) and re-attach the C-Clip



5) Push the gear housing back into the gear box. It will need a slight tap to reseal the O-Ring. And screw in the bolt (don't over tighten).

Took the car for a drive and it is reading almost 100% accurate with the GPS.

This is the best \$50 I have spent on my car.

PS: In case you are wondering - I did top up the gear box oil.

Electronic Correction

An electronic kit takes the pulses from the sender unit and “corrects” or “Re-adjusts” them to be what you want, then sends the signal to the speedo.

There are a few different types of electronic correction devices available, the most common would be from Marks adapters. This device can be quite expensive but allows you to have two (2) settings so you can have different sets of tyre's configured.

Nissan Patrol Reference Document

A cheaper option is the do it yourself from Jaycar. If you are handy with a soldering iron it will only take you 30 minutes to knock one up. Don't forget to buy the corresponding case to house it in. The kit has a huge adjustment range so all tyre sizes are easily catered for and it knows about the special way Nissans send their pulses (different to Holden's, Ford's etc).

CAT. NO. KC5435 - Speedo Corrector MkII Kit

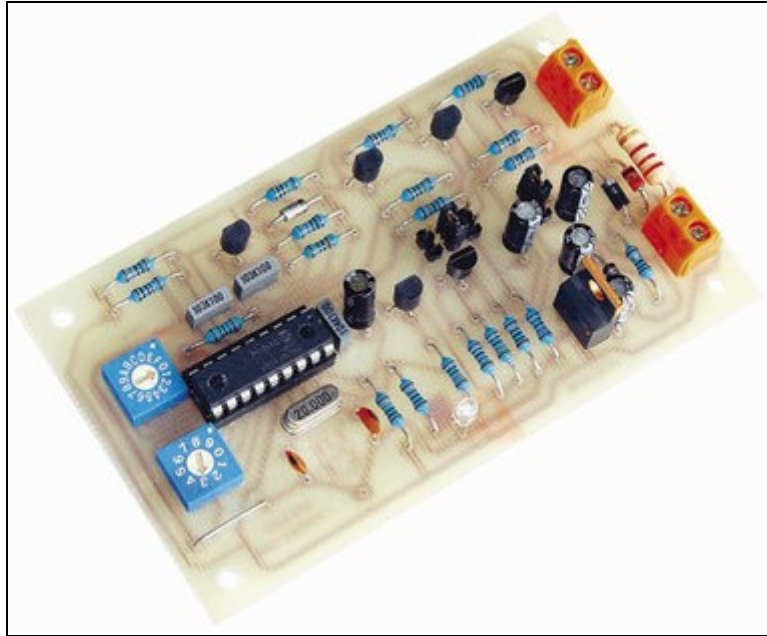

My advice would be to seek a qualified car electrician to install it for you. It will need power as well as the feed from the speedo sender unit.

Nissan Patrol Reference Document

STEERING CASTOR CORRECTION - AFTER LIFT

Well all and all this topic can cause a few differing opinions. Most people will tell you, 4wd suppliers and installers included, that for a 2" lift you need no castor correction.

In my Patrol (2" lift) this is what I was told by the installer but found that the front end became very "light" to steer and I had lost some road feel. I installed one as the wheel alignment place said I had little to no adjustment left. If you have a bigger lift then you should install the right degrees to bring the adjustment close to standard.

WHICH KIT

Well this again can start a few discussions on which are better. I personally installed a 2 degree kit with poly bushes. Most people seem to like the rubber ones but I have heard and know people who have had issues with both "chopping out", but this will occur more often when doing a fair bit of hard 4WDing. The rubber slotted bushes seem to chop out faster in extreme driving, they are easily compressed and twisted.



Typical Rubber Bushes



Typical Poly Bushes

TECHNICAL EXPLANATION

Caster (or castor) angle is the angular displacement from the vertical axis of the suspension of a steered wheel in a car, bicycle or other vehicle, measured in the longitudinal direction. It is the angle between the pivot line (in a car - an imaginary line that runs through the center of the upper ball joint to the center of the lower ball joint) and vertical. Car racers sometimes adjust caster angle to optimize their car's handling characteristics in particular driving situations.

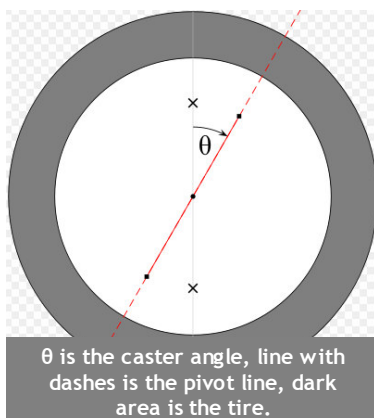

The pivot points of the steering are angled such that a line drawn through them intersects the road surface slightly ahead of the contact point of the wheel. The purpose of this is to provide a degree of self-centering for the steering - the wheel casters around so as to trail behind the axis of steering. This makes a car easier to drive and improves its straight line stability (reducing its tendency to wander). Excessive caster angle will make the steering heavier and less responsive, although, in racing, large caster angles are used to improve camber gain in cornering. Caster angles over 10 degrees with radial tyres are common. Power steering is usually necessary to overcome the jacking effect

The steering axis (the dotted line) does not have to pass through the center of the wheel, so the caster can be set independently of the mechanical trail, which is the distance between where the steering axis hits the ground, in side view, and the point directly below the axle. The interaction between caster angle and trail is complex, but roughly speaking they both aid steering, caster tends to add damping, while trail adds 'feel', and return ability. In the extreme case of the shopping trolley wheel, the system is un-dampened but stable, as the wheel oscillates around the 'correct' path. The shopping trolley/cart setup has a great deal of trail, but

Nissan Patrol Reference Document

no caster. Complicating this still further is that the lateral forces at the tyre do not act at the center of the contact patch, but at a distance behind the nominal contact patch. This distance is called the pneumatic trail and varies with speed, load, steer angle, surface, tyre type, tyre pressure and time. A good starting point for this is 30 mm behind the nominal contact patch.

OTHER TYRE WEAR- SIMPLE EXPLANATIONS

Camber

As the vehicle moves forward, the wheels lean to one side or the other in relation to the axle centre ("positive" or "negative" camber). The angle of the camber is a factor in the design of steering geometry and incorrect camber will affect handling, and cause excessive wear to the edge of the tyres.

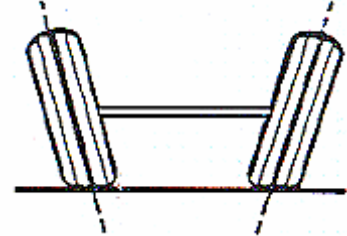

Castor

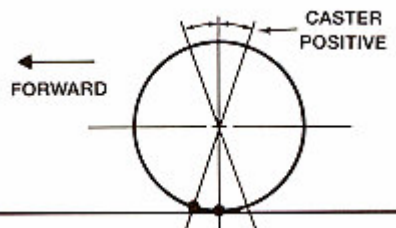

Looking at the vehicle from the side, the wheels lean forward or back in relation to the axle centre. This function is also part of the steering design, and if the castor is set incorrectly, this will affect steering and handling characteristics.

Toe-In and Toe-Out

As the wheels face forward, they turn in towards each other slightly (toe-in) or turn outwards (toe-out). If this adjustment is not correct, rubber is scraped off the entire tread of the tyres shortening life and affecting handling.

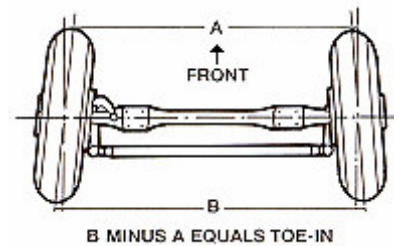

Wheel Balance

Wheels and tyres must be evenly balanced as they revolve around the axle. If they rotate unevenly, the tyre tread will wear unevenly and excessively, causing wheel wobble, and vibration in the steering, which stress the vehicle and tire the driver.

Tyre Pressures

Incorrect tyre pressures can dramatically reduce tyre life and can cause the steering to pull to one side. If tyre pressure is as little as 10% above or below the correct setting, this can cause an increase in tyre wear from 20% to 80%

Nissan Patrol Reference Document

SWAY BAR EXTENSION BRACKET KIT - AFTER LIFT

Why use them? Because they are cheap at \$14 a set from ARB so why not, you can't make them for that price. They are designed to lower your rear sway bar links back to their normal position on a 2 inch lift. What this does is re-align the sway bar and takes some pressure off and lifts the rear of the car. This should improve articulation. As I have heavy duty springs my car lifted about 1.5 inches.



**GU Rear Sway-Bar Extension Bracket Kit
P/N: FK18**

When installing the instruction sheet is pretty straight forward. The earlier model Patrols make it a 10 minute job as the right hand bracket already has the holes drilled by Nissan. In my 2005 model I had to drill the holes myself.



Right hand side prior to fitting



Left hand side prior to fitting

Note in the above pictures the angle of the sway bar, it is tilted upwards. Below are a couple of other side pictures that show the angle a bit better.

Nissan Patrol Reference Document



Right hand side prior to fitting



Left hand side prior to fitting

The following pictures are after the brackets have been installed. On mine the left hand bracket took a whole 3 minutes to install. The right hand was about an hour, I needed to jack up that side of the car and remove the bump stop to give myself enough clearance for the drill to drill one of the holes.

Holes I drill in my car are always coated with Rust Eater. Also do as the instructions states and use a thread locking product on all the nuts, I always use Loktite.



Right hand bracket installed



Left hand bracket installed

In the below pictures it shows how the sway bar has been angled back down close to where it should be and almost horizontal to the ground.

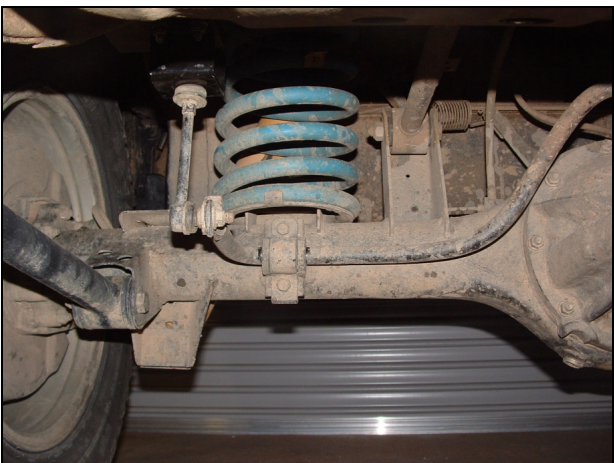

Nissan Patrol Reference Document

VNT SCREW ADJUSTMENT

This method of adjustment does not take into consideration any modifications you have performed to the engine, like a larger diameter exhaust, non standard air filter etc.

It is necessary to dismount the VNT actuator to reach the adjustable screw which is located behind the VNT lever. **Do not modify the adjustment nut painted in yellow on the picture below.** You will then have to remove the circlip (E clip) holding on to the arm on the VNT actuator. Then loosen the screw and adjust to suit and tighten.

The only true way to adjust the VNT correctly and without error is to install a boost gauge and take readings prior to blocking the EGR using the “HOW TO TEST IF YOUR VEHICLE IS AFFECTED” method, then you will be certain as to what the boost level should be for your particular model vehicle.

1. Firstly get a rag and tuck it around and into the turbo so that when you remove the 10mm nuts you do not lose one into the Turbo.
2. Remove the 10mm nuts.

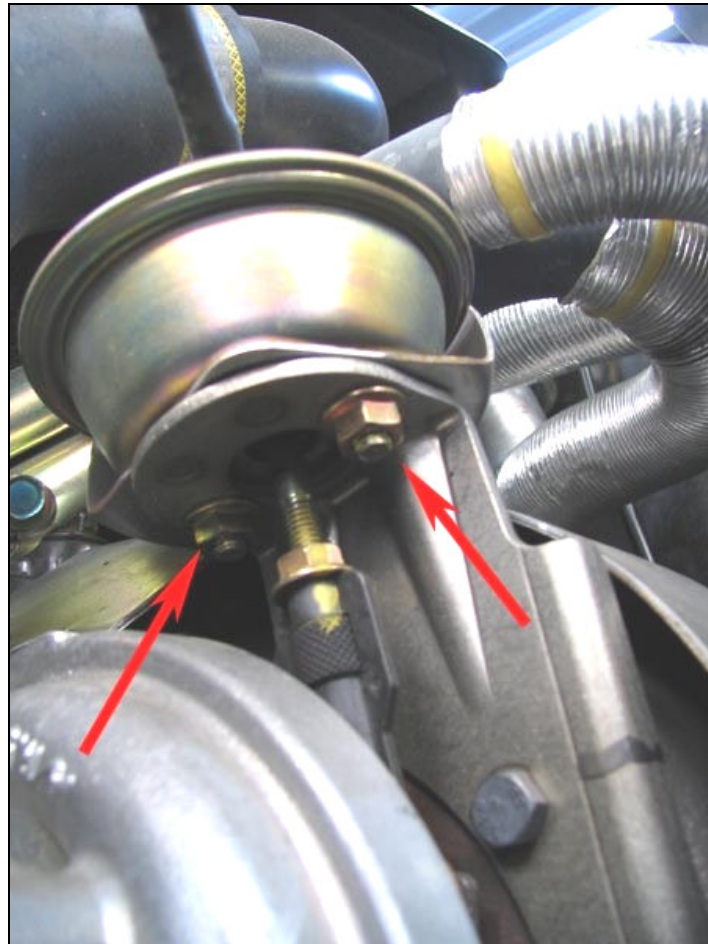

3. Lift the whole mechanism up and stuff some rag in below and around the bottom of the lever where the clip is. This will allow the clip to be stopped and caught if it tries to flick off somewhere. Be careful of the mechanism do not be too rough with it there is a elastic membrane in there that does not like being damaged.
4. Remove the clip with a small screw driver or a hook, careful not to lose it.
5. Once the clip is off, lift the arm off the pin and you can move it up and sideways to get at the adjustment screw.

Nissan Patrol Reference Document

6. Firstly get a permanent felt pen or marker and draw a line down the screw onto the nut and then casing so you have a reference point of where the screw was originally set.
7. Loosen the lock nut you will need an 8 mm ring spanner for this, use the ring end there is not enough room for an open ended spanner to turn.
8. Turn the nut at least a third to a half a turn to loosen, anticlockwise.

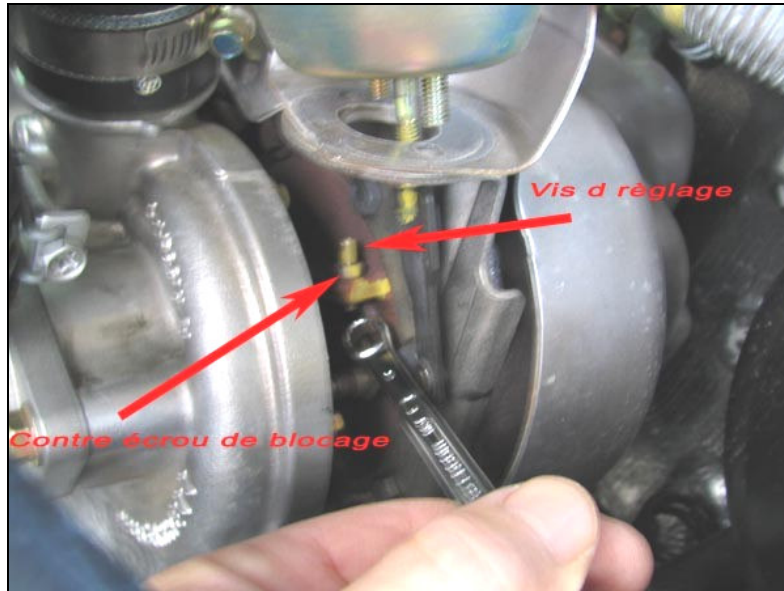

9. Using a pair of needle nose pliers grab the top of the screw and turn it clockwise until it is half a turn.
10. Tighten the lock nut while hold the screw to stop it from turning.
11. Reassemble the unit by reversing what has just been done.

Now test the vehicle as described in the section titled "HOW TO TEST IF YOUR VEHICLE IS AFFECTED" in this document.

If you get the safety error, go back through the above process and turn the screw a further quarter of a turn until it no longer occurs.

Be cautious as all the components will be hot and you will need to let it all cool down first.

The only true way to adjust the VNT correctly and without error is to install a boost gauge and take readings prior to blocking the EGR using the "HOW TO TEST IF YOUR VEHICLE IS AFFECTED" method, then you will be certain as to what the boost level should be for your particular model vehicle.

Finally, after any engine adjustments disconnect your battery(s) for 20 minutes to allow the ECU to reset. Make sure you save your trip meter reading or you will lose them. This reset allows the vehicle to start back at factory defaults and re-learn its sensors and set up accordingly.

Nissan Patrol Reference Document

TRIMS, MOULDINGS ETC

BUBBLING DASH

Yes on the 2005 model and some 2006 model Patrols it has been known that the dash's start bubbling if they are subjected to a lot of "in the sun" time.

On my dash I had a series of small bubbles in a line where the sun visor did not quite reach and the sun was getting past.

On a friends DX he had bubbles the length of your middle finger and as thick as a thumb.

In both cases we treated the dash's differently. I only ever use a damp sponge to clean mine and he used Armorall. I always use a sun visor, and he did not. My vehicle was purchased in August 2005 his October 2005.

I do know of another person with a 2005 model GU that did not have dash bubbling problem until he stopped using his sun visor for about a month, his visor covered the whole windscreen unlike my slightly shorter one.

So as you can see there is no real trigger to get the dash bubbling except the sun.

Needless to say apparently Nissan have a whole heap of dash mats on back order, and no one can confirm whether the problem is fixed or not.

Just as a side note, Nissan is not the only manufacturer that has had an issue with bubbling dash's, there is a well know Australian car manufacturer that does as well.

I probably should have taken some pictures of both dash's before replacement but never got around to it, so if yours is bubbling please send me a pic or two so I can put in this document for all to see.

Nissan Patrol Reference Document

DRIVERS SEAT MOVEMENT - GU

As most of us know the driver's seat on a GU can get loose, well not really, they are manufactured that way!

While my car was in having a service I wandered around the Nissan dealer and decided to test all the Patrols they had in the lot. There was:

- 2 x ZD3.0 ST (manual seats)
- 1 x ST-S ZD3.0 (electric seats)
- 2 x 4.2 Tray Backs (manual seats)

Of those cars that I looked at **ALL** of the drivers seats had play in them. You could grab the seat cushion and pull the seat up and down and there was movement. **NONE** of the passenger seats had any movement?

Apparently Nissan has released a bulletin BT06-003 that covers this issue.

To fix mine I pulled out the driver's seat and located where the bracket under the seat was loose, it seems that the bolt is longer than the depth of the hole so even when it is tight there is still play in the mechanism.

In the below diagram, you will see where I added an additional washer to pad out the bolt so when tightened there was no play. This does not fix the issue totally, you will still have play in the seat but it will be far less.

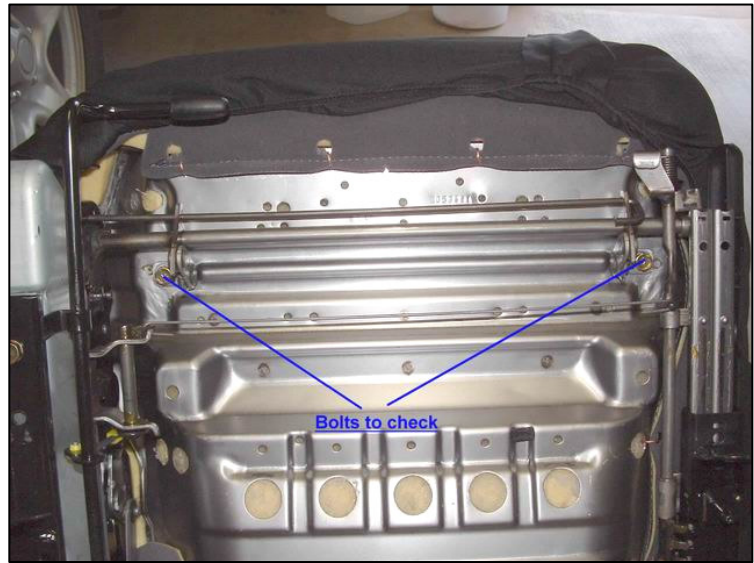

Nissan Patrol Reference Document

POLLEN FILTER KIT

I know, I know, why Nissan couldn't squeeze the extra \$70 pollen filter into the price I have no idea either.

The pollen filter is a kit you can buy and is easily installed within about 30 minutes. If you have sinuses like me then it is a necessary idea. Also the filter is placed in front of the air conditioning cooling radiator so it will keep it cleaner.

The instructions that come with the kit are straight forward and easy to read so I will not go into how to install.

Here are a few photos to get you interested.

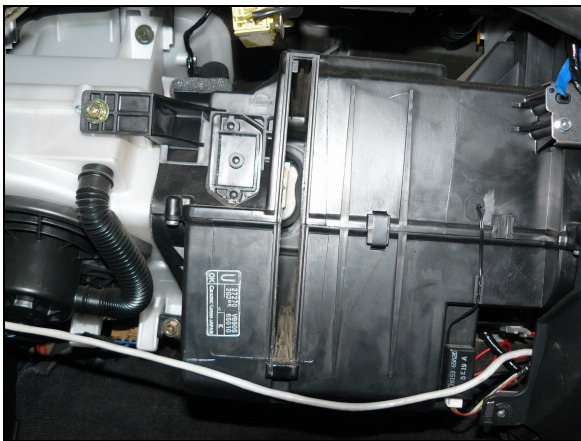

Slot where the pollen filters sit is easy to see and cut out with a Stanley knife



After the filters are installed



A dirty filter ready for a clean after 10,000klms

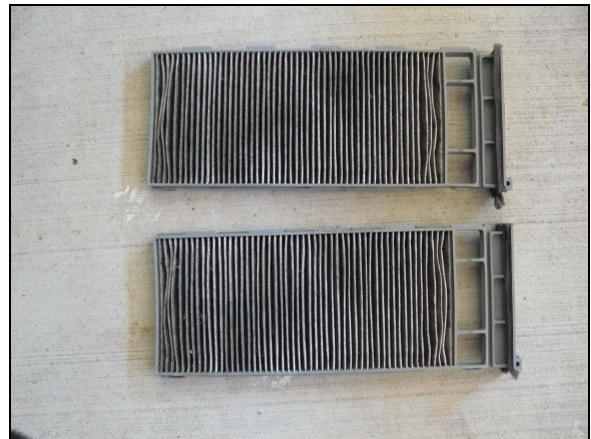

No so dirty after a tap out

Nissan Patrol Reference Document

TRIMS - SILVER PLASTIC ON DOORS AND DASH

Yes the GU4 and similar plastic trims will scratch easily and will wear off.

After 2 years my drivers door trim rubbed back to the black plastic underneath as my leg rests on it while driving.

This was replaced under warranty and typically it is the same again with the new trim.

Expect this from this model, the trims scratch easily and wear.

WHITE PAPERS, BULLETINS AND PRODUCT TESTING

AIR FILTER TEST REPORT - SPICERS ISO 5011 DURAMAX

From the Internet at <http://duramax-diesel.com/spicer/index.htm>

Sept 2004

SCOPE

This report presents the results of an ISO 5011 test of several air filters designed for the GM Duramax Diesel. The test was independently performed under controlled conditions using a \$285,000 machine at Testand Corp of Rhode Island (manufacturer of the machine). Arlen Spicer, a GM Duramax Diesel owner/enthusiast organized the test. Ken an employee of Testand offered to perform the tests at no charge. (These tests typically cost approx \$1700.00 per filter). Ken, also a Diesel enthusiast and owner of a Ford Power Stroke Diesel, shared Arlen's interest in performing an accurate unbiased test of different types and brands of diesel engine air filters. The filters used in the test were purchased retail and donated by Arlen and other individual Duramax Diesel owners. The detailed reports from the test have been compiled and are presented in the following pages. The final pages of this report present the interesting story how and why Arlen organized the test.

ISO 5011 TEST

The ISO 5011 Standard (formerly SAE J726) defines a precise filter test using precision measurements under controlled conditions. Temperature & humidity of the test dust and air used in the test are strictly monitored and controlled. As Arlen learned in attempting his own tests, there are many variables that can adversely affect filter test results. A small temperature change or a small change in humidity can cause the mass of a paper filter to change by several grams. To obtain an accurate measure of filter efficiency, it's critical to know the EXACT amount of test dust being fed into the filter during the test. By following the ISO 5011 standard, a filter tested in Germany can be compared directly compared to another filter tested 5 years later in Rhode Island. The ISO 5011 filter test data for each filter is contained in two test reports; Capacity-Efficiency and Flow Restriction.

CAPACITY AND EFFICIENCY

The Capacity and Efficiency test report presents the test results of feeding an initially clean filter with *PTI Course Test Dust* (dirt) at a constant rate and airflow. The course test dust has a specific distribution of particle sizes ranging from less than 2.5 microns to greater than 80 microns (see table below). Every filter is initially tested at 350 CFM and the *Initial Restriction* or differential pressure across the filter is recorded in IN-H₂O (Inches of Water). The filter is then tested by feeding test dust at a nominal rate of 9.8 grams per minute with a constant airflow of 350 CFM. The test is continued until the flow restriction exceeds the *Initial Restriction + 10 IN-H₂O*. At this point the test is terminated and the amount dust passed through the filter - *Accumulative Gain* - is measured. Dirt passing through the filter is captured in the Test Station's *Post Filter*. The exact amount of dirt passed is determined by measuring the before and after weight of the *Post Filter*. Similarly, the amount of dirt retained by the Filter under test - *Accumulative Capacity* - is measured by taking the difference between the before and after weights of the Filter. From these results the overall % *Efficiency* of the filter is calculated. This test also indicates how long a Filter will last before replacement is required (or cleaning for reusable filters).

FLOW RESTRICTION

This report presents flow restriction of a clean filter resulting from an increasing airflow. The differential pressure restriction across the filter is reported in inches of water (IN H₂O) versus Air Flow in cubic feet per minute CFM.

Data from these reports has been compiled and presented in the following bar graphs, Plots and data tables.

Nissan Patrol Reference Document

FILTER EFFICIENCY

Filter efficiency is a measure of the filters overall ability to capture dirt.

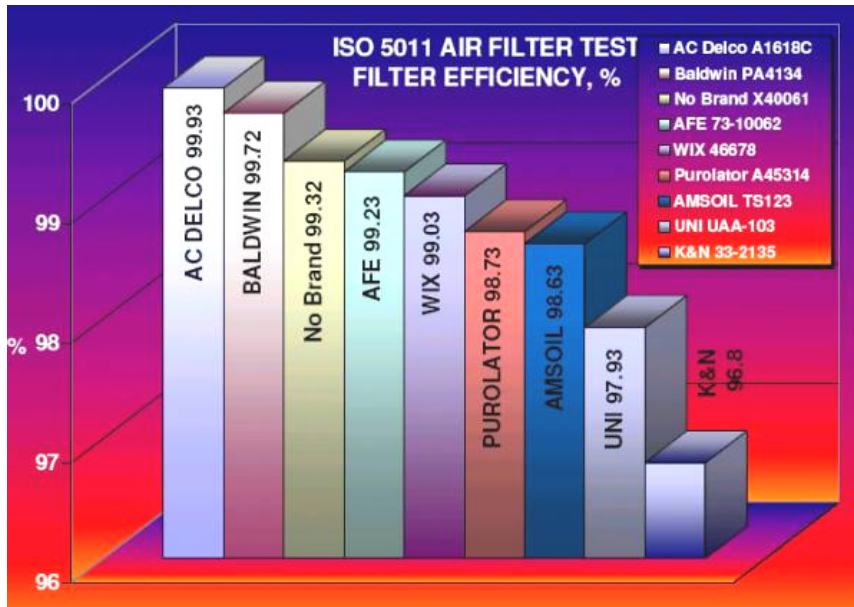

ACCUMULATIVE CAPACITY

“Accumulative Capacity” is a measure of dirt holding/loading capacity before reaching the maximum restriction limit - *Initial Restriction + 10 IN-H₂O*.

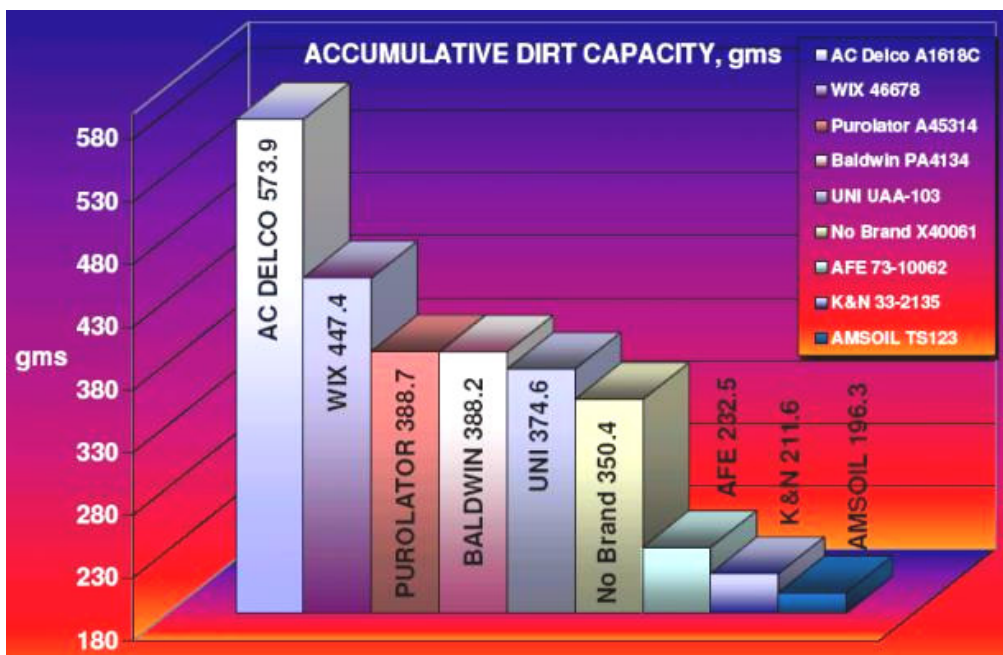

Nissan Patrol Reference Document

ACCUMULATIVE GAIN

"Accumulative Gain" is the total amount of dirt that passed through the filter during the test.

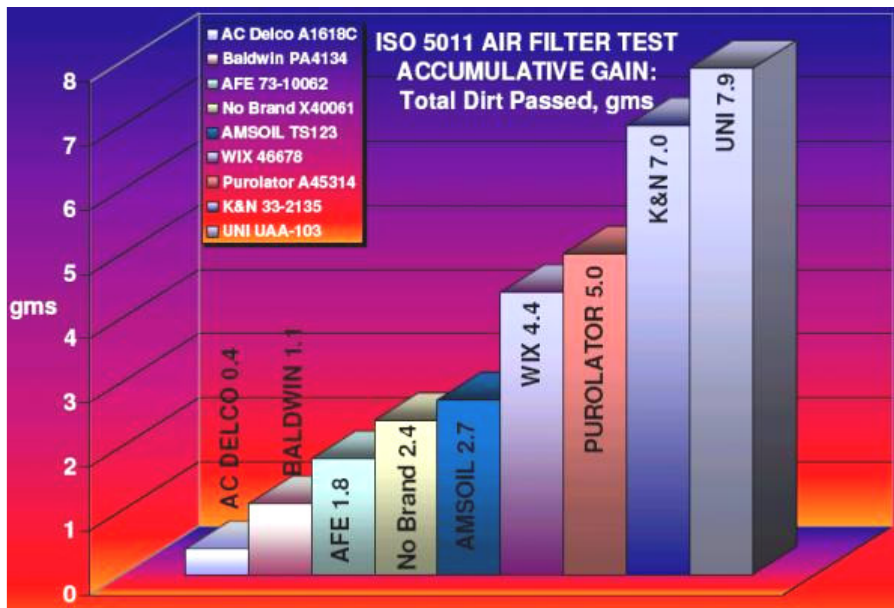

(Note: The Purolator was reported to have a seal malfunction during the test and passed more dirt than it would have with a good seal.)

INITIAL RESTRICTION

Initial Restriction is the Filter under test's resistance to flow at 350 CFM.

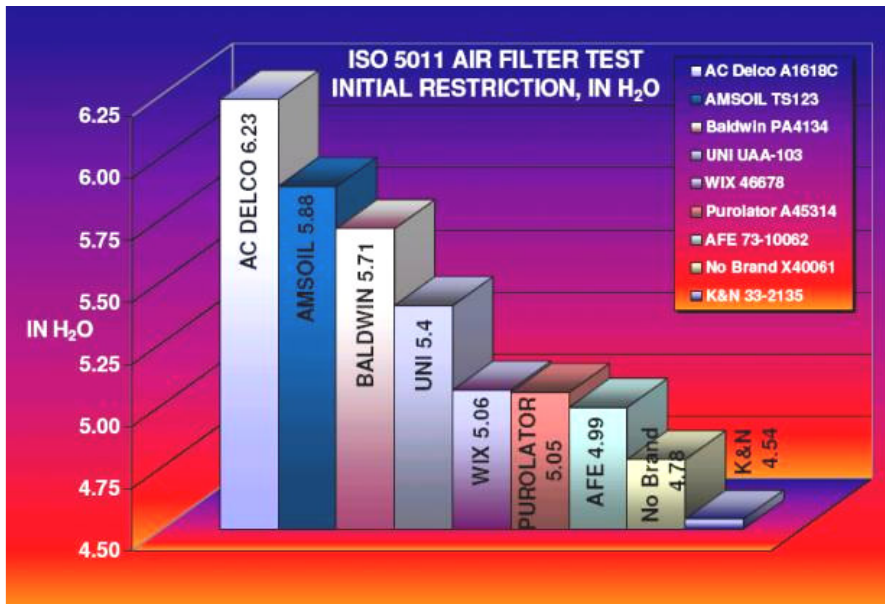

Nissan Patrol Reference Document

DIRT PASSED VERSUS TOTAL TEST TIME

This graph shows each the duration of each filter’s test versus dirt passed (Accumulative Gain). (Note: The Purolator was reported to have a seal malfunction during the test and passed more dirt than it would have with a good seal.)

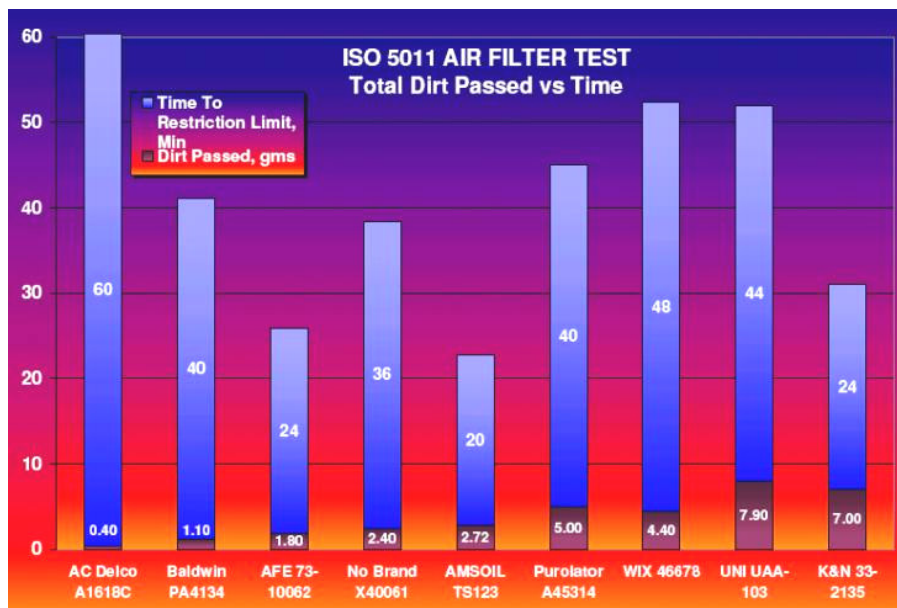

In the chart above it’s important to note the different test durations for each filter. The AC Delco filter test ran for 60 minutes before exceeding the restriction limit while the AMSOIL and K&N tests each ran for 20 and 24 minutes respectively before reaching max restriction. In 60 minutes the AC Filter accumulated 574gms of dirt and passed only 0.4gms. After only 24 minutes the K&N had accumulated 221gms of dirt but passed 7.0gms. Compared to the AC, the K&N “plugged up” nearly 3 times faster, passed 18 times more dirt and captured 37% less dirt. See the data tables for a complete summary of these comparisons.

DUST LOADING

The dust loading curves show graphically how each filter responded to a constant 9.8 gms/min dust flow before reaching the maximum restriction limit.

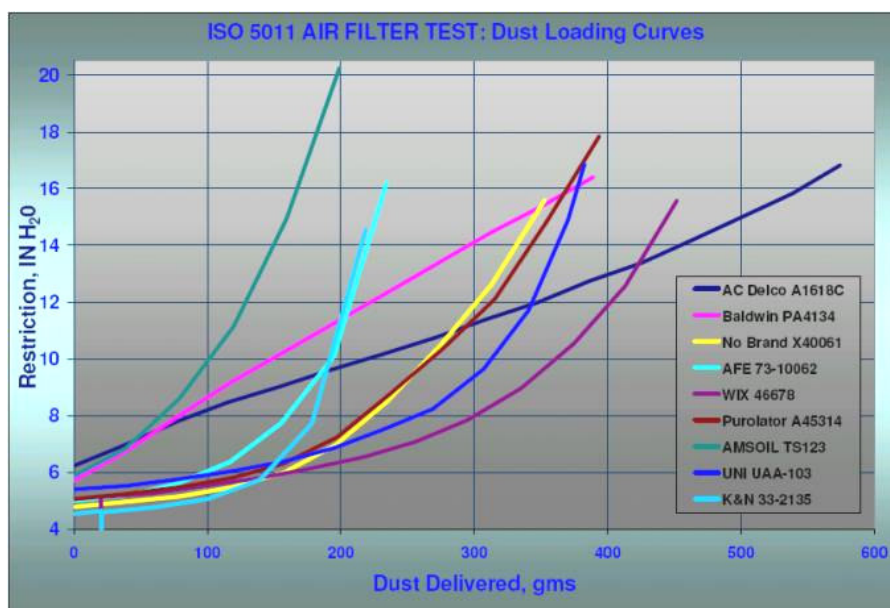

Nissan Patrol Reference Document

It's interesting to note the shape of these Dust Loading Curves. The AC and Baldwin filters each had near linear responses until reaching maximum restriction. Restriction for these filters increased at a constant rate versus the 9.8 gms/min dust feed rate. The other filters, most notably the oiled reusable types, had an exponential loading response before reaching maximum restriction. These filters had a lower initial restriction, but they became exponentially more restrictive under a constant flow of dirt. Also notice the length of the curves as it shows the relative test time for each filter (time to max restriction).

RESTRICTION TO FLOW

The Restriction to Flow curves graphically show how each "clean" filter responded to a steadily increasing flow of air up to 350 CFM.

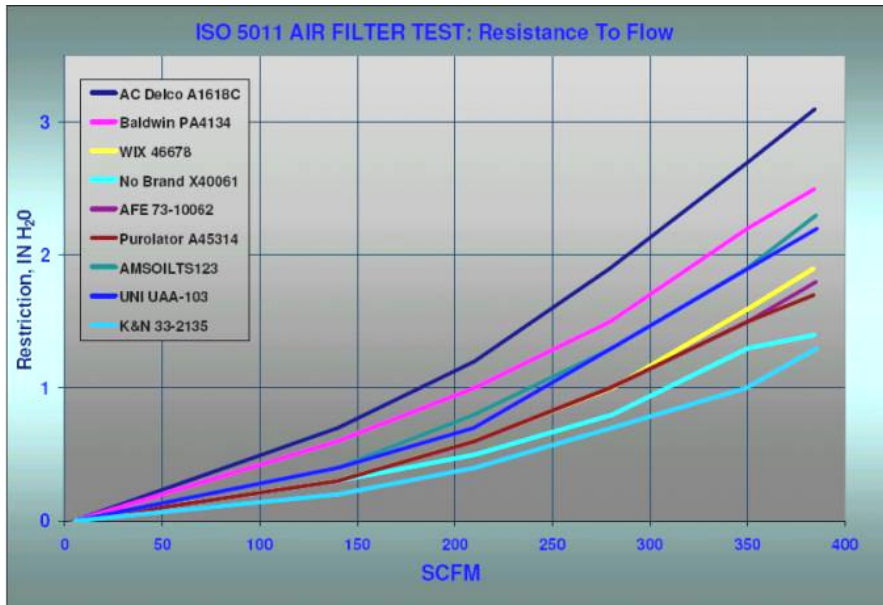

The Flow Restriction response curves for each filter have the same basic shape. However, note how the AC Filter, which passed the smallest amount of dirt and had the highest dirt capacity and efficiency, also had the highest relative restriction to flow. The less efficient filters correspondingly had less restriction to flow. This illustrates the apparent trade-offs between optimizing a filter for dirt capturing ability and maximum airflow.

TEST DATA TABLES

Nissan Patrol Reference Document

ISO 5011 Capacity & Efficiency Filter	AC Delco A1618C	Baldwin PA4134	AFE 73-10062	No Brand X40061	AMSOIL TS123	Purolator A45314
Efficiency	99.93	99.72	99.23	99.32	98.63	98.73
Dirt Passed, gms	0.40	1.10	1.80	2.40	2.72	5.00
Times Dirt Passed Compared to the AC Delco	1 X	3 X	5 X	6 X	7 X	13 X
Initial Restriction	6.23	5.71	4.99	4.78	5.88	5.05
Accumulative Capacity, gms	573.898	388.154	232.516	350.402	196.323	388.659
% Dirt Accumulated Compared to the AC Delco	100%	68%	41%	61%	34%	68%
Restriction Limit,	60	40	24	36	20	40
Report Date	7/12/2004	7/12/2004	7/12/2004	7/12/2004	7/12/2004	7/12/2004
Barometric Pressure, inHg	29.68	29.68	29.69	29.69	29.64	29.87
Air Flow Setpoint, SCFM	350	350	350	350	350	350
Air Flow Type	Variable	Variable	Variable	Variable	Variable	Variable
Relative Humidity, %	63.39%	63.44%	61.95%	57.54%	64.44%	63.48%
Typ of Dust	Course	Course	Course	Course	Course	Course
Batch #	4724C	4724C	4724C	4724C	4724C	4724C
Temperature, deg F	74.83	74.84	74.92	74.94	75.59	75.87
Dust Feed Rate, gms/Min	9.8	9.8	9.8	9.8	9.8	9.8

ISO 5011 Capacity & Efficiency Filter	WIX 46678	UNI UAA-103	K&N 33-2135	AFE 72-90008 (fine dust)	K&N 33-2135 (fine dust)	
Efficiency	99.03	97.93	96.8	92.33	89.85	
Dirt Passed, gms	4.40	7.90	7.00	10.90	20.95	
Times Dirt Passed Compared to the AC Delco	11 X	20 X	18 X			
Initial Restriction	5.06	5.4	4.54	2.08	4.67	
Accumulative Capacity, gms	447.366	374.638	211.58	131.188	185.436	
% Dirt Accumulated Compared to the AC Delco	78%	65%	37%	23%	32%	
Restriction Limit,	44	44	20	20	12	
Report Date	7/13/2004	7/12/2004	7/13/2004	7/13/2004	7/13/2004	
Barometric Pressure, inHg	29.94	29.68	29.87	29.57	29.62	
Air Flow Setpoint, SCFM	350	350	350	350	350	
Air Flow Type	Variable	Variable	Variable	Variable	Variable	
Relative Humidity, %	57.63%	65.36%	61.92%	63.61%	67.22%	
Typ of Dust	Course	Course	Course	Fine	Fine	
Batch #	4724C	4724C	4724C	4444D	4444D	
Temperature, deg F	75.25	75.02	75.8	75.34	75.39	
Dust Feed Rate, gms/Min	9.8	9.8	9.8	9.8	9.8	

Nissan Patrol Reference Document

ISO 5011 Filter Test, Flow Restriction														
Filter	AC Delco A1618C		Baldwin PA4134		WIX 46678		No Brand X40061		AFE 73-10062		Purolator A45314		AMSOILTS123	
Report Date	7/6/2004		7/6/2004		7/6/2004		7/6/2004		7/6/2004		7/6/2004		7/6/2004	
Barometric Pressure, inHg	30.20		30.16		30.17		30.21		30.17		30.21		30.20	
Flow, SCFM	350		350		350		350		350		350		350	
Relative Humidity, %	46.69%		47.67%		54.16%		49.19%		47.26%		51.19%		47.78%	
Temperature, deg F	78.05		79.19		74.58		77.32		79.1		75.88		77.71	
Test Data:	Flow, SCFM	Rstrn IN H ₂ O	Flow, SCFM	Rstrn IN H ₂ O	Flow, SCFM	Rstrn IN H ₂ O	Flow, SCFM	Rstrn IN H ₂ O	Flow, SCFM	Rstrn IN H ₂ O	Flow, SCFM	Rstrn IN H ₂ O	Flow, SCFM	Rstrn IN H ₂ O
	4.813	0.0	4.861	0.0	3.675	0.0	4.291	0.0	4.789	0.0	3.590	0.0	4.870	0.0
	140.052	0.7	139.936	0.6	139.794	0.3	140.080	0.3	139.974	0.3	139.846	0.3	139.968	0.4
	209.869	1.2	210.002	1.0	209.731	0.6	210.442	0.5	210.288	0.6	209.807	0.6	209.890	0.8
	279.383	1.9	279.621	1.5	280.688	1.0	290.740	0.8	279.546	1.0	279.437	1.0	280.613	1.3
	350.139	2.7	349.817	2.2	350.751	1.6	350.195	1.3	350.239	1.5	349.989	1.5	349.575	1.9
	384.591	3.1	384.397	2.5	383.887	1.9	384.320	1.4	385.161	1.8	383.978	1.7	385.113	2.3

ISO 5011 Filter Test, Flow Restriction												
Filter	UNI UAA-103		K&N 33-2135		USED AC Delco A1618C		USED UNI UAA-103		USED K&N 33-2135		USED, Cleaned & Re-oiled K&N 33-2135	
Report Date	7/6/2004		7/6/2004		7/6/2004		7/6/2004		7/6/2004		7/13/2004	
Barometric Pressure, inHg	30.17		30.17		30.18		30.18		31.19		29.62	
Flow, SCFM	350		350		350		350		350		350	
Relative Humidity, %	48.24%		48.47%		45.63%		45.73%		46.31%		67.82%	
Temperature, deg F	79.09		79.28		78.51		78.67		78.24		75.03	
Test Data:	Flow, SCFM	Rstrn IN H ₂ O	Flow, SCFM	Rstrn IN H ₂ O	Flow, SCFM	Rstrn IN H ₂ O	Flow, SCFM	Rstrn IN H ₂ O	Flow, SCFM	Rstrn IN H ₂ O	Flow, SCFM	Rstrn IN H ₂ O
	4.905	0.0	5.008	0.0	4.820	0.0	4.797	0.0	4.881	0.0	0.075	0.0
	139.998	0.4	140.137	0.2	140.222	1.0	140.196	0.3	140.255	0.2	140.046	0.2
	209.650	0.7	210.040	0.4	210.205	1.8	209.540	0.7	210.274	0.4	209.561	0.4
	280.352	1.3	280.298	0.7	280.085	2.7	280.303	1.2	280.606	0.7	280.435	0.7
	350.319	1.9	349.240	1.0	350.677	3.9	349.909	1.7	349.685	1.1	349.740	1.1
	385.620	2.2	385.616	1.3	385.629	4.5	385.004	1.9	385.331	1.3	385.496	1.3

Nissan Patrol Reference Document

ISO 5011 Capacity & Efficiency Filter Test												
Filter	AC Delco A1618C			Baldwin PA4134			No Brand X40061			AFE 73-10062		
Report Date	7/12/2004			7/12/2004			7/12/2004			7/12/2004		
Barometric Pressure, inHg	29.68			29.68			29.69			29.69		
Air Flow Setpoint, SCFM	350			350			350			350		
Air Flow Type	Variable			Variable			Variable			Variable		
Relative Humidity, %	63.39%			63.44%			57.54%			61.95%		
Typ of Dust	Course			Course			Course			Course		
Batch #	4724C			4724C			4724C			4724C		
Temperature, deg F	74.83			74.84			74.94			74.92		
Dust Feed Rate, gms/Min	9.8			9.8			9.8			9.8		
Test Data:	Rstrn IN H ₂ O	Time, Min	Dust Fed, gms	Rstrn IN H ₂ O	Time, Min	Dust Fed, gms	Rstrn IN H ₂ O	Time, Min	Dust Fed, gms	Rstrn IN H ₂ O	Time, Min	Dust Fed, gms
	6.23	0	0.0	5.71	0	0.0	4.78	0	0.0	4.99	0	0.0
	6.99	4	39.5	6.75	4	39.1	4.96	4	39.3	5.18	4	39.2
	7.79	8	77.2	7.98	8	78.2	5.15	8	79.1	5.60	8	77.7
	8.47	12	115.5	9.17	12	117.6	5.48	12	118.7	6.36	12	116.9
	9.02	16	154.3	10.22	16	156.5	6.00	16	157.7	7.74	16	155.4
	9.60	20	192.0	11.30	20	196.5	6.96	20	195.9	10.09	20	194.7
	10.16	24	231.3	12.36	24	235.7	8.51	24	235.0	16.22	24	234.3
	10.74	28	270.2	13.39	28	273.5	10.45	28	274.1		28	
	11.39	32	308.6	14.45	32	312.3	12.64	32	313.3		32	
	11.98	36	347.2	15.37	36	350.1	15.60	36	352.8		36	
	12.74	40	386.3	16.41	40	389.3		40			40	
	13.37	44	424.7		44			44			44	
	14.20	48	463.8		48			48			48	
	15.02	52	501.5		52			52			52	
	15.82	56	538.1		56			56			56	
	16.83	60	574.3		60			60			60	

ISO 5011 Capacity & Efficiency Filter Test												
Filter	WIX 46678			Purolator A45314			AMSOIL TS123			UNI UAA-103		
Report Date	7/13/2004			7/12/2004			7/12/2004			7/12/2004		
Barometric Pressure, inHg	29.94			29.87			29.64			29.68		
Air Flow Setpoint, SCFM	350			350			350			350		
Air Flow Type	Variable			Variable			Variable			Variable		
Relative Humidity, %	57.63%			63.48%			64.44%			65.36%		
Typ of Dust	Course			Course			Course			Course		
Batch #	4724C			4724C			4724C			4724C		
Temperature, deg F	75.25			75.87			75.59			75.02		
Dust Feed Rate, gms/Min	9.8			9.8			9.8			9.8		
Test Data:	Rstrn IN H ₂ O	Time, Min	Dust Fed, gms	Rstrn IN H ₂ O	Time, Min	Dust Fed, gms	Rstrn IN H ₂ O	Time, Min	Dust Fed, gms	Rstrn IN H ₂ O	Time, Min	Dust Fed, gms
	5.06	0	0.0	5.05	0	0.0	5.88	0	0.0	5.40	0	0.0
	5.14	2	20.0	5.24	4	39.9	6.83	4	38.5	5.52	4	38.9
	-0.01	4	20.2	5.48	8	79.6	8.59	8	78.9	5.75	8	77.8
	5.12	0	20.3	5.81	12	119.2	11.15	12	119.7	6.03	12	117.4
	5.26	4	59.6	6.31	16	157.4	14.95	16	159.4	6.37	16	156.2
	5.53	8	99.2	7.23	20	196.9	20.27	20	199.0	6.85	20	194.5
	5.79	12	138.2	8.75	24	236.5		24		7.52	24	232.4
	6.13	16	177.0	10.35	28	276.4		28		8.23	28	268.9
	6.53	20	216.6	12.11	32	315.4		32		9.64	32	307.0
	7.07	24	255.8	14.85	36	354.5		36		11.71	36	340.8
	7.84	28	294.9	17.85	40	393.7		40		14.90	40	370.2
	8.96	32	335.0		44			44		16.87	44	382.5
	10.53	36	374.5		48			48			48	
	12.57	40	413.2		52			52			52	
	15.58	44	451.8		56			56			56	
		48			60			60			60	
		52										
		56										
		60										

Nissan Patrol Reference Document

ISO 5011 Capacity & Efficiency Filter Test									
Filter	K&N 33-2135			AFE 72-90008 (fine)			K&N 33-2135 (fine)		
Report Date	7/13/2004			7/13/2004			7/13/2004		
Barometric Pressure, inHg	29.87			29.57			29.62		
Air Flow Setpoint, SCFM	350			350			350		
Air Flow Type	Variable			Variable			Variable		
Relative Humidity, %	61.92%			63.61%			67.22%		
Typ of Dust	Course			Fine			Fine		
Batch #	4724C			4444D			4444D		
Temperature, deg F	75.8			75.34			75.39		
Dust Feed Rate, gms/Min	9.8			9.8			9.8		
Test Data:	Rstrn IN H ₂ O	Time, Min	Dust Fed, gms	Rstrn IN H ₂ O	Time, Min	Dust Fed, gms	Rstrn IN H ₂ O	Time, Min	Dust Fed, gms
	4.54	0	0.0	2.08	0	0.0	4.67	0	0.0
	4.63	2	20.7	2.26	4	42.1	4.95	2	51.5
	-0.01	4	20.4	2.54	8	68.8	5.45	4	89.6
	4.59	0	20.4	3.02	12	91.5	6.29	0	120.8
	4.76	4	59.7	4.92	16	114.4	9.06	4	148.3
	5.06	8	100.0	14.77	20	142.1	14.23	8	174.0
	5.74	12	139.6		24		26.30	12	206.4
	7.72	16	178.4		28			16	
	14.56	20	218.6		32			20	
		24			36			24	
		28			40			28	
		32			44			32	
		36			48			36	
		40			52			40	
		44			56			44	
		48			60			48	
		52						52	
		56						56	
		60						60	

To be consistent with common industry practice all filters were tested using PTI Course Test Dust. Course dust is more commonly used since it will produce higher % efficiency numbers.

TEST DUST Specifications:		
micron size	% in Fine	% in Course
0-2.5	19.7	5.3
0-5	37.3	11.5
5-10	18.2	11.6
10-20	17.7	14.9
20-40	16.6	22.4
40-80	9.9	28.7
80+	.4	10.9

THE STORY BEHIND THE TEST

First of all, many thanks to Arlen Spicer and Ken at Testand for organizing and facilitating the test. Arlen is a professional Firefighter who also operates a small tree service on the side. The tree service is the reason he owns a diesel truck. This study was the result of nearly a year of work by Arlen to get accurate independent data on air filters for the GM Duramax Diesel. Arlen originally set out to build his own Filter Test Stand so that he could perform accurate, repeatable and independent measurements on the various filters available for the Duramax. Arlen questioned the claims made by aftermarket filter manufacturers that their filters were superior to the conventional OEM style paper filters. After spending many months, hours and a considerable amount of his own money, he learned first hand how difficult it was to perform an accurate air filter test. He found it was difficult to maintain all the necessary controls to insure an accurate measurement. It was at this juncture that Arlen received a call from Ken at Testand offering to perform the ISO 5011 test free of charge. Ken found Arlen's idea for an independent comparison study very interesting and offered to do the ISO 5011 testing using one of Testand's industrial Filter Test Machines. Arlen posted the news in an internet forum and immediately the

Nissan Patrol Reference Document

offers by forum members to purchase and send filters for the test started rolling in. Some members purchased and donated filters and others made contributions to cover the expenses and the cost of shipping the filters to Teststand. It was truly a team effort. The end result is the top quality data presented in this report. The following is a quote from a post in the forum. (Arlen) SPICER wrote,

“Now that I am not doing the tests and my objectivity is not necessary, let me explain my motivation. The reason I started this crusade was that I was seeing people spend a lot of money on aftermarket filters based on the word of a salesperson or based on the misleading, incomplete or outright deceiving information printed on boxes and in sales literature. Gentlemen and Ladies, Marketing and the lure of profit is VERY POWERFUL! It is amazing how many people believe that better airflow = more power! Unless you have modifications out the wazoo, a more porous filter will just dirty your oil! Some will say "I have used aftermarket brand X for XXX # years with no problems. The PROBLEM is you spent a chunk of ching on a product that not only DID NOT increase your horsepower, but also let in a lot of dirt while doing it! Now how much is a lot? ANY MORE THAN NECESSARY is TOO MUCH!

Others are persuaded by the claims of aftermarket manufacturers that their filters filter dirt "better than any other filter on the market." Sounds very enticing. To small timers like you and me, spending \$1500 to test a filter sounds like a lot. But if you were a filter manufacturer and you believed your filter could filter dirt better than any other media on the market, wouldn't you want to prove it? Guess what. Test your filter vs. the OE paper. It will cost you \$3000 and for that price you will have the data that you can use in your advertisements. Your investment will be returned a thousand fold! EASIER than shooting fish in a barrel! So why don't these manufacturers do this? Hmmm? Probably not because they would feel guilty about taking more market share.

Now I am not saying that ALL aftermarket filters are useless. A paper filter does not do well if directly wetted or muddy. It may collapse. This is why many off-road filters are foam. It is a compromise between filtering efficiency and protection from a collapsed filter. Now how many of our trucks collapse their filters from mud and water? However, if a filter is using "better airflow" as their marketing tool, remember this....Does it flow better? At very high airflow volumes, probably. BUT, Our trucks CAN'T flow that much air unless super-modified, so what is the point? The stock filter will flow MORE THAN ENOUGH AIR to give you ALL THE HORSEPOWER the engine has to give. And this remains true until the filter is dirty enough to trip the air filter life indicator. At that point performance will decline somewhat. Replace the filter and get on with it.

Hopefully the results of this test will do 2 things. Shed some light on the misleading marketing claims of some aftermarket manufacturers and/or give us new insight on products already on the market that are superior to our OE filter. I stand for truth and will eat my words publicly if my statements prove wrong. I appreciate all of the help and support that you members have offered in this project. It would simply be impossible without your help. A huge thanks to Ken at Testand for his willingness to take on this project. I would be spinning my wheels from here to eternity without his help... SPICER”

Our thanks to Arlen and Ken for making the test happen and providing the valuable test results for the benefit of all.

Nissan Patrol Reference Document

CHIP TUNING OR PERFORMANCE MODULES OR ELECTRONIC TUNING DEVICES

Adapted from and article written for the Land Cruiser Owners On Line (LCOOL) Web Site - Vist Them At <http://www.lcool.org>

WHAT ARE THEY

Chip tuning refers to changing or modifying an EPROM chip in a car's or other vehicle's electronic control unit (ECU) to achieve better performance, whether it be more power, cleaner emissions, or better fuel economy.

This was done with early engine computers in the 1980s and 1990s. Today, the term chip tuning can be misleading, as people will often use it to describe ECU tuning that does not involve swapping the chip. Modern ECUs can be tuned by simply updating their software through a standard interface, such as OBDII. This procedure is commonly referred to as engine or ECU tuning. ECUs are a relatively recent addition to the automobile, having first appeared in the late 1970s.

As technology advanced, so did the electronics that go into cars. The ECU in a modern automobile, together with advanced engine technology, makes it possible to control many aspects of the engine's operation, such as spark timing and fuel injection. The ECU may also control electronic throttle control (drive-by-wire), valve timing, boost control (in turbocharged engines), ABS, the automatic transmission, and the electronic stability control system. Performance gains are realized by adjusting the ignition timing advance. Higher timing may result in higher performance. However, to cope with advanced timing, one must run high-octane gasoline to avoid pre-ignition detonation or pinging. Manufacturers design for a specific timing and this may limit performance accordingly.

In addition, changing fuel maps to coincide with the stoichiometric ratio for gasoline combustion may also realise performance increase. Most manufactures tune for optimum emissions and fuel economy purposes which can limit performance.

Another reason to change the ECU map is if there are engine, intake, or exhaust modifications to the car. These "bolt-on" modifications alter the way that the engine flows, often causing the air to fuel ratio to change. Without re-mapping the fuel tables, some of the performance gains from the modifications may not be realized.

A common misconception is that the ECU can be tuned to provide different power maps optimized for different driving courses (e.g. race tracks). In fact, once the ECU is tuned for optimal torque at all RPM ranges, there is no reason to "de-tune" the ECU for any RPM. A poorly tuned ECU can result in decreased performance, drive ability, and may even cause engine damage.

DIESEL TUNING DEVICES

With the advent of electronic control of diesel injection systems there are many tuning devices that have been released on the market. With these devices, promises of improved power and torque are often realised so no matter which of the readily available chips or computers is chosen, gains will be felt through the seat of the pants.

One could easily draw the conclusion that they are all essentially the same. After all, they simply alter the state of tune of the engine in order to improve performance. One may quote a power figure and the other a tad less. And to confuse the issue further, the one quoting less power may, in fact quote more torque than the first, and so it goes, leaving the consumer even more confused and eventually making a choice without being fully informed.

Many manufacturers have made it very easy for anyone with a basic knowledge of electronics to modify the fuel injection characteristics and to create what is essentially an electronic version of the main set screw from a good old mechanical pump. Most of the chips available are just

Nissan Patrol Reference Document

that - simple devices that alter the amount of fuel injected into the engine. Whilst performance is improved they are very crude and do little more than "turn up the fuel".

At the other end of the range there are complete computer systems that have independent control of the injection timing, the amount of fuel injected, a variety of compensation strategies for situations such as high heat etc and perform these functions at precisely controlled intervals throughout the engine's operating range and throttle range.

Conversely, computer chips targeted for EFI petrol engines generally have independent control of fuel, ignition timing, boost pressure via an array of data points that combine engine rpm, throttle position and sometimes turbocharger boost pressure. This allows them to alter the EFI parameters at discrete engine RPM/throttle position combinations rather than a bulk change of, for example, a fixed percentage change to the injection volume regardless of engine RPM or throttle position.

Generally, the diesel computer aftermarket industry has a decade of catching up to do over those who have been developing computers for petrol engine vehicles. That said there are sophisticated computers for diesel engines that not only employ these advanced features, but also add diesel specific features for advanced engine protection.

There are two equally important issues that one needs to consider. The computer or chip features and the actual numbers or data that is programmed into these chips and computers. No doubt, one can have the most advanced computer hardware, however if the programmed data is incorrect or far from optimum, then performance, durability, fuel economy and throttle response will suffer. To begin with, let's deal with the chip or computer hardware and features.

CHIPS AND COMPUTERS - HOW DO THEY GO ABOUT IMPROVING PERFORMANCE?

There is nothing magical about altering the state of tune of a modern diesel engine. Given the optimum mass of fuel injected into the combustion chamber at the optimum time in the engine's compression cycle and you have the optimum engine power and torque. It really is that simple. The standard ECU has data points stored in its memory that determine the mass of fuel injected and the timing at which that occurs. These data points vary quite markedly depending upon the engine's RPM and throttle position.

At this point in time, all the readily available tuning chips and computers do not alter these stored values but instead take that value and offset it by an amount that is stored in the performance chip or computer. The benefit of this approach is that when the performance device is removed, the engine is returned back to standard control and tuning.

BASIC BASIC BASIC UNIVERSAL FUEL INCREASE UNITS....AND CHEAP TO MANUFACTURE

The simplest devices attack the fuel side of the injection pump only. Some claim that timing is altered as the fuel volume alters, though this is a tad misleading because the way the pump injects fuel is to hold the injector open for a longer period of time - hence the timing is altered. But this can in no way be called independent timing control.

The most basic of these devices increase the amount of fuel by a fixed percentage across the RPM/throttle range. Some may offer the option of several different percentages via an adjustable potentiometer or jumper switches, but again it's a bulk change across all engine operating conditions. These devices are very cheap to produce and technically well within the realms of the basic electronics novice. In fact, the ease with which bulk fuel changes can be made has brought out products from people with limited electronics experience who have no diesel expertise or at best, just own a diesel vehicle. At under \$1,000, these products may seem attractive in price however when one considers that at most it is \$25 of parts from the clearance bin of the local electronics shop, little or no R&D along with the very poor level of tuning expertise that has gone into the product, it is an item that no owner would be associated with.

Nissan Patrol Reference Document

In addition, due to the increase in combustion particulates through bulk over fueling in either the engine oil contamination becomes a serious issue and will more often than not require oil and oil filter service interval of 2,500 km instead of the standard 5,000 km interval.

What the above product has done is to simply mimic the main set screw of a traditional mechanical injection pump and cause a fixed change in the amount of fuel injected regardless of engine RPM and engine load.

	1000 RPM	2000 RPM	3000 RPM	4000 RPM
All Throttle Positions	+ 15%	+ 15%	+ 15%	+ 15%

BASIC BASIC....MULTI POINT FUEL ADJUSTMENT

The ability to adjust the amount of fuel injected at a number of different parts of the RPM range is a major step forward from the bulk percentage adjustment offered by units above. Multi point units will allow a different percentage increase at low engine RPM for example from that at high engine RPM. The advantage with these units is that they begin to address some of the limitations programmed into the factory engine management systems.

Due to strict European emission requirements, manufacturers purposely limits the amount of fuel at low engine RPM. This results in an engine that feels sluggish at low RPM but gets up and goes when the engine revs beyond 1800 - 2000 RPM. Most owners of diesels will have experienced this and most probably mistaken it for turbo lag (which it isn't - more correctly it is fuel lag).

The percentage increase in fuel at low RPM can be greater than that at higher engine RPM whilst still maintaining excellent engine durability. For example, at low engine RPM, a 30% increase in fuel may be appropriate, though at high engine RPM, only 15% increase. Multi point fuel adjustment allows for this variation through the RPM range whilst the very basic bulk adjustment units would have to be limited to the 15% increase in order to maintain engine durability and forsake the additional improvement at low RPM. Interestingly, both units may have identical peak power and torque figures, however the more advanced multi point adjustment unit will deliver superior low RPM torque and response.

The table below is an example of various fuel adjustment points that may apply regardless of the throttle position.

	1000 RPM	2000 RPM	3000 RPM	4000 RPM
All Throttle Positions	+ 30%	+ 20%	+ 15%	+ 10%

DESIRABLE FUEL MAPPING

Taking the above multi point fuel adjustment further, we now get close to the capabilities of a sophisticated fuel management system where one can program many fuel points across the combination of engine RPM and throttle position.

Nissan Patrol Reference Document

Below is a simple example showing individual adjustment points for fuel injected at different engine operating conditions.

	1000 RPM	2000 RPM	3000 RPM	4000 RPM
20% Throttle	+ 10%	+ 10%	+ 15%	+ 15%
60% Throttle	+ 20%	+ 15%	+ 15%	+ 12%
100% Throttle	+ 30%	+ 20%	+ 15%	+ 10%

But all is not quite as clear cut as it may seem. A unit that allows discrete adjustments as shown above must have the capability to interpolate between points (or to use the correct terminology - load sites). Because the example above is fairly coarse, using large jumps between load sites, the unit must be able to ramp up or down between load sites. For example, the 100% throttle adjustment goes from 30% at 1000 RPM to 20% at 2000 RPM. Interpolation means that at 1500 RPM, the unit will automatically adjust to 25% - and so on. This provides smoother engine operation particularly when cruising at or close to an RPM point where a change in percentage rate adjustment is made.

INDEPENDENT INJECTION TIMING

The ability to have independent injection timing on a vehicle is technically difficult to implement successfully. In fact, most manufacturers of performance chips ignore this very important aspect of engine tuning because it is so difficult - settling instead for performance improvements through over fueling alone.

The benefits of sophisticated injection timing control to the performance enthusiast however are significant - not only for improved engine performance, but more importantly for efficient engine operation (improve fuel economy) and engine durability (lowering peak combustion temperatures).

In addition, without effective independent control of timing - particularly at low RPM - engine oil contamination from combustion particulates becomes a serious issue. By making minor timing adjustments on the engines, oil contamination is minimised and there is no need to make any adjustments to the service schedule. On the other hand, a bulk fuel only device such as those mentioned above may require more frequent oil and oil filter changes - typically every 2,500 km.

It is very desirable to employ the same capability as we saw previously with the fuel map to adjust the injection timing at a number of points across the entire range of RPM and throttle position combinations. Again due to strict European emission requirements, the injection timing is purposely set to values that are not optimum for engine power and torque or indeed engine response - particularly at low engine RPM by the manufacturer.

The chart below shows a simplified map of injection timing adjustments at different engine operating conditions.

	1000 RPM	2000 RPM	3000 RPM	4000 RPM
20% Throttle	+ 4 deg	+ 3 deg	+ 4 deg	+ 3 deg
60% Throttle	+ 3 deg	+ 1 deg	+ 3 deg	+ 3 deg
100% Throttle	+ 3 deg	+ 2 deg	+ 1 deg	+ 2 deg

In the case of turbocharged diesel engines, sophisticated injection timing maps can be used to dramatically improve the turbocharger response characteristics and effectively improve the

Nissan Patrol Reference Document

range at which the turbocharger is performing at high efficiency - producing strong boost pressure.

Briefly, the energy contained in the exhaust gases drive the turbocharger. The higher the amount of exhaust gas energy, the higher potential for the turbocharger to convert that energy into useful work. Of particular interest is the point in the engine's RPM range where the turbocharger begins to produce strong boost pressure - typically around 1800 RPM.

By slightly retarding the injection timing at that point in the RPM range, additional exhaust gas energy is created, thus allowing the turbocharger to deliver boost pressure earlier. This effectively widens the range where the turbocharger is operating efficiently. The above is certainly valid at large throttle openings when overtaking, however at small throttle openings the opposite is required. To run retarded timing under cruise or light throttle applications results in inefficient engine operation and increased fuel consumption. It is important then to advance the injection timing under these cruise conditions.

A simplified example may be seen below.

	1000 RPM	2000 RPM	3000 RPM	4000 RPM
20% Throttle	+ 4 deg	+ 3 deg	+ 4 deg	+ 3 deg
60% Throttle	+ 3 deg	+ 1 deg	+ 3 deg	+ 3 deg
100% Throttle	+ 2 deg	- 2 deg +2 deg	+ 2 deg	+ 2 deg

Following on from the above discussion regarding retarded injection timing (as shown at load site 100% throttle/2000 RPM) to improve turbocharger response, a tuning strategy that employs this feature ideally will also have the capability to treat this in a transient manner. In other words, use the retarded value only (shown bolded) until the turbocharger has settled and is producing the desired boost pressure level. Then the computer could creep that negative timing adjustment up into positive values (shown bold and italics) so that the engine will be operating at peak engine efficiency under steady state conditions. Circumstances where this is of use to the driver is when towing up a hill. You put your foot down, the turbocharger builds boost pressure quickly (transient tuning parameters) and as the engine settles into the task of pulling the load up the hill, the tuning computer changes the tuning parameters for steady state conditions.

In summary - regarding independent injection timing control, this is a technically difficult feature to implement and requires sophisticated hardware and software. The improvements in engine performance and throttle response can be dramatic as can the enhancements to engine durability when adjusted in conjunction with increased fuel injection volume.

ENGINE DURABILITY

The whole idea of improving engine performance really goes out the window if engine durability is significantly affected. Very few people would consider a device that will break an engine - regardless of the performance improvement. It is important that a good deal of development goes into ensuring that engine durability is not adversely affected - preferably enhanced.

To this end, the performance features such as independent injection timing control are important for enhanced durability, as are the numbers that are programmed into each chip or computer. However the more highly technically advanced units also employ a number of safety features in order to add further engine protection under sever operating conditions.

Nissan Patrol Reference Document

For example, if engine coolant temperature increases above a certain point, the standard engine management system will take some action to rectify the situation by making small adjustments to the fuel injection volume. If however an overfueling only chip such as that first described is installed, it will simply continue to supply 15% - 20% more fuel on top of the fuel volume that the standard computer is injecting. This will result in engine damage if allowed to continue because the standard ECU's safety program is not designed to cope with a large bulk increase in fuel. A more advanced unit however will continually read the engine coolant temperature and when above a certain point, make changes to the injected fuel volume in order to save the engine.

There may also be other items such as air temperature, boost pressure etc that may be used for tuning compensation as well, though this makes wiring more complicated since more and more signal wires to and from the standard ECU must be spliced into if not utilising a plug in loom. Actually, this raises yet another issue that may not at first be seen as an engine durability feature. If a unit has a plug in adaptor that has access to all the signals entering and exiting the standard ECU, then the higher the chances that even more sophisticated engine protection strategies are in place.

In any case, from a chip or computer hardware point of view, those that have built-in safety features are by far preferable to those that do not.

Another aspect is the data that is stored inside the standard ECU. Most factory computer systems log and store operational data such as vehicle speed, throttle position, temperatures, boost pressure etc. This data often cannot be erased by traditional means such as removing power from the factory ECU. Hence if the logging of altered operating conditions is of concern, the devices which monitor and control the input of the ECU as well as the output should be of interest. These devices will often present data to the ECU that reflects normal operating conditions. There has been talk that the standard ECU may not log this data, however those comments have been made by those who do not have the equipment to read it.

PROGRAMMING, NUMBERS, DATA - THE STUFF THAT GOES INTO A COMPUTER

So far we have dealt with the chip or computer features that are used to improve performance. As has been indicated throughout, regardless of the features, if the data programmed (or in the case of simple over fueling devices, jumper or screw position) is not appropriate, then engine performance, engine durability, fuel economy or all will suffer.

Not unlike the issues faced mechanical injection pumps, simple over fueling devices face the same issues when it comes to adjustment. Put simply, it is a matter of how much risk the tuner or owner is prepared to take. The greater the volume of fuel injected, the higher the risk. Since there is no other adjustment for timing or inbuilt safety, the improvement will be at best a compromise.

Typically, these devices will be set up on the road without extensive use of data logging equipment, gas analyser or chassis dyno. Hence with little knowledge of what is happening to the engine during the combustion of the greater volume of fuel over standard.

More sophisticated devices that have provision for independent timing adjustment and fuel adjustment through comprehensive maps are typically programmed using elaborate test and measurement equipment as well as on road testing. The complexity of these devices demand the right tuning equipment as well as tuners who have a deep knowledge of not only diesel engine operation, but the ability to properly comprehend exhaust gas analysis, oil analysis etc and to understand how this data relates to fuel combustion and engine operation. Setting up of these devices cannot be performed successfully on road alone as it is impossible to have all the relevant equipment connected and operated under controlled conditions. These devices, once tuned, will typically be locked so that tampering or altering of the programmed values is prohibited. This is mainly due to the fact that those who wish to tamper will more often than

Nissan Patrol Reference Document

not have no access to the relevant test and measurement equipment that is so important in achieving the optimum parameters.

CONCLUSIONS

As stated up front, with the advent of electronic control of diesel injection systems, a plethora of tuning devices have been released on the market to tempt the performance enthusiast. Let's face it, a chip is a chip isn't it?

On the face of it, all promise improved performance however as is plainly seen from all of the above, there is a huge leap in going from a simple over fueling device to a sophisticated plug in computer system with comprehensive fuel map, independent timing map as well as built in safety features.

The cost of these units on the other hand is not necessarily relative to their features or capabilities. For example, simple over fueling devices can cost between \$600 - \$1300. It could be argued that, given that these devices are very simple and inexpensive to develop and manufacture, the retail price is geared more towards preying upon consumer ignorance rather than technical merit.

Owners should now be in a position to better evaluate the variety of options for their vehicles and to ask more relevant questions rather than relying simply upon quoted power and torque figures. In fact, these very figures which may have at first been the most significant criteria, are ultimately the least important, for all devices will deliver an improvement. The important criteria are those that are used to determine which devices deliver the best improvement in engine performance across the entire RPM range and throttle range, fuel economy and engine protection at a reasonable cost.

Nissan Patrol Reference Document

DIFFERENTIALS (DIFFS)

WHAT ARE THEY

In cars and other four-wheeled vehicles a differential is a device, usually consisting of gears, that allows each of the driving wheels to rotate at different speeds while supplying equal torque to each.

A STANDARD (OPEN) DIFFERENTIAL

A vehicle's wheels rotate at different speeds, especially when turning corners. The differential is designed to drive a pair of wheels with equal force, while allowing them to rotate at different speeds. In vehicles without a differential, such as karts, both driving wheels are forced to rotate at the same speed, usually on a common axle driven by a simple chain-drive mechanism. When cornering, the inner wheel travels a shorter distance than the outer wheel, resulting in the inner wheel spinning and/or the outer wheel dragging. This results in difficult and unpredictable handling, damage to Tyres and roads and strain on, and possible failure of the entire drive train.

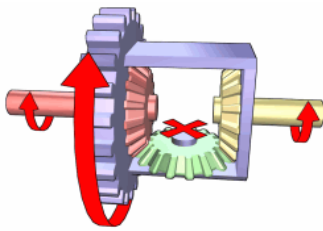

Input torque is applied to the ring gear, which turns the entire carrier (all blue), providing torque to both side gears (red and yellow), which in turn may drive the left and right wheels. If the resistance at both wheels is equal, the planet gear (green) does not rotate, and both wheels turn at the same rate.

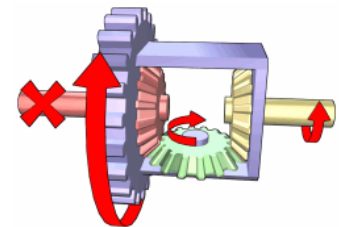

If the left side gear (red) encounters resistance, the planet gear (green) rotates about the left side gear, in turn applying extra rotation to the right side gear (yellow).

One undesirable side effect of a differential is that it can reduce overall torque - the rotational force which propels the vehicle. The amount of torque required to propel the vehicle at any given moment depends on the load at that instant - how heavy the vehicle is, how much drag and friction there is, the gradient of the road, the vehicle's momentum and so on.

Many people believe that a 4WD and traction go hand in hand; you can't have one without the other. The truth is most 4WDs send power to the wheels with the least amount of traction when difficult terrain is encountered. This occurs because your vehicle's standard (or open) differential is designed to allow each wheel to turn independently, thus eliminating binding during cornering. Unfortunately, an open differential means that when one or more of your vehicle's wheels lose traction a standard differential directs all power to those spinning wheels, and momentum is lost. Newer vehicles with limited slip differentials (LSD) etc may offer some improvement over standard differentials, but more often you'll find the slipping is not "limited" enough to maintain forward progress.

When a vehicle with four wheel drive engaged is driven in a straight line, the standard differentials in most vehicles allow equal transfer of engine torque to all four wheels. When the vehicle turns a corner, torque to all four wheels that experience the least resistance (inside wheels will rotate freely) and power is delivered to the outside wheels) to prevent tyres from scuffing and wearing out prematurely.

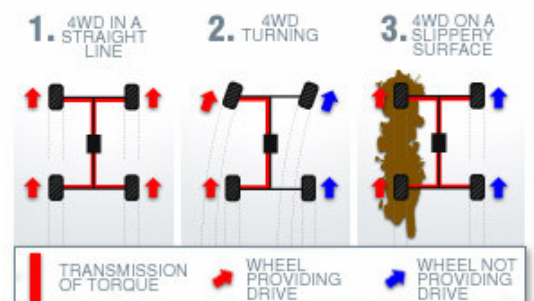

Because the standard differentials transfer the torque to the wheels that encounter the least resistance, you will lose drive when on loose/slippery ground or if one wheel is suspended in mid air. This becomes a problem as the wheel will spin and will not allow the wheel on firmer ground to drive the vehicle out of the situation.

TRACTION-ADDING DEVICES

Nissan Patrol Reference Document

There are various devices for getting more traction from vehicles with differentials.

- One solution is the limited slip differential (LSD), the most well-known of which is the clutch-type LSD. With this differential, the side gears are coupled to the carrier via a stack of clutch plates which limits the speed difference between the two wheels.
- A locking differential employs a mechanism for allowing the planetary gears to be locked relative to each other, causing both wheels to turn at the same speed regardless of which has more traction; this is equivalent to removing the differential entirely.
- The torsen differential preferably sends torque to the slower moving wheel.
- Electronic traction control systems usually use the ABS system to detect a spinning wheel and apply the brake to it. This progressively raises the reaction torque at that wheel, and the differential compensates by transmitting more torque through the other wheel - the one with better traction.
- A viscous coupling unit replaces the differential entirely. It works on the principle of allowing the two output shafts to counter-rotate relative to each other within a viscous fluid. The fluid allows slow relative movements of the shafts, such as those caused by cornering, but will strongly resist high-speed movements, such as those caused by a single wheel spinning.

A four-wheel-drive vehicle will have at least two differentials (one for each pair of wheels) and possibly a centre differential to apportion power between the front and rear axles. Vehicles without a centre differential should not be driven on dry, paved roads in four wheel drive mode, as small differences in rotational speed between the front and rear wheels cause a torque to be applied across the transmission. This phenomenon is known as "wind-up" and can cause damage to the transmission. On loose surfaces these differences are absorbed by the slippage on the road surface.

WHATS A LOCKING DIFFERENTIAL OR LOCKER

Above describes in basics what a locking differential is, but as we hear people within the club discussing this type of differential more often than not, let's get into a bit more detail shall we.

A locking differential or "selectable" locker (as apposed to automatic locker) is a variation on the standard automotive differential. A locking differential provides increased traction compared to a standard or "open" differential by disallowing wheel speed differentiation between two wheels on the same axle under certain conditions. A locking differential is designed to overcome the chief limitation of a standard open differential by essentially "locking" both wheels on an axle together as if on a common shaft while still allowing them to rotate at different speeds when it is required (such as when negotiating a turn). Once engaged, the locker operates by locking in both axles and delivering equal drive to both wheels. This means that an equal amount of engine torque is transferred to both wheels, giving you the best possible chance of powering through the toughest terrain.

The operation of a locking differential is simple and straight forward. Utilising compressed air or electrical solenoids, the internal mechanisms will engage. Once the Locker is engaged it forms a solid drive the differential is now locked and will deliver equal drive to both axles. In an air activated locker, unlocking the differential involves the pressurised air being redirected through an exhaust port on the solenoid valve. A spring in the actuator pushes the mechanisms back, which in turn pulls the locker out of engagement. The differential is now unlocked and the gears are free to differentiate as before.

With its design and robustness it is generally considered that installing a locker can assist in the strengthening of a differential in a vehicle that can be prone to breakage. You also need to change your 4WD driving style to take into consideration the action of the differential(s) on differing terrain.

Nissan Patrol Reference Document

Some car manufacturers will provide a differential locker as a factory option, for instance the new Mitsubishi triton has a rear locker option. In most factory fitments the lockers are activated via an electric solenoid, for aftermarket companies like TJM and ARB the lockers are air pressure activated, which means you need to also install a compressor to activate the locker. In both types of systems it is just the flick of a switch or two on the dash that will activate the locker(s).

Nissan Patrol Reference Document

INTERCOOLERS

WHAT ARE THEY

An intercooler, or charge air cooler, is an air-to-air or air-to-liquid heat exchange device used on turbocharged and supercharged internal combustion engines to improve their efficiency by increasing intake air charge density through cooling. A decrease in air intake temperature provides a denser intake charge to the engine and allows more air and fuel to be combusted per engine cycle, increasing the output of the engine. The inter prefix in the device name originates from historic compressor designs. In the past, aircraft engines were built with air charge coolers that were typically installed between multiple stages of supercharging, thus the designation of inter. Modern automobile designs are technically designated after coolers because of their placement at the end of supercharging chain.



Intercoolers can vary dramatically in size, shape, and design, depending on the performance and space requirements of the entire supercharger system. Common spatial designs are front mounted intercoolers (FMIC), top mounted intercoolers (TMIC), hybrid mount intercoolers (HMIC). Each type can be cooled with an air-to-air system, air-to-liquid system, or a combination of both.

Turbochargers and superchargers are engineered to forcefully induct more gas, primarily oxygen, in an engine's intake manifold. A larger intake charge generally provides more torque than a naturally aspirated engine of identical size. Intercooling is a method used to compensate for heating caused by rapid gas compression, a natural by-product of the compression process. At very high output pressures, intake charges become excessively hot, significantly lowering the performance gains of supercharging due to decreased density. Increased intake charge temperature can also increase the cylinder combustion temperature, causing excessive wear or heat damage to an engine block.

Passing a compressed, and subsequently heated, intake charge through an intercooler lowers its temperature and reduces its density. This increases performance by recovering some losses of the inefficiency of the compressing process by dumping excess heat to the atmosphere. Additional cooling can be provided by externally spraying fluid on the intercooler surface to further reduce intake charge temperature through evaporative cooling, or installing a fan to ensure a continuous supply of cooling air through the intercooler.

AIR TO AIR INTERCOOLERS

Intercoolers that exchange their heat with the atmosphere are designed to be mounted in areas of an automobile with maximum air flow. These types are mainly mounted in front mounted systems (FMIC). Cars such as the Nissan Skyline, Saab (except the Subaru WRX-based 9-2X Aero), Dodge SRT-4, Mitsubishi Lancer Evolution all use front mounted intercooler(s) mounted near the front bumper, in line with the car's radiator.



ZD30 CRD top mount air to liquid intercooler

Many older turbo-charged cars, such as the Toyota Supra, Saab 900, Volkswagen, Audi, and Turbo Mitsubishi Eclipse use side-mounted air-to-air intercoolers (SMIC), which are mounted in the front corner of the bumper or in front of one of the wheels. Side-mounted intercoolers are generally smaller, mainly due to space constraints, and sometimes two are used to gain the performance of a larger, single intercooler. Cars such as the Subaru Impreza WRX, MINI Cooper S

Nissan Patrol Reference Document

and the MAZDASPEED 6 use air-to-air top mounted intercoolers (TMIC) located on top of the engine. Air is directed through the intercooler through the use of a hood scoop. Top mounted intercoolers sometimes suffer from heat diffusion due to proximity with the engine, warming them and reducing their overall efficiency. Some World Rally Championship cars use a reverse-induction system design whereby air is forced through ducts in the front bumper to a horizontally-mounted intercooler.

FRONT MOUNTING AN INTERCOOLER?

Because FMIC systems require open bumper design for optimal performance, the entire system is vulnerable to debris. Some engineers choose other mount locations due to this reliability concern. FMIC can be located in front of or behind the radiator, depending on the heat dissipation needs of the engine.



AIR-TO-LIQUID INTERCOOLERS

The use of a liquid system to cool intake charge is sometimes known as a charge cooler. Air-to-liquid intercoolers are heat exchangers that eject intake charge heat to an intermediate fluid, usually water/coolant, which finally ejects heat to the air. These systems use radiators in other locations, usually due to space constraints, to eject unwanted heat, similar to an automotive radiator cooling system. Charge coolers are usually heavier than their air-to-air counterparts due to more components making up the system.



Aftermarket PWR air to liquid intercooler

Nissan Patrol Reference Document

MASS AIRFLOW SENSOR (MAF)

WHAT IS IT

A device that's used in many electronic fuel injection systems for measuring the volume of air entering the engine. Some use a spring-loaded vane while others use a hot wire or heated filament to sense air flow. The Nissan uses a hot wire type.

A mass airflow sensor is used to determine the mass of air entering an electronically fuel-injected engine. The air mass information is necessary for the engine control unit (ECU) to calculate and deliver the correct fuel mass to the engine. Air changes its density as it expands and contracts with temperature and pressure. In automotive applications, air density varies with the ambient temperature and altitude, and this is an ideal application for a mass sensor.

There are two common types of mass airflow sensors in usage on gasoline engines. These are the vane meter and the hot wire. Neither design employs technology that measures air mass directly. However, with an additional sensor or two, the engine's air mass flow rate can be accurately determined.

Both approaches are used almost exclusively on electronic fuel injection (EFI) engines. Both sensor designs output a 0 - 5.0 volt signal that is proportional to the air mass flow rate, and both sensors have an intake air temperature (IAT) sensor incorporated into their housings.

HOT WIRE SENSOR

A hot wire mass airflow sensor determines the mass of air flowing into the engine's air intake system. This is achieved by heating a wire with an electric current that is suspended in the engine's air stream, not unlike a toaster wire.

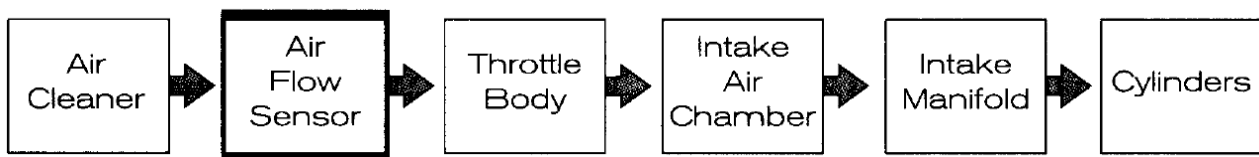

The wire's electrical resistance increases as the wire's temperature increases, which limits electrical current flowing through the circuit. When air flows past the wire, the wire cools, decreasing its resistance, which in turn allows more current to flow through the circuit. As more current flows, the wire's temperature increases until the resistance reaches equilibrium again. The amount of current required to maintain the wire's temperature is directly proportional to the mass of air flowing past the wire. The integrated electronic circuit converts the measurement of current into a voltage signal which is sent to the ECU.

If air density increases due to pressure increase or temperature drop, but the air volume remains constant, the denser air will remove more heat from the wire indicating a higher mass airflow. The hot wire responds directly to air density. This sensor's capabilities are well suited to support the gasoline combustion process which fundamentally responds to air mass, not air volume.

Nissan Patrol Reference Document

Some of the benefits of a hot-wire MAF:

- responds very quickly to changes in air flow
- low airflow restriction
- smaller overall package
- less sensitive to mounting location and orientation
- no moving parts improve its durability
- less expensive
- separate temperature and pressure sensors are not required (to determine air mass)

There are some drawbacks:

- dirt and oil can contaminate the hot-wire deteriorating its accuracy
- installation requires a laminar flow across the hot-wire



Early MAF, these have a circular entry point into the air duct.
GU4 MAFs have a rectangular entry point and can only be inserted one way.

HOW TO REMOVE

On a GU4 you will need a special torx (star type) security bit size T20 to remove the MAF. You can get these just about anywhere good tools are sold. Simply disconnect the wiring connector and unscrew the 2 screws. It then just slides outwards. MAF location circled below.

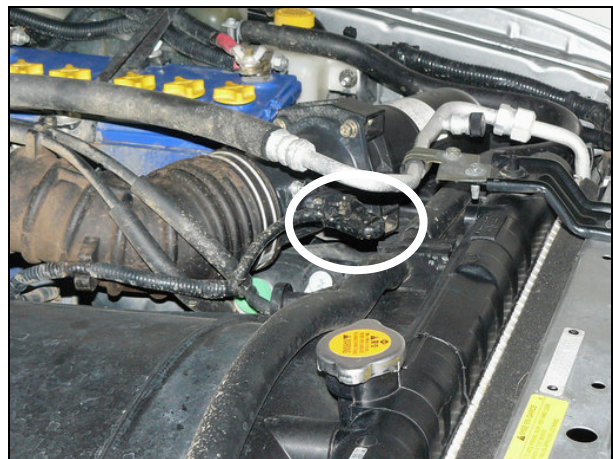
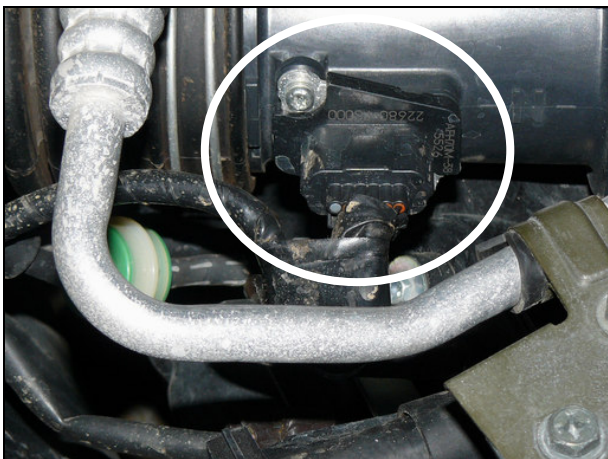

Nissan Patrol Reference Document

NISSAN BULLETIN ON ZD30 ENGINE OIL - SEPT 2004

This bulletin was released in 2004 for Patrols that were built **AROUND THAT TIME OR BEFORE**. For the newer series of vehicles and their oil requirement consult your owner's manual.

First Published: 30th September 2004
Bulletin No: MA04-001
Re: Revised Engine Oil Specification
Applied Model: Y61 & D22
Applied range: ZD30 Engines

Please be advised that the specification for the 011 fill on the ZD30 has been revised. Engine Oils that meet the specification listed below are the only oils that are permitted for use in the ZD30 Engine. 011 Specification: ACEA 83 or JASO DH.1. Nissan strongly recommend that a viscosity rating of 10W40 be used. For specific viscosity relating to ambient temperature ranges please refer to the viscosity chart in the relevant workshop manual.

Note: API CG-4 0118 must never be used In the ZD30 engine.
To support the revision in oil specification, Nissan has developed a semi-synthetic 10W-40 engine oil that meets all the operational demands of this engine. The revision of the new oil specification is retrospective and will apply to all ZD30 engines.

The oil will be available from Nissan Parts & Accessories in 51t and 200lt Quantities using the following part numbers.
51t- B3005-10W40PK
2001t- B3200..10W40PK

Authorised by:
R Bahn
Manager. Engineering Support
National Service & Engineering Department

NISSAN MOTOR GO.
Locked Bag 1450. Dandenong South, VIC, :3154 Phone. (03) 97974111 Fax. (03) 97974400

Nissan Patrol Reference Document

PCV VALVE

The Positive Crankcase Ventilation valve, or PCV valve, is a one-way valve (in petrol engines, a diesel generally does not use a one way valve) that ensures continual evacuation of gases from inside a combustion engine's crankcase.

The remainder of this section talks about petrol or gasoline engines, besides the one way valve which commonly a diesel does not use, the rest is still relevant and will give you an understanding of what the crankcase breather is for and how it works. As a diesel does not have a one way valve the air expelled is sucked in and out or "pulses" out of the breather tube back into the air intake.

EXPLANATION

As an engine runs, gases from the cylinders leak past the piston's sealing rings into the crankcase (containing the crankshaft and other parts). This leaked gas is sometimes referred to as "blow by" because the pressure within the cylinders "blows" them "by" the piston rings. These gases include compounds harmful to an engine, particularly hydrocarbons (unburned fuel), as well as carbon dioxide and water vapor. If allowed to remain in the crankcase, or become too concentrated, the harmful compounds will condense out of the air within the crankcase and form corrosive acids and sludge on the engine's interior surfaces. This can harm the engine as it tends to clog small inner passages, causing overheating, poor lubrication, and high emissions levels. To keep the crankcase air as clean as possible, some sort of ventilation system must be present.

HISTORY

Prior to the early 1960s, automobile gasoline engines ventilated directly to the atmosphere through a simple vent tube. Frequently this consisted of a pipe (the "road draft tube") that extended out from the crankcase down to the bottom of the engine compartment. The bottom of the pipe was open to the atmosphere, and was placed such that when the car was in motion a slight vacuum would be hopefully obtained, helping to extract combustion gases as they collected in the crankcase. The system was not positive though, as gases could travel both ways, or not move at all, if conditions were just right. Modern diesel engines still use this type of system to dispose of crankcase fumes. During World War II however, a different type of crankcase ventilation had to be invented to allow tank engines to operate during deep fording operations, where the normal draft tube ventilator would have allowed water to enter the crankcase and destroy the engine. The PCV system and its control valve were invented to meet this need but the need for it on automobiles was not recognized.

In 1952, Professor A. J. Haagen-Smit, of the California Institute of Technology at Pasadena, postulated that unburned hydrocarbons were a primary constituent of smog, and that gasoline powered automobiles were a major source of those hydrocarbons. After some investigation by the GM Research Laboratory (Dr. Lloyd L. Withrow) it was discovered in 1958 that the road draft tube was a major source, (about half) of the hydrocarbons coming from the automobile. GM's Cadillac Division, which had built many tanks during WWII, recognized that the simple PCV valve could be used to become the first major reduction in automotive hydrocarbon emissions. After confirming the PCV valves effectiveness at hydrocarbon reduction, GM offered the PCV solution to the entire U.S. automobile industry royalty free through its trade association, the Automobile Manufacturers Association (AMA). In the absence of any legislated requirement, the AMA members agreed to put it on all California cars voluntarily in the early 1960s, with national application following one year later.

Following its introduction into production, several years later the PCV became the subject of a Federal grand jury investigation in 1967, when it was alleged by some industry critics that the AMA was conspiring to keep several such smog reduction devices like the PCV on the shelf to delay smog control. After eighteen months of investigation by U.S. Attorney Samuel Flatow, the grand jury returned a "no-bill" decision, clearing the AMA, but resulting in a "Consent Decree"

Nissan Patrol Reference Document

that all U.S. automobile companies agreed not to work jointly on smog control activities for a period of ten years.

PCV SYSTEM

The PCV valve is only one part of the PCV system, which is essentially a variable and calibrated air leak, whereby the engine returns its crankcase combustion gases. Instead of the gases being vented to the atmosphere, gases are fed back into the intake manifold, to re-enter the combustion chamber as part of a fresh charge of air and fuel. The PCV system is not a classical "vacuum leak." Remember that all the air collected by the air cleaner (and metered by the mass air flow sensor, on a fuel injected engine) goes through the intake manifold anyway. The PCV system just diverts a small percentage of this air via the breather to the crankcase before allowing it to be drawn back in to the intake tract again. It is an "open system" in that fresh exterior air is continuously used to flush contaminants from the crankcase and into the combustion chamber.

The system relies on the fact that, while the engine is running, the intake manifold's air pressure is always less than crankcase air pressure. The lower pressure of the intake manifold draws air towards it, pulling air from the breather through the crankcase (where it dilutes and mixes with combustion gases), through the PCV valve, and into the intake manifold.

The PCV system consists of the breather tube and the PCV valve. The breather tube connects the crankcase to a clean source of fresh air, such as the air cleaner body. Usually, clean air from the air cleaner flows in to this tube and in to the engine after passing through a screen, baffle, or other simple system to arrest a flame front, to prevent a potentially explosive atmosphere within the engine crank case from being ignited from a back-fire in to the intake manifold. The baffle, filter, or screen also traps oil mist, and keeps it inside the engine.

Once inside the engine, the air circulates around the interior of the engine, picking up and clearing away combustion byproduct gases, including a large amount of water vapor, and then exits through a simple baffle, screen or mesh to trap oil droplets before being drawn out through the PCV valve, and into the intake manifold.



OPERATION

Should the intake manifold's pressure be higher than that of the crankcase (which can happen in a turbo charged engine or under certain conditions, such as an intake backfire), the PCV valve closes to prevent reversal of the exhausted air back into the crankcase again. This is where the positive comes from in the name. Positive is basically a synonym for one-way.

It is critical that the parts of the PCV system be kept clean and open; otherwise air flow will be insufficient. A plugged or malfunctioning PCV system will eventually damage an engine. PCV problems are primarily due to neglect or poor maintenance, typically engine oil change intervals

Nissan Patrol Reference Document

that are inadequate for the engine's driving conditions. A poorly-maintained engine's PCV system will eventually become contaminated with sludge, causing serious problems. If the engine's lubricating oil is changed with adequate frequency, the PCV system will remain clear practically for the life of the engine. However, since the valve is operating continuously as one operates the vehicle, it will fail over time. Typical maintenance schedules for gasoline engines include PCV valve replacement whenever spark plugs are replaced. The long life of the valve despite the harsh operating environment is due to the trace amount of oil droplets suspended in the air that flows through the valve that keep it lubricated.

Not all gasoline engines have PCV valves. Engines not subject to emission controls, such as certain off-road engines, retain road draft tubes. Dragsters use a scavenger system and venturi tube in the exhaust to draw out combustion gases and maintain a small amount of vacuum in the crankcase to prevent oil leaks on to the race track. Small gasoline two cycle engines use the crank case to compress incoming air. All blow by in these engines is burned in the regular flow of air and fuel through the engine. Many small four-cycle engines such as lawn mower engines and small gasoline generators simply use a draft tube connected to the intake, between the air filter and carburetor, to route all blow by back into the intake mixture. The higher operating temperature of these small engines has a side effect of preventing large amounts of water vapor and light hydrocarbons from condensing in the engine oil.



Aftermarket PCV Valves

Nissan Patrol Reference Document

TRAILER WIRING DIAGRAMS

Flat



12 Pin Plug

12 Pin Socket

PIN No.	CIRCUIT	COLOUR
1	Left-hand turn	Yellow
2	Reversing signal	Black
3	Earth return	White
4	Right-hand turn	Green
5	Service brakes	Blue
6	Stop Lamps	Red
7	Rear lamps, clearance & side marker lamps	Brown
8	Battery supply	Orange
9	Auxiliaries	Pink
10	Earth return	White
11	Rear fog lamp	Grey
12	Auxiliaries	Violet

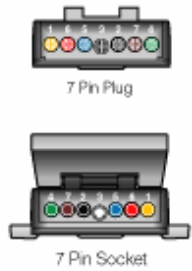

7 Pin Plug

7 Pin Socket

PIN No.	CIRCUIT	COLOUR
1	Left-hand turn	Yellow
2	Reversing signal	Black
3	Earth return	White
4	Right-hand turn	Green
5	Service brakes	Blue
6	Stop Lamps	Red
7	Rear lamps, clearance & side marker lamps	Brown

Large Round



7 Pin Plug

7 Pin Socket

PIN No.	CIRCUIT	COLOUR
1	Left-hand turn	Yellow
2	Reversing signal	Black
3	Earth return	White
4	Right-hand turn	Green
5	Service brakes	Blue
6	Stop Lamps	Red
7	Rear lamps, clearance & side marker lamps	Brown



5 Pin Plug

5 Pin Socket

PIN No.	CIRCUIT	COLOUR
2	Left-hand turn	Yellow
3	Earth return	White
5	Right-hand turn	Green
6	Stop lamps	Red
7	Rear lamps, clearance & side marker lamps	Brown

Small Round



7 Pin Plug

7 Pin Socket

PIN No.	CIRCUIT	COLOUR
1	Left-hand turn	Yellow
2	Reversing signal	Black
3	Earth return	White
4	Right-hand turn	Green
5	Service brakes	Blue
6	Stop Lamps	Red
7	Rear lamps, clearance & side marker lamps	Brown



6 Pin Plug

6 Pin Socket

PIN No.	CIRCUIT	COLOUR
1	Tail/Clearance lamp	Brown
2	Left-hand turn	Yellow
3	Right-hand turn	Green
4	Stop lamps	Red
5	Service brakes	Blue
6	Earth return	White

Heavy Duty



Manufactured in accordance with the SAEJ560 Standard and in accordance with the proposed Australian Standard. These connectors are rated at 40 amp continuous duty. Pin number 1 is self grounded (die cast only) with a peak rating of 70 amp and accepts wire sizes from 4–8mm².



PIN No.	CIRCUIT	COLOUR
1	Earth return	White
2	Reversing signal	Black
3	Left-hand turn	Yellow
4	Stop Lamps	Red
5	Right-hand turn	Green
6	Rear lamps, clearance & side marker lamps	Brown
7	Service brakes	Blue

Nissan Patrol Reference Document

TURBO TECH 101 (BASIC) BY GARRETT

How a Turbo System Works

Engine power is proportional to the amount of air and fuel that can get into the cylinders. All things being equal, larger engines flow more air and as such will produce more power. If we want our small engine to perform like a big engine, or simply make our bigger engine produce more power, our ultimate objective is to draw more air into the cylinder. By installing a Garrett turbocharger, the power and performance of an engine can be dramatically increased.

So how does a turbocharger get more air into the engine? Let us first look at the schematic below:

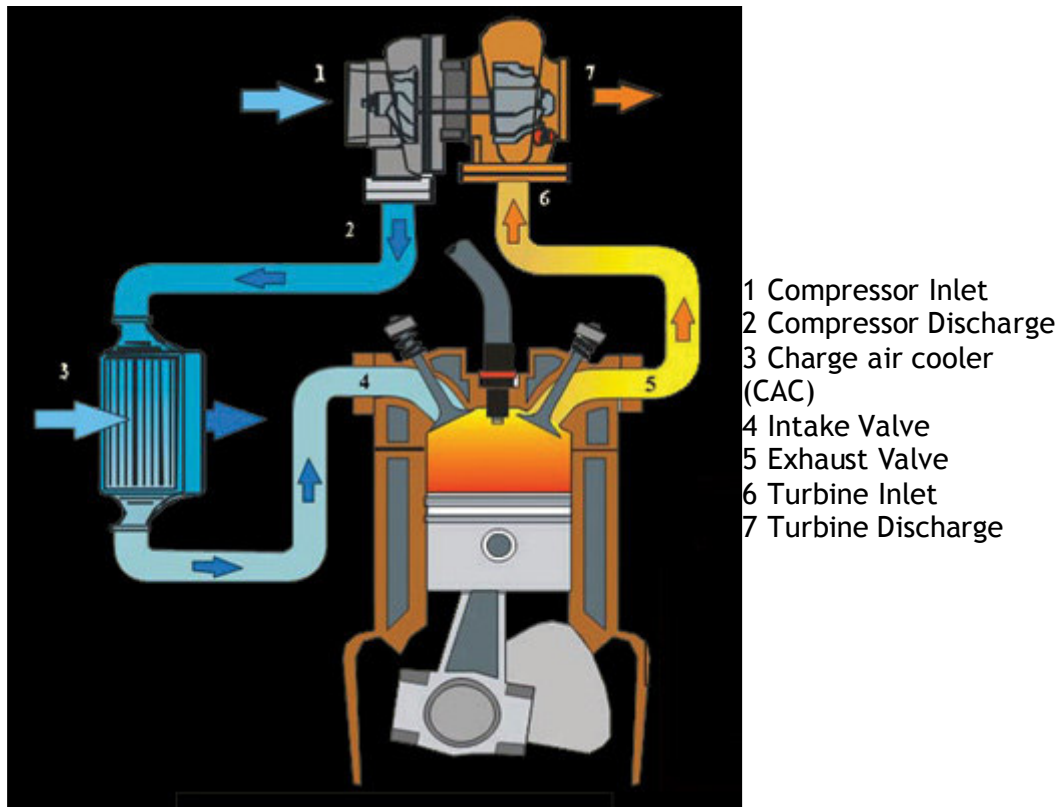

The components that make up a typical turbocharger system are:

- The air filter (not shown) through which ambient air passes before entering the compressor (1)
- The air is then compressed which raises the air's density (mass / unit volume) (2)
- Many turbocharged engines have a charge air cooler (aka intercooler) (3) that cools the compressed air to further increase its density and to increase resistance to detonation
- After passing through the intake manifold (4), the air enters the engine's cylinders, which contain a fixed volume. Since the air is at elevated density, each cylinder can draw in an increased mass flow rate of air. Higher air mass flow rate allows a higher fuel flow rate (with similar air/fuel ratio). Combusting more fuel results in more power being produced for a given size or displacement
- After the fuel is burned in the cylinder it is exhausted during the cylinder's exhaust stroke in to the exhaust manifold (5)
- The high temperature gas then continues on to the turbine (6). The turbine creates backpressure on the engine which means engine exhaust pressure is higher than atmospheric pressure

Nissan Patrol Reference Document

- A pressure and temperature drop occurs (expansion) across the turbine (7), which harnesses the exhaust gas' energy to provide the power necessary to drive the compressor

What are the components of a turbocharger?

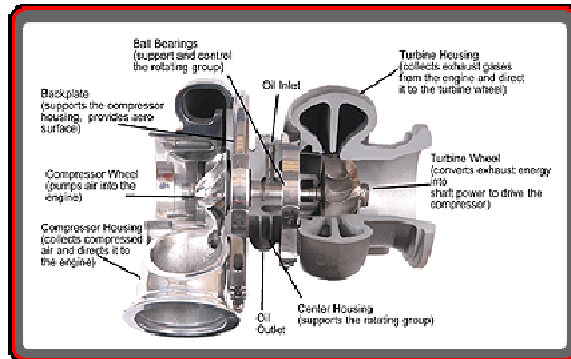

The layout of the turbocharger in a given application is critical to a properly performing system. Intake and exhaust plumbing is often driven primarily by packaging constraints. We will explore exhaust manifolds in more detail in subsequent tutorials; however, it is important to understand the need for a compressor bypass valve (commonly referred to as a Blow-Off valve) on the intake tract and a Wastegates for the exhaust flow.

Other Components

Blow-Off (Bypass) Valves

The Blow-Off valve (BOV) is a pressure relief device on the intake tract to prevent the turbo's compressor from going into surge. The BOV should be installed between the compressor discharge and the throttle body, preferably downstream of the charge air cooler (if equipped). When the throttle is closed rapidly, the airflow is quickly reduced, causing flow instability and pressure fluctuations. These rapidly cycling pressure fluctuations are the audible evidence of surge. Surge can eventually lead to thrust bearing failure due to the high loads associated with it.

Blow-Off valves use a combination of manifold pressure signal and spring force to detect when the throttle is closed. When the throttle is closed rapidly, the BOV vents boost in the intake tract to atmosphere to relieve the pressure; helping to eliminate the phenomenon of surge.



Nissan Patrol Reference Document

Wastegates

On the exhaust side, a Wastegates provides us a means to control the boost pressure of the engine. Some commercial diesel applications do not use a Wastegates at all. This type of system is called a free-floating turbocharger.

However, the vast majority of gasoline performance applications require a Wastegates. There are two (2) configurations of Wastegates, **internal** or **external**. Both internal and external Wastegates provide a means to bypass exhaust flow from the turbine wheel. Bypassing this energy (e.g. exhaust flow) reduces the power driving the turbine wheel to match the power required for a given boost level. Similar to the BOV, the Wastegates uses boost pressure and spring force to regulate the flow bypassing the turbine.

Internal Wastegates are built into the turbine housing and consist of a “flapper” valve, crank arm, rod end, and pneumatic actuator. It is important to connect this actuator only to boost pressure; i.e. it is not designed to handle vacuum and as such should not be referenced to an intake manifold.

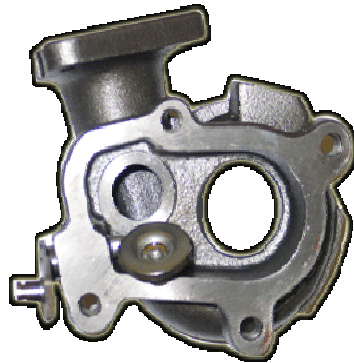

External Wastegates are added to the exhaust plumbing on the exhaust manifold or header. The advantage of external Wastegates is that the bypassed flow can be reintroduced into the exhaust stream further downstream of the turbine. This tends to improve the turbine’s performance. On racing applications, this Wastegated exhaust flow can be vented directly to atmosphere.

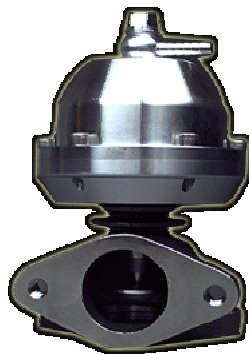

Oil & Water Plumbing

The intake and exhaust plumbing often receives the focus leaving the oil and water plumbing neglected.

Nissan Patrol Reference Document

Garrett ball bearing turbochargers require less oil than journal bearing turbos. Therefore an oil inlet restrictor is recommended if you have oil pressure over about 60 psig. The oil outlet should be plumbed to the oil pan above the oil level (for wet sump systems). Since the oil drain is gravity fed, it is important that the oil outlet points downward, and that the drain tube does not become horizontal or go “uphill” at any point.

Following a hot shutdown of a turbocharger, heat soak begins. This means that the heat in the head, exhaust manifold, and turbine housing finds its way to the turbo’s center housing, raising its temperature. These extreme temperatures in the center housing can result in oil coking.

To minimize the effects of heat soak-back, water-cooled center housings were introduced. These use coolant from the engine to act as a heat sink after engine shutdown, preventing the oil from coking. The water lines utilize a thermal siphon effect to reduce the peak heat soak-back temperature after key-off. The layout of the pipes should minimize peaks and troughs with the (cool) water inlet on the low side. To help this along, it is advantageous to tilt the turbocharger about 25° about the axis of shaft rotation.

Many Garrett turbos are water-cooled for enhanced durability.

Which Turbocharger is Right for Me or more affectionately known as My Turbo & Me

Selecting the proper turbocharger for your specific application requires many inputs. With decades of collective turbocharging experience, the Garrett Performance Distributors can assist in selecting the right turbocharger for your application.

The primary input in determining which turbocharger is appropriate is to have a target horsepower in mind. This should be as realistic as possible for the application. Remember that engine power is generally proportional to air and fuel flow. Thus, once you have a target power level identified, you begin to hone in on the turbocharger size, which is highly dependent on airflow requirements.

Other important factors include the type of application. An autocross car, for example, requires rapid boost response. A smaller turbocharger or smaller turbine housing would be most suitable for this application. While this will trade off ultimate power due to increased exhaust backpressure at higher engine speeds, boost response of the small turbo will be excellent.

Alternatively, on a car dedicated to track days, peak horsepower is a higher priority than low-end torque. Plus, engine speeds tend to be consistently higher. Here, a larger turbocharger or turbine housing will provide reduced backpressure but less-immediate low-end response. This is a welcome tradeoff given the intended operating conditions.

Selecting the turbocharger for your application goes beyond “how much boost” you want to run. Defining your target power level and the primary use for the application are the first steps in enabling your Garrett Performance Distributor to select the right turbocharger for you.

Journal Bearings vs. Ball Bearings

The journal bearing has long been the brawn of the turbocharger, however a ball-bearing cartridge is now an affordable technology advancement that provides significant performance improvements to the turbocharger.

Ball bearing innovation began as a result of work with the Garrett Motorsports group for several racing series where it received the term the ‘cartridge ball bearing’. The cartridge is a single sleeve system that contains a set of angular contact ball bearings on either end, whereas the traditional bearing system contains a set of journal bearings and a thrust bearing

Nissan Patrol Reference Document

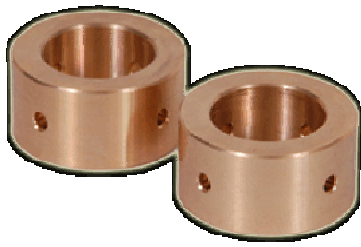

Journal Bearings



Ball Bearings

Turbo Response - When driving a vehicle with the cartridge ball bearing turbocharger, you will find exceptionally crisp and strong throttle response. Garrett Ball Bearing turbochargers spool up 15% faster than traditional journal bearings. This produces an improved response that can be converted to quicker 0-60 mph speed. In fact, some professional drivers of Garrett ball-bearing turbocharged engines report that they feel like they are driving a big, normally aspirated engine.

Tests run on CART turbos have shown that ball-bearings have up to half of the power consumption of traditional bearings. The result is faster time to boost which translates into better drivability and acceleration.

On-engine performance is also better in the steady-state for the Garrett Cartridge Ball Bearing

Speed response when throttle is suddenly opened
at 2000 rpm (2 litre S.I engine)

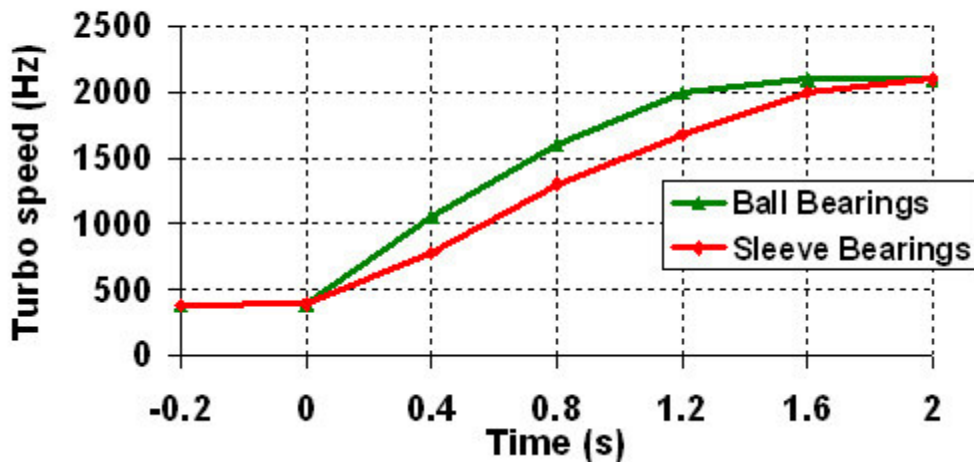

Reduced Oil Flow - The ball bearing design reduces the required amount of oil required to provide adequate lubrication. This lower oil volume reduces the chance for seal leakage. Also, the ball bearing is more tolerant of marginal lube conditions, and diminishes the possibility of turbocharger failure on engine shut down.

Improved Rotordynamics and Durability - The ball bearing cartridge gives better damping and control over shaft motion, allowing enhanced reliability for both everyday and extreme driving conditions. In addition, the opposed angular contact bearing cartridge eliminates the need for the thrust bearing commonly a weak link in the turbo bearing system.

Competitor Ball Bearing Options - Another option one will find is a hybrid ball bearing. This consists of replacing only the compressor side journal bearing with a single angular contact ball bearing. Since the single bearing can only take thrust in one direction, a thrust bearing is still necessary and drag in the turbine side journal bearing is unchanged. With the Garrett ball

Nissan Patrol Reference Document

bearing cartridge the rotor-group is entirely supported by the ball bearings, maximizing efficiency, performance, and durability.

Ball Bearings in Original Equipment - Pumping up the MAZDASPEED Protégé's heart rate is a Garrett T25 turbocharger system. With Garrett technology on board, the vehicle gains increased acceleration without sacrificing overall efficiency and it has received many rave reviews from the world's top automotive press for its unprecedented performance.

Nissan Patrol Reference Document

TYRE TERMINOLOGY

ALL TERRAIN TIRES

All Terrain Tyres or AT are a compromise. All Terrains are an attempt to offer good performance both on road as well as offroad. The ALL TERRAIN TREAD is intended to perform well under a variety of conditions found offroad while still offering acceptable on-highway performance. This is accomplished by using a tread pattern design where the lugs are tighter together than a more aggressive mud tire's tread. The result is usually a quieter ride on the street than a mud tire due to its lesser aggressive tread pattern. When compared to a street tire, All Terrain Tyres usually produce more noise. The payoff of an All Terrain Tire is that they perform well on a variety of terrains: rocks, sand, somewhat in the mud while still offering decent traction on the paved road. One drawback of an all terrain is that the tread design tends to pack with mud however some of the AT designs perform surprisingly well in muddy conditions. The AT All Terrain is typically the tire for the 4-wheeler who drives their 4x4 as a daily driver and will see minimal trail use and more on highway driving.

MUD TERRAIN TYRES

MUD TYRES or MT (Mud Terrain) are as you might have gathered from the name, designed to perform most specifically in the mud. But when you look at the tread design of many mud Tyres, they generally perform well in other conditions such as on the rocks, in deeper snow, as well as in loose gravel and in the softer, constantly changing terrain of wooded trails. This is because mud Tyres are usually designed from a softer compound with wider gaps (voids) between the lugs, which grab onto anything it can hook one of its lug edges around, especially when aired down. Tread designs typically are what make or break a mud tire and vary widely from manufacturer to manufacturer. Drawbacks of the MT Mud Terrain tire are they perform poorly on the highway especially in the rain where the wide lug pattern results in less of a tire footprint on the road. Even worse, the MT can be downright dangerous in icy conditions. Mud Tyres also tend to wear quicker than an all terrain or a street tire and depending on your perspective, the on-highway noise level can be considerably higher especially after they wear down with highway use.

BIAS-PLY TYRES AND RADIAL TYRES

There are two basic types of tire construction that mud, all terrain and street Tyres use as their foundation. They are bias-ply and radial designs. Each type of tire construction has its own unique set of characteristics that are the key to its performance, whether on road or off road and these characteristics can help to define the purpose of the tire. The following information will explain what identifies the difference between a bias ply tire and a radial type tire.

BIAS PLY

The simple definition of a Bias Ply Tire: The bias ply tire construction utilizing rubber-coated layers known as plies composed of textile cords, usually nylon and sometimes Kevlar. The plies layered diagonal from one bead to the other bead at about a 30 degree angle. One ply is set on a bias in one direction as succeeding plies are set alternately in opposing directions as they cross each other and the ends are wrapped around the bead wires, anchoring them to the rim of the wheel. The layers of plies are then covered with more rubber to form the tread of the tire. Bias ply Tyres are sometimes called cross-ply Tyres.

Performance and Purpose of a Bias Ply

Bias ply Tyres have a limited purpose in life and are only used for specific purposes or jobs. The reason for this is because of its performance characteristics. However for some jobs the bias ply tire is an idea tire for the purpose such as for the Tyres of a towed trailer, farm equipment Tyres, some purpose built Tyres like extreme terrain Tyres and some forms of racing still use bias ply Tyres. The reasons for this limited use are:

- The bias-ply tire casing is constructed to form one working unit. When the sidewalls deflect or bend under load, the tread squeezes in and distorts. The distortion affects the Tyres footprint and can decrease traction and increases wear depending on the terrain.

Nissan Patrol Reference Document

The tread distortion also causes abrasion from the ground surface, which reduces the life of the tire. These factors are why bias ply Tyres are not ideal for passenger car Tyres or as Tyres that may see highway use unless used as Tyres for a towed trailer.

- The way to increase the strength of bias-ply Tyres is by increasing the number of plies and bead wires. More plies means more mass which, increasing heat retention and reducing tire life.
- Because of the bias ply inherent construction, sidewall strength is less than that of a radial tire's construction and cornering is significantly less effective. This is probably one of the main reasons bias ply Tyres are not used for passenger cars and trucks.
- However because of the bias ply construction and inherent strength of a properly inflated tire, the bias ply is ideal for straight line towing.

RADIAL

The simple definition of a Radial type tire: The radial is a type of tire that is constructed with rubber coated, reinforcing steel cable belts that are assembled parallel and run from side to side, bead to bead at an angle of 90 degrees to the circumferential centreline of the tire. (As opposed to the 30 degree alternating application lengthwise as in bias ply Tyres). This makes the tire more flexible which reduces rolling resistance to improve fuel economy. Then numerous rubber coated steel belts are then constructed into the "crown" of the tire under the tread to form a strong stable two-stage unit.

Performance and purpose of Radial Tyres

Radial Tyres are the preferred tire of choice in most applications for several key reasons.

- The combination of steel stabilising belts in the single-layer radial casing allows the tread and sidewall to act independently. The sidewall flexes more easily under the weight of the vehicle and its cargo, while the tank-track type tread provides even contact with the ground. Greater vertical deflection is achieved with radial Tyres. This is desirable because extreme flexing greatly increases resistance to punctures.
- To increase a radial tire's strength, larger diameter steel cables are used. Larger steel cables can help reduce punctures, tears and flats. Larger steel cables also help distribute heat, resulting in a cooler running tire and improving fuel economy. Unlike bias ply Tyres larger steel cables have little negative affect on performance.
- The parallel stabilising steel belts of the radial minimise tread distortion. As the sidewalls flexes under load, the belts hold the tread firmly and evenly on the ground or object and thus minimizing tread scrub and greatly increasing tread life.
- When cornering the independent action of the tread and sidewalls keeps the tread flat on the road. This allows the tire to hold to its path.
- When offroad, the radial tire's stabilizing steel belt design aids in greater traction by holding the tread evenly over obstacles allowing the tread of the tire to have a better chance of finding traction.

What are Sipes?

Sipes are the small slots that are cut or moulded into a tire tread surface. These slots are meant to aid in increasing traction in snow, ice, mud, and wet road surfaces. The name of the concept of siping a tire comes from a man named John Sipe, who received a patent in the 1920's, after realizing that an array of small transverse cuts in the heels of his shoes gave him better traction. Later Goodyear received a US patent claiming that the "sipes" improved traction characteristics in Tyres.

Tire tread is a series of block shapes, groove configurations,

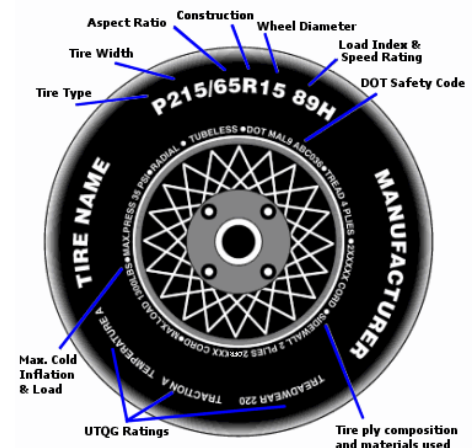

Nissan Patrol Reference Document

and sipes, all of which have an affect on the Tyres traction and noise level. Typically, wide, straight grooves running in the direction that the tire travels will have a lower noise level and good water removal. More lateral grooves running from side to side will usually increase traction while increasing noise levels. Sipes are the small grooves or slits that are cut across larger tread elements. Up to a point, more sipes give more traction in snow and mud as well as over various terrains found offroad.

READING A TIRE

All Tyres are required to have certain information moulded into the side of the tire in a location known as the sidewall. Some of the information is self explanatory while other information requires a little knowledge to decipher. The following will help you understand what this information means.

Tire Type - This Defines the intended proper use of the tire. P indicates this is a passenger car tire while LT indicates the tire would be for a light truck with a heavier load rating.

Tire Width - This is the width of the tire measured in millimeters from sidewall to sidewall. An example might be 215 representing 215 millimeters.

Aspect Ratio - This is the the ratio of the height of the tire's cross-section to its width. An example of this might be 65, which means that the height is equal to 65% of the tire's width. To calculate the aspect ratio, multiply the first number (e.g. 215) by the second number with a decimal before the number (e.g. .65). Using the example numbers the Tyres aspect ratio would calculate as $215 \times .65 = 139.75$ where 139.75 is the Tyres height in millimetres. This is the height of the rubber from rim to tread on one side of the tire.

To convert the aspect ratio to a full tire height in inches:

Convert the above calculated tire height (aspect ratio) in millimetres to inches by multiplying the millimetres by .03937 ($139.75 \times .03937 = 5.5$ inches). Then take the inches and multiply by two and add the rim size. Example: $5.5 \times 2 + 15$ (rim size in inches) = a 26 inch tall tire.

Construction - This indicates how the how the tire was put together and will say much about the Tyres handling characteristics. R indicates the tire is a radial type tire. For more information about what a radial is, B indicates the tire is a bias ply type tire. For more information about bias ply type Tyres.

Wheel Diameter - This is the width of the opening in the tire where it would be mounted to a wheel. This is measured from one bead across the opening to the other side of the same bead. This measurement is in inches and an example would be 15 and indicates that this tire is for a 15 inch rim, or wheel.

Load Index - This is a number corresponds to the maximum load in pounds that a tire can support when properly inflated. You will also find the maximum load in pounds and in kilograms moulded elsewhere on the tire sidewall.

Load Index	kg	lbs	Load Index	kg	lbs	Load Index	kg	lbs	Load Index	kg	lbs
60	250	551	90	600	1323	120	1400	3086	150	3350	7385
61	257	567	91	615	1356	121	1450	3197	151	3450	7606
62	265	584	92	630	1389	122	1500	3307	152	3550	7826
63	272	600	93	650	1433	123	1550	3417	153	3650	8047
64	280	617	94	670	1477	124	1600	3527	154	3750	8267
65	290	639	95	690	1521	125	1650	3638	155	3875	8543
66	300	661	96	710	1565	126	1700	3748	156	4000	8818
67	307	677	97	730	1609	127	1750	3858	157	4125	9094
68	315	694	98	750	1653	128	1800	3968	158	4250	9370

Nissan Patrol Reference Document

Load Index	kg	lbs	Load Index	kg	lbs	Load Index	kg	lbs	Load Index	kg	lbs
69	325	716	99	775	1709	129	1850	4079	159	4375	9645
70	335	739	100	800	1764	130	1900	4189	160	4500	9921
71	345	761	101	825	1819	131	1950	4299	161	4625	10196
72	355	783	102	850	1874	132	2000	4409	162	4750	10472
73	365	805	103	875	1929	133	2060	4541	163	4875	10747
74	375	827	104	900	1984	134	2120	4674	164	5000	11023
75	387	853	105	925	2039	135	2180	4806	165	5150	11354
76	400	882	106	950	2094	136	2240	4938	166	5300	11684
77	412	908	107	975	2149	137	2300	5071	167	5450	12015
78	425	937	108	1000	2205	138	2360	5203	168	5600	12346
79	437	963	109	1030	2271	139	2430	5357	169	5800	12787
80	450	992	110	1060	2337	140	2500	5512	170	6000	13228
81	462	1019	111	1090	2403	141	2575	5677	171	6150	13558
82	475	1047	112	1120	2469	142	2650	5842	172	6300	13889
83	487	1074	113	1150	2535	143	2725	6008	173	6500	14330
84	500	1102	114	1180	2601	144	2800	6173	174	6700	14771
85	515	1135	115	1215	2679	145	2900	6393	175	6900	15212
86	530	1168	116	1250	2756	146	3000	6614	176	7100	15653
87	545	1202	117	1285	2833	147	3075	6779	177	7300	16094
88	560	1235	118	1320	2910	148	3150	6944	178	7500	16535
89	580	1279	119	1360	2998	149	3250	7165	179	7750	17086

Speed Rating - This is a number that corresponds to the maximum service speed for a tire.

Speed Category Symbol	Speed km/h	Speed Category Symbol	Speed km/h
E	70	Q	160
F	80	R	170
G	90	S	180
J	100	T	190
K	110	U	200
L	120	H	210
M	130	V	240
N	140	W	270
P	150	Y	300
		Z	OVER 240

PSI – Pounds per square inch - used to measure air pressure in a tire. The PSI rating on Tyres is typically the maximum recommended tire pressure for that tire. Tire pressure should always be checked periodically and when the Tyres are cold. Under normal operation, Tyres can lose approximately 1 PSI of pressure every month. For every 10 degree change in ambient temperature, tire pressure can change by approximately 1 PSI.

DOT - This means the tire is compliant with all applicable safety standards established by the U.S. Department of Transportation (DOT). Adjacent to this is a tire identification or serial number; a combination of numbers and letters with up to 12 digits.

UTQG - This stands for Uniform Tire Quality Grading, which is a quality rating system developed by the Department of Transportation (DOT). The DOT requires the manufacturers to grade passenger car Tyres based on three performance factors: tread wear, traction, and temperature resistance. Note: snow Tyres are exempt from the UTOG rating system.

Tread Wear

Nissan Patrol Reference Document

Greater than 100 Better
100 Baseline

Less than 100 Poorer

The tread wear grade is a comparative rating based on the wear rate of the tire when tested under controlled conditions on a specified government test track. A tire graded 200 would wear twice as long on the government test track as one graded 100. Your actual tire mileage depends upon the conditions on which they are used and will vary with driving habits, service practices (alignments, proper air pressure, etc), differences in road characteristics and climate. Note: Tread wear grades are valid only for comparisons within a manufacturer's product line. They are not valid for comparisons between manufacturers.

Traction

- A Best
- B Intermediate
- C Acceptable

Traction grades represent the tire's ability to stop on wet pavement as measured under controlled conditions on specified government test surfaces of asphalt and concrete. The Traction grade is based upon "straight ahead" braking tests; it does not indicate cornering ability.

Temperature

- A Best
- B Intermediate
- C Acceptable

The temperature grades represent the tire's resistance to the generation of heat when tested under controlled conditions on a specified indoor laboratory test wheel. Sustained high temperatures can cause the materials of the tire to degenerate and thus reduce tire life. Excessive temperatures can lead to tire failure. Federal law requires that all Tyres meet at least the minimal requirements of Grade C.

LIGHT TRUCK SIDEWALL DESIGNATIONS

Light truck size designation using **aspect ratio**

LT 255/85B16

LT = Light truck tire

255 = Approximate cross section width in millimetres

85 = Aspect ratio (height to width)

B = Bias ply construction (R = Radial construction)

16 = Rim diameter in inches

Light truck size designation using **inches**

33x12.50R15 LT

33 = Approximate diameter in inches

12.50 = Approximate cross section width in inches

R = Radial construction (**B** = bias ply construction)

15 = Rim diameter in inches

LT = Light truck tire

TIRE COMPONENTS

Belts – One or more rubber-coated plies (layers) of steel, polyester, nylon, Kevlar or other material running circumferentially around the tire under the tread. They are designed to

Nissan Patrol Reference Document

reinforce body plies to hold the tread flat on the road. Belts reduce squirm to improve tread wear and resist damage from impacts and penetration.

Carcass (Casing) – The main body of the tire consisting of wire beads and body plies. The carcass does not including the tread or sidewall rubber.

Inner Liner – A layer of specially compounded rubber forming the inside of a tubeless tire, designed to inhibit loss of air pressure.

Plus Sizing – Plus Sizing is among the simplest ways for you to dramatically improve both the look and performance of your vehicle. The concept is to alter the wheel diameter and the tire aspect ratio. There are three common categories of Plus Sizing: Plus Zero, Plus One and Plus Two. One or two layers of heat and impact resistant, rubber-coated fabric used to form the body of the tire. Automobile and light truck tire plies are normally constructed of nylon or polyester cords.

Ply – One or two layers of heat and impact resistant, rubber-coated fabric used to form the body of the tire. Automobile and light truck tire plies are normally constructed of nylon or polyester cords.

Tread – The portion of the tire which comes in contact with the road. Tread designs vary widely depending the the specific purpose of the tire.

Tread Groove – The space or area between two tread rows or blocks.

Tread Design – The Pattern of Grooves and Tread Elements

Tread Pattern, Lugs, Voids – The tread pattern refers to the overall structure of the tread. The tread pattern is made up of tread lugs and tread voids. The lugs are the sections of rubber that make contact with the terrain. Voids are the spaces that are located between the lugs.

The mud-terrain tire pattern is characterized by large lugs in the tread pattern with large voids between these lugs. The large lugs provide plenty of bite in poor traction conditions while the large voids allow the tire to clean itself (Self Cleaning) by releasing and expelling the mud or other material while spinning. The all-terrain tire pattern is characterized by smaller voids and lugs when compared to the mud terrain tire. A denser pattern of lugs and smaller voids make all terrains quieter on the street than the mud terrain tire. The downside to an all terrain is that the smaller voids cannot clean themselves as easily of mud, slush or material as would the larger voids on the mud tire. When voids fill up with mud the tire loses much of it's bite and traction. However the all terrain is a good compromise to general highway driving and minimal off-road use.

Self Cleaning – Self Cleaning is the effect of a tire's tread pattern to allow the release of mud or material from the voids of tread, thereby providing a good bite on every rotation of the tire. The better mud terrain Tyres will allow the mud or material to easily be released from the tread voids.

Asymmetrical Tread Design, Non-symmetrical design - The design of the tread pattern changes from one side of the tread face to the other, in order to have two or more different types of tread patterns on one tire for better overall performance.

Directional Tread Design – A tire designed to rotate in only one direction for maximum performance, especially on wet roads or in mud.

Sidewall Strength – Sidewall strength refers to the Tyres resistance to punctures and tears in its sides. The strength is typically a result of the number plies extending into the sidewall and by the tread design and tread pattern that extends down onto the sidewalls. Typically the

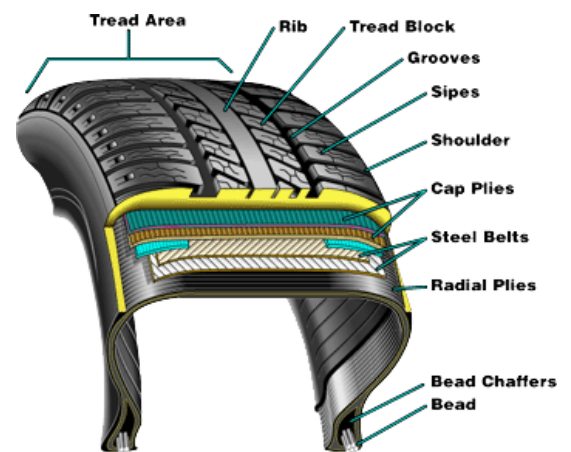

Nissan Patrol Reference Document

greater the sidewall strength, the more resistant the tire is to flex even when aired down to lower pressures.

Mud & Snow Tread Design – A tire with a heavy bar or block tread element design to provide maximum traction in mud or snow conditions. The tire will be marked M+S or MT on the sidewall.

Non-Directional Tread Design – A tire designed to rotate in either direction without loss in performance.

Aspect Ratio – A numerical term which expresses the relationship between the section height of the tire and the cross section width. The lower the aspect ratio, the wider the tread and the shorter the sidewall.

Hydroplaning – Associated with driving on rain-slicked roads with worn or poorly treaded Tyres. It is the lifting action on a tire when water pressure forces the tire upward, leaving a cushion of water between the tire and road surface.

Load Range – A term which is gradually replacing the term "Ply Rating" and which is indicated as Standard Load (SL) and Extra Load (XL) for auto Tyres and Load Range C, D etc. for light truck Tyres. (The carrying capacity of the tire at specific air inflation pressures.)

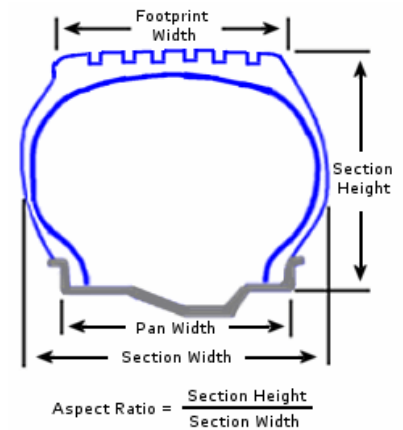

Service Description – A marking consisting of the load index and speed symbol, ie. 87S.

Tread Depth – A mound of rubber in the tread measured in 32nds of an inch from the tread surface to the bottom of the tread grooves.

Tread Design – The pattern of grooves and tread elements.

Tread Wear Indicator – Narrow bars of rubber molded into the tread at a height of 2/32nds of an inch. When wear reaches the tread wear indicator, it is time to replace the tire.

Wheel Alignment – The measuring, analyzing, and setting of angles to predetermined manufacturer recommended specifications to ensure maximum tire service life, vehicle handling, and safety. Proper wheel alignment is attained when each wheel's position, relative to the vehicle and specification, is correct.

Four-Wheel Alignment – Four-wheel alignment is the setting of all four wheels to specifications and referenced to the vehicle centerline.

Two-Wheel Alignment – Two-wheel alignment is normally performed on solid axle rear wheel drive vehicles, and is the setting of the front wheels relative to one another.

Wheel Balancing – Adding external weights to compensate for unequal distribution of tire and wheel weight. Unbalanced tire and wheel assembly is balanced by clamping appropriate metal weight to the rim.

Nissan Patrol Reference Document

WINCH CONSIDERATIONS

Purchasing a winch can be a daunting task especially if you are on a budget. Considering the job of a winch, which is to recover your vehicle when you are sometimes miles from civilisation, you must make an educated decision as to which winch you should buy. The cost of a winch alone can vary and can cost thousand of dollars. Then you have to factor in the costs of accessories and mounting options that go along with a winch. You may even have to consider upgrades to your vehicle such as a better battery and alternator if yours are marginal. Like a fire extinguisher, you hope you never need it but when you do need to winch out of a sticky situation, you don't want to doubt the choices you made. So it's wise to educate yourself about the fundamentals of a winch so that you can buy the one that is best for your purpose. We hope this winch guide may help to explain the different types of winches and the components of a winch in order to help you make an educated decision with possibly one of the larger purchases for 4x4.

MAJOR CONSIDERATIONS

How much Winch do you need?

Recommended winch capacity over vehicle weight. Typically manufacturers and resellers will suggest you should calculate the winch rating by taking the gross vehicle weight and multiplying it by 1.5 and that would be your minimum winch size. But this minimum rating is just that, a minimum. Certain factors can quickly cause your winch capacity to be exceeded so you need to think about your intended usage. Be aware that certain terrains and situations can put a much greater demand on a winch over the typical 1.5 multiplication rule of thumb. For instance a common cause for winching is mud. Mud however has an incredible suction force on a stuck vehicle and in many cases that 1.5 rule of thumb is far inadequate. Steep hills and frequent winching also put great demand on an electric winch. Understanding the purpose and safe use of winch accessories such as a snatch block can be invaluable when you need it most.

How often and how hard will you probably use the winch?

This is an important factor in deciding what type of winch motor you will want to buy. Permanent magnet motors vs. series wound vs. Hydraulic winches. Each has an intended purpose. Light duty winching and a permanent magnet motor winch will do. Heavier and more frequent winching and you should consider a Series Wound winch. If you winch all day long, then consider a Hydraulic winch. We will cover all three types in the articles within this winch section.

What is your budget?

For many of us, it all comes down to available dollars and this is what is going to dictate what winch we are going to buy. Of course we'd love to get the top of the line \$2500 monster winch but we have to be frugal. So for those of use on a budget, we have to decide how much money we have available. This dollar amount will have to cover the winch, the accessories and possibly a new front bumper or mounting kit. You may even have to consider installation if you are not confident about installation.

Do you have any weight or dimensional limitations or requirements?

The weight of the winch can vary somewhat. If you're primary consideration is to keep weight down, you may want to pay attention to those specifications. More important may be the dimensions of your winch. There are many aftermarket bumpers where the winch mounts internally. Therefore size may matter. Of the many different types of winches on the market, the sizes and dimensions can vary considerably.

Solenoid mounting can be a major consideration. Winches can either have an Integrated or Remote Solenoid pack. A remote solenoid is externally mounted off of the winch. An integrated solenoid is part of the winch either within a "bridge" over the cable or mounted elsewhere on the winch such as above the motor. There are benefits to both types of solenoid mounting options. With space restrictions a remote solenoid can reduce the space required to

Nissan Patrol Reference Document

mount the winch itself while the solenoid can be mounted remotely while an integrated solenoid offers protection in a compact package.

OTHER CONSIDERATIONS

Warranty - Read the warranty as they widely vary from a few months to years.

Serviceability - What if it breaks? Can you find a service centre that will fix it for you or can you order parts to fix it yourself? Some of the bargain winches are not such a bargain when you have to hunt down hard to find parts especially after the warranty period.

Necessary Upgrades - With almost any upgrade to a vehicle there are usually repercussions to changing something from stock to aftermarket, whether good or bad. With the addition of a winch, the demand on your electrical system can exceed the system's capabilities itself. Consider upgrading your alternator to a high output alternator and be sure your car battery is up to the demand of winching.

WINCH COMPONENTS

When you look at fundamental differences in common electric winches, a few important components and design characteristics stand out. Of the differences in common winches, the motor and the gear train are the top two design differences that will determine the quality and stamina for an intended use. The motor will vary in motor type and in the horsepower rating. The gear train will vary with different types of gear systems, each with their own characteristics and benefits. Both the motor and gear train work together resulting in the final rating of an electric winch. Understanding these important fundamentals will help you understand what winch you should buy

Electrical Motor Types

Winches use two types of DC motors, **Permanent Magnet Motors** and **Series Wound Motors**. All electric DC winch motors consist of one set of coils, called an armature, inside another set of coils or a set of permanent magnets, called the stator. It is the job of the stator to produce a magnetic field which will cause the rotor (or armature) to rotate when an electric current flows through it.

Applying a voltage to the coils produces a torque in the armature, resulting in motion. With all types of motors, the higher the

horsepower rating, the more torque and power the motor will have. The winch rating is a combination of motor torque and gear train gear ratio reduction. Motor horsepower has a direct effect on both line speed & pulling power.



Permanent Magnet Motors - In a permanent magnet motor, the stator uses permanent magnets and there are no field coils. With permanent magnet motors, the drain on your battery tends to be less than series wound motors, which uses field coils in the stator rather than magnets. Permanent magnet motors are better suited for light to medium duty winching because they tend to generate more heat and overheat. Winching time & load should be carefully monitored as they have the tendency to overheat. The magnets in permanent magnet motors can lose their field strength over time and repeated use.

Series Wound Motors - With a series wound motor, the field coils are connected in series with the armature coil. Series wound motors are powerful and efficient at high speed and generate the most torque for a given current. A series wound motor will use more current over a permanent magnet motor because they use field coils to generate a magnetic field. Series wound winches are heavier duty winches, and tend to be more expensive.

A permanent magnetic motor will pull the same as a series wound motor, at less of an amperage draw on the battery and charging system. However, as the permanent magnet motor gets

Nissan Patrol Reference Document

warmer, the power will drop as the amperage draw will increase. The amperage draw on a series wound motor will stay the same throughout the duty cycle.

Winch Ratings - Most winch ratings are generally limited by the maximum amperage draw, with right around 400 being the cut-off point. Any more than that would most likely damage the power source or charging system. In order to reduce the amperage usually the gear ratio will need to be increased numerically, to relieve the motor from the increasing stress; however, this will also reduce the line speed at the same time.

Gear Train - Gear Systems and Spool Diameter. There are three common gearing systems, planetary gear, worm gear, and spur gear. The job of the gear system on all three types is to gear down the high speed motor to a low speed, high torque output to turn the winch drum. The gear reduction ratio is how much the motor's output revolutions are reduced for the spindle. The greater the reduction, the more revolutions the motor has to turn for one spindle revolution and the less the motor has to work for that revolution. The difference in the gearing systems is mainly in their transfer efficiency

Planetary Gears - Planetary gears are the most common and provide both strength and smooth operation with good resistance to torque loads. The planetary gear systems have a 65% efficiency and have a tendency to free spool when loaded; therefore a braking mechanism is needed.

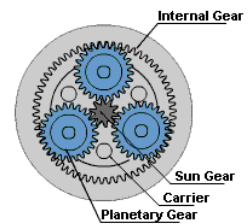

Worm Gear - The worm gear has a transfer efficiency of 35-40%. This causes the winch to be self-braking even under heavy loads, but this means the unit will need a clutch mechanism for free spooling. Worm gears offer the most reduction, very high reliability, built-in braking mechanism, and generally a slower winching speed. Worm drives are generally stronger and simpler than other gear systems such as the planetary due to the lack of the need for a braking system as well as the extreme gear reductions possible. The primary drawback of a worm gear system is the noticeable reduction in overall line speed, especially in a 'no load' cable reel-up situation. Here, the planetary has an advantage.

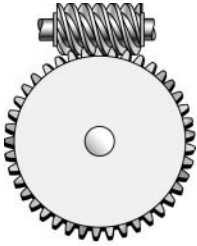

Spur Gear - The spur gear systems have efficiency of 75% and like the planetary gear system, they have a tendency to free spool when loaded, therefore a braking mechanism is needed. Typically used on high mount winches.

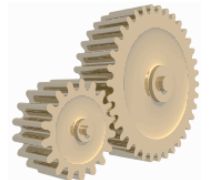

Spool Diameter - The Drum diameter & Gear Ratio have a direct effect on pulling power while affecting line speed at the same time. The width of the drum determines the inevitable loss of pulling power as the cable spools in. As the layers on the drum increase, the effective gear ratio drops reducing the pulling power. The narrower the drum, the quicker the cable spools up and therefore, loses its pulling power quicker as compared to a wider drum.

Typical Drum Layered Power Loss 12,000 lbs. Winch Example

Layers Of Cable Remaining on 3" Drum	Available Pull Power
(Bare) 1	12,000 lbs.
2	9,480 lbs.
3	7,800 lbs.
4	6,720 lbs.
5	5,760 lbs.

Nissan Patrol Reference Document

(Full) 6 5,160 lbs.

WINCH SOLENOID

What is the Solenoid?

Solenoids are electromagnetic switches. When electricity is sent to the solenoid via the remote switch, a magnetic field forms causing the circuit to the winch to complete and the winch motor to move either forward or backward depending on which solenoids are activated.

Solenoid Mounting

Solenoid mounting can be a major consideration. Winches can either have an Integrated or Remote Solenoid pack. A remote solenoid is externally mounted off of the winch. An integrated solenoid is part of the winch either within a "bridge" over the cable or mounted else where on the winch such as above the motor. There are benefits to both types of solenoid mounting options. With space restrictions a remote solenoid can reduce the space required to mount the winch itself while the solenoid can be mounted remotely while an integrated solenoid offers protection in a compact package.

2 or 4 Solenoids?

Some winches have two solenoids, and others have four. Two solenoids configurations are typically found in permanent magnet motor winches and are cheaper, less powerful, heavier and less reliable. Four solenoid configurations are typically found in series wound winches and are stronger, lighter and more reliable.

Nissan Patrol Reference Document

WHEEL TERMINOLOGY

Offset - The distance from the centreline of the wheel to the face of the mounting surface of the wheel that contacts the hub.

Negative offset - Indicates the mounting pad is behind (or inboard) the centreline of the rim. This is often found on standard rear-wheel-drive vehicles and on so-called reversed rims.

Positive offset - Refers to wheels that have the mounting pad in front (or outboard) of the centreline of the rim. Most often found on front-drive applications.

Centreline - The exact centre of the rim width. The width is measured between where the tyres rest.

Bolt circle size - The bolt circle represents the diameter of an imaginary circle that goes through the centre of the bolt holes (A). On a four-lug wheel, this is determined by measuring the distance between opposite holes (B). For a five-lug application, measure the centre-to-centre distance between two adjacent wheel studs (C) and reference the table below.

2.645 in. = 4 ½ in. circle

2.792 in. = 4 ¾ in. circle

2.939 in. = 5 in. circle

3.233 in. = 5 ½ circle

Moving up to a larger tyre and wheel requires planning, considering the effects on gearing. The most important factor is the actual rolling height and width of the tyre. Actual height often differs from nominal heights, so measuring the actual rolling radius of the tyre would be the ideal way to know the exact effect on gearing, speedometer, etc. But measuring rolling tyres, which may "grow" a little at speed, is impractical, so tyres are measured as they sit.

There is no more practical method for sizing new tyres than to simply tape measure the old against the (proposed) new rubber. For most calculations, this measurement is accurate enough. However understanding tyre-size nomenclature is important, and will help immensely in getting the most tyre with the least hassle.

Many types of high-performance specialty-tread truck tyres are sized according to height, width, and wheel diameter. A tyre listed as a 33/12.50R-15 is a 33-inch-tall radial (R), 12.50 inches wide and built for a 15-inch wheel. If there is no R in the designation, you can assume it is a bias-ply tyre. Keep in mind, this 33-inch diameter is a nominal number which could vary by as much as seven percent (in this case, more than two full inches) according to industry standards.

A FEW TERMS

Diameter - The actual height of the tyre measured through the centre, in inches. Not always marked on the tyre.

Section height - The vertical distance between the edge of the wheel rim and the top of the tyre tread. Expressed in millimetres, this number is not usually marked on the tyre.

Section width - The horizontal distance between the tyre's sidewalls. Expressed in millimetres, this number is usually the first number in a metric designation.

Aspect ratio - The relationship between section height and section width. The higher the aspect ratio number, the skinnier the tyre, relative to its height. An aspect ratio of 75 means that section height is 75 percent of section width. A tyre with a lower aspect ratio of 60 will have a

Nissan Patrol Reference Document

"lower profile" than a 75, and a fatter look. This is normally the second number listed on a metric-sized tyre.

LT Metric tyre designation a light truck tyre.

ST Designation for a trailer tyre.

P Designation for a passenger-car tyre.

Looking at a tyre marked LT305/85R16, the buyer knows that it is a 16-inch radial tyre built for light trucks with an 85-percent aspect ratio and 305 millimetres of section width. To determine the height of the tyre, you must calculate its section height in inches, dividing by 25.4, the number of millimetres in an inch (see equivalency chart). Next, convert the aspect ratio to a decimal by dividing by 100. Multiply the quotients of these two numbers to find the section height in inches. Double that figure and add the wheel diameter, and you will have the tyre's height. The logical equation works out as:

Section Width / 25.4 = Section Width Result

Aspect Ratio / 100 = Aspect Ratio Result

Section Width Result x Aspect Ratio Result = Section Height (Inches)

Double = Section Height (Inches) x 2

Add Wheel Diameter + Double = Tyre Height

So to it practically, using a 285/70R 17 tyre:

$285 / 25.4 = 11.22$

$70 / 100 = .70$

$11.22 \times .70 = 7.85$

$7.85 \times 2 = 15.71$

$17 + 15.71 = \mathbf{32.71 \text{ Inches in diameter}}$

Some of the most popular tyre sizes, and their approximate metric equivalents, can be found in this chart.

Flotation	Diameter (in.)	Metric size
27x8.50R14	26.5	225/75R14
	27.5	215/75R15
29x9.50R15	28.5	235/75R15
30x9.50R15	29.5	245/75R15
31x10.50R15	30.5	265/75R15
32x11.50R15	31.5	295/75R15
33x12.50R15	32.5	315/70R15
33x12.50R16	32.8	285/75-16

Nissan Patrol Reference Document

WHY SYNTHETIC OILS ARE SUPERIOR

You may have heard that synthetic oils are superior to conventional oils, that with synthetic oil cars run cleaner and more efficiently for longer? Would you like to learn why synthetic oils are superior and discover some of the benefits you can get from specifying synthetic oils for your car? If so the information below should provide answers to most of your queries.

ENGINE OIL BASICS

Motor oil is more than just old dinosaur bones and prehistoric tree trunks. It's the lifeblood of an engine. Motor oil keeps engine parts from wearing and reduces friction by providing a protective layer between the metal parts of an engine, and helps carry heat and impurities away from engine components. Motor oil also has to deal with the harsh operating environment inside an engine with its combination of heat, combustion by-products, chemical residues and high pressures. It's because of this harsh operating environment that motor oil gradually ages and needs to be changed regularly. Synthetic oils typically have a far greater resistance to deterioration and therefore have far greater drain intervals.

WHAT IS LUBRICATING OIL?

Motor oils are made up of selected base oils combined with performance enhancing additives. Why are additives required?

- Additives improve the original properties of base oils
- Additives impart new performance characteristics to base oils (to suit particular applications)
- Additives help extend the product life

Motor oils typically are 75-85% basestock with the balance being additives. That's why basestock quality is such a critical contributor to the performance of the final blended product. You'll find out more about additives below.

THERE ARE FOUR DIFFERENT TYPES OF MOTOR OIL BASE STOCKS

We know that basestock composition has a significant effect on the overall performance of motor oil. There are four different types of base stock used in the motor oil market today.

Group 1 - Conventional - Mineral oil derived from crude oil

Group 2 - Hydroprocessed - Highly refined mineral oil

Group 3 - Severe hydroprocessed - Ultra refined mineral oil

Group 4 - Full synthetics (chemically derived) - Chemically built Polyalphaolefins (PAO).

As it infers Groups 1 - 3 basestocks are derived from crude oil pumped from the ground whereas Group 4 basestocks are chemically derived, most often from ethylene gas, and contain none of the contaminants present in mineral oils. Just as distilled water is pure water derived from gas so Group 4 basestocks are pure oils derived from gas.

AND THERE ARE A VARIETY OF ADDITIVES

Additives enhance the performance of motor oil basestocks and help adjust the performance of the oil to suit its intended application. Additives are the key to unlock the performance potential of basestocks but even the best additives won't turn bad oil into good oil.

Nissan Patrol Reference Document

Some common additives include:

- Viscosity Index Improvers - improve ability to handle heat and severe conditions
- Pour Point Depressants - lower oil freezing point in cold conditions
- Anti-wear Additives - protect against metal-to-metal contact
- Detergents & Dispersants - keep components clean and prevent sludging
- Oxidation Inhibitors - maintain oil stability over service intervals
- Corrosion & Rust Inhibitors - protect against the effects of condensation
- Defoamants - prevent oil foaming and cavitation

Additives work symbiotically with the base stock and are added in different proportions according to the application. Some examples are that racing oils may not require rust inhibitors but could need extra defoamants for dry sump oil systems, domestic or consumer engine oils may need special additives that don't interfere with the operation of catalytic converters or diesel oils may require additional protection against combustion byproducts.

LET'S LOOK AT CONVENTIONAL (MINERAL) OIL

Conventional motor oils use base stocks created by the conventional refining of crude oil pumped from the ground. Crude oil is a complex mix of hydrocarbon compounds and a variety of sophisticated refining techniques are used to remove/reduce the amount of undesirable components such as asphalts, waxes and chemically unstable sulphur & nitrogen compounds. Conventional motor oils use conventional mineral base stocks so are usually known as Mineral oils.

Mineral base oils have performance limitations. After refining what remains is a lubricating base stock that despite the degree of chemical refinement still contains undesirable materials such as oxygen, sulphur, nitrogen compounds, trace metals and carbon residues.

There are literally thousands of compounds present in crude oil. While many of them are removed or upgraded by refining, a significant concentration of these undesirable materials remains in lubricating oil base stocks. These residual undesirable materials mean additive packs can't operate to full effect because the additive has to compete for space with the impurities when they attempt to bond with the baseoil molecules. Consequently the molecular structure of the oil is inconsistent, limiting the performance capabilities and useful service life of the resulting blended oil.

HYDROPROCESSED OIL

Hydroprocessed motor oils use base stocks made by the additional refining of mineral oil. While refined to a greater extent than conventional mineral base oils, hydroprocessed base oils still have similar performance limitations due to the presence of undesirable impurities which cannot be completely removed from crude oil. Hydroprocessed motor oils use extra refined mineral base stocks.

SEVERE HYDROPROCESSED OIL

Severe hydroprocessed oils are further refined hydroprocessed oils but they still contain some undesirable impurities which cannot be completely removed. Most engine oils on the Australian market advertised as synthetic use severe hydroprocessed basestocks.

SEMI-SYNTHETICS

Semi-Synthetics use base stocks comprising conventional or hydroprocessed base oil in combination with severely hydroprocessed or synthetic (PAO) basestocks. The proportion of severely hydroprocessed or synthetic basestocks in semi-synthetic oil is a closely guarded secret, but is usually between 10% and 25%.

SYNTHETICS

Nissan Patrol Reference Document

Synthetic motor oils contain a high proportion of base stocks created from pure chemicals. Since synthetic base stocks such as PAO are essentially pure chemicals themselves they avoid the performance limitations imposed by the impurities present in conventional and hydroprocessed base oils. PAO synthetic base oils are therefore pure compounds containing none of the impurities found in conventional base oils derived from crude oil, as mentioned earlier.

In addition, chemically derived synthetic base stock technology allows the base oil molecules to be designed specifically for particular lubrication applications with purpose designed features such as the exact desired viscosity, superior viscosity stay in grade capability, low volatility etc. Synthetic base stocks can also be specifically tailored to suit different additives required for different applications. Additionally because synthetic oils are 'pure' they contribute lower emissions and are kinder to catalytic converters. Synthetic oils can also be engineered to have less internal molecular friction allowing an engine to develop maximum power and provide best possible economy.

Synthetics can therefore be "tailored" to suit specific lubrication applications. The molecular engineering that goes into chemically derived synthetic base stocks enable a base oil to be designed for a specific purpose. For example specific base oil molecules have been designed for use in Mobil Jet Oil II (which is used by 70% of the world's commercial jet aircraft). Similarly and very specific Mobil 1 formulations have been designed for Formula 1 racing applications. This same highly specific molecular engineering approach has been used to design the best base oil molecules for use in consumer synthetic motor oils such as Mobil 1.

BASE OILS SUMMARY

Mineral & Hydroprocessed Base Oils

- Refined from Crude Oil
- Mixture of compounds
- Include compounds poorly suited for lubrication

Chemically Derived Synthetic Base Oils

- Synthetic polymers
- Tailor made from controlled building units
- Specifically designed to suit the lubrication application

Unlike base oils derived from crude oil, synthetic base oils can be designed specifically (i.e. "tailor made") to give optimum performance in synergy with the additive compounds with which they are formulated to produce the final motor oil.

SO WHAT DOES THIS ALL MEAN?

Motor oils perform differently under extremes. Under extreme driving conditions synthetic oils offer clearly superior motor oil protection and performance than that provided by mineral oil.

Severe conditions include;

- Stop-and-go driving
- Short trips
- High temperature conditions (especially modern turbo engines)
- Cold start-ups
- Competition

Nissan Patrol Reference Document

Severe driving conditions aren't confined to the racetrack or rally stage. Day-to-day driving conditions with stop/start traffic, short trips and cold starts can also be severe conditions that push motor oils to their limits.

THERE IS A CLEAR DIFFERENCE IN MOTOR OIL PROTECTION AND PERFORMANCE

Differences under extreme conditions:

- Conventional (mineral) Motor Oils break down under extreme hot temperatures and form solids under extreme cold temperatures.
- Hydroprocessed Motor Oils and Semi-Synthetics vary depending on their composition, but generally perform better than conventional (mineral) formulas but not as well as full synthetic oils.
- Fully Synthetic Motor Oils offer the maximum protection against engine wear under extreme hot and cold temperatures and in other severe service conditions, unmatched by conventional or hydroprocessed formulas.

Fully synthetic motor oils offer the best engine protection and allow an engine to develop its maximum potential, leading to increased power and improved economy when compared to equivalent mineral oils.

GLOSSARY

- BOOST SPIKE** A boost spike is a brief period of uncontrolled boost, usually encountered in lower gears during the onset of boost. Typically spikes occur when the boost controller cannot keep up with the rapidly changing engine conditions.
- ECU** Engine Control Unit. Also known as an Engine Control Module (ECM) or Powertrain Control Unit/Module (PCU, PCM) if it controls both an engine and a transmission, is an electronic control unit which controls various aspects of an internal combustion engine's operation. The most simple ECUs simply control the quantity of fuel injected into each cylinder each engine cycle. More advanced ECUs found on most modern cars also control the ignition timing, Variable Valve Timing (VVT), the level of boost maintained by the turbocharger (in turbocharged cars), and control other peripherals. ECUs determine the quantity of fuel, ignition timing and other parameters by monitoring the engine through sensors. These can include, MAP/MAF sensor, throttle position sensor, air temperature sensor, oxygen sensor and many others.
- EFI** Electronic Fuel Injection. Is a means of metering fuel into an internal combustion engine. In modern automotive applications, fuel metering is one of several functions performed by an "engine management system". A fuel injection system is designed and calibrated specifically for the type(s) of fuel it will handle: gasoline (petrol), Autogas (LPG, also known as propane), ethanol, methanol, methane (natural gas), hydrogen or diesel. The majority of fuel injection systems are for gasoline or diesel applications. With the advent of electronic fuel injection, the diesel and gasoline hardware has become quite similar. EFI's programmable firmware has permitted common hardware to be used with multiple different fuels. For gasoline engines, carburetors were the predominant method to meter fuel before the widespread use of fuel injection. However, a wide variety of injection systems have existed since the earliest usage of the internal combustion engine. The primary functional difference between carburetors and fuel injection is that fuel injection atomizes the fuel by forcibly pumping it through a small nozzle under high pressure, while a carburetor relies on the vacuum created by intake air rushing through it to add the fuel to the airstream. The fuel injector is only a nozzle and a valve: the power to inject the fuel comes from farther back in the fuel supply, from a pump or a pressure container
- EGT** Exhaust Gas Temperature. EGT's are generally measured using a gauge that has a probe attached to either the exhaust manifold or exhaust pipe. The closer the probe to the exit point of the engine/turbo the better the reading. There can be a difference of 200c between a manifold and exhaust fitted probe.
- EGR** Exhaust Gas Reticulation. Was a method of re burning exhaust gases to reduce emissions to the atmosphere. Generally beneficial to petrol engines as the fuel air mixtures can be better controlled and can actually be advantageous to the power of the engine. In Diesel engines it was a way of trying to meet emission laws for some countrys, some Diesel manufacturers have now stated that they will not have EGR based systems in the future due to the issues it causes.
- MAF** Mass Airflow Sensor. Most EFI systems around today use air mass flow in determining the mixture under given operating conditions. Typically there is also throttle position, intake manifold pressure and/or temperature, exhaust gas oxygen (EGO), etc. Some systems use volume air flow sensors rather than mass air flow sensors. You can not set up a good EFI system with neither, using throttle position (TPS), manifold absolute pressure (MAP), engine speed (RPM) and an oxy sensor (EGO). The advantage to a mass air flow sensor over a volume flow sensor is that it allows the ECU to compensate for changes in atmospheric temperature, barometric pressure, and humidity. There are a variety of other sensors that the ECU reads to regulate things like fast (cold) idle, turning up the

Nissan Patrol Reference Document

idle when the AC is on, etc. The mass air flow (MAF) sensor signal and engine speed are the primary determinants of fuel injector pulse length.

STOICHIOMETRIC Pertaining to or involving substances that are in the exact proportions required for a given reaction, or calculation of the quantities of reactants and products in a chemical reaction.

TURBOCHARGER A turbocharger (short for turbo-supercharger) is an exhaust gas driven forced induction device used in internal combustion engines to improve engine performance by forcing compressed air into the combustion chambers, allowing more fuel to be burned, resulting in a larger power output.

VGT Variable geometry turbochargers. Are a family of turbochargers, usually designed to allow the effective A/R ratio of the turbo to be altered as conditions change. This is done because optimum A/R at low engine speeds is very different from that at high engine speeds. If the A/R ratio is too large, the turbo will fail to create boost at low speeds; if the A/R ratio is too small, the turbo will choke the engine at high speeds, leading to large exhaust manifold pressures, high pumping losses and ultimately lower power output. By altering the geometry of the turbine housing as the engine accelerates, the turbo's A/R ratio can be maintained at its optimum. Because of this, VGTs have a minimal amount of lag, have a low boost threshold and are very efficient at higher engine speeds. In many configurations, VGTs do not even require a wastegate, however this depends on whether the fully open position is sufficiently open to allow boost to be controlled to the desired level at all times. Some VGT implementations have been known to over-boost if a wastegate is not fitted, see **BOOST SPIKE**. Usually, the vanes are controlled by a membrane actuator identical to the one on a wastegate, although electric servo actuated vanes are becoming more common. Other common terms include Variable Turbine Geometry (VTG), Variable Geometry Turbo (VGT), Variable Vane Turbine (VVT) and Variable Nozzle Turbine (VNT).