

# SUZUKI

# LJ20

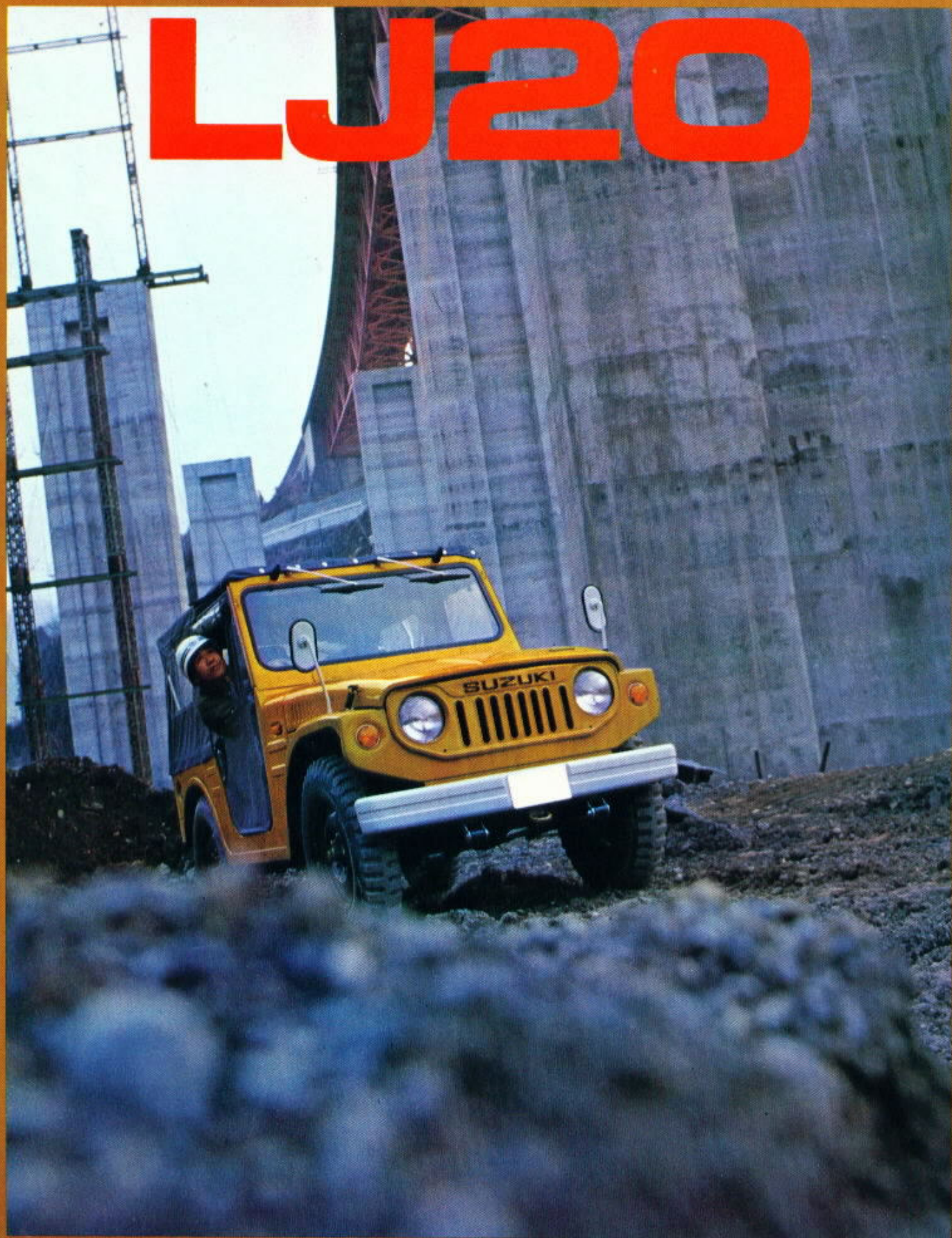

**SUZUKI MOTOR CO., LTD.**

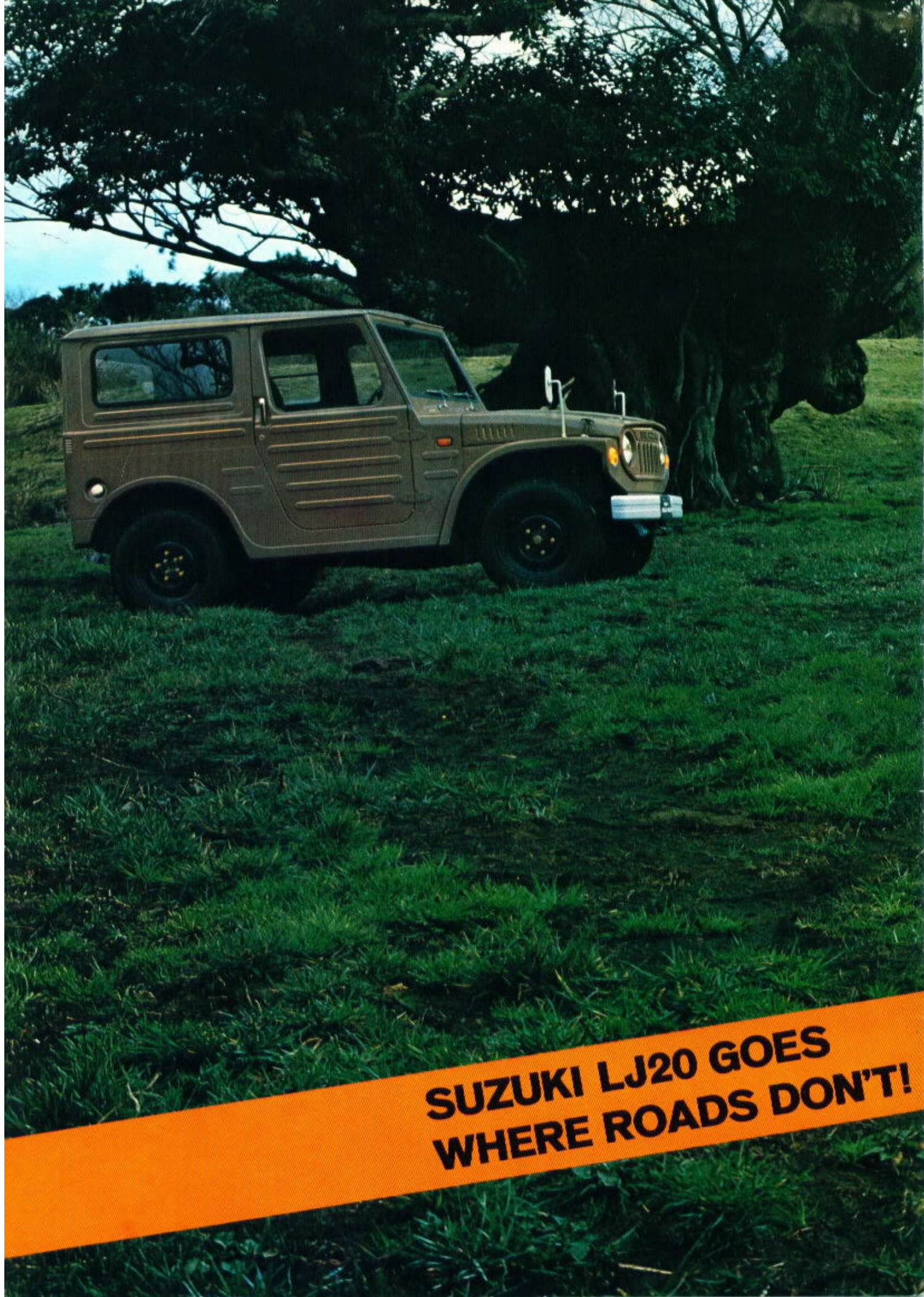

**SUZUKI LJ20 GOES  
WHERE ROADS DON'T!**



**WORLDWIDE USERS PRAISE  
LJ20'S ADAPTABILITY!**

# SUZUKI LJ20 IS A LIGHTWEIGHT COMPACT FOUR-WHEEL-DRIVE VEHICLE CAPABLE OF RUNNING ON ANY BAD ROAD

The four-wheel-drive system enables driving on roads under all unfavorable conditions such as in the desert, sandy ground, muddy ground, rough road, steep grade and snowy ground.

The vehicle is driven by the rear wheels like ordinary cars on paved roads. On bad roads, operating the transfer, the power is also transmitted to the front wheels. Assisted by the transfer (auxiliary transmission) with a high-low speed selector, the vehicle is capable of running under conditions which match the road conditions.

In addition, its climbing ability is 35 degrees. It readily climbs such steep grades that cannot be climbed by men without use of the hands on the ground. Thanks to its compact size, LJ20 can make tight turns. LJ20 lightly drives through narrow mountain roads.

## TOUGH! WATER-COOLED 2-STROKE ENGINE

LJ20 is powered by a high performance "water-cooled" 2-stroke engine that enables LJ20 to fully exhibit the power of its four-wheel-drive.

"Reed valve" providing superior suction efficiency are adopted to enable the engine to exhibit the power to its maximum capacity. Consequently, the engine is powerful and tough, producing high torque at low and medium speeds.

The method of cooling employed is to cool the radiator located in front simultaneously by air from the front and

by a cooling fan. This system exhibits superior cooling effect that does not change cylinder temperature even during extended driving over a long period. The engine is powerful and withstands the uses under any severe conditions.

## EPOCH-MAKING DIRECT LUBRICATION SYSTEM SUZUKI CCI

SUZUKI CCI is a mechanism that warrants high engine performance which is inherent to 2-stroke engines. Pure undiluted lubricating oil is directly supplied to the crankshaft and big ends of connecting rods at the rates matching the power output of the engine. As the oil is also supplied to cylinders at the same time, ideal lubrication is provided in the interior of the engine, resulting in improved performance and extended durability.

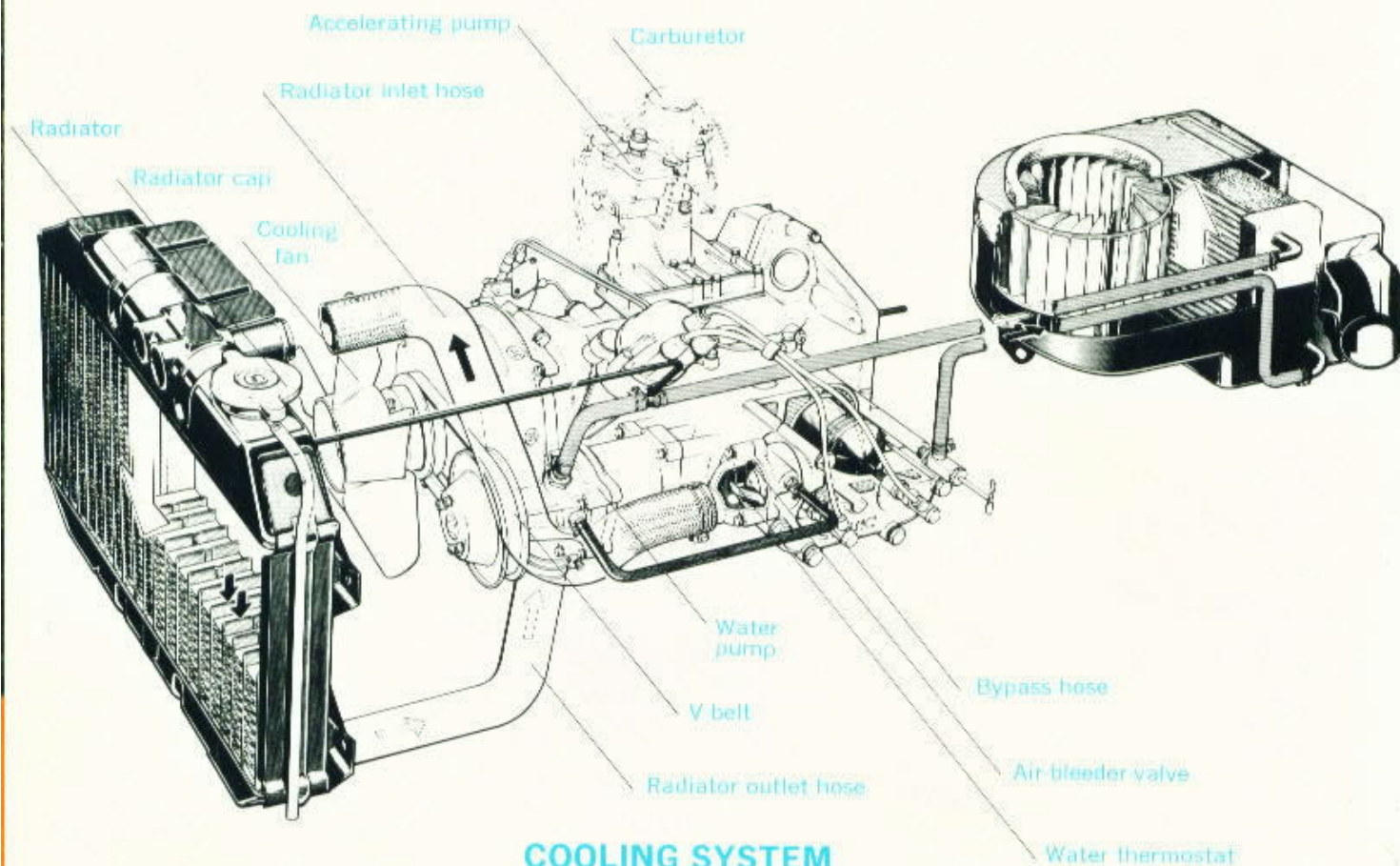
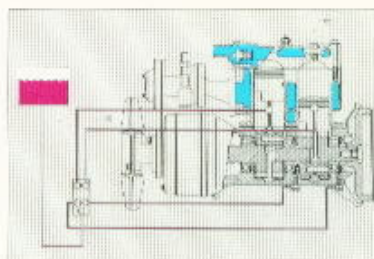



#### WATER PUMP

Install a water pump on the rear bed and drive it by the power from the PTO. It can take an active part in pumping and draining work at construction sites and in agricultural farms.



#### WELDER

Install a welder on the rear bed and drive it by the power from the PTO. Thus, welding work can be accomplished at construction sites without an outside power supply.

#### SPRAYER

Install a sprayer on the rear bed and drive it by the power from the PTO. It exhibits its power in blight control work and water spraying work in the orchards located on steep grades.



#### VTR (VIDEO TAPE RECORDER)

Install a generator on the rear bed and drive it by the power from the PTO. By utilizing this electric power from the generator, informative activities such as operation of video cassettes and photographing with video cameras are possible.



## A HIGHLY EFFICIENT DESIGN WITH CAREFUL ATTENTION TO THE MINUTEST DETAILS



SUZUKI LJ20 is noted for its lack of noise and absence of vibration. This is achieved by careful design and also the use of special mounting which absorb vibrations usually transmitted to the chassis, completely.

The seats are made for maximum comfort to the occupants even when travelling over trackless wasted or rocky desert areas. Also to ensure the occupants receive adequate heating in cold climates, the full-hot heater is available as optional parts.

### DRIVER'S COMPARTMENT



- Speedometer
- Grab handle
- Choke lever
- 4-way flasher switch
- Light switch

- Oil level lamp
- High Beam lamp
- Charging lamp
- Turn signal indication lamp
- Fuel gauge

- Shift lever
- Ashtray
- Transfer-control-lever
- Parking brake lever

- Pull out tray
- Ventilation lever
- Wiper switch
- Window-washer

#### TRANSFER (AUXILIARY TRANSMISSION) WITH HIGH-LOW SELECTOR

The transfer comprises a system to select rear wheel-drive or four-wheel-drive and a system to select high speed or low speed with four wheel-drive. In combination with the 4-speed fully synchronized transmission (main transmission) it is capable of making use of the power of the engine to its maximum, to enable driving up grades of 35 degrees as well as on bad roads.

#### LARGE DIAMETER 16 INCH TIRES

Both front and rear wheels are equipped with large diameter tires of 6.00-16-4PR which are as large as the ones for large four-wheel drive vehicles. Consequently, the ground clearance is 230mm (9.0 in). It is high enough to drive through rough and muddy roads.

#### BODY IS AS RIGID AS POSSIBLE

The chassis adopted is a box frame which is strong against torsion and bend. Square steel pipes are used on both sides. As it is combined with four cross members the strength and rigidity of the frame are superior. Because front wheels are used for both driving and steering, a ball joint system is adopted, providing a higher degree of durability.

#### SAFE CENTER BRAKE

Center brake system is adopted for the parking brake. Because it is independent of the wheel brakes, there is no fear about entry of water. Even if wheel brakes become wet when driving through water or a muddy road, sufficient braking effect can be obtained if the center brake is actuated.

**SUZUKI'S  
ATTENTION  
TO THE DETAILS  
GOES FURTHER!**

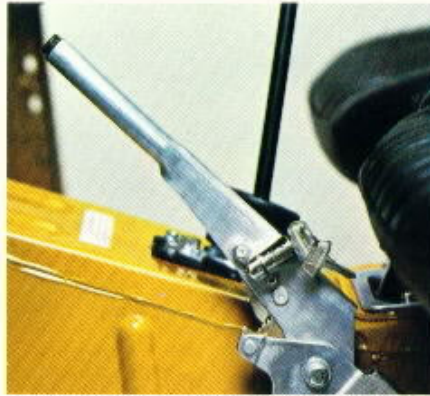

Parking brake with anti-theft locking device (LJ20)



Spare tire which ensures wide cargo space (LJ20)



Window washer (LJ20, LJ20V)



Towing bar & foot step (LJ20, LJ20V)



Full width back door (LJ20V)

**EASEFUL CANVAS HOOD  
IN SETTING  
AND DETACHING**



1. Fold the side and rear canvas sheets up.



2. Disconnect the hooks connecting the top canvas to the front window. Then roll the top canvas together with the side and rear canvas sheets towards the rear of the vehicle.
3. Loosen the knobs fixing the frames of the canvas sheets to the body. Then collapse the frames towards the rear.
4. Detach the canvas doors by unfastening the buttons attaching the doors to the sides of the front window.



\*The hood (including doors) is optional.

**LJ20 can be modified or converted into various vehicles for exclusive uses.**



FIRE PUMP



MAIL CART

LJ20



LJ20V



**SPECIFICATIONS**

	LJ20	LJ20V
Maximum Speed	80kph (50 mph)	80kph (50mph)
Maximum Horsepower	28hp/5,500rpm	28hp/5,500rpm
Maximum Torque	3.8kg-m (27.5 lb-ft) /5,000rpm	3.8kg-m (27.5 lb-ft) /5,000rpm
Climbing Ability	35°	32.5°
Engine Type	2-stroke, water-cooled, 2-cylinder	2-stroke, water-cooled, 2-cylinder
Piston Displacement	359cc (21.9 cu-in)	359cc (21.9 cu-in)
Bore x Stroke	61.0 x 61.5mm (2.40 x 2.41 in)	61.0 x 61.5mm (2.40 x 2.41 in)
Transmission	4-speed forward, all synchromesh, 1 reverse	4-speed forward, all synchromesh, 1 reverse
Transfer	2-speed	2-speed
Fuel Tank Capacity	26 ltr (6.86/5.72 gal, US/Imp)	26 ltr (6.86/5.72 gal, US/Imp)
Oil Tank Capacity	2.8 ltr (0.74/0.62 gal, US/Imp)	2.8 ltr (0.74/0.62 gal, US/Imp)
Cooling System	Water-cooling	Water-cooling
Maximum Load Capacity	250kg (550 lbs)	200kg (440 lbs)
Seating Capacity	2 persons	2 persons
Overall Length	3,195mm (125.8 in)	3,025mm (119.1 in)
Overall Width	1,295mm ( 51.0 in)	1,295mm ( 51.0 in)
Overall Height	1,670mm ( 65.7 in)	1,615mm ( 63.6 in)
Wheelbase	1,930mm ( 76.0 in)	1,930mm ( 76.0 in)
Tires	6.00-16, 4PR	5.60-15, 4PR
Curb Weight	625kg (1,378 lbs)	660kg (1,455 lbs)

\*Specifications subject to change without notice.

LJ20

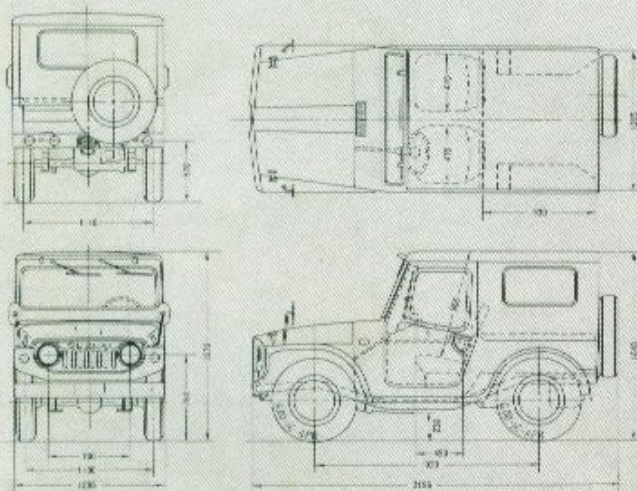

LJ20V

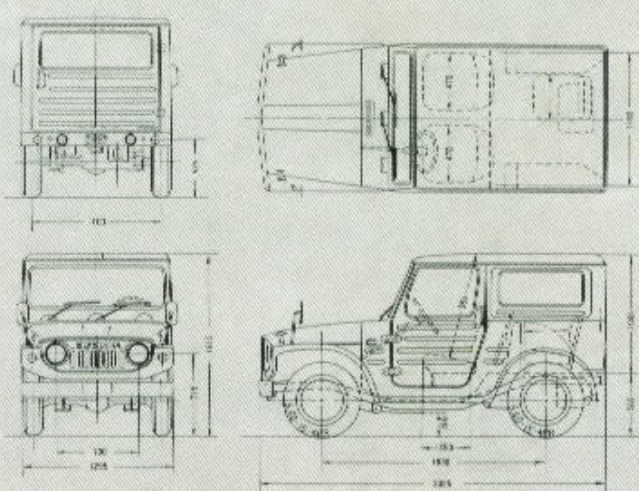

Sun Stone Cream

Indi Ocher

Sirius Green

Alphald Beige

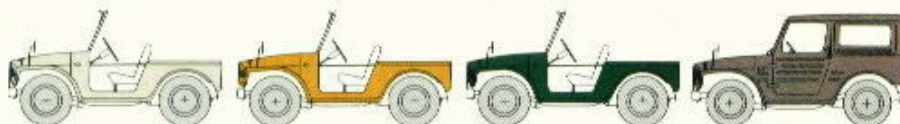

...akes, there is no  
 **CCI**  
**SUZUKI MOTOR CO., LTD.**  
 300 Takatsuka, Hamamatsu, Japan  
 Printed in Japan