

## SECTION 16

# DIFFERENTIAL

### CONTENTS

16-1. GENERAL DESCRIPTION .....	16-2
16-2. REMOVAL .....	16-3
16-3. DISASSEMBLY .....	16-6
16-4. INSPECTION AND ADJUSTMENT OF COMPONENTS .....	16-7
16-5. REASSEMBLY .....	16-13
16-6. INSTALLATION .....	16-15
16-7. MAINTENANCE SERVICES .....	16-16
16-8. RECOMMENDED TORQUE SPECIFICATIONS .....	16-16

## 16-1. GENERAL DESCRIPTION

The two axles, front and rear, are identical as far as the designs of pinion-and-gear drive and differential gearing are concerned. The major difference in this limited sense lies in the shape of the housing.

Each axle may be regarded as consisting, speaking roughly, of supporting parts (axle sleeves, differential housing and carrier case) and drive transmitting parts (bevel pinion and gear, differential gearing and live axle shafts). In the present section, only the bevel pinion and gear and differential gearing are taken up under the collective title of "differential."

The bevel gear drive is of hypoid design; pinion and gear have hypoid gear teeth. This means that the pinion is located slightly below the center of the bevel gear to permit the car body to be lowered in design, and that some wiping or sliding action occurs in tooth meshing between pinion and gear. Here lies the reason why use of hypoid gear oil is specified for the differential.

Four differential pinions are used in the differential case to qualify this gearing for heavy-duty "differential" drive. Thus, a total of 8 gears—a drive pinion, a crown gear, two side gears and four pinions—are inside the differential housing, all mounted on the differential carrier case bolted to the housing.

This differential is so constructed that the bevel pinion bearing preload is adjusted by tightening the bevel pinion nut to compress the spacer.

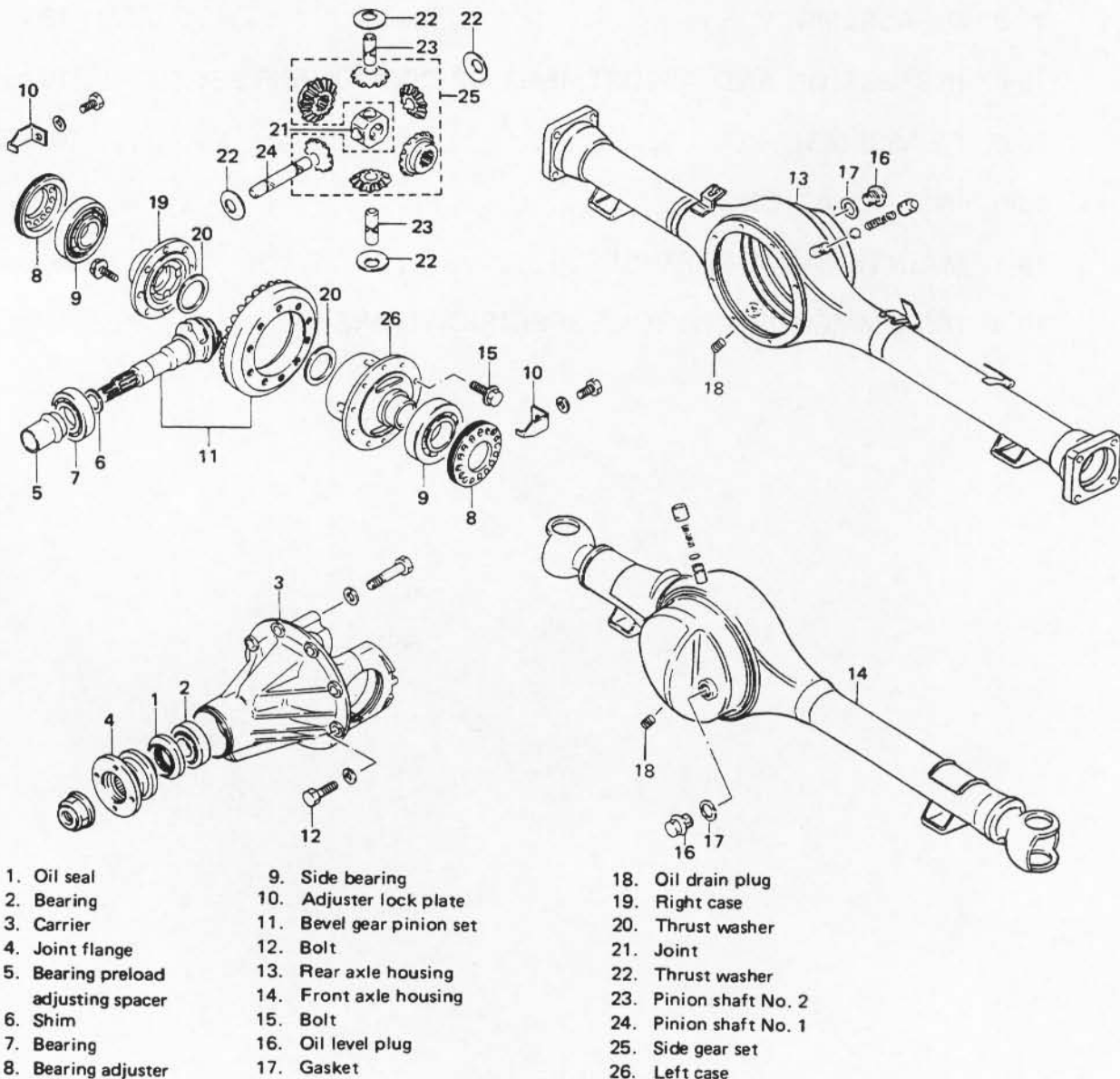


Fig. 16-1

## 16-2. REMOVAL

1. Loosen, but do not remove, wheel nuts of front or rear wheels, and raise car off the floor by jacking.  
Rest car steady on safety stands.
2. Drain out oil in differential housing by loosening drain plug.
3. Remove wheel nuts and take off wheels, front or rear. Each wheel has five wheel nuts.

### For Front Differential

After taking down front wheels, remove disc brake caliper with carrier.

#### NOTE:

Hang removed caliper with a wire hook or the like so as to prevent brake hose from bending and twisting excessively or being pulled.

Don't operate brake pedal with caliper removed.

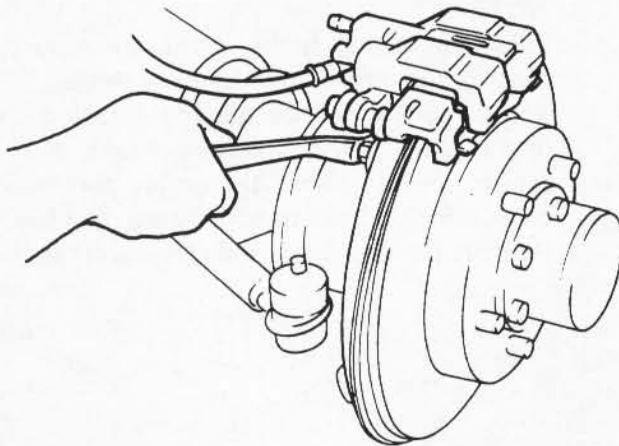


Fig. 16-2

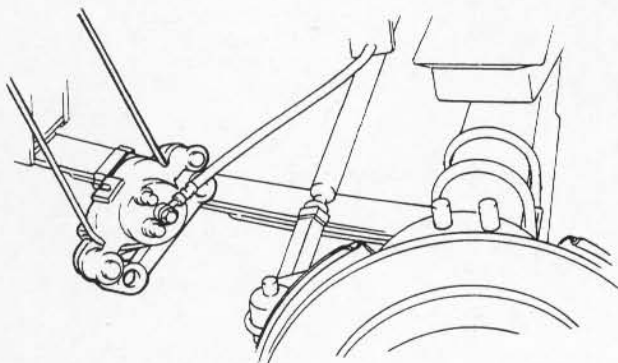


Fig. 16-3

At each tie rod end, remove nut and disconnect the end from steering knuckle using special tool

Ⓐ

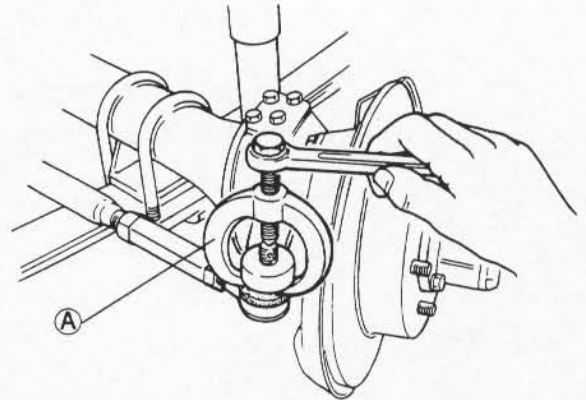


Fig. 16-4

Ⓐ Special tool (Tie rod end remover 09913-65210)

Remove 8 oil seal cover securing bolts. From steering knuckle, take off felt pad, oil seal and seal retainer.

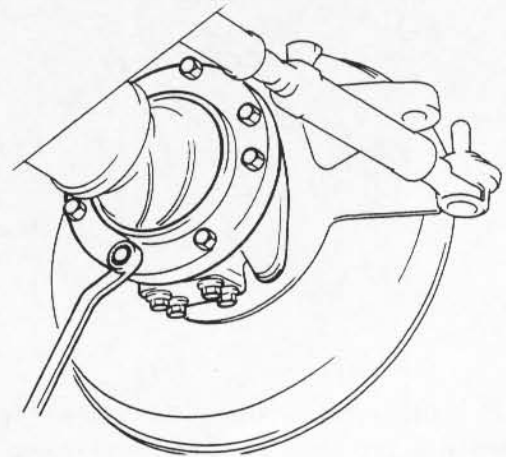


Fig. 16-5

Remove top and bottom kingpins from knuckle by removing 4 bolts securing each pin.

#### NOTE:

The removed top and bottom kingpins must be kept separated so as to prevent an error when putting them back in their place in reassembly.

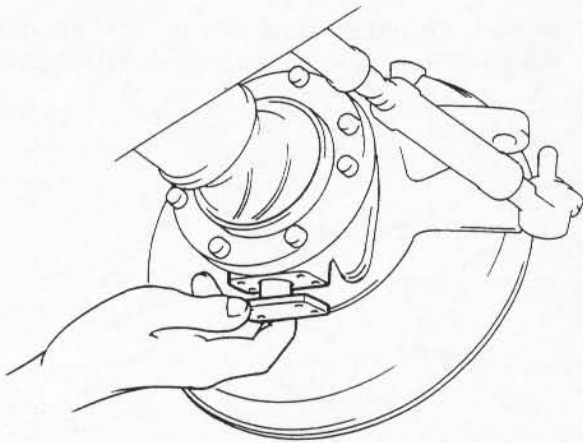


Fig. 16-6

Draw out live axle shaft from axle housing.

**NOTE:**

At this time, lower kingpin bearing sometimes falls off. So remove bearing while pulling off knuckle gradually.

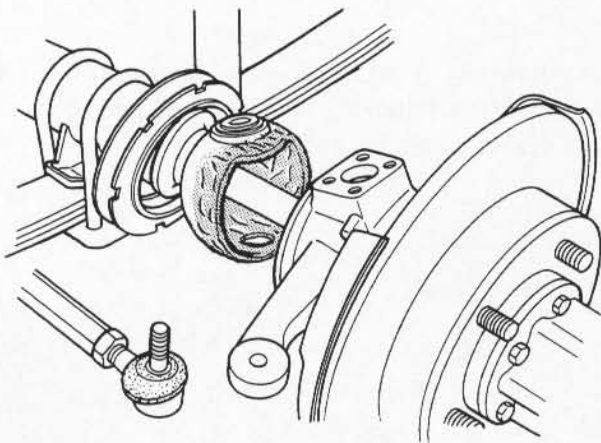


Fig. 16-7

At differential housing, disconnect propeller shaft by removing bolts securing flange yoke to companion flange. Remove 8 bolts holding fast differential carrier case to housing, and take down carrier assembly.

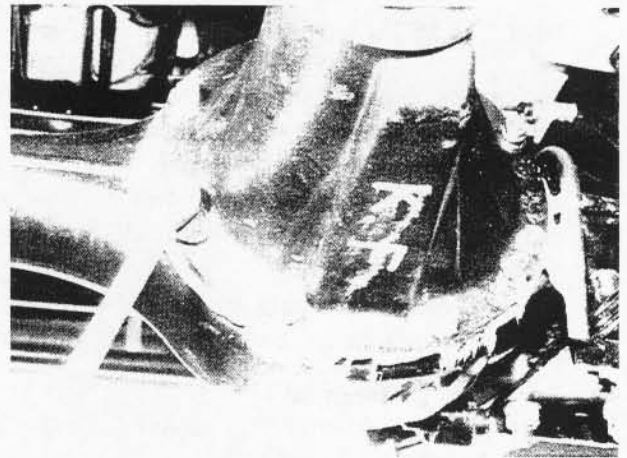


Fig. 16-8

**For Rear Differential**

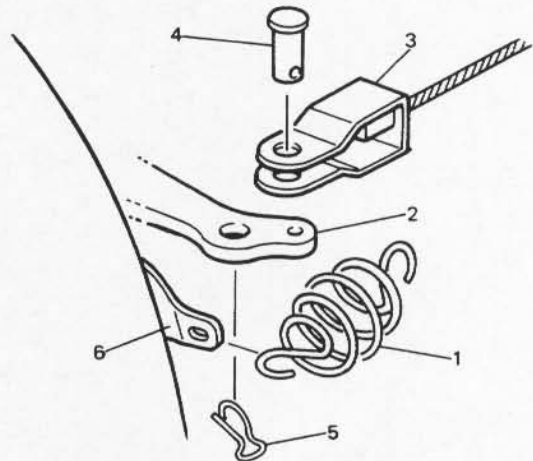
After taking down rear wheels, remove brake drums by using special tools.

**NOTE:**

Before removing brake drum, check to ensure that parking brake lever is not pulled up.

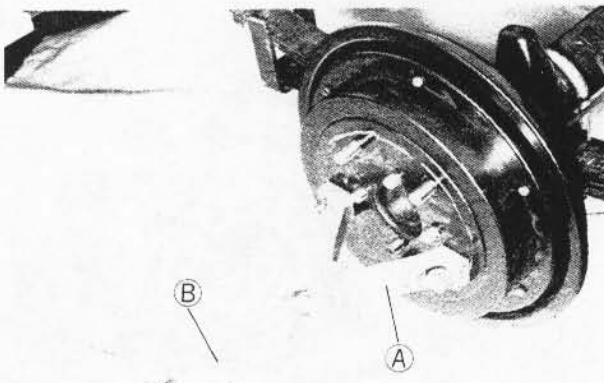
To increase clearance between brake shoe and brake drum, remove parking brake shoe lever return spring ① and disconnect parking brake cable joint ③ from parking brake shoe lever ②.

Remove parking brake shoe lever stopper plate.

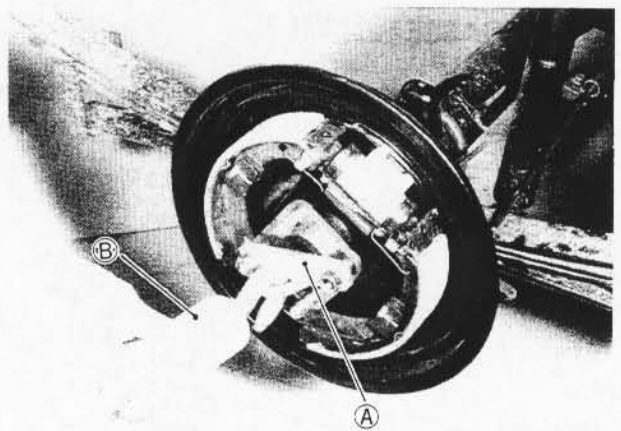


- |   |                     |
|---|---------------------|
| 1. Parking brake shoe lever return spring | 4. Pin              |
| 2. Parking brake shoe lever               | 5. Clip             |
| 3. Parking brake cable joint              | 6. Brake back plate |

Fig. 16-9

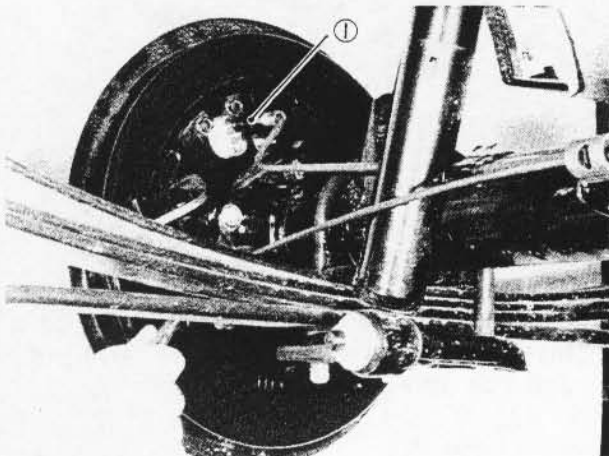


**Fig. 16-9-1** (A) Special tool (Brake drum remover 09943-35511)  
 (B) Special tool (Sliding hammer 09942-15510)



**Fig. 16-10** (A) Special tool (Rear axle remover 09922-66010)  
 (B) Special tool (Sliding hammer 09942-15510)

Disconnect brake pipe from wheel cylinder. Have a small plug ready for use when disconnecting pipe. As pipe comes off the wheel cylinder, plug the pipe to prevent brake fluid from leaking out. And remove 4 brake backing plate securing bolts.



**Fig. 16-9-2** (1) Plug

Disconnect propeller shaft as in the case of front axle, and detach and take down differential carrier case from housing by removing 8 bolts.



**Fig. 16-11**

Using special tools indicated below, draw out each live axle shaft with brake backing plate.

### 16-3. DISASSEMBLY

Lock flange immovable by using special tool, and remove nut from the end of bevel pinion shank.

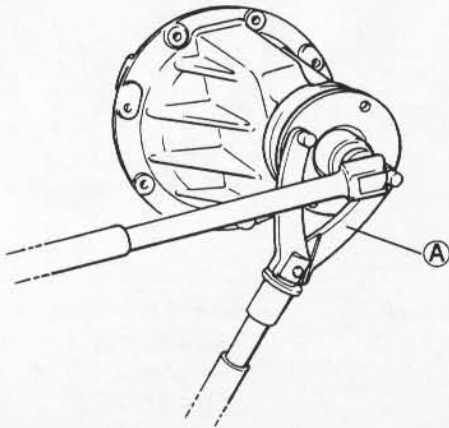


Fig. 16-12 (A) Special tool (Rotor holder 09930-40113)

Scribe marks on each cap bolted to the saddle portion of carrier case and holding down the side bearing. The marks are to identify caps. This means that there are right and left caps, so identified and so handled at the time of reassembly.

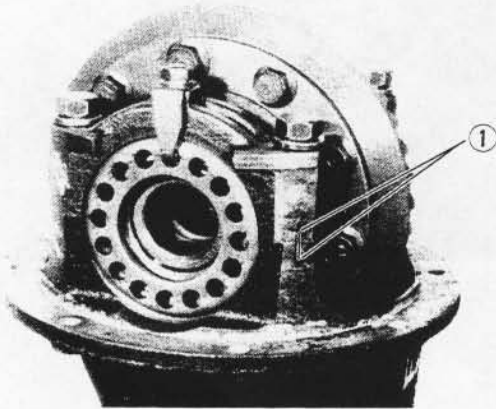


Fig. 16-13 (1) Scribed match marks

At each side, loosen bolts on bearing adjuster stopper, remove bearing cap securing bolts, and take off cap. Lift differential case assembly, complete with bevel gear, off the carrier.

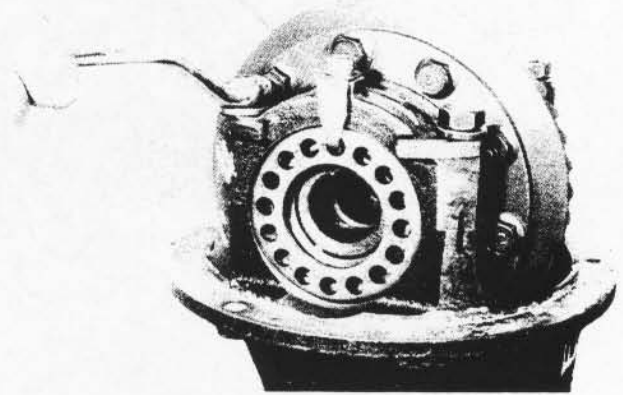


Fig. 16-14

Remove 10 bolts securing bevel gear to differential case, and separate gear from case.

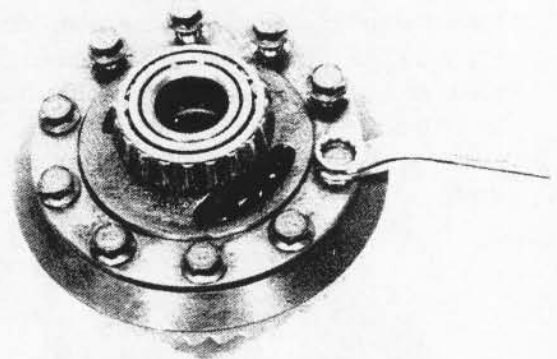


Fig. 16-15

There are 8 bolts fastening two differential case halves together. Remove these bolts to sever right-hand case half from left-hand one, and take off right-hand one.

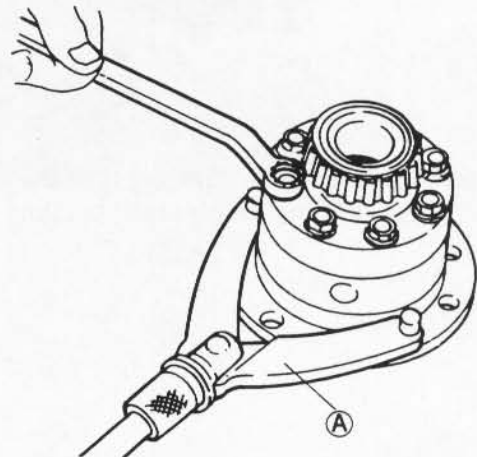


Fig. 16-16 (A) Special tool (Rotor holder 09930-40113)

Remove side gears, differential pinions and thrust washers.

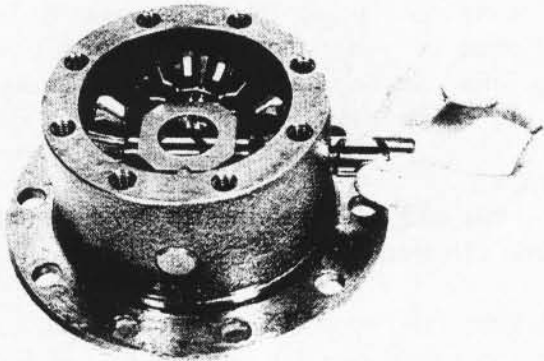


Fig. 16-17

Using special tools indicated below, extract side bearing from each differential case half.

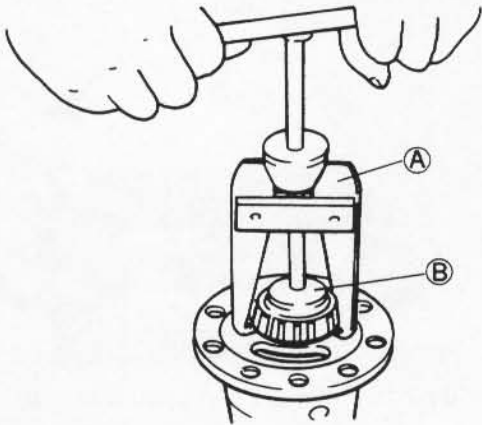


Fig. 16-18 (A) Special tool (Bearing puller 09913-60910)  
(B) Special tool (Side bearing removing jig 09913-85230)

Using puller and hydraulic press, remove inner race of bevel pinion bearing.

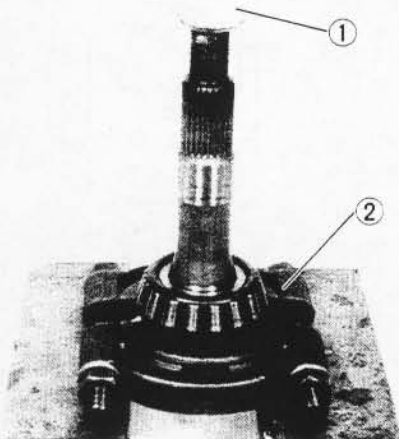


Fig. 16-18-1 (1) Hydraulic press (2) Puller

## 16-4. INSPECTION AND ADJUSTMENT OF COMPONENTS

### Side Gear Thrust Play

To check thrust play, assemble differential gearing and case, as shown in Fig. 16-19, fastening together two case halves by tightening securing bolts to prescribed torque. By comparing thrust play reading, taken as shown in Fig. 16-19, against thrust play indicated below, increase or decrease total thickness of thrust washers, which are located in two places, that is, on the inner side of each case half.

Side gear thrust play specification	0.12 – 0.37 mm (0.005 – 0.014 in)
-------------------------------------	--------------------------------------

Available thrust washer sizes (thickness)	0.9, 1.0, 1.1 & 1.2 mm (0.035, 0.039, 0.043 & 0.047 in)
---	--

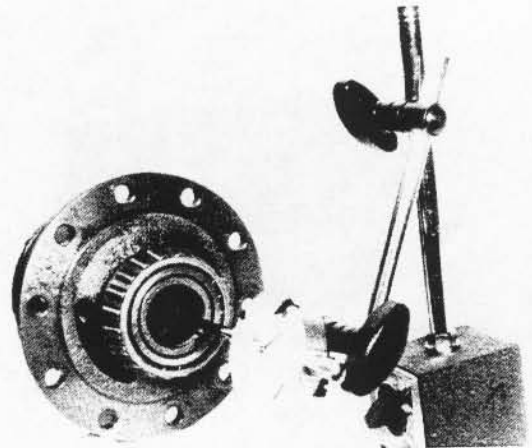


Fig. 16-19

### Determination of Shim Thickness for Bevel Pinion

Thickness of shims to be used on the bevel pinion varies from one vehicle to another on account of factors involved in machining and assembling. Thus, for each vehicle, the thickness of shims necessary for locating pinion in correct position (for producing a proper backlash in the mesh between pinion and gear) must be determined anew at the time of reassembly.

In order to facilitate this determination, a two-piece dummy tool (special tool) is made available. Following procedure is based on use of this tool and supposes that pinion dummy (one of the two pieces) is set in carrier, without any shims, as shown in Fig. 16-20.

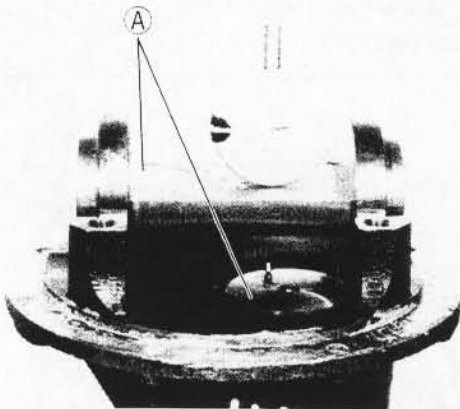


Fig. 16-20 A Special tool (Bevel pinion mounting dummy 09926-78310)

- Set dial indicator on dummy, letting the indicator spindle protrude 5 to 6 mm from the bottom of dummy as shown in Fig. 16-21-1.

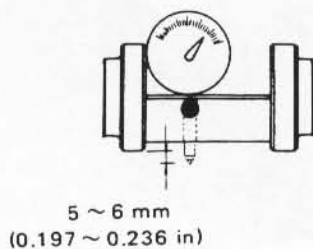


Fig. 16-21-1

- 2) Feed dummy pinion with bearings into the carrier, positioning it properly, and install joint flange.

And then tighten bevel pinion nut until specified starting torque of bevel pinion is obtained. Refer to item 2) and 3) of "Bevel Pinion Bearing Preload Adjustment" described on next page.

#### NOTE:

In this case, fit only bearings to bevel pinion. Don't fit spacer.

- 3) Rest dummy with dial indicator on carrier and pinion dummy, and set dial indicator to zero.

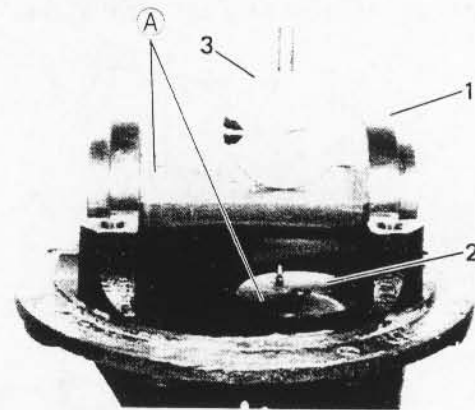


Fig. 16-21-2 1. Dummy 2. Pinion dummy 3. Dial indicator

- 4) Referring to Fig. 16-21-3, note that three dimensions are involved: "a" "b" and "c". The value of "b" is unknown, and is to be determined now for calculating the required thickness of shims. The values of "a" and "c" are given: the sum, "a" + "c", is 94 mm, which is indicated on the dummy tool.

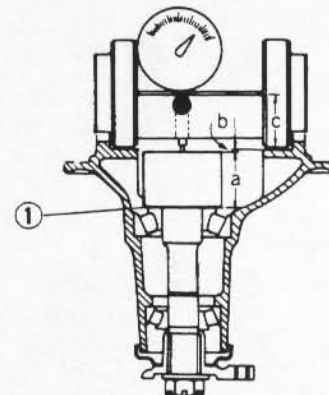


Fig. 16-21-3



Rest dummy with dial indicator on surface plate, and the dial indicator pointer may have deflected from "0" mark to show a certain value; read this value, which is "b".

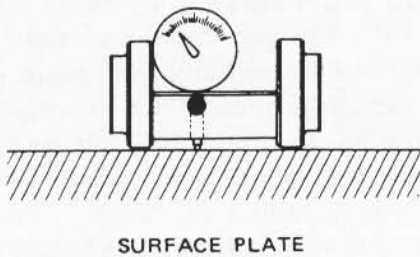


Fig. 16-21-4

Add this reading to 94 mm (= "a" + "c") and, from the sum, subtract the value marked on bevel pinion. The remainder is required shim thickness:  $(94 + "b") - \text{marked value} = \text{required shim thickness}$

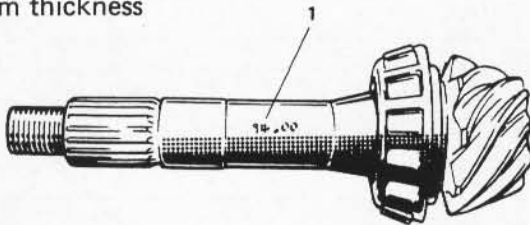


Fig. 16-22 1. Marked value

5) Shim stock is available in twelve selective thicknesses. Select one or two shim(s) from the below to obtain the closest thickness to above required thickness, and insert selected shim piece(s) into clearance indicated as Fig. 16-21-3- ①.

Sizes of shims for bevel pinion	1.00, 1.03, 1.06, 1.09, 1.12, 1.15, 1.18, 1.21, 1.24, 1.27, 1.30 & 0.3 mm
	{ 0.039, 0.041, 0.042, 0.043, 0.044, 0.045, 0.046, 0.047, 0.048, 0.049, 0.050 & 0.012 in. }

### Bevel Pinion Bearing Preload Adjustment

The bevel pinion, as installed in normal manner in carrier, is required to offer a certain torque resistance when checked by using prescribed preload adjuster (special tool A) as shown in Fig. 16-23. This resistance is a "preload," which is due to the tightness of the two tapered roller bearings by which the pinion is held in the carrier. And this tightness is determined primarily by tightening torque of bevel pinion nut. Adjust preload of bevel pinion bearings as follows.

1) Install pinion bearings, spacer, bevel pinion, oil seal and universal joint flange to differential carrier.

At this time, be sure to apply gear oil to bearings lightly and grease to oil seal lip.

2) Tighten bevel pinion nut by hand, and install special tool to universal joint flange.

3) After turning pinion several times, tighten pinion nut gradually, while checking pinion starting torque with spring balance, and stop tightening when starting torque reaches specification given below.

4) Caulk bevel pinion nut to prevent it from loosening.

### NOTE:

Bevel pinion bearing preload is adjusted by tightening bevel pinion nut to crush spacer. Therefore, be sure to use a new spacer for adjustment and tighten pinion nut step by step and check for starting torque (preload) as often as tightening to prevent over crushing of spacer. If exceeds specification given below during adjustment, replace spacer and repeat preload adjustment procedure. Attempt to decrease starting torque (preload) by loosening pinion nut will not do.

The below data are not tightening torque of pinion nut but pinion bearing preload.

Pinion bearing preload	9.0 – 17.0 kg-cm (7.8 – 14.7 lb-in)
Starting torque (When using special tool)	1.8 – 3.4 kg (4.0 – 7.5 lb)

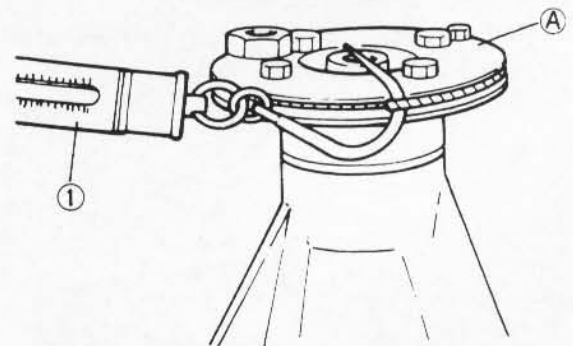


Fig. 16-23 ① Spring balance  
A Special tool (Differential gear preload adjuster 09922-75221)

### Bevel Gear Backlash Adjustment

Backlash between bevel gear and pinion is checked as shown in Fig. 16-24. Note that differential case assembly is mounted in the normal manner, and fastened down by tightening the side bearing cap bolts to 1.0 – 2.0 kg-m (7.5 – 14.0 lb-ft). At this time, screw in each adjuster till it contacts bearing outer race so that outer race is prevented from inclining. The dial indicator spindle is pointed squarely to "heel" on drive side (convex side) of gear tooth. Hold bevel pinion rigidly, and turn gear back and forth.

The dial indicator reading, which is bevel gear backlash, must be within this range:

Bevel gear backlash	0.10 – 0.15 mm (0.004 – 0.006 in.)
---------------------	---------------------------------------

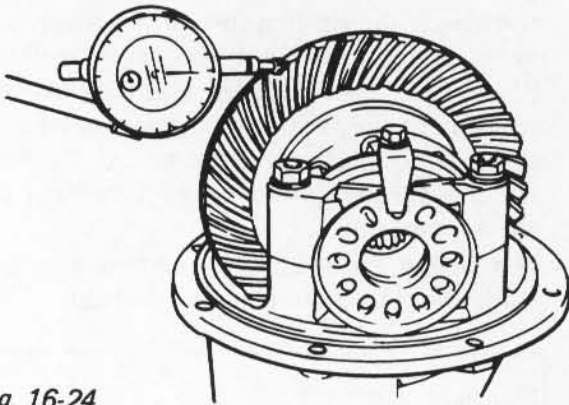


Fig. 16-24

To increase or decrease backlash for adjustment, displace bevel gear toward or away from pinion by running in one adjuster and running out the other adjuster by equal amount.

Turning the adjuster one notch changes backlash by about 0.05 mm (0.002 in.).

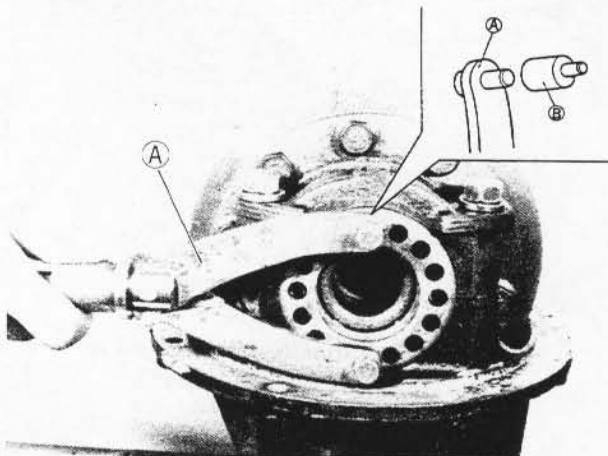
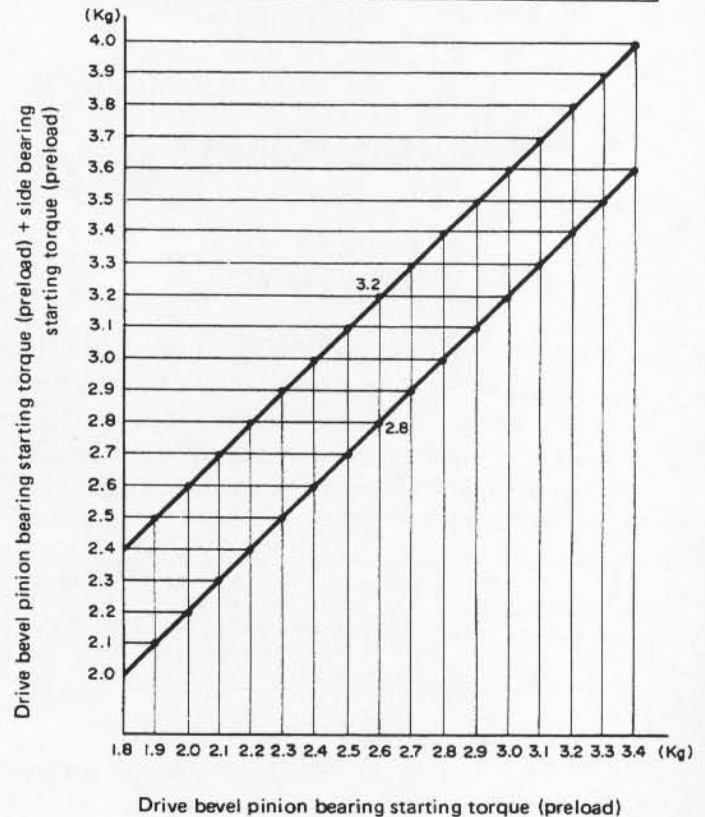


Fig. 16-25 (A) Special tool (Rotor holder 09930-40113)

16-10 (B) (Attachment 09930-40120)

### CAUTION:

- Adjust preload on side bearing during back-lash adjustment: mount special tool on drive bevel pinion as shown in Fig. 16-23 and measure using spring balance ①. If reading at the instant bevel gear starts moving is within the range given below, side bearing preload is acceptable. Referring to the graph, for example, when the drive bevel pinion bearing preload measured as shown in Fig. 16-23 is 2.6 kg (5.73 lb), drive bevel pinion bearing preload (kg) + bevel gear side bearing preload (kg) should be 2.8 – 3.2 kg (6.17 – 7.05 lb).
- Upon completion of this adjustment, be sure to tighten bearing cap bolts to 7.0 – 10.0 kg-m or 51.0 – 72.0 lb-ft.

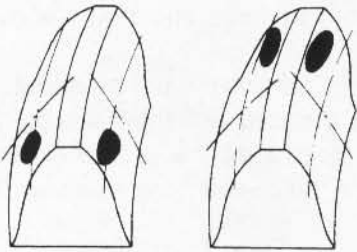
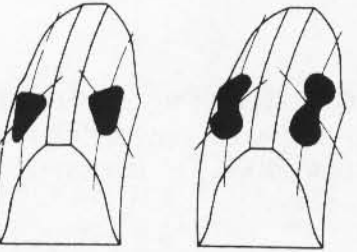


### Pinion-to-gear Tooth Contact Pattern Check and Adjustment

In addition to proper backlash, proper tooth contact must be secured in the mesh of bevel pinion and gear, so that there will be no "gear noise" coming from the axle and that the hypoid teeth will not be overstressed in transmitting drive.

After the specified amount of backlash has been secured, check the pinion and gear for tooth contact by "rolling" contact patterns in a manner consistent with the standard shop practice: use a red lead paste to paint ten teeth, both drive side and coast side, of the gear, turn the gear back and forth by hand while holding the pinion in a "braking" manner, and examine the contact patterns in reference to the following chart:

	Contact patterns	Diagnosis, and what to do
Normal contact pattern		<p>Contact is roughly centered and somewhat more displaced toward toe than toward heel on both drive side (concave) and coast (convex) side.</p>
Patterns due to improper shim adjustment		<p>High contact: Contact is on heel (drive side) and on toe (coast side). This condition means that the pinion is too far back and must be brought forward by increasing its shim thickness used in "mounting distance" adjustment.</p>
		<p>Low contact: Contact is on toe (drive side) and on heel (coast side). This condition means that the pinion is too far out from the carrier and must be backed away by decreasing its shim thickness.</p>
Pattern due to defective parts		<p>These contact patterns indicate that the "offset" of differential carrier is too much or too little. The remedy is to replace the carrier with a new one.</p>

	Contact patterns	Diagnosis, and what to do
Patterns due to defective parts		<p>These contact patterns, located on toe or heel on both drive and coast sides, mean that 1) both pinion and gear are defective, 2) carrier is not true and square, or 3) gear is not properly seated on differential case. The remedy is to replace the defective member.</p>
		<p>Irregular patterns: If the pattern is not oval, it means that bevel gear is defective. High or low spots on tooth surfaces or on the seat of bevel gear are the cause of irregular patterns appearing on some teeth. The remedy is to replace the pinion and-gear set and, if the seat is defective, so is differential case.</p>

**CAUTION:**

When applying red lead paste to teeth, be sure to paint tooth surfaces uniformly. The paste must not be too dry or too fluid.

## 16-5. REASSEMBLY

Reverse disassembly procedure for reassembly, noting the following.

### NOTE:

Bevel pinion and bevel gear are supplied as a set. Even when only bevel pinion or bevel gear replacement is necessary, be sure to replace both as a set.

### Differential Pinion Shaft (Shorter)

When installing shaft into differential case and pinion, insert its "A" side into pinion joint.

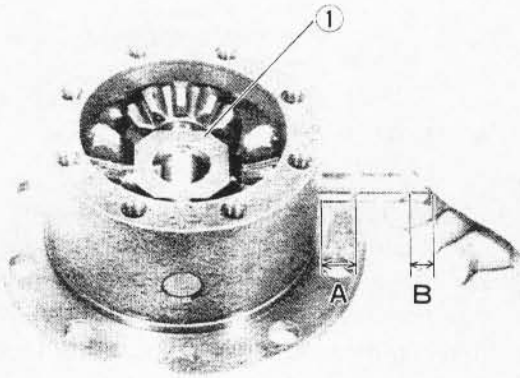


Fig. 16-26 ① Pinion joint  
 $A > B$  ("A" is longer than "B".)

### Drive Bevel Gear Bolts

Bolts securing bevel gear to differential case are subject to shear stress since drive is transmitted by these bolts from gear to case. For this reason, they are special bolts made from chrome steel and must never be replaced by common bolts.

When mounting gear onto case, be sure to apply **THREAD LOCK CEMENT SUPER 1333B** (99000-32020) to these bolts before running them in.

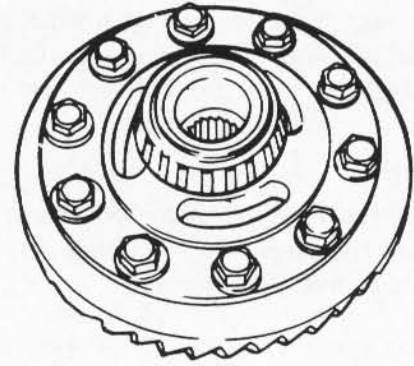


Fig. 16-26-1

### Differential Side Bearings

Press-fit these bearings into differential case by using special tool. Driving the bearing into case is not permitted.

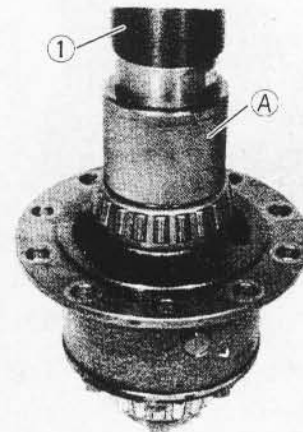


Fig. 16-27

- ① Press
- Ⓐ Special tool (Bearing installer 09940-53111)

### Bevel Pinion Bearings

A press must be used to install two tapered roller bearings on bevel pinion. Outer races are press-fitted into the differential carrier and inner races onto the pinion.

#### NOTE:

When replacing bevel pinion bearings, check to ensure that gear side and flange side bearings are the same marker's products.

- 1) For outer race of flange side bearing, use special tool as shown below.

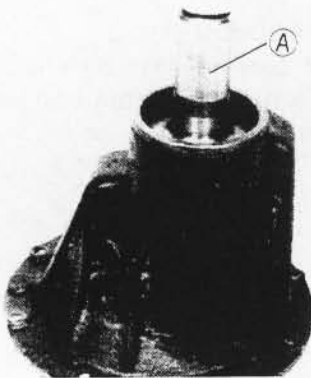


Fig. 16-28 (A) Special tool (Bearing installer 09913-75510)

- 2) For outer race of gear side bearing, use special tools.

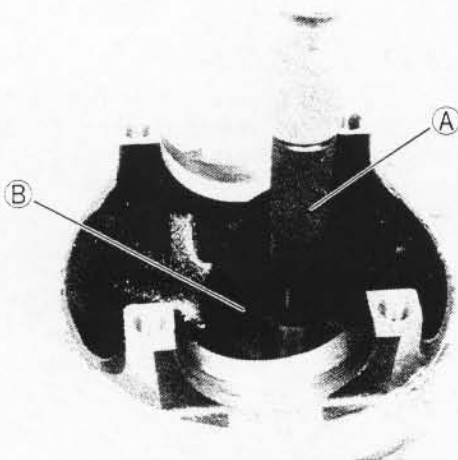
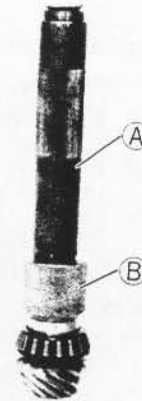


Fig. 16-29 (A) Special tool (Bearing installer attachment 09924-74510)  
(B) Special tool (Bearing installer 09926-68310)

- 3) After installing proper bevel pinion shim(s), press-fit inner race to bevel pinion using special tools.



(A) Special tool (Bearing installer 09925-18010)

(B) Special tool (Bearing installer 09940-53111)

Fig. 16-30

- 4) After installing bevel pinion, spacer, bearings and universal joint flange to carrier and carrying out "bevel pinion bearing preload adjustment" as described previously, caulk bevel pinion nut to prevent it from loosening.

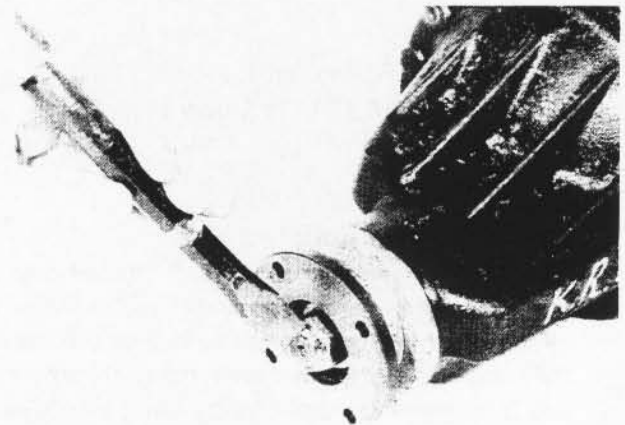


Fig. 16-30-1

### Side Bearings Caps

When putting on side bearing caps, be sure to discriminate the right-hand cap from the left-hand one by referring to match marks scribed at the time of disassembly.

Then, after carrying out "Bevel gear backlash adjustment" as described on p. 16-10 torque cap bolts to specification.

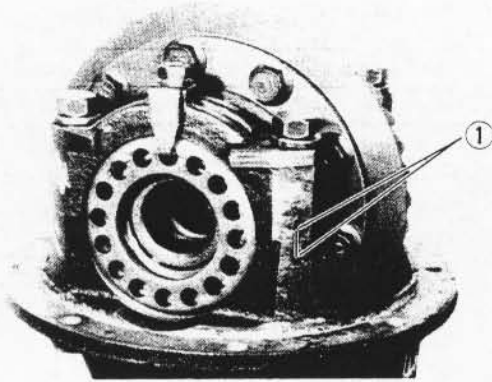


Fig. 16-31 ① Scribed match marks

## 16-6. INSTALLATION

Reverse removal procedure for installation, noting the following.

### Differential

Before installing differential ass'y to axle housing, clean mating surfaces of differential carrier and housing and apply sealant to them.

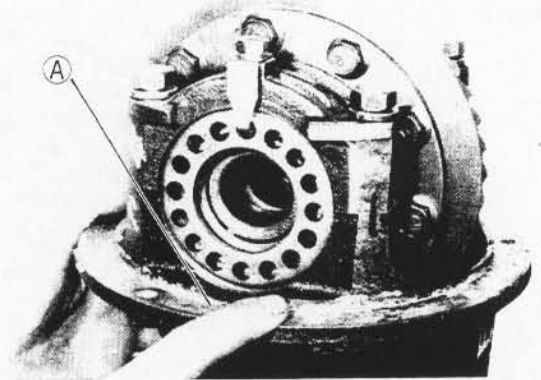


Fig. 16-32 ① Sealant (SUZUKI BOND NO. 1215 99000-31110)

### Front Axle Shaft and Steering Knuckle

For installation them, refer to "Front Suspension Installation" in SECTION 17 of this manual.

### Rear Brake Drum

For installation of rear brake drum, refer to "Rear Brake Installation" in SECTION 19 of this manual.

### Differential Gear Oil

Refill differential housing with new specified oil. Refer to "MAINTENANCE SERVICE" in this section for refill.

### Brake Circuit Air Purging

If brake pipe (right & left) was disconnected from wheel cylinder as in Fig. 16-9-2, make sure to purge air out of brake circuit. Refer to section 19. BRAKES for "air purging" operation. Then check to ensure that joint seam of pipe is free from oil leak.

## 16-7. MAINTENANCE SERVICES

### Inspection

Inspect differential and differential housing for evidence of oil leakage.

Oil level is checked by means of its oil level plug. Refer to p. 1-17 for level inspection.

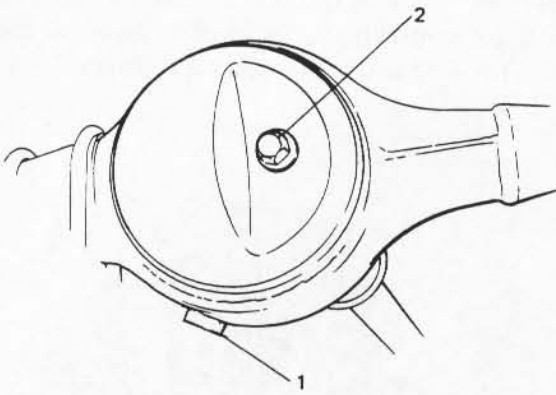


Fig. 16-33 ① Drain plug  
② Oil level & filler plug

### Oil Change

- 1) Remove oil drain plug and drain oil.
- 2) Reinstall drain plug and tighten it to specified tightening torque.
- 3) Remove oil level & filler plug and fill differential housing with new specified oil.

Differential oil specification		Hypoid gear oil SAE90 or 80W, 75W/80 – 85
Oil capacity	Front	2.0 litres (4.2/3.5 US/Imp pt.)
	Rear	1.5 litres (3.2/2.6 US/Imp pt.)

### NOTE:

For vehicles used in such areas where ambient temperature becomes lower than  $-15^{\circ}\text{C}$  ( $5^{\circ}\text{F}$ ) during the coldest season, it is recommended that oil be changed with SAE 80W or 75W/80 – 85 on such occasion as periodic maintenance service.

- 4) Reinstall oil level & filler plug and tighten it to specified tightening torque.

## 16-8. RECOMMENDED TORQUE SPECIFICATIONS

Fastening parts	Tightening torque		
	N-m	kg-m	lb-ft
Side bearing cap bolt	70 – 100	7.0 – 10.0	51.0 – 72.0
Drive bevel gear bolt	80 – 90	8.0 – 9.0	58.0 – 65.0
Differential case bolt	37 – 45	3.7 – 4.5	27.0 – 32.5
Side bearing adjuster lock bolt	9 – 14	0.9 – 1.4	7.0 – 10.0
Differential carrier bolt	18 – 28	1.8 – 2.8	13.5 – 20.0
Oil level & filler plug	35 – 50	3.5 – 5.0	25.5 – 36.0
Oil drain plug	18 – 25	1.8 – 2.5	13.5 – 18.0