

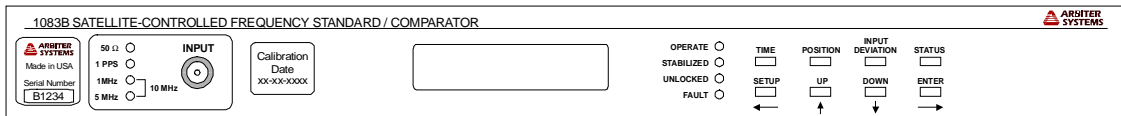

MODEL 1083B SATELLITE-CONTROLLED FREQUENCY STANDARD / COMPARATOR OPERATION MANUAL



Model 1083B

ARBITER SYSTEMS, INC.
PASO ROBLES, CALIFORNIA
U.S.A.

This manual is issued for reference only, at the convenience of Arbiter Systems. Every reasonable effort was made to verify that all contents were accurate as of the time of publication. Check with Arbiter Systems at the address below for any revisions made since the original date of publication.

Arbiter Systems, Inc.
1324 Vendels Circle, Suite 121
Paso Robles, CA 93446
(805) 237-3831
website: www.arbiter.com
<mailto:techsupport@arbiter.com>
<mailto:sales@arbiter.com>

Definition

This manual describes the Model 1083B GPS Satellite Controlled Frequency Standard / Comparator.

ROM Dates

This version of the manual is written for clocks having ROM dates of 11-16-99 or later. Any changes made in subsequent revisions which affect operation or specifications will be noted with either (a) a new manual or (b) a revised version of this manual.

To display the ROM date for your instrument, press and hold down the SETUP key at power-on. The ROM date (software version) will be displayed. The ROM date can also be read via RS-232, using the "V" command; see Appendix A.

Firmware Updates

Firmware updates are available to customers on an exchange basis. Contact our factory service department for information. Where applicable, this update may include new documentation, such as a new version of this manual.

LIMITED WARRANTY

Arbiter Systems makes no warranty, expressed or implied, on any product manufactured or sold by Arbiter Systems except for the following limited warranty against defects in materials and workmanship on products manufactured by Arbiter Systems.

GPS products manufactured by Arbiter Systems are guaranteed against defective materials and workmanship under normal use and service for five years from date of delivery. The responsibility of Arbiter Systems under this warranty is limited to repair or replacement, at Arbiter Systems' option, of any product found to be defective. Arbiter Systems shall have no liability under this warranty unless it receives written notice of any claimed defect, within:

- Five years from the date of delivery.

For warranty service or repair, products must be returned to a service facility designated by Arbiter Systems. Buyer shall prepay all shipping charges to Arbiter Systems, and Arbiter Systems shall pay shipping charges incurred in returning the product to Buyer. However, Buyer shall pay all shipping charges, duties and taxes for products returned to Buyer in a country other than the United States of America.

THE WARRANTY SET FORTH HEREIN CONSTITUTES THE ONLY WARRANTY OBLIGATIONS OF ARBITER SYSTEMS, EXPRESSED OR IMPLIED, STATUTORY, BY OPERATION OF LAW, OR OTHERWISE. ARBITER SYSTEMS DISCLAIMS ANY WARRANTY OF MERCHANTABILITY OR FITNESS FOR A PARTICULAR PURPOSE, AND BUYER EXPRESSLY WAIVES ALL OTHER WARRANTIES.

This limited warranty does not extend to any product, which has been subject to

- i. Improper use or application, abuse, or operation beyond its rated capacity, or contrary to the instructions in the operation and maintenance manuals (if any);
- ii. Accident;
- iii. Repair or maintenance performed by Buyer, except in accordance with the operation and maintenance manuals, if any, and any special instructions of Arbiter Systems;
- iv. Modification without the prior written authorization of Arbiter Systems (whether by the substitution of non-approved parts or otherwise).

The remedies provided herein are Buyer's sole and exclusive remedies. In no event shall Arbiter Systems be liable for direct, indirect, incidental or consequential damages (including loss of profits), whether based on contract, tort, or other legal theory.

FOR THE FASTEST POSSIBLE SERVICE, PLEASE PROCEED AS FOLLOWS:

1. Notify Arbiter Systems, Inc., specifying the instrument model number and serial number and giving full details of the difficulty. Service data or "instrument return" authorization will be provided upon receipt of this information.
2. If instrument return is authorized, forward prepaid to the manufacturer. If it is determined that the instrument is not covered by this warranty, an estimate will be made before the repair work begins, if requested.

1324 Vendels Circle, Ste. 121, Paso Robles, CA 93446

(805) 237-3831 FAX (805) 238-5717

website: www.arbiter.com

Support:

<mailto:techsupport@arbiter.com>

<mailto:sales@arbiter.com>

Model 1083B Satellite-Controlled Frequency Standard / Comparator

Operation Manual

- Table of Contents
- Section One: General Information
- Section Two: Technical Specifications
- Section Three: Physical Configuration
- Section Four: Operation
- Section Five: Firmware Configuration
- Appendixes: RS-232 Commands
- Options

©Copyright Arbiter Systems Incorporated 2001
All rights reserved. International copyright secured.

Table of Contents

1.0 GENERAL INFORMATION	1
1.1 Scope	1
1.2 Equipment Needed	1
1.2.1 Antenna, Cables and Accessories Chart.....	1
1.2.2 Available Accessories	2
1.3 Options	3
1.3.1 Option 26, Rack Slide Kit	3
1.3.2 Optional Sine Wave Outputs.....	3
2.0 TECHNICAL SPECIFICATIONS AND OPERATIONAL PARAMETERS	5
2.1 Scope	5
2.2 Receiver Characteristics	5
2.2.1 Input Signal	5
2.2.2 Time Accuracy	5
2.2.3 Position Accuracy (rms).....	5
2.2.4 Satellite Tracking	5
2.2.5 Acquisition	5
2.2.6 Antenna	6
2.2.7 Antenna Cable	6
2.3 Frequency Outputs	6
2.3.1 Frequency Amplitude.....	6
2.3.2 Frequency Accuracy.....	6
2.3.3 Frequency Stability and Spectral Purity.....	6
2.4 Oscillator	7
2.5 Frequency Measurement Capability.....	7
2.6 Time Interval Measurement	7
2.7 Operator Interface.....	8
2.7.1 Front Panel Keys	8
2.7.2 Display.....	8
2.7.3 Instrument Annunciators	8
2.7.4 System Interface.....	9
2.8 I/O Configuration	9
2.8.1 I/O Connector Locations	9
2.8.2 Output Signals (at time of purchase).....	9
2.8.3 Input Signal	10
2.9 Physical Characteristics.....	10
2.9.1 Dimensions.....	10
2.9.2 Weight	10
2.9.3 Power Requirements (Instrument).....	10
2.9.4 Power Connector	10
2.9.5 Electro-Magnetic Interference (EMI).....	10
2.9.6 Temperature and Humidity	10
3.0 PHYSICAL CONFIGURATION.....	11
3.1 Instrument.....	11

3.1.1	Location Considerations	11
3.1.2	Power Requirements	11
3.1.3	Rear Panel Layout.....	13
3.1.4	Rack Mounting.....	13
3.2	Antenna.....	13
3.2.1	Antenna Location.....	13
3.2.2	Antenna Gain Pattern.....	14
3.2.3	Antenna Mounting	14
3.2.4	Optional Antenna Mounting Kit.....	14
3.3	Antenna Cable.....	15
3.3.1	Length and Loss Considerations.....	15
3.3.2	Routing Considerations.....	16
3.3.3	Antenna Module Power	17
3.3.4	Connection to Antenna	17
3.3.5	Connection to Clock	17
3.3.6	Antenna and Cable Operational Test	18
3.3.7	User-Supplied Antenna Cables.....	18
4.0	OPERATION	19
4.1	Front Panel Controls and Indicators	19
4.1.1	LED Input Signal Status Indicators	19
4.1.2	LED Instrument Status Indicators.....	20
4.1.3	Vacuum Fluorescent Display (VFD)	20
4.1.4	Front Panel Keys.....	20
4.2	Satellite Acquisition and Positional Data	21
4.2.1	Almanac and Positional Data.....	21
4.2.2	Satellite Acquisition Time	22
4.3	Startup Sequence.....	22
4.4	Status Display Modes	23
4.4.1	Fault Conditions.....	23
4.4.2	Position-Hold Mode – ON.....	25
4.4.3	Position-Hold Mode – OFF	25
4.4.4	Receiver Status Display	25
4.4.5	OCXO Status Display.....	26
4.4.6	EEPROM Status Display	26
4.5	Time Display Modes.....	26
4.5.1	Date and Time Display, Universal Time Coordinated (UTC).....	26
4.5.2	Time of Year Display, Universal Time Coordinated (UTC).....	27
4.5.3	Date and Time Display, Local Time.....	27
4.5.4	Time of Year, Local Time	28
4.6	Position Display Modes	28
4.6.1	Set Initial Position.....	30
4.7	Position-Hold and Auto Survey Modes	31
4.7.1	Position Hold Methods	31
4.7.2	Position Accuracy Requirements.....	32
4.7.3	Auto-Survey Mode Activation.....	32
4.7.4	Position-Hold Mode Activation.....	33

4.8	Input Deviation Measurements, Recording and Display Modes.....	36
4.8.1	Measurement Methods	36
4.8.2	Measuring Deviation of a 1, 5, 10-MHz, or 1 PPS Signal	38
5.0	FIRMWARE CONFIGURATION	41
5.1	General	41
5.2	Change Configuration Using Setup Menu	41
5.2.1	Configuration Flow Charts	42
6.0	APPENDIX A. RS-232 COMMAND SUMMARY	49
7.0	INDEX.....	65

List of Tables and Figures

Figure 3-1. Model 1083B Rear Panel 13

Figure 4-1. Model 1083B Front Panel 19

Figure 4-2. Status Display Mode Response Flow Chart..... 24

Figure 4-3. Time Display Mode Response Flow Chart 27

Figure 4-4. Set Initial Position Flow Chart 31

Figure 4-5. Auto-Survey Mode Flow Chart..... 33

Figure 4-6. Position-Hold Mode Flow Chart 35

Figure 4-7 Changing phase between two signals..... 36

Figure 4-8. Reciprocal Frequency Measurement..... 37

Figure 4-9. 1 PPS Deviation Measurement..... 38

Figure 5-1. RS-232 Setup Menu flow Chart 43

Figure 5-2. Set Local Hour Flow Chart 44

Figure 5-3. Set Out-of-lock Flow Chart..... 45

Figure 5-4. Set Systems Delays Flow Chart 46

Figure 5-5. Set $\Delta F / \Delta T$ Mode Flow Chart..... 47

1.0 General Information

1.1 Scope

This manual describes Model 1083B GPS Satellite-Controlled Frequency Standard / Comparator, and is divided into five sections and one appendix as follows:

- Section 1: General Information.
- Section 2: Technical Specifications and Operational Parameters.
- Section 3: Physical Configuration and Installation.
- Section 4: Operation.
- Section 5: Firmware Setup and Configuration.
- Appendix A: RS-232 Commands.

1.2 Equipment Needed

The standard Model 1083B uses detachable connectors for Power, Antenna, and all input/output connections.

1.2.1 Antenna, Cables and Accessories Chart

A standard Model 1083B Satellite-Controlled Frequency Standard/Comparator comes equipped with the following accessories:

- | | |
|--|-----------|
| ▪ GPS Antenna, pipe mount | AP0004800 |
| ▪ 15-m (50-ft) Antenna Cable | CA0021315 |
| ▪ Rack-Mount Kit (for standard 19-inch rack) | AS0028200 |
| ▪ Operation Manual | AS0027000 |
| ▪ Power Cord | P01 – P10 |

Antenna and Cable: The antenna supplied with the 1083B is specifically designed for use with GPS receivers. Housed in a weatherproof case, it includes 15 meters (50 feet) of RG-6 weatherproof, low loss, coaxial cable. Longer cable runs require one of the optional cable assemblies listed (see paragraph 1.2.2) intended to be added to the existing 15-meter cable.

Main Power Module: The Model 1083B comes equipped with a 85 – 264 Vac, 47 – 440 Hz or 110 – 275 Vdc, 12 VA, IEC-320 type power input module, with an IEC-320 ac cord. Specify the ac power cord type P1 – P10 (see paragraph 3.1.2.5).

Mounting: The Model 1083B includes two separate brackets for mounting in a 19-inch rack. It also includes rubber feet for desktop use. Cover mounting hardware allows easy attachment of the rack-mount ears to the Model 1083B.

1.2.2 Available Accessories

Available accessories and associated part numbers for the Model 1083B are listed below. This list does not include available options. For options see paragraph 1.3, Options.

<u>Description</u>	<u>Order No.</u>
15-m (50-ft) RG-6 Antenna Cable	CA0021315
30-m (100-ft) RG-6 Antenna Cable	CA0021330
45-m (150-ft) RG-6 Antenna Cable	CA0021345
60-m (200-ft) RG-6 Antenna Cable	CA0021360
75-m (250-ft) RG-6 Antenna Cable	CA0021375
GPS Antenna Mounting Kit	AS0044600
21-dB In-Line Preamplifier	AS0044700
GPS Surge Protector Kit	AS0049000
Grounding Block Kit	AS0048900
1000-ft Roll RG-11 Cable	WC0004900
RG-6 Crimp Tool	TF0006400
RG-11 Crimp Tool + 25 Type F Connectors	AS0044800

For RG-6 cable lengths of greater than 75 meters (250 feet) Arbiter Systems offers an inline 21-dB preamplifier to make up for the signal loss (see paragraphs 3.2 and 3.3 for further information concerning Antennas and Cables). The same 21-dB preamplifier makes up the signal loss for RG-11 cable lengths of greater than 120 meters (400 feet) and up to 240 meters (800 feet).

1.2.2.1 Standard, RG-6 Antenna Cable

The standard antenna cable assembly included with the clock is constructed using a 15-meter (50-foot) length of RG-6 type low-loss coaxial cable, terminated with male Type F RF connectors. Cable delay is 119 ns per 100 feet. Optional lengths of RG-6 coax are separately available for longer runs; see paragraph 3.5.1.3.

1.2.2.2 GPS Antenna Mounting Kit

A mounting kit, separately available as P/N AS0044600, can be used to mount the antenna to a vertical mast (up to approximately 2-in. diameter), or to the wall or roof of a structure such as an antenna tower or a building. This kit contains a short length of threaded, plastic pipe, a stainless steel bracket, and hardware to attach the pipe to the bracket in any of several orientations. With this kit, it is possible to mount the bracket to any surface from vertical to horizontal, while maintaining acceptable orientation for the antenna. This bracket will accept user-supplied screws for surface mounting, and straps (such as pipe clamps) for mounting to a pipe or mast.

1.2.2.3 GPS Surge Protector Kit

Designed for GPS protection against lightning and other surges. Multi-stage circuitry with a heavy-duty gas discharge tube, toroidal inductor, MOV, and capacitors provides less than 1 nanosecond response time and power handling capacity of 20,000 amps (8/20 μ s). Passes dc

power to the antenna and preamplifier. Connections are two female, Type F connectors. Includes two mating connectors for RG-6; crimp tool is available separately. Operating temperature is -40° to $+120^{\circ}$ C.

1.2.2.4 Grounding Block Kit

The Grounding Block Kit consists of a Type-F bulkhead feedthrough mounted in an extruded aluminum bracket with grounding screw. It also includes two mating connectors for RG-6; a crimp tool is available.

1.2.2.5 RG-11 Cable, 1000-foot Roll

A larger diameter cable, RG-11 comes in a 1000-foot roll for individual applications. With a lower loss characteristic than RG-6 (5.25 dB compared to 9 dB), it can be used where longer runs are required. Also, its quad-shield design and provides better shielding from nearby interfering signals to the low-level GPS signal.

1.2.2.6 RG-6 Crimp Tool

This crimp tool is designed for use with a 0.360" RG-6, hex crimp connector. Advanced design crimp ring of connector can accommodate a wide range of cable sizes, and is made of brass. Connection provides excellent shielding and mechanical retention.

1.2.2.7 RG-11 Crimp Tool and 25 Connectors

This crimp tool is designed for use with 0.480" RG-11, hex crimp connector. Crimp-on center pin of 0.030" prevents potential damage to F female. Attached crimp ring, of connector, provides excellent electrical shielding and mechanical retention.

1.3 Options

The Model 1083B allows for installation of options, which can enhance various aspects of performance and/or features. Available options for the Model 1083B Satellite-Controlled Frequency Standard/Comparator are as follows:

1.3.1 Option 26, Rack Slide Kit

Option 26 includes detachable, rack slides and custom mounts for a standard 19-in. EIA relay rack. Also included are thumbscrews to lock unit in place. Option 26 allows Model 1083B to be removed from the rack without special tools.

1.3.2 Optional Sine Wave Outputs

The Model 1083B can be configured with up to eight separate sine wave outputs at 1, 5 or 10 MHz, mounted internally. Each sine wave output is a separate module that comes with its own BNC connector and at the chosen frequency. Therefore, the Model 1083B can be configured with any combination of the above frequencies and from one to eight output modules. For example, as a minimal configuration, the Model 1083B could be configured with only one sine wave output at 1, 5 or 10 MHz. Or, it could have from two to eight sine wave outputs in any combination of frequencies.

Option Numbering for Optional Sine Wave Boards

Frequency and location are used to determine option numbers for sine wave boards. The first number represents the frequency and the second number represents the frequency output location. Designations are as follows:

1083Boptxy,

where,

$$x = 1, 2, \dots, 8$$

as the numbered option slot

and

$$y = A, B, C, D, E \text{ and } F$$

with

$$A = 1 \text{ MHz, BNC}$$

$$B = 5 \text{ MHz, BNC}$$

$$C = 10 \text{ MHz, BNC}$$

$$D = 1 \text{ MHz, TNC}$$

$$E = 5 \text{ MHz, TNC}$$

$$F = 10 \text{ MHz, TNC}$$

Example: 1 Mhz in Option Slot 1 and BNC connector = 1083Bopt1A

2.0 Technical Specifications and Operational Parameters

2.1 Scope

This section contains information pertinent to the functional and operational characteristics of the standard Model 1083B, including Receiver Characteristics, Operator Interface(s), System Interface(s) and Physical Characteristics.

NOTE: Specifications are subject to change without notice.

2.2 Receiver Characteristics

2.2.1 Input Signal

- 1575.42 MHz, GPS L1 C/A code

2.2.2 Time Accuracy

- ± 150 ns peak (at 1PPS output), to GPS/UTC time, when receiving 4 or more satellites (one satellite if position is known within 25 meters). Typically is <30 ns rms over 24 hours.

2.2.3 Position Accuracy (rms)

- 25 meters, with SA¹ off
- 100 meters, with SA on
- 140 meters (Elevation), with SA on
- 10 meters (referenced to WGS84) after 24 hours of averaging in a static position.

2.2.4 Satellite Tracking

8 channel, C/A code (1575.42 MHz)

The receiver simultaneously tracks up to eight satellites. Results from all tracked satellites are averaged in Position-Hold Mode or, with Position-Hold – Off, using least-squares estimation.

2.2.5 Acquisition

- 30 seconds (90% confidence), with ephemeris² less than 4 hours old or uninterrupted clock operation.
- 66 seconds (90% confidence), with almanac less than 1 month old or uninterrupted clock operation.
- 2 minutes (typical)
- 25 minutes (90% confidence), cold start

¹ USA Department of Defense Selective Availability: Time accuracy and long-term frequency stability specifications apply in the presence of SA, when used in Position-Hold Mode. With Position-Hold Mode off, a degradation of 3x to 4x is possible.

² Ephemeris data is a list of (accurate) positions or locations of a celestial object as a function of time. This is transmitted as a part of the GPS satellite transmission and is valid for approximately 4 hours.

2.2.6 Antenna

- External, 3/4-in. pipe thread mounting (19-mm)
- Size: 77.3-mm diameter x 74.6-mm height (3.04 in. x 2.94 in.)

2.2.7 Antenna Cable

- 15 meters (50 feet) included
- Other cable styles and lengths available – see paragraph 3.3.1.3

2.3 Frequency Outputs

- Analog sine wave outputs of 1, 5, and 10 MHz through BNC connectors. These are configurable at the factory.

2.3.1 Frequency Amplitude

- 1 Vrms into 50 Ω (+13 dBm)

2.3.2 Frequency Accuracy

- 2×10^{-12} after 24 hours of averaging (typical, better than 5×10^{-13})

2.3.3 Frequency Stability and Spectral Purity

Includes warm-up, locking to GPS signal and the effects of SA when used in the Position-Hold Mode. With Position-Hold – Off, a degradation of 3x to 4x is possible.

Phase Noise (@ 5 MHz)

- -130 dBc/Hz, 10 Hz offset (typical)
- -155 dBc/Hz, 100 Hz offset (typical)
- -165 dBc/Hz, 1 kHz or greater offset (typical)

Spurious

- -100 dBc, non-harmonically related.

Harmonics

- -40 dBc

Frequency Stability

- 10 seconds $< 5 \times 10^{-11}$ (5×10^{-12} typical)
- 1 day $< 2 \times 10^{-12}$ (5×10^{-13} typical)

Allan Variance, Typical

- 10 seconds: TBD
- 100 seconds: TBD
- 1 day: TBD

2.4 Oscillator

- Type: 5 MHz, Wenzel Associates Small Fry, SC cut, 3rd overtone
- Stability: 1 day: 1.0×10^{-9} ; Over Temperature: 5.0×10^{-9}
- Warm-up: 1 hour

1-PPS Timing Outputs	1 PPS (Pulse-Per-Second) through a BNC connector
1-PPS Timing Amplitude	TTL compatible into 50 Ω (5 V CMOS levels)
1-PPS Rising Edge	Rise Time < 20 nanoseconds; Rising edge on time

2.5 Frequency Measurement Capability

Frequency Offset of external frequencies at 1, 5, 10 MHz

Input Level	1 to 5 V, peak-to-peak
Input Impedance	Selectable, 50 ohms or Hi-Z
Offset Range	$\pm 1 \times 10^{-5}$

Offset Resolution	<u>Averaging Time</u>	<u>Resolution</u>	<u>Typical Noise Level</u>
	1 second	10^{-12}	10^{-11}
	10 seconds	10^{-13}	10^{-12}
	100 seconds	10^{-14}	10^{-13}
	1000 seconds	10^{-15}	10^{-14}

2.6 Time Interval Measurement

The instrument measures the interval between the internal GPS clock-derived 1-PPS reference and a 1-PPS input from an external source.

Input Level	TTL compatible with capture on the leading edge of the pulse
Input Impedance	Selectable, 50 Ω or Hi-Z (High Impedance)
Input Range	± 0.5 second, with negative indication corresponding to late arrival of the applied pulse
Input Resolution	10 nanoseconds
Input Accuracy	± 20 nanoseconds

2.7 Operator Interface

Interface of the Model 1083B Satellite-Controlled Frequency Standard/Comparator consists of eight front panel keys, 2 x 20 fluorescent display, eight status LEDs and RS-232C serial port.

2.7.1 Front Panel Keys

Eight keys provide input for the Model 1083B and fall into two groups—upper and lower. The upper keys are labeled TIME, POSITION, INPUT DEVIATION and STATUS and are used to interrogate the frequency standard/comparator operation. The lower keys are labeled SETUP, UP, DOWN and ENTER and are used to configure the Model 1083B functions.

2.7.2 Display

Visual display is provided by a 2-line by 20-character vacuum fluorescent display (VFD). This bright display may be clearly seen in the dark, or in a poorly lit environment.

2.7.3 Instrument Annunciators

Operate:	(Green)
Stabilized:	(Green)
Unlocked:	(Red)
Fault:	(Red)

Input Mode Annunciators

50 Ω :	(Green)
1 PPS:	(Green)
1 MHz:	(Green)*
5 MHz:	(Green)*

*Both of these illuminate when configured for a 10 MHz input signal

2.7.4 System Interface

RS-232C Port:

Connector: 9-pin D-type subminiature:

- Pin 2 = Receive Data
- Pin 3 = Transmit Data
- Pin 4 = Auxiliary Output
- Pin 5 = Ground
- Pin 8 = Auxiliary Input

Baud Rate 1,200 – 19,200 baud; 7 or 8 data bits, 1 or 2 stop bits, odd/even/no parity.
 Supports all keyboard functions, plus continuous output data in the following formats:

<u>Broadcast Mode</u>	<u>Output String</u>
ASCII Standard	< SOH >ddd:hh:mm:ss<CR><LF>
Vorne Standard	44hhmmss<CR><LF>55ddd<CR><LF> ...<BEL>
Extended ASCII	<CR><LF>Q_yy_ddd_hh:mm:ss.000____<CR><LF>
ASCII w/Time Quality	<SOH>ddd:hh:mm:ssQ<CR><LF>
ASCII Year w/ Time Qual.	<SOH>yyyy:ddd:hh:mm:ssQ<CR><LF>
1 PPS Mode	< SOH>ttttt.ttt:sssss.sss: yyyy:ddd:hh:mm:ssQ<CR><LF>
Frequency Mode	< SOH>ffffff.fff: yyyy:ddd:hh:mm:ssQ<CR><LF>

Key

1. <BEL> (Hex 07) = Tone generated in a PC (an ASCII control character)
2. <CR><LF> = Carriage-Return, Line-Feed characters (ASCII control characters)
3. <SOH> (Hex 01) = Start Of Header, “smiley face” (an ASCII control character)

2.8 I/O Configuration

2.8.1 I/O Connector Locations

- Signals, ten potential, 50-Ω BNC connectors
- 4 Standard 50-ohm
- 5 Additional – available as options (rear panel)
- 1 External Input, 50-ohm or High-Z (front panel)

2.8.2 Output Signals (at time of purchase)

- 8 Sine wave; configurable at 1, 5, or 10 MHz, +13 dBm (2.8 Vpp) nominal into 50 Ω
- 1 PPS, 5V CMOS; 20-Ω source impedance; fanout 15 standard 1.6 mA TTL (60 LS-TTL) loads; rise time of less than 20 nanoseconds.
- 4 Option holes in chassis, not used at this time

2.8.3 Input Signal

External signal input to front-panel BNC connector, 1 PPS, 1, 5 or 10 MHz

2.9 Physical Characteristics

2.9.1 Dimensions

Instrument: 430-mm W x 44-mm H x 260-mm D (16.9-in. x 1.7-in. x 10.1-in.)
 Antenna: 77.3-mm diameter x 74.6-mm H (3.04-in. x 2.94-in.)

2.9.2 Weight

Instrument: 2.0 kg (4.5 lb) net
 Antenna and Cable: 2.0 kg (4.5 lb) net
 Shipping: 8.0 kg (17 lb)

2.9.3 Power Requirements (Instrument)

85 – 264 Vac, 47 – 440 Hz, 110 – 275 Vdc, 20 VA Max., 12 VA typical

2.9.4 Power Connector

IEC-320 fused; mating ac cord provided (specified as option P1 through P10) – see paragraph 3.1.2.5

2.9.5 Electro-Magnetic Interference (EMI)

Conducted Emissions: power supply complies with FCC 20780, Class A and VDE 0871/6.78, Class A.

Radiated Susceptibility: passes walkie-talkie test

2.9.6 Temperature and Humidity

<u>Temperature</u>	<u>Operating</u>	<u>Storage</u>
Instrument	0 to 50°C	-40 to 75°C
Antenna	-40 to 85°C	-55 to 100°C
Antenna Cable	-40 to 60°C	-40 to 80°C
<u>Humidity</u>	10 to 90%	non-condensing

3.0 Physical Configuration

3.1 Instrument

3.1.1 Location Considerations

Designed for operation in an environment having an ambient temperature range of 0°C to 50°C (32°F to 122°F), the Model 1083B requires no external ventilation. Though operation is possible at temperatures from -20° to +65°C, performance may be degraded. Normal operation will be restored once the temperature has returned to the specified range.

Allow adequate clearance for rear-panel connections, especially in rack-mounting situations, to prevent damage to the connectors, cables, or the instrument. Ideally, locate the Model 1083B close enough to the antenna to use the standard 15-meter (50-foot) cable. The loss and delay characteristics of the cable are important factors in the calibration and accuracy of the instrument (refer to paragraph 3.3.1.3); thus, the entire cable length should be used, with any excess coiled up and placed out of the way.

Using RG-6 style cable, the Model 1083B can operate with antenna cable lengths up to 75 meters (250 feet) without a preamplifier and up to 150 meters (500 feet) using an in-line preamplifier. Using RG-11 style cable, operation is possible with cable lengths of up to 120 meters (400 feet) without a preamplifier and up to 240 meters (800 feet) with an in-line preamplifier. Refer to paragraph 1.2.2 for a description of available options and part numbers.

3.1.2 Power Requirements

Standard configuration for the Model 1083B is an IEC-320 power input module at 85 – 264 Vac, 47 Hz – 440 Hz or 110 – 275 Vdc, 12 VA typical, including an IEC-320 ac power cord (see paragraph 3.1.2.5).

3.1.2.1 Power Line Connection

The standard Model 1083B is equipped with an IEC Power Input Module.

3.1.2.2 AC Operation

AC operation is possible with an ac input voltage range of 85 – 264 Vac at 47 – 440 Hz. Choice of mating power cord depends upon the option (P1 through P10) specified at the time of purchase. For further information about the power cord see paragraph 3.1.2.5.

To connect the input power, first plug the end of the power cord having the mating IEC connector into the power inlet module on the rear panel, then plug the other end into an appropriate power outlet.

<p>WARNING For maximum safety and best performance, always connect the input cord to a properly grounded power source.</p>

3.1.2.3 DC Operation

For 110 – 275 Vdc operation, the dc voltage should be applied between the LINE and NEUTRAL terminals of the power-inlet module, without regard to polarity (the internal power supply will accept either polarity). When viewing the power-inlet module from the rear of the instrument, the LINE connection is the one nearest the bottom, and the NEUTRAL is nearest the top. The GROUND terminal is offset from the others, and protrudes slightly farther out of the connector. Supplied mating power cord depends upon the option (P01 – P10) specified at the time of purchase.

WARNING Only connect the input to a properly grounded power source.

3.1.2.4 Fuse Replacement

The IEC-320 connector assembly includes a 1 A L 250 VF fast acting 5 x 20-mm fuse, contained in a small compartment with a snap-fit latch. Spare fuses are stored adjacent to the in-circuit fuse.

CAUTION For continued protection, replace the input fuse only with one of the same type, voltage rating, and current rating as originally supplied.

The fuse compartment is located directly adjacent to the input-connector socket, and can be opened by pulling both sides directly out away from the chassis, or by gently prying with a small flat-blade screwdriver. To replace the fuse, first disconnect the line cord from the power source and then remove the cord from the rear-panel IEC connector. The in-circuit fuse is the innermost one; inspect it to determine whether it is open. As required, replace with fuse in the outer compartment.

3.1.2.5 Power Cords and Plug Styles

The following list shows the available IEC-320 power cords and plug styles.

<u>Option No.</u>	<u>Country</u>	<u>Specification</u>	<u>Voltage Rating</u>
P01	Continental Europe	CEE 7/7	220 V
P02	Australia/NZ/PRC	1981	240 V
P03	U.K.	BS 1363	240 V
P04	Denmark	Afsnit 107-2-01	240 V
P05	India	BS 546	220 V
P06	Israel	SI 32	220 V
P07	Italy	CEI 23-16/VII 1971	220 V
P08	Switzerland	SEV 1011.1959	220 V
P09	North America and ROC	NEMA 5-15P CSA C22.2 #42	120 V
P10	Japan	JIS8303	120 V

3.1.3 Rear Panel Layout

When viewed from the behind, the rear panel of a standard Model 1083B is arranged in the following manner, left to right (see Figure 3-1):

- Eight available holes configurable for standard sine wave outputs at 1 MHz, 5 MHz or 10 MHz. Each output module (mounted internally) has a BNC-type connector.
- Four plugged holes (BNC size), are not used at this time.
- One BNC-type connector used for 1 PPS output.
- One 9-pin D-subminiature connector for the RS-232C serial interface. See paragraph 2.9 for a pin designation.
- One Type F RF connector (female) to accept the antenna cable.
- One IEC-320 power inlet connector with built-in fuse holder is provided.

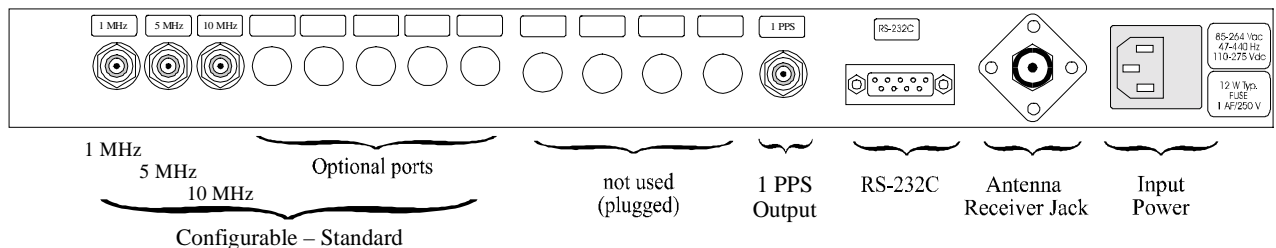

Figure 3-1. Model 1083B Rear Panel

3.1.4 Rack Mounting

Rack-mounting ears are included to facilitate mounting the instrument in a standard 483-mm (19-inch) equipment rack. To install the rack-mounting ears, observe the following steps:

1. Using a T-25 driver, remove the two screws on one side of the unit. Leave the cover in place.
2. Position one of the rack-mounting ears on the side of the unit, so that the rack-mounting flange is at the front of the instrument and extends away from the front panel.
3. Replace the cover screws by routing them through the lower set of holes in the rack-mounting ear, and back into the threaded holes in the instrument.
4. Repeat the above steps for the opposite rack-mounting ear.

3.2 Antenna

3.2.1 Antenna Location

The antenna module supplied with the standard Satellite Clock is designed for outdoor use in all weather conditions. The operating temperature range extends from -40°C to +85°C (-40°F to +185°F), and the module is both weatherproof and waterproof. For maximum signal strength and satellite acquisition capability, the antenna should be mounted out-of-doors and away from large structures. Mounting height is not particularly critical, provided that the antenna has the clearest

possible view of the sky in all directions. An ideal installation is one in which the view is unobstructed from the horizon to directly overhead at each point of the compass.

Alternatively, mount the antenna indoors, below a skylight or other structure that is transparent to RF energy at the GPS-L1 frequency of 1.575 GHz. When in doubt as to the suitability of such a structure, there is no harm in trying it. Such an installation can reduce costs and improve reliability, because even though the antenna and cable are intended for outdoor mounting, operating life will be extended by exposure to a more benign environment.

3.2.2 Antenna Gain Pattern

When the antenna module is mounted to a vertical pole, the maximum-gain lobe extends vertically above the antenna, and is nearly spherical in shape. Therefore, the antenna should be oriented with the mounting surface parallel to the ground, i.e. mounted to a vertical pole. In this position, the gain of the antenna above the horizon will be nearly uniform in all directions, which will allow the best overall reception of all visible satellites. Mount to non-vertical surfaces using the GPS Antenna Mounting Bracket (Part No. AS0044600).

3.2.3 Antenna Mounting

The standard antenna module is designed for pole mounting on a 26-mm (1.05-in. OD, or 3/4-in. ID pipe) pole, with either a standard 1" – 14 (approximately M25.4 x 1.81) marine-mount thread or a 3/4-in. NPT pipe thread. The Type F RF connector on the inside of the antenna module is protected from direct exposure to the elements when the antenna is mounted in this way. This will extend the operational life of the antenna-to-cable interface.

When mounting the antenna, route the supplied antenna cable up through the pole and attach the Type F RF connector on the end of the cable to the mating connector inside the antenna-mounting socket before mounting on the pole. To reduce stress on the cable and connection, allow the cable to rotate freely when screwing the antenna onto the pole. Or, you can rotate the pole while holding the antenna in a fixed position.

3.2.4 Optional Antenna Mounting Kit

A mounting kit, separately available as P/N AS0044600, can be used to mount the antenna to a vertical mast (up to approximately 2 inches in diameter), or to the wall or roof of a structure such as an antenna tower or a building. This kit contains a short length of threaded plastic pipe, a stainless-steel bracket, and hardware to attach the pipe to the bracket in various orientations. With this kit, it is possible to mount the bracket to any surface from vertical to horizontal, while maintaining acceptable orientation for the antenna. This bracket will also accept user-supplied screws for surface mounting, or straps (such as pipe clamps) for mounting to a pipe or mast.

3.3 Antenna Cable

3.3.1 Length and Loss Considerations

3.3.1.1 Standard Antenna Cable

Included with the clock is a standard antenna cable assembly, constructed using a 15-meter (50-foot) length of RG-6 type low-loss coaxial cable and terminated with male Type F RF connectors. Optional lengths of RG-6 coax are separately available for longer runs; see paragraph 3.3.1.3.

3.3.1.2 Effects of Cable Parameters

The type and length of the cable are important with regard to proper reception of GPS signals and operation of the clock, due to their effect on specific parameters described in the following paragraphs. Any changes to the length and/or type of antenna cable should be made carefully. Damaged cables may also affect performance.

3.3.1.2.1 Cable delay

Cable delay is determined from the velocity factor and the physical length of the cable. During the initial factory calibration of the clock, a value for cable delay (based upon the length and type of cable supplied) is entered into the clock memory. Firmware uses this figure to counteract the effect that the delay has upon GPS timing accuracy. The value entered for a standard 15-meter cable is 60 nanoseconds. For other cable options, the delay is tabulated in paragraph 3.3.1.3. The formula for calculating cable delay is:

$$T = \lambda \frac{1}{CK_v} + 1ns$$

Where:

T = Cable delay, in nanoseconds;

λ = Cable length, in meters;

C = Speed of light (3×10^8 meters per second);

K_v = Nominal velocity of propagation (0.85).

One nanosecond is added to the calculated value to account for the length and velocity factor of the short connecting cable inside of the clock.

3.3.1.2.2 Attenuation

Attenuation depends upon the cable length, and the loss per unit length. The total attenuation must be limited to 21 dB maximum at the GPS L1 frequency of 1575.42 MHz. Loss up to 42 dB can be accommodated with the separately available (P/N AS0044700) 21-dB in-line preamplifier.

3.3.1.2.3 DC Resistance

The cross-sectional area and length of the conductors in the cable determine the dc resistance. Since dc power to the RF preamplifier in the antenna module is supplied via the antenna cable, excessive dc resistance (more than 15 Ω total loop resistance) will degrade performance.

3.3.1.3 Available Antenna Cables and Accessories for Longer Runs

Arbiter Systems offers longer antenna cables for use with all clock models when the standard 15-meter (50-foot) cable is inadequate. In addition, using a 21-dB in-line amplifier (P/N AS0044700) allows use of antenna cables having twice the length and loss (as without the amplifier). By using lower-loss, RG-11 cable (P/N WC0004900), runs of 120 meters (400 feet) without the in-line preamplifier or 240 meters (800 feet) with the AS0044700 amplifier are possible.

The available cables and antenna accessories are summarized here:

<u>Part No.</u>	<u>Description</u>	<u>Delay, ns</u>	<u>Gain/Loss</u>
CA0021315	15-m (50-ft) cable, RG-6 trishield (standard)	60 ns	-5 dB
CA0021330	30-m (100-ft) cable, RG-6	119 ns	-9 dB
CA0021345	45-m (150-ft) cable, RG-6	177 ns	-13 dB
CA0021360	60-m (200-ft) cable, RG-6	236 ns	-17 dB
CA0021375	75-m (250-ft) cable, RG-6	295 ns	-21 dB
WC0004900	305-m (1000-ft) roll RG-11 quadshield cable (unterminated)	3.92 ns/m 1.19 ns/ft	-17.5 dB/100 m -5.25 dB/100 ft
TF0006400	RG-6 Crimp Tool	N/A	N/A
AS0044800	Kit, crimp tool and 25 connectors for RG-11 style cable	N/A	N/A
AS0044700	21-dB in-line preamplifier	1 ns	+21 dB

3.3.2 Routing Considerations

3.3.2.1 Orientation

The ends of the antenna cable have identical connectors, so cable orientation is not important.

3.3.2.2 Physical Protection

To protect it from physical damage, route the antenna cable away from closing doors, falling objects, foot traffic, etc. Also, when routing around corners, sufficient bend radius should be allowed to prevent kinking. Extra length should be allowed at both ends of the cable to prevent tension on the connectors, which could cause damage or failure. Extra length is useful as a service loop, in the event that a connector needs replacement.

Do not stretch the cable mid-air over any appreciable distance without support. Cable degradation or failure could result. Always leave a “drip loop” wherever the cable enters a structure, to prevent water from entering the structure via the cable jacket.

Exercise care when routing the cable near sources of heat to avoid cable damage, as the maximum operating temperature is 60°C (140°F).

3.3.2.3 Adjacent Signals

Be cautious when routing near high power RF sources or alongside cables carrying high-power RF, such as transmitter cables. Although the standard RG-6 style cable is triple-shielded and has excellent shielding properties, these sources of energy may interfere with the GPS signal. In these applications, consider using RG-11 type cable (P/N WC0004900). Its quad-shielded design provides even more isolation.

3.3.3 Antenna Module Power

For normal operation, the GPS antenna requires 5 Vdc at 22 mA. A power supply within the clock generates this voltage, which appears at the antenna connector on the clock and is applied to the antenna module through the antenna cable. Avoid shorting the center conductor to the shield of the coaxial cable as it may damage the preamplifier. Conversely, a high-resistance connection or open circuit would deprive the preamplifier of power. Either a short- or open-circuit condition in the antenna cable will render the clock inoperable.

Prior to initial operation or if problems are suspected, perform the Antenna/Cable Operational Test Procedure contained in paragraph 3.3.6.

If the optional antenna cable preamplifier (P/N AS0044700) is used, it requires 22 mA of additional current that is supplied by the clock power supply.

3.3.4 Connection to Antenna

Connect the male Type F RF connector on one end of the antenna cable with the female Type F connector on the antenna module. Avoid placing mechanical stress on the cable attachment to the antenna module. See paragraph 3.2.3.

3.3.5 Connection to Clock

Connect the male Type F RF connector on the opposite end of the antenna cable to the female Type F connector on the rear panel of the Satellite Clock.

3.3.6 Antenna and Cable Operational Test

Prior to initial operation or any time antenna/cable problems are suspected, perform the following procedure. This procedure is performed at the location of the Model 1083B, and does not require access to the antenna location.

NOTE Perform the following test with the antenna connected normally at the far end of antenna cable. *The results of this test will be affected if your installation includes the AS0044700 in-line amplifier. Consult the separate data provided with this unit for guidance.*

1. Disconnect antenna cable from rear panel of the clock.
2. At the rear panel Antenna connector, connect a voltmeter between the center connector and ground. The voltage measured should be approximately +5 V.
3. Connect an ohmmeter between the cable center conductor and the cable shield. The dc resistance should be approximately 4 k Ω but should not exceed 10 k Ω (typically from 2 Ω to 8 Ω).
4. If the resistance measured exceeds 10 kohm, it may indicate an open-circuit condition (typically measuring >100 Ω if open).
5. If the resistance measured is less than 1 kohm, it may indicate a short-circuit condition (typically measuring <100 Ω if shorted).

CAUTION Do not attempt to operate the Model 1083B until all errors are corrected. Any errors encountered during this test will prevent proper operation.

3.3.7 User-Supplied Antenna Cables

Any RF cable meeting the requirements described above for loss (≤ 21 dB at 1575 MHz) and dc resistance (≤ 15 Ω total loop resistance) may be used with the clock. However, prior to using a non-standard antenna cable, verify proper installation by performing the Operational Test contained in paragraph 3.3.6.

4.0 Operation

4.1 Front Panel Controls and Indicators

The Model 1083B front panel is illustrated in Figure 4-1 and described in the following paragraphs. Front panel components are as follows, left to right:

- 4 LED input signal status indicators
- 1 BNC Signal Input Connector
- 2-line by 20-character Vacuum Fluorescent Display (VFD)
- 4 LED Instrument status indicators
- 8 Status and Configuration Keys

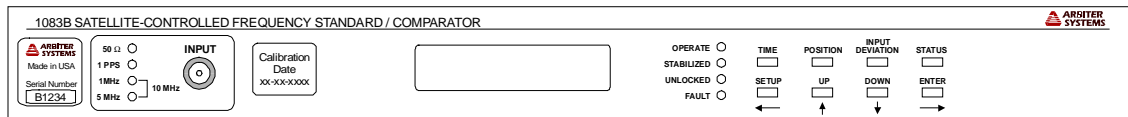

Model 1083B

Figure 4-1. Model 1083B Front Panel

4.1.1 LED Input Signal Status Indicators

Located directly to the left of the fluorescent display on Model 1083B are four LED indicators. These indicators provide information about the input load and frequency selected for the comparator function (see paragraph 4.8.3.1 for information about configuring input modes). Each indicator is described below.

50 Ω

The 50-Ω LED illuminates to indicate that input impedance of 50 Ω has been selected. If HI-Z is selected, this LED is off.

1 PPS

The 1-PPS LED illuminates to indicate that the input has been configured for a 1-PPS signal.

1 MHz

The 1-MHz LED illuminates to indicate that the input has been configured for a 1-MHz signal.

5 MHz

The 5-MHz LED illuminates to indicate the input has been configured for a 5-MHz signal.

1 MHz & 5 MHz

Both the 1-MHz and 5-MHz LEDs illuminate to indicate that the input has been configured for a 10-MHz input signal.

4.1.2 LED Instrument Status Indicators

Four LED indicators, located directly to the right of the fluorescent display on Model 1083B, provide information about the operational status of the instrument. These are described below.

Operate LED

The OPERATE LED illuminates when power is being supplied to the Model 1083B.

Stabilized LED

The STABILIZED LED illuminates incrementally to indicate that the unit has achieved a level of stabilization. Until satellite lock is achieved, the LED is extinguished. Approximately five minutes after satellite lock, the LED flashes at a rate of approximately once per second for approximately 5 to 6 hours (until reaching maximum stability). At this time the LED illuminates steadily.

Unlocked LED

The UNLOCKED LED illuminates when loss of satellite lock occurs (after a preset delay).

Fault LED

The FAULT LED illuminates when fault conditions exist in the receiver, oven-controlled oscillator (OCXO) or the frequency output amplifiers (refer to paragraph 4.4.1).

4.1.3 Vacuum Fluorescent Display (VFD)

The standard Model 1083B front panel contains a bright vacuum fluorescent display (VFD) that provides a 2-line by 20-character readout. Display brightness enables the Model 1083B to be read clearly in the dark or poorly lit conditions. The VFD displays instrument status, time, position and input deviation data. It is also used to display the current configuration of operational parameters.

4.1.4 Front Panel Keys

Eight keys on the front panel control the various features of the Model 1083B. These features include operating and configuring the Model 1083B. If necessary, the RS-232 FB and FL commands may be used to disable the front panel keys and display functions. Full operation is still possible via the RS-232 interface. Otherwise, restore normal front-panel key functions by using the FE command. Refer to Appendix A (Table A-4) for a detailed description of those commands. The front panel keys are described below.

Time Key

The TIME key sets the display to the desired Time Display Mode. Select the desired Time Mode by repeatedly pressing the TIME key. Changing the time display has no effect on the time data, which is output from rear-panel connections.

Position Key

The POSITION key cycles the display through the longitude, latitude, and elevation data readouts of the antenna location according to the most recent position fix, user-entered position data, or the results of a survey average.

Input Deviation Key

The INPUT DEVIATION key displays the deviation of the input signal as compared to the appropriate internal signal.

Status Key

The STATUS key toggles between four “Status” display modes: Frequency Standard/Comparator, Receiver, OCXO, and EEPROM. It also displays data relative to GPS satellite acquisition and synchronization.

Setup Key

The SETUP key invokes a series of sub-menus used to adjust configurable parameters within the 1083B. In the numeric data entry mode, it moves the cursor to the left.

Up Key

The UP key is used in conjunction with the SETUP menus to adjust values upward, or to scroll upward through available menu choices.

Down Key

The DOWN key is used in conjunction with the SETUP menus to adjust values downward, or to scroll downward through available menu choices.

Enter Key

The ENTER key is used to confirm changes made within SETUP sub-menus. Generally, pressing ENTER also advances to the next parameter, or returns to the previous menu level. Press ENTER, in numeric data entry mode, to move the cursor to the right.

4.2 Satellite Acquisition and Positional Data**4.2.1 Almanac and Positional Data**

The GPS receiver module employed in the Model 1083B Satellite-Controlled Frequency Standard/Comparator includes non-volatile memory for storage of almanac data (satellite orbit) and position information (longitude, latitude, and elevation). Normally, the receiver updates position data in the non-volatile memory when meeting all of the following conditions for a period of greater-than 10 seconds:

- Shifting position more than 50 km.
- Having a Position Dilution of Precision (PDOP) of less than 5.

- Having a continuous position fix from at least four satellites.

If input power is removed from the instrument, the last recorded values for these parameters are retained. This will expedite the acquisition of satellites when power is restored.

4.2.2 Satellite Acquisition Time

When starting a GPS Frequency Standard / Comparator for the first time, initial satellite acquisition could take as long as 25 minutes. Satellite acquisition time depends upon the accuracy and age of the almanac and the last stored position data. The GPS receiver stores an updated version of this information for the new operating location according to paragraph 4.2.1. After this, satellite acquisition should typically occur in about 2 minutes.

To reduce *initial* acquisition time, the receiver latitude and longitude can be set manually to the nearest 10 degrees of the actual antenna position. While this step is not required, it will typically reduce acquisition time to around 2 minutes. Refer to paragraph 4.6.1 for a detailed description.

4.3 Startup Sequence

Upon the initial power-on sequence, the OPERATE, ON-LINE and UNLOCKED status LEDs will illuminate and the VFD will display the following message for approximately four seconds:

ARBITER SYSTEMS GPS
FREQUENCY STANDARD

Followed by:

COPYRIGHT © 1999
ARBITER SYSTEMS, INC

After the initial message, the 1083B will automatically default to the status display mode. Prior to achieving satellite lock, the following message will appear on the VFD:

FREQ STANDARD STATUS
STARTUP

After achieving satellite lock the UNLOCKED LED will extinguish and the VFD will display the following message:

FREQ STANDARD STATUS
FREQUENCY NOT READY

The message, “Frequency not Ready” indicates that the Model 1083B is locked, but that the internal Oven-controlled Oscillator has not stabilized. After the oscillator has stabilized, the STABILIZED LED will illuminate and the VFD will display one of three messages. If the Model 1083B is not in position hold mode, it will display the following message:

FREQ STANDARD STATUS
LOCKED TO GPS

If the Model 1083B is performing a survey with position hold ON and is locked to the GPS system, the second line will change to read, LOCKED***SURVEY MODE. If the Model 1083B has completed a survey and is in position hold mode, then the second line will read, LOCKED*POSITION HOLD.

4.4 Status Display Modes

When initially switching on power to the Model 1083B, it will default to “FREQ STANDARD STATUS” display mode. The Clock Status Display Mode provides the status of specific clock parameters. These status display readouts are SURVEY MODE, POSITION-HOLD ON, OCXO, EEPROM, FAULT CONDITIONS and RECEIVER STATUS.

- The Survey and Position Hold status displays occur only *after* the instrument has achieved satellite lock and are dependent upon whether the Auto Survey and Position-Hold Modes are enabled (ON) or disabled (OFF).
- The Fault Condition status will be displayed whenever a fault condition exists.
- The OCXO status displays internal oscillator temperature and tuning information.
- The EEPROM status displays the number of data bit errors detected and corrected.
- The Receiver Status readout displays how many GPS satellites are visible and tracked.

The Status Display Flowcharts shown in Figure 4-2 illustrate the various readouts displayed and correspond to their descriptions contained in the following paragraphs. Press the STATUS key repeatedly to toggle the display back and forth between the status display modes.

Note that the flow chart entitled “NO LOCK” should be followed when a Model 1083B is in Startup mode and has not locked to the GPS system. The flow chart entitled “NORMAL” should be followed under normal power-on, lockup, survey & position hold (if chosen), and stabilized conditions. The flow chart entitled “LOSS OF LOCK” should be followed when a Model 1083B has lost lock during normal operation. Note that the second line of the display will indicate the length of time (up to 99 minutes) that the frequency standard has been out of lock.

4.4.1 Fault Conditions

The FAULT LED will illuminate after any one of the following conditions are met:

Fault	Possible Cause	Indication
Receiver Failure	Usually indicates a major failure in the receiver, and does not indicate a missing GPS signal, or loss of lock.	Fault LED ON
VCXO Tuning Error	Usually indicates that the OCXO tuning voltage is not controlling it. Incorrect or missing digital-to-analog conversion. This condition sometimes occurs briefly (a few seconds) at initial lock-on.	Fault LED ON
Output Sense Low	One of the frequency outputs is low or has failed.	Fault LED ON
Output Slot X	Usually indicates a failure in the output board in the specified slot. The slot numbers are referenced from the left to right when looking from the rear of the clock.	Fault LED ON

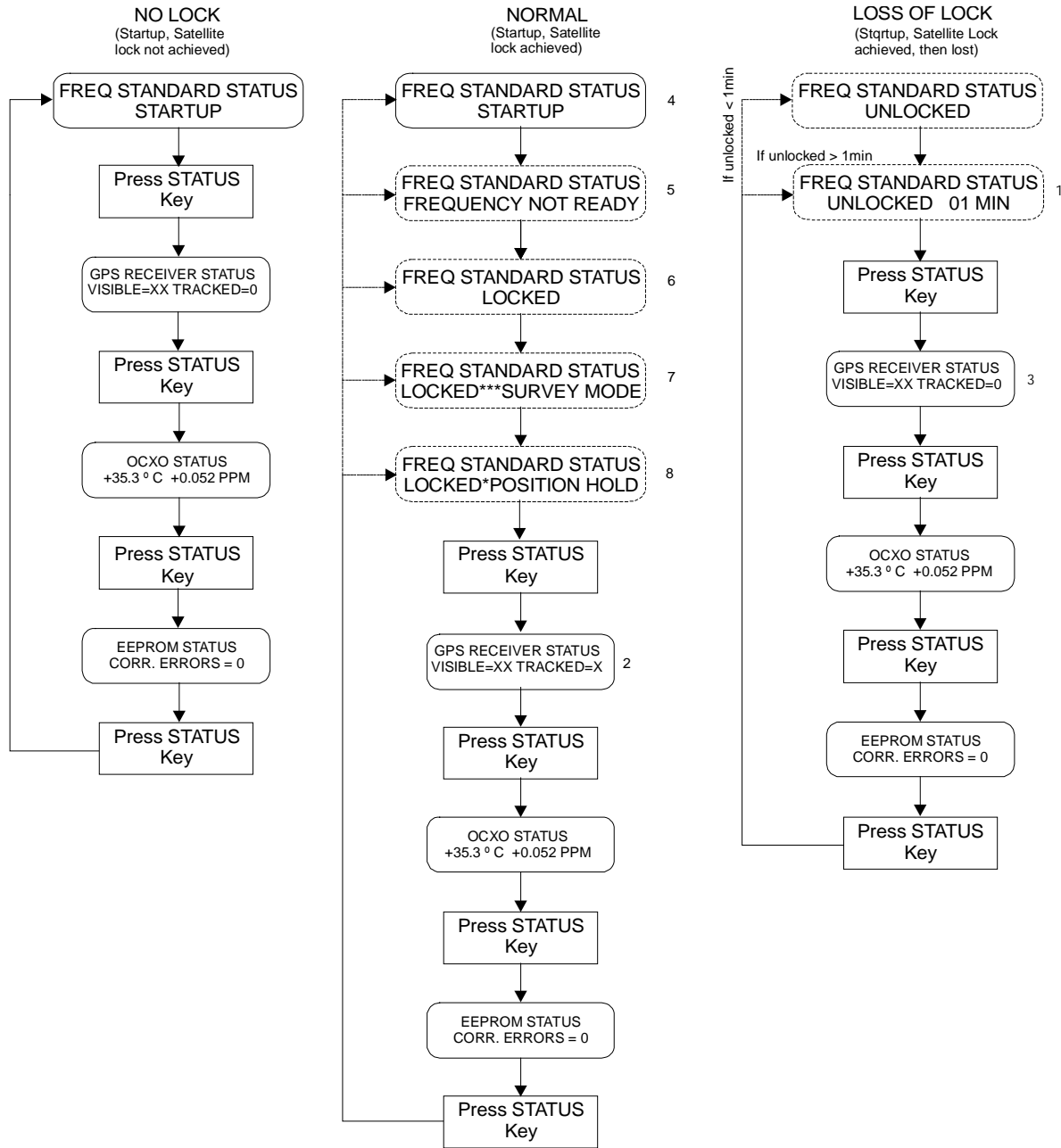

Notes:

- 1 - Amount of time satellite lock has been continuously lost (max: 99 min).
- 2 - Number of satellites available for tracking and number actually tracked.
- 3 - Same as #2 above, however, number of satellites tracked during Out-of-Lock is always zero.
- 4 - Unit is in startup and unlocked.
- 5 - Unit is locked, but OCXO has not stabilized (to stated accuracy).
- 6 - Unit is locked and OCXO has stabilized while NOT in Position Hold mode.
- 7 - Unit is locked and stabilized while continuing to perform a Survey in Position Hold mode.
- 8 - Unit is locked and stabilized while in Position Hold mode.

Figure 4-2. Status Display Mode Response Flow Chart

4.4.2 Position-Hold Mode – ON

This display signifies that the clock is locked to at least one satellite with one form of Position-Hold Mode active. In this case, the instrument is using the position data, which was last stored in non-volatile memory to compute the time. The Model 1083B *does not* update its position while in Position Hold (based on received satellite data), and the display should indicate as follows:

FREQ STANDARD STATUS
LOCKED*POSITION HOLD

NOTE The factory default setting for Position-Hold Mode is enabled (ON).

4.4.3 Position-Hold Mode – OFF

When Position Hold Mode is OFF and as soon as the 1083B successfully acquires and locks to the first satellite, the display should indicate as follows:

FREQ STANDARD STATUS
LOCKED TO GPS

The Model 1083B uses the most recent position fix from the GPS satellites for the time calculation. It must also simultaneously track four satellites to provide an accurate position fix; otherwise it uses the previous position data stored in non-volatile memory.

4.4.4 Receiver Status Display

At power up, the Model 1083B defaults to the FREQ STANDARD STATUS display mode. Pressing the STATUS key once sequences the display to the GPS RECEIVER STATUS display mode. The purpose of the receiver status mode is to display the condition of the internal GPS Receiver with respect to the GPS Satellite System.

When in the Receiver Status Mode, the display should indicate as follows:

GPS RECEIVER STATUS
VISIBLE=XX TRACKED=X

The number equated to VISIBLE is the number of known satellites that are within view of the antenna (given a full view of the sky) and could potentially be used. This figure is based on the last almanac data stored in the non-volatile memory. The number equated to “TRACKED” indicates the number of satellites that are actually being used to obtain position and time data (a maximum of eight). Receiver Autonomous Integrity Monitoring (RAIM) monitors the received satellite signals and ignores satellites with large timing errors.

A TRACKED value of zero indicates that the instrument has lost synchronization with the GPS system. The “FREQ STANDARD STATUS” display mode, the “OUT-OF-LOCK” output, and the front panel unlocked indicator will also reflect this condition.

4.4.5 OCXO Status Display

Press the status key to sequence the 1083B from the GPS RECEIVER STATUS to OCXO STATUS. When in the OCXO STATUS mode the display should indicate as shown below.

OCXO STATUS
+XX.XX °C +X.XXX PPM

Format:

‘+XX.XX °C’ is the ambient temperature measured adjacent to the oscillator case.

‘+X.XXX PPM’ is the corrected difference between internal oscillator and GPS System Reference. The timing range of the internal oscillator is ± 1.00 PPM.

4.4.6 EEPROM Status Display

The EEPROM STATUS mode displays the number of Data Bit errors detected and corrected. A new instrument should indicate zero Data-Bit errors. Increasing Data-Bit errors over time indicate possible required maintenance. The display should indicate as follows:

EEPROM STATUS
CORR. ERRORS = X

Format:

‘X’ equals the number of Data Bit errors detected and corrected.

4.5 Time Display Modes

To display the date and time, press the time function key, located on the front panel (The 1083B must first establish GPS synchronization). Pressing the time function key repeatedly will cause the LCD display to sequence through each of its four time and date formats – two in LOCAL and two in UTC. Flowcharts illustrating these program sequences are shown in Figure 4-3 and illustrate the various time formats that correspond to their descriptions that follow.

4.5.1 Date and Time Display, Universal Time Coordinated (UTC)

UTC, as maintained by the United States Naval Observatory (USNO), uses the following format indicated on the display:

UTC DATE/TIME www
dd mmm yyyy hh:mm:ss

Format:

“www” = day of the week (Mon – Sun)	“hh” = the hour (00 – 23)
“dd” = day of the month	“mm” = the minute (00 – 59)
“mmm” = month (Jan – Dec)	“ss” = the second (00 – 59)
“yyyy” = year	

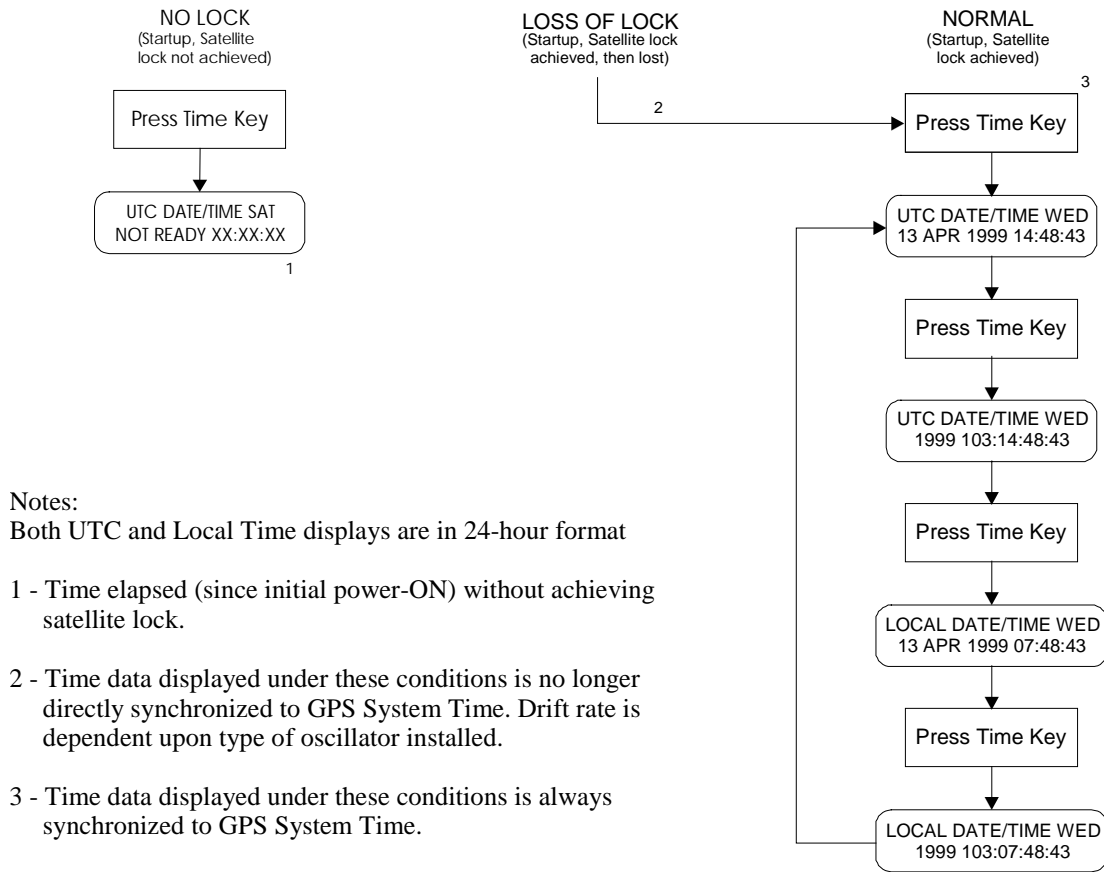

Figure 4-3. Time Display Mode Response Flow Chart

4.5.2 Time of Year Display, Universal Time Coordinated (UTC)

This readout also displays UTC, with a display format that differs from the previous display as follows (see Date and Time, UTC above for nomenclature):

UTC DATE/TIME www
yyyy ddd:hh:mm:ss

Format:

"ddd" = day of the year (001-366).

4.5.3 Date and Time Display, Local Time

Date and time reflect local time zone offsets and daylight saving time offsets. The following display format is used to show local date and time (see Date and Time, UTC above for nomenclature):

LOCAL DATE/TIME www
dd mmm yyyy hh:mm:ss

NOTE Unless the daylight saving and local offset parameters have been set properly, this display may not reflect the correct local time (see paragraph 5.2).

4.5.4 Time of Year, Local Time

“Time of Year, Local Time” displays the date and time after the daylight saving correction and local offset has been applied, but in the same formats as that of the Time of Year UTC display (see Date and Time, UTC above for nomenclature):

LOCAL DATE/TIME www
yyyy ddd:hh:mm:ss

NOTE Unless the daylight saving and local offset parameters have been set properly, this display may not reflect the correct local time (see paragraph 5.2).

4.6 Position Display Modes

Press the POSITION key to access position information. When the Model 1083B is first switched ON, and prior to acquisition of satellites, the only position information available is that which is stored in the non-volatile memory of the GPS receiver module. This position information reflects the location of the receiver at the last point in time at which all of the criteria necessary for accurate position location were satisfied (see paragraph 4.7.2). If this position data is grossly in error, use the “Set Initial Position” function as described in paragraph 4.6.1 to reduce acquisition time.

On Model 1083B longitude, latitude, and elevation data values can be accessed using the front panel key labeled POSITION. Press the POSITION key repeatedly to scroll the display through these values. If pressed prior to acquisition of enough satellites to accurately determine and update position data, the displayed values will correspond to those last stored in the GPS receiver non-volatile memory.

If a survey is initiated, and the POSITION key is pressed, the position information may indicate that a survey is in progress and insufficient data is available. Each survey is equivalent to 60 fixes, which should take approximately one minute. This message should read as follows:

SURVEY 0 LONGITUDE
WAITING FOR DATA

Successively pressing the position key cycles through the latitude and elevation. As soon as the first one-minute of survey is completed the display will indicate a position as follows:

SURVEY 1 LONGITUDE
XXX XX' XX.XXX" W

‘X’ values indicate either the position in degrees, minutes and seconds or elevation in meters WGS-84 (World Geodetic System 1984). If an initial position was not set prior to applying power in a new location the display may read “POSITION UNCERTAIN” until the new position is determined.

To accurately determine longitude, latitude, and elevation, synchronization to a minimum of four satellites is necessary. When this minimum satellite lock requirement is met, and POSITION

HOLD is disabled, the displayed position coordinates will accurately correspond to the actual antenna location.

The position values are displayed in the following sequence and formats:

Longitude:

ANTENNA LONGITUDE
XXX° XX' XX.XXX" W*

*West, or E (EAST)

Latitude:

ANTENNA LATITUDE
XX° XX' XX.XXX" N**

**North, or S (SOUTH)

Elevation:

ANTENNA ELEVATION
XXXXX.XX METERS WGS-84

4.6.1 Set Initial Position

This feature is particularly useful if the clock has been physically moved a long distance (typically greater than 1000 km). It provides for setting of the approximate position of the clock (to the nearest 10 degrees) *upon initial power-ON* and prior to acquisition of satellites. This step is not required but will typically reduce acquisition time to around 2 minutes.

Setting an initial position provides the clock with its approximate longitude and latitude. The Model 1083B uses this initial location to begin searching for satellites that should be visible from that specific location in accordance with the stored Almanac data. To set Initial Position, perform the following steps prior to initial acquisition of satellites. Figure 4-4 provides a flow chart of this procedure. Elevation cannot be set from this menu as in EDIT POSITION.

NOTE If Auto-Survey Mode is OFF and Position-Hold Mode is ON, setting of an initial position will cause the Position-Hold Mode to be disabled (switched Off).

1. Press the front panel SETUP key *after initial power-on* and CLOCK STATUS STARTUP is displayed. Use the UP/DOWN keys to navigate to the "SET INITIAL POSITION" menu.
2. When the "SET INITIAL POSITION?" message is displayed, press ENTER.
3. The display message will change to "SET INIT LATITUDE?" Use the UP/DOWN keys to modify the latitude (UP increments North and DOWN increments South). Press ENTER.
4. The display message will change to "SET INIT LONGITUDE?" Use the UP/DOWN keys to modify longitude (UP increments East and DOWN increments West) and press ENTER.

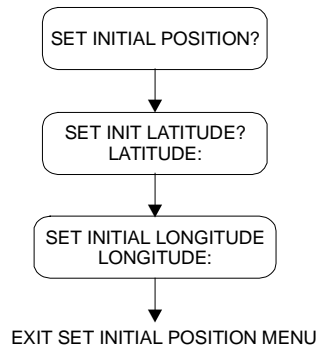

Figure 4-4. Set Initial Position Flow Chart

4.7 Position-Hold and Auto Survey Modes

Operation in Position-Hold Mode forces the clock to utilize a single set of position data as a reference for time calculations, rather than the position information obtained from the continuously updated receiver position fix. Using accurate information, such as a newly surveyed position, results in a reduced standard deviation for the time data. The Model 1083B can use position data from any one of the following sources:

- It can use values previously stored in the receiver non-volatile memory.
- It can use a new position fix determined at power-up (Auto Survey).
- It can use values entered via RS-232C commands (refer to Appendix A, Table A-8).
- It can use values edited via the front panel using the SETUP menu.

The Model 1083B also has the ability to determine its own position with greater accuracy than is possible with a single fix using the Auto Survey Mode. This function operates by accurately averaging a specified number of position fixes – from 1 to 86,400. Firmware allows averaging choices from none to approximately 24 hours of fixes (86,400). Because Selective Availability (SA) is a pseudo-random error, averaging reduces this error. A one-hour average provides a position uncertainty of approximately 6-meters in latitude and longitude and 20-meters in elevation.

For longer and shorter averages these errors scale approximately with the inverse square root of the ratio of the number of fixes. For example, a 24-hour average is approximately $1/\sqrt{24}$ or 0.2 x uncertainty for a 1-hour average. This is approximately 0.04 arc-seconds and 4 meters elevation (1 sigma).

4.7.1 Position Hold Methods

Depending on the requirement and setting, the Model 1083B is designed to provide three different methods for holding position; these are three-dimensional, altitude hold and altitude track. Three-dimensional position (3D HOLD ON) hold mode averages the elevation, longitude and latitude to help reduce the effects of selective availability. Altitude track (ALT TRACK ON) allows the

Model 1083B to continuously update its latitude and longitude, and average only the elevation position (up to a total of 24 hours – 86400 fixes). Altitude hold (ALT HOLD ON) keeps the elevation position static and updates only the latitude and longitude. Use the front panel Setup menu, or nPH command found in Appendix A, Table A-6, to set any of these modes.

4.7.2 Position Accuracy Requirements

Errors in Position of up to 100 meters have only a small effect on timing accuracy. A GPS position fix, even in the presence of SA, is generally within 100 meters of the correct position, and can be used directly with minimal errors if a more accurate position is not available. If a surveyed position is available, using this data can eliminate these residual errors. A position within 0.5 arc-second of latitude and longitude and 5 meters elevation is sufficient to eliminate these residual errors almost completely.

Known position parameters improve clock accuracy – even if only one accurate parameter is known. Edit these parameters while leaving the others unchanged. If latitude and longitude are known from an accurate survey but elevation is unknown, edit the latitude and longitude. If elevation is obtained from a topographic map, but accurate longitude and latitude position is unavailable, edit only elevation.

Using the best available information will give the best overall performance. This is particularly true for elevation, since elevation errors will cause a bias (or offset) error in the time solutions of up to 3-ns per meter (typically 1.75 ns/meter). In general, latitude and longitude errors, if large enough, cause an increase in the rms variations of the time solution, but cause only a minimal bias error.

4.7.3 Auto-Survey Mode Activation

The Auto Survey function (Figure 4-5) can be activated via RS-232C command (refer to Appendix A, Table A-9) or via front panel keys as described below. Started surveys can be suspended and resumed. The clock retains the newly determined position in non-volatile memory when concluding the survey.

1. Access the SETUP menu by pressing the front panel key labeled SETUP. Scroll through the menu structure by repeatedly pressing the SETUP key, or by using the UP and DOWN keys, until the display indicates as follows:

SET AUTO SURVEY?

2. Press the ENTER key. The readout changes to read:

SELECT SURVEY MODE
XXXXXXXXX SURVEY

Where: XXXXXXXXX is either TURN OFF, SINGLE, or POWER-ON. If SINGLE or POWER-ON were previously selected, two other choices are available: SUSPEND or RESUME.

3. Use the UP or DOWN keys to select SINGLE, or POWER-ON, depending on which type of survey is needed, and press ENTER. The display will change to read:

SET # OF FIXES
60 (1 Min or more)

4. Use the UP and DOWN arrow keys to select the desired number of fixes (see Figure 4-5), and press ENTER.
5. After pressing ENTER (from #4 above) the next Setup menu selection is “SET POSITION HOLD?” Position-Hold information follows in paragraph 4.7.4 below.

Warning In order to start the survey, Position-Hold must be ON.

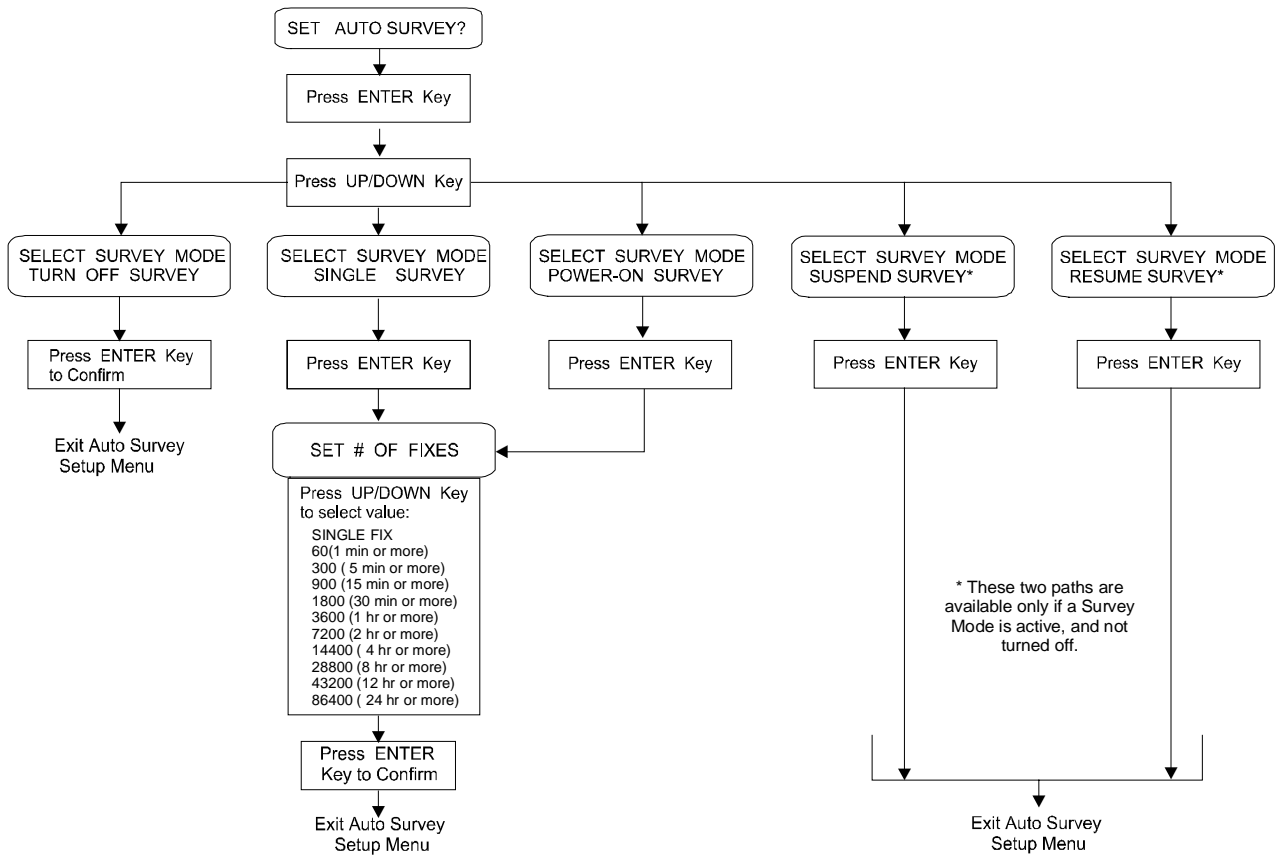

Figure 4-5. Auto-Survey Mode Flow Chart

4.7.4 Position-Hold Mode Activation

The flow chart of Figure 4-6 illustrates the following sequence of steps required to activate Position-Hold Mode from the front panel:

1. Access the SETUP menu by pressing the front panel key labeled SETUP. Scroll through the menu structure by repeatedly pressing the SETUP key, or by using the UP/DOWN keys, until the display indicates as follows:

SET POSITION HOLD?

2. Press the ENTER key and the display will change as shown below, with the second line (displayed as a row of X's) selectable by using the UP and DOWN arrow keys. Four choices are possible; these are HOLD OFF, 3D HOLD ON, ALT HOLD ON, or ALT TRACK ON.

POSITION HOLD
XXXXXXXXXX

3. If HOLD OFF is selected, the instrument will return to displaying the next sub-menu of the SETUP menu, and will begin calculating its position. Position information will be updated, as it is determined, and will be reflected as such in the front-panel position display.

The Model 1083B may be returned to normal operation by pressing one of the primary function keys (e.g., POSITION).

4. If selecting 3D HOLD ON (using the UP DOWN arrow keys), press ENTER and the display will indicate as follows:

EDIT POSITION
HOLD DATA?

**NOTE: Position Hold Data can not be edited if Auto Survey is in progress.
Turn off Survey Mode to manually edit Position Hold data.**

If changes to the position hold data are not required, press SETUP to return to the main SETUP menu and then press one of the primary function keys (e.g., POSITION).

If changes to the position hold data (e.g., to match a surveyed position) are required, proceed to the next step.

5. Press ENTER to proceed with position data editing. The readout display will change to:

EDIT LONGITUDE
XXX° XX' XX.XXX" E (EAST or WEST)

- a. Press the UP and DOWN keys to increase or decrease the Longitude data in steps of 0.01 arc-second. (A raw GPS position fix will generally be within 4 arc-seconds of the accurate, surveyed position.)
- b. When the correct value is displayed, press ENTER. The readout display will change to:

EDIT LATITUDE
XX° XX' XX.XXX" N (NORTH or SOUTH)

- c. Adjust Latitude data in accordance with steps a and b, above.
- d. When the desired value is displayed, press ENTER. The display will change to read:

EDIT ELEVATION
XXXXX.XX M WGS-84

- e. Adjust Elevation data in accordance with steps a and b, above.

To exit from the SETUP menu, press one of the primary function keys (e.g., POSITION).

6. If selecting ALT HOLD ON, press ENTER and follow the steps a through e enumerated under 5. Edit the position as shown, or simply press one of the primary function keys to escape.
7. If selecting ALT TRACK ON, press ENTER and the Model 1083B will continuously average the elevation measurements using a 24-hour trailing average (calculating continuous latitude and longitude positions), and apply an approximate correction to the timing solution for the error introduced by altitude offsets.
8. If either 3D HOLD ON or ALT HOLD ON is selected, exit from any part of the EDIT POSITION menu by pressing any of the upper STATUS keys.

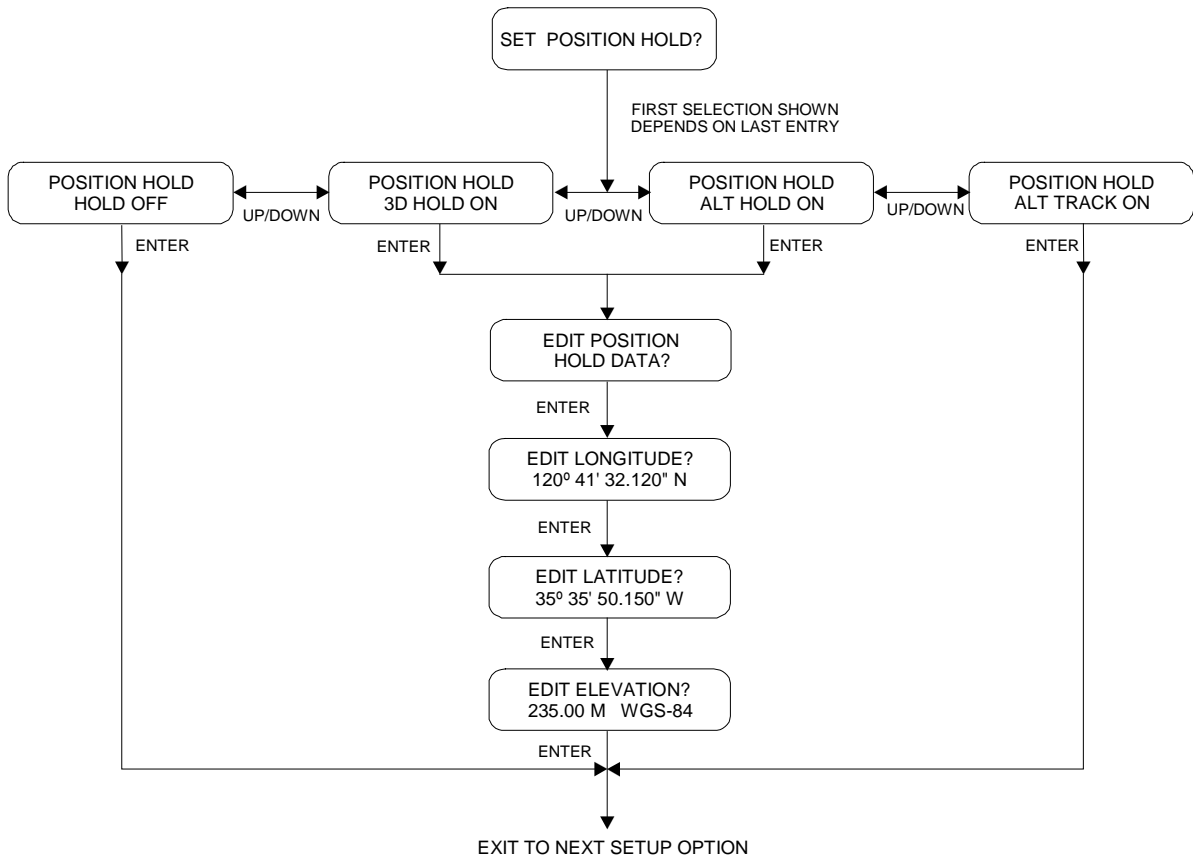

Figure 4-6. Position-Hold Mode Flow Chart

4.8 Input Deviation Measurements, Recording and Display Modes

The Model 1083B is a high performance Satellite-Controlled Frequency Standard / Comparator configured to measure 1-MHz, 5-MHz, 10-MHz and a 1-PPS signals by comparing them to a standard reference signal (Figure 4-7). The reference signal, in this case, is generated within the Model 1083B and synchronized to the GPS. Also provided, as a standard, front-panel selection, is a 50-Ω termination that provides correct impedance matching to sources with 50-Ω outputs. This 50-Ω termination can be applied to any of the 1-PPS, 1-MHz, 5-MHz or 10-MHz signals. Within the Model 1083B, the firmware refers to the different input signals as *modes*.

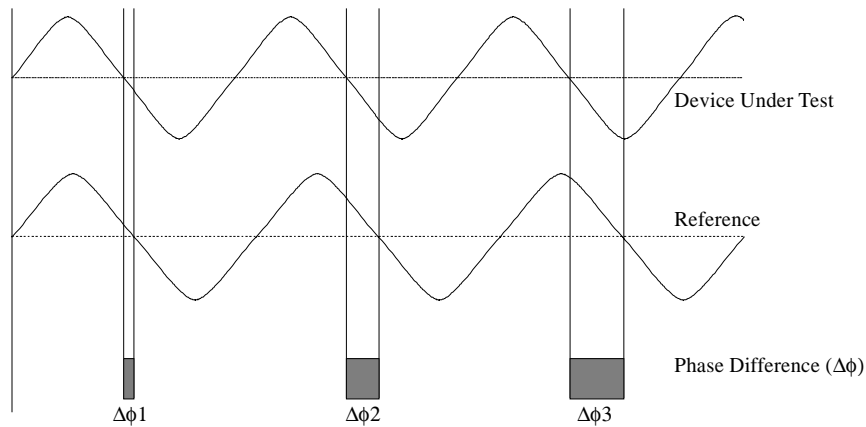

Figure 4-7 Changing phase between two signals

4.8.1 Measurement Methods

4.8.1.1 1, 5 & 10 MHz Deviation

Frequency measurement within the Model 1083B is by the *reciprocal method*. Using a *reciprocal counter* comprised of a state-of-the-art measurement board and associated firmware, the Model 1083B essentially measures the rate-of-change of phase between two signals. Both the unknown (measured) signal and the internal GPS-synchronized (reference) signal are converted down by heterodyning to a 100 Hz intermediate frequency (IF), which increases measurement resolution by a factor of 10^4 . Measurement circuits and firmware then time tag the rising edges of each 100 Hz signal to calculate the difference in phase (see equations 1 – 5 and Figure 4-8). To increase resolution, several measurement time periods are firmware selectable (1, 10, 100 and 1000 seconds for K). Fractional Frequency Error ($\text{Error}_{\text{frac}}$) is determined as follows:

$$(1) \quad \tau_f = \frac{1}{N} (K - t_1 + t_2) \quad (\text{period, } \approx 10 \text{ ms})$$

$$(2) \quad F_{if} = \frac{1}{\tau_f} = \frac{N}{(K - t_1 + t_2)} \quad (\text{frequency, } \approx 100 \text{ Hz})$$

$$(3) \quad Error_f = F_{if} - 100 = \frac{N}{(K - t_1 + t_2)} - 100 \quad (\text{frequency error, Hz})$$

$$(4) \quad Error_{frac} = \frac{Error_f}{f_o}; f_o = 1 \text{ MHz} \quad (\text{fractional error})$$

$$(5) \quad Error_{frac} = \left[\frac{N}{(K - t_1 + t_2)} - 100 \right] \bullet 10^{-6}$$

To perform time interval determination with optimum accuracy, the measured signal and reference signal, each heterodyned down to 100 Hz, are applied to an ASIC for processing. It is within the ASIC that the resultant (100 MHz) time base counts are measured to determine frequency accuracy and Allan variance.

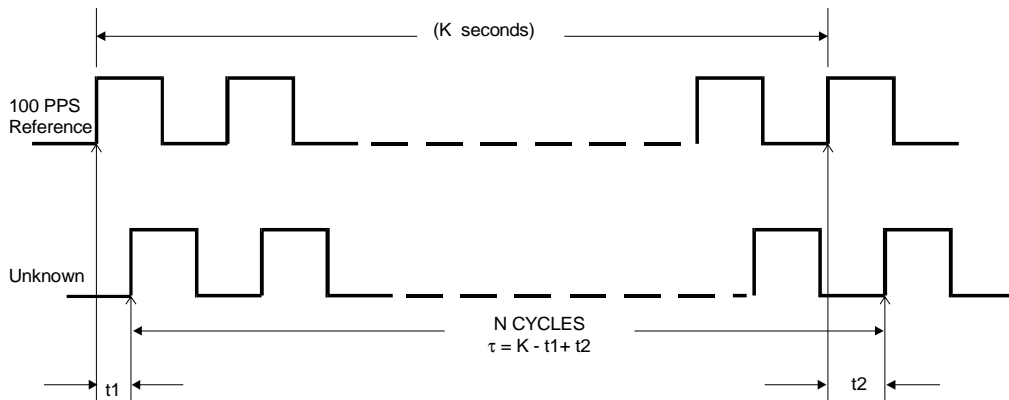

Figure 4-8. Reciprocal Frequency Measurement

Allan Variance

Allan variance is a non-classical statistic used to determine the stability of a frequency standard in the time domain. It is a dimensionless statistic comparing a time variance of phase over successive intervals of time. Therefore, the units of time drop out. Phase deviations are measured at uniform intervals, accumulated and compared to successive deviations. This gives successive differences in phase called offsets. Since the confidence level of a stability estimate like this improves with averaging time, longer measurements can reduce the margin of error.

4.8.1.2 1 PPS Deviation

The Model 1083B determines the 1-PPS deviation using the same counter and recording scheme used for deviation measurements explained above, but makes the assumption that the signal is periodic only at 1 Hz. By counting the number of 100 MHz pulses between the start and stop signals the Model 1083B can determine the deviation to within 10-ns resolution. (See equations 1 – 5 and figure 4.9) This count is determined by time tagging both pulses with 10-ns (100-MHz) resolution, and subtracting the time tags. The resultant count can be either positive (if the unknown 1 PPS arrives before the internal 1 PPS) or negative (if the unknown 1 PPS arrives after the internal 1 PPS).

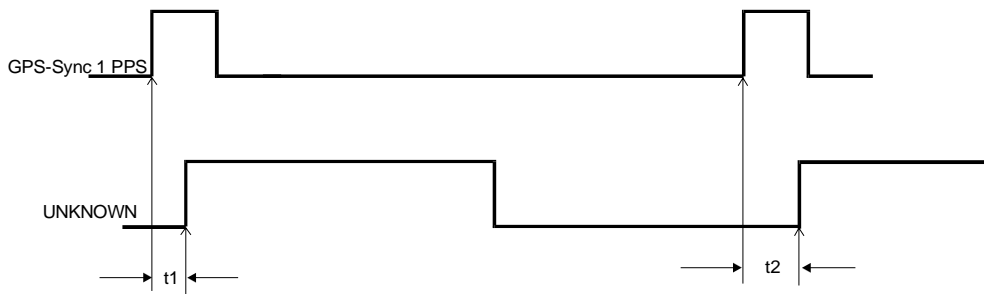

Figure 4-9. 1 PPS Deviation Measurement

4.8.2 Measuring Deviation of a 1, 5, 10-MHz, or 1 PPS Signal

Apply the signal to be measured to the BNC connector on the left front panel of the Model 1083B. If the source requires a 50-ohm load, change the configuration to 50 Ω , either from the front panel keys, or by firmware through the RS-232 port. Input signal levels are specified between 1 and 5 V peak-to-peak into 50 ohms (sine wave) or TTL compatible (1 PPS).

Input modes are selected by using either the front panel keys, or by using the firmware commands through the RS-232C serial port. The inputs are dc-coupled at all times. The threshold in frequency mode is 0 Vdc. If you wish to measure a logic-level frequency signal, it will be necessary to ac-couple this signal externally, to ensure that it is centered around 0 Vdc.

Configuring Input Modes – Front Panel

To configure one of the input modes through the front panel, press the status key until the display reads as follows (refer to Figure 5-5 Flow Chart in Paragraph 5):

SET $\Delta F / \Delta T$ MODE?

Press ENTER and the display will change to read

SELECT INPUT MODE?
MODE= 5 MHz DEVIATION

Make the desired signal mode selection by pressing the UP/DOWN keys, which will scroll through the available choices (i.e. 1 MHz, 5 MHz, 10 MHz, 1 PPS). Finally, press ENTER to confirm the signal mode selection. If you have selected 1 PPS, go to SELECT TERMINATION.

After selecting signal mode, the next choice is the measurement time or measurement interval. If you have selected 1, 5 or 10 MHz, the display choice reads:

SELECT MEASURE TIME
TIME= 1 SECOND

Press the UP or DOWN keys to change the value of seconds to one of the available choices (i.e. 1 second, 10 seconds, 100 seconds, or 1000 seconds). Finally, press ENTER to confirm the choice and proceed to select termination input mode.

SELECT TERMINATION
TERMINATION= HI-Z

Press the UP or DOWN keys to change the termination value to either HI-Z or to 50 Ω , and press ENTER to confirm the choice. The 50- Ω input status LED should illuminate if “50 Ω ” is selected. Other input termination combinations are available – see Appendix A, Table A-5.

Press the INPUT DEVIATION key and (before settling) it should read:

```
FREQUENCY OFFSET
 $\Delta F = \text{-----}$ 
```

After settling the display should read:

```
FREQUENCY OFFSET
 $\Delta F = \pm X.XXXe-XX$ 
```

This is the only display available if selecting 1, 5 or 10 MHz. If selecting “1 PPS”, then the display will change to read:

```
1 PPS:       $\pm X.XXX \mu S$ 
SIGMA:      $\pm X.XXX \mu S$ 
```

4.8.2.1 Configuring Allan Variance (1, 5 and 10 MHz only)

Select the number of Allan Variance data points by entering the Input menu (see Configuring Input Modes above). The selection menu exactly follows the “SET SYSTEM DELAYS?” menu, and appears in the INPUT selection menu as follows (refer to Figure 5-5 Flow Chart):

```
SET  $\Delta F / \Delta T$  MODE?
```

Press the ENTER key *until* the display reads as follows – *1 PPS must not be selected*:

```
SET ALLAN VARIANCE
DATA POINTS = XXXXXX
```

Press the UP or DOWN keys until the desired number of points is selected. Available choices are OFF, 10, 20, 50, 100, 200, 500, 1000, 2000, 5000, 10000, 20000, 50000, 100000, 172800 and take one second per point to measure. SELECT MEASURE TIME? (or Interval) from above is a separate measurement and does not affect Allan Variance.

If the number of DATA POINTS selected is not OFF, then the INPUT DEVIATION menu changes to include Allan Variance calculations and countdown time. Press the INPUT DEVIATION key to see the following:

```
(1e1) ALLAN VARIANCE
AVG  $\Delta F = \pm X.XXXe-XX$ 
```

The value in parenthesis indicates the number of data points selected (i.e. 1e1, 1e2, 1e3, 1e4, 1e5). Press the INPUT DEVIATION key again and the display changes to read:

```
AD[1e0s] = X.XXXe-XX
AD[2e0s] = X.XXXe-00
```

Depending on the number of data points selected, subsequent presses of the INPUT DEVIATION key will reveal additional intermediate Allan Variance values.

Press the INPUT DEVIATION key again and the display changes to read (XX is the number of count down seconds to zero before computing the average Allan Variance):

ALLAN VARIANCE
RESULTS IN XXX Sec

4.8.2.2 Configuring Input Modes – Using Serial Commands

Select the desired measurement mode with one or all of the following RS-232C commands:

<u>Command</u>	<u>Purpose</u>
nMM	Set Measurement Mode – Signal Type (1, 5, 10 MHz or 1 PPS)
nMT	Set Measurement Termination – HI-Z or 50 Ω (n values are 0, 1, 2, 3)
nMP	Set Measurement Time, or Interval (1, 10, 100, 1000 second intervals)
nMR	Returns the various measurement board results (1-PPS deviation average, sigma, frequency deviation, Allan Variance data)
nMA	Set number of data points for Allan Variance (10, 100, 1000, 10000, 100000)

The value for “n” is numerical and determines the mode selection. See Appendix A. RS-232 Commands, Table A-5, for a complete description of these commands. For example, if the 1-MHz input signal mode is desired, the correct command would be “0mm” .

Example

Input Mode: Allan Variance measurement with 100 data points at 10 MHz. Send the following commands through a terminal emulation program (see Appendix A, Table A-5):

2mm	sets the input board to 10 MHz
2mt	sets the termination to 50 Ω (Frequency), or HI-Z (Time)
100ma	sets the number of Allan Variance data points to 100

The Model 1083B will then begin to measure frequency deviation and calculate Allan Variance. It will display the value after the number of data points have been measured (in 100 seconds).

Configuring a Model 1083B using the serial port is very simple and quick. If programming through the serial port to send commands, do not press ENTER, or send carriage-return, line-feed characters. Commands are entered with the last character received.

4.8.2.3 Frequency Measurement Caution

Because of the heterodyne conversion used in the Model 1083B frequency comparator, an input frequency with an error of -200 ppm will create the false impression of an “on-frequency” signal. Be careful to apply signals with known errors of ± 10 ppm (10^{-5}) or less to ensure accurate results. This is easily verified with any common laboratory frequency counter.

5.0 Firmware Configuration

5.1 General

Certain operational parameters of the Model 1083B Satellite-Controlled Clock can be modified for specific user requirements. These changes are performed either through hardware settings, or by changing internal operating firmware configuration (or combination of both). The following paragraphs describe the general procedures used to modify these parameters through firmware configuration – by using the front panel keys or sending commands through the serial port.

5.2 Change Configuration Using Setup Menu

To change operating conditions of the Model 1083B, press the SETUP key on the front panel. All of the four keys on the bottom row are used for making configuration changes (exit SETUP menu by pressing any of the four, top keys). Generally, continuing to press the SETUP key can access any of the setup functions. Alternatively, you can move forward or backward through the menus by pressing the UP/DOWN keys after first pressing SETUP. However, some of the menus are hidden from view under certain operating conditions. One of these conditions is the “Set Initial Position” menu only visible prior to satellite lock.

Changes to configuration can also be made through the serial port using most currently available terminal emulation software packages and a null-modem cable. HyperTerminal™, found in Microsoft Windows™, is one such terminal program useful in communicating with the Model 1083B.

NOTE RS-232 commands FB (blank front panel display and disable keyboard) and FL (lock setup keys) will disable the setup menus. RS-232 setup (refer to Appendix A) is still active, and full keyboard control may be re-enabled using the FE command (enable keyboard and display).

The SETUP menu consists of eight (8) sub-menus, which control many of the operating functions of the Model 1083B. All are illustrated in flow chart format in Figures 4-4 through 4-8 (in Section 4) and Figures 5-1 through 5-8. The figures are generally in the same sequence as their respective menu selections when scrolling through the SETUP menu:

Figure 5-1. Set RS-232

Figure 4-4. Set Initial Position*

Figure 5-2. Set Local Hour

Figure 4-5. Set Auto Survey

Figure 5-3. Set Out-of-Lock

Figure 4-6. Set Position Hold

Figure 5-4. Set System Delays

Figure 5-5. Set $\Delta F / \Delta T$ Mode

* Set Initial Position only appears in SETUP menu prior to lock at startup.

All flow charts in this section are for reference only. Each graphically illustrates the basic firmware configuration of that specific operating parameter. Each configuration parameter may be modified; however, all possible combinations are not shown.

To access individual setup menus:

1. Press the SETUP key on the front panel.
2. Navigate through the series of menu selections by using either the SETUP (forward only) or the UP/DOWN keys (to move forward/back respectively).
3. Confirm the selection by pressing the ENTER key.

<p>NOTE After entering the selected menu and while viewing parameters, some selections can be bypassed by pressing the SETUP key.</p>
--

4. If a parameter is adjustable, use the UP and DOWN keys to change the value. In the numeric data entry mode, the SETUP key will increment the cursor to the next left-hand digit and the ENTER key will decrement the cursor to the next right-hand digit.
5. After modifying the parameter, press ENTER to confirm the new value and proceed to either the next parameter or to exit the menu. Press any of the four, top keys to exit the SETUP menu.

5.2.1 Configuration Flow Charts

All of the Model 1083B configuration flow diagrams are found in the following pages and in Section 4 Operation (see List of Tables and Figures in the front of this manual).

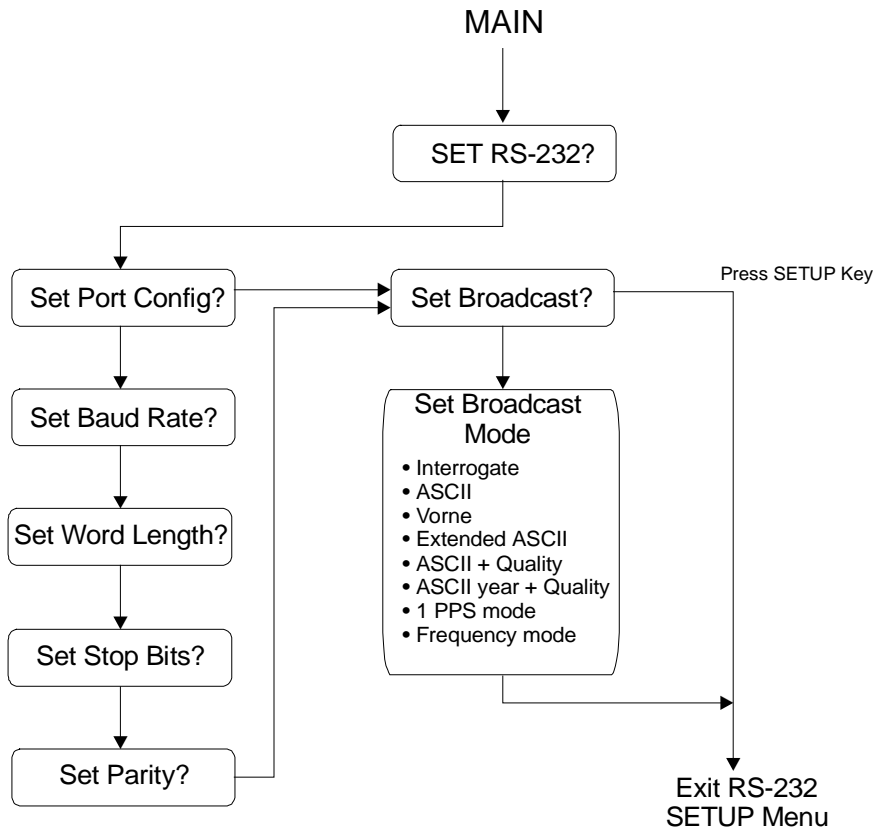

NOTES:

1. Pressing SETUP key during Port Configuration is the same as pressing the ENTER key in that the value is confirmed and the display increments to the next parameter.
 - Baud Rate: selectable from 1200 to 19200.
 - Word Length: 7 or 8.
 - Stop bits: 1 or 2.
 - Parity: OFF (NONE), EVEN, ODD.
2. Broadcast Mode:
 - Interrogate Mode
 - Broadcast ASCII Standard
 - Vorne Standard
 - Extended ASCII
 - ASCII with Time Quality Indicator
 - ASCII Year & Time with Quality
 - 1 PPS mode with time, sigma, year time & Quality
 - Frequency mode with frequency deviation, year time & Quality
3. Broadcast Mode Data Format is shown in Appendix A.

Figure 5-1. RS-232 Setup Menu flow Chart

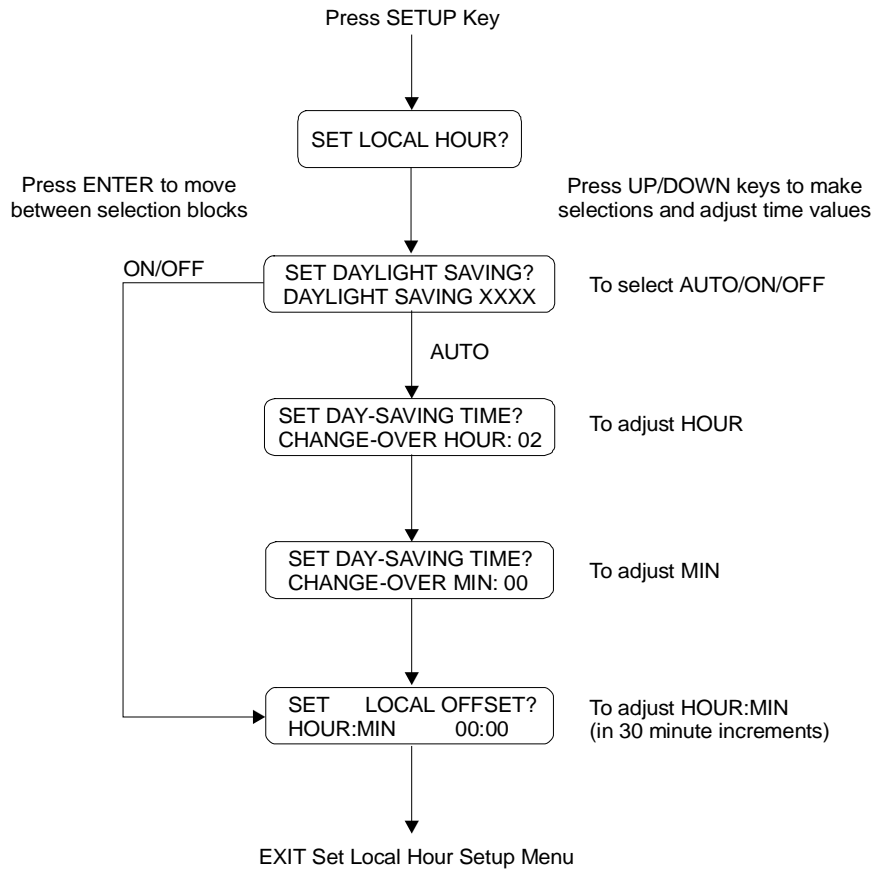

NOTES:

1. Press ENTER or SETUP to move from between “SET LOCAL HOUR” blocks.
2. Press the UP/DOWN keys to make selections or adjust time in each block.
3. Adjust Day-Saving Time for time-of-day that Daylight Savings time adjustment occurs. Selectable in hours and minutes.
4. Set Local Offset for difference, in hours and minutes, between Local and UTC Time.

Figure 5-2. Set Local Hour Flow Chart

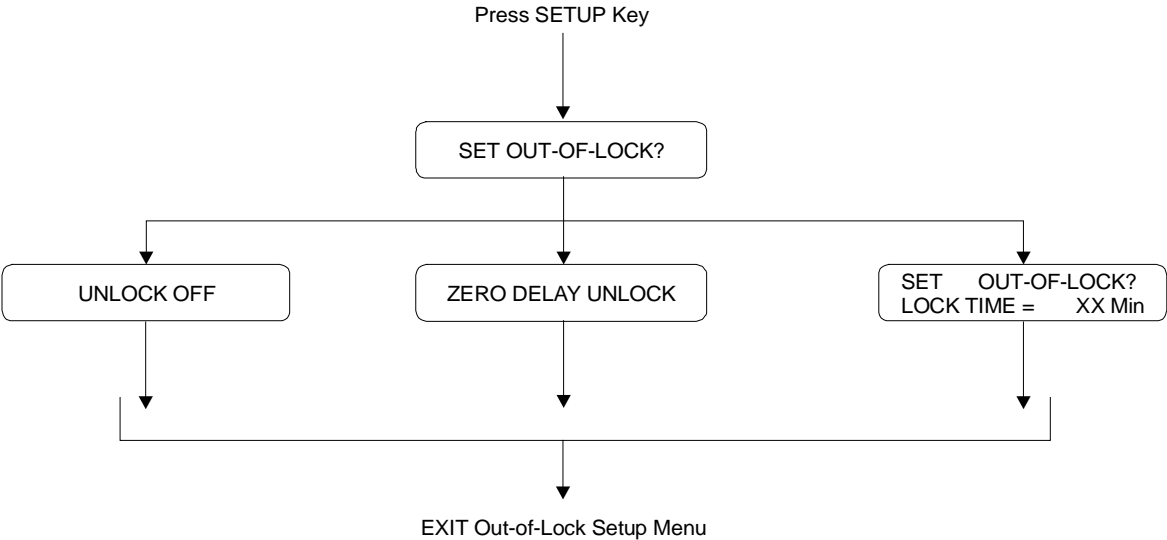

- NOTES:
- 1. Press ENTER to enter the "Set Out-of-Lock" Menus
 - 2. Use UP/DOWN keys to move between the three Out-of-Lock selections
 - 3. When in the SET OUT-OF-LOCK time block, use the UP/DOWN keys to set the out-of-lock time in minutes (0 - 99 minutes).
 - 4. Press ENTER to confirm the selection and exit the Out-of-Lock Menu.

Figure 5-3. Set Out-of-lock Flow Chart

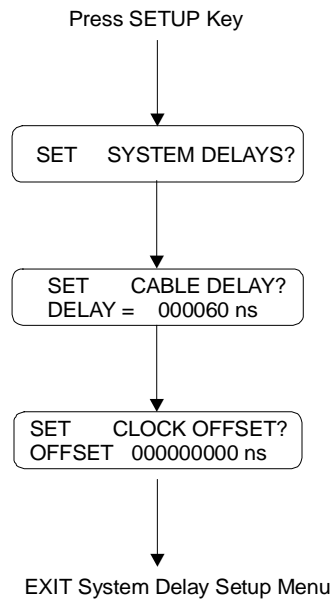
**NOTES:**

1. Press ENTER to enter the "Set System Delay" Menus and move to different System Delay menus.
2. Press the UP/DOWN keys to adjust the Cable Delay values.
3. Once the cursor appears, press SETUP and ENTER keys to select the desired digit, left or right of the cursor, in the Clock Offset menu.
4. Press ENTER to confirm the Cable Delay value and move to next menu.
5. Press the UP/DOWN keys to adjust the Clock Offset values.
6. Press ENTER to confirm the Clock Offset value and exit the System Delay menus.

Figure 5-4. Set Systems Delays Flow Chart

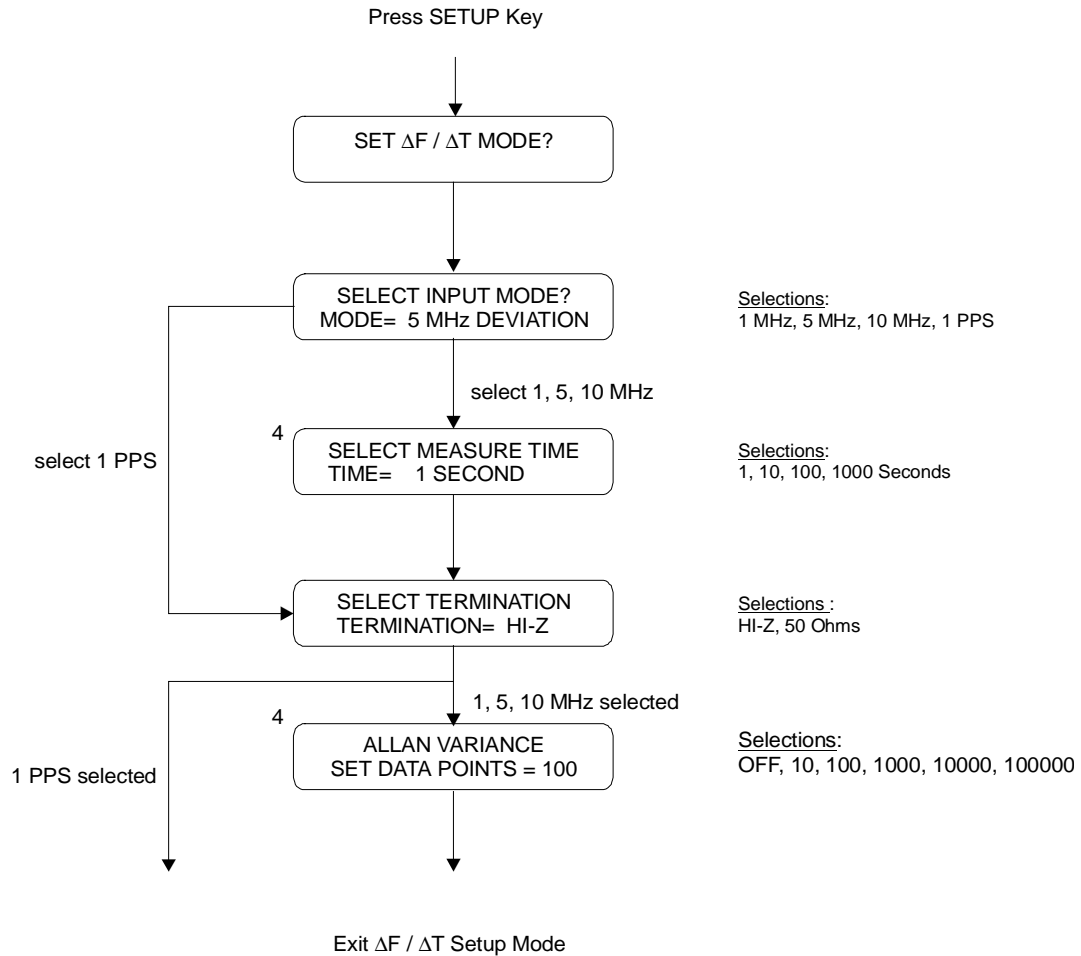

NOTES:

1. Press ENTER to enter the "Set ΔF / ΔT MODE?" menus.
2. Use the UP/DOWN keys to move between the selections in each group.
3. Press ENTER to confirm the selections and exit to the Auto Survey Menu.
4. Some menus are visible only when certain selections are made.

Figure 5-5. Set ΔF / ΔT Mode Flow Chart

6.0 Appendix A. RS-232 Command Summary

The following appendix contains a listing of commands, which may be used to control and communicate with the Model 1083B via the RS-232C serial interface. All of the RS-232 commands are functionally grouped into 12 tables. For example, Table A-8 lists all of the commands used to both set and retrieve the date and time in one of the standard formats.

Each command name and syntax is highlighted in bold at the first line of each definition. For example, the first command in this summary is Broadcast Mode Off. The exact RS-232 command to switch the broadcast mode off is 0B (zero-B). Following this heading is additional information to use and interpret the inputs and outputs. Sending 1B (Broadcast Mode-ASCII) to the Model 1083 causes it to send out the Time and Date to the serial port once per second.

When a command requests information from the Model 1083B, it returns the most current data available. Numeric data is returned as an ASCII string of numeric characters, with leading sign and embedded decimal point as needed. Strings are terminated with carriage return and line feed characters. When entering RS-232 commands, do not press ENTER or send carriage-return line-feed characters. Commands are received and processed when the last character is typed.

The following symbols and syntax are used throughout and are repeated here for emphasis:

␣	Shorthand for <CR><LF> (carriage-return, line-feed).
'A'	Channel A
'U'	UTC Time, Channel A
'L'	Local Time, Channel A.
<SOH>	(Hex 01) = Start of Header, "smiley face" (an ASCII control character)
<BEL>	(Hex 07) = Tone generated by the PC (an ASCII control character)

Underlines are used for clarity only and graphically represents the location of ASCII SPACES.

TABLE A-1. BROADCAST MODE COMMANDS	51
Broadcast Modes, nB	51
Broadcast Data – Local, BL	52
Broadcast Data – UTC, BU	52
Broadcast Display Buffer, nDZ	52
TABLE A-2. STATUS MODE COMMANDS	53
Clock Status, SC	53
OCXO Status, SD	53
EEPROM Status, SE	53
Receiver Status, SR	53
Survey Status, SQ	54
TABLE A-3. LOCAL DAYLIGHT SAVINGS TIME SETUP COMMANDS	55
Daylight Saving – Off / On / Auto, nDS	55
Daylight Saving – Auto Changeover Time, hh:mmDT	55
Local Offset, ±hh[:mm]TO	55

TABLE A-4. FRONT PANEL CONTROL COMMANDS	56
Disable Control Panel, FB	56
Enable Control Panel, FE.....	56
Lock Setup Keys, FL	56
TABLE A-5. MEASUREMENT MODE ($\Delta F / \Delta T$) COMMANDS.....	57
Set Measurement Mode – Frequency, nMM	57
Set Measurement Mode – Termination, nMT.....	57
Set Frequency Measurement Time, or Interval, nMP.....	57
Measurement Mode, nMR	58
Set Allan Variance Data Points, nMA	58
TABLE A-6. POSITION DATA AND POSITION-HOLD COMMANDS	59
Set Position-Hold – Elevation, MMMMM.mmH.....	59
Set Position-Hold – Latitude, dd:mm:ss.sssN(S).....	59
Set Position-Hold – Longitude, ddd:mm:ss.sssE(W)	59
Elevation, LH.....	59
Latitude, LA	60
Longitude, LO.....	60
Position-Hold – HOLD OFF / 3D HOLD ON / ALT HOLD ON / ALT TRACK ON, nPH.....	60
TABLE A-7. SURVEY MODE COMMANDS	61
Auto Survey Mode, m:nPQ.....	61
TABLE A-8. DATE AND TIME COMMANDS	62
Set Receiver Time, yyyy:mm:dd:hh:mmTS	62
Local Date, DL.....	62
UTC Date, DU	62
Local Time, TL.....	62
UTC Time, TU.....	62
TABLE A-9. DISPLAY MODE COMMANDS	63
Set Display Mode, nDM	63
TABLE A-10. ANTENNA SYSTEM DELAY COMMANDS	63
Set Antenna Delay, nnnnnnDA.....	63
Set Clock Offset, nnnnnnnnDD	63
TABLE A-11. OUT-OF-LOCK COMMANDS	64
Set Out-of-Lock Time, (-)nPL	64
TABLE A-12. MISCELLANEOUS COMMANDS	64
Firmware Version, V	64
Display Buffer, Z	64
Debug Mode – OFF, nDG	64

Table A-1. Broadcast Mode Commands

Broadcast Modes**nB**

Activates one or deactivates all of the broadcast modes. Typing the command starts or stops broadcasting the particular mode. Valid commands are: 0B, 1B, 2B, 3B, 4B, 5B, 6B and 7B.

<u>n</u>	<u>Broadcast Mode</u>	<u>Response</u>
0	none	↵ (turns off any Broadcast mode)
1	ASCII Standard	<SOH>ddd:hh:mm:ss↵
2	Vorne Standard	44hhmmss↵ (UTC/Local time) 55ddd↵(day-of-year) <BEL> (<BEL> = Hex 07)
3	Extended ASCII	<CRLF>Q_yy_ddd_hh:mm:ss.000_
4	ASCII with Time Quality Indicator	<SOH>dd:hh:mm:ssQ↵
5	ASCII year + quality	<SOH>yyyy:ddd:hh:mm:ssQ<CR><LF>
6	1 PPS Mode Frequency Mode	<SOH>ttttt.ttt: sssss.sss:yyyy:ddd:hh:mm:ss<CR><LF> <SOH>ffffff.fff: yyyy:ddd:hh:mm:ss<CR><LF>

Command Details

1. ASCII Standard – <SOH> = Hex 01. The start-bit of the <SOH> character is transmitted on time, and is broadcast once per second.
2. Vorne Standard – Configure RS-232 Broadcast Mode to support Vorne large format time displays. Refer to Arbiter Systems Application Note 103 for more information. Response (1/sec; number and order of strings returned depend upon options ordered with clock). Data is transmitted *ahead-of-time*, and the <BEL> character is transmitted *on-time*. When properly configured, the Vorne displays update simultaneously upon receipt of the <BEL> character.
3. Extended ASCII – Configure RS-232C Broadcast Mode to send time-of-day as ASCII data using an extended format prefaced with a Time Quality Indicator. Response is 1 / second. <CR><LF> are carriage-return line-feed characters, with the start bit of the CR being transmitted on time. Q is the quality indicator and may be represented by: space – locked, maximum accuracy; ? (ASCII 63) – unlocked. The underline used in the response represents the location of ASCII spaces and is used for clarity.
4. ASCII with Time Quality Indicator – Configure RS-232C Broadcast Mode to send time-of-day as ASCII data appended with a Time Quality Indicator. Response is 1 / second. The start bit of <SOH> character is transmitted on time. Q is a Time Quality Indicator represented by a:

Space	Locked, maximum accuracy	# (ASCII 35)	Error < 100 microseconds
. (ASCII 46)	Error < 1 microsecond	? (ASCII 63)	Error > 100 microseconds
* (ASCII 42)	Error < 10 microsecond		

5. ASCII Year Date & Time with Quality Indicator – Configures RS-232C Broadcast Mode to send year date & time with quality in ASCII format. Response is as follows:
 ASCII year with Quality <SOH>yyyy:ddd:hh:mm:ssQ<CR><LF>
6. 1 PPS Mode – Configures the RS-232 Broadcast Mode to send time deviation and sigma with year-date and quality as follows (t = 1-PPS deviation, s = 1-PPS sigma):
 1 PPS Mode <SOH>ttttt.ttt: ssssss.sss:yyyy:ddd:hh:mm:ssQ<CR><LF>

Frequency Mode – Configures the RS-232 Broadcast Mode to send frequency deviation or Allan Variance with year-date information with Time Quality as follows:

Frequency Mode	<SOH>ffffff.fff:yyyy:ddd:hh:mm:ssQ<CR><LF>	(Delta F)
	+1.456e-11 +5.233e-12 +1.903e-12 +1.168e-12	(Allan Variance
	+5.014e-13 -1.000e+00 -1.000e+00 -1.000e+00	100 points)
	-1.000e+00 -1.000e+00 -1.000e+00 -1.000e+00	
	-1.000e+00 -1.000e+00 -1.000e+00 -1.000e+00	
	-1.010e-13 T1999:321:18:18:50	

Broadcast Data – Local

BL

BL configures the RS-232C Broadcast Mode to return data using the Local Time reference. Broadcast Data – Local may be used concurrently with other Broadcast commands.

Response: ↵

Broadcast Data – UTC

BU

BU configures the RS-232C Broadcast Mode to return data using UTC Time Reference. Broadcast Data – UTC may be used concurrently with other Broadcast commands.

Response: ↵

Broadcast Display Buffer

nDZ

nDZ sets Model 1083B to display the chosen value and broadcast the display buffer as follows:

<u>Format:</u>	<u>n</u> ≡	<u>Value</u>
	0	turns off the display buffer broadcast mode
	1	Date & Time, UTC
	2	Time of Year, UTC
	3	Date & Time, Local
	4	Time of Year, Local
	5	Longitude
	6	Latitude
	7	Elevation
	8	Receiver Status
	9	DCXO Status
	10	EEPROM Status
	11	returns the Event/Deviation display

Response: # above respective display

Table A-2. Status Mode Commands

Clock Status

SC

SC returns the current clock status.

Response: L/U U=xx S=nn↵

Format: L Clock currently locked to GPS (“U” for unlocked).
 xx Indicates loss of lock period, up to 99 minutes.
 nn User specified out-of-lock delay, 00 to 99 minutes (refer to Table A-8). If the out-of-lock function is deactivated, this field is returned as S=Off. S=ZDL indicates zero delay.

OCXO Status

SD

SD returns the OCXO (Oven-Controlled Crystal Oscillator) status.

Response: ±tt.tt°C ±pp.ppp PPM↵

Format: tt.tt Temperature in degrees C, adjacent to the oscillator housing
 pp.ppp OCXO tuning voltage, expressed in ppm

EEPROM Status

SE

SE returns the EEPROM status.

Response: T=t CE=eee

Format: t = 0, No Timeout Error
 = 1, Timeout Error
 eee = Number of corrected errors in reading EEPROM data

Receiver Status

SR

SR returns the current receiver status.

Response: V=vv S=ss T=t P=Off E=0↵

Format: vv Number of satellites, which should be visible to the antenna, per almanac.
 ss Indication of relative signal strength (S=0 means no signal; S=50 is good).
 t Number of satellites being actively tracked
 P=Off Indicates that the time dilution of precision (TDOP) calculation is not being performed. Returns 1.0 – 99.0, depending on satellite geometry, when TDOP calculation is being performed. A TDOP calculation is NOT performed if less than 3 satellites are visible, OR if Position-Hold is active.
 E=0 Describes the status of internal communications between the receiver and clock boards. A “0” indicates no errors. If clock operation is improper and any other character is persistently returned, contact Arbiter Systems.

Survey Status**SQ**

SQ returns Auto Survey Mode data. For a survey in progress, it returns current status of the survey. For a completed survey, it returns the final results of the survey, i.e. the averaged position.

Response: Sn Pm Fnnnn #nnnn Tyyyy:ddd:hh:mm:ss Eddd:mm:ss.sss Ndd:mm:ss.sss Hmmmmm.mm↵

Format: Sn Represents the status of the Auto-Survey Mode
 Pm Represents the status of the Position-Hold Mode
 Fnnnn Current number of fixes
 #nnnn Total number of fixes required
 yyyy:ddd:hh:mm:ss Time of completion of the most recent average, updated each 60 fixes (approximately each minute).

Table 1 shows the significant three bits of the Auto Survey Status byte, weighting and assignments. Table 2 shows the significant three bits of the Position Hold Status byte, weighting and assignments.

TABLE 1

Bit	Weight	Function †
0 (LSB)	1	Single Auto Survey
1	2	Power-On Auto Survey
2	4	Suspend Survey = 1, otherwise = 0
3-7	N/A	

† may simultaneously set more than one bit.

TABLE 2

Bit	Weight	Function	Position Hold Status = 1	Status = 0
0 (LSB)	1	User hold setup	Enabled	Disabled
1	2	Receiver Hold Status	Enabled	Disabled
2	4	Position Hold I.D.	User position input	Surveyed
3	8	Position Hold type	3D Position	Alt. Hold
4	16	Flag bit for internal use		
5	32	not used		
6	64	not used		
7	128	Altitude Track mode	On	

The remainder of the information is the running position average, including all fixes since the beginning of the Auto Survey cycle. Gives latitude and longitude in degrees, minutes and seconds. Indicates E, W, N, and S respectively as East or West longitude and North or South latitude, and H indicating elevation in meters WGS-84 (World Geodetic System 1984).

Table A-3. Local Daylight Savings Time Setup Commands

Daylight Saving – Off / On / Auto**nDS**

nDS sets the Daylight Saving time adjust feature as follows:

<u>n</u>	<u>Feature</u>
0	Deactivates the Daylight Saving time adjust feature (does not add 1 hour to local time display and output)
1	Activates Daylight Saving time feature (adds 1 hour to local time display and output)
2	Provides for the automatic adjustment of local time to standard daylight saving time. Time changes occur on the first Sunday in April (add 1 hour) and the last Sunday in October (subtract 1 hour). Local time adjustment normally occurs at 0200, which can be changed using the DT command.

Response: ↵

Daylight Saving – Auto Changeover Time**hh:mmDT**

hh:mmDT provides the ability to define when the daylight saving time automatic adjustment occurs (a time other than 0200).

hh	0 – 23 hours
mm	0 – 59 minutes

Response: ↵

Local Offset**±hh[:mm]TO**

±hh[:mm]TO configures the instrument to display and output Local time corresponding to UTC by setting the time offset (difference in number of hours between local and UTC).

Maximum offset: ±12 hours, 30 minutes [minutes optional].

Response: ↵

Table A-4. Front Panel Control Commands

Disable Control Panel **FB**

FB disables all control-panel keys and blanks the front panel display.

Response: ↵

Enable Control Panel **FE**

FE enables all control-panel keys and activates the front panel display.

Response: ↵

Lock Setup Keys **FL**

FL disables setup control keys and activates the front panel display.

Response: ↵

Table A-5. Measurement Mode (ΔF / ΔT) Commands**Set Measurement Mode – Frequency****nMM**

nMM sets the measurement board mode to one of the four measurement frequencies (n).

<u>Format:</u>	<u>n</u>	<u>Value</u>
	0	enables 1 MHz operation
	1	enables 5 MHz operation
	2	enables 10 MHz operation
	3	enables 1-PPS operation

Response: ↵

Set Measurement Mode – Termination**nMT**nMT sets the measurement terminator to either HI-Z or 50 Ω .

<u>Format:</u>	<u>n</u>	<u>Termination Value (s)</u>
	0	High Impedance, HI-Z – either Δ Time or Δ Frequency
	1	50- Ω Δ Time, or HI-Z Δ Frequency
	2	HI-Z Δ Time, or 50- Ω Δ Frequency
	3	50- Ω Δ Time and 50- Ω Δ Frequency

Response: ↵

Set Frequency Measurement Time, or Interval**nMP**

nMP sets the measurement time, or period, for deviation measurement to the values listed.

<u>Format:</u>	<u>n</u>	<u>Value</u>
	0	Sets the measurement time period to 1 second
	1	Sets the measurement time period to 10 seconds
	2	Sets the measurement time period to 100 seconds
	3	Sets the measurement time period to 1000 seconds

Response: ↵

Measurement Mode**nMR**

nMR returns the deviation measurement data.

<u>Format:</u>	<u>n</u> ≡	<u>Value</u>
	0	Returns the 1 PPS deviation 16 sample average
	1	Returns the 1 PPS deviation 16 sample sigma
	2	Returns the frequency difference.
	3	Returns Allan Variance data

Response: ↵

Set Allan Variance Data Points**nMA**

nMA sets the number of measurement board Allan variance data points with n.

<u>Format:</u>	<u>n</u> ≡	<u>Value</u>
	0	Turns OFF the Allan variance measurements
	1	Sets number of Allan variance points with n = 1 to 172800 in the following steps: 10, 20, 50, 100, 200, 500, 1000, 2000, 5000, 10000, 20000, 50000, 100000, 172800.

Return Allan Variance Points**nMQ**

nMQ will return 200 Allan Variance points, starting at address n.

Table A-6. Position Data and Position-Hold Commands

Set Position-Hold – Elevation**MMMMM.mmH**

MMMMM.mmH sets the antenna elevation in meters WGS-84 (World Geodetic System 1984); fractional meters of elevation are optional.

Format: 'MMMMM.mm'

'M' meters (from -1000.00 to +18000.00 meters wgs-84)
 'm' fractional meters (from 00 to 99 centimeters)

Response: ↵

Set Position-Hold – Latitude**dd:mm:ss.sssN(S)**

dd:mm:ss.sssN(S) sets the antenna latitude (in Position-Hold Mode) in degrees, minutes and seconds, North or South.

Format: 'dd' degrees (from 0 to 89 degrees)
 'mm' minutes (from 0 to 59 minutes)
 'ss' seconds (from 0 to 59 seconds)
 '.sss' fractional seconds (from 0 to 999 milliseconds – optional)
 'N' North ('S' for South)

Response: ↵

Set Position-Hold – Longitude**ddd:mm:ss.sssE(W)**

ddd:mm:ss.sssE(W) sets the antenna longitude (in Position-Hold Mode) in degrees, minutes and seconds, East or West.

Format: 'ddd' degrees (from 0 to 179 degrees)
 'mm' minutes (from 0 to 59 minutes)
 'ss' seconds (from 0 to 59 seconds)
 '.sss' fractional seconds (from 0 to 999 milliseconds – optional)
 'E' East ('W' for West)

Response: ↵

Elevation**LH**

LH returns the current antenna elevation based on the Position Hold selection made. In the HOLD OFF mode it returns the last calculated position. In the 3D HOLD ON mode it returns the current position-hold elevation setting. In the ALT HOLD ON mode it returns the currently held antenna position. In ALT TRACK ON mode it returns the currently tracked elevation position (up to 24 hours trailing average).

Response: nnnnn.nn↵

Format: 'nnnnn.nn' Elevation in meters according to WGS-84

Latitude**LA**

LA returns the current antenna latitude. In Position-Hold Mode, it returns the current position-hold latitude setting.

Response: Ndd:mm:ss.sss↵

Format: 'N' North ('S' for South)
 'dd' degrees
 'mm' minutes
 'ss.sss' seconds (fractional seconds optional)

Longitude**LO**

LO returns the current antenna Longitude. In Position-Hold mode, it returns the current Position-Hold longitude setting.

Response: Wddd:mm:ss.sss↵

Format: 'W' West ('E' for East)
 'ddd' degrees
 'mm' minutes
 'ss.sss' seconds (fractional seconds optional)

Position-Hold – HOLD OFF / 3D HOLD ON / ALT HOLD ON / ALT TRACK ON nPH

Activates or deactivates the different position hold modes as follows:

Format:	n =	Mode
	0	Sets the position hold function to off. This mode deactivates the position-hold-timing mode and the receiver resumes computing time and position solutions.
	1	Sets the position-hold mode to 3D HOLD. Uses the elevation position averaged from a single or power-on survey.
	2	Sets the position-hold mode to ALT HOLD ON. Uses the last elevation in memory and holds it for timing solutions. Elevation be changed with the "H" command.
	3	Sets the position-hold mode to ALT TRACK ON. Calculates the elevation position and averages these using a 24 hour trailing average. Model 1083B continues to compute latitude and longitude.

Response: ↵

Table A-7. Survey Mode Commands

Auto Survey Mode

m:nPQ

m:nPQ sets the Survey Mode (m) and number of fixes (n) to average. Used to automatically determine position for Position-Hold position.

Format:

<u>m</u>	<u>Condition</u>	<u>n</u>	<u>Condition</u>
0	Survey Off	0	Single position fix.
1	Initiate single auto-survey	1	60 fixes (approximately 1 minute)
2	Perform auto survey at power on.	2	300 fixes (5 minutes).
3	Temporarily suspend auto survey.	3	900 fixes (15 minutes).
4	Resume suspended auto survey.	4	1800 fixes (30 minutes).
		5	3600 fixes (60 minutes).
		6	7200 fixes (2 hours).
		7	14400 fixes (4 hours).
		8	28800 fixes (8 hours).
		9	43200 fixes (12 hours).
		10	86400 fixes (24 hours).

Response: ↵

During a survey, obtain a Survey Status with the 'SQ' command. Activate the Position-Hold mode with the '1PH' command.

Table A-8. Date and Time Commands

Set Receiver Time**yyyy:mm:dd:hh:mmTS**

yyyy:mm:dd:hh:mmTS sets Receiver (UTC) Time. The *command is ignored* when the receiver is locked to satellites. When the receiver is initially activated, and has not locked onto satellites, acquisition time may be improved by giving the clock an initial estimate of UTC time, which it can use (with stored position and almanac data) to determine which satellites and Doppler shifts to use in acquisition.

Format: ‘yyyy’ year
 ‘mm’ month
 ‘dd’ day
 ‘hh’ hour
 ‘mm’ minute

Response: ↵

Local Date**DL**

Returns the current date, in local time.

Response: ddmmmyyyy↵

UTC Date**DU**

Returns the current date, in UTC time.

Response: ddmmmyyyy↵

Local Time**TL**

Returns the current Local time.

Response: ddd:hh:mm:ss↵

UTC Time**TU**

Returns the current UTC time.

Response: ddd:hh:mm:ss↵

Note: The DL, DU, TL and TU command formats are as follows:

Format:	‘yyyy’	year	‘hh’	hour
	‘mmm’	month (JAN – DEC)	‘mm’	minute
	‘dd’	day of month	‘ss’	second
	‘ddd’	day of year		

Table A-9. Display Mode Commands

Set Display Mode**nDM**

nDM sets the display mode as follows:

Format:	n =	Value
	0	Selects the current status display
	1	Displays the Date & Time, UTC
	2	Displays the Time of Year, UTC
	3	Displays the Date & Time, Local
	4	Displays the Time of Year, Local
	5	Displays the antenna longitude
	6	Displays the antenna latitude
	7	Displays the antenna elevation
	8	Frequency Standard Status (Locked, Survey, or Position Hold)
	9	GPS Receiver Status; number of satellites visible and tracked
	10	OCXO Status; in degrees C and PPM
	11	Displays input deviation status
Response:	↵	

Table A-10. Antenna System Delay Commands

Set Antenna Delay**nnnnnnDA**

nnnnnnDA sets antenna system delay compensation value. Note: Factory default setting for the standard 15-meter (50-foot) cable is 60 ns. The exact syntax for a 60-ns delay is 60DA. See paragraph 3.3.1.2.1 for information on calculating cable delay.

Time Range: 'nnn...' 0 to 999999 ns

Response: ↵

Set Clock Offset**nnnnnnnnDD**

The "...DD" command sets internal system delay compensation value. It is used to advance the output pulse by an arbitrary offset of up to one second, from actual time.

Time Range: 'nnn...' 0 to 999999999 ns

Response: ↵

Table A-11. Out-of-lock Commands

Set Out-of-Lock Time

(-)nPL

The “(-)nPL” command sets the amount of delay time (in minutes) following loss of satellite synchronization before an out-of-lock signal is generated and output via rear panel connector.

Format: ‘n’ 0 to 99 minutes*
 ‘-n’ disables this function (Out-of-Lock always ‘HI’ when power is ON.)

*a value of 0 results in no delay between loss of lock and out-of-lock indication.

Response: ↵

Table A-12. Miscellaneous Commands

Firmware Version

V

V returns the Firmware Revision dates of the installed program and measurement ROMs.

Response: MN dd mmm yyyy↵
 MZ dd mmm yyyy↵

Display Buffer

Z

Z returns the contents of Display Buffer.

Response: Echoes current display (40 characters). No line wrap.

Debug Mode – OFF

nDG

Activates or deactivates the broadcast of debug output data streams.

7.0 Index

A

Accessories
 Standard, 1
 Accuracy, Clock
 Improved, 32
 Acquisition Time, 5
 Allan Variance
 configuring front panel, 39
 configuring serial port, 40
 data points, 39
 specification, 6
 theory, 36, 37
 Amplifier
 Antenna, Inline, 2
 Annunciators, LED, 8
 Antenna
 cable, 6
 gain pattern, 14
 location, 13
 loss and delay characteristics, 11
 mounting, 14
 mounting bracket, 14
 mounting kit, 14
 size, 6
 Antenna & Cable, 1
 Antenna Cable
 accessories, 16
 adjacent signals, 17
 differences, 11
 module power, 17
 operational test, 18
 protection, 16
 standard, 15
 user supplied, 18
 Antenna Cable parameters
 attenuation, 15
 cable delay, 15
 DC Resistance, 15
 Antenna/System Delay Commands
 Set Antenna Delay, 63
 Set Clock Offset, 63
 Auto Survey Mode, 61

B

Broadcast Commands
 Broadcast Data-Local, 52
 Broadcast Data-UTC, 52
 Broadcast Mode OFF, 51
 Broadcast Data-Local, 52
 Broadcast Data-UTC, 52
 Broadcast Mode Off, 51

C

Cable Type, 6
 Configure Firmware
 Using Setup Menu, 41
 Connectors
 allow clearance, 11
 Detachable, 1
 fuse replacement, 12
 I/O, Input/Output, 9
 IEC-320, 11
 power supply, 10
 Power Supply, 1
 rear panel drawing, 13
 RS-232, Serial Port, 9
 Cover removal, 13

D

Date and Time Commands
 Send Local Date, 62
 Send Local Time, 62
 Send UTC Date, 62
 Send UTC Time, 62
 Set Receiver Time, 62
 Daylight Saving Auto Changeover Time, 55
 Daylight Saving Off, 55
 Daylight Savings Time Commands
 Daylight Saving Auto Changeover, 55
 Daylight Saving Off, 55
 Local Offset, 55
 DCXO Status, 53
 Debug Mode Off, 64
 Debug Mode OFF Command, 64
 Dimensions, 10

Disable Control Panel, 56
 Display Buffer Command, 64

E

Edit
 Elevation, 34
 Latitude, 34
 Longitude, 34
 Position, 34
 EEPROM Status, 53
 Electro-Magnetic Interference (EMI), 10
 Enable Control Panel, 56
 Environmental
 operating conditions, 10
 Ephemeris Data, 5
 Errors, Corrected, 26

F

Firmware
 Setup Menus, 41
 Firmware Setup
 Accessing, 42
 Firmware Version Command, 64
 Frequency
 GPS, 14, 15
 Stability, 6
 Frequency Measurement
 caution, 40
 Front Panel Commands
 Disable Control Panel, 56
 Enable Control Panel, 56
 Lock Setup Keys, 56
 Fuse
 for Options 8 & 10, 12
 Replacement, 12

H

Harmonics, 6
 Humidity. *See* Environmental

I

IEC-320, 11
 IEC-320 Power Supply, 1
 Initial Position
 Resetting, 30

Input Measurements
 1 PPS, 37
 Configuring, front panel, 38
 Configuring, serial port, 40
 Methods, 36
 Input/Output Connectors, 9
 Internal Battery
 annunciators, 8

L

Local Offset, 55
 Lock Setup Keys, 56

M

Mounting Clock, 1

O

Options
 07, AC Operation, 11
 07, DC Operation, 12
 Out-of-Lock Commands
 Set Out-of-Lock, 64

P

PDOP, 21
 Phase Noise, 6
 Position accuracy. *See* Specifications
 Position Data Commands
 Send Altitude, 59
 Send Latitude, 60
 Send Longitude, 60
 Position Fixes, 31
 Position Hold Commands
 Position Hold OFF, 60
 Set Position Hold - Altitude, 59
 Set Position Hold - Latitude, 59
 Set Position Hold - Longitude, 59
 Position Hold Off, 60
 Power
 Input, 1
 Power Connector, 10
 Power Requirements, 10
 Power Supply
 standard, 11

R

Rack mounting, 13
Rear Panel layout, 13
Receiver Characteristics, 5
RS-232 Connector
 Pin locations. *See* Specifications

S

Satellite Tracking, 5
Selective Availability, SA, 31
Send Altitude, 59
Send Clock Status, 53
Send Display Buffer, 64
Send Firmware Version, 64
Send Latitude, 60
Send Local Time, 62
Send Longitude, 60
Send Receiver Status, 53
Send Survey Status, 54
Send UTC Date, 62
Send UTC Time, 62
Set Antenna Delay, 63
Set Clock Offset, 63
Set Local Date, 62
Set Out-of-Lock Time, 64
Set Position Hold-Altitude, 59
Set Position Hold-Latitude, 59
Set Position Hold-Longitude, 59
Set Receiver Time, 62

Specifications

 frequency stability & spectral purity, 6
 physical characteristics, 10
 receiver, 5
 system interface, 9
 time accuracy, 5
Spurious Harmonics, 6
Status Mode Commands
 DCXO Status, 53
 EEPROM Status, 53
 Send Clock Status, 53
 Send Receiver Status, 53
 Send Survey Status, 54
Survey Mode Commands
 Auto Survey Mode, 61
Synchronization, 29

T

Time accuracy. *See* Specifications

V

Ventilation, 11
Visible & Tracked, 25

W

Weight, 10
WGS-84
 World Geodetic System 1984, 28