



Instruction Manual

Model 2650 3.3GHz/Model 2658 8.5GHz Spectrum Analyzer

Before Starting to Use the Unit

- **When you use the unit, please observe the following notes listed on the rear of the body.**



- **For you to use it safely**

- 1) When abnormal sounds, abnormal smell and smoke are emitting from the unit, remove the battery and AC adapter and stop the use.
- 2) Never use with hands that are wet, because doing so may cause damage to the unit and/or cause electric shock to the user.
- 3) Never use it under the lightning. There is a possibility of receiving a lightning bolt.
- 4) Never use an AC adapter other than the one specified, because doing so may cause damage to the unit. For static electricity protection, ground the unit by connecting the three cores if possible. Not grounding the unit can damage it and the object measured.
- 5) Never use a battery other than the one specified, because doing so may cause damage to the unit. When removing or installing the battery, be sure to do it after you turn off the unit and disconnect the AC adapter.
- 6) When replacing the fuse, disconnect the AC adapter, open the battery cover on the back and remove battery, and then take sufficient care to perform the replacement. Use 5A/250V fuse (IEC127-2 sheet 3, slow-blow type).
Never use a fuse not specified because doing so may cause damage to the unit.

• **Guarantee of quality**

Guarantee period

Guarantees that the unit will be repaired for any failure free of charge if the failure occurs because of our responsibility within one year after original owners date of purchase. However, the above guarantee does not apply to such a failure that:

- 1) is caused by a fire, natural disasters, etc.
- 2) is caused by inappropriate handling of the unit, such as dropping it while moving it after purchasing.
- 3) is caused by handling counter to the instructions or precautions listed in the operating manual.
- 4) is caused by modifying the unit or by being considered to be your responsibility because of inappropriate use.

We will not be responsible for direct or indirect damage caused by use of this product or by a failure of this product.

Warm-up time

In order to stabilize the electric performance at the time of turning on the unit, please perform warming-up for at least 10 minutes.

Precautions for storage

- 1) Strictly observe the storage conditions specified for this unit, such as avoiding direct sunlight and dust.
- 2) Store this unit in a place where -20°C to 60°C , less than $60^{\circ}\text{C}/70\%RH$, variations in temperature and humidity are small.

After service

If you have any question about the contents of this product or how to operate it, please contact us at:

B&K Precision Corporation

22820 Savi Ranch Parkway – Yorba Linda, CA 92887

TEL. 714-921-9095

FAX. 714-921-6422

URL: <http://www.bkprecision.com>

E-mail: sales@bkprecision.com

Contents

1. Outlines	1
1.1 Product outlines	2
1.2 Standard accessories	2
1.3 Optical accessories	2
2. Specifications	3
2.1 2650 performances	3
2.2 2658 performances	7
2.3 Outline	10
3. Description of Panel	11
4. Description of Screen	14
5. Function Key Menu	15
5.1 List of the function key menus	15
5.2 Menu tree	16
6. Preparing for Operation	21
6.1 Stand	21
6.2 Connection to power supply	21
6.3 Replacing the fuse	22
6.4 Installing the battery	22
6.5 Soft carrying case	22
7. Center Frequency <FREQ>	23
7.1 Setting with the step keys	23
7.2 Setting with the encoder	23
7.3 Setting with the numeric keys	23
7.4 According to the marker position	24
8. Frequency Span 	24
9. Reference Level <REFER>	25
9.1 Setting the reference level	26
9.2 Switching units of amplitude axis	26
9.3 Reference level setting range for each unit	26
9.4 Relation between the reference level and ATT·AMP	27
9.5 Setting the offset level	27
9.6 Setting the input impedance correction	28
10. Display Scale <SCALE>	28
10.1 Setting with the keys	28
10.2 Setting with the encoder	28
11. Resolution Bandwidth <RBW>	29
11.1 MANUAL mode	29
11.2 AUTO mode	29
11.3 ALL AUTO mode	29
12. Video Bandwidth <VBW>	29
12.1 MANUAL mode	30
12.2 AUTO mode	30
12.3 ALL AUTO mode	30
13. Sweep Axis · Detection mode <SWEEP>	30
13.1 MANUAL mode	30
13.2 AUTO mode	30
13.3 ALL AUTO mode	31
13.4 Setting the detection mode	31
14. AUTO Tuning <AUTO TUNE>	31
15. Hold/Run <HOLD/RUN>	31

16. Calculation Function <CALC>	31
16.1 NORM mode	32
16.2 MAX HOLD mode	32
16.3 MIN HOLD mode	32
16.4 AVERAGE mode	32
16.5 OVER WRITE mode	33
16.6 SPURIOUS FREE mode	33
17. Marker · Peak Search <MKR>	34
17.1 Moving the marker	34
17.2 Setting the peak search <PEAK SEARCH>	35
17.3 Changing the unit of marker point	35
18. Save/Load <SAVE/LOAD>	36
18.1 Saving the data	36
18.2 Loading the data	36
18.3 Clearing the data	37
18.4 Clearing the loaded trace	37
18.5 Presetting (Initialization)	37
19. Measuring Function <MEAS>	38
19.1 Channel power measurement <Ch Power>	39
19.2 Adjacent channel leakage power measurement <Adj Ch Pw>	40
19.3 Occupied frequency bandwidth measurement <Occ Bw>	41
19.4 Electric field strength measurement <E/F ANT>	42
19.5 Magnetic field strength measurement <M/F PROBE>.(optional)	47
20. Screen Control <DSPL>	49
20.1 Adjusting the contrast	49
20.2 Switching ON and OFF the LCD backlight	49
20.3 Adjusting the brightness of the LCD backlight	49
20.4 Inverting the display	49
20.5 Enabling or disabling the beep	49
21. Printing <PRINT> (optional)	50
21.1 Hard copy of the screen	50
22. Data Output <RS232C>	51
22.1 Selecting the trace to transfer	51
22.2 Selecting the communication speed (baud rate)	51
22.3 Transfer the data	51
23. RS-232C Interface	53
23.1 RS-232C specifications	53
23.2 How to connect	53
23.3 Command description	53
23.4 Input the frequency	59
23.5 Writing of original compensation data	59
23.6 Sample Programs	61
24. PC Software Model AK 2650 (optional)	61
25. Basis Performance Test (2650 only)	63
25.1 Frequency characteristics	63
25.2 Accuracy of reference level	64
25.3 The display accuracy of the center frequency	64
25.4 The display accuracy of the frequency span	65
25.5 Linearity of the amplitude axis	

1. Outlines

2650/2658

1.1 Product outlines

2650/2658 is an authentic spectrum analyzer providing performance and functions that are comparable to those of large-size bench type equipment, in a compact, lightweight and inexpensive model.

1) Compact and lightweight, 1.8 kg(2650/2658)

The external dimensions are as small as (W×H×D) 6.4×2.8×10.2” (162×70×260 mm), and the weight is only 3.7 lb. (1.8 kg) including the battery. It is very convenient for outdoor use and while on business trips.

2) Measuring frequency bandwidth 50kHz to 3.3GHz(2650)/ 50kHz to 8.5GHz(2658)

This bandwidth covers those of W-CDMA, CDMA, PDC, PHS, GSM, 2.4GHz band wireless LAN, Bluetooth, etc.

3) Operation with battery for 120 minutes

When battery BP 2650 is new & fully charged, 2650/2658 works for about 120 minutes (with the back light turned off). It is extremely convenient for outdoor use and for use in the survey of wireless LAN installation environment.

4) Performance that is comparable to that of large-size bench type equipment

2650/2658 guarantees a highly stable frequency axis by PLL synthesizer system. The center frequency setup resolution is 100kHz. Furthermore, the mean noise level is -110dBm or less. Thus, a broad dynamic range is secured and the reference level can be set in 1 dB steps.

5) Abundant functions

- Measuring functions... Channel power measurement, Adjacent channel leakage power measurement, Occupied frequency bandwidth measurement, Electric field strength measurement, Magnetic field strength measurement (optional).
 - * Electric field strength measurement: Optimum for measurement of cellular phone and wireless LAN working environment.
 - * Magnetic field strength measurement: Optimum for EMI design of printed circuit boards and for evaluation of signal quality.
- Calculation functions... MAX HOLD, MIN HOLD, AVERAGE, OVER WRITE
- Marker & peak search
- Save/load

6) Auto tuning

The center frequency is set at the spectrum of the maximum level in the 3.3GHz(2650)/8.5GHz(2658) band, and in addition, optimum reference level, resolution bandwidth, video bandwidth and sweep time are set when the AUTO TUNE key is pressed. This function is very convenient for measurement of an unknown signal.

7) Auto range motion

The resolution bandwidth, video bandwidth and sweep time are set automatically based on the set frequency span. It is also possible to set auto range motion only one out of resolution bandwidth, video bandwidth and sweep time.

8) Hard copy of the image

Connect a printer PT 2650 (optional) and press the [PRINT] key on 2650/2658. The image on the screen is printed as it is.

9) High resolution display on the PC screen

The trace is displayed at high resolution, 1001 points in the horizontal axis, on the PC screen when “PC Software AK 2650” (optional) is used.

1.2 Standard accessories

1. AC adaptor BC 2650
2. Soft carrying case LC 2650
3. Accessory pouch
4. Fuse (It has been installed in the inside)
5. Operating manual
6. Ni-MH Battery BP 2650 (Refer to “6.4 Installing the battery” for details.)

1.3 Optional accessories

1. Antenna AN 301, AN 302, AN 303, AN 304, AN 305, AN 306
(Refer to “19.4 Electric field strength measurement” for details.)
2. Magnetic field probe PR 26M with a dedicated double shielded coaxial cable
(Refer to “19.5 Magnetic field strength measurement” for details.)
3. PC software AK 2650 (Refer to “24. PC Software” for details.)
4. Printer PT 2650 with AC adaptor. 4pcs of AA batteries, a roll paper (Refer to “21. Printing” for details.)
5. Roll paper PX 2650 for optional printer PT 2650(with 10 rolls)
6. SMA coaxial cables

Model	Connector	Cable length	Frequency range
CC 301	SMA(P)/SMA(P)	1.6ft (0.5m)	DC to 10GHz
CC 302	SMA(P)/SMA(P)	3.28ft (1.0m)	DC to 10GHz
CC 303	SMA(P)/SMA(P)	4.92ft (1.5m)	DC to 10GHz
CC 304	SMA(P)/N(J)	6.5 inch (0.2m)	DC to 4GHz
CC 305	SMA(P)/N(P)	6.5 inch (0.2m)	DC to 4GHz
CC 306	SMA(P)/BNC(J)	6.5 inch (0.2m)	DC to 2GHz
CC 307	SMA(P)/BNC(P)	6.5 inch (0.2m)	DC to 2GHz

* All impedance is 50Ω.

* Performances change by bending and deteriorate by repeating the insertion and extraction.

2. Specifications

2.1 Performances

2650

• Frequency section

Frequency range	50kHz to 3.3GHz
Center frequency	
Setting resolution	100kHz Allows Rotary encoder, numeric key and function key
Accuracy	within $\pm(30+20T)$ kHz ± 1 dot (frequency span: 200kHz to 10MHz, RBW: 30kHz, 23 $\pm 5^{\circ}$ C) T: Sweep time(s) within $\pm(100+700T)$ kHz ± 1 dot (frequency span: 20MHz to 3.3GHz, RBW: 100kHz, 23 $\pm 5^{\circ}$ C) T: Sweep time(s)
RBW frequency error	within $\pm 6\%$ of RBW (RBW: 3kHz, 30kHz) within $\pm 30\%$ of RBW (RBW: 100kHz to 3MHz)
Frequency span	
Setting range	0Hz(zero span), 200kHz to 2GHz(1-2-5step) and 3.3GHz(full span)
Accuracy	within $\pm 3\% \pm 20$ TkHz ± 1 dot (frequency span: 200kHz to 10MHz, 23 $\pm 5^{\circ}$ C) within $\pm 3\% \pm 200$ TkHz ± 1 dot (frequency span: 20MHz to 3.3GHz, 23 $\pm 5^{\circ}$ C) T: Sweep time(s)
Display resolution	Frequency span/250 Frequency span/1000 (only the measurement by RS-232C communication)
Display dot number	251 dots, 1001 dots (only the measurement by RS-232C communication) (The unit displays data in 251 horizontal dots, but it internally captures the trace in 1001 dots)
Resolution bandwidth	3dB bandwidth
Setting range	3kHz to 3MHz(1-3step) and AUTO
Accuracy	within $\pm 20\%$
Selectivity	1:12 (typical, 3dB : 60dB)
Video bandwidth	100Hz to 1MHz(1-3step), and AUTO
SSB phase noise	-90dBc/Hz (typical, 100kHz offset, RBW: 3kHz, VBW: 100Hz, Sweep time: 0.3s)
Spurious response	less than -60dBc
Harmonics	less than -40dBc (100MHz to 3.3GHz)

• Amplitude section

Reference level	
Setting range	+10 to -60dBm (1dB step)
Accuracy	within ± 0.8 dB ± 1 dot (center frequency: 100MHz, RBW: 3MHz, VBW: 1MHz, ATT: 0dB, 23 $\pm 5^{\circ}$ C)

Unit	dBm, dBV, dBmV, dB μ V, dB μ V/m, dB μ A/m (dB μ V/m and dB μ A/m is used the measuring function)
Average noise level	-110dBm (typical, center frequency: 100MHz, RBW: 3kHz, VBW: 100Hz)
Frequency Characteristic	within $\pm 2.0\text{dB} \pm 1\text{dot}$ (100kHz to 100MHz) within $\pm 1.0\text{dB} \pm 1\text{dot}$ (100MHz to 3.3GHz)
Input impedance	50 Ω
Input VSWR	less than 2.0
Input attenuator	
Operating range	0 to 25dB (1dB step), coupled with reference level
Switching error	within $\pm 0.6\text{dB}$
RBW switching error	within $\pm 0.6\text{dB}$
Display dot number	200dots
Display scale	
Scale	10dB/div, 2dB/div
Accuracy	within $\pm 0.8\text{dB}/10\text{dB} \pm 1\text{dot}$ within $\pm 0.2\text{dB}/2\text{dB} \pm 1\text{dot}$ within $\pm 1.6\text{dB}/70\text{dB} \pm 1\text{dot}$
Input damage level	+23dBm(CW average power), 25VDC
• Sweep section <hr/>	
Sweep time	
Setting range	10ms to 30s (1-3step, frequency span: 0 to 2GHz) and AUTO 30ms to 30s (1-3step, frequency span: full span) and AUTO
Accuracy	within $\pm 0.1\% \pm 1\text{dot}$ (frequency span: 0 to 2GHz) within $\pm 1.5\% \pm 1\text{dot}$ (frequency span: full span)
Trigger mode	AUTO(frequency span: zero span)
Detection mode	Positive peak, Negative peak, Sample (When sweep time is 10ms or 30ms, only Sample can be set)
• Functions <hr/>	
Marker	NORM: displays frequency (7digits max) and level (4digits max) at marker point. DELTA: displays differential frequency and level between 2 markers.
Peak search	NORM: searches a peak point within 10div. Available NEXT peak (10max). ZONE: searches a peak point within a zone designated by center and width. Marker moves to a peak point each sweep.

Calculation	NORM, MAX HOLD, MIN HOLD, AVERAGE, OVER WRITE MAX/MIN HOLD: 2 to 1024 times, AVERAGE: 2 to 256
Measuring	Channel power, Adjacent channel leakage power, Occupied frequency bandwidth, Electric field strength (needs antenna), Magnetic field strength (needs optional magnetic field probe) measurement.
AUTO tuning	When pushing AUTO TUNE key, the maximum level spectrum within 3.3GHz bandwidth is adjusted to center, and reference level, RBW, VBW and sweep time are adjusted to optimum values.
Save/Load	
Save	Saves 100 traces and 100 setups
Load	Loads 1 trace and 1 setup

• **General**

Immunity of radiated interference

Level display at 10V/m Less than -35dBc (reference level: 10dBm)

Immunity to cabled interference

Level display at transient interference of 4.0kV Less than -30dBc (reference level: 10dBm)

Input connector SMA(J)

Communication

Interface RS-232C

Baud rate 2400 to 38400bps

Hard copy Allows direct hard copy with an optional printer.

Display

Display LCD

Backlight CFL backlight

Resolution 240 (V) × 320 (H) dots

Power source

Battery Ni-MH battery (optional)

External DC source DC jack,+4.75 to +5.25 VDC/4A

• **Other**

Operating temperature	0 to 40°C (Guaranteed at 23±10°C, without soft carrying case)
Operating humidity	less than 40°C/80%RH (Guaranteed at less than 33°C /70%RH, without soft carrying case)
Storage temperature	-20 to 60°C, less than 60°C/70%RH
Dimensions	162 (W) × 70 (H) × 260 (D) mm (exclude projections and stand)
Weight	approx. 1.8kg (include battery), approx. 1.5kg (without battery)

Specification and information is subject to change without notice.
Please visit www.bkprecision.com for the most current product information

2.2 Performances

• Frequency section

Frequency range	50kHz to 8.5GHz
Center frequency	
Setting resolution	100kHz Allows Rotary encoder, numeric key and function key
Accuracy	within $\pm(30+20T)$ kHz ± 1 dot (frequency span: 200kHz to 10MHz, RBW: 30kHz, 23 $\pm 5^{\circ}$ C) T: Sweep time(s) within $\pm(60+300T)$ kHz ± 1 dot (frequency span: 20MHz to 8.5GHz, RBW: 100kHz, 23 $\pm 5^{\circ}$ C) T: Sweep time(s)
RBW frequency error	within $\pm 6\%$ of RBW (RBW: 3kHz, 30kHz) within $\pm 30\%$ of RBW (RBW: 100kHz to 3MHz)
Frequency span	
Setting range	0Hz(zero span), 200kHz to 5GHz(1-2-5step) and 8.5GHz(full span)
Accuracy	within $\pm 3\% \pm 20$ TkHz ± 1 dot (frequency span: 200kHz to 10MHz, 23 $\pm 5^{\circ}$ C) within $\pm 3\% \pm 200$ TkHz ± 1 dot (frequency span: 20MHz to 8.5GHz, 23 $\pm 5^{\circ}$ C) T: Sweep time(s)
Display resolution	Frequency span/250 Frequency span/1000 (only the measurement by RS-232C communication)
Display dot number	251dots, 1001dots (only the measurement by RS-232C communication) (The unit displays data in 251 horizontal dots, but it internally captures the trace in 1001 dots)
Resolution bandwidth	3dB bandwidth
Setting range	3kHz to 3MHz(1-3step) and AUTO
Accuracy	within $\pm 20\%$
Selectivity	1:12 (typical, 3dB : 60dB)
Video bandwidth	100Hz to 1MHz(1-3step), and AUTO
SSB phase noise	-90dBc/Hz (typical, 100kHz offset, RBW: 3kHz, VBW: 100Hz, Sweep time: 0.3s)
Spurious response	less than -60dBc
Harmonics	less than -40dBc (100MHz to 8.5GHz)

• Amplitude section

Reference level	
Setting range	+10 to -60dBm (1dB step)
Accuracy	within ± 0.8 dB ± 1 dot (center frequency: 100MHz, RBW: 3MHz, VBW: 1MHz, ATT: 0dB, 23 $\pm 5^{\circ}$ C)

Unit	dBm, dBV, dBmV, dB μ V, dB μ V/m, dB μ A/m (dB μ V/m and dB μ A/m is used the measuring function)
Average noise level	-110dBm (typical, center frequency: 1GHz, RBW: 3kHz, VBW: 100Hz)
Frequency Characteristic	within $\pm 2.0\text{dB} \pm 1\text{dot}$ (100kHz to 100MHz) within $\pm 1.0\text{dB} \pm 1\text{dot}$ (100MHz to 8.5GHz)
Input impedance	50 Ω
Input VSWR	less than 2.0
Input attenuator	
Operating range	0 to 25dB (1dB step), coupled with reference level
Switching error	within $\pm 0.6\text{dB}$
RBW switching error	within $\pm 0.6\text{dB}$
Display dot number	200dots
Display scale	
Scale	10dB/div, 2dB/div
Accuracy	within $\pm 0.8\text{dB}/10\text{dB} \pm 1\text{dot}$ within $\pm 0.2\text{dB}/2\text{dB} \pm 1\text{dot}$ within $\pm 1.6\text{dB}/70\text{dB} \pm 1\text{dot}$
Input damage level	+23dBm(CW average power), 25VDC
• Sweep section <hr/>	
Sweep time	
Setting range	10ms to 30s (1-3step, frequency span: 0 to 2GHz) and AUTO 30ms to 30s (1-3step, frequency span: 5GHz) and AUTO
Accuracy	within $\pm 0.1\% \pm 1\text{dot}$ (frequency span: 0 to 5GHz) within $\pm 2.5\% \pm 1\text{dot}$ (frequency span: full span)
Trigger mode	AUTO(frequency span: zero span)
Detection mode	Positive peak, Negative peak, Sample
• Functions <hr/>	
Marker	NORM: displays frequency (7digits max) and level (4digits max) at marker point. DELTA: displays differential frequency and level between 2 markers.
Peak search	NORM: searches a peak point within 10div. Available NEXT peak (10max). ZONE: searches a peak point within a zone designated by center and width. Marker moves to a peak point each sweep.

Calculation	NORM, MAX HOLD, MIN HOLD, AVERAGE, OVER WRITE MAX/MIN HOLD: 2 to 1024 times, AVERAGE: 2 to 256
Measuring	Channel power, Adjacent channel leakage power, Occupied frequency bandwidth, Electric field strength (needs antenna), Magnetic field strength (needs optional magnetic field probe) measurement.
AUTO tuning	When pushing AUTO TUNE key, the maximum level spectrum within 8.5GHz bandwidth is adjusted to center, and reference level, RBW, VBW and sweep time are adjusted to optimum values.
Save/Load	
Save	Saves 100 traces and 100 setups
Load	Loads 1 trace and 1 setup

• **General**

Immunity of radiated interference

Level display at 10V/m Less than -35dBc (reference level: 10dBm)

Immunity to cabled interference

Level display at transient interference of 4.0kV Less than -30dBc (reference level: 10dBm)

Input connector SMA(J)

Communication

Interface RS-232C

Baud rate 2400 to 38400bps

Hard copy Allows direct hard copy with an optional printer.

Display

Display LCD

Backlight CFL backlight

Resolution 240 (V) × 320 (H) dots

Power source

Battery Ni-MH battery (optional)

External DC source DC jack,+4.75 to +5.25 VDC/4A

• Other

Operating temperature

Operating humidity 0 to 40°C (Guaranteed at 23±10°C, without soft carrying case)
less than 40°C/80%RH

Storage temperature (Guaranteed at less than 33°C /70%RH, without soft carrying case)

Dimensions -20 to 60°C, less than 60°C/70%RH

Weight 162 (W) × 70 (H) × 260 (D) mm (exclude projections and stand)
approx. 1.8kg (include battery), approx. 1.5kg (without battery)

2.3 Outline

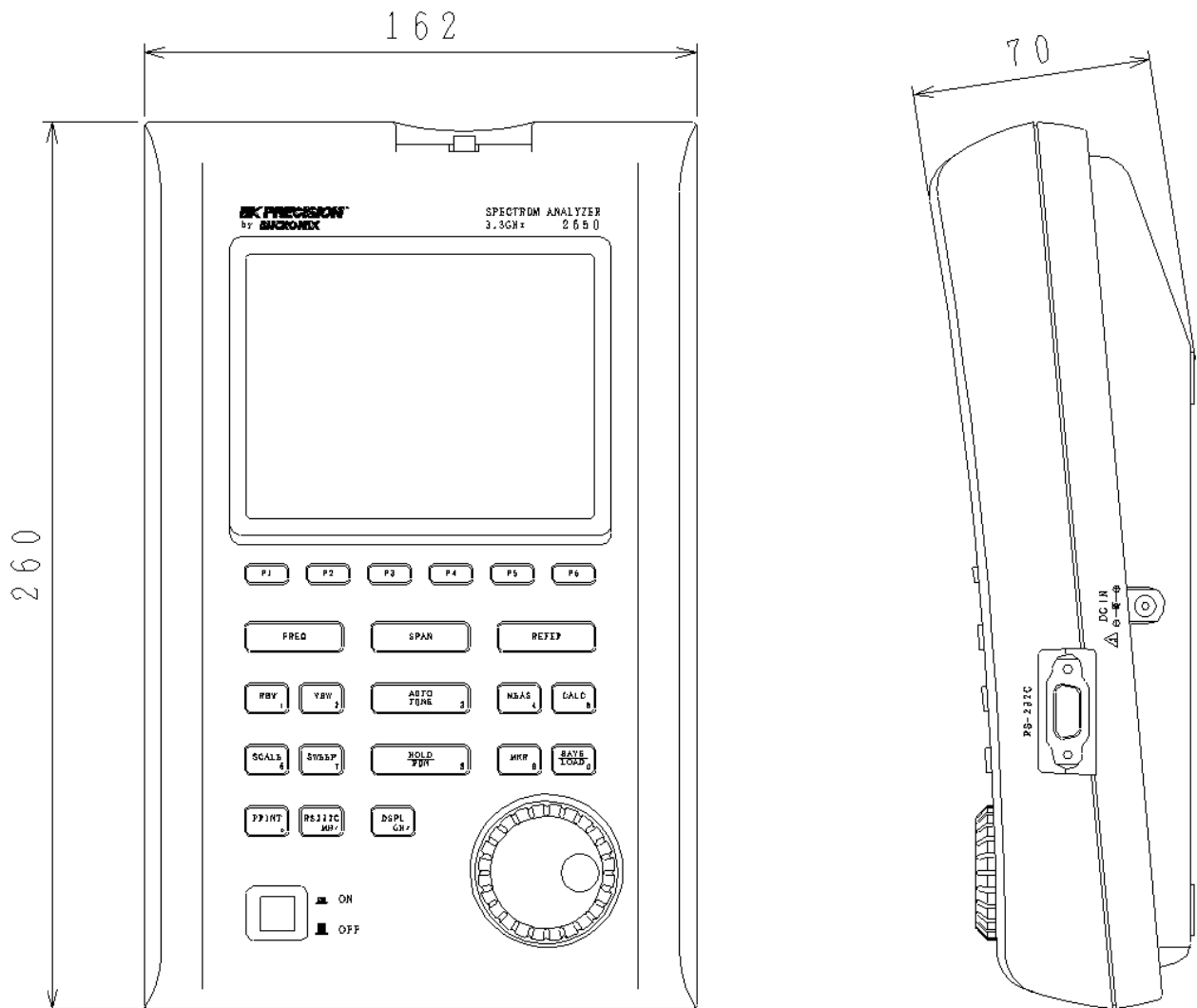

[Unit: mm]

* B&K Precision Corporation reserves the right to make changes in design, specification and other information without prior notice.

3. Description of Panel

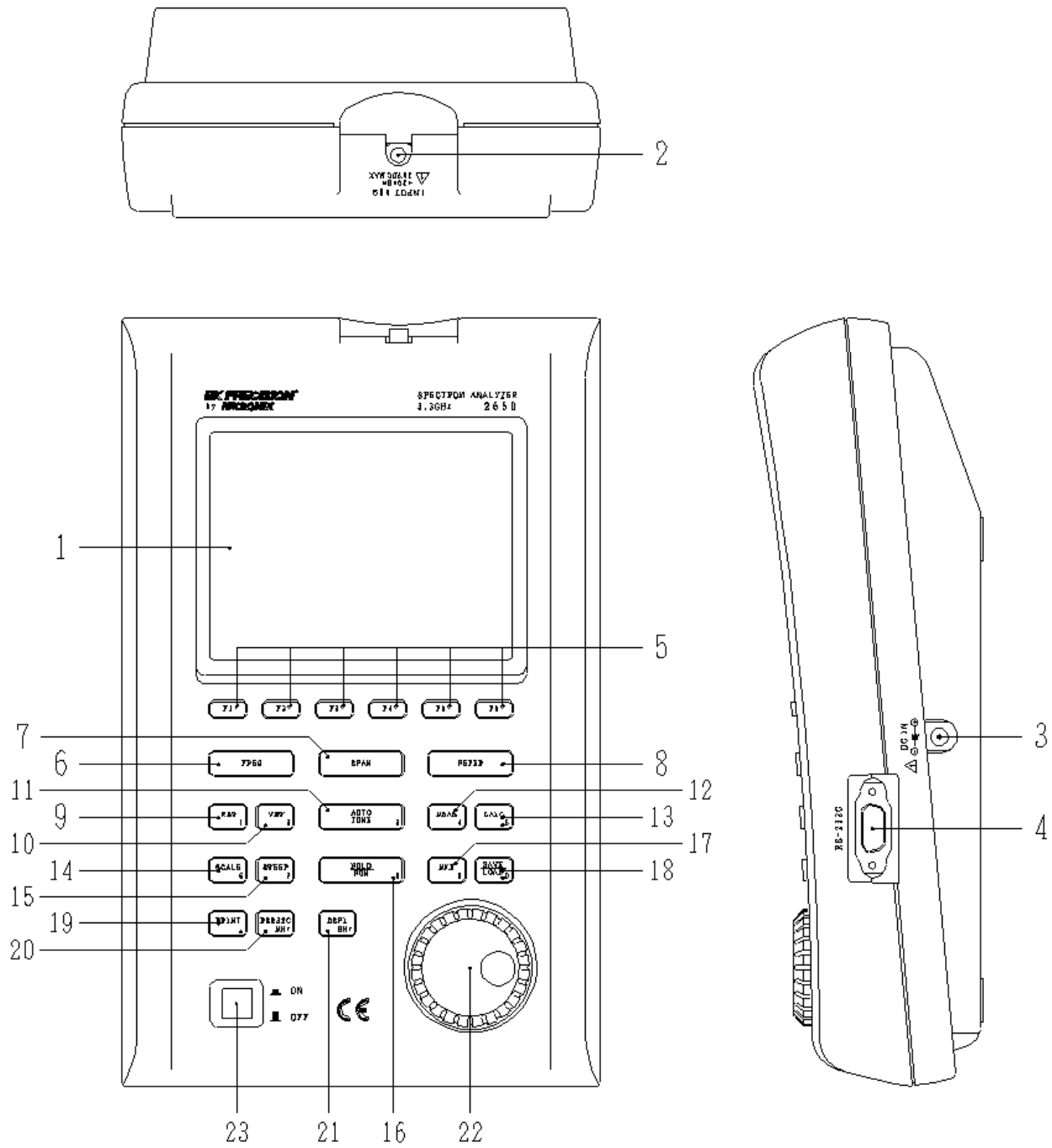

1) LCD screen

This is a large liquid crystal display with 240 (V) × 320 (H) dots. It simultaneously displays traces (8 div × 10 div), various setting values, measured values, etc.

2) Input connector

SMA (J) connector.

3) Input connector for DC power source

Connects AC adaptor BC2650.

4) RS-232C connector

Connects PC and printer, by using RS-232C cable.

5) Function keys (F1 to F6)

Functions change according to operation. Have functions corresponding to the on-screen displays.

6) Center frequency key

2650: Use this key to set the center frequency. It can set between 0 to 3.3GHz (100kHz step).

2658: Use this key to set the center frequency. It can set between 0 to 8.5GHz (100kHz step).

7) Frequency span key

2650: Use this key to set the frequency span. It can set between 200kHz to 2GHz, ZERO SPAN and FULL SPAN (3.3GHz).

2658: Use this key to set the frequency span. It can set between 200kHz to 5GHz, ZERO SPAN and FULL SPAN (8.5GHz).

8) Reference level key

Set the reference level, etc. Reference level can set between +10dBm and -60dBm (1dB step).

9) Resolution bandwidth key

Use this key to set the resolution bandwidth. It can set between 3kHz and 3MHz.

10) Video bandwidth key

Use this key to set the video bandwidth. It can set between 100Hz and 1MHz.

11) AUTO tuning key

Tune up to the maximum level in 3.3GHz(2650)/8.5GHz(2658) zones, and display by the optimal setup.

This does not operate normally when the signal level is lower than -40dBm, or when the input frequency is below 50MHz, or when the frequency span is ZERO SPAN or FULL SPAN.

12) Measuring function key

Available for Channel power, Adjacent channel leakage power, Occupied frequency bandwidth, Electric field strength and Magnetic field strength measurement (optional).

13) Calculation function key

Available for Max hold, Min hold, Average and Over write.

14) Display scale key

Use this key to select the display scale of amplitude axis from 2dB/div or 10dB/div.

15) Sweep key

Use this key to set the sweep time between 10ms to 30s or set the detection mode.

16) Hold/Run key

Stops or restarts the measurement.

17) Marker & Peak search key

Use this key to set and move a marker.

18) Save/Load key

Saves 100traces and 100setups, and loads 1trace and 1setup.

19) Print key

When pressing this key, the image is printed with a printer PT 2650 (optional) as it is.

20) RS-232C key

Sets baud rate and transfers a current or saved trace.

21) Display control key

Sets contrast, backlight ON/OFF, brightness of backlight, invert display and buzzer ON/OFF.

22) Rotary encoder

Use this to make various settings.

23) Power switch

Use this to turn the power ON or OFF.

4. Description of Screen

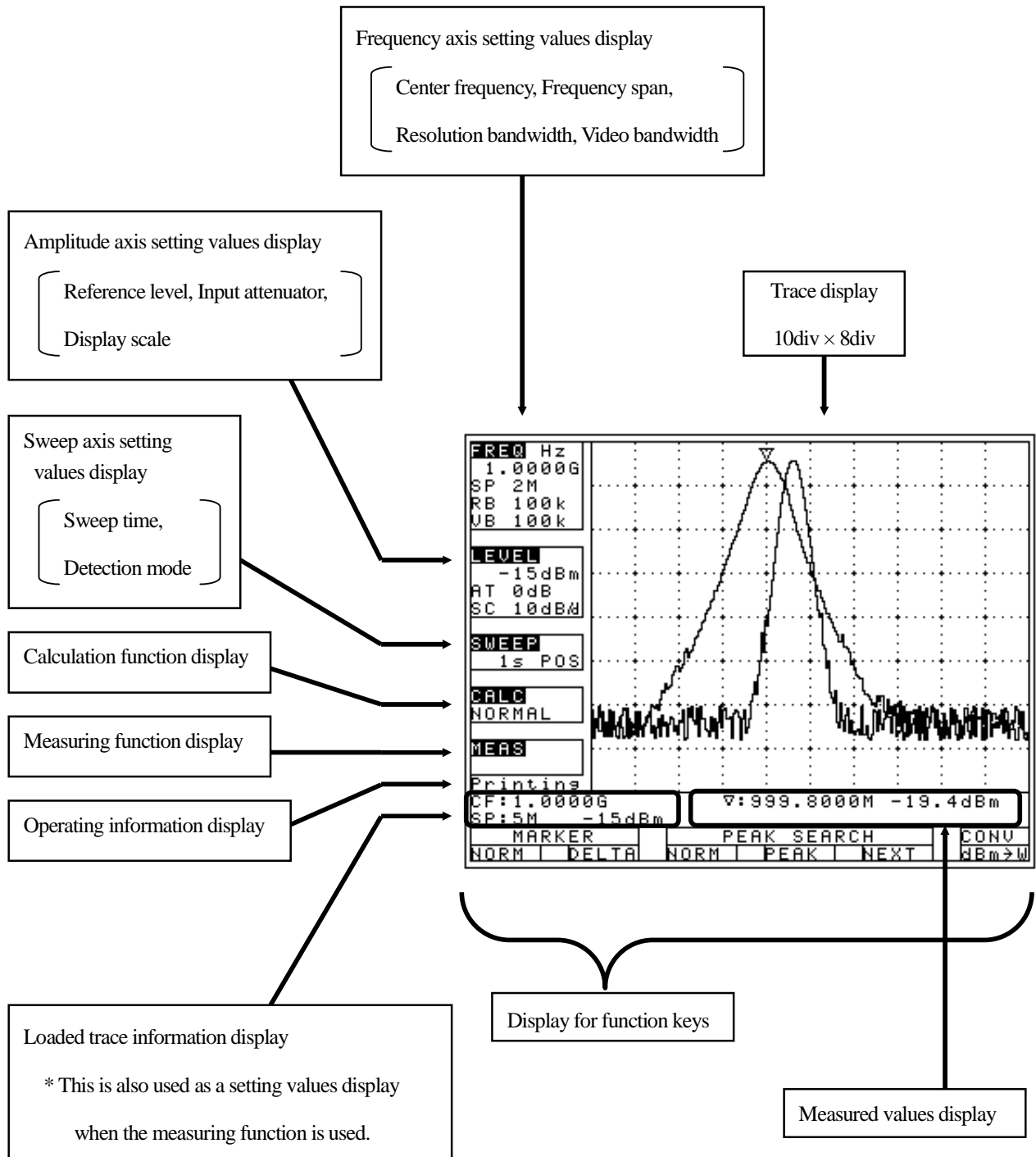

5. Function Key Menu

5.1 List of the Function key menus

The types of function keys are shown in the table below. For description of each function, see the detailed pages. For the flow of change in the function key display, refer to “5.2 Menu tree”.

	Function key menus	Key flow	Detailed page		Function key menus	Key flow	Detailed page	
A)	Adj Ch OF S	MEAS→(F6)→(F2) →F2	39	M)	MODE	MEAS→(F6)→(F1 ~3)→F1	38、 39、 40	
	Adj Ch Pw	MEAS→(F6)→F2	39		N)	NORM	CALC→F1	32
	Adj Ch W I DTH	MEAS→(F6)→(F2) →F3	39			NUM	FREQ→F5	23
	ANT	MEAS→(F6)→(F5) →F1	42		O)	Occ BW	MEAS→(F6)→F3	40
	AVER	CALC→F4	32			OF SdB	REFER→F5	27
			OVRWR	CALC→F5		33		
B)	B.L.	DSPL→F2	48	P)	PEAK SEARCH CNTR	MKR→(F3)→F4	33	
	BACK SPAC E	FREQ→F5→F6	23		PEAK SEARCH NEXT	MKR→(F3)→F5	33	
	BAND CNTR	MEAS→(F6)→(F1) → (F1)→F2	38		PEAK SEARCH NORM	MKR→(F3)→F3	33	
	BAND WIDT H	MEAS→(F6)→(F1) → (F1)→F3	38		PEAK SEARCH PEAK	MKR→(F3)→F4	33	
	BAUD	RS232C→F2	50		PEAK SEARCH WIDTH	MKR→(F3)→F5	33	
	BLCTR	DSPL→F3	48		PEAK SEARCH ZONE	MKR→(F3)→F3	33	
	BUZZR	DSPL→F5	48		PRE SET	SAVE / LOAD→F6	36	
					PROBE	MEAS→(F6)→(F5) →F1	47	
			R)		RATIO	MEAS→(F6)→(F3) →F2	40	
C)	CENTER FR EQ →	FREQ→F1		23	RBW ALL	RBW→F3	29	
	CENTER FR EQ ←	FREQ→F2		23	RBW AUTO	RBW→F2	29	
	Ch Power	MEAS→(F6)→F1		38	RBW MANU	RBW→F1	29	
	CLEAR	SAVE / LOAD→F3		36	REFERENCE CN TR	MEAS→(F6)→(F2) →F4	38	
	CONV	MKR→F6		34	REFERENCE WI DTH	MEAS→(F6)→(F2) →F5	38	
	CTRS	DSPL→F1		48				
D)	DET	SWEEP→F4	30					
	DISP CLEA R	SAVE / LOAD→F4	36					

E)	E / F ANT	MEAS→(F 6)→(F 3) →F 4	4 1
	EncST	FREQ→F 4	2 3
	EXEC	RS 2 3 2 C→F 3	5 0
I)	IMP	REFER→F 6	2 8
	INVT	DSPL→F 4	4 8
K)	KeyST	FREQ→F 3	2 3
L M)	LOAD	SAVE / LOAD→F 2	3 5
	M / F PROBE	MEAS→(F 6)→F 5	4 6
	MAXHD	CALC→F 2	3 2
	MEAS OFF	MEAS→(F 1~5)→F 6	3 7
	MINHD	CALC→F 3	3 2
	MKR DELTA	MKR→F 2	3 3
	MKR NORM	MKR→F 1	3 3

S)	SAVE	SAVE / LOAD→F 1	3 5
	SCALE 10 dB	SCALE→F 1	2 8
	SCALE 2 dB	SCALE→F 2	2 8
	SET MKR	FREQ→F 6	2 4
	SWEEP ALL	SWEEP→F 3	3 0
	SWEEP AUTO	SWEEP→F 2	3 0
	SWEEP MANU	SWEEP→F 1	3 0
	TRACE	RS 2 3 2 C→F 1	5 0
	UNIT	REFER→F 1~4	2 6
V)	VBW ALL	VBW→F 3	3 0
	VBW AUTO	VBW→F 2	3 0
	VBW MANU	VBW→F 1	3 0

5.2 Menu tree

The displayed items on the bottom of the screen correspond to the function keys under them, as shown in the figure below:

“Displayed items on the bottom of the screen”

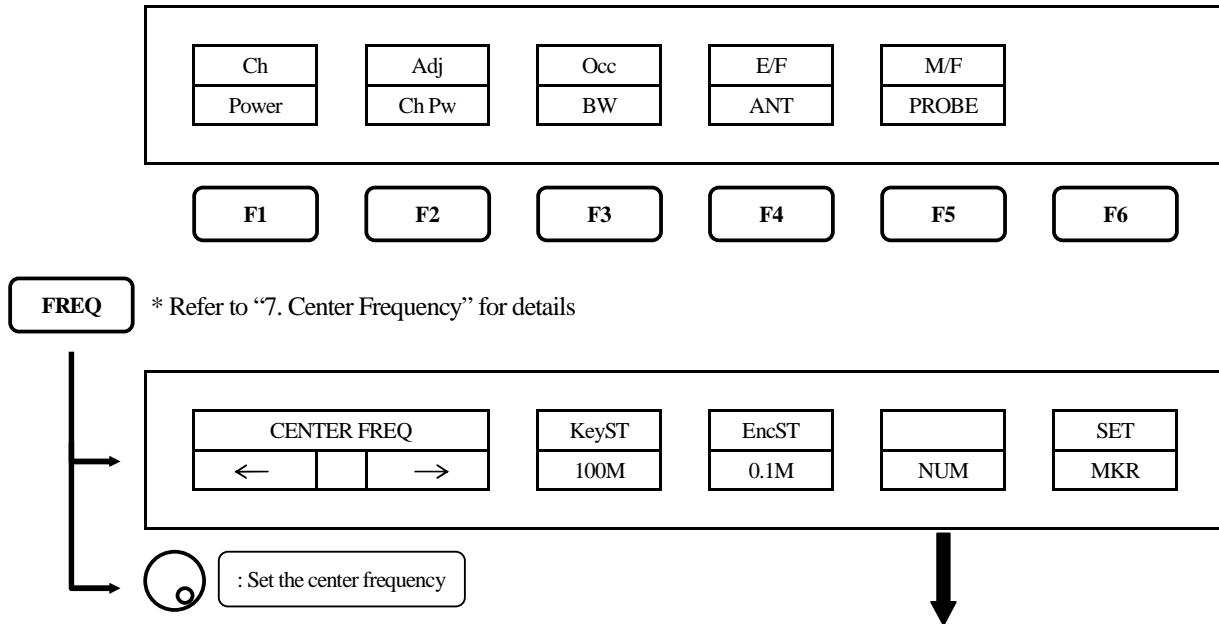



REFER * Refer to "9. Reference Level" for details

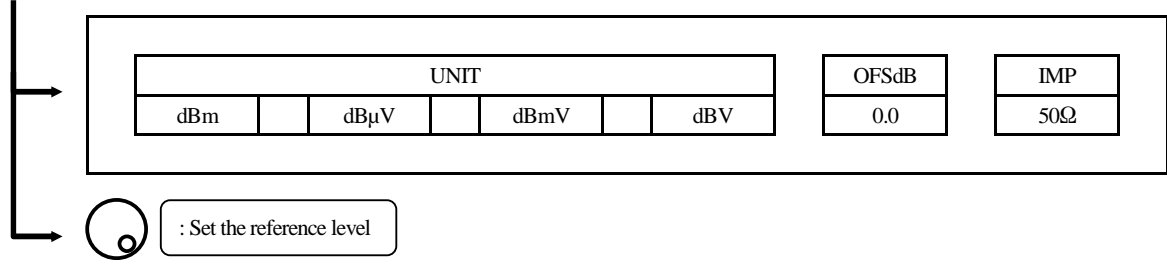

RBW * Refer to "11. Resolution Bandwidth" for details

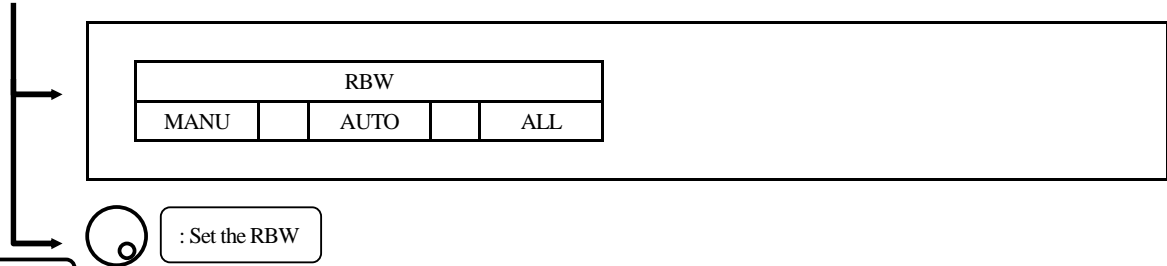

VBW * Refer to "12. Video Bandwidth" for details

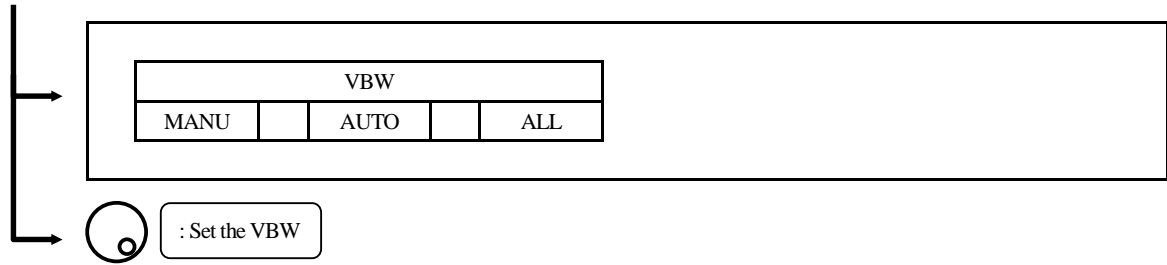

MEAS (1/2) * Refer to "19. Measuring Function" for details

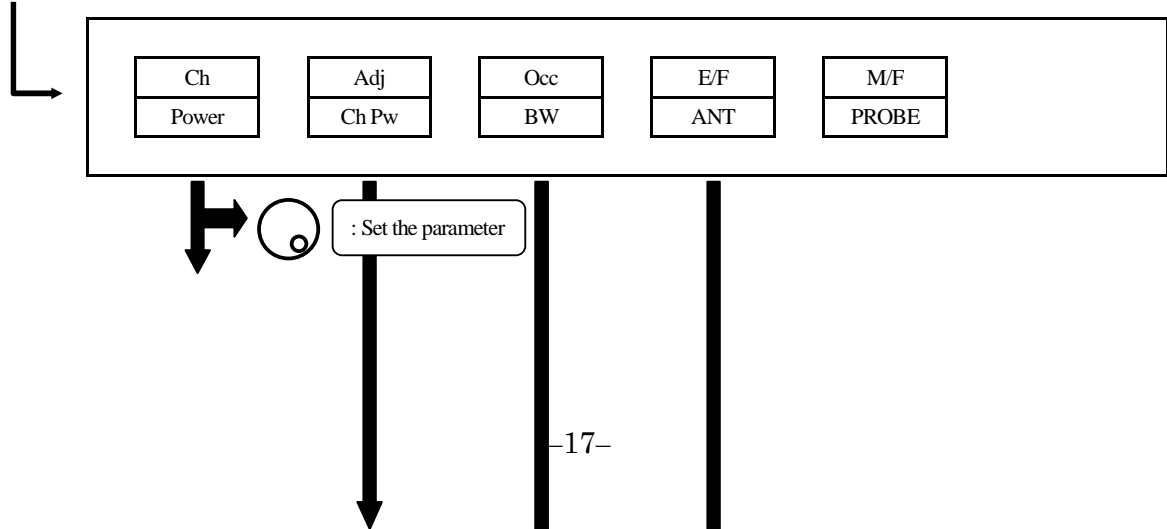

MODE	BAND		MEAS
BAND	CNTR	WIDTH	OFF

➔  : Set the parameter

MODE	Adj Ch Pw		REFERENCE	MEAS	
TOTAL	OFS	WIDTH	CNTR	WIDTH	OFF

➔  : Set the parameter

MODE	RATIO	MEAS
N%	99.5%	OFF

ANT	MEAS
AN301	OFF

MEAS (2/2)



Ch	Adj	Occ	E/F	M/F
Power	Ch Pw	BW	ANT	PROBE

Input the probe ID (first time only) *Refer to “19.5 Magnetic field strength measurement” for details.

PROBE	MEAS
PR 26M	OFF

CALC * Refer to “16. Calculation Function” for details

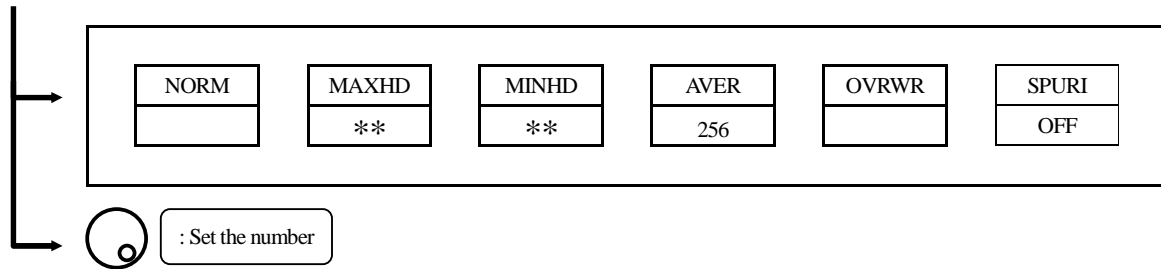

SCALE * Refer to “16. Display Scale” for details

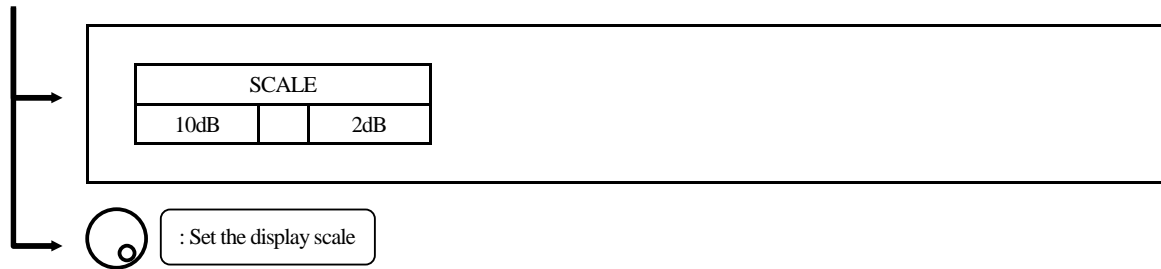

SWEEP * Refer to “12. Sweep Area Detection Mode” for details

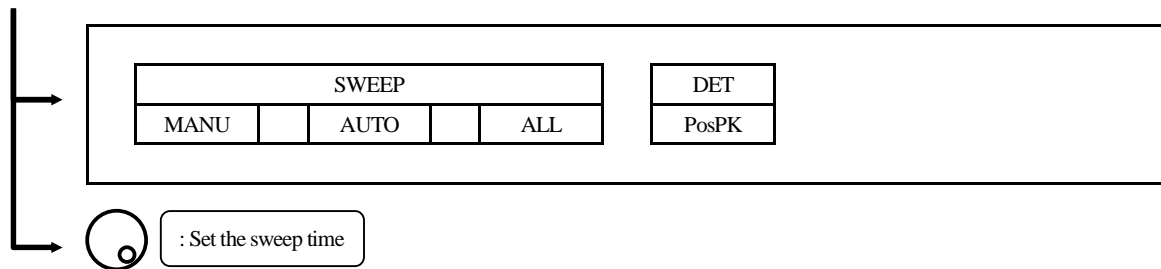

MKR * Refer to “17. Marker · Peak Search” for details
Changing for marker mode of the one that selected it last.

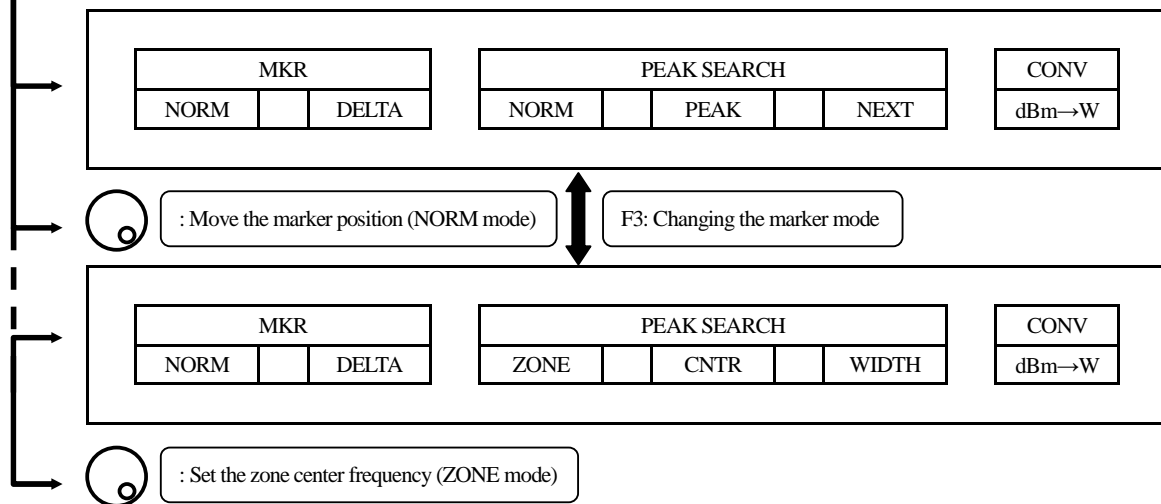

RS232C * Refer to “22. Data Output” for details

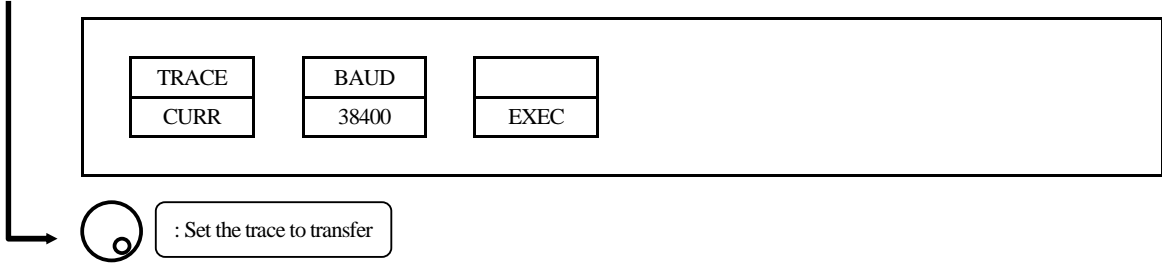

DSPL * Refer to "20. Screen Control" for details

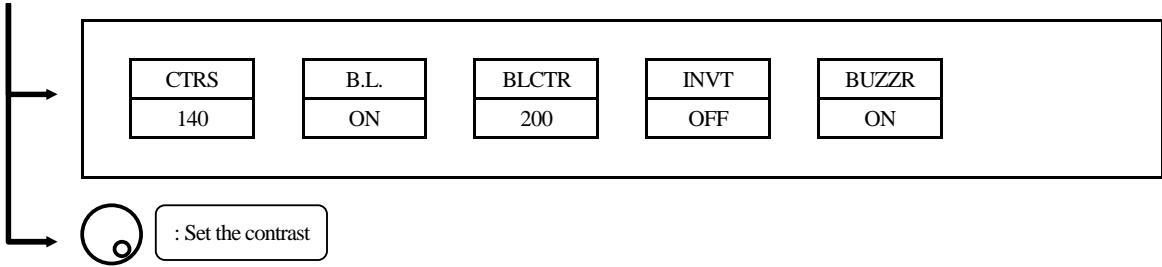

SAVE/LOAD * Refer to "18. Save/Load" for details

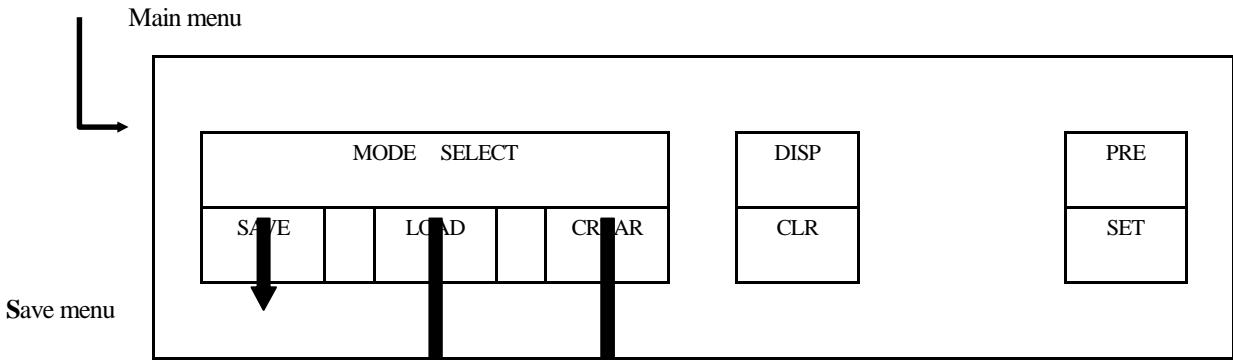

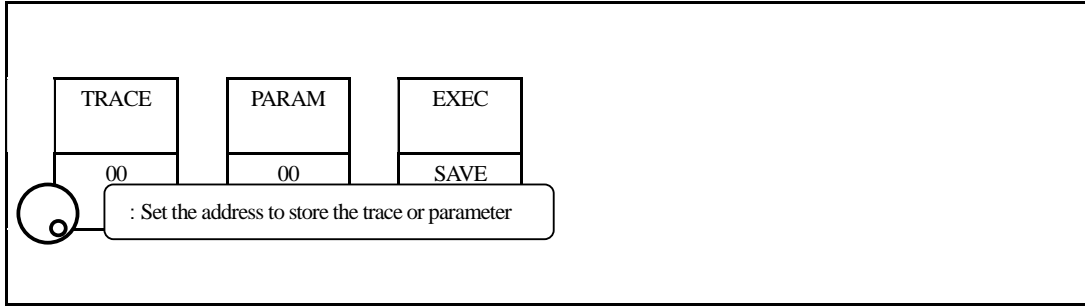

Load menu

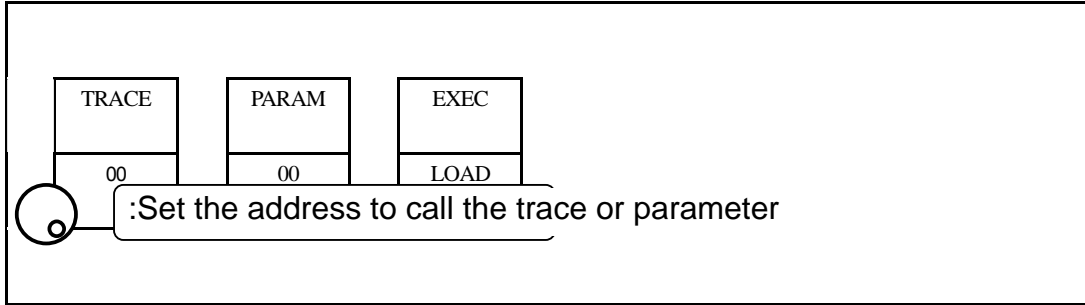

D
DDelete menu

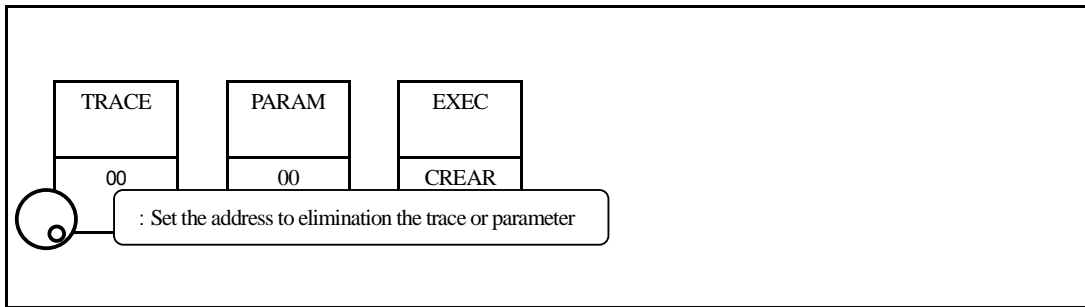

6. Preparing for Operation

6.1 Stand

Utilize the stand on the back to use the screen in an easier-to-see angle on the desk.

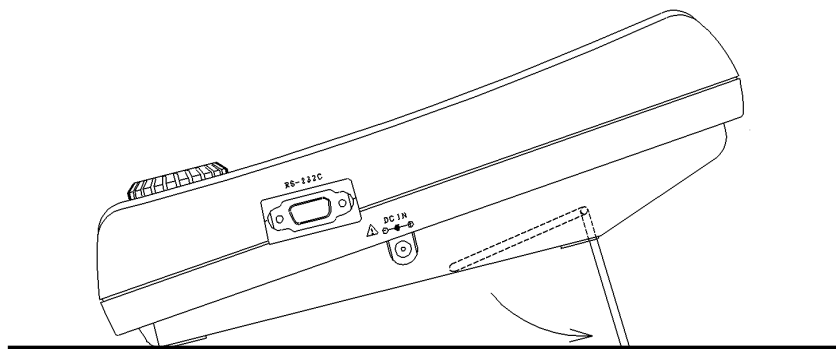

6.2 Connection to power supply

The BC 2650 AC adapter is both for the use with AC power supply and for charging the BP 2650 built-in battery (optional). (charge is started automatically if AC adapter is connected)

Connect the adapter as in the figure below and connect the AC plug to the power line (100-240 VAC, 50/60 Hz). For static electricity protection, ground the unit by connecting the three cores if possible. Not grounding the unit can damage it and the object measured. Do not use an AC adapter other than the BC 2650 supplied with the unit. Using an AC adapter other than the BC 2650 may cause damage to the unit.

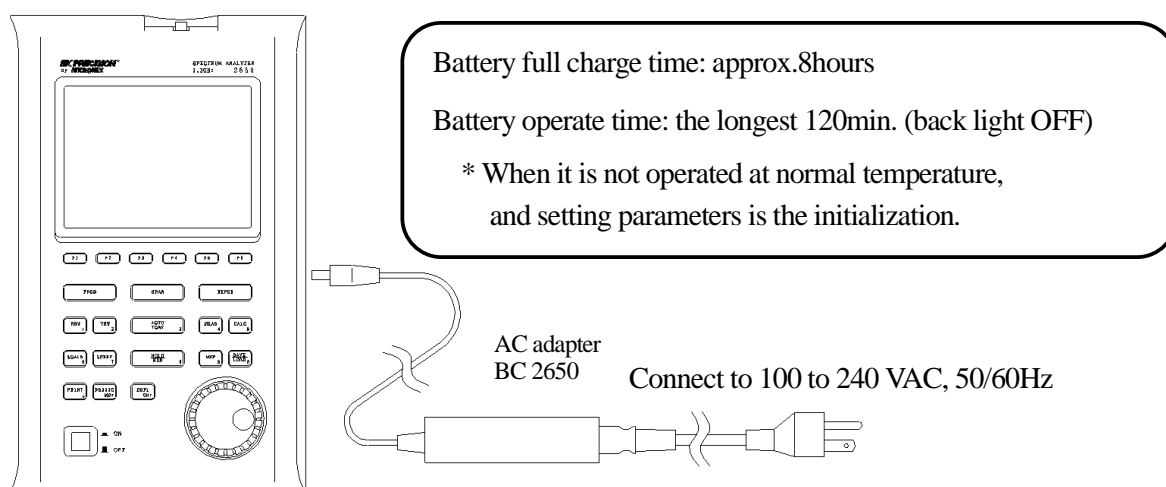

* If the voltage of a battery becomes low at the time of battery operation, it will be displayed on a screen as “Low Batt”, and a buzzer will sound (it sounds, even if it is set up so that a buzzer may not sound), and a power supply will be shut off within several minutes. At that time, since the switch is the position of “ON”, please push once and return to the position of “OFF”. If it is with the position of “ON” after a power supply is shut off, it discharges inside, will be in electric overdischarge state, and becomes the cause of contracting the life of a battery. Please take care.

- * Moreover, under low temperature (near 0°C), since a battery performance falls and voltage becomes low, even when capacity remains enough, it may display on a screen as “Low Batt”.
- * When a battery repeats charge and electric discharge, the fall (the fall of capacity and increase in internal resistance) of a battery performance begins from about 200 times, and capacity falls to the original half by about 500 times also under good conditions. On bad conditions (high temperature, etc.), the life of battery will be shorter than this.

6.3 Replacing the fuse

5A/250V fuse (IEC127-2 sheet3, slow-blow type) is used for the battery power supply. When replacing it, turn the power off first, disconnect the AC adapter, remove the battery cover and on the back as shown in the figure below, remove the battery, and then take sufficient care to perform the replacement.

Be sure to use the fuse supplied with the unit, or specified one.

6.4 Installing the battery

When installing the battery, turn the power off first, disconnect the AC adapter, open the battery cover on the back of the unit after removing the two screws as shown in the figure below, and then take sufficient care to perform the installation. Be sure to use the specified battery, BP 2650.

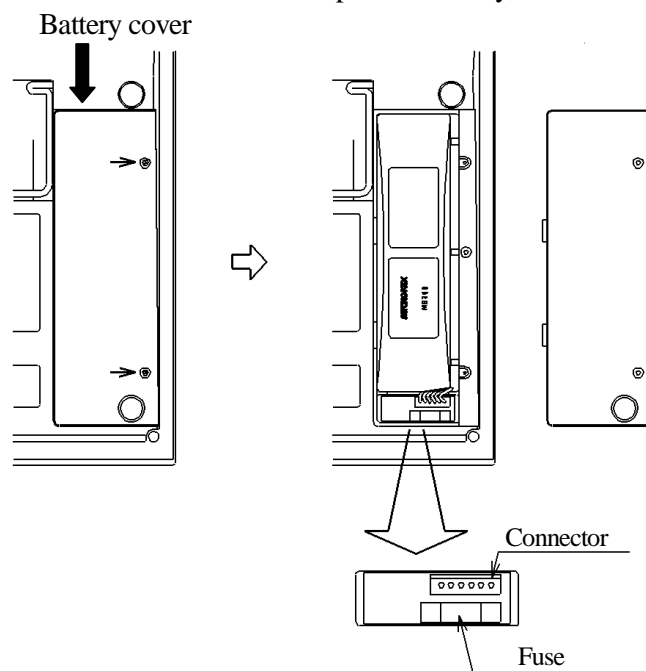

6.5 Soft carrying case

When carrying the unit or using it outdoors, the soft carrying case is convenient. You can also carry the AC adapter and printer with it, putting them in the accessory pouch.

- * Avoid using the unit in the soft carrying case in places where temperature is high because, with the soft carrying case, the temperature inside becomes higher than the ambient temperature.

7. Center Frequency <FREQ>

Press **FREQ** to switch over to the function screen shown below:

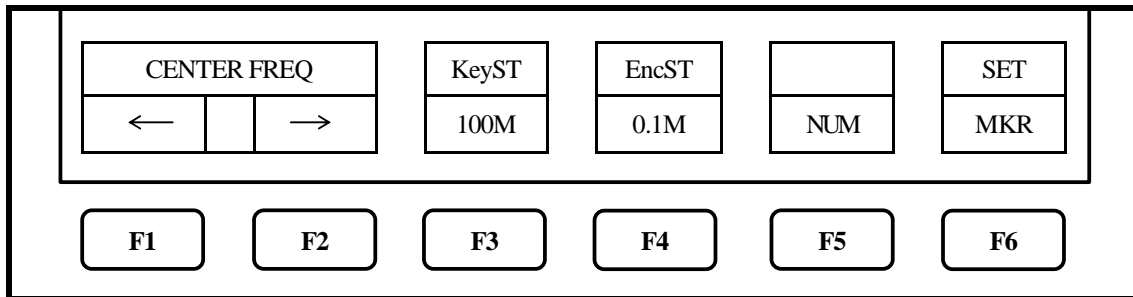

* Center frequency can be set between 0 to 3.3GHz.(2650)

* Center frequency can be set between 0 to 8.5GHz.(2658)

* Center frequency may shift for the time being (1 to 10 sec.), after changing a setting.

7.1 Setting with the step keys ([F1], [F2])

1. Each time **F1** is pressed, the center frequency decreases in the set step size.
2. Each time **F2** is pressed, the center frequency increases in the set step size.
3. Setting the step size:

Each time **F3** is pressed, it is set in the following order:

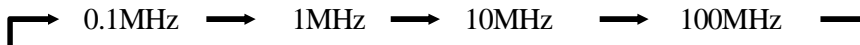

7.2 Setting with the encoder

1. When  is turned, the center frequency changes in the set step size.
2. Setting the step size:

Each time **F4** is pressed, it is set in the following order:

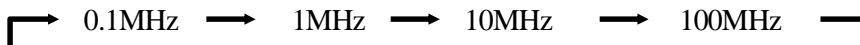

7.3 Setting with the numeric keys

1. Press **F5** to enter into the numeric key input mode.
 - * [F5] functions as the <CLEAR> key. [F6] functions as the <BACK SPACE> key.
 - * In this mode, setting with [F1], [F2] or the encoder is not accepted.
2. The center frequency can be directly input according to the “Numeric Key Mapping Diagram”.
3. The value is entered by pressing a unit key, [MHz (RS232C)] or [GHz (DSPL)].

* Any figures below the resolution (100 kHz) will be discarded.

4. Changing the setting:

F5 : Deletes the entire value and allows you to input one from the beginning.

F6 : Deletes the last input figure.

5. Canceling the numeric key mode:

FREQ : Enables setting with step keys ([F1], [F2]) or the encoder again.

“Numeric Key Mapping Diagram”

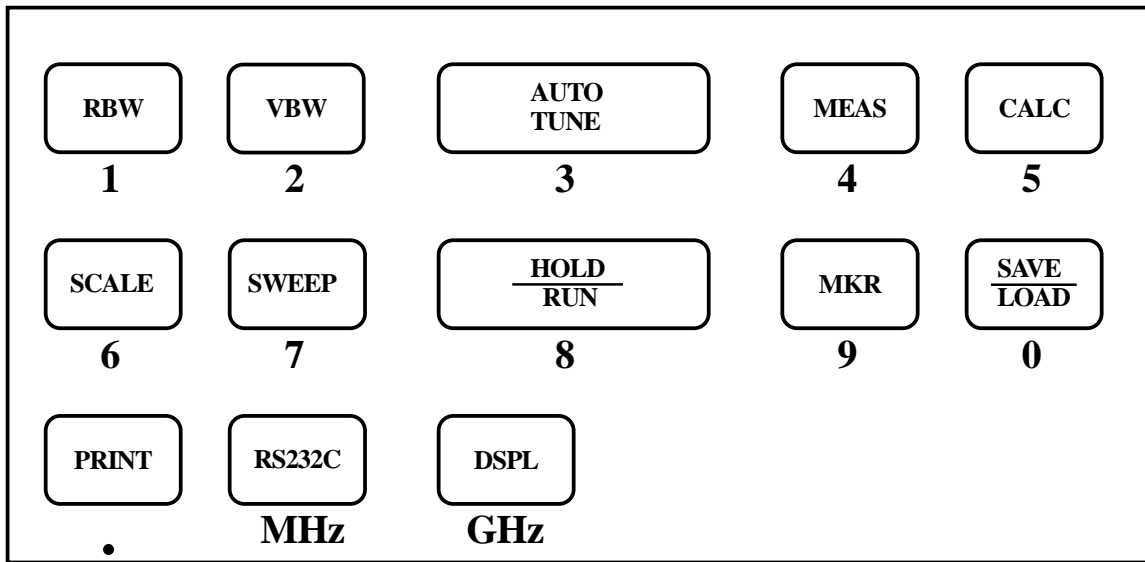

7.4 According to the Marker position

1. When **F6** is pressed, the center frequency is set according to the frequency of current marker position.

* Any figures below the resolution (100 kHz) will be discarded.

* This does not operate when the marker is not displayed. (and the function display disappears.)

**8. Frequency Span **

Press **SPAN** → Use to set the frequency span.

*The frequency span can be set only with the encoder. Function keys are not available.

2650 : When is turned, the frequency span changes in the specified step.



[Hz]

2658 : When  is turned, the frequency span changes in the specified step.

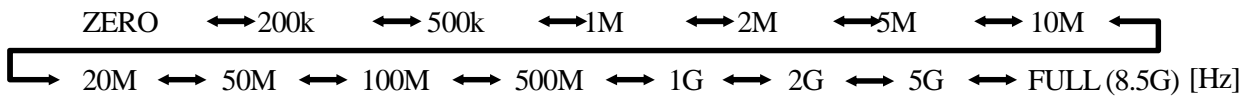

■ Switching frequency band

2658 consists of the following three bands.

Frequency band	Measured frequency range
Base band	50kHz to 3.5GHz
Band 1 -	3.3GHz to 6.3GHz
Band 1 +	6.2GHz to 8.5GHz

The frequency band is selected to be the least band number, based on Center frequency and Span.

(At the span less than 200MHz, only one band is used.)

When the setting frequency range belongs to two bands, the lower band has priority.

Note: Switch frequency band allows only to automatical setting.

The frequency connection point of two bands is fixed as below table.

Two bands	Frequency connection point
Base band and band 1 -	3.4GHz
Band 1 - and band 1 +	6.2GHz

Note: The trace may fall into disorder just a little at the frequency connection point. For the precise measurement is needed, Center frequency or Span should be set so that the measured frequency range is in one band.

9. Reference Level <REFER>

Press  to switch over to the function screen shown below:

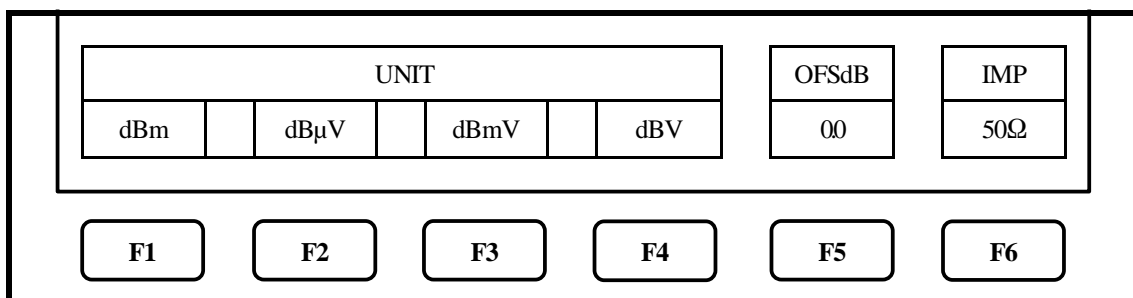





9.1 Setting the Reference level

1. When  is turned, the reference level changes.

(Refer to “9.3 Reference level setting range for each unit” for details.)

9.2 Switching units of amplitude axis (dB μ V/m and dB μ A/m are optional. Refer to “19.4 Electric field strength measurement” and “19.5 Magnetic field strength measurement” for details.)

1. Press  to switching units to dBm.
 Press  to switching units to dB μ V
 Press  to switching units to dBmV
 Press  to switching units to dBV

9.3 Reference level setting range for each unit

UNIT	dBm	dB μ V	dBmV	dBV
MAXIMUM	10	117	57	-3
MINIMUM	-40	67	7	-53
MINIMUM (shifted trace data)	-60	47	-13	-33

“Unit that is able to use it with the measuring function”

UNIT	dB μ V/m (Electric field strength measurement)						dB μ A/m (Magnetic field strength measurement)	
	Setting	AN301	AN302	AN303	AN304	AN305	AN306	PR 26M
MAXIMUM		143	146	148	150	137	159	160 to 203
MINIMUM		93	96	98	100	87	109	110 to 153
MINIMUM (shifted trace data)		73	76	78	80	67	89	90 to 133

- * When the reference level is set between the “MINIMUM” and “MINIMUM (shifted trace data)”, the trace in “MINIMUM” is shifted and displayed on a screen. When the reference level is set below to the “MINIMUM”, the ATT display area is displayed as “S/W AMP”.

Calculation expression (conversion formula to and from dBm)

- A [dB μ V] = 107+X [dBm]
- B [dBmV] = 47+X [dBm]
- C [dBV] = -13+X [dBm]
- D [dB μ V/m] = 68.8/ $\lambda \times \sqrt{(X/Gar)}$ [dBm] λ : Wavelength[m] Gar: Antenna absolute gain [times]
- E [dB μ A/m] = 180+X+F [dBm] F: probe calibration coefficient * changes by frequency



9.4 Relation between the reference level and ATT · AMP (in dBm indication)

The programmable attenuator (ATT) and the input amplifier (AMP) inside 2650/2658 are automatically set according to the setting value of the reference level (REFER). (ATT cannot be set independently.)

REFER (dBm)	ATT (dB)	AMP (dB)	REFER (dBm)	ATT (dB)	AMP (dB)	REFER (dBm)	ATT (dB)	AMP (dB)	REFER (dBm)	ATT (dB)	AMP (dB)
10	25	0	-3	12	0	-16	20	21	-29	7	21
9	24	0	-4	11	0	-17	19	21	-30	6	21
8	23	0	-5	10	0	-18	18	21	-31	5	21
7	22	0	-6	9	0	-19	17	21	-32	4	21
6	21	0	-7	8	0	-20	16	21	-33	3	21
5	20	0	-8	7	0	-21	15	21	-34	2	21
4	19	0	-9	6	0	-22	14	21	-35	1	21
3	18	0	-10	5	0	-23	13	21	-36	5	26
2	17	0	-11	4	0	-24	12	21	-37	4	26
1	16	0	-12	3	0	-25	11	21	-38	3	26
0	15	0	-13	2	0	-26	10	21	-39	2	26
-1	14	0	-14	1	0	-27	9	21	-40	1	26
-2	13	0	-15	0	0	-28	8	21			

* When the input signal level is higher than the suitable level for 1st mixer's terminal, it generates harmonics distortion and spurious. 2650/2658 is designed so that the input signal level of 1st mixer is determined to proper level by the reference level.

9.5 Setting the offset level

1.  →  to set the offset of reference level.

When amplifier and attenuator are used externally, display level can be matched by offset.

The setting range is from -50.0 to 50.0dB (0.1dB step).



Offset is calculated to the reference level, and it is displayed.

* When offset is set, it is displayed on LEVEL display area as "OFS".

Furthermore, the value of a marker point is displayed reflecting the calculated offset.

* Offset of dBμV, dBmV, dBV, W, etc. are changed automatically.

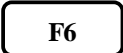
9.6 Setting the input impedance compensation

1.  →  to select the input impedance compensation.
 $50\Omega \longleftrightarrow 75\Omega$

When $50\Omega/75\Omega$ coaxial impedance matching pad is attached, and choose “ 75Ω ”, then offset is calculated to the reference level, and it changes for the measured value as 75Ω system, and display it.

- * When “ 75Ω ” is selected, “ 75Ω ” is displayed in the LEVEL area on the screen. When “ 75Ω ” is selected, the offset is set to 5.7dB (insertion loss of $50\Omega/75\Omega$ coaxial impedance matching pad). Moreover, can set offset.

Moreover, while setting the unit of the marker point to [W, V, V/m] etc, it changes from dBm correctly.

- * When you set it as “ 75Ω ”, please be sure to attach $50\Omega/75\Omega$ coaxial impedance matching pad.

10. Display Scale <SCALE>

Press  to switch over to the function screen shown below:

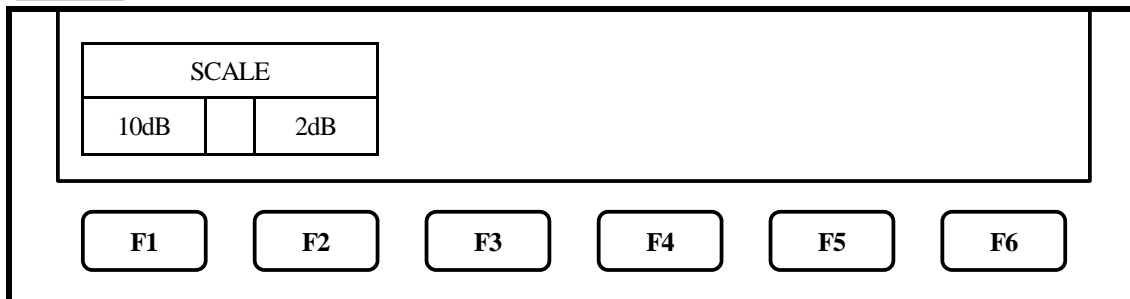

10.1 Setting with the keys ([F1], [F2])

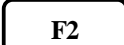
1. Press  to set the 10dB/div display scale.
2. Press  to set the 2dB/div display scale.

10.2 Setting with the encoder

1. Turn  to switch between the 10dB/div and 2dB/div display scale.
 $10dB \longleftrightarrow 2dB$

- * In 2dB/div, display level may not become smaller than fixed level, by frequency compensation.

11. Resolution Bandwidth <RBW>

Press **RBW** to switch over to the function screen shown below:

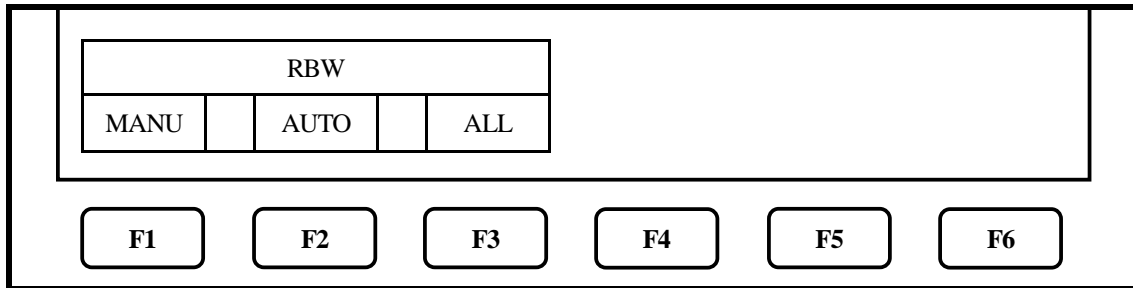

* Any selected parts of MANU, AUTO and ALL become inverted display.

11.1 MANUAL mode

1. Press **F1** or turn the  to enter MANUAL mode. Use  to set the RBW.

3kHz ↔ 10kHz ↔ 30kHz ↔ 100kHz ↔ 300kHz ↔ 1MHz ↔ 3MHz

11.2 AUTO mode

1. When **F2** is pressed, optimum RBW is set according to the settings of SPAN and SWEEP.

* Since "*" is displayed on the right end of RBW setting value display portion of a screen when set as AUTO mode, it can check being set as AUTO mode.

11.3 ALL AUTO mode

1. When **F3** is pressed, optimum RBW, VBW and SWEEP are set according to the setting of SPAN.

* Since "*" will be displayed on the right end of each setting value display portion of RBW, VBW, and SWEEP if ALL AUTO mode is set up, it can check being set as ALL AUTO mode.

* When RBW is set as 3kHz or 10kHz, selectivity (60dBc) becomes larger than an actual value, by influence of SSB phase noise.

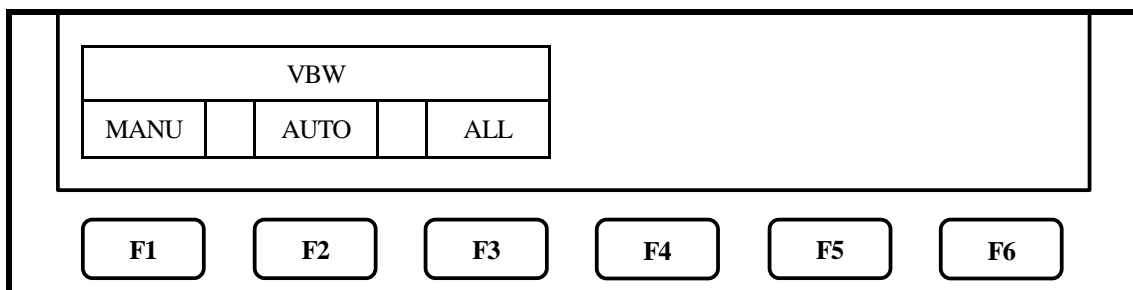

12. Video Bandwidth <VBW>

Press **VBW** to switch over to the function screen shown below:



* Any selected parts of MANU, AUTO and ALL become inverted display.

12.1 MANUAL mode

1. Press **F1** or turn the  to enter MANUAL mode. Use  to set the VBW.
- 100Hz ↔ 300Hz ↔ 1kHz ↔ 3kHz ↔ 10kHz ↔ 30kHz
- 100kHz ↔ 300kHz ↔ 1MHz

12.2 AUTO mode

1. When **F2** is pressed, VBW is set according to the settings of SPAN and SWEEP.
- * Since “*” is displayed on the right end of VBW setting value display portion of a screen when set as AUTO mode, it can check being set as AUTO mode.

12.3 ALL AUTO mode

1. When **F3** is pressed, RBW, VBW and SWEEP are set according to the setting of SPAN.
- * Since “*” will be displayed on the right end of each setting value display portion of RBW, VBW, and SWEEP if ALL AUTO mode is set up, it can check being set as ALL AUTO mode.

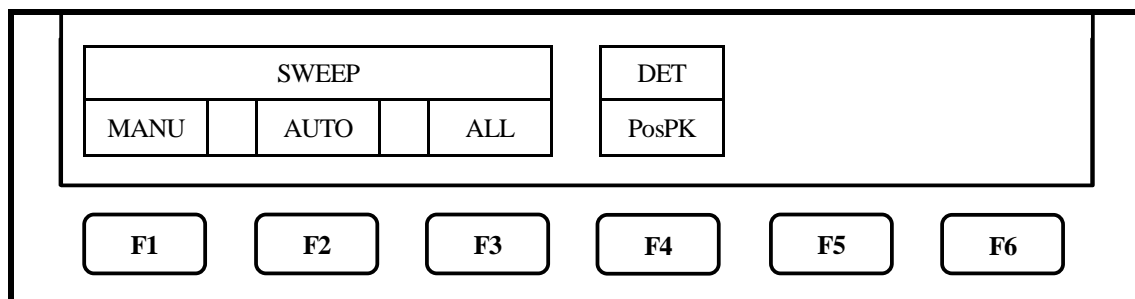

13. Sweep Axis · Detection Mode <SWEEP>

Press **SWEEP** to switch over to the function screen shown below:



- * Any selected parts of MANU, AUTO and ALL become inverted display.
When [F4] is pressed, the part of DET become inverted display.

13.1 MANUAL mode

1. Press **F1** or turn the  to enter MANUAL mode. Use  to set the SWEEP.
- 10ms ↔ 30ms ↔ 0.1s ↔ 0.3s ↔ 1s ↔ 3s ↔ 10s ↔ 30s
- * 2650: Can't set 10ms at the FULLSPAN.
* 2658: 30ms to 30s and AUTO @ Span 0 to 5GHz 0.1 to 30s and AUTO @ Full span

13.2 AUTO mode

1. When **F2** is pressed, SWEEP is set according to the settings of SPAN and RBW.
- * Since “*” is displayed on the right end of SWEEP setting value display portion of a screen when set as AUTO mode, it can check being set as AUTO mode.

13.3 ALL AUTO mode

1. When **F3** is pressed, RBW, VBW and SWEEP are set according to the setting of SPAN.

* Since “**” will be displayed on the right end of each setting value display portion of RBW, VBW, and SWEEP if ALL AUTO mode is set up, it can check being set as ALL AUTO mode.

13.4 Setting the Detection mode

1. Pressing **F4** allows you to change the method to capture the trace.



· PosPK (Positive Peak) : Traces the maximum value of the sample points.

· SMPL (Sample) : Traces the momentary value of the sample points.

· NegPK (Negative Peak) : Traces the minimum value of the sample points.

14. AUTO Tuning <AUTO TUNE>

When **AUTO TUNE** is pressed, center frequency is set at the spectrum of the maximum level in the 3.3GHz(2650)/8.5GHz(2658) band, and in addition, optimum reference level, RBW, VBW and SWEEP are set according to the setting of SPAN.

* The AUTO tuning does not operate normally, at the time of the following 4 conditions.

- 1) ZERO SPAN
- 2) FULL SPAN
- 3) Signal level is -40dBm or lower
- 4) Signal frequency is 50MHz or lower

15. Hold/Run <HOLD/RUN>

Press **HOLD/RUN** to switch to between sweep halt and continuous sweep.

* This operates only with the key press, with no function indication.

16. Calculation Function <CALC>

Press **CALC** to switch over to the function screen shown below:

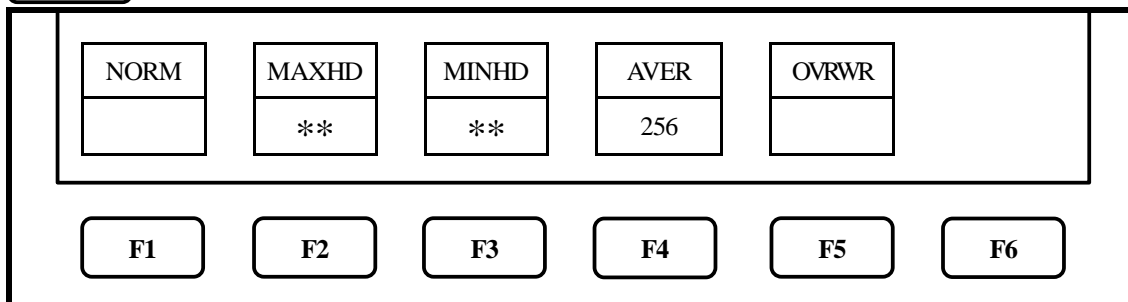

* After sweeps stops, press **HOLD/RUN** to restart sweep.

* Press [F1] to [F5] to set the CALC mode.

* Use  to set the number of sweeps.

16.1 NORM mode

1. Press **F1** Calculation is not performed in this mode. The number of sweeps is always unlimited.

* Usually, please choose this mode.

* “NORMAL” is displayed in the CALC area on the LCD screen.

(Refer to “4. Description of Display” for details)

16.2 MAX HOLD mode

1. Press **F2** → Use  to set the number of sweeps.

2. Sweeps are performed the set number of times, the maximum value of each point of trace data is displayed as a trace, and then sweep is halted.

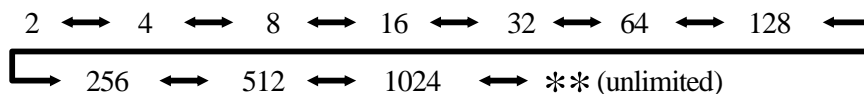

* “MAX --- (number of sweeps)” is displayed in the CALC area on the LCD screen.

(Refer to “4. Description of Display” for details)

16.3 MIN HOLD mode

1. Press **F3** → Use  to set the number of sweeps.

2. Sweeps are performed the set number of times, the minimum value of each point of trace data is displayed as a trace, and then sweep is halted.

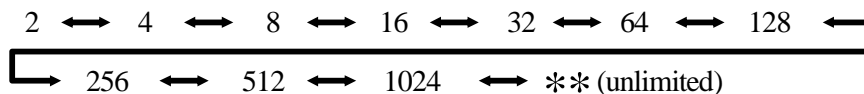

* “MIN --- (number of sweeps)” is displayed in the CALC area on the LCD screen.

(Refer to “4. Description of Display” for details)

16.4 AVERAGE mode

1. Press **F4** → Use  to set the number of sweeps.

2. Sweeps are performed the set number of times, average value of each point of trace data is displayed as a trace, and then sweep is halted.



* “AVG --- (number of sweeps)” is displayed in the CALC area on the LCD screen.

(Refer to “4. Description of Display” for details)

16.5 OVER WRITE mode

1. Press **F5** to enter into the OVER WRITE mode, where traces are written one over another.

The number of sweeps is unlimited.

* "OVER WR" is displayed in the CALC area on the LCD screen.

(Refer to "4. Description of Display" for details)

* Only the last one trace is saved.

16.6 SPURIOUS FREE mode

1. By pushing **F6** it will become the SPURIOUS FREE mode which simply deletes spurious characteristic at band 1+.

* "SPR." is displayed beside CALC in liquid crystal screen CALC area.

(Refer to "4. Description of Display" for details)

* The SUPURIASU characteristic at band 1+ is a spurious calculated by the following formula for a input signal over 6.76GHz, in case of measurement at band 1+.

(Refer to "8. Frequency Span" for details)

$$\text{Spurious characteristic at band 1+ [GHz]} = (\text{Input signal [GHz]} + 5.64\text{GHz}) / 2$$

* SPURIOUS FREE mode

1. SPURIOUS FREE mode is the mode which simply deletes SUPURIASU characteristic at band 1+.
2. SPURIOUS FREE mode has a special effect in measurement of a regular wave.
3. If SPURIOUS FREE mode is used in measurement of a signal with level change or frequency change, the phenomenon will happen that an amplitude level falls.

* How to discriminate SPURIOUS characteristic at band 1+ in manual operation

The procedure for discriminating SUPURIASU characteristic at band 1+ is as follows.

1. Set to SPAN = 10MHz.
2. Set the frequency of SUPURIASU to be discriminated to the center frequency of 2658.
3. Verify that SUPURIASU to be discriminated is at the center of a screen, and change the main frequency by +1MHz.
4. Judge by measured trace data.

The same frequency as the frequency set up first. → Measurement data.

2MHz over Main frequency changed by +1MHz → Spurious characteristic at band 1+

Example: Discriminate SUPEKUTORAMU displayed on 7GHz.

1. Set 2658 to SPAN = 10MHz and main frequency = 7 GHz.
2. Verify that SUPEKUTORAMU is at 7 GHz.
3. Set 2658 to Main frequency = 7.001 GHz.
4. Measure spectrum and distinguish as follows.

Spectrum is at 7GHz. → Measurement data.

Spectrum is at 7.003 GHz. → SUPURIA S characteristic at band 1+.

17. Marker · Peak Search <MKR>

Press **MKR** to switch over to the function screen shown below:

· The display when a NORM marker is selected.

The marker is manually moved at NORM mode. Peak search function, NEXT peak search function are available.

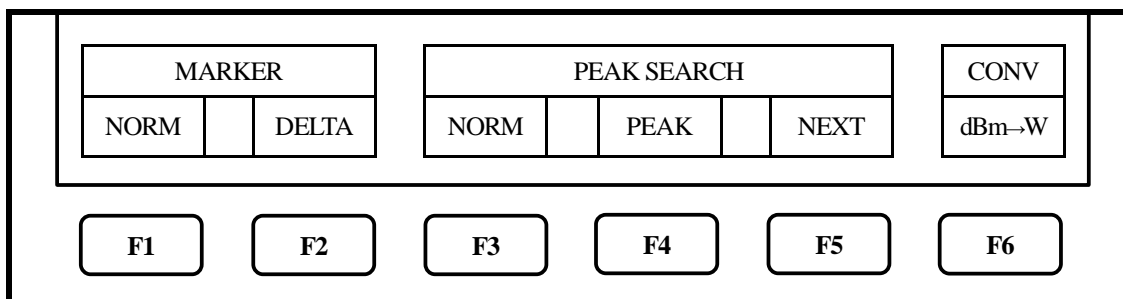

· The display when a ZONE marker is selected.

The marker moves to the biggest peak position automatically at ZONE mode, inside specified zone.

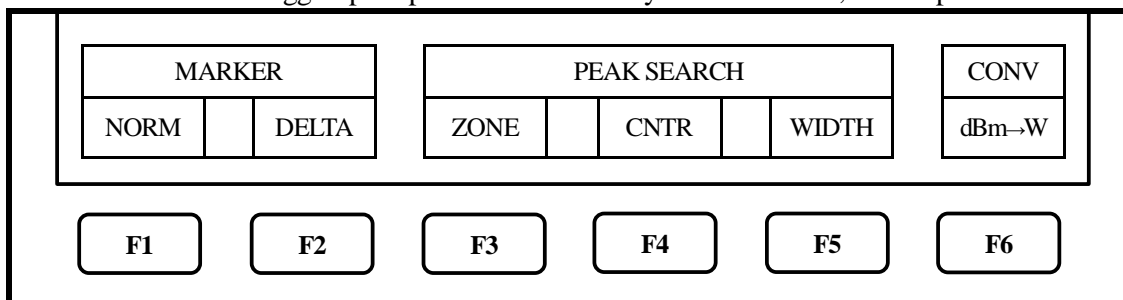

17.1 Moving the marker

Use **F1** → to move the marker.

Use **F2** to put DELTA REF at the current marker position.

17.2 Setting the peak search <PEAK SEARCH>

· NORM mode (Use **F3** to select NORM.)

Use **F4** to move the marker to the maximum peak position.

Use **F5** to move the marker successively from higher to lower peak positions other than the maximum peak. (The marker moves to 10 peaks.)

* When you move the marker to the 10th peak or moving the marker, the NEXT peak search function stops and the function display disappears.

· ZONE mode (Use **F3** to select ZONE.)

Use **F4** →  to move the center position.

Use **F5** →  to change the width.

17.3 Changing the unit of marker point

Press **F6** to change the unit of marker point.

When unit of reference level is dBm, the unit is changed from [dBm] to [W].

When unit of reference level is dB μ V, the unit is changed from [dB μ V, dBmV, dBV] to [V].

When unit of reference level is dB μ V/m, the unit is changed from [dB μ V/m] to [V/m].

When unit of reference level is dB μ A/m, the unit is changed from [dB μ A/m] to [A/m].

Moreover, according to each unit, it is displayed as follows.

[W] → [W, mW, μ W, nW, pW, fW]

[V] → [V, mV, μ V, nV]

[V/m] → [V/m, mV/m, μ V/m, nV/m]

[A/m] → [A/m, mA/m, μ A/m, nA/m]

18. Save/Load <SAVE/LOAD>

Press **SAVE/LOAD** to switch over to the function screen shown below:

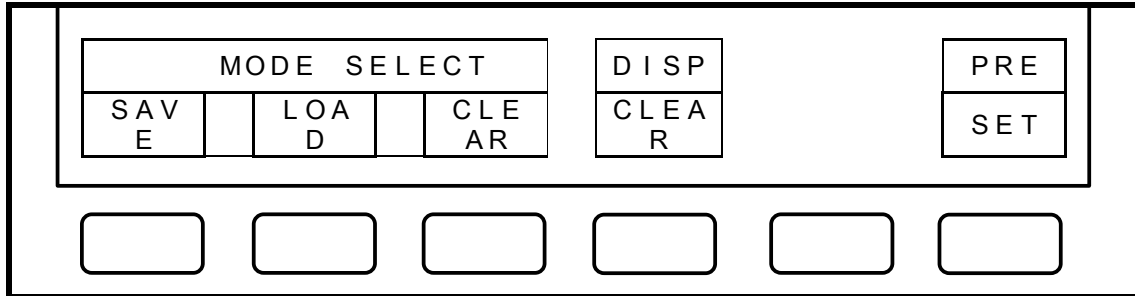

18.1 Saving the data

1. Press **F1** to move to a save menu.

2. Operating **F1** **F2** chooses objects (trace or parameter).

3. Use  to set the number of location.

00 ↔ 01 ↔ 02 ↔ 03 ↔ 04 ↔ ... ↔ 98 ↔ 99

4. Press **F3** to save the data.

* This saves the trace when TRACE is selected, or the setting parameters when PARAM is selected.

* “*” is displayed on the right end of the number of location place at which data is saved.

* It can be overwritten, too

18.2 Loading the data

1. Press **F2** to move to a load menu.

2. Operating **F1** **F2** chooses objects (trace or parameter).

3. Use  to set the number of location.

00 ↔ 01 ↔ 02 ↔ 03 ↔ 04 ↔ ... ↔ 98 ↔ 99

4. Press **F3** to load the data.

* This reads out the trace when TRACE is selected. The setting parameter of the loaded trace is displayed in the loaded trace information display area.

(Refer to “4. Description of Display” for details)

* This reads out the setting parameters when PARAM is selected.

* When you load a trace, the current trace disappears, the HOLD state is set, and the loaded trace

is displayed. For the loaded trace, you can use the marker, but cannot use a measuring function.

When you press the HOLD/RUN key, the loaded and the current traces are displayed overlapping each other.

* “*” is displayed on the right end of the number of location place at which data is saved.

18.3 Clearing the date

1. Press **F3** to move to a clear menu.
2. Operating **F1** **F2** chooses objects (trace or parameter).
3. Use  to set the number of clear.
00 ↔ 01 ↔ 02 ↔ 03 ↔ 04 ↔ ... ↔ 98 ↔ 99
4. Press **F3** to clear the data.

18.4 Clearing the loaded trace

1. Press **F5** to clear the loaded trace that has been displayed.

18.5 Presetting (Initialization)

1. Press **F6** to preset the setting parameters as the Initialization shown below:

“Initialization”

Items	Parameter
Center frequency	1GHz
Frequency span	20MHz
Reference level	10dBm
Offset	0.0dB
Impedance	50Ω
Sweep time	0.3s
Detection mode	Positive peak mode
RBW	100kHz
VBW	10kHz
Display scale	10dB/div

19. Measuring Function<MEAS>

Press **MEAS** to switch over to the function screen shown below:

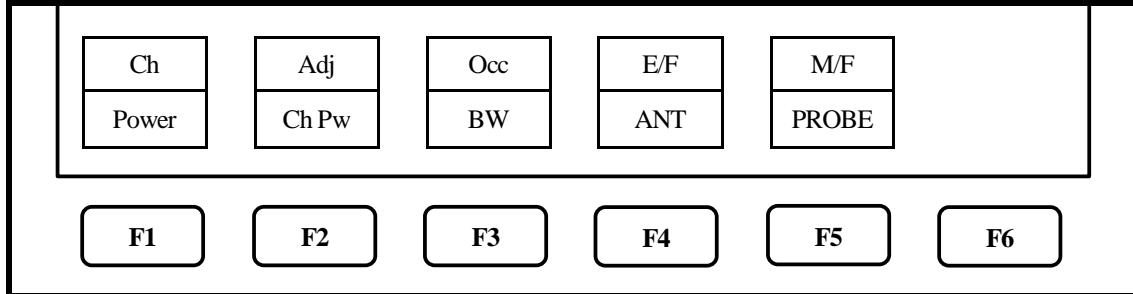

Select the measuring function:

- F1** **Ch Power** Channel power measurement
- F2** **Adj Ch Pw** Adjacent channel leakage power measurement
- F3** **Occ BW** Occupied frequency bandwidth measurement
- F4** **E/F ANT** Electric field strength measurement
- F5** **M/F PROBE** Magnetic field strength measurement (optional)

* Once you select the measuring function, pressing **MEAS** next time will directly bring up the function screen for the function you selected the last time. If you want to stop the measuring function, or if you want to select another measuring function, press [F6] (MEAS OFF). This stops the measuring function and switches to the above screen, which allows you to select the measuring function.

* The measuring function is stops, when push **MKR** while these 3 functions (Channel power , Adjacent channel leakage power, Occupied frequency bandwidth) are selected. Because each 3 functions and marker operation cannot be used simultaneously. Similarly, the function of the marker stops, when the functions of these 3 measurements are selected while using the marker.

* The unit displays data in 251 horizontal dots, but it internally captures the trace and calculates the measured value (Channel power measurement, Adjacent channel leakage power measurement and Occupied frequency bandwidth measurement) in 1004 dots.

19.1 Channel power measurement <Ch Power>

F1

Measures the sum of the power in the zone specified. Two modes, TOTAL and BAND, are available.

- TOTAL mode [Use **F1** (MODE) to select TOTAL.]

Measure the sum of the power in the zone specified by the center frequency and frequency span (whole range of the screen).

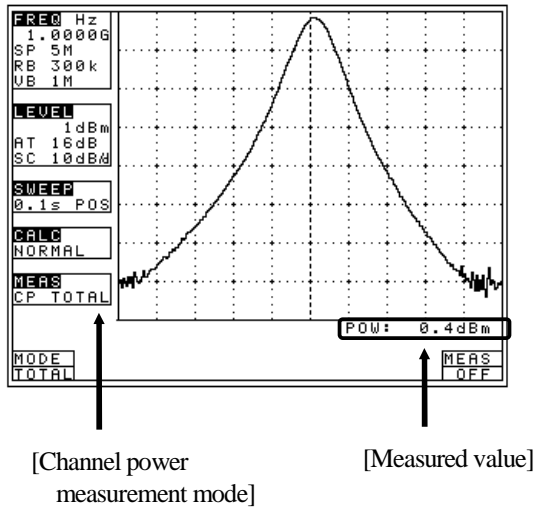

* It is shown on MEAS area of LCD as “CP TOTAL”

* The measured value is displayed at the right lower corner on the screen.

- BAND mode [Use **F1** (MODE) to select BAND.]

Measure the sum of the power in the zone specified by the zone center frequency and zone width.

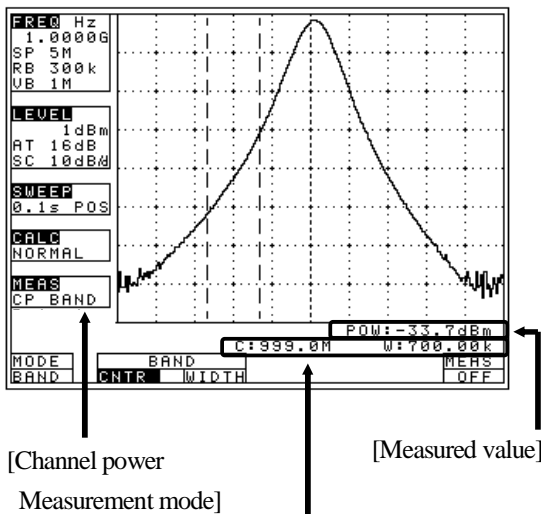

* It is shown on MEAS area of LCD as “CP BAND”.

* The measured value and setting parameter are displayed at the right lower corner on the screen.

1. Use **F2** (CNTR) →  to set the zone center frequency.

2. Use **F3** (WIDTH) →  to set the zone width.

[Parameter]

19.2 Adjacent channel leakage power measurement <Adj Ch Pw>

F2

Measures the adjacent channel leakage power as the ratio of the power in the range specified by the offset frequency against the reference frequency (reference carrier frequency) and the bandwidth, to the carrier wave power. Two channels of adjacent waves on the upper and lower sides of the same offset frequency are measured. In addition, you can select from three modes, TOTAL (total power method), REF BAND (in-band method) and PEAK (reference level method), according to the classification of definitions of carrier wave.

- Mode selection and measurement [Use **F1** (MODE) to select a mode: TOTAL, BAND or PEAK.]

* It is each shown on MEAS area of LCD as “ACP TOT”, “ACP BAND” or “ACP PK”.

* The measured value and setting parameter are displayed at the right lower corner on the screen.

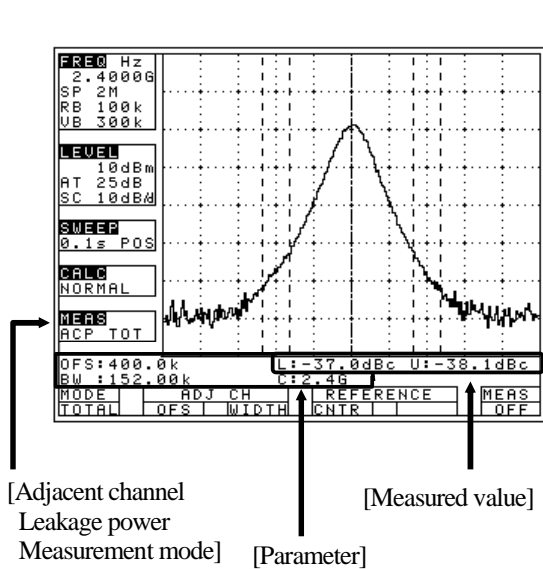

1. Use **F2** (Adj Ch OFS) → to set the offset frequency of adjacent channel.

* The offset is from the center of the reference carrier wave.

2. Use **F3** (Adj Ch WIDTH) → to set the band width of adjacent channel.

3. Use **F4** (REFERENCE CNTR) → to set the center frequency of reference carrier.

* [F4] is only for the TOTAL and BAND mode.

4. Use **F5** (REFERENCE WIDTH) → to set the band width of reference carrier.

* [F5] is only for the BAND mode.

- Definition of the reference carrier for each mode

TOTAL (total power method)

This is based on the sum total of the power of whole range on the screen. Use [F4] to set center frequency of the reference carrier wave.

BAND (in-band method)

This is based on the sum total of the power within the set bandwidth. Use [F4] to set center frequency of the reference carrier wave.

PEAK (reference level method)

This is based on the power of the peak on the screen. Center frequency of the reference carrier wave is set up to the peak inside the screen automatically.

19.3 Occupied frequency bandwidth measurement <Occ BW>

F3

Measures the bandwidth at the point of N [%] of total power (N% POWER) or the bandwidth at the point X [dB] down from the peak level (XdB DOWN). Two modes are available.

- N% POWER mode [Use **F1** (MODE) to select N%.]

Measures the bandwidth at the point of N [%] of total power displayed on the screen.

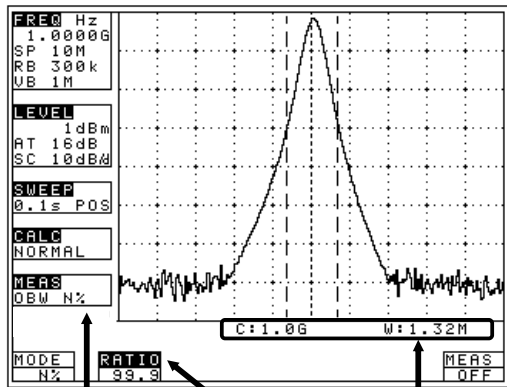

[Occupied frequency bandwidth measurement mode] [Parameter] [Measured value]

- * It is shown on MEAS area of LCD as “OBW N%”
- * The measured value is displayed at the right lower corner on the screen.

1. Use **F2** (RATIO) →  to set the percentage to total power.

* Setting range: 80.0 to 99.9%

- XdB DOWN mode [Use **F1** (MODE) to select XdB.]

Measures the bandwidth at the point X [dB] down from the peak level,

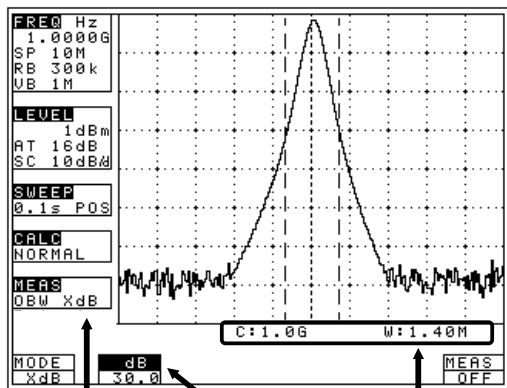

[Occupied frequency bandwidth measurement mode] [Parameter] [Measured value]

- * It is shown on MEAS area of LCD as “OBW XdB”
- * The measured value is displayed at the right lower corner on the screen.

1. Use **F2** (dB) →  to set the down level from peak level.

* Setting range: 0.1 to 80.0dB

19.4 Electric field strength measurement <E/F ANT>

F4

Measures electric field strength by connecting an optional antenna.

Allows using an antenna other than options by creating and inputting the original compensation table.

(Refer to “23.6 Writing of original compensation data” for how to create and write)

[Antenna connection]

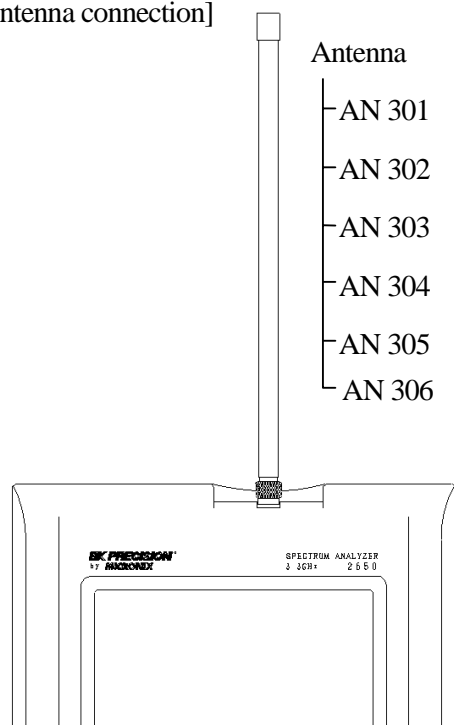

[Measurement environment]

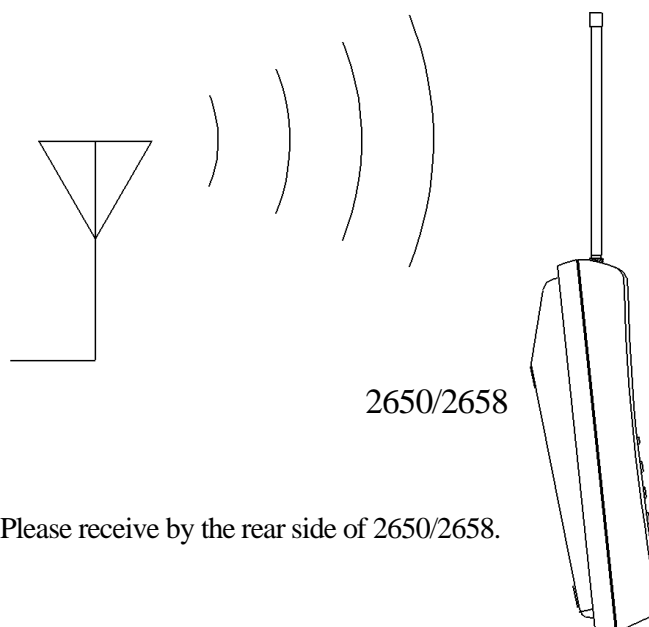

“Specifications of the antenna (antenna gain and VSWR are specified at a center of frequency range).”

Items	AN 301	AN 302	AN 303	AN 304	AN 305	AN 306
Type	Sleeve	Sleeve	Sleeve	Sleeve	1/4 λ whip	Sleeve
Frequency range	0.8 to 1.0GHz	1.25 to 1.65GHz	1.70 to 2.20GHz	2.25 to 2.65GHz	300 to 500MHz	4.7 to 6.2GHz
Antenna gain	+1dBi or higher	+1dBi or higher	+1dBi or higher	+1dBi or higher	+1dBi or higher	+1dBi or higher
VSWR	1.5 or lower	1.5 or lower	1.5 or lower	1.5 or lower	1.5 or lower	1.5 or lower
Dimensions	7.5φ×250mm	7.5φ×250mm	7.5φ×180mm	7.5φ×180mm	8.0φ×195mm	7.5φ×100mm
Weight	approx.20g	approx.20g	approx. 20g	approx.20g	approx.30g	approx.10g
Reference level setting range (except for the minimum value in screen shift)	93 to 143dBμV/m	96 to 146dBμV/m	98 to 148dBμV/m	100 to 150dBμV/m	87 to 137 dBμV/m	109 to 159 dBμV/m

* Measured value varies depending on how to have HM5033 main unit. Moreover, if the person who has is different, measured value will vary. Because M305 is 1/4 λ whip antenna. Therefore, in the measurement used an antenna M305, measurement errors occurs. The error value is several dB

or 10dB or more. In order to lessen the error value, use it, separating from the body as much as possible so that there is no influence of human body.

• Mode selection and measurement

Use **F1** (ANT) to select an antenna, AN 301, AN 302, AN 303, AN 304, AN 305, AN 306 or USER.

As soon as the antenna is entered, the measurement is taken.

* It is each shown on MEAS area of LCD as “E/F AN301”, “E/F AN302”, “E/F AN303”, “E/F AN304”, “E/F AN305”, “E/F AN306” or “E/F USER”.

* USER” is an original compensation table the user crates.

(Refer to “23.1 Command description” for details.)

* Trace may exceed from a screen by antenna gain compensation.

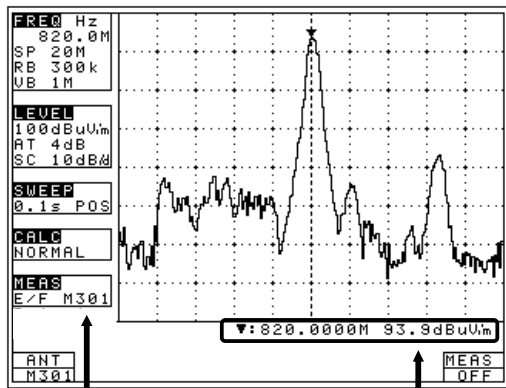

[Electric field strength measurement mode]

[Measured value]

Unit of amplitude axis changes to [dBμV/m]

* Optimum center frequency and frequency span are set according to the antenna.

In addition, a trace is not displayed for frequencies outside those supported by the antenna.

Example) case of AN 301

Center frequency: 900MHz

Frequency span: 200MHz

• Antenna directivity (reference data)

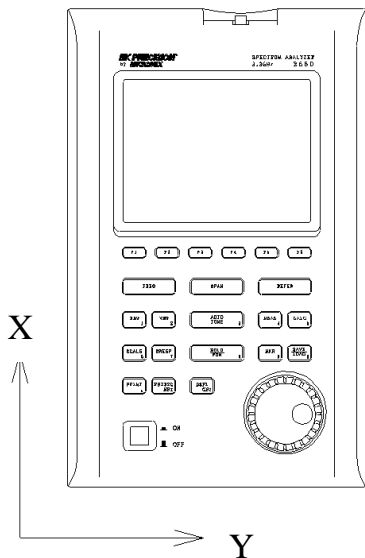

E plane: X-Y axis (X direction=0°)

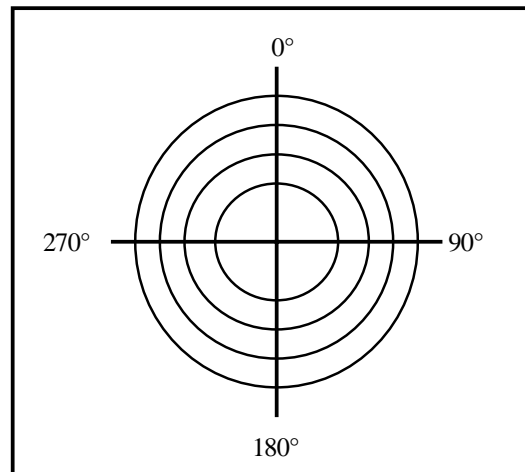

* All the data are those when the antenna is connected to the RF input with no obstacles around.

* However, data of 305 is reference data of the conditions in which people have 2650/2658 attached 305.

So, the directivity changes in practice, because, for example, the unit is carried by people.

AN 301 (900MHz, E plane)

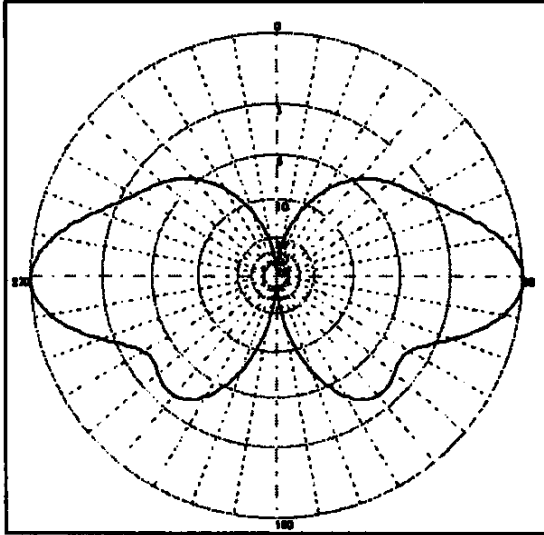

Antenna gain vs Frequency

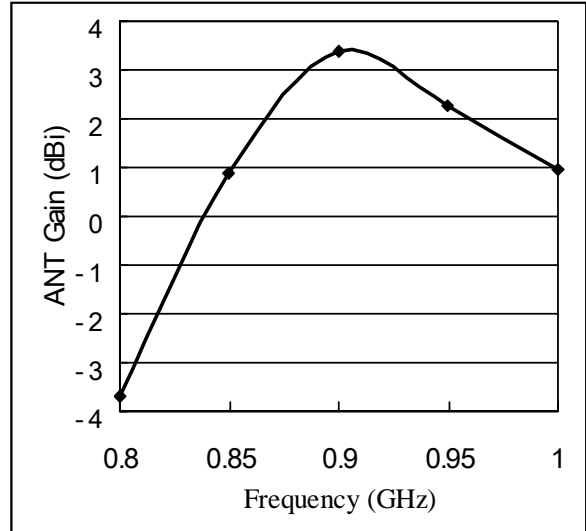

AN 302 (1.5GHz, E plane)

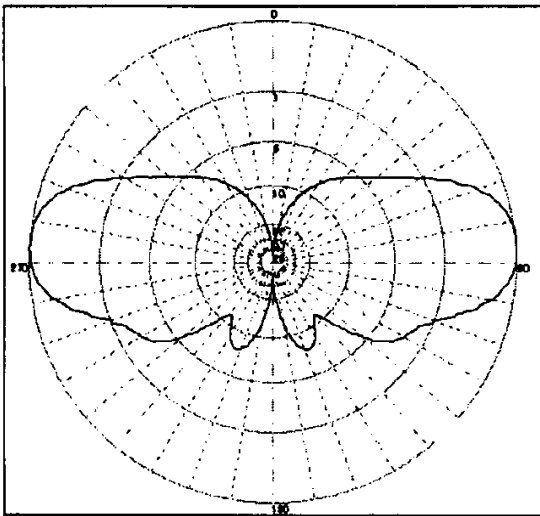

Antenna gain vs Frequency

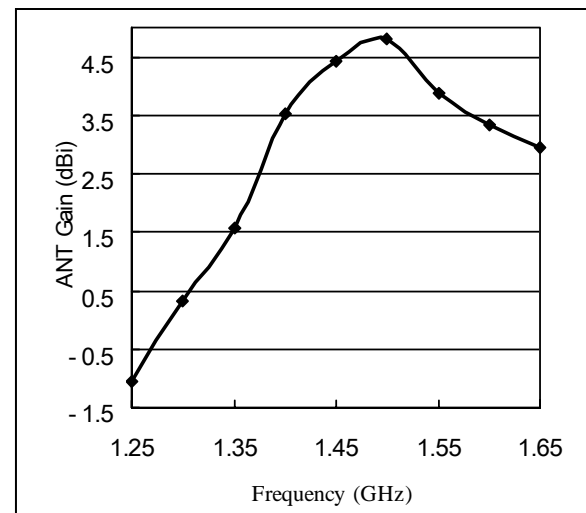

AN 303 (2.0GHz, E plane)

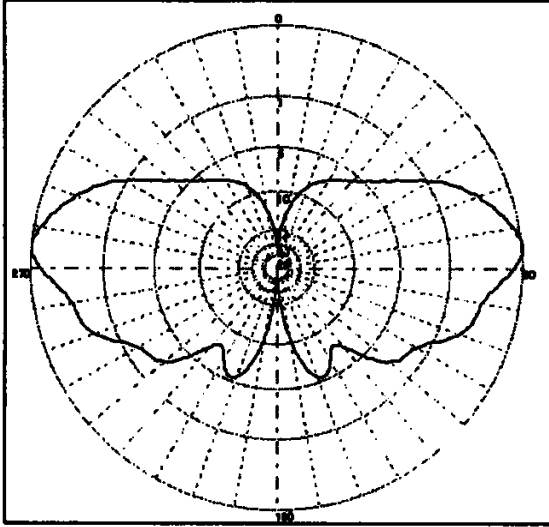

Antenna gain vs Frequency

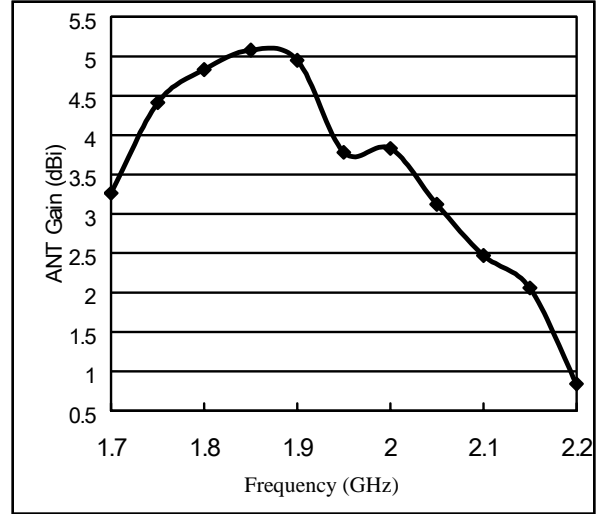

AN 304 (2.4GHz, E plane)

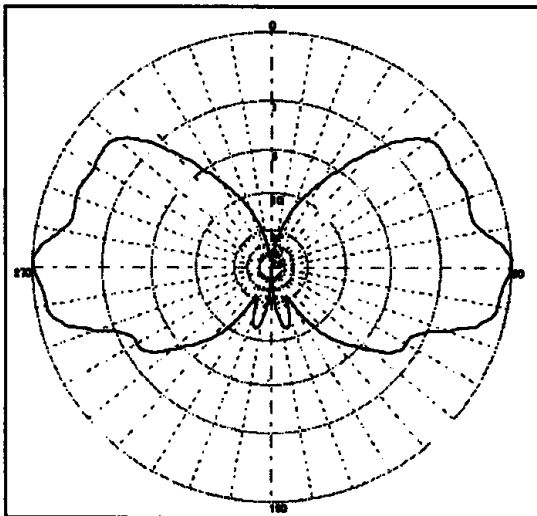

Antenna gain vs Frequency

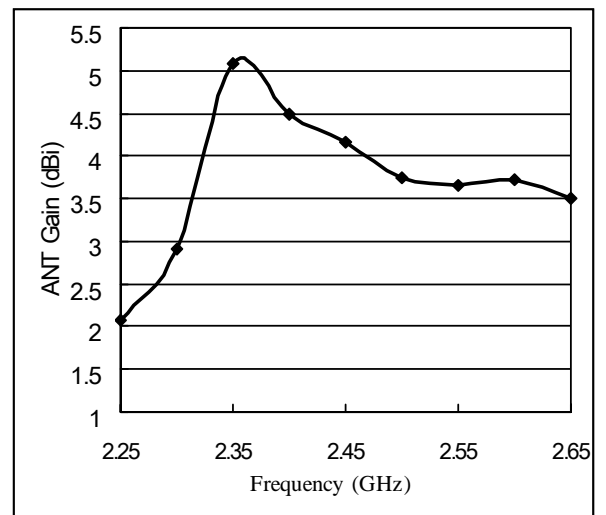

AN 305 (horizontal plane)

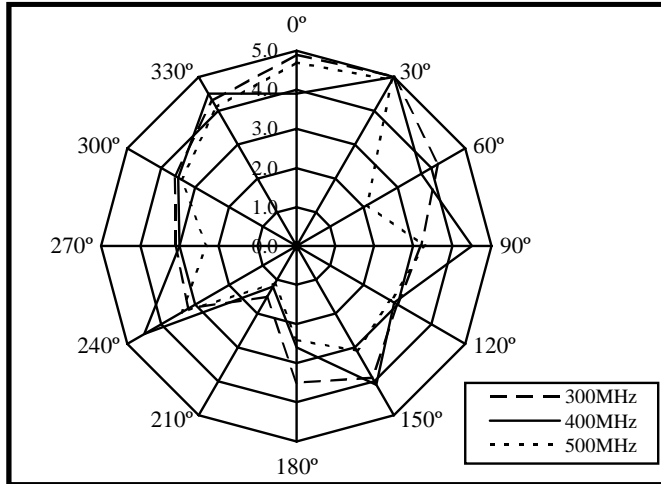

Antenna gain vs Frequency

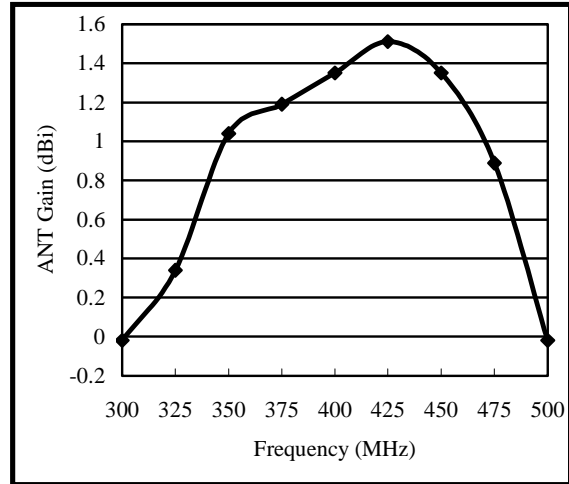

AN 306 (5.4GHz, E plane)

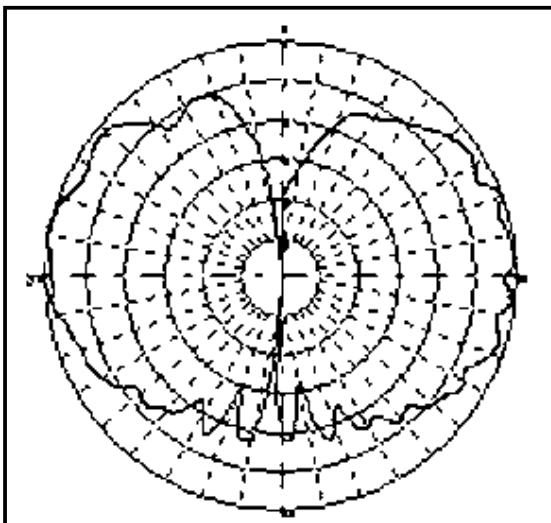

Antenna gain vs Frequency

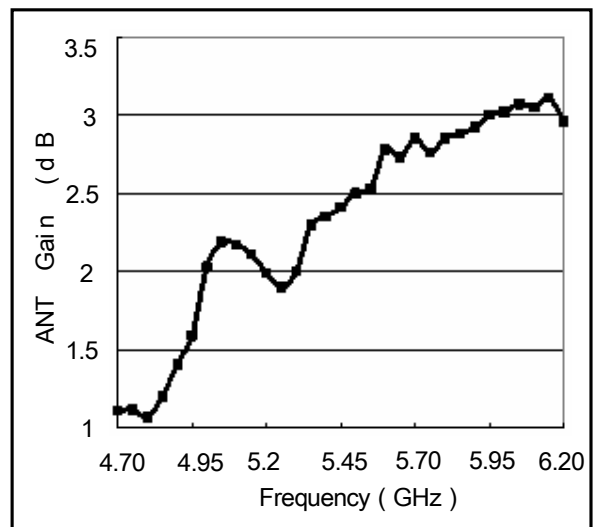

19.5 Magnetic field strength measurement <M/F PROBE> (optional)

F5

Measures the magnetic field strength using the optional magnetic field probe PR 26M.

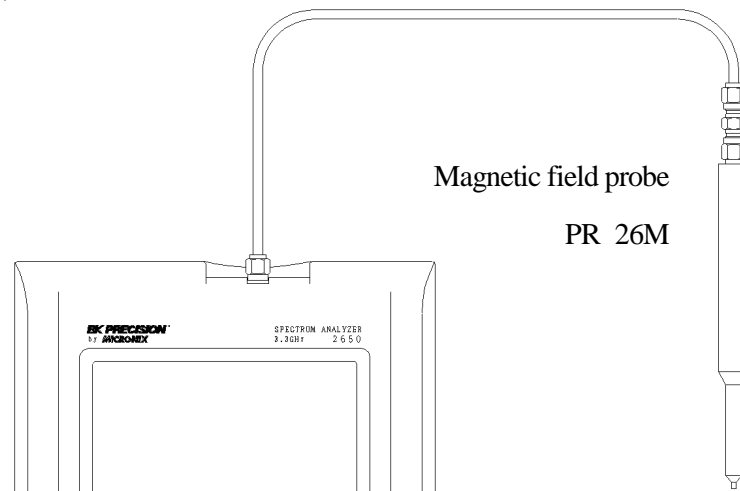

“Specifications of magnetic field probe PR 26M”

Items	Specifications
Frequency range	10MHz to 3GHz
Space resolution (-6dB)	approx.0.25 mm (Depending on objects)
Dimensions	Outside: 12φ×135mm probe tip: 2mm(W)×1mm(T)
Connector	SMA (P)
Reference level setting range (maximum)	160 to 203dBμA/m
Reference level setting range (except for the minimum value in screen shift)	110 to 153dBμA/m
Measurement error	approx.±1dB (Probe simple substance)

The tip of the optional magnetic field probe PR 26M is made of glass-ceramic board. Take care when handling the probe even though the strength of the glass-ceramic board is sufficiently ensured under normal operation.

(Refer to the operating manual for PR 26M for details.)

• Registration of the probe ID

Magnetic field strength measurement cannot be used without entering the “Probe ID” attached to the optional magnetic field probe, PR 26M. Once you have entered it, you don't need to enter it again.

When you press **MEAS** and **F6** in that order, “Input PROBE ID” will appear in the measured

value display area on the screen. Then, input the 14-digit “Probe ID” with the numeric keypads.

Press **F4** (ENTER) to confirm it. Press **F5** (CLEAR) to delete the entire value and allow you to input one from the beginning. Press **F6** (BACK SPACE) to delete the last input figure.

Press **F3** to cancel the probe ID input display.

• Mode selection and measurement

Use **F1** (PROBE) to select a probe, PR 26M or USER. As soon as the probe is entered, the measurement is taken.

* It is each shown on MEAS area of LCD as “M/F PR 26M” or “M/F USER”.

* “USER” is an original calibration table the user creates.

(Refer to “23.1 Command description” for details.)

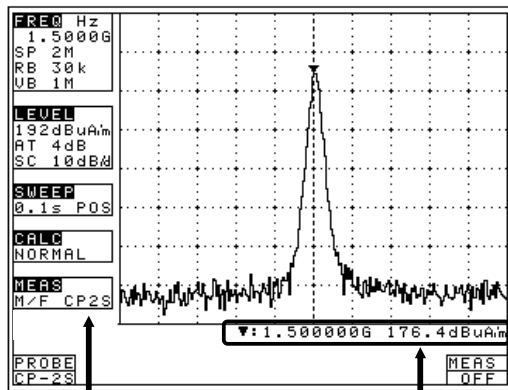

[Measuring mode]

[Measured value]

Unit of amplitude axis are changing to [dB μ A/m]

* A trace is not displayed for frequencies outside those supported by the probe.

20. Screen Control <DSPL>

Press **DSPL** to switch over to the function screen shown below:

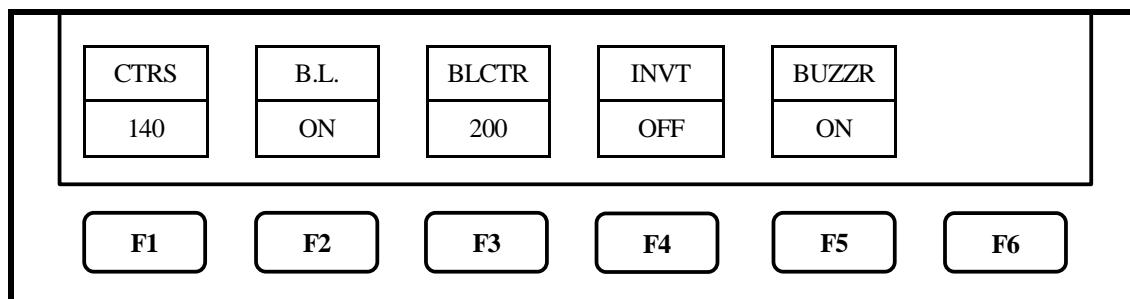

20.1 Adjusting the contrast

Use **F1** →  to adjust the contrast.

20.2 Switching ON and OFF the LCD backlight

Each time **F2** is pressed, the LCD backlight is alternately switched to ON or OFF.

20.3 Adjusting the brightness of the LCD backlight

Use **F3** →  to set the brightness.

20.4 Inverting the display

Press **F4** to invert the screen display. Press **F4** again to return it to the previous state.

20.5 Enabling or disabling the beep

Pressing **F5** allows you to disable the beep that sounds when you operate a key or the encoder.

Press **F5** again to return it to the previous state.

* If the voltage of a battery becomes low at the time of battery operation, it will be displayed on a screen as “Low Batt”, and a buzzer will sound (it sounds, even if it is set up so that a buzzer may not sound), and a power supply will be shut off within several minutes.

21. Printing <PRINT> (optional)

When using the optional printer, connect the RS-232C cable as shown in the figure below.

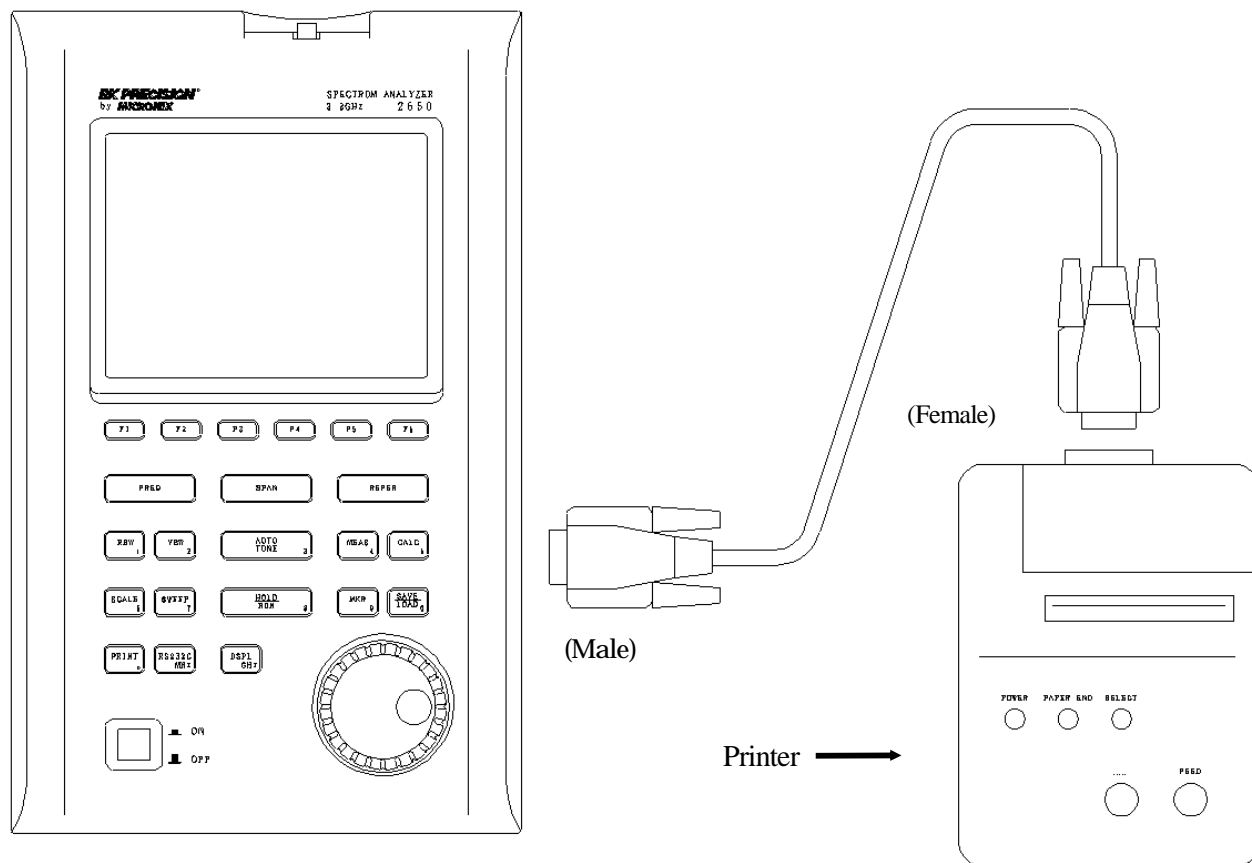

21.1 Hard copy of the screen

When you press the **PRINT** with the printer (optional) connected to the unit, it is set to the HOLD state and starts printing. It remains in the HOLD state after the printing is finished. It stops printing if you press the **PRINT** again during printing.

Since the printer operates with power supply from either the AC adapter or dry batteries, you can easily produce a hard copy of measured data even when outdoors where no AC power supply is available. When battery-powered, the printer operates for approximately 30 minutes (continuous use), allowing you to produce about 80 hard copies of the screen image.

22. Data Output <RS232C>

Press **RS232C** to switch over to the function screen shown below:

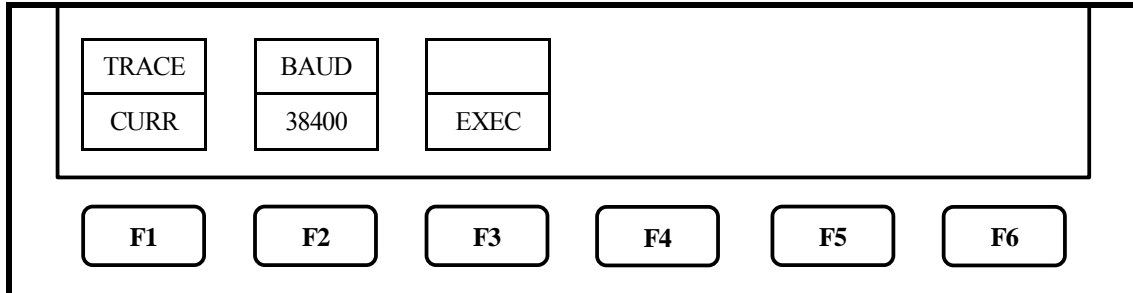

*Refer to “23. RS-232C” for “How to connect” and “RS-232C specifications”

* The trace currently displayed on the screen is transmitted when “CURR” is selected.

22.1 Selecting the trace to transfer

Use **F1** →  to select a trace.

CURR ↔ 00 ↔ 01 ↔ 02 ↔ 03 ↔ ... ↔ 98 ↔ 99

An asterisk () appears when there is a saved trace at the selected number as well as “SAVE/LOAD”.

22.2 Selecting the communication speed (baud rate)

Use **F2** →  to select a baud rate.

2400 ↔ 4800 ↔ 9600 ↔ 19200 ↔ 38400

22.3 Transfer the data

Press **F3** to start the transfer.

The data are transmitted as ASCII cord character strings.

· Contents of data

Character strings	Description	Example
PARAM	This means that the data from the next line are “setting parameters”.	PARAM
CF **	Center frequency Refer to 1	CF 2.5140G
SP **	Frequency span Refer to 2	SP 20M
RF **	Reference level Refer to 3	RF 10dBm
ST ** ##	Sweep time and detection mode Refer to 4	ST 30ms SMP
RB **	Resolution bandwidth Refer to 5	RB 300k
VB **	Video bandwidth Refer to 6	VB 1M
SC **	Display scale (**=10dB/d or 2dB/d)	SC 10dB/d
TRACE	This means that the data from the next line are “trace data”.	TRACE
** , ** , ...	These are trace data. Ten two-digit hexadecimal characters separated by commas make a line, and there are 26 lines (251data) of data in total. For Trace 1001 data transfer, there are 101 lines (1001 data) of data in total.	24, 20, 1f, 1f, 1e, 23

**“CR(0D[HEX])+LF(0A[HEX])” is added to the tail of every data.

1: Center frequency

2650 : CF ** [**=0.0M, 0.1M to 999.9M (0.1step), 0.0001G to 3.3G(0.0001step)]
 2658 : CF ** [**=0.0M, 0.1M to 999.9M (0.1step), 0.0001G to 8.5G(0.0001step)]

2: Frequency span

2650: SP ** [**=ZERO, 200k, 500k, 1M, 2M, 5M, 10M, 20M, 50M, 100M, 200M, 500M, 1G, 2G, FULL]
 2658: SP ** [**=ZERO, 200k, 500k, 1M, 2M, 5M, 10M, 20M, 50M, 100M, 200M, 500M, 1G, 2G,5G FULL]

3: Reference level

RF ** [**=-60 to 10dBm, 47 to 117dBμV, -13 to 57dBmV, -33 to -3dBv,
 72 to 149dBμV/m, 89 to 203dBμA/m (all 1step)]

4: Sweep time and Detection mode

ST ** ## [**=10ms, 30ms, 0.1s, 0.3s, 1s, 3s, 10s, 30s]
 [##=POS, NEG, SMP]

5: Resolution bandwidth

RB ** [**=3k, 10k, 30k, 100k, 300k, 1M, 3M]

6: Video bandwidth

VB ** [**=100, 300, 1k, 3k, 10k, 30k, 100k, 300k, 1M]

23. RS-232C Interface

23.1 RS-232C specifications

- Transfer rate : 2400/4800/9600/19200/38400bps
- Data bit length : 8bit
- Stop bit : 1bit
- Parity check : none

23.2 How to connect

When using the RS-232C interface, connect the RS-232C interface cable as shown in the figure below.

* RS-232C interface cable specifications ··· Cable length: approx. 1.5m

Connector: D-sub 9pin male / D-sub 9pin female

Wiring: straight

* Refer to “22. Data Output” about changing baud rate.

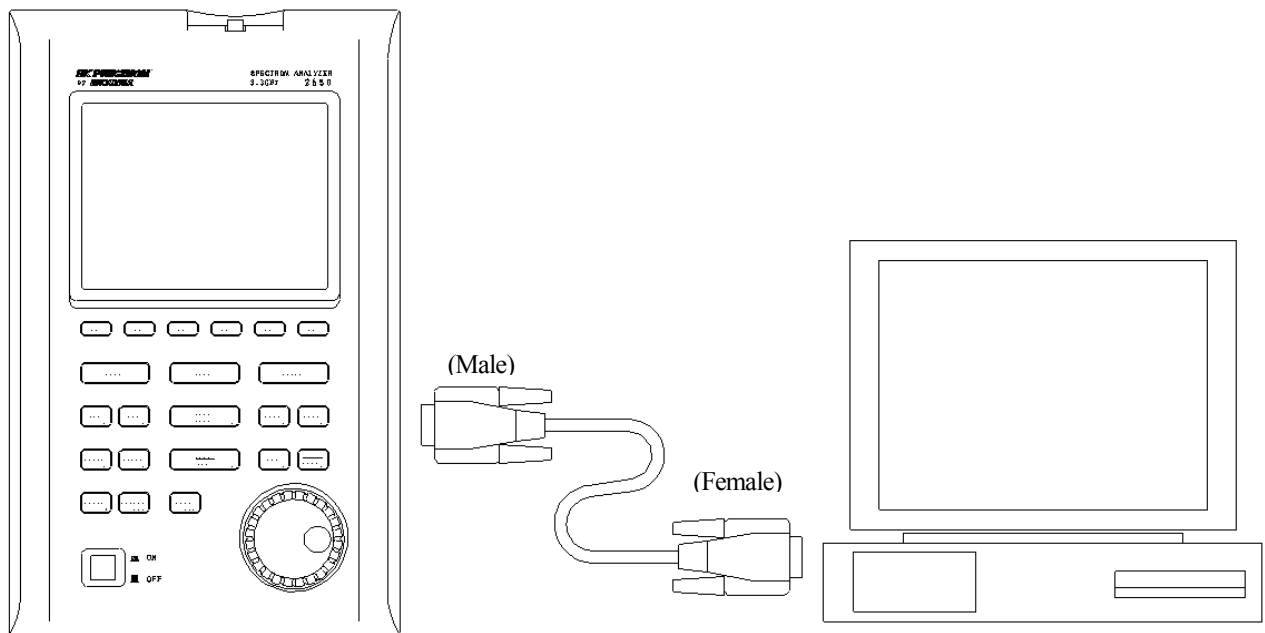

COM PORT (D-sub 9pin, male)

*Use the conversion connector, in the case that is D-sub 25pin (male)

23.3 Command description

* “CR(0D[HEX])+ LF(0A[HEX])” is added to the tail of every command. When you send a command from your PC, 2650/2658 returns a response. Responses include “OK” + CR + LF, “ERR” + CR +LF and “(response to command)” + CR + LF.

* By inputting “?” instead of “**” for each command, the current setting parameters are returned. Except for “···Request” command and command for inputting corrected data.

1) Set the center frequency

Command: **FREQ*******

(*****=Refer to [23.4 Input the frequency])

2) Request the set marker

Command: **FREQSETMKR**

*The center frequency is set according to the frequency of current marker position.

3) Set the span

2650: Command: **SPAN*******

(*****=ZERO, 200K, 500K, 1M, 2M, 5M, 10M, 20M, 50M, 100M, 500M, 1G, 2G, FULL[unit: Hz])

2658: Command: **SPAN*******

(*****=ZERO, 200K, 500K, 1M, 2M, 5M, 10M, 20M, 50M, 100M, 500M, 1G, 2G, 5G, FULL[unit: Hz])

4) Set the reference level

Command: **REF*****

(***=-60 to 10[1step, unit: dBm])

*For units other than dBm, use the conversion formulas in “9.3 Reference level setting range for each unit” to convert them into dBm before inputting the value.

5) Set the reference unit

Command: **UNIT*******

(*****=DBM, DBVU, DBMV, DBV)

Command	Unit
DBM	dBm
DBUV	dB μ V
DBMV	dBmV
DBV	dBV

6) Set the RBW

Command: **RBW*******

(*****=3K, 10K, 30K, 100K, 300K, 1M, 3M, AUTO, ALL[unit: Hz])

7) Set the VBW

Command: **VBW*******

(*****=100, 1K, 3K, 10K, 30K, 100K, 300K, 1M, AUTO, ALL[unit: Hz])

8) Start/Stop the measuring function

Command: **MEAS*****

(***=CP, ACP, OBW, EF, MF, OFF)

Command	Measuring function
CP	Channel power measurement
ACP	Adjacent channel leakage power measurement
OBW	Occupied frequency bandwidth measurement
EF	Electric field strength measurement
MF	Magnetic field strength measurement
OFF	OFF

9) Request the result of measuring function

Command: **MEASRES**

*Example of the return data

Case of channel power measurement... POW: -25.5dBm

Case of adjacent channel power measurement... L: -44.7dBc U: -48.3dBc

Case of occupied bandwidth measurement... C: 1.45G W: 20.00k

10) Set the mode of channel power measurement

Command: CPMODE*****
(*****=TOTAL, BAND)

Command	Mode
TOTAL	Measure the power of whole range on the screen
BAND	Measure the power within zone set

11) Set the zone center frequency of channel power measurement

Command: CPCNTR*****
(*****=Refer to [23.4 Input the frequency])

12) Set the zone width of channel power measurement

Command: CPWIDTH*****
(*****=Refer to [23.4 Input the frequency])

13) Set the mode of adjacent channel power measurement

Command: ACPMODE*****
(*****=TOTAL, REF, PEAK)

Command	Mode
TOTAL	TOTAL(total power method)
BAND	BAND(in-band method)
PEAK	PEAK(reference level method)

14) Set the band offset of adjacent channel power measurement

Command: ACPOFS*****
(*****=Refer to [23.4 Input the frequency])

15) Set the bandwidth of adjacent channel power measurement

Command: ACPCHBW*****
(*****=Refer to [23.4 Input the frequency])

16) Set the reference band center frequency of adjacent channel power measurement

Command: ACPREF*****
(*****=Refer to [23.4 Input the frequency])

17) Set the reference bandwidth of adjacent channel power measurement

Command: ACPREFBW*****
(*****=Refer to [23.4 Input the frequency])

18) Set the mode of occupied bandwidth measurement

Command: OBWMODE**
(**=N%, DB)

Command	Mode
N%	N% POWER mode
DB	XdB DOWN mode

19) Set the N% ratio of occupied bandwidth measurement

Command: OBWRATIO***
(***=80.0 to 99.9[0.1step, unit: %])

20) Set the XdB down of occupied bandwidth measurement

Command: OBWDB***
(***=0.1 to 40.0[0.1step, unit: dB])

21) Set the antenna of electric field strength measurement

Command: EFANT****
 (****=AN301, AN302, AN303, AN304, AN305, AN306, USER)

Command	Antenna
AN301	Setting date for AN 301
AN302	Setting date for AN 302
AN303	Setting date for AN 303
AN304	Setting date for AN 304
AN305	Setting data for AN 305
AN306	Setting data for AN 306
USER	Setting date for user's original antenna

22) Transfer the user-compensation data of electric field strength measurement

Command: EFUSER***
 Example of the compensation data: ***=2.25G:2.08DBI,..2.65G:3.5DBI

*If the compensation coefficient is -0.3dBi at 2.5GHz, the compensation data is "2.5G:-0.3DBI"
 Set apart by ";" between data and input from lower frequency. 10data are available.

23) Set the probe of magnetic field strength measurement

Command: MFPROBE*****
 (*****=PR26M, USER)

Command	Probe
PR26M	Setting data for PR 26M
USER	Setting data for user's original probe

24) Transfer the user-compensation date for magnetic field strength measurement

Command: MFUSER***
 Example of the compensation data: ***=10M:86.7DB, 100M:69.2DB,..3G:40dB

*If the compensation coefficient is 86.7dB at 10MHz, the compensation data is "10M:86.7DB"
 Set apart by ";" between data and input from lower frequency. 10data are available.

25) Start/Stop Calculation

Command: CALC***
 (***=OFF, MAX, MIN, AVE, OVR)

Command	Calculation
OFF	OFF
MAX	MAX HOLD
MIN	MIN HOLD
AVE	AVERAGE
OVR	OVER WRITE

26) Set the number of MAX HOLD

Command: MAXNO****
 (****=2, 4, 8, 16, 32, 64, 128, 256, 512, 1024, 0) * Command: 0 = unlimited

27) Set the number of MIN HOLD

Command: MINNO****
 (****=2, 4, 8, 16, 32, 64, 128, 256, 512, 1024, 0) * Command: 0 = unlimited

28) Set the number of AVERAGE

Command: AVENO***
 (***=2, 4, 8, 16, 32, 64, 128, 256)

29) Set the display scale of amplitude axis

Command: SCALE** (**=2, 10)

Command	Display scale
2	2dB/div
10	10dB/div

30) Set the sweep time

Command: SWEEP****

(****=10M, 30M, 0.1S, 0.3S, 1S, 3S, 10S, 30S, AUTO, ALL)

Command	Sweep time
10M	10ms
30M	30ms
0.1S	0.1s
0.3S	0.3s
1S	1s

Command	Sweep time
3S	3s
10S	10s
30S	30s
AUTO	AUTO
ALL	ALL AUTO

31) Set the detection mode

Command: DET***

(***=POS, NEG, SMP)

Command	Detection mode
POS	Positive peak mode
NEG	Negative peak mode
SMP	Sample mode

32) Request the AUTOTUNE

Command: AUTO

*Returns the response after tuning.

33) Request the action

Command: HOLD/RUN

34) Request the marker information

Command: MKRRES

*Example of returned data: 1.42G -15dBm

35) Set the marker mode

Command: MKR*****

(***=NORM, DELTA)

Command	Marker mode
NORM,	Normal marker
DELTA	Delta marker

36) Set the marker position

Command: NORMMKR*****

(*****=Refer to [23.4 Input the frequency])

37) Set the peak search mode

Command: PEAK****

(****=NORM, ZONE)

Command	Peak search mode
NORM	Normal peak search
ZONE	Zone peak search

38) Request the peak search

Command: PKSEARCH**

(**=01, 02, 03, 04, 05, 06, 07, 08, 09, 10, 11)

Command	Position to where the marker moves
01	Position of the maximum peak on the screen
02	Position of the 2nd highest peak on the screen
...	...
11	Position of the 11th highest peak on the screen

39) Set the zone center frequency of peak search

Command: PKCNTR*****

(*****=Refer to [23.4 Input the frequency])

40) Set the zone width of peak search

Command: PKWIDTH*****
 (*****=Refer to [23.4 Input the frequency])

Command	Unit of marker
DBM	dBm
W	W
DBV	dBV
V	V
DBUVM	dB μ V/m
VM	V/m

41) Set the unit of marker

Command: CONV*****
 (*****=DBM, M, DBV, V, DBUVM, VM)

42) Request the transfer of hard copy

Command: PRT
 *When transferring the returned data to optional printer, hard copy is performed.

43) Request to transfer trace

Command: SRS***
 (***=CURR, 00 to 99)

Command	Trace that is transferd
CURR	Trace of Current
00	Trace of save data 1
...	...
99	Trace of save data 100

44) Request to transfer 1001 date of trace

Command: SRSF
 (Refer to “22.3 Transfer the data” about returned data.)

45) Request the preset

Command: PRESET

46) Set the remote control

Command: REMOTE***
 (***=ON, OFF)
 * When remote control is ON, “REMOTE” is displayed in the operating information display area on the LCD screen.
 (Refer to “4. Description Of Screen”for details)

Command	Remote control
ON	Any operation from the keys or the encoder of the main body will not be accepted. Control the unit with RS-232C commands.
OFF	The operation from the keys or the encoder of the main body and RS-232C commands will be accepted.

47) Single sweep

Command: CAPT
 * It sweeps only once and will be in a HOLD state.

48) Setting of the offset level

Command: OFFSET*****
 (*****=-50.0 to 50.0 [0.1step, unit:dB])

49) Setting the input impedance

Command: IMP**
 (**=50, 75)

Command	Offset level
50	Offset level is set to 0dB.
75	Offset level is set to 5.7dB.

* When selecting of “75 Ω ”, please attach the 50 Ω /75 Ω coaxial impedance matching pad to an input connector.

50) Clearing of saved trace-data and parameter

Command: MCLR****

(****=WALL, SALL, W00 to W99, S00 to S99)

Command	Clearing data
WALL	All of saved trace-data
SALL	All of saved-parameter
W00	Trace-data of save-No. 00
...	...
W99	Trace-data of save-No. 99
S00	Parameter of save-No. 00
...	...
S99	Parameter of save-No. 99

23.4 Input the frequency

For the items written (*****)=Refer to [23.4 Input the frequency] in [23.3 Command description] above, enter a frequency as follows.

*****=0.0k to 999.9k[0.1step, unit: Hz]

0.0M to 999.9M[0.1step, unit: Hz]

2650: 0.0000G to 3.3G[0.0001step, unit: Hz]

2658: 0.0000G to 8.5G[0.0001step, unit: Hz]

* However, the offset frequency and zone width can be input only in the range decided by the center frequency and frequency span. The value out of the range becomes error.

* Values of the offset frequency and the zone width will change as you alter the frequency span.

23.5 Writing of original compensation data

On the case of electric field strength measurement used the antenna prepared by the visitor, or, on the case of magnetic field strength measurement used the magnetic field probe prepared by the visitor, it is necessary to write the data of the antenna gain or the magnetic probe field compensation coefficient to 2650/2658 main unit. Please write the antenna gain or the magnetic probe field compensation coefficient according to the following description. There are two kinds of methods, “method 1: use PC software AK 2650 (optinal)” and “method 2: use communication program which is prepared by user”.

1) Preparation things

- RS-232C interface cable
- Windows® PC (with RS-232C interface) * It is not writable with 2650/2658 main unit only.
- PC software AK 2650 (case of “Method 1 of writing data”)

2) Write-in data

As example, the compensation data (antenna gain) of antenna AN 305 and the compensation data (compensation coefficient) of magnetic field probe PR 26M are shown below.

- Compensation data (antenna gain) of antenna AN 305.

Frequency	300MHz	350MHz	400MHz	450MHz	500MHz
Antenna gain	0.0dBi	1.0dBi	1.4dBi	1.4dBi	0.0dBi

- Compensation data (compensation coefficient) of magnetic field probe PR 26M.

Frequency	10MHz	100MHz	1GHz	2GHz	3GHz
Compensation coefficient	86.7dB	69.2dB	50.7dB	44.9dB	40.1dB

* Here, although the number of data is five points, it is possible to write even the data of maximum of ten points. Data cannot be written in 0Hz.

3) Method 1 of writing data

The method which used the optional PC software [AK 2650](#).

* Please use [AK 2650](#) of the version more than 1.03b.

The software can be updated. [Please contact to our company for details.](#)

1. Write the antenna gain to text file.

Please create a new text file by new creation of a personal computer, and open by the text editor.

· Format

“Frequency”：“Antenna gain”, “Frequency”：“Antenna gain”, “Frequency”：“Antenna gain”, ...

Example) case of [AN 305](#)

300M:0.0DB,350M:1.0DB,400M:1.4DB,450M:1.4DB,500M:0.0DB

* Please write unit with a capital letter. Moreover, Frequency can also use G (GHz).

2. It writes in by PC software [AK 2650](#).

Connect the personal computer to [2650/2658](#) by RS-232C interface cable. Turn on the power of [2650/2658](#). Start the PC software [AK 2650](#). Please set the same baud rate of [2650/2658](#) and [AK 2650](#). (Refer to “[2650/2658](#) operating manual” for details)

On the case of electric field strength measurement, please choose [File] → [Write E/F User Data], on the case of magnetic field strength measurement, please choose [File] → [Write M/F User Data], from the upper menu of software, and select the text file which made some time ago. Then, data is written.

4) Method 2 of writing data

It is method of writing in which does not use [AK 2650](#). A user needs to prepare communication program.

1. Prepare the RS-232C communication software.

Connect the personal computer to [2650/2658](#) by RS-232C interface cable. Turn on the power of [2650/2658](#). Start the RS-232C communication software. Please set the same baud rate of [2650/2658](#) and software, and unite the setting of communication. (Refer to “22. Data Output” for details.)

2. Write the data

Please transmit data of the following format to [2650/2658](#) from RS-232C communication software.

· Format

Case of compensation data of electric field strength measurement.

EFUSER“Frequency”：“Antenna gain”, “Frequency”：“Antenna gain”, ...

Case of compensation data of magnetic field strength measurement.

MFUSER“Frequency”：“Compensation coefficient”, “Frequency”：“Compensation coefficient”, ...

Example) case of PR 26M

MFUSER10M:86.7DB,100M:69.2DB,1G:50.7DB,2G:44.9DB,3G:40.1DB

* Please write unit with a capital letter.

3. After writing is completed correctly, “OK” is returned from 2650/2658.

5) How to use

1. Please set the measuring function of 2650/2658 to electric field strength measurement mode or magnetic field strength measurement mode.

On the case of electric field strength measurement, please select [MEAS] → [E/F ANT],

on the case of magnetic field strength measurement, please select [MEAS] → [M/F PROBE],

Please push [F1] and display [USER] on the upper of [F1].

Now, electric field strength measurement or magnetic field strength measurement by the written compensation data can be performed.

* When the power supply of 2650/2658 is turned off at once and turned on again it returns from electric field strength measurement mode or magnetic field strength measurement mode to the usual measurement mode. Then if it goes into electric field measurement mode or magnetic field strength measurement mode once again, it can measure in the same state.

6) About the antenna gain

In this contents, the antenna gain is meaning absolute gain [dBi].

When antenna gain is relative gain, it can change into absolute gain by adding +2.15dB.

· Absolute gain [dBi] = Relative gain [dBd] + 2.15dB

As reference, the conversion formula to electric field strength is using the following.

· $E = \sqrt{480 \pi^2 \times Pa \div (Ga \times \lambda^2)}$

E: Electric field strength [V/m]

Pa: Received electric power [W]

Ga: Antenna gain [times] = $10^{(\text{antenna gain [dBi]} \div 10)}$

λ : Wavelength [m] = $(3 \times 10^8) \div \text{frequency [Hz]}$

23.6 Sample program

An example program to send following setting with RS-232C is shown below:

Setting: Center frequency 1GHz

10		'FREQ SETTING
20	OPEN "COM1:N81N" AS #1	
30	PRINT #1 "FREQ1G";	"FREQ1G" OUTPUT
40	INPUT #1 AS\$	"OK" READ
50	CLOSE #1	

24. PC Software (optional)

This is the software **AK 2650** that controls **2650/2658** by RS-232C. All setting can be performed from PC. Although the 251 points of trace data is displayed on horizontal axis in the screen of the **2650/2658**, 1001 points of trace data are taken per sweep. When this software is used, all of these 1001 points data are transformed to a PC and trace is displayed at high resolution.

Corresponding OS

Hardware Requirements

Computer that is able to act normally Windows[®], and able to use the COM port and CD-ROM drive.

Screen size 1024x768 or more computers.

Operating system

Windows[®] 95/98/2000/Me/NT 4.0 * XP

Communication method

Bidirectional communication by RS-232C.

Installation procedure

1. Start windows[®].
2. Insert the **AK 2650** software CD into the CD-ROM drive.
The setup will start automatically and the initial screen will appear.
3. Follow the instructions on the screen.

* If the setup does not start,

1. Double-click on the My Computer icon.
2. Double-click on the CD-ROM icon.
3. Double-click on “setup.exe”.
4. Follow the instructions on the screen.

Refer to the “README” in the **AK 2650** for details.

* The software can be updated. Please contact to our company for details.

25. Basis Performance Test (2650 only)

To keep the quality of the unit, regular performance testing is recommended. This section describes a method and specification of basic performance testing. If a problem is found in the results of basic performance testing, or formal testing is needed, please contact the dealership where you purchased the product, or contact us.

[Connection diagram]

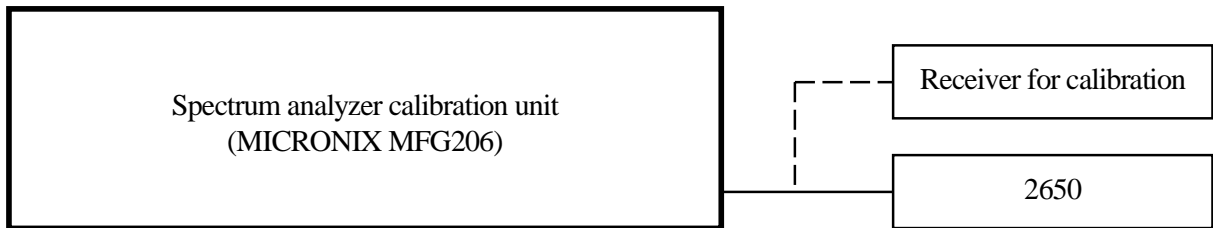

25.1 Frequency characteristics

Adjust the output level of the spectrum analyzer calibration unit (thereafter, "calibration unit") so that the displayed power value is -15dBm at each frequency for this unit, and measure the absolute value with a receiver for calibration (microwave power meter, etc.).

Setting of 2650			Specifications	Measurement value	Judgment
Center frequency	Frequency span	RBW			
50kHz	200kHz	10kHz	Within Reference±2.6dB±1dot		
100kHz	200kHz	30kHz	Within Reference±2.6dB±1dot		
1MHz	2MHz	100kHz	Within Reference±1.6dB±1dot		
10MHz	10MHz	3MHz	Within Reference±1.0dB±1dot		
100MHz	10MHz	3MHz	Reference		
1GHz	10MHz	3MHz	Within Reference±1.0dB±1dot		
2GHz	10MHz	3MHz	Within Reference±1.0dB±1dot		
3.3GHz	10MHz	3MHz	Within Reference±1.0dB±1dot		

* RBW switching error is included at RBW other than 3MHz.

· Setting of 2650

Reference level : -15dBm
 VBW : 1MHz
 Sweep time : 1s
 Detection mode : SMPL
 Display scale : 2dB/div

· Setting of calibration unit

Frequency : Same as a center frequency of 2650.
 Output power : Adjust the power indication of 2650 to -15dBm.

25.2 Accuracy of reference level

Adjust the output level of the calibration unit so that the displayed value of this unit is the 0th div from the top, and calibrate the absolute value with the receiver for calibration (microwave power meter, etc.).

Setting of 2650		Specifications	Measurement value	Judgment
Reference level				
+10dBm		within $\pm 1.4\text{dB} \pm 1\text{dot}$		
0dBm		within $\pm 1.4\text{dB} \pm 1\text{dot}$		
-10dBm		within $\pm 1.4\text{dB} \pm 1\text{dot}$		
-15dBm		within $\pm 0.8\text{dB} \pm 1\text{dot}$		
-20dBm		within $\pm 1.4\text{dB} \pm 1\text{dot}$		
-30dBm		within $\pm 1.4\text{dB} \pm 1\text{dot}$		
-40dBm		within $\pm 1.4\text{dB} \pm 1\text{dot}$		

* Input attenuator switching error is included at the reference level other than -15dBm.

· Setting of 2650

Center frequency : 100MHz
 Frequency span : 10MHz
 RBW : 3MHz
 VBW : 1MHz
 Sweep time : 1s
 Detection mode : SMPL
 Display scale : 2dB/div

· Setting of calibration unit

Frequency : 100MHz
 Output power : Adjust it so that the indicated value of 2650 is at the 0th div from the top.

25.3 The display accuracy of the center frequency

Measure the frequency with the peak search function of 2650.

Setting of 2650			Specifications	Measurement value	Judgment
Center frequency	Frequency span	RBW			
100MHz	200kHz	3kHz	within $\pm 130\text{kHz} \pm 1\text{dot}$		
100MHz	10MHz	30kHz	within $\pm 130\text{kHz} \pm 1\text{dot}$		
100MHz	20MHz	100kHz	within $\pm 800\text{kHz} \pm 1\text{dot}$		
100MHz	200MHz	100kHz	within $\pm 800\text{kHz} \pm 1\text{dot}$		
1GHz	500MHz	100kHz	within $\pm 800\text{kHz} \pm 1\text{dot}$		
1GHz	2GHz	3MHz	within $\pm 800\text{kHz} \pm 1\text{dot}$		
1.65GHz	FULL(3.3GHz)	3MHz	within $\pm 800\text{kHz} \pm 1\text{dot}$		

· Setting of 2650

Reference level : -15dBm
 VBW : AUTO
 Sweep time : 1s
 Detection mode : SMPL
 Display scale : 10dB/div

· Setting of calibration unit

Frequency : Same as a center frequency of 2650.

Output power : -15dBm

* However, calibrate the signal generator in advance.

25.4 The display accuracy of the frequency span

Adjust the frequency of the calibration equipment so that the peaks are at the positions of f_1 and f_9 , and measure the frequencies of f_1 and f_9 . Calculate from f_1 and f_9 the display accuracy of the frequency span.

Setting of 2650			Specifications	f_1 Measurement value	f_9 Measurement value	$(f_9 - f_1)$ × 1.25	Judgment
Frequency span	Center Frequency	RBW					
200kHz	100MHz	3kHz	within $\pm 26\text{kHz} \pm 1\text{dot}$				
10MHz	100MHz	100kHz	within $\pm 320\text{kHz} \pm 1\text{dot}$				
20MHz	100MHz	300kHz	within $\pm 0.8\text{MHz} \pm 1\text{dot}$				
200MHz	100MHz	3MHz	within $\pm 6.2\text{MHz} \pm 1\text{dot}$				
500MHz	1GHz	3MHz	within $\pm 15.2\text{MHz} \pm 1\text{dot}$				
2GHz	1GHz	3MHz	within $\pm 60.2\text{MHz} \pm 1\text{dot}$				
FULL(3.3GHz)	1.65GHz	3MHz	within $\pm 99.2\text{MHz} \pm 1\text{dot}$				

* f_1 : 1st div from the left on the trace screen f_9 : 9th div from the left on the trace screen

· Setting of 2650

Reference level : -15dBm
 VBW : AUTO
 Sweep time : 1s
 Detection mode : SMPL
 Display scale : 2dB/div

· Setting of calibration unit

Frequency : Adjust it to the positions of f_1
 and f_9 .
 Output power : -15dBm

25.5 Linearity of the amplitude axis

Adjust the level of the calibration unit so that the peak is at the top of the amplitude axis (0th div), and regard the point set at that time as the reference. Gradually lower the output, starting from the reference, and measure the amplitude value of 2650.

Setting of 2650	Output of calibration unit	Specifications	Measurement value	Judgment
Display scales				
10dB/div	XdBm (adjust it to the 0th div)	Reference(-15dBm)	(-15dBm)	
	X-10dBm	Within $-25\text{dBm} \pm 0.8\text{dB} \pm 1\text{dot}$		
	X-70dBm	Within $-85\text{dBm} \pm 1.6\text{dB} \pm 1\text{dot}$		
2dB/div	XdBm (adjust it to the 0th div)	Reference(-15dBm)	(-15dBm)	
	X-2dB	Within $-17\text{dBm} \pm 0.2\text{dB} \pm 1\text{dot}$		
	X-10dB	Within $-25\text{dBm} \pm 0.8\text{dB} \pm 1\text{dot}$		

· Setting of 2650

Center frequency : 100MHz
 Reference level : -15dBm
 Frequency span : 10MHZ
 RBW : 3MHz
 VBW : 1MHz
 Sweep time : 1s
 Detection mode : SMPL

· Setting of calibration unit

Frequency : 100MHz



Limited Two-Year Warranty

B&K Precision Corp. warrants to the original purchaser that its product and the component parts thereof, will be free from defects in workmanship and materials for a period of two years from the date of purchase.

B&K Precision Corp. will, without charge, repair or replace, at its' option, defective product or component parts. Returned product must be accompanied by proof of the purchase date in the form a sales receipt.

To obtain warranty coverage in the U.S.A., this product must be registered by completing and mailing the enclosed warranty card to B&K Precision Corp., 22820 Savi Ranch Parkway, Yorba Linda, CA 92887 within fifteen (15) days from proof of purchase.

Exclusions: This warranty does not apply in the event of misuse or abuse of the product or as a result of unauthorized alternations or repairs. It is void if the serial number is alternated, defaced or removed.

B&K Precision Corp. shall not be liable for any consequential damages, including without limitation damages resulting from loss of use. Some states do not allow limitation of incidental or consequential damages, so the above limitation or exclusion may not apply to you.

This warranty gives you specific rights and you may have other rights, which vary from state-to-state.

Model Number: _____

Date Purchased: _____

22820 Savi Ranch Parkway
Yorba Linda, CA 92887
www.bkprecision.com



Service Information

Warranty Service: Please return the product in the original packaging with proof of purchase to the below address. Clearly state in writing the performance problem and return any leads, connectors and accessories that you are using with the device.

Non-Warranty Service: Return the product in the original packaging to the below address. Clearly state in writing the performance problem and return any leads, connectors and accessories that you are using with the device. Customers not on open account must include payment in the form of a money order or credit card. For the most current repair charges contact the factory before shipping the product.

Return all merchandise to B&K Precision Corp. with pre-paid shipping. The flat-rate repair charge includes return shipping to locations in North America. For overnight shipments and non-North America shipping fees contact B&K Precision Corp..

B&K Precision Corp.
22820 Savi Ranch Parkway
Yorba Linda, CA 92887

Email: service@bkprecision.com

Include with the instrument your complete return shipping address, contact name, phone number and description of problem.

