



## Model 2650A/2651 Series

## 3.3 GHz/8.5 GHz Spectrum Analyzer

### USER MANUAL



# Before Using the Product

- Please note the following described on the back panel.

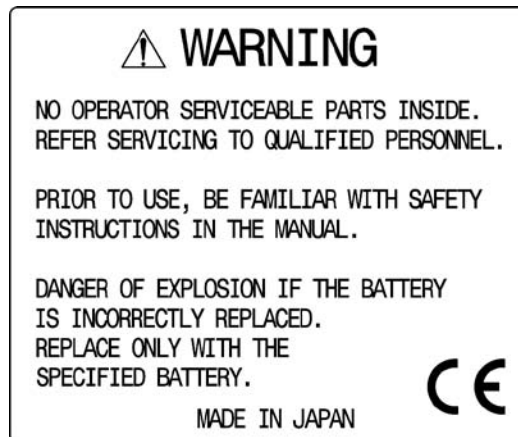

- **For safe use:**

- 1) When a normal sound, abnormal smell or smoke is found, stop using the product and remove the battery and AC adapter.
- 2) Never handle this product with wet hands to prevent risks of electric shock, fire, or damage.
- 3) Never use this product under lightning conditions to prevent risks of damage.
- 4) Never use any AC adapter other than specified, or it will cause damage. Connect the power cable only to three-terminal outlet for protection from static electricity, otherwise this product or a device under test may be damaged.
- 5) Never use any battery other than specified, or it may damage this product. Turn off the power and disconnect the AC adapter before removing the battery out of the battery compartment.
- 6) Be sure to charge the battery as specified in the instructions in this manual. Moreover, an explosion, fire or smoke may occur if battery is handled improperly.

Please read the notes for handling the battery.

## • **Set clock function**

The time information is set at Japan standard time. Set the year, month, day and time when the 2650A series is used for the first time. (Refer to “24.4 Setting the clock” for the details.)

## • **Quality assurance**

### **Warranty**

If the defect by our responsibility occurs within one year after delivered, it shall be repaired free of charge. However, this warranty does not cover such defect that :

- 1) is caused by a fire or natural disasters.
- 2) is caused by inappropriate handling such as dropping while moving the unit delivered.
- 3) is caused by handling in contradiction to usage or precautions described in the operating manual.
- 4) is caused by modification or misuse.

We will not be responsible for direct or indirect damage caused by use or defect of this product.

Refer to the end of this manual for details.

### **Warm-up time**

Warm up the product for at least ten minutes after turning on the power in order to stabilize the internal circuit.

### **Precautions for storage**

- 1) Avoid direct sunlight or dust.
- 2) Store this unit in a place where temperature is between -20 °C to 60 °C, humidity less than 60 °C/70 %RH and variations in temperature and humidity are small.

### **After service**

Please contact us without hesitation if you have any questions about this product:

B&K PRECISION  
22820 Savi Ranch Parkway  
Yorba Linda CA, 92887  
TEL. (714) 921 - 9095                      FAX. (714) 921 - 6422  
URL: <http://www.bkprecision.com>

# Contents

<b>1. OUTLINE</b>	<b>1</b>
1.1 PRODUCT OUTLINES	1
1.2 STANDARD ACCESSORIES	2
1.3 OPTIONAL ACCESSORIES	2
1.4 OVERVIEW OF ALL FOUR MODELS	3
<b>2. SPECIFICATIONS</b>	<b>4</b>
2.1 PERFORMANCE	4
2.2 EXTERNAL VIEW	7
<b>3. EXPLANATION OF PANEL</b>	<b>8</b>
<b>4. EXPLANATION OF SCREEN</b>	<b>11</b>
<b>5. FUNCTION MENU</b>	<b>12</b>
5.1 LIST OF FUNCTION MENU	12
5.2 MENU TREE	13
<b>6. PREPARING FOR OPERATION</b>	<b>19</b>
6.1 STAND	19
6.2 CONNECTION TO POWER SUPPLY	19
6.3 BATTERY CHARGE	20
6.4 INSTALLATION OF BATTERY	20
<b>7. CENTER FREQUENCY &lt;FREQ&gt;</b>	<b>21</b>
7.1 SETTING WITH STEP KEYS ( [F1], [F2] )	21
7.2 SETTING WITH ENCODER	21
7.3 SETTING WITH NUMERIC KEY	22
7.4 ACCORDING TO MARKER POSITION	23
<b>8. FREQUENCY SPAN &lt;SPAN&gt;</b>	<b>23</b>
8.1 SWITCHING FREQUENCY BAND	24
<b>9. REFERENCE LEVEL &lt;REFER&gt;</b>	<b>25</b>
9.1 SETTING OF REFERENCE LEVEL	25
9.2 CHANGE OF UNIT OF AMPLITUDE AXIS	25
9.3 SETTING OF STEP SIZE OF REFERENCE LEVEL	25
9.4 ON-OFF SETTING OF OFFSET	25
9.5 SETTING OF OFFSET LEVEL	25
9.6 SETTING OF INPUT IMPEDANCE	26
9.7 REFERENCE LEVEL SETTING RANGE FOR EACH UNIT	26
9.8 RELATIONSHIP BETWEEN REFERENCE LEVEL AND ATT/AMP (AT DBM)	27
<b>10. DISPLAY SCALE &lt;SCALE&gt;</b>	<b>28</b>
10.1 SETTING THE FUNCTION KEY	28
<b>11. RESOLUTION BANDWIDTH &lt;RBW&gt;</b>	<b>28</b>
11.1 MANUAL MODE	28
11.2 AUTO MODE	29
11.3 ALL AUTO MODE	29

<b>12.</b>	<b>VIDEO BANDWIDTH &lt;VBW&gt;</b>	<b>29</b>
12.1	MANUAL MODE	29
12.2	AUTO MODE	29
12.3	ALL AUTO MODE	30
<b>13.</b>	<b>SWEEP AXIS / DETECTION MODE &lt;SWEEP&gt;</b>	<b>30</b>
13.1	MANUAL MODE	30
13.2	AUTO MODE	30
13.3	ALL AUTO MODE	30
13.4	SETTING OF DETECTION MODE	30
13.5	SETTING OF TRIGGER SOURCE	31
<b>14.</b>	<b>AUTO TUNING &lt;AUTO TUNE&gt;</b>	<b>31</b>
<b>15.</b>	<b>HOLD / RUN &lt;HOLD/RUN&gt;</b>	<b>31</b>
<b>16.</b>	<b>CALCULATION FUNCTION &lt;CALC&gt;</b>	<b>32</b>
16.1	NORMAL MODE	32
16.2	MAX HOLD MODE	32
16.3	MIN HOLD MODE	32
16.4	AVERAGE MODE	33
16.5	OVERWRITE MODE	33
16.6	SPURIOUS FREE MODE (2658A ONLY)	33
<b>17.</b>	<b>MARKER &amp; PEAK SEARCH &lt;MKR&gt;</b>	<b>34</b>
17.1	MOVEMENT AND BASIC FUNCTION OF MARKER	35
17.2	NORMAL PEAK SEARCH	35
17.3	ZONE PEAK SEARCH	35
17.4	CHANGE UNIT OF MARKER LEVEL	36
<b>18.</b>	<b>SAVE / LOAD &lt;SAVE/LOAD&gt;</b>	<b>36</b>
18.1	SELECTION OF STORAGE DEVICE	37
18.2	SAVE FUNCTION	38
18.3	ABOUT FILE NAME	38
18.4	LOAD FUNCTION	39
18.5	DELETE FUNCTION	40
18.6	PRESETTING (INITIALIZATION)	40
<b>19.</b>	<b>MEASURING FUNCTION &lt;MEAS&gt;</b>	<b>41</b>
19.1	CHANNEL POWER MEASUREMENT <CH POWER>	41
19.2	ADJACENT CHANNEL LEAKAGE POWER MEASUREMENT <ACP>	42
19.3	OCCUPIED BANDWIDTH MEASUREMENT <OBW>	44
19.4	ELECTRIC FIELD STRENGTH MEASUREMENT <E/F ANT>	44
19.5	MAGNETIC FIELD STRENGTH MEASUREMENT <M/F PROBE>	48
19.6	FREQUENCY COUNTER <FREQ COUNT>	50
<b>20.</b>	<b>EMI TEST (2651)</b>	<b>50</b>
20.1	ADDITIONAL FUNCTION FOR EMI TEST	50
20.2	EMI TEST	51
<b>21.</b>	<b>SCREEN CONTROL &lt;DSPL&gt;</b>	<b>53</b>
21.1	SETTING SCREEN DISPLAY COLOR	54
21.2	ON/OFF SWITCHING OF LCD BACKLIGHT	54
21.3	ADJUSTING BRIGHTNESS OF LCD BACKLIGHT	54

<b>22.</b>	<b>TRACKING GENERATOR MODE (2652A)</b>	<b>54</b>
22.1	SPECIFICATION OF T.G. FUNCTION	54
22.2	DESCRIPTION OF I/O CONNECTOR	55
22.3	ON/OFF SWITCHING OF T.G. FUNCTION	55
22.4	NORMALIZING FUNCTION	56
<b>23.</b>	<b>STORAGE/PRINT SCREEN IMAGE &lt;COPY&gt;</b>	<b>57</b>
23.1	SELECTION OF IMAGE AREA	57
23.2	PRINT ON PRINTER	57
23.3	STORAGE INTO USB MEMORY	57
23.4	TRANSFERRING INTERNAL DATA TO USB MEMORY IN LUMP SUM	58
23.5	USB PRINTER (OPTION)	58
23.6	USB MEMORY	59
<b>24.</b>	<b>UTILITY FUNCTION &lt;UTIL&gt;</b>	<b>60</b>
24.1	LABEL FUNCTION	60
24.2	MENU OFF	61
24.3	BUZZER SETTING	61
24.4	SETTING THE CLOCK	61
<b>25.</b>	<b>USB DEVICE FUNCTION</b>	<b>63</b>
25.1	OUTLINE	63
25.2	HOW TO CONNECT	63
25.3	INSTALLATION OF DRIVER	63
25.4	SAMPLE PROGRAM	63
25.5	EXPLANATION OF COMMAND	64
25.6	INPUT OF FREQUENCY	73
25.7	TRANSFER OF SPECTRUM DATA	73
25.8	WRITING OF ORIGINAL COMPENSATION DATA	74
<b>26.</b>	<b>OPTION</b>	<b>76</b>
<b>27.</b>	<b>BASIC PERFORMANCE TEST (2650A/2651/2652A/2658A)</b>	<b>77</b>
27.1	FREQUENCY CHARACTERISTICS	77
27.2	ACCURACY OF REFERENCE LEVEL	78
27.3	DISPLAY ACCURACY OF CENTER FREQUENCY	78
27.4	DISPLAY ACCURACY OF FREQUENCY SPAN	79
27.5	LINEARITY OF AMPLITUDE AXIS	79

# 1. Outline

## 1.1 Product outlines

The 2650A series are authentic spectrum analyzers in a compact and lightweight form factor providing performance and functions comparable to large-size bench type instruments.

The features are as follows.

1) Compact and lightweight 1.8 kg.

The dimensions are 162(W)×71(H)×265(D) mm, and the weight is only 1.8 kg including the battery, making the instrument very convenient for field use.

2) Large color TFT display

5.7 inches, 640×480 color LCD

3) Four hours battery operation

The included Lithium-ion battery, when fully charged, can provide power for up to four hours of operation with the backlight turned off. And about 3 ½ hours with the backlight set to the minimum level.

4) USB host adapter

USB host port can be used with removable storage USB flash drives. The screen image is stored as BMP format, and the spectrum and the setting parameters are stored as CSV format. The port conforms to USB 1.1 standards and is backwards compatible with USB 2.0 devices.

5) USB device for PC connectivity

USB interface with transfer rates up to 12 Mbps maximum (conform to USB 1.1 standards).

6) Accurate frequency measurement by PLL synthesizer

The center frequency is accurately set by PLL (Phase Locked Loop) synthesizer. Moreover, the frequency counter (factory option) enables more accurate measurements of the frequency of a signal.

7) Average noise level -127 dBm

The low average noise level of -127 dBm @ 1 GHz provides a wide dynamic range.

8) 100 dB display dynamic range

Wide dynamic range display with a display scale of 100 dB/10div (at 10 dB/div) in the amplitude axis.

9) Easy operation with AUTO mode

- Auto range operation: RBW, VBW and sweep time are automatically selected based on the frequency span.
- Auto tuning operation: The center frequency is adjusted to the maximum level within full span, and the optimum RBW, VBW and sweep time are chosen.

## 10) Abundant functions

- Measuring functions : Channel power, Adjacent channel power, Occupied bandwidth, Electric field strength, Magnetic field strength and Frequency measurement.
- Calculation functions : Max hold, Min hold, Averaging, Over write
- Marker measurement and peak search function
- Save/Load function
- Hard copy with printer

## 11) PC Software

The included PC software controls all four models of the 2650A/2651 series via PC. The software emulates the front panel keys and supports transfer of 1001 point trace data from the analyzer to the PC. Screen images can be stored in BMP format and the spectrum data in CSV format (stores frequency and level).

## 12) Options

There are many options available, such as dipole antennas, magnetic field probes and USB printer

### **1.2 Standard accessories**

1. AC adaptor MA400
2. Carrying case LC2650A
3. Accessory pouch
4. User manual
5. PC software and USB cable
6. Lithium Ion battery MB400

### **1.3 Optional accessories**

1. Dipole antennas M401, M402, M403, M404, M405, M406
2. Magnetic field probe PR 26M with a dedicated double shielded coaxial cable
3. Printer PT2650A with AC adaptor, 4pcs of AA batteries, one roll paper
4. Roll paper PX2650A for PT2650A printer (with 10 rolls)



## 1.4 Overview of all four models

Model	Contents
2650A	50 kHz to 3.3 GHz Applications: Cellular phone, 2.4 GHz wireless LAN, 2.5 GHz WiMAX, RF-ID, Broadcasting
2658A	50 kHz to 8.5 GHz Covering most of the wireless communication frequency spectrum Applications: 5 GHz wireless LAN, 3.5/5.8 GHz WiMAX, Maintenance of wireless base station
2652A	50 kHz to 3.3 GHz With 5 MHz to 3.3 GHz tracking generator Applications: Frequency characteristics measurement of electronic component/circuit and return loss measurement
2651	50 kHz to 3.3 GHz For EMI test Applications: Radiated and conducted emission measurement

# 2. Specifications

## 2.1 Performance

### ▪ Frequency section

	2650A, 2652A, 2651	2658A		
Frequency range	50 kHz to 3.3 GHz		50 kHz to 8.5 GHz	
		Frequency range	Frequency band	Harmonic order
		50 k to 3.5 GHz	Base band	1
		3.3 G to 6.3 GHz	Band 1-	1
		6.1 G to 8.5 GHz	Band 1+	1
Center frequency				
Setting resolution	20 kHz Allows rotary encoder, numeric key and function key			
Accuracy	within $\pm(30+20T)$ kHz $\pm 1$ dot @frequency span: 200 kHz to 10 MHz, RBW 3 kHz, 23 $\pm$ 5°C within $\pm(60+300T)$ kHz $\pm 1$ dot @frequency span: 20 MHz to 3.3 GHz, RBW 100 kHz, 23 $\pm$ 5°C T: sweep time (s)		within $\pm(30+20T)$ kHz $\pm 1$ dot @frequency span: 200 kHz to 10 MHz, RBW 3 kHz, 23 $\pm$ 5°C within $\pm(60+300T)$ kHz $\pm 1$ dot @frequency span: 20 MHz to 8.5 GHz, RBW 100 kHz, 23 $\pm$ 5°C T: sweep time (s)	
RBW frequency error	within $\pm 4$ kHz @ 3 kHz, 10 kHz, 30 kHz within 20% of RBW @ RBW: 100 kHz, 300 kHz within 10% of RBW @ RBW: 1 MHz, 3 MHz			
Frequency span				
Setting range	0 Hz (zero span), 200 kHz to 2 GHz (1-2-5 step) and 3.3 GHz (full span)		0 Hz (zero span), 200 kHz to 5 GHz (1-2-5 step) and 8.5 GHz (full span)	
Accuracy	within $\pm 3\% \pm 1$ dot @ sweep time of 0.3s, 23 $\pm$ 5 °C			
Display resolution # of points per trace	501 dots on LCD screen, 1001 dots readout via PC (501 dots are visible on the display, 1001 dots of trace data are captured internally and can be transferred to a PC via USB device interface.)			
Resolution bandwidth	3 dB bandwidth (6 dB for 2651 @ 9 kHz, 120 kHz)			
Setting range	3 kHz to 3 MHz (1-3 step) and AUTO (2651: 3 kHz, 9 kHz, 30 kHz, 120 kHz, 300 kHz, 1 MHz, 3 MHz)			
Accuracy	$\pm 20\%$			
Selectivity	1:12 (typical, 3 dB : 60 dB)			
Video bandwidth	100 Hz to 1 MHz (1-3 step) and AUTO			
SSB phase noise	-90 dBc/Hz (typical) @100 kHz offset, RBW : 3 kHz, VBW : 100 Hz, sweep time: 1 s			
Spurious response	less than -60 dBc			
Harmonics	less than -40 dBc @ $\geq 100$ MHz			

▪ **Amplitude section**

		2650A, 2652A, 2651	2658A
Reference level			
	Setting range	+10 to -60 dBm (1dB step)	
	Accuracy	within $\pm 0.8$ dB $\pm 1$ dot @ center frequency : 100 MHz, RBW : 3 MHz, VBW : 1 MHz, REF : -15 dBm, 23 $\pm$ 5 °C	
	Unit	dBm, dBV, dBmV, dB $\mu$ V, dB $\mu$ V/m, dB $\mu$ A/m (dB $\mu$ V/m and dB $\mu$ A/m are used for measurement functions)	
Average noise level		-127 dBm (typical) @ CF : 1 GHz, RBW : 3 kHz, VBW : 100 Hz, Ref. level < -40dBm ( preamp automatically ON)	
Frequency characteristics		within $\pm 2.0$ dB $\pm 1$ dot @50 kHz to 100 MHz within $\pm 1.0$ dB $\pm 1$ dot @ 100 MHz to 3.3 GHz	within $\pm 2.0$ dB $\pm 1$ dot @50 kHz to 100 MHz within $\pm 1.0$ dB $\pm 1$ dot @100 MHz to 8.5 GHz
Input impedance		50 $\Omega$	
Input VSWR		less than 2.0	
Input attenuator			
	Operating range	0 to 25 dB (1 dB step), coupled with reference level	
	Switching error	$\pm 0.6$ dB @100 MHz	
RBW switching error		$\pm 0.6$ dB	
Display resolution (vertical)		381 dots/10div	
Display scale	Scale	10 dB/div, 5 dB/div, 2 dB/div	
	Accuracy	$\pm(0.2$ dB+1dot)/2 dB $\pm(0.4$ dB+1dot)/5 dB $\pm(0.8$ dB+1dot)/10 dB $\pm(1.8$ dB+1dot)/83 dB	
Input damage level		+27 dBm (CW average power), 25 VDC	

▪ **Sweep section**

		2650A, 2652A, 2651	2658A
Sweep time			
	Setting range	10 ms to 30 s and AUTO @frequency span : 0 to 2 GHz 30 ms to 30 s and AUTO @frequency span : full span 1-3 step	10 ms to 30 s and AUTO @frequency span : 0 to 2 GHz 30 ms to 30 s and AUTO @frequency span : 5 GHz, full span 1-3 step
	Accuracy	Within $\pm 0.1$ % $\pm 1$ dot @frequency span : 0 to 2GHz within $\pm 1.5$ % $\pm 1$ dot @ full span	Within $\pm 0.1$ % $\pm 1$ dot @frequency span : 0 to 5GHz within $\pm 2.5$ % $\pm 1$ dot @ full span
Trigger			
	Trigger mode	AUTO (Available only for zero span)	
	Trigger source	Internal and External	

External trigger	1 to 10 Vp-p
Input voltage range	DC to 5 MHz
Frequency range	DC coupling
Input coupling	approx. 0.56 V(fix)
Trigger level	approx. 10 k $\Omega$ /less than 15 pF
Input RC	$\pm$ 50 V(DC+AC peak)
Input damage level	SMA(J)
Input connector	
Detection mode	Positive peak, Negative peak, Sample ( QP and AV for model 2651 only.)

### ▪ Function

	2650A, 2652A, 2658A, 2651 common	
Marker measurement	NORM : displays frequency (8digits max) and level (4digits max) at marker point. DELTA : displays frequency difference and level difference between two markers.	
Peak search function	Searches for peak level with all of 10 div (NORM mode) or within ZONE specified (ZONE mode) and displays frequency and level at peak level, and moreover NEXT peak at NORM mode.	
Calculation function	NORM, MAX HOLD, MIN HOLD, AVERAGE, OVER WRITE Number of sweeps is 2 to 1024 (power of 2 ) and infinite.	
Measuring function	Channel power, Adjacent channel power, Occupied bandwidth, Electric field strength (needs optional dipole antenna), Magnetic field strength (needs optional magnetic field probe) and Frequency counter	
Auto tuning	When pressing AUTO TUNE key, the spectrum of maximum level within full span is adjusted to center, and reference level, RBW, VBW and sweep time are set to optimum parameters.	
Save/ Load	Save	Saves 200 spectrums and 200 setting parameters
	Load	Loads one spectrum and one setting parameter

### ▪ General

	2650A, 2652A, 2658A, 2651 common	
Input connector	N(J) connector	
USB Communication		
	Protocol	USB version 1.1 (will also work with USB 2.0 devices)
	Device Connector	B plug
	Transfer rate	12 Mbps
Hard copy	USB printer (option) connected to A plug (host) enables hard copy of screen.	
host connector	A plug	
Display		
	Display	5.7 inches and color LCD
	Backlight	LED backlight
	Number of dots	640(H) x 480(V) dots
Power supply		
	Dedicated AC adaptor	Input : 100 to 240 VAC Output : 9 VDC/2.6 A
	Lithium-ion battery Charge function	MB400 : 7.4 V/5000 mAh Li-Ion battery Capable of charging during power-off. Indicates 4 conditions with two colors LED (red and green).
	Remainder indication	5 level indicator

▪ Other

	2650A, 2652A, 2658A, 2651 common
Operating temperature	0 to 50° C (guaranteed at 23±10 °C, without soft carrying case)
Operating humidity	less than 40 °C/80 %RH (guaranteed at less than 33 °C/70 %RH, without soft carrying case)
Storage temperature	-20 to 60 °C, less than 60 °C/70 %RH
Dimensions	162(W) x 71(H) x 265(D) mm , 6.38 (W) x 2.80 (H) x 10.43 (D) inch (excluding projections, protection bumper and stand)
Weight	approx. 1.8 kg or 4 lbs (including battery)

\* Refer to section 22) Tracking Generator Mode for the specifications of the tracking generator, model 2652A.

## 2.2 External view

[Unit : mm]

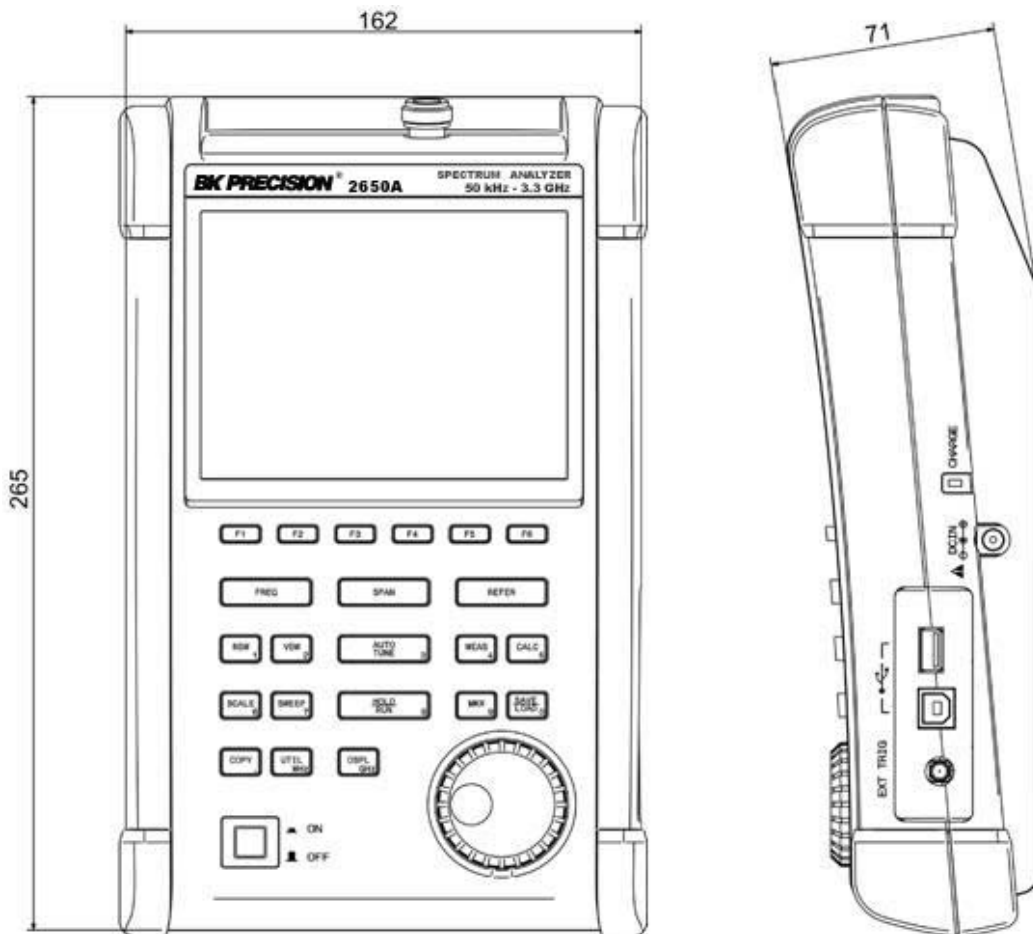

\* B&K Precision reserves the right to make changes in design, specification and other information without prior notice.

# 3. Explanation of Panel

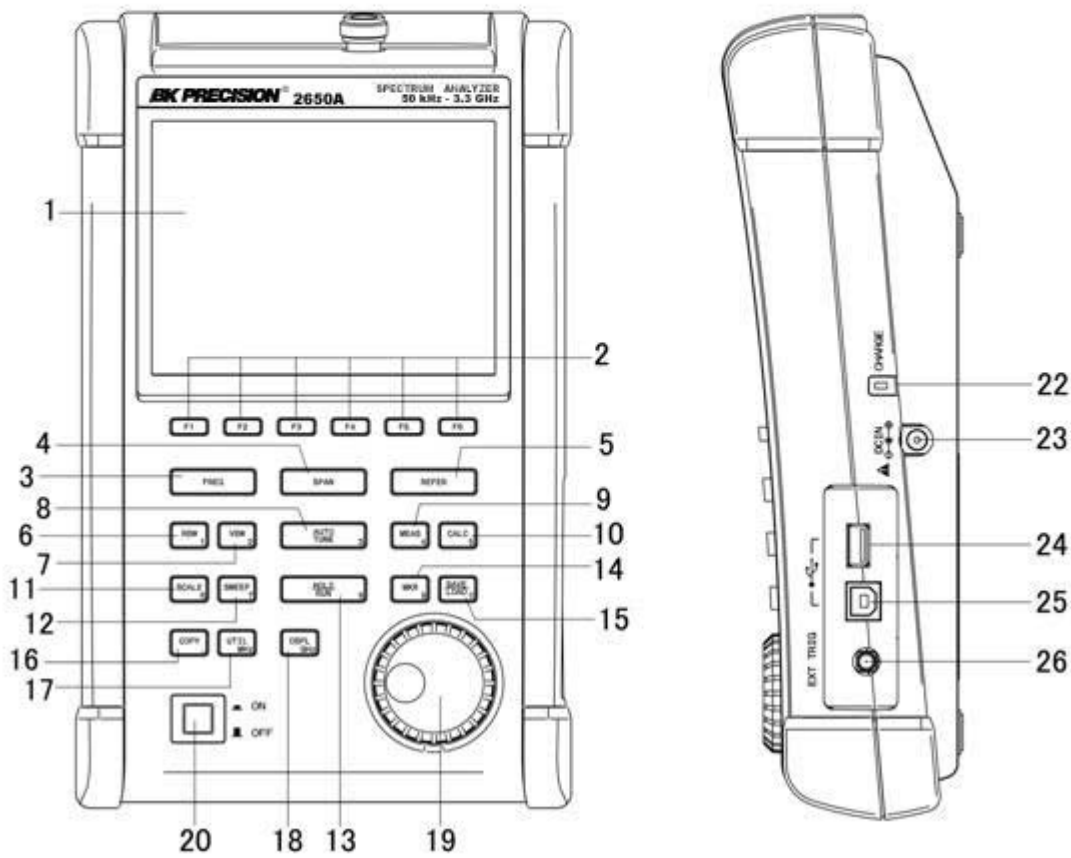
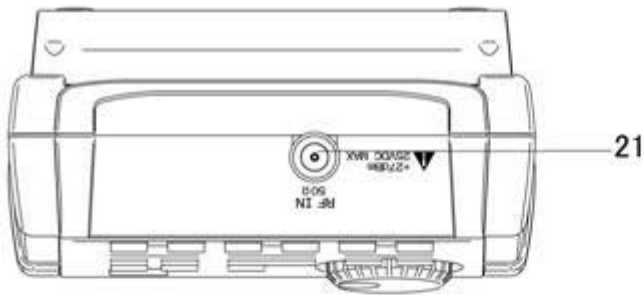

## 1) TFT display

This is a large liquid crystal display with 640 (H) x 480 (V) dots. It simultaneously displays spectrum (10div x 10 div), various setting parameters and measured values.

## 2) Function key (F1 to F6)

The function can change according to the operation key.

## 3) Center frequency key

The center frequency is set with this key. The setting range is 0 to 3.3 GHz (for 2650A, 2652A, and 2651), and 0 to 8.5 GHz (for 2658A). The setting resolution is 20 kHz.

#### **4) Frequency span key**

The frequency span is set with this key.

For 2650A, 2652A, and 2651, it is set in the range from 200 kHz to 2 GHz, ZERO SPAN or FULL SPAN (3.3 GHz). For 2658A, it is set in the range from 200 kHz to 5 GHz, ZERO SPAN or FULL SPAN (8.5 GHz).

#### **5) Reference level key**

The reference level is set with this key. It can be set in the range from +10 dBm to –60 dBm by 1 dB step.

#### **6) Resolution bandwidth key**

The resolution bandwidth is set with this key. It can be set in the range from 3 kHz to 3 MHz and to AUTO.

#### **7) Video bandwidth key**

The video bandwidth is set with this key. It can be set in the range from 100 Hz to 1 MHz and to AUTO.

#### **8) AUTO tuning key**

When pushing this key, the spectrum with the maximum level is searched within full span (3.3 GHz @ 2650A/2652A/2651 and 8.5 GHz @ 2658A), and then it is adjusted to the center of the screen, and the optimum setting parameters are set. In the case when in zero span, full span, input signal level lower than –40 dBm and input frequency lower than 50 MHz, this function will not work correctly.

#### **9) Measuring function key**

Available for Channel power, Adjacent channel leakage power, Occupied frequency bandwidth, Electric field strength, and Magnetic field strength measurement.

#### **10) Calculation function key**

Available for Max hold, Min hold, Average and Over write.

#### **11) Display scale key**

The display scale of amplitude axis can be selected as 2 dB/div, 5 dB/div or 10 dB/div with this key.

#### **12) Sweep key**

The sweep time can be set in the range from 10 ms to 30 s or AUTO. This key can also select the detection mode.

#### **13) Hold/Run key**

Used to hold or run measurements.

#### **14) Marker & Peak search key**

This key is used for setting marker or peak search.

#### **15) Save/Load key**

Used for saving or loading a spectrum or settings parameters.

#### **16) Copy key**

This key allows the screen image to be printed on USB printer (option) or stored in USB memory.

#### **17) UTIL key**

Used for setting label entry, clock, and buzzer.

#### **18) Display control key**

Used for setting color, backlight ON/OFF or brightness of backlight.

#### **19) Rotary encoder**

This is used for adjusting settings and parameters.

#### **20) Power switch**

This is for power ON or OFF.

#### **21) Input connector**

N(J) connector

#### **22) Indicator for charging condition**

Two color LED indicates the charging conditions of battery.

#### **23) Input connector for DC power source**

Connect AC adaptor MA400.

#### **24) USB A plug**

For connecting USB printer (option) or USB memory.

#### **25) USB B plug**

For interfacing with a PC



# 4. Explanation of Screen

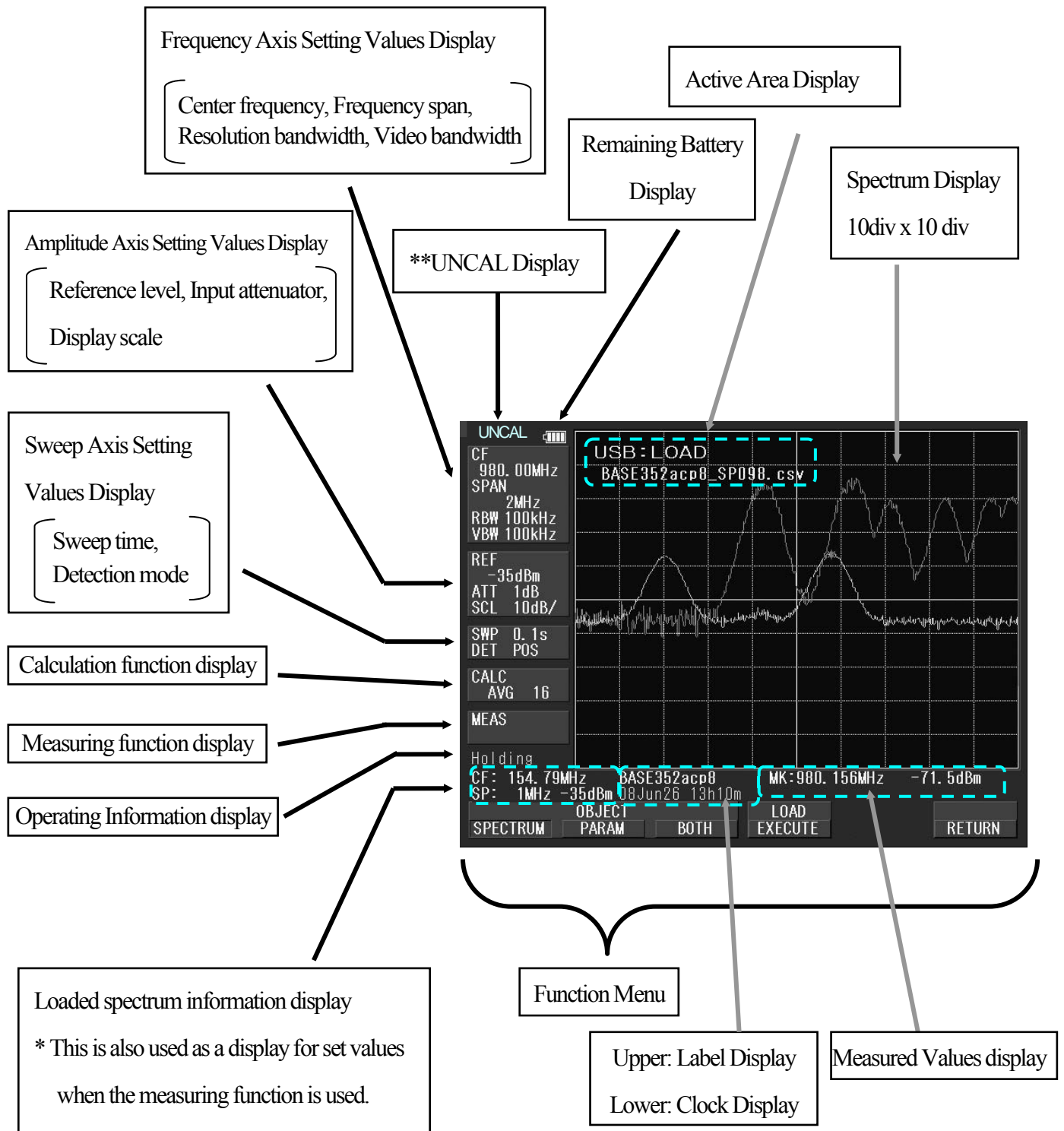

\*\*UNCAL is displayed when a normal measurement cannot be done due to sweep rate being too fast. In such cases, slowing down the sweep rate will change this indicator.

# 5. Function Menu

## 5.1 List of Function Menu

The function menu is shown in the table below. For descriptions of each function, see their respective page. For the sequence of selection for the function menu, refer to “5.2 Menu tree”.

	Function menu	Key Sequence	Page	
<b>A</b>	ACP OFFSET	MEAS → (F2) → F2	42	
	ACP	MEAS → F2	41	
	ACP WIDTH	MEAS → (F2) → F3	42	
	ANT	MEAS → (F4) → F1	44	
	AVG	CALC → F4	32	
<b>B</b>	BACK LT	DSPL → F2	53	
	BACK SPACE	FREQ → F6 → F5	21	
	BAND CNTR	MEAS → (F1) → (F1) → F2	41	
	BAND WIDTH	MEAS → (F1) → (F1) → F3	41	
	BRIGHT	DSPL → F3	53	
	BUZZER	UTIL → F3	59	
	<b>C</b>	CENTER FREQ ←	FREQ → F1	20
CENTER FREQ →		FREQ → F2	20	
CH POWER		MEAS → F1	41	
CLEAR		FREQ → F6 → F4	21	
CLOCK CONFIG		UTIL → F4	59	
COLOR		DSPL → F1	53	
CONV		MKR → F6	33	
<b>D</b>		DELETE	SAVE/LOAD → F3	36
		DEVICE MEM	SAVE/LOAD → F4	36
	DET	SWEEP → F4	29	
	DISP CLEAR	SAVE/LOAD → F2 → F5	38	
<b>E</b>	E/F ANT	MEAS → F4	43	
	EncST	FREQ → F4	20	
	EMI-C **1	SAVE/LOAD → F6 → F2	50	
	EMI-R **1	SAVE/LOAD → F6 → F3	50	
<b>F</b>	FREQ COUNT	MEAS → F6	49	
<b>I</b>	IMP	REFER → F6	25	
<b>K</b>	KeyST	FREQ → F3	20	
<b>L</b>	LABEL	UTIL → F1	58	
	LOAD	SAVE/LOAD → F2	38	
<b>M</b>	M/F PROBE	MEAS → F5	47	
	MAX HLD	CALC → F2	31	
	MEAS OFF	MEAS → (F1~5) → F6	41	
	MIN HLD	CALC → F3	31	
	MARKER DELTA	MKR → F2	33	
	MARKER NORMAL	MKR → F1	33	

	Function menu	Key Sequence	Page	
<b>M</b>	MODE	MEAS → (F1 → F3) → F1	41 to 43	
	<b>N</b>	NEXT PEAK	MKR → (F4) → F2	34
NORMAL		CALC → F1	31	
NORMAL **1		SAVE/LOAD → F6 → F1	50	
<b>O</b>	OBW	MEAS → F3	42	
	OFSdB	REFER → F5	24	
	OFS STEP	REFER → F3	24	
	OVR WR	CALC → F5	32	
<b>P</b>	PEAK SEACH	MKR → (F5) → F1	34	
	PEAK SERCH NORM	MKR → F4	34	
	PEAK SERCH ZONE	MKR → F5	34	
	PRE SET	SAVE/LOAD → F6	36	
	PROBE	MEAS → (F5) → F1	48	
	<b>R</b>	RATIO	MEAS → (F3) → F2	43
RBW ALL AUTO		RBW → F3	28	
RBW AUTO		RBW → F2	28	
RBW MANUAL		RBW → F1	27	
REFERENCE CENTER		MEAS → (F2) → F4	42	
REFERENCE WIDTH		MEAS → (F2) → F1 → F5	42	
<b>S</b>		SAVE	SAVE/LOAD → F1	36
		SCALE 5dB	SCALE → F3	27
	SET MKR	FREQ → F5	20	
	SPR. FR **2	CALC → F6	32	
	SWEEP AUTO	SWEEP → F2	29	
	SWEEP MANUAL	SWEEP → F1	29	
	<b>T</b>	T.G. MODE **3	SWEEP → F6	55
TRIG		SWEEP → F5	30	
Ten Key MODE		FREQ → F6	20	
<b>U</b>	UNIT	REFER → F1 → 4	24	
<b>V</b>	VBW ALL AUTO	VBW → F3	29	
	VBW AUTO	VBW → F2	28	
	VBW MANUAL	VBW → F1	28	
<b>Z</b>	ZONE CENTER	MKR → (F5) → F1	35	
	ZONE WIDTH	MKR → (F5) → F2	35	

\*\*1 2651 only \*\*2 2658A only \*\*3 2652A only

## 5.2 Menu Tree

The following is the sequence of selection for the function menu. The function menu corresponds to the function key of F1 to F6.

### “Function menu”

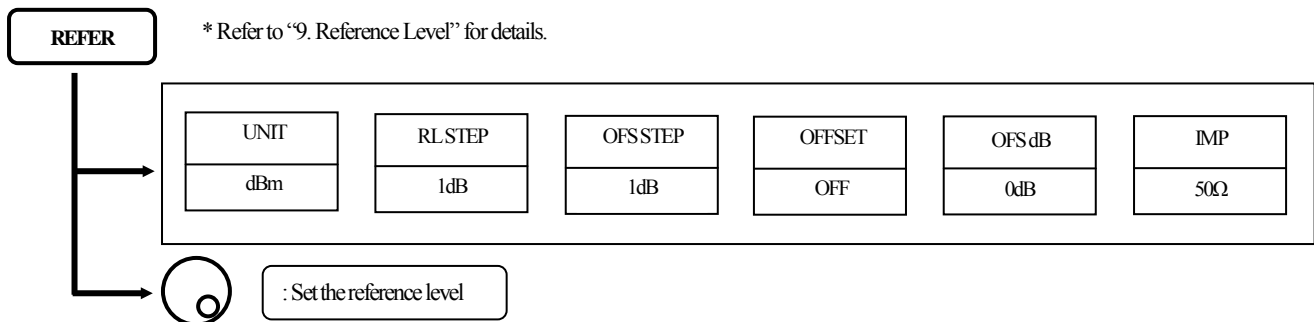
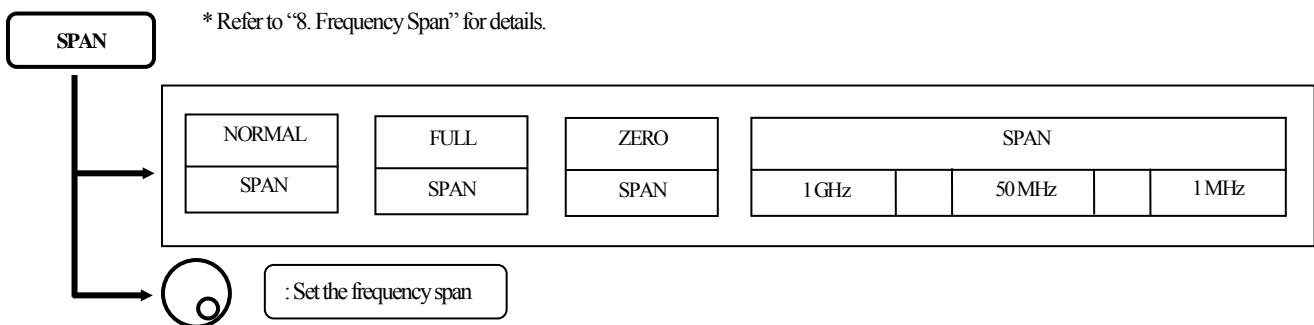
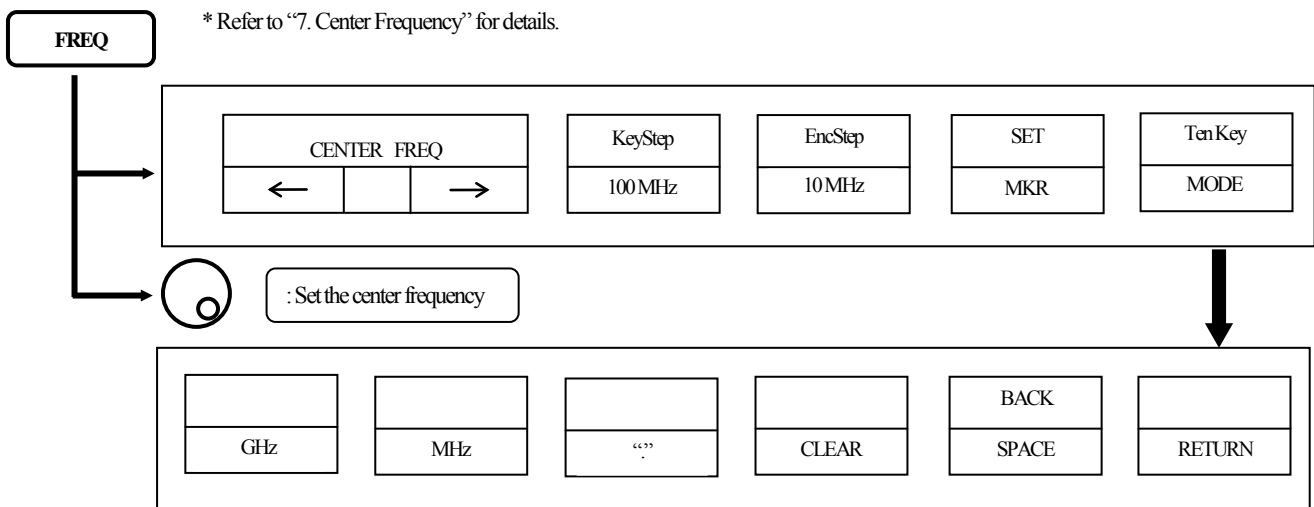
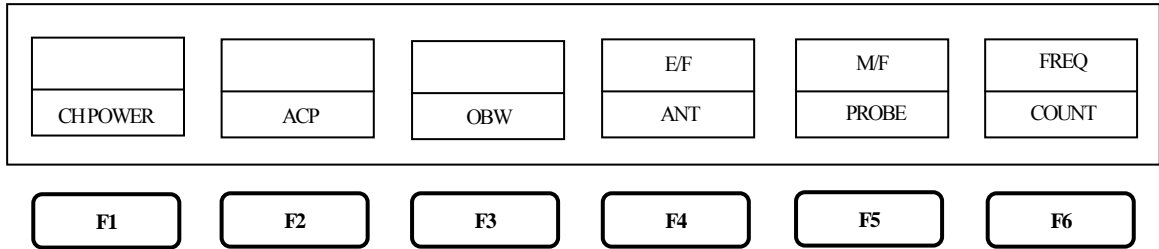

**SCALE** \* Refer to "10. Display scale" for details.

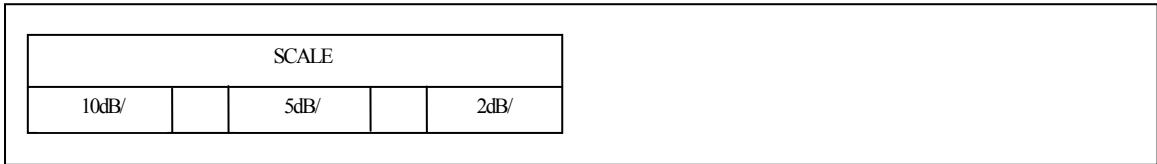

: Set the display scale

**RBW** \* Refer to "11. Resolution Bandwidth" for details.

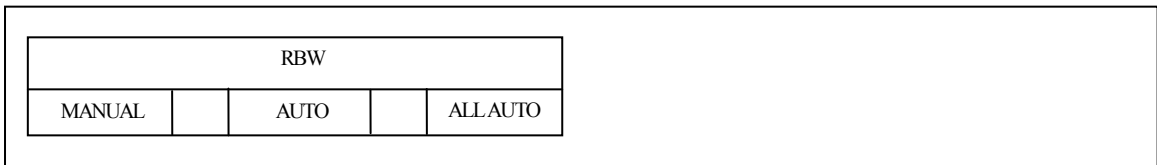

: Set the RBW

**VBW** \* Refer to "12. Video Bandwidth" for details.

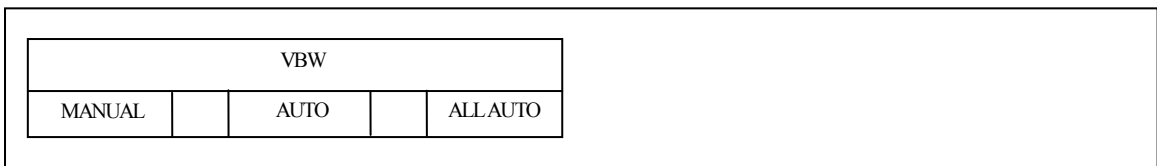

: Set the VBW

**SWEEP** \* Refer to "13. Sweep Axis / Detection Mode" for details.

\* T.G. MODE is only for 2658A.

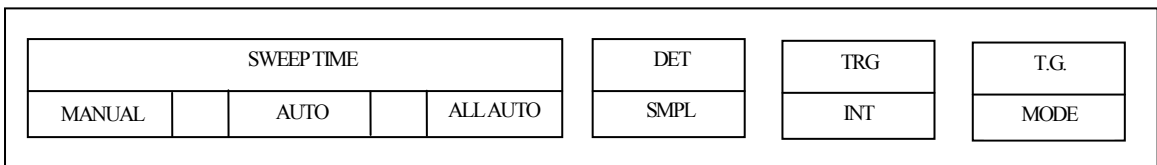

: Set the sweep time



**CALC**

\* Refer to "16. Calculation Function" for details.

\* "SPR. FR" is only for 2658A.

NORMAL	MAXHLD	MINHLD	AVG	OVR WR	SPR. FR
	256	256	256	256	OFF

 : Set the number

**MKR**

\* Refer to "17. Marker & Peak Search" for details.

MARKER				PEAK SEARCH		CONV
NORMAL		DELTA		OFF	NORMAL	ZONE
						dBm → W

 : Move the marker (NORM mode)

F4: Peak Search

PEAK	NEXT	
SEARCH	PEAK	RETURN

 : Move the marker (NORM mode)

F5: Zone marker

ZONE			
CENTER		WIDTH	RETURN

 : Set the zone center frequency (ZONE mode)

**SAVE/LOAD**

\* Refer to "18. Save / Load" for details.

Main menu

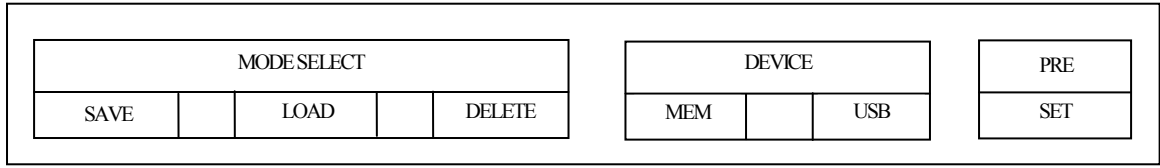

Save menu

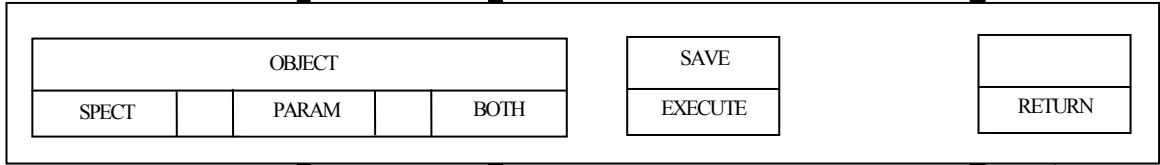

Load menu

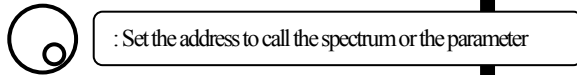
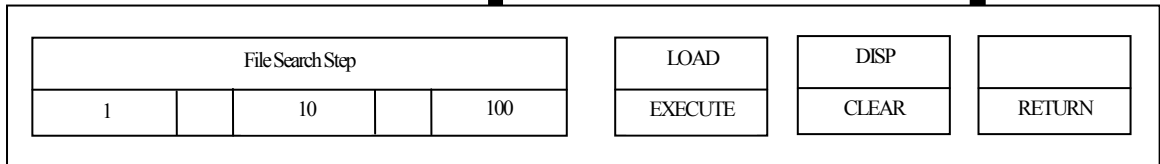

Delete menu

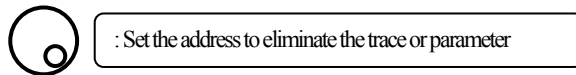
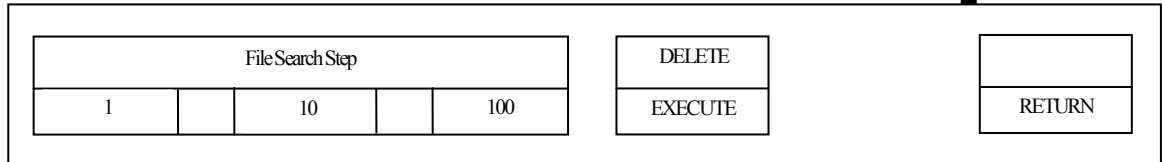

For 2651

Preset menu for 2651

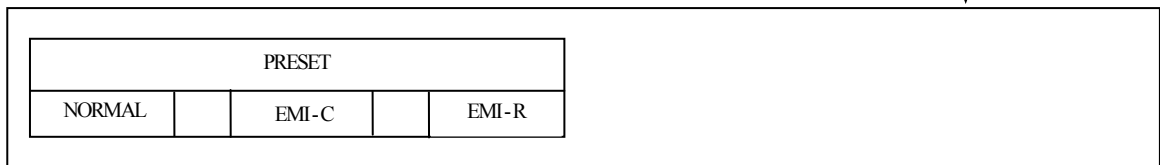

MEAS

\* Refer to "19. Measuring Function" for details

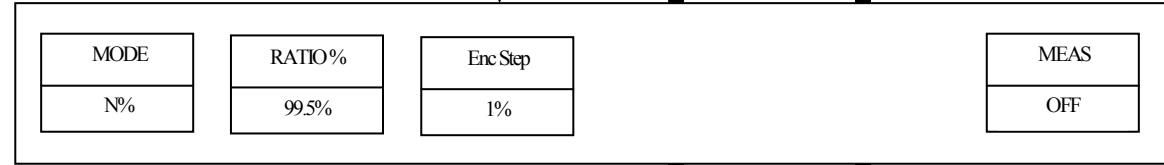
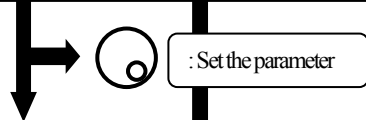
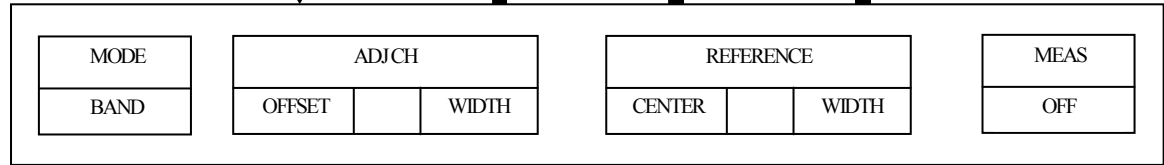
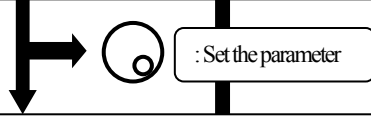
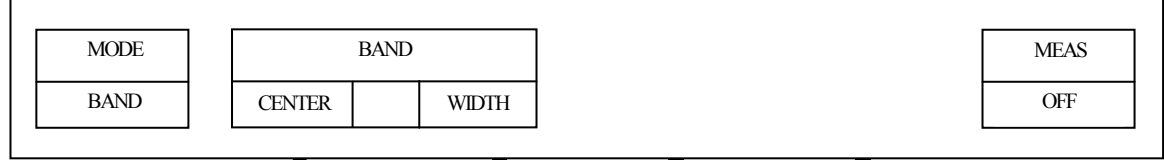
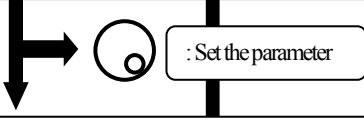
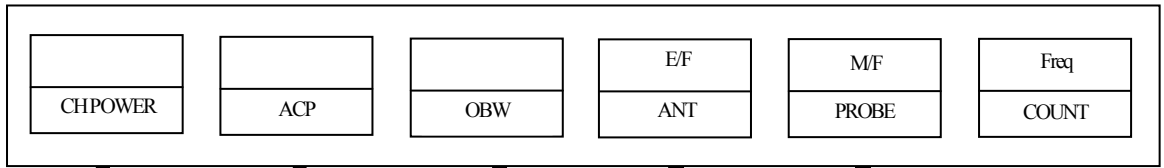

Input the probe ID (first time only) \*Refer to "19.5 Magnetic field strength measurement" for details.

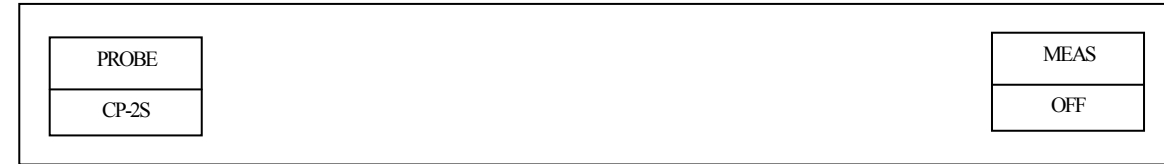

**DSPL**

\* Refer to "21. Screen Control" for details

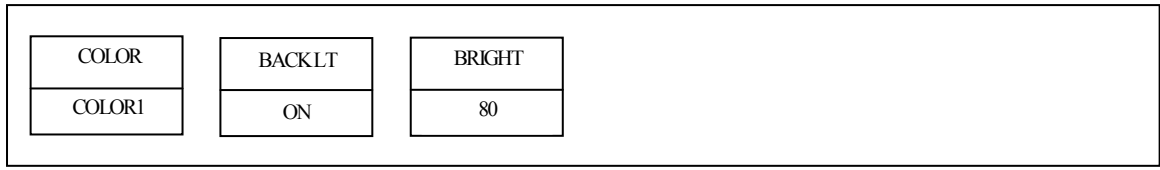

**COPY**

\* Refer to "23. Storage/Print Screen Image" for details

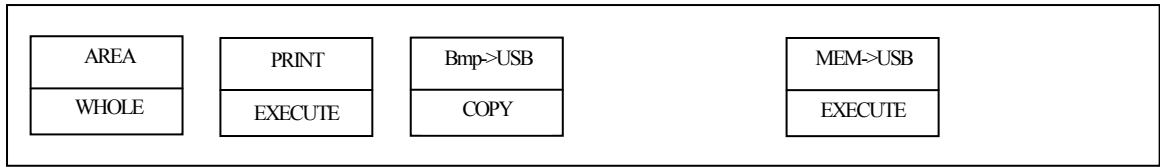

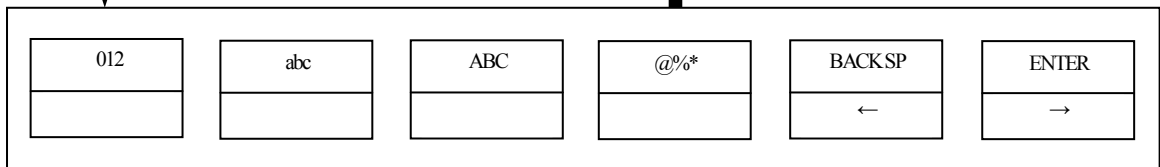
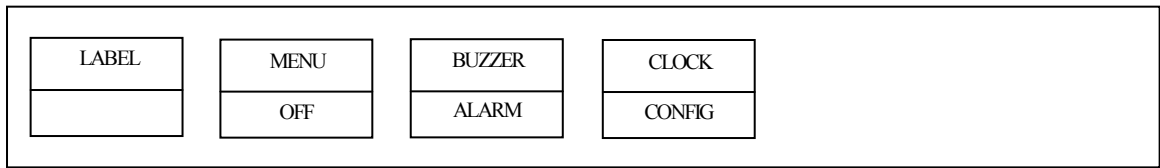

**UTIL**

\* Refer to "24. Utility Function" for details

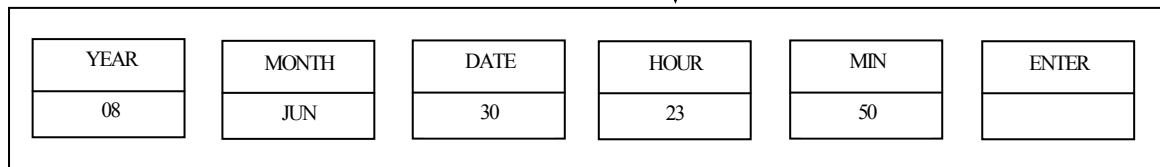

 : Select the character



 : Select the numeric value



# 6. Preparing for Operation

## 6.1 Stand

Utilize the stand on the back to use the screen in an easier-to-see angle on the desk.

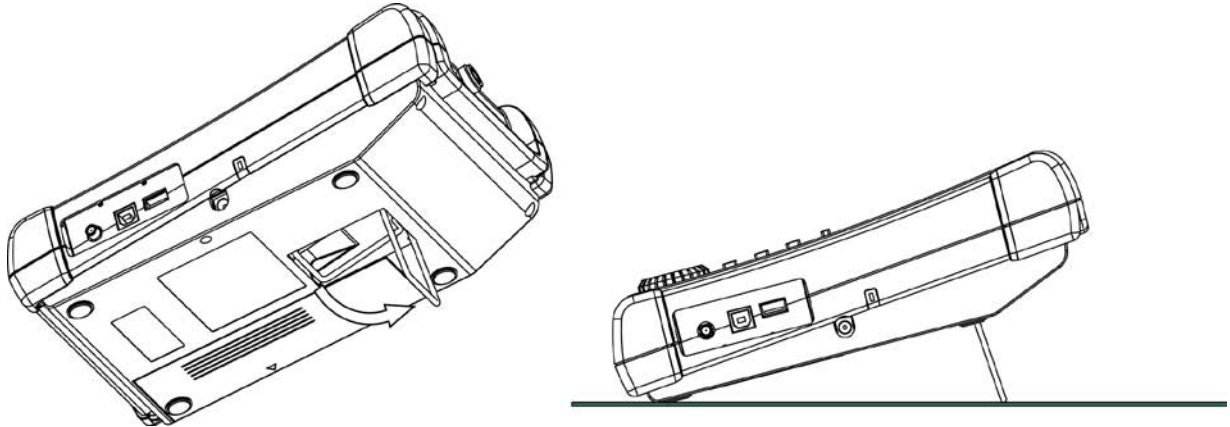

## 6.2 Connection to power supply

The AC adapter MA400 is used to power the instrument and for charging the MB400 battery. (Charging starts automatically if the AC adapter is connected and unit is power-off.) Connect the adapter as in the figure below and connect the AC plug to the power line (100-240 VAC, 50/60 Hz). For static electricity protection, ground the unit by connecting the three cores if possible. Not grounding the unit can damage the unit and/or device being measured. Do not use an AC adapter other than the MA400 supplied with the unit. Using an AC adapter other than the MA400 may cause damage to the unit.

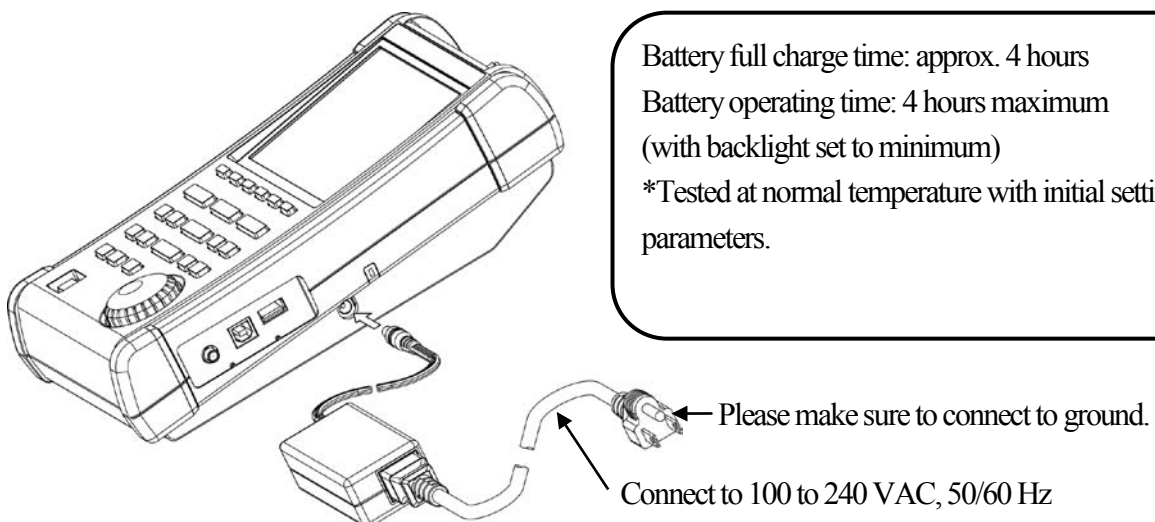

The battery indicator is divided into five levels and is displayed on the screen. When the mark of the battery remainder displays , the buzzer will sound even if buzzer is OFF under settings, and the power will turn off within a few minutes. Ensure to protect any data or measurements promptly by saving into memory to prevent data lost if the unit shuts down.

## 6.3 Battery Charge

When the unit is powered off and connected to AC adaptor MA400, the battery will be charged. The charging conditions are indicated by two colors LED, and they correspond to the table below.

Charging condition	Color of LED
On Charge	Red
Completion of Charge	Green
No battery	Green
Abnormal	Blinking Red

Good usage of battery
Remove the battery when unit is connected to the AC adaptor. Otherwise, battery life will be shortened.

※LED is turned off at power-on.

The “abnormal” condition means that the charging time is more than the time expected, or the battery voltage is too high.

**Note:** The battery charges only when the unit is turned off (and the AC adaptor connected). **It is not possible to charge the batteries while the unit is turned on.** Please charge batteries with ambient temperature in the range of 0 °C to 40 °C.

### Caution

Misuse of the battery may cause leaks, abnormal heat, fire or explosion.

For safe use, please observe the following precautions fully.

- \* Do not short-circuit the terminal of the removed battery.
- \* Do not cause an impacted shock due to throwing, dropping or striking.
- \* Do not disassemble or remodel the battery.
- \* Do not throw the battery into a fire or any sources with heat.
- \* Do not leave the battery in a place with high temperature.
- \* Do not wet the terminal of the battery.
- \* Do not cool the battery, and do not charge it in cold outdoor conditions. It decreases performance and battery life.
- \* Do not charge the battery in any other way except according to specifications.
- \* When you keep the battery, please keep it in a cool, dark environment where humidity is low. Moreover, please keep it out of reach from children. If the battery remains not used for a long time, it might decrease its charges.
- \* Please exchange the battery for a new one (MB400) when operating time extremely shortens.

## 6.4 Installation of Battery

To install the battery, please turn off the power and unplug the AC adaptor if in use. Remove the battery cover on the back of the unit by first pressing down with light pressure, then slide towards the direction of the arrow as shown in Fig.1. Next, put the battery as shown in Fig.2. Move it in the direction of the arrow shown in Fig.3 until it locks in. Use only the MB400 battery as specified. Otherwise, the unit may cause problems or malfunction.

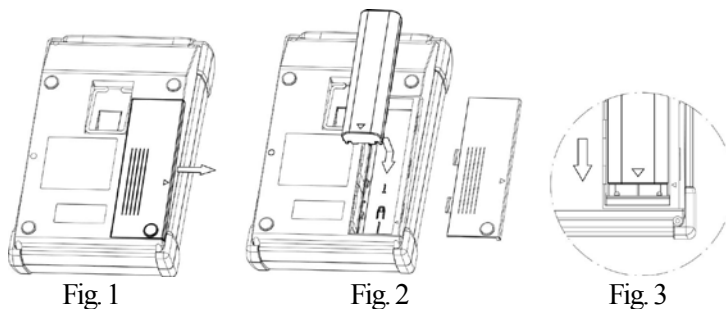

# 7. Center Frequency <FREQ>

When **FREQ** is pushed, the following function menu is displayed.

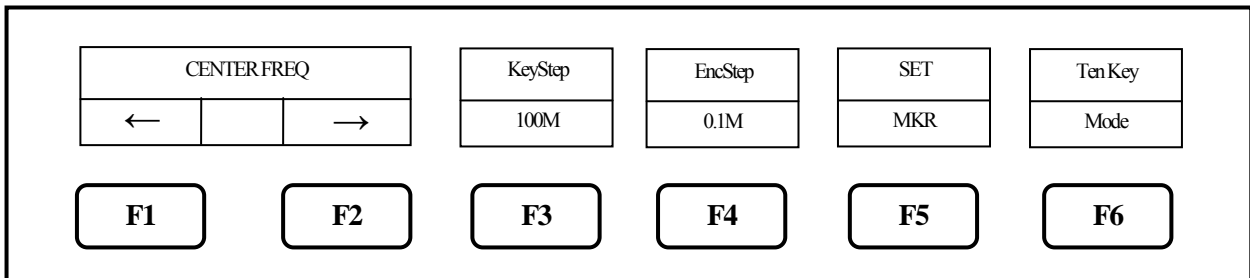

\* Center frequency setting range: 0 to 3.3 GHz for 2650A/2652A/2651, 0 to 8.5 GHz for 2658A

\* The center frequency may shift for a while (up to 10 sec.), after setting is changed.

## 7.1 Setting with step keys ( [F1], [F2] )

1. When **F1** is pushed, the center frequency decreases in the set step size.
2. When **F2** is pushed, the center frequency increases in the set step size.
3. Setting step size:

When **F3** is pushed, the step size is changed according to the following.



**AUTO**: The step size is 1/10 of the frequency span.

However, only for 500 kHz frequency span, the step size is set to 50 kHz.

If the frequency span is less than 500 kHz, the step size is set to 20 kHz.

AUTO is recommended for normal use.

## 7.2 Setting with encoder

1. By rotating , the center frequency is changed in the set step size.
2. Setting step size:

When **F4** is pushed, the step size is changed according to the following.

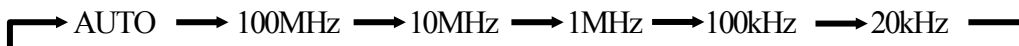

**AUTO**: The step size is 1/500 of the frequency span

However, if the frequency span is less than 5 MHz, the step size is set to 20 kHz.

AUTO is recommended for normal use.

## 7.3 Setting with numeric key

1. When **F6** is pushed, the following function menu is displayed.

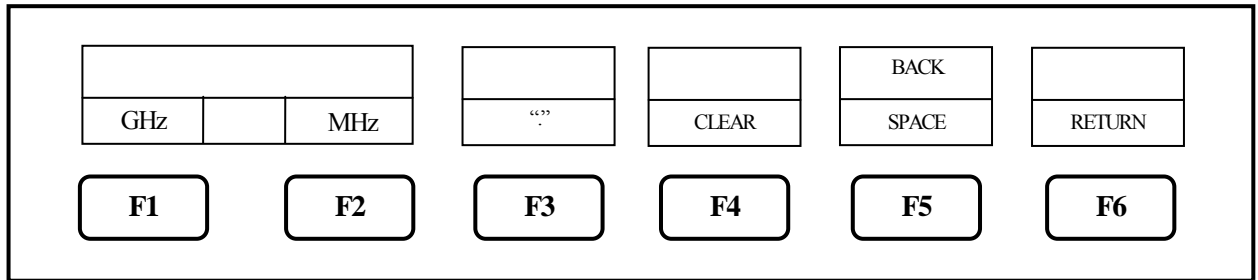

2. **F1**, **F2** and **F3** correspond to <GHz>, <MHz> and <.>

**F4** and **F5** correspond to <CLEAR> and <BACK SPACE>.

Changing the center frequency by encoder is available in Ten Key Mode.

3. The center frequency can be entered directly according to “Numeric Key Mapping Diagram” as follows.

“Numeric Key Mapping Diagram”

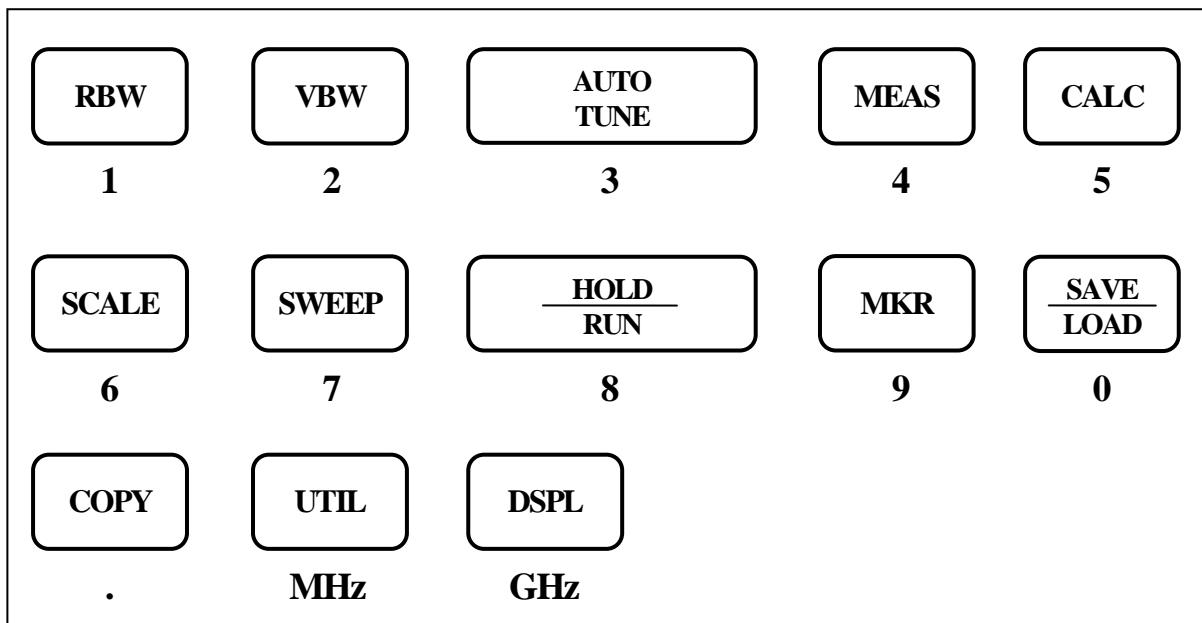

4. The center frequency is determined by inputting the unit of frequency.

To enter the unit, **UTIL** and **DSPL** are available.

( **F1** and **F2** are also available.)

\* Any figures below the setting resolution (20 kHz) will be truncated.

5. Change of setting

The setting can be changed before pushing the unit key.

**F4** : The setting values are cleared.

**F5** : The last input digit is deleted.

## 6. Cancel of Ten Key Mode

By pushing **FREQ** or **F6**, unit will return to function menu.

## 7.4 According to Marker Position

When **F5** is pushed, the center frequency is set according to the frequency of current marker position.

\* Any figures below the setting resolution (20 kHz) will be truncated.

\* When the marker is not displayed, this operation is invalid. (The menu option disappears.)

# 8. Frequency Span <SPAN>

When **SPAN** is pushed, the following function menu is displayed.

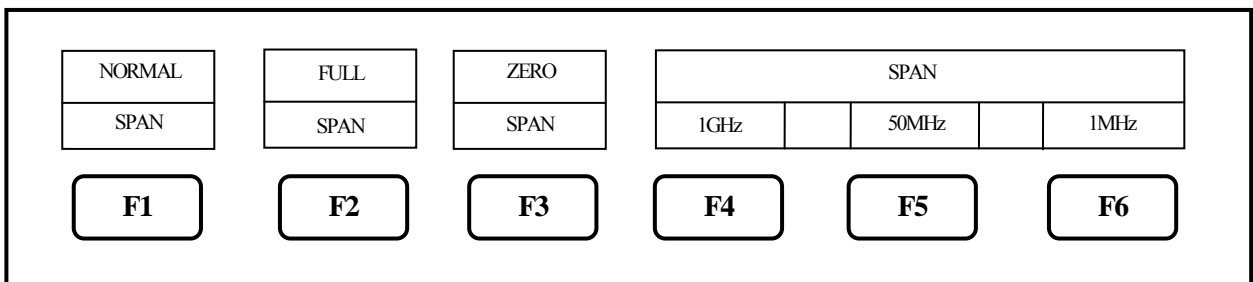

By operating **SPAN** → , the frequency span is set.

2650A / 2652A / 2651

By rotating , the frequency span is changed in the specified step size as follows.

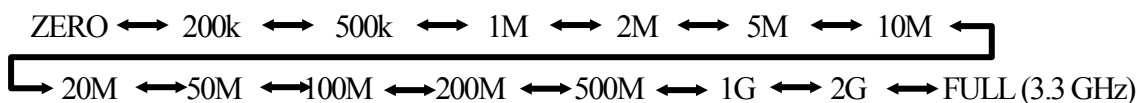

2658A

1. By rotating , the frequency span is changed in the specified step size as follows.

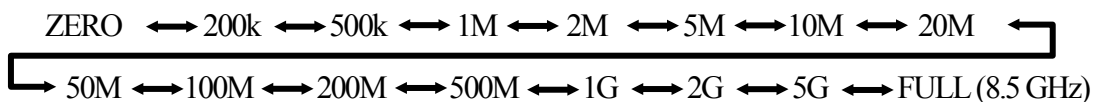

2. By pushing **F2**, the frequency span is set to FULL SPAN. Under this condition, the instrument will return to the former span when the rotary knob is rotated.

3. By pushing **F3**, the frequency span is set to ZERO SPAN.

4. When **F1** is pushed and then the setting is FULL or ZERO span, the frequency span is returned to the last setting.
5. By pushing **F4** ~ **F6**, the frequency span in function menu is set.

## 8.1 Switching Frequency Band

2658A has three frequency bands.

Frequency band	Measured frequency range
Base band	50 kHz to 3.5 GHz
Band 1-	3.3 GHz to 6.3 GHz
Band 1+	6.1 GHz to 8.5 GHz

The frequency band is automatically set to the appropriate band based on the center frequency and span.

(At the span less than 200 MHz, only one band is used.)

When the setting frequency range belongs to two bands, the lower band has priority.

The frequency connection point of two bands is fixed as follows.

Two bands	Frequency connection point
Base band and Band 1-	3.4 GHz
Band 1- and Band 1+	6.2 GHz

Note: The spectrum may change a little at the frequency connection point.

For accurate measurement, center frequency and span should be set as the measured frequency range in one band.

# 9. Reference Level <REFER>

When **REFER** is pushed, the following function menu is displayed.

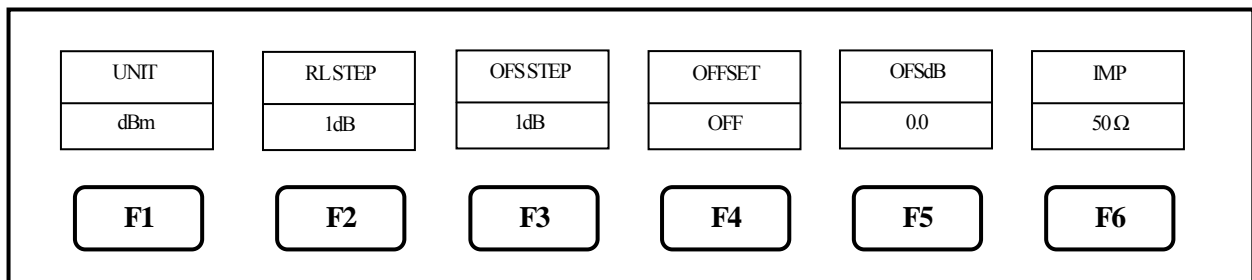

## 9.1 Setting of Reference Level

By rotating , the reference level is changed.

(Refer to “9.7 Reference Level Setting Range for Each Unit” for details.)

## 9.2 Change of Unit of Amplitude Axis

When **F1** is pushed, the unit is set as follows.

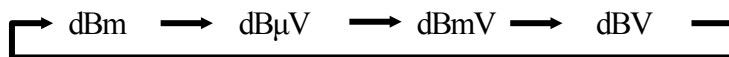

## 9.3 Setting of Step Size of Reference Level

By pushing **F2**, the step size is changed to 10 dB or 1 dB.

## 9.4 On-Off Setting of Offset

By pushing **F4**, the offer set ON/OFF is changed.

## 9.5 Setting of Offset Level

1. By operating **F5** , the offset of reference level is set.

When external amplifier or attenuator is used, the display level can be matched by the offset.

The setting range is -50.0 to 50.0 dB.

The reference level is displayed including the offset.

\* If the offset is set, “OFST” is displayed in Amplitude axis setting values display area.

Furthermore, the level at the marker point is displayed including the offset.

\* If the unit is changed to dB $\mu$ V, dBmV, dBV or dBm, the offset is automatically changed.

2. By pushing **F3**, the step size of offset is changed. (10 dB, 1 dB, 0.1 dB)

## 9.6 Setting of Input Impedance

By pushing **F6**, the input compensation can be set to 50  $\Omega$  (no offset) or 75  $\Omega$ . (5.6 dB offset compensation)

The reference level is adjusted automatically, based on the input impedance selection. When the input impedance is set to 75  $\Omega$ , the reference level is displayed including offset and conversion of 75 $\Omega$ . For the amplitude reading to be correct, a coaxial 50  $\Omega$  /75  $\Omega$  impedance conversion adapter must be connected to the RF input.

\* When “75  $\Omega$ ” is selected, values in Amplitude axis setting values display area will change according to 75  $\Omega$ , and the offset is set to 5.7 dB (insertion loss of 50  $\Omega$  /75  $\Omega$  adapter ). Moreover, the offset can be changed.

When the unit at marker point is set to W, V, V/m or other, it is converted correctly from dBm.

\* Be sure to attach a coaxial 50  $\Omega$  /75  $\Omega$  impedance conversion adapter when selecting “75  $\Omega$ ”

## 9.7 Reference Level Setting Range for Each Unit

Unit	dBm	dB $\mu$ V	dBmV	dBV
Maximum	10	117	57	-3
Minimum	-40	67	7	-53
Minimum (shifted spectrum data)	-60	47	-13	-73

“Available unit in measuring function”

Unit	dB $\mu$ V/m (Electric field strength measurement)						dB $\mu$ A/m (Magnetic field strength measurement)
	M401	M402	M403	M404	M405	M406	
Setting							CP-2S
Maximum	143	146	149	150	137	159	160 ~ 203
Minimum	93	96	99	100	87	109	110 ~ 153
Minimum (shifted spectrum data)	73	76	79	80	67	89	90 ~ 133

\* When the reference level is set between “Minimum” and “Minimum (shifted spectrum data)”, the spectrum of “Minimum” is shifted and displayed on the screen.



\* When the reference level is set below “Minimum”, “\*S/W AMP” is displayed in Amplitude axis setting values display area on the screen.

Calculation formula (conversion from dBm)

- $A[\text{dB}\mu\text{V}] = 107 + X [\text{dBm}]$
- $B[\text{dBmV}] = 47 + X [\text{dBm}]$
- $C[\text{dBV}] = -13 + X [\text{dBm}]$
- $D[\text{dB}\mu\text{V}/\text{m}] = 68.8 / \lambda \times \sqrt{X/\text{Gar}} [\text{dBm}]$        $\lambda$  : Wavelength[m]      Gar : Antenna absolute gain[times]
- $E[\text{dB}\mu\text{A}/\text{m}] = 107 + X + F[\text{dBm}]$       F : Probe calibration coefficient[dB] \*\*changes depending on the frequency.

## 9.8 Relationship Between Reference Level and ATT/AMP (at dBm)

REFER (dBm)	ATT (dB)	AMP (dB)
10	25	0
9	24	0
8	23	0
7	22	0
6	21	0
5	20	0
4	19	0
3	18	0
2	17	0
1	16	0
0	15	0
-1	14	0
-2	13	0

REFER (dBm)	ATT (dB)	AMP (dB)
-3	12	0
-4	11	0
-5	10	0
-6	9	0
-7	8	0
-8	7	0
-9	6	0
-10	5	0
-11	4	0
-12	3	0
-13	2	0
-14	1	0
-15	0	0

REFER (dBm)	ATT (dB)	AMP (dB)
-16	20	21
-17	19	21
-18	18	21
-19	17	21
-20	16	21
-21	15	21
-22	14	21
-23	13	21
-24	12	21
-25	11	21
-26	10	21
-27	9	21
-28	8	21

REFER (dBm)	ATT (dB)	AMP (dB)
-29	7	21
-30	6	21
-31	5	21
-32	4	21
-33	3	21
-34	2	21
-35	1	21
-36	5	26
-37	4	26
-38	3	26
-39	2	26
-40	1	26

Internal input attenuator (ATT) and IF amplifier (AMP) are automatically set to the optimum values based on the reference level (REFER). (The input attenuator cannot be set independently.)

\* When the input signal level is higher than the proper level for 1st mixer’s terminal, harmonics distortion and spurious are generated.

This product is designed so that the input signal level of 1st mixer is determined to proper level based on the reference level.

# 10. Display Scale <SCALE>

When **SCALE** is pushed, the following function menu is displayed.

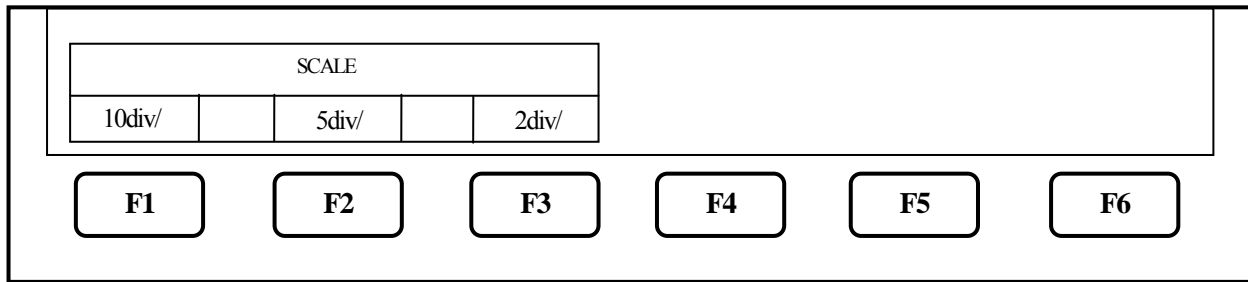

## 10.1 Setting the Function Key

1. By pushing F1 , 10 dB/div display scale is set.
2. By pushing F2 , 5 dB/div display scale is set.
3. By pushing F3 , 2 dB/div display scale is set.

# 11. Resolution Bandwidth <RBW>

When **RBW** is pushed, the following function menu is displayed.

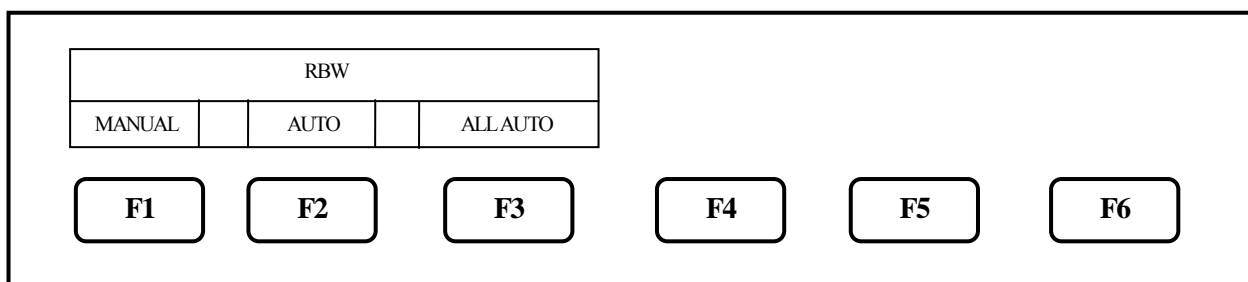

## 11.1 MANUAL Mode

By pushing F1 or rotating , MANUAL mode is set.

By rotating , RBW is set as follows.

2650A/2652A/2658A: 3kHz ↔ 10kHz ↔ 30kHz ↔ 100kHz ↔ 300kHz ↔ 1MHz ↔ 3MHz

2651: 3kHz ↔ 9kHz ↔ 30kHz ↔ 120kHz ↔ 300kHz ↔ 1MHz ↔ 3MHz

## 11.2 AUTO Mode

By pushing **F2**, the optimum RBW is set based on the frequency span and sweep time.

\* When AUTO mode is set, “\*” is displayed on the right end of RBW setting value display.

## 11.3 ALL AUTO Mode

By pushing **F3**, the optimum RBW, VBW and sweep time are set based on the frequency span.

\* When ALL AUTO mode is set, “\*” is displayed on the right end of each setting value display.

\* When RBW is set to 3 kHz or 10 kHz, the selectivity at 60 dB becomes larger than an actual value due to SSB phase noise.

# 12. Video Bandwidth <VBW>

When **VBW** is pushed, the following function menu is displayed.

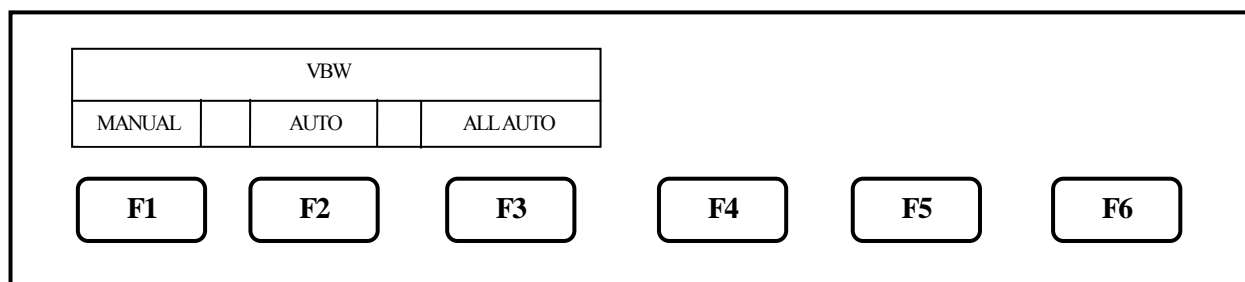

## 12.1 MANUAL Mode

By pushing **F1** or rotating , MANUAL mode is set.

By rotating , VBW is set as follows.

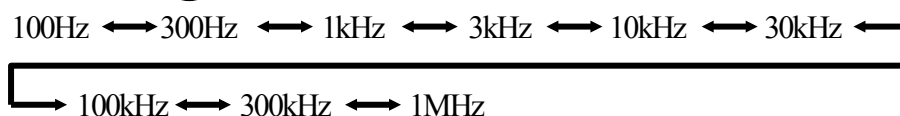

## 12.2 AUTO Mode

By pushing **F2**, the optimum VBW is set based on the frequency span and sweep time.

When AUTO mode is set, “\*” is displayed on the right end of VBW setting value display.

## 12.3 ALL AUTO Mode

By pushing  , the optimum RBW, VBW and sweep time are set based on the frequency span.

\* When ALL AUTO mode is set, “\*” is displayed on the right end of each setting value display.

# 13. Sweep Axis / Detection Mode <SWEEP>

When  is pushed, the following function menu is displayed.

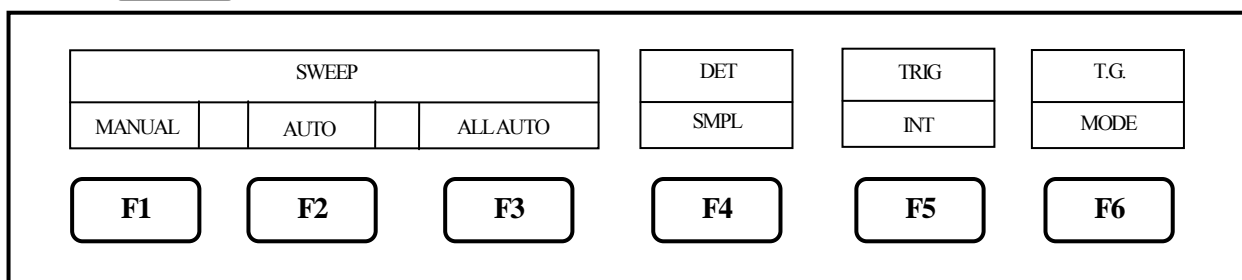

\* T.G. MODE [F6] is only for 2652A. This menu is not displayed on 2650A, 2651 and 2658A.

For the details, refer to “22. Tracking Generator Mode”. [F5] is only displayed when an external trigger signal is detected at the trigger port.

## 13.1 MANUAL Mode

By pushing  or rotating  , MANUAL mode is set.

By rotating  , sweep time is set as follows.

10ms ↔ 30ms ↔ 0.1s ↔ 0.3s ↔ 1s ↔ 3s ↔ 10s ↔ 30s

\* For 2650A, 2651 and 2652A, when the setting is FULLSPAN, it cannot be set to 10 ms.

\* For 2658A, when the setting is 5 GHz SPAN or FULLSPAN, it cannot be set to 10 ms.

## 13.2 AUTO Mode

By pushing  , the optimum sweep time is set based on the frequency span and RBW.

\* When AUTO mode is set, “\*” is displayed on the right end of SWEEP setting value display.

## 13.3 ALL AUTO Mode

By pushing  , the optimum RBW, VBW and sweep time are set based on the frequency span.

\* When ALL AUTO mode is set, “\*” is displayed on the right end of each setting value display.

## 13.4 Setting of Detection Mode

(For 2651, refer to “20. EMI test”)

By pushing **F4**, the detection mode is set.



POS (Positive Peak): The maximum value of the sample points is detected.

SMPL (Sample): The momentary value of the sample points is detected.

NEG (Negative Peak): The minimum value of the sample points is detected.

## 13.5 Setting of Trigger Source

By pushing **F5**, the trigger source is set.

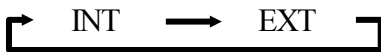

INT: The sweep is automatically repeated. This setting is normally used.

EXT: When the signal over the trigger level (0.56 V) is input to external trigger input, the sweep starts. The sweep automatically starts without an input. (Available only for zero span)

## 14. AUTO Tuning <AUTO TUNE>

When **AUTO TUNE** is pushed, the spectrum with the maximum level is searched within full span, and then it is adjusted to the center of the screen, and the optimum setting parameters are set.

- \* Set the frequency span before setting AUTO tuning.
- \* There is no function menu displayed for this mode. Auto tuning will execute upon pushing the key.
- \* The auto tuning does not operate normally in the following conditions.
  - 1) Zero span
  - 2) Full span
  - 3) The signal level is  $-40$  dBm or lower.
  - 4) The signal frequency is 50 MHz or lower.

## 15. Hold / Run <HOLD/RUN>

By pushing **HOLD/RUN**, the sweep is switched to halt and continuance.

- \* There is no function menu displayed for this mode.

# 16. Calculation Function <CALC>

When **CALC** is pushed, the following function menu is displayed.

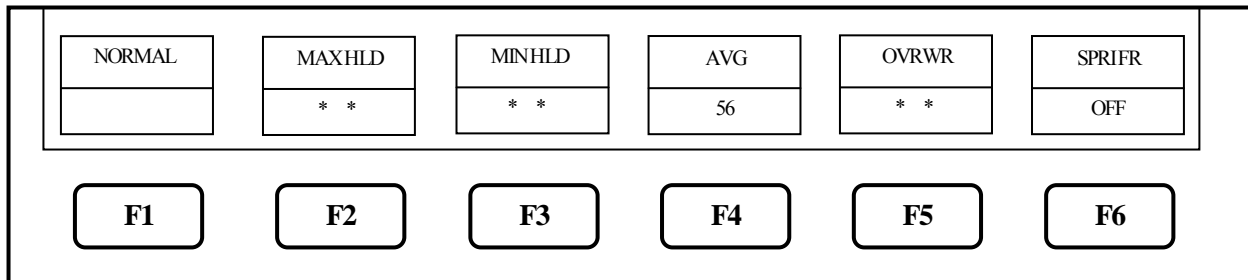

\* By pushing **HOLD/RUN**, the sweep is restarted.

\* By pushing **F1** ~ **F5**, the calculation function is selected.

By rotating , the number of times of the sweep can be set.

## 16.1 NORMAL Mode

1. When **F1** is pushed, the normal mode is set. The calculation is not performed in this mode. The number of times of the sweep is infinite. This mode is normally used.

\* When this mode is set, "NORMAL" is displayed in the CALC area on the screen.

(Refer to "4. Explanation of Screen" for the details.)

## 16.2 MAX HOLD Mode

1. By the operation of **F2** → , the number of times of the sweep in the MAX HOLD mode is set.

2. The update spectrum data is compared with the data left last time at each point, and the larger one is retained and displayed.

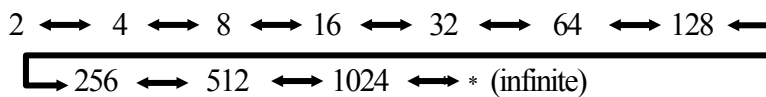

\* When this mode is set, "MAX --- (number of times)" is displayed in the CALC area on the screen.

(Refer to "4. Explanation of Screen" for the details.)

## 16.3 MIN HOLD Mode

1. By the operation of **F3** → , the number of times of the sweep in the MIN HOLD mode is set.

- The update spectrum data is compared with the data left last time at each point, and the smaller one is retained and displayed.

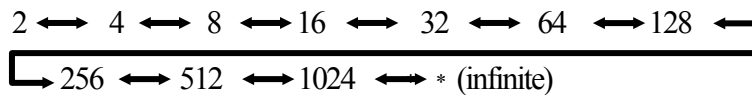

\* When this mode is set, “MIN --- (number of times)” is displayed in the CALC area on the screen.

(Refer to “4. Explanation of Screen” for the details.)

## 16.4 AVERAGE Mode

- By the operation of **F4** → , the number of times of the sweep in the AVERAGE mode is set.
- The simple averaging process is executed at each sweep.

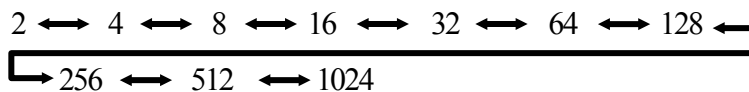

\* When this mode is set, “AVG --- (number of times)” is displayed in the CALC area on the screen.

(Refer to “4. Explanation of Screen” for the details.)

## 16.5 OVERWRITE Mode

- By the operation of **F5** → , the number of times of the sweep in the OVER WRITE mode is set.
- The image on the screen is not cleared at each sweep, and the overwriting display is executed.

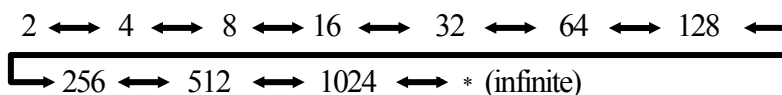

\* When this mode is set, “OVER WR” is displayed in the CALC area on the screen.

(Refer to “4. Explanation of Screen” for the details.)

\* Only the last spectrum is saved.

## 16.6 SPURIOUS FREE Mode (2658A only)

- By pushing **F6**, the SPURIOUS FREE mode, by which the spurious response at band 1- and band 1+ is simply deleted, is selected.
  - \* “SPR” is displayed in CALC area on the screen.
 (Refer to “4. Explanation of Screen” for the details.)

\* Differing from base band at which the up-conversion of input frequency is done with a frequency mixer, the spurious response peculiar to band 1- and band 1+ is generated because the down-conversion is done at those two bands.

\* About SPURIOUS FREE mode

1. SPURIOUS FREE mode is a mode by which the spurious response peculiarly caused at band 1+ is simply deleted.
2. SPURIOUS FREE mode is especially effective in the measurement of a stationary wave.
3. If SPURIOUS FREE mode is used in measurement of a signal with level change or frequency change, the phenomenon that the level goes down will occur.
4. The noise level goes down a little in case of a noise changing at random. In short, the same phenomenon as MIN HOLD function happens.

\* How to judge SPURIOUS response at band 1- and band 1+

The procedure for judging SPURIOUS response at band 1- and band 1+ is as follows.

1. Set the center frequency to  $\langle (\text{current setting value}) + f \rangle$ .
2. The spectrum shifting left by  $f$  is a correct spectrum, but another spectrum shifting such as left by  $2f$ , left by  $3f$ , right by  $f$ , right by  $2f$  or right by  $3f$  is a spurious response.

\* “ $f$ ” should be changed according to SPAN for easy judgment. For reference;

$$f = \text{SPAN} / (10 \text{ to } 50) \text{ (corresponding to } 0.2 \text{ to } 1 \text{ div)}$$

Example: judging a spectrum displayed at 6.92 GHz

(setting : center frequency 6.92 GHz and SPAN 500 MHz)

1. Set the center frequency to  $\langle 6.92 \text{ GHz} + 500 \text{ MHz}/25 \rangle = 6.94 \text{ GHz}$ .
2. A spectrum at 6.92 GHz (shifting left by  $f$  from 6.94 GHz) is correct. A spectrum at 6.98 GHz (shifting right by  $2f$  from 6.94 GHz) is spurious.

\* Additionally, a spurious response mentioned above shifting right by  $2f$  at band 1+ is largest, and other spurious response are about 25 to 50 dB smaller than that.

## 17. Marker & Peak Search <MKR>

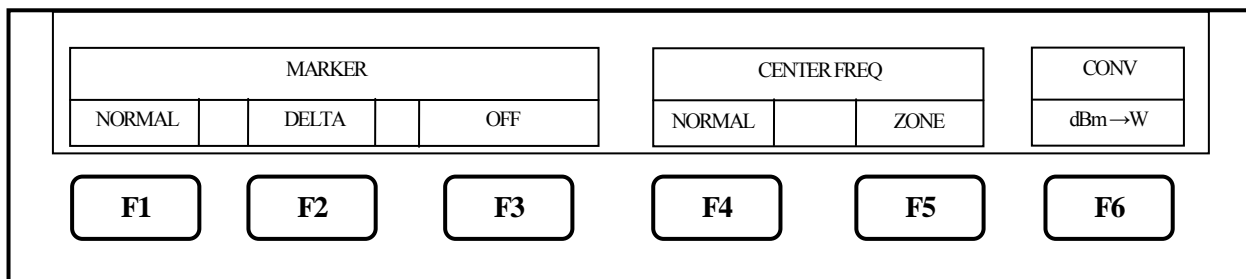

When **MKR** is pushed, the following function menu is displayed.

- Main menu of marker function





## 17.1 Movement and Basic Function of Marker

1. By rotating , the marker moves.
2. By pushing , the normal marker mode is selected and the marker operates as an independent marker.

The frequency and the level at the marker point are displayed in the lower right side.

3. When  is pushed, the delta marker mode is selected, and the reference marker and the active marker are displayed.

The frequency and the level at the marker points are displayed as follows;

Frequency = (freq. at active marker) – (freq. at reference marker)

Level = (level at active marker) – (level at reference marker)



4. By pushing , the marker is erased (marker off).

## 17.2 Normal Peak Search

- Menu of normal peak search

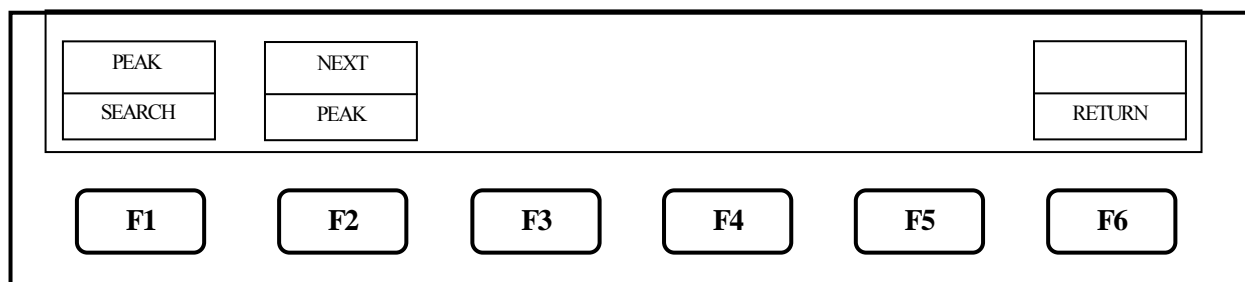
When  is pushed, the following function menu is displayed.

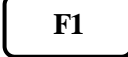

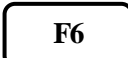
1. When  is pushed, the marker moves to the maximum peak position of spectrums.
2. When  is pushed, the marker moves to the next highest peak. Fifty or less peaks are available.
3. When  is pushed, the function menu is returned to the main menu of marker function.

## 17.3 Zone Peak Search

- Menu of normal peak search

When  is pushed, the following function menu is displayed.

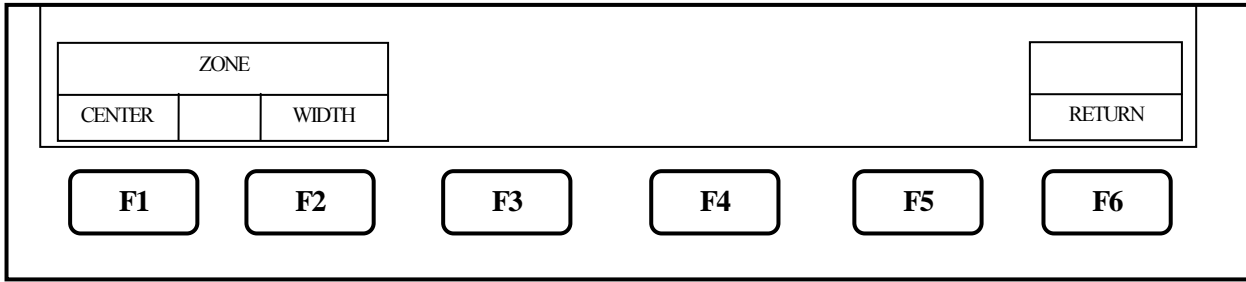

At the Zone mode, the marker automatically moves to the maximum peak point within the range set beforehand. When entering this mode, the zone is displayed with thin blue shadow in the spectrum display area.

The marker moves to maximum level within this zone at each sweep.

The center of the zone can be adjusted by pressing **F1** →

The width of the zone can be adjusted by pressing **F2** →

Note: The marker does not move in HOLD.

## 17.4 Change Unit of Marker Level

When **F6** is pushed, the unit of the marker level is changed.

If the unit of the reference level is dBm, it can be changed to [dBm] ↔ [W].

If the unit of the reference level is dBμV, dBmV or dBV, it can be changed to [dBμV, dBmV, dBV] ↔ [V].

If the unit of the reference level is dBμV/m, it can be changed to [dBμV/m] ↔ [V/m].

If the unit of the reference level is dBμA/m, it can be changed to [dBμA/m] ↔ [A/m].

Note: “V/M” is only displayed when the electric field strength measurement is selected

“A/M” is only displayed when the magnetic field strength measurement is selected

Each unit change as described above has their own sub-menu for more unit display options. They are shown below:

[W] → [W, mW, μW, nW, pW, fW]

[V] → [V, mV, μV, nV]

[V/m] → [V/m, mV/m, μV/m, nV/m]

[A/m] → [A/m, mA/m, μA/m, nA/m]

## 18. Save / Load <SAVE/LOAD>

When **SAVE/LOAD** is pushed, SAVE/LOAD menu is displayed as follows.

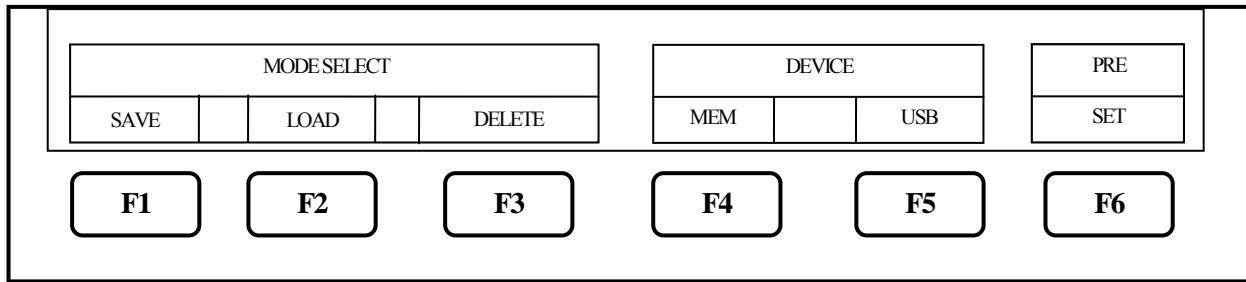

## 18.1 Selection of Storage Device

1. When **F4** is pushed, the built-in flash memory is selected as a storage device.

When **F5** is pushed, the external USB memory is selected as a storage device.

\* Install the USB memory in USB A- plug on the right side firmly. Refer to the figure below.

\* **Once you disconnect, then reconnect the same or a different USB flash memory drive, the 2650A series will not automatically recognize the new USB drive.** After connecting the drive, you must first press the Save/Load key, followed by F5 key (USB) in order for the 2650A to "see" the new drive., then proceed as described below.



## 18.2 Save Function

When **F1** is pushed, SAVE menu is displayed as follows.

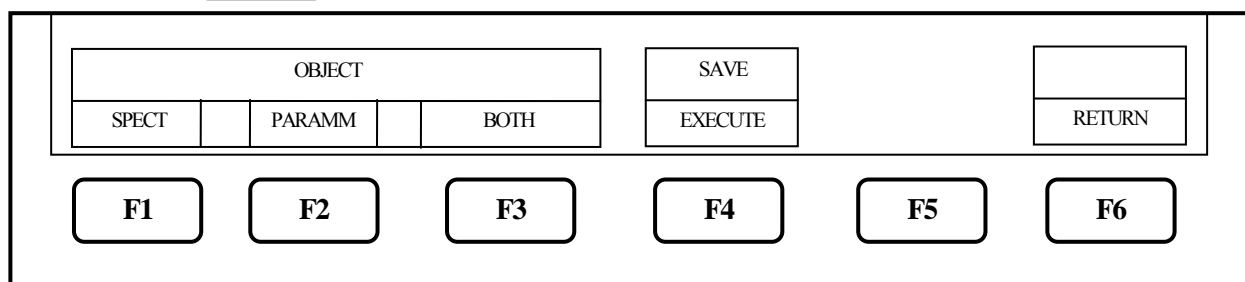

- In this function, the data is stored in the built-in memory or USB memory by CSV format.  
The data stored in USB memory can be used with a personal computer as a CSV file.  
“2650A\_csvData” folder will automatically be created and the data will be stored in it as a file.
- The object to be stored is selected with **F1** , **F2** or **F3** .  
SPECT: The current spectrum on the screen is stored.  
PARAM: The setting parameters are stored.  
BOTH: The spectrum and setting parameters are stored as one file.  
\* The selected key will look pushed-in on the display.
- When **F4** is pushed, SAVE is executed.  
The data is stored based on the file name displayed in the active area (refer to “4. Explanation of screen”).  
As for the file name, refer to “18.3 About File Name”.  
Up to 200 files can be stored in the built-in memory.  
Up to 1000 files can be stored in USB memory.
- Pushing **F6** will return to the former menu.

## 18.3 About File Name

- The file name is attached to the file stored using this function as follows.

$$\frac{\text{LABEL-SP001.csv}}{\text{(1) (2)(3) (4)}}$$

- (1) This is the label entered from the label function. Refer to “24.1 Label function.” Note: Symbols and spaces are not recognized as a file name.
- (2) S: The object stored is the spectrum (SPECT).  
P: The object stored is the setting parameters (PARAM).  
SP: The object stored is both of spectrum and setting parameters (BOTH).
- (3) The consecutive three digit number from “000” is automatically attached if (1) and (2) are same.
- (4) This is the extension showing CSV format and is automatically attached.

2. If the label is not named, “2650A” will be the first part of the file name instead. For example:

2650A\_SP001.csv

3. About file name at the time of storage

When SAVE is selected, the file name is displayed in the active area following according to the above labeling convention.

When SAVE is executed as it is, the data is stored with that file name. If the file exists in the storage device and is rotated left  before SAVE is executed, those file names are displayed one by one.

If SAVE is executed with an existing file name displayed, the data is overwritten on it.

## 18.4 Load Function

When  is pushed, LOAD menu is displayed as follows.

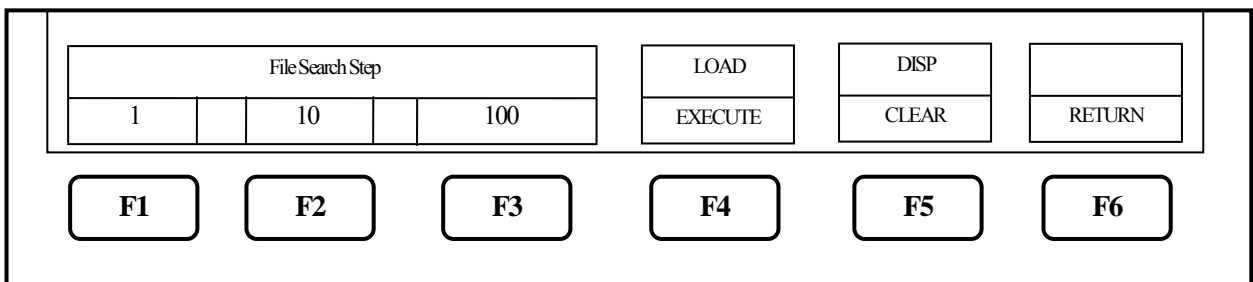



1. When  is rotated right or left, the stored file name is displayed one by one from the specified storage device in the active area as follows.

- 1) USB : LOAD
- 2) 2650A\_SP012.csv
- 3) 12

- 1) The storage device in which the file is stored.  
(USB: USB memory, MEM: built-in memory)
- 2) The file name selected.
- 3) Number attached to file

The files in the specified folder of the storage device are sorted in alphabetical order, and this shows that number.

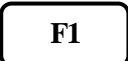
2. To search files, press

 →  , and the file will be displayed in order of the number attached to it in the active area.

The search steps can be adjusted by pressing  to search in steps of 10 files at a time or pressing

 to search in steps of 100 files at a time.

Select it according to the number of stored files.

3. When  is pushed, LOAD is executed.

\* When SPECT is selected, a spectrum waveform is loaded. The setting parameters of loaded spectrum are displayed in the setting parameters display area.

[Refer to “4. Explanation of screen” for details.]

\* When PARAM is selected, setting parameters are loaded.

\* When the spectrum is loaded, the 2650A series enters HOLD state and the current spectrum disappears, replacing it with the loaded spectrum on main display.

When **HOLD/RUN** is pushed right after, the loaded spectrum and a current spectrum are displayed together.

4. When **F5** is pushed, the loaded spectrum can be cleared on display.

## 18.5 Delete Function

When **F3** is pushed, DELETE menu is displayed as follows.

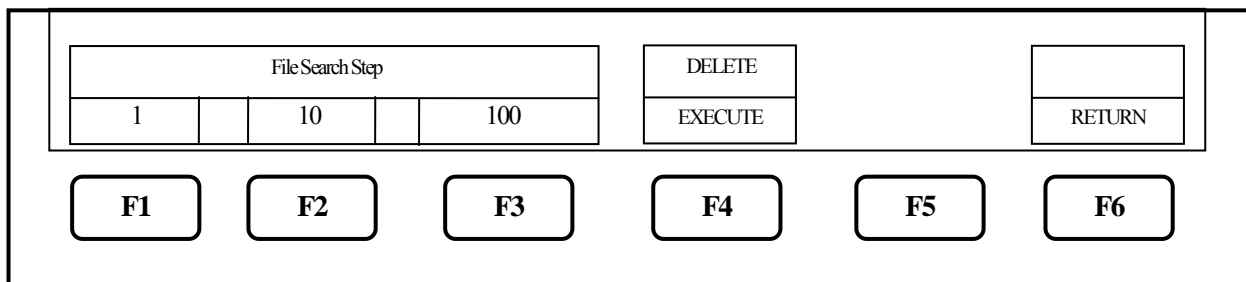

1. The file name to be deleted is selected from the specified device with , and the active area will indicate this name. As for the number of search steps, it is the same as “18.4 Load Function”.
2. When **F4** is pushed, DELETE is executed. The file displayed in the active area is deleted at this time.
3. Repeat step 1 and 2 above to delete more than one file.

## 18.6 Presetting (Initialization)

(For 2651, refer to “20. EMI test”)

When **F6** is pushed, the setting parameters are reset to the preset values as shown below.

Items	Parameters
Center frequency	1 GHz
Frequency span	20 MHz
Reference level	10 dBm
Offset	0.0 dB
Impedance	50 Ω
Sweep time	30 ms
Detection mode	Sample mode (SMPL)
RBW	100 kHz
VBW	30 kHz
Display scale	10 dB/div

# 19. Measuring Function <MEAS>

When **MEAS** is pushed, the following function menu is displayed.

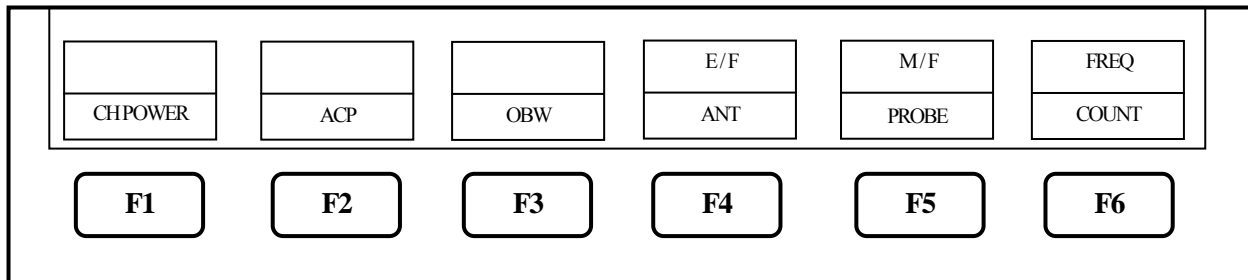

The measuring function can be selected as follows.

- F1** CH POWER ----- Channel power measurement
- F2** ACP ----- Adjacent channel leakage power measurement
- F3** OBW ----- Occupied bandwidth measurement
- F4** E/F ANT ----- Electric field strength measurement
- F5** M/F PROBE ----- Magnetic field strength measurement
- F6** FREQ COUNT ----- Frequency counter (factory option)

\* Once the measuring function is set, when **MEAS** is pushed, the function menu is directly returned to the last setting of the measuring function. In order to stop the measuring function or to select the other measuring function, push [F6] key (MEAS OFF), then the function menu is returned to the main menu of the measuring function.

\* Each of the four functions (Channel power, Adjacent channel leakage power, Occupied bandwidth and Frequency counter) and the marker function cannot be used at the same time. When **MKR** is pushed while each of the four functions is selected, the measuring function will stop.

Similarly, when the measuring function is selected while using the marker function, the marker function will stop.

\* Although 501 points can be displayed on the screen, the number of points calculated in the instrument is 1001.

## 19.1 Channel Power Measurement <CH POWER>

The total power in the specified frequency band is measured.

Two modes, TOTAL and BAND, are available.

- **TOTAL mode** [ By pushing **F1** (MODE), TOTAL mode is selected.]

The sum of power in the displayed spectrum specified by center frequency and frequency span is measured.

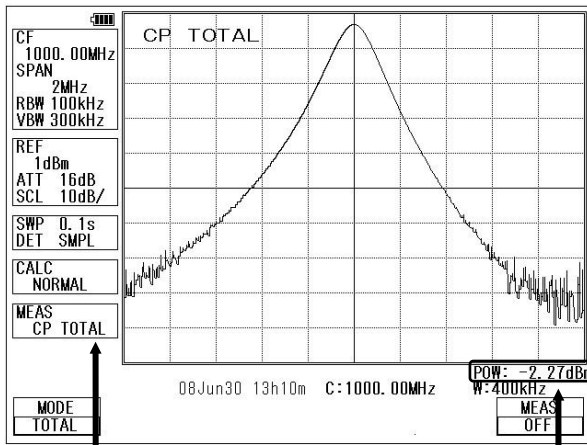

- \* “CP TOTAL” is displayed in MEAS area on the screen.
- \* The measured value is displayed at the lower right corner on the screen.

[Measuring Mode]

[Measured Value]

- **BAND mode** [ By pushing **F1** (MODE), BAND mode is selected.]

The sum of power in the band specified by band center and bandwidth is measured.

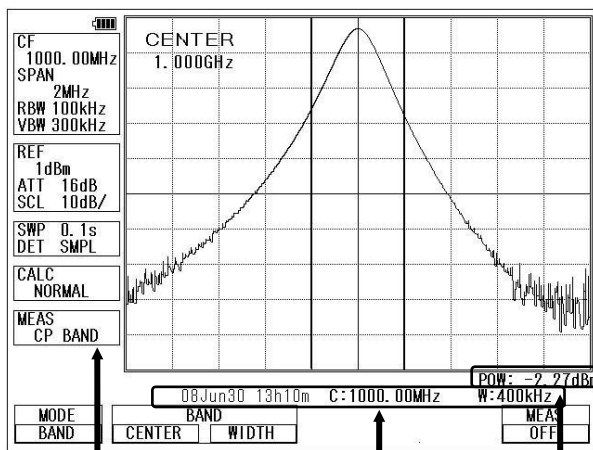

- \* “CP BAND” is displayed in MEAS area on the screen.
- \* The measured value and the setting parameter are displayed at the lower part of the screen.

1. By **F2** (BAND ENTER) → 

the band center is set.

2. By **F3** (BAND WIDTH) → 

the band width is set.

[Measuring Mode]

[Measured Value]

[Setting parameter]

## 19.2 Adjacent Channel Leakage Power Measurement <ACP> **F2**

The adjacent channel leakage power is measured as the ratio of power in the range specified by offset frequency and bandwidth to carrier power. Both leakage power at the upper and lower side are measured.

Furthermore, the method for measurement is selected out of three methods based on the classification of definition of carrier power; total power method, reference level method and in-band method.

- **Mode selection and measurement**

[ By pushing **F1** (MODE), TOTAL, BAND or PEAK mode is selected.]

\* “ACP TOTAL”, “ACP BAND” or “ACP PK” is displayed in MEAS area on the screen.



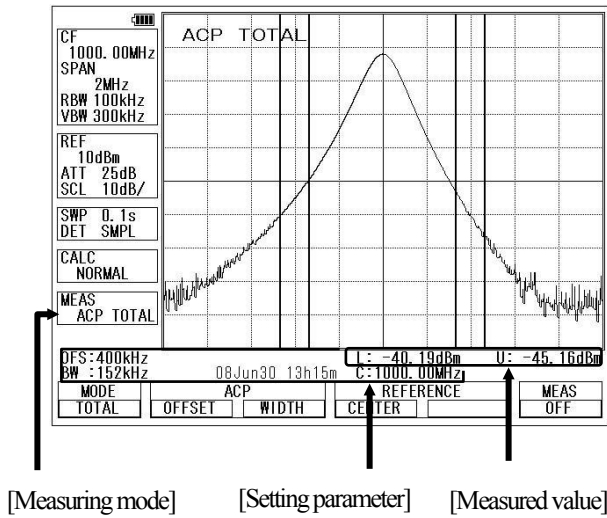

\* The measured value and the setting parameter are displayed at the lower part of the screen.



1. By **F2** (ACP OFFSET) → , the offset frequency of adjacent channel is set.

\* The offset is from the center frequency of the reference carrier.

2. By **F3** (ACP WIDTH) → , the band width of adjacent channel is set.

3. By **F4** (REFERENCE CENTER) → , the center frequency of the reference carrier is set.

\* [F4] is only for TOTAL and BAND mode.

4. By **F5** (REFERENCE WIDTH) → , the band width of reference carrier is set.

\* [F5] is only for BAND mode.

### • Definition of Reference Carrier for each Mode

**TOTAL (total power method)**

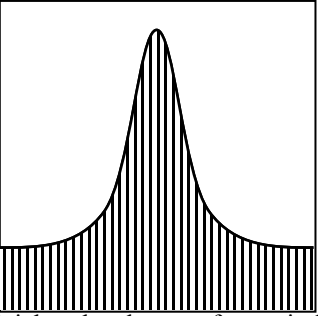

This is based on the sum of power in the displayed spectrum. The center frequency of the reference carrier is set by [F4].

**BAND (in-band method)**

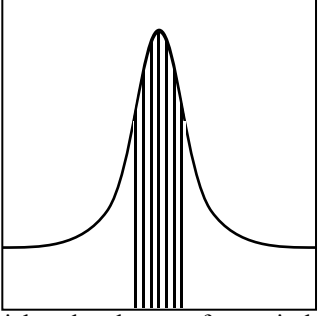

This is based on the sum of power in the specified bandwidth. The center frequency of the reference carrier is set by [F4].

**PEAK (reference level method)**

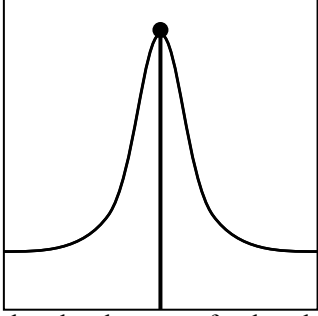

This is based on the power of peak on the screen. The center frequency of the reference carrier is automatically set to the peak on the screen.

## 19.3 Occupied Bandwidth Measurement <OBW>

F3

It is possible to measure the occupied frequency bandwidth defined as the width of points at N(%) of the total power (N% POWER), or as the width of points that are X(dB) lower than the peak level (XdB DOWN).

- **N% POWER mode** [ By pushing **F1** (MODE), N% POWER mode (N%) is selected.]

The bandwidth of points at N(%) of the total power is measured.

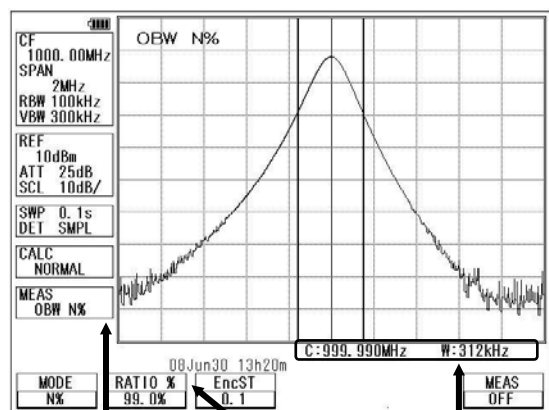

[Measuring mode] [Setting parameter] [Measured value]

\* “OBW N%” is displayed in MEAS area on the screen.

\* The measured value is displayed at the lower right corner on the screen.

1. By **F2** (RATIO %) → , the percentage of the total power is set.

\* Setting range : 80.0 to 99.9%

2. By **F3**, the step size of RATIO % can be set to 1% or 0.1%.

- **XdB DOWN mode** [ By pushing **F1** (MODE), XdB DOWN mode (X dB) is selected.]

The bandwidth of points that are X(dB) lower than the peak level is measured.

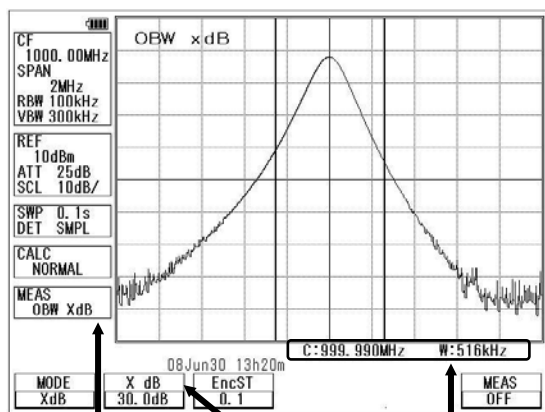

[Measuring mode] [Setting parameter] [Measured value]

\* “OBW XdB” is displayed in MEAS area on the screen.

\* The measured value is displayed at the lower right corner on the screen.

1. By **F2** (XdB) → , the down level from the peak level is set.

\* Setting range : 0.1 to 99.0dB

2. By **F3**, the step size of XdB can be set to 1dB or 0.1dB.

## 19.4 Electric Field Strength Measurement <E/F ANT>

F4

Connecting a dipole antenna (option) to the RF input enables the measurement of the electric field strength.

Other than the optional antenna is also available by creating the original compensation data.

(Refer to “25.8 Writing of Original Compensation Data” for the details.)

[Antenna connection]

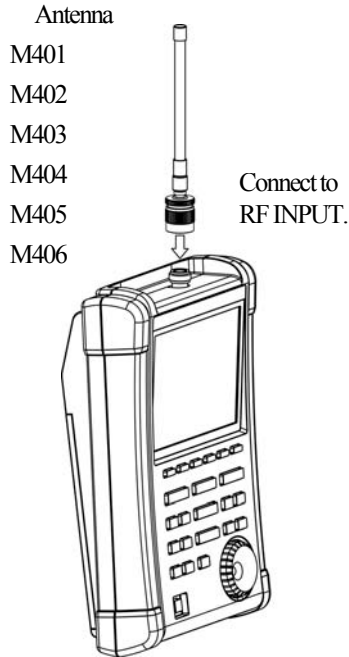

[Measurement environment]



2650A series

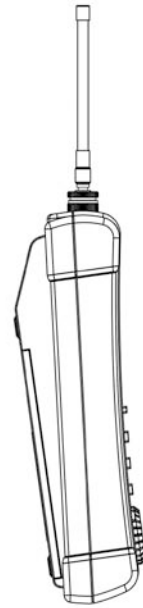

\* Turn the back to the signal source.

[Specifications of dipole antenna (The antenna gain and VSWR are specified at the center of frequency range.)]

Items	M401	M402	M403	M404	M405	M406
Type	Sleeve	Sleeve	Sleeve	Sleeve	$\frac{1}{4}\lambda$ whip	Sleeve
Frequency range	0.8 to 1GHz	1.25 to 1.65GHz	1.7 to 2.2GHz	2.25 to 2.65GHz	300 to 500MHz	4.7 to 6.2GHz
Antenna gain	>1dB	>1dB	>1dB	>1dB	>1dB	>1dB
VSWR	<1.5	<1.5	<1.5	<1.5	<1.5	<1.5
Dimensions	7.5φ ×280mm	7.5φ ×280mm	7.5φ ×210mm	7.5φ ×210mm	8.0φ ×212mm	7.5φ ×152mm
Weight	Approx. 58g	Approx. 60g	Approx. 58g	Approx. 56g	Approx. 62g	Approx. 54g
Reference level setting range (except for the minimum value in screen shift)	93 to 143 dBμV/m	96 to 146 dBμV/m	99 to 149 dBμV/m	100 to 150 dBμV/m	87 to 137 dBμV/m	109 to 159 dBμV/m

\* When M405 is used, the measurement errors will occur due to how to hold of instrument and influence of human body, because M405 is  $\frac{1}{4}\lambda$  whip antenna. The error value will be several dB or more. In order to reduce the error, separate 2650A series from human body as much as possible.

• **Mode Selection and Measurement**

By pushing F1 (ANT), the antenna (M401/M402/M403/M404/M405/M406/USER) can be selected  
The measurement starts as soon as the antenna is selected.

\* “E/F M40X” or “E/F USER” is displayed in MEAS area on the screen.

\* “USER” is the original compensation data which is created by the user.

(Refer to “25.8 Writing of Original Compensation Data” for the details.)

\* The spectrum may exceed the area on the screen depending on the antenna gain compensation.

The unit of amplitude axis automatically changes into [dBμV/m].

\* The optimum center frequency and frequency span are automatically set according to the antenna.

In addition, a spectrum other than the frequency range of the antenna is not displayed.

- **Directivity of Antenna (reference data)**

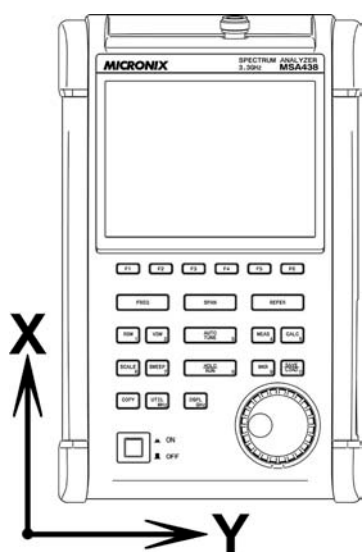

E plane: X-Y axis (X direction=0°)

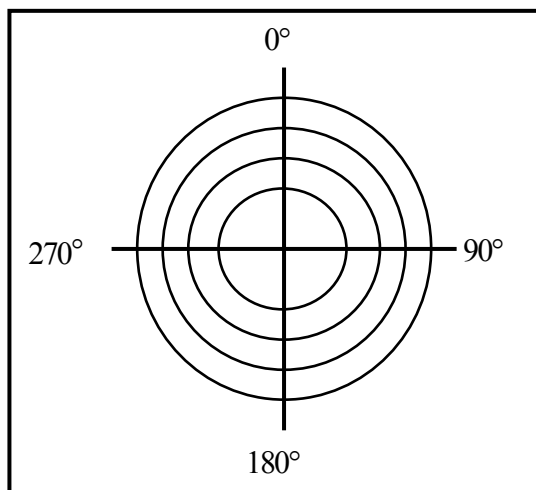

\* The following are the data when the antenna is connected to RF input directly with no obstacles around.

Actually, the directivity changes due to the human body when handling the unit.

\* However, the data of M405 is the reference data which is included the influence of the human body.

M401 (900 MHz, E plane)

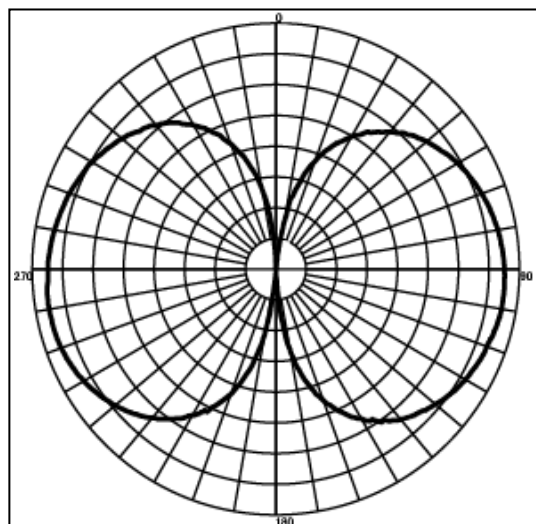

Antenna gain vs. Frequency

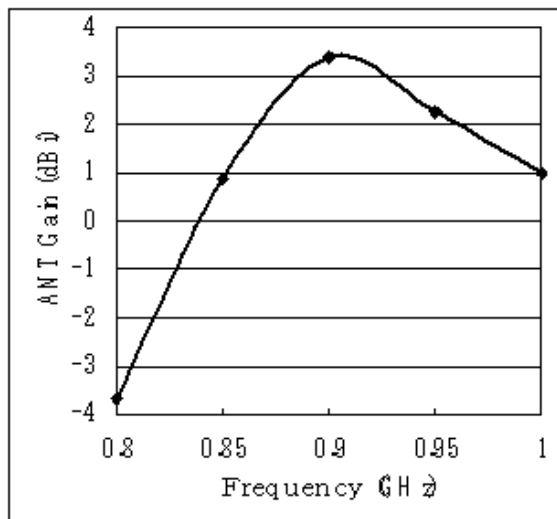

M402 (1.5 GHz, E plane)

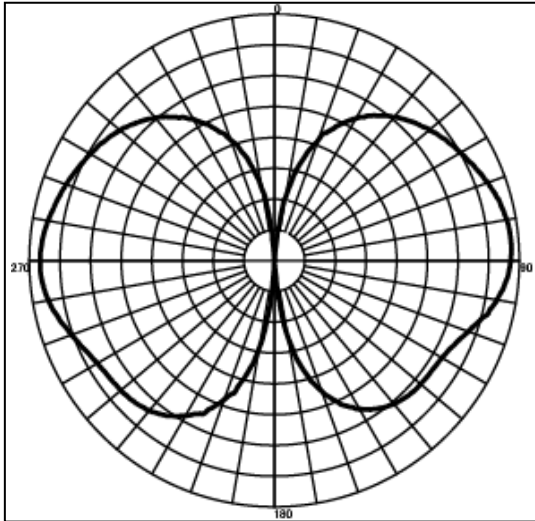

Antenna gain vs. Frequency

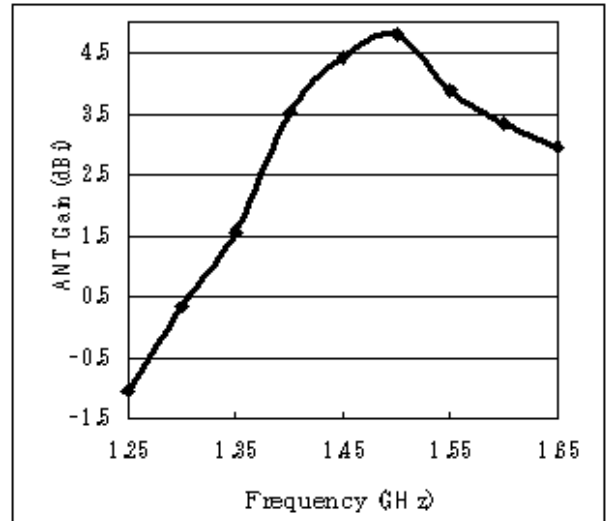

M403 (2 GHz, E plane)

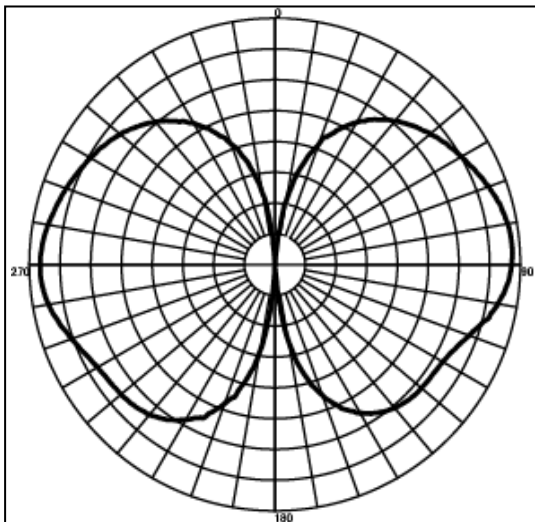

Antenna gain vs. Frequency

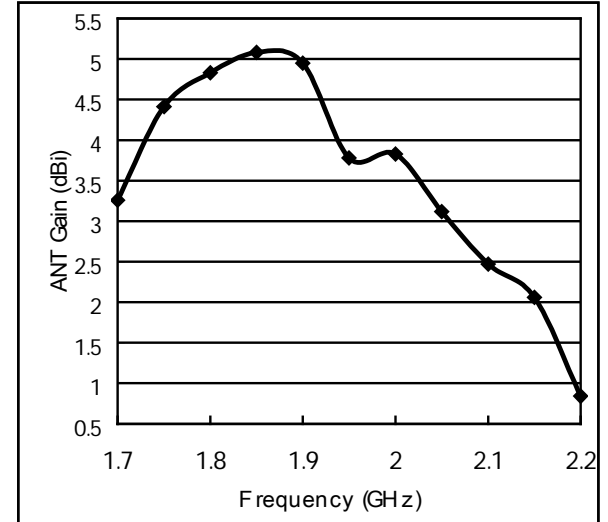

M404 (2.4 GHz, E plane)

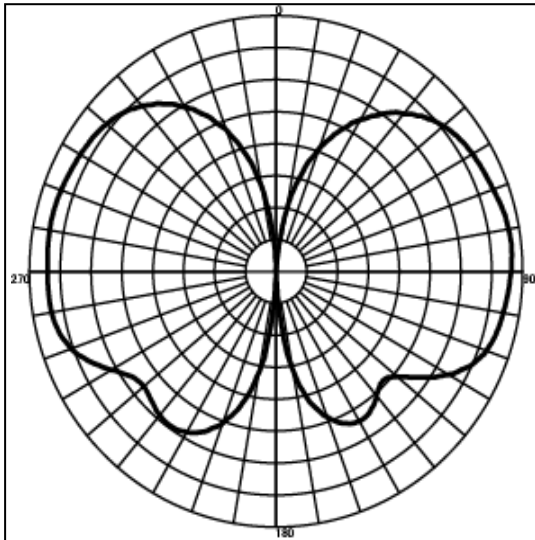

Antenna gain vs. Frequency

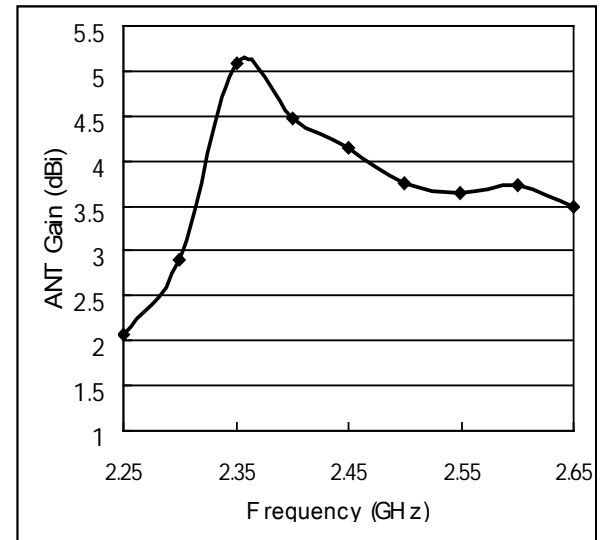

M405 (horizontal plane)

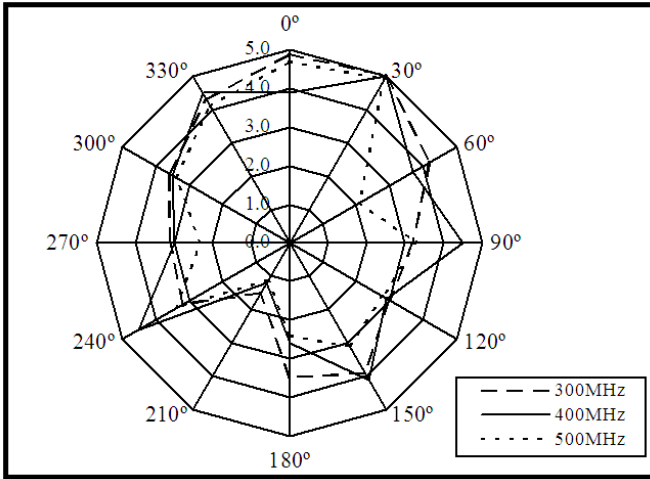

Antenna gain vs. Frequency

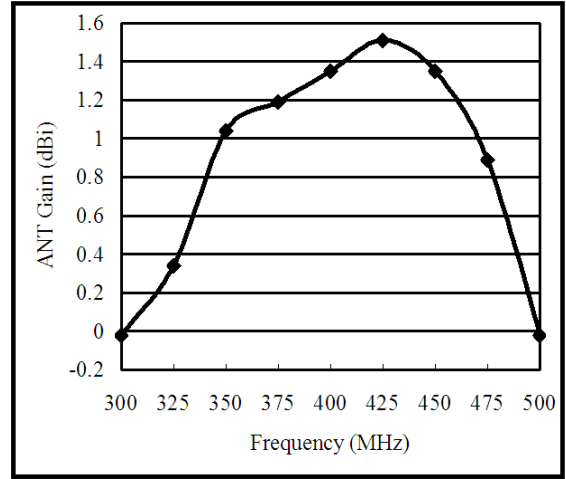

M406 (5.4 GHz, E plane)

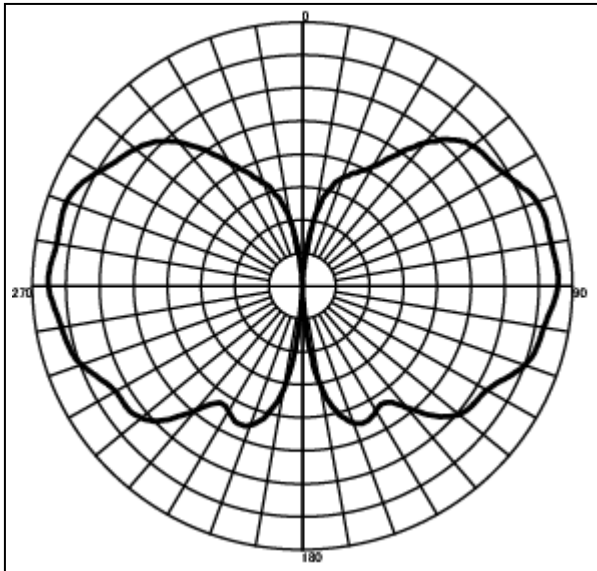

Antenna gain vs. Frequency

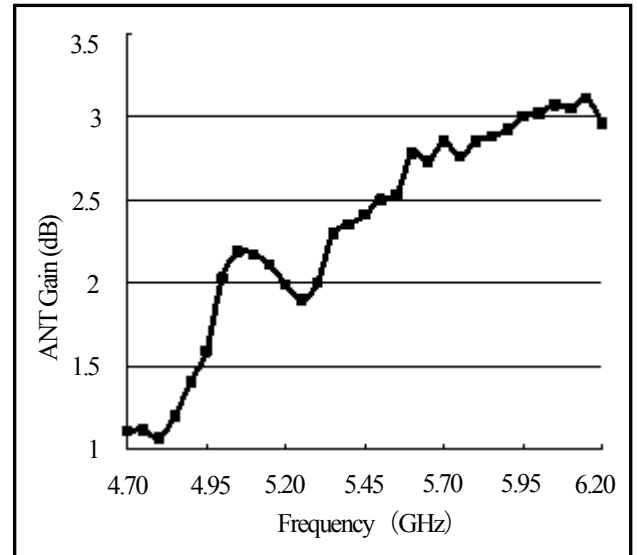

## 19.5 Magnetic Field Strength Measurement <M/F PROBE>

F5

The magnetic field distribution can be measured by using the magnetic field probe CP-2S (option).

[Magnetic field probe connection]

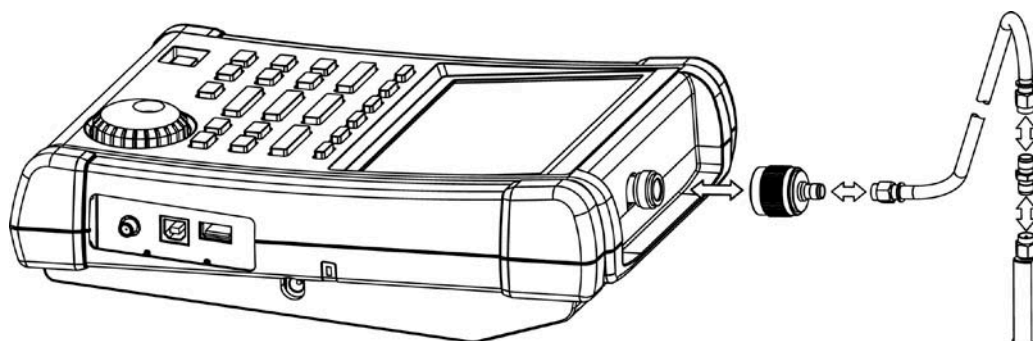

The tip of the magnetic field probe CP-2S is made of glass-ceramic board. Take care when handling the probe even though the strength of the glass-ceramic board is durable under normal operation.

“Specifications of magnetic field probe CP-2S” (Refer to the operating manual of CP-2S for the details.)

Item	Specifications
Frequency range	10 MHz to 3 GHz
Space resolution (-6 dB)	approx. 0.25 mm (depending on objects)
Reference level setting range: maximum	160 to 203 dB $\mu$ A/m
Reference level setting range: minimum (except for the minimum value in screen shift)	110 to 153 dB $\mu$ A/m
Measurement error	approx. $\pm 1$ dB (probe simple substance)

- **Mode Selection and Measurement**

By pushing **F1** (PROBE), CP-2S or USER mode is selected.

The measurement starts as soon as the probe is selected.

\* “M/F CP2S” or “M/F USER” is displayed in MEAS area on the screen.

\* “USER” is the original compensation data which is created by the user.

(Refer to “25.8 Writing of Original Compensation Data” for the details.)

The unit of amplitude axis automatically changes into [dB $\mu$ A/m].

\* A spectrum other than the frequency range of the probe is not displayed.

## 19.6 Frequency Counter <FREQ COUNT>

F6

This function currently not supported.

# 20. EMI Test (2651)

## 20.1 Additional Function for EMI Test

Detection mode (Refer to “13.4 Setting of Detection mode”)

By pushing **SWEEP** → **F6**, the detection mode can be set.



In the 2651, QP detection and AV detection are added for EMI measurement.

- POS (Positive Peak) : The spectrum of the maximum value between the sample points
- SMPL (Sample) : The spectrum of the momentary value between the sample points
- NEG (Negative Peak) : The spectrum of the minimum value between the sample points
- QP (Quasi Peak) : The spectrum of the quasi peak value between the sample points
- AV (Average) : The spectrum of the average value between the sample points

As for QP detection, the following characteristics are chosen according to RBW settings.

(based on CISPR16)

RBW	charging time constant	dis-charging time constant	meter time constant
9kHz	1ms	160ms	160ms
120kHz	1ms	550ms	100ms

- Preset (Initialization) (Refer to “18. Save / Load”)

In the 2651, the radiated emission measurement and the conducted emission measurement are added to the preset as a default setting.

By pushing **SAVE/LOAD** → **F6**, the menu is displayed

- F1** NORMAL : The initial parameters of normal mode are set.
- F2** EMI-C : The initial parameters of conducted emission measurement are set.
- F3** EMI-R : The initial parameters of radiated emission measurement are set

In the radiated mission measurement, “USER” is selected as an antenna.

It is necessary to input the compensation data of antenna beforehand.



## 20.2 EMI Test

The QP detection is usually used in both of the radiated and conducted emission measurements, and the AV detection is usually used in the conducted emission measurement. The measurement time can be shortened by using them in the final measurement to the spectrums narrowed by the PK detection.

### Conducted Emission Measurement

The conducted emission discharged through the power supply line is measured.

In this measurement, LISN\* (Line Impedance Stabilization Network) device is needed.

The connection is shown in the figure below. Please refer to the manual of LISN for details of the connection and notes.

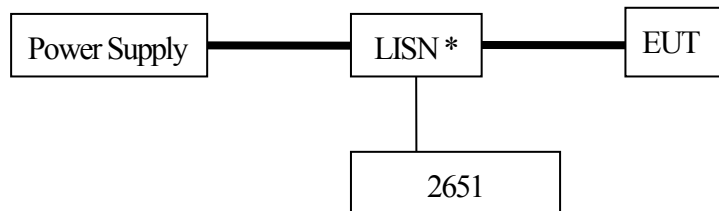

1. Turn on the power of the 2651 after the connection.

2. Set the initial parameters of conducted emission measurement by pushing

**SAVE/LOAD** → **F6** → **F2** . The setting parameters are as follows.

Center Frequency : 25.5 MHz

Frequency span : 50 MHz

RBW : 9 kHz

VBW : 1 MHz

Sweep time : 3 sec

Detection mode : Positive peak mode

3. Confirm whether the connection and the operation are correct by supplying the power to the EUT and measuring.

4. Set the number of times of the sweep in the MAX HOLD mode by operating

**CALC** → **F2** → 

5. Search the frequency of disturbance noise that exceeds the AV or QP limits by using the marker function.

6. Set the center frequency to the point that exceeds the limits, the SPAN to 2 MHz and the SWEEP to 0.1 sec. And measure the frequency accurately.

7. Moreover, measure the frequency detected in the above with QP or AV detection, then the SPAN is 200 kHz and the SWEEP is 10 sec.

### Radiated Emission Measurement

The electric field strength of disturbance noise that EUT radiates in the air is measured.

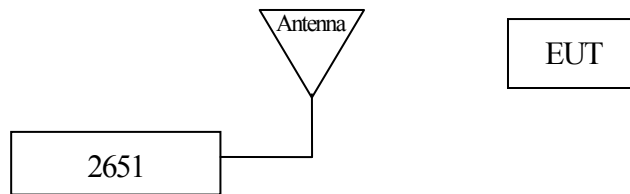

1. Set the compensation data of the antenna beforehand.

Refer to “25.8 Writing original compensation data” for the details.

2. Turn on the power of the 2651 after connection.

3. Set the initial parameters of radiated emission measurement by pushing



Center Frequency	: 515 MHz
Frequency span	: 1 GHz
RBW	: 120 kHz
VBW	: 1 MHz
Sweep time	: 0.3 sec
Detection mode	: Positive peak mode

4. Confirm whether the connection and the operation are correct by supplying the power to the EUT and measuring.

5. Set the number of times of the sweep in the MAX HOLD mode by operating **CALC** → **F2** → .

6. Search the frequency of disturbance noise that exceeds the QP limits by using the marker function.

7. Set the center frequency to the point that exceeds the limits, the SPAN to 50MHz and the SWEEP to 30 msec. And measure the frequency accurately.

8. Moreover, measure the frequency detected in the above with QP detection, then the SPAN is 1MHz and the SWEEP is 30 sec.

## EMI standards (selected)

	Frequency	Quasi Peak	Average	
CISPR22 class A Limits of conducted disturbance at mains ports	0.15 MHz to 0.50 MHz 0.50 MHz to 30 MHz	79 dBuV 73 dBuV		
CISPR22 class B Limits of conducted disturbance at mains ports	0.15 MHz to 0.50 MHz 0.50 MHz to 5 MHz 5 MHz to 30 MHz	66 to 56 dBuV 56 dBuV 60 dBuV	56 to 46 dBuV 46 dBuV 50 dBuV	Decreasing linearly with the logarithm of the frequency
CISPR22 class A Limits of radiated disturbance	30 MHz to 230 MHz 230 MHz to 1000 MHz 1000 MHz to 3000 MHz 3000 MHz to 6000 MHz	40 dBuV/m 47 dBuV/m 76 dBuV/m 80 dBuV/m	— — 56 dBuV/m 60 dBuV/m	Measurement distance 10 m
CISPR22 class B Limits of radiated disturbance	30 MHz to 230 MHz 230 MHz to 1000 MHz 1000 MHz to 3000 MHz 3000 MHz to 6000 MHz	30 dBuV/m 37 dBuV/m 70 dBuV/m 74 dBuV/m	— — 50 dBuV/m 54 dBuV/m	Measurement distance 10 m
VCCI class A Limits of conducted disturbance at mains ports	0.15 MHz to 0.50 MHz 0.50 MHz to 30 MHz	79 dBuV 73 dBuV	66 dBuV 60 dBuV	
VCCI class B Limits of conducted disturbance at mains ports	0.15 MHz to 0.50 MHz 0.50 MHz to 5 MHz 5 MHz to 30 MHz	66 to 56 dBuV 56 dBuV 60 dBuV	56 to 46 dBuV 46 dBuV 50 dBuV	Decreasing linearly with the logarithm of the frequency.
VCCI class A Limits of radiated disturbance	30 MHz to 230 MHz 230 MHz to 1000 MHz	40 dBuV/m 47 dBuV/m	— —	Measurement distance 10 m
	1000 MHz to 3000 MHz 3000 MHz to 6000 MHz	76 dBuV/m 80 dBuV/m	56 dBuV/m 60 dBuV/m	Measurement distance 3 m
VCCI class B Limits of radiated disturbance	30 MHz ~ 230 MHz 230 MHz ~ 1000 MHz	30 dBuV/m 37 dBuV/m	— —	Measurement distance 10 m
	1000 MHz to 3000 MHz 3000 MHz to 6000 MHz	70 dBuV/m 74 dBuV/m	50 dBuV/m 54 dBuV/m	Measurement distance 3 m
FCC part15 subpartB class A Limits of conducted disturbance at mains ports	0.15 MHz to 0.50 MHz 0.50 MHz to 30 MHz	79 dBuV 73 dBuV	66 dBuV 60 dBuV	
FCC part15 subpartB class B Limits of conducted disturbance at mains ports	0.15 MHz to 0.50 MHz 0.50 MHz to 5 MHz 5 MHz to 30 MHz	66 to 56 dBuV 56 dBuV 60 dBuV	56 to 46 dBuV 46 dBuV 50 dBuV	Decreasing linearly with the logarithm of the frequency.
FCC part15 subpartB class A Limits of radiated disturbance	30 MHz to 88 MHz 88 MHz to 216 MHz 216 MHz to 960 MHz over 960 MHz	39.1 dBuV/m 43.5 dBuV/m 46.4 dBuV/m 49.5 dBuV/m	— — — —	Measurement distance 10 m
FCC part15 subpartB class B Limits of radiated disturbance	30 MHz to 88 MHz 88 MHz to 216 MHz 216 MHz to 960 MHz over 960 MHz	40 dBuV/m 43.5 dBuV/m 46 dBuV/m 54 dBuV/m	— — — —	Measurement distance 3 m

(Note: Information provided in this table serves as a reference only. B&K Precision is not liable for any damages due to any mistakes in the table.)

## 21. Screen Control <DSPL>

When DSPL is pushed, the following function menu is displayed.

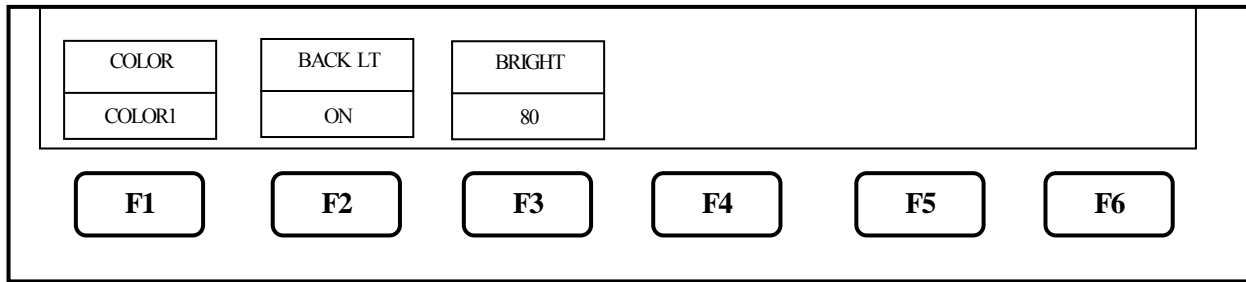

## 21.1 Setting Screen Display Color

When F1 is pushed, the color of screen display can be selected.



- COLOR1 : For normal use
- COLOR2 : For printing screen
- MONO : Monochrome

## 21.2 ON/OFF Switching of LCD Backlight

Use F2 button to toggle the backlight ON or OFF.

## 21.3 Adjusting Brightness of LCD Backlight

Use F3 → to set the brightness. It can be set in the range of 0 to 100.

# 22. Tracking Generator Mode (2652A)

## 22.1 Specification of T.G. Function

Item	Specification
Frequency range	5 MHz to 3.3 GHz
Output Level	-10 dBm ± 1 dB @1 GHz(Fixed value)
Output flatness	±1.5 dB
Output impedance	50 Ω
Output VSWR	Less than 2.0
Output connector	N(J) connector

## 22.2 Description of I/O Connector

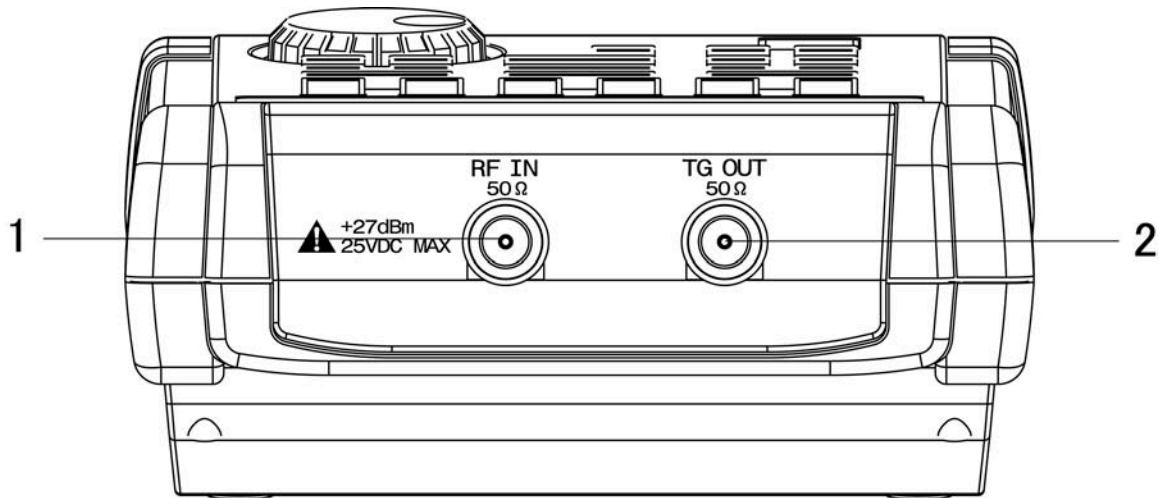

### 1) Input connector

N (J) connector

Input for an external signal

Make sure that the total power of input signals does not exceed +27 dBm.

### 2) Output connector

N (J) connector

It is an output terminal of Tracking Generator.

**\*Please set to “TG : OFF” to prevent the influence of the leak from the Tracking Generator in case of disuse of the T.G. function..**

## 22.3 ON/OFF Switching of T.G. Function

When **SWEEP** is pushed, the following function menu is display.

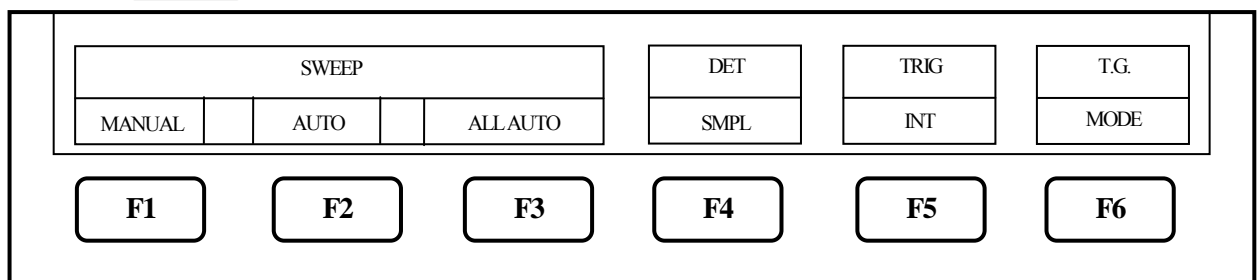

1. When **F6** is pushed, T.G. MODE is set.

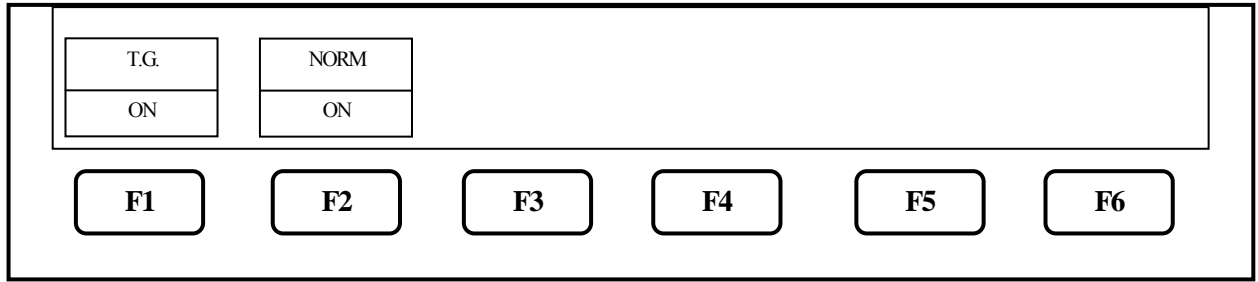

2. Each time **F1** is pressed, T.G. output is alternately switched to ON or OFF.

## 22.4 Normalizing Function

NORM ON: The input level is made flat to the red line on the screen.

1. When **SWEEP** is pushed, the same function menu as the previous item is displayed.
2. When **F6** is pushed, TG. MODE is set.
3. Each time **F2** is pushed, the normalizing function is alternately switched to ON or OFF.  
If the normalizing function is switched to ON, "NORM ON" is displayed on the screen.

\* If the setting is changed as follows, the normalizing function is automatically turned off.

- The span is expanded. · The center frequency is changed beyond the range normalized.  
(When SPAN is changed from FULL SPAN according to center frequency, it is turned off.)
- The magnetic field strength measurement is selected.
- The AUTO tuning is executed. · The power supply is turned off. · The presetting is executed.

\* When the scale is 2 dB or 5 dB, the normalizing function does not operate correctly if the spectrum level is not displayed at a proper position on the screen.

## 23. Storage/Print Screen Image <COPY>

The following function menu is displayed when **COPY** is pushed.

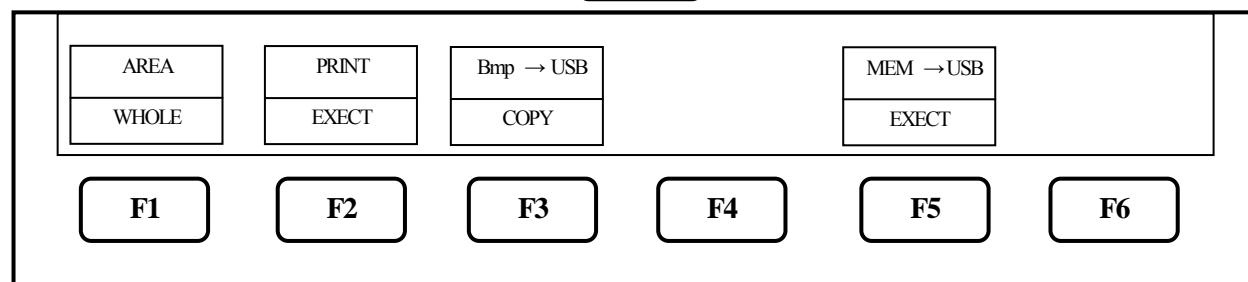

### 23.1 Selection of Image Area

When **F1** is pushed, the image area to be stored or printed can be selected.

WHOLE : the whole screen image is stored or printed.

SPECT : only the spectrum display area is stored or printed.

### 23.2 Print on Printer

When pushing **F2** after connecting the printer (option), the area selected in 23.1 is printed.

### 23.3 Storage into USB Memory

When pushing **F3** after connecting USB memory (removable storage) to this unit, the area selected in 23.1 is stored in USB memory in BMP (bit map) format. As for the file name, the number is automatically set and incremented in the form "2650A\_001.bmp". In the case when some characters are written in the label area, the file name will consist of it and the number put automatically such as "LABEL001.bmp". The folder "2650A\_IMG" is automatically generated and these files are stored inside.

To change the color of the display before print, refer to "21. Screen Control".

※ **Once you disconnect, then reconnect the same or a different USB flash memory drive, the 2650A series will not automatically recognize the new USB drive.** After connecting the drive, you first must press the Save/Load, followed by F5 key (USB) in order for the 2650A to "see" the new drive, then proceed with copying data to the drive.

## 23.4 Transferring Internal Data to USB Memory in Lump Sum

When pushing F5 after connecting USB memory (removable storage) to this unit, the data stored in the internal memory with SAVE/LOAD function are transferred to USB memory in a lump sum. During the transfer process, the screen on the lower right corner will display "Saving". Wait until it disappears, indicating that transfer is complete, before continuing operation. The folder "2650A\_SaveAll" is automatically generated and these files are stored inside.

※ **Once you disconnect, then reconnect the same or a different USB flash memory drive, the 2650A series will not automatically recognize the new USB drive.** After connecting the drive, you must first press the Save/Load key, followed by F5 key (USB) in order for the 2650A to "see" the new drive, then proceed as normal.



## 23.5 USB Printer (option)

The 2650A/2651 series enables a hard copy of the screen by connecting a USB printer (option) to USB A plug with the included USB cable.



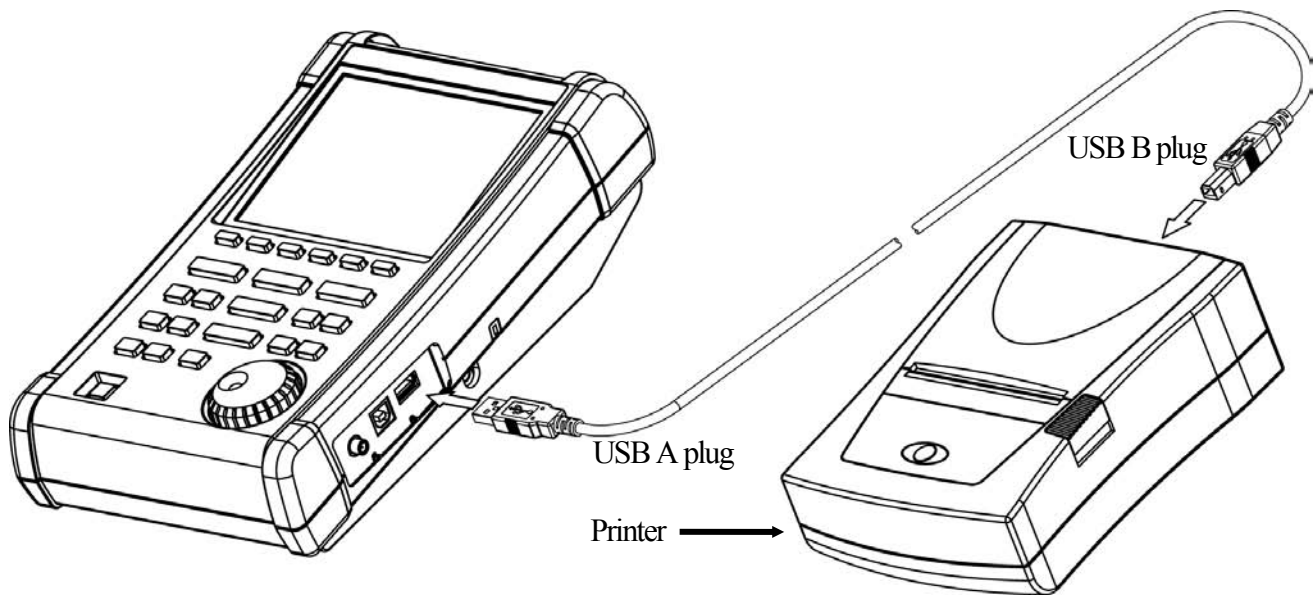

\* Turn on the power of the 2650A/2651 series unit first. After that, turn on the power of USB printer. Otherwise, it will not work correctly.

## 23.6 USB Memory

USB memory can be used as a removable storage.



# 24. Utility Function <UTIL>

When **UTIL** is pushed, the following function menu is displayed.

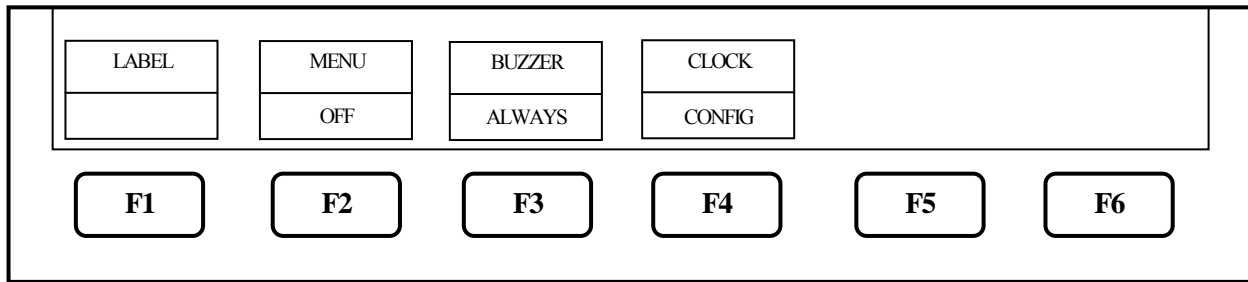

- F1** Label Function : Enters the label menu for customizing filename.
- F2** Menu Off : Turns off menu and active area display.
- F3** Buzzer Setting : Sets the condition of the buzzer sound.
- F4** Clock Function Setting : Sets the built-in clock.

## 24.1 Label Function

When **UTIL** → **F1** is pushed, the following function menu is displayed.

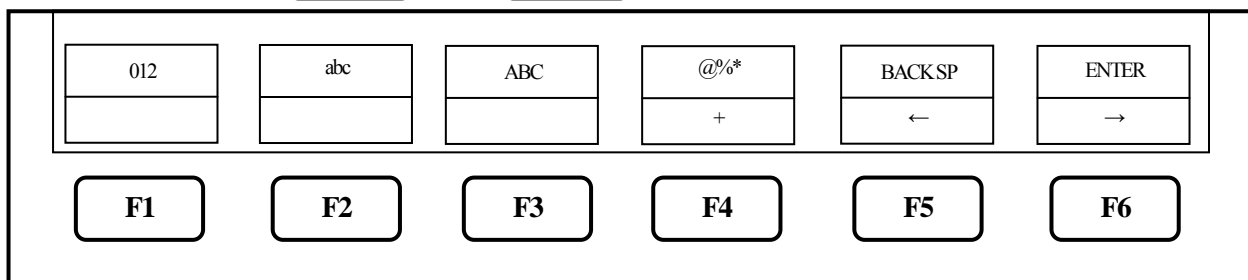

1. The kind of character to be written is selected with **F1** to **F4**.

- F1** 012 : 0 to 9 (numeral)
- F2** abc : a to z (lower case alphabet)
- F3** ABC : A to Z (upper case alphabet)
- F4** @%\* : Special characters (!"#\$%&'()\*+,-./:;<=>@[¥]^\_{Ω}μ)

\*Note: Certain special characters may not be recognized or valid as a filename.

2. A block cursor will be displayed in the label display area.

By rotating , a number, small letter alphabet, capital letter alphabet or special character will be indicated on the cursor position. Turn the knob until the desired label character is displayed.

3. When **F6** is pushed, the cursor position will move right by one character. And the previous character is set.

4. When **F5** is pushed, the cursor position will move left by one character. To change the character, turn the encoder. To delete, press F5 again. Characters previously entered can be deleted by consecutively pushing F5.
5. When finished, press **UTIL** to exit the label menu.

## 24.2 Menu Off

By pushing **F2**, the display of the function menu and the active area can be turned off temporarily.

## 24.3 Buzzer Setting

By pushing **F3**, the buzzer sound can be set to beep when keys are pressed or rotary encoder is turned. The following three options are selectable by pressing F3 until the desired option is displayed.

- OFF : The buzzer is off.
- ALARM : The buzzer will sound off when an incorrect setting is made.
- ALWAYS : The buzzer will sound whenever a key or the rotary encoder is operated.

※ When the battery voltage becomes low during battery operation, the buzzer will sound.  
(Even if OFF is selected, it will sound.)





## 24.4 Setting the Clock

When **UTIL** → **F4** is pushed, the following function menu is displayed.

YEAR	MONTH	DATE	HOUR	MIN	ENTER
08	JUN	30	23	50	
<b>F1</b>	<b>F2</b>	<b>F3</b>	<b>F4</b>	<b>F5</b>	<b>F6</b>

The year, month, day and time are displayed below the screen. (Refer to “4. Explanation of Screen”)  
Set the year, month, day and time when 2650A/2651 series is used for the first time.  
The time information is updated even if the power is turned off.

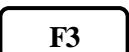
1. By rotating  , the values for a selected parameter (chosen by pressing any button between F1 and F5) can be changed.

2.  Used to set the year. Two last digits of the year are displayed. This can be set from 00 to 99.
-  Used to set the month. This can be set from 1 to 12.
-  Used to set the date. This can be set from 1 to 31.
-  Used to set the hour. It is displayed in twenty-four hour format. Values can be set from 1 to 24.
-  Used to set the minute.

3. By pushing  , the values which are set from item 2. above are saved. The values are updated only when this key is pushed.

\* The clock function of the 2650A/2651 series is driven by a dedicated LSI, and the power is supplied by a built-in lithium battery.

# 25. USB Device Function

## 25.1 Outline

The 2650A/2651 series is equipped with two kinds of USB connectors; A and B plugs. The A plug is for USB host and is connected to USB devices such as USB memory or printer. The B plug is for USB device and is connected to USB host such as a personal computer. The device function is explained in this chapter. As for the host function using USB A plug, refer to “23. Storage and print of screen image”.

## 25.2 How to Connect

When using the USB device, connect with the included USB cable as illustrated

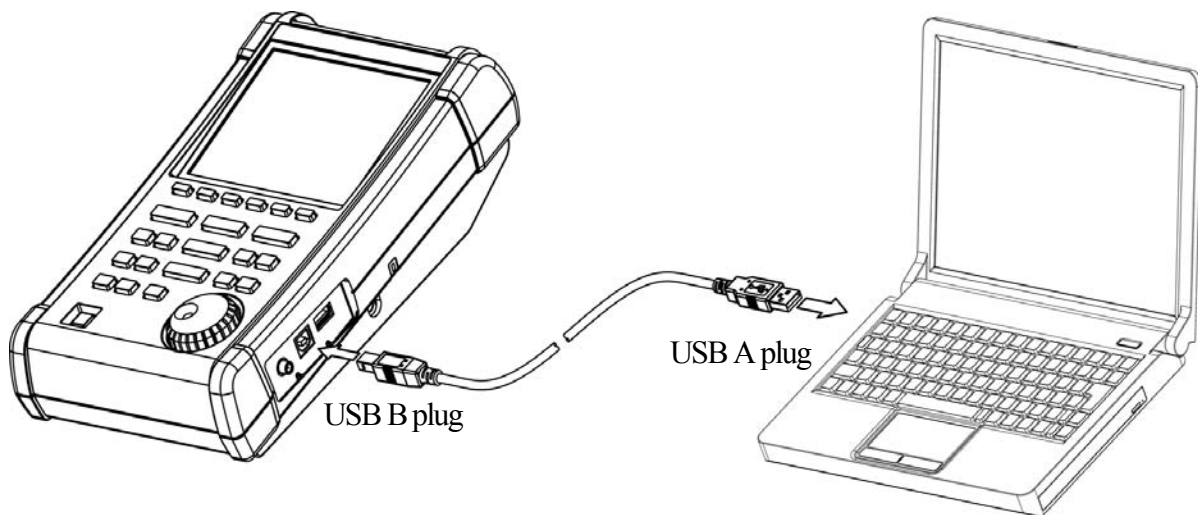

## 25.3 Installation of Driver

An instrument specified USB driver is necessary in order to control the 2650A/2651 series with a PC via USB interface, and should be installed in the PC prior to using the software. The driver along with instructions can be downloaded from our website [www.bkprecision.com](http://www.bkprecision.com). (Go to the Support section and select download). After the downloaded file is unzipped, the 2650A/2651 series is connected to a PC with the USB cable and then the power is turned on. The detection wizard for the USB driver starts on the PC screen the moment the power of the 2650A/2651 series is turned on, and install it following this wizard.

## 25.4 Sample Program

Please contact us at [www.bkprecision.com](http://www.bkprecision.com) to request a sample code which demonstrates how to write a custom program using the commands in the following section.

## 25.5 Explanation of Command

\* “CR(0D[HEX])+LF(0A[HEX])” is added to the end of every command. When the command is sent from PC, 2650A/2652A/2651 and 2658A return some responses, which include “OK” + CR + LF, “ERR” + CR + LF, or “(response to command)” + CR + LF.

\* By inputting “?” instead of “\* \* \* \* \*” for each command, the current setting parameters will be queried and a response of the value will be received by the PC.

(Except for “---- Request” command and the command for inputting corrected data.)

### 1) Setting center frequency

Command : `FREQ* * * * *`

(\* \* \* \* \* : Refer to “25.6 Input of frequency”)

Example: `FREQ1.235G`

Query: `FREQ?`

### 2) Request set marker

Command : `FREQSETMK`

\* The center frequency is set according to the frequency of current marker position.

### 3) Setting frequency span

Command : `SPAN* * * *`

2650A, 2652A, 2651:

(\* \* \* \* = ZERO, 200K, 500K, 1M, 2M, 5M, 10M, 20M, 50M, 100M, 200M, 500M, 1G, 2G, FULL [unit : Hz])

2658A :

(\* \* \* \* = ZERO, 200K, 500K, 1M, 2M, 5M, 10M, 20M, 50M, 100M, 200M, 500M, 1G, 2G, 5G, FULL [unit : Hz])

Example: `SPAN500K`

Query: `SPAN?`

\* When the unit is other than dBm, convert into dBm by using calculation formula in “9.8 Relation between reference level and ATT/AMP”.

### 4) Setting reference level

Command : `REF* * *`

(\* \* \* = -60 to 10 [1 step, unit : dBm])

Example: `REF 5`

Query: `REF?`

### 5) Setting reference level unit

Command : `UNIT* * * *`

(\* \* \* \* = DBM, DBUV, DBMV, DBV)

Example: `UNITDBUV`

Command	Unit
DBM	dBm
DBUV	dB $\mu$ V
DBMV	dBmV
DBV	dBV

6) Setting RBW

Command : RBW\* \* \*

2650A, 2652A, 2658A :

(\* \* \* \* = 3K, 10K, 30K, 100K, 300K, 1M, 3M, AUTO, ALL [ unit : Hz ])

2651 :

(\* \* \* \* = 3K, 9K, 30K, 120K, 300K, 1M, 3M, AUTO, ALL [ unit : Hz ])

\* ALL : The optimum RBW, VBW, and sweep time are set based on the frequency span.

\* AUTO : The optimum RBW is set based on the frequency span.

Example: RBW3M

Query: RBW?

7) Setting VBW

Command : VBW\* \* \* \*

(\* \* \* \* = 100, 300, 1K, 3K, 10K, 30K, 100K, 300K, 1M, AUTO, ALL [ unit : Hz ])

\* ALL : The optimum RBW, VBW and sweep time are set based on the frequency span.

\* AUTO : The optimum RBW is set based on the frequency span.

Example: VBW300

Query: VBW?

8) Selecting Measuring Function

Command : MEAS\* \* \*

(\* \* \* = CP, ACP, OBW, EF, MF, FC, OFF)

Example: MEASOBW

(To change measuring function when in

a different measurement mode, set function OFF first by sending MEASOFF)

Query: MEAS?

Command	Measuring function
CP	Channel power measurement
ACP	Adjacent channel power measurement
OBW	Occupied bandwidth measurement
EF	Electric field strength measurement
MF	Magnetic field strength measurement
FC	Frequency counter (factory option)
OFF	OFF

9) Request measuring result

Command : MEASRES

\* Example of measuring result

Channel power measurement ---- POW: - 25.5 dBm

Adjacent channel power measurement ---- L: - 47.7 dBc U: - 48.3 dBc

Occupied bandwidth measurement ---- C: 1.45 G W: 20.00 k

Frequency counter ---- FC: 2400.0000 M

\* If the frequency counter is not installed, "Invalid for F/C" is responded.

\* If the level of spectrum is low and unmeasurable, "Non Signal" is responded.

10) Setting mode for channel power measurement

Command : CPMODE\*\*\*\*\*

(\*\*\*\*\* = TOTAL, BAND)

Example: CPMODETOTAL

Query: CPMODE?

Command	Mode
TOTAL	The sum of power on the screen is measured.
BAND	The sum of power in the band specified is measured.

11) Setting zone center frequency for channel power measurement

Command : CPCNTR\*\*\*\*\*

(\*\*\*\*\*: =0-500: screen position, center = 250)

Example: CPCNTR300

Query: CPCNTR?

12) Setting zone width for channel power measurement

Command : CPWIDTH\*\*\*\*\*

(\*\*\*\*\*: =0-500: screen position, center = 250)

Example: CPWIDTH200

Query: CPWIDTH?

13) Setting mode for adjacent channel power measurement

Command : ACPMODE\*\*\*\*\*

(\*\*\*\*\* = TOTAL, BAND, PEAK)

Example: ACPMODEPEAK

Query: ACPMODE?

Command	Mode
TOTAL	TOTAL (total power method)
BAND	BAND (in-band method)
PEAK	PEAK (reference level method)

14) Setting band offset for adjacent channel power measurement

Command : ACPOFS\*\*\*\*\*

(\*\*\*\*\*: =0-500: screen position, center = 250)

Example: ACPOFS100

Query: ACPOFS?

15) Setting bandwidth for adjacent channel power measurement

Command : ACPCHBW\*\*\*\*\*

(\*\*\*\*\*: =0-500: screen position, center = 250)

Example: ACPCHBW30

Query: ACPCHBW?

16) Setting reference band center frequency for adjacent channel power measurement

Command : ACPREF\*\*\*\*\*



(\*\*\*\*\*: =0-500: screen position, center = 250)

Example: ACPREF250

Query: ACPREF?

17) Setting reference bandwidth for adjacent channel power measurement

Command : ACPREFBW\*\*\*\*\*

(\*\*\*\*\*: =0-500: screen position, center = 250)

Example: ACPREFBW50

Query: ACPREFBW?

18) Setting mode for occupied bandwidth measurement

Command : OBWMODE\*\*

(\*\* : N%, DB)

Example: OBWMODEN%

Query: OBWMODE?

Command	Mode
N%	N% POWER mode
DB	XdB DOWN mode

19) Setting N% RATIO for occupied bandwidth measurement

Command : OBWRATIO\*\*\*

(\*\*\*: 80.0 to 99.9 [ 0.1 step , unit : %] )

Example: OBWRATIO85.6

Query: OBWRATIO?

20) Setting XdB DOWN for occupied bandwidth measurement

Command : OBWDB\*\*\*

(\*\*\*: 0.1 to 99.0 [ 0.1 step , unit : dB] )

Example: OBWDB45.3

Query: OBWDB?

21) Setting antenna for electric field strength measurement

Command : EFANT\*\*\*\*

(\*\*\*\*: M401 / M402 / M403 / M404 / M405 / M406 / USER)

Example: EFANTM405

Query: EFANT?

Command	Antenna
M401	Setting data for M401
M402	Setting data for M402
M403	Setting data for M403
M404	Setting data for M404
M405	Setting data for M405
M406	Setting data for M406
USER	Setting data for user's original antenna

22) Transfer user-compensation data for electric field strength measurement

Command : EFUSER\*\*\*\*\*

(Refer to “25.8 Writing of Original Compensation Data” for the details.)

Example: EFUSER300M:0.0DBI,350M:1.0DBI

23) Setting probe for magnetic field strength measurement

Command : MFPROBE\* \* \* \*

(\* \* \* \*: CP2S / USER)

Example: MFPROBECP2S

Query: MFPROBE?

24) Transfer user-compensation data for magnetic field strength measurement

Command : MFUSER\* \* \* \* \*

(Refer to "25.8 Writing of Original Compensation Data" for the details.)

Example: MFUSER300M:0.0DBI,350M:1.0DBI

25) Start and Stop calculation function

Command : CALC\* \* \* \*

(\* \* \* \*: OFF / MAX / MIN / AVE / OVR)

Example: CALCMIN

Query: CALC?

Command	Calculation
OFF	OFF
MAX	MAX HOLD
MIN	MIN HOLD
AVR	AVERAGE
OVR	OVER WRITE

26) Setting number of times to sweep for MAX HOLD

Command : MAXNO\* \* \* \* \*

(\* \* \* \* \*: 2 / 4 / 8 / 16 / 32 / 64 / 128 / 256 / 512 / 1024 / 0) \* 0 = unlimited)

Example: MAXNO1024

Query: MAXNO?

27) Setting number of times to sweep for MIN HOLD

Command : MINNO\* \* \* \* \*

(\* \* \* \* \*: 2 / 4 / 8 / 16 / 32 / 64 / 128 / 256 / 512 / 1024 / 0) \* 0 = unlimited)

Example: MINNO512

Query: MINNO?

28) Setting number of times to sweep for AVERAGE

Command : AVENO\* \* \* \* \*

(\* \* \* \* \*: 2 / 4 / 8 / 16 / 32 / 64 / 128 / 256 / 512 / 1024 / 0) \* 0 = unlimited)

Example: AVENO16

Query: AVENO?

29) Setting number of times to sweep for OVERWRITE

Command : OVWNO\* \* \* \* \*

(\* \* \* \* \*: 2 / 4 / 8 / 16 / 32 / 64 / 128 / 256 / 512 / 1024 / 0) \* 0 = unlimited)

Example: OVWNO128

Query: OVWNO?

30) Setting display scale

Command : SCALE\* \*  
 (\*\*: 2 / 5 / 10)  
 Example: SCALE10  
 Query: SCALE?

Command	Display scale
2	2dB/div
5	5dB/div
10	10dB/div

31) Setting sweep time

Command : SWEEP\* \* \* \*  
 (\*\*\*\*: 10M / 30M / 0.1S / 0.3S / 1S / 3S / 10S / 30S / AUTO / ALL)

Command	Sweep time
10M	10ms
30M	30ms
0.1S	0.1s
0.3S	0.3s
1S	1s

Command	Sweep time
3S	3s
10S	10s
30S	30s
AUTO	AUTO
ALL	ALL AUTO

Example: SWEEP0.1S  
 Query: SWEEP?

32) Setting detection mode

Command : DET\* \* \*  
 (\*\*\*: POS / NEG / SMP)  
 Example: DETPOS  
 Query: DET?

Command	Detection mode
POS	Positive peak mode
NEG	Negative peak mode
SMP	Sample mode
QP	QP mode (only for MSA438E)
AVG	AVG mode (only for MSA438E)

33) Setting trigger source

Command : TRG\* \* \*  
 (\*\*\*: INT / EXT)  
 Example: TRGEXT  
 Query: TRG?

Command	Trigger source
INT	Internal
EXT	External

34) Request AUTOTUNE

Command : AUTO

\* The response is returned after tuning.

35) Hold/Run function

Command : HOLD  
 Command : RUN

36) Request marker information

Command : MKRRES  
 Query: MKRRES?

\* Example of returned data : 1.42G -15dBm

37) Setting marker mode

Command : MKR\*\*\*\*\*  
 (\*\*\*\*\*: NORM/DELTA)  
 Example: MKRDELTA  
 Query: MKR?

Command	Marker mode
NORM	Normal marker
DELTA	Delta marker

38) Setting marker position by frequency

The position of active marker is set by frequency.  
 Command : NORMMKR\*\*\*\*\*  
 (\*\*\*\*\*: Refer to “25.6 Input of Frequency”)  
 Query: NORMMKR?

39) Setting marker position by number of points on horizontal axis

The position of active marker is set by number of points on horizontal axis.  
 Command : MKRPOSI\*\*\*  
 (\*\*\*: 0 to 500 ; 0 = far left, 500 = far right)  
 Example: MKRPOSI40

40) Setting peak search mode

Command : PEAK\*\*\*\*\*  
 (\*\*\*\*\*: NORM/ZONE)  
 Example: PEAKZONE  
 Query: PEAK?

Command	Peak search mode
NORM	Normal peak search
ZONE	Zone peak search

41) Request peak search

Command : PKSEARCH\*\*  
 (\*\*: 01 / 02 / 03 / 04 / 05 / 06  
 / 07 / 08 / 09 / 10 / 11)  
 Example: PKSEARCH09

Command	Destination of marker
01	The maximum peak on the screen
02	The 2nd peak on the screen
...	...
11	The 11th peak on the screen

42) Setting zone center frequency for peak search

Command : PKCNTR\*\*\*\*\*  
 (\*\*\*\*\*: Refer to “25.6 Input of Frequency”)  
 Example: PKCNTR1.345G  
 Query: PKCNTR?

43) Setting zone width for peak search

Command : PKWIDTH\*\*\*\*\*  
 (\*\*\*\*\*: Refer to “25.6 Input of Frequency”)  
 Example: PKWIDTH256M  
 Query: PKWIDTH?

44) Setting unit of marker

Command : CONV\*\*\*  
 (\*\*\*: DBM/W/DBV/V/DBUVM/VM)  
 Example: CONVDBUVM  
 Query: CONV?

Command	Unit of marker
DBM	dBm
W	W
DBV	dBV
V	V
DBUVM	dBμV/m
VM	V/m

45) Request print on printer

Command : PRTSIW  
 USB printer connected to USB A plug prints.

46) Request for transfer of spectrum

Command : SRS\*\*\*\*  
 (\*\*\*\*: CURR/000 to 199)  
 Example: SRSCURR

Command	Transferred spectrum
CURR	Current spectrum
000	Spectrum data of 000
...	...
199	Spectrum data of 199

\*The number of the commands is given to the saved file.  
 \*Refer to “25.7 Transfer of Spectrum Data” for the returned data.

47) Request for transfer of spectrum in USB memory

Command : SRSU\*\*\*\*  
 (\*\*\*\*: 000 to 199)  
 Example: SRSU111

Command	Transferred spectrum
000	Spectrum data of 000 in USB memory
...	...
999	Spectrum data of 999 in USB memory

\* The number of the command is given to the saved file.  
 \* Refer to “25.7 Transfer of Spectrum Data” for the returned data.

48) Request for transfer of spectrum data of 1001 points

Command : SRSF \* Refer to “25.7 Transfer of Spectrum Data” for the returned data.

49) Request preset

Command : PRESET

Command	Remote control
ON	Operation by function key and encoder cannot be done. Control the unit with USB commands.
OFF	Operation by function key and encoder can be done. USB commands are available

50) Setting remote control

Command : REMOTE\*\*\*  
 (\*\*\*: ON/OFF)  
 Example: REMOTEON  
 Query: REMOTE?

\* When the remote control is ON, "REMOTE" is displayed in the operating information area on the screen. ( Refer to "4. Explanation of Screen" for the details.)

51) Single sweep

Command : CAPT \* It sweeps only once and will be in a HOLD state.

52) Setting offset level

Command : OFFSET\*\*\*\*\*  
 (\*\*\*\*\*: -50.0 to 50.0 [0.1 step, unit: dB] )  
 Example: OFFSET-25.6  
 Query: OFFSET?

Command	Offset level
50	Offset level is set to 0dB.
75	Offset level is set to 5.7dB.

53) Setting input impedance

Command : IMP\*\*  
 (\*\* : 50 / 75)  
 Example: IMP75  
 Query: IMP?

\* When the input impedance is selected, the offset level is set as described above.

54) Clearing spectrum data and parameter

Command : MCLR\*\*\*  
 (\*\*\*: ALL / 000 to 199)  
 Example: MCLRWALL  
 \* For internal memory only.

Command	Cleared data
ALL	All of spectrum data
000	Spectrum data of 000
...	...
199	Spectrum data of 199

55) Setting character for label

Command : LBL\*\*\*  
 (\*\*\*: The number of characters is 16 or less)  
 Example: LBLsample\_spectrum  
 Query: LBL?

56) Setting clock

Command : CLC\*\*\*\*\*  
 (\*\*\*\*\* : aabbccdd ; aa: two last digits of year, bb: month (01 to 12), cc: hour (00 to 23), dd: minute (00 to 59)  
 Example: CLC0902111103  
 Query: CLC?

57) Setting tracking generator

Command : TG\* \* \*

( \* \* \*: ON / OFF)

Example: TGON

Query: TG?

58) Setting normalizing function

Command : NORM\* \* \*

( \* \* \*: ON / OFF)

Example: NORMOFF

Query: NORM?

59) Save/Load function

Command : DEV\*\*\*

( \* \* \*: MEN/USB)

60) Request On/Off of Offset Level

Command: OFFSETOF?

\*Returned data: ON or OFF.

61) Request firmware version

Command: VER

## 25.6 Input of Frequency

The frequency is input as follows.

\* \* \* \* \* : 0.0k to 999.9k (0.1 step, unit: Hz)  
: 0.0M to 999.9M (0.1 step, unit: Hz)  
: 0.0000G to 3.3G (0.0001 step, unit: Hz) — 2650A, 2652A, 2651  
: 0.0000G to 8.5G (0.0001 step, unit: Hz) — 2658A

\* The offset frequency and the zone width can be input only in the range decided by the center frequency and frequency span. If the value out of the range is input, an error occurs.

\* The offset frequency and the zone width change when the frequency span is changed.

## 25.7 Transfer of Spectrum Data

The spectrum data outputs as a numeric string separated by commas “,”. [\*\*.\*\*, \*\*.\*\*, ....., \*\*.\*\*]

The unit is dBm, and it is available up to two decimal places.

- Description

String	Explanation	Example
SPECT	The data which follows the string "SPECT" is the spectrum data.	SPECT
**, **, ...	It is the spectrum data. This string consists of all data points separated by a comma “,” after each data value, and the string can have a total of ten data points per line. For example, transferring spectrum data of 1001 points require a total of 101 lines.	-102.01, -102.03, ..., ..., -110.12,

## 25.8 Writing of Original Compensation Data

When antennas or probes other than the option is used in electric field strength measurement or magnetic field strength measurement, it is necessary to write each original compensation data into the unit.

Please write the data into the unit according to the following description.

There are two methods for writing. Either use the 2650A PC Software or write a custom program using interface commands.

### 1) Preparation items

- \* Windows PC (with USB interface) [The writing can be done with 2650A/2651 series unit only.]
- \* 2650A PC software (Refer to 3) below)

### 2) Example of writing data

As an example, the compensation data (antenna gain) of antenna M405 and the compensation data (compensation coefficient) of magnetic field probe CP-2S are shown below.

\* Compensation data (antenna gain) of antenna M405

Frequency	300MHz	350MHz	400MHz	450MHz	500MHz
Antenna gain	0.0dBi	1.0dBi	1.4dBi	1.4dBi	0.0dBi

\* Compensation data (compensation coefficient) of magnetic field probe CP-2S

Frequency	10MHz	100MHz	1GHz	2GHz	3GHz
Compensation coefficient	86.7dB	69.2dB	50.7dB	44.9dB	40.1dB

\* Data of ten points or less can be written. 0Hz is not valid as a data point.

### 3) Using 2650A PC software for writing

1. Create the text file of compensation data.



Create a new text file, and open it with a text editor.

Write the frequency and compensation data in the following format.

\* Format

“frequency”:”compensation data”, “frequency”: “compensation data”, ...

Example of M405

**300M:0.0DBI,350M:1.0DBI,400M:1.4DBI,450M:1.4DBI,500M:0.0DBI**

\* Write the unit with a capital letter as it is case sensitive. G (GHz) is also available.

## 2. Write the text file into the unit with 2650A PC software.

Connect the personal computer to 2650A series with the included USB cable and turn on the power of the 2650A/2651 series.

From the upper menu of the PC software,

select [File] → [Write E/F User Data] in case of electric field strength measurement, or

select [File] → [Write M/F User Data] in case of magnetic field strength measurement.

When the text file created beforehand is selected, the data is written.

\* Install the specified USB driver in the personal computer prior to using the PC software.

(Refer to “25.3 Installation of Driver”)

## 4) Method of using original program for writing

### 1. Prepare the USB communication software.

Connect the personal computer to the 2650A/2651 series with the included USB cable and turn on the power of the 2650A/2651 series.

### 2. Write the data into the unit.

Transfer the data in the following format with the USB communication software.

\* Format

In case of electric field strength measurement;

EFUSER “frequency”:”compensation data”, “frequency”: “compensation data”, ...

In case of magnetic field strength measurement;

MFUSER “frequency”:”compensation data”, “frequency”: “compensation data”, ...

Example of CP-2S

**MFUSER10M:86.7DB,100M:69.2DB,1G:50.7DB,2G:44.9DB,3G:40.1DB**

\* Write the unit with a capital letter as it is case sensitive. G (GHz) is also available.

### 3. When the writing ends correctly, “OK” is returned.

## 5) How to use

Set the measuring function of the 2650A/2651 series to electric field strength measurement mode or magnetic field strength measurement mode.

By pushing [MEAS] → [E/F ANT], electric field strength measurement mode is set.

By pushing [MEAS] → [M/F PROBE], magnetic field strength measurement mode is set.

Select “USER” from antennas or probes on the display by pushing [F1].

Then, the measurement by the written data will begin.

\* The written data remains even if power is turned off.

\* The measuring mode returns to a usual measurement mode when turning off power.

## 6) About antenna gain

In the following context, the antenna gain means an absolute gain.

When the antenna gain is a relative gain, it can change into an absolute gain by adding +2.15 dB.

$$\text{Absolute gain [dBi]} = \text{Relative gain [dBd]} + 2.15 \text{ dB}$$

As a reference, the conversion formula to electric field strength is indicated below:

$$E = \sqrt{(480\pi^2 \times Pa) / (Ga \times \lambda^2)}$$

E: Electric field strength [V/m]

Pa: Received electric power [W]

Ga: Antenna gain [times] =  $10^{(\text{antenna gain [dBi]} \div 10)}$

$\lambda$ : Wavelength [m] =  $(3 \times 10^8) \div \text{frequency [Hz]}$

## 26. Option

- **Dipole antenna M401 to M406** Connector : N (P)  
Refer to “19.4 Electric Field Strength Measurement” for the details.
- **Magnetic field probe CP-2S.**  
Refer to “19.5 Magnetic Field Strength Measurement” for the details.

Specification	
Frequency range	: 10 MHz to 3 GHz
Space resolution	: approx.0.25 mm (depending on objects)
Dimensions	: outside 12 φ ×135 mm probe tip 2 mm(W)×1 mm(T)
Connectors	: SMA(P)

- **USB printer** With AC adaptor and one roll of paper  
Refer to “23. Storage / Print of Screen Image” for the details.

Specification	
Printing method	: Thermal line dot method
Paper	: 80 mm width thermal paper
Power source	: internal : AA-sized alkaline battery (4 pcs) external : 7.5 VDC/3 A (dedicated AC adapter)
Dimensions	: 134(W)×60(H)×180(D) mm
Weight	: approx.450 g (mainframe only)

- **Roll printer (10 rolls)** For USB printer

# 27. Basic Performance Test

## (2650A/2651/2652A/2658A)

To keep the quality of the unit, regular performance testing is recommended. This section describes a method and specification of basic performance testing. If a problem is found in the results of basic performance testing, or formal testing is required, please contact B&K Precision.

[Connection diagram]

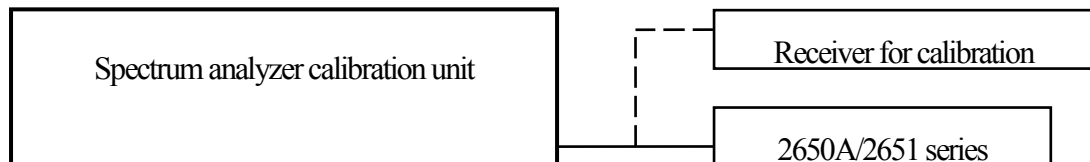

### 27.1 Frequency Characteristics

Adjust the output level of the spectrum analyzer calibration unit (thereafter, “calibration unit”) so that the displayed power value is -15dBm at each frequency for this unit, and measure the absolute value with a receiver for calibration (microwave power meter, etc.).

Setting of 2650A/2652A/2651/2658A			Specifications	Measurement value	Judgment
Center frequency	Frequency span	RBW *1)			
50 kHz	200 kHz	10 kHz	Within Reference±2.6 dB±1 dot		
100 kHz	200 kHz	30 kHz	Within Reference±2.6 dB±1 dot		
1 MHz	2 MHz	100 kHz	Within Reference±2.6 dB±1 dot		
10 MHz	10 MHz	3 MHz	Within Reference±2.0 dB±1 dot		
100 MHz	10 MHz	3 MHz	Reference		
1 GHz	10 MHz	3 MHz	Within Reference±1.0 dB±1 dot		
2 GHz	10 MHz	3 MHz	Within Reference±1.0 dB±1 dot		
3.3 GHz	10 MHz	3 MHz	Within Reference±1.0 dB±1 dot		
6.2 GHz *2)	10 MHz	3 MHz	Within Reference±1.0 dB±1 dot		
8.5 GHz *2)	10 MHz	3 MHz	Within Reference±1.0 dB±1 dot		

\*1) RBW switching error is included at RBW other than 3 MHz. \*2) 2658A only

· Setting of 2650A/2652A/2651/2658A

Reference level : -15 dBm  
 VBW : 1 MHz  
 Sweep time : 1 s  
 Detection mode : SMPL  
 Display scale : 2 dB/div

· Setting of calibration unit

Frequency : Same as a center frequency of 2650A/2652A/2651/2658A.  
 Output power : Adjust the power indication of 2650A/2652A/2651/2658A to -15 dBm.

## 27.2 Accuracy of Reference Level

Adjust the output level of the calibration unit so that the displayed value of this unit is the 0th div from the top, and calibrate the absolute value with the receiver for calibration (microwave power meter, etc.).

Setting of 2650A/2652A/2651/2658A Reference level	Specifications	Measurement value	Judgment
+10 dBm	within $\pm 1.4$ dB $\pm 1$ dot		
0 dBm	within $\pm 1.4$ dB $\pm 1$ dot		
-10 dBm	within $\pm 1.4$ dB $\pm 1$ dot		
-15 dBm	within $\pm 0.8$ dB $\pm 1$ dot		
-20 dBm	within $\pm 1.4$ dB $\pm 1$ dot		
-30 dBm	within $\pm 1.4$ dB $\pm 1$ dot		
-40 dBm	within $\pm 1.4$ dB $\pm 1$ dot		

\* Input attenuator switching error is included at the reference level other than -15 dBm.

· Setting of 2650A/2652A/2651/2658A

Center frequency : 100 MHz  
Frequency span : 10 MHz  
RBW : 3 MHz

VBW : 1 MHz  
Sweep time : 1 s  
Detection mode : SMPL  
Display scale : 2 dB/div

· Setting of calibration unit

Frequency : 100 MHz  
Output power : Adjust it so that the indicated value of 2650A/2652A/2651/2658A is at the 0th div from the top.

## 27.3 Display Accuracy of Center Frequency

Measure the frequency with the peak search function of 2650A/2652A/2651/2658A.

Setting of 2650A/2652A/2651/2658A			Specifications	Measurement value Center frequency	Judgment Frequency span
Center frequency	Frequency span	RBW			
100 MHz	200 kHz	3 kHz	within $\pm 50$ kHz $\pm 1$ dot $\pm$ RBW x 6%	100 MHz	200 kHz
100 MHz	10 MHz	30 kHz		100 MHz	10 MHz
100 MHz	20 MHz	100 kHz		100 MHz	20 MHz
100 MHz	200 MHz	100 kHz	within $\pm 360$ kHz $\pm 1$ dot $\pm$ RBW x 20%	100 MHz	200 MHz
1 GHz	20 MHz	100 kHz		1 GHz	20 MHz
2 GHz	20 MHz	100 kHz		2 GHz	20 MHz
3.3 GHz *1	20 MHz	100 kHz		3.3 GHz *1	20 MHz
6.1 GHz *2	20 MHz	100 kHz		6.1 GHz *2	20 MHz
8.5 GHz *2	20 MHz	100 kHz		8.5 GHz *2	20 MHz

\*1 2650A/2652A/2651 only

\*2 2658A only

· Setting of 2650A/2652A/2651/2658A

Reference level : -15 dBm  
VBW : AUTO  
Sweep time : 1 s  
Detection mode : SMPL  
Display scale : 10 dB/div

· Setting of calibration unit

Frequency : Same as a center frequency of 2650A/2652A/2651/2658A.  
Output power : -15 dBm  
\* However, calibrate the signal generator in advance.

## 27.4 Display Accuracy of Frequency Span

Adjust the frequency of the calibration equipment so that the peaks are at the positions of  $f_1$  and  $f_9$ , and measure the frequencies of  $f_1$  and  $f_9$ . Calculate from  $f_1$  and  $f_9$  the display accuracy of the frequency span.

\*  $f_1$ : 1<sup>st</sup> div from the left on the spectrum display     $f_9$ : 9<sup>th</sup> div from the left on the spectrum display

Setting of 2650A/2652A/2651/2658A			Specifications	$f_1$ Measurement value	$f_9$ Measurement value	$(f_9 - f_1)$	Judgment
Frequency span	Center Frequency	RBW					
200 kHz	100 MHz	3 kHz	within $\pm 180 \text{ kHz} \times 3\% \pm 1 \text{ dot}$				
10 MHz	100 MHz	100 kHz	within $\pm 8 \text{ MHz} \times 3\% \pm 1 \text{ dot}$				
20 MHz	100 MHz	300 kHz	within $\pm 18 \text{ MHz} \times 3\% \pm 1 \text{ dot}$				
200 MHz	100 MHz	3 MHz	within $\pm 180 \text{ MHz} \times 3\% \pm 1 \text{ dot}$				
500 MHz	1 GHz	3 MHz	within $\pm 400 \text{ MHz} \times 3\% \pm 1 \text{ dot}$				
2 GHz	1 GHz	3 MHz	within $\pm 1.8 \text{ GHz} \times 3\% \pm 1 \text{ dot}$				
FULL(3.3 GHz)*1	1.65 GHz	3 MHz	within $\pm 2.64 \text{ GHz} \times 3\% \pm 1 \text{ dot}$				
2 GHz *2	4.8 GHz	3 MHz	within $\pm 1.8 \text{ GHz} \times 3\% \pm 1 \text{ dot}$				
2 GHz *2	7.4 GHz	3 MHz	within $\pm 1.8 \text{ GHz} \times 3\% \pm 1 \text{ dot}$				
FULL(8.5 GHz)*2	4.25 GHz	3 MHz	within $\pm 6.8 \text{ GHz} \times 3\% \pm 1 \text{ dot}$				

\*1 2650A/2652A/2651 only

\*2 2658A only

· Setting of 2650A/2652A/2651/2658A

Reference level : -15 dBm  
 VBW : AUTO  
 Sweep time : 1 s  
 Detection mode : SMPL  
 Display scale : 10 dB/div

· Setting of calibration unit

Frequency : Adjust it to the positions of  $f_1$   
and  $f_9$ .  
 Output power : -15 dBm

## 27.5 Linearity of Amplitude Axis

Adjust the level of the calibration unit so that the peak is at the top of the amplitude axis (0th div), and regard the point set at that time as the reference. Gradually lower the output, starting from the reference, and measure the amplitude value of 2650A/2652A/2651/2658A.

Setting of 2650A/2652A/2651/2658A	Output of calibration unit	Specifications	Measurement value	Judgment
Display scales				
10 dB/div	X dBm (adjust it to the 0th div)	Reference(-15 dBm)	(-15 dBm)	
	X-10 dBm	Within $-25 \text{ dBm} \pm 0.8 \text{ dB} \pm 1 \text{ dot}$		
5 dB/div	X dBm (adjust it to the 0th div)	Reference(-15 dBm)	(-15 dBm)	
	X-5 dBm	Within $-20 \text{ dBm} \pm 0.4 \text{ dB} \pm 1 \text{ dot}$		
2 dB/div	X dBm (adjust it to the 0th div)	Reference(-15 dBm)	(-15 dBm)	
	X-2 dB	Within $-17 \text{ dBm} \pm 0.2 \text{ dB} \pm 1 \text{ dot}$		

· Setting of 2650A/2652A/2651/2658A

· Setting of calibration unit

Center frequency : 100 MHz  
Reference level : -15 dBm  
Frequency span : 10 MHz  
RBW : 3 MHz  
VBW : 1 MHz  
Sweep time : 1 s  
Detection mode : SMPL

Frequency : 100 MHz

## SERVICE INFORMATION

---

**Warranty Service:** Please go the support and service section on our website [www.bkprecision.com](http://www.bkprecision.com) to obtain a RMA #. Return the product in the original packaging with proof of purchase to the address below. Clearly state on the RMA the performance problem and return any leads, probes, connectors and accessories that you are using with the device.

**Non-Warranty Service:** Please go the support and service section on our website [www.bkprecision.com](http://www.bkprecision.com) to obtain a RMA #. Return the product in the original packaging to the address below. Clearly state on the RMA the performance problem and return any leads, probes, connectors and accessories that you are using with the device. Customers not on an open account must include payment in the form of a money order or credit card. For the most current repair charges please refer to the service and support section on our website.

Return all merchandise to B&K Precision Corp. with pre-paid shipping. The flat-rate repair charge for Non-Warranty Service does not include return shipping. Return shipping to locations in North America is included for Warranty Service. For overnight shipments and non-North American shipping fees please contact B&K Precision Corp.

B&K Precision Corp.  
22820 Savi Ranch Parkway  
Yorba Linda, CA 92887  
[www.bkprecision.com](http://www.bkprecision.com)  
714-921-9095

**Include with the returned instrument your complete return shipping address, contact name, phone number and description of problem.**

## LIMITED TWO-YEAR WARRANTY

B&K Precision Corp. warrants to the original purchaser that its products and the component parts thereof, will be free from defects in workmanship and materials for a period of two years from date of purchase.

B&K Precision Corp. will, without charge, repair or replace, at its option, defective product or component parts. Returned product must be accompanied by proof of the purchase date in the form of a sales receipt.

To obtain warranty coverage in the U.S.A., this product must be registered by completing a warranty registration form on our website [www.bkprecision.com](http://www.bkprecision.com) within fifteen (15) days of purchase.

**Exclusions: This warranty does not apply in the event of misuse or abuse of the product or as a result of unauthorized alterations or repairs. The warranty is void if the serial number is altered, defaced or removed.**

B&K Precision Corp. shall not be liable for any consequential damages, including without limitation damages resulting from loss of use. Some states do not allow limitations of incidental or consequential damages. So the above limitation or exclusion may not apply to you.

This warranty gives you specific rights and you may have other rights, which vary from state-to-state.

B&K Precision Corp.  
22820 Savi Ranch Parkway  
Yorba Linda, CA 92887  
[www.bkprecision.com](http://www.bkprecision.com)  
714-921-9095

# **BK PRECISION®**

22820 Savi Ranch Parkway

Yorba Linda, CA 92887

[www.bkprecision.com](http://www.bkprecision.com)

© 2009 B&K Precision Corp.

Printed in Japan