

Section 1

Introduction

1-1 Introducing the 50,000 Count Dual Display Multimeter

NOTE

1. This operation manual contains information and warning that must be followed to ensure user operation safety and to retain the meter safety condition.



Precaution!

TO ENSURE PERSONAL SAFETY AND TO AVOID DAMAGING THE METER AND THE EQUIPMENT CONNECTED, READ “GETTING STARTED” IN SECTION 2-2 BEFORE USING THE METER.

The meter is 50,000 count Dual Display Multi-meter. The meter is designed for bench-top, field service, and system applications with a high performance/price ratio. Impression

With the RS-232 computer interface (standard), the meter is fully programmable for use on the RS-232 interface.

1-2 Features

The main features provided by the meter are:

- 50,000 Count Dual Display
- Vacuum-fluorescent Display (VFD)
- Low Cost and High Performances
- DCV, ACV, DCA, ACA, Frequency, Diode Continuity
- DCV Measurement to 1000V, ACV to 750V (Up 1200Vdc, 1000Vac are measurable)
- AC/DC Current Measurements to 10A (Up to 20A is measurable in less than 20 seconds).
- True RMS (AC, AC+DC), 30Hz to 100kHz Measurement Bandwidth.
- AC Current Measurement Bandwidth from 30Hz to 20kHz.
- Frequency Measurements Up to 500KHz, 0.01 Hz Resolution.
- Resistance Measurement Up to 50 M Ω , 10m Ω Resolutions.
- dBm measurement with variable reference impedance from 2 Ω to 8000 Ω .
- Auto or Lock Ranging Relative Calculation.
- Auto or Lock Ranging Dynamic Recording (MIN/MAX) with elapsed time.
- Compare (Hi/Lo/Pass) function for quick in-tolerance test.
- Percentage function transfers the measuring value to proportional percentage (%) display.
- Fast Electronic and Closed-case calibration.
- Data Hold to freeze displayed value.
- Refresh Hold for difficult measuring place.
- External trigger a one-time measurement to get the result as your needs.
- RS 232 Interface.

1-3 Accessories

Standard accessories come with the meter are:

- Power cord
- Operation Manual
- Test leads (Tip-type probe)

Available optional accessories are listed as below:

- TL 36 Test leads (Lantern-type probe)
- TL 35 Test leads (Tip-type probe)
- TH 02 Insulation piercing clip
- AK 5491A RS-232 PC Link software and cable
- RK 01 Rack-mount kit (used for single meter)

1-4 How to use this manual

This manual is designed to help the user to get a quick start. Though it is not necessary to read the entire manual to operate the unit effectively, we recommend the manual to be read thoroughly in order to use the meter to its full advantages.

First scan the Tables of contents to be familiar with the outline of the manual. Then read “Getting Started” in Section 2-2. Refer to the appropriate section of the manual as needed. The contents of each section are summarized below.

Section 1. Introduction

Introducing the general information of features, options, accessories, and operation manual for the 50,000 count Dual Display Multi-meter.

Section 2. Getting Started

Introducing how to prepare the meter for operation and to start taking basic front panel operations and measurements quickly.

Section 3. Operating the Meter from the Front Panel

Providing a complete description of each operation, which can be performed by using the pushbuttons on the front panel. All related information for operations and functions are grouped together.

Section 4. Measurement Application Examples

Describing how to use the meter in more advanced and sophisticated operations and applications.

Section 5. Calibrating the Meter

Describing the basic information to calibrate the meter if necessary.

Section 6. RS-232 Remote Operation

Describing how to connect the meter to a terminal or a host computer and operate the meter via RS-232 interface.

Appendices





Appendix A: Specifications

Appendix B: Maintenance

1-5. SAFETY

This meter has been designed and tested according to EN61010-1 (IEC1010-1), Safety Requirements for Electronic Measuring Apparatus. This manual contains information and warns which must be followed to ensure safe operation and retain the meter in safe condition. Use of this instrument in a manner not specified herein may impair the protection provided by the equipment. Some common international electrical symbols used in this manual are shown below Table:

Table 1-1. International Electrical Symbols

	AC - Alternating Current
	DC - Direct Current
	AC and DC - Alternating and Direct Current
	Ground
	See Explanation In The Manual

Before using the meter, read the following safety information carefully. In this manual, "WARNING," is reserved for conditions and actions that pose hazard(s) to the user; "CAUTION," is reserved for conditions and actions that may damage your meter.

WARNING

TO AVOID ELECTRICAL SHOCK OR OTHER INJURY:

- Be sure the meter is in good operating condition and avoid working alone.
- Follow all safety procedures for equipment being tested.
- Inspect the test leads for damaged insulation or exposed metal. Check test lead continuity. Damaged leads should be replaced.
- This equipment operates from a power source that does not apply more than 250V rms between the supply conductors or each supply conductor and ground. A protective ground connection by way of the grounding conductor in the power cord is essential for safe operation.
- This equipment is grounded through the grounding conductor of the power cord. To avoid electrical shock, plug the power cord into a properly wired receptacle before connecting to the equipment input or output terminals.

- To avoid explosion, do not operate this product in an explosive atmosphere.
- To avoid personal injury, do not remove the cover or panel. Refer servicing to qualified personnel.
- Select the proper function for your measurement.
- To avoid electrical shock, use caution when working above 60V dc or 30V ac RMS.
- Disconnect the live test lead before disconnecting the common test lead.
- Disconnect the power and discharge high-voltage capacitors before testing in Ω and diode.
- When making a current measurement, turn the circuit power off before connecting the meter in the circuit.
- To avoid fire hazard, always use a specified fuse.
- Use clamp-on probes when measuring circuits exceeding 10 amps.
- When servicing the meter, use only the replacement parts specified.
- Do not allow meter to be used if it is damaged or if its safety is impaired.
- The meter is safety-certified in compliance with EN61010-1 and EN61010-2-31 (IEC1010-1 & IEC1010-2-31) Installation Category II 600V and CAT I 1000V Pollution Degree 2. In order to maintain its insulation properties, please be sure to use with the standard or compatible test probes.
- CE requirement: Under the influence of R.F field according to standard, the supplied test leads will pick up induced noise. To have better shielding effect, a short-twisted lead should be used.

Getting Started

2-1 Introduction

Section 2 describes the front panel operational keys, displays, input terminals and rear panel of the meter, adjusting handle, explains general operating features.

2-2 Getting Started

- **Unpacking and Inspecting the Meter**

Carefully remove the meter from its shipping container and inspect it for possible damage or missing items. If the meter is damaged or something is missing, contact the place of purchase immediately. Save the container and packing material in case user has to return the meter.

- **Front Panel**

The front panel (shown in Figure 2-1) has three main elements: the input terminals on the left, the primary/secondary displays, and the pushbuttons. The pushbuttons are used to select major functions, ranging operations, and function modifiers. These elements are described in detail in Section 3.

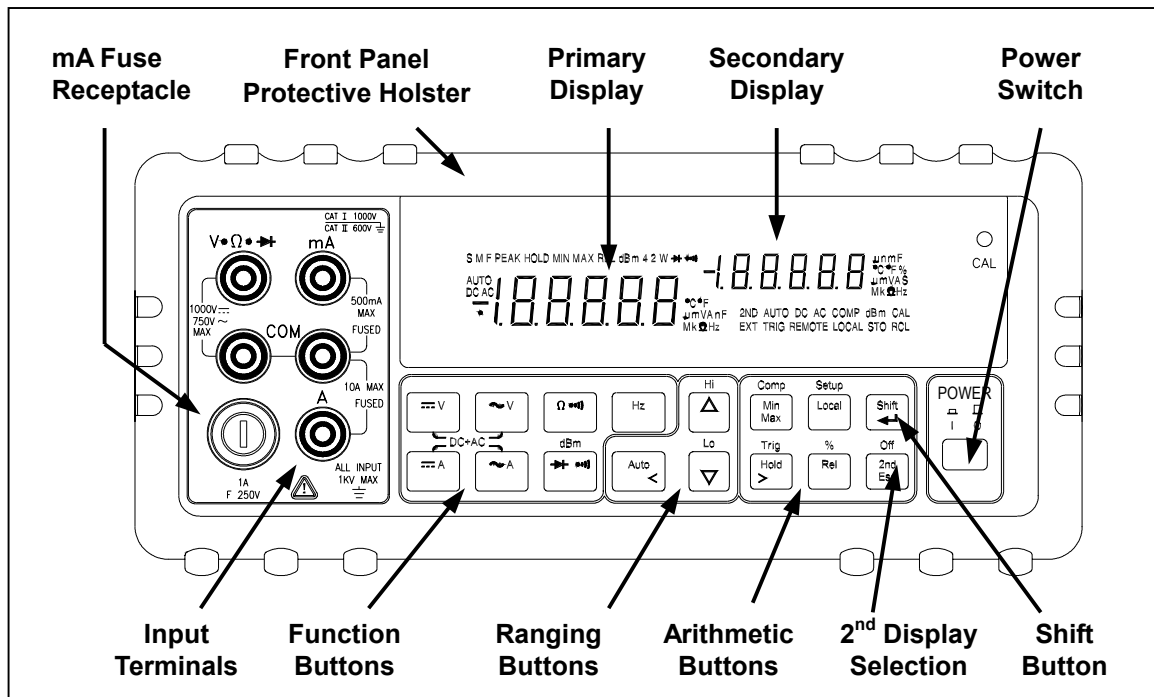

Figure 2-1. Front Panel

- **Rear Panel**

The rear panel (shown in Figure 2-2) contains a line fuse, the power-line cord connector, an RS-232 interface connector.

- **Line Power**

- Figure 2-2 illustrates the location of the Line Voltage Selector with Fuse Holder housing. If user has already done so, plug the line cord into the connector on the rear of the meter. The meter will operate at any line voltage between 90Vac and 264Vac when “line voltage selector” is set properly, and its frequency range is at 50/60Hz. For operation safety, DO NOT APPLIES a line voltage that exceeds the range specified to line cord connector on the rear panel of the meter.

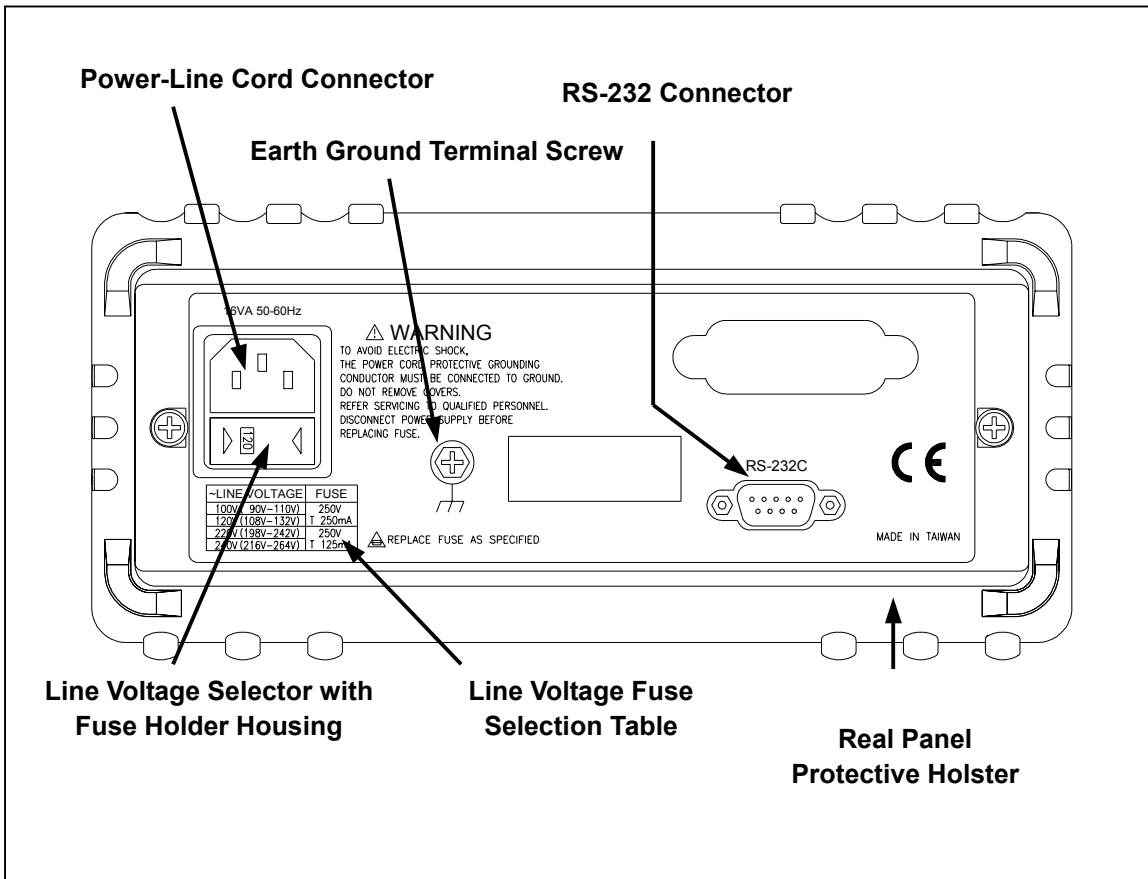

Figure 2-2. Rear Panel

⚠ CAUTION!

BEFORE TURNING THE METER ON, MAKE SURE THE LINE VOLTAGE SELECTOR IS SET TO THE CORRECT POSITION FOR APPLIED LINE VOLTAGE TO THE POWER-LINE CORD CONNECTOR.

- The “line voltage selector” is settable for 100Vac, 120Vac, 220Vac, and 240Vac line voltages.
- The correct fuse ratings: 250mA fuse for 100Vac or 120Vac is selected, and 125mA fuse for 220Vac or 240Vac is selected.

- **Case, Panels and Holsters**

To avoid electric shock or injury, do not operate the meter without panels or case in place.

The meter is provided with special designed anti-slippery protective holsters on the front and rear panel sides (shown in Figure 2-1 and 2-2).

The holsters provide a protection to both front and rear panels of the meter as well as its corners. User may stack up one meter on the top of the other without concerning the slide off of the units (shown in Picture 2-1).

The holsters can be easily removed when install the rack-mounted ears to the meter in order to mount the meter into a 19-inch standard rack. Refer to Section 2-7 for Rack Mounting procedures.

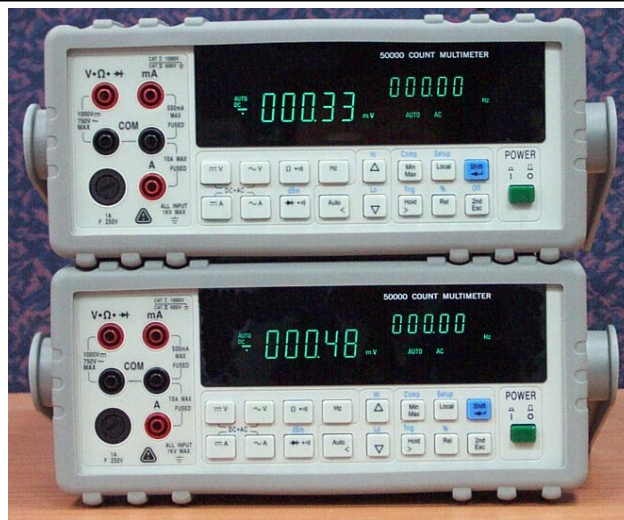

Picture 2-1. Stack up the Meters with Holsters

- **Grounding the Meter**

The meter is grounded through power cord. To avoid electric shock or injury, grounding wire in the power line cord must be connected.

- **Operating in Explosive Atmospheres**

The meter does not provide explosion protection for explosive gasses or arcing components. Do not operate the meter in such circumstances.

- **Adjusting Handle**

For bench-top use, the handle can be adjusted to provide three viewing angles. For viewing positions, pull the ends out to a hard stop (about 1/4 inch on each side) and rotate it to one of four stop positions (shown in Figure 2-3).

⚠ WARNING

Be sure to put the meter on a table before removing the handle.

To remove the handle, adjust it to the vertical stop position and pull the ends all the way out.

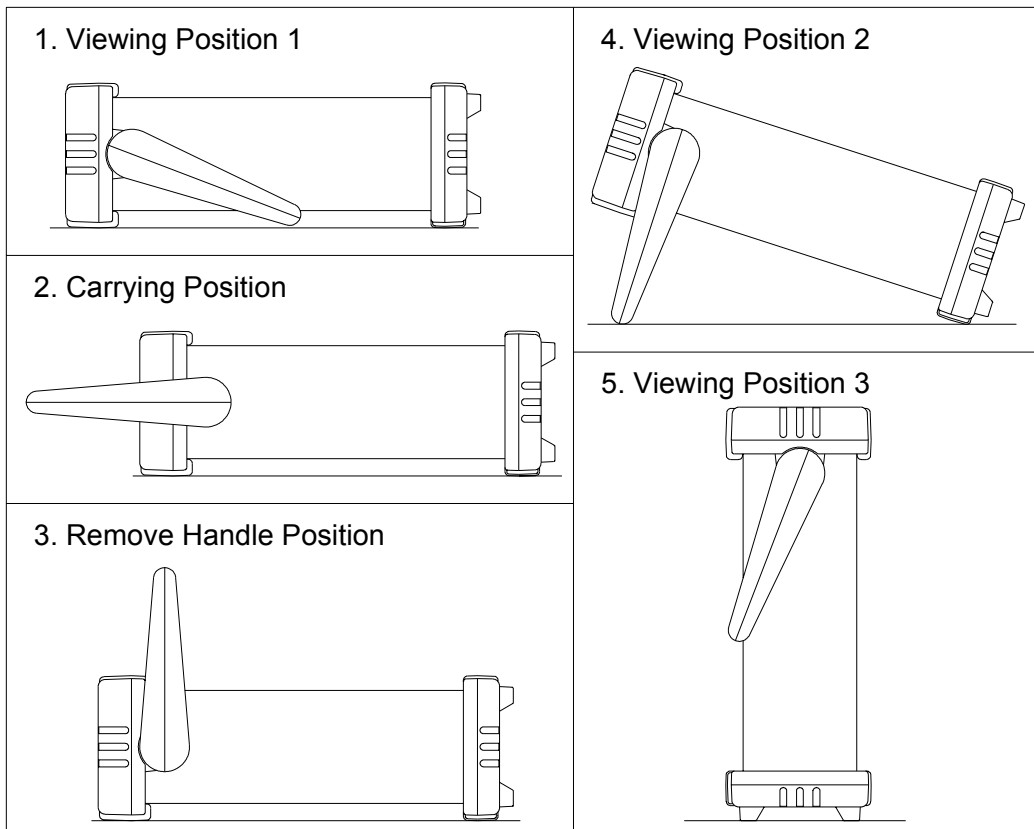

Figure 2-3. Adjusting Handle

2-3 Turning the Meter ON

To turn the meter on, press the **Power** button to “IN” position located on the lower right of the front panel. When the meter is turned on, the primary and secondary displays light for about 2 seconds while an internal self-test running by its digital circuitry. If the **Hold** button is pressed while the power-up sequence is in progress, all segments and annunciators of the entire display remain on until another button is pressed. Then the power-up sequence continues.

After the meter completing its power-up sequence, it resumes the power-up measurement configuration stored in non-volatile memory. The power-up default configuration status set at factory is shown in Table 3-2.

2-4 Selecting Current Input Terminals and Measurement Range

If current (dc or ac) is being measured in the Auto-ranging mode, with a signal input on the 500mA terminal, the meter will select the range 500 μ A~500mA automatically.

If a signal input is applied to the 10A input terminal, the meter will select the 5A or 10A range automatically.

2-5 Using the Pushbuttons



The meter functions and operations can be selected by pressing the pushbuttons on the front panel select.

A summary of pushbuttons is shown in Figure 2-4.

Pushbuttons can be used in three ways. User can:



- Press a single button to select a function or operation.

EXAMPLE:

 (Press)  to select AC voltage measurement for the primary display.

- Press a combination of buttons, one after the other.

EXAMPLE:

  then followed by  to select dBm calculation.

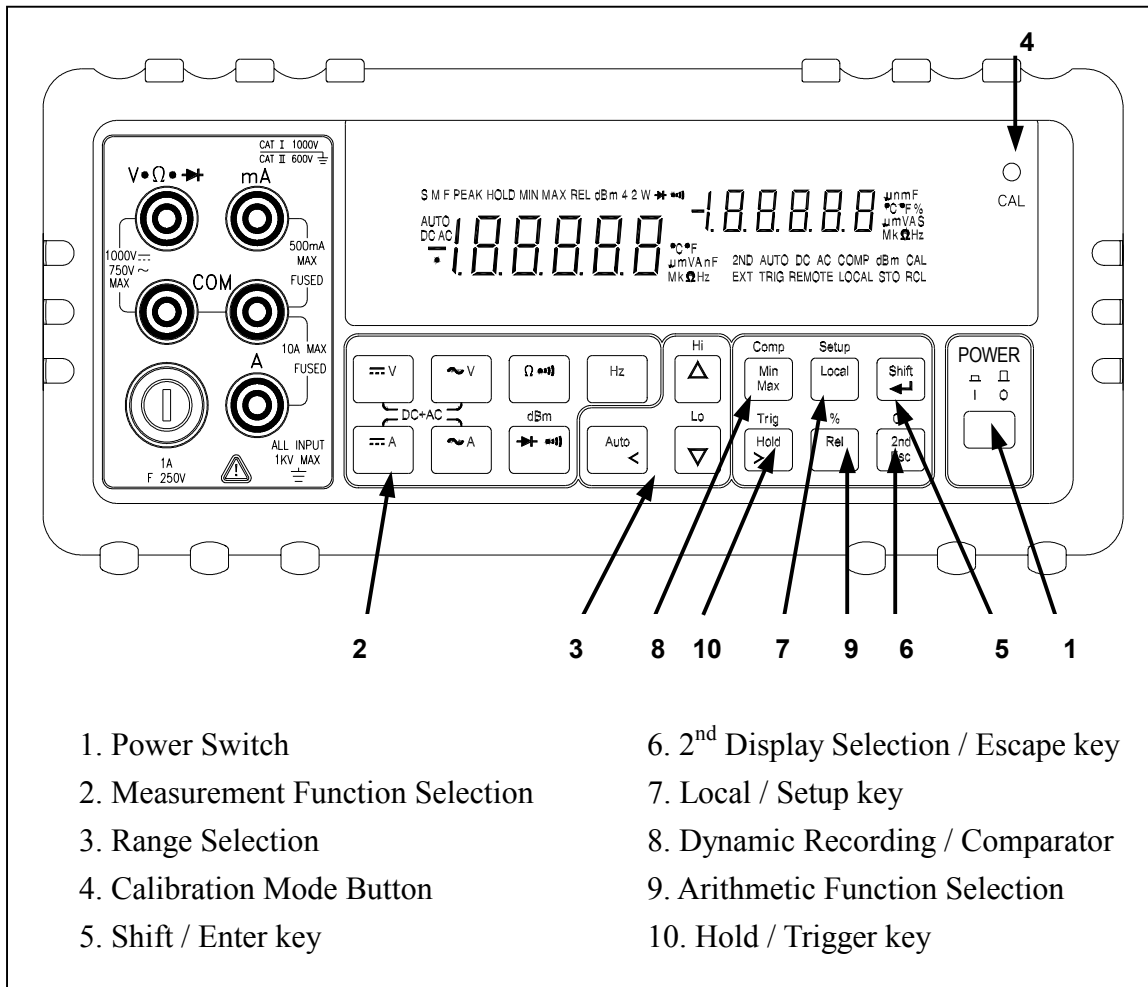





Figure 2-4. Front Panel Pushbuttons

- Press multiple buttons simultaneously.

EXAMPLE:

  and  simultaneously to select True RMS AC volts and DC volts (calculated) on the primary display.

More detail operations are described in Section 3.

2-6 Basic Measurement Examples

This section describes the basic measurement procedures via operations in front panel. These procedures as follows provide the user who wants to get a quick start, but does not want to read the entire manual thoroughly. But it is still recommended to read this manual thoroughly in order to fully utilize all advantages in the meter.

- **Voltage, Resistance or Frequency Measurements**

Press the desired function button and connect the test leads as shown in Figure 2-5 to measure voltage, resistance, or frequency. The meter will select the appropriate range in the auto-range mode, and an annunciator on the display will indicate measurement units.

NOTE

Excessive error may occur when making measurements with 10 to 100 μV resolutions after measuring high voltage up to 1000 volts dc. It requires two minutes before making low-level measurements.

- **Current Measurements**

To measure current, connect the test leads to mA input terminal or 10A input terminal for measured current above 500mA as shown in Figure 2-6.

Be sure to turn off the power in the circuit to be measured before taking connection.

Break the circuit on the groundside to minimize the common mode voltage) to be measured, and place the meter in series at that point.

Turn on power to the circuit, and then read the display. The meter will select the appropriate range automatically, and an annunciator on the display will indicate the units of the measurement value shown.

Turn off power to the circuit and disconnect the meter from the tested circuit.

NOTE

After making a high current measurement using the 10A input, thermal voltages are generated that may create errors when making high-resolution low-level dc measurements of volts, amps, or ohms. It requires ten minutes to allow the thermals to settle out before making low-level measurements in order to obtain the best accuracy.

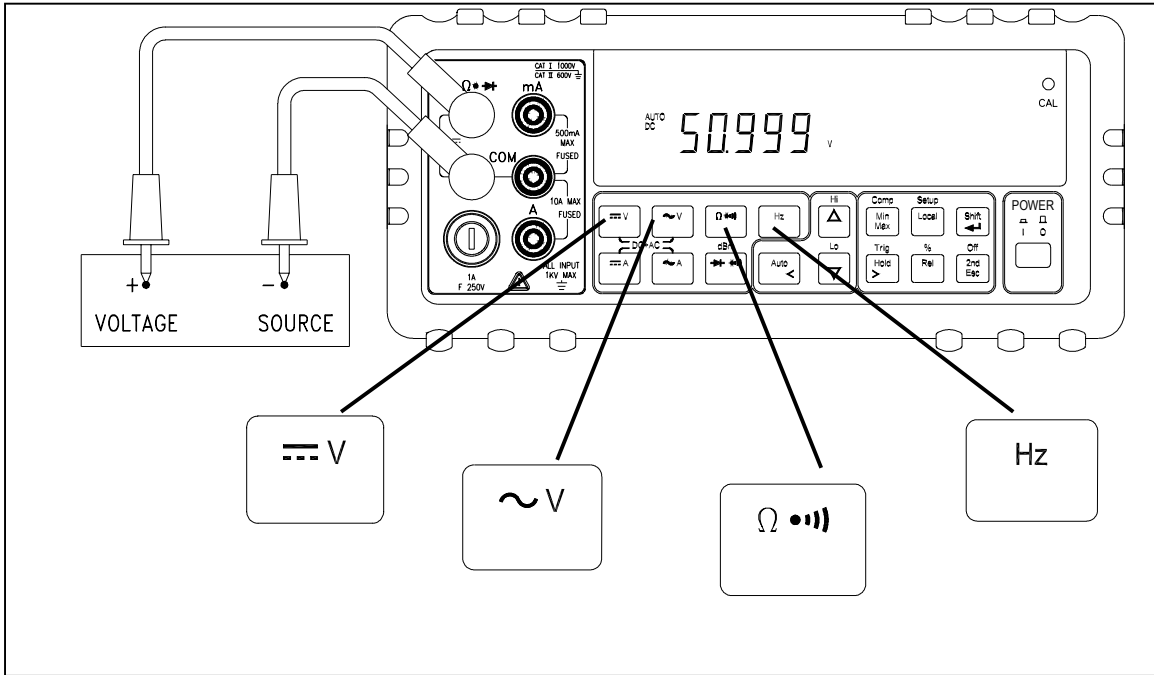

Figure 2-5. Voltage, Resistance or Frequency Measurements

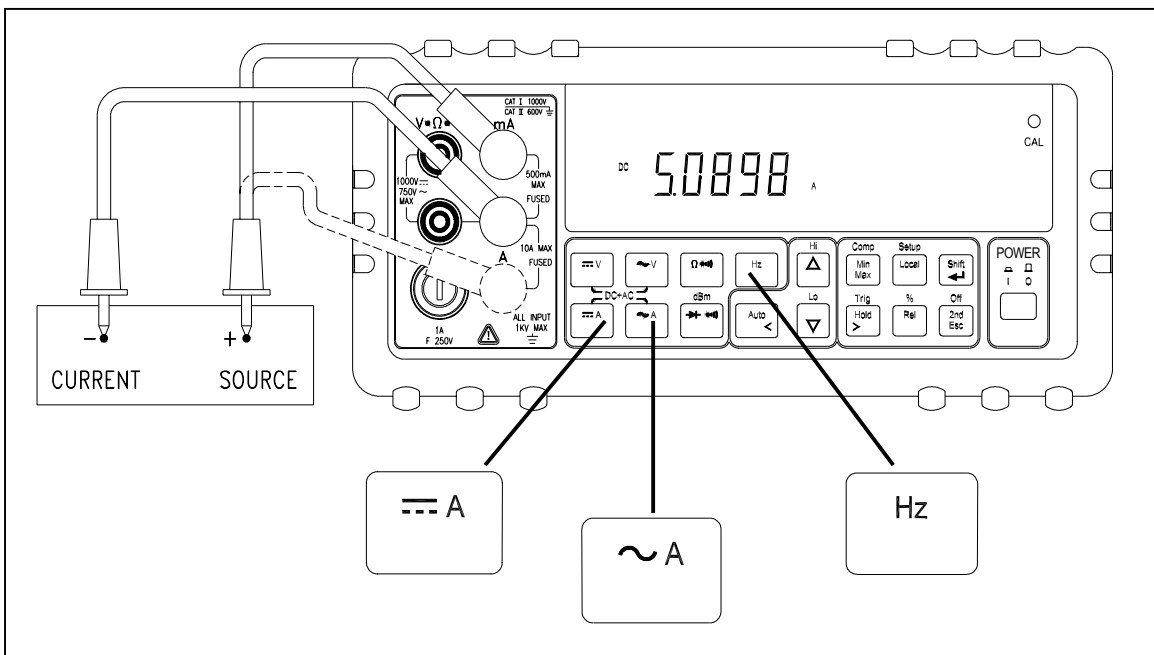





Figure 2-6. Current or Frequency Measurements

- **VFD Brightness Control**

Press  and hold, then press  or  step by step to select the VFD brightness to darker level (4 steps in this function and factory setting is set at highest light level),

- **Overload Alert**

The meter has provided an overload alert for voltage and current measurements. The beeper sounds tones periodically once the measuring value is exceeded the value shown as below Table 2-1:

Table 2-1. Beeper Responses for overload Alert Points

Measuring Function	Start Alerting Value
DC V	>1000V
AC V	>750V
DC + AC V	>750V
DC A	>10A
AC A	>10A
DC + AC A	>10A

If the input values over above points, the beeper still sounds tones whatever the beeper has been set to OFF state, or not.

- **Diode Continuity Tests**

Press  to select diode continuity function, then connect the test leads across the diode under test as shown in Figure 2-7 (Reversing the polarity will reverse-bias the diode).

The diode test measures the forward voltage of a semiconductor junction at approximately 0.5mA. The beeper generates a single beep tone when the input voltage drops below +0.7V (approximately 1.4kΩ) and generates a continuous beep tone when the input voltage drops below +50mV (approximately 100Ω).

Readings are displayed in the 2.3V range. “OL” is displayed for voltage above 2.3V. If the diode continuity test is performed, readings are displayed in 0.1mV resolution on the 2.3000V range.

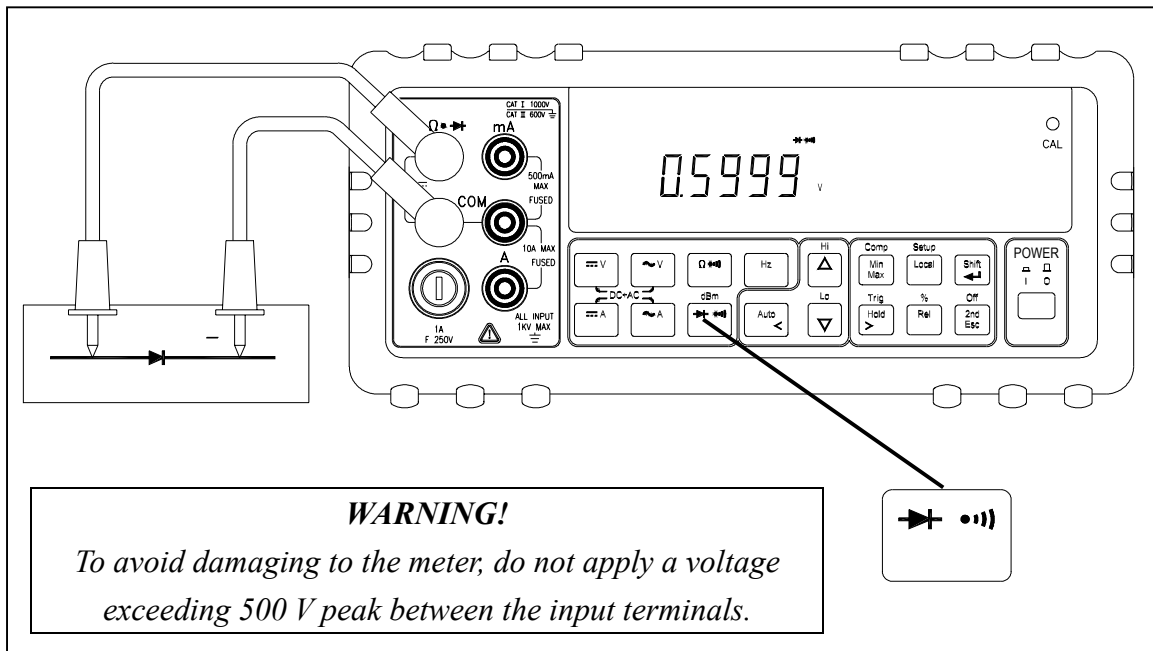

Figure 2-7. Diode Continuity Test

- **Resistance/Continuity Tests**



In Ohm test, press  button momentarily to set continuity function ON. The  sign will be lit and lock the range to 500 Ω. Then connect the test leads and across the tested circuit as shown in Figure 2-8. While testing continuity, the beeper will sound if the resistance is less than 10Ω. For other ranges, the beeper will sound if the resistance falls below the typical values indicated in Table 2-2.

Table 2-2. Beeper Responses in Continuity Test

Measuring range	Beeper On
500.00 Ω	<10 Ω
5.0000 kΩ	<100 Ω
50.000 kΩ	<1 kΩ
500.00 kΩ	<10 kΩ
5.0000 MΩ	<100 kΩ
50.000 MΩ	<1 MΩ

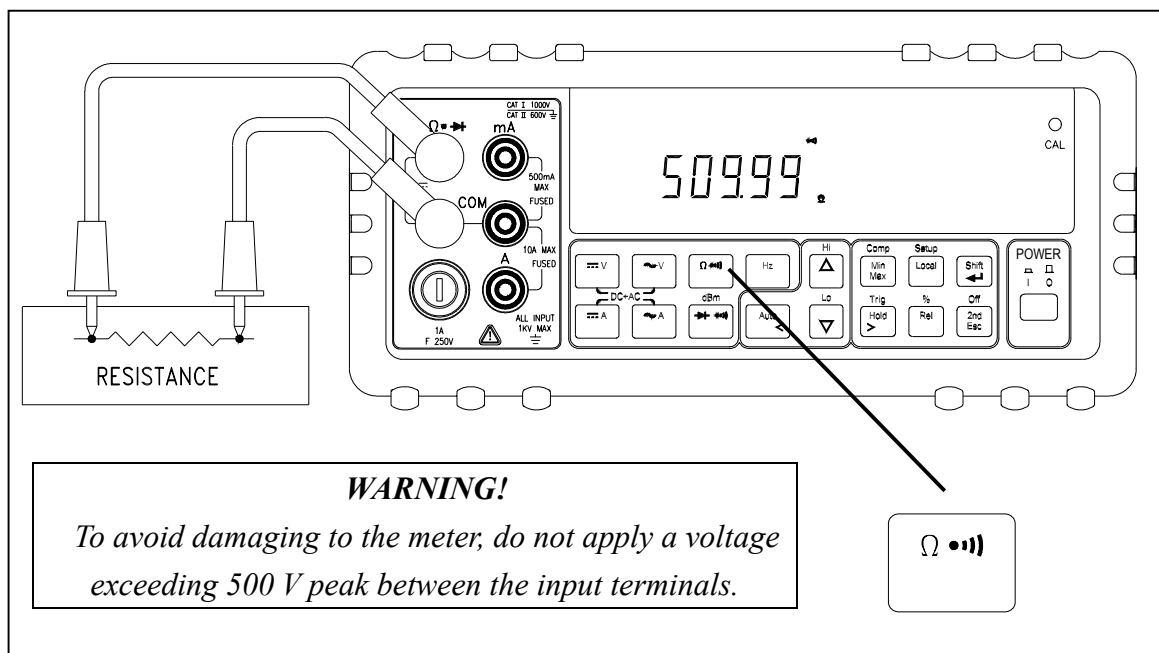

Figure 2-8. Ω/Continuity Test

2-7 Rack Mounting

User can mount the meter into a standard 19-inch rack using RK-01 (for single meter) Rack Mount Kit. The front and rear protective holsters can be removed when mount the meter into a rack.

To install RK-01 rack mount kit, refer to following procedures and Figure 2-9 or the instructions provided with it:

1. Adjusting the handle of the meter to its upward vertical stop position (refer to Figure 2-3) and pull the ends all the way out.
2. Removing two protective holsters out of the front panel and rear panel of the meter.
3. Installing the rack mount ears onto the left and right hand side of the meter frame by using four screws provided with RK-01.
4. Paste two blind plates on the handle hole.
5. Mount the meter with RK-01 into the standard 19" rack.

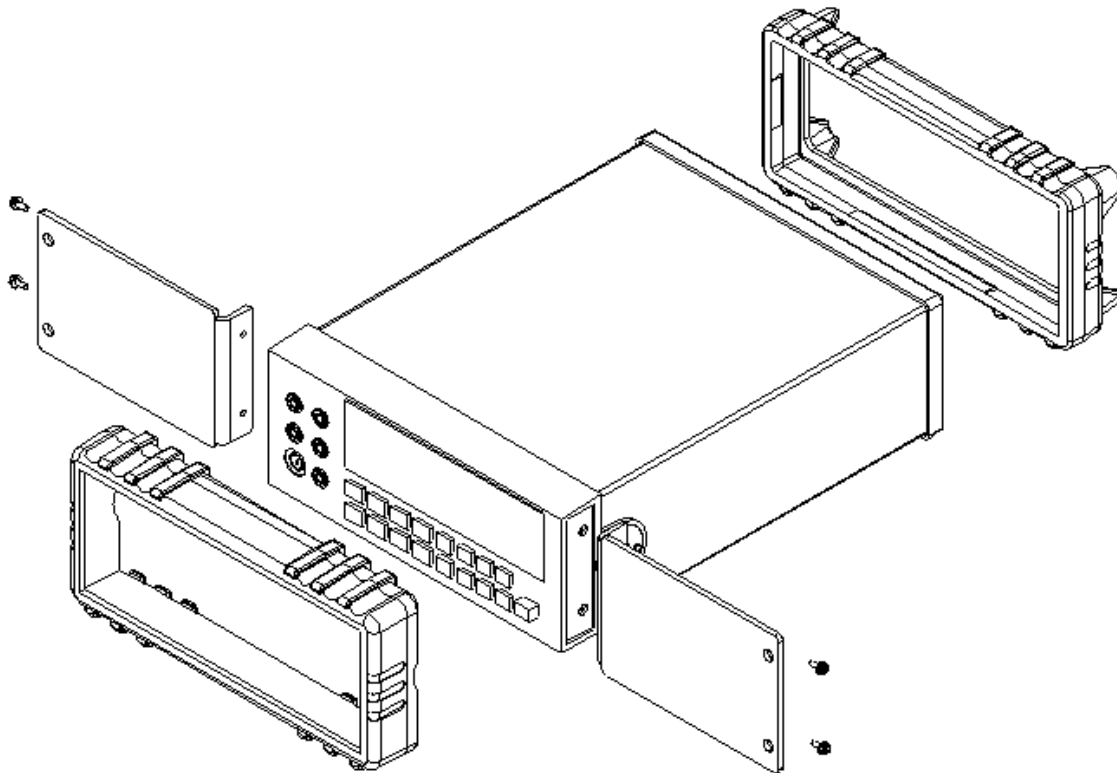

Figure 2-9. Installing the Rack Mount Kit

Front Panel Operation

3-1 Introduction

This section provides a complete description of each operation that can be performed by using the pushbuttons on the front panel.

All related information for operations and functions are grouped together.

3-2 Front Panel Operations

The following operations can be performed from the front panel:

- Select a measuring function (Vdc, Vac, Adc, Aac, resistance/continuity, frequency, and diode continuity test) for the primary display.
- Base on primary display press  to select the related function for secondary display.
- Take a measurement and display a reading.
- Select the manual or auto-range mode (AUTO)
- Manually select a measuring range for the primary display.
- Select function modifier that cause the meter to display relative readings (REL), minimum or maximum values (MIN MAX) or decibels (dBm and dB), or to enter the Data Hold mode or Refresh Hold (HOLD) to hold a reading on the primary display.
- Set the dB reference impedance (REF Ω).
- Take a measurement and compare (COMP) it against a tolerance range (Hi, Lo, or Pass).
- Take a measurement and percentage (%) display.
- Select the brightness for VFD display.
- Use the "editor" to select from option list, to enter a HI-LO range for the compare mode and percentage mode.
- Configure the computer interface (RS-232).
- Send measurement directly to a printer or terminal through the RS-232 interface (RS-232 print only mode)





These and other front panel operations are described in the remainder of Section 3.

3-3 Primary and Secondary Displays

The meter is 50,000 count, Vacuum-Fluorescent dual display (VFD). This display shows measuring readings, annunciator, and messages. The annunciator indicates measuring units and the meter's operating configuration.

The dual display allows you to see two properties (e.g. Vac and frequency) of the input signal you are measuring. The display contains two major parts, primary display and secondary display (See figure 3-1).

The primary display contains of larger digits and annunciators and is located on the left side of the dual display. Readings using the relative (REL), minimum maximum (MIN MAX), data/refresh hold (HOLD), or decibels (dBm) modifier can be shown on the primary display.

The secondary display contains of a set of smaller digits on the right side of the dual display. To press  to turn the secondary display on and select the related function with the primary display. Press  cycling to turn the secondary display off or Press  then followed by  to turn off the secondary display directly and all arithmetic functions will be disabled.

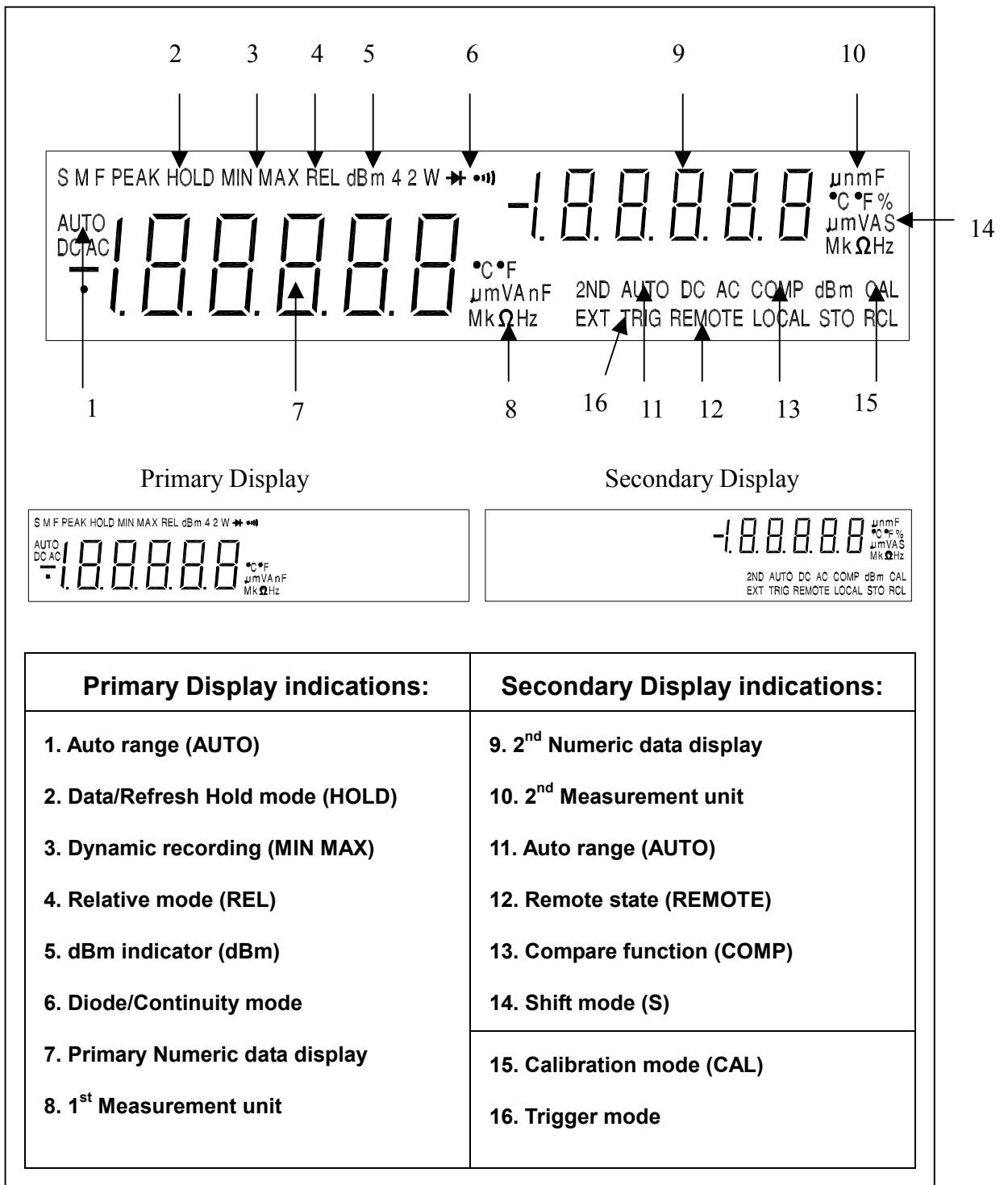

Figure 3-1 Dual Display Illustrations

3-4 Input Terminals

The input terminals, shown in Figure 3-2 are located on the left side of the front panel. The meter is protected against overloads up to the limits shown in Table 3-1. Exceeding these limits poses a hazard to both the meter and operator.

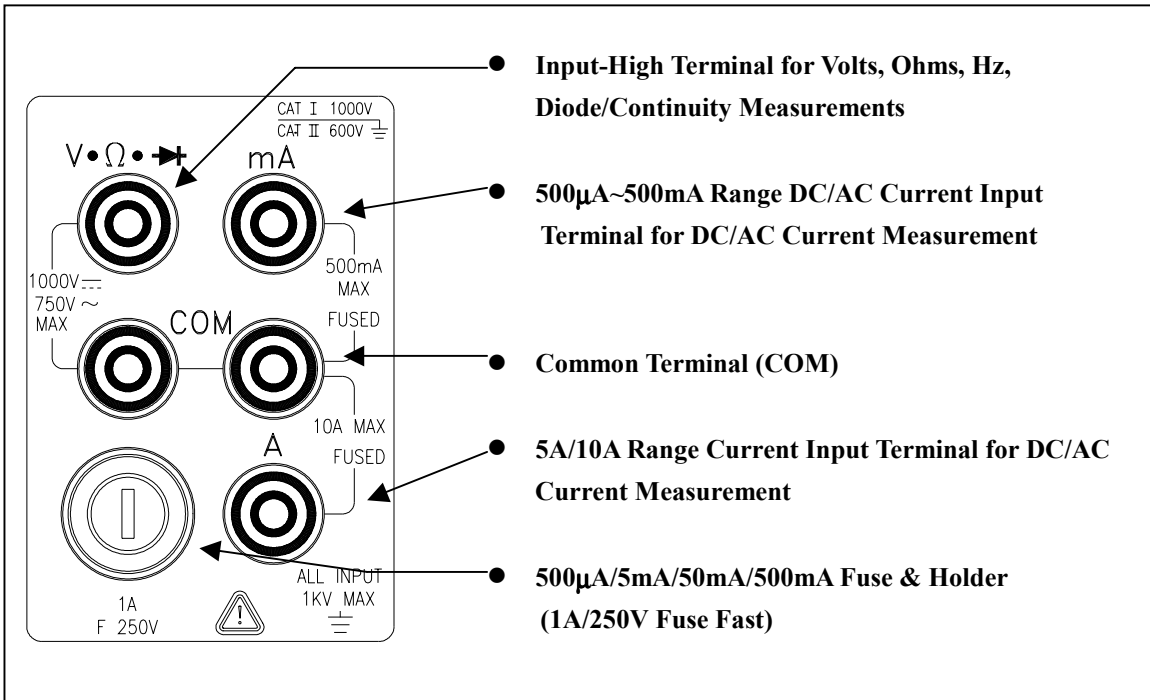

Figure 3-2 Input Terminals

Table 3-1 Input Protection Limits

Function	Input Terminal	Maximum Allowable Input
Vdc	V • Ω • ▶ to COM	1200V ⁽¹⁾ dc
Vac, Hz	V • Ω • ▶ to COM	750V ⁽²⁾ ac rms, 1100V peak, 2x10 ⁷ V-Hz normal mode, or 1x10 ⁶ V-Hz common mode
mA, Hz	mA to COM	500mA dc or ac rms
10A, Hz	10A to COM	10A ⁽³⁾ dc or ac rms
Ω	V • Ω • ▶ to COM	500V dc or ac rms
▶ • •)	V • Ω • ▶ to COM	500V dc or ac rms
All functions	Any terminal to earth	1000V dc or peak ac
<p>(1) In Vdc 1000V range, 1200Vdc is readable with audio warning</p> <p>(2) In Vac 750V range, 1000Vdc is readable with audio warning</p> <p>(3) 10A dc or ac rms continuous, and >10A dc or ac rms for 20 seconds maximum</p>		

3.5 Initialization of Measurement Conditions

- **Power up default configuration Status:**

When turning the meter on, it assumes its power-up configuration. The power-up configuration set at the factory is shown in Table 3-2.





As configuration data for RS-232 baud rate, data bit, stop bit, parity, echo and so on are stored in the non-volatile memory, they are not changed when power is cycled off and on until the configurations are changed by the user.

Table 3-2 Default configuration Status

Parameters	Default Settings	
Function	DCV	
Range	Auto Range	
Remote/Local	Local	
Data / Refresh Hold	OFF	
Trigger Type	Internal	
Compare mode	OFF	HI: 10000(10000E+0)
Percentage (%)		LO: 00000(00000E+0)
Relative mode	OFF	
Dynamic Recording	OFF	
Secondary Display mode	OFF	
CAL mode	OFF	

3-6 Selecting A Measurement Function

Press a function button shown in Figure 3-3, to select a measuring function.

To select ac + dc total true RMS readings, press  and  or  and , simultaneously.

Press  toggling to turn the secondary display on and select the related function.

The summary of ranges and scale values are shown in Table 3-3

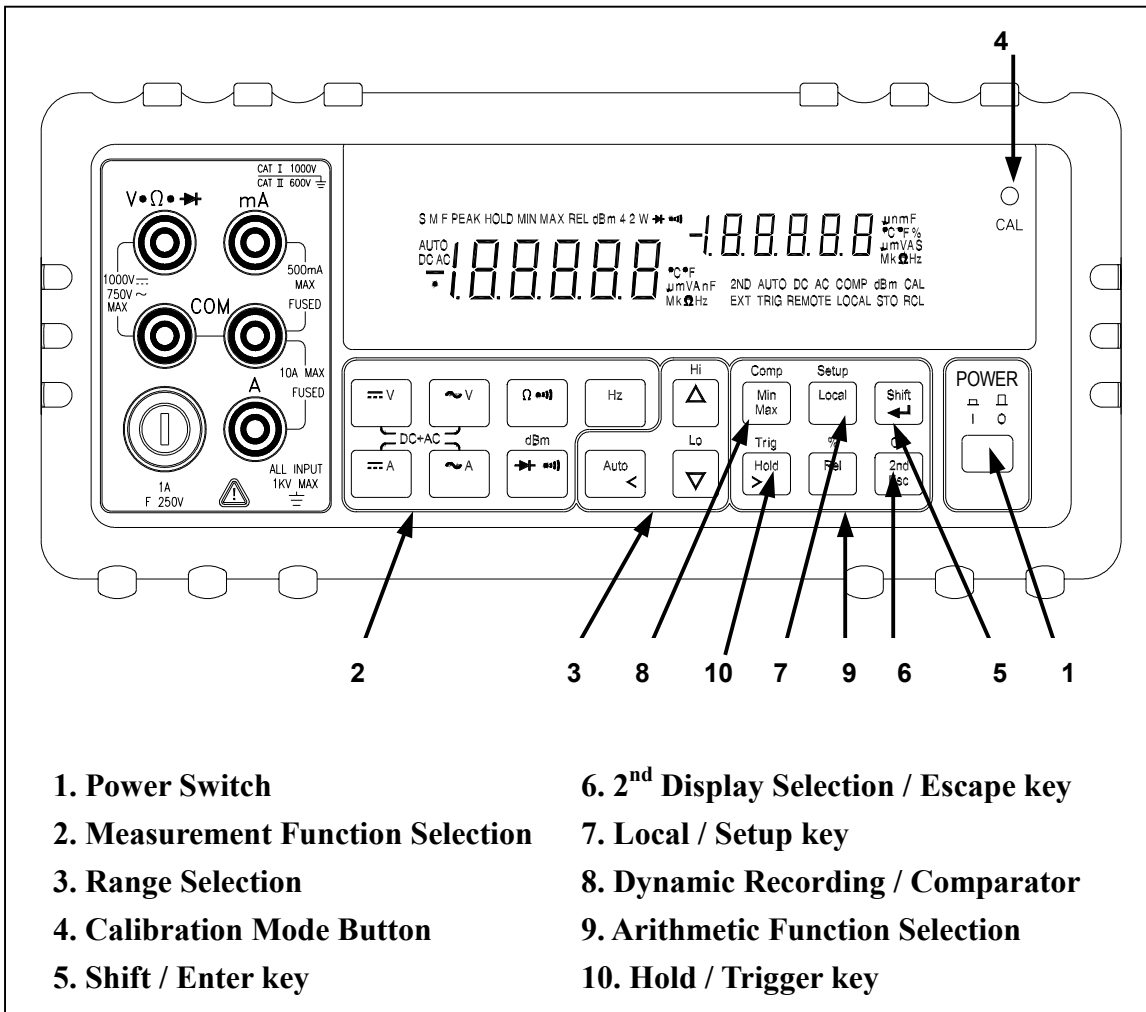

- | | |
|--|---|
| 1. Power Switch | 6. 2nd Display Selection / Escape key |
| 2. Measurement Function Selection | 7. Local / Setup key |
| 3. Range Selection | 8. Dynamic Recording / Comparator |
| 4. Calibration Mode Button | 9. Arithmetic Function Selection |
| 5. Shift / Enter key | 10. Hold / Trigger key |

Figure 3-3 Front Panel Pushbuttons



Table 3-3 Range Scale Value

Function	Range Scale	Auto Ranging
	500mV, 5V, 50V, 500V, 1000V ⁽¹⁾	•
$\sim V$, $V+$ $\sim V$	500mV, 5V, 50V, 500V, 750V ⁽²⁾	•
A , $\sim A$, A + $\sim A$	500 μ A, 5mA, 50mA, 500mA	•
A , $\sim A$, A + $\sim A$	5A, 10A ⁽³⁾	•
Hz	500Hz, 5kHz, 50kHz, 500kHz	•
Ω ⁽⁴⁾	500, 5k, 50k, 500k, 5M, 50M Ω	•
	2.3V	Fixed range
	500, 5k, 50k, 500k, 5M, 50M Ω (Continuity Mode)	•
<p>(1) In Vdc 1000V range, 1200Vdc is readable with audio warning (2) In Vac 750V range, 1000Vdc is readable with audio warning (3) 10A dc or ac rms continuous, and 20A dc or ac rms for 20 seconds maximum (with audio warning) (4) In order to eliminate the noise interference, which might be induced to the test leads, it is recommended to use a shielded test cable for measuring resistance above 500KΩ.</p>		

More operations of selecting a measurement function are described below:

- to select DC voltage measurement
- to select AC voltage measurement
- to select DC current measurement
- to select AC current measurement
- to select frequency measurement
- to select Diode Continuity measurements
- to select resistance or resistance Continuity measurements mode by toggling
- then to select dBm calculation
- (and) simultaneously to select DC+AC RMS volts calculation
- (and) simultaneously to select DC+AC RMS amps calculation

3-7 Selecting Measurement Range (, and)

Ranging operations are performed by using the ,  and  buttons (see Figure 3-3).

Measuring ranges can be selected automatically by the meter in “Auto-ranging” or manually operated by the user.



The range setting is synchronous for dual display for current or voltage measurement. In auto ranging mode, the range setting for both the primary and secondary display are corresponding to the higher range of two displays. In manual ranging mode, the range setting for secondary display is following to the range setting of primary display.

- **Auto-Ranging**

Press  to toggle in and out of manual ranging. When meter is in auto-range mode, the AUTO annunciator is lit.

In auto-range, the meter selects the next higher range automatically when a reading is greater than full scale. If no higher range is available, ‘OL’ (overload) will be displayed on primary or secondary display. Likewise, the meter will automatically selects a lower range when a reading is less than approximately 9.5% of the full scale.

That will be another way to set Auto-ranging for Current measurement.

You can press  then  to toggle auto-ranging path for mA and A terminals.



- **Manual Range**



Press  to toggle in and out of manual ranging. The range user is in when user enters the manual range mode will become the selected range. In manual range, the meter remains in the selected range regardless of input.

Press  to back auto-ranging. The range setting is performed both on readings shown in the primary display and secondary display.



- **Selecting A Measuring Range**

To manually select a range,

  to toggle in (and out) of the manual ranging mode, or



  or  to select higher range or lower range directly.

In manual range mode,



-   or  to select higher range or lower range to the desired one.

3-8 Selecting Secondary Display



- **To Enable the Secondary Display Mode**

  to turn the secondary display on and select the related function with the primary display.

- **To Disable the Secondary Display Mode**

  cycling to turn off the secondary display (see Table 3-6.

Descriptions for Combination of Dual Display) or

  then followed by  to disable the secondary display mode.

The display remains in Primary display mode.

- **Combination of Dual Display Settings**

Table 3-4 provides the available combination of inputs for the primary display and secondary display in the dual display mode.



Table 3-4 Descriptions for Combination of Dual Display



Primary Display	Secondary Display				
	Step1	Step 2	Step 3	Step 4	Step5
Vdc	Hz	Vac	dBm	X ⁽²⁾	
Vac	Hz	Vdc	dBm	X ⁽²⁾	
Vac + Vdc	Hz	Vac	Vdc	dBm	X ⁽²⁾
DBm	Vac	Vdc	Vac + Vdc		
Adc	Hz	Aac	X ⁽²⁾		
Aac	Hz	Adc	X ⁽²⁾		
Aac + Adc	Hz	Aac	Adc	X ⁽²⁾	
Hz ⁽¹⁾	Vac/Aac	Aac/Vac			
COMP (Measuring Value)	HI, LO, PASS				
Percentage (%) (Measuring Value)	%				
<p>(1) a. The Frequency reading is corresponding to the current or voltage input signal, respectively.</p> <p>b. The frequency measurement is always working on auto-ranging mode. The Buttons of AUTO, UP and DOWN are used to select the range of measuring signal.</p> <p>c. If the current measurement is set before selecting Hz function, the step1 will show Aac first, else show Vac.</p> <p>(2) The secondary display is blanking and the next step is step1.</p>					



Note: In DCV/A dual ACV/A, ACV/A dual DCV/A, (AC+DC) V/A dual DCV/A, (AC+DC) V/A dual ACV/A mode, the ranges setting of both the primary and secondary display are corresponding to the higher range of two displays (auto range mode), the ranges of secondary display are same as the primary display (manual range mode).



3-9 Entering Setup Mode



User may select computer interface, set RS-232 interface (standard) and beeper mode on Setup Mode. To ensure the remote interface will operate appropriately, user may need to configure the remote interface parameters by following the procedures as shown below: (refer Table 3-5)



  then followed by  to enter the **setup mode** to configure the remote interface parameters.

  or  to select RS232 in first tier menu if necessary.

  to enter second tier menu. The original parameter is indicated in primary display.

  or  to select the parameters of the menu item. The selecting parameter will be flashing once it is different to original parameter.

  to confirm your changes. The selected parameter is indicated in primary display without flash.

  to quit the second tier menu to first tier menu.



  again to quit setup mode and save *all parameters into non-volatile memory then.*

Table 3-5 describes the outline of the setup menu item and indicates the factory settings and user selectable communication parameters for using RS-232 interface (standard). [Some menu items would not appear once GPIB interface didn't install.](#)

Table 3-5. Descriptions for Outline of Setup Menu Item

First Tier Menu	Second Tier Menu	Factory Setting	Selectable Parameters
Remote ⁽¹⁾		RS-232	RS-232 or GPIB
RS-232	Baud Rate	9600	9600, 4800, 2400, 1200,600, and 300
	Parity	None	None, Odd or Even
	Data Bit	8	7 or 8
	Stop Bit	1	1 or 2
	ECHO	OFF	ON or OFF
	Printer-Only	OFF	ON or OFF

Ref Ω		600Ω	8000, 1200, 1000, 900, 800, 600, 500, 300, 250, 150, 135, 125, 124, 110, 93, 75, 50, 16, 8, 4, 2 Ω
Beeper	Beep	ON	ON or OFF
	Frequency	4096Hz	4096, 2048, 1024, 8192Hz
Refresh	State	OFF	ON or OFF
Hold	Variation Count ⁽²⁾	300	100, 200,, 1000

⁽¹⁾ These items will be appeared once GPIB interface is installed.

⁽²⁾ Variation count is used to recognize new value will be updated once the variation of measuring value is exceeded the settling value.

3-10 Selecting Local Operation Mode

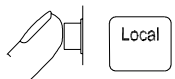

 to return the operation control priority from remote mode (computer controlled) to local mode (user controlled).

3-11 Operating Arithmetic Functions

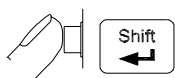

- **Using dBm Modifier**

The dBm measurement is used for decibel conversion of power per 1mW consumption into a 600Ω load and can be applied to Vdc, Vac and Vdc+Vac measurements only. Voltage measurement is converted to dBm by using the following formula:

$$\text{dBm} = 10 \times \log_{10} [1000 \times (\text{measuring value})^2 / \text{reference}]$$



 then followed by  to toggle in (and out) dBm modifier mode



The meter will display the dBm modifier on the primary display and the reference impedance will be indicated and flashed on the secondary display within 3 seconds. The default value by factory is 600Ω.

In dBm modifier mode, press  and  to select the different impedance desired, the reference impedance will be indicated and flashed on the secondary display within 3 seconds. The new setting value will be kept until power off.

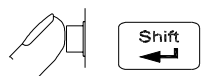
Any of the following 21 types of reference impedance may be selected:
8000Ω, 1200Ω, 1000Ω, 900Ω, 800Ω, 600Ω, 500Ω, 300Ω, 250Ω,
150Ω, 135Ω, 125Ω, 124Ω, 110Ω, 93Ω, 75Ω, 50Ω, 16Ω, 8Ω, 4Ω, 2Ω

- **Operation procedures:**

 then followed by  to enter dBm calculation mode.

 or  to scroll to the desired impedance value shown as the following

operation example. The secondary display will indicate the measuring value of voltage after finished impedance selection.

• **Operation Example:**

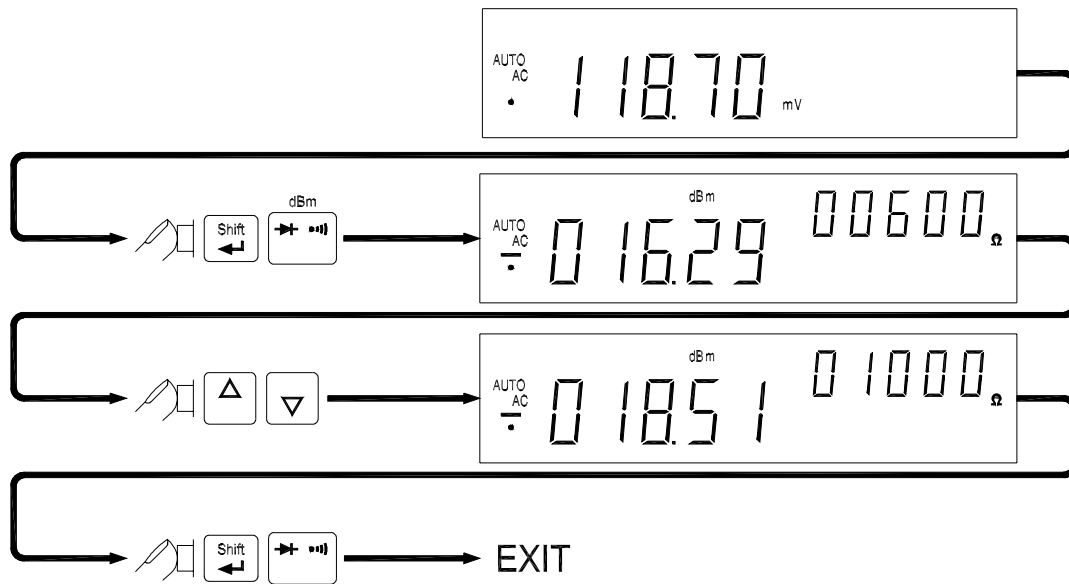

• **Using MIN.MAX Modifier for Dynamic Recording**

“**MIN MAX**” modifier enables the meter to store the minimum and the maximum input signals measured and elapsed time the value recorded since the “**MIN MAX**” modifier was selected. The definitions of “**MIN**” and “**MAX**” are defined as follows:

MIN: Minimum value of calculation results for measured signal

MAX: Maximum value of calculation results for measured signal

If “**MAX**” modifier is selected, the display indicates the latest maximum reading and elapsed time accordingly until next measurement reading exceeds the previous recorded reading.



If “**MIN**” modifier is selected, the display indicates the latest minimum reading and elapsed time accordingly until next measurement reading drops below the previous recorded reading.



If “**MIN MAX**” mode is selected, the display indicates the actual value of input signal. Selecting this modifier in auto range, it will record the value of MAX, MIN for different ranges.



The elapsed time is recorded since the modifier has been selected. The elapsed time is shown on the secondary display with “**HH.MM.SS**”. The HH is 0~19 hours, MM is 0~59 minutes and SS is 0~59 seconds. The display will indicate with “**— . — . —**” once over the maximum time of “19.59.59”.

***Note:** If the beep mode is set to “ON”, the beeper will emit a single tone when an effective maximum or minimum value is recorded.*

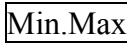
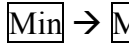
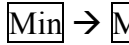

- **Operation Procedures**

  to enable “MIN.MAX” modifier.

The recording mode will rotate as the following sequences if keep pressing the  key:  →  →  → 

  for more than one second to disable “MIN MAX” modifier.

Or

  then followed by  to turn off all modifiers.

- **Operation Example**

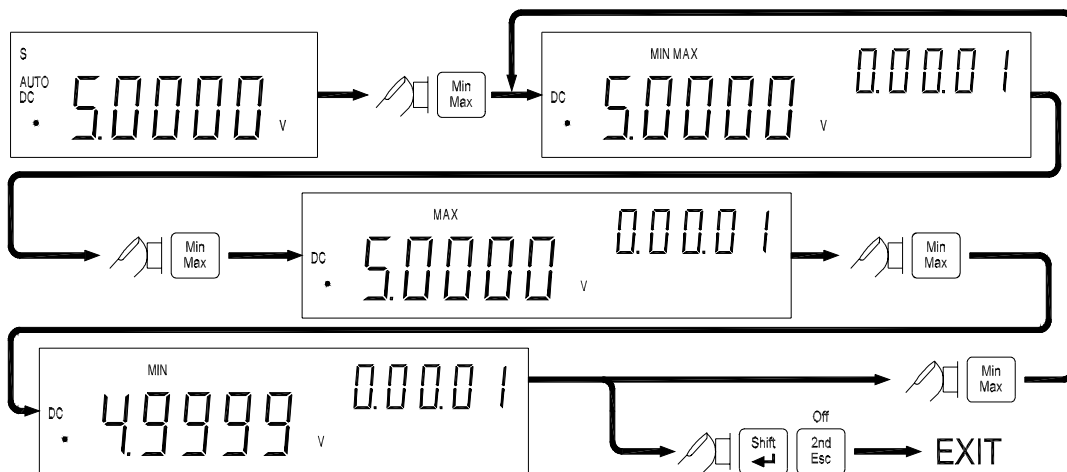

- **Selecting HOLD (Data /Refresh Hold) Modifier**

- Date Hold**

The data hold function allows operators to freeze the displayed value. This feature is useful when user wants to keep the measuring reading, user may press  to freeze the primary display and then read the display reading without losing the reading.



- Refresh Hold**



[You can select Refresh Hold to replace Data Hold at setup mode.](#) The Refresh Hold allows you to take measurement in dangerous or difficult measuring field and you can't look at the display. This function will update hold value with new measuring value automatically, and sound a tone to remind user. The operation of push button is same as the operations of Data hold.

Press  to enter Refresh Hold mode. The present value will be held and the “**HOLD**” will be lit. It will be ready to hold new measuring value once the variation of measuring value exceed the setting of variation count, and the “**HOLD**” will be flashed. The hold value will be updated until the measuring value is stable, then stop flash and light “**HOLD**” and sound a tone to remind user.

For voltage and current measurements, the holding value will not be updated when the reading below 500 counts. For resistance and diode measurements, the holding value will not be updated if the reading at “**OL**” or open state. The holding value may not be updated once the reading can’t reach stable state for all measurements.

- **Operation Procedures**

  to enable Data Hold mode, and the annunciator **HOLD** will be shown on the primary display.

  again to disable Data Hold mode.

Note: The Data Hold mode can be used for other arithmetic functions such as dBm, REL and Min / Max.

- **Selecting REL (Relative) Modifier**

The relative function subtracts a stored value from the primary display and indicates the result. This function is used for primary display only.

Press  momentarily to set the relative mode. This sets the display to zero and stores the displayed reading as a reference value. The “**REL**” will be lit also. Both ranges of auto or manual can set relative mode. The relative mode can’t set when an overload has occurred. If the relative mode is set in auto-ranging condition, enable the COMP or Percentage function will clear the relative mode. You do need to set relative function again.

Press  again to exit the relative mode.

● Using COMP (Compare) Function

“COMP” function compares the measurement inputs with the pre-set **HI** and **LO** limits. The compare function calculation expression is based on counts without decimal point.

HI: Measurement value > High (HI) limit value

LO: Measurement value < Low (LO) limit value

PASS: High limit value \geq Measurement value \geq Low limit value

When “COMP” function is enabled, the actual measuring value will be shown in primary display and a comparison result “HI”, “LO”, or “PASS” will be shown in secondary display.



The beeper will sound three tones as the result is changed from “PASS” to “HI” or “LO”, and one tone from “HI” or “LO” to “PASS”.

Notes:

1. The Compare function can be used with other arithmetic functions such as **REL**, **MINMAX**, and **dBm** modifiers
2. For frequency measurement, it will be locked to the range user is in when user enters this mode will become the selected range.



● Operation Procedures

  then followed by  to enable the “COMP” function.





  then followed by  again to disable the “COMP” function.



● Setting a Compare Limit / Percentage Value



Using the following procedure to set the HI and the LO limit values for “COMP” / “Percentage” function:

  then followed by  to enter the HI limit setup mode.

The HI limit will be shown in primary display.

 , ,  or  to change this value.

  to store the HI limit value in counts.

  then followed by  and repeat the above steps to set and store

the LO limit value.

Note: 1. After set the Hi and/or the LO limits, the limits can be used for all ranges. However, at different range, the HI and the LO limits represent different values according to their respective counts.

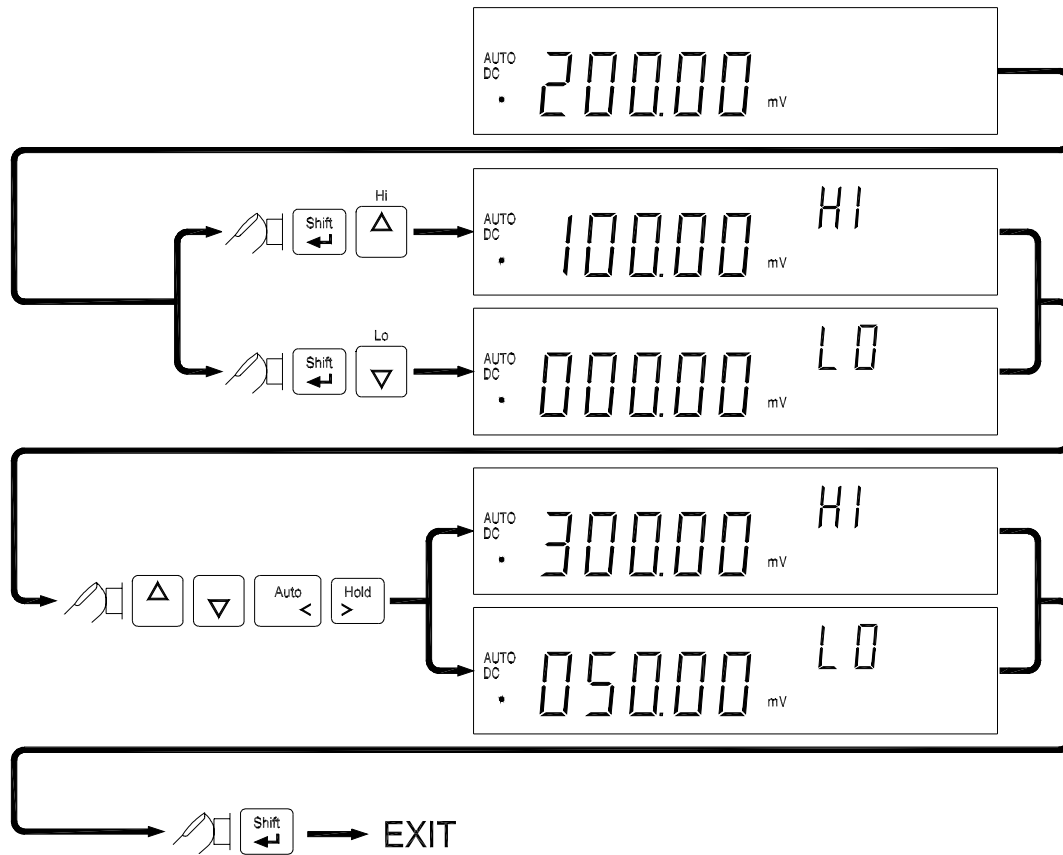

The RIGHT and LEFT button is used to select which digit will be adjusted. Push the buttons to left shift or right shift five digits.

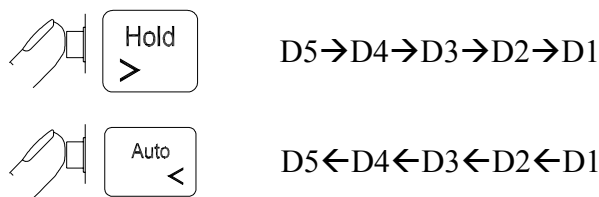

The UP and DOWN button is used to adjust the value, press UP or down button to increase or decrease one count for each digit, respectively. For the most significant digit (D5), its digital variation is shown as following:

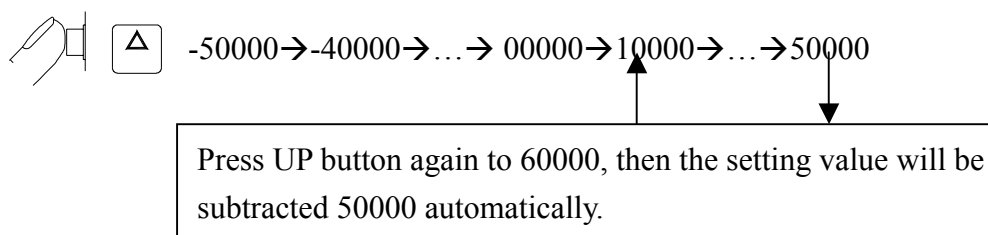

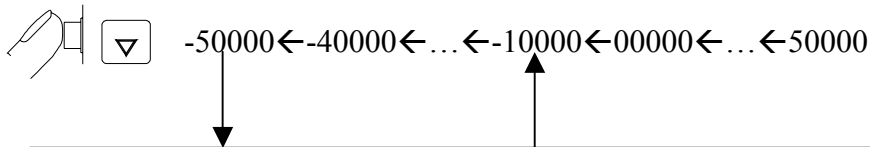

Press DOWN button again to -60000, then the setting value will be subtracted -50000 automatically.

For digits of D4 to D1, these digits can be adjusted from -9~9 by pressing UP and down buttons. Once the value of D5 has been set to 5 or -5, any adjustment to other digits will cause the setting value to subtract 50000 or -50000 automatic, respectively.

Press SHIFT button to store the settling value and exit this mode. Once the settling value is conflicted with other limits, the current settling will be replaced with LO limit or HI limit, respectively. For example, to store HI limit of 30000 but LO limit was 40000. The settling value will be replaced with LO limit of 40000, and the beeper sounds three tones to alert user to set HI limit again. It doesn't quit settling mode in this situation.

- **Using Percentage (%) Function**



To transfer the measuring value with a proportional percentage (%) display. For example, transfer the current of 4-20 mA to 0%~100% display for transmitter. It is based on the settling value of HI and LO limits (same as compare function) and according to following formula to calculate



$$\text{Percentage (\%)} = \frac{\text{Measuring value} - \text{LO}}{\text{HI} - \text{LO}} \times 100\%$$

If HI limit is equal to LO limit, the formula is change to as below:

$$\text{Percentage (\%)} = \frac{\text{Measuring value} - \text{HI}}{\text{HI}} \times 100\%$$

For example, transfer the current of 4-20 mA to 0%~100% display for transmitter. You should set LO limit to 4,000 counts and HI limit to 20,000 counts and measure in the range of 50mA.

Press  then followed by  to enter percentage function. The actual measuring value will be shown in primary display and the secondary display will indicate calculation result for percentage (%). An “OL” will be indicated

once over the maximum display of 999.99 %. This function will be used for lock range. If select this function during auto-ranging, it will lock to existing range. Press  then followed by  to exit percentage function

Notes:

1. *The Auto-ranging Relative mode or auto-ranging dynamic record will be closed when percentage function is set. For relative or dynamic record function should be selected again if necessary.*
2. *For frequency measurement, it will be locked to the range user is in when user enters this mode will become the selected range.*

3-12 Selecting Trigger mode

This meter has two types of trigger mode. One is internal to continuous update reading, and the other one is external control by bus or front panel. The default trigger mode is internal after the power up.

The external trigger is used with delay settling has been set by meter automatically. The amount of trigger delay varies depending on different function.

When external trigger is enabled, the meter determines the ranges for the primary display based on the input at that time. The meter is then ready to begin measuring the input on the optimum range as soon as the trigger is received. If the input changes so that either display auto ranges after the trigger is received, the auto ranging response times may be required before each measuring result is displayed.

The meter takes measurements when it is triggered to do so. The two trigger types available on the meter fall into two basic categories:











- An "internal trigger" triggers measurements continuously.
- An "external trigger" triggers a measurement only at the direction of the user.

A measurement can be externally triggered in three ways:



1. Front panel by TRIG key.
2. RS-232 interface. Please refer to chapter 6 for TGS<n> and TGM<n>.
3. GPIB interface. Please refer to chapter 7 for related commands.

● Operation Procedures for Front Panel

To enable an external trigger and trigger a measurement from the front panel, perform the following procedures:

1. Press  then followed by  to enter trigger mode and standby condition. The annunciator of TRIG will be lit, and display is indicated with “”.
2. Press  to get a new value. After a measuring, then the result will be indicated and held on display.
3. Press  to get a new value again.
4. Press ,  or  to select auto-ranging or manual range as necessary.
5. Press other function keys to select what you want.
6. Press  then followed by  to disable external trigger.

Notes:

1. *When external trigger is enabled, all the arithmetic functions will be disabled.*
2. Press  then followed by  may disable external trigger also.
3. The trigger mode will disable the secondary display except frequency function in primary display.

Section 4

Measurement Application Examples

4-1 Introduction

Section 4 describes some advanced features and applications that help the user to operate the meter more effectively. The user must be familiar with the basic measurement operations described in Section 2 and Section 3 and has a basic understanding of electronics knowledge.

4-2 Applications for Using Dual Display

The dual display capability is one of the most useful features provided with the meter. User may take the advantages to greatly enhance the test and measurement capabilities.

Some common combinations and applications of using dual display are provided in Table 4-1.

Table 4-1. Typical Combinations and Applications for Using Dual Display

Primary Display	Secondary Display	Applications
Vdc	Vac	• Testing DC to AC or AC to DC converter circuit
Vac+Vdc	Vdc	• Measuring DC level and AC ripple of power supply
Vac	Hz	• Measuring AC frequency response of amplifier circuit
Aac	Hz	• Adjusting AC motor control
Adc	Aac	• Measuring AC ripple and DC current of power supply
Aac+Adc	Adc	• Measuring current dissipation for power supply analysis
dBm	Reference Ω	• Setting dB reference impedance and show dBm
dBm	Vdc	• Indicating DC voltage and dBm
dBm	Vac	• Indicating AC voltage and dBm

4-2-1 Dual Display Operation Examples



This section will describe some practical operations of using dual display features.

- **Measuring DC voltage and AC ripple on a rectification circuit.**

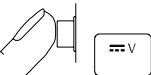

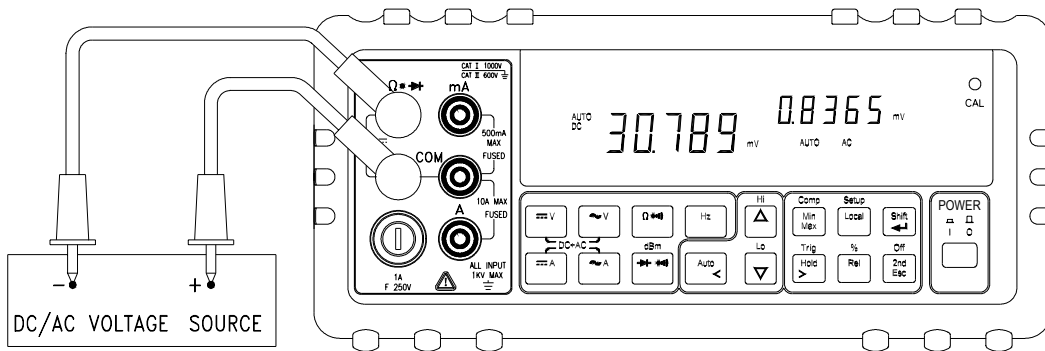
To display DC voltage in primary display, and AC voltage in secondary display or vice versus while testing a rectifier circuit, user may check the DC voltage supplied and its AC ripples by taking a single meter.

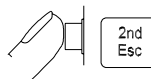
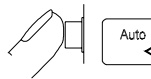
1.  to select DC voltage measurement for primary display.
2. Connect the meter to the unit under test as shown below:



3.  cycling to select AC voltage measurement for secondary display.
4. ,  or  to select auto-ranging or manual range as necessary.

Notes:

1. Press  then followed by  may turn off secondary display directly.
2. Press  to select the suitable range, if the DCV + AC ripple is over the scale of present range.
3. Regarding secondary display function setting, please refer to Section 3-6.

- **Measuring AC and DC current on a rectification circuit.**

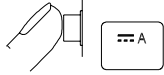

To display AC current in primary display and DC current in secondary display or vice versus while testing a rectifier circuit, user may check the DC current component and its AC ripples by taking a single meter.

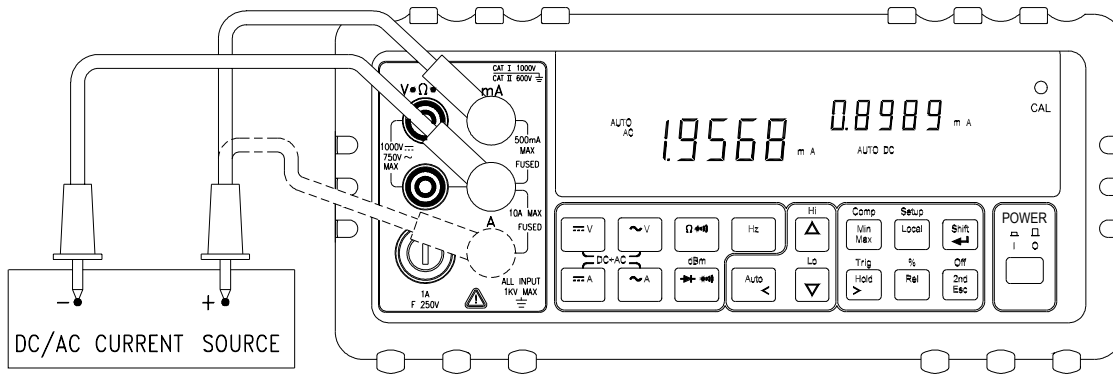
1.  to select DC current measurement for primary display
2. Connect the meter to the unit under test as shown below:



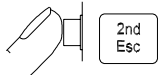
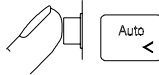

⚠ WARNING!

1. Select a correct input terminal according to the input range to be used.
2. To avoid damaging the meter do not apply current exceeding specified range to input terminals of "mA" or "A" (see the appendix A Specifications).

3.  cycling to select AC current measurement for secondary display.
4. ,  or  to select auto-ranging or manual range as necessary.

Notes:

1. Press  then followed by  may turn off secondary display.
2. Regarding secondary display function setting, please refer to Section 3-6.

- **Measuring AC voltage and frequency on an AC circuit.**

To display AC voltage in primary display and the frequency in secondary display or vice versus while measuring an AC signal, user may check AC voltage and its frequency of an AC Power Supply or circuit by taking a single meter.

1. to select AC voltage measurement function for primary display.
2. Connect the meter to the unit under test as shown below:

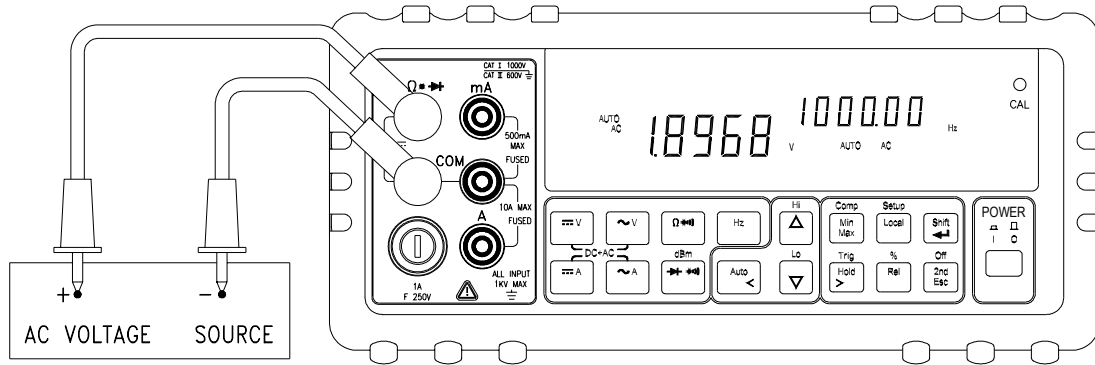

3. to select frequency measurement for secondary display.
4. , or to select auto-ranging or manual range for primary display as necessary.

Notes:

1. Press then followed by may turn off secondary display directly.
2. Regarding secondary display function setting, please refer to Section 3-6.



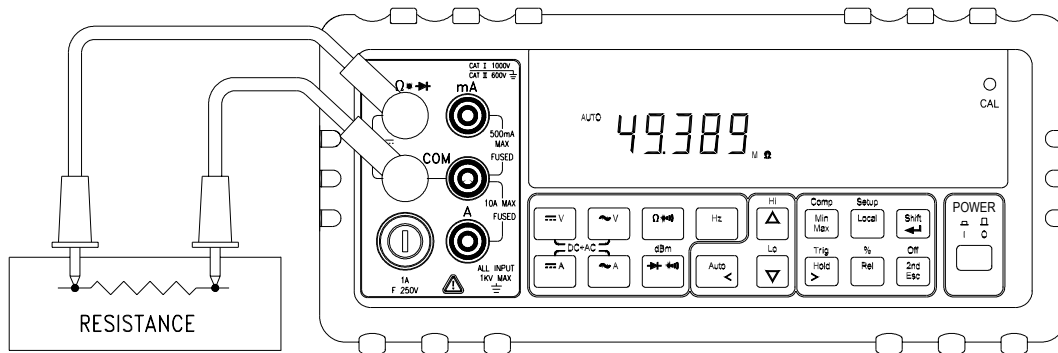

4-3 Measuring Resistance

1. Connect a resistor under test to Ω and **COM** input terminals as shown below:



WARNING!





Do not apply a voltage exceeding 500 V peak between Ω and **COM** input terminals.

2.  Ω to select Ω measurement.
3.  Auto,  or  to select auto-ranging or manual range for primary display.

Note: When measuring low resistance, use “REL” modifier function to reduce the measuring error created by the test leads resistance and contact resistance in the test loop ($0.1\Omega \sim 0.5\Omega$ typical).

4-4 Measuring True RMS AC+DC

The meter can measure the true rms value of ac voltages and currents.

When  and  or  and  are pressed simultaneously, the meter will measure the dc and ac signals alternatively then calculate and display the ac+dc rms value by using the following formula:

$$(\text{AC+DC}) \text{ RMS} = \sqrt{dc^2 + ac^2}$$

Note: When voltage (ac+dc) measurement function is selected, the Vdc input impedance is paralleled with an ac-coupled 1.1MΩ ac divider.

- **Measurement example:**

To take a true rms voltage ac+dc measurement on an ac signal, assuming the input ac is 0.1V_{rms} 1kHz sine wave ac signal and with a dc offset voltage +4.5 volts, the meter will read and display the results approximately as:

$$\sqrt{4.5^2 + 0.1^2} \doteq 4.5011 \text{ volts}$$

Section 5

Calibrating the Meter

5-1 Introduction

 **CAUTION!**

TO AVOID DAMAGING THE DEFAULT CALIBRATION DATA STORED IN A NON-VOLATILE MEMORY, A CALIBRATION TO THE METER CAN ONLY BE DONE BY AN AUTHORIZED SERVICE CENTER AND QUALIFIED PERSONNEL WITH APPROPRIATE EQUIPMENT.

THE WARRANTY WILL BE EXPIRED IF THE SEALED LABEL ON THE CAL BUTTON OF THE FRONT PANEL IS BROKEN.

FOR MORE DETAIL INFORMATION ABOUT CALIBRATION PROCEDURES, PLEASE CONTACT FACTORY OR AUTHORIZED DISTRIBUTOR.

It is recommended to recalibrate and verify the meter at least once a year to ensure it meets the original designed performance and specifications.

The meter is designed with closed-case calibration capability (no internal adjustment). To enter calibration mode by pressing the CAL button located in the hole on the upper right position of the front panel display screen.

The meter can be calibrated and verified by keystrokes via the front panel or through RS-232 interface command with appropriate equipment and qualified personnel only.

5-2 Environmental Condition

Calibration or verification test should be performed under laboratory condition which ambient temperature/ relative humidity can be controlled.

5-3 Warm up

Allow up to at least 60 minutes warm-up time before performing calibration or a verification test to the meter. After exposure or storage in a high humidity (condensing) environment, 2 hours warm-up time is essentially required.

5-4 Recommended Test Equipment

The test equipment requirements listed in Table 5-1 or equivalents are required to perform the calibration and performance verification test procedures. Alternative equipment may be used as long as the accuracy is at least as good as those listed.

Table 5-1 Standard Equipment Requirements

Standard Source	Operating Range	Accuracy Required	Recommended Equipment
DC Voltage Calibrator	Range, 0 to 1000VDC	$\leq \pm 0.002\%$	Fluke 5520A or equivalent
AC Voltage Calibrator	Range, 0 to 750V, 1kHz	$\leq \pm 0.03\%$	Fluke 5520A or equivalent
DC Current Calibrator	10mA to 100mA	$\leq \pm 0.01\%$	Fluke 5520A or equivalent
	1A to 10A	$\leq \pm 0.03\%$	
AC Current Calibrator	10mA to 1000mA, 1kHz	$\leq \pm 0.1\%$	Fluke 5520A or equivalent
	1A to 10A, 1kHz	$\leq \pm 0.2\%$	
Resistance Calibrator	450 Ω , 4.5k Ω , 45k Ω , 450k Ω , 4.5M Ω	$\leq \pm 0.01\%$	Fluke 5520A or equivalent
	30M Ω	$\leq \pm 0.05\%$	Fluke 5520A or equivalent
Audio Level Generator	2V/4500Hz	$\leq \pm 0.005\%$	Fluke 5520A or equivalent

Appendix A

Specifications

A-1 Introduction

Appendix A describes the complete specifications of this meter.

A-2 Technical Specifications

- **Specifications assumptions:**

- One-year calibration cycle.
- Operating temperature at 18°C to 28°C (64.4°F to 82.4°F).
- Accuracy is expressed as: \pm (% of reading + digits) after 30 minutes warm-up.
- Temperature coefficient: Add \pm [0.15 x (the applicable accuracy)/°C] for 0°C to 18°C and 28°C to 50°C.
- Relative Humidity (RH): up to 80% (60% for 50M Ω range of resistance measurement).
- All specifications are specified under single display mode in operation only.

- **Display Counts and Reading Rates**

Full Scale Display Counts: 51,000 Counts

Reading Rate (Approx.)

Measuring Function	Readings/Sec	Measuring Function	Readings/Sec
DCV	3	DCV / Frequency	1.3/2
DCA	3	ACV / Frequency	3/2
Diode	3	ACV+DCV / Frequency	1.3/2
ACV	3	DCA / ACA	1.3
ACA	3	ACA+DCA / DCA	1.3
Ω	3	ACA+DCA / ACA	1.3
Frequency/ACV or ACA	2/3	DCA / Frequency	1.3/2
ACV+DCV	1.3	ACA / Frequency	3/2
ACA+DCA	1.3	ACA+DCA / Frequency	1.3/2
DCV / ACV	1.3	dBm / DCV	3
ACV+DCV / DCV	1.3	dBm / ACV	3
ACV+DCV / ACV	1.3	dBm / ACV+DCV	1.3

Notes:

1. The reading rate is measured as above combinations and applications at lock range.
2. Using RS-232 or GPIB remote interface, the reading rate is similar to normal mode.

- DC Voltage

Resolution, Full Scale Reading and Accuracy

Range	Resolution	Full Scale Reading	Accuracy (1 year)	Typical Input Impedance ⁽²⁾
500mV	10 μ V	510.00	0.08% + 4	10.0M Ω
5V	100 μ V	5.1000	0.02% + 4	11.1M Ω
50V	1mV	51.000	0.02% + 4	10.1M Ω
500V	10mV	510.00	0.02% + 4	10.0M Ω
1000V	100mV	1200.0 ⁽¹⁾	0.02% + 4	10.0M Ω

(1) In 1000V range, 1200V is readable with audio warning.
 (2) Input Impedance is in paralleled with capacitance <100pF.

- Maximum input voltage: 1200Vdc or peak ac on any range
- Response Time: Approximately 1.0 second when the displayed reading reaches 99.9% dc value of the tested input signal at the same range.

Note: When voltage (ac+dc) measurement is selected, the Vdc input impedance is paralleled with an ac-coupled 1.1M Ω ac divider.

Noise Rejection Ratio

CMRR ⁽¹⁾	NMRR ⁽²⁾
>90dB at dc, 50/60Hz \pm 0.1% (1k Ω Unbalanced)	>50dB at 50/60Hz \pm 0.1%

(1) CMRR is the Common Mode Reject Ratio
 (2) NMRR is the Normal Mode Rejection Ratio

- AC Voltage (True RMS, AC Coupling)

Resolution, Full Scale Reading and Accuracy

Range	Resolution	Full Scale Reading	Accuracy (1 year) ⁽²⁾			
			30 to 50 Hz	50 to 10k Hz	10k to 30k Hz	30k to 100k Hz
500mV	10μV	510.00	1% + 40	0.5% + 40	2% + 60	3% +120
5V	100μV	5.1000	1% + 20	0.35% + 15	1% + 20	3% + 50
50V	1mV	51.000	1% + 20	0.35% + 15	1% + 20	3% + 50
500V	10mV	510.00	Not Specified	0.35% + 15	1% + 20 ⁽³⁾	3% + 50 ⁽³⁾
750V	100mV	1000.0 ⁽¹⁾	Not Specified	0.5% + 15	1% + 20 ⁽³⁾	Not Specified

⁽¹⁾ In 750V range, 1000.0V is readable with audio warning.

⁽²⁾ Accuracy specified at input >5% of Range.

⁽³⁾ Input Voltage < 200V rms.

- Measurement method: True RMS
- Maximum Crest Factor: 3.0 at full scale
- Maximum input voltage: 1000V rms, 1400V peak ac
 - 2x10⁷ V-Hz product on any range, normal mode input
 - 1x10⁶ V-Hz product on any range, common mode input
- Input Impedance: 1MΩ in parallel with capacitance <100pF
- Response Time: Approximately 1.5 seconds when the displayed reading reaches 99.9% ac rms value of the tested input signal at the same range.

- DC Current

Resolution, Full Scale Reading and Accuracy

Range	Resolution	Full Scale Reading	Accuracy (1 year)	Burden Voltage ⁽¹⁾ & Shunt Resistor
500μA	10nA	510.00	0.05% + 5	<0.06V / 100Ω
5mA	100nA	5.1000	0.05% + 4	<0.6V / 100Ω
50mA	1μA	51.000	0.05% + 4	<0.08V / 1Ω
500mA	10μA	510.00	0.05% + 4	<0.8V / 1Ω
5A	100μA	5.1000	0.25% + 5	<0.3V / 0.01Ω
10A	1mA	20.000 ⁽²⁾	0.25% + 5	<0.6V / 0.01Ω

⁽¹⁾ Typical at full scale reading and voltage across the input terminals

⁽²⁾ In 10A range, >10~20Adc is readable for 20 seconds maximum with audio warning.

- Response Time: Approximately 1.0 second when the displayed reading reaches 99.9% dc value of the tested input signal at the same range.

- **AC Current (True RMS, AC Coupling)**

Resolution, Full Scale Reading and Burden Voltage

Range	Resolution	Full Scale Reading	Accuracy (1 year) ⁽⁵⁾				Burden Voltage ⁽¹⁾ & Shunt Resistor
			30 to 50 Hz	50 to 2k Hz	2k to 5k Hz	5k to 20k Hz	
500μA	10nA	510.00	1.5% + 50	0.5% + 20	1.5% + 50	3% + 75 ⁽⁴⁾	<0.06V / 100Ω
5mA	100nA	5.1000	1.5% + 40	0.5% + 20	1.5% + 40	3% + 60	<0.6V / 100Ω
50mA	1μA	51.000	1.5% + 40	0.5% + 20	1.5% + 40	3% + 60	<0.08V / 1Ω
500mA	10μA	510.00	1.5% + 40	0.5% + 20	1.5% + 40	3% + 60	<0.8V / 1Ω
5A	100μA	5.1000	2% + 40 ⁽³⁾	0.5% + 30	Not Specified		<0.3V / 0.01Ω
10A	1mA	20.000 ⁽²⁾	2% + 40 ⁽³⁾	(<1kHz)			<0.6V / 0.01Ω

(1) Typical at full scale reading and voltage across the input terminals
(2) In 10A range, >10~20Aac is readable for 20 seconds maximum with audio warning.
(3) Input Current < 3 Arms.
(4) Input Current > 35μArms.
(5) Accuracy specified at input >5% of range and >1A for 10A range except other specified.

- Measurement method: True RMS
- Maximum Crest Factor: 3.0 at full scale
- Response Time: Approximately 1.5 seconds when the displayed reading reaches 99.9% ac rms value of the tested input signal at the same range.

- **AC Voltage (True RMS, AC+DC Coupling)**

Resolution, Full Scale Reading and Accuracy

Range	Resolution	Full Scale Reading	Accuracy (1 year) ⁽²⁾		
			50 to 10k Hz	10k to 30k Hz	30k to 100k Hz
500mV	10μV	510.00	0.5% + 50	2% + 70	3% + 130
5V	100μV	5.1000	0.5% + 25	1% + 30	3% + 60
50V	1mV	51.000	0.5% + 25	1% + 30	3% + 60
500V	10mV	510.00	0.5% + 25	1% + 30 ⁽³⁾	3% + 60 ⁽³⁾
750V	100mV	1000.0 ⁽¹⁾	0.5% + 25	1% + 30 ⁽³⁾	Not Specified

(1) In 750V range, 1000.0V is readable with audio warning.
(2) Accuracy specified at input >5% of Range.
(3) Input Voltage < 200V rms.

- Measurement method: True RMS
- Maximum Crest Factor: 3.0 at full scale
- Maximum input voltage: 1000V rms, 1400V peak ac
 2×10^7 V-Hz product on any range, normal mode input
 1×10^6 V-Hz product on any range, common mode input
- Input Impedance: 1MΩ in parallel with capacitance <100pF
- Response Time: Approximately 1.5 seconds when the displayed reading reaches 99.9% ac rms value of the tested input signal at the same range.

- AC Current (True RMS, AC+DC Coupling)

Resolution, Full Scale Reading and Burden Voltage

Range	Resolution	Full Scale Reading	Accuracy (1 year)(4)			Burden Voltage ⁽¹⁾ & Shunt Resistor
			50 to 2k Hz	2k to 5k Hz	5k to 20k Hz	
500μA	10nA	510.00	0.5% + 30	1.5% + 60	3% + 85 ⁽³⁾	<0.06V / 100Ω
5mA	100nA	5.1000	0.5% + 30	1.5% + 50	3% + 70	<0.6V / 100Ω
50mA	1μA	51.000	0.5% + 30	1.5% + 50	3% + 70	<0.08V / 1Ω
500mA	10μA	510.00	0.5% + 30	1.5% + 50	3% + 70	<0.8V / 1Ω
5A	100μA	5.1000	0.5% + 40	Not Specified		<0.3V / 0.01Ω
10A	1mA	20.000 ⁽²⁾	(<1kHz)			<0.6V / 0.01Ω

(1) Typical at full scale reading and voltage across the input terminals

(2) In 10A range, >10~20A is readable for 20 seconds maximum with audio warning.

(3) Input Current > 35μArms.

(4) Accuracy specified at input >5% of range and >1A for 10A range except other specified.

- Measurement method: True RMS
- Maximum Crest Factor: 3.0 at full scale
- Response Time: Approximately 1.5 seconds when the displayed reading reaches 99.9% ac rms value of the tested input signal at the same range.

- Resistance/Continuity

Resolution, Full Scale Reading, Test Reading and Accuracy

Range ⁽¹⁾	Resolution	Full Scale Reading	Test Current	Accuracy (1 year)
500Ω	10mΩ	510.00	0.5mA	0.1% + 5 ⁽²⁾
5kΩ	100mΩ	5.1000	0.45mA	0.1% + 3 ⁽²⁾
50kΩ	1Ω	51.000	45μA	0.1% + 3
500kΩ	10Ω	510.00	4.5μA	0.1% + 3
5MΩ	100Ω	5.1000	450nA	0.1% + 3
50MΩ	1KΩ	51.000	45nA	0.3% + 3

(1) In order to eliminate the noise interference, which might be induced to the test leads, it is recommended to use a shielded test cable for measuring resistance above 500KΩ. ⁽²⁾ Use relative (REL) modifier.

- Open Circuit Voltage: +6.0V dc approx.
- Audible Tone: Continuous beep for reading is less than 1,000 counts
- Zeroing error: 0.05Ω or less (excluding test lead resistances) in each range when REL modifier is used
- Response time: Approximately 1.5 seconds for 5MΩ and ranges below 5MΩ; approximately 5 seconds for 50MΩ range.
- Maximum Input Protection: 500V dc or ac rms

- **Diode Test/Continuity**

Resolution, Full Scale Reading and Accuracy

Range	Resolution	Full Scale Reading	Accuracy
2.3V	100 μ V	2.3000V	0.05% + 5

- Open Circuit Voltage / Test Current: +6.0V dc / 0.5mA approx.
- Audible Tone: Continuous beep for continuity and single tone for normal forward-biased diode or semiconductor junction
- Continuity level: Approximately below +50mVdc
- Maximum Input Protection: 500V dc or ac rms

- **Frequency**

Resolution, Full Scale Reading and Accuracy

Range	Measuring Range	Resolution	Full Scale Reading	Accuracy (1 year)
500 Hz	5Hz~ 500Hz	0.01 Hz	510.00	0.01 + 5
5kHz	500Hz~5kHz	0.1 Hz	5.1000	0.01 + 3
50kHz	5 KHz~50 kHz	1 Hz	51.000	0.01 + 3
500kHz	50kHz~500 kHz	10 Hz	999.99	0.01 + 3

- Response Time: Approximate 1 second when the displayed reading reaches 99.9% of frequency value.

Sensitivity for Voltage Measurement

Input Range	Minimum Sensitivity (RMS Sine-wave)	
	5Hz ~ 100kHz	100kHz ~ 500kHz
500 mV	35mV	200mV
5V	0.25V	0.5V
50V	2.5V	5V
500V	25V	NO SPEC.
750V	50V	NO SPEC.

- Maximum input V-Hz and Input Impedance, please refer to AC Voltage measurement.

Sensitivity for Current Measurement

Input Range	Minimum Sensitivity (RMS Sine-wave)
	30Hz~20kHz
500 μ A	35 μ A
5mA	0.25mA
50mA	2.5mA
500mA	25mA
5A	0.25A (<2kHz)
10A	2.5A (<2kHz)

- Maximum input, please refer to AC Current measurement.

- dBm (decibel calculation)

Reference Impedance ⁽¹⁾

2Ω	50Ω	135Ω	800Ω
4Ω	75Ω	150Ω	900Ω
8Ω	93Ω	250Ω	1000Ω
16Ω	110Ω	300Ω	1200Ω
	124Ω	500Ω	8000Ω
	125Ω	600Ω ⁽²⁾	

⁽¹⁾ Reference impedance is selectable at setup mode or during measurement. Please refer to the chapter for related operation.

⁽²⁾ Default reference impedance

Range and Accuracy

Voltage Range ^(1,2)	Input Voltage	dBm ⁽³⁾ Range @ 600Ω Ref	Accuracy (dB)		
			30 to50 Hz	50 to10k Hz	10k to 100k Hz
500mV	25mV ~ 500mV	-29.82 ~ -3.80	0.3	0.3	0.7
5V	500mV ~ 5V	-3.80 ~ 16.20	0.2	0.2	0.5
50V	5V ~ 50V	16.20 ~ 36.20	0.2	0.2	0.5
500V	50V ~ 500V	36.20 ~ 56.20	0.2 ⁽⁵⁾	0.2	0.5 ⁽⁵⁾
1000V (dc)	500V ~ 1000V	56.20 ~ 62.22	Not Specified	0.2 ⁽⁴⁾	Not Specified
750V (ac)	500V ~ 750V	56.20 ~ 59.72	Not Specified	0.2 ⁽⁴⁾	Not Specified

⁽¹⁾ Auto-ranging is used when dBm function is selected

⁽²⁾ In Vdc 1200V range and Vac 1000 V are readable

⁽³⁾ Reading displayed in dB when REL modifier is used

⁽⁴⁾ For input voltage at frequency between 50Hz to 1kHz

⁽⁵⁾ Input Voltage < 200V rms.

- 0dBm: 1 mW @ 600Ω Reference Impedance
- Resolution: 0.01dB for all ranges.
- CMRR: > 90dB for dc signal
- Response Time: Same as dc, ac or ac+dc voltage measurements.

A-3 General Specifications

General Items	Specifications
Warm up time	At least 30 minutes
Temperature Coefficient	Add 0.15 x (the applicable accuracy)/°C at 0°C to 18°C and 28°C to 50°C
Operating Temperature	0°C to 50°C (32°F to 122°F)
Storage Temperature	-20°C to 60°C
Altitude	Up to 2000 M
Pollution Degree	II
Over-voltage Category	CAT II-600V and CAT I-1000V
Relative Humidity	Up to 80% (60% for 50MΩ range of resistance measurement)
Common Mode Voltage	1000V dc or peak ac rms maximum between any input and earth ground
Dimension	Approx. 255(w) x 105(h) x 305(d) mm (with holsters)
Weight	<3.0kgs
Line Voltage	100V / 120V / 220V / 240V ac ±10%, 50/60Hz, 16VA maximum
Interface	<ul style="list-style-type: none"> • RS-232 (DB-9, male connector) • Baud rates: 9600, 4800, 2400, 1200, 600, 300 • Data length: 7 or 8 bits • Parity: even / odd / none • Stop bit: 1 or 2 bits • Echo: on / off • Print mode: on / off
Safety Requirement	Designed in compliance with EN61010-1 (IEC1010-1)
Installation Category	CAT-I 750VAC/1000VDC or CAT-II 600V, Pollution Degree 2 Environment
EMC Requirement	Designed in compliance with EN61326-1.

Appendix B

Maintenance

B-1 Introduction

Appendix C describes the basic maintenance procedures to this Multi-meter.

B-2 Cleaning the Meter

⚠ WARNING!

To avoid electrical shock or damaging the meter, never get water inside the case.

Before cleaning this meter, make sure the power is switched in OFF position and the power cord is disconnected from the AC outlet. To clean the meter, wipe the dirty parts with gauze or soft cloth soaked with diluted neutral detergent. Do not get too wet to prevent the detergent from penetrating into inside parts and causing damages. After cleaning, leave the instrument until it dries completely.

B-3 Configure the Line Voltage

⚠ Caution!

Before setting the line voltage selector, the main power should be turned off and remove Power cord from the meter. This meter operates on a 100V, 120V, 220V or 240V AC, 50/60Hz line voltage source.

Extract the fuse drawer from the AC socket with the aid of a screwdriver to move the fuse holder with the voltage selector from the fuse holder.

Pull out the fuse link from the fuse holder with the voltage selector. Replace a new fuse with a rated voltage with specific required line voltage. Select the voltage according to users local line voltage. If the line voltage used is 230V, be sure to switch the line voltage selection to 240V.

Be sure the line voltage is indicated to your need.

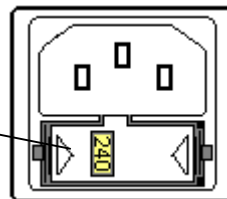

B-4 Accessories and Replacement Parts

Standard Accessories:

Description
Power Cord
Test Leads (Red and Black)
Operation manual
Fuse, 1A/250V Fast Blow 6*31mm

Optional Accessories:

Model	Description
AK 5491A	RS232 cable and PC Link software.
TH 02	Insulation piercing clip
TL 35	Tip-type Probes (Red and Black)
TL 36	Lantern type Probes (Red and Black)
RK 01	Rack mount kit for single meters