

INSTRUCTION MANUAL



Model 501A

Semiconductor Curve Tracer



A Product of DYNASCAN CORPORATION 1801 West Belle Plaine • Chicago, Illinois 60613

PRICE \$2.00





Dear Friend:

Congratulations on your purchase of B & K — Precision Test Equipment, and welcome to the B & K family. We hope your experience with your new test equipment will make you a lifetime B & K customer.

Your instrument is backed by more than 20 years of experience in designing and manufacturing. Our most important goal is your satisfaction. At B & K, test equipment is made to meet the demands of the field, focusing on dependability and accuracy. We also concentrate on simplicity and operating ease with features that reduce the possibility of human error and speed the servicing process.

In order to determine the type of test units that are needed we have been guided by letters and reports from technicians and engineers who use the equipment daily. Our field tests and studies have helped provide better and faster service techniques. Close contact has been maintained with the manufacturers of consumer products which our test units will be checking and trouble-shooting.

Key personnel in our company cut their eye teeth in the TV service business. This is why we have more "sensitivity" for the problems and conditions under which the test equipment will be used.

B & K product designs are constantly reviewed, and refinements are made or new models developed to meet advances in our industry and to fill your needs. We set our standards high so you can be assured that the B & K test instruments you buy represent advanced design, quality construction, and dependable long-term performance at a price you can afford.

If you have any comments or thoughts about our products, or test equipment in general, I would be delighted to hear from you.

Thanks for your confidence in B & K and we look forward to serving you for a long time to come.

Sincerely,

A handwritten signature in cursive script that reads "Carl Korn".

Carl Korn
President

INSTRUCTION MANUAL

FOR

B & K/PRECISION

MODEL 501A

**SEMICONDUCTOR
CURVE TRACER**

B & K DIVISION OF DYNASCAN CORPORATION

1801 W. Belle Plaine Avenue

Chicago, Illinois 60613

Copyright 1972

TABLE OF CONTENTS

	Page
INTRODUCTION	1
SPECIFICATIONS	1
CONTROLS AND OPERATOR'S FACILITIES	3
OPERATING INSTRUCTIONS	4
CURVE TRACER SET-UP	5
OSCILLOSCOPE SET-UP AND CALIBRATION	5
Vertical Calibration	5
Horizontal Calibration	6
Low Voltage Horizontal Calibration	6
High Voltage Horizontal Calibration	7
Oscilloscope Connections to Curve Tracer	8
SEMICONDUCTOR DEVICE CONNECTIONS TO CURVE TRACER	8
Plug-in Transistors	8
Non Plug-in Transistors	8
In-Circuit Probe	9
Diodes	9
TYPICAL SEMICONDUCTR TESTS	9
Familiarization with the Curve Tracer	9
Transistor Testing Procedure	9
Effects of Curve Tracer Controls	11
Sorting and Matching Transistors	12
In-Circuit Transistor Testing	13
CURVE TRACER APPLICATIONS	14
Testing Bipolar Transistors	14
NPN vs. PNP Transistors	14
CURRENT GAIN MEASUREMENT	14
DC Current Gain (DC beta)	15
AC Current Gain (AC beta)	15
Summary of Transistor Current Gain	16
Current Gain Linearity vs. Distortion	16
BREAKDOWN VOLTAGE MEASUREMENT	18
LEAKAGE MEASUREMENT ($I_{C_{EO}}$)	19
SATURATION VOLTAGE [$V_{CE(sat)}$]	19
OUTPUT ADMITTANCE (h_{oe})	20
EFFECTS OF TEMPERATURE	20
TESTING FET'S	21
Transconductance (Gain) Measurement	22
Pinch-Off (V_p) Voltage Measurement	23
TESTING SIGNAL AND RECTIFIER DIODES	24
Testing Zener Diodes	25
TESTING UNIJUNCTION TRANSISTORS	26
TESTING SILICON CONTROLLED RECTIFIERS	27
TESTING TRIACS	28
TESTING TUNNEL DIODES	29
TESTING OTHER SEMICONDUCTOR DEVICES	30
Diacs	30
Integrated Circuits	30
MAINTENANCE AND CALIBRATION	30
Calibration Procedure	30
Alternate Method using an Oscilloscope	30
Curve Display Modification	30
Troubleshooting	31
CIRCUIT DESCRIPTION	32

B & K PRECISION MODEL 501-A PARTS LIST

488-1113-9-002 B

SCHEMATIC SYMBOL DESCRIPTION B & K PART No.

TRANSFORMERS

T-1 Power Transformer, 117V AC Primary065-067-9-001
 T-1 Power Transformer, 234V AC Primary065-067-9-002

MISCELLANEOUS

F-1 1/4 Amp, 3AG 250V Slo-Blo Fuse190-251-3-104
 Front Panel255-095-9-903
 Molded Plastic Side, Left271-013-9-001
 Molded Plastic Side, Right271-013-9-002
 Bottom Panel272-087-9-902
 Rubber Foot380-120-9-001
 Glamour Cap384-008-9-001
 PL-1 Neon Lamp/Resistor401-001-9-002
 Line Cord420-013-9-001
 Instruction Manual480-130-9-001
 Mylar Overlay482-033-9-902
 Composite Schematic/Parts List499-037-9-001
 Red Lead, (Banana Plug Both Ends)539-036-0-000
 Black Lead, (Banana Plug Both Ends)539-037-0-000
 Transistor Socket749-076-9-001
 Knob751-005-9-005
 Banana Jack, Red774-001-9-001
 Banana Jack, Black774-001-9-002
 Banana Jack, Blue774-001-9-003
 Banana Jack, Green774-001-9-004
 Banana Jack, Yellow774-001-9-006
 Ferrite Core870-002-9-001
 FP-5 ProbeFP-5

NOTE: Standard value resistors and capacitors are not listed, values may be obtained from schematic diagram.

Minimum charge \$2.00 per invoice. Orders will be shipped C.O.D. unless previous open account arrangements have been made or remittance accompanies order. Advance remittance must cover postage or express charge.

Specify serial number when ordering replacement parts.

B & K PRECISION MODEL 501-A PARTS LIST

488-1113-9-002 B

SCHEMATIC SYMBOL DESCRIPTION B & K PART No.

CAPACITORS

C-1, 2 1000 μ fd, 35 Volt Electrolytic Capacitor022-001-9-015
 C-3, 4, 5 100 μ fd, 25 Volt Electrolytic Capacitor022-081-9-001

RESISTORS

R-1/SW-1 15K, 1/2 Watt Pot/Switch (Sweep Voltage)008-168-9-001
 R-4 5.1K, 2 Watt 5% Glass Resistor003-002-8-512
 R-9 100 Ω , 1/4 Watt 1% Carbon Film Resistor002-011-9-001
 R-10 49.9 Ω , 1/4 Watt 1% Carbon Film Resistor002-004-9-001
 R-11 20 Ω , 1/4 Watt 1% Carbon Film Resistor002-013-9-001
 R-12 10 Ω , 1/4 Watt 1% Carbon Film Resistor002-010-9-001
 R-13, 14, 40, 41, 42, 43 10K, 1/4 Watt 1% Carbon Film Resistor002-012-9-001
 R-17 2.15K, 1/4 Watt 1% Carbon Film Resistor002-007-9-001
 R-18 4.99K, 1/4 Watt 1% Carbon Film Resistor002-005-9-001
 R-36 2K, 1/4 Watt Trimpot (Calibrate)008-170-9-001
 R-37 10K, 1/4 Watt Trimpot (Offset Adjust)008-038-9-001
 R-39 1K, 2 Watt 1% Wirewound Resistor006-001-9-005
 R-44 24.9K, 1/4 Watt 1% Carbon Film Resistor002-006-9-001
 R-45 24.9K, 1/4 Watt 1% Carbon Film Resistor002-009-9-001
 R-46 12.4K, 1/4 Watt 1% Carbon Film Resistor002-008-9-001
 RP-1 Resistor Package012-001-9-001

DIODES

D-1, 2, 3, 4, 5, 6, 7, 8 Diode, 1 Amp, 600 PIV Silicon Rectifier151-018-9-001
 D-9, 10 Diode, Zener, 15 Volt 5% 1 Watt 1N7444152-031-9-001
 D-11, 12 Diode, Germanium 1N100150-001-9-006

INTEGRATED CIRCUITS

IC-1 723C Voltage Regulator307-009-9-001
 IC-2 7402P Quad 2-Input Nor Gate307-011-9-001
 IC-3, 4 7473P Dual J-K Flip-Flop307-010-9-001
 IC-5, 6, 7, 8 741C Operational Amplifier307-016-9-001

TRANSISTORS

Q-1 Transistor, 2N3738 NPN Silicon Power, H.V.172-012-9-001
 Q-2, 3 Transistor, 2N5550, NPN Silicon Signal, H.V.176-033-9-001
 Q-4 Transistor, D40A5, NPN Silicon Power172-005-9-001
 Q-5, 6, 11, 12 Transistor, SPS2306, NPN Silicon Signal176-023-9-001
 Q-8, 9, 10 Transistor, MPSA70, PNP Silicon Signal177-008-9-001

SWITCHES

SW-2 Slide Switch, 4PDT084-026-9-001
 SW-3 Slide Switch, DPDT084-017-9-001
 SW-4 Rotary Switch, Vertical Range083-131-9-001
 SW-5 Rotary Switch, Step Selector083-132-9-001

COMPOSITE

499-037-9-001 B

7. RY1 IS A 1/4W, 1% DIP RESISTOR PACKAGE. VALUES ARE:
 PIN 1 - 250K
 PIN 2 - 200K
 PIN 3 - 10K
 PIN 4 - 50K
 PIN 5 - 2.5K

- NOTE - UNLESS OTHERWISE SPECIFIED:
 1. IC2 - PIN 4 IS +5V, PIN 7 TO GND
 1C3 & IC4 - PIN 4 TO +5V, PIN 11 TO GND
 2. ALL RESISTORS 1/4W, 5%, VALUES SPECIFIED IN DIMS.
 3. CAPACITORS IN MICROFARADS.
 4. VOLTAGES MEASURED WITH VTVM & IITVAC (WHT TO CURVE TRACER, NPN TO CURVE TRACER, PNP TO CURVE TRACER, WHT/RED TO CURVE TRACER). NOMINAL VOLTAGE TOLERANCE: 10% (INFERRED TO GROUND).
 5. ROTARY SWITCHES SHOWN IN FULL CW POSITION, CURVE TRACER SET UP THUS:
 • SWEEP SELECTOR SET TO 0.5 VOLTS/STEP
 • VERTICAL SENSITIVITY SET TO 50V/DIV
 • SOCKET SELECTOR SET TO RIGHT POSITION
 • VERTICAL POSITIONING ADJUST SOCKET TERMINALS C-E
 • 10K RESISTOR THROUGH RIGHT SOCKET TERMINALS C-E

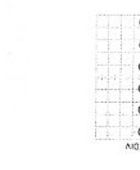

LAST IN	NOT USED
R46	25, 26, 27
IC3	1, 2, 3, 4, 5, 6, 7, 8, 9, 10, 11, 12, 13, 14, 15, 16, 17, 18, 19, 20, 21, 22, 23, 24, 25, 26, 27, 28, 29, 30, 31, 32, 33, 34, 35, 36, 37, 38, 39, 40, 41, 42, 43, 44, 45, 46, 47, 48, 49, 50, 51, 52, 53, 54, 55, 56, 57, 58, 59, 60, 61, 62, 63, 64, 65, 66, 67, 68, 69, 70, 71, 72, 73, 74, 75, 76, 77, 78, 79, 80, 81, 82, 83, 84, 85, 86, 87, 88, 89, 90, 91, 92, 93, 94, 95, 96, 97, 98, 99, 100
IC4	1, 2, 3, 4, 5, 6, 7, 8, 9, 10, 11, 12, 13, 14, 15, 16, 17, 18, 19, 20, 21, 22, 23, 24, 25, 26, 27, 28, 29, 30, 31, 32, 33, 34, 35, 36, 37, 38, 39, 40, 41, 42, 43, 44, 45, 46, 47, 48, 49, 50, 51, 52, 53, 54, 55, 56, 57, 58, 59, 60, 61, 62, 63, 64, 65, 66, 67, 68, 69, 70, 71, 72, 73, 74, 75, 76, 77, 78, 79, 80, 81, 82, 83, 84, 85, 86, 87, 88, 89, 90, 91, 92, 93, 94, 95, 96, 97, 98, 99, 100
IC2	1, 2, 3, 4, 5, 6, 7, 8, 9, 10, 11, 12, 13, 14, 15, 16, 17, 18, 19, 20, 21, 22, 23, 24, 25, 26, 27, 28, 29, 30, 31, 32, 33, 34, 35, 36, 37, 38, 39, 40, 41, 42, 43, 44, 45, 46, 47, 48, 49, 50, 51, 52, 53, 54, 55, 56, 57, 58, 59, 60, 61, 62, 63, 64, 65, 66, 67, 68, 69, 70, 71, 72, 73, 74, 75, 76, 77, 78, 79, 80, 81, 82, 83, 84, 85, 86, 87, 88, 89, 90, 91, 92, 93, 94, 95, 96, 97, 98, 99, 100
IC1	1, 2, 3, 4, 5, 6, 7, 8, 9, 10, 11, 12, 13, 14, 15, 16, 17, 18, 19, 20, 21, 22, 23, 24, 25, 26, 27, 28, 29, 30, 31, 32, 33, 34, 35, 36, 37, 38, 39, 40, 41, 42, 43, 44, 45, 46, 47, 48, 49, 50, 51, 52, 53, 54, 55, 56, 57, 58, 59, 60, 61, 62, 63, 64, 65, 66, 67, 68, 69, 70, 71, 72, 73, 74, 75, 76, 77, 78, 79, 80, 81, 82, 83, 84, 85, 86, 87, 88, 89, 90, 91, 92, 93, 94, 95, 96, 97, 98, 99, 100
IC3	1, 2, 3, 4, 5, 6, 7, 8, 9, 10, 11, 12, 13, 14, 15, 16, 17, 18, 19, 20, 21, 22, 23, 24, 25, 26, 27, 28, 29, 30, 31, 32, 33, 34, 35, 36, 37, 38, 39, 40, 41, 42, 43, 44, 45, 46, 47, 48, 49, 50, 51, 52, 53, 54, 55, 56, 57, 58, 59, 60, 61, 62, 63, 64, 65, 66, 67, 68, 69, 70, 71, 72, 73, 74, 75, 76, 77, 78, 79, 80, 81, 82, 83, 84, 85, 86, 87, 88, 89, 90, 91, 92, 93, 94, 95, 96, 97, 98, 99, 100
IC4	1, 2, 3, 4, 5, 6, 7, 8, 9, 10, 11, 12, 13, 14, 15, 16, 17, 18, 19, 20, 21, 22, 23, 24, 25, 26, 27, 28, 29, 30, 31, 32, 33, 34, 35, 36, 37, 38, 39, 40, 41, 42, 43, 44, 45, 46, 47, 48, 49, 50, 51, 52, 53, 54, 55, 56, 57, 58, 59, 60, 61, 62, 63, 64, 65, 66, 67, 68, 69, 70, 71, 72, 73, 74, 75, 76, 77, 78, 79, 80, 81, 82, 83, 84, 85, 86, 87, 88, 89, 90, 91, 92, 93, 94, 95, 96, 97, 98, 99, 100
IC2	1, 2, 3, 4, 5, 6, 7, 8, 9, 10, 11, 12, 13, 14, 15, 16, 17, 18, 19, 20, 21, 22, 23, 24, 25, 26, 27, 28, 29, 30, 31, 32, 33, 34, 35, 36, 37, 38, 39, 40, 41, 42, 43, 44, 45, 46, 47, 48, 49, 50, 51, 52, 53, 54, 55, 56, 57, 58, 59, 60, 61, 62, 63, 64, 65, 66, 67, 68, 69, 70, 71, 72, 73, 74, 75, 76, 77, 78, 79, 80, 81, 82, 83, 84, 85, 86, 87, 88, 89, 90, 91, 92, 93, 94, 95, 96, 97, 98, 99, 100
IC1	1, 2, 3, 4, 5, 6, 7, 8, 9, 10, 11, 12, 13, 14, 15, 16, 17, 18, 19, 20, 21, 22, 23, 24, 25, 26, 27, 28, 29, 30, 31, 32, 33, 34, 35, 36, 37, 38, 39, 40, 41, 42, 43, 44, 45, 46, 47, 48, 49, 50, 51, 52, 53, 54, 55, 56, 57, 58, 59, 60, 61, 62, 63, 64, 65, 66, 67, 68, 69, 70, 71, 72, 73, 74, 75, 76, 77, 78, 79, 80, 81, 82, 83, 84, 85, 86, 87, 88, 89, 90, 91, 92, 93, 94, 95, 96, 97, 98, 99, 100

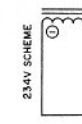
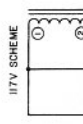
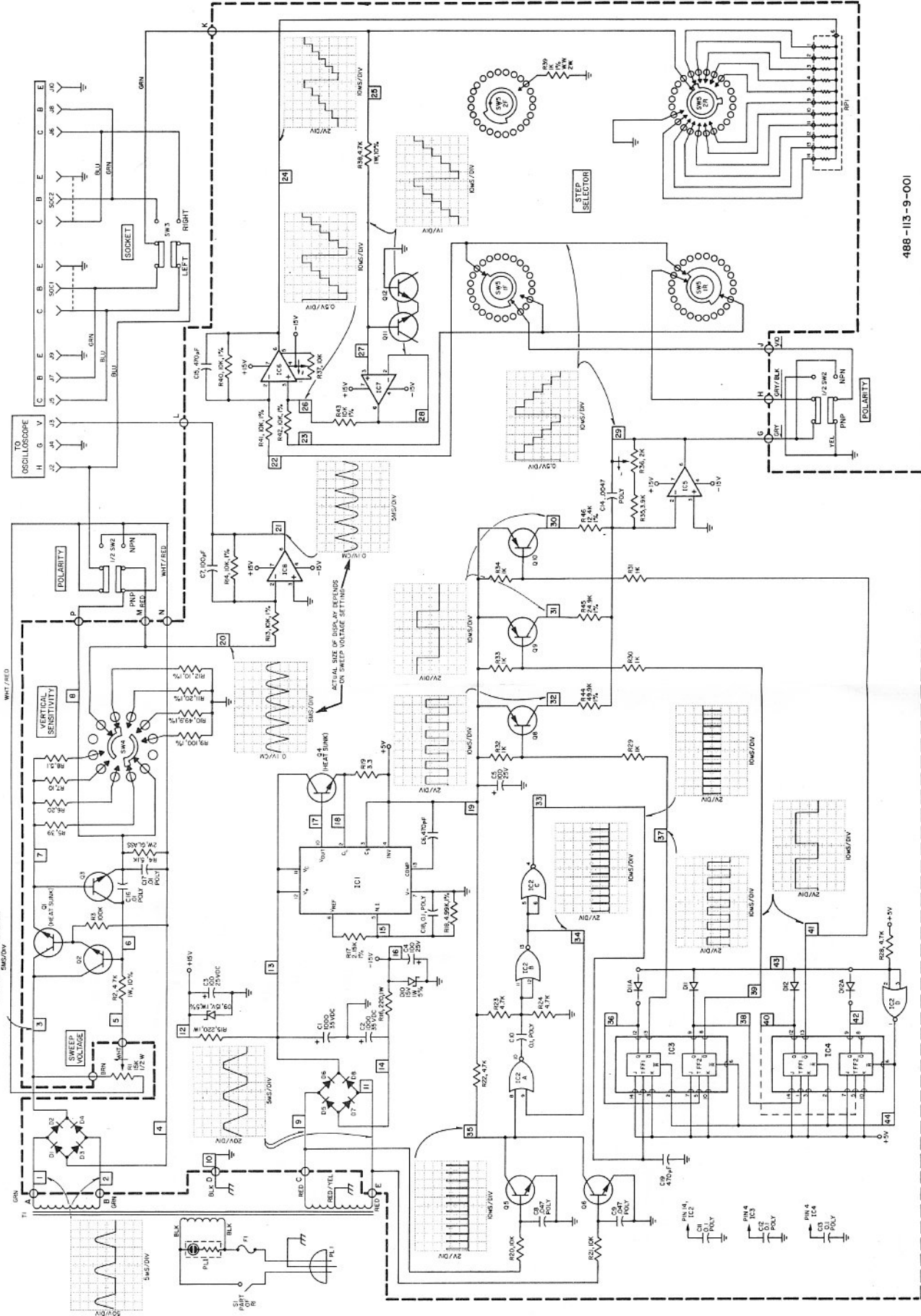

- COLOR CODE FOR THE SCHEMATIC
- ① = BLK
 - ② = BLK/YEL
 - ③ = BLK/RED
 - ④ = BLK/WHT

INTRODUCTION

The semiconductor curve tracer displays a family of dynamic characteristic curves for transistors, FET's, diodes, Zener diodes, triacs, tunnel diodes and all other semiconductor devices on the screen of an oscilloscope. Most authorities agree that a dynamic curve tracer is the best instrument for testing semiconductors, since it simulates actual operating conditions of changing voltage and current. Some of the characteristics which may be measured are gain (beta), leakage, breakdown voltage, output admittance, linearity, effects of capacitance and effects of temperature.

When first introduced, semiconductor curve tracers were primarily employed in engineering laboratories to select transistors with specific characteristics for design applications. Later the instruments became widely used for sorting, inspecting and testing semiconductors in production assembly and by technicians for troubleshooting. The latest application has been the discovery that curve tracers can be used for troubleshooting without removing the semi-

conductor from the circuit. In addition, a semiconductor curve tracer offers several other servicing advantages. By matching characteristics, balanced and/or complementary pairs may be selected. Matching also allows sorting and selection of transistors for substitution, resulting in an inventory reduction of replacement parts.

An oscilloscope must be used in conjunction with the curve tracer for the display. Almost any 3-inch or larger general purpose oscilloscope is satisfactory as long as it has external horizontal facilities, and is DC coupled. The B & K Models 1440, 1460 and 1465 Oscilloscopes are ideal companions for the Model 501A Curve Tracer. A graticule overlay for the oscilloscope screen and built-in calibration signals from the curve tracer makes the unit complete.

The special 3-tip probe supplied with the unit simplifies in-circuit testing by contacting base, collector and emitter simultaneously with a single probe. This is very convenient for testing transistors mounted on circuit boards.

SPECIFICATIONS

COLLECTOR SWEEP

Range0-100 volts DC peak @ 100 mA maximum.
PolarityNPN (N-Chan) or PNP (P-Chan).
Current Limiting Automatic at approximately 130% of full scale for each vertical attenuator range.

SWEEP GENERATOR

Current Ranges1/2/5/10/20/50 μ A and (11 total) .1/.2/.5/1/2 mA per step, \pm 3% constant-current steps.
Voltage Ranges0.05/.1/.2/.5/1 volts per step, (5 total) \pm 4%; Source resistance: 1K Ω
Number of Steps6, Continuous Display.
Steps Per Second....120
Step PolaritySame as Collector sweep (NPN or PNP); Inverted in VOLTS/STEP positions.

CALIBRATION

Source \pm .05 to 5 volts p-p, \pm 3% accuracy.
Attenuator Range ...1/2/5/10 mA per division vertically, \pm 3%.

ADDITIONAL

SocketsTwo TO-5 type transistor sockets (right and left) with each pin (3 per socket) paralleled by a banana jack for external cables. Slide switch selects right or left socket.
Output Terminals ...Banana jacks for vertical, horizontal, ground outputs to oscilloscope.
AccessoriesCables to scope; mylar 10x10 division graticule; instruction manual; FP-5 probe.
Power Requirements.105-125 VAC, 50/60 Hz; supplied with 3-wire line cord.
Size (H x W x D)....4" x 10" x 9 1/2"
Weight6 lbs.

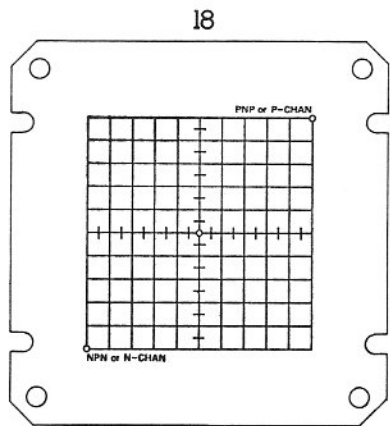
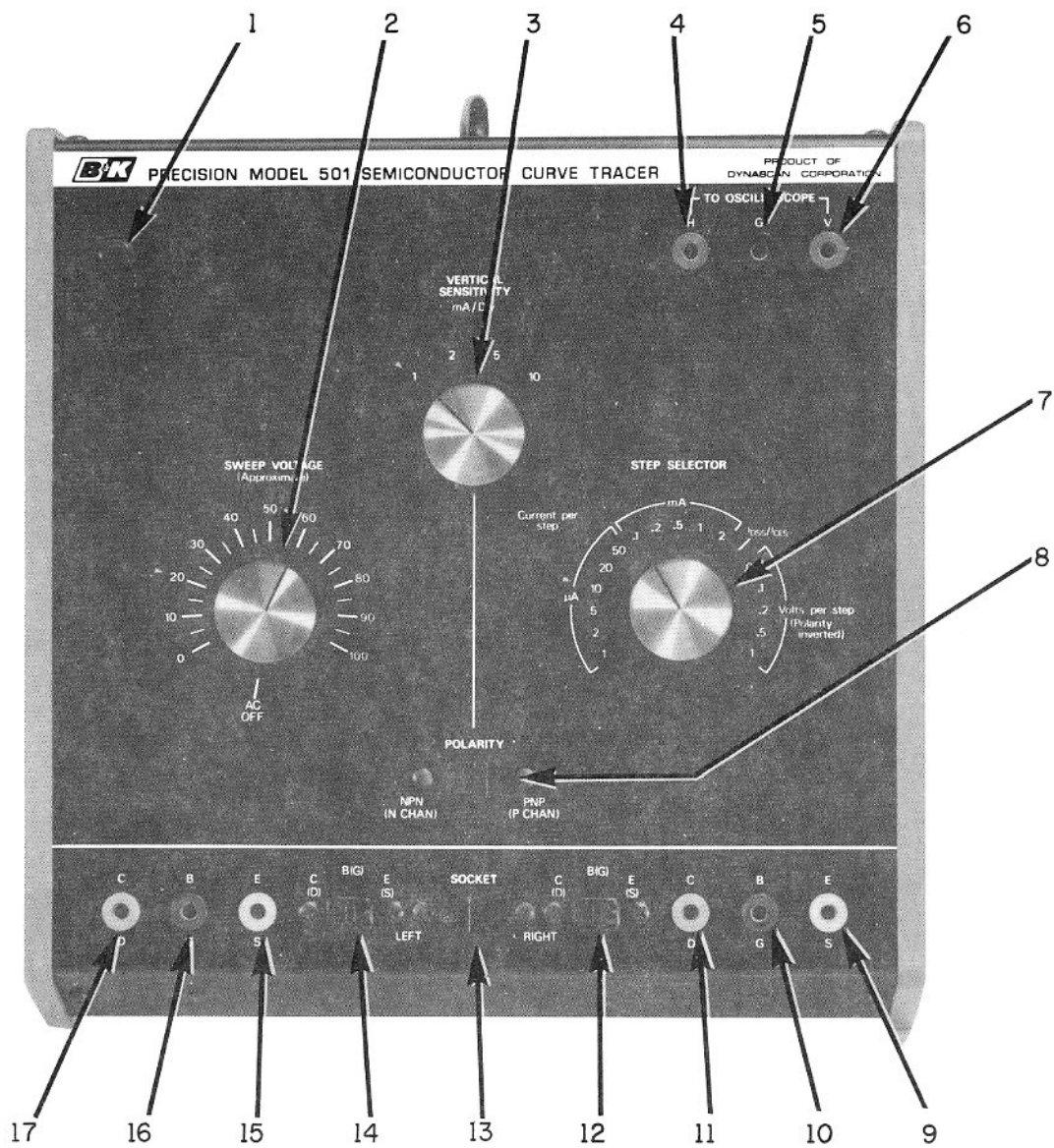

Figure 1. Controls and Operator's Facilities

CONTROLS AND OPERATOR'S FACILITIES

1. Pilot Lamp	Lights when unit is on.	9. E,S Terminal	Connection to emitter or source of semiconductor to be tested. Active when SOCKET switch is in RIGHT position.
2. SWEEP VOLTAGE Control	Combination on-off switch and sweep voltage control. In the completely counter-clockwise AC OFF position, power to the unit is off. Clockwise rotation turns unit on and sets the maximum value of the pulsating voltage at the collector (C) terminals; continuously adjustable from 0 to 100 volts.	10. B, G Terminal	Connection to base or gate of semiconductor to be tested. Active when SOCKET switch is in RIGHT position.
3. VERTICAL SENSITIVITY Switch	Selects the vertical sensitivity of the oscilloscope so the collector current can easily be read. Four scales are provided which equal 1,2,5 or 10 milliamps per division of the graticule scale when the oscilloscope has been calibrated.	11. C,D Terminal	Connection to collector or drain of semiconductor to be tested. Active when SOCKET switch is in RIGHT position.
4. H Terminal	Output of Curve Tracer to horizontal input of oscilloscope.	12. Right Socket	Test socket for plug-in transistor or FET. Active when SOCKET switch is in RIGHT position.
5. G Terminal	Ground terminal to oscilloscope.	13. SOCKET Switch	Selects LEFT or RIGHT socket and terminals for test.
6. V Terminal	Output of Curve Tracer to vertical input of oscilloscope.	14. Left Socket	Same as 12 except active when SOCKET switch is in LEFT position.
7. STEP SELECTOR Switch	17-position rotary switch for selecting current or voltage steps.	15. E,S Terminal	Same as 9 except active when SOCKET switch is in LEFT position.
A. Current Per Step positions	Selects the base current step values. The unit automatically generates base current in five increasing steps. The switch offers 11 selections from 1 μ A to 2 mA per step.	16. B,G Terminal	Same as 10 except active when SOCKET switch is in LEFT position.
B. I_{DSS}/I_{CES} position	Shorts gate to source terminal for measuring "0 Volt" gate bias drain-to-source current and shorts base to emitter terminal for measuring collector-emitter leakage current with "0 Volt" base bias.	17. C,D Terminal	Same as 11 except active when SOCKET switch is in LEFT position.
C. Volts per step positions (Polarity Inverted)	Selects the gate voltage step value for testing FET's. The unit automatically generates gate voltage in five increasing reverse bias steps and offers 5 selections from .05 to 1 volt per step.	18. Graticule	Overlay for oscilloscope screen divides horizontal and vertical display into 10 divisions for calibrated readings.
8. POLARITY Switch	Selects correct polarity for testing NPN or PNP transistors, and N channel or P channel FET's.	19. Probe	Provides simultaneous connection to all three leads of a transistor or FET for convenient in-circuit testing.

OPERATING INSTRUCTIONS

GENERAL DESCRIPTION OF INSTRUMENT OPERATION

The semiconductor curve tracer is essentially a signal generator that generates precision test signals for application to a semiconductor, the results of which are displayed on an oscilloscope. See Figure 2.

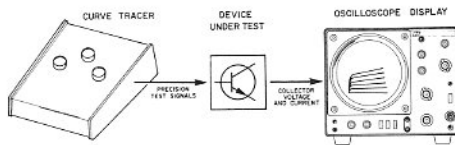

Figure 2. Basic Curve Tracer Operation

The curve tracer generates two signals that are applied to the semiconductor device under test. One signal is a variable amplitude 120-Hz sweep voltage (full-wave rectified DC) which is normally applied to the collector. The other signal consists of constant-current steps which are normally applied to the base. For FET's, constant-voltage steps rather than constant-current steps are generated and applied to the gate.

The 120-Hz sweep voltage is continuously adjustable from 0 to 100 volts peak with the SWEEP VOLTAGE control. This pulsating dc voltage is of positive polarity when the POLARITY switch is set to NPN (N CHAN) and of negative polarity when the switch is set to PNP (P CHAN).

The step generator signal consists of five constant-current steps plus a zero-current step. The STEP SELECTOR switch offers 11 settings from 1 μA to 2 mA per step to match normal operating conditions for a full range of transistor types. For example, with the STEP SELECTOR switch set at 50 μA per step, the current steps are 0, 50 μA , 100 μA , 150 μA ,

200 μA and 250 μA , then repeated. When the POLARITY switch is in the NPN position, the steps are of positive polarity, in the PNP position, negative polarity. In the VOLTS PER STEP positions of the STEP SELECTOR switch, constant-voltage steps are generated for testing FET's. Five selections from .05 to 1 volt per step are offered. The polarity of the voltage steps is inverted in relation to the current steps. That is, the N CHAN position produces negative voltage steps, and the P CHAN position produces positive voltage steps (reverse bias steps are required for testing FET's).

The sweep voltage that is applied to the collector of the transistor is also applied to the horizontal input of the oscilloscope. As the voltage increases from zero to maximum and returns to zero, a horizontal sweep is produced. A precision resistor in series with the sweep voltage source develops a voltage that is proportional to the resultant collector current. The voltage developed across this resistor is applied to the vertical input of the oscilloscope; therefore, vertical deflection represents collector current. Actually, four different precision resistors are included and selected by the VERTICAL SENSITIVITY switch on the curve tracer. This allows greater versatility for displaying a wide range of collector currents.

The steps of the step generator are synchronized with the pulses from the sweep generator. The base current remains at a fixed value while the sweep voltage increases from zero to maximum and returns to zero. The base current then steps to the next higher fixed value while the sweep voltage completes another cycle. The result is a family of six curves, one for each step, with each base current step increase producing a higher collector current. The display is a dynamic collector current (I_c) vs. collector voltage (V_c) graph.

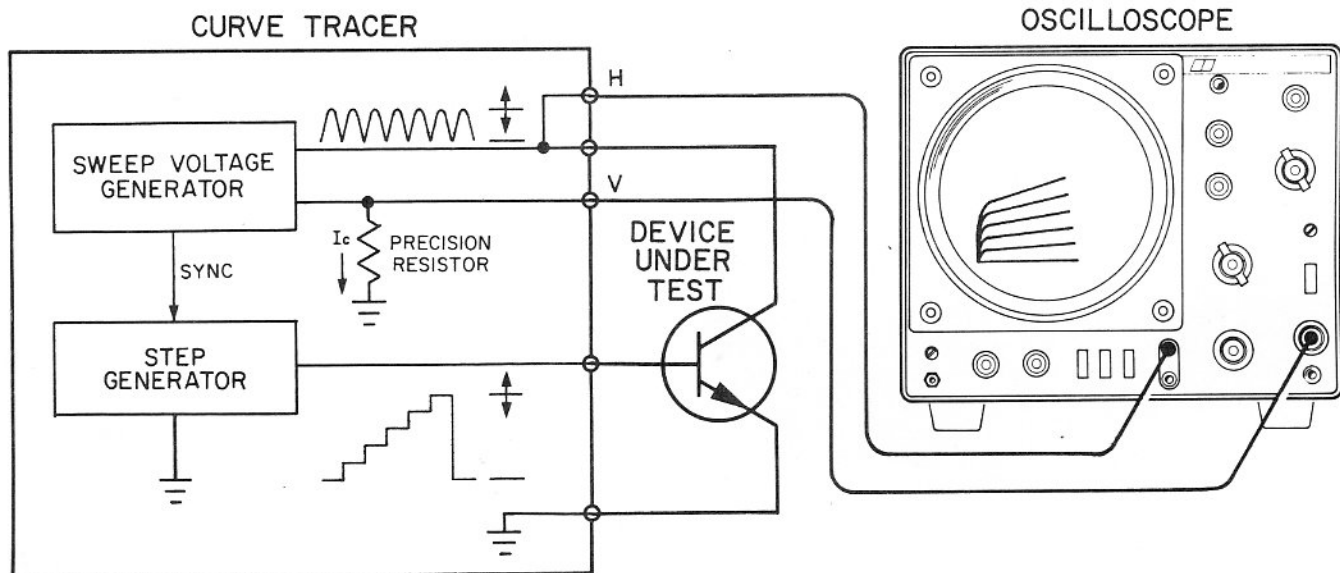

Figure 3. Basic Block Diagram

CURVE TRACER SET-UP

Refer to Figure 4.

1. Connect the plug of the power cord to a 117-volt, 50/60-Hz ac outlet.
2. Set the STEP SELECTOR switch and VERTICAL SENSITIVITY switch to the ▼ marker. This provides a good starting point for all small signal transistors and is low enough to prevent damage, even to very delicate transistors. It is recommended that these controls always be placed

in this "fast set-up" reference position before connecting transistors for test.

3. The SWEEP VOLTAGE control may be turned clockwise to check the AC outlet; the pilot lamp will light indicating that the unit is energized. Always return this control to "0" before inserting a transistor for testing.

The semiconductor curve tracer is now ready to be connected to the oscilloscope.

- ① CONNECT THE POWER PLUG TO A 117 VAC 50/60 HZ OUTLET.
- ② TURN UNIT ON. TO CHECK AC (ALWAYS RETURN TO "0" BEFORE INSERTING A TRANSISTOR FOR TEST.
- ③ ROTATE STEP SELECTOR & VERTICAL SENSITIVITY CONTROLS TO FAST SET-UP MARKERS (▶).

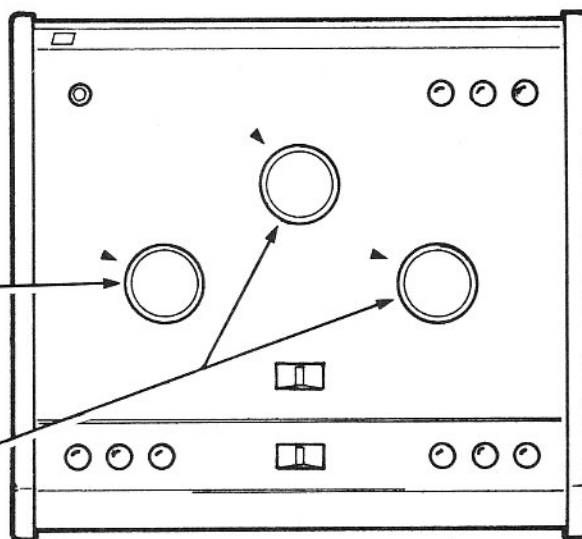

Figure 4. Initial Curve Tracer Set-Up

OSCILLOSCOPE SET-UP AND CALIBRATION

An oscilloscope must be used with the semiconductor curve tracer. Any 3-inch or larger general purpose oscilloscope with external horizontal input is satisfactory. The sweep circuits of the oscilloscope are not used—only the horizontal and vertical deflection circuits. The oscilloscope should have dc coupled circuitry; ac (capacitor) coupling produces trace shift that will distort the display of curves. High-frequency bandwidth, however, is unimportant, just as long as it reaches 10KHz or greater.

To interpret meaningful results from the data displayed on the oscilloscope, the vertical divisions of the graticule must accurately represent the current thru the semiconductor being tested, and the horizontal divisions must accurately represent the sweep voltage applied to the semiconductor being tested; that is, the oscilloscope must be calibrated. This is easily accomplished using the calibration source built into the curve tracer.

Vertical Calibration

The curve tracer requires that the oscilloscope vertical gain be set for 1 volt full scale sensitivity (10 divisions of the special graticule). Once set the display is accurately calibrated for all ranges of the VERTICAL SENSITIVITY switch on the curve tracer. An accurate ($\pm 3\%$) 1-volt p-p source is available at the base (B) jacks of the curve tracer when the STEP SELECTOR switch is placed in the .2 VOLTS PER

STEP position. The voltage steps from 0 to 1 volt in 5 steps of 0.2 volt each (6 steps if 0 volts is counted as a step), resulting in a series of six vertical dots on the oscilloscope screen. The vertical gain should be adjusted so one of the dots coincide with every second division.

A step-by-step procedure follows (refer to Figure 5)

1. Place the special graticule over the screen of the oscilloscope; cut it, if necessary, to fit on oscilloscopes without camera mounting studs.
2. Connect a test lead from the G (ground) jack of the curve tracer to oscilloscope ground.
3. Turn on the curve tracer and oscilloscope.
4. Set the oscilloscope for external horizontal operation, but do not apply a horizontal input at this time. The horizontal input may be grounded if desired.
5. Adjust the oscilloscope horizontal and vertical centering controls, if required, to place a dot in the approximate center of the screen. Do not allow a spot to burn the CRT.
6. Connect a test lead from one of the B (base) jacks of the curve tracer to the vertical input of the oscilloscope. If the left B jack is used, the SOCKET switch must be in the LEFT position, and if the right B jack is used, the SOCKET switch must be in the RIGHT position.

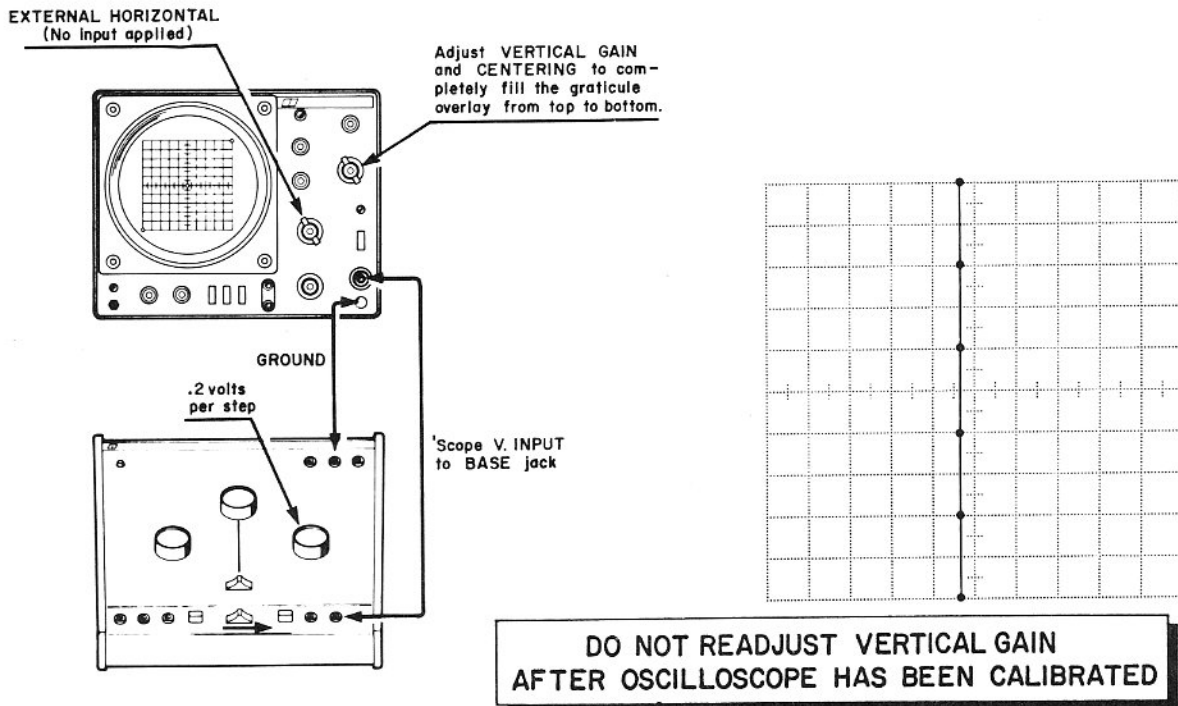

Figure 5. Oscilloscope Vertical Calibration

7. Set the STEP SELECTOR switch of the curve tracer to the .2 volts per step position.
8. The display should resemble that shown in Figure 5, a series of six vertical dots, and possibly a light vertical trace between dots. Adjust the vertical gain of the oscilloscope so the display exactly fills the graticule from top to bottom (10 divisions). Adjust the vertical centering as required.
9. This completes vertical calibration of the oscilloscope. **ONCE THE OSCILLOSCOPE IS CALIBRATED, DO NOT READJUST THE VERTICAL GAIN.** During operation, vertical positioning may be readjusted as required, but the display must be adjusted to the desired size by controls on the curve tracer.

Horizontal Calibration

A horizontal calibration of 1 volt per division can be very accurately obtained using the B (base) jack output of the curve tracer when the STEP SELECTOR switch is in the 1 volt per step position. The voltage steps from 0 to 5 volts in 5 steps of 1 volt each (6 steps if 0 volts is counted as the first step), resulting in a series of six horizontal dots on the oscilloscope screen. The horizontal gain can be adjusted so the dots coincide with 5 divisions of the graticule. This gives a full scale value of 10 volts which is adequate for testing most small signal transistors.

Only slightly less accuracy is obtained by adjusting the horizontal gain for two dots per division, thus giving a full scale value of 20 volts.

For higher test voltages, a less accurate ($\pm 15\%$) method of reading the horizontal voltage is available by connecting the sweep voltage output of the curve tracer (H jack) to the horizontal input of the oscilloscope. This method will produce a horizontal trace rather than the series of dots. The maximum sweep voltage can be set for any desired convenient value,

such as 50 or 100 volts, as read from the SWEEP VOLTAGE dial. The horizontal gain of the oscilloscope can then be set for a full scale horizontal trace (10 divisions of the graticule). Each division then equals 10% of the maximum sweep voltage.

Low Voltage Horizontal Calibration

(Refer to Figure 6)

1. Complete vertical calibration of the oscilloscope as previously described.
2. Leave the oscilloscope set for external horizontal input, and the common ground connected between the curve tracer and the oscilloscope.
3. Disconnect the vertical input from the oscilloscope. Ground the vertical input if desired.
4. Connect a test lead from one of the B (base) jacks on the curve tracer to the horizontal input of the oscilloscope. If the left B jack is used, the SOCKET switch must be in the LEFT position, and if the right B jack is used, the SOCKET switch must be in the RIGHT position.
5. Set the STEP SELECTOR switch on the curve tracer to the 1 volt per step position.
6. The display should resemble that shown in Figure 6, a series of six horizontal dots, and possibly a light horizontal trace between dots. Adjust the horizontal gain of the oscilloscope so the display fills exactly 5 divisions of the graticule. Adjust the horizontal and vertical centering controls as required.
7. This completes horizontal calibration of the oscilloscope at 1 volt per division. **ONCE THE OSCILLOSCOPE IS CALIBRATED, DO NOT READJUST THE HORIZONTAL GAIN.** During operation, horizontal centering may be readjusted as required.
8. To calibrate the horizontal display for 2 volts per division, follow the same procedure except adjust the horizontal gain for two dots per divi-

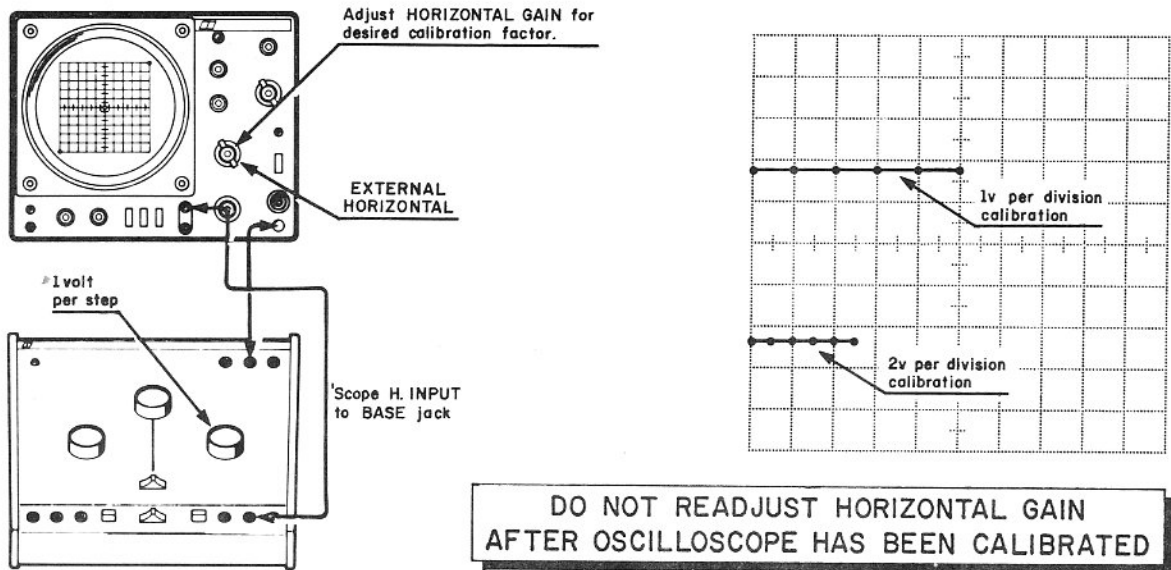

Figure 6. Oscilloscope Horizontal Calibration—Low Voltage

sion. That is, the first, third, and fifth dots exactly coincide with three sequential division markers.

High Voltage Horizontal Calibration

(Refer to Figure 7)

1. Complete vertical calibration of the oscilloscope as previously described.
2. Leave the oscilloscope set for external horizontal input, and the common ground connected between the curve tracer and the oscilloscope.
3. Remove the vertical input from the oscilloscope. Ground the vertical input if desired.
4. Connect a test lead from the H jack of the curve tracer to the horizontal input of the oscilloscope.
5. Set the SWEEP VOLTAGE control to the desired value such as 50 or 100.
6. Adjust the horizontal gain of the oscilloscope for a full scale trace (10 divisions of graticule). Readjust horizontal centering as required.
7. Each graticule division represents 10% of the value at which the SWEEP VOLTAGE control is now set. Do NOT readjust the horizontal gain of the oscilloscope until the horizontal sensitivity is recalibrated to a new value.

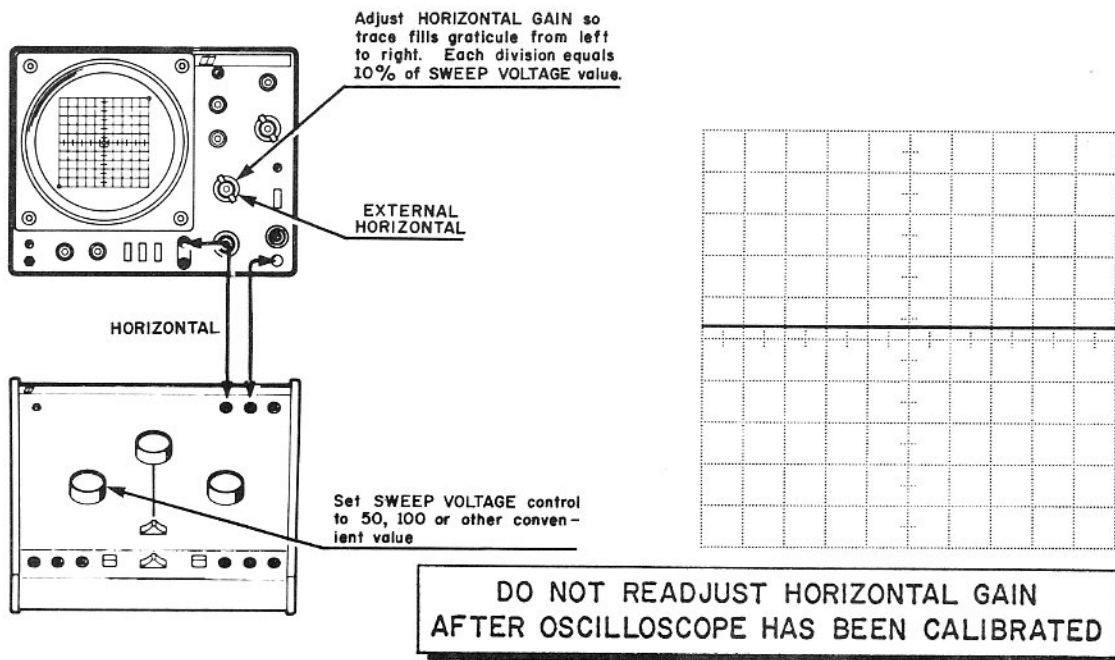

Figure 7. Oscilloscope Horizontal Calibration—High Voltage

Oscilloscope Connections to Curve Tracer

Test leads connecting the curve tracer to the oscilloscope should be set-up as follows:

CURVE TRACER	OSCILLOSCOPE
V jack	Vertical Input
H jack	Horizontal Input
G jack	Chassis Ground

Once the oscilloscope has been calibrated, the calibration steps need not be repeated until the hook-up has been dismantled and made anew, or the setting of the vertical and horizontal gain controls of the oscilloscope have been tampered with. An occasional recheck of calibration is suggested, since it is easy and quick to perform.

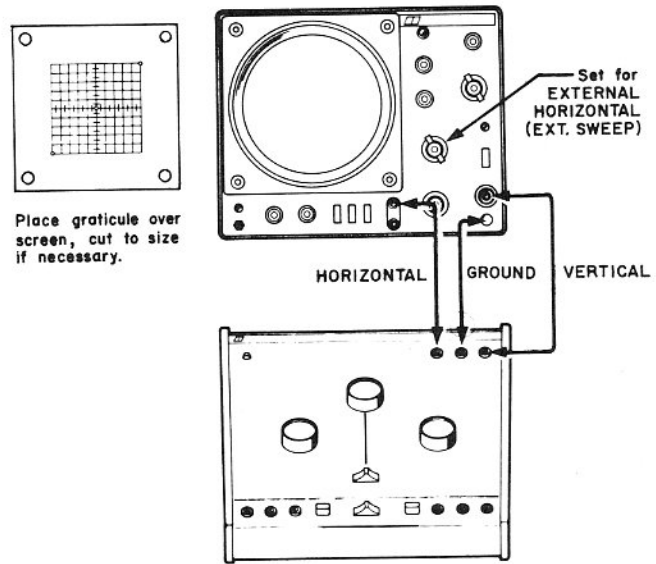

Figure 8. Oscilloscope Connections to Curve Tracer

SEMICONDUCTOR DEVICE CONNECTIONS TO CURVE TRACER

Refer to Figure 9.

Plug-in Transistors

The curve tracer contains two identical sockets into which most small signal transistors or FET's may be inserted. Either the left or right socket may be used, but the SOCKET switch must be in the left position to activate the left socket or in the right position to activate the right socket. This is very convenient for selecting matched pairs because the curve tracer can be instantaneously switched from one semiconductor to the other. The SOCKET switch may also be used to start and stop the test of the semiconductor; merely activate the empty socket to stop the test. This allows complete removal of test signals while inserting and removing semiconductors from the socket.

The collector, base and emitter of the transistor (drain, gate and source of FET) are inserted into the

correspondingly labelled pins of the socket.

- | | |
|---------------|------------|
| C = collector | D = drain |
| B = base | G = gate |
| E = emitter | S = source |

For transistors with a grounded case, the fourth pin can either be inserted into the socket along with the EMITTER lead or externally jumpered to either of the 2 yellow EMITTER jacks.

Non Plug-In Transistors

For power transistors, semiconductors with rigid leads, semiconductors with special lead configuration, or for any other reason that prevents use of the plug-in sockets, test leads may be connected from the C-D, B-G and E-S jacks to the elements of the semiconductor. Two sets of jacks are provided, one set on the left side and one set on the right side

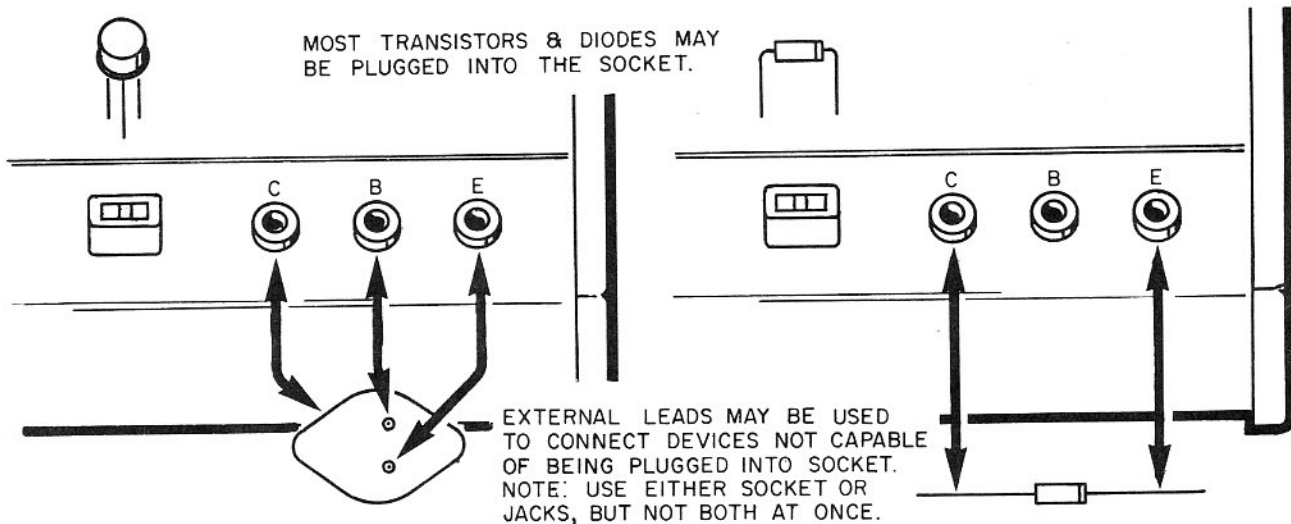

Figure 9. Semiconductor Device Connections to Curve Tracer

of the curve tracer front panel. Either set of jacks may be used. The SOCKET switch activates only the left or right set of jacks at a given time, along with the respective plug-in socket.

The external transistor jacks, FP5 probe tips and plugs have been color-coded for easy identification:

COLOR	TRANSISTOR	FET
blue	collector	drain
green	base	gate
yellow	emitter	source

After a short period of usage, the color-code scheme becomes so automatic that no time is required for lead identification.

In-Circuit Probe

Most transistors in consumer and industrial equipment are mounted on printed circuit boards with the collector, base and emitter quite closely spaced. Measurements in such circuits are normally made from the side opposite the components. The B & K Model FP-5 Probe, supplied with the curve tracer, is ideal for in-circuit testing of semiconductors in such circuits. The probe has three tips which permit contact with the collector, base and emitter (or drain, gate and source of FET) simultaneously and each one pivots to allow for different spacing. Since all three connections can be made using only one hand to manipulate the probe, troubleshooting is accelerated.

COMPLETELY REMOVE POWER FROM EQUIPMENT UNDER TEST. THE CURVE

TRACER SUPPLIES THE COMPLETE TEST SIGNAL. ANY ADDITIONAL SIGNAL OR DC CURRENT MAY INVALIDATE THE TEST RESULTS AND COULD RESULT IN DAMAGE TO THE EQUIPMENT.

To use the probe, connect the plugs of the probe cable to the C-D, B-G and E-S jacks of the curve tracer. Connect the yellow, blue and green plugs to the correspondingly colored jacks. Either the left or right set of jacks may be used; the SOCKET switch selects the set that is activated at a given time. The emitter and collector tips of the probe are slightly longer than the base tip. Normally the emitter and collector connection is made first by holding the probe perpendicular to the circuit board, then tilting the probe until the base tip makes connection. Identify the base, collector and emitter of the semiconductor from the manufacturer's diagrams of the equipment under test.

Diodes

Connections to diodes are made using only the collector-emitter terminals. Polarity is not of particular importance since it is easily reversed with the POLARITY switch. However, if the cathode of the diode is always connected to the emitter terminal, the POLARITY switch is set to PNP for reverse bias and to NPN for forward bias. Reverse bias is applied for testing zener diodes, leakage of signal and rectifier diodes and inverse peak breakdown voltage. Forward bias characteristics show voltage drop across the diode junction and resistive or open conditions.

TYPICAL SEMICONDUCTOR TESTS

Familiarization with the Curve Tracer

To become familiar with using the curve tracer, it is suggested that you gather an assortment of good semiconductor devices and test them one by one, observing the normal results, effects of readjusting the controls, peculiarities of various semiconductors, etc. More specific information on analyzing the displays to accurately measure gain (beta), voltage breakdown, etc., is given later in this manual. At this point, more emphasis should be placed on recognizing normal and abnormal displays and how to set the curve tracer controls to obtain a normal display.

The user should become familiar with the normal results obtained by testing semi-conductors out of circuit before starting to use the curve tracer for in-circuit testing.

Transistors and other semiconductor devices are tested with respect to manufacturer's specification sheets, which state certain conditions of the test and minimum performance standards. It should be realized that it is normal for characteristics of some devices to vary quite widely from one semiconductor to another although they have the same type number. However, manufacturer's specification sheets are not always readily available. Additionally, the manufacturer and type number are not always

easily determined. Nevertheless, the semiconductors may be tested and determined to be good or bad. In fact, the test will help identify or categorize the semiconductor. Most transistor failures are of the catastrophic type, wherein it will be shorted or open. The curve tracer will immediately show such failure. It will also immediately identify a good transistor of unknown type as NPN or PNP. The normal operating current range can be rapidly determined and, with experience or reference data, the device can be categorized.

Transistor Testing Procedure

A typical test of a transistor follows: (refer to Figure 10):

1. Turn on the curve tracer and oscilloscope. Calibrate the oscilloscope if not already calibrated.
2. Set the VERTICAL SENSITIVITY and STEP SELECTOR controls to the "fast set-up" markers (▲). Set the SWEEP VOLTAGE control to zero.
3. Plug the transistor into the left or right socket on the curve tracer, or connect test leads from the left or right C, B and E jacks to the collector, base and emitter of the transistor. Set the SOCKET switch to select the socket or jacks in use.
4. Set the POLARITY switch to NPN or PNP to

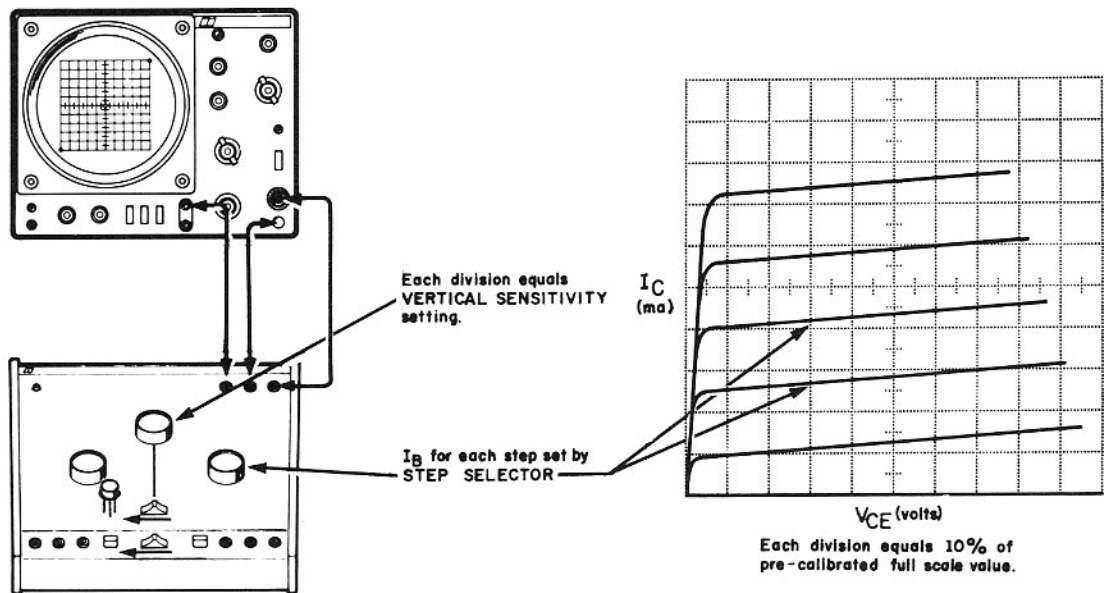

Figure 10. Typical Test of an NPN Transistor

match the transistor type. Slowly increase the SWEEP VOLTAGE control until a complete display appears on the oscilloscope screen. If the type of the transistor is undetermined, do not exceed the "fast set-up" marker of the SWEEP VOLTAGE control (20V) if a display does not appear; return the SWEEP VOLTAGE to zero, reverse POLARITY, and slowly increase the SWEEP VOLTAGE again until a complete display appears.

- Adjust the centering controls of the oscilloscope to properly position the family of curves. For

NPN transistors, the display should be positioned so the curves start at the left hand bottom corner of the graticule scale. For PNP transistors, the display should be positioned so the curves start at the right hand top corner of the graticule scale (see Figure 11).

- If the transistor is shorted there will only be a vertical trace (see Figure 12). The current (vertical trace) increases sharply to the current limiting value determined by the curve tracer. There is no family of curves, since the value of base current applied has no effect.

NPN

PNP

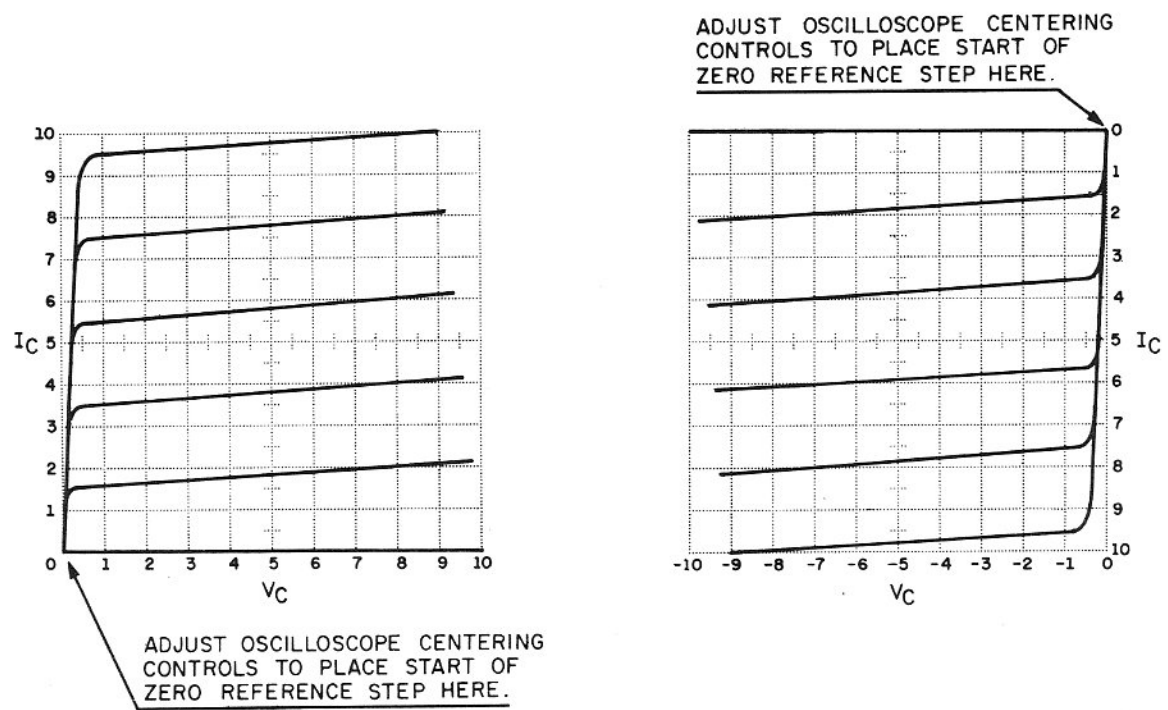

Figure 11. Characteristic Curves of NPN vs. PNP Transistors

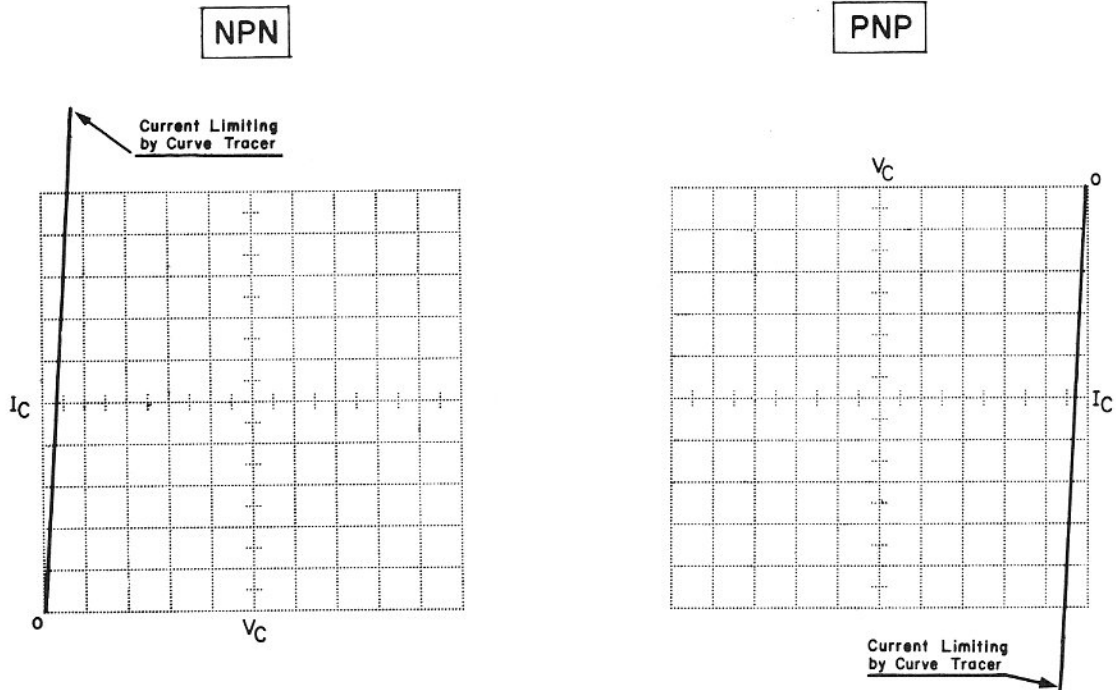

Figure 12. Shorted Transistor Curves

- If the transistor is open, there will be a horizontal trace only, since no collector current will flow. (see Figure 13).

Effects of Curve Tracer Controls

POLARITY switch—If the POLARITY switch is set to the wrong polarity, the oscilloscope will display reverse breakdown characteristic of the transistor base-emitter junction (See *Sorting and Matching Transistors*).

For familiarization, check several transistors, placing the POLARITY switch in both the correct and incorrect positions and observing the results.

SWEEP VOLTAGE control—The SWEEP VOLTAGE control adjusts the peak collector voltage (V_C) and, thereby, the horizontal width of the display.

Increasing the setting widens the display and may cause the display to go off-scale. Decrease and increase the setting of the control and note the effect upon the display. If increasing the setting drives the display off-scale, recalibrate the oscilloscope horizontal axis to a higher voltage. As the sweep voltage is increased, collector breakdown will be observed on the oscilloscope display. The current limiter in the curve tracer prevents damage to the transistor. Collector breakdown is observed as a sharp turn in the curves (sharp increase in collector current). Most tests are conducted below collector breakdown voltage. After observing the effects of collector breakdown, reduce the setting somewhat below the breakdown point. (Refer to the "Breakdown Voltage Measurement" portion of this manual

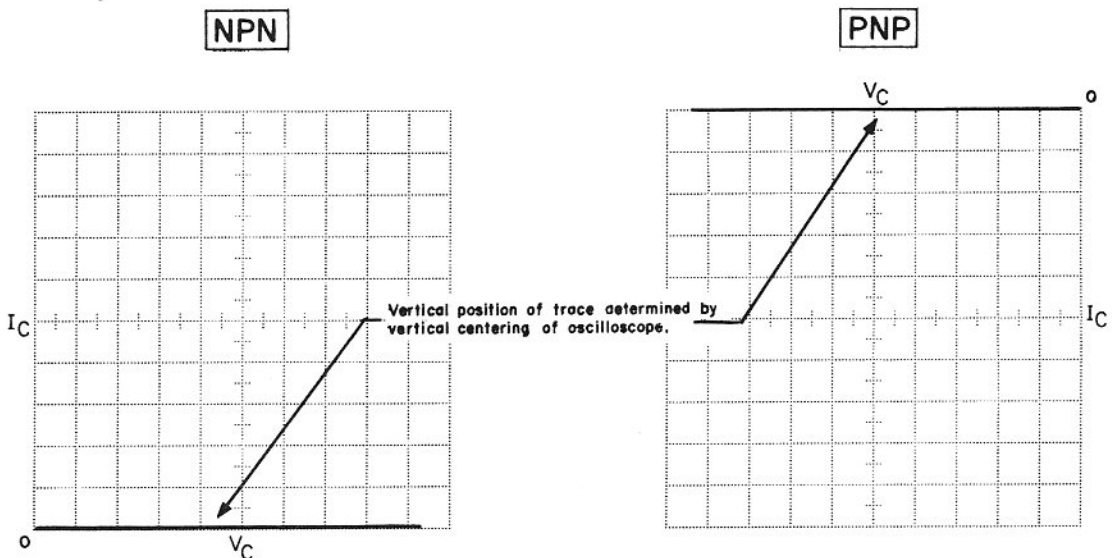

Figure 13. Open Transistor Curves

for more detail).

VERTICAL SENSITIVITY—The setting of the VERTICAL SENSITIVITY control is determined primarily by physical size of the transistor or semiconductor being tested. Most small signal transistors, including most small plastic case transistors, should be tested at the 1 mA/Div position. Some small signal transistors, including several metallic case transistors, should be tested at the 2 mA/Div position. The 5 mA/Div and 10 mA/Div positions are primarily for power transistors. The 5 mA/Div is for low to medium power transistors and include most plastic case power transistors and those with self-contained heat radiating cases. High power transistors should be tested at 10 mA/Div. Power transistors may be tested without their usual heat sinks if testing is limited to a few seconds; just long enough to make the reading. It is especially important to keep testing time short during periods of voltage breakdown and current limiting to prevent overheating and thermal runaway damage.

The curve tracer employs current limiting in the collector voltage supply to prevent damage to the transistor being tested. However, the point of current limiting is increased with each step of the VERTICAL SENSITIVITY control. Thus, the lowest acceptable setting of the control must be used to protect small transistors. Start with the lowest position (1 mA/Div) and increase to a higher setting only as necessary.

STEP SELECTOR—The STEP SELECTOR switch selects the base current steps. The approximate setting of this control also is somewhat related to the physical size of the transistor. The fast set-up position (10 μ A per step) is a good starting point for most signal transistors. Very High-gain small signal transistors will require a lower setting. Large signal and power transistors will require a higher setting.

If transistor specification sheets are available, it is desirable to use the manufacturer's data and set the STEP SELECTOR to produce the specified collector current where Beta is to be measured. If data sheets are not available, the general rule is to adjust the STEP SELECTOR for the most curves displayed

on the VERTICAL SENSITIVITY range being used. If the setting is too high, some of the curves may reach the current limiting value and be superimposed on each other, causing less than five curves to be displayed. When more than one position displays all five curves, select the position that produces the most even spacing between curves.

The Volts per Step positions are for testing FET's. In these positions, step polarity is reversed with respect to the sweep voltage. The method of adjustment is the same; set for the maximum number of curves and the most even spacing between curves on the vertical range being used.

Sorting and Matching Transistors

A better method of oscilloscope set-up simplifies sorting and matching of transistors when the types are mixed or unknown. This technique is especially helpful when trying to match the gain of two opposite polarity devices (NPN vs PNP).

1. Calibrate the oscilloscope vertical axis for 1 volt full scale and the horizontal axis for 30 volts full scale.
2. Adjust the oscilloscope positioning controls to place the CRT trace (dot, with no inputs) within the center circle of the special graticule.
3. Adjust 501 SWEEP VOLTAGE until the trace sweeps out to either edge of the graticule, depending on which position the POLARITY switch is set.
4. Set VERTICAL SENSITIVITY to the 2 mA position.
5. Set STEP SELECTOR to the 10 μ A position.

NPN transistors will now display curves in the upper right-hand quarter of the graticule, and PNP in lower left-hand quarter. The polarity of an unknown device can immediately be determined by inserting it into either socket, switching to that socket, and throwing the 501 POLARITY switch back and forth until curves appear, noting its position (See Figure 14). Once curves are displayed, the STEP SELECTOR may need readjustment to bring all 6 into view on the screen. Note that when POLARITY is set to PNP for an NPN device and vice versa, a

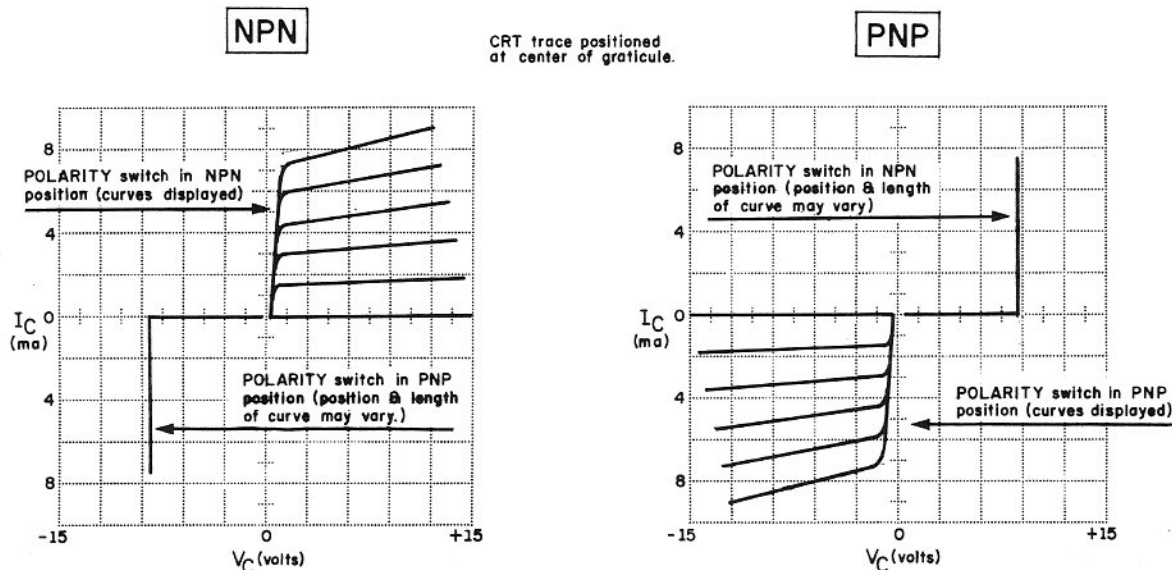

Figure 14. Determining Transistor Polarity

single curve appears on the screen opposite to where normal curves appear. This represents base-emitter breakdown voltage of the device under test.

Matching two complementary devices may be accomplished by inserting the PNP unit in the right socket and the NPN unit in the left socket. Simultaneously switch both the 501 POLARITY and SOCKET switches in unison while watching the CRT display. When the devices are matched, both sets of curves will appear to be the same, only opposite in polarity. The technique is similar if the external transistor jacks are used (Figure 15).

In-Circuit Transistor Testing

It is possible to use the semiconductor curve tracer as an analysis tool for determining the condition of a transistor in-circuit. Although quantitative measurements are not possible, a GO/NO-GO test of device can be performed. The curves obtained using this method most often appear badly distorted due to in-circuit impedances (capacitors, resistors, inductors, etc.), but if properly interpreted, they will at least indicate transistor action. However, some devices will not produce in-circuit curves, or may produce curves that are totally inaccurate. For example, a transistor used as a series pass regulator will test "shorted" because the large value filter capacitors around it act as a low impedance to the curve tracer sweep signal. Another example is where all the curve tracer step drive signal is shunted away by a very low in-circuit base-emitter resistance. In these cases, it is best to remove the device for out-of-circuit testing.

The in-circuit probe supplied with this instrument is ideal for making contact to transistors mounted on P.C. Boards. Refer to the "In-circuit Probe" section for more information.

When performing in-circuit tests use the fast set-up markers on the 501 front panel as a starting point. Since circuit impedances may shunt away base drive to the device under test, it may be necessary to re-adjust the STEP SELECTOR to produce curves. The SWEEP VOLTAGE, however, should not require re-adjustment throughout testing. Also, it is not recommended that breakdown voltage tests be performed with the device in-circuit.

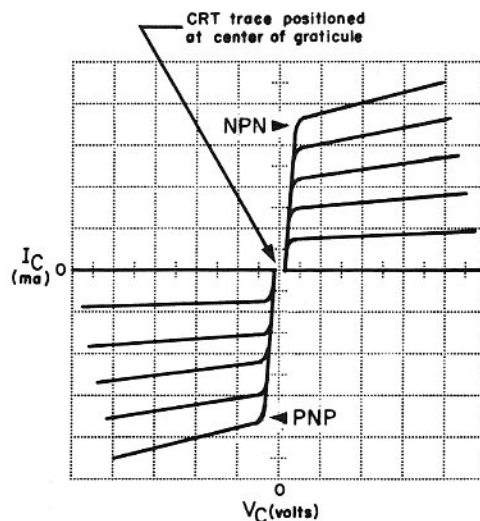

Figure 15. Matching NPN and PNP Transistors

CAUTION:

COMPLETELY REMOVE POWER FROM THE EQUIPMENT UNDER TEST.

Figure 16 illustrates some typical in-circuit curves of normally functioning transistors. The loops on the NPN curves are caused by capacitance in the device's collector leg. Note, though, that 5 loops and a baseline can be seen. This indicates that every base step produces a definite collector current, meaning the device is probably good. The PNP curves, taken from a transistor in an oscillator circuit, indicate severe leakage even though device has none. The best way to interpret in-circuit curve displays is through experience. Practice with several types of circuits and devices to obtain a general idea of good vs bad in-circuit semiconductors.

Greater precision for in-circuit testing with the curve tracer can be obtained if the normal waveform display of each stage is available for comparison to the results obtained. A list of test conditions should accompany the reference display; that is, sweep voltage, current per step, oscillator calibration, etc. Such comparisons go one step further than go no-go tests and allow abnormal conditions such

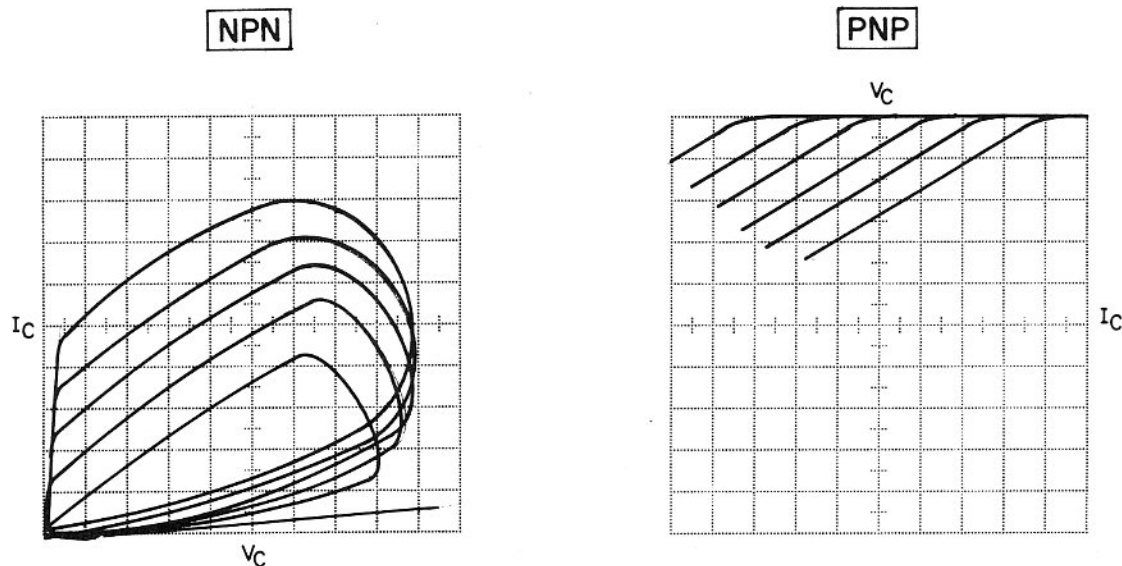

Figure 16. In-Circuit Transistor Curves

as insufficient gain to be detected. Until equipment manufacturers begin to supply such information on their schematics or servicing diagrams, servicemen must rely on the go no-go test or develop their own

reference files of normal waveform displays. For shops which specialize in servicing a specific brand of solid state products, the time required to produce a reference file may be well worthwhile.

CURVE TRACER APPLICATIONS

TESTING BIPOLAR TRANSISTORS

The most common application of the B & K Model 501A Semiconductor Curve Tracer is the testing of NPN and PNP junction transistors made of either germanium or silicon. The instrument will accurately measure several parameters of such transistors under dynamic conditions. Range adjustments allow measurements from the smallest signal transistor to high current power transistors. An extensive list of parameters include:

- Current Gain (DC and AC beta)
- Collector-emitter breakdown
- Collector-base breakdown
- Base-emitter reverse breakdown
- Output admittance
- Saturation Voltage
- Saturation Resistance
- Cutoff current
- Leakage current
- Linearity and distortion
- Effects of temperature
- Identification of germanium or silicon
- Matching
- Sorting and substitution

The application and analysis of results described in this section of the manual assume the use of previous "Operating Instructions" for properly connecting the transistor and setting controls to obtain a display of a family of curves. However, the following precautions should be observed:

PRECAUTIONS

1. Keep the SWEEP VOLTAGE control below collector breakdown level except during the short period of a collector voltage breakdown test. Although the current limiter prevents destruction of the transistor, high internal temperatures from longer periods of operation may cause failure.

CURRENT GAIN MEASUREMENT

The current gain of a transistor is its single most important characteristic and is usually measured before any other tests are performed. The general condition of a device can most often be determined while testing for current gain.

Transistors are said to amplify because a small change in base current causes a proportionately larger change in collector current. The ratio of change, called "current gain", is stated numerically. A current gain of 100 means that a base current change of 1 part will produce 100 parts of collector current change. More specifically, current gain can be measured two ways:

- a. DC current gain (symbolized h_{FE})—also known

2. Limit testing of power transistors without heat sinks to a few seconds, just long enough to accurately make a reading. Excessive temperatures may result from longer periods of operation. Tests may be stopped and started without disconnecting the transistor by using the SOCK-ET switch.
3. Keep the VERTICAL SENSITIVITY control as low as will adequately perform the test. The higher settings use higher values of current limiting which could damage small transistors. It is good practice to return the VERTICAL SENSITIVITY to the 1 mA/Div position after each test so that the next test begins with full protection.

NPN vs PNP Transistors

As described previously in the "Typical Test" section, the family of curves of an NPN transistor is in a positive direction. That is, zero volts is at the left and zero current is at the bottom of the display. The curves sweep to the right and upward as collector voltage and current increases from zero. The collector sweep voltage is of positive polarity.

The family of curves of a PNP transistor, by contrast, is in the negative direction. That is, zero volts is at the right and zero current is at the top of the display. The curves sweep to the left and downward as collector voltage and current increase from zero. The collector sweep voltage is of negative polarity.

All transistor measurements described in this manual apply equally to NPN and PNP transistors. Any examples showing only an NPN or PNP type should be understood to apply to its counterpart as well; basic characteristics of both types are the same. Their displays are merely inverted with reference to one another. Therefore, any measurement that can be made for NPN transistors can also be made for PNP transistors and vice versa.

as static current gain, DC beta or static forward current transfer ratio.

- b. AC current gain (symbolized h_{fe})—also known as dynamic current gain, AC beta or small-signal short circuit forward current transfer ratio.

Note the difference in symbols for both types. The DC parameter subscript is written in capitals; the AC parameter subscript in lower case letters, so as to distinguish between the two. For convenience purposes, this manual will refer mainly to DC beta and AC beta respectively. Lastly, "beta" is often symbolized by the lower case Greek alphabet letter β .

DC Current Gain (DC beta)

The DC or static current gain of a transistor is defined as the ratio of collector current to base current measured at one specific point of collector voltage and current (hence the term "static" meaning stationary). The validity of this test is dependent upon the point of measurement and this point is usually specified on manufacturer's data sheets; it most often centers about the typical operating range for which the device was designed. The following is an example:

CHARACTERISTIC	SYM	MIN	TYP	MAX	UNIT
DC Current Gain	h_{FE}	40	125	400

$I_C = 5\text{mA}$, $V_C = 10\text{V}$

The conditions of test are clearly defined under "DC Current Gain" as a collector current (I_C) of 5 mA and a collector voltage (V_C), of 10 volts. Since current gain can vary substantially between devices of even the same type, minimum-maximum conditions are usually specified. Note that in the example, gain can vary by 10 to 1.

Figure 17A demonstrates the technique for measuring DC beta. The point of measurement has been conveniently centered on the graticule by using 1 mA/Division vertical and 2 Volts/division horizontal calibration. With the STEP SELECTOR set at 10 μA , the third curve (30 μA) just happens to pass thru the measurement point. It is now obvious that 30 μA of base current produces 5 mA of collector current at the 10 volt collector point. Using the simple formula:

$$\text{DC beta} = \frac{I_C}{I_B} = \frac{5 \text{ mA}}{.03 \text{ mA}} = 166$$

The only difficulty that may be encountered is conversion of units used in the calculation. Remember that 1000 $\mu\text{A} = 1 \text{ mA}$ or similarly, .001 mA = 1 μA .

The example in Figure 17B demonstrates how to

calculate DC beta even though none of the curves pass through the measurement point. Simply approximate the percentage of distance between the curves above and below the point; use it as a "percentage" of one step to obtain total base current when added to the number of current steps below the point. In the example, the measurement point is above the 20 μA base step, yet below the 30 μA step. If its position is approximated, it can be thought of as 30% of the distance between 20 and 30 μA , or 23 μA total.

AC Current Gain (AC beta)

The AC or dynamic current gain of a transistor is defined as the ratio of change in collector current to the change in base current at a specified collector voltage. This measurement is ultimately more useful than DC beta because the transistor is tested under actual operating conditions and from it, performance can be predicted. AC beta may be calculated from the display of curves as follows (refer to Fig. 18):

1. Measure the difference in collector current (ΔI_C) between two curves of the display. The setting of the VERTICAL SENSITIVITY control shows the amount of collector current represented by each vertical division of the graticule scale. Be sure that both readings are taken at the same collector voltage (V_C). Each horizontal division of the graticule scale represents a specific collector voltage. Make both readings at one of the horizontal division markers.
2. Note the change in base current (ΔI_B) from the STEP SELECTOR control. Each step produces one of the curves of the display. Therefore, for the 10 μA position, ΔI_B equals 10 μA between two curves of the display.
3. Calculate beta by dividing ΔI_C by ΔI_B . For example: if ΔI_C equals 2 mA and ΔI_B equals 10 μA , beta equals 200.

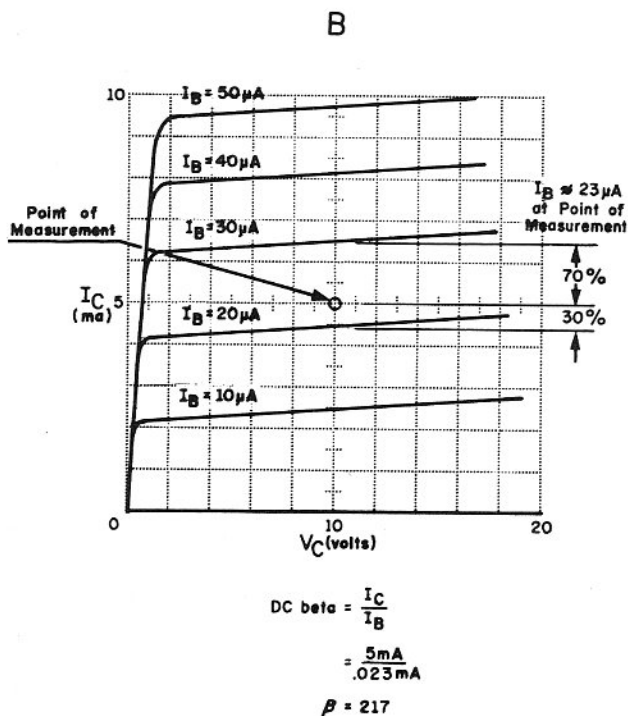
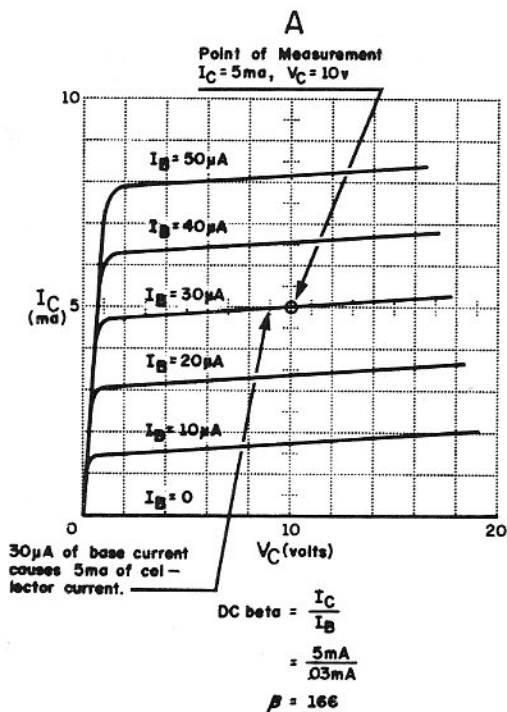

Figure 17. DC Current Gain (DC Beta) Measurement

$$AC \text{ beta} = \frac{\Delta I_C}{\Delta I_B} = \frac{2 \text{ mA}}{.01 \text{ mA}} = 200$$

The ΔI_C measurement is usually made between the centermost curves of the display. The ΔI_C measurement may be made between two non-adjacent curves if desired. For example, the difference between the collector current of the second and fourth curves may be used for measurement of ΔI_C . If this method is used, be sure to include two steps of base current for determining ΔI_B when calculating beta (refer to Fig. 18B).

If the transistor data sheet is available, beta should be measured at the approximate collector current and voltage specified. If not, the STEP SELECTOR is usually adjusted for a display of the most evenly and widely spaced curves.

Summary of Transistor Current Gain

Note that the beta of a transistor is not constant, but is dependent upon the point of measurement. The distance between all curves is seldom equal, which means that ΔI_C is not the same at various regions of base current and, to some lesser extent, at various collector voltages. Base current values that produce curves that are closer together are in the region of lower gain. Gain is usually higher in the normal operating region of the transistor and is lower at collector currents above or below the normal operating region.

Current Gain Linearity vs. Distortion

Measuring the linearity and distortion of a transistor is an extension of the gain or beta test. As pointed out in the beta test procedure, beta is not necessarily constant, but may vary with collector current. When such variation of gain occurs, the transistor is non-linear and will introduce distortion if operated in the non-linear region. Typically,

transistors have lower current gain at high values of collector current as shown in Figure 19A. This is apparent by the fact that the curves are closer together at higher collector current. Each base current step has precisely the same amount of increase, which should cause the collector current curves to be separated by equal amounts if the gain were constant. When gain decreases, the curves are closer together. Some transistors have an opposite characteristic in that their gain increases at high values of collector current (Figure 19B). A few transistor types have nearly uniform gain over a very wide range of collector current. Such transistors have low distortion and a wide region of linearity. The curves from such transistors are equally spaced.

Not all applications require that the transistors have good linearity and distortion-free characteristics. Examples are switching transistors, some class C amplifiers, and frequency multipliers. In fact, some applications require non-linearity and depend upon this characteristic for operation. Of course, most class A and B amplifiers, including audio and video amplifiers, do require linear and distortion-free operation over the dynamic range of the input signal. For most small signal applications, a linear region can usually be found. For larger signals, a wider linear region is required.

To measure linearity and distortion, adjust the STEP SELECTOR control for the most evenly spaced curves of the display, or so that the centermost curves of the display are the most evenly spaced. Note that it will not be possible to obtain evenly spaced curves for some transistor types. Set the sweep voltage to approach, but not reach, collector breakdown. Note that the curves are somewhat shorter at higher collector currents. Plot an imaginary line along the ends of the curves as shown in Figure 20. This line is called the "Test Load Line". Plot an "Operating

$$AC \text{ CURRENT GAIN } (h_{fe}) = \frac{\Delta I_C}{\Delta I_B}$$

$$\beta = \frac{\Delta I_C}{\Delta I_B} \quad \beta = \frac{2 \text{ mA}}{10 \mu\text{A}} \quad \beta = 200 \text{ at } V_C \text{ of } 5 \text{ volts}$$

$$\beta = \frac{\Delta I_C}{\Delta I_B} \quad \beta = \frac{3.5 \text{ mA}}{20 \mu\text{A}} \quad \beta = 175 \text{ at } V_C \text{ of } 5 \text{ volts}$$

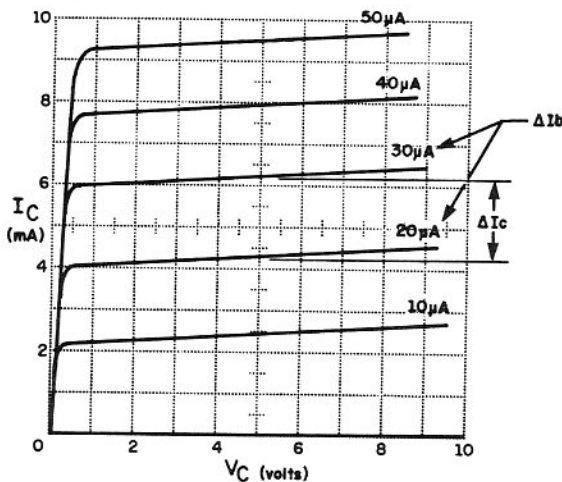

A

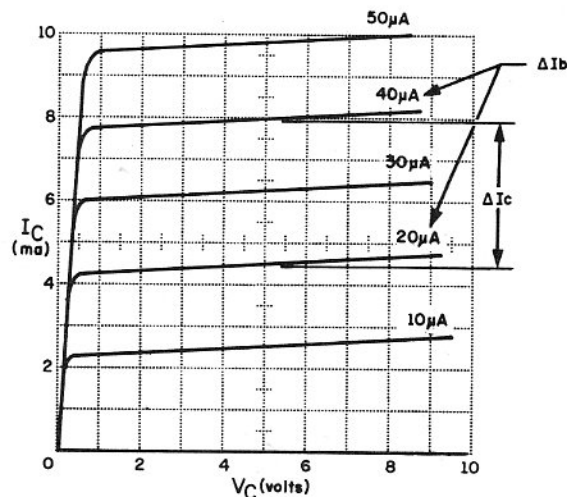

B

Figure 18. AC Current Gain (AC Beta) Measurement

Load Line" in parallel with the test load line, but intersecting the zero I_C line at the rated operating V_C for the transistor. Pick three successive curves which represent the normal operating base current region for the transistor, probably those with the most even spacing. Measure and compare the change in collector current (ΔI_C) between the curves along the operating load line. If, for example, measurements are made between the 1st, 2nd and 3rd curves, measure the ΔI_C between the 1st and 2nd curves, then between the 2nd and 3rd curves. Finally, compare the two measurements of ΔI_C . If the ΔI_C are equal, the transistor is operating

in a linear region and does not introduce distortion. If ΔI_C 's are imbalanced, distortion will be introduced due to this non-linearity. The greater the imbalance, the greater the distortion.

The distortion measurement can be analyzed by examining the application of a signal such as a sinusoidal wave to the transistor which has its family of curves displayed in Figure 20. Assume a quiescent state bias of $20 \mu\text{A}$ and a $20 \mu\text{A}$ peak-to-peak signal variation, $10 \mu\text{A}$ above and below the $20 \mu\text{A}$ static bias. As the signal swings positively, to an instantaneous base current of $30 \mu\text{A}$ (3rd curve), the collector current increases from 4 mA to

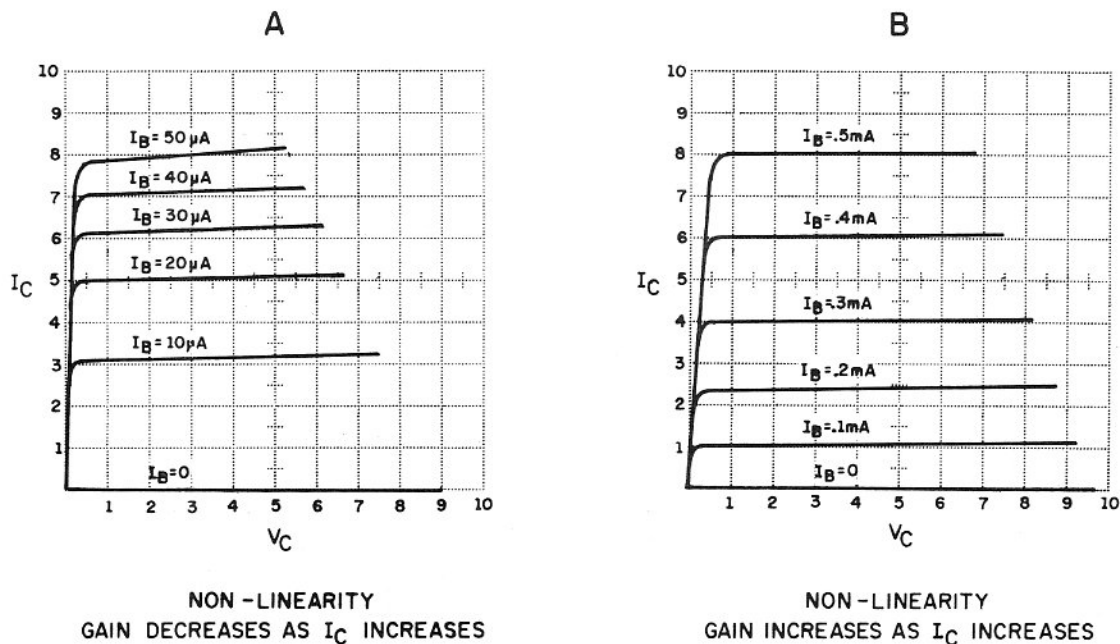

Figure 19. Current Gain Non-Linearity

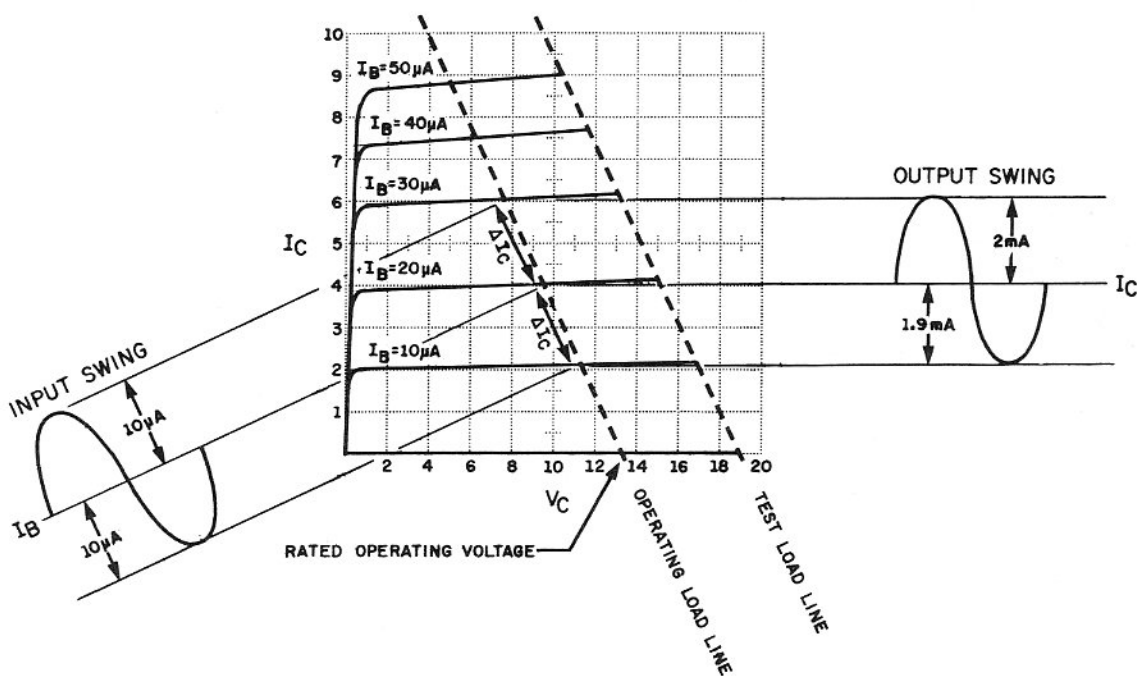

Figure 20. Measuring Current Gain Non-Linearity

6 mA, a 2mA change. As it swings negatively to 10 μ A (1st curve), the collector current decreases for 4 mA to 2.1 mA, a 1.9 mA change. Out of the 3.9 mA total collector current swing, the imbalance between the positive and negative swing is 0.1 mA. This amounts to approximately 2½% distortion (0.1 mA \div 3.9 mA = .0256), acceptable for some applications—not acceptable for others.

The measurement should be taken along the operating load line rather than at a specific V_C , because it more nearly duplicates the dynamic conditions of

operation. The transistor will operate with a load, not at a specific fixed V_C . The load causes operation along the load line, since an increase in collector current will reduce collector voltage and vice versa. With transistors which exhibit near horizontal collector current curves such as shown in Figure 19B, there is little difference between using the load line or a specific V_C . However, in transistors with more slope to the collector current curves, the collector voltage affects the collector current and could produce considerably different results in the linearity and distortion measurement.

BREAKDOWN VOLTAGE MEASUREMENT

As sweep voltage is increased, a collector breakdown will be reached. The value at which this occurs depends upon the transistor type. The curve tracer tests breakdown up to 100 volts, which is sufficient to test all but the high voltage rated transistors. At collector breakdown voltage, the collector current becomes independent of base current and rises sharply to the current limiting protection limit of the curve tracer. Except for this feature of the curve tracer, the transistor would be destroyed by the test. Figure 21 shows a typical family of curves with the sweep voltage set high to cause collector breakdown. In the examples shown in the figure, breakdown occurs at a collector voltage of approximately 40 volts for both transistors. Note that base current has little effect upon the point at which the increase in collector current occurs. Keep the test as short as possible to prevent excessive temperature damage to the transistor. Even with current limiting, the current value is much higher than normal and causes temperature increase. If operated in this condition for an extended period, damage could occur. Be sure the VERTICAL SENSITIVITY control

is in a proper range for the type of transistor being tested. If the setting is too high, the current limiting action may be too high to protect the transistor.

Figure 21. Typical Transistor Breakdown Curves

1. To perform the measurement, first adjust for a normal family of curves on the display. This display should not fill the graticule scale horizontally.
2. Next, increase the SWEEP VOLTAGE control until the upturn in collector current at the tail of the curves is observed. This upturn will be very sharp for most transistors, but more gradual for other types.
3. Read the collector voltage value at which the upturn occurs. Read this value from the horizontal graticule scale. If a breakdown voltage specification for the transistor is available, use the figure to determine whether or not the transistor is acceptable. If specifications are not available, a good rule of thumb is that the transistor should withstand approximately twice the collector supply voltage of the circuit in which it is to be used.

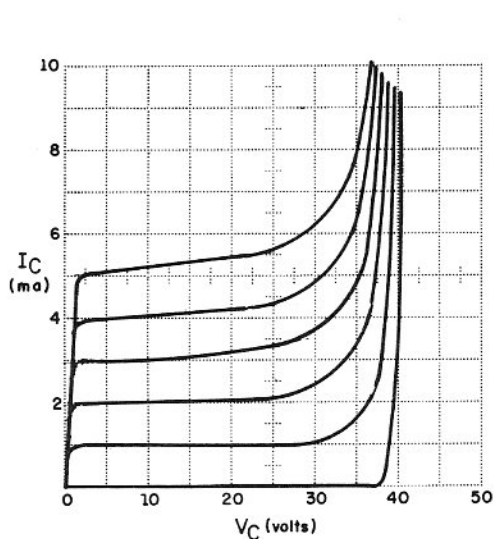

ABRUPT BREAKDOWN

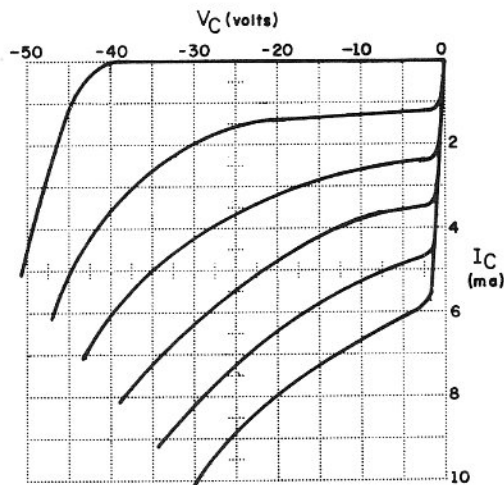

GRADUAL BREAKDOWN

Figure 21. Typical Transistor Breakdown Curves

LEAKAGE MEASUREMENT (I_{CEO})

Collector leakage current is the collector-to-emitter current that flows when the transistor is supposed to be completely off. If the transistor is leaky, increasing collector voltage causes the collector current to increase independently of the base current. Germanium transistors normally exhibit some amount of leakage, but silicon transistors should exhibit no measurable amount of leakage. When measured in relation to specification data, tests should be made at the indicated collector voltage and temperature. Leakage current is normally temperature dependent.

Leakage can be measured by observing the zero base current line (neglect the remainder of the family of curves). Any sloping of this line indicates a leakage current (See Figure 22). However, a situation can occur that will cause apparent leakage current even though the device under test has none. The horizontal input of the oscilloscope used in conjunction with the curve tracer will produce an actual leakage current because it is connected across the collector-emitter terminals. Typically, 100 K Ω impedance will cause 1 mA of apparent leakage at 100V. This can be taken into account by switching the

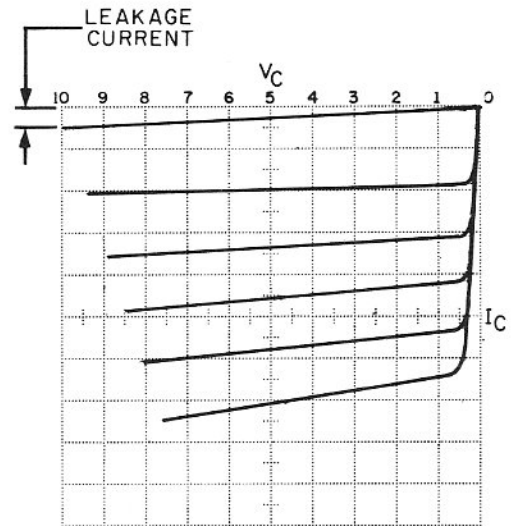

Figure 22. Leakage Current Measurement

transistor under test in and out while watching for movement in the baseline.

SATURATION VOLTAGE [$V_{CE(sat)}$]

The collector saturation region of a transistor is that portion of the family of curves in the area of low collector voltage and current below the knee of each curve. Notice that the knee of each curve occurs at approximately the same collector voltage, regardless of base current. Notice, also, that collector voltage above the knee has little effect upon collector current and base current has the predominant effect. Saturation voltage, $V_{CE(sat)}$, is the collector voltage at the knee of the curve. For measurement in comparison to specifications, base current and collector current should be stated. The specification value is the maximum value at which the knee should occur. Therefore, if the specification value is on or above the knee, the transistor is acceptable.

To measure saturation voltage on the curve tracer, only the saturation region need be displayed. This is the low collector voltage portion up to and including the knee of each curve. The display should be "spread out" using a low voltage horizontal calibration, such as 0.2 volt per division, to accurately measure the low collector voltage value.

Saturation resistance, $r_{CE(sat)}$, can be calculated if desired. It equals the collector voltage divided by collector current for a given value of base current in the collector saturation region.

$$r_{CE(sat)} = \frac{V_C}{I_C}$$

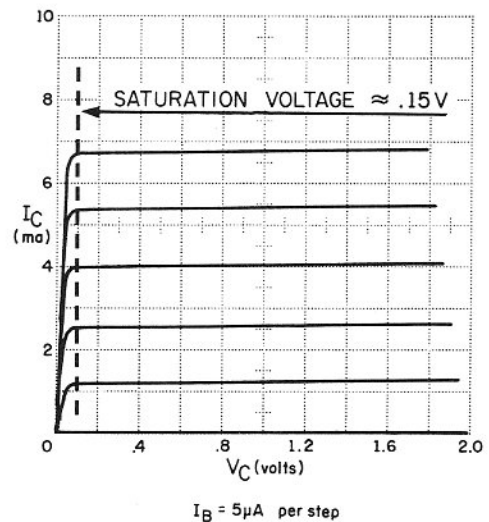

Figure 23. Saturation Voltage

The specification values of saturation resistance is usually stated as the maximum acceptable limit. Dynamic resistance is found by calculating or plotting the average saturation resistance over a range of base current.

OUTPUT ADMITTANCE (h_{oe})

The dynamic output admittance of a transistor is the measurement of the change in collector current (ΔI_C) resulting from a specific change in collector voltage (ΔV_C) at a constant base current. Admittance is measured in mhos. The "h" parameter for output admittance in the common emitter configuration is stated as:

$$h_{oe} = \frac{\Delta I_C}{\Delta V_C}$$

Example:

$$\frac{\Delta I_C}{\Delta V_C} = \frac{14\text{mA} - 11\text{mA}}{7\text{V} - 3\text{V}} = \frac{3\text{mA}}{4\text{V}} = .75 \text{ millimhos or } 750 \mu\text{mhos at } I_B \text{ of } 150 \mu\text{A}$$

A change in collector voltage normally causes change in collector current. For some transistors, the effect is quite apparent because the curves have a noticeable slope. Such a transistor has a comparatively high output admittance. Other transistors display a near horizontal curve with a very small change in collector current. These transistors have a low output admittance.

Output admittance is measured from the same family of curves as displayed for gain or beta measurement. The measurement is taken at a constant base current, that is, along one of the curves in the display. If specification data is used for reference, use the base current specified. Otherwise, select a base current curve that is typical for the normal operating range of the transistor being tested. The measurement is made between two specific collector voltages. When testing per specification, use the specified voltages. Without specifications, select two voltages, one just above the saturation knee of the curve and one somewhat below collector breakdown. For measuring very small ΔI_C values, a higher vertical gain for the oscilloscope would be helpful, but the oscilloscope must remain calibrated. If the oscilloscope gain can be increased in steps, such as 10:1, without changing the fine vertical sensitivity setting, the use of such a setting may be

$$\text{OUTPUT ADMITTANCE } h_{oe} = \frac{\Delta I_C}{\Delta V_C}$$

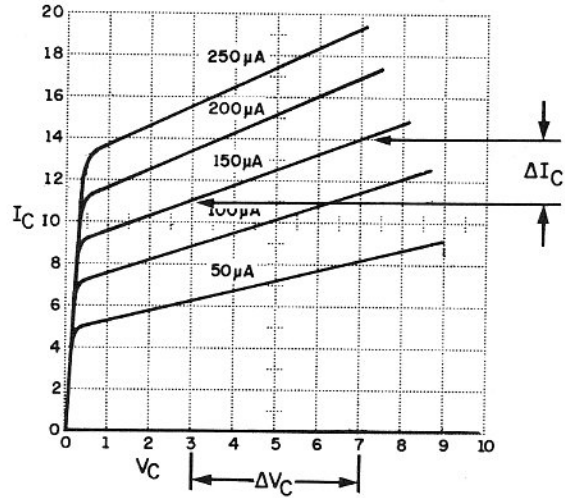

$$h_{oe} = \frac{\Delta I_C}{\Delta V_C} \quad h_{oe} = \frac{3\text{mA}}{4} \quad h_{oe} = .75 \times 10^{-3} \quad h_{oe} = 750 \mu\text{mhos at } I_B \text{ of } 150 \mu\text{A}$$

Figure 24. Output Admittance

valuable.

The transistor's output impedance (or collector resistance) is the reciprocal of its output admittance and is measured in ohms. It may be calculated by transposing the current and voltage values used in determining output admittance. The transistor provides maximum power transfer if the load impedance equals the transistor's output impedance.

$$\text{Output Impedance} = \frac{V_C}{I_C}$$

Example:

$$\frac{V_C}{I_C} = \frac{3 \text{ mA}}{4\text{V}} = 1.33 \text{ K}\Omega$$

EFFECTS OF TEMPERATURE

The conduction of current through a transistor results in heat generation. The amount of heat increases with the value of collector voltage and current. An excessive heat build-up will result if the transistor cannot dissipate the heat generated. If excessive heat is generated while testing with the curve tracer, the results can easily be detected in the display.

A high temperature may produce a noticeable loop in the curves (Figure 25A). Collector capacitance or inductance can also cause a loop in the curves but can be distinguished from a temperature loop. For a temperature loop, the loop size decreases and disappears when the base current steps or collector voltage are reduced. The reason for the loop in the curves is that collector current does not increase and decrease at the same rate when the sweep voltage is applied. As sweep voltage starts from

zero, the transistor is cool. As the sweep voltage increases to maximum, a collector current sweep is made. Meanwhile, the temperature is increasing. The temperature increase causes an additional amount of collector current. As the sweep voltage returns to zero, the collector current decreases, but at a lag. During the return sweep, the temperature drops from maximum to normal, but a time lag is required for this cooling to occur. Therefore, the top portion of the loop is the increasing sweep current and the bottom portion of the loop is the decreasing sweep current.

Another effect in some transistors is that collector current droops at the high end of the curve. In this case, the increase in temperature causes a decrease in collector current (Figure 25B).

Excessive current to the extent that thermal runaway begins is observed as a "vertical roll" effect.

(Figure 25C). The entire family of curves moves in the direction of higher collector current as the temperature build-up continues. This regenerative or "runaway" phenomena may easily destroy the transistor if not stopped immediately.

CAUTION

Testing procedures should not be conducted at sweep voltage levels and base current step levels that cause any of the previously mentioned conditions. Testing at values which cause excessive temperature is probably not representative of typical operating conditions for the transistor and may damage or destroy the device.

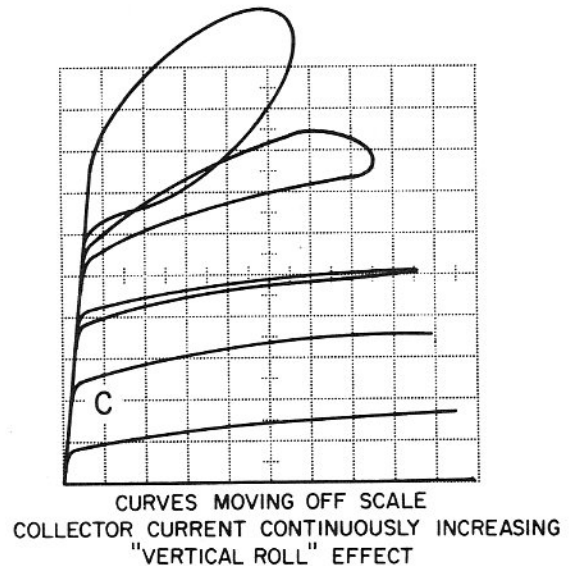
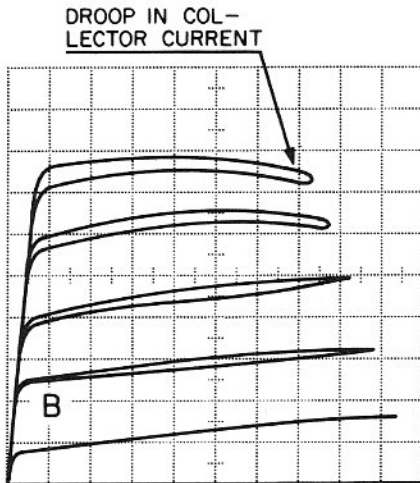
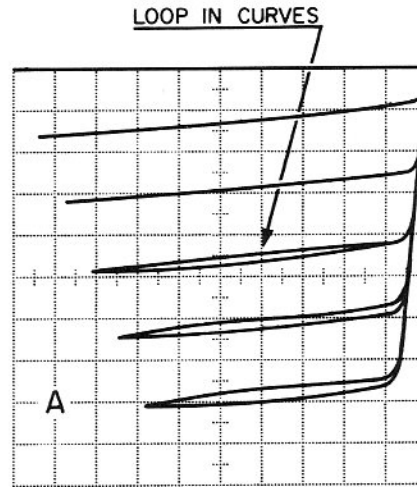

TESTING FET'S

Comparison to Bipolar Tests

In many respects, the testing of field effect transistors (FET's) including metal-oxide-silicon field effect transistors (MOS FET's), is similar to testing NPN and PNP transistors. A family of curves is displayed on the oscilloscope in each case and the curves have a similar appearance. N channel FET's have a family of curves similar to NPN transistors (Figure 26), and P Channel FET's curves are similar to PNP transistors. Transistor curves are a graph of collector current vs collector voltage at various base currents; FET curves are a graph of drain current vs drain voltage at various gate voltages. FET breakdown voltage may be observed and measured by the same method used for transistors.

In several other respects, testing FET's is different from testing transistors. For testing FET's, the STEP SELECTOR switch of the curve tracer is placed in the "Volts per Step" positions. The curve tracer supplies constant voltage steps rather than constant current steps. Also, the polarity of the step voltage

is reversed in relation to the sweep voltage. While the zero base current step of a transistor usually produces no collector current, the zero volt step at the gate of an FET produces the highest drain current. Each reverse bias voltage step results in less drain current, and when the gate voltage is sufficiently high, drain current is pinched off. The point of pinch-off can be measured with the curve tracer. The method of gain measurement of an FET is similar to the gain measurement of a transistor, but the forward transconductance of a FET has a voltage input characteristic which cannot be directly compared with the beta of a transistor which has a current input characteristic.

Typical Test Procedure

1. Before plugging in or connecting the FET to the curve tracer, set the controls as follows:

SWEEP VOLTAGE:	zero
VERTICAL SENSITIVITY:	1 mA/Div
STEP SELECTOR:	I_{DSS}/I_{CES}
POLARITY:	Depends on device

2. Plug the FET to be tested into either of the sockets of the curve tracer, or it may be connected to the D, G and S jacks with test leads. Use the FET manufacturer's basing diagram, if available, to identify the gate (G), drain (D) and source (S) leads. The socket pins are labeled for FET's as well as transistors. If there is a separate pin for the shield of the FET, clip a test lead to the shield pin and ground it to the E - S jack; do not leave it open. Make sure the SOCKET switch is in the correct position (LEFT or RIGHT) to activate the socket containing the FET.
3. Increase the SWEEP VOLTAGE setting a nominal amount to attain a horizontal display but stay well below breakdown voltage (typically 5 to 10 volts). A single curve should be displayed on the oscilloscope. If the FET type was unknown, try both the N CHAN and P CHAN positions of the POLARITY switch to obtain the curve.
4. Position the curve as required with the centering controls of the oscilloscope. If the curve extends off-scale vertically, move to next position of the VERTICAL SENSITIVITY control.
5. Increase the SWEEP VOLTAGE as desired, but reduce the setting if breakdown is observed.
6. Rotate the STEP SELECTOR control to the "Volts per Step" positions, increasing the setting until a family of six curves is observed with the greatest attainable spacing between curves. If the setting is too low, the curves will be too closely spaced to take a reading. If set too high, some of the gate voltage steps may exceed pinch-off and result in less than six curves being displayed.

Important Considerations

In general FET's are more susceptible to damage from excess voltage or current than NPN or PNP transistors. Starting with the recommended control settings eliminates the possibility of applying test signals that are too high. Control settings should be

increased after the FET is inserted only as much as is necessary to make the tests. Some MOS FET's can be damaged by a voltage transient from a static charge carried by the person handling the device. Safeguard against such damage and discharge any static charge by touching ground with one hand before and while handling the MOS FET with the other hand.

The I_{DD5}/I_{CES} position of the STEP SELECTOR control displays the drain current of the FET with the gate shorted to the source. This is the zero bias condition and produces a single curve on the display which is representative of the maximum drain current normally flowing through the FET. Most FET's normally operate in the depletion mode with a reverse bias. The constant voltage steps of a reverse bias polarity as generated by this curve tracer drive the FET into the depletion mode, with the curves showing lower resultant drain current with each successive step. To test the few enhancement mode FET's, the gate lead can be disconnected from the curve tracer and connected to a dc bias supply which will provide the forward bias voltage. Be sure any such bias supply's reference is common to the source of the FET by connecting a test lead between the bias supply and the S jack of the curve tracer.

For testing dual-gate MOS FET's, one gate should be grounded or biased while testing the other gate; do not leave the gate open circuited. One gate can be plugged into the socket of the curve tracer and a test lead can be clipped to the other gate. To ground the gate, connect the test lead to the source (S) jack of the curve tracer. To bias the gate, connect the test lead to a dc bias supply. Varying the bias supply voltage shows the effects of simultaneous inputs on the two gates of the FET. If a dc bias supply is used, be sure to ground its dc reference to the source (S) jack of the curve tracer.

Transconductance (Gain) Measurement

The most useful and common measurement to be made for an FET is the gain measurement. The dynamic gain, or gate-to-drain forward transconductance (gm) in the common source configuration,

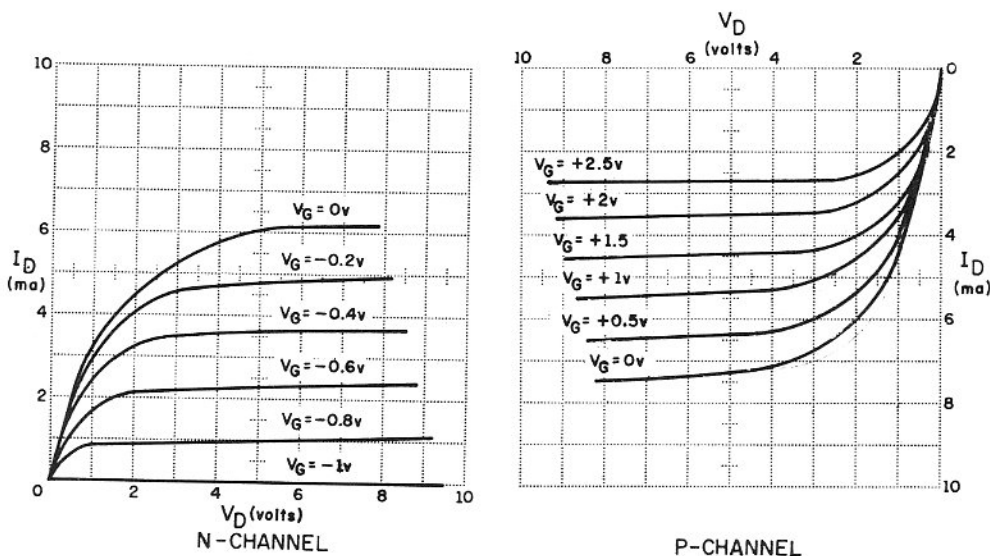

Figure 26. Typical FET Characteristic Curves

$$g_m = \frac{\Delta I_D}{\Delta V_G} \text{ at a given drain voltage}$$

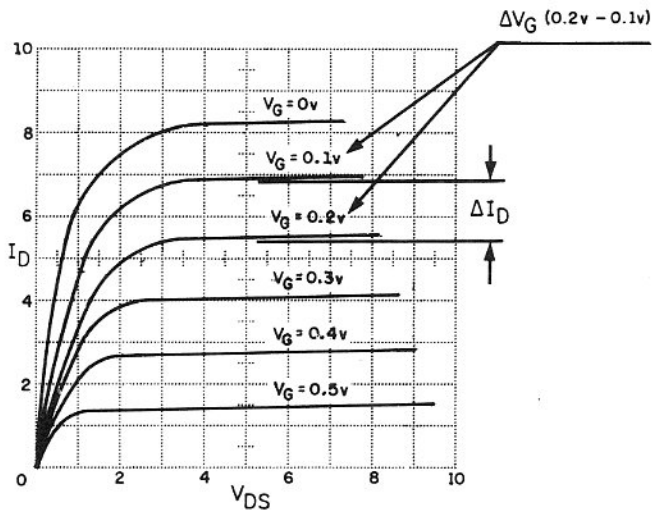

Figure 27. FET Gain (Transconductance) Measurement

is the ratio of change in drain current to the change in gate voltage at a given drain voltage. Transconductance is measured in mhos. As an example, if increasing the gate voltage from 1 volt to 1.5 volt ($\Delta V_G = .5$ V) causes the drain current to decrease from 6 mA to 4 mA ($\Delta I_D = 2$ mA) at a drain voltage of 6 volts, the forward transconductance of the FET is 4000 micromhos. Another example is shown in Figure 27.

To calculate g_m , note the difference in drain current between two curves (ΔI_D), at the same drain voltage from the family of curves. Note the change in gate voltage (ΔV_G) from the STEP SELECTOR switch setting. Calculate g_m by dividing ΔV_G into ΔI_D .

As with NPN and PNP transistors, the gain of a FET is not constant over its entire voltage and current range. The gain is normally calculated in its typical operating range. Distortion and linearity may be determined by the same method as described for transistors; if the spacing between curves is equal, the FET is linear.

Pinch-Off (V_p) Voltage Measurement

An important characteristic for depletion mode FET's is the amount of gate voltage required to turn off drain current. This value is called the pinch-off voltage characteristic and may be measured from the family of curves.

An example is shown in Figure 28. Figure 28 A shows the STEP SELECTOR set at .5 volt per step and the entire family of curves is displayed. Drain current continues to flow at its highest step of -2.5 volts. Figure 28 B shows that when the STEP SELECTOR is increased to 1 volt per step that the entire family of curves is not displayed. In fact, the -3 volt, -4 volt and -5 volt curves are superimposed upon each other at zero drain current. All gate voltage values greater than -3 volts prevent drain current. We can conclude that pinch-off occurs between -2.5 volts and -3 volts. A more precision measurement could be made, if necessary, by connecting an external dc bias supply to the gate of the FET, adjusting the bias supply, and observing the exact value of pinch-off voltage on the oscilloscope.

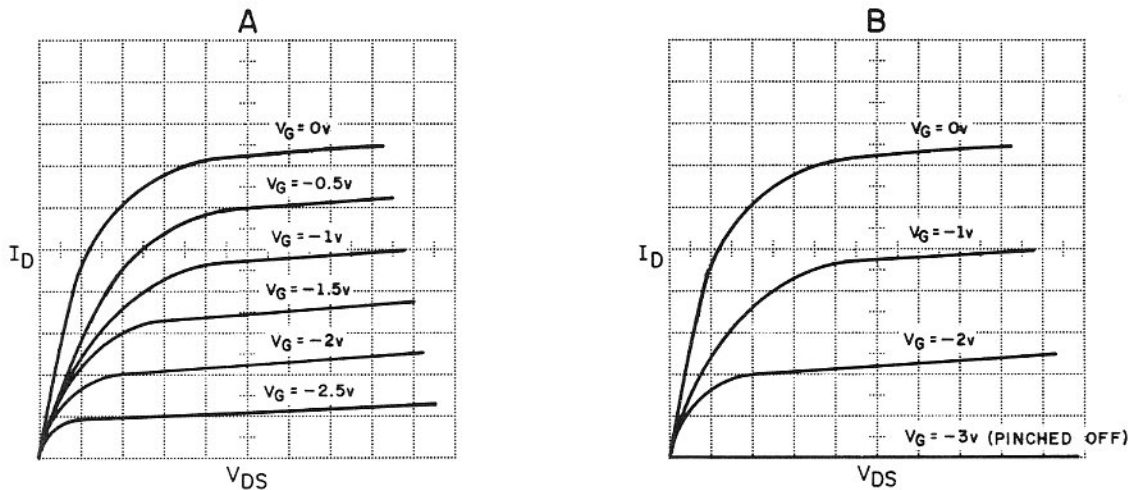

Figure 28. Determining FET Pinch-Off Voltage

TESTING SIGNAL and RECTIFIER DIODES

Signal and rectifier diodes conduct easily in one direction and are non-conductive in the opposite direction. These properties may be tested and observed with the curve tracer and oscilloscope. For testing diodes, the pulsating dc sweep voltage is applied across the diode. The diode current and voltage are plotted on the oscilloscope screen. The step current, step voltage signal that was used for testing transistors and FET's is not used in diode testing, and the STEP SELECTOR control has no effect upon the results.

The diode to be tested is plugged into the collector and emitter pins of the transistor socket, or directly into the collector (C) and emitter (E) jacks of the curve tracer; test leads also may be run from the E and C jacks to the diode terminals. Since the polarity of the sweep voltage can easily be reversed with the POLARITY switch, the diode may be inserted into the socket without observing polarity. Of course, diodes inserted at one polarity will produce an oscilloscope display which deflects to the right and upward from its starting point, while the opposite polarity produces a display which deflects downward and to the left from its starting point. A consistent display can be obtained by always connecting the cathode of the diode to the emitter jack. With this polarity connection, the POLARITY switch should be in the NPN position for forward bias of the diode. The display will be the positive reading type as shown in Figure 29.

For measuring the forward diode properties, the oscilloscope horizontal sensitivity should be calibrated to some low voltage value. A sensitivity of 0.5 volt per division or less is necessary to obtain any degree of accuracy in the voltage reading. A calibrated sensitivity of 0.25 volt per division is easily obtained by using the output of the B, G jack applied to the horizontal input of the oscilloscope. Set the STEP SELECTOR at 0.5 volts per step. The oscilloscope can be adjusted to place the markers at every other division of the graticule scale.

When testing diodes, only one curve is displayed, not a family of curves as displayed for transistors and FET's. The forward bias measurements that can be made are forward voltage drop and diode resistance. As shown in Figure 29, no current flows until the applied voltage exceeds the junction barrier. This forward voltage drop is about 0.3 volt for germanium diodes and 0.6 volt for silicon diodes. Above this point, current increases rapidly with an increase in forward voltage. The current increases more rapidly and the "elbow" has a sharper bend for silicon diodes than for germanium diodes. The dynamic resistance of the diode equals the change in forward voltage (V_F) divided by the change in forward current (I_F). Germanium diodes, with more slope to their curves, have higher dynamic resistance than silicon diodes.

There is no need to increase the SWEEP VOLTAGE control setting beyond that which gives a full scale vertical presentation, although there is very little danger that a higher setting will do harm. The VERTICAL SENSITIVITY control may be set to the 1 mA/Div position for examining the low current characteristics, or to a lower sensitivity position, such as 10 mA/Div, for observing a wider range of forward current conduction.

The reverse bias condition of a diode may be displayed to check leakage (Figure 29). When the POLARITY switch is set to the opposite position as used for the forward bias tests, there should be only a horizontal line displayed. The oscilloscope centering must be readjusted because of the polarity reversal causes the trace to move off-screen. Leakage current is easier to check with a much higher voltage than was used for forward bias testing. The oscilloscope may be recalibrated for 10 volts per division, which allows display of the test up to 100 volts. Any measurable current which is displayed as a slope to the oscilloscope trace can be attributed to leakage current. If peak inverse breakdown of the diode occurs below 100 volts, it will be displayed as

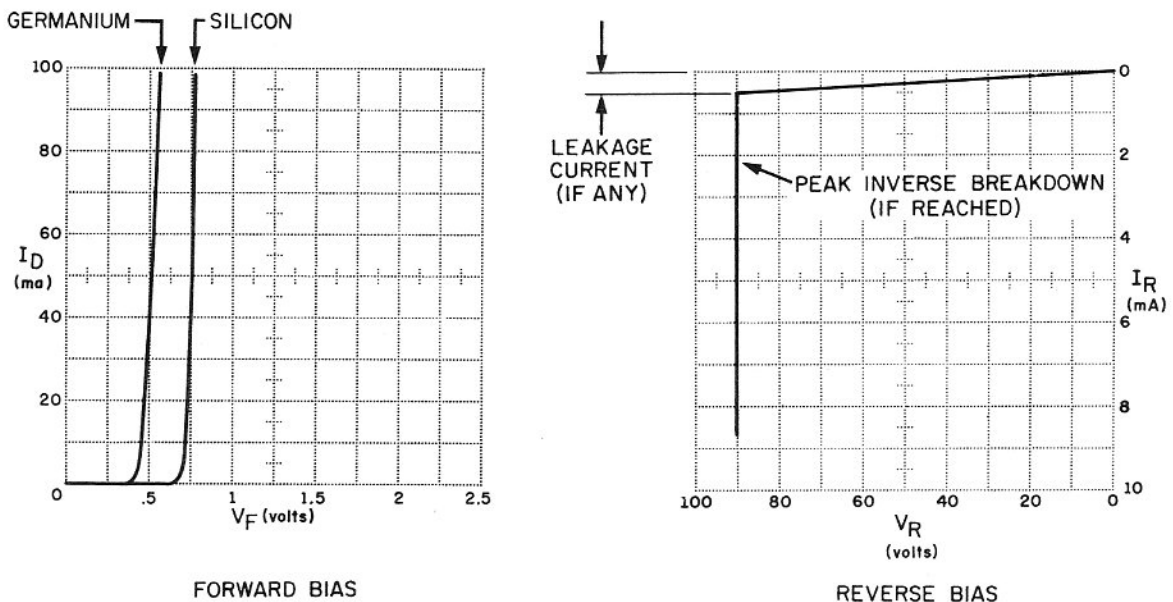

Figure 29. Typical Diode Curves

shown in Figure 29. Note: Refer to "Breakdown Voltage Measurement" if the oscilloscope being used has less than 1 M Ω of horizontal input impedance.

TESTING ZENER DIODES

The procedure for testing Zener diodes is almost the same as for testing signal and rectifier diodes. In fact, the forward characteristics of the diodes are essentially identical and the test procedures would be the same, except that forward voltage measurements are seldom used for Zener diodes. Zener diodes are designed to be used in the reverse voltage breakdown mode. In this region, a large change in reverse current occurs while the Zener voltage remains nearly constant. Because of this characteristic, they are most often used as voltage regulators.

The zener voltage value (reverse voltage breakdown value) may be measured with the curve tracer and oscilloscope. This is the parameter that is most often checked for a Zener diode. Set up the curve tracer and oscilloscope as described for reverse voltage measurement of signal and rectifier diodes.

To obtain the most accurate voltage reading possible, calibrate the full scale oscilloscope horizontal sensitivity to a convenient value slightly above the Zener voltage. For example, for a 6-volt diode, calibrate full scale at 10 volts; for a 15-volt diode, calibrate full scale at 20 volts; etc.

Be sure the POLARITY switch is set to display the reverse voltage condition. Increase the SWEEP VOLTAGE control setting to display the Zener region as shown in Figure 30. No reverse current should flow until the reverse breakdown voltage value is reached. At that point, there should be a very sharp "elbow" and a very vertical current trace. If the "elbow" is rounded or the vertical current trace has a measurable voltage slope, the Zener diode is probably defective. Read the Zener voltage value from the display as accurately as possible. There may be variation of Zener voltage from one diode to another of the same type number. If the Zener voltage value falls outside the limits that can be used for your application, select another one that will meet the requirements.

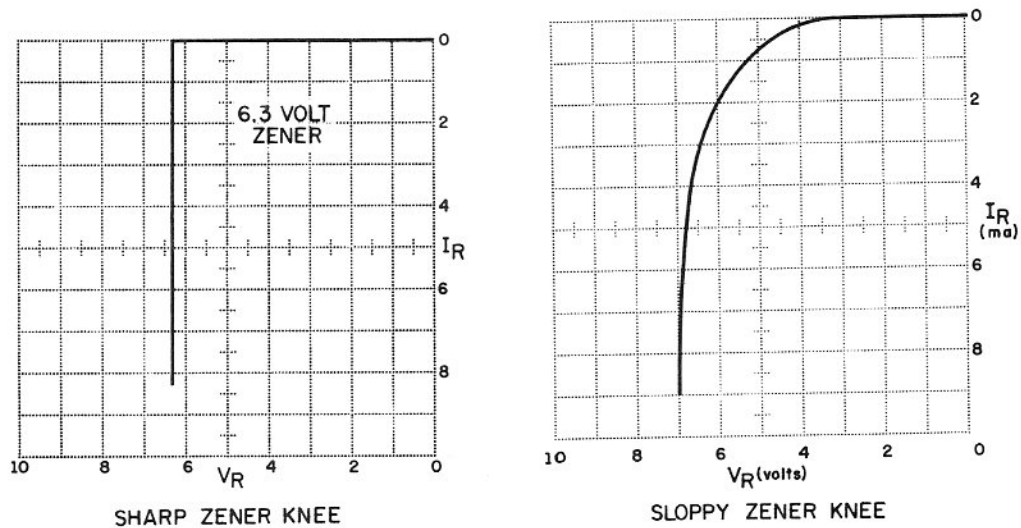

Figure 30. Typical Zener Diode Curves

TESTING UNIJUNCTION TRANSISTORS

A unijunction transistor (UJT), as the name implies, is a *single junction* device possessing three terminals. Conduction from base 1 to base 2 is purely resistive until an emitter current is applied. A small trigger current applied to the emitter causes a negative resistance condition. The value of trigger voltage is dependent upon the voltage between base 1 and base 2. An examination of a UJT's operation can be displayed on the oscilloscope by using the curve tracer.

Connect the UJT to the curve tracer as shown in Figure 31; base 1 to the emitter jack, base 2 to the base jack and emitter to the collector jack, or plug the UJT into the socket using the same lead configuration. (Base 1 and base 2 are interchangeable). Set the POLARITY switch to NPN. Increase the SWEEP VOLTAGE from zero until the trigger voltage is exceeded, which produces the high emitter current spike on the oscilloscope. Set the STEP SELECTOR to the "Current per Step" position that produces the most curves on the display. The curves

appear quite close together and careful observation may be required to distinguish the individual curves. It may be helpful to "spread out" the display by increasing the horizontal sensitivity of the oscilloscope, or use expanded sweep magnification of the area of interest. With this test configuration, the step current of the curve tracer is applied from base 1 to base 2 and the sweep voltage applied to the emitter is the UJT trigger voltage. Note that as the sweep voltage is slowly increased from the trigger threshold producing the first current spike, that the other curves are added one by one. Thus, for each base current step, the emitter trigger voltage can be measured.

Interbase resistance (R_{BB}) can be displayed (Figure 32), by connecting base 1 and base 2 to the collector and emitter jacks of the curve tracer and leaving the emitter lead of the UJT open circuited. This displays a linear trace of forward current (I_F) vs interbase voltage (V_{BB}).

$$R_{BB} = V_{BB}/I_F$$

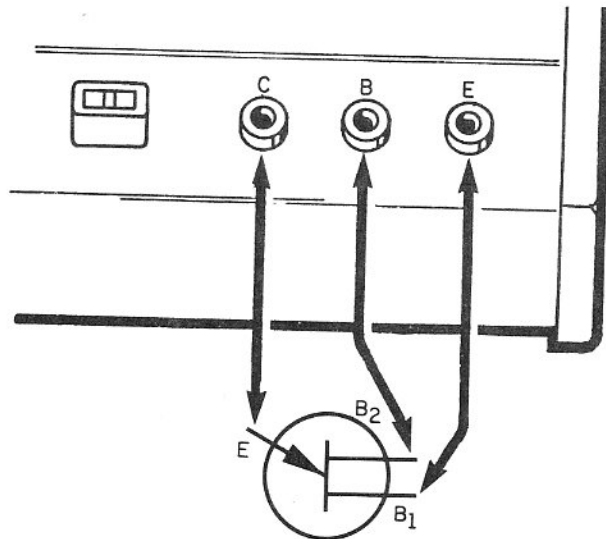

Figure 31. Set-Up and Typical Display of Unijunction Transistors

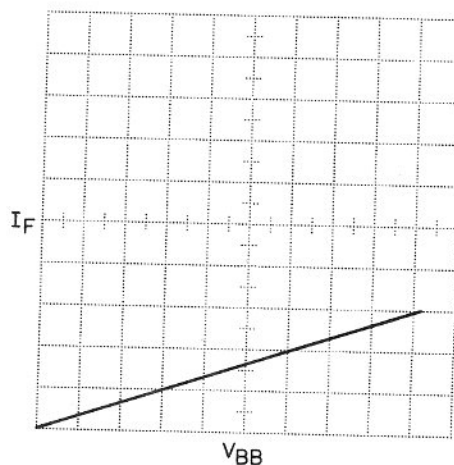
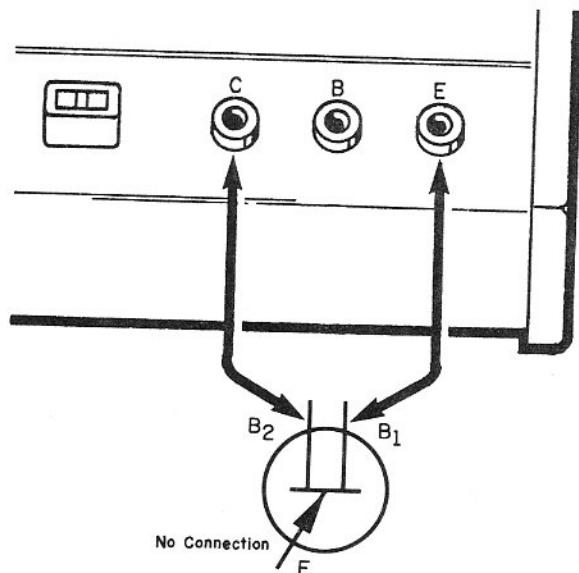
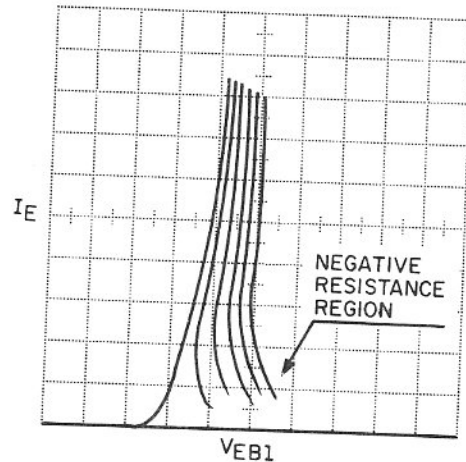

Figure 32. Measuring Interbase Resistance (V_{BB}) of UJT's

TESTING SILICON CONTROLLED RECTIFIERS (SCR's)

SCR's (also called thyristors) are four layer p-n-p-n semiconductors with three terminals; cathode, anode and gate. During conduction, the SCR has the characteristics of two series diodes. However, the device is normally nonconductive until a trigger current is applied to its gate. Once triggered into conduction, the SCR cannot be turned off until the anode-cathode current drops below a holding current value necessary to sustain conduction. This holding current is usually a small percentage of the permissible peak current.

The following characteristics of an SCR can be displayed and measured with the semiconductor curve tracer:

- Forward Blocking Voltage
- Reverse Blocking Voltage
- Leakage Current
- Holding Current
- Forward Voltage Drop for Various Forward Current
- Gate Trigger Voltage for Various Forward Voltages

SCR Connections to Curve Tracer (Figure 33)

For all measurements except gate trigger voltage the SCR should be connected to the curve tracer as follows:

- CATHODE to EMITTER jack or emitter pin of socket
- ANODE to COLLECTOR jack or collector pin of socket
- GATE to BASE jack or base pin of socket

Forward Blocking Voltage (Figure 34)

Forward blocking voltage is the maximum anode-cathode voltage in the forward direction that the device will withstand before conduction, at zero gate current. The curve tracer will measure forward blocking voltage up to 100 volts.

To measure forward blocking voltage, set the STEP SELECTOR to the I_{CES} position. This shorts the gate and cathode to satisfy the zero gate current requirement. Set the POLARITY switch to NPN. Increase the SWEEP VOLTAGE until the SCR "fires", that is, the anode current suddenly increases and the anode voltage drops to near zero. Read the highest anode voltage point in the display. This is the maximum forward blocking voltage. Any anode current at anode voltage below the "firing" point is forward leakage current, and can be read directly from the display.

Reverse Blocking Voltage

Reverse blocking voltage is the maximum reverse anode-cathode voltage at zero gate current that the device can withstand before voltage breakdown. It is similar to the peak inverse voltage of a diode. Reverse blocking voltage is normally higher than forward blocking voltage. The Model 501A can measure reverse blocking voltage up to 100 volts.

The procedure for measuring reverse blocking voltage is the same as for measuring forward blocking voltage except that the POLARITY switch is set to PNP. The voltage at which voltage breakdown occurs, which is a sudden increase in anode current, is the reverse blocking voltage value. Any anode current at voltages below breakdown is reverse

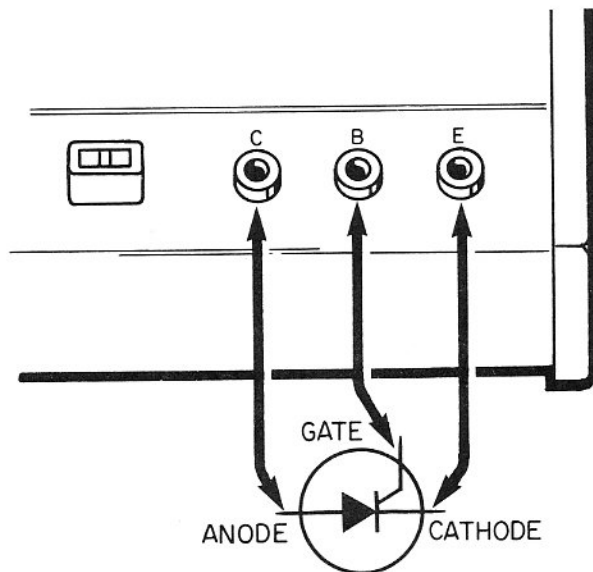

Figure 33. SCR Connections to Curve Tracer

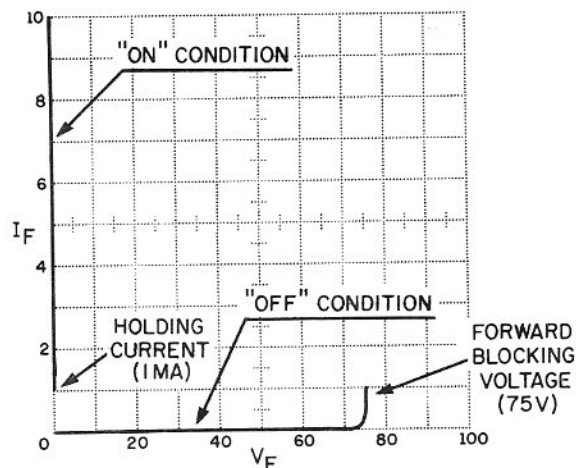

Figure 34. Testing Forward Blocking Voltage and Holding Current of SCR's

leakage current, and can be read directly from the display.

Holding Current

Holding current is the minimum anode current required to sustain conduction once the SCR has been fired. With the same procedure as used for the forward blocking voltage test, note the lowest current displayed for the "on" condition. This is the holding current. The measurement may also be made with the STEP SELECTOR in one of the "Current per Step" positions so that less sweep voltage is required to place the SCR in the "on" condition.

Forward Voltage Drop

The forward voltage drop during the "on" condition at various forward current levels may be measured by increasing the horizontal sensitivity of the oscilloscope and displaying a low voltage portion of the forward voltage. Increase the STEP SELECTOR "Current per Step" setting so that sweep voltage may be reduced. The VERTICAL SENSITIVITY may be reduced to 10 mA per division for a greater

range of voltage vs current. Read the forward voltage drop directly from the display.

Gate Trigger Voltage (Figure 35)

The "turn on" point of an SCR is dependent upon the forward voltage and gate voltage. As gate voltage is increased, less forward voltage is required to switch on the SCR. Conversely, as forward voltage is increased, less gate voltage is required to switch on the SCR. Gate trigger voltage values can be measured by connecting a dc bias supply to the gate terminal of the SCR. The bias supply reference must be connected to the emitter jack, or the cathode of

the SCR. Otherwise, the curve tracer is set up as for forward blocking voltage measurement. Two types of measurements can be made:

1. Set the sweep voltage a to a specified forward anode-cathode voltage and increase the dc bias supply until the SCR switches on. Measure the value of gate voltage at which switching occurred.
2. Set the dc bias supply to a specified gate voltage and increase the sweep voltage until the SCR switches on. Read the peak value of sweep voltage which was required.

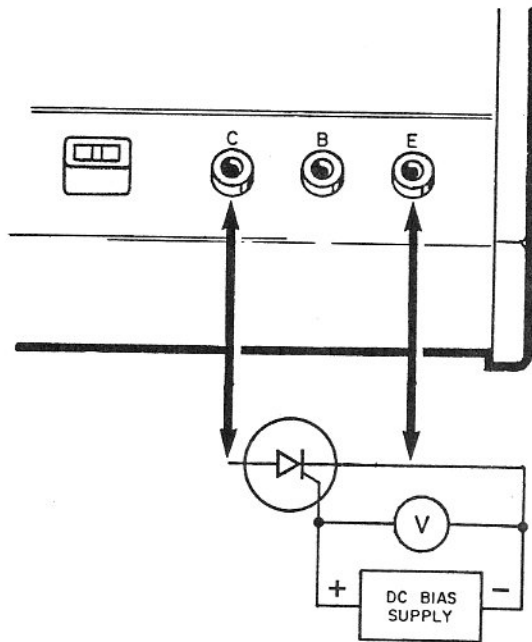
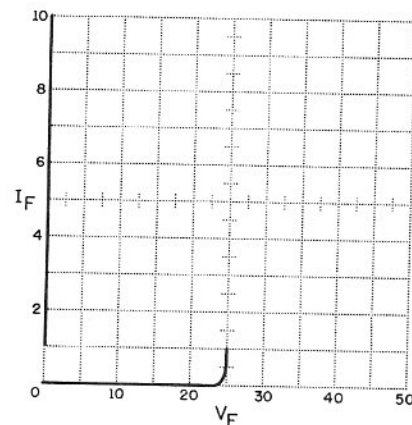

Figure 35. Testing Gate Trigger Voltage of SCR's



TESTING TRIACS

Triacs are four-layer p-n-p-n semiconductors with the same characteristics in both directions, and may be used for ac applications. A triac is the equivalent of two SCR's connected in parallel, but oriented in opposite directions (See Figure 36). The device has

three terminals; main terminal 1, main terminal 2 and gate.

Triacs may be tested exactly as SCR's except that forward tests should be repeated for both directions, and there will be no reverse blocking voltage measurement.

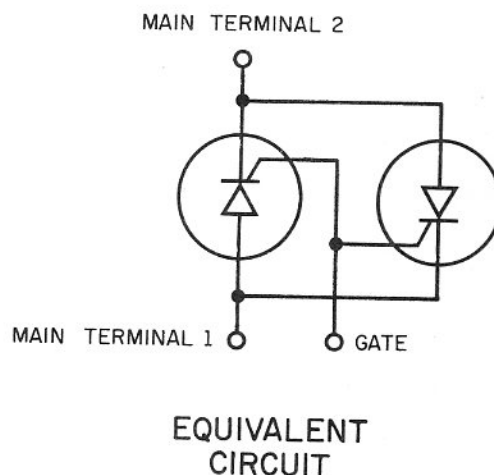
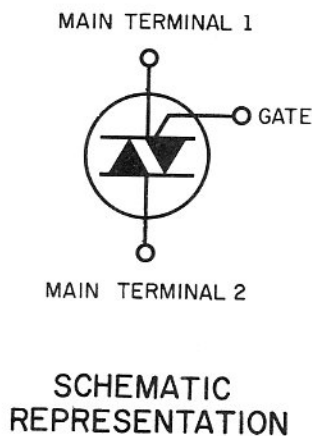

Figure 36. Triacs

TESTING TUNNEL DIODES

Tunnel diodes are small p-n junction semiconductors with a negative resistance or "tunnel" region. The "tunnel" region makes it possible to use the diode as an amplifier, oscillator, or pulse generator. The diode conducts very easily in one direction (at much lower voltage than conventional signal diodes) but the tunnel region is in the direction of higher resistance. Tunnel diodes are normally operated at very low voltage and current levels.

The characteristics of tunnel diodes may be measured with the curve tracer. Connect the diode between the emitter and collector pins of one of the sockets. The tunnel diode is connected with the cathode to the emitter jack and the anode to the collector jack, set the POLARITY switch to NPN. If the cathode cannot be readily identified, try both positions of the POLARITY switch when the other controls have been properly set for the test. Calibrate the oscilloscope horizontal amplifier for high sensitivity such as 0.1 volt per division. It may be necessary to use X5 magnification or horizontal scale expansion on the oscilloscope to achieve this sensitivity. Set the SWEEP VOLTAGE control to a low value, so it will just sweep through the tunnel region. Set the VERTICAL SENSITIVITY as required for the largest possible on-scale display. A display similar to that shown in Figure 37 should be presented on the oscilloscope.

Several characteristics of the tunnel diode can be measured directly from the display. Note: A trace will normally not be displayed in the negative resistance region.

- I_p — peak current, start of tunnel region
- I_v — valley current, end of tunnel region
- V_p — peak voltage, start of tunnel region
- V_v — valley voltage, end of tunnel region

The average negative resistance can be calculated from these measurements:

$$\text{Average negative resistance} = \frac{V_v - V_p}{I_p - I_v}$$

Tunnel rectifiers have most of the same general characteristics as tunnel diodes, but do not use the negative resistance characteristic in their operation. The region which tends to tunnel is more resistive in tunnel rectifiers and peak current is not as pronounced. Because of this characteristic, a high front-to-back resistance ratio at low voltages allows the semiconductor to be used as a very low signal voltage rectifier. It conducts very easily in one direction with very little voltage drop (actually the opposite direction from conventional diodes insofar as the N and P material is concerned, thus the devices are sometimes called back diodes). The reverse direction (direction which tends to tunnel) is resistive at low voltage values, but conducts readily at voltage which approximates the forward drop of a conventional diode. Therefore, the peak voltage of the signal to be rectified should not exceed the resistive region. The curves should be displayed as described for tunnel diodes. Tests using both polarities of sweep voltage are required to examine the forward vs reverse conduction characteristic. Examination of the reverse direction conduction curve reveals the peak voltage that may be used without exceeding the resistive region.

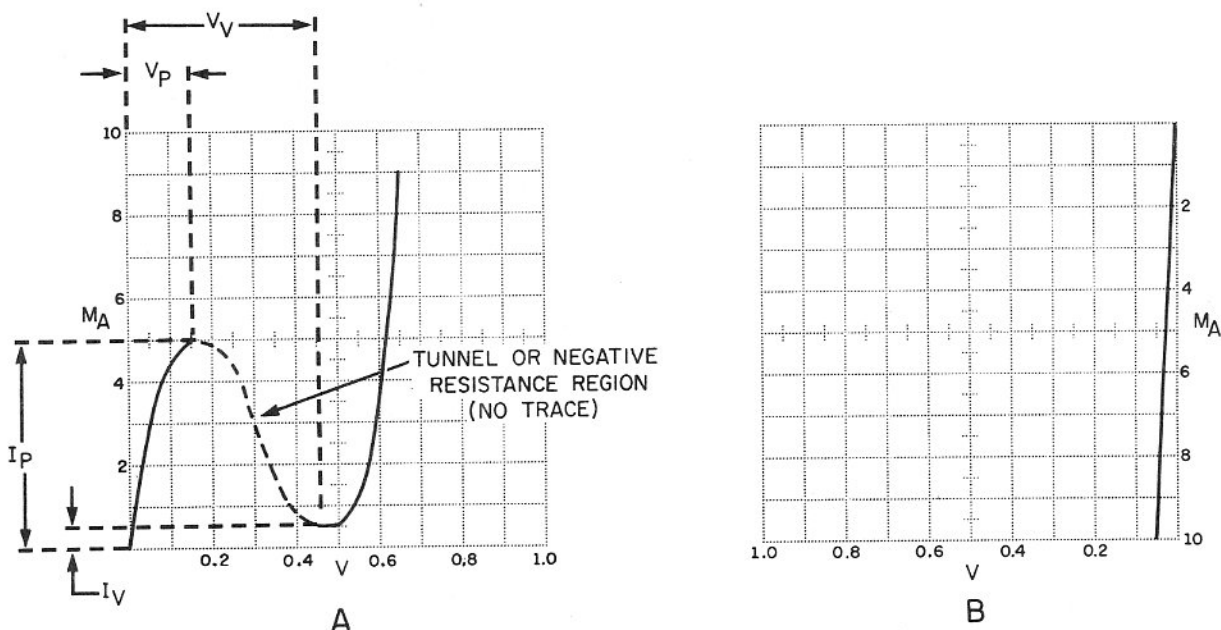

Figure 37. Tunnel Diode Characteristic Curves

TESTING OTHER SEMICONDUCTOR DEVICES

Diacs

A diac is a two-terminal, three-layer semiconductor that exhibits the breakdown characteristic of two zener diodes placed back-to-back (birectional breakdown). It is non-conductive until the applied voltage exceeds its breakdown value, then current avalanches and the voltage drops across the terminals drops to near zero. Once conduction has started, it continues until the current drops below a holding current value necessary to sustain operation. Leakage current, breakdown voltage, and holding current can be measured with the curve tracer (the display

will be similar to that of an SCR). Since it is bi-directional, it should be tested in both polarities.

Integrated Circuits

Integrated circuits (IC's) are often multiple transistors or semiconductor devices packaged together. The curve tracer may be used to test such IC's. If the semiconductor devices can be identified and isolated to specific terminals of the IC, they can be individually tested with the curve tracer. Be aware that other circuit elements may be present in the IC which may cause variation in the expected display, such as loops in the curves.

MAINTENANCE and CALIBRATION

The 501A is precisely calibrated at the factory for optimum performance and should never require re-adjustment except in rare cases of failure and repair. If recalibration is necessary, however, it can be accomplished by using a digital voltmeter and a few jumper wires. To achieve the rated specification accuracy, it is necessary that the digital meter be a 3½ digit unit, and possess a 0.1% accuracy. An alternate but less accurate method (using an oscilloscope) is given if a digital meter is not available.

CALIBRATION PROCEDURE

- Stand the unit on its left end panel and remove 3 screws retaining the bottom plate. Pry loose the bottom plate and remove.
- Remove 4 screws retaining the right end panel to the main assembly; two of these are on the exterior surface and the other two hold the PC board to this panel. Pull off the end panel.
- Using jumpers or temporarily soldered wires, short TP30, TP31 and TP32 to the +5 Volt line on the PC board.
- Attach a digital voltmeter to TP29 and turn on AC power to the unit.
- Adjust the CALIBRATE pot R36 for a reading of -3.50 Volts on the digital meter.
- Remove the wires as indicated in step #3.
- Attach the digital voltmeter to TP24A temporarily short TP29 to ground, and adjust the ZERO pot, R37, for a zero reading on the voltmeter. Remove the temporary short. The unit is now calibrated.

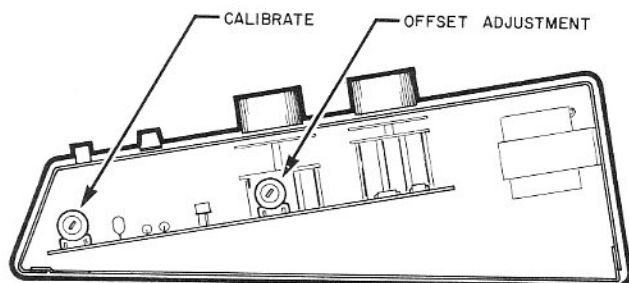

Figure 38. Location of Internal Adjustments

Alternate Method using an Oscilloscope (less accuracy):

- Attach the direct input probe of a well-calibrated DC coupled oscilloscope to TP29. Ground the scope to the 501A ground.
- Turn on AC power to the curve tracer and synchronize the oscilloscope to view the negative going staircase present at TP29.
- Once synchronized, adjust CALIBRATE trimmer R36, to obtain 0.5 Volt between each step of the staircase.
- Turn the unit off and attach a 10K resistor between the B-E terminals of one side of the unit (SOCKET switch towards that side); temporarily short TP29 to ground.
- Attach a DC voltmeter across the 10K resistor and set it for the most sensitive DC range. Note: Ensure that the meter is properly zeroed before attaching it.
- Rotate the 501A STEP SELECTOR to the 2mA position and set POLARITY to NPN.
- Turn the AC power on and adjust the ZERO trimmer on the 501A PC board until the DC voltmeter reads "0". Remove temporary short from TP29. Note: The trimmer has a negative and positive range; preset it to center before adjustment.

CURVE DISPLAY MODIFICATION

The Model 501A is factory adjusted to display 6 curves — 5 active and a zero reference baseline, sometimes referred to as step "0". Thru simple manipulation of the reset diodes, it is possible to display any number of curves from 2 through 8. Figure 39 shows the locations of these diodes on the PC board. Note the two extra "dotted" diodes (marked D11A and D12A) on the top side nomenclature. These are extra positions left open for such modification. The chart below indicates the placement of diodes that will produce a given number of curves.

Number of Display Curves:	Position of Diode(s):
2	D11
3	D11 and D11A
4	D12
5	D11A and D12
6	D11 and D12
7	D11, D11A, and D12
8	Short TP43 to GROUND

For displaying 7 curves, it is necessary to add a third diode. Any general purpose germanium device is acceptable.

TROUBLESHOOTING

The schematic diagram possesses all the information necessary to expedite repair of the instrument in case of failure. Waveform diagrams have been included and all major test points are clearly labeled with reference to the PC board. It is most important

to follow the explicit control setting and set-up procedure as given in the "notes" column in order to obtain the illustrated waveforms. Point-by-point signal tracing with a triggered-sweep oscilloscope is recommended because it provides the best indication of dynamic conditions in a stage, which will reduce time in locating defective components. If the reason for malfunction cannot be determined, refer to the Warranty Service Instructions on the last page of this manual.

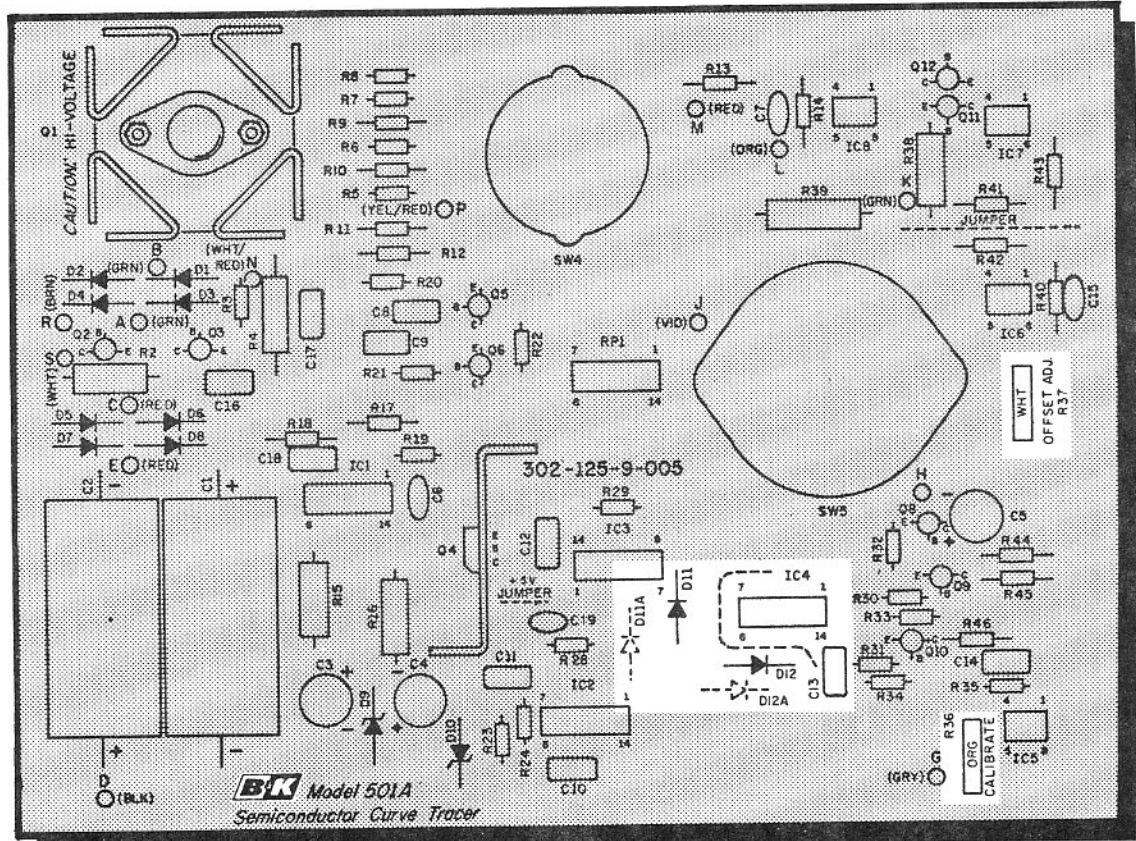

Figure 39. Curve Display Modification Diode Location

CIRCUIT DESCRIPTION

The B & K Model 501A utilizes a total of 8 integrated circuits for an equivalent discrete transistor count of 204 devices.

Three of the IC's are digital and 5 are linear. Each unit's function is explained in greater detail within the following circuit analysis.

Refer to Figure 40, the Block Diagram. Beginning at the left, a dual-secondary transformer is used for isolation from the line and to reduce the 117V AC for low voltage rectification. The low voltage secondary AC is rectified by diode bridge D5 through D8. It is center-tapped to produce both positive and negative voltages with respect to ground, each filtered by large value electrolytics. The raw ± 22 volts thus obtained are regulated down to three different levels: +15 Volts, -15 Volts and +5 Volts. Both the + and -15 volt regulators are simple zener diodes (D9 and D10) which power all operational amplifiers in the unit. The +5 volt line is highly regulated by use of an IC (IC1) and series pass transistor (Q4). This IC possesses virtually all the components necessary to produce a highly stable and accurate dc regulator, such as the reference source, feedback amplifier, and output transistor. In addition, it is internally current-limited so a shorted output condition will not cause damage. Resistor R19 establishes the limiting value to about 200 mA. The +5 volt line is highly regulated because it not only powers the digital IC's but is used as the reference voltage for producing a precise staircase waveform. Long term stability of the overall regulator is better than 0.5%.

Transistors Q5 and Q6 comprise a pulse former that produces a narrow pulse each time the AC line crosses zero. It is this zero crossing that synchronizes the entire unit. All line noise is eliminated from these pulses by a pulse shaper, IC2 a, b, and c, arranged in a monostable multivibrator mode with buffered output. The pulse shaper output is routed

to a countdown chain composed of 3 flip-flops within two IC packages (IC3 and 4). The second flip-flop of IC4 is not used except for gating a different number of display curves. The three flip-flops would normally count to a maximum of 7 and then start over if it were not for the reset gate and buffer D11, D12 and IC2d. The two diodes are factory inserted to sense the sixth count of the flip-flops and cause the entire chain to reset to zero (start over again). Only 5 curves are displayed by this arrangement because the sixth count is never allowed to run its course. A different number of curves may be displayed with the unit by appropriately re-arranging the position of the diodes as indicated under the "Maintenance and Calibration" section of this manual.

The flip-flop outputs of the count chain drive 3 transistor switches (Q8, 9 and 10) each in series with a precision resistor (1244, 45 and 46). The solid-state switches short and open the resistors to the highly regulated +5 volt line in a binary coded sequence as determined by the state of each flip-flop. The other end of the resistors are tied to the inverting input of operational amplifier IC5 which acts as both a summing device and current-to-voltage converter. A negative-going voltage staircase appears at the output of this amplifier. The level change between each step is determined by position of the feedback resistance, CALIBRATE trimmer R36, and is precisely adjusted for 0.5 volt.

The reference staircase from IC5 is routed thru a polarity reversal slide switch (front panel POLARITY switch) which determined which input of the differential amplifier, inverting or non-inverting, will receive the staircase. However, it is inverted again through the STEP SELECTOR switch in the "Volts per Step" positions for F.E.T. testing.

The DIFFERENTIAL AMPLIFIER, RANGING RESISTORS and ERROR FEEDBACK BUFFER are all

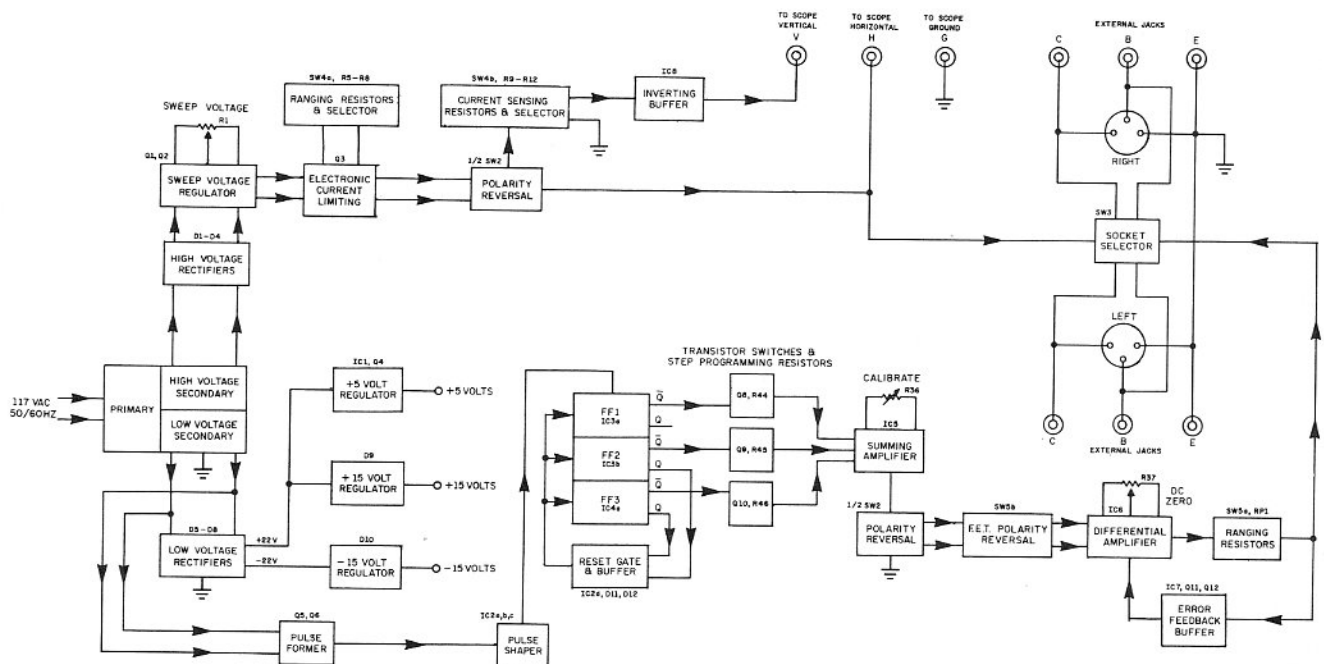

Figure 40. Block Diagram

linked together forming an accurate constant-current source for driving bipolar transistors.

The precise voltage staircase from IC5 is injected into either the non-inverting or inverting input of DIFFERENTIAL AMPLIFIER IC6, depending on the position of the two POLARITY reversal switches. The non-inverting input maintains a negative staircase for driving PNP transistors, and the inverting input transposes the polarity for driving NPN devices. The staircase is then processed by IC6 and passed through one of the RANGING RESISTORS selected by the STEP SELECTOR to produce current steps.

Because transistors have an inherent amount of turn-on voltage, the current would not be exact if not accounted for. Therefore, this amount of offset, called an "error signal" is buffered by ERROR FEEDBACK BUFFER IC7 and fed back to the opposite input of IC6. The DIFFERENTIAL AMPLIFIER (IC6) then strives to maintain the proper amount of current flowing thru the RANGING RESISTOR by adding this error signal to its output. The net result is a true constant-current flowing into the transistor under test, regardless of initial base turn-on voltage. The DC ZERO trimmer R37 is used to zero out the minor initial offset voltages produced by the IC's themselves.

In the "Volts per Step" positions of the STEP SELECTOR, a precision resistor is used to reconvert the known current steps into exact voltage steps for testing FET's. RP1 is a thick-film resistor network, contained within a 14 pin Dual In-Line Package (DIP). It possesses all of the 11 precision resistors used for current ranging. The processed current or voltage steps are finally routed through the SOCKET SELECTOR to the desired test socket (RIGHT or LEFT).

The higher voltage secondary of the power trans-

former is full-wave rectified by a diode bridge (D1 through D4) to produce a 120Hz "sweep" signal. No capacitance filtering is used in order to retain fidelity of the positive half sine-waves. At this point, the amplitude is approximately 100 volts peak and is processed through Q1 which acts as a series pass element in conjunction with Q2 and R1. These devices comprise the SWEEP VOLTAGE REGULATOR. R1 is a front panel SWEEP VOLTAGE control which allows adjustment of the sweep signal from 0 to maximum. This scheme also lends itself to addition of an ELECTRONIC CURRENT LIMITING section, Q3, in conjunction with RANGING RESISTORS R5 through R8. The range resistors are programmed by the VERTICAL SENSITIVITY switch to limit the maximum current available from the SWEEP REGULATOR to approximately 130% of the full scale mA/DIV setting. This limiting feature prevents destruction of sensitive semiconductors by over dissipation.

The POLARITY REVERSAL switch references either the positive or negative end of the SWEEP REGULATOR to ground through current-sensing resistors for testing NPN or PNP transistors. The ungrounded end of the regulator is routed to the collector of the transistor under test through SOCKET SELECTOR SW3 and also to the oscilloscope horizontal output terminal.

Sensing resistors R9 through R12 are chosen to produce a constant full-scale voltage value in 4 ranges (selected by VERTICAL SENSITIVITY) to avoid recalibrating the oscilloscope each time a different test current value is desired.

The voltage signal representing the current which appears across the sensing resistors is processed through INVERTING BUFFER IC8 to produce curves as normally displayed throughout the industry.

WARRANTY SERVICE INSTRUCTIONS

1. Refer to the maintenance section of the instruction manual for adjustments that may be applicable.
2. Check common electronic parts such as tubes, transistors and batteries. Always check instruction manual for applicable adjustments after such replacement.
3. Defective parts removed from units which are within the warranty period should be sent to the factory prepaid with model and serial number of product from which removed and date of product purchase. These parts will be exchanged at no charge.
4. If the above mentioned procedures do not correct the difficulty, pack the product securely (preferably in original carton or double packed). A detailed list of troubles encountered must be enclosed as well as your name and address. Forward prepaid (express preferred) to the nearest B & K authorized service agency.

Contact your local B & K Distributor for the name and location of your nearest service agency, or write to

Service Department
B&K DIVISION OF DYNASCAN CORPORATION
2815 Irving Park Road
Chicago, Illinois 60618

WARRANTY

"B & K warrants that each product manufactured by it will be free from defects in material and workmanship under normal usage and service for a period of ninety days after its purchase new from an authorized B & K distributor. Our obligation under this warranty is limited to repairing, or replacing any product or component which we are satisfied does not conform with the foregoing warranty and which is returned to our factory or our authorized service contractor, transportation prepaid, and we shall not otherwise be liable for any damages, consequential or otherwise. *The foregoing warranty is exclusive and in lieu of all other warranties (including any warranty of merchantability), whether expressed or implied.* Such warranty shall not apply to any product or component (i) repaired or altered by anyone other than B & K or its authorized service contractor (except normal tube replacement) without B & K's prior written approval; (ii) tampered with or altered in any way or subjected to misuse, negligence or accident; (iii) which has the serial number altered, defaced or removed; or (iv) which has been improperly connected, installed or adjusted otherwise than in accordance with B & K's instructions. B & K reserves the right to discontinue any model at any time or change specifications or design without notice and without incurring any obligation. *The warranty shall be void and there shall be no warranty of any product or component if a B & K warranty registration card is not properly completed and postmarked to the B & K factory within five days after the purchase of the product new from an authorized B & K distributor.*"