

**Instruction Manual 23-4J**

for the  
**AC/DC High-Pot  
Testers**

**Catalog Numbers  
230425 and 230425-1**



*A member of the THORN EMI Group*



**Biddle Instruments**

BLUE BELL, PA. 19422

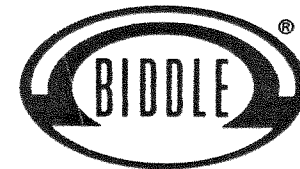

**Biddle Instruments**

BLUE BELL, PA. 19422

INSTRUCTION MANUAL 23-4J  
FOR  
AC/DC HIGH POT TESTERS  
CATALOG NUMBERS 230425 AND 230425-1

Copyright 1985  
The James G. Biddle Co.

---



Figure 1. Biddle AC/DC High Pot Tester,  
Catalog No. 230425

-ii-

**DANGER!**

**THE HIGH VOLTAGES PRODUCED BY THIS EQUIPMENT  
CAN BE EXTREMELY DANGEROUS!**

**ANY EQUIPMENT TO BE TESTED MUST FIRST BE  
DISCONNECTED FROM ITS POWER SUPPLY.**

**ALL PERSONNEL MUST BE KEPT CLEAR OF CONNECTIONS  
AND BARE PARTS OF EQUIPMENT WHERE HIGH VOLTAGES  
MAY BE PRESENT.**

**SAFETY IS THE RESPONSIBILITY OF THE USER.**

**ALL USERS OF THIS EQUIPMENT SHOULD READ AND UNDERSTAND  
THIS MANUAL BEFORE OPERATING THE EQUIPMENT AND SHOULD  
FOLLOW ALL SAFETY INSTRUCTIONS.**

**iii**

## TABLE OF CONTENTS

<u>SECTION</u>		<u>PAGE</u>
A	INTRODUCTION	A1
B	SAFETY PRECAUTIONS	B1
	General Safety Precautions	B4
	for DC Testing	
C	RECEIVING INSTRUCTIONS	C1
D	SPECIFICATIONS	D1
	Physical Characteristics	D1
	Environmental Recommendations	D1
	Input	D1
	Input Protection	D1
	Output	D2
	Metering	D2
	Controls	D3
	Indicators	D4
	Accessories	D4
	Test Connections	D4
	Tests Performed	D5
E	DESCRIPTION	E1
	Control and Connector Identification	E1
F	OPERATION	F1
	Safety Precautions	F1
	Test Areas	F1
	Suggestions	F2
	Preliminary Routine	F2
	Shutdown Procedure	F2
	Operating Notes	F2
	Operating Procedure	F3

## TABLE OF CONTENTS (Cont'd.)

<u>SECTION</u>	<u>PAGE</u>
G APPLICATION NOTES	G1
Properties of Insulation	G1
Dielectric Voltage-Withstand	
Test Characteristics	G4
Instructions for Setting the	
Leakage Sensitivity Control	G7
Dielectric Withstand Testing of	
120V AC Appliances	G9
H MAINTENANCE	H1
Routine Maintenance	H1
Calibration	H8
I TROUBLESHOOTING GUIDE	I1
J REPLACEABLE PARTS LIST	J1
K WARRANTY AND REPAIR	K1
 <u>ILLUSTRATIONS</u>	
Figure 1. Biddle AC/DC High Pot Tester Catalog No. 230425	ii
Figure 2. Controls and Connectors	E4
Figure 3. Typical Output Characteristics of the Biddle AC/DC High Pot Tester in the AC Mode	G5
Figure 4. Typical Output Characteristics of the Biddle AC/DC High Pot Tester in the DC Mode	G6
Figure 5. Internal View of Tester	I2
Figure 6. Schematic Diagram of Biddle AC/DC High Pot Testers 230425 and 230425-1	J9

## Section A INTRODUCTION

This instruction manual covers the operation and maintenance of the Biddle portable AC/DC High Pot Tester. The input and output characteristics of the tester are indicated by its catalog number, as follows:

230425	- 120V, 50/60 Hz input, 4 kV AC output or 5 kV DC output
230425-1	- 240V, 50/60 Hz input, 4 kV AC output or 5 kV DC output

This compact, self-contained unit is a high-voltage, low-energy source for testing the dielectric strength of electrical insulation. Dielectric withstand (high-pot) testing of electrical insulation is a valuable method of detecting assembly flaws (such as stray wire strands, etc.) and defects in marginally sound insulation. Such conditions can be hazardous to the user and may cause product failure during normal use.

The Tester has been designed to simplify testing procedures and to minimize hazards to both the operator and the item under test. The Tester meets all standards for sensitivity, voltage regulation and failure detection currently required by Underwriters Laboratories (UL) for test equipment used in production line voltage-withstand testing of electrical appliances and components.

The instructions and suggestions provided in this manual anticipate the normal use of the Tester for testing electrical insulation systems on motors, transformers and most line-operated electrical appliances.

## Section B

### SAFETY PRECAUTIONS

THE VOLTAGES AND CURRENTS PRODUCED BY THE TESTER CAN CAUSE HARMFUL OR FATAL ELECTRIC SHOCK TO THE USER OR BYSTANDER. FOR YOUR PROTECTION, FOLLOW ALL SAFETY PROCEDURES GIVEN IN THIS MANUAL.

#### SAFETY IS THE RESPONSIBILITY OF THE USER.

The Biddle AC/DC High Pot Tester has been designed with careful attention to safety. Biddle has conducted formal safety reviews of the initial equipment design and all subsequent changes. This procedure, followed for all new instruments, covers areas in addition to those included in the ANSI standard.

Because hazards exist with all electrical test equipment, proper procedures and precautions must be observed by the user when operating this instrument. The basic safety procedures to be followed when operating this equipment are given in this section. Additional safety instructions are provided in other sections as appropriate. In addition, the instrument has been marked with precautionary warnings.

Three safety notations used in this manual indicate various degrees of hazard to personnel or equipment. The notations are listed below, with brief explanations of how they are applied.

#### DANGER

Used when the condition represents a hazard to the life of the operator.

#### WARNING

Used when the condition may cause damage to the Tester or to the unit under test.

## Section B

### SAFETY PRECAUTIONS (Cont'd.)

#### CAUTION

Used when the condition may interfere with the proper execution of a test procedure.

Before using the Tester, read and understand this entire instruction manual. When operating the Tester, carefully follow the testing procedures given in this manual and all applicable safety instructions, with special emphasis on those that follow:

1. Provide a dry test area, with operator and all equipment shielded from traffic and onlookers.
2. Perform tests on a secure insulated mounting area. The insulation must isolate the item to be tested from ground and from any adjacent conductors.
3. Place the item under test out of the operator's normal reach. Treat the item under test as a shock hazard until it is proven safe by tests performed in accordance with procedures given in this manual.
4. Plug in the high-voltage test probe assembly (W1) only when it is being used. Handle its clips only by the insulators; never touch the clips directly! At the completion of a test, do not touch the clips until the voltage shown on the voltmeter is zero (0). Unplug the high-voltage test probe assembly from the Tester during periods when testing is not actively being done and before leaving the test area.
5. For all tests, connect the black lead of the high-voltage test probe assembly (W1) first. Connect and disconnect the item under test only when high voltage is off.

## Section B

### SAFETY PRECAUTIONS (Cont'd.)

6. Practice test procedures until they become familiar before actually performing tests on equipment.
7. Unskilled personnel who use the Tester should be trained in a fixed operating routine for each test setup and supervised by a person who fully understands the operation of the Tester.
8. Do not use the Tester or any of its accessories for any purposes other than those described in this manual.
9. Never operate the Tester with its case removed; dangerous voltages are present within the instrument.
10. Use only qualified personnel to repair the Tester. Observe all precautions and follow the procedures in Section I, Troubleshooting Guide.
11. Maintain the Tester with a regular maintenance program.

The Tester may be used in a great variety of applications, thus it is not possible to foresee every potential hazard that may arise. To insure safe use of all equipment involved in a test, always treat it carefully. It is essential that the user, in addition to following all safety instructions in this manual, carefully consider all safety aspects of each test before it is performed.

For further details on safety practices and precautions for high-voltage and high-power testing, refer to IEEE Standard 510-1983, IEEE Recommended Practices for Safety in High-Voltage and High-Power Testing.

**Section B**  
**SAFETY PRECAUTIONS (Cont'd.)**

GENERAL SAFETY PRECAUTIONS FOR DC TESTING

In addition to the basic safety practices described above, observe the following precautions when conducting DC tests.

1. When not in use, devices insulated by solid or solid/liquid dielectric should be grounded and short-circuited with bonding jumpers.
2. Capacitive objects should be short-circuited as follows:
  - A. If any capacitive object not in use might be within the influence of a DC electric field, its exposed high-voltage terminal should be grounded. Otherwise, the DC electric field may induce a voltage in the capacitive object.
  - B. Capacitive objects with a solid dielectric should be short-circuited after DC proof testing. Otherwise, dielectric absorption in the insulation may result in a buildup of voltage on the object. The short circuit should remain on the object until the dielectric absorption has dissipated or until the object has been reconnected to a circuit.

NOTE: All capacitive devices should remain short-circuited when not in use.

- C. Any open-circuited capacitive device should be short-circuited and grounded before it is touched by personnel.

**Section C**  
**RECEIVING INSTRUCTIONS**

When your Biddle instrument arrives, check the equipment received against the packing list to ensure that all materials are included. Notify Biddle Instruments, Blue Bell, PA, of any shortage of materials.

Examine the instrument for damage received in transit. If any damage is discovered, file a claim with the carrier at once and notify Biddle Instruments or its nearest authorized sales representative. Be sure to provide a detailed description of the damages observed.

This instrument has been thoroughly tested and inspected to meet rigid inspection specifications before being shipped. It is ready for use when set up as indicated in Section F.



**Section D**  
**SPECIFICATIONS**

PHYSICAL CHARACTERISTICS

Dimensions: 8-3/8" D x 9" W x 8-1/8" H  
(213 x 229 x 206mm)

Weight: 13.5 lbs. (6.1 kg)

ENVIRONMENTAL RECOMMENDATIONS

Operating Temperature: 25°F to 104°F (-4°C to 40°C)

Storage Temperature: -22°F to 131°F (-30°C to 55°C)

Humidity: Operation and storage limits 5 to 95% RH.

Climate: Operation prohibited in direct rain or snow.

INPUT

120 volts  $\pm 10\%$ , 1A, 50/60 Hz single phase with ground (Cat. No. 230425). Connection to the Tester is made via a removable 7-1/2 ft. power cord, with a molded PVC grounding plug PH-290B (NEMA configuration 5-15P) on one end and a molded PVC grounding connector SPH-386 on the other.

240 volts  $\pm 10\%$ , 0.5A, 50/60 Hz single phase with ground (Cat. No. 230425-1). Connection to the Tester is made via a removable 6-1/2 ft. power cord, with a molded PVC grounding plug PH-44 (NEMA configuration 6-15P) on one end and a molded PVC grounding connector SPH-386 on the other.

INPUT PROTECTION

2-pole, 1 Amp, 250V, rocker handle circuit breaker.

**Section D**  
**SPECIFICATIONS (Cont'd.)**

OUTPUT

AC Mode:

0-4000 VAC, continuously adjustable.

Maximum short-circuit current: 12.6 mA (electronic limitation).

Maximum load at maximum voltage: 0.008  $\mu$ F (60 Hz)  
0.010  $\mu$ F (50 Hz)

Maximum capacitive loads are proportionally higher at reduced output voltages. (See Figure 3 in Section G, Application Notes).

DC Mode:

0-5000 VDC, continuously adjustable.

Maximum current: 12.6 mA (electronic limitation).

Maximum ripple: 0.4% RMS per mA at full voltage (no capacitive load).

NOTE: Ripple will be greatly reduced with a capacitive load.

For complete loading capability, see Figure 4 in Section G, Application Notes.

METERING

Average reading, average calibrated.

Style: 3-1/2", zero left analog meter with high-torque, ruggedized movement.

Range: 0-5000V (NOTE: AC readings stop at 4 kV.)

Accuracy:  $\pm$ 2% Full Scale

**Section D**  
**SPECIFICATIONS (Cont'd.)**

CONTROLS

Voltage Control

Voltage is controlled manually by means of an adjustable autotransformer with zero-start interlock.

Mode Selection

Four pushbuttons provide the following selections.

One-Second Test: Momentary actuation of the ONE SEC pushbutton turns on high voltage for a period of from 1 second (minimum) to 1.3 seconds (maximum) unless a failure occurs. This test is recommended for AC testing only, since DC testing usually involves a high initial charging current which may cause a failure signal. To begin initial testing, or after a failure, the RESET pushbutton must be actuated or the VOLTAGE CONTROL returned to the ZERO START (RESET) position. Once the Tester is reset, the One-Second Test can be repeated as many times as desired.

Continuous Test: Momentary actuation of the CONT pushbutton turns on high voltage until the HV OFF pushbutton is actuated or a failure occurs. Each time high voltage is turned off, or after a failure, the RESET pushbutton must be actuated or the VOLTAGE CONTROL returned to the ZERO START (RESET) position.

HV Off: Momentary actuation of the HV OFF pushbutton turns off high voltage.

Reset: Momentary actuation of the RESET pushbutton stops failure signals and allows further testing.

NOTE: The RESET pushbutton is also a zero-start override. When the output voltage has been preset and the HV OFF pushbutton has been depressed, high voltage can be turned on to the preset value by depressing the RESET button then the CONT or ONE SEC test pushbutton.

**Section D**  
**SPECIFICATIONS (Cont'd.)**

Failure Detection and Automatic Shutdown

The failure detection circuit indicates a failure, by audible and visual alarms, and switches off high voltage within 50 ms whenever arcing occurs or the total leakage current exceeds a preset value. The leakage current trip level is adjustable between 0.3 mA  $\pm 5\%$  to 12 mA  $\pm 5\%$  by means of the LEAKAGE SENSITIVITY control knob.

INDICATORS

- Tester Grounded: Lights when the Tester is connected to a properly wired supply.
- HV On: Lights when the high-voltage output is energized.
- Power: Integral to power switch. Lights when power is available to the Tester.
- Failure: Lights when a breakdown occurs or an excessive leakage current is drawn by the item under test.
- Audible Alarm: Sounds when the failure lamp is lit.

ACCESSORIES

- Catalog No. 230425-2: Removable high-voltage test probe assembly, 4 feet long, with retractile test tips.

TEST CONNECTIONS

The item to be tested is connected by means of the alligator clips on the 4-ft. long removable high-voltage test probe assembly.

**Section D**  
**SPECIFICATIONS (Cont'd.)**

TESTS PERFORMED

Tester Grounded

A low current (less than 0.5 mA, 120 V operation) line monitoring circuit is connected between the "HOT" side and the ground side of the incoming power line. This circuit lights a white neon lamp as soon as the Tester is connected to a correctly wired power supply. The grounded circuit of the Tester is interlocked with the dielectric voltage-withstand test so that high voltage cannot be applied if either of the following common faults exist:

- a. Ground wire open.
- b. "HOT" and "NEUTRAL" wires interchanged (120V operation).

Dielectric Voltage-Withstand

A high-voltage transformer supplies test voltage to two panel jack assemblies. A slide selects the desired panel jack assembly (either AC or DC) and automatically connects the proper metering circuit. A high-voltage test probe assembly plugs into the open panel jack assembly for output. A voltmeter indicates the test voltage. Visual and audible alarms signal when the total leakage current exceeds an adjustable preset value or when arcing occurs.

## Section E

### DESCRIPTION

#### CONTROL AND CONNECTOR IDENTIFICATION

The locations of controls and connectors and their schematic reference numbers are shown in Figure 2. Their functions are described below.

#### CB1 - Input Circuit Breaker/Power Switch

This circuit breaker controls the power input to the Tester. It disconnects the power circuit if more than 1 ampere is drawn by the Tester.

#### DS1 - Power

This indicator is an integral part of the Input Circuit Breaker/Power Switch (CB1). It lights when power is available to the Tester.

#### DS2 - Failure

This indicator lights and an audible alarm sounds when a breakdown occurs or an excessive leakage current is drawn by the item under test.

#### DS3 - HV On

This indicator lights when high voltage is available to the Output Receptacle (J8) and the high-voltage test probe receptacle (J9).

#### DS5 - Tester Grounded

This indicator lights when the Tester is connected to a correctly wired power supply.

NOTE: Since the current through this lamp is limited to 0.5 mA (120V operation), this lamp will not be as bright as the other indicators.

**Section E**  
**DESCRIPTION (Cont'd.)**

J8 - AC Output Receptacle

This receptacle accepts the high-voltage test probe assembly (W1) for AC high-voltage testing.

J9 - DC Output Receptacle

This receptacle accepts the high-voltage test probe assembly (W1) for DC high-voltage testing.

M1 - Kilovoltmeter

This meter shows the voltage being applied to the item under test.

P7 - Input Inlet

This inlet accepts the input power cord (W3).

R77 - Leakage Sensitivity

This variable potentiometer allows the leakage current trip level to be set between 0.3 mA and 12 mA.

S1 - One Sec

This pushbutton initiates the one-second high-voltage test.

**NOTE:** This test is recommended for AC testing only, since DC testing usually involves a high initial charging current which may cause a failure signal.

S2 - Cont

This pushbutton is provided for high-voltage testing for any desired length of time. When this button is used, high voltage remains on until the HV OFF pushbutton is depressed or a failure occurs.

**Section E**  
**DESCRIPTION (Cont'd.)**

S3 - HV Off

This pushbutton switches off high voltage. It may be used at any time.

S4 - Reset

This pushbutton stops failure signals and allows further testing.

T3 - Voltage Control

This autotransformer serves as voltage control, reset, and zero start.

W1 - High-Voltage Test Probe Assembly (not shown)

This lead assembly plugs into either the AC or DC output receptacle (J8 or J9) for high-voltage testing.

W2 - Input Power Cord (not shown)

This cord plugs into the input inlet (P7). It is provided with an outboard end appropriate to the input voltage requirement (120V or 240V).

Output Receptacle Slide

This slide connects voltmeter (M1) to either the AC or the DC circuit.

## Section F OPERATION

### SAFETY PRECAUTIONS

Follow all safety precautions given in Section B of this manual.

### TEST AREA

Wherever the Tester is used, the test area should be arranged according to the following guidelines.

1. Select a dry test area where the operator and all equipment are shielded by suitable barriers from traffic and onlookers.
2. Locate the Tester within six feet of a 3-wire grounded outlet and within four feet of the item to be tested.
3. Provide a secure insulated mounting area for the item to be tested. The insulation must isolate the item to be tested from ground and from any adjacent conductors. If the insulation of the mounting area is questionable, a rubber electrical-grade insulation mat or a suitable piece of acrylic plastic or phenolic can be used as insulation.
4. Place the item to be tested out of the operator's normal reach. Arrange the work area so that the operator can reach the controls of the Tester without any danger of touching the item under test.

NOTE: Rubber gloves or shoes are not required, but Biddle considers their use an excellent safety practice when handling the item under test.

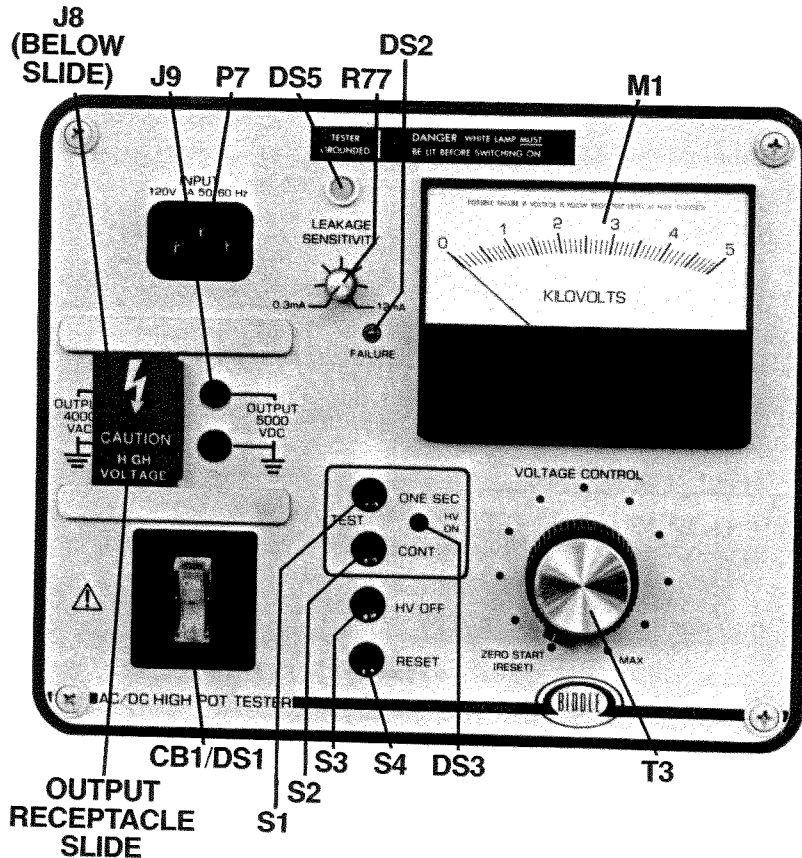

Figure 2. Controls and Connectors

## Section F OPERATION (Cont'd.)

### SUGGESTIONS

A sturdy wood workbench is recommended for the test area. A simple support may be used to hold the entire Tester in a convenient position, with the Tester case secured to the support. A space on the workbench may be arranged so that the item to be tested can be clamped securely in place and insulated from ground.

Barriers are strongly recommended to prevent accidental contact with the item under test.

### PRELIMINARY ROUTINE

Before conducting any test, carry out the following routine:

1. Review any damage report that has been submitted covering the item to be tested.
2. Visually inspect the item to be tested.
3. Repair any visible defects before testing.

### SHUTDOWN PROCEDURE

To remove high voltage from the item under test, set the power switch (CB1) to the OFF position or depress and release the HV OFF pushbutton.

Note: At the completion of a test, when voltage has been switched off, do not touch the high-voltage test probe assembly alligator clips until the voltage shown on the voltmeter is 0.

### OPERATING NOTES

High voltage cannot be switched on unless the following interlock conditions are met:

## Section F OPERATION (Cont'd.)

1. The TESTER GROUNDED lamp (DS5) must be lit.
2. The VOLTAGE CONTROL (T3) must be in the ZERO START (RESET) position or the RESET pushbutton (S4) must be depressed.

### OPERATING PROCEDURE

To insure safety and accurate test results, observe the following procedure when operating the Tester:

1. With the power switch (CB1) off, connect the input power cord (W2) to the Tester INPUT inlet (P7); then plug the input power cord (W2) into a grounded outlet.
2. Verify that the TESTER GROUNDED lamp (DS5) is lit.

### DANGER!

**IF THE TESTER GROUNDED LAMP (DS5) IS NOT LIT, DO NOT PROCEED ANY FURTHER. UNPLUG THE INPUT POWER CORD (W2) AND REFER TO SECTION I, TROUBLESHOOTING GUIDE.**

3. To connect the item under test, attach the high-voltage test probe assembly (W1) to either the AC or DC OUTPUT receptacle (J8 or J9). Connect the black lead of the high-voltage test probe assembly (W1) to the low (or ground or return) side of the item under test. Connect the red lead to the high potential side of the item under test.
4. Set the LEAKAGE SENSITIVITY control (R77) to the desired setting. Refer to SECTION G, APPLICATION NOTES for detailed instructions for setting this control.
5. Turn the power switch (CB1) on. The switch should light.

**Section F**  
**OPERATION (Cont'd.)**

6. To enable high-voltage testing, set the VOLTAGE CONTROL (T3) to the ZERO START (RESET) position or press the RESET pushbutton (S4).
7. Select the desired test, either one-second or continuous.

NOTE: The one-second test is recommended for AC testing only, since the high initial charging current usually present in DC testing may cause a failure signal.

**A. CONTINUOUS TEST**

1. Press the CONT pushbutton (S2). The HV ON lamp (DS3) will light.

**DANGER!**

**THE TESTER IS NOW CAPABLE OF  
PRODUCING HIGH VOLTAGE.**

2. While observing the kilovoltmeter (M1) indication, raise the voltage to the desired level by rotating the VOLTAGE CONTROL (T3) clockwise. Maintain the selected voltage level for the required time.

NOTE: In a DC test, increasing voltage too fast may cause a failure signal.

3. To end the test, return the VOLTAGE CONTROL (T3) to the ZERO START (RESET) position; then press the HV OFF pushbutton (S3). The HV ON lamp (DS3) will go out.

**DANGER!**

**DO NOT PROCEED UNTIL THE KILOVOLTMMETER READS 0.**

**Section F**  
**OPERATION (Cont'd.)**

**B. ONE-SECOND TEST**

This test is used when several identical items are being tested.

1. With the item under test connected, set the voltage as for the continuous test (A2 above), but press the HV OFF pushbutton (S3) without returning the VOLTAGE CONTROL (T3) to the ZERO START (RESET) position.
2. To start a series of one-second tests, press the RESET pushbutton (S4); then press the ONE SEC pushbutton (S1) each time a test is to be performed.
3. To end a series of tests, return the VOLTAGE CONTROL (T3) to the ZERO START (RESET) position and press the HV OFF pushbutton (S3).

**DANGER!**

**DO NOT PROCEED UNTIL THE KILOVOLTMMETER (M1) READS 0.**

8. To proceed with additional testing after the HV OFF pushbutton (S3) has been pressed, return the VOLTAGE CONTROL (T3) to the ZERO START (RESET) position or press the RESET pushbutton (S4).
9. During high-voltage testing, be alert to failure symptoms such as the sounding of the audible alarm, lighting of the FAILURE lamp (DS2), a sudden voltage drop, or an erratic kilovoltmeter (M1) reading.



**Section F**  
**OPERATION (Cont'd.)**

10. When the Tester detects a failure, the audible alarm sounds, the FAILURE lamp (DS2) lights and high voltage is switched off.

To turn off the failure signals and continue testing, return the VOLTAGE CONTROL (T3) to the ZERO START (RESET) position or press the RESET pushbutton (S4).

**Section G**  
**APPLICATION NOTES**

PROPERTIES OF INSULATION

Leakage Current

All electrical insulating structures, when subjected to voltage, conduct some current. When alternating voltage is applied, this current is made up of two components: one due to conduction through or across the surface of the insulator (the resistive), and one due to the capacitance of the structure (the capacitive). Both of these components are undesirable and by design are kept very small in new equipment. Nevertheless, some current of both types always "leaks" around or through any insulator, hence the name "leakage current." (Under some definitions, only the resistive component is called leakage, but this manual follows current practice by also including the capacitive.)

Leakage current of both resistive and capacitive components increases with voltage and generally with the size of equipment. Capacitive current, in particular, is high for items that have windings (motors, transformers) or long runs of wire (wired control panels, etc.). In good new equipment, the resistive component is usually much smaller than the capacitive.

Leakage that occurs during a dielectric voltage-withstand test (high-voltage leakage) should not be confused with the leakage that occurs when an appliance is energized at its normal operating voltage and for which limits are specified by various safety standards, such as UL. This operating leakage is an important safety consideration, but it is related only indirectly to high-voltage leakage and is normally much smaller. Operating leakage cannot be measured by a high pot tester. Other Biddle instruments are available for measuring this line-voltage leakage current. The term "leakage current" is used in this manual to refer to high-voltage leakage current.

**Section G**  
**APPLICATION NOTES (Cont'd.)**

The schematic diagram below represents the leakage current paths during a dielectric voltage-withstand test. In good equipment,  $I_R$  is usually much less than  $I_C$ .

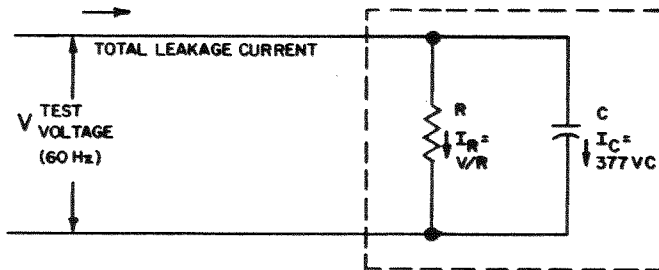

**Section G**  
**APPLICATION NOTES (Cont'd.)**

Insulation Failure

When defective insulation is subjected to a high voltage, one of two things happens:

- a. Leakage current increases greatly because part of the insulation has become conductive.
- b. A spark jumps across an air gap which has become too short to withstand the applied voltage.

Condition (a) may lead to (b), and (b) usually leads to a continuing "breakdown" discharge which emits light, heat, and a crackling sound and carries as much current as the Tester will deliver, causing the detection circuit to signal a failure. Such a discharge also causes high-frequency (RF) variations in the current which are useful in detection.

Failure is often caused by defects such as:

- a. Dirt on the insulation, which causes increased resistive current. This may heat the surface and cause a further increase and may lead to a discharge.
- b. Cracks or pinholes in insulation, which usually lead to a quick breakdown and discharge.
- c. Shortened air gap due to defective assembly, which may cause discharge across the gap. An example is a loose strand of wire near the frame.
- d. Insulation saturated with moisture. This condition may cause a large increase in either component of leakage current.

**Section G**  
**APPLICATION NOTES (Cont'd.)**

DIELECTRIC VOLTAGE-WITHSTAND TEST CHARACTERISTICS

Output

Figure 3, a graph showing output voltage and capacitance, illustrates the typical output characteristics of the Tester in the AC mode. Figure 4, a graph showing output voltage and output current, illustrates the typical output characteristics of the Tester in the DC mode.

Automatic Failure Detection

The Tester is equipped with a failure detection circuit that detects insulation failure in the form of excessive leakage current or an arcing fault. The leakage current trip level is adjustable between 0.3 mA and 12 mA by the LEAKAGE SENSITIVITY control (R77). The Tester indicates a failure by the audible alarm and the FAILURE lamp (DS2), and it switches off high voltage within 50 ms.

Occasionally the operator may detect a visible or audible discharge or erratic voltmeter indication without an accompanying failure signal from the Tester. These represent borderline cases in which the discharge energy remains small and does not build up to a full breakdown. If such indications are observed repeatedly during a test period, they should be considered signs of failure.

If a single "snap" or "pop" occurs and is not repeated, it may be due to a stray projection or dirt which has burned off, in which case the item under test may be acceptable. Such weak "pops" seldom occur at higher test voltages or with high-capacitance test items. However, some complex structures, such as relays and transformers, may emit a more continuous buzz at high voltage. This is a very low energy "corona" discharge and generally not a sign of insulation failure.

**Section G**  
**APPLICATION NOTES (Cont'd.)**

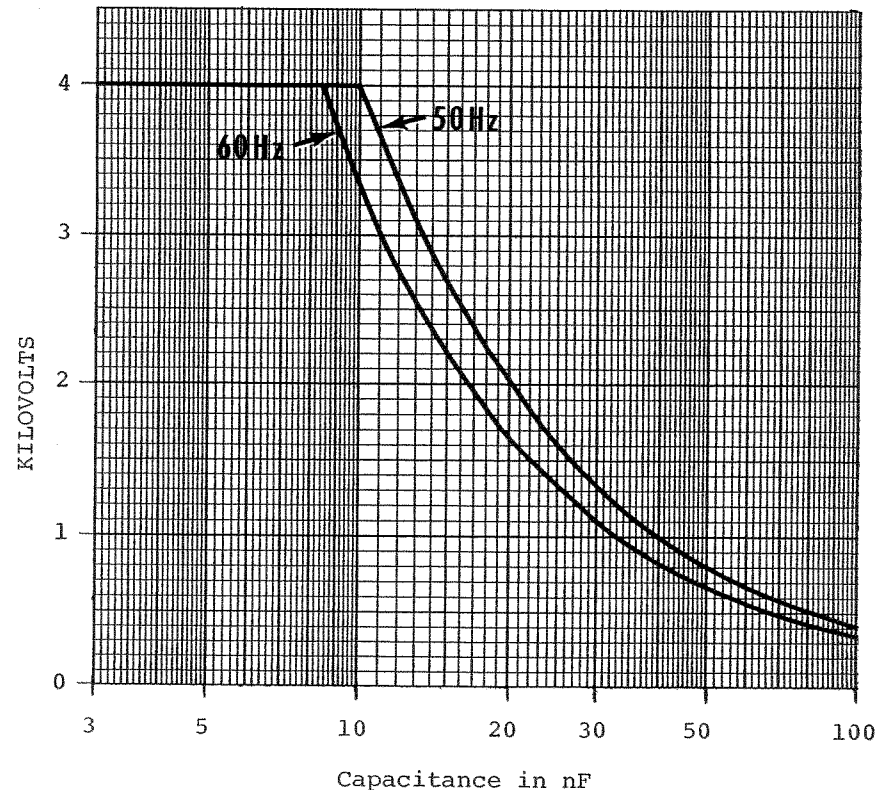

Figure 3. Typical Output Characteristics of the Biddle AC/DC High Pot Tester in the AC Mode.

Section G  
APPLICATION NOTES (Cont'd.)

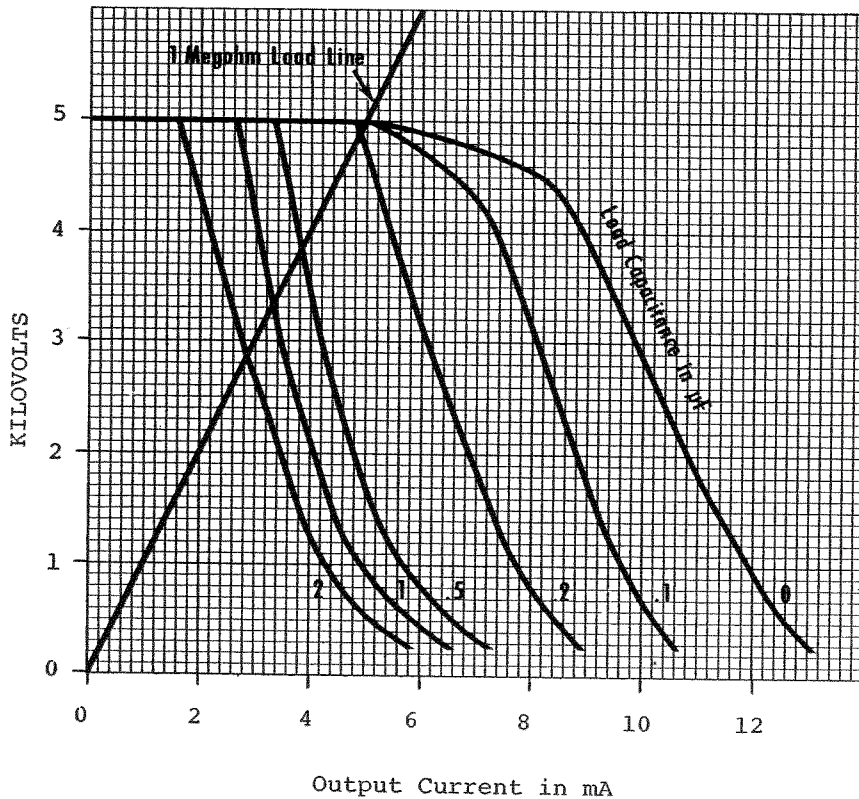

Figure 4. Typical Output Characteristics of the Biddle AC/DC High Pot Tester in the DC Mode.

Section G  
APPLICATION NOTES (Cont'd.)

INSTRUCTIONS FOR SETTING THE LEAKAGE SENSITIVITY CONTROL

AC Testing

Set the LEAKAGE SENSITIVITY control (R77) according to the capacitance of the item under test, if known, Follow the guidelines given below:

Capacitance of Item Unknown

If the capacitance of the item under test is unknown, always set the LEAKAGE SENSITIVITY control (R77) at the most sensitive setting. Rotate the control knob counterclockwise toward the 0.3 mA position. This insures the best test results and maximum protection for both the operator and the item under test.

Low-Capacitance Items

The capacitance of most items is well below 1000 pF, which implies a leakage current less than 0.3 mA when tested at 1000 to 1200 volts. In such cases, the Tester can be used with the LEAKAGE SENSITIVITY control (R77) at the 0.3 mA position.

Medium- to High-Capacitance Items

If an item has a capacitance greater than 1000 pF and its capacitance-voltage point falls below the maximum output line in Figure 3, it can be tested with the LEAKAGE SENSITIVITY control (R77) at some intermediate position between 0.3 mA and 12 mA.

Excessively High-Capacitance Items that Cannot be Tested

If the capacitance of an item is so large that its capacitance-voltage point falls beyond the maximum output line in Figure 3, it is too large for this

**Section G**  
**APPLICATION NOTES (Cont'd.)**

Tester to handle. This will be clear when attempting to test; since even on a good appliance, a failure indication will be signalled before the voltage reaches the desired value.

DC Testing

The maximum capacitance of an item that can be tested with AC is approximately 10 nF; however, the capacitance that can be tested with DC is virtually infinite. The upper limit is unlikely to be encountered in practice.

The maximum output capability of the Tester in the DC mode depends on the combination of the capacitance and resistance of the item under test. When the capacitance and resistance of the item are known, Figure 4 can be used to determine the approximate setting of the LEAKAGE SENSITIVITY control (R77).

To use Figure 4, first draw a load line representing the resistance of the item. As a guide, a load line representing a resistance of 1 Megohm has been drawn. The ratio of the desired test voltage to the voltage at the point where the load line and the appropriate capacitance curve intersect gives an approximate setting for the LEAKAGE SENSITIVITY control (R77) in terms of the full travel of the control knob.

If the desired test voltage falls to the right of the capacitance curve, i.e., a ratio of greater than 1, the item cannot be tested.

If the capacitance and resistance of the item under test are unknown, the setting of the LEAKAGE SENSITIVITY control (R77) can be determined by trial and error during the testing of an identical known good item. Always set the control to the most sensitive setting, as described above for AC testing.

**Section G**  
**APPLICATION NOTES (Cont'd.)**

DIELECTRIC WITHSTAND TESTING OF 120V AC APPLIANCES

Most 120V AC tools and appliances are frequently tested at 2 times working voltage +1000 volts (1240V). Some standards, however, call for other values of dielectric withstand voltage. Such standards are issued by many different authorities. The latest issue of the standard which applies in each particular case should be consulted. A few standard authorities are listed below in alphabetical order.

American National Standards Institute (ANSI)  
1430 Broadway  
New York, NY 10018 USA

Canadian Standards Association (CSA)  
178 Rexdale Boulevard  
Rexdale, Ontario, Canada M9W1R3

International Electrotechnical Commission (IEC)  
1 Rue de Varembe  
Geneva, Switzerland  
(Copies of IEC standards can be obtained from ANSI.)

Underwriters Laboratories, Inc. (UL)  
333 Pfingsten Road  
Northbrook, IL 60062 USA

## Section H MAINTENANCE

### ROUTINE MAINTENANCE

Certain routine maintenance procedures are necessary to insure safe and correct operation of the Tester. These are described below. Always make all of these inspections after repairs to the Tester and at regularly scheduled intervals. Make the inspections at least once a year, more often if the set is in heavy use.

### Mechanical Inspection (Exterior)

1. Case. Note that hinges and case lock function properly. Check for cracks in the case or lid. Inspect the condition of the handle.
2. Clean the case, panel, test probe assembly and input power cord.
3. Panel. Note that all knobs are secure on their shafts, that all controls operate smoothly without binding and all mounting screws are tight.
4. Test Probe Assembly. Check for cracks in the insulation. Note that the alligator clips and boots are complete.
5. Input Power Cord. Check for cracks in the insulation. Check cord plugs for cracked housings or broken pins.
6. Mechanically set the kilovoltmeter to zero.
7. Repair any defects found.

**Section H**  
**MAINTENANCE (Cont'd.)**

Mechanical Inspection (Interior)

**DANGER!**

**THE TESTER MUST BE TURNED OFF AND DISCONNECTED FROM THE POWER SUPPLY BEFORE IT IS REMOVED FROM ITS CASE.**

1. To remove the panel assembly from the case:
  - a. Remove and set aside the four panel screws.
  - b. Carefully turn the case so that the panel assembly faces down.
  - c. Slide the case up off the panel assembly.

**DANGER!**

**HAZARDOUS VOLTAGES MAY BE RETAINED IN THE C-30 CAPACITOR LOCATED ON THE AC/DC METERING CIRCUITS ASSEMBLY BOARD EVEN AFTER THE TESTER HAS BEEN TURNED OFF. DO NOT HANDLE THE TESTER UNTIL THIS CAPACITOR HAS BEEN GROUNDED AND SHORT-CIRCUITED FOR AT LEAST ONE MINUTE.**

- d. Turn the panel assembly right side up and place on a clean dry surface.
2. Clean any accumulated dust from the interior of the case and the panel assembly.
3. Visually inspect all components and leads for defects.
4. Repair any defects found.
5. Remove the short circuit from capacitor C-30.
6. Reinstall the panel assembly in its case and replace the mounting screws.

**Section H**  
**MAINTENANCE (Cont'd.)**

Electrical Inspection

Perform the electrical inspection only after both mechanical inspections have been completed. Before performing this inspection, read the entire procedure given below, as well as Sections B, E and F. Follow all safety precautions.

If the Tester does not function exactly as it should during any of the following tests, refer to Section I, Troubleshooting Guide.

1. Setup

- a. With the power switch (CB1) off, connect the input power cord (W2) to the Tester INPUT inlet (P7); then plug the input power cord (W2) into a grounded outlet.
- b. Verify that the TESTER GROUNDED lamp (DS5) is lit.

**DANGER!**

**IF THE TESTER GROUNDED LAMP (DS5) IS NOT LIT, DO NOT PROCEED FURTHER. UNPLUG THE INPUT POWER CORD (W2) AND REFER TO SECTION I, TROUBLESHOOTING GUIDE.**

2. Dielectric Voltage-Withstand Circuit

When the TESTER GROUNDED lamp (DS5) is lit, the dielectric withstand circuit can be checked. The following items are required to conduct the tests:

- a. 1.0 M $\Omega$ , 1/4 W resistor
- b. 25 k $\Omega$ , 5 W resistor
- c. stopwatch

**Section H**  
**MAINTENANCE (Cont'd.)**

**A. Zero Start (Reset) Test**

1. Disconnect the high-voltage test probe assembly (W1) from the Tester.
2. Move the output receptacle slide to the far right to cover the DC OUTPUT receptacle (J9).
3. Rotate the VOLTAGE CONTROL (T3) to the first dot above the ZERO START (RESET) position.
4. Press the HV OFF pushbutton (S3).
5. Press the CONT pushbutton (S2). Observe the following conditions:
  - The HV ON lamp (DS3) should not light.
  - The kilovoltmeter (M1) should read zero.
6. Press the RESET pushbutton (S4).
7. Press the CONT pushbutton (S2). Observe the following conditions:
  - The HV ON lamp (DS3) should light.
  - The kilovoltmeter (M1) should read a few hundred volts.
8. Press the HV OFF pushbutton (S3). The HV ON lamp (DS3) should go out.
9. Rotate the VOLTAGE CONTROL (T3) counterclockwise to the ZERO START (RESET) position.
10. Press the CONT pushbutton (S2). Observe the following conditions:

**Section H**  
**MAINTENANCE (Cont'd.)**

- The HV ON lamp (DS3) should light.
- The kilovoltmeter (M1) should read zero.

11. Press the HV OFF pushbutton (S3). The HV ON lamp (DS3) should go out.

**B. Leakage Sensitivity Test**

1. Set the power switch (CB1) to the OFF position.
2. Connect the high-voltage test probe assembly (W1) to the AC OUTPUT receptacle (J8).
3. Connect the 1.0 MΩ resistor (item a) between the leads of the high-voltage test probe assembly (W1).
4. Insulate the resistor/test probe assembly for at least 4000 volts; locate the assembly to prevent accidental contact with persons.
5. Set the LEAKAGE SENSITIVITY control (R77) to 0.3 mA.
6. Rotate the VOLTAGE CONTROL (T3) to the ZERO START (RESET) position.
7. Set the power switch (CB1) to the ON position. The switch should light.

**DANGER!**

**DO NOT TOUCH OR PERMIT ANYONE ELSE TO TOUCH THE RESISTOR/TEST PROBE ASSEMBLY.**

8. Press the CONT pushbutton (S2). The HV ON lamp (DS3) should light.



**Section H**  
**MAINTENANCE (Cont'd.)**

9. Slowly rotate the VOLTAGE CONTROL (T3) clockwise while observing the kilovoltmeter (M1) indication. When the kilovoltmeter (M1) shows between 100 and 400 volts, the FAILURE lamp (DS2) should light and the audible alarm should sound.
10. Rotate the VOLTAGE CONTROL (T3) to the ZERO START (RESET) position.
11. Repeat steps 1 through 10, using the 25 k $\Omega$  resistor (item b) instead of the 1.0 M $\Omega$  resistor (item a) and with the LEAKAGE SENSITIVITY control (R77) set at 12 mA instead of 0.3 mA.
12. Repeat steps 1 through 11, with the high-voltage test probe assembly (W1) connected to the DC OUTPUT receptacle (J9).
13. Set the power switch (CB1) to the OFF position. Disconnect the 25 k $\Omega$  resistor (item b).

C. Breakdown Sensitivity Test

1. Connect the high-voltage test probe assembly (W1) to the AC OUTPUT receptacle (J8).
2. Place the black and red alligator clip leads of the high-voltage test probe assembly (W1) approximately 1/16 inch apart. They must not touch each other.
3. Insulate the test probes for at least 4000 volts and locate the test probe alligator clips to prevent accidental contact with persons.

**Section H**  
**MAINTENANCE (Cont'd.)**

4. Rotate the VOLTAGE CONTROL (T3) to the ZERO START (RESET) position.
5. Set the power switch (CB1) to the ON position. The switch should light.

**DANGER!**

**DO NOT TOUCH OR PERMIT ANYONE ELSE TO TOUCH THE HIGH-VOLTAGE TEST PROBE ALLIGATOR CLIPS.**

6. Press the CONT pushbutton (S2). The HV ON lamp (DS3) should light.
7. Slowly rotate the VOLTAGE CONTROL (T3) clockwise while observing the kilovoltmeter (M1) indication. When there is an arc between the high-voltage test probe assembly (W1) alligator clips, the FAILURE lamp (DS2) should light and the audible alarm should sound.
8. Rotate the VOLTAGE CONTROL (T3) to the ZERO START (RESET) position.
9. Set the power switch (CB1) to the OFF position.

**NOTE:** If no arc occurs between the test probe alligator clips, check that they are spaced approximately 1/16 inch apart and repeat the test.

10. Connect the high-voltage test probe assembly (W1) to the DC OUTPUT receptacle (J9) and repeat steps 2 through 9.

**Section H**  
**MAINTENANCE (Cont'd.)**

D. One-Second Test

1. Rotate the VOLTAGE CONTROL (T3) to the ZERO START (RESET) position.
2. Disconnect the high-voltage test probe assembly (W1) from the Tester.
3. Set the power switch (CB1) to the ON position. The switch should light.
4. Press the ONE SEC pushbutton (S1). The HV ON lamp (DS3) should light and stay on for 1 to 1.3 seconds. Time the high-voltage-on period with a stopwatch.
5. Set the power switch (CB1) to the OFF position.

If the dielectric withstand circuit functions properly and all other circuit tests have been completed successfully, the electrical inspection of the Tester may be considered complete.

If the dielectric withstand circuit does not function properly, refer to Section I, Troubleshooting Guide.

CALIBRATION

NOTE: Because of the dangerous voltages developed during operation of the Tester, the following calibration should be carried out only by qualified personnel.

The following items are required for the calibration procedure:

**Section H**  
**MAINTENANCE (Cont'd.)**

- a. Insulated screwdriver.
- b. For the AC mode of the Tester, a standard AC voltmeter with a range of 4000 volts rms and overall accuracy of 0.5% or better.
- c. For the DC mode of the Tester, a standard DC voltmeter with a range of 5000 volts DC and overall accuracy of 0.5% or better.

Setup

1. Remove the panel assembly from the Tester case. Refer to step 1 of the Mechanical Inspection (Interior) procedure for details on removal of the panel assembly.

**DANGER!**

**THE INTERIOR OF THE TESTER DEVELOPS DANGEROUS VOLTAGES WHILE IN OPERATION. THESE VOLTAGES MAY BE RETAINED EVEN AFTER THE UNIT HAS BEEN TURNED OFF. THEREFORE, BE SURE NOT TO MAKE CONTACT WITH ANY OF THE UNIT'S HIGH-VOLTAGE COMPONENTS WHILE PERFORMING THE CALIBRATION.**

2. Set up the Tester according to the setup procedure given for conducting an electrical inspection of the unit.

Calibration Procedure

1. With the power switch (CB1) off, connect the high-voltage test probe assembly (W1) to the AC OUTPUT receptacle (J8) and connect the standard AC voltmeter (item b) between the alligator clips of the high-voltage test probe assembly (W1).
2. Insulate the standard voltmeter and all leads from ground and from each other for at least 4000 volts; locate the standard voltmeter to prevent accidental contact with persons.

**Section H**  
**MAINTENANCE (Cont'd.)**

3. Rotate the VOLTAGE CONTROL (T3) to the ZERO START (RESET) position.
4. Set the LEAKAGE SENSITIVITY control (R77) to 0.3 mA.
5. Set the power switch (CB1) to the ON position. The switch should light.

**DANGER!**

**WHILE THE TESTER IS ENERGIZED, DO NOT TOUCH OR PERMIT ANYONE ELSE TO TOUCH ANY EXPOSED PARTS.**

6. Press the CONT pushbutton (S2). The HV ON lamp (DS3) should light.
7. Slowly rotate the VOLTAGE CONTROL (T3) clockwise while observing the standard voltmeter. Set the voltage to 3 kV. The Tester kilovoltmeter (M1) should also read 3 kV  $\pm 2\%$  of full scale.

If there is a discrepancy, use the insulated screwdriver to rotate the AC CAL pot (R91) until the standard voltmeter and the Tester kilovoltmeter (M1) show the same voltage.

**NOTE:** The calibration pots are located on the AC/DC metering circuits assembly board (A3).

8. Check several other voltages and be sure that all are within tolerance.
9. After the kilovoltmeter (M1) is calibrated and checked, rotate the VOLTAGE CONTROL (T3) to the ZERO START (RESET) position, press the HV OFF pushbutton (S3) and set the power switch (CB1) to the OFF position.

**Section H**  
**MAINTENANCE (Cont'd.)**

10. Repeat steps 1 through 9 with the high-voltage test probe assembly (W1) connected to the DC OUTPUT receptacle (J9) and the standard DC voltmeter (item c) connected between the alligator clips of the high-voltage test probe assembly (W1). Set the voltage to 4 kV and use the DC CAL pot (R97) to correct for any discrepancy between the standard DC voltmeter and the Tester kilovoltmeter (M1).
11. Unplug the input power cord (W2), reinstall the panel assembly into its case and replace the mounting screws.

## Section I TROUBLESHOOTING GUIDE

### REPAIRS

Biddle Instruments maintains a complete instrument repair service. Should this instrument ever require repair, we recommend that it be returned to the factory for repair by our instrument specialists. When instruments are returned for repair, either in or out of warranty, they should be shipped Prepaid and Insured, and marked for the attention of the Instrument Service Manager.

Before troubleshooting is attempted, the Tester should be completely checked for proper operation as described in Section H, Maintenance.

NOTE: The Tester develops dangerous interior voltages and employs printed circuit card construction, therefore, repairs must be made only by qualified persons.

Figure 5 shows some of the internal components of the Tester and gives their schematic reference numbers. Section J, Replaceable Parts List, identifies all components used in the Tester and gives the Biddle Part Numbers. For safety, it is recommended that only Biddle replacement parts be used when making repairs to the Tester.

Refer to the AC/DC High Pot Tester schematic in Section J, Replaceable Parts List, in this manual for any required circuit details.

Contact the factory if major problems are encountered while troubleshooting or making repairs or if assistance is required.

After repairs have been made, always perform a complete inspection of the Tester, as detailed in Section H, Maintenance.

The brief troubleshooting guide that follows identifies some of the problems that may interfere with the proper operation of the Tester.

**Section I**  
**TROUBLESHOOTING GUIDE (Cont'd.)**

TESTER GROUNDED

PROBLEM

PROBABLE CAUSE

TESTER GROUNDED lamp (DS5) not lit.

- No voltage at service outlet for the Tester.
- Ground wire open or ground contact of service outlet not grounded.
- "Hot" and "neutral" wires on service outlet interchanged (120V operation).
- Defective input power cord (W2).
- Defective opto-isolator (U4).
- Defective TESTER GROUNDED lamp (DS5).

DIELECTRIC WITHSTAND

PROBLEM

PROBABLE CAUSE

HV ON lamp (DS3) lit.  
Kilovoltmeter (M1) reads zero when VOLTAGE CONTROL (T3) is rotated toward MAX position.  
No output voltage.  
Failure indications may occur.

- High-voltage circuits internally shorted or open.

HV ON lamp (DS3) lit.  
Kilovoltmeter (M1) reads zero when VOLTAGE CONTROL (T3) is rotated toward MAX position.  
Output voltage present.

- Defective kilovoltmeter (M1).
- Defective meter selector microswitches (S7, S8).
- Defective diodes (CR40, CR41).

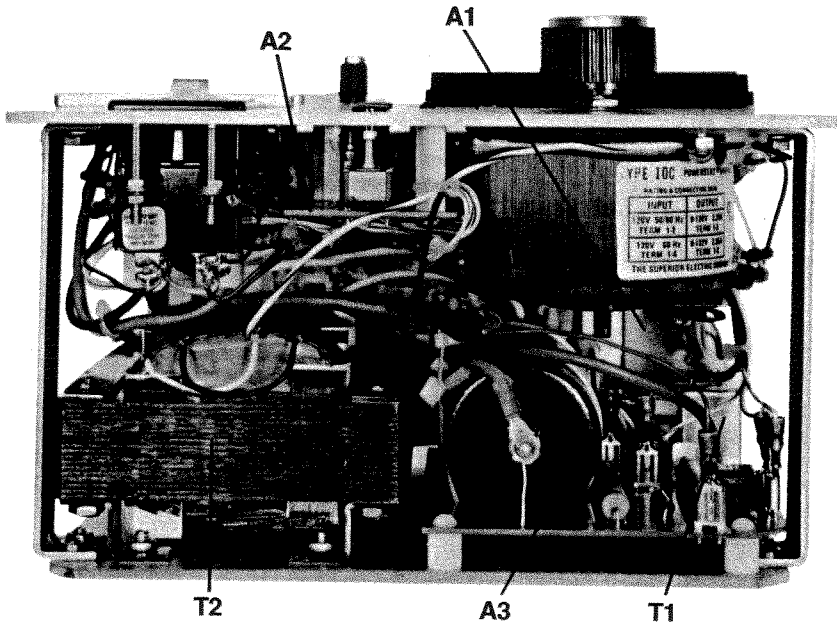

Figure 5. Internal View of Tester.

**Section I**  
**TROUBLESHOOTING GUIDE (Cont'd.)**

DIELECTRIC WITHSTAND (CONT'D)

<u>PROBLEM</u>	<u>PROBABLE CAUSE</u>
One-second or continuous test not functioning. HV ON lamp (DS3) not lit. Kilovoltmeter (M1) reads zero when VOLTAGE CONTROL (T3) is rotated toward MAX position. No output voltage. TESTER GROUNDED lamp (DS5) lit (IC U1, U4 operating).	-Defective pushbutton (S1 for one-second test, S2 for continuous). -Defective relay (K1). -Defective IC (U3). -Defective transistor (Q3, Q4, Q5).
Pressing HV OFF pushbutton (DS3) does not turn off high voltage.	-Defective pushbutton (S3). -Defective IC (U2, U3). -Defective transistor (Q3, Q4, Q5).
FAILURE lamp (DS2) and audible alarm (LS1) do not operate when failure occurs. High voltage does not switch off or power switch (CB1) trips when failure occurs.	-Defective LEAKAGE SENSITIVITY control (R77). -Defective IC (U1, U2, U3). -Defective surge protector (CR4, CR5).
FAILURE lamp (DS2) and audible alarm (LS1) do not operate when failure occurs. High voltage switches off when failure occurs.	-Defective IC (U1, U3). -Defective transistor (Q1, Q2).
Returning VOLTAGE CONTROL (T3) to ZERO START (RESET) position or pressing RESET pushbutton (S4) does not turn off failure signals.	-Defective opto-isolator (U5). -Defective IC (U1, U2, U3). -Defective RESET pushbutton (S4). -Defective ZERO START (RESET) contact. -Defective transistor (Q2).

-I4-

**Section J**  
**REPLACEABLE PARTS LIST**

<u>Schematic Symbol</u>	<u>Description</u>	<u>Biddle Part No.</u>
C1, C11*, C20*	Capacitor, .22 $\mu$ F, 50V	17127-13
C2*	Capacitor, 1000 $\mu$ F, 25V	23908-1
C3*	Capacitor, .01 $\mu$ F, 1000V	9865-25
C4*	Capacitor, 47 $\mu$ F, 20V	17132-3
C5*, C13*, C14*	Capacitor, .47 $\mu$ F, 100V	19836-8
C6*-C8*, C17*	Capacitor, 1000 pF, 100V	17127-1
C9*	Capacitor, 470 pF, 1000V	7950-24
C10*	Capacitor, .047 $\mu$ F, 100V	17127-2
C12*	Capacitor, .01 $\mu$ F, 100V	17127-9
C15*	Capacitor, .01 $\mu$ F, 630V	19836-10
C16*	Capacitor, .001 $\mu$ F, 1000V	7950-12
C19*, C22*	Capacitor, .1 $\mu$ F, 50V	17127-5
C18*, C21*, C23*	Capacitor, 4700 pF, 100V	17127-4
C30***	Capacitor, .25 $\mu$ F, 6000V	25731

\* Part of PC Board Assembly (A1), Biddle P/N 25138

\*\* Part of PC Board Assembly (A2), Biddle P/N 25134

\*\*\* Part of PC Board Assembly (A3), Biddle P/N 25729

-J1-

**Section J**  
**REPLACEABLE PARTS LIST (Cont'd.)**

<u>Schematic Symbol</u>	<u>Description</u>	<u>Biddle Part No.</u>
CB1	Circuit Breaker, 2-Pole, 250V, 1A	23964
CR1*, CR3*	Bridge Rectifier, VM18	22921
CR2*, CR6*-CR27*, CR35**, CR40***, CR41***	Diode, 1N4148	11637-40
CR42***	Diode, H463-5	19173
CR4*, CR5*	Transzorb, 1.5 KE20CA	17040-5
DS1	Neon Part of CB1	-
DS2**	FAILURE LED (Yellow)	17142-1
DS3**	HV ON LED (Red)	17142
DS5	TESTER GROUNDED Neon (White) 250V, 1/3W	4499-8
E1*, E13***	Male Quick-Disconnect Tab	17029-1
E5, E6	Insulated Standoff	23063
E9*, E10*, E11*	2-Pin Male Strip	22931-2
F1*	Subminiature Fuse, 1/16A	25421-1

\* Part of PC Board Assembly (A1), Biddle P/N 25138  
 \*\* Part of PC Board Assembly (A2), Biddle P/N 25134  
 \*\*\* Part of PC Board Assembly (A3), Biddle P/N 25729

**Section J**  
**REPLACEABLE PARTS LIST (Cont'd.)**

<u>Schematic Symbol</u>	<u>Description</u>	<u>Biddle Part No.</u>
J8, J9	High-voltage Receptacle	23978-1
K1*	Relay Coil 12 VDC, Contact 250 VAC, 3A	25114
LS1*	Alarm, AT-03	25198
M1	Kilovoltmeter (5 kV Full Scale)	19937-9
P7	Recessed Power Inlet, 250V, 6A	18305
Q1*-Q5*	Transistor, 2N3904	11638-62
R2*, R26*, R33*, R37*, R42*, R48*, R66*	Resistor, 1 M $\Omega$ , 1/4W, $\pm$ 5% Carbon Composition	4501-508
R3*	Resistor, 33 k $\Omega$ , 1/2W, $\pm$ 5% Carbon Composition	4501-186
R4*	Resistor, 220 $\Omega$ , 2W, $\pm$ 5% Carbon Composition	4501-407
R5*, R54*	Resistor, 47 k $\Omega$ , 1/4W, $\pm$ 5% Carbon Composition	4501-514
R6*	Resistor, 15 k $\Omega$ , 1/4W, $\pm$ 5% Carbon Composition	4501-71

\* Part of PC Board Assembly (A1), Biddle P/N 25138  
 \*\* Part of PC Board Assembly (A2), Biddle P/N 25134  
 \*\*\* Part of PC Board Assembly (A3), Biddle P/N 25729

**Section J**  
**REPLACEABLE PARTS LIST (Cont'd.)**

<u>Schematic Symbol</u>	<u>Description</u>	<u>Biddle Part No.</u>
R7*,R68*,R76**	Resistor, 820Ω, 1/4W ±5% Carbon Composition	4501-69
R8*	Resistor, 470Ω, 1/4W, ±5% Carbon Composition	4501-575
R9*	Resistor, 430Ω, 1/4W, ±5% Carbon Composition	4501-576
R10*	Resistor, 10 kΩ, 1/4W, ±5% Carbon Composition	4501-506
R11*,R23*	Resistor, 681Ω, ±1%, RN55D	12398-71
R12*,R13*,R19*, R30*,R31*,R38*, R39*,R45*,R46*, R50*,R60*,R65*	Resistor, 100 kΩ, 1/4W, ±5%	4501-91
R14*	Resistor, 10 MΩ, 3W, ±1%, 6 kV	10646-17
R15*,R90***	Resistor, 37.4 kΩ, ±1%, RN55D	12398-19
R16*	Resistor, 20 kΩ, ±1%, RN55D	12398-1
R17*	Resistor, 11 kΩ, ±1%, RN55D	12398-176
R18*	Potentiometer, 10 kΩ	12340-10

\* Part of PC Board Assembly (A1), Biddle P/N 25138  
 \*\* Part of PC Board Assembly (A2), Biddle P/N 25134  
 \*\*\* Part of PC Board Assembly (A3), Biddle P/N 25729

**Section J**  
**REPLACEABLE PARTS LIST (Cont'd.)**

<u>Schematic Symbol</u>	<u>Description</u>	<u>Biddle Part No.</u>
R20*	Resistor, 1 kΩ, ±1%, RN55D	12398-16
R21*	Resistor, 19.6 Ω, ±1%, RN55D	12398-191
R22*	Resistor, 200Ω, ±1%, RN55D	12398-4
R24*	Resistor, 56 kΩ, 1/4W, ±5% Carbon Composition	4501-90
R25*	Resistor, 680Ω, 1/4W, ±5% Carbon Composition	4501-66
R27*,R36*	Resistor, 5.1 MΩ, 1/4W, ±5% Carbon Composition	4501-540
R29*,R49*	Resistor, 470 kΩ, 1/4W, ±5% Carbon Composition	4501-513
R32*	Resistor, 360 kΩ, 1/2W, ±5% Carbon Composition	4501-536
R34*,R35*,R40* R41*,R43*,R67*	Resistor, 510 kΩ, 1/4W, ±5% Carbon Composition	4501-509
R28*,R44*,R47*	Resistor, 200 kΩ, 1/4W, ±5% Carbon Composition	4501-525
R51*	Resistor, 392 kΩ, ±1%, RN55D	12398-192

\* Part of PC Board Assembly (A1), Biddle P/N 25138  
 \*\* Part of PC Board Assembly (A2), Biddle P/N 25134  
 \*\*\* Part of PC Board Assembly (A3), Biddle P/N 25729



**Section J**  
**REPLACEABLE PARTS LIST (Cont'd.)**

<u>Schematic Symbol</u>	<u>Description</u>	<u>Biddle Part No.</u>
R52*	Resistor, 2 M $\Omega$ , $\pm 1\%$ , RN55D	12398-193
R53*	Resistor, 330 k $\Omega$ , 1/4W, $\pm 5\%$ Carbon Composition	4501-510
R55*	Resistor, 150 $\Omega$ , 1/4W, $\pm 5\%$ Carbon Composition	4501-545
R56*,R57*	Resistor, 1 k $\Omega$ , 1/4W, $\pm 5\%$ Carbon Composition	4501-51
R58*	Resistor 1 M $\Omega$ , $\pm 1\%$ , RN55D	12398-81
R59*,R61*	Resistor, 100 k $\Omega$ , $\pm 1\%$ , RN55D	12398-27
R62*	Resistor, 5.62 k $\Omega$ , $\pm 1\%$ , RN55D	12398-7
R63*	Resistor, 4.75 k $\Omega$ , $\pm 1\%$ , RN55D	12398-155
R64*	Resistor, 100 k $\Omega$ , 1W, $\pm 5\%$ Carbon Composition	4501-371
R67*	Resistor, 4.7 k $\Omega$ , 1/4W, $\pm 5\%$ Carbon Composition	4501-53
R69*	Resistor, 2 M $\Omega$ , 1/4W, $\pm 5\%$ Carbon Composition	4501-511

- \* Part of PC Board Assembly (A1), Biddle P/N 25138  
 \*\* Part of PC Board Assembly (A2), Biddle P/N 25134  
 \*\*\* Part of PC Board Assembly (A3), Biddle P/N 25729

**Section J**  
**REPLACEABLE PARTS LIST (Cont'd.)**

<u>Schematic Symbol</u>	<u>Description</u>	<u>Biddle Part No.</u>
R70*,R71*,R72*	Resistor, 22 k $\Omega$ , 1/4W, $\pm 5\%$ Carbon Composition	4501-554
R75**	Resistor, 10 k $\Omega$ , 2W, $\pm 5\%$ Carbon Composition	4501-423
R77**	Potentiometer, 50 k $\Omega$	17135-7
R91***	Potentiometer, 20 k $\Omega$	23986-5
R92***	Resistor, 15 k $\Omega$ , $\pm 1\%$ , RN55D	12398-15
R93***,R94***	Resistor, 8 M $\Omega$ , 5W, $\pm 1\%$ , 10 kV	10646-45
R96***	Resistor, 5.36 k $\Omega$ , $\pm 1\%$ , RN55D	12398-52
R97***	Potentiometer, 5 k $\Omega$	23986-4
S1**-S4**	Pushbutton Switch	17137
S6*	Line Selector Switch	18620
S7***,S8***	Microswitch	25727
T1	Transformer, Primary 115/230V Secondary 16V C.T. @0.4A	15573-12

- \* Part of PC Board Assembly (A1), Biddle P/N 25138  
 \*\* Part of PC Board Assembly (A2), Biddle P/N 25134  
 \*\*\* Part of PC Board Assembly (A3), Biddle P/N 25729

**Section J**  
**REPLACEABLE PARTS LIST (Cont'd.)**

<u>Schematic Symbol</u>	<u>Description</u>	<u>Biddle Part No.</u>
T2	High-Voltage Transformer	25140
T3	Autotransformer (120V Tester)	6408-2
T3	Autotransformer (240V Tester)	17787
U1*	Integrated Circuit, Schmidt Trigger Quad Nand Gate, 4093	25045-8
U2*,U3*	Integrated Circuit, Quad Op Amp, LM324	25045-27
U4*,U5*	Integrated Circuit, Opto-Isolator, IL-250	25257
VR1*	Voltage Regulator, LM340AT	23691-5
W1	High-Voltage Test Probe Assembly	25149
W2	Input Power Cord (120V Tester)	17032
W2	Input Power Cord (240V Tester)	17032-2
-	Zero Start Contact Mounted on T3	23202
-	Output Receptacle Slide	25725
-	Knob (for T3)	4690-25
-	Knob (for R77)	25146
-	Case Assembly	10998
-	Lid Assembly	22389-4
-	Instruction Card	26112

NOTE: The following components on PC Board Assembly (A1), Biddle P/N 23138, are not used:  
 CR3, E9, E10, R14, R15, R16, R17, R18, R19

\* Part of PC Board Assembly (A1), Biddle P/N 25138  
 \*\* Part of PC Board Assembly (A2), Biddle P/N 25134  
 \*\*\* Part of PC Board Assembly (A3), Biddle P/N 25729

1e  
No.  
0  
-2  
7  
5-8  
5-27  
7  
11-5  
19  
32  
32-2  
32  
25  
0-25  
46  
98  
89-4  
12  
1),

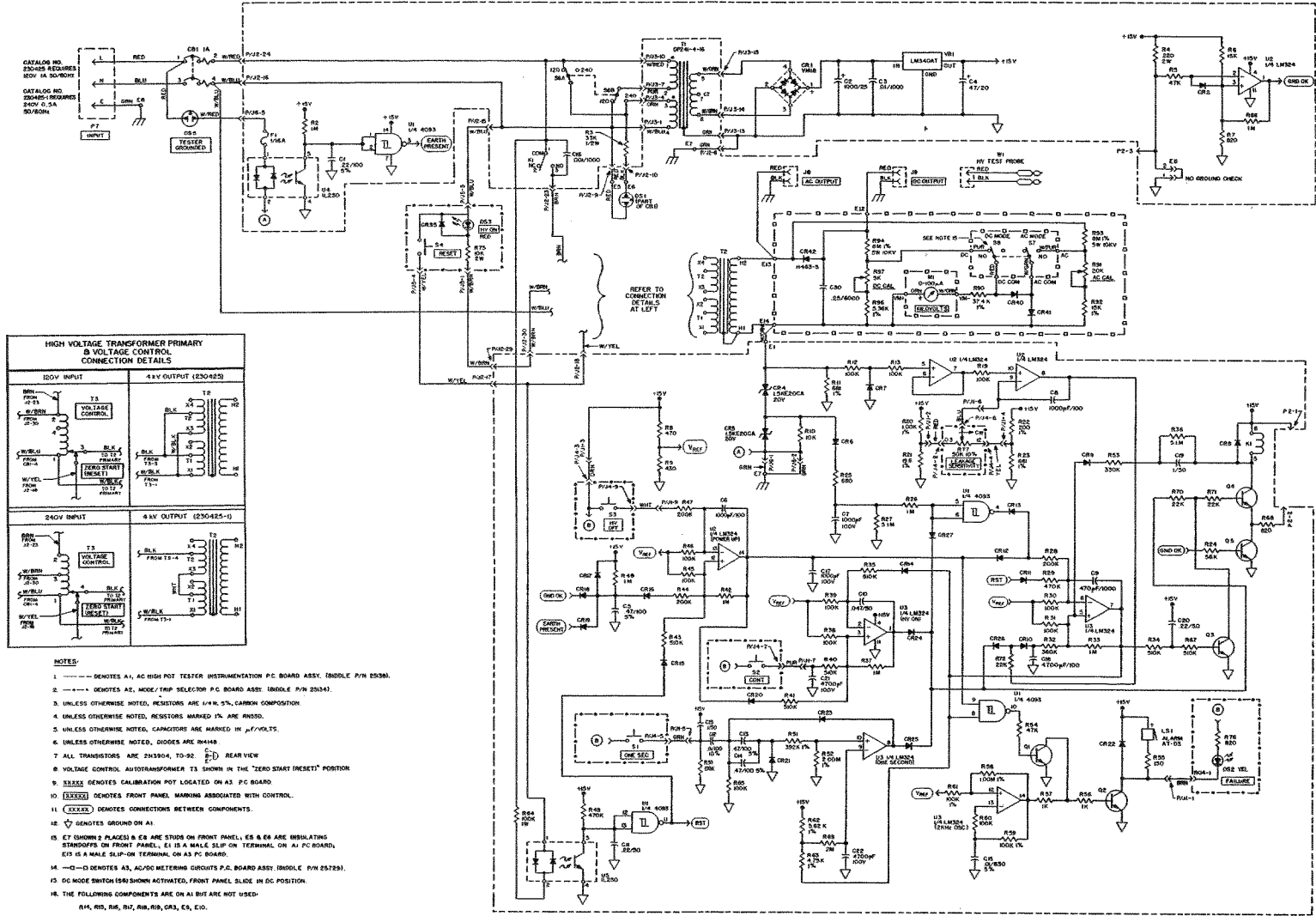

Figure 6. Schematic Diagram of Biddle AC/DC High Pot Testers 230425 and 230425-1

**Section K**  
**WARRANTY AND REPAIR**

WARRANTY

All products supplied by Biddle Instruments are warranted against all defects in material and workmanship for a period of one year following shipment. Our liability is specifically limited to replacing or repairing, at our option, defective equipment. Equipment returned to the factory for repair will be shipped Prepaid and Insured. The warranty does not include batteries or lamps, where the original manufacturer's warranty shall apply. WE MAKE NO OTHER WARRANTY.

The warranty is void in the event of abuse or failure by the customer to perform specified maintenance as indicated in this manual.

REPAIRS

Biddle Instruments maintains a complete instrument repair service. Should this instrument ever require repair, we recommend that it be returned to the factory for repair by our instrument specialists. When instruments are returned for repair, either in or out of warranty, they should be shipped Prepaid and Insured, and marked for the attention of the Instrument Service Manager.