

**Instruction Manual  
72-350Jc**

**Versa-Cal™  
Digital  
Thermocouple /  
Millivolt  
Calibrator**

**Catalog No. 720350 Series**

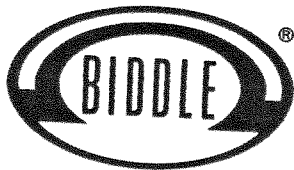

**Biddle Instruments**

BLUE BELL, PA. 19422

Printed in U.S.A.

10 6/88W

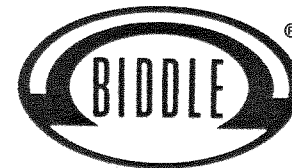

**Biddle Instruments**

BLUE BELL, PA. 19422 • (215) 646-9200

**Instruction Manual 72-350Jc**

**for the use of Versa-Cal™  
DIGITAL THERMOCOUPLE / MILLIVOLT  
CALIBRATOR**

**Catalog No. 720350 Series**

**Revised August 1985  
to include product improvements  
introduced at Serial No. 91,400  
Reprinted June 1988 with minor corrections**

**Biddle Instruments  
Blue Bell, PA 19422 (215-646-9200)**

## TABLE OF CONTENTS

Section	Page Number
<b>A</b>	<b>Introduction</b> ..... 2-4
	1. General Description ..... 2
	2. Reference-Junction Compensation ..... 2, 3
	3. Dual In/Out Channels ..... 3
	4. Measuring Circuit Accuracy and Sensitivity ..... 3
	5. Standard and Special Thermocouple Types ..... 3
	6. Calibration Output ..... 3
	7. DC Control Loop Measurements ..... 4
	8. Digital Electronics ..... 4
	9. Applications ..... 4
<b>B</b>	<b>Safety Precautions</b> ..... 5
<b>C</b>	<b>Receiving Instructions</b> ..... 6
<b>D</b>	<b>Specifications</b> ..... 7-12
<b>E</b>	<b>Basic Circuit Description</b> ..... 13-19
<b>F</b>	<b>Control and Terminal Functions</b> ..... 20-22
	1. General ..... 20
	2. Controls and Terminals ..... 20, 21
<b>G</b>	<b>Connections</b> ..... 23-24
	1. Temperature Measurement with a Thermocouple ..... 23
	2. Checking Recorders, Indicators, or Controllers ..... 23, 24
<b>H</b>	<b>Operating Procedure</b> ..... 25-28
	1. General ..... 25
	2. Temperature Measurements Using TC Ranges ..... 25, 26
	3. Checking Recorders, Indicators, or Controllers, TC Type, Using TC Range ..... 26, 27
	4. Battery Charging ..... 27
	5. Checking Operation ..... 27, 28
	6. Other Operating Procedures ..... 28
<b>I</b>	<b>Applications</b> ..... 29-40
	1. Temperature Measurements Using mV Range ..... 29, 30
	2. Checking Thermocouples ..... 30-32
	3. Checking Recorders, Indicators, or Controllers TC Type, Using mV Range ..... 32, 33

*Continued ...*

## Table of Contents (Cont'd)

Section	Page Number
<b>I (con't)</b>	
4. Calibrating Potentiometer Indicators, Recorders or Controllers, mV Type .....	33, 34
5. Accurate T/C Calibration after Temperature Shock ...	34-36
6. Measuring Ambient Temperature in Thermometer Mode .....	36, 37
7. Long-Term Output Stability .....	37
8. DC Current Calibration using the Shunt Box Accessory .....	37
9. Resistance and Resistance Thermometer Measurements .....	37
10. Voltage Divider Ratio Measurement .....	38
11. AC, Oscilloscope and other Electronic Circuit Applications .....	38, 39
12. Voltage Divider Ratio Measurement .....	40
13. AC, Oscilloscope, other Electronic Circuit Applications .....	40
<b>J Calibration</b> .....	41-48
1. General .....	41
2. Equipment Recommended .....	41, 42
3. Calibration of Millivolt Range .....	42-44
4. Calibration of Thermocouple Ranges Using Melting Ice Bath .....	45-47
5. Calibration of Thermocouple Ranges Ref:Jct Comp. Method .....	47, 48
6. Check Mode Verification .....	48
7. Calibration of Low Battery Blink Point .....	48
<b>K Maintenance</b> .....	51-53
1. General .....	51
2. Removal of Test Set from Case .....	51
3. Calibration Adjustments .....	51
4. Battery Replacement .....	51, 52
5. Analog PC Board Replacement .....	52
6. Digital and Display PC Board Replacement .....	52
7. ROM Replacement .....	52, 53
<b>L Troubleshooting</b> .....	54-55
1. General .....	54
2. Symptoms .....	54, 55

Continued ...

## Table of Contents (Cont'd)

Section	Page Number
<b>M Field Replaceable Parts List</b> .....	56-58
<b>N Warranty and Repair</b> .....	59
<b>Appendix 1</b> — Thermocouple Measurement Methods ...	60-65
<b>Appendix 2</b> — Special Thermocouple Ranges .....	66-67
<b>Appendix 3</b> — Literature References .....	68
<b>Illustrations, Drawings and Tables</b>	
Figure 1 The Cat. No. 720350-2 Digital Thermocouple / Millivolt Test Set .....	1
Figure 2 Display Format .....	12
Figure 3 Block Diagram of the Test Set (back of manual) .....	70
Figure 4 Cat. No. 720350-2 Control Identification .....	22
Figure 5 Connection to a Thermocouple .....	23
Figure 6 Connection for Calibrating Another Instrument .....	24
Figure 7 Checking Thermocouples .....	31
Figure 8 Shock Error After 10°F Ambient Change vs. Time (with Muffler) .....	35
Figure 9 Schematic of Cat. No. 72-910 Volt Box Connected for Calibrating a DVM .....	38
Figure 10 Schematic of Cat. No. 72-920 Shunt Box Connected for Calibrating a 4-20 mA Process Control Unit .....	38
Figure 11 Measuring an Unknown Resistance by Comparison to a Known Reference Resistor .....	40
Figure 12 Measuring a Voltage Divider Ratio .....	40
Figure 13 Calibration of Thermocouple Ranges by Ice-Bath Method ..	44
Figure 14 Calibration of Thermocouple Ranges by Reference Junction Compensation Method .....	48
Figure 15 Location of Calibration Trimmers and Test Points (Internal Photograph) .....	49
Figure 16 Interior view of Current Model .....	50
Table 1 Ranges, Resolution and Limit of Error .....	7
Table 2 Calibration Table (mV Check) .....	36
Table 3 Calibration Table (T/C Check) .....	43
Table 4 Cat. No. 720350 Instrument Being Calibrated .....	47



**Figure 1:** The Catalog No. 720350-2 Versa-Cal™  
Digital Thermocouple/Millivolt Calibrator.

## Section A INTRODUCTION

### 1. General Description

The Biddle Catalog No. 720350 Series Versa-Cal™ Digital Thermocouple/Millivolt Calibrators are portable, lightweight, rugged, and completely self-contained multi-range instruments which measure and simulate up to seven thermocouple types in both °F and °C as well as millivolts. These test sets feature automatic reference-junction and thermocouple linearity compensation to provide a direct digital display of temperature. The thermocouple output mode is also reference-junction compensated and linearized so that the digital display, when energizing external equipment, indicates a temperature exactly as if it had originated at a thermocouple. (Reference-junction compensation is not used with the Millivolt range.) The test sets are simple to operate, easy to read, and maintain their high accuracy over a wide ambient temperature range. A simple arrangement of internal calibration adjustments is also provided. The instruments are battery-powered with self-contained rechargers.

The test sets have many unusual features to insure the highest possible accuracy over a full range of operating conditions, described briefly below.

### 2. Reference-Junction Compensation Under Field Conditions

Biddle recognizes that reference-junction compensation ("RJC") is extremely important for a field calibrator which may be exposed to wide temperature swings as part of daily routine. Therefore, we designed the Versa-Cal RJC system not only for a wide range of stable temperatures, but also for severe temperature shock conditions. We believe our RJC specification for stable temperature is the best available, and our specification for temperature shock (step change recovery) is the *only* one available. The key points in these pioneering specifications are:

1. At stable ambient temperature: 0.017 degrees per degree over 32° to 113°F, with 0.01 available as an option.
2. After step change of ambient temperature from anywhere in the storage range (-40 to +122°F) into the operating range: 0.003 degrees per degree in 30 minutes.

We obtain this performance by installing a carefully selected fast-response temperature sensor at the RJ of each connection channel, actually embedded in the brass binding posts.

## Introduction (Cont'd)

### 3. Dual In/Out Channels

Two pairs of binding post terminals, with a selector switch, are provided for use on input or output. The dual channels, not provided on most comparable instruments, are indispensable in many applications such as, for example, the calibration of one thermocouple by comparison to a second (standard) thermocouple.

### 4. Measuring Circuit Accuracy and Sensitivity

Careful electronic and thermal design enable one-microvolt resolution and zero stability, and 0.005% full scale calibration. This precision is far better than is provided by most measuring instruments or even other calibrators which typically have only a 10-microvolt capability; such instruments can not deal with temperature regions where thermocouple output falls to only one or two microvolts per degree. Nevertheless the system tolerates the high levels of interference often found in industrial applications.

### 5. Standard and Special Thermocouple Types

The Catalog No. 720350-1 incorporates the three most popular thermocouple ranges, J, K and T, with readout in degrees F or C, plus a millivolt range. The Catalog No. 720350-2 has these ranges plus four additional thermocouple ranges, E, R, S, and C.

Other models include other thermocouple types such as B, N, Platinel II™, European standards, 1948 IPTS, or in fact any needed type. These models are identified by an additional -(XX) number following the base catalog number. The Versa-Cal is protected against obsolescence by the option to easily convert a standard set of ranges to any special combination. This can be done quickly at the factory or by the user with a field kit which is a plug-in conversion in most cases.

### 6. Calibration Output

The instruments are equipped with highly reliable wire-wound coarse and fine output controls which enable the user to quickly set the calibration output anywhere within range to the full resolution of the display.

## Introduction (Cont'd)

### 7. DC Control Loop Measurements

The Versa-Cal can be retrofitted at any time with a "Loop" module which adds a full set of current loop and DC voltage measurement and calibration output capabilities. There are five convenient preset outputs, at 0, 25, 50, 75 and 100% of range.

### 8. Digital Electronics

The test sets utilize the high-reliability Type 1802 CMOS microprocessor developed for military use. This microprocessor calculates the linearity correction for each thermocouple reading using equations developed by the National Bureau of Standards or other best source.

### 9. Applications

The following are typical applications:

1. Measuring temperature with thermocouples.
2. Comparison of working and reference thermocouples.
3. Measuring millivolts from thermocouples or other sources.
4. Calibrating thermocouple-type recorders, controllers, indicators, and other instruments of the deflection, null-balance, or digital type.
5. Calibrating millivolt-type recorders, controllers and indicators.
6. Troubleshooting in thermocouple or millivolt dc control loops.

### Need More Help?

If, after reading this manual, you have difficulty in using this instrument or understanding the instructions, feel free to contact the factory for assistance. Our telephone number is 215-646-9200.

### Need Something a Little Different?

We grow by responding to our customer's needs! If you have a suggestion for a new feature or a need for added performance, please drop us a line. We will try to answer all inquiries, and may be able to supply a useful modification to your present instrument. Our address is: BIDDLE Instruments, 510 Township Line Road, Blue Bell, PA 19422.

**Section B**  
**SAFETY PRECAUTIONS**

—SAFETY IS THE RESPONSIBILITY OF THE USER—

—LA SEGURIDAD ES EL CARGO DEL OPERADOR—

These test sets have been designed and manufactured to meet the requirements of ANSI C39.5-1974 "Safety Requirements for Electrical and Electronic Measuring and Controlling Instrumentation." The test sets themselves do not present any unusual shock hazard during operation; however, all persons making or assisting in tests must use all practical safety precautions to prevent contact with energized parts of other test equipment and related circuits.

Corrective maintenance must be performed only by a person who is familiar with the construction and operation of the test sets and the shock hazard involved. The high voltage output of the DC/DC Converter which powers the gas discharge display is nominally 175V dc and can deliver up to 35mA. This can be hazardous and particularly could cause injury due to involuntary reaction. Use caution when handling the test set when it is removed from its case. The test set should be battery operated when performing maintenance to avoid the shock hazard from the ac supply line.

**Section C**  
**RECEIVING INSTRUCTIONS**

Your Versa-Cal Digital Thermocouple/Millivolt Test Set has been thoroughly tested and inspected to rigid specifications before being shipped. Check the equipment received against the packing list. Notify Biddle Instruments, Blue Bell, PA 19422 of any shortage of materials. The instrument should be examined for damage received in transit. If any damage is found, file a claim with the carrier at once and notify Biddle Instruments or its nearest representative giving a detailed description of the damages observed.

**BEFORE INITIAL USE OF TEST SET,  
CHARGE BATTERIES FOR AT LEAST 14 HOURS.**

Refer to Section H4 on page 27 for charging procedure.



## Section D SPECIFICATIONS

### Ranges, Resolution, and Limit of Error:

Range Switch Pos.	<sup>1</sup> T/C	Mode	Range	Table 1	
				Resolution and Repeatability	<sup>2</sup> Limit of Error 25 ± 10°C, 1 year
1	<sup>2</sup> mV, Lo mV, Hi mV, Lo mV, Hi	Meas. Meas. Output Output	0 to ±20mV ±20 to ±101.1mV -12 to +20mV +20 to +101.1mV	0.001mV 0.01mV 0.001mV 0.01mV	±(0.03% of rdg + 5 lsd) ±(0.03% of rdg + 2 lsd) ±(0.03% of rdg + 5 lsd) ±(0.03% of rdg + 2 lsd)
2	J	Meas. & Output	-346 to +2192°F -210 to +1200°C	0.1°F 0.1°C	±1°F ±0.6°C
3	K	Meas. & Output	-328 to +2501°F -200 to +1372°C	0.1°F 0.1°C	±1°F ±0.6°C
4	T	Meas. & Output	Primary: -337 to +752°F -205 to +400°C Extended: -405 to -337°F -243 to -205°C	0.1°F 0.1°C 0.1°F 0.1°C	±1°F ±0.6°C ±10°F ±6°C
<sup>4</sup> 5	E	Meas. & Output	Primary: -389 to +1832°F -234 to +1000°C Extended: -422 to -389°F -252 to -234°C	0.1°F 0.1°C 0.1°F 0.1°C	±1°F ±0.6°C ±5°F ±3°C
<sup>4</sup> 6,7	R,S	Meas. & Output	-58 to +3214°F -50 to +1768°C	1°F 1°C	±2°F ±1°C
<sup>4</sup> 8	C	Meas. & Output	Primary: +32 to 2192°F 0 to 1200°C Extended: 2192 to 3812°F 3812 to 4200°F 1200 to 2100°C 2100 to 2315°C	1°F 1°C 1°F 1°F 1°C 1°C	±1°F ±1°C ±2°F ±3°F ±1°C ±2°C
Special	<sup>5</sup> B	Meas. & Output	Primary: 600 to 1820°C 1112 to 3308°F Extended: 360 to 6000°C 680 to 1112°F	1°C 1°F 1°C 1°F	±1.5°C ±2°F ±2°C ±3°F

See Notes on next page.

## Specifications (Cont'd)

### Notes for Table 1:

- Standard Thermocouple symbols and curves are as defined by ANSI MC96.1 except for type C which is based on data supplied by Hoskins Mfg. Co.:
    - J—Iron—Constantan
    - K—Chromel—Alumel
    - T—Copper—Constantan
    - E—Chromel—Constantan
    - R—Platinum/13% Rhodium—Platinum
    - S—Platinum/10% Rhodium—Platinum
    - C—Tungsten/5% Rhenium—Tungsten/26% Rhenium
- All are calibrated to the 1968 International Practical Temperature Scale (IPTS). Other thermocouple types are supplied on request. See Appendix 2 for information.
- Millivolt measure range has automatic range change, with hysteresis, at  $\pm 19.95$  mV.
  - Includes linearization conformity, zero error, span error, noise and reference junction compensation error. Applies to operation with charger off, after warmup of 15 minutes at stable ambient conditions. The linearization conformity to NBS table is within  $0.2^\circ\text{F}$  for all thermocouple types within primary range.  
  
On the TC ranges an additional error of up to  $+0.5^\circ\text{F}$  may occur, within primary range, when operating with charger on.
  - Switch positions 5-8 on Catalog No. 720350-2 only.
  - Measurement accuracy for "B" is based on reference junction temperature between  $10$  and  $35^\circ\text{C}$  ( $50$ - $95^\circ\text{F}$ ). See Appendix 1, paragraph A1.8.

### Reference Junction Compensation:

Basic accuracy (applies to Types J, K, T, E, R, S, N, displaying temperature above ambient and with reference junction in range  $32$ - $113^\circ\text{F}$ ):

Static error (after stabilizing):  $0.017$  degrees on display per degree of RJ deviation from  $77^\circ\text{F}$  ( $25^\circ\text{C}$ ). (Note that  $25 \pm 10^\circ\text{C}$  effect is already included in Table 1.)

Temperature shock initial offset: 1% of ambient step change in still air.

## Specifications (Cont'd)

Temperature shock recovery: offset drops by  $\frac{2}{3}$  in 30 minutes.

Type C thermocouple: as above except for display above  $1200^\circ\text{C}$ ; then multiply error and offset by 1.5.

For display of temperature below ambient, the error and offset figures given above must be multiplied by the ratio of thermocouple output in mV per degree of ambient temperature to that at the displayed temperature.

Millivolts and Type B: no compensation.

### Warm-Up Time (for specified limit of error):

<One minute for  $1^\circ$  or  $0.01$  mV ranges

<15 minutes for  $0.1^\circ$  or  $0.001$  mV ranges

### Settling Time to Rated Accuracy: 0.5 second after input change.

**Thermometer Mode:** Displays temperature of either (—) binding post. Range  $32$ - $113^\circ\text{F}$ ; accuracy  $0.2^\circ\text{F} + 1.7\%$  of deviation from  $77^\circ\text{F}$ .

**Input Resistance (Measure Mode):**  $>1000\text{M}\Omega$

**Source Resistance Effect (Measure Mode):**  $2\text{k}\Omega$  source resistance causes less than one digit error on all ranges.

**Output Mode Resistance:**  $37\Omega$

**Overvoltage:**  $120\text{V}$  dc or  $120\text{V}$  ac RMS continuous without damage, except in output mode.

**Normal Mode Rejection:**  $>50\text{db}$  @  $50/60$  Hz.

### Common Mode Rejection Ratio:

Operating on batteries: not applicable.

Operating on AC:  $>140$  db with  $300\text{V}$  isolation.

**Operating Modes:** selectable by rotary switch.

Measure: for measurement within range listed in Table 1.

Output: for generating output within range listed in Table 1.

Check: for checking instrument reading against separate internal "reference" value. The displayed reading can be compared with the recorded value marked on the label in the instrument lid.

Off: Power off, but battery may be charged.

## Specifications (Cont'd)

### Range Selector Switch:

4-range unit: 4-position rotary switch (J, K, T, mV).

8-range unit: 8-position rotary switch (J, K, T, E, R, S, C, mV).

**Output Adjust Control:** Continuously adjustable concentric 10-turn coarse and fine potentiometers. Output adjustable to full display resolution everywhere in ranges shown in Table 1.

**°F/°C Selection:** Recessed slide switch.

**Input/Output Terminals:** 5-way binding posts. Two pairs, with toggle type selector switch.

**Display:** (See Figure 2 on page 12)

Type: 7-bar gas discharge with 0.33" character height.

Digits: Five, with decimal point and (-) sign.

Units: °F or °C for thermocouple ranges; E for millivolt range.

Format: See Figure 2.

Reading update rate: two per second.

Diagnostic messages for the following conditions (details shown in Figure 2): Low Battery, Overrange, Open Thermocouple, Malfunction, Display Segment Check

### Battery and Charger:

Five nickel-cadmium cells, "C" size in welded assembly.

Operating time after full charge: minimum of 9 hours, continuous.

Battery Charging Time: 14 to 16 hours when off; up to 48 hours when on.

Battery Life: at least 500 charge/discharge cycles.

Continuous Charging: Battery can be charged indefinitely without damage.

Continuous operation: Instrument can be operated continuously while on charge.

Power supply for charger: 115/230V  $\pm$  15%, 50/60 Hz, 10 watts maximum. The nominal voltage is selected by an internal switch.

## Specifications (Cont'd)

Low battery warning: Display blinks off/on when about 15 minutes of service is left.

Battery discharge protection: Load automatically switched off approximately 15 minutes after start of low battery indication.

**Operating Temperature Range:** - 10° to 45°C (14° to 113°F)

### Storage Temperature Range:

- 40° to + 50°C (- 40° to 122°F) with battery.

- 40° to + 70°C (- 40° to 158°F) with battery removed.

**Safety:** Meets ANSI C39.5-1974 specification "Electrical Safety Requirements for Electrical Measuring and Controlling Instrumentation;" insulated case and panel.

**Accessories:** AC line cord for battery charger included with instrument, 6 ft. long.

**Enclosure:** Impact-resistant molded ABS plastic case with handle and hinged removable lid, blue textured finish. Plastic panel with off-white finish. Storage compartment in lid for manual, test leads, and charger cord.

## Specifications (Cont'd)

### Display Format

CONDITION	DISPLAY							
T/C—J, K, T, E {	+	2	5	0	1	6	0	L or F
	-	-	3	8	9	0	0	L or F
T/C—R, S, C {	+		1	7	6	8	0	L or F
	-	-			4	7	0	L or F
mV, LOW RANGE {	+		1	9	9	5	0	E
	-	-	1	9	9	5	0	E
mV, HIGH RANGE {	+		1	0	1	1	0	E
	-	-	1	0	1	1	0	E
TC Above + Full Scale but Below 101.1mV		H	1	6	H			
TC Below - Full Scale but Above -101.1mV			L	0				
TC or mV Above + 101.1mV or Malfunction*		E	r	r	0	r		
Input Below -101.1mV or Open Input		0	P	E	n			
Segment Check (at Turn- On or Range Change)		8	8	8	8	8	8	
LOW BATTERY	DISPLAY FLASHES ON-OFF							

\* Malfunction explained in Section L. (Make sure output control is not set too high.)

Figure 2: Display Format and Diagnostic Messages.

## Section E BASIC CIRCUIT DESCRIPTION

### 1. General

The Versa-Cal Test Set accepts the millivolt output of a thermocouple (or other input) and provides a digital display of the equivalent temperature. To accomplish this, the instrument converts the input voltage to digital form (a "conversion") and displays the result. Because the voltage generated by the thermocouple is a nonlinear function of temperature, the circuitry includes a "linearizer". (More information on the basics of thermocouple measurements is given in Appendix 1).

The measuring circuitry of the Catalog No. 720350 is shown in block diagram form in the back of the manual.

The major functional elements of this test set are as follows:

Microprocessor	Digital Section
Power Supply/Battery	Display Section
Analog Section	

### 2. Measurement Control Cycle

The microprocessor (DL 10, Figure 3) program automatically controls the following functions, in either Measure or Output modes:

- determines appropriate preamplifier gain (20, 50, 70 or 200).
- measures reference junction ("RJ") temperature.
- calculates thermocouple temperature, corrected for RJ temperature.
- formats the display with appropriate resolution (0.1° or 1°).
- formats the display with appropriate messages.

The display is updated two times per second, except as noted later. Each update is the result of two conversions, which are referred to as conversion A and conversion B. The time required for conversion A is 200 milliseconds while conversion B takes 300 milliseconds. Conversion A makes a preliminary measurement of the input signal at an amplifier gain of 20. If the signal does not exceed the full scale capability of the preamplifier ( $\pm 101.1\text{mV}$ ), the gain to be used during conversion B is determined from the result of

## Basic Circuit Description (Cont'd)

conversion A. An open thermocouple test is also made during conversion A. The result of conversion B is used in calculating the temperature (or millivolts) to be displayed.

During the first of every ten update intervals conversion B measures the reference junction temperature. During the other nine update intervals conversion B measures the thermocouple output voltage. The measured thermocouple voltage is transformed to a temperature reading corrected for the reference junction temperature determined during the first of the ten intervals. Thus the display update rate is 2 per second, except during the conversion when the reference junction temperature is measured. During this time, the display is not updated. When the millivolt range is selected the microprocessor program ignores the reference junction temperature; thus the update rate is always 2 per second.

During conversion A, a 30 nanoamp current ( $100M\Omega$  connected to  $-3V$ ) is fed into the thermocouple junction. If the thermocouple is open, the input voltage will go to  $-3$  volts, causing the display to show "OPEN". During conversion B, the 30 nanoamp current is disconnected; thus it does not affect the accuracy of the displayed temperature.

The functions of conversions A and B are summarized in the following tabulation. The display messages as a function of the selected range and input voltage are also listed.

### First Update Period (Reference Junction Temperature Measurement)

#### Conversion A:

- (a) Amplifier gain = 20
- (b) Measures thermocouple input signal (result not used)

#### Conversion B:

- (a) Amplifier gain = 20
- (b) Measures output of reference junction temperature sensor. This is used in the nine subsequent conversions to correct the temperature calculation for the reference junction temperature.

#### Conversion A:

- (a) Amplifier gain = 20

## Basic Circuit Description (Cont'd)

### Next Nine Update Periods (Actual Measurements)

- (b) Measures thermocouple (or mV) input signal (preliminary):
  - (1) If signal is above +FS but below +101.1 mV, display "HIGH" (TC range only).
  - (2) If signal is below -FS but above -101.1 mV, display "LO" (TC range only).
  - (3) If signal is above +101.1 mV, display "ERROR".
  - (4) If signal is below -101.1 mV or open input, display "OPEN".
  - (5) If signal is within range, measure it to determine preamplifier gain to be used during conversion B.

#### Conversion B:

- (a) Amplifier gain as determined in conversion A. The gain will be as follows:
  - (1) If signal is 0 to  $\pm 20$  mV, gain = 200.
  - (2) If signal is  $\pm 20$  to  $\pm 57.1$  mV, gain = 70.
  - (3) If signal is  $\pm 57.1$  to  $\pm 80.0$  mV, gain = 50.
  - (4) If signal is  $\pm 80.0$  to  $\pm 101.1$  mV, gain = 20.
- (b) Measure thermocouple or mV input signal (final)

### 3. Power Supply/Battery

The instrument is powered by a battery made up of five series-connected C size nickel-cadmium cells (PS5 in Figure 3) rated at 2.0 ampere hours. The nominal load current of 210 milliamps can be provided for at least nine hours. A built-in transformer (PS2), rectifier (PS3), and current regulator (PS4), are used for charging the battery. An internal switch (PS1) permits operation from either 115 or 230 volts, 50 to 60 Hz. The battery can be charged with the system either on or off. In either case, the battery charging current will be approximately 180 milliamps. When the system is turned on, the charger furnishes an additional 210 milliamps to power the system.

The battery voltage is applied to a DC-DC converter which generates four regulated voltages: +5, +180, +13 and -13 volts. The 5 and 180 volt supplies are referenced to digital ground. The two 13 volt supplies are used for the analog circuitry. Note that the digital circuitry, analog circuitry and

## Basic Circuit Description (Cont'd)

metal chassis are all isolated from each other.

The low battery detector (PS8) senses when the battery voltage drops to less than 5.90 volts. A signal is then fed to the microprocessor which in turn causes the display to flash on-off. The power-off detector (PS7) senses when the battery voltage drops to less than 5.85 volts, at which point the system power is turned off to reduce the possibility of the battery being completely discharged.

### 4. Analog Section

The analog section contains the following functional circuits:

- (a) dual-slope, auto-zeroed integrating voltage-to-time-interval converter, a part of the analog-digital converter (PC5).
- (b) preamplifier (PC4)
- (c) digital controls for above circuits (PC6)
- (d) reference junction temperature sensors (U1 and U2; single Q5 on older sets).
- (e) open thermocouple bias source (PC1)
- (f) output mode voltage adjustor (R49)
- (g) precision reference voltage (PC2)
- (h) check mode voltage source (PC2)

The dual-slope converter resolves a full scale input of  $\pm 4.0192$  volts into  $\pm 40192$  counts ( $100\mu\text{volts}$  per count). There are four time intervals which make up each conversion. These intervals are as follows:

- (a) AUTO-ZERO PHASE — The preamplifier input is grounded and any offsets due to the buffer, integrator or comparator are stored in a capacitor. The effects of these offsets will be cancelled out during subsequent integration intervals.
- (b) INPUT INTEGRATION PHASE — The input signal is fed through a preamplifier whose gain is controlled by the microprocessor. The amplified thermocouple, millivolt or reference junction temperature signal is integrated for exactly 100 ms.
- (c) POLARITY SENSING PHASE — This interval is the last 1.91 ms of the input integration phase. During this interval, the polarity of the

## Basic Circuit Description (Cont'd)

integrator output is sensed. If the input signal is negative, a pulse (POL) will be generated at the beginning of this interval and sent to the digital circuitry on the POL/EOC line. For positive input signals, the POL pulse is not generated.

- (d) REFERENCE INTEGRATION PHASE — The 4.0192 volts reference is integrated until the comparator output ramps down to zero, at which time an end-of-conversion pulse (EOC) is generated.

The digital controls receive information from the microprocessor (DL10) and control the gain of the preamplifier and the state of the A/D converter. Pulse information is received via two pulse transformers (DL1) which transmit ADVANCE and SET-UP pulses. The ADVANCE pulses determine the state of the A/D converter. The SET-UP pulses determine gain of the preamplifier and the type of conversion: that is, conversion A or B, and millivolts, thermocouple, or reference junction conversion. The auto-zero state is initiated when the microprocessor circuitry simultaneously generates a SET-UP pulse and an ADVANCE pulse. This generates a reset pulse within the reset circuit (PC8). Additional SET-UP pulses, up to a maximum of 13, are used to determine the preamplifier gain, etc.

The reference junction temperature is measured by sensors U1 and U2 (single sensor Q5 as shown in Figure 3 for serial numbers below 91,400) which are thermally connected to the (–) input terminals. The sensors generate currents of one  $\mu\text{A}$  per  $^{\circ}\text{K}$ . For example, at a temperature of  $25^{\circ}\text{C}$  ( $298.2^{\circ}\text{K}$ ), the output current is  $298.2\mu\text{A}$ . This current is transformed into  $149.1\text{ mV}$  by passing through 500 ohms. The preamplifier gain is always 20 when the output of the reference junction temperature sensor is to be digitized. The resolution of the measurement is  $0.01^{\circ}\text{C}$ . The TEMP ZERO trimmers are used to eliminate any error in the output of the sensor.

The reference junction temperature is used in calculating the displayed temperature reading in the MEASURE and OUTPUT modes. In these modes, the measured reference junction temperature is converted to the equivalent thermocouple voltage for the selected range. This voltage is added to the measured thermocouple voltage. The result is then converted to temperature. Both conversions are performed by a power series expansion in the microprocessor.

The reference voltage for the measuring system is generated across a 6.3-volt precision zener diode within (PC2). The current through this diode is

## Basic Circuit Description (Cont'd)

held at 2 milliamps, giving maximum temperature stability of the reference voltage. A precision voltage divider is used to reduce the 6.3-volt reference to 4.0192 volts as required by the A/D converter.

In the OUTPUT mode an internally generated regulated voltage is fed to the dual potentiometer (R49), which can adjust the output between -12 and +101 mV. This voltage is applied to the selected pair of input binding posts and is displayed in the selected measurement range units (mV or degrees F or C).

In the CHECK mode, a stable voltage of approximately 5 millivolts is developed within (PC2). This voltage is applied through the mode selector switch to the system input in place of the thermocouple input. Proper operation is indicated when the displayed reading matches the value recorded in the lid of the instrument. In this mode, the output of the RJ temperature sensor is shorted to ground. The microprocessor is programmed to recognize this zero output as an indication that the CHECK mode has been selected. Since there is no RJ signal, the check reading of temperature is not influenced by the RJ temperature.

### 5. Digital Section

All digital timing is controlled by the 2.41152 MHz oscillator (DL4). This clock is divided by six in divider (DL6) and applied to an 8-bit binary counter (DL7). The output of this counter occurs every 636.9  $\mu$ S and is used as the interrupt for the microprocessor. The 8-bit counter ( $2^8$ ) also serves as part of the result counter for the A/D converter. The result counter is completed by a software counter which can count up to 157. The complete result counter, in combination with the system clock, determines the period of the A/D converter first integration and the full scale count capability of the converter, as follows:

$$\text{Period of input integration} = \frac{6 \times 256 \times 157}{2.41152 \times 10^6} = 0.10 \text{ second}$$

$$\text{Full scale converter counts} = 256 \times 157 = 40192.$$

Note that, although the resolution of the converter is one part in 40192 at full scale, the displayed resolution never exceeds one part in 20,000 in the mV mode (at 20.000 millivolt input), or one part in 25016 in the temperature mode (a K thermocouple at 2501.6°F).

## Basic Circuit Description (Cont'd)

The POL/EOC logic (DL5) detects the end-of conversion (EOC) pulse which is generated by the analog circuitry at the end of the reference integration interval. At this time, part of the result exists in the 8-bit counter while the rest of the result exists in the software  $\times 157$  counter. The number in the 8-bit counter is stored in an 8-bit latch (DL8). This can then be entered into the microprocessor via the data bus and combined with the number stored in the software counter. The ADVANCE and SET-UP pulses are also generated to control the A/D analog circuitry.

The microprocessor (DL10) has four error flag (EF) inputs which are utilized as follows:

EF1: This accepts the output of the low battery detector.

EF2: Accepts the POL pulse.

EF3: This accepts the output of the °F/°C switch on the display card.

EF4: Accepts the output of the RANGE switch in the display section.

To generate the required 13-bit memory address, a 5-bit latch (DL11) is used to provide the five most significant bits.

Address decoding (DL14) is also used for addressing the memory.

### 6. Display Section

The multiplexed display contains seven digits which utilize 0.33" planar gas discharge displays.

Digit and segment data are loaded from the data bus into two 8-bit latches. Latch DS1 is used to select one digit at a time while latch DS2 contains the 7-segment plus decimal point data for the selected digit. Each digit is turned on for one interrupt interval (636.9 microseconds). Nine interrupt intervals (5.73 milliseconds) are used to scan all digits. For two of these intervals, no digit is turned on.

The °F/°C switch connects one of the microprocessor ERROR FLAG inputs to +5 volts for °F or ground for °C.

The range switch is connected to the eight digit-drive outputs of latch DS1. The position of the switch can be sensed by the microprocessor because of the fact that, at any given instant, only one of the digit drive lines will be at a high logic level.

## Section F CONTROL AND TERMINAL FUNCTIONS

### 1. General

Since proper operation of the Biddle Versa-Cal Digital Thermocouple/Millivolt Test Set depends on correct use of switches and controls, the function of these devices is described prior to the operating procedures. The locations of the controls on the panel are shown in Figure 4.

### 2. Controls and Terminals

(a) MODE Selector:

This is a rotary switch having the following four mode selections:

- (1) Off: Turns instrument off. Remember to turn *off* instrument when not in use to conserve battery power. The battery may be charged with the instrument either on or off (off recommended).
- (2) Measure: In this position the unit will measure and display temperature (or mV) in accordance with the setting of the Range selector switch, for the connection made to the selected TC binding post pair (A or B).

NOTE: Refer to Section D Specifications or the Figure 2 Display Format for diagnostic messages.

- (3) Output: In this position the selected binding post pair (A or B) is driven at a voltage determined by the setting of the Output Adjust control. The instrument displays the simulated temperature (or mV) in accordance with the setting of the Range selector switch.

NOTE: Connection of a thermocouple to the selected TC binding posts will short out the output voltage thus defeating the operation of this mode.

- (4) Check: In this position the instrument input is disconnected from the binding posts on the front panel and connected to an internally generated reference voltage (approximately 5mV). The reference-junction circuit is simultaneously disabled. The normal reading for your instrument, on each range, is recorded on a label in the lid of the instrument. Obtaining normal readings assures the operator that the measuring circuitry is functioning properly.



### Control and Terminal Functions, (Cont'd)

- (b) RANGE Selector:  
Selects the desired thermocouple or millivolt range.
- (c) °F/°C Selector:  
Selects the desired °F or °C temperature display.
- (d) OUTPUT ADJUST:  
Concentric dual ten-turn controls for adjusting the instrument output voltage when operating in the Output mode. The inner ("Coarse") control covers the full output range; the outer ("Fine") control covers about 1% of the full range. Turning the controls clockwise causes the output voltage to become more positive.
- (e) BINDING POSTS (Channel A or Channel B):  
For connection to input or output.
- (f) CHANNEL Selector:  
Selects the desired pair of binding posts (A or B).
- (g) CHARGE Receptacle:  
This receptacle is provided for recharging the batteries. An internal switch permits operation from either 120 or 240V, 50 to 60 Hz. The front panel is marked to indicate the setting at the time of manufacture. A special ac line cord is furnished with the instrument and is stored in the lid compartment.

### Control and Terminal Functions, (Cont'd)

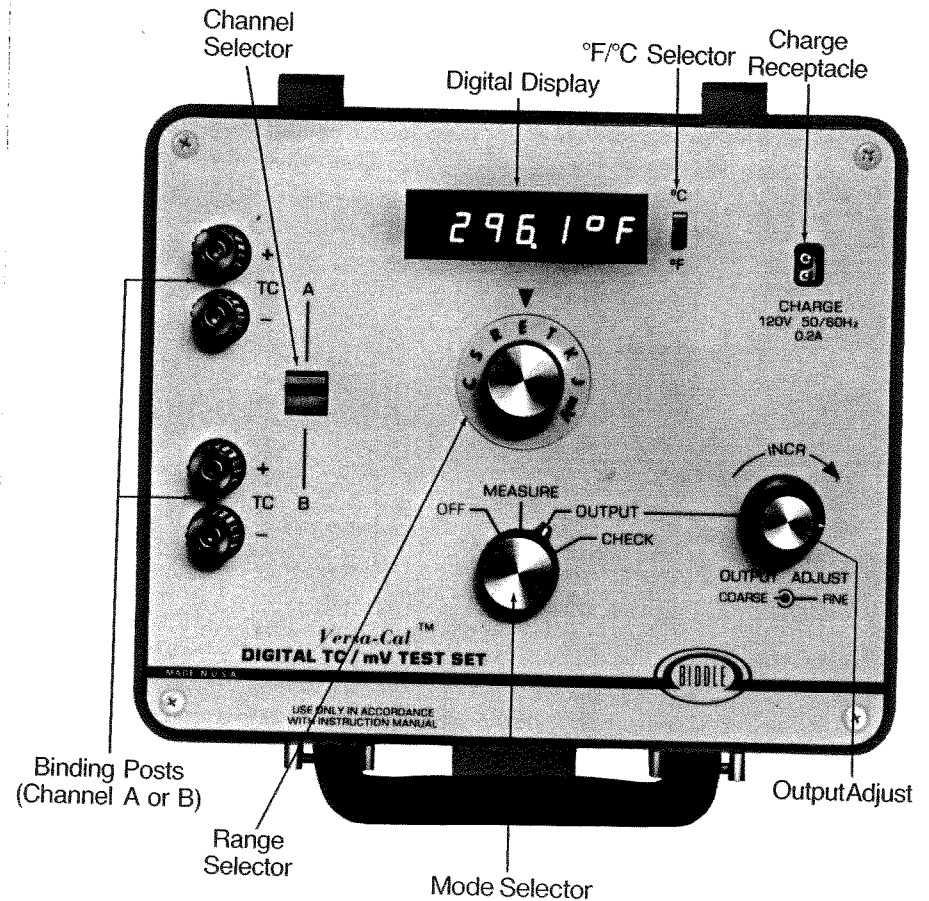

**Figure 4:** Front panel view of Versa-Cal Calibrator showing location of controls. (This view shows the early name for the instrument, "TC/mV Test Set").

## Section G CONNECTIONS

### 1. Temperature Measurement With a Thermocouple

Connect the thermocouple to be measured to either pair of input binding posts (A or B) as shown in Figure 5, taking care to connect the negative thermocouple wire (red) to the (-) binding post and the positive wire to the (+) binding post. Thermocouple extension leadwires of the same type as the thermocouple *must* be used if it is desired to make the measurement at a remote location from the thermocouple termination.

If a shielded thermocouple is used, it is recommended that the shield be returned to the (-) input binding post along with the negative thermocouple lead.

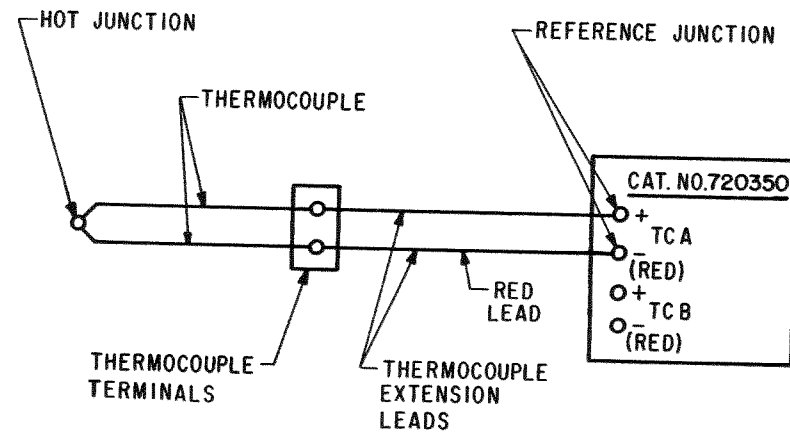

Figure 5: Connection to a Thermocouple.

### 2. Calibrating Recorders, Indicators or Controllers

Connect the instrument to be checked to either pair of the test set binding posts (A or B) as shown in Figure 6. When using the TC range of the test set, thermocouple extension leadwires of the same type as the instrument calibration *must* be used to connect the two instruments. Take care to

## Connections, (Cont'd)

connect the negative thermocouple wire (red) to the (-) terminals of both instruments and the positive wire to the (+) terminals of both instruments.

Use copper wire to connect the two instruments when using the mV range of the test set.

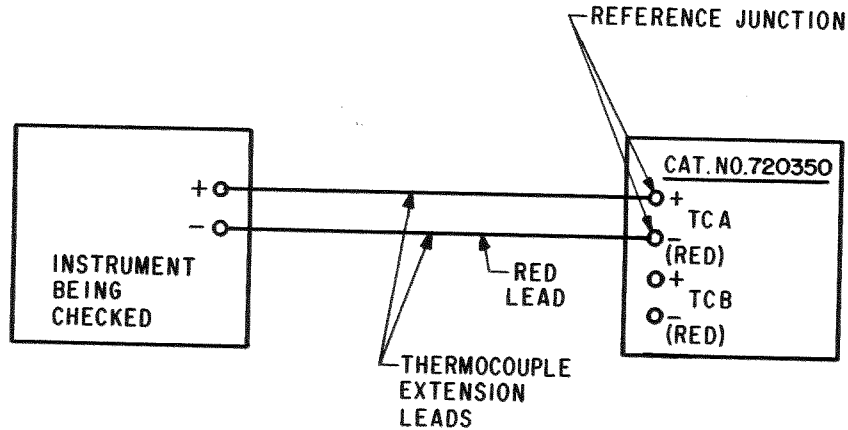

**Figure 6:** Connection for Calibrating Another Instrument (use Copper Leads if Test Set is on mV Range).

## Section H OPERATING PROCEDURE

**To Save Batteries Turn Set Off When Not In Use!**

### 1. General

The Versa-Cal test set can be operated in any position and is unaffected by normal vibration. The warmup time is less than one minute for the instrument to settle to within 1° or 0.01 mV. The test set has been designed to maintain its high accuracy over a wide ambient temperature range for both battery-powered and ac line operation; however, the following operating precautions should be observed to obtain maximum accuracy:

- Operate test set in an area free from drafts where the temperature is stable. If drafts cannot be avoided, wrap the terminals with a muffler consisting of 2 layers of soft cloth or other convenient insulating material.
- Before starting measurements allow the test set to normalize for a few minutes in the test ambient. If the set has been subjected to an extreme ambient temperature change, see Section I-5.
- Make measurements with the charger not connected to minimize internal temperature rise.
- When making TC measurements with the charger connected, wrap the terminals with a soft cloth to minimize temperature gradients at the terminals caused by the internal temperature rise.
- When recording measurements, it is convenient to also record the thermometer-mode reading for reference.

### 2. Temperature Measurements Using TC Ranges

Proceed as follows:

- Connect the instrument as described in Section G1 and as shown in Figure 5.
- Set the Channel selector switch to the position corresponding to the pair of binding posts used.

### Operating Procedure (Cont'd)

- (c) Rotate the Range selector switch to the TC position which corresponds to the thermocouple type being measured.
- (d) Set the °F/°C slide switch to the position corresponding to the desired temperature display.
- (e) Rotate the Mode selector switch to the MEASURE position.
- (f) Read the value of the measured temperature on the display.

NOTE: The cold or reference-junction compensation circuitry is functioning in this mode so that the test set reads the correct hot junction temperature.

### 3. Calibrating Recorders, Indicators, or Controllers, TC Type, Using TC Range

Proceed as follows:

- (a) Connect the instrument as described in Section G2 and as shown in Figure 6. Use thermocouple extension leadwires.
- (b) Set the Channel selector switch to the position corresponding to the pair of binding posts used.
- (c) Standardize the instrument to be checked, if required.
- (d) Rotate the Range selector switch to the TC position which corresponds to the thermocouple type of the instrument to be checked.
- (e) Set the °F/°C slide switch to the position corresponding to the desired temperature display.
- (f) Rotate the Mode selector switch to the OUTPUT position.
- (g) On millivoltmeter pyrometers it will be necessary to add an external resistance in either one of the connection leads to compensate for the lead resistance of the millivoltmeter. The value of this resistance should be equal to the resistance value which is marked on the scale of the millivoltmeter pyrometer being checked.
- (h) Adjust the OUTPUT ADJUST of the test set so that the instrument to be checked comes to the selected check point.

### Operating Procedure (Cont'd)

- (i) Read the value of the simulated temperature on the display. By repeating the procedure at various check points, a series of correction factors may be obtained.

NOTE: In some cases it may be more convenient to set the test set to the desired simulated temperature and then observe the reading on the instrument to be checked.

The cold or reference-junction compensation circuitry is functioning in this mode so that the test set and the instrument to be checked need not be at the same temperature.

When checking manual-balance instruments which have a low-resistance circuit (<200 ohms) set the check instrument to the desired check value, then adjust the output of the test set. This will avoid annoying interaction between the instruments due to off-null loading of the test set output circuit.

### 4. Battery Charging

To charge the battery, plug the battery charger line cord into the CHARGE receptacle and the appropriate 120 or 240V, 50/60 Hz power line as indicated by the marking on the front panel. The battery can be charged with the instrument either on or off; likewise, the instrument can be operated while on charge indefinitely. A fully charged battery will provide a minimum of nine hours of continuous operation and can be fully charged in 14 to 16 hours (overnight). The battery should not be charged below 40°F (4°C).

NOTE: The battery cannot be harmed if it is continuously charged for extended periods of time. However, it is a characteristic of all Ni Cad batteries that their capacity will decrease if they are subjected to an extended overcharge. Therefore, a system which has been charged for a period of time much greater than 16 hours will actually provide less than nine hours of operation. This "memory" effect is, however, not permanent. The full capacity of the battery can be recovered by fully discharging and then recharging for the recommended 14 to 16 hours. In a similar fashion, a battery which has been left in a discharged condition for a long period of time might exhibit decreased capacity after it has been charged. However, a complete charge-discharge-charge cycle should restore the battery to full capacity.

## Operating Procedure (Cont'd)

### 5. Check-Mode Operation

Proceed as follows:

- (a) Rotate the Mode selector switch to the CHECK position.
- (b) Set the °F/°C slide switch to the °C position.
- (c) Rotate the Range selector switch to the desired TC (or mV) position.
- (d) The test set should display the temperature (or mV) value as marked on the Range label in the instrument lid. The check reading tolerances, at  $25 \pm 10^\circ\text{C}$  ambient, are as follows:

mV:  $\pm 0.012$  mV  
Types J, E:  $\pm 0.3^\circ\text{C}$   
Types K, T:  $\pm 0.4^\circ\text{C}$   
Types R, S, C:  $\pm 2^\circ\text{C}$

- (e) Tolerances for special thermocouple types are listed in Appendix 2, Table A2-1.

NOTE: If the check reading is out of tolerance it is recommended that a calibration check be performed on the test set.

### 6. Other Operating Procedures

Refer to Section I, Applications, for additional operating procedures.

## Section I APPLICATIONS

### 1. Temperature Measurements Using mV Range

Proceed as follows:

- (a) Connect the test set as described in Section G1 and as shown in Fig. 5.

NOTE: The automatic reference-junction compensator is not in the circuit on mV calibrated range; therefore, copper leads may be used in place of thermocouple extension leadwire between the test set and the thermocouple termination.

- (b) Measure the thermocouple reference-junction temperature with an accurate mercury-in-glass thermometer and record the temperature.

NOTE: The reference-junction is at the point where the thermocouple leads or thermocouple extension leads are connected to the test set; however, if copper leads are used in place of thermocouple extension leads the reference-junction will be located at the point where the copper leads are connected to the thermocouple.

- (c) Convert the reference-junction temperature (thermometer) reading to millivolts by referring to the appropriate table in Biddle manual 72-35T, (or other source such as those in Appendix 3.)
- (d) Set the Channel selector switch to the position corresponding to the pair of binding posts used.
- (e) Rotate the Range selector switch to the mV position.
- (f) Rotate the Mode selector switch to the MEASURE position.
- (g) Read and record the value of the measured emf.
- (h) Add, algebraically, the measured emf reading and the millivolt equivalent of the reference-junction temperature (step c).
- (i) Convert the corrected millivolts to temperature directly from the same conversion table. This value is the measuring ("hot") junction temperature reading.

## Applications (Cont'd)

Example: When ambient temperature is above 32°F, test set emf reading is ..... 35.98 mV  
 Reference junction at 75°F Type J is ..... 1.22 mV  
 Sum ..... 37.20 mV

From conversion table 37.20 mV = 1235°F

Example: When ambient temperature is below 32°F, Test set emf reading is ..... 15.07 mV  
 Reference junction at 20°F Type J is ..... -0.34 mV  
 Sum ..... 14.73 mV

From conversion table 14.73 mV = 520°F

## 2. Checking Thermocouples

In order to check a thermocouple, some means such as an electric checking furnace must be provided to maintain the measuring ("hot") junction of the thermocouple at a known temperature. The Versa-Cal is ideally suited for comparing the emf output of a thermocouple to be checked against that of a reference thermocouple because of its two identical A and B input channels. The procedure is as follows:

- (a) Insert the measuring ("hot") junctions of the two thermocouples, to a sufficient depth, into a temperature equalizing block within the checking furnace. This will maintain thermal uniformity between the two thermocouples and also will prevent the hot junction of the couples from being affected by heat flow along the wires. Connect the thermocouples to the test set as shown in Figure 7, observing proper polarity as described in Section G1.

NOTE: When optimum accuracy is not required, the temperature equalizing block can be eliminated; however, if practical, the thermocouples should be inserted into the check furnace in intimate contact with each other and necessary precautions should be taken to minimize errors at the hot junction due to non-uniformity of temperature.

- (b) Adjust the furnace control to the temperature at which the thermocouples are to be checked.
- (c) Set the Channel selector switch to position A.

## Applications (Cont'd)

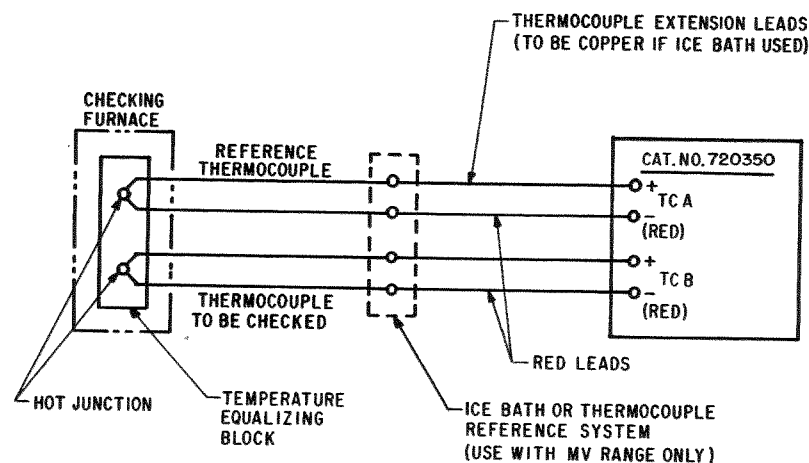

Figure 7: Checking Thermocouples.

- (d) Rotate the Range selector switch to the TC position which corresponds to the thermocouple type being measured. (Alternately, to use millivolt range, see Note 3 on the next page.)
- (e) Set the °F/°C slide switch to the desired position.
- (f) Rotate the Mode selector switch to the MEASURE position.
- (g) Re-adjust the controls on the checking furnace, if necessary, until the desired temperature is obtained.
- (h) Read the value of the measured temperature (Reference Thermocouple).
- (i) Set the Channel selector switch to position B.
- (j) Read the value of the measured temperature (Check Thermocouple). The thermocouple error is the difference between the temperature measured with the Check Thermocouple from that measured with the Reference Thermocouple.

NOTE: (1) By repeating the above procedure at various known temperatures, a thermocouple can be checked for accuracy over its intended measurement range.

### Applications (Cont'd)

- (2) It is not critical that the checking furnace be adjusted to the exact check temperature since the thermocouples are compared by a temperature difference method.
- (3) To check a thermocouple using a millivolt calibrated range, follow the procedure as outlined in Section I-1. Maximum accuracy, in this case, can be achieved by maintaining the reference junction precisely at 32°F (0°C) by using a melting ice bath or an equivalent ice-point thermocouple reference system. A Gallium Melting-Point Standard, which maintains the reference junction precisely at 29.772°C, may also be used; however, this method is not as convenient to use due to the unavailability of thermocouple temperature-millivolt conversion tables based on this reference temperature.

### 3. Calibrating Recorders, Indicators, or Controllers, TC Type, Using mV Range

Proceed as follows:

- (a) Connect the instrument to be checked to the desired binding posts (A or B) of the test set using copper wire and observing proper polarity. (See Figure 6, Page 24).

NOTE: (1) The automatic reference junction compensator is not in the circuit on the mV calibrated range.

- (2) On millivoltmeter pyrometers it will be necessary to add an external resistance in either one of the connection leads to compensate for the lead resistance of the millivoltmeter. The value of the resistance must be equal to the resistance value which is marked on the scale of the pyrometer.
- (b) Measure the reference junction temperature with an accurate mercury-in-glass thermometer and record the temperature. The reference junction is located at the thermocouple terminals of the instrument to be checked.
- (c) Convert the reference-junction temperature reading to millivolts by referring to the appropriate table in Biddle manual 72-35T, (or other source such as those in Appendix 3.)

### Applications (Cont'd)

- (d) Standardize the instrument to be checked, if required.
- (e) Disconnect the leadwire at the instrument to be checked.
- (f) Connect a short circuit jumper across the input terminals if the instrument is a null balance type; leave open-circuited for deflection-type instruments.
- (g) The instrument to be checked should indicate the same reference-junction temperature as measured above. If necessary, adjust the reference-junction compensation for the correct temperature indication.
- (h) Remove the short circuit jumper and reconnect the leadwire.
- (i) Set the Channel selector switch to the position corresponding to the pair of binding posts used.
- (j) Rotate the Range selector switch to the mV position.
- (k) Rotate the Mode selector switch to the OUTPUT position.
- (l) Convert the temperature point to be checked to the equivalent millivolt value using the proper temperature-millivolt conversion table. Subtract, algebraically, the millivolt equivalent of the reference-junction temperature (Step c). This value is the corrected hot junction equivalent millivolts for the simulated temperature.
- (m) Adjust the OUTPUT ADJUST of the test set to the corrected hot junction equivalent millivolt value.
- (n) The temperature indicated on the check instrument should agree with the selected check point temperature value.

### 4. Calibrating Potentiometer Indicators, Recorders, or Controllers, mV Type

Proceed as follows:

- (a) Connect the instrument to be checked to the desired binding posts (A or B) of the test set using copper wire and observing proper polarity. See Figure 6.
- (b) Standardize the instrument to be checked, if required.
- (c) Set the Channel selector switch to the channel in use.
- (d) Rotate the Range selector switch to the mV position.

## Applications (Cont'd)

- (e) Rotate the Mode selector switch to the OUTPUT position.
- (f) Adjust the OUTPUT ADJUST of the test set so that the instrument to be checked balances at the selected check point.
- (g) The mV value indicated on the instrument being calibrated should agree with the mV reading on the test set.

NOTE: The automatic reference junction compensation is not in the circuit on mV calibrated ranges.

### 5. Accurate T/C Calibration After Temperature Shock

#### INTRODUCTION

"Temperature shock" occurs in such common situations as bringing the instrument from a hot car into a controlled work area where the ambient temperature is within the specification range 59-95°F (15-35°C). The temperature difference between the inside and the outside of the Versa-Cal disturbs RJ compensation, shifting the display in the direction of the inside temperature. (The effect does not occur in the uncompensated millivolt range.)

To minimize temperature shock, store and transport the instrument in the best available temperature zone (inside your car, rather than in the trunk, for example). To reduce the error to any desired level, proceed at the work place using either the "timing" method or the "speedup" method, which are described in the following paragraphs.

In the timing method you use the known settling rate of the Versa-Cal to estimate a waiting time before taking readings. This method is simple and effective, but in case of extreme temperature difference it may take quite a long time to reduce the error to a low value. The alternate "Speedup" method is helpful in these cases, although it requires more active attention by the operator.

Note that both procedures call for use of a "muffler" over the binding posts. Without the muffler, the errors will be about 3 times as great as those stated.

#### TIMING METHOD

- (a) Measure or estimate the ambient temperature in both the "before" location and the work area. (The Versa-Cal can be used in its thermometer mode to read the "before" temperature: jumper one pair of terminals with copper wire and read as, say, Type T.)

## Applications (Cont'd)

- (b) Cover the binding posts with a muffler consisting of 3 or 4 layers of soft cloth draped over and around them and sealing them from outside air; avoid drafts.
- (c) Wait 5 minutes. If the instrument is used now its error will be less than 0.1°F for each 10°F of temperature shock.
- (d) For further error reduction wait until the error reaches the level desired, using Figure 8.

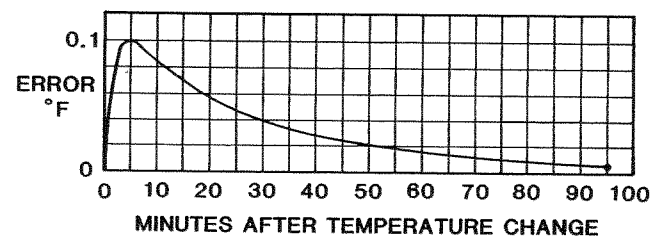

Figure 8: Shock error after 10°F ambient change vs. time (with muffler). (The error decreases by 2/3 for each half-hour.)

#### SPEEDUP METHOD

The waiting can be reduced by speeding up the temperature change inside the Versa-Cal. To speed up settling, either place the instrument in a draft or create one by turning a fan on it, or remove the entire instrument from its case, or both. Then use the Versa-Cal in its thermometer mode to monitor the change of internal temperature, as follows:

- (a) Connect a copper jumper across Channel B and read it as Type T, (this is the thermometer mode; it gives the temperature of the RJ sensor in the binding post).
- (b) Record the time and the Channel B reading at intervals as the temperature settles. Also note the ambient temperature using a separate thermometer.
- (c) When the Channel B reading comes within the range 59-95°F, proceed to set up for the test. Replace the instrument in its case, switched on, and connect the working leads to Channel A. Cover both sets of binding posts with a "muffler" consisting of 3 or 4 layers of soft cloth draped over and around them and sealing them from outside air; avoid drafts.



## Applications (Cont'd)

- (d) Wait at least 5 minutes after step (c) is set up. (If the Versa-Cal was removed from its case, wait 10 minutes.) Continue observing the ambient thermometer and the Channel B sensor temperature until both temperatures are within the range 59-95°F, and the difference between them is less than 18°F (10°C).
- (e) Proceed to perform calibration or measurement on Channel A in the usual way. The temperature shock error depends on the remaining temperature difference as shown in Table 2.

Table 2: Residual Temperature Shock Errors

Temperature Difference Ambient/Internal	Additional Error of T/C Readings, with Muffler
20°F	0.2°F
10°F	0.1°F
5°F	Negligible

### SPECIAL CASES

The error amounts shown are conservative for T/C readings above ambient for all standard T/C types except Type C. For Type C readings above 1200°C (about 2200°F) multiply the error by 1.5. For readings below 0°C using Types J, K, T, or N, multiply by 1.5 at -125°C, by 2 at -175°C.

For more background on dealing with RJ errors, see Appendix 1.

## 6. Measuring Ambient Temperature in Thermometer Mode

The reference junction sensor in each (-) binding post is an excellent thermometer over the range 0-50°C (32-122°F). It shows the temperature of the binding post inside its panel insulator; this will normally be very close to ambient air temperature. After the instrument warms up it may rise a degree or so above ambient (and with the charger on, several degrees).

To read this temperature, proceed as follows:

- (a) Connect a copper jumper across the binding post; a coin will do.
- (b) Set the range to any of the standard T/C types, say J, K, or T.
- (c) Wait at least 5 seconds and read the display.

## Applications (Cont'd)

### 7. Long-Term Output Stability

The millivolt output signal once set is stable to within a few microvolts for an hour or longer. The display accurately shows any drift that may occur and if necessary the output may be readjusted to the original value.

In the thermocouple ranges, the millivoltage generated internally is equally stable, but the output signal includes also the reference junction emf generated at the Versa-Cal binding posts. Therefore the overall output will change with ambient temperature, and the Versa-Cal binding posts should be protected from ambient temperature fluctuations if long-term calibration stability is important. The display continues to accurately show the output equivalent in degrees F or C, and the output can be adjusted as often as necessary to keep the display at the desired value.

### 8. Measuring From Several Thermocouples

Up to six (or more) thermocouples can be quickly measured by using the Biddle Catalog No. 72-990 Thermocouple Selector Switch accessory unit.

Connect the POT binding posts of the Thermocouple Selector Switch to the desired binding posts of the test set. Observe polarity of all connections. One to six thermocouples may be connected to the pairs of the thermocouple binding posts located on the accessory unit which may then be selected by the rotary switch for connection to the measuring instrument. Measurements are made by following the procedure in Section H2. Up to six more T/C's can be handled by using a second Selector Switch connected to the second pair of T/C binding posts.

For best cold junction compensation, connect the Selector Switch to the test set using the pair of gold-plated copper links provided. In any event, the Selector Switch should be located as close to the test set as possible to keep them both at the same temperature.

### 9. Measurements to 1000 Volts Using the Volt Box Accessory

The Biddle Cat. No. 72-910 Volt Box extends the measurement range of the test set to 1000 volts. Combined limit of error is 0.08% of reading, equivalent to a four-digit DVM. The connections are shown in Figure 9. Further details are given in the Instruction Sheet supplied with the Volt Box.

## Applications (Cont'd)

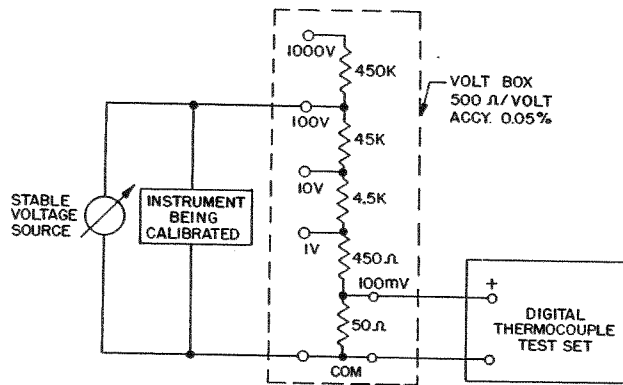
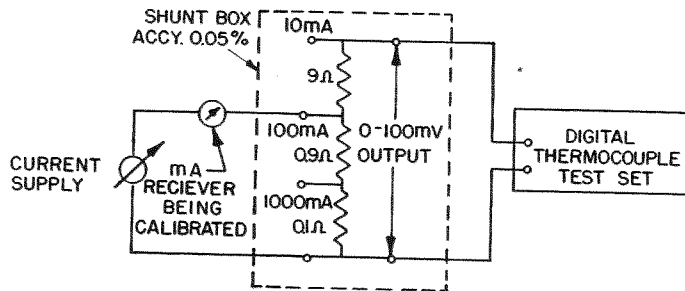

**Figure 9:** Schematic of Cat. No. 72-910 Volt Box Connected for Calibrating a DVM or other instrument in the 0-100 Volt Range.

## 10. DC Current Calibration Using the Shunt Box Accessory

The Biddle Cat. No. 72-920 Shunt Box adapts the test set to measurement of dc current up to 1 ampere, and a sensitivity of 0.1 microampere. Ranges of 10, 100, and 1000 mA provide 100 mV output. Overall accuracy is  $\pm 0.08\%$  of reading on all ranges.

Connections are shown in Figure 10. Further details are given on the Instruction Sheet supplied with the Shunt Box.



**Figure 10:** Schematic of Cat. No. 72-920 Shunt Box Connected for Calibrating a 4-20 mA Process Control Unit.

## Applications (Cont'd)

### 11. Resistance and Resistance Thermometer Measurements

The Versa-Cal test set is an ideal instrument for precision low resistance measurement by the comparison method. Lead resistances of hundreds of ohms cause no error. In this method, the unknown is compared to a known reference resistor by passing a current through both resistors in series and measuring the voltage across each, taking advantage of the convenient dual input terminals of the test set. As shown in Figure 11, a stable, preferably adjustable current supply is required.

Best accuracy of  $\pm 0.02\%$  is obtained if both resistors are of the same order of magnitude, say within 2 to 1, and if both voltage drops fall in the upper part of the test set range. Range limitations are as follows:

Upper limit =  $10,000\Omega$ , because of input resistance limitations.

Lower limit =  $1\mu\Omega$ , when a test current of 1A is used.

A convenient procedure is the following:

- Determine the approximate current to be used based on the resistor ratings, the current available, and the test set range. Compute the expected voltage across the reference resistor. Connect as in Figure 11.
- Set the Channel switch to binding posts A. (reference resistor).
- Set the Mode switch to MEASURE, and the Range switch to mV.
- Adjust the current adjusting rheostat or adjustable current supply to obtain the desired millivolt value. Record the reading as  $V_R$ .
- Select Channel B, the unknown, and record the new reading as  $V_X$ .
- Check the  $V_R$  reading again to make sure that the current has remained stable. This is especially important when reading a resistance thermometer to measure temperature, as any changes in its resistance due to change in temperature may change the current.
- Find the value of the unknown resistor from the following equation:

$$R_X = \frac{V_X}{V_R} \times R_R$$

## Section J CALIBRATION

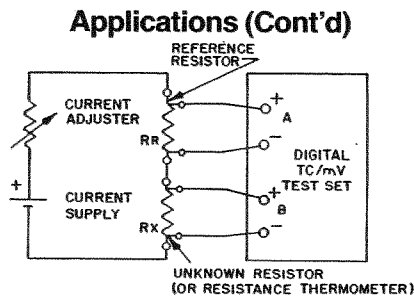

**Figure 11:** Measuring an Unknown Resistance by Comparison to a known Reference Resistor. Cat. No. 72-920 Shunt Box is an Excellent Reference Resistor; a Large Dry Cell Supplies Currents to 1A.

### 12. Voltage Divider Ratio Measurement

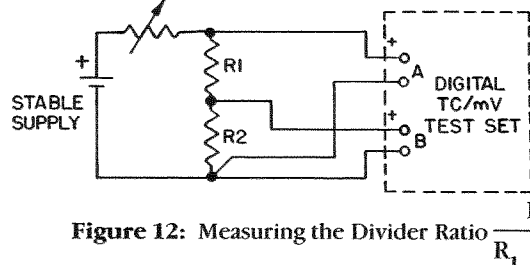

**Figure 12:** Measuring the Divider Ratio  $\frac{R_2}{R_1 + R_2}$

With the connections as shown in Figure 12, proceed as follows:

- (a) Adjust the current for a voltage near full range across  $R_1 + R_2$  ( $V_A$ ).
- (b) Measure  $V_A$  and  $V_B$ .
- (c) The voltage divider ratio is:  $\frac{R_2}{R_1 + R_2} = \frac{V_B}{V_A}$

Full accuracy is obtained for values of  $R_1$  and  $R_2$  up to 10,000 ohms.

### 13. AC, Oscilloscope, Other Electronic Circuit Applications

In sensitive electronic circuits, the test set has special advantages:

- (a) It is completely floating and has low impedance so it can be used anywhere in the circuit without introducing noise.
- (b) It is more accurate and sensitive than the usual electronic test gear, and provides a calibrated output. Useful applications are:
  - Improving oscilloscope accuracy by 10 or more for dc or pulses.
  - AC current measurement using Shunt Box and Oscilloscope.
  - DC or pulse amplifier gain measurement.

### 1. General

The purpose of this Section is to check or correct changes caused by component aging or by replacement of critical parts. Before attempting to recalibrate the test set, check for proper operation. A complete overall accuracy check, including verification of the CHECK readings (Section H, Para. 5), should be performed before attempting to readjust any of the calibration trimmers. A calibration check should be made at least once a year and should be performed in a laboratory free from drafts and where the temperature is stable and maintained at  $25^\circ\text{C} \pm 2^\circ\text{C}$ . The test set should be battery-operated for the entire calibration and should first be fully charged and then be *off* charge for at least 2 hours before starting calibration.

Two calibration methods are described for checking the thermocouple ranges, one using a melting ice bath (or equivalent ice-point thermocouple reference system) in conjunction with a reference millivolt potentiometer; the other using a reference millivolt potentiometer having a built-in reference junction compensator. The melting-ice bath method is recommended; however, the other is generally more convenient.

Parts 3-6 that follow must be performed in the order given.

### 2. Equipment Recommended

- (a) Precision millivolt potentiometer or adjustable voltage standard. Output range 100mV, accuracy  $\pm 0.01\%$  of reading, resolution and stability  $1\mu\text{V}$ . (For calibration to full accuracy.), or  
Precision millivolt potentiometer, Biddle Cat. No. 72-3110, with manual reference-junction compensator. Output range 100mV, accuracy  $\pm 0.03\%$  of reading, resolution and stability  $1\mu\text{V}$ . (For calibration to 0.03% accuracy.)
- (b) Melting-ice bath or equivalent ice-point thermocouple reference system capable of maintaining a temperature of  $32^\circ\text{F}$  ( $0^\circ\text{C}$ )  $\pm 0.2^\circ\text{F}$ , or  
Large aluminum heat sink block for room temperature reference point. (See Figure 14).
- (c) Thermocouple extension leads, "J" Type.

### Calibration (Cont'd)

- (d) Mercury thermometer capable of reading 32°F (0°C) or ambient temperature; accuracy  $\pm 0.2^\circ\text{F}$ .
- (e) Variable power supply 0 to 10 volts dc output, 1A (to set low battery blink point).
- (f) Digital voltmeter, accuracy  $\pm 0.2\%$ .
- (g) Oscilloscope.

### 3. Calibration of Millivolt Range

After conditioning the instrument as in J-1, and without removing it from its case, proceed as follows:

- (a) Connect the Versa-Cal directly to the check instrument (the standard precision potentiometer) using copper wire and observing proper polarity.
- (b) Set the Channel selector switch of both instruments to the proper position.
- (c) Rotate the function selector switch of the check instrument to the EMF OUTPUT position.
- (d) Rotate the Range selector switch of the test set to the mV position.
- (e) Rotate the Mode selector switch of the test set to the MEASURE position.
- (f) Set the mV output of the check instrument to the values shown in TABLE 3. Follow the sequence indicated.
- (g) Read the corresponding mV values on the test set. The displayed readings should agree with the TABLE 3 values within the tolerance indicated. Mark a check (✓) in the last column of TABLE 3 if the reading is within tolerance.
- (h) If the deviation exceeds the allowable tolerance, remove the test set from the case (four panel screws) to gain access to the calibration trimmers. (See Figure 15).

**WARNING**  
 Body contact with any electrically-conductive part in the high voltage (175V dc) circuit is a potential shock hazard! Refer to Section B, Safety Precautions.

### Calibration (Cont'd)

Table 3

Check Inst. Set at (mV)	Versa-Cal Reading (mV)	Allowable Tolerance (mV)	Calibration Trimmer Symbol	Versa-Cal Reading Within Tolerance
0.000	0.000	$\pm 0.003$	mV Zero	
15.000	15.000	$\pm 0.006$	K4	
40.000	40.00	$\pm 0.01$	K3	
70.000	70.00	$\pm 0.01$	K2	
90.000	90.00	$\pm 0.02$	K1	
-15.000	-15.000	$\pm 0.006$	K4	
-40.000	-40.00	$\pm 0.01$	K3	
-70.000	-70.00	$\pm 0.01$	K2	
-90.000	-90.00	$\pm 0.02$	K1	

- (i) Following steps (f) and (g), readjust the calibration trimmers as indicated in Table 3 to obtain the indicated test set display reading. If necessary adjust the indicated trimmer to balance the error between positive and negative inputs.
- (j) If unable to obtain readings within tolerance, the Preamp Offset (R21) trimmer probably requires adjustment. This should seldom be necessary. To adjust this trimmer, proceed as follows using an oscilloscope:
  - (1) Use test set mV Range and MEASURE mode.
  - (2) Short the input binding posts of test set with copper wire.
  - (3) Connect scope External Trigger probe between the "TP7" and "GND" (ground) test points on the analog card.
  - (4) Set scope sweep at 20 ms per division and trigger on leading (+ going) edge of trace.
  - (5) Connect scope input probe to the preamp output (TP2) test point on the analog card. Ground the probe shield.
  - (6) The waveform will alternate between two different voltage levels. Adjust the Preamp Offset trimmer R21 so that both voltage levels are less than  $\pm 0.1$  volt. Note that once every five seconds the waveform will go to a large positive value. This is the output of the reference-junction temperature sensor and should be ignored.
- (k) If Preamp Offset (R21) trimmer has been readjusted, repeat the entire calibration procedure steps (a) through (i).

## Calibration (Cont'd)

- (l) Place the test set in its case and proceed with the remaining calibration checks.

NOTE: If the test set error exceeds the TABLE 3 tolerance values, after readjusting all previously noted calibration trimmers, it is recommended that the test set be returned to the factory. However, a careful check of the setup should be made as this is a very accurate instrument.

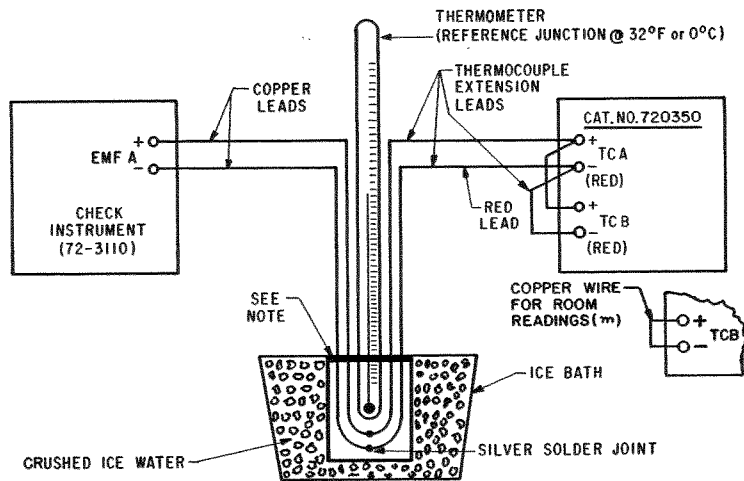

NOTE: THERMOCOUPLE & THERMOMETER IN METAL TUBE, SEALED AT TOP TO PREVENT AIR FROM CIRCULATING IN & OUT OF TUBE. BOTTOM OF TUBE TO BE PACKED WITH HEAT SINK COMPOUND TO COVER THERMOCOUPLE JUNCTION & THERMOMETER BULB.

**Figure 13:** Calibration of Thermocouple Ranges by Ice-Bath Method. Follow standard precautions in construction and use of ice bath such as those given in References 5 and 6 in Appendix 3.

## 4. Calibration of Thermocouple Ranges Using Melting Ice Bath

Proceed as follows:

- (a) Connect the test set to the check instrument (Biddle Cat. No. 72-3110) as shown in Figure 13. Use "J" type thermocouple extension

## Calibration (Cont'd)

leadwires to connect the ice bath to the test set. (Alternately, another T/C type may be used, with the procedure changed accordingly).

- (b) Check thermometer to make sure temperature of melting ice bath is  $32^{\circ}\text{F}$  ( $0^{\circ}\text{C}$ )  $\pm 0.2^{\circ}\text{F}$ .
- (c) Rotate the Function selector switch of the check instrument to the EMF OUTPUT position.
- (d) Set the Channel selector switch of both instruments to position (A).
- (e) Rotate the Range selector switch of the test set to the "J" thermocouple position.
- (f) Rotate the Mode selector switch of the test set to the MEASURE position.
- (g) Set the  $^{\circ}\text{F}/^{\circ}\text{C}$  slide switch to the  $^{\circ}\text{F}$  position.
- (h) Set the output of the check instrument to 0.000 mV.
- (i) Allow the test set to warm up for at least 20 minutes, then read the temperature value on the test set. The displayed reading should agree with the TABLE 4 value within the tolerance indicated. Also check the reading on the  $^{\circ}\text{C}$  range. Mark a check ( $\checkmark$ ) in the last column of TABLE 4 if the reading is within tolerance. Change the A/B switch on the test set to (B) and repeat. (For Serial Numbers below 91,400, omit the B step.)
- (j) If the deviation of either A or B, or their difference, exceeds the given tolerance, note the amount of each deviation in  $^{\circ}\text{F}$  and remove the test set from the case to gain access to the calibration trimmers.
- (k) The reading may change slightly as a result of removing the instrument from its case. The following adjustment procedure will compensate for any such drift.

Find the TEMP ZERO trimmers. For current model instruments, there are two trimmers, one for Channel A binding posts and one for B. These are located on the RJC board as shown in Figure 16. For older instruments there is only one trimmer, located on the Analog Board (shown on Figure 15) and it applies to both A and B binding post pairs.

Adjust the "A" trimmer (or the single trimmer) as follows: Note the

## Calibration (Cont'd)

amount of correction required from earlier reading of step (i); then with the setup of the first part of step (i) adjust the trimmer to change the displayed reading by that amount.

NOTE: This calibrates the measurement of the reference junction temperature. However, this temperature is actually measured at five-second intervals. Therefore, the change in the displayed reading will be delayed for up to five seconds after the TEMP ZERO control has been adjusted.

Adjust Channel B to match, as follows (omit on single-trimmer instruments): With the Channel Select switch at "A" wait for settling and note the display. Switch to B and adjust TEMP ZERO B to obtain the same display. Check and readjust as required.

- (l) Replace the instrument in its case and repeat step (i). Readings should now be within tolerance.
  - (m) Remove the thermocouple extension leads from the B binding posts and place a copper wire jumper between them. Set the Channel Select switch to B.
  - (n) Read the temperature value on the test set for each of the thermocouple ranges. The display should indicate the room ambient temperature value (nominally 77°F). The agreement between the temperature values should be within the tolerances indicated on TABLE 4. Record a check (✓) if within tolerance.
  - (o) Repeat the above step on the °C test set range (nominal 25°C ambient temperature).
  - (p) Return °F/°C slide switch to the °F position, and binding post selector switch to position (A).
  - (q) Set the output of the check instrument to the remaining two TABLE 4 values.
  - (r) Read the corresponding temperature values on the test set, both in °F and °C. The displayed readings should agree with the TABLE 4 values within the tolerance indicated. Record a check (✓) if within tolerance.
- NOTE: A three-point check on only one T/C range is sufficient for verifying the accuracy of all the thermocouple ranges. The test set's microprocessor automatically measures the thermocouple input voltage and the reference-junction temperature then

## Calibration (Cont'd)

calculates all T/C linearity corrections based on equations developed by NBS, after correcting for reference junction temperature.

If the test set error exceeds the TABLE 4 tolerance value, after readjusting all previously noted calibration trimmers, it is recommended that the test set be returned to the factory.

Table 4

Step	Check Inst Set at mV	Cat. No. 720350 Instrument Being Calibrated							
		Range Switch Set at	Channel Select	Nominal Reading (°F)	Allowable Tolerance* (°F)	Nominal Reading (°C)	Allowable Tolerance (°C)	Trimmer Adjustment	OK (✓)
(i-l)	0.000	J	A	32.0	0.4	0.0	0.2	T. Zero A	
(i-r)	0.000	J	B	32.0	0.4	0.0	0.2	T. Zero B	
(m-o)	—	J	B	Nominal 77°F Ambient Temp.	0.4	Nominal 25°C Ambient Temp.	0.2	—	
(m-o)	—	K	B		0.4		0.2	—	
(m-o)	—	I	B		0.4		0.2	—	
(m-o)	—	E	B		0.4		0.2	—	
(m-o)	—	R	B		1		1	—	
(m-o)	—	S	B		1		1	—	
(m-o)	—	C	B	1	1	—			
(p-f)	67.240	J	A	2120.0	0.7	1160.0	0.4	—	
(p-f)	-6.159	J	A	-220.0	0.6	-140.0	0.3	—	

Note: Table based on using a "J" type thermocouple for calibration.

\*Tolerance values for steps m-o apply to each reading relative to all other readings higher in the table.

## 5. Calibration of Thermocouple Ranges Using Reference-Junction Compensation Method

Proceed as follows:

- (a) Connect the test set to the check instrument (Cat. No. 72-3110) as shown in Figure 14. Use "J" type thermocouple extension lead-wires to connect the heat sink block to the test set. (Alternately, another T/C type may be used, with the procedure changed accordingly.)
- (b) Measure the reference-junction temperature in the Heat Sink Block with the mercury-in-glass thermometer.
- (c) Set the reference-junction emf (equivalent to the reference-junction temperature for the type "J" or other appropriate thermocouple) on the REF JCT Compensator dial of the Cat. No. 72-3110 check instrument. The procedure is explained in the Cat. No. 72-3110 instruction manual.
- (d) Rotate the Function Selector switch of the Cat. No. 72-3110 check instrument to the TC OUTPUT position.

## Calibration (Cont'd)

NOTE: The reference-junction compensator of the Cat. No. 72-3110 is functioning in this output position.

- (e) Following the exact procedure of Paragraph 4, steps (d) through (r), proceed with the calibration check for the thermocouple ranges.

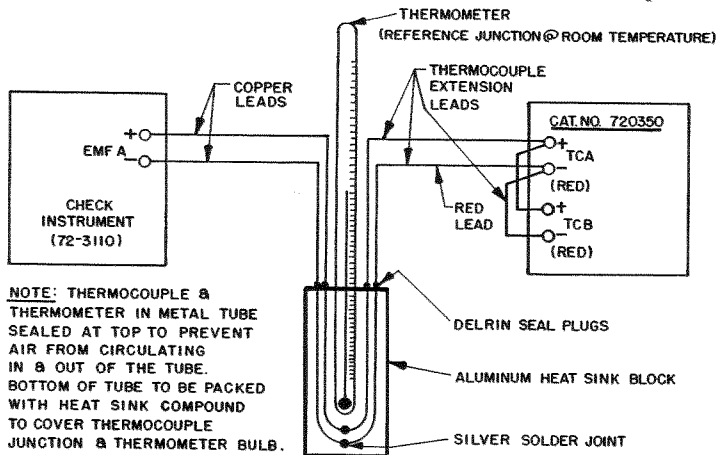

Figure 14: Calibration of Thermocouple Ranges Using Reference Junction Compensation Method.

## 6. Check Mode Verification

Following the procedure as described in Section H, Paragraph 5, verify the test set check readings.

NOTE: Long-term component aging or recalibration of the test set may dictate re-marking the Check Readings on the instrument range label. The change, however, should be very minimal.

## 7. Calibration of Low Battery Blink Point

Proceed as follows:

- Disconnect the battery cable from connector (J4) on the digital card.
- Connect the variable dc Power Supply (Para. 2, item f) to the same connector observing proper polarity. The red wire is positive (+) polarity.
- Rotate the Mode selector switch of the test set to the CHECK position.
- Set the BTRY LOW trimmer (See Figure 15) so the threshold of blinking is between 5.87 to 5.93 volts input voltage.
- Reconnect the battery cable, and replace the test set in its case.

## Calibration (Cont'd)

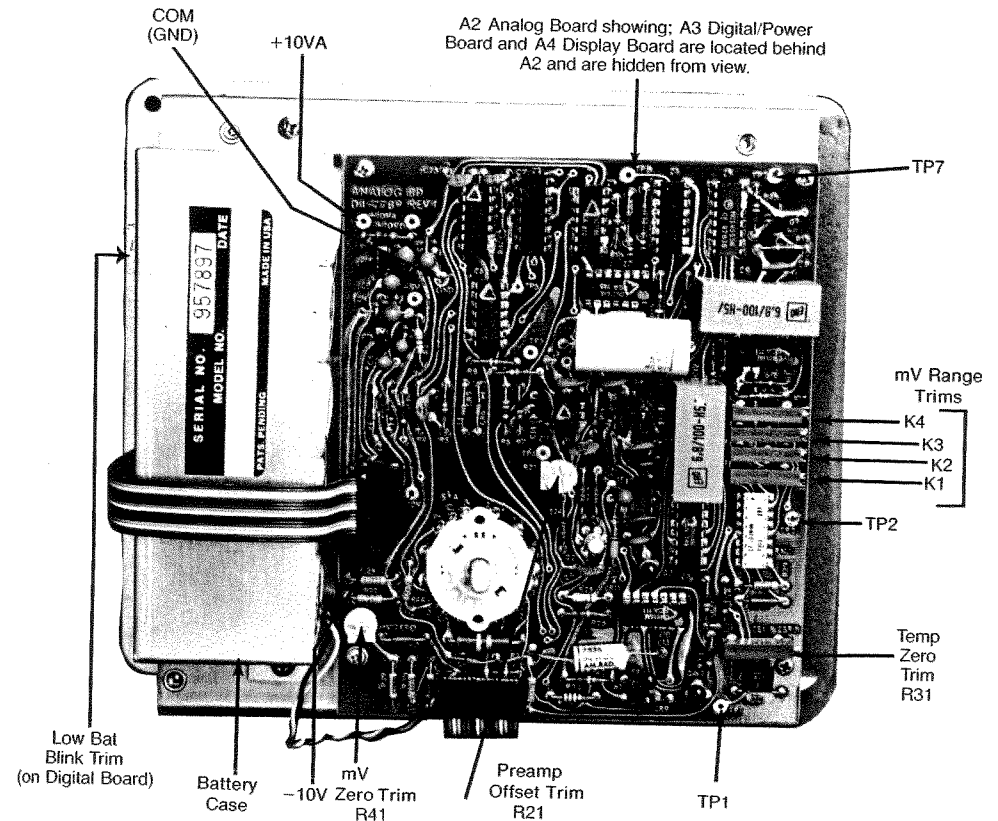
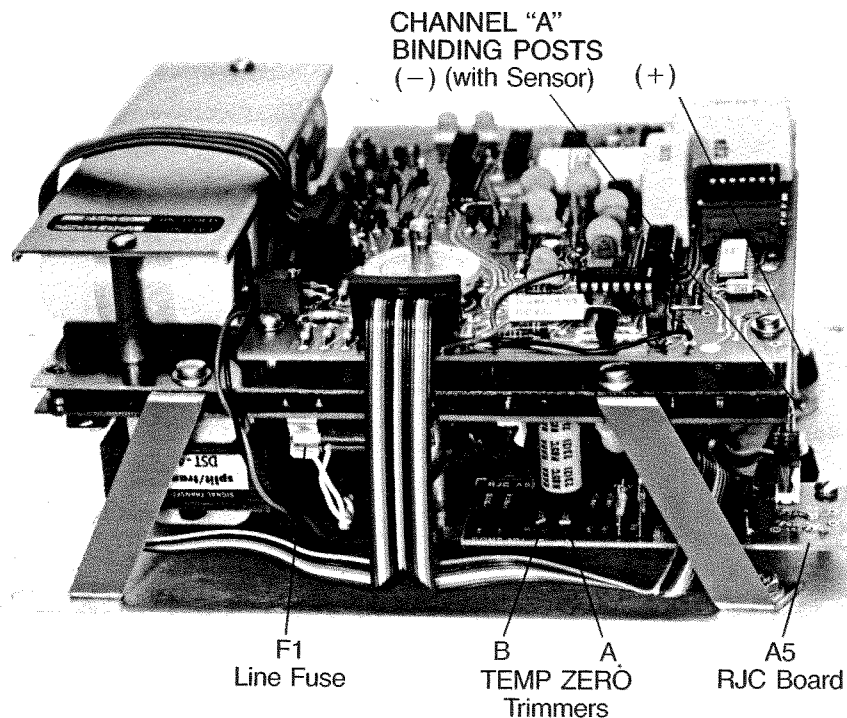

Figure 15: Interior Rear View showing Analog Board with location of Calibration Trimmers and Test Points. This layout is typical of early production (Serial Numbers below 91,400), with single Temp Zero trimmer on Analog Board.

## Calibration (Cont'd)



**Figure 16:** Interior angle view of a current model (Serial Number 91,400 and higher) with dual Temp Zero adjustments on RJC board.

## Section K MAINTENANCE

### 1. General

For maintenance not described below, or the replacement of parts not listed in Section M, it is recommended that the test set be returned to the factory. Additional service support documentation 72-350S is available from Biddle. It consists of a set of detailed schematic diagrams with component information.

### 2. Removal of Test Set From Case

Unscrew the four front panel mounting screws and lift the unit out of its case. With the unit out of its case it may be inspected for broken wires or unplugged or loose connectors or subassemblies.

#### WARNING

Be sure the Mode selector switch is in the OFF position before attempting to replace any parts. Body contact with any electrically conductive part in the high voltage (175V dc) circuit is a potential shock hazard. See Section B, Safety Precautions.

### 3. Calibration Adjustments

All calibration adjustments are found on the underside of the unit. The detailed calibration for the test set is described in Section J.

### 4. Battery Replacement

The symptom of a battery pack failure is the inability of the batteries to hold a charge.

To replace the battery pack, proceed as follows:

- Unplug the battery cable from connector J4 on Digital/Power Supply board.
- Remove the battery housing's two hold-down screws.
- Unsolder the red and black connector wires at the battery solder tabs.



## Maintenance (Cont'd)

- (d) When installing a new battery pack, connect the red cable wire to the positive (+) battery solder tab, and the black wire to the negative (-) solder tab.

### 5. Analog PC Board Replacement

To replace the analog board, proceed as follows:

- (a) Unplug the two ribbon cables from the connectors J1 and J3 on the analog board. The plugs are secured with a plastic hold-down strap.
- (b) Remove the analog board's four corner mounting screws; then remove the board.
- (c) When replacing the board, align the flat of the switch rotor with the flat on the switch shaft. Also make sure the cable plugs are resecured with the hold-down straps.

### 6. Digital and Display PC Board Replacement

(Perform steps *a* and *b* only on S/N below 90,000.)

- (a) Remove the four front panel control knobs.
- (b) Remove the plastic front panel from the metal sub-panel. It is held in place by double-sided adhesive tape.
- (c) Remove the four nuts and lockwashers which hold the chassis legs to the sub-panel. (On S/N below 90,000 remove screws, not nuts.) Separate the chassis assembly from the panel assembly.
- (d) Unplug ribbon cables as necessary. The cable plugs are secured with a plastic hold-down strap.
- (e) The digital board and the display board can now be removed by removing four screws from each board.
- (f) When replacing the boards, align the flat of all switch rotors with the flat on the respective switch shaft. Also make sure all cable plugs are resecured with the hold-down straps.

### 7. ROM Replacement

To replace the ROM on the Digital Board, proceed as follows:

The 4K ROM memory, U3/U4 on the digital board, has been implemented from time to time with several different component types. Each type re-

## Maintenance (Cont'd)

quires a specific pattern of three jumpers from points E4, E7, and E10 to points E3, E5, E6, E8, E9, E11 or E12. Since serial number about 91,000, a single 32K EPROM, type 2732, Biddle P/N 23872-2 or -3, has been supplied on new instruments and for field replacement. To install in older instruments using other types, proceed as follows:

1. Remove old U3 and/or U4 from their sockets directly beneath the A/B switch, and discard.
2. Change existing connections between "E" points located beside U4, removing jumpers or cutting paths and adding jumpers as required. The new arrangement shall be the following:

E4-E12, E7-E6, E10-E3, and no other.

## Section L TROUBLESHOOTING

### 1. General

Before proceeding be sure that the operation of the test set as well as the steps listed below are fully understood. Components shown in parenthesis are a possible cause of the problem.

#### WARNING

Body contact with any electrically-conductive part in the high voltage (175V dc) circuit is a potential shock hazard! Refer to Section B, Safety Precautions.

### 2. Symptoms

#### (a) Display does not light.

- (1) Check that Mode switch is *not* in OFF position.
- (2) Check that battery cable is plugged into J4 connector on digital board.
- (3) Check that ribbon cable from connector P2 on display board to connector J2 on digital board is plugged in properly.
- (4) Check battery fuse (printed wiring fuse F2 on digital board). If blown, replace with AWG 32 or 34 uninsulated copper wire connected between points E1 and E2.
- (5) Replace the glass-tube fuse if blown; (F1 on digital board).
- (6) Charge battery. Check that line voltage selector switch S2 on digital board is set properly *before* connecting line cord.
- (7) Check that the 5-volt supply voltage is between 4.85 to 5.10 volts; (U20, Q3, CR4, C11 or T3 on digital board). Check voltage between terminal 11 and ground terminal 10 of J2 connector on digital board.
- (8) Check calibration of BTRY LOW adjustment. Refer to Section J, paragraph 7.
- (9) Check that battery voltage is greater than 6 volts.

#### (b) Same segment does not light on all display digits.

(U2; Q15 thru Q22 on display board).

## Troubleshooting (Cont'd)

### (c) One digit does not light.

(U1; Q1, Q2 for left digit; Q3, Q4 for second digit; Q5, Q6 for third digit; Q7, Q8 for fourth digit; Q9, Q10 for fifth digit; Q11, Q12 for sixth digit; Q13, Q14 for seventh digit). All components are located on display board.

### (d) Display always indicates "OPEN".

Check that ribbon cable from front panel is plugged into connector J3 on analog board.

### (e) Display indicates "ERROR".

If always indicating ERROR, check ribbon cable from digital board P1 to analog board J1. If continuously indicating ERROR only when input signal is near a range change value (See Section E2), check gain settings of gain trimmers K1-K4 per Section J3; (C10).

### (f) One or more of the "mV Range" calibration trimmers, K1 thru K4 cannot be adjusted properly.

(U5, U9 on analog board).

### (g) Readings are noisy or test set cannot be calibrated; See Figure 15 for location of test points.

- (1) Check that voltage at C3+ to GND test point on analog board is between 12.5 to 13.5 volts dc. (T3, CR6, C15 on digital board; C3, U14 on analog board).
- (2) Check that voltage across C6 (ungrounded measurement) on analog board is between 12.5 to 13.5 volts dc. (T3, CR5, C16 on digital board; C6, U15 on analog board).
- (3) Check that voltage between test points +10VA to GND on analog board is  $+10.0 \pm 0.5$  volts. (U14 on analog board).
- (4) Check that voltage between test points -10V to GND on analog board is  $-10.0 \pm 0.5$  volts. (U15 on analog board).
- (5) Check that voltage between test points TP1 to GND on analog board is  $4.019 \pm 0.010$  volts dc. (U13, CR11, Q3 on analog board).

## Section M FIELD REPLACEABLE PARTS LIST

Designation	P/N	Qty.	Description
E1, E3	11166-2	2	Binding Posts (+) (Superior #DF31BC)
E2, E4	25593-2, -3 or -4	2	Binding Post assembly (-) with sensor for S/N >91,400. Select -2, -3 or -4 same as on RJC Board. Also see Kit 25011.
U1, U2	—	—	RJ temperature sensor for S/N >91,400. Order E2, E4.
E2, E4	11166-2	2	Binding post (-) w/o sensor, for S/N <91,400.
	14877-2	1	Knob, Mode Selector
	14877-3	1	Knob, Dual; Output Adjust, for 3-turn pot used on most units with S/N <90,000.
	14877-4	1	Knob, Dual; Output Adjust for 10-turn pot used on S/N >90,000 and on earlier instruments having "R" following Cat. No.
	18601-1	1	Knob, skirted, Range Selector, 4-range.
	14877-6	1	Knob, skirted, Range Selector, 8-range.
S3	25237	1	Paddle Switch, 3-pole, Alco MHL-306D-20M (0) (S/N >91,400 and some earlier).
S3	14870-6	1	Paddle Switch 2-pole, C & K #7201-J602Q (S/N >90,500 and some later).
R49A/B	10231	1	Potentiometer, Output Adjust, 10 turns dual. For current models and to replace 3-turn pot of early models.
	18603	1	Filter, Display
	14910	1	Receptacle, 120Vac
P1	14911	1	Line Cord, 120V/220V ac, 6 feet.
B1	18600	1	Battery Pack (5 cells) without cable
	19812	1	Battery clamp plate
	16790-1	1	Marked Overlay for panel
	10124-6	4	Screw, nylon panel corners
	10998	1	Case Bottom
	10997-16	1	Case Lid (w/o range label)
	18605-2	1	Range label, (4 or 8-range)
Q1	18610	1	Ref. Junct. Sensor S/N <91,400 (Analog Devices AD590JH)
E2, E4, A5	25011	1	Ref. Junct. Kit for S/N >91,400. Matched set of E2, E4 and A5, also listed separately.
Manual	72-350J	1	Instruction Manual, Cat. No. 720350 Series
Manual	72-35T	1	Temperature-Millivolt Conversion Tables
P3	19814	1	Plug & ribbon cable assembly; J3 on Analog Board to various points. 11 wires (only 8 used on S/N <91,400).

### Field Replaceable Parts List (Cont'd)

Designation	P/N	Qty.	Description
A5	25596-( )	1	RJC Board Used on S/N >91,400 (Parts Follow). Select -2, -3 or -4 same as existing assembly to match existing sensors; also see Kit 25011.
R3, R7	25192-8	2	Potentiometer, 50 ohms, COMP ADJ
R4, R8	10027-123	2	Resistor, 480 ohms, precision, 5ppm/°C
R2, R6	—	2	Resistor, to match sensor as follows: For 25596-2 use P/N 12398-207, 1.78M, 1% For 25596-3 omit For 25596-4 use P/N 12398-206, 1.43M, 1%
A4	18606		DISPLAY P.C. BOARD ASSEMBLY (Parts Follow.)
DS1	18608-1	1	Display, 3-digit (Beckman SP333)
DS2, 3	18608-2	2	Display, 2-digit (Beckman SP332)
Q-	11638-60	15	Transistor, (Q1, Q3, Q6, Q7, Q10, Q12, and Q14 thru Q22) (Motorola MPSA42)
Q-	11638-61	7	Transistor, (Q2, Q4, Q5, Q8, Q9, Q11, and Q13) (Motorola MPSA93)
U1, 2	19826-13	2	Integrated Circuit (RCA CD4508BE)
S4	18607	1	Switch, °F/°C
RN1	19825-1	1	Resistor Network, 7X33K
RN2	19825-2	1	Resistor Network, 7X10K
P2	19815-1	1	Ribbon Cable, 16-pin plug each end
A3	18609	1	DIGITAL P.C. BOARD ASSEMBLY (Parts Follow.)
C11	19824-3	1	Capacitor, electrolytic, 1000µF, 10 V DC, (Mallory VTL 1000 S10)
C15-17	17132-9	3	Capacitor, tantalum, 3.3µF, ± 20°, 25VDC (Sprague 196D)
CR4	11637-39	1	Diode, (1N4933)
CR5, 6	11637-6	2	Diode, (1N914)
F1	2567-8	1	Fuse, 3AG, 0.2A, 250V, (Littlefuse 313.200)
Q3, 5	11638-62	2	Transistor, (2N3904)
R6	19848-9	1	Trimmer, cermet, 10KΩ ± 20%, (BTRY LOW) (CTS type 375X)
T2	19108-3	1	Transformer line (Signal #DST4-24)
T3	18622	1	Transformer
U20	19850	1	I.C. Switching Regulator, (Fairchild #78S40)
U1, 2	19839-1	2	Memory, 256X4 RAM, (RCA MWS5101EL3X)
U3	—	0	No longer used. Replace U3 & U4 with new U4.

### Field Replaceable Parts List (Cont'd)

Designation	P/N	Qty.	Description
U4	23872-3	1	32K BYTE EPROM standard ranges. (See SECTION K-7 for installation.)
U4	—	—	32K EPROM for special ranges. (Number marked on existing part.)
U5	19846-1	1	Microprocessor, RCA #CDP1802CEX
S2	18620	1	Switch, 115V or 230V, (Switchcraft #46206LFR with PC terminals)
P1	19815-1	1	Same as Display Board, P2.
Y1	19851-1	1	Crystal, 2.41152 MHz.
A2	18624-2	1	ANALOG P.C. BOARD ASSEMBLY (S/N >91,400) (Parts Follow.)
C1-6	17132-9	6	See Digital Board C15.
C9, 12	25440-1	2	Capacitor, 6.8/100, met. polycarb.
CR11	12074-48	1	Diode, reference 1N4578 selected 6.2/6.4V
Q3, 4	11638-63	2	Transistor, (2N5246)
R20	13183-4	1	Trimmer, cermet, 100Ω, (K1 adjustment) (Bourns #3006P-1-101)
R18, 19	13183-3	2	Trimmer, cermet, 50Ω, (K2, K3 adjustment) (Bourns #3006P-1-500)
R17	25192-10	1	Trimmer, 10Ω, precision film (K4 adjustment)
R21, 41	5694-7	2	Trimmer, cermet, 5KΩ, 25 turns. (Replaces 1-turn in early units)
R44	12398-119	1	Resistor, 37.4Ω, 1%
U2	19826-11	1	Integrated Circuit, CD40175BE
U5	19826-15	1	Integrated Circuit, CD4555BE
U7-10	19847-7	4	Integrated Circuit, CD4016AE, selected
U11	19845-1	1	Integrated Circuit, LM393 dual comparator
U12, 13	18614	2	Integrated Circuit, LF353N
U14, 15	18615	2	Integrated Circuit, 10-volt regulator, Texas Instr. UA78L10ACL (Replaces LM340LAZ-10 in early units; 78L09 and two diodes in 1981 units)
A2	18624	1	ANALOG P.C. BOARD ASSEMBLY (S/N <91,400) (Parts Follow.)
Components as for 18624-2 and also:			
R32	10027-96	1	Resistor, 490 ohms, 0.1%, 5 ppm/°C
R31	25192-9	1	Trimmer, 25-turn, 20Ω, precision film (Temp Zero)

## **Section N WARRANTY**

All products supplied by Biddle Instruments are warranted against all defects in material and workmanship for a period of one year following shipment. Our liability is specifically limited to replacing or repairing, at our option, defective equipment. Equipment returned to the factory for repair will be shipped Prepaid and Insured. The warranty does not include batteries, lamps or tubes, where the original manufacturer's warranty shall apply. WE MAKE NO OTHER WARRANTY.

The warranty is void in the event of abuse or failure by the customer to perform specified maintenance as indicated in the manual.

## **REPAIRS**

Biddle Instruments maintains a complete instrument repair service. Should this instrument ever require repairs, we recommend it be returned to the factory for repair by our instrument specialists. When returning instruments for repairs, either in or out of warranty, they should include the instrument catalog number, serial number; your name, address, telephone number, and a description of the problem or repair/rework instructions. The instrument should be shipped Prepaid and Insured, and marked for the attention of the Instrument Service Manager.

## Appendix 1 THERMOCOUPLE MEASUREMENT METHODS

### A1.1 Basic Ideas

Whenever a junction of two dissimilar wires is heated above absolute zero, it develops a voltage called its thermal emf. This emf can be measured across the far ends of the two wires. Certain metal combinations are used in this way to form temperature sensors called thermocouples ("T/C's"). Combinations are used which have a high emf output and are stable under working conditions. Well-made couples have a very predictable curve of emf vs. temperature, as shown in Figure A1-1.

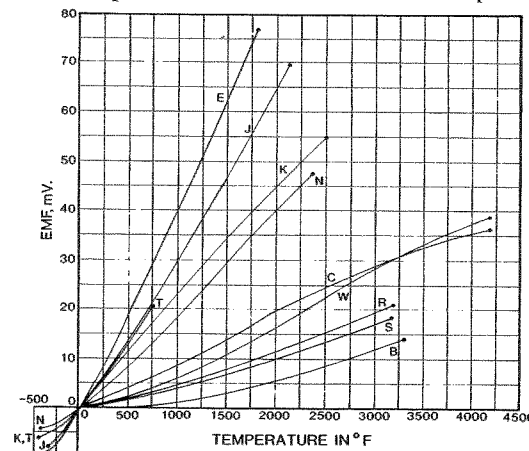

**Figure A1-1: Temperature-Millivolt Graph for ANSI thermocouples and two tungsten types (C,W).**

control these unwanted voltages, the unwanted junctions are often kept at a controlled temperature, say in an ice bath. Then the voltmeter is calibrated to add the known 0°C output of these junctions to the reading. This corrects for their bucking effect in the measured circuit.

### A1.2 Reference Junction

It turns out that if the two unwanted junctions at the instrument are both at the same temperature, their total emf as seen by the voltmeter is the same as the emf of a single junction of the original T/C materials at the same temperature. This has led to the practice of constructing the unwanted junctions close together so as to be at the same temperature,

## Thermocouple Measurement (Cont'd)

also treating them in computations as a single junction. Further, since "it" is often held at a controlled reference temperature, it is known as "the" reference junction ("RJ") (or often being in ice, sometimes called the "cold junction").

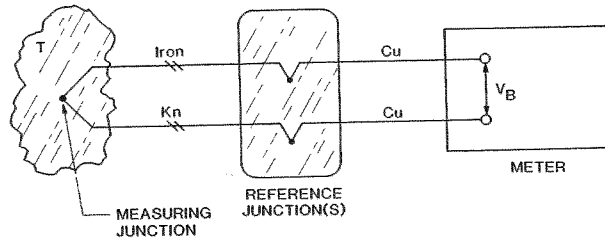

**Figure A1-2:** Thermocouple Measurement with Reference Junction in a Temperature-Controlled Chamber. Type J (Iron-Constantan) materials are shown. Meter sees the difference between emf's of the measuring junction and the reference junction.

The original sensing couple is known as the "measuring junction" or where applicable as the "hot junction". Figure A1-2 shows schematically the arrangement just discussed. As shown, the copper of the instrument is extended out to form the reference junction in a container such as an ice bath where its temperature can be controlled.

Reference data on T/C output emf vs. temperature is usually given as the net emf after subtracting the emf of the reference junction at the ice point, 0°C (32°F). This is the case for the curves of Figure A1-1 as can be seen by the fact that they all pass through zero millivolts at 32°F. Thus they are "referenced to 0°C". Tables published by standards groups such as NBS, ANSI, ISA, etc. follow this pattern. Such tables give temperature directly from measured millivolts if the RJ is at 0°C.

### A1.3. Reference Junction Compensation

In portable instruments the reference junction ("RJ") is not held at a constant temperature. Instead, it is allowed to follow the ambient and a sensor is used to detect its temperature. The instrument then compensates the RJ emf by converting the RJ temperature into an emf ( $E_C$  in Figure A1-3) which equals the RJ emf but is connected to oppose it.

Summarizing the measurement, voltage  $V_D$  which reaches the display is:

$$V_D = E_M - E_R + E_C$$

## Thermocouple Measurement (Cont'd)

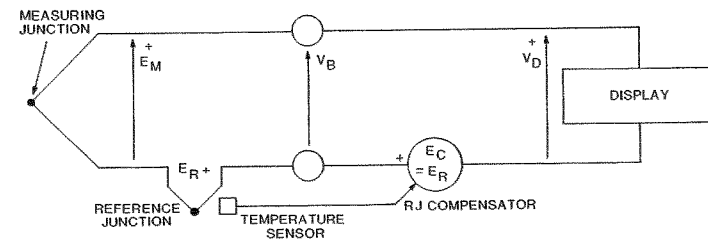

**Figure A1-3:** Schematic of Measurement with Compensated Reference Junction.  $E_C$  bucks out  $E_R$ , the RJ emf.

where  $E_R$  is the emf of the reference junction and  $E_C$  is the compensation voltage. If  $E_C = E_R$ , then  $V_D = E_M$  as desired.

In the Versa-Cal instrument the RJ is at the binding posts. The temperature of the RJ is sensed by a tiny semiconductor clamped in a hole in the negative binding post very close to the actual junction. With this construction the sensor follows the RJ temperature accurately and with rapid response to changes. The RJ comp voltage is derived from the RJ temperature by the microprocessor and is actually added digitally to the binding-post voltage; not precisely as shown in Figure A1-3, but with the same result.

### A1.4 Linearization

Referring to the curves of Figure A1-1, the instrument must convert measured emf to temperature units with a different curve for each T/C type; a process called "linearization". In the Versa-Cal this is done by a microprocessor and memory system. The accuracy with which the instrument matches the actual T/C tables is called the "conformity" of the linearization.

### A1.5 Simulating a Thermocouple

The Versa-Cal in its Output mode is used to calibrate other T/C instruments by imitating or "simulating" a T/C at a given temperature.

In the Output mode, as shown in Figure A1-4, the Versa-Cal generates an output voltage at the binding posts. It measures this voltage as though it were an input from a thermocouple. The resulting display corresponds to the temperature of the thermocouple being simulated. This can be shown as follows:

## Thermocouple Measurement (Cont'd)

Referring to the schematic, Figure A1-5, the internal source is now represented by voltage  $E_B$  across the binding posts.

When this is set to obtain the desired display,  $T$ , the output voltage is:

$$V_o(T) = E_B + E_R$$

At the same time the display voltage which produces the display  $T$  is:

$$V_D(T) = E_B + E_C$$

Since  $E_C = E_R$ , we have  $V_o(T) = V_D(T)$ ; that is the output voltage equals the thermocouple emf corresponding to the displayed temperature, as desired.

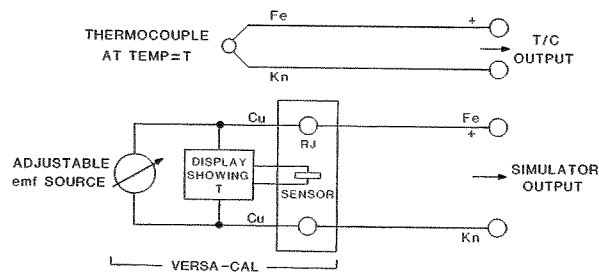

**Figure A1-4:** Versa-Cal Simulating a Thermocouple. (The two output voltages are the same when the source is adjusted to make the display read  $T$ . T/C extension leads are an essential part of the simulation.)

### A1.6 Stability of Output

As just pointed out, the output voltage consists of  $E_B$ , a stable adjustable source, and  $E_R$ , the reference junction emf.

This total output voltage is quite stable as long as the ambient temperature does not change. However, when the temperature changes, the RJ emf follows. The display also changes, thus continuously showing the actual output.

## Thermocouple Measurement (Cont'd)

### A1.7 Possible Errors in Reference Junction Compensation

There are two factors which may contribute to RJC error:

- Sensor error (sensor output  $E_C$  not the same as RJ output  $E_R$  when both are at the same temperature). May be measured as equivalent temperature error of the sensor.
- Thermal coupling error (sensor temperature not the same as RJ temperature).

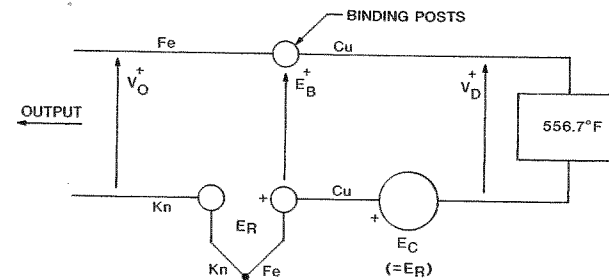

**Figure A1-5:** Schematic of Versa-Cal in Output Mode.

In the Versa-Cal specifications, the RJC "static error" is essentially the sensor error. Thermal coupling is sufficiently good (sensor is actually embedded in the brass binding post) that it does not show up under static conditions. It does show up, however, as a time lag when there is a change in ambient temperature; this is covered by the "Temperature Shock" specifications.

These errors, although they can be expressed as temperature units at the RJ, do not translate directly into temperature units of the display. Any error of the sensor output  $E_C$  is converted to a display error according to the slope (mV per degree) of the T/C curve at the displayed temperature. As a result, the error of the displayed temperature is equal to the RJ temperature error multiplied by a factor which is simply the ratio of the T/C curve slope at the RJ temperature to that at the displayed temperature.

Figure A1-1 shows several T/C curves. It can be seen that the slopes do not change greatly above 25°C. In fact, the slope ratios are less than 1



### Thermocouple Measurement (Cont'd)

over most of this range. A conservative slope ratio of 1 is used in the Versa-Cal specification for the basic RJC accuracy. The exception for the high section of the Type C curve is because of the reduced slope there. All T/C types reduce in slope severely at temperatures below room temperature, making the slope ratio large. For Types J, K, E, T, and N, the slope ratio rises approximately as follows:

Temperature, °C	Slope Ratio
25	1
-175	2
-210	2.7
-243	5
-252	7

Obviously, for displays of such low temperatures, extra care should be taken to control the reference junction temperature.

#### A1.8 Measurements with Type B Thermocouple

The Type B couple has very little output below 100°C, which is to say that it normally has very little RJ output. Thus it is customary to use copper extension leads and omit any RJ compensation in instrumentation. However, if the RJ is held in the range 0-50°C, its output can reach a maximum offset of 2.6 microvolts. This, being uncompensated, becomes an error at the display whose magnitude depends on the slope at the displayed temperature. Here are a few examples:

Displayed Temperature, °C	Error from 2.6 Microvolts, °C
200	1.3
300	0.9
400	0.6
600-700	0.4
800-1200	0.3
1300-1800	0.2

When measuring temperature with a Versa-Cal or any instrument, the installed RJ, which is the junction of T/C and copper extension leads normally located at or near the T/C installation, might reach temperatures beyond the 0-50°C range. In such a case much larger errors may result. For best accuracy, matching extension leads should be used to bring the RJ out of the heat to a "room-temperature" zone.

This problem does not arise in calibrating an instrument with the Versa-Cal. Copper leads are used, there is no RJ, and neither instrument introduces an RJC voltage.

## Appendix 2 SPECIAL THERMOCOUPLE RANGES

### Instrument Configuration

Your instrument may be supplied with thermocouple ranges different from the standard ranges listed in Section D. Instruments having special ranges can be identified by the following external points:

- Catalog Number has a numerical suffix which identifies the special ranges. For example, in Cat. No. 720350-2-8, the "8" signifies that Type B replaces Type E, and Type S per 1948 IPTS replaces Type C.
- Range knob has code symbols indicating the special T/C types.
- The range label indicates the special ranges and corresponding check readings.

Internally, the only difference is that the plug-in EPROM (U4 on the Digital Board) has a special part number.

### Modifying Installed Ranges

Any existing Versa-Cal can be modified to change the installed ranges, either at the factory or as a kit for field conversion. Conversions are reversible.

### Available Special T/C Types

T/C types established as of this publication date are listed in Table A2-1, giving code letter, composition, range, display resolution, and check number tolerance. The following comments apply:

- Designation codes B and N are per ANSI MC96.1. Others are more or less arbitrarily assigned by Biddle. Codes are printed on the range knob and on the range label in the instrument lid.
- All ranges are to the 1968 IPTS unless otherwise noted.
- Ranges to NBS data: B, N, S48, S.1.
- Ranges to Hoskins Mfg. data: D, W.
- Ranges to Engelhard Industries data: PL2.
- Ranges to General Electric Co. data: NM
- Ranges to AMAX Specialty Metals data: future
- Ranges to DIN standards: future

## Special Thermocouple Ranges (Cont'd)

TABLE A2-1:  
Special T/C Types in Production as of Publication Date

Code	Description	Range Covered	Resolution, Degrees	Check Tolerance $\pm$ °C
B	Pt30%Rh/Pt6%Rh	285-1820°C	1	2
N	Nicrosil vs. Nisil	0-1300°C	0.1	0.5
D	W3%Re/W25%Re	0-2350°C	1	2
W	W/W26% Re	0-2320°C	1	2
PL2	Platinel II (Engelhard)	0-1390°C	0.1	0.5
S48	Type S (1948 IPTS)	0-1760°C	1	2
S.1	Type S, 0.1 degree	-50/1768°C	0.1	1.5
NM	Ni/Ni18% Mo (1927 IPTS)	-18/1300°C	1	2

## Appendix 3 LITERATURE REFERENCES

1. Biddle Instruments Manual 72-35T entitled "Thermocouple Temperature—Millivolt Conversion Tables for T/C Types B, E, J, K, R, S, and T". Manual contains millivolt tables in 1-degree increments, plus other useful data on these couples and their extension wires (Tables based on Reference 2).
2. NBS Monograph 125. Contains emf tables and much detailed background on derivation of tables, mathematical representations, uses and precautions for the various materials. Covers types B, E, J, K, R, S, and T.
3. NBS Monograph 161. Contains similar data for Nicrosil-Nisil (Type "N").  
Monographs 125 and 161 are available from Superintendent of Documents. US Government Printing Office, Washington, DC 20402 (Monograph 125 is SD Catalog No. CDE13.44.125).
4. ANSI MC96.1 "American National Standard for Temperature Measurement Thermocouples". Covers wire coding, limits of error, selection, installation, and tables on popular T/C's. Revised 1982. (Also available from ISA, and supersedes several ISA RP documents.)  
Available from American National Standards Institute, Inc., 1430 Broadway, New York, NY 10018.
5. ASTM Number STP470B "Manual on the Use of Thermocouples in Temperature Measurement". Published in 1981; 258 pages, hard cover. An excellent reference with chapters on Principles, Materials, Designs, Measurements, Reference Junctions, T/C Calibration, Installation Effects, Cryogenics, and Uncertainty of Measurements.
6. ASTM Standard E-563 "Preparation and Use of Freezing Point Baths"; brief outline with many references.  
ASTM publications are available from American Society for Testing and Materials, 1916 Race Street, Philadelphia, PA 19103.
7. Kinzie, Paul A. "Thermocouple Temperature Measurement". John Wiley, New York, 1973; 278 pages, hard cover. A compendium of information on T/C types, common and uncommon, with information and references on each. Some 142 are covered; with even more mentioned briefly; 20 are mentioned as being in common use in the United States.
8. Benedict, Robert P. "Fundamentals of Temperature, Pressure and Flow Measurements". John Wiley, New York, 1969; 353 pages, hard cover. Over half is on temperature, covering basics, calibration and special measurement problems. (also, Second Edition, 1985).

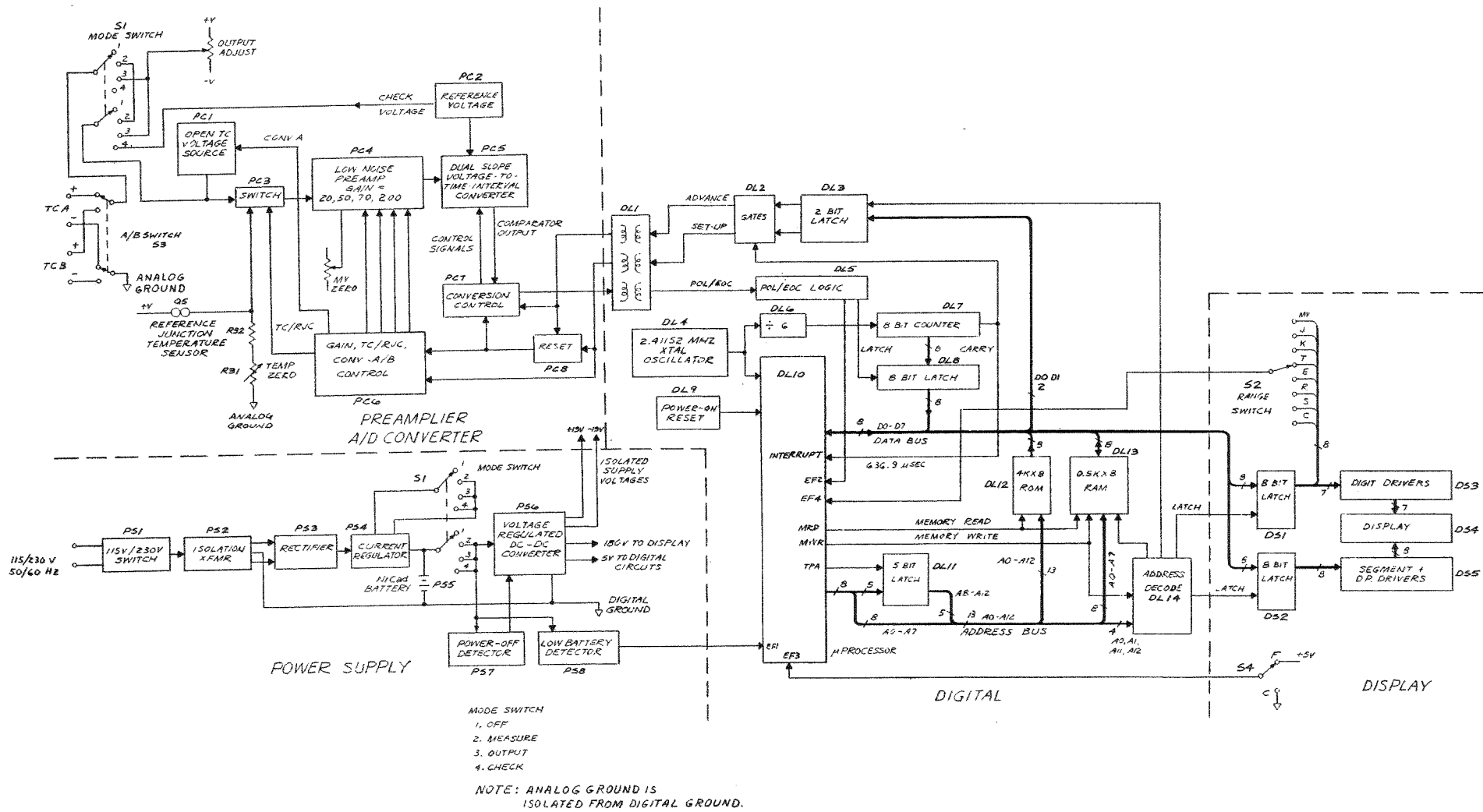

Figure 3: Block Diagram of the Catalog No. 720350 Test Set.