**Instruction Manual
AVTM246003J**

for the

Enhanced Battery Impedance Test Equipment (EBITE)

Catalog Number 246003 and 246003-47

**High-Voltage Equipment
Read the entire manual before operating.**

**Aparato de Alto Voltaje
Antes de operar este producto lea este manual enteramente.**

**AVO International
510 Township Line Road
Blue Bell, PA 19422 U.S.A.
(215) 646-9200**

***Enhanced Battery
Impedance Test
Equipment (EBITE)***

Instruction Manual

Copyright Notice

Copyright© 1995 by AVO International. All rights reserved.

Disclaimer Notice

The information contained in this instruction manual is believed to be adequate for the intended use of the product. If the product or its individual instrument are used for purposes other than those specified herein, confirmation of their validity and suitability must be obtained from AVO International. Refer to the warranty information included at the end of this instruction manual.

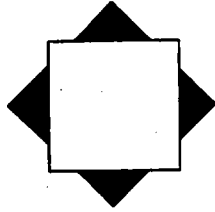

Contents

| | |
|---|-----------|
| PREFACE | IX |
| What You Should Receive with the EBITE | x |
| If the EBITE Is Damaged..... | x |
| Safety Requirements | x |
| About this Manual..... | xii |
| Conventions Used in this Manual..... | xiv |
| Controls and Indicators | xv |
| Lists..... | xv |
| Notes, Cautions, and Warnings..... | xv |
| | |
| CHAPTER 1: INTRODUCTION | 1 |
| What Is the EBITE? | 2 |
| How Does the EBITE Work?..... | 2 |
| What Does the EBITE Include?..... | 3 |
| What Kinds of Battery Systems Can Be Tested Using the EBITE?..... | 5 |
| EBITE Measurements..... | 5 |
| | |
| CHAPTER 2: CONTROLS, CONNECTORS, AND INDICATORS | 7 |
| Transmitter Controls, Connectors, and Indicators | 8 |
| Transmitter Connector Panel | 9 |
| Transmitter Keys..... | 10 |
| Example of How to Use the Transmitter Keys | 11 |
| Transmitter Disconnect Switch..... | 11 |

| | |
|--|-----------|
| Receiver Controls, Connectors, and Indicators..... | 13 |
| Receiver Keys | 14 |
| Example of How to Use the Receiver Keys..... | 15 |
| Resetting the Receiver | 16 |
| | |
| CHAPTER 3: PERFORMING TESTS..... | 17 |
| Overview..... | 18 |
| Step 1: What to Do Before You Start the Test..... | 19 |
| Step 2: Powering on the Receiver..... | 20 |
| Step 3: Scanning Test Information with the Wand (Optional) | 22 |
| If You Do Not Want to Scan Information Using the Wand..... | 22 |
| If You Want to Scan Information Using the Wand | 23 |
| Step 4: Splitting the Strap (If Needed)..... | 24 |
| If You Do Not Want to Split the Strap | 24 |
| If You Want to Split the Strap | 25 |
| Step 5: Connecting the EBITE to the Battery..... | 26 |
| Step 6: Measuring the Cell and the Strap..... | 31 |
| Measuring the Next Section of a Sectioned Battery String | 36 |
| Step 7: What to Do When the Test Is Complete..... | 37 |
| Reviewing a Test..... | 38 |
| Retesting Cells and Straps | 38 |
| Powering Down and Disconnecting the EBITE | 39 |
| | |
| CHAPTER 4: TRANSFERRING, VIEWING, AND PRINTING TEST RESULTS | 43 |
| Overview..... | 44 |
| Importing Test Results from the Receiver..... | 44 |
| Importing Test Results from the Receiver to the Transmitter | 45 |
| Importing Test Results from the Receiver to a PC | 48 |
| Exporting Test Results from the Transmitter Directly to a PC..... | 51 |
| Exporting Test Results from the Transmitter via a Modem | 54 |
| Editing the Phone List Used for Modem Calls | 58 |

| | |
|---|-----------|
| Viewing Test Results | 61 |
| Printing Test Results | 62 |
| Clearing Test Results | 65 |
| Clearing Tests from the Receiver..... | 65 |
| Clearing Tests from the Receiver after Importing Data..... | 65 |
| Clearing Tests from the Receiver by Choosing Clear Data from Menu 2 | 66 |
| Clearing Tests from the Transmitter..... | 66 |
| Clearing Tests from the Transmitter after Exporting Data | 67 |
| Clearing Tests from the Transmitter by Choosing Clear Data from Menu 1 | 67 |
| | |
| CHAPTER 5: INTERPRETING TEST RESULTS..... | 69 |
| Overview..... | 70 |
| Short-Term Interpretation | 70 |
| Long-Term Interpretation | 71 |
| Temperature Corrections..... | 72 |
| | |
| CHAPTER 6: SETTING OPTIONS..... | 73 |
| Overview..... | 74 |
| Setting Options in the Transmitter..... | 74 |
| Turning the Transmitter Backlight On and Off | 74 |
| Adjusting the Transmitter Backlight..... | 75 |
| Adjusting the Transmitter Screen Contrast..... | 76 |
| Setting the Transmitter Clock | 76 |
| Setting Options in the Receiver | 78 |
| Turning the Receiver Backlight On and Off..... | 78 |
| Adjusting the Receiver Screen Contrast | 79 |
| Selecting the Receiver Language..... | 79 |
| Setting the Receiver Clock..... | 80 |

| | |
|---|------------|
| CHAPTER 7: MAINTENANCE AND TROUBLESHOOTING | 83 |
| Cleaning and Inspecting the EBITE | 84 |
| Charging the Receiver..... | 84 |
| Replacing Batteries in the Receiver | 85 |
| Maintaining the Charger | 88 |
| Replacing Fuses in the Charger | 88 |
| Maintaining Fuses in the Transmitter | 89 |
| Verifying a Transmitter Fuse Problem | 90 |
| Identifying a Primary Fuse Problem | 91 |
| Identifying a Secondary Fuse Problem | 91 |
| Replacing Fuses in the Transmitter..... | 92 |
| Replacing the Transmitter Primary Fuse | 93 |
| Replacing the Transmitter Secondary Fuses..... | 94 |
| Replacing the Transmitter Clock Battery | 95 |
| Loading Paper in the Built-In Printer..... | 97 |
| Interpreting Error Messages..... | 99 |
| If the EBITE Needs Repairs..... | 100 |
| | |
| CHAPTER 8: OPTIONAL EQUIPMENT AND TEST PROCEDURES.. | 101 |
| Optional Equipment..... | 102 |
| Optional Test Procedures..... | 103 |
| Reversing the Current Source Leads If a High Current or Low Current Message Is Displayed on the Transmitter..... | 104 |
| Verifying the Source Current If a Low Current Message Is Displayed on the Transmitter | 104 |
| Sectioning a Battery System | 105 |
| Sectioning a Battery System with Parallel Strings | 105 |
| Sectioning a Battery System with More Than 250 Volts | 106 |
| Sectioning High Voltage UPS Batteries | 108 |
| Sectioning Noisy UPS Systems | 109 |

APPENDIX A: TECHNICAL SPECIFICATIONS 111

APPENDIX B: REPLACEABLE PARTS LIST 117

APPENDIX C: EXPORT DATA FORMAT SPECIFICATION 121

APPENDIX D: GLOSSARY 125

INDEX

WARRANTY

List of Figures

| | |
|---|-----|
| Figure 1: EBITE components and accessories..... | 4 |
| Figure 2: Transmitter. | 8 |
| Figure 3: Transmitter connector panel..... | 9 |
| Figure 4: Transmitter Menu 1..... | 11 |
| Figure 5: Sample transmitter test screen showing DISCON (disconnect) switch..... | 12 |
| Figure 6: Receiver controls, connectors, and indicators..... | 13 |
| Figure 7: Receiver Menu 1..... | 15 |
| Figure 8: Receiver RESET switch..... | 16 |
| Figure 9: EBITE connected to the battery..... | 28 |
| Figure 10: Receiver probes positioned on top of the battery cell terminals..... | 32 |
| Figure 11: Receiver probes positioned on top of battery strap terminals..... | 34 |
| Figure 12: Generic Curve of Impedance Cell Life..... | 71 |
| Figure 13: Replacing batteries in the receiver..... | 87 |
| Figure 14: Transmitter secondary fuses (top view)..... | 90 |
| Figure 15: Reversing the current source leads on a single string of cells when a high current or low current message is displayed..... | 103 |
| Figure 16: Sectioning a parallel string of cells..... | 106 |
| Figure 17: Sectioning a battery system with more than 250 V..... | 107 |

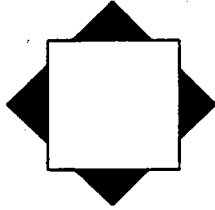

Preface

Welcome to AVO International's Enhanced Battery Impedance Test Equipment (EBITE). This instrument has been thoroughly tested and inspected to meet rigid specifications before being shipped.

It is ready for use when set up and operated as described in this manual.

✓ ***NOTE: Before attempting to use the EBITE, be sure that you read and understand the safety requirements and operating procedures contained in this manual.***

What You Should Receive with the EBITE

When you receive the EBITE, check the equipment against the packing list to ensure that all the materials you ordered are included. If anything is missing, contact AVO International at (215) 646-9200.

If the EBITE Is Damaged

Examine the EBITE for possible damage during transit. If you find any damage, immediately file a claim with the carrier, and also notify AVO International or its nearest authorized sales representative. Be sure to give a detailed description of the damage.

Safety Requirements

The EBITE and its recommended operating procedures have been designed with careful attention to safety. However, it is not possible to eliminate all hazards from electrical test equipment or to foresee every possible hazard that may occur. Therefore, it is essential that the user, in addition to following the safety precautions contained in this manual, also carefully consider all safety aspects of the operation before proceeding.

It should be understood that any use of electricity inherently involves some degree of safety hazard. While every effort has been made by AVO International to reduce the hazard, the operator must assume responsibility for his or her own safety. Any work on batteries is hazardous and requires constant attention to safety. You should guard particularly against the possibility of acid spills, explosion, and electrical shock.

- This instrument has been designed to the IEC-1010-1 safety standard.
- Observe all industry standard safety rules for testing batteries.
- The EBITE is designed for connection to energized systems. Keep the transmitter S1 power switch set to O (OFF) or use the DISCON (disconnect) feature when making connections or disconnections at the battery. Always wear rubber gloves during these operations.
- Always connect the source leads to the transmitter before connecting to the battery under test.
- Always remove the instrument test leads from the battery under test when not in use.
- The purpose of this equipment is limited to use as described in this manual. Do not use the equipment or its accessories for any purpose other than specifically described.
- Do not operate in an explosive atmosphere. Explosive gases such as hydrogen can be present around batteries. A properly vented battery environment is considered safe, but it is the responsibility of the operator to verify conditions before using the EBITE.
- Wear protective clothing and eye protection to guard against skin and eye damage from battery acid or the event of short-circuit sparking.
- Ensure that test leads and probes are in good condition, clean and free of broken or cracked insulation. Replacement leads can be obtained from AVO International.

- Observe all cautions and warnings in this manual and on the equipment.
- This instrument is only to be used by suitably trained personnel who are familiar with the hazards involved in testing high voltage dc systems.
- Safety is the responsibility of the operator.

The EBITE operates from a single-phase power source. It has a three-wire power cord and requires a two-pole, three-terminal, live, neutral, and ground type connector. The voltage to ground from either pole of the power source must not exceed the maximum rated operating voltage (250 V). Before making connection to the ac power source, determine that the instrument rating matches the voltage of the power source and has a suitable two-pole, three-terminal grounding type connector. *The fuse carrier/voltage selector* must be inserted so that the arrow located on the connector panel, directly to the left of the J1 receptacle, is pointing to the arrow on the fuse carrier that corresponds to the proper supply voltage (120 V or 220 V, 50/60 Hz).

The power input plug must be inserted only into a mating receptacle with a ground contact. Do not bypass the grounding connection. Any interruption of the grounding connection can create an electric shock hazard. Make sure that the receptacle is properly wired before inserting the plug. The catalog number 246003-47 is not supplied with a power input plug. Depending on whether the test set is supplied with a black, white and green input supply cord or a brown, blue and green/yellow supply cord, the black or brown cord lead must be connected to the live pole and the white or blue cord lead must be connected to the neutral pole of an approved power input plug. The green or green/yellow ground lead of the input supply cord must be connected to the protective ground (earth) contact of the input plug.

Refer fuse replacement to qualified service personnel only. To avoid electric shock and fire hazard, use only the fuse specified (see Appendix A) which is identical in respect to type, voltage rating, and current rating.

Cautions and **warnings** are included where applicable in this manual and should be strictly observed. They are contained within **shadow-boxes** so that you can easily identify them. Examples are shown below.

CAUTION: Cautions describe actions or conditions that might cause you to damage the equipment.

WARNING: Warnings alert you to conditions or practices that could result in personal injury or loss of life.

About this Manual

This manual is organized into eight chapters and four appendices:

Chapter 1 describes the EBITE unit and contains an overview of how it works.

Chapter 2 describes the locations and functions of controls, connectors, and indicators used when operating the transmitter and receiver.

Chapter 3 contains the procedures needed to perform a test, including conducting pretest activities, scanning bar code information with the wand, connecting the EBITE to the battery, and taking the test measurements. It also explains what to do when the test is complete.

Chapter 4 explains how to transfer, view, and print test results. It also describes how to clear test results that are no longer needed from both the receiver and the transmitter.

Chapter 5 explains how to interpret the results of tests.

Chapter 6 contains the procedures needed to set options that control the EBITE, including backlight and contrast values, time and language, and other default values.

Chapter 7 provides information about properly maintaining the EBITE. It also contains EBITE error messages and procedures used to verify fuse-related problems.

Chapter 8 describes optional equipment that can be purchased for the EBITE. It also contains optional test procedures.

Appendix A lists the technical specifications of the EBITE.

Appendix B lists the replaceable parts of the EBITE.

Appendix C contains export data format specifications.

Appendix D contains a glossary of terms associated with EBITE test procedures.

An **index** and **warranty** are provided after Appendix D.

Conventions Used in this Manual

Information in this manual is formatted using the following conventions.

Controls and Indicators

The names of controls and indicators used when operating the EBITE are shown in capital letters (for example, the UP ARROW or ENTER key).

Lists

Numbered lists (1., 2., ...) indicate a procedure with two or more sequential steps. Numbered lists are displayed in bold type so that you can easily identify them.

Lists preceded by bullets (•) provide information, but not procedural steps.

Notes, Cautions, and Warnings

Throughout this manual, certain types of information appear as notes, cautions, and warnings.

Notes are preceded by a ✓. They alert you to something of significance that needs to be pointed out as an aside to the current discussion.

Cautions and **warnings** are contained within **shadow-boxes**. Cautions describe actions or conditions that might cause you to damage the equipment. Warnings alert you to conditions or practices that could result in personal injury or loss of life. (See the “Safety Requirements” section of this manual.)

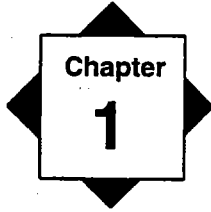

Introduction

This chapter introduces the EBITE and provides an overview of how it works.

- ✓ **NOTE:** *Before you use the EBITE, be sure that you read and understand the safety information contained in the Preface to this manual.*

What Is the EBITE?

The EBITE is a testing device used to evaluate the condition of stationary battery strings. It measures:

- ac impedance
- dc terminal voltage
- interconnection resistance

These measurements along with other maintenance data, such as ambient and pilot cell temperatures and ac ripple currents, help determine the condition of a battery system.

The EBITE consists of a transmitter and a receiver that enable an operator to test for conditions of sulfating plates, post-strap corrosion, poor internal connections, and poor intercell connections.

How Does the EBITE Work?

The operator connects the current source leads from the EBITE transmitter to a battery string so that a 60 Hz (50 Hz for Cat. No. 246003-47) ac test current is capacitively coupled through the battery cells. It is best to test the string when it is operating at full float (that is, at a constant charge level). Since the impedance of a healthy battery is small compared to the load or the battery charger, most of the ac current passes through the battery.

The EBITE receiver is then used to measure across the cell terminals. When the small ac voltage value impressed across the cell terminals is divided by the ac source test current passing through the battery, the resultant value is considered battery cell

impedance. This impedance value gives the operator an indication of the overall condition of the cell, with high impedance typically indicating an unhealthy cell.

A number of factors influence an impedance value, such as the size and type of the cell, ambient and electrolyte temperature, and state-of-charge. Therefore, to determine the impedance of a healthy cell, the operator should measure a large number of similar cells under similar conditions and then calculate the average value. Deteriorating cells can be easily identified since their impedance values are higher than the average.

✓ *NOTE: Average impedance values for different types of batteries are available upon request from AVO International.*

The EBITE automatically measures and records the cell voltage and the time and date of the test. This voltage represents individual cell float voltage while measuring an operational string of cells.

The EBITE is also used to measure intercell or strap connections and store them with the cell impedance values.

What Does the EBITE Include?

The EBITE includes the following components and accessories (see Figure 1):

- Transmitter with a built-in printer
- Receiver
- Current source leads
- Clamp-on current sensor (CT) with a 6-ft extension cable

- Canvas carrying case for leads
- Charger
- Instruction manual

The EBITE is easily operated by one person. The receiver is lightweight and portable. The transmitter is housed in a rugged plastic case with a carrying strap.

Figure 1: EBITE components and accessories.

What Kinds of Battery Systems Can Be Tested Using the EBITE?

Installations that can be tested using the EBITE include:

- Telecommunications
- Electrical power substations
- Electrical power generation plants
- UPS systems
- Aircraft power supplies
- Marine and military applications

For information about other installations that might benefit from EBITE testing, contact AVO International.

EBITE Measurements

Impedance readings are calibrated to 5 percent of reading over the specified temperature range. For ac impedance, the receiver screen presents data as ranges 1.000, 10.00, and 100.0 m Ω . The maximum measurement is 100.0 m Ω .

Test numbers start with number one (01) and toggle upward after each successful dc terminal voltage and ac milliohm reading. Data acquisition is initiated by the operator pulling a TRIGGER on the receiver. Measurement range for dc voltage is from 0 to 25 V dc with an accuracy of 1 percent of reading.

Cell strap and intertier connection measurements are made following the ac internal cell impedance measurements when STRAP is displayed on the test screen of the receiver. This feature provides resistance measurements in the same ranges as the cell/module impedance with 5 percent accuracy.

Source current is monitored with each impedance measurement to compute both cell and strap impedance. Accuracy is 5 percent. Filtering has been selected at the factory as either 50 Hz or 60 Hz depending on the transmitter ordered.

A low current cutoff alarm is maintained at 3 A and the maximum current allowed is 15 A for ac milliohm computations. An ac current over-range display warns of high ripple current contribution. A low current warning is displayed for source current below 3 A.

The time and date are automatically recorded and stored with the test information.

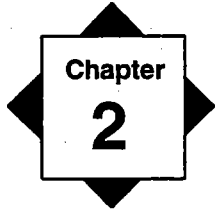

Controls, Connectors, and Indicators

This chapter explains the locations and functions of EBITE controls, connectors, and indicators.

Transmitter Controls, Connectors, and Indicators

Figure 2 shows a front view of the transmitter.

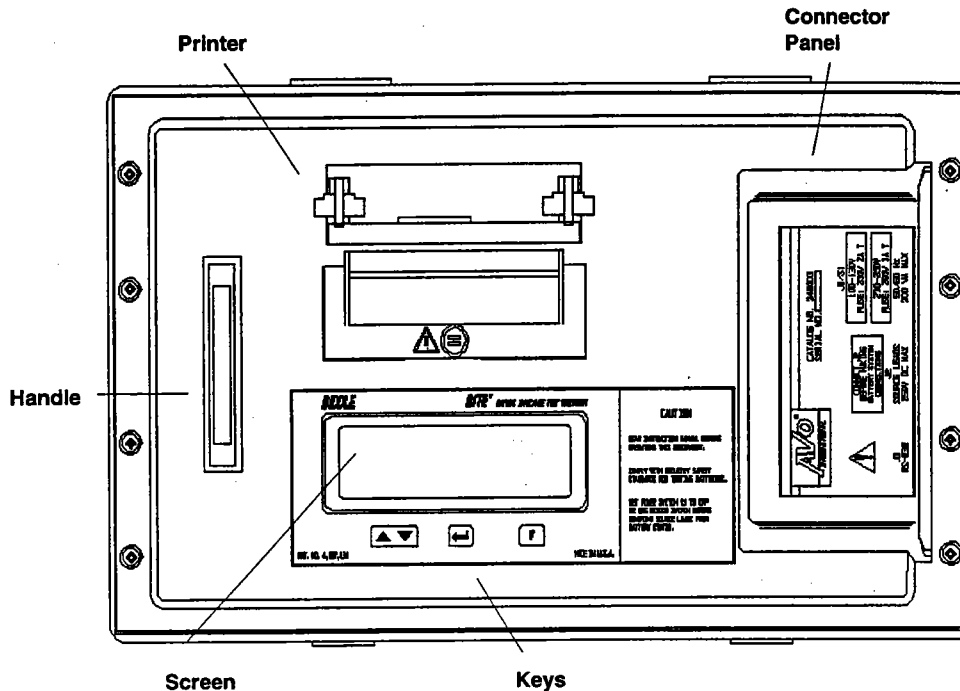

Figure 2: Transmitter.

Printer—The built-in printer prints test results on demand.

Screen—The graphics-type LCD displays menu choices and transmitter-related information. (Refer to the following subsection, “Transmitter Keys,” for a description of the keys associated with the screen.)

Handle—The pop-up handle is used to position the transmitter.

Connector panel—The connector panel is located on the right side of the transmitter. It contains the ac power receptacle, power switch, fuse carrier, line voltage selector, connector for the current source leads, and connector for the RS-232 communication cable.

Buzzer—The buzzer prompts the user to input data. It also sounds under certain error conditions.

Transmitter Connector Panel

Figure 3 shows a close-up of the transmitter connector panel.

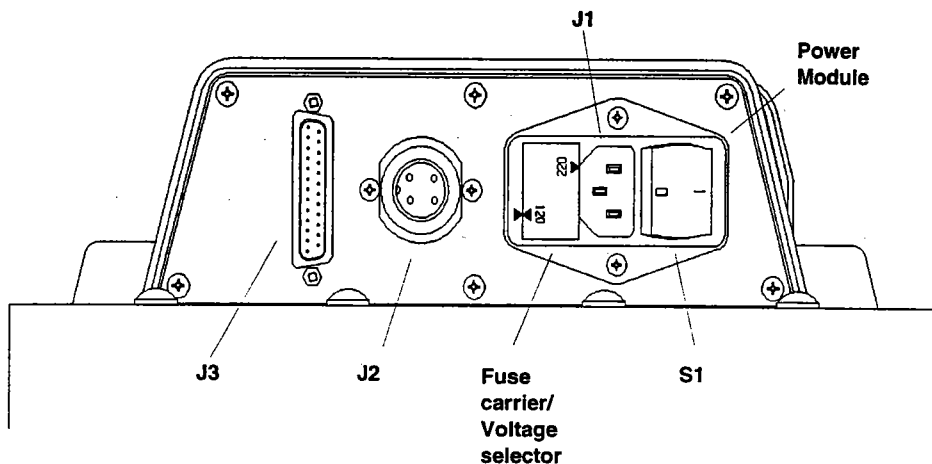

Figure 3: Transmitter connector panel.

Power module—The transmitter power module comprises the following components:

J1 receptacle—The standard power cord supplied with the instrument is inserted into this 120 V or 240 V 50/60 Hz receptacle for ac power.

S1 power switch—The power switch is pressed to turn the transmitter on and off. The power switch is marked with a | (for on) and a O (for off).

Fuse carrier/voltage selector—The fuse carrier is removed as needed to replace fuses. The arrow located on the connector panel directly to the left of the J1 receptacle should point to the arrow on the fuse carrier that corresponds to the proper voltage (120 V or 220 V 50/60 Hz).

J2 connector—The transmitter current source leads are connected from this connector to the battery under test.

J3 connector—The RS-232 communication cable is inserted into this 25-PIN connector to transfer test data to and from the transmitter.

Transmitter Keys

The three keys located on the front of the transmitter are used to operate the transmitter and to navigate through information displayed on the screen:



The **UP ARROW** and **DOWN ARROW** keys are used to move up and down through menu options and select them. Depending on the screen being displayed on the transmitter, these keys can also serve as the DISCON (disconnect) switch for ac source current.



The **ENTER** key is used to choose items that have been selected from the menu and to respond to menu prompts.

F The **FUNCTION** key is used to access menus and to cancel and resume functions.

Example of How to Use the Transmitter Keys

Suppose that the transmitter Menu 1 is displayed on the screen as shown in Figure 4.

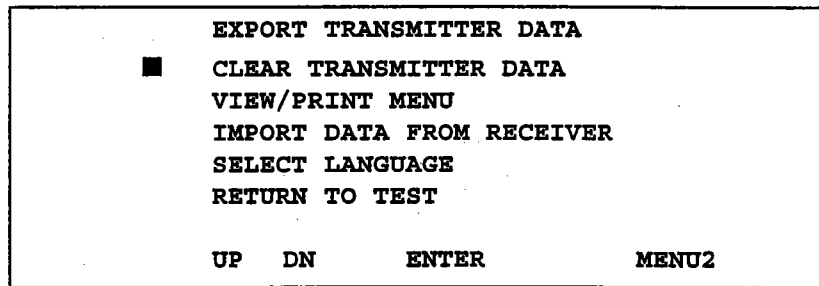

Figure 4: Transmitter Menu 1.

To select the Menu 1 option called Clear Transmitter Data, press the UP ARROW or DOWN ARROW key until the pointer is positioned to the left of Clear Transmitter Data. Then press the ENTER key.

However, to move from Menu 1 to Menu 2, press the F key.

Transmitter Disconnect Switch

In addition to the three keys that are physically located on the outside of the transmitter, the transmitter sometimes displays an on-screen DISCON (disconnect) switch. See the sample screen shown in Figure 5.

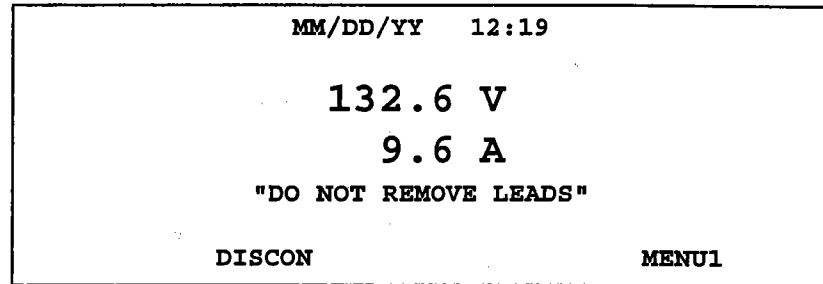

Figure 5: Sample transmitter test screen showing DISCON (disconnect) switch.

The DISCON switch is used to temporarily “disconnect” the transmitter from the battery under test *without turning the EBITE off*. That is, the DISCON switch temporarily blocks the current from being sent to the battery.

To use the DISCON switch, press one of the keys located directly below it (for example, in Figure 5, this would mean pressing the UP ARROW or DOWN ARROW key). The dc source current leads could then be moved to another location in the battery string without having to first turn off the EBITE, move the current source leads, and then wait for the transmitter to power back on. The DISCON switch is particularly helpful when using the EBITE to test parallel sectioned battery strings.

Receiver Controls, Connectors, and Indicators

Figure 6 shows a front view of the receiver.

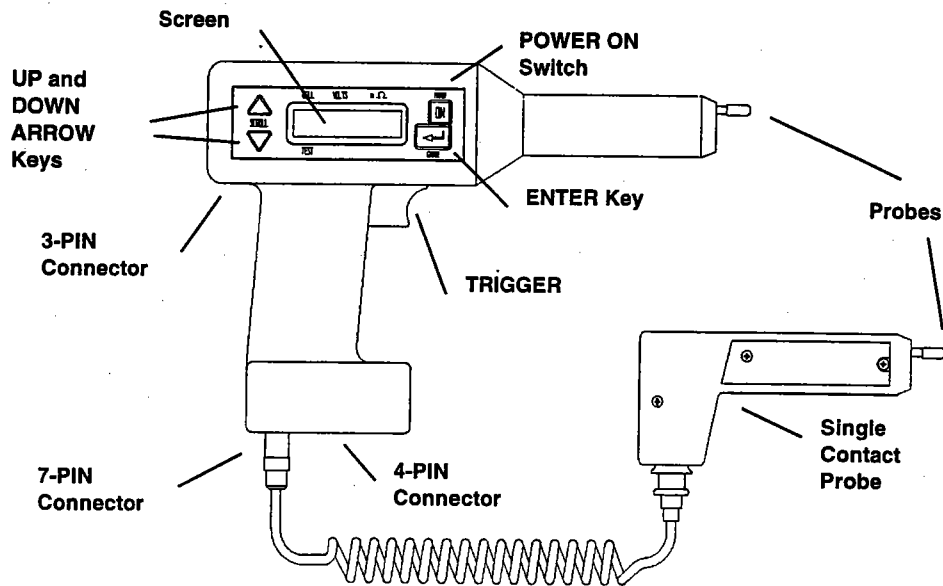

Figure 6: Receiver controls, connectors, and indicators.

POWER ON Switch—The POWER ON switch is pressed to power on the receiver. However, it is important to note that this switch does not power off the receiver. You must choose Power Down from the receiver Menu 1.

Screen—The graphics-type LCD displays menu choices and receiver-related information. (See the following subsection, “The Receiver Keys,” for information about keys associated with the screen.)

Probes—The probes are used to take cell impedance, voltage, and strap resistance measurements.

TRIGGER—The TRIGGER is pulled to perform functions on the receiver, including entering test information.

7-PIN connector—The 7-PIN connector is used to insert one of the following: RS-232 communication cable, bar code wand (optional), or single contact probe.

4-PIN connector—The 4-PIN connector is used to insert the clamp-on current sensor (CT).

3-PIN connector—The 3-PIN connector is used to insert the battery charger.

Buzzer—The buzzer prompts the user to input data. It also sounds under certain error conditions.

Receiver Keys

There are three keys located on the receiver that are used to operate the receiver and navigate through information displayed on the screen:



The UP ARROW and DOWN ARROW keys are used to select information displayed next to these keys on the screen. These keys are also used to scroll up and down through receiver screens.



The ENTER key is used to access receiver menus.

Example of How to Use the Receiver Keys

Suppose that the receiver Menu 1 is displayed on the screen as shown in Figure 7.

To select Export Data, press the DOWN ARROW key.

However, to move from Menu 1 to Menu 2, press the ENTER key.

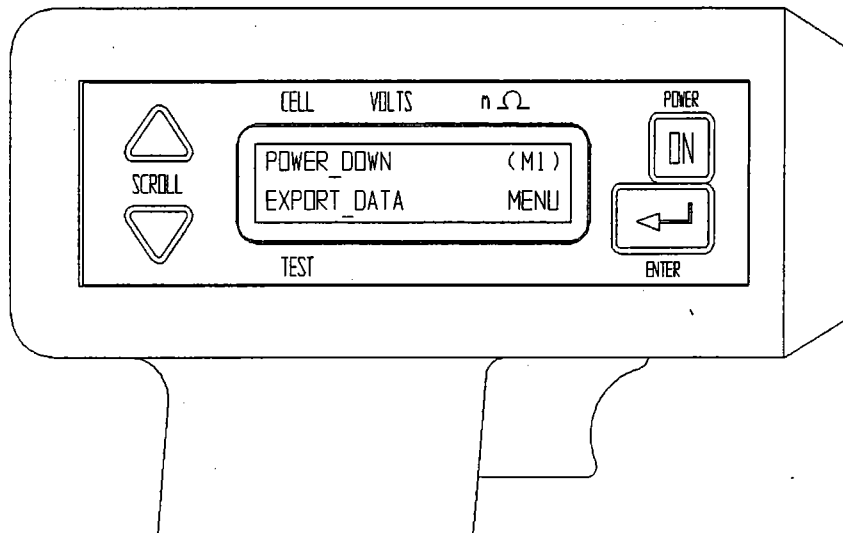

Figure 7: Receiver Menu 1.

Resetting the Receiver

The RESET switch (see Figure 8) located on the EBITE receiver back panel de-energizes the receiver. This feature should be used only if the receiver does not respond to the POWER DOWN menu selection.

To activate the RESET switch, use a pen or similar tool to reach into the access hole labeled RESET. Momentarily press on the switch shaft. The receiver should de-energize.

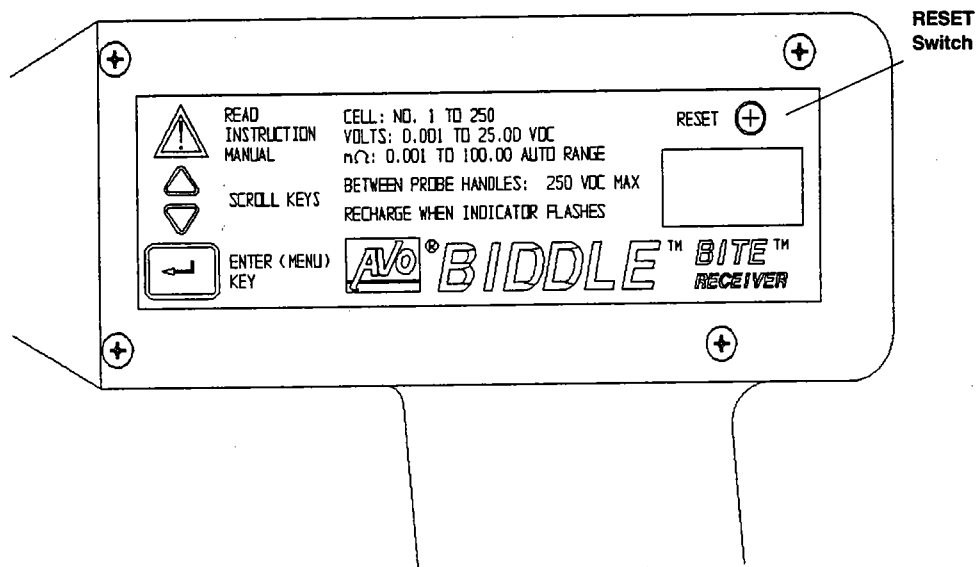
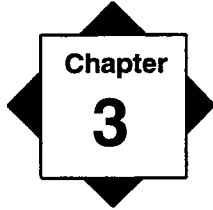

Figure 8: Receiver RESET switch.



Performing Tests

This chapter explains how to use the EBITE to test the condition of a battery, including:

- What to do before you start the test
- Powering on the receiver
- Scanning test information with the wand (optional)
- Splitting the strap (if needed)
- Connecting the EBITE to the battery
- Measuring the cell and the strap
- What to do after the test is completed

The testing procedure explained in this chapter represents a generic application of the EBITE. Actual test scenarios may differ with each application. Contact AVO International if you need additional information about a specific test procedure.

✓ ***NOTE: Before performing tests on any battery systems, read, understand, and observe all safety precautions as indicated in the “Safety Requirements” section, which starts on page x.***

Overview

The EBITE is used to test a battery string while the dc system is at float potential. It can store measurements on a per cell/module basis for battery strings of up to 1,000 cells. The transmitter can provide test current for battery strings of up to 250 V dc.

✓ **NOTE:** *If the battery under test is greater than 250 V dc, the string must be tested in sections. Refer to Chapter 8 for information on sectioning a battery.*

Using the EBITE to test a battery string involves the following steps:

1. Performing pretest activities such as recording information about the test site, visually inspecting the condition of the battery, and recording the temperature.
2. Powering on the receiver.
3. Scanning test information with the wand (optional).
4. Splitting the strap (if needed).
5. Connecting the EBITE source leads to the battery and then powering on the transmitter.
6. Measuring the cell impedance, voltage, and strap resistance.
7. Performing **post-test** activities such as transferring data, reviewing and clearing data, and powering down and disconnecting the EBITE.

The detailed procedures needed to perform these steps are explained in the following subsections.

WARNING: Before you attempt to use the EBITE to perform a test, be sure that you first read and understand the safety precautions explained in the Preface to this manual. When using the EBITE, strictly observe all safety precautions.

Step 1: What to Do Before You Start the Test

Before you actually begin testing a battery, you need to record information about the test site, visually inspect the condition of the battery, and record the temperature.

1. **From the information at the battery test site, record the installation date and the type and location of the cells you are going to test.**

You can record the information on a data sheet or on the top of the paper output from the built-in printer.

2. **If the battery is to be measured while on standby, ensure that the charger associated with the battery is supplying normal float current and that the battery is not in a discharged condition.**

The best repeatable test information occurs when the battery is operating at recommended float voltage.

- ✓ **NOTE:** *Do not perform a test while the battery is under a heavy charge or discharge. If the battery under test has been recently subjected to boost charging, a waiting period of 72 hours is recommended before performing an ac impedance test. If the battery alone is supplying load current, nonrelative impedance measurements can be calculated. Relative impedance values are affected by charge and discharge status, cell age, and ambient temperature considerations.*

3. Perform a visual check of all cells and connections.

For flooded cells, use a flashlight and mirror (if necessary) and check for plate corrosion and other internal defects. Record and correct all problems encountered before testing impedance.

4. Insert a thermometer into a fill tube or vent cap of a pilot cell, and then measure and record the electrolyte temperature of the cell.

Cell impedance can be affected by changing electrolyte temperature.

✓ **NOTE:** *For valve-regulated (sealed) cells, measure the temperature by placing a contact probe on the negative connection post.*

5. Record the ambient (or room) temperature.

Cell impedance can be affected by changing ambient temperature.

After you have successfully performed these pretest activities, you are ready to power on the receiver. The following subsection contains the procedures you need.

Step 2: Powering on the Receiver

After you successfully perform the pretest activities described in “Step 1: What to Do Before You Start the Test,” you are ready to power on the receiver.

- 1. Make sure the receiver charger is disconnected from the receiver.**

✓ **NOTE:** Do not use the receiver to perform tests while the charger is connected to the receiver.

2. Insert the single contact probe cable assembly into the 7-PIN connector on the receiver.

See Chapter 2, "Receiver Controls, Connectors, and Indicators," for the location of the 7-PIN connector.

3. Press the receiver POWER ON switch.

The receiver powers on and several initialization screens are displayed.

✓ **NOTE:** If the receiver is not sufficiently charged, a low battery message is displayed to alert you. You can work for a short time on a low battery; however, you should charge the receiver as soon as possible to ensure that your work is not disrupted because of low battery power.

✓ **NOTE:** If the available memory in the receiver is low (that is, if there is not much space left to store test information), a message is displayed to alert you. In this case, you may want to export prior test results to either the transmitter or a PC and then clear those test results from the receiver. Doing so will make more memory available for the test you are about to perform.

When the receiver is finished initializing, it displays a screen that prompts you to decide whether you want to scan test-related, bar code information using the wand. The following subsection contains the procedures you need.

Step 3: Scanning Test Information with the Wand (Optional)

When the receiver is finished initializing, a screen prompts you to decide whether you want to scan the test location ID, ambient temperature, and pilot temperature using preprinted bar codes provided by AVO International.

| | | |
|---|--------------|------|
| Y | WAND (Y/N) ? | |
| N | | MENU |

If you choose to use the wand, the scanned information is stored in the receiver along with the results of the test. It is important to note that the wand is optional and, although it provides a quick and convenient way of recording information, it is not needed to perform a test.

✓ **NOTE:** *If you connect the wand before powering on the receiver, the receiver automatically prompts you to scan the location ID.*

The procedure you follow regarding the wand depends on if you have a wand and if you want to use it, as explained in the following subsections.

If You Do Not Want to Scan Information Using the Wand

If you do not have a wand or you do not want to scan information about this test, press the DOWN ARROW key on the receiver. The DOWN ARROW key corresponds to the N (for no) and instructs the receiver to bypass the scanning procedures.

The receiver then prompts you to decide whether you want to split the strap. See the following subsection, “Step 4: Splitting the Strap,” explained later in this chapter.

If You Want to Scan Information Using the Wand

If you have a wand and you want to scan information about this test:

1. **Press the UP ARROW key on the receiver.**

The UP ARROW key corresponds to the Y (for yes).

The receiver prompts you to connect the wand.

CONNECT WAND!

2. **Using the wand adapter cable, insert the wand into the 7-PIN connector on the receiver.**

See Chapter 2, “Receiver Controls, Connectors, and Indicators,” for the location of the 7-PIN connector.

The receiver prompts you to begin scanning the test information. For information on creating bar code labels, refer to the documentation provided with the wand.

3. **Scan the location ID. Then scan Enter.**

✓ **NOTE:** *The receiver buzzer should sound and the wand LED should light each time you scan information with the wand. If these indications do not occur, the information was not entered into the receiver.*

4. **Scan the ambient temperature. Then scan Enter.**

5. Scan the pilot cell temperature. Then scan Enter.

You are finished scanning information and the receiver prompts you to disconnect the wand.

| |
|---------------------------------------|
| DISCONNECT WAND:WAITING..... |
|---------------------------------------|

6. Disconnect the wand from the 7-PIN connector on the receiver.

The receiver now prompts you to decide whether you want to split the strap. See "Step 4: Splitting The Strap" for the procedures you need.

Step 4: Splitting the Strap (If Needed)

After you either use or bypass the wand, the receiver displays a screen that asks whether you want to split the strap.

| | | |
|---|-------------|------|
| Y | SPLIT STRAP | |
| N | (Y/N) ? | MENU |

You need to split the strap if the strap you want to measure consists of more cables than the diameter of the clamp-on current sensor (CT) can encompass.

The following subsections contain the procedures you need to specify whether or not to split the strap.

If You Do Not Want to Split the Strap

If you do not want to split the strap, simply press the DOWN ARROW key on the receiver. The DOWN ARROW key

corresponds to the N (for no) and instructs the receiver not to split the strap.

You are prompted to connect the CT to the strap. See the subsection, "Step 5: Connecting the EBITE to the Battery," explained later in this chapter.

If You Want to Split the Strap

If you want to split the strap:

1. Press the UP ARROW key on the receiver to enter Y (for yes).

The receiver prompts you to enter a multiplier, which is a numeric value that the receiver uses to determine the measurement of the entire strap.

| | | |
|----|------------|--------|
| UP | MULTIPLIER | |
| DN | >1_< | ACCEPT |

For example, suppose that the strap you want to measure consists of four cables, but you can get the CT around only two of them. You would need to enter a multiplier of 2 (since $2 \times 2 = 4$). The receiver would then multiply the reading you take by two so that the proper test results are computed for all four cables.

2. Press the UP ARROW or DOWN ARROW key to specify the multiplier you want.

Pressing the UP ARROW key increases the multiplier. Pressing the DOWN ARROW key decreases the multiplier.

3. When the multiplier you want to use is displayed, press the ENTER key to accept the multiplier value.

If you are splitting the strap, keep in mind the multiplier you specified. When the CT is connected, the receiver displays a measurement of the system ripple current.

- ✓ **NOTE:** *Loads, parallel strings, and charging equipment can create parallel paths for the measurement current. Therefore, place the CT at a location that verifies the source measurement current for the cells under test. Do not place the CT around the source lead. This may not represent the current flowing through the battery string.*

3. **Pull the receiver TRIGGER to advance the receiver and store the ripple current reading.**

The receiver prompts you to connect and power on the transmitter.

CONNECT & POWER
TRANSMITTER: XX.X

4. **Before connecting the transmitter to the battery, make sure that the transmitter is powered off.**

The transmitter S1 power switch should be in the O (off) position.

5. **Insert the plug of the current source leads into the transmitter connector marked J2. Then rotate the plug collar clockwise to tighten it.**

See Chapter 2, "Transmitter Controls, Connectors, and Indicators" for the position of the J2 connector.

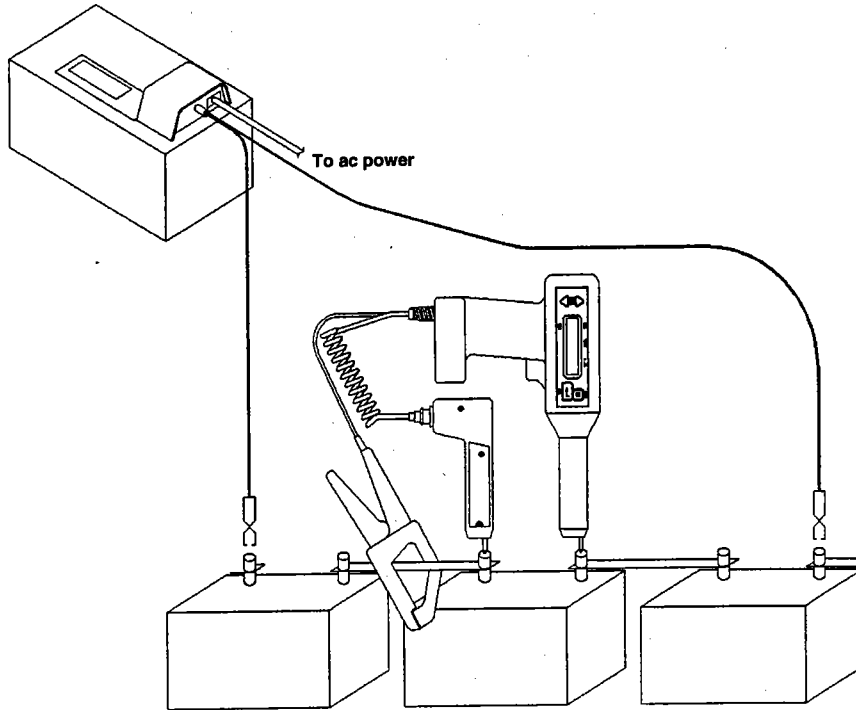

Figure 9: EBITE connected to the battery.

- 6. Connect the current source leads to the end positive and negative posts of the battery.**

✓ **NOTE:** *Be sure to make the connections to the battery post and not to intercell connection hardware.*

CAUTION: You can use the EBITE transmitter to provide test current for measurements on each cell/module for a battery string of up to 250 V dc. If the battery under test exceeds this limit, the transmitter prompts you to section the battery into portions that are less than 250 V. For information on sectioning a battery, refer to Chapter 8.

7. Insert the power cord into the J1 power receptacle on the transmitter. Then plug the power cord into a 120 V (or 220 V for 246003-47 models) outlet, as appropriate.
8. Power on the transmitter by pressing the S1 power switch to the | (on) position.

The transmitter screen displays initialization information.

- ✓ **NOTE:** *If test information is stored in the transmitter when it is powered on, you are automatically prompted to export data, import data, clear data, or resume testing. To resume testing, press the UP ARROW or DOWN ARROW key on the transmitter to highlight Resume Testing. Then press the ENTER key. (To export, import or clear data, refer to Chapter 4.)*

If there is no test information stored in the transmitter, the transmitter displays the following screen.

CONNECT ALL LEADS

PRESS ENTER TO CONTINUE

ENTER

9. Press the ENTER key on the transmitter.

The transmitter indicates that it is sequencing dc power through the current source leads and charging the internal dc blocking capacitor to the dc potential of the battery under test.

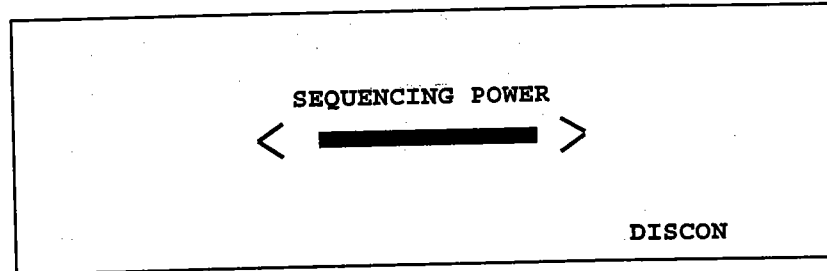

After approximately 20 seconds, a test screen similar to the one shown below is displayed on the transmitter screen. This screen indicates that the transmitter is applying an ac current to the battery and its connections.

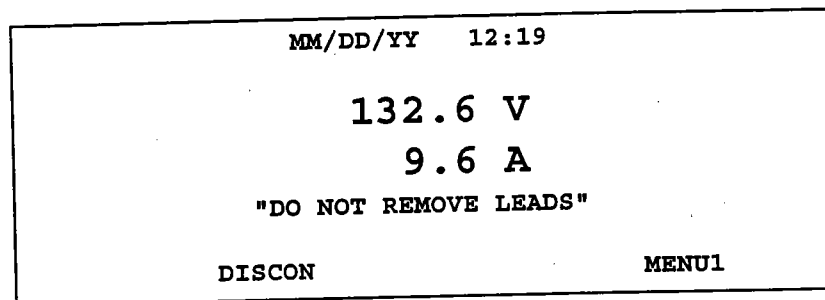

CAUTION: You can use the EBITE transmitter to provide test current for measurements on each cell/module for a battery string of up to 250 V dc. If the battery under test exceeds this limit, the transmitter prompts you to section the battery into portions that are less than 250 V. For information on sectioning a battery, refer to Chapter 8.

10. Observe the current reading displayed on the receiver screen.
11. Pull the receiver TRIGGER to advance the receiver and store the source current reading.

The receiver displays the first test screen, which prompts you to measure the first cell. Refer to the following subsection,

“Step 6: Measuring the Cell and the Strap,” for the procedures you need.

- ✓ **NOTE:** *If there is less than 3 A flowing within the string of cells selected, the EBITE receiver displays a message indicating low current (LO_A). This ensures proper current magnitude for accurate measurement since the total current includes both current from the EBITE and any ac ripple current produced by the battery charger. If significant ripple current is present and out of phase with the injected source current, a low current condition may occur. If this happens, reverse the source leads to bring the two currents in phase. For the majority of applications, this will not present any difficulty. (Refer to Chapter 8 for more information.)*

Step 6: Measuring the Cell and the Strap

CAUTION: Do not exceed 25 V dc, the maximum voltage allowed between the receiver potential probes.

After the EBITE is connected to the battery and the transmitter is powered on, the receiver displays the first test screen.

| CELL | VOLTS | mΩ |
|------|-------|-------|
| 001 | XX.XX | XX.XX |
| T01 | | |

The digits displayed in the upper left corner of the screen (001) indicate that you are ready to test the first cell. The digits in the lower left corner indicate the number of the test you are performing (for example, T01 for test one, T02 for test two, and so on).

To begin testing the first cell in the string:

1. **Position the receiver probes on top of the battery cell terminals, and then press the probes down.**

The twisting action of the probe tips as the handle is pushed down cleans the point of contact and allows a positive test connection. See Figure 10.

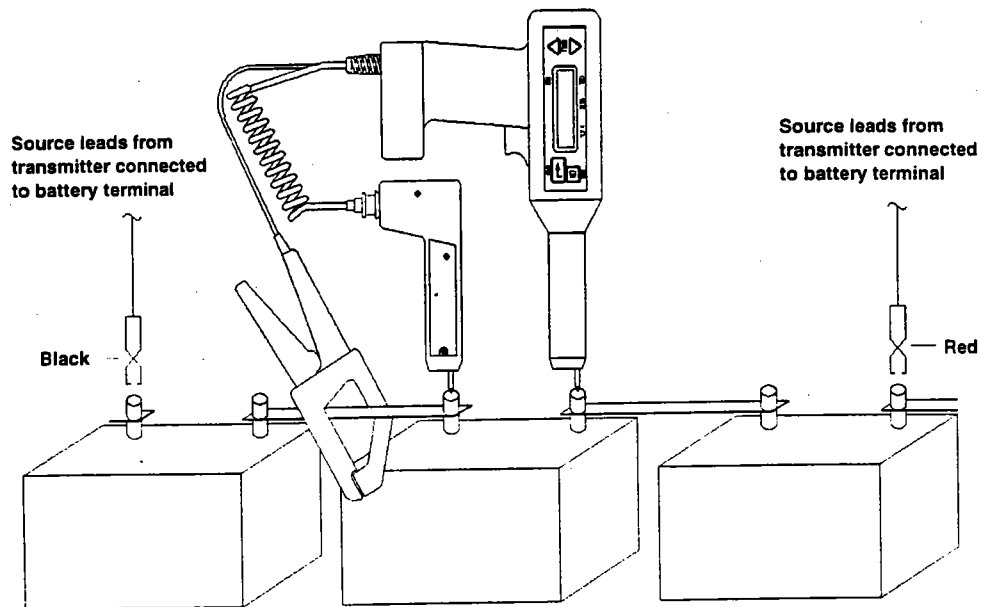

Figure 10: Receiver probes positioned on top of the battery cell terminals.

2. **View the cell terminal voltage and ac impedance values that are displayed on the receiver screen.**

A sample screen is shown on the next page.

| CELL | VOLTS | mΩ |
|------|-------|-------|
| 001 | 23.43 | 23.33 |
| T01 | | |

- When the voltage and impedance values displayed on the screen stabilize, pull the TRIGGER on the receiver to store the reading.

The measurements are stored in the receiver.

The receiver test screen now displays the word STRAP, which prompts you to test the strap that is associated with the cell you just tested.

| CELL | VOLTS | mΩ |
|-----------|-------|-------|
| 001 | 23.43 | 23.33 |
| T01 STRAP | | 0.112 |

- ✓ **NOTE:** *If you do not want to test the strap, pull the TRIGGER and go directly to step 6.*

- Position the receiver probes on top of the battery strap terminals, and then press the probes down.

See the sample placement shown in Figure 11.

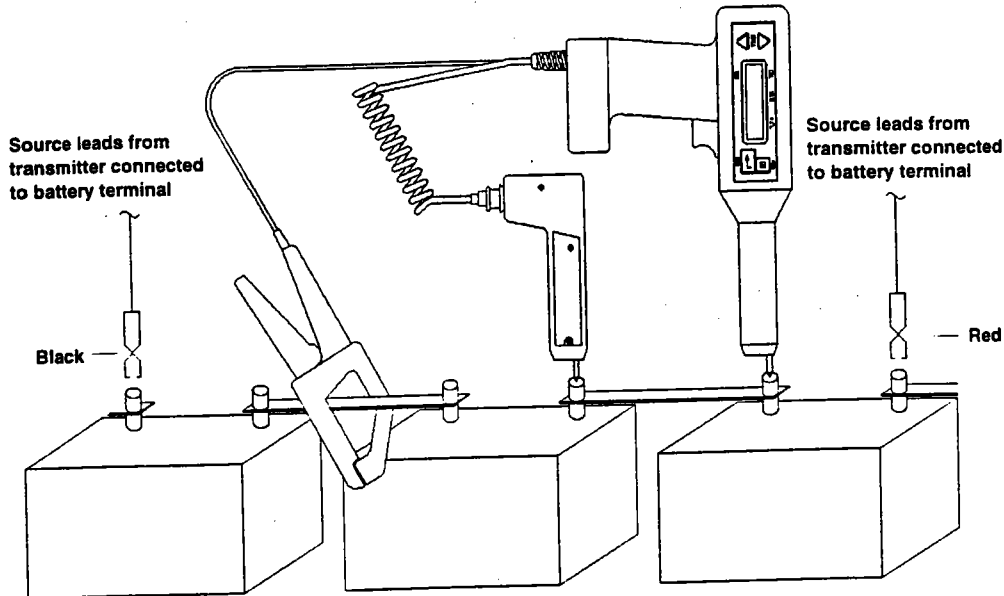

Figure 11: Receiver probes positioned on top of battery strap terminals.

5. When the strap values displayed on the screen stabilize, pull the **TRIGGER** on the receiver to store the reading.

The measurements are stored in the receiver.

The receiver now displays the digits 002 in the top left corner of the test screen. This means that you are ready to test the second cell.

6. Continue to measure the other cells and straps in the string.

✓ **NOTE:** *If you are testing a sectioned battery string and want to test the next section, refer to the following subsection, "Measuring the Next Section of a Sectioned Battery String," for the procedures you need.*

✓ **NOTE:** Review the test information that is stored in the receiver. Scroll through the results and, if needed, retest individual cells and straps. (Refer to the following subsection, "Reviewing a Test.")

7. When you are finished measuring all the cells and straps, press the **DOWN ARROW** key on the receiver to complete the test.

The receiver prompts you to confirm that the test is complete.

| | | |
|----------|----------------------|-------------|
| Y | TEST COMPLETE | |
| N | (Y/N) ? | MENU |

8. Press the **UP ARROW** key on the receiver to enter **Y** (for yes).

The receiver prompts you again to confirm that the test is complete.

| | | |
|----------|---------------------|-------------|
| Y | ARE YOU SURE | |
| N | (Y/N) ? | MENU |

9. Press the **UP ARROW** key on the receiver to enter **Y** (for yes).

The receiver displays a screen to indicate that the test is complete.

| |
|--------------|
| DONE! |
|--------------|

For instructions on what to do following the test, see the subsection, "What to Do When the Test Is Complete," explained later in this chapter.

Measuring the Next Section of a Sectioned Battery String

If you are finished testing the first section of a sectioned battery string and want to measure the next section:

1. Press the DISCON (disconnect) switch on the transmitter.

This temporarily blocks the current from being sent to the battery, without powering down the transmitter. The transmitter displays the following menu.

| | |
|---|----------------------------|
| ■ | EXPORT TRANSMITTER DATA |
| | CLEAR TRANSMITTER DATA |
| | VIEW/PRINT MENU |
| | IMPORT DATA FROM RECEIVER |
| | SELECT LANGUAGE |
| | RETURN TO TEST |
| | UP DN ENTER MENU2 |

✓ *NOTE: If you have to move the transmitter to test the next section, you may need to power down and disconnect the transmitter rather than using the DISCON function. (See "Powering Down and Disconnecting the EBITE.")*

2. Remove the current source leads from the battery. Then move them to the next section to be tested.

| |
|--|
| <p>WARNING: Do not remove the EBITE transmitter current source leads from the battery until the EBITE transmitter is powered off or the current DISCON (disconnect) feature is applied. Always disconnect the current source leads from the battery before removing them from the J2 connector on the transmitter. Do not leave the EBITE connected to the battery when not in use.</p> |
|--|

3. Press the UP ARROW or DOWN ARROW key on the transmitter to select Return to Test. Then press the ENTER key.

The current is sent to the battery and you can continue testing.

4. Test the section.

Repeat the procedure, as needed, depending on the number of sections in the battery string.

Step 7: What to Do When the Test Is Complete

You can perform the following EBITE operations after a test is complete:

- **Transfer the test information to the transmitter or a PC.** You can then use the transmitter or PC to view or print the test results. (Refer to Chapter 4.)
- **Clear the test information from the receiver.** Doing so deletes the test results from the receiver memory. (Refer to Chapter 4.)
- **Start a new test.** You can perform a new test. (Refer to Chapter 3.)
- **Power down and disconnect the EBITE.** You will need to do this if you are finished using the EBITE for this testing session. (Refer to the subsection, "Powering Down and Disconnecting the EBITE," explained later in this chapter.)

Reviewing a Test

At any time while you are performing a test, you can review the results of the current test that are already stored in the receiver.

- ✓ **NOTE:** *You cannot review tests after they have been completed. (Refer to Chapter 3, "Step 6: Measuring the Cell and the Strap," steps 7, 8 and 9 for a description of completing a test.)*

To review the current test, press the UP ARROW key on the receiver to scroll back through the active test screens.

Press the DOWN ARROW key to scroll forward through the active test screens.

Retesting Cells and Straps

If needed, you can retest any of the cells or straps in the current test.

- ✓ **NOTE:** *You cannot review tests after they have been completed. (Refer to Chapter 3, "Step 6: Measuring the Cell and the Strap," steps 7, 8 and 9 for a description of completing a test.)*

1. Navigate through the test screens until information about the cell or strap you want to retest is displayed.
2. Pull the TRIGGER.

The receiver enters into test mode.

- ✓ **NOTE:** *If you accidentally pull the TRIGGER while reviewing a test and do not want to take a new measurement, press the ENTER key to access the receiver Menu 2. Then press the UP ARROW key to select Resume Test.*

3. Position the receiver probes on top of the battery cell terminals, and then press the probes down.

The twisting action of the probe tips as the handle is pushed down cleans the point of contact and allows a positive test connection. See Figure 10 earlier in this chapter.

4. View the cell terminal voltage and ac impedance values that are displayed on the receiver screen.
5. When the voltage and impedance values displayed on the screen stabilize, pull the TRIGGER on the receiver to store the reading.
6. Position the receiver probes on top of the battery strap terminals, and then press the probes down.

See the sample placement shown in Figure 11 earlier in this chapter.

7. When the strap values displayed on the screen stabilize, pull the TRIGGER on the receiver to store the reading.

Powering Down and Disconnecting the EBITE

To power down and disconnect the EBITE, first power down and disconnect the receiver and then power down and disconnect the transmitter. Carefully follow these steps:

1. To power down the receiver, press the ENTER key on the receiver until you access the receiver Menu 1.

| | |
|-------------|------|
| POWER DOWN | (M1) |
| EXPORT DATA | MENU |

2. Press the UP ARROW key on the receiver to choose POWER DOWN.

The receiver prompts you to confirm your decision.

| | | |
|---|---------------|------|
| Y | ARE YOU SURE? | |
| N | (Y/N) ? | MENU |

3. Press the UP ARROW key on the receiver to enter Y (yes).

The receiver powers down.

4. Disconnect the CT from the battery and the receiver.

You can now power down the transmitter.

5. To power down the transmitter, press the transmitter S1 power switch to the O (off) position.

| |
|---|
| WARNING: Do not remove the EBITE transmitter current source leads from the battery until the EBITE transmitter is powered down or the current DISCON (disconnect) feature is applied. Always disconnect the current source leads from the battery before removing them from the J2 connector on the transmitter. |
|---|

6. Remove the current source leads from the battery.
7. Remove the current source leads from the J2 connector on the transmitter.

- 8. Unplug the power cable and then disconnect it from the J1 receptacle on the transmitter.**

Remember to recharge the receiver battery. Refer to Chapter 7 for detailed procedures.

CAUTION: Do not leave the EBITE connected to the battery when not in use.

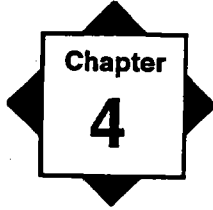

Transferring, Viewing, and Printing Test Results

This chapter explains how to transfer, view, and print test results. Specifically, it includes the procedures you need to:

- Transfer test results from the receiver to the transmitter or a personal computer (PC)
- Transfer test results from the transmitter to a personal computer (PC)
- View test results on the transmitter screen
- Print test results on the built-in printer
- Clear test results from the receiver
- Clear test results from the transmitter

Overview

When a test is completed using the EBITE, the results are automatically stored in the receiver. If needed, test information can be transferred from the receiver to:

- *The transmitter*—where it can be viewed on the transmitter screen or output using the built-in printer. Information transferred to the transmitter is automatically stored in the transmitter (until cleared).
- *A personal computer (PC)*—where it can then be viewed or printed. If the PC has the appropriate software, the test information can be imported into standard spreadsheet programs for further analysis.

If test information is transferred to the transmitter, it can be transferred again from the transmitter to a PC.

Test results that are no longer needed can also be cleared (or deleted) from both the receiver and the transmitter.

The following subsections contain the procedures you need to carry out these operations.

Importing Test Results from the Receiver

Test results can be imported from the receiver to:

- The transmitter
- A personal computer (PC)

Importing Test Results from the Receiver to the Transmitter

To import test results from the receiver to the transmitter:

1. Make sure the transmitter is powered on.

✓ *NOTE: If the transmitter has just been powered on and the display shows "DATA IS PRESENT", skip step 2 below.*

2. Press the F key on the transmitter to access the transmitter Menu 1.

```
EXPORT TRANSMITTER DATA
CLEAR TRANSMITTER DATA
VIEW/PRINT MENU
■ IMPORT DATA FROM RECEIVER
SELECT LANGUAGE
RETURN TO TEST

UP  DN      ENTER      MENU2
```

3. Press the UP ARROW or DOWN ARROW key on the transmitter to select Import Data From Receiver. Then press the ENTER key.

The transmitter displays the following screen.

```
REQUIREMENTS:

MAKE CONNECTION TO TRANSMITTER
PROGRAM RECEIVER FOR EXPORT
PRESS ENTER TO CONTINUE

ENTER      CANCEL
```

4. Press the ENTER key on the transmitter.

The transmitter screen indicates that it is ready to receive data.

5. Press the receiver POWER ON switch to energize the receiver.
6. Press the ENTER key on the transmitter.

The transmitter screen indicates that it is ready to receive data.

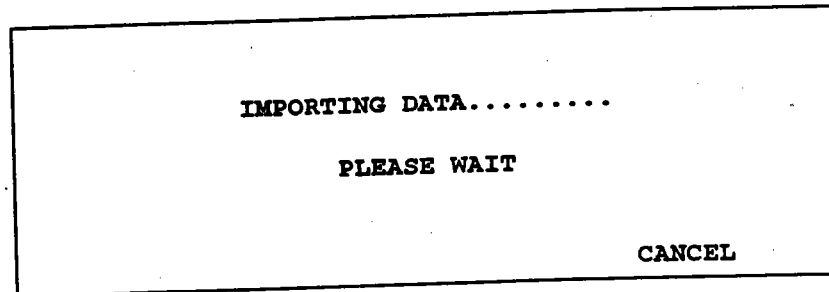

7. Press the ENTER key on the receiver to access the receiver Menu 1.



✓ *NOTE: If you insert the RS-232 communication cable into the receiver before powering on the receiver, the Transmit Data Menu is automatically displayed in place of Menu 1.*

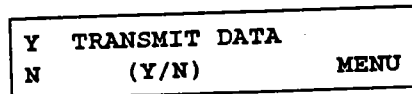

Press the UP ARROW key on the receiver to select Y and skip steps 7 and 8 below.

8. Insert the plug of the RS-232 communication cable (Cat. No. 30648) into the 7-PIN connector on the receiver. Then insert the 25-PIN end of the communication cable into the J3 RS-232 connector on the transmitter.

9. Press the DOWN ARROW key on the receiver to select EXPORT DATA.

The receiver prompts you to select TRANSMITTER or PC.

| | |
|-------------|------|
| TRANSMITTER | |
| PC | MENU |

- ✓ *NOTE: If the RS-232 communication cable is not connected, the receiver displays a message instructing you to connect it.*

10. Press the UP ARROW key on the receiver to select TRANSMITTER.

Screens on both the receiver and the transmitter tell you to wait as the test results are transferred.

When the transfer is complete, the transmitter returns to Menu 1. The receiver prompts you to choose whether to delete the test results you just exported.

| | | |
|---|-------------|------|
| Y | DELETE DATA | |
| N | (Y/N)? | MENU |

11. If you do not want to clear the test results from the receiver, press the DOWN ARROW key on the receiver to enter N (for NO).

You are returned to the receiver Menu 1.

If you do want to clear the test results from the receiver, press the UP ARROW key on the receiver to enter Y (for yes).

As an added safety precaution, the receiver now asks if you want to keep the test results.

| | | |
|----------|--------------------|-------------|
| Y | RETAIN DATA | |
| N | (Y/N)? | MENU |

12. To clear the data, press the **DOWN ARROW** key on the receiver to enter **N** (for no).

The test results are deleted from the receiver.

13. Disconnect the **RS-232** communication cable from both the receiver and the transmitter.

14. Turn off the power to the transmitter and receiver.

Refer to Chapter 3.

Importing Test Results from the Receiver to a PC

The results of a test can be imported from the receiver to a PC. You can transfer the results directly to the PC (or indirectly through a modem and the transmitter). Refer to Appendix C for the export data format specification.

1. Run the software on the PC that you are using to import the data.

If needed, refer to the instruction manual that came with the software.

2. Press the receiver **POWER ON** switch to energize the receiver.
3. Press the **ENTER** key on the receiver to access the receiver **Menu 1**.

| | |
|--------------------|-------------|
| POWER DOWN | (M1) |
| EXPORT DATA | MENU |

- ✓ **NOTE:** If you insert the RS-232 communication cable into the receiver before powering on the receiver, the Transmit Data Menu is automatically displayed in place of Menu 1.

| | | |
|----------|----------------------|-------------|
| Y | TRANSMIT DATA | |
| N | (Y/N) | MENU |

Press the UP ARROW key on the receiver to select Y and skip steps 4 and 5 below.

4. Insert the plug of the RS-232 communication cable (Cat. No. 30648) into the 7-PIN connector on the receiver. Then insert the 25-PIN end of the communication cable into the COM port on the PC.
5. Press the DOWN ARROW key on the receiver to select EXPORT DATA.

The receiver prompts you to select TRANSMITTER or PC.

| | |
|--------------------|-------------|
| TRANSMITTER | |
| PC | MENU |

- ✓ **NOTE:** If the RS-232 communication cable is not connected, the receiver displays a message instructing you to connect it.
6. Press the DOWN ARROW key on the receiver to select PC.

A screen on the receiver tells you to wait as the test results are transferred.

When the transfer is complete, the receiver prompts you to choose whether to delete the test results you just exported.

| | | |
|----------|--------------------|-------------|
| Y | DELETE DATA | |
| N | (Y/N)? | MENU |

- 7. If you do not want to clear the test results from the receiver, press the DOWN ARROW key on the receiver to enter N (for NO).**

You are returned to the receiver Menu 1.

If you do want to clear the test results from the receiver, press the UP ARROW key on the receiver to enter Y (for yes).

As an added safety precaution, the receiver now asks if you want to keep the test results.

| | | |
|----------|--------------------|-------------|
| Y | RETAIN DATA | |
| N | (Y/N)? | MENU |

- 8. To clear the data, press the DOWN ARROW key on the receiver to enter N (for no).**

The test results are deleted from the receiver.

- 9. Disconnect the RS-232 communication cable from both the receiver and the PC.**

- 10. Turn off the power to the transmitter and receiver.**

Refer to Chapter 3.

Exporting Test Results from the Transmitter Directly to a PC

If test results have been imported from the receiver to the transmitter, they can be exported from the transmitter directly to a PC. Refer to Appendix C for the export data format specification.

1. Make sure the transmitter is powered on.

✓ *NOTE: If the transmitter has just been powered on and the display shows "DATA IS PRESENT", skip step 2 below.*

2. Press the F key on the transmitter to access the transmitter Menu 1.

| | |
|---|--|
| ■ | EXPORT TRANSMITTER DATA |
| | CLEAR TRANSMITTER DATA |
| | VIEW/PRINT MENU |
| | IMPORT DATA FROM RECEIVER |
| | SELECT LANGUAGE |
| | RETURN TO TEST |
| | UP DN ENTER MENU2 |

3. Press the UP ARROW or DOWN ARROW key on the transmitter to select Export transmitter Data. Then press the ENTER key.

You are asked whether you want to export the test results to a PC or a modem or edit the phone list.

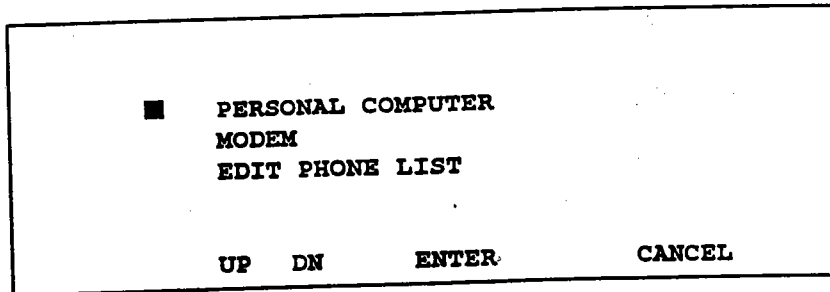

4. Press the UP ARROW or DOWN ARROW key on the transmitter to select Personal Computer. Then press the ENTER key.

The transmitter displays the following screen.

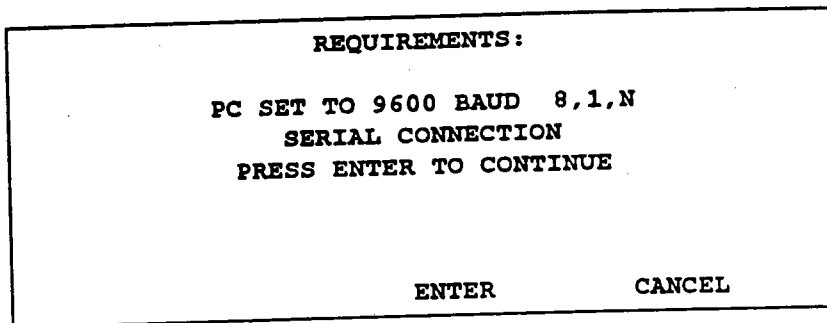

Follow the on-screen instructions.

5. Set the PC to receive data at a 9600 baud rate, with 8 data bits, 1 stop bit, and no parity. Then insert the RS-232 communication cable (Cat. No. 30648) into the J3 connector on the transmitter. Insert the other end into the serial port on the PC.
6. Press the ENTER key on the transmitter to start exporting the data.

When the transfer is complete, you are prompted to clear the data from the transmitter.

EXPORT COMPLETE
CLEAR STORAGE (Y/N) ?

YES NO

7. If you do not want to clear the data from the transmitter, press the **DOWN ARROW** key on the transmitter to enter No.

You are returned to the transmitter Menu 1.

If you do want to clear the data from the transmitter, press the **UP ARROW** key on the transmitter to enter Yes.

You are asked again if you want to clear the data.

CONFIRM
CLEAR STORAGE (Y/N) ?

YES NO

8. To clear the data, press the **UP ARROW** key on the transmitter to enter Yes.

The test results are deleted from the transmitter.

9. Disconnect the RS-232 communication cable from both the transmitter and the PC.

10. Turn off the power to the transmitter and receiver.

Refer to Chapter 3.

Exporting Test Results from the Transmitter via a Modem

If test results have been imported from the receiver to the transmitter, they can be exported via a modem from the transmitter to a PC. Refer to Appendix C for the export data format specification.

1. Make sure the transmitter is powered on.

✓ *NOTE: If the transmitter has just been powered on and the display shows "DATA IS PRESENT", skip step 2 below.*

2. Press the F key to access the transmitter Menu 1.

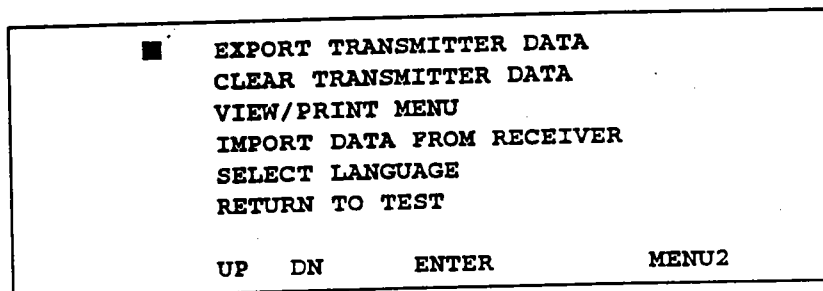

3. Press the UP ARROW or DOWN ARROW key on the transmitter to select Export Transmitter Data. Then press the ENTER key.

You are asked if you want to export the test results to a PC or modem or edit the phone list. The option to edit the phone list is unavailable if the message "DATA IS PRESENT" appeared in Step 1 above.

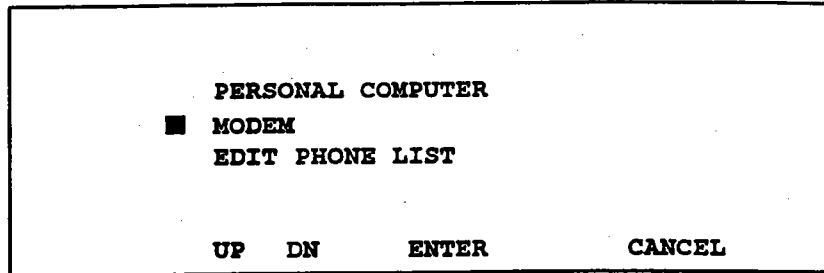

4. Press the UP ARROW or DOWN ARROW key on the transmitter to select Modem. Then press the ENTER key.

The transmitter displays the phone numbers, if any, that are already stored in the transmitter. (See the following sample screen.)

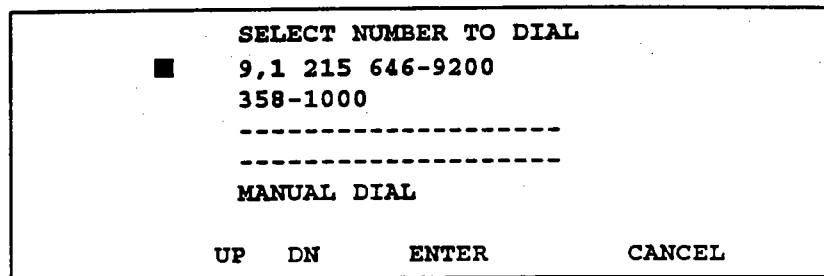

5. Press the UP ARROW or DOWN ARROW key to select the phone number you want. Then press the ENTER key to dial the number.

If the number you want is not displayed on the transmitter screen, select Manual Dial and then press the ENTER key.

The transmitter prompts you to enter the first digit of the phone number you want to dial. Press the UP ARROW or DOWN ARROW key to enter a number from 0 to 9, a space, a comma, or a dash. Press the OK key to move the cursor to the next digit, and then enter the next digit. When you are finished entering the complete phone number, press the DONE key.

The transmitter displays the following screen.

```
REQUIREMENTS :  
  
ATTACH MODEM  
CONNECT PHONE LINE  
  
PRESS ENTER TO CONTINUE  
  
ENTER          CANCEL
```

Follow the on-screen instructions.

6. Insert the RS-232 communication cable (Cat. No. 30648) into the J3 connector on the transmitter. Insert the other end into the serial port on the modem. Connect a standard telephone company modular plug phone line into the phone jack on the modem.
7. Configure the personal computer (PC) software and modem.

The PC operator starts the PC modem software (such as PROCOMM or CROSSTALK) and configures the PC modem for 9600 baud, 8 data bits, 1 stop bit, no parity and "AUTO ANSWER" configuration.

8. Press the ENTER key on the transmitter to continue.

```
ESTABLISHING PHONE  
CONNECTION  
  
PLEASE WAIT .....
```

A message appears on the screen of the personal computer (PC) that prompts the PC operator to begin a "RAW ASCII" transfer using the PC modem software. The PC operator must press the ENTER key on the PC to start the data transfer.

When the transmitter begins the data transfer to the PC via the modem, the transmitter screen shows the status of the exporting process. When the transfer is complete, you are prompted to clear the data from the transmitter.

| |
|--|
| <p style="text-align: center;">EXPORT COMPLETE</p> <p style="text-align: center;">CLEAR STORAGE (Y/N) ?</p> <p style="text-align: center;">YES NO</p> |
|--|

9. If you do not want to clear the data from the transmitter, press the DOWN ARROW key on the transmitter to enter No.

You are returned to the transmitter Menu 1.

If you do want to clear the data from the transmitter, press the UP ARROW key on the transmitter to enter Yes.

You are asked again if you want to clear the data.

| |
|--|
| <p style="text-align: center;">CONFIRM</p> <p style="text-align: center;">CLEAR STORAGE (Y/N) ?</p> <p style="text-align: center;">YES NO</p> |
|--|

10. To clear the data, press the UP ARROW key on the transmitter to enter Yes.

The test results are deleted from the transmitter. The transmitter returns to Menu 1.

11. Disconnect the RS-232 communication cable from both the transmitter and the modem.
12. Turn off the power to the transmitter and receiver.

Refer to Chapter 3.

Editing the Phone List Used for Modem Calls

You can create a phone list of up to four telephone numbers frequently used to export data. Each telephone number can contain up to 20 characters.

1. Make sure the transmitter is powered on.

✓ *NOTE: If the transmitter has just been powered on and the display shows "DATA IS PRESENT", skip step 2 below.*

2. Press the F key to access the transmitter Menu 1.

■ EXPORT TRANSMITTER DATA
CLEAR TRANSMITTER DATA
VIEW/PRINT MENU
IMPORT DATA FROM RECEIVER
SELECT LANGUAGE
RETURN TO TEST

UP DN ENTER MENU2

3. Press the UP ARROW or DOWN ARROW key on the transmitter to select Export Transmitter Data. Then press the ENTER key.

You are asked whether you want to export data to a PC or modem or edit the phone list.

PERSONAL COMPUTER
MODEM
■ EDIT PHONE LIST

UP DN ENTER CANCEL

4. Press the UP ARROW or DOWN ARROW key on the transmitter to select Edit Phone List. Then press the ENTER key.

The transmitter displays the phone numbers, if any, that are currently stored in the transmitter. If a number is not stored on an available line, a series of 20 dashes is displayed.

SELECT NUMBER TO DIAL
9,1 215 646-9200
■ -----

SAVE AND RETURN

UP DN ENTER CANCEL

5. Press the UP ARROW or DOWN ARROW key on the transmitter to select the phone number you want to edit. Then press the ENTER key.

A screen is displayed in which you can edit the telephone number. The transmitter prompts you to enter the first digit of

the telephone number by showing the digit in reverse video. The second display line shows 20 dashes, which represent the 20 character spaces available for the phone number.

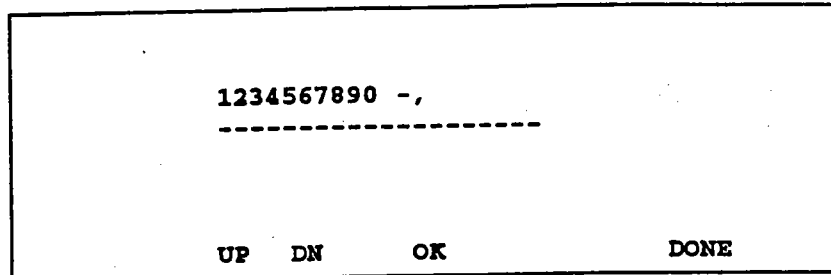

6. Press the UP ARROW or DOWN ARROW key to enter a number from 0 to 9, a space, a comma, or a dash. Then press the ENTER key to accept the entry and to move to the next digit.
7. Continue entering the phone number, as needed.
8. Make sure that the cursor is positioned after the last digit of the phone number and then press the F key to signify that you are done.

The phone number is placed in the list and the transmitter returns to the Edit Phone List menu.

9. Press the UP ARROW or DOWN ARROW key on the transmitter to select Save and Return.

The phone number is stored in the transmitter memory. The transmitter returns to Menu 1.

Viewing Test Results

Test information transferred to the transmitter can be viewed on the transmitter screen.

1. Make sure the transmitter is powered on.

✓ *NOTE: If the transmitter has just been powered on and the display shows "DATA IS PRESENT", skip step 2 below and refer to Chapter 3, "Step 5: Connecting the EBITE to the Battery" for the procedures you need to access the Transmitter Menu 1.*

2. Press the F key on the transmitter to access the Transmitter Menu 1.

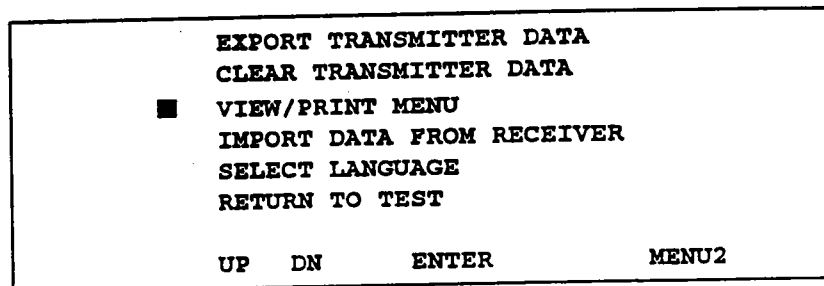

3. Press the UP ARROW or DOWN ARROW key on the transmitter to select View/Print Menu. Then press the ENTER key.

The View/Print Menu is displayed.

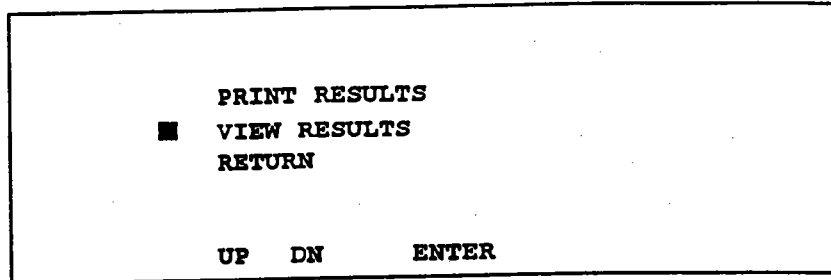

4. Press the UP ARROW or DOWN ARROW key on the transmitter to select View Results. Then press the ENTER key.

The information is displayed on the transmitter screen. See the sample test information shown below.

| TEST 001 | | | | MM/DD/YY |
|-------------|--------------|--------------|-------------|-------------|
| <u>CELL</u> | <u>Zb mΩ</u> | <u>Rs mΩ</u> | <u>V DC</u> | <u>TIME</u> |
| 001 | 1.025 | 0.258 | 2.155 | 12:58 |
| 002 | 1.036 | 0.265 | 2.145 | 12:59 |
| 003 | 1.054 | 0.365 | 2.225 | 13:02 |
| 004 | 1.024 | 0.555 | 2.215 | 13:04 |
| 005 | 1.006 | 0.235 | 2.135 | 13:09 |

- ✓ *NOTE: Press the ENTER key for the next test group. Press the F key to exit view mode.*

Printing Test Results

Test results transferred to the transmitter can be printed using the built-in printer.

1. Make sure the transmitter is powered on.

- ✓ *NOTE: If the transmitter has just been powered on and the display shows "DATA IS PRESENT", skip step 2 below and refer to*

Chapter 3, "Step 5: Connecting the EBITE to the Battery" for the procedures you need to access the Transmitter Menu 1.

2. Press the F key on the transmitter to access the Transmitter Menu 1.

```
EXPORT TRANSMITTER DATA
CLEAR TRANSMITTER DATA
■ VIEW/PRINT MENU
IMPORT DATA FROM RECEIVER
SELECT LANGUAGE
RETURN TO TEST

UP   DN   ENTER   MENU2
```

3. Press the UP ARROW or DOWN ARROW key on the transmitter to select View/Print Menu. Then press the ENTER key.

The View/Print Menu is displayed.

```
■ PRINT RESULTS
VIEW RESULTS
RETURN

UP   DN   ENTER
```

4. Press the UP ARROW or DOWN ARROW key on the transmitter to select Print Results. Then press the ENTER key.

The test information is printed. Refer to the following sample report.

Sample Battery Analysis Report

Notes: _____

05/05/95

Ambient Temp. 74 Pilot Temp. 68
 AC R 0.00A AC 1 9.40A
 User ID: _____

| <u>Cell</u> | <u>Notes</u> | <u>Zb mΩ</u> | <u>Rs mΩ</u> | <u>Volts DC</u> | <u>Time</u> |
|-------------|--------------|--------------|--------------|-----------------|-------------|
| 001 | ----- | 2.46 | 0.356 | 6.18 | 10:56 |
| 002 | ----- | 2.34 | 0.359 | 6.23 | 10:57 |
| 003 | ----- | 2.65 | 0.341 | 6.23 | 10:57 |
| 004 | ----- | 2.47 | 0.355 | 6.18 | 10:58 |
| 005 | ----- | 2.34 | 0.337 | 6.23 | 10:58 |
| 006 | ----- | 2.65 | 0.347 | 6.23 | 10:58 |

Cell Impedance Summary

| <u>Minimum</u> | <u>Average</u> | <u>Maximum</u> |
|----------------|----------------|----------------|
| 2.34 | 2.48 | 2.65 |

Percent Deviation from Average

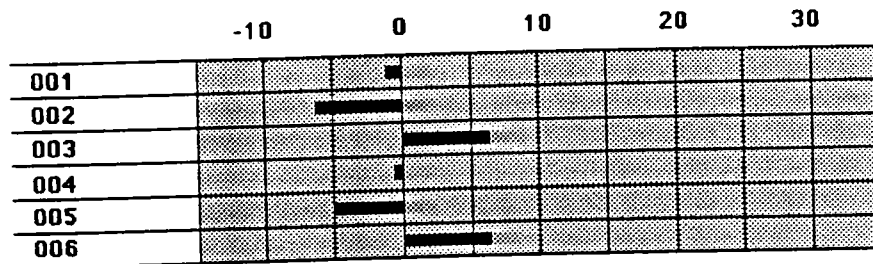

Where:

| | |
|-------------------|--|
| CELL = | CELL NUMBER |
| Zb = | BATTERY CELL IMPEDANCE IN mΩ |
| Rs = | STRAP OR INTERCONNECT RESISTANCE |
| VOLTS DC = | DC VOLTAGE AT TIME OF IMPEDANCE READING |
| TIME = | RECORDED AT TIME OF IMPEDANCE READING |
| Minimum = | LOWEST VALUE CELL IMPEDANCE CURRENTLY STORED |
| Average = | AVERAGE VALUE CELL IMPEDANCE CURRENTLY STORED |
| Maximum = | MAXIMUM VALUE CELL IMPEDANCE CURRENTLY STORED |

Clearing Test Results

When the results of a test are no longer needed, they can be cleared (or deleted) from the receiver and the transmitter.

See the following subsections for the procedures you need.

Clearing Tests from the Receiver

The procedure for clearing test results from the receiver depends on whether the information is cleared:

- After importing data from the receiver to the transmitter or a PC
- By choosing Clear Data from the receiver Menu 2

Clearing Tests from the Receiver after Importing Data

After you import data from the receiver, you are automatically asked whether you want to delete the data.

To delete data in this way, see the subsection, "Importing Test Results from the Receiver," explained earlier in this chapter.

Clearing Tests from the Receiver by Choosing Clear Data from Menu 2

To clear test results from the receiver by choosing Clear Data from the receiver Menu 2 (that is, without first importing data):

1. Press the ENTER key on the receiver to access the receiver Menu 2.

| | |
|-------------|------|
| RESUME TEST | (M2) |
| CLEAR DATA | MENU |

2. Press the DOWN ARROW key on the receiver to choose Clear Data.

The receiver asks if you are sure you want to clear the data.

| | | |
|---|---------------|------|
| Y | ARE YOU SURE? | |
| N | (Y/N) | MENU |

3. Press the UP ARROW key on the receiver to enter Y (for yes).

The test results are cleared and you are returned to the receiver Menu 1.

Clearing Tests from the Transmitter

The procedure for clearing tests from the transmitter depends on whether you want to clear the information:

- After exporting data from the transmitter to a PC
- By choosing Clear Data from the Transmitter Menu 1

Clearing Tests from the Transmitter after Exporting Data

After you export data from the transmitter to a PC, the transmitter automatically asks whether you want to delete the data.

To delete data in this way, see the subsection, "Exporting Test Results from the Transmitter," explained earlier in this chapter.

Clearing Tests from the Transmitter by Choosing Clear Data from Menu 1

To clear test results from the transmitter by choosing Clear Data from the Transmitter Menu 1 (that is, without first transferring data):

1. Make sure the transmitter is powered on.

✓ *NOTE: If the transmitter has just been powered on and the display shows "DATA IS PRESENT", skip step 2 below.*

2. Press the F key to access the Transmitter Menu 1.

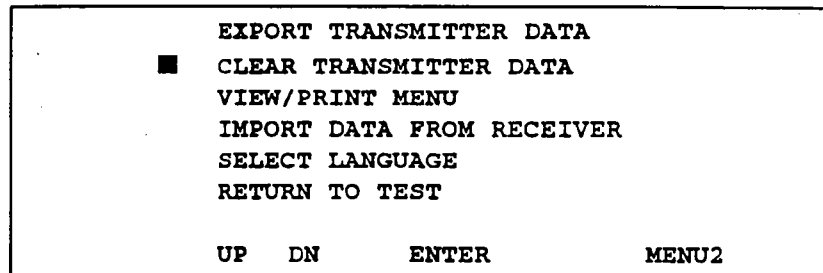

3. Press the UP ARROW or DOWN ARROW key on the transmitter to select Clear Transmitter Data. Then press the ENTER key.

A message asks if you are sure you want to clear the test data stored in the transmitter.

CONFIRM
CLEAR STORAGE (Y/N) ?
YES NO

4. Press the UP ARROW key to enter Y (for yes).

The test results are deleted and you are returned to the Transmitter Menu 1.