

AVTM TTR100  
Rev. B  
October 2003

**Instruction Manual AVTM TTR100  
for  
Single-Phase Handheld TTR<sup>â</sup>  
Transformer Turn Ratio Test Set  
Catalog No. TTR100**

**High-Voltage Equipment  
Read the entire manual before operating.**

**Aparato de Alto Voltaje  
Antes de operar este producto lea este manual enteramente.**

**Megger** 

2621 Van Buren Ave  
Norristown, PA 19403-2329  
610-676-8500

[www.megger.com](http://www.megger.com)



**Single-Phase Handheld TTR<sup>â</sup>  
Transformer Turn Ratio Test Set  
Instruction Manual**

#### Copyright Notice

Copyright© 2003 by Megger. All rights reserved.

#### Disclaimer Notice

The information contained in this manual is believed to be adequate for the intended use of the product. If the product or its individual instrument are used for purposes other than those specified herein, confirmation of their validity and suitability must be obtained from Megger. Refer to the warranty information included at the end of this instruction manual. Specifications are subject to change without notice.

## TABLE OF CONTENTS

INTRODUCTION.....	1
Receiving Instructions.....	1
General Information.....	1
SAFETY.....	5
SPECIFICATIONS.....	9
Electrical.....	9
Environmental Conditions.....	11
Physical Data.....	12
Accessories Supplied.....	12
Optional Accessories.....	12
DESCRIPTION.....	15
Principle of Operation.....	15
Controls, Indicators, and Connectors (Figure 4-2).....	16
SETUP AND CONNECTIONS.....	19
General Instructions.....	19
Transformers.....	19
Single-Phase, Two-Winding Transformers.....	20
Distribution Transformers with Two Secondary Windings.....	20
Current Transformers (CTs).....	23
T-Type Transformers.....	26
Connections and Vector Voltage Diagrams.....	27
OPERATION.....	53
General Operating Procedure.....	53
Description of Menus and Test Screens.....	53
Quick Test Single Phase Transformer.....	59
Quick Test Three Phase Transformer.....	60

Quick Test T-Type Transformers .....	61
Error Messages.....	70
Use with the Optional Printer .....	74
SERVICE.....	81
Maintenance .....	81
Calibration.....	81
Battery Maintenance.....	82
Troubleshooting .....	83
Repair .....	84
ORDERING INFORMATION AND SPARE PARTS LIST .....	85
GLOSSARY .....	89
WARRANTY.....	91
INDEX.....	93

## LIST OF ILLUSTRATIONS

Figure 4-1.	Single-Phase TTR Test Set Block Diagram .....	16
Figure 4-2	Single-Phase TTR Display & Control Panel.....	17
Figure 4-3.	Top Side Connector Panel.....	18
Figure 5-1.	Setup for Testing Single-Phase Transformer.....	21
Figure 5-2.	Setup for Testing Single-Phase Autotransformer .....	21
Figure 5-3.	Setup for Testing Single-Phase, Type A (Straight Design) Step Voltage Regulator .	22
Figure 5-4.	Setup for Testing Single-Phase, Type B (Inverted Design) Step Voltage Regulator.	22
Figure 5-5.	Setup for Testing Unmounted Current Transformer .....	24
Figure 5-6.	Setup for Testing Taps on Multiple Tap CT .....	24
Figure 5-7.	Setup for Testing BCT Mounted on Single-Phase Two-Winding Transformer.....	25
Figure 6-1.	Opening Display Screen.....	54
Figure 6-2.	Main Menu Screen.....	55
Figure 6-3.	Transformer Configuration Screen.....	56
Figure 6-4.	Single Phase Transformer Configuration Screen .....	57
Figure 6-4a.	Additional Single Phase Transformer Configuration Screen.....	57
Figure 6-5.	Three Phase Transformer Configuration Screen.....	58
Figure 6-5a.	Three Phase Transformer Configuration Screen.....	58
Figure 6-6.	T - Type Transformer Configuration Screen.....	58
Figure 6-7.	Transformer Rating Screen.....	59
Figure 6-8.	TEST SETUP Screen.....	62
Figure 6-9.	Custom Configs. Screen .....	65
Figure 6-10.	SYSTEM SETUP Screen 1 .....	66
Figure 6-11.	SYSTEM SETUP Screen 2 .....	67
Figure 6-12.	SAVED READINGS Screen.....	68
Figure 6-13a.	Sample Test Report Header .....	74
Figure 6-13b.	Sample Single Phase Test Report .....	74
Figure 6-14.	Report Printout .....	79

## LIST OF TABLES

Table 5-1. ANSI Transformer Winding Phase Relationship.....	26
Table 5-2. ANSI Transformer Winding Phase Relationship.....	29
Table 5-3. CEI/IEC 76-1:1993 Transformer Winding Phase Relationship.....	37
Table 5-4. Transformer Winding Phase Relationship (Australian Std. 2374, Part 4 - 1982) .....	47
Table 6-1. Self-test Error Messages .....	70
Table 6-2. Test Error Messages.....	71
Table 6-3. Test Result Error Messages.....	72
Table 6-4. Miscellaneous Messages.....	73
Table 7-1. Troubleshooting Guide .....	83



# 1

## INTRODUCTION

### *Receiving Instructions*

Check the equipment received against the packing list to ensure that all materials are present. Notify Megger of any shortage.  
Telephone 610-676-8500.

Examine the instrument for damage received in transit. If any damage is discovered, file a claim with the carrier at once and notify Megger or its nearest authorized sales representative, giving a detailed description of the damage.

This instrument has been thoroughly tested and inspected to meet rigid specifications before being shipped. It is ready for use when set up as indicated in this manual.

### *General Information*

The Single-Phase Handheld TTR<sup>®</sup> Test Set is fully automatic, self-checking, self-calibrating, menu-driven unit. The test set measures the turn ratio, phase shift, excitation current, dc winding resistance and polarity of single and three phase (phase by phase) distribution transformers, as well as power, potential & current transformers. The Single-Phase Handheld TTR<sup>®</sup> Test Set is powered by rechargeable NIMH batteries. The test set is a portable instrument housed in a sturdy plastic case. A carrying case with strap and an accessory pouch is provided with the test set.

The test set can be used to test single-phase and three-phase transformers, both with and without taps in accordance with the requirements of the IEEE C57.12.90 – 1997 standards. For three-phase transformers, the test set is connected to each of the three phases of the transformer to be tested, and measurements are made on a phase by phase basis.

Turn ratio, phase shift, excitation current, dc winding resistance readings, transformer vector group, and polarity are displayed on a large LCD. Transformer excitation current as well as phase shift angle helps to detect transformer shorted

turns or an unequal number of turns connected in parallel. Operating condition (error) messages identify incorrect test connections, abnormal operating condition, or winding problems. Test results can be saved internally within the test set, printed out on an optional printer, or uploaded to a personal computer (PC).

Features include:

- Fully automatic operation.
- Self-checking at power-up.
- Self-calibration at each measurement.
- User-friendly, menu-driven operation.
- Test turn ratio, phase shift (in either degree or centiradian), excitation current, vector group (1PH0 or 1PH6), dc winding resistance and polarity.
- Easy measuring of single and three phase (phase by phase) transformers, as well as potential & current transformers.
- Storage capacity for up to 200 tests results for retrieving, printing out, or uploading to a PC.
- Saving up to 100 custom transformer settings for faster and easier testing.
- Checking reverse connections at start of each test.
- External optional printer records test data.
- External PC or laptop can be connected instead of a printer to transfer test results and to provide full transformer test report.
- Quick test mode provides the fastest testing of a transformer.
- Two auto selected excitation test voltages: 8 V, and 1.5 V.
- Testing to ANSI, IEC, or Australian standards.
- Leads marked to ANSI, IEC, and Australian standards.
- Choice of six languages.
- Large, easy-to-read LCD shows alphanumeric data

- Meets the requirements of both the European EMC and Low Voltage Directives.
- Trouble-free operation in switchyards under electrostatic and magnetic interference conditions.

Megger<sup>®</sup>

# 2

## SAFETY

The TTR100 must be used on de-energized transformers. However, the transformer to which the test set is connected is a possible source of high-voltage electrical energy and all persons making or assisting in tests must use all practical safety precautions to prevent contact with potentially energized parts of the transformer and related circuits. Persons actually engaged in the test must stand clear of all parts of the complete high-voltage circuit, including all connections, unless the test set is de-energized and all parts of the test circuit are grounded. Persons not directly involved with the work must be kept away from test activities by suitable barriers, barricades, or warnings.

Treat all terminals of high-voltage power equipment as a potential electric shock hazard. There is always the possibility of voltages being induced at these terminals because of proximity to energized high-voltage lines or equipment. Always disconnect test leads from power equipment before attempting to disconnect them at the test set. The ground connection must be the first made and the last removed. Any interruption of the grounding connection can create an electric shock hazard.

This TTR100 operates from a re-chargeable battery pack. A universal charger, for re-charging the battery pack, is provided with the instrument. The TTR100 can be utilized while its battery pack is being charged. The universal charger is equipped with a three-wire power cord and requires a two-pole, three-terminal, live, neutral, and ground type connector. The voltage to ground from the live pole of the power source must be within the following rated operating voltage:

100 to 250 V ac single phase, 50/60 Hz  $\pm$ 2 Hz

The neutral pole must be at ground potential. Before making connection to the power source, determine that the charger rating matches the voltage of the power source and has a suitable two-pole, three-terminal grounding type connector.

The power input plug must be inserted only into a mating receptacle with a ground contact. Do not bypass the grounding connection. Any interruption of the

grounding connection can create an electric shock hazard. Determine that the receptacle is properly wired before inserting the plug.

For 230 V input, the neutral terminal of the charger input supply cord (white or blue lead) must be connected to the neutral pole of the line power source. The ground terminal of the input supply cord (green or yellow/green lead) must be connected to the protective ground (earth) terminal of the line power source. The black or brown cord lead is the live (hot) lead.

The instrument's battery pack can also be charged with an automobile battery and an optional 12 VDC to 120/230V AC inverter.

Any repair or component replacement must be performed by qualified service personnel.

Megger has made formal safety reviews of the initial design and any subsequent changes. This procedure is followed for all new products and covers areas in addition to those included in applicable standards. Regardless of these efforts, it is not possible to eliminate all hazards from electrical test equipment. For this reason, every effort has been made to point out in this instruction manual the proper procedures and precautions to be followed by the user in operating this equipment and to mark the equipment itself with precautionary warnings where appropriate. It is not possible to foresee every hazard that may occur in the various applications of this equipment. It is therefore essential that the user, in addition to following the safety rules in this manual, also carefully consider all safety aspects of the test before proceeding.

- Safety is the responsibility of the user.
- Follow your company safety procedures.
- Misuse of this equipment can be extremely dangerous.
- The purpose of this equipment is limited to use as described in this manual. Do not use the equipment or its accessories with any device other than specifically described.
- Never connect the test set to energized equipment.
- Do not use the test set in an explosive atmosphere.
- Corrective maintenance must only be performed by qualified personnel who are familiar with the construction and operation of the test set and the hazards involved.

- Refer to IEEE 510 - 1983, IEEE Recommended Practices for Safety in High-Voltage and High-Power Testing, for additional information.

If the test equipment is operated properly and all grounds correctly made, test personnel need not wear rubber gloves. As a routine safety procedure, however, some users require that rubber gloves be worn, not only when making connections to the high-voltage terminals, but also when manipulating the controls. Megger considers this an excellent safety practice.

Users of equipment should note that high-voltage discharges and other sources of strong electric or magnetic field may interfere with the proper functioning of heart pacemakers. Persons with heart pacemakers should obtain expert advice on the possible risks before operating this equipment or being close to the equipment during operation.

Warning and caution notices are used throughout this manual where applicable and should be strictly observed. These notices appear in the format shown below and are defined as follows:



## **WARNING**

**Warning, as used in this manual, is defined as a condition or practice which could result in personal injury or loss of life.**



## **CAUTION**

**Caution, as used in this manual, is defined as a condition or practice which could result in damage to or destruction of the equipment or apparatus under test.**

Megger<sup>®</sup>



# 3

## SPECIFICATIONS

### *Electrical*

#### **Type of Power**

Re-chargeable NIMH battery pack, 3.6 V, 3800 mAh

#### **Pollution Degree**

TTR is designed for Pollution Degree II

#### **Environmental Protection**

Dust and shower protection to IP54

#### **Output Test Voltage and Current**

2 test voltages, auto selectable: 8V rms for testing transformers & PTs; 1.5V rms or 8V rms for testing CTs.

Current: up to 100 mA

#### **Test Frequency**

55Hz, internally generated providing a universal 50 / 60 Hz test set.

#### **Loading of Test Transformer**

Less than 0.1 VA

## Measuring Ranges

Turn ratio:	8 V rms: 0.8 to 20,000, 5 digit resolution (For transformers & PT and CT testing) 1.5V rms: 5.0 to 2220, 5 digit resolution (For CT testing)
Current:	0 to 100 mA, 4 digit resolution
Phase deviation:	$\pm 180$ degrees, 1 decimal point for the minutes display, 2 decimal point for the degree display, 2 decimal points for the centiradian display
DC Winding Resistance:	0 to 2000 Ohms, 4 digit resolution
Transformer Polarity:	Additive or Subtractive, single phase transformers
Transformer vector group:	1PH0 or 1PH6

## Calculated Value

Ratio Deviation, %	Difference between calculated and measured turn ratios, in %
--------------------	--

## Accuracy

Turn ratio:	$\pm 0.1\%$ (0.8 to 2000) $\pm 0.15\%$ (2001 to 4000) $\pm 0.20\%$ (4001 to 10,000) $\pm 0.25\%$ (10,001 to 20,000)
Current (rms):	$\pm(2\%$ of reading + 1 digit)
Phase deviation:	$\pm 3$ minutes
DC Winding Resistance:	$\pm(10\%$ of reading $\pm 1$ digit) (10 to 2000 Ohms range)  $\pm(10\%$ of reading $\pm 1$ mOhm) (10mOhm to 9.99 Ohms range)  $\pm(10\%$ of reading $\pm 0.5$ mOhm) (0.10mOhm to 9.99 mOhms range)

## Measurement Method

In accordance with ANSI/IEEE C57.12.90

## Transformer Winding Phase Relationship

ANSI C57.12.70-1978

CEI/IEC 76-1:1993 and Publication 616:1978

AS-2374, Part 4-1982 (Australian Standard)

## Measuring Time

4 - 6 sec for turns ratio, phase shift, excitation current, polarity, and transformer vector group testing;

20 – 120 sec for turns ratio, phase shift, excitation current, polarity, transformer vector group, and winding d.c. resistance testing depending on type and power rating of transformer.

## Display

Wide temperature range LCD module, 128 x 64 dots, 21 characters by 8 lines.

## Memory Storage

Up to 200 test results (single phase or 3-phase transformers) and up to 100 user defined transformer settings.

## Interface

RS232C port, 9 pin, up to 57.6 Kbaud (19.2 Kbaud for printer)

## *Environmental Conditions*

Operating temperature range: -4° to 131°F (-20 to 55 °C)

Storage temperature range: -58° to 140°F (-50 to 60 °C)

Relative humidity: 0 to 90% noncondensing (operating)  
0 to 95% noncondensing (storage)

## ***Physical Data***

Dimensions:	9.5 x 4.5 x 1.875 in. (241 x 115 x 48 mm) (H x W x D)
Weight (test set):	3.3 lb. (1.5 kg)
Case:	Light gray color ABS case

## ***Accessories Supplied***

- Carrying case with strap for instrument and attachable pouch for provided accessories, (p/n 55-20008).
- Power supply cord for battery charger, determined by country.
- Universal battery charger, (p/n 35757)
- H winding test cable, 6 ft (1.8 m), two leads (marked H1 and H2) for single phase transformer testing, and ground lead (marked GROUND), shielded, heavy-duty clip-end terminated, (p/n 35502 – 521).
- X winding test cable, 6 ft (1.8 m), three leads (marked X1, X2, and X3) for single phase (with up to two secondary windings) transformer testing, shielded, heavy-duty clip-end terminated, (p/n 35502 – 511).
- Software for uploading test results to a PC, (p/n 35794 – 2).
- RS232 cable for connecting the TTR to a PC, (p/n 33147 – 18).
- Quick start guide, (p/n 55-20013).
- Instruction manual, (AVTMTTR100).

## ***Optional Accessories***

- Battery/line-powered serial thermal printer package for 120 V ac (p/n 35755-1). The package includes the thermal printer, a battery pack, an AC adapter and interface cable.
- Battery/line-powered serial thermal printer package for 230 V ac (p/n 35755-2). The package includes the thermal printer, a battery pack, an

AC adapter and interface cable. Printed out data includes date, transformer vector group according to ANSI, IEC or AS (Australian) standard, transformer under test ID, calculated and measured turn ratios, ratio deviations, polarity, phase deviation angle, test voltage, exciting current values, and winding resistance.

- X winding test cable, 12 ft (3.6 m), three leads (marked X1, X2, and X3) for single phase (with up to two secondary windings) transformer testing, shielded, heavy-duty clip-end terminated (p/n 35502-510).
- H winding test lead, 12 ft (3.6 m), two leads (marked H1 and H2) for single phase transformer testing, and ground lead (marked GROUND), shielded, heavy-duty clip-end terminated (p/n 35502-520).
- Semi hard fabric transport case, (p/n 35788)
- Additional battery pack, (p/n 35753)
- Additional printer paper, one roll, (p/n 27705-1)
- Deluxe kit with 120 V printer (p/n55-10002)
- Deluxe kit with 230 V printer (p/n55-10003)
- Inverter 12VDC/120Vac (p/n 35754)

Megger<sup>®</sup>

# 4

## DESCRIPTION

### *Principle of Operation*

The TTR test set provides accurate measurements of the transformer input and output voltages and then calculates a transformer turn ratio. The TTR also measures phase shift between primary and secondary windings of a transformer, the DC resistance winding and transformer excitation current. In addition, it provides polarity indications for single phase distribution transformers.

A block diagram of single-phase TTR is shown in Figure 4-1. The excitation voltage oscillator applies a 55-Hz test voltage to a transformer under test. There are three test voltages: 0.3 V used for checking connections, 1.5 V used for current transformer testing, and 8 V used for current and voltage transformer testing.

Resistance measuring circuitry tests primary and secondary winding resistance at 25 mA (max) DC current.

Input and output transformer voltages go through conditioning circuitry. This circuitry improves signal-to-noise ratio of the test signal, and provides full voltage range of the test signals at A/D converter inputs.

A/D converter is used to convert the analog measurement signals to their digital replica. The converted output digital signals are applied to CPLD (complex programmable logic device) and then are transferred to microprocessor.

The microprocessor is the main part of the TTR test set. It provides proper timing sequence of operation, gathers and calculates the test result, and interfaces with peripherals. There are five main peripherals in the TTR test set: RTC (real time clock), external memory, RS-232/Printer port, LCD display, and alphanumeric keypad.

DC power supply converts the primary battery voltage (NiMH battery pack, 3.6 V, 3800 mAh) into the voltages needed for proper operation of the test set.

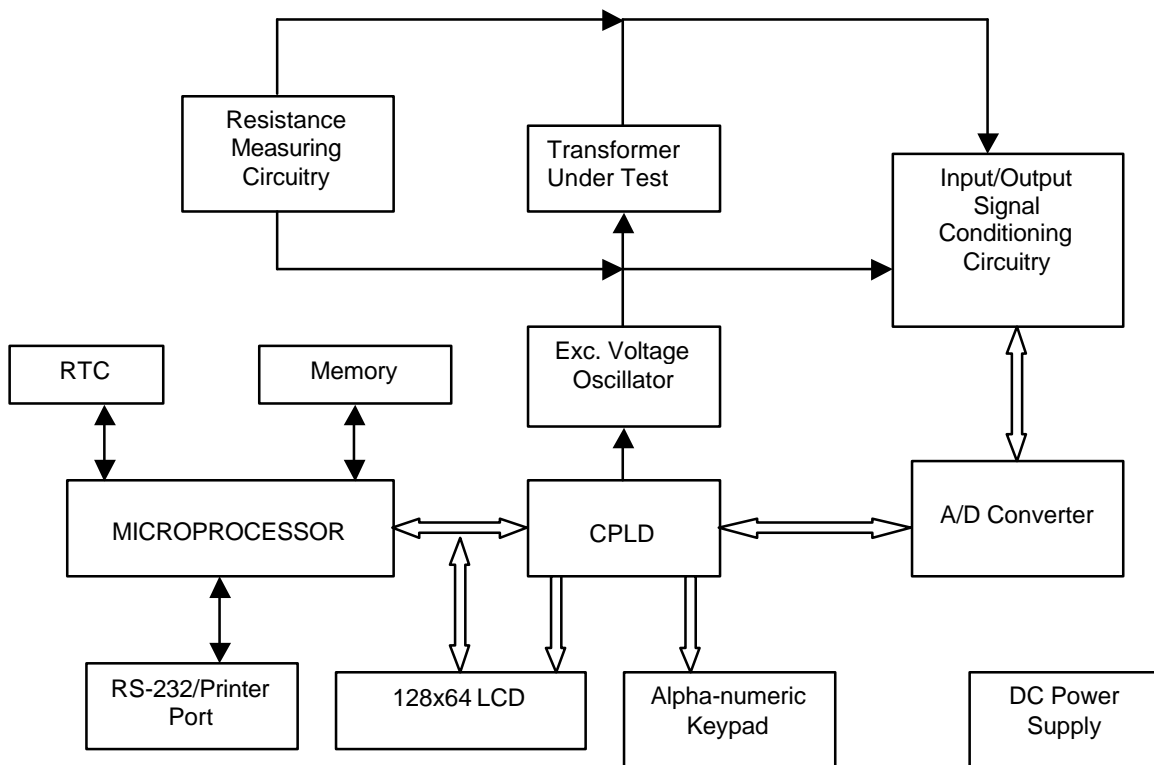

Figure 4-1. Single-Phase TTR Test Set Block Diagram

## Controls, Indicators, and Connectors (Figure 4-2)

Contrast	This knob adjusts the viewing resolution of the screen.
Backlight	A momentary depression of the switch will either activate or deactivate the backlight. It will remain ON for a period of three minutes without activity.
Power ON Switch	Depressing this switch momentarily will activate the TTR100.
Power OFF Switch	Depressing this switch momentarily will deactivate the TTR100.
EMERGENCY TEST OFF	By depressing any key on the keypad will terminate the test in progress.
DISPLAY SCREEN	LCD displays menus and test information. A low battery indicator will be displayed in the upper right corner when one hour of energy is remaining in the battery pack.



## KEYPAD

16-button keypad for entering menu selections and navigating through the various screens. In addition to alpha-numeric keys, there is a left & right scroll (◀) (▶) button, a space (␣) button which is combined with the number 1 button, a backspace - clear (←) button, an enter (↵) button, a combined decimal point, slash & dash sign button (. / -), and an asterisk ( \* ) button.

*NOTE: the asterisk button is used to return to the Main Menu screen from any other screen.*



Figure 4-2 Single-Phase TTR Display & Control Panel

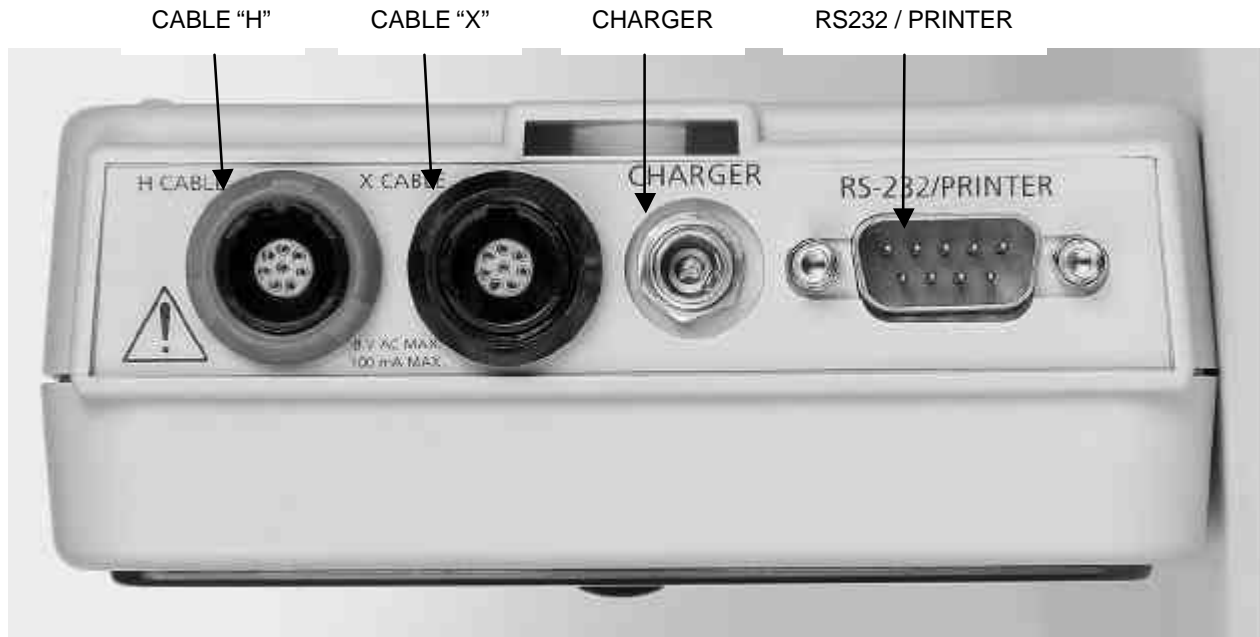

Figure 4-3. Top Side Connector Panel

**CABLE "H"** Plug receptacle for connecting test leads to the high-voltage (H) winding of a transformer. The plug and receptacle are keyed to prevent the cable from being inserted incorrectly, and to make certain that the correct cable is used.

**CABLE "X"** Plug receptacle for connecting test leads to the low-voltage (X) winding of a transformer. The plug and receptacle are keyed to prevent the cable from being inserted incorrectly, and to make certain that the correct cable is used.

**CHARGER INPUT** Connecting the universal charger will charge the battery pack.



**CAUTION**

**Do not connect charger if battery is disconnected or removed from unit.**

**RS232/PRINTER** A DB-9 male connector for connecting a printer or connecting the TTR100 to a PC.

# 5

## SETUP AND CONNECTIONS

### *General Instructions*

When testing high-voltage transformers, caution must be used at all times and all safety precautions followed. Read and understand all safety information contained in Section 2, Safety.

#### **WARNING**



**Ensure that the transformer to be tested is completely de-energized. Check every winding. Ensure that all terminals of the transformer are disconnected from line or load at the transformer. For some transformers, connections to ground may be left in place.**

**Never interchange connections between the high- and low-voltage transformer terminals. Failure to observe proper connections will result in a safety hazard and may result in damage to the test set or transformer.**

---

The TTR100 has been designed to test a variety of transformers, such as: Single phase, Three phase (one phase at a time), CTs, PTs and Regulators. The connection instructions of the TTR100 to the device to be tested are contained and illustrated within the TTR100.

***NOTE: The illustrated connection diagrams are provided as connection guides and do not suggest the physical location of the bushings/terminals of the device being tested.***

### *Transformers*

The setup and connection instructions pertaining to ratio, polarity, and phase relation assume that the transformer under test, connections, and terminal markings comply with the requirements of ANSI C57.12.70-1978 *American National Standards Terminal Markings and Connections for Distribution and Power Transformers*. The H test leads of the test set are the exciting leads. The TTR100 will utilize the 8 or 1.5V test voltage level when testing CTs, and it will

automatically switch between the indicated voltages. All other transformers will be tested at 8 V.

When testing DC winding resistance, it is important that reliable connections are made with the transformer being tested. Measuring time will vary depending on size and vector group of the transformer being tested.

*NOTE: The polarity indicated by the TTR100 is relative to the manner in which it is connected to the device under test.*

## ***Single-Phase, Two-Winding Transformers***

Perform the following setup procedure for single-phase, two-winding transformers:

1. Connect the H and X test cables to the respective H and X receptacles of the test set. Make sure that the connectors are fully engaged into the receptacles.
2. Connect the ground lead of the H test lead set to a low-impedance earth ground. Connect the clips marked H1 and H2 of the test lead to the corresponding (high-voltage winding) terminals of the transformer under test.
3. Connect the clips marked X1, X2 of the test lead to the corresponding (low-voltage winding) terminals of the transformer under test. Keep X3 clear of ground and test setup. Figures 5-1 and 5-2 show test setups for single-phase transformers.

Figures 5-3 and 5-4 show test setups for regulators. These and additional connection diagrams are found within the TTR100.

## ***Distribution Transformers with Two Secondary Windings***

The TTR100 may test the turn ratios of both distribution transformer secondary windings simultaneously. Perform the following setup procedure for single-phase distribution transformer with two secondary windings:

1. Connect the H and X test cables to the respective H and X receptacles of the test set. Make sure that the connectors are fully engaged into the receptacles.
2. Connect the ground lead of the H test lead set to a low-impedance earth ground. Connect the clips marked H1 and H2 of the test lead to the corresponding (high-voltage winding) terminals of the transformer under test.
3. Connect the clips marked X1, X2 and X3 of the test lead to the corresponding (low-voltage winding) terminals of the transformer under test when testing both halves of secondary winding (X1 – X2 and X3 – X2).

When testing full secondary winding (X1 – X3), connect X1 lead to X1 terminal, connect X2 lead to X3 terminal (X3 lead is not used in such test, and it should be kept clear of ground and other terminals). Remove the ground connection to X2 terminal.

Notes:

1. The connection instructions of the TR100 to distribution transformer do not suggest the physical location of the bushing/terminals of the transformer under test.
2. Polarity of the transformer is displayed for the connections shown.

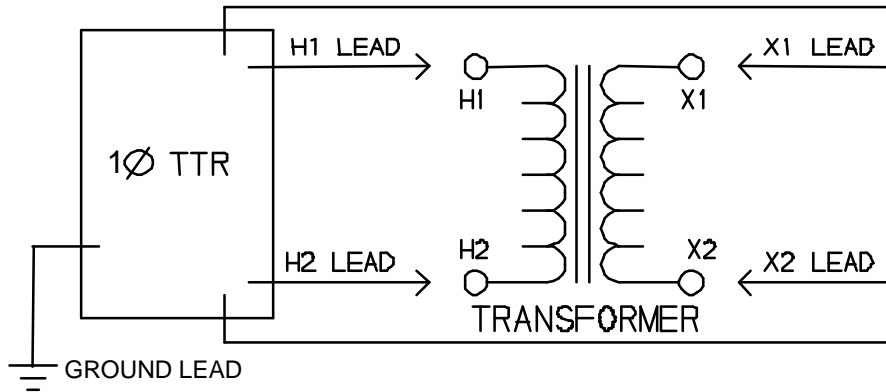

Figure 5-1. Setup for Testing Single-Phase Transformer

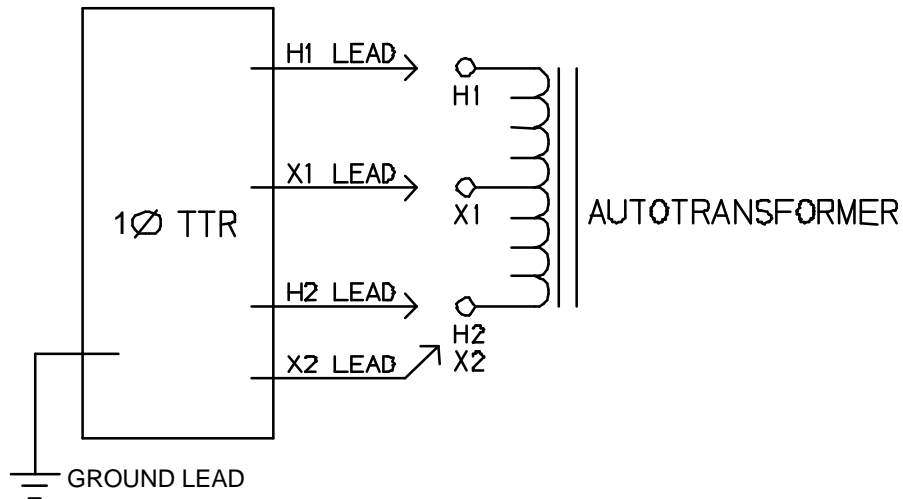

Figure 5-2. Setup for Testing Single-Phase Autotransformer

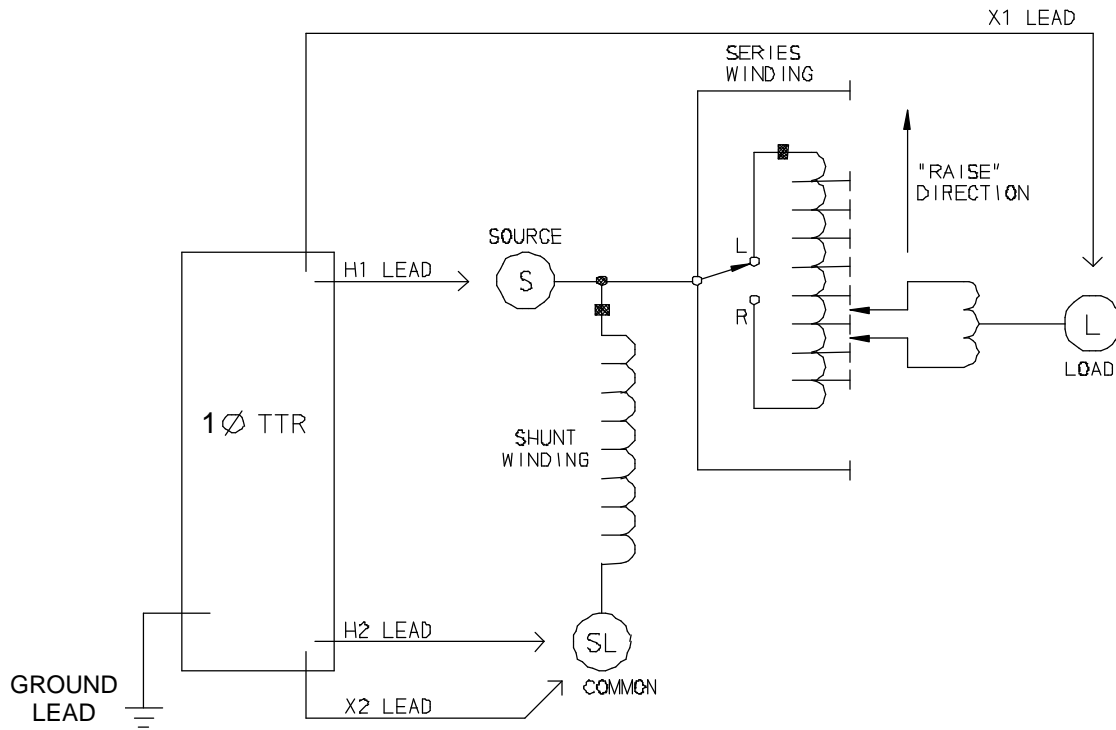

Figure 5-3. Setup for Testing Single-Phase, Type A (Straight Design) Step Voltage Regulator

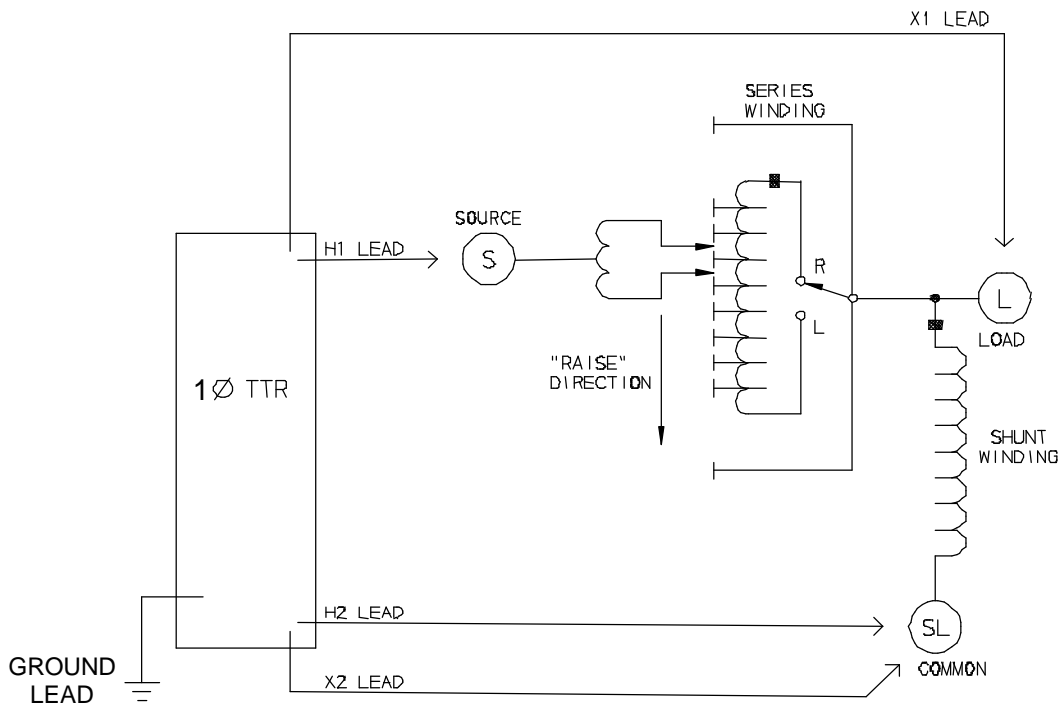

Figure 5-4. Setup for Testing Single-Phase, Type B (Inverted Design) Step Voltage Regulator

## Current Transformers (CTs)

Connections to CTs are made backwards compared to power, distribution or potential transformers. The H terminals on the test set must be connected to the X terminals on the CT; and the X terminals on the test set must be connected to the H terminals on the CT.

*NOTE: Dots on the housing of the transformer are commonly used to identify terminals of the same polarity.*



### WARNING

**Failure to observe proper connections will result in a safety hazard and may result in damage to the test set or CT. Failure to observe voltage rating of low-current X winding may result in damage to the CT.**

*NOTE: The TTR100 may supply up to 100 mA of excitation current. The TTR100 will automatically select the appropriate test voltage (8 V or 1.5 V) when testing CTs. Some current transformers with turn ratio of 150:5 and less requires more than 100 mA of excitation current when excited from 1.5 V source. These CTs can not be tested with the TTR100.*

## Unmounted CTs

The connection instructions of the TTR100 to the device to be tested are contained and illustrated within the TTR100.

*NOTE: The illustrated connection diagrams are provided as connection guides and do not suggest the physical location of the bushings / terminals of the device being tested.*

Figure 5-5 shows the setup for testing unmounted current transformers. Figure 5-6 shows the setup for testing the taps on a multiple-tap CT.

## Bushing Current Transformer (BCT) Mounted on Single-Phase, Two-Winding Transformer

A turn-ratio test can be performed on a BCT after it has been mounted on a circuit breaker or power transformer entrance bushing. The test can be performed without removal of the BCT from the equipment. Connect the TTR100 to BCT as shown in Figure 5-7.

*NOTE: A jumper lead is not supplied with the TTR100.*

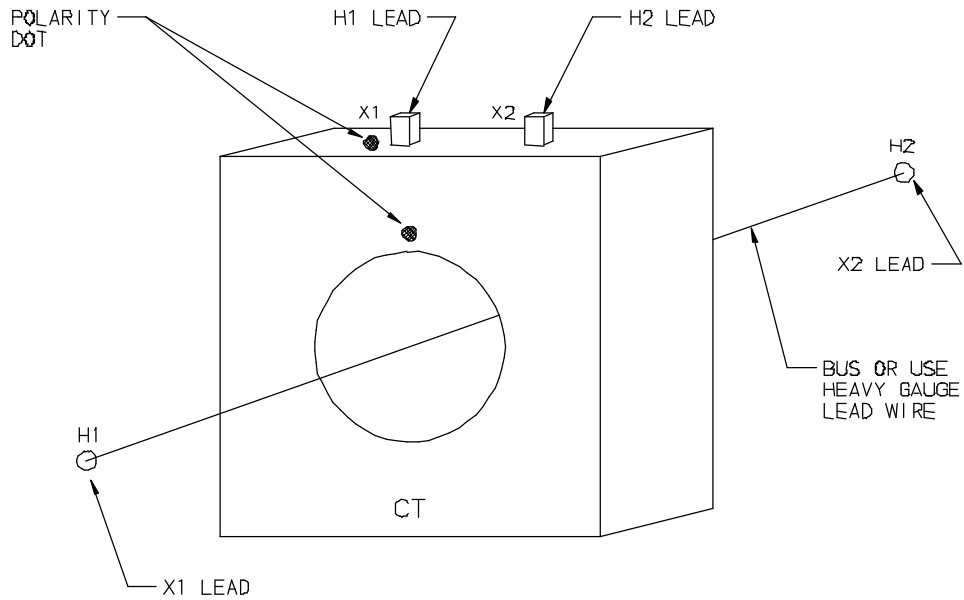

Figure 5-5. Setup for Testing Unmounted Current Transformer

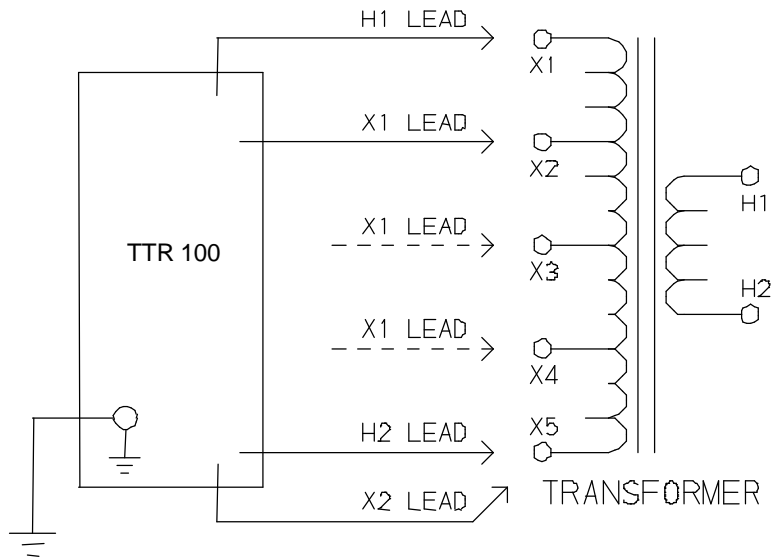
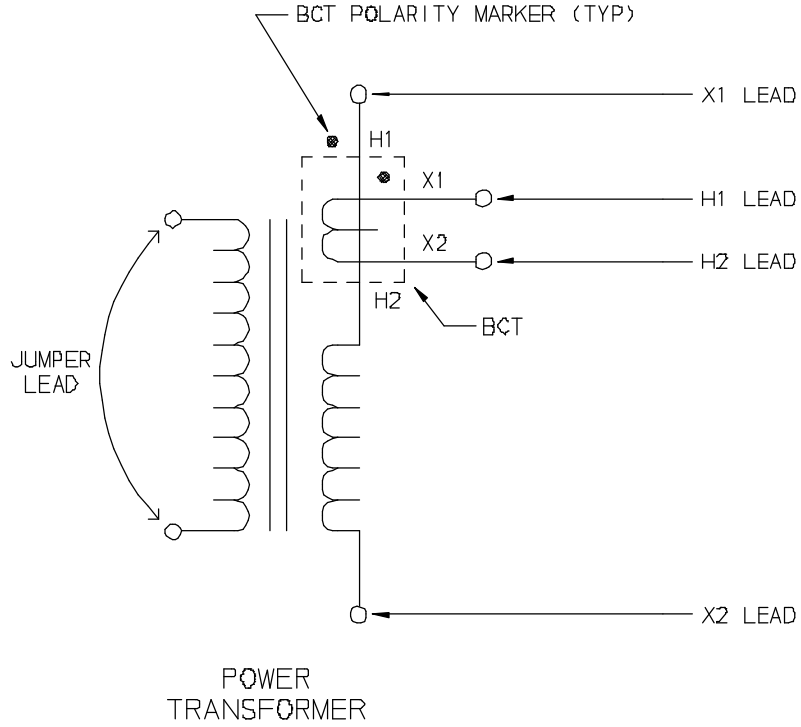

Figure 5-6. Setup for Testing Taps on Multiple Tap CT





NOTE: TEST PER DIAGRAM NO. 1 FOR ANSI

Figure 5-7. Setup for Testing BCT Mounted on Single-Phase Two-Winding Transformer

## T-Type Transformers

T-type transformers represent the special type of three-phase transformers. This transformer may be tested as a single phase transformer.

To make a measurement on a T-type transformer, match the vector diagram from the transformer nameplate to the corresponding winding connection diagram from Table 5-3, then select the corresponding IEC vector group (column 1 of table) on the appropriate setup menu of the instrument.

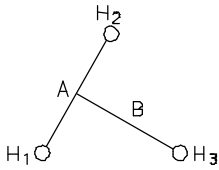
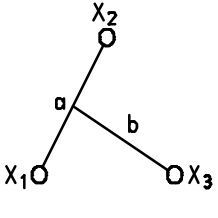
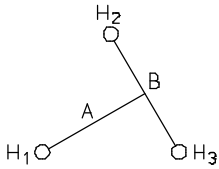
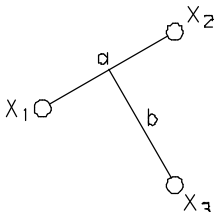
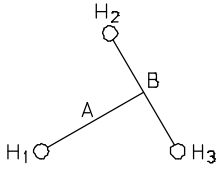
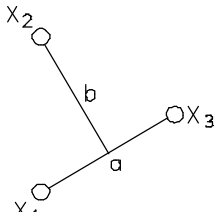
IEC Vector Group	Winding Connection		External Jumpers	Phase tested	Winding Tested		Calculated Turn Ratio
	High-Voltage Winding (H)	Low-Voltage Winding (X)			High-Voltage Winding	Low-Voltage Winding	
T-T 0			-  H <sub>1</sub> - H <sub>2</sub> X <sub>1</sub> - X <sub>2</sub>	A  B	H <sub>1</sub> - H <sub>2</sub>  H <sub>1</sub> - H <sub>3</sub>	X <sub>1</sub> - X <sub>2</sub>  X <sub>1</sub> - X <sub>3</sub>	$\frac{V_H}{V_X}$  $\frac{V_H}{V_X}$
T-T 30 lag			H <sub>2</sub> - H <sub>3</sub>  X <sub>1</sub> - X <sub>2</sub>	A  B	H <sub>1</sub> - H <sub>3</sub>  H <sub>2</sub> - H <sub>3</sub>	X <sub>1</sub> - X <sub>2</sub>  X <sub>1</sub> - X <sub>3</sub>	$\frac{V_H}{V_X} \cdot \frac{\sqrt{3}}{2}$  $\frac{V_H}{V_X} \cdot \frac{2}{\sqrt{3}}$
T-T 30 lead			H <sub>2</sub> - H <sub>3</sub>  X <sub>1</sub> - X <sub>3</sub>	A  B	H <sub>1</sub> - H <sub>3</sub>  H <sub>2</sub> - H <sub>3</sub>	X <sub>1</sub> - X <sub>3</sub>  X <sub>2</sub> - X <sub>1</sub>	$\frac{V_H}{V_X} \cdot \frac{\sqrt{3}}{2}$  $\frac{V_H}{V_X} \cdot \frac{2}{\sqrt{3}}$

### NOTES:

1. The connection instruction of the TTR100 to the device to be tested is contained within the TTR100. The connection information is provided as connection guides and do not suggest the physical location of the bushings / terminals of the device being tested.
2. Any connection(s) to ground/case of T-type transformer on H or X side should be removed before testing a transformer.

### *Connections and Vector Voltage Diagrams*

Table 5-2 shows winding diagrams for standard transformers and nonstandard transformers for power and distribution transformers marked in accordance with the ANSI standard. Table 5-3 shows winding diagrams for power transformers marked in accordance with the CEI/IEC standard, and Table 5-4 shows winding diagrams for power transformers marked in accordance with the Australian standard.

To make a measurement on a three-phase power transformer, match the vector diagram from the transformer nameplate to the corresponding winding connection diagram from Table 5-2 through 5-4, then select the corresponding IEC vector group (column 2 of table) on the appropriate setup menu of the instrument.

The tables show the windings tested for each of the three phases. The tables also show the relationship between the measured turn ratio and the actual line-to-line voltage ratio. For the ANSI specification, the rated voltage on the high-voltage winding is represented by  $V_H$ ;  $V_X$  represents rated voltage on the low-voltage winding.

## Notes to Table 5-2

Transformer terminal markings for distribution and power transformers marked in accordance with requirements of American National Standard Institute, Inc (ANSI) standard C57.12.70 – 1978.

### **Definition of Symbol Designations**

H <sub>1</sub> , H <sub>2</sub> , H <sub>3</sub>	External terminals on HV transformer winding.
X <sub>1</sub> , X <sub>2</sub> , X <sub>3</sub>	External terminals on LV transformer winding.
H <sub>0</sub>	External neutral terminal on HV transformer winding.
X <sub>0</sub>	External neutral terminal on LV transformer winding.
*	Inaccessible neutral point on HV or LV transformer winding.
V <sub>H</sub>	Nameplate voltage rating (line-to-line) of HV transformer winding.
V <sub>X</sub>	Nameplate voltage rating (line-to-line) of LV transformer winding.
A, B, C	Winding tested on HV side of transformer.
a, b, c	Winding tested on LV side of transformer.

**Table 5-2. ANSI Transformer Winding Phase Relationship**

Copyright 1999© Megger

Diag No.	IEC Vector Group	Winding Connection		Phase Tested	External Jumpers	Winding Tested		Measured Turn Ratio
		High-Voltage Winding	Low-Voltage Winding			High-Voltage Winding	Low-Voltage Winding	
1	1φ 1ph0			1φ	—	H <sub>1</sub> - H <sub>2</sub>	X <sub>1</sub> - X <sub>2</sub>	$\frac{V_H}{V_X}$
2	1φ 1ph6			1φ	—	H <sub>1</sub> - H <sub>2</sub>	X <sub>2</sub> - X <sub>1</sub>	$\frac{V_H}{V_X}$
3	Dd0			A B C	—	H <sub>1</sub> - H <sub>3</sub> H <sub>2</sub> - H <sub>1</sub> H <sub>3</sub> - H <sub>2</sub>	X <sub>1</sub> - X <sub>3</sub> X <sub>2</sub> - X <sub>1</sub> X <sub>3</sub> - X <sub>2</sub>	$\frac{V_H}{V_X}$
4	Dd6			A B C	—	H <sub>1</sub> - H <sub>3</sub> H <sub>2</sub> - H <sub>1</sub> H <sub>3</sub> - H <sub>2</sub>	X <sub>3</sub> - X <sub>1</sub> X <sub>1</sub> - X <sub>2</sub> X <sub>2</sub> - X <sub>3</sub>	$\frac{V_H}{V_X}$
5	Dyn1			A B C	—	H <sub>1</sub> - H <sub>3</sub> H <sub>2</sub> - H <sub>1</sub> H <sub>3</sub> - H <sub>2</sub>	X <sub>1</sub> - X <sub>0</sub> X <sub>2</sub> - X <sub>0</sub> X <sub>3</sub> - X <sub>0</sub>	$\frac{V_H \cdot \sqrt{3}}{V_X}$
6	Dyn7			A B C	—	H <sub>1</sub> - H <sub>3</sub> H <sub>2</sub> - H <sub>1</sub> H <sub>3</sub> - H <sub>2</sub>	X <sub>0</sub> - X <sub>1</sub> X <sub>0</sub> - X <sub>2</sub> X <sub>0</sub> - X <sub>3</sub>	$\frac{V_H \cdot \sqrt{3}}{V_X}$
7	YNyn0			A B C	—	H <sub>1</sub> - H <sub>0</sub> H <sub>2</sub> - H <sub>0</sub> H <sub>3</sub> - H <sub>0</sub>	X <sub>1</sub> - X <sub>0</sub> X <sub>2</sub> - X <sub>0</sub> X <sub>3</sub> - X <sub>0</sub>	$\frac{V_H}{V_X}$

**Table 5-2. ANSI Transformer Winding Phase Relationship**

Copyright 1999© Megger

Diag No.	IEC Vector Group	Winding Connection		Phase Tested	External Jumpers	Winding Tested		Measured Turn Ratio
		High-Voltage Winding	Low-Voltage Winding			High-Voltage Winding	Low-Voltage Winding	
8	YNyn6			A B C	—	H <sub>1</sub> - H <sub>0</sub> H <sub>2</sub> - H <sub>0</sub> H <sub>3</sub> - H <sub>0</sub>	X <sub>0</sub> - X <sub>1</sub> X <sub>0</sub> - X <sub>2</sub> X <sub>0</sub> - X <sub>3</sub>	$\frac{V_H}{V_X}$
9	YNd1			A B C	—	H <sub>1</sub> - H <sub>0</sub> H <sub>2</sub> - H <sub>0</sub> H <sub>3</sub> - H <sub>0</sub>	X <sub>1</sub> - X <sub>2</sub> X <sub>2</sub> - X <sub>3</sub> X <sub>3</sub> - X <sub>1</sub>	$\frac{V_H}{V_X \cdot \sqrt{3}}$
10	YNd7			A B C	—	H <sub>1</sub> - H <sub>0</sub> H <sub>2</sub> - H <sub>0</sub> H <sub>3</sub> - H <sub>0</sub>	X <sub>2</sub> - X <sub>1</sub> X <sub>3</sub> - X <sub>2</sub> X <sub>1</sub> - X <sub>3</sub>	$\frac{V_H}{V_X \cdot \sqrt{3}}$
11	Dy1			A B C	H <sub>3</sub> - H <sub>2</sub> H <sub>1</sub> - H <sub>3</sub> H <sub>2</sub> - H <sub>1</sub>	H <sub>1</sub> - H <sub>3</sub> H <sub>2</sub> - H <sub>1</sub> H <sub>3</sub> - H <sub>2</sub>	X <sub>1</sub> - * X <sub>2</sub> - * X <sub>3</sub> - *	$\frac{V_H \cdot \sqrt{3}}{V_X}$
12	Dyn5			A B C	—	H <sub>1</sub> - H <sub>3</sub> H <sub>2</sub> - H <sub>1</sub> H <sub>3</sub> - H <sub>2</sub>	X <sub>3</sub> - X <sub>0</sub> X <sub>1</sub> - X <sub>0</sub> X <sub>2</sub> - X <sub>0</sub>	$\frac{V_H \cdot \sqrt{3}}{V_X}$
13	Dy5			A B C	H <sub>3</sub> - H <sub>2</sub> H <sub>1</sub> - H <sub>3</sub> H <sub>2</sub> - H <sub>1</sub>	H <sub>1</sub> - H <sub>3</sub> H <sub>2</sub> - H <sub>1</sub> H <sub>3</sub> - H <sub>2</sub>	X <sub>3</sub> - * X <sub>1</sub> - * X <sub>2</sub> - *	$\frac{V_H \cdot \sqrt{3}}{V_X}$

**Table 5-2. ANSI Transformer Winding Phase Relationship**

Copyright 1999© Megger

Diag No.	IEC Vector Group	Winding Connection		Phase Tested	External Jumpers	Winding Tested		Measured Turn Ratio
		High-Voltage Winding	Low-Voltage Winding			High-Voltage Winding	Low-Voltage Winding	
14	Dy7			A B C	H <sub>3</sub> - H <sub>2</sub> H <sub>1</sub> - H <sub>3</sub> H <sub>2</sub> - H <sub>1</sub>	H <sub>1</sub> - H <sub>3</sub> H <sub>2</sub> - H <sub>1</sub> H <sub>3</sub> - H <sub>2</sub>	* - X <sub>1</sub> * - X <sub>2</sub> * - X <sub>3</sub>	$\frac{V_H \cdot \sqrt{3}}{V_X}$
15	Dyn11			A B C	—	H <sub>1</sub> - H <sub>3</sub> H <sub>2</sub> - H <sub>1</sub> H <sub>3</sub> - H <sub>2</sub>	X <sub>0</sub> - X <sub>3</sub> X <sub>0</sub> - X <sub>1</sub> X <sub>0</sub> - X <sub>2</sub>	$\frac{V_H \cdot \sqrt{3}}{V_X}$
16	Dy11			A B C	H <sub>3</sub> - H <sub>2</sub> H <sub>1</sub> - H <sub>3</sub> H <sub>2</sub> - H <sub>1</sub>	H <sub>1</sub> - H <sub>3</sub> H <sub>2</sub> - H <sub>1</sub> H <sub>3</sub> - H <sub>2</sub>	* - X <sub>3</sub> * - X <sub>1</sub> * - X <sub>2</sub>	$\frac{V_H \cdot \sqrt{3}}{V_X}$
17	Dz0			A B C	—	H <sub>1</sub> - H <sub>3</sub> H <sub>2</sub> - H <sub>1</sub> H <sub>3</sub> - H <sub>2</sub>	X <sub>1</sub> - X <sub>3</sub> X <sub>2</sub> - X <sub>1</sub> X <sub>3</sub> - X <sub>2</sub>	$\frac{V_H}{V_X}$
18	Dz6			A B C	—	H <sub>1</sub> - H <sub>3</sub> H <sub>2</sub> - H <sub>1</sub> H <sub>3</sub> - H <sub>2</sub>	X <sub>3</sub> - X <sub>1</sub> X <sub>1</sub> - X <sub>2</sub> X <sub>2</sub> - X <sub>3</sub>	$\frac{V_H}{V_X}$
19	YNy0			A B C	H <sub>2</sub> - H <sub>0</sub> H <sub>3</sub> - H <sub>0</sub> H <sub>1</sub> - H <sub>0</sub>	H <sub>1</sub> - H <sub>0</sub> H <sub>2</sub> - H <sub>0</sub> H <sub>3</sub> - H <sub>0</sub>	X <sub>1</sub> - * X <sub>2</sub> - * X <sub>3</sub> - *	$\frac{V_H}{V_X}$

**Table 5-2. ANSI Transformer Winding Phase Relationship**

Copyright 1999© Megger

Diag No.	IEC Vector Group	Winding Connection		Phase Tested	External Jumpers	Winding Tested		Measured Turn Ratio
		High-Voltage Winding	Low-Voltage Winding			High-Voltage Winding	Low-Voltage Winding	
20	Yyn0			A B C	—	H <sub>1</sub> - H <sub>3</sub> H <sub>2</sub> - H <sub>1</sub> H <sub>3</sub> - H <sub>2</sub>	X <sub>1</sub> - X <sub>3</sub> X <sub>2</sub> - X <sub>1</sub> X <sub>3</sub> - X <sub>2</sub>	$\frac{V_H}{V_X}$
21	Yy0			A B C	—	H <sub>1</sub> - H <sub>3</sub> H <sub>2</sub> - H <sub>1</sub> H <sub>3</sub> - H <sub>2</sub>	X <sub>1</sub> - X <sub>3</sub> X <sub>2</sub> - X <sub>1</sub> X <sub>3</sub> - X <sub>2</sub>	$\frac{V_H}{V_X}$
22	YNy6			A B C	H <sub>2</sub> - H <sub>0</sub> H <sub>3</sub> - H <sub>0</sub> H <sub>1</sub> - H <sub>0</sub>	H <sub>1</sub> - H <sub>0</sub> H <sub>2</sub> - H <sub>0</sub> H <sub>3</sub> - H <sub>0</sub>	* - X <sub>1</sub> * - X <sub>2</sub> * - X <sub>3</sub>	$\frac{V_H}{V_X}$
23	Yyn6			A B C	—	H <sub>1</sub> - H <sub>3</sub> H <sub>2</sub> - H <sub>1</sub> H <sub>3</sub> - H <sub>2</sub>	X <sub>3</sub> - X <sub>1</sub> X <sub>1</sub> - X <sub>2</sub> X <sub>2</sub> - X <sub>3</sub>	$\frac{V_H}{V_X}$
24	Yy6			A B C	—	H <sub>1</sub> - H <sub>3</sub> H <sub>2</sub> - H <sub>1</sub> H <sub>3</sub> - H <sub>2</sub>	X <sub>3</sub> - X <sub>1</sub> X <sub>1</sub> - X <sub>2</sub> X <sub>2</sub> - X <sub>3</sub>	$\frac{V_H}{V_X}$
25	Yzn1			A B C	—	H <sub>1</sub> - H <sub>3</sub> H <sub>2</sub> - H <sub>1</sub> H <sub>3</sub> - H <sub>2</sub>	X <sub>1</sub> - X <sub>0</sub> X <sub>2</sub> - X <sub>0</sub> X <sub>3</sub> - X <sub>0</sub>	$\frac{V_H \cdot \sqrt{3}}{V_X}$



**Table 5-2. ANSI Transformer Winding Phase Relationship**

Copyright 1999© Megger								
Diag No.	IEC Vector Group	Winding Connection		Phase Tested	External Jumpers	Winding Tested		Measured Turn Ratio
		High-Voltage Winding	Low-Voltage Winding			High-Voltage Winding	Low-Voltage Winding	
26	Yz1			A B C	H <sub>3</sub> - H <sub>2</sub> H <sub>1</sub> - H <sub>3</sub> H <sub>2</sub> - H <sub>1</sub>	H <sub>1</sub> -(H <sub>3</sub> +H <sub>2</sub> ) H <sub>2</sub> -(H <sub>1</sub> +H <sub>3</sub> ) H <sub>3</sub> -(H <sub>2</sub> +H <sub>1</sub> )	X <sub>1</sub> - X <sub>2</sub> X <sub>2</sub> - X <sub>3</sub> X <sub>3</sub> - X <sub>1</sub>	$\frac{V_H \cdot \sqrt{3}}{V_X \cdot 2}$
27	Yzn5			A B C	—	H <sub>1</sub> - H <sub>3</sub> H <sub>2</sub> - H <sub>1</sub> H <sub>3</sub> - H <sub>2</sub>	X <sub>3</sub> - X <sub>0</sub> X <sub>1</sub> - X <sub>0</sub> X <sub>2</sub> - X <sub>0</sub>	$\frac{V_H \cdot \sqrt{3}}{V_X}$
28	Yz5			A B C	H <sub>3</sub> - H <sub>2</sub> H <sub>1</sub> - H <sub>3</sub> H <sub>2</sub> - H <sub>1</sub>	H <sub>1</sub> -(H <sub>3</sub> +H <sub>2</sub> ) H <sub>2</sub> -(H <sub>1</sub> +H <sub>3</sub> ) H <sub>3</sub> -(H <sub>2</sub> +H <sub>1</sub> )	X <sub>3</sub> - X <sub>1</sub> X <sub>1</sub> - X <sub>2</sub> X <sub>2</sub> - X <sub>3</sub>	$\frac{V_H \cdot \sqrt{3}}{V_X \cdot 2}$
29	Yzn7			A B C	—	H <sub>1</sub> - H <sub>3</sub> H <sub>2</sub> - H <sub>1</sub> H <sub>3</sub> - H <sub>2</sub>	X <sub>0</sub> - X <sub>1</sub> X <sub>0</sub> - X <sub>2</sub> X <sub>0</sub> - X <sub>3</sub>	$\frac{V_H \cdot \sqrt{3}}{V_X}$
30	Yz7			A B C	H <sub>3</sub> - H <sub>2</sub> H <sub>1</sub> - H <sub>3</sub> H <sub>2</sub> - H <sub>1</sub>	H <sub>1</sub> -(H <sub>3</sub> +H <sub>2</sub> ) H <sub>2</sub> -(H <sub>1</sub> +H <sub>3</sub> ) H <sub>3</sub> -(H <sub>2</sub> +H <sub>1</sub> )	X <sub>2</sub> - X <sub>1</sub> X <sub>3</sub> - X <sub>2</sub> X <sub>1</sub> - X <sub>3</sub>	$\frac{V_H \cdot \sqrt{3}}{V_X \cdot 2}$

**Table 5-2. ANSI Transformer Winding Phase Relationship**

Copyright 1999© Megger

Diag No.	IEC Vector Group	Winding Connection		Phase Tested	External Jumpers	Winding Tested		Measured Turn Ratio
		High-Voltage Winding	Low-Voltage Winding			High-Voltage Winding	Low-Voltage Winding	
31	Yzn11			A B C	—	H <sub>1</sub> - H <sub>3</sub> H <sub>2</sub> - H <sub>1</sub> H <sub>3</sub> - H <sub>2</sub>	X <sub>0</sub> - X <sub>3</sub> X <sub>0</sub> - X <sub>1</sub> X <sub>0</sub> - X <sub>2</sub>	$\frac{V_H \cdot \sqrt{3}}{V_X}$
32	Yz11			A B C	H <sub>3</sub> - H <sub>2</sub> H <sub>1</sub> - H <sub>3</sub> H <sub>2</sub> - H <sub>1</sub>	H <sub>1</sub> - (H <sub>3</sub> + H <sub>2</sub> ) H <sub>2</sub> - (H <sub>1</sub> + H <sub>3</sub> ) H <sub>3</sub> - (H <sub>2</sub> + H <sub>1</sub> )	X <sub>1</sub> - X <sub>3</sub> X <sub>2</sub> - X <sub>1</sub> X <sub>3</sub> - X <sub>2</sub>	$\frac{V_H \cdot \sqrt{3}}{V_X} \cdot \frac{\sqrt{3}}{2}$
33	ZNy5			A B C	—	H <sub>1</sub> - H <sub>0</sub> H <sub>2</sub> - H <sub>0</sub> H <sub>3</sub> - H <sub>0</sub>	X <sub>3</sub> - X <sub>1</sub> X <sub>1</sub> - X <sub>2</sub> X <sub>2</sub> - X <sub>3</sub>	$\frac{V_H}{V_X \cdot \sqrt{3}}$
34	Zy5			A B C	H <sub>3</sub> - H <sub>2</sub> H <sub>1</sub> - H <sub>3</sub> H <sub>2</sub> - H <sub>1</sub>	H <sub>1</sub> - (H <sub>3</sub> + H <sub>2</sub> ) H <sub>2</sub> - (H <sub>1</sub> + H <sub>3</sub> ) H <sub>3</sub> - (H <sub>2</sub> + H <sub>1</sub> )	X <sub>3</sub> - X <sub>1</sub> X <sub>1</sub> - X <sub>2</sub> X <sub>2</sub> - X <sub>3</sub>	$\frac{V_H \cdot \sqrt{3}}{V_X} \cdot \frac{\sqrt{3}}{2}$
35	ZNy11			A B C	—	H <sub>1</sub> - H <sub>0</sub> H <sub>2</sub> - H <sub>0</sub> H <sub>3</sub> - H <sub>0</sub>	X <sub>1</sub> - X <sub>3</sub> X <sub>2</sub> - X <sub>1</sub> X <sub>3</sub> - X <sub>2</sub>	$\frac{V_H}{V_X \cdot \sqrt{3}}$
36	Zy11			A B C	H <sub>3</sub> - H <sub>2</sub> H <sub>1</sub> - H <sub>3</sub> H <sub>2</sub> - H <sub>1</sub>	H <sub>1</sub> - (H <sub>3</sub> + H <sub>2</sub> ) H <sub>2</sub> - (H <sub>1</sub> + H <sub>3</sub> ) H <sub>3</sub> - (H <sub>2</sub> + H <sub>1</sub> )	X <sub>1</sub> - X <sub>3</sub> X <sub>2</sub> - X <sub>1</sub> X <sub>3</sub> - X <sub>2</sub>	$\frac{V_H \cdot \sqrt{3}}{V_X} \cdot \frac{\sqrt{3}}{2}$

**Table 5-2. ANSI Transformer Winding Phase Relationship**

Copyright 1999© Megger

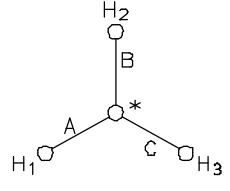
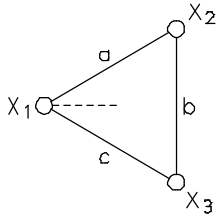
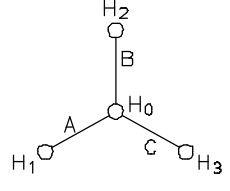
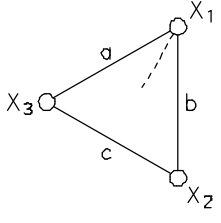
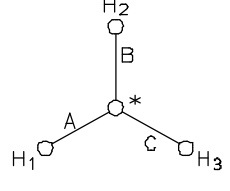
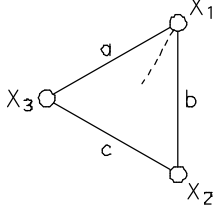
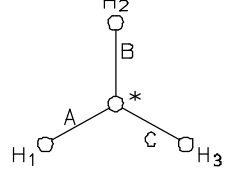
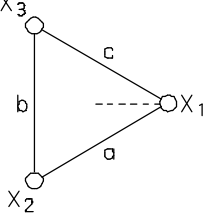
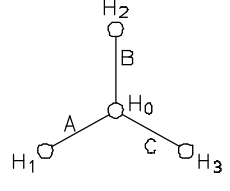
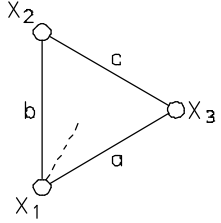
Diag No.	IEC Vector Group	Winding Connection		Phase Tested	External Jumpers	Winding Tested		Measured Turn Ratio
		High-Voltage Winding	Low-Voltage Winding			High-Voltage Winding	Low-Voltage Winding	
37	Yd1			A B C	H <sub>3</sub> - H <sub>2</sub> H <sub>1</sub> - H <sub>3</sub> H <sub>2</sub> - H <sub>1</sub>	H <sub>1</sub> - (H <sub>3</sub> + H <sub>2</sub> ) H <sub>2</sub> - (H <sub>1</sub> + H <sub>3</sub> ) H <sub>3</sub> - (H <sub>2</sub> + H <sub>1</sub> )	X <sub>1</sub> - X <sub>2</sub> X <sub>2</sub> - X <sub>3</sub> X <sub>3</sub> - X <sub>1</sub>	$\frac{V_H \cdot \sqrt{3}}{V_X \cdot 2}$
38	YNd5			A B C	—	H <sub>1</sub> - H <sub>0</sub> H <sub>2</sub> - H <sub>0</sub> H <sub>3</sub> - H <sub>0</sub>	X <sub>3</sub> - X <sub>1</sub> X <sub>1</sub> - X <sub>2</sub> X <sub>2</sub> - X <sub>3</sub>	$\frac{V_H}{V_X \cdot \sqrt{3}}$
39	Yd5			A B C	H <sub>3</sub> - H <sub>2</sub> H <sub>1</sub> - H <sub>3</sub> H <sub>2</sub> - H <sub>1</sub>	H <sub>1</sub> - (H <sub>3</sub> + H <sub>2</sub> ) H <sub>2</sub> - (H <sub>1</sub> + H <sub>3</sub> ) H <sub>3</sub> - (H <sub>2</sub> + H <sub>1</sub> )	X <sub>3</sub> - X <sub>1</sub> X <sub>1</sub> - X <sub>2</sub> X <sub>2</sub> - X <sub>3</sub>	$\frac{V_H \cdot \sqrt{3}}{V_X \cdot 2}$
40	Yd7			A B C	H <sub>3</sub> - H <sub>2</sub> H <sub>1</sub> - H <sub>3</sub> H <sub>2</sub> - H <sub>1</sub>	H <sub>1</sub> - (H <sub>3</sub> + H <sub>2</sub> ) H <sub>2</sub> - (H <sub>1</sub> + H <sub>3</sub> ) H <sub>3</sub> - (H <sub>2</sub> + H <sub>1</sub> )	X <sub>2</sub> - X <sub>1</sub> X <sub>3</sub> - X <sub>2</sub> X <sub>1</sub> - X <sub>3</sub>	$\frac{V_H \cdot \sqrt{3}}{V_X \cdot 2}$
41	YNd11			A B C	—	H <sub>1</sub> - H <sub>0</sub> H <sub>2</sub> - H <sub>0</sub> H <sub>3</sub> - H <sub>0</sub>	X <sub>1</sub> - X <sub>3</sub> X <sub>2</sub> - X <sub>1</sub> X <sub>3</sub> - X <sub>2</sub>	$\frac{V_H}{V_X \cdot \sqrt{3}}$

**Table 5-2. ANSI Transformer Winding Phase Relationship**

Copyright 1999© Megger								
Diag No.	IEC Vector Group	Winding Connection		Phase Tested	External Jumpers	Winding Tested		Measured Turn Ratio
		High-Voltage Winding	Low-Voltage Winding			High-Voltage Winding	Low-Voltage Winding	
42	Yd11			A B C	H <sub>3</sub> - H <sub>2</sub> H <sub>1</sub> - H <sub>3</sub> H <sub>2</sub> - H <sub>1</sub>	H <sub>1</sub> -(H <sub>3</sub> +H <sub>2</sub> ) H <sub>2</sub> -(H <sub>1</sub> +H <sub>3</sub> ) H <sub>3</sub> -(H <sub>2</sub> +H <sub>1</sub> )	X <sub>1</sub> - X <sub>3</sub> X <sub>2</sub> - X <sub>1</sub> X <sub>3</sub> - X <sub>2</sub>	$\frac{V_H}{V_X} \cdot \frac{\sqrt{3}}{2}$

## Notes to Table 5-3

Transformer terminal markings for power transformers marked in accordance with requirements of International Standard CEI/IEC 76-1:1993.

### Definition of Symbol Designations

1U, 1V, 1W	External terminals on HV transformer winding (alternate notation U, V, W).
2U, 2V, 2W	External terminals on LV transformer winding (alternate notation u, v, w).
1N	External neutral terminal on HV transformer winding (alternate notation N).
2N	External neutral terminal on LV transformer winding (alternate notation n).
*	Inaccessible neutral point on HV or LV transformer winding.
U1	Nameplate voltage rating (line-to-line) of HV transformer winding.
U2	Nameplate voltage rating (line-to-line) of LV transformer winding.
U, V, W	Phase tested.

**Table 5-3. CEI/IEC 76-1:1993 Transformer Winding Phase Relationship**

Copyright 1999© Megger								
Diag No.	IEC Vector Group	Winding Connection		Phase Tested	External Jumpers	Winding Tested		Measured Turn Ratio
		High-Voltage Winding	Low-Voltage Winding			High-Voltage Winding	Low-Voltage Winding	
1	1φ 1ph0	1.1 ○ ——— ○ 1.2	2.1 ○ ——— ○ 2.2	1φ	—	1.1-1.2	2.1-2.2	$\frac{U_1}{U_2}$
2	1φ 1ph6	1.1 ○ ——— ○ 1.2	2.2 ○ ——— ○ 2.1	1φ	—	1.1-1.2	2.2-2.1	$\frac{U_1}{U_2}$
3	Dd0			U V W	— — —	1U-1V 1V-1W 1W-1U	2U-2V 2V-2W 2W-2U	$\frac{U_1}{U_2}$
4	Dd2			U V W	— — —	1U-1V 1V-1W 1W-1U	2W-2V 2U-2W 2V-2U	$\frac{U_1}{U_2}$
5	Dd4			U V W	— — —	1U-1V 1V-1W 1W-1U	2W-2U 2U-2V 2V-2W	$\frac{U_1}{U_2}$
6	Dd6			U V W	— — —	1U-1V 1V-1W 1W-1U	2V-2U 2U-2V 2U-2W	$\frac{U_1}{U_2}$
7	Dd8			U V W	— — —	1U-1V 1V-1W 1W-1U	2V-2W 2W-2U 2U-2V	$\frac{U_1}{U_2}$
8	Dd10			U V W	— — —	1U-1V 1V-1W 1W-1U	2U-2W 2V-2U 2W-2V	$\frac{U_1}{U_2}$

**Table 5-3. CEI/IEC 76-1:1993 Transformer Winding Phase Relationship**

Copyright 1999© Megger

Diag No.	IEC Vector Group	Winding Connection		Phase Tested	External Jumpers	Winding Tested		Measured Turn Ratio
		High-Voltage Winding	Low-Voltage Winding			High-Voltage Winding	Low-Voltage Winding	
9	Dyn1			U V W	— — —	1U-1W 1V-1U 1W-1V	2U-2N 2V-2N 2W-2N	$\frac{U1 \cdot \sqrt{3}}{U2}$
10	Dy1			U V W	1V-1W 1W-1U 1U-1V	1U-1W 1V-1U 1W-1V	2U- 2V- 2W-*	$\frac{U1 \cdot \sqrt{3}}{U2}$
11	Dyn5			U V W	— — —	1V-1U 1W-1V 1U-1W	2U-2N 2V-2N 2W-2N	$\frac{U1 \cdot \sqrt{3}}{U2}$
12	Dy5			U V W	1V-1W 1W-1U 1U-1V	1V-1U 1W-1V 1U-1W	2U- 2V- 2W-*	$\frac{U1 \cdot \sqrt{3}}{U2}$
13	Dyn7			U V W	— — —	1W-1U 1U-1V 1V-1W	2U-2N 2V-2N 2W-2N	$\frac{U1 \cdot \sqrt{3}}{U2}$
14	Dy7			U V W	1V-1W 1W-1U 1U-1V	1W-1U 1U-1V 1V-1W	2U- 2V- 2W-*	$\frac{U1 \cdot \sqrt{3}}{U2}$

<b>Table 5-3. CEI/IEC 76-1:1993 Transformer Winding Phase Relationship</b>								
Copyright 1999© Megger								
Diag No.	IEC Vector Group	Winding Connection		Phase Tested	External Jumpers	Winding Tested		Measured Turn Ratio
		High-Voltage Winding	Low-Voltage Winding			High-Voltage Winding	Low-Voltage Winding	
15	Dyn11			U V W	— — —	1U-1V 1V-1W 1W-1U	2U-2N 2V-2N 2W-2N	$\frac{U_1 \cdot \sqrt{3}}{U_2}$
16	Dy11			U V W	1V-1W 1W-1U 1U-1V	1U-1V 1V-1W 1W-1U	2U-* 2V-* 2W-*	$\frac{U_1 \cdot \sqrt{3}}{U_2}$
17	Dzn0			U V W	1V-1W 1W-1U 1U-1V	1U-(1V+1W) 1V-(1W+1U) 1W-(1U+1V)	2U-2N 2V-2N 2W-2N	$\frac{1.5U_1}{U_2}$
18	Dz0			U V W	— — —	1U-1V 1V-1W 1W-1U	2U-2V 2V-2W 2W-2U	$\frac{U_1}{U_2}$
19	Dzn2			U V W	1V-1W 1W-1U 1U-1V	1U-(1V+1W) 1V-(1W+1U) 1W-(1U+1V)	2N-2V 2N-2W 2N-2U	$\frac{1.5U_1}{U_2}$
20	Dz2			U V W	— — —	1U-1V 1V-1W 1W-1U	2W-2V 2U-2W 2V-2U	$\frac{U_1}{U_2}$

**Table 5-3. CEI/IEC 76-1:1993 Transformer Winding Phase Relationship**

Copyright 1999© Megger

Diag No.	IEC Vector Group	Winding Connection		Phase Tested	External Jumpers	Winding Tested		Measured Turn Ratio
		High-Voltage Winding	Low-Voltage Winding			High-Voltage Winding	Low-Voltage Winding	
21	Dzn4			U V W	1V-1W 1W-1U 1U-1V	1U-(1V+1W) 1V-(1W+1U) 1W-(1U+1V)	2W-2N 2U-2N 2V-2N	$\frac{1.5U_1}{U_2}$
22	Dz4			U V W	— — —	1U-1V 1V-1W 1W-1U	2W-2U 2U-2V 2V-2W	$\frac{U_1}{U_2}$
23	Dzn6			U V W	1V-1W 1W-1U 1U-1V	1U-(1V+1W) 1V-(1W+1U) 1W-(1U+1V)	2N-2U 2N-2V 2N-2W	$\frac{1.5U_1}{U_2}$
24	Dz6			U V W	— — —	1U-1V 1V-1W 1W-1U	2V-2U 2W-2V 2U-2W	$\frac{U_1}{U_2}$
25	Dzn8			U V W	1V-1W 1W-1U 1U-1V	1U-(1V+1W) 1V-(1W+1U) 1W-(1U+1V)	2V-2N 2W-2N 2U-2N	$\frac{1.5U_1}{U_2}$
26	Dz8			U V W	— — —	1U-1V 1V-1W 1W-1U	2V-2W 2W-2U 2U-2V	$\frac{U_1}{U_2}$



**Table 5-3. CEI/IEC 76-1:1993 Transformer Winding Phase Relationship**

Copyright 1999© Megger								
Diag No.	IEC Vector Group	Winding Connection		Phase Tested	External Jumpers	Winding Tested		Measured Turn Ratio
		High-Voltage Winding	Low-Voltage Winding			High-Voltage Winding	Low-Voltage Winding	
27	Dzn10			U V W	1V-1W 1W-1U 1U-1V	1U-(1V+1W) 1V-(1W+1U) 1W-(1U+1V)	2N-2W 2N-2U 2N-2V	$\frac{1.5U_1}{U_2}$
28	Dz10			U V W	— — —	1U-1V 1V-1W 1W-1U	2U-2W 2V-2U 2W-2V	$\frac{U_1}{U_2}$
29	YNyn0			U V W	— — —	1U-1N 1V-1N 1W-1N	2U-2N 2V-2N 2W-2N	$\frac{U_1}{U_2}$
30	YNy0			U V W	1V-1N 1W-1N 1U-1N	1U-1N 1V-1N 1W-1N	2U-* 2V-* 2W-*	$\frac{U_1}{U_2}$
31	Yyn0			U V W	— — —	1U-1V 1V-1W 1W-1U	2U-2V 2V-2W 2W-2U	$\frac{U_1}{U_2}$
32	Yy0			U V W	— — —	1U-1V 1V-1W 1W-1U	2U-2V 2V-2W 2W-2U	$\frac{U_1}{U_2}$

**Table 5-3. CEI/IEC 76-1:1993 Transformer Winding Phase Relationship**

Copyright 1999© Megger

Diag No.	IEC Vector Group	Winding Connection		Phase Tested	External Jumpers	Winding Tested		Measured Turn Ratio
		High-Voltage Winding	Low-Voltage Winding			High-Voltage Winding	Low-Voltage Winding	
33	YNyn6			U V W	— — —	1U-1N 1V-1N 1W-1N	2N-2U 2N-2V 2N-2W	$\frac{U_1}{U_2}$
34	YNy6			U V W	1V-1N 1W-1N 1U-1N	1U-1N 1V-1N 1W-1N	*-2U *-2V *-2W	$\frac{U_1}{U_2}$
35	Yyn6			U V W	— — —	1U-1V 1V-1W 1W-1U	2V-2U 2W-2V 2U-2W	$\frac{U_1}{U_2}$
36	Yy6			U V W	— — —	1U-1V 1V-1W 1W-1U	2V-2U 2W-2V 2U-2W	$\frac{U_1}{U_2}$
37	Yzn1			U V W	— — —	1U-1W 1V-1U 1W-1V	2U-2N 2V-2N 2W-2N	$\frac{U_1 \cdot \sqrt{3}}{U_2}$

**Table 5-3. CEI/IEC 76-1:1993 Transformer Winding Phase Relationship**

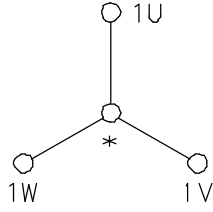
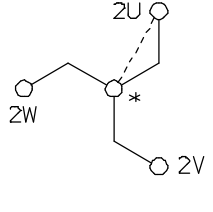
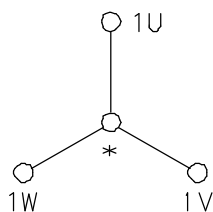
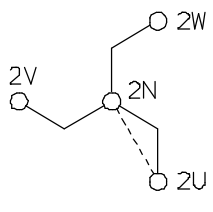
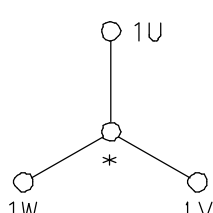
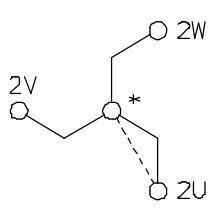
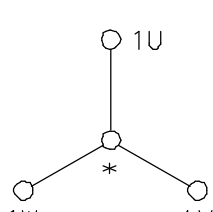
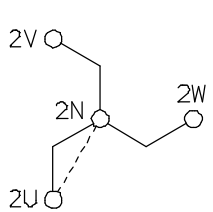
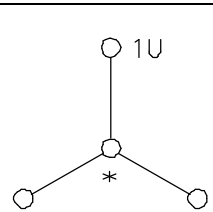
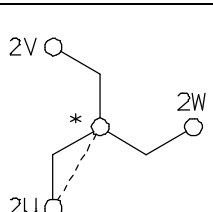
Copyright 1999© Megger								
Diag No.	IEC Vector Group	Winding Connection		Phase Tested	External Jumpers	Winding Tested		Measured Turn Ratio
		High-Voltage Winding	Low-Voltage Winding			High-Voltage Winding	Low-Voltage Winding	
38	Yz1			U V W	1V-1W 1W-1U 1U-1V	1U-(1V+1W) 1V-(1W+1U) 1W-(1U+1V)	2U-2V 2V-2W 2W-2U	$\frac{U_1 \cdot \sqrt{3}}{U_2 \cdot 2}$
39	Yzn5			U V W	— — —	1U-1V 1V-1W 1W-1U	2N-2U 2N-2V 2N-2W	$\frac{U_1 \cdot \sqrt{3}}{U_2}$
40	Yz5			U V W	1V-1W 1W-1U 1U-1V	1U-(1V+1W) 1V-(1W+1U) 1W-(1U+1V)	2W-2U 2U-2V 2V-2W	$\frac{U_1 \cdot \sqrt{3}}{U_2 \cdot 2}$
41	Yzn7			U V W	— — —	1U-1V 1V-1W 1W-1U	2V-2N 2W-2N 2U-2N	$\frac{U_1 \cdot \sqrt{3}}{U_2}$
42	Yz7			U V W	1V-1W 1W-1U 1U-1V	1U-(1V+1W) 1V-(1W+1U) 1W-(1U+1V)	2V-2U 2W-2V 2U-2W	$\frac{U_1 \cdot \sqrt{3}}{U_2 \cdot 2}$

**Table 5-3. CEI/IEC 76-1:1993 Transformer Winding Phase Relationship**

Copyright 1999© Megger

Diag No.	IEC Vector Group	Winding Connection		Phase Tested	External Jumpers	Winding Tested		Measured Turn Ratio
		High-Voltage Winding	Low-Voltage Winding			High-Voltage Winding	Low-Voltage Winding	
43	Yzn11			U V W	— — —	1U-1V 1V-1W 1W-1U	2U-2N 2V-2N 2W-2N	$\frac{U_1 \cdot \sqrt{3}}{U_2}$
44	Yz11			U V W	1V-1W 1W-1U 1U-1V	1U-(1V+1W) 1V-(1W+1U) 1W-(1U+1V)	2U-2W 2V-2U 2W-2V	$\frac{U_1}{U_2} \cdot \frac{\sqrt{3}}{2}$
45	YNd1			U V W	— — —	1U-1N 1V-1N 1W-1N	2U-2V 2V-2W 2W-2U	$\frac{U_1}{U_2 \cdot \sqrt{3}}$
46	Yd1			U V W	1V-1W 1W-1U 1U-1V	1U-(1V+1W) 1V-(1W+1U) 1W-(1U+1V)	2U-2V 2V-2W 2W-2U	$\frac{U_1}{U_2} \cdot \frac{\sqrt{3}}{2}$
47	YNd5			U V W	— — —	1U-1N 1V-1N 1W-1N	2W-2U 2U-2V 2V-2W	$\frac{U_1}{U_2 \cdot \sqrt{3}}$

**Table 5-3. CEI/IEC 76-1:1993 Transformer Winding Phase Relationship**

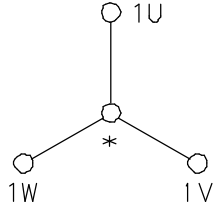
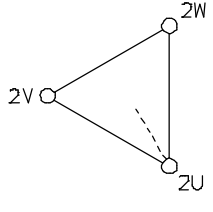
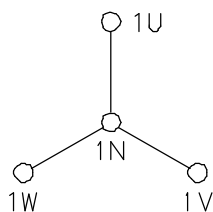
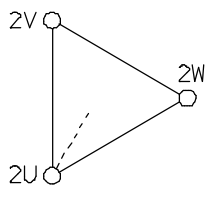
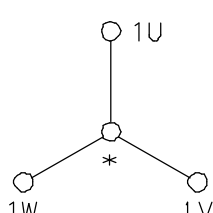
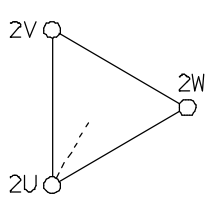
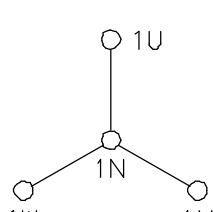
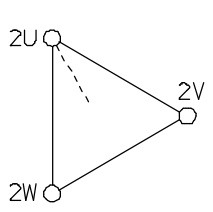
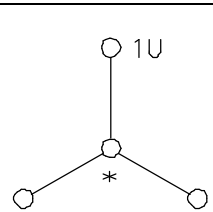
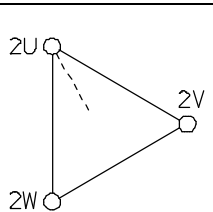
Copyright 1999© Megger								
Diag No.	IEC Vector Group	Winding Connection		Phase Tested	External Jumpers	Winding Tested		Measured Turn Ratio
		High-Voltage Winding	Low-Voltage Winding			High-Voltage Winding	Low-Voltage Winding	
48	Yd5			U V W	1V-1W 1W-1U 1U-1V	1U-(1V+1W) 1V-(1W+1U) 1W-(1U+1V)	2W-2U 2U-2V 2V-2W	$\frac{U_1}{U_2} \cdot \frac{\sqrt{3}}{2}$
49	YNd7			U V W	— — —	1U-1N 1V-1N 1W-1N	2V-2U 2W-2V 2U-2W	$\frac{U_1}{U_2 \cdot \sqrt{3}}$
50	Yd7			U V W	1V-1W 1W-1U 1U-1V	1U-(1V+1W) 1V-(1W+1U) 1W-(1U+1V)	2V-2U 2W-2V 2U-2W	$\frac{U_1}{U_2} \cdot \frac{\sqrt{3}}{2}$
51	YNd11			U V W	— — —	1U-1N 1V-1N 1W-1N	2U-2W 2V-2U 2W-2V	$\frac{U_1}{U_2 \cdot \sqrt{3}}$
52	Yd11			U V W	1V-1W 1W-1U 1U-1V	1U-(1V+1W) 1V-(1W+1U) 1W-(1U+1V)	2U-2W 2V-2U 2W-2V	$\frac{U_1}{U_2} \cdot \frac{\sqrt{3}}{2}$

## Notes to Table 5-4

Transformer terminal markings for power transformers marked in accordance with requirements of Australian Standard 2374, Part 4-1982.

### *Definition of Symbol Designations*

A <sub>2</sub> , B <sub>2</sub> , C <sub>2</sub>	External terminals on HV transformer winding (A <sub>x</sub> , B <sub>x</sub> , C <sub>x</sub> ).
a <sub>2</sub> , b <sub>2</sub> , c <sub>2</sub>	External terminals on LV transformer winding (a <sub>x</sub> , b <sub>x</sub> , c <sub>x</sub> ).
N	External neutral terminal on HV transformer winding.
n	External neutral terminal on LV transformer winding.
*	Inaccessible neutral point on HV or LV transformer winding.
HV	Nameplate voltage rating (line-to-line) of HV transformer winding.
LV	Nameplate voltage rating (line-to-line) of LV transformer winding.
A, B, C	Winding tested on HV side of transformer.
a, b, c	Winding tested on LV side of transformer.

**Table 5-4. Transformer Winding Phase Relationship (Australian Std. 2374, Part 4 - 1982)**

Copyright 1999© Megger

Diag No.	IEC Vector Group	Winding Connection		Phase Tested	External Jumpers	Winding Tested		Measured Turn Ratio
		High-Voltage Winding	Low-Voltage Winding			High-Voltage Winding	Low-Voltage Winding	
1	1φ 1ph0			1φ	—	A <sub>2</sub> - A <sub>1</sub>	a <sub>2</sub> - a <sub>1</sub>	$\frac{HV}{LV}$
2	1φ 1ph6			1φ	—	A <sub>2</sub> - A <sub>1</sub>	a <sub>1</sub> - a <sub>2</sub>	$\frac{HV}{LV}$
3	Dd0			A B C	— — —	A <sub>2</sub> - B <sub>2</sub> B <sub>2</sub> - C <sub>2</sub> C <sub>2</sub> - A <sub>2</sub>	a <sub>2</sub> - b <sub>2</sub> b <sub>2</sub> - c <sub>2</sub> c <sub>2</sub> - a <sub>2</sub>	$\frac{HV}{LV}$
4	Dd6			A B C	— — —	A <sub>2</sub> - B <sub>2</sub> B <sub>2</sub> - C <sub>2</sub> C <sub>2</sub> - A <sub>2</sub>	b <sub>1</sub> - a <sub>1</sub> c <sub>1</sub> - b <sub>1</sub> a <sub>1</sub> - c <sub>1</sub>	$\frac{HV}{LV}$
5	Dyn1			A B C	— — —	A <sub>2</sub> - C <sub>2</sub> B <sub>2</sub> - A <sub>2</sub> C <sub>2</sub> - B <sub>2</sub>	a <sub>2</sub> - n b <sub>2</sub> - n c <sub>2</sub> - n	$\frac{HV \cdot \sqrt{3}}{LV}$
6	Dy1			A B C	B <sub>2</sub> - C <sub>2</sub> C <sub>2</sub> - A <sub>2</sub> A <sub>2</sub> - B <sub>2</sub>	A <sub>2</sub> - C <sub>2</sub> B <sub>2</sub> - A <sub>2</sub> C <sub>2</sub> - B <sub>2</sub>	a <sub>2</sub> - * b <sub>2</sub> - * c <sub>2</sub> - *	$\frac{HV \cdot \sqrt{3}}{LV}$
7	Dyn11			A B C	— — —	A <sub>2</sub> - B <sub>2</sub> B <sub>2</sub> - C <sub>2</sub> C <sub>2</sub> - A <sub>2</sub>	a <sub>2</sub> - n b <sub>2</sub> - n c <sub>2</sub> - n	$\frac{HV \cdot \sqrt{3}}{LV}$

**Table 5-4. Transformer Winding Phase Relationship (Australian Std. 2374, Part 4 - 1982)**

Copyright 1999© Megger

Diag No.	IEC Vector Group	Winding Connection		Phase Tested	External Jumpers	Winding Tested		Measured Turn Ratio
		High-Voltage Winding	Low-Voltage Winding			High-Voltage Winding	Low-Voltage Winding	
8	Dy11			A B C	B <sub>2</sub> - C <sub>2</sub> C <sub>2</sub> - A <sub>2</sub> A <sub>2</sub> - B <sub>2</sub>	A <sub>2</sub> - B <sub>2</sub> B <sub>2</sub> - C <sub>2</sub> C <sub>2</sub> - A <sub>2</sub>	a <sub>2</sub> - * b <sub>2</sub> - * c <sub>2</sub> - *	$\frac{HV \cdot \sqrt{3}}{LV}$
9	Dzn0			A B C	B <sub>2</sub> - C <sub>2</sub> C <sub>2</sub> - A <sub>2</sub> A <sub>2</sub> - B <sub>2</sub>	A <sub>2</sub> - (B <sub>2</sub> +C <sub>2</sub> ) B <sub>2</sub> - (C <sub>2</sub> +A <sub>2</sub> ) C <sub>2</sub> - (A <sub>2</sub> +B <sub>2</sub> )	a <sub>4</sub> - n b <sub>4</sub> - n c <sub>4</sub> - n	$\frac{1.5 HV}{LV}$
10	Dz0			A B C	— — —	A <sub>2</sub> - B <sub>2</sub> B <sub>2</sub> - C <sub>2</sub> C <sub>2</sub> - A <sub>2</sub>	a <sub>4</sub> - b <sub>4</sub> b <sub>4</sub> - c <sub>4</sub> c <sub>4</sub> - a <sub>4</sub>	$\frac{HV}{LV}$
11	Dzn6			A B C	B <sub>2</sub> - C <sub>2</sub> C <sub>2</sub> - A <sub>2</sub> A <sub>2</sub> - B <sub>2</sub>	A <sub>2</sub> - (B <sub>2</sub> +C <sub>2</sub> ) B <sub>2</sub> - (C <sub>2</sub> +A <sub>2</sub> ) C <sub>2</sub> - (A <sub>2</sub> +B <sub>2</sub> )	n - a <sub>3</sub> n - b <sub>3</sub> n - c <sub>3</sub>	$\frac{1.5 HV}{LV}$
12	Dz6			A B C	— — —	A <sub>2</sub> - B <sub>2</sub> B <sub>2</sub> - C <sub>2</sub> C <sub>2</sub> - A <sub>2</sub>	b <sub>3</sub> - a <sub>3</sub> c <sub>3</sub> - b <sub>3</sub> a <sub>3</sub> - c <sub>3</sub>	$\frac{HV}{LV}$
13	YNyn0			A B C	— — —	A <sub>2</sub> - N B <sub>2</sub> - N C <sub>2</sub> - N	a <sub>2</sub> - n b <sub>2</sub> - n c <sub>2</sub> - n	$\frac{HV}{LV}$



# SETUP AND CONNECTIONS

<b>Table 5-4. Transformer Winding Phase Relationship (Australian Std. 2374, Part 4 - 1982)</b>								
Copyright 1999© Megger								
Diag No.	IEC Vector Group	Winding Connection		Phase Tested	External Jumpers	Winding Tested		Measured Turn Ratio
		High-Voltage Winding	Low-Voltage Winding			High-Voltage Winding	Low-Voltage Winding	
14	YNy0			A B C	B <sub>2</sub> - N C <sub>2</sub> - N A <sub>2</sub> - N	A <sub>2</sub> - N B <sub>2</sub> - N C <sub>2</sub> - N	a <sub>2</sub> - * b <sub>2</sub> - * c <sub>2</sub> - *	HV LV
15	Yyn0			A B C	— — —	A <sub>2</sub> - B <sub>2</sub> B <sub>2</sub> - C <sub>2</sub> C <sub>2</sub> - A <sub>2</sub>	a <sub>2</sub> - b <sub>2</sub> b <sub>2</sub> - c <sub>2</sub> c <sub>2</sub> - a <sub>2</sub>	HV LV
16	Yy0			A B C	— — —	A <sub>2</sub> - B <sub>2</sub> B <sub>2</sub> - C <sub>2</sub> C <sub>2</sub> - A <sub>2</sub>	a <sub>2</sub> - b <sub>2</sub> b <sub>2</sub> - c <sub>2</sub> c <sub>2</sub> - a <sub>2</sub>	HV LV
17	YNyn6			A B C	— — —	A <sub>2</sub> - N B <sub>2</sub> - N C <sub>2</sub> - N	n - a <sub>1</sub> n - b <sub>1</sub> n - c <sub>1</sub>	HV LV
18	YNy6			A B C	B <sub>2</sub> - N C <sub>2</sub> - N A <sub>2</sub> - N	A <sub>2</sub> - N B <sub>2</sub> - N C <sub>2</sub> - N	* - a <sub>1</sub> * - b <sub>1</sub> * - c <sub>1</sub>	HV LV
19	Yyn6			A B C	— — —	A <sub>2</sub> - B <sub>2</sub> B <sub>2</sub> - C <sub>2</sub> C <sub>2</sub> - A <sub>2</sub>	b <sub>1</sub> - a <sub>1</sub> c <sub>1</sub> - b <sub>1</sub> a <sub>1</sub> - c <sub>1</sub>	HV LV

**Table 5-4. Transformer Winding Phase Relationship (Australian Std. 2374, Part 4 - 1982)**

Copyright 1999© Megger

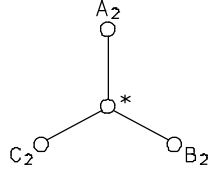
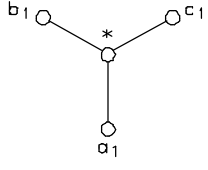
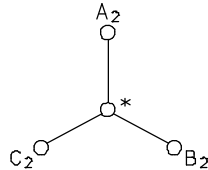
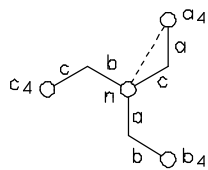
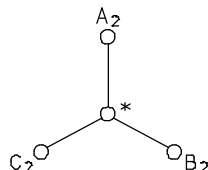
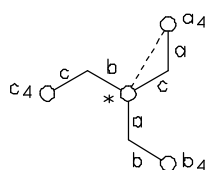
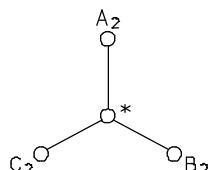
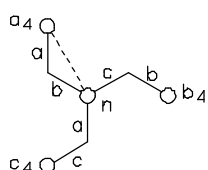
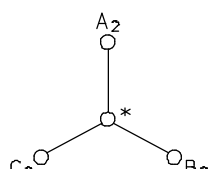
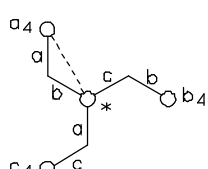
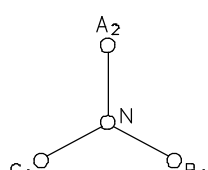
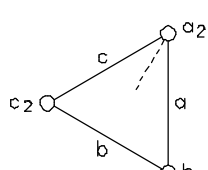
Diag No.	IEC Vector Group	Winding Connection		Phase Tested	External Jumpers	Winding Tested		Measured Turn Ratio
		High-Voltage Winding	Low-Voltage Winding			High-Voltage Winding	Low-Voltage Winding	
20	Yy6			A B C	— — —	A <sub>2</sub> - B <sub>2</sub> B <sub>2</sub> - C <sub>2</sub> C <sub>2</sub> - A <sub>2</sub>	b <sub>1</sub> - a <sub>1</sub> c <sub>1</sub> - b <sub>1</sub> a <sub>1</sub> - c <sub>1</sub>	$\frac{HV}{LV}$
21	Yzn1			A B C	— — —	A <sub>2</sub> - C <sub>2</sub> B <sub>2</sub> - A <sub>2</sub> C <sub>2</sub> - B <sub>2</sub>	a <sub>4</sub> - n b <sub>4</sub> - n c <sub>4</sub> - n	$\frac{HV \cdot \sqrt{3}}{LV}$
22	Yz1			A B C	B <sub>2</sub> - C <sub>2</sub> C <sub>2</sub> - A <sub>2</sub> A <sub>2</sub> - B <sub>2</sub>	A <sub>2</sub> - (B <sub>2</sub> + C <sub>2</sub> ) B <sub>2</sub> - (C <sub>2</sub> + A <sub>2</sub> ) C <sub>2</sub> - (A <sub>2</sub> + B <sub>2</sub> )	a <sub>4</sub> - b <sub>4</sub> b <sub>4</sub> - c <sub>4</sub> c <sub>4</sub> - a <sub>4</sub>	$\frac{HV}{LV} \cdot \frac{\sqrt{3}}{2}$
23	Yzn11			A B C	— — —	A <sub>2</sub> - B <sub>2</sub> B <sub>2</sub> - C <sub>2</sub> C <sub>2</sub> - A <sub>2</sub>	a <sub>4</sub> - n b <sub>4</sub> - n c <sub>4</sub> - n	$\frac{HV \cdot \sqrt{3}}{LV}$
24	Yz11			A B C	B <sub>2</sub> - C <sub>2</sub> C <sub>2</sub> - A <sub>2</sub> A <sub>2</sub> - B <sub>2</sub>	A <sub>2</sub> - (B <sub>2</sub> + C <sub>2</sub> ) B <sub>2</sub> - (C <sub>2</sub> + A <sub>2</sub> ) C <sub>2</sub> - (A <sub>2</sub> + B <sub>2</sub> )	a <sub>4</sub> - c <sub>4</sub> b <sub>4</sub> - a <sub>4</sub> c <sub>4</sub> - b <sub>4</sub>	$\frac{HV}{LV} \cdot \frac{\sqrt{3}}{2}$
25	YNd1			A B C	— — —	A <sub>2</sub> - N B <sub>2</sub> - N C <sub>2</sub> - N	a <sub>2</sub> - b <sub>2</sub> b <sub>2</sub> - c <sub>2</sub> c <sub>2</sub> - a <sub>2</sub>	$\frac{HV}{LV \cdot \sqrt{3}}$

<b>Table 5-4. Transformer Winding Phase Relationship (Australian Std. 2374, Part 4 - 1982)</b>								
Copyright 1999© Megger								
Diag No.	IEC Vector Group	Winding Connection		Phase Tested	External Jumpers	Winding Tested		Measured Turn Ratio
		High-Voltage Winding	Low-Voltage Winding			High-Voltage Winding	Low-Voltage Winding	
26	Yd1			A B C	B <sub>2</sub> - C <sub>2</sub> C <sub>2</sub> - A <sub>2</sub> A <sub>2</sub> - B <sub>2</sub>	A <sub>2</sub> - (B <sub>2</sub> +C <sub>2</sub> ) B <sub>2</sub> - (C <sub>2</sub> +A <sub>2</sub> ) C <sub>2</sub> - (A <sub>2</sub> +B <sub>2</sub> )	a <sub>2</sub> - b <sub>2</sub> b <sub>2</sub> - c <sub>2</sub> c <sub>2</sub> - a <sub>2</sub>	$\frac{HV}{LV} \cdot \frac{\sqrt{3}}{2}$
27	YNd11			A B C	— — —	A <sub>2</sub> - N B <sub>2</sub> - N C <sub>2</sub> - N	a <sub>2</sub> - c <sub>2</sub> b <sub>2</sub> - a <sub>2</sub> c <sub>2</sub> - b <sub>2</sub>	$\frac{HV}{LV \cdot \sqrt{3}}$
28	Yd11			A B C	B <sub>2</sub> - C <sub>2</sub> C <sub>2</sub> - A <sub>2</sub> A <sub>2</sub> - B <sub>2</sub>	A <sub>2</sub> - (B <sub>2</sub> +C <sub>2</sub> ) B <sub>2</sub> - (C <sub>2</sub> +A <sub>2</sub> ) C <sub>2</sub> - (A <sub>2</sub> +B <sub>2</sub> )	a <sub>2</sub> - c <sub>2</sub> b <sub>2</sub> - a <sub>2</sub> c <sub>2</sub> - b <sub>2</sub>	$\frac{HV}{LV} \cdot \frac{\sqrt{3}}{2}$
29	ZNd0			A B C	b <sub>2</sub> - c <sub>2</sub> c <sub>2</sub> - a <sub>2</sub> a <sub>2</sub> - b <sub>2</sub>	A <sub>4</sub> - N B <sub>4</sub> - N C <sub>4</sub> - N	a <sub>2</sub> - (b <sub>2</sub> +c <sub>2</sub> ) b <sub>2</sub> - (c <sub>2</sub> +a <sub>2</sub> ) c <sub>2</sub> - (a <sub>2</sub> +b <sub>2</sub> )	$\frac{HV}{1.5 LV}$
30	Zd0			A B C	— — —	A <sub>4</sub> - B <sub>4</sub> B <sub>4</sub> - C <sub>4</sub> C <sub>4</sub> - A <sub>4</sub>	a <sub>2</sub> - b <sub>2</sub> b <sub>2</sub> - c <sub>2</sub> c <sub>2</sub> - a <sub>2</sub>	$\frac{HV}{LV}$
31	ZNd6			A B C	b <sub>1</sub> - c <sub>1</sub> c <sub>1</sub> - a <sub>1</sub> a <sub>1</sub> - b <sub>1</sub>	A <sub>4</sub> - N B <sub>4</sub> - N C <sub>4</sub> - N	(b <sub>1</sub> +c <sub>1</sub> ) - a <sub>1</sub> (c <sub>1</sub> +a <sub>1</sub> ) - b <sub>1</sub> (a <sub>1</sub> +b <sub>1</sub> ) - c <sub>1</sub>	$\frac{HV}{1.5 LV}$

**Table 5-4. Transformer Winding Phase Relationship (Australian Std. 2374, Part 4 - 1982)**

Copyright 1999© Megger

Diag No.	IEC Vector Group	Winding Connection		Phase Tested	External Jumpers	Winding Tested		Measured Turn Ratio
		High-Voltage Winding	Low-Voltage Winding			High-Voltage Winding	Low-Voltage Winding	
32	Zd6			A B C	— — —	A <sub>4</sub> - C <sub>4</sub> B <sub>4</sub> - A <sub>4</sub> C <sub>4</sub> - B <sub>4</sub>	b <sub>1</sub> - a <sub>1</sub> c <sub>1</sub> - b <sub>1</sub> a <sub>1</sub> - c <sub>1</sub>	$\frac{HV}{LV}$
33	ZNy1			A B C	— — —	A <sub>4</sub> - N B <sub>4</sub> - N C <sub>4</sub> - N	a <sub>2</sub> - b <sub>2</sub> b <sub>2</sub> - c <sub>2</sub> c <sub>2</sub> - a <sub>2</sub>	$\frac{HV}{LV \cdot \sqrt{3}}$
34	Zy1			A B C	B <sub>4</sub> - C <sub>4</sub> C <sub>4</sub> - A <sub>4</sub> A <sub>4</sub> - B <sub>4</sub>	A <sub>4</sub> - (B <sub>4</sub> +C <sub>4</sub> ) B <sub>4</sub> - (C <sub>4</sub> +A <sub>4</sub> ) C <sub>4</sub> - (A <sub>4</sub> +B <sub>4</sub> )	a <sub>2</sub> - b <sub>2</sub> b <sub>2</sub> - c <sub>2</sub> c <sub>2</sub> - a <sub>2</sub>	$\frac{HV}{LV} \cdot \frac{\sqrt{3}}{2}$
35	ZNy11			A B C	— — —	A <sub>4</sub> - N B <sub>4</sub> - N C <sub>4</sub> - N	a <sub>2</sub> - c <sub>2</sub> b <sub>2</sub> - a <sub>2</sub> c <sub>2</sub> - b <sub>2</sub>	$\frac{HV}{LV \cdot \sqrt{3}}$
36	Zy11			A B C	B <sub>4</sub> - C <sub>4</sub> C <sub>4</sub> - A <sub>4</sub> A <sub>4</sub> - B <sub>4</sub>	A <sub>4</sub> - (B <sub>4</sub> +C <sub>4</sub> ) B <sub>4</sub> - (C <sub>4</sub> +A <sub>4</sub> ) C <sub>4</sub> - (A <sub>4</sub> +B <sub>4</sub> )	a <sub>2</sub> - c <sub>2</sub> b <sub>2</sub> - a <sub>2</sub> c <sub>2</sub> - b <sub>2</sub>	$\frac{HV}{LV} \cdot \frac{\sqrt{3}}{2}$

# 6

## OPERATION

### *General Operating Procedure*

Proceed only after reading and fully understanding Section 2, Safety, and setting up the test set as described. An operator who is familiar with the contents of this manual, the test setup, and the operation of the test set may follow the condensed operating instructions provided with the test set.

#### **EMERGENCY SHUTDOWN**

**(Removal of Test Voltage from device being tested.)**

**Press any alphanumeric button or special function button on the keypad to terminate test or turn power off (RED KEY).**

**Note: "On" button and "backlight switch" button will NOT interrupt test or turn off power.**

### *Description of Menus and Test Screens*

Data shown on the menus and test screens in Figures 6-1 through 6-14 are for illustrative purposes only. The TTR test set menus and test screens are operated by using the keypad. On power up, the test set performs a self-test check, and all hardware and software variables are initialized.

## Opening Display Screen

The LCD displays the opening screen (Figure 6-1) as the test set performs a diagnostic self-check of the electronics.

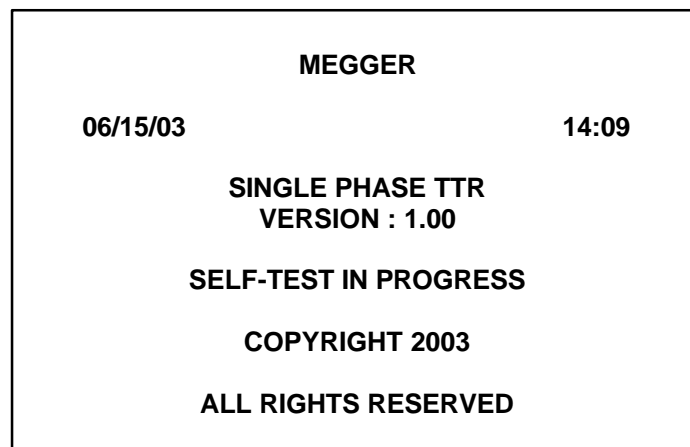

*Figure 6-1. Opening Display Screen*

If at power-up self-testing any errors are detected, one of the error messages listed in the ERROR MESSAGES section will be displayed on the screen.

If no errors are detected, the main menu screen (Figure 6-2) appears.

---

## MAIN MENU Screen

After a successful self-test check, the main menu screen (Figure 6-2) appears.

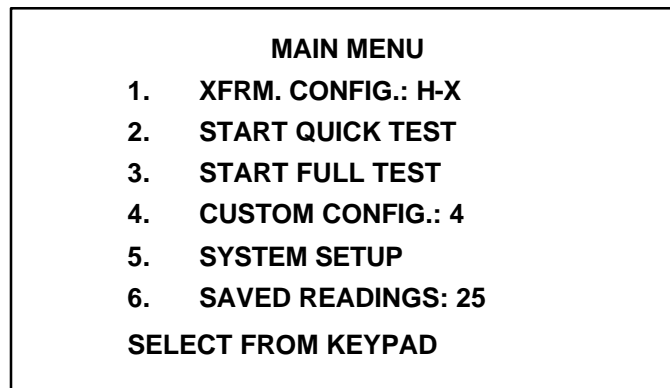
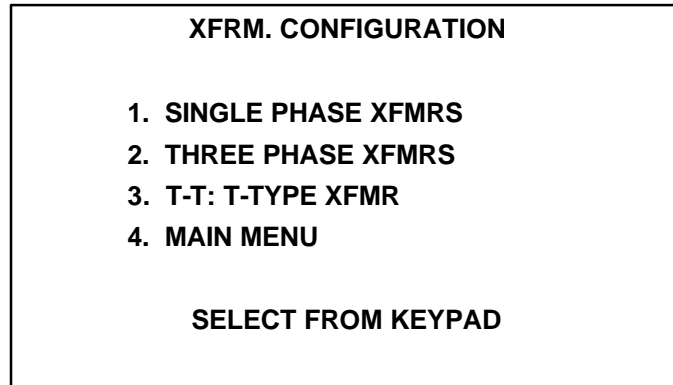

Figure 6-2. Main Menu Screen

- |                            |  |
|----------------------------|--|
| <b>1. XFRM. CONFIG.</b>    | Allows operator to select single phase, three phase, or T-T transformer to be tested. The lead connections will be shown on test setup screen for selected single phase transformer. For 3 phase and T-T transformers, the lead connections are shown for each tested phase. Currently selected transformer configuration is displayed after colon mark. |
| <b>2. START QUICK TEST</b> | Allows operator to perform testing with minimal steps and data entries.  |
| <b>3. START FULL TEST</b>  | Allows full testing of transformer. Test report includes transformer nameplate data, calculated and measured turn ratio, ratio deviation (%), phase displacement, polarity, IEC vector group (1PH0 or 1PH6), and winding resistance.   |
| <b>4. CUSTOM CONFIGS.:</b> | Allows complete testing as per <b>START FULL TEST</b> using up to 100 stored configurations. Custom configurations are input by operator. The number of stored custom configurations is displayed after colon mark.  |
| <b>5. SYSTEM SETUP</b>     | This menu permits choice of transformer standards, phase display units, resistance and polarity display, language and setting of date and time.  |
| <b>6. SAVED READINGS:</b>  | Allows viewing, deleting, printing or uploading to PC up to 200 saved test results. The number of saved readings is displayed after colon mark.  |

## TRANSFORMER CONFIGURATION Screen

If 1 (XFRM. CONFIG.) is selected on the main menu, the XFRM. CONFIGURATION screen (Figure 6-3) appears.



*Figure 6-3. Transformer Configuration Screen*

From this screen one can select the type of transformers to test or return to the Main Menu screen.

By selecting #1, various single-phase transformer configurations will be displayed on the screen. For example: H-X: No taps, a single-phase transformer with no taps on either windings; H-X2: a single phase transformer with two secondary windings (distribution transformer), and etc. One can return to the Previous Menu by selecting #5, or select additional single-phase transformer types by selecting 6. Refer to Figure 6-4 & Figure 6-4a.

A connection diagram for a single phase transformer will be displayed on the screen after a transformer type has been selected for test. From this screen the displayed diagram can be selected, by pressing the enter button, or using the scroll buttons other transformer diagrams are displayed that can be selected.

***NOTE: The displayed diagrams provide wiring information only. They are not intended to provide physical location of bushing and or terminals of the transformer being tested.***

By selecting #2, various three phase transformer configurations will be displayed on the screen. For example: Y-Y, Y-D, D-D and etc., Refer to Figure 6-5.

Selecting a three phase transformer type the screen will display various vector groups for the selected configuration, refer to Figure 6-5a. for vector groups of a Y - Y transformer type.



Having selected the appropriate vector group, the MAIN MENU screen, Figure 6-2, with the selected transformer configuration / type is displayed.

By selecting #3, various “T” type transformer configurations will be displayed on the screen. For example: T-T0, T-T30 Lag or T-T30 Lead. Refer to Figure 6-6.

Having selected the appropriate T type transformer, the MAIN MENU screen, Figure 6-2, with the selected transformer configuration/type is displayed.

Selecting #4, the Main Menu screen, Figure 6-2 will be displayed.

*NOTE: One can also return to the Main Menu screen by depressing the asterisk button on the keypad. Depressing the asterisk button from any screen, will revert to the Main Menu screen.*

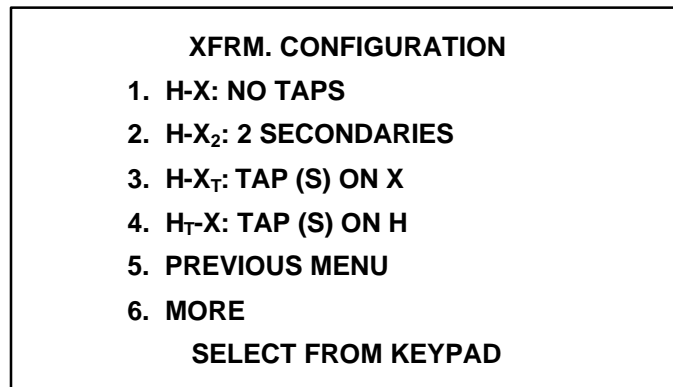

Figure 6-4. Single Phase Transformer Configuration Screen

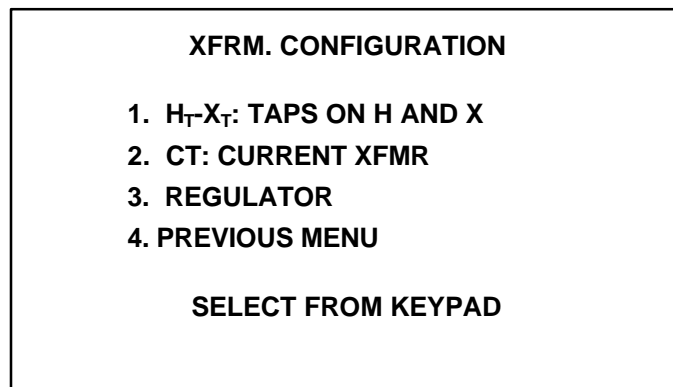

Figure 6-4a. Additional Single Phase Transformer Configuration Screen (when 6. MORE is selected on the screen shown in Figure 6-4)

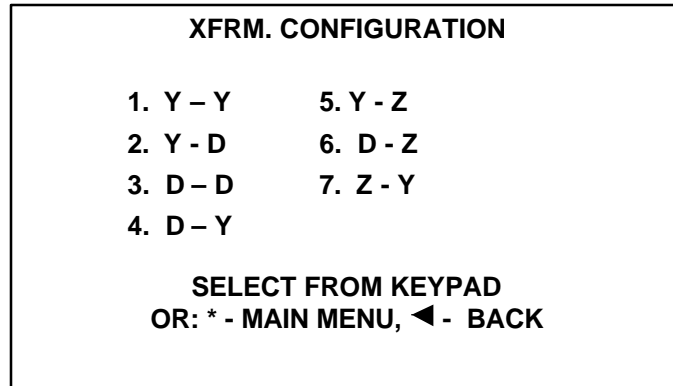

Figure 6-5. Three Phase Transformer Configuration Screen

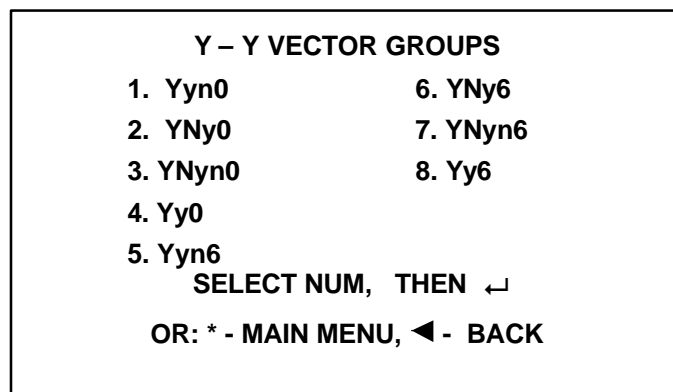

Figure 6-5a. Three Phase Transformer Configuration Screen

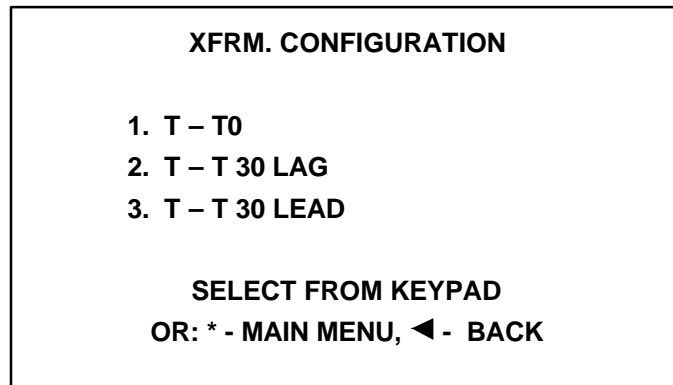

Figure 6-6. T - Type Transformer Configuration Screen

Having selected the transformer type to test, return to the Main Menu screen and select type of test to perform, Quick or Full test.

## Quick Test Single Phase Transformer

Upon selecting Quick test for a single-phase type transformer, and with the TTR100 connected as indicated by the connection diagram that was previously displayed when the transformer type was selected, a XFMR Rating screen, shown in Figure 6-7, appears (if polarity test was selected for ANSI standard). Select the number which is appropriate for the transformer being tested. After the selection, a TEST IN PROGRESS screen appears.

**XFMR RATING**

1. P>200 KVA H>8660V
2. P>200KVA H<=8660V
3. P<=200KVA H<=8660V
4. P<=200KVA H>8660V
5. MAIN MENU

**SELECT FROM KEYPAD**

Figure 6-7. Transformer Rating Screen

A test number will be displayed in the upper left hand corner of the screen that can be used as a reference for the test being conducted. Also, a Stop message is displayed on the lower portion of the screen. "PRESS ANY KEY TO STOP TEST."

At the completion of the test, TEST RESULT 1 screen is displayed containing the measured turn ratio, ratios for multiple windings, and polarity (additive or subtractive) of the transformer, if function is activated on the SYSTEM SETUP menu. Letter "A" or "S" in the parentheses indicates the expected polarity of the transformer.

TEST RESULT 2 screen is displayed by pressing the right scroll key, containing the following information: Test Number, Vector Group, Phase displacement between high side and low side windings, Excitation current (no-load), DC winding resistance of the high side and the low side(s), if function is activated on the SYSTEM SETUP menu. When "N/A" is displayed for resistance, it means the resistance value is above the specified range.

Pressing 1 in the TEST RESULT 2 screen, one can provide HEADER information such as, Company name, Substation name or location, Manufacturer name, Transformer rating, Temperature, %RH and Operator's name. This information will be available for the test report when printed. In addition, one can print the HEADER from this screen or return to TEST RESULT 2 screen.

From the TEST RESULT 2 screen, one can also select the following by pressing the appropriate number: Print the test result (on an optional printer) by selecting 2, Store the test result (for future viewing and / or printing and / or uploading to a PC) by selecting 3, Re-test by selecting 4, return to TEST RESULT 1 screen by selecting the left scroll key, or return to the MAIN MENU by pressing the asterisk key. Returning to the MAIN MENU screen will erase any test results that have been accumulated but have not been saved.

TEST RESULT 2 screen will not be available for transformers such as, CTs, regulators and tapped winding(s). However, all the above-mentioned information (except polarity) will be found on the TEST RESULT 1 screen.

## ***Quick Test Three Phase Transformer***

A screen, containing connection information in text form, will be displayed for each phase when testing a three phase transformer in the Quick test mode. Connect the TTR100 test leads to the transformer to be tested as per the information displayed and press 1 to start test or press 2 to return to the previous screen.

At the completion of the test, TEST RESULT 1 screen is displayed containing the measured turns ratio for the phase being tested, in addition to a test number.

TEST RESULT 2 screen will be displayed by pressing the right scroll key. Vector group, Excitation current (no-load), and Phase displacement results are displayed. From this screen one can return to the TEST RESULT 1 screen, go to the TEST RESULT 3 screen, or return to the MAIN MENU screen by selecting the appropriate displayed key. Returning to the MAIN MENU screen will erase any test results that have been accumulated during the test.

TEST RESULT 3 screen displays DC winding resistance of the high side and the low side windings, provided that the function is activated. From this screen one can re-test the phase, continue testing the other phases, return back to the previous TEST RESULT screen, or return to the MAIN MENU screen by selecting the appropriate displayed key.

Selecting CONTINUE, phase B connection information will be displayed. The testing of phase B will begin by selecting 1 and the results are displayed in TEST RESULTS 1, 2 & 3, as mentioned above. Phase C will be tested by selecting CONTINUE and then the number 1. The results are also displayed as they were displayed for phase A and B.

Selecting CONTINUE at the conclusion of the Phase C test, one can provide HEADER information, PRINT header and the test results, STORE the test results, continue with the *NEXT TEST* if testing a tapped transformer, or return to either the previous TEST RESULT screen or to the MAIN MENU.

---

## ***Quick Test T-Type Transformers***

A screen, containing connection information in text form, will be displayed for each phase when testing a T- type transformer in the Quick test mode. Connect the TTR100 test leads to the transformer to be tested as per the information displayed and press 1 to start test or press 2 to return to the previous screen.

At the completion of the test, TEST RESULT 1 screen is displayed containing the measured turn ratio for the phase being tested, in addition to a test number.

TEST RESULT 2 screen will be displayed by pressing the right scroll key. Vector group, Excitation current (no-load), and Phase displacement results are displayed. From this screen one can return to the TEST RESULT 1 screen, go to the TEST RESULT 3 screen, or return to the MAIN MENU screen by selecting the appropriate displayed key. Returning to the MAIN MENU screen will erase any test results that have been accumulated.

TEST RESULT 3 screen displays DC winding resistance of the high side and the low side windings, provided that the function is activated. From this screen one can re-test the phase, continue testing the other phase, return back to the previous TEST RESULT screen, or return to the MAIN MENU screen by selecting the appropriate displayed key.

Selecting CONTINUE, Phase B connection information will be displayed. The testing of phase B will begin by selecting 1 and the results are displayed in TEST RESULTS 1, 2 & 3, as mentioned above.

Selecting CONTINUE at the conclusion of the Phase B test, one can provide HEADER information, PRINT header and the test results, STORE the test results, or return to either the previous TEST RESULT screen or to the MAIN MENU.

## Full Test Single Phase Transformer

Upon selecting Full test for a single-phase type transformer, and with the TTR100 connected as indicated by the connection diagram that was previously displayed when the transformer type was selected, a test setup screen appears. The last tested transformer information (previously entered) is displayed on the screen.

Refer to Figure 6-8.

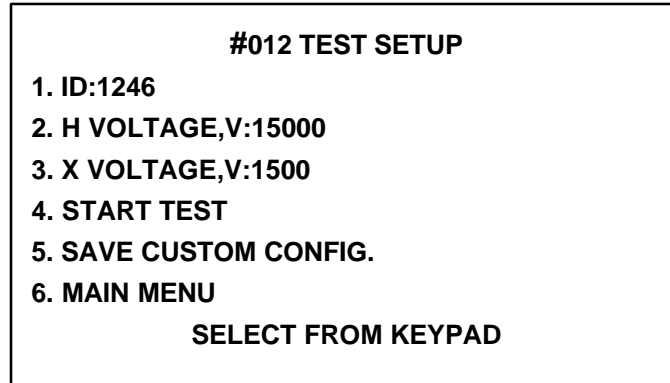

Figure 6-8. TEST SETUP Screen

Prior to testing, enter the ID number of the transformer to be tested by selecting 1. Once the ID information is entered, depress the ENTER key to accept the information. Next enter the H & X voltages (line-to-line) and accept the values with the enter key. The voltage values will be used in calculating the turns ratio and then compared with the measured value to determine the % deviation. At this point, one can start the test by selecting 4, or save the entered information as custom configuration for future use by selecting 5.

*NOTE: In the event that the configuration of the transformer to be tested had been previously saved, one would first select 4 CUSTOM CONFIGS., from the MAIN MENU, followed by 1, from the CUSTOM CONFIGS. menu and finally the appropriate configuration is selected from the stored configurations within the TTR100.*

Selecting 4, from the TEST SETUP menu, will start the test and a screen, shown in Figure 6-6 appears. After selecting a transformer rating, a TEST IN PROGRESS screen appears.

A test number will be displayed in the upper left hand corner of the screen that can be used as a reference for the test being conducted. The H & X voltages are displayed and a Stop message is displayed on the lower portion of the screen. "PRESS ANY KEYS TO STOP TEST."

At the completion of the test, TEST RESULT 1 screen is displayed containing the test number, the ID number, the calculated turns ratio, measured turns ratio, ratios for multiple windings, the % Deviation, and polarity (additive or subtractive) of the transformer, if function is activated. Letter "A" or "S" in the parentheses indicates the expected polarity of the transformer.

TEST RESULT 2 screen is displayed by pressing the right scroll key. It contains the following information: Test Number, Vector Group, Phase displacement between high side and low side windings, Excitation current (no-load), DC winding resistance of the high side and the low side(s), if function is activated.

Pressing 1 in the TEST RESULT 2 screen, one can provide HEADER information such as, Company name, Substation name or location, Manufacturer name, Transformer rating, Temperature, %RH and Operator's name. This information will be available for the test report when printed. In addition, one can print the HEADER from this screen or return to TEST RESULT 2 screen.

From the TEST RESULT 2 screen, one can also select the following by pressing the appropriate number: Print the test result by selecting 2, Store the test result by selecting 3, Re-test by selecting 4, return to TEST RESULT 1 screen by selecting the left scroll key, or return to the MAIN MENU by pressing the asterisk key. Returning to the MAIN MENU screen will erase any test results that have been accumulated but not saved.

### **Full Test Single Phase Tapped Transformer**

When testing tapped transformers, the procedure will be the same as described above. However, additional information will be requested in the various Test Setup screens such as: number of taps, nominal tap number, highest tap number and etc. TTR100 accepts letter, numeric and R-N-L (for the tap changers) designation of the taps on both H and X side of transformer. Should an error be made in entering the information, select the associated information number and re-enter the information. The voltages at the taps to be tested are displayed on the screen.

At the conclusion of the test, store the test result prior to testing the next tap. Otherwise the test results will be lost. A different test number will identify each tap test results, however the transformer ID will remain the same based on the information provided in the header information.

To test other taps, select 5 "Next Test" on TEST RESULT 2 screen. Additional TEST SETUP screens will be displayed. Select 2, and enter the number of the tap to be tested, followed by 3. Start Test. Continue this process until all of the taps have been tested.

## Full Test CTs

When testing CTs, follow the same procedure as indicated for single-phase transformers. Selecting Full Test, a set up screen will be displayed requesting information such as device ID, Primary amps and etc. Once the information has been provided, one can store the configuration for future use. If one selects not to store the configuration, select Start Test.

A test in progress screen will be displayed, followed by a TEST RESULT 1 screen. This screen contains Test Number, ID number, Primary & Secondary amps, calculated and measured ratios and % deviation.

TEST RESULT 2 screen is displayed when the right scroll key is selected and the following results are shown: Test voltage (8 or 1.5 Vrms), Vector Group, DC winding resistance of low side, phase displacement and Excitation current. From this screen the Header information can be entered, test results can be Printed or Stored, the CT can be RE-TESTED or one can return to the PREVIOUS or Main Menu.

## Full Test Regulator

When testing regulators, follow the same procedure as indicated for single-phase transformers. Selecting Full Test, a TEST SETUP screen will be displayed requesting device ID and H VOLTAGE value information. Select CONTINUE once the requested information has been entered. A second TEST SETUP screen will be displayed requesting X VOLTAGE value and number / quantity of TAPS associated with the device being tested. Select CONTINUE once the requested information has been entered. An additional TEST SETUP screen will be displayed with the provided information. At this point, one can modify the entered information, save to custom configs, return to the Main Menu or START TEST.

Selecting Start Test, a test in progress screen is displayed showing the test and ID numbers, as well as the H & X voltage values that were entered. TEST RESULT 1 screen will be displayed at the end of test, showing the CALCULATED & Measured ratios, % DEVIATION, POLARITY and the previously mentioned information.

TEST RESULT 2 screen contains the VECTOR GROUP, Phase displacement between windings, EXCITATION current, at no load, and DC winding resistances, if function is activated. Also, from this screen the HEADER information can be entered and then printed, test results PRINTED or STORED, device RE-TESTED, or return to the TEST RESULT 1 screen or MAIN MENU.



---

## Custom Configurations

Up to 100 custom transformer configurations, test plans, can be stored in the TTR100. The CUSTOM CONFIGS. screen is accessed by selecting 4, CUSTOM CONFIGS., on the Main Menu. The number of stored configurations is indicated on the Main Menu. Refer to Figure 6-9 for the CUSTOM CONFIGS. screen.

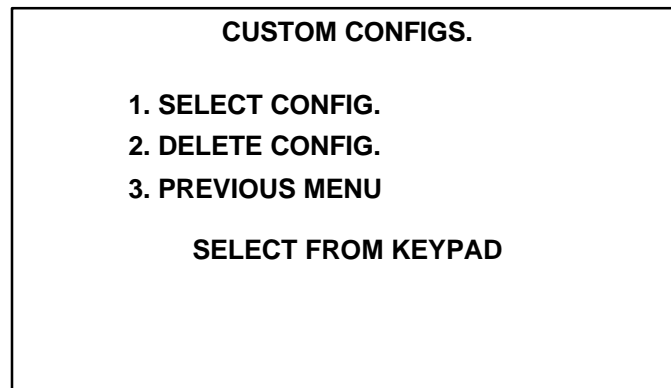

Figure 6-9. Custom Configs. Screen

To select a specific configuration, select 1, SELECT CONFIG. Numerous screens with the stored configurations may be available. The configurations are stored in ascending order of IDs. Scroll through the screens by using the left & right scroll keys until the desired configuration appears. To select the configuration, choose the associated number and press the ENTER key. All saved transformer information will be displayed on FULL TEST screen(s).

To delete a specific configuration, select 2, DELETE CONFIG. Numerous screens listing stored configurations may be available. Scroll through the screens by using the left & right scroll keys until the desired configuration appears. To delete a configuration, choose the associated number and press the ENTER key. The TTR100 will ask if the selected configuration is to be deleted? Enter 0 for NO, and 1 for YES.

### NOTES:

1. *CUSTOM CONFIGURATIONS can be saved when conducting a FULL TEST on devices.*
2. *If transformer ID number and transformer configuration exceeds 18 characters, the transformer configuration is NOT displayed on the CUSTOM CONFIGURATION screen. Only the transformer ID will be displayed.*

---

## SYSTEM SETUP

When selection 4, SYSTEM SETUP, on the MAIN MENU is chosen, the SYSTEM SETUP MENU screen appears as shown in Figure 6-10.

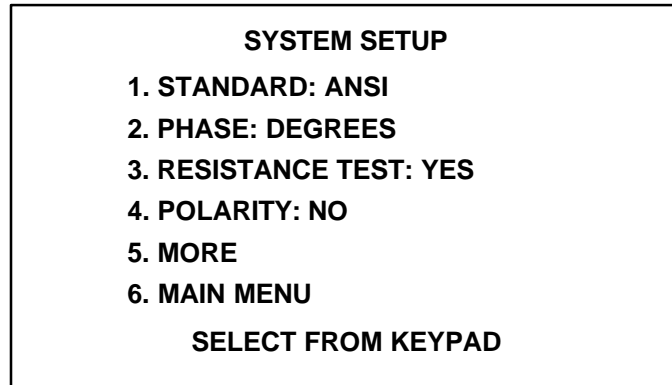

*Figure 6-10. SYSTEM SETUP Screen 1*

1. **STANDARD:** This selection is for entering the desired transformer standard. Three transformer standards are available to select from: ANSI, IEC, or AS (Australia Standard). Selecting 1 and using the scroll keys until the appropriate standard appears on the screen choose the desired standard by depressing the ENTER key.
2. **PHASE:** This selection allows a choice of the phase display units: DEGREES, CENTIRADS or NONE. If DEGREES is selected, any phase test results below 1 degree will be displayed in minutes. If CENTIRADS is selected, the phase test results will be displayed in centiradians (1 centiradian = 0.573 degrees). If NONE is selected, the phase test results will not be displayed. ). Selecting 2 and using the scroll keys until the appropriate unit or none appears on the screen choose the entry by depressing the ENTER key.
3. **RESISTANCE TEST:** DC winding resistance function can either be active (YES) or inactive (NO). Selecting 3 and using the scroll keys until the appropriate functional state is displayed on the screen choose the desired state by depressing the ENTER key.
4. **POLARITY:** Polarity test function can either be active (YES) or inactive (NO). Selecting 4 and using the scroll keys until the appropriate functional state is displayed on the screen choose the desired state by depressing the ENTER key.
5. **MORE:** Selecting 4, an additional SYSTEM SETUP screen is displayed, Refer to Figure 6-11.

6. MAIN MENU: Selecting 6 or asterisk, will return one to the MAIN MENU screen.

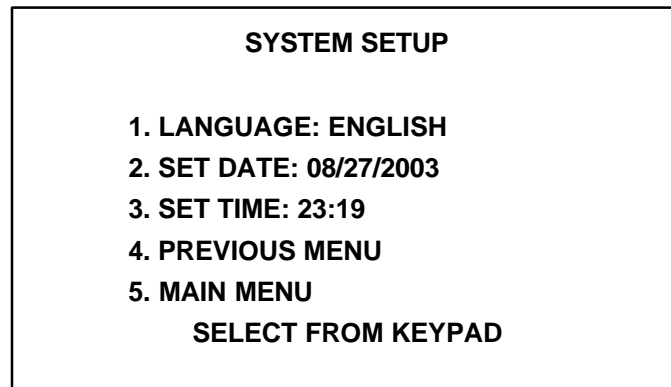
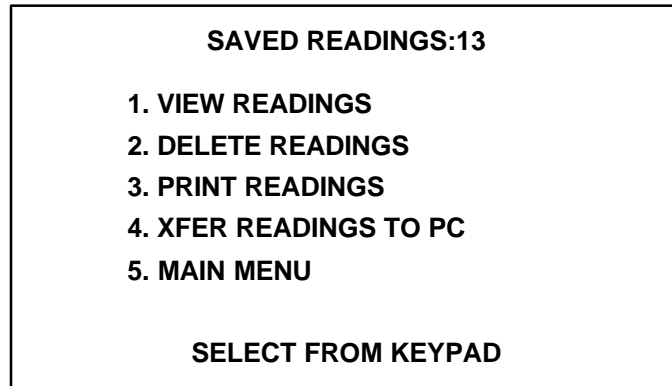

Figure 6-11. SYSTEM SETUP Screen 2

7. LANGUAGE: This selection allows a choice of six languages; English, French, Spanish, Portuguese, German and Italian. To chose a language, merely select the number associated with the desired language. Text on all screens except for the opening display screen will appear in the language chosen.
8. SET DATE: This selection is for entering the date. Year has four-digit representation (mm/dd/yyyy). To set the date, select 2 and a curser will be flashing on the leading digit of the month if mm/dd/yyyy format used, or curser will be flashing on the leading digit of the day if dd/mm/yyyy format is used. The month or day is adjusted by using the scroll keys. Once the correct month or day is displayed, depress the ENTER key to make selection. The curser will move to the day or month segment. Make your adjustment by using the scroll keys and select by Depressing the ENTER key. The year is adjusted in the same manner. To change date format from mm/dd/yyyy to dd/mm/yyyy, select 2 and then depress the asterisk key.
9. SET TIME: This selection is for entering the time. Time is displayed on a 00:00 to 24:00 format. To set the time, select 3 and a curser will be flashing on the leading hour digit. Adjust by using the scroll keys. Once the correct hour is displayed, depress the ENTER key to select. The curser will move to the minute segment. Adjust as necessary with the use of the scroll keys, and select by depressing the ENTER key.
10. PREVIOUS MENU: SELECTING 4, will return one to the SYSTEM SETUP screen 1.
11. Selecting 5, will return one to the MAIN MENU screen.

## SAVED READINGS Screen

When 6, SAVED READINGS is selected on the MAIN MENU screen the SAVED READINGS screen appears as shown in Figure 6-12. The total number of saved readings is displayed on the MAIN MENU screen, following the SAVED READINGS selection, and it is also displayed in the SAVED READINGS menu screen.



*Figure 6-12. SAVED READINGS Screen*

1. **VIEW READINGS:** This selection allows one to view saved HEADER information and associated test results. A prompt line will request the test number to view. Enter the number and then depress the ENTER key. The first screen shown is the HEADER screen containing information such as: Company name, Substation name, equipment Manufacturer and etc. This information should have been entered at the time of test. If it had not been entered, the information can be entered or corrected at this time. In addition, the test number and test date is also displayed on this screen.

The scroll keys will allow one to view the test result screens. The number of available test result screens will vary depending on the type of device tested, as well as the type of test conducted. The HEADER information and associated test results can be printed from the final test result screen of the selected test number.

To view the subsequent HEADER screen and associated test results, select 8. To view the previous HEADER screen and associated test results from a HEADER screen, use the left scroll key. To exit the VIEW READINGS mode and return to the SAVED READINGS screen, select 9.

2. **DELETE READINGS:** This selection allows one to DELETE saved header information and associated test results. Prompt lines will be displayed at the

bottom of the screen. If all saved readings are to be deleted, enter 0; if a specific test result is to be deleted enter the associated test number and depress the ENTER key; if a range of test results are to be deleted enter the starting range number followed by a dash followed by the last test number to be deleted. In all cases, one will be asked to validate the request.

3. PRINT READINGS: This selection allows one to PRINT saved HEADER information and associated test results. Prompt lines will be displayed at the bottom of the screen. If all saved readings are to be PRINTED, enter 0; if a specific test result is to be PRINTED enter the associated test number and depress the ENTER key; if a range of test results are to be PRINTED enter the starting range number followed by a **dash** followed by the last test number to be PRINTED. In all cases, a message will be flashed at the bottom of the screen indicating that PRINTING is completed.
4. XFER READINGS TO PC: This selection allows one to TRANSFER TO a PC saved HEADER information and associated test results. Prompt lines will be displayed at the bottom of the screen. If all saved readings are to be TRANSFER, enter 0. A message may be displayed indicating that the readings are being transferred; if a specific test result is to be TRANSFER enter the associated test number and depress the ENTER key; if a range of test results are to be TRANSFER enter the starting range number followed by a **dash** followed by the last test number to be TRANSFER. A message may be displayed indicating that the readings are being transferred. In all cases, a message will be flashed at the bottom of the screen indicating that TRANSFER is completed.
5. MAIN MENU: This selection will return one to the MAIN MENU.

## Error Messages

All TTR100 error messages are divided by 4 categories: self-test error messages, test error messages, test result error messages, and miscellaneous error messages.

The self-test error messages may appear on the opening screen during power-up self-test procedure. The Table 6-1 below shows the messages.

**Table 6-1. Self-test Error Messages**

Error Message	Description of error and action required
CHECKING PLD:BAD	CPLD chip is not working properly. Contact the factory for repair.
CHECKING DISPLAY:BAD	LCD display is not working properly. Contact the factory for repair.
CHECKING RAM:BAD	Microprocessor RAM is not working. Contact the factory for repair.
REPAIR REQUIRED! CONTACT FACTORY	There was a self-test error. Contact the factory for repair.
UNIT INOPERATIVE	One of the input voltages is too low, or A/D converter is not working for the reference oscillator. Contact the factory for repair.
CHARGE BATTERY!	The battery voltage is less than 3.3 volts. Charge the battery.
LOW BATTERY	The battery voltage is between 3.3 volts and 3.42 volts. Charge the battery.
BAD TEMP SENSOR	Temperature sensor is not working. Contact the factory for repair.
BAD REALTIME CLOCK	Can't read the real time clock. Contact the factory for repair.
BAD SERIAL EEPROM	Serial EEPROM can't be written to or read from. Contact the factory for repair.
ONEWIRE FAILED	There was an error trying to connect to both the temperature sensor and the real time clock. Contact the factory for repair.

The test error messages may appear on the screens during testing of transformer. The Table 6-2 below shows the messages.

**Table 6-2. Test Error Messages**

Error Message	Description of error and action required
CHARGE BATTERY!	The battery voltage is less than 3.3 volts. Charge the battery.
LOW BATTERY (Battery image in upper right corner of screen)	The battery voltage is between 3.3 volts and 3.42 volts. Charge the battery.
EXC.CURRENT TOO HIGH	Excitation current is too high. Check for any wrong connections.
CHECK CONNECTIONS	The lead(s) are not properly connected to transformer. Connect the leads properly.  Test lead(s) is open. Contact the factory for repair.
CONNECTIONS REVERSED	H and X connections are reversed. Connect H and X test leads properly.
TURN RATIO TOO HIGH	The turn ratio is too high during a quick test. Causes test to stop. Check connections.
TURN RATIO > 20000	The turn ratio is too high during a full test. Causes test to stop. Check connections.
TURN RATIO TOO LOW	The turn ratio is too low during a quick test. Causes test to stop. Check connections.
TURN RATIO < 0.8	The turn ratio is too low during a full test. Causes test to stop. Check connections.
BAD SERIAL EEPROM	Serial EEPROM can't be written to or read from. Contact the factory for repair.
ONEWIRE FAILED	Temperature sensor and the real time clock interface failed. Contact the factory for repair.
ADC FAILED	A/D converter failed. Contact the factory for repair.
ADC TIMEOUT	A/D converters didn't respond. Contact the factory for repair.

The test result error messages may appear on the test result screens after test is complete. The Table 6-3 below shows the messages.

**Table 6-3. Test Result Error Messages**

Error Message	Description of error and action required
RATIO<	Turns ratio is less than 0.8. Check for any wrong connections.
RATIO>	Turns ratio is greater than 20000. Check for any wrong connections.



The miscellaneous error messages may appear on the screens during saving, printing, or uploading functions. The Table 6-4 below shows the messages.

**Table 6-4. Miscellaneous Messages**

Error Message	Description of error and action required
MEMORY IS FULL.DELETE  A CONFIG.? 0=NO 1=YES	The maximum number of custom configurations have been saved. In order to save this one, one has to be deleted.
MEMORY IS FULL.DELETE  TEST RESULT? 0=N 1=Y	The maximum number of tests have been saved. In order to save this one, one has to be deleted.
PRINT ERROR	There was an error during printing a report. Try again. If failed, contact the factory for repair.
TRANSFER ERROR	There was an error while transferring test results to a PC. Try again. If failed, contact the factory for repair.

When an error message appears on a screen indicating an abnormal operating condition, verify the condition by taking a repeat measurement before attempting to take any corrective action. Also, refer to the Troubleshooting section for malfunctions and possible causes.

Open connections, wrong connections, open windings, shorted windings, high resistance windings, other abnormal transformer problems, or a combination of these may cause a large deviation from normal turn ratio or indicate an unusual message. The unusual operating conditions may be caused by an abnormal leakage reactance or capacitive coupling within the transformer windings.

## Use with the Optional Printer

If you are using the optional printer, plug the printer cable into the RS232/PRINTER receptacle on the TTR100 test set and turn it on. A separate manual is supplied with the printer. Refer to it for specific information about how to connect, operate, and care for the printer.

Header information and test results may be printed from QUICK & FULL TEST results screens and from SAVED READINGS screen.

```
Megger
1-ph TRANSFORMER TURN RATIO TESTER
CATALOG NO. TTR100

-----

TRANSFORMER TEST REPORT
COMPANY: T-TCOMPANY
SUBSTATION: KENT
MANUFACTURER 25
TRANSFORMER RATING: 750KVA
AMBIENT TEMPERATURE: 21 C
RELATIVE HUMIDITY: 58%
TTR S/N: E105
OPERATOR (S): GREG
COMMENTS/NOTES:
```

Figure 6-13a. Sample Test Report Header

```
DATE (M/D/Y) : 06/01/1999 12:25
TEST: 002
TRANSFORMER ID: 12A-76M/2
TYPE: SINGLE PHASE TRANSFORMER 1ph0
TAPS TESTED: 3 - 17
H VOLTAGE: 10000
X VOLTAGE: 10000
CALCULATED TURNS RATIO: 1.0000
TEST VOLTAGE: 8V

RATIO                1.0013
% DEVIATION           0.13
PHASE(min)           -14.7
lexc(ma)             0.03
```

Figure 6-13b. Sample Single Phase Test Report

---

## Using COMLink Program

COMLink program provides the operator interface for:

- transferring readings from TTR to a PC
- viewing test data
- printing out test reports
- creating transformer test results database

Test data stored in the internal memory of the TTR100 test set may be transferred to a PC. COMLink program supplied with the TTR provides the operator interface for transferring stored data from the TTR to the PC. With this software the user can print out test reports from the PC and save the test data as a (.txt) file or into the database incorporated into the COMLink Upload software. With these two file formats the user can either open the data into an Excel spreadsheet or open the database using MS Access.

## System Requirements

Windows NT3.1 or, Windows 95 or later as your operating system.<sup>1</sup>

An 80386 Processor or higher

A VGA monitor or one with higher screen resolution

Set the Display Properties for the Desktop area 800 by 600 pixels and small fonts.

16 M of RAM

Comm port 38.4 kBaud or better

CD Drive

## Installation

The COMLink files are contained on the a CD which is shipped with the TTR. To install the program, insert the COMLink CD into the CD drive

- On Windows 95, Windows NT 4.0 or Windows XP: Select Run from the Taskbar Start menu, type the full name of the file (for example, D:\Setup.exe), press the Enter key, and follow the prompts.
- On Windows NT 3.1: activate the Program Manager, select Run from the File menu, type the full name of the file (for example, D:\Setup.exe), press the Enter key, and follow the prompts.
- COMLINK is a 32-bit program and Win 3.1 won't handle it.

---

<sup>1</sup> Windows NT, Windows XP, Windows 95, and MS ACCESS are registered trademark of Microsoft Inc.

## Upgrade Instructions

Follow the installation instructions above. You can install the upgraded version of COMLink to the same location as a previously installed copy of COMLink or AVOLink.

## Documentation

For full documentation, press the F1 key or click on the help button on the main screen. For context sensitive help, click on the help button on the screen you are working on.

## Usage

Once the software is installed, all that is needed is to press “Start” on the menu bar then select “Program\COMLink\COMLink ” to start the COMLink TTR Upload software, or double click on the desk top icon.

### **Transferring readings from TTR to PC (Get from TTR window)**

To transfer data to a PC, log to the disk drive and or directory that contains the COMLink program and select it. Connect the TTR's RS232 port to the PC through a cable (Megger p/n 33147-18) supplied.

If the USB port is used, plug a USB serial adapter, USA-19QW or equivalent, into the USB port of the PC. Connect the TTR's RS232 port to the adapter. Install the software drivers for USB serial adapter (supplied with the adapter).

The COMLink program starts with the opening window. In the Select Device window, select Single Phase TTR. The Transfer Readings to PC screen appears. Select Maintenance tab, then, select the Setup Serial Port tab. The COMLink Setup serial port window will appear. This window allows you set up the serial port for communication to the remote device.

The baud rate, parity, stop bits and data bits must match exactly those in the remote device. The following parameters should be selected:

- Select the com. port to be used
- Baud Rate: 38.4 kBaud
- Parity: N(none)
- Stop bits: 1
- Data bits: 8

*NOTE: The serial port settings are already appropriately set for the selected device. However, the COM port will need to be selected.*

Select Save Settings to set the serial port parameters to those you selected and to initialize the serial port. Select OK button.

Select Restore Settings to leave the serial port parameters unchanged.

Press Transfer Readings to PC button. The opening window will appear.

All the test data transferred from the TTR is stored in an ASCII text file. The data items in each test are separated by commas. Each test is separated by a carriage return and line feed.

On the PC:

- specify the path where the test data file will be stored, or accept the default path.
- specify the file name which will contain the test data, or accept the default path.
- select the Transfer Readings to PC test data button. This causes the program to go into a wait state where it waits for the TTR to send the test data. At this time the Stop Reading Transfer button is enabled so you can cancel waiting for the TTR.

On the TTR:

- select 6 (SAVED READINGS) from the Main Menu screen
- select 4 (TRANSFER READINGS TO PC) on SAVED READINGS screen
- enter 0 to transfer all readings, a message will be displayed indicating that data is being transferred,

or

- enter start test number, followed by a dash, followed by the last test number to be transferred to transfer a group of test results to a PC, then press ↵,

or

- enter a test number to transfer a specific test result to a PC, then press ↵.

After receiving all data, communication status window will change message from "Waiting for data" to "Received all data successfully." If uploading close to 200 tests, the upload may take 1-2 minutes. Any screen saver that is set for a shorter time than the data transfer time may interrupt the data transfer. In this case either lengthen the screen saver idle time or temporarily disable the screen saver.

The uploaded data is automatically saved to a default “C” drive COMLink directory, or to a previously selected directory as a “.txt” file using the name which appears in the “Test data file name” box.

## **Viewing test data on PC (View test data window)**

You can view the test data, in a specified file, by pressing the “View Readings from File” button. A window “Readings Uploaded from TTR” opens. At this time all the user entry data can be entered into the fields which are in the upper portion of the window.

Excel or Note Pad can also be used to view this “.txt” data. Excel is assumed to be in its default installation directory C:\Program Files\Microsoft Office\Office. Notepad is assumed to be in the windows directory C:\Windows. When you have selected a program, click on the Start Program button to start the program.

Saving the selected data to a file can be accomplished by pressing the "Save to File" button. This data is saved to a selected path/directory as a ".txt" file, using the name assigned in the "Test Data File Name" box.

## **User Entry Fields**

Prior to printing the test report, the user needs to fill in the transformer information to properly document the test. If the information has been entered during testing, it is displayed in the fields. However, at this time it may be corrected.

- COMPANY, once the database has been saved the company name will reappear when future readings are uploaded. You can change this at any time. As the user enters additional entries, the pull-down menu on the right will include it in all past entries.
- SUBSTATION and MANUFACTURER, as the user enters more entries the pull down on the right of these two fields will include all past entries. This assists in consistent data entries.
- TRANSFORMER RATINGS, AMBIENT TEMPERATURE, RELATIVE HUMIDITY, OPERATOR AND COMMENTS / NOTES are entries made every time a printout is to be made.
- MAX % RATIO DEVIATION PERMITTED is a field used to determine whether the ratio deviation is within limits and the results will appear in the PASS/FAIL column of the report.
- The blank field on the top of the window may be used to enter, for example, the name of a test company, etc.

**Printing a Transformer Test Report**

To select the transformer test report to be printed:

1. Click the left mouse button and drag the mouse to highlight a group of tests  
OR
2. Press and hold "Control" then clicking the left mouse button to highlight multiple tests
3. Then, press print button.



Figure 6-14. Report Printout

## *Saving Test Results to Database*

To save transformer test result to database:

1. Click the left mouse button and drag the mouse to highlight a group of tests to be saved.
2. Press and hold "Control" then click the left mouse button to highlight multiple tests.
3. Press "Save Selection to PC Database" button.

The database can be opened with MS ACCESS using the path C:\program files\Megger\COMLink\trdatabase.

## *Viewing Test Results from the Database*

To view the reading from the PC database: From the COMLink Main Menu:

1. Select the Login tab.
2. Press "View Readings form PCDB".
3. Select transformer's test results.



# 7

## SERVICE

### *Maintenance*

Maintenance should be performed only by qualified persons familiar with the hazards involved with high-voltage test equipment. Read and understand Section 2, Safety, before performing any service.

The TTR100 test set is sturdily constructed and requires no periodic maintenance. Routine maintenance is all that is required for the TTR test sets. Inspect the cable assemblies occasionally to ensure they are in good condition.

The appearance of the TTR test set can be maintained by occasionally cleaning the case, panel and cable assemblies. Clean the outside of the carrying case with detergent and water. Dry with a clean, dry cloth. Clean the control panel with a cloth dampened with detergent and water. Do not allow water to penetrate panel holes, because damage to components on the underside may result. An all-purpose, household spray cleaner can be used to clean the panel. Polish with a soft, dry cloth, taking care not to scratch the display screen cover. Clean the cables and mating panel receptacles with isopropyl or denatured alcohol applied with a clean cloth.

### *Calibration*

A complete performance and calibration check should be made at least once every year. This will ensure that the TTR test set is functioning and calibrated properly over the entire measurement range. The MEGGER Calibration Standard Cat. No. 550555 or Cat. No. 550055 can be used to make this check.

1. A simplified self-check can be performed at unity ratio. Proceed as follows:
2. Turn TTR100 power off (red button on a keypad). Connect H1 lead to X1 lead, and H2 lead to X2 lead.
3. Turn TTR100 power on (green button on a keypad). Select 5.SYSTEM SETUP on the main menu screen. Set 3.RESISTANCE TEST:NO, then return to the main menu screen.

4. Select 1 on the main menu screen. When the TRANSFORMER CONFIGURATION menu appears, select 1, then select 1 again and press enter.
5. When the main menu appears, select 2.START QUICK TEST.

## WARNING



Keep the leads, which are energized, clear of ground and personnel.  
Keep X3 lead clear of ground and test setup.

6. Turn Ratio reading on the test result screen should be from 0.9990 to 1.0010.

## ***Battery Maintenance***

In order to take full advantage of properties of the Ni-MH battery pack and also to prevent problems due to improper use, please note the following points:

1. Charge battery only when low battery sign appears.
2. Charge battery with an ambient temperature range of 0°C to 40°C.
3. If low battery sign appears during testing, there is enough battery power for approximately 1 hour of normal operation. At this point, the supplied charger may be connected to the TTR100. You may continue testing while charging the battery.
4. Do NOT leave the battery exposed to direct sunlight or temperatures below -20°C or above 45°C for storing.
5. Normally a battery will last 2 years (or 500 cycles) if used under proper conditions and not overcharged or over discharged. However, failure to satisfy conditions concerning charging, discharging, temperature, and other factors during actual use can lead to shortened life (or cycle life) damage to products and deterioration in performance due to leakage and shortened service life.

## Troubleshooting

The Troubleshooting Guide, Table 7-1, is arranged to help you evaluate the reasons for TTR100 test set malfunction. The table lists possible test set malfunctions which may be encountered during operation and lists possible causes. Electronic circuit repairs should not be attempted in the field. Refer to Repair section. Refer to Section 8 for a list of spare parts.

**Table 7-1. Troubleshooting Guide**

MALFUNCTION	POSSIBLE CAUSE
Display stays blank after POWER switch is turned on.	<ul style="list-style-type: none"> <li>▪ Battery is discharged.</li> <li>▪ CONTRAST potentiometer not adjusted.</li> <li>▪ Defective display or electronics.</li> </ul>
Any error message on the screens	See ERROR MESSAGES section
Test results erratic	<ul style="list-style-type: none"> <li>▪ Defective test leads (open circuit, poor connection).</li> <li>▪ Problem in test specimen (poor connection).</li> <li>▪ Problem in TTR100 measuring circuit.</li> <li>▪ Incorrect setting of transformer configuration</li> <li>▪ Incorrect connection of leads.</li> <li>▪ Incorrect marking of a transformer.</li> </ul>
Cannot obtain printout when printer is connected.	<ul style="list-style-type: none"> <li>▪ Printer power not turned on.</li> <li>▪ Printer battery discharged.</li> <li>▪ Problem in TTR100 printer interface electronics.</li> </ul>

## *Repair*

Megger offers a complete repair and calibration service and recommends that its customers take advantage of this service in the event of equipment malfunction. Contact your Megger representative for instructions and a return authorization (RA) number. Equipment returned for repair should be shipped prepaid and insured and marked for the attention of the Repair Department. Please indicate all pertinent information including problem symptoms and attempted repairs. The catalog number and serial number of the test set should also be specified. Pack the TTR test set, including all cables, in a carton (original shipping carton if available) with adequate dunnage in accordance with best commercial practice. Seal the carton with waterproof tape.

Ship to:                   **Megger.**  
Valley Forge Corporate Center  
2621 Van Buren Avenue  
Norristown, PA 19403

# 8

## ORDERING INFORMATION AND SPARE PARTS LIST

### Ordering Information

<b>Item</b>	<b>Cat. No.</b>
Single phase Transformer Turns Ratio Test Set	TTR100
<b>Included Accessories</b>	
Canvas carrying bag and Accessory Pouch	55-20008
Battery pack	35753
Universal battery charger	35757
Power supply cord	Determined by Country
<b>Test Leads</b>	
H winding, 6 ft (1.8 m)	35502-521
X winding, 6 ft (1.8 m)	35502-511
Software for uploading test results to a PC	35794-2
RS232 cable for connecting to a PC	33147-18
Quickstart guide	55-20013
Instruction manual	AVTMTTR100

## Optional Accessories

Battery/line-powered serial thermal printer package, 120 V ac	35755-1
Battery/line-powered serial thermal printer package, 230 V ac	35755-2
Test Leads	
H winding, 12 ft (3.6 m)	35502-520
X winding, 12 ft (3.6 m)	35502-510
Semi-hard fabric transport case	35788
Inverter cigarette adapter with power cable, 12V dc to 115V ac 60 Hz (Non –CE marked)	35973
Additional battery pack	35753
Additional printer paper, 1 roll	27705-1
Certificate of calibration	CERT-NIST
Deluxe kit (all optional accessories with 120 V printer)	55-10002
Deluxe kit (all optional accessories with 230 V printer)	55-10003

## Spare Parts

<b>Item</b>	<b>Megger Part Number</b>
Front housing	55-20001
Rear housing	55-20002
Battery door	55-20003
Window, silk screened	55-20005
Knob, CONTRAST	55-20004
Quick start guide	55-20013
Keypad	55-20006
Battery pack	35753
Universal battery charger	35757
Cable, H winding, 6 ft (1.8 m)	35502-521
Cable, X winding, 6 ft (1.8 m)	35502-511
Cable, H winding, 12 ft (3.6 m)	35502-520
Cable, X winding, 12 ft (3.6 m)	35502-510

Megger<sup>®</sup>



# 9

## GLOSSARY



Use only in accordance with instruction manual.

ANSI

American National Standards Institute

BCT

Bushing current transformer

CEI/IEC

The initials of the official French name, Commission Electrotechnique Internationale, of the International Electrotechnical Commission.

Centiradian

Phase display option in SYSTEM SETUP screen.  
1 centiradian = 0.573 degrees.

CT

Current transformer

LCD

Liquid crystal display

LTC

Load tap changer. A selector switch device used to change transformer taps with the transformer energized and carrying full load.

Safety ground stick

An insulated stick (sometimes called a hot stick) with a hook type electrode connected to ground via an insulated cable. In some discharge sticks, a resistor is connected between the electrode and the ground cable. Both are used to discharge capacitive specimens by providing a low-impedance path to ground. They must be suitable rated for the voltage and capacitance of the specimen to be discharged.

Transient

A change in the steady-state condition of voltage or current, or both.

TTR	Transformer turn ratio; a registered trademark of MEGGER.
Turns ratio	The ratio of the number of turns in a higher voltage winding to that in a lower voltage winding.

# 10

## WARRANTY

Products supplied by Megger are warranted against defects in material and workmanship for a period of one year following shipment. Our liability is specifically limited to replacing or repairing, at our option, defective equipment. Equipment returned to the factory must be shipped prepaid and insured. This warranty does not include batteries, lamps, or other expendable items, where the original manufacturer's warranty shall apply. We make no other warranty. The warranty is void in the event of abuse (failure to follow recommended operating procedures) or failure by the customer to perform specific maintenance as indicated in this manual.

Megger<sup>®</sup>

# 11

## INDEX

### A

Accessories Supplied, 12  
ANSI Transformer Winding Phase Relationship, 29  
Australian Transformer Winding Phase Relationship, 47

### B

Battery Maintenance, 82  
Bushing Current Transformer, 23

### C

Calibration, 81  
CAUTION, 7, 18  
CEI/IEC 76-1, 1993 Transformer Winding Phase Relationship, 37  
COMLink, 75  
Connections, 19, 27  
Connector Panel, 18  
Connectors, 16  
Control Panel, 17  
Controls, 16  
Custom Configurations, 65

### D

Display, 17  
Distribution Transformers with Two Secondary Windings, 20

### E

Electrical, 9  
EMERGENCY SHUTDOWN, 53  
Environmental Conditions, 11  
Error Messages, 70

### F

Full Test CTs, 64  
Full Test Regulator, 64

Full Test Single Phase Tapped Transformer, 63  
Full Test Single Phase Transformer, 62

## **G**

General Information, 1  
General Instructions, 19  
General Operating Procedure, 53  
Glossary, 89

## **I**

Indicators, 16  
Installation, 75

## **M**

MAIN MENU Screen, 55  
Maintenance, 81  
Menus, 53

## **O**

Opening Display Screen, 54  
Operation, 53  
Optional Accessories, 12  
Ordering Information, 85

## **P**

Physical Data, 12  
Principle of Operation, 15  
Printer, 74  
Printing a Transformer Test Report, 79

## **Q**

Quick Test Single Phase Transformer, 59  
Quick Test Three Phase Transformer, 60  
Quick Test T-Type Transformers, 61

## **R**

Receiving Instructions, i, 1  
Repair, 84

## **S**

Safety, 5  
SAVED READINGS Screen, 68  
Saving Test Results to Database, 80  
Service, 81  
Setup, 19  
Setup for Testing Single-Phase Autotransformer, 21  
Setup for Testing Single-Phase Transformer, 21

---

Setup for Testing Single-Phase, Type A (Straight Design) Step Voltage Regulator, 22  
Setup for Testing Single-Phase, Type B (Inverted Design) Step Voltage Regulator, 22  
Single-Phase, Two-Winding Transformers, 20  
Spare Parts, 85  
Specifications, 9  
SYSTEM SETUP, 66

**T**

Test Screens, 53  
TRANSFORMER CONFIGURATION Screen, 56  
Transformer Winding Phase Relationship  
    ANSI, 29  
    Australian Standard 2374, Part 4 - 1982, 47  
    CEI/IEC 76-1, 1993, 37  
Troubleshooting, 83  
T-Type Transformers, 26

**U**

Unmounted CTs, 23

**V**

Vector Voltage Diagrams, 27  
Viewing test data on PC, 78  
Viewing the Database, 80

**W**

WARNING, 7, 19, 23, 82  
Warranty, 91

Megger<sup>®</sup>