

**INSTRUCTION BOOK**  
**for**  
**MODELS 323 and 323-01**  
**TRUE RMS VOLTMETERS**

STARTING WITH SERIAL No. 301



**BALLANTINE LABORATORIES, INC.**

**BOONTON, NEW JERSEY**

## WARRANTY

Each Ballantine Laboratories, Inc. instrument, or part thereof, is warranted to be free from defects in material and workmanship. Ballantine Laboratories, Inc. obligation under this warranty is limited to repairing or replacing any instrument or part thereof, except vacuum tubes and batteries, which shall within one year after shipment to the original purchaser prove upon Ballantine Laboratories, Inc. examination to have become defective.

**INSTRUCTION BOOK CONTENTS**  
**FOR**  
**MODELS 323 and 323-01 TRUE RMS VOLTMETERS**

	Page
<b>1. GENERAL INFORMATION</b> .....	1
1.1 Features .....	1
1.2 Some Applications of the Models 323 and 323-01 .....	1
1.3 Technical Characteristics .....	1
<b>2. OPERATION</b> .....	3
2.1 Function of Controls .....	3
2.2 Connectors .....	3
2.3 Power Connection .....	3
2.3.1 Line Voltage Conversion .....	3
2.4 Starting Procedure .....	3
2.4.1 Line Operation .....	3
2.4.2 Battery Operation, Battery Charge, 323 Only .....	5
2.4.3 Warmup Period .....	5
2.5 Measurement of AC Voltage .....	5
2.6 Possible Error Sources .....	5
2.6.1 Pointer Stays Extreme Left .....	5
2.6.2 Pointer Stays Extreme Right .....	5
2.6.3 Loading Error, Input Characteristics .....	6
2.6.4 Ground Current Errors .....	6
2.6.5 Transmission Line Error .....	6
2.6.6 Magnetic and/or Electrostatic Field Error .....	6
2.7 Use of the DB Scale .....	6
2.8 Effect of Harmonics .....	7
2.9 Effect of Crest Factor .....	7
2.9.1 Flat-Topped Waveforms .....	7
2.10 Effect of DC Component .....	7
2.11 Measurement of Noise, Random Signals .....	7
2.12 Measurement of Waveforms with Crest Factor Greater than 5.....	8
2.13 Use as Null Detector .....	8
2.14 Measurements Below 300 $\mu$ V.....	8
2.15 Measurements Above 330 V.....	9
2.16 Overload Protection .....	9
2.17 Influence of Power Line Voltage .....	9
2.18 Influence of Battery Voltage, 323 Only .....	9
2.19 Influence of Ambient Temperature .....	9
2.20 Measurement of RMS Currents .....	9
2.21 Measurement of Power .....	10
2.22 DC Output .....	10
2.23 RC Time Constant, Reset, Response Time .....	10
2.24 Indicator Flutter, Beats at Lower Frequencies .....	11
<b>3. CIRCUIT DESCRIPTION</b> .....	11
3.1 Basic Circuitry .....	11
3.2 Input Attenuator .....	11
3.3 Input Protection .....	11
3.4 Wideband Amplifier .....	12
3.5 Output Attenuator .....	12

	Page
3.6 RMS Detector .....	12
3.7 94 Hz Modulator .....	12
3.8 94 Hz Amplifier .....	13
3.9 Rectifier, Meter, DC Output .....	13
3.10 Chopper Drive .....	13
3.11 Power Supply, Model 323 .....	13
3.12 Power Supply, Model 323-01 .....	13
<b>4. MAINTENANCE .....</b>	<b>13</b>
4.1 General .....	13
4.2 Equipment Required .....	13
4.3 Recommended Checks .....	13
4.4 Checks .....	13
4.4.1 Scale Adjustment .....	13
4.4.2 Attenuator .....	16
4.4.3 Sensitivity .....	16
4.4.4 DC Output .....	16
4.4.5 NULL Operation .....	16
<b>5. SERVICE AND TROUBLESHOOTING .....</b>	<b>16</b>
5.1 General .....	16
5.1.1 Equipment Required .....	16
5.2 Line Voltage Conversion .....	16
5.3 Access to Instrument Adjustments, Components .....	17
5.4 Battery Charging Current, 323 Only .....	17
5.5 Battery Replacement, 323 Only .....	17
5.6 Chopper Drive Adjustments .....	17
5.7 Chopper Replacement .....	18
5.8 Transistor Replacement .....	18
5.9 High Frequency Adjustments .....	18
5.10 Low Frequency Checks .....	19
5.11 Attenuator Repairs .....	20
5.12 Addition of Time Constants .....	20
5.13 Troubleshooting .....	20
5.13.1 DC Voltages .....	20
5.13.2 Signal Tracing .....	21
5.13.3 Power Supply .....	21
5.13.4 Chopper Drive .....	21
5.13.5 Troubleshooting Chart .....	21
<b>6. SHIPPING INSTRUCTIONS .....</b>	<b>22</b>
<b>7. REPLACEMENT PARTS LIST — Model 323-01 .....</b>	<b>27</b>
<b>8. REPLACEMENT PARTS LIST — Model 323 .....</b>	<b>31</b>

---

---

## ILLUSTRATIONS AND DIAGRAMS

	Page
Figure 1 Ballantine Model 323 True RMS Voltmeter .....	IV
Figure 2 Rack Mounted Model 323 Using Model 800 Rack Mounting Kit....	IV
Figure 3 Location of Controls — Models 323, 323-01 .....	4
Figure 4 Input Resistance vs. Frequency .....	6
Figure 5 Crest Factor vs. Duty Cycle for Pulse Trains .....	7
Figure 6 Connection of External DC Blocking Capacitor .....	7
Figure 7 Crest Factor Error with White Noise .....	8
Figure 8 External Attenuator to Extend Crest Factor Limit .....	8
Figure 9 Typical Calibration of 1 mV Range in NULL Mode .....	8
Figure 10 Typical Battery Voltage vs. Discharge Time .....	9
Figure 11 Simplified Schematic, Models 323, 323-01 .....	12
Figure 12 Instrument Adjustments, Front View .....	14
Figure 13 Instrument Adjustments, Side View .....	14
Figure 14 Instrument Adjustments, Rear View .....	15
Figure 15 Chopper Drive Symmetry Adjustment Circuit .....	17
Figure 16 Frequency Response Check .....	19
Figure 17 Typical Frequency Response, 1 mV Range .....	19
Figure 18 Component Location, Amplifier Board, Models 323, 323-01.....	23
Figure 19 Component Location, Power Supply Board, Model 323 .....	24
Figure 20 Component Location, Power Supply Board, Model 323-01.....	25
Figure 21 Accessories for Models 323, 323-01.....	26
Figure 22 Schematic, Model 323-01 .....	Rear
Figure 23 Schematic, Model 323 .....	Rear

## TABLES

I Input Parameters vs. Range .....	6
II Maximum Safe Input Voltage .....	9
III Capacitance vs. Time Constant .....	10
IV Attenuation vs. Range Switch .....	11
V High Frequency Adjustment vs. Range .....	19



Fig. 1. Ballantine Model 323 True RMS Voltmeter

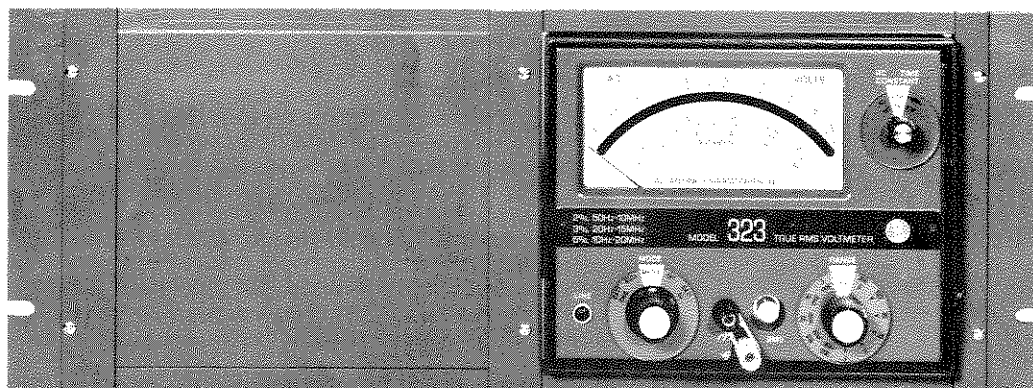

Fig. 2. Rack Mounted Model 323 Using Model 800 Rack Mounting Kit

# 1. GENERAL INFORMATION

## 1.1 Features

The Ballantine Models 323 and 323-01 True RMS Voltmeters are compact, portable, general purpose ac voltmeters. The Model 323 operates from either line power or internal rechargeable batteries; the Model 323-01 operates from line power only.

Among the electrical features are high sensitivity, wide voltage range, wide frequency range, high accuracy, high input impedance, and high stability.

The signal-rectifier response is **true rms** and should not be confused with **average** or **peak** responding instruments calibrated to provide rms indication on sine waves only. Thus this instrument indicates the rms value on all types of waveforms which fall within its frequency and crest factor specifications.

The logarithmic meter provides the same high accuracy of indication at all points on the scale, while the associated linear decibel scale permits automatic conversion of voltage ratio to decibel units without recourse to charts or tables.

When desired, several time constants\* may be selected by means of a front panel control.

For field operation, or when ground loops prove troublesome, the Model 323 may be operated from internal batteries for periods of up to 20 hours. An internal charging circuit completely recharges the batteries in a 15 hour period.

Three-terminal, unsymmetrical input permits grounding of the instrument case independent of the signal ground. Input circuit protection allows the maximum measurable voltage (330 V) to be applied to the most sensitive range (1 mV) at frequencies up to 1000 Hz with no damage.

A dc output, which is a squared function of the input voltage, is available at a rear mounted connector.

In the NULL mode of operation, signal voltages down to 70  $\mu$ V are detectable.

With accessory shunt resistors (Ballantine Laboratories, Inc., Model 600 Series) the instrument may also be used as a sensitive accurate ac current indicator.

The use of solid-state active devices throughout leads to low power consumption, low internal temperature rise, stability and freedom from frequent recalibrations.

\*Early production units had only one time constant of 0.4 s.

Mechanically the instrument is of simple, rugged design providing excellent accessibility to adjustments and components. The use of etched circuit boards and solid state components leads to compactness and light weight. A pair of adjustable bails permits tilting of the instrument for better viewing either at bench or shelf level. The half-rack modular case may be rack mounted in minutes by using the Model 800 Rack Mounting Kit.

## 1.2 Some Applications of the Models 323 & 323-01

General rms voltage and current measurements.

Noise measurements of tubes, transistors, and other components.

True-rms vibration measurements in conjunction with vibration pickup.

Noise tests of audio, video, and wide band systems.

Acoustic level and power measurements when used with suitable transducers.

Harmonic distortion measurements in conjunction with fundamental suppression filters.

## 1.3 Technical Characteristics

### Voltage Ranges

300 V, 100 V, 30 V, 10 V, 3 V, 1 V  
300 mV, 100 mV, 30 mV, 10 mV, 3 mV, 1 mV

Max continuous input any range: 330 V rms or 500 V peak up to 1 kHz; 600 V dc

Min detectable level as null detector: 70  $\mu$ V

### Decibel Range

-70 dB to +50 dB referred to 1 V

### Frequency Range for all Voltage and Decibel Ranges

10 Hz to 20 MHz

### Accuracy at All Points on Scale, All Ranges, 18-30°C

Frequency	Voltage	Decibel
50 Hz to 10 MHz	2%	0.2 dB
20 Hz to 15 MHz	3%	0.3 dB
10 Hz to 20 Hz	5%	0.5 dB
15 MHz to 20 MHz	5% to 100 V	0.5 dB
	10% to 300 V	1.0 dB

## Input

Type	Three-terminal, unsymmetrical		
Connectors	BNC, convertible to binding posts		
Common mode rejection			
	dc	> 120 dB	
	ac	> 120 dB at 1 kHz	
	ac	> 80 dB at 1 MHz	
Maximum case to signal ground voltage	600 V peak		
Equivalent noise	input shorted	< 30 $\mu$ V	
all ranges	input open	< 35 $\mu$ V	
Swinging (60, 120, 180 Hz)	< $\pm 0.25\%$		
Impedance			
	FS Range	R	C
		High to Low	
	1 mV - 30 mV	2 M $\Omega$	25 pF
	100 mV - 300 V	2 M $\Omega$	15 pF
		Low to Common	
	1 mV - 300 V	>100 M $\Omega$	400 pF
		High to Common	
	1 mV - 300 V	>100 M $\Omega$	0 pF*

\*When BNC connector is used

## Response

Type	rms, calibrated rms		
Crest factor	5 at full scale 15 at down scale		
Waveforms	sine, complex, pulse or random		

## Scales

Parameter	Range	Type	Length	Divisions
Voltage	3.0 to 10.6	log	$\cong 4.6''$	58
Voltage	0.95 to 3.3	log	$\cong 4.2''$	34
Decibel	0 to 10	linear	$\cong 3.3''$	50

## Stability, All Ranges

Reference conditions:	
Line voltage	120 V, $\pm 2\%$
Line frequency	50 to 420 Hz, $\pm 1\%$
Warmup period	1 hour
Temperature	21 $^{\circ}$ C to 25 $^{\circ}$ C
Warmup time	usable after 15 s < 0.5% drift after 15 min.
Effect of $\pm 12\%$ line V	< 0.2%
Effect of $\pm 3\%$ line freq.	< 0.2%

## Response Time, All Ranges

Time Constant	Up Scale	Down Scale
0.25 s	< 1 s	< 2 s
0.5 s	2 s	3 s

## Overload Recovery

Time Constant	Overload at FS	Time*
0.25 s	10 dB	2 s
0.25 s	20 dB	5 s
0.25 s	40 dB	< 15 s
0.5 s	10 dB	3.5 s
0.5 s	20 dB	8 s
0.5 s	40 dB	< 30 s

\*Time to return to within 1% of final indication

## DC Output

Connector	BNC, rear mounted
Function	proportional to square of input
Amplitude	-100 mV to -1 V $\pm 1\%$ for each voltage range
Linearity	$\pm 0.3\%$ fs
Source resistance	1.67 k $\Omega$ , $\pm 5\%$
Min load resistance	0 $\Omega$

## Battery Operation, 323 Only

Operating time with full charge	20 hours
Charging time for full charge	15 hours

## Power Requirements

Voltage	105 V to 135 V 210 V to 270 V
Frequency	50 Hz to 420 Hz
Power	6 W
Fuse	323                      323-01 120 V, 1/10 A, Slo-Blo    1/16 A, Slo-Blo 240 V, 1/16 A, Slo-Blo    1/32 A, Slo-Blo
Battery*	12 V, 6 V tap, 1.2 Ah, Ni Cd, (323 only)                      rechargeable

\*Early production units employed two batteries:  
6 V, 450 mAh, Ni Cd, rechargeable  
6 V, 1.2 Ah, Ni Cd, rechargeable

## Mechanical Specifications

Color	gray panel, charcoal gray case			
Dimensions	H	W	D	
Portable	6.1	7.8	10.2	inches
	15,5	19,6	25,9	cm
Rack (One or two Model 323's mounted on Model 800 Rack Panel)	7	19	10.2	inches
	17,8	48,2	25,9	cm
Weight			9.5 lbs	4,3 kg
Shipping weight			14 lbs	6,35 kg
Model 800 Rack Mounting Kit	4	lbs	1,8	kg



## 2. OPERATION

### 2.1 Function of Controls (See Fig. 3)

#### MODE Switch, 323

- BATT 6 V** Provides battery check; when meter indication is less than 6 on upper meter scale, batteries should be recharged.
- OFF** Turns power off.
- METER** Instrument operates as voltmeter from power line or internal batteries, with dc output proportional to square of signal level available at DC OUT connector.
- NULL** Instrument operates as a sensitive ac null indicator with maximum sensitivity of  $70 \mu\text{V}$ ; calibration is not accurate, merely relative.
- BATT CHG** When connected to line, instrument fully charges batteries in 15 hour period; instrument is inoperative in this position.

#### MODE Switch, 323-01

- OFF** Turns power off.
- METER** Instrument operates as voltmeter with dc output proportional to square of signal level available at DC OUT connector.
- NULL** Instrument operates as a sensitive ac null indicator with maximum sensitivity of  $70 \mu\text{V}$ ; calibration is not accurate, merely relative.

**RANGE Switch** Selects voltage range.

#### RC TIME CONSTANT

- Switch** Selects detector time constant.
- > 100 Hz\***  
**0.25 s** Provides time constant of 0.25 s, to be used for frequencies above 100 Hz.
- > 10 Hz**  
**0.5 s** Provides time constant of 0.5 s, to be used for frequencies above 10 Hz.
- RESET** Provides for rapid discharge of time constant capacitors, to "erase" indications when long time constants are used or following input overloads.
- LINE** Pilot lamp indicating when instrument is connected to power line.

\*Early production units had only one time constant, 0.4 s, marked NORMAL.

### 2.2 Connectors

#### Input

- BNC** Coaxial signal input; may be converted to binding post with Ballantine Model 618 Adaptor supplied.
- Black Binding Post** Connector for signal ground.
- White Binding Post** Connector for case ground.
- DC OUT** BNC connector located on rear of instrument; low side is connected to signal ground.

### 2.3 Power Connection

The voltmeter is supplied ready to operate on either 105 V to 135 V or 210 V to 270 V, 50 Hz to 420 Hz power, as indicated on the decal located on the back of the case adjacent to the power cord.

#### 2.3.1 Line Voltage Conversion

To change the operating line voltage of this instrument, proceed as follows:

- A. Remove instrument cover.
- B. Locate line voltage switch at lower left hand corner of the rear panel (while facing the front of the instrument).
- C. Move the switch to its upper position for 120 V operation, to the lower position for 240 V operation.
- D. If the voltage chosen in step C does not agree with that on the decal located on the rear cover, revise the decal marking to avoid damage or malfunction.
- E. Install a fuse consistent with the line voltage, chosen as follows:

Line	323	323-01
120 V	1/10 A, Slo-Blo	1/16 A, Slo-Blo
240 V	1/16 A, Slo-Blo	1/32 A, Slo-Blo

### 2.4 Starting Procedure

#### 2.4.1 Line Operation

Insert the power plug into a source conforming with the requirements stated on the decal located on the rear panel. Set the MODE switch

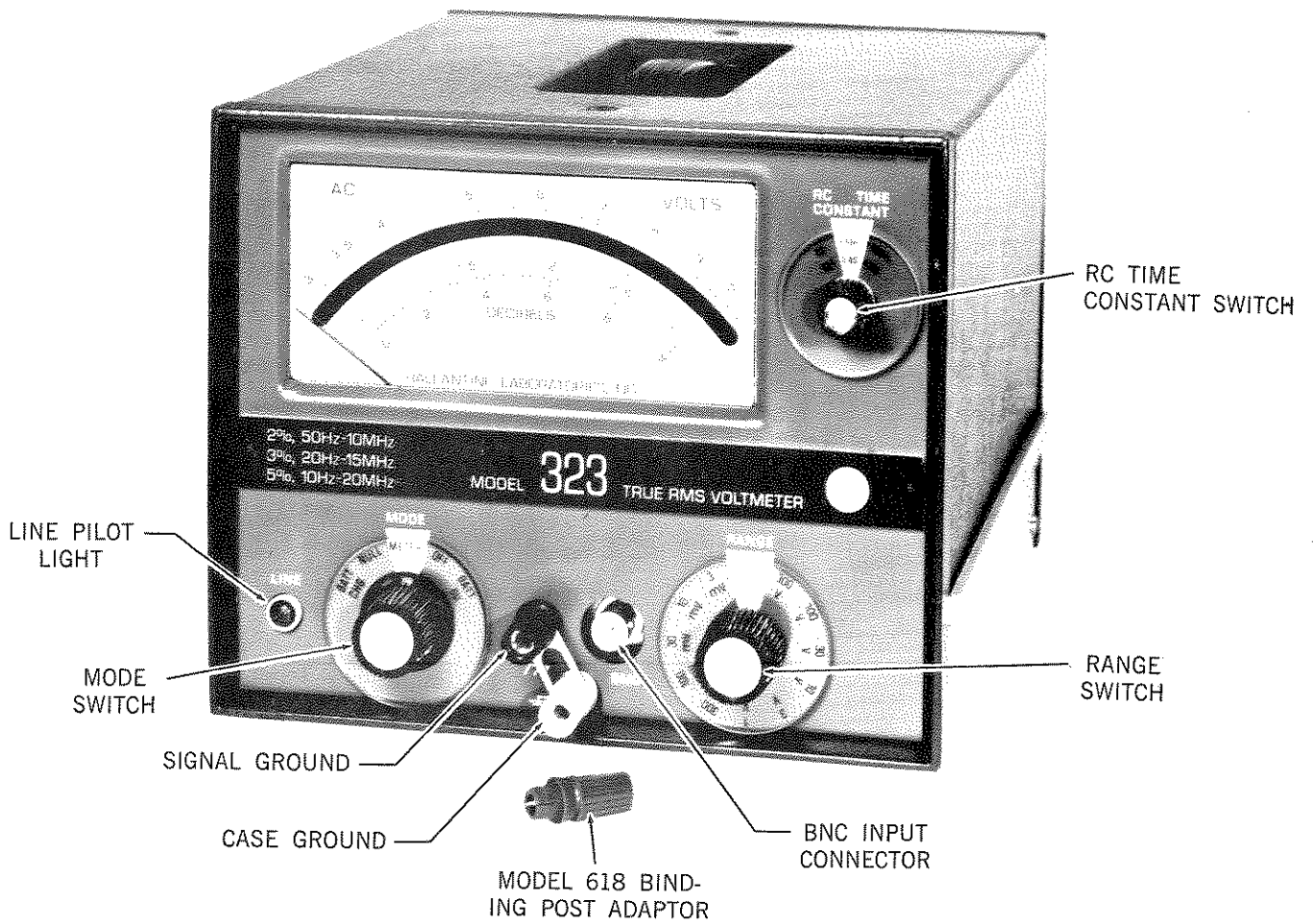

Fig. 3. Location of Controls — Models 323, 323-01

to METER or NULL as desired. The LINE pilot lamp should glow.

#### 2.4.2 Battery Operation, Battery Charge, 323 Only

Check the batteries by setting the MODE switch to BATT 6 V; the meter must indicate 6 or greater on the upper scale. If the indication is under 6 the batteries must first be recharged (see below). NOTE: On battery operation the LINE pilot lamp will not glow.

If the indication is 6 or greater, set the MODE switch to METER or NULL as desired.

To recharge the batteries, connect the power cord to a source conforming with the requirement stated on the decal located on the rear of the instrument. Rotate the MODE switch to BATT CHG. The batteries will be brought to a full charge after 15 hours; longer periods of charging (up to several weeks) are permissible and do no harm.

While the instrument is line operated, the batteries are continuously being charged at a rate equal to approximately one-half that of the BATT CHG position. Thus in an instrument which is continuously line operated for a period of 30 hours or more the batteries will be at or near full charge. It is recommended, however, that when 20 hours continuous use is necessary the batteries be charged on the BATT CHG position for 15 hours prior to use.

#### 2.4.3 Warmup Period

The instrument is usable after approximately 15 seconds. After 15 minutes of operation the drift will be less than 0.5%.

When the instrument has not been in operation for many months, or when it has been stored in an area of high humidity, or when the meter indication is less than 6 with MODE switch at BATT 6 V, allow a warmup period of at least one hour.

The power dissipated in this instrument is small and leads to little temperature rise. Therefore no particular air circulation is needed for proper operation.

#### 2.5 Measurement of AC Voltage

Set	To
MODE Switch	METER
RANGE Switch	300 V
RC TIME CONSTANT	0.5 s, or 0.25 s

Connect the unknown voltage to the input and rotate the RANGE switch until an on-scale indication is obtained. The position of the RANGE switch together with the meter indication gives the voltage at the input.

#### 2.6 Possible Error Sources

Some of the more common sources of error in voltage measurements are listed below.

##### 2.6.1 Pointer Stays Extreme Left

- RANGE switch incorrectly set.
- MODE switch incorrectly set.
- RC TIME CONSTANT switch incorrectly set.
- Input voltage lower than 300  $\mu$ V (70  $\mu$ V on NULL).
- Input voltage or frequency above or below range of the instrument.
- Defective power cord, fuse, or line voltage switch set to wrong position.

##### 2.6.2 Pointer Stays Extreme Right

- RANGE switch incorrectly set.
- MODE switch on NULL rather than METER.
- Input leads exposed to high electrostatic and/or magnetic field.
- Input voltage greater than 330 V rms.
- Instrument not fully recovered from severe overload; set RC TIME CONSTANT switch to RESET to accelerate recovery.

Because of the wide frequency range and high sensitivity of the Model 323, measuring errors not noted on less sensitive, narrow-band instruments may be encountered. In most instances proper measurement techniques can either eliminate or reduce to negligible proportions errors of this nature. The most common of these are listed below. A more comprehensive analysis is contained in an NBS Conference on Standards and Electronic Measurements Paper entitled, "Techniques and Errors in High Frequency Voltage Calibration" by Dr. E. Uiga and W. F. White. A copy of this paper is available from Ballantine Laboratories without charge.

### 2.6.3 Loading Error, Input Characteristics

The input impedance of this instrument may be represented as a delta configuration of three resistances and capacitances (See Fig. 4). The

low frequency value of these resistances and capacitances is given in Table I. While the capacitances are essentially independent of frequency, the value of RA is not, and is shown in Fig. 4.

Table I — Input Parameters vs Range

Ranges	RA	RB	RC	CA	CB	CC
1 mV - 30 mV	2 MΩ	> 100 MΩ	> 100 MΩ	25 pF	≅ 400 pF	≅ 0 pF*
100 mV - 300 V	2 MΩ	> 100 MΩ	> 100 MΩ	15 pF	≅ 400 pF	≅ 0 pF*

\*With BNC input connector

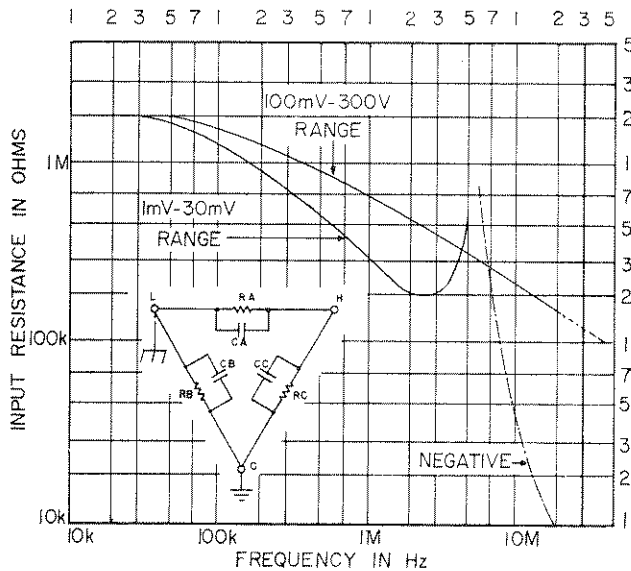

Fig. 4. Input Resistance vs. Frequency

It should be noted that RA becomes negative at higher frequencies on the four most sensitive ranges. If a circuit or inductor resonant in this region is connected across the input terminals (H, L) oscillation may result. This can be eliminated by connecting a resistance across the input terminals equal to or lower than the negative resistance. At lower frequencies on these ranges, and at all frequencies on the other ranges, the effect of the input impedance is to load and/or detune the source; this should be considered when the source impedance is high or is a tuned circuit.

### 2.6.4 Ground Current Errors

A common source of error in low level measurements is ground current, i.e. a current of signal, power, or other frequency flowing in a ground lead impedance. This results in a voltage in addition to the desired signal voltage appearing

at the input terminals. The effect of such a current may be eliminated or reduced by:

- Eliminating or reducing the ground current where possible. Isolation transformers (low capacitance, high resistance) in power line leads are effective in breaking power and other low frequency ground current loops.
- Employing coaxial signal leads and keeping these as short and direct as possible.
- Making all known ground impedance as low as possible.
- Operating the Model 323 on battery.

### 2.6.5 Transmission Line Error

At higher frequencies and with long lengths of connecting coax, errors caused by standing waves in unmatched systems may result. This is most easily dealt with by employing a matched system.

### 2.6.6 Magnetic and/or Electrostatic Field Error

Strong electrostatic and/or magnetic fields close to signal leads or the voltmeter itself can give rise to errors, particularly at the higher frequencies. Shielding and distance can be effectively employed to reduce or eliminate errors of this nature.

### 2.7 Use of the DB Scale

The dB scale on the Model 323 is referenced to 1 on the voltage scale. If 1 V is selected as a zero reference, measurements from +50 dB to -70 dB may be made. Each step of the range knob either adds or subtracts 10 dB from a selected level.

To help compute and convert dB levels from one reference to another, a dB slide rule is available (free of charge) from Ballantine Laboratories.

## 2.8 Effect of Harmonics

With complex waveforms this instrument measures the true rms value independent of the phase relationship of the harmonics, provided that all the harmonics fall within the frequency range of the instrument. The error caused by harmonics falling outside the calibrated range of the instrument is a function of both the relative energy contained in these harmonics as well as the relative response of the voltmeter in this area. Although the instrument is calibrated from 10 Hz to 20 MHz the response extends beyond these frequencies. It is down 3 dB at approximately 4 Hz and 30 MHz. To compute the rms value of a voltage when the rms magnitudes of its components are known, equation 1 may be used.

$$E_{\text{RMS}} = (E_1^2 + E_2^2 + E_3^2 \dots E_N^2)^{1/2} \quad (1)$$

$E_{\text{RMS}}$  rms amplitude of the complex waveform  
 $E_1 \dots E_N$  rms amplitude of harmonic

## 2.9 Effect of Crest Factor

The instrument has a crest factor (ratio of peak to rms amplitude) capability of 5 at full scale, increasing proportionately to 15 down scale. Crest factors greater than this cause errors because of detector response and/or amplifier overloading.

### 2.9.1 Flat-Topped Waveforms

Specified accuracy is maintained for flat-topped waveforms providing the crest factor and bandwidth specifications are not exceeded. Fig. 5 is a curve showing the relationship of crest factor to duty cycle for pulse trains.

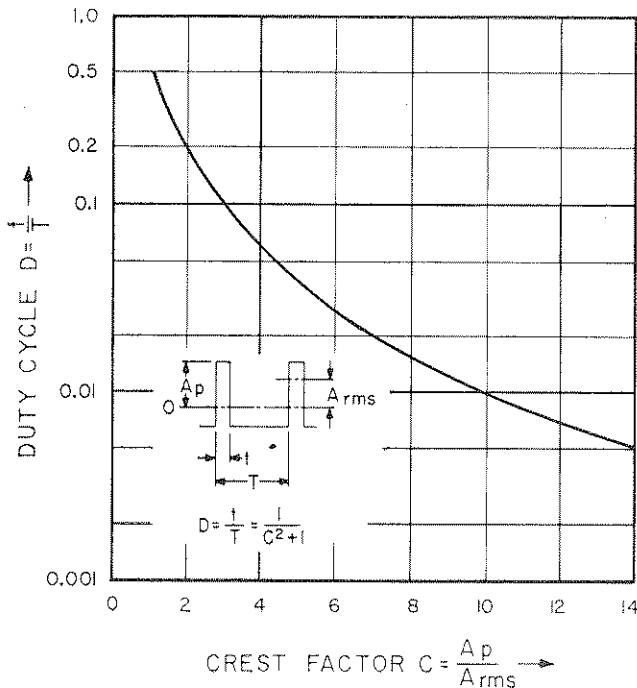

Fig. 5. Crest Factor vs. Duty Cycle for Pulse Trains

## 2.10 Effect of DC Component

This instrument responds only to the ac component of a waveform. If it is desired to include the dc component present in a waveform, this component should be measured separately with a dc voltmeter.

The true rms value may now be computed from:

$$E_{\text{RMS}} = (E_{\text{dc}}^2 + E_{\text{ac}}^2)^{1/2} \quad (2)$$

Example:

1 V dc is chopped into square pulses with 1 V peak amplitude. This pulse train has a dc component of 0.5 V which may be measured with a dc voltmeter. The ac component of this waveform will be 0.5 V rms when measured with the Model 323, 323-01. The total rms value is

$$E_{\text{RMS}} = (E_{\text{dc}}^2 + E_{\text{ac}}^2)^{1/2} = (0.5^2 + 0.5^2)^{1/2} = 0.707 \text{ V}$$

The dc component of waveform is blocked by an input capacitor which has a 600 V dc maximum rating. When a dc component exceeding 600 V is present, an external blocking capacitor with a suitable dc rating should be connected as in Fig. 6. The value of this capacitor should be at least 0.1  $\mu\text{F}$  if it is desired to measure to the lowest specified frequency (10 Hz).

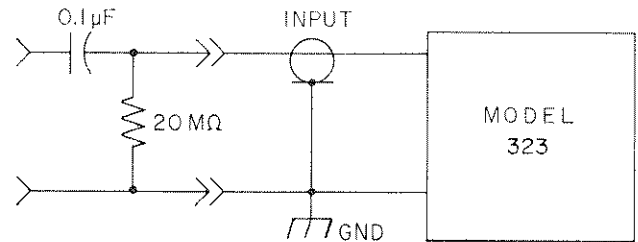

Fig. 6. Connection of External DC Blocking Capacitor

## 2.11 Measurement of Noise, Random Signals

When noise or random signals are measured an error which is a function of bandwidth and crest factor limitations may be introduced. The rms value of "white" noise is given by

$$E_{\text{rms}} = (4KRT\Delta F)^{1/2} \quad (3)$$

where

$K$  = Boltzmann's constant =  $1.374 \times 10^{-23}$

$R$  = source resistance

$T$  = temperature in  $^{\circ}$  Kelvin

$\Delta F$  = bandwidth in Hz

For wideband noise measurement the bandwidth of this instrument may be taken as 30 MHz. For measurement of noise sources with a bandwidth greater than 30 MHz, equation (3) may be used to calculate the error introduced by bandwidth limitation. Crest factor limitations introduce an error when measuring noise or random occurrences with Gaussian amplitude distribution. This error is depicted

in Fig. 7. The crest factor limit of 5 at full scale introduces an error of less than 0.01% which is negligible. If an element (such as a preamplifier) having a lower crest factor capability is used ahead of the instrument, it may be necessary to consider this source of error.

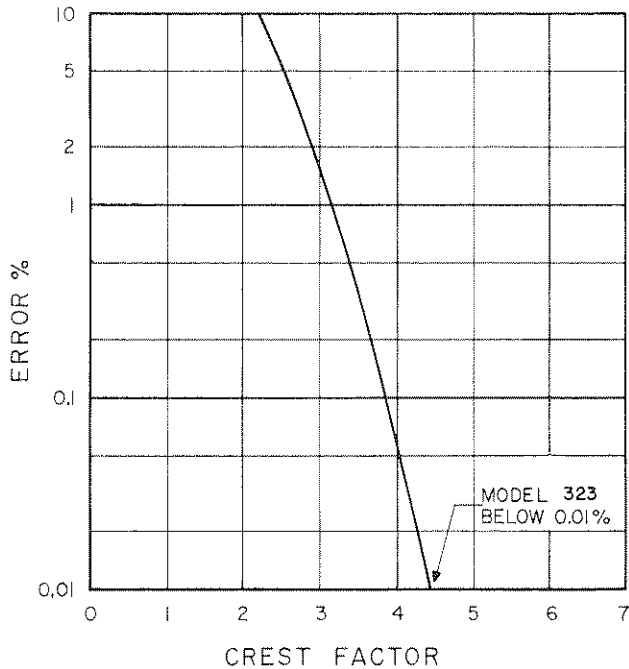

Fig. 7. Crest Factor Error with White Noise

### 2.12 Measurement of Waveforms with Crest Factor Greater than 5

While the crest factor limit is 5 at full scale, crest factors greater than this are permissible at lower scale indications. See Equation 4.

$$CF = \frac{5}{K} \quad (4)$$

where K = fraction of full scale indication.

Thus at half scale or below, waveforms with a crest factor of 10 may be measured. Fig. 8 shows an external 2:1 attenuator which may be used to bring indications to the lower half of the scale, permitting waveforms with crest factors as high as 10 to be measured. With indications which would normally fall on the upper portion of the scale, the switch is set to X2 and the indication multiplied by 2.

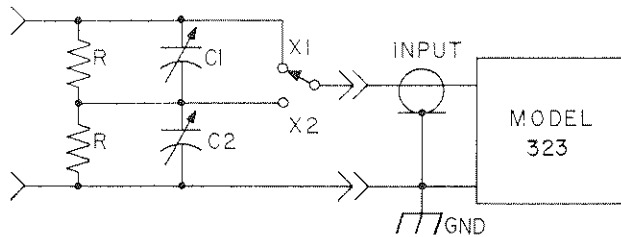

Fig. 8. External Attenuator to Extend Crest Factor Limit

The resistors R should be matched to 0.1%, and capacitor C1 should be adjusted (while connected to the voltmeter) for an accurate 2:1 attenuation at the highest frequency of interest.

At very low frequencies where all the harmonic components fall within its range, a ratio transformer may be used.

### 2.13 Use as Null Detector

When the signal voltage applied to the input terminals falls below 300 μV, measurements in the METER mode are no longer possible since the meter indication falls below the lowest calibrated point on the scale.

Setting the MODE switch to NULL brings the meter indicator up in the absence of any signal, making possible null indications down to approximately 70 μV. In this mode of operation considerable indicator fluctuation is normal and does not indicate malfunction of the instrument. A curve typical of the indication vs input voltage in the NULL mode is shown in Fig. 9.

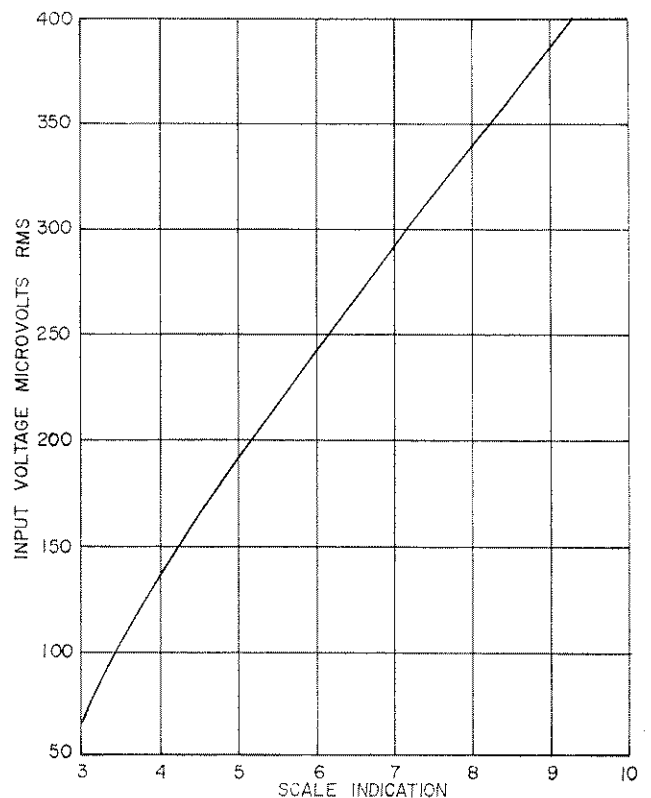

Fig. 9. Typical Calibration of 1 mV Range in NULL Mode

### 2.14 Measurements Below 300 μV

By setting the MODE switch to NULL, approximate measurements below 300 μV become possible. Fig. 9 is a curve showing the typical relationship between,

the indication and the signal level at the input terminals.

### 2.15 Measurements Above 330 V

Voltages up to 10 kV rms may be measured by using the Ballantine Model 1301 (binding post termination) or Model 1311 (coaxial termination) High Voltage Probe in conjunction with the Model 323, 323-01. This probe is an accurate 10,000:1 (80 dB) attenuator, and presents an input impedance of 4.5 pF in parallel with 10,000 MΩ minimum. The frequency range of the probe is 30 Hz to 1 MHz when used with the Model 323, 323-01. The additional error introduced by the probe is 1% or less.

### 2.16 Overload Protection

The instrument is fully protected against overloads up to 330 V\* input on any range at frequencies up to 1 kHz. At frequencies above this the maximum input voltage on the 1 mV through 30 mV ranges (4 ranges) must not be greater than

$$E_{\max} = 33 \text{ mV or } \frac{330 \text{ V}}{f_2} \text{ whichever is greater (5)}$$

where  $f_2$  is in kHz. See Table II.

**Table II — Maximum Safe Input Voltage**

Ranges	$f_2 < 1 \text{ kHz}$	$f_2 > 1 \text{ kHz}$
1 mV - 30 mV	330 V*	33 mV or $\frac{330 \text{ V}}{f_2 \text{ in kHz}}$ whichever is greater
100 mV - 300 V	330 V*	330 V

Equation 5 assumes that the signal source impedance is zero or very low, which is almost never the case at these frequencies. It will be found that in general no precautions need be taken about overloads providing the input voltage does not exceed 330 V.

\*500 V peak

### 2.17 Influence of Power Line Voltage

#### Model 323

Operation on line voltages of 105 V to 135 V (210 V to 270 V) causes no discernible change in indications on the Model 323, providing the battery is properly charged. See Section 2.4.2.

#### Model 323-01

Operation on line voltages of 105 V to 135 V (210 V to 270 V) causes no discernible change in indications on the Model 323-01.

### 2.18 Influence of Battery Voltage, 323 Only

The battery employed in this instrument is a nickel-cadmium rechargeable type, affording 20 hours continuous operation from a fully charged condition. A curve of voltage vs discharge is shown in Fig. 10.

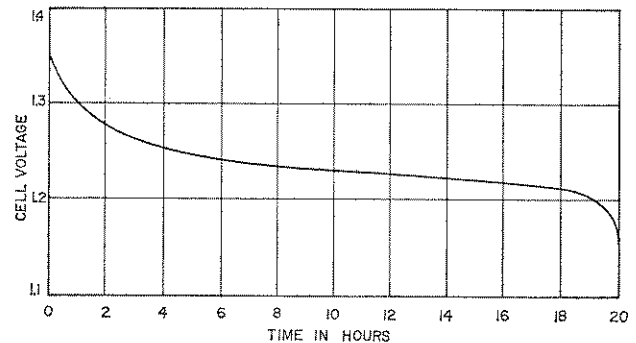

**Fig. 10. Typical Battery Voltage vs. Discharge Time**

It will be noted that over most of the discharge period the battery voltage is essentially constant. Near the very end of the discharge time the voltage begins to fall rapidly. Over the "flat" portion of battery discharge the Model 323 will meet all specifications; near the very end an additional error of up to -1% may be encountered.

### 2.19 Influence of Ambient Temperature

The instrument accuracies (See Section 1.3 Technical Characteristics) apply over the ambient temperature range of 18°C to 30°C. For ambient temperatures in the region of 10°C to 40°C an additional uncertainty of one-half the stated accuracy may be incurred.

The above assumes that the instrument has been allowed to stabilize for a period and is not subject to temperature gradients or drafts.

### 2.20 Measurement of RMS Current

The voltage drop caused by a current flowing through a resistor can be measured with the Model 323, 323-01, and the rms value of the current computed. The Ballantine Model 600 series of precision wirewound resistors are designed for this purpose and are available in decade ranges from 0.01 Ω to 1000 Ω. The range of current with these resistors is 300 nA to 10 A. The crest factor is the same as for voltage measurements, while the frequency range is dependent upon the resistor used. The 0.01 Ω resistor is suitable for RMS current measurements to 20 kHz, the 1000 Ω resistor is good to 200 kHz.

## 2.21 Measurement of Power

The power dissipated in a pure resistive load may be measured with the Model 323, 323-01 from the formula

$$P = \frac{E^2}{R} \quad (6)$$

Power ratios are frequently expressed in decibels (dB) obtained from

$$PR \text{ (dB)} = 10 \log_{10} \frac{P_2}{P_1} \quad (7)$$

When the resistance across which  $P_2$  and  $P_1$  are developed is the same

$$PR \text{ (dB)} = 10 \log_{10} \frac{\frac{E_2^2}{R}}{\frac{E_1^2}{R}} = 20 \log_{10} \frac{E_2}{E_1} \quad (8)$$

Thus the decibel scale on the Model 323, 323-01 may be used to measure power ratios directly across a common resistance, or equal resistances. The 0 on the decibel scale is referenced to 1 on the voltage scale; other voltage references are available on special order.

## 2.22 DC Output

A dc voltage, which is a squared function of the ac input voltage, is available on each voltage range at a rear mounted BNC connector. The "low" terminal is at signal ground potential and may be tied to systems ground as desired. The amplitude is  $-1 \text{ V}$ ,  $\pm 1\%$  for a meter indication of  $10 \text{ V}$ , with a linearity error not exceeding  $\pm 0.3\%$  of full scale. The source resistance is approximately  $1667 \text{ ohms}$ . The load resistance may be as low as zero  $\Omega$  in which case a current of  $600 \mu\text{A}$ ,  $\pm 3\%$  will be delivered.

The time constant associated with this dc output is  $0.25 \text{ s}$  or  $0.5 \text{ s}$ , selectable by the RC TIME CONSTANT switch on the front panel. Other time constants are available or may be added to the instrument. See Sections 2.23, 5.12 and Table III.

The ripple voltage at  $1 \text{ kHz}$  is  $< 1.5\%$  increasing to  $< 4.0\%$  at  $10 \text{ Hz}$ , with the  $0.5 \text{ s}$  TIME CONSTANT.

Table III — Capacitance vs Time Constant

Time Constant Seconds	Capacitance Calculated Value	Capacitors Standard Value
1.0	4.76 $\mu\text{F}$	5.0 $\mu\text{F}$
2.0	9.53 $\mu\text{F}$	10.0 $\mu\text{F}$
3.0	14.4 $\mu\text{F}$	15.0 $\mu\text{F}$
5.0	23.8 $\mu\text{F}$	22.0 $\mu\text{F}$
7.0	33.3 $\mu\text{F}$	33.0 $\mu\text{F}$
10.0	47.6 $\mu\text{F}$	47.0 $\mu\text{F}$
20.0	95.3 $\mu\text{F}$	100.0 $\mu\text{F}$
30.0	144.0 $\mu\text{F}$	150.0 $\mu\text{F}$

### CAUTION

**Damage to the signal rectifiers, meter movement or both may result if a source of voltage or current (dc or ac) is connected to the dc output connector.**

If in an application there is any doubt, the external device should be checked with both a sensitive ac and dc voltmeter.

## 2.23 RC Time Constant, Reset, Response Time

The rc time constant in this instrument refers specifically to the DC OUT (See Section 2.22) and somewhat less specifically to the meter indication, since the meter movement electromechanically introduces a square root function. The two are not independent of each other, and are determined for the most part by the same circuit elements (meter ballistics enter the situation with fast time constants). The dominant time constant for all but very short ones is determined by the rc filter at the output of the rms detector.

The instrument is supplied with two time constants,  $0.25 \text{ s}^*$  and  $0.5 \text{ s}$ , selectable by the RC TIME CONSTANT switch. The faster  $0.25 \text{ s}$  is for frequencies above  $100 \text{ Hz}$ ; below this frequency there will be considerable error and needle flutter. The  $0.5 \text{ s}$  time constant is usable from  $10 \text{ Hz}$  upward. Other time constants (up to  $30 \text{ s}$ ) are available on special order or may be added by the user. See Section 5.12 and Table III.

The response time (meter indication or DC OUT) is directly related to the time constant, i.e. the longer the time constant, the longer the response time. It takes approximately 4.5 time constants to achieve 99% of the final indication or DC OUT. Thus on the  $0.5 \text{ s}$  time constant the response time (for 99% of final) would be approximately  $2 \text{ s}$ .

When this instrument is subjected to severe input overloads while employing long rc time constants, the recovery time may be excessive. The crest factor capabilities of the wideband amplifier and rms detector make it possible to charge up the capacitors

\*Early production units incorporated only one time constant  $0.4 \text{ s}$ , which was labelled NORMAL.



in the rc filter far beyond normal levels on input overloads; the capacitors must then discharge to normal levels. To speed up this discharge, shorting positions have been incorporated on the RC TIME CONSTANT switch and are designated RESET. Actually it is necessary only to advance this switch one position clockwise to discharge the capacitors in use. It should be noted that the use of the RESET does not fully discharge the capacitors; a property of all capacitors called "dielectric absorption" prevents their giving up all their energy in zero time.

### 2.24 Indicator Flutter, Beats at Lower Frequencies

There are two sources of indicator flutter or beating in this instrument at the lower frequencies. Both are related to filtering following the rms detector. One, however, is also a function of the chopper frequency, while the other is not.

The first source of flutter is the ac ripple present on the dc output from the rms detector and its filter. This ripple is inversely related to frequency and may be reduced by increasing the rc time constant in the rms detector output. See Sections 2.23, 5.12. However, increases in time constant also result in increases in response and overload recovery time.

A second source of indicator fluctuation is beating between ripple components in the rms detector filter output and the chopper frequency (94 Hz). These beats (as opposed to flutter) will be noted with signals at or near the chopper frequency, its subharmonics, and to a lesser extent, its harmonics. Again the fluctuation may be reduced or eliminated by increasing the rc time constant, with attendant increases in response time and overload recovery. See Sections 2.23, 5.12.

## 3. CIRCUIT DESCRIPTION

### 3.1 Basic Circuitry

The basic circuitry of this instrument is shown in Fig. 11, Simplified Schematic, while a complete schematic, Figs. 22, 23, is located at the end of the manual.

Tracing the signal, the ac input is attenuated as necessary, amplified in the wideband amplifier, attenuated again as necessary, converted to dc in the rms detector, converted to 94 Hz ac by means of a mechanical modulator, amplified further in the 94 Hz amplifier, demodulated, passed through a meter to provide indication, and through a resistor to provide a dc output.

Since the basic sensitivity of the instrument is 1 mV full scale, it is necessary either to change this sensitivity or to use attenuators for higher level signals. A pair of attenuators is used and Table IV is a schedule of attenuation vs range setting.

Table IV — Attenuation vs Range Switch

Range	Input Attenuation	Output Attenuation	Total Attenuation
1 mV	0 dB	0 dB	0 dB
3 mV	0 dB	10 dB	10 dB
10 mV	0 dB	20 dB	20 dB
30 mV	0 dB	30 dB	30 dB
100 mV	40 dB	0 dB	40 dB
300 mV	40 dB	10 dB	50 dB
1 V	40 dB	20 dB	60 dB
3 V	40 dB	30 dB	70 dB
10 V	80 dB	0 dB	80 dB
30 V	80 dB	10 dB	90 dB
100 V	80 dB	20 dB	100 dB
300 V	80 dB	30 dB	110 dB

The following sections discuss in some detail the basic units, their circuitry and, in some instances, components used.

### 3.2 Input Attenuator

The input attenuator provides attenuation of 0, 40, and 80 dB and is of the resistance-capacitance type. At low frequencies the attenuation-ratio is determined entirely by the resistors, at high frequencies by the capacitors. The crossover from resistive to capacitive attenuator occurs at approximately 25 kHz.

The resistors used are high-stability, metal-film units initially matched to 0.1%. The capacitors use polystyrene (adjustable) and mica (fixed) as dielectrics, which afford high stability and excellent high frequency characteristics.

### 3.3 Input Protection

A set of four diodes connected in series parallel across the input of the wideband amplifier limit the voltage to the input device to approximately  $\pm 1.8$  V maximum. The series reactance of the input capacitor and a small series resistor limit the diode current to safe values at frequencies below 1 kHz with 330 V applied to the input. In general, at frequencies higher than 1 kHz the generator or source resistance also serves to limit the current flow to a safe value.

It should be noted that the protective circuit is necessary primarily on the four most sensitive ranges. On all higher ranges the input attenuator reduces the input voltage to a safe value provided that no more than 330 V is applied to the input terminals.

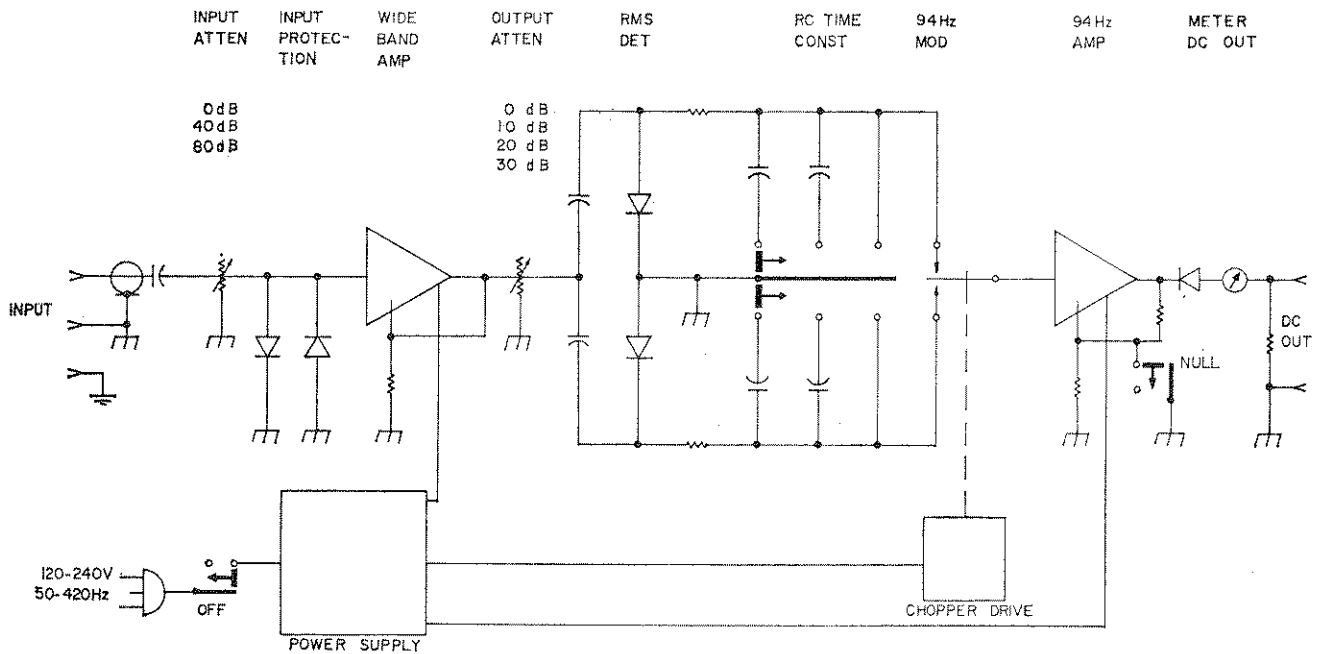

Fig. 11. Simplified Schematic, Models 323, 323-01

### 3.4 Wideband Amplifier

The wideband amplifier provides a voltage gain of approximately 6 over the frequency range of 10 Hz to > 20 MHz. Although the voltage gain is rather modest the power gain is large because of the great disparity in input and output resistance. The output voltage of the amplifier is developed across the output attenuator which has an impedance of approximately 200  $\Omega$ .

### 3.5 Output Attenuator

The output attenuator provides attenuation of 0, 10, 20 and 30 dB and is of the ladder variety. The attenuator is essentially resistive over the entire frequency range; capacitance trimming is used to correct small departures at the highest frequencies on some positions.

Metal film resistors, initially matched to 0.1%, and ceramic capacitors are used.

The output of the attenuator goes to the rms detector.

### 3.6 RMS Detector

The rms detector converts the ac signal over a frequency range of 10 Hz to 20 MHz and over an amplitude range of 10 dB (approximately 1.9 mV to 6 mV) to a balanced dc signal with a corresponding amplitude range of 20 dB (approximately 50  $\mu$ V to 500  $\mu$ V). A dual section rc filter is employed as an integrating and averaging device. A switch in

this circuit permits a choice of rc time constants as well as a shorting position (RESET) to help remove capacitor charge following overloads.

The detector diodes are of the silicon Uni-Tunnel or "backward" type. By operating these units at a low level (near the origin on V, I curve) a nearly perfect square law relationship between the input ac and output dc is obtained. Moreover the dynamic range of the "square-law" region can be made large enough to permit relatively large crest factors (at least 5:1).

The output of the rms detector goes to the 94 Hz modulator.

### 3.7 94 Hz Modulator

The 94 Hz modulator converts the balanced dc signal from the rms detector to a 94 Hz square wave, and passes it on to the 94 Hz amplifier.

An electromechanical modulator (chopper) is used since, of the various types available, it displays:

1. Highest conversion efficiency
2. Lowest residual noise level
3. Lowest residual dc
4. Lowest dc drift

To avoid dependence on power supply frequency and to reduce the effects of power supply hum, the chopper operates at a frequency of 94 Hz. Thus the power supply frequency is limited only by other considerations (transformer, ripple, etc.) and may be any of the common supply frequencies between 50 and 420 Hz.

### 3.8 94 Hz Amplifier

The low level ac signal (94 Hz) from the modulator is amplified by the 94 Hz amplifier to a level suitable for driving an indicator. This amplifier, while not sharply tuned, does fall off at frequencies above and below 94 Hz, thereby reducing undesirable low and high frequency noise.

The amplifier uses silicon junction transistors in a three stage circuit. The first two transistors are direct coupled and operated at very low current to provide high input impedance and low noise. In the output stage one of the two transistors is operated in grounded base configuration to provide a high collector impedance for the other unit. Overall ac feedback is employed to stabilize the gain against component changes, environmental effects, etc. In the NULL mode of operation the feedback is removed to provide greater sensitivity. There is an attendant loss of stability, increase in noise, etc.

### 3.9 Rectifier, Meter, DC Output

AC signal current from the 94 Hz amplifier is rectified by a pair of diodes to provide dc current for the meter; this current is also passed through a resistor to provide a dc output. A capacitor across the meter and dc load reduces pointer fluctuation and ripple. Because of the high drive impedance, shorting the dc output has little or no effect on meter indications. The signal diodes are hermetically sealed silicon units virtually immune to aging and environmental

effect. The meter has a taut-band suspension and employs shaped pole pieces to achieve a logarithmic characteristic.

### 3.10 Chopper Drive

The chopper drive employs 4 silicon transistors to convert 6 V dc to a 94 Hz square wave. Two of the transistors, operating as a multivibrator, drive the other two transistors as switches.

### 3.11 Power Supply, Model 323

The power supply uses a line transformer and full-wave bridge rectifier to provide dc current for battery charging. The current is regulated to the proper charging rate (120 mA) by a solid state regulator employing a zener diode and transistor. The 12 V nickel-cadmium battery provides operating potentials for both amplifiers; a 6 V tap provides potential to the chopper drive circuit. THIS BATTERY IS NECESSARY TO THE OPERATION OF THE INSTRUMENT EVEN WHEN ON LINE POWER. NO ATTEMPT SHOULD BE MADE TO OPERATE WITHOUT BATTERIES.

### 3.12 Power Supply, Model 323-01

This power supply uses a line transformer and full-wave bridge rectifier to supply dc operating potentials for the amplifiers and chopper drive circuit. A zener diode is used to stabilize the voltage for chopper drive, while a pair of zeners and a transistor are used to regulate the supply voltage to the amplifiers.

## 4. MAINTENANCE

### 4.1 General

The Model 323, 323-01 has been designed for extended, trouble-free operation, and should seldom require servicing or maintenance. The design employs all silicon devices except for one germanium transistor (323 only) in the power supply, and all components are operated well below their maximum ratings. Checks at Ballantine Laboratories, Inc. indicate that at least several thousand hours of operation can be expected before there is any need for recalibration.

The purpose of this section is to provide procedures for checking performance and correcting if necessary. The Periodic Checks (Section 4.4) not only check performance, but may also help detect incipient failure and assure instrument accuracy until the next periodic check.

### 4.2 Equipment Required

- A. Stable, accurately-calibrated ac voltage source, with a voltage range of at least 500  $\mu$ V to 100 V rms, and at a frequency of 400 Hz to 1 kHz. The Ballantine Model 421A is recommended.
- B. An accurate, high impedance dc voltmeter covering a range of at least 100 mV to 1 V. The Ballantine Model 365 is recommended.

- C. An accurate, high impedance ac voltmeter covering a range of at least 5 to 10 V. The Ballantine Model 300G, 300H, 302C, 303, 310B, 320A and 323 are recommended.

### 4.3 Recommended Checks

It is recommended that the checks outlined in Section 4 be made every 2,000 hours of operation, or once a year. If the instrument is stored or operated under severe environmental conditions the frequency of these checks should be increased to a rate consistent with these conditions.

### 4.4 Checks

#### 4.4.1 Scale Adjustment

To make the scale adjustment, proceed as follows:

- A. Connect a stable signal of 400 Hz - 1 kHz to the input and adjust for an indication of precisely 10 on the 1 V range.
- B. Reduce the signal level by the precise factor of 0.3162 (10 dB) and note the indication on the scale. If the meter does not indicate 3.162 (1 on the lower scale) adjust the SCALE adjustment (see Fig. 13) for this indication.

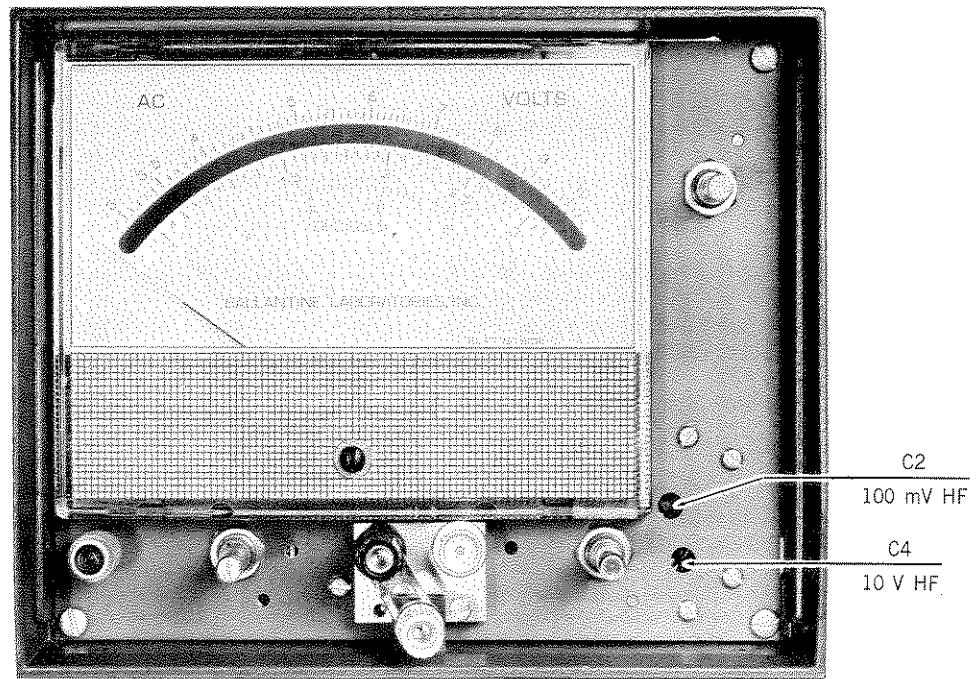

Fig. 12. Instrument Adjustments, Front View

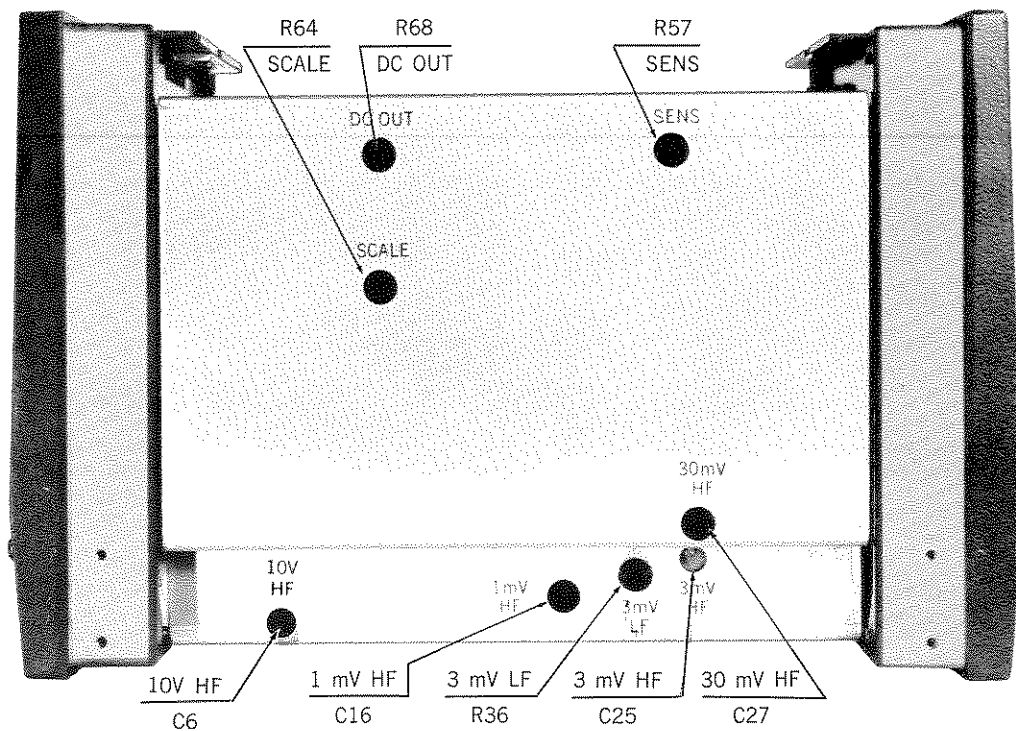
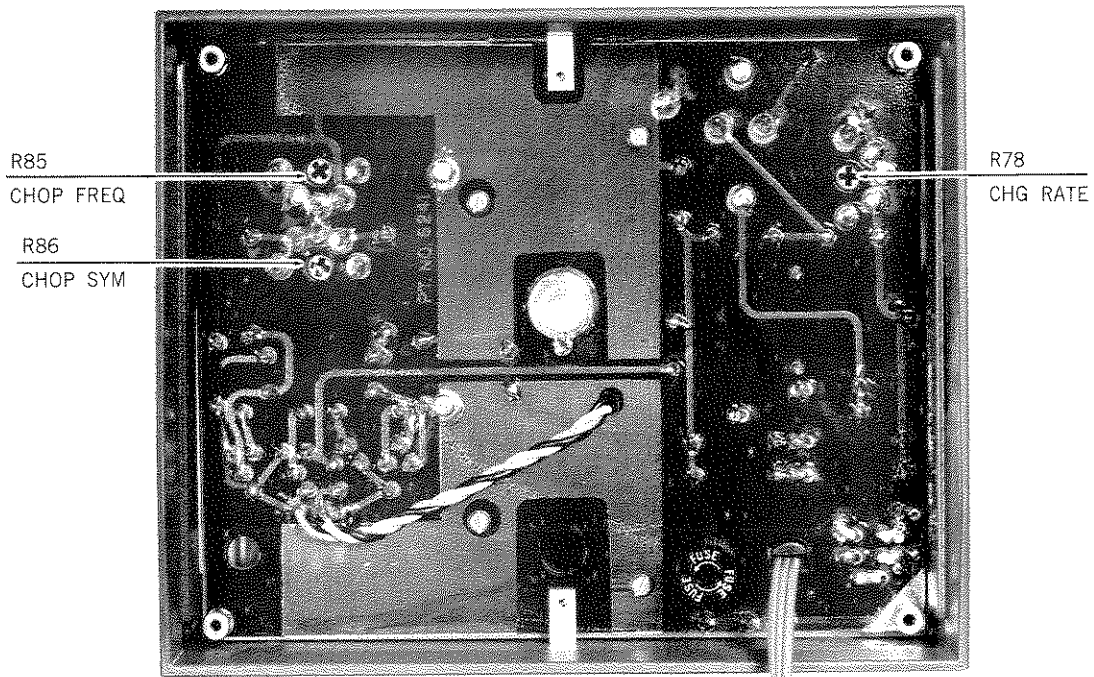
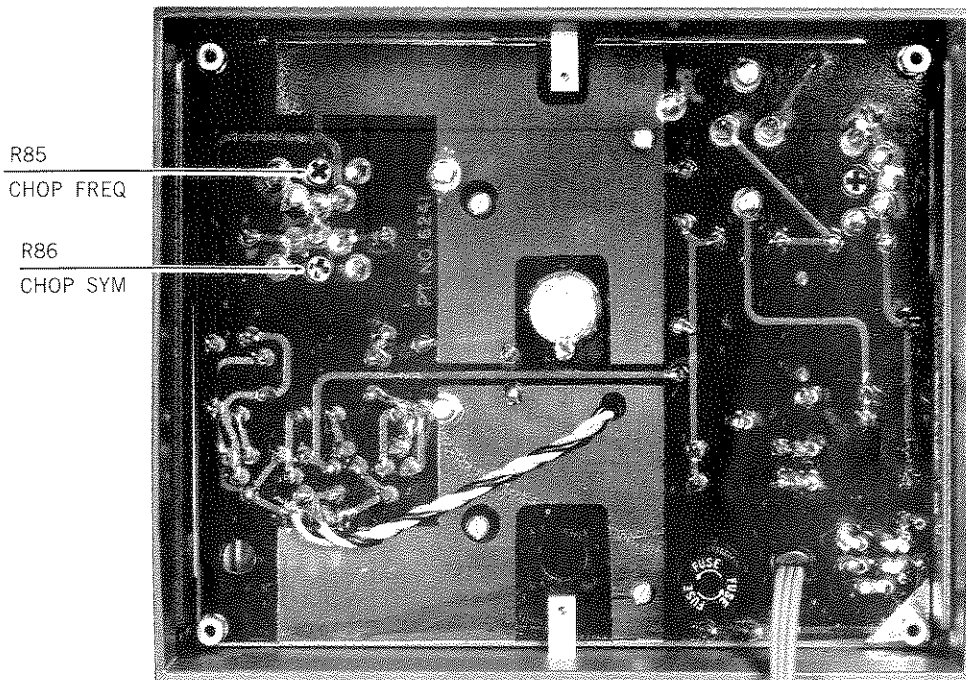

Fig. 13. Instrument Adjustments, Side View



Model 323



Model 323-01

Fig. 14. Instrument Adjustments, Rear View

- C. Repeat steps A and B if necessary. Normally there will be little interaction between these adjustments unless the SCALE adjustment is initially greatly out of adjustment.

#### 4.4.2 Attenuator

To check the midband attenuator operation proceed as follows:

- A. On the 1 mV range put in a signal to produce a precise deflection at some point, e.g. 5 or 10 on the scale.
- B. Increase the input by precise factors of 3.162 (10 dB) advancing the range knob accordingly. Note the deviation from the initial indication; these should be within  $\pm 0.25\%$  maximum.
- C. If the deviations on the 3 mV, 10 mV, or 30 mV ranges exceed  $\pm 0.25\%$ , reduce these by adjusting the 3 mV LF adjustments (see Fig. 13) for better agreement with the 1 mV range.

#### 4.4.3 Sensitivity

To adjust the sensitivity proceed as follows:

- A. Complete the checks outlined in sections 4.4.1 and 4.4.2.
- B. Connect a signal of precisely 1 V rms, 400 Hz to 1 kHz, on the 1 V range. Successively, set the input signal to 0.9, 0.8,

0.7, 0.6, 0.5, 0.4, 0.3, 0.25, 0.2, 0.15, 0.1 volts noting the magnitude and sign of the error at each point.

- C. Adjust the SENS control (see Fig. 13) so that the maximum positive and maximum negative errors obtained in step B are equal.

#### 4.4.4 DC Output

To adjust the dc output proceed as follows:

- A. Connect a signal to produce an indication of precisely 10 on the scale, and note the dc output voltage. If this is not  $-1.0, \pm 1\% V$ , adjust the DC OUT control (see Fig. 13) for this condition.
- B. Reduce the input voltage by a precise factor of 0.3162 (10 dB). The dc output voltage should be  $-100, \pm 3\% mV$ . If this is not obtained recheck the scale adjustment as outlined in section 4.4.1.

#### 4.4.5 NULL Operation

To check the NULL operation proceed as follows:

- A. With the MODE switch on METER connect a signal to produce an indication of 0 db on the meter.
- B. Set the MODE switch to NULL and note the increase in indication; this should be at least 6.5 dB on the dB scale.

## 5. SERVICE AND TROUBLESHOOTING

### 5.1 General

In case of voltmeter malfunction, servicing by the user is feasible, provided skilled personnel using recommended equipment follow the procedures outlined below. However, it should be pointed out that these procedures are somewhat simplified; refined servicing and calibration may require special equipment not generally available to the user. If this is the case, or if trouble develops which cannot be corrected by the procedures outlined, the instrument should be returned to Ballantine Laboratories, Inc. for servicing. In all cases the instrument should be preceded by a letter stating the exact nature of the trouble and/or the desired servicing.

#### 5.1.1 Equipment Required

- A. An accurate, high impedance dc voltmeter, covering at least the range of 1 mV to 100 V. The Ballantine Model 365 is recommended.
- B. An accurate, low resistance dc ammeter covering at least the range of 100  $\mu A$  to

150 mA. The Ballantine Model 365 is recommended.

- C. A variable frequency generator or generators covering a frequency range of 10 Hz to 20 MHz, with an output of 1 mV to 10 V or higher.
- D. Wideband level monitor or monitors, covering a frequency range of 10 Hz to 20 MHz. The Ballantine Model 440 Micropotentiometers, and Ballantine Model 393 HF Transfer Voltmeter are recommended.
- E. A sensitive, accurate, high impedance ac voltmeter covering a frequency range of at least 60 Hz to 1000 Hz, and a voltage range of at least 100  $\mu V$  to 10 V. The Ballantine Models 300H, 302C, 310B, 320A, 321 are recommended.

### 5.2 Line Voltage Conversion

To change the operating line voltage of this instrument proceed as follows:

- A. Remove instrument cover.
- B. Locate line voltage switch at lower left hand corner of the rear panel (while facing the front of the instrument).
- C. Move the switch to its upper position for 120 V operation, to the lower position for 240 V operation.
- D. If the voltage chosen in step C does not agree with that on the decal located on the rear cover, revise the decal marking to avoid damage or malfunction.
- E. Install a fuse consistent with the line voltage, chosen as follows:

Line	323	323-01
120 V	1/10 A, Slo-Bl0	1/16 A, Slo-Bl0
240 V	1/16 A, Slo-Bl0	1/32 A, Slo-Bl0

### 5.3 Access to Instrument Adjustments, Components

The instrument adjustments are shown in Figs. 12, 13, and 14.

To gain access to these adjustments proceed as follows:

- A. Remove the two flat head screws securing top cover to instrument, and remove.
- B. Remove four screws securing the right side rail to instrument, and loosen four screws clamping bails to side rail; remove side rail. All side adjustments are now available through access holes in internal shield. To gain further access to components, etc., remove four screws securing internal shield.
- C. Remove three knobs, and four screws securing front escutcheon plate; remove escutcheon plate.
- D. Remove four screws securing rear panel; remove rear panel

### 5.4 Battery Charging Current, 323 Only

To check the battery charging current, proceed as follows:

- A. Disconnect the lead at the positive 12 V terminal of the battery.
- B. Connect a low resistance current meter between the positive terminal and the lead disconnected.
- C. With the instrument connected to the line, set the MODE switch to BATT CHG. The current meter should indicate  $120 \pm 3\%$  mA. If it does not, adjust the CHG RATE control (see Fig. 14) for 120 mA.

### 5.5 Battery Replacement, 323 Only

To replace the battery in the Model 323, proceed as follows:

- A. Unscrew the knurled nuts\* on the battery terminals and remove leads.
- B. Remove the screws securing the battery retainer to the chassis.
- C. Install new battery, reversing above procedure.
- D. In all of the above take precautions to avoid shorting the batteries with tools, leads, etc.

### 5.6 Chopper Drive Adjustments

To adjust the chopper drive frequency proceed as follows:

- A. On any range connect a signal of 94 Hz  $\pm 0.25\%$  to the input terminals of the instrument, and adjust the amplitude for an up scale meter indication.
- B. Adjust the CHOP FREQ control (see Fig. 14) for zero (or as close to zero as possible) beat as noted by meter fluctuation.

To adjust the chopper drive symmetry proceed as follows:

- A. Connect the test circuit shown in Fig. 15.

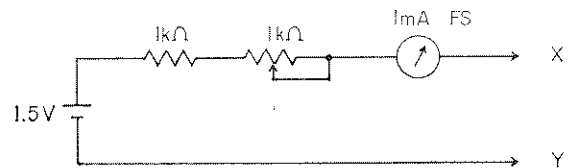

**Fig. 15. Chopper Drive Symmetry Adjustment Circuit**

- B. Connect test prods X & Y together and adjust the 1 KΩ pot for a full scale indication of 1 mA.
- C. Set the instrument RANGE switch to 300 V with zero input signal, MODE switch to METER.
- D. Connect test prods X & Y to chopper terminals 7 & 6, and then terminals 7 & 1, noting the indication in each case. These indications should be slightly less than  $500 \mu\text{A}$  and should be equal. If they are not equal, adjust for this condition with CHOP SYM control (see Fig. 14).

\*Early production units employed two distinct batteries with soldered leads to tabs on one unit; here these leads would have to be unsoldered.

## 5.7 Chopper Replacement

To replace the chopper in this instrument proceed as follows:

- A. Unsolder the four leads connected to the base terminals, noting where each goes.
- B. Remove the two screws securing the chopper to the printed circuit board.
- C. Remove the top connector, and remove the chopper.
- D. Install the new chopper observing the reverse of the above procedure.
- E. Use only non-corrosive solder-flux when re-connecting leads removed in step A above.

Remove all solder-flux and other foreign material by cleaning with a solvent such as acetone or pure grain alcohol. In areas where high humidity is frequently encountered, coat the connections and terminals with a moisture-resistant coating such as Humiseal 1A27.\*

## 5.8 Transistor Replacement

All of the transistors in this instrument are operated well within their maximum ratings and it should normally never be necessary to replace any unit. Because of the wide variation or spread in transistor parameters it is necessary in an instrument of this type to do a certain amount of selection and matching. Those units which are selected are so indicated on the Replacement Parts List, Section 7.

If replacement should become necessary, unselected units may be replaced with a unit of the same type designation. Selected units should be obtained from Ballantine Laboratories, Inc. In ordering a selected unit give the type, symbol designation (Q1, Q2, etc.) and color code (center dot, side dot, etc.) if any.

In removing and replacing a transistor (or other component) care should be exercised to avoid damage to the printed circuit board. Land areas on the board may lose their adhesion if subjected to excessive heat and pressure. A procedure to minimize the possibility of damage is to:

- A. Clip the transistor or component leads on the component side of the board to remove the defective item.

\*Columbia Technical Corporation, 24-30 Brooklyn Queens Expressway West, Woodside 77, N. Y.

- B. With pliers or tweezers remove the lead from the component side of the board while heating the solder on the reverse side.
- C. With the solder on the land area still molten, insert a scribe or other pointed tool into the lead hole (solder side) keeping it there until the solder solidifies after heat removal. Push out any solder which may have solidified in the hole from the solder side of the board.
- D. When inserting the leads of the new component, check to see that they pass through the circuit board hole freely and exert no pressure on the land area on the solder side of the board.
- E. After lead insertion carefully solder using a non-corrosive flux. Clean all flux and other residue from the affected area of the board with a solvent such as acetone or pure grain alcohol.
- F. In areas of high humidity the affected area should be coated with a moisture-resistant coating such as Humiseal 1A27.

## 5.9 High Frequency Adjustments

The high frequency performance of this instrument is determined by the input attenuator, the wideband amplifier, the output attenuator, and rms detector. Each of these items except for the rms detector has a control or controls for adjusting the high frequency performance. These controls have been adjusted during the calibration at Ballantine Laboratories, Inc. and should seldom, if ever, require readjustment. Before any readjustment is made it should be fully established that readjustment is necessary, and the procedures outlined in this section should be followed.

The controls involved may affect all ranges, a group of ranges, or a certain sequence of ranges. In making a readjustment it is necessary to follow a sequence for proper results. Table V gives a listing of the controls affecting the high frequency performance of each range. On any range the performance should be checked for each adjustment listed, in a left to right sequence. Thus on the 3 V range it would be necessary to check (and readjust if required)

First — 1 mV range

Second — 30 mV range

Third — 100 mV range

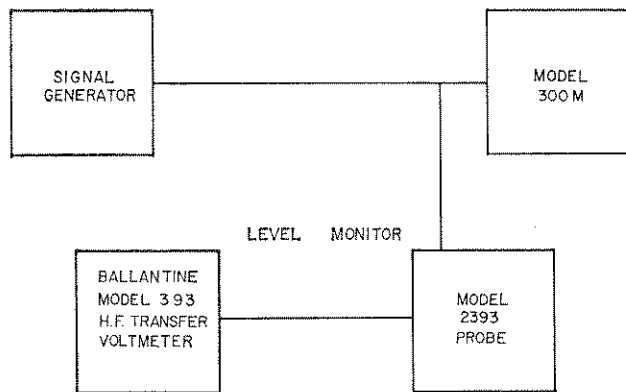
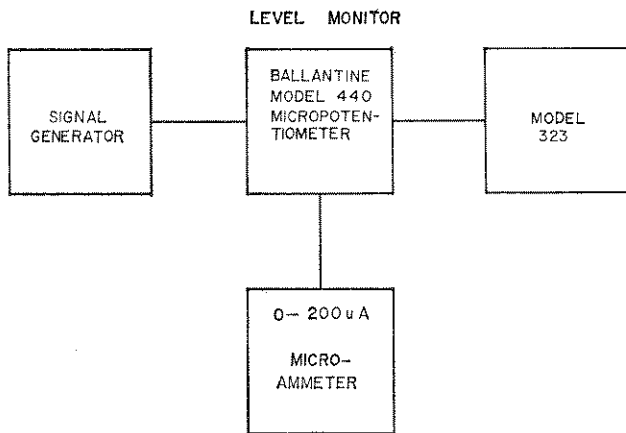

**Table V — High Frequency Adjustments vs. Range**

Range	Control				
	1 mV HF	3 mV HF	30 mV HF	100 mV HF	10 V HF
1 mV	×				
3 mV	×	×			
10 mV	×				
30 mV	×		×		
100 mV	×			×	
300 mV	×	×		×	
1 V	×			×	
3 V	×		×	×	
10 V	×				×
30 V	×	×			×
100 V	×				×
300 V	×		×		×

× denotes that control at top of column influences that range.

The test setup of equipment to check the frequency response on any range is shown in Fig. 16. The con-

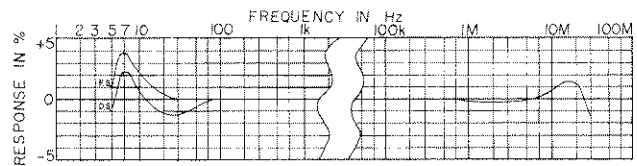

**Fig. 16. Frequency Response Check**

nection between the Model 323 and the level monitor should be as short and direct as possible so that the signal at the input of each will be identical at high frequencies. The signal generator and level monitor must operate at levels consistent with the range to be checked. For ranges up to 300 mV the Ballantine Model 440 Micropotentiometer is recommended as a level monitor; for ranges from 1 V to 100 V the Ballantine Model 393 HF Transfer Voltmeter is recommended.

To check the 1 mV range proceed as follows:

- A. At a frequency of 1 kHz set the amplitude for an on-scale indication (e.g. 1 mV) on the instrument and note the indication of the level monitor.
- B. In succession set the generator frequency to 10 kHz, 100 kHz, 1 MHz, 5 MHz, 10 MHz, 15 MHz and 20 MHz, adjusting the generator amplitude at each frequency for the same indication on the level monitor as was noted at 1 kHz. At each frequency also note the instrument indication. It is helpful to either tabulate or plot this response in % vs frequency. The 1 mV HF adjustment (see Fig. 13) should be adjusted (if necessary) for the flattest response to 10 MHz. A rise of approximately 0.5% at 10 MHz is typical and a further rise beyond this point is also typical and desirable. A typical response for the 1 mV range is shown in Fig. 17.



**Fig. 17. Typical Frequency Response, 1 mV Range**

The procedure for the adjustment of all other ranges is similar to that for the 1 mV range. In each case any adjustment made should be to provide flattest response to 10 MHz and best agreement with the 1 mV range.

### 5.10 Low Frequency Checks

The low frequency response of this instrument is determined primarily by the wideband amplifier and rms detector and hence is independent of range selector setting. There are no controls for adjustment; need for readjustment probably indicates a faulty component.

To check the low frequency response connect the in-

strument as shown in Fig. 16 and proceed as follows:

- A. At a frequency of 1 kHz set the amplitude for an on-scale indication (e.g. 1 V) on the instrument and note the indication on the level monitor.
- B. In succession set the generator frequency to 100 Hz, 50 Hz, 30 Hz, 20 Hz, and 10 Hz, adjusting the amplitude at each frequency for the same indication on the level monitor noted at 1 kHz. At each frequency also note the instrument indication. A typical low frequency response is shown in Fig. 17. It will be noted that the response at full scale and down scale are different below 50 Hz; this is inherent and normal.

### 5.11 Attenuator Repairs

The resistors used in the range attenuators of this instrument are a precision metal film type and are initially matched to a tolerance of  $\pm 0.1\%$ , with temperature coefficients matched to  $\pm 100$  ppm. If the procedure outlined in Section 4.4.2 reveals that an attenuator is in error, it is recommended that the entire attenuator involved be replaced with a matched set obtained from Ballantine Laboratories, Inc.

The attenuator actually causing the error can be isolated by the use of Table IV and the schematic Figs. 22 and 23.

Example: All ranges are normal except the 100 mV, 300 mV, 1 V and 3 V where an error of  $-6\%$  is noted. Scanning Table IV would quickly reveal that the 40 dB input attenuator (R4, R5 and R6) is common to these four ranges and no others. The output attenuator would not be suspect since it is involved on the eight other ranges which are normal.

Example: The 30 mV, 3 V, and 300 V ranges exhibit an error of  $+2\%$  with all other ranges normal. Table IV shows that the 30 dB output attenuator (R39 and R42) is common to these three ranges and no others.

Example: The only ranges normal are the 1 mV, 100 mV, and 10 V ranges. All other ranges exhibit approximately the same error of  $+7\%$ . The use of Table IV, the schematic Figs. 22, 23, and a little reasoning would soon indicate that the 10 dB step of the output attenuator is in error.

In replacing attenuator resistor a few precautions should be observed:

- A. Note the position of the original resistors and place replacement resistors similarly.
- B. Avoid excessive heat while soldering; too much heat can cause shifts in the values of the attenuator resistors, and loss of spring tension in the attenuator switch clips.
- C. When soldering use a non-corrosive flux and clean areas involved with a solvent such as acetone or pure grain alcohol.

If attenuator errors are experienced only at high frequencies and cannot be corrected by means of readjustment as outlined in 5.9, procedures similar to the above may be employed to isolate the defective component.

After any attenuator repair it is recommended that the checks outlined in Sections 4.4.2 and 5.9 be made.

### 5.12 Addition of Time Constants

It is possible to incorporate a third time constant in this instrument in addition to the two normally supplied (0.25 s, 0.5 s).<sup>\*</sup> To accomplish this proceed as follows:

- A. Remove the instrument cover, right side rail, and internal shield, to gain access to the RC TIME CONSTANT switch.
- B. It will be noted that the switch, in addition to four capacitors, has four pieces of bus bar or shorting links running between the two decks. Remove the two links adjacent to the existing capacitors ( $180^\circ$  apart).
- C. In place of the two links removed in step B, observing the polarity of existing capacitors, solder in the two capacitors for the new time constant. See Table III for values. The capacitors used here must be of the highest quality. For the higher values tantalum electrolytes, such as the Sprague Type 150D, are recommended.
- D. When soldering use only a non-corrosive flux and clean all surfaces involved to remove flux traces, etc. Acetone or pure grain alcohol is recommended as a cleaning agent.
- E. It is possible to add a fourth time constant by removing the two remaining short links (see step B) adjacent to the switch strut screws. However, the RESET (see section 2.23) function would be lost for this time constant.

### 5.13 Troubleshooting

If it appears that the instrument is not operating properly, the possibility of a misadjustment should be eliminated first. Sections 4 and 5 outline checks useful for this purpose.

A visual inspection for broken leads, components, or other physical defects is sometimes a rapid method of locating a cause of malfunction.

In most cases it is possible to isolate the trouble to a particular circuit or section of the instrument. Fig. 11, simplified schematic, and Figs. 22, 23, schematic, will be found useful in this process.

#### 5.13.1 DC Voltages

In many instances a defective component can be readily located by a check of pertinent dc operating potentials. All important dc operat-

<sup>\*</sup>Early production units incorporated only one time constant of 0.5 s.

ing voltages are shown on the schematic Figs. 22, 23, located at the rear of this manual. It should be noted that the voltages shown are typical; with the wide variations encountered in transistor parameters, voltage variations of up to  $\pm 20\%$  may be normal.

### 5.13.2 Signal Tracing

A highly successful method of locating a defective section or component is signal tracing. Signal voltages at all pertinent points are shown on the schematic Figs. 22, 23 at the rear of this manual. It should be noted that the signal goes through several frequency transformations as follows:

- A. Input to rms detector: signal frequency
- B. RMS detector to chopper: 0 Hz (dc)
- C. Chopper to linear detector: 94 Hz
- D. Linear detector to meter and dc output: 0 Hz (dc)

### 5.13.3 Power Supply

The power supply employs a full wave solid state rectifier to convert ac of line frequency to dc for operating potentials and currents. Zener diodes as reference elements and transistors are employed to regulate the dc current or voltages. All the pertinent dc and ac potentials for this section are shown on the schematic Figs. 22, 23, at the rear of this manual. It should be noted that in the case of the Model 323, the batteries are essential to operation even when on line power; no attempt should be made to operate without batteries.

### 5.13.4 Chopper Drive

The chopper drive employs two transistors Q10, Q11 in a multivibrator driving a second pair of transistors Q12, Q13, as switches to connect a dc supply alternately across each half of the chopper drive coil. The schematic Figs. 22, 23, at the end of this manual shows all pertinent dc and ac voltages, as well as waveforms.

### 5.13.5 Troubleshooting Chart

Symptom	Possible Cause and/or Remedy	Pertinent Section
Instrument inoperative on battery power	Battery discharged (323 only) : recharge Battery defective (323 only) : replace MODE switch improperly set: reset RC TIME CONSTANT switch on RESET: set to 0.25 s*, 0.5 s	2.4.2, 3.11, 5.4 5.5 2.1, 2.5, 2.13 2.1, 2.23
Instrument inoperative on line power	Battery discharged (323 only) and Fuse blown: replace Line cord defective: replace Power supply defective: correct Line voltage switch in wrong position: set to correct position	2.4.2, 3.11, 5.4 3.11, 5.2.4 5.2
Instrument indication with no input	MODE switch on NULL: set to METER Defective chopper: replace Amplifier oscillating: correct	2.1, 2.5, 2.13 3.7, 5.7 5.13, 5.13.1, 5.13.2, 5.13.3
Normal dc output but no meter indication	Defective meter: replace Defective MODE switch: repair or replace	2.21, 3.9

\*Early production units incorporated only one time constant marked NORMAL.

Symptom	Possible Cause and/or Remedy	Pertinent Section
Indications in error, all ranges	Scale misadjusted: reset Sensitivity misadjusted: reset Battery discharged (323 only): recharge Defective meter: replace MODE switch to NULL: set to METER Input leads unshielded: shield or use coax Heavy ground current: reduce or eliminate Instrument in strong rf or magnetic field: reduce field by shielding or separation Wideband amp, rms detector, 94 Hz amp defective: correct	4.4.1 4.4.3 2.4.2, 3.11, 5.4 2.1, 2.5, 2.13 2.6.4 2.6.6
Indications in error on 100 mV, 300 mV, 1 V, 3V ranges only	Defective or misadjusted 40 dB input attenuator (R4, R5, R6, C2, C3): readjust, or isolate and correct defective component	4.4.2, 5.12
Indications in error on 10 V, 30 V, 100 V, 300 V ranges only	Defective or misadjusted 80 dB input attenuator (R7, R8, R9, R10, Cr, C5, C6): readjust or isolate and correct defective component	4.4.2, 5.12
Indications in error on 30 mV, 3 V, 300 V ranges only	Defective or misadjusted output attenuator, 30 dB step (R39, R42, C27): readjust or isolate and correct defective component	4.4.2, 5.12
Indications in error by same amount on 10 mV, 30 mV, 1 V, 3 V, 100 V, 300 V ranges only	Defective output attenuator, 20 dB step (R38, R41, C26): isolate and correct defective component	4.4.2, 5.12
Indications in error by same amount on 3 mV, 10 mV, 30 mV, 300 mV, 1 V, 3 V, 30 V, 100 V, 300 V ranges, other ranges normal	R36 misadjusted: correct C25 misadjusted: correct Defective output attenuator, 10 dB step (R37, R40): isolate and correct defective component	4.4.2, 5.12

## 6. SHIPPING INSTRUCTIONS

If it should be necessary to return the instrument to Ballantine Laboratories, please make certain that at least four inches of padding material surrounds the instrument to prevent damage during shipment. Ship via REA Express, motor truck, or air freight to

Ballantine Laboratories, Inc.  
90 Fanny Road  
Boonton, New Jersey

A letter describing the malfunction and/or the desired servicing should precede the instrument.

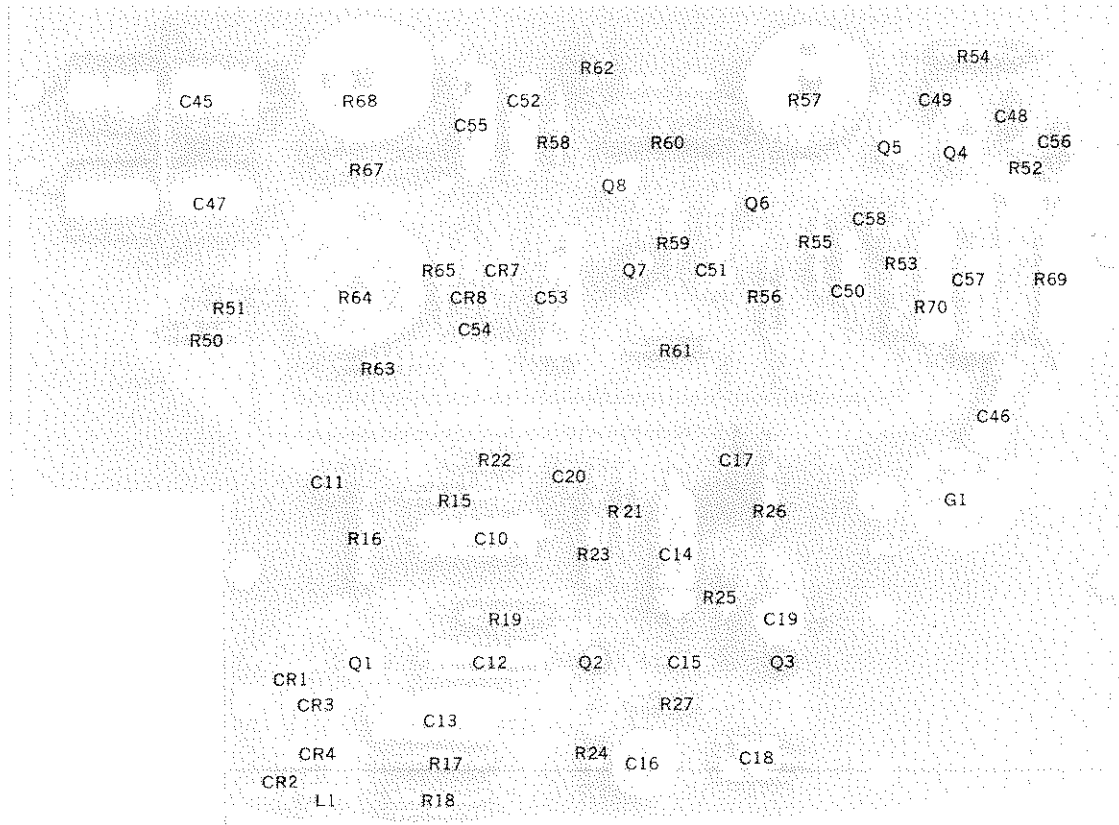

**Fig. 18. Component Location,  
Amplifier Board, Models 323, 323-01**

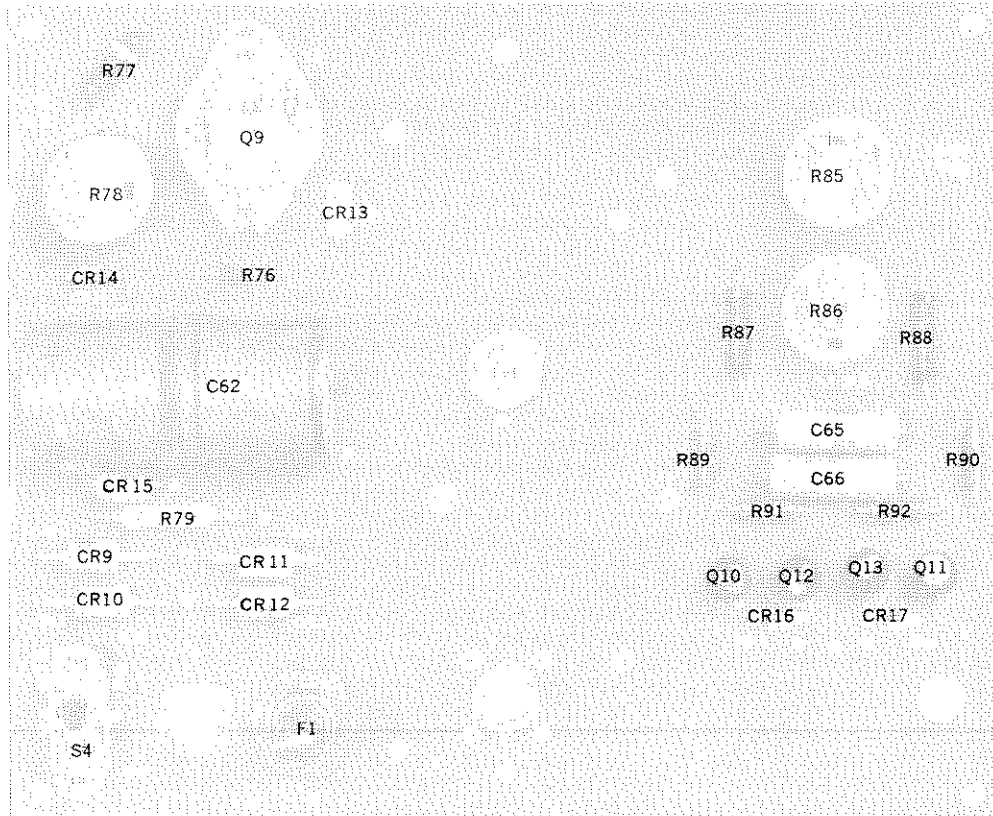

**Fig. 19. Component Location,  
Power Supply Board, Model 323**

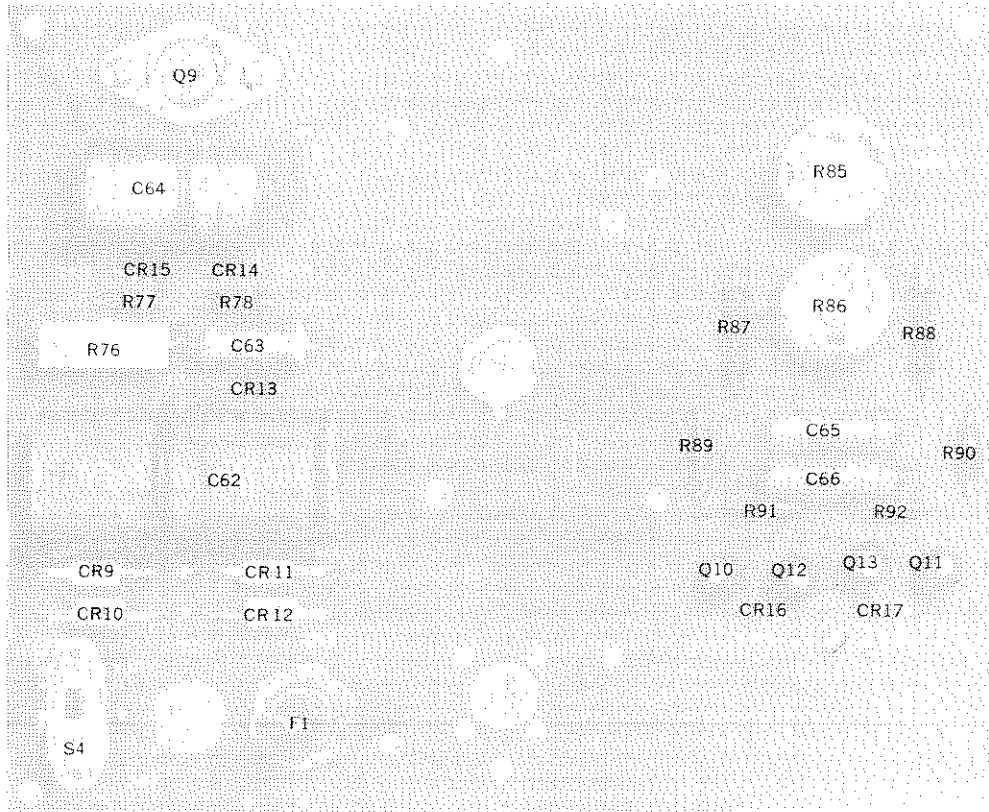

**Fig. 20. Component Location,  
Power Supply Board, Model 323-01**

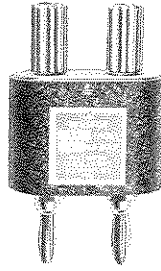

**Series 600 Precision Resistor (optional)**  
(In decade values from 0.1 ohm to 1,000 ohms  
for measuring current)



**Model 618 BNC-to-Binding Post Adapter**  
(One Supplied with each Models 323, 323-01)

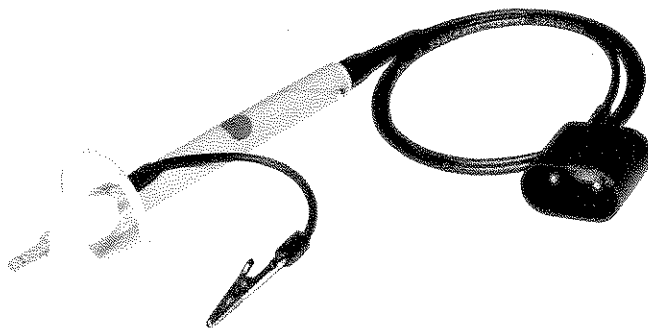

**Model 1301 High Voltage Probe (optional)**  
(For measurements to 10,000 volts, Plugs into  
 $\frac{3}{4}$  inch-spaced binding posts)

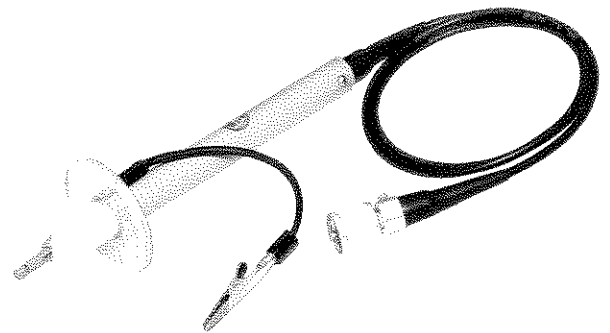

**Model 1311 High Voltage Probe (optional)**  
(For measurements to 10,000 volts. Requires  
UG-2 55/U UHF to BNC Adapter)

**Fig. 21. Accessories for Models 323, 323-01**



## 7. REPLACEMENT PARTS LIST

REFER TO MODEL 323-01 SCHEMATIC DWG. ME-3450F

**NOTE: This replacement parts list applies only to the Model 323-01 — For Model 323 please see replacements parts list on page 31.**

B. L. Part No.	Circuit Symbol	Capacitors	Manufacturer
2140	C1	0.047 $\mu$ F, 5%, 600 V, Type 148P	Sprague
2454	C2	0.7-3.0 pF, 350 V, Type 535-000	Erie
2282	C3	330 pF, 5%, 500 V, Type 653-015	Erie
2454	C4	0.7-3.0 pF, 350 V, Type 535-000	Erie
2282	C5	330 pF, 5%, 500 V, Type 653-015	Erie
2598	C6	4.7 pF, 5%, 500 V, Type QC	Quality Components
2096	C10	50 $\mu$ F, -10% +75%, 15 V, Type 30D	Sprague
2592	C11	1000 pF, 10%, 1000 V, Type CCD-102	Arco
7817	C12	27 $\mu$ F, 10%, 20 V, Type 150D276X9020R2	Sprague
2783	C13	50 $\mu$ F, -10% +75%, 6 V, Type 30D	Sprague
7841	C14	32 $\mu$ F, -10%, +50%, 40 V, Type C426AR/G32	Amperex
7819	C15	1.8 $\mu$ F, $\pm$ 10%, 20 V, Type 150D185X9020A2	Sprague
2441	C16	9-35 pF, 500 V, Type 538-002	Erie
2535	C17	0.01 $\mu$ F, Type BYA-6S1	Cornell-Dubilier
2228	C18	50 pF, $\pm$ 5%, 500 V, Type CM-15	Arco
7816	C19	47 $\mu$ F, 10%, 20 V, Type 150D476X9020R2	Sprague
2592	C20	1000 pF, 10%, 1000 V, Type CCD-102	Arco
2441	C25	9-35 pF, 500 V, Type 538-002	Erie
8116	C26	15 pF, 5%, 500 V, Type QC	Quality Components
2441	C27	9-35 pF, 500 V, Type 538-002	Erie
7818	C35	6.8 $\mu$ F, 10%, 6 V, Type 150D685X9006A2	Sprague
7818	C36	6.8 $\mu$ F, 10%, 6 V, Type 150D685X9006A2	Sprague
7819	C37	1.8 $\mu$ F, $\pm$ 10%, 20 V, Type 150D185X9020A2	Sprague
2583	C38	1000 pF, 500 V, Type SB4A	Allen-Bradley
2583	C39	1000 pF, 500 V, Type SB4A	Allen-Bradley
7819	C40	1.8 $\mu$ F, $\pm$ 10%, 20 V, Type 150D185X9020A2	Sprague
7840	C41	0.47 $\mu$ F, $\pm$ 10%, 35 V, Type 150D474X9035A2	Sprague
7840	C42	0.47 $\mu$ F, $\pm$ 10%, 35 V, Type 150D474X9035A2	Sprague
7840	C43	0.47 $\mu$ F, $\pm$ 10%, 35 V, Type 150D474X9035A2	Sprague
7840	C44	0.47 $\mu$ F, $\pm$ 10%, 35 V, Type 150D474X9035A2	Sprague
7820	C45	400 $\mu$ F, -10% +50%, 16 V, Type C437AR/E400	Amperex
or 7821	C45	400 $\mu$ F, -10% +75%, 15 V, Type 34D407G015GE2	Sprague
2394	C46	0.1 $\mu$ F, 5%, 200 V, Type 192P	Sprague
7820	C47	400 $\mu$ F, -10% +50%, 16 V, Type C437AR/E400	Amperex
or 7821	C47	400 $\mu$ F, -10% +75%, 15 V, Type 34D407G015GE2	Sprague
2593	C48	50 pF, 10%, 1000 V, Type CCD-500	Arco
2592	C49	1000 pF, 10%, 1000 V, Type CCD-102	Arco
8118	C50	0.0068 $\mu$ F, 5%, 200 V, Type 192P	Sprague
7814	C51	1 $\mu$ F, -10% +75%, 12 V, Type 30D	Sprague
7814	C52	1 $\mu$ F, -10% +75%, 12 V, Type 30D	Sprague
7843	C53	75 $\mu$ F, -10%, +50%, 15 V, Type 30D756F015CC4	Sprague
2592	C54	1000 pF, 10%, 1000 V, Type CCD-102	Arco
7816	C55	47 $\mu$ F, 10%, 20 V, Type 150D476X9020R2	Sprague
2592	C56	1000 pF, 10%, 1000 V, Type CCD-102	Arco

## REPLACEMENT PARTS LIST (Continued)

REFER TO MODEL 323-01 SCHEMATIC DWG. ME-3450F

**NOTE:** This replacement parts list applies only to the Model 323-01 — For Model 323 please see replacement parts list on page 31.

B. L. Part No.	Circuit Symbol	Capacitors	Manufacturer
2394	C57	0.1 $\mu$ F, 5%, 200 V, Type 192P	Sprague
2592	C58	1000 pF, 10%, 1000 V, Type CCD-102	Arco
7836	C62	100 $\mu$ F, -10% +50%, 64 V, Type C437AR/H100	Amperex
or 7837	C62	100 $\mu$ F, -10% +75%, 50 V, Type 30D107G050DH4	Sprague
2096	C63	50 $\mu$ F, -10% +75%, 15 V, Type 30D	Sprague
7824	C64	250 $\mu$ F, -10% +75%, 50 V, Type 39D257G050HE4	Sprague
or 7825	C64	250 $\mu$ F, -10% +50%, 64 V, Type C437AR/H250	Amperex
2354	C65	0.15 $\mu$ F, 10%, 200 V, Type 192P	Sprague
2354	C66	0.15 $\mu$ F, 10%, 200 V, Type 192P	Sprague
<b>Resistors</b>			
6070	R1	1 M $\Omega$ , 1%, Type MF6C	Electra
6070	R2	1 M $\Omega$ , 1%, Type MF6C	Electra
1672	R3	100 $\Omega$ , 1%, Type N-20	Corning
6070	R4 <sup>(1)</sup>	1 M $\Omega$ , 1%, Type MF6C	Electra
6070	R5 <sup>(1)</sup>	1 M $\Omega$ , 1%, Type MF6C	Electra
6076	R6 <sup>(1)</sup>	20.2 k $\Omega$ , 1%, Type MF5C	Electra
6070	R7 <sup>(2)</sup>	1 M $\Omega$ , 1%, Type MF6C	Electra
6070	R8 <sup>(2)</sup>	1 M $\Omega$ , 1%, Type MF6C	Electra
6076	R9 <sup>(2)</sup>	20.2 k $\Omega$ , 1%, Type MF5C	Electra
6078	R10 <sup>(2)</sup>	202 $\Omega$ , 1%, Type MF5C	Electra
1057	R15	1 k $\Omega$ , 5%, Type EB	Allen-Bradley
1327	R16	5 k $\Omega$ , 1%, Type CPX-1/2	Aerovox
1338	R17*	1 k $\Omega$ , 1%, Type CPX-1/2	Aerovox
2706	R18	25 $\Omega$ , 1%, Type CPX-1/2	Aerovox
1305	R19	200 k $\Omega$ , 1%, Type CPX-1/2	Aerovox
1117	R21	10 $\Omega$ , 5%, Type EB	Allen-Bradley
1054	R22	2 k $\Omega$ , 5%, Type EB	Allen-Bradley
1338	R23	1 k $\Omega$ , 1%, Type CPX-1/2	Aerovox
1074	R24	30 $\Omega$ , 5%, Type EB	Allen-Bradley
1044	R25	10 k $\Omega$ , 5%, Type EB	Allen-Bradley
1338	R26	1 k $\Omega$ , 5%, Type CPX-1/2	Aerovox
1083	R27	82 $\Omega$ , 5%, Type EB	Allen-Bradley
1066	R35	160 $\Omega$ , 5%, Type EB	Allen-Bradley
1954	R36	10 k $\Omega$ , $\pm$ 20%, Type X201	CTS
6073	R37 <sup>(3)</sup>	136.8 $\Omega$ , 1%, Type MF5C	Ballantine
6073	R38 <sup>(3)</sup>	136.8 $\Omega$ , 1%, Type MF5C	Ballantine
6073	R39 <sup>(3)</sup>	136.8 $\Omega$ , 1%, Type MF5C	Ballantine
6074	R40 <sup>(3)</sup>	92.5 $\Omega$ , 1%, Type MF5C	Ballantine

\* In some instruments the component listed may not be used at all or its value may differ from the value shown.

<sup>(1)</sup> Resistors R4, R5, R6 are part of a matched set and must be purchased as Set No. 8859.

<sup>(2)</sup> Resistors R7, R8, R9, R10 are part of a matched set and must be purchased as Set No. 8860.

<sup>(3)</sup> Resistors R37, R38, R39, R40, R41, R42 are part of a matched set and must be purchased as Set No. 8858.

## REPLACEMENT PARTS LIST (Continued)

REFER TO MODEL 323-01 SCHEMATIC DWG. ME-3450F

**NOTE:** This replacement parts list applies only to the Model 323-01 — For Model 323 please see replacements parts list on page 31.

B. L. Part No.	Circuit Symbol	Resistors	Manufacturer
6074	R41 <sup>(3)</sup>	92.5 Ω, 1%, Type MF5C	Ballantine
6075	R42 <sup>(3)</sup>	63.25 Ω, 1%, Type MF5C	Ballantine
8861	R45	105 kΩ, 1%, Type MF5C, CHAR. D	Electra
8861	R46	105 kΩ, 1%, Type MF5C, CHAR. D	Electra
8861	R47	105 kΩ, 1%, Type MF5C, CHAR. D	Electra
8861	R48	105 kΩ, 1%, Type MF5C, CHAR. D	Electra
1083	R50	82 Ω, 5%, Type EB	Allen-Bradley
1098	R51	120 Ω, 5%, Type EB	Allen-Bradley
1231	R52	200 Ω, 5%, Type CB	Allen-Bradley
1320	R53	20 kΩ, 1%, Type CPX-1/2	Aerovox
2685	R54	10 Ω, 1%, Type CPX-1/2	Aerovox
1014	R55	510 kΩ, 5%, Type EB	Allen-Bradley
1040	R56	20 kΩ, 5%, Type EB	Allen-Bradley
6867	R57	10 Ω, ±10%, Type 115	CTS
1021	R58	270 kΩ, 5%, Type EB	Allen-Bradley
1017	R59	390 kΩ, 5%, Type EB	Allen-Bradley
1358	R60*	60 Ω, 1%, Type CPX-1/2	Aerovox
1065	R61	200 Ω, 5%, Type EB	Allen-Bradley
8455	R62	3.5 Ω, 1%, Type M61	Mepco
1036	R63	33 kΩ, 5%, Type EB	Allen-Bradley
6854	R64	10 kΩ, ±10%, Type 115	CTS
1019	R65	330 kΩ, 5%, Type EB	Allen-Bradley
2732	R67	1.58 kΩ, 1%, Type CPX-1/2	Aerovox
6861	R68	200 Ω, ±10%, Type 115	CTS
7250	R69	10.4 MΩ, 1%, Type MF72C	Electra
7250	R70	10.4 MΩ, 1%, Type MF72C	Electra
8026	R76	430 Ω, 5%, Type PW3	IRC
1094	R77	2.4 kΩ, 5%, Type EB	Allen-Bradley
1094	R78	2.4 kΩ, 5%, Type EB	Allen-Bradley
6854	R85	10 kΩ, ±10%, Type 115	CTS
6854	R86	10 kΩ, ±10%, Type 115	CTS
7261	R87	45.6 kΩ, 1%, Type MF7C	Electra
7261	R88	45.6 kΩ, 1%, Type MF7C	Electra
1111	R89	1.8 kΩ, 5%, Type EB	Allen-Bradley
1111	R90	1.8 kΩ, 5%, Type EB	Allen-Bradley
1098	R91	120 Ω, 5%, Type EB	Allen-Bradley
1098	R92	120 Ω, 5%, Type EB	Allen-Bradley

\* In some instruments the component listed may not be used at all or its value may differ from the value shown.

<sup>(3)</sup> Resistors R37, R38, R39, R40, R41, R42 are part of a matched set and must be purchased as Set No. 8858.

## REPLACEMENT PARTS LIST (Continued)

REFER TO MODEL 323-01 SCHEMATIC DWG. ME-3450F

**NOTE: This replacement parts list applies only to the Model 323-01 — For Model 323 please see replacements parts list on page 31.**

B. L. Part No.	Circuit Symbol	Other Components	Manufacturer
7920	CR1	Diode, Type 1N4148	General Electric
7920	CR2	Diode, Type 1N4148	General Electric
7920	CR3	Diode, Type 1N4148	General Electric
7920	CR4	Diode, Type 1N4148	General Electric
7924	CR5	Diode, Unitunnel, Type HU5A, Selected	Ballantine
7924	CR6	Diode, Unitunnel, Type HU5A, Selected	Ballantine
7920	CR7	Diode, Type 1N4148	General Electric
7920	CR8	Diode, Type 1N4148	General Electric
7921	CR9	Rectifier, Silicon, Type 36591	Ballantine
7921	CR10	Rectifier, Silicon, Type 36591	Ballantine
7921	CR11	Rectifier, Silicon, Type 36591	Ballantine
7921	CR12	Rectifier, Silicon, Type 36591	Ballantine
7910	CR13	Diode, Zener, Type 1N957B, $\pm 5\%$ , 6.8 V	Hughes
7910	CR14	Diode, Zener, Type 1N957B, $\pm 5\%$ , 6.8 V	Hughes
7910	CR15	Diode, Zener, Type 1N957B, $\pm 5\%$ , 6.8 V	Hughes
7920	CR16	Diode, Type 1N4148	General Electric
7920	CR17	Diode, Type 1N4148	General Electric
2806	F1	Fuse, 1/16 A, Slo-Blo, for 120 V operation, Type 313.062, 3AG	Littelfuse
or 2811	F1	Fuse, 1/32 A, Slo-Blo, for 240 V operation, Type 313.031, 3AG	Littelfuse
3099	G1	Chopper, 6.3 V, Type 33A-6B	Airpax
3490	I1	Pilot Light, Type 2110A1	Industrial Devices
6267	L1	Inductor, Special	Ballantine
7933	Q1	Transistor, Type 2N4221A, Selected*	Ballantine
7926	Q2	Transistor, Type 2N3563, Selected*	Ballantine
7926	Q3	Transistor, Type 2N3563, Selected*	Ballantine
7938	Q4	Transistor, Type A322, Selected*	Ballantine
7938	Q5	Transistor, Type A322, Selected*	Ballantine
7938	Q6	Transistor, Type A322, Selected*	Ballantine
7927	Q7	Transistor, Type 2N3638, Selected*	Ballantine
7938	Q8	Transistor, Type A322, Selected*	Ballantine
7930	Q9	Transistor, Type 2N3766	Motorola
7927	Q10	Transistor, Type 2N3638	Fairchild
7927	Q11	Transistor, Type 2N3638	Fairchild
7927	Q12	Transistor, Type 2N3638	Fairchild
7927	Q13	Transistor, Type 2N3638	Fairchild
6018	M1	Microammeter, Logarithmic Type, 60 - 600 $\mu$ A	Ballantine
7765	S1	Switch, Range, Special	Ballantine
7766	S2	Switch, Time Constant, Special	Ballantine
7763	S3	Switch, Mode	Ballantine
7775	S4	Switch, Slide, Type G126-PC	Continental Wirt
6262	T1	Transformer, Power, Special	Ballantine

\*If replacement of selected transistors is necessary, order from Ballantine Laboratories giving type, symbol, designation (Q1, Q2, etc.) and color code (center dot, side dot, etc.) if any.

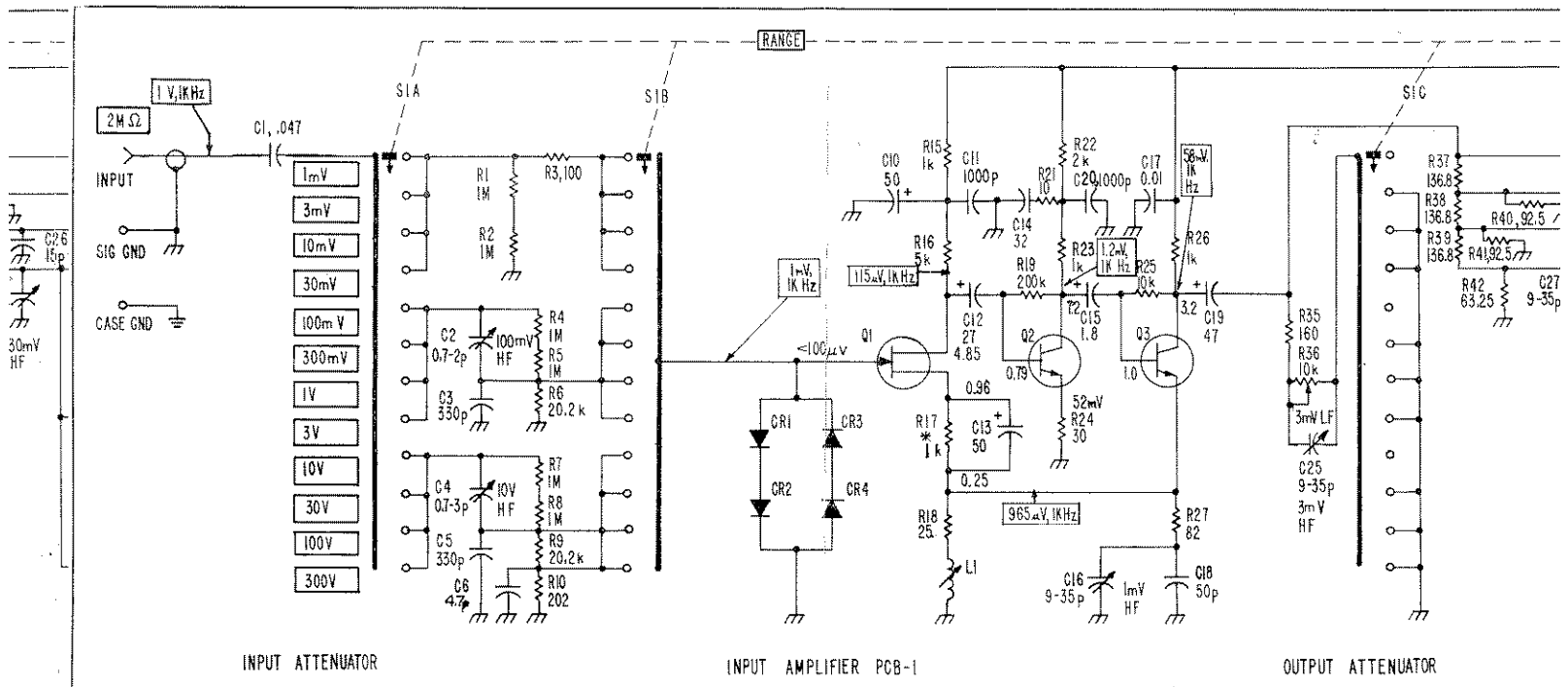

120V OPERATION: FI, 1/16A  
 240V OPERATION: FI, 1/32A

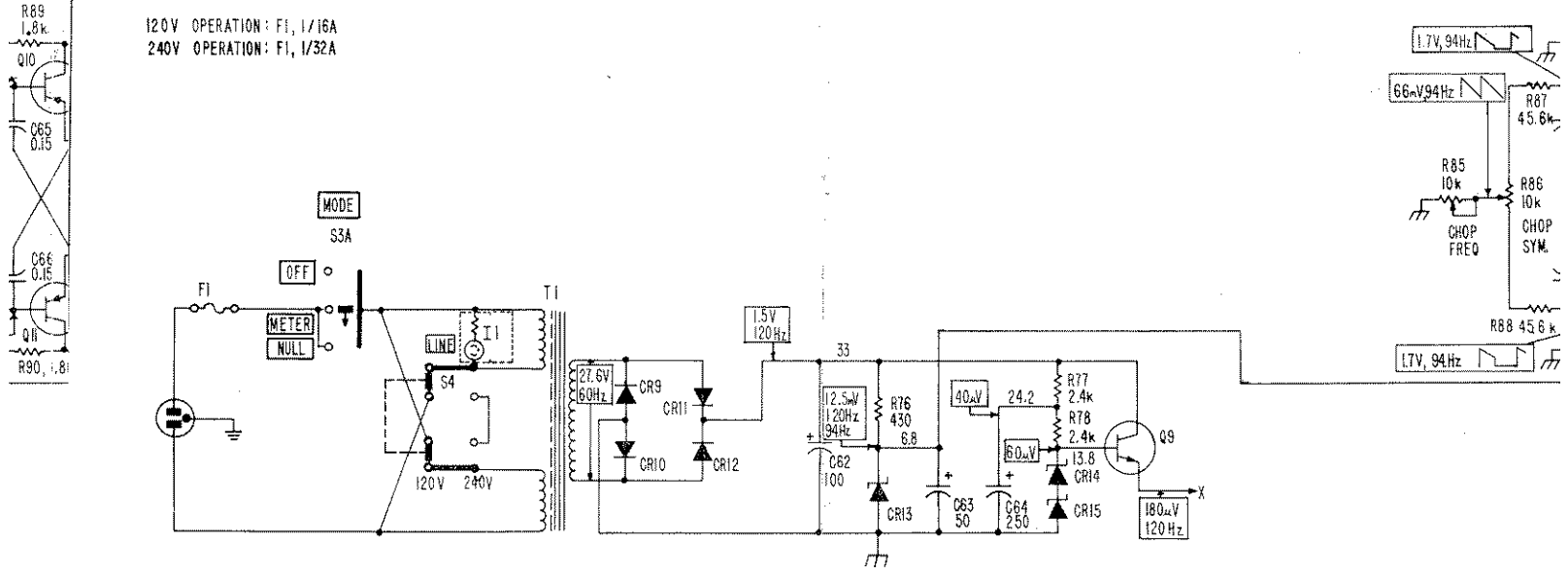

- CAPACITORS: NOT MARKED — MICROFARADS ( $10^{-6}$  F)  
 P — PICO FARADS ( $10^{-12}$  F)
- RESISTORS: NOT MARKED — OHMS ( $\Omega$ )  
 k — KILOHMS ( $10^3 \Omega$ )  
 M — MEGOHMS ( $10^6 \Omega$ )
- VOLTAGE: NOT MARKED — VOLTS (V)  
 mV — MILLIVOLTS ( $10^{-3}$  V)

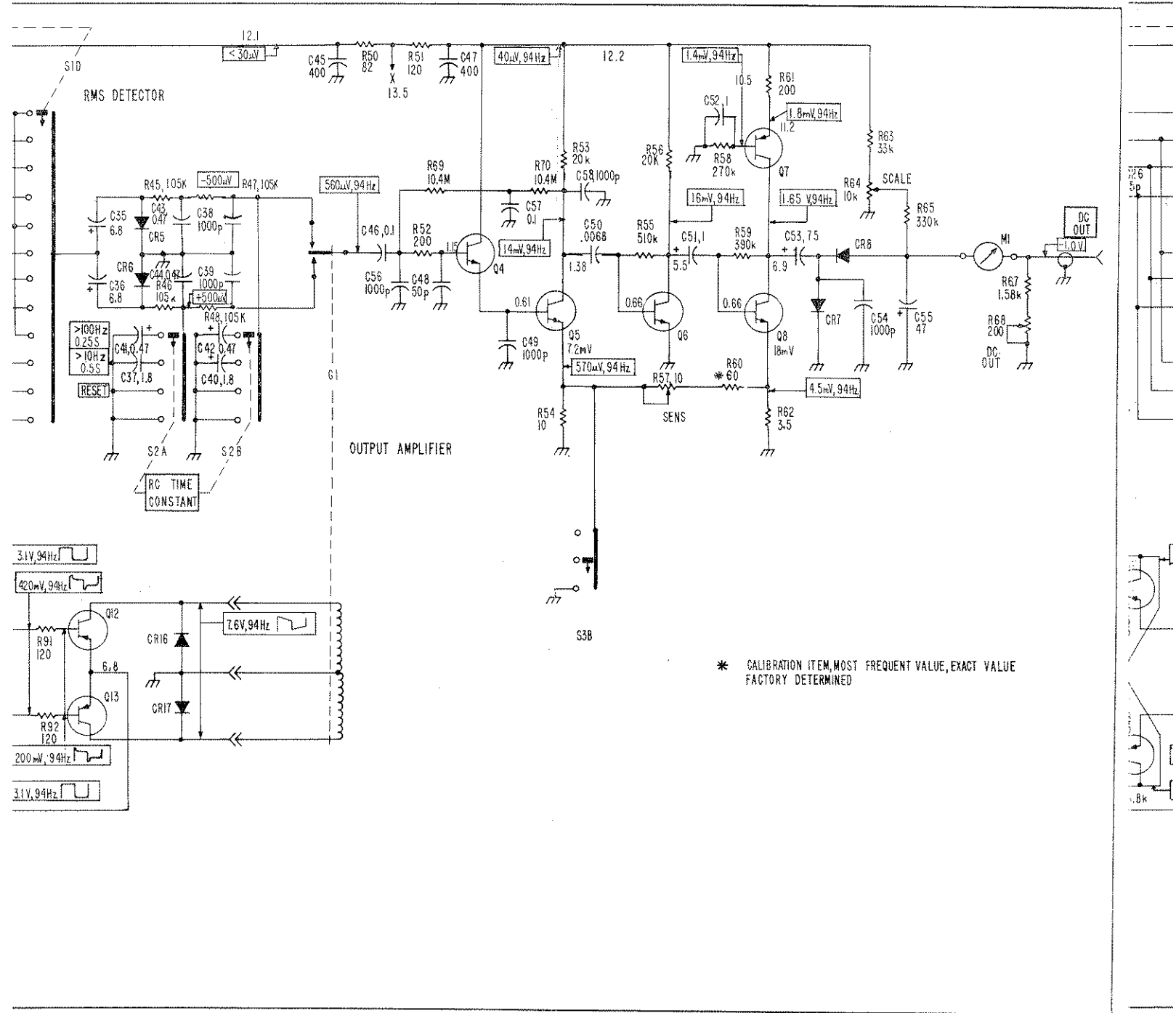

Fig. 22. Wiring Diagram of Model 323-01 True RMS Voltmeters  
Drawing No. ME-3450F

BALLANTINE LABORATORIES, INC.  
Boonton, New Jersey

## 8. REPLACEMENT PARTS LIST

REFER TO MODEL 323 SCHEMATIC DWG. ME-3449G

**NOTE: This replacement parts list applies only to the Model 323 — For Model 323-01 please see replacement parts list on page 27.**

B. L. Part No.	Circuit Symbol	Capacitors	Manufacturer
2140	C1	0.047 $\mu$ F, 5%, 600 V, Type 148P	Sprague
2454	C2	0.7-3.0 pF, 350 V, Type 535-000	Erie
2282	C3	330 pF, 5%, 500 V, Type 653-015	Erie
2454	C4	0.7-3.0 pF, 350 V, Type 535-000	Erie
2282	C5	330 pF, 5%, 500 V, Type 653-015	Erie
2598	C6	4.7 pF, 5%, 500 V, Type QC	Quality Components
2096	C10	50 $\mu$ F, -10% +75%, 15 V, Type 30D	Sprague
2592	C11	1000 pF, 10%, 1000 V, Type CCD-102	Arco
7817	C12	27 $\mu$ F, 10%, 20 V, Type 150D276X9020R2	Sprague
2783	C13	50 $\mu$ F, -10% +75%, 6 V, Type 30D	Sprague
7841	C14	32 $\mu$ F, -10%, +50%, 40 V, Type C426AR/G32	Amperex
7819	C15	1.8 $\mu$ F, $\pm$ 10%, 20 V, Type 150D185X9020A2	Sprague
2441	C16	9-35 pF, 500 V, Type 538-002	Erie
2535	C17	0.01 $\mu$ F, Type BYA-6S1	Cornell-Dubilier
2228	C18	50 pF, $\pm$ 5%, 500 V, Type CM-15	Arco
7816	C19	47 $\mu$ F, 10%, 20 V, Type 150D476X9020R2	Sprague
2592	C20	1000 pF, 10%, 1000 V, Type CCD-102	Arco
2441	C25	9-35 pF, 500 V, Type 538-002	Erie
8116	C26	15 pF, 5%, 500 V, Type QC	Quality Components
2441	C27	9-35 pF, 500 V, Type 538-002	Erie
7818	C35	6.8 $\mu$ F, 10%, 6 V, Type 150D685X9006A2	Sprague
7818	C36	6.8 $\mu$ F, 10%, 6 V, Type 150D685X9006A2	Sprague
7819	C37	1.8 $\mu$ F, $\pm$ 10%, 20 V, Type 150D185X9020A2	Sprague
2583	C38	1000 pF, 500 V, Type SB4A	Allen-Bradley
2583	C39	1000 pF, 500 V, Type SB4A	Allen-Bradley
7819	C40	1.8 $\mu$ F, $\pm$ 10%, 20 V, Type 150D185X9020A2	Sprague
7840	C41	0.47 $\mu$ F, $\pm$ 10%, 35 V, Type 150D474X9035A2	Sprague
7840	C42	0.47 $\mu$ F, $\pm$ 10%, 35 V, Type 150D474X9035A2	Sprague
7840	C43	0.47 $\mu$ F, $\pm$ 10%, 35 V, Type 150D474X9035A2	Sprague
7840	C44	0.47 $\mu$ F, $\pm$ 10%, 35 V, Type 150D474X9035A2	Sprague
7820	C45	400 $\mu$ F, -10% +50%, 16 V, Type C437AR/E400	Amperex
or 7821	C45	400 $\mu$ F, -10% +75%, 15 V, Type 34D407G015GE2	Sprague
2394	C46	0.1 $\mu$ F, 5%, 200 V, Type 192P	Sprague
7820	C47	400 $\mu$ F, -10% +50%, 16 V, Type C437AR/E400	Amperex
or 7821	C47	400 $\mu$ F, -10% +75%, 15 V, Type 34D407G015GE2	Sprague
2593	C48	50 pF, 10%, 1000 V, Type CCD-500	Arco
2592	C49	1000 pF, 10%, 1000 V, Type CCD-102	Arco
8118	C50	0.0068 $\mu$ F, 5%, 200 V, Type 192P	Sprague
7814	C51	1 $\mu$ F, -10% +75%, 12 V, Type 30D	Sprague
7814	C52	1 $\mu$ F, -10% +75%, 12 V, Type 30D	Sprague
7843	C53	75 $\mu$ F, -10%, +50%, 15 V, Type 30D756F015CC4	Sprague
2592	C54	1000 pF, 10%, 1000 V, Type CCD-102	Arco
7816	C55	47 $\mu$ F, 10%, 20 V, Type 150D476X9020R2	Sprague

## REPLACEMENT PARTS LIST (Continued)

REFER TO MODEL 323 SCHEMATIC DWG. ME-3449G

**NOTE:** This replacement parts list applies only to the Model 323 — For Model 323-01 please see replacement parts list on page 27.

B. L. Part No.	Circuit Symbol	Capacitors	Manufacturer
2592	C56	1000 pF, 10%, 1000 V, Type CCD-102	Arco
2394	C57	0.1 $\mu$ F, 5%, 200 V, Type 192P	Sprague
2592	C58	1000 pF, 10%, 1000 V, Type CCD-102	Arco
7836	C62	100 $\mu$ F, -10% +50%, 64 V, Type C437AR/H100	Amperex
or 7837	C62	100 $\mu$ F, -10% +75%, 50 V, Type 30D107G050DH4	Sprague
2354	C65	0.15 $\mu$ F, 10%, 200 V, Type 192P	Sprague
2354	C66	0.15 $\mu$ F, 10%, 200 V, Type 192P	Sprague
<b>Resistors</b>			
6070	R1	1 M $\Omega$ , 1%, Type MF6C	Electra
6070	R2	1 M $\Omega$ , 1%, Type MF6C	Electra
1672	R3	100 $\Omega$ , 1%, Type N-20	Corning
6070	R4 <sup>(1)</sup>	1 M $\Omega$ , 1%, Type MF6C	Electra
6070	R5 <sup>(1)</sup>	1 M $\Omega$ , 1%, Type MF6C	Electra
6076	R6 <sup>(1)</sup>	20.2 k $\Omega$ , 1%, Type MF5C	Electra
6070	R7 <sup>(2)</sup>	1 M $\Omega$ , 1%, Type MF6C	Electra
6070	R8 <sup>(2)</sup>	1 M $\Omega$ , 1%, Type MF6C	Electra
6076	R9 <sup>(2)</sup>	20.2 k $\Omega$ , 1%, Type MF5C	Electra
6078	R10 <sup>(2)</sup>	202 $\Omega$ , 1%, Type MF5C	Electra
1057	R15	1 k $\Omega$ , 5%, Type EB	Allen-Bradley
1327	R16	5 k $\Omega$ , 1%, Type CPX-1/2	Aerovox
1338	R17*	1 k $\Omega$ , 1%, Type CPX-1/2	Aerovox
2706	R18	25 $\Omega$ , 1%, Type CPX-1/2	Aerovox
1305	R19	200 k $\Omega$ , 1%, Type CPX-1/2	Aerovox
1117	R21	10 $\Omega$ , 5%, Type EB	Allen-Bradley
1054	R22	2 k $\Omega$ , 5%, Type EB	Allen-Bradley
1338	R23	1 k $\Omega$ , 1%, Type CPX-1/2	Aerovox
1074	R24	30 $\Omega$ , 5%, Type EB	Allen-Bradley
1044	R25	10 k $\Omega$ , 5%, Type EB	Allen-Bradley
1338	R26	1 k $\Omega$ , 1%, Type CPX-1/2	Aerovox
1083	R27	82 $\Omega$ , 5%, Type EB	Allen-Bradley
1066	R35	160 $\Omega$ , 5%, Type EB	Allen-Bradley
1954	R36	10 k $\Omega$ , $\pm$ 20%, Type X201	CTS
6073	R37 <sup>(3)</sup>	136.8 $\Omega$ , 1%, Type MF5C	Ballantine
6073	R38 <sup>(3)</sup>	136.8 $\Omega$ , 1%, Type MF5C	Ballantine
6073	R39 <sup>(3)</sup>	136.8 $\Omega$ , 1%, Type MF5C	Ballantine
6074	R40 <sup>(3)</sup>	92.5 $\Omega$ , 1%, Type MF5C	Ballantine
6074	R41 <sup>(3)</sup>	92.5 $\Omega$ , 1%, Type MF5C	Ballantine
6075	R42 <sup>(3)</sup>	63.25 $\Omega$ , 1%, Type MF5C	Ballantine

\* In some instruments the component listed may not be used at all or its value may differ from the value shown.

<sup>(1)</sup> Resistors R4, R5, R6 are part of a matched set and must be purchased as Set No. 8859.

<sup>(2)</sup> Resistors R7, R8, R9, R10 are part of a matched set and must be purchased as Set No. 8860.

<sup>(3)</sup> Resistors R37, R38, R39, R40, R41, R42 are part of a matched set and must be purchased as Set No. 8858.



## REPLACEMENT PARTS LIST (Continued)

REFER TO MODEL 323 SCHEMATIC DWG. ME-3449G

**NOTE:** This replacement parts list applies only to the Model 323 — For Model 323-01 please see replacement parts list on page 27.

B. L. Part No.	Circuit Symbol	Resistors	Manufacturer
8861	R45	105 kΩ, 1%, Type MF5C, CHAR. D	Electra
8861	R46	105 kΩ, 1%, Type MF5C, CHAR. D	Electra
8861	R47	105 kΩ, 1%, Type MF5C, CHAR. D	Electra
8861	R48	105 kΩ, 1%, Type MF5C, CHAR. D	Electra
1083	R50	82 Ω, 5%, Type EB	Allen-Bradley
1098	R51	120 Ω, 5%, Type EB	Allen-Bradley
1231	R52	200 Ω, 5%, Type CB	Allen-Bradley
1320	R53	20 kΩ, 1%, Type CPX-1/2	Aerovox
2685	R54	10 Ω, 1%, Type CPX-1/2	Aerovox
1014	R55	510 kΩ, 5%, Type EB	Allen-Bradley
1040	R56	20 kΩ, 5%, Type EB	Allen-Bradley
6867	R57	10 Ω, ±10%, Type 115	CTS
1021	R58	270 kΩ, 5%, Type EB	Allen-Bradley
1017	R59	390 kΩ, 5%, Type EB	Allen-Bradley
1358	R60*	60 Ω, 1%, Type CPX-1/2	Aerovox
1065	R61	200 Ω, 5%, Type EB	Allen-Bradley
8455	R62	3.5 Ω, 1%, Type M61	Mepco
1036	R63	33 kΩ, 5%, Type EB	Allen-Bradley
6854	R64	10 kΩ, ±10%, Type 115	CTS
1019	R65	330 kΩ, 5%, Type EB	Allen-Bradley
8852	R66	54.5 kΩ, 1%, Type MF6C	Electra
2732	R67	1.58 kΩ, 1%, Type CPX-1/2	Aerovox
6861	R68	200 Ω, ±10%, Type 115	CTS
7250	R69	10.4 MΩ, 1%, Type MF72C	Electra
7250	R70	10.4 MΩ, 1%, Type MF72C	Electra
1054	R76	2 kΩ, 5%, Type EB	Allen-Bradley
1489	R77	51 Ω, 2%, Type C32	Corning
6867	R78	10 Ω, ±10%, Type 115	CTS
1097	R79	47 Ω, 5%, Type EB	Allen-Bradley
6854	R85	10 kΩ, ±10%, Type 115	CTS
6854	R86	10 kΩ, ±10%, Type 115	CTS
7261	R87	45.6 kΩ, 1%, Type MF7C	Electra
7261	R88	45.6 kΩ, 1%, Type MF7C	Electra
1111	R89	1.8 kΩ, 5%, Type EB	Allen-Bradley
1111	R90	1.8 kΩ, 5%, Type EB	Allen-Bradley
1098	R91	120 Ω, 5%, Type EB	Allen-Bradley
1098	R92	120 Ω, 5%, Type EB	Allen-Bradley

\* In some instruments the component listed may not be used at all or its value may differ from the value shown.

## REPLACEMENT PARTS LIST (Continued)

REFER TO MODEL 323 SCHEMATIC DWG. ME-3449G

**NOTE: This replacement parts list applies only to the Model 323 — For Model 323-01 please see replacement parts list on page 27.**

B. L. Part No.	Circuit Symbol	Other Components	Manufacturer
8603	B1	Battery, 12 V, 6 V Tap, 1.2 AH, Type MP	Ballantine
7920	CR1	Diode, Type 1N4148	General Electric
7920	CR2	Diode, Type 1N4148	General Electric
7920	CR3	Diode, Type 1N4148	General Electric
7920	CR4	Diode, Type 1N4148	General Electric
7924	CR5	Diode, Unitunnel, Type HU5A, Selected	Ballantine
7924	CR6	Diode, Unitunnel, Type HU5A, Selected	Ballantine
7920	CR7	Diode, Type 1N4148	General Electric
7920	CR8	Diode, Type 1N4148	General Electric
7921	CR9	Rectifier, Silicon, Type 36591	Ballantine
7921	CR10	Rectifier, Silicon, Type 36591	Ballantine
7921	CR11	Rectifier, Silicon, Type 36591	Ballantine
7921	CR12	Rectifier, Silicon, Type 36591	Ballantine
7921	CR13	Rectifier, Silicon, Type 36591	Ballantine
7910	CR14	Diode, Zener, Type 1N957B, $\pm 5\%$ , 6.8 V	Hughes
7920	CR16	Diode, Type 1N4148	General Electric
7920	CR17	Diode, Type 1N4148	General Electric
2810	F1	Fuse, 1/10 A, Slo-Blo, for 120 V operation, Type 313.100, 3AG	Littelfuse
or 2806	F1	Fuse, 1/16 A, Slo-Blo, for 240 V operation, Type 313.062, 3AG	Littelfuse
3099	G1	Chopper, 6.3 V, Type 33A-6B	Airpax
3490	I1	Pilot Light, Type 2110A1	Industrial Devices
6267	L1	Inductor, Special	Ballantine
7933	Q1	Transistor, Type 2N4221A, Selected*	Ballantine
7926	Q2	Transistor, Type 2N3563, Selected*	Ballantine
7926	Q3	Transistor, Type 2N3563, Selected*	Ballantine
7938	Q4	Transistor, Type A322, Selected*	Ballantine
7938	Q5	Transistor, Type A322, Selected*	Ballantine
7938	Q6	Transistor, Type A322, Selected*	Ballantine
7927	Q7	Transistor, Type 2N3638, Selected*	Ballantine
7938	Q8	Transistor, Type A322, Selected*	Ballantine
7929	Q9	Transistor, Type 2N555	Motorola
7927	Q10	Transistor, Type 2N3638	Fairchild
7927	Q11	Transistor, Type 2N3638	Fairchild
7927	Q12	Transistor, Type 2N3638	Fairchild
7927	Q13	Transistor, Type 2N3638	Fairchild
6018	M1	Microammeter, Logarithmic Type, 60 - 600 $\mu$ A	Ballantine
7765	S1	Switch, Range, Special	Ballantine
7766	S2	Switch, Time Constant, Special	Ballantine
7764	S3	Switch, Mode, Special	Ballantine
7775	S4	Switch, Slide, Type G126-PC	Continental Wirt
6262	T1	Transformer, Power, Special	Ballantine

\*If replacement of selected transistors is necessary, order from Ballantine Laboratories giving type, symbol, designation (Q1, Q2, etc.) and color code (center dot, side dot, etc.) if any.

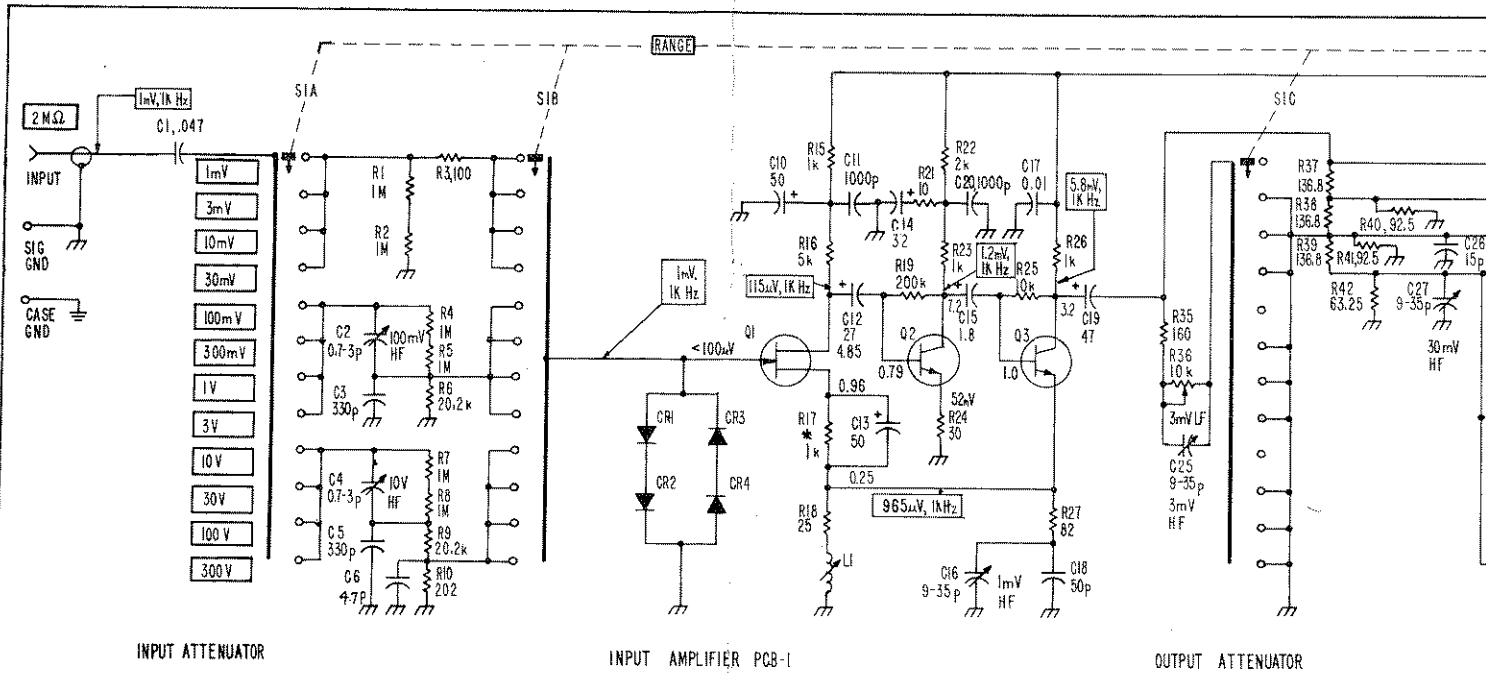

120V OPERATION - FI 1/10A  
 220V OPERATION - FI 1/16A

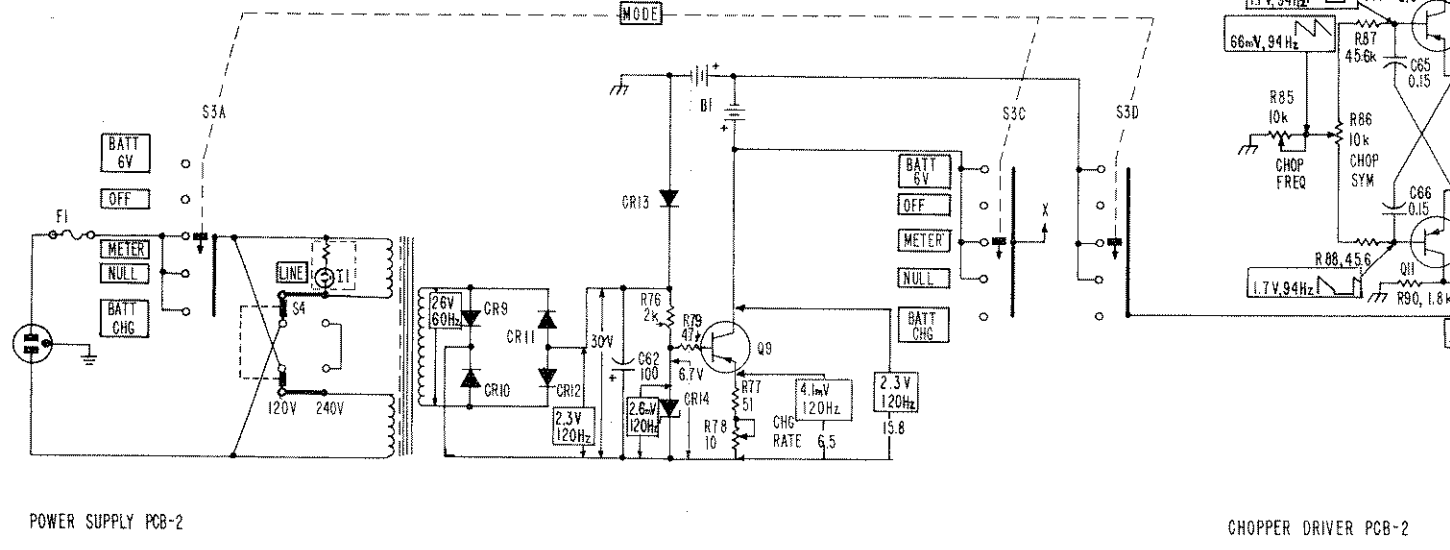

MEASURED  
 LESS 01

- CAPACITORS: NOT MARKED — MICROFARADS (10<sup>-6</sup>F)  
 P — PICOFARADS (10<sup>-12</sup>F)
- RESISTORS: NOT MARKED — OHMS (Ω)  
 k — KILOHMS (10<sup>3</sup>Ω)  
 M — MEGOHMS (10<sup>6</sup>Ω)
- VOLTAGE: NOT MARKED — VOLTS (V)  
 mV — MILLIVOLTS (10<sup>-3</sup>V)
- ALL DC, AC VOLTAGES M  
 TO SIGNAL GROUND UNL

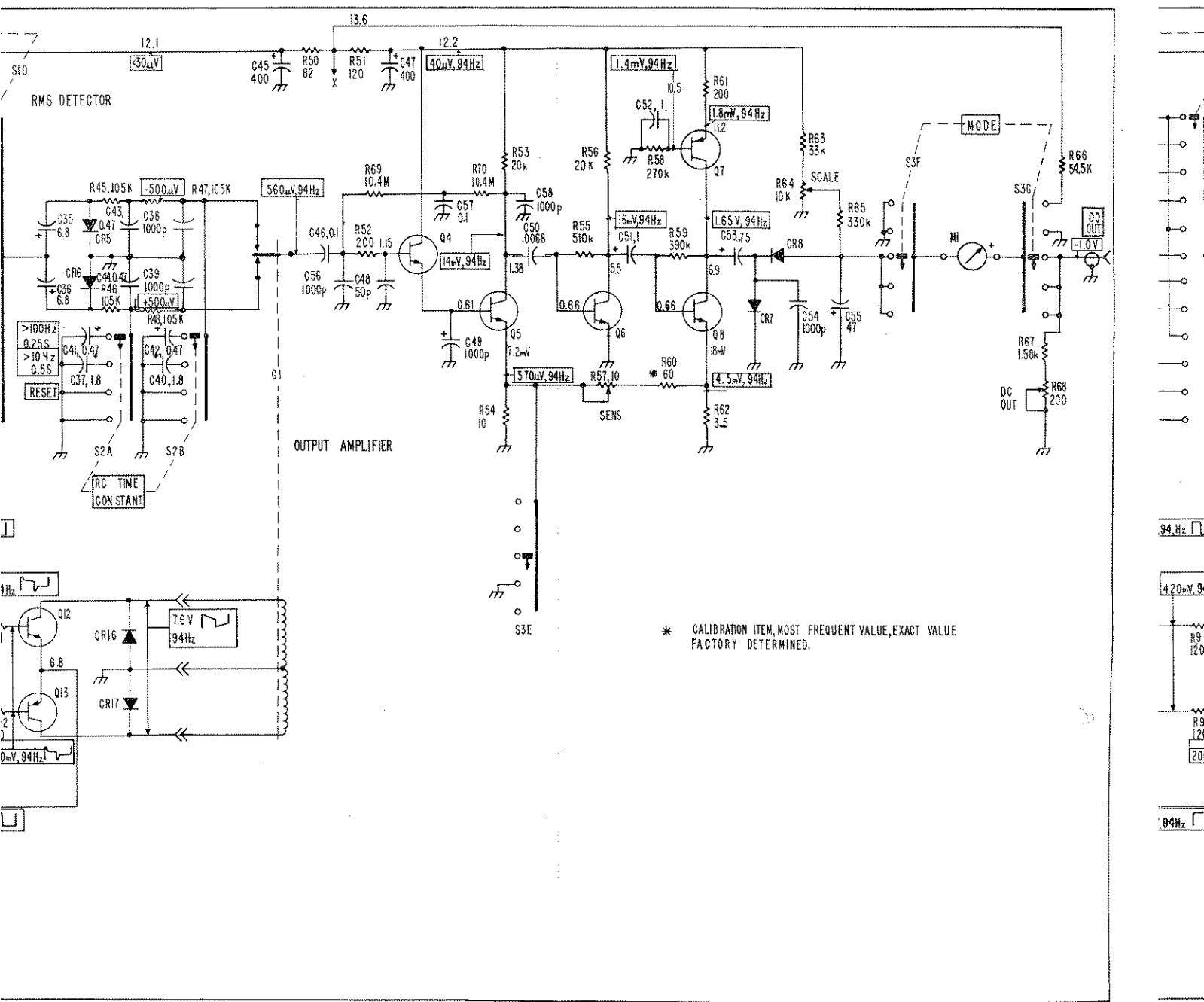

Fig. 23. Wiring Diagram of Model 323 True RMS Voltmeters  
Drawing No. ME-3449G

BALLANTINE LABORATORIES, INC.  
Boonton, New Jersey

1TH REFERENCE  
:WISE INDICATED

SURED W  
IS OTHER