

4530 SERIES RF POWER METER INSTRUCTION MANUAL

This manual is applicable to:

Instrument serial numbers: ALL*

Operating Firmware Versions: 20021119 and later*

**earlier firmware may not contain all capabilities listed herein*

Revision date: 11/26/2002

Manual P/N: 98404800C

CD P/N: 98404899C

BOONTON[®]

BOONTON ELECTRONICS

A subsidiary of Noise/Com -- A Wireless Telecom Group Company
25 Eastmans Road
Parsippany, NJ 07054-0465

Web Site: www.boonton.com
Email: boonton@boonton.com
Telephone: 973-386-9696
Fax: 973-386-9191

© 1998-2001, 2002 Boonton Electronics. All rights reserved.

BOONTON® is a registered trademark of Boonton Electronics, a subsidiary
of Noise/Com, a Wireless Telecom Group Company

Boonton Electronics
25 Eastmans Road
Parsippany, NJ 07054-0465

Information contained in this manual is subject to change without notice. Boonton Electronics makes no warranty of any kind with regard to this material, including, but not limited to, the implied warranties of merchantability and fitness for a particular purpose. Boonton Electronics shall not be liable for errors contained herein or for incidental or consequential damages in connection with the furnishings, performance, or use of this material. No part of this document may be photocopied, reproduced, or translated to another language without the prior written consent of Boonton Electronics.

Contents

CHAPTER/SECTION	PAGE
List of Tables	vii
List of Illustrations	viii
Safety Summary	ix
Repair Policy and Warranty	xi
1. GENERAL INFORMATION	
1.1 Description	1-1
1.2 Features	1-2
1.3 Accessories	1-2
1.4 Specifications	1-2
1.4.1 General	1-2
1.4.2 Calibration Sources	1-3
1.4.3 Trigger	1-3
1.4.4 Sampling Characteristics	1-3
1.4.5 Measurement Characteristics	1-3
1.4.6 Sensor Characteristics	1-4
1.4.7 Interface	1-4
1.4.8 Environmental Specifications	1-5
1.4.9 Physical Specifications	1-6
2. INSTALLATION	
2.1 Unpacking and Re-Packing	2-1
2.2 Power Requirements	2-1
2.3 Internal Battery	2-1
2.4 Preliminary Check	2-1
3. OPERATION	
3.1 Operating Controls, Indicators and Connections	3-1
3.2 Key Function Summary	3-2

Contents (Cont)

CHAPTER/SECTION	PAGE
3.3 Display Functions	3-5
3.3.1 Header	3-5
3.3.2 Measurement Window	3-5
3.3.3 Status Window	3-5
3.3.4 Channel Selection	3-5
3.3.5 Header / Page Selection	3-5
3.4 Operating Mode Summary	3-6
3.4.1 Menu Mode	3-6
3.4.2 Text Mode	3-6
3.4.3 Graph Mode	3-7
3.4.4 Edit Mode	3-7
3.4.5 Zero/Calibration Mode	3-7
3.5 Menu Mode Operation	3-8
3.5.1 Entry	3-8
3.5.2 Navigation	3-8
3.5.3 Menu Items	3-8
3.5.4 Menu Screen Display	3-9
3.5.5 Menu Syntax	3-10
3.6 Text Mode Operation	3-10
3.6.1 Entry	3-11
3.6.2 Measurement Page Selection	3-11
3.6.3 Channel Selection	3-11
3.6.4 Measurement Control	3-11
3.6.5 Parameter Editing from Text Mode	3-11
3.7 Graph Mode Operation	3-11
3.7.1 Entry	3-12
3.7.2 Measurement Page Selection	3-12
3.7.2 Channel Selection	3-12
3.7.3 Measurement Control	3-12
3.7.4 Parameter Editing from Graph Mode	3-12
3.8 Edit Mode Operation	3-12
3.8.1 Entry, Exit and Channel Selection	3-12
3.8.2 Screen Display	3-12
3.8.3 Parameter Selection	3-12
3.8.4 Parameter Editing	3-13

Contents (Cont)

CHAPTER/SECTION	PAGE
3.9 Display Formats	3-14
3.9.1 Channel Selection and Paging	3-14
3.9.2 Mixed Mode Operation	3-15
3.10 Sensor Connection and Calibration	3-16
3.10.1 Sensor Connection	3-17
3.10.2 Zero Offset Adjustment	3-18
3.10.3 Fixed Calibration	3-18
3.10.4 Automatic (step) Calibration	3-18
3.10.5 Frequency Calibration	3-18
3.10.6 Calibrator Selection	3-18
3.10.7 Calibration Volatility	3-19
3.10.8 Zero/Cal Menu Navigation	3-19
3.11 Menu Reference	3-21
3.11.1 Measure Menu	3-22
3.11.2 Channel Menu	3-23
3.11.3 Markers Menu	3-30
3.11.4 Trig/Time Menu	3-31
3.11.5 Statistical Menu	3-34
3.11.6 Calibratr Menu	3-35
3.11.7 Save/Recl Menu	3-37
3.11.8 Utilities Menu	3-37
3.11.9 Help Menu	3-43
3.11.10 Defaults Menu	3-43
3.11.11 Menu Summary	3-44
3.12 Error Messages and Status Codes	3-47
3.13 Recorder Output Calibration	3-49
3.14 Firmware Update	3-50
4. REMOTE OPERATION	
4.1 GPIB Configuration	4-1
4.2 Serial Port Operation	4-1
4.3 SCPI Language Syntax	4-2

Contents (Cont)

CHAPTER/SECTION	PAGE
4.4 Basic Measurement Operation	4-3
4.5 Command Reference	4-4
4.5.1 MEASure Queries	4-4
4.5.2 INITiate and ABORt Commands	4-5
4.5.3 FETCh Commands	4-6
4.5.4 READ Subsystem	4-9
4.5.5 Native Mode Queries	4-12
4.5.6 SENSE Subsystem	4-19
4.5.7 Calculate Subsystem	4-24
4.5.8 MARKer Subsystem	4-28
4.5.9 DISPlay Subsystem	4-29
4.5.10 TRIGger Subsystem	4-33
4.5.11 TRACe Data Array Commands	4-36
4.5.12 SENSE:MBUF Data Array Commands	4-37
4.5.13 SENSE:SBUF Data Array Commands	4-39
4.5.14 SENSE:HIST & SENSE:CALTAB Data Array Cmnds	4-40
4.5.15 CALibration Sybsystem	4-42
4.5.16 MEMory Subsystem	4-43
4.5.17 OUTput Subsystem	4-44
4.5.18 SYSTem Subsystem	4-48
4.5.19 STATus Commands	4-50
4.5.20 IEEE-488.2 Commands	4-52
4.5.21 Remote Interface Command Summary	4-56
4.6 Remote Sensor Calibration	4-61
4.6.1 AutoCal	4-61
4.6.2 Zero and Fixed Cal	4-61
4.7 Native Mode Programming	4-62
4.8 SCPI Example Program Fragments	4-63
4.8.1 Pulse Mode	4-63
4.8.2 Modulated Mode	4-65
4.8.3 CW Mode	4-65
4.8.4 Statistical Mode - CDF, CCDF, DISTRIBUTION	4-66
4.9 Error and Status Codes	4-67

Contents (Cont)

CHAPTER/SECTION	PAGE
5. MAKING MEASUREMENTS	
5.1 Sensor Types	5-1
5.1.1 Thermal RF Power Sensors	5-1
5.1.2 CW Dual-Diode RF Power Sensors	5-1
5.1.3 RF Voltage Sensors	5-2
5.1.4 Peak Power Sensors	5-2
5.2 Selecting the Right Sensor	5-3
5.2.1 CW Signals	5-3
5.2.2 Modulated Signals	5-3
5.3 Measurement Modes	5-3
5.3.1 CW Mode	5-3
5.3.2 Modulated Mode	5-4
5.3.3 Statistical Mode	5-4
5.3.4 Pulse Mode	5-5
5.4 Selecting the Right Measurement Mode	5-6
5.4.1 CW Mode	5-6
5.4.2 Modulated Mode	5-6
5.4.3 Pulse Mode	5-6
5.4.4 Statistical Mode	5-7
5.5 Setting Measurement Parameters	5-7
5.5.1 What You Need to Know	5-7
5.5.2 Channel Parameters Menu Settings	5-7
5.5.3 Trig/Time Menu Settings	5-8
5.6 Settings for some Common Signal Types	5-9
5.6.1 Measuring GSM and EDGE	5-9
5.6.2 Measuring NADC	5-9
5.6.3 Measuring iDEN	5-10
5.6.4 Measuring Bluetooth	5-11
5.6.5 Measuring CDMA	5-12
5.6.6 Measuring HDTV	5-13
5.7 Measurement Accuracy	5-13
5.7.1 Error Contributions	5-14
5.7.2 Discussion of Error Terms	5-14
5.7.3 Sample Uncertainty Calculations	5-17

Contents (Cont)

CHAPTER/SECTION	PAGE
APPENDIX A	
Available Sensors	A-1
APPENDIX B	
Model 2530 1 GHz Calibrator	B-1
Accessories	B-1
Specification	B-1

List of Tables

TABLE	PAGE
3-1 Keyboard Controls, Indicators and Connectors	3-2
3-2 4530 Graph and Text Mode Edit Menus	3-13
3-3 Measurement Pages	3-14
3-4 Zero/Cal Menu	3-20
3-5 Main Menu Summary	3-44
3-6 Graph/Text Header Error and Status Messages	3-47
3-7 Sensor and Probe Error Messages	3-47
3-8 Sensor Zero / Cal Status Codes	3-48
3-9 Startup Error Messages	3-48
4-1 Remote Command Summary	4-55
4-2 Remote Interface Error Codes	4-67
4-3 Measurement Result Status Codes	4-67

List of Illustrations

ILLUSTRATION	PAGE
C-1 4530 Series RF Power Meter	x
2-1 Unpacking and Packing	2-2
3-1 4530 Series, Front Panel	3-1
3-2 4530 Series, Rear Panel	3-1
3-3 Display Areas	3-5
3-4 Menu Mode Display	3-6
3-5 Text Mode Display	3-6
3-6 Graph Mode Display	3-7
3-7 Edit Mode Display	3-7
3-8 Zero/Cal Mode Display	3-8
3-9 Main Menu	3-8
3-10 Digit Editing Mode Display	3-9
3-11 Menu Mode Display	3-9
3-12 Text Mode Display	3-10
3-13 Graph Mode Display	3-11
3-14 Edit Mode Display	3-13
3-15 Graphic Mixed Mode Measurement Displays	3-15
3-16 Graphic Mixed Mode Edit Displays	3-15
3-17 Text Mixed Mode Measurement Displays	3-16
3-18 Text Mixed Mode Edit Displays	3-16
3-19 External Calibrator Connection	3-19
3-20 Zero/Calibration Menu	3-19

SAFETY SUMMARY

The following general safety precautions must be observed during all phases of operation and maintenance of this instrument. Failure to comply with these precautions or with specific warnings elsewhere in this manual violates safety standards of design, manufacture, and intended use of the instruments. Boonton Electronics Corporation assumes no liability for the customer's failure to comply with these requirements.

INSTRUMENT MUST BE GROUNDED

To minimize shock hazard, the instrument chassis and cabinet must be connected to an electrical ground. The instrument is equipped with a three conductor, three prong AC power cable. The power cable must either be plugged into an approved three-contact electrical outlet or used with a three-contact to a two-contact adapter with the (green) grounding wire firmly connected to an electrical ground at the power outlet.

DO NOT OPERATE THE INSTRUMENT IN AN EXPLOSIVE ATMOSPHERE

Do not operate the instrument in the presence of flammable gases or fumes.

KEEP AWAY FROM LIVE CIRCUITS

Operating personnel must not remove instrument covers. Component replacement and internal adjustments must be made by qualified maintenance personnel only. Never replace components or operate the instrument with the covers removed and the power cable connected. Even with the power cable removed, dangerous voltages may be present. Always remove all jewelry (rings, watches, etc.) and discharge circuits before touching them. Never attempt internal service or adjustment unless another person, capable of rendering first aid and resuscitation, is present.

DO NOT SUBSTITUTE PARTS OR MODIFY INSTRUMENT

Do not substitute parts or perform any unauthorized modification of the instrument. Return the instrument to Boonton Electronics for repair to insure that the warranty and safety features are maintained.



This safety requirement symbol has been adopted by the International Electrotechnical Commission. Document 66 (Central Office) 3, Paragraph 5.3, which directs that an instrument be so labeled if, for the correct use of the instrument, it is necessary to refer to the instruction manual. In this case it is recommended that reference be made to the instruction manual when connecting the instrument to the proper power source. Verify that the correct fuse is installed for the power available.

NOTE

The appearance of **NOTE** indicates that clarifying information follows immediately. In many cases this information is necessary for proper operation or is a further explanation of important data.

CAUTION

The CAUTION sign denotes a hazard. It calls attention to an operating procedure which, if not correctly performed or adhered to, could result in damage to the instrument or equipment under test. Do not proceed beyond a CAUTION sign until the indicated conditions are fully understood and met.

WARNING

The WARNING sign denotes a hazard. It calls attention to an operating procedure, which, if not correctly performed or adhered to could result in personal injury. Do not proceed beyond a WARNING sign until the indicated conditions are fully understood and met.



Figure C-1 4530 Series RF Power Meter

Repair Policy

Model 4531 / 4532 Instrument. If the Boonton Model 4531/4532 RF Power Meter is not operating correctly and requires service, contact the Boonton Electronics Service Department for return authorization. You will be provided with an RMA number and shipping instructions. Customers outside the USA should contact the authorized Boonton distributor for your area. The entire instrument must be returned in its original packing container. If the original container is not available, Boonton Electronics will ship a replacement container and you will be billed for the container cost and shipping charges.

Boonton Peak Power Sensors. Damaged or defective peak power sensors are repaired as separate accessories. Note that sensors which have failed due to overloading, improper mating, or connecting to an out-of-tolerance connector are not considered defective and will not be covered by the Boonton Warranty. If repair is needed, contact the Boonton Electronics Service Department for return authorization. You will be provided with an RMA number and shipping instructions. Customers outside the USA should contact the authorized Boonton distributor for your area. Only the defective sensor should be returned to Boonton, not the entire instrument. The sensor must be returned in its original packing container. If the original container is not available, Boonton Electronics will ship a replacement container and you will be billed for the container cost and shipping charges. If a new sensor is ordered, note that it does not include a sensor cable - this item must be ordered separately.

Contacting Boonton. Customers in the United States having questions or equipment problems may contact Boonton Electronics directly during business hours (8 AM to 5 PM Eastern) by phoning (973) 386-9696. FAX messages may be sent at any time to (973) 386-9191. Email inquiries should be sent to service@boonton.com. International customers should contact their authorized Boonton Electronics representative for assistance. A current list of authorized US and international representatives is available on the Boonton website at www.boonton.com.

Limited Warranty

Boonton Electronics warrants its products to the original Purchaser to be free from defects in material and workmanship and to operate within applicable specifications for a period of one year from date of shipment for instruments, probes, power sensors and accessories. Boonton Electronics further warrants that its instruments will perform within all current specifications under normal use and service for one year from date of shipment. These warranties do not cover active devices that have given normal service, sealed assemblies which have been opened, or any item which has been repaired or altered without Boonton's authorization.

Boonton's warranties are limited to either the repair or replacement, at Boonton's option, of any product found to be defective under the terms of these warranties.

There will be no charge for parts and labor during the warranty period. The Purchaser shall prepay inbound shipping charges to Boonton or its designated service facility and shall return the product in its original or an equivalent shipping container. Boonton or its designated service facility shall pay shipping charges to return the product to the Purchaser for domestic shipping addresses. For addresses outside the United States, the Purchaser is responsible for prepaying all shipping charges, duties and taxes (both inbound and outbound).

THE FOREGOING WARRANTIES ARE IN LIEU OF ALL OTHER WARRANTIES, EXPRESS OR IMPLIED, INCLUDING, BUT NOT LIMITED TO, THE IMPLIED WARRANTIES OF MERCHANTABILITY AND FITNESS FOR A PARTICULAR PURPOSE. Boonton will not be liable for any incidental damages or for any consequential damages, as defined in Section 2-715 of the Uniform Commercial Code, in connection with products covered by the foregoing warranties.

GENERAL INFORMATION

1

1.1 DESCRIPTION

The 4530 Series RF Power Meter is a new generation of instruments. It allows high-resolution power measurement of a wide range of CW and modulated RF signals over a dynamic range of up to 90dB depending on sensor. The power meter is available configured as the single-channel Model 4531, or as the dual-channel Model 4532. For the remainder of this manual, the series designation of 4530 will be used to indicate either model, except when otherwise stated.

The 4530 is really several instruments in one, and can function as a CW Power Meter, a Peak Power Meter, a Statistical Power Analyzer, and an RF Voltmeter. It accepts the full series of Boonton RF power and voltage sensors, which includes coaxial dual-diode sensors and thermal sensors. Sensor data and calibration information is automatically downloaded from the sensor or “smart adapter” whenever a new sensor is connected, eliminating the need to manually enter calibration factors.

When used as a CW power meter, the 4530 provides seamless measurement performance due to the extremely wide dynamic range of its input stage. Thermal and peak power sensors require no range switching under any conditions, and even CW diode sensors spanning a 90dB dynamic range require only two widely overlapping ranges. This means that practically any measurement can be performed without the interruptions and non-linearities associated with the range changes of conventional power meters.

For modulated signals, the 4530 can make accurate average and peak power measurements with modulation bandwidths as high as 20MHz, making it ideal for high-speed digitally modulated carriers such as CDMA, W-CDMA, GSM, TDMA, HDTV and UMT. Periodic and pulse waveforms can be displayed in graphical format, and a host of automatic measurements are available which characterize the time and power profiles of the pulse. Effective sampling rates up to 50MSa/sec and user programmable cursors allow instantaneous power measurements at precise time delays from the pulse edge or an external trigger as well as time gated or power gated peak and average power.

For spread-spectrum or randomly modulated signals such as CDMA, the 4530’s powerful statistical analysis mode allows full profiling of the power probability at all signal levels. Sustained acquisition rates in excess of one million readings per second along with rangeless operation insure that a representative population can be acquired and analyzed in minimum time. By analyzing the probability of occurrence of power levels approaching the absolute peak power, it is possible to characterize the occasional power peaks that result in amplifier compression and data errors. Because of the random and very infrequent nature of these events, they are next to impossible to spot with the conventional techniques used in other universal power meters. In addition, the instrument’s extremely wide video bandwidth insures that even the fastest peaks will be accurately measured.

The 4530’s powerful dual-processor architecture permits advanced measurement capabilities with unprecedented speed and performance. A high-speed, floating-point digital signal processor (DSP) performs the measurements. It gathers and processes the power samples from the sensors, performs time-stamping, linearity correction, gain adjustment and filtering, all in fractions of a microsecond. The processed measurements are then passed to a dedicated, 32-bit I/O processor that monitors the keyboard, updates the LCD display and responds to RS-232 and GPIB requests for formatted measurements. This design eliminates the speed tradeoffs between measurement data input (acquisition) and output (over the GPIB) that are so common among other power meters.

Instrument operating firmware is stored in flash memory that may be field reprogrammed with any PC via the onboard RS-232 port. Free firmware upgrades permit the easy addition of new features or capabilities that may become available in the future. Visit the Boonton website at WWW.BOONTON.COM for upgrade information and to download the latest firmware version.

1.2 FEATURES

<i>Multi-mode capability</i>	Utilizes CW sensors, Peak Power sensors and Voltage probes with automatic sensing and setup for each type. Measures conventional CW power and voltage, power versus time for pulse analysis, and statistical power distributions for spread spectrum signals.
<i>Text and Graphics</i>	The backlit LCD display shows numerical results as well as graphical results for all measurements. Measurements are displayed using a large, easy-to-read numerical format, or in graph mode with a fast-updating, oscilloscope-like trace.
<i>Dual Independent Channels</i>	Model 4532 is equipped with two identical independent measurement channels with the capability to display two pulse measurements, two statistical measurements or two CW measurements at the same time.
<i>Remote Programming</i>	All functions except power on/off can be controlled by a GPIB interface or via an RS-232 serial connection. The programming language follows the SCPI model with added non-SCPI commands for special applications.

1.3 ACCESSORIES

Supplied accessories:	1 – NEMA type power cable 1 – Fuse Kit 1 – 4530 Series Operators Instruction Manual
Other accessories:	Rack Mounting Kit See Boonton Electronics Power Sensor Manual for power sensors available.
Options:	Model 4531 Single Channel RF Power Meter Model 4532 Dual Channel RF Power Meter Rear panel sensor inputs Rear panel calibrator output

1.4 SPECIFICATIONS MODEL 4531 and 4532

1.4.1 General.

Sensor Inputs (Performance depends upon sensor model selected)

Channels:	Single Input: Model 4531 Dual Input: Model 4532
RF Frequency Range:	10 kHz to 110 GHz (Sensor dependent)
Peak Power Measurement Range:	-40 to +20 dBm (Sensor dependent)
CW Measurement Range:	-70 to +44 dBm (Sensor dependent)
Relative Offset Range:	±99.99 dB
Video Bandwidth:	20 MHz (Sensor dependent)
Single Shot Bandwidth:	250 kHz (based on 10 samples per pulse)
Pulse Repetition Rate:	1.8 MHz maximum for stable, internal trigger

1.4.2 Calibration Sources

Internal Calibrator

Output Frequency:	50 MHz \pm 0.005%
Level:	-60 to +20 dBm
Resolution:	0.1 dB steps
Source SWR:	1.05 (reflection coefficient = 0.024)
Accuracy, 0° to 20°C, NIST traceable:	At 0 dBm: \pm 0.055 dB (1.27%) +20 to -39 dBm: \pm 0.075 dB (1.74%) -40 to -60 dBm: \pm 0.105 dB (2.45%)
RF Connector:	Type N

External Calibrator (See Appendix B)

Model 2530 1 GHz Calibrator	(Purchased separately if required)
-----------------------------	------------------------------------

1.4.3 Trigger (Peak power modes only.)

Modes:	Pre-trigger and post-trigger
Trigger Time Resolution:	20 ns
Trigger Delay:	\pm 900 μ s for timespans 5 μ s and faster \pm 4ms for timespans 10 μ s to 50 μ s \pm (80 x TimeSpan) for timespans 50 μ s to 2ms \pm (30 x TimeSpan) for timespans 5ms and slower
Trigger Holdoff:	0 μ s to 1 sec, resolution 1 μ s
Internal Trigger Range:	Equivalent to -30 to +20 dBm pulse amplitude range.
External Trigger Range:	\pm 5 volts, \pm 50 volts with 10:1 divider probe.
External Trigger Input:	1 megohm in parallel with approximately 15pF, dc coupled.
External Trigger Connector:	Rear-panel BNC input

1.4.4 Sampling Characteristics

Effective sampling rate:	50 Megasamples per second (each channel, pulse mode)
Sustained sampling rate:	2.5 Megasamples per second (each channel, pulse mode)
Measurement Technique:	Continuous and triggered (burst) sampling

1.4.5 Measurement Characteristics

Measurements:	Average Power* Maximum Average Power* Minimum Average Power* Maximum Instantaneous (“Peak”) Power* Minimum Instantaneous Power* Peak to Average Power Ratio* Cumulative Distribution Functions: CDF, 1- CDF, Probability Distribution (histogram) Power at a percent statistical probability Statistical probability at a power level CW Power RF Voltage
---------------	--

* All measurements marked with an asterisk (*) may be performed continuously, or in a synchronous, triggered mode. When triggered, these measurements may be made at a single time offset relative to the trigger, or over a defined time interval. The time offset or interval may be before or after, or may span the trigger interval.

Channel Math:	Displays the ratio, sum (power sensors) or difference (voltage sensors) between channels or between a channel and a reference measurement (Modulated and CW modes only).
Trace Averaging:	1 to 4096 samples per data point.
Panel setup storage:	4 complete setups.
Measurement rate (via GPIB):	Greater than 200 two-channel measurements per second, neglecting bus master overhead, or 500 single-channel measurements per sec.

1.4.6 Sensor Characteristics

CW Power Sensors

Power Detection Technique:	Dual diode, single diode or thermo-electric.
Internal Data:	Frequency and linearity calibration tables, frequency range, power range, sensor type, serial number and other sensor dependent information are stored in EEPROM within the sensor cable or in a cable-adapter for use with existing CW sensors.

Peak Power Sensors

Power Detection Technique:	Dual diode with selectable detector bandwidth.
Signal compression:	The use of logarithmic signal compression circuitry in the sensor enables the instrument to measure and analyze changes in power exceeding 60 dB in a single range.
Internal Data:	Frequency, linearity and temperature calibration tables, frequency range, power range, sensor type, serial number and other sensor dependent information are stored in EEPROM within the peak power sensor.
Sensor Cable:	The sensor cable is detachable from both sensor and instrument. The standard cable length is 5 feet. Optional cable lengths are 10, 20, 25, and 50 feet. Additional cable length will affect measurement bandwidth.

RF Voltage Sensors

Dual diode detector.

1.4.7 Interface

Video Output:	Compressed representation of detected RF envelope of peak channel(s) envelope for external oscilloscope monitor or external device synchronization. <i>This output is roughly logarithmic with input power, is not calibrated, and <u>can not</u> be used for making any measurements.</i>
Recorder Output:	Programmable voltage output which may be used for monitoring measurements or status of either channel, or for outputting a fixed, programmable voltage. When used as a measurement monitor, the output is proportional to displayed signal level with programmable or automatic scaling. Output range: 0 to 10V (unipolar), or -10V to +10V (bipolar) Output resolution: 5.0mV Output impedance: 9K Absolute accuracy: $\pm 100\text{mV}$ typical, $\pm 200\text{mV}$ max, uncalibrated $\pm 20\text{mV}$ after user calibration Linearity: 0.1% typical
GPIB Interface:	Complies with IEEE-488.1. Implements AH1, SH1, T6, LE0, SR1, RL1, PP0, DC1, DT1, C0, and E1.
RS-232 Interface:	Accepts GPIB commands (except bus dependent commands). Provides for user software updates.
Remote Programming:	SCPI (1990) compliant and Native Mode commands via GPIB or RS-232 interfaces.
Software Drivers:	LABVIEW drivers available.

1.4.8 Environmental Specifications

General:	Manufactured to the intent of MIL-T 28800E, Type III, Class 5, Style E
CE Mark:	Conforms to EU specifications: EN 61010-1(90)(+A1/92)(+A2/95) EN 61010-2-031 EN 61326-1(97) EN 55022(94)(A2/97)Class B
Display:	Graphic type LCD, with LED backlight. Text and trace displays.
Operating Temperature:	0 to 50° C
Ventilation:	Fan cooled
Altitude:	Operation up to 15,000 feet.
Storage Temperature:	-40 to 75° C
Humidity:	95% $\pm 5\%$ maximum (non-condensing).
Shock:	Withstands $\pm 20\text{G}$, 42ms impulse in X, Y, and Z axes, as per MIL-STD-810.
Vibration:	Conforms to MIL-STD-167-1.
Power Requirements:	90 to 260 VAC, 47 to 63 Hz, <50 VA, <30 Watts. No voltage switching required.
Battery:	One Lithium coin cell for maintaining non-volatile memory information. Not user replaceable. Typical battery life: 10 years.

1.4.9 Physical Specifications

Dimensions:	3.5 inches (8.9 cm) high, 8.4 inches (21.3 cm) wide, 13.5 inches (34.3 cm) deep, <i>All dimensions are approximate, and exclude clearance for feet and connectors. Feet may be removed for rack mounting.</i>
Weight:	7 lbs. (3.2kg)
Connector location option:	Sensor input(s) and calibrator connector: Front or rear panel.
Construction:	Surface mount, multilayer printed circuit boards mounted to rigid aluminum frame and front extrusion/casting with aluminum sheet metal enclosure.

Note: All specifications are subject to change without notice.

INSTALLATION

2

2.1 UNPACKING & REPACKING

The 4530 Series RF Power Meter is shipped complete and ready to use upon receipt. Figure 2-1 shows the packaging material. Save the packing material and container to ship the instrument if necessary. If the original materials are not available, contact Boonton Electronics to purchase replacements. Store materials in a dry environment.

2.2 POWER REQUIREMENTS

The 4530 Series is equipped with a switching power supply that permits operation from a 90 to 260 volt, 47 to 63 Hz, single-phase AC power source. Power consumption is 50 VA maximum. For replacement fuses, use the fuse kit supplied.

CAUTION

Before connecting the instrument to the power source, make certain that the correct fuse(s) are installed in the power entry module on the rear panel.

WARNING

Before removing the instrument cover for any reason, place the entry module power switch in the OFF (0=Off) position and remove the line cord from the entry module.

2.3 INTERNAL BATTERY

The 4530 Series contains a coin cell Lithium battery to provide memory backup when the power source is off. The battery has an expected life of ten years and is not user replaceable.

2.4 PRELIMINARY CHECK

The following preliminary check verifies that the instrument is operational and has the correct software installed. It should be performed before the instrument is placed into service. To perform the preliminary check, proceed as follows:

1. Connect the AC power cord to a suitable AC power source.
2. Press the upper half of the rocker type power switch located in the power entry module on the rear panel.
3. If the instrument does not start up, press the **ON/STBY** key on the front panel.
4. A banner message should appear on the LCD display, followed by a self-check display and sensor detection messages. If any fatal errors occur during the startup, the process will terminate with a failure message on the display. Any marginal conditions detected will be indicated with a cautionary message, but the startup process will be allowed to proceed.
5. When the startup process is complete, press the **Menu** key twice to force the Main Menu to be displayed. Using the arrow keys to move through the list of menu items and the **Enter** key to select **Utilities > Sys-Tests > SystemInf** display. Verify that the Serial Number matches the number on the rear panel tag. If the numbers do not match, contact Boonton Electronics technical support.

6. The sensors supplied with the instrument may vary widely in model number and type. Refer to Section 3-9 for information on connecting and calibrating sensors.
7. Upon successful calibration of the supplied sensors, the instrument is ready for use.

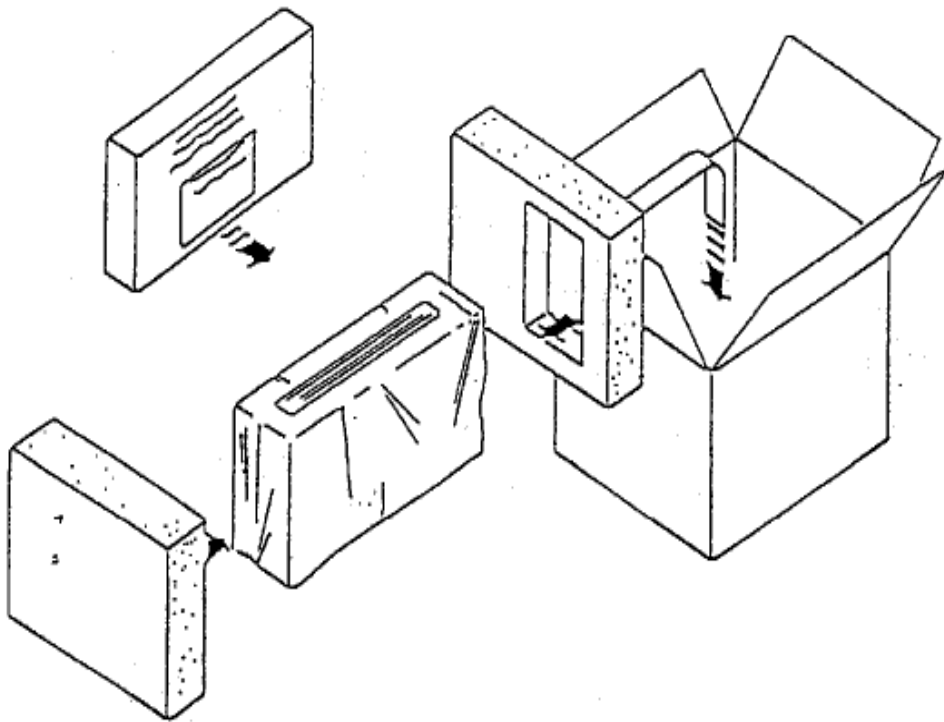

Figure 2-1. Packing and Unpacking Diagram

OPERATION

3

3.1 OPERATING CONTROLS, INDICATORS AND CONNECTIONS

Controls, indicators and connectors for the 4530 Series RF Power Meter are shown in figures 3-1 and 3-2. The front panel is illustrated in figure 3-1 and the rear panel in figure 3-2.

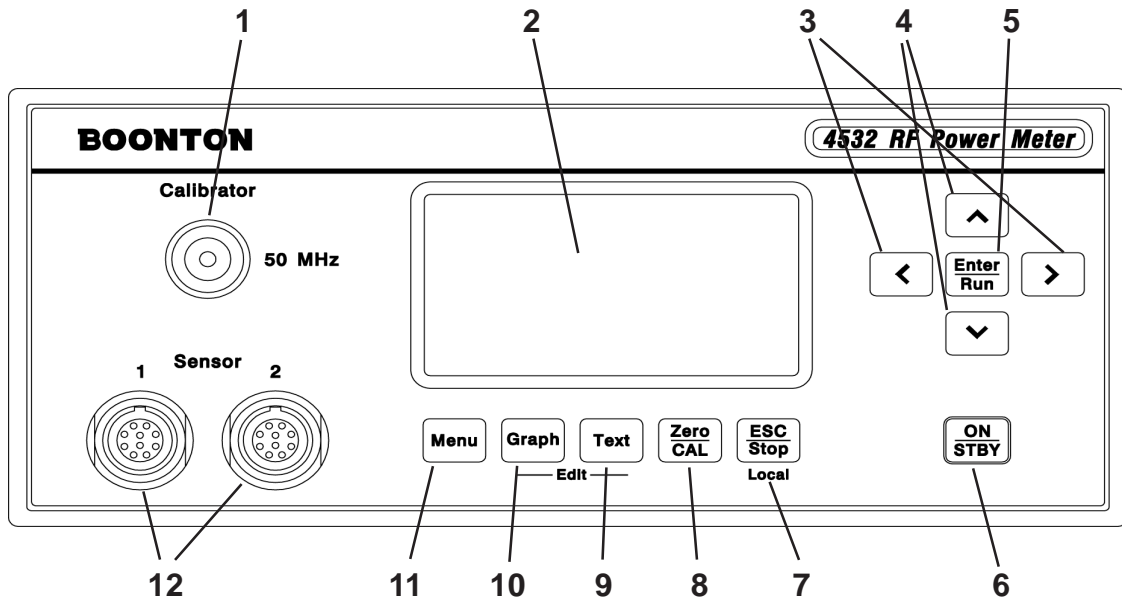

Figure 3-1. 4530 Series, Front Panel

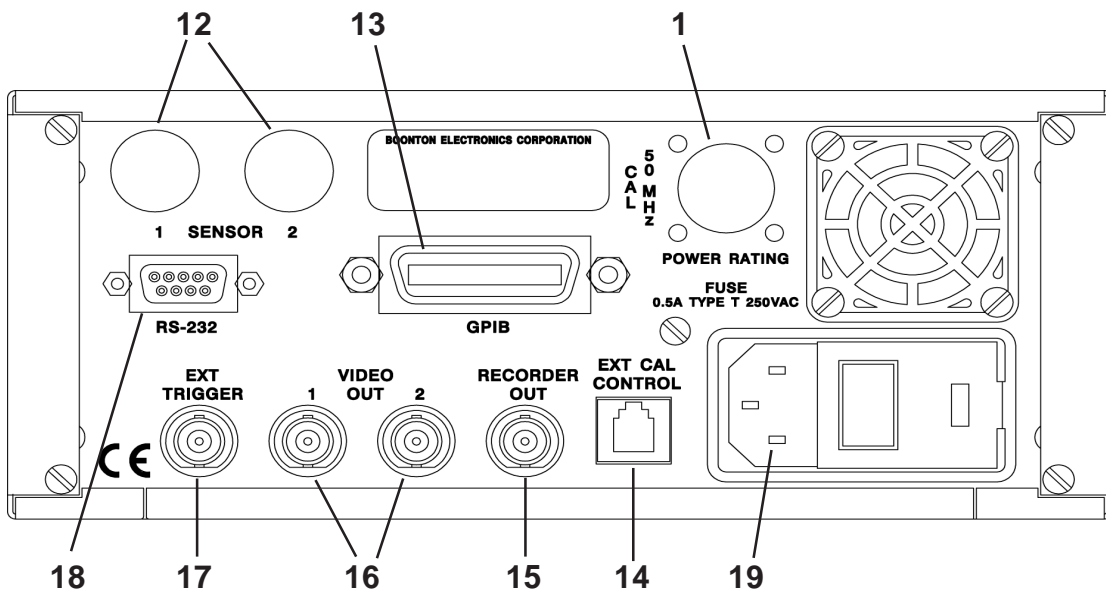

Figure 3-2. 4530 Series, Rear Panel

3.2 KEY FUNCTION SUMMARY

Table 3-1 references each operating key or connector to a callout in Figure 3-1 or 3-2 and briefly describes the key function

Table 3-1. Keyboard Controls and Connectors

Item	Figure 3-1	Function
50 MHz Calibrator	1	The output of the built-in 50MHz programmable calibrator is available from a Type-N connector located on the front or optionally on the rear panel of the instrument. This calibrator is used to automatically calibrate sensor offset and linearity, and can also be used as a general purpose calibration signal source.
Display	2	The 4530 Series RF Power Meter uses a 160x80 pixel graphic liquid crystal display module with a switchable LED backlight. The display contrast may be adjusted by holding down the ESC key while pressing the ^ or v keys.
< and > Keys	3	Used to navigate between levels of the menu structure while in Menu Mode or Zero/Cal Mode and to select individual editing numeric parameters. In Text Mode and Graph mode these keys can be used to switch the display between channels. In Text or Graph Edit Modes, the < and > keys scroll the header line left or right through a list of editable parameters.
^ and v Keys	4	Used to scroll up and down through a list of items when in Menu Mode or Zero/Cal Mode. They are also used to increment and decrement parameter values or individual digits when editing. In certain Text Modes, these keys can be used to page up or down through a series of measurement screens.
(Key Repeat)	--	Note - If the ^ or v key is pressed and held when incrementing or decrementing a variable, it enters auto-repeat mode. At first, there is a short delay, and then the number begins to increment at a slow rate. The increment rate accelerates to a medium rate after 2 seconds, and to a high rate after 7 seconds. To select and hold the medium repeat rate, double-click the key - releasing and immediately pressing the key will inhibit the high-speed auto-repeat rate so the value doesn't "run away" just as the desired number is being approached.
Enter/Run Key	5	Activates a menu selection or completes update of a parameter in Menu Mode or Zero/Cal Mode. Pressing Enter/Run while stopped in Text Mode or Graph Mode will start (or restart) the measurement process.
ON/STBY Key	6	Switches the power meter between on and standby modes. When in standby, some circuitry remains powered to reduce drain on the battery used to maintain the non-volatile memory.

Table 3-1. Keyboard Controls and Connectors (Cont)

Item	Figure 3-1	Function
ESC/Stop Key	7	Aborts any operation in progress when in Menu Mode or Zero/Cal Mode. Pressing ESC/Stop while running in Text Mode or Graph Mode first causes the measurement process to stop. Pressing it when already stopped will clear the screen and reset all measurement values. Pressing ESC/Stop when the instrument is in remote mode (the GPIB has control of the instrument and keyboard entry is disabled) will return it to local mode (the instrument is under keyboard control) unless the local lockout command, LLO, has been issued by the controller.
Zero/CAL Key	8	Places the instrument in Sensor Zero/Calibration Mode and displays a menu to allow automatic sensor offset and gain adjustments using the built-in 50MHz calibrator or an external calibrator.
Text Key	9	Places the instrument in Text Mode to display the current measurements in a numeric format. Pressing Text while already in Text Mode toggles the top portion of the display between the normal Text Mode header and Edit Mode for each active channel.
Graph Key	10	Places the instrument in Graph Mode to display the current measurement waveforms in a graphical format. Pressing Graph while already in Graph Mode toggles the top portion (header) of the display between the normal Graph Mode header and Edit Mode for the active channel.
Menu Key	11	Places the instrument in Menu Mode to allow navigation of the menu structure. Pressing Menu while already in Menu Mode returns the user to the top-level Main Menu.
Sensor 1 - 2	12	One or two sensor inputs are located on the front, or optionally on the rear panel of the instrument. These are 10-pin precision connectors designed to accept <i>only</i> Boonton Peak or CW power sensors and Boonton voltage sensors. The sensor inputs are <i>not</i> measurement terminals and cannot be used for other than the intended purpose.
GPIB	13	<div style="border: 1px solid black; padding: 2px; display: inline-block;">CAUTION</div>
		<p><i>Do not attempt to connect anything other than a Boonton sensor or sensor adapter to the Sensor inputs!</i></p>
		A rear-panel 24-pin GPIB (IEEE-488) connector is available for connecting the power meter to the remote control General Purpose Instrument Bus. GPIB parameters can be configured through the menu.

Table 3-1. Keyboard Controls and Connectors (Cont)

Item	Figure 3-1	Function
EXT CAL CONTROL	14	<p>An RJ-11 type modular telephone jack is used to connect the instrument to a Boonton Model 2530 1GHz Programmable Calibrator. This feature must be used to calibrate peak power sensors that cannot be calibrated at 50MHz, the operating frequency of the built-in calibrator.</p> <div style="text-align: center;"> <div data-bbox="889 495 1040 543" data-label="Section-Header"> <p>CAUTION</p> </div> <div data-bbox="703 575 1305 667" data-label="Text"> <p><i>Do not attempt to connect the External Calibrator Control RJ-11 port to a telephone line or to any device other than a Boonton Model 2530, 1 GHz Calibrator!</i></p> </div> </div>
RECORDER OUT	15	<p>A rear-panel BNC programmable analog output is available for connection to an external chart recorder or other device. The output voltage range is unipolar or bipolar 10 volts, and a 9K output impedance allows for simple scaling using a single external load resistor. The output can be programmed to produce a voltage proportional to signal level, or a logic-level status voltage for signaling when the RF power is above or below preset “alarm limit” thresholds. Recorder output parameters can be configured through the menu.</p>
VIDEO OUT 1-2	16	<p>Two rear-panel video BNC outputs are used to view the demodulated RF envelope for each channel on an external oscilloscope when using peak sensors. The output voltage is 0 to 2.5 volts, and is approximately proportional to the logarithm of the sensor power. These outputs are uncalibrated, and should not be used for making any type of external measurement.</p>
EXT TRIGGER	17	<p>A rear-panel BNC input is available for connecting an external trigger source to the power meter. The input impedance is 1 megohm to allow triggering from a common 10x oscilloscope probe, and the input voltage range is +5 to -5 volts to simplify triggering from logic-level signals.</p>
RS-232	18	<p>A rear-panel 9-pin female “D” connector is used to connect the instrument to a PC or other serial device. The power meter will directly interface with most PC serial ports using a straight-through type RS-232 cable. RS-232 parameters can be configured through the menu.</p>
AC Line Input	19	<p>A multi-function power input module (lower right of rear panel) is used to house the AC line input, main power switch, and safety fuse. The module accepts a standard AC line cord, included with the power meter. The power switch is used to shut off main instrument power. The safety fuse may also be accessed once the line cord is removed. The instrument’s power supply accepts 90 to 260VAC, so no line voltage selection switch is necessary.</p> <div style="text-align: center;"> <div data-bbox="894 1822 1032 1871" data-label="Section-Header"> <p>CAUTION</p> </div> <div data-bbox="618 1898 1159 1925" data-label="Text"> <p><i>Replace fuse only with specified type and rating!</i></p> </div> </div>

3.3 DISPLAY FUNCTIONS

The screen display of the 4530 is divided into three sections: the *header*, the *measurement* window and the *status* window. Because these functions apply to all modes of operation, it is very important to understand them thoroughly. Note that the display contrast may be adjusted by holding down the **ESC** key while pressing the **▲** or **▼** keys.

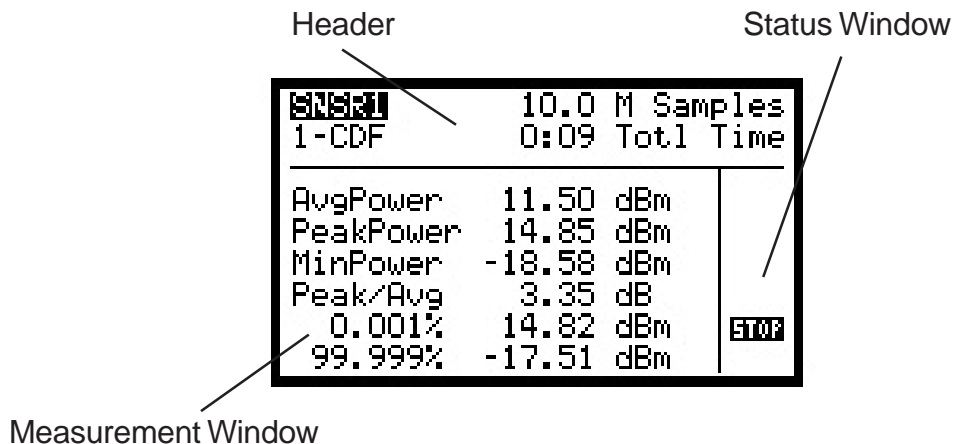

Figure 3-3. Display Functions

- 3.3.1 **Header.** The header appears at the top of the screen. It displays a title line and a line of text describing the status of the currently highlighted item (sensor status, measurement status or auxiliary measurement values). If the item is a submenu, a short description of the menu's function will appear. If it is a parameter, the present value for that parameter is shown. If it is an action item, the action will be described, and upon activation, the message will change to indicate that the action has occurred. The header is also used as a two-line parameter editing window when in the Edit mode.
- 3.3.2 **Measurement Window.** The major portion of the screen displays the current measurement results in a single (4531) or split-channel (4532) format. The text display shows a trace for the primary measurement of the channel(s) (usually average power), which updates as samples are acquired. In addition, while in the text mode, the channel source (sensor, reference, or math function) is displayed along with measurement units. While in the Graph mode, at slower display timebases, the trace will roll from right to left in chart recorder format, while faster timebases use an oscilloscope-like sweep.
- 3.3.3 **Status Window.** The right-hand portion of the screen displays six annunciators that indicate status for the GPIB, calibrator and measurement. The first four indicate GPIB status: REM, TLK, LSN, and SRQ. Position five is a measurement status indicator, that can display: STOP, RUN, AUTO, ARMD, or SNGL. Position six displays CAL when the calibrator output is active.
- 3.3.4 **Channel Selection.** Pressing the < or > keys while in text or graph mode toggles the measurement window between channels. If Channel 1 is active, pressing < from a split-channel display will display only Channel 1, and pressing > at that point returns to the split channel display. Similarly, pressing > from the split-channel screen switches to the Channel 2 only display and < returns to the split-channel format. Note that in the single-channel Model 4531, there is no "Channel 2 only" display, and while the split-channel display is present, there are no measurements for Channel 2.
- 3.3.5 **Header / Page Selection.** Pressing the ▲ and ▼ Keys while in text or graph mode scrolls the display through a series of three "measurement pages", each displaying a different set of measurements or status indicators. In single-channel text mode, the entire measurement window may change, while in graph mode or split-channel format, only the "auxiliary" measurements shown in the header will change.

3.4 OPERATING MODE SUMMARY

The 4530 can operate in several modes. It is possible to move between these modes without interrupting the measurements currently being performed, even though the measurement display may not always be present.

3.4.1 **Menu Mode.** The Menu Mode and is used to set operating parameters and start or stop measurements. A series of displayed menus may be navigated using the front-panel arrow keys to access any instrument function. The menu is an inverted tree, which begins at the top-level Main Menu, and branches downwards through several levels of menu items and submenus. Refer to Table 3-5 for a summary of the instrument's entire menu structure. The first time the **Menu** key is pressed after power-up, the instrument enters the Menu Mode and displays the Main Menu. Subsequent entries into Menu Mode will return the user to the same position in the menu tree that was last used. Pressing the **Menu** key twice (or pressing it at any time when already in Menu Mode) will always return to the Main Menu.

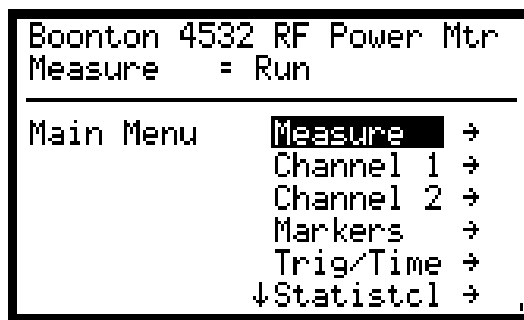
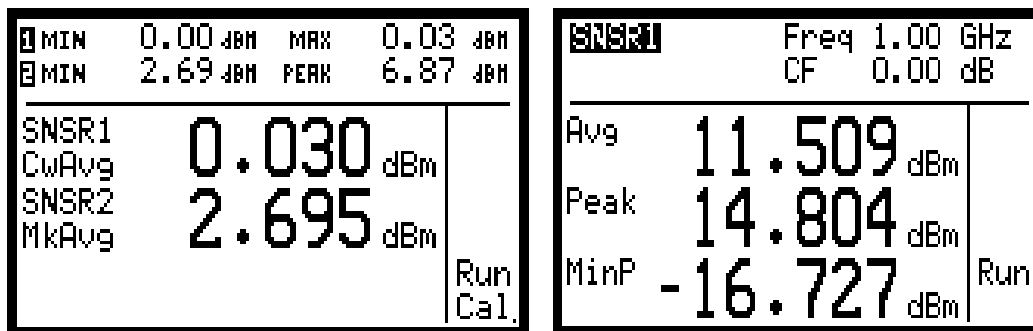

Figure 3-4. Menu Mode

3.4.2 **Text Mode.** In Text Mode, the measurements are presented in a numerical format. A summary split-channel (4532) display which shows the key measurement values for each channel in a large font may be selected, or detailed single-channel (4531) display that presents a number of different measurements in a tabular format. In the dual-channel text display, a programmable bargraph can be displayed to aid in viewing fluctuating signals.



Dual Channel (Example)

Single Channel (Example)

Figure 3-5. Text Mode

3.4.3 **Graph Mode.** The Graph Mode can present an oscilloscope style trace of power versus time or power versus percent probability in statistical mode. Each channel may be viewed individually, or both can be overlaid to make channel-to-channel comparisons. User programmable cursors can be moved back and forth or up and down on the trace to define measurement regions of interest.

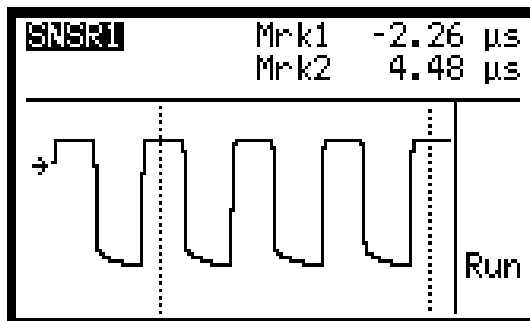

Figure 3-6. Graph Mode (Example)

3.4.4 **Edit Mode.** Edit Mode is an extension of the basic Graph Mode or Text Mode operation. The screen's measurement window continues to display and update the active measurement, but the two-line header area at the top of the screen is used as an edit window. The arrow keys scroll through a list of commonly accessed parameters, and allow these parameters to be updated “on the fly” without the need to return to Menu Mode.

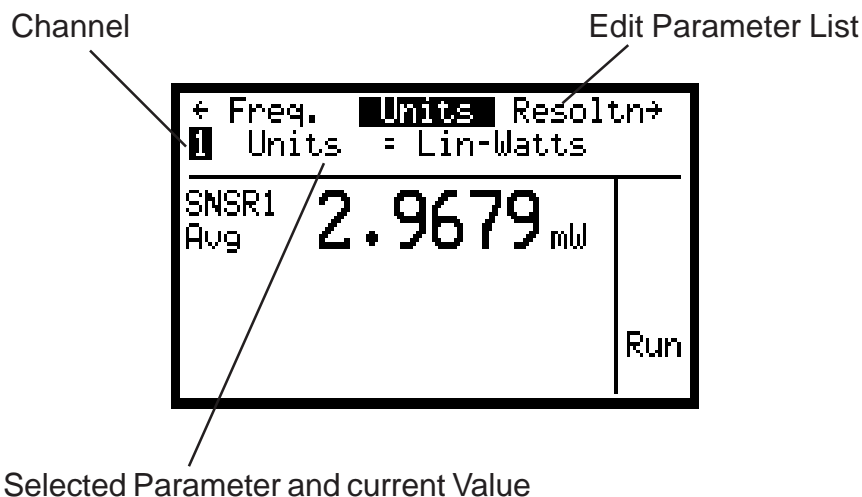

Figure 3-7. Edit Mode (Example)

3.4.5 **Zero/Calibration Mode.** When the 4530 is placed in Zero/Calibration Mode, a special menu is displayed that allows quick, single-key access to the instrument's sensor zeroing and linearity calibration functions. A configuration submenu is available for each channel to set up certain calibration parameters.

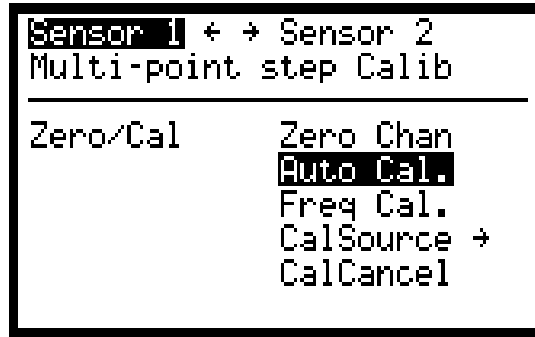

Figure 3-8. Zero/Cal Mode (Example)

3.5 MENU MODE OPERATION

3.5.1 **Entry.** When the **Menu** key is pressed, the instrument enters Menu Mode (See Figure 3-9). The first time the **Menu** key is pressed after power-up, the instrument will always enter Menu Mode displaying the Main Menu. Subsequent entries into Menu Mode will return the user to the same position in the menu tree that was last used.

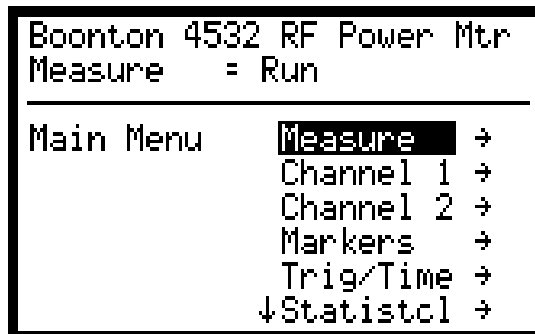

Figure 3-9. Main Menu Screen

3.5.2 **Navigation.** The menu tree is navigated using the arrow keys until the desired menu is highlighted, and then that item may be activated. The **^** and **v** keys are used to move the cursor up and down through the current menu's item list. Pressing **>** or **Enter/Run** will activate the highlighted item and move to a subordinate menu item associated with the selected item. Pressing **<** or **ESC** will return to the parent menu. Pressing **Graph, Text** or **Zero/Cal** will exit Menu mode and abort any parameter editing in progress.

3.5.3 **Menu Items.** Menu items may be one of four types: *Submenu*, *Numerical Value*, *Picklist*, or *Action*.

- a. **Submenus.** A submenu is simply a menu at a lower level containing more items. Activating a submenu item will cause the current menu to become the parent menu, and the submenu will then be opened and become the current menu.
- b. **Numerical Values.** A numerical value is an operating parameter that can be edited. When a numerical value item is activated, that item name (parameter) is displayed along with the highlighted current value of the parameter. Editing is performed with the arrow keys. The default edit mode is *increment/decrement mode*. Only the **^** and **v** keys are used to increment or decrement the parameter's value by a preset amount.

If a precise value is required, a special *digit editing mode* (Figure 3-10) may be selected. This mode is entered from increment/decrement mode by pressing the > key. When > is pressed, a digit pointer will be displayed below the leftmost digit field, and the ^ and v keys will change that digit of the parameter by one count. Pressing > or < will move the digit pointer right or left so any digit of the numeric parameter may be selected. Pressing < when the leftmost digit is selected will return to increment/decrement mode.

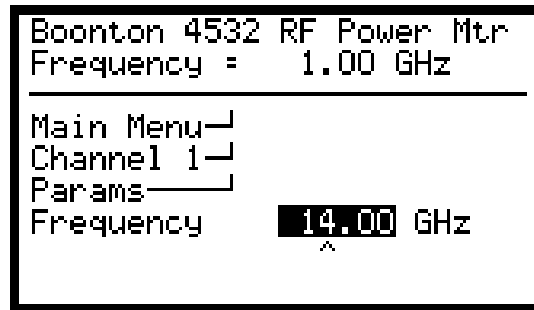

Figure 3-10. Digit Editing Mode (Example)

In either editing mode, the parameter's value is always clamped to valid limits, and cannot be advanced beyond these limits. When editing is complete, press **Enter/Run** to save the new value and return to the previous level menu. Press **ESC** to abort the edit and restore the original value before returning.

- c. *Picklist*. A picklist is used to select a parameter's value from a list of two or more fixed entries. When a picklist is activated, the list of available values is displayed with the current value highlighted. Use the ^ and v keys to move the cursor up and down through the list until the desired value is highlighted. Press **Enter/Run** to save the new value and return to the previous level menu, or press **ESC** to abort the edit and restore the original value before returning. If the number of items in the picklist exceeds what can be displayed on the screen, a ↓ or ↑ will appear to the left of the top or bottom item to indicate that there are more list items that are scrolled off the top or bottom of the display.
- d. *Action Item*. An action item is a menu selection that causes an event to occur or be initiated immediately when the item is activated. In some cases (such as AutoSetup), the user will first be prompted to confirm the action before continuing.

3.5.4 Menu Screen Display. The menu screen is divided into three sections: the *header*, the *path*, and the list of *menu items* (see figure 3-11).

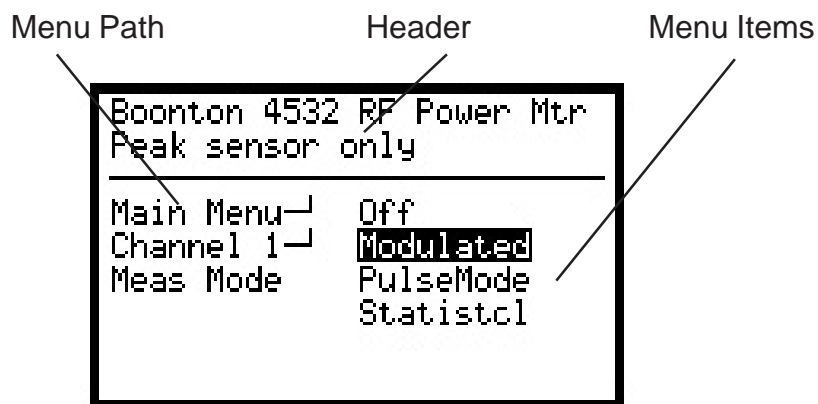

Figure 3-11. Typical Menu Screen

- a. *Header.* The header displays a title line and a line of text describing the currently highlighted item (sensor or measurement status, or auxiliary measurement values). A short description of a selected submenu, or action item, is listed or the value of a selected parameter is displayed.
- b. *Path.* The path appears on the left side of the screen, and is a list of each branch of the menu tree used to get to the current position. Each time a new menu item is opened, that item is highlighted, and then that item may be activated. Pressing **>** or **Enter** will activate the highlighted item and move to a subordinate menu item associated with the selected item. Pressing **<** or **ESC** will return to the parent menu. Pressing **Graph**, **Text** or **Zero/CAL** will exit Menu Mode, and abort any parameter editing in progress. Table 3-5 shows the complete menu structure of the 4530.
- c. *Menu items.* The list of menu items appears on the right side of the screen, where individual selections may be highlighted and activated. The menu is always entered with the top item highlighted, and the **^** and **v** keys may be used to move the cursor up and down through the list. If a **↓** or **↑** appears to the left of the top or bottom menu item, it means that the list extends above or below what is currently displayed on the screen. In this case, the list can be scrolled up or down to allow access to these additional items.

As each item is highlighted, the header will show a brief description of that item or its current value. If the item is a submenu, numeric value or picklist, a **→** will be shown to the right of the item to indicate that activating that item moves you down another menu level or an edit screen. Action items have nothing displayed to the right of the item since there is no “next level” associated with them.

3.5.5 **Menu Syntax.** When referring to item locations within the menu hierarchy, it is convenient to describe them by their *path*. Each menu level will be separated by a “>” (indicating the **>** or **Enter/Run** key must be pressed at this point to move down a level). Since Menu Mode always remains within the Main Menu, this manual will always show the path beginning with the first item picked from the Main Menu level. For example, to set the IEEE-488 bus address to 13, the following path string will be used:

Utilities > IEEE-488 > Bus Setup > Address > 13

To execute this function, you must first enter Menu Mode by pressing the **Menu** key.

3.6 TEXT MODE OPERATION

In Text Mode, the current measurements are displayed in a numeric format with optional fast-responding bargraph readouts. Since the 4530 can measure more than just average power, most modes have a number of measurements associated with them. The flexible text presentation allows you to view key average power measurements in a traditional format or a tabular format to show a larger number of items on the screen.



Figure 3-12. Text Mode (Example)

- 3.6.1 **Entry.** When the **Text** key is pressed, the 4530 enters Text Mode.
- 3.6.2 **Measurement Page Selection.** Pressing the **▲** or **▼** keys while in Text Mode pages up or down through a series of pages that contain all the measurements being performed in the current mode. See paragraph 3.9 (Display Formats) for a list of what measurements are displayed in each format.
- 3.6.3 **Channel Selection.** Pressing the **<** or **>** keys while in Text mode switches the display between channels. The keys toggle the display between “CH1 <> BOTH <> CH2”. In addition to the primary measurement, the CH1 and CH2 displays may show a number of secondary measurements for that channel. The BOTH display format shows the primary measurements only in the main display window, along with an optional bargraph. In some cases, secondary measurements for each channel may appear in the header. Single-channel units (Model 4531) can only page between the CH1 and BOTH display formats. See paragraph 3.9 (Display Formats) for a list of what measurements are displayed in each format.
- 3.6.4 **Measurement Control.** Pressing **Enter/Run** while in Text Mode starts the measurement if it is stopped, or arms the trigger if single-sweep mode is active. Pressing **ESC/Stop** stops the measurement if it is running and holds the current measurement values. Once stopped, pressing **ESC/Stop** again clears the measurement result, and resets for a new measurement. Anytime measurement is stopped, you can change display settings or certain measurement parameters, and the current measurements displayed are updated accordingly.
- 3.6.5 **Parameter Editing from Text Mode.** Pressing **Text** while already in Text Mode will enter Edit mode for the first active channel. The screen’s measurement window continues to display and update the active measurement, but the two-line header area at the top of the screen is used as an edit window. Pressing **Text** again switches to Edit Mode for the second channel, if active. Another press of the **Text** key will return to normal Text Mode. See paragraph 3.8 (Edit Mode Operation) for more details.

3.7 GRAPH MODE OPERATION

Graph Mode is used to present the current measurements in a real-time graphic or trace-type format. This can be a plot of signal amplitude (usually power) versus time, similar to an oscilloscope screen, or power versus percent probability. Power is always presented on the Y-axis, while time or probability is on the X-axis. Both axes can be scaled, and vertical or horizontal cursors can be positioned on the trace to perform measurements at specific time or percent offsets of each cursor or in the region between the two cursors.

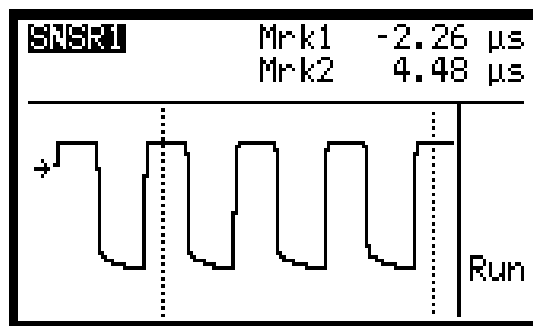

Figure 3-13. Graph Mode (Example)

- 3.7.1 **Entry.** When the Graph key is pressed, the 4530 enters Graph Mode.
- 3.7.2 **Measurement Page Selection.** Pressing the \wedge or \vee keys while in Graph Mode pages the header display up or down through several commonly used measurements or parameters. See paragraph 3.9 (Display Formats) for a list of what measurements are displayed in each format.
- 3.7.3 **Channel Selection.** Pressing the $<$ or $>$ keys while in Text mode switches the display between channels. The keys toggle the display between “CH1 $<>$ BOTH $<>$ CH2”. This is helpful to distinguish between traces when two channels are being viewed, or to concentrate on settings for one of the channels. Single-channel units (Model 4531) can only page between the CH1 and BOTH display formats.
- 3.7.4 **Measurement Control.** Pressing **Enter/Run** while in Graph Mode starts the measurement, if it is stopped, or arms the trigger if Single-Sweep Mode is active. Pressing **ESC/Stop** stops the measurement if it is running and holds the current measurement values. Once stopped, pressing **ESC/Stop** again clears the measurement result, and resets for a new measurement. Any time measurement is stopped, it is possible to change display settings or certain measurement parameters, and the current measurements displayed will be updated accordingly. Also, cursors can be moved around to view the power at selected times without the need to restart the measurement.
- 3.7.5 **Parameter Editing from Graph Mode.** Pressing **Graph** while already in Graph Mode will enter Edit Mode for the first active channel. The screen’s measurement window continues to display and update the active measurement, but the two-line header area at the top of the screen is used as an edit window. Pressing **Graph** again switches Edit Mode to the second channel, if active. Another press of the **Graph** key returns to normal Graph Mode. See paragraph 3.8 (Edit Mode Operation) for more details.

3.8 **EDIT MODE OPERATION**

Edit mode is an extension of Graph Mode or Text Mode operation which allows common measurement parameters to be edited in the header area while the active measurements continue to update in the measurement window. The arrow keys scroll through a list of commonly accessed parameters, and allow these parameters to be updated “on the fly” without the need to return to Menu Mode. This interactive mode allows parameters to be changed in real time while viewing the effect of these changes as they are made.

- 3.8.1 **Entry, Exit, and Channel Selection.** Edit Mode is entered from Text Mode by pressing the **Text** key or from Graph Mode by pressing the **Graph** key. Edit mode is always entered for the first active channel currently displayed. If the display is in single-channel mode, only one channel is displayed and Edit Mode is entered for that channel. If both channels are active and displayed, Channel 1 will be active first. Pressing **Text** or **Graph** again switches to the next active channel, or returns to regular Text Mode or Graph Mode once both channels have been accessed or if the next channel is not active.
- 3.8.2 **Screen Display.** When Edit Mode is active, the two-line header area becomes the *edit window* while the rest of the display continues to function normally. The top line of the Edit Window is used for parameter selection. It is a list of parameters that are commonly accessed from the present mode. The second line displays the active channel and the value of the currently selected parameter for that channel. Note that some parameters are global (not channel specific), and may be accessed from either channel with the same results.
- 3.8.3 **Parameter Selection.** The $<$ and $>$ keys are used to scroll the top header line to select an item to display or edit. The list is a continuous loop, which may be scrolled left or right, and the center item on the display is always highlighted to indicate it is currently selected.

3.8.4 **Parameter Editing.** The \wedge and \vee keys are used to increment or decrement the value of the currently selected edit parameter. The increment and decrement intervals are preset, although their values may change depending on current settings. Note that key repeat is active, and holding the key will cause the parameter to continue to advance. See the “Key Repeat” section above for tips on most effective use of the auto-repeat feature.

Note that if a specific value that is considerably different from the current value of the parameter is desired, it may be more convenient to enter Menu Mode, and edit the parameter using digit editing mode rather than try to increment or decrement a long distance to the new value.

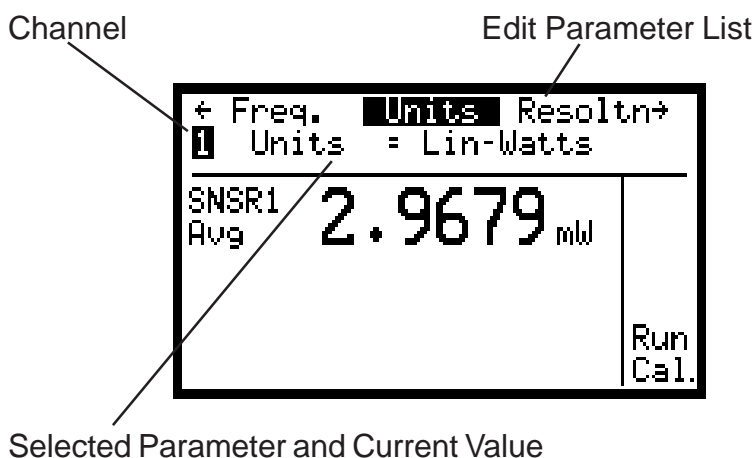

Figure 3-14. Edit Mode Operation (Example)

Table 3-2. Graph and Text Mode Edit Menus

Meas Mode	Edit Menu Parameters / Values						
CW (Text)	0.001 to 110.00 GHz * Impedance for voltage sensors: 50-2500Ω	Units dBm Watts Volts dBV dBmV dBuV	Resoltn	Filter	Ld/ClrR	DutyCyc	Offset
Modulated (Text)			1 to 3 significant digits	None, Auto, 0.01 to 15.00 sec	\wedge to Ld Ref \vee to Clr Ref	0.01 to 100.00%	-100.00dB to +100.00dB
Pulse (Text)			TimeSpn	TrigDly	TrigLvl	Marker1	Marker2
Statistical (Text)			2.5μS to 5 seconds	TimeSpan Dependent	-40dBm to +20dBm	Trace start to trace end in display window	
			StatMode	TermCnt	MarkrMod	Marker1	Marker2
			CDF, 1-CDF, Distribution	2M to 4000M	Off, Vertical, Horizontal	Vert: 0.000 to 100.000% Horz: -99.99 to +99.99dBm	
CW (Graph)	Log Scaling: 0.1dB to 100dB Linear Scaling: 1nW to 1MW	Log Scaling: -100dBm to +100dBm Linear Scaling: (VertSpan dependent)	TimeSpan	Filter	Ld/ClrR	DutyCyc	Offset
Modulated (Graph)			1 second to 1 hour	None, Auto, 0.01 to 15.00 sec	\wedge to Ld Ref \vee to Clr Ref	0.01 to 100.00%	-100.00dB to +100.00dB
Pulse (Graph)			2.5μS to 5 seconds	TimeSpan Dependent	-40dBm to +20dBm	Marker1	Marker2
Statistical (Graph)			1 to 100%	%Offset	MarkrMod	Marker1	Marker2
			HorzSpn	Dependent	Off, Vertical, Horizontal	Vert: 0.000 to 100.000% Horz: -99.99 to +99.99dBm	

3.9 DISPLAY FORMATS

3.9.1 **Channel Selection and Paging.** Pressing the \wedge or \vee keys while in Graph Mode or Text Mode pages the measurement window and header display up or down through a series of up to three measurement “pages”, each showing one or more common measurements or parameters. Pressing the $<$ or $>$ keys switches the display between channels in a “CH1 $\langle \rangle$ BOTH $\langle \rangle$ CH2” format. In the single-channel Text Mode display, the page selection may change only the header display, only the main measurement window, or both. In Graph Mode and the dual-channel Text Mode, the page selection changes only the header, while the main measurement window shows only the primary measurement or trace. Between page selection and channel selection, there are a considerable number of possible displays for each operating mode. Table 3-3 shows what measurements are displayed for each combination of measurement mode, channel and page setting. Note that single-channel units (Model 4531) can only page between the CH1 and BOTH display formats.

Table 3-3. Measurement Pages

Measurement Mode / Display Page	Single Channel Text Mode		Dual Channel Text Mode		Single Channel Graph Mode	Dual Channel Graph Mode
	Main Window	Header	Main Window	Header	Header	Header
CW Page 1	CW Average Max Hold Min Hold	Frequency CalFactor	CW Average, Opt. Bargraph	Frequency CalFactor	DutyCycle PulsePower	Frequency CalFactor
CW Pg 2		Frequency CalFactor		Max Hold Min Hold		Max Hold Min Hold
CW Pg 3		Duty Cycle Pulse Power		CW Average Pulse Power		CW Average Pulse Power
Modulated Pg 1	Modulated Avg Peak Hold Min Hold	Frequency CalFactor	Modulated Avg Opt. Bargraph	Frequency CalFactor	PkToAvg Ratio	Frequency CalFactor
Modulated Pg 2		Snsr Temp Acal Temp		Pk or Max Hold Min Hold		Pk or Max Hold Min Hold
Modulated Pg 3		PkToAvg Ratio		Modulated Avg PkToAvg Ratio		Modulated Avg PkToAvg Ratio
Pulse Pg 1	Marker Measurements	Mrkr1 Position Mrkr2 Position	Avg Betw Mrkrs Opt. Bargraph	Pwr@Mrkr 1 Pwr@Mrkr 2	Mrkr1 Position Mrkr2 Position	Pwr@Mrkr 1 Pwr@Mrkr 2
Pulse Pg 2	Waveform Time Measurements			Pk Betw Mrkrs Min Betw Mrkrs		Pk Betw Mrkrs Min Betw Mrkrs
Pulse Pg 3	Waveform Power Measurements			Avg Betw Mrkrs Pk/Avg Bet Mrkrs		Avg Betw Mrkrs Pk/Avg Bet Mrkrs
Statistical Pg 1	LongTerm Avg Peak Power Min Power PkToAvg Ratio Mrkr1 Pwr & % Mrkr2 Pwr & %	# MegaSamples Total Time	LongTerm Avg Opt. Bargraph	Pwr@Mrkr 1 Pwr@Mrkr 2	# MegaSamples Total Time	Pwr@Mrkr 1 Pwr@Mrkr 2
Statistical Pg 2				Peak Power Min Power		Peak Power Min Power
Statistical Pg 3				Long Term Avg PkToAvg Ratio		Long Term Avg PkToAvg Ratio

3.9.2 Mixed Mode Operation. All of the measurement functions of the 4532 series can be performed in two independent channels. The trigger system is common to both channels, but either can be selected as the trigger source. There are some restrictions imposed on two-channel operation when both channels are not in the same measurement mode. This situation is referred to as “mixed mode”.

Pulse Mode cannot be combined with Modulated Mode or Statistical Mode when two peak sensors are connected. The CW voltage and power modes can be freely combined with any measurement mode in the opposite channel. When Statistical mode is used CW or modulated mode, the graphical display must be interpreted as having two overlapping horizontal axes with different dimensions. The statistical graph will be referred to a horizontal axis with percentage units, while the CW/modulated graph will be referred to a horizontal axis with time units.

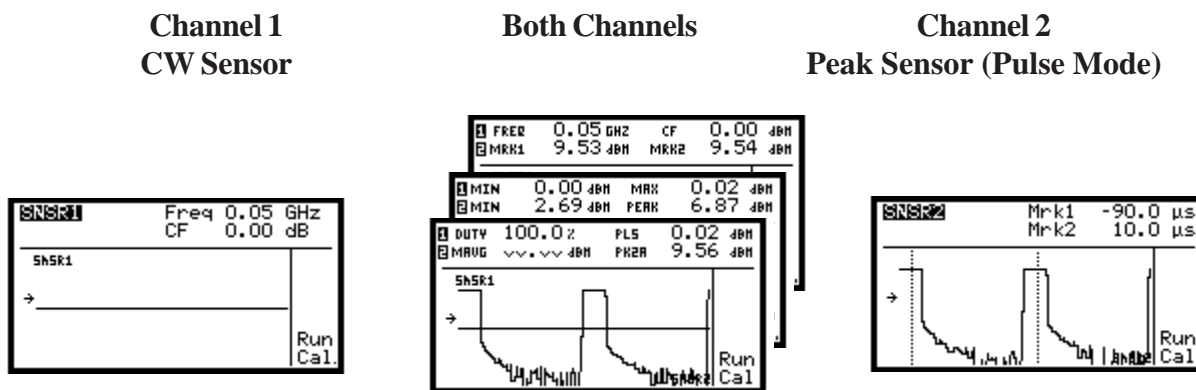

Figure 3-15. Graphic Mixed Mode Displays

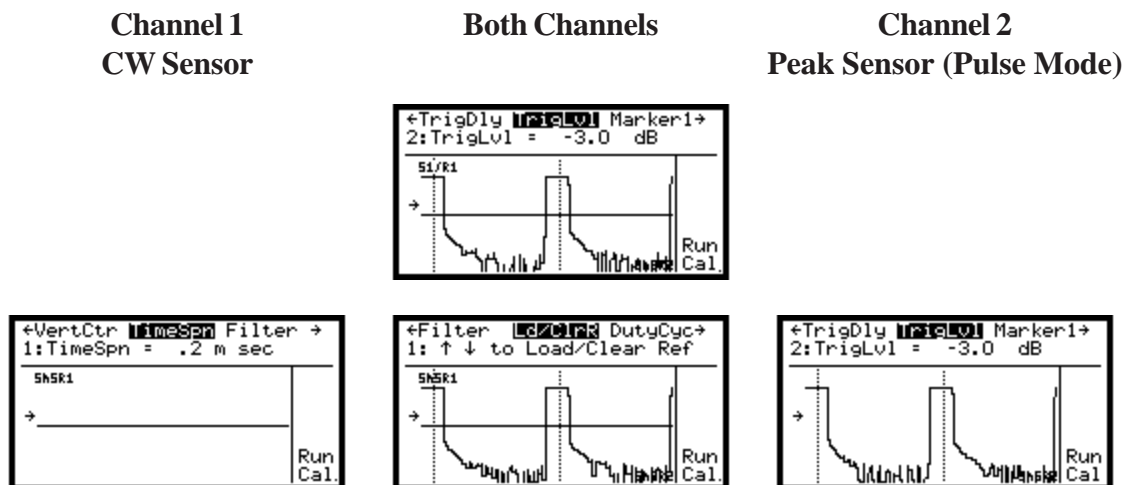

Figure 3-16. Graphic Mixed Mode Edit Displays

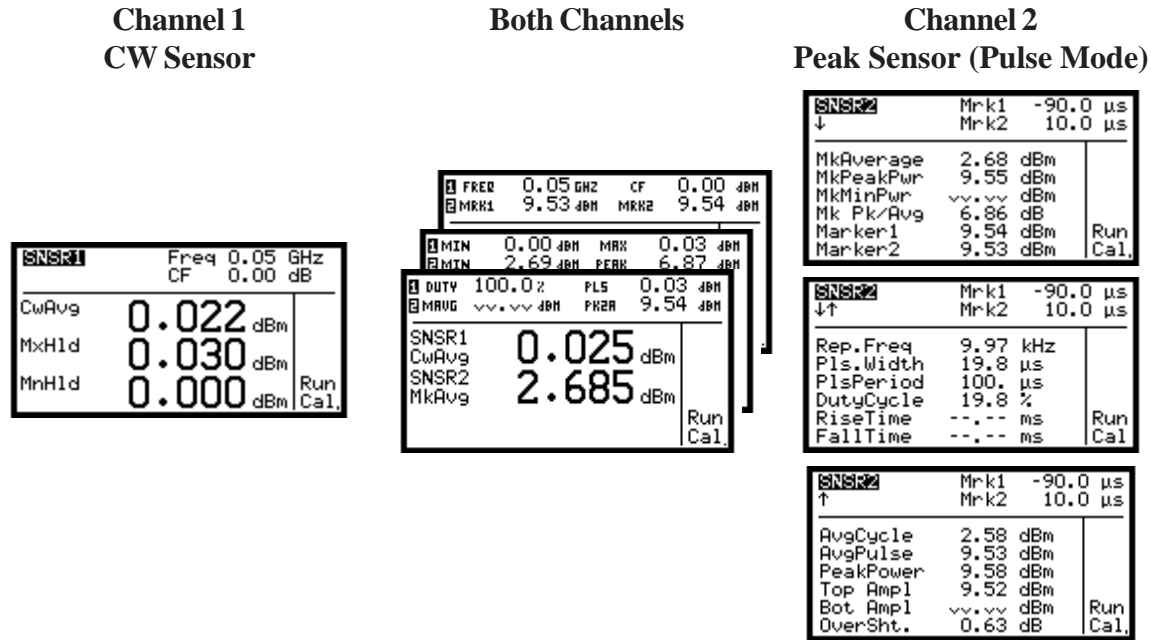

Figure 3-17. Text Mixed Mode Measurement Displays

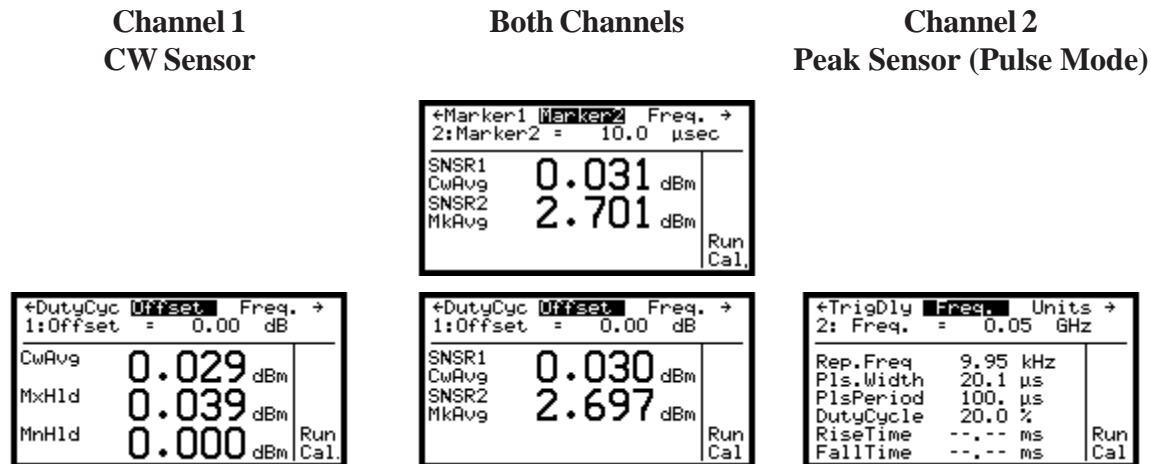

Figure 3-18. Text Mixed Mode Edit Displays

3.10 SENSOR CONNECTION AND CALIBRATION

RF Power Sensors or Voltage Probes are used to sense the high-frequency RF signal and convert it to a voltage that is proportional to the input amplitude. A number of different sensor types are available depending on the frequency, power level, modulation and impedance of the signal to be measured. These sensors generally consist of an input connector appropriate for the signal's frequency band, and internal RF detection and processing circuitry, as well as a non-volatile EEPROM memory that stores sensor characteristics and calibration information. A power sensor cable routes the sensor's output signal to the sensor input connectors on the 4530's front or rear panel. In CW sensors, the EEPROM is located at the instrument end of the sensor cable rather than in the sensor itself.

Since each sensor is different, the power meter must know the precise relationship between RF input amplitude and the sensor's detected output. Information about this relationship can be characterized at the factory, and stored in the sensor's EEPROM, then used by the power meter to calculate the input power from the sensor's output. This technique is known as *shaping*, because it corrects the shape of the sensor's nonlinear transfer function into a linear function of power. Because the sensor's output curve is not perfectly stable with time and temperature, greater absolute accuracy may be gained by calibrating points on the transfer function at the time of measurement, and including these factors in the shaping calculation.

The most basic field calibration consists of two reference points on the curve. By correcting these two points so they read the expected values, the accuracy of the entire curve is increased. Generally, 0mW and 1mW are chosen as calibration points. The 0mW calibration is known as a *Zero* adjustment, and the 1mW (0dBm) calibration is known as a *FixedCal*. These power reference levels are generated by a precision RF calibrator that is built in to the power meter.

The accuracy of the shaping technique can be further improved by increasing the number of power calibration points. For this purpose, the 4530 is equipped with a programmable step calibrator, which generates precise RF power levels between +20dBm and -60dBm. By stepping through the entire power range of the sensor (including zero power), the basic accuracy of the shaping technique is significantly increased over a simple, two-point calibration. This technique is known as an *AutoCal*.

All peak sensors and most CW sensors are calibrated using a precision step calibrator. The Model 4530 has a built-in 50 MHz step calibrator, and can program an optional Model 4530 1 GHz Calibrator Accessory (see Appendix B). All 57000 series peak sensors can be calibrated using either calibrator. Most 56000 series peak sensors require the 1 GHz calibrator. All CW sensors except waveguide types, and sensors with more than 20 dB attenuation, can also use the FixedCal method. This method uses either calibrator at a fixed level in combination with shaping curves to produce a correct reading, but offers less accuracy than a full step calibration. Waveguide sensors and a few other models must use the FreqCal method. An external 0 dBm source at the calibration frequency is required. All calibration data is saved in non-volatile memory. No calibration is required for voltage probe/sensors; only zero offset adjustment is available.

When a peak or CW sensor is step calibrated (AutoCal) a zeroing procedure is performed followed by a power step calibration in small increments over the entire dynamic range of the sensor. The resulting calibration table is saved in non-volatile memory. If a new peak sensor, which has not been AutoCal'ed, is plugged in, the AutoCal message will appear in the graphics and text headers indicating that a calibration must be performed before any measurements can be made, since there is not yet a valid calibration table for the peak sensor in use. When a new calibration has successfully completed, the previous one will be overwritten.

Occasionally, a zero or calibration procedure may not complete successfully. In most cases, this can be traced to the sensor not being connected to the active calibrator. Zeroing can be performed any time the signal source is turned completely off or the sensor RF port is disconnected. Fixed or autocal must be performed with the sensor connected to the instrument's internal calibrator port, or the port of a Model 2530 1GHz Calibrator. In either case, the active calibration source must be set to match the calibrator being used in the *Zero/Cal > CalSource* menu. If zeroing or calibration fails, a status code is reported on the display. See table 3-8 for a list of calibration status codes.

3.10.1 Sensor Connection. Connect the sensor to the 4530 by plugging one end of a sensor cable into the power sensor and the other end into the sensor input on the instrument's front (or rear) panel. Peak power sensor cables are the same on both ends, so it does not matter which end of the cable is inserted into the sensor. CW power sensors and RF voltage probes use a two-pin connector on the sensor, and the cable has a multi-pin *smart adapter* on the instrument end. This adapter contains the EEPROM that holds the sensor's characteristics and calibration information, so the cable/adapter assembly must be matched to the sensor. Serial number labels on each should be used to identify matching assemblies.

When the sensor is connected to the 4530, message is displayed indicating the type and model of the sensor, and will download its calibration information. At this point, CW and voltage sensors may be used to take measurements using the default shaping calibration technique. For best accuracy, however, a sensor zero and/or calibration should be performed. Peak sensors require a multi-point calibration (autocal) before measurements can be taken for the first time.

- 3.10.2 Zero Offset Adjustment. After a CW sensor is connected, and anytime a low-level measurement is about to be taken, the sensor should be zeroed. To zero a sensor, press the **Zero/CAL** button to display the Zero/Calibration menu. Peak sensors may also be zeroed once they have been autocal, but this is not necessary immediately following an autocal, since zeroing is performed as part of any autocal process. If more than one sensor is connected to the 4530, the < and > keys may be used to select the desired sensor. The Zero/Cal menu is shown in Table 3-4. Connect the sensor to the instrument's calibrator or to a terminated connector with no RF present, and use the ^ and v keys to select Zero Chan, then press **Enter/Run** to start the process. Zeroing the sensor takes approximately 20 seconds, and the instrument will display a status line indicating progress. When zeroing is complete, the sensor can be removed from the calibrator and measurements can be started, or a Fixed Calibration can be performed to adjust for gain errors.
- 3.10.3 Fixed Calibration (CW sensors). Fixed calibration adjusts the slope (gain) of the sensor's shaping curve by measuring power at a single, reference level (usually 0dBm, or 1mW) from the internal calibrator. To perform a fixed calibration, connect the sensor to the instrument's calibrator and press the **Zero/CAL** key. Use the ^ and v keys to select Fixed Cal, and then press **Enter/Run** to start the process. This will take several seconds. When fixed calibration is complete, the sensor can be removed from the calibrator and measurements can be taken. Fixed calibration is very fast, and provides good accuracy for many applications. However, for best accuracy, a step calibration (AutoCal) is recommended when available.
- 3.10.4 Automatic (step) Calibration. A multi-point step calibration, or autocal uses the 4530's built-in 50MHz programmable calibrator or an external Model 2530 1GHz programmable calibrator to step through the entire power range of the sensor and store a shaping correction at each point. To perform an autocal, connect the sensor to the instrument's calibrator and press the **Zero/Cal** key. Use the ^ and v keys to select AutoCal, and then press **Enter/Run** to start the process. The autocal process takes from one to two minutes, during which time the instrument will display a status line indicating the current power point being calibrated. When autocal is complete, the sensor can be removed from the calibrator and measurements can be taken.
- 3.10.5 Frequency Calibration. If no other calibration factor is entered, the instrument calculates a calibration factor for the current operating frequency by interpolating between entries from this list. If, however, greater accuracy is desired, the user may perform a single-point frequency calibration using an external 0 dBm reference signal at the desired test frequency. To perform a frequency calibration, first make sure the channel's operating frequency is set to the frequency of the external reference signal to be used. Connect the sensor to the reference source, set the source for 0.00 dBm, and press the **Zero/Cal** key. Use the ^ and v keys to select FreqCal, and then press **Enter/Run** to start the process. The process takes several seconds. When the frequency calibration is complete, the sensor can be removed from the reference source and measurements can be taken.
- 3.10.6 Calibrator Selection. Certain peak power sensors have a video bandwidth that is too high to permit calibration using the 4530's built-in 50MHz calibrator. In this case, an external 1GHz calibrator must be used to autocal the sensor. The Boonton Model 2530 1GHz Programmable Calibrator is designed to connect directly to the 4530 and operate under instrument control in the same manner as the internal calibrator. (See Appendix B.) To use an external 2530 calibrator to calibrate sensors, first make sure the 2530 is connected to the **EXT CAL CONTROL** connector on the rear of the instrument using a standard RJ-11 type modular telephone cable (see Figure 3-20). The calibrator's power must be turned on, and proper connection can be verified by pressing **MainMenu > Calibratr > SelectExt** to select the external calibrator, then pressing **MainMenu > Calibratr > ExtStatus** to view status information from the 2530. If an error message appears, check the connections and repeat the process.



Figure 3-20. External Calibrator Connection

Once proper connection has been verified, the 2530 may be used to automatically calibrate sensors. To select it as the calibration source, press the **Zero/Cal** key. Use the **^** and **v** keys to select Configure, and then press **Enter/Run** to view the configuration menu for the selected channel. Select 2530/1GHz as the calibrator for that sensor, and then press **Enter/Run**. Now anytime a fixed cal or autocal is performed on that channel, the sensor must be connected to the 2530 calibrator rather than the internal 50MHz calibrator. The status line during any zero or calibration process will display the currently active calibrator. If the sensor is connected to the wrong calibration source or not connected at all, the calibration will usually fail and an error message will be displayed.

- 3.10.7 Calibration Volatility. When any user calibration process (zero, fixed cal, frequency cal, autocal) is performed, the 4530 saves the correction factors calculated during that process. If instrument power is switched off, these factors are all restored when power is reapplied. They are also preserved if the sensor is unplugged and reconnected to the same input. Removing a sensor and replacing it with a different sensor will require that a new calibration be performed, unless there have been no other calibrations done on that channel since that sensor was last connected. If instrument power is switched off, these factors are all restored when power is restored, although it is a good idea to repeat the zero adjustment before any low-level measurements.
- 3.10.8 Zero/Cal Menu Navigation. Navigating the Zero/Cal menu is similar to navigating the 4530's main menu. Press the **Zero/Cal** key to enter the menu from any display mode. The **^** and **v** keys are used to scroll up and down through the available menu selections, and the **<** and **>** keys select between Sensor 1 and Sensor 2. Pressing **Enter** will start the selected calibration procedure, and pressing **ESC** will exit the Zero/Cal menu. When the procedure is complete, the instrument will generally return the display mode that was active when the **Zero/Cal** key was pressed. If CalSource is selected, the **^** and **v** keys are used to select either the internal 50MHz or external 1GHz calibrator.



Figure 3-19. Zero/Calibration Menu

Table 3-4. Zero/Cal Menu

Zero Chan (ALL SENSOR TYPES) Zero the sensor to remove the low-level power offsets of the sensor without doing a complete AutoCal. This procedure is used to remove the effects of thermal drift. On non-temperature compensated peak sensors, an advisory message will appear in the graphical and text headers when the sensor's temperature changes more than 4 degrees Celsius from the calibration temperature. This is not an error message. The need to zero is determined by the signal level measured and the desired repeatability. It is recommended that a sensor be re-zeroed immediately before performing any measurement in the lowest 10 dB of the sensor's dynamic range.

When a sensor zero is performed, the sensor must be removed from any RF source, or connected to the selected calibrator. Allow the sensor to settle for at least 30 seconds before zeroing if a high level signal was previously applied.

GPIB Command Syntax: CALibration:{INTernal|EXTernal}:ZERO[?]

NOTE

The CALibrate commands ending with a question mark (?) are combined command/queries. At the end of the calibration procedure, they return a zero character in the read buffer if successful, and a one character if unsuccessful. This is in addition to any service request flags in use.

AutoCal (PEAK AND CW SENSORS) Performs a zero and complete step calibration of the sensor over its specified dynamic range. This is required when the sensor is changed or when the temperature of the environment has changed a significant amount. Peak sensor bandwidth is automatically set to low and restored to its original setting at the end of the calibration process. This is the preferred method of calibration for most CW sensors, and the required method for peak sensors. Frequency is automatically set to the correct value during calibration and restored to the previous value afterward.

GPIB Command Syntax: CALibration:{INTernal|EXTernal}:AUTOcal[?]

FixedCal (CW SENSORS ONLY) Perform a fixed level calibration of the CW sensor. The calibration signal level used depends upon the sensor's input attenuation. A Zero adjustment should always be performed before a FixedCal. Frequency is automatically set to the correct value during calibration and restored to the previous value afterwards. In most cases, AutoCal provides a more accurate calibration.

<u>Attenuation</u>	<u>Calibration Level</u>	<u>Example</u>
0 dB	0 dBm	51075
10 dB	+10 dBm	51077
20 dB	+20 dBm	51079

GPIB Command Syntax: CALibration:{INTernal|EXTernal}:FIXEDcal[?]

FreqCal (ALL POWER SENSORS) A single frequency, 0 dBm calibration with a user supplied reference source of known accuracy. Set the channel's frequency parameter to the frequency of the external power reference. On peak sensors, an AutoCal of the sensor must be completed before a FreqCal may be performed.

GPIB Command Syntax: CALibration:USER:FREQcal[?]

NOTE

To change the calibration method of the sensor in use from the AutoCal to the FreqCal method, perform a CancelCal to erase the AutoCal data.

Table 3-4. Zero/Cal Menu - (Cont)

CalSource Selects the calibrator to be used for calibration. Two calibration sources are possible for FixedCal and AutoCal procedures, and the Zero command also allows a calibrator to be specified. In the case of the zero, it does not actually use the selected calibrator, but the CalSource is used to determine which calibrator’s RF output will be turned off during sensor zeroing. All Model 4530 Series RF Power Meters contain a 50 MHz step calibrator. An optional accessory 1 GHz calibrator Model 2530 can also be used for sensor calibration to reduce measurement uncertainty on signals close to or above 1 GHz (See Appendix B). The CalSource setting has no effect on FreqCal, since it uses a user source for the power reference.

Int/50MHz Select the internal 50 MHz calibrator
Ext/1GHz Select the external 1 GHz 2530 calibrator

GPIO Command Syntax: CALibration:INTernal:{ZERO|AUTOcal|FIXEDcal|}[?] for 50 MHz
CALibration:EXTernal:{ZERO|AUTOcal|FIXEDcal|}[?] for 1 GHz

CalCancel Cancel the sensor calibration and zero data in non-volatile memory and set default values. Do not use this function to abort a calibration in progress. Press the ESC/Stop key to abort calibration and restore saved values. There is no equivalent GPIO command for this menu item.

3.11 MENU REFERENCE

The section contains a list of all menu commands accepted by the Model 4530. The list is grouped by menus, with the “Main Menu” as the top level. When a sub-menu or item is highlighted, pressing the **Enter/Run** key will activate that option or, in some cases, take you to a further submenu or option. For example, to set markers to the Vertical Mode, scroll to and highlight Markers. Press **Enter/Run** and scroll to Mrkr Mode, highlight and press **Enter/Run**. Highlight Vertical and press **Enter/Run**.

Main Menu > Markers > Mrkr Mode > Vertical (> = **Enter** key or right arrow key)

Sections 3.11.1 to 3.11.10 contain detailed descriptions of all items in each top-level menu, and the final section contains a summary of the entire menu structure.

<u>Menu</u>	<u>Description</u>	<u>Section</u>	<u>Page</u>
Measure	Select Run/Stop Capture	3.11.1	3-22
Channel 1	Edit Channel 1 Settings	3.11.2	3-23
Channel 2	Edit Channel 2 Settings	3.11.2	3-23
Markers	Set/Position Markers	3.11.3	3-30
Trig/Time	Set Trigger/Time Span	3.11.4	3-31
Statistcl	Set Statistical Mode Parameters	3.11.5	3-34
Calibratr	Calibrator Controls	3.11.6	3-35
Save/Recl	Save and Recall Settings	3.11.7	3-37
Utilities	Status, Display, Bus, Clock	3.11.8	3-37
Help	Keyboard Help Display	3.11.9	3-43
Defaults	Initialize to Default Settings	3.11.10	3-43
Summary	Summary of entire menu tree	3.11.11	3-44

3.11.1 Measure Menu. The Measure menu contains items that control the taking of measurements.

Main Menu>Measure>	Select Run/Stop Capture
Stop	Stop data capture. INITiate:CONTInuous OFF
Run	Restart Data Capture. INITiate[:IMMediate[:ALL] or INITiate:CONTInuous ON
SnglSweep	Perform Single Sweep. For time span (TSPAN) settings from 2 μ sec to 50 μ sec, the single trace will be made up of 125 pixels at 1 sample/pixel. For TSPAN settings from 5 sec to 5 μ sec, the 125 trace pixels will each be the average of 2 or more samples. 1) With INITiate:CONTInuous OFF, and TRIGger:SOURce BUS trigger a single measurement with *TRG or {GET}. 2) With INITiate:CONTInuous OFF, and TRIGger:SOURce BUS>SNSR1 arm for a single measurement with *TRG or {GET}. When the sensor signal trigger qualifiers are met, a single trace measurement will be made. <p style="text-align: center;"><u>NOTE</u></p> <p><i>For TSPAN settings from 20 μsec to 2.5 μsec, multiple triggers are needed to fill all 125 pixels. For this reason, a triggered measurement with averaging set to one is recommended if repetitive triggers are possible. This procedure will use the minimum number of triggers to fill all 125 pixels.</i></p>
Clr/Reset	In the Stop mode clear all measurement results. This will cause all displayed readings to be replaced by dashes. For GPIB operation this occurs when measurements are initiated using the INITiate command. This guarantees fresh measurement data rather than a re-read of previously read (stale) data. The measurement status flag that precedes each GPIB query result also warns of stale data.
AutoSetup	For the Pulse Mode automatically adjust the trigger and position controls to produce a waveform on the display. This does not override a channel set to OFF.

- 3.11.2 **Channel Menu.** The Channel menu contains items that affect a single measurement channel. The “channel” is a full measurement path, starting at (and sometimes before) the sensor, and including data acquisition, processing of measurements, and display of the processed information. The Model 4531 single channel power meter has only a Channel 1 menu, while the dual-channel Model 4532 has separate menus for Channel 1 and Channel 2.

Main Menu > Channel 1 | 2 > MeasMode

Set or return the measurement mode of the selected channel. CW and MODULATED are continuous measurement modes, PULSE is a triggered, oscilloscope-like mode, and CDF, CCDF and DIST are various presentation formats of statistical mode, which gathers and analyzes a large number of samples over a relatively long time interval.

Off	Disable measurement
Modulated	Measure the true average power of the applied signal. (Peak sensor default)
PulseMode	Measure power versus time of a triggered signal. (Peak sensors only)
Statistcl	Measure the CCDF, CDF or Distribution of the input signal. <i>See Paragraph 3.11.5 for Statistical Mode Parameter Settings.</i> (Peak sensors only)
CW	Measure the CW input signal. (CW & Voltage sensor default)
Remote Command:	CALCulate:MODE <Modulated, Pulse, CDF, CCDF, DIST, CW>

Main Menu > Channel 1 | 2 > Params > dB Offset

Set a constant measurement offset. Used to account for attenuators and couplers in the RF signal path. In the main TEXT display, a small triangle (Delta) symbol will appear above the units if the offset is not set to zero.

Range:	-100.00 to 100.00 dB
Default:	0.00 dB
Remote Command:	SENSe:CORRection:OFFset <n>

Main Menu > Channel 1 | 2 > Params > Frequency

Set the frequency of the input signal. Causes frequency cal factor to be automatically calculated from sensor EEPROM data and applied to the measurement.

Range:	0.001 to 110.000 GHz
Default:	0.050 GHz (CW sensor) or 1.000 GHz (peak sensor)
Remote Command:	SENSe:CORRection:FREQuency <n>

Main Menu > Channel 1 | 2 > Params > Averaging

Set the number of traces averaged together in pulse mode to form the measurement result. Used to reduce noise. Also known as “video averaging” on competitive peak power meters.

Range:	1 to 4096
Default:	4
Remote Command:	SENSe:AVERAge <n>

Main Menu > Channel 1 | 2 > Params > Filter

Set the integration time of the digital filter to reduce noise in Modulated and CW modes. Longer filter times reduce noise, but increase the settling time of the measurement. The AUTO setting will adaptively set the filter time for a good tradeoff between noise and settling time based on the signal's current power level. The digital filter performs an unweighted average of the measured power during the last N seconds, where N is the filter time setting. The settling time of the filter is exactly equal to the filter time.

Range: Auto, None, 0.01 to 15.00 seconds
Default: Auto
Remote Command: SENSE:FILTer:STATe <OFF, ON, AUTO>
SENSE:FILTer:TIME <n> (forces STATE to ON)

Main Menu > Channel 1 | 2 > Params > Peak Hold

Set the operating mode of the peak hold feature in Pulse, CW and Modulated modes.

Off Peak readings are held for a short time, then automatically decayed according to the averaging selected. This is useful for slowly fluctuating modulated signals. (Default)
Inst Hold The maximum instantaneous peak value is held until reset.
Avg Hold Holds the maximum average (filtered) power until reset.
Remote Command: CALCulate:PKHLD <OFF, INST, AVG>

Main Menu > Channel 1 | 2 > Params > CalFactor

Displays or changes the current frequency cal-factor value in dB. Selecting the menu item will show the calfactor currently in use, whether manually entered or automatically calculated from sensor data and the current frequency. Entering a value temporarily overrides the sensor table value. Changing the frequency restores sensor table values.

Range: -3.00 to 3.00 (dB)
Default: 0.00 dB
Remote Command: SENSE:CORRection:CALFactor <n>

Main Menu > Channel 1 | 2 > Params > Video BW

Selects the peak sensor's video bandwidth.

High Setting normally used for measurements. Actual bandwidth is determined by the peak sensor model used. (Default)
Low Setting used during calibration and available for measurements. For 57000 series peak sensors, the low video bandwidth is less than 500 kHz to allow calibration at 50 MHz.
Remote Command: SENSE:BANDwidth <HIGH, LOW>

Main Menu > Channel 1 | 2 > Params > DutyCycle

Sets the duty-cycle in percent for calculated CW pulse power measurements. Valid only for thermal sensors and CW sensors in the square-law region and subject to the accuracy of the duty-cycle value. Setting the duty-cycle to 100% is equivalent to a CW measurement. Note that this method of measuring pulse power should be used only if a peak power measurement cannot be used.

Range: 0.01 to 100.00 %
Default: 100.00 %
Remote Command: CALCulate:DCYC <n>

Main Menu > Channel 1 | 2 > Params > Def Pulse >

This submenu is used to sets the define pulse reference levels and times which are used to calculate all readings that are referenced to pulse parameters. The distal, mesial and proximal parameters are related to pulse geometry in accordance with IEEE definitions. Time gating is used to define the “useful portion” of a pulse or burst - the interval over which power should be averaged, and represents a percentage

Main Menu > Channel 1 | 2 > Params > Def Pulse > [Distal, Mesial, Proximal]

The mesial level defines the “midpoint” of the pulse transition, and is used for pulse width and power measurements. The proximal and distal levels are the lower and upper thresholds used for edge transition time measurements. These power levels are entered as a percentage, and the actual power levels are calculated by multiplying this percentage by the pulse’s current top power.

Range: 0 to 100%
Default: Proximal: 10%, Mesial: 50%, Distal: 90%
Remote Command: SENSE:PULSE:{DISTal | PROXimal | MESIal} <n>

Main Menu > Channel 1 | 2 > Params > Def Pulse > Units

Set the units to which the pulse parameters apply. Note that 90% voltage level corresponds to 81% power level; 50% voltage to 25% power; and 10% voltage to 1% power. This relationship must be preserved in order to relate risetime and bandwidth in the voltage and power domains.

Volts Choosing this setting and the default distal and proximal levels above will preserve the conventional assumption that risetime equals 0.35/BANDWIDTH. (Default)

Watts Choosing this setting and 81% and 1% distal and proximal levels, respectively, will preserve the bandwidth assumption above.

Remote Command: SENSE:PULSE:UNITs VOLTS

Main Menu > Channel 1 | 2 > Params > Def Pulse > [StartGate, EndGate]

The average power of a pulse can be measured with “automatic gating” rather than by “time specified gating with markers”. This is useful in GSM and TDMA applications to exclude the rising and falling transition intervals. The gate start and end is automatically determined as a percentage of detected pulse width and the average power during the “useful portion” of the pulse is returned as AvgPulse power in the auto-measure array. The pulse start and end are defined as the times at which the pulse’s rising and falling edges crosses the mesial level. Setting to 0 and 100% will measure average power over the entire pulse from start to end.

Range: StartGate: 0 to 40%, EndGate: 60 to 100%
Default: StartGate: 5%, EndGate: 95%
Remote Command: SENSE:PULSE:{STARTGT | ENDGT} <n>

Main Menu > Channel 1 | 2 > Params > Range

Select the instrument's internal measurement range when using CW power sensors or Voltage sensors. The 4530 series uses two widely overlapping ranges for power measurements, and voltage sensors add a third range for very high level signals. Auto is the preferred setting, and should be used in all cases except when the signal makes frequent, large, level transitions, or when the absolute fastest settling is needed after a large power step. Note that improper range settings may result in incorrect or overrange readings.

Auto Automatically chooses the best range for the current signal. (Default)
Range 0 Range 0 is used for low-level signals (below approximately -10dBm)
Range 1 Range 1 is used for higher signals (above approximately -30dBm).
Range 2 Range 2 is only needed for voltage measurements above 3 volts.
Remote Command: CALCulate:RANGe <AUTO, 0, 1, 2>

Main Menu > Channel 1 | 2 > Params > Alarm >

Controls the power limit alarm operation. When alarm operation is enabled (ON), the “primary measurement” (average power in CW or Modulated modes, average power between markers in Pulse mode) is monitored, and compared to preset upper and lower power limits. If the power is beyond either of these limits, a ↑ or ↓ will appear in the main text display above the units to indicate an out-of-limit measurement. Additionally, remote interface flags are set to save a trip condition even if the power has returned to within the normal limits.

Off Disable alarms (Default)
On Enable alarms
Remote Command: CALCulate:LIMit:STATe <OFF, ON>

Hi Limit, Lo Limit Set the upper and lower alarm limits.
Range: -100.00 to 100.00 dBm
Default: Hi Limit: 100.00dBm, Lo Limit: -100.00dBm
Remote Command: CALCulate:LIMit:UPPer <n>

Main Menu > Channel 1 | 2 > Params > Impedance

Characteristic impedance is used only for voltage to power conversions. This is useful for calculating and displaying power from a voltage measured across a load impedance using a voltage probe.

Range: 10.0 to 2500.0 ohms
Default: 50.0 ohms
Remote Command: SENSE:IMPEDance <n>

Main Menu > Channel 1 | 2 > Display > VertSpan

Select the vertical sensitivity for the full height of the graph display in a 1-2-5 scaling sequence. Note that the vertical span setting controls only the graph display presentation, and has no effect on measurement. Full dynamic range measurements are always available even if the trace is off scale.

Range: 0.1 to 100 dB in a 1-2-5 sequence (log units)
1nW to 1MW in a 1-2-5 sequence (watts)
1nV to 1MV in a 1-2-5 sequence (volts)
1% to 10000% in a 1-2-5 sequence (ratiometric mode with linear units)
Default: 100 dB (log units)
Remote Command: DISPlay:TRACe:{LOGSPAN | LINSpan | PCTSPAN} <n>

Main Menu > Channel 1 | 2 > Display > VertCntr

Set the power or voltage level that corresponds to the center of the display. Note that the vertical center setting controls only the graph display presentation, and has no effect on measurement. Full dynamic range measurements are always available even if the trace is off scale.

Range: -100.00 to 100.00 dBm (log units)
1nW to 1MW (watts)
1nV to 1MV (volts)
0.01 to 9999.99% (ratiometric mode with linear units)
Default: 0dBm (log units)
Remote Command: DISPlay:TRACe:{LOGCNTR | LINCNTR | PCTCNTR} <n>

Main Menu > Channel 1 | 2 > Display > Units

Select the measurement units for both the display and remote interface. Note that some display settings have different sets of values depending on the measurement units selected.

Log-dBm Power in dB relative to 1 milliwatt (Default)
Lin-Watts Power in watts (calculated from voltage and user-supplied impedance for voltage probes)
Lin-Volts RF Voltage (calculated from power and sensor impedance for power sensors)
Log-dBV Voltage in dB relative to 1 volt
Log-dBmV Voltage in dB relative to 1 millivolt
Log-dBuV Voltage in dB relative to 1 microvolt
VSWR Calculated VSWR (ratiometric measurements only)
Remote Command: CALCulate1:UNITs <DBM, WATTS, VOLTS, DBV, DBMV, DBUV, VSWR>

Main Menu > Channel 1 | 2 > Display > Resolutn

Select the display resolution for the main readings. Note display resolution has no effect on internal measurement accuracy or the resolution of readings returned over the remote interface. Measurements are always made with full, internal resolution. Log resolution specifies a radix point following one leading digit with the number of remaining places selected. Linear resolution specifies a total number of places without regard to the radix point.

Range: Log units: 1 (x.x), 2 (x.xx) 3 (x.xxx), Linear units: 1 (xxx), 2 (xxxx), 3 (xxxxx)
 Default: Maximum resolution (3, x.xxx or xxxxx)
 Remote Command: DISPlay:TEXT1:RESolution <1, 2, 3>

Main Menu > Channel 1 | 2 > Display > Disp Srce

Select the source or sources combined in an arithmetic operation for the displayed reading. For ratio, sum and difference calculations, both sensors must be of the same type, i.e. power or voltage. For power sensors, the power ratio of two sources in dB relative (dBr) or percent and the sum of the power of two sources in dBm or linear units is provided. For voltage sensors, the voltage ratio of two sources in dB relative (dBr) or percent and the voltage difference between two sources in volts or log units are provided. The following list shows only the available settings for channel 1, but channel 2 (on 2 channel units) has a matching list of settings.

Sensor 1 Display Sensor 1 power or voltage. (Default)
Ref 1 Display Reference1 power or voltage
Sen1/Ref1 Ratio of Sensor1 to Ref1
Sen1+Ref1 Power Sum (power sensors only): Sensor1 (watts) + Ref1 (watts)
Sen1-Ref1 Voltage Difference (voltage sensors only) Sensor1 (volts) - Ref1 (volts)
Sen1/Sen2 Ratio of Sensor1 to Sensor2
Sen1+Sen2 Power Sum (power sensors only): Sensor1 (watts) + Sensor2 (watts)
Sen1-Sen2 Voltage Difference (voltage sensors only): Sensor1 (volts) - Sensor2 (volts)
 Remote Command: CALCulate:MATH <CH1, REF1, REF_RAT, REF_SUM, REF_DIFF, CH_RAT, CH_SUM, CH_DIFF>

Main Menu > Channel 1 | 2 > Display > Bar Graph

Enable or disable the bar graph feature. The bar graph appears along the bottom of the main Text display and gives a visual indication of the size and variation of the reading. In the Model 4532, there are two independent bar graphs, one for each channel.

Off Disable bar graph. (Default)
On Enable bar graph
 Remote Command: DISPlay:TEXT BARgraph <OFF, ON>

Main Menu > Channel 1 | 2 > FrDepOfst >

Submenu to control the Frequency Dependent Offset feature. Frequency dependent offsets are used to compensate for external devices such as couplers or attenuators in the RF signal path that have known loss characteristics that vary with frequency. In the main TEXT display, an asterisk (“*”) symbol will appear above the units if a frequency dependent offset table is in use (setting is TBLA or TBLB). A frequency dependent offset is similar to a sensor calfactor - it is changed automatically when the operating frequency parameter is changed. The value is looked up or interpolated from entries in the active FDOF table.

Main Menu > Channel 1 | 2 > FrDepOfst > Ofst Src

Select which, if either, of the two frequency dependent offset tables is to be used.

Off	Disable the frequency dependent offset feature. (Default)
Table-A	Enable the frequency dependent offset feature using “Table A” offset data.
Table-B	Enable the frequency dependent offset feature using “Table B” offset data.
Remote Command:	SENSe:CORRection:FDOFfset <OFF, TBLA, TBLB>

Main Menu > Channel 1 | 2 > FrDepOfst > [Modify-A, Modify-B]

View or edit the frequency dependent offset tables. When this item is selected, the display will show the current table. Three columns will be displayed: On the left is the table index (entry number), the center column is the frequency in GHz, and the right column is the offset in dB for that frequency. By positioning the cursor on the index, the ^ and v keys will move the cursor up and down to different entries. To edit an entry, position the cursor on that index, then use the < and > keys to select either the frequency or offset for that entry. To make a new table entry, position the cursor on the “Add” index. To delete an entry, select the entry, and use the v key to change its frequency to “-.- GHz” (just below 0.000 GHz). When done editing, press **ENTER** to save the table, or **ESC** to abort and restore the old table.

Remote Command: MEMory:FDOFfset <entire table>

Main Menu > Channel 1 | 2 > Snsr Data >

Submenu to view sensor parameters stored in the sensor’s EEPROM.

Main Menu > Channel 1 | 2 > Snsr Data > SnsrInfo

Displays a sensor information screen showing key operating parameters that are stored in the EEPROM of the currently installed sensor. A list is displayed showing type, model number, serial number, EEPROM checksum result, input attenuation, input impedance, and power range. Pressing the v key will display a screen showing sensor temperature compensation information for all sensors with this feature.

Remote Command: TKSDATA (SYSTem:LANGUage must be set to BOON)

Main Menu > Channel 1 | 2 > Snsr Data > [FastTable, SlowTable, FreqTable]

Displays a sensor information screen showing the frequency calfactor table that is stored in the EEPROM of the currently installed sensor. The list shows each frequency and its corresponding calfactor. Use the ^ and v keys to scroll up or down through the list. Peak sensors contain a “fast” and “slow” table for high and low video bandwidth settings, respectively. CW sensors contain a single “frequency” table.

Remote Command: TKFAST, TKSLOW (SYSTem:LANGUage must be set to BOON)

Main Menu > Channel 1 | 2 > Snsr Data > TempComp

Enable or disable peak sensor temperature compensation. This feature is only available if the installed sensor’s calibration includes a factory temperature characterization, otherwise the menu item is not displayed. If temperature compensation is active, the temperature drift warning will not be displayed until temperature has drifted by 30C from the Autocal temperature. TempComp always defaults to ON when the instrument is powered up or whenever a new sensor is installed.

Remote Command: SENSe:CORRection:TEMPComp <ON, OFF>

Main Menu > Channel 1 | 2 > Snsr Data > GainConst

Displays a sensor information screen showing the linearity calibration table that is stored in the EEPROM of the currently installed sensor (CW sensors only). The list shows each “range” (measurement segment), along with an Upscale and Downscale coefficient for that range. CW sensors have 7 ranges, for a total of 14 coefficients. Voltage sensors add a midscale coefficient and an eighth range, for a total of 24 coefficients.

Remote Command: TKSCWRG (SYSTEM:LANGUage must be set to BOON)

Main Menu > Channel 1 | 2 > Load Ref

Loads the current average power level as the ratiometric mode reference level, and switches the measurement to ratiometric (relative) mode. The power level applied to the sensor is stored as the reference level, and all power readings will be in dBr, relative to this level. Immediately after the reference is loaded, the display should always indicate 0.000 dBr until the applied power changes.

Remote Command: CALCulate[1|2]:REFerence:COLlect

Main Menu > Channel 1 | 2 > Ref Off

Disables ratiometric (reference) mode. The measurement will revert to a normal, absolute (non-ratiometric) power measurement mode. The stored reference level is, however, preserved, and it is possible to enter ratiometric mode without reloading the reference by using the Channel > Display > DispSrc menu item to set the display source to “Snsr1 / Ref1”.

Remote Command: CALCulate[1|2]:REFerence:STATe OFF

Main Menu > Channel 1 | 2 > Enter Ref

Enters a ratiometric reference level from the keyboard, and switches the measurement to ratiometric (relative) mode. The power level entered is always in dBm, and the arrow keys are used to edit the value. All power readings will be in dBr, relative to this level.

Remote Command: CALCulate[1|2]:REFerence:DATA <n>

3.11.3 Markers Menu. The Markers menu is used to configure and locate measurement markers (cursors) at specific points on the processed measurement waveform. Markers are used in Pulse mode to perform measurements at or between two time offsets relative to the trigger, and in Statistical mode to measure the power at a particular statistical percent, or the percent at a specified power level. In Pulse mode, the markers can only be placed on the visible portion of the trace (as defined by the timespan and trigger delay settings), while Statistical mode markers may be placed at any power or percent value and will still return readings.

Main Menu > Markers > Mrkr Mode

Selects the global marker orientation for the pulse and statistical modes. Markers 1 and 2 are always paired and operate together. Markers are not used in the CW and modulated modes.

Off Markers are not displayed, and no marker measurements are performed.

Vertical Vertical markers appear as vertical bars on the graph display, and measure the power at a particular time (Pulse mode) or percent (Statistical mode). (default)

Horizontal Horizontal markers appear as horizontal bars, and measure the percent at a particular power level in Statistical mode. Horizontal markers may also be used in Pulse mode graph display as “reference lines”, to indicate certain power levels. In this case they are strictly visual tools, and no marker measurements can be performed.

Remote Command: MARKer:MODE <OFF, VERT, HORZ>

Main Menu > Markers > [Mrk1 Pos, Mrk2 Pos]

Sets the position of Marker 1 or Marker 2. The function and parameter range for this menu item are dependent on marker mode and measurement mode.

Vertical Markers, Pulse Mode: Sets the marker position in time relative to the trigger. Note that time markers must be positioned within the time limits of the trace window in the graph display. If any attempt is made to position them outside these limits, they will be forced back into the range of the trace window. Note that if timespan, trigger delay, or trigger position settings are changed, the marker *positions* on the graph display will remain unchanged, but their *times* relative to the trigger will change. For this reason, it is a good idea to set all timing and trigger parameters *before* setting the marker times. Time limits are: TrigDly - (TimeSpan / 2) < MarkerTime < TrigDly + (TimeSpan / 2).

Vertical Markers, Statistical Mode: Sets the marker position in percent probability. Note that the power value returned for each marker will depend on the setting of CALCulate:MODE. When set to CDF, the highest power levels are towards the right side of the screen, with maximum (highest peak) power occurring at 100%. When set to CCDF (also called 1-CDF), the highest levels are towards the left, with peak power at 0%.

Horizontal Markers: Sets the marker position in absolute power. Note that horizontal markers may be positioned at any power level, regardless of the vertical span setting, and will not necessarily appear on the graph display.

Range: -150.0 to 150.0 sec (Vert Markers, Pulse Mode - see restrictions above)
 0.000 to 100.000% (Vertical Markers, Statistical Mode)
 -99.99 to +99.99 dBm (Horizontal Markers)

Remote Command: MARKer:POSition[1|2]:TIME <n> (Vertical Markers, Pulse Mode)
 MARKer:POSition[1|2]:PERcent <n> (Vertical Markers, Statistical Mode)
 MARKer:POSition[1|2]:POWER <n> (Horizontal Markers)

3.11.4 Trig/Time Menu. The Trig/Time menu is used to configure trigger and timing settings for time domain measurements. In pulse mode, the timebase and trigger settings are very similar to those of a digital storage oscilloscope for a familiar operating feel. They control selection of a hardware trigger source and polarity, setting a trigger level, configuring delay and holdoff timing, and setting the trigger position on the display. The Time Span setting also controls the graph mode display for Modulated and CW modes, although it has no effect on the measurement.

Main Menu > Trig/Time > TimeSpan

Select the horizontal time span of the display for Pulse, CW and Modulated modes. The 4530 has fixed timespan settings in a 1-2-5 sequence. Note that trigger delay and holdoff settings are restricted to certain values based on the timespan setting, and marker positions must always fall within the trace window. It is always a good idea to set the timespan before setting any other parameters when in Pulse mode. In CW or Modulated mode, this setting affects the display only, and has no effect on the measurement.

Range: 2.5e-6 to 5.0 seconds (Pulse), 1.0 to 3600 seconds (CW, Modulated)

Default: 0.001 second (Pulse), 1 second (CW, Modulated)

Remote Command: DISPlay:TSPAN <n>

Main Menu > Trig/Time > Trig Pos

Selects the position of the trigger event on displayed sweep. The following descriptions assume zero trigger delay. If trigger delay is positive, the trigger position will move further to the left (less pre-trigger and more post-trigger information is shown). Negative trigger delay has the opposite effect.

Left	The trigger location will be at the left edge of the display, and the entire trace will be pre-trigger.
Middle	The trigger location will be at the center of the display. The left portion of the trace will be pre-trigger, and the right portion will be post-trigger. (Default)
Right	The trigger location will be at the right edge of the display, and the entire trace will be post-trigger.
Remote Command:	TRIGger:POSition <LEFT, MIDDLE, RIGHT>

Main Menu > Trig/Time > TrigDelay

Sets the trigger delay time with respect to the trigger. Positive values cause the actual trigger to occur after the trigger condition is met. This places the trigger event to the left of the trigger point on the display, and is useful for viewing events during a pulse, some fixed delay time after the rising edge trigger. Negative trigger delay places the trigger event to the right of the trigger point on the display, and is useful for looking at events before the trigger edge. Due to memory limitations, positive or negative trigger delay is restricted in all timespans, but is always at least 30 times the timespan setting, and considerably greater for some settings.

Range:	-900 μ s < TrigDly < 900 μ s for timespans 5 μ s and faster -4.00ms < TrigDly < 4.00ms for timespans 10 μ s to 50 μ s (-80 x TimeSpan) < TrigDly < (80 x TimeSpan) for timespans 50 μ s to 2ms (-30 x TimeSpan) < TrigDly < (30 x TimeSpan) for timespans 5ms and slower
Default:	0.0 seconds
Remote Command:	DISPlay:DELay <n>

Main Menu > Trig/Time > TrigLevel

Sets the trigger threshold signal level for synchronizing data acquisition with the a pulsed input signal or external trigger pulses. If there is an global offset applied to the channel, the trigger level should be entered in offset units. For internal trigger, the trigger level is always set/returned in dBm, and for external trigger, the units are volts. Note that there is a small amount of hysteresis built in to the trigger system, and the signal should have at least one dB greater swing than the trigger level setting, and somewhat more at low levels. Note that setting a trigger level when Trigger Mode is set to PkToPk will force the trigger mode back to Auto.

Range:	[-40.0 to +20.0] + Offset (dBm) (Trigger Source = Sensor) -5.0 to +5.0 (Trigger Source = External)
Default:	-3.0 dBm (Sensor), 0 Volts (External)
Remote Command:	TRIGger:LEVel <n>

Main Menu > Trig/Time > TrigSlope

Sets the slope or polarity for the active trigger edge.

Pos (+)	Triggers will be generated when a signal's rising edge crosses the trigger level threshold. (Default)
Neg (-)	Triggers will be generated when a signal's falling edge crosses the trigger level threshold.
Remote Command:	TRIGger:SLOPe <POS, NEG>

Main Menu > Trig/Time > HoldOff

Sets the trigger holdoff time. Trigger holdoff is used to disable the trigger for a specified amount of time after each trigger event. The holdoff time starts immediately after each valid trigger edge, and will not permit any new triggers until the time has expired. When the holdoff time is up, the trigger re-arms, and the next valid trigger event (edge) will cause a new sweep. This feature is used to help synchronize the power meter with burst waveforms such as a TDMA or GSM frame. The trigger holdoff resolution is one microsecond, and it should be set to a time that is just slightly shorter than the frame repetition interval.

Range: 10 e-6 to 0.999999 seconds, 0.0 = no holdoff

Default: 0.0 seconds

Remote Command: TRIGger:HOLDoff <n>

Main Menu > Trig/Time > Trig Srce

Select the source of the trigger signal. In the Modulated, CW and Statistical modes, a measurement can be triggered. In the Pulse mode, the trace can be triggered to synchronize the waveform and the combination of the waveform and measurement can be triggered as well. Any trigger source that includes "BUS" uses a GPIB measurement trigger qualifier. In these cases, the GPIB trigger arms a signal trigger circuit. This permits bus synchronization of a process that includes a signal-triggered measurement. These modes DO NOT APPLY to manual operation. Use **ESC/Stop** and **Enter/Run** from the keypad. It is a reportable error to attempt to make triggered measurements with INITiate:CONTinuous ON. "INITiate:CONTinuous OFF" is required.

Immediate	No trigger. Measurement starts on INITiate.
Bus	Group Execute Trigger or *TRG from GPIB. No hardware trigger.
Sensor1	Internal signal from sensor1 (Pulse Mode only) (Default)
Sensor2	Internal signal from sensor2 (Pulse Mode only)
External	External signal input (Pulse Mode only)
Bus/Snsr1	GET or *TRG arms the Sensor1 trigger. (Pulse Mode only)
Bus/Snsr2	GET or *TRG arms the Sensor2 trigger. (Pulse Mode only)
Bus/Ext	GET or *TRG arms the External trigger. (Pulse Mode only)
Remote Command:	TRIGger:SOURce < IMMEDIATE, BUS, SENSOR1, SENSOR2, EXTERNAL, BUS>SNSR1, BUS>SNSR2, BUS>EXT >

Main Menu > Trig/Time > Trig Mode

Selects the trigger mode for synchronizing data acquisition with pulsed signals.

Norm	Normal mode will cause a sweep to be triggered each time the power level crosses the preset trigger level in the direction specified by TRIGger:SLOPe. If there are no edges that cross this level, no data acquisition will occur.
Auto	Auto mode operates in much the same way as Normal mode, but will automatically generate a trace if no trigger edges are detected for a period of time (100 to 500 milliseconds, depending on timespan). This will keep the trace updating even if the pulse edges stop.
PkToPk	Peak-To-Peak mode operates the same as AUTO mode, but will adjust the trigger level to halfway between the highest and lowest power levels detected. This aids in maintaining synchronization with a pulse signal of varying level. Note that a setting of PKTOPK will be overridden and forced back to AUTO if a trigger level is set. (Default)
Remote Command:	TRIGger:MODE <NORM, AUTO, PKTOPK>

3.11.5 **Statisticl Menu.** The Statisticl menu is used to configure data acquisition and measurement parameters for statistical mode operation. Statistical mode is a special operating mode that acquires a very large sample population, and analyzes the distribution of power levels rather than the measuring power in the time domain as is done in conventional power meters. This mode uses peak power sensors only, and is useful for measuring signals that don't have a periodic or predictable time component on which to trigger.

Main Menu > Statisticl > Horz Span

Select the horizontal display span for the Statistical Mode graph display. Note that display scaling does not affect the statistical mode measurement in any way. Full power and probability resolution are available in all settings.

Range: 1 to 100% in a 1-2-5 sequence.
Default: 100%
Remote Command: DISPlay:%SPAN <n>

Main Menu > Statisticl > % Offset

Select the horizontal display offset for the Statistical Mode graph display. Note that display scaling does not affect the statistical mode measurement in any way. Full power and probability resolution are available in all settings.

Range: 0 to (100 - HorzSpan) %
Default: 0%
Remote Command: DISPlay:%OFST <n>

Main Menu > Statisticl > Stat Mode

Select the Statistical Mode display presentation format.

CDF Stat Cumulative distribution function. The measurement is the probability that the power will be *below* a particular level. This results in the highest probabilities corresponding to the highest power levels. The peak power is at 100.0% CDF, which will appear on the right side of the graph display. (Default)

1 - CDF Inverse (complimentary) CDF, also known as CCDF. The measurement is the probability that the power will be *above* a particular level. This results in the lowest probabilities corresponding to the highest power levels. The peak power is at 0.0% CCDF, which will appear on the left side of the graph display. This display presentation is generally easier to use, since changing the span will have the effect of zooming in on the peak power area

Distribut Probability distribution histogram. A bar-type histogram is displayed. Ten bars are displayed, which represent an equal spread of ten power ranges across the current vertical span setting. When log units are in use, each histogram bar will span an even number of dBm. For linear units, each bar spans an even number of milliwatts.

Remote Command: CALCulate:MODE <CDF, 1-CDF, DIST>

Main Menu > Statistic1 > TrmCount

Sets the terminal count (sample population size) for statistical mode acquisition. When the terminal count is reached, the CDF is considered “complete”, and the instrument will halt acquisition if INITiate:CONTinuous is set to OFF. If INITiate:CONTinuous is ON, sample acquisition will continue in the manner specified by the TRIGger:CDF:DECimate setting.

Range: 2 to 4000 MegaSamples
Default: 4000 MegaSamples
Remote Command: TRIGger:CDF:COUNt <n>

Main Menu > Statistic1 > TrmAction

Select the action to be taken when the Statistical Mode terminal count is reached.

Stop Stop sampling when the terminal count is reached. The measurement halts and no further samples are added to the population. (Default)

Restart Clear the measurement and restart acquisition of a new sample population once the terminal count is reached. This setting is used when the signal changes and old data must be periodically flushed to maintain valid statistics. Note that it may take several seconds after each restart before enough samples are taken for a statistically significant population.

Decimate Decimate the current sample population (divide all sample counts in half), and continue adding new samples to the same population. The effect is to “decay” the old information, and more heavily weight the new information. This provides a technique for coping with changing signals without the invalid interval associated with the Restart setting, but the setting should be used with caution, as it may take some time for all old data to be decimated away, depending on the Terminal Count setting.

Remote Command: INITiate:CONTinuous <OFF, ON> for Stop or Continuous running
TRIGger:CDF:DECimate <OFF, ON> to select between Restart and Decimate.

3.11.6 **Calibratr Menu.** The Calibratr Menu is used to control both the internal, 50 MHz RF calibrator, and an optional, external 1 GHz accessory calibrator (Model 2530). Both calibrators may be used as precision RF reference levels for testing or measurements. The internal calibrator is CW only, while the external calibrator may be pulse modulated using either a built-in pulse generator, or via a rear-panel BNC pulse input. Note that this menu does not contain any items related to sensor calibration - it is only for controlling the calibrator for use as a signal source. For sensor calibration information, refer to Section 3.10 of this manual.

Main Menu > Calibratr > [Int Signal, Ext Signal]

Control the on/off state of the selected calibrator, and modulation source for the External Calibrator.

Off	Disable the selected calibrator's RF output. (Power-on default)
On CW	Enable the selected calibrator's RF output. The output signal will be unmodulated (CW).
Int/Pulse	Enable the external calibrator's RF output, modulated by the calibrator's internal pulse generator.
Ext/Pulse	Enable the external calibrator's RF output, modulated by the rear-panel pulse modulation input.
Remote Commands:	OUTPut:{INTernal EXTernal}:SIGNAL <ON, OFF> OUTPut:EXTernal:MODulation <CW, PULSE> (controls modulation) OUTPut:EXTernal:PULSe:SOURce <INT, EXT> (modulation source)

Main Menu > Calibratr > [Int Level, Ext Level]

Set the output level of the selected calibrator in 0.1dB steps.

Range:	-60.0 to +20.0 dBm
Default:	0.0 dBm
Remote Command:	OUTPut:{INTernal EXTernal}:LEVEL <n>

Main Menu > Calibratr > PlsPeriod

Select the pulse period for the internal pulse modulator of the external calibrator.

Range:	10, 1.0 or 0.1 millisecond (100 Hz, 1kHz or 10kHz)
Default:	10 ms
Remote Command:	OUTPut:EXTernal:PULSe:PERiod <10, 1, 0.1>

Main Menu > Calibratr > DutyCycle

Select the duty cycle for the internal pulse modulator of the external calibrator.

Range:	10% to 90% in 10% steps
Default:	10%
Remote Command:	OUTPut:EXTernal:PULSe:DCYC <10, 20, 30, 40, 50, 60, 70, 80, 90>

Main Menu > Calibratr > [IntStatus, ExtStatus]

Display a status screen for the selected calibrator. For the internal calibrator, this monitors the oscillator drive level to verify proper operation. For the external calibrator the software version, serial number, calibration date, internal temperature and calibration factor are shown.

Remote Command:	None.
-----------------	-------

Main Menu > Calibratr > [SelectInt, SelectExt]

Selects the active calibrator. Only the menu item for the currently inactive calibrator is displayed. Note that attempting to select the external calibrator will generate an error if it is not connected or turned on.

Remote Command: No explicit command. INT or EXT is embedded in any command that requires a calibrator to be specified.

3.11.7 Save/Recl Menu. The Calibratr Menu is used to control both the internal, 50 MHz RF calibrator, and an optional, external 1 GHz accessory calibrator (Model 2530). Both calibrators may be used as precision RF reference levels for testing or measurements. The internal calibrator is CW only, while the external calibrator may be pulse modulated using either a built-in pulse generator, or via a rear-panel BNC pulse input. Note that this menu does not contain any items related to sensor calibration - it is only for controlling the calibrator for use as a signal source. For sensor calibration information, see section 3.10 of this manual.

Main Menu > Save/Recl > SetupSave

Save the instrument setup to one of four non-volatile memory locations for later recall.

Range: Memory 1, Memory 2, Memory 3 or Memory 4

Remote Command: MEMory:SYS[n]:STORE <1, 2, 3, 4>

Main Menu > Save/Recl > SetupRecl

Recalls the instrument setup from one of four non-volatile memory locations. *NOTE: The Recall function returns with the Calibrator output OFF even if it was on when the setup was saved. This is a safety measure to prevent damage to sensitive circuits that may have been connected to the output since the setup was saved. Also, the communications parameters for the GPIB and RS-232 interfaces remain unaffected. This is necessary because the recall function can be commanded using the GPIB or RS-232. If these parameters are changed by the recall, communications may be terminated with a fatal error.*

Range: Memory 1, Memory 2, Memory 3 or Memory 4

Remote Command: MEMory:SYS[n]:LOAD <1, 2, 3, 4>

3.11.8 Utilities Menu. The Utilities Menu is used to control instrument functions and systems that are not directly related to performing measurements. This includes hardware, communication, and auxiliary output configuration, as well as system tests and diagnostics.

Main Menu > Utilities > InstrStat

Displays a status screen for the current measurement setup. The screen contents show the setup for one channel. If a second channel is present, the ^ and v keys may be used to scroll up and down between channels. Exact display is somewhat mode dependent.

Main Menu > Utilities > Display > Contrast

Adjust the contrast of the LCD backlight. This setting updates immediately upon pressing the ^ and v keys, and once changed, cannot be restored by hitting the ESC key..

Remote Command: None

Main Menu > Utilities > Display > Backlight

Selects the operating mode of the LCD backlight. Turning the backlight off reduces power consumption of the power meter, and extends the life of the display.

- On** Backlight is always on (Default).
 - On/5 min** Backlight turns on with any user input, off after 5 minutes of inactivity.
 - On/1 min** Backlight turns on with any user input, off after 1 minute of inactivity.
 - Off** Backlight is always off
- Remote Command: SYSTem:LIGHT <ON, ON_5, ON_1, OFF>

Main Menu > Utilities > Key Beep

Enables or disables the audible key beep. Also affects beep during errors.

- Off** Key beep is disabled (Default).
 - On** Key beep is enabled.
- Remote Command: SYSTem:BEEP <OFF, ON>

Main Menu > Utilities > IEEE-488 > Bus Setup > Address

Set the primary GPIB address. This parameter must be set - setting instrument defaults has no effect.

- Range: 0 to 30
- Remote Command: SYSTem:COMMunicate:GPIB:ADDRes <n>

Main Menu > Utilities > IEEE-488 > Bus Setup > ListnTerm

Select the LISTENER line termination (EOS) character. This character is used to terminate any command the instrument receives over the GPIB. However, since the instrument always responds to an EOI command from the controller, it is not necessary for the user to transmit the EOS character unless the controller doesn't set EOI on the last command byte. This parameter must be set - setting instrument defaults has no effect.

- CR** Use carriage return (ASCII CR, 13, 0x0D hex) as listen termination character.
 - LF** Use line feed (ASCII LF, 10, 0x0A hex) as listen termination character.
- Remote Command: SYSTem:COMMunicate:GPIB:LISTen <CR, LF>

Main Menu > Utilities > IEEE-488 > Bus Setup > Talk Term

Select the TALKER line termination (EOS) character(s). This character(s) is sent by the instrument at the end of any response string it transmits. However, since it always asserts EOI on the last character of any string, it may not be necessary to use any EOS character if the controller recognizes the EOI. In this case, set the talk termination to NONE. This parameter must be set - setting instrument defaults has no effect.

- CRLF** Use carriage return followed by a line feed to terminate all strings sent, with EOI.set on the last (LF) byte.
 - CR** Use a carriage return only (with EOI set) to terminate all strings sent.
 - LF** Use a line feed only (with EOI set) to terminate all strings sent.
 - None** Don't use any termination character when sending strings - just set EOI on the last byte of the message.
- Remote Command: SYSTem:COMMunicate:GPIB:TALK <CRLF, CR, LF, NONE>

Main Menu > Utilities > IEEE-488 > SRQ Mask

Set the GPIB Service Request Enable mask value. This value is used to enable particular bits for generating a service request (SRQ) over the GPIB when certain conditions exist in the Status Byte register. When a mask bit is set, and the corresponding STB bit goes true, an SRQ will be generated. No SRQ can be generated for that condition if the mask bit is clear. The bits in the Status Byte register are generally summary bits, which are the logical OR of the enabled bits from other registers. This parameter must be set - setting instrument defaults has no effect.

Range: 0 to 255
Remote Command: *SRE <n>

Main Menu > Utilities > IEEE-488 > View Bufr

View the contents of the GPIB listen (receive) and talk (transmit) buffers on the LCD display. This is useful for debugging communication difficulties. A command sequence may be sent to the power meter, and then the listen buffer may be examined to see if the entire command was received correctly. Similarly, examining the talk buffer will show the response that the instrument has generated and is prepared to send (or has sent). The ^ and v keys are used to scroll between the two buffers.

Main Menu > Utilities > IEEE-488 > Mnemonic

View a table of all valid SCPI remote interface command mnemonics on the LCD display. This table is in alphabetical order by command group or subsystem, and is useful for reviewing the command names and their acceptable shortcut forms, but it should be no substitute for studying this manual.

Main Menu > Utilities > Serial > Baud Rate

Select the serial port's baud rate (speed). If it appears characters are being skipped during serial communications, try a lower baud rate setting. This parameter must be set - setting instrument defaults has no effect.

Range: 1200, 2400, 4800, 9600, 19200, 38400
Remote Command: SYSTem:COMMunicate:SERial:BAUD <n>

Main Menu > Utilities > Serial > Data Bits

Select the number of data bits for the serial port. This parameter must be set - setting instrument defaults has no effect.

Range: 7 or 8
Remote Command: SYSTem:COMMunicate:SERial:BITS <n>

Main Menu > Utilities > Serial > Stop Bits

Select the number of stop bits for the serial port. This parameter must be set - setting instrument defaults has no effect.

Range: 1 or 2
Remote Command: SYSTem:COMMunicate:SERial:SBITS <n>

Main Menu > Utilities > Serial > ParityBit

Select whether the serial port will transmit a parity bit, and if so, its polarity. This parameter must be set - setting instrument defaults has no effect.

- | | |
|-----------------|--|
| None | Don't transmit any parity bit. |
| Odd | Transmit an odd parity bit: sends a 1 if the number of 1's in the data bits is odd, otherwise sends a 0. |
| Even | Transmit an even parity bit: sends a 1 if the number of 1's in the data bits is even, otherwise sends a 0. |
| Remote Command: | SYSTem:COMMunicate:SERial:PARity <NONE, ODD, EVEN> |

Main Menu > Utilities > Serial > Handshake

Select the serial port handshake mode for the RTS line. This parameter must be set - setting instrument defaults has no effect.

- | | |
|-----------------|--|
| None | No handshaking takes place - the RTS line is ignored, and the DTR line is always asserted. |
| RTS | The RTS line is used for hardware handshaking. |
| Remote Command: | SYSTem:COMMunicate:SERial:CONTrol:RTS <OFF, ON> |

Main Menu > Utilities > Recorder > Outp.Sig

Select whether the recorder output will be enabled.

- | | |
|-----------------|--|
| Off | The recorder output is disabled, and will always output 0.0 volts. (Default) |
| On | The recorder output is enabled, using the defined mode. |
| Remote Command: | OUTput:RECOrder:SIGNAL <OFF, ON> |

Main Menu > Utilities > Recorder > Channel

Select which channel's measurement will be tracked by the recorder output.

- | | |
|------------------|---|
| Channel 1 | The recorder output will generate a voltage proportional to the primary measurement of channel 1. (Default) |
| Channel 2 | The recorder output will generate a voltage proportional to the primary measurement of channel 2. |
| Remote Command: | OUTput:RECOrder:SOURce <CH1, CH2> |

Main Menu > Utilities > Recorder > Meas Mode

Select the measurement and scaling mode for the recorder output.

- | | |
|-------------|--|
| Auto | The recorder output will generate an automatically ranged signal that follows the primary reading of the selected channel. The output voltage is automatically scaled, and will span the full output voltage once for each decade of signal level. The voltage will be proportional to power when linear units are in use, and proportional to the log of power when logarithmic units are in use. (Default) |
|-------------|--|

Manual The recorder output will generate a manually ranged signal that follows the primary reading of the selected channel. The output voltage is scaled using the preset minimum and maximum signal levels to correspond to minimum and maximum output voltages. The voltage will be proportional to power when linear units are in use, and proportional to the log of power when logarithmic units are in use.

Alarm The recorder output is used as an alarm condition indicator so external circuitry may detect when the selected channel's primary measurement has exceeded the acceptable range of conditions (see the Channel > Parameters > Alarm submenu). The output is TTL compatible, and will be zero volts for a normal condition, and +5 volts when an alarm condition exists.

Remote Command: OUTput:RECOder:MEAS <AUTO, MANUAL, ALARM>

Main Menu > Utilities > Recorder > Outp.Mode

Select the output polarity mode (span) for the recorder output.

Unipolar Minimum voltage = 0.0 volts, Maximum voltage = +10.0 volts. (Default)

Bipolar Minimum voltage = -10.0 volts, Maximum voltage = +10.0 volts.

Remote Command: OUTput:RECOder:POLarity <UNIPOLAR, BIPOLAR>

Main Menu > Utilities > Recorder > [Set Min, Set Max]

Set the signal levels corresponding to the minimum scale (0.0V or -10.0V, depending on polarity setting) and maximum scale (+10.0V) recorder output signal.

Range: -100.00 to +100.00 dBm

Default: 0.00 dBm

Remote Command: OUTput:RECOder:{MIN | MAX} <n>

Main Menu > Utilities > Recorder > Fast Mode

Select whether Fast Mode is active for the recorder output.

Off Use standard recorder output speed - typically about 50ms update rate. Display and other functions have priority over the recorder output. (Power-on default)

On Enable a special, high-speed recorder output mode. This mode gives priority to updating the recorder output, and should only be used where the absolute, fastest recorder output response is required. Latency will be under 10ms in Modulated Mode. Note that display update speed may slow down.

Remote Command: OUTput:RECOder:FAST <OFF, ON>

Main Menu > Utilities > Recorder > Force

Sets the recorder output to a user specified voltage. This will override all other recorder settings in effect, but is only temporary. Setting Recorder > Outp.Sig will cancel the force voltage, and restore normal recorder output operation. Although the setting resolution is 1mV, the recorder's actual resolution is 5mV, so the nearest value will be set.

Range: -10.000 to +10.000 volts

Remote Command: OUTput:RECOder:FORCE <n>

Main Menu > Utilities > Recorder > Calibrate > Slope Adj

Adjusts the slope, or gain of the recorder output. This command is typically used with a recorder Zero Adj command to calibrate the recorder output for maximum absolute accuracy. The setting represents the deviation in percent from the factory default slope value, and may be adjusted in 0.01% increments, corresponding to 1mV at fullscale, although actual output resolution is 5mV. Changing the slope “pivots” the curve around the 0.0 volt setting, and will have maximum effect at -10.0 volts and +10.0 volts. *Note that this setting is not permanent unless “Save Cal” is used.*

Range: -10.00 to +10.00% (corresponds to actual slope of 90.00 to 110.00% of default)

Remote Command: OUTput:RECOOrder:CALibration:SLOPe <n>

Main Menu > Utilities > Recorder > Calibrate > Zero Adj

Adjusts the zero, or voltage offset of the recorder output. This command is typically used with a recorder Slope Adj command to calibrate the recorder output for maximum absolute accuracy. The setting increases or decreases the actual output voltage by a fixed amount, and may be adjusted in 1mV increments, although actual output resolution is 5mV. Changing the offset moves the entire curve up or down, and has equal effect at all output levels. *Note that this setting is not permanent unless “Save Cal” is used.*

Range: -1.000 to +1.000V

Remote Command: OUTput:RECOOrder:CALibration:ZERO <n>

Main Menu > Utilities > Recorder > Calibrate > Save Cal

Saves the recorder Zero and Slope adjustments to the instrument’s non-volatile calibration memory once they have been set. If this step is not performed, the settings will revert back to the previous settings next time instrument power is applied.

Remote Command: OUTput:RECOOrder:CALibration:SAVE <n>

Main Menu > Utilities > Sys-Tests > SystemInf

Display a set of information screens showing system information. Info includes: serial number, model number, internal firmware versions, calibration information, accumulated hours, power cycles, memory checksums, and sensor calibration settings. The information will be on two or more pages, and the ^ and v keys may be used to scroll back and forth.

Main Menu > Utilities > Sys-Tests > Voltages

Display an of information screen showing internal system voltages and current sensor temperature. Pressing the ^ and v keys may be used to scroll back and forth between the measured values, and the raw A/D counts.

Main Menu > Utilities > Sys-Tests > Disp Test

Perform a diagnostic test on the LCD display. The screen will first set and clear all pixels by wiping across, then will display the full character set of each of the internal fonts. Note that if the display appears too light or dark, the contrast may be adjusted by holding down the ESC key while pressing the ^ or v keys.

Main Menu > Utilities > Sys-Tests > Keypad

Perform a diagnostic test of the front panel keypad. Pressing any key should highlight the symbol for that key, and pressing it multiple times should cause the count to increment each time. To test the full keypad, press each key at least once. Press the ESC key last, as this key terminates the test.

Main Menu > Utilities > Sys-Tests > Recorder

Perform a diagnostic test of the recorder output. While the test is running, the recorder output should generate a repeating ramp waveform that spans the full output range of the recorder output from -10.0V to +10.0 volts. The signal may be monitored with an external oscilloscope, and it is normal for the waveform to have a “stair-step” appearance. Pressing any key terminates the test.

Main Menu > Utilities > Sys-Tests > CycleRly

Perform a diagnostic test of the power meters internal relays. This test is used primarily at the factory to burnish the relay contacts that are in the signal or calibration path. This significantly improves the repeatability of the relay’s contact resistance. Press the **ESC** key to terminate the test.

Main Menu > Utilities > Sys-Tests > DnldFlash

Restart the power meter in a special mode for downloading new firmware. Although new firmware can be downloaded and installed anytime the system is in Menu Mode, rebooting to the special Download Menu always sets the serial port for the maximum baud rate, and insures that no other processes are running that might interfere with firmware download and programming. This insures the fastest possible update speed. The Download Menu may also be entered by turning on instrument power while holding down the **ESC** key. When this is done, the power on diagnostic may report a stuck **ESC** key, but this is not a problem.

Main Menu > Utilities > Sys-Tests > EraseSnsr

Erase the contents of the selected sensor EEPROM. This is a special utility that is only intended for customers that have an existing sensor “Smart Adapter”, and need to use it on a different sensor. It erases all sensor identity and calibration information from the adapter or sensor EEPROM. *Be absolutely certain this is what you intend to do before executing this command - once erased, there is no way to restore the calibration information, and the sensor must be recalibrated.* A confirmation dialog will appear, prompting the user to press **ENTER** to complete the erase operation. Press any other key to abort.

Adapter 1 Erase the information in the smart adapter or sensor plugged into the Sensor 1 input.

Adapter 2 Erase the information in the smart adapter or sensor plugged into the Sensor 2 input.

3.11.9 Help Menu. The Help Menu displays a series of help screens describing keyboard operation of the Model 4530. These screens show only the top-level function of the keys, and are no substitute for the detailed information that is available by consulting Chapter 3 of this manual.

3.11.10 Defaults Menu. The Defaults Menu item is used to reset the operating configuration of the power meter to a known, default state. Most measurement and some system parameters are set to the default settings, which are listed in this section 3.11 of this manual. Communication parameters for the GPIB and serial port are not affected by this operation.

Remote Command: *RST

3.11.11 **Menu Summary.** The following table is a compressed summary the entire menu structure of the Model 4530. Each level of indent indicates a new submenu

Table 3-5. Main Menu Summary

Measure	Measurement Control Menu
Stop	Stop data capture
Run	Restart data capture
SnglSweep	Arm for Single Sweep
Clr/Reset	Clear current measurement
AutoSetup	Setup automatically using current signal
Channel / Channel 2	Channel Settings Menu
Meas Mode	Select mode <Off, CW, Modulated, Pulse, Statistical>
Params	Channel Parameters Submenu
dB Offset	Set measurement offset
Frequency	Set operating frequency
Averaging	Set video averaging (Pulse Mode only)
Filter	Set filter time (CW & Modulated modes)
Peak Hold	Select PeakHold mode (Peak Sensors only)
CalFactor	Set CalFactor (Power Sensors only)
Video BW	Select sensor BW (Peak Sensors only)
Duty Cycle	Set pulse duty cycle (CW Sensors only)
Def Pulse	Pulse Config Submenu (Pulse Mode only)
Distal	Set Distal %
Mesial	Set Mesial %
Proximal	Set Proximal %
PulsUnits	Set pulse units <%Volts or %Watts>
StartGate	Define pulse start %
EndGate	Define pulse end %
Range	Select Gain Range (CW & Voltage Sensors only)
Alarm	Alarm Configuration Submenu
Off	Disable Alarm
On	Enable Alarm
HiLimit	Set upper alarm power limit
LoLimit	Set lower alarm power limit
Impedance	Set probe impedance (Voltage Sensors only)
Display	Display Configuration Submenu
Vert Span	Set graph mode vertical sensitivity
Vert Cntr	Set graph mode vertical center
Units	Select display units
Resolution	Select text mode display resolution
DispSrce	Select channel math functions
Bar Graph	Enable/disable bargraph

Table 3-5. Main Menu Summary - (Cont)

FrDepOfst	Freq Dependent Offset Submenu
Ofst Src	Select Offset Table <None, TableA, TableB>
Modify-A	View/edit Freq Dep Offset Table A
Modify-B	View/edit Freq Dep Offset Table B
Snsr Data	Sensor Data Submenu
SensrInfo	View general sensor information
FastTable	View high-bw calfactor table (Peak Sensors only)
SlowTable	View low-bw calfactor table (Peak Sensors only)
FreqTable	View frequency calfactor table (CW Sensors only)
GainConst	View linearity calibration table (CW Sensors only)
TempComp	Select temperature compensation mode <On, Off>
Load Ref	Load Reference level from currently measured power
Ref Off	Disable Reference
Enter Ref	Enter Reference level from keyboard
Markers	Marker Control Menu
Mrkr Mode	Select Marker Mode <Off, Vertical, Horizontal>
Mrk1 Pos	Set Marker 1 position
Mrk2 Pos	Set Marker 2 position
Trig/Time	Trigger / Time Configuration Menu
Time Span	Select measurement time span
Trig Pos.	Select trigger position (Pulse Mode only)
TrigDelay	Set trigger delay time (Pulse Mode only)
TrigLevel	Set trigger level (Pulse Mode only)
TrigSlope	Select trigger slope (Pulse Mode only)
HoldOff	Set trigger holdoff time (Pulse Mode only)
Trig Srce	Select trigger source (Pulse Mode only)
Trig Mode	Select trigger mode <Auto, Norm, Pk-to-Pk>
Statisticl	Statistical Mode Configuration Menu
Horz Span	Select horizontal axis sensitivity
% Offset	Set horizontal axis display center
Stat Mode	Select mode <CDF, 1-CDF, Histogram>
TrmCount	Set number of samples to acquire
TrmAction	Select action at TermCount <stop, restart, decimate>
Calibratr	Calibration Control Menu
[Int Ext] Signal	Select output signal <Off, On, (Int-Pulse, Ext-Pulse)>
Level	Set calibrator output level
PlsPeriod	Select Pulse Period (external calibrator only)
DutyCycle	Select Pulse Duty Cycle (external calibrator only)
[Int Ext] Status	View status of internal/external calibrator
Select [Int Ext]	Select internal/external calibrator
Save/Recl	Instrument Save/Recall Menu
SetupSave	Save current setup to memory[1,2,3,4]
SetupRecl	Recall current setup from memory[1,2,3,4]

Table 3-5. Main Menu Summary - (Cont)

Utilities	Instrument Utilities Menu
InstrStat	View configuration status
Display	Adjust display settings
Contrast	Adjust LCD display contrast
Backlight	Select backlight mode <On, 1-min, 5-min, Off>
Key Beep	Select key beep <On, Off>
IEEE-488	IEEE-488 Configuration Submenu
Bus Setup	Bus Setup submenu
Address	Set instrument address
ListnTerm	Select Listen Terminator <CR, LF>
Talk Term	Select Talk Terminator <CRLF, LF, CR, none>
SRQ Mask	Set SRQ mask value
View Bufr	View Talk/Listen Buffers
Mnemonic	View list of SCPI remote commands
Serial	Serial Port Configuration Submenu
Baud Rate	Select baud rate
Data Bits	Select data bits
Stop Bits	Select stop bits
ParityBit	Select parity bit
Handshake	Select hardware handshake mode
Recorder	Recorder Output Configuration Submenu
Outp.Sig	Select recorder enable <Off, On>
Channel	Select recorder channel <Channel1, Channel2>
Meas Mode	Select recorder mode <Auto, Manual, Alarm>
Outp.Mode	Select recorder polarity <Unipolar, Bipolar>
Set Min	Set recorder lower manual limit
Set Max	Set recorder upper manual limit
Fast Mode	Select fastest update (slows GPIB & display)
Force	Force recorder output to a voltage level
Calibrate	Recorder Output Calibration Submenu
Slope Adj	Calibrate slope (gain) of recorder output
Zero Adj	Calibrate zero offset of recorder output
Save Cal	Save current slope and zero adjustments
Sys-Tests	System Test Submenu
SystemInf	Display system information screens
Voltages	Display internal voltages
Disp Test	Test LCD display
Keypad	Test front panel keypad
Recorder	Test recorder output
CycleRly	Cycle internal relays for burn-in
DnldFlash	Reboot in firmware update mode
EraseSnsr	Erase sensor 1 or 2 adapter information
Help	Keyboard Help Display
Defaults	Set instrument to default state

3.12 ERROR MESSAGES AND STATUS CODES

The following tables show the various error, warning or status messages that may appear from time to time, along with an explanation of the meaning of the message. In some cases, the messages may be ignored, while other messages indicate a major malfunction or error that prevents the power meter from performing measurements.

Table 3-6. Graph/Text Header Error and Status Messages

These messages may appear in the Header at the top of the display in Graph or Text mode.

NoSensor	There is no sensor present on this channel.
SnsrCalT	The sensor's (internal EEPROM) cal factor tables are invalid.
AutoCal	The peak sensor's serial/model number does not match the previous device that was auto-calibrated on this channel. A new AutoCal is needed.
InstrCal	The DSP cal table for this peak sensor is not initialized. An AutoCal is needed.
TmpDrift	The temperature of the peak sensor has drifted by more than 4 degrees C from the temperature at which the sensor was AutoCaled. For best measurement accuracy, a new auto-calibration should be performed.
Meas Off	The measurement mode (or display mode) for this channel is turned off.

Table 3-7. Sensor and Probe Error Messages

These messages may appear briefly on the main display when a sensor or probe is plugged-in.

Page Error: nnnnnnnn	One or more of the sensor's internal EEPROM tables contains a checksum error.
No Calib. Tables	No peak sensor calibration tables have been saved. A new auto-cal is needed before measurements can be made.
AutoCal Required	The peak sensor's serial and model number do not match the sensor for which calibration tables have been saved. A new auto-cal is needed before measurements can be made.
Using Default Cal	The CW sensor's serial and model number do not match the sensor for which the zero or fixed-cal factors were last performed. Default values will be used until a zero and fixed-cal or AutoCal are done for this sensor.

Table 3-8. Sensor Zero / Cal Status Codes

00	operation complete, no errors
03	coarse peak offset failed
04	top power code too low or too high
05	zero power point invalid
06	power entries nonmonotonic
07	code entries nonmonotonic (sensor may not be warmed up - try again)
08	too far (over 32dB) to extend table
13	zero offset signal level too low
14	zero offset signal level too high (sensor probably connected to signal source)
15	zero offset code value out of range (sensor probably connected to signal source)
23	step calibration signal level too high
24	zero offset adjustment invalid
26	autocal step signal level too high
27	autocal step signal level too low (sensor probably not connected to correct calibrator)
28	step calibration linearity questionable (sensor may not be warmed up - try again)
29	fixed cal power level invalid (fixed cal should be attempted only at 0dBm)
2A	fixed cal input power level too high
2B	fixed cal input power level too low

Table 3-9. Startup Error Messages

These messages appear briefly during startup if a system error is detected. The error status may also be viewed on the display menu Utilities>Sys-Tests>SystemInf. Try a power off/on cycle to recover normal operation. If this fails, service may be required.

DSP S/W Failed	The DSP is not running or failed to respond.
DSP - NoResp	During normal operation, the DSP failed to respond to a command.
DSP-CalTbl	During the boot-up process, an error occurred while down loading the calibration tables to the DSP.
DSP-IniErr	During the boot-up process, an error occurred while down loading the channel parameters to the DSP.
No System Calib. Tables	The calibrator is missing its internal calibration tables. This requires factory recalibration of the internal 50 MHz calibrator for proper operation.
No DC Calibration Data	The instrument is missing its CW channel gain calibration table. This requires factory recalibration for proper operation.
Chan# Cal Table: Err	The DSP cal table for this peak sensor is not initialized. An autocal is needed.
Sensor# EEPROM: Err	Checksum Error in one of the EEPROM pages. If this error occurs again after a power cycle, sensor service may be required.
No DSP Data Records	The flash memory does not contain valid DSP instruction code. Try reinstalling operating firmware.

3.13 RECORDER OUTPUT CALIBRATION

The recorder output may be user calibrated for maximum in-system accuracy when used as a measurement monitor. The output span of the hardware is -10.0 to +10.0 volts. This span is covered by a 12-bit D/A converter, which generates 4096 voltage steps to cover the 20 volt span, or about 5 millivolts per step. The absolute accuracy specification is about 100 millivolts at any point on the transfer function, which may be further degraded by loading of the output. However, the zero offset and gain may be adjusted by the user to provide better absolute accuracy stand-alone and in system. After calibration, an absolute accuracy of 20mV at all points should be easily achievable. It should be noted, however, that calibration of the gain and offset does not change the minimum and maximum voltages that are generated, only the transfer function in between. The minimum and maximum voltages are determined by hardware tolerances, and are still subject to the 100 millivolt absolute accuracy specification.

The procedure to adjust the recorder output consists of setting the recorder output voltage level to two different values, recording the voltage, and adjusting offset and slope to achieve the desired readings. From the front panel, the following menu commands are used for the calibration. See the section 3.11.8 for detailed descriptions of these menu commands.

Utilities > Recorder > Force (sets voltage)
Utilities > Recorder > Calibrate > Zero Adj (adjusts offset)
Utilities > Recorder > Calibrate > Slope Adj (adjusts slope, or gain)
Utilities > Recorder > Calibrate > Save Cal (saves the adjustment to nonvolatile calibration memory)

If performing the calibration from the remote interface, the bus commands should be substituted for the menu commands. See section 4.5.17 for detailed descriptions of these remote commands.

OUTPut:RECOOrder:FORCE
OUTPut:RECOOrder:CALibration:ZERO
OUTPut:RECOOrder:CALibration:SLOPe
OUTPut:RECOOrder:CALibration:SAVE

To perform the recorder output calibration, the following steps should be followed:

1. Connect a precision, high-impedance (10M or greater) DVM to the recorder output, with the recorder also connected to your monitoring system, if desired.
2. Force voltage to 0.000 volts using the *Force* command, and record the DVM reading. Other voltages may be used, if desired.
3. Use the *Zero Adj* command to adjust the zero offset, and achieve a reading as close to the force setting (normally 0.000 volts) as possible, typically within 3mV. Use the \blacktriangle and \blacktriangledown keys to adjust the value up or down, then press **Enter/Run** to update the voltage. The zero offset may be adjusted up or down by 1.000 volt, corresponding to approximately 10% of the range. If the DVM reading is positive, the zero offset setting should be decreased by approximately that same value. For example, if the reading is 27.2mV, and the current *Zero Adj* setting is 0.004 volts, the new setting should be: $4.0\text{mV} - 27.2\text{mV} = -23.2\text{mV} = -0.023$ volts. Note that the output voltage resolution is only 5mV, so not all setting changes will result in a change in the output voltage.
4. Force the voltage to 9.000 volts using the *Force* command, and record the DVM reading. Other voltages may be used, if desired.
5. Use the *Slope Adj* command to adjust the slope, or gain of the output., and achieve a reading as close to the force setting (normally 9.000 volts) as possible, typically within 3mV. Use the \blacktriangle and \blacktriangledown keys to adjust the value up or down, then press **Enter/Run** to update the voltage. The slope is stored adjusted as a “delta percent” from the default slope, and may be adjusted up or down by 10% (corresponding to 90% to 110% of default). If the DVM reading is positive, the slope setting should be decreased by an appropriate amount. For example, if the reading is 9.260 volts, and the current *Slope Adj* setting is 1.61%, the slope is too high by: $((9.260 / 9.000) - 1) \times 100 = 2.89\%$. This means the new slope setting should be $1.61 - 2.89 = -1.28\%$. Note that the output voltage resolution is only 5mV, so not all setting changes will result in a change in the output voltage.

6. The slope adjustment has no effect on the output voltage when the force setting is 0.000 volts. If a voltage other than zero volts was chosen for setting the offset in step 2, it will be necessary to iteratively repeat steps 2 through 5 to achieve convergence upon the desired transfer line. If you are calibrating the recorder output to a “custom” transfer line (the output voltages desired are not exactly equal to the “force” settings), modify steps 3 and 5 by substituting your desired output voltage for the force setting in the equations.
7. Verify the output voltage for several voltage levels by forcing a voltage, and checking the DVM reading. An optimally calibrated output should be within about 5mV at all points, and 8mV worst case. This allows some room for time and temperature drift while still staying within the 20mV absolute calibrated accuracy specification.
8. Once it has been verified that the recorder output calibration is acceptable, it should be saved to the instrument’s non-volatile EEPROM calibration memory using the *Save Cal* command. Once this has been performed, the slope and zero offset adjustment settings will become permanent, and will be reloaded whenever instrument power is turned on.

3.14 FIRMWARE UPDATE

The 4530 Series RF Power Meter uses field reprogrammable “flash” memory to store the operating firmware. From time to time, Boonton Electronics may release new firmware versions for the instrument which add new features, enhance performance, or extend operating capabilities. Firmware is automatically updated to the latest version any time the power meter is returned for factory service or calibration, but it is also possible to download firmware from the Boonton Electronics website (www.boonton.com), and install the firmware into the instrument via the serial port on most personal computers (Windows 95, 98, 2000, ME, XP, and NT).

To update instrument firmware, the following steps should be followed:

1. Locate the software update executable file (the filename will be something like: upd4530_000425.exe). If you downloaded the update file from the web or via email, a file icon should be embedded in the message, or the file should be saved in your default directory for downloads or email attachments.
2. Connect a nine-pin serial port extension cable (DB9 M-F) from your computer's serial communication port (COM1) to the 4530's RS-232 connector on the rear panel. The cable should be a “straight-through type” - DO NOT use a null modem cable or adapter! (If your computer only has COM2 available, see special instructions below).
3. From the main menu select:

Utilities > Sys-Tests > DnldFlash [ENTER]

Then, when prompted, press [ENTER] again to confirm the download.

The instrument will re-boot with the 4530 Downloader menu for setting serial communication parameters.

4. Execute the update file by double-clicking on the filename or file icon from your browser or email client. If you save the file to disk, you can also execute the file from Windows Explorer, by typing the filename (or the full pathname) at a command prompt (“MS-DOS”) window, or from the RUN selection in the Windows Startup menu.
5. The program will immediately attempt to establish serial communication with the 4530. If successful, it will report the baud rate and serial parameters used and begin loading the new software.

The progress of loading and programming will be reported on your computer's display and on the 4530's front panel. It takes about 6 minutes to complete the download. When finished, the word “Done.” will appear. The program has terminated at this point and it is safe to close the window.

If the 4530 does not restart at the end of the loading process, turn the power off and on to force a restart. From the main menu select Utilities > Sys-Tests > SystemInf [ENTER]. Two Software date codes should be displayed: a

main software version, and a DSP software version. They may not be the same, but the more recent of these dates should match the datecode of the update file just downloaded. If the updated versions do not appear, the download failed and the old software is still installed.

TROUBLESHOOTING:

If serial communication cannot be established, the update program will respond: "Unable to determine baud rate", or "No response on COM1". If this happens, check the following items:

1. Make sure you are connected to COM1.
2. Make sure you are using a 9-pin straight-through type serial cable.
3. Try setting the 4530 to download at a slower baud rate. The update program will automatically detect the 4530 baud rate if it is set to 9600, 19200 or 38400 baud, so there is no need to change settings on the computer.

When the downloader is invoked, the 4530's initial serial port settings are always:

Baud rate: 38400
Data bits: 8
Stop bits: 1
Parity bit: none
Handshake: none

Check to make certain that these settings are correct. If you wish to try a slower baud rate, try selecting Serial > BaudRate > 19200 from the downloader menu.

4. If COM1 is not available on your computer (perhaps it is in use by another device or program), you may force the install program to use COM2 by executing it with "-2" in the command line. To do this, you must either execute from a command prompt or from the Windows Start Menu, and specify the "-2" command line argument. Note that the file must be saved to a disk first. This action cannot be performed from a browser or email client.

a) FROM A COMMAND PROMPT ("MS-DOS") WINDOW:

Open a command prompt window, and type the full pathname of the install file, followed by a space and "-2". Alternatively, CD to the directory containing the install file, and just type the filename followed by "-2". The following example assumes the install file is in a directory called "download" under the root directory.

```
CD c:\download <enter>  
UPD4530_020501 -2 <enter>
```

b) FROM WINDOWS START MENU:

Click on the Windows "Start" button, and select "Run". When the dialog appears, click "Browse", and locate the install file. Select (highlight) the file, then click "OK", and the full pathname of the install file should appear in the "Open" box of the Run window. Next, place the mouse cursor at the end of the filename, and add "-2" (don't forget the space), then click "OK" to execute the program.

5. Note that versions of the installation program prior to firmware version 20020501 accessed the serial port hardware directly, and some newer Microsoft operating systems may impose limitations on this type of operation which slow or totally prevent serial communications from taking place. It is recommended that MS-DOS, Windows 3.x, or Windows 95 be used when loading these firmware versions. Version 20020501 (filename UPD4530_020501.EXE) and later use standard, 32-bit, Windows calls for widest compatibility, but will not operate under MS-DOS or Windows 3.x operating systems. Should you require a firmware loader that runs under MS-DOS or Windows 3.x, please contact the factory.

Windows® is a registered trademark of Microsoft Corporation.

REMOTE OPERATION

4

4.1 GPIB CONFIGURATION.

The 4530 Series GPIB interface is configured using the main menu key at menu level **Main Menu>Utilities>IEEE-488>BusSetup**. The primary listen/talk address (MLTA) under menu item **>Address** can be set to any value from 0 to 30. The value assigned must be unique to each GPIB device. Secondary address is not implemented.

The Listen string terminator character (EOS) can be set under menu item **>ListnTerm** to ASCII character LF (or NL, decimal 10) or CR (decimal 13). The 4530 Series always responds to the GPIB end signal (EOI), which may be sent by the controller with the last character of the command string or with the EOS character. If the controller does not, or cannot send the EOI signal, a mutually agreed upon EOS character must be used.

The Talk string terminator character (EOS) can be set under menu item **>TalkTerm** to ASCII character LF (or NL, decimal 10), CR (decimal 13), the two character sequence CRLF or None. The 4530 Series always sends the GPIB end signal (EOI) with the last character of every string. If a one or two character EOS is selected, the EOI signal will be sent with the last EOS character. If EOS is set to None, the EOI signal will be sent with the last character of the string. In accordance with IEEE-488 specifications the EOI signal and EOS characters are not used with serial poll status byte messages.

The string terminators must agree or be compatible with the controller in use for communication to take place. For SCPI operation, both EOS characters should be set to LF (or NL, decimal 10).

At menu item **>IEEE488>SRQ MASK**, the bus service request enable byte mask value can be set. If the value is zero, SRQ is disabled.

The menu item **IEEE-488>View Buffer** shows the current contents of the Listen and Talk internal buffers. Use the **▲** and **▼** arrow keys to alternate between the Talk and Listen buffer displays. This feature is very useful for analyzing bus communication problems. The buffers show what has been received from the controller and what has been returned.

The menu item **IEEE-488>MNEMONIC** is a multi-page list of all valid SCPI mnemonics in an outline format. Use the **▲** and **▼** arrow keys to scan through the pages. For non-SCPI commands and more detailed information, refer to this manual.

4.2 SERIAL PORT OPERATION.

General. The RS-232 serial interface is available for 4530 Series remote control when the GPIB is not in use. The command set and data transfer protocol are nearly identical to those for the GPIB. The **Main Menu>Utilities>Serial** menu is used to configure the serial interface to match the settings the terminal or host computer in use. In serial remote operation, the GPIB end-of-string termination characters and SRQ Mask values are used for the serial port as well. All the normal SCPI and native-mode control commands are available over the serial port; only GPIB-specific functions such as SRQ, serial poll, LLO, and GET can not be used in serial port remote operation.

Serial Remote Mode. The 4530 enters serial remote mode when the ASCII “SI” control code (hexadecimal 0F, Ctrl-O) is received. In the remote state, the front panel keyboard is disabled, except for the **ESC/Stop** key, which serves as the return to local function. The status window on the LCD display will show the **SER** annunciator to indicate that serial remote mode is active. The instrument can also be returned to local mode by sending it the ASCII “SO” (hexadecimal 0E, Ctrl-N) control code. When in remote mode and set for native-mode operation, the 4530 will continuously place formatted measurements in its talk buffer, which can be transmitted by issuing a single character.

Serial Listen and Talk Addressing. Since the RS-232 serial port is a single-device full-duplex interface, the 4530 is always active as both a talker and a listener in serial remote mode. Any character the remote terminal transmits over the interface will be received by the instrument, and there is no provision to “unaddress” the 4530 as a listener. Requesting a response or measurement is accomplished by issuing the ASCII “DC2” (hexadecimal 12, Ctrl-R) control

code. Upon receiving this code, the instrument immediately transmits the string currently in its talk buffer. If the buffer is empty, the response will be delayed until a string is available. Once a single string and its terminator has been sent, the instrument will not send any further data until another DC2 has been received. Although this behavior is similar to the GPIB when it is addressed to talk, the RS-232 transmitter is always “on the bus”, and actively transmitting a high or low signal level; there is no way to “unaddress” it and force the transmitter to a high impedance state.

4.3 SCPI LANGUAGE SYNTAX.

The 4530 Series instruments follow the SCPI programming language conventions and also provide a non-SCPI protocol extension for special situations. The default language is:

SYSTem:LANGUage SCPI

The SCPI Model of the 4530 Series provides a single or dual SENSE sub-system to handle sensor input and a matching single or dual CALCulate sub-system to process the data obtained from the sensors into useful results. A TRIGger sub-system provides for measurement and signal synchronization. The CALibration sub-system is used to calibrate both CW and Peak Power sensors. For the dual channel Mode1 4532, channel dependent commands end with a 1 or 2 to indicate the desired channel. If the number is omitted, channel 1 is selected by default. For the single channel Model 4531, only channel 1 is valid. The number 1 can be specified or omitted as desired.

Commands may be transmitted together if separated by a semicolon “;” character. The 4530’s listen buffer can accept over 1000 characters, so buffer overflow should not be a problem. It is a good idea, however, to limit strings of commands to a manageable size for ease in troubleshooting communication difficulties. Also, programmers should be aware that sending long strings of commands reduces the “sequential” nature of the command execution, and can cause some of the more complex commands (such as mode changes), which take longer to complete, to “overlap” the short commands. If some commands are mode or context dependent, it may be a good idea to use the *WAI IEEE-488.2 command to force sequential execution.

Most commands have an optional short form that reduces the number of characters necessary over the bus. When commands are printed in this document, the short form letters will be capitalized, with the remaining characters in lower case. If a channel number designation and/or query ? symbol is needed, it is appended to either the long or short form of the command. Commands which take numerical or literal arguments require an ASCII space between the command and the argument.

Example:

CALCULATE1:STATE?	queries the current value of channel 1’s measurement state
CALC1:STAT?	is the short form equivalent
SENSE:AVERAGE 128	sets channel 1’s trace averaging to 128 (channel 1 is implied)
SENS:AVER 128	is the short form equivalent
SENS:CORR:OFF 0.42;TRIG:LEV 14.2	is two commands issued together as one string

In the discussion and tables below, the following notation will be used:

Command name long and short form:	SYSTem
Optional command name in brackets:	SYSTem:ERRor[:NEXT]?
Command with channel dependence:	CALCulate[1 2]:REFerence:COLLect
Default channel 1:	CALCulate:REFerence:COLLect
Explicit channel 1:	CALCulate1:REFerence:COLLect
Select channel 2:	CALCulate2:REFerence:COLLect
Short Form:	CALC2:REF:COLL

Command which takes numeric argument:	SENSE1:AVERage <n>
Command with literal text argument:	TRIGger:SOURce <asc>
Command to set a parameter:	CALCulate[1 2]:LIMit:UPPer <n>
Same command; query that parameter:	CALCulate[1 2]:LIMit:UPPer?
Command with no query form:	*CLS
Command with query form only:	SENSE[1 2]:TEMPerature?

NOTES

A literal argument denoted by <asc> indicates a text string, which must exactly match one of the choices for the command, while an argument denoted by <n> is a string which can be converted to a number which is within the range of valid arguments. Numerical values can generally be in any common form including decimal and scientific notation.

The vertical separator bar | character is used to separate a set of optional command choices. This character is for showing syntax only, and should not be entered as part of the command.

Square brackets [] are used to enclose one or more optional command entries, separated by the vertical separator bar | character. None or one of the enclosed options may be inserted into the command, and the brackets should not be entered as part of the command.

*Curly braces { } are used to enclose two or more possible choices for a mandatory entry, separated by the vertical separator bar | character. One of the enclosed options **MUST** be inserted into the command, and the braces should not be entered as part of the command.*

4.4 BASIC MEASUREMENT OPERATION.

The easiest way to obtain a reading is by use of the MEASure command. This command initiates one complete measurement sequence which includes a default configuration. Examples are:

- MEAS1:POWER? To return the average power of channel 1, or
- MEAS1:VOLTAGE? To return the average voltage of channel 1.

For finer control over the measurement, individual configuration and function commands should be used. Readings are obtained using the FETCH[1|2]? command for current data or the READ[1|2]? command for fresh data. These commands may return multiple results if an array is read.

Readings are in fundamental units as set by the CALCulate[1|2]:UNITs command. Each reading is preceded by a condition code, which has the following meaning:

- 1 Measurement is STOPPED. Value returned is not updated.
- 0 Error return. Measurement is not valid.
- 1 Normal return. No error.
- 2 An Over-range or Under-range condition exists.

These conditions may also be retrieved from the error system by command.

With the INITiate:CONTInuous OFF condition, a single measurement cycle is started by use of the INITiate:IMMEDIATE] command, where bracketed commands are optional. Multiple triggered measurement cycles are enabled by INITiate:CONTInuous ON and a TRIGger source selection. If TRIGger:SOURce IMMEDIATE is selected, a free running measurement process is started. Otherwise, a measurement cycle begins with each valid trigger condition.

4.5 COMMAND REFERENCE.

This section contains a list of all remote commands accepted by the 4530. The list is grouped by SCPI or IEEE488 function, and detailed descriptions of each commands may be located by section. The final section contains a summary list of commands.:

<u>Command Group</u>	<u>Section</u>	<u>Page</u>
MEASure Queries	4.5.1	4-4
INITiate and ABORt Commands	4.5.2	4-5
FETCh Queries	4.5.3	4-6
READ Queries	4.5.4	4-9
Native Mode Commands	4.5.5	4-12
SENSe Subsystem	4.5.6	4-19
CALCulate Subsystem	4.5.7	4-24
MARKer Subsystem	4.5.8	4-28
DISPlay Subsystem	4.5.9	4-29
TRIGger Subsystem	4.5.10	4-33
TRACe Data Array Commands	4.5.11	4-36
SENSe:MBUF Data Array Commands	4.5.12	4-37
SENSe:SBUF Data Array Commands	4.5.13	4-39
SENSe:HIST and SENSe:CALTAB Data Array Commands	4.5.14	4-40
CALibration Subsystem	4.5.15	4-42
MEMory Subsystem	4.5.16	4-43
OUTPut Subsystem	4.5.17	4-44
SYSTem Subsystem	4.5.18	4-48
STATus Subsystem	4.5.19	4-50
IEEE-488.2 Commands	4.5.20	4-52
Remote Interface Command Summary	4.5.21	4-56

4.5.1 MEASure Queries - The MEASure group of commands is used to acquire data using a set of high level instructions. They are structured to allow the user to trade off interchangeability with fine control of the measurement process. MEASure? provides a complete capability where the power meter is configured, a measurement taken, and results returned in one operation. The instrument is set to a basic, predefined measurement state with little user intervention necessary or possible. Sometimes, more precise control of measurement is required. In these cases, MEASure? should not be used. Rather, a sequence of configuration commands, generally from the CALCulate and SENSe groups should be used to set up the instrument for the measurement, then READ? or FETCH? commands are used to return the desired measurement data in a specific format.

MEASure:POWER

- Description: Return average power using a default instrument configuration
- Syntax: Measure[1|2]:POWER?
- Returns: Average power in dBm
- Modes: Automatically sets to Modulated or CW voltage mode before measurement

MEASure:VOLTage

Description:	Return average voltage using a default instrument configuration.
Syntax:	MEASure[1 2]:VOLTage?
Returns:	Average voltage in linear volts
Valid Modes:	Automatically sets to Modulated or CW voltage mode before measurement.

4.5.2 INITiate and ABORt Commands - The purpose of the INITiate group of commands is to start and control the process of data acquisition once a measurement has been configured. Depending on settings, the power meter may be commanded to begin either a single measurement (INITiate:CONTInuous OFF) which stops when complete, or enter a “free-run” mode where data acquisition occurs continuously (INITiate:CONTInuous ON). The ABORt command terminates any operation in progress and prepares the instrument for an INITiate command. In some operating modes, the INITiate commands do not actually start measurements, but rather arm a hardware trigger, which is then used to gate the actual measurements cycle.

INITiate:CONTInuous

Description:	Set or return the data acquisition mode for single or free-run measurements. If INITiate:CONTInuous is set to ON, the 4530 immediately begins taking measurements (Modulated, CW and Statistical modes), or arms its trigger and takes a measurement each time a trigger occurs (Pulse mode). If set to OFF, the measurement will begin (or be armed) as soon as the INITiate command is issued, and will stop once the measurement criteria (averaging, filtering or sample count) has been satisfied. Note that INITiate:IMMEDIATE and READ commands are only valid when INITiate:CONTInuous is set to OFF.
Syntax:	INITiate:CONTInuous <asc>
Argument:	<asc> = ON, OFF
Valid Modes:	Any

INITiate:IMMEDIATE

Description:	Starts a single measurement cycle when INITiate:CONTInuous is set to OFF. In CW or Modulated mode, the measurement will complete once the power has been integrated for the full FILTER time. In Pulse mode, enough trace sweeps must be triggered to satisfy the AVERaging setting. In Statistical mode, acquisition stops once the sample count reaches the preset terminal count. In each case, no reading will be returned until the measurement is complete. This command is not valid when INITiate:CONTInuous is ON.
Syntax:	INITiate[:IMMEDIATE[:ALL]]
Argument:	None
Valid Modes:	Any
Restrictions:	INITiate:CONTInuous must be OFF

ABORt

Description:	Terminates any measurement in progress and resets the state of the trigger system. Note that ABORt will leave the measurement in a stopped condition, and forces INITiate:CONTInuous to OFF.
Syntax:	ABORt
Argument:	None
Valid Modes:	Any

4.5.3 FETCh Queries - The FETCh? group of queries is used to return specific measurement data from a measurement cycle that has been INITiated and is complete or free-running. FETCh? performs the data output portion of the measurement. FETCh? does not start a new measurement, so a series of FETCh? queries may be used to return more than one set of processed measurements from a complete set of acquired data. FETCh? usually returns the current value of measurements, and should be used anytime free running data acquisition is taking place (INITiate:CONTInuous ON). If FETCh? is used for single measurements (INITiate:CONTInuous OFF), no data will be returned until a measurement has been INITiated and is complete.

FETCh:CW:POWer

Description:	Returns the current average reading of the specified channel in power units.
Syntax:	FETCh[1 2]:CW:POWer?
Returns:	power in <dBm, Watts>
Valid Modes:	CW, Modulated and Statistical modes
Special Case:	If in ratiometric mode, reading will be in units of dBr (log) or Percent Power (linear).

FETCh:CW:VOLTage

Description:	Returns the current average reading of the specified channel in voltage units.
Syntax:	FETCh[1 2]:CW:VOLTage?
Returns:	voltage in <dBuV, dBmV, dBV, Volts>
Valid Modes:	CW, Modulated and Statistical modes
Special Case:	If in ratiometric mode, reading will be in units of dBr (log) or Percent Voltage (linear).

FETCh:MARKer:POWer

Description:	Returns the current power reading <i>at</i> the specified marker on the specified channel.
Syntax:	FETCh[1 2]:MARKer[1 2]:POWer?
Returns:	power or voltage in active units
Valid Modes:	Pulse and Statistical modes
Restrictions:	MARKer:MODE must be set to VERT

FETCh:ARRay:MARKer:POWer

Description: Returns the current power readings at *both* markers on the specified channel.
Syntax: FETCh[1|2]:ARRay:MARKer:POWer?
Returns: Pwr@Marker1, Pwr@Marker2 in active units
Valid Modes: Pulse and Statistical modes
Restrictions: MARKer:MODE must be set to VERT

FETCh:ARRay:MARKer:PERcent

Description: Returns the current statistical percent readings at *both* markers on the specified channel.
Syntax: FETCh[1|2]:ARRay:MARKer:PERcent?
Returns: Percent@Marker1, Percent@Marker2
Valid Modes: Statistical mode only
Restrictions: MARKer:MODE must be set to HORZ

FETCh:ARRay:CW:POWer

Description: Returns the current average, maximum, minimum powers and peak-to-average ratio in dB (peak sensor) or pulse power (CW sensor) of the specified channel. Note that the values for maximum and minimum power will depend on the peak hold mode; see the description of the CALCulate:PKHLD command for details. If a CW sensor is used, the pulse power returned is computed from the measured average power and the preset duty cycle (see CALCulate:DCYC command).
Syntax: FETCh[1|2]:ARRay:CW:POWer?
Returns: Pavg, Pmax, Pmin, PkToAvgRatio (Modulated mode) or Ppulse (CW mode)
Valid Modes: CW and Modulated modes

FETCh:ARRay:CW:VOLTage

Description: Returns the current average, maximum, minimum voltage and peak-to-average ratio in dB (peak sensor) or pulse voltage (CW sensor) for the specified channel. Note that the values for maximum and minimum voltage will depend on the peak hold mode; see the description of the CALCulate:PKHLD command for details. If a CW sensor is used, min and max powers returned are always the highest and lowest filtered average readings that have occurred since the start of the measurement, and the pulse voltage returned is computed from the measured average power and the preset duty cycle (see CALCulate:DCYC command). Note the peak-to-average ratio is returned in dB for log units, and percent for linear units.
Syntax: FETCh[1|2]:ARRay:CW:VOLTage?
Returns: Vavg, Vmax, Vmin, PkToAvgRatio (Modulated mode) or Vpulse (CW mode)
Valid Modes: CW and Modulated modes

FETCh:ARRay:PULse:POWer

Description:	Returns an array of the current marker measurements for the specified channel. The array consists of the average, maximum, and minimum power and peak-to-average ratio <i>between</i> the two markers, powers <i>at both</i> markers, and the ratio of the two markers. Note the peak-to-average ratio and marker ratio are returned in dB for log units, and percent for linear units.
Syntax:	FETCh[1 2]:ARRay:PULSe:POWer?
Returns:	Pavg, Pmax, Pmin, PkToAvgRatio, Pwr@Marker1, Pwr@Marker2, Mrk1/Mrk2 ratio
Valid Modes:	Pulse mode only

FETCh:ARRay:AMEAsure:TIMe

Description:	Returns an array of the current automatic timing measurements performed on a periodic pulse waveform. Measurements performed are: the frequency, period, width, offtime and duty cycle of the pulse waveform, and the risetime and falltime of the edge transitions. For each of the measurements to be performed, the appropriate items to be measured must be visible on the screen if the power meter is place in GRAPH mode. Pulse frequency, period, offtime and duty cycle measurements require that an entire cycle of the pulse waveform (minimum of three edge transitions) be present. Pulse width measurements require that at least one full pulse is visible, and are most accurate if the pulse width is at least 15% of the screen width (timespan). Risetime and falltime require that the edge being measured is visible, and will be most accurate if the transition takes at least 5% of the screen width. It is always best to have the power meter set on the fastest timespan possible that meets the edge visibility restrictions. Set the trace averaging as high as practical to reduce fluctuations and noise in the pulse timing measurements. Note that the timing of the edge transitions is defined by the settings of the SENSE:PULSe:DISTal, :MESIal and :PROXimal settings; see the descriptions for those commands.
Syntax:	FETCh[1 2]:ARRay:AMEAsure:TIMe?
Returns:	PulseFreq, PulsePeriod, PulseWidth, Offtime, DutyCycle, Risetime, Falltime in fundamental units
Valid Modes:	Pulse mode only
Restrictions:	Timespan must be set appropriately to allow measurements (see above)

FETCh:ARRay:AMEAsure:POWer

Description:	Returns an array of the current automatic power measurements performed on a periodic pulse waveform. Measurements performed are: peak power during the pulse, average power over a full cycle of the pulse waveform, average power during the pulse, IEEE top amplitude, IEEE bottom amplitude, and overshoot. Note the pulse overshoot is returned in dB for log units, and percent for linear units. Also, the pulse “on” interval used for peak and average power calculations is defined by the SENSE:PULSe:STRGT and :ENDGT time gating settings. A full pulse must be visible to make average and peak pulse power measurements, and a full cycle of the waveform must be visible to calculate average cycle power.
Syntax:	FETCh[1 2]:ARRay:AMEAsure:POWer?
Returns:	PulseOnPeak, PulseCycleAvg, PulseOnAvg, PulseTop, PulseBot, Overshoot.
Valid Modes:	Pulse mode only
Restrictions:	Timespan must be set appropriately to allow measurements (see above)

FETCh:ARRay:AMEASURE:POWER

Description:	Returns an array of the current automatic statistical measurements performed on a sample population. Measurements performed are: long term average, peak and minimum powers, peak-to-average ratio, power at each marker, statistical percent at each marker, and the sample population size in megasamples. Note the peak-to-average ratio is returned in dB for log units, and percent for linear units. Depending on the setting of MARKer:MODE, either the power or the percent can be the marker position, and the opposite item will be the calculated value at that position.
Syntax:	FETCh[1 2]:ARRay:AMEASURE:POWER?
Returns:	Pavg, Ppeak, Pmin, PkToAvgRatio, Pwr@Mrk1, Pwr@Mrk2, Pct@Mrk1, Pct@Mrk2, SampCnt
Valid Modes:	Statistical mode only

4.5.4 READ Queries - The purpose of the READ? group of queries is to initiate a measurement cycle, acquire data, and return specific measurement data. READ? performs the initiation, data acquisition, postprocessing, and data output portions of the measurement. READ? is equivalent to ABORTing any operation in progress, INITiating a new measurement, then FETChing the data when it is ready. READ? generally does not return data unless acquisition is complete. Since READ? INITiates a new measurement every time it is issued, READ? queries should not be used for free running data acquisition (INITiate:CONTinuous ON) - in this case, use FETCh queries instead. For CW and Modulated modes, the measurement is generally considered complete when the integration filter (see SENSE:FILTer) is filled. In Pulse mode, the measurement is considered complete when all the number of complete traces specified by the SENSE:AVERAge command have been acquired and averaged together. In statistical mode, the measurement is considered complete when the number of samples specified by TRIGger:CDF:COUNT has been gathered.

READ:CW:POWER

Description:	Performs a single measurement and returns the average reading of the specified channel in power units.
Syntax:	READ[1 2]:CW:POWER?
Returns:	power in <dBm, Watts>
Valid Modes:	CW, Modulated and Statistical modes
Special Case:	If in ratiometric mode, reading will be in units of dBr (log) or Percent Power (linear).

READ:CW:VOLTage

Description:	Performs a single measurement and returns the average reading of the specified channel in voltage units.
Syntax:	READ[1 2]:CW:VOLTage?
Returns:	voltage in <dBuV, dBmV, dBV, Volts>
Valid Modes:	CW, Modulated and Statistical modes
Special Case:	If in ratiometric mode, reading will be in units of dBr (log) or Percent Voltage (linear).

READ:MARKer:POWer

Description:	Performs a single measurement and returns the power reading <i>at</i> the specified marker on the specified channel.
Syntax:	READ[1 2]:MARKer[1 2]:POWer?
Returns:	power or voltage in active units
Valid Modes:	Pulse and Statistical modes
Restrictions:	MARKer:MODE must be set to VERT

READ:ARRAy:MARKer:POWer

Description:	Performs a single measurement and returns the power readings at <i>both</i> markers on the specified channel.
Syntax:	READ[1 2]:ARRAy:MARKer:POWer?
Returns:	Pwr@Marker1, Pwr@Marker2 in active units
Valid Modes:	Pulse and Statistical modes
Restrictions:	MARKer:MODE must be set to VERT

READ:ARRAy:MARKer:PERcent

Description:	Performs a single measurement and returns the statistical percent readings at <i>both</i> markers on the specified channel.
Syntax:	READ[1 2]:ARRAy:MARKer:PERcent?
Returns:	Percent@Marker1, Percent@Marker2
Valid Modes:	Statistical mode only
Restrictions:	MARKer:MODE must be set to HORZ

READ:ARRAy:CW:POWer

Description:	Performs a single measurement and returns the average, maximum, minimum powers and peak-to-average ratio in dB (peak sensor) or pulse power (CW sensor) of the specified channel. Note that the values for maximum and minimum power will depend on the peak hold mode; see the description of the CALCulate:PKHLD command for details. If a CW sensor is used, the pulse power returned is computed from the measured average power and the preset duty cycle (see CALCulate:DCYC command).
Syntax:	READ[1 2]:ARRAy:CW:POWer?
Returns:	Pavg, Pmax, Pmin, PkToAvgRatio (Modulated mode) or Ppulse (CW mode)
Valid Modes:	CW and Modulated modes

READ:ARRay:CW:VOLTage

- Description: Performs a single measurement and returns the average, maximum, minimum voltage and peak-to-average ratio in dB (peak sensor) or pulse voltage (CW sensor) for the specified channel. Note that the values for maximum and minimum voltage will depend on the peak hold mode; see the description of the CALCulate:PKHLD command for details. If a CW sensor is used, min and max powers returned are always the highest and lowest filtered average readings that have occurred since the start of the measurement, and the pulse voltage returned is computed from the measured average power and the preset duty cycle (see CALCulate:DCYC command). Note the peak-to-average ratio is returned in dB for log units, and percent for linear units.
- Syntax: READ[1|2]:ARRay:CW:VOLTage?
- Returns: Vavg, Vmax, Vmin, PkToAvgRatio (Modulated mode) or Vpulse (CW mode)
- Valid Modes: CW and Modulated modes

READ:ARRay:PULSe:POWER

- Description: Performs a single measurement and returns an array of marker measurements for the specified channel. The array consists of the average, maximum, and minimum power and peak-to-average ratio *between* the two markers, powers *at* each of the markers, and the ratio of the two marker powers. Note the peak-to-average ratio and marker ratio are returned in dB for log units, and percent for linear units.
- Syntax: READ[1|2]:ARRay:PULSe:POWER?
- Returns: Pavg, Pmax, Pmin, PkToAvgRatio, Pwr@Marker1, Pwr@Marker2, Mrk1/Mrk2 ratio
- Valid Modes: Pulse mode only

READ:ARRay:AMEASURE:TIME

- Description: Performs a single measurement and returns an array of automatic timing measurements performed on a periodic pulse waveform. Measurements performed are: the frequency, period, width, offtime and duty cycle of the pulse waveform, and the risetime and falltime of the edge transitions. For each of the measurements to be performed, the appropriate items to be measured must be visible on the screen if the power meter is place in GRAPH mode. Pulse frequency, period, offtime and duty cycle measurements require that an entire cycle of the pulse waveform (minimum of three edge transitions) be present. Pulse width measurements require that at least one full pulse is visible, and are most accurate if the pulse width is at least 15% of the screen width (timespan). Risetime and falltime require that the edge being measured is visible, and will be most accurate if the transition takes at least 5% of the screen width. It is always best to have the power meter set on the fastest timespan possible that meets the edge visibility restrictions. Set the trace averaging as high as practical to reduce fluctuations and noise in the pulse timing measurements. Note that the timing of the edge transitions is defined by the settings of the SENSE:PULSe:DISTal, :MESIal and :PROXimal settings; see the descriptions for those commands.
- Syntax: READ[1|2]:ARRay:AMEASURE:TIME?
- Returns: PulseFreq, PulsePeriod, PulseWidth, Offtime, DutyCycle, Risetime, Falltime in fundamental units
- Valid Modes: Pulse mode only
- Restrictions: Timespan must be set appropriately to allow measurements (see above)

READ:ARRay:AMEAsure:POWer

Description:	Performs a single measurement and returns an array of automatic power measurements performed on a sample population. Measurements performed are: peak power during the pulse, average power over a full cycle of the pulse waveform, average power during the pulse, IEEE top amplitude, IEEE bottom amplitude, and overshoot. Note the pulse amplitude is returned in dB for log units, and percent for linear units. Also, the pulse “on” interval used for peak and average power calculations is defined by the SENSE:PULSe:STRTGT and :ENDGT time gating settings. A full pulse must be visible to make average and peak pulse power measurements, and a full cycle of the waveform must be visible to calculate average cycle power.
Syntax:	READ[1 2]:ARRay:AMEAsure:POWer?
Returns:	PulseOnPeak, PulseCycleAvg, PulseOnAvg, PulseTop, PulseBot, Overshoot
Valid Modes:	Pulse mode only
Restrictions:	Timespan must be set appropriately to allow measurements (see above)

READ:ARRay:AMEAsure:POWer

Description:	Performs a single measurement and returns an array of automatic statistical measurements performed on the sample population. Measurements performed are: long term average, peak and minimum powers, peak-to-average ratio, power at each marker, statistical percent at each marker, and the sample population size in megasamples. Note the peak-to-average ratio is returned in dB for log units, and percent for linear units. Depending on the setting of MARKer:MODE , either the power or the percent can be the marker position, and the opposite item will be the calculated value at that position.
Syntax:	READ[1 2]:ARRay:AMEAsure:POWer?
Returns:	Pavg, Ppeak, Pmin, PkToAvgRatio, Pwr@Mrk1, Pwr@Mrk2, Pct@Mrk1, Pct@Mrk2, SampCnt
Valid Modes:	Statistical mode only

4.5.5 Native Mode Commands - The 4530 native instructions are not SCPI commands, and do not follow standard SCPI syntax. They are used for special purposes - primarily as optimized queries issued in combination with SCPI configuration commands to return measurements with significantly less overhead and higher speed than is possible using SCPI compliant queries. In most cases, the data formats are similar to **FETCh?** queries, but a single native-mode query (“talkmode” command) is issued in advance, and the measurement data is returned every time the 4530 is re-addressed. There is no need to transmit the query command for each measurement - simply re-address the power meter as a talker. By processing the measurement data to be returned in the desired format in advance and saving the overhead of transmitting a query for each measurement, much higher sustained measurement speed is possible over the GPIB. Native mode supports all SCPI instructions for compatibility. Note that in SCPI mode, the instrument returns data only in response to an explicit query, while in native mode it will always return a value when addressed to talk. This can potentially result in some confusion when interleaving control and measurement commands. See Section 4.7 for more information on programming the power meter in native mode.

CH1

Description: Configures native mode talk instructions to return Channel 1 measurement data
Syntax: CH1
Argument: None
Valid Modes: All
Restrictions: SYSTem:LANGUage must be set to BOON to use native mode instructions

CH2

Description: Configures native mode talk instructions to return Channel 2 measurement data
Syntax: CH2
Argument: None
Valid Modes: All
Restrictions: SYSTem:LANGUage must be set to BOON to use native mode instructions

TALKMODE

Description: Returns the current native mode active channel and talk mode.
Syntax: TALKMODE?
Returns: Active channel <CH1, CH2> and talkmode mnemonic
Valid Modes: All
Restrictions: SYSTem:LANGUage must be set to BOON to use native mode instructions

TKERR

Description: Returns the next queued error code number, 0 if no error. See section 4.9 for a more detailed description of the error codes that may be returned.
Syntax: TKERR?
Returns: <numeric error code>
Valid Modes: All
Restrictions: SYSTem:LANGUage must be set to BOON to use native mode instructions

TKERRMSG

Description: Returns the next queued error code number followed by a quoted ASCII text string describing the error. See section 4.9 for a more detailed description of the error codes that may be returned.
Syntax: TKERRMSG?
Returns: <numeric error code>, "QUOTED ERROR DESCRIPTION"
Valid Modes: All
Restrictions: SYSTem:LANGUage must be set to BOON to use native mode instructions

TKSDATA

- Description: Returns the sensor data table from sensor's EEPROM. Note that year codes are excess-1990, that is 5 means 1995, and 11 means 2001. Power and attenuation levels are coded as dBm x 100; that is, -3500 means -35.00 dBm. All other values are in fundamental units. Model numbers are only shown as the base number - any special "S" version number will not appear.
- Syntax: TKSDATA?
- Returns: numeric array < type, model#, build month, day, year, serial#, calibration month, day, year, attenuation, impedance, min pwr, max pwr, CW min pwr, CW max pwr >
- Valid Modes: All
- Restrictions: SYSTem:LANGUage must be set to BOON to use native mode instructions

TKSSLOW

- Description: Returns the low bandwidth frequency calfactor table from sensor's EEPROM. Frequencies are in GHz and the calfactors are in dB. Count is the total number of data items in the string including the upper and lower frequency limits.
- Syntax: TKSSLOW?
- Returns: numeric array < Count, LowerFreq, UpperFreq, Freq0, CF0, Freq1, CF1, Freq2, CF2... FreqN, CFn >
- Valid Modes: All
- Restrictions: SYSTem:LANGUage must be set to BOON to use native mode instructions

TKSFAST

- Description: Returns the high bandwidth frequency calfactor table from sensor's EEPROM. Frequencies are in GHz and the calfactors are in dB. Count is the total number of data items in the string including the upper and lower frequency limits.
- Syntax: TKSFAST?
- Returns: numeric array < Count, LowerFreq, UpperFreq, Freq0, CF0, Freq1, CF1, Freq2, CF2... FreqN, CFn >
- Valid Modes: All
- Restrictions: SYSTem:LANGUage must be set to BOON to use native mode instructions

TKSCWRG

Description: Returns the CW sensor linearity calibration table from sensor's EEPROM. CW power sensors have 7 pairs of upscale / downscale gain factors, and voltage probes have eight pairs of upscale / midscale / downscale gain factors. Upscale factors have a nominal value of 5000, and midscale and downscale factors have a nominal value of 0. On voltage probes, the eighth pair of up/downscale factors and all eight midscale factors is returned at the end of the array for compatibility with CW sensors.

Syntax: TKSCWRG?

Returns: numeric array: <DS0,US0,DS1,US1, ...DS6,US6 [,DS7,US7,MS0,MS1, ...MS7]>

Valid Modes: All

Restrictions: SYSTem:LANGUage must be set to BOON to use native mode instructions

TKSMMSG

Description: Returns the sensor text message from sensor's EEPROM. This message is programmed at the factory or during sensor calibration.

Syntax: TKSMMSG?

Returns: <Message String>

Valid Modes: All

Restrictions: SYSTem:LANGUage must be set to BOON to use native mode instructions

TKAVG

Description: Sets the talkmode to return the average power of the selected channel each time the 4530 is addressed to talk. This is a "permanent" talkmode, and will remain in effect until a new talkmode is set. Use this command in 4530 native mode for the fastest possible sustained reading rate of single-channel average power over the bus. Power is returned in current units.

Syntax: TKAVG

Returns: Average (or CW) Power

Valid Modes: CW and Modulated modes

Restrictions: SYSTem:LANGUage must be set to BOON to use native mode instructions

Special Case: If in ratiometric mode, reading will be in units of dBr (log) or Percent Power (linear).

TKPWR

Description: Sets the talkmode to return the average, maximum and minimum power and peak-to-average ratio (or pulse power, for CW sensors) for the selected channel each time the 4530 is addressed to talk. This is a “permanent” talkmode, and will remain in effect until a new talkmode is set. Power is returned in current units, and peak-to-average ratio is in dB for log units, and percent for linear units.

Syntax: TKPWR

Returns: Pavg, Pmax, Pmin, PkToAvgRatio (Modulated mode) or Ppulse (CW mode)

Valid Modes: CW and Modulated modes

Restrictions: **SYSTEM:LANGUage** must be set to BOON to use native mode instructions

Special Case: If in ratiometric mode, average power readings will be in units of dBr (log) or Percent Power (linear).

TKBOTH

Description: Sets the talkmode to return the average power of both channels each time the 4530 is addressed to talk. This is a “permanent” talkmode, and will remain in effect until a new talkmode is set. Power is returned in current units. Use this command in 4530 native mode for the fastest possible sustained reading rate of two-channel average power over the bus.

Syntax: TKBOTH

Returns: Pavg (ch1), Pavg (ch2)

Valid Modes: CW and Modulated modes

Restrictions: **SYSTEM:LANGUage** must be set to BOON to use native mode instructions

Special Case: If in ratiometric mode, power readings will be in units of dBr (log) or Percent Power (linear).

TKMK1

Description: Sets the talkmode to return the reading at marker 1 for the active channel each time the 4530 is addressed to talk. This is a “permanent” talkmode, and will remain in effect until a new talkmode is set. Power is returned in current units.

Syntax: TKMK1

Returns: Pwr@Marker1

Valid Modes: Pulse and Statistical modes

Restrictions: **MARKer:MODE** must be set to VERT. **SYSTEM:LANGUage** must be set to BOON to use native mode instructions.

TKMK2

- Description: Sets the talkmode to return the reading at marker 2 for the active channel each time the 4530 is addressed to talk. This is a “permanent” talkmode, and will remain in effect until a new talkmode is set. Power is returned in current units.
- Syntax: TKMK2
- Returns: Pwr@Marker2
- Valid Modes: Pulse and Statistical modes
- Restrictions: MARKer:MODE must be set to VERT. SYSTem:LANGUage must be set to BOON to use native mode instructions.

TKPLSTIM

- Description: Sets the talkmode to return an array of automatic timing measurements performed on a periodic pulse waveform each time the 4530 is addressed to talk. Measurements performed are: the frequency, period, width, offtime and duty cycle of the pulse waveform, and the risetime and falltime of the edge transitions. For each of the measurements to be performed, the appropriate items to be measured must be visible on the screen if the power meter is place in GRAPH mode. Pulse frequency, period, offtime and duty cycle measurements require that an entire cycle of the pulse waveform (minimum of three edge transitions) be present. Pulse width measurements require that at least one full pulse is visible, and are most accurate if the pulse width is at least 15% of the screen width (timespan). Risetime and falltime require that the edge being measured is visible, and will be most accurate if the transition takes at least 5% of the screen width. It is always best to have the power meter set on the fastest timespan possible that meets the edge visibility restrictions. Set the trace averaging as high as practical to reduce fluctuations and noise in the pulse timing measurements. Note that the timing of the edge transitions is defined by the settings of the SENSE:PULSE:DISTal, :MESIal and :PROXimal settings; see the descriptions for those commands. This is a “permanent” talkmode, and will remain in effect until a new talkmode is set. Power is returned in current units.
- Syntax: TKPLSTIM
- Returns: PulseFreq, PulsePeriod, PulseWidth, Offtime, DutyCycle, Risetime, Falltime in fundamental units
- Valid Modes: Pulse mode only
- Restrictions: Timespan must be set appropriately to allow measurements (see above). SYSTem:LANGUage must be set to BOON to use native mode instructions.

TKPLSPWR

- Description: Sets the talkmode to return an array of automatic power measurements performed on a periodic pulse waveform each time the 4530 is addressed to talk. Measurements performed are: peak power during the pulse, average power over a full cycle of the pulse waveform, average power during the pulse, IEEE top amplitude, IEEE bottom amplitude, and overshoot. Note the pulse overshoot is returned in dB for log units, and percent for linear units. Also, the pulse “on” interval used for peak and average power calculations is defined by the SENSE:PULSE:STRTGT and :ENDGT time gating settings. A full pulse must be visible to make average and peak pulse power measurements, and a full cycle of the waveform must be visible to calculate average cycle power. This is a “permanent” talkmode, and will remain in effect until a new talkmode is set. Power is returned in current units.
- Syntax: TKPLSPWR
- Returns: PulseOnPeak, PulseCycleAvg, PulseOnAvg, PulseTop, PulseBot, Overshoot
- Valid Modes: Pulse mode only
- Restrictions: Timespan must be set appropriately to allow measurements (see above). SYSTEM:LANGUAGE must be set to BOON to use native mode instructions.

TKMKMEAS

- Description: Sets the talkmode to return an array of marker measurements for the specified channel each time the 4530 is addressed to talk. The array consists of the average, maximum, and minimum power and peak-to-average ratio *between* the two markers, powers *at* each of the markers, and the ratio of the two marker powers. Note the peak-to-average ratio and marker ratio are returned in dB for log units, and percent for linear units. This is a “permanent” talkmode, and will remain in effect until a new talkmode is set. Power is returned in current units.
- Syntax: TKMKMEAS
- Returns: Pavg, Pmax, Pmin, PkToAvgRatio, Pwr@Marker1, Pwr@Marker2, Mrk1/Mrk2 ratio
- Valid Modes: Pulse mode only
- Restrictions: SYSTEM:LANGUAGE must be set to BOON to use native mode instructions.

TKSMEAS

- Description: Sets the talkmode to return an array of automatic statistical measurements performed on the sample population each time the 4530 is addressed to talk. Measurements performed are: long term average, peak, and minimum powers, peak-to-average ratio, power at each marker, statistical percent at each marker, and the sample population size in megasamples. Note the peak-to-average ratio is returned in dB for log units, and percent for linear units. Depending on the setting of MARKer:MODE, either the power or the percent can be the marker position, and the opposite item will be the calculated value at that position.. This is a “permanent” talkmode, and will remain in effect until a new talkmode is set. Power is returned in current units.
- Syntax: TKSMEAS
- Returns: Pavg, Ppeak, Pmin, PkToAvgRatio, Pwr@Mrk1, Pwr@Mrk2, Pct@Mrk1, Pct@Mrk2, SampCnt
- Valid Modes: Statistical mode only
- Restrictions: SYSTEM:LANGUAGE must be set to BOON to use native mode instructions.

4.5.6 SENSE Subsystem - The purpose of the SENSE command subsystem is to directly configure device specific settings used to make measurements, generally parameters related to the RF power sensor and signal processing. The SENSE commands are used to configure the power meter for acquiring data. SENSE enables you to change measurement parameters such as filtering or averaging, sensor bandwidth, operating frequency and cal factors, and measurement gain or offset. The numeric suffix of the SENSE program mnemonic in the SENSE commands refers to a hardware measurement “channel”, that is SENSE1 and SENSE2 represent the power meter’s SENSOR 1 and SENSOR 2 signal paths, respectively. The SENSE commands generally DO NOT affect the data processing and display portion of the measurement (see the CALCulate subsystem, below). Note that SENSE2 commands will generate an error if used with a single channel Model 4531.

SENSE:AVERage

Description: Set or return the number of traces averaged together to form the measurement result on the selected channel. Can also be used to reduce display noise on both the visible trace, and on marker and automatic pulse measurements. Trace averaging is a continuous process in which the measurement points from each sweep are weighted (multiplied) by a appropriate factor, and averaged into the existing trace data points. In this way, the most recent data will always have the greatest effect on the trace shape, and older measurements will be decayed at a rate determined by the averaging setting and trigger rate. Note that for timespans faster than 50uS, the 4530 acquires samples using a technique called *equivalent time* or *interleaved* sampling. In this mode, not every pixel on the trace gets updated on each sweep, and the total number of sweeps needed to satisfy the AVERage setting will be increased by the sample interleave ratio of that particular timespan.

Syntax: SENSE[1|2]:AVERage <n>

Argument: <n> = Numeric value from 1 to 4096 (1 = no trace averaging)

Valid Modes: Pulse

SENSE:FILTer:STATe

Description: Set or return the current setting of the integration filter on the selected channel. OFF provides no filtering, and can be used at high signal levels when absolute minimum settling time is required. ON allows a user-specified integration time, from 10 milliseconds to 15 seconds (see SENSE:FILTer:TIME command). Note that setting the filter time will force the state to ON. AUTO uses a variable amount of filtering, which is set automatically by the power meter based on the current signal level to a value that gives a good compromise between measurement noise and settling time at most levels.

Syntax: SENSE[1|2]:FILTer:STATe <asc>

Argument: <asc> = OFF, ON, AUTO

Valid Modes: CW and Modulated modes

SENSE:FILTer:TIME

Description: Set or return the current length of the integration filter on the selected channel. If the filter state is set to AUTO, querying the time will return -0.01, and if set to OFF, a time query will return 0.00. Note that setting the filter time will force the state to ON.

Syntax: SENSE[1|2]:FILTer:TIME <n>

Argument: <n> = 0.01 to 15.00 seconds

Valid Modes: CW and Modulated modes

SENSE:BANDwidth

Description: Set or return the sensor video bandwidth for the selected sensor. HIGH is the normal setting for most measurements. The actual bandwidth is determined by the peak sensor model used. For 57000 series peak sensors the LOW video bandwidth is less than 500 kHz to allow calibration at 50 MHz. Use LOW bandwidth for additional noise reduction when measuring CW or signals with very low modulation bandwidth. If LOW bandwidth is used on signals with fast modulation, measurement errors will result because the sensor cannot track the fast changing envelope of the signal.

Syntax: SENSE[1|2]:BANDwidth <asc>

Argument: <asc> = LOW, HIGH

Valid Modes: Peak sensors only

SENSE:IMPEDance

Description: Set or return voltage probe sensor impedance for power calculations for the selected channel. Characteristic impedance is used only for voltage to power conversions. This can be used to calculate and display power from a voltage measurement across a load impedance using a voltage probe.

Syntax: SENSE[1|2]:IMPEDance <n>

Argument: <n> = 10 to 2500 ohms

Valid Modes: Voltage probes only

SENSE:CORRection:OFFset

Description: Set or return a measurement offset in dB for the selected sensor. This is used to compensate for external couplers, attenuators or amplifiers in the RF signal path ahead of the power sensor. In the main TEXT display, a small triangle (delta symbol) will appear above the units if the offset is not set to zero.

Syntax: SENSE[1|2]:CORRection:OFFset <n>

Argument: <n> = -100.00 to 100.00 dB

Valid Modes: Any

SENSe:CORRection:FDOFFset

Description: Set or return the name of the current frequency dependent offset table in use on the selected channel. Two tables (TableA and TableB) are available, and each holds a list of up to 64 frequencies and corresponding offset values. See the MEMory:FDOFFset commands for entering these tables. Whenever the operating frequency is changed with one of the tables active, a new frequency dependent offset value will be calculated and applied. Setting the active table to OFF cancels any frequency dependent offset. Frequency dependent offsets are used to compensate for external devices such as couplers or attenuators in the RF signal path that have known loss characteristics that vary with frequency. In the main TEXT display, an asterisk (“*”) symbol will appear above the units if a frequency dependent offset table is in use (setting is TBLA or TBLB).

Syntax: SENSe[1|2]:CORRection:FDOFFset <asc>

Argument: <asc> = OFF, TBLA, TBLB

Valid Modes: All Power Sensors

SENSe:CORRection:FREQuency

Description: Set or return the RF frequency for the current sensor, and apply the appropriate frequency calfactor from the sensor’s EEPROM table. Application of this calfactor cancels out the effect of variations in the flatness of the sensor’s frequency response. If an explicit calfactor has been set, either manually or via the SENSe:CORRection:CALFactor command, entering a new frequency will override this calfactor and use only the “automatic” frequency calfactor.

Syntax: SENSe[1|2]:CORRection:FREQuency <n>

Argument: <n> = 0.01 to 110.00 GHz

Valid Modes: All Power Sensors

SENSe:CORRection:CALFactor

Description: Set or return the frequency calfactor currently in use on the selected channel. Note setting a calfactor with this command will override the “automatic” frequency calfactor that was calculated and applied when the operating frequency was set, and setting the operating frequency will override this calfactor setting.

Syntax: SENSe[1|2]:CORRection:CALFactor <n>

Argument: <n> = -3.00 to 3.00 dB

Valid Modes: All Power Sensors

SENSe:CORRection:TEMPComp

Description: Set or return the state of the peak sensor temperature compensation system. This system compensates for drift that might otherwise be caused by changes in the temperature of the peak power sensors. When set to OFF, a warning will be displayed if the sensor temperature drifts more than 4 degrees C from the autocal temperature. When ON, the warning will not appear until temperature has drifted by 30C.

Syntax: SENSe[1|2]:CORRection:TEMPComp <asc>

Argument: <asc> = OFF, ON (always defaults to ON on power up, or when new sensor inserted)

Valid Modes: Peak Sensors Only

SENSe:PULSe:UNITs

Description: Set the units for entering the pulse distal, mesial and proximal levels. If units is set to VOLTS, the pulse transition levels will be defined as the specified percentage in voltage. If set to WATTS, the levels are defined in percent power. Many pulse measurements call for 10% to 90% voltage (which equates to 1% to 81% power) for risetime and falltime measurements, and measure pulse widths from the half-power (-3dB, 50% power, or 71% voltage) points.

Syntax: SENSe[1|2]:PULSe:UNITs <asc>

Argument: <asc> = WATTS, VOLTS

Valid Modes: Pulse mode only

SENSe:PULSe:DISTal

Description: Set or return the pulse amplitude percentage, which is used to define the end of a rising edge or beginning of a falling edge transition. Typically, this is 90% voltage or 81% power relative to the “top level” of the pulse. This setting is used when making automatic pulse risetime and falltime calculations returned by FETCh:ARRay:AMEASure:POWER.

Syntax: SENSe[1|2]:PULSe:DISTal <n>

Argument: <n> = 0 to 100 percent

Valid Modes: Pulse mode only

SENSe:PULSe:MESIal

Description: Set or return the pulse amplitude percentage, which is used to define the midpoint of a rising or falling edge transition. Typically, this is 50% voltage or 25% power relative to the “top level” of the pulse. This setting is used when making automatic pulse width and duty cycle calculations returned by FETCh:ARRay:AMEASure:POWER.

Syntax: SENSe[1|2]:PULSe:MESIal <n>

Argument: <n> = 0 to 100 percent

Valid Modes: Pulse mode only

SENSe:PULSe:PROXimal

Description: Set or return the pulse amplitude percentage, which is used to define the beginning of a rising edge or end of a falling edge transition. Typically, this is 10% voltage or 1% power relative to the “top level” of the pulse. This setting is used when making automatic pulse risetime and falltime calculations returned by FETCh:ARRay:AMEASure:POWER.

Syntax: SENSe[1|2]:PULSe:PROXimal <n>

Argument: <n> = 0 to 100 percent

Valid Modes: Pulse mode only

SENSe:PULSe:STARTGT

Description: Set or return the point on a pulse, which is used to define the beginning of the pulse's "active" interval. This point is defined in percent of the total pulse duration, with 0% corresponding to the midpoint of the rising edge, and 100% corresponding to the midpoint of the falling edge, as defined by the mesial setting. For most pulse "on" average power measurements, it is desirable to exclude the rising and falling intervals, and only measure power over the active portion of the pulse. This is often known as time gating, and is used for the automatic pulse measurements returned by `FETCh:ARRay:AMEASure:POWER`.

Syntax: `SENSe[1|2]:PULSe:STARTGT <n>`

Argument: `<n>` = 0 to 40 percent

Valid Modes: Pulse mode only

SENSe:PULSe:ENDGT

Description: Set or return the point on a pulse, which is used to define the end of the pulse's "active" interval. This point is defined in percent of the total pulse duration, with 0% corresponding to the midpoint of the rising edge, and 100% corresponding to the midpoint of the falling edge, as defined by the mesial setting. For most pulse "on" average power measurements, it is desirable to exclude the rising and falling intervals, and only measure power over the active portion of the pulse. This is often known as time gating, and is used for the automatic pulse measurements returned by `FETCh:ARRay:AMEASure:POWER`.

Syntax: `SENSe[1|2]:PULSe:ENDGT <n>`

Argument: `<n>` = 60 to 100 percent

Valid Modes: Pulse mode only

SENSe:TEMPerature

Description: Return the current internal temperature of the selected peak power sensor. This temperature may be compared to the autocal temperature (see `SENSe:CALTemp?`) to aid in deciding whether the sensor temperature has drifted enough to warrant a new autocal. The 4530 displays a warning message on the LCD if a non-temperature compensated peak sensor is in use, and the temperature has drifted more than 4C from the autocal temperature.

Syntax: `SENSe[1|2]:TEMPerature?`

Returns: SensorTemp in degrees C

Valid Modes: Peak Sensors only

SENSe:CALTemp

Description: Return the internal peak power sensor temperature at the time of autocalibration. This temperature may be compared to the current sensor temperature (see `SENSe:TEMPerature?`) to aid in deciding whether the sensor temperature has drifted enough to warrant a new autocal. The 4530 displays a warning message on the LCD if a non-temperature compensated peak sensor is in use, and the temperature has drifted more than 4C from the autocal temperature.

Syntax: `SENSe[1|2]:CALTemp?`

Returns: AutocalTemp in degrees C

Valid Modes: Peak Sensors only

4.5.7 CALCulate Subsystem - The CALCulate group of the command subsystem is used to configure post acquisition data processing. Functions in the CALCulate subsystem are used to configure the measurement mode and control which portions of the acquired measurement data is used and how it is processed to yield a finished measurement. In addition to measurement mode, CALCulate is used to define mathematical operations, measurement units, and limit monitoring. The numeric suffix of the CALCulate program mnemonic in the CALCulate commands refers to a processing and display “channel”, that is CALCulate1 and CALCulate2 represent the power meter’s Channel 1 and Channel 2 functions. The CALCulate commands generally DO NOT affect the data acquisition portion of the measurement (see the SENSE subsystem, above). In a signal-flow block diagram, the CALCulate block operations will follow those of the SENSE block. Note that CALCulate2 commands will generate an error if used with a single channel Model 4531.

CALCulate:STATe

Description: Set or return the measurement state of the selected channel. When ON, the channel performs measurements; when OFF, the channel is disabled and no measurements are performed.

Syntax: CALCulate[1|2]:STATe <asc>

Argument: <asc> = ON, OFF

Valid Modes: Any

CALCulate:MODE

Description: Set or return the measurement mode of the selected channel. CW and MODULATED are continuous measurement modes, PULSE is a triggered, oscilloscope-like mode, and CDF, CCDF and DIST are various presentation formats of statistical mode, which gathers and analyzes a large number of samples over a relatively long time interval.

Syntax: CALCulate[1|2]:MODE <asc>

Argument: <asc> = CW, MODULATED, PULSE, CDF, CCDF, DIST

Valid Modes: Sensor dependent. CW and voltage sensors may select CW mode only. If CW mode is selected for a peak sensor, it will be forced to MODULATED mode.

CALCulate:MATH

Description: Set or return the signal source or sources combined in an arithmetic operation for the displayed reading on the selected channel. Ratiometric displays may be made between two sensors, or between a sensor and a stored reference (see CALCulate:REFerence commands), and sum or difference operations may be performed between two sensors, depending on sensor type. For power sensors, the power ratio of two sources in dB relative (dBr) or percent power, or the sum of power of two sources in dBm or linear units is available. Voltage sensors allow voltage ratios in dBr or percent power, and voltage difference in log or linear voltage units.

Syntax: CALCulate[1|2]:MATH <asc>

Argument: <asc> = CH{1|2}, REF{1|2}, REF_RAT, REF_SUM, REF_DIFF, CH_RAT, CH_SUM, CH_DIFF

Valid Modes: CW and Modulated modes

Restrictions: For calculations between sensors, both sensors must be of the same type (power or voltage sensors).

CALCulate:DCYC

Description: Set or return the pulse duty cycle in percent of the input waveform of the selected channel. This value is used to calculate the theoretical pulse power based on an average power measurement of a periodic pulse waveform. The pulse power result is valid only for thermal sensors or for CW diode sensors operating in the square-law (true-RMS) region of their dynamic range, and subject to the accuracy of the duty cycle value. Setting the duty cycle to 100% is equivalent to a CW measurement.

Syntax: CALCulate[1|2]:DCYC <n>

Argument: <n> = 0.01 to 100 %

Valid Modes: CW Sensors only

CALCulate:RANGe

Description: Set or return the hardware measurement range for the selected CW channel. When set to AUTO, the 4530 automatically selects the best range for noise and overload headroom. For certain applications with large, frequent signal swings, setting the range manually can improve settling time. Range 0 is used below approximately -10dBm on CW diode sensors and on all thermal sensors. Range 1 is used above approximately -30dBm on CW diode sensors. Range 2 is used only on voltage sensors when the input is above about 3.0 volts.

Syntax: CALCulate[1|2]:RANGe <asc>

Argument: <asc> = AUTO, 0, 1, 2

Valid Modes: CW and Voltage sensors only

CALCulate:PKHLD

Description: Set or return the operating mode of the selected channel's peak hold function. OFF: instantaneous peaks are only held for a short time, and then decayed towards the average power at a rate proportional to the filter time. This is the best setting for most signals, because the peak will always represent the peak power of the current signal, and the resulting peak-to-average ratio will be correct shortly after any signal level changes. INST: instantaneous peaks are held until reset by a new INITiate command. This setting is used to hold the highest peak over a long measurement interval. AVG: The held peaks correspond to the highest and lowest filtered average power, and are held until reset. This is useful for monitoring average power fluctuations over a period of time. In the case of pulse mode, note that all average and peak hold measurements are performed on the interval between the markers. Note that because CW sensors do not measure instantaneous power, they always operate with the PKHLD mode equivalent to AVG.

Syntax: CALCulate[1|2]:PKHLD <asc>

Argument: <asc> = OFF, AVG, INST

Valid Modes: Modulated and Pulse modes

CALCulate:UNITs

Description: Set or return default programming/display units for the selected channel. For power sensors, voltage is calculated with reference to the sensor input impedance. For voltage sensors, power is calculated using the user supplied impedance parameter. Note that in ratiometric mode, the current UNITs setting will be overridden: log units will always return as dBr (dB relative), and linear units will represent the ratio in percent power (for WATTS) or percent voltage (for VOLTS).

Syntax: CALCulate[1|2]:UNITs <asc>

Argument: <asc> = WATTS, DBM, VOLTS, DBV, DBMV, DBUV

Valid Modes: Any

CALCulate:REFerence:STATe

Description: Set or return the state of the ratiometric reference mode for the selected channel. When reference level is loaded or entered, enabling reference mode will cause the channel's primary measurement to calculate the ratio of the current average power to the stored reference. Units will be changed to dBr (dB relative) for log units, or percent (power or voltage) for linear units. Note that the stored reference should be loaded from the same sensor that is currently in use on the channel.

Syntax: CALCulate[1|2]:REFerence:STATe <asc>

Argument: <asc> = OFF, ON

Valid Modes: CW and Modulated modes

CALCulate:REFerence:COLLect

Description: Load (or "collect") the current average power level as the ratiometric mode reference level for the selected channel. The power level applied to the sensor is stored as the reference level, and all power readings will be in dBr, relative to this level. Immediately after the reference is loaded, the ratiometric power reading will always be 0.000 dBr until the applied power changes.

Syntax: CALCulate[1|2]:REFerence:COLLect

Argument: None

Valid Modes: CW and Modulated modes

CALCulate:REFerence:DATA

Description: Set or return the ratiometric mode reference level for the selected channel. When the reference level is set using this command, the power specified by the argument will become the current reference level, and all power readings will be in dBr, relative to this level.

Syntax: CALCulate[1|2]:REFerence:DATA <n>

Argument: <n> = Power in current units

Valid Modes: CW and Modulated modes

CALCulate:LIMit:UPPer

Description: Set or return the upper limit power level for the selected channel. This limit is used for level alarms. When the measured average power is above the upper limit, an up arrow will appear on the display above the units on the main text screen, and flag bits are set in the alarm register which may be accessed using CALCulate:LIMit commands.

Syntax: CALCulate[1|2]:LIMit:UPPer <n>

Argument: <n> = -100.00 to +100.00 dBm

Valid Modes: CW and Modulated modes

CALCulate:LIMit:LOWer

Description: Set or return the lower limit power level for the selected channel. This limit is used for level alarms. When the measured average power is below the lower limit, a down arrow will appear on the display above the units on the main text screen, and flag bits are set in the alarm register which may be accessed using CALCulate:LIMit commands.

Syntax: CALCulate[1|2]:LIMit:LOWer <n>

Argument: <n> = -100.00 to +100.00 dBm

Valid Modes: CW and Modulated modes

CALCulate:LIMit:STATe

Description: Set or return the limit alarm system state for the selected channel. When alarms are enabled (ON), the measured average power is compared to the preset upper and lower limits, and the error flags are set if out of range. When OFF, no action occurs if the power is out of range.

Syntax: CALCulate[1|2]:LIMit:STATe <asc>

Argument: <asc> = OFF, ON

Valid Modes: CW and Modulated modes

CALCulate:LIMit:FAIL

Description: Return the list of alarm limit status flags for the selected channel. The five flags are separated by commas, and each will be either a "1", indicating the specified alarm condition is active, or a "0", indicating that condition is normal. Three of the flags are latched, and indicate if any limit violation has occurred since the start of the measurement, while the other two indicate the current status. See the CALCulate:LIMit:CLEar command for resetting the latched flags.

Syntax: CALCulate[1|2]:LIMit:FAIL?

Returns: < AnyLimitTripped, BelowLowerLimit, AboveUpperLimit, LowerLimitTripped, UpperLimitTripped >

Valid Modes: CW and Modulated modes

CALCulate:LIMit:CLEar

Description:	Reset (clear to zero) the selected channel's latched alarm limit status flags. Note that the "current status" limit flags will continue to indicate the current alarm state.
Syntax:	CALCulate[1 2]:LIMit:CLEar[:IMMEDIATE]
Argument:	none
Valid Modes:	CW and Modulated modes

4.5.8 MARKer Subsystem - The MARKer group of commands is used to configure and locate measurement markers (cursors) at specific points on the processed measurement waveform. FETCH? or READ? queries may then be used to retrieve measurements at the two markers and in the interval between them. Markers are used in Pulse mode to perform measurements at or between two time offsets relative to the trigger, and in Statistical mode to measure the power at a particular statistical percent, or the percent at a specified power level. In Pulse mode, the markers can only be placed on the visible portion of the trace (as defined by the timespan and trigger delay settings), while Statistical mode markers may be placed at any power or percent value and will still return readings.

MARKer:MODE

Description:	Set or return the global marker orientation for the pulse and statistical modes. Markers 1 and 2 are always paired and operate together. Markers are not used in the CW and modulated modes. Vertical markers appear as vertical bars on the graph display, and measure the power at a particular time (Pulse mode) or percent (Statistical mode). Horizontal markers appear as horizontal bars, and measure the percent at a particular power level in Statistical mode. Horizontal markers may also be used in Pulse mode graph display as "reference lines", to indicate certain power levels. In this case they are strictly visual tools, and no marker measurements can be performed.
Syntax:	MARKer:MODE <asc>
Argument:	<asc> = OFF, VERT, HORZ
Valid Modes:	Pulse and Statistical modes

MARKer:POSition:POWER

Description:	Set or return the power level (position) of the selected horizontal marker. Note that horizontal markers may be positioned at any power level, regardless of the vertical span setting, and will not necessarily appear on the graph display.
Syntax:	MARKer:POSition[1 2]:POWER <n>
Argument:	<n> = -99.99 to +99.99 dBm
Valid Modes:	Pulse and Statistical modes. MARKer:MODE must be HORZ.

MARKer:POSition:TIME

- Description: Set or return the time (position) of the selected vertical marker relative to the trigger. Note that time markers must be positioned within the time limits of the trace window in the graph display. If any attempt is made to position them outside these limits, they will be forced back into the range of the trace window. Note that if timespan, trigger delay, or trigger position settings are changed, the marker *positions* on the graph display will remain unchanged, but their *times* relative to the trigger will change. For this reason, it is a good idea to set all timing and trigger parameters *before* setting the marker times.
- Syntax: MARKer:POSition[1|2]:TIME <n>
- Argument: <n> = +/- ### seconds (see restrictions)
- Valid Modes: Pulse mode only. MARKer:MODE must be VERT.
- Restrictions: TrigDly - (TimeSpan / 2) < MarkerTime < TrigDly + (TimeSpan / 2)

MARKer:POSition:PERcent

- Description: Set or return the percent probability (position) of the selected vertical marker. Note that the power value returned for each marker will depend on the setting of CALCulate:MODE. When set to CDF, the highest power levels are towards the right side of the screen, with maximum (highest peak) power occurring at 100%. When set to CCDF (also called 1-CDF), the highest levels are towards the left, with peak power at 0%.
- Syntax: MARKer:POSition[1|2]:PERcent <n>
- Argument: <n> = 0.000 to 100.000 %
- Valid Modes: Statistical mode only. MARKer:MODE must be VERT.

4.5.9 DISPlay Subsystem - The DISPlay group of commands is used to control the selection and presentation of textual, graphical and TRACe measurements. With one exception (DISPlay:TSPAN), the DISPlay commands are independent of, and do not modify, how data is returned to the bus controller. But since it does configure the measurement data presentation on the front panel LCD, DISPlay can be considered an optional third and final block in a signal-flow block diagram of the power meter. Text (TXT1, TXT2, TXTB) or graph (GRPH1, GRPH2, GRPHB) display modes may be selected with either or both channels visible. When the power meter is in text mode, reading resolution and bargraph visibility may be configured. In graph mode, waveform scaling and centering are set. Note that in the special case of DISPlay:TSPAN, the setting of the display timespan may effect what portion of a pulse waveform can be measured; measurements may only be performed on the portion of the trace falling within the left and right limits of the display window. These same restrictions apply even when the power meter is in TEXT mode and the trace is not displayed.

DISPlay:%SPAN

- Description: Set or return the horizontal trace display span in statistical percent. The power meter has fixed display range settings in a 1, 2, 5 sequence, and if the argument does not match one of the settings, it will be forced to the next highest entry.
- Syntax: DISPlay:%SPAN <n>
- Argument: <n> = 1, 2, 5, 10, 20, 50, 100 %
- Valid Modes: Statistical mode only
- Restrictions: The sum of %SPAN and %OFST must not be greater than 100%.

DISPlay:%OFST

Description: Set or return the horizontal trace offset in statistical percent.
Syntax: DISPlay:%OFST <n>
Argument: <n> = 0 to 99 % (see restrictions)
Valid Modes: Statistical mode only
Restrictions: The sum of %SPAN and %OFST must not be greater than 100%.

DISPlay:TSPAN

Description: Set or return the horizontal time span of the display. The 4530 has fixed timespan settings in a 1-2-5 sequence, and if the argument does not match one of these settings, it will be forced to the next highest entry. Note that trigger delay and holdoff settings are restricted to certain values based on the timespan setting, and marker positions must always fall within the trace window. It is always a good idea to set the timespan before setting any other parameters when in Pulse mode.
Syntax: DISPlay:TSPAN <n>
Argument: <n> = 2.5e-6 to 5.0 seconds (Pulse), 1.0 to 3600 seconds (CW, Modulated)
Valid Modes: CW, Modulated and Pulse modes

DISPlay:GRPH

Description: Set the display to single channel graph mode showing the trace of only the selected channel, and set the header page to the value specified by the command argument. Although this command accepts an argument, there is no query form.
Syntax: DISPlay:GRPH{1|2} <n>
Argument: <n> = 1, 2 or 3
Valid Modes: Any

DISPlay:GRPHB

Description: Set the display to dual channel graph mode showing the traces of both channels, and set the header page to the value specified by the command argument. Although this command accepts an argument, there is no query form.
Syntax: DISPlay:GRPHB <n>
Argument: <n> = 1, 2 or 3
Valid Modes: Any

DISPlay:TXT

Description: Set the display to single channel text mode showing measurements for only the selected channel, and set the header and measurement page to the value specified by the command argument. Setting the display to single channel mode usually allows supplementary measurements or additional measurement detail to be displayed in the main measurement window, while the dual-channel display only shows the primary measurement for each channel. Although this command accepts an argument, there is no query form.

Syntax: DISPlay:TXT{1|2} <n>

Argument: <n> = 1, 2 or 3

Valid Modes: Any

DISPlay:TXTB

Description: Set the display to dual channel text mode showing primary measurements for both channels, and set the header and measurement page to the value specified by the command argument. Setting the display to single channel mode usually allows supplementary measurements or additional measurement detail to be displayed in the main measurement window, while the dual-channel display only shows the primary measurement for each channel. Although this command accepts an argument, there is no query form.

Syntax: DISPlay:TXTB <n>

Argument: <n> = 1, 2 or 3

Valid Modes: Any

DISPlay:TRACe:LOGSPAN

Description: Set or return the vertical span (sensitivity) of the selected channel's graph display when using log units. The 4530 has fixed vertical span settings in a 1-2-5 sequence, and if the argument does not match one of these settings, it will be forced to the next highest entry.

Syntax: DISPlay:TRACe[1|2]:LOGSPAN <n>

Argument: <n> = 0.1, 0.2, 0.5, 1, 2, 5, 10, 50, 100 dB

Valid Modes: CALCulate:UNITs = <DBM, DBV, DBMV, DBUV>

DISPlay:TRACe:LINSPAN

Description: Set or return the vertical span (sensitivity) of the selected channel's graph display when using linear units. The 4530 has fixed vertical span settings in a 1-2-5 sequence, and if the argument does not match one of these settings, it will be forced to the next highest entry.

Syntax: DISPlay:TRACe[1|2]:LINSPAN <n>

Argument: <n> = 1nW to 1MW, or 1nV to 1MV

Valid Modes: CALCulate:UNITs = <VOLTS, WATTS>

DISPlay:TRACe:PCTSPAN

Description: Set or return the vertical span (sensitivity) of the selected channel's graph display when using linear units in ratiometric (reference) mode. The 4530 has fixed vertical span settings in a 1-2-5 sequence, and if the argument does not match one of these settings, it will be forced to the next highest entry.

Syntax: DISPlay:TRACe[1|2]:PCTSPAN <n>

Argument: <n> = 0.1 to 10,000 %

Valid Modes: Ratiometric (reference) mode with CALCulate:UNITs = <VOLTS, WATTS>

DISPlay:TRACe:LOGCNTR

Description: Set or return the vertical center power value for the selected channel's graph display when using log units.

Syntax: DISPlay:TRACe[1|2]:LOGCNTR <n>

Argument: <n> = -100.00 to 100.00 (power in current log units)

Valid Modes: CALCulate:UNITs = <DBM, DBV, DBMV, DBUV>

DISPlay:TRACe:LINCNTR

Description: Set or return the vertical center power value for the selected channel's graph display when using linear units.

Syntax: DISPlay:TRACe[1|2]:LINCNTR <n>

Argument: <n> = 1nW to 1MW, or 1nV to 1MV (see restrictions)

Valid Modes: CALCulate:UNITs = <VOLTS, WATTS>

Restrictions: The vert center may be no more than 100 times the value of the current vertical span setting.

DISPlay:TRACe:PCTCNTR

Description: Set or return the vertical center power value for the selected channel's graph display when using linear units in ratiometric (reference) mode.

Syntax: DISPlay:TRACe[1|2]:PCTCNTR <n>

Argument: <n> = 0.01 to 9999.99 percent

Valid Modes: Ratiometric (reference) mode with CALCulate:UNITs = <VOLTS, WATTS>

DISPlay:TEXT:BARGRAPH

Description: Set or return the visibility state of the selected channel's bargraph display. When enabled, the bargraph appears along the bottom of the main measurement window in dual-channel text display mode, and gives a visual indication of the magnitude and fluctuations of the reading. In the Model 4532 there are two independent bargraphs, one for each channel. The bargraph value is calculated using the same settings and limits as the recorder output, so it is possible to set the resolution and mode with the OUTPut:RECOOrder commands.

Syntax: DISPlay:TEXT[1|2]:BARgraph <asc>

Argument: <asc> = OFF, ON

Valid Modes: dual-channel text display

DISPlay:TEXT:RESolution

Description: Set or return the display resolution for the selected channel's reading in the main text display. When logarithmic units are in use, the argument sets the number of digits displayed after the decimal point. For linear units, the number of significant digits displayed is approximately equal to the argument plus two. Note that any readings displayed in a small font (secondary readings in the header or on some of the single-channel text displays) are not affected by this setting. Resolution of the measurements returned over the bus is also not affected by this command.

Syntax: DISPlay:TEXT[1|2]:RESolution <n>

Argument: <n> = 1, 2 or 3

Valid Modes: Large font text display

4.5.10 TRIGger Subsystem - The TRIGger group of commands is used to control synchronization of data acquisition with external events. TRIGger commands generally effect Pulse mode only, and control selection of a hardware trigger source and polarity, setting a trigger level, configuring delay and holdoff timing, and setting the trigger position on the display.

TRIGger:POSition

Description: Set or return the position of the trigger event on displayed sweep. Assuming zero trigger delay, setting the position to LEFT causes the entire trace to be post-trigger. Setting it to RIGHT causes the entire trace to be pre-trigger. And setting to MIDDLE will display both the pre- and post-trigger portions of the trace. Note that the TRIGger:DElay setting is in addition to this setting, and will cause the trigger position to appear in a different location.

Syntax: TRIGger:POSition <asc>

Argument: <asc> = LEFT, MIDDLE, RIGHT

Valid Modes: Pulse mode only

TRIGger:DElay

Description: Set or return the trigger delay time with respect to the trigger. Positive values cause the actual trigger to occur after the trigger condition is met. This places the trigger event to the left of the trigger point on the display, and is useful for viewing events during a pulse, some fixed delay time after the rising edge trigger. Negative trigger delay places the trigger event to the right of the trigger point on the display, and is useful for looking at events before the trigger edge. Due to memory limitations, positive or negative trigger delay is restricted in all timespans, but is always at least 30 times the timespan setting, and considerably greater for some settings.

Syntax: TRIGger:DElay <n>

Argument: <n> = -150.00 to 150.00 seconds (see restrictions)

Valid Modes: Pulse mode only

Restrictions: -900 μ s < TrigDly < 900 μ s for timespans 5 μ s and faster
-4.00ms < TrigDly < 4.00ms for timespans 10 μ s to 50 μ s
(-80 x TimeSpan) < TrigDly < (80 x TimeSpan) for timespans 50 μ s to 2ms
(-30 x TimeSpan) < TrigDly < (30 x TimeSpan) for timespans 5ms and slower

TRIGger:HOLDoff

Description: Set or return the trigger holdoff time. Trigger holdoff is used to disable the trigger for a specified amount of time after each trigger event. The holdoff time starts immediately after each valid trigger edge, and will not permit any new triggers until the time has expired. When the holdoff time is up, the trigger re-arms, and the next valid trigger event (edge) will cause a new sweep. This feature is used to help synchronize the power meter with burst waveforms such as a TDMA or GSM frame. The trigger holdoff resolution is one microsecond, and it should be set to a time that is just slightly shorted than the frame repetition interval.

Syntax: TRIGger:HOLDoff <n>

Argument: <n> = 10 e-6 to 0.999999 seconds, 0.0 = no holdoff

Valid Modes: Pulse mode only

TRIGger:LEVel

Description: Set or return the trigger level for synchronizing data acquisition with a pulsed input signal or external trigger pulses. If there is a global offset applied to the channel, the trigger level entered should include this offset. For internal trigger, the trigger level is always set and returned in dBm, and for external trigger, the units are volts. Note that there is a small amount of hysteresis built in to the trigger system, and the signal should have at least one dB greater swing in each direction past the trigger level setting, and somewhat more at low levels. Note that explicitly setting the trigger level while TRIGger:MODE is set to PKTOPK will cancel the PKTOPK setting, and force the trigger mode back to AUTO.

Syntax: TRIGger:LEVel <n>

Argument: <n> = -40 to +20 dBm (plus channel offset, if any) or -5.0 to +5.0 volts (external trigger)

Valid Modes: Pulse mode only

TRIGger:MODE

Description: Set or return the trigger mode for synchronizing data acquisition with pulsed signals. NORM mode will cause a sweep to be triggered each time the power level crosses the preset trigger level in the direction specified by TRIGger:SLOPe. If there are no edges that cross this level, no data acquisition will occur. AUTO mode operates in much the same way as NORM mode, but will automatically generate a trace if no trigger edges are detected for a period of time (100 to 500 milliseconds, depending on timespan). This will keep the trace updating even if the pulse edges stop. The third setting, PKTOPK operates the same as AUTO mode, but will adjust the trigger level to halfway between the highest and lowest power levels detected. This aids in maintaining synchronization with a pulse signal of varying level. Note that a setting of PKTOPK will be overridden and forced back to AUTO if a TRIGger:LEVel is set.

Syntax: TRIGger:MODE <asc>

Argument: <asc> = NORM, AUTO, PKTOPK

Valid Modes: Pulse mode only. PKTOPK mode functions only for internal trigger sources.

TRIGger:SLOPe

Description: Set or return the trigger slope or polarity. When set to POS, triggers will be generated when a signal's rising edge crosses the trigger level threshold. When NEG, triggers are generated on the falling edge of the pulse.

Syntax: TRIGger:SLOPe <asc>

Argument: <asc> = NEG, POS

Valid Modes: Pulse mode only.

TRIGger:SOURce

Description: Set or return the trigger source used for synchronizing data acquisition. SENSOR1 and SENSOR2 settings use the signal from either of the sensors. EXTERNAL uses the signal applied to the instrument's rear panel external trigger input. IMMEDIATE will trigger a new sweep without any trigger edge as soon as the previous sweep is complete or the trigger has been armed. BUS will trigger a new sweep when a *TRG command or GET signal is received on the bus. BUS>SNSR1, BUS>SNSR2, and BUS>EXT will *arm* the hardware trigger when a *TRG or GET is received, and will then *trigger* the sweep when a trigger edge is detected on the specified input.

Syntax: TRIGger:SOURce <asc>

Argument: <asc> = SENSOR1, SENSOR2, EXTERNAL, IMMEDIATE, BUS, BUS>SNSR1, BUS>SNSR2, BUS>EXT

Valid Modes: Pulse mode only.

TRIGger:CDF:COUNT

Description: Set or return the terminal count (sample population size) for statistical mode acquisition. When the terminal count is reached, the CDF is considered "complete", and the instrument will halt acquisition if INITiate:CONTInuous is set to OFF. If INITiate:CONTInuous is ON, sample acquisition will continue in the manner specified by the TRIGger:CDF:DECIimate setting.

Syntax: TRIGger:CDF:COUNT <n>

Argument: <n> = 1 to 4000 million samples

Valid Modes: Statistical mode only.

TRIGger:CDF:DECIimate

Description: Set or return the decimation when running continuously in statistical mode. This action occurs when the terminal count is reached (as defined by TRIGger:CDF:COUNT), and when set to OFF, the CDF will simply clear all data and restart. If set to ON, the entire sample population will be decimated (divided by two), and new samples will be continue to accumulate into this data set. Decimating has the effect of maintaining the "shape" of the CDF while slowly decaying away the effect of past history and updating to include new events. This setting works best with relatively small terminal counts (1 to 10 million counts).

Syntax: TRIGger:CDF:DECIimate <asc>

Argument: <asc> = OFF, ON

Valid Modes: Statistical mode only.

4.5.11 TRACe Data Array Commands - The TRACe group of commands is used to control the output of acquired measurement arrays, which appear as a display trace when the power meter is in Graph mode. The TRACe commands allow outputting a channel's entire trace (126 measurement points) as one large array, or selecting and returning the array in smaller portions. These commands are useful for capturing the displayed waveform and importing it into a database on the host.

TRACe:COUNT

Description: Set or return the number of trace points, which will be returned each time the TRACe:DATA? query is issued. At the completion of each read, INDEX is automatically incremented by COUNT. If COUNT is set to a number greater than the number of points remaining in the trace, the array will be truncated. Setting COUNT to 126 (and INDEX to zero each time) will return the entire trace array. Setting COUNT to zero will return a single point, but does not increment INDEX, and can be used to repeatedly query the same trace point.

Syntax: TRACe:COUNT <n>

Argument: <n> = 0 to 126

Valid Modes: Any

TRACe:INDEX

Description: Set or return the array index for the first trace point to be returned next time the TRACe:DATA? query is issued. Index 0 is the start of the trace buffer, and corresponds to the leftmost pixel on the graph display. Index 125 is the last point, and is the rightmost pixel. Each time a block of data is read, INDEX is automatically incremented by the COUNT value, so the full array can be split up into blocks of manageable size and read with successive TRACe:DATA? queries. INDEX must be reset to zero for each new trace that is to be dumped, whether or not all the points have been read.

Syntax: TRACe:INDEX <n>

Argument: <n> = 0 to 125

Valid Modes: Any

TRACe:DATA

Description: Return a comma-delimited array of power points corresponding to all or a portion of the graph mode display trace for the selected channel. Note that graph mode does not have to be active to read the trace, and the power points are returned without regard to display vertical span and center settings. The array will consist of COUNT trace points, beginning at point number INDEX, up to the last point of the trace (index = 125), and will be returned in the currently selected units.

Syntax: TRACe[1|2]:DATA?

Returns: P(index), P(index+1), P(index+2)... P(index+count)

Valid Modes: Any

4.5.12 SENSE:MBUF Data Array Commands - The MBUF commands (which are grouped under the SENSE subsystem) are used to control buffered data capture and output of a long array of sequential readings (the “Measurement BUffer”). This capability is useful for capturing readings at a rate higher than the host system can read back in real time. These commands are used in all but Statistical modes, and allow control of buffer size, reading rate, status reporting, and buffer array output. Up to 4,096 readings may be captured at programmable rates up to 1000 readings per second in Modulated or CW mode, and up to 500 triggered readings per second in Pulse Mode (timespan dependent). In Modulated and CW mode, each stored reading in the measurement buffer is the value that would be returned as the current average power measurement over the GPIB, including all filtering. To ensure no overlap between measurements, it may be preferable to set filtering off, or to a value shorter than the buffer period, which is the inverse of the SENSE:MBUF:RATE setting. In Pulse mode, each stored reading in the measurement buffer is the value that would be returned as the “average power between markers” over the GPIB, including all averaging. To ensure no overlap between measurements, SENSE:AVERAGE should be set to 1, and DISPLAY:TSPAN should be set to 50 microseconds or slower. If it is important that the average power over *every* pulse be recorded, sufficient time after the trigger must be allowed for the power meter to complete the sweep, and rearm for the next sweep. Typically, this time is 3ms longer than the current timespan setting, assuming the trigger edge is kept close to the left edge of the screen. For example, on a 10ms timespan, the pulse repetition frequency should not exceed 80 Hz ($1 / 10 + 3\text{ms}$), or some pulses may be missed.

SENSE:MBUF:SIZE

Description: Set or return the size of the measurement buffer. This controls how many readings will be buffered before the buffer is considered full. If set to zero, the measurement buffer is disabled, and the instrument operates in normal mode. If INITiate:CONTinuous is OFF, measurements will be considered complete, and the instrument will stop when the buffer has filled. Time to fill the buffer is determined by SIZE divided by RATE in Modulated and CW modes (see below), and by the trigger rate in Pulse mode.

Syntax: SENSE[1|2]:MBUF:SIZE <n>

Argument: <n> = 0 to 4096 (0 = Buffered Measurements disabled)

Valid Modes: Modulated, CW or Pulse modes

SENSE:MBUF:RATE

Description: Set or return the reading acquisition rate for the measurement buffer in Modulated and CW modes. This controls how fast readings are placed into the measurement buffer, and SIZE divided by RATE determines how many seconds it will take to fill the buffer. Note that buffer readings may be repeated if RATE is set faster than the internal measurement rate of the instrument (500 readings/sec in Modulated mode, 300 readings/second in CW mode), and best performance is achieved when RATE equals, or is an exact submultiple of the internal measurement rate. Note that this command has no effect on Pulse mode buffering.

Syntax: SENSE[1|2]:MBUF:RATE <n>

Argument: <n> = 1 to 1000 buffered readings/second

Valid Modes: Modulated and CW modes

SENSe:MBUF:POSition

Description: Return the current acquisition position into the measurement buffer, which is the index of the next buffer point which will be written to. This command is useful for determining whether the measurement buffer is full. A value of zero indicates that no points have been buffered yet, and a value of RATE indicates that the buffer is full.

Syntax: SENSe[1|2]:MBUF:POSition?

Returns: current index value, 0 to 4096

Valid Modes: Modulated, CW or Pulse modes

SENSe:MBUF:COUNT

Description: Set or return the number of measurement buffer readings which will be returned each time the SENSe:MBUF:DATA? query is issued when the measurement buffer is active. At the completion of each read, INDEX is automatically incremented by COUNT. If COUNT is set to a number greater than the number of points remaining in the measurement buffer, the array will be truncated. Setting COUNT to SIZE will return the entire measurement buffer.

Syntax: SENSe:MBUF:COUNT <n>

Argument: <n> = 0 to 4096

Valid Modes: Modulated, CW or Pulse modes

SENSe:MBUF:INDEX

Description: Set or return the array index for the first measurement buffer point to be returned next time the SENSe:MBUF:DATA? query is issued. Index 0 corresponds to the first point in the buffer, and index SIZE-1 is the last. Each time a block of data is read, INDEX is automatically incremented by the COUNT value, so the full array can be split up into blocks of manageable size and read with successive SENSe:MBUF:DATA? queries. INDEX must be reset to zero for each new measurement buffer that is to be dumped, whether or not the entire buffer has been read.

Syntax: SENSe:MBUF:INDEX <n>

Argument: <n> = 0 to 4095

Valid Modes: Modulated, CW or Pulse modes

SENSe:MBUF:DATA

Description: Return a comma-delimited array of power readings corresponding to all or a portion of the measurement buffer for the selected channel. The array will consist of COUNT buffer points, beginning at point number INDEX. Power is returned in currently selected units for that channel.

Syntax: SENSe[1|2]:MBUF:DATA?

Returns: P(index), P(index+1), P(index+2)... P(index+count)

Valid Modes: Modulated, CW or Pulse modes, SENSe:MBUF:SIZE must be >0.

4.5.13 SENSE:SBUF Data Array Commands - The SBUF commands (which are grouped under the SENSE subsystem) are used to control data capture and output of a long array of sequential measurement samples (the “Sample BUffer”). This capability is useful for capturing very long, single, triggered events in the time domain. These commands are used in PULSE mode, and allow control of data sampling and array output. Up to 12,000 points may be captured at programmable rates up to 2.5 million power readings per second for importing long baseline measurements into a database on the host.

SENSE:SBUF:MODE

Description: Set or return the on/off state of “user” sampling mode. When user mode is active (ON), the timespan and trigger delay settings are overridden, and user programmed parameters are used to configure sample rate, buffer size, and trigger position. Note that user mode is only for outputting long measurement arrays, and that marker and automatic measurements are not active in this mode. Setting to OFF restores normal operation.

Syntax: SENSE:SBUF:MODE <asc>

Argument: <asc> = OFF, ON

Valid Modes: Pulse mode only

SENSE:SBUF:PERiod

Description: Set or return the sampling period in internal, 80ns counts for “user” sampling mode. Sample rate = $(12.5 / n)$ MHz.

Syntax: SENSE:SBUF:PERiod <n>

Argument: <n> = 5 to 12500 (equivalent to 2.5 MSa/sec to 1.0 KSa/sec)

Valid Modes: Pulse mode only, SENSE:SBUF:MODE must be ON.

SENSE:SBUF:PREsamp

Description: Set or return the number of pretrigger samples: points which are gathered for each sweep *before* arming the trigger in “user” sampling mode. When the array is read, these points will appear with a negative INDEX.

Syntax: SENSE:SBUF:PREsamp <n>

Argument: <n> = 0 to 12000 (see restrictions)

Valid Modes: Pulse mode only, SENSE:SBUF:MODE must be ON.

Restrictions: PREsamp + POSTsamp must be less than 12,000

SENSE:SBUF:POSTsamp

Description: Set or return the number of posttrigger samples: points which are gathered for each sweep *after* the trigger has been armed and a valid edge has been received. When the array is read, these points will appear with a negative INDEX.

Syntax: SENSE:SBUF:POSTsamp <n>

Argument: <n> = 0 to 12000 (see restrictions)

Valid Modes: Pulse mode only, SENSE:SBUF:MODE must be ON.

Restrictions: PREsamp + POSTsamp must be less than 12,000

SENSe:SBUF:COUNT

- Description: Set or return the number of samples (power readings), which will be returned each time the SENSE:SBUF:DATA? query is issued in “user” sampling mode. At the completion of each read, INDEX is automatically incremented by COUNT. If COUNT is set to a number greater than the number of points remaining in the sample array, the array will be truncated. Setting COUNT to (1 + PREsamp + POSTsamp), (and INDEX to zero each time) will return the entire sample buffer.
- Syntax: SENSE:SBUF:COUNT <n>
- Argument: <n> = 0 to 12000 (see restrictions)
- Valid Modes: Pulse mode only, SENSE:SBUF:MODE must be ON.
- Restrictions: COUNT <= (PREsamp + POSTsamp)

SENSe:SBUF:INDEX

- Description: Set or return the array index for the first sample buffer point to be returned next time the SENSE:SBUF:DATA? query is issued. Index 0 corresponds to the sample at (or closest to) the trigger point. Samples with negative INDEX values are pretrigger points, and positive values are posttrigger points. Each time a block of data is read, INDEX is automatically incremented by the COUNT value, so the full array can be split up into blocks of manageable size and read with successive SENSE:SBUF:DATA? queries.
- Syntax: SENSE:SBUF:INDEX <n>
- Argument: <n> = -12000 to +12000 (see restrictions)
- Valid Modes: Pulse mode only, SENSE:SBUF:MODE must be ON.
- Restrictions: -PREsamp <= INDEX <= POSTsamp

SENSe:SBUF:DATA

- Description: Return a comma-delimited array of power points corresponding to all or a portion of the “user” mode sample buffer for the selected channel. Note that graph mode does not have to be active to read the buffer, and the power points are returned without regard to display vertical span and center settings. The array will consist of COUNT buffer points, beginning at point number INDEX. The buffer may span both pretrigger and posttrigger intervals. Power is returned in currently selected units for that channel.
- Syntax: SENSE[1|2]:SBUF:DATA?
- Returns: P(index), P(index+1), P(index+2)... P(index+count)
- Valid Modes: Pulse mode only, SENSE:SBUF:MODE must be ON.

4.5.14 SENSe:HIST and SENSe:CALTAB Data Array Commands - The purpose of the HIST and CALTAB groups of commands (which are grouped under the SENSE subsystem) are to output a power distribution histogram array and corresponding power point array. These commands are used in STATISTICAL mode, and allow for EXTERNAL statistical analysis of a long acquisition of power samples via a spreadsheet or other database program. The HIST commands return a histogram, which is an array of 4096 “bins”, each one corresponding to a particular power level, and containing the number of samples that have occurred at that power level. The CALTAB commands return the power calibration table (or “caltable”), which is the same size as the histogram (4096 points), and contains the power level for each corresponding bin in the histogram. The power values are not equally spaced, so it is necessary to know both the histogram and caltable arrays to compute statistical information about the input signal.

SENSE:HIST:COUNT

Description: Set or return the number of histogram elements (bins), which will be returned each time the SENSE:HIST:DATA? query is issued. At the completion of each read, INDEX is automatically incremented by COUNT. If COUNT is set to a number greater than the number of points remaining in the histogram, the array will be truncated. Setting COUNT to 4096 (and INDEX to zero each time) will return the entire histogram array. Setting COUNT to zero will return a single point, but does not increment INDEX, and can be used to repeatedly query the same histogram bin.

Syntax: SENSE:HIST:COUNT <n>

Argument: <n> = 0 to 4096

Valid Modes: Statistical mode only.

SENSE:HIST:INDEX

Description: Set or return the array index for the first histogram element (bin) to be returned next time the SENSE:HIST:DATA? query is issued. Index 0 is the first bin in the histogram, and corresponds to the lowest power level in the power calibration table. Index 4095 is the last bin, and contain counts for the highest power level. Each time a block of data is read, INDEX is automatically incremented by the COUNT value, so the full array can be split up into blocks of manageable size and read with successive SENSE:HIST:DATA? queries. INDEX must be reset to zero for each new histogram that is to be dumped, whether or not all the bins have been read.

Syntax: SENSE:HIST:INDEX <n>

Argument: <n> = 0 to 4095

Valid Modes: Statistical mode only.

SENSE:HIST:DATA

Description: Return a comma-delimited array of integer counts corresponding to all or a portion of the statistical mode power histogram for the selected channel. Each bin is 32 bits wide, and may consist of a number from zero (indicating no hits to that power level) to 4 billion (indicating all hits in the histogram were at that power level). The array will consist of COUNT histogram bins, beginning at bin INDEX, up to the last bin of the histogram (index = 4095).

Syntax: SENSE[1|2]:HIST:DATA?

Returns: N(index), N(index+1), N(index+2)... N(index+count)

Valid Modes: Statistical mode only.

SENSE:CALTAB:COUNT

Description: Set or return the number of caltable entries, which will be returned each time the SENSECALTAB:DATA? query is issued. At the completion of each read, INDEX is automatically incremented by COUNT. If COUNT is set to a number greater than the number of points remaining in the caltable, the array will be truncated. Setting COUNT to 4096 (and INDEX to zero each time) will return the entire caltable array.

Syntax: SENSE:CALTAB:COUNT <n>

Argument: <n> = 0 to 4096

Valid Modes: Statistical mode only.

SENSe:CALTAB:INDEX

- Description: Set or return the array index for the first caltable element to be returned next time the SENSe:CALTAB:DATA? query is issued. Index 0 is the first element in the caltable, and will contain the lowest power level in the sensor's calibration. Index 4095 is the last element, and contains the highest power level. Note that the table may be extrapolated, so it is normal for the table extremes to be outside the power measurement range of the connected sensor. Each time a block of data is read, INDEX is automatically incremented by the COUNT value, so the full array can be split up into blocks of manageable size and read with successive SENSe:CALTAB:DATA? queries. INDEX must be reset to zero for each new caltable that is to be dumped, whether or not all the bins have been read.
- Syntax: SENSe:CALTAB:INDEX <n>
- Argument: <n> = 0 to 4095
- Valid Modes: Statistical mode only.

SENSe:CALTAB:DATA

- Description: Return a comma-delimited array of integer counts corresponding to all or a portion of the statistical mode power histogram for the selected channel. Each bin is 32 bits wide, and may consist of a number from zero (indicating no hits to that power level) to 4 billion (indicating all hits in the histogram were at that power level). The array will consist of COUNT histogram bins, beginning at bin number INDEX, up to the last bin of the histogram (index = 4095).
- Syntax: SENSe[1|2]:CALTAB:DATA?
- Returns: P(index), P(index+1), P(index+2)... P(index+count)
- Valid Modes: Statistical mode only.

4.5.15 CALibration Subsystem - The CALibration group of commands is used to control automatic zero offset and linearity adjustments to the RF power sensor and the channel to which it is connected. Zero offset adjustment can be performed any time no RF signal is applied to the sensor. Linearity calibration requires that the sensor be connected to a calibration signal source (INTernal 50MHz, EXTernal 1GHz or USER supplied reference), as specified in the CALibration command sequence. The numeric suffix of the CALibration program mnemonic in the CALibration commands refers to a measurement channel, that is CALibration1 and CALibration2 represent SENSOR 1 and SENSOR 2 input channels, respectively. Note that CALibration2 commands will generate an error if used with a single channel Model 4531. Also note that although CALibration commands do not accept any arguments, all have a query form, which returns an error flag upon completion of the zero or calibration process. This allows the user to determine when the process has completed, and whether it was successful.

CALibration:{INTernal|EXTernal}:ZERO

- Description: Performs a sensor zero offset null adjustment of the selected sensor. This procedure should always be performed immediately before making any measurements within the lowest 10dB of a sensor's dynamic range.
- Syntax: CALibration[1|2]:{INTernal|EXTernal}:ZERO[?]
- Returns: 0 if successful, 1 otherwise (query form only)
- Valid Modes: Power sensors only. Peak sensors must be AUTOCALed before a zero can be performed.

CALibration:{INTernal|EXTernal}:FIXedcal

Description:	Performs a single point sensor gain calibration of the selected sensor with selected calibrator. This procedure calibrates the sensor's gain at a single point. At other levels, that gain setting is combined with stored linearity factors to compute the actual power.
Syntax:	CALibration[1 2]:{INTernal EXTernal}:FIXedcal[?]
Returns:	0 if successful, 1 otherwise (query form only)
Valid Modes:	CW sensors only. For peak sensors, use AUTOcal.

CALibration:{INTernal|EXTernal}:AUTOcal

Description:	Performs a multi-point sensor gain calibration of the selected sensor with selected calibrator. This procedure calibrates the sensor's linearity at a number of points across its entire dynamic range, and is the recommended method when maximum accuracy is required.
Syntax:	CALibration[1 2]:{INTernal EXTernal}:AUTOcal[?]
Returns:	0 if successful, 1 otherwise (query form only)
Valid Modes:	Power sensors only.

CALibration:USER:FREQcal

Description:	Performs a single-point sensor gain calibration of the selected sensor using an external (user-supplied) 0dBm power reference at the current operating frequency. This method can be combined with an AUTOCAL to yield the most accurate power readings at frequencies that are far from the calibration frequency. It temporarily replaces the calfactor computed from the sensor's factory-stored values with a measured value.
Syntax:	CALibration[1 2]:USER:FREQcal[?]
Returns:	0 if successful, 1 otherwise (query form only)
Valid Modes:	Power sensors only.

4.5.16 MEMory Subsystem - The MEMory group of commands is used to save and recall instrument operating configurations, and to edit and review user-supplied frequency dependent offset (FDOF) tables for external devices in the signal path. Up to four configurations may be saved, and two frequency dependent offset tables. Note, however that assigning a stored FDOF table to a particular measurement channel is not a MEMory command; it is handled through the SENSE subsystem.

MEMory:SYS:LOAD

Description:	Recall a stored instrument setup from location 1 thru 4.
Syntax:	MEMory:SYS{1 2 3 4}:LOAD
Argument:	None
Valid Modes:	Any

MEMory:SYS:STORe

Description: Saves the current instrument setup to internal memory location 1 thru 4.
Syntax: MEMory:SYS{1|2|3|4}:STORe
Argument: None
Valid Modes: Any

MEMory:FDOFset:DATA

Description: Set or read back the data array for frequency dependent offset table A or B. The array must be in comma delimited format, and should consist of up to 40 data pairs, each consisting of a frequency, followed by the offset for that frequency. Frequencies are in GHz, and may be any valid number within the operating range of the sensor. Offsets are in dB, and may range from -9.99 to +9.99dB. Querying an empty FDOF table will return "0.00,0.00".
Syntax: MEMory:FDOFset:{TBLA|TBLB}:DATA <asc>
Argument: Freq1, Ofst1, Freq2, Ofst2 ... FreqN, OfstN
Valid Modes: Power sensors only.

4.5.17 OUTPut Subsystem - The OUTPut group of commands is used to control the RF calibrator and recorder outputs of the power meter. For calibrators, either the internal 50MHz, or optional external 1GHz RF calibration source(s) may be specified. The internal calibrator is CW, and only ON/OFF status and output levels may be set. The external calibrator (Boonton Model 2530, see appendix) can operate in CW mode, and can also be configured as a programmable pulse source, with options for modulation rate and duty cycle. The 4530's rear-panel recorder output is completely programmable, and may be used as a DC voltage output, or configured to output a voltage proportional to the measured signal on either display channel with adjustable or automatic scaling.

OUTPut:{INTernal|EXTernal}:SIGNal

Description: Set or return the on/off state of the selected calibrator's output signal..
Syntax: OUTPut:{INTernal|EXTernal}:SIGNal <asc>
Argument: <asc> = OFF, ON
Valid Modes: Any. Model 2530 must be connected if EXTernal is selected.

OUTPut:{INTernal|EXTernal}:LEVel

Description: Set or return the power level for the selected calibrator's output signal.
Syntax: OUTPut:{INTernal|EXTernal}:LEVel <asc>
Argument: <asc> = -60.0 to +20.0 dBm (0.1dB resolution)
Valid Modes: Any. Model 2530 must be connected if EXTernal is selected.

OUTPut:EXtErnal:MODulation

Description: Set or return the output modulation state for the 2530 external calibrator. If set to CW, a calibrated CW signal will be generated. If set to PULSE, the output will be pulse modulated as specified by the OUTPut:EXtErnal:PULse:PERiod, :DCYC, and :SOURce settings.

Syntax: OUTPut:EXtErnal:MODulation <asc>

Argument: <asc> = CW, PULSE

Valid Modes: Any

OUTPut:EXtErnal:PULse:PERiod

Description: Set or return the pulse period for the 2530 external calibrator's internal pulse modulator.

Syntax: OUTPut:EXtErnal:PULse:PERiod <asc>

Argument: <asc> = 0.1, 1, 10 milliseconds

Valid Modes: Any

OUTPut:EXtErnal:PULse:DCYC

Description: Set or return the pulse duty cycle for the 2530 external calibrator's internal pulse modulator.

Syntax: OUTPut:EXtErnal:PULse:DCYC <asc>

Argument: <asc> = 10, 20, 30, 40, 50, 60, 70, 80, 90 %

Valid Modes: Any

OUTPut:EXtErnal:PULse:SOURce

Description: Set or return the pulse modulation source for the 2530 external calibrator. If set to INT, the internal pulse generator is used. EXT selects the signal from the calibrator's rear-panel "Ext Pulse" input. Note this input is 50 ohms, and requires TTL compatible signal levels.

Syntax: OUTPut:EXtErnal:PULse:SOURce <asc>

Argument: <asc> = INT, EXT

Valid Modes: Any

OUTPut:RECOOrder:SIGnal

Description: Set or return the on/off state of the instrument's rear-panel Recorder Output port.

Syntax: OUTPut:RECOOrder:SIGnal <asc>

Argument: <asc> = OFF, ON

Valid Modes: Any

OUTPut:RECOOrder:SOURce

Description: Set or return the source channel for the recorder output.

Syntax: OUTPut:RECOOrder:SOURce <asc>

Argument: <asc> = CH1, CH2

Valid Modes: Any

OUTPut:RECOOrder:MEAS

Description: Set or return the recorder output's measurement mode. If set to AUTO, the output level is automatically scaled to match the display, and generally will "downscale" every decade as power increases. In MANUAL mode, the output level is scaled using the minimum and maximum powers set with OUTPut:RECOOrder:MIN and :MAX as the downscale and fullscale values. This allows very wide range or very high resolution. Setting to ALARM will cause the recorder output to behave as a logic-level alarm status indicator, which will be 0V under normal conditions and 5V when an alarm condition exists.

Syntax: OUTPut:RECOOrder:MEAS <asc>

Argument: <asc> = AUTO, MANUAL, ALARM

Valid Modes: Any

OUTPut:RECOOrder:POLarity

Description: Set or return the recorder output polarity. UNIPOLAR selects 0.0 volts and 10.0 volts to as minimum and maximum output levels, and BIPOLAR selects -10.0 to +10.0 volts.

Syntax: OUTPut:RECOOrder:POLarity <asc>

Argument: <asc> = UNIPOLAR, BIPOLAR

Valid Modes: Any

OUTPut:RECOOrder:MIN

Description: Set or return the recorder output minimum, or downscale (-10.0V or 0.0V) power reference level. For voltage probes, this is the equivalent power at the current impedance setting.

Syntax: OUTPut:RECOOrder:MIN <n>

Argument: <n> = -100.00 to +100.00 dBm

Valid Modes: OUTPut:RECOOrder:MEAS must be set to MANUAL.

OUTPut:RECOOrder:MAX

Description: Set or return the recorder output maximum, or fullscale (+10.0V) power reference level. For voltage probes, this is the equivalent power at the current impedance setting.

Syntax: OUTPut:RECOOrder:MAX <n>

Argument: <n> = -100.00 to +100.00 dBm

Valid Modes: OUTPut:RECOOrder:MEAS must be set to MANUAL.

OUTPut:RECOOrder:FORCE

Description: Set or return the recorder output voltage directly. This is useful to generate a fixed, DC voltage level for controlling an external device in a test system. Issuing a FORCE command will temporarily override all other recorder output settings.

Syntax: OUTPut:RECOOrder:FORCE <n>

Argument: <n> = -10.0 to +10.0 volts

Valid Modes: Any

OUTPut:RECOOrder:FAST

Description: Set or return the state of the recorder “fast mode” setting. OFF is the instrument’s power-on default setting, and uses standard recorder output speed (about 50ms). Display and other functions including bus operation have priority over recorder output update. ON enables a special, high-speed recorder output mode. This mode gives priority to updating the recorder output, and should only be used where the absolute, fastest recorder output response is required. Latency will be under 10ms in Modulated Mode. Note that display update speed and bus response may be slowed.

Syntax: OUTPut:RECOOrder:FAST <asc>

Argument: <asc> = OFF, ON

Valid Modes: Any

OUTPut:RECOOrder:CALibration:SLOPe

Description: Adjusts the slope, or gain of the recorder output. This command is typically used with a recorder Zero Adj command to calibrate the recorder output for maximum absolute accuracy. The setting represents the deviation in percent from the factory default slope value, and may be adjusted in 0.01% increments, corresponding to 1mV at fullscale, although actual output resolution is 5mV. Changing the slope “pivots” the curve around the 0.0 volt setting, and will have maximum effect at -10.0 volts and +10.0 volts. *Note that this setting is not permanent unless “Save Cal” is used.*

Syntax: OUTPut:RECOOrder:CALibration:SLOPe <n>

Argument: <n> = -10.0 to +10.0 %

Valid Modes: Any

OUTPut:RECOOrder:CALibration:ZERO

Description: Adjusts the zero, or voltage offset of the recorder output. This command is typically used with a recorder Slope Adj command to calibrate the recorder output for maximum absolute accuracy. The setting increases or decreases the actual output voltage by a fixed amount, and may be adjusted in 1mV increments, although actual output resolution is 5mV. Changing the offset moves the entire curve up or down, and has equal effect at all output levels. *Note that this setting is not permanent unless “Save Cal” is used.*

Syntax: OUTPut:RECOOrder:CALibration:ZERO <n>

Argument: <n> = -1.000 to +1.000 V

Valid Modes: Any

OUTPut:RECOOrder:CALibration:SAVE

Description: Saves the recorder Zero and Slope adjustments to the instrument’s non-volatile calibration memory once they have been set. If this step is not performed, the settings will revert back to the previous settings next time instrument power is applied.

Syntax: OUTPut:RECOOrder:CALibration:SAVE

Argument: None

Valid Modes: Any

4.5.18 SYSTem Subsystem - The SYSTem group of commands is used to control system-level functions not directly related to instrument measurement performance. SYSTem commands are used to return error codes or messages from the power meter error queue, control hardware features (backlight and keybeep), set the command language, and configure communication parameters for the GPIB and serial interfaces.

SYSTem:VERSion

Description: Return the SCPI version compliance claimed.
Syntax: SYSTem:VERSion?
Returns: Version Code as <year.version> YYYY.V (will return 1990.0)
Valid Modes: Any

SYSTem:ERRor

Description: Returns the next queued error code number followed by a quoted ASCII text string describing the error. Note that errors are stored in a “first-in-first-out” queue, so if more than one error have occurred, repeating this command will report the errors in the sequence they happened. The action of reading the error will clear that error, so once the most recent error has been read, any more queries will report a code of zero, and “No Error”. See section 4.9 for a more detailed description of the error codes that may be returned.
Syntax: SYSTem:ERRor[:NEXT]?
Returns: <numeric error code>, “QUOTED ERROR DESCRIPTION”
Valid Modes: Any

SYSTem:LANGuage

Description: Set or return the remote interface “language”, SCPI (SCPI compliant), or BOON (native mode). The instrument always powers up in the SCPI state. Activating the BOON language extension will enable the 4530 Native Mode commands (see paragraph 4.5.5), while still supporting all SCPI commands. Native mode is useful for reporting high-speed measurements over the remote interface with a minimum overhead.
Syntax: SYSTem:LANGuage <asc>
Argument: <asc> = SCPI, BOON
Valid Modes: Any

SYSTem:BEEP

Description: Set or return the on/off state of the key beep: ON = audible, OFF = silent.
Syntax: SYSTem:BEEP <asc>
Argument: <asc> = ON, OFF
Valid Modes: Any

SYSTem:LIGHT

Description: Set or return the display backlight status. OFF = always off, ON = always on, ON_1 and ON_5 = on at any key press, off after 1 or 5 minutes of keyboard inactivity,
Syntax: SYSTem:LIGHT <asc>
Argument: <asc> = ON, OFF, ON_1, ON_5
Valid Modes: Any

SYSTem:COMMunicate:SERial:BAUD

Description: Set or return the serial port baud rate.
Syntax: SYSTem:COMMunicate:SERial:BAUD <n>
Argument: <n> = 1200, 2400, 4800, 9600, 19200, 38400
Valid Modes: Any

SYSTem:COMMunicate:SERial:BITS

Description: Set or return the number of serial port data bits.
Syntax: SYSTem:COMMunicate:SERial:BITS <n>
Argument: <n> = 7 or 8
Valid Modes: Any

SYSTem:COMMunicate:SERial:SBITs

Description: Set or return the number of serial port stop bits.
Syntax: SYSTem:COMMunicate:SERial:SBITs <n>
Argument: <n> = 1 or 2
Valid Modes: Any

SYSTem:COMMunicate:SERial:PARity

Description: Set or return the serial port parity status to NONE, ODD or EVEN.
Syntax: SYSTem:COMMunicate:SERial:PARity <asc>
Argument: <asc> = NONE, ODD, EVEN
Valid Modes: Any

SYSTem:COMMunicate:SERial:CONTRol:RTS

Description: Set or return the serial port handshake mode for the RTS line. ON = use as handshake line, OFF = always deassert. The DTR line is always asserted.
Syntax: SYSTem:COMMunicate:SERial:CONTRol:RTS <asc>
Argument: <asc> = OFF, ON
Valid Modes: Any

SYSTem:COMMunicate:GPIB:ADDRess

Description: Set or return the instrument's primary GPIB address. Use this command with caution, as GPIB communication could become locked up if proper addressing does not occur.

Syntax: SYSTem:COMMunicate:GPIB:ADDRess <n>

Argument: <n> = 0 to 30

Valid Modes: Any

SYSTem:COMMunicate:GPIB:LISTen

Description: Set or return the LISTENER line termination (EOS) character. This character is used to terminate any command the instrument receives over the GPIB. However, since the instrument always responds to an EOI command from the controller, it is not necessary for the user to transmit the EOS character unless the controller doesn't set EOI on the last command byte.

Syntax: SYSTem:COMMunicate:GPIB:LISTen <asc>

Argument: <asc> = CR, LF

Valid Modes: Any

SYSTem:COMMunicate:GPIB:TALK

Description: Set or return the TALKER line termination (EOS) character(s). This character(s) is sent by the instrument at the end of any response string it transmits. However, since it always asserts EOI on the last character of any string, it may not be necessary to use any EOS character if the controller recognizes the EOI. In this case, set the talk termination to NONE.

Syntax: SYSTem:COMMunicate:GPIB:TALK <asc>

Argument: <asc> = NONE, CR, LF, CRLF

Valid Modes: Any

4.5.19 STATUS Commands - The STATus command subsystem enables you to control the SCPI defined status reporting structures. The user may examine the status of the power meter by monitoring the Operation Status Register and Questionable Status Register. Note that IEEE-488.2 commands may be used to monitor device registers (See IEEE-488.2 Commands).

STATus:PRESet

Description: Sets device dependent SCPI registers to default states. The Operational Enable and Questionable Enable mask registers are both cleared so an SRQ will not be generated for these conditions, and the error queue is cleared.

Syntax: STATus:PRESet

Argument: None

Valid Modes: Any

STATus:OPERation:EVENT

Description: Return the SCPI Operation Status Event register, which contains the latched bits of the Operation Status register. If any of the bits in the status register have gone high, the corresponding bit in the event register will be set, indicating that the event of interest is present or has occurred. The event register bits are cleared after reading.

Syntax: STATus:OPERation:EVENT?

Returns: 16-bit register value (0 to 32767)

Valid Modes: Any

STATus:OPERation:CONDition

Description: Return the current value (condition) of the SCPI Operation Status register. The following table shows the bit assignments in the register:

Bit	Value	Definition	
0	1	Calibrating	1 = sensor calibration in progress.
1 - 4	--	Not used	always returns 0
5	32	Trigger Status	1 = waiting for a trigger signal.
6 - 12	--	Not used	always returns 0
13	8192	Instrument Summary	
14	16384	Program Running	1 = the instrument is executing a program.
15 - 16	--	Not used	always returns 0

Syntax: STATus:OPERation:CONDition?

Returns: 16-bit register value (0 to 32767)

Valid Modes: Any

STATus:OPERation:ENABLE

Description: Set or return the Operation Enable mask value. This value is used to enable particular bits for generating a service request (SRQ) over the GPIB when certain conditions exist in the Operation Status register. When a mask bit is set, and the corresponding STB bit goes true, an SRQ will be generated. No SRQ can be generated for that condition if the mask bit is clear. The bits in the Status Byte register are generally summary bits, which are the logical OR of the enabled bits from other registers.

Syntax: STATus:OPERation:ENABLE <n>

Argument: <n> = 0 to 32767

Valid Modes: Any

STATus:QUESTIONable:EVENT

Description: Return the SCPI Questionable Status Event register, which contains the latched bits of the Questionable Status register. If any of the bits in the status register have gone high, the corresponding bit in the event register will be set, indicating that the event of interest is present or has occurred. The event register bits are cleared after reading.

Syntax: STATus:QUESTIONable:EVENT?

Returns: 16-bit register value (0 to 32767)

Valid Modes: Any

STATus:QUESTionable:CONDition

Description: Return the current value (condition) of the SCPI Questionable Status register. The following table shows the bit assignments in the register:

Bit	Value	Definition	
0	1	Voltage	1 = an internal power supply voltage is out of spec.
1 - 2	–	Not used	always returns 0
3	8	Power	1 = there has been a power error.
4	16	Temperature	1 = a sensor has drifted by more than 4C from autocal.
5 - 7	–	Not used	always returns 0
8	256	Calibration	1 = sensor requires calibration and/or zeroing
9 - 12	–	Not used	always returns 0
13	8192	Instrument Summary	
14	16384	Command Warning	
15	–	Not used	always returns 0

Syntax: STATus:QUESTionable:CONDition?

Returns: 16-bit register value (0 to 32767)

Valid Modes: Any

STATus:QUESTionable:ENABLE

Description: Set or return the Questionable Enable mask value. This value is used to enable particular bits for generating a service request (SRQ) over the GPIB when certain conditions exist in the Questionable Status register. When a mask bit is set, and the corresponding STB bit goes true, an SRQ will be generated. No SRQ can be generated for that condition if the mask bit is clear. The bits in the Status Byte register are generally summary bits, which are the logical OR of the enabled bits from other registers.

Syntax: STATus:QUESTionable:ENABLE <n>

Argument: <n> = 0 to 32767

Valid Modes: Any

4.5.20 IEEE-488.2 Commands - The purpose of IEEE488.2 commands is to provide management and data communication instructions for the system by defining a set of “*” commands (an asterisk followed by a three character code). These commands allow device control and status monitoring, and are the basis for some of the commands of the SCPI STATus subsystem (see previous).

*CLS

Description: Clear Status command. This command resets the SCPI status registers (Questionable Status and Operation Status), the error queue, the IEEE488.2 Status Byte (STB) and Standard Event Status (ESR) registers, and the measurement.

Syntax: *CLS

Argument: None

Valid Modes: Any

***ESE**

Description: Set or return the Standard Event Status Enable Register. The mask value in this register is used to enable particular bits for generating a service request (SRQ) over the GPIB when certain conditions exist in the Event Status Register. When a mask bit is set, and the corresponding ESR bit goes true, an SRQ will be generated, provided the Event Status Summary bit (ESB, bit 5) is enabled in the SRE register. No SRQ can be generated for that condition if the mask bit is clear. See the *ESR command for bit assignments.

Syntax: *ESE <n>

Argument: <n> = 0 to 255

Valid Modes: Any

***ESR**

Description: Return the current value of the Standard Event Status Register, then clear the register. This register has bits assigned to a number of possible events or conditions of the instrument. The register value may be read using this command, or may be used to generate a service request (SRQ) over the GPIB when certain conditions exist. Individual bits may be enabled or disabled for SRQ generation using the ESE mask (see *ESE command). The following table shows the bit assignments in the Standard Event Status Register:

<u>Bit</u>	<u>Value</u>	<u>Definition</u>	
0	1	Operation Complete flag	1 = all current operations have completed execution.
1	2	Not used	always returns 0
2	4	Not used	always returns 0
3	8	Device Dependent Error	1 = the instrument encountered a device dependent error.
4	16	Execution Error	1 = the instrument encountered an execution error.
5	32	Command Error	1 = a remote interface command error exists.
6	64	Not used	always returns 0
7	128	PON	1 = the instrument power has been turned on.

Syntax: *ESR?

Returns: Current Value of Event Status Register (0 to 255)

Valid Modes: Any

***IDN**

Description: Return the instrument identification string. This string contains the manufacturer, model number, serial number and firmware version number.

Syntax: *IDN?

Returns: < Mfgr, Model#, Serial#, Version >

Valid Modes: Any

***OPC**

Description: Clear or read the OPC (Operation Complete) status flag. Issuing this command with no arguments clears the flag (resets it to zero), and the query form of the command returns the flag's current value. The flag is bit 0 (the LSB) of the Standard Event Status Register (ESR), and is set to one when all pending operations have completed. Using the OPC flag requires that it be immediately cleared before an operation is started. Once the flag has been cleared by sending *OPC, the next command should be issued. After this, the flag may be queried by *OPC? until a value of one is returned, indicating the command has completed. Note that the query is not a true query - a value of zero will never be returned. Rather, *OPC? will not return a result until the OPC flag has been set to one by the completion of the previous operation. This has the disadvantage that the GPIB will be "hung" while waiting for OPC to become true. Another way to handle this is to enable the OPC bit (bit 0) in the Standard Event Status Enable mask so an SRQ is generated when the operation completes.

Syntax: *OPC[?]

Returns: < Mfgr, Model#, Serial#, Version >

Valid Modes: Any

***RST**

Description: Perform a global reset of the instrument, which sets most registers and measurement parameters to default values.

Syntax: *RST

Argument: None

Valid Modes: Any

***SRE**

Description: Set or return the mask value in the Service Request Enable Register. This value is used to enable particular bits for generating a service request (SRQ) over the GPIB when certain conditions exist in the SStatus Byte register. When a mask bit in the SRE Register is set, and the corresponding STB register bit goes true, an SRQ will be generated. No SRQ can be generated for that condition if the mask bit is clear. The bits in the Status Byte register are generally summary bits, which are the logical OR of the enabled bits from other registers. See the *STB command for bit assignments.

Syntax: *SRE <n>

Argument: <n> = 0 to 255

Valid Modes: Any

***STB**

Description: Return the current value of the S**T**atus Byte register. This register has bits assigned to a number of possible events or conditions of the instrument. The register value may be read using this command, or may be used to generate a service request (SRQ) over the GPIB when certain conditions exist. Individual bits may be enabled or disabled for SRQ generation using the SRE mask (see *SRE command). Note that the bits in the S**T**atus Byte register are generally summary bits, which are the logical OR of the enabled bits from other registers. The following table shows the bit assignments in the S**T**atus Byte register:

<u>Bit</u>	<u>Value</u>	<u>Definition</u>	
0	1	Not used	
1	2	Not used	
2	4	Not used	
3	8	QUE S Tionable Status Summary	1 = an enabled QUE S Tionable condition is true.
4	16	Message A V ailable flag bit	1 = an output message is ready to transmit.
5	32	Event Status Summary	1 = an enabled Event Status condition is true.
6	64	SRQ Summary Status	1 = an enabled Service Re Q uest condition exist.
7	128	OPERation Status Summary	1 = an enabled OPERation condition is true.

Syntax: *STB?

Returns: Current Value of Status Byte register (0 to 255)

Valid Modes: Any

***TST**

Description: Self-test query. This command initiates a self-test of the instrument, and returns a result code when complete. The result is zero for no errors, or a signed, 16-bit number if any errors are detected.

Syntax: *WAI

Returns: Error Code

Valid Modes: Any

***WAI**

Description: Wait command. This command insures sequential, non-overlapped execution. Occasionally, the 4530 will execute commands in parallel for faster response. If a long-duration command is being processed, and a second command is issued, their execution may overlap. If the second command requires a setting that the first command was changing, or is invalid until the first command has executed, it is a good idea to issue a *WAI command to insure that the second command won't begin executing until the first one has completed. An example of this is a mode change such as CALCulate:MODE PULSE, followed by setting a pulse-mode-only parameter such as DISPlay:TSPAN. In this case, separate the two commands with a *WAI command to ensure that there will be no conflicts. Another option is to simply program a short delay (50mS) between such commands.

Syntax: *WAI

Argument: None

Valid Modes: Any

***TRG**

Description:	Trigger a measurement. This command is equivalent to receiving a GET command from the GPIB bus controller. If the trigger is armed (usually by an INITiate command) and trigger source is set to BUS, a new measurement will begin when *TRG is received.
Syntax:	*TRG
Argument:	None
Valid Modes:	Any

4.5.21 Remote Interface Command Summary - The following table is only a summary, and does not contain all command information necessary to program the remote interface. See previous the sections in this chapter for detailed command descriptions and usage syntax. SCPI commands are listed in alphabetical order, and native mode commands are at the end of the table.

Table 4-1 Remote Command Summary

*CLS	Clear status command to instrument
*ESE	set/return Event Status Enable mask
*ESR?	return value of Event Status Register
*IDN?	return instrument identification string
*OPC[?]	Set OPC flag false, or Return flag when it becomes true
*RST	Global Reset command.
*SRE	set/return value of Service Request Enable mask
*STB?	return status byte, except bit 6 (srq summary) always = 0
*TRG	Trigger a measurement; same action as GET
*TST?	Self test query. Return zero for no errors; signed 16-bit otherwise
*WAI	No-Op for sequential non-overlapped execution
ABORT	immediately set the measurement trigger system to idle
CALCulate[1 2]:DCYC	set/return pulse duty cycle, <n> = 0.01 to 100%
CALCulate[1 2]:MATH <asc>	set/return the calc math function, <asc> = [see command description]
CALCulate[1 2]:MODE <asc>	set/return measurement mode, <asc> = [see command description]
CALCulate[1 2]:LIMit:FAIL?	return alarm limit status flags
CALCulate[1 2]:LIMit:STATe <asc>	set/return upper and lower limit alarms, <asc> = ON, OFF
CALCulate[1 2]:LIMit:CLEar[:IMMediate]	action: reset channel alarm limit status flags
CALCulate[1 2]:LIMit:LOWer <n>	set/return the lower limit power level, <n> = -100.00 to +100.00 dBm
CALCulate[1 2]:LIMit:UPPer <n>	set/return the upper limit power level, <n> = -100.00 to +100.00 dBm
CALCulate[1 2]:PKHLD <asc>	set/return the state of the peak hold function, <asc> = OFF, AVG, INST
CALCulate[1 2]:RANGe <asc>	set/return meas range for CW & Voltage sensors, <asc>=AUTO, 0, 1, 2
CALCulate[1 2]:REFerence:STATe <asc>	set/return reference measurement mode, <asc> = ON, OFF
CALCulate[1 2]:REFerence:COLLect	action: load the sensor's current power reading as the reference level
CALCulate[1 2]:REFerence:DATA <n>	set/return power value of the reference level, <n> = nn.nn dBm
CALCulate[1 2]:STATe <asc>	set/return calc channel status, <asc> = ON, OFF
CALCulate[1 2]:UNITs <asc>	set/return measurement units, <asc> = [see command description]

Table 4-1 Remote Command Summary (Cont)

CALibration[1 2]:{INTernal EXTernal}:ZERO[?]	Performs sensor zero offset null adjustment, [return err flag]
CALibration[1 2]:{INTernal EXTernal}:FIXEDcal[?]	Performs single-point sensor gain calibration, [return err flag]
CALibration[1 2]:{INTernal EXTernal}:AUTOcal[?]	Performs multi-point sensor gain "step" calibration, [return err flag]
CALibration[1 2]:USER:FREQcal[?]	Performs single-point snsr gain cal with user ref signal, [return err flag]
DISPlay:%SPAN <n>	set/return statistical mode horizontal trace span in percent
DISPlay:%OFST <n>	set/return statistical mode horizontal trace offset in percent
DISPlay:TSPAN <n>	set/return horizontal time span <n> = [mode dependent]
DISPlay:DATA?	return 3200 chars+terminator which encode pixels of the display
DISPlay:TEXT[1 2]:BARgraph <asc>	set/return bargraph visibility, <asc> = OFF, ON
DISPlay:TEXT[1 2]:RESolution <n>	set/return main readout resolution in decimal places, <n> = 1, 2, 3
DISPlay:GRPH[1 2] <n>	action: select single channel graph display, <n>=1, 2, 3 is display page
DISPlay:GRPHB <n>	action: select dual channel graph display, <n>=1, 2, 3 is display page
DISPlay:TXT[1 2] <n>	action: select single channel text display, <n>=1, 2, 3 is display page
DISPlay:TXTB <n>	action: select dual channel text display, <n>=1, 2, 3 is display page
DISPlay:TRACe[1 2]:LOGSPAN <n>	set/return vertical span in dB
DISPlay:TRACe[1 2]:LINSpan <n>	set/return vertical span in Watts / Volts
DISPlay:TRACe[1 2]:PCTSPAN <n>	set/return vertical span in Percent
DISPlay:TRACe[1 2]:LOGCNTR <n>	set/return vertical center in dBm / dBr
DISPlay:TRACe[1 2]:LINCNTR <n>	set/return vertical center in Watts / Volts
DISPlay:TRACe[1 2]:PCTCNTR <n>	set/return vertical center in Percent.
FETCh[1 2]:CW:POWer?	return current average reading in power units
FETCh[1 2]:CW:VOLTagE?	return current average reading in voltage units
FETCh[1 2]:MARKer[1 2]:POWer?	return current reading at the specified marker
FETCh[1 2]:ARRay:MARKer:POWer?	return current readings at both markers
FETCh[1 2]:ARRay:MARKer:PERcent?	return current statistical percent at both markers
FETCh[1 2]:ARRay:CW:POWer?	return array of current power readings
FETCh[1 2]:ARRay:CW:VOLTagE?	return array of current voltage readings
FETCh[1 2]:ARRay:PULse:POWer?	return array of current marker measurements
FETCh[1 2]:ARRay:AMEASure:TIME?	return array of current automatic pulse timing measurements
FETCh[1 2]:ARRay:AMEASure:POWer?	return array of current automatic pulse power measurements
INITiate:CONTInuous <asc>	set/return state of mode which triggers meas cycles continuously
INITiate[:IMMediate[:ALL]]	set mode which starts a measurement cycle when trigger event occurs
MARKer:MODE <asc>	set/return global marker mode, <asc> = OFF, VERT, HORZ
MARKer:POSition[1 2]:POWer <n>	set/return marker power, <n> = -99.99 to +99.99 dBm
MARKer:POSition[1 2]:TIME <n>	set/return marker time relative to the trigger, <n> = (+/- SPAN/2+Tdly)
MARKer:POSition[1 2]:PERcent <n>	set/return marker statistical percent, (vertical marker) <n> = 0 to 100 %
MEASure[1 2]:POWer?	return average power measurement using default configuration
MEASure[1 2]:VOLTagE?	return average voltage measurement using default configuration

Table 4-1 Remote Command Summary (Cont)

MEMory:SYS[1 2 3 4]:LOAD	recall stored instrument setup from setup memory location 1 thru 4.
MEMory:SYS[1 2 3 4]:STORE	store instrument setup in setup memory location 1 thru 4.
MEMory:FDOFFset:TBLA:DATA <asc>	set/return data array for frequency-dependent offset table A
MEMory:FDOFFset:TBLB:DATA <asc>	set/return data array for frequency-dependent offset table B
OUTPut:{INTernal EXTernal}:SIGNal <asc>	set/return selected calibrator output state, <asc> = OFF, ON
OUTPut:{INTernal EXTernal}:LEVel <n>	set/return selected calibrator output level, <n> = -60.0 to +20.0 dBm
OUTPut:EXTernal:MODulation <asc>	set/return external calibrator modulation, <asc> = CW, PULSE
OUTPut:EXTernal:PULse:PERiod <asc>	set/return external calibrator pulse period, <asc> = .1, 1, 10 ms
OUTPut:EXTernal:PULse:DCYC <asc>	set/return external calibrator pulse duty cycle, <asc> = 10 to 90 %
OUTPut:EXTernal:PULse:SOURce <asc>	set/return external calibrator modulation source, <asc> = INT, EXT
OUTPut:RECOOrder:SIGNal <asc>	set/return Recorder Output state, <asc> = OFF, ON
OUTPut:RECOOrder:SOURce <asc>	set/return Recorder Output source, <asc> = CH1, CH2
OUTPut:RECOOrder:MEAS <asc>	set/return Recorder function, <asc> = AUTO, MANUAL, ALARM
OUTPut:RECOOrder:POLarity <asc>	set/return Recorder Output polarity, <asc> = UNIPOLAR, BIPOLAR
OUTPut:RECOOrder:MIN <n>	set/return Recorder Output dnscale level, <n> = -100.00 to +100.00 dBm
OUTPut:RECOOrder:MAX <n>	set/return Recorder Output fullscale level, <n> = -100.00 to +100.00 dBm
OUTPut:RECOOrder:FORCE <n>	set/return Recorder Output level directly, <n> = -10.0 to +10.0 volts
OUTPut:RECOOrder:CALibration:SLOPe <n>	set/return Recorder Output slope adjustment, <n> = -10.00 to +10.00%
OUTPut:RECOOrder:CALibration:ZERO <n>	set/return Recorder Output zero adjustment, <n> = -1.000 to +1.000 volts
OUTPut:RECOOrder:CALibration:SAVE	save Recorder Output adjustments to non-volatile calibration memory
READ[1 2]:CW:POWER?	perform measurement, return new average reading in power units
READ[1 2]:CW:VOLTagE?	perform measurement, return new average reading in voltage units
READ[1 2]:MARKer[1 2]:POWER?	perform measurement, return reading at the specified marker
READ[1 2]:ARRay:MARKer:POWER?	perform measurement, return readings at both markers
READ[1 2]:ARRay:MARKer:PERcent?	perform measurement, return statistical percent at both markers
READ[1 2]:ARRay:CW:POWER?	perform measurement, return array of power readings
READ[1 2]:ARRay:CW:VOLTagE?	perform measurement, return array of voltage readings
READ[1 2]:ARRay:PULse:POWER?	perform measurement, return array of marker measurements
READ[1 2]:ARRay:AMEAsure:TIME?	perform measurement, return array of automatic pulse timing measrmnts
READ[1 2]:ARRay:AMEAsure:POWER?	perform measurement, return array of automatic pulse pwr measrmnts
SENSe[1 2]:AVERage <n>	set/return trace averaging count, <n> = 1 to 4096
SENSe[1 2]:BANDwidth <asc>	set/return sensor video bandwidth, <asc> = LOW, HIGH
SENSe[1 2]:CORRection:OFFset <n>	set/return sensor offset value in dB, <n> = -100.00 to +100.00 dB
SENSe[1 2]:CORRection:FREQUency <n>	set/return sensor measurement frequency in GHz, <n> = 0.05 to 110.0
SENSe[1 2]:CORRection:CALFactor <n>	set/return sensor cal factor in dB, <n> = -3.00 to +3.00 dB
SENSe[1 2]:CORRection:FDOFFset <asc>	set/return current freq dependent offset table, <asc> = OFF, TBLA, TBLB
SENSe[1 2]:CORRection:TEMPComp <asc>	set/return peak sensor temperature compensation state, <asc> = OFF, ON
SENSe[1 2]:FILTer:STATe <asc>	set/return filter state, <asc> = OFF, ON, AUTO
SENSe[1 2]:FILTer:TIME <n>	set/return filter time, <n> = 0.01 to 9.99 seconds
SENSe[1 2]:IMPEDance <n>	set/return voltage probe sensor impedance for power calculations

Table 4-1 Remote Command Summary (Cont)

SENSe[1 2]:PULse:DIStal <n>	set/return pulse distal level in percent of top power, <n> = 0 to 100%
SENSe[1 2]:PULse:MEsIal <n>	set/return pulse mesial level in percent of top power, <n> = 0 to 100%
SENSe[1 2]:PULse:PROXimal <n>	set/return pulse proximal level in % of top power, <n> = 0 to 100%
SENSe[1 2]:PULse:UNITs <asc>	set/return power units used for DIST, MESI and PROX arguments
SENSe[1 2]:PULse:STARTGT <n>	set/return pulse gate start in % of pulse duration, <n> = 0 to 40%
SENSe[1 2]:PULse:ENDGT <n>	set/return pulse gate end in % of pulse duration, <n> = 60 to 100%
SENSe[1 2]:HIST:COUNT <n>	set/return the number of histogram bins to return, <n> = 0 to 4096
SENSe[1 2]:HIST:INDEX <n>	set/return index of first histogram bin to return, <n> = 0 to 4095
SENSe[1 2]:HIST:DATA?	return "count" bin values from the signal histogram, starting at "index"
SENSe[1 2]:CALTAB:COUNT <n>	set/return the number of cal table values to return, <n> = 0 to 4096
SENSe[1 2]:CALTAB:INDEX <n>	set/return index of first cal table value to return, <n> = 0 to 4095
SENSe[1 2]:CALTAB:DATA?	return "count" power values from the cal table, starting at "index".
SENSe[1 2]:MBUF:SIZE <n>	set/return the number readings needed to fill meas buffer, <n> = 0 to 4096
SENSe[1 2]:MBUF:RATE <n>	set/return meas buffer rate for Mod & CW, <n> = 1 to 1000 rdgs/sec
SENSe[1 2]:MBUF:POSition?	return current acquisition index position of measurement buffer
SENSe[1 2]:MBUF:COUNT <n>	set/return the number of meas buffer readings to return, <n> = 0 to 4096
SENSe[1 2]:MBUF:INDEX <n>	set/return index of first meas buffer reading to return, <n> = 0 to 4095
SENSe[1 2]:MBUF:DATA?	return "count" stored readings from the meas buffer, starting at "index"
SENSe[1 2]:SBUF:MODE <asc>	set/return status of user defined sample buffer, <asc> = ON, OFF
SENSe[1 2]:SBUF:PERiod <n>	set/return the A/D sampling period, <n> = 5 to 12,500
SENSe[1 2]:SBUF:PREsamp <n>	set/return the number of samples before the trigger, <n> = 0 to 12,000
SENSe[1 2]:SBUF:POSTsamp <n>	set/return the number of samples after the trigger, <n> = 0 to 12,000
SENSe[1 2]:SBUF:COUNT <n>	set/return the total number of samples to return, <n> = 1 to 12,000
SENSe[1 2]:SBUF:INDEX <n>	set/return the index of next data point relative to trigger position
SENSe[1 2]:SBUF:DATA?	return "count" power samples from captured buffer starting at "index".
SENSe[1 2]:TEMPerature?	return sensor internal temperature in degrees Celsius
SENSe[1 2]:CALTemp?	return sensor calibration temperature in degrees Celsius
STATus:PRESet	set device dependent SCPI and device status registers
STATus:OPERation:EVENT?	return value of Operation Status Register
STATus:OPERation:CONDition?	return value of Operation Condition Register (unlatched)
STATus:OPERation:ENABLE <n>	set/return value of Operation Enable Mask, <n> = 0 to 32767
STATus:QUEStionable:EVENT?	return value of Questionable Status Register
STATus:QUEStionable:CONDition?	return value of Questionable Condition Register (unlatched)
STATus:QUEStionable:ENABLE <n>	set/return value of Questionable Enable Mask, <n> = 0 to 32767
SYSTem:BEEP <asc>	set/return keypad audible beeper status, <asc> = ON, OFF
SYSTem:ERRor[:NEXT]?	return next queued error code number and description
SYSTem:COMMunicate:SERial:BAUD <n>	set/return serial port baud rate, <n> = 1200 to 38400 baud
SYSTem:COMMunicate:SERial:BITS <n>	set/return number of serial port data bits, <n> = 7 or 8
SYSTem:COMMunicate:SERial:SBITs <n>	set/return number of serial port stop bits, <n> = 1 or 2
SYSTem:COMMunicate:SERial:PARity <asc>	set/return state of serial port parity bit, <asc> = NONE, ODD, EVEN
SYSTem:COMMunicate:SERial:CONTRol:RTS <asc>	set/return serial RTS handshake mode: OFF, ON

Table 4-1 Remote Command Summary (Cont)

SYSTem:COMMunicate:GPIB:ADDRess <n>	set/return instrument's own GPIB primary address, <n> = 0 to 30
SYSTem:COMMunicate:GPIB:LISTen <asc>	set/return LISTENER line termination, <asc> = CR, LF
SYSTem:COMMunicate:GPIB:TALK <asc>	set/return TALKER line termination, <asc> = NONE, CR, LF, CRLF
SYSTem:LANGUage <asc>	set/return language selection, <asc> = SCPI, BOON
SYSTem:LIGHT <asc>	set/return display backlight status, <asc> = ON, OFF, ON_1, ON_5
SYSTem:VERSion?	return SCPI version compliance if claimed, YYYY.V as 1990.0
TRACe[1 2]:COUNT <n>	set/return the total number of trace pwr points to return, <n> = 0 to 126
TRACe[1 2]:INDEX <n>	set/return the index of the next trace power point, <n> = 0 to 125
TRACe[1 2]:DATA?	return "count" trace power points in current units starting at "index".
TRIGger:CDF:COUNT <n>	set/return the statistical mode terminal count, <n> = 1 to 4000 million
TRIGger:CDF:DEClmate <asc>	set/return decimation action when reaching term cnt, <asc> = ON, OFF
TRIGger:DElay <n>	set/return trigger delay with respect to the trigger
TRIGger:HOLDoff <n>	set/return trigger holdoff, <n> = 0 to 0.999999 seconds
TRIGger:LEvel <n>	set/return trigger level <n> = -40 to 20dBm
TRIGger:MODE <asc>	set/return trigger mode, <asc> = PKTOPK, AUTO, NORM
TRIGger:POSition <asc>	set/return trigger position on display, <asc> = LEFT, MIDDLE, RIGHT
TRIGger:SLOPe <asc>	set/return trigger slope, <asc> = NEGative, POSitive
TRIGger:SOURce <asc>	set/return trigger source, <asc> = [see command description]
CH1	Native: Set Ch 1 to be the active channel for chan-depend talkmodes
CH2	Native: Set Ch 2 to be the active channel for chanl-depend talkmodes
TALKMODE?	Native: return active channel and current talkmode mnemonic
TKERR	Native: return next queued error code number, 0 = no error
TKERRMSG	Native: return next queued error code number and description
TKSDATA	Native: return sensor data page from sensor's eeprom
TKSSLOW	Native: return slow freq calfactor table page from sensor EEPROM
TKSFAST	Native: return fast freq calfactor table page from sensor EEPROM
TKSCWRG	Native: return CW linearity factor table from sensor EEPROM
TKSMMSG	Native: return message page from sensor EEPROM
TKAVG	Native talkmode: return current average reading for active channel
TKPWR	Native talkmode: return current power array for active channel
TKBOTH	Native talkmode: return current average reading for both channels
TKMK1	Native talkmode: return current reading at Marker1 for active channel
TKMK2	Native talkmode: return current reading at Marker2 for active channel
TKPLSPWR	Native talkmode: return current automatic pulse pwr meas for act chan
TKPLSTIM	Native talkmode: return current automatic pls timing meas for act chan
TKMKMEAS	Native talkmode: return current marker measurements for act chan
TKSMEAS	Native talkmode: return array of statistical meas for active channel

4.6 REMOTE SENSOR CALIBRATION

4.6.1 AutoCal (Peak or CW Sensors) - When maximum accuracy is required, an automatic sensor calibration (AutoCal) should be used. This steps the sensor through a series of calibrated power levels and builds the sensor's linearity calibration table for its entire dynamic range. AutoCal is performed using the internal 50 MHz step calibrator or the optional external 1 GHz step calibrator. The calibration process requires up to 2 minutes to accomplish with CW and wider dynamic range peak sensors. The simplest way to accomplish this is to program a delay of approximately 2 minutes before reading the result flag from the 4530.

CAL2:INT:AUTOCAL?	Calibrate the sensor connected to the SENSOR 2 input using the internal 50 MHz step calibrator and return a "0" if the calibration has completed success fully or a "1" if it has not.
{ WAIT 2 MINUTES }	Allow sufficient time for the longest anticipated calibration.
{ READ flag }	Read the result flag and proceed accordingly.

This method is simple but has a disadvantage. You must anticipate the time required. An incorrect estimate will waste time or cause an error. A better but more complicated method makes use of the service request capability of the GPIB:

*CLS	Clear all status registers.
*ESE 1	Enable the operation complete flag in the Event Status Register.
*SRE 32	Enable the Event Status Register to initiate a request for service by setting the SRQ line of the GPIB true.
CAL2:INT:AUTOCAL?; *OPC	Calibrate the peak sensor connected to the SENSOR 2 input using the internal 50 MHz step calibrator and return a "0" if the calibration has completed successfully or a "1" if it has not. Begin an operation complete sequence.
{ WAIT FOR SRQ }	Wait for an SRQ from the power meter over the GPIB bus.
{ SPOLL status byte }	Perform Serial Poll sequence to read the instrument's status byte and clear the SRQ condition.
{ READ flag }	Read the result flag and proceed accordingly.

If other STB or ESR bits are enabled, or if other instruments on the bus are able to set an SRQ, it may be necessary to further examine the source of the SRQ to be certain that the completion of the calibration procedure is the cause.

4.6.2 Zero and FixedCal (CW Sensors only) - Where maximum accuracy is not necessary, most CW sensors can be quickly calibrated by zeroing the sensor followed by a single-point FixedCal. Calibration and zeroing is accomplished using the internal 50 MHz step calibrator or the optional external 1 GHz step calibrator. The zeroing process requires up to 2 minutes to accomplish and the calibration process takes a few seconds. The simplest way to accomplish this is to program a delay reading the result flag from the 4530.

CAL1:INT:ZERO?	Zero the CW sensor connected to the SENSOR 1 input using the internal 50 MHz step calibrator and return a "0" if zeroing has completed successfully or a "1" if it has not.
{ WAIT 2 MINUTES }	Allow sufficient time for the longest anticipated calibration.
{ READ flag }	Read the result flag and proceed accordingly.
CAL1:INT:FIXED?	Calibrate the CW sensor connected to the SENSOR 1 input at a fixed level using the internal 50 MHz step calibrator and return a "0" if the calibration has completed successfully or a "1" if it has not.
{ WAIT 5 SECONDS }	Allow sufficient time for the longest anticipated calibration.
{ READ flag }	Read the result flag and proceed accordingly.

This method is simple but has a disadvantage. You must anticipate the time required. An incorrect estimate will waste time or cause an error. A better but more complicated method makes use of the service request capability of the GPIB. Apply the alternate method shown in paragraph 4.6.1 for the ZERO and FIXEDCAL functions.

4.7 NATIVE MODE PROGRAMMING.

The native mode is invoked with:

SYSTem:LANGUage BOON

The native mode retains almost all of the SCPI functions, but allows for current readings to be returned by simply addressing the instrument to TALK. The format of the returned data is pre-determined by setting an active channel and a Talk Mode. This simplified procedure overcomes some of the latency involved in GPIB bus operations, but is entirely instrument specific. All GPIB command strings are case insensitive.

Talkmodes

A talkmode is a preprogrammed response format, where the user instructs the instrument to return measurement data in a particular format every time it is addressed to talk. The only exception is when an overriding query command (anything containing a "?") is issued, in which case the response immediately following that query will contain the queried parameter. This query is active for only one "talk address" cycle, and following this, the response format will revert to the programmed talkmode for any further talk addressing. Queries such as this are sometimes referred to as "temporary talkmodes". Talkmodes are enabled only when the power meter is set to native mode by setting the language to BOON.

Native Commands

CH1 Set Channel 1 active for readings.
CH2 Set Channel 2 active for readings.

Set the active channel. When addressed to TALK, 4530 returns the current measurement string for whichever channel is set as "active". (Note that one command (TKBOTH), reports the readings on both channels without regard to the active channel setting.) The result string consists of one or more measurement values, each preceded by a condition code (cc) flag, with all flags and readings separated by commas. The code values and interpretations are:

-1 Measurement is STOPPED. Value returned may be "stale data".
0 Error return. Measurement is not valid.
1 Normal return - no error. Measurement is valid.
2 An Over-range or Under-range condition exists.

Typical Measurement Responses

The return string when the talkmode is set to TKAVG will be in the form of:

<cc, Average Power> (cc is one of the condition codes shown above)

sample return string:

1, 12.135 Since the condition code is 1, the returned measurement value is valid.

When the talkmode is set to TKPWR, the return string will be in the form of:

<cc, Average Power, cc, Maximum Power, cc, Minimum Power>

sample return string:

1, 0.051, 1, 10.105, 2, -99.99 Avg and Max are valid (cc=1), but Min Pwr is underrange (cc=2)

4.8 SCPI EXAMPLE PROGRAM FRAGMENTS.

4.8.1 Pulse Mode Example - Signal in: 100 microsecond wide periodic pulse waveform, modulating a 1 GHz carrier. Peak sensor in use, trigger level is valid and results in synchronized trace when viewed in GRAPH mode.

NOTE

When the trigger source is set to Bus or to Bus in combination with a signal source, the READ command cannot be used. If it is, a trigger deadlock error code is generated. READ is a macro command which is equivalent to the sequence ABORT;INITiate;FETCh[:<function>]?

a. Using the GPIB bus trigger to initiate a single measurement:

CALC1:MODE pulse	Set for pulse measurement mode
TRIG:SOURce bus	Set trigger source for bus
ABORT	Measurements STOP and triggers go to idle.
INIT:CONT off	Set for single, triggered measurement
INIT:IMMEDIATE	STOP with blank graph and empty readings
{send GET}	One random trace appears in graph mode
FETCH1:MARKER1:POWER?	Returns reading.
{send GET}	No effect; measurement is complete.

b. Using the GPIB bus trigger to initiate successive measurements:

CALC1:MODE pulse	Set for pulse measurement mode
SENS1:AVER 1	Make each measurement display independent.. For > 1, successive triggered traces will be averaged.
TRIG:SOUR bus	Set trigger source for bus
ABORT	Measurements STOP and triggers go to idle.
INIT:CONT on	Continuous measurements subject to signal trigger conditions.
(INIT:IMMEDIATE)	CAN'T USE since INIT:CONT is ON -- Error condition!
{send GET}	One random trace appears in graph mode.
FETCH1:MARKER1:POWER?	Returns reading.
{send GET}	New measurement cycle for each trigger.

c. Use an internal signal trigger to initiate a single measurements:

CALC1:MODE pulse	Set for pulse measurement mode
TRIG:SOUR sensor1	Set trigger source for sensor1 input signal
ABORT	Measurements STOP and triggers go to idle.
INIT:CONT off	Set for single, triggered measurement
INIT:IMMEDIATE	Single measurement trace.
FETCH1:MARKER1:POWER?	Returns reading. Repeat INIT:IMMEDIATE for each additional measurement cycle.

d. Use an internal signal trigger to initiate successive measurements.

CALC1:MODE pulse	Set for pulse measurement mode
TRIG:SOUR sensor1	Set trigger source for sensor1 input signal
ABORT	Measurements STOP and triggers go to idle.
INIT:CONT on	Continuous measurements subject to signal trigger conditions.
(INIT:IMMEDIATE)	Error if used.
FETCH1:MARKER1:POWER?	Returns reading.

e. Use a bus trigger to enable a single internal signal triggered measurement:

CALC1:MODE pulse	Set for pulse measurement mode
TRIG:SOUR bus>snsr1	Set to arm trigger via bus command, and trigger from sensor1 input signal.
ABORT	Measurements STOP and triggers go to idle.
INIT:CONT off	Set for single, triggered measurement
INIT:IMMEDIATE	Stop with blank graph and empty readings.
{send GET}	Enables signal trigger to make one measurement if signal trigger condition is met.
FETCH1:MARKER1:POWER?	Returns reading.

Repeat from INIT:IMMEDIATE for each additional measurement cycle.

f. Use a bus trigger to enable successive internal signal triggered measurements:

CALC1:MODE pulse	Set for pulse measurement mode
TRIG:SOUR bus>snsr1	Set to arm trigger via bus command, and trigger from sensor1 input signal.
ABORT	Measurements STOP and triggers go to idle.
INIT:CONT on	Stop with blank graph and empty readings until .GET.
(INIT:IMMEDIATE)	CAN'T USE since INIT:CONT is ON -- Error condition!
{send GET}	Enables signal trigger to make continuous measurements if signal trigger condition of level and slope is met.
FETCH1:MARKER1:POWER?	Returns reading.

Once GET starts the process, signal triggered measurements continue as long as signal trigger conditions are met and the ABORT command has not been sent.

4.8.2 Modulated Mode Example - Signal in: 100 microsecond wide periodic pulse waveform, modulating a 1 GHz carrier. Peak sensor in use.

NOTE

When the trigger source is set to Bus or to Bus in combination with a signal source, the READ command cannot be used. If it is, a trigger deadlock error code is generated. READ is a macro command which is equivalent to the sequence ABORT;INITiate;FETCh[:<function>]?

a. Using the GPIB bus trigger to initiate a single averaged measurement:

CALC1:MODE modulated	Set for modulated measurement mode
TRIG:SOURce bus	Set trigger source for bus
ABORT	Measurements STOP and triggers go to idle.
INIT:CONT off	Set for single, triggered measurement
INIT:IMMEDIATE	STOP with blank graph and empty readings
{send GET} or *TRG	One random trace appears in graph mode
FETCH1:MARKER1:POWER?	Returns reading.
{send GET}	No effect; measurement is complete

b. To make successive measurements of average power in the Modulated mode, set TRIG:SOURce to IMMEDIATE and INIT:CONT on. Then use the FETCH command as above to get readings. The bus trigger is not needed and will be ignored if sent.

4.8.3 CW Mode Example - Signal in: 0dBm, 50MHz CW signal from internal calibrator. CW sensor in use.

NOTE

When the trigger source is set to Bus or to Bus in combination with a signal source, the READ command cannot be used. If it is, a trigger deadlock error code is generated. READ is a macro command which is equivalent to the sequence ABORT;INITiate;FETCh[:<function>]?

a. Using the GPIB bus trigger to make single complete measurements.

CALC1:MODE cw	Set for CW measurement mode
TRIG:SOUR bus	Set trigger source for bus
ABORT	Measurements STOP and triggers go to idle.
INIT:CONT off	Set for single, triggered measurement
while { more = 1 }	Loop for a series of complete measurements.
INIT:IMMEDIATE	STOP with blank graph and empty readings
{send GET} or *TRG	One random trace appears in graph mode
FETCH1:MARKER1:POWER?	Returns reading. Sending GET again has no effect; the measurement is complete.
{ end while }	

b. Making successive measurements.

CALC1:MODE cw	Set for CW measurement mode
TRIG:SOUR bus	Set trigger source for bus
ABORT	Measurements STOP and triggers go to idle.
{send GET} or *TRG	One random trace appears in graph mode
FETCH1:MARKER1:POWER?	Returns reading. Sending GET again has no effect; the measurement is complete.

(The bus trigger serves no purpose unless an ABORT command is issued to reset the trigger system and stop the measurement. Otherwise, just set TRIGger:SOURce immediate and use FETCH to input readings on demand.)

4.8.4 Statistical Mode Example - (CDF, CCDF, DISTRIBUTION) - Signal in: CDMA signal at 0dBm average power, at a 900MHz center frequency.

a. Start a CCDF measurement.

CALC1:MODE CCDF	Set CCDF display mode.
TRIG:SOUR immediate	Set for “immediate” start on trigger arming
ABORT	Reset the trigger system.
INIT:CONT off	Set for single, triggered measurement
INIT:IMMEDIATE	Restart statistical processing.
FETCH1:MARKER1:POWER?	Return reading.

b. Using the bus trigger to start a CCDF measurement.

CALC1:MODE CCDF	Set CCDF display mode
TRIG:SOUR bus	Set trigger source for bus
ABORT	Reset trigger system.
INIT:CONT off	Set for single, triggered measurement
INIT:IMMEDIATE	Reset measurement.
{send GET or *TRG}	Start the measurement
FETCH1:MARKER1:POWER?	Read power

4.9 ERROR AND STATUS CODES.

The following table shows codes that will be returned in response to any command that is unrecognized, invalid, or not applicable in the current state. A list of these errors may be read in the sequence they occurred using the SCPI command `SYSTem:ERRor`. This command will report each error by code and a short, quoted text description. An error code of zero corresponds to “No Error”.

Table 4-2. Remote Interface Error Codes

E-101	User sent a command that included a sub-command field, where none was expected.
E-103	User sent a command that did not include a sub-command field, where one was expected.
E-108	User included arguments, however none were expected.
E-109	Argument expected, but not found.
E-121	Arguments were present, but wrong type (such as alpha-text present where only numerical data is expected).
E-200	Cannot select channel 2 on a single channel instrument.
E-213	Cannot set <code>INITiate:IMMEDIATE</code> (start a single measurement) while <code>INITiate:CONTinuous</code> is set to ON (free-run mode).
E-214	Cannot perform read command while trigger source is set to bus.
E-221	Attempting to set a parameter or talkmode while in the wrong measurement mode (such as setting a statistical talkmode while in peak-continuous mode, or setting the marker in percent while in peak-pulse mode, or using a Boonton language command in an SCPI-only mode).
E-222	Numeric argument out of range.
E-224	Text argument does not match a valid list entry.
E-230	Fetch command performed and no valid data available.

Table 4-3. Measurement Result Status Codes

-1	Measurement is STOPPED. Value returned may be “stale data”.
0	Error return. Measurement is not valid.
1	Normal return - no error. Measurement is valid.
2	An Over-range or Under-range condition exists.

MAKING MEASUREMENTS

5

5.1 SENSOR TYPES

The 4530 Series RF Power Meter can operate with any type of Boonton sensor to measure CW or modulated RF power or voltage over a wide range of operating frequencies. Refer to Appendix A for a description of the most popular sensors. Those sensors listed cover the great majority of applications used. For special requirements, contact Boonton Electronics for a complete listing of available sensors. There are four key types of sensors:

5.1.1 Thermal RF Power Sensors. Thermal sensors use the RF energy to produce a temperature rise in a thermal detector that produces a voltage output which is proportional to the applied RF power. Since the detector output is very linear with input power over its entire operating range, and the thermal time constant is longer than most signal fluctuations due to modulation, a thermal sensor may be used to accurately measure the average RF power of both CW and modulated signals. Even very narrow duty-factor pulse signals can be accurately measured, since the detector senses the long-term heating effect of the input signal. Thermal sensors are very linear, and generally offer up to 50dB of dynamic range. They can be optimized to measure as low as about one microwatt (-30dBm), but are sometimes combined with input pads (attenuators) to allow measurement of higher power levels.

Frequency and linearity correction factors for Boonton Thermal Power Sensors are stored in the sensor adapter, and power measurements can be taken immediately upon inserting the sensor. For best performance, zero the sensor before taking any low-level measurements. A single- or multi-point calibration can be performed, if desired, to enhance the absolute accuracy of the measurement. See the Sensor Connection and Calibration information in Chapter 3.

5.1.2 CW Dual-Diode RF Power Sensors. CW Diode sensors use high-frequency semiconductor diodes to detect the RF voltage developed across a terminating load resistor. Two diodes are used so both the positive and negative carrier cycles are detected; this makes the sensor relatively insensitive to even harmonic distortion. The diodes' output signals are filtered by smoothing capacitors, and the resulting DC output voltage is proportional to power at low signal levels and proportional to voltage at higher levels. To achieve high sensitivities, the load resistance driven by the diode's output is typically several megohms.

Below about -20dBm, the RF voltage is not high enough to cause the diodes to fully conduct in the forward direction. Instead, they behave as non-linear resistors, and produce a DC output that is closely proportional to the square of the applied RF voltage. This is referred to as the "square-law" region of the diode sensor. When operated in this region, the average DC output voltage will be proportional to average RF power, even if modulation is present. This means a CW sensor can be used to measure modulated signals, provided the instantaneous (peak) power remains within the square-law region of the diodes at all times.

Above about 0 dBm, the diodes go into forward conduction on each cycle of the carrier, and the peak RF voltage is held by the smoothing capacitors. In this region, the sensor is behaving as a peak detector (also called an envelope detector), and the DC output voltage will be equal to the peak-to-peak RF input voltage minus two diode drops. If modulation is present, the output voltage will rapidly slew to the highest peaks, then slowly decay once the signal drops. Since the input signal could be at any amplitude during the time the capacitor voltage is decaying, it is impossible to deduce the actual average power level of a modulated signal once the peak RF power gets into this peak-detecting region of the diode.

CW Diode sensors can offer up to a 90dB dynamic range, and are extremely sensitive; some can measure signals as low as about 100pW (-70dBm). They are also available with built-in input attenuators for calibrated measurement of higher power signals.

Frequency and linearity correction factors for Boonton CW Power Sensors are stored in the sensor adapter, and power measurements can be taken immediately upon inserting the sensor. For best performance, zero the sensor before taking any low-level measurements. A single- or multi-point calibration can be performed if desired to enhance the absolute accuracy of the measurement. See the Sensor Connection and Calibration information in Chapter 3.

- 5.1.3 **RF Voltage Sensors.** In some cases, it is necessary to measure the RF voltage without terminating or significantly loading the source. For these applications, a voltage sensor (or voltage probe) is used. The voltage probe is very similar to a CW power sensor, but there is no load termination resistor, and the diodes simply detect the applied RF voltage. Since the voltage probe must have a reasonably high input impedance, it will appear as a short section of unterminated transmission line to an external source. This open circuit causes signal reflections that limit the upper frequency range of the voltage probe to no more than several GHz. The low frequency range can extend as low as 10Hz, depending on the model.

Voltage probes are designed to measure primarily CW voltage, but they can also be used to measure the true-RMS value of a fluctuating or modulated voltage, provided the peaks stay within the square-law region of the diodes' transfer curve. The threshold voltage is about 20mV RMS. Above 20mV RMS the curve is no longer a square-law function, and at about 200mV it has transitioned into the peak-detecting range.

Boonton RF Voltage Probes do not use frequency correction. Linearity correction factors are stored in the sensor adapter, and voltage measurements can be taken immediately upon inserting the sensor. For best performance, zero the sensor before taking any low-level measurements. This is the only calibration procedure applicable to voltage sensors; their gain is factory preset, and they cannot be user calibrated.

- 5.1.4 **Peak Power Sensors.** Although they can accurately measure CW power within the square-law region, CW diode sensors cannot track rapid power changes (amplitude modulation), and will yield erroneous readings if power peaks occur that are above the square-law region. By optimizing the sensor for response time (at the tradeoff of some low-level sensitivity), it is possible for the diode detector to track amplitude changes due to modulation. Peak sensors use a low-impedance load across the smoothing capacitors that discharges them very quickly when the RF amplitude drops. This, in combination with a very small smoothing capacitance, permits peak power sensors to achieve video bandwidths of several tens of megahertz, and risetimes in the ten nanosecond range.

It should be noted that the term *video bandwidth* implies the frequency range of the power envelope fluctuations, or the AM component of the modulation. If a signal has other modulation components (FM or phase modulation), the bandwidth of those modulating signals does not have any direct affect on the video bandwidth unless it causes additional AM modulation as an intermodulation product. A pure FM or phase modulated signal contains very little AM, and may be considered a CW signal for the purposes of power measurement. Power sensors are sensitive to only the *amplitude* of an RF signal, and not to its frequency or phase.

Although the output of the sensor tracks the signal envelope, the transfer function is nonlinear - it is proportional to RF voltage at higher levels, and proportional to the square of RF voltage at lower levels. By sampling the sensor output and performing linearity correction on each sample *before* any signal integration or averaging occurs, it is possible to calculate average and peak power of a modulated signal even if the input signal does not stay within the square-law region of the diode. Additionally, a large number of power samples can be analyzed to yield statistics about the signal's power distribution, as well as assembled into an oscilloscope-like power-vs-time trace.

Boonton peak power sensors employ proprietary signal processing circuitry to compress the dynamic range of the sensor before the signal is sampled. This compression is later removed digitally, but it permits the sensors to maintain very high modulation bandwidths over a wide dynamic range. Conventional peak power meters must set the gain (range) of the input channel to match the signal level being measured. This has several undesirable side-effects including a bandwidth reduction as the input gain is increased, and brief periods where measurements are invalid whenever the amplifiers must switch between gain ranges. Range-

less operation allows continuous measurement of signals without the loss of data that would be incurred whenever the signal crosses a power range threshold (typically every 10dB). The top and bottom of pulse transitions can be measured without worrying about artifacts introduced by input amplifier saturation, and a single-shot burst of samples can be acquired without the need to set the correct range in advance. And range switching makes statistical sample analysis impossible, since it causes signal-related “holes”, clipped intervals, or synchronization in the sampling. When this happens, the sample population can become somewhat or even strongly correlated with the signal rather than completely random. Statistical analysis requires a completely random sample population for the results to be valid.

5.2 SELECTING THE RIGHT SENSOR

5.2.1 **CW Signals.** The absolute or relative power of CW Signals may be accurately measured using any type of Boonton power sensor: CW Diode Sensors, CW Thermal Sensors, or Peak Power Sensors. The choice depends mainly upon the signal’s power range. If the signal is always unmodulated or if the power level never exceeds -20dBm, a CW diode sensor is the best choice due to its wide dynamic range. Although thermal sensors and peak power sensors will work fine for many CW applications, they offer no distinct advantages, and have somewhat less sensitivity for low-level signals.

5.2.2 **Modulated Signals.** For low-level modulated signals, a CW sensor is often the best choice. But whenever the peak power of a modulated signal exceeds about -20dBm, the average power reading from a CW diode sensor becomes unreliable due to its peak-detecting characteristics at higher power levels.

In these cases, a peak power sensor offers accurate average power measurements over the sensor’s entire dynamic range, plus the ability to fully characterize the time-domain or statistical power characteristics. Note, however, that peak sensors must possess sufficient video bandwidth to track any modulation-induced signal variations. If the signal modulation bandwidth is above the sensor bandwidth, the sensor cannot track the fastest signal changes, and the measurement accuracy is degraded.

In these cases, a thermal sensor may offer the best choice. The detector accurately integrates (averages) the effect of any modulation present over a period of several tens or hundreds of milliseconds, regardless of power level or frequency content. This type of sensor will measure the true, average power of any signal within its power and frequency range. The primary drawback is slow response time, and lack of sensitivity for low-level measurements.

5.3 MEASUREMENT MODES

The 4530 Series RF Power Meter can accept any type of Boonton power or voltage sensor, and each sensor type can operate in one or more measurement modes.

5.3.1 **CW Mode.** CW diode sensors, thermal sensors and voltage probes all operate in CW mode. CW mode uses a low-noise, high-resolution analog channel to process and digitize the sensor voltage. A wide dynamic-range sigma-delta A/D converter allows elimination of the ranging that plagues conventional power meters. Range changing causes the hardware to switch to different gain settings for different signal levels. Each time this is done, there is an interruption in the measurement process, and an additional settling time for the amplifiers to stabilize at the gain setting. Additionally, it is difficult to get the gain settings to “splice together” smoothly so that a signal measured at the top of one range is exactly equal to that same signal measured at the bottom of the next range. This results in linearity errors, or steps in the reading as the power level changes. Eliminating ranging allows the full dynamic range of a thermal sensor or the entire square-law region of a diode sensor may be measured without the need for changing ranges. To optimize performance and measurement speed at higher levels, the instrument switches to a higher-speed low-gain setting for the upper region of diode sensors.

CW mode measures the average power of CW signals (and modulated signals if using a thermal sensor or diode sensor within the square-law region), and displays a high-resolution measurement. The power is automatically corrected for sensor frequency response, and filtered using user-selectable parameters, then displayed on the front panel readout. The display format, scaling, units (both linear and logarithmic) and resolution are programmable. Two auxiliary measurements can be shown: the minimum and maximum held power (after filtering).

The measurement may also be presented in a graphical format showing power (or voltage) versus time. The display can span from one second to one hour, and in the slower time settings, it goes into roll mode, which presents a chart-recorder type scrolling trace. This can be very useful for observing a drifting signal.

The primary display may be the actual sensor signal amplitude, offset amplitude, or a mathematical function (ratio, sum or difference) of the sensor signal and the signal from a second sensor or stored reference.

5.3.2 Modulated Mode. Modulated mode operates only with peak power sensors. In this mode, the instrument measures the average, instantaneous peak and instantaneous minimum power of a modulated RF signal. One or more of these measurements can be displayed on the screen in a text or graphical format.

The processed sensor signal is continuously sampled and digitized by a high-speed A/D converter. Each A/D sample is linearized to convert to a power reading, then adjusted for gain offset and sensor frequency factor. The running average of these readings is calculated to yield the average modulated power. Additionally, each sample is checked for a new instantaneous minimum or peak. Every time a new peak occurs, it replaces the previous value. These values may be held to show the highest and lowest instantaneous power that has occurred since measurement started, or may be automatically decayed after a preset time interval so the current peak-to-average power may be viewed. This is especially convenient if the overall signal level is changing. Held minimum and maximum average (filtered) power may also be displayed.

In most ways, Modulated Mode is similar to CW mode. The display can show the sensor signal level or a math function, and displays a power-versus-time trace in graph mode, and text mode allows a full choice of display formats. The primary difference is that the minimum and maximum power measurements include the lowest and highest *instantaneous* readings, while in CW mode, only the lowest and highest *filtered* readings may be displayed.

5.3.3 Statistical Mode. Statistical Mode operates only with peak power sensors, and is used to provide a statistical analysis of the distribution of power over a period of time. By acquiring a very large number of power samples, it is possible to determine, with a high degree of confidence, the statistical probability that the power will fall within a specific range. This technique is very helpful for digitally modulated signals for observing amplifier linearity with real signals, and predicting compression and bit error rate.

The processed sensor signal is continuously sampled and digitized by the high-speed A/D, and the number of times each A/D code occurs is counted. In this fashion, a high-resolution histogram is formed which can be processed to yield a CDF (cumulative distribution function), CCDF (the complement to the CDF, also known as 1-CDF) or a conventional bar-type histogram with each bar showing the probability that the power will fall within a certain range.

These functions can be displayed in graphical format, and screen cursors can be moved to specific probabilities or power levels on the curve, and the corresponding value read at that point. The text display can show the cumulative average power, or a tabular display that adds a number of other measurements including the highest and lowest power points during the entire interval. Note that in graph mode, the displayed trace is power versus percent probability, while all the other 4530 measurement modes show power versus time. If the instrument is in mixed mode (one channel is in Statistical Mode, and the other is in Modulated Mode or CW Mode), two completely separate unit systems are presented on the X-axis of the graph display.

Although the sample rate in statistical mode is high enough to gather a large sample population in a very short time (over one million power samples are recorded each second), the strength of this mode is that it can be allowed to run for a long period of time to capture very infrequent events. The sample counters are 32 bits, so the runtime for a single CDF can be programmed to be more than an hour. For continuous running processes, the CDF can be programmed to automatically restart or to decimate the sample counters when a programmed count is reached.

Although statistical mode can display the average, minimum and peak power, it is important to note that these are all *cumulative* results that take into account the entire sample history since the run was started. If the power level or other signal characteristic is changed, the run should be cleared and restarted by pressing **ESC/Stop** twice (once to stop, again to clear), then pressing **Enter/Run** to start acquiring a fresh data set.

5.3.4 **Pulse Mode.** For periodic or pulsed signals, it is often necessary to analyze the power for a portion of the waveform, or a certain region of a pulse or pulse burst. For these applications, the 4530 Series has a triggered Pulse Mode. Operation in this mode is similar to a digital storage oscilloscope - power samples are stored in a circular memory buffer until a trigger signal is received. The samples, with the desired relationship to the trigger signal, are then selected and processed to obtain a power-versus-time trace.

The trigger signal can be either internal, triggered from a rising or falling edge on the measured signal; or external, triggered from a rear-panel BNC input. The trigger level and polarity are both programmable, as is the trigger delay time and trigger holdoff time. Displays of both pre- and post-trigger data are available, and an auto-trigger mode can be used to keep the trace running when no trigger edges are detected. A “peak-to-peak” trigger level setting can be chosen to automatically set the trigger level based on the currently applied signal. The time span of the graph display can be selected from 2.5 microseconds to 5 seconds. This would be equivalent to the 250nS/div to 500ms/div timebase settings on an oscilloscope, since a typical scope screen has 10 horizontal divisions. The 4530 has no visible graticule, however, so horizontal sensitivity is set as the *timespan*, which is the time interval spanned by the visible trace window.

Programmable time markers can be moved to any portion of the trace that is visible on the screen, and these can be used to mark regions of interest for detailed power analysis. The instrument can display power at each marker, as well as average, minimum and maximum power in the region between the two markers. This is very useful for examining the power during a TDMA or GSM burst when only the modulated portion in the center region of a timeslot is of interest. By adjusting trigger delay and other parameters, it is possible to measure the power of specific timeslots within the burst. Trigger holdoff allows burst synchronization even if there is more than one edge in the burst which may satisfy the trigger level. Simply set the holdoff time to slightly shorter than the burst’s repetition interval to guarantee that triggering occurs at the same point in the burst each sweep.

Pulse Mode is unlike the other operating modes of the 4530 in that it is discontinuous. For each sweep, data acquisition into the circular buffer is restarted, and it runs at high speed until a trigger edge has been detected and all post-trigger samples acquired. At this point, acquisition stops, and the buffer is processed and displayed before another trace is restarted. Because the 4530’s trigger system and peak sensor sampling system are common to both channels, it is not possible to run one channel in Pulse Mode while the other is in Statistical or Modulated mode. The burst and continuous sampling processes can not be operated simultaneously. No such limitations exist if the second channel is in CW mode, and it is perfectly acceptable to run one channel in Pulse Mode and the other in CW mode. Note, however, that in this case the CW sensor bandwidth is not nearly high enough to display signal amplitude changes at most timespan settings, and it is not possible to use a CW sensor as a trigger source.

For periodic waveforms, automatic measurement of waveform parameters is available in pulse mode. Whenever a stable, periodic signal is detected, the 4530 will automatically calculate a number of pulse parameters such as pulse frequency, width, duty-cycle, rise and fall times, top and bottom powers, pulse on power, overshoot, and average power over one full cycle. These measurements can be viewed on secondary pages of the single-channel text display. For added flexibility, certain time and power thresholds used to define start and end of pulse transitions are user-programmable.

5.4 SELECTING THE RIGHT MEASUREMENT MODE

Since the 4530 Series RF Power Meter can accept any type of Boonton power or voltage sensor, and each sensor type can operate in one or more measurement modes.

5.4.1 CW Mode. CW diode sensors, thermal sensors and voltage probes all operate in CW Mode, and CW Mode is only available for these types of sensors. As its name implies, CW Mode is intended primarily for CW (unmodulated) signals, but there are other cases in which you may wish to use it. CW Mode may be the best choice if your measurement meets any of the following conditions:

- Signal level is very low (below about -40dBm).
- Signal is a single, unmodulated RF carrier (CW).
- Need to measure average power only of *any signal* (modulated or CW) that falls within dynamic range of thermal sensor (-30 to +20dBm).
- Need to measure average power only of *any signal* (modulated or CW) that falls within the true-RMS (square-law) range of a diode sensor (-70 to -20dBm) at all times.
- Need to measure a spread-spectrum signal, or a composite signal that consists of multiple carriers or channels spanning a wide (20 MHz or higher) frequency range.

If you wish to measure a modulated signal, a peak sensor operating in Modulated Mode or Pulse Mode is often your best choice, provided the modulation bandwidth of the signal is within the sensor's bandwidth specification.

5.4.2 Modulated Mode. Modulated Mode is only available when using a peak power sensor, and is best choice for most continuously modulated signals as well as for many pulse modulated signals. Since Modulated Mode is a continuous measurement mode, it does not differentiate between the times that a pulsed or periodic signal is off, and the times it is on. If you wish to make measurements that are synchronous with a period waveform, consider Pulse Mode. Modulated Mode is best for the following types of measurements:

- Moderate signal level (above about -40dBm).
- Signal is continuously modulated with a modulation bandwidth that is less than about 20MHz.
- Signal modulation may be periodic, but only non-synchronous measurements are needed (overall average and peak power).
- "Noise-like" digitally modulated signals such as CDMA or COFDM when only average and peak power measurements are needed. If peak probability information is required, consider Statistical Mode.

5.4.3 Pulse Mode. Pulse Mode is only available when using a peak power sensor, and is best choice for most pulse modulated and periodic signals. Pulse mode requires a repeating signal edge that can be used as a trigger, or an external trigger pulse that is synchronized with the modulation cycle. Pulse mode performs measurements that are *synchronous* with the trigger - that is the measurements are timed or "gated" so that the same portion of the waveform is measured on each successive modulation cycle. Multiple modulation cycles may be averaged together, and measurement intervals may span both before and after the trigger. Pulse Mode is best for the following types of measurements:

- Moderate signal level (above about -40dBm except when modulation is "off").
- Signal is periodic.
- A time snapshot of a single event is needed (minimum single-shot time is 50 microseconds).
- Typical modulation and signal types: NADC, GSM (and extensions), TDMA, RADAR, SatCom, TCAS, Bluetooth, iDEN, NTSC, Wireless LAN.

5.4.4 **Statistical Mode.** Statistical Mode is only available when using a peak power sensor, and is best choice for analyzing “noise-like” signals that are modulated in a random, nonperiodic fashion. Statistical mode yields information about the *probability of occurrence* of various power levels without regard for *when* those power levels occurred. Many digitally modulated spread-spectrum formats use a bandwidth coding techniques or many individual modulated carriers to distribute a source’s digital information over a wide bandwidth, and temporally spread the data for improved robustness against interference. When these techniques are used, it is difficult to predict when peak signal levels will occur. Analysis of millions of data points gathered during a sustained measurement of several seconds or more can yield the statistical probabilities of each signal level with a high degree of confidence. Statistical Mode is best of the following types of measurements:

- Moderate signal level (above about -40dBm except when modulation is “off”).
- “Noise-like” digitally modulated signals such as CDMA (and all its extensions) or COFDM when probability information is helpful in analyzing the signal.
- Any signal with random, infrequent peaks, when you need to know just *how infrequent* those peaks are.

5.5 SETTING MEASUREMENT PARAMETERS

Once a sensor and measurement mode have been chosen, it is often possible to begin making very basic measurements simply by using the power meter’s default menu settings. In most cases, however, better results are available by customizing the measurement parameters to match your specific signal. The following list gives some guidelines for how to best configure the 4530 for specific types of measurements, but remember that there is no substitute for understanding the characteristics of the signal that you are trying to measure. Most of these items are not required settings, and many are not applicable to all measurement modes, but consider setting each of these items when setting up the meter for any type of measurement.

5.5.1 **What You Need To Know.** To perform accurate measurements, the following is a minimum list of things you should know about the signal that you wish to measure.

Signal frequency - The center frequency of the carrier must be known to allow sensor frequency response compensation.

Modulation Bandwidth - If the signal is modulated, know the type of modulation and its bandwidth. Note that power sensors respond only to the the *amplitude modulation* component of the modulation, and constant envelope modulation types such as FM can be considered a CW carrier for power measurement purposes.

Modulation Timing - If the modulation is periodic, know the pulse repetition rate, frame rate, and any other relevant timing information. This is not important unless you intend to perform synchronous (triggered) measurements in Pulse Mode.

5.5.2 Channel Parameters Menu Settings

Frequency (Required setting for all modes) - Setting the frequency tells the power meter what frequency RF signal is being applied to the power sensor. This frequency is used to automatically apply a calibration factor to compensate for the sensor’s frequency response deviations.

Offset (Optional setting for all modes) - Inform the power meter of a global gain offset to scale the reading. Used to compensate for attenuators, couplers or amplifiers in the signal chain.

Filter (Optional setting for CW and Modulated mode) - Sets the signal integration filter to a user-defined value to reduce measurement noise. The normal setting is “Auto”, but setting a manual filter allows user control of the tradeoff between measurement noise and settling time.

Averaging (Optional setting for Pulse Mode) - Sets the trace averaging for reducing noise on the trace display, marker measurements, and automatic pulse measurements. The default setting is 4, but setting to 32 or higher can significantly reduce noise for low-level pulse waveforms.

Peak Hold (Optional setting for Modulated and Pulse modes) - Allows setting the peak-hold feature so instantaneous peaks are held indefinitely or automatically decayed, or the mode may be set so the highest and lowest *averaged* readings are held.

5.5.3 Trig/Time Menu Settings. These settings are only needed if you will be operating in Pulse Mode.

Time Span (Required setting for Pulse Mode) - The timespan setting is similar to the timebase setting on an oscilloscope. Setting the timespan tells the power meter how much of a periodic signal to acquire at a time. The timespan defines the displayed portion of the waveform in graph mode, and limits the interval over which measurements may be performed. For pulse signals, it is usually a good starting point to set the timespan to a little longer than the pulse repetition interval, or to a little longer than the pulse width. Once a stable waveform is visible on the screen, the timespan and trigger delay setting (see below) may be adjusted to show exactly the desired portion of the measured signal.

Trigger Delay (Required setting for Pulse Mode) - Setting the trigger delay tells the powermeter how much measurement time before and after the trigger is needed. Assuming Trigger Position is set to Middle (the default setting), a trigger delay value of 0 will split the measurement interval evenly between pretrigger and posttrigger. If the timespan is set to 50 microseconds, the measurement interval will begin 25 microseconds before the trigger edge, and will end 25 microseconds after the edge. If the trigger delay is then set to -15 microseconds, the measurement will be skewed in the pretrigger direction: it will begin 40 microseconds before the trigger, and end 10 microseconds after.

HoldOff (Optional setting for Pulse Mode) - Trigger holdoff is used to aid in synchronizing with a periodic burst waveform when the period is longer than the timespan setting, and multiple valid trigger edges may exist. Trigger holdoff will disable (hold off) triggering for a preset time interval after every valid trigger, and then re-arm the trigger after the holdoff time is up. This way, the instrument will trigger at the same point on the waveform each cycle. For example, when viewing a GSM base station signal, more than one time slot may be active, and the instrument could be triggered by the rising edge of the RF signal on any of the active timeslots. Setting the trigger delay to just a bit less than the frame rate of 4.62mS will guarantee that there will be no false triggers during other active timeslots.

Trigger Source (Required setting for Pulse Mode) - Set the trigger source to “Sensor 1” to trigger from the measured signal itself, or “Ext” to trigger from an external synchronization pulse. See Chapter 3 for other options.

Trigger Mode (Optional setting for Pulse Mode) - The default trigger mode is “Peak-to-Peak Auto”, which works fine for most applications, and will always generate a sweep. If signal edges are present, the powermeter will detect the signal amplitude and adjust the trigger level automatically. If no triggerable signal is found, the sweep will be triggered anyway after a short time period. Trigger mode may also be set to “Normal”, which requires a trigger level be set, and will only generate a sweep if a trigger occurs. “Auto” also uses the preset trigger level, but will still generate a sweep even if there are no trigger edges.

Trigger Level (Optional setting for Pulse Mode) - The trigger level must only be set if Trigger Mode is not set to “Peak-to-Peak”. The level should generally be set between 3 and 15dB below the maximum expected signal level, but sometimes it may be necessary to experiment for best results.

5.6 SETTINGS FOR SOME COMMON SIGNAL TYPES

The following list discusses some of the common telecommunication formats that are frequently measured. While this list should give enough setup information to read back the most used measurements, some of the advanced features of the 4530 Series can return other data as well. This information is not intended as a tutorial on each of the signal types, but rather a guide on how to get started.

5.6.1 Measuring GSM and EDGE. The GSM (Global System for Mobil Communications) signal is a Time Division Multiple Access (TDMA) multiplexing scheme that uses a repeating sequence of 8 time slots in a frame. The data frame duration is 4615 μ s, and each time slot is 577 μ s. Handsets transmit during one of the eight timeslots. Base stations transmit during all timeslots, but usually at different levels for each timeslot. The power envelope of the GMSK modulation is relatively flat during each timeslot, and it is generally desired to measure the average power during the “active” portion of the timeslot, or the middle 90%, or 520 μ s. The first and last 5% (28 μ s) is excluded from the average to allow for RF power ramping at the edges of the timeslot. This is accomplished by using Pulse Mode, and setting markers at the desired points in time.

EDGE is an extension of the GSM format (Enhanced Data for GSM Evolution) which uses 8PSK modulation during the burst. This modulation does not share the flat envelope of GSM’s GMSK, so there is a significant peak-to-average ratio, and the measurement of this is generally of interest. The setup shown below will return the peak-to-average ratio as well as average power during the burst.

Meas Mode:	Pulse
Frequency:	0.90 GHz (or whatever operating frequency is in use)
Averaging:	4 (use less for faster response time, more for better noise rejection)
TimeSpan:	1 ms (shows the full 577 μ s burst and both edges)
Trig Source:	Sensor 1 (triggers on RF signal)
Trig Slope:	Positive (trigger on leading edge of pulse)
Trig Mode:	Pk-To-Pk (automatically sets based on signal level)
Trig Position:	Left (position trigger point at left edge of screen)
Trig Delay:	-0.2 ms (moves leading edge of pulse 200 μ s to the right to center pulse in display)
Trig Holdoff:	4.500 ms (delay for almost a full frame, and arm trigger 100 μ s before next expected edge)
Marker Mode:	Vertical (set markers to measure power at time offsets)
Marker1 Pos:	30 μ s (set Marker 1 at beginning of timeslot’s “active interval”)
Marker2 Pos:	550 μ s (set Marker 2 at end of timeslot’s “active interval”)
Query Cmd:	FETCh1:ARRAy:PULse:POWer? (returns array including average pwr betwn markers)

Other measurements may include timing information such as burst rate, width, and transition times of the leading and trailing edges of the burst.

To measure GSM basestation signals reliably, it is necessary to either limit the basestation to transmitting during only one timeslot, or provide an external trigger pulse that is synchronized with the frame. Otherwise, it is difficult to guarantee that the power meter will synchronize with the desired portion of the frame (timeslot). The entire, 8-timeslot frame may be viewed by setting the timespan to 5ms, and power of each timeslot can be measured by moving marker positions to each timeslot.

5.6.2 Measuring NADC. The IS-136 NADC (North American Digital Cellular) signal is a Time Division Multiple Access (TDMA) multiplexing scheme that uses a repeating sequence of three time slots in a 20ms frame. The full frame length is actually six time slots (40ms), with two time slots active, but there is little difference between the two, and measuring either the first or second set should produce the same result. The data frame duration is 20ms, and each time slot is 6667 μ s. Handsets transmit during one of the three timeslots (or two of the six, depending how you view things). Base stations transmit during all timeslots, but usually at different levels for each timeslot. The power envelope of the DQPSK modulation varies during each timeslot, and it is generally desired to measure the average power and peak-to-average ratio during the “active” portion of the timeslot, or the middle 96%, or 6.4ms. The first and last 2% (100 μ s) is excluded from the average to allow for RF power ramping at the edges of the timeslot. This is accomplished by using Pulse Mode, and setting markers at the desired points in time.

Meas Mode: Pulse
Frequency: 850 MHz (or whatever operating frequency is in use)
Averaging: 4 (use less for faster response time, more for better noise rejection)
TimeSpan: 10 ms (shows the full 6.67ms burst and both edges)
Trig Source: Sensor 1 (triggers on RF signal)
Trig Slope: Positive (trigger on leading edge of pulse)
Trig Mode: Pk-To-Pk (automatically sets based on signal level)
Trig Position: Left (position trigger point at left edge of screen)
Trig Delay: -2.0 ms (moves leading edge of pulse 2ms to the right to center pulse in display)
Trig Holdoff: 19.000 ms (delay for almost a full frame, and arm trigger 1ms before next expected edge)
Marker Mode: Vertical (set markers to measure power at time offsets)
Marker1 Pos: 0.10ms (set Marker 1 at beginning of timeslot's "active interval")
Marker2 Pos: 6.50ms (set Marker 2 at end of timeslot's "active interval")
Query Cmd: FETCh1:ARRay:PULse:POWer? (returns array including average pwr betwn markers)

Other measurements may include timing information such as burst rate, width, and transition times of the leading and trailing edges of the burst.

To measure NADC basestation signals reliably, it is necessary to either limit the basestation to transmitting during only one timeslot, or provide an external trigger pulse that is synchronized with the frame. Otherwise, it is difficult to guarantee that the power meter will synchronize with the desired portion of the frame (timeslot). The entire, 6-timeslot frame may be viewed by setting the timespan to 50ms, and power of each timeslot can be measured by moving marker positions to each timeslot.

An alternative method for measuring average and peak power for the NADC reverse link (handset) is to use modulated mode. Peak power is measured directly. Overall average power may be accurately measured, and average power during the burst may be calculated by multiplying the overall average by 3 since the burst is active during one of every three timeslots. This can be done by setting the measurement offset to 4.77dB. Note, however, that this will make the peak power and peak-to-average ratio read 4.77dB too high, since the peak power does not vary with duty cycle. Since the pulse repetition rate is relatively slow, the integration filter should be set for an integral number of frames, or at some multiple of 40mS. This ensures that the signal will be averaged over one or more full cycles, and the average reading will be the same no matter where in the frame the reading is synchronized. The following table shows how to use modulated mode for this measurement.

Meas Mode: Modulated
Frequency: 850 MHz (or whatever operating frequency is in use)
Filter: 400ms (average power over ten full frames. Any multiple of 40ms is OK.)
Offset: 4.77dB (multiply power by 3.0 to account for the 1/3 duty cycle of the signal)
Query Cmd: FETCh1:ARRay:CW:POWer? (returns array including average and peak power)

- 5.6.3 Measuring iDEN. The iDEN (integrated Digital Enhanced Network) signal is a Time Division Multiple Access (TDMA) multiplexing scheme that uses a repeating sequence of 6 time slots in a frame. The data frame duration is 90ms, and each time slot is 15ms. Handsets transmit during one of the six timeslots. Base stations transmit during all timeslots, but often at different levels for each timeslot. The power envelope of the 4-carrier QAM modulation varies during each timeslot, and it is generally desired to measure the average power and peak-to-average ratio during the entire 15ms timeslot. This is accomplished by using Pulse Mode, and setting markers at the desired points in time.

Meas Mode: Pulse
Frequency: 0.815 GHz (or whatever operating frequency is in use)
Averaging: 8 (use less for faster response time, more for better noise rejection)
TimeSpan: 20 ms (shows the full 15ms burst and both edges)
Trig Source: Sensor 1 (triggers on RF signal)
Trig Slope: Positive (trigger on leading edge of pulse)
Trig Mode: Pk-To-Pk (automatically sets based on signal level)
Trig Position: Left (position trigger point at left edge of screen)
Trig Delay: -2.0 ms (moves leading edge of pulse 2ms to the right to center pulse in display)
Trig Holdoff: 88.000 ms (delay for almost a full frame, and arm trigger 2ms before next expected edge)
Marker Mode: Vertical (set markers to measure power at time offsets)
Marker1 Pos: 0.0ms (set Marker 1 at the beginning of pulse)
Marker2 Pos: 15.0ms (set Marker 2 at the end of pulse)
Query Cmdnd: FETCh1:ARRay:PULse:POWer? (returns array including average pwr betwn markers)

Other measurements may include timing information such as burst rate, width, and transition times of the leading and trailing edges of the burst.

To measure iDEN basestation signals reliably, it is necessary to either limit the basestation to transmitting during only one timeslot, or provide an external trigger pulse that is synchronized with the frame. Otherwise, it is difficult to guarantee that the power meter will synchronize with the desired portion of the frame (timeslot). The entire, 6-timeslot frame may be viewed by setting the timespan to 100ms, and power of each timeslot can be measured by moving marker positions to each timeslot.

An alternative method for measuring average and peak power for the iDEN reverse link (handset) is to use modulated mode. Peak power is measured directly. Overall average power may be accurately measured, and average power during the burst may be calculated by multiplying the overall average by 6 since the burst is active during one of every three timeslots. This can be done by setting the measurement offset to 7.78dB ($10 \times \log_{10}[6]$). Note, however, that this will make the peak power and peak-to-average ratio read 7.78dB too high, since the peak power does not vary with duty cycle. Since the pulse repetition rate is relatively slow, the integration filter should be set for an integral number of frames, or at some multiple of 90mS. This ensures that the signal will be averaged over one or more full cycles, and the average reading will be the same no matter where in the frame the reading is synchronized. The following table shows how to use modulated mode for this measurement.

Meas Mode: Modulated
Frequency: 0.87 MHz (or whatever operating frequency is in use)
Filter: 360ms (average power over four full frames. Any multiple of 90ms is OK.)
Offset: 7.78dB (multiply power by 6.0 to account for the 1/6 duty cycle of the signal)
Query Cmdnd: FETCh1:ARRay:CW:POWer? (returns array including average and peak power)

5.6.4 Measuring Bluetooth. The Bluetooth signal is a frequency hopping multiplexing scheme that uses variable length packets to transmit digital data. Each packet occupies one or more fixed-length 625 μ s timeslots. One common type of packet is the DH1 (high rate data packet), which uses one timeslot. Although the timeslot is 625 μ s in duration, the transmitting device may only be active for 366 μ s of the timeslot, unless a multi-timeslot packet is being set. This allows time for signal propagation and for frequency switching at the end of the timeslot. The master and slave devices usually transmit during alternate timeslots, and these packets may repeat at a rapid rate, so the transmitted signal envelope for a continuous series of DH1 packets will appear as a 366 μ s pulse repeating at a 1250 μ s (800Hz) rate. The modulation format is GFSK (Gaussian Frequency Shift Keying), which has a relatively flat power envelope while the pulse is on, so typically only average power during the burst is of interest. The first and last 2.7% (0.4ms) is excluded from the average to allow for RF power settling at the edges of the timeslot. This is accomplished by using Pulse Mode, and setting markers at the desired points in time.

Meas Mode: Pulse
Frequency: 2.44 GHz (center frequency of Bluetooth band)
Averaging: 4 (use less for faster response time, more for better noise rejection)
TimeSpan: 0.5 ms (shows the full 366 μ s burst)
Trig Source: Sensor 1 (triggers on RF signal)
Trig Slope: Positive (trigger on leading edge of pulse)
Trig Mode: Pk-To-Pk (automatically sets based on signal level)
Trig Position: Left (position trigger point at left edge of screen)
Trig Delay: -0.07 ms (moves leading edge of pulse 70 μ s to the right to center pulse in display)
Trig Holdoff: 1.200 ms (delay for almost two time slots, and arm trigger 50 μ s before next expected edge)
Marker Mode: Vertical (set markers to measure power at time offsets)
Marker1 Pos: 5.0 μ s (set Marker 1 at beginning of timeslot's "active interval")
Marker2 Pos: 360 μ s (set Marker 2 at end of timeslot's "active interval")
Query Cmnd: FETCh1:ARRay:PULse:POWer? (returns array including average pwr betwn markers)

Other measurements may include timing information such as burst rate, width, and transition times of the leading and trailing edges of the burst.

5.6.5 Measuring CDMA (all types). The CDMA (Code Division Multiple Access) signal is a spread-spectrum multiplexing scheme that modulates data at a very high rate by use of a "spreading code" to produce a very wide spectrum signal that is quite immune to interference. The spreading code is unique for each user, and has the effect of sending each bit as a predictable series of bits. The receiver is able to correlate the codes of one device even though a number of other devices may be transmitting simultaneously on the same frequency, since each user has his own spreading code. This requires that each user's signal reach the receiver with approximately the same amplitude, which necessitates very careful control of transmitted power. The modulated signal appears very much like random noise in the time domain, with a fairly high peak-to-average ratio (sometimes called "crest factor"). There is no periodicity, and it is not very helpful to use a triggered measurement such as Pulse Mode. It is a simple matter to measure average power and peak-to-average ratio in Modulated Mode (default settings are usually fine), but this doesn't tell the whole story. A Statistical Mode measurement taken over several seconds is a much better choice, and can be used to display the probability of occurrence of all power levels in the sample population.

Meas Mode: Statistical
Frequency: 0.90 GHz (or whatever operating frequency is in use)
Stat Mode: 1 - CDF
Terminal Count: 10 Msamples
Marker Mode: Vertical (set markers to measure power at a percent probability)
Marker1 Pos: 0.1% (returns power level exceeded by 0.1% of all samples)
Marker2 Pos: 0.001% (returns power level exceeded by 0.001% of all samples)
Query Cmnd: FETCh1:ARRay:AMEASure:POWer? (returns array of statistical measurements)

Statistical measurements include long term average power, minimum and maximum instantaneous powers, peak-to-average ratio, power at each marker, percent at each marker, and total number of samples. This measurement format is valid for all CDMA formats including cdmaOne, cdma2000, and W-CDMA.

The video bandwidth of the 4530 Series power meters with a Boonton 575xx peak power sensors is wide enough to easily cover these formats. For future wideband formats that may require more than the 6MHz bandwidth of the 575xx sensors, the 573xx sensors offer a bandwidth of 20MHz when used with the 4530 Series.

5.6.6 Measuring HDTV. Both of the common HDTV formats (8-VSB and COFDM) are very similar to CDMA in many respects. They are both spread-spectrum formats, usually occupying a 6MHz television channel. The modulated signal appears very much like random noise in the time domain, with a fairly high peak-to-average ratio (sometimes called “crest factor”). There is no periodicity, and it is not very helpful to use a triggered measurement such as Pulse Mode. It is a simple matter to measure average power and peak-to-average ratio in Modulated Mode (default settings with a longer filter are usually fine), but this doesn’t tell the whole story. A Statistical Mode measurement taken over several seconds is a much better choice, and can be used to display the probability of occurrence of all power levels in the sample population.

```
Meas Mode:    Statistical
Frequency:    0.283 GHz (or whatever operating frequency is in use)
Stat Mode:    1 - CDF
Terminal Count: 10 Msamples
Marker Mode:  Vertical (set markers to measure power at a percent probability)
Marker1 Pos:  0.1% (returns power level exceeded by 0.1% of all samples)
Marker2 Pos:  0.001% (returns power level exceeded by 0.001% of all samples)
Query Cmdnd:  FETCh1:ARRay:AMEASURE:POWER? (returns array of statistical measurements)
```

Statistical measurements include long term average power, minimum and maximum instantaneous powers, peak-to-average ratio, power at each marker, percent at each marker, and total number of samples.

The video bandwidth of the 4530 Series power meters with a Boonton 575xx peak power sensors is just wide enough to cover a 6MHz channel. For HTDV formats using more than 6MHz of spectrum space, the 573xx series sensors should be used.

5.7 MEASUREMENT ACCURACY

The 4530 Series includes a precision internal RF reference calibrator that is traceable to the National Institute for Standards and Technology (NIST). When the instrument is maintained according to the factory recommended one year calibration cycle, the calibrator enables you to make highly precise measurements of CW and modulated signals. The error analyses in this chapter assumes that the power meter is being maintained correctly and is within its valid calibration period.

Measurement uncertainties are attributable to the instrument, calibrator, sensor, and impedance mismatch between the sensor and the device under test (DUT). Individual independent contributions from each of these sources are combined mathematically to quantify the upper error bound and probable error. The probable error is obtained by combining the linear (percent) sources on a root-sum-of-squares (RSS) basis.

Note that uncertainty figures for individual components may be provided given in either percent or dB. The following formulas may be used to convert between the two units:

$$U_{\%} = (10^{(U_{dB}/10)} - 1) \times 100 \quad \text{and} \quad U_{dB} = 10 \times \text{Log}_{10}(1 + (U_{\%} / 100))$$

It should be noted that measurement uncertainty calculation is a very complex process, and the techniques shown here are somewhat simplified to allow easier calculation. For a more complete information, the following publications may be consulted:

1. “ISO Guide to the Expression of Uncertainty in Measurement,” International Organization for Standardization, Geneva, Switzerland, ISBN 92-67-10188-9, 1995.
2. ANSI/NCSL Z540-2-1996, “U.S. Guide to the Expression of Uncertainty in Measurement,” National Conference of Standards Laboratories, Boulder, CO 80301, 1996.

5.7.1 **Error Contributions.** The total measurement uncertainty is calculated by combining the following terms:

1. Instrument Uncertainty
2. Calibrator Level Uncertainty
3. Calibrator Mismatch Uncertainty
4. Source Mismatch Uncertainty
5. Sensor Shaping Error
6. Sensor Temperature Coefficient
7. Sensor Noise
8. Sensor Zero Drift
9. Sensor Calibration Factor Uncertainty

The formula for worst-case measurement uncertainty is:

$$U_{\text{WorstCase}} = U_1 + U_2 + U_3 + U_4 + \dots U_N$$

where U_1 through U_N represent each of the worst-case uncertainty terms.

The worst case approach is a very conservative method where the extreme condition of each individual uncertainty is added to one another. If the individual uncertainties are independent of one another, the probability of all being at the extreme condition is small. For this reason, these uncertainties are usually combined using the RSS method. RSS is an abbreviation for “root-sum-of-squares”. In this method, each uncertainty is squared, added to one another, and the square root of the summation is calculated. The formula for RSS measurement uncertainty is:

$$U_{\text{RSS}} = \sqrt{U_1^2 + U_2^2 + U_3^2 + U_4^2 + \dots U_N^2}$$

where U_1 through U_N represent each of the worst-case uncertainty terms. This calculation method yields a statistical confidence factor of approximately 62%.

5.7.2 **Discussion of Error Terms.** Following is a discussion of each term, its definition, and how it is calculated.

Instrument Uncertainty. This term represents the amplification and digitization uncertainty in the power meter, as well as internal component temperature drift. In most cases, this is very small, since absolute errors in the circuitry are calibrated out by the AutoCal process. The instrument uncertainty is 0.20% for the 4530 Series.

Calibrator Level Uncertainty. This term is the uncertainty in the calibrator’s output level for a given setting for calibrators that are maintained in calibrated condition. The figure is a calibrator specification which depends upon the output level:

50MHz Calibrator Level Uncertainty:

At 0 dBm:	±0.055 dB (1.27%)
+20 to -39 dBm:	±0.075 dB (1.74%)
-40 to -60 dBm:	±0.105 dB (2.45%)

1GHz Calibrator Level Uncertainty:

± (0.065 dB (1.51%) at 0 dBm + 0.03 dB (0.69%) per 5 dB from 0 dBm)

The value to use for calibration level uncertainty depends upon the sensor calibration technique used. If AutoCal was performed, the calibrator’s uncertainty at the measurement power level should be used. For sensors calibrated with FixedCal, the calibrator is only used as a single-level source, and you should use the calibrator’s uncertainty at the FixedCal level, (0dBm, for most sensors). This may make FixedCal seem *more accurate* than AutoCal at some levels, but this is usually more than offset by the reduction in shaping error afforded by the AutoCal technique.

Calibrator Mismatch Uncertainty. This term is the mismatch error caused by impedance differences between the calibrator output and the sensor’s termination. It is calculated from the reflection coefficients of the calibrator (ρ_{CAL}) and sensor (ρ_{SNSR}) at the calibration frequency with the following equation:

$$\text{Calibrator Mismatch Uncertainty} = \pm 2 \times \rho_{CAL} \times \rho_{SNSR} \times 100 \%$$

The calibrator reflection coefficient is a calibrator specification:

Internal Calibrator Reflection Coefficient (ρ_{CAL}): 0.024 (at 50MHz)

External 2530 Calibrator Reflection Coefficient (ρ_{CAL}): 0.091 (at 1GHz)

The sensor reflection coefficient, ρ_{SNSR} is frequency dependent, and may be looked up in the sensor datasheet or the *Boonton Electronics Power Sensor Manual*.

Source Mismatch Uncertainty. This term is the mismatch error caused by impedance differences between the measurement source output and the sensor’s termination. It is calculated from the reflection coefficients of the source (ρ_{SRCE}) and sensor (ρ_{SNSR}) at the measurement frequency with the following equation:

$$\text{Source Mismatch Uncertainty} = \pm 2 \times \rho_{SRCE} \times \rho_{SNSR} \times 100 \%$$

The source reflection coefficient is a characteristic of the RF source under test. If only the SWR of the source is known, its reflection coefficient may be calculated from the source SWR using the following equation:

$$\text{Source Reflection Coefficient } (\rho_{SRCE}) = (SWR - 1) / (SWR + 1)$$

The sensor reflection coefficient, ρ_{SNSR} is frequency dependent, and may be looked up in the sensor datasheet or the *Boonton Electronics Power Sensor Manual*. For most measurements, this is the single largest error term, and care should be used to ensure the best possible match between source and sensor.

Sensor Shaping Error. This term is sometimes called “linearity error”, and is the residual non-linearity in the measurement after an *AutoCal* has been performed to characterize the “transfer function” of the sensor (the relationship between applied RF power, and sensor output, or “shaping”). Calibration is performed at discrete level steps and is extended to all levels. Generally, sensor shaping error is close to zero at the autocal points, and increases in between due to imperfections in the curve-fitting algorithm.

An additional component of sensor shaping error is due to the fact that the sensor’s transfer function may not be identical at all frequencies. The published shaping error includes terms to account for these deviations. If your measurement frequency is close to your *AutoCal* frequency, it is probably acceptable to use a value lower than the published uncertainty in your calculations.

For CW sensors using the fixed-cal method of calibrating, the shaping error is higher because it relies upon stored “shaping coefficients” from a factory calibration to describe the shape of the transfer function, rather than a transfer calibration using a precision power reference at the current time and temperature. For this reason, use of the *AutoCal* method is recommended for CW sensors rather than simply performing a *FixedCal*. The shaping error for CW sensors using the *FixedCal* calibration method is listed in the *Boonton Electronics Power Sensor Manual* as “Power Linearity Uncertainty”, and depends upon signal level. If the *AutoCal* calibration method is used with a CW sensor, a fixed value of 1.0% may be used for all signal levels.

All peak power sensors use the *AutoCal* method only. The sensor shaping error for peak sensors is listed on the sensor’s datasheet.

Sensor Temperature Coefficient. This term is the error which occurs when the sensor’s temperature has changed significantly from the temperature at which the sensor was *AutoCal*’d. This condition is detected by the Model 4530 and a “temperature drift” message warns the operator to recalibrate the sensor for drift exceeding $\pm 4C$ on *non-temperature compensated peak sensors*. For these sensors, the typical temperature effect 4 degrees from the *AutoCal* temperature is shown as a graph versus level on the sensor datasheet.

Temperature compensated peak sensors have a much smaller temperature coefficient, and a much larger temperature deviation, $\pm 30\text{C}$ is permitted before a warning is issued. For these sensors, the maximum uncertainty due to temperature drift from the autocal temperature is:

$$\text{Temperature Error} = \pm 0.04\text{dB} (0.93\%) + 0.003\text{dB} (0.069\%) / \text{degreeC}$$

Note that the first term of this equation is constant, while the second term (0.069%) must be multiplied by the number of degrees that the sensor temperature has drifted from the AutoCal temperature.

CW sensors have no built-in temperature detectors, so it is up to the user to determine the temperature change from AutoCal temperature. Temperature drift for CW sensors is determined by the temperature coefficient of the sensor. This figure is 0.01dB (0.23%) per degreeC for the 51075 and many other CW sensors. Consult the *Boonton Electronics Power Sensor Manual* for the exact figure to use. Sensor temperature drift uncertainty may be assumed to be zero for sensors operating exactly at the calibration temperature.

Sensor Noise. The noise contribution to pulse measurements depends on the number of samples averaged to produce the power reading, which is set by the “averaging” menu setting. For continuous measurements with CW sensors, or peak sensors in modulated mode, it depends on the integration time of the measurement, which is set by the “filter” menu setting. In general, increasing filtering or averaging reduces measurement noise. Sensor noise is typically expressed as an absolute power level. The uncertainty due to noise depends upon the ratio of the noise to the signal power being measured. The following expression is used to calculate uncertainty due to noise:

$$\text{Noise Error} = \pm \text{Sensor Noise (in watts)} / \text{Signal Power (in watts)} \times 100 \%$$

The noise rating of a particular power sensor may be found on the sensor datasheet, or the *Boonton Electronics Power Sensor Manual*. It may be necessary to adjust the sensor noise for more or less filtering or averaging, depending upon the application. As a general rule (within a decade of the datasheet point), noise is inversely proportional to the filter time or averaging used. Noise error is usually insignificant when measuring at high levels (25dB or more above the sensor’s minimum power rating).

Sensor Zero Drift. Zero drift is the long-term change in the zero-power reading that is not a random, noise component. Increasing filter or averaging will not reduce zero drift. For low-level measurements, this can be controlled by zeroing the meter just before performing the measurement. Zero drift is typically expressed as an absolute power level, and its error contribution may be calculated with the following formula:

$$\text{Zero Drift Error} = \pm \text{Sensor Zero Drift (in watts)} / \text{Signal Power (in watts)} \times 100 \%$$

The zero drift rating of a particular power sensor may be found on the sensor datasheet, or the *Boonton Electronics Power Sensor Manual*. Zero drift error is usually insignificant when measuring at high levels (25dB or more above the sensor’s minimum power rating). The drift specification usually indicates a time interval such as one hour. If the time since performing a sensor Zero or AutoCal is very short, the zero drift is greatly reduced.

Sensor Calibration Factor Uncertainty. Sensor frequency calibration factors (“calfactors”) are used to correct for sensor frequency response deviations. These calfactors are characterized during factory calibration of each sensor by measuring its output at a series of test frequencies spanning its full operating range, and storing the ratio of the actual applied power to the measured power at each frequency. This ratio is called a calfactor. During measurement operation, the power reading is multiplied by the calfactor for the current measurement frequency to correct the reading for a flat response.

The sensor calfactor uncertainty is due to uncertainties encountered while performing this frequency calibration (due to both standards uncertainty, and measurement uncertainty), and is different for each frequency. Both worst case and RSS uncertainties are provided for the frequency range covered by each sensor, and are listed on the sensor datasheet and in the *Boonton Electronics Power Sensor Manual*.

If the measurement frequency is between sensor calfactor entries, the most conservative approach is to use the higher of the two corresponding uncertainty figures. It is also possible to estimate the figure by linear interpolation.

If the measurement frequency is identical to the AutoCal frequency, a calfactor uncertainty of zero should be used, since any absolute error in the calfactor cancels out during AutoCal. At frequencies that are close to the AutoCal frequency, the calfactor uncertainty is only partially cancelled out during AutoCal, so it is generally acceptable to take the uncertainty for the next closest frequency, and scale it down.

5.7.3 Sample Uncertainty Calculations. The following examples show calculations for two measurement applications - one using a CW sensor (Model 51075), and the other with a peak power sensor (Model 57518). The figures used in these examples are meant to show the general techniques, and do not apply to all applications. Some “common sense” assumptions have been made to illustrate the fact that uncertainty calculation is not an exact science, and requires some understanding of your specific measurement conditions.

Typical Example #1: Model 51075 CW Power Sensor

Measurement conditions:

Source Frequency: 10.3GHz
 Source Power: -55 dBm (3.16 nW)
 Source SWR : 1.50 (reflection coefficient = 0.2) at 10.3 GHz
 AutoCal Source: Internal 50MHz Calibrator
 AutoCal Temperature: 25C
 Current Temperature: 25C

In this example, we will assume that an AutoCal has been performed on the sensor immediately before the measurement. This will reduce certain uncertainty terms, as discussed below.

Step 1: The Instrument Uncertainty figure for the 4530 Series is $\pm 0.20\%$. Since a portion of this figure is meant to include temperature drift of the instrument, and we know an AutoCal has just been performed, we’ll estimate (for lack of more detailed, published information) that the instrument uncertainty is $\pm 0.10\%$, or half the published figure.

$$U_{\text{Instrument}} = \pm 0.10\%$$

Step 2: The Calibrator Level Uncertainty for the power meter’s internal, 50MHz calibrator may be read from the calibrator’s specification. It is $\pm 0.105\text{dB}$, or $\pm 2.45\%$ at a level of -55dBm .

$$U_{\text{CalLevel}} = \pm 2.45\%$$

Step 3: The Calibrator Mismatch Uncertainty is calculated using the formula in the previous section, using the internal 50MHz calibrator’s published figure for ρ_{CAL} and calculating the value ρ_{SNSR} from the SWR specification on the 51075’s datasheet.

$$\rho_{\text{CAL}} = 0.024 \text{ (internal calibrator’s reflection coefficient at 50MHz)}$$

$$\rho_{\text{SNSR}} = (1.15 - 1) / (1.15 + 1) = 0.070 \text{ (calculate reflection coefficient of 51075, max SWR = 1.15 at 50MHz)}$$

$$\begin{aligned} U_{\text{CalMismatch}} &= \pm 2 \times \rho_{\text{CAL}} \times \rho_{\text{SNSR}} \times 100 \% \\ &= \pm 2 \times 0.024 \times 0.070 \times 100 \% \\ &= \pm 0.34\% \end{aligned}$$

Step 4: The Source Mismatch Uncertainty is calculated using the formula in the previous section, using the DUT’s specification for ρ_{SRCE} and calculating the value ρ_{SNSR} from the SWR specification on the 51075’s datasheet.

$$\rho_{\text{SRCE}} = 0.20 \text{ (source reflection coefficient at 10.3GHz)}$$

$$\rho_{\text{SNSR}} = (1.40 - 1) / (1.40 + 1) = 0.167 \text{ (calculate reflection coefficient of 51075, max SWR = 1.40 at 10.3GHz)}$$

$$\begin{aligned} U_{\text{SourceMismatch}} &= \pm 2 \times \rho_{\text{SRCE}} \times \rho_{\text{SNSR}} \times 100 \% \\ &= \pm 2 \times 0.20 \times 0.167 \times 100 \% \\ &= \pm 6.68\% \end{aligned}$$

Step 5: The uncertainty caused by Sensor Shaping Error for a 51075 CW sensor that has been calibrated using the AutoCal method can be assumed to be 1.0%, as per the discussion in the previous section.

$$U_{\text{ShapingError}} = \pm 1.0\%$$

Step 6: The Sensor Temperature Drift Error depends on how far the temperature has drifted from the sensor calibration temperature, and the temperature coefficient of the sensor. In this example, an AutoCal has just been performed on the sensor, and the temperature has not drifted at all, so we can assume a value of zero for sensor temperature drift uncertainty.

$$U_{\text{SnsrTempDrift}} = \pm 0.0\%$$

Step 7: This is a relatively low-level measurement, so the noise contribution of the sensor must be included in the uncertainty calculations. We'll assume default filtering. The signal level is -55dBm, or 3.16nW. The RMS noise specification for the 51075 sensor is 30pW, from the sensor's datasheet. Noise uncertainty is the ratio of these two figures.

$$\begin{aligned} U_{\text{NoiseError}} &= \pm \text{Sensor Noise (in watts)} / \text{Signal Power (in watts)} \\ &= \pm 30.0\text{e-}12 / 3.16\text{e-}9 \times 100\% \\ &= \pm 0.95\% \end{aligned}$$

Step 8: The Sensor Zero Drift calculation is very similar to the noise calculation. For sensor zero drift, the datasheet specification for the 51075 sensor is 100pW, so we'll take the liberty of cutting this in half to 50pW, since we just performed an AutoCal, and it's likely that the sensor hasn't drifted much.

$$\begin{aligned} U_{\text{ZeroDrift}} &= \pm \text{Sensor Zero Drift (in watts)} / \text{Signal Power (in watts)} \\ &= \pm 50.0\text{e-}12 / 3.16\text{e-}9 \times 100\% \\ &= \pm 1.58\% \end{aligned}$$

Step 9: The Sensor Calfactor Uncertainty is calculated from the uncertainty values in the *Boonton Electronics Power Sensor Manual*. There is no entry for 10.3GHz, so we'll have to look at the two closest entries. At 10GHz, the calfactor uncertainty is 5.33%, and at 11GHz it is 4.71%. Since we're closer to 10GHz, and that is the higher number anyway, choosing the 10GHz value should provide a conservative estimate.

$$U_{\text{CalFactor}} = \pm 5.33\%$$

Step 10: Now that each of the individual uncertainty terms has been determined, we can combine them to calculate the worst-case and RSS uncertainty values:

	VALUE (%)	VALUE ² (% ²)
1. instrument uncertainty	±0.10	0.0100
2. calibrator level uncertainty	±2.45	6.003
3. calibrator mismatch uncertainty	±0.34	0.1156
4. source mismatch uncertainty	±6.68	44.62
5. sensor shaping error uncertainty	±1.00	1.000
6. sensor temperature drift uncertainty	±0.00	0.0000
7. sensor noise uncertainty	±0.95	0.9025
8. sensor zero drift uncertainty	±1.58	2.496
9. sensor calibration factor uncertainty	±5.33	28.41

Total worst case uncertainty:	±18.43 %	
Total sum of squares:		84.568 % ²
Total RSS uncertainty:	±9.20 %	

From this example, it can be seen that the two largest contributions to total uncertainty are the source mismatch, and the sensor calfactor. Also note that the RSS uncertainty is approximately one-half the value of the worst-case uncertainty. This is not surprising, since the majority of the uncertainty comes from just two sources. If the measurement frequency was lower, these two terms would be reduced, and the RSS would probably be less than half the worst-case. Conversely, if one term dominated (for example if a very low level measurement was being performed, and the noise uncertainty was 30%), the RSS value would be expected to approach the worst-case value. The RSS uncertainty is 0.38dB.

Typical Example #2: Model 57518 Peak Power Sensor

Measurement conditions:

- Source Frequency: 900 MHz
- Source Power: 13 dBm (20mW)
- Source SWR : 1.12 (reflection coefficient = 0.057) at 900 MHz
- AutoCal Source: External 2530 1GHz Calibrator
- AutoCal Temperature: 38C
- Current Temperature: 49C

In this example, we will assume that an AutoCal was performed on the sensor earlier in the day, so time and temperature drift may play a role in the uncertainty.

Step 1: The Instrument Uncertainty figure for the 4530 Series is $\pm 0.20\%$. Since it has been a while since AutoCal, we'll use the published figure.

$$U_{\text{Instrument}} = \pm 0.20\%$$

Step 2: The Calibrator Level Uncertainty for the Model 2530 1GHz external calibrator may be calculated from the calibrator's specification. The 0dBm uncertainty is 0.065dB, or 1.51%. To this figure, we must add 0.03dB or 0.69% per 5dB step from 0dBm. 13dBm is 2.6 5dB steps (13/5) away from 0dBm. Any fraction must always be rounded to the next highest whole number, so we're 3 steps away.

$$\begin{aligned} U_{\text{CalLevel}} &= \pm(1.51\% + (3 \times 0.69\%)) \\ &= \pm 3.11\% \end{aligned}$$

Step 3: The Calibrator Mismatch Uncertainty is calculated using the formula in the previous section, using the 2530 calibrator's published figure for ρ_{CAL} and calculating the value ρ_{SNSR} from the SWR specification on the 57518's datasheet.

$$\begin{aligned} \rho_{\text{CAL}} &= 0.091 \text{ (external 2530 calibrator's reflection coefficient at 1GHz)} \\ \rho_{\text{SNSR}} &= (1.15 - 1) / (1.15 + 1) = 0.070 \text{ (calculate reflection coefficient of 57518, max SWR = 1.15 at 1 GHz)} \\ U_{\text{CalMismatch}} &= \pm 2 \times \rho_{\text{CAL}} \times \rho_{\text{SNSR}} \times 100 \% \\ &= \pm 2 \times 0.091 \times 0.070 \times 100 \% \\ &= \pm 1.27\% \end{aligned}$$

Step 4: The Source Mismatch Uncertainty is calculated using the formula in the previous section, using the DUT's specification for ρ_{SRCE} and calculating the value ρ_{SNSR} from the SWR specification on the 57518's datasheet.

$$\begin{aligned} \rho_{\text{SRCE}} &= 0.057 \text{ (source reflection coefficient at 900 MHz)} \\ \rho_{\text{SNSR}} &= (1.15 - 1) / (1.15 + 1) = 0.070 \text{ (calculate reflection coefficient of 57518, max SWR = 1.15 at 0.9 GHz)} \\ U_{\text{SourceMismatch}} &= \pm 2 \times \rho_{\text{SRCE}} \times \rho_{\text{SNSR}} \times 100 \% \\ &= \pm 2 \times 0.057 \times 0.070 \times 100 \% \\ &= \pm 0.80\% \end{aligned}$$

Step 5: The uncertainty caused by Sensor Shaping Error for a 57518 peak sensor is 4% at all levels, from the sensor's datasheet. But since we're measuring at 900MHz, which is very close to the 1GHz AutoCal frequency, we'll assume that the frequency-dependent portion of the shaping error becomes very small, and we'll estimate that 2% remains.

$$U_{\text{ShapingError}} = \pm 2.0 \%$$

Step 6: The Sensor Temperature Drift Error depends on how far the temperature has drifted from the sensor calibration temperature, and the temperature coefficient of the sensor. In our case, we are using a temperature compensated sensor, and the temperature has drifted by 11 degrees C (49C - 38C) from the AutoCal temperature. We will use the equation in the previous section to calculate sensor temperature drift uncertainty.

$$\begin{aligned} U_{\text{SnsrTempDrift}} &= \pm (0.93\% + 0.069\% / \text{degreeC}) \\ &= \pm (0.93 + (0.069 \times 11.0)) \% \\ &= \pm 1.69\% \end{aligned}$$

Step 7: This is a relatively high-level measurement, so the noise contribution of the sensor is probably negligible, but we'll calculate it anyway. We'll assume modulate mode with default filtering. The signal level is 13dBm, or 20mW. The "noise and drift" specification for the 57518 sensor is 50nW, from the sensor's datasheet. Noise uncertainty is the ratio of these two figures.

$$\begin{aligned} U_{\text{Noise\&Drift}} &= \pm \text{Sensor Noise (in watts)} / \text{Signal Power (in watts)} \\ &= \pm 50.0\text{e-}9 / 20.0\text{e-}3 \times 100 \% \\ &= \pm 0.03\% \end{aligned}$$

Step 8: A separate Sensor Zero Drift calculation does not need to be performed for peak sensors, since "noise and drift" are combined into one specification, so we'll just skip this step.

Step 9: The Sensor Calfactor Uncertainty needs to be interpolated from the uncertainty values in the *Boonton Electronics Power Sensor Manual*. At 1 GHz, the sensor's calfactor uncertainty is 2.23%, and at 0.5GHz it is 1.99%. Note, however, that we are performing our AutoCal at a frequency of 1GHz, which is very close to the measurement frequency. This means that the calfactor uncertainty cancels to zero at 1GHz, as discussed in the previous section. We'll use linear interpolation between 0.5GHz and 1GHz to estimate a value. 900MHz is only 20% (one fifth) of the way from 1GHz down to 500MHz, so the uncertainty figure at 0.5GHz can be scaled by one fifth.

$$\begin{aligned} U_{\text{CalFactor}} &= 1.99 \times (900 - 1000) / (500 - 1000) \\ &= 1.99 \times 0.2 \\ &= \pm 0.40\% \end{aligned}$$

Step 10: Now that each of the individual uncertainty terms has been determined, we can combine them to calculate the worst-case and RSS uncertainty values:

	VALUE (%)	VALUE ² (% ²)
1. instrument uncertainty	±0.20	0.040
2. calibrator level uncertainty	±3.11	9.672
3. calibrator mismatch uncertainty	±1.27	1.613
4. source mismatch uncertainty	±0.80	0.640
5. sensor shaping error uncertainty	±2.00	5.00
6. sensor temperature drift uncertainty	±1.69	2.856
7. sensor noise & drift uncertainty	±0.03	0.0009
8. sensor calibration factor uncertainty	±0.40	0.160

Total worst case uncertainty:	±9.50 %
Total sum of squares:	18.982 % ²
Total RSS uncertainty:	±4.36 %

From this example, different error terms dominate. Since the measurement is close to the calibration frequency, and matching is rather good, the shaping and level errors are the largest. RSS uncertainty of 4.36% translates to an uncertainty of about 0.19dB in the reading.

Sensors

Appendix A

SENSORS

This appendix lists the characteristics of most common Boonton Electronics sensors used with the 4530 Series RF Power Meter. Those sensors listed generally are suitable for the great majority of standard measurements. Additional sensor types are available for special requirements. Contact Boonton Electronics for assistance in selecting a special sensor to meet your specific requirements.

Two basic types of sensors are available: Peak Power Sensors and CW Power Sensors. Models 56218, 56318, 56326, 56418, 56518, 57318, 57340, 57518 and 57540 are peak sensors, and should be used for peak and average power measurements of CW and Modulated signals. CW power sensors listed are Models 51075, 51077, 51079, 51071, 51072, 51100, 51101, 51102, 51200, 51201, 51300, 51301, 51011(EMC), 51011(4B), 51012(4C), 51013(4E), 51015(5E), 51033(6E) and 51078. CW diode sensors should only be used for CW signals, or for measuring the average power of modulated signals, provided the power remains within the square-law region of the diode detector's measurement range. Thermal sensors may be used for measuring CW or modulated signals. See Sections 5.1 and 5.2 of this manual for more information on available power sensor types and choosing the correct sensor for your application.

Applications for Peak Power sensors include peak power, average power, and peak-to-average ratio (crest factor) measurements, continuous or time-gated, for all pulse and spread-spectrum telecom signals including GSM, GSM-EDGE, CDMA, WCDMA, COFDM, and QAM. If the signal power envelope is not stationary, peak power peak power capability is essential. All peak power sensors feature balanced dual-diodes for high sensitivity and even-order harmonic suppression. Low input VSWR minimizes mismatch error. Frequency calibration factors (NIST-traceable) and other data are stored within the peak power sensors. Linearity calibration is performed by the calibrator (internal or optional 1 GHz external as required). The first listed group of peak power sensors (56000 series) requires the optional Model 2530 1 GHz external calibrator (see Appendix B) for calibration, since their frequency range does not extend low enough for 50MHz calibration. The 57000 series sensors are DC-coupled, and have an extended low-frequency limit in the low-bandwidth setting, so are able to be calibrated from the built-in 50 MHz calibrator of the 4530 Series RF Power Meter. All CW power sensors listed require only the built-in 50 MHz calibrator of the 4530 Series. One five-foot long peak sensor cable is included per channel except when one or more CW sensors are ordered with the 4530. In this case, a data adapter and cable is substituted for a peak sensor cable in each instance.

The following specification sheets list the characteristics of the various sensors mentioned above.

Peak Power Sensors

Model Impedance RF Conn	Frequency Range High BW (Low BW)	Dynamic Range Peak Pwr Range CW Pwr Range Int. Trig Range	Overload Rating Pulse / Continuous	Sensor Risettime Video Bandwidth		Maximum SWR	
				Hi BW Setting	Low BW Setting	Frequency	SWR
<i>For use with the 4530 Series RF Power Meter plus optional Model 2530 1 GHz Calibrator accessory only</i>							
56218 50Ω N(M)	0.03 to 18 GHz	-24 to +20 dBm -34 to +20 dBm -10 to +20 dBm	1 W for 1μs 200 mW	<150 ns 2 MHz	<500 ns 700 kHz	0.03 to 1 GHz 1 to 6 GHz 6 to 18 GHz	1.15 1.20 1.25
56318 50Ω N(M)	0.5 to 18 GHz	-24 to +20 dBm -34 to +20 dBm -10 to +20 dBm	1 W for 1μs 200 mW	<20 ns 20 MHz	<200 ns 1.75 MHz	0.5 to 1 GHz 1 to 6 GHz 6 to 16 GHz 16 to 18 GHz	1.15 1.20 1.28 1.34
56326 50Ω K(M)	0.5 to 26.5 GHz	-24 to +20 dBm -34 to +20 dBm -10 to +20 dBm	1 W for 1μs 200 mW	<20 ns 20 MHz	<200 ns 1.75 MHz	0.5 to 1 GHz 1 to 4 GHz 4 to 18 GHz 18 to 26.5 GHz	1.15 1.20 1.45 1.50
56418 50Ω N(M)	0.5 to 18 GHz	-34 to +5 dBm -40 to +5 dBm -18 to +5 dBm	1 W for 1μs 200 mW	<30 ns 15 MHz	<100 ns 6 MHz	0.5 to 1 GHz 1 to 6 GHz 6 to 16 GHz 16 to 18 GHz	1.15 1.20 1.28 1.34
56518 50Ω N(M)	0.5 to 18 GHz	-40 to +20 dBm -50 to +20 dBm -27 to +20 dBm	1 W for 1μs 200 mW	<100 ns 6 MHz	<300 ns 1.2 MHz	0.5 to 1 GHz 1 to 6 GHz 6 to 16 GHz 16 to 18 GHz	1.15 1.20 1.28 1.34
<i>The following four sensors do not require the optional Model 2530 1 GHz calibrator</i>							
57318 50Ω N(M)	0.5 to 18 GHz (0.05 to 18 GHz)	-24 to +20 dBm -24 to +20 dBm -10 to +20 dBm	1 W for 1μs 200 mW	<20 ns 20 MHz	<10 μs 350 kHz	0.05 to 2 GHz 2 to 6 GHz 6 to 16 GHz 16 to 18 GHz	1.15 1.20 1.28 1.34
57340 50Ω K(M)	0.5 to 40 GHz (0.05 to 40 GHz)	-24 to +20 dBm -34 to +20 dBm -10 to +20 dBm	1 W for 1μs 200 mW	<20 ns 20 MHz	<10 μs 350 kHz	0.05 to 4 GHz 4 to 38 GHz 38 to 40 GHz	1.25 1.65 2.00
57518 50Ω N(M)	0.1 to 18 GHz (0.05 to 18 GHz)	-40 to +20 dBm -50 to +20 dBm -27 to +20 dBm	1 W for 1μs 200 mW	<100 ns 6 MHz	<10 μs 350 kHz	0.05 to 2 GHz 2 to 6 GHz 6 to 16 GHz 16 to 18 GHz	1.15 1.20 1.28 1.34
57540 50Ω K(M)	0.1 to 40 GHz (0.05 to 40 GHz)	-40 to +20 dBm -50 to +20 dBm -27 to +20 dBm	1 W for 1μs 200 mW	<100 ns 6 MHz	<10 μs 350 kHz	0.05 to 4 GHz 4 to 38 GHz 38 to 40 GHz	1.15 1.65 2.00

CW Power Sensors

Model Impedance RF Conn	Frequency Range	Dynamic Range	Overload Rating Pulse / Continuous	Maximum SWR	
				Frequency	SWR
Wide Dynamic Range Dual Diode Sensors					
51075 50Ω N(M)	500 kHz to 18 GHz	-70 to +20 dBm	1 W for 1μs 300 mW	500 kHz to 2 GHz 2 GHz to 6 GHz 6 GHz to 8 GHz	1.15 1.20 1.40
51077 50Ω N(M)	500 kHz to 18 GHz	-60 to +30 dBm	10 W for 1μs 3 W	500 kHz to 2 GHz 2 GHz to 6 GHz 6 GHz to 18 GHz	1.15 1.20 1.40
51079 50Ω N(M)	500 kHz to 18 GHz	-50 to +40 dBm	100 W for 1μs 25 W	500 kHz to 2 GHz 2 GHz to 6 GHz 6 GHz to 18 GHz	1.15 1.20 1.40
51071 50Ω K(M)	10 MHz to 26.5 GHz	-70 to +20 dBm	1 W for 1μs 300 mW	10 MHz to 2 GHz 2 GHz to 4 GHz 4 GHz to 18 GHz 18 GHz to 26.5 GHz	1.15 1.20 1.45 1.50
51072 50Ω K(M)	30 MHz to 40 GHz	-70 to +20 dBm	1 W for 1μs 300 mW	30 MHz to 4 GHz 4 GHz to 38 GHz 38 GHz to 40 GHz	1.25 1.65 2.00
Thermocouple Sensors					
51100 (9E) 50Ω N(M)	10 MHz to 18 GHz	-20 to +20 dBm	15 W for 1μs 300 mW	10 MHz to 30 MHz 30 MHz to 16 GHz 16 GHz to 18 GHz	1.25 1.18 1.28
51101 50Ω N(M)	100 kHz to 4.2 GHz	-20 to +20 dBm	15 W for 1μs 300 mW	100 kHz to 300 kHz 300 kHz to 2 GHz 2 GHz to 4.2 GHz	1.70 1.35 1.60
51102 50Ω K(M)	30 MHz to 26.5 GHz	-20 to +20 dBm	150 W for 1μs 300 mW	30 MHz to 2 GHz 2 GHz to 18 GHz 18 GHz to 26.5 GHz	1.35 1.40 1.60
51200 50Ω N(M)	10 MHz to 18 GHz	0 to +37 dBm	150 W for 1μs 10 W	10 MHz to 2 GHz 2 GHz to 12.4 GHz 12.4 GHz to 18 GHz	1.10 1.18 1.28
51201 50Ω N(M)	100 kHz to 4.2 GHz	0 to +37 dBm	150 W for 1μs 10 W	100 kHz to 2 GHz 2 GHz to 4.2 GHz	1.10 1.18

CW Power Sensors (Cont)

Model Impedance RF Conn	Frequency Range	Dynamic Range	Overload Rating Pulse / Continuous	Maximum SWR	
				Frequency	SWR
<i>Thermocouple Sensors - Continued</i>					
51300 50Ω N(M)	10 MHz to 18 GHz	0 to +44 dBm	150 W for 1μs 50 W	10 MHz to 2 GHz 2 GHz to 12.4 GHz 12.4 GHz to 18 GHz	1.10 1.18 1.28
51301 50Ω N(M)	100 kHz to 4.2 GHz	0 to +44 dBm	150 W for 1μs 50 W	100 kHz to 2 GHz 2 GHz to 4.2 GHz	1.10 1.18
<i>Special Purpose Dual Diode Sensors</i>					
51011 (EMC) 50Ω N(M)	10 kHz to 8 GHz	-60 to +20 dBm	1 W for 1μs 300 W	10 kHz to 2 GHz 2 GHz to 4 GHz 4 GHz to 8 GHz	1.12 1.20 1.40
51011 (4B) 50Ω N(M)	100 kHz to 12.4 GHz	-60 to +20 dBm	1 W for 1μs 300 mW	100 kHz to 2 GHz 2 GHz to 4 GHz 4 GHz to 11 GHz 11 GHz to 12.4 GHz	1.12 1.20 1.40 1.60
51012 (4C) 75Ω N(M)	100 kHz to 1 GHz	-60 to +20 dBm	1 W for 1μs 300 mW	100 kHz to 1 GHz	1.18
51013 (4E) 50Ω N(M)	100 kHz to 18 GHz	-60 to +20 dBm	1 W for 1μs 300 mW	100 kHz to 4 GHz 4 GHz to 10 GHz 10 GHz to 18 GHz	1.30 1.50 1.70
51015 (5E) 50Ω N(M)	100 kHz to 18 GHz	-50 to +30 dBm	10 W for 1μs 2 W	100 kHz to 1 GHz 1 GHz to 2 GHz 2 GHz to 4 GHz 4 GHz to 12.4 GHz 12.4 to 18 GHz	1.07 1.10 1.12 1.18 1.28
51033 (6E) 50Ω N(M)	100 kHz to 18 GHz	-40 to +33 dBm	10 W for 1μs 2 W	100 kHz to 1 GHz 1 GHz to 2 GHz 2 GHz to 4 GHz 4 GHz to 12.4 GHz 12.4 GHz to 18 GHz	1.07 1.10 1.12 1.18 1.28
51078 50Ω N(M)	100 kHz to 18 GHz	-20 to +37 dBm	100 W for 1μs 7 W	100 kHz to 4 GHz 4 GHz to 12 GHz 12 GHz to 18 GHz	1.15 1.25 1.40

Model 2530 1GHz Calibrator Appendix B

MODEL 2530 1 GHz CALIBRATOR

The Model 2530 operates as an optional accessory of the Model 4531 and 4532 RF Power Meters to provide calibration and test signals at an output frequency of 1.024 GHz. The Model 2530 is controlled by the power meter through its manual and remote programming systems and GPIB commands are defined for it. The 1.024 GHz calibrator is necessary for sensors that cannot be calibrated at 50 MHz because of a higher low-frequency cutoff. It is also closer to commonly used frequencies for telecom applications, and can reduce measurement uncertainty by requiring less interpolation of sensor frequency cal factors. The Model 2530 calibrator must be connected to the 4530 powermeter using the supplied RJ-11 control cable as shown in the diagram on the following page.

Accessories

Supplied accessories:	1 - NEMA type power cable 1 - RJ-11 Control Cable 1 - Fuse kit 1 - 2530 Operators Instruction Manual
Other accessories:	Rack Mounting Kit

Specifications

RF Section

Operating Modes:	CW, Internal or external pulse
Output Frequency:	1.024 GHz \pm 0.005%
Level Range:	-60.0 to +20.0 dBm
Resolution:	0.1 dB
Source SWR (Refl. Coef.):	1.20 (0.091) maximum, CW mode
Accuracy (NIST traceable):	+20 to -40 dBm
Absolute:	\pm 0.065 dB (1.5%) at 0 dBm, CW mode
Linearity:	\pm 0.03 dB per 5 dB from 0 dBm, CW mode
Harmonics:	-35 dB minimum to 40 GHz
Spurious:	-60 dB minimum

Pulse Generator

Internal Pulse Period:	100 ms, 1 ms or 10 ms
Internal Pulse Duty Cycle:	10% to 90% in 10% increments
Pulse polarity:	+ or – for Internal and External pulses
RF Connector:	Type N, front or optional rear panel location
External Pulse Modulation Input:	Type BNC, rear panel, TTL compatible
Controller connector:	RJ-11
Controller:	Boonton Electronics Model 4531/4532 RF Power Meter

Miscellaneous

Power requirements:	90 to 260 VAC, 47 to 63 Hz, < 50 VA, < 30 watts No voltage switching required.
Cooling:	Internal fan.
Dimensions:	3.5 inches (8.9 cm) high, 8.4 inches wide (21.3 cm), approx. 13.5 inches (34.3 cm) length , not including removable feet and connector clearances.



External Calibrator Connection Diagram