

POWER SENSOR MANUAL

Revision Date: 12/04
MANUAL P/N 985019000E
CD P/N 98501999E
DATE 12/04

BOONTON

Boonton Electronics

A Wireless Telecom Group Company
25 Eastmans Road
Parsippany, NJ 07054-0465

Web Site: www.boonton.com
Email: boonton@boonton.com
Telephone: 973-386-9696
Fax: 973-386-9191

SAFETY SUMMARY

The following general safety precautions must be observed during all phases of operation and maintenance of this instrument. Failure to comply with these precautions or with specific warnings elsewhere in this manual violates safety standards of design, manufacture, and intended use of the instruments. Boonton Electronics Corporation assumes no liability for the customer's failure to comply with these requirements.

THE INSTRUMENT MUST BE GROUNDED.

To minimize shock hazard the instrument chassis and cabinet must be connected to an electrical ground. The instrument is equipped with a three conductor, three prong AC power cable. The power cable must either be plugged into an approved three-contact electrical outlet or used with a three-contact to a two-contact adapter with the (green) grounding wire firmly connected to an electrical ground at the power outlet.

DO NOT OPERATE THE INSTRUMENT IN AN EXPLOSIVE ATMOSPHERE.

Do not operate the instrument in the presence of flammable gases or fumes.

KEEP AWAY FROM LIVE CIRCUITS.

Operating personnel must not remove instrument covers. Component replacement and internal adjustments must be made by qualified maintenance personnel. Do not replace components with the power cable connected. Under certain conditions dangerous voltages may exist even though the power cable was removed; therefore, always disconnect power and discharge circuits before touching them.

DO NOT SERVICE OR ADJUST ALONE.

Do not attempt internal service or adjustment unless another person, capable of rendering first aid and resuscitation, is present.

DO NOT SUBSTITUTE PARTS OR MODIFY INSTRUMENT.

Do not install substitute parts or perform any unauthorized modification of the instrument. Return the instrument to Boonton Electronics for repair to ensure that the safety features are maintained.

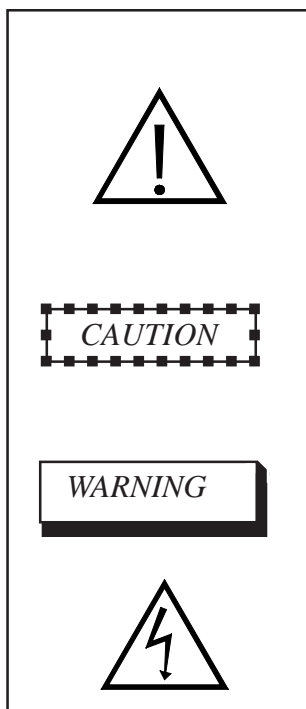

This safety requirement symbol has been adopted by the International Electrotechnical Commission, Document 66 (Central Office) 3, Paragraph 5.3, which directs that an instrument be so labeled if, for the correct use of the instrument, it is necessary to refer to the instruction manual. In this case it is recommended that reference be made to the instruction manual when connecting the instrument to the proper power source. Verify that the correct fuse is installed for the power available, and that the switch on the rear panel is set to the applicable operating voltage.

The CAUTION sign denotes a hazard. It calls attention to an operation procedure, practice, or the like, which, if not correctly performed or adhered to, could result in damage to or destruction of part or all of the equipment. Do not proceed beyond a CAUTION sign until the indicated conditions are fully understood and met.

The WARNING sign denotes a hazard. It calls attention to an operation procedure, practice, or the like, which, if not correctly performed or adhered to, could result in injury or loss of life. Do not proceed beyond a warning sign until the indicated conditions are fully understood and met.

This SAFETY REQUIREMENT symbol has been adopted by the International Electrotechnical Commission, document 66 (Central Office) 3, Paragraph 5.3 which indicates hazardous voltage may be present in the vicinity of the marking.

Contents

Paragraph	Page
1 Introduction	
1-1 Overview	1
1-2 Sensor Trade-offs	1
1-3 Calibration and Traceability	3
2 Power Sensor Characteristics	5
3 Power Sensor Uncertainty Factors	16
4 Low Frequency Response and Standing-Wave-Ratio (SWR) Data	26
5 Pulsed RF Power	30
5-1 Pulsed RF Power Operation	30
5-2 Pulsed RF Operation Thermocouple Sensors	31
5-3 Pulsed RF Operation Diode Sensors	32
6 Calculating Measurement Uncertainty	33
6-1 Measurement Accuracy	33
6-2 Error Contributions	34
6-3 Discussion of Error Terms	34
6.4 SampleUncertainty Calucations	39
7 Warranty	45

Figures

Figure		Page
1-1	Error Due to AM Modulation (Diode Sensor)	2
1-2	Linearity Traceability	3
1-3	Calibration Factor Traceability	4
4-1	Model 51071 Low Frequency Response	26
4-2	Model 51072 Low Frequency Response	26
4-3	Model 51075 Low Frequency Response	27
4-4	Model 51071 SWR Data	27
4-5	Model 51072 SWR Data	27
4-6	Model 51075 SWR Data	28
4-7	Model 51078 SWR Data	28
4-8	Model 51100 SWR Data	28
4-9	Model 51101 SWR Data	29
4-10	Model 51102 SWR Data	29
5-1	Pulsed RF Operation	30
5-2	Pulsed Accuracy for Thermocouple Sensors	31
5-3	Pulsed Accuracy for Diode Sensors	32
6-1	Mismatch Uncertainty	37

Tables

Table		Page
2-1	Dual Diode and Thermal Sensor Characteristics	5
2-2	Peak Power Sensor Characteristics	9
2-3	Legacy Diode CW Sensor Characteristics	11
2-4	Legacy Waveguide Sensor Characteristics	13
2-5	Legacy Peak Power Sensor Characteristics	15
3-1	Diode & Thermocouple Power Sensor Calibration Factor Uncertainty Models 51011(4B), 51011(EMC), 51012(4C), 51013(4E), 51015(5E), 51033(6E)	16
3-1	Diode & Thermocouple Power Sensor Calibration Factor Uncertainty (Cont.) Models 51071, 51072, 51075, 51077, 51078, 51079	17
3-1	Diode & Thermocouple Power Sensor Calibration Factor Uncertainty (Cont.) Models 51071A, 51072A, 51075A, 51077A, 51078A, 51079A	18
3-1	Diode & Thermocouple Power Sensor Calibration Factor Uncertainty (Cont.) Models 51085, 51086, 51087	19
3-1	Diode & Thermocouple Power Sensor Calibration Factor Uncertainty (Cont.) Models 51081, 51100, 510101(9E),51101,51102,51200,51201	20
3-1	Diode and Thermocouple Power Sensor Calibration Factor Uncertainty (con't) Models 51300, 51301, 51082	21

Tables (Con't)

Table		Page
3-2	Peak Power Sensor Calibration Factor Uncertainty Models 56218, 56226, 56318, 56326, 56418	22
3-2	Peak Power Sensor Calibration Factor Uncertainty (con't) Models 56518, 56526, 56540	23
3-2	Peak Power Sensor Calibration Factor Uncertainty (con't) Models 57318, 57340, 57518, 57540	24
3-3	Waveguide Sensor Calibration Factor Uncertainty Models 51035(4K), 51036(4KA), 51037(4Q), 51045(4U), 51046(4V), 51047(4W), 51942(WRD-180)	25

Introduction

1-1 Overview

The overall performance of a power meter is dependent upon the sensor employed. Boonton Electronics (Boonton) has addressed this by providing quality power sensors to meet virtually all applications. Boonton offers a family of sensors with frequency ranges spanning 10 kHz to 100 GHz and sensitivity from 0.1 nW (-70 dBm) to 25 W (+44 dBm). A choice of Diode or Thermocouple Sensors with 50 or 75 ohms impedances in Coaxial or Waveguide styles are available.

1-2 Sensor Trade-offs

Both the Thermocouple and Diode Sensors offer unique advantages and limitations. Thermocouple Sensors measure true RMS power over a dynamic range from 1.0 μ W (-30 dBm) to 100 mW (+20 dBm), and therefore, are less sensitive to non-sinusoidal signals and those signals with high harmonic content. The Thermocouple Sensors also provide advantages when making pulsed RF measurements with extremely high crest factors. While the headroom (the difference between the rated maximum input power and burnout level) for CW (continuous wave) measurements is only a few dB (decibels), Thermocouple Sensors are very rugged in terms of short duration overload. For example, a sensor that operates up to 100 mW average power (CW) can handle pulses up to 15 watts for approximately two microseconds. One of the major limitations to the Thermocouple Sensor is on the low-end sensitivity. Low-end sensitivity of these sensors is limited by the efficiency of the thermal conversion. For this reason, the Diode Sensor is used for requirements below 10 μ W (-20 dBm).

CW Diode Sensors provide the best available sensitivity, typically down to 0.1 nW (-70 dBm). Boonton Diode Sensors are constructed using balanced diode detectors. The dual diode configuration offers increased sensitivity as well as harmonic suppression when compared to a single diode sensor. The only significant drawback to Diode Sensors is that above the level of approximately 10 μ W (-20 dBm), the diodes begin to deviate substantially from square-law detection. In this region of 10 μ W (-20 dBm) to 100 mW (20 dBm), peak detection is predominant and the measurement error due to the presence of signal harmonics is increased.

The square-law response can be seen in Figure 1-1, where a 100% amplitude modulated signal is shown to have virtually no effect on the measured power at low levels. Of course, frequency modulated and phase modulated signals can be measured at any level, since the envelope of these modulated signals is flat. Frequency shift keyed and quadrature modulated signals also have flat envelopes and can be measured at any power level.

This non-square-law region may be "shaped" with meter corrections, but only for one defined waveform, such as a CW signal. By incorporating "shaping", also referred to as "Linearity Calibration", Boonton offers a dynamic range from 0.1 nW (-70 dBm) to 100 mW (+20 dB) with a single sensor module. For CW measurements, the entire 90 dB range can be used, however, when dealing with non-sinusoidal and high-harmonic content signals, the Diode Sensor should be operated only within its square-law region (10 μ W and below).

Although thermal sensors provide a true indication of RMS power for modulated (non-CW) signals, they are of limited use for characterizing the short-term or instantaneous RF power due to their rather slow response speed. For accurate power measurements of short pulses or digitally modulated carriers, Boonton has developed a line of wideband diode sensors called Peak Power Sensors. These sensors are specially designed for applications where the instantaneous power of an RF signal must be measured with high accuracy. They are for use with the Boonton Model 4400 peak Power Meter and the Model 4500 Digital Sampling Power Analyzer. Because the bandwidth of Peak Power Sensors is higher than most modulated signals (30 MHz or more for some sensor models), they accurately respond to the instantaneous power envelope of the RF signal, and the output of the sensor may be fully linearized for any type of signal, whether CW or modulated. Boonton Peak Power Sensors contain built-in nonvolatile memory that stores sensor information and frequency correction factors. The linearity correction factors are automatically generated by the instrument's built-in programmable calibrator. With the high sensor bandwidth, and frequency and linearity correction applied continuously by the instrument, it is possible to make many types of measurements on an RF signal; average (CW) power, peak power, dynamic range, pulse timing, waveform viewing, and calculation of statistical power distribution functions.

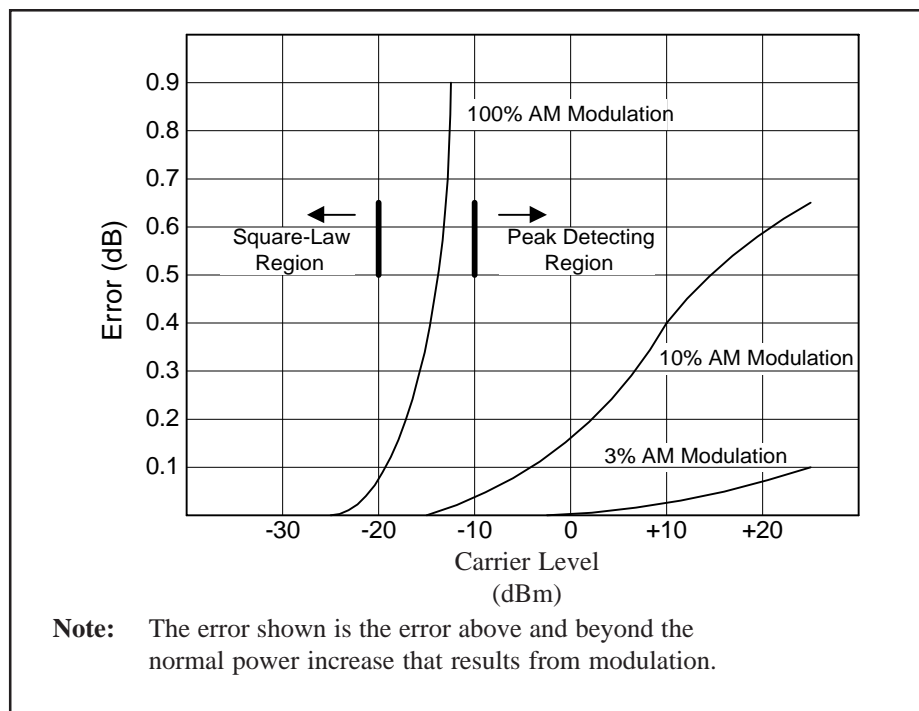

Figure 1-1. Error Due to AM Modulation (Diode Sensor)

1-3 Calibration and Traceability

Boonton employs both a linearity calibration as well as a frequency response calibration. This maximizes the performance of Diode Sensors and corrects the non-linearity on all ranges.

Linearity calibration can be used to extend the operating range of a Diode Sensor. It can also be used to correct non-linearity throughout a sensor's dynamic range, either Thermocouple or Diode. A unique traceability benefit offered is the use of the 30 MHz working standard. This is used to perform the linearization. This standard is directly traceable to the 30 MHz piston attenuator maintained at the National Institute of Standards Technology (NIST). Refer to Figure 1-2. Linearity Traceability.

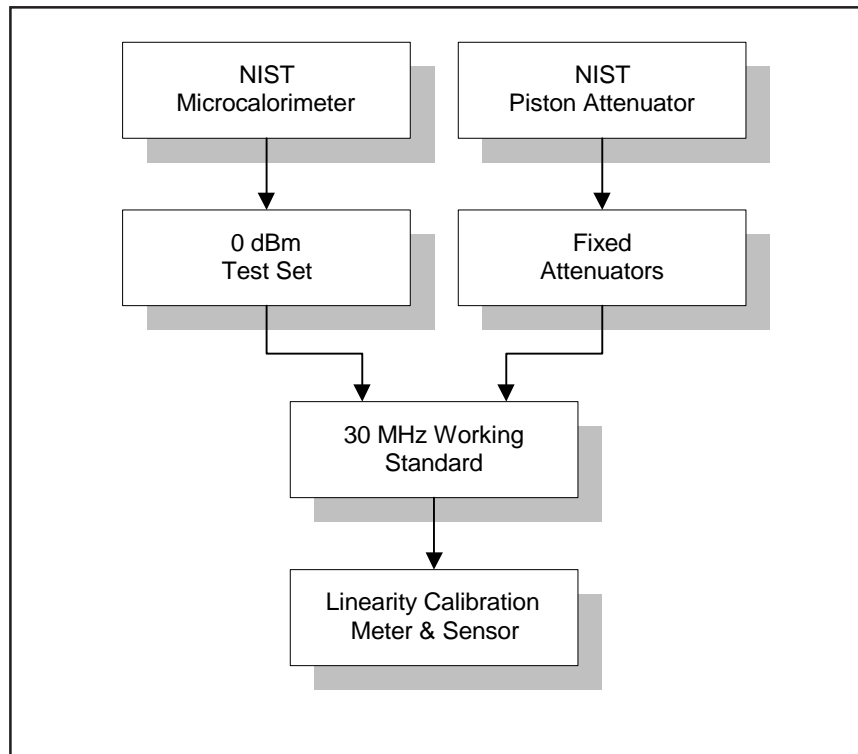

Figure 1-2. Linearity Traceability

Power sensors have response variations (with respect to the reference frequency) at high frequencies. Calibration factors ranging from ± 3 dB are entered into the instrument memories at the desired frequencies. Generally, calibration factors are within ± 0.5 dB. These calibration factors must be traceable to the National Institute of Standards Technology (NIST) to be meaningful. This is accomplished by sending a standard power sensor (Thermocouple type) to NIST or a certified calibration house and comparing this standard sensor against each production sensor. The predominant error term is the uncertainty of the reference sensor, which is typically 2% to 6%, depending on the frequency. Refer to Figure 1-3. Calibration Factor Traceability.

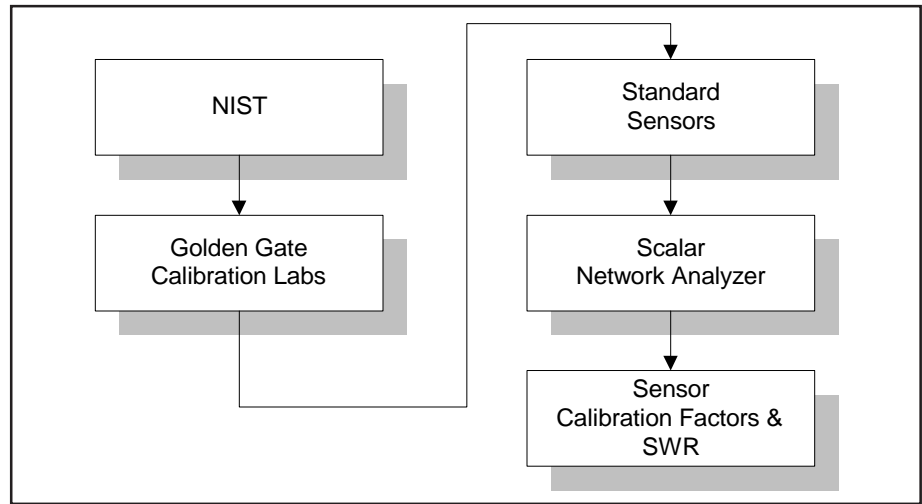

Figure 1-3. Calibration Factor Traceability

Power Sensor Characteristics

The power sensor has three primary functions. First the sensor converts the incident RF or microwave power to an equivalent voltage that can be processed by the power meter. The sensor must also present to the incident power an impedance which is closely matched to the transmission system. Finally, the sensor must introduce the smallest drift and noise possible so as not to disturb the measurement.

Table 2-1 lists the characteristics of the latest line of Continuous Wave (CW) sensors offered by Boonton. The latest Peak Power sensor characteristics are outlined in Table 2-2. This data should be referenced for all new system requirements.

Table 2-1. Diode and Thermal CW Sensor Characteristics

Model Impedance RF Connector	Frequency Range	Dynamic Range ⁽¹⁾ (dBm)	Overload Rating Peak Power CW Power	Maximum SWR		Drift and Noise Lowest Range		
				Frequency (GHz)	SWR	Drift (typ.) 1 Hour	Noise	
							RMS (typical)	2 σ
WIDE DYNAMIC RANGE DUAL DIODE SENSORS								
51075 50 Ω N(M)	500 kHz to 18 GHz	-70 to +20 ⁽²⁾	1 W for 1 μ s 300 mW	to 2 to 6 to 18	1.15 1.20 1.40	100 pW ⁽⁶⁾	30 pW	60 pW
51077 50 Ω GPC-N(M)	500 kHz to 18 GHz	-60 to +30 ⁽³⁾	10 W for 1 μ s 3 W	to 4 to 8 to 12 to 18	1.15 1.20 1.25 1.35	2 nW ⁽⁷⁾	300 pW	600 pW
51079 50 Ω GPC-N(M)	500 kHz to 18 GHz	-50 to +40 ⁽⁴⁾	100 W for 1 μ s 25 W	to 8 to 12 to 18	1.20 1.25 1.35	20 nW ⁽⁷⁾	3 nW	6 nW
51071 50 Ω K(M)	10 MHz to 26.5 GHz	-70 to +20 ⁽²⁾	1 W for 1 μ s 300 mW	to 2 to 4 to 18 to 26.5	1.15 1.20 1.45 1.50	100 pW ⁽⁷⁾	30 pW	60 pW
51072 50 Ω K(M)	30 MHz to 40 GHz	-70 to +20 ⁽²⁾	1 W for 1 μ s 300 mW	to 4 to 38 to 40	1.25 1.65 2.00	100 pW ⁽⁷⁾	30 pW	60 pW

5107xA Series of RF Sensors

The “A” series sensors were created to improve production calibration results. These sensors possess the same customer specifications as the non-A types (i.e.: 51075 and 51075A), however, the utilization of new calibration methods enhances the testing performance over previous techniques. In doing this, Boonton can provide the customer with a better product with a higher degree of confidence.

The “A” series sensors utilize “Smart Shaping” technology to characterize the linearity transfer function. This is accomplished by performing a step calibration to determine the sensors response to level variations. The shaping characteristics are determined during the calibration and then the coefficients are stored in the data adapter that is supplied with the sensor. This provides improved linearity results when used with the 4230A and 5230 line of instruments with software version 5.04 (or later).

Instruments that are equipped with step calibrators such as the 4530 already perform this function when the Auto Cal process is performed. For these instruments an “A” type sensor performs the same as a non-“A” type and no discernable difference is realized.

Table 2-1. Diode and Thermal CW Sensor Characteristics (con't.)

Model Impedance RF Connector	Frequency Range	Dynamic Range ⁽¹⁾ (dBm)	Overload Rating Peak Power CW Power	Maximum SWR		Drift and Noise Lowest Range		
				Frequency (GHz)	SWR	Drift (typ.) 1 Hour	Noise	
							RMS (typical)	2 σ
WIDE DYNAMIC RANGE DUAL DIODE SENSORS								
51075A 50 Ω N(M)	500 kHz to 18 GHz	-70 to +20 ⁽²⁾	1 W for 1 μ s 300 mW	to 2 to 6 to 18	1.15 1.20 1.40	100 pW ⁽⁶⁾	30 pW	60 pW
51077A 50 Ω GPC-N(M)	500 kHz to 18 GHz	-60 to +30 ⁽³⁾	10 W for 1 μ s 3 W	to 4 to 8 to 12 to 18	1.15 1.20 1.25 1.35	2 nW ⁽⁷⁾	300 pW	600 pW
51079A 50 Ω GPC-N(M)	500 kHz to 18 GHz	-50 to +40 ⁽⁴⁾	100 W for 1 μ s 25 W	to 8 to 12 to 18	1.20 1.25 1.35	20 nW ⁽⁷⁾	3 nW	6 nW
51071A 50 Ω K(M)	10 MHz to 26.5 GHz	-70 to +20 ⁽²⁾	1 W for 1 μ s 300 mW	to 2 to 4 to 18 to 26.5	1.15 1.20 1.45 1.50	100 pW ⁽⁷⁾	30 pW	60 pW
51072A 50 Ω K(M)	30 MHz to 40 GHz	-70 to +20 ⁽²⁾	1 W for 1 μ s 300 mW	to 4 to 38 to 40	1.25 1.65 2.00	100 pW ⁽⁷⁾	30 pW	60 pW

Table 2-1. Diode and Thermal CW Sensor Characteristics (con't.)

Model Impedance RF Connector	Frequency Range	Dynamic Range ⁽¹⁾ (dBm)	Overload Rating Peak Power CW Power	Maximum SWR		Drift and Noise Lowest Range		
				Frequency (GHz)	SWR	Drift (typ.) 1 Hour	Noise	
							RMS (typical)	2 σ
WIDE DYNAMIC RANGE DUAL DIODE SENSORS								
51085 50 Ω N(M)	500 kHz to 18 GHz	-30 to +20 ⁽²⁾	1 W for 1 μ s 300 mW	to 4 to 12.4 to 18	1.15 1.20 1.25	2 μ W ⁽⁶⁾	500 nW	1 μ W
51086 50 Ω K(M)	10 MHz to 26.5 GHz	-30 to +20 ⁽²⁾	1 W for 1 μ s 300 mW	to 18 to 26.5	1.30 1.35	2 μ W ⁽⁷⁾	500 nW	1 μ W
51087 50 Ω K(M)	30 MHz to 40 GHz	-30 to +20 ⁽²⁾	1 W for 1 μ s 300 mW	to 18 to 26.5 to 40	1.30 1.35 1.40	2 μ W ⁽⁷⁾	500 nW	1 μ W

Table 2-1. Diode and Thermal CW Sensor Characteristics (con't.)

Model Impedance RF Connector	Frequency Range	Dynamic Range ⁽¹⁾ (dBm)	Overload Rating Peak Power CW Power	Maximum SWR		Drift and Noise Lowest Range		
				Frequency (GHz)	SWR	Drift (typ.) 1 Hour	Noise	
							RMS (typical)	2 σ
THERMOCOUPLE SENSORS								
51100 (9E) 50 Ω N(M)	10 MHz to 18 GHz	-20 to +20 ⁽²⁾	15 W 300 mW ⁽⁸⁾	to 0.03 to 16 to 18	1.25 1.18 1.28	200 nW ⁽⁵⁾	100 nW	200 nW
51101 50 Ω N(M)	100 kHz to 4.2 GHz	-20 to +20 ⁽²⁾	15 W 300 mW ⁽⁸⁾	to 0.3 to 2 to 4.2	1.70 1.35 1.60	200 nW ⁽⁵⁾	100 nW	200 nW
51102 50 Ω K(M)	30 MHz to 26.5 GHz	-20 to +20 ⁽²⁾	15 W 300 mW ⁽⁸⁾	to 2 to 18 to 26.5	1.35 1.40 1.60	200 nW ⁽⁵⁾	100 nW	200 nW
51200 50 Ω N(M)	10 MHz to 18 GHz	0 to +37 ⁽²⁾	150 W 10 W ⁽⁹⁾	to 2 to 12.4 to 18	1.10 1.18 1.28	20 μ W ⁽⁵⁾	10 μ W	20 μ W
51201 50 Ω N(M)	100 kHz to 4.2 GHz	0 to +37 ⁽²⁾	150 W 10 W ⁽⁹⁾	to 2 to 4.2	1.10 1.18	20 μ W ⁽⁵⁾	10 μ W	20 μ W
51300 50 Ω N(M)	10 MHz to 18 GHz	0 to +44 ⁽²⁾	150 W 50 W ⁽⁹⁾	to 2 to 12.4 to 18	1.10 1.18 1.28	50 μ W ⁽⁵⁾	25 μ W	50 μ W
51301 50 Ω N(M)	100 kHz to 4.2 GHz	0 to +44 ⁽²⁾	150 W 50 W ⁽⁹⁾	to 2 to 4.2	1.10 1.18	50 μ W ⁽⁵⁾	25 μ W	50 μ W

- NOTES: 1) Models 4731, 4732, 4231A, 4232A, 4300, 4531, 4532, 5231, 5232, 5731, 5732
 2) Power Linearity Uncertainty at 50 MHz:
 <10 dBm: 1% (0.04dB) for 51071, 51072, 51075, 51085, 51086 and 51087 sensors.
 10 to 17 dBm: 3% (0.13 dB) for 51071, 51072 and 51075 sensors.
 10 to 20 dBm: 6% (0.25 dB) for 51085, 51086 and 51087 sensors.
 17 to 20 dBm: 6% (0.25 dB) for 51071, 51072 and 51075 sensors.
 30 to 37 dBm: 3% (0.13 dB) for 51078 sensor.
 all levels: 1% (0.04dB) for 51100, 51101, 51102, 51200, 51201, 51300 and 51301 sensors.
 3) Power Linearity Uncertainty 30/50 MHz for 51077 sensor.
 -50 to +20 dBm: 1% (0.04 dB) +20 to +30 dBm: 6% (0.27 dB)
 4) Power Linearity Uncertainty 30/50 MHz for 51079 sensor.
 -40 to +30 dBm: 1% (0.04 dB) +30 to +40 dBm: 6% (0.25 dB)
 5) Temperature influence: 0.01 dB/°C (0 to 55°C)
 6) Temperature influence: 0.02 dB/°C (0 to 25°C), 0.01 dB/°C (25 to 55°C)
 7) Temperature influence: 0.03 dB/°C (0 to 55°C)
 8) Thermocouple characteristics at 25°C: Max pulse energy = 30 W μ sec/pulse
 9) Thermocouple characteristics at 25°C: Max pulse energy = 300 W μ sec/pulse

Table 2-2. Peak Power Sensor Characteristics

Model	Frequency Range	Power Measurement	Overload Rating	Rise Time		Maximum SWR		Drift & Noise
				Fast High Bandwidth (ns)	Slow Low Bandwidth (ns)	Frequency (GHz)	SWR	
Impedance RF Connector	(GHz)	Peak CW ⁽¹⁾ Int. Trigger (dBm)	Peak Power CW Power					Peak Power CW Power
DUAL DIODE PEAK POWER SENSORS								
Sensors below are for use with 4400, 4500, 4400A and 4500A RF Peak Power Meters and 4530 Series RF Power Meter when combined with Model 2530 1 GHz calibrator accessory.								
56218 50 Ω N(M)	0.03 to 18	-24 to 20 -34 to 20 -10 to 20 ⁽³⁾	1W for 1us 200 mW	< 150 (3 MHz)	< 500 (700 kHz)	to 2 to 6 to 18	1.15 1.20 1.25	4 uW 0.4 uW
56318 50 Ω N(M)	0.5 to 18	-24 to 20 -34 to 20 -10 to 20 ⁽³⁾	1W of 1 us 200 mW	< 15 ⁽²⁾ (35 MHz)	< 200 (1.75 MHz)	to 2 to 6 to 16 to 18	1.15 1.20 1.28 1.34	4 uW 0.4 uW
56326 50 Ω K(M)	0.5 to 26.5	-24 to 20 -34 to 20 -10 to 20 ⁽³⁾	1W of 1 us 200 mW	< 15 ⁽²⁾ (35 MHz)	< 200 (1.75 MHz)	to 2 to 4 to 18 to 26.5	1.15 1.20 1.45 1.50	4 uW 0.4 uW
56418 50 Ω N(M)	0.5 to 18	-34 to 5 -40 to 5 -18 to 5 ⁽³⁾	1W of 1 us 200 mW	< 30 (15 MHz)	< 100 (6 MHz)	to 2 to 6 to 16 to 18	1.15 1.20 1.28 1.34	400 nW 100 nW
56518 50 Ω N(M)	0.5 to 18	-40 to 20 -50 to 20 -27 to 20 ⁽⁴⁾	1W of 1 us 200 mW	< 100 (6 MHz)	< 300 (1.16 MHz)	to 2 to 6 to 16 to 18	1.15 1.20 1.28 1.34	400 nW 100 nW

- NOTES: 1) Models 4400, 4500, 4400A and 4500A only.
2) Models 4531 and 4532: <20ns, (20MHz).
3) Shaping Error (Linearity Uncertainty), all levels 2.3%
4) Shaping Error (Linearity Uncertainty), all levels 4.0%

Table 2-2. Peak Power Sensor Characteristics (con't.)

Model	Frequency Range	Power Measurement	Overload Rating	Rise Time		Maximum SWR		Drift & Noise
				Fast High Bandwidth (ns)	Slow Low Bandwidth (ns)	Frequency (GHz)	SWR	
Impedance RF Connector	(GHz)	Peak CW ⁽¹⁾ Int. Trigger (dBm)	Peak Power CW Power					Peak Power CW Power
DUAL DIODE PEAK POWER SENSORS								
Sensors below are for use with 4400, 4500, 4400A, 4500A and 4530. Compatible with 4530 Series internal 50 MHz calibrator.								
57318 50 Ω N(M)	0.5 to 18 (0.05 to 18)	-24 to 20 -34 to 20 -10 to 20 (3)	1W of 1 us 200 mW	< 15 ⁽²⁾ (35 MHz)	< 10 us (350 kHz)	to 2 to 6 to 16 to 18	1.15 1.20 1.28 1.34	4 uW 0.4 uW
57340 50 Ω K(M)	0.1 to 40 (0.03 to 40)	-24 to 20 -34 to 20 -10 to 20 (3)	1W of 1 us 200 mW	< 15 ⁽²⁾ (35 MHz)	< 10 us (350 kHz)	to 4 to 38 to 40	1.25 1.65 2.00	4 uW 0.4 uW
57518 50 Ω N(M)	0.1 to 18 (0.05 to 18)	-40 to 20 -50 to 20 -27 to 20 (4)	1W of 1 us 200 mW	< 100 (6 MHz)	< 10 us (350 kHz)	to 2 to 6 to 16 to 18	1.15 1.20 1.28 1.34	50 nW 5 nW
57540 50 Ω K(M)	0.1 to 40 (0.05 to 40)	-40 to 20 -50 to 20 -27 to 20 (5)	1W of 1 us 200 mW	< 100 (6 MHz)	< 10 us (350 kHz)	to 4 to 38 to 40	1.25 1.65 2.00	50 nW 5 nW

- NOTES: 1) Models 4400, 4500, 4400A and 4500A only.
 2) Models 4531 and 4532: <20ns, (20MHz).
 3) Shaping Error (Linearity Uncertainty), all levels 2.3%
 4) Shaping Error (Linearity Uncertainty), all levels 4.0%
 5) Shaping Error (Linearity Uncertainty), all levels 4.7%

Frequency calibration factors (NIST traceable) and other data are stored within all the Peak Power Sensors. Linearity calibration is performed by the built-in calibrator of the peak power meter.

MODELS 4400, 4500, 4400A and 4500A:

All Peak Power sensors can be used with these models and calibrated with the internal 1GHz step calibrator.

MODELS 4531 and 4532:

The Peak Power sensors in the lower group above may be used with these models and calibrated with the internal 50 MHz step calibrator. The sensors on the upper group may be used if the Model 2530 1 GHz Accessory Calibrator is used for calibration.

A five-foot long sensor cable is standard. Longer cables are available at a higher cost. Effective bandwidth is reduced with longer cables.

Sensor characteristics of Boonton legacy sensors are presented in tables 2-3 (CW) and 2-4 (Waveguide). This data is presented for reference only. Contact the sales department for availability.

Table 2-3. Legacy Diode CW Sensor Characteristics

Model Impedance RF Connector	Frequency Range	Dynamic Range (¹) (³) (dBm)	Overload Rating Peak Power CW Power	Maximum SWR		Drift and Noise Lowest Range		
				Frequency (GHz)	SWR	Drift (typ.) 1 Hour (²) (⁵)	Noise	
							RMS (typical)	2 σ
DUAL DIODE SENSORS								
51011 (EMC) 50 Ω N(M)	10 kHz to 8 GHz	-60 to +20	1 W for 1 μ s 300 mW	to 2 to 4 to 8	1.12 1.20 1.40	150 pW	65 pW	130 pW
51011 (4B) 50 Ω N(M)	100 kHz to 12.4 GHz	-60 to +20	1 W for 1 μ s 300 mW	to 2 to 4 to 11 to 12.4	1.12 1.20 1.40 1.60	150 pW	65 pW	130 pW
51012 (4C) 75 Ω N(M)	100 kHz to 1 GHz	-60 to +20	1 W for 1 μ s 300 mW	to 1	1.18	150 pW	65 pW	130 pW
51012-S/4 75 Ω N(M)	100 kHz to 2 GHz	-60 to +20	1 W for 1 μ s 300 mW	to 2	1.18	150 pW	65 pW	130 pW
51013 (4E) 50 Ω N(M)	100 kHz to 18 GHz	-60 to +20	1 W for 1 μ s 300 mW	to 4 to 10 to 18	1.30 1.50 1.70	150 pW	65 pW	130 pW
51015 (5E) 50 Ω N(M)	100 kHz to 18 GHz	-50 to +30	10 W for 1 μ s 2 W	to 1 to 2 to 4 to 12.4 to 18	1.07 1.10 1.12 1.18 1.28	1.5 nW	0.65 nW	1.3 nW
51033 (6E) 50 Ω N(M)	100 kHz to 18 GHz	-40 to +33	100 W for 1 μ s 2 W	to 1 to 2 to 4 to 12.4 to 18	1.07 1.10 1.12 1.18 1.28	15 nW	6.5 nW	13 nW

Table 2-3. Legacy Diode CW Sensor Characteristics (con't.)

Model Impedance RF Connector	Frequency Range	Dynamic Range (¹) (dBm)	Overload Rating Peak Power CW Power	Maximum SWR		Drift and Noise Lowest Range		
				Frequency (GHz)	SWR	Drift (typ.) 1 Hour (²)	Noise	
							RMS (typical)	2 σ
DUAL DIODE SENSORS								
51078 50 Ω N(M)	100 kHz to 18 GHz	-20 to +37 (³) (⁸)	100 W for 1 μ s 7 W	to 4 to 12 to 18	1.15 1.25 1.40	150 nW (⁶)	65 nW	130 nW
DC COUPLED SINGLE DIODE SENSORS								
51081 50 Ω k(M)	1 MHz to 40 GHz	-30 to +10 (⁴)	200 mW	to 0.5 to 40	1.04 2.00	200 pW (⁷)	200 pW	400 pW
51082 50 Ω V(M)	40 GHz to 50 GHz	-30 to +10 (⁴)	200 mW	50 MHz (ref.) 40 to 50	1.04 2.20	200 pW (⁷)	200 pW	400 pW

- NOTES: 1) Applies to all Boonton Power Meters unless otherwise indicated with the exception of Model 4200 and 4200A. The lower limit of the Dynamic Range for Models 4200 and 4200A does not extend below -60 dBm and the upper limit is degraded by 10 dB with the exception of sensor Model 51033 where the Dynamic range is -40 to +30 dBm.
- 2) After two-hour warm-up: High frequency power linearity uncertainty: (worst case) (0.005 x f) dB per dB, where f is in GHz above +4 dBm for sensors 51011, 51012, 51013 ; above +14 dBm for sensor 51015; above +24 dBm for sensor 51033
- 3) Power Linearity Uncertainty at 50 MHz:
 <10 dBm: 1% for 51011, 51012, 51013, 51015, and 51033 sensors.
 10 to 20 dBm: 1% for 51015 and 51033 sensors; 3% for 51011, 51012 and 51013 sensors.
 20 to 33 dBm: 3% for 51015 and 51033 sensors.
 30 to 37 dBm: 3% for 51078 sensor.
- 4) Power Linearity Uncertainty 30/50 MHz. -30 to -10 dBm: 6% (0.27 dB), -10 to +10 dBm: 4% (0.18 dB)
- 5) Temperature influence: 0.02 dB/°C (0 to 25°C), 0.01 dB/°C (25 to 55°C)
- 6) Temperature influence: 0.03 dB/°C (0 to 55°C)
- 7) Temperature influence: -30 to -10 dBm: 0.03 dB/°C, -10 to +10 dBm: 0.01 dB/°C (0 to 55°C)
- 8) Not available on 4200 series.

Table 2-4. Legacy Waveguide Sensor Characteristics

Model Impedance RF Connector	Frequency Range (Ref. Freq.)	Dynamic Range ⁽²⁾ (dBm)	Overload Rating CW Power	Maximum SWR		Drift and Noise Lowest Range		
				Frequency (GHz)	SWR	Drift after 2 hr. (/hr)	Noise	
							RMS (typical)	2 σ
WAVEGUIDE SENSORS								
51035 (4K) WR-42 UG-595/U	18 GHz to 26.5 GHz	-50 to +10 ⁽¹⁾	100 mW	18 to 26.5	1.45	200 pW	60 pW	120 pW
51036 (4KA) WR-28 UG-599/U	26.5 GHz to 40 GHz	-50 to +10 ⁽¹⁾	100 mW	26.5 to 40	1.45	60 pW	15 pW	30 pW
51037 (4Q) WR-22 UG-383/U	33 GHz to 50 GHz	-50 to +10	100 mW	33 to 50	1.45	60 pW	15 pW	30 pW
51045 (4U) WR-19 UG-383/U	40 GHz to 60 GHz	-50 to +10	100 mW	40 to 60	1.45	60 pW	15 pW	30 pW
51046 (4V) WR-15 UG-385/U	50 GHz to 75 GHz	-50 to +10	100 mW	50 to 75	1.45	60 pW	15 pW	30 pW
51047 (4W) WR-10 UG-387/U	75 GHz to 100 GHz	-45 to +10	100 mW	75 to 100	1.45	60 pW	15 pW	30 pW
51136 (4Ka) WR-28 (UG-599/U)	26.5 to 40 GHz (33 GHz)	-40 to +10	50 mW	26.5 to 40	1.45	100 pW	60 pW	120 pW
51236 (4Ka) WR-28 (UG-599/U)	26.5 to 40 GHz (33 GHz)	-50 to +10	50 mW	26.5 to 40	1.45	60 pW	15 pW	30 pW
51137 (4Q) WR-22 (UG-383/U)	33 to 50 GHz (40 GHz)	-40 to +10	50 mW	33 to 50	1.45	60 pW	15 pW	30 pW
51237 (4Q) WR-22 (UG-383/U)	33 to 50 GHz (40 GHz)	-50 to +10	50 mW	33 to 50	1.45	60 pW	15 pW	30 pW

Table 2-4. Legacy Waveguide Sensor Characteristics (con't.)

Model Impedance RF Connector	Frequency Range (Ref. Freq.)	Dynamic Range ⁽²⁾ (dBm)	Overload Rating CW Power	Maximum SWR		Drift and Noise Lowest Range		
				Frequency (GHz)	SWR	Drift after 2 hr. (/hr)	Noise	
							RMS (typical)	2 σ
WAVEGUIDE SENSORS								
51145 (4U) WR-19 (UG-383/U)	40 to 60 GHz (50 GHz)	-40 to +10 dBm	50 mW	40 to 60	1.45	60 pW	15 pW	30 pW
51245 (4U) WR-19 (UG-383/U)	40 to 60 GHz (50 GHz)	-50 to +10 dBm	50 mW	40 to 60	1.45	60 pW	15 pW	30 pW
51146 (4V) WR-15 (UG-385/U)	50 to 75 GHz (60 GHz)	-40 to +10 dBm	50 mW	50 to 75	1.45	60 pW	15 pW	30 pW
51246 (4V) WR-15 (UG-385/U)	50 to 75 GHz (60 GHz)	-50 to +10 dBm	50 mW	50 to 75	1.45	60 pW	15 pW	30 pW
51147 (4V) WR-10 (UG-387/U)	75 to 100 GHz (94 GHz)	-40 to +10 dBm	50 mW	75 to 100	1.45	60 pW	15 pW	30 pW
51247 (4V) WR-10 (UG-387/U)	75 to 100 GHz (94 GHz)	-50 to +10 dBm	50 mW	75 to 100	1.45	60 pW	15 pW	30 pW

NOTES: 1) -40 to +10 dBm Dynamic Range if used with Model 4200A.

2) Uncertainties:

- a) Power Linearity Uncertainty at Reference Frequency: +/- 0.5 dB
- b) Cal Factor Uncertainty: +/- 0.6 dB
- c) Additional Linearity Uncertainty (referred to -10 dBm): +/- 0.01 dB/dB

Sensor characteristics of Boonton legacy Peak Power Sensors are presented in table 2-5. This data is presented for reference only. Contact the sales department for availability.

Table 2-5. Legacy Peak Power Sensor Characteristics

Model	Frequency Range	Power Measurement	Overload Rating	Rise Time		Maximum SWR		Drift & Noise
				Fast High Bandwidth (ns)	Slow Low Bandwidth (ns)	Frequency (GHz)	SWR	
Impedance RF Connector	(GHz)	Peak CW ⁽¹⁾ Int. Trigger (dBm)	Peak Power CW Power	Fast High Bandwidth (ns)	Slow Low Bandwidth (ns)	Frequency (GHz)	SWR	Peak Power CW Power
DUAL DIODE PEAK POWER SENSORS								
Sensors below are for use with 4400, 4500, 4400A and 4500A RF Peak Power Meters and 4530 Series RF Power Meter when combined with Model 2530 1 GHz calibrator accessory.								
56218-S2 50 Ω K(M)	0.03 to 26.5	-24 to 20 -34 to 20 -10 to 20 (3)	1W of 1 us 200 mW	< 150 (3 MHz)	< 500 (700 kHz)	to 2 to 6 to 18 to 26.5	1.15 1.20 1.25 1.50	4 uW 0.4 uW
56226 50 Ω K(M)	0.03 to 26.5	-24 to 20 -34 to 20 -10 to 20 (3)	1W of 1 us 200 mW	< 150 (3 MHz)	< 500 (700 kHz)	to 1 to 6 to 18 to 26.5	1.15 1.20 1.25 1.50	4 uW 0.4 uW
56340 50 Ω K(M)	0.5 to 40	-24 to 20 -34 to 20 -10 to 20 (3)	1W of 1 us 200 mW	< 15 ⁽²⁾ (35 MHz)	< 200 (1.75 MHz)	to 4 to 38 to 40	1.25 1.65 2.00	4 uW 0.4 uW
56526 50 Ω K(M)	0.5 to 26.5	-40 to 20 -50 to 20 -27 to 20 (4)	1W of 1 us 200 mW	< 100 (6 MHz)	< 300 (1.16 MHz)	to 2 to 4 to 18 to 26.5	1.15 1.20 1.45 1.50	50 nW 5 nW
56540 50 Ω K(M)	0.5 to 40	-40 to 20 -50 to 20 -27 to 20 (4)	1W of 1 us 200 mW	< 100 (6 MHz)	< 300 (1.16 MHz)	to 4 to 38 to 40	1.25 1.65 2.00	50 nW 5 nW

- NOTES: 1) Models 4400, 4500, 4400A and 4500A only.
2) Models 4531 and 4532: <20ns, (20MHz).
3) Shaping Error (Linearity Uncertainty), all levels 2.3%
4) Shaping Error (Linearity Uncertainty), all levels 4.7%

Power Sensor Uncertainty Factors

The uncertainty factors, as a function of frequency for the Diode and Thermocouple, Peak and Waveguide sensors, are listed in Tables 3-1, 3-2 and 3-3 respectively. These values represent typical results based on factory test data.

The percent (%) column is the sum of all test system uncertainties including mismatch uncertainties, the uncertainty of the standard sensor and transfer uncertainty which is traceable to NIST (National Institute of Standards Technology). The probable uncertainty (% RSS) is derived by the square root of the sum of the individual uncertainties squared. % RSS is expressed with a coverage factor of 2 yielding a 95% confidence level.

**Table 3-1. Diode and Thermocouple Power Sensor Calibration Factor Uncertainty
Models 51011(4B), 51011-EMC, 51012(4C), 51013(4E), 51015(5E), 51033(6E)**

Freq	Model (Alias)											
	51011 (4B)		51011-EMC (EMC)		51012 (4C)		51013 (4E)		51015 (5E)		51033 (6E)	
GHz	%	% RSS	%	% RSS	%	% RSS	%	% RSS	%	% RSS	%	% RSS
WIDE DYNAMIC RANGE DUAL DIODE SENSORS												
0.03	1.9	1.1	1.9	1.1	1.8	1.0	2.0	1.1	2.1	1.2	2.0	1.1
0.1			1.7	0.9	1.7	1.0						
0.3			1.6	0.9								
0.5			1.6	0.9	2.0	1.1						
1	1.7	0.9	1.8	1.0	2.3	1.4	1.7	1.0	1.9	1.0	1.7	0.9
1.5					2.4	1.5						
2	1.9	1.1	2.1	1.2	2.4	1.4	1.9	1.1	1.9	1.0	1.8	1.0
3	2.0	1.1	2.4	1.4			2.0	1.2	2.2	1.2	1.9	1.0
4	2.1	1.2	2.6	1.6			2.1	1.2	2.3	1.2	1.9	1.1
5	2.2	1.2	2.8	1.7			2.4	1.4	2.0	1.1	2.0	1.1
6	2.5	1.5	3.1	2.2			2.5	1.6	1.9	1.1	1.9	1.0
7	2.5	1.7	3.2	2.5			2.6	1.9	2.0	1.1	1.7	1.0
8	3.0	2.2	3.7	3.1			3.1	2.3	2.2	1.3	2.0	1.1
9	4.9	4.1					5.3	4.6	2.8	1.7	2.8	1.7
10	5.8	4.8					6.1	5.3	3.4	2.3	3.2	2.1
11	6.1	5.2					6.4	5.5	4.2	2.9	3.3	2.3
12	6.3	5.6					6.3	5.7	3.4	2.2	3.2	2.0
13							6.5	6.3	3.7	2.6	3.4	2.2
14							6.6	6.0	4.0	2.7	3.6	2.3
15							7.7	7.2	3.8	2.6	3.2	2.2
16							7.1	6.4	3.7	2.4	3.3	2.2
17							6.7	6.7	3.5	2.3	2.7	1.5
18							6.4	5.7	4.4	3.1	3.6	2.2

**Table 3-1. Diode and Thermocouple Power Sensor Calibration Factor Uncertainty (con't.)
Models 51071, 51072, 51075, 51077, 51078, 51079**

Freq	Model											
	51071		51072		51075		51077		51078		51079	
GHz	%	% RSS	%	% RSS	%	% RSS	%	% RSS	%	% RSS	%	% RSS
WIDE DYNAMIC RANGE DUAL DIODE SENSORS												
0.03	1.1	0.8	1.4	1.0	2.0	1.1	2.1	1.2	2.1	1.1	3.3	2.3
1	1.7	1.1	2.0	1.2	1.8	1.0	1.8	1.0	1.8	1.0	3.0	2.2
2	1.7	1.1			2.0	1.1	2.0	1.1	1.9	1.0	3.1	2.2
3	1.8	1.2	2.4	1.4	2.1	1.2	2.3	1.3	1.9	1.1	3.1	2.3
4	1.9	1.2			2.2	1.3	2.1	1.1	2.3	1.3	3.2	2.3
5	2.0	1.3	2.7	1.7	2.4	1.4	2.0	1.1	2.4	1.4	3.2	2.3
6	2.2	1.5			2.5	1.5	2.1	1.2	2.2	1.3	3.2	2.3
7	2.4	1.6	3.4	2.4	2.3	1.5	2.1	1.3	2.4	1.6	2.9	2.2
8	2.6	1.8			2.5	1.6	2.2	1.3	2.6	1.7	3.1	2.2
9	3.7	3.1	5.4	4.9	3.5	2.3	2.9	1.8	3.8	2.6	4.8	4.0
10	3.9	3.4			4.0	2.8	3.3	2.1	3.9	2.6	5.4	4.2
11	3.9	3.7	5.4	5.1	4.3	3.0	3.2	2.2	3.8	2.5	5.5	4.3
12	4.1	3.8			4.4	3.2	4.2	3.0	4.5	3.3	5.2	4.2
13	4.2	3.8	5.7	5.2	3.7	2.6	3.6	2.4	4.5	3.5	5.8	5.2
14	4.2	3.5			3.5	2.3	3.6	2.3	3.8	2.5	6.1	5.3
15	4.3	3.4	5.4	4.4	4.2	2.9	4.3	2.9	4.2	3.0	6.5	5.5
16	4.3	3.4			4.0	2.7	3.9	2.6	4.7	3.4	6.5	5.5
17	4.2	3.1	5.2	3.9	3.3	2.2	3.4	2.2	4.1	3.0	5.7	5.2
18	4.2	3.2			3.8	2.5	3.5	2.1	5.0	3.8	6.2	5.3
19	4.7	3.6	5.0	3.5								
20	4.8	3.6										
21	5.2	4.0	5.9	4.4								
22	5.6	4.3										
23	5.7	4.2	6.4	4.7								
24	5.8	4.3										
25	5.3	3.9	7.1	5.4								
26	5.5	4.1										
26.5	6.4	4.6										
27			7.4	5.2								
28			6.5	4.6								
29			6.7	4.7								
30			6.8	4.8								
31			7.0	4.9								
32			6.8	4.6								
33			6.8	4.7								
34			6.0	4.1								
35			5.2	3.4								
36			4.6	2.9								
37			4.3	2.9								
38			5.4	3.9								
39			6.5	4.9								
40			7.0	5.6								

**Table 3-1. Diode and Thermocouple Power Sensor Calibration Factor Uncertainty (con't.)
Models 51071A, 51072A, 51075A, 51077A, 51078A, 51079A**

Freq	Model											
	51071A		51072A		51075A		51077A		51078A		51079A	
GHz	%	% RSS	%	% RSS	%	% RSS	%	% RSS	%	% RSS	%	% RSS
WIDE DYNAMIC RANGE DUAL DIODE SENSORS												
0.03	1.1	0.8	1.4	1.0	2.0	1.1	2.1	1.2	2.1	1.1	3.3	2.3
1	1.7	1.1	2.0	1.2	1.8	1.0	1.8	1.0	1.8	1.0	3.0	2.2
2	1.7	1.1			2.0	1.1	2.0	1.1	1.9	1.0	3.1	2.2
3	1.8	1.2	2.4	1.4	2.1	1.2	2.3	1.3	1.9	1.1	3.1	2.3
4	1.9	1.2			2.2	1.3	2.1	1.1	2.3	1.3	3.2	2.3
5	2.0	1.3	2.7	1.7	2.4	1.4	2.0	1.1	2.4	1.4	3.2	2.3
6	2.2	1.5			2.5	1.5	2.1	1.2	2.2	1.3	3.2	2.3
7	2.4	1.6	3.4	2.4	2.3	1.5	2.1	1.3	2.4	1.6	2.9	2.2
8	2.6	1.8			2.5	1.6	2.2	1.3	2.6	1.7	3.1	2.2
9	3.7	3.1	5.4	4.9	3.5	2.3	2.9	1.8	3.8	2.6	4.8	4.0
10	3.9	3.4			4.0	2.8	3.3	2.1	3.9	2.6	5.4	4.2
11	3.9	3.7	5.4	5.1	4.3	3.0	3.2	2.2	3.8	2.5	5.5	4.3
12	4.1	3.8			4.4	3.2	4.2	3.0	4.5	3.3	5.2	4.2
13	4.2	3.8	5.7	5.2	3.7	2.6	3.6	2.4	4.5	3.5	5.8	5.2
14	4.2	3.5			3.5	2.3	3.6	2.3	3.8	2.5	6.1	5.3
15	4.3	3.4	5.4	4.4	4.2	2.9	4.3	2.9	4.2	3.0	6.5	5.5
16	4.3	3.4			4.0	2.7	3.9	2.6	4.7	3.4	6.5	5.5
17	4.2	3.1	5.2	3.9	3.3	2.2	3.4	2.2	4.1	3.0	5.7	5.2
18	4.2	3.2			3.8	2.5	3.5	2.1	5.0	3.8	6.2	5.3
19	4.7	3.6	5.0	3.5								
20	4.8	3.6										
21	5.2	4.0	5.9	4.4								
22	5.6	4.3										
23	5.7	4.2	6.4	4.7								
24	5.8	4.3										
25	5.3	3.9	7.1	5.4								
26	5.5	4.1										
26.5	6.4	4.6										
27			7.4	5.2								
28			6.5	4.6								
29			6.7	4.7								
30			6.8	4.8								
31			7.0	4.9								
32			6.8	4.6								
33			6.8	4.7								
34			6.0	4.1								
35			5.2	3.4								
36			4.6	2.9								
37			4.3	2.9								
38			5.4	3.9								
39			6.5	4.9								
40			7.0	5.6								

**Table 3-1. Diode and Thermocouple Power Sensor Calibration Factor Uncertainty (con't.)
Models 51085, 51086, 51087**

Freq	Model									
	51085		51086		51087					
GHz	%	% RSS	%	% RSS	%	% RSS	%	% RSS	%	% RSS
WIDE DYNAMIC RANGE DUAL DIODE SENSORS										
0.03	2.0	1.1	1.1	0.8	1.4	1.0				
1	1.8	1.0	1.7	1.1	2.0	1.2				
2	2.0	1.1	1.7	1.1						
3	2.1	1.2	1.8	1.2	2.4	1.4				
4	2.2	1.3	1.9	1.2						
5	2.4	1.4	2.0	1.3	2.7	1.7				
6	2.5	1.5	2.2	1.5						
7	2.3	1.5	2.4	1.6	3.4	2.4				
8	2.5	1.6	2.6	1.8						
9	3.5	2.3	3.7	3.1	5.4	4.9				
10	4.0	2.8	3.9	3.4						
11	4.3	3.0	3.9	3.7	5.4	5.1				
12	4.4	3.2	4.1	3.8						
13	3.7	2.6	4.2	3.8	5.7	5.2				
14	3.5	2.3	4.2	3.5						
15	4.2	2.9	4.3	3.4	5.4	4.4				
16	4.0	2.7	4.3	3.4						
17	3.3	2.2	4.2	3.1	5.2	3.9				
18	3.8	2.5	4.2	3.2						
19			4.7	3.6	5.0	3.5				
20			4.8	3.6						
21			5.2	4.0	5.9	4.4				
22			5.6	4.3						
23			5.7	4.2	6.4	4.7				
24			5.8	4.3						
25			5.3	3.9	7.1	5.4				
26			5.5	4.1						
26.5			6.4	4.6						
27					7.4	5.2				
28					6.5	4.6				
29					6.7	4.7				
30					6.8	4.8				
31					7.0	4.9				
32					6.8	4.6				
33					6.8	4.7				
34					6.0	4.1				
35					5.2	3.4				
36					4.6	2.9				
37					4.3	2.9				
38					5.4	3.9				
39					6.5	4.9				
40					7.0	5.6				

**Table 3-1. Diode and Thermocouple Power Sensor Calibration Factor Uncertainty (con't.)
Models 51081, 51100(9E), 51101, 51102, 51200, 51201**

Freq	Model (Alias)											
	51081		51100 (9E)		51101		51102		51200		51201	
GHz	%	% RSS	%	% RSS	%	% RSS	%	% RSS	%	% RSS	%	% RSS
DIODE AND THERMOCOUPLE SENSORS												
0.03	1.4	0.9	2.4	1.3	2.0	1.1	1.4	1.1	2.5	1.4	2.6	1.5
1	2.1	1.2	1.7	0.9	1.8	1.0	1.6	1.1	1.7	1.0	2.3	1.4
2			1.8	1.0	2.0	1.1	1.6	1.1	1.9	1.0	2.4	1.4
3	2.2	1.3	1.9	1.0	2.4	1.4	1.6	1.1	1.9	1.0	3.0	2.1
4			2.3	1.3	2.6	1.6	1.6	1.1	2.3	1.3	3.1	2.1
5	2.2	1.3	2.3	1.3			1.7	1.1	2.3	1.3		
6			2.3	1.3			1.7	1.1	2.3	1.3		
7	2.6	1.5	2.3	1.4			1.7	1.1	2.3	1.5		
8			2.6	1.6			1.8	1.1	2.6	1.6		
9	3.1	2.0	3.3	2.1			1.9	1.2	3.2	2.0		
10			3.5	2.3			1.9	1.2	3.5	2.3		
11	3.3	2.4	3.8	2.6			2.0	1.4	3.8	2.5		
12			3.3	2.1			2.3	1.6	3.4	2.2		
13	3.8	2.9	3.1	1.9			2.6	1.8	3.2	2.1		
14			3.6	2.4			2.8	1.9	3.6	2.4		
15	4.9	3.9	3.8	2.6			2.7	1.7	3.8	2.6		
16			4.2	2.8			2.6	1.6	4.1	2.8		
17	5.7	4.5	3.4	2.2			3.6	2.4	3.4	2.2		
18			4.4	3.1			4.5	3.4	4.1	2.8		
19	6.5	5.4					5.2	4.1				
20							4.9	3.7				
21	7.2	6.1					4.3	3.0				
22							4.6	3.3				
23	7.2	5.7					4.8	3.4				
24							5.6	4.0				
25	7.0	5.3					6.1	4.6				
26							6.4	4.8				
26.5							6.7	4.7				
27	8.9	6.6										
28	8.1	6.3										
29	8.2	6.4										
30	8.3	6.5										
31	8.8	7.2										
32	9.3	7.7										
33	10.0	8.4										
34	9.7	8.6										
35	9.4	8.4										
36	9.1	8.7										
37	8.4	8.3										
38	8.5	8.1										
39	9.0	8.2										
40	8.6	7.7										

**Table 3-1. Diode and Thermocouple Power Sensor Calibration Factor Uncertainty (con't.)
Models 51300, 51301, 51082**

Freq	Model			
	51300		51301	
GHz	%	% RSS	%	% RSS
THERMOCOUPLE				
0.03	2.5	1.4	2.4	1.3
1	1.7	1.0	2.9	2.0
2	1.9	1.0	2.7	1.7
3	1.9	1.0	2.6	1.6
4	2.3	1.3	2.9	1.9
5	2.3	1.3		
6	2.3	1.3		
7	2.3	1.5		
8	2.6	1.6		
9	3.2	2.0		
10	3.5	2.3		
11	3.8	2.5		
12	3.4	2.2		
13	3.2	2.1		
14	3.6	2.4		
15	3.8	2.6		
16	4.1	2.8		
17	3.4	2.2		
18	4.1	2.8		

Freq	Model	
	51082	
GHz	%	% RSS
DIODE		
0.05	2.0	1.4
40	10.6	11.1
41	10.3	10.5
42	10.9	10.8
43	10.9	10.1
44	10.1	8.1
45	10.7	9.0
46	10.5	8.8
47	9.1	7.4
48	7.7	6.1
49	10.3	9.3
50	13.5	11.7

 Denotes legacy sensors. For reference only. Not for new designs.

**Table 3-2. Peak Power Sensor Calibration Factor Uncertainty
Models 56218, 56226, 56318, 56326, 56340, 56418**

Freq	Model											
	56218		56226		56318		56326		56340		56418	
GHz	%	% RSS	%	% RSS	%	% RSS	%	% RSS	%	% RSS	%	% RSS
DUAL DIODE PEAK POWER SENSORS												
0.03	2.0	1.2	2.9	2.9								
0.5	1.7	1.1	2.9	2.9	1.6	1.1	2.4	1.6	2.2	1.5	1.7	1.1
1	1.8	1.2	3.4	3.0	1.5	0.9	1.8	1.1	1.7	1.1	1.6	1.0
2	2.2	1.5	3.4	3.0	2.0	1.3	2.1	1.4	1.9	1.2	2.0	1.4
3	2.3	1.6	3.7	3.3	2.1	1.5	2.2	1.5	2.1	1.4	2.1	1.5
4	2.1	1.4	3.7	3.3	2.0	1.3	2.4	1.6	2.2	1.5	2.1	1.4
5	2.4	1.6	3.7	3.3	2.4	1.6	2.4	1.7	2.3	1.6	2.4	1.7
6	2.1	1.5	3.7	3.3	2.2	1.5	2.5	1.8	2.4	1.7	2.2	1.5
7	1.6	1.1	3.8	3.3	1.6	1.1	2.5	1.8	2.6	2.0	1.7	1.1
8	1.7	1.1	3.8	3.3	1.6	1.0	2.5	1.7	2.8	2.2	1.8	1.2
9	2.6	1.7	5.5	5.6	2.4	1.6	3.2	2.6	4.1	3.6	2.7	1.8
10	3.3	2.4	5.5	5.6	3.2	2.3	3.2	2.6	4.1	3.8	3.3	2.4
11	3.4	2.5	5.3	5.6	3.5	2.6	3.3	2.8	4.1	4.0	3.5	2.6
12	3.0	2.1	5.4	5.6	3.2	2.3	3.4	2.9	4.2	3.9	3.4	2.5
13	2.8	2.0	5.6	5.6	2.9	2.0	3.6	3.0	4.3	3.9	3.2	2.4
14	3.2	2.3	5.8	5.6	3.3	2.4	3.8	3.0	4.6	4.1	3.3	2.4
15	3.1	2.3	5.9	5.7	3.4	2.5	3.8	2.9	4.8	4.1	3.5	2.7
16	3.8	2.8	6.1	5.7	3.8	2.8	3.8	2.8	4.9	4.2	3.9	2.9
17	3.1	2.3	6.2	5.7	3.5	2.8	3.8	2.7	5.0	4.2	3.3	2.5
18	3.4	2.4	6.3	5.7	3.9	2.9	4.2	3.1	5.1	4.2	3.8	2.8
19			8.5	8.6			5.0	3.9	5.8	5.0		
20			8.6	8.6			5.3	4.3	6.3	5.6		
21			8.7	8.6			5.4	4.3	6.7	5.9		
22			9.0	8.7			5.3	4.1	6.8	5.8		
23			9.2	8.8			5.3	3.9	6.6	5.4		
24			9.5	8.9			5.3	3.8	6.3	4.9		
25			9.6	8.9			5.1	3.7	6.3	4.9		
26			9.8	9.0			5.4	3.9	6.4	4.9		
26.5			10.3	9.1			6.3	4.5				
27									7.4	5.6		
28									6.9	5.4		
29									6.9	5.3		
30									6.8	5.2		
31									6.9	5.3		
32									6.8	5.1		
33									7.2	5.5		
34									6.6	5.1		
35									5.8	4.4		
36									5.3	4.2		
37									4.9	4.1		
38									5.6	4.7		
39									7.9	7.3		
40									9.4	9.3		

**Table 3-2. Peak Power Sensor Calibration Factor Uncertainty (con't.)
Models 56518, 56526, 56540**

Freq	Model					
	56518		56526		56540	
GHz	%	% RSS	%	% RSS	%	% RSS
DUAL DIODE PEAK POWER SENSORS						
0.5	1.2	0.8	2.3	1.6	2.2	1.5
1	1.3	0.8	1.7	1.1	1.6	1.1
2	1.6	1.0	1.9	1.2	1.8	1.2
3	1.7	1.1	2.0	1.3	2.0	1.3
4	1.6	1.0	2.0	1.3	2.2	1.5
5	2.0	1.2	2.1	1.4	2.3	1.6
6	2.1	1.4	2.2	1.4	2.4	1.7
7	1.8	1.2	2.2	1.4	2.7	2.0
8	1.9	1.2	2.4	1.6	2.9	2.2
9	2.6	1.8	3.2	2.5	4.1	3.6
10	2.9	2.1	3.3	2.7	4.2	3.8
11	3.7	2.7	3.5	3.0	4.3	4.1
12	3.7	2.8	3.5	3.1	4.3	4.2
13	3.1	2.2	3.7	3.0	4.5	4.2
14	3.4	2.5	3.6	2.8	4.7	4.2
15	3.6	2.6	3.5	2.4	4.9	4.3
16	3.8	2.8	3.7	2.6	5.1	4.4
17	3.6	2.9	4.0	2.9	5.1	4.2
18	3.7	2.6	4.2	3.2	5.2	4.3
19			5.1	4.0	5.9	5.0
20			5.8	4.9	6.2	5.4
21			6.2	5.2	6.3	5.4
22			5.8	4.5	6.1	5.0
23			5.1	3.7	6.1	4.8
24			5.3	3.9	6.3	4.9
25			5.6	4.1	6.0	4.5
26			6.6	5.1	5.8	4.3
26.5			7.6	5.8	6.2	4.4
27					6.7	4.9
28					6.4	4.8
29					6.6	5.0
30					6.7	5.0
31					7.1	5.5
32					7.2	5.6
33					7.2	5.6
34					6.2	4.8
35					5.6	4.3
36					5.2	4.0
37					4.8	4.0
38					5.5	4.5
39					7.0	6.1
40					8.1	7.6

**Table 3-2. Peak Power Sensor Calibration Factor Uncertainty (con't.)
Models 57318, 57340, 57518, 57540**

Freq	Model							
	57318		57340		57518		57540	
GHz	%	% RSS	%	% RSS	%	% RSS	%	% RSS
DUAL DIODE PEAK POWER SENSORS								
0.5	1.6	1.1	2.5	1.7	1.6	1.0	2.3	1.5
1	1.7	1.1	1.9	1.3	1.7	1.1	1.7	1.1
2	2.0	1.3	2.0	1.3	2.1	1.5	1.8	1.2
3	2.1	1.5	2.2	1.5	2.2	1.5	2.0	1.3
4	2.0	1.3	2.4	1.7	2.0	1.3	2.2	1.5
5	2.2	1.5	2.5	1.8	2.4	1.7	2.3	1.5
6	2.3	1.7	2.7	2.0	2.2	1.5	2.4	1.6
7	1.9	1.4	3.0	2.3	1.6	1.1	2.7	1.9
8	1.9	1.2	3.2	2.6	1.7	1.1	2.9	2.2
9	2.5	1.7	4.7	4.4	2.5	1.7	4.2	3.8
10	3.2	2.4	4.8	4.7	3.1	2.2	4.4	4.1
11	3.6	2.6	4.9	5.0	3.3	2.5	4.5	4.4
12	3.1	2.2	4.9	5.0	3.3	2.4	4.5	4.4
13	2.8	1.9	5.1	5.0	3.2	2.5	4.7	4.4
14	3.5	2.6	5.3	5.0	3.5	2.7	5.0	4.5
15	3.8	2.8	5.1	4.6	3.4	2.5	5.0	4.4
16	3.8	2.8	4.9	4.1	4.1	3.0	4.8	4.0
17	3.2	2.4	4.6	3.7	3.3	2.5	4.7	3.7
18	3.5	2.5	4.5	3.5	3.4	2.4	4.7	3.7
19			4.7	3.6			5.2	4.2
20			4.9	3.7			5.4	4.4
21			5.3	4.2			5.7	4.6
22			5.9	4.6			6.0	4.8
23			6.1	4.8			6.3	5.0
24			6.3	4.8			6.6	5.2
25			6.3	4.8			6.3	4.9
26			6.5	5.0			6.6	5.2
26.5			6.9	5.1			7.1	5.2
27			7.4	5.6			7.6	5.8
28			6.6	5.1			6.8	5.3
29			6.4	4.8			6.7	5.1
30			6.3	4.7			6.7	5.0
31			6.5	4.9			6.8	5.1
32			6.9	5.3			6.7	5.0
33			7.3	5.6			6.7	5.0
34			6.6	5.1			6.1	4.7
35			6.5	5.3			5.9	4.6
36			5.7	4.7			5.5	4.5
37			4.9	4.3			5.3	4.6
38			5.6	4.7			6.4	5.7
39			6.4	5.4			8.0	7.5
40			6.6	5.6			8.4	7.9

 Denotes legacy sensors. For reference only. Not for new designs.

Table 3-3. Waveguide Sensor Calibration Factor Uncertainty
Models 51035(4K), 51036(4KA), 51037(4Q), 51045(4U), 51046(4V), 51047(4W), 51942(WRD-180)

Model (Alias)	Reference Frequency	at Reference Frequency		Over Sensor Bandwidth	
	GHz	%	% RSS	%	% RSS
WAVEGUIDE SENSORS					
51035 (4K)	22	6	5	6	5
51036 (4KA)	33	6	5	10	7
51037 (4Q)	40	10	6	13	7
51045 (4U)	40	10	6	13	8
51046 (4V)	60	12	6	13	9
51047 (4W)	94	12	9	13	11
51942 (WRD-180)	33	6	5	10	7

 Denotes legacy sensors. For reference only. Not for new designs.

Low Frequency Response and Standing-Wave-Ratio (SWR) Data

The typical performance data that follows is not guaranteed, however, it represents a large number of production units processed. Therefore, it is a good guideline for user expectations. The worst case specifications are quite conservative in accordance with Boonton's general policy.

Detailed SWR data is supplied with each sensor unit shipped against a customer order to give the user specific information required to properly evaluate errors in a particular application. Please consult the factory for optional units with more stringent specifications.

The typical low frequency response for three sensor models are shown in Figures 4-1 through 4-3. Figures 4-4 through 4-10 represent SWR Data.

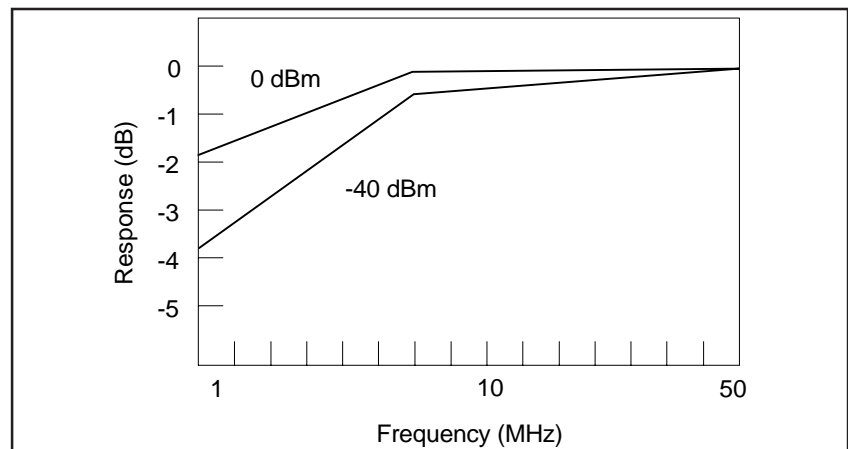

Figure 4-1. Model 51071 Low Frequency Response

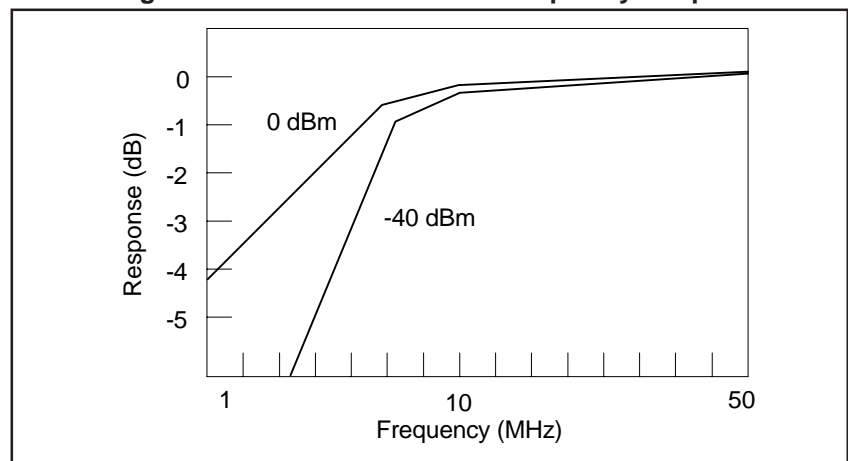

Figure 4-2. Model 51072 Low Frequency Response

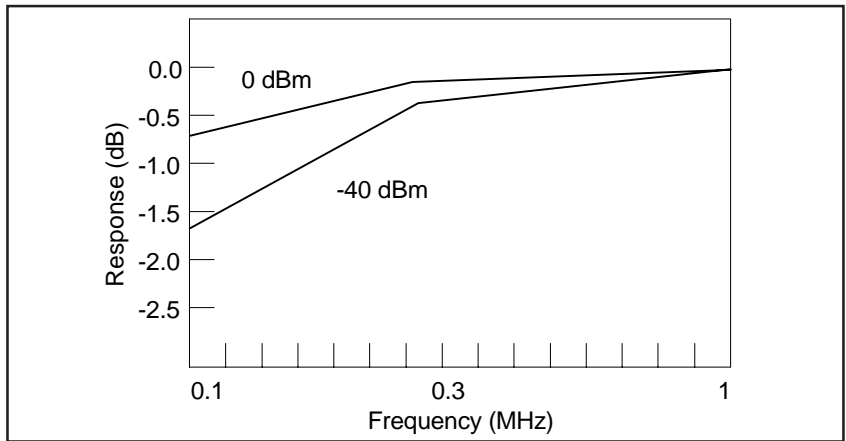

Figure 4-3. Model 51075 Low Frequency Response

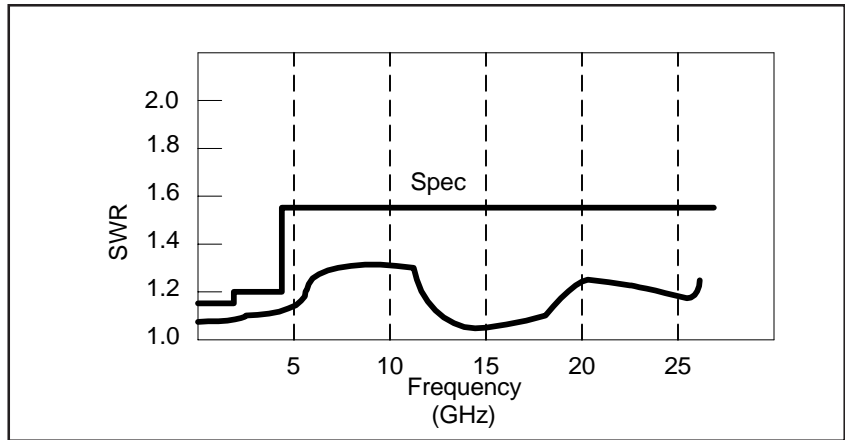

Figure 4-4. Model 51071 SWR Data

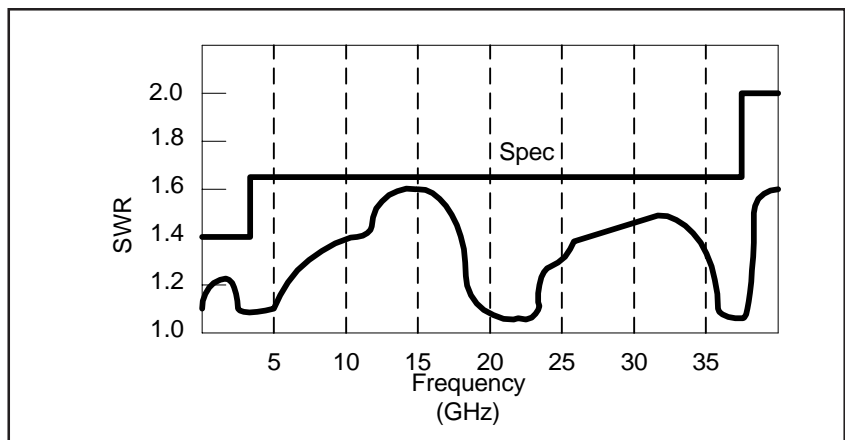

Figure 4-5. Model 51072 SWR Data

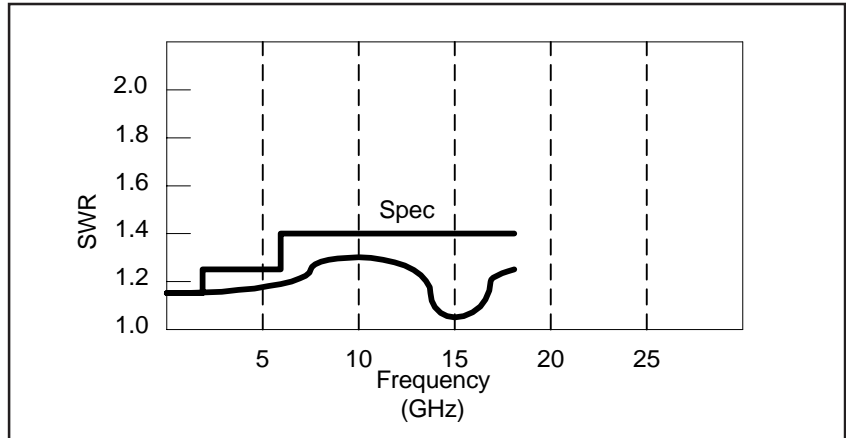

Figure 4-6. Model 51075 SWR Data

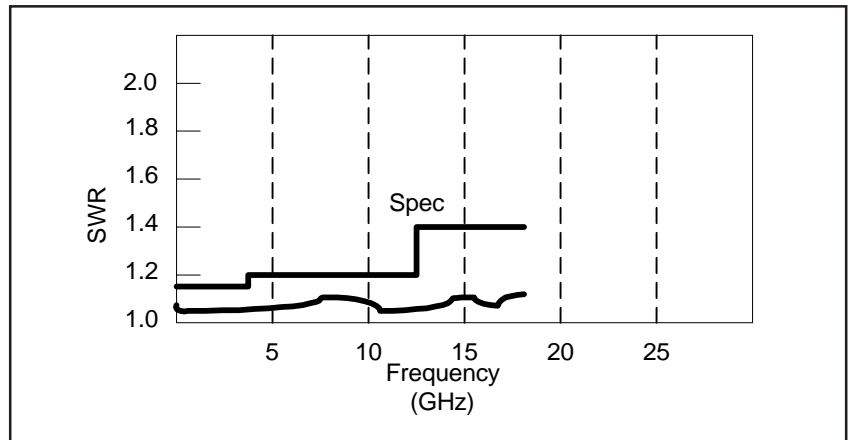

Figure 4-7. Model 51078 SWR Data

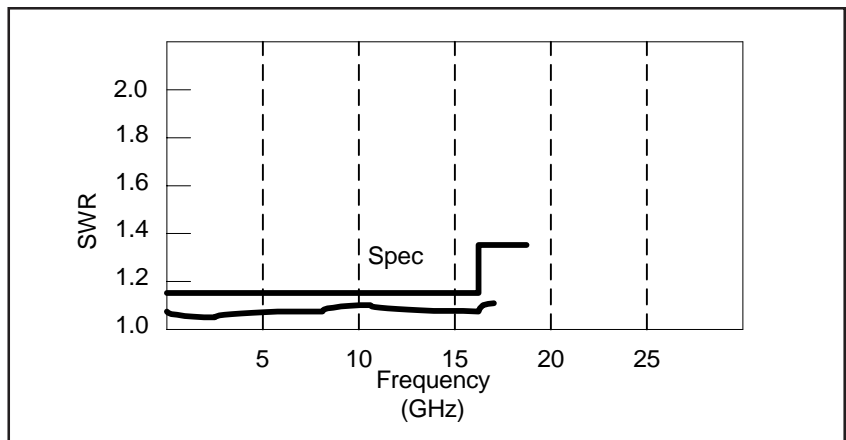

Figure 4-8. Model 51100 SWR Data

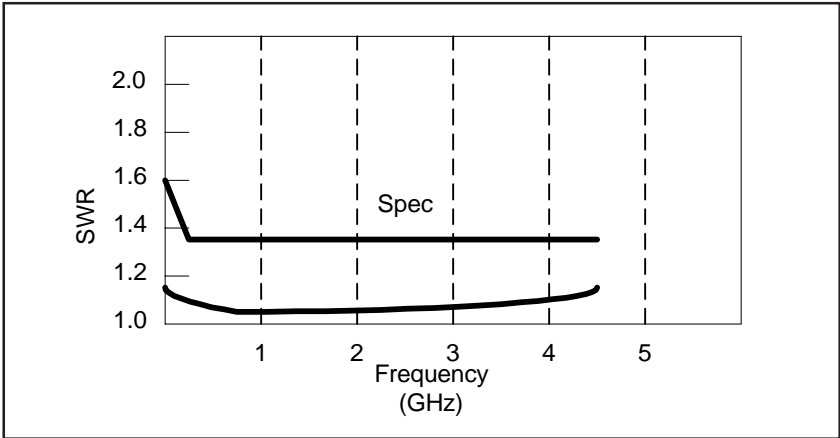

Figure 4-9. Model 51101 SWR Data

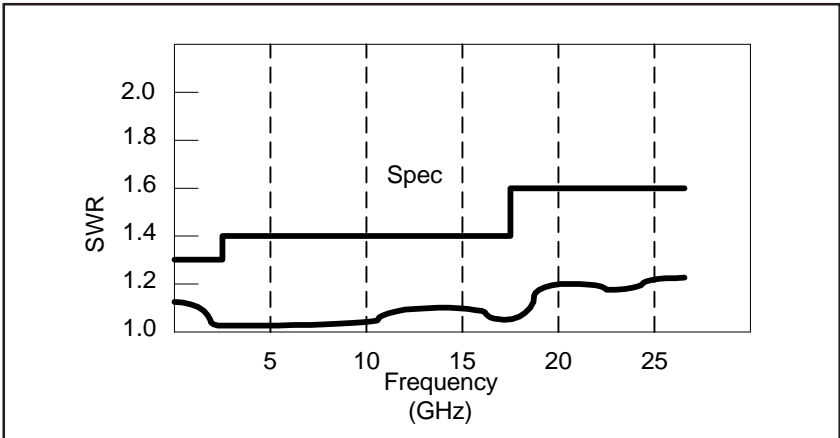

Figure 4-10. Model 51102 SWR Data

Pulsed RF Power

5-1 Pulsed RF Power Operation

Although this manual discusses power sensors used with average responding power meters, for rectangular pulsed RF signals, pulse power can be calculated from average power if the duty cycle of the reoccurring pulse is known. The duty cycle can be found by dividing the pulse width (T) by the period of the repetition frequency or by multiplying the pulse width times the repetition frequency as shown in Figure 5-1.

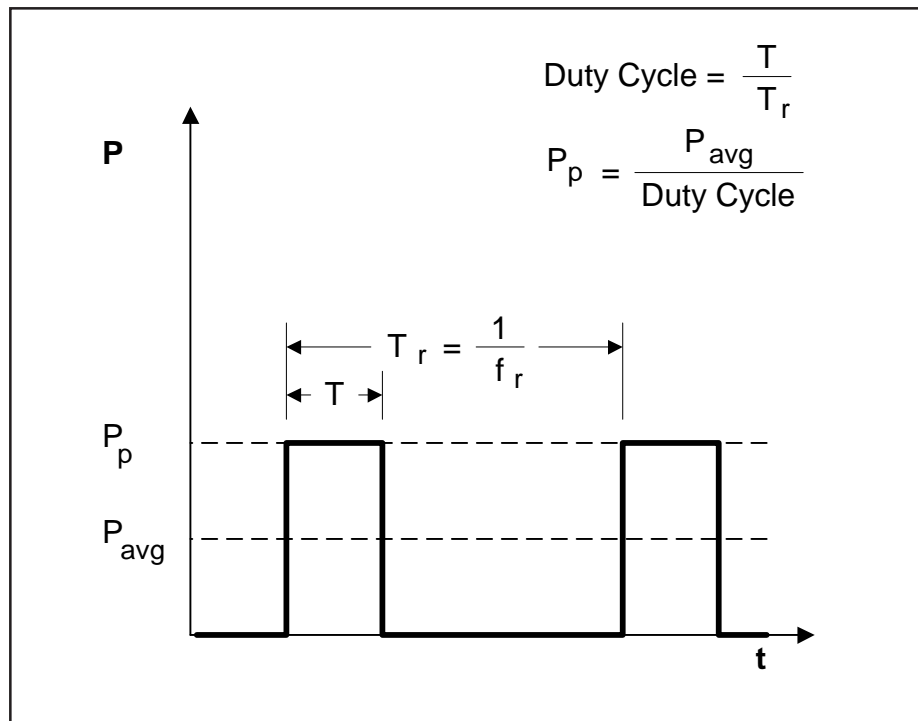

Figure 5-1. Pulsed RF Operation

This technique is valid for the entire dynamic range of Thermocouple Sensors and allows very high pulse powers to be measured. For Diode Sensors, this technique is valid only within the square-law region of the diodes.

5-2 Pulsed RF Operation Thermocouple Sensors

Figure 5-2 shows the regions of valid duty cycle and pulse power that apply to the Thermal Sensors. As the duty cycle decreases, the average power decreases for a given pulse power and the noise becomes a limitation. Also, there is a pulse power overload limitation. No matter how short the duty cycle is, this overload limitation applies. Lastly, the average power cannot be exceeded (there is some headroom between the measurement limitation and the burnout level of the sensor).

Since the detection process in Thermal Sensors is heat, Thermal Sensors can handle pulse powers that are two orders of a magnitude larger than their maximum average power. This makes them ideal for this application. The minimum pulse repetition frequency for the Thermal Sensors is approximately 100 Hz.

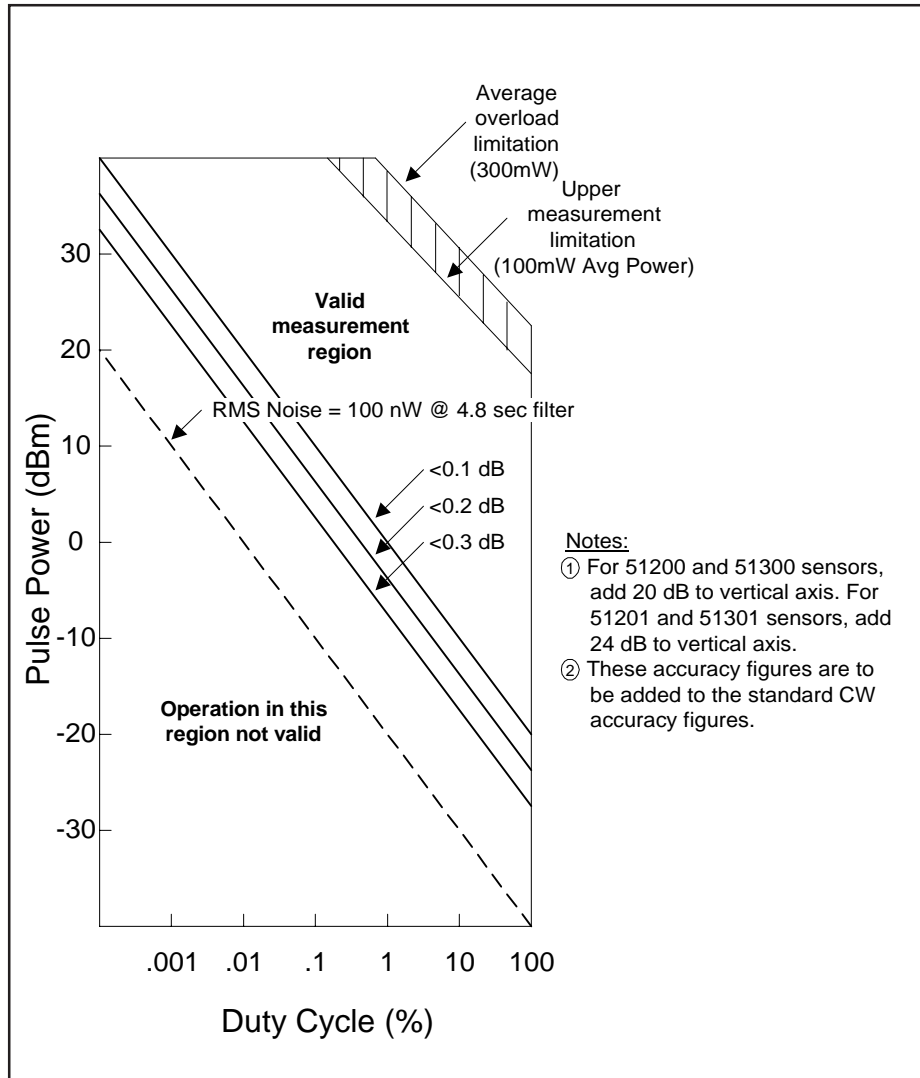

Figure 5-2. Pulsed Accuracy for Thermocouple Sensors

5-3 Pulsed RF Operation Diode Sensors

Figure 5-3 shows the valid operating region for the Diode Sensors. As with Thermal Sensors, the bottom end measurement is limited by noise, getting worse as the duty cycle decreases. At the top end, the limitation is on pulse power because even a very short pulse will charge up the detecting capacitors. The burnout level for Diode Sensors is the same for the pulsed and CW waveforms. The minimum pulse repetition frequency is 10 kHz.

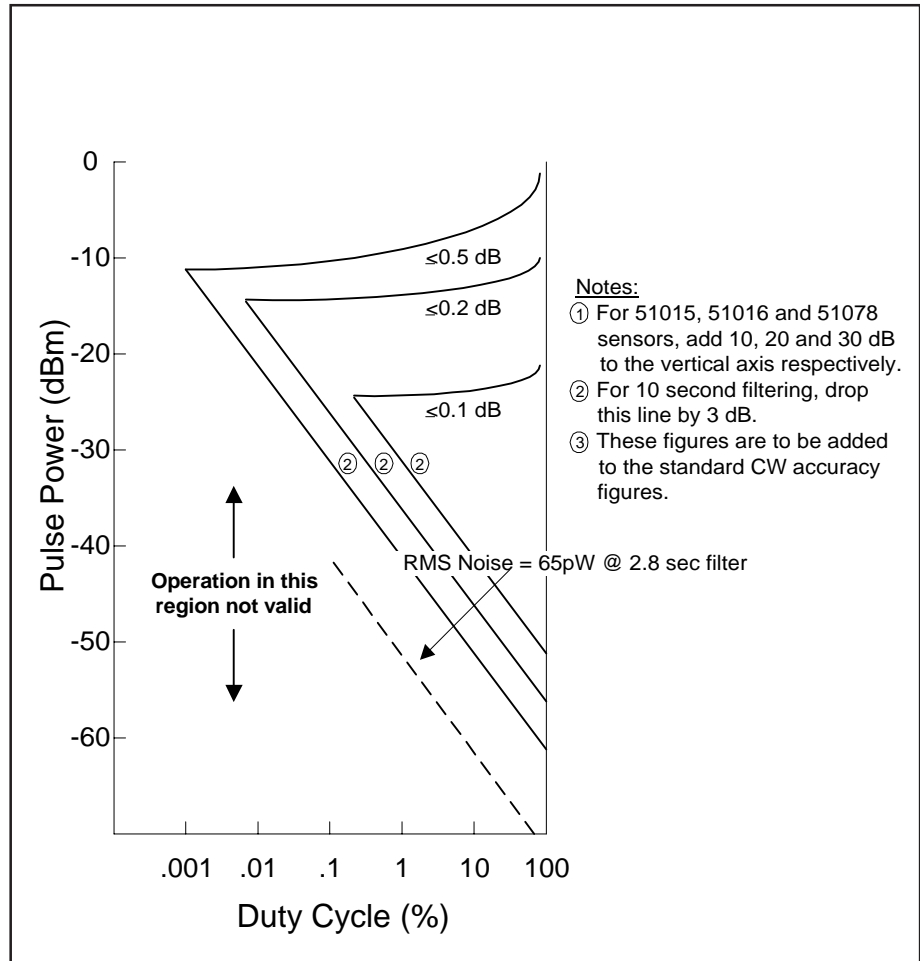

Figure 5-3. Pulsed Accuracy for Diode Sensors

Calculating Measurement Uncertainty

6-1 Introduction

This Section has been extracted from the 4530 manual since it provides examples using CW and Peak Power sensors. As such, in calculating Power Measurement Uncertainty, specifications for the 4530 are used. If one of Boonton's other Power Meters are in use, refer to its Instruction Manual for Instrument Uncertainty and Calibrator Uncertainty.

The 4530 Series includes a precision internal RF reference calibrator that is traceable to the National Institute for Standards and Technology (NIST). When the instrument is maintained according to the factory recommended one year calibration cycle, the calibrator enables you to make highly precise measurements of CW and modulated signals. The error analyses in this chapter assumes that the power meter is being maintained correctly and is within its valid calibration period.

Measurement uncertainties are attributable to the instrument, calibrator, sensor, and impedance mismatch between the sensor and the device under test (DUT). Individual independent contributions from each of these sources are combined mathematically to quantify the upper error bound and probable error. The probable error is obtained by combining the linear (percent) sources on a root-sum-of-squares (RSS) basis.

Note that uncertainty figures for individual components may be provided given in either percent or dB. The following formulas may be used to convert between the two units:

$$U_{\%} = (10(U_{\text{dB}}/10) - 1) * 100 \quad \text{and} \quad U_{\text{dB}} = 10 * \text{Log}_{10}(1 + (U_{\%} / 100))$$

Section 6-2 outlines all the parameters that contribute to the power measurement uncertainty followed by a discussion on the method and calculations used to express the uncertainty.

Section 6-3 continues discussing each of the uncertainty terms in more detail while presenting some of their values.

Section 6-4 provides Power Measurement Uncertainty calculation examples for both CW and Peak Power sensors with complete Uncertainty Budgets.

References used in the Power Measurement Uncertainty analysis are:

1. "ISO Guide to the Expression of Uncertainty in Measurement,"
Organization for Standardization, Geneva, Switzerland,
ISBN 92-67-10188-9, 1995.
2. "U.S. Guide to the Expression of Uncertainty in Measurement",
National Conference of Standards Laboratories, Boulder, CO 80301, 1996.
ANSI/NCSL Z540-2-1996,

6-2 Uncertainty Contributions

The total measurement uncertainty is calculated by combining the following terms:

1. Instrument Uncertainty
2. Calibrator Level Uncertainty
3. Calibrator Mismatch Uncertainty
4. Source Mismatch Uncertainty
5. Sensor Shaping Error
6. Sensor Temperature Coefficient
7. Sensor Noise
8. Sensor Zero Drift
9. Sensor Calibration Factor Uncertainty

The formula for worst-case measurement uncertainty is:

$$U_{\text{WorstCase}} = U_1 + U_2 + U_3 + U_4 + \dots U_N$$

where U_1 through U_N represent each of the worst-case uncertainty terms.

The worst-case approach is a very conservative method where the extreme condition of each individual uncertainty is added to one another. If the individual uncertainties are independent of one another, the probability of all being at the extreme condition is small. For this reason, these uncertainties are usually combined using the RSS method. RSS is an abbreviation for “root-sum-of-squares”. In this method, each uncertainty is squared, added to one another, and the square root of the summation is calculated resulting in the Combined Standard Uncertainty. The formula is:

$$U_C = (U_1^2 + U_2^2 + U_3^2 + U_4^2 + \dots U_N^2)^{0.5}$$

where U_1 through U_N represent normalized uncertainty based on the uncertainty's probability distribution. This calculation yields what is commonly referred to as the combined standard uncertainty with a level of confidence of approximately 68%.

To gain higher levels of confidence an Expanded Uncertainty is often employed. Using a coverage factor of 2 ($2 * U_C$) will provide an Expanded Uncertainty with a confidence level of approximately 95%.

6-3 Discussion of Uncertainty Terms

Following is a discussion of each term, its definition, and how it is calculated.

Instrument Uncertainty. This term represents the amplification and digitization uncertainty in the power meter, as well as internal component temperature drift. In most cases, this is very small, since absolute errors in the circuitry are calibrated out by the AutoCal process. The instrument uncertainty is 0.20% for the 4530 Series. (Refer to the Instruction Manual of the instrument in use for instrument uncertainty.)

Calibrator Level Uncertainty. This term is the uncertainty in the calibrator’s output level for a given setting for calibrators that are maintained in calibrated condition. The figure is a calibrator specification which depends upon the output level:

50MHz Calibrator Level Uncertainty:

- At 0 dBm: ± 0.055 dB (1.27%)
- +20 to -39 dBm: ± 0.075 dB (1.74%)
- 40 to -60 dBm: ± 0.105 dB (2.45%)

1GHz Calibrator Level Uncertainty:

- $\pm (0.065$ dB (1.51%) at 0 dBm + 0.03 dB (0.69%) per 5 dB from 0 dBm)

The value to use for calibration level uncertainty depends upon the sensor calibration technique used. If AutoCal was performed, the calibrator’s uncertainty at the measurement power level should be used. For sensors calibrated with FixedCal, the calibrator is only used as a single-level source, and you should use the calibrator’s uncertainty at the FixedCal level, (0dBm, for most sensors). This may make FixedCal seem *more accurate* than AutoCal at some levels, but this is usually more than offset by the reduction in shaping error afforded by the AutoCal technique. (Refer to the Instruction Manual of the instrument in use for calibrator level uncertainty.)

Calibrator Mismatch Uncertainty. This term is the mismatch error caused by impedance differences between the calibrator output and the sensor’s termination. It is calculated from the reflection coefficients of the calibrator (D_{CAL}) and sensor (D_{SNSR}) at the calibration frequency with the following equation:

$$\text{Calibrator Mismatch Uncertainty} = \pm 2 * D_{CAL} * D_{SNSR} * 100 \%$$

The calibrator reflection coefficient is a calibrator specification:

- Internal Calibrator Reflection Coefficient (D_{CAL}): 0.024 (at 50MHz)
- External 2530 Calibrator Reflection Coefficient (D_{CAL}): 0.091 (at 1GHz)

The sensor reflection coefficient, D_{SNSR} is frequency dependent, and may be looked up in Section 2 of this manual. (Refer to the Instruction Manual of the instrument in use for calibrator SWR specifications.)

Source Mismatch Uncertainty. This term is the mismatch error caused by impedance differences between the measurement source output and the sensor’s termination. It is calculated from the reflection coefficients of the source (D_{SRCE}) and sensor (D_{SNSR}) at the measurement frequency with the following equation:

$$\text{Source Mismatch Uncertainty} = \pm 2 * D_{SRCE} * D_{SNSR} * 100 \%$$

The source reflection coefficient is a characteristic of the RF source under test. If only the SWR of the source is known, its reflection coefficient may be calculated from the source SWR using the following equation:

$$\text{Source Reflection Coefficient } (D_{SRCE}) = (SWR - 1) / (SWR + 1)$$

The sensor reflection coefficient, D_{SNSR} is frequency dependent, and can be referenced in Section 2 of this manual. For most measurements, this is the single largest error term, and care should be used to ensure the best possible match between source and sensor. Figure 6-1. plots Mismatch Uncertainty based on known values of both source and sensor SWR.

Sensor Shaping Error. This term is sometimes called "linearity error", and is the residual non-linearity in the measurement after an AutoCal has been performed to characterize the "transfer function" of the sensor (the relationship between applied RF power, and sensor output, or shaping). Calibration is performed at discrete level steps and is extended to all levels. Generally, sensor shaping error is close to zero at the autocal points, and increases in between due to imperfections in the curve-fitting algorithm.

An additional component of sensor shaping error is due to the fact that the sensor's transfer function may not be identical at all frequencies. The published shaping error includes terms to account for these deviations. If your measurement frequency is close to your AutoCal frequency, it is probably acceptable to use a value lower than the published uncertainty in your calculations.

For CW sensors using the fixed-cal method of calibrating, the shaping error is higher because it relies upon stored "shaping coefficients" from a factory calibration to describe the shape of the transfer function, rather than a transfer calibration using a precision power reference at the current time and temperature. For this reason, use of the AutoCal method is recommended for CW sensors rather than simply performing a FixedCal. The shaping error for CW sensors using the FixedCal calibration method is listed as part of the "Sensor Characteristics" outlined in Section 2 of this manual. If the AutoCal calibration method is used with a CW sensor, a fixed value of 1.0% may be used for all signal levels.

All peak power sensors use the AutoCal method only. The sensor shaping error for peak sensors is also listed in Section 2 of this manual.

Sensor Temperature Coefficient. This term is the error which occurs when the sensor's temperature has changed significantly from the temperature at which the sensor was AutoCal'd. This condition is detected by the Model 4530 and a "temperature drift" message warns the operator to recalibrate the sensor for drift exceeding ± 4 °C on non-temperature compensated peak sensors.

Temperature compensated peak sensors have a much smaller temperature coefficient, and a much larger temperature deviation, ± 30 °C is permitted before a warning is issued. For these sensors, the maximum uncertainty due to temperature drift from the autocal temperature is:

$$\text{Temperature Error} = \pm 0.04\text{dB} (0.93\%) + 0.003\text{dB} (0.069\%) / ^\circ\text{C}$$

Note that the first term of this equation is constant, while the second term (0.069%) must be multiplied by the number of degrees that the sensor temperature has drifted from the AutoCal temperature.

CW sensors have no built-in temperature detectors, so it is up to the user to determine the temperature change from AutoCal temperature. Temperature drift for CW sensors is determined by the temperature coefficient of the sensor. This figure is 0.01dB (0.23%) per degreeC for the 51075 and many other CW sensors. Refer to Section 2 for the exact figure to

Mismatch Uncertainty

$$p = \frac{\text{SWR} - 1}{\text{SWR} + 1}$$

Relative Power Uncertainty

$$\text{P.U.} = (1 \pm p_L p_S)$$

Where p_L = Load SWR

p_S = Source SWR

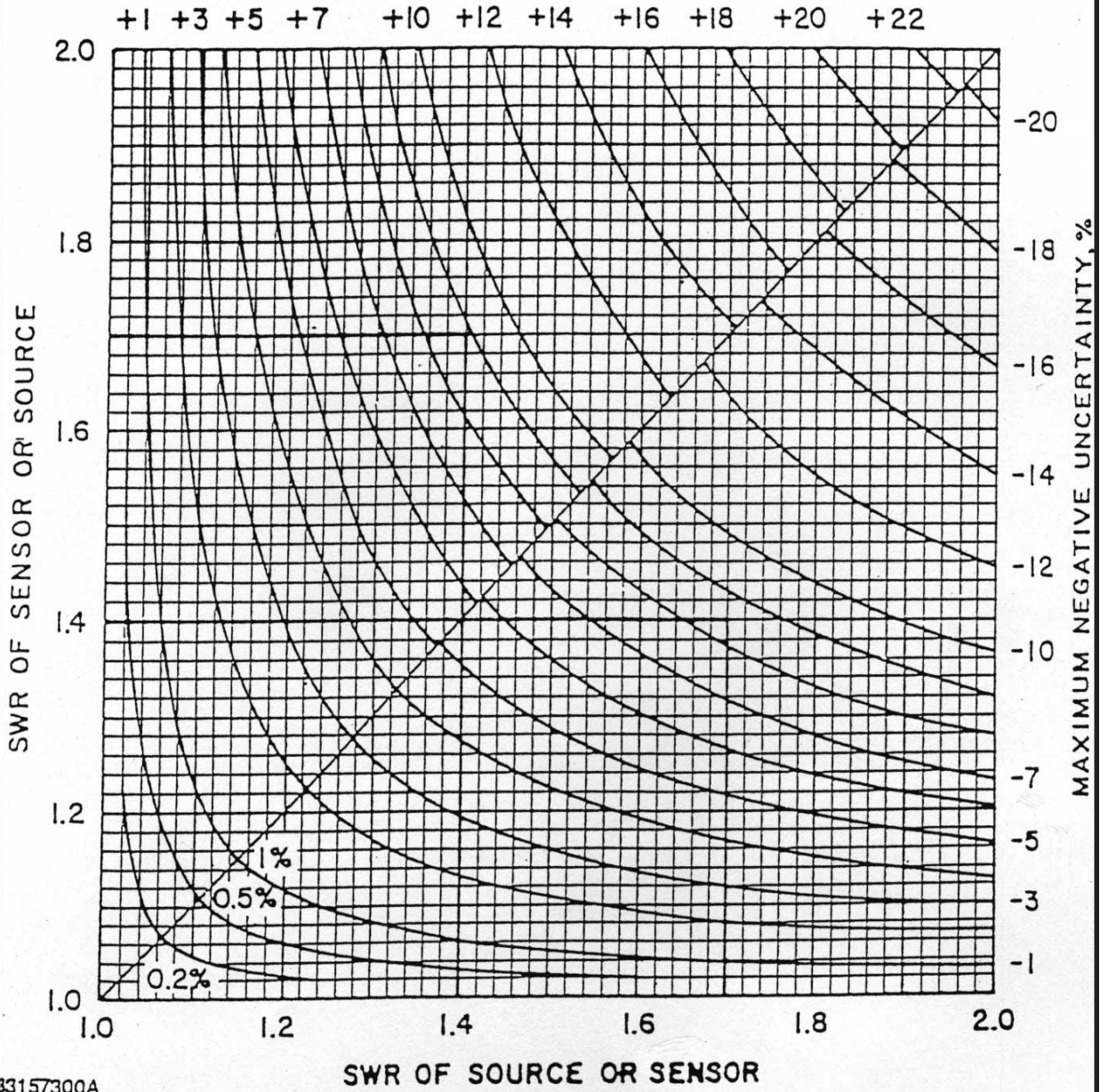

33157300A

Figure 6-1. Mismatch Uncertainty

use. Sensor temperature drift uncertainty may be assumed to be zero for sensors operating exactly at the calibration temperature.

Sensor Noise. The noise contribution to pulse measurements depends on the number of samples averaged to produce the power reading, which is set by the "averaging" menu setting. For continuous measurements with CW sensors, or peak sensors in modulated mode, it depends on the integration time of the measurement, which is set by the "filter" menu setting. In general, increasing filtering or averaging reduces measurement noise. Sensor noise is typically expressed as an absolute power level. The uncertainty due to noise depends upon the ratio of the noise to the signal power being measured. The following expression is used to calculate uncertainty due to noise:

$$\text{Noise Error} = \pm \text{Sensor Noise (in watts)} / \text{Signal Power (in watts)} * 100 \%$$

The noise rating of a particular power sensor may be found in Section 2 of this manual. It may be necessary to adjust the sensor noise for more or less filtering or averaging, depending upon the application. As a general rule (within a decade of the datasheet point), noise is inversely proportional to the filter time or averaging used. Noise error is usually insignificant when measuring at high levels (25dB or more above the sensor's minimum power rating).

Sensor Zero Drift. Zero drift is the long-term change in the zero-power reading that is not a random, noise component. Increasing filter or averaging will not reduce zero drift. For low-level measurements, this can be controlled by zeroing the meter just before performing the measurement. Zero drift is typically expressed as an absolute power level, and its error contribution may be calculated with the following formula:

$$\text{Zero Drift Error} = \pm \text{Sensor Zero Drift (in watts)} / \text{Signal Power (in watts)} * 100 \%$$

The zero drift rating of a particular power sensor may be found in Section 2 of this manual. Zero drift error is usually insignificant when measuring at high levels (25dB or more above the sensor's minimum power rating). The drift specification usually indicates a time interval such as one hour. If the time since performing a sensor Zero or AutoCal is very short, the zero drift is greatly reduced

Sensor Calibration Factor Uncertainty. Sensor frequency calibration factors ("calfactors") are used to correct for sensor frequency response deviations. These calfactors are characterized during factory calibration of each sensor by measuring its output at a series of test frequencies spanning its full operating range, and storing the ratio of the actual applied power to the measured power at each frequency. This ratio is called a calfactor. During measurement operation, the power reading is multiplied by the calfactor for the current measurement frequency to correct the reading for a flat response.

The sensor calfactor uncertainty is due to uncertainties encountered while performing this frequency calibration (due to both standards uncertainty, and measurement uncertainty), and is different for each frequency. Both worst case and RSS uncertainties are provided for the frequency range covered by each sensor, and are listed in Section 3 of this manual.

If the measurement frequency is between sensor calfactor entries, the most conservative approach is to use the higher of the two corresponding uncertainty figures. It is also possible to estimate the figure by linear interpolation.

If the measurement frequency is identical to the AutoCal frequency, a calfactor uncertainty of zero should be used, since any absolute error in the calfactor cancels out during AutoCal. At frequencies that are close to the AutoCal frequency, the calfactor uncertainty is only partially cancelled out during AutoCal, so it is generally acceptable to take the uncertainty for the next closest frequency, and scale it down.

6-4 Sample Uncertainty Calculations

The following examples show calculations for two measurement applications - one using a CW sensor (Model 51075), and the other with a peak power sensor (Model 57518). The figures used in these examples are meant to show the general techniques, and do not apply to all applications. Some "common sense" assumptions have been made to illustrate the fact that uncertainty calculation is not an exact science, and requires some understanding of your specific measurement conditions.

Typical Example #1: Model 51075 CW Power Sensor

Measurement conditions:

Source Frequency:	10.3 GHz
Source Power:	-55 dBm (3.16 nW)
Source SWR :	1.50 (reflection coefficient = 0.2) at 10.3 GHz
AutoCal Source:	Internal 50MHz Calibrator
AutoCal Temperature:	25 °C
Current Temperature:	25 °C

In this example, we will assume that an AutoCal has been performed on the sensor immediately before the measurement. This will reduce certain uncertainty terms, as discussed below.

Step 1: The Instrument Uncertainty figure for the 4530 Series is $\pm 0.20\%$. Since a portion of this figure is meant to include temperature drift of the instrument, and we know an AutoCal has just been performed, we'll estimate (for lack of more detailed, published information) that the instrument uncertainty is $\pm 0.10\%$, or half the published figure.

$$U_{\text{Instrument}} = \pm 0.10\%$$

Step 2: The Calibrator Level Uncertainty for the power meter's internal, 50MHz calibrator may be read from the calibrator's specification. It is $\pm 0.105\text{dB}$, or $\pm 2.45\%$ at a level of -55 dBm.

$$U_{\text{CalLevel}} = \pm 2.45\%$$

Step 3: The Calibrator Mismatch Uncertainty is calculated using the formula in the previous section, using the internal 50MHz calibrator's published figure for D_{CAL} and calculating the value D_{SNSR} from the SWR specification on the 51075's datasheet.

$$D_{CAL} = 0.024 \text{ (internal calibrator's reflection coefficient at 50MHz)}$$

$$D_{SNSR} = (1.15 - 1) / (1.15 + 1) = 0.070$$

(calculated reflection coefficient of 51075, max SWR = 1.15 at 50MHz)

$$U_{CalMismatch} = \pm 2 * D_{CAL} * D_{SNSR} * 100 \%$$

$$= \pm 2 * 0.024 * 0.070 * 100 \%$$

$$= \pm 0.34\%$$

Step 4: The Source Mismatch Uncertainty is calculated using the formula in the previous section, using the DUT's specification for D_{SRCE} and calculating the value D_{SNSR} from the SWR specification on the 51075's datasheet.

$$D_{SRCE} = 0.20 \text{ (source reflection coefficient at 10.3GHz)}$$

$$D_{SNSR} = (1.40 - 1) / (1.40 + 1) = 0.167$$

(calculated reflection coefficient of 51075, max SWR = 1.40 at 10.3GHz)

$$U_{SourceMismatch} = \pm 2 * D_{SRCE} * D_{SNSR} * 100 \%$$

$$= \pm 2 * 0.20 * 0.167 * 100 \%$$

$$= \pm 6.68\%$$

Step 5: The uncertainty caused by Sensor Shaping Error for a 51075 CW sensor that has been calibrated using the AutoCal method can be assumed to be 1.0%, as per the discussion in the previous section.

$$U_{ShapingError} = \pm 1.0 \%$$

Step 6: The Sensor Temperature Drift Error depends on how far the temperature has drifted from the sensor calibration temperature, and the temperature coefficient of the sensor. In this example, an AutoCal has just been performed on the sensor, and the temperature has not drifted at all, so we can assume a value of zero for sensor temperature drift uncertainty.

$$U_{SnsrTempDrift} = \pm 0.0 \%$$

Step 7: This is a relatively low-level measurement, so the noise contribution of the sensor must be included in the uncertainty calculations. We'll assume default filtering. The signal level is -55dBm, or 3.16nW. The RMS noise specification for the 51075 sensor is 30pW, from Section 2. Noise uncertainty is the ratio of these two figures.

$$U_{NoiseError} = \pm \text{Sensor Noise (in watts)} / \text{Signal Power (in watts)}$$

$$= \pm 30.0e-12 / 3.16e-9 * 100 \%$$

$$= \pm 0.95\%$$

Step 8: The Sensor Zero Drift calculation is very similar to the noise calculation. For sensor zero drift, the datasheet specification for the 51075 sensor is 100pW, so we'll take the liberty of cutting this in half to 50pW, since we just performed an AutoCal, and it's likely that the sensor hasn't drifted much.

$$\begin{aligned}
 U_{\text{ZeroDrift}} &= \pm \text{Sensor Zero Drift (in watts)} / \text{Signal Power (in watts)} \\
 &= \pm 50.0\text{e-}12 / 3.16\text{e-}9 * 100 \% \\
 &= \pm 1.58\%
 \end{aligned}$$

Step 9: The Sensor Calfactor Uncertainty is calculated from the uncertainty values specified in Section 3 of this manual. There is no entry for 10.3GHz, so we'll have to look at the two closest entries. At 10GHz, the calfactor uncertainty is 4.0 % and at 11GHz it is 4.3 %. A linear interpolation must be done to determine the Calfactor at 10.3 GHz. The uncertainty is then;

$$\begin{aligned}
 U_{\text{CalFactor}} &= [(F - F_1) * ((CF_2 - CF_1) / (F_2 - F_1))] + CF_1 \\
 \text{where;} \quad &F = 10.3 \\
 &F_1 = 10 \quad \quad CF_1 = 4.0 \\
 &F_2 = 11 \quad \quad CF_2 = 4.3 \\
 \\
 &= [(10.3 - 10.0) * ((4.3 - 4.0) / (11.0 - 10.0))] + 4.0 \\
 &= [(0.3) * ((0.3) / (1.0))] + 4.0 \\
 &= [(0.3) * (0.3)] + 4.0 \\
 &= 4.09 \%
 \end{aligned}$$

Step 10: Now that each of the individual uncertainty terms has been determined, we can create an uncertainty budget and calculate the combined standard uncertainty (Uc).

Source of Uncertainty	Symbol	Value (+/- %)	Probability Distribution	Divisor	Ustd (+/- %)
Instrument	I	0.10	normal	2	0.05
Calibrator					
Level	R	2.45	rectangular	(3) ^{0.5}	1.41
Mismatch	M _C	0.34	U-shaped	(2) ^{0.5}	0.24
Source					
Mismatch	M _S	6.68	U-shaped	(2) ^{0.5}	4.72
Sensor					
Shaping	S	1.00	rectangular	(3) ^{0.5}	0.58
Temp. Drift	T	0	rectangular	(3) ^{0.5}	0.00
Noise	N	0.95	normal	2	0.48
Zero drift	Z	1.58	rectangular	(3) ^{0.5}	0.91
Cal Factor	K	4.09	normal	2	2.05
Combined Standard Uncertainty	Uc		normal		5.47
Expanded Uncertainty	U		normal (k=2)		10.94

From the previous example, it can be seen that the two largest contributions to the combined standard uncertainty are the source mismatch, and the sensor calfactor.

Typical Example #2: Model 57518 Peak Power Sensor

Measurement conditions:

Source Frequency:	900 MHz
Source Power:	13 dBm (20mW)
Source SWR :	1.12 (reflection coefficient = 0.057) at 900 MHz
AutoCal Source:	External 2530 1GHz Calibrator
AutoCal Temperature:	38C
Current Temperature:	49C

In this example, we will assume that an AutoCal was performed on the sensor earlier in the day, so time and temperature drift may play a role in the uncertainty.

Step 1: The Instrument Uncertainty figure for the 4530 Series is $\pm 0.20\%$. Since it has been a while since AutoCal, we'll use the published figure.

$$U_{\text{Instrument}} = \pm 0.20\%$$

Step 2: The Calibrator Level Uncertainty for the Model 2530 1GHz external calibrator may be calculated from the calibrator's specification. The 0dBm uncertainty is 0.065dB, or 1.51%. To this figure, we must add 0.03dB or 0.69% per 5dB step from 0dBm. 13dBm is 2.6 5dB steps (13/5) away from 0dBm. Any fraction must always be rounded to the next highest whole number, so we're 3 steps away.

$$\begin{aligned} U_{\text{CalLevel}} &= \pm (1.51\% + (3 * 0.69\%)) \\ &= \pm 3.11\% \end{aligned}$$

Step 3: The Calibrator Mismatch Uncertainty is calculated using the formula in the previous section, using the 2530 calibrator's published figure for D_{CAL} and calculating the value D_{SNSR} from the SWR specification outlined in Section 2 of this manual.

$$\begin{aligned} D_{\text{CAL}} &= 0.091 \text{ (external 2530 calibrator's reflection coefficient at 1GHz)} \\ D_{\text{SNSR}} &= (1.15 - 1) / (1.15 + 1) = 0.070 \\ &\text{(calculated reflection coefficient of 57518, max SWR = 1.15 at 1 GHz)} \end{aligned}$$

$$\begin{aligned} U_{\text{CalMismatch}} &= \pm 2 * D_{\text{CAL}} * D_{\text{SNSR}} * 100 \% \\ &= \pm 2 * 0.091 * 0.070 * 100 \% \\ &= \pm 1.27\% \end{aligned}$$

Step 4: The Source Mismatch Uncertainty is calculated using the formula in the previous section, using the DUT's specification for D_{SRCE} and calculating the value D_{SNSR} from the SWR specification found in Section 2.

$$D_{SRCE} = 0.057 \text{ (source reflection coefficient at 900 MHz)}$$

$$D_{SNSR} = (1.15 - 1) / (1.15 + 1) \\ = 0.070 \\ \text{(calculated reflection coefficient of 57518, max SWR = 1.15 at 0.9 GHz)}$$

$$U_{\text{SourceMismatch}} = \pm 2 * D_{SRCE} * D_{SNSR} * 100 \% \\ = \pm 2 * 0.057 * 0.070 * 100 \% \\ = \pm 0.80\%$$

Step 5: The uncertainty caused by Sensor Shaping Error for a 57518 peak sensor is 4% at all levels (from table 2-2). But since we're measuring at 900MHz, which is very close to the 1GHz AutoCal frequency, we'll assume that the frequency-dependent portion of the shaping error becomes very small, and we'll estimate that 2% remains.

$$U_{\text{ShapingError}} = \pm 2.0 \%$$

Step 6: The Sensor Temperature Drift Error depends on how far the temperature has drifted from the sensor calibration temperature, and the temperature coefficient of the sensor. In our case, we are using a temperature compensated sensor, and the temperature has drifted by 11 degrees C (49C - 38C) from the AutoCal temperature. We will use the equation in the previous section to calculate sensor temperature drift uncertainty.

$$U_{\text{SnsrTempDrift}} = \pm (0.93\% + 0.069\% / ^\circ\text{C}) \\ = \pm (0.93 + (0.069 * 11.0)) \% \\ = \pm 1.69 \%$$

Step 7: This is a relatively high-level measurement, so the noise contribution of the sensor is probably negligible, but we'll calculate it anyway. We'll assume modulate mode with default filtering. The signal level is 13dBm, or 20mW. The "noise and drift" specification for the 57518 sensor is 50nW, from Table 2-2 (Peak Power Sensor Characteristics). Noise uncertainty is the ratio of these two figures.

$$U_{\text{Noise\&Drift}} = \pm \text{Sensor Noise (in watts) / Signal Power (in watts)} \\ = \pm 50.0\text{e-}9 / 20.0\text{e-}3 * 100 \% \\ = \pm 0.0003 \%$$

Step 8: A separate Sensor Zero Drift calculation does not need to be performed for peak sensors, since "noise and drift" are combined into one specification, so we'll just skip this step.

Step 9: The Sensor Calfactor Uncertainty needs to be interpolated from the uncertainty values given in Table 3-2 (Peak Power Sensor Calibration Factor Uncertainty). At 1 GHz, the sensor's calfactor uncertainty is 1.7 %, and at 0.5 GHz it is 1.6 %. Note, however, that we are performing our AutoCal at a frequency of 1 GHz, which is very close to the measurement frequency. This means that the calfactor uncertainty cancels to zero at 1 GHz. We'll use linear interpolation between 0.5 GHz and 1 GHz to estimate a value. 900 MHz is only 20% (one fifth) of the way from 1GHz down to 500MHz, so the uncertainty figure at 0.5 GHz can be scaled by one fifth.

$$U_{\text{CalFactor}} = [(F - F_1) * ((CF_2 - CF_1) / (F_2 - F_1))] + CF_1$$

where; $F = 0.9$

$$F_1 = 0.5 \quad CF_1 = 1.6$$

$$F_2 = 1.0 \quad CF_2 = 0.0$$

$$= [(0.9 - 0.5) * ((0.0 - 1.6) / (1.0 - 0.5))] + 1.6$$

$$= [(0.4) * ((-1.6) / (0.5))] + 1.6$$

$$= [(0.4) * (-1.6)] + 1.6$$

$$= 0.32 \%$$

Step 10: Now that each of the individual uncertainty terms has been determined, we can create an uncertainty budget and calculate the combined standard uncertainty (Uc).

Source of Uncertainty	Symbol	Value (+/- %)	Probability Distribution	Divisor	Ustd (+/- %)
Instrument	I	0.2	normal	2	0.10
Calibrator					
Level	R	3.11	rectangular	$(3)^{0.5}$	1.80
Mismatch	M_C	1.27	U-shaped	$(2)^{0.5}$	0.90
Source					
Mismatch	M_S	0.80	U-shaped	$(2)^{0.5}$	0.57
Sensor					
Shaping	S	2.00	rectangular	$(3)^{0.5}$	1.15
Temp. Drift	T	1.69	rectangular	$(3)^{0.5}$	0.98
Noise	N	0.03	normal	2	0.02
Cal Factor	K	0.32	normal	2	0.16
Combined Standard Uncertainty	Uc		normal		2.58
Expanded Uncertainty	U		normal (k=2)		5.17

From this example, different uncertainty terms dominate. Since the measurement is close to the calibration frequency, and matching is rather good, the shaping and level errors are the largest. The Expanded Uncertainty of 5.17 % translates to an uncertainty of about 0.22 dB in the reading.

Warranty

Boonton Electronics (Boonton) warrants its products to the original Purchaser to be free from defects in material and workmanship for a period of one year from date of shipment for instrument, and for one year from date of shipment for probes, power sensors and accessories. Boonton further warrants that its instruments will perform within all current specifications under normal use and service for one year from date of shipment. These warranties do not cover active devices that have given normal service, sealed assemblies which have been opened or any item which has been repaired or altered without Boonton's authorization.

Boonton's warranties are limited to either the repair or replacement, at Boonton's option, of any product found to be defective under the terms of these warranties.

There will be no charge for parts and labor during the warranty period. The Purchaser shall prepay shipping charges to Boonton or its designated service facility and shall return the product in its original or an equivalent shipping container. Boonton or its designated service facility shall pay normal ground shipping charges to return the product to the Purchaser. The Purchaser shall pay all shipping charges, duties and taxes if a product is returned to Boonton from outside of the United States.

THE FOREGOING WARRANTIES ARE IN LIEU OF ALL OTHER WARRANTIES, EXPRESSED OR IMPLIED, INCLUDING, BUT NOT LIMITED TO, THE IMPLIED WARRANTIES OF MERCHANTABILITY AND FITNESS FOR A PARTICULAR PURPOSE. Boonton shall not be liable to any incidental or consequential damages, as defined in Section 2-715 of the Uniform Commercial Code, in connection with the products covered by the foregoing warranties.