

MODEL 7405  
NEAR-FIELD PROBE SET  
USER'S MANUAL  
© 1991

.....

.....

**MODEL 7405  
NEAR-FIELD PROBE SET  
USER'S MANUAL**

**TABLE OF CONTENTS**

|    |   |    |
|----|---|----|
| 1  | I. PREFACE  | 1  |
| 1  | II. WARRANTY                                      | 1  |
| 2  | III. GENERAL DESCRIPTION                          | 2  |
| 2  | A. CONTENTS OF THE SET                            | 2  |
| 2  | B. DESCRIPTION OF THE MAGNETIC-FIELD PROBES       | 2  |
| 3  | C. DESCRIPTION OF THE ELECTRIC-FIELD PROBES       | 3  |
| 3  | 1. The Ball Probe                                 | 3  |
| 4  | 2. The Stub Probe                                 | 4  |
| 4  | D. PROBE TECHNICAL DATA                           | 4  |
| 5  | E. PROBE PERFORMANCE FACTORS                      | 5  |
| 5  | 1. PERFORMANCE FACTOR FOR THE 901 6 CM LOOP PROBE | 5  |
| 6  | 2. PERFORMANCE FACTOR FOR THE 902                 | 6  |
| 7  | 3 CM LOOP PROBE                                   | 7  |
| 7  | 3. PERFORMANCE FACTOR FOR THE 903                 | 7  |
| 7  | 1 CM LOOP PROBE                                   | 7  |
| 7  | 4. PERFORMANCE FACTOR FOR THE 904                 | 7  |
| 8  | BALL PROBE  | 8  |
| 8  | 5. PERFORMANCE FACTOR FOR THE 905                 | 8  |
| 8  | STUB PROBE  | 8  |
| 8  | F. PREAMPLIFIER FREQUENCY RESPONSE                | 8  |
| 9  | G. PREAMPLIFIER TECHNICAL DATA                    | 9  |
| 10 | IV. SET-UP AND USE                                | 10 |
| 10 | A. PROBE SELECTION                                | 10 |
| 11 | B. PREAMPLIFIER USE                               | 11 |
| 12 | V. COMMON DIAGNOSTIC TECHNIQUES                   | 12 |
| 12 | A. OVERVIEW                                       | 12 |
| 12 | B. PROCEDURE FOR LOCATING RADIATING               | 12 |
| 12 | SOURCES   | 12 |
| 12 | C. PROCEDURE FOR DIAGNOSING THE REASON FOR        | 12 |
| 17 | RADIATION   | 17 |
| 17 | D. PROCEDURE FOR PRE-SCREENING ALTERNATE          | 17 |
| 23 | SOLUTIONS   | 23 |
| 29 | VI. MAINTENANCE                                   | 29 |
| 29 | A. CHARGING BATTERIES                             | 29 |
| 29 | B. CHANGING BATTERIES                             | 29 |
| 30 | VII. PROBE SET PARTS LIST                         | 30 |



## **I. PREFACE**

The Near-Field Probe Set is a set of 3 magnetic field and 2 electric field passive, hand-held, near-field probes designed for use in the solution of emissions problems. The set comes with a 20 cm extension handle, which fits any of the probes. A custom carrying case is provided with each set. An optional preamplifier and pre-amp battery charger are available.

The set was designed as a versatile and easy-to-use EMI diagnostic aid. These probes provide a self-contained means of accurately detecting both magnetic (H) and electric (E) field emissions even where access is limited. The extension handle provides access to remote areas in larger units. The probes allow circuit design, EMC, and QC engineers a faster and easier means of detecting and identifying signal sources that could prevent their products from meeting federal regulatory requirements.

## **II. WARRANTY**

The Near-Field Probe Set is warranted for a period of two years from the date of shipment against defective materials and workmanship. This warranty is limited to the repair or replacement of defective parts and is void if unauthorized repair or modification is attempted. Repairs for damage due to misuse or abnormal operating conditions will be performed at the factory and will be billed at our commercial hourly rates. Our estimate will be provided before the work is started.

### III. GENERAL DESCRIPTION

The Probe Set is designed as a diagnostic aid for locating and characterizing sources of E or H-field emissions. Versatile and easy-to-use, this set is a convenient and inexpensive tool for extending the capability of your spectrum analyzer, oscilloscope or signal generator. Using the probe set, you can detect and identify the signal sources that might prevent your products from meeting federal regulatory requirements.

Made of injection molded industrial grade plastic, the five probes in the Probe Set are durable, light-weight and compact. Alone or with the extension handle, they can be used where larger, more bulky probes cannot reach.

#### A. CONTENTS OF THE SET

The Probe Set includes three H-field probes and two E-field probes, a 20 cm extension handle, documentation and a convenient, foam-lined carrying case (Figure 1). The set is also available with an optional preamplifier. The entire set is covered by a two-year warranty.

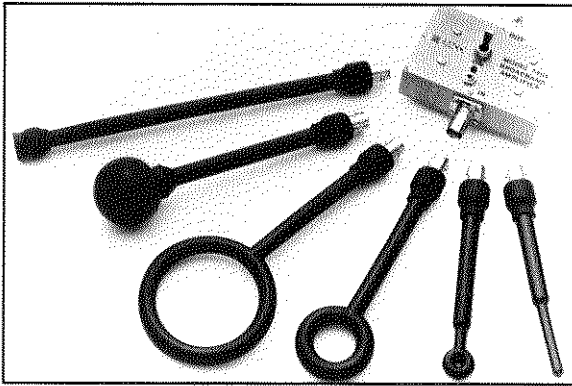

Figure 1. Both magnetic and electric field probes are required for maximum diagnostic versatility.

#### B. DESCRIPTION OF THE MAGNETIC-FIELD PROBES

The Probe Set contains three H-field probes of varying size and sensitivity (Figure 2). Each of the H-field loop probes contain a single turn, shorted loop inside a balanced E-field shield. The loops are constructed by taking a single piece of 50 ohm, semi-rigid coax from the connector and turning it into a loop. When the end of the coax meets the shaft of the probe, both the center conductor and the shield are 360 degree soldered to the shield at the shaft (Figure 3). Thus a single, shorted turn is formed. A notch is then cut at the high point of the loop. This notch creates a balanced E-field shield of the coax shield.

The ball probe shaft (Figure 5) is constructed of a length of 50 ohm coax. The coax is terminated at its end with a 50 ohm resistor in order to present a conjugate termination to the 50 ohm line. Then the center conductor is extended beyond the

#### 1. The Ball Probe

Two different E-field probes are included in the set (Figure 4). These probes are used for tracing high-impedance fields, such as those produced by inadequately grounded circuits.

### C. DESCRIPTION OF THE ELECTRIC-FIELD PROBES

Figure 3. H-field Probe

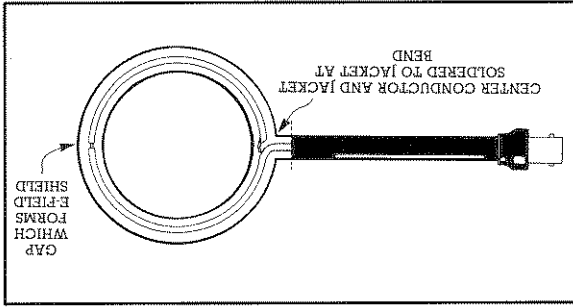
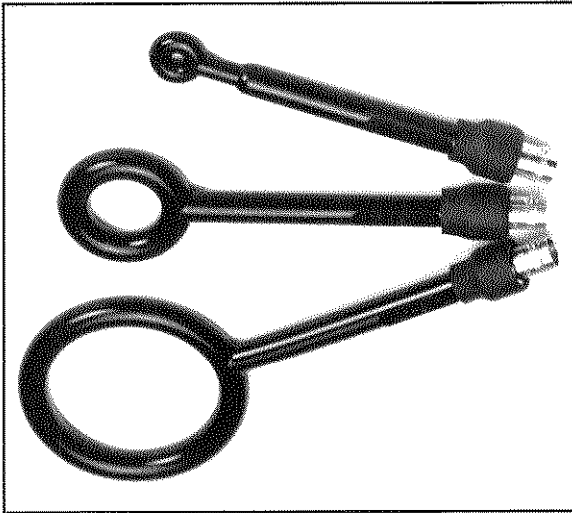

Figure 2. These probes are highly selective of the H field while being relatively immune to the E-field.



The loops highly reject E-field signals due to the balanced shield.

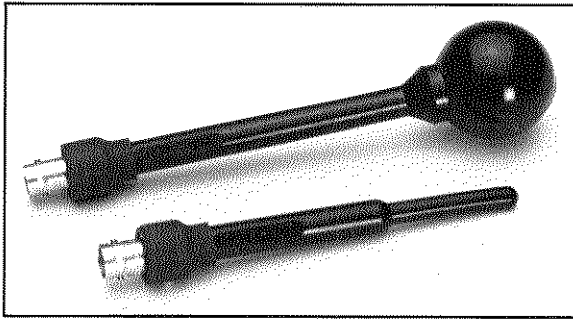

Figure 4. This stub probe and ball probe are sensitive only to the E-field. Because they have almost no current pickup capacity, they are highly insensitive to the H-field.

50 ohm termination and attached to a 3.6 cm diameter metal ball. The ball serves as an E-field pick up. However, the absence of a closed loop prevents current flow, allowing the ball probe to reject the H-field.

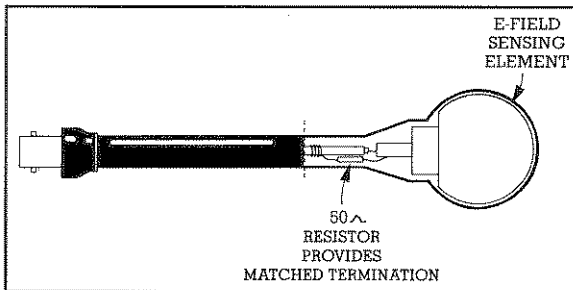

Figure 5. E-field Ball Probe

## 2. The Stub Probe

The stub probe (Figure 6) is made of a single piece of 50 ohm, semi-rigid coaxial cable which has 6 mm of the center conductor exposed at the tip. This short length of center conductor serves as a monopole antenna to pick up E-field emanations. As there is no loop structure to carry current, the unit highly rejects the H-field.

The stub probe is relatively insensitive, due to its small sensing element. This is actually an advantage when the precise location of a radiating source must be determined. While moving the stub probe over the pins of an IC chip, variations will be noted at spaces as close as 2 or 3 pins. This allows for very precise location of the source.



The probe performance factor is defined as the ratio of the field presented to the probe to the voltage developed by the probe at its BNC connector,  $PF = EM$ . By adding the performance factor to the voltage measured from the probe, the field amplitude may be obtained.

## E. PROBE PERFORMANCE FACTORS

Figure 7-11. Probe Characteristics.

| Model Number | Probe Type    | Primary Sensor Type | E/H or H/E Rejection | Upper Resonant Frequency* |
|--------------|---------------|---------------------|----------------------|---------------------------|
| 901          | 6 cm Loop     | H-Field             | 41 dB                | 790 MHz                   |
| 902          | 3 cm Loop     | H-Field             | 29 dB                | 1.5 GHz                   |
| 903          | 1 cm Loop     | H-Field             | 11 dB                | 2.3 GHz                   |
| 904          | 3.6 cm Ball   | E-Field             | 30 dB                | > 1 GHz                   |
| 905          | 6 mm Stub Tip | E-Field             | 30 dB                | > 3 GHz                   |

\* See Section IV A.

## D. PROBE TECHNICAL DATA

Figure 6. E-field Stub Probe



By comparison, the ball probe is much more sensitive. Its larger sensing element does not offer the highly refined definition of the source location which the stub probe allows. However, it is capable of tracing much weaker signals. The impedance of the stub probe is the essentially the same as that of an unterminated length of 50 ohm coaxial cable.

The graphs in the following sections present typical calibration results for these designs. Individual probe results may vary from these values.

All the probes were calibrated in a TEM cell, which presented the probes with a 377 ohm field. The H-Field probes only respond to the H-Field. However, the equivalent E-Field response is graphed. This may be done if the field is assumed to be a plane wave with an impedance of 377 ohms. The reason for graphing the factors this way is to allow for easy estimation of the strength of the far field. (This is explained further in section V. C., "Procedure for Diagnosing the Reason for Radiation.") If the H-Field amplitude is desired, 51.52 dB must be subtracted from the performance factor found on the Graph (Figures 7-11).

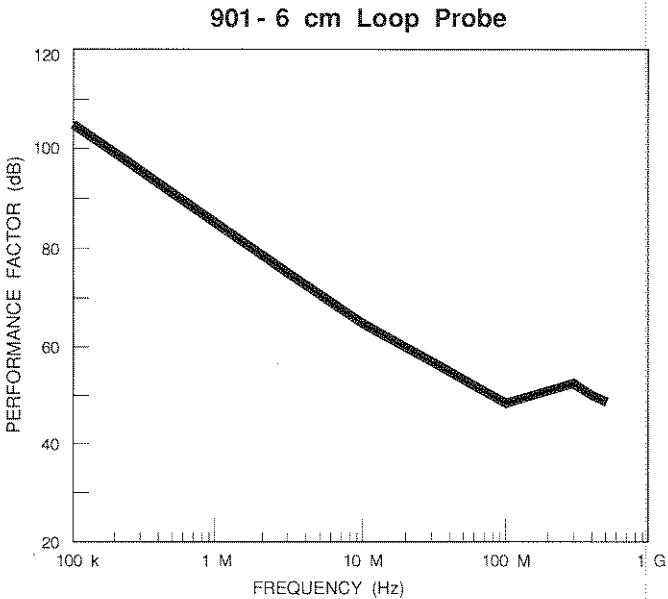

Figure 7. Performance Factor for the 901 6 cm Loop Probe

Figure 9. Performance Factor for the 903 1 cm Loop Probe

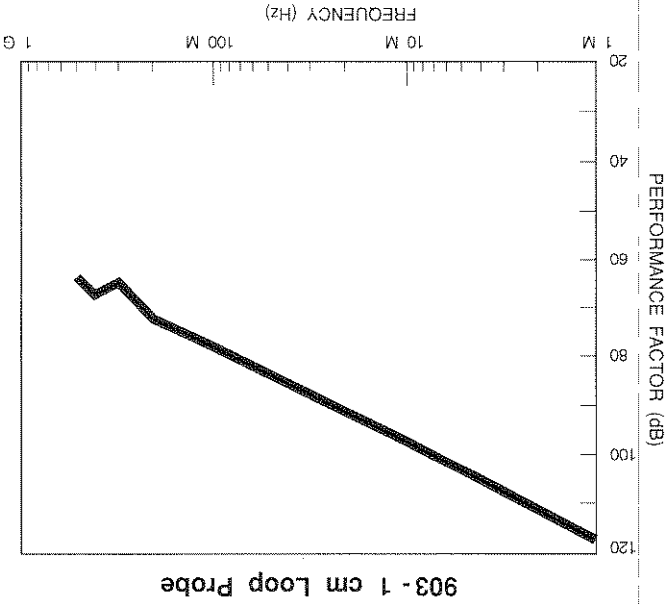
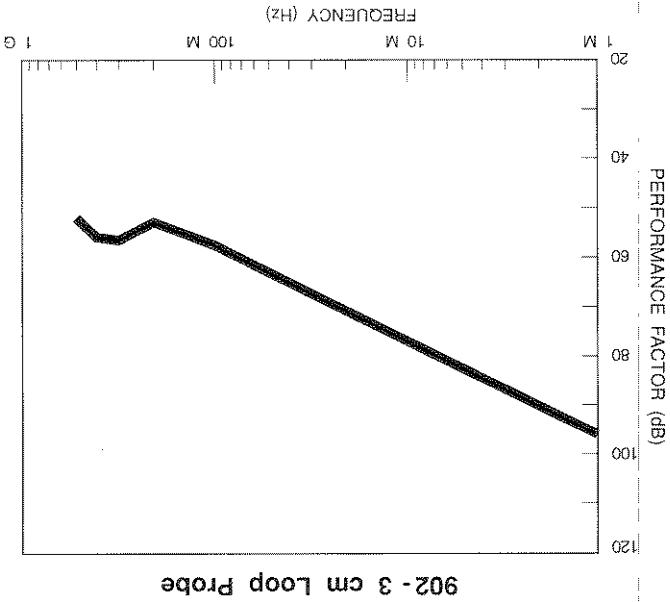

Figure 8. Performance Factor for the 902 3 cm Loop Probe



### 904 - E-Field Ball Probe

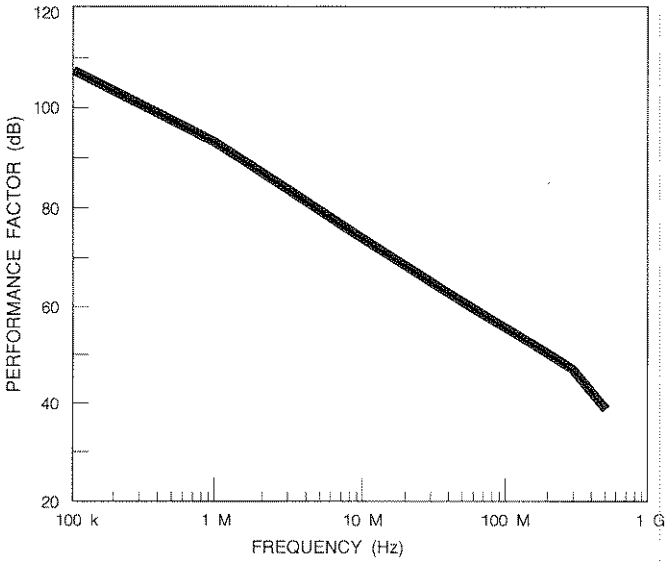

Figure 10. Performance Factor for the 904 Ball Probe

### 905 - E-Field Stub Probe

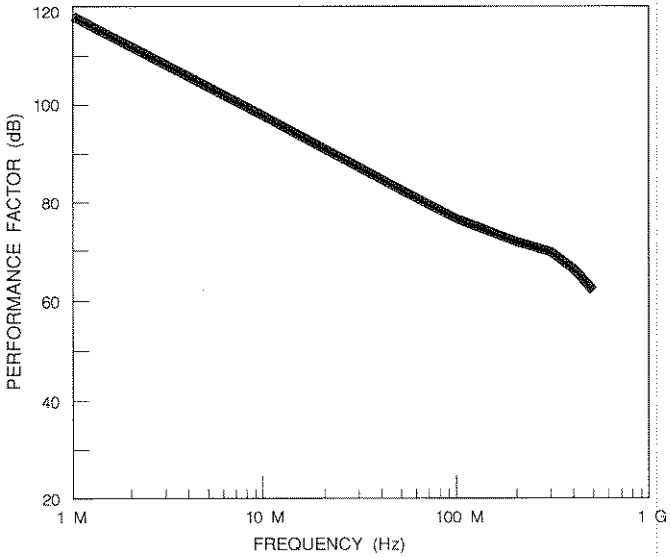

Figure 11. Performance Factor for the 905 E - Field Stub Probe

G. PREAMPLIFIER TECHNICAL DATA

**ABSOLUTE MAXIMUM RATINGS:**

Input Voltage (DC) -6.0 VDC  
 Input Voltage (AC) -5.0 V-PP  
 Operating Temperature -55 C. to +125 C

**FEATURES:**

Bandwidth (to -3 dB points) -300 Hz -600 MHz  
 Gain (nominal) -18 dB  
 Noise Figure (Rel. 50 ohms) -6 dB typical  
 Saturated Output Power (at F = 100 MHz) -  
 +7.0 dBm

1 dB Gain Compression (at F = 100 MHz) -  
 +4.0 dBm  
 Third-Order Intermodulation Intercept - +17.0  
 dBm  
 Second-Order Intermodulation Intercept -  
 +24.0 dBm

Battery Life (typical) -20 Hours

**BATTERIES:**

N cell Nickel Cadmium are supplied.  
 Order EMCO P/N 400017 replacement batteries.  
 N cell Alkaline may be used, such as:

Duracell  
 Eveready  
 Ray-O-Vac  
 Radio Shack

#M9100  
 #E90  
 #81C  
 #23-023

Figure 12. F. Preamplifier Frequency Response

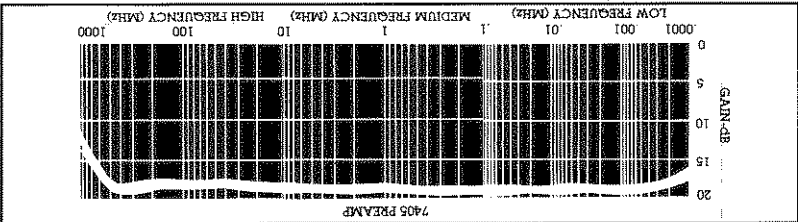

## IV. SET-UP AND USE

The Probe Set was designed with ease of use in mind. First, the appropriate probe is chosen. Then a coaxial cable is connected between the probe and the signal analyzing device; typically this is a spectrum analyzer or oscilloscope. If the extension handle is needed, it is placed between the probe and the coaxial cable. Finally, the signal analyzing device must be adjusted for the best presentation of the signal of interest (Figure 13). That is all there is to it. The probe is now ready to use.

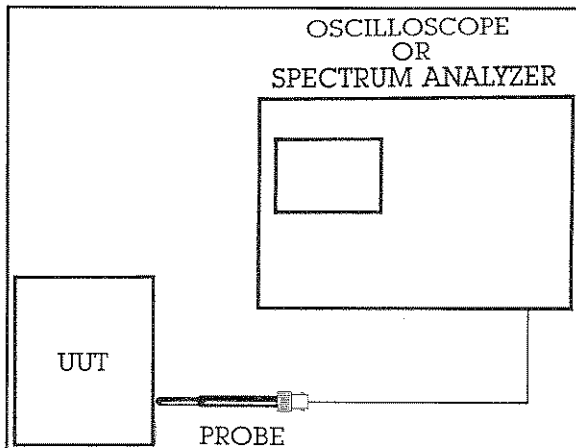

Figure 13. Typical Probe Configuration.

### A. PROBE SELECTION

Your choice of the correct probe will be determined by five factors: whether the signal is E or H, the strength of the signal, the frequency of the signal, the physical size of the space where the probe must fit, and how closely you want to define the location of the source.

The first question is: Is the signal primarily E or H-field? If it is E-field use the ball or stub probe. If it is H-field use one of the loop probes. If you do not know try one of each, and use the one which best picks up the signal.

Next you must select a probe which adequately receives your signal of interest (Figure 14). The ball probe and the 6 cm loop are the most sensitive E and H-field probes, respectively. The stub probe and the 1 cm loop are the least sensitive probes.

If your signal is above 790 MHz, there is a chance that some of the probes may go into resonance. To avoid probe resonance the upper resonant frequencies are listed in the Probe Technical Data section, section III. D.

The optional Model 910 preamplifier is used to increase the sensitivity of your test system. When needed, the preamplifier is connected to the input of the signal analyzing device. The coaxial cable coming from the probe is then connected to the preamplifier. A switch located on the pre-amplifier activates power to the unit, indicated when the panel light is on. The unit is powered by four internal 1.5 VDC ni-cad batteries. If power to the preamplifier is interrupted or batteries fail, the preamplifier will not become active and no signal will pass to the analyzing device. A battery charger is provided to recharge the internal batteries.

## B. PREAMPLIFIER USE

A variety of different size probes is provided, which allows you to use a probe small enough to fit into very tight spaces. Finally, choose the probe which lets you identify the signal source as closely as you need to. Typically you will begin with the larger probes and begin probing outside a unit. As you move closer to the source you will change to smaller and smaller probes to get a clearer idea of where the source is. The smallest probes should allow you to determine exactly which circuit on a printed circuit board is radiating. This kind of refinement allows you the sophistication of stopping the radiation at the source rather than just shielding an entire unit.

Figure 14. A ball probe is used to examine a flat cable. The distributed inductance over the length of the cables makes them particularly susceptible to common mode problems. High-impedance sources such as this cable are best examined with an E-field probe.

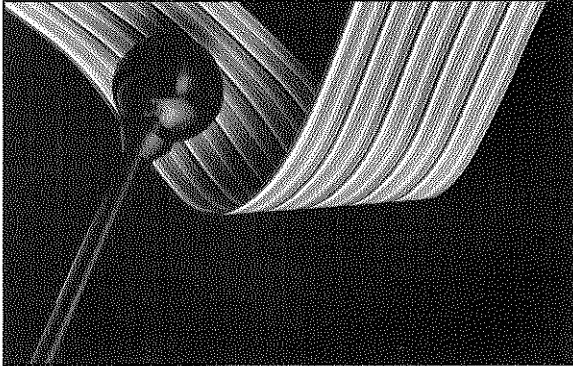

## V. COMMON DIAGNOSTIC TECHNIQUES

### A. OVERVIEW

The first lesson most engineers learn about EMI is that getting accurate, repeatable results requires a carefully established and calibrated test setup, usually an open field test site or a shielded room. Final qualification must be performed in the required test environment of a screen room or an open field site. However, a great deal of preliminary EMI testing can be done with a sniffer probe and signal analyzing instrument (Figure 15). The following sections of this manual explain how sniffer probes can be used in various phases of the engineering task.

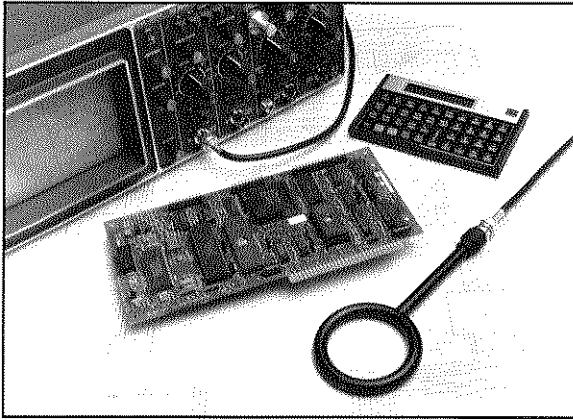

Figure 15. An oscilloscope and diagnostic probe provide a powerful tool in dealing with EMI/RFI problems. This combination enhances the engineer's efficiency by providing fast and accurate diagnostic insight into an emanating circuit.

### B. PROCEDURE FOR LOCATING RADIATING SOURCES

How do you locate the source of a signal in a piece of equipment? The first step is to relate the emissions failure to signals used in the EUT being tested. To do this an understanding of the nature of the time domain to frequency domain transform is necessary. The various specifications are all given in the frequency domain, so many dBuV at a particular bandwidth over a given frequency range (Figure 16). However, most EUT operations are characterized in the time domain: 150 ns memory access time, 300 V/ms slew rate, etc. This section presents a technique which will aid in linking emissions with the signals which create them.

When you test your equipment, you may be told something like, "It fails by 10 dB at 40 MHz and 3 dB at 120 MHz". The challenge is to find what EUT function is creating these emissions. You may be able to simply connect the probe to a spectrum analyzer and locate the source (Figure 17).



Often however, within an EUT, many sources are found to be emitting at a given frequency. Most of these emissions are non-propagating, reactive fields. The problem is to locate the sources creating a propagating field. To solve the problem, the most helpful first step is to demodulate the offending signal while it is being received in the far-field. Demodulation gives a time domain representation of the signal. This time domain representation will appear in some way similar to an oscilloscope trace of the radiating signal.

Figure 17. Locating the source of an emanating signal begins by finding its exit points. Cover seams and air flow vent holes are primary suspects. In this figure, a loop probe traces the cover seams in the effort to find where a signal is escaping.

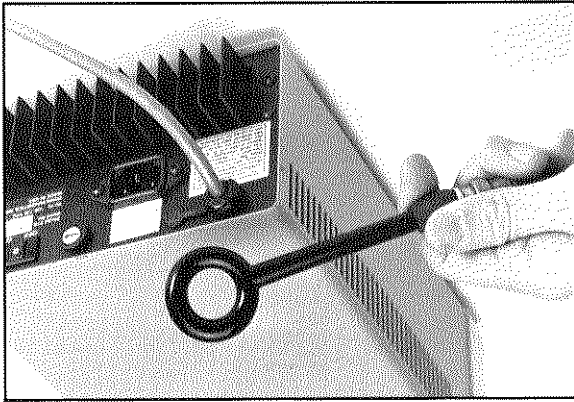
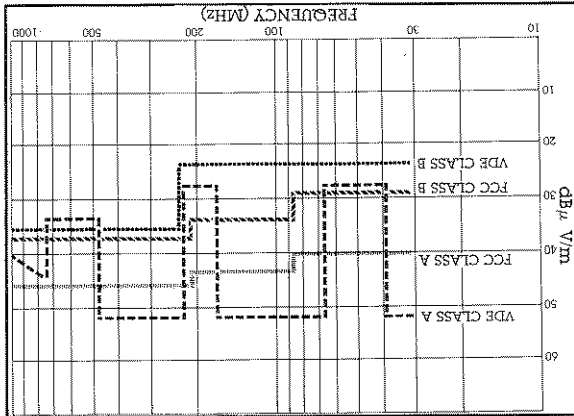

Figure 16. FCC and VDE Radiated Requirements. While these requirements are stated in terms of the frequency domain, the engineer must find the source in the time domain.



To accomplish this, first set the spectrum analyzer for a 0 Hz frequency span and tune to the signal of interest. This essentially changes the spectrum analyzer into a tuned receiver and makes its display a frequency filtered oscilloscope.

Take the video output off your spectrum analyzer and run it to the scope (Figure 18). You could use the spectrum analyzer display, but the oscilloscope will allow you much greater flexibility in adjusting the signal amplitude and in triggering according to your purposes. Get a clear picture of the signal produced on the oscilloscope. You now have on the oscilloscope a good representation of what you are looking for when you start "sniffing" with your probe.

A few scope photos of the demodulated trouble frequencies prepares you to return to your lab. Now with a set of "sniffer" probes you begin to look for similar signals in your equipment. As you locate close matches to the demodulated signals, you have strong clues to the source of these signals. As you find the sources, you know on which subassemblies, circuits or even gates to work.

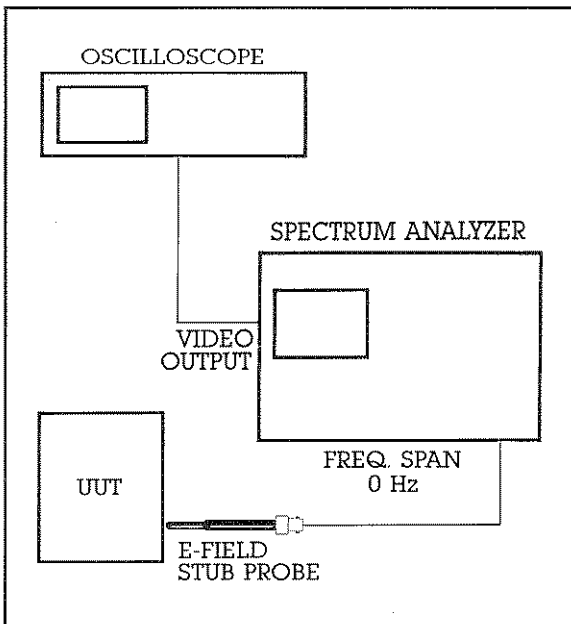

Figure 18. A Simple Technique for Signal Demodulation. By using the video output of a spectrum analyzer, an oscilloscope may be used to capture a time domain representation of the signal of interest.

There are several physical phenomenon which cause lower frequency signals to modulate and radiate as higher frequency signals. A working

knowledge of FM, AM, audio rectification and other phenomenon gives greater facility in understanding and interpreting the data revealed by demodulated signals. This understanding gives good insight into what kind of radiating structure must be present to produce the observed event. This understanding also allows greater facility in recognizing the original signal from its altered, and often distorted, modulated representation.

Frequently the demodulated picture will contain just the transitions of a digital signal. At times, only the rising or falling edge will be present in a high frequency signal. Understanding the radiation physics allows the appearance of the original signal to be surmised. Often all that will be present in the photograph from the oscilloscope presentation is the high frequency components of a signal. These waveform components are the source of the radiation.

Getting an idea of what the waveform may look like through demodulation is not the only use for the time domain-frequency domain transform. A little analysis and thought will usually reveal what component of the waveform is causing the problem. For example, if you have a 16 MHz clock and you have a 16 MHz problem, then you know that the base signal is causing the problem. More typically your probing may lead you to the 16 MHz clock when trying to find a 208 MHz problem. Remember a 208 MHz signal has a wavelength  $1/13$  of 16 MHz.

If the problem is caused by a rise or fall time, you may be looking for a waveform component which is between a wavelength and  $1/8$  of a wavelength of the radiating frequency. In our 208 MHz example a wavelength is  $1/13$  of the 16 MHz clock.  $1/8$  of a wavelength is  $1/104$  of a 16 MHz pulse width. So look at the oscilloscope picture for waveform components on the 16 MHz clock that are  $1/13$ - $1/104$  of the 16 MHz wavelength. You soon begin to zero in on undershoot and overshoot or other parasitic components. You may not have to quiet the entire circuit, but rather just roll off the offending components. What you have done is mentally transform a frequency domain failure to a time domain picture which you can work on in your lab.

Having identified what the signal of interest looks like on the oscilloscope, it must now be located within the equipment. At times this will have already been accomplished during the demodulation process. For example, as you demodulated a 50 MHz signal, perhaps it became clear that the 50 MHz was pulsing on at a 40 kHz rate. You may know that the only 40 kHz source in your unit is the switching rate in the power supply. If nothing else in the unit operates at that frequency, you have identified your source. Thus, the first step in identifying a signal source is to review what subassemblies in the unit may produce a signal similar to the one you are seeing radiated.

Typically, there are several possible sources for a given signal. To identify the particular one in question, you begin by using your “sniffer” probes. A very common procedure is to have a set of loop probes of varying size. You begin with the largest, which is the most sensitive. Starting several feet from the unit, you look for the signal of interest. You search for its maximum and begin approaching the unit along the line of maximum emission. As you get close to the unit, you switch to the next smaller probe. This probe will be less sensitive but will allow you to differentiate the signal source more narrowly. Often the initial probing locates where the signal is escaping from the unit. This indicates the point of escape from the unit housing. Once inside the unit, and inside of any shielding, you are looking for the source itself. Finally, you will be using the smallest diameter probe in your set to define as precisely as possible the source of your signal. At times you will switch at this point to an E-field “stub” probe. This is a very small and insensitive E-field probe which can be used to get very close to the signal source. Use the probe which allows you to best identify the signal source. Finding both the point of escape from the unit and its actual source is important. Having both bits of information gives you a choice in engineering the solution. You may decide to improve the unit's shielding or you may decide to suppress the source itself. The more solution alternatives you identify along the way the greater will be your chance of identifying one which meets all the requirements of schedule, cost and performance under which you will be working.

Another procedure which is sometimes used is to use electro-magnetic probes in conjunction with regular scope probes. As you close in, you may want to hook up a regular scope probe and switch back and forth to help refine the actual offending components as finely as possible. Using this combination you can define a radiating source down to a specific signal line. At times you will want to disable portions of a circuit to make a final determination of where the source is. For example, you may disable a line driver in order to see if the radiation is coming from the base unit or from some I/O cable. This kind of identification can be tricky up close. Normally, when disabling parts of a circuit, you will want to use a more sensitive probe and take your readings several meters from the unit. It is easy to be misled by strong, non-propagating, reactive fields. Also be careful to clear the scope probe out of the unit when making radiated readings. An attached scope probe can easily radiate and mask the real problem in its own emissions. By the time you are through, you will have a very good idea of exactly from where inside your unit the offending signal is emanating.

In summary the basic logic of locating the source of a given signal is very straightforward. First, you get a time domain representation of the signal on your oscilloscope. This step is best performed at the EMC/EMI test site because you will want to be sure that you are identifying the signal which is, in fact, radiating into the far-field, and you will need the use of a spec-

One of the most common ways for all lines in a circuit to become high-impedance lines is for the ground servicing that circuit to contain a significant inductance. At some frequency, this ground inductance becomes a high-impedance. Because the entire circuit references ground, this impedance in the ground path effectively is in series with every line in the circuit. The return flow in this situation is developed by capacitive coupling

cut. Remember that the impedance spoken of here is the total impedance at the radiating frequency. Often what appear to be low-impedance connections are really high-impedance due to the inductance in the physical circuit.

Magnetic fields typically are produced by local current loops within a unit. These loops may be analyzed as differential mode. Electric fields require high-impedance sources. Since the changing potential is isolated by substantial impedance on all lines into the circuit, all lines will carry just the forward current.

Electric field is produced. Will determine whether a predominantly magnetic or predominantly electric field will predominate. The impedance of the radiating source these vectors will cause a change in current and vice versa, one of a change in voltage will cause a change in current and vice versa, one of current flow and electric fields with common mode current flow. Although high degree of correlation between magnetic fields with differential mode difference, causing an electric field (Figure 19). Experience has shown a causing a magnetic field, or by an instantaneous change of a potential. Radiation is caused either by an instantaneous change in current flow.

Secondly, he must know why that component or circuit is radiating. address the situation. First, he must know what is radiating inside the unit. EMC/EMI problem needs to know two things before he can efficiently appropriate solutions to his problem. The engineer presented with an agency to the diagnostic procedure by quickly guiding the engineer to knowing the field impedance of an EMI problem can bring great efficiency.

to diagnose the radiation physics of a given situation. rough estimate of the field impedance. The field impedance then is used rectify a problem. This section will deal with using sniffer probes to get a techniques. Good diagnosis saves many false starts and random attempts to fix, the engineer can quickly select the most appropriate design technique. By determining the nature of the radiating structure, a small sniffer probe can help diagnose the cause of an electromagnetic interference problem.

## RADIATION

### C. PROCEDURE FOR DIAGNOSING THE REASON FOR

identify the particular component or circuit which is causing the problem. smallest probes, often in conjunction with regular scope probes, you can the signal path and the signal source. Finally, using the least sensitive and turn analyzer. The second step is to use a set of "sniffer" probes to identify

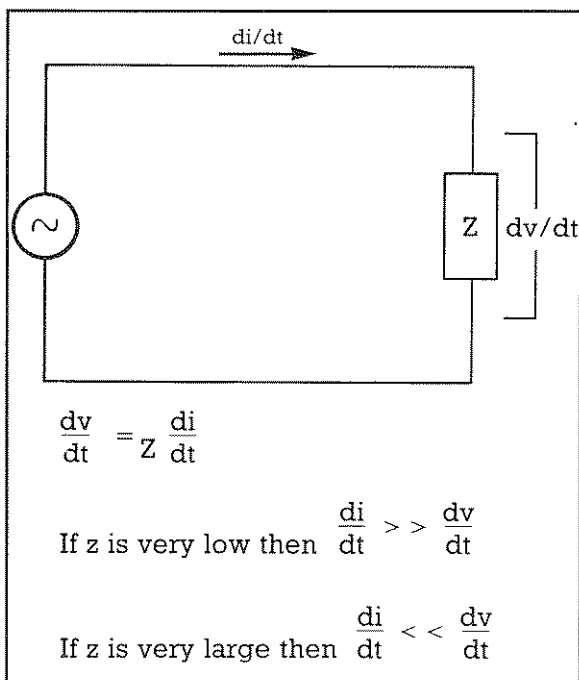

Figure 19. All Electromagnetic Radiation is caused by either a change in the current or a change in the voltage. A radiating circuit's source impedance determines whether magnetic or electric flux will dominate in the near-field.

to conductors external to the unit or to fortuitous conductors within the unit.

From the local perspective of the unit, this is a common mode situation (Figure 20). In other words, EMC/EMI problems may be classified principally as current-related or voltage-related. Current-related problems normally will be associated with differential mode situations. Likewise, voltage problems normally will be associated with common mode circuit situations. Too often solutions are attempted before the radiating parameter is understood. Unfortunately, solutions effective for differential mode are seldom effective against a common mode problem. Hence, knowledge of the field impedance is essential if many fruitless attempts are to be avoided.

Before proceeding to the measurement procedure, a brief review of the physics of the situation is required. In the far-field, that is more than about one wavelength from the source, the ratio of the E and H-field components of the propagating wave resolve themselves to the free space impedance of 377 ohms. In the far-field the E and H-field vectors will always have a ratio of 377 ohms. In the near-field that ratio radically

changes. The ratio of E to H-field, or field impedance, is determined in the near-field by the source impedance. As you probe in close to the equipment you can switch between an E-field probe and an H-field probe. By noting the rate of change of the field strength versus distance from the source and the relative amplitude measured by the probes, the relative field impedance may be determined.

Low-impedance sources or current-generated fields initially will have pre-dominantly magnetic fields. The magnetic component of the field will pre-dominate in the near-field but will display a rapid fall-off as you move away from the unit. This change may be observed through an H-field probe.

Figure 20. Illustrations of common and differential mode current flow.

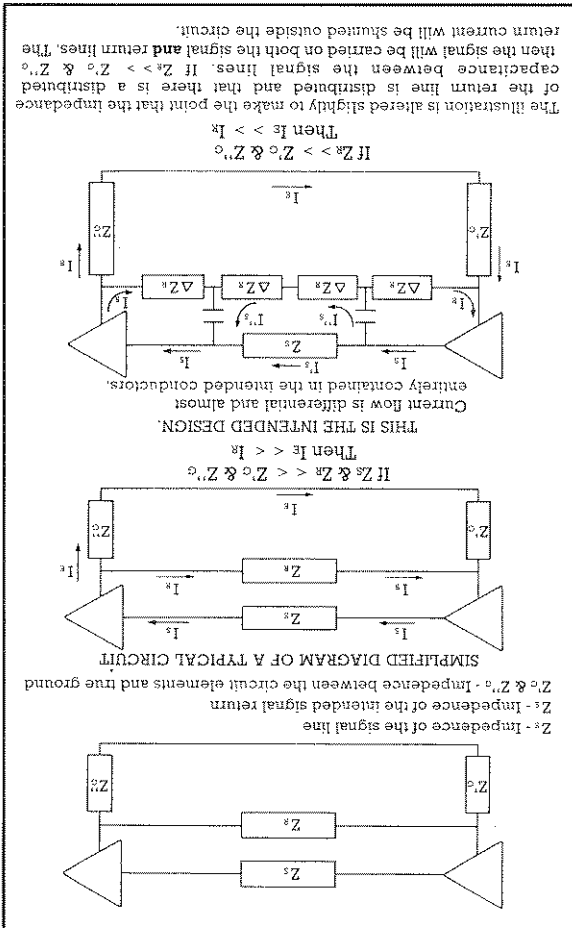

Low-impedance sources also will give a much higher reading, in the near-field, on an H-field probe than on an E-field probe. Alternately, high-impedance sources will display a rapid fall-off when observed through an E-field probe.

There are two ways of determining the nature of the source impedance. The first is to map the rate of fall-off of the E and H-fields. One of these vectors will fall off more rapidly than the other. The second method is to measure both vectors at the same point and by their ratio determine the field impedance. The equation  $E/H = Z$  is calculated and compared to the free space impedance of 377 ohms. Values higher than 377 ohms will indicate a predominance of the electric field. Lower values will indicate that the magnetic field component is predominating. From this you can plan your approach to the problem by tailoring it to a differential mode situation or a common mode situation.

Field theory leads us to expect a  $1/R$  fall-off for a plane wave, where R is the distance from the source. In the near-field, the nonpropagating, reactive field will drop off at multiple powers of the inverse of the distance,  $1/R^N$ . Typically, the reactive field will fall off at something approaching  $1/R^3$ . Hence, we would predict these measurements relative to measurements at distance equal to one.

DISTANCE

A to B = 1.5 2.0 3.0

PROPAGATING FIELD

$1/R$  -3.52 dB -6.02 dB -9.54 dB

REACTIVE-FIELD

$1/R^3$  -10.57 dB -18.06 dB -28.63 dB

The way to perform these measurements is very straightforward. After the source is identified, two or three angles of approach are measured. A typical situation would record 2 points at .5 and 1.5 meters from the source along 2 radials from the source. The signal is measured at each point with a probe which is highly selective of the H-field and another probe which is highly selective of the E-field (Figure 21). The rate of fall-off is noted for each probe and the relative amplitude between the probes is noted. In deciding what the relative amplitude is, the conversion factor of each probe must be taken into account (Figure 22).

Generally, differential mode data is well behaved. The amplitude measured with the H-field probe will be significantly higher than that measured with the E-field probe. Also the H-field will drop off at a much faster rate than the E-field rate. Common mode measurements often are less well behaved. Often the best indicator is the relative amplitude. The E-field probe will have a much higher reading than the H-field probe. The drop-off rate will be faster when measured with the E-field probe. However, experience shows that the E-field, being a high potential field, is much more susceptible to perturbation. Often the reading will be very



A qualitative knowledge of the field impedance indicates how to approach the EMC/EMI design for the problem. By determining the dynamics of the radiating structure, it can be surmised what kinds of designs will be effective in solving the radiation problem. A primarily H-field or magnetic field problem signifies that current flow predominates.

Figure 22. By using two probes to measure the field strength at a single location, the field impedance at that point may be determined.

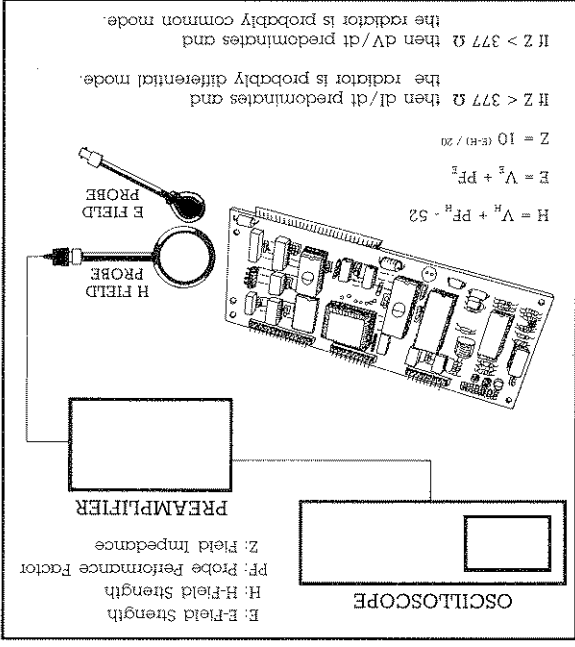

sensitive to cable placement and differences in the position of the person holding the probe. This susceptibility to being perturbed can be a hint that the field is coming from a high potential source.

Figure 21. H and E field probes are being used to diagnose a problem on a printed circuit board. (By mapping the rate of roll-off of the H and E fields, the source impedance may be determined.)

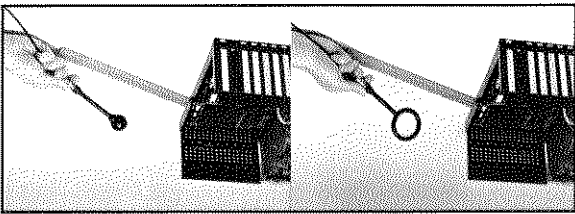

The other possibility is that the problem is predominately electrical or E-field. In this case the field impedance is relatively high. A high field impedance means there is a potential build-up across some impedance, and this high potential region is the radiating source.

Knowing that a problem is differential mode indicates that it will respond to remedies such as:

- reducing circuit loop area.
- reducing signal voltage swing.
- shielding of the entire radiating loop. (But it will not respond well to partial shielding of the radiating loop. Partial shielding typically occurs when the path of the return current is mapped incorrectly and so not included inside the shield).
- filtering the radiating signal line.

However, notice the perplexing results which arise when differential mode solutions are applied to a common mode problem.

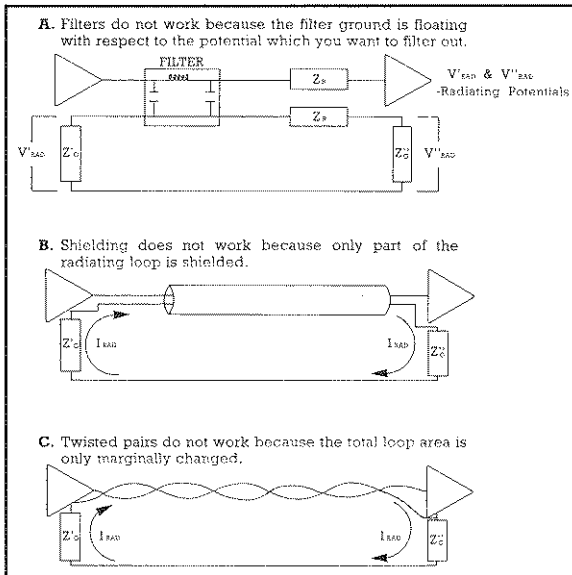

Figure 23. Why some traditional differential mode techniques do not work in common mode situations.

Many of the techniques useful in the differential mode context will prove totally ineffective (Figure 23). For example:

- Reducing circuit loop area. The radiating signal is on the signal and supposed return path, so this will be ineffective. Using twisted pair wires or even coax will yield little in the way of signal reduction.

1. Improve the decoupling on the board in general.
  2. Improve the power and ground griding or put in a ground plane.
  3. Decouple that end to chassis ground.
  4. Place a common mode choke on the output I/O.
- Preview testing of alternate implementations of a solution is a vital, time saving step in the process of resolving an electromagnetic problem. An example might be, "I have a common mode radiating off the end of the unit holding the I/O connections." Solutions may be to:
- ## D. PROCEDURE FOR PRE-SCREENING ALTERNATE SOLUTIONS

Some traditional common mode techniques do not work in differential mode situations (Figure 24).

- Increased decoupling of power to ground.
  - Reduced lead or trace inductance by reducing their length or making them wider.
  - Inserting ground and power grids or planes.
  - Shielding, using a ground separate from signal ground.
  - Relocating I/O cables to a lower impedance area on the ground structure.
  - Placing common mode filters on the output lines using dissipating elements.
- Once it is known that a common mode problem is being dealt with, use techniques which have a good potential for success. Start by analyzing the ground and power distribution system. The key will be to understand what RF impedances these systems present, then reduce the excessive impedance. Techniques which might be tried are:
- Shielding the entire loop. A problem arises when you try to decide where to ground the shield. The radiating potential is on signal ground. If you tie the shield to signal ground, all you have done is add more radiating antenna to the system.
  - Filtering the signal line. Once again to what ground should the filter be tied? Using signal ground will be totally ineffective since the filter will simply float with the radiating potential.
  - Shielding the entire loop. A problem arises when you try to decide where to ground the shield. The radiating potential is on signal ground. If you tie the shield to signal ground, all you have done is add more radiating antenna to the system.
  - Filtering the signal line. Once again to what ground should the filter be tied? Using signal ground will be totally ineffective since the filter will simply float with the radiating potential.
- any one of these gates in isolation will not yield much signal additive effects of a number of gates. Hence, suppression of will be built up on the power or ground system through the more deeply in the circuitry. At times the radiating potential ing potential is developed not at the output signal driver but times it too will be ineffective; for example, when the radiat- Reducing the signal voltage swing. This may help. At other

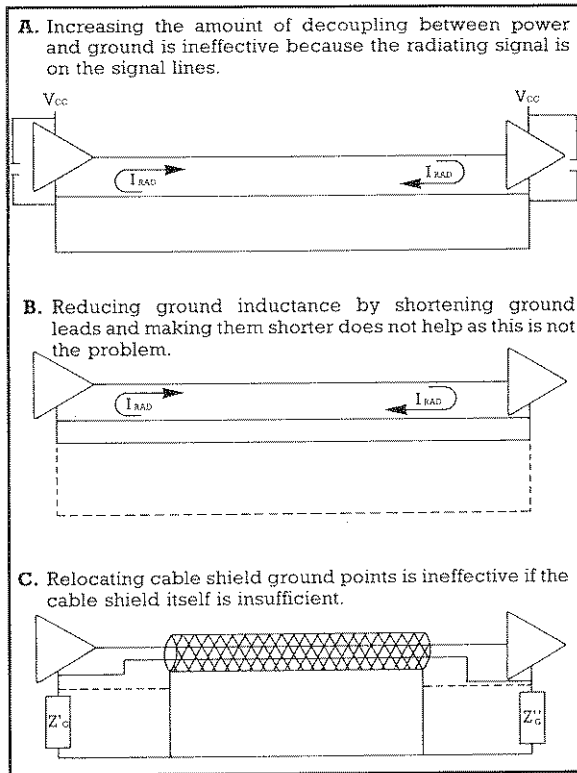

Figure 24. Why some traditional common mode techniques do not work in differential mode situations.

Any of these solutions may work. The most economical solution may be a hybrid of two of the above options applied in conjunction. Obviously each of the above options could be implemented in a number of ways. The physical mechanization of a particular approach will have a tremendous bearing on its effectiveness. The role of pre-screening is to provide a relatively quick way to sort through a matrix of possible implementations and solutions.

In evaluating various solutions we have to exercise great skill and awareness. It is in this area that the far-field/near-field effects can be the most misleading. The E and H-field vectors are initially determined by the source impedance. As we move away from the source, these vectors increasingly balance until the radiating field is isolated as a plane wave with a characteristic impedance of 377 ohms.

In the near-field the field strength can contain, in addition to the radiating field, a significant non-radiating reactive component. This reactive component does not propagate far. The radiating field will fall off proportion-

The more distant measurement points may lose the signal into the system noise. It always should be kept in mind that a given solution may only redirect the beam. Especially with narrow beam problems, solution will allow quantitative measurement of the reduction.

solution gives a dramatic reduction, this point may be the only one which away. Also, choose one or two points quite close to the source. If a given will be, most of the points should be somewhat distant, one to four meters number. Since the object is to get some idea of what the far-field results shows a typical fix evaluation setup.) Two to six points would be a typical The first step in each procedure is to choose a set of points. (Figure 26

rate design solutions. are two approaches which normally yield good results in evaluating alternate field will also mean that the radiating field has also been reduced. There near-field probing can be had. Generally, a reduction of the non-radiating As long as a linear relationship is not expected, some real benefit from near-field will translate into an attenuation of the far-field reading as well. Often, perhaps even normally, an attenuation of the field strength in the However, technical imprecision does not eliminate a method totally.

suspicion of the analytical validity of near-field readings. field and so after the field it is measuring. In summation, have a healthy associated cabling (Figure 25). The probe itself will re-radiate the received inductance between the circuit being measured and the probe with its probe affects the circuit being probed. There will be capacitance and Another factor which affects near-field readings is that the presence of the ing.

radiating, reactive field may show relatively little effect on the far-field read- A reflection pattern is often established near the unit by the direct wave combining with its reflection off of parts of the unit and other items in the vicinity. A design which reduces field strength by attenuating the non-

pattern set up near the unit. may be lower than expected because of nulls created by the interference from far-field data due to the presence of the reactive field. Alternately, it readings will often seem higher than expected based on extrapolations be expected based on an extrapolation of the far-field reading. Near-field First, the near-field reading will often be dramatically different than would points should be observed.

Typically the reactive field will fall off at a rate approaching  $1/R^2$ . Two reciprocally with the reciprocal of the first power of the distance from the source,  $1/R$ . However, the reactive component will fall off proportionate with the reciprocal of multiple powers of the distance from the source,  $1/R^n$ .

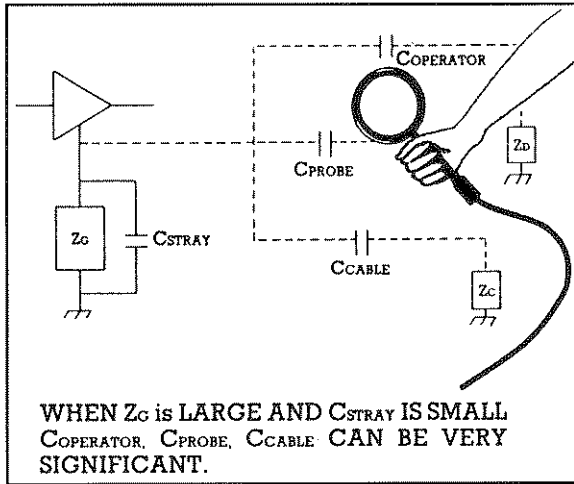

Figure 25. A probe becomes part of the circuit during near-field measurements. Stray capacitance to the probe, its cabling and the operator are particular problems with high-impedance sources. Furthermore, reradiation from the probe can alter the field distribution substantially.

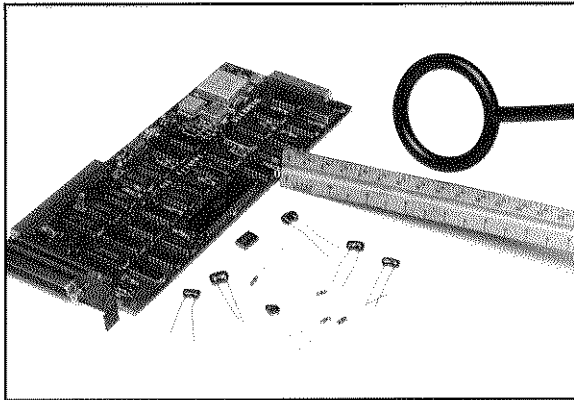

Figure 26. Using near-field measurements makes rapid evaluation of various fixes relatively simple. Although analytically imprecise, this technique offers tremendous qualitative insight in sorting through alternate implementations.

attempts frequently only shift the beam so that it radiates in a different direction (Figure 27). In choosing the test points, this possibility of shifting the signal should be guarded against.

After the measurement points are chosen, the unit is baselined. Each point is measured with both an E-field and an H-field probe. Then each

The second method is to provide multiple solution paths. Several possible solutions are identified which seem to be effective. Continuing with the hypothetical situation in which a signal falls by 3 dB, an experienced engineer seldom has the problem has been identified, much problem thinking of even more possible alternatives.

The two procedures differ at this point in how they approach the measurements which have been taken. The first method is based upon finding a solution with a large safety margin. Suppose a signal falls the required limit by 3 dB. Once that signal is found in the lab, it may be measured in the near field. Now you can set as your goal a reduction in this near field reading by the required 3 dB plus a safety factor of 6 or 10 dB. You are allowing an extremely large margin of error due to near field effects. Furthermore, any solution which seems to pass even this criterion will be held only as a possible solution until it has been confirmed by far-field measurements.

design alternative is implemented and measured over the same set of points.

Figure 27. The possibility that a particular fix only redirects a signal always must be guarded against. In this example, the placement of ground strap changes the geometry of the radiating current loop. While such a ground strap may reduce the signal, it also will redirect it. To properly assess this modification, the perimeter of the unit must be scanned.

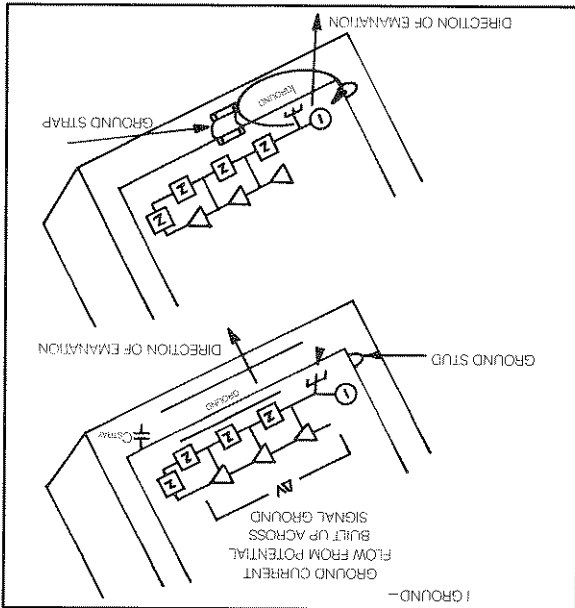

Based upon quick pre-screening in the lab, perhaps three solutions may be selected from a matrix of possibilities. These three might show near-field reductions of 3 to 10 dB. Then these three are taken to the test range and tried in order of their appeal.

You might try the least expensive solution first or the solution with the greatest potential for success, depending on your project priorities. The benefit is that in the convenience and efficiency of your lab, you quickly sort through various ideas and go to the test range with some pre-screening having been done. In effect this process forces you to formulate a test plan with several fall back positions. Just the process of formulating a test plan makes the pre-screening effort worthwhile because of the efficiency it brings to the range testing.

Prescreening provides empirical evidence that a noise reduction technique has been correctly applied. This kind of probing tells you when you have properly analyzed the problem and carried your understanding to the point of designing an effective solution. Preview testing helps reduce the time it takes to close the gap between good analysis and having a technically sufficient solution. It is an intermediate step between the thinking at the desk and the final qualification test.

A final benefit is the value prescreening adds to the inevitable failures. Too often failures are walked away from with valuable information left behind. An attempt to reduce an emission fails for one of four reasons:

1. The diagnosis was wrong.
2. The technique used was inappropriate to the diagnosis.
3. The technique was improperly applied.
4. There is some outside factor involved, such as a second source radiating at the same frequency.

The exercise of trying to determine why a solution appeared to work in the lab but failed in the final test is well worth the effort. As an example a solution which worked in the lab and on the range before 10 AM, failed later in the day. Analysis revealed that the rise in temperature was affecting the values of decoupling capacitors, making them less effective at higher temperatures.

The key to effectively using the probes is to keep your purposes clearly in mind. The purposes of using near-field probes and an oscilloscope are:

1. To gain information about the source and location of the radiating member which was previously unavailable to you.
2. To reduce test expense by adding relatively inexpensive equipment into your store of resources available for solving EMC/EMI problems.
3. To reduce test time by quickly pre-screening various solutions and alternate implementations of the same solution.

When constrained to its proper niche, the near-field probe is an essential tool for quick, efficient EMC/EMI engineering.



## VI. MAINTENANCE

### A. CHARGING BATTERIES

In order to charge the internal batteries, simply plug the battery charger provided into a 115 or 220 VAC wall outlet, depending on model, and then connect it to the charging jack on the front of the preamplifier. Make sure that the switch on the preamplifier is in the "OFF" position. A full charge will take from 10 to 12 hours.

Due to the nature of ni-cad batteries, for longest life always allow the batteries to fully discharge before recharging. Repeated recharging of partially charged batteries may result in reduced battery life.

The switch on the front panel is connected so that in the "ON" position the batteries are connected to the amplifier circuit and disconnected from the battery charger port. In the "OFF" position the batteries are connected to the charger port and disconnected from the amplifier circuit. For this reason it is impossible to run the preamplifier off the battery charger.

### B. CHANGING BATTERIES

The internal ni-cad batteries will require periodic replacement. In order to change the ni-cad batteries follow these instructions. First obtain a small Phillips head screwdriver and 4 new 1.2 VDC, Ni-cell ni-cad batteries. Remove the back cover of the preamplifier. This will expose the 4 internal Ni-cell batteries. Remove the old batteries and replace them. Be careful to follow the polarity instructions on the inside of the back cover. These polarity indicators are meant to be read while lying flat, beside the preamplifier (Figure 28). Replace the back cover and charge the new batteries.

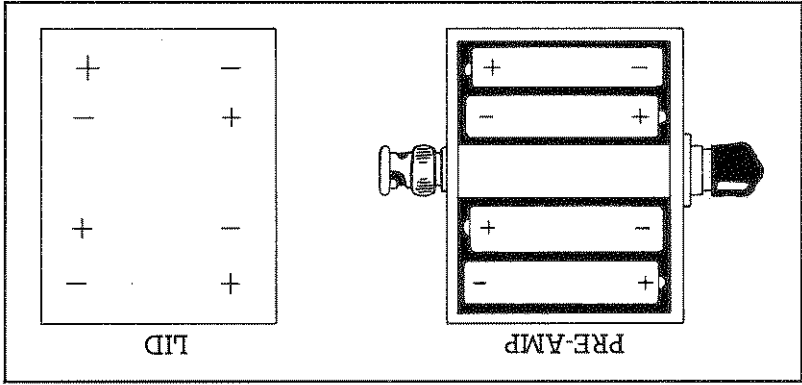

Figure 28. Battery orientation.

## VII. PROBE SET PARTS LIST

1. -6 cm Magnetic-Field Loop Probe
2. -3 cm Magnetic-Field Loop Probe
3. -1 cm Magnetic-Field Loop Probe
4. -3.6 cm Electric-Field Ball Probe
5. -6 mm (Tip) Electric-Field Stub Probe
6. -20 cm Extension Handle
7. -CC -Custom Carrying Case

### OPTIONAL ITEMS

8. -Broadband Preamplifier
9. -Battery Charger for Preamplifier (included with Preamplifier).