



**FEI-Zyfer Inc.**

**CommSync II  
Model 385  
Redundant GPS Synchronized  
Time and Frequency System  
User's Manual**

**Document 385-8000  
Revision AB**





DATE	REVISIONS
12/22/2000	Rev A: Moved address information from page i to page iv and added additional contact information. Incorporated spelling and grammar corrections. Changed specifications to be consistent with published specifications. Added Section 5 and Section 6.
01/22/2001	Rev B: Changed applicable pages to reflect KDC V1.04.00, GTF V1.07.00 firmware changes, and added external Sync Input related descriptions.
03/14/2001	Rev C: Changed applicable pages in Section 6 to reflect the addition of the TIME OFFSET capability in the Time Code module 385-4020-01, -02.
08/03/2001	Rev D: Added SAASM specific information. Changed Section 6 to reflect module status information. Corrected typographical errors.
09/18/2001	Rev E: Added DTF-specific information. Added RS-232 I/O External Input module information to Section 6. Added Menu 7 to Front Panel information.
12/17/2001	Rev F: Updated LPN Sine wave information for new modules. Added Frequency Synthesizer module and +12VDC Power Supply module information.
03/27/2002	Rev G: Updated Frequency Synthesizer module Added Ethernet I/O (385-4038), 1 MHz TTL module (385-4010-10), and Pulse Rate TTL module (385-4033-02) information.
06/11/2002	Rev H: Separated out Section 6, Option Module information to new User's Manual (385-8003).
07/15/2002	Rev J: Added Paragraph 2.2
10/30/2002	Rev K: Added Power Supply specifications to General Specifications. Updated Declaration of Conformity.
04/10/2003	Rev L: Added information on VCXO version of GTF/DTF. Added information for DTF setup. Rearrange manual to separate GTF and DTF operation.
07/16/2003	Rev M: Updated contact information and FEI-Zyfer references.
02/03/2004	Rev N: Updated GPS receiver interfaces for NavMan receiver
03/29/2004	Rev P: Updated for variations in GPS receiver operations.
07/29/2004	Rev R: Added information on time to Ready LED light.
12/05/2004	Rev S: Changed applicable pages to reflect GTF V1.31.00 firmware changes.

03/22/2005	Rev T: Corrected Section 2.2.6.1(Keying the SAASM receiver).
06/06/2005	Rev U: Added Ruggedized DC Power Supply module (385-4077-05).
08/10/2005	Rev V: Added Menu 7.3 for System External 1 PPS Delay, Added Phase Aligned modules in Module ID codes and messages list
07/05/2006	Rev W: Added cable mismatch information at end of Section 2.2.3.1. Updated Section 2.2.3.2 to reflect new line amplifiers.
03/06/2007	Rev Y: Major manual update.
06/12/07	Rev Z: Updated glossary, adjusted index entries, performed general formatting cleanup and corrected various typographical errors.
09/21/07	Rev AA: Updated with Kill backup memory (SAASM), HINT Information and Baud rate setting options.
2/7/08	Rev AB: Updated for New 385-4103-xx SAASM GTF Modules, added 385-4090 Dual Port Ethernet module.

**WARRANTY**

FEI-Zyfer, Inc.'s standard warranty is for one year unless otherwise agreed upon by contract or purchase order. Warranty terms and conditions are explained in the Standard Terms and Conditions of Sale provided with the quotation.

**DISCLAIMER**

This document reflects the specifications and features of the equipment that were current at the time of release of this manual. FEI-Zyfer, Inc. disclaims responsibility for any errors contained herein, and reserves the right to make changes to this manual and related equipment without notice or obligation.

**TRADEMARKS**

Windows 95, Windows 98, and Windows are registered trademarks of Microsoft Corporation. All brand names and product names used in this document are trademarks, registered names of their respective holders. FEI-Zyfer, Inc. is not associated with any referenced product or manufacturer mentioned in this document.

**FEDERAL COMMUNICATIONS COMMISSION (FCC)**

This equipment has been tested and found to comply with the limits for a Class B digital device, pursuant to part 15 of the FCC Rules. These limits are design to provide reasonable protection against harmful interference in a residential installation. This equipment generates, uses and can radiate radio frequency energy and, if not installed and used in accordance with the instructions, may cause harmful interference to radio communications. However, there is no guarantee that interference will not occur in a particular installation. If this equipment does cause harmful interference to radio or television reception, which can be determined by turning the equipment off and on, the user is encouraged to try to correct the interference by one or more of the following measures:

- Reorient or relocate the receiving antenna.
- Increase the separation between the equipment and the receiver
- Connect the equipment into a outlet on a circuit different from that to which the receiver is connected.
- Consult the dealer or an experienced radio/TV technician for help.

THIS PRODUCT IS NOT AUTHORIZED FOR USE AS A CRITICAL COMPONENT IN LIFE SUPPORT DEVICES OR SYSTEMS WITHOUT THE EXPRESSED WRITTEN CONSENT OF THE CHIEF EXECUTIVE OFFICER OF FEI-ZYFER, INC.

## **WARNINGS**

Warning statements in this manual call attention to conditions or practices that could result in injury or loss of life.

## **CAUTIONS**

Caution statements in this manual call attention to conditions or practices that could result in damage to the CommSync II unit.

## **GENERAL SAFETY PRECAUTIONS**

Always locate heavy equipment towards the bottom of the cabinet (rack) to avoid accidental tip-over of the cabinet (rack).

Make certain the maximum operating ambient temperature does not exceed 55° C.

Never restrict the airflow through the instrument's vents, located on the top and bottom of the instrument.

Never apply a voltage to any terminal that is outside the range specified for the terminal

If the instrument is configured to operate from an AC power source, pay special attention to the following:

- Connect the instrument only to a properly rated supply circuit
- The supplied 3-prong power cord provides safety grounding. Do not defeat this feature. The user must comply with all applicable national and local electrical regulations regarding grounding and safety
- Always ensure that the power switch is OFF (switch position 0) prior to removing an AC Power Supply module from a CommSync II system
- Never remove the protective cover from the AC Power Supply module
- Replace fuse(s) with same type and rating as marked

**CONTACT INFORMATION*****FEI-Zyfer, Inc (North America)***

Technical Support:

Phone (714) 933-4003  
(888) 886-7465 (USA only)  
Fax (714) 933-4001  
Email techsupport@fei-zyfer.com

Sales:

Phone (714) 933-4002  
Fax (714) 933-4001  
Email sales@fei-zyfer.com

Data Sheets:

<http://www.fei-zyfer.com/>

RMA Numbers:

Phone (714) 933-4000  
Fax (714) 933-4001

Shipping Address for Repairs&gt;Returns:

FEI-Zyfer, Inc.  
Attention: RMA #####  
7321 Lincoln Way  
Garden Grove, CA 92841-1428  
USA

Please obtain a Returned Material Authorization (RMA) number prior to returning a product to FEI-Zyfer, Inc.

This page intentionally left blank



## Contents at a Glance

<b>Legal Information</b> .....	<b>5</b>
<b>Safety Information</b> .....	<b>6</b>
<b>Contact Information</b> .....	<b>7</b>
<b>Table of Figures</b> .....	<b>15</b>
<b>List of Tables</b> .....	<b>16</b>
<b>1 Manual Overview</b> .....	<b>17</b>
1.1 Introduction.....	17
1.2 Assumptions.....	17
1.3 Related Manuals and Reference Documents.....	17
1.4 Conventions .....	18
1.5 Where to Look.....	18
<b>2 Quick Start Guide - GPS Timing and Frequency System (GTF)</b> .....	<b>19</b>
<b>3 Quick Start Guide - Distribution Timing and Frequency System (DTF)</b> .....	<b>21</b>
<b>4 General Information</b> .....	<b>23</b>
4.1 Basic System Configuration Information .....	24
4.2 Reference.....	25
4.3 Basic System Description.....	25
4.4 GTF (GPS Time/Frequency) Modules.....	27
4.5 DTF (Distribution Time/Frequency) Modules .....	28
4.6 Rear Panel Modules.....	29
4.7 Power Supply Modules.....	29
4.8 System Monitor/Control and/or Ext Input Modules (slots 14 and 15 only) .....	30
4.9 Remote Firmware Upgrade .....	31
4.10 Output Option Modules .....	31
4.11 System Redundancy and Switchover Considerations.....	32
4.12 Storage Considerations (SAASM Receivers).....	33
<b>5 GPS Timing and Frequency Systems</b> .....	<b>35</b>
5.1 Details of GTF Operation .....	36
5.2 Getting Started .....	38
<b>6 Distribution Timing and Frequency Systems</b> .....	<b>61</b>
6.1 Details of DTF Operation.....	62
6.2 Getting Started .....	65
<b>7 Display Menus and Controls</b> .....	<b>77</b>
7.1 Introduction.....	78
7.2 Front Panel General Description .....	78
7.3 Menu/Display Overview.....	79
7.4 Screen Descriptions .....	79
<b>8 General Specifications</b> .....	<b>97</b>
8.1 Introduction.....	98

8.2	Mechanical .....	98
8.3	Environmental .....	98
8.4	Power Requirements.....	98
8.5	System Electrical Signals .....	100
8.6	Output Signals.....	102
8.7	Antenna Interface.....	103
8.8	Optional Antenna Kits.....	103
8.9	I/O Control/Monitor Interface .....	104
8.10	Outline and Mounting .....	105
8.11	Certifications and Compliance.....	106
<b>9</b>	<b><i>Maintenance and Repair .....</i></b>	<b>107</b>
9.1	Introduction.....	108
9.2	Periodic Service and Calibration .....	108
9.3	Troubleshooting.....	108
9.4	Repair Procedure .....	114
<b>10</b>	<b><i>Power Supply Modules .....</i></b>	<b>117</b>
10.1	Introduction.....	118
10.2	AC Power Supply Module 385-4021 .....	119
10.3	24 VDC and 48 VDC Power Supply Module 385-4022 .....	121
10.4	+12 VDC Power Supply Module 385-4042 .....	124
10.5	Ruggedized 28 VDC Power Supply Module 385-4077-05 .....	127
<b>Appendix A</b>	<b><i>Declaration of Conformity .....</i></b>	<b>130</b>
<b>Appendix B</b>	<b><i>Glossary of Terms .....</i></b>	<b>131</b>
<b>Index</b>	<b><i>.....</i></b>	<b>135</b>

---

## Table of Contents

---

<b>Legal Information</b> .....	<b>5</b>
<b>Safety Information</b> .....	<b>6</b>
<b>Contact Information</b> .....	<b>7</b>
<b>Table of Figures</b> .....	<b>15</b>
<b>List of Tables 16</b>	
<b>1 Manual Overview</b> .....	<b>17</b>
1.1 Introduction.....	17
1.2 Assumptions.....	17
1.3 Related Manuals and Reference Documents.....	17
1.4 Conventions .....	18
1.5 Where to Look.....	18
<b>2 Quick Start Guide - GPS Timing and Frequency System (GTF)</b> .....	<b>19</b>
<b>3 Quick Start Guide - Distribution Timing and Frequency System (DTF)</b> .....	<b>21</b>
<b>4 General Information</b> .....	<b>23</b>
4.1 Basic System Configuration Information .....	24
4.1.1 GPS Timing/Frequency system (GTF - GPS receiver based) .....	24
4.1.2 Distribution Time/Frequency (DTF - Non-GPS receiver based) .....	24
4.1.3 System Control .....	24
4.1.4 Option Modules .....	24
4.2 Reference.....	25
4.3 Basic System Description.....	25
4.3.1 Chassis.....	25
4.3.2 Front Panel.....	25
4.3.3 Rear Panel Antenna Connections .....	26
4.4 GTF (GPS Time/Frequency) Modules.....	27
4.5 DTF (Distribution Time/Frequency) Modules .....	28
4.6 Rear Panel Modules.....	29
4.7 Power Supply Modules.....	29
4.8 System Monitor/Control and/or Ext Input Modules (slots 14 and 15 only) .....	30
4.9 Remote Firmware Upgrade .....	31
4.10 Output Option Modules .....	31
4.11 System Redundancy and Switchover Considerations.....	32
4.11.1 GTF Modules.....	32
4.11.2 Output Modules .....	32
4.11.3 Online GTF Selection .....	33
4.11.4 Fault Switchover Rules.....	33
4.12 Storage Considerations (SAASM Receivers).....	33
<b>5 GPS Timing and Frequency Systems</b> .....	<b>35</b>
5.1 Details of GTF Operation .....	36
5.1.1 Warm-Up Mode .....	36

---

5.1.2	GPS LOCK (Warm Start/Cold Start).....	36
5.1.3	Time Locked / Frequency Locked Mode .....	36
5.1.4	Coasting or Holdover Mode.....	37
5.1.5	Recovery Mode .....	37
5.1.6	Discipline in Time Locked Mode.....	37
5.1.7	Discipline in Frequency Locked Mode.....	38
5.1.8	System Monitor/Control (slots 15 and 14) .....	38
5.2	Getting Started .....	38
5.2.1	Introduction.....	38
5.2.2	Preparing For Use .....	38
5.2.3	Overview .....	39
5.2.4	Installing the Antenna System.....	39
5.2.5	Connecting the External Reference Source .....	43
5.2.6	Connecting Power .....	44
5.2.7	Connecting I/O .....	47
5.2.8	Powering-Up the System.....	47
5.2.9	SAASM GTFs.....	48
5.2.10	Power Up Indications .....	49
5.2.11	Set Antenna Cable Delay Compensation .....	51
5.2.12	Reset Internal GPS Receivers.....	53
5.2.13	SAASM Receiver SRAM Memory Reset .....	54
5.2.14	Hot Start .....	57
5.2.15	Set Local Time .....	57
5.2.16	Select GTF Discipline Source Mode.....	59
<b>6</b>	<b><i>Distribution Timing and Frequency Systems .....</i></b>	<b>61</b>
6.1	Details of DTF Operation.....	62
6.1.1	Description .....	62
6.1.2	Typical Distribution System (Block Diagram).....	62
6.1.3	DTF (Distribution Time/Frequency) Modules.....	64
6.1.4	System Monitor/Control and External Input (slots 15 and 14 only).....	64
6.1.5	Combination Systems (GTF/DTF) .....	64
6.2	Getting Started .....	65
6.2.1	Introduction.....	65
6.2.2	Preparing For Use .....	65
6.2.3	Overview .....	66
6.2.4	The External Reference Source .....	66
6.2.5	Connecting the External Reference Source to the system .....	67
6.2.6	Connecting Power .....	67
6.2.7	Connecting I/O .....	68
6.2.8	Applying Power .....	68
6.2.9	Configuring Discipline Reference Mode .....	69
6.2.10	Setting Time in a DTF system .....	72
6.2.11	Cross-Discipline Mode, combination GTF/DTF systems .....	75
<b>7</b>	<b><i>Display Menus and Controls .....</i></b>	<b>77</b>
7.1	Introduction.....	78
7.2	Front Panel General Description .....	78
7.2.1	LCD Module Screen .....	78

7.2.2	Display Cursor .....	78
7.2.3	Display Contrast Adjustment .....	78
7.2.4	Keypad .....	79
7.3	Menu/Display Overview.....	79
7.4	Screen Descriptions .....	79
7.4.1	MENU 0 – Fault/Alarm Status Screens .....	81
7.4.2	MENU 1 - Time and Status.....	81
7.4.3	MENU 2, and MENU 4 – GTF GPS Control .....	84
7.4.4	MENU 3 and MENU 5 – GTF Module Frequency Discipline Status .....	87
7.4.5	MENU 6.....	91
7.4.6	MENU 7 – Input Control Menu .....	91
7.4.7	MENU 8 – Output Module Menu .....	93
7.4.8	MENU 9 - Maintenance .....	94
<b>8</b>	<b>General Specifications .....</b>	<b>97</b>
8.1	Introduction.....	98
8.2	Mechanical .....	98
8.3	Environmental .....	98
8.4	Power Requirements.....	98
8.4.1	AC Input Power (385-4021-0X) .....	98
8.4.2	24 VDC and 48 VDC Input Power (385-4021-0X) .....	99
8.4.3	12 VDC Input Power (385-4042-01) .....	99
8.4.4	28 VDC Input Power (385-4077-05) .....	99
8.5	System Electrical Signals .....	100
8.5.1	System 10 MHz .....	100
8.5.2	System 1 PPS .....	101
8.5.3	External Reference Input.....	101
8.5.4	RS-232 I/O Port.....	102
8.5.5	PLGR Port.....	102
8.6	Output Signals.....	102
8.7	Antenna Interface .....	103
8.8	Optional Antenna Kits.....	103
8.8.1	Direct Connection.....	103
8.8.2	Optical Connection .....	103
8.9	I/O Control/Monitor Interface .....	104
8.9.1	RS-232 I/O Module.....	104
8.9.2	Ethernet I/O Module .....	104
8.10	Outline and Mounting .....	105
8.11	Certifications and Compliance.....	106
<b>9</b>	<b>Maintenance and Repair .....</b>	<b>107</b>
9.1	Introduction.....	108
9.2	Periodic Service and Calibration .....	108
9.3	Troubleshooting.....	108
9.3.1	System Fault Diagnosis.....	108
9.3.2	Option Module Fault Reporting.....	111
9.3.3	Understanding the SSTA Message .....	111
9.3.4	Front Panel Troubleshooting .....	114

9.4	Repair Procedure .....	114
9.4.1	Record Fault Code .....	114
9.4.2	Record Firmware Versions .....	114
9.4.3	Contact Technical Support .....	114
9.4.4	Remove Module .....	114
9.4.5	Install Replacement .....	115
9.4.6	Confirm Correct Diagnosis .....	115
9.4.7	Obtain RMA.....	115
9.4.8	Ship to FEI-Zyfer, Inc. ....	115
<b>10</b>	<b>Power Supply Modules .....</b>	<b>117</b>
10.1	Introduction.....	118
10.2	AC Power Supply Module 385-4021 .....	119
10.2.1	LED Status Indicators.....	119
10.2.2	Operation.....	119
10.2.3	Status .....	119
10.2.4	Commands .....	120
10.2.5	Specifications .....	120
10.3	24 VDC and 48 VDC Power Supply Module 385-4022 .....	121
10.3.1	LED Status Indicators.....	121
10.3.2	Operation.....	121
10.3.3	24 VDC and 48 VDC Input Power Connections .....	121
10.3.4	Status .....	122
10.3.5	Commands .....	122
10.3.6	Specifications .....	123
10.4	+12 VDC Power Supply Module 385-4042 .....	124
10.4.1	Status Indicators.....	124
10.4.2	Operation.....	124
10.4.3	12 VDC Input Power Connections.....	124
10.4.4	Status .....	125
10.4.5	Commands .....	125
10.4.6	Specifications .....	126
10.5	Ruggedized 28 VDC Power Supply Module 385-4077-05 .....	127
10.5.1	LED Status Indicators.....	127
10.5.2	Operation.....	127
10.5.3	28 VDC Input Power Connections.....	128
10.5.4	Status .....	128
10.5.5	Commands .....	129
10.5.6	Specifications .....	129
<b>Appendix A</b>	<b>Declaration of Conformity .....</b>	<b>130</b>
<b>Appendix B</b>	<b>Glossary of Terms .....</b>	<b>131</b>
<b>Index</b>	<b>.....</b>	<b>135</b>

---

## Table of Figures

---

Figure 4-1	Commsync II Front View - GTF .....	26
Figure 4-2	Commsync II Front View - DTF .....	26
Figure 4-3	Commsync II Rear View .....	29
Figure 4-4	Commsync II Rear View – With Communication Modules .....	31
Figure 4-5	System Block Diagram .....	32
Figure 5-1	AC Power Connections .....	44
Figure 5-2	24 and 48 VDC Power Connections.....	45
Figure 5-3	12 VDC Power Connections.....	45
Figure 5-4	28 VDC Power Connections.....	46
Figure 5-5	RS-232 Interconnect Diagrams .....	47
Figure 5-6	Commsync II Front Panel Port and Indicator Locations – GTF Systems .....	48
Figure 6-1	Distribution System Block Diagram .....	62
Figure 6-2	DTF System Functional Diagram .....	63
Figure 6-3	RS-232 Interconnect Diagrams .....	68
Figure 6-4	Commsync II Front Panel Port and Indicator Locations – DTF Systems .....	69
Figure 7-1	Menu Tree .....	80
Figure 8-1	Outline and Mounting .....	105
Figure 9-1	SSTA Decode (Part1).....	112
Figure 9-2	SSTA Decode (Part2).....	113

---

## *List of Tables*

---

Table 4-1	Reference Documents and Programs .....	25
Table 4-2	GTF Types .....	27
Table 4-3	DTF Types.....	28
Table 4-4	I/O and External Input Module Options .....	30
Table 5-1	Start-up Process - GPS Timing and Frequency Systems .....	39
Table 5-2	Antenna Cable Loss Characteristics .....	41
Table 5-3	Amplifier Characteristics.....	42
Table 5-4	28 VDC Power Connection Pin Designation .....	46
Table 5-5	RS-232 Port DE-9 Connector Pin Designation.....	47
Table 5-6	CV Indicators (Crypto-Variable) .....	49
Table 5-7	Antenna Cable Delay Characteristics.....	51
Table 5-8	PLGR Port DE-9 Connector Pin Designation .....	57
Table 6-1	Start-up Process – Distribution Timing and Frequency Systems .....	66
Table 6-2	RS-232 Port DE-9 Connector Pin Designation.....	68
Table 7-1	Frequency Discipline Machine (FDM) Descriptions .....	90
Table 9-1	GTF Indicator Function.....	108
Table 9-2	Evaluating GTF Indicators.....	109
Table 9-3	Evaluating Menu 0.....	109
Table 9-4	Evaluating Menu 3.....	110
Table 10-1	AC Power Supply Status .....	120
Table 10-2	24 & 48 VDC Power Connection Pin Designation .....	121
Table 10-3	24 & 48 VDC Power Supply Input Power .....	122
Table 10-4	24 & 48 VDC Power Supply Status .....	122
Table 10-5	12 VDC Power Connection Pin Designation .....	124
Table 10-6	12 VDC Power Supply Input Power.....	125
Table 10-7	12 VDC Power Supply Status .....	125
Table 10-8	28 VDC Power Connection Pin Designation .....	128
Table 10-9	28 VDC Power Supply Input Power.....	128
Table 10-10	28 VDC Power Supply Status .....	128



# 1 Manual Overview

## 1.1 Introduction

This User's Manual describes how to set-up, use and troubleshoot the CommSync II Time and Frequency System. It is applicable for CommSync II systems that are configured as GPS Timing and Frequency Systems (GTF) as well as those units that are configured as Distribution Timing and Frequency Systems (DTF). This manual also provides detailed information regarding the various power supply options that are available for the CommSync II system. Although this manual does provide some information concerning the use of various rear panel Command I/O modules, complete operating instructions and specifications for all of the rear panel option modules are provided in a separate Option Modules User's Manual (385-8003).

## 1.2 Assumptions

The User's Manual paragraphs that describe the controlling and monitoring of the CommSync II system assume that it has been equipped with an optional front panel Keypad/Display (KDC) module. If the unit is not equipped with this module, then system operation can be monitored and controlled via serial commands through either an RS-232 port mounted on the GTF/DTF module's front panel or an optional Command I/O module. The serial interface commands are detailed in FEI-Zyfer Serial Communications Protocol document 385-8002.

## 1.3 Related Manuals and Reference Documents

The following table identifies all of the reference documents and utility programs referred to in this manual:

- *Serial Communications Protocol (385-8002)* – describes the complete command set and provides detailed instructions for using a computer to control the CommSync II system.
- *Option Module User's Manual (385-8003)* - provides information on removal and installation of the available option modules as well as the operation, configuration, and specifications for each available option modules for the CommSync II.
- *CommSync II Fiber Optic Antenna Option Users Manual (385-8007)* – describes how to set-up and use an optional fiber optic antenna system that replaces the direct connection between the CommSync II and antenna with a fiber optic link.
- *Boot Code and Firmware Upgrade Instructions (385-8088)* – instructions for the upgrading of new firmware from via the serial port into the CommSync II.
- *TFTP Remote Upgrade Instructions (385-8088)* – instructions for the upgrading of new firmware from a remote location into the CommSync II.
- *ZyferTFTP.exe (990-3015)* – TFTP server utility for remote upgrade of CommSync II firmware.
- *FEI-Zyfer custom MIB (385-3044)* – document that lists all of the SNMP commands available for the control and monitoring of the CommSync II system.
- *Zyfer CS2 GUI (385-3140)* - Graphical User Interface utility program that can be used for the control and monitoring of the CommSync II system.
- *GTF Hot Start Procedure (385-8006)* – tells how to perform a hot start on CommSync II units equipped with SAASM GPS receivers.

## 1.4 Conventions

This manual uses the following conventions:

- Names of front panel indicators, rear panel indicators, system operational modes, and front panel LCD menus appear in *italics*.
- Names appear in the manual in the same case that they are displayed on the CommSync II panels and menus.
- Front panel LCD screen text and general notes also appear in *italics*.
- References to front panel control keys and editable menu fields appear in **BOLDFACE** type.
- Names of connectors and ports also appear in **BOLDFACE** type, but they are also enclosed within double quotation marks (“”).

## 1.5 Where to Look

Section 2, *Quick Start Guide - GPS Timing and Frequency System (GTF)* on page 19 briefly describes the very basics of setting up a GTF equipped CommSync II System as a GPS-disciplined time and frequency reference.

Section 3, *Quick Start Guide - Distribution Timing and Frequency System (DTF)* on page 21 briefly describes the very basics of setting up a DTF equipped CommSync II System as time and frequency distribution system synchronized to an external source.

Section 4, *General Information* on page 23 provides a full description of the CommSync II system.

Section 5, *GPS Timing and Frequency Systems* on page 35 provides all of the operational details for setting up and using a GTF based CommSync II System.

Section 6, *Distribution Timing and Frequency Systems* on page 61 provides all of the operational details for setting up and using a DTF based CommSync II System.

Section 7, *Display Menus and Controls* on page 77 describes how to use the front panel Keypad/Display module's menu and control functions.

Section 8, *General Specifications* on page 97 contains detailed specifications for a CommSync II system configured with the following basic options: Chassis with optional front panel Keypad/Display, AC Power Supply module, DC Power Supply module, GTF module equipped with a crystal or rubidium oscillator.

Section 9, *Maintenance and Repair* on page 107 contains the periodic service, troubleshooting, and repair procedures.

Section 10, *Power Supply Modules* on page 117 provides all of the specifications and operational details for the power supplies options available for the CommSync II.

Appendix A - *Declaration of Conformity*, on page 130 provides a list of all of the standards to which conformity is declared.

Appendix B - *Glossary of Terms*, on page 131 provides definitions for many of the terms used in this manual.

## 2 Quick Start Guide - GPS Timing and Frequency System (GTF)

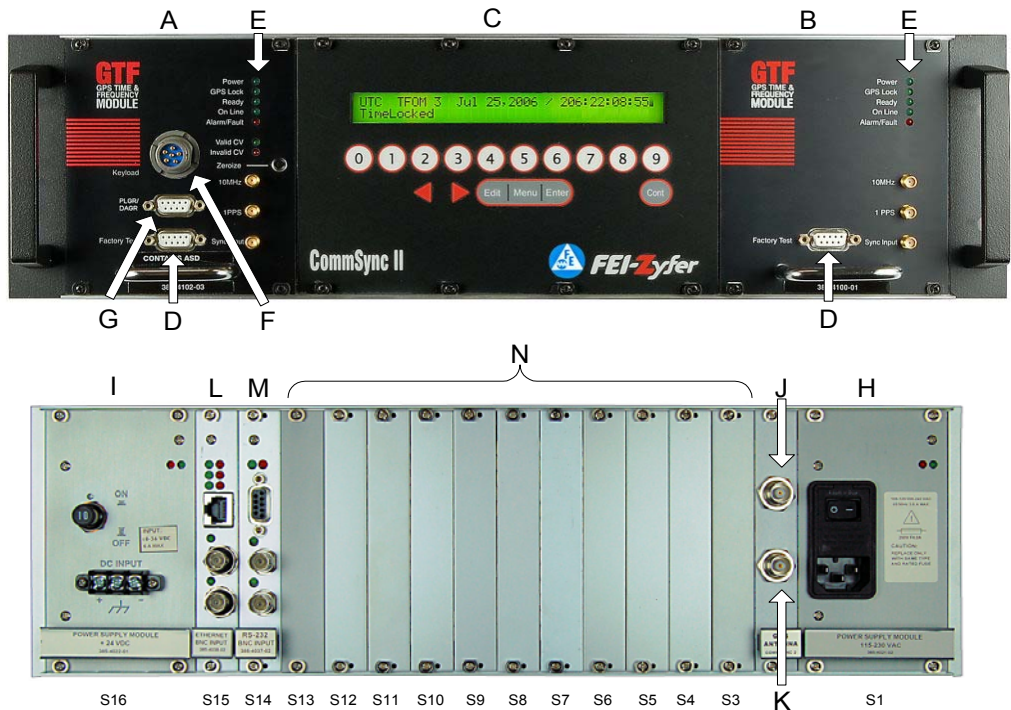

- (A) GTF 1
- (B) GTF 2
- (C) Front Panel Display
- (D) RS-232 Port
- (E) Status LED(s)
- (F) Keypad Port
- (G) PLGR/DAGR Port (Hot Start)
- (H) Power Supply #1 (S1)
- (I) Power Supply #2 (S16)
- (J) Antenna Connection GTF 1
- (K) Antenna Connection GTF 2
- (L) Primary Com (S15)
- (M) Secondary Com (S14)
- (N) Option Module Slots (S3– S13)

Note: The information shown is for illustration only, and will vary depending on system configuration.

- Install the CommSync II into the equipment cabinet.
- Mount the antenna in the desired location. At the antenna, connect one end of the antenna cable to the antenna connector.
- Connect the antenna system cable(s) to the system’s rear panel TNC connectors as follows: Connect the antenna cable for GTF#1 (left side module) to the upper connector and the antenna cable for GTF#2 (right side module) to the lower connector.
- Connect power source to the CommSync II.
- If communication is desired, the CommSync II comes with a standard RS-232 port on the GTF module’s front panel. Connect a serial cable between this port and a PC serial port. Note that other I/O options such as Ethernet are available depending on the system’s configuration.
- Apply power to the system – at this time the following events occur:
  - After a moment, the front panel display backlight illuminates and the system runs through its self-test diagnostics. During this time the *Ready* indicator flashes and the *Alarm/Fault* indicator is illuminated (~5 sec).
  - After the completion of the self-test, the *Power* indicator on the GTF module(s) will illuminate, the GTF#1 *On Line* indicator will illuminate and a greeting message will appear on LCD screen which is followed shortly thereafter with the *Time and Status* screen.
- At this point the system enters Warm-Up and the *Alarm/Fault* indicator flashes.

Note: The information shown on the following LCD screens is for illustration only, and may be different in actual systems.

Section

5.2.2

5.2.4

5.2.6

5.2.7

5.2.8

```
UTC TFOM 9 Jan 06,1980 / 006:00:00:53=
Warm-Up                      GTF 1 ONLINE
```

The above screen (Menu 1 – Screen 1, power-up default) indicates that the online receiver (GTF#1) is operating from initial power up as indicated by the date (start of GPS Time Jan 06, 1980), the Time Figure Of Merit (TFOM) of the system's timing, and the status (*Warm-Up*).

- All GTFs receivers operate in Coarse Acquisition mode (C/A without user intervention. GTFs with a SAASM receiver installed are also capable of operating in P/Y mode. To use the P/Y mode, the receiver must be keyed.
- Initially, upon power-up, the GTF module's internal receiver(s) default to the *Survey* mode; at this point the GTF modules report that they are not ready and that they are in *Warm-up* mode.

5.2.9

*Note: After relocating the system, it is recommended that the user perform a Cold Start to clear stored parameters (almanac) in the GPS receiver.*

5.2.12

- As soon as the GPS receiver acquires an initial position fix and valid time the *GPS Lock* indicator illuminates on the GTF and the current time is displayed:

```
UTC TFOM 9 Nov 09,2000 / 324:21:30:15=
Warm-Up                      GTF 1 ONLINE
```

This screen indicates the date and UTC time, the Time Figure Of Merit (TFOM) of the system's timing, and the status (*Warm-Up*).

- The Time To First Fix (TTFF) depends on the satellite visibility. When operating in the *Survey* mode at power-up and with many satellites visible, the receiver requires a minimum of 2 minutes and at most 30 minutes to determine the coarse antenna position (First Fix).
- When *Survey* is complete the GTF automatically switches to the *Known* mode.

*Note: The SAASM Receiver operates in Dynamic mode only.*

- Further operation is automatic. After the GTF module's receiver has locked to the satellites and the initial oscillator warm-up (~10 minute after power-up) has taken place, the disciplining of the internal timing and frequency starts.

```
UTC TFOM 9 Nov 06,2000 / 311:21:54:28=
Recovering                    GTF 1 ONLINE
```

*Note: In some system versions "Acquire" is shown in place of "Recovering".*

- After the internal timing and oscillator frequency have been adjusted sufficiently to provide accurate output signals, the *Time and Status* screen indicates the exact time, Time Figure Of Merit (TFOM), and the status *Time Locked*. Typical time from GPS Lock to time lock is 1½ to 2 hours. The GTF module's front panel *Ready* indicator illuminates.

```
UTC TFOM 4 Nov 06,2000 / 311:22:03:28=
TimeLocked                    GTF 1 ONLINE
```

### 3 Quick Start Guide - Distribution Timing and Frequency System (DTF)

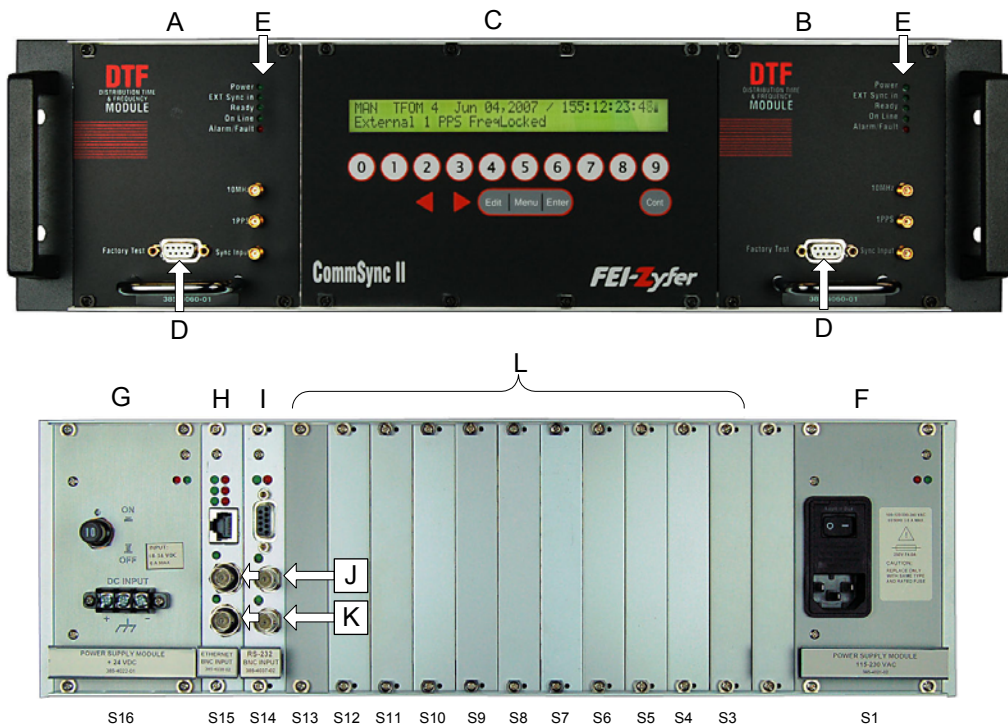

- (A) DTF 1
- (B) DTF 2
- (C) Front Panel Display
- (D) RS-232 Port
- (E) Status LED(s)
- (F) Power Supply #1 (S16)
- (G) Power Supply #2 (S1)
- (H) Primary Com (S15)
- (I) Secondary Com (S14)
- (J) EXT SYNC A
- (K) EXT SYNC B
- (L) Option Module Slots (S3– S13)

Note: The information shown is for illustration only, and will vary depending on system configuration.

- Install the CommSync II into the equipment cabinet. 6.2.2
- The system can be equipped with a variety of optional I/O External Input module configurations. These input modules can be located in either Slot 15 (Primary) or Slot 14 (Secondary) or both. The Primary slot communicates directly with the online DTF module, while the Secondary slot communicates directly with the offline (redundant) DTF module. 6.2.4
- Connect the external reference source(s) to an available rear panel I/O External Input module(s). The external reference source(s) can be applied to the module’s “EXT SYNC A” input, the “B” input, or both inputs. Both inputs to a module should be the same frequency. The module can then be configured to auto select (A priority) or “A” or “B”. 6.2.5
- Connect power source to the CommSync II. 6.2.6
- If communication is desired, the CommSync II comes with a standard RS-232 port on the DTF module’s front panel. Connect a serial cable between this port and a PC serial port. Note that other I/O options such as rear panel RS-232 and Ethernet ports are available depending on the system’s configuration. 6.2.7
- Apply power to the system – at this time the following events occur: 6.2.8
  - After a moment, the front panel display backlight illuminates and the system runs through its self-test diagnostics. During this time the *Ready* indicator flashes and the *Alarm/Fault* indicator is illuminated (~5 sec).
  - After the completion of the self-test, the *Power* indicator on the DTF module(s) will illuminate, the DTF#1 *On Line* indicator will illuminate and a greeting message will appear on LCD screen which is followed shortly thereafter with the *Time and Status* screen.
- At this point the system enters Warm-Up and the *Alarm/Fault* indicator flashes.

Section

6.2.2

6.2.4

6.2.5

6.2.6

6.2.7

6.2.8

## 22 Section 3 - Quick Start Guide - Distribution Timing and Frequency System

Note: The information shown on the following LCD screens is for illustration only, and may be different in actual systems.

```
RUN TFOM 9 / 000:00:00:01 =
External 5MHz Warm-up 1 ONLINE
```

The above screen (Menu 1 - Screen 1, power-up default) indicates that the online module (DTF#1) is operating from initial power up as indicated by the Run mode. The Time Figure Of Merit (TFOM) is an indication of the frequency accuracy (referenced to the external input), the reported time is the running time clock and the status (Warm-Up).

Section

- DTF Input Configuration - The external reference type (1PPS or frequency) for each DTF module must be selected; this can be done via the front panel controls.

6.2.9.1.1

- Press key **3** until *Frequency Discipline Status 1* screen is selected.

```
DTF#1 EXT-5MHz Warm-Up FDM Mode: 2 =
Time Difference:-000001932 ns DAC:31264
```

- To view/select the Discipline Source mode:
- Press **Edit**.

```
DTF#2 External Sync Type:5 MHz =
Sync Source Type: External Only
```

- Use the arrow keys until the desired reference mode (1PPS, 1MHz, 5MHz, 10MHz) is selected.
- Press **Menu** to exit the edit mode without any selection change, or
- Press **Enter** to accept the selected Discipline Source mode.
- Further operation is automatic. After the DTF modules have an external reference input, the disciplining of the internal timing and frequency starts.

- External Input Module Configuration – Menu 7 - Screen 1 is used to set the I/O external input module configuration. Menu 7 - Screen 1 is for the primary control (Slot 15), and Menu 7 - Screen 2 is for the secondary control (Slot 14).

6.2.9.1.4

```
Primary CTL (Slot 15) Ext In: 10MHz=
Input: AUTO To: BOTH Status: 0x1A
```

- To configure the module, press **Edit**.
- Set the Input to AUTO (allows the module to select between A or B), A, or B.
- Set to BOTH (sends sync input to both DTF's), DTF#1, DTF#2, or NONE.
- Repeat for Secondary Control if installed.

If the external reference input is applied and the module is configured properly, the DTF *Ext Sync In* indicator will illuminate, indicating that the DTF is receiving the input signal.

Note: Typical time from applying the external reference to reference lock (Ready indicator illuminates) is 1½ to 2 hours.

- Setting DTF Time - The DTF default time mode is RUN time. The Time displayed on Menu 1 is the time (days, hours, minutes, and seconds) that the DTF system has been in operation - in many cases this is sufficient. If time output is desired, time can be set either by manual time entry or with the optional Time Code Input module via an IRIG-B time signal.

- DTF time via manual time entry.

6.2.10.1.1

- DTF time via Time Code Input module.

6.2.10.1.4

---

## 4 General Information

- 4.1 Basic System Configuration Information 25
  - 4.1.1 GPS Timing/Frequency system (GTF - GPS receiver based) 24
  - 4.1.2 Distribution Time/Frequency (DTF - Non-GPS receiver based) 24
  - 4.1.3 System Control 24
  - 4.1.4 Option Modules 24
- 4.2 Reference 25
- 4.3 Basic System Description 25
  - 4.3.1 Chassis 25
  - 4.3.2 Front Panel 25
  - 4.3.3 Rear Panel Antenna Connections 26
- 4.4 GTF (GPS Time/Frequency) Modules 27
- 4.5 DTF (Distribution Time/Frequency) Modules 28
- 4.6 Rear Panel Modules 29
- 4.7 Power Supply Modules 29
- 4.8 System Monitor/Control and/or Ext Input Modules (slots 14 and 15 only) 30
- 4.10 Output Option Modules 31
- 4.11 System Redundancy and Switchover Considerations 32
  - 4.11.1 GTF Modules 32
  - 4.11.2 Output Modules 32
  - 4.11.3 Online GTF Selection 33
  - 4.11.4 Fault Switchover Rules 33

## 4.1 Basic System Configuration Information

The CommSync II system offers two basic types of reference system sources - GPS Timing/Frequency (GTF) and Distribution Timing/Frequency (DTF).

### 4.1.1 GPS Timing/Frequency system (GTF - GPS receiver based)

A CommSync II system configured with GPS Timing/Frequency (GTF) modules functions as a self-contained GPS-disciplined reference. In this configuration the CommSync II provides highly accurate timing and frequency output signals that are synchronized to Coordinated Universal Time (UTC) via the Global Positioning System (GPS). The CommSync II GTF module utilizes the GPS system's 1 PPS as a reference to discipline an internal oscillator; this disciplined oscillator allows the CommSync II system to continue providing accurate outputs whenever sufficient GPS signals are unavailable. Additionally, the user can also configure the unit to use an external 1 PPS source as a reference, this is done by connecting the reference to either the GTF module's *Sync Input* connector or to an optional Command I/O module located at the rear of the unit (refer to paragraph 4.1.2, *External Reference Source*).

*Note: In a GTF system, the system's output time is obtained from the Global Positioning System (GPS), whereas the 1 PPS alignment can be referenced to either GPS or an external reference.*

### 4.1.2 Distribution Time/Frequency (DTF - Non-GPS receiver based)

A CommSync II System configured with Distribution Timing/Frequency (DTF) modules is a timing and frequency source normally disciplined to an external 1 PPS source, such as a Hydrogen-Maser or Cesium laboratory standard. Configured this way, the CommSync II functions as a distribution system with all the functionality of the GPS-referenced system, but synchronized to an external source instead of the GPS system. If an optional input module (385-4037, 385-4038 or 385-4090) is installed, an external frequency source of 1 MHz, 5 MHz or 10 MHz, or an alternate 1 PPS source can be used as the reference source instead of the 1 PPS source connected to the DTF module's *Sync Input* connector.

*Note: In a DTF system, the system's output time is either manually set or set via a Time Code Input module; the 1 PPS alignment is dependent on the external reference source.*

### 4.1.3 System Control

Methods of controlling and monitoring the performance are provided via an optional front panel Keypad/Display (KDC) as well as through either an RS-232 port mounted on the GTF/DTF module's front panel or through an optional Ethernet I/O module. The serial interface commands are detailed in FEI-Zyfer Serial Communications Protocol document 385-8002.

### 4.1.4 Option Modules

The system has many possible option modules. See the Option Module User's Manual, 385-8003, for details and specifications.



## 4.2 Reference

The following table identifies all of the reference documents referred to in this manual:

Table 4-1 Reference Documents and Programs	
Document Number	Document Title
All Systems	
385-8002	Serial Communications Protocol
385-8003	Option Module User's Manual
385-8008	Boot Code and Firmware Upgrade Instructions
Fiber Optic Antenna Equipped Systems	
385-8007	CommSync II Fiber Optic Antenna Option Users Manual
Ethernet Equipped Systems	
385-3044	FEI-Zyfer Custom MIB
385-3140	CommSync II Family Graphical User Interface Software
385-8088	TFTP Remote Upgrade Instructions
990-3015	FEI-TFTP (TFTP server utility for remote upgrade of CommSync II Family firmware)
SAASM Equipped Systems	
385-8006	GTF Hot Start Procedure

*Note: All of the documents listed in Table 4-1 are available at [www.fei-zyfer.com](http://www.fei-zyfer.com).*

## 4.3 Basic System Description

The following paragraphs contain a summary of the basic system and its options.

### 4.3.1 Chassis

The basic system consists of a chassis with a 3U (5.25"x17.65") frame and a passive backplane. The chassis mounts in a standard 19" rack. Cooling is through conduction and natural convection. No cooling fan is required.

### 4.3.2 Front Panel

Optionally available is a front panel mounted Keypad and LCD module. When provided, the backlit display provides indication of time, position, satellite information, operating status, oscillator performance, system setup and installed option modules. The Keypad allows for data entry and display screen selection.

*Note: Failure or malfunction of the Keypad/Display, or the internal Keypad Display Controller (KDC), will not affect system operation or interrupt system outputs.*

The two slots, on either side of the keypad and display controller (KDC), are for the redundant/hot-replaceable GTF/DTF modules. These modules are the precision sources used to generate the time and frequency generated by the system.



Figure 4-1 CommSync II Front View - GTF

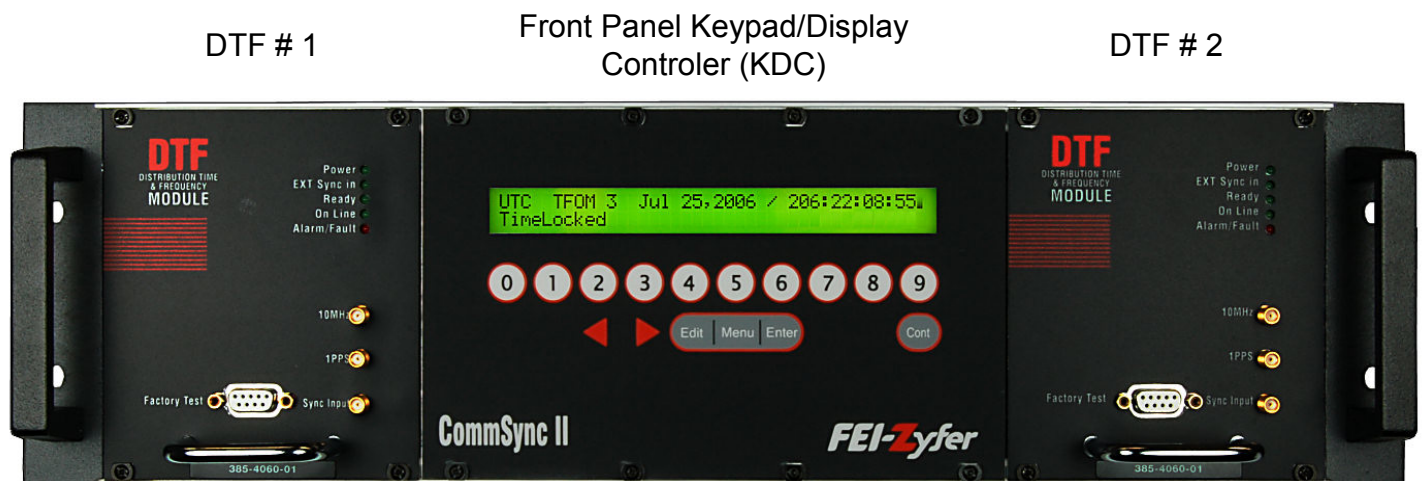

Figure 4-2 CommSync II Front View - DTF

### 4.3.3 Rear Panel Antenna Connections

Also installed in the chassis (Rear panel, slot 2) are two connectors for connection of the “active” GPS antennas to the system. The upper connector is the antenna connection for GTF Module 1 (located in the far-left slot of the chassis), and the lower connector is the antenna connection for GTF Module 2 (located in the far right slot of the chassis). These connectors also provide a DC voltage used as the power source for the active GPS antennas. In a Distribution Chassis, the antenna connectors may be omitted. Refer to Figure 4-3, CommSync II Rear View for antenna connection locations.

#### 4.4 GTF (GPS Time/Frequency) Modules

The following table outlines the primary differences between GTF types.

Table 4-2 GTF Types						
P/N		Dash	Oscillator	Ext. Sync	Hot Start	GPS Rcvr
385-1105	Mark I	-01	Rubidium	No	No	C/A Only
		-02	OCXO	No	No	C/A Only
385-4000/ 385-4100	Mark III	-01	Rubidium	Yes	No	C/A Only
		-02	OCXO	Yes	No	C/A Only
385-4002/ 385-4102	Mark III	-01	Rubidium	Yes	No	SAASM
		-02	OCXO	Yes	No	SAASM
385-4102	Mark III	-13	Rubidium	Yes	Yes	SAASM
		-14	OCXO	Yes	Yes	SAASM
385-4100	Mark IV	-05	Rubidium	Yes	No	C/A Only
		-06	OCXO	Yes	No	C/A Only
385-4102	Mark IV	-05	Rubidium	Yes	Yes	SAASM
		-06	OCXO	Yes	Yes	SAASM
385-4103	Mark IV	-05	Rubidium	Yes	Yes	SAASM
		-06	OCXO	Yes	Yes	SAASM

*Note: References in this manual to External Sync and GPS modes are conditioned by these differences and will not apply to all GTFs.*

The Mark III and subsequent GTFs versions include the external synchronization input feature.

The Mark IV and subsequent GTF versions also include additional memory space for future option module support.

Each GTF module contains a self-contained Frequency Discipline Machine (FDM), consisting of an ultra-stable oscillator (either rubidium or oven-controlled crystal), a GPS receiver, along with a microprocessor Controller and bus interface drivers.

While locked to GPS the GTF module learns the characteristics of its precision oscillator, using GPS as reference. This learned data is used to maintain the stability of the time and frequency outputs if the system enters holdover (loss of GPS lock condition).

While locked to GPS, the GTF module's output signals and the system's time are synchronized to UTC. The module's GPS receiver 1 PPS output is used as reference to align the system's 1 PPS output to UTC 1 PPS.

In a system configured with a Mark III or later GTF module (refer to Table 4-2 for GTF types and part numbers), an external 1 PPS signal connected through the *Sync Input* port can be used as reference in the event the GPS reference is not available or is interrupted. The GTF may also be commanded to use this sync input. (See FEI-Zyfer document 385-8002, DISC command.)

In the *Switch* mode, GPS is the default reference source. If GPS becomes unavailable and the external reference input is present, the module will automatically switch to the external 1 PPS. If the external 1 PPS is not present, then the module will go into *Coasting* or *Holdover* mode. When GPS becomes available again, the module will return to the GPS source.

*Note: The system 1 PPS output is normally aligned with the GPS reference. If the external 1 PPS reference source is not aligned with the system 1 PPS output, then the system 1 PPS output will be synchronized to the external input. This may cause a shift of the system 1 PPS output, but will not affect the system's frequency output signals.*

#### 4.5 DTF (Distribution Time/Frequency) Modules

The following table outlines the oscillator selections for DTF modules.

P/N		Dash	Oscillator
385-4060	Mark III	-01	Rubidium
		-02	OCXO
	Mark IV	-05	Rubidium
		-06	OCXO

The Mark IV and subsequent DTF versions also include additional memory space for future option module support.

The DTF modules also include a self-contained Frequency Discipline Machine (FDM) consisting of an ultra-stable oscillator (either Rubidium or OCXO) along with the microprocessor Controller and bus interface drivers.

While locked, the DTF module will also learn the characteristics of its oscillator. This learned data is used to maintain the stability of the time and frequency outputs if the system enters holdover (loss of external reference condition).

*Note: In a DTF (distribution) system, time can be manually set and the system's 1 PPS alignment is dependent on the reference source.*

## 4.6 Rear Panel Modules

There are a total of 16 rear panel option slots. All modules are designed to be hot swap/replaceable. Slots 1 and 16 are designated for Power Supply modules. Slots 3 through 15 accept any of the output option modules, while slots 14 and 15 are designated for either I/O modules or output option modules. Slot 2 is used for the GPS antenna inputs in GTF systems (Slot 2 is unused in DTF systems).

All option module status is available via an optional front panel Keypad/Display, RS-232 ports mounted on the GTF/DTF front panel, or through an optional I/O module. Each rear panel module has two LED indicators to provide immediate visual status. These are typically module power (green) and module fault (red).

*Note: Depending on the current firmware version of a fielded system, option module installed in the field may require GTF/DTF and KDC firmware upgrades.*

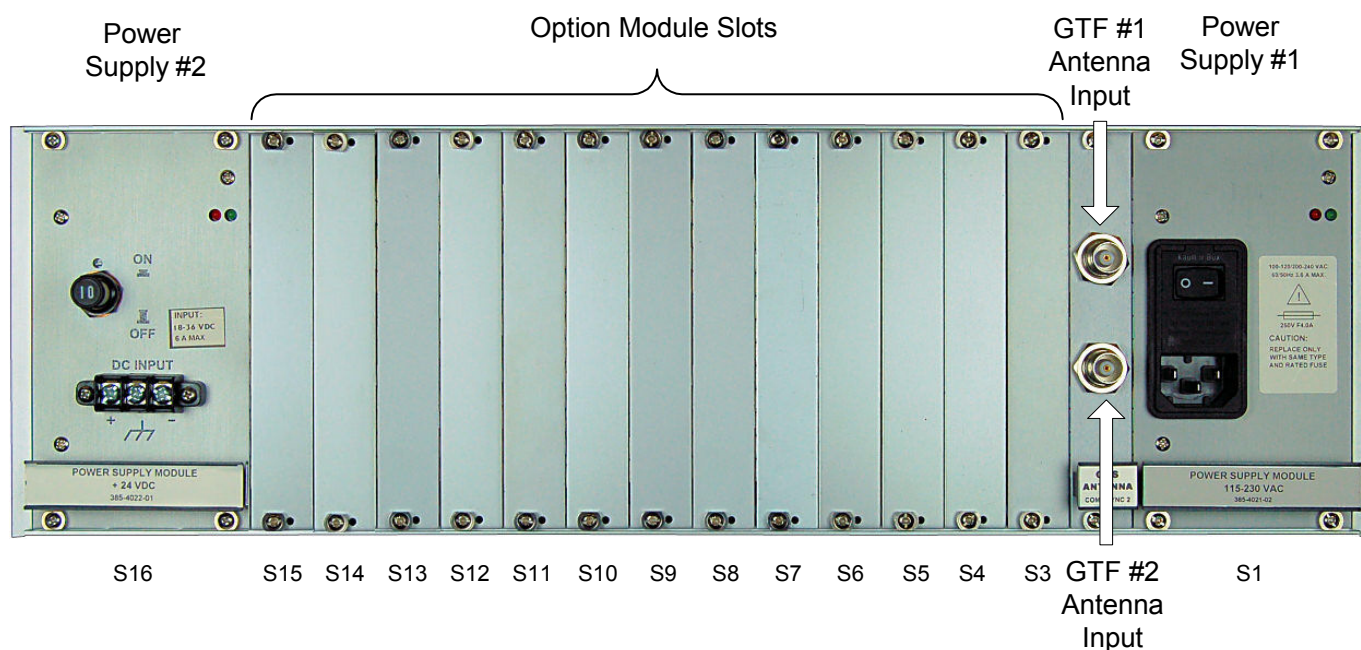

Figure 4-3 Commsync II Rear View

## 4.7 Power Supply Modules

Two rear panel slots (slots 1 and 16) are provided for redundant hot swap/replaceable power supplies. See Option Module User's Manual, 385-8003, Power Supply 385-4021 and 385-4022 for more information. Any of the available power supply options can be used in any combination. Refer to Figure 4-3, Commsync II Rear View for power supply locations.

#### 4.8 System Monitor/Control and/or Ext Input Modules (slots 14 and 15 only)

The system's operation can be monitored and controlled via serial commands through an optional Command I/O module(s).

In a non-redundant system configuration (only one GTF/DTF module installed), the I/O module must be installed in slot 15. In a redundant system configuration (two GTF/DTF modules installed), up to two I/O modules can be installed using slots 14 and 15. The I/O module in slot 15 provides a command path through the online GTF/DTF module. The I/O module in slot 14 provides a redundant command path through the offline GTF/DTF module. Either slot may be used to control and/or monitor the system. The command set used for monitoring and control is contained in FEI-Zyfer Serial Communications Protocol document 385-8002.

In addition to providing for communications, some I/O modules include options that accommodate frequency inputs that allow the system to be synchronized to an external reference, while other I/O modules allow the system to receive time via IRIG time codes.

Table 4-4 I/O and External Input Module Options

Module Name	Part Number	RS-232 Ports	Ethernet Ports	SNMP	Ext Input	Time Code
RS-232 I/O Module	385-4005-01	One	None	No	None	None
RS-232 I/O External Input Module	385-4037-02	One	None	No	Two BNCs	None
RS-232 I/O External Input Module	385-4037-03	One	None	No	Two Fiber Optic	None
Ethernet I/O Module	385-4024-01	None	One	No	None	None
Ethernet I/O External Input Module	385-4038-01	One	One	Yes	None	None
Ethernet I/O External Input Module	385-4038-02	None	One	Yes	Two BNCs	None
Ethernet I/O External Input Module	385-4038-03	None	One	Yes	Two Fiber Optic	None
Ethernet I/O External Input Module	385-4038-04	One	One	Yes	Two BNCs	None
Dual Port Ethernet I/O External Input Module	385-4090-01	None	Two	Yes	None	None
Dual Port Ethernet I/O External Input Module	385-4090-02	None	Two	Yes	Two BNCs	None
Dual Port Ethernet I/O External Input Module	385-4090-03	None	Two	Yes	Two Fiber Optic	None
Time Code Input Module	385-4040-01	None	None	No	Two BNCs	Two BNCs
Time Code Input Module	385-4040-03	One	None	No	None	Two BNCs

See Option Module User's Manual, 385-8003 for connector pin-out and connection instructions.

Pri Sec  
Com Com  
Slot Slot

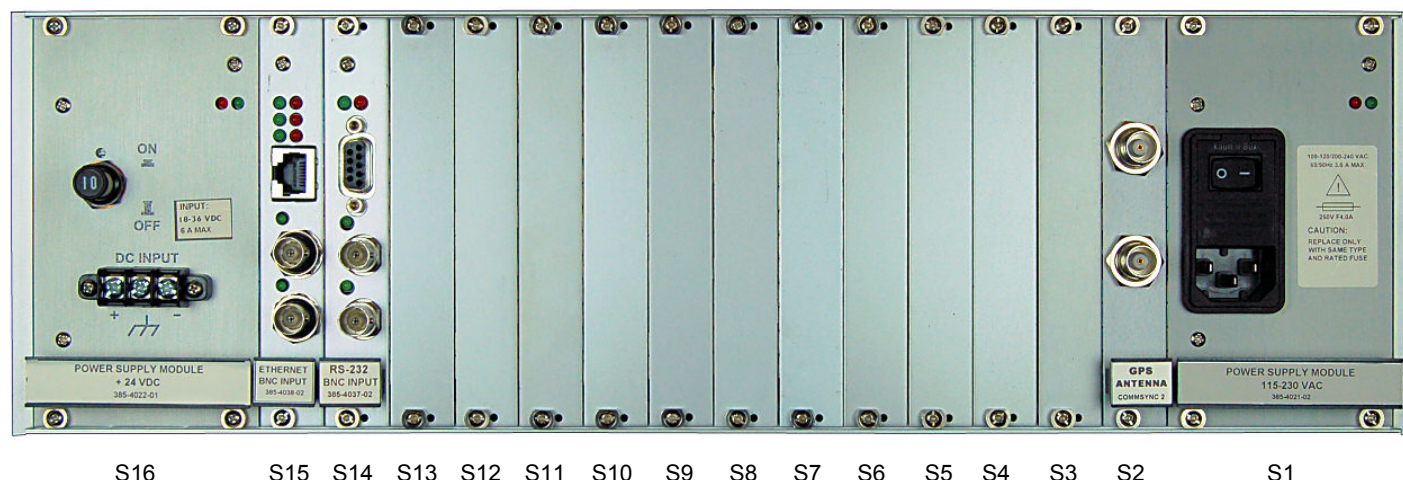

Figure 4-4 Commsync II Rear View – With Communication Modules

#### 4.9 Remote Firmware Upgrade

CommSync II systems equipped with a 385-4038-xx or 385-4090 Ethernet module and a GTF/DTF with firmware version 407-3001 or 407-3002, have the ability of upgrading its Ethernet, KDC, GTF and DTF firmware from a remote location. Refer to 385-8088, TFTP Remote Upgrade Instructions, CommSync II Family, for more information.

#### 4.10 Output Option Modules

Slots 3 through 15 accept a wide variety of option modules.

See Option Modules User's Manual, 385-8003, for details and specifications of all available modules.

## 4.11 System Redundancy and Switchover Considerations

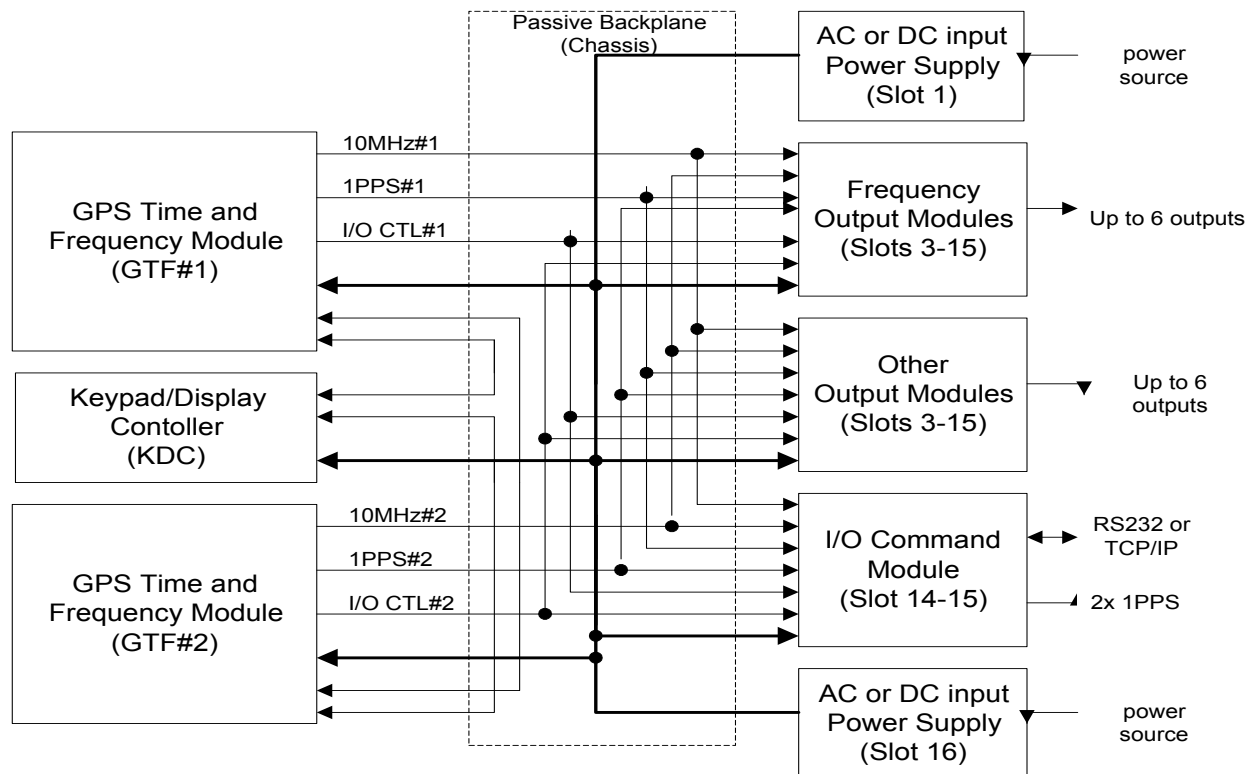

Figure 4-5 System Block Diagram

### 4.11.1 GTF Modules

Each GTF module is a self-contained Frequency Discipline Machine (FDM), consisting of a precision oscillator, reference source (GPS), and a microprocessor-controller.

The microprocessor-controller also provides the command port interface (through an I/O command module or the RS-232 port mounted on the GTF/DTF module's front panel), the cross coupling with the other GTF module, and a serial interface with the Keypad Display Controller. The online GTF module also monitors the status of each output module on the bus.

### 4.11.2 Output Modules

Each output module receives the disciplined outputs of both GTF/DTF modules, and provides the logic to select the online GTF/DTF module as its reference source. Typically, each output module contains its own VCXO to minimize the effects of a fault induced switchover.



### 4.11.3 Online GTF Selection

The online, or active GTF module selection is determined within the GTF modules themselves and is governed by a few simple rules. Upon power-up of system, GTF#1 will be online, but the first module to complete warm-up will go online and become the active module. If the online GTF module develops a fault, it will switch offline and the redundant module will take over.

### 4.11.4 Fault Switchover Rules

There are two categories of switchover criteria:

- **Hard Faults:** If a GTF module is online and develops a fault, it causes a switch over to the other module if the other module is not faulted and is *Ready* (completed warm-up). All Hard Faults are latched. Replacing the module can only reset the latch. Hard faults consist of the following internal failures within the GTF module: 10MHz, 1 PPS, GPS receiver, and +3/+5/+12V power supplies.
- **Soft Faults:** If the online GTF loses GPS lock (for a predetermined time), or the system performance degrades (1 PPS error > 1  $\mu$ S), then the redundant (standby) GTF module is placed online. Soft faults are not latched, as they could recover.

## 4.12 Storage Considerations (SAASM Receivers)

385-4102-xx SAASM GTFs that have not been on for more than 24 hours and are going to have power removed for more than two (2) days must have their SRAM memory reset. 385-4102-xx SAASM GTFs that have been on for more than 24 hours and are going to have power removed for more than five (5) days must have their SRAM memory reset. When reset, the 385-4102-xx SAASM GTF will have the following information cleared: Crypto Key, Almanac, Ephemeris and Location. Refer to paragraph 5.2.13 for SRAM memory reset instructions.

This page intentionally left blank

---

## **5 GPS Timing and Frequency Systems**

- 5.1 Details of GTF Operation 36
  - 5.1.1 Warm-Up Mode 36
  - 5.1.2 GPS LOCK (Warm Start/Cold Start) 36
  - 5.1.3 Time Locked / Frequency Locked Mode 36
  - 5.1.4 Coasting or Holdover Mode 37
  - 5.1.5 Recovery Mode 37
  - 5.1.6 Discipline in Time Locked Mode 37
  - 5.1.7 Discipline in Frequency Locked Mode 38
- 5.2 Getting Started 38
  - 5.2.1 Warm-Up Mode 36
  - 5.2.2 Preparing For Use 38
  - 5.2.3 Overview 39
  - 5.2.4 Installing the Antenna System 39
  - 5.2.5 Connecting the External Reference Source 43
  - 5.2.6 Connecting Power 44
  - 5.2.7 Connecting I/O 47
  - 5.2.8 Powering-Up the System 47
  - 5.2.9 SAASM GTFs 48
  - 5.2.10 Power Up Indications 49
  - 5.2.11 Set Antenna Cable Delay Compensation 51
  - 5.2.12 Reset Internal GPS Receivers 53
  - 5.2.14 Hot Start 16
  - 5.2.15 Set Local Time 57
  - 5.2.16 Select GTF Discipline Source Mode 59

## 5.1 Details of GTF Operation

### 5.1.1 Warm-Up Mode

*Note: The SAASM receiver does not operate in all the same modes as the C/A receiver. Some of the receiver mode explanations do not apply to the SAASM receiver.*

When power is applied (power-up), the system enters the *Warm-Up* mode. During this period the internal GPS receiver initializes in the *Survey* mode. (*Survey* mode is also known as *Position Averaging* mode). When the receiver acquires a minimum of three satellites, it resolves its initial position. At this point the system verifies that the existing antenna position data stored in non-volatile memory is correct. If the antenna position has changed the receiver continues to operate in the *Survey* mode using data from the GPS receiver to calculate an accurate position. After this process is finished, the receiver automatically switches to the *Known* mode, storing the new antenna position in non-volatile memory. The disciplining of the system's oscillator starts as soon as the receiver locks to GPS and the oscillator is determined to be stable.

If a non-SAASM GTF system set to operate in "automatic switchover" mode, has not locked to GPS within 20 minutes, then the system switches to the external reference input (if the external 1 PPS signal is present).

### 5.1.2 GPS LOCK (Warm Start/Cold Start)

The GPS *Warm Start* mode is active when power is applied (power-up) and the system's receiver has previously collected satellite almanac data. In the *Warm Start* mode the receiver normally achieves GPS lock in 3 to 5 minutes. If the receiver does not have a valid almanac, it defaults to the *Cold Start* mode. In this mode the receiver collects new almanac data from the GPS satellites. This process takes from 12 to 30 minutes. The time (days through seconds) is not valid until sufficient data has been collected and the receiver has locked to the GPS time.

### 5.1.3 Time Locked / Frequency Locked Mode

In the *Time Locked* mode the GTF module's output signals and the system's time are synchronized to UTC. The 1 PPS output from the GPS receiver is used as reference to discipline the module's oscillator and to align the 1 PPS output pulse.

If a GTF module operates in the *Frequency Locked* mode, the GTF module's output signals are synchronized to the external reference input signal. The external input signal is also used to discipline the module's oscillator and to align the 1 PPS output pulse.

The Time Figure Of Merit, TFOM, indicates the timing accuracy of the output signals. Normally, the TFOM value is 4. The TFOM value is available through the command I/O interface via the System Status message (SSTA). The front panel display *Time and Status* screen also displays the system TFOM.

*Note: Time from reference signal (either GPS lock or external input) to time lock or frequency lock (Completion of Warm-up-Ready indicator is illuminated) is typically 1½ to 2 hours.*

### 5.1.4 Coasting or Holdover Mode

If a GTF module using GPS as reference loses satellite lock, then the module enters the *Coasting* mode. The *Coasting* mode can only be entered after the module has operated in the *Time Locked* mode. If the system is configured with two (redundant) GTF modules and the online module loses GPS lock and enters the *Coasting* mode while the other module is in the *Time Locked* mode, then the redundant GTF module switches online.

If a GTF module is set to operate in “automatic switchover mode” (*Switch* mode) and the external reference signal is present, then the module switches to and uses the external signal as reference when satellite lock is lost. If the external reference signal is not present, the system enters the *Coasting* mode. If the system is configured with two (redundant) GTF modules and the online module loses GPS lock and switches to the external reference input, then the redundant GTF module switches online (assuming it is operating in the *Time Locked* mode).

The Holdover Integrity (HINT) command indicates the learning algorithm has acquired the parameters necessary to meet the holdover specification defined in the Product Documentation, and therefore the oscillator will be tuned with those parameters in the absence of GPS or external reference.

The required parameters include:

- Factory temperature learning has occurred.
- The system has been locked for at least 24 hours.
- The locked performance occurred within certain limits, including:
  - Temperature Change
  - 1PPS Time Error
  - Oscillator Frequency shifts

The HINT status is also available through the command I/O interface via the System Status message (SSTA).

### 5.1.5 Recovery Mode

The *Recovery* mode is entered from the *Coasting* mode. In this mode the 1 PPS alignment and the frequency of the internal oscillator is adjusted until the *Time Locked* mode or, in case of a module using an external reference input signal, the *Frequency Locked* mode criteria is met.

### 5.1.6 Discipline in Time Locked Mode

The first time a module enters the *Time Locked* mode after power is applied, the time and frequency output signals are “jam” synchronized to GPS, and are phase and frequency corrected as needed to maintain the specified accuracy of the output signals. The Frequency Discipline Machine (FDM) continuously compares the module’s GPS receiver 1 PPS output with the generated 1 PPS derived from the module’s oscillator to determine the correction necessary to discipline the oscillator. The FDM filters out the short-term variations inherent in the GPS 1 PPS.

### 5.1.7 Discipline in Frequency Locked Mode

If a module uses the external reference input, the module's output signals are synchronized to, and disciplined by the external input signal.

### 5.1.8 System Monitor/Control (slots 15 and 14)

Each I/O module provides for a communication path to the GTF module. The I/O module in slot 15 is the primary module and will communicate directly with the online GTF. The I/O module (if installed) in slot 14 is the secondary module and will communicate with the offline GTF. In a non-redundant system configuration (only one GTF/DTF module installed), the I/O module must be installed in slot 15.

## 5.2 Getting Started

### 5.2.1 Introduction

This section contains the step-by-step procedures to place a GTF-based system into operation. For DTF-based systems, refer to paragraph 6.2.

### 5.2.2 Preparing For Use

Install the instrument into the equipment cabinet (rack) as follows:

- Set the rear panel power switch, if supplied, to the OFF position.
- Place the instrument in the desired cabinet (rack) location.

### **WARNING!**

*Always locate heavy equipment towards the bottom of the cabinet (rack) to avoid accidental tip-over of the cabinet (rack).*

*Make certain the maximum operating ambient temperature does not exceed 55° C.*

*Never restrict the airflow through the instrument's vents, located on the top and bottom of the instrument.*

- Fasten the rack-mount brackets to the equipment cabinet (rack).
- Prior to use, the instrument must be connected to an antenna, AC or DC power source. It is recommended that it be connected to a compatible serial interface.
- If the instrument is configured to operate from an AC power source, pay special attention to the following:
  - *Connect the instrument only to a properly rated supply circuit.*
  - *The supplied 3-prong power cord provides safety grounding. Do not defeat this feature. The user must comply with all applicable national and local electrical regulations regarding grounding and safety.*
- In order to receive System Status messages or send serial commands, it is recommended that the instrument be connected to a compatible serial interface. Refer to paragraph 5.2.7 for I/O connection details.

### 5.2.3 Overview

The following table is the recommended start-up process and associated paragraphs:

Table 5-1 Start-up Process - GPS Timing and Frequency Systems	
Process	Page
1. Install Antenna System	39 para. 5.2.4
2. Connect Power	44 para. 5.2.6
3. Connect I/O	47 para. 5.2.7
4. Connect External Reference Source (if applicable)	43 para. 5.2.5
5. Connect Outputs	385-8003*
6. Apply Power	44 para. 5.2.6
7. Key SAASM Receiver (if applicable)	48 para. 5.2.9
8. Set Antenna Cable Compensation	51 para. 5.2.11
9. Reset GPS Receivers (if required)	53 para. 5.2.12
10. Set Local Time (if desired)	57 para. 5.2.15
11. Select Discipline Reference mode (if applicable)	59 para. 5.2.16
12. Configure Option Modules (as required)	385-8003*

\*Refer to Option Module User's Manual, 385-8003, for specific input/output module descriptions.

### 5.2.4 Installing the Antenna System

The standard CommSync II system is configured to utilize either a L1 GPS antenna (C/A equipped systems) or a L1/L2 GPS antenna (SAASM equipped systems) that are connected directly to the system's antenna input connector via a low loss coaxial cable. Additionally, an optional fiber optic antenna system is available that replaces the direct connection between the CommSync II and antenna with a fiber optic link.

The L1 signal strength from the GPS Satellite at the input of the CommSync II antenna is typically -158 to -155 dBw with a minimum of -160 dBw. The minimum amount of signal required at the input of the GPS receiver is -145 dBw for a C/A receiver and -140 dBw for a SAASM receiver. These minimum input levels must be taken into account when setting up the antenna system.

#### 5.2.4.1.1 Standard Antenna System

The system requires one antenna, suitable for retrieving the GPS satellite signals, for each GTF module. For a redundant system, two antennas are required.

*Note: Special care must be taken when routing antenna cable near sources of potential interference, such as a power bus, high frequency antenna couplers, and other transmitting equipment.*

The antenna mounting location should be free of any objects that might obstruct satellite visibility within 10° of the horizon. Obstructions that obscure significant areas of the sky will result in degraded performance. The antenna should be located at least 50 cm away from any other GPS antenna. The antenna must be mounted with the connector side down. The antenna must not be mounted in the path of, or near any radio frequency or microwave sources.

Mount the antenna in the desired location. At the antenna, connect one end of the antenna cable to the antenna connector. Application of a weatherproofing compound to the antenna/cable connection is recommended to impede corrosion.

#### 5.2.4.1.2 Antenna Cable

The antennas available from FEI-Zyfer have a minimum gain of 30 dB. This allows for a maximum antenna cable loss of 15 dB (1575 MHz) when operating with a C/A receiver and 10 dB with a SAASM receiver.

Other lengths and types of cable can be used as long as the signal loss at 1575 MHz does not exceed 15 dB.

*Note: SAASM receivers typically require 5 dB higher signal levels than C/A receivers.*

### **CAUTION!**

*Not all coaxial cable exhibits the same amount of attenuation or shielding quality. These parameters can vary between manufacturers as well as manufacturer's type.*

FEI-Zyfer has evaluated several manufactures and types of cable, and has found that Belden® type 9311 (RG-58), Belden® type 8267 (RG-213), Belden® type 9913 (RG-8), Belden® type 9104 (RG-59), and Times Microwave LMR type cable provide good performance.



The following table indicates the maximum length of recommended cable type when used with the antenna available from FEI-Zyfer.

Table 5-2 Antenna Cable Loss Characteristics		
Cable Type	Max. Length	Comments
RG-58 (Belden® 9311)	75 ft (23 m)	Loss 20 dB per 100 ft (30 m)
RG-213 (Belden® 8267)	125 ft (38 m)	Loss 12 dB per 100 ft (30 m)
RG-59 (Belden® 9104)*	150 ft (46 m)	Loss 10 dB per 100 ft (30 m)
RG-8 (Belden® 9913)	250 ft (75 m)	Loss 6 dB per 100 ft (30 m)
LMR400 (Times Microwave)	275 ft (84 m)	Loss 5.4 dB per 100 ft (30 m)

For long runs it is necessary to use an in-line amplifier or low loss foam dielectric cable such as the Heliac series manufactured by Andrew Corporation, Orland Park, IL, USA.

*\*Note: Most of the above recommended cables have 50 Ohm impedance, the RJ59 Cable has 75 Ohm impedance. When using cable with 75 Ohm impedance a mismatch appears to exist between the cable and the antenna, and/or between the cable and the GPS receiver. The primary advantage of using 75 Ohm impedance cable is the improved signal levels at the frequencies of interest. (Note the max cable length between RG-58 and RG-59) The benefits of the increased signal level far outweigh any potential impedance mismatch issues.*

#### 5.2.4.1.3 In-Line Amplifier

In some cases it may be more cost effective to place an amplifier in the antenna cable system to make up for the signal attenuation caused by long cable runs.

Amplifiers are available from several manufacturers including Raven Industries (formerly Starlink Incorporated), Austin, TX, USA, and FEI-Zyfer. The following paragraphs detail the characteristics of some of the amplifiers available from FEI-Zyfer.

Amplifiers 0810403 and 0810433 are configured with a male TNC connector at the input side and a female TNC connector at the output side. This allows the amplifier to screw directly on to the GPS antenna without the need for additional cables. It also provides protection from the environment when the antenna is installed using a pipe that also surrounds the amplifier. This configuration allows for a cable loss between the output of the amplifier and the input of the GPS receiver up to 35 dB when operating with a C/A receiver and 30 dB with a SAASM receiver.

*Note: SAASM receivers typically require 5 dB higher signal levels than C/A receivers.*

Amplifiers 0810397 and 0810428 are configured with a female TNC connector at both the input side and the output side. This allows the amplifier to be installed in-line with the antenna cable. The optimum location for the amplifier is at a point in the antenna cable where the cable loss is approximately 15 dB. This configuration allows for a total cable loss between the output of the amplifier and the input of the GPS receiver of up to 35 dB when operating with a C/A receiver and 30 dB with a SAASM receiver.

Table 5-3 Amplifier Characteristics		
Parameter	0810428 and 0810433 Characteristics	0810397 and 0810403 Characteristics
GPS Band	L1 (Fc = 1575.42 MHz)	L1 (Fc = 1575.42 MHz) L2 (Fc = 1223.60 MHz)
Gain	22 +/- 2 dB @ Fc	20 +/- 3 dB @ Fc
Filter Characteristics	> 80 dB Attenuation @ 50 MHz From Fc	20 dB Attenuation @ 20 MHz from Fc
Input Power	4.0 VDC to 15 VDC, 22 mA max with voltage pass-through	4.0 VDC to 28 VDC, 20 mA max with voltage pass-through
Noise Figure	< 3.5 dB	< 3.0 dB
Connector	TNC Male Input/TNC Female Output	

Additional amplifiers with different gains are available to allow compensating for other levels of signal loss in antenna installations. Please contact FEI-Zyfer for more details.

#### 5.2.4.1.4 Lightning Protection

In areas where lightning is present it is recommended to install a surge protector in the antenna system. Surge protectors are available from several manufactures such as: Part number 095-0518C-A from PolyPhaser Corporation, Minden, Nevada, U.S.A. The use of this device requires TNC to N-type adapters. Another surge protector, fitted with TNC-type connectors, part number P8AX09TNCWFF is available from Citel, Miami, Florida, U.S.A. In order to be effective, the protector must be connected as close as possible to the point where the antenna cable enters the building, and must be connected to earth ground using a very low-inductance conductor. Contact the manufacturers for installation details.

*Note: Signal strength losses due to the use of lightning protectors and associated connections must be taken into account when determining the appropriate gain of the antenna system.*

### WARNING!

*When installing grounding electrodes, lightning rods, grounding conductors, etc., comply with all the rules prescribed by local/state electrical building ordinances and codes.*

#### 5.2.4.1.5 Weatherproofing

The optional FEI-Zyfer supplied antenna is designed for exposure to all-weather conditions. However, care should be taken with the connectors and cable couplers, if used. These components should be shielded from the elements, or weather protected using butyl rubber tape. Weatherproofing kit P/N 221213 is available from Andrew Corporation, Orland Park, Illinois, U.S.A. This kit includes butyl rubber and plastic tape. Instructions are included with the kit.

#### 5.2.4.1.6 Fiber Optic Antenna System

The CommSync II system is designed to utilize an optional fiber optic antenna system that receives the GPS signal and then sends it, via fiber optic cable, to the CommSync II. The fiber optic system consists of a Fiber Optic Transmitter assembly (P/N 385-1048-01) and a Fiber Optic Antenna Interface module (P/N 385-4006-01), associated fiber optic cable and one antenna suitable for retrieving the GPS satellite signals.

Typically, the Fiber Optic Transmitter assembly is placed near the GPS antenna, while the Fiber Optic Antenna Interface module is installed in the CommSync II system. The fiber optic antenna system receives GPS signals from the GPS antenna at the transmitter assembly. The transmitter assembly converts the GPS signal to an optical signal and sends it to the antenna interface module in the CommSync II. The antenna interface module converts the optical signal to GPS signal and routes it to the CommSync II antenna input

Refer to the CommSync II Fiber Optic Antenna Option Users Manual, 385-8007 for installation instructions.

#### 5.2.4.1.7 Connecting the Antenna Input

Connect the antenna system cable(s) to the system's rear panel TNC connectors as follows: Connect the antenna cable for GTF#1 (left side module) to the upper connector, and the antenna cable for GTF#2 (right side module) to the lower connector. Refer to Figure 4-3, Commsync II Rear View for antenna connection locations.

### 5.2.5 Connecting the External Reference Source

In a system configured with a Mark III or later GTF module (refer to Table 4-2 for GTF types and part numbers), if a 1 PPS external reference source input is required, connect the input signal to the *Sync Input* connector on the front panel of the GTF module(s).

*Note: This is a high impedance input, and will require an external termination.*

After application of input power, configure the function as outlined in paragraph 5.2.8. Refer to paragraph 8.5.3 for electrical input signal specifications.

### 5.2.6 Connecting Power

There are five Power Supply module options available for the CommSync II resulting in the following groupings of connector types:

- Standard AC input (refer to Figure 5-1 and paragraph 10.2).
- 24 VDC and 48 VDC inputs refer to Figure 5-2 and paragraph 10.3).
- 12 VDC input (refer to Figure 5-3 and paragraph 10.4).
- 28 VDC input (refer to Figure 5-4, Table 5-4 and paragraph 10.5).

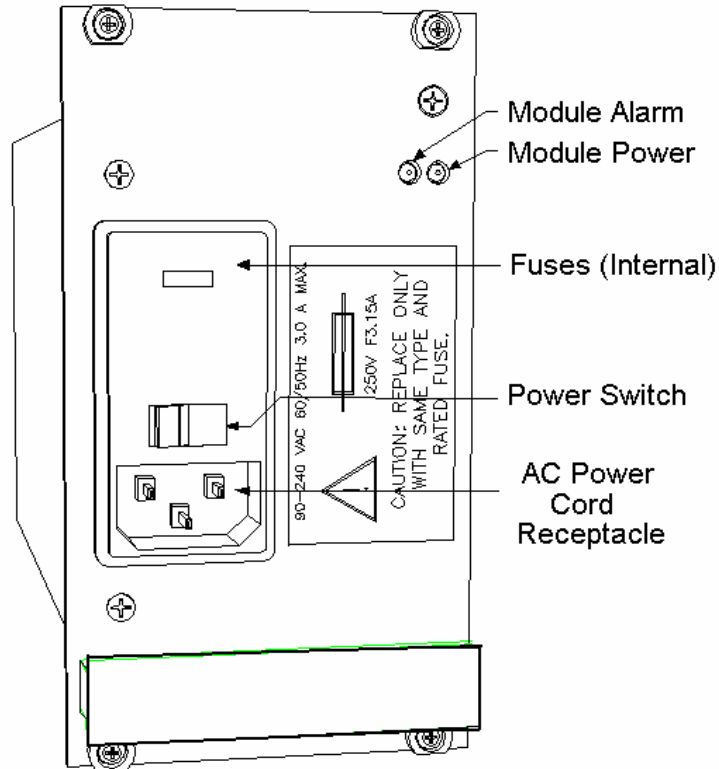

Figure 5-1 AC Power Connections

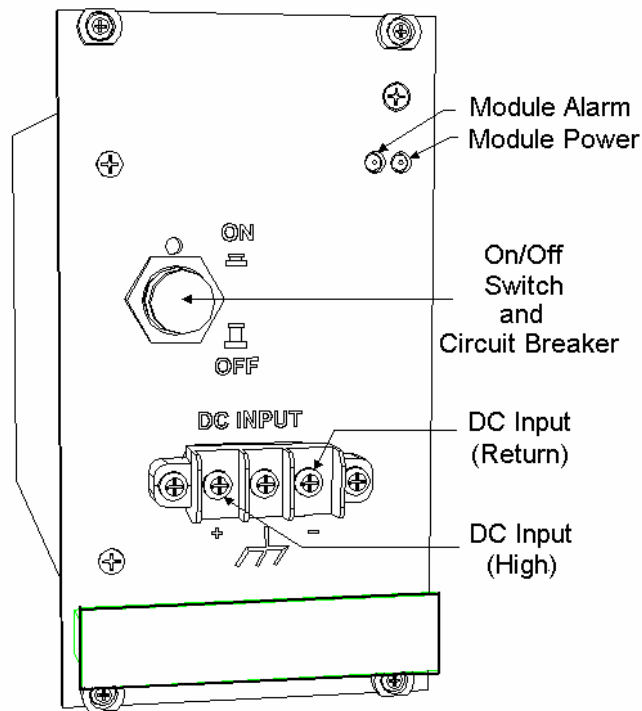

Figure 5-2 24 and 48 VDC Power Connections

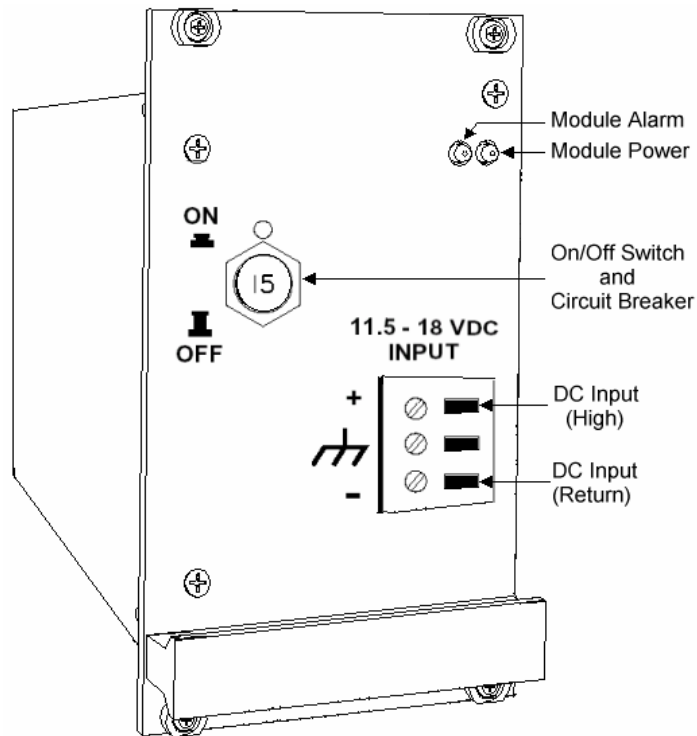

Figure 5-3 12 VDC Power Connections

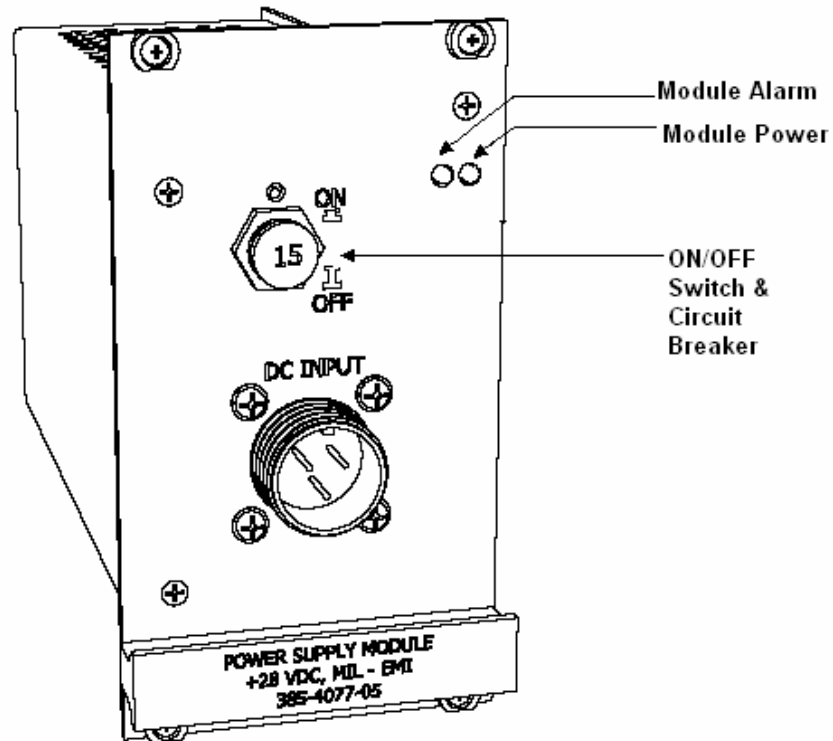

Figure 5-4 28 VDC Power Connections

Table 5-4 28 VDC Power Connection Pin Designation	
Terminal	Function
B	+ DC Input (High side of isolated input)
A	Chassis Ground
C	- DC Input (Low side of isolated input)

### 5.2.7 Connecting I/O

The CommSync II comes with a standard RS-232 port on the GTF module's front panel (refer to Figure 5-5 for RS-232 Interconnect Diagrams). There are additional I/O options available, including several RS-232 and Ethernet I/O option module versions. Refer to the Option Module User's Manual, 385-8003, for additional information on these option modules.

The standard RS-232 port uses a DE-9 female connector with the following pin out:

PIN	SIGNAL	DESCRIPTION
2	OUTPUT (TXD)	RS-232 OUTPUT
3	INPUT (RXD)	RS-232 INPUT
5	RTN	Signal Ground

*Note: The required mating connector is a 9-contact male "D-Subminiature" connector.*

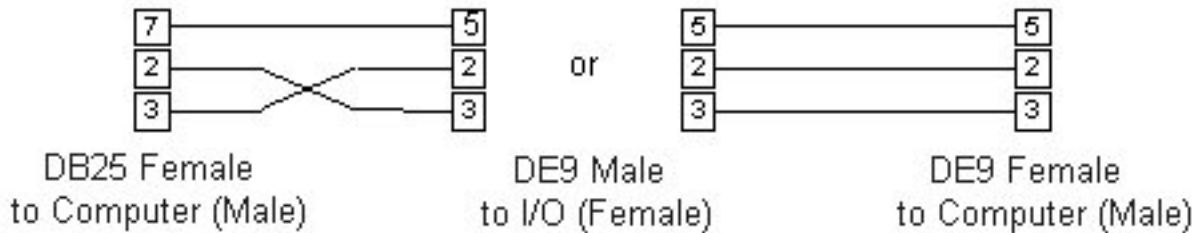

Figure 5-5 RS-232 Interconnect Diagrams

### 5.2.8 Powering-Up the System

Mount the system in the desired location, such as an equipment cabinet. Verify that the antenna cable(s) and the input power source(s) are connected. Apply power to the system. When power is applied (power-up) the following sequence of events takes place:

- After a moment, the system runs through its self-test diagnostics, and is waiting for a firmware download command. During this time the *Ready* indicator flashes and the *Alarm/Fault* indicator is illuminated (~5 sec).
- After the completion of the self-test, the *Power* indicator on the GTF modules will illuminate. GTF#1 *On Line* indicator will illuminate.

During Warm-Up the *Alarm/Fault indicator flashes*. (*Warm-Up mode*).

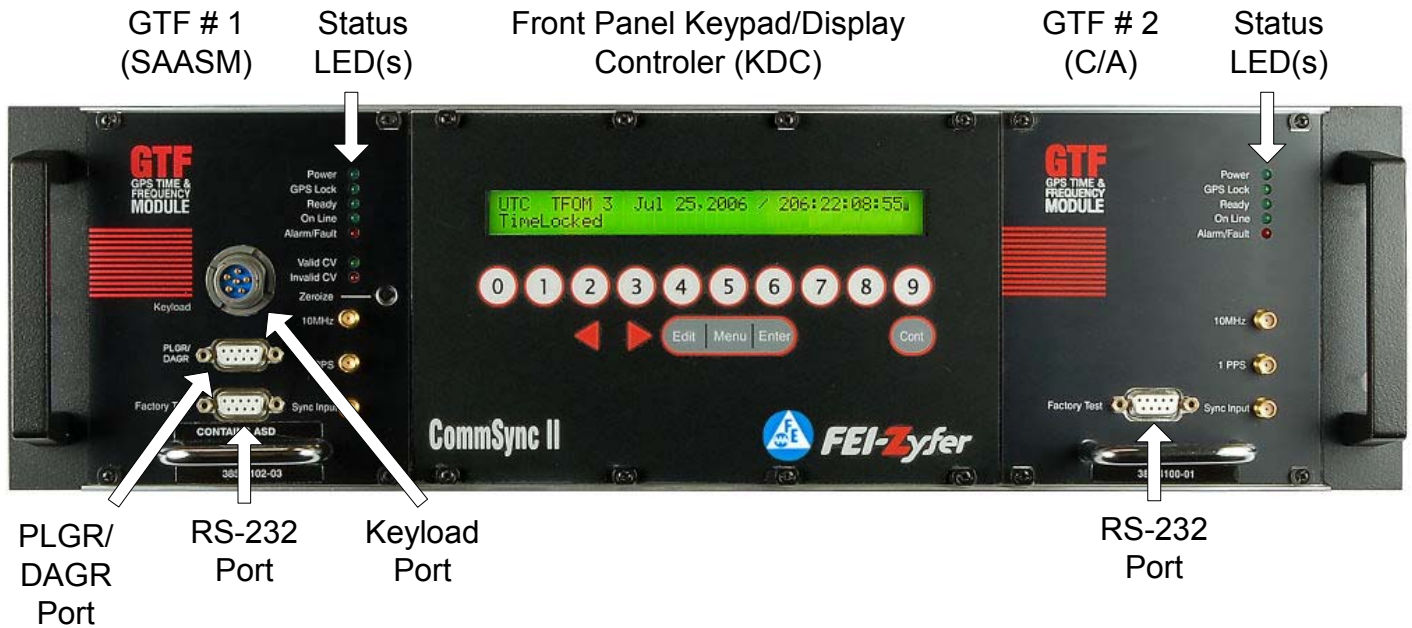

Figure 5-6 Commsync II Front Panel Port and Indicator Locations – GTF Systems

### 5.2.9 SAASM GTFs

All GTFs operate in C/A mode without user intervention. GTFs with a SAASM receiver installed (385-4002-xx, 385-4102-xx or 3854103-xx) are also capable of operating in P/Y mode. To use the P/Y mode, the receiver must be keyed.

#### 5.2.9.1.1 Keying the Receiver

The SAASM GTF has a *Keyload* port on the front panel for the KYK-13, KYX-15 or KOI-18 Crypto Keyloaders. Verify a valid key is installed in the keyloader and SAASM receiver as follows:

*Note: The connector has spring-loaded pins and may take some force to connect. Use care when attaching the keyloader.*

- Connect the keyloader to the *Keyload* port on the front of the GTF.
- Turn on the keyloader. If using a KYK-13, verify the indicator flashes, indicating a transfer.
- Turn off the keyloader and disconnect it from the GTF.

The key is now installed in the SAASM receiver. The *CV Valid* or *CV Invalid* indicator should illuminate indicating a keyload. Once the *CV Valid* indicator is lit (it may take up to 20 minutes to validate the key), the *CV Invalid* indicator extinguishes. The GTF now operates in the P/Y mode. The key will remain in non-volatile memory until it expires or is zeroized.

*Note: If the key expires, the CV Invalid indicator will illuminate.*

This process will need to be completed on the second GTF, if present, as well.



## IMPORTANT NOTE

For 385-4102-xx GTF Modules only: In the case of KDP software in OPS Version 0.9, the SAASM receiver, after being keyed, may lose GPS lock. If this occurs, or if the CV Invalid indicator remains illuminated for more than 20 minutes, the receiver will need to be reset. The reset process is accomplished via the front panel Keypad/Display or the Serial I/O Port.

To reset the receiver a Cold Start must be performed, refer to paragraph 5.2.12 for detailed instructions. After the reset process is finished, the GTF starts normal operation. For receivers with OPS Version 1.0 or higher, this anomaly has been remedied.

### 5.2.9.1.2 Zeroizing the Receiver

The key can be erased from the receiver via the front panel of the GTF. To erase the key, press and hold the ZEROIZE button on the front of the GTF. The CV Valid indicator will extinguish, indicating the receiver is zeroized.

### 5.2.9.1.3 CV Valid/Invalid Indicators

The CV Valid and CV Invalid indicators provide the following information:

CV Valid	CV Invalid	Description
OFF	OFF	No key installed/Zeroized.
OFF	ON	Key loaded; being validated
ON	OFF	Valid key loaded
ON	ON	KDP fault

### 5.2.10 Power Up Indications

*Note: The information shown on the following LCD screens is for illustration only, and may be different in actual systems.*

When power is applied (power-up), the front panel display backlight illuminates and after the ~5 second self-test delay, a greeting message appears, followed shortly thereafter with the *Time and Status* screen. If no characters appear on the LCD screen, depress and hold down the **Cont** key until characters appear. (Refer to paragraph 7.2.3.)

```

UTC TFOM 9 Jan 06,1980 / 006:00:00:53  =
Warm-Up                               GTF 1 ONLINE

```

The above screen (Menu 1 - Screen 1, power-up default) indicates that the online receiver (GTF#1) is operating from initial power up as indicated by the date (start of

GPS Time Jan 06, 1980), the Time Figure Of Merit (TFOM) of the system's timing, and the status (*Warm-Up*).

Initially, upon power-up, both modules report that they are not ready, and are in *Warm-up* mode. At *first power-up*, the system's internal receiver(s) defaults to the *Survey* mode. In this mode the receiver begins to search the sky for available satellites, and calculate a position fix as soon as sufficient satellites are tracked.

*Note: When a system is installed in a new location, it is recommended that the user perform a Cold Start (para.5.2.12) to clear stored parameters (almanac) in the GPS receiver.*

After power-up, the receiver starts to acquire and track satellites immediately, based on satellite availability data contained in the receivers' almanac.

*Note: The Time To First Fix (TTFF) depends on the satellite visibility. When operating in the Survey mode at power-up and with many satellites visible, the receiver requires a minimum of 2 minutes and at most 30 minutes to determine the coarse antenna position (First Fix).*

When the Survey is complete the GTF automatically switches the receiver to *Known* mode. If the initial position matches the stored position to within 100 meters, the position solution reverts to the *Known* mode with the stored position.

*Note: The SAASM Receiver operates in Dynamic mode only.*

As soon as the GPS receiver acquires an initial position fix and valid time the *GPS Lock* indicator illuminates and the current time is displayed:

```
UTC TFOM 9 Nov 09,2000 / 324:21:30:15=
Warm-Up                      GTF 1 ONLINE
```

This screen indicates the date and UTC time, the Time Figure Of Merit (TFOM) of the system's timing, and the status (*Warm-Up*).

Further operation is automatic. After the GTF module's receiver has locked to the satellites and the initial oscillator warm-up (~10 minute after power-up) has taken place, the disciplining of the internal timing and frequency starts.

```
UTC TFOM 9 Nov 06,2000 / 311:21:54:28=
Recovering                    GTF 1 ONLINE
```

*Note: In some system versions "Acquire" is shown in place of "Recovering".*

After the internal timing and oscillator frequency have been adjusted sufficiently to provide accurate output signals, the *Time and Status* screen indicates the exact time, Time Figure Of Merit (TFOM), and the status Time Locked. Typical time from GPS Lock to time lock is 1½ to 2 hours. The module's front panel *Ready* indicator illuminates.

```
UTC TFOM 4 Nov 06,2000 / 311:22:03:28=
TimeLocked                GTF 1 ONLINE
```

### 5.2.11 Set Antenna Cable Delay Compensation

For the most accurate 1 PPS timing, it is necessary to compensate for the signal delay caused by the antenna system. The delay is the sum of all signal delays between the antenna and the receiver. The major contributor is the delay caused by the antenna cable length. The typical amount of error is on the order of a few hundred nanoseconds.

Delay values for recommended cable types are listed in the following table.

Table 5-7 Antenna Cable Delay Characteristics	
CABLE TYPE	DELAY VALUE
Belden® 9311 (RG-58)	4.36 ns/m (1.33 ns/ft)
Belden® 8267 (RG-213)	4.99 ns/m (1.52 ns/ft)
Belden® 9104 (RG-59)	4.00 ns/m (1.22 ns/ft)
Belden® 9913 (RG-8)	3.90 ns/m (1.19 ns/ft)

In applications where exact timing is required, calculate the antenna system cable delay by multiplying the actual cable length and the delay value from the above table.

*Note: In system configurations in which two GTF modules are installed, it is necessary to calculate and enter the cable delay compensation of each antenna system.*

For example: If the antenna system for GTF#1 (left side module) includes 50 feet of RG-59 cable and 100 feet of RG-59 for GTF#2 (right side module), then the cable delay compensation value to be entered in GTF#1 is: 50 ft x 1.22 ns/ft = 61 ns, and the value to be entered in GTF#2 is: 100 ft x 1.22 ns/ft = 122 ns.

When entering the data, round off the delay value to the nearest nanosecond.

#### 5.2.11.1 GTF#1 Antenna Cable Delay

The antenna cable delay value can be entered through the use of the front panel Keypad/Display or a serial interface command.

### 5.2.11.1.2 Serial Port Command

To set the antenna cable delay compensation for GTF#1 to 61 ns, use the serial command:

```
$ANT1,61*<cr/lf>
```

### 5.2.11.1.3 Front Panel Keypad and Display

The value of the antenna cable delay compensation can be monitored and changed through the use of the front panel Keypad/Display.

- Press key **2** until *GTF#1 Control Menu 4* screen is selected.



```
GTF#1  =  
Antenna Cable Delay: 000050 ns
```

This screen indicates that the antenna cable delay is set to 000050 ns.

- Press **Menu** to end the Antenna Cable Delay selection process, or

To alter the amount of cable delay compensation:

- Press **Edit** until *Antenna Cable Delay [0]0050* is flashing.
- Use the numeric and arrow keys to specify the desired delay compensation in nanoseconds.
- Press **Enter** to accept the new value.

### 5.2.11.1.4 GTF#2 Antenna Cable Delay

The antenna cable delay value can be entered through the use of the front panel Keypad/Display and via a serial interface command.

### 5.2.11.1.5 Serial Port Command

To set the antenna cable delay compensation for GTF#2 to 122 ns, use the serial command:

```
$ANT2,122*<cr/lf><cr/lf>
```

### 5.2.11.1.6 Front Panel Keypad and Display

The value of the cable delay compensation can be monitored and changed through the use of the front panel Keypad/Display.

- Press key **4** until *GTF#2 Control Menu 4* screen is selected.
- Repeat process outlined in GTF#1 Antenna Cable Delay process above.

### 5.2.12 Reset Internal GPS Receivers

In rare circumstances when it is suspected that the GTF module receiver's memory has been corrupted causing erroneous results or no operation at all, the receiver should be reset. Two reset modes are available: *Cold Start* and *Warm Start*.

- *Cold Start* - Forces the collection of new almanac data and ephemeris, resulting in a "search the sky" mode until sufficient data has been collected from the satellites. To complete the collection of new data requires from 12 to 30 minutes, depending on satellite visibility conditions. *Cold Start* should be performed only when necessary.

*Note: In some system versions, the Cold Start function is directly accessible through key 2 and key 4, Menu 4 (GPS Cold Start screen) in place of key 2 and key 4 Menu 2 sub-screen, as described in the following paragraphs.*

- *Warm Start* - Forces the receiver to search for, acquire, and track satellites using the current almanac data and ephemeris, position mode and antenna position data. The time required to track satellites is up to a few minutes, depending on satellite visibility.

#### 5.2.12.1.1 Reset Receiver in GTF#1

The receiver can be reset through the use of the front panel Keypad/Display and via serial interface commands.

#### 5.2.12.1.2 Serial Port Command

To set the receiver in the GTF#1 module to Cold Start, use serial interface command:

```
$RSG1,C*<cr/lf>
```

To set the receiver in the GTF#1 module to Warm Start, use serial interface command:

```
$RSG1,W*<cr/lf>
```

#### 5.2.12.1.3 Front Panel Keypad and Display

The GTF module's receiver can be Cold Started through the use of the front panel Keypad/Display. (*The receiver cannot be Warm Started through the use of the Keypad/Display.*)

To force the receiver to *Cold Start*:

- Press **Menu**.
- Press key **2** until *GTF#1 Control Menu 2* screen is selected.
- Press **Edit** to access the edit mode.



```
GTF#1
GPS Cold Start: Disabled
```

- Press **Edit**. Use the arrow keys to select **Enabled**. Press **Enter** and observe the following warning message:

```
THIS WILL RESET THE GPS RECEIVER AND
FORCE IT INTO COLD START. CONTINUE: [No ]
```

- Use the arrow keys to select **Yes**.
- Press **Enter** to force the receiver into the *Cold Start* operation mode. The screen will display the following message for five seconds:

```
Cold Starting GPS Receiver...
```

This will cause the receiver to delete its almanac and reset its latitude, longitude, and elevation. The receiver defaults to the *Survey* mode, starts the satellite search, and acquisition process, and collects a new almanac. This process can take up to 30 minutes.

#### 5.2.12.1.4 Reset Receiver in GTF#2

The GTF#2 receiver can be reset through the use of the front panel Keypad/Display and via serial interface commands in the same way as GTF#1.

#### 5.2.12.1.5 Serial Port Command

To set the receiver in the GTF#2 module to Cold Start, use serial interface command:

```
$RSG2,C*<cr/lf>
```

To set the receiver in the GTF#2 module to Warm Start, use serial interface command:

```
$RSG2,W*<cr/lf>
```

#### 5.2.12.1.6 Front Panel Keypad and Display

The GTF module's receiver can be Cold Started through the use of the front panel Keypad/Display using Menu 4. (*The receiver cannot be Warm Started through the use of the Keypad/Display*).

### 5.2.13 SAASM Receiver SRAM Memory Reset

385-4102-xx SAASM GTF's that have not been on for more than 24 hours and are going to have power removed for more than two (2) days must have their SRAM memory reset. 385-4102-xx SAASM GTF's that have been on for more than 24 hours and are going to have power removed for more than five (5) days must have their SRAM memory reset. When reset, the SAASM receiver will have the following information cleared: Crypto Key, Almanac, Ephemeris and Location.

## IMPORTANT NOTE!

For 385-4102-xx GTF Modules only: The SRAM Memory Reset command must be performed just before removing power. To ensure that information remains cleared, unit must not be left on after issuing this command.

### 5.2.13.1.1 SAASM Receiver SRAM Reset - GTF#1

#### 5.2.13.1.1.1 Serial Port Command

To reset the SRAM in the GTF #1 SAASM receiver, use serial interface command:

```
$RSG1,K*<cr/lf>
```

Remove System power.

#### 5.2.13.1.1.2 Front Panel Keypad and Display

The SRAM Memory Reset command can be performed through the use of the front panel Keypad/Display.

To achieve a SRAM Memory Reset:

- Press **Menu**.
- Press key **2** until *GTF#1 Control Menu 2* screen is selected.
- Press **Edit** to access the edit mode.

```
GTF#1                                     ≡
GPS Cold Start: Disabled
```

- Use the arrow keys to select **Clear Backup Memory**.

```
GTF#1                                     ≡
GPS Cold Start: CLEAR BACKUP MEMORY
```

- Press **Enter** and observe the following warning message:

```
THIS WILL CLEAR THE BACKUP MEMORY
& RESET THE GTF1 RECEIVER. CONTINUE: [No ]
```

- Use the arrow keys to select **Yes**.

- Press **Enter** to force the receiver into the clear memory. The screen will display the following message for five seconds:



```
Clearing Backedup Memory
& Resetting GPS Receiver...
```

This will cause the receiver to clear its backed up memory and reset it.

Remove system power.

### 5.2.13.1.2 SAASM Receiver SRAM Reset - GTF#2

#### 5.2.13.1.2.1 Serial Port Command

To reset the SRAM in the GTF #2 SAASM receiver, use serial interface command:

```
$RSG2,K*<cr/lf>
```

Remove System power.

#### 5.2.13.1.2.2 Front Panel Keypad and Display

The SRAM in the GTF #2 SAASM receiver can be reset in a similar manner as 5.2.13.1.1 with key 4 instead of key 2.

Remove System power.



### 5.2.14 Hot Start

Hot Start provides the capability for the SAASM equipped CommSync II to acquire and lock directly to the military Precise Positioning Service (PPS P/Y) GPS signal without the Coarse Acquisition (C/A) commercial GPS signal. (Refer to the GTF Hot Start Procedure Document 385-8006 for information on Hot Start instructions)

Table 5-8 PLGR Port DE-9 Connector Pin Designation		
PIN	SIGNAL	DESCRIPTION
1	GPS Receiver 1PPS In	1PPS sync input to receiver only (used during Hot Start)
2	GPS Receiver 1PPS In RTN	Signal Ground
3	Ground	Signal Ground
4 & 5	N/C	
6	GPS Receiver 1PPS Out	1PPS sync output, from receiver only (used during Hot Start)
7 - 10	N/C	
11	Ground	Signal Ground
12	N/C	
13	Serial Data Port Enable	Enables the serial port
14	Serial Data Port Out	ICD-GPS-153 Protocol output port
15	Serial Data Port In	ICD-GPS-153 Protocol input port

### 5.2.15 Set Local Time

The system's time can be expressed in UTC or GPS time, and can be adjusted for local time zone offset. The default setting is UTC without local offset.

UTC is offset from GPS time by the number of accumulated leap seconds that have occurred since midnight of January 6, 1980 UTC. When operating in the GPS (or Local GPS) time mode, the system's current output time is in referenced to GPS time. When operating in the UTC (or Local UTC) mode, the output time is referenced to UTC.

The time reference mode and local time zone offset can be changed through the use of the front panel Keypad/Display and via a serial interface command.

### 5.2.15.1.1 Serial Port Command

Set the antenna local time offset from UTC using serial command:

```
$TIMM,M,h,m*<cr/lf>
```

Example 1: \$TIMM,3,8,0\*<cr/lf>

In this command, “3” selects Local UTC time mode, with the time offset +8 hours, 0 minutes from UTC. The offset value can range from -14 hours, 30 minutes to +14 hrs, 30 minutes.

Example 2: \$TIMM,4,-12,30\*<cr/lf>

In this command, “4” selects Local GPS time mode, with the time offset -12 hours, 30 minutes from UTC. The offset value can range from -14 hours, 30 minutes to +14 hrs, 30 minutes.

Example 3: \$TIMM,2\*<cr/lf>

In this command, “2” selects UTC time mode. Offset hours/minutes offset fields do not need to be selected; if they are selected, the hours/minutes data is ignored.

Example 4: \$TIMM,1\*<cr/lf>

In this command, “1” selects GPS time mode. Offset hours/minutes offset fields do not need to be selected; if they are selected, the hours/minutes data is ignored.

Daylight Saving Time – Automatic Daylight Saving Time is not implemented in the CommSync II. When the system is configured to display Local UTC or Local GPS time, the local time offset must be changed by the user to compensate for Daylight Saving Time.

### 5.2.15.1.2 Front Panel Keypad and Display

*Note: For systems with HaveQuick, IRIG, or NTP time outputs – these outputs are in UTC time mode. The \$TIME command does not affect these outputs, but does affect the \$TIME message output and the time displayed on the front panel display.*

The value of the local time zone offset can be monitored and changed through the use of the front panel Keypad/Display.

- Press key 1 until *Time and Status* Menu 2 screen is selected.

A screenshot of the front panel display showing the text "LOCAL TIME-ZONE OFFSET: +00.00 =" inside a rectangular border.

This screen indicates that the Local Time Zone Offset is +00.00 hours.

To alter the offset value:

- Press **Edit** and observe **[+]**0:00 is flashing.
- Press the arrow keys to select the offset polarity (+ or –), then press **Enter**.
- Press the arrow keys to select the hours offset, then press **Enter**.
- Press the arrow keys to select the minute offset (0 or 30), then press **Enter**.

*Note: The offset is now entered, but will not be used unless the Time mode is set to local mode: LGPS or LUTC. Refer to paragraph 7.4.2.1.3 for mode selection instructions.*

### 5.2.16 Select GTF Discipline Source Mode

In a system equipped with a GTF module that is configured for external sync input operation (385-4000 or 385-4100), the discipline reference for the module can be selected to be the 1 PPS from the module's GPS receiver, or a 1PPS signal from an external source connected to the "**Sync Input**" port, or a 1PPS from an External Input module (refer to paragraph 6.2.9.1.4 for external input configuration information). The selected source can be fixed or can be set to automatically switch from GPS 1 PPS to the external input in the event the GPS 1 PPS source is not usable. The factory default selection is GPS. The source selection is non-volatile.

#### 5.2.16.1.1 GTF#1 Discipline Reference

The Discipline Source mode can be selected through the use of the front panel controls and via a serial interface command.

#### 5.2.16.1.2 Serial Port Command

Select the Discipline Source mode for GTF#1 using serial command:

```
$DIS1,N*<cr/lf>
```

In this command "N" is the Discipline Source mode as follows:

G = GPS 1 PPS Only; E = External Source; S = Switch Mode.

*Note: In the Switch mode, the GPS 1 PPS is the default source. When the GPS 1 PPS is not available or is lost during operation, then the module automatically switches to the external source if the external input signal is present. If not, the module starts to operate in the Coasting mode. When the GPS 1 PPS becomes available again, the module automatically switches to the GPS 1 PPS source.*

### 5.2.16.1.3 Front Panel Keypad and Display

The GTF module's Discipline Source mode can be selected through the use of the front panel Keypad/Display.

- Press key **3** until *Frequency Discipline Status 1* screen is selected.

```
GTF#1 TimeLocked FDM Mode:11
Time Difference:-000000032 ns DAC:31264
```

To view/select the Discipline Source mode:

- Press **Edit**.

```
GTF#1 External Sync Type:1 PPS
Sync Source Type: GPS Only
```

- Use the arrow keys until the desired Discipline Source mode (**GPS Only**, **External Only**, or **Switch Mode** is flashing.
- Press **Menu** to exit the edit mode without any selection change, or
- Press **Enter** to accept the selected Discipline Source mode.

### 5.2.16.1.4 GTF#2 Discipline Reference

The Discipline Source mode can be selected through the use of the front panel controls and via a serial interface command in the same way that GTF#1 is selected.

### 5.2.16.1.5 Serial Port Command

Select the Discipline Source mode for GTF#1 using serial command:

```
$DIS2,N*<cr/lf>
```

### 5.2.16.1.6 Front Panel Keypad and Display

The GTF module's Discipline Source mode can be selected through the use of the front panel Keypad/Display via Menu 5. Refer to GTF#1 instructions for reference.

---

## **6 Distribution Timing and Frequency Systems**

- 6.1 Details of DTF Operation 62
  - 6.1.1 Description 62
  - 6.1.2 Typical Distribution System (Block Diagram) 62
  - 6.1.3 DTF (Distribution Time/Frequency) Modules 64
  - 6.1.4 System Monitor/Control and External Input (slots 15 and 14 only) 64
- 6.2 Getting Started 65
  - 6.2.1 Introduction 65
  - 6.2.2 Preparing For Use 65
  - 6.2.3 Overview 66
  - 6.2.4 The External Reference Source 66
  - 6.2.5 Connecting the External Reference Source to the system 67
  - 6.2.6 Connecting Power 67
  - 6.2.7 Connecting I/O 68
  - 6.2.8 Applying Power 68
  - 6.2.9 Configuring Discipline Reference Mode 69
  - 6.2.10 Setting Time in a DTF system 72

## 6.1 Details of DTF Operation

### 6.1.1 Description

The CommSync II system (with GTF modules) is designed as a primary reference source (PRS), to provide highly accurate timing and frequency output signals, synchronized to Coordinated Universal Time (UTC) through the Global Positioning System (GPS).

The CommSync II Distribution system is designed to augment the CommSync II family providing highly accurate timing and frequency output signals, synchronized to an external frequency source (1 MHz, 5 MHz, or 10 MHz) or 1 PPS. A CommSync II would be an ideal source providing either 1 PPS, frequency (Sine or Square wave) or Fiber-Optic frequency source.

*Note: The CommSync II (PRS) 1 PPS output is normally aligned with the GPS reference. While locked to the external reference the DTF module's output signals and the system's time are synchronized to the external 1 PPS, or the divided output from the external frequency input.*

### 6.1.2 Typical Distribution System (Block Diagram)

A simple Distribution system would include one DTF module and an I/O external input module.

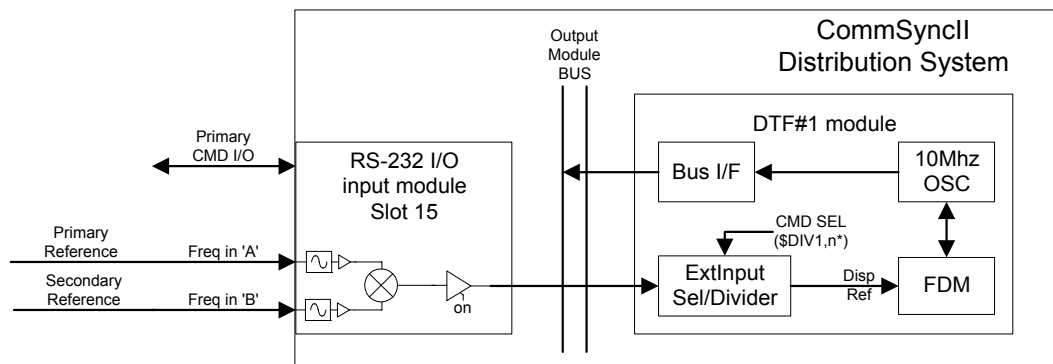

Figure 6-1 Distribution System Block Diagram

A Redundant (fully configured) Distribution system would include two DTF modules and two I/O external input modules.

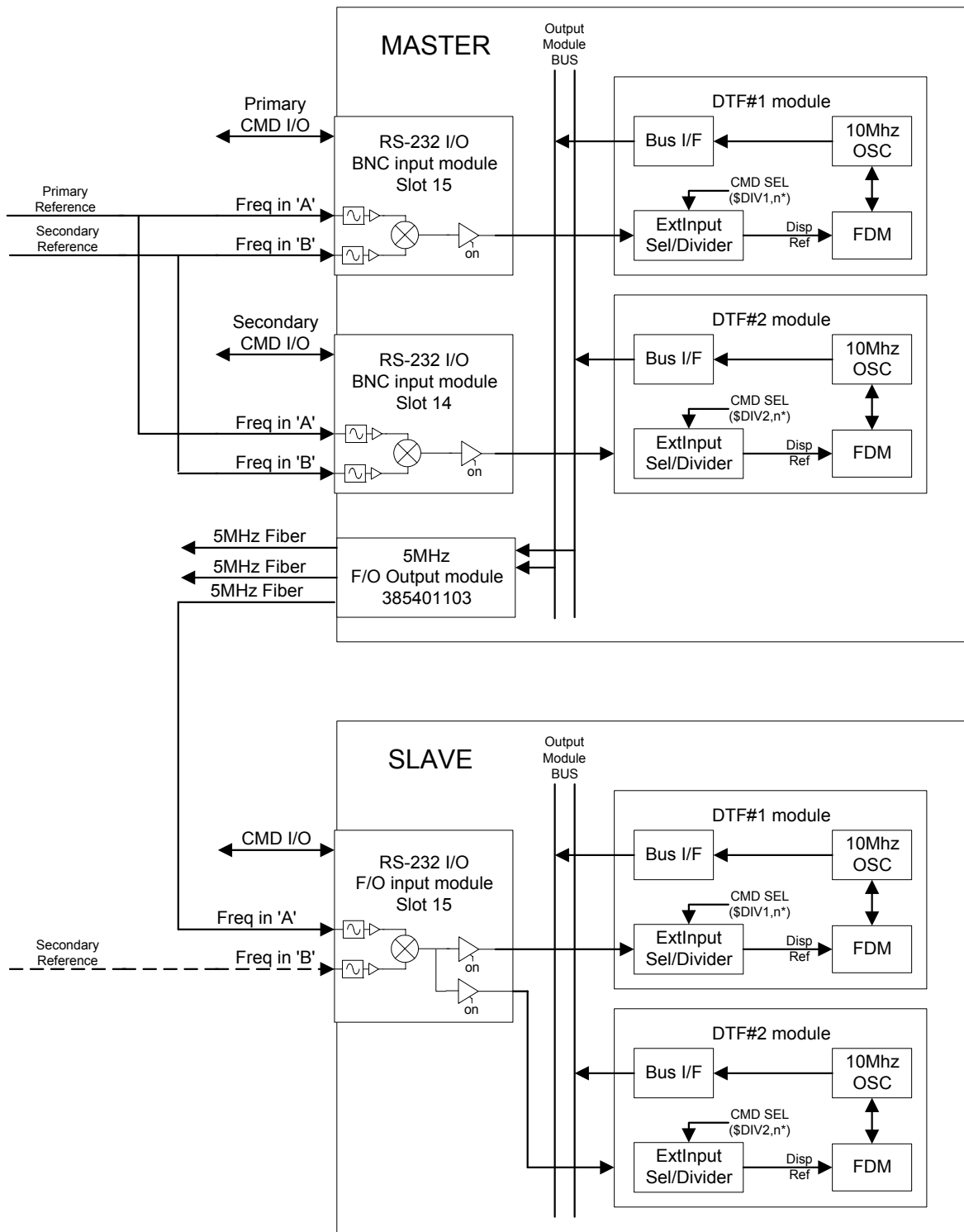

Figure 6-2 DTF System Functional Diagram

### **6.1.3 DTF (Distribution Time/Frequency) Modules**

Each DTF module contains a self-contained Frequency Discipline Machine (FDM), consisting of an ultra-stable oscillator (either rubidium or oven-controlled crystal), a external input frequency divider, along with a Microprocessor Controller and bus interface drivers.

### **6.1.4 System Monitor/Control and External Input (slots 15 and 14 only)**

The DTF system can be configured with an optional external input module(s) each of which provide two external (A and B) reference input ports and, in most cases, an additional communication path to the system's microprocessor, for external input module options refer to Table 4-4.

The reference input ports accept a wide range of signal levels. An input switch monitors each input (presence detector) and automatically switches from the A input to the B input in event of a failure of the A input. The RS-232 I/O External Input module includes an optional lock input (from an external oscillator lock indicator) that can also control the input switch.

For communication, the I/O module in slot 15 is the primary module and will communicate directly with the online GTF. The I/O module (if installed) in slot 14 is the secondary module and will communicate with the offline DTF. In a non-redundant system configuration (only one DTF module installed), the I/O module must be installed in slot 15.

For external synchronization inputs, each input (A/B) on the external input module will accept a wide range of input levels. The input switch monitors each input (presence detector) and will automatically switch to the B input in event of a failure. The external input module can be configured to provide various external sync input options to one or both of the DTFs in the system.

### **6.1.5 Combination Systems (GTF/DTF)**

For systems with a combination of a GTF (typically in slot #1) and a DTF (slot #2), the DTF may be set up with an external reference input (see DTF description) or may be setup to be cross-disciplined by the GTF module 1 PPS output. In a combination system the DTF time is automatically set by the GTF (when locked to GPS).

The Discipline Source mode can be selected through the use of the front panel controls and via a serial interface command.



## 6.2 Getting Started

### 6.2.1 Introduction

This section contains the step-by-step procedures to place a DTF-based system into operation. For GTF-based systems, refer to paragraph 5.2.

### 6.2.2 Preparing For Use

Install the instrument into the equipment cabinet (rack) as follows:

- Set the rear panel power switch, if supplied, to the OFF position.
- Place the instrument in the desired cabinet (rack) location.

#### **WARNING!**

*Always locate heavy equipment towards the bottom of the cabinet (rack) to avoid accidental tip-over of the cabinet (rack).*

*Make certain the maximum operating ambient temperature does not exceed 55° C.*

*Never restrict the airflow through the instrument's vents, located on the top and bottom of the instrument.*

- Fasten the rack-mount brackets to the equipment cabinet (rack).
- Prior to use, the instrument must be connected to an AC or DC power source. It is recommended that it be connected to a compatible serial interface.
- If the instrument is configured to operate from an AC power source, pay special attention to the following:
  - *Connect the instrument only to a properly rated supply circuit.*
  - *The supplied 3-prong power cord provides safety grounding. Do not defeat this feature. The user must comply with all applicable national and local electrical regulations regarding grounding and safety.*
  - In order to receive System Status messages or send serial commands, it is recommended that the instrument be connected to a compatible serial interface. Refer to paragraph 6.2.7 for I/O connection details.

### 6.2.3 Overview

The following table is the recommended start-up process and associated paragraphs:

Table 6-1 Start-up Process – Distribution Timing and Frequency Systems	
Process	Page
1. Connect Power	67 para. 6.2.6
2. Connect I/O	67 para. 6.2.7
3. Connect External Reference Source	66 para. 6.2.4
4. Connect Outputs	385-8003*
5. Apply Power	68 para. 6.2.8
9. Configure Discipline Reference mode	69 para. 6.2.9
10. Set Manual Time (if desired)	72 para. 6.2.10
11. Configure Option Modules (as required)	385-8003*

\*Refer to Option Module User's Manual, 385-8003, for specific input/output module descriptions.

### 6.2.4 The External Reference Source

The CommSync II Distribution System utilizes one several input modules:

#### 6.2.4.1 385-4037-xx RS-232 I/O External Input Modules

The 385-4037-01 modules offer an RS232 I/O system control port and direct-coupled TTL inputs (1 PPS, or 1, 5, or 10 MHz), or AC coupled sine wave inputs (1, 5, or 10 MHz) through BNC connectors. (See 385-8003 for further information.)

The 385-4037-02 modules offer the RS232 I/O port and fiber optic (1, 5, or 10 MHz 850 nm Square Wave) inputs.

The 385-4037-xx modules offer a lock input to qualify the source input. Refer to Option Module User's Manual, 385-8003, for specific information on use of the lock input.

#### 6.2.4.2 385-4038-xx Ethernet I/O External Input Modules

The 385-4038-02 modules offer a 10/100BaseT Ethernet I/O system control port and direct-coupled TTL inputs (1 PPS, or 1, 5, or 10 MHz), or AC coupled sine wave inputs

The 385-4038-03 modules offer the 10/100BaseT Ethernet port and fiber optic (1, 5, or 10 MHz 850 nm Square Wave) inputs. (See 385-8003 for further information.)

### 6.2.4.3 385-4090-xx Dual Port Ethernet I/O External Input Modules

The 385-4090-02 modules offer a 10/100BaseT Ethernet I/O system control port and direct-coupled TTL inputs (1 PPS, or 1, 5, or 10 MHz), or AC coupled sine wave inputs

The 385-4090-03 modules offer the 10/100BaseT Ethernet port and fiber optic (1, 5, or 10 MHz 850 nm Square Wave) inputs. (See 385-8003 for further information.)

### 6.2.4.4 385-4040-xx Time Code Input External Input Modules

The 385-4040-01, Time Code Input module will accept an IRIG-B time input, and direct-coupled TTL inputs (1 PPS, or 1, 5, or 10 MHz), or AC coupled sine wave inputs (1, 5, or 10 MHz) through BNC connectors. (See 385-8003 for further information.)

The Time Code Input module accepts IRIG on the “**IRIG A**” or “**B**” input. This input will set the time for the DTF. The module can also be commanded to supply a derived 1 PPS from the IRIG input as an external sync source for the DTF system.

### 6.2.5 Connecting the External Reference Source to the system

Refer to Figure 6-2. Synchronization frequency inputs can be applied to the “**EXT SYNC A**” input, the “**B**” input, or both inputs on the external input module. The only consideration is that both inputs on one module should be the same frequency. The module can then be configured to auto select (A priority) or “**A**” or “**B**”. Connect the BNC or fiber optic input to the desired connector on the I/O external input module.

At initial power-up the DTF modules and the external input module must be configured for proper operation.

### 6.2.6 Connecting Power

There are five Power Supply module options available for the CommSync II resulting in the following groupings of connector types:

- Standard AC input (refer to Figure 5-1 and paragraph 10.2).
- 24 VDC and 48 VDC inputs ( refer to Figure 5-2 and paragraph 10.3).
- 12 VDC input (refer to Figure 5-3 and paragraph 10.4).
- 28 VDC input (refer to Figure 5-4, Table 5-4 and paragraph 10.5).

### 6.2.7 Connecting I/O

The CommSync II comes with a standard RS-232 port on the GTF module's front (refer to Figure 6-3 for RS-232 Interconnect Diagrams). There are additional I/O options available, including several RS-232 and Ethernet I/O option modules versions. Refer to the Option Module User's Manual, 385-8003, for additional information on these option modules.

The standard RS-232 port uses a DE-9 female connector with the following pin out:

Table 6-2 RS-232 Port DE-9 Connector Pin Designation		
PIN	SIGNAL	DESCRIPTION
2	OUTPUT (TXD)	RS-232 OUTPUT
3	INPUT (RXD)	RS-232 INPUT
5	RTN	Signal Ground

*Note: The required mating connector is a 9-contact male "D-Subminiature" connector.*

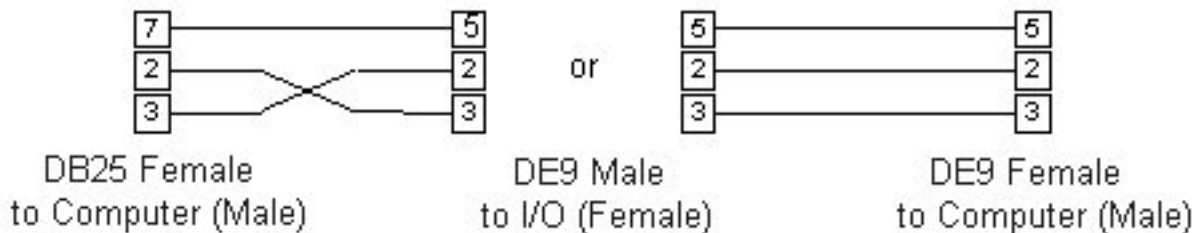

Figure 6-3 RS-232 Interconnect Diagrams

### 6.2.8 Applying Power

Mount the system in the desired location, such as an equipment cabinet. Verify that the input reference source and the input power sources are connected. Apply power to the system. When power is applied the following sequence of events takes place:

- After a moment, the system runs through its self-test diagnostics, and is waiting for a firmware download command. During this time the *Ready* indicator flashes and the *Alarm/Fault* indicator is illuminated (~5 sec).
- After the completion of the self-test, the *Power* indicators on the DTF modules will illuminate and the DTF#1 *On Line* indicator will illuminate.
- When the external input is verified (presence of signal), the DTF modules *Ext Sync In* indicator illuminates.

During Warm-Up the *Alarm/Fault* indicator flashes (*Warm-Up* mode).

*Note: The information shown on the following LCD screens is for illustration only, and may be different in actual systems.*



Figure 6-4 Commsync II Front Panel Port and Indicator Locations – DTF Systems

When power is applied (power-up), the front panel display back-light illuminates and after the ~5 second self test delay, a greeting message appears, followed shortly thereafter with the *Time and Status* screen. If no characters appear on the LCD screen, depress and hold down the **Cont** key until characters appear.

```

RUN  TFOM 9          / 000:00:00:01≡
External 5MHz Warm-Up      DTF 1 ONLINE

```

The above screen (Menu 1 - Screen 1, power-up default) indicates that the online module (DTF#1) is starting as indicated by the *RUN* mode (the time reported is the running time clock). The Time Figure Of Merit (TFOM) is an indication of the frequency accuracy (as referenced to the external input), and the status (*Warm-Up*).

### 6.2.9 Configuring Discipline Reference Mode

The DTF modules and the external input modules must be configured to the user's desired operation. This configuration includes the frequency divider for the DTF as well as the optional outputs for the external input module(s). This configuration is stored in the DTF modules and should not need to be repeated once the initial setup is completed. The system will power up with the settings from the factory and may be changed by the user as required.

### 6.2.9.1.1 DTF Input Configuration

The external reference type (1 PPS, or frequency) for each DTF module is selected through the use of the front panel controls or via a serial interface command,

### 6.2.9.1.2 Serial Interface

The DTF module's Discipline Source mode can be selected through the use of the serial interface commands.

The following command is used to set the DTF for the expected frequency input:

```
$DIV#,N*<cr||f>
```

where # is the DTF being set (DTF1 or DTF2) and N = 0 for 1 PPS, 1 for 1 MHz, 2 for 5 MHz, or 3 for 10 MHz. (refer to the 385-8002 Serial Communications Protocol document for more information.)

The command will need to be sent to DTF#1 (\$DIV1,N\*) and DTF#2 (\$DIV2,N\*).

### 6.2.9.1.3 Front Panel Keypad and Display

The DTF module's Discipline Source mode can be selected through the use of the front panel Keypad/Display.

- Press key **3** until *Frequency Discipline Status 1* screen is selected.

```
DTF#1 EXT-5MHz Warm-Up      FDM Mode: 2 ≡
Time Difference:-000001932 ns  DAC:31264
```

To view/select the Discipline Source mode:

- Press **Edit**.

```
DTF#2 External Sync Type:5 MHz      ≡
Sync Source Type: External Only
```

- Use the arrow keys until the desired reference mode (**1PPS, 1MHz, 5MHz, 10MHz**) is selected.
- Press **Menu** to exit the edit mode without any selection change, or
- Press **Enter** to accept the Sync Type and advance to the next setting.
- Use the Arrow key to select "External Only".
- Press **Enter** to accept the selected Discipline Source mode.

*Note: "Cross-Discipline" mode is for GTF/DTF combination systems (refer to paragraph 6.1.5).*

Further operation is automatic. After the DTF modules have an external reference input, the disciplining of the internal timing and frequency starts.

#### 6.2.9.1.4 External Input Module Configuration

Once set, the I/O external input module(s) settings are stored in non-volatile memory in the DTF modules. At initial power-up, the input modules should be reconfigured via the front panel Keypad/Display or the serial interface to meet the user's system requirements. The following parameters must be observed for setting this configuration:

Only one sync input is allowed to each DTF. Either the Primary or the Secondary module may provide the sync input, but not both.

- They may be configured to have Slot 15 drive BOTH, in which case Slot 14 must drive NONE.
- They may be configured to have Slot 15 drive DTF#1 and Slot 14 drive DTF#2 (or vice versa).
- They may be configured to have Slot 14 drive BOTH, in which case Slot 15 must drive NONE.

If a single I/O external input module is to provide the sync frequency to both DTF's, it should be installed in Slot 15 and be set for BOTH.

Configuration of this module will include determining which input to the module will be used to drive the DTF, which module will drive which DTF, and handling of the optional external LOCK input.

#### 6.2.9.1.5 Serial Interface commands

The I/O external input module can be configured using the serial interface.

The following command is used to configure the module:

```
$INPC,b,p,r,o*<cr|lf>
```

Where:

- b selects which Input Module is being configured (0 = Primary, 1 = Secondary).
- p selects A, B, Auto or IRIG (0 = Auto, 1 = A, 2 = B, 3 = IRIG\*).
- r selects sync input routing (0 = None, 1 = DTF#1, 2 = DTF#2, 3 = Both).
- o determines the handling of the LOCK input (0 = Override both, 1 = Enable A Lock, 2 = Enable B Lock, 3 = enable both A and B Lock inputs).

*\*Note: Selection 3 only applies to systems equipped with a Time Code Input module (3854040XX). It should also be noted that disciplining to an IRIG signal may cause a severe degradation of system accuracy.*

It will be necessary to send commands to configure both the Primary Control and the Secondary Control (if installed).

Note that the LOCK input function is optional. Configuration of this function is only available through serial command. If not configured, the default is to override this input. (Refer to the Serial Command Protocol Document 385-8002 for information on commands.)

### 6.2.9.1.6 Front Panel and Display

Menu 7 - Screen 1 is used to set the I/O external input module configuration. Menu 7 - Screen 1 is for the primary control (Slot 15), and Menu 7 - Screen 2 is for the secondary control (Slot 14).

Primary CTL (Slot 15)	Ext In: 10MHz=
Input: AUTO To: BOTH	Status: 0x1A

To configure the module, press **Edit**.

- Set the Input to AUTO (allows the module to select between A or B), A, B, or IRIG\*.
- Set to BOTH (sends sync input to both DTF's), DTF#1, DTF#2, or NONE.
- Repeat for Secondary Control if installed.

*\*Note: Selection 3 only applies to systems equipped with a Time Code Input module (3854040XX). It should also be noted that disciplining to an IRIG signal may cause a sever degradation of system accuracy.*

If the external reference input is applied and the module is configured properly, the DTF *Ext Sync In* indicator will illuminate, indicating that the DTF is receiving the input signal.

*Note: Typical time from applying the external reference to reference lock (Ready indicator illuminates) is 1½ to 2 hours*

### 6.2.10 Setting Time in a DTF system

The DTF default time mode is RUN time. The Time displayed on Menu 1 is the time (days, hours, minutes, and seconds) that the DTF system has been in operation - in many cases this is sufficient.

If time output is desired, time can be set either by manual time entry or with the optional Time Code Input module(385-4040-xx) via an IRIG-B time signal.



### 6.2.10.1.1 Manual Time Mode

*Note: In Manual Time mode the time provided is only as accurate as the time entered and should not be considered a primary reference source for time. If a primary reference source for time is needed, use a GTF-based system.*

Manual time is set through serial interface commands or the front panel. (Refer to the Serial Command Protocol Document 385-8002 for information on commands.)

### 6.2.10.1.2 Serial Interface

To set the Manual Time mode, send the following:

```
$MANM,n,Y,M,D,h,m,s*<cr|lf>
```

#### Where:

- n selects manual time (0 = off, 1 = on).
- Y is the four-digit year.
- M is the current month.
- D is the day of the month.
- h is the hour on a 24-hour basis.
- m is the minutes.
- s is seconds.

When the *Manual Time* mode is set to 1, both DTF's will assume the time entered in the command and keep time based on the starting point entered.

*Note: Prior to setting into Manual Time mode, the DTF provides a Run Time display, indicating the amount of time the DTF has been powered. Once Manual Time is started, the run time indication is no longer available. The only way to return to run time is to recycle power to the system.*

### 6.2.10.1.3 Front Panel Keypad and Display

To change to Manual mode:

- Press key **1** to select *Time and Status Menu 1 Screen 1*.
- Press **Edit** to enable the edit mode.
- Press the arrow keys until the manual mode (MAN) is flashing.
- Press **Enter** to accept the selected reference, or Press **Menu** to exit.
- In MAN mode, the time will also need to be set. After Manual mode has been selected, press **Enter** and the cursor will advance to the year field. Use the arrow and number keys to enter year.
- Press **Enter** and the cursor will advance to the month field. Use the arrow keys to select month.
- Press **Enter** and the cursor will advance to the day of month field. Use the arrow and number keys to enter day of month.
- Press **Enter** and the cursor will advance to the hour field. Use the arrow and number keys to enter hour.
- Press **Enter** and the cursor will advance to the minute field. Use the arrow and number keys to enter minutes.
- Press **Enter** and the cursor will advance to the second field. Use the arrow and number keys to enter seconds.
- Press **Enter** to accept changes and to exit edit mode.

#### 6.2.10.1.4 IRIG-B Input Time Mode

*Note: This section is only applicable for systems with a Time Code Input module Installed.*

The Time Code Input module (385-4040-xx) has connections for IRIG-B input (time information), and connections for external synchronization input. This module accepts IRIG on the “**IRIG A**” or “**B**” input and is used to set the time in the DTF module. The Time Code Input module is configured from the factory for IRIG-B AM (amplitude modulated) time code on both inputs. (See the 385-8003 Option module manual for additional information on module set-up). The “**A**” and “**B**” inputs are auto selectable (A priority), but may be set for manual selection. The synchronization input signals are used to discipline the DTF.

The Time Code Input module compares the DTF time with the IRIG time and automatically sets and updates the time in the DTF system. This takes approximately 2 minutes after power-up. The Time mode on the front panel will change from RUN to IRIG indicating that the time has been accepted by both DTF modules in a redundant system

*Note: Prior to setting IRIG Time mode, the DTF provides a Run Time display, indicating the amount of time the DTF has been powered. Once IRIG Time is set, the run time indication is no longer available.*

#### 6.2.11 Cross-Discipline Mode, combination GTF/DTF systems

The typical combination system would consist of a GTF (disciplined by GPS) in Slot #1, and a DTF in Slot #2. For this type of system the DTF can be setup to be cross-disciplined by the GTF module’s 1 PPS output, or by an external reference.

The Discipline Source mode can be selected through the serial interface command or the front panel controls.

##### 6.2.11.1.1 Serial Port Command

The Discipline Source mode for the DTF (slot #2) may be setup using the following command:

```
$DIS2,N*<cr/lf>
```

In this command “N” is the Discipline Source mode as follows:

E = External Source; X = Cross-Discipline mode (the GTF module in slot #1).

*Note: In the External mode, the DTF is disciplined by the external reference (refer to paragraphs 6.2.4 and 6.2.5 for external input information). In Cross-Discipline mode, the reference for the DTF is the GTF 1 PPS reference and will remain so as long as the GTF is Time Locked. However, if the GTF losses lock the DTF module will operate in the Coasting mode. Once the GTF reacquires Time Lock, the DTF module will automatically enter Recovery mode and lock to the GTF 1 PPS source.*

### 6.2.11.1.2 Front Panel Keypad and Display

DTF module's (slot #2) Discipline Source mode can be selected through the use of the front panel Keypad//Display.

- Press key **5** until *Frequency Discipline Status 1* screen is selected.

```
GTF#2 Cros-Disp FreqLocked FDM Mode:11 ≡  
Time Difference:-000000032 ns DAC:31264
```

To view/select the Discipline Source mode:

- Press **EDIT**.

```
DTF#2 External Sync Type: 1 PPS ≡  
Sync Source Type: Cross-Disc
```

- Use the arrow keys until the desired External Sync Type (**1 PPS** for Cross-Discipline).
- Press **Menu** to exit the edit mode without any selection change, or Press **Enter** to accept the selected Discipline Source mode.
- Use the arrow keys until the desired Discipline Source mode (External Only, or Cross-Disc).
- Press **Menu** to exit the edit mode without any selection change, or Press **Enter** to accept the selected Discipline Source mode.

---

## **7 Display Menus and Controls**

- 7.1 Introduction 78
- 7.2 Front Panel General Description 78
  - 7.2.1 LCD Module Screen 78
  - 7.2.2 Display Cursor 78
  - 7.2.3 Display Contrast Adjustment 78
  - 7.2.4 Keypad 79
- 7.3 Menu/Display Overview 79
- 7.4 Screen Descriptions 79
  - 7.4.1 MENU 0 – Fault/Alarm Status Screens 81
  - 7.4.2 MENU 1 - Time and Status 81
  - 7.4.3 MENU 2, and MENU 4 – GTF GPS Control 84
  - 7.4.4 MENU 3 and MENU 5 – GTF Module Frequency Discipline Status 87
  - 7.4.5 MENU 6 91
  - 7.4.6 MENU 7 – Input Control Menu 91
  - 7.4.7 MENU 8 – Output Module Menu 93
  - 7.4.8 MENU 9 - Maintenance 94

## 7.1 Introduction

This section provides a description of the CommSync II system's front panel module's menu and control functions that are accessible using the front panel keypad and are displayed on the front panel LCD module (Liquid Crystal Display) via various menus and screens.

## 7.2 Front Panel General Description

The front panel contains the LCD module, keypad, and display contrast adjustment control.

### 7.2.1 LCD Module Screen

The LCD module screen provides information to the user with 2 lines of 40 characters. Several different sets of screen information can be displayed. Screen displays can also be menus, permitting the user to access other screens, non-editable screens that display information only, or screens with active data fields that can be changed by the user.

A representative screen is the *Time and Status* Menu 1 of 3 display as shown below:

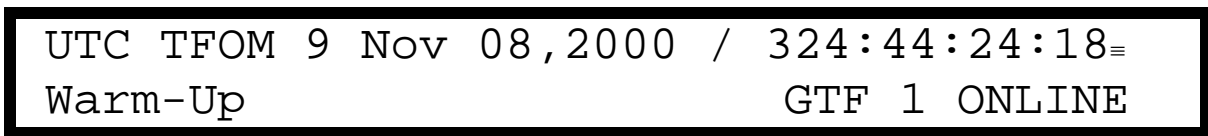

```
UTC TFOM 9 Nov 08,2000 / 324:44:24:18=  
Warm-Up GTF 1 ONLINE
```

### 7.2.2 Display Cursor

When a screen parameter is editable, a flashing cursor highlights the display character located at the cursor position. This parameter is changeable by the user.

### 7.2.3 Display Contrast Adjustment

Pressing front panel **Cont** key, located at the lower right of the keypad, allows the user to optimize the contrast and viewing angle of the displayed text. It may be necessary to depress the key for several seconds in order to notice any changes. Releasing the key for a couple of seconds and then depressing it again causes the adjustment direction of the viewing angle to reverse. Repetitive pressing of the key moves the viewing angle in the same direction. The last setting is retained in non-volatile memory, and only needs to be changed when gross changes in ambient temperature occur.

### 7.2.4 Keypad

In addition to the **Cont** key the keypad has 15 momentary action keys, consisting of ten numeric keys and five control keys - **Left** (◀) and **Right** (▶) **arrow** keys, **Edit**, **Menu**, and **Enter**. The keys are located below the LCD module and serve the following functions:

- The number keys are used for menu selection and data entry.
- The **Left** and **Right arrow** keys are used during data entry. Pressing these keys moves the flashing cursor right or left to select the parameter to be modified.
- The **Edit** key is used to access any available sub-screens of the currently displayed screen and activate the screen editor. It can also be used to move to the next available data field without modifying the current data field.
- The **Menu** key, when pressed, allows viewing of the active menu screen title and number. When pressed during an edit operation, the operation is automatically exited.
- The **Enter** key is used to load the currently entered data or parameters and move to the next available data field (if any).

### 7.3 Menu/Display Overview

The user selects the desired menu screen using the number keys. After being selected, the menu screen initially only displays information. The user can alter the displayed information (if allowed) by pressing the **Edit** key. Once the editor is activated, the user may select a data or selection field, enter new data or change selection, and press the **Enter** key to load the new data/selection. Sub-menu screens appear as appropriate if additional related parameters exist for the entry being edited.

If the **Edit** or **Menu** key is pressed instead of the **Enter** key, the original information or selection for that field will be retained. The display reverts back to the information only (non-editable) screen after data for the last field of a screen or sub-screen has been accepted with the **Enter** key. This allows the operator to verify the changes that were entered.

Most displayed data and status can be queried and set through the serial I/O port(s). The commands are contained in FEI-Zyfer Serial Communications Protocol document 385-8002.

Figure 7-1 Menu Tree is included to provide a quick overview of the display menus that can be accessed through the number keys.

### 7.4 Screen Descriptions

The remainder of this section describes the information displayed on each of the menu screens and how the user can change operating parameters.

Note: This information is for the current version of the front panel Keypad/Display. Other versions may vary.

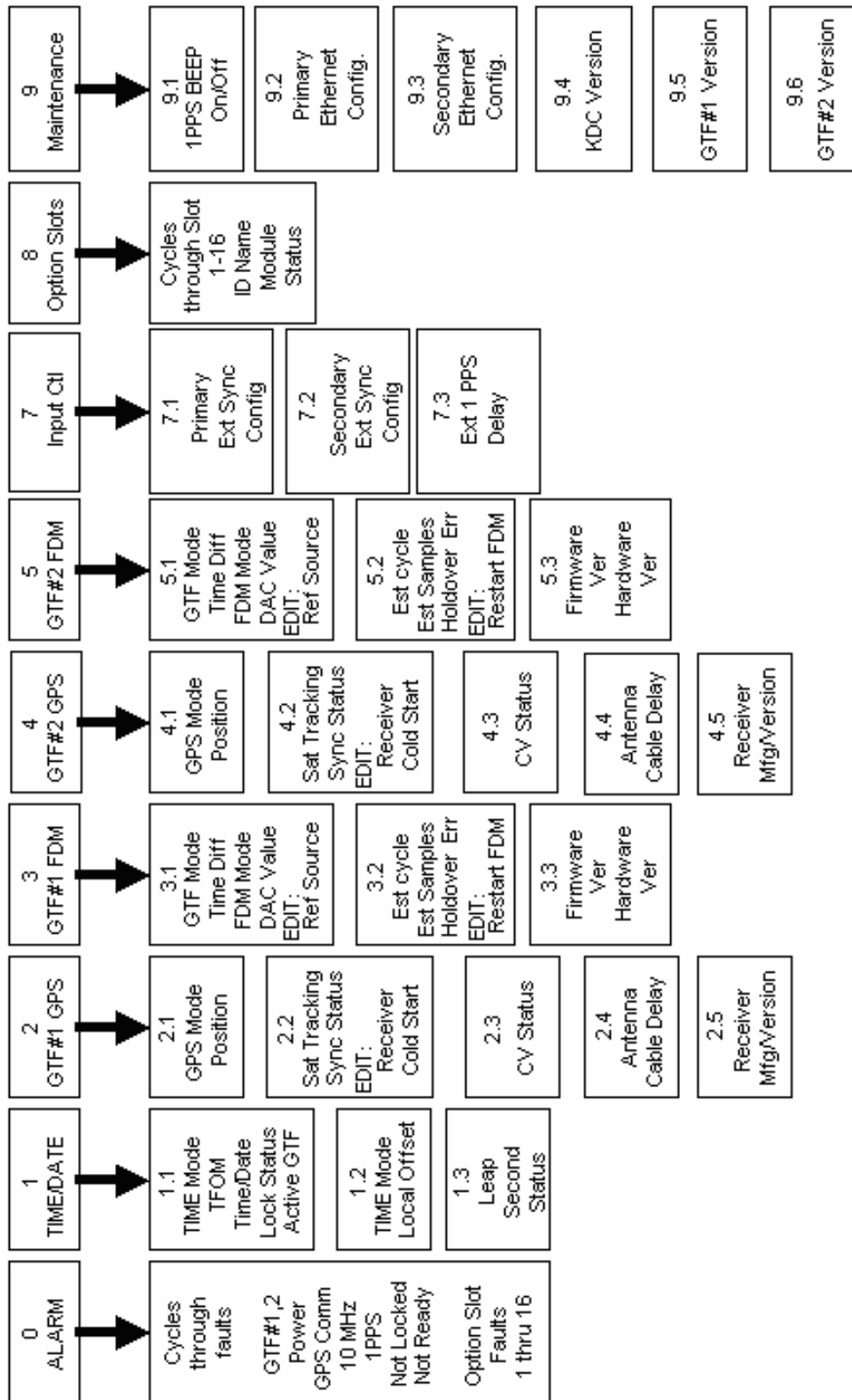

Figure 7-1 Menu Tree



### 7.4.1 MENU 0 – Fault/Alarm Status Screens

This menu screen cycles through the alarms and or faults within the system, including the output option module faults.

Press key **0** to select the *Alarm* Menu 0 screen.

When system is working under normal conditions the display should be as follows:

```
System
No Faults
```

The following is a typical display of an alarm condition. This particular alarm will be displayed when the GTF module's internal +5 or +12VDC power is out of tolerance (refer to Table 9-3 Evaluating Menu 0, for other alarm conditions):

```
GTF Fault
Power Fault Detected
```

### 7.4.2 MENU 1 - Time and Status

There are three screens associated with Menu 1. Sub-screens 1 and 2 of this menu allow the user to change some operating parameters.

#### 7.4.2.1.1 Time Reference and Online GTF Module Selection (Menu 1 - Screen 1)

- Press key **1** to select *Time and Status* Menu 1 screen. This screen displays the current general operating status of the system:

```
UTC TFOM 9 Nov 08, 2000 / 324:44:24:18
Time Locked
```

- **Time Reference** GPS, UTC, LGPS, or LUTC.
- **Accuracy** (Time Figure of Merit - TFOM) of timing output.
- **Current date and time.**
- **Discipline Reference Source:** External 1 PPS (if applicable).
- **Status:** *Warm-Up*, *Recovering (Acquire)*, *Time Locked*, and *Coasting*.

#### 7.4.2.1.2 Time Reference Mode Selection

The system's online GTF module's receiver provides the time and date. The system Time Reference mode and the online GTF module can be changed with this menu. The time and date can be referenced to UTC, GPS, local UTC, or local GPS time (Local Time Zone offset applied). To change Time Reference and/or active (online) GTF module:

#### 7.4.2.1.3 Generic Mode Selection

- Press key **1** to select *Time and Status* Menu 1 Screen 1.
- Press **Edit** to enable the edit mode.
- Press the arrow keys until the desired Time Reference (GPS, UTC, LUTC, or LGPS) is flashing.
- Press **Enter** to accept the selected reference, or Press **Menu** to exit.

#### 7.4.2.1.4 Manual Mode Selection

Time can also be set to Manual Time mode (MAN). Note that In Manual Time mode the time provided is only as accurate as the time entered.

To change to Manual mode:

- Press key **1** to select *Time and Status* Menu 1 Screen 1.
- Press **Edit** to enable the edit mode.
- Press the arrow keys until the manual mode (*MAN*) is flashing.
- Press **Enter** to accept the selected reference, or Press **Menu** to exit.
- In *MAN* mode, the time will also need to be set. After Manual mode has been selected, press **Enter** and the cursor will advance to the year field. Use the arrow and number keys to enter year.
- Press **Enter** and the cursor will advance to the month field. Use the arrow keys to select month.
- Press **Enter** and the cursor will advance to the day of month field. Use the arrow and number keys to enter day of month.
- Press **Enter** and the cursor will advance to the hour field. Use the arrow and number keys to enter hour.
- Press **Enter** and the cursor will advance to the minute field. Use the arrow and number keys to enter minutes.
- Press **Enter** and the cursor will advance to the second field. Use the arrow and number keys to enter seconds.
- Press **Enter** to accept changes and to exit edit mode.

#### 7.4.2.1.5 Local Time Zone Offset Selection (Menu 1 - Screen 2)

The second screen associated with Menu 1 is the Local Time Zone Offset.

- Press key 1 until *Time and Status* Menu 2 Screen 2 is selected (*Local Time Offset*).

```
Local Time-Zone Offset:+00:00      =
```

- Press **Edit** to enable the edit mode.
- Press the arrow keys to toggle between + and – offset, then press **Enter**.
- Press the arrow keys to select the hours offset, then press **Enter**.
- Press the arrow keys to select the minute offset (0 or 30), then press **Enter**.

*Note: The offset is now entered, but will not be used unless the Time mode is set to local mode, LGPS or LUTC.*

#### 7.4.2.1.6 Leap Second Status (Menu 1 - Screen 3)

- Press key 1 until *Time and Status* Menu 3 Screen 3 is selected (*Leap Second Status*).

```
Leap Second Pending Flag: 0      =  
Leap Seonds (UTC<GPS): 14
```

Coordinated Universal Time (UTC) is occasionally adjusted by 1 second to insure that the difference between the International Atomic Time (TAI) does not differ from the Earth's rotational time by more that 0.9 seconds. The first leap second was added on 1 January 1972. The CommSync II derives its time from the Global Positioning System (GPS). The difference between UTC and GPS time is the number of leap seconds in effect since the start of GPS time at 0 hours on 6 January 1980. GPS time is always ahead of UTC and is not affected by a Leap Second event. The Leap Second pending status is transmitted through the GPS satellites approximately 30 days prior to the event. The CommSync II implements the leap second automatically.

Normally, a second is added (+Leap Second) rather than subtracted when adjustments are necessary. When a leap second is pending, the event occurs on 30 June or 31 December at Midnight UTC. Leap seconds are always inserted at UTC midnight by altering the second time count only. Thus, the time count goes from 23:59:59 to 23:59:60 to 00:00:00 to add an extra second (+Leap Second). The time count goes from 23:59:58 to 00:00:00 to 00:00:01 to subtract a second (–Leap Second).

*Note: For DTF systems, the Leap Second status is not applicable.*

### 7.4.3 MENU 2, and MENU 4 – GTF GPS Control

There are five screens associated with Menu 2 and Menu 4. Menu key **2** is associated with GTF#1 and Menu key **4** is associated with GTF#2. Sub-screens 2, 3 and 4 of these menus allow the user to change some operating parameters.

*Note: The screens shown are for GTF#1 only.*

#### 7.4.3.1.1 Receiver Antenna Position Data/Mode (Menu 2 & 4 - Screen 1)

The receiver must know the antenna's position (longitude, latitude, and elevation) before it can obtain accurate time. At initial power-up, the receiver's position solution mode normally defaults to *Survey* mode. If the exact position of the antenna is not known, but the location is stationary, the user can select the *Survey* mode and the receiver will determine the antenna's position solution. The receiver will determine the antenna's position by averaging the position solution. After the survey is complete the mode will automatically switch to *Known* mode, using the calculated refined position solution.

*Note: If the antenna is on a moving platform the receiver **must** be operated in Dynamic mode.*

*Note: For SAASM-based GTFs, the receiver is always in Dynamic mode.*

- Press key **2** or **4** until GTF#1 or GTF#2 Control Menu 2 or 4 Screen 1 is selected (*Position mode and Position*).

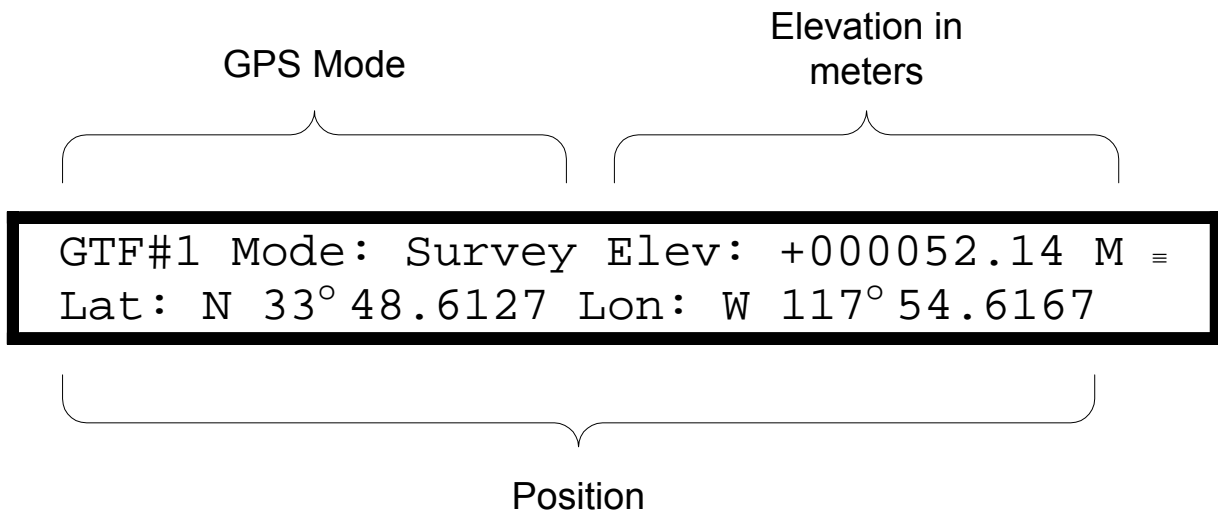

This screen indicates the receiver's antenna position, and that the active position solution mode is *Survey*.

### 7.4.3.1.2 Receiver Status and Tracking (Menu 2 & 4 - Screen 2)

The synchronization status and the GPS Time Figure Of Merit (GTFOM) of GTF module receiver's 1 PPS output, the number of satellites and which satellites are tracked, can be viewed as follows:

- Press key 2 or 4 until *GTF#1* or *GTF#2 Control* Menu 2 or 4 Screen 2 is selected (*GPS Timing and Satellites*).

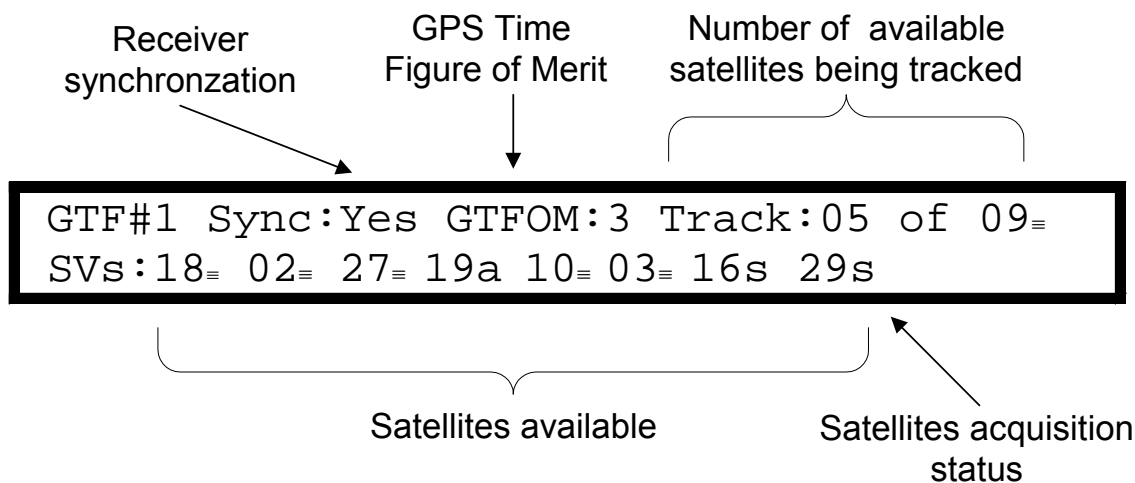

This screen indicates that the GTF#1 receiver is synchronized to the GPS 1 PPS, has a GTFOM of 3 (is within 100 nS of UTC), is tracking 5 of 9 satellites available (SVs 18, 02, 27, 10, and 03), is acquiring satellite 19, and is searching for satellites 16 and 29.

### 7.4.3.1.3 GPS Receiver Cold Start

In rare circumstances the receiver's stored data may be corrupted causing erroneous operation and possibly preventing proper acquisition of satellites. If it is suspected that this condition exists, it is necessary to erase the data used by the receiver, and allow collection of new data from the satellites by forcing the receiver to the *Cold Start* mode. To force the receiver to *Cold Start*, see Reset Internal GPS Receivers, para. 5.2.12.

### 7.4.3.1.4 CV Status (Menu 2 & 4 - Screen 3)

#### 7.4.3.1.5 GTFs equipped with C/A Receivers

For GTFs equipped with C/A receivers, this menu will display the following key status.

```
GTF#1 CV Status
C/A Receiver: No Key Required
```

#### 7.4.3.1.6 GTFs equipped with SAASM Receivers

For GTFs equipped with SAASM receivers, this menu will display the key status.

```
GTF#1 CV Status: C/A to P/Y
Mode:1,0 CV:None Time:0 Pos:0 Alm:0
```

#### 7.4.3.1.7 GPS Receiver Antenna Cable Delay (Menu 2 & 4 - Screen 4)

The antenna cable delay is the sum of all satellite signal delays between the antenna and the receiver, including delays due to antenna cable length and delays due to an in-line amplifier and/or filter (if used in the system). The maximum delay compensation setting is 999999 ns. (Refer to Table 5-7 Antenna Cable Delay Characteristics for details)

*Note: The cable delay compensation is only used to align the timing outputs to UTC. If the system is used only as a frequency reference the cable delay compensation is of no consequence.*

To view the present Primary Receiver antenna cable delay value:

- Press key **2** or **4** until *GTF#1* or *GTF#2 Control Menu 2* or *4 Screen 4* is selected (*Antenna Cable Delay*).

This screen indicates the antenna cable delay.

```
GTF#1                                     ≡  
Antenna Cable Delay: 000050ns
```

To alter the amount of cable delay compensation:

- Press **Edit** until *Antenna Cable Delay [0]00050* is flashing.
- Use the numeric and arrow keys to specify the desired delay compensation in nanoseconds.
- Press **Enter** to accept the new value.

#### 7.4.3.1.8 GPS Receiver Type and Version (Menu 2 & 4 - Screen 5)

The manufacturer's name and firmware revision of the GPS receiver installed in the GTF module can be verified. To view this screen:

- Press key **2** or **4** until *GTF#1* or *GTF#2 Control Menu 2* or *4 Screen 5* is selected (*GPS Brand and Version*).

```
GTF#1 GPS Engine: Jupiter-T               ≡  
GPS Version: 93.07
```

This display indicates the manufacturer of the Receiver and the hardware/firmware version.

The above screen information is for illustration, and may be different in actual systems.

*Note: In some system versions, the GPS Receiver Type and Version information is accessible through Control Menu 5.*

#### 7.4.4 MENU 3 and MENU 5 – GTF Module Frequency Discipline Status

There are three screens associated with menus 3 and 5. Menu key **3** is associated with GTF#1 and Menu key **5** is associated with GTF#2. Screen 1 has an editable sub-screen in systems configured for external sync operation, and Screen 2 allows the user to restart the Frequency Disciplining Machine (FDM).

*Note: The screens shown are for GTF#1 only.*

##### 7.4.4.1.1 Mode and Discipline Status (Menu 3 & 5 - Screen 1)

Screen 1 indicates the operating mode and disciplining status of the GTF module. Through the screen the module's discipline reference source, GPS Only, External Only, and automatic Switch mode can be selected. To view the screen

- Press key **3** or **5** until GTF#1 or GTF#2 *Freq Discipline Status* Menu 3 or 5 Screen 1 is selected (*1 PPS-GPSREF TIMD DAC Value*).

```
GTF#1 TimeLocked          FDM Mode:11  =
Time Difference:-000000032 ns DAC:31264
```

*GTF#1* - The operating mode of the GTF module is displayed. The mode can be *Warm-Up, Time Locked, Coasting, Recovering, Frequency Locked, Manual, or Failed*.

*FDM mode* indicates the status of the Frequency Disciplining Machine (refer to Table 7-1 for Frequency Discipline Machine (FDM) Descriptions. Additional details are available in the System Status and command (SSTA) section of the Serial Communications Protocol, FEI-Zyfer document 385-8002.

*Note: In some system versions, Freq Error is shown in place of the FDM mode.*

*Time Difference* is the instantaneous difference between the module's 1 PPS output and the raw GPS receiver 1 PPS output reference.

*DAC value* is the control value sent to the digital-to-analog converter that controls the module's oscillator. For OCXO systems this number ranges from 1000 to 64535 and for Rubidium systems the DAC ranges from 1000 to 31767.

#### 7.4.4.1.2 Discipline Reference Source Mode

The source used by the module to synchronize and discipline its output signals can be GPS 1 PPS or an external reference source.

*Note: Some system versions are not configured with an external reference source capability.*

To select the Discipline Source mode:

- Press key **3** or **5** until GTF#1 or GTF#2 *Freq Discipline Status* Menu 3 or 5 Screen 1 is selected (*1 PPS-GPSREF TIMD DAC Value*).
- Press **Edit** to access the editable sub-screen.

```
GTF#1 External Sync Type:1 PPS      =  
Sync Source Type: GPS Only
```

- Use the arrow keys until the desired reference source (**GPS Only**, **External Only**, or **Switch Mode**) is flashing.
- Press **Menu** to exit the edit mode without any selection change, or
- Press **Enter** to accept the selected reference source.



#### 7.4.4.1.3 Discipline Reference Source

The source used by the module to synchronize and discipline its output signals can be a 1 PPS, 1MHz, 5MHz, or 10MHz external reference source.

To select the reference Sync Type and source mode:

- Press key **3** or **5** until *DTF#1* or *DTF#2 Freq Discipline Status* Screen 1 is selected.
- Press **Edit** to access the editable sub-screen.

```
DTF#1 External Sync Type:1 PPS      =
Sync Source Type: GPS Only
```

- Use the arrow keys until the desired Sync Type (**1 PPS**, **1 MHz**, **5 MHz**, or **10 MHz**) is flashing.
- Press **Menu** to exit the edit mode without any selection change, or
- Press **Enter** to accept the selected Sync Type.

```
DTF#1 External Sync Type:1 PPS      =
Sync Source Type: External Only
```

- Use the arrow keys until the desired reference source (**External Only**, or **Cross-Disc**) is flashing.
- Press **Menu** to exit the edit mode without any selection change, or
- Press **Enter** to accept the selected reference source.

#### 7.4.4.1.4 Estimator Status (Menu 3 - Screen 2)

This screen indicates the number of estimator cycles for which the oscillator has been disciplined (each cycle is 24 hours), and the number of samples in the current estimator cycle. The sample count increments only when the system is time locked or frequency locked (when using a GTF module configured with an external sync input).

To view the screen:

- Press key **3** or **5** until *GTF#1* or *GTF#2 Freq Discipline Status* Menu 3 or 5 Screen 2 is selected (FDM Estimator Status).

```
Estimator Cycle:00000 Samples:0014867 =
Est Holdover Error:0.00E+000
```

*Note: Some systems versions have an additional data field, Std Error of Holdover Est. If displayed, then:*

*Std Error of Holdover* value represents the standard error of estimate calculated for the prediction of the holdover frequency error. The value is updated once per second when the system is Time Locked. For example, if the displayed value is 3.00E-009, it indicates that 67% of the measured differences between the GPS receiver's 1 PPS and the 1 PPS derived from the online oscillator were less than or equal to the estimated time solution of +/- 3.00E-008 (i.e. +/- 3 ns, 1 sigma).

If the Frequency Disciplining needs to be reset, the command can be sent from this screen. To access the reset command, press **Edit**. Use the arrow keys to select **Yes** and press **Enter**. This will reinitialize the Frequency Discipline Machine.

Table 7-1 Frequency Discipline Machine (FDM) Descriptions	
FDM Modes, 2 ASCII characters where:	
The first char represents the FDM state	
First Char	Description
2	Do Discipline, Recovery mode
3	Measure/Evaluate System Stability
4	Holdover/Coasting mode, GPS lost
5	1PPS Phase recovery mode, 100nS/S step
8	Measure/Evaluate Osc stability
A	Initialize filter variables
B	Do Discipline, locked to reference
The second char represents the FDM learn status	
Second Char	Description
0	Disc to GPS, Manual mode, no OSC learning
1	Disc to GPS, Normal Operation, Using learned OSC comp
2	Disc to GPS, Learning mode, factory test only
4	Ext Disc, Manual mode, no OSC learning
5	Ext Disc, Normal Operation, Using learned OSC comp
6	Ext Disc, Learning mode, factory test only
8	Cross-Disc, Manual mode, no OSC learning
9	Cross-Disc, Normal Operation, Using learned OSC comp
A	Cross-Disc, Learning mode, factory test only

#### 7.4.4.1.5 GTF Firmware/Hardware Revisions (Menu 3 & 5 - Screen 3)

This screen is for information only. To view the screen:

- Press key **3** or **5** until GTF#1 or GTF#2 *Freq Discipline Status* Menu 3 or 5 screen is selected (*Firmware Hardware Version*).

```
GTF#1 Firmware Ver:X1.25.04,385-3058  =
      Hardware Ver:45
```

This screen will indicate the firmware version of the GTF as well as the version of the FPGA.

#### 7.4.5 MENU 6

This menu is not applicable to CommSync II.

#### 7.4.6 MENU 7 – Input Control Menu

There are three screens associated with Menu 7. The first screen is for the Primary module (Slot 15), and the second screen is for the Secondary module (Slot 14). These two screens allow the user to set the I/O external input module(s) for required operation. The third screen can be used to align the timing outputs to an external 1 PPS input

##### 7.4.6.1.1 Input Selection (Menu 7 - Screen 1)

This menu is applicable to DTF systems with an external input module installed in slot 15.

From this screen the user can set the external input module for required operation.

```
Primary CTL (Slot 15)      Ext In: 10MHz=
Input: AUTO   To: BOTH      Status: 0x1A
```

The first line of the display indicates which slot is being displayed/edited and the frequency input expected by the DTF. The second line indicates the following:

- Input: Which input (**A**, **B** or **AUTO**) on the I/O external input module is selected Input may be set for **A** (top connector on the external input module), **B** (bottom connector), or **AUTO**. In **AUTO**, the external input module selects the best input.
- To: To which DTF the sync frequency is being sent (may be sent to **DTF#1**, **DTF#2**, or **BOTH**. Refer to paragraph 6.2.4 for rules regarding these settings).
- Status: The hex value of the status response (see Table 3-1).

#### 7.4.6.1.2 Input Selection (Menu 7 - Screen 2)

This menu is applicable to DTF system with an external input module installed in slot 14.

From this screen the user can set the external input module for required operation.

```
Secondary CTL (Slot 14)   Ext In: 10MHz=
Input: AUTO   To: BOTH           Status: 0x1A
```

Menu operation is similar to Menu 7 Screen 1.

#### 7.4.6.1.3 External 1 PPS Source Delay (Menu 7 - Screen 3)

From this screen the user can align the timing outputs to an external 1 PPS input.

*Note: The external 1 PPS delay compensation is only used to align the timing outputs to an external 1 PPS input. If the system is used only as a frequency reference, the external 1 PPS delay compensation is of no consequence.*

To view the present external input delay value:

- Press key **7** until *Input Control Menu 7 Screen 3* is selected (*External 1 PPS Source Delay*).

This screen indicates the external 1 PPS delay value.

```
System                                     =
External 1PPS Delay: 0075 ns
```

To alter the amount of external input delay compensation:

- Press **Edit** until External 1 PPS Delay [0]075 is flashing.
- Use the numeric and arrow keys to specify the desired delay compensation in nanoseconds.
- Press **Enter** to accept the new value.

### 7.4.7 MENU 8 – Output Module Menu

When this menu is selected the screen cycles through the output modules, displaying the slot location, module name, module status, and module configuration. To terminate the cycling, press any active menu key, such as key 1. Some modules, such as the Clock Rate modules are editable through the displayed screen (Refer to the applicable module description in the Option Module User's Manual, 385-8003, for details). To start the automatic cycling:

- Press key **8** to select the *Output Module* Menu.
- Observe that the screen displays information relative to the module present in the lowest number slot, and then starts to cycle through all other active slots.

```
Slot 4 Clock Rate RS-422 Output 0x31  =
Status: 0x00 Set @ 2048 kHz      256
```

The module code, in HEX, is in the upper right corner. The status byte, in HEX, is displayed in the lower left-hand corner.

*Note: The No-Fault status for Power Supply modules is 0x40. For most types of modules, except the Time Code Output and Time Code/TOD Output modules, the no-fault status is 0x00. Refer to Option Module User's Manual, 385-8003, Time Code Output module 385-4020-01, -02, for detailed status and configuration codes relative to the Time Code and Time Code/TOD Output modules.*

To view a screen for a longer duration, it is possible to halt the automatic cycling and manually step through each available screen. To halt the automatic cycling:

- Press **Edit**.
- Use the arrow keys to select the screen of the slot to be observed.
- To resume the automatic cycling:
- Press **Menu** or **Enter**.

To exit the Output Module Menu:

- Press any active menu number key (such as key **1**) while in the automatic cycling mode.

### 7.4.8 MENU 9 - Maintenance

There are six primary screens accessible through Menu 9. Sub-screens 1, 2 and 3 of this menu allow the user to change some operating parameters.

#### 7.4.8.1.1 Baud Rate & 1 PPS Beep Speaker Control (Menu 9 - Screen 1)

- Press key **9** until *Maintenance Menu 1* screen is selected (*Speaker Control & Baud Rate*).

```
BAUD RATE:19200,8,N,1           =
1PPS BEEP: On
```

- Press **Edit** to enable the edit mode.
- Press the arrow keys to select the desired baud rate (**19200** or **9600**).
- Press **Enter** to accept the selection, or press **Menu** or **Edit** to exit the edit mode without accepting the selection
- Press **Edit** to enable the Beep setting
- Press the arrow keys until the desired mode is flashing (**On** or **Off**).
- Press **Enter** to accept the selection, or press **Menu** or **Edit** to exit the edit mode without accepting the selection.

#### 7.4.8.1.2 Primary Ethernet I/O Configuration (Menu 9 - Screen 2)

This menu is made up of two submenus and is only in effect if an Ethernet I/O module (385-4038 or 385-4090) is installed in Slot 15 (Primary slot). The first menu (9.2a) allows the user to read and/or set the IP Address and NetMask. The second menu (9.2b) allows the user to read and/or set the Gateway and SNMP Trap Addresses. If no Ethernet I/O module is installed, the menu will not display 9.2b. Further, if the earlier Ethernet I/O module (385-4024) is installed, the menu will indicate such.

- Press key **9** until *Maintenance Menu 9 Screen 2* is selected (*Primary Slot TCP/IP Addresses*).
- Press **Edit** to enable the edit mode.
- Using the number keys, enter the first 3-digit number. Press **Enter**.
- Repeat for the second, third, and fourth 3-digit numbers. Note that all four numbers are entered in 3-digit fashion. If the required number is not a 3-digit number, the number must be preceded by 0(s). Example: 198.058.069.005 equates to 198.58.69.5.
- Repeat the process for the Subnet Mask. (Typical Subnet Mask is 255.255.255.000.)

*Note: If the Subnet Mask is not to be edited, press **Enter** four times to complete the editing of the IP Address.*

- To view and/or edit the second submenu (Gateway and Trap Addresses), press key **9** again. The screen will indicate 9.2b and display the addresses for the Gateway and SNMP Trap. To edit these addresses, repeat the process above.

#### 7.4.8.1.3 Secondary Ethernet I/O Configuration (Menu 9 - Screen 3)

This menu is the same as the Primary Ethernet I/O Configuration Menu (9.2), but reads and/or sets the information for the Secondary Ethernet I/O module (Slot 14).

- Press key **9** until *Maintenance* Menu 9 Screen 3 is selected (*Secondary Slot TCP/IP Addresses*).
- Repeat the processes from para 7.4.8.1.2 to edit this menu.

#### 7.4.8.1.4 KDC Firmware Version Status (Menu 9 - Screen 4)

The firmware and hardware versions can be read via the Keypad/Display. This submenu screen lists the firmware version and part number for the front panel display.

- Press key **9** until *Maintenance* Menu 9 Screen 4 is selected. (Keypad/Display Firmware Version).

```
Keypad/Display Controller (KDC)           =  
Firmware Ver:V1.21.00 385-3059
```

#### 7.4.8.1.5 GTF #1 Firmware Version Status (Menu 9 - Screen 5)

- Press key **9** until *Maintenance* Menu 9 Screen 5 is selected. (GTF#1 Firmware/Hardware Versions).
- The information on this screen is identical to the information on Menu 3 – Submenu 3, and includes the version for the firmware in the GTF as well as the part number for that firmware, and the version of the FPGA.

#### 7.4.8.1.6 GTF #2 Firmware Version Status (Menu 9 - Screen 6)

- Press key **9** until *Maintenance* Menu 9 Screen 6 is selected. (GTF#2 Firmware/Hardware Versions).
- The information on this screen is identical to the information on Menu 5 Submenu 3, and includes the version for the firmware in the GTF as well as the part number for that firmware, and the version of the FPGA.

This page intentionally left blank



---

## **8 General Specifications**

- 8.1 Introduction 98
- 8.2 Mechanical 98
- 8.3 Environmental 98
- 8.4 Power Requirements 98
  - 8.4.1 AC Input Power 98
  - 8.4.2 24 VDC and 48 VDC Input Power 99
  - 8.4.3 12 VDC Input Power 99
  - 8.4.4 28 VDC Input Power 99
- 8.5 System Electrical Signals 100
  - 8.5.1 System 10 MHz 100
  - 8.5.2 System 1 PPS 101
  - 8.5.3 External Reference Input 101
  - 8.5.4 RS-232 I/O Port 102
  - 8.5.5 PLGR Port 102
- 8.6 Output Signals 102
- 8.7 Antenna Interface 103
- 8.8 Optional Antenna Kits 103
  - 8.8.1 Direct Connection 103
  - 8.8.2 Optical Connection 103
- 8.9 I/O Control/Monitor Interface 104
  - 8.9.1 RS-232 I/O Module 104
  - 8.9.2 Ethernet I/O Module 104
- 8.10 Outline and Mounting 105
- 8.11 Certifications and Compliance 106

## 8.1 Introduction

The following paragraphs contain condensed specifications for a CommSync II configured with the following basic options: AC Power Supply module, DC Power Supply module, GTF module with a Standard Positioning Service (SPS) GPS receiver and crystal or rubidium oscillator. The modules are installed in a chassis with a Keypad/Display.

Detailed option specifications are located in Option Modules User's Manual, 385-8003.

## 8.2 Mechanical

Height.....	5.25" (134 mm) maximum
Chassis Width.....	17.65" (448 mm) maximum
Front Panel Width (with rack mounts).....	19.00" (483 mm) maximum
	Mounts in 19" EIA rack
Depth (excluding connector protrusions) .....	15" (381 mm) maximum
Weight .....	25 lb (11.3 kg) maximum
Panel Color.....	Black Satin finish

## 8.3 Environmental

Operating Altitude.....	-60 m to 4000 m
Storage Altitude .....	-60 m to 9000 m
Operating Temperature .....	0° C to +50° C
Cooling .....	Natural convection
Temperature Rate of Change .....	±10° C/Hour
Storage Temperature .....	-40° C to +85° C
Relative Humidity.....	5% to 95%, non-condensing

## 8.4 Power Requirements

The input power depends on the system's configuration. The system may be powered by AC and/or DC power, with the following specifications (refer to section 10 for detailed information on power supply module options).

### 8.4.1 AC Input Power (385-4021-0X)

Voltage .....	90 to 132 VAC and 180 to 264 VAC, 47-63 Hz
Power (+25° C / Warm-up) .....	80 W (typical) / 120 W (maximum) <b>(-01)</b>
	..... 160 W (maximum) <b>(-02)</b>
	depending on installed modules
Overload Protection.....	Fuses in both lines
Connector .....	IEC

**8.4.2 24 VDC and 48 VDC Input Power (385-4021-0X)**

Input Voltage	
24 VDC Configuration .....	18 to 36 VDC (-01)
48 VDC Configuration .....	36 to 76 VDC (-02)
Input Power .....	120 W maximum
Isolation .....	2k VAC
	between input and earth and signal return
Input Connection .....	3-Position terminal block
Input Line Protection.....	Circuit breaker
	(also functions as on/off switch)
Output Voltage.....	24 VDC +/- 1%
Output Power.....	100 W maximum
Output Protection.....	Over voltage and short circuit protected
Load Regulation .....	0.8%
Line Regulation.....	0.4%

**8.4.3 12 VDC Input Power (385-4042-01)**

Input Voltage .....	11.5 to 18 VDC
Input Power .....	185 W maximum
Isolation .....	2K VAC
	between input and earth and signal return
Input Connection .....	3-Position terminal block
Input Line Protection.....	Circuit breaker
	(also functions as on/off switch)
Output Voltage.....	24 VDC +/- 1%
Output Power.....	150 W maximum
Output Protection.....	Over voltage and short circuit protected
Load/Line Regulation (Full Load).....	0.5%
Load/Line Regulation (Nominal) .....	1.0%

**8.4.4 28 VDC Input Power (385-4077-05)**

Input Voltage .....	22 to 29 VDC
Input Power .....	180 W maximum
Isolation .....	2k VAC
	between input and earth and signal return
Input Connection .....	3-Pin military style connector
Input Line Protection.....	Circuit breaker
	(also functions as on/off switch)
Output Voltage.....	24 VDC +/- 1%
Output Power.....	150 W maximum
Output Protection.....	Over voltage and short circuit protected
Load Regulation .....	0.8%
Line Regulation.....	0.4%
Input Ripple Amplitude .....	1.5 Vpp maximum
Distortion Factor .....	0.035 maximum

## 8.5 System Electrical Signals

The system's output signal accuracy and stability depend on the online GTF/DTF module. Two versions of the GTF/DTF module are available. One GTF/DTF module is configured with a rubidium oscillator; the other uses an oven-controlled crystal oscillator. The online module's oscillator is the frequency reference for all of the system's frequency and timing output signals. The major difference between the performance of the rubidium and crystal oscillator equipped GTF/DTF modules is the frequency and timing error accumulated while the system operates in the *Coasting (Holdover)* mode. During Coasting, the oscillator is not being disciplined by the GPS 1 PPS reference signal, but the oscillator frequency is adjusted for temperature and aging-induced changes, using data learned during factory tests and during operation while locked to GPS.

*Note: Time from reference signal (either GPS lock or external input) to time lock or frequency lock (Ready indicator illuminates) is typically 1½ to 2 hours.*

Unless otherwise stated, the specifications apply when the system is locked to GPS, is operating in the *Known* mode, the antenna's geodetic position is known within 25 meters, the antenna is in a fixed location, and the internal oscillator has been disciplined for at least 2 days.

### 8.5.1 System 10 MHz

The online GTF or DTF module generates the system 10 MHz. The signal is made available via the system's bus to other plug-in option modules. For test purposes, a buffered 10 MHz output is provided on the front panel of the GTF module.

Number of Outputs .....	1
Connector Type .....	SMA female
Frequency .....	10 MHz
Wave Shape .....	Square
Duty Cycle .....	50 % (nominal)
Output Drive	
High Level .....	≥ +2.2 V into 50 Ω load (≥ 3.0 V open circuit)
Low Level .....	≤ +0.5 V into 50 Ω load
Accuracy (24 hour average)	
Time Locked .....	< 1E-12
Holdover (Coasting) (After 24 hours)	
Rubidium oscillator GTF module online .....	< 5E-11
Crystal oscillator GTF module online .....	< 1E-10
<u>Allan Variance</u>	<u>Rubidium GTF</u> <u>Crystal GTF</u>
1 Sec	< 3E-11                      < 1E-11
10 Sec	< 1E-11                      < 1E-11
100 Sec	< 3E-12                      < 1E-10

### 8.5.2 System 1 PPS

The online GTF or DTF module generates the System 1 PPS. The signal is made available via the system's bus to other plug-in option modules. For test purposes, a buffered 1 PPS output is provided on the front panel of the GTF module.

Number of Outputs .....	1
Connector Type .....	SMA female
Rate .....	1 PPS
Wave Shape .....	Pulse
Pulse Width .....	2 mS
Synchronization .....	Rising (leading) edge on-time
Synchronization Reference .....	UTC
Output Drive	
High Level .....	$\geq +2.2$ V into 50 $\Omega$ load ( $\geq 3.0$ V open circuit)
Low Level .....	$\leq +0.5$ V into 50 $\Omega$ load
Accuracy	
Time Locked .....	< 100 nS at 95% probability to UTC while tracking 4 or more satellites as measured at the 1 PPS connector on the GTF front panel.
Holdover (Coasting) (After 24 hours)	
Rubidium oscillator GTF module online .....	< 3 $\mu$ S
Crystal oscillator GTF module online .....	< 7 $\mu$ S
<i>Note: The GTF front panel 1PPS test point may be ahead of the rear panel modules 1 PPS outputs by as much as the following:</i>	
Mark III GTFs and below .....	200 nS
Mark IV GTFs and above .....	40 nS

### 8.5.3 External Reference Input

The GTF module normally uses its GPS receiver's 1 PPS output as disciplining source. The external reference input enables the module to continue to operate if the GPS source is not available, using the external source as reference. Mark III or later GTF module (refer to Table 4-2 for GTF types and part numbers) uses the external source input.

*Note: The required accuracy of the input signal is dependent upon the type of oscillator in the GTF/DTF. The two types of oscillators available include rubidium (Rb) and Crystal (OCXO).*

*Note: The DTF (385-4060) uses the external reference from an RS-232 I/O External Input module. (See Option Module User's Manual, 385-8003, for additional information.)*

Connector Identification .....	Sync Input
Connector Type .....	SMA female
Rate .....	1 PPS
Wave Shape .....	Pulse

Pulse Width .....	1 uS minimum
Synchronization .....	Rising (leading) edge on-time
Synchronization Mode .....	User selected (Factory default set to Disabled)
Input Levels	
Positive-going .....	$\geq +3.0$ V
Negative-going .....	$\leq +1.0$ V
Maximum .....	+15 V, -15 V
Input Impedance .....	100 k $\Omega$
Input Accuracy Error .....	$\leq 1E-10$ (Rb)

#### 8.5.4 RS-232 I/O Port

The CommSync II comes with a standard RS-232 port on the GTF/DTF module's front panel that provides a bi-directional serial interface for remote control and monitor of the system. Refer to Table 5-5 for RS-232 port pin designations.

Connector .....	9-Contact female D-Subminiature
Signal .....	Per RS-232C
Baud Rate .....	19200
Data Bits .....	8
Stop Bits .....	1
Parity .....	None
Command Protocol .....	Per FEI-Zyfer Document 385-8002

#### 8.5.5 PLGR Port

In order to facilitate GPS receiver Hot Start, SAASM equipped GTF modules come with a front panel PLGR port that provides a bi-directional interface directly to the SAASM receiver. Refer to Table 5-8 for PLGR port pin designations.

Connector Type .....	15-Contact male D-Subminiature
GPS Receiver 1PPS In	
Logic 1 .....	+2.5 to +5 VDC
Logic 0 .....	0 to 0.8 VDC
GPS Receiver 1PPS Out	
Logic 1 .....	+3 to +5 VDC
Logic 0 .....	0 to 0.5 VDC
Serial Data Port In	
Logic 1 .....	-3 to -25 VDC
Logic 0 .....	+3 to +25 VDC
Serial Data Port Out	
Logic 1 .....	-5 to -14 VDC
Logic 0 .....	+5 to +14 VDC
Command Protocol .....	Per ICD-GPS-153

#### 8.6 Output Signals

Several output options are available that provide frequency, pulse rate, and other types of signals. Please refer to Option Module User's Manual, 385-8003, for detailed specifications.

## 8.7 Antenna Interface

Two connectors are provided to connect the GPS satellite signals, received by external antennas, to the receiver contained in the installed GTF module(s). The center conductor of these connectors can also be used to supply DC power to the connected antennas and, if used, in-line amplifiers. The connectors are located on the GPS Antenna Input module.

Connector Type .....	TNC female
Cable Loss .....	15 dB @ 1575 MHz maximum (C/A Receiver)
	10 dB @ 1575 MHz maximum (SAASM Receiver)
	when connected to optional FEI-Zyfer antenna
Power Source for External Antenna .....	+ 5 VDC, +/- 10% at 100 mA
Protection .....	short circuit to ground

## 8.8 Optional Antenna Kits

There are two methods of connecting the RF signal from the antenna(s) to the system: direct connection using coaxial cable, and an isolated connection using fiber optic cable.

### 8.8.1 Direct Connection

Direct connection of the RF signal can be accomplished by the use of an antenna kit FEI-Zyfer P/N 0810384, consisting of a 50 ft (15 m) RG-59 coaxial cable, an antenna with internal low noise pre-amplifier, and a pipe adapter.

Connector Type .....	TNC female
Operating Temperature .....	-40° C to +85° C
Storage Temperature .....	-40° C to +100° C
Humidity .....	Outdoors / All-weather
Power Requirements .....	+5 VDC, +/-10% at 30 mA maximum
	(Supplied by the CommSync II)

### 8.8.2 Optical Connection

Isolated connection of the RF signal can be accomplished by the use of a Fiber Optic Transmitter assembly FEI-Zyfer P/N 385-1048-01, Fiber Optic Antenna Interface module FEI-Zyfer P/N 385-4006-01, and an antenna such as is included in the FEI-Zyfer antenna kit (see paragraph above).

Detailed information on the Fiber Optic Antenna system is contained in FEI-Zyfer document 385-8007 (supplied with Transmitter 385-1048-01). The following is an overview of the Fiber Optic antenna system.

#### Fiber Optic Transmitter Assembly

Order Number.....	385104801
RF Input Connector Type .....	TNC female
Optical/Fiber Output Connector .....	FC/APC Tight Fit
Fiber Optic Cable Type.....	Single mode 9/125
Fiber Optic Cable Length.....	4 km maximum

#### Fiber Optic Antenna Interface Module

Order Number.....	385400601
Optical/Fiber Input Connector Type .....	FC/APC Tight Fit
RF Output Connector .....	SMA

## 8.9 I/O Control/Monitor Interface

Two standard I/O modules are available: an RS-232 I/O module and an Ethernet I/O module. There is also an RS-232 I/O External Input module for use with DTF-based systems, and an Ethernet I/O module with SNMP capability available with both external input (BNC or Fiber Optic) capability or with an additional RS-232 connection (no external input).

### 8.9.1 RS-232 I/O Module

This module provides a bi-directional serial interface for remote control and monitor of the system. (See Option Module User's Manual, 385-8003, for additional information on the RS-232 I/O External Input module.)

Connector Type .....	9-Contact female D-Subminiature
Signal .....	Per RS-232C
Baud Rate .....	19200
Data Bits .....	8
Stop Bits .....	1
Parity .....	None
Command Protocol.....	Per FEI-Zyfer Document 385-8002

In addition to the serial interface signals, the module provides two buffered 1 PPS output signals and two hardware status output signals. Please refer to Option Module User's Manual, 385-8003, *RS-232 I/O External Input module*, for detailed specifications.

### 8.9.2 Ethernet I/O Module

The Ethernet I/O module provides TCP/IP control/monitor and network time service.

Connector Type .....	RJ-45
Signal .....	10/100Base-T
Configuration .....	IP address, netmask and gateway address
Compatibility .....	TC/IP, Ethernet version 2.0/IEEE 802.3
NTP Support.....	Version 1, 2, 3, and SNTP
Command Protocol.....	Per FEI-Zyfer Document 385-8002

In addition to the control and monitor function, the module provides two buffered 1 PPS output signals. Please refer to Option Module User's Manual, 385-8003, *Ethernet I/O module*, for detailed specifications.





### 8.11 Certifications and Compliance

The CommSync II conforms to the following international EMC and safety requirements/specifications:

EMC	<p>Meets the requirements of FCC Code of Federal Regulations 47 CFR, Part 15, Subpart B, Class B.</p> <p>Meets MIL-STD-461D RE102 (Navy fixed and AF)</p> <p>Meets intent of Directive 89/336/EEC for Electromagnetic Compatibility.</p> <p>EN 55011, Class B, Radiated Emissions EN 55011, Class B, Conducted Emissions EN 61000-3-2, Class D, Harmonics EN 61000-3-3 Voltage Flicker EN50082-1: 1998 EN 61000-4-2 Electrostatic Discharge EN 61000-4-3 Radiated susceptibility EN 61000-4-4 Power line fast transients EN 61000-4-5 Power line surge immunity EN 61000-4-6 Conducted immunity to RF fields EN 61000-4-8 Magnetic immunity EN 61000-4-11 Voltage dips and variations</p>
LVD	<p>Meets intent of Low Voltage Directive 72/23/EEC as amended by 93/68/EEC:</p>
Safety	<p>EN 61010-1:1993 Safety requirements for electrical equipment for measurement, control and laboratory use.</p> <p>UL/CUL 60950, third edition: 2000</p>

---

## **9 Maintenance and Repair**

- 9.1 Introduction 108
- 9.2 Periodic Service and Calibration 108
- 9.3 Troubleshooting 108
  - 9.3.1 System Fault Diagnosis 108
  - 9.3.2 Option Module Fault Reporting 111
  - 9.3.3 Understanding the SSTA Message 111
  - 9.3.4 Front Panel Troubleshooting 114
- 9.4 Repair Procedure 114
  - 9.4.1 Record Fault Code 114
  - 9.4.2 Record Firmware Versions 114
  - 9.4.3 Contact Technical Support 114
  - 9.4.4 Remove Module 114
  - 9.4.5 Install Replacement 115
  - 9.4.6 Confirm Correct Diagnosis 115
  - 9.4.7 Obtain RMA 115
  - 9.4.8 Ship to FEI-Zyfer, Inc. 115

## 9.1 Introduction

This section contains the periodic service, troubleshooting, and repair procedures.

## 9.2 Periodic Service and Calibration

The CommSync II, including all associated Option Modules, has been designed such that all routine service activities have been eliminated. Because of this design, there are **NO** elements that require measurement, adjustment, or calibration for the life of the product.

## 9.3 Troubleshooting

Prior to initiating the following troubleshooting guide, be sure to confirm all external connections to/from the CommSync II are secure and correct.

The design of the CommSync II modules provide built-in fault detection and reporting capability. The following paragraphs describe the troubleshooting or fault reporting functions.

### 9.3.1 System Fault Diagnosis

#### 9.3.1.1.1 GTF Module Indicator Function

The GTF fault detection and reporting consists of five indicators (4 green and 1 red). Additionally, GTF modules equipped with the SAASM receiver option have two Crypto-Variable status indicators.

The following table summarizes the function of these Indicators.

Indicator Label	Indicator Color	Function
<i>Power</i>	Green	ON Indicates internal power is present (5 sec delay after power-up).
<i>GPS Lock</i>	Green	ON indicates GPS receiver has locked to satellites. Flashing indicates antenna fault (open or short).
<i>Ready</i>	Green	ON indicates internal oscillator synchronized to GPS reference.
<i>On Line</i>	Green	ON Indicates module is primary source of system reference signals.
<i>Alarm/Fault</i>	Red	Normally OFF; ON for 5 sec at power-up; Flashes during <i>Warm-Up</i> . ON indicates GTF latched fault.
<i>CV Valid</i>	Green	Refer to Table 5-6 for function details (SAASM only)
<i>CV Invalid</i>	Red	Refer to Table 5-6 for function details (SAASM only)

**9.3.1.1.2 GTF Indicator Evaluation**

Use the following table to diagnose faults indicated by indicator action.

Table 9-2 Evaluating GTF Indicators	
Fault indication	Description and possible cause
<i>GPS Lock</i> Indicator off	Loss of GPS reference for > 30 seconds - Verify antenna connections. Check antenna.
<i>GPS Lock</i> Indicator Flashes	Antenna Current is over 80 mA - Check antenna cable for shorts. Check antenna.
<i>GPS Lock</i> Indicator Flashes	Antenna current under 10 mA/no power to antenna pre-amp - Check antenna cable for open connection. Check antenna.
<i>Fault</i> Indicator on	<ul style="list-style-type: none"> <li>• GTF Module internal power +5, <math>\pm 12V</math> - GTF out of tolerance.</li> <li>• Missing two 10 MHz edges – Possible 10 MHz OSC fault.</li> <li>• Missing communication from receiver for 60 seconds – Possible GPS receiver fault.</li> <li>• Missing two 1 PPS pulses - Possible FPGA fault.</li> </ul> (Refer to paragraph 9.3.1.1.4 (Menu 0) for more information)

Refer to paragraph 5.2.8 for description of initial indicator status.

Refer to paragraph 5.1 for detailed description of the GTF module function.

Refer to paragraphs 4.11.3 and 4.11.4 for a description of the GTF online and switchover conditions.

**9.3.1.1.3 Front Panel Display Evaluation****9.3.1.1.4 MENU 0**

Table 9-3 Evaluating Menu 0		
GTF#1/2 Indication	Description	Likely Reason
Not Locked	GPS not locked	<i>Warm Up</i> (Normal operation)
Not Ready	GTF not ready	<i>Warm Up</i> (Normal operation)
Antenna Under Current	Antenna not drawing current	Antenna or cable is open.
Antenna Over Current	Antenna drawing too much current	Antenna or cable is shorted.
10 MHz Fault	10 MHz oscillator failed	Missed 2 pulses (latched fault) <sup>1</sup>
1 PPS Fault	1 PPS failed	Missed 1 pulse (latched fault) <sup>1</sup>
Power Fault	GTF Power supply failure	Failed GTF
GPS Comm Fault	GPS receiver not communicating	GPS receiver failed <sup>1</sup>

If Menu 0 indicates an Option Module in Slot x reports a fault, select Menu 8 and read fault indication for the referenced slot, then refer to Figure 9-1 Troubleshooting Guide.

#### 9.3.1.1.5 MENU 2

If Menu 2 - Screen 2 (Satellite Tracking Status) indicates no satellites are being tracked (either no satellites are listed or no signal strength is shown), press the **Edit** key on the Display Panel. Use the arrow keys to change "Disabled" to "Enabled". Press **Enter**. Use the arrow keys to select **Yes** and press **Enter**. This will reinitialize the GPS receiver. If the receiver does not track satellites after 20 minutes, the problem may be in the antenna or connections.

#### 9.3.1.1.6 MENU 3

The following is a table of CommSync II mode indications

Table 9-4 Evaluating Menu 3		
Indication	Description	Likely Reason
Warm-up	GTF in <i>Warm Up</i>	Normal start up process
Time Locked	GTF has time lock	Normal operation
Coasting	GTF is in <i>Holdover</i>	Operating without Reference (GPS or External signal)
Recovering	GTF is recovering lock	Normal operation after recovering Reference (GPS or External signal)
Failed	GTF indicates failure	GTF problem

## **9.3.2 Option Module Fault Reporting**

The fault reporting for all option modules consists of LED indicators on each module, “fault code” reporting using Menu 8 of the front panel display, and the System Status message (SSTA) provided via any of the installed Serial Communication Ports (RS-232 or Ethernet).

### **9.3.2.1.1 LED Indicators**

All available option modules are described in Option Module User’s Manual, 385-8003. Paragraph 1.1 of each module description defines the fault associated with the Red and Green LED indicators on the panel of the respective module.

### **9.3.2.1.2 Front Panel Display (Menu 8)**

In addition to the indicators mentioned above, fault codes are reported using Menu 8 of the front panel display. Refer to paragraph 7.4.7 for a description of the fault codes for the rear panel modules.

### **9.3.2.1.3 Serial Communication System Status message (SSTA).**

Fault code reporting is also available via (optional) serial communication ports. FEI-Zyfer document 385-8002, Serial Communications Protocol, contains the detailed description of the serial communication. Refer to the System Status (SSTA) command for obtaining system status output.

## **9.3.3 Understanding the SSTA Message**

The System Status message (SSTA) outputs the current status of the system and plug-in modules. This response is output whenever there is a change in any status field. It is also available by sending the System Status command. Refer to FEI-Zyfer document 385-8002, Serial Communications Protocol for complete details regarding the SSTA message/command. Refer to Figure 9-1 and Figure 9-2 for an example SSTA Decoding.

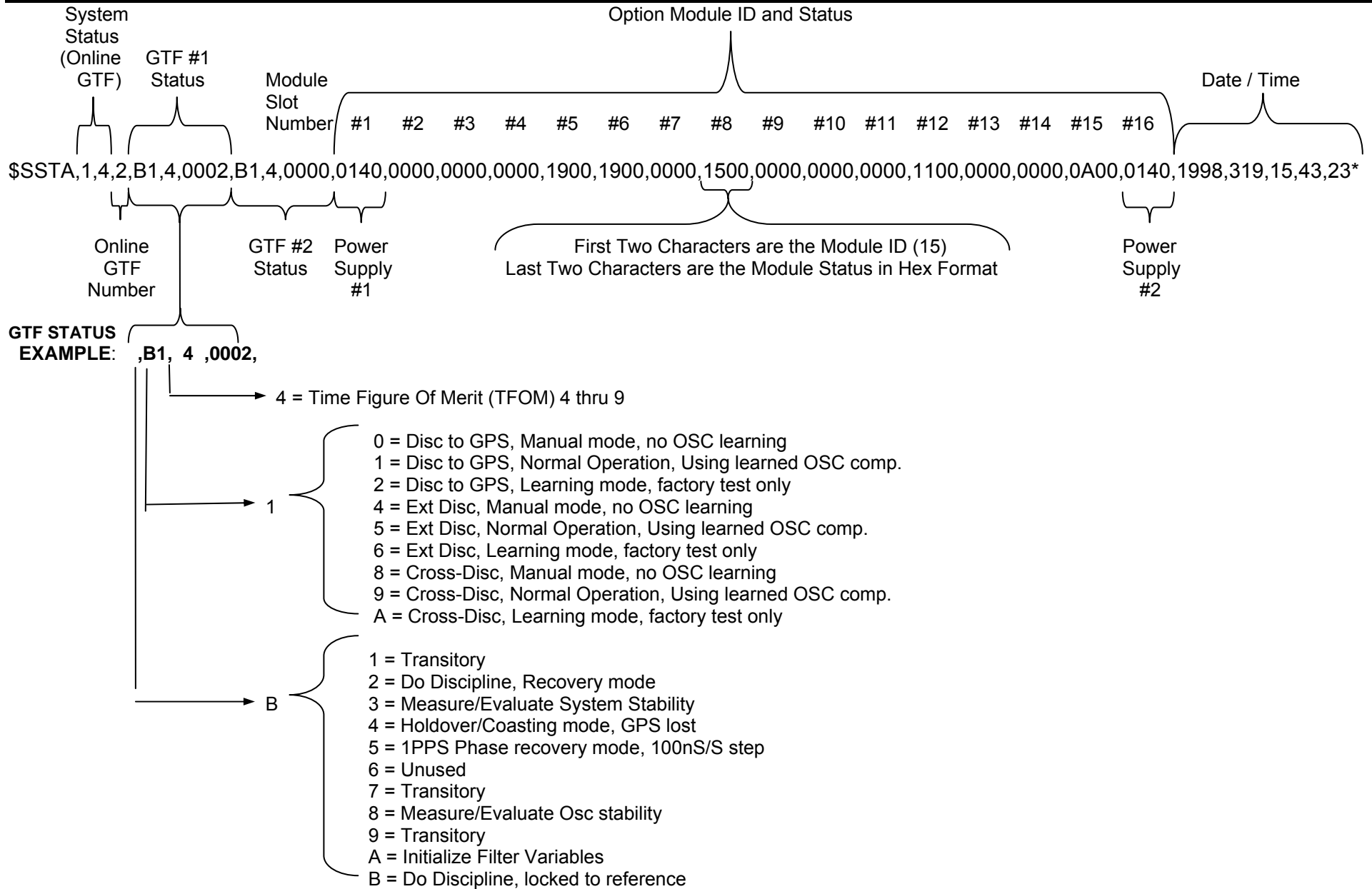

**NOTE:** Module slot number 2 will always read 0000

Figure 9-1 SSTA Decode (Part1)





### 9.3.4 Front Panel Troubleshooting

The Front Panel assembly does not contain fault detection capability. The diagnostic procedure is limited to:

- Any key pressed should result in an audible beep and the corresponding expected change to the LCD module (except for Menu 6, which is not used at this time). No audible beep or screen change suggests a keypad failure.
- Any visibly absent or corrupted character on the LCD module screen.
- No LCD module backlight present.

## 9.4 Repair Procedure

Due to the modular architecture of the CommSync II if a module has failed,, the repair procedure is simply to remove the failed (or suspect) module and replace it with a functional module. Option modules and antenna's notwithstanding, no other field repairs are possible for a failed CommSync II system. When removing an option module no special tools or adjustments are required. The following sequence is the recommended repair procedure.

### 9.4.1 Record Fault Code

Prior to removing the failed (or suspect) module, record the fault code reported via Menu 8 of the front panel display. Providing this fault code information with the failed unit will assist the factory diagnostic and repair.

*Note: The Front Panel assembly has no fault codes.*

### 9.4.2 Record Firmware Versions

Record the Firmware/Hardware Versions reported via Menu 9 of the front panel display for the Front Panel assembly (KDC) and the GTF/DTF modules.

### 9.4.3 Contact Technical Support

Whenever possible, it is recommended that Zyfer Technical Support be contacted prior to removing a suspect module. Technical Support will confirm the failure, make troubleshooting recommendations and assist in gathering important failure information.

### 9.4.4 Remove Module

All modules (except the Front Panel assembly) are removed from the chassis by removing the mounting screws (either 2 or 4) and pulling the module out. The Front Panel assembly must have its ribbon cable connector unplugged after removing the 8 mounting screws.

All modules including the Front Panel assembly are **hot swappable**.

#### 9.4.5 Install Replacement

Remove the replacement module from the shipping container (if available) and save the container for returning the failed module. Install the replacement module.

### CAUTION!

*When replacing the Front Panel assembly, be sure to keep the ribbon cable connector properly aligned with the mating pins. **Misalignment may damage the assembly!***

#### 9.4.6 Confirm Correct Diagnosis

After replacing the module, confirm the fault condition has been corrected.

*Note: In some instances it may be necessary to wait a few minutes for the fault indication to be cleared subsequent to module replacement.*

#### 9.4.7 Obtain RMA

Contact FEI-Zyfer Customer Service to obtain an RMA (Returned Material Authorization) number. Refer to page 7 of this document for the contact information.

#### 9.4.8 Ship to FEI-Zyfer, Inc.

Place the failed module in the shipping box provided with the replacement module (if available). Please include the fault code discussed in paragraph 9.4.1 (if possible) and the firmware/hardware versions from paragraph 9.4.2.

Ship to the address listed on page 7.

This page intentionally left blank

---

## **10 Power Supply Modules**

- 10.1 Introduction 118
- 10.2 AC Power Supply Module 385-4021 119
- 10.3 24 VDC and 48 VDC Power Supply Module 385-4022 121
- 10.4 +12 VDC Power Supply Module 385-4042 124
- 10.5 Ruggedized 28 VDC Power Supply Module 385-4077-05 127

### **10.1 Introduction**

This section provides information on the following power supplies options available for the CommSync II:

- AC Power Supply modules - Two power supplies are available that use 100 to 132 VAC and 200 to 264 VAC to provide the necessary 24 VDC for the system (385-4021).
- DC Power Supply modules - Four power supplies are available that use a DC input to provide the necessary 24 VDC for the system. These use 24 VDC (385-4022-01), 48 VDC (385-4022-02), 12 VDC (385-4042-01) or 28 VDC (385-4077-05).

## 10.2 AC Power Supply Module 385-4021

The AC Power Supply module is used to power the CommSync II System from an AC power source. The module converts AC utility power to regulated +24 VDC CommSync II bus power. The module can be installed in slot 1 or slot 16. When a second Power Supply module is installed and powered, the module is “hot swappable”. It can be removed or installed without removing power from the CommSync II System or interrupting operations.

### 10.2.1 LED Status Indicators

The module’s LEDs indicate the status of the module.

The Green LED indicates power to the module.

The Red LED is the Alarm indicator that illuminates when the module senses it is no longer providing 24 VDC power to the system.

### 10.2.2 Operation

The 115-230 VAC Power Supply module converts the standard AC input to the required +24 VDC output for the CommSync II system. A standard AC cord is provided to plug into the AC Cord Receptacle. When AC power is applied, the CommSync II is powered when the Power Switch is set to I.

The system is designed to be redundant. If two Power Supply modules are installed, either module can supply the required power. As long as one module is operating, the other can be powered off and removed if necessary without interrupting operation.

### 10.2.3 Status

The status of the AC Power Supply module can be obtained from the GTF module SSTA message or viewed from the front panel display (Menu 8). The status message consists of an identification number (first byte) in hex format and a bus status message (second byte).

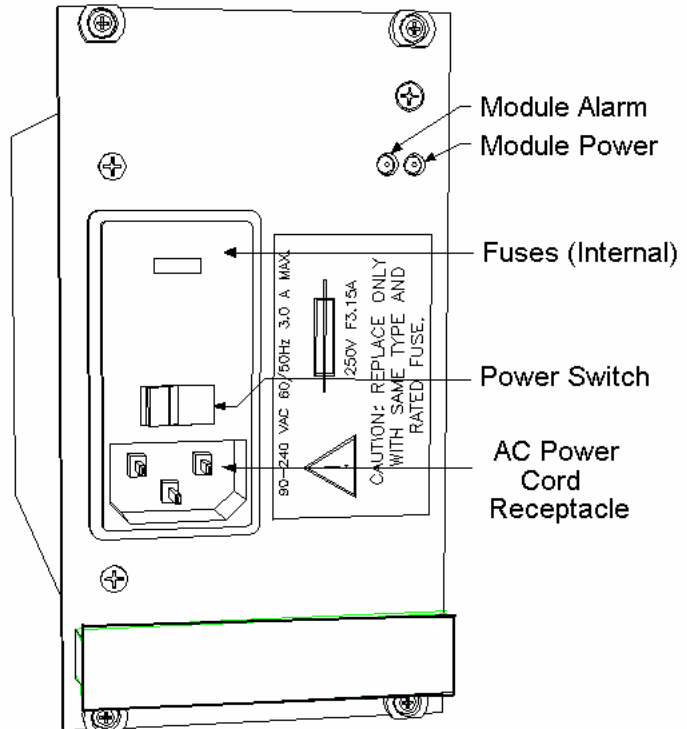

### 10.2.3.1.1 Status Message

Table 10-1 AC Power Supply Status	
ID	Status
0x01	Bit6=VCC Fault (0=fault) Bit7=Reset Fault (24 VDC Output Fault) (1=fault) Nominal Operation = 0x40

### 10.2.3.1.2 Front Panel Display (Example)

```
Slot 1 115-230 VAC Power Supply 0x01 =
Status: 0x40 No Faults
```

### 10.2.4 Commands

There are no commands specific to this module.

### 10.2.5 Specifications

Input Voltage .....	100 to 132 VAC and 200 to 264 VAC
Input Power (-01).....	120 W maximum
Input Power (-02).....	160 W maximum
Input Frequency.....	47-63 Hz
Input Connector .....	IEC
Input Line Protection.....	Fuses in both lines
Output Voltage.....	24 VDC +/- 5%
Output Power (-01).....	100 W maximum
Output Power (-02).....	130 W maximum
Output Protection.....	Over voltage and short circuit protected
Load Regulation .....	1%
Line Regulation.....	0.3%

## WARNING!

*Replace fuse(s) with same type and rating as marked.*



**10.3 24 VDC and 48 VDC Power Supply Module 385-4022**

The DC Power Supply module is used to power the CommSync II System from a DC power source. The 385-4022-01 Power Supply module accepts a +24 VDC input power source and the 385-4022-02 accepts a 48 VDC input source to provide regulated +24 VDC to the CommSync II power bus. A module can be installed in either slot 1 or 16, or both. When a second Power Supply module is installed and powered, the modules are “hot swappable”.

**10.3.1 LED Status Indicators**

The module’s LEDs indicate the status of the module.

The Green LED indicates power to the module.

The Red LED is the Alarm indicator that illuminates when the module senses it is no longer providing 24 VDC power to the system.

**10.3.2 Operation**

The 24 VDC and 48 VDC Power Supply modules convert the DC input to the required +24 VDC output for the CommSync II system and provides isolation from the input power source. A circuit breaker is provided to protect the external power source.

The system is designed to be redundant. If two Power Supply modules are installed, either module can supply the required power. As long as one module is operating, the other module can be powered off and removed if necessary without interrupting operation.

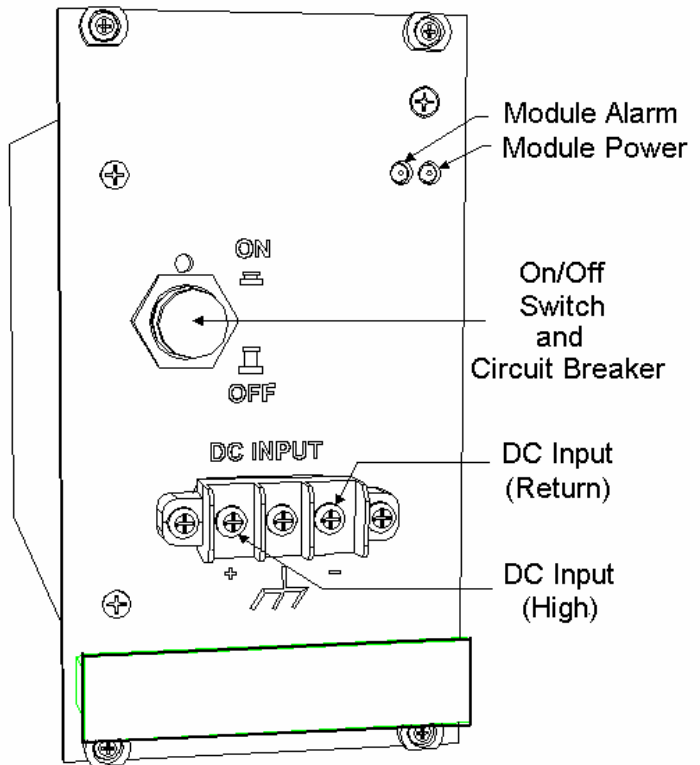

**10.3.3 24 VDC and 48 VDC Input Power Connections**

Connect the system for operation from an external DC power source as follows:

Table 10-2 24 & 48 VDC Power Connection Pin Designation	
Terminal	Function
+	+ DC Input (High side of isolated input)
(center)	Chassis Ground
-	- DC Input (Low side of isolated input)

For the 24 VDC Power Supply module, 18 AWG wire size is recommended. The start-up current could approach 6 Amps in systems configured with two Rubidium oscillators. For the 48 VDC Power Supply module, 20 AWG wire size is recommended. The start-up current could approach 4 Amps in systems configured with two Rubidium oscillators.

Table 10-3 24 & 48 VDC Power Supply Input Power		
Module	Input Voltage	Input Current
385-4022-01	18 to 36 VDC (24 VDC nom)	4.8A @ 24 VDC max
385-4022-02	36 to 76 VDC (48 VDC nom)	2.5A @ 48 VDC max

### 10.3.4 Status

The status of the DC Power Supply module can be obtained from the GTF module SSTA message or viewed from the front panel display (Menu 8). The status message consists of an identification number (first byte) in hex format and a bus status message (second byte).

#### 10.3.4.1.1 Status Message

Table 10-4 24 & 48 VDC Power Supply Status		
Dash Number	ID	Status
-01	0x02	Bit6=VCC Fault (0=fault) Bit7=Reset Fault (24 VDC Output Fault) (1=fault)
-02	0x03	Nominal Operation = 0x40

#### 10.3.4.1.2 Front Panel Display (Example)

```
Slot 16 +24 VDC Power Supply      0x02 =
Status: 0xC0 Reset
```

### 10.3.5 Commands

There are no commands specific to this module.

### 10.3.6 Specifications

Input Voltage	
385-4022-01.....	18 to 36 VDC
385-4022-02.....	36 to 76 VDC
Input Power .....	120 W maximum
Isolation .....	2k VAC
	between input and earth and signal return
Input Connection .....	3-Position terminal block
Input Line Protection.....	Circuit breaker
	(also functions as on/off switch)
Output Voltage.....	24 VDC +/- 1%
Output Power.....	100 W maximum
Output Protection.....	Over voltage and short circuit protected
Load Regulation .....	0.8%
Line Regulation.....	0.4%

## 10.4 +12 VDC Power Supply Module 385-4042

The +12 VDC Power Supply module is used to power the CommSync II System from a +12 VDC power source. The module can be installed in either slot 1 or 16, or both. When a second Power Supply module is installed and powered, the modules are “hot swappable”.

### 10.4.1 Status Indicators

The module’s LEDs indicate the status of the module.

The Green LED indicates power to the module.

The Red LED is the Alarm indicator that illuminates when the module senses it is no longer providing 24 VDC power to the system.

### 10.4.2 Operation

The +12 VDC Power Supply module converts the 12 V input to the required +24 VDC output for the CommSync II system and provides isolation from the input power source. A circuit breaker is provided to protect the external power source.

The system is designed to be redundant. If two Power Supply modules are installed, either module can supply the required power. As long as one module is operating, the other module can be powered off and removed if necessary without interrupting operation.

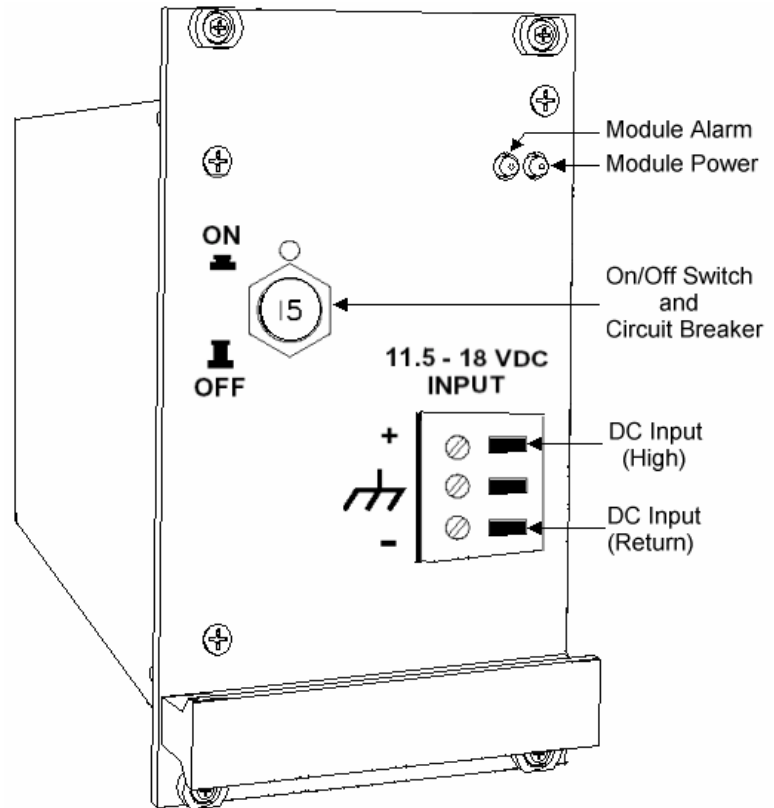

### 10.4.3 12 VDC Input Power Connections

Connect the system for operation from an external DC power source as follows:

Terminal	Function
+	+ DC Input (High side of isolated input)
(center)	Chassis Ground
-	- DC Input (Low side of isolated input)

The recommended wire size for connecting input power to the +12 VDC Power Supply module is 16 AWG. The start-up current could approach 12 Amps in systems configured with two Rubidium oscillators.

Table 10-6 12 VDC Power Supply Input Power		
Module	Input Voltage	Input Current
385-4042-01	11.5 to 18 VDC (12 VDC nom)	10A @ 12 VDC max

#### 10.4.4 Status

The status of the +12 VDC Power Supply module can be obtained from the GTF module SSTA message or viewed from the front panel display (Menu 8). The status message consists of an identification number (first byte) in hex format and a bus status message (second byte).

##### 10.4.4.1.1 Status Message

Table 10-7 12 VDC Power Supply Status		
Dash Number	ID	Status
-01	0x04	Bit4=PS2 Fault (0=fault) Bit5=PS1 Fault (0=fault) Bit6=VCC Fault (0=fault) Bit7=Reset Fault (24 VDC Output Fault) (1=fault) Nominal Operation = 0x70

##### 10.4.4.1.2 Front Panel Display (Example)

```
Slot 16 +12 VDC Power Supply      0x04 =
Status: 0x10 PS2 Fault
```

#### 10.4.5 Commands

There are no commands specific to this module.

**10.4.6 Specifications**

Input Voltage .....	11.5 to 18 VDC
Input Power .....	185 W maximum
Isolation .....	2K VAC
	between input and earth and signal return
Input Connection .....	3-Position terminal block
Input Line Protection.....	Circuit breaker
	(also functions as on/off switch)
Output Voltage.....	24 VDC +/- 1%
Output Power.....	150 W maximum
Output Protection.....	Over voltage and short circuit protected
Load/Line Regulation (Full Load).....	0.5%
Load/Line Regulation (Nominal) .....	1.0%

### 10.5 Ruggedized 28 VDC Power Supply Module 385-4077-05

The Ruggedized 28 VDC Power Supply module is used to power the CommSync II System from a DC power source.

The 385-4077-05 module accepts +28 VDC (Aircraft) input to provide regulated +24 VDC to the CommSync II power bus. The module can be installed in either slot 1 or 16, or both. When a second Power Supply module is installed and powered, the modules are “hot swappable”.

The 385-4077-05 is designed to meet the conducted emission/conducted susceptibility per MIL-STD-461E; and input transients per MIL-STD-704F (Fig 13, Fig 14 & Fig 15).

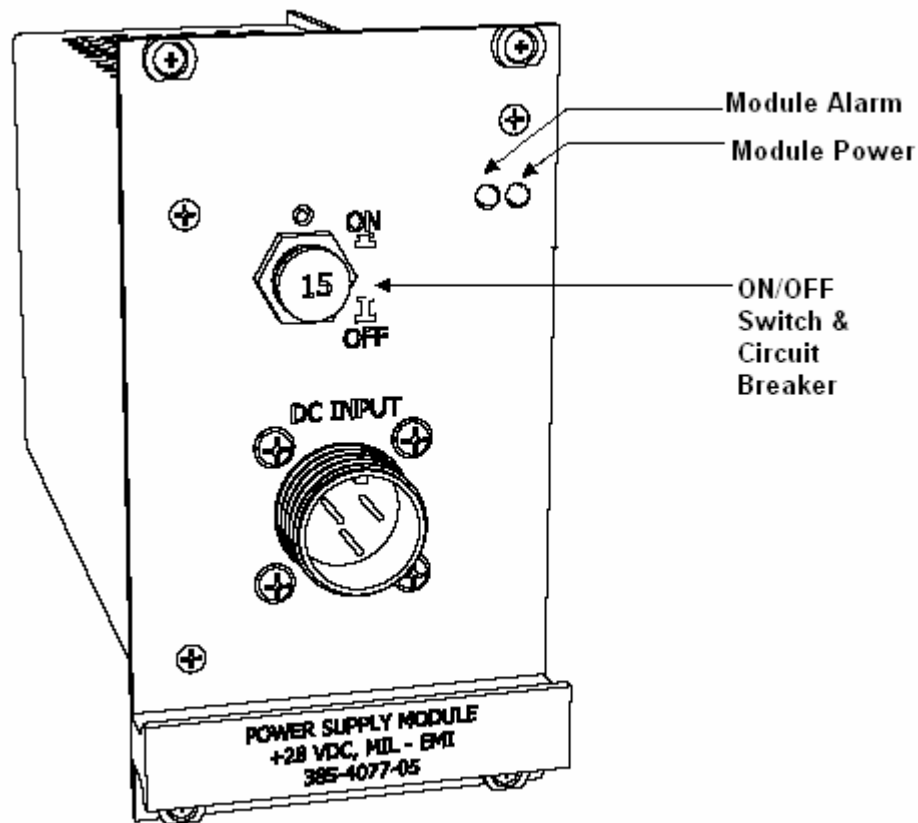

#### 10.5.1 LED Status Indicators

The module's LED's indicate the status of the module.

The Green LED indicates power to the module.

The Red LED is the Alarm indicator that illuminates when the module senses it is no longer providing 24 VDC power to the system.

#### 10.5.2 Operation

The Ruggedized 28 VDC Power Supply module converts the DC input to the required +24 VDC output for the CommSync II system and provides isolation from the input power source. A circuit breaker is provided to protect the external power source.

The system is designed to be redundant. If two Power Supply modules are installed, either module can supply the required power. As long as one module is operating, the other module can be powered off and removed if necessary without interrupting operation.

### 10.5.3 28 VDC Input Power Connections

Connect the system for operation from an external DC power source using the MIL – connector as follows:

Table 10-8 28 VDC Power Connection Pin Designation	
Terminal	Function
B	+ DC Input (High side of isolated input)
A	Chassis Ground
C	- DC Input (Low side of isolated input)

For the 28 VDC Power Supply modules, 18 AWG wire size is recommended. The start-up current could approach 6 Amps in systems configured with two Rubidium oscillators.

Table 10-9 28 VDC Power Supply Input Power		
Module	Input Voltage	Input Current
385-4077-05	22 to 29 VDC (28 VDC nom)	4.8A @ 28 VDC max

### 10.5.4 Status

The status of the 28 VDC Power Supply module can be obtained from the GTF module SSTA message or viewed from the front panel display (Menu 8). The status message consists of an identification number (first byte) in hex format and a bus status message (second byte).

#### 10.5.4.1.1 Status Message

Table 10-10 28 VDC Power Supply Status		
Dash Number	ID	Status
-05	0x05	Bit6=VCC Fault (0=fault) Bit7=Reset Fault (24 VDC Output Fault) (1=fault) Nominal Operation = 0x40



**10.5.4.1.2 Front Panel Display (Example)**

```
Slot 16 Ruggedized DC Power Supply 0x05 =
Status: 0xC0 Reset
```

**10.5.5 Commands**

There are no commands specific to this module.

**10.5.6 Specifications**

Input Voltage .....	22 to 29 VDC
Input Power .....	180 W maximum
Isolation .....	2k VAC
	between input and earth and signal return
Input Connection .....	3-Pin military style connector
Input Line Protection.....	Circuit breaker
	(also functions as on/off switch)
Output Voltage.....	24 VDC +/- 1%
Output Power.....	150 W maximum
Output Protection.....	Over voltage and short circuit protected
Load Regulation .....	0.8%
Line Regulation.....	0.4%
Input Ripple Amplitude .....	1.5 Vpp maximum
Distortion Factor .....	0.035 maximum

## ***Declaration of Conformity***

Application of Council Directive: 89/336/EEC

EMC Standards to which Conformity is Declared: EN55011 Class B  
 EN61000-3-2  
 EN61000-3-3  
 EN50082-1:1998  
 EN61000-4-2  
 EN61000-4-3  
 EN61000-4-4  
 EN61000-4-5  
 EN61000-4-6  
 EN61000-4-8  
 EN61000-4-11

Equipment Class: ITE - Class B

Application of Council Directive: 72/23/EEC

Safety Standards to which Conformity is Declared: EN61010-1:1993

Equipment Class: I

Manufacturer's Name and Address: FEI-Zyfer, Inc.  
 7321 Lincoln Way  
 Garden Grove, CA 92841

Equipment Description: Redundant GPS Synchronized  
 Time and Frequency System.

Model Number(s): 385-xxx

Product Options: This declaration covers all  
 options of this product.

Meets the requirements of FCC Code of Federal Regulations 47 CFR, Part 15,  
 Subpart B, Class B

Meets UL/CUL 60950, third edition: 2000

I, the undersigned, hereby declare that the equipment specified above, conforms  
 to the above Directive(s) and Standard(s).

Garden Grove, California, Feb. 6, 2008

  
 \_\_\_\_\_  
 Chris Staffieri, Quality Manager

**Alarm/Fault Indicator** refer to Table 9-1 for indicator function.

**almanac** satellite navigation message that contains orbit information on all GPS satellites – includes clock corrections and atmospheric delay parameters that allows a receiver to predict the approximate location of the satellites.

**antenna** the active antenna system consists of a low-profile, micro-strip patch antenna, with a narrow-bandpass filter, and a preamplifier contained within the antenna enclosure. The preamplifier is powered through the antenna cable with 3 to 5 volts DC from the GTF module.

**C/A code** see Coarse Acquisition code.

**Coarse Acquisition Code (or clear code)** acquisition signal used to acquire the precision military signal (p-code), also serves as the civilian navigation, positioning and timing signal.

**Coasting** see Holdover.

**Cold Start mode** the mode where the GPS receiver collects new almanac and ephemeris, resulting in a “search the sky” mode until sufficient data has been collected from the satellites. To complete the collection of new data requires from 12 to 30 minutes, depending on satellite visibility conditions. The time (days through seconds) is not valid until sufficient data has been collected and the receiver has locked to the GPS time.

**Coordinated Universal Time (UTC)** the time scale based on the atomic second that is occasionally adjusted by 1 second (leap second) to insure that the difference between the International Atomic Time (TAI) does not differ from the Earth’s rotational time by more than 0.9 seconds. The first leap second was added on 1 January 1972.

**CV** see Crypto-Variable.

**CV Valid Indicator** refer Table 5-6 for indicator function.

**CV Invalid Indicator** refer Table 5-6 for indicator function.

**Crypto-Variable (CV)** encryption key

**DAC value** is the control value sent to the digital-to-analog converter that controls the module’s oscillator. For OCXO systems this number ranges from 1000 to 64535 and for Rubidium systems the DAC ranges from 1000 to 31767.

**DDS** see direct digital synthesis.

**direct digital synthesis (DDS)** method of digitally creating various waveforms and frequencies from a single fixed frequency source.

**Distribution Time and Frequency (DTF)** the DTF module utilizes an external signal source as a reference to discipline the DTF’s internal oscillator (Rubidium or OCXO). The DTF contains a self-contained Frequency Discipline Machine (FDM) along with a uP controller and bus interface drivers.

**DTF** see Distribution Time and Frequency.

**Dynamic mode** is the default mode for the GPS receiver. In this mode the receiver is computing both time and position.

**Est. Holdover Error** a value that represents the standard error of estimate calculated for the prediction of the holdover frequency error. The value is updated once per second when the system is Time Locked. For example, if the displayed value is 3.00E-009, it indicates that 67% of the measured differences between the GPS receiver’s 1 PPS and the 1 PPS derived from the oscillator were less than or equal to the estimated time solution of +/- 3.00E-008 (i.e. +/- 3 ns, 1 sigma).

**Estimator Cycle** a period of 24 hours in which the reference oscillator has been disciplined,

**FDM** see Frequency Discipline Machine.

**Frequency Discipline Machine (FDM)** the FDM consists of a GPS receiver, an ultra-stable oscillator, time interval counter circuitry and a frequency discipline algorithm.

**Frequency Locked mode** the mode where the system's output signals are synchronized to the external reference input signal. The external input signal is also used to discipline the module's oscillator and to align the 1 PPS output pulse.

**Geodetic Position** a position of a point on the surface of the earth expressed in terms of geodetic latitude and geodetic longitude.

**Global Positioning System (GPS)** constellation consisting of a minimum of 24 satellites orbiting the earth at a nominal altitude of 11,000 miles. GPS satellites transmit signals that allow the accurate determination of GPS receiver locations. Each is a traveling Cesium clock that circles the earth, calibrated daily by the US Air Force. The GPS constellation provides users with between five and eight SVs visible from anywhere on the globe.

**GPS** see Global Positioning System.

**GPS Lock** the condition when the GPS receiver has acquired an initial position fix and valid time via GPS.

**GPS Lock Indicator** refer to Table 9-1 for indicator function.

**GPS receiver** the GPS timing receiver, installed in the GTF module, is an eight-channel design capable of tracking eight satellites simultaneously and outputs a very accurate 1 pulse per second (1 PPS) that is synchronized to UTC.

This 1 PPS provides the precise reference to discipline the Rubidium or quartz oscillator. The receiver stores the operating parameters, satellite ephemeris data, and almanac information in battery back-up RAM within. The GTF module provides the battery back-up power.

**GPS Time and Frequency (GTF)** the GTF module utilizes the GPS system as a reference to discipline the GTF's internal oscillator (Rubidium or OCXO). The GTF contains a self-contained Frequency Discipline Machine (FDM) along with a uP controller and bus interface drivers.

**GPS Time Figure Of Merit (GTFOM)** indicates the timing accuracy of the GPS receiver's output signals.

**GTF** see GPS Time and Frequency.

**GTFOM** see GPS Time Figure Of Merit.

**HINT** see Holdover Integrity.

**Holdover Integrity (HINT)** indicates the learning algorithm has acquired the parameters necessary to meet the holdover specification defined in the Product Documentation, and therefore the oscillator will be tuned with those parameters in the absence of GPS or external reference.

**Holdover (Coasting)** condition where the system loses satellite lock and is waiting for conditions needed to start the recovery process from Holdover to Time Locked. The time and frequency accuracy is maintained by applying corrections to the oscillator using temperature and aging effect data obtained during GPS locked operation. The Holdover mode can only be entered after the system has operated in the Time Locked mode.

**ICD-GPS-153** GPS user equipment interface control document for the GPS standard serial interface protocol

(GSSIP) of DoD standard GPS user equipment radio receivers.

**International Atomic Time (TAI)** is a very accurate and stable time scale that is an average of many atomic clocks (cesium) all over the world.

**Internet Protocol Address (IP Address)** is a unique number that devices use in order to identify and communicate with each other on a network utilizing the Internet Protocol standard.

**IP Address** see Internet Protocol Address.

**KDC** see Keypad Display Controller.

**Known mode** the mode where the GPS receiver no longer computes the solution for position, resulting in an improved time solution.

**Keypad Display Controller (KDC)** allows for data entry and display screen selection.

**LCD** liquid crystal display.

**leap second pending (LSP)** indicates that a leap second is about to happen.

**LGPS** Local GPS.

**local time offset** the hours difference (up to  $\pm 14.5$  hours) between UTC time and IRIG time.

**Local Time Zone Offset** offset applied to change the systems time reference to local UTC (LUTC) or local GPS (LGPS) time.

**LSP** see leap second pending.

**LUTC** Local UTC.

**Management Information Base** a database of commands used to manage equipment in a network.

**Manual Time mode** in this mode, the system's time is entered manually by the user. Note that In Manual Time mode the time provided is only as accurate as the time entered.

**MIB** see Management Information Base.

**Net Mask or Subnet Mask** a bitmask used to tell how much of an IP address identifies the **subnetwork** the host is on and how much identifies the host.

**OCXO** Oven Controlled Crystal Oscillator.

**Online Indicator** refer to Table 9-1 for indicator function.

**Position Averaging mode** see Survey mode.

**Power Indicator** refer to Table 9-1 for indicator function.

**P/Y code** the precise or precision code of the GPS signal, used by the SAASM receiver.

**Ready indicator** refer to Table 9-1 for indicator function.

**Ready mode** the mode that indicates the DTF's internal Rubidium oscillator is synchronized to GPS reference.

**Recovery mode** is entered from the Coasting mode. In this mode the 1 PPS alignment and the frequency of the internal oscillator is adjusted until the Time Locked mode criteria is met.

**SAASM** see Selective Availability Anti-Spoof Module.

**SNMP** see Simple Network Management Protocol.

**Simple Network Management Protocol** an application layer protocol (part of the TCP/IP protocol suite) that facilitates the exchange of management information between network devices. When equipped with the appropriate Ethernet I/O module, the protocol can be used to monitor and command the CommSync II.

**Survey mode (Position Averaging)** the mode where the GPS receiver begins to search the sky for available satellites. Once a sufficient number of

satellites are tracked, the receiver will calculate an average position over a period of time. The receiver will then use this average position to enter the Known position mode.

**Switch mode** the mode where GPS is the default reference source and an external signal is the secondary reference. If GPS becomes unavailable and the external reference input is present, the module will automatically switch to the external 1 PPS input.

**TAI** see International Atomic Time.

**TCP/IP** see Transmission Control Protocol/Internet Protocol.

**TFOM** see Time Figure Of Merit.

**Time Figure Of Merit (TFOM)** indicates the timing accuracy of the CommSync II's output signals. Normally, the TFOM value is 4.

**Time Locked mode** mode where the CommSync II system's output signals and the system's time are synchronized to UTC. The 1 PPS output from the receiver is used as reference to discipline the system's oscillator and to align the 1 PPS output pulse.

**time quality** an indicator of time accuracy or synchronization relative to UTC.

**Time to First Fix (TTFF)** is the average time a GPS receiver takes to lock onto the first four available satellite signals.

**TOD** Time of Day.

**Transmission Control Protocol/Internet Protocol (TCP/IP)** communications protocols on which the Internet and most commercial networks operate.

**TTFF** see Time to First Fix.

**UTC** see Coordinated Universal Time.

**Warm Start mode** the mode where power is applied (power-up) and the system's GPS receiver searches for, acquires, and tracks satellites using the current almanac data and ephemeris, position mode and antenna position data. In the Warm Start mode the receiver normally achieves lock in 3 to 5 minutes.

**Warm-Up mode** condition after power-up where the internal oscillator is warming up and the internal receiver is acquiring satellites.

**Zeroized** the condition in which the Crypto-Variable has been erased subsequent to pressing the *ZEROIZE* key on the front panel.

- 
- 1 PPS, 24, 27, 28, 36, 37, 51, 59, 60, 62, 67, 70, 87, 88, 92, 101, 104, 131, 132, 133, 134
  - 1 PPS Fault, 109
  - 10 MHz Fault, 109
  - 12 VDC Input Power, 99
  - 12 VDC Power Connection, 45, 124
  - 12 VDC Power Supply module, 124, 125
  - 24 VDC Input Power, 99
  - 24 VDC Power Connection, 45, 121
  - 24 VDC Power Supply module, 98, 121, 122
  - 28 VDC Power Connection, 46, 120, 121, 124, 128
  - 28 VDC Power Supply module, 127, 128
  - 48 VDC Input Power, 99
  - 48 VDC Power Connection, 45
  - 48 VDC Power Connection, 121
  - 48 VDC Power Supply module, 121, 122
  - AC input, 44, 67
  - AC Input Power, 98
  - AC Power Connection, 44
  - AC Power Supply module, 98, 118, 119
  - AC Voltage, 98
  - accuracy, 36, 37, 69, 100, 101, 102, 132, 134
  - Alarm/Fault* indicator, 47, 68, 108, 131
  - Allan Variance, 100
  - amplifier connector, 41, 42
  - antenna, 29, 39, 40, 41, 42, 43, 50, 51, 53, 84, 103, 108, 109, 114, 131, 134
  - antenna cable*, 40, 41, 42, 43, 47, 51, 86
  - antenna cable delay, 51, 52, 86
  - antenna connection, 26, 40, 109, 110
  - antenna connector, 26, 39, 40, 103
  - antenna position data, 36
  - arrow key, 79
  - assumptions, 17
  - automatic switchover mode, 37
  - backplane, 25
  - Baud Rate, 102, 104
  - C/A, 27, 39, 57, 131
  - C/A mode, 48
  - C/A receiver, 36, 39, 40, 41, 42, 85
  - calibration, 108
  - CAUTION, 6, 40, 115
  - Certifications and Compliance, 106
  - chassis, 25, 26, 98, 114
  - chassis ground, 46, 121, 124, 128
  - chassis width, 98
  - coasting, 90, 100, 101, 110, 131, 132
  - Coasting* mode, 28, 37, 60, 87, 100, 133
  - Cold Start, 36, 49, 50, 53, 54, 55, 85
  - Cold Start* mode, 36, 54, 56, 85, 131
  - combination system, 64, 75
  - Command I/O module, 24, 30
  - Command Protocol, 71, 73, 102, 104
  - compatibility, 104, 106
  - configuration, 24, 30, 38, 51, 64, 70, 71, 72, 93, 94, 95, 104
  - connector, 43, 47, 57, 68, 128
  - connector identification, 101
  - connector type, 44, 67, 98, 99, 100, 101, 102, 103, 104, 120, 129
  - Cont, 49, 69, 78, 79
  - Contact Information, 7
  - conventions, 18
  - cooling, 25, 98
  - Coordinated Universal Time, 24, 62, 83, 131, 134
  - cross coupling, 32
  - cross-discipline, 64, 75
  - Cross-Discipline* mode, 75
  - CV indicator, 49
  - CV Invalid*, 131
  - CV Invalid* indicator, 48, 49, 108
  - CV Valid*, 131
  - CV Valid* indicator, 48, 49, 108
  - DAC* value, 87
  - data bits, 102, 104
  - Data Sheets, 7
  - DC input, 44, 46, 67, 121, 124, 128
  - DC Power Supply module, 118, 122
  - DE-9, 47, 57, 68
  - Declaration of Conformity, 130
  - depth, 98
  - discipline reference source, 88
  - Discipline Source mode, 59, 60, 64, 70, 75, 76, 88
  - Disclaimer, 5
  - display backlight, 49
  - distortion factor, 99, 129
  - Distribution Chassis, 26
  - DTF, 24, 25, 28, 62, 63, 64, 65, 67, 68, 69, 70, 71, 72, 73, 75, 83, 92, 100, 101, 131
-

- 
- duty cycle, 100
  - Dynamic* mode, 50, 84, 131
  - Edit key, 79
  - Email, 7
  - EMC, 106
  - Enter key, 79
  - estimator cycle, 89, 132
  - Estimator Status, 89
  - Ethernet, 94, 111
  - Ethernet I/O Configuration, 95
  - Ethernet I/O External Input module, 30, 66, 67
  - Ethernet I/O module, 24, 30, 94, 95, 104
  - Ethernet port, 30, 66, 67
  - external 1 PPS, 24, 28, 36
  - external 1 PPS delay, 92
  - external frequency input, 62
  - external frequency source, 24, 62
  - external input module, 30, 62, 63, 64, 67, 69, 71, 72, 91, 92
  - external input signal, 36, 38, 60, 132
  - External* mode, 75
  - external reference*, 24, 28, 30, 62, 70, 72, 75, 101
  - external reference input, 28, 36, 37, 38, 64, 70, 72, 101, 132, 134
  - external reference signal, 37
  - external reference source, 24, 43, 66, 67, 88, 89
  - external sync, 27
  - external sync input, 59, 64, 89
  - failed, 110
  - Failed* mode, 87
  - fault reporting, 108, 111
  - Fax, 7
  - FCC, 5
  - FDM, 27, 28, 32, 37, 64, 87, 90, 131, 132
  - FDM Estimator Status, 89
  - FDM* mode, 87
  - Federal Communications Commission, 5
  - fiber optic, 30, 66, 67
  - fiber optic antenna, 39, 43, 103
  - Fiber Optic Antenna Interface module, 43, 103
  - fiber optic cable, 43, 103
  - fiber optic link, 39
  - Fiber Optic Transmitter assembly, 43, 103
  - frequency, 25, 37, 51, 62, 70, 100
  - frequency accuracy, 69, 132
  - Frequency Discipline Machine, 27, 28, 32, 37, 64, 87, 90, 131, 132
  - Frequency Discipline Status, 87
  - frequency error, 131
  - frequency input, 30, 67
  - frequency lock, 36, 89, 100
  - Frequency Locked* mode, 36, 37, 38, 87, 132
  - frequency output, 24, 27, 28, 37, 62, 100
  - frequency reference, 86, 92, 100
  - frequency source, 24
  - front panel, 25, 29, 52, 59, 60, 70, 72, 73, 78, 98, 114
  - Front Panel assembly, 114, 115
  - Front Panel Display, 49, 69, 95, 110, 111
  - Front Panel Display Evaluation, 110
  - fuse, 6
  - General Safety Precautions, 6
  - Global Positioning System, 24, 62, 83, 132
  - GPS Comm Fault, 109
  - GPS lock, 27, 33, 36, 37, 49, 100, 132
  - GPS Lock* indicator, 50, 108, 109, 132
  - GPS receiver, 20, 22, 24, 27, 36, 39, 41, 42, 50, 59, 86, 87, 98, 101, 108, 109, 110, 131, 132, 133, 134
  - GTF, 24, 25, 26, 27, 28, 30, 32, 33, 36, 37, 38, 40, 43, 48, 49, 50, 51, 53, 54, 55, 59, 60, 62, 64, 65, 73, 82, 85, 86, 87, 89, 91, 95, 98, 100, 101, 108, 109, 110, 119, 122, 125, 128, 131, 132
  - GTFOM, 85, 132
  - hard faults, 33
  - height, 98
  - HINT, 37
  - holdover, 27, 28, 90, 100, 101, 110, 131, 132
  - Holdover Integrity, 37
  - Holdover* mode, 28, 37, 100
  - Hot Start, 25, 57, 102
  - hot swap/replaceable, 29
  - hot swappable, 114, 119, 121, 124, 127
  - humidity, 98, 103
-



- 
- I/O module, 29, 30, 38, 47, 64
  - ICD-GPS-153, 57, 102, 132
  - Important Note, 49, 55
  - indicators, 29, 111
  - in-line amplifier, 41, 86
  - input connection, 99, 123, 126, 129
  - input current, 122, 125, 128
  - input frequency, 120
  - input impedance, 102
  - input level, 102
  - input line protection, 99, 120, 123, 126, 129
  - input power, 42, 98, 99, 120, 123, 126, 129
  - input ripple amplitude, 99, 129
  - input voltage, 99, 120, 122, 123, 125, 126, 128, 129
  - IP Address, 94, 104, 133
  - IRIG, 30, 71, 72, 75, 133
  - isolation, 99, 123, 126, 129
  - itime code input, 24
  - jam, 37
  - KDC, 24, 25, 27, 133
  - Keyload connector, 48
  - Keyload port, 48
  - keyloader, 48
  - Keypad, 25, 133
  - Keypad Display Controller, 25, 27, 32
  - Keypad/Display, 24, 25, 27, 29, 51, 52, 53, 54, 55, 57, 59, 60, 71, 95, 98
  - Known mode*, 36, 50, 84, 100, 133, 134
  - L1, 39, 42
  - L1 GPS antenna, 39
  - L1/L2 GPS antenna, 39
  - L2, 42
  - LCD module, 25, 78
  - learned data, 27, 28
  - Left arrow key, 79
  - Legal Information, 5
  - lightning protection, 42
  - line regulation, 99, 120, 123, 126, 129
  - load regulation, 99, 120, 123, 126, 129
  - LOCK input, 71
  - LVD, 106
  - maintenance, 94
  - Manual Time mode*, 73, 82, 87, 133
  - MENU 0, 81, 109
  - MENU 1, 81
  - MENU 2, 84, 110
  - MENU 3, 87, 110
  - MENU 4, 84
  - MENU 5, 87
  - MENU 6, 91
  - MENU 7, 91
  - MENU 8, 93
  - MENU 9, 94
  - Menu key, 79
  - Menu Tree, 80
  - NetMask, 94, 104
  - NTP Support, 104
  - N-type, 42
  - number keys, 79
  - On Line* indicator, 47, 108
  - operating altitude, 98
  - operating temperature, 98, 103
  - option module, 24, 29, 31, 81, 100, 101, 108, 110, 111, 114
  - Option Module ID and Status, 112
  - Option Module User's Manual, 29, 30, 31, 39, 47, 66, 68
  - option slots, 29
  - oscillator, 24, 27, 28, 32, 36, 64, 87, 89, 98, 100, 101, 109, 131, 132, 133
  - Outline and Mounting, 105
  - output drive, 100, 101
  - output module, 32, 93
  - output power, 99, 120, 123, 126, 129
  - output protection, 99, 120, 123, 126, 129
  - output voltage, 99, 120, 123, 126, 129
  - overload protection, 98
  - P/Y, 57, 133
  - P/Y mode, 48
  - panel color, 98
  - parity, 102, 104
  - phase, 37
  - Phone, 7
  - PLGR port, 57, 102
  - position averaging, 133
  - Position Averaging mode*, 36, 133
  - Power Fault, 109
  - Power indicator*, 47, 108
  - power requirements, 98, 103
  - Power Supply module, 29, 44, 67, 93, 119, 121
  - power-up, 33, 36, 47, 49, 50, 67, 69, 71, 75, 84, 108, 134
  - power-up default, 49, 69
-

- 
- PPS, 57
  - Precise Positioning Service, 57
  - primary control, 71, 72
  - primary module, 38, 64, 71, 91
  - primary reference source, 62, 73
  - primary slot, 94
  - protection, 103
  - protective cover, 6
  - PRS, 62
  - pulse width, 101, 102
  - Quick Start Guide – DTF, 18, 21
  - Quick Start Guide - GTF, 18, 19
  - Ready*, 33, 133
  - Ready indicator*, 36, 47, 51, 68, 72, 100, 108, 133
  - rear panel, 26, 29, 111
  - rear panel module, 29
  - recovering, 110
  - Recovery mode*, 37, 87, 90, 112, 133
  - relative humidity, 98
  - repair procedure, 108, 114
  - Repairs, 7
  - returned material authorization, 115
  - Returned Material Authorization, 7
  - Returns, 7
  - Right arrow key, 79
  - RMA, 7, 115
  - RS-232, 47, 68, 111
  - RS-232 I/O External Input module, 30, 64, 66, 101, 104
  - RS-232 I/O module, 30, 104
  - RS-232 port, 24, 30, 32, 47, 68, 102
  - SAASM, 27, 36, 39, 48, 57, 84, 133
  - SAASM receiver*, 36, 39, 40, 41, 42, 48, 49, 50, 85, 108, 133
  - safety, 6, 106
  - safety grounding, 6, 38, 65
  - Safety Information, 6
  - Sales, 7
  - secondary control, 71, 72
  - secondary module, 38, 64, 71, 91
  - serial command, 24, 30, 38, 51, 52, 53, 54, 57, 59, 60, 65, 70, 71, 73
  - Serial Communications Protocol, 24
  - serial interface command, 70, 71
  - service, 108
  - Shipping Address, 7
  - signal, 102, 104
  - signal ground, 47, 68
  - signal strength, 39, 42
  - slot 14, 92, 95
  - slot 15, 91, 94
  - slot 2, 26, 29
  - slots 1 and 16, 29
  - slots 14 and 15, 29, 30, 38, 64, 71, 72, 91
  - slots 3 through 15, 29, 31
  - SNMP, 30, 94, 95, 104, 133
  - SNTP, 104
  - soft faults, 33
  - speaker control, 94
  - SRAM memory reset, 54
  - SSTA, 36, 37, 87, 111, 112, 113, 119, 122, 125, 128
  - Standard Positioning Service, 98
  - start-up current, 122, 125, 128
  - start-up process, 39, 66
  - stop bits, 102, 104
  - storage altitude, 98
  - storage temperature, 98, 103
  - Subnet Mask, 94, 133
  - surge protector, 42
  - surge suppressor connector, 42
  - Survey mode*, 36, 50, 54, 56, 84, 133
  - Switch mode*, 28, 37, 60, 134
  - switchover, 32, 33, 36, 109
  - Sync Input*, 24, 28, 43, 59, 71, 101
  - synchronization, 101, 102
  - synchronization input, 64, 67, 75
  - Synchronization mode, 102
  - synchronization reference, 101
  - system fault diagnosis, 108
  - System Status command, 111
  - System Status message, 36, 37, 38, 65, 111
  - Technical Support, 7, 114
  - temperature rate of change, 98
  - TFOM, 36, 50, 51, 69, 112, 134
  - time, 25
  - time accuracy, 132, 134
  - Time and Status, 59, 78, 81
  - Time and Status* screen, 49, 51, 69
  - Time Code Input module, 30, 67, 72, 75
  - Time Code Output module, 93
  - Time Figure Of Merit, 36, 50, 51, 69, 85, 112, 132, 134
  - time lock, 36, 51, 100
-

- 
- time locked, 89, 100, 101, 110, 131, 132, 133, 134
  - Time Locked* mode, 36, 37, 87, 132, 133, 134
  - time output, 27, 28, 37, 72
  - Time screen, 36
  - Time To First Fix*, 50
  - timing accuracy, 132, 134
  - timing output, 24, 62, 100
  - timing source, 24
  - TNC, 41, 42, 43, 103
  - Trademarks, 5
  - Trap Address, 94, 95
  - troubleshooting, 108, 110, 114
  - TTF*, 50, 134
  - UTC, 24, 27, 36, 50, 57, 58, 62, 82, 83, 86, 101, 131, 133, 134
  - Warm Start, 36, 53, 54, 55, 134
  - Warm Start* mode, 36, 134
  - warm-up, 33, 36, 50, 69, 98, 108, 110
  - Warm-Up* mode, 36, 47, 50, 68, 87, 134
  - WARNING, 6, 38, 42, 65, 120
  - Warranty, 5
  - wave shape, 100, 101
  - weatherproofing, 40, 43
  - weight, 98
  - Where to Look, 18
  - wire size, 122, 125, 128
  - zeroize, 48, 49, 134