

25/27 Multimeter

OPERATOR'S MANUAL
MANUEL D'INSTRUCTION
BEDIENUNGS-HANDBUCH
MANUALE D'IMPIEGO
MANUAL DE INSTRUCCIONES

ユーザーズ・マニユアル

FLUKE®

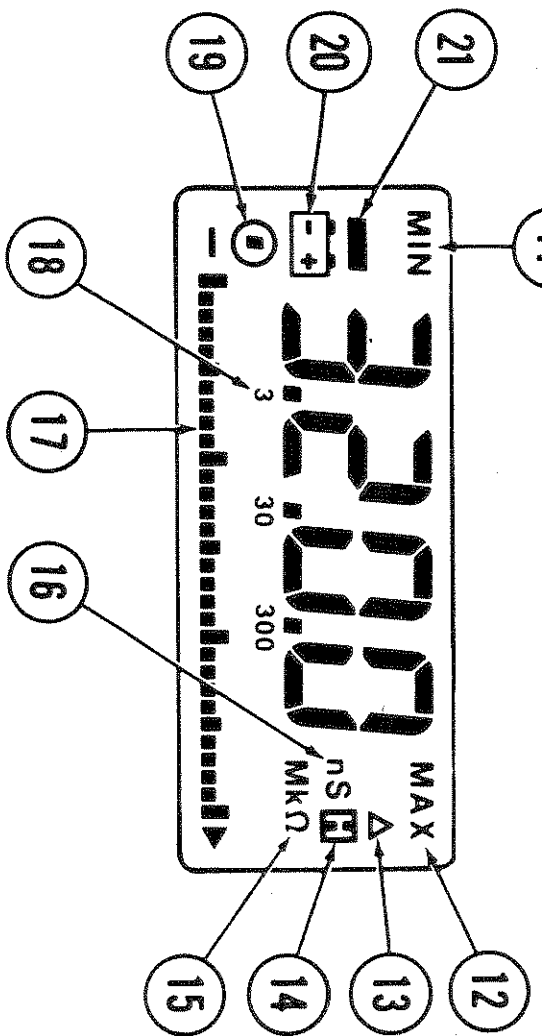
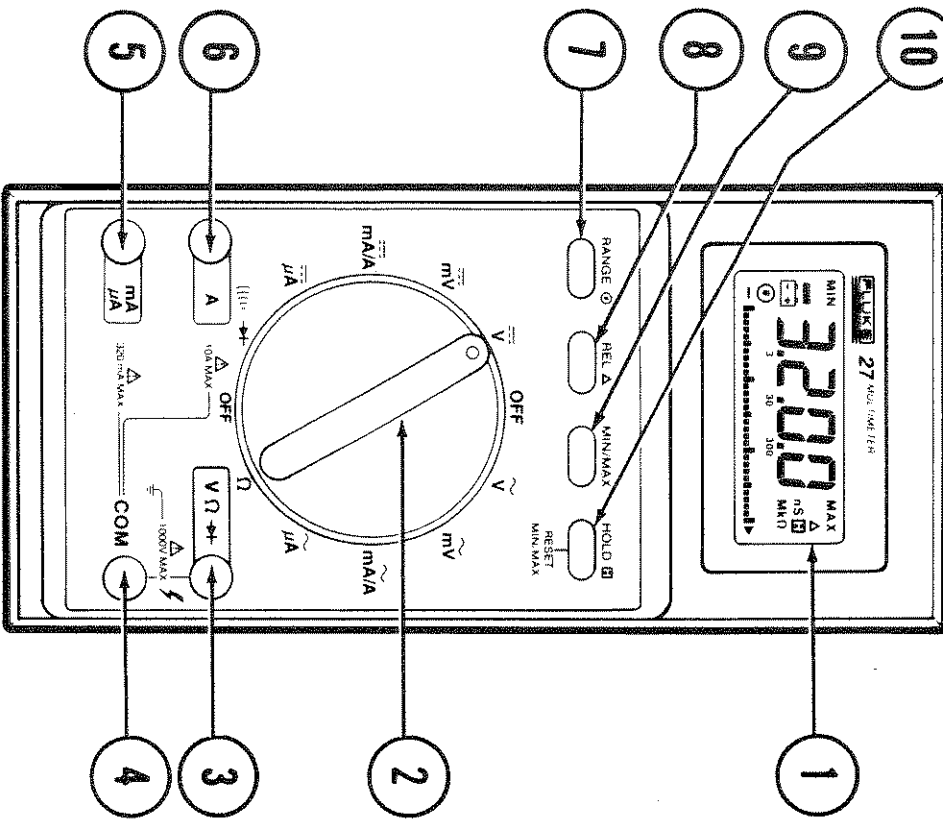

01.01

SEE PAGE 4
 VOIR PAGE 24
 SIEHE SEITE 46
 VEDI PAGINA 69
 VER PAGINA 92
 114 ページ参照

**25
27**

MULTIMETER

English

Français

Deutsch

Italiano

Español

日本語



PN 738088

July 1984 Rev.5, 2/93

© 1993 John Fluke Mfg. Inc., All rights reserved. Litho in U.S.A.









Operating Instructions

This meter has been designed and tested according to IEC Publication 348. Safety Requirements for Electronic Measuring Apparatus. This manual contains information and warnings which must be followed to ensure safe operation and retain the meter in safe condition.

MULTIMETER SAFETY

Read this information before using the meter. WARNINGS denote hazards to the operator. CAUTIONS denote hazards to the meter. If the meter is not used as described in this manual, the safety features of the meter might be impaired. The following safe practices and proper operation procedures should be followed when using any multimeter:

- Inspect the test leads for insulation damage or exposed metal. Damaged leads should be replaced.
- Check test lead continuity using the diode test (| | | | | →+) mode.
- Be certain the digital multimeter (DMM) itself is in good operating condition. During the continuity test, a meter reading that goes from overload (OL) to 0 generally means the meter is working properly.
- Select the proper function and range for your measurement.
- Do not allow the meter to be used if it is damaged or if its safety is impaired.

	OFF (power) SWITCH POSITION		DANGEROUS VOLTAGE
	ON (power) SWITCH POSITION		GROUND
	AC-ALTERNATING CURRENT		SEE EXPLANATION IN MANUAL
	DC-DIRECT CURRENT		DOUBLE INSULATION (Protection Class II)
	EITHER DC OR AC		FUSE

International Electrical Symbols

WARNING

TO AVOID ELECTRICAL SHOCK, USE CAUTION WHEN WORKING ABOVE 60V DC OR 25V AC RMS. SUCH VOLTAGES POSE A SHOCK HAZARD.

- Electrically disconnect the live, or hot, test lead before disconnecting the common test lead.
- Follow all equipment safety procedures. Disconnect the input power and discharge all high-voltage

2

capacitors through a protective impedance before testing in Ω and ( with the multimeter.

- Avoid working alone.
- When making a current measurement, turn the power off before connecting the multimeter in the circuit. Overloading a current shunt will cause excessive heat.
- When measuring transformer secondary or motor winding current, check the multimeter fuses first. (See Fuse Test in the Operator Maintenance Section.) An open fuse will allow high voltage build-up, which is potentially hazardous.

- The use of makeshift fuses and the short-circuiting of fuse holders is prohibited.

- Whenever it is likely that the protection has been impaired, the apparatus shall be made inoperative and be secured against any unintended operation.

WARNING

TO AVOID ELECTRICAL SHOCK OR DAMAGE TO THE METER, DO NOT APPLY MORE THAN 1000V BETWEEN ANY TERMINAL AND EARTH GROUND.

Table 1. Input Terminals and Limits

FUNCTION	INPUT TERMINALS Red Lead Black Lead	MIN DISPLAY READING	MAX DISPLAY READING	MAXIMUM INPUT
$\overline{\text{V}}$	V Ω \rightarrow COM	0.001V	1000V	1000V
$\overline{\text{mV}}$	V Ω \rightarrow COM	0.1 mV	320.0 mV	500V
Ω (nS)	V Ω \rightarrow COM	0.1 Ω	32.00 M Ω	500V
	V Ω \rightarrow COM	0.01 nS	32.00 nS	500V
$\overline{\text{mA}}$	V Ω \rightarrow COM	0.001V	2.08V	500V
$\overline{\text{mA/A}}$	A	0.01A	20.00A*	10A* 600V
	mA μ A	0.01 mA	320.0 mA	320 mA 600V
$\overline{\mu\text{A}}$	mA μ A	0.1 μ A	3200 μ A	320 mA 600V
*10A continuous, 20A for 30 seconds maximum				

OPERATING FEATURES

The following features are keyed by number to the illustration inside the front cover.

1 Digital Display:

3200 count, liquid crystal display with automatic decimal point positioning. Updated two times per second. When the meter is first turned on, all display segments appear while the instrument performs a brief power-up self-test.

2 Function Selector Rotary Switch:

Turn to select any of 10 different functions, or OFF. Refer to the Specifications for available ranges and to Table 1 for input terminals and limits.

$\overline{\overline{V}}$	Volts dc
$\overline{\overline{mV}}$	Millivolts dc
$\sim V$	Volts ac
$\sim mV$	Millivolts ac
Ω	Ohms (resistance), also conductance (1/ Ω) in nanoseimens (nS)

$(|)|(|) \rightarrow$ Continuity or diode test

$\overline{\overline{mA/A}}$ Milliamps or amperes dc

$\overline{\overline{\mu A}}$ Microamps dc

$\sim mA/A$ Milliamps or amperes ac

$\sim \mu A$ Microamps ac

3 $V \Omega \rightarrow$ Volt, Ohms, Diode Test Input Terminal:

Input terminal used in conjunction with the volts, mV (ac or dc), ohms, or diode test position of the function selector rotary switch.

4 COM Common Terminal:

Common or return terminal used for all measurements.

5 $mA \mu A$ Milliamp/Microamp Input Terminal:

Input terminal used for current measurements up to 320 mA (ac or dc) with the function selector rotary switch in the mA or μA position.

6 A Amperes Input Terminal:

Input terminal used for current measurements up to 10A continuous (20A for 30 seconds) with the function selector rotary switch in the mA/A position (ac or dc).

7 RANGE  Manual Range Mode Pushbutton:
Press once to enter manual range mode, press again to increment range, press and hold for 2 seconds to return to autorange. Meter returns to autorange if the function selector is switched to any other position. There is no autorange annunciator; absence of the manual range annunciator indicates the meter is in autorange. If RANGE is depressed (>1 second) while the function switch is moved from OFF to any ON position, manual ranging will be selected in all functions.

8 REL  Relative Mode Pushbutton (Fluke 27 only):
Press momentarily to enter the Relative mode and store the displayed reading. The display will read zero. Press again to update the stored digital reading. Press and hold for 2 seconds to exit the Relative mode. The Relative mode stores a digital reading and displays the change (difference) between the stored reading and any following

reading. For example, if the stored reading is 15.00V and the present reading is 14.10V, the display will indicate -0.90V. The analog bar graph continues to display the actual reading (14.10V). If the difference exceeds 3999 counts (without overloading the input), OF (overflow) is displayed. The Relative mode selects manual ranging; changing ranges automatically exits the Relative mode.

9 MIN/MAX Mode Pushbutton (Fluke 27 only):

Press momentarily to enter MIN/MAX mode, press again to toggle between MIN and MAX indications. Press and hold for 2 seconds to exit MIN/MAX mode. The meter stores the minimum and maximum digital readings, and will display either reading as selected by the operator. Press the HOLD/RESET button to reset the MIN/MAX readings to the present input. The MIN/MAX mode selects manual ranging; use a range that can record the maximum anticipated input. Range changes reset previously recorded MIN/MAX readings. Exiting the MIN/MAX mode does not reset the previously recorded readings unless the range or function is changed. The MIN/MAX mode overrides the Touch-Hold mode.

WARNING
TOUCH HOLD WILL NOT CAPTURE UNSTABLE OR NOISY READINGS. DO NOT USE TOUCH HOLD TO DETERMINE THAT CIRCUITS WITH DANGEROUS VOLTAGES ARE DEAD.

- 10** **HOLD**  **Touch-Hold Mode Pushbutton:** Press momentarily to enter Touch-Hold mode. In Touch-Hold, the meter captures a stable measurement and holds it in the display. The operator can watch the probes while taking measurements in difficult or hazardous circuits, then look at the display when convenient. The meter beeps and the display is automatically updated each time a new, stable measurement is made. Press momentarily to manually update reading. Press and hold for 2 seconds to exit Touch-Hold mode. If HOLD is depressed (>1 second) while the function switch is moved from OFF to any ON position, the Touch-Hold mode will only update to a new reading when the HOLD button is pressed. (Automatic Touch-Hold updates are defeated.) This is useful when you want to take a reading at a specific time and hold it.
- 11** **MIN** **Minimum Annunciator (Fluke 27 only):** Indicates that the meter is in the MIN/MAX recording mode, and the value displayed is the minimum

digital reading taken since reset or since entering MIN/MAX. Refer to item 9 for operation.

- 12** **MAX** **Maximum Annunciator (Fluke 27 only):** Indicates that the meter is in the MIN/MAX recording mode, and the value displayed is the maximum digital reading taken since reset or since entering MIN/MAX. Refer to item 9 for operation.
- 13** **Δ** **Relative Annunciator (Fluke 27 only):** Indicates that the meter is in the Relative mode and that the value displayed is relative (the difference between the present measurement and the previously stored reading). Refer to item 8 for operation.
- 14** **H** **Touch-Hold Mode Annunciator:** Displayed when the touch-hold mode is in use. Refer to item 10 for operation.
- 15** **MkΩ** **Resistance Annunciators:** The appropriate annunciator (Ω, k, or M) is displayed for the resistance range in use.
- 16** **nS** **Conductance Range Annunciator (nS):** Top range of the resistance function is the conductance range. Displays conductance in nS

(nanosiemens). 1000/nS converts to megohms. (Example: 2 nS converts to 500 MΩ.) Use for measuring resistance above 32 megohms. Select Ω, open test leads, press RANGE button twice. (Refer to item 7 for manual range operation.)

 **Analog Bar Graph Display:**
Analog representation of input. Composed of 31 segments which illuminate starting from the left as the input increases. (See display inside rear cover.) A minus sign (-) is displayed for reverse-polarity inputs. Updated 25 times per second.

 **Decimal Point/Range Indicator:**
Decimal point position and the digits (3, 30, 300) under the decimal point indicate the range in use.

 **Manual Range Annunciator:**
Displayed in the Manual Range mode or if the selected function has only one range. Absence of the indicator implies autorange mode in use. The meter powers-up in autorange. In autorange, the meter automatically selects the measurement range. Refer to item 7 for operation.

 **Low Battery Annunciator:**
At least 60 hours of battery life remain when first

displayed. Battery voltage is tested each time the function switch is moved to a new position.

 **Negative Polarity Annunciator:**
Automatically indicates negative inputs.

 **Overload Indication:**
These symbols indicate the input is too large for the input circuitry. (The location of the decimal point depends on the measurement range.)

 **Overflow Indication (Fluke 27 only):**
These symbols indicate the calculated difference in the Relative mode is too large to display (>3999 counts) and that the input is not overloaded.

 **Beeper (not illustrated):**
The beeper can produce beeps, clicks, or a continuous tone. It is used for audible indication in the diode test mode, when operating the push buttons, and when a new reading is displayed in the Touch-Hold mode.

TILT BAIL ADJUSTMENT

To use the tilt bail as a handle, lift the bail slightly (about 1 inch or 2.5 cm), pull the ends out, and insert the ends in the alternate set of holes.

APPLICATIONS Voltage, AC/DC

All ranges present an input impedance of approximately 10 megohms in parallel with less than 100 pF. Measurement errors, due to circuit loading, can result when making either ac or dc voltage measurements on circuits with high source resistance. However, in most cases the error is negligible (0.1% or less) if the measurement circuit source resistance is 10 kilohms or less.

When measuring voltages above 320V in Touch-Hold mode, use manual ranging to minimize readings of stray voltages.

Current, AC/DC

WARNING

INSTRUMENT DAMAGE AND OPERATOR INJURY MAY RESULT IF THE FUSE BLOWS WHILE CURRENT IS BEING MEASURED IN A CIRCUIT WHICH EXHIBITS AN OPEN CIRCUIT VOLTAGE GREATER THAN 600V. DO NOT ATTEMPT AN IN-CIRCUIT CURRENT MEASUREMENT WHERE THE POTENTIAL IS GREATER THAN 600V.

All current ranges are fuse protected. Approximate terminal resistances for the current ranges are: 0.05 ohms for A, 5.6 ohms for mA, and 500 ohms for μ A. The voltage developed

across the terminal resistance is specified as burden voltage. If a fuse opens, refer to the fuse replacement procedures in the Operator Maintenance section of this manual.

Resistance Measurement

CAUTION

Turn test circuit power off and discharge all capacitors before attempting in-circuit resistance measurements.

Test lead resistance may influence measurement accuracy on the 320-ohm range. To determine the error, short the test leads together and read the lead resistance. Correct the measurement by subtracting the lead resistance from the measurement, or use the Relative (REL) mode on the Fluke 27 to zero the display. The error is usually 0.1 to 0.2 ohms for a standard pair of test leads.

Some in-circuit resistance measurements can be made without removing diodes and transistors from the circuit. The full-scale measurement voltage produced on ranges below 32 megohms does not strongly forward bias silicon diodes or transistor junctions. Use the highest range you can (except 32 megohm) to minimize the possibility of turning on diodes or transistor junctions. Full scale measurement voltage in the 32-megohm range does strongly forward bias a diode or transistor.

Diode Test and Continuity

In diode test, there is only one range: 0 to +2.08 volts. Voltage is developed across the component(s) under test by a test current output from the Fluke 25/27. Voltages greater than 2.08V or open test leads produce an overload (OL) condition. Negative inputs produce a negative indication (they are not suppressed). In the diode test function (| | | | \rightarrow +), the beeper produces a continuous tone if the input is less than 0.1V, and the beeper beeps once when the input descends through a 0.7V threshold.

Audible continuity testing is also performed with the function selector switch in the diode test/continuity position. A continuous tone sounds for test resistances below approximately 150 ohms. An intermittent connection produces erratic beeps, and can be a valuable troubleshooting aid. Erratic beeps can also occur, due to environmental noise, if a test value is very close to the threshold (150 ohms). Test resistances from approximately 150 ohms to 1000 ohms produce a short tone similar to a forward biased diode. Test resistances less than approximately 20 kilohms will produce an on-scale reading.

Conductance

Conductance measurement is performed with the function selector switch in the ohms (Ω) function. The conductance

range can only be entered using manual range selection; autorange cannot enter the conductance range. The conductance range can be used both to measure conductance ($1/\Omega$, the inverse of resistance) and to measure very high resistances (greater than 32 megohms).

High value resistance measurements are susceptible to induced noise, and may require careful shielding. Conductance measurements are displayed in nanosiemens (nS). Calculate megohms by dividing 1000 by the nanosiemens displayed (1000/nS is equivalent to megohms). Example: 2 nS converts to 500 megohms ($1000/2$).

Leakage Testing

The conductance range effectively extends the resistance measurement capability of the Fluke 25/27 to the point where it can provide useful leakage measurements on passive components. For example, the operator can detect leaky diodes, cables, connectors, printed circuit boards, etc. In all cases, the test voltage is less than 2V dc.

Leakage testing on purely resistive components such as cables and printed circuit boards is straightforward. Select the ohms function and manually increment the range to conductance (nS). Connect the test leads to the test points

on the unit under test, and read the leakage in terms of conductance.

NOTE

There is normally a small residual reading with open test leads in the conductance range. To ensure accurate measurements, connect clean test leads to the Fluke 25/27, and (with the leads open) read the residual leakage in nanosiemens. Correct subsequent measurements by subtracting the residual from the readings. This can be done automatically using the Relative mode (REL) in the Fluke 27.

Diode leakage tests require that the diode junction be reverse biased when being measured. This is accomplished by connecting the anode of the diode to the COMMON input terminal and the cathode (ring) of the diode to the volts/ohms/diode test terminal. Leakage at the test voltage being applied can then be read in terms of conductance.

High-voltage stacked diode assemblies can usually be tested for forward and reverse resistance changes using

10

conductance. These assemblies typically have such high forward voltage drops that the diode test or resistance modes cannot test them.

ANALOG BAR GRAPH APPLICATIONS

In looking at the analog bar graph, notice that it is composed of segments that simulate an analog needle. The bar graph performs the same function as an analog meter needle, but it eliminates the mechanical overshoot inherent in needle movements.

A negative (—) annunciator is displayed at the left end of the bar graph when taking a reverse polarity dc measurement. Assume that a slowly varying dc voltage is the input signal. As the input goes more positive (from zero), a bar graph segment is displayed, and additional segments are displayed from left to right, to indicate the input level as it increases. Now, assume that the input level slowly decreases. Fewer bar graph segments are displayed as the signal decreases, then the — annunciator flashes as the signal level passes through 0. As the signal goes more negative, the — annunciator is displayed, and additional bar graph segments are displayed from left to right, indicating a more negative input signal. The first segment is an indication greater than or equal to 20 counts.

Note that every fifth segment of the bar graph is slightly larger than those in between, and every tenth segment is larger yet. These larger segments provide a quick reference for bar graph indications. The largest segments (every 10th segment) divide the display into thirds. Thus, if the bar graph indicates 11 segments on the 32.00V range, the input voltage is 10 to 11 volts; if the bar graph indicates 11 segments on the 320.0V range, the input voltage is 100 to 110 volts. If the input equals or exceeds 3000 counts on the range selected, the bar graph displays an arrow at the far right of the display. If the manual range annunciator (⊙) is not displayed, the Fluke 25/27 automatically switches to the next higher range if the input exceeds approximately 3260 counts.

Using the Analog Bar Graph

The analog bar graph is most useful in making adjustments and performing limited diagnostics. Bar graph response is fast and precise, so it can be used to easily reach a setting within a few percent of the final adjustment. The bar graph can be used to make rough adjustments quickly; then the 3200-count digital display can be used for final adjustment.

The analog bar graph is useful for performing limited diagnostics in applications where rapidly fluctuating signal levels cause the flashing digits of a digital display to be

useless. Like the traditional VOM needle, the analog bar graph excels at displaying trends, or slowly changing signals. In addition, autoranging on the Fluke 25/27 allows monitoring the signal change through changing ranges.

Many diagnostic routines using the bar graph require practice. The operator is looking for good or bad signal patterns that occur over some span of time. Capacitance checks and noisy resistance measurements create such patterns. Therefore, familiarity with analog bar graph response and movement is necessary to accurately interpret a signal pattern. Compare the bar graph response when making measurements on a known-good unit to the bar graph response when making measurements on a faulty unit.

Specific Applications--Nulling

The Fluke 25/27 bar graph is ideal for nulling adjustments. As an adjustment approaches zero, fewer bar graph segments are displayed, then no bar graph segments are displayed. The — annunciator flickers when the input level is within 10 counts of zero. The flickering null indication is displayed every time the input approaches zero or swings from one polarity to the other. The operator merely watches for the — annunciator indication, then reverses the direction

of the adjustment when the polarity sign is displayed. In one or two passes, a near-zero input level is possible, then the digital display can be used for exact zero adjustment.

Specific Applications--Contact Bounce

When subject to vibration, relay contacts may begin to bounce open. Checking for this intermittent problem is a routine troubleshooting measure associated with many types of equipment, including computers. Since the bounce problem will worsen as the relay fatigues, early diagnosis is important.

When the contact bounces open, its resistance value changes momentarily from zero to infinity and back. Ordinary hand-held DMMs take more than 300 milliseconds to update their displays--much too long to detect a brief contact bounce. A traditional VOM needle will move slightly at the instant of contact bounce, but the inertia of the needle movement dampens the response.

The analog bar graph, however, will display at least one segment the moment the contact opens. The bar graph can detect contact bounce as brief as 0.2 milliseconds, while most analog needle movements require a 3 millisecond opening before they will respond.

12

Specific Applications--Checking Capacitors

Volt-ohm meters are often used as simple capacitor checkers. In the capacitor kick test, the needle of the VOM in the resistance mode moves quickly from open (infinite ohms) toward short (zero ohms) as the capacitor is placed across the VOM input. The VOM battery charges the capacitor and the needle slowly moves back to the open (infinite ohms) position. The higher resistance ranges offer increased sensitivity for checking smaller capacitors.

The analog bar graph can make similar checks in the resistance function, even in the autoranging mode. As a capacitor is placed across the inputs, the analog bar graph quickly shortens, then rapidly down-ranges, depending on the size of the capacitor. As the capacitor charges, the bar graph slowly extends back to its full 31-segment length, up-ranging if necessary. For capacitors as small as 0.02 μ F, only the 30-megohm range is involved, the last few segments blink off, then back on.

In a fixed range (using manual range mode), the time it takes for the bar graph to extend from zero to full scale indicates the approximate capacitance value. Table 2 gives typical capacitance values for various charge times on different resistance ranges. For very small capacitors, use the conductance (nS) mode.

Table 2. Capacitance Vs. Time to Full Scale

Resistance Range	320Ω	3.2kΩ	32kΩ	320kΩ	3.2MΩ	32MΩ
Capacitance Value						
10,000 μF	4 sec	33 sec	5 min	ext	ext	ext
1,000 μF	blink	4 sec	30 sec	ext	ext	ext
100 μF	nil	blink	4 sec	32 sec	ext	ext
10 μF	nil	nil	blink	4 sec	30 sec	ext
1 μF	nil	nil	nil	blink	3 sec	19 sec
0.1 μF	nil	nil	nil	nil	blink	2 sec
0.02 μF	nil	nil	nil	nil	nil	blink
ext = extended time, nil = no indication						

The Fluke 25/27 resistance measurement circuit is designed to tolerate ac noise far better than the usual DMM. Readable, 2-kilohm readings can be obtained even in the presence of 1V ac noise. Readings of 1 megohm may be obtained with up to 2V ac noise. The noise appears as about 50 counts of change and an oscillating bar graph.

OPERATOR MAINTENANCE

WARNING

TO AVOID ELECTRICAL SHOCK, REMOVE THE TEST LEADS AND ANY INPUT SIGNALS BEFORE REPLACING THE BATTERY OR FUSES. CLOSE CASE AND REPLACE SCREWS BEFORE USING METER.

Battery Installation or Replacement

A single 9V battery (NEDA 1604, 6F22, or 006P) supplies power to operate the Fluke 25/27. Referring to Figure 1, use the following procedure to replace the Fluke 25/27 battery:

1. Turn the rotary switch to OFF, and remove the test leads.

Specific Applications--Noisy Resistance Measurements

Most digital multimeters are so sensitive they can not tolerate as much as 50 mV of line noise while making resistance measurements; their digital displays become unreadable due to the line noise. On the other hand, because of the mechanical inertia of the analog needle, the noise alternately pulls the needle to the left and then to the right, averaging out any movement and leaving a fairly stable resistance reading.

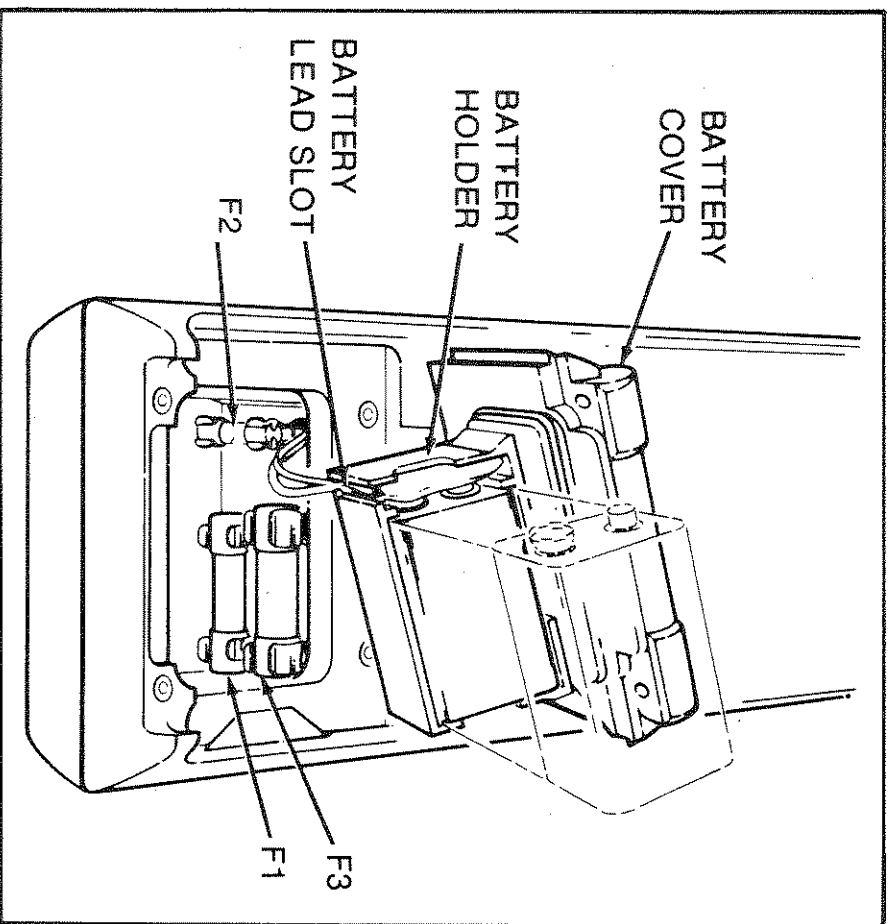

Figure 1. Battery and Fuse Replacement

14

2. Lift the instrument stand on the back of the Fluke 25/27, then remove the four black, #6 X 32, Pozidrive® screws from the battery cover.

3. Pull the battery cover straight out from the back of the Fluke 25/27. (A coin-slot in the side of the battery cover facilitates removal.)

4. Remove the battery from the battery holder, then disconnect the battery connector.

5. Snap the battery connector to the terminals on the new battery, then slide the battery into the battery holder. Slip each battery lead into the slot in the holder as shown in Figure 1.

6. Insert the battery holder/cover into the Fluke 25/27, then start the four screws removed in step 2. Press firmly on the battery cover while tightening the screws in a diagonal pattern.

Fuse Test

1. Turn the function selector switch to the Ω position.

2. Connect a test lead from the V Ω \rightarrow input terminal to the A input terminal.

3. The display should indicate between 0.1 ohm and 0.3 ohm. This tests F3 (15A, 600V fast).
4. Move one end of the test lead from the A input terminal to the mA/ μ A input terminal.
5. The display should indicate between 5.3 ohms and 6.0 ohms. This tests F1 (3A, 600V fast) and F2 (630 mA, 250V fast).
6. If either of the above display indications is OL (overload), replace the appropriate fuse.

Fuse Replacement

WARNING

THE USE OF MAKESHIFT FUSES AND THE SHORT-CIRCUITING OF FUSE HOLDERS CAN RESULT IN DAMAGE TO THE METER AND SERIOUS INJURY TO THE USER.

Referring to Figure 1, use the following procedure to check or replace the Fluke 25/27 fuses:

1. Perform steps 1 through 3 of the battery replacement procedure.

2. Remove the defective fuse (or check continuity through the suspected fuse), and if necessary install a new fuse of the same size and rating. Remove the battery from the battery holder to gain access to a spare fuse for F2.
3. Reinstall the battery holder/cover as instructed in step 6 of the battery replacement procedure.

General Maintenance

Clean the case with a damp cloth and detergent; do not use abrasives or solvents.

The Fluke 25 and 27 are sealed to protect the instrument. To maintain proper sealing, open only the battery/fuse compartment.

Have the meter calibrated and the seals (part number 738112) replaced by a qualified technician once a year to ensure specified performance. Contact the nearest Fluke Service Center or refer to the Fluke Service Manual (part number 738138) for calibration or repair. Refer to the parts list at the end of this manual for operator replaceable parts.

ENGLISH

SERVICE

If the instrument fails, forward it, postage paid, to the nearest Fluke Service Center (refer to the list at the back of this manual). Include a description of the difficulty, and pack the instrument securely; Fluke shall assume NO responsibility for damage in transit.

IN WARRANTY: Instruments covered by the limited warranty will be promptly repaired or replaced, at Fluke's option, and returned, all at no charge. See the registration card for warranty terms.

OUT OF WARRANTY (USA AND CANADA): The instrument will be repaired and returned for a fixed fee. (Repairs needed because of abuse or accidental damage will be quoted.) Contact the nearest Service Center for current prices. Include a check, money order, or purchase order with the instrument.

OUT OF WARRANTY (OUTSIDE USA AND CANADA): Service programs may vary by country. Contact the nearest Service Center for information.

FLUKE 25/27 SPECIFICATIONS

FUNCTION	RANGE	RESOLUTION	ACCURACY *
V̄	3.200V	0.001V	±(0.1%+1)
	32.00V	0.01V	±(0.1%+1)
	320.0V	0.1V	±(0.1%+1)
	1000V	1V	±(0.1%+1)
mV̄	320.0 mV	0.1 mV	±(0.1%+1)
	320.0Ω	0.1Ω	±(0.3%+2)
Ω (nS)	3.200 kΩ	0.001 kΩ	±(0.2%+1)
	32.00 kΩ	0.01 kΩ	±(0.2%+1)
	320.0 kΩ	0.1 kΩ	±(0.2%+1)
	3.200 MΩ	0.001 MΩ	±(0.2%+1)
	32.00 MΩ	0.01 MΩ	±(1%+1)
	32.00 nS	0.01 nS	±(2%+10)
	2.080V	0.001V	±(1%+1) typical
V̂	3.200V	0.001V	40 Hz-2 kHz ±(0.5%+3)
	32.00V	0.01V	±(0.5%+3)
	320.0V	0.1V	±(0.5%+3)
	1000V	1V	±(1%+3)
mV̂	320.0 mV	0.1 mV	±(0.5% +3)
			2 kHz-10 kHz ±(2%+3)
			10 kHz-30 kHz ±(4%+10)

FUNCTION	RANGE	RESOLUTION	ACCURACY*	TYPICAL BURDEN VOLTAGE
$\overline{\text{m}}/\text{A}$	32.00 mA 320.0 mA 10.00A	0.01 mA 0.1 mA 0.01A	$\pm(0.75\%+2)$ $\pm(0.75\%+2)$ $\pm(0.75\%+2)$	5.6 mV/mA 5.6 mV/mA 50 mV/A
$\overline{\mu}\text{A}$	320.0 μA 3200 μA	0.1 μA 1 μA	$\pm(0.75\%+2)$ $\pm(0.75\%+2)$	0.5 mV/ μA 0.5 mV/ μA
\sim mA/A	32.00 mA 320.0 mA 10.00A	0.01 mA 0.1 mA 0.01A	$\pm(1.5\%+2)$ $\pm(1.5\%+2)$ $\pm(1.5\%+2)$	5.6 mV/mA 5.6 mV/mA 50 mV/A
\sim μA	320.0 μA 3200 μA	0.1 μA 1 μA	$\pm(1.5\%+2)$ $\pm(1.5\%+2)$	0.5 mV/ μA 0.5 mV/ μA

* Accuracy is specified as \pm [% of reading] + [number of least significant digits].

Basic electrical accuracy is specified from 18°C to 28°C with relative humidity up to 95%, for a period of one year after calibration. All ac conversions are ac coupled, average responding, and calibrated to read the true rms value of a sine wave input.

Ranging is either automatic or manual in all functions with more than one range. Test resistance below approximately 150 Ω in the (||||) \rightarrow function produces a continuous audible tone.

FUNCTION	OVERLOAD PROTECTION	INPUT IMPEDANCE (nominal)	COMMON MODE REJECTION RATIO (1 k Ω unbalance)	NORMAL MODE REJECTION
\bar{V}	1000V rms	10 M Ω in // with <100 pF	>120 dB at dc, 50 Hz, or 60 Hz	>60 dB at 50 Hz or 60 Hz
\overline{mV}	500V rms	10 M Ω in // with <100 pF	>120 dB at dc, 50 Hz, or 60 Hz	>60 dB at 50 Hz or 60 Hz
$\sim V$	1000V rms (10 ⁷ V-Hz max)	10 M Ω in // with <100 pF (ac coupled)	>60 dB, dc to 60 Hz	
$\sim mV$	500V rms (10 ⁷ V-Hz max)	10 M Ω in // with <100 pF (ac coupled)	>60 dB, dc to 60 Hz	
Ω	500V rms	OPEN CIRCUIT TEST VOLTAGE <2.8V dc	FULL SCALE VOLTAGE Up to 3.2 M Ω <420 mV dc	32 M Ω or nS <1.3V dc

MAXIMUM VOLTAGE BETWEEN ANY TERMINAL AND EARTH GROUND
1000V

FUNCTION	FUSE PROTECTION
mA or μ A A	630 mA 250V FAST, 3A 600V FAST 15A 600V FAST

Digital Display	3200 counts, updates 2/sec
Analog Display	31 segments, updates 25/sec
Operating Temperature	-15° C to 55° C, to -40° C for 20 minutes when taken from 20° C
Storage Temperature	-55° C to 85° C
Temperature Coefficient	0.1 x (specified accuracy)/°C (<18° C or >28° C)
Relative Humidity	0% to 95% (0° C to 35° C) 0% to 70% (35° C to 55° C)
Battery Type	9V, NEDA 1604 or 6F22 or 006P
Battery Life	1000 hrs typical
Shock, Vibration and Water Resistance	Per MIL-T-28800 for a Style A, Class 2 Instrument
Size (HxWxL)	2.2 in x 3.75 in x 8 in (5.6 cm x 9.5 cm x 20.3 cm)
Weight	1.6 pounds (0.75 kg)
Safety	Protection Class II per IEC 348 and ANSI C39.5