



TYPE 1310-A

OSCILLATOR

OPERATING INSTRUCTIONS

TYPE 1310-A OSCILLATOR

Form 1310-0100-A
1D-900
February, 1966

Copyright 1966 by General Radio Company
West Concord, Massachusetts, U.S.A

GENERAL RADIO COMPANY
WEST CONCORD, MASSACHUSETTS, USA

● SPECIFICATIONS

FREQUENCY

Range: 2 c/s to 2 Mc/s in 6 decade ranges; continuously adjustable, one-turn, high-resolution dial with 4¼:1 drive.

Accuracy: ±2% of reading.

Stability: Typical warmup drift, under 0.1%; typical drift after warmup, 0.001% short term (1 min), 0.03% long term (12 h); all at 1 kc/s.

Synchronization: Telephone jack provided for external phase-locking signal. Locking range is about ±3% for 1-V, rms, input reference signal. Frequency dial can be used for phase adjustment.

OUTPUT

Power: 160 mW into 600 Ω.

Voltage: Over 20 V, open circuit; continuously adjustable attenuator (approximately 50 dB).

Amplitude Stability: Typical drift after warmup, 0.02% short term (1 min), 1.0% long term (12 h); both at 1 kc/s.

Frequency Characteristic: ±2%, 20 c/s to 200 kc/s, open circuit or 600-Ω resistive load.

Impedance: Approximately 600 Ω.

Distortion: <0.25%, 50 c/s to 50 kc/s, with linear loads. **Hum:** <0.02% independent of attenuator setting.

Synchronization: High-impedance, constant-amplitude, 0.8-V, rms, output for use with oscilloscope, counter, or other oscillators.

GENERAL

Power Required: 105 to 125, 195 to 235, or 210 to 250 V, 50 to 400 c/s, 12 W.

Terminals: Two Type 938 Binding Posts, one grounded to panel.

Accessories Supplied: Type CAP-22 Power Cord, spare fuses.

Accessories Available: Type 1560-P95 Adaptor Cable (telephone plug to Type 274-M Double Plug) for connection to synchronizing jack.

Mounting: Convertible-bench cabinet.

Dimensions: Width 8", height 6", depth 8½ inches (210 by 155 by 210 mm), over-all.

Net Weight: 7¾ lb (3.6 kg).

Shipping Weight: 10 lb (4.6 kg).

Catalog Number _____ *Description*

1310-9701 **Type 1310-A Oscillator**

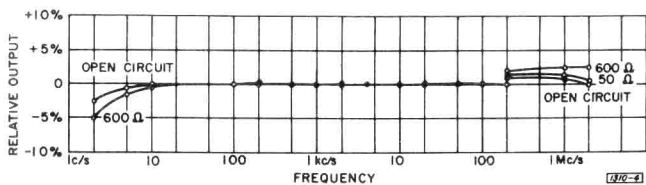

Typical output voltage-vs-frequency characteristics for various load impedances.

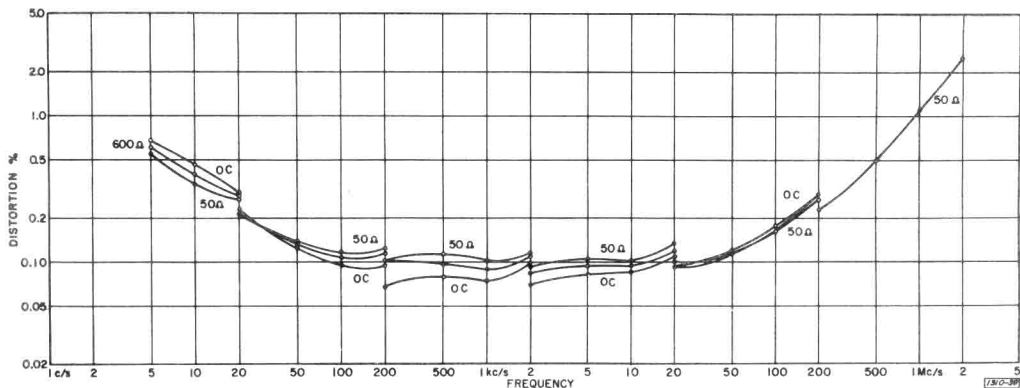

Measured harmonic distortion of a typical Type 1310-A Oscillator for 50-ohm and 600-ohm loads and open circuit. When the attenuator is used for open-circuit output voltages of five volts or less, the load seen by the oscillator is 600 ohms.



● CONDENSED OPERATING PROCEDURE

- a. Set the **FREQUENCY** range switch to the desired frequency range.
- b. Set the **FREQUENCY** dial to the desired frequency.
- c. Set the **LEVEL** control for the desired amplitude.

After power is applied, allow a 1-minute warmup for the tube and the thermistor to reach their normal operating temperature. For best amplitude and frequency stability, allow a 30-minute warmup.

● CONTENTS

Section 1 Introduction	1
Section 2 Installation	5
Section 3 Operating Procedure	11
Section 4 Principles of Operation	27
Section 5 Service and Maintenance	36
Section 6 Parts List and Schematic	46

SECTION 1 INTRODUCTION

1.1 Purpose	1
1.2 Description	1
1.3 Controls and Connectors	2
1.4 Accessories Supplied	3
1.5 Supplementary Equipment Available	4

● 1.1 PURPOSE

The Type 1310-A Oscillator is a general-purpose signal source for laboratory or production use. It features wide frequency range; high output; low distortion, hum, and noise; high stability and accuracy; plus a synchronizing feature which allows such varied uses as filtering, leveling, frequency multiplying, jitter reducing, and slaving.

● 1.2 DESCRIPTION

A capacitance-tuned, RC Wien-bridge oscillator drives a low-distortion output amplifier, which isolates the oscillator from the load and delivers a constant voltage behind 600 ohms.

A jack is provided for introduction of a synchronizing signal for phase-locking or to furnish a signal, independent of the output attenuator setting, to operate a counter or to synchronize an oscilloscope or another oscillator.

● 1.3 CONTROLS AND CONNECTORS

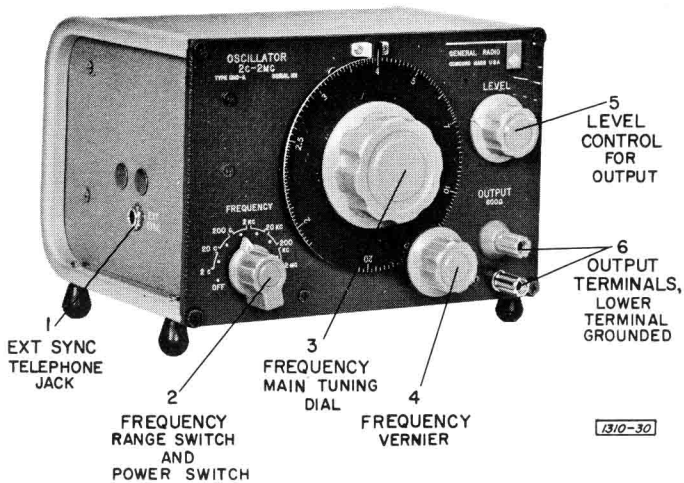

The following controls and connectors are on the front panel or on the side of the oscillator:

- | | |
|----------------------------|--|
| 1 EXT SYNC | Input/output telephone jack. For introducing a synchronizing or phase-locking signal from an external source or for providing a synchronizing signal, independent of the output level, to an oscilloscope, counter, or another oscillator. |
| 2 FREQUENCY range | Seven-position rotary switch. Combination power switch and frequency range switch. |
| 3 FREQUENCY dial | Continuously adjustable dial. Used with FREQUENCY range switch to set output frequency. |
| 4 FREQUENCY vernier | Fine frequency control (4.25:1) for FREQUENCY dial. |
| 5 LEVEL | A constant-impedance, bridged-T attenuator which sets output level over a 50-dB range. |
| 6 OUTPUT | $\frac{3}{4}$ -inch-spaced bindingpost pair; lower terminal grounded to chassis. For connection to oscillator output. |

1.3 CONTROLS AND CONNECTORS *continued*

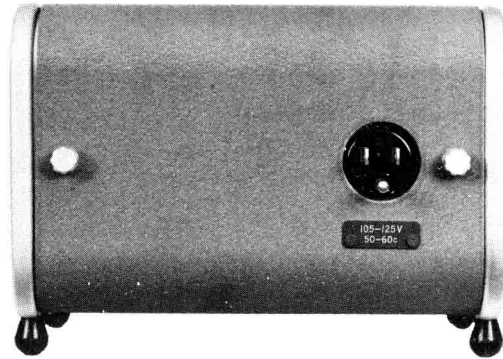

The following connector is on the rear panel:

Power input Three-terminal male connector. For connection to power line.

● 1.4 ACCESSORIES SUPPLIED

	<i>Part Number</i>
Instruction book	1310-0100
Power cord, 3-wire	4200-9622
Fuses (2), 0.25 A for 115-V operation or:	5330-0700
0.125 A for 230-V operation	5330-0450

● 1.5 SUPPLEMENTARY EQUIPMENT AVAILABLE

Type 0480-4638 Relay-Rack Adaptor Set

This adaptor set allows the Type 1310-A to be mounted in a standard 19-inch relay-rack (see paragraph 2.5).



Type 0480-9636 Relay-Rack Adaptor Set

This adaptor set allows the Type 1310-A to be mounted side-by-side with another 8 x 5¼-inch, convertible-bench instrument in a standard 19-inch relay rack (see paragraph 2.5).



Type 1396 Tone Burst Generator.

This instrument allows the output of the Type 1310-A to be gated on and off coherently. The gate-on and gate-off times are independently adjustable from 2 to 128 cycles of any output frequency of the Type 1310-A up to 500 kc/s.

With the Type 0480-9636 Relay-Rack Adaptor Set, listed above, the Type 1396 and Type 1310-A can be bolted together to form a single unit for either bench or rack installation.



Type 1232 Tuned Amplifier and Null Detector.

This instrument, with the Type 1310-A, forms a detector-oscillator assembly with a sensitivity of 0.1 μ V and a frequency range of 20 c/s to 20 kc/s, plus two fixed frequencies of 50 and 100 kc/s.

With the Type 0480-9636 Relay-Rack Adaptor Set, listed above, the Type 1232 and Type 1310-A can be bolted together to form a single unit for either bench or rack installation.

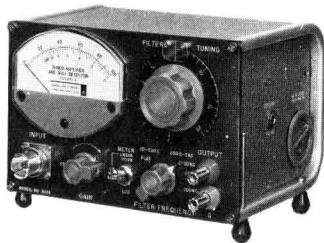

SECTION 2

INSTALLATION

2.1 Dimensions	5
2.2 Grounding	5
2.3 Temperature	5
2.4 Humidity	5
2.5 Rack-Mounting	6
2.6 Power Connection	8
2.7 Output Signal Connection	9
2.8 External Sync Connection	10

● 2.1 DIMENSIONS

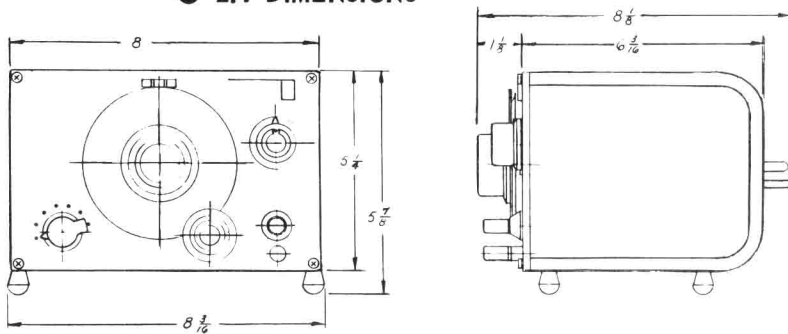

● 2.2 GROUNDING

A three-wire power cord is used; the third wire (ground) is connected to the instrument case.

● 2.3 TEMPERATURE

The Type 1310-A is designed to operate with ambient temperatures of from 0 to 50°C and is designed to be stored with ambient temperatures of -40° to +70°C.

● 2.4 HUMIDITY

As with all low-frequency, variable-capacitance, RC oscillators, the oscillator circuit in the Type 1310-A operates at impedance levels of over 1000 megohms. Consequently, circuit operation, especially frequency accuracy on the lower ranges, may be affected under conditions of very high humidity.

These effects may be minimized with a warmup period which allows the internally generated heat to reduce the humidity within the instrument.

● 2.5 RACK-MOUNTING

Relay-rack adaptor sets. The Type 1310-A Oscillator can be rack-mounted, alone or with another 8-by-5 $\frac{1}{4}$ -inch convertible-bench instrument, by means of the appropriate adaptor set listed below. The adaptor panels are finished in charcoal-gray crackle paint to match the front panel of the instrument and come complete with the necessary hardware to mount to the instruments and to the rack.

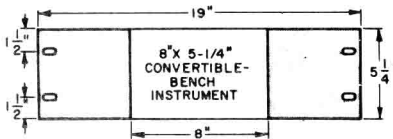
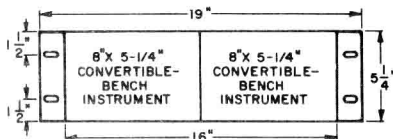
<i>Type</i>	<i>Description</i>	<i>Catalog Number</i>
	Relay Rack Adaptor Set used to rackmount the Type 1310-A alone.	0480-9638
	Relay Rack Adaptor Set used to rackmount the Type 1310-A with a Type 1232, 1311, or 1396.	0480-9636

INSTALLING ADAPTOR SETS

- a. Remove the rubber feet, if necessary, to clear an instrument mounted below.
- b. Remove the screws that secure the front panel to the aluminum end frames.
- c. Remove the spacers between the front panel and the end frames.

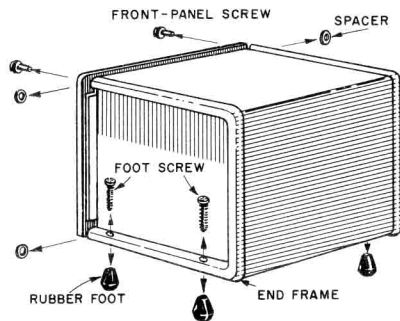

6 TYPE 1310-A OSCILLATOR

2.5 RACK-MOUNTING continued

If two instruments are to be mounted side-by-side, join them together as follows:

- e. On one instrument, install the clips with the front-panel screws removed earlier and install the nut plates with the foot screws removed earlier.
- f. Secure the two instruments together with front-panel screws through the remaining hole in each clip and with a foot screw through the remaining hole in the nut plate.

Note that the instruments can be *bench-mounted* side-by-side in this manner:

Simply do not remove the two feet from each outside end frame and do not install the adaptor plates.

- g. Install two clips on each adaptor plate with the wing screws, lockwashers, and nuts supplied.

- h. Install the adaptor plates to the instrument with the front-panel screws removed earlier.
- i. Mount the assembly in the rack with the 10-32 screws supplied.

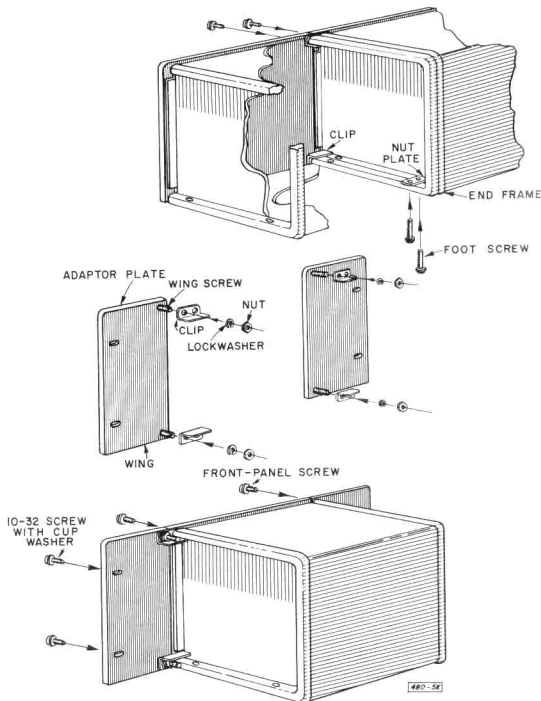

RACKMOUNTING EARLY CONVERTIBLE-BENCH INSTRUMENTS

Type 1310-A Oscillators accept the relay-rack adaptor sets directly; no rework is required. However, the end frames of convertible-bench instruments manufactured before 1965 butt directly to the front panel (no spacers) and these instruments do require slight rework before they will accept the adaptor plates:

- a. Remove both end frames and cut 1/16-inch off the ends.
- b. Notch the lip on the end panels to accept the clips.
- c. Reinstall the end frames.

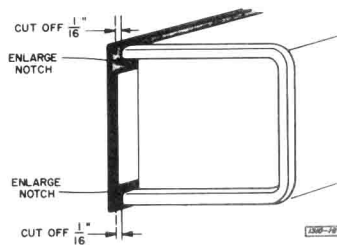

● 2.6 POWER CONNECTION

The power transformer can be wired to accept 50- to 400-cycle line voltages of 105 to 125, 195 to 230, or 210 to 250 volts.

115-volt line. Power required is 105 to 125V, 50 to 400 c/s, 12W. Input plate for 115-V operation is part number 5590-0500 and attaches to the rear of the cover, under the hole for the power connector, by means of two 4-40 x 3/16-inch screws with attached lockwashers, part number 7090-4030 each. For transformer wiring, connect 1 to 3 and 2 to 4. Fuses for F501 and F502 are 0.25A, 3AG Slo-Blo, part number 5330-0700 each. Domestic instruments are shipped with this connection unless ordered otherwise.

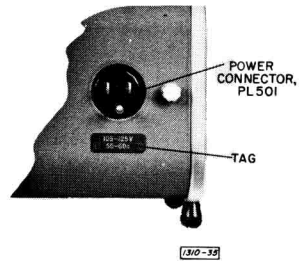

215-volt line. Power required is 195 to 235V, 50 to 400 c/s, 12W. Input plate for 215-V operation is part number 5590-1668 and attaches to the rear of the cover, under the hole for the power connector, by means of two 4-40 x 3/16-inch screws with attached lockwashers, part number 7090-4030 each. For transformer wiring, connect 3 to 2L only. Fuses for F501 and F502 are 0.125A, 3AG Slo-Blo, part number 5330-0450 each. Export instruments are shipped with this connection unless ordered otherwise.

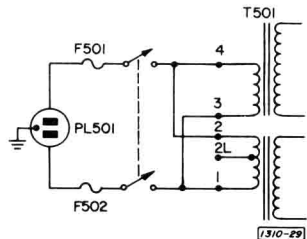

230-volt line. Power required is 210 to 250V, 50 to 400 c/s, 12W. Input plate for 230-volt operation is part number 5590-1664 and attaches to the rear of the cover, under the hole for the power connector, by means of two 4-40 x 3/16-inch screws with attached lockwashers, part number 7090-4030 each. For transformer wiring, connect 2 to 3 only. Fuses for F501 and F502 are 0.125 A, 3AG Slo-Blo, part number 5330-0450 each.

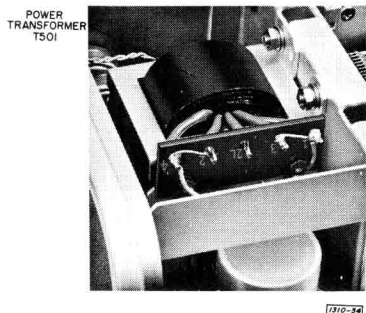

● 2.7 OUTPUT SIGNAL CONNECTION

The OUTPUT connectors are standard, 1/4-inch-spaced binding posts which accept banana plugs, standard telephone tips, alligator clips, crocodile clips, spade terminals, and all wire sizes up to number 10. A wide variety of GR patch cords is also available, as well as a full line of adaptors to convert the OUTPUT terminals for use with most commercial and military coaxial connectors:

NOTE: GR874 connectors are 50 Ω and are mechanically sexless, i.e., any two although identical, can be plugged together.

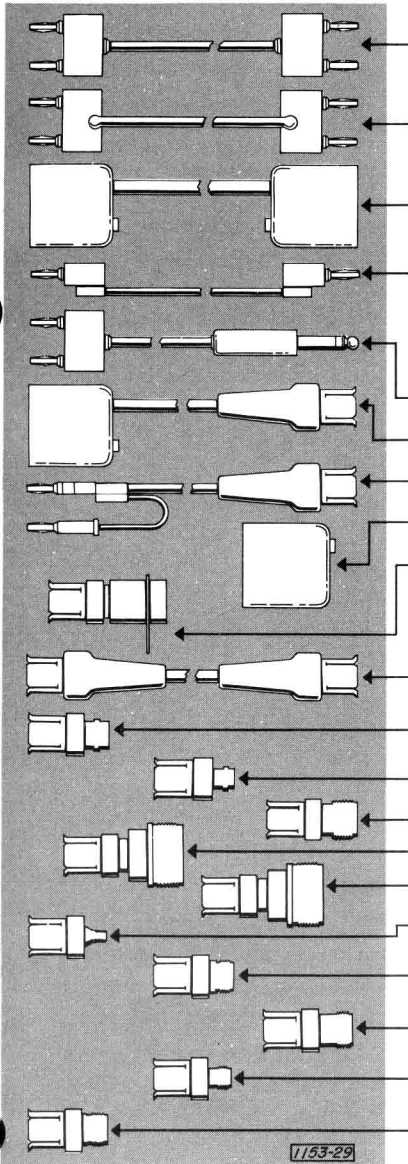

274-NQ	Double-plug patch cord, in-line cord, 36" long	0274-9860
274-NQM	Double-plug patch cord, in-line cord, 24" long	0274-9896
274-NQS	Double-plug patch cord, in-line cord, 12" long	0274-9861
274-NP	Double-plug patch cord, right-angle cord, 36" long	0274-9880
274-NPM	Double-plug patch cord, right-angle cord, 24" long	0274-9892
274-NPS	Double-plug patch cord, right-angle cord, 12" long	0274-9852
274-NL	Shielded double-plug patch cord, 36" long	0274-9883
274-NLM	Shielded double-plug patch cord, 24" long	0274-9882
274-NLS	Shielded double-plug patch cord, 12" long	0274-9862
274-LLB	Single-plug patch cord, black, 36" long	0274-9468
274-LLR	Single-plug patch cord, red, 36" long	0274-9492
274-LMB	Single-plug patch cord, black, 24" long	0274-9847
274-LMR	Single-plug patch cord, red, 24" long	0274-9848
274-LSB	Single-plug patch cord, black, 12" long	0274-9849
274-LSR	Single-plug patch cord, red, 12" long	0274-9850
1560-P95	Adaptor cable, double-plug to telephone plug, 36" long	1560-9695
874-R34	Coaxial patch cord, double plug to GR874, 36" long	0874-9692
874-R33	Coaxial patch cord, two plugs to GR874, 36" long	0874-9690
274-QBJ	Adaptor, shielded double plug to BNC	0274-9884
874-Q9	Adaptor, double plug to GR874	0874-9874
874-R20A	Coaxial patch cord, low-loss	0874-9680
874-R20LA	Coaxial patch cord, low-loss cable, locking connectors	0874-9681
874-R22A	Coaxial patch cord, general-purpose cable	0874-9682
874-R22LA	Coaxial patch cord, general-purpose cable, locking connectors	0874-9683
874-QBJA	Adaptor, GR874 to Type BNC	0874-9700
874-QBJL	Locking adaptor, GR874 to Type BNC	0874-9701
874-QCJA	Adaptor, GR874 to Type C	0874-9702
874-QCJL	Locking adaptor, GR874 to Type C	0874-9703
874-QHJA	Adaptor, GR874 to Type HN	0874-9704
874-QLJA	Adaptor, GR874 to Type LC	0874-9706
874-QLTJ	Adaptor, GR874 to Type LT	0874-9708
874-QMDJ	Adaptor, GR874 to Type Microdot	0874-9720
874-QMDJL	Locking adaptor, GR874 to Type Microdot	0874-9721
874-QNJA	Adaptor, GR874 to Type N	0874-9710
874-QNJL	Locking adaptor, GR874 to Type N	0874-9711
874-QSCJ	Adaptor, GR874 to Type SC	0874-9712
874-QSCJL	Locking adaptor, GR874 to Type SC	0874-9713
874-QTNJ	Adaptor, GR874 to Type TNC	0874-9716
874-QTNJL	Locking adaptor, GR874 to Type TNC	0874-9717
874-QUJ	Adaptor, GR874 to Type UHF	0874-9718
874-QUJL	Locking adaptor, GR874 to Type UHF	0874-9719

● 2.8 EXTERNAL SYNC CONNECTION

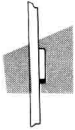

The EXT SYNC connector on the left-hand side of the Type 1310-A is a telephone jack that accepts a standard telephone plug. When a Type 1560-P95 Adaptor Cable and a GR874-Q2 adaptor are used, all of the GR874 patch cords and adaptors listed for the OUTPUT connector can also be used.

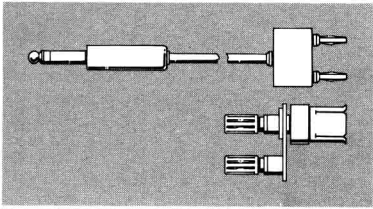

1560-P95	Adaptor cable, telephone plug to double plug, 36" long	1560-9695
874-Q2	Adaptor, double-plug to GR874	0874-9870

SECTION 3 OPERATING PROCEDURE

3.1 Normal Operation.....	11
3.2 Characteristics	12
3.3 Synchronization Jack	14
3.4 Applications.....	18

● 3.1 NORMAL OPERATION



- Set the FREQUENCY range switch to the desired frequency range.
- Set the FREQUENCY dial to the desired frequency
- Set the LEVEL control for the desired amplitude.

After power is applied, allow a one-minute warmup for the tube and the thermistor to reach their normal operating temperature. For best amplitude and frequency stability, allow a 30-minute warmup.

● 3.2 CHARACTERISTICS

3.2.1 FREQUENCY RESPONSE

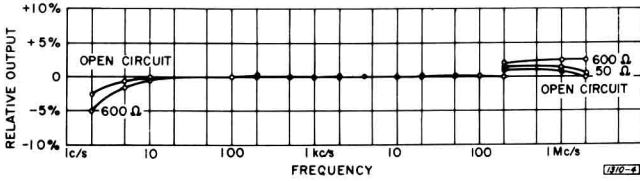

The output is 20 volts, open-circuit, behind 600 ohms and is adjustable over a 50-dB range by a constant-percentage-resolution attenuator. The output is constant within $\pm 2\%$ from 20 c/s to 200 kc/s for loads of 600 ohms or higher. Within the audio range, changes are imperceptible on the usual analog type of voltmeter.

3.2.2 FREQUENCY STABILITY

Typical short-term drift

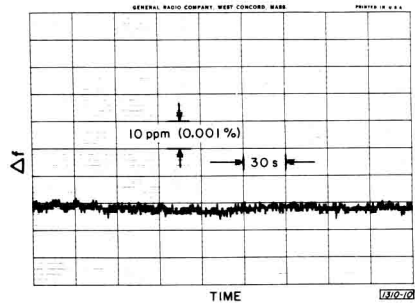

Typical long-term drift

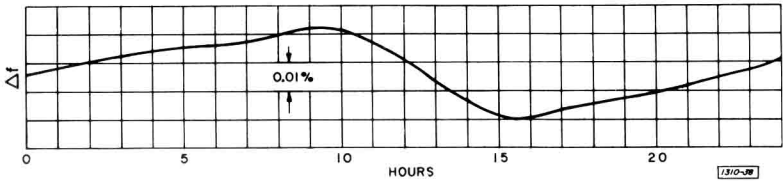

High-stability, frequency-determining components in the oscillator and low, internal power dissipation result in a stable output frequency. Drift during warm-up is typically below 0.1% at frequencies above 20 c/s.

Typically short- and long-term stabilities after warmup are shown at 1 kc/s. Both are with a sampling time of 0.1 s (100 periods) and under normal laboratory conditions during the winter months (heat on during the day and off at night).

3.2 CHARACTERISTICS continued

3.2.3 NOISE

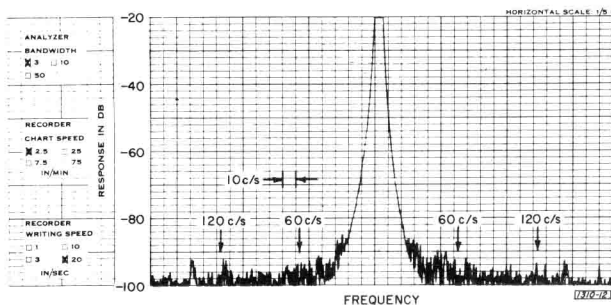

Hum is below 0.02% of the output (typically 0.005%), regardless of the attenuator setting. Noise at frequencies distant from a 1-kc fundamental, measured in a bandwidth of 5 c/s to 500 kc/s, is typically less than 0.02%. Noise close to the fundamental is also low as the spectrum analysis of a 1-kc output shows. Note the absence of components at the line frequency or its multiples.

3.2.4 OUTPUT DISTORTION



Harmonic distortion is less than 0.25% over most of the audio range (50 c/s to 50 kc/s). This low distortion is always available, even at full output, because it remains essentially constant regardless of the size of the linear load applied, including a short circuit.

When the attenuator is set for open-circuit output voltages of five volts or less, the load seen by the oscillator is 600 ohms, regardless of the size of the external load.

● 3.3 SYNCHRONIZATION JACK

3.3.1 GENERAL

A telephone jack (EXT SYNC, J103) is located on the left-hand side of the oscillator. This is an input/output connector and is used to connect a signal to the oscillator or to take one from it.

There are three important characteristics associated with the use of the EXT SYNC feature:

1. Output characteristic.
2. Input synchronizing or phase-locking characteristic.
3. Input frequency-selectivity or filtering characteristic.

3.3.2 OUTPUT CHARACTERISTIC

A nominal 0.8-volt, rms, output signal, behind $25\text{ k}\Omega$, is available from the EXT SYNC jack. The level of this sync output signal is independent of the LEVEL control or the front-panel OUTPUT load. One side of the sync output is grounded and the signal is 180° out-of-phase with the front-panel OUTPUT.

The sync output will drive any size load without increasing oscillator distortion. However, only high-impedance loads are recommended where full frequency accuracy is required. The worst-case load, a short circuit, will decrease the frequency 1 or 2%.

Stray capacitance of most shielded leads or coaxial cables is about 30 pF per foot which, at 100 kc/s , amounts to shunt impedance of about $55\text{ k}\Omega$. Therefore, cable length should be kept to a minimum when a high-impedance load is to be driven at high frequencies.

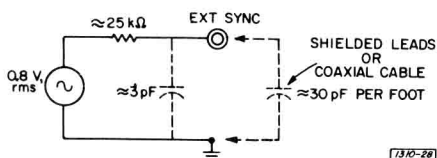

3.3.3 INPUT SYNCHRONIZING CHARACTERISTIC

The oscillator frequency may be synchronized or locked with any input signal which is applied to the EXT SYNC jack, if the oscillator is tuned to the approximate frequency of the input. The range of frequencies over which this synchronization will take place is a function of the amplitude of the frequency component to which the oscillator locks. It increases approximately linearly, and produces a lock range of about $\pm 3\%$ for each volt input.

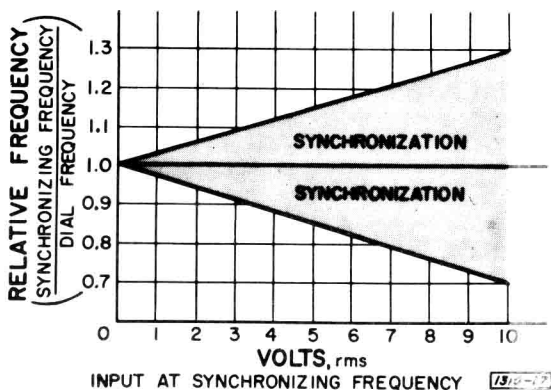

3.3 SYNCHRONIZATION JACK *continued*

The oscillator maintains synchronization within the lock range if either the oscillator dial frequency or the synchronizing frequency is changed. However, there is a time constant of about one second associated with the synchronization mechanism. Thus if the amplitude or frequency of the sync signal or the dial setting of the oscillator is changed, there will be transient changes in amplitude and phase for a few seconds before the oscillator returns to steady-state synchronization.

This time constant is caused by the thermistor amplitude regulator as it readjusts to the different operating conditions. The thermistor is sensitive only to changes in average values of frequency or amplitude where the averaging time is in the order of seconds. Hence, frequency-modulated and amplitude-modulated sync signals, which have a constant average value of frequency and amplitude over a period of a second or less, are *not* affected by *this* time constant. They *are* affected by the equivalent time constant of the filter characteristic discussed in paragraph 3.3.4.

For slow changes in frequency or amplitude, the lock range and the capture range are the same; i.e., the frequency or amplitude at which the oscillator goes from the synchronized state to the unsynchronized state is the same as when it goes from the unsynchronized state to the synchronized state.

Synchronization is a true phase-lock because it maintains a constant phase difference between the sync input and the oscillator output. The phase difference is 0° when the dial frequency is identical to the sync frequency and approaches $\pm 90^\circ$ as the frequency approaches the limits of the lock range. Note that the phase difference is also a function of the amplitude of the sync signal because the lock range is a function of the amplitude.

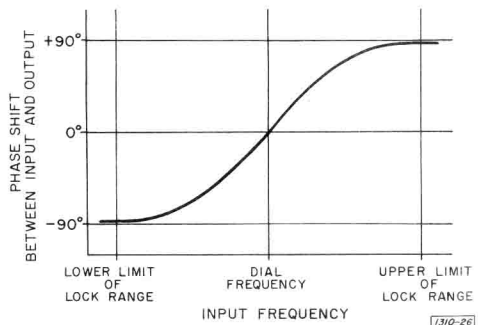

The *input impedance* of the EXT SYNC jack is $25\text{ k}\Omega$ at all frequencies except the synchronizing frequency. At the synchronizing frequency the impedance, in general, is complex and can vary over a wide range including negative values because the jack is also a source at the synchronizing frequency.

Since the jack is a simultaneous source and input, care should be taken to insure the sync output voltage does not interfere with the drive source. The high output impedance of the EXT SYNC jack makes it easy to minimize the sync output signal. For example if the jack is fed from a 600-ohm source, less than 20 mV will appear across the source.

3.3 SYNCHRONIZATION JACK continued

3.3.4 INPUT FREQUENCY SELECTIVITY

The RC network in the oscillator used to determine the frequency of oscillation and to reduce hum, noise, and distortion can also be used to filter signals applied externally. Signals applied to the EXT SYNC jack, which are close to the frequency of synchronization, will be amplified in the output but those frequencies distant from the frequency of synchronization will be reduced. The intrinsic selectivity or Q of this filter is constant and determined only by the RC Wien network.

The voltage gain between the EXT SYNC jack and the OUTPUT terminals is constant at any frequency except the frequency of oscillation, regardless of the amplitude of the incoming signals. The curve may be used directly to determine the amplitude of any frequency component in the oscillator output if the amplitude of the input is known.

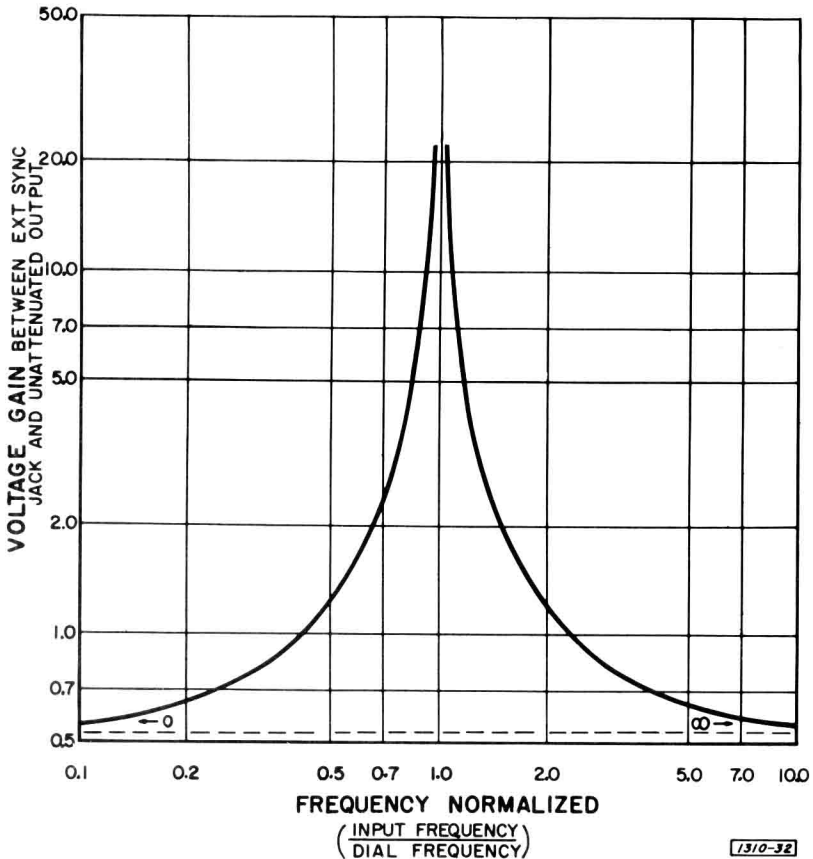

3.3 SYNCHRONIZATION JACK continued

For example, we wish to determine the reduction in the harmonic content of a 1-volt, 1-kc signal which has approximately 10% (0.1V) second-harmonic distortion. The signal is applied to the EXT SYNC jack of the Type 1310-A; the output of the Type 1310-A is 20 volts and, from the graph, the gain at the second harmonic is approximately 1.2.

$$\text{distortion, in \%} = \frac{\text{amplitude of harmonics}}{\text{total amplitude}} \times 100 = \frac{1.2 \times 0.1}{20} \times 100 = 0.6\%$$

If the amplitude of the external signal is reduced to 0.5 V (0.05 V harmonic content), the distortion at the output of the Type 1310-A becomes:

$$\frac{0.05 \times 1.2}{20} = 0.30\%$$

In general, it is not possible to reduce the distortion below the level normally present in the oscillator and little would be gained in the preceding example by reducing the input to less than 0.25 volts.

Often the amplitude of a frequency component relative to the amplitude of the frequency of oscillation is of greater interest than the absolute amplitude. The figure shows this response for three different input amplitudes. Notice that the apparent selectivity or Q in this relative response is a function of the input amplitude. This is because the output at the frequency of oscillation remains constant while the output at other frequencies varies with the input amplitude.

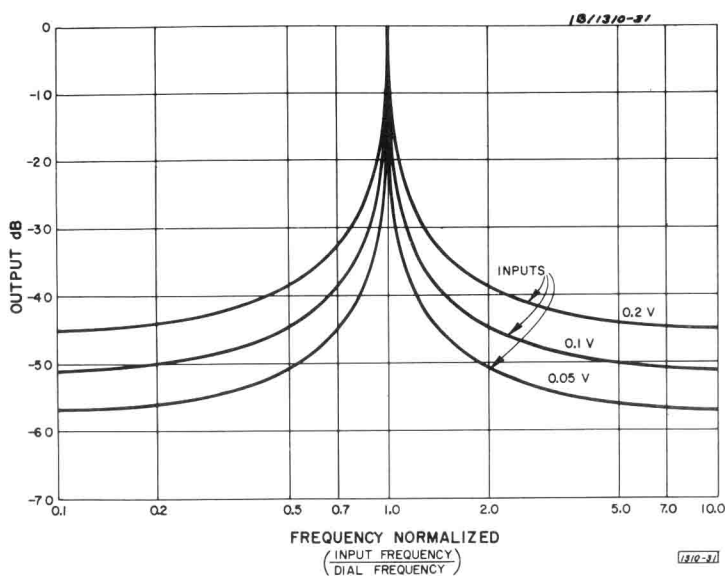

● 3.4 APPLICATIONS

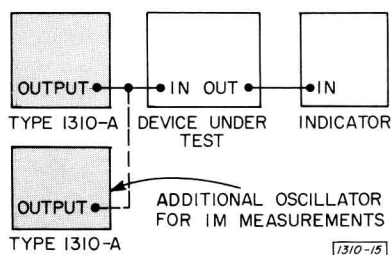

Response measurements. Constant output over a wide frequency range facilitates frequency-response measurements.

Distortion measurements. Low hum and low distortion make it very useful for amplifier distortion measurements.

AM and IM measurements. Low noise levels close to the fundamental allow amplitude modulation in magnetic recordings and intermodulation products in any device to be measured with ease.

3.4.1 SIGNAL SOURCE WITHOUT LINE-FREQUENCY BEATS

Beat frequency elimination. The ability to lock onto any external signals is useful. Often it is desirable to make measurements or to have a source at the line frequency or some multiple of the line frequency. A free-running oscillator may beat with the line frequency, but when the oscillator is locked to the line or its harmonics, there will be no beat and the phase can be adjusted with the FREQUENCY dial to minimize the other effects of pickups.

3.4.2 SLAVED OSCILLATORS

Slaving. Because the EXT SYNC jack is simultaneously an input and an output connector, two or more oscillators can be synchronized if their EXT SYNC jacks are connected together. Oscillators connected in this manner will operate at the same frequency or multiples of the same frequency and can be made to differ in phase ($180^\circ \pm 75^\circ$) by adjustment of the FREQUENCY dials within the lock range.

3.4 APPLICATIONS continued

3.4.3 WAVEFORM SYNTHESIZER

Fourier synthesis. The ability to lock onto harmonics lends the oscillator to interesting applications such as the Fourier synthesis of waveforms.

In the following example, a square wave is synthesized by locking the oscillators on the successive odd harmonics present in the original square wave. Any waveform can be synthesized in this manner, provided a source of the necessary harmonics is available and the Fourier coefficients are known.

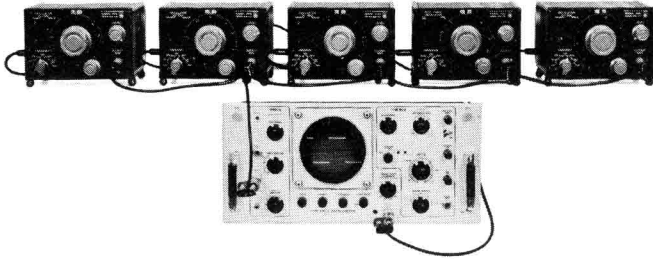

All sync inputs are paralleled and connected to the oscilloscope's square-wave calibrator output.

Original 1-kc square wave from oscilloscope.



Fifth harmonic which, like the output of all the oscillators, is sinusoidal.

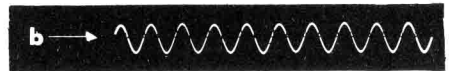

Synthesized square wave. The five outputs are adjusted for phase coherence and are summed in the ratio of their respective Fourier coefficients.

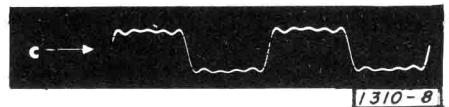

3.4 APPLICATIONS continued

3.4.4 ACCURATE FREQUENCY SOURCE WITH CLEAN, HIGH, SHORTABLE OUTPUT

One obvious application for the sync capability is to lock one or more oscillators to a reference frequency for higher accuracy and greater long-term stability. With the oscillator synchronized, its accuracy and long-term stability will be identical with the reference; short-term stability or jitter will be the same as if the oscillator were free-running.

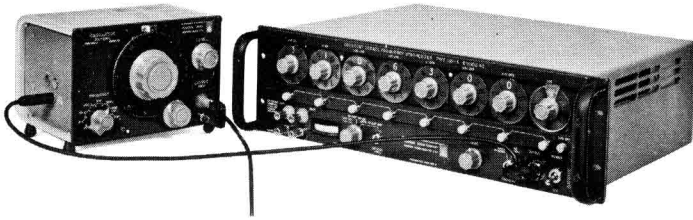

A Type 1310-A is locked to the output of a Type 1161-A7C Coherent Decade Frequency Synthesizer, used here as the reference-frequency source. The oscillator increases the 2-volt output of the synthesizer and reduces the already low harmonic content for a precision frequency modulation experiment. The frequency of 31.063 kc/s, when used to modulate an fm generator, produces a null in the carrier for a $\pm 75,000$ -kc frequency deviation.

The advantages of this arrangement accrue from the output characteristics of the oscillator:

Distortion and hum reduction. The frequency selectivity of the synchronized oscillator reduces distortion and hum in the reference source.

For example, the figure below is the spectrum of a typical 1-kc, sinusoidal, frequency, derived by division from a crystal oscillator.

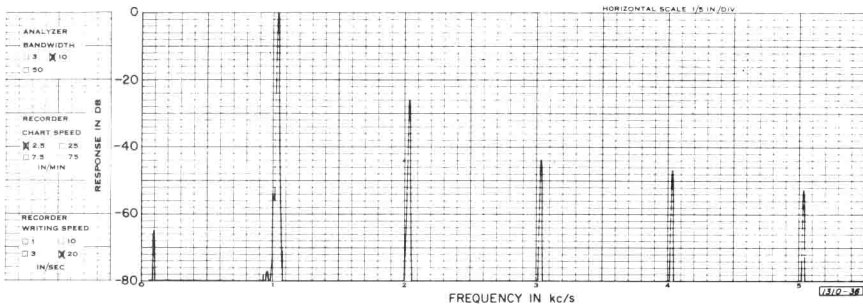

3.4 APPLICATIONS continued

The next figure is the spectrum of the output of a Type 1310-A Oscillator synchronized to the 1-kc frequency on the opposite page. Note the significant reduction in distortion, noise, and hum.

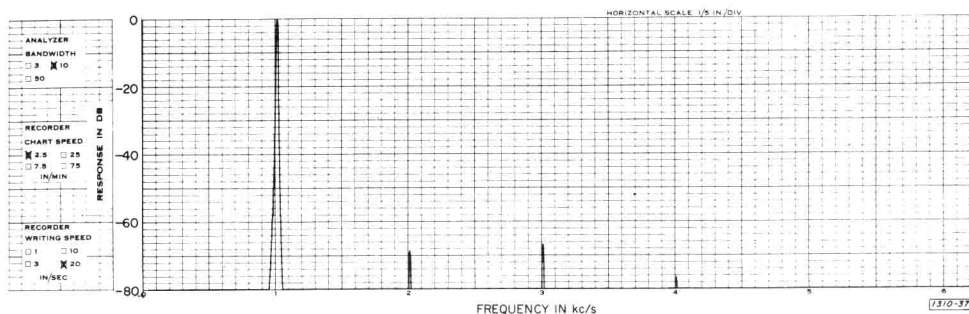

Frequency multiplication. The harmonic content of the reference can be used for precise frequency multiplication since the oscillator can be synchronized to the harmonics. The accuracy and long-term stability of the submultiple reference are maintained and the oscillator output is, of course, sinusoidal. This technique can be used with most signals because harmonics are usually present or can be easily generated.

Amplification. Less than a volt into the high-impedance EXT SYNC jack produces a full 20-volt open-circuit, or 160-mW into 600 ohms, output.

Isolation. The oscillator isolates and protects the reference source from short circuits and nonlinear loads.

Amplitude stabilization. The output has the same long-term amplitude stability as the normal unsynchronized output and is thus free from changes in the output level of the reference source.

Level control. The oscillator provides adjustable output levels which are kept constant automatically with changes in frequency.

3.4 APPLICATIONS continued

3.4.5 TRACKING, NARROW-BAND FILTER

Jitter or incidental fm reduction.* Although the short-term stability or jitter of the synchronized oscillator can not be better than when it is free-running, it can be better than the source to which it is synchronized. In this respect it behaves as a phase-locked oscillator or automatic-phase-control (APC) oscillator.** Or, to express it differently, it behaves as a tracking, narrow-band filter to reduce short-term instability.

The selectivity of the filter is a function of the input sync signal, and the tracking mechanism has a time constant in the order of one second. The effective bandwidth to small frequency perturbations or small fm deviations is related to the lock range as it is in conventional APC oscillators; i.e., the lock range is the 3-dB cutoff frequency of an equivalent low-pass filter.

Since the lock range is a linear function of the sync-signal amplitude, the effective bandwidth is also the same function of the amplitude. For example, if a 1-volt signal is used to synchronize the oscillator at 100 kc/s and provides a $\pm 3\%$ lock range, the oscillator will have a 3-dB bandwidth of 3 kc/s (3% of 100 kc/s) to perturbations in frequency. Thus frequency deviations in the 100-kc source at a 3-kc rate will be reduced 3 dB in the oscillator output.

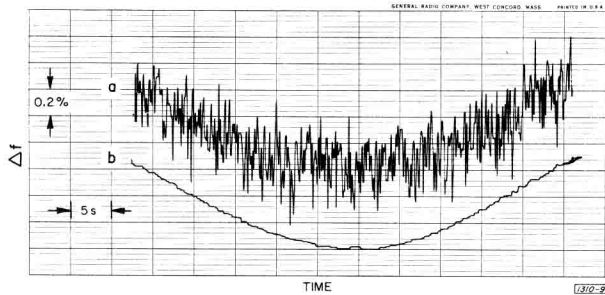

The figure shows one example of jitter reduction:

- Output frequency of a drifting 10-cycle, jittery source.
- Output frequency of an oscillator synchronized to the 10-cycle source. Note the cycle-to-cycle change in frequency has been greatly reduced, yet the relatively long-term change of about 1% has been faithfully tracked.

The low frequency used in this example was chosen for convenience in making the graphic recordings. A reduction in jitter or fm can be made at any frequency within the range of the oscillator (2 c/s to 2 Mc/s). The ability to track drift, however, is still limited by the one-second time constant of the thermistor (paragraph 3.3.3).

* See D.D. Weiner and B.J. Leon, "The Quasi-Stationary Response of Linear Systems to Modulated Waveforms," *Proceedings of the IEEE*, Vol 53, June 1965, pp 564 to 575 and references.

** Harold T. McAleer, "A New Look at the Phase Locked Oscillator," *Proceedings of the IRE*, Vol 47, pp 1137 to 1143, June 1959 (GR Reprint No. A-79).

3.4 APPLICATIONS continued

Incidental am reduction. Just as the oscillator can be used to reduce jitter or fm in a signal, it can also be used to reduce am. This is a natural consequence of the oscillator's similarity to a high-Q filter. The amplitude modulation on any signal to which a Type 1310-A is synchronized is reduced to the extent that the modulation sidebands fall outside the passband of the oscillator.

The reduction can be calculated from the graph on page 16. For example, we wish to determine the reduction in amplitude modulation of a 0.1-volt, 10-kc signal which has 10% amplitude modulation at 1 kc/s (5% or 0.005 V in each side band). The signal is applied to the EXT SYNC jack of the Type 1310-A; the output of the Type 1310-A is 20 volts and, from the graph, the gain at 9 kc/s and at 11 kc/s is 8.5.

$$\text{am, in \%} = \frac{\text{amplitude of side bands}}{\text{total amplitude}} \times 100 = \frac{(8.5 \times 0.005) + (8.5 \times 0.005)}{20}$$

$$\times 100 = 0.425\%$$

The figures show one example of am reduction:

10-kc signal modulated at 500c/s applied to EXT SYNC jack.

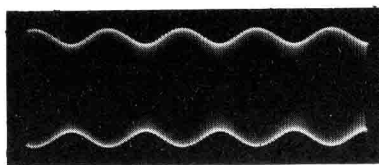

Reduction in am in the output of the oscillator locked to the signal above.

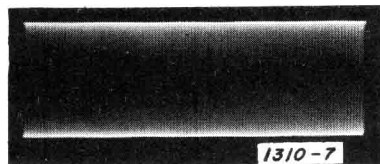

3.4 APPLICATIONS continued

3.4.6 AMPLITUDE-MODULATED OSCILLATOR

Amplitude modulation. If the oscillator is operated outside of the lock range, the sync signal will beat with the oscillator frequency and produce an audio-frequency, amplitude-modulated output. The modulation will be approximately sinusoidal for modulation levels up to about 10%.

This arrangement is not ideal, but it does provide amplitude-modulated signals in the audio range where normally they are not conveniently obtainable. Modulated outputs of this type can be used to measure the effects of incidental am on other measurements and to provide a modulated source to reduce meter-friction errors in ac measurements.

The figure shows one example of amplitude modulation:

10-kc output of an oscillator modulated at 500 c/s by a 9.5-kc signal applied to the EXT SYNC jack.

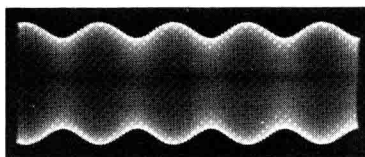

3.4 APPLICATIONS continued

3.4.7 OUTPUT SYNC

Oscilloscope trigger. Since the sync output is independent of the output level, it can be used to trigger an oscilloscope in applications where the oscillator output is often varied, thereby eliminating frequent readjustment of the oscilloscope trigger circuits.

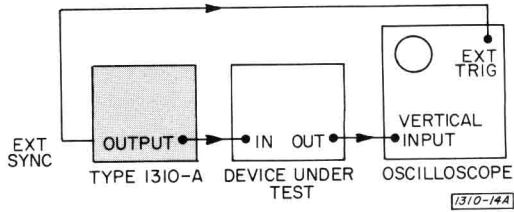

Counter trigger. A counter can be driven from the EXT SYNC jack when more precise adjustment of frequency is desired or when the front-panel output is not sufficient to trigger the counter.

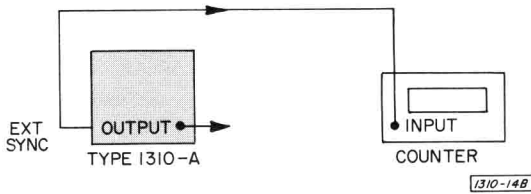

Balanced output. The output sync signal is 180° out-of-phase with the front-panel output, which makes it possible to obtain a high-impedance output, balanced with respect to ground, to drive push-pull circuits. The degree of balance is conveniently set with the LEVEL control.

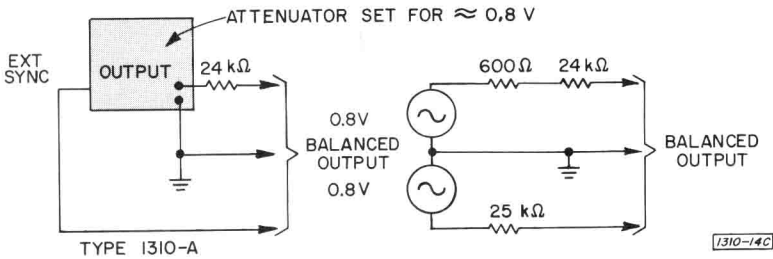

SECTION 4

PRINCIPLES OF OPERATION

4.1 Bridge 27
4.2 Amplifier 32
4.3 Power Supply 34
4.4 Synchronization 35

● 4.1 BRIDGE

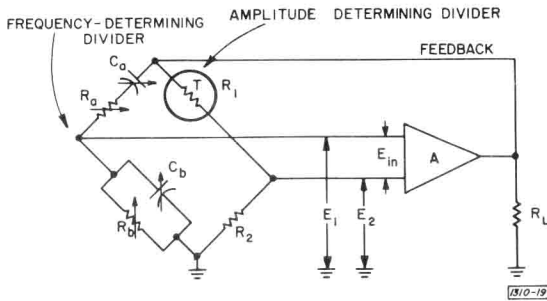

A Wien bridge consists of two parts, a frequency-determining impedance divider which provides positive feedback to sustain oscillation and an amplitude-determining resistive divider which provides negative feedback to stabilize amplitude.

4.1 BRIDGE continued

4.4.1 FREQUENCY

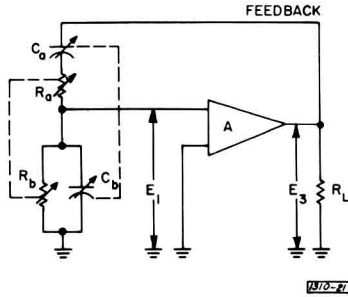

The operating frequency, f_o , of a Wien-bridge oscillator depends on the values of the components in the impedance divider:

$$f_o = \frac{1}{2\pi\sqrt{R_a C_a R_b C_b}} \quad ; \quad \text{since } \omega = 2\pi f \text{ then } \omega_o = \sqrt{\frac{1}{R_a C_a R_b C_b}}$$

In the Type 1310-A, R_a is made equal to R_b and C_a is made equal to C_b .

R_a and R_b consist of six pairs of resistors selected by the range switch. Stable, low-temperature-coefficient, metal-film resistors are used on all ranges except the lowest where glass-sealed carbon resistors are used. C_a and C_b consist of two variable, air capacitors ganged together and controlled by the frequency dial.

4.1 BRIDGE continued

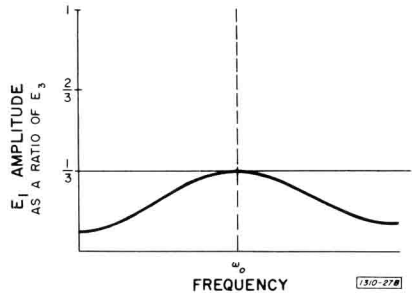
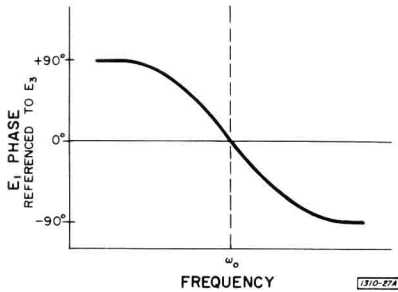

The transfer function (gain and phase shift) of the frequency divider is:

$$\frac{E_1}{E_3} = \frac{1}{3 + j\left(\frac{\omega}{\omega_0} - \frac{\omega_0}{\omega}\right)}$$

At the operating frequency, $\omega = \omega_0$, therefore: $\frac{E_1}{E_3} = \frac{1}{3}$

This means that at the operating frequency of the oscillator, one-third of the signal applied to the divider appears at the input to the amplifier.

To sustain oscillations in any oscillator, a loop gain of unity is necessary, i.e., the gain from any one point in the circuit, around the loop and back to that same point, must be equal to one. Thus:

$$G_L = G_A \times \frac{E_1}{E_3} = 1$$

loop gain amplifier gain divider gain

Or:

$$G_A = \frac{G_L}{E_1/E_3} = \frac{1}{1/3} = 3$$

The amplifier, then, must have a gain of 3 to preserve unity gain in the loop and therefore to sustain oscillation at ω_0 .

4.1 BRIDGE continued

4.1.2 AMPLITUDE STABILIZATION

Under ideal conditions, the only requirement for stable oscillations is a constant loop gain of 1, i.e., if the amplifier gain and impedance divider gain remained constant with changes in frequency, circuit parameters, and environment, only the frequency-determining impedance divider would be necessary.

However, changes in frequency and environment affect the gain, phase, and terminal impedance of the amplifier and slight unbalances in C and R affect the gain (voltage ratio) of the divider. These factors change the loop gain and would cause the oscillator amplitude to increase or decrease.

For example, if these anomalies resulted in a momentary decrease in E_3 , E_1 would decrease, further decreasing E_3 , and so on until the amplitude became zero. Conversely, if E_3 were to *increase* momentarily, E_1 would increase, further increasing E_3 until the amplifier saturated. This latter case can be easily demonstrated by removing the thermistor, R107, and monitoring the output. The output will be square waves instead of sine waves and will not necessarily be at the frequency indicated on the dial.

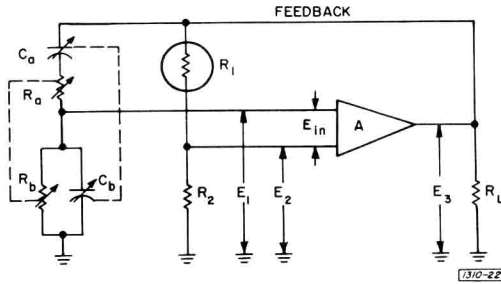

To overcome this problem with a single divider, a second divider, R_1 and R_2 , is added. The output, E_2 of this divider takes the place of the input ground reference and the input to the amplifier is now the difference between the output of the two dividers (E_2 is *negative* feedback and if it increases, E_3 decreases). Note that the amplifier is across the bridge as is the detector/amplifier of any bridge.

The transfer function of the resistance divider is the simple voltage ratio:

$$\frac{E_2}{E_3} = \frac{R_2}{R_1 + R_2}$$

The loop gain is now: $G_L = G_A \left(\frac{E_1}{E_3} - \frac{E_2}{E_3} \right)$ or =

$$G_L = G_A \left[\frac{1}{3 + j \left(\frac{\omega}{\omega_0} - \frac{\omega_0}{\omega} \right)} - \frac{R_2}{R_1 + R_2} \right]$$

and must still be equal to 1 for stable amplitude.

4.1 BRIDGE continued

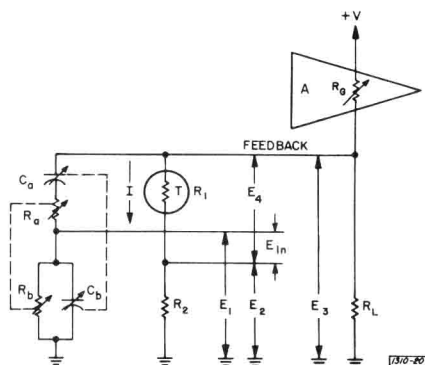

In order to stabilize E_3 with changes in frequency and amplifier gain, a negative-temperature-coefficient thermistor is used for R_1 . An ordinary resistor is linear, its resistance remains essentially constant as the current through it changes. But the thermistor used in the Type 1310-A is non linear, its resistance *decreases* as the current through it *increases*.

To explain the action of the thermistor, the amplifier is shown as a current source with a certain current-delivering capability (represented by the constant voltage, $+V$, and a resistor, R_g).

Note that the same voltage, E_3 , is across all three legs (impedance divider, resistance divider, and R_L):

$$E_3 = E_2 + E_4$$

$$E_2 = IR_2$$

$$E_4 = IR_1$$

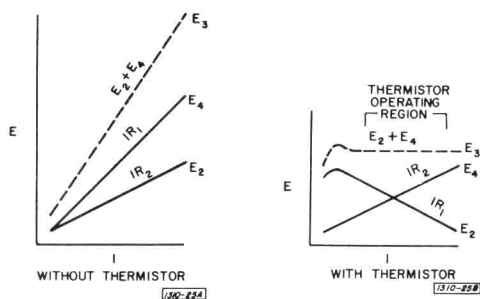

When an ordinary resistor is used for R_1 , the voltage drops across R_1 and R_2 change in direct proportion to the current through them, which, in turn, changes in direct proportion to the gain (current-delivering capability) of the amplifier. In the above graph, the result of increasing current, I , is shown. Since E_3 is the sum of E_2 and E_4 , E_3 rises linearly as the gain of the amplifier rises.

When a thermistor is used for R_1 , and its resistance characteristic is chosen so that the slope of its IR drop is equal to the slope of the IR_2 drop but of opposite sign, E_3 remains constant with changes in amplifier *gain*.

● 4.2 AMPLIFIER

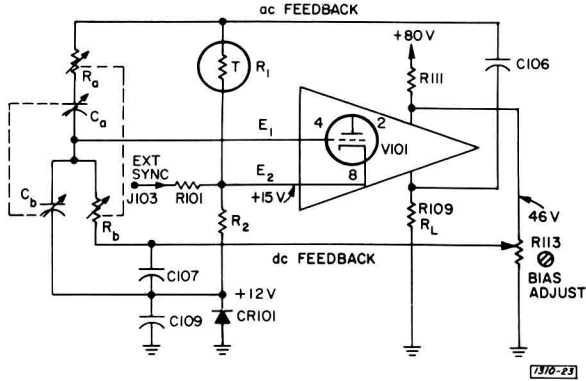

The differential input stage is a Nuvistor, V101, a small, rugged, non-microphonic, metal-ceramic tube. The positive feedback voltage E_1 , from the bridge is applied to the grid, pin 4, and the negative feedback voltage E_2 , is applied to the cathode, pin 8. The bridge is returned to ac ground via C107, CR101 and C109.

4.2 AMPLIFIER continued

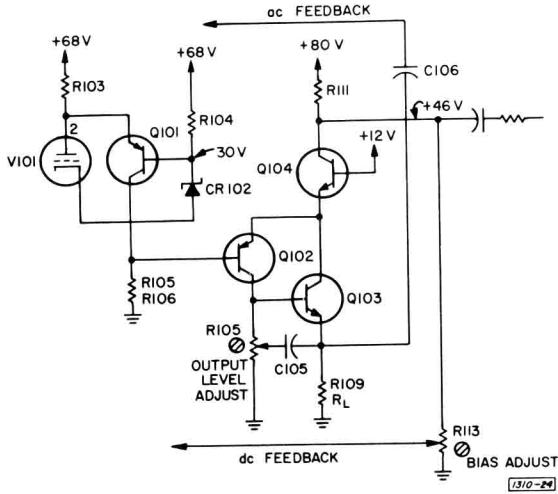

The plate current of V101 is applied to a grounded-base amplifier, Q101. Dc bias for V101 is maintained at +15 volts by a divider, R104 and CR402. The amplified signal is taken from the collector and applied to the base of Q102 in a common-emitter connection.

The output of Q102 is taken from the collector and applied to the base of an emitter-follower, Q103. The output of Q103 is taken across R109 (R_L) which is connected through C106 to the top of the bridge and forms the ac paths for the impedance divider and resistance divider described earlier.

The collector current of Q103 drives the grounded-base stage, Q104, whose output appears across R111 and is applied through the attenuator to the OUTPUT terminal J101. Dc negative feedback is used around the entire direct-coupled amplifier to maintain stable dc-operating conditions. This feedback path is from the collector of Q104, through R113 which controls the magnitude of the feedback, and to the grid of V101.

● 4.3 POWER SUPPLY

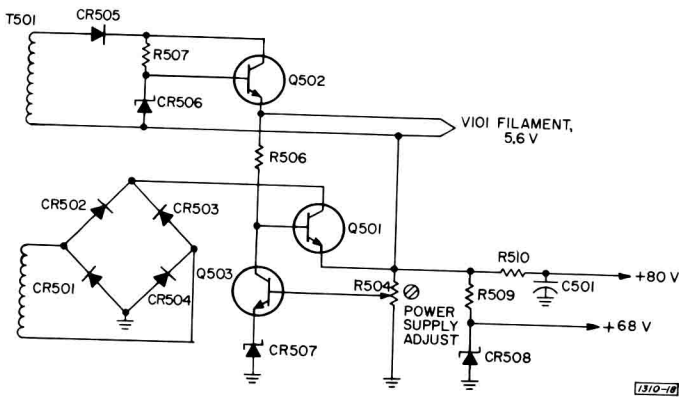

The power supply contains two regulators which provide three outputs: V101 filament, +80 volts B+, and +68 volts B+.

The filament supply consists of a half-wave rectifier (CR505) and a series regulator (Q502). The output is taken from the emitter of Q502 which is maintained at 5.6 volts by CR506, a 6.2-volt zener diode in the base circuit.

The B+ supply consists of a full-wave bridge rectifier (CR501 through CR504), a series regulator (Q501), and an amplifier-comparator (Q503). The +80-volt output is taken from the emitter of Q501 through a decoupling network, R510 and C501. Error voltage from the center arm of R504 is applied to the base of the comparator, Q503, whose bias is set by a 68-volt zener diode, CR507. The comparator amplifies and inverts the error voltage and applies it to the base of the series regulator to maintain a constant, low-ripple, +80-volt output.

The +68-volt output is taken from the center of a divider, R509 and CR508, connected to the +80-volt supply. CR508 is a 68-volt zener diode which maintains a constant output.

● 4.4 SYNCHRONIZATION

The method used to synchronize the oscillator is commonly called injection locking and is the same mechanism that causes some oscillators to beat with the power-line frequency or to lock with it. It is an old phenomenon and has been frequently discussed in the literature.*

Injection locking is a natural extension of the normal oscillator operation and, except for an isolating resistance and capacitance, is dependent only upon the proper operation of the oscillator. The naturalness of the extension is apparent when it is realized that normal operation is, in fact, only an amplitude-regulated, frequency-selective regeneration of noise sources within the oscillator. Synchronization is an amplitude-regulated, frequency-selective regeneration of an externally applied signal.

* W.A.Edson, *Vacuum-Tube Oscillators*, John Wiley & Sons, Inc., New York, Chapter 13; 1953.
P.R.Aigrain and E.M.Williams, "Pseudo-synchronization in Amplitude Stabilized Oscillators," *Proceedings of the IRE*, Vol. 36, pp 800-801; June, 1948.
Robert Adler, "A Study of Locking Phenomena in Oscillators," *Proceedings of the IRE*, Vol. 34, pp 351-357; June, 1946.
Marcel J.E.Golay, "Normalized Equations of the Regenerative Oscillator-Noise, Phase Locking and Pulling," *Proceedings of the IEEE*, Vol. 52, pp 1311-1330; November, 1964.

SECTION 5 SERVICE AND MAINTENANCE

5.1	Warranty	36
5.2	Service	36
5.3	Routine Maintenance	36
5.4	Cover Removal	37
5.5	Pilot Lamp Replacement	37
5.6	Access to Etched-Board Components	37
5.7	Minimum Performance-Specifications	38
5.8	Trouble-Shooting Notes	39
5.9	Amplifier Open-Loop Testing	40
5.10	Calibration Procedure	41

● 5.1 WARRANTY

We warrant that each new instrument sold by us is free from defects in material and workmanship, and that, properly used, it will perform in full accordance with applicable specifications for a period of two years after original shipment. Any instrument or component that is found within the two-year period not to meet these standards after examination by our factory, district office, or authorized repair agency personnel, will be repaired, or, at our option, replaced without charge, except for tubes or batteries that have given normal service.

● 5.2 SERVICE

The two-year warranty stated above attests the quality of materials and workmanship in our products. When difficulties do occur, our service engineers will assist in any way possible. If the difficulty cannot be eliminated by use of the following service instructions, please write or phone our Service Department (see rear cover), giving full information of the trouble and of steps taken to remedy it. Be sure to mention the serial and type numbers of the instrument.

Before returning an instrument to General Radio for service, please write to our Service Department or nearest district office, requesting a Returned Material Tag. Use of this tag will ensure proper handling and identification. For instruments not covered by the warranty, a purchase order should be forwarded to avoid unnecessary delay.

● 5.3 ROUTINE MAINTENANCE

None required.

● 5.4 COVER REMOVAL

Turn the two knurled nuts on the rear of the cover counterclockwise and pull the cover straight back and off.

● 5.5 PILOT LAMP REPLACEMENT

The pilot lamp and lens form an integral assembly that should last the life of the instrument. However, it can be removed by pushing it out or tapping it out with a hammer, from the rear.

● 5.6 ACCESS TO ETCHED-BOARD COMPONENTS.

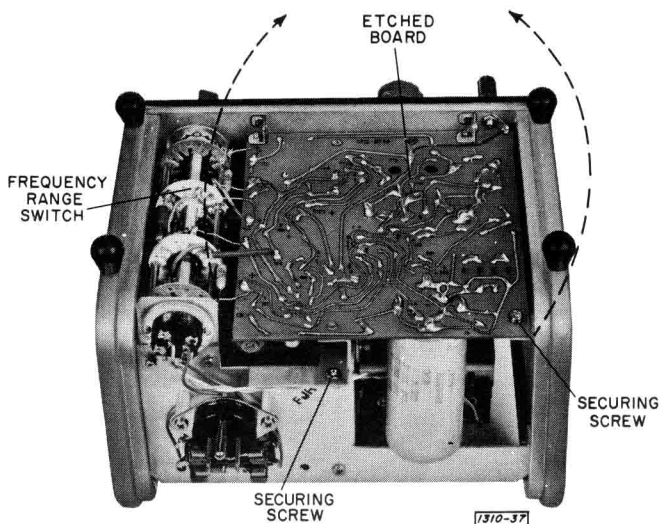

Disconnect from the etched board the six wires that are connected to the FREQUENCY range switch, remove the two securing screws, and swing the board up.

● 5.7 MINIMUM PERFORMANCE SPECIFICATIONS

The following specifications are recommended for incoming inspection or periodic operational checks. Detailed procedures are given in the Calibration Procedure, paragraph 5.10.

Conditions : 115-V line, 30-minute warmup.

<i>Calibration Procedure Step</i>	<i>Check</i>	<i>OUTPUT LEVEL Setting</i>	<i>FREQUENCY</i>		<i>Specifications</i>
			<i>Range Setting</i>	<i>Dial Setting</i>	
5.10.4	Output level	fully cw	200c-2kc	10	>20V, rms
5.10.5	Frequency	fully cw	each	10	±2% of indicated value
5.10.6	Distortion	fully cw	20c-200c	5	< 0.25%
		fully cw	2kc-20kc	5	< 0.25%
5.10.7	Hum	fully cw	200c-2kc	10	< 0.02%
5.10.8	Sync output	—	200c-2kc	10	≥ 0.8V, rms
5.10.9	Output power	fully cw	200c-2kc	10	>9.8V, rms into 600-Ω load
5.10.9	Output response	set for 10v, rms	200c-2kc	10	
			200c-2kc	2	9.8 to 10.2V, rms
			200c-2kc	20	9.8 to 10.2V, rms

● 5.8 TROUBLE-SHOOTING NOTES

Additional troubleshooting information is contained in the Calibration Procedure, paragraph 5.10, and on the schematic page.

In all cases, except total failures such as a blown fuse, first check the power supply voltages and dc operating level. These must be correct for proper operation.

Always allow a 30-minute warmup before making any final adjustments.

V101 filament supply	+85.5V dc at Q502 emitter
+80-V B+	+80 V dc at TPB, adjust R504
+68-V B+	+68 V dc at C502
Dc bias	+46 V dc at TPA, adjust R113

Inaccurate frequency *High end of 2-20c range: C114.*

200kc-2Mc range: C102 misadjusted, refer to paragraph 5.10.5 for adjustment procedure.

One range only: R_a or R_b for that range.

Lower ranges: Dirt, grease, or high humidity may have affected R_a or R_b, frequency will be too high.

All ranges: C_a or C_b or improper frequency adjustments, refer to paragraph 5.10.5 for adjustment procedure.

Excessive distortion Output level improper, adjust R108 for minimum distortion (about 20.5V, rms, at OUTPUT terminal, voltage must be over 20V and R108 must not be adjusted to either of its extremes). Dc bias improper, adjust R113 for +46V at TPA.

Excessive hum Power supply not regulating properly and one or more of the voltages contain excessive ripple:

<i>Supply</i>	<i>Check Point</i>	<i>Dc Value</i>	<i>Maximum Ripple</i>
V101 fil	Q502 e	+85.5V	60mv, p-to-p
+80V B+	TPB	+80 V	10mv, p-to-p
+68V B+	C502	+68 V	1mv, p-to-p

Poor response (Output varies with frequency) R107 (thermistor) or grossly improper frequency adjustments, refer to paragraph 5.10.5 adjustment procedure.

Instability or excessive noise . . . CR102 (select for low noise), C104, or Q104. Dust between plates of C101 or wiper dirty or otherwise making poor contact.

● 5.9 AMPLIFIER OPEN-LOOP TESTING

The oscillator uses a large amount of feedback so that trouble at one point will manifest itself at most other points and no clear idea of where the trouble originates is possible. In these cases, open-loop testing is recommended; i.e., testing the amplifier alone, without feedback:

- a. Unsolder the lead to AT110 on the etched board and unsolder one end of the thermistor, R107 to open the ac feedback path.
- b. Set the controls as follows:
 FREQUENCY range 2kc-20kc
 FREQUENCY dial 2 (2 kc/s)
 LEVEL control fully cw
- c. Apply a 1-mV, p-to-p, 1-kc signal to the EXT SYNC jack, J103.
- d. Trace the signal through the amplifier with an oscilloscope with a short, low-capacitance, high-impedance probe to prevent spurious oscillations:

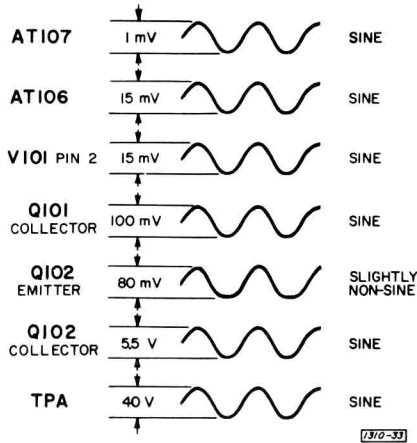

Voltages are approximate. Actual voltages may vary 2 to 1 in individual instruments.

● 5.10 CALIBRATION PROCEDURE

5.10.1 INTRODUCTION

This procedure can be used for troubleshooting or calibration.

If used for troubleshooting, the steps can be performed in any order. The usual practice would be to perform only the step that pertains to the suspected circuit.

If used for calibration, the steps should be performed in sequence since one step serves as a foundation for the next. A complete calibration insures that all circuits are operating properly and within specifications. The Type 1310-A Oscillator incorporates the high reliability one would expect of conservatively designed, semiconductor circuits and routine calibrations are unnecessary.

5.10.2 EQUIPMENT REQUIRED

The following equipment is required for a complete calibration of the Type 1310-A Oscillator. The specifications given for the equipment are those necessary for the calibration of the Type 1310-A and are not necessarily those of the recommended equipment.

Metered, adjustable autotransformer

Output: 105 to 125V (or 195 to 235 or 210 to 250V), 12W.

Meter: Ac, $\pm 3\%$ accuracy.

The Type W5MT3W Metered Variac[®] Autotransformer is recommended.

Electronic voltmeter

Voltage: 40 to 80V, dc; 0.8 to 25V, rms, 20 c/s to 2 Mc/s, $\pm 2\%$ accuracy.

Impedance: 100 k Ω or greater.

The Type 1806 Electronic Voltmeter is recommended

Digital frequency meter (counter)

Frequency: 2 c/s to 2 mc/s, $\pm 0.1\%$ accuracy.

Sensitivity: 1 to 25V, rms.

Impedance: 100 k Ω or greater.

The Type 1151 Digital Time and Frequency Meter with a Type 1156 Decade Scaler is recommended.

The frequency accuracy of the Type 1310-A is $\pm 2\%$. The counter accuracy should be at least 20 times this, or 0.1%, to prevent counter errors from entering into the measurements. The \pm one-count uncertainty in a counter with a 100-kc time base represents an error of greater than 0.1% unless the measurement conditions are as follows:

- above 1000 c/s; direct frequency measurement, 1-second counting interval.
- below 1000 c/s; period measurement, 10-period count.

5.10 CALIBRATION PROCEDURE *continued*

Oscilloscope

Bandwidth: 2 c/s to 2 mc/s (-3 dB points)
Sensitivity: 1 to 25V, rms.
Impedance: 100k Ω or greater.

Wave Analyzer

Frequency: 50 c/s to 150 kc/s.
Sensitivity: 20 mV to 25V, rms.
Impedance: 100 k Ω or greater.

Test Oscillator

Frequency: 1 kc/s.
Amplitude: 1 V, rms, into 25 k Ω .
The Types 1210, 1310 and 1311 Oscillators are recommended.

Load resistors

50 Ω \pm 1%, 1W. The Type 500-C Resistor is recommended.
600 Ω \pm 1%, 1W. The Type 500-G Resistor is recommended.

5.10.3 POWER SUPPLY and BIAS VOLTAGES

Connect the Type 1310-A to an ac line via a metered adjustable auto-transformer and set the transformer for 115-V output. Set the Type 1310-A controls as follows:

FREQUENCY range 200 c-2 kc
FREQUENCY dial 10 (1 kc/s)
LEVEL control fully cw

R504 Power Supply. Connect a voltmeter to TPB and adjust R504 for +80V, dc.

R113 Bias. Connect a voltmeter to TPA and adjust R113 for +46V, dc.

Ripple. Connect an oscilloscope to TPB and check ripple at 105, 115, and 125-V line; must be less than 10 mV, p-to-p.

Allow a 30-minute warmup then recheck the adjustment of R504 and R113.

5.10 CALIBRATION PROCEDURE *continued*

5.10.4 OUTPUT LEVEL

FREQUENCY range 200 c-2 kc
FREQUENCY dial 10 (1 kc/s)
LEVEL control fully cw

R108 **Maximum output.** Connect a voltmeter to the OUTPUT terminal and adjust R108 for 20.5V, rms. The instrument should be on for at least 30 minutes before this adjustment is made.

LEVEL control operation. Vary the LEVEL control over its full range the output level must change smoothly. If it does not, the LEVEL potentiometer, R117, is noisy and should be replaced.

5.10.5 FREQUENCY

FREQUENCY range 200 c-2 kc
FREQUENCY dial 2(200 c/s)
LEVEL control fully cw

200 c/s mechanical adjustment. Connect a counter and a voltmeter to the EXT SYNC jack and set the FREQUENCY dial for a ten-period count of exactly 50 ms. Loosen the set screws on the FREQUENCY dial and position the dial on the shaft to read exactly 2 with a reading of 50 ms on the counter. Snug-up the set screws but don't tighten. Note the voltmeter reading.

C111 **C112** **2 kc/s, capacitor adjustments.** Set the FREQUENCY dial to exactly 20. Simultaneously adjust C111 and C112 for a counter frequency reading of exactly 2 kc/s and the same voltmeter reading noted above.

The mechanical adjustment and capacitor adjustments interact; repeat until the measurements are correct and the voltmeter readings are equal at both ends of the dial.

Stability. Disconnect the voltmeter and connect an oscilloscope in its place. Rotate the FREQUENCY dial over the entire 200 c-2 kc range; there must be no instability or other erratic operation. If there is, it is usually caused by the rotor wiper arm of the tuning capacitor, C101, or dust in C101. Disconnect the oscilloscope.

C102 **2-Mc adjustment.** Set the FREQUENCY range to 200 kc-2 Mc and set the FREQUENCY dial to 20 (2 Mc/s). Adjust C102 for a counter frequency reading of exactly 2 Mc/s.

Frequency checks. Perform the following frequency checks:

5.10 CALIBRATION PROCEDURE *continued*

<i>Range Setting</i>	<i>Dial Setting</i>	<i>Counter Reading</i>	<i>Remarks</i>
*200c-2kc	2 (200c/s)	Ten period 49 to 51 ms	*Mechanically position FREQUENCY dial
200c-2kc	5 (500c/s)	Ten period 19.6 to 20.4 ms	
200c-2kc	10 (1kc/s)	Frequency: 980 to 1020 c/s	*Adjust C111 and C112.
200c-2kc	15 (1.5kc/s)	Frequency: 1470 to 1530 c/s	
*200c-2kc	20 (2kc/s)	Frequency: 1960 to 2040 c/s	
2kc-20kc	10 (10kc/s)	Frequency: 9.8 to 10.2 kc/s	*Adjust C102
20kc-200kc	10 (100kc/s)	Frequency: 98 to 102 kc/s	
200kc-2Mc	10 (1Mc/s)	Frequency: 0.98 to 1.02Mc/s	*Adjust C102
*200kc-2Mc	20 (2Mc/s)	Frequency: 1.96 to 2.04Mc/s	
20c-200c	20 (200c/s)	Ten period 49 to 51 ms	
20c-200c	2 (20c/s)	Ten period 490 to 510 ms	
2c-20c	2 (2c/s)	Ten period 4900 to 5100 ms	
2c-20c	10 (10c/s)	Ten period 980 to 1020 ms	
2c-20c	20 (20c/s)	Ten period 490 to 510 ms	

*Adjusted earlier in this step.

5.10.6 DISTORTION

FREQUENCY range 20-200 c
 FREQUENCY dial 5 (50 c/s)
 LEVEL control fully cw

50 c/s. Disconnect the counter from the OUTPUT terminals and connect a wave analyzer in its place. Measure the second- and third-harmonic distortion (100 c/s and 150 c/s); total distortion must be less than 0.25%.

$$\text{Total distortion} = \sqrt{(\text{second-harmonic distortion})^2 + (\text{third-harmonic distortion})^2}$$

50 kc/s. Change the FREQUENCY range to 20 kc-200 kc (50 kc/s) and measure the second- and third-harmonic distortion (100 kc/s and 150 kc/s); total distortion must be less than 0.25%.

These measurements may also be made with a distortion meter.

5.10 CALIBRATION PROCEDURE *continued*

5.10.7 HUM

FREQUENCY range 200 c-2 kc
FREQUENCY dial 10 (1 kc/s)
LEVEL control fully cw

Open circuit hum. Keep the wave analyzer connected to the OUTPUT terminals and measure the hum at 60, 120, and 180 c/s; total hum must be less than 0.02%.

$$\text{total hum} = \sqrt{(\text{hum at } 60 \text{ c/s})^2 + (\text{hum at } 120 \text{ c/s})^2 + (\text{hum at } 180 \text{ c/s})^2}$$

5.10.8 SYNCHRONIZATION

FREQUENCY range 200 c-2 kc
FREQUENCY dial 10 (1 kc/s)
LEVEL control fully cw

Sync in. Disconnect the wave analyzer from the OUTPUT terminals and connect a counter in its place. Connect the output of another oscillator (test oscillator) to the EXT SYNC jack and set the test oscillator for 1V, rms, of exactly 1 kc/s.

Very slowly increase the FREQUENCY dial setting of the Type 1310-A until it drops out of sync (counter reading changes from 1 kc/s to some higher frequency). Reduce the output amplitude of the test oscillator to below 50 mV, rms, or turn its power switch off and note the counter reading (free-running frequency of the Type 1310-A); must be greater than 1030 c/s (1 kc/s $\pm 3\%$).

Sync out. Disconnect the test oscillator from the EXT SYNC jack and connect a voltmeter in its place. The sync out amplitude must be 0.8V, rms, or greater.

5.10.9 OUTPUT RESPONSE

Connect a 600-ohm load and a voltmeter to the OUTPUT terminals and check as follows:

<i>FREQUENCY</i>		
<i>Range Setting</i>	<i>Dial Setting</i>	<i>Output voltage, rms</i>
200c-2kc	10 (1kc/s)	> 9.8V
200c-2kc	10 (1kc/s)	Set LEVEL control for exactly 10V
200c-2kc	2 (200c/s)	9.8 to 10.2V
200c-2kc	20 (2kc/s)	9.8 to 10.2V
2kc-20kc	20 (20kc/s)	9.8 to 10.2V
20kc-200kc	20 (200kc/s)	9.8 to 10.2V
20c-200c	2 (20c/s)	9.8 to 10.2V

SECTION 6 PARTS LIST and SCHEMATIC

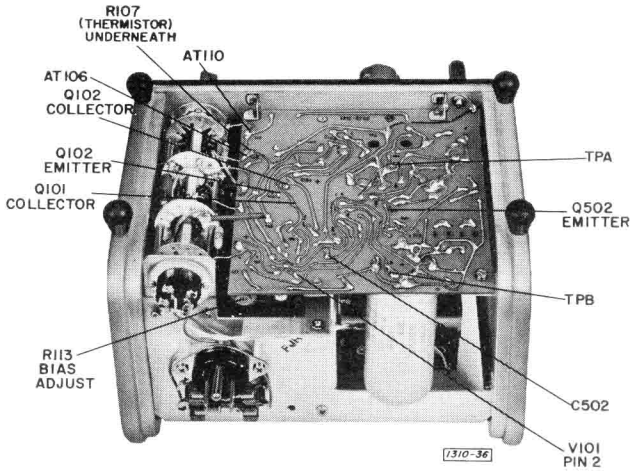
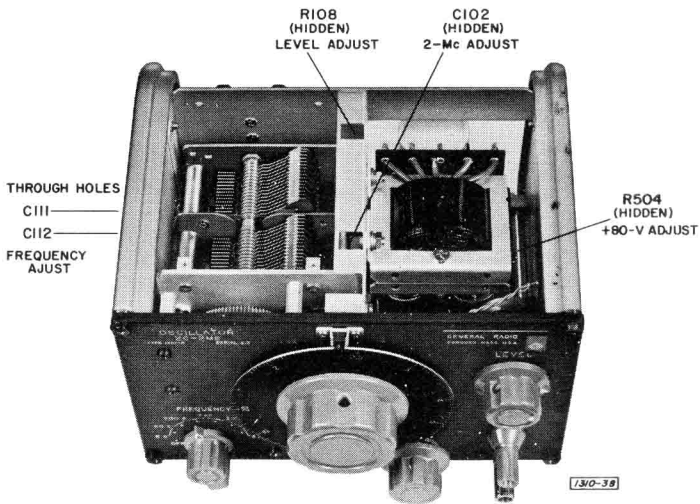

R115, R17A, R17B AND R18B
IMPEDANCE BRIDGED-T
ATTENUATOR

R1

LEVEL

EXT SYNC

FREQUENCY RANGE

FREQUENCY DIAL

FREQUENCY
200C 2K 20K
20C 200 2000
2.5C 25 250
OFF

200K
20K
2000

SECTION 2 REAR SECTION 3 FRONT

PANEL LEGEND FOR 5101

FOR 115V OPERATION
CONNECT T103 & T104
F501 & F502 - 25 AMPS

FOR 230V OPERATION
CONNECT T103 & T104
F501 & F502 - 12.5 AMPS

FOR 230V OPERATION
CONNECT T103
F501 & F502 - 25 AMPS

POWER SUPPLY

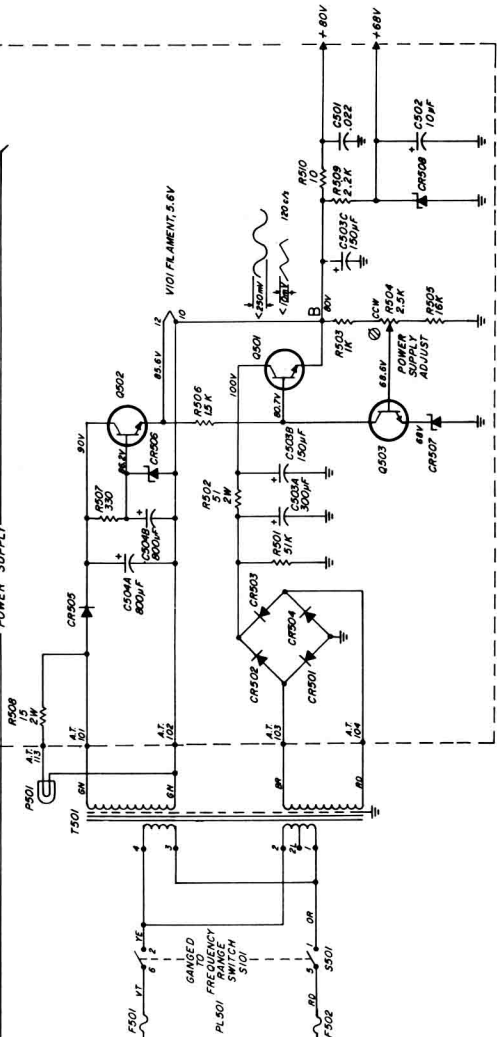
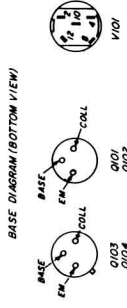

- ANCHOR TERMINALS (USED AT J01 THRU J14)**
NOTE: UNLESS SPECIFIED:
- 1 POSITION OF ROTARY SWITCHES
 - 2 CONTACT NUMBERING OF SWITCHES
 - 3 REFER TO SERVICE MANUAL INSTRUCTION BOOK
 - 4 APPEARING ON DIAGRAM
 - 5 RESISTANCE IN OHMS
 - 6 OVER IN MICROFARADS, LESS AND THIN ONE IN MICROFARADE
 - 7 OVER IN MICROFARADS, LESS AND THIN ONE IN MICROFARADE
 - 8 SCHEMATIC CONTROL
 - 9 AT ANCHOR TERMINAL
 - 10 TP - TEST POINT



REF NO.	DESCRIPTION	PART NO.
CAPACITORS C101	Variable air, 630 pF	main tuning 1210-4000
C102	Trimmer, 5 to 25 pF	4910-1150
C103	Electrolytic, 40 μ F +100-10% 6V	4450-3600
C104	Ceramic, 5.6 pF \pm 5% 500V	4400-0560
C105	Electrolytic, 200 μ F +100-10% 6V	4450-2610
C106	Electrolytic, 200 μ F +100-10% 12V	4450-0400
C107	Electrolytic, 200 μ F +100-10% 6V	4450-2610
C108	Electrolytic, 300 μ F +100-10% 75V	4450-5620
C109	Ceramic, 0.1 μ F +80-20% 50V	4403-4100
C110	Electrolytic, 10 μ F +100-10% 25V	4450-3800
C111	Trimmer, 5.5 to 18 pF 350V	4910-2041
C112	Trimmer, 5.5 to 18 pF 350V	4910-2041
C113	Mica, 39 pF \pm 5% 500V	4640-0200
C114	Ceramic, 3.6 pF \pm 10% 500V	4400-0500
C115	Ceramic, 0.001 μ F +80-20% 500V	4404-2109
C116	Ceramic, 1.8 pF \pm 5% 500V	4400-0180
C501	Ceramic, 0.022 μ F +80-20% 500V	4407-3229
C502	Electrolytic, 10 μ F +100-10% 150V	4450-3100
C503	Electrolytic, 300 μ F x 150 μ F x 150 μ F +100-10% 150V	4450-5602
C504	Electrolytic, 800 μ F x 800 μ F +100-10% 10V	4450-5603
DIODES CR101	Type 1N759A	6083-1014
CR102	Type 1N965B, selected for low noise	6083-1047
CR103	Type 1N628	6082-1013
CR501	Type 1N3254	6081-1002
CR502	Type 1N3254	6081-1002
CR503	Type 1N3254	6081-1002
CR504	Type 1N3254	6081-1002
CR505	Type 1N3253	6081-1001
CR506	Type 1N753A	6083-1006
CR507	Type 1N981B	6083-1042
CR508	Type 1N981B	6083-1042
FUSES F501	For 115-V operation: 0.25A, 3AG, Slo-Blo For 230-V operation: 0.125A, 3AG, Slo-Blo	5330-0700 5330-0450
F502	For 115-V operation: 0.25A, 3AG, Slo-Blo For 230-V operation: 0.125A, 3AG, Slo-Blo	5330-0700 5330-0450
JACKS J101	Binding post assembly: 1 binding post, red plastic top 2 insulators, red plastic	OUTPUT 4060-0400 4130-0300
J102	Binding post assembly: 1 binding post, metal top 1 bushing	OUTPUT ground 4060-1800 7800-0600
J103	Phone jack, two contact, Switchcraft Type 11	EXT SYNC
LAMP P501	Translucent monogram, 6V 200 mA, size T-1-3/4	pilot lamp 5600-1001
PLUG PL501	3-terminal power plug assembly	4240-0700
TRANSISTORS Q101	Type 2N2188	8210-1045
Q102	Type 2N2188	8210-1045
Q103	Type 2N2218	8210-1028

REF.NO.	DESCRIPTION	PART NO.
Q104	Type 2N3498, uses 5700-1010 heat sink	8210-1099
Q501	Type 2N2196	8210-1041
Q502	Type 2N697	8210-1040
Q503	Type 2N2714	8210-1047
RESISTORS		
R101	Composition, 27 k Ω \pm 5% 1/2w	6100-3275
R102	Composition, 1 k Ω \pm 5% 1/2w	6100-2105
R103	Composition, 15 k Ω \pm 5% 1/2w	6100-3155
R104	Composition, 18 k Ω \pm 5% 1/2w	6100-3185
R105	Composition, 1 k Ω \pm 5% 1/2w	6100-2105
R106	Composition, 8.2 k Ω \pm 5% 1/2w	6100-2825
R107	Thermistor, 68 Ω	6740-2021
R108	Potentiometer, composition, 2.5 k Ω \pm 20%	6040-0500
R109	Composition, 75 Ω \pm 5% 1w	6110-0755
R110	Composition, 100 Ω \pm 5% 1/2w	6100-1105
R111	Wire-wound, 510 Ω \pm 5% 5w	6660-1515
R112	Composition, 220 k Ω \pm 5% 1/2w	6100-4225
R113	Potentiometer, composition, 100 k Ω \pm 20%	6040-1000
R114	Composition, 100 k Ω \pm 5% 1/2w	6100-4105
R115	Composition, 470 k Ω \pm 5% 1/2w	6100-4475
R116	Composition, 620 Ω \pm 5% 1/2w	6100-1625
R117	Attenuator potentiometer, uses 5530-1200 gray knob	LEVEL 6045-1070
R118	Composition, 620 Ω \pm 5% 1/2w	6100-1625
R119	Film, 133 M Ω \pm 1% 1w	6182-6133
R120	Film, 133 M Ω \pm 1% 1w	6182-6133
R121	Film, 13.3 M Ω \pm 1% 1w	6450-5133
R122	Film, 13.3 M Ω \pm 1% 1w	6450-5133
R123	Film, 1.33 M Ω \pm 1% 1/2w	6450-4133
R124	Film, 1.33 M Ω \pm 1% 1/2w	6450-4133
R125	Film, 133 k Ω \pm 1% 1/2w	6450-3133
R126	Film, 133 k Ω \pm 1% 1/2w	6450-3133
R127	Film, 13.3 k Ω \pm 1% 1/2w	6450-2133
R128	Film, 13.3 k Ω \pm 1% 1/2w	6450-2133
R129	Film, 1.33 k Ω \pm 1% 1/2w	6450-1133
R130	Film, 1.33 k Ω \pm 1% 1/2w	6450-1133
R131	Composition, 6.8 M Ω \pm 5% 1/2w	6100-5685
R132	Composition, 100 Ω \pm 5% 1/2w	6100-1105
R501	Composition, 51 k Ω \pm 5% 1/2w	6100-3515
R502	Composition, 51 k Ω \pm 5% 2w	6120-0515
R503	Composition, 1 k Ω \pm 5% 1/2w	6100-2105
R504	Potentiometer, composition, 2.5 k Ω \pm 20%	6040-0500
R505	Composition, 16 k Ω \pm 5% 1/2w	6100-3165
R506	Composition, 1.5 k Ω \pm 5% 1/2w	6100-2155
R507	Composition, 330 Ω \pm 5% 1/2w	6100-1335
R508	Wire-wound, 15 Ω \pm 10% 2w	6760-0159
R509	Composition, 2.2 k Ω \pm 5% 1/2w	6100-2225
R510	Composition, 10 Ω \pm 5% 1/2w	6100-0105
SWITCHES		
S101	Rotary, 7 position, 4 section uses 5500-0800 gray knob	FREQUENCY 7890-3970
S501	Power switch, part of S101	power
TRANSFORMER		
T501	Power transformer	0345-4140
TUBE		
V101	Type 8056 Nuistor	8380-8056