



INSTRUCTION MANUAL

**Type 1650-B
Impedance Bridge**

B

GENERAL RADIO

Contents

SPECIFICATIONS
INTRODUCTION – SECTION 1
BASIC MEASUREMENTS – SECTION 2
SPECIAL MEASUREMENTS – SECTION 3
ACCURACY – SECTION 4
PRINCIPLES OF OPERATION – SECTION 5
SERVICE AND MAINTENANCE – SECTION 6
PARTS LISTS AND DIAGRAMS

WARRANTY

We warrant that each new instrument manufactured and sold by us is free from defects in material and workmanship and that, properly used, it will perform in full accordance with applicable specifications for a period of two years after original shipment. Any instrument or component that is found within the two-year period not to meet these standards after examination by our factory, District Office, or authorized repair agency personnel will be repaired or, at our option, replaced without charge, except for tubes or batteries that have given normal service.

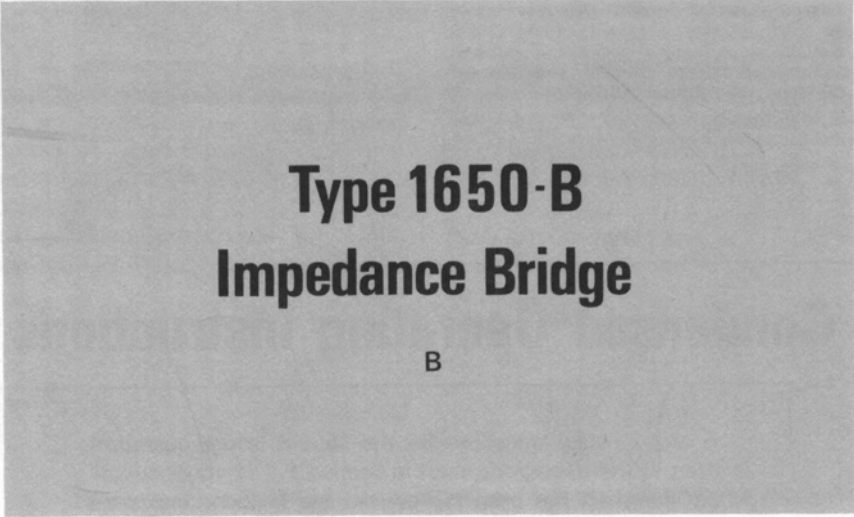

Type 1650-B Impedance Bridge

B

©GENERAL RADIO COMPANY 1968

West Concord, Massachusetts, U.S.A. 01781

Form 1650-0120-B

June 1970

ID-0100

Specifications

RANGES OF MEASUREMENT

ACCURACY

	20 Hz to 20 kHz†	DC	Residuals
Capacitance 1 pF to 1100 μF, series or parallel, 7 ranges	±1% ±1 pF		≈ 0.5 pF
Inductance 1 μH to 1100 H, series or parallel, 7 ranges	±1% ±1 μH		≈ 0.2 μH
Resistance ac or dc, 1 mΩ to 1.1 MΩ, 7 ranges	±1% ±1 mΩ	±1%, 1 Ω to 100 kΩ, ext supply or detector required >100 kΩ and <1 Ω.	≈ 1 mΩ
Conductance ac or dc, 1 nanomho to 1.1 mhos, 7 ranges	±1% ±1 nanomho	±1%, 10 micromhos to 1 mho, ext supply or detector required <10 micromhos.	
Dissipation Factor, D , at 1 kHz, 0.001 to 1 of series C, 0.1 to 50 of parallel C.	±5% ±0.001 at 1 kHz and lower		
Storage Factor, Q , at 1 kHz, 0.02 to 10 of series L, 1 to 1000 of parallel L.	$\frac{1}{Q}$ accurate to ±5% ±0.001 at 1 kHz or lower		

† Bridge operates up to 100 kHz with reduced accuracy.

GENERAL

Generator: Internal; 1 kHz ±2%. Type 1310 or 1311 Oscillator recommended if external generator is required. Internal dc supply, 6 V, 60 mA, max.

Detector: Internal or external; internal detector response flat or selective at 1 kHz; sensitivity control provided. Type 1232-A Tuned Amplifier and Null Detector is recommended if external detector is required. Combination of 1311 oscillator and 1232 detector is available as the Type 1240 Bridge Oscillator-Detector.

DC Polarization: Capacitors can be biased to 600 V from external dc power supply for series capacitance measurements.

Power Required: 4 size-D cells, supplied.

Accessories Required: None. Earphones can be used for high precision at extremes of bridge ranges.

Accessories Available: Type 1650-P1 Test Jig.

Mounting: Flip-Tilt Cabinet.

Dimensions (width x height x depth): Portable, 13 x 6¾ x 12¼ in. (330 x 175 x 315 mm); rack, 19 x 12¼ x 4⅞ in. (485 x 315 x 105 mm).

Net Weight (est): Portable, 17 lb (8 kg); rack, 18 lb (8.5 kg).

Shipping Weight (est): Portable, 21 lb (10 kg); rack, 30 lb (13.5 kg).

Patent Nos D187,740 and 2,966,257.

Condensed Operating Instructions

A step-by-step procedure for the 1650-B Bridge operation is given in the operations chart in Section 2. For your convenience, the chart has been reproduced and included inside the flip-tilt cabinet of the instrument.

NOTE: This instrument is equipped with our new snap-on knob for added convenience and safety. Refer to the Service Section for details.

Contents

Section 1—Introduction

1.1	Description	1-1
1.2	Opening and Tilting the Cabinet	1-1
1.3	Power Supply	1-1
1.4	Symbols, Abbreviations, and Definitions	1-2
1.5	Series and Parallel Components	1-2
1.6	Portable-to-Rack Conversion	1-3
1.7	Connections	1-4

Section 2—Basic Measurements

2.1	General	2-1
2.2	DC and AC Sensitivity	2-4
2.3	DC Voltage and Current Limits	2-4
2.4	Connection of External Generator	2-6
2.5	Maximum Applied AC Voltage	2-6
2.6	Operating Procedure with Orthonull	2-7

Section 3—Special Measurements

3.1	General	3-1
3.2	Application of DC Bias to Capacitors	3-1
3.3	Application of DC to Inductors	3-2
3.4	DC Bias for AC Resistance Measurements	3-4
3.5	Measurement of AC Resistance or Conductance with Reactance	3-5
3.6	Measurement of Transducers	3-5
3.7	Resonant Frequency of Tuned Circuits	3-6
3.8	Shielded Three-Terminal Components	3-6
3.9	Remote Measurements	3-6
3.10	Measurement of Grounded Components	3-7
3.11	Use of the Type 1650-P1 Test Jig	3-7
3.12	Limit Testing	3-7

Section 4—Accuracy

4.1	General	4-1
4.2	DC Resistance	4-1
4.3	AC Resistance	4-1
4.4	Inductance	4-2
4.5	Capacitance	4-2
4.6	Effects of Capacitance to Ground	4-2
4.7	D and Q Accuracy	4-3
4.8	Orthonull Accuracy	4-3
4.9	D and Q Ranges vs Frequency	4-5
4.10	Corrections for Residuals	4-5
4.11	Operation below 1kHz	4-5
4.12	Operation above 1kHz	4-5

Section 5—Principles of Operation

5.1	General	5-1
5.2	1650 Bridge	5-5

Section 6—Service and Maintenance

6.1	Warranty	6-1
6.2	Service	6-1
6.3	Minimum Performance Standards	6-1
6.4	Trouble Analysis	6-4
6.5	Repair Notes	6-5
6.6	Calibration Procedure	6-6
6.7	Knob Removal	6-8
6.8	Knob Installation	6-8

Parts Lists and Diagrams	6-10
------------------------------------	------

Appendix

BIAS jack.

Voltage bias for capacitors: Apply bias only if PARAMETER switch is in C_s position. For C_p , refer to Section 2. Max voltage is 600 V dc. Add a resistor as a current limiter to prevent short circuit.

Current bias for inductors: Apply bias only if PARAMETER switch is in L_p position. For L_s , refer to Section 2.

GENERATOR switch.

Turns bridge on, selects internal or external generator, ac or dc, checks battery.

Internal OSCillator LEVEL control.

PARAMETER switch.

UNKNOWN terminals.

MULTIPLIER switch.

Multiply CGRL dial setting by switch range for result.

DETECTOR SENSitivity control.

OPP ARM jack.

Connect external decade capacitor for reactive balance of resistors.

CGRL dial.

Main balance control. For greatest accuracy, choose MULTIPLIER setting for balance between 1 and 10.

Ground.

DETECTOR jack.

Useful to connect external amplifier or earphones for additional sensitivity or selectivity.

DQ dial.

ORTHONULL® switch.

When set to IN, clutch engaged between two main dials, false nulls are avoided and balance is faster for high D and low Q measurements. Switch to IN when CGRL and DQ dials are both in white sectors.

EXTERNAL DQ jack.

Useful for extending DQ range with a decade box.

EXTERNAL GENERATOR jack.

Max power: 0.05 W.

Max voltage: 500 V dc; or $\frac{f}{5}$ V ac rms where f is in Hz, or 100 V ac rms, whichever is smaller.

Frequency range for L and C: 20 Hz to 20 kHz.

Figure 1-1. Type 1650-B Impedance Bridge.

Section 1—Introduction

1.1 DESCRIPTION.

The 1650-B Impedance Bridge (Figure 1-1) is a self-contained impedance-measuring system, which includes six bridges for the measurement of capacitance, resistance, conductance, and inductance, as well as the generators and detectors necessary for dc and 1-kHz measurements. Features of this bridge include one-percent C, G, R, and L accuracy over all ranges, high D and Q accuracy, a mechanism to facilitate low Q measurement, a slow-motion mechanism on the CGRL dial, visual ac and dc null indications, complete portability, and a convenient tilting mechanism and carrying case. The slow-motion mechanism turns the CGRL dial slowly and effortlessly about a 1-in. sector. Extra torque must be applied to move the dial beyond the 1-in. sector.

In the relay-rack model (Figure 1-2), the captive cover of the Type 1650-B is replaced with a relay-rack adaptor panel (paragraph 1.6).

1.2 OPENING AND TILTING THE CABINET.

The directions for opening the Type 1650-B Impedance Bridge are given on the handle support of the instrument. Once open, the instrument may be tilted to any convenient angle. The angle should be chosen to give the most comfortable access to the knobs and the best view of the meter and dials.

The instrument may be locked fully open by the same slide pins that are used to lock the instrument closed. Thus, the instrument can be carried in the open position with the cover firmly in place.

Whether the instrument is open, or closed, the cover forms a convenient storage place for the instruction manual and for any other test data that should be kept with the instrument.

1.3 POWER SUPPLY.

The Type 1650-B is powered by four D cells, which slide into a fiber tube inside the instrument. These batteries, supplied with the instrument, should be installed with the positive terminals (center buttons) facing the open end of the tube. The batteries are protected from leakage and accidental discharge during shipment by an insulating disk inserted between the cap and the last cell. To remove the disk, proceed as follows:

- a. Open the instrument cabinet and place it in the locked position.
- b. Remove the two cabinet screws (Figure 1-4).
- c. Lift the instrument from its cabinet.
- d. Follow the directions on the battery tube, and remove the disk.
- e. Place the battery tube back in its holder.
- f. Replace the instrument in its cabinet.
- g. Replace the two cabinet screws.

The instrument is now ready to operate as soon as it is in the desired position and turned on.

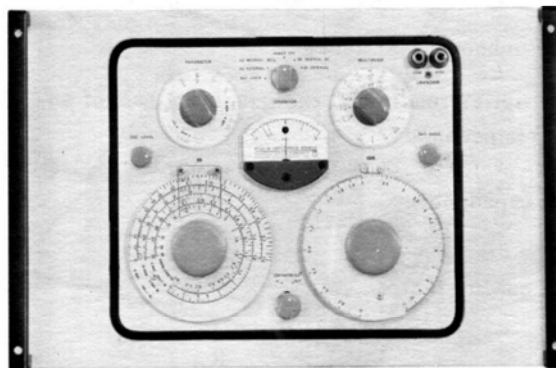
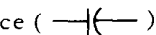
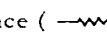



Figure 1-2. Type 1650-B Impedance Bridge in rack panel.

1.4 SYMBOLS, ABBREVIATIONS, AND DEFINITIONS.

The following symbols, abbreviations, and definitions are used on the panel of the Type 1650-B and in this instruction manual:

C	capacitance ()
C _D	external decade capacitor
C _O	bridge residual capacitance
C _P	parallel capacitance
C _S	series capacitance
C _T	standard capacitor (0.1 μF)
C _X	unknown capacitance
G	conductance (), the inverse of resistance
G _X	unknown conductance
L	inductance ()
L _O	bridge residual inductance
L _P	parallel inductance
L _S	series inductance
L _X	unknown inductance
R	resistance (), the real part of an impedance
R _A	ratio arm resistance
R _B	standard 10 kΩ resistor
R _N	CGRL rheostat resistance
R _O	bridge residual resistance
R _P	parallel resistance
R _S	series resistance
R _T	DQ rheostat resistance
R _X	unknown resistance
X	series reactance, the imaginary part of an impedance
Z	impedance

$$Q \quad \text{quality factor} = \frac{X}{R} = \frac{B}{G} = \frac{1}{D} = \tan \theta = \cot \delta$$

$$\text{for inductors} \quad \frac{\omega L_S}{R_S} \quad \text{or} \quad \frac{R_P}{\omega L_P}$$

D	dissipation factor = $\frac{R_S}{X} = \frac{G}{B} = \frac{1}{Q} = \cot \theta = \tan \delta$
	for capacitors $\omega C_S R_S$ or $\frac{1}{\omega C_P R_P}$
PF	power factor = $\frac{R}{Z} = \frac{R}{R^2 + X^2} = \cos \theta$
f	frequency
ω	angular frequency, 2πf
Ω	ohm, a unit of resistance, reactance, or impedance
kΩ	kilohm, 1 kΩ = 1000 ohms
M	multiplying factor applied to D and Q at frequencies other than 1 kHz
MΩ	megohm, 1 MΩ = 1 × 10 ⁶ ohms
μF	microfarad, a unit of capacitance
mΩ	milliohm, 1 mΩ = 1 × 10 ⁻³ ohm
nF	(or mμF) nanofarad (or millimicrofarad), 1 nF = 1 μμF = 1 × 10 ⁻³ μF
pF	(or μμF) picofarad (or micromicrofarad), 1 pF = 1 μμF = 1 × 10 ⁻⁶ μF
H	henry, a unit of inductance
mH	millihenry, 1 mH = 1 × 10 ⁻³ H
μH	microhenry, 1 μH = 1 × 10 ⁻⁶ H
	ground, case (chassis)
∩	mho, a unit of conductance

1.5 SERIES AND PARALLEL COMPONENTS.

An impedance that is neither a pure reactance nor a pure resistance may be represented at any specific frequency by either a series or a parallel combination of resistance and reactance. Keeping this concept in mind will be invaluable for properly interpreting the bridge results. The values of resistance and reactance used in the equivalent circuit depend on whether a series or a parallel combination is used. The equivalent circuits are shown in Figure 1-3. A nomograph for series-parallel conversion at 1 kHz is given in the Appendix.

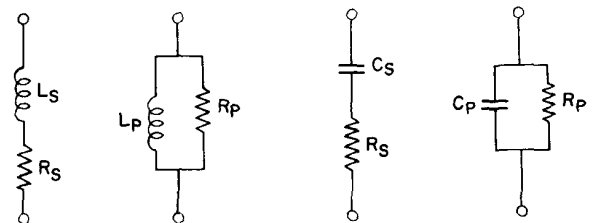

Figure 1-3. Equivalent circuits for complex impedance.

The relationships between the circuit elements are tabulated below. They are easily derived.

RESISTANCE AND INDUCTANCE

$$Z = R_s + j\omega L_s = \frac{j\omega L_p R_p}{R_p + j\omega L_p} = \frac{R_p + jQ^2\omega L_p}{1 + Q^2}$$

$$Q = \frac{1}{D} = \frac{\omega L_s}{R_s} = \frac{R_p}{\omega L_p}$$

$$L_s = \frac{Q^2}{1 + Q^2} L_p = \frac{1}{1 + D^2} L_p$$

$$L_p = \frac{1 + Q^2}{Q^2} L_s = (1 + D^2) L_s$$

$$R_s = \frac{1}{1 + Q^2} R_p; R_p = (1 + Q^2) R_s$$

$$R_s = \frac{\omega L_s}{Q}; R_p = Q\omega L_p$$

RESISTANCE AND CAPACITANCE

$$Z = R_s + \frac{1}{j\omega C_s} = \frac{R_p}{j\omega C_p} = \frac{D^2 R_p + \frac{1}{j\omega C_p}}{1 + D^2}$$

$$D = \frac{1}{Q} = \omega R_s C_s = \frac{1}{\omega R_p C_p}$$

$$C_s = (1 + D^2) C_p; C_p = \frac{1}{1 + D^2} C_s$$

$$R_s = \frac{D^2}{1 + D^2} R_p; R_p = \frac{1 + D^2}{D^2} R_s$$

$$R_s = \frac{D}{\omega C_s}; R_p = \frac{1}{\omega C_p D}$$

1.6 PORTABLE-TO-RACK CONVERSION.

The following procedure is given so that a 1650-B Bridge can be converted from a portable assembly to a rack-mounted assembly. To accomplish the mechanical and electrical changeover, a Rack Adaptor Set (P/N 1650-3350) must be ordered from General Radio.

To mount the instrument in a rack adaptor panel, proceed as follows (Figure 1-4):

a. Open the instrument to its horizontal position (full open) and lock the handle.

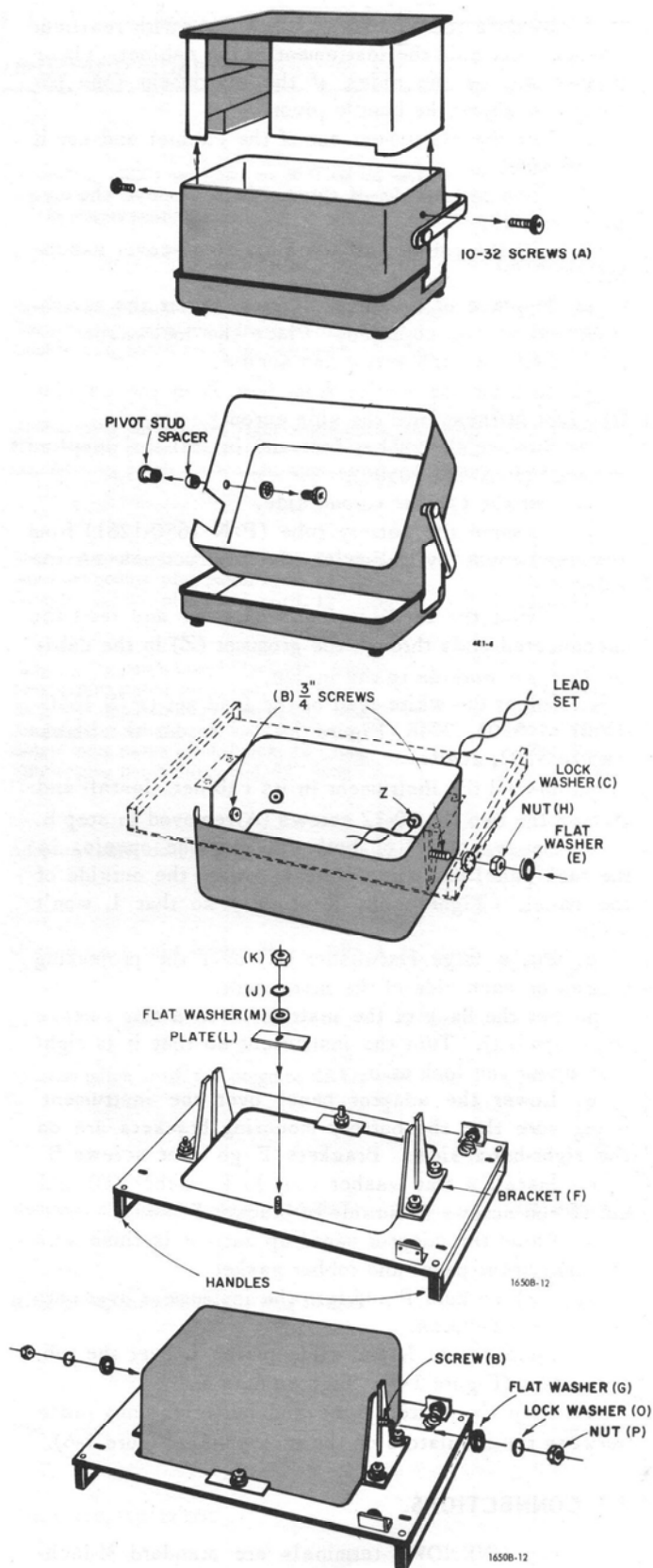

Figure 1-4. Rack mounting the 1650-B.

b. Remove the No. 10-32 screws (A) with resilient washers that hold the instrument in the cabinet. These screws are on the sides of the instrument (one per side) just above the handle pivot.

c. Lift the instrument out of the cabinet and set it to one side.

d. From the inside of the cabinet, remove the two pivot screws.

e. Lift the cabinet off the handle-and-cover assembly.

f. In place of the pivot screws, insert the two $\frac{3}{4}$ -inch screws (B) supplied. Place the lockwasher (C) and nut (H) on each screw and secure.

g. Remove the eyelet from foot Z in the cabinet (the foot farthest from the side cutout).

h. Remove the rubber foot and install the supplied grommet (P/N 4110-0500).

i. Set the cabinet to one side.

j. Remove the battery tube (P/N 1650-1261) from the instrument by following the instructions on the tube.

k. Twist the lead-set leads together and feed the unconnected ends through the grommet (Z) in the cabinet from the outside to the inside.

l. Solder the white lead of the lead set (P/N 1650-0280) to S103, 204R (Figure 6-9). Solder the black lead to S102, 204R.

m. Install the instrument in its cabinet. Install and tighten the two No. 10-32 screws (A) removed in step b.

n. Loosen nut K on both sides of the opening in the rack panel and slide plate L toward the outside of the panel. Tighten nut K slightly so that L won't slide.

o. Put a large flatwasher (E) over the projecting screws on each side of the instrument.

p. Set the back of the instrument on a flat surface (face upward). Turn the instrument so that it is right side up as you look at it.

q. Lower the adaptor panel over the instrument being sure that the battery mounting brackets are on the right-hand side. Brackets F go over screws B.

r. Install a flat washer (G), lock washer (O) and nut (P) on screws B outside of bracket F.

s. Raise the adaptor panel up until it is flush with the instrument panel and rubber gasket.

t. Tighten nuts P and turn the instrument over onto the adaptor handles.

u. Loosen nuts K and slide plates L over the rubber gasket (Figure 1-5). Tighten nuts K.

v. Snap the battery tube and batteries into place between the insulators on the rack panel (Figure 1-6).

1.7 CONNECTIONS.

The UNKNOWN terminals are standard $\frac{3}{4}$ -inch-spaced binding posts that accept banana plugs, standard telephone tips, alligator clips, crocodile clips,

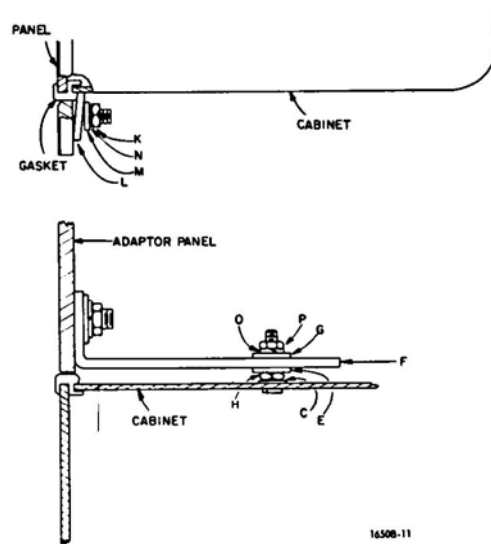

Figure 1-5. Detail view of panel mounting.

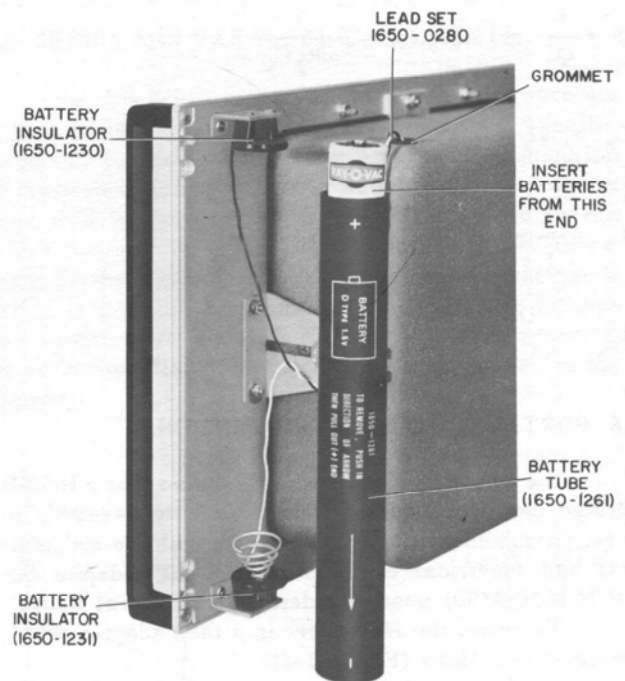
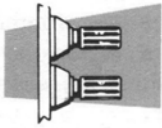

Figure 1-6. Battery mounting for rack-mounted 1650-B Bridge.

TABLE 1 - 1

AVAILABLE PATCH CORDS AND ADAPTORS



Panel Connectors

NOTE: GR874 connectors are 50 Ω and are mechanically sexless; i.e., any two, although identical, can be plugged together.

TYPE NO.	DESCRIPTION	CATALOG NO.
274-NQ	Double-plug patch cord, in-line cord, 36'' long	0274-9860
274-NQM	Double-plug patch cord, in-line cord, 24'' long	0274-9896
274-NQS	Double-plug patch cord, in-line cord, 12'' long	0274-9861
274-NP	Double-plug patch cord, right-angle cord, 36'' long	0274-9880
274-NPM	Double-plug patch cord, right-angle cord, 24'' long	0274-9892
274-NPS	Double-plug patch cord, right-angle cord, 12'' long	0274-9852
274-NL	Shielded double-plug patch cord, 36'' long	0274-9883
274-NLM	Shielded double-plug patch cord, 24'' long	0274-9882
274-NLS	Shielded double-plug patch cord, 12'' long	0274-9862
274-LLB	Single-plug patch cord, black, 36'' long	0274-9468
274-LLR	Single-plug patch cord, red, 36'' long	0274-9492
274-LMB	Single-plug patch cord, black, 24'' long	0274-9847
274-LMR	Single-plug patch cord, red, 24'' long	0274-9848
274-LSB	Single-plug patch cord, black, 12'' long	0274-9849
274-LSR	Single-plug patch cord, red, 12'' long	0274-9850
1560-P95	Adaptor cable, double-plug to telephone plug, 36'' long	1560-9695
874-R34	Coaxial patch cord, double plug to GR874, 36'' long	0874-9692
874-R33	Coaxial patch cord, two plugs to GR874, 36'' long	0874-9690
274-QBJ	Adaptor, shielded double plug to BNC	0274-9884
776-A	Patch cord, shielded double plug to BNC	0776-9701
776-B	Patch cord, GR874 to BNC	0776-9702
776-C	Patch cord, BNC to BNC	0776-9703

spade terminals and all wire size up to number eleven (Figure 1-7).

The EXT DQ, DET, and BIAS jacks accept a two-terminal telephone plug such as the Switchcraft No. 440.

The EXT GEN, G, and OPP ARM jacks accept a single banana plug such as the GR Type 274-DB1 or 2 (P/N 0274-9454 or 9455, respectively). These

jacks are spaced $\frac{3}{4}$ -inch on centers so that a GR Type 274-MB Insulated Double Plug (P/N 0274-9875) can be used between the EXT GEN and G terminals or the OPP ARM and G terminals.

General Radio also makes a variety of interconnecting cables that can be used in various system interconnections. Some of these cables are shown in Table 1-1.

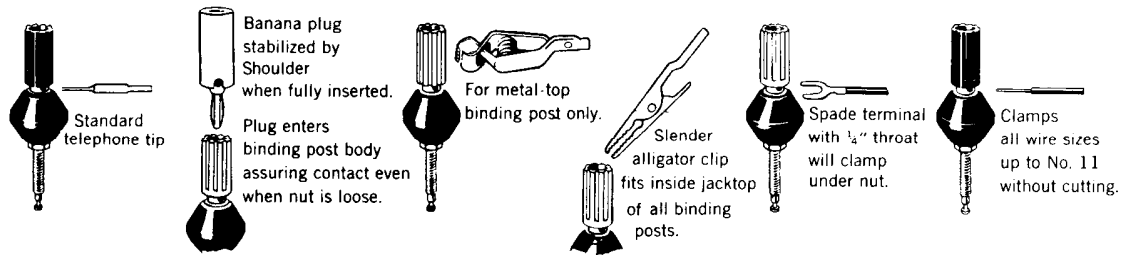

Figure 1-7. Methods of connection to the measurement terminals.

Section 2—Basic Measurements

2.1 GENERAL.

Figure 2-1 shows the six bridge circuits used in the Type 1650-B Impedance Bridge, as well as the balance equations. Hays and Maxwell inductance bridges and series and parallel capacitance comparison bridges are used to provide wide coverage over the D and Q ranges. Full use of these wide ranges at low Q and high D values is achieved by means of an Orthonull® balancing mechanism (paragraph 5.4). Both ac and dc measurements may be made with the bridge,

which has a magnitude responsive detector.

The next two pages concisely state the information needed for making basic measurements. The schematics include all relevant bridge terminals to aid the user in making special measurements that require bias, etc. The symbols on the diagrams are the same as those defined in Section 1. A short discussion of Orthonull usage, detector sensitivity, etc. relating to basic measurement practice follows the instruction chart.

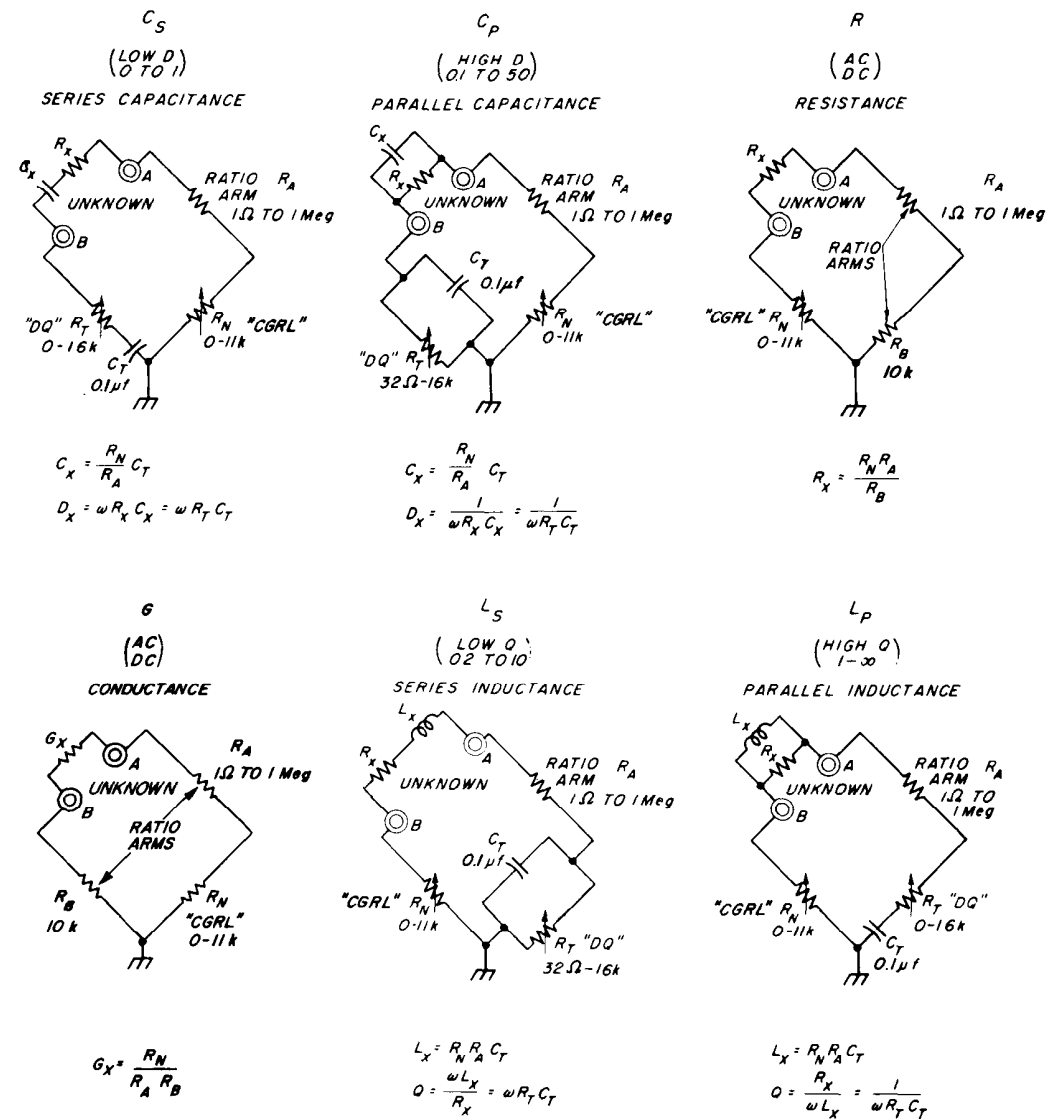

1650B-14

Figure 2-1. Bridge circuits used in impedance bridge.

C_s

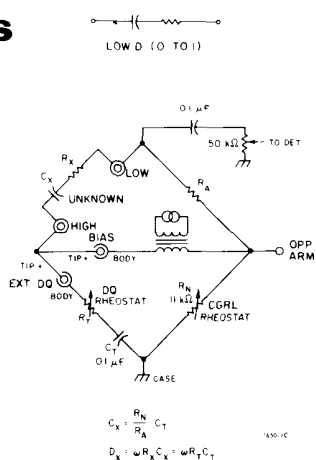

	pF	nF		μF			
MULT	100	1	10	100	1	10	100
RA Ω	1M	100k	10k	1k	100	10	1

- Turn GENERATOR switch to BAT CHECK position. If the meter pointer is not in the BAT sector, replace the batteries.
- Turn GENERATOR switch to AC EXTERNAL or AC INTERNAL 1 kHz.
- Turn PARAMETER switch to C_s.
- Connect the unknown so that most stray capacitance is between the LOW terminal and the 1650-B case.
- Turn ORTHONULL[®] switch to OUT.
- Turn OSC LEVEL clockwise. The panel control affects only the internal oscillator.
- Turn DQ dial near 0.05 on the LOW D scale.
- Turn CGRL dial near 11.
- Adjust DET SENS for about 6 divisions deflection.
- Turn MULTIPLIER switch for minimum meter reading.
- Alternately adjust, first the CGRL dial, then the DQ dial for the best null, increasing the DET SENS as needed.
- ORTHONULL[®] is not used on this bridge unless the DQ dial reading times f(kHz) approaches or exceeds 1.
- If the DQ dial goes into the uncalibrated portion, the unknown should be measured as C_p.
- The series capacitance of the unknown equals the product of the CGRL-dial reading and the MULTIPLIER-switch setting.
- The D equals the reading on the DQ dial times f (kHz).
- Turn GENERATOR switch to OFF.

C_p

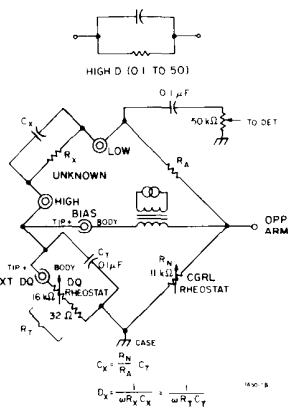

	pF	nF		μF			
MULT	100	1	10	100	1	10	100
RA Ω	1M	100k	10k	1k	100	10	1

- Turn GENERATOR switch to BAT CHECK position. If the meter pointer is not in the BAT sector, replace the batteries.
- Turn GENERATOR switch to AC EXTERNAL or AC INTERNAL 1 kHz.
- Turn PARAMETER switch to C_p. Large electrolytics should be measured at a low frequency (120 Hz) for greater accuracy.
- Connect the unknown so that most stray capacitance is between the LOW terminal and the 1650-B case.
- Turn ORTHONULL[®] switch to OUT.
- Turn OSC LEVEL clockwise. The panel control affects only the internal oscillator.
- Turn DQ dial near 0.2 on the HIGH D scale.
- Turn CGRL dial near 11.
- Adjust DET SENS for about 6 divisions deflection.
- Turn MULTIPLIER switch for minimum meter reading.
- Alternately adjust, first the DQ dial, then the CGRL dial for the best null, increasing the DET SENS as needed.
- ORTHONULL[®] switch should be set to IN if the DQ dial reading times 1/f (kHz) approaches or exceeds 1.
- If the DQ dial reaches the stop at 0.1, the unknown should be measured as C_s.
- The parallel capacitance of the unknown equals the product of the CGRL-dial reading and the MULTIPLIER-switch setting.
- The D equals the reading on the DQ dial times 1/f (kHz).
- Turn GENERATOR switch OFF.

R

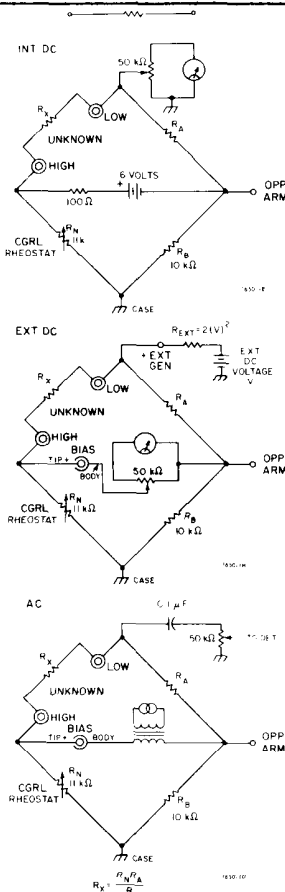

	mΩ	Ω		kΩ			
MULT	100	1	10	100	1	10	100
RA Ω	1	10	100	1k	10k	100k	1M

- Check mechanical zero of meter.
- Turn GENERATOR switch to the BAT CHECK position. If the meter pointer is not in the BAT sector, replace the batteries.
- Turn GENERATOR switch to the desired generator source. The OSC LEVEL control affects only the internal oscillator.
- Turn ORTHONULL[®] switch to OUT and PARAMETER switch to R.
- Turn CGRL dial near 11.
- Adjust DET SENS control for about 6 divisions deflection.
- Turn MULTIPLIER switch for minimum reading to the left of center if making a dc measurement. Null as usual if making an ac measurement. (DQ rheostat not in the circuit.)
- Adjust CGRL dial for best ac null, or zero the pointer if using dc. If ac null is not sharp, a reactive balance may be necessary, see instruction manual.
- The unknown resistance is the CGRL-dial reading multiplied by the MULTIPLIER switch setting.
- Turn GENERATOR switch to OFF.

OPERATING INSTRUCTIONS

G

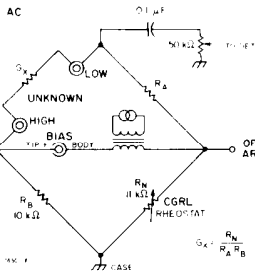
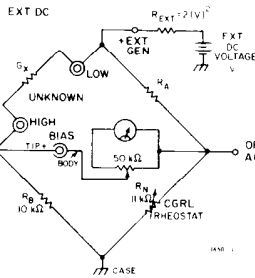
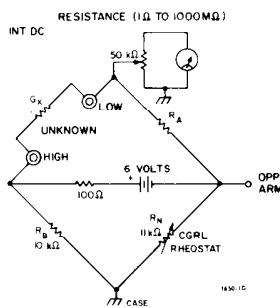

	μS	μS		mS	
MULT	100	1	10	100	1 10 100
$R_A \Omega$	1M	100k	10k	1k	100 10 1

- Check mechanical zero of meter.
- Turn GENERATOR switch to the BAT CHECK position. If the meter pointer is not in the BAT sector, replace the batteries.
- Turn GENERATOR switch to the desired generator source. The OSC LEVEL control affects only the internal oscillator.
- Turn ORTHONULL[®] switch to OUT and PARAMETER switch to G.
- Turn CGRL dial near 11.
- Adjust DET SENS control for about 6 divisions deflection.
- Turn MULTIPLIER switch for minimum reading to the left of center if making a dc measurement. Null as usual if making an ac measurement. (DQ rheostat not in the circuit.)
- Adjust CGRL dial for best ac null, or zero the pointer if using dc. If ac null is not sharp, a reactive balance may be necessary, see instruction manual.
- The unknown conductance is the CGRL-dial reading multiplied by the MULTIPLIER switch setting.
- Turn GENERATOR switch to OFF.

L_s

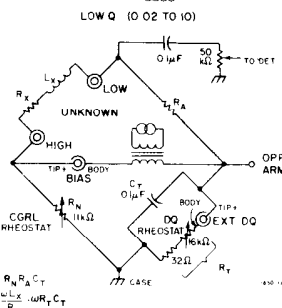

	μH	mH		H	
MULT	100	1	10	100	1 10 100
$R_A \Omega$	1	10	100	1k	10k 100k 1M

- Turn GENERATOR switch to BAT CHECK. If the meter pointer isn't in the BAT sector, replace the batteries.
- Turn GENERATOR switch to AC EXTERNAL or AC INTERNAL 1 kHz. Air core rf chokes should be measured at a high frequency (10 kHz) to get a reasonable Q.
- Turn PARAMETER switch to L_s.
- Connect unknown so that most stray capacitance is between the LOW terminal and the 1650-B case.
- Turn ORTHONULL[®] switch to OUT.
- Turn OSC LEVEL clockwise. The panel control affects only the internal oscillator. Use full output except for nonlinear unknowns. Iron core inductors are often nonlinear.
- Turn DQ dial near 4 on the LOW Q scale.
- Turn CGRL dial near 11.
- Adjust DET SENS for about 6 divisions deflection.
- Turn MULTIPLIER switch for minimum meter reading.
- Alternately adjust the CGRL and DQ dials for the best null, DQ dial first, increasing the DET SENS as needed. Null means bring the pointer as near to the center of the meter as possible. Usually it won't be possible to center the pointer.
- ORTHONULL[®] should be switched IN if the DQ-dial reading times f (kHz) approaches or is less than 1.
- If a sharp null cannot be obtained and the Q dial is near 10, switch to L_p.
- The series inductance of the unknown equals the product of the CGRL-dial reading and the MULTIPLIER-switch setting.
- The Q of the unknown equals the Q-dial reading times f (kHz).
- Turn GENERATOR switch OFF.

L_p

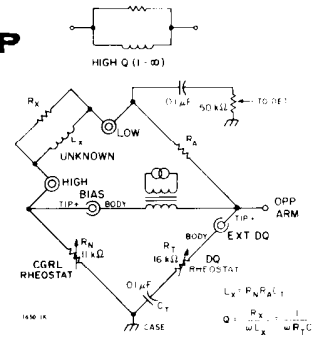

	μH	mH		H	
MULT	100	1	10	100	1 10 100
$R_A \Omega$	1	10	100	1k	10k 100k 1M

- Turn GENERATOR switch to BAT CHECK. If the meter pointer isn't in the BAT sector, replace the batteries.
- Turn GENERATOR switch to AC EXTERNAL or AC INTERNAL 1 kHz.
- Turn PARAMETER switch to L_p.
- Connect unknown so that most stray capacitance is between the LOW terminal and the 1650-B case.
- Turn ORTHONULL[®] switch to OUT.
- Turn OSC LEVEL clockwise. The panel control affects only the internal oscillator. Use full output except for nonlinear unknowns. Iron core inductors are often nonlinear.
- Turn DQ dial near 5 on the HIGH Q scale.
- Turn CGRL dial near 11.
- Adjust DET SENS for about 6 divisions deflection.
- Turn MULTIPLIER switch for minimum meter reading.
- Alternately adjust the CGRL and DQ dials for the best null, CGRL first, increasing the DET SENS as needed. Null means bring the pointer as near to the center of the meter as possible. Usually it won't be possible to center the pointer.
- ORTHONULL[®] is not used on this bridge unless the DQ dial reading times 1/f (kHz) approaches 1 or less.
- If a sharp null cannot be obtained, the unknown is too lossy and must be measured as L_s, or the unknown is not inductive.
- The parallel inductance of the unknown equals the product of the CGRL-dial reading and the MULTIPLIER-switch setting.
- The Q of the unknown equals the dial reading times 1/f (kHz).
- Turn GENERATOR switch to OFF.

2.2 DC AND AC SENSITIVITY.

With the internal 6-volt supply, one-percent balances may be easily made up to $10k\Omega$ and with care up to $100k\Omega$. Above $100k\Omega$ a higher external voltage should be used (paragraph 3.2). Below 1Ω , the sensitivity limits the accuracy to $\pm 10m\Omega$. A more sensitive meter may be placed in series with the internal meter by plugging it into the BIAS jack on the side of the bridge.

A $100\text{-}\Omega$ resistor in series with the internal 6-V supply limits the current in the unknown to 60 mA. The unknown is in series with the CGRL rheostat for external dc, so that the unknown current is greatest when the CGRL dial is at zero.

The maximum power that can be applied to the bridge by the internal supply is 0.09W; thus there is no danger of injuring components rated at 0.1W or more.

At range extremes it is often desirable to make 1-kHz ac measurements to increase sensitivity. For most resistors, the difference between the measured 1-kHz and dc values is negligible.

An external tuned null detector, such as the 1232, is very desirable when making measurements at frequencies other than 1kHz. It may be connected between the LOW UNKNOWN terminal and the 1650-B case. The screw near the UNKNOWN binding post is a convenient ground point.

2.3 DC VOLTAGE AND CURRENT LIMITS.

WARNING

Bridge voltages must be limited to protect the bridge and the unknown component from damage. It is also advisable to limit the current to 5 mA or less to protect the operator from injury. The maximum voltage limit, standard EIA test voltages and some military test voltages are described below.

Unless the utmost in sensitivity or a standard test voltage is desired, a supply of about 100 V (e.g., a 90-V battery), with about $25k\Omega$ in series, is recom-

TABLE 2-1
MAXIMUM DC BRIDGE VOLTAGE
AND CURRENT

Range Full Scale	Range Multiplier	E Max	I* Max
1Ω	$100m\Omega$	71 V	100 mA
10Ω	1Ω	71 V	100 mA
100Ω	10Ω	71 V	71 mA
$1k\Omega$	100Ω	71 V	22 mA
$10k\Omega$	$1k\Omega$	71 V	14.1 mA
$100k\Omega$	$10k\Omega$	223 V	14.1 mA
$1M\Omega$	$100k\Omega$	500 V	14.1 mA

* It is preferable to limit current to avoid shock hazard or to reduce voltage to 10 V.

TABLE 2-2
EIA STANDARD TEST VOLTAGES
(RS 196 FIXED-FILM RESISTORS
REC 117 LOW-POWER WIRE-WOUND RESISTORS)

Resistance Range	Bridge Mult Range	EIA Max Test Voltage	Max Bridge Voltage †
less than 10Ω	1Ω	0.3 V	**
$10 - 99\Omega$	10Ω	1 V	**
$100 - 999\Omega$	100Ω	3 V	33 V
$1000 - 9999\Omega$	$1k\Omega$	10 V	20 V
$10 - 99k\Omega$	$10k\Omega$	30 V	33 V
$100k\Omega$ up	$100k\Omega$	100 V	101 V

REC 117 applies only up to 9999Ω .

* At EXT GEN terminals.

** Maximum allowance bridge voltage will not give maximum test voltage.

TABLE 2-3
EIA STANDARD TEST VOLTAGES
(RS 172 - FIXED COMPOSITION RESISTORS)

Resistance Range	Bridge Mult Range	EIA Test Voltage Range	Bridge* Voltage
$2.7 - 99\Omega$	1Ω	0.5 - 1 V	**
	10Ω	0.5 - 1 V	50 - 71 V***
$100 - 999\Omega$	100Ω	2.5 - 3 V	27.5 - 33 V
$1000 - 9999\Omega$	$1k\Omega$	8 - 10 V	16 - 20 V
$10 - 99k\Omega$	$10k\Omega$	24 - 30 V	26.4 - 33 V
$100k\Omega$ up	$100k\Omega$	80 - 100 V	80 - 100 V

* at EXT GEN terminals

** cannot get required bridge voltage

*** limited to 71 V by bridge

TABLE 2-4
VARIABLE RESISTORS
(Military Specifications)

Spec. Title & Date Description	Resistance Tolerance	Measurement Accuracy (all Meas. at dc).	Test Voltage
Mil-R-94B 7/30/57 Amend. No. 2 2/27/62 Resistors Variable Composition - continuous operation when properly derated, at any ambient temp. up to 120° C	±10 & 20%	Qualification inspection: not to exceed ±0.5% Acceptance inspection: ±1% GR Bridges: Qualification: 1608 and 1652 GR Bridges Acceptance: 1608, 1650, & 1652	Table 2-6
Mil-R-22097B 5/14/62 Lead-screw-actuated Nonwirewound Variable - at maximum ambient temps. of 70° C, 85° C, & 125° C.	±10%	±1.0% GR Bridges: 1608, 1652, & 1650	Table 2-5
Mil-R-23285A 11/18/65 Nonwirewound Metal Film Variable - continuous full rated load operation at an ambient temp. of 125° C.	±5 & 10%	Qualification inspection: ±0.5% Quality conformance: ±1% GR Bridges Qualification: 1608 & 1652 GR Bridges Conformance: 1608, 1652, 1650	Table 2-7
Mil-R-19A 11/9/56 Amend. No. 2 1/6/59 Low Operating Temp. Wirewound Variable - ambient temp. of 40° C up to 105° C.	±10%	±1.0% GR Bridges: 1608, 1652, & 1650	As small as practical
Mil-R-22B 3/21/62 Power Type Wirewound Variable	±10%	±1.0% GR Bridges: 1608, 1652, & 1650	As small as practical

TABLE 2-5*
MIL-R-22097B TEST VOLTAGES

Resistor Range (Ω)	Test Voltage (V) (DO NOT EXCEED)
less than 1	0.1
1 to 9.99	0.3
10 to 99.9	1.0
100 to 999	3.0
1k to 9.99 k	10
10k to 99.9 k	30
100k up	100

* 0.5 W and larger resistors.

TABLE 2-6
MIL-R-94B TEST VOLTAGES

Resistor Range (Ω)	Test Voltage Range (V)
100 to 999	.01 to 2
1 k to 9.99 k	0.1 to 4
10 k to 99.99 k	1.0 to 15
100 k up	20 to 40

TABLE 2-7
MIL-R-23285A TEST VOLTAGES

Resistor Range (Ω)	Voltage Range (V)
2.7 to 99	0.3 to 0.5
100 to 990	0.5 to 1.5
1 k to 9.9 k	1.5 to 4.5
10 k to 99 k	4.5 to 15
100 k or higher	15 to 45

mended. The available power from such a supply is 0.1 W, which is a low enough dissipation for almost all resistors, and the maximum current is 4 mA. Such a supply permits measurements up to 1 M Ω with 1% accuracy. For resistance over 1 M Ω , a higher voltage is desirable for good sensitivity, but it should be noted that the maximum EIA test voltage is 100 V, and that various types of resistors have different voltage ratings.

The maximum voltage and current that may be applied to the bridge for each range are given in Table 2-1. Careful observation of both of these limits will prevent damage to the bridge.

Because the full voltage may be applied to the unknown, it is advisable to limit the available power to a value less than the power rating of the unknown component.

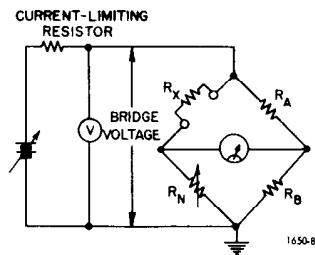

Figure 2-2. Circuit for standard test voltage measurements.

Various EIA standards for testing different types of resistors are summarized in Tables 2-2 and 2-3. Various military standards are listed in Tables 2-4 through 2-7. A suggested setup for tests at these voltages is shown in Figure 2-2. The voltmeter here indicates the bridge voltage and should be set as listed in Tables 2-2 and 2-3. An alternate scheme is to put the voltmeter directly across the unknown resistor, assuming that the input resistance of the voltmeter is large enough to cause no error.

2.4 CONNECTION OF EXTERNAL GENERATOR.

In most cases when an external generator is used it should be connected to the EXT GEN jack on the side of the bridge. In this connection, the external generator is connected directly to the internal bridge transformer when the function switch is in the AC EXTERNAL position, and the low generator terminal is connected to the bridge chassis (which should be grounded; paragraph 4.6). A second ground connection to the generator should be avoided.

If the external generator can be overdriven when connected to a low-impedance load, it is generally desirable to place a resistor in series with the ungrounded generator connection to the bridge. This resistor should be large enough to prevent distortion even when

the bridge input is short-circuited. The bridge input impedance at the EXT GEN jack is a minimum of 30 Ω (resistive) at 1 kHz when the bridge is set to measure a short circuit on the UNKNOWN terminals. This is shunted by the inductance of the primary of the bridge transformer, which is approximately 0.25 H.

In some cases where more input power is required, particularly in measurements of low impedance, a matching transformer between generator and bridge is useful. This transformer need not be shielded. The GR Type 1311 Audio Oscillator is recommended for this application at frequencies of 50, 60, 100, 120, 400, 500, 1000, 2000, 5000, and 10,000 Hz because its output will not be distorted by over-loading and it has a matching transformer to drive low-impedance loads.

When the desired bridge voltage is higher than can be applied by the internal bridge transformer, the generator can be connected directly in the bridge circuit by connection to the BIAS jack (Figure 2-3a). In this connection, the generator is ungrounded and capacitance from its terminals to ground must be considered. Capacitance from the negative BIAS terminal to ground can cause a large error at high frequencies when low impedances are measured. Therefore, use a shielded cable and use the outer conductor to connect the low generator terminal to the positive BIAS terminal. Capacitance of over 100 pF from the positive BIAS terminal to ground can cause appreciable error (paragraph 4.6). A bridge transformer can be used to connect a generator to the BIAS jack, but this has no advantage over the use of the internal bridge transformer unless the external transformer has a higher voltage rating, as do the GR Type 578 Transformers (Figure 2-3b).

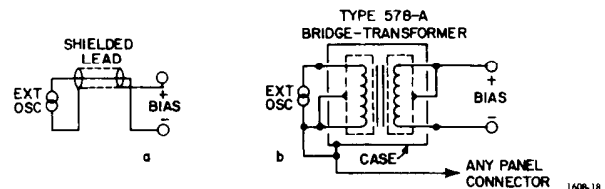

Figure 2-3. Methods of applying external ac.

2.5 MAXIMUM APPLIED AC VOLTAGE.

The maximum ac voltage that may be applied to the 1650-B Impedance Bridge depends on:

- the voltage and power ratings of each component (including the unknown),
- the bridge circuit used,
- the range used,
- the position of the variable components,
- the method of applying the voltage.

Exact limits for any specific measurement can be calculated from the circuit diagrams of Figure 2-1, and by insuring that the power dissipation in the ratio-arm

resistors and the rheostats is less than 0.5 W. If such a maximum voltage is applied, care must be taken to avoid any adjustments of the panel controls that would result in an overload.

A much simpler approach is to limit the power into the bridge to 0.5 W so that no bridge components can be damaged under any conditions. If the power rating of the unknown is less than 0.5 W, the input power should be reduced accordingly. A series resistor is the simplest way to limit the power. It should have a value of $R = \frac{E^2}{4P}$, where E is the open-circuit generator voltage and P the power rating of the unknown component.

The input transformer imposes the following further limit on the voltage applied to the EXT GEN jack:

$$E_{\max} = \frac{f}{5} \text{ volts (f in Hz), or 100 volts,}$$

whichever is smaller. This transformer has a 3-to-1 step-down ratio and an equivalent resistance, referred to the primary, of 20Ω . Therefore, to limit the power applied to the bridge to 0.5 W, a series resistor of $\frac{E^2}{2} - 20 \Omega$ should be placed in series with the external supply.

2.6 OPERATING PROCEDURE WITH ORTHONULL.

In the measurement of inductors whose Q is less than 1 or capacitors whose D is greater than 1, balancing procedure can be simplified and false nulls avoided by the use of Orthonull. It should be noted that Orthonull operates on all four bridges (C_s , C_p , L_s , L_p) and at any frequency. It will facilitate the balance when the unknown is very lossy, i.e., has a high D or a low Q at the frequency of measurement. The white sectors of the DQ dial are adjusted for 1kHz. At other frequencies they don't apply. The balancing procedure (essentially the same as without Orthonull once the Orthonull mechanism is engaged) is as follows:

a. Set the bridge switches as described in the Operating Procedure Chart, depending on what is being measured. Connect the unknown to the UNKNOWN terminals and connect the external generator (if one is used) as described in paragraph 2.4.

b. Set the ORTHONULL SWITCH to IN.

- c. Set the CGRL dial upscale (10 or 11).
- d. Make the first balance with the DQ dial.
- e. Adjust the CGRL dial for further balance (the DQ dial, ganged to the CGRL dial by the Orthonull mechanism, will follow). If the CGRL setting is less than 1 at balance, turn the CGRL MULTIPLIER switch to a lower range and rebalance.
- f. Make further balances using first the DQ dial, then the CGRL dial, then the DQ dial, etc. until the meter reading cannot be reduced further.

When the Q is very low, the meter deflection will give several sharp dips as the CGRL dial is rotated. To find the best dip, rotate the CGRL dial slowly over a wide range without making another DQ adjustment.

Often the Q is higher at some other frequency, and it is desirable to change the frequency of measurement. This is necessary if the inductor is above resonance and appears capacitive. A DQ Coverage Chart is shown in Figure 2-4.

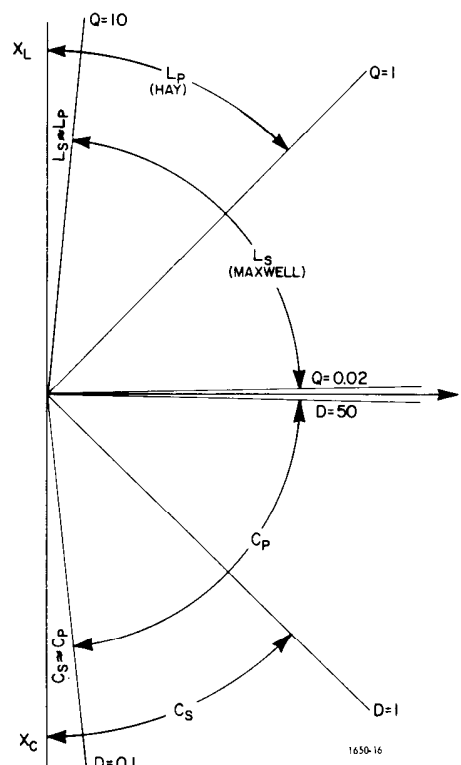

Figure 2-4. DQ coverage chart.

Section 3—Special Measurements

3.1 GENERAL.

The inclusion of the EXT DQ, BIAS, and OPP ARM jacks in the 1650-B permits many special measurements to be made. The EXT DQ jack allows extension of the DQ coverage at frequencies below 100 Hz, the BIAS jack allows a bias voltage or current to be applied across or through an unknown impedance, and the OPP ARM jack allows more accurate balancing of reactive resistors. The following section presents a few of the many applications possible with these external connection jacks.

3.2 APPLICATION OF DC BIAS TO CAPACITORS.

3.2.1 INTERNAL OSCILLATOR OPERATION.

Up to 600 V of dc bias may be applied to the unknown capacitor by any of several different methods.

The simplest method can be used for measuring only series capacitance; fortunately, this is how most capacitors are specified.

WARNING

Charged capacitors form a shock hazard, and care should be taken to ensure personal safety during measurement and to be sure that the capacitors are discharged after measurement. The external dc supply should also be handled carefully.

It is advisable to limit the power that may be drawn from the external dc supply to 0.5 W (by a resistor, fuse, or circuit breaker) in order to protect the bridge components in case the unknown is short-circuited.

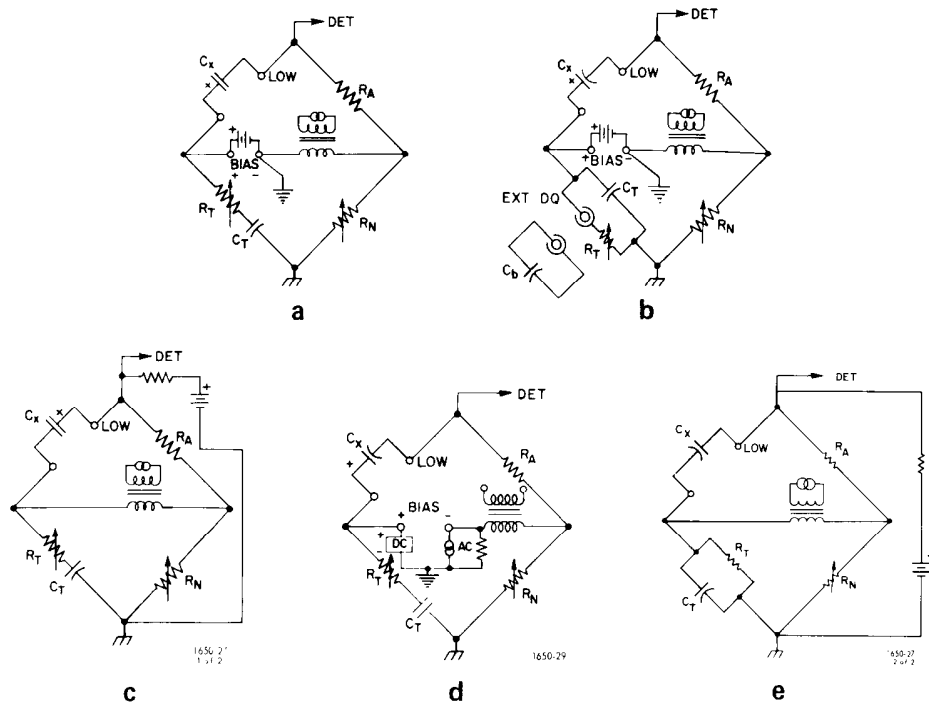

Figure 3-1. Methods of applying dc voltages to capacitance.

The various methods of applying dc bias to capacitors and suggestions for their use are described in the three methods that follow:

Method 1. C_s Bridge (Figure 3-1a).

In this method, up to 600 V may be applied on any range. Connect the negative terminal of the unknown capacitor (if polarized) to the LOW UNKNOWN terminal. The dc supply used should have a low ac output impedance. It is usually helpful to ground the negative side of the dc supply and to leave the bridge floating to avoid hum from the power line. If the negative side of the supply (BIAS jack body) is grounded, the bridge panel and LOW UNKNOWN terminal will be at low dc potential with low signal voltage on them.

Method 2. C_p Bridge (Figure 3-1b).

The same precautions mentioned in Method 1 apply here, and a blocking capacitor should be added using the EXT DQ jack. The positive side of the blocking capacitor should be tied to the tip of the phone plug. The voltage rating of this capacitor should be sufficient for the full dc applied. The capacitance required depends on the D of the unknown and on the accuracy required. The errors caused by this capacitor are:

$$C \text{ measured} = C_x \left(1 - \frac{C_t}{C_b} D_x^2\right) \quad \text{where } C_t = 0.1 \mu\text{F}$$

$$D \text{ measured} = D_x \left(1 + \frac{C_t}{C_b} D^2\right) \quad \text{and } C_b \gg C_t$$

Method 3. C_s or C_p Bridge (Figure 3-1c and e).

This method is recommended for small capacitors. The maximum voltages that may be applied to the C_s and C_p bridge are given in Table 3-1, but the maximum voltage on the bridge are a function of the CGRL-and-DQ-dial settings.

The ac impedance of the dc source should be high (>10kΩ) to avoid shunting the detector, and the dc source should have low hum. The advantages of this circuit are that the bridge and supply are both grounded and the dc current can be easily limited by a resistor, since the impedance of the source should be high.

WARNING

Note that the LOW UNKNOWN terminal has the high voltage on it in this method.

3.2.2 EXTERNAL AC GENERATOR OPERATION.

When both external ac and dc supplies are used, hum may be introduced by the capacitance to the line in the power transformers of these generators. The bridge should be set up as shown in Figure 3-1, with

Range Multiplier	Max Volts On Bridge	Max Volts On Unknown
100 pF	505 V	500 V
1 nF	242 V	220 V
10 nF	142 V	71 V
100 nF	78 V	7 V
1 μF	72 V	0.7 V
10 μF	71 V	0.07 V
100 μF	71 V	0.007 V

both the ac and dc supplies grounded and the bridge not grounded. The ac generator should be shunted by a resistor if it does not provide a path for dc.

Method 3, paragraph 3.2.1, may also be used to apply dc bias. The bridge and both the ac and dc supplies are grounded (Figure 3-1), and the ac generator is connected to the EXT GEN jacks. This method is particularly useful for high-frequency measurements of small capacitors (paragraphs 2.4 and 3.2.1).

3.3 APPLICATION OF DC TO INDUCTORS.

Direct current may be supplied to inductors during measurement by any of several different methods so that incremental inductance measurements may be made. The various methods are described below along with suggestions for their use. A blocking capacitor (C_b in Figure 3-2) is needed only for the L_s bridge shown. This capacitor (not supplied with the bridge) should be connected by a phone plug inserted into the EXT DQ jack. The errors caused by this capacitor are:

$$(1) L_s \text{ measured} = L_x \left(1 - \frac{C_t}{C_b} \frac{1}{Q_x^2}\right) \quad C_t = 0.1 \mu\text{F}$$

$$(2) Q \text{ measured} = Q_x \left(1 - \frac{C_t}{C_b} \frac{1}{Q_x^2}\right)$$

To get the corrected results add $\left(\frac{C_t}{C_b}\right)\left(\frac{1}{Q_x^2}\right)$ to the measured L_s and Q. It will be necessary to solve for Q_x in equation (2) but usually Q_{measured} ≈ Q_x.

WARNING

Large inductors carrying high currents are shock hazards. Reduce the dc to zero before disconnecting the dc supply or unknown inductor.

Method 1. (Figure 3-2a.)

The maximum current is limited to that given in Table 3-2. The dc supply may be tied to ground and the instrument left floating as shown, where the capacitance of the bridge to ground shunts R_N and causes a D (1/Q) error of $-\omega R_N C$. If the dc supply has low internal capacitive coupling to the power line, the bridge may be grounded and the dc supply left floating.

The source impedance of the dc supply must be low compared with that of the unknown, since the bridge measures both of these impedances in series. A large capacitor (C_d) shunting the dc supply is sometimes useful.

Method 2. (Figure 3-2b.)

The maximum current in this method is limited to that given in Table 3-2. The dc supply is connected to the BIAS jack with the signs reversed in order to keep the bridge case and dc supply both at zero volts dc from ground. The blocking capacitor C_B must be able to take the full dc voltage. The ground connection may be made to either the panel or the dc supply.

Method 3. (Figure 3-2c.)

This method is recommended for large inductors, since the maximum current is the same for any range. In this method both the bridge and the dc supply are grounded.

The maximum allowable current for any range is 40 mA. The output impedance of the dc supply should

be high enough to avoid loading the detector (a series resistor is often useful) and should have low hum.

The blocking capacitor C_e must be able to take the dc IR drop across the unknown inductor, and C_b must be able to take the whole dc voltage.

Method 4. (Figure 3-2d.)

This method must be used with very large dc. The maximum voltage on the unknown is limited only by the rating of C_f . The ac source impedance of the dc supply must be much higher than the impedance of the unknown since the bridge measures the parallel combination of these two impedances. A large inductor, L_a , may be connected as shown to provide a high source impedance. Often it is possible to resonate the feed inductor to increase the source impedance further.

Range Multiplier		Maximum Current	R_a (Ratio Arm)
L	R		
100 μ H	100 m Ω	100 mA	1 Ω
1 mH	1 Ω	100 mA	10 Ω
10 mH	10 Ω	71 mA	100 Ω
100 mH	100 Ω	22 mA	1 k Ω
1 H	1 k Ω	7.1 mA	10 k Ω
10 H	10 k Ω	2.2 mA	100 k Ω
100 H	100 k Ω	0.5 mA	1 M Ω

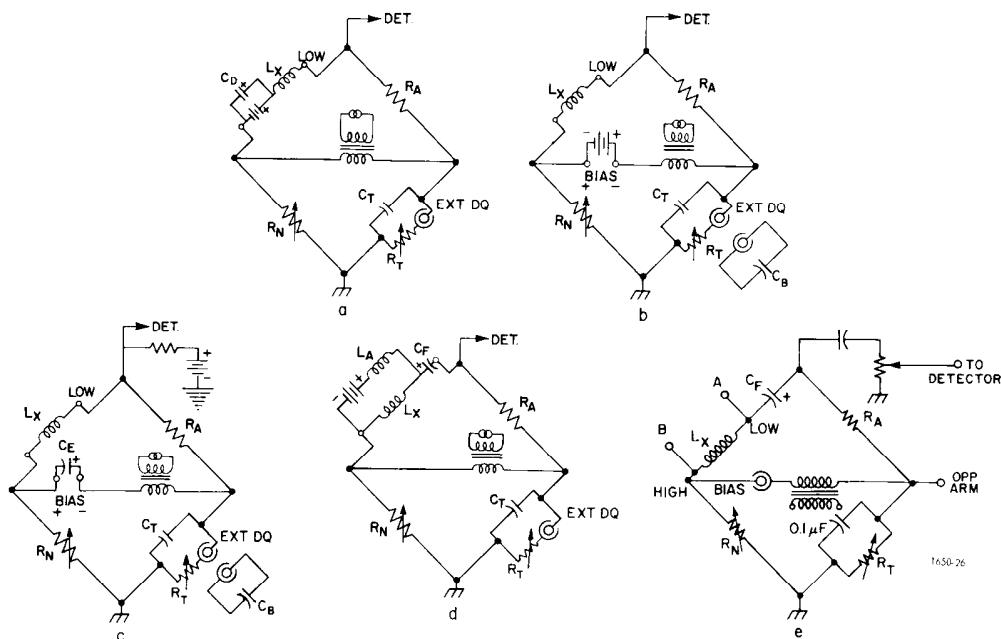

Figure 3-2. Methods of applying dc to inductors. (Blocking capacitor C_B is not supplied with the bridge.)

Also, the impedance of the blocking capacitor, C_f , should be low compared with the impedance of the unknown since it is directly in series with the unknown.

Method 5. (See Figure 3-2e.)

This method permits large or small dc currents by connecting a current source in parallel with the unknown inductor. The dc voltage is isolated from the bridge by capacitor C_f . The impedance of C_f should be low compared to the unknown since they are in series. The current source impedance must be high relative to the unknown at the measuring frequency.

A current source with the proper impedance must be constructed because: 1) most regulated supplies that have current limiting have a large capacitor across the output terminals causing a low ac impedance, and 2) even the high slewing rate operational supplies

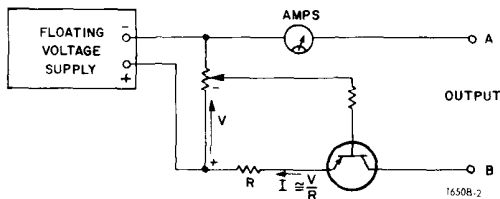

Figure 3-3. Dc-current supply for inductor measurements.

usually have a network across the output terminals that reduces their impedance to a few thousand ohms at 1 kHz. To construct a high impedance supply use any common ungrounded voltage supply (Kepco ABC series units) and feed the output through the circuit in Figure 3-3. Connect the output of this circuit to the unknown inductor (Figure 3-2e).

CAUTION

Short out the current source before disconnecting the inductor to prevent large transient voltages.

3.4 DC BIAS FOR AC RESISTANCE MEASUREMENTS.

A dc bias voltage and current may be applied to various types of nonlinear resistive elements such as diodes, varistors, and thermistors in order to measure small ac signal resistance. For voltage-sensitive devices, diodes, and varistors, the ac resistance is the slope of the dc voltage-current curve. For thermally sensitive devices, the ac resistance is equal to the dc resistance as long as the time constant is much longer than the period of the ac signal. Several methods of applying dc are shown in Figure 3-4.

Method 1. (Figure 3-4a.)

In this method all of the current supplied flows through the unknown. The current is limited to the

amount given in Table 3-2. The dc source impedance should be low compared with that of the unknown, or the source should be shunted by a large capacitor as shown. If the dc supply is grounded, the bridge chassis may be at a potential of up to 6 V.

Method 2. (Figure 3-4b.)

This method removes the dc supply from the bridge arm so that its impedance is not so important. The current in the unknown is equal to the current supplied multiplied by $\frac{R_b}{R_a + R_b}$, and should be limited to that given in Table 3-2. The voltage applied should be limited to 71 V. If the dc supply is grounded, the bridge chassis may be at a potential of up to 37 V.

Method 3. (Figure 3-4c.)

This method permits grounding of both the bridge chassis and the dc supply. The current through the unknown is equal to the current supplied multiplied by $\frac{R_a}{R_a + R_x}$. The dc current and voltage limits are given in Table 2-1.

Method 4. (Figure 3-4d.)

This method permits large currents through low resistors, since no current flows in the bridge. The resistor R_f should be large compared with the unknown, and the blocking capacitor, C_f , should be able to take the dc voltage $I_{dc}R_x$. The impedance of the blocking capacitor should be low compared with that of the unknown.

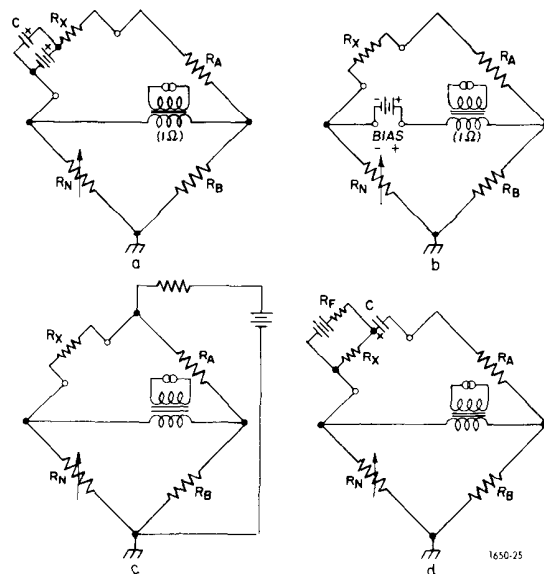

Figure 3-4. Methods of applying dc for ac resistance measurements.

3.5 MEASUREMENT OF AC RESISTANCE OR CONDUCTANCE WITH REACTANCE.

The ac resistance and conductance bridges of the 1650-B are very useful for making incremental measurements of nonlinear components like Thyrite® varistors or diodes, and for measuring input and output impedances of field-effect transistors or transistor amplifiers, gyrators, impedance scalars, etc. For example, a negative impedance converter was being used to cancel some positive resistance in one arm of a bridge circuit, but the bridge was not balancing properly. A resistor was put in series with the negative impedance converter and the input impedance was measured. It was determined that the negative resistance had an inductive component, discussed below, which calculations showed to be the result of phase shift in the operational amplifier (Figure 3-5).

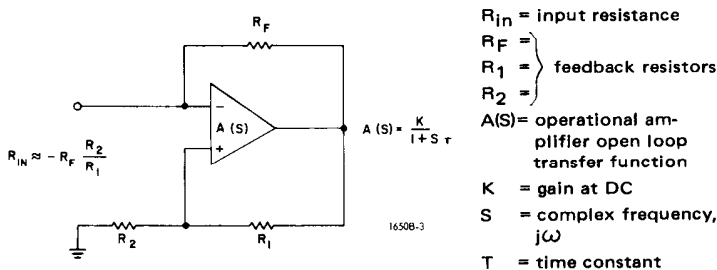

Figure 3-5. Operational amplifier.

If the null is not sharp, i.e., sensitive to a small change in the CGRL dial position, the "resistance" is either capacitive or inductive. A capacitive resistance is measured by connecting an external capacitance decade box (C_D) from the HIGH UNKNOWN post on the bridge to the case (Figure 3-6). An inductive measurement is made by connecting an external capacitance decade box between the OPP ARM banana jack on the bridge and the case (Figure 3-7).

Measurements can be made in terms of conductance, also. The conductance bridge has R_A and R_B

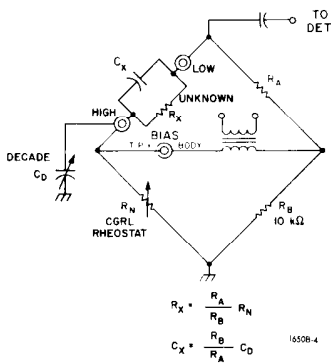

Figure 3-6. Circuit for measuring capacitive resistors.

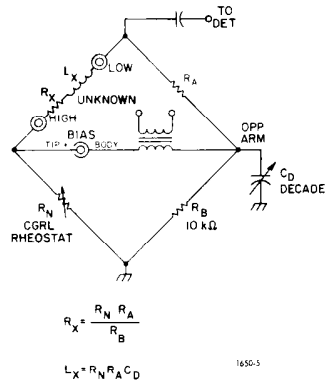

Figure 3-7. Circuit for measuring inductive resistors.

interchanged, causing the balance formulas to be as follows:

$$G_X = \frac{R_N}{R_A R_B}$$

$$C_X = \frac{R_N C_D}{R_A}$$

$$L_X = R_B R_A C_D$$

(Refer to paragraph 1.4 for term definitions.)

Monitor the active circuit's output voltage with an oscilloscope, and keep the 1650-B Bridge oscillator level reduced as much as possible to keep the device under test from saturating.

NOTE

A sliding null can occur if the unknown is inductive because R_N appears in the null equations of both R_X and L_X .

3.6 MEASUREMENT OF TRANSDUCERS.

The small residuals, careful frequency compensation, Orthonull, and relatively high DQ resolution of the 1650-B Bridge facilitate impedance analysis of transducers up to 100 kHz. Microphones, vibration pickoffs and ultrasonic transducers can be analyzed^{1,2} by the use of the 1650-B Bridge to plot their impedance versus frequency curves.

Useful accessories for this work are a recording wave analyzer (GR Type 1910 Recording Wave Analyzer) and a frequency counter (GR Type 1191 Counter). Mechanical resonances are usually high Q, and since it takes time to balance the bridge for every point, one would like to know where the interesting regions are. The best procedure is to balance the bridge every 1 kHz or so, and sweep up and down about the frequency with the wave analyzer in the tracking generator mode. The measurements should be made with an 80-dB potentiometer in the level recorder. When bumps occur in the plot of null voltage versus frequency, a region of interest is indicated and can be analyzed by balancing the bridge at this frequency. The wave analyzer is also very useful as a tuned null detector at frequencies above 20 kHz. The GR Type 1232 Tuned Amplifier and Null Detector can be used below 20 kHz for a detector, and with the addition of the GR Type 1232-P1 RF Mixer, frequencies greater than 20 kHz can be analyzed. The input impedance of the wave analyzer is high enough so that it can be connected between the LOW UNKNOWN terminal and

¹Frederick V. Hunt, *Electroacoustics*, Harvard Monographs in Applied Science Number 5, 1954, Harvard University Press (New York: John Wiley & Sons, Inc.)

²L. E. Kinsler and A. R. Frey, *Fundamentals of Acoustics*, John Wiley & Sons, Inc., 1962.

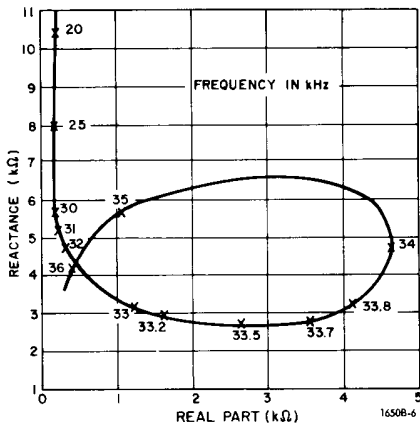

Figure 3-8. Typical impedance-vs-frequency response of an ultrasonic transducer.

the case, but the rf mixer will have to be driven from the DET output jack.

The frequency counter is necessary to obtain high frequency resolution and accuracy. Conversion from C and D to real and imaginary parts of impedance are most conveniently done by a short computer program. Typical impedance curves are shown in Figures 3-8 and 3-9. Consult paragraph 4.12 for measurement procedures and accuracy above 20 kHz.

3.7 RESONANT FREQUENCY OF TUNED CIRCUITS.

The resonant frequency of a series or parallel tuned circuit may be found by means of an external variable-frequency oscillator and the ac resistance bridge. The external oscillator is connected as described in paragraph 2.4, and the tuned circuit is connected to the UNKNOWN terminal.

The frequency and the CGRL dial are then varied for the best null attainable. The bridge indicates, at balance, the effective series resistance of a series tuned circuit or the effective parallel resistance of a parallel tuned circuit, while the oscillator indicates the resonant frequency.

3.8 SHIELDED THREE-TERMINAL COMPONENTS.

When the unknown is shielded and the shield is not tied to either unknown terminal, a three-terminal component is formed (Figure 3-10). The impedance Z of the component itself is the direct impedance of the

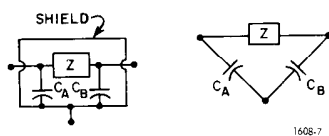

Figure 3-10. Shielded three-terminal impedance.

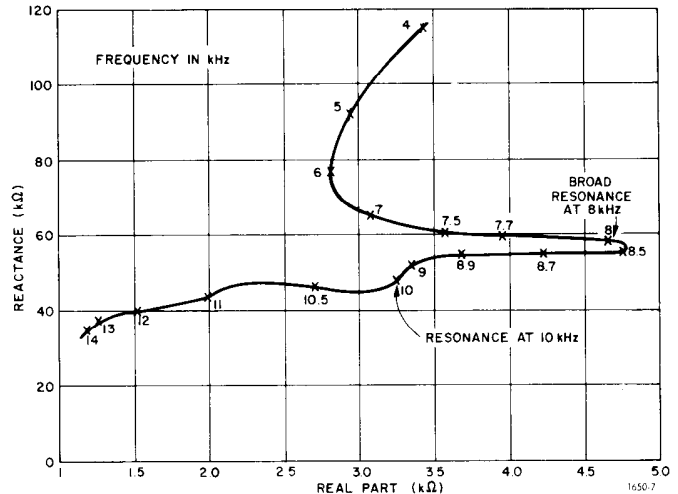

Figure 3-9. Typical impedance-vs-frequency response of a piezoelectric microphone.

three-terminal system. To measure the direct capacitance of a three-terminal system, connect the third terminal to the panel of the instrument, using any grounded panel terminal or a ground lug with screw just below the UNKNOWN terminals. The capacitances to the shield have negligible effect as long as one of them is reasonably small (paragraph 4.6).

Often the shield of an inductor is not connected to either terminal. When the inductance and frequency are low so that stray capacitance across the inductor causes negligible error, the shield should be connected to the UNKNOWN terminal marked LOW. When the inductance (or frequency) is high, the effective inductance is increased because of the shunting capacitance. The error is $+100(\omega^2 L_x C_x)\%$ (paragraph 4.4). To avoid an inductance error, the shield may be tied to the panel of the bridge. The inductor terminal that has the larger capacitance to the shield should be tied to the LOW bridge terminal. A Q error results from the capacitance from the other UNKNOWN terminal to the shield but a better measurement of L_x is possible. (This connection does not affect the winding capacitance itself.)

3.9 REMOTE MEASUREMENTS.

Due to the small effect of stray capacitance to ground, particularly for capacitance measurements (paragraph 4.6), the unknown may be placed some distance away from the bridge. If at least one of the connecting leads is shielded, the capacitance between the leads is avoided. The shielded lead should be connected to the LOW UNKNOWN terminal, and the bridge should be grounded. The other lead may also be shielded, at the cost of increased capacitance to ground. When low impedance measurements are made, the effect of the lead resistance and inductance should be considered (paragraph 4.10).

3.10 MEASUREMENT OF GROUNDED COMPONENTS.

If the component to be measured is connected directly to ground, the component may be measured with the case of the 1650-B floating off ground.

Either unknown terminal of an unknown capacitor may be grounded. Grounding the low terminal tolerates large capacitance from the case to ground, but increases sensitivity to hum. However, most of the hum can be removed by the internal 1-kHz filter in the amplifier. Grounding the other unknown terminal decreases sensitivity to hum, but a capacitance of 1000 pF from the case to ground causes a 1% capacitance error (paragraph 4.6).

If the unknown is an inductor, the LOW terminal should be grounded.

Even when the bridge is floating, the bridge panel can be used as a guard terminal for three-terminal or remote measurements.

3.11 USE OF THE TYPE 1650-P1 TEST JIG.

3.11.1 GENERAL.

The Type 1650-P1 Test Jig (Figure 3-11) provides a means of making quick connections to the bridge with a pair of conveniently located clip terminals. When the 1650-B is set up for limit measurements (paragraph 3.12), the combination facilitates the rapid sorting of electrical components.

The jig is also useful for measurements on small capacitors because of its small zero capacitance and because the unknown component is positioned and shielded to make repeatable measurements possible.

3.11.2 INSTALLATION.

The test jig is connected to the bridge UNKNOWN terminals by means of the shielded Type 274 Connector attached to the jig. A three-terminal connection is necessary. The third connection is made by means of the screw, located directly below the UNKNOWN terminals, and the lug on the shield of the connector. This screw makes the ground connection to the jig and also holds the connector in place.

The leads of the test jig may be brought around in back of and underneath the bridge so that the jig may be located directly in front of the bridge without interference from the leads.



Figure 3 - 11. Type 1650-P1 Test Jig.

3.11.3 RESIDUAL IMPEDANCES OF THE TEST JIG.

The residual resistance of the leads is about 80 m Ω (total) and the inductance is about 2 μ H. The zero capacitance, when the leads are connected to the bridge, is negligible (≈ 0.2 pF). The shielded leads cause a capacitance to ground of about 100 pF each. Corrections may be necessary for the residual resistance and inductance when measurements are made on low impedances (paragraph 4.10). The capacitance to ground causes no error for capacitance measurements, but can cause a D (1/Q) error up to about 0.007 for inductance measurements (paragraph 4.6).

3.12 LIMIT TESTING.

The Type 1650-B may be set up to provide a go-no-go indication useful for component testing. The panel meter is used as the indicator. The setup procedure is as follows:

- a. Balance the bridge with one of the components to be measured (preferably one within tolerance).
- b. Offset the CGRL dial by the desired tolerance, if the tolerance is symmetrical, or by one half of the total allowable spread if unsymmetrical.
- c. Adjust the SENSITIVITY control for a five-division meter deflection.
- d. Set the CGRL dial to the center value (the nominal value if the tolerance is symmetrical).
- e. Connect each component to the bridge (or Type 1650-P1 Test Jig). If the meter deflection is less than five divisions, the component is within limits.

When the unknown has a tolerance greater than $\pm 10\%$, the limits may be in error by more than 1% if the above method is used. A sure method is to set the CGRL dial so that unknown components at both limits give the same deflection.

Section 4—Accuracy

4.1 GENERAL.

Basically the 1650-B measures C, R, L, and G to within 1%, and D and Q to 5%; however, at the range extremes the accuracy naturally decreases. To know when the accuracy of your instrument decreases, consider the following:

1. What is the approximate magnitude of the impedance at the measuring frequency? A common 100- μ F capacitor has a 150-m Ω impedance at 10-kHz (see Reactance Chart in the Appendix). The bridge residuals of 1 m Ω and 0.2 μ H (10 m Ω impedance) are in series with this low impedance along with the self inductance of any connecting leads to the unknown, thus causing the error to approach 10%. Therefore, be wary of low impedances.

2. Visualize the unknown as having a reactive part and a real part in parallel. If the real part is very small then it essentially controls the impedance and the DQ dial will be the major balancing control. That is, the position of the CGRL dial won't affect the balance much, hence low accuracy. Therefore, be wary of high-loss components. Conversely, very low-loss components will not be too dependent on the DQ balance and hence will have low DQ accuracy. For example, measure the residual bridge capacitance.

In summary, if the impedance to be measured is very low, very high, or very lossy, read the relevant paragraphs in this section and make the required corrections. Note that, by increasing the measuring frequency, very small inductive impedances can often be

moved up; by decreasing the frequency, small capacitive impedances can be moved up into more easily measured areas.

4.2 DC RESISTANCE.

The accuracy of dc resistance measurements is $\pm 1\%$ if the CGRL dial reading is between 1 and 11 as long as there is enough sensitivity. Below 1 Ω , the accuracy is limited to ± 10 m Ω by the sensitivity. Above 100 k Ω , an external supply is required to get 1% accuracy.

For low-resistance measurements, short, heavy leads should be used as connections to the unknown. The zero resistance of the leads should be measured with the free ends connected together, and subtracted from the bridge reading with the unknown in place. The user should be particularly careful when using banana-pin connections. For best connection to the bridge, tighten the binding post hard enough to notch the wire inserted in the hole.

4.3 AC RESISTANCE.

The accuracy of the R reading is $\pm 1\%$ if the balance is made between 1 and 11 on the CGRL dial. Below 1 on the dial the accuracy is $\pm \frac{1}{2}$ a division. Thus the over-all accuracy is $\pm 1\%$ or ± 1 milliohm, whichever is greater, as long as the 1-milliohm residual resistance is subtracted from the R reading.

The residual resistance of $1\text{ m}\Omega$ is that of the binding posts themselves. For low-resistance measurements, short, heavy leads should be used as connections to the unknown. The zero resistance of the leads should be measured with the free ends connected together, and subtracted from the bridge reading with the unknown in place. The user should be particularly careful when using banana-pin connections. For best connection to the bridge, tighten the binding post hard enough to notch the wire inserted in the hole.

Since there is no internal Q adjustment on the R bridge, reactance affects only the ability to get a good sharp null. If the reactance is large enough to prevent a satisfactory balance, an external capacitor may be used to make a reactance balance (paragraph 3.5).

4.4 INDUCTANCE.

The accuracy of the L reading is $\pm 1\%$ if the balance is made between 1 and 11 on the CGRL dial. Below 1 on the dial the accuracy is $\pm \frac{1}{2}$ division. Thus the over-all accuracy is $\pm 1\%$ or $\pm 1\ \mu\text{H}$, whichever is greater, since $1\ \mu\text{H}$ is $\frac{1}{2}$ dial division on the lowest range. The Q accuracy is given in terms of $D = 1/Q$ and is $\pm 5\%$ or ± 0.001 , whichever is greater, with a CGRL reading of 1 or higher.

The residual (zero) inductance is less than $0.2\ \mu\text{H}$, which is less than the accuracy of the bridge and therefore negligible. If external leads are used to connect to the unknown, this zero inductance is increased and should be subtracted from the bridge reading.

The residual resistance of the bridge is 1 milliohm, which causes a small D ($1/Q$) error. This error is less than 0.001 if L_x is more than $160\ \mu\text{H}$. If long leads are used to connect to the unknown, this error can become appreciably greater and require a correction. The D error is

$$\frac{R_o}{\omega L_x} \quad (\text{the Q error is } Q^2 \frac{R_o}{\omega L_x})$$

where R_o is the total lead resistance.

The residual zero capacitance of $0.5\ \text{pF}$ theoretically causes an error for inductors above $250\ \text{H}$. However, this small capacitance is almost always negligible compared with the capacitance of the winding of such a large inductor. If the inductor is shielded, a three-terminal measurement will reduce the effect of stray capacitance to the shield (paragraph 3.8). In order to reduce the effect of the winding capacitance it is necessary to reduce the measurement frequency. The inductance error due to a shunt capacitance C_o is $\omega^2 C_o L_x^2$, and this amount should be subtracted from the bridge reading (paragraph 4.10).

The inductance accuracy is reduced slightly if Q is less than 0.1. However, even with Orthonull, balance to 1% is impossible. Errors at other frequencies are discussed in paragraphs 4.11 and 4.12.

4.5 CAPACITANCE.

The accuracy of the C reading is $\pm 1\%$ if the balance is made between 1 and 11 on the CGRL dial. Below 1 on the dial the accuracy is $\pm \frac{1}{2}$ division. Thus the over-all accuracy possible is $\pm 1\%$ or $\pm 1\ \text{pF}$, whichever is greater, since $1\ \text{pF}$ is $\frac{1}{2}$ a dial division on the lowest range. The D accuracy is $\pm 5\%$ or ± 0.001 , whichever is greater, with a CGRL dial reading of 1 or higher.

The residual ("zero") capacitance of the bridge terminals is approximately $\frac{1}{2}\ \text{pF}$, which is less than the accuracy of the bridge and, therefore, negligible. If external leads are used to connect the unknown, this zero capacitance is increased and should be subtracted from the bridge reading.

The residual resistance of the bridge is $1\ \text{m}\Omega$, which theoretically causes a D error of 0.006 when $C_x = 1000\ \mu\text{F}$. In practice, capacitors of this size have such large D values that such an error is negligible. However, if leads are used to connect large capacitors, this D error can become important and a correction should be made. The D error is $+\omega R_o C_x$ (where R_o is the lead resistance), and this amount should be subtracted from the D reading.

The residual inductance causes negligible error at 1 kHz even if $C_x = 1000\ \mu\text{F}$. However, connecting leads could have enough inductance to cause a C error when large capacitors are measured. The error is $+\omega L_o C_x$ (when L_o is the lead inductance) and this amount should be subtracted from the C reading.

The capacitance accuracy is reduced on the C_p bridge when D becomes larger than 10. However, even with the Orthonull balancing mechanism, balance to 1% precision is impossible; thus this error is negligible (paragraphs 4.8 and 5.2.4).

Errors for capacitance measurements at other frequencies are discussed in paragraphs 4.11 and 4.12.

4.6 EFFECTS OF CAPACITANCE TO GROUND.

The Type 1650 Bridge generally measures "ungrounded" components, since neither UNKNOWN terminal is connected directly to the panel. The panel should be connected to a good ground, especially if high-impedance components are to be measured. If the panel is not grounded, stray capacitances from the UNKNOWN terminals and panel to ground can produce an effective capacitance across the UNKNOWN terminals. With the panel grounded, capacitances from the UNKNOWN terminals to ground have a much less

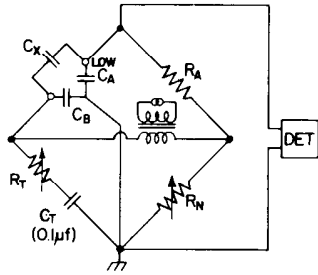

Figure 4 - 1. Capacitance to ground for capacitance measurement.

serious effect. (For measurements of grounded components refer to paragraph 3.10.)

The effects of stray capacitances to the panel (ground) are usually negligible in the capacitance bridges (Figure 4-1). Capacitance from the LOW terminal to ground (C_A) shunts the detector and causes no error. Capacitance from the other terminal to ground (C_B) shunts the standard capacitor (C_T) and produces an error of

$$-\frac{C_B}{C_T} \times 100\% = \frac{C_B}{0.1 \mu F} \times 100\%$$

Since C_T is large, it takes 1000 pF to produce a 1% error (when D is small).

In the inductance bridge (Figure 4-2) C_A is across the detector and has no effect, but C_B shunts the CGRL rheostat. Capacitance across this rheostat causes a D ($1/Q$) error of $-\omega R_N C_B$. The L error is usually negligible except when Q_x is very low.

$$L \text{ meas} = L_x \left(1 + \frac{\omega R_N C_B}{Q_x} \right)$$

Thus, for inductance measurements, it is desirable to connect the terminal with the most capacitance to ground to the UNKNOWN terminal marked LOW.

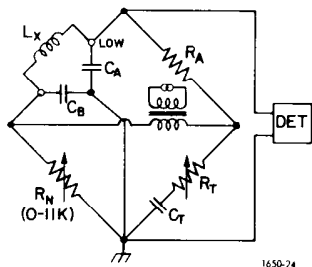

Figure 4 - 2. Capacitance to ground for inductance measurement.

4.7 D AND Q ACCURACY.

D (or $1/Q$) accuracy is dependent upon frequency and the CGRL dial setting.

CGRL dial setting of 1 or above:

1-kHz or lower: $\pm 0.001 \pm 5\%$

Above 1-kHz: $\pm 0.001 (f/1 \text{ kHz}) \pm 5\%$

CGRL dial setting below 1:

1-kHz or lower: $\pm (0.001)(1/\text{CGRL dial setting}) \pm 5\%$

Above 1-kHz: $\pm (0.001)(1/\text{CGRL dial setting}) (f/1 \text{ kHz}) \pm 5\%$

NOTE

The percentage accuracy, 5%, applies directly to Q, but the fixed-accuracy term, ± 0.001 , does not apply directly because $Q = 1/D = 1/\pm 0.001 = \pm 1000$, which is not true. Also, the corrections for residual and lead impedances must be taken into account (paragraph 4.10).

4.8 ORTHONULL ACCURACY.

The advantage of Orthonull is illustrated in Figure 4-3, which is a plot of the numbers of adjustments necessary for a balance. Not only does the Orthonull reduce the number of balances, but it permits 1% measurements that would otherwise be impossible below a Q of $1/3$, due to the finite resolution of the DQ rheostat. This finite resolution causes the meter indication to vary in jumps when Orthonull is used at Q's below $1/3$. However, by choosing the best null, 1% accuracy is possible with Q's of less than 0.2. As Q is further reduced, it is eventually impossible to achieve 1% balances. The accuracy that can be ex-

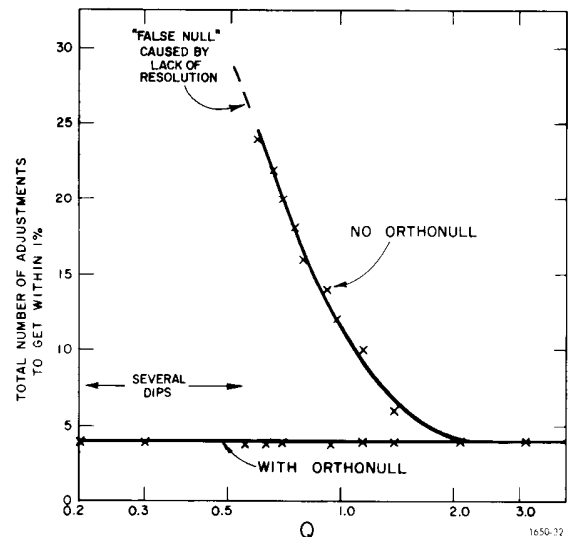

Figure 4 - 3. Number of balances vs Q.

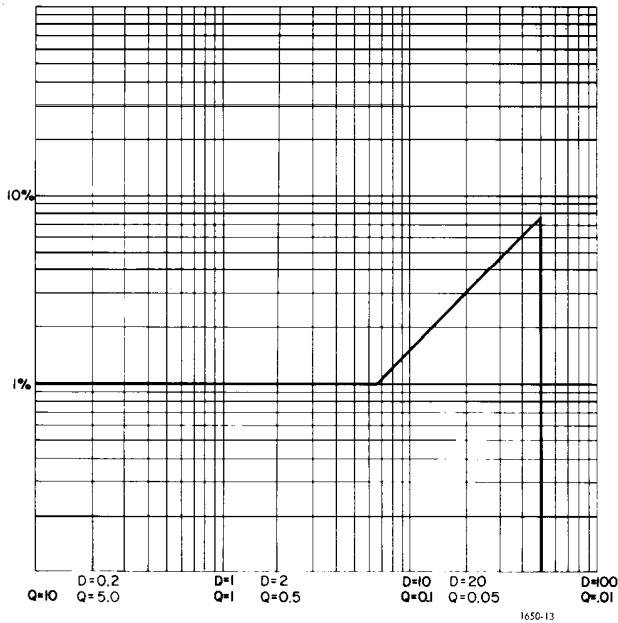

Figure 4-4. Accuracy vs D or Q.

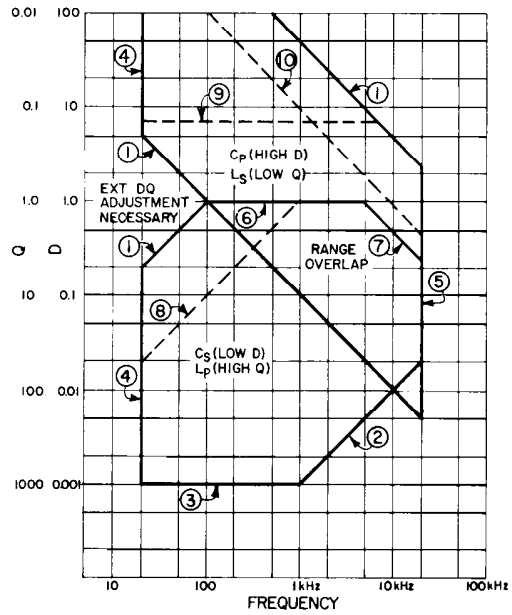

Figure 4-5. DQ ranges vs frequency.

TABLE 4-1
CORRECTION TERMS FOR ERRORS DUE TO
RESIDUAL AND LEAD IMPEDANCES*

Measured Quantity	Series Resistance R_0 (1 m Ω + leads)	Series Inductance L_0 (0.2 μ H + leads)	Parallel Capacitance C_0 (0.5 pF + leads)
C_s	No Error	$-\omega^2 L_0 C_x^2$	$-C_0 (1 - D_x^2)$
D	$-\omega C_x R_0$	$-\omega^2 L_0 C_x D_x$	$+D_x \frac{C_0}{C_x} (1 + D_x^2)$
C_p	$+2 R_0 \omega D_x C_x^2$	$-\omega^2 L_0 C_x^2 (1 - D_x^2)$	$-C_0$
D	$-\omega C_x R_0 (1 + D_x^2)$	$-\omega^2 L_0 C_x D_x (1 + D_x^2)$	$+\frac{C_0}{C_x} D_x$
R	$-R_0$		
L_s	No Error	$-L_0$	$-\omega^2 C_0 L_x (1 - \frac{1}{Q_x^2})$
Q	$+Q_x^2 \frac{R_0}{\omega L_x}$	$-\frac{L_0}{L_x} Q_x$	$+\omega^2 C_0 L_x (Q_x + \frac{1}{Q_x^2})$
L_p	$\frac{2R_0}{\omega Q}$	$-L_0 (1 - \frac{1}{Q^2})$	$-\omega^2 C_0 L_x^2$
Q	$+\frac{R_0}{\omega L_x} (1 + Q^2)$	$-\frac{L_0}{L_x} (Q + \frac{1}{Q})$	$+\omega^2 C_0 L_x Q$

*Add or subtract from measured value as indicated.

TABLE 4-2
C_p-L_s ACCURACY BETWEEN
0.4 AND 4 ON THE CGRL DIAL.

Frequency	Basic Bridge Accuracy	Limits of Error Added Above 20 kHz	Net Accuracy Limits*
50 kHz	±1%	+0, -1%	+1%, -2%
100 kHz	±1%	+0, -2.5%	+1%, -3.5%

* below line 10 in Figure 4-5

Points to remember in measurements above 20 kHz are:

1. The C_p - L_s bridges are more accurate than the C_s - L_p bridges.
2. Accuracy is greater with the CGRL dial at a low setting, say between 0.4 and 4.
3. While the basic 1% bridge accuracy may be plus or minus, the error introduced above 20 kHz is always minus. For greater accuracy between 50 and 100 kHz, add 1% to the indicated value.

4. When measuring D or Q above 20 kHz, always use the C_p - L_s bridges.

The above information is given merely as a guide for those wondering what accuracy they might reasonably expect at frequencies from 20 to 100 kHz.

NOTE

Bridges are not tested at these frequencies, and thus operation above 20 kHz is not included in the specifications.

Section 5—Principles of Operation

5.1 GENERAL.

5.1.1 NULL METHODS.

Null methods have long been recognized as the most precise and convenient way to measure all types of impedance — resistive and reactive, inductive and capacitive, from low frequencies to uhf. Most null-type instruments are evolved from the century-old Wheatstone bridge, still the fundamental circuit for measuring dc resistance. Other null circuits, such as the admittance meter and transfer-function bridge, have been developed by General Radio to meet the diverse requirements of modern measurement. In all, General Radio produces bridges covering virtually the entire field of impedance measurement. Some of these bridges include built-in generator and detector and are thus complete, self-contained measurement systems. Others are available in combination with various GR oscillators and detectors, as complete assemblies.

5.1.2 DC BRIDGES.

The Wheatstone bridge measures an unknown resistance, R_x , in terms of calibrated standards of resistance connected as shown in Figure 5-1. The relation is:

$$R_x = \frac{R_3 R_2}{R_1} \quad (1)$$

which is satisfied when the voltage across the detector terminals is zero.

5.1.3 AC BRIDGES.

The Wheatstone bridge circuit is easily adapted to ac measurement. With complex impedances, two balance conditions must be satisfied, one for the resistive component and one for the reactive component. At balance:

$$Z_x = R_x + jX_x = Z_3 Y_1 Z_2 \quad (2)$$

or

$$Y_x = G_x + jB_x = Y_3 Z_1 Y_2 \quad (3)$$

Equation (2) expresses the unknown in terms of impedance components; equation (3) expresses the admittance. To satisfy these equations, at least one of the three arms 1, 2, or 3 must be complex.

The reactance X_x can be measured in terms of a similar reactance in an adjacent arm (Figure 5-2) or an unlike reactance in the opposite arm (Figure 5-3).

The complex arm required to satisfy the balance conditions of equation (2) or (3) is a combination of a

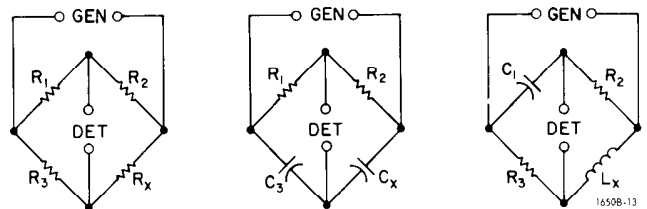

Figure 5-1. The general Wheatstone bridge circuit.

Figures 5-2 and 5-3. Circuits for capacitance bridges in which like reactances (left) or unlike reactances (right) are compared.

reactance, in series or in parallel. With a series combination in an arm adjacent to the unknown or a parallel combination in the arm opposite the unknown, the bridge measures the equivalent series components of the unknown. Conversely, an adjacent parallel or an opposite series combination will yield a measurement of equivalent parallel components. (Every impedance can be expressed in terms of either series or parallel equivalents, as discussed below.)

If both components of this complex arm are adjustable, the balances for the real and imaginary parts of the unknown will be independent of each other and orthogonal. If only one component of the combination is adjustable, this component will be proportional to either the D or the Q of the unknown impedance. If the adjustable component is the more prominent of the two, as it is when very low-Q inductors are measured, the balance convergence is slow, if not impossible. The general-purpose Type 1650 Impedance Bridge uses a mechanical ganging of the bridge controls (called Orthonull) to facilitate convergence.

5.1.4 D AND Q.

An important characteristic of an inductor or a capacitor, and often of a resistor, is the ratio of resistance to reactance or of conductance to susceptance. The ratio is called dissipation factor, D, and its reciprocal is storage factor, Q. These terms are defined in Figure 5-4 in terms of phase angle θ and loss angle δ . Dissipation factor is directly proportional to energy dissipated, and storage factor to energy stored, per cycle. Power factor ($\cos \theta$ or $\sin \delta$) differs from dissipation factor by less than 1% when their magnitudes are less than 0.1.

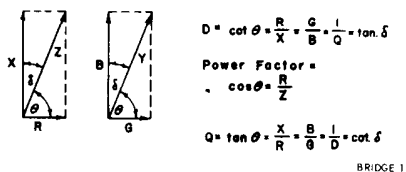

Figure 5-4. Vector diagram showing the relations between factors D and Q, and angles θ and δ .

In Figure 5-4, R and X are series resistance and reactance, and G and B are parallel conductance and susceptance, of the impedance or admittance involved.

Dissipation factor, D, which varies directly with power loss, is commonly used for capacitors. Storage factor, Q, is more often used for inductors because it is a measure of the voltage step-up in a tuned circuit. Q is also used for resistors, in which case it is usually very small.

Series and Parallel Components

The 1650 gives the user the option of measuring the unknown in terms of either its series or parallel

equivalents. The choice is a matter of convenience for the problem at hand. Since the distinction between series and parallel equivalents is sometimes overlooked in texts, we will briefly summarize the relationships here.

Regardless of physical configuration, every impedance can be expressed, for any given frequency, as either a series or a parallel combination of resistance and reactance, as shown in Figure 5-5. The relations between the elements of Figure 5-5 are:

$$R_p = \frac{1}{G_p} = \frac{R_s^2 + X_s^2}{R_s} = R_s (1 + Q^2)$$

$$X_p = \frac{1}{B_p} = \frac{R_s^2 + X_s^2}{X_s} = X_s (1 + D^2)$$

In terms of series and parallel capacitive and inductive reactances, these relations become:

$$C_p = C_s \left(\frac{1}{1 + D^2} \right)$$

$$C_s = C_p (1 + D^2)$$

$$L_p = L_s \left(1 + \frac{1}{Q^2} \right)$$

$$L_s = L_p \left(\frac{Q^2}{1 + Q^2} \right)$$

Where:

$$Q = \frac{X_s}{R_s} = \frac{R_p}{X_p} = \frac{B_p}{G_p} = \frac{\omega L_s}{R_s} = \frac{R_p}{\omega L_p} = \frac{1}{D}$$

and

$$D = \frac{1}{Q} = \frac{R_s}{X_s} = \frac{X_p}{R_p} = \frac{G_p}{B_p} = \omega R_s C_s = \frac{1}{\omega R_p C_p}$$

If Q is 10 or more (or if D is 0.1 or less), the difference between series and parallel reactance is no more than 1%. For very low Q's or high D's, however, the difference is substantial: when $Q = 1$, X_p is twice X_s . If there were no losses in the reactive elements (i.e., $D = 0$), X_s and X_p would be equal.

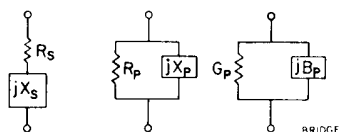

Figure 5-5. Series and parallel components of impedance.

Substitution Methods

In many ac bridges, the unknown is connected in series or in parallel with the main adjustable component, and balances are made before and after the unknown is connected. The magnitude of the unknown then equals the change made in the adjustable component, since the total impedance of the unknown arm remains constant. The chief advantage of this substitution technique is that its accuracy depends only on the calibration of the adjustable arm and not on the other bridge arms (as long as they are constant). The substitution principle can also be used to advantage with any bridge if the balances are made with an external, calibrated, adjustable component.

5.1.5 BRIDGES WITH ACTIVE ELEMENTS.

If a potentiometer-amplifier combination is connected as a bridge element, fixed capacitance and conductance standards can be used, with current adjusted by variation of voltage rather than of impedance magnitude. The principle is used in the GR Type 1633 Incremental-Inductance Bridge, which can accurately measure nonlinear elements.

5.1.6 THE TRANSFORMER RATIO-ARM BRIDGE.

Transformer ratio arms, introduced almost a century ago, have recently come into considerable favor because of certain outstanding advantages. Ratio accuracies of a few parts per million are possible, even for transformer ratios of up to 1000 to 1, and the ratio is virtually unaffected by age, temperature, and voltage.

Figure 5-6 shows a transformer bridge in elementary form. The balance condition for capacitance is

$$\frac{C_X}{C_N} = \frac{N_N}{N_X}$$

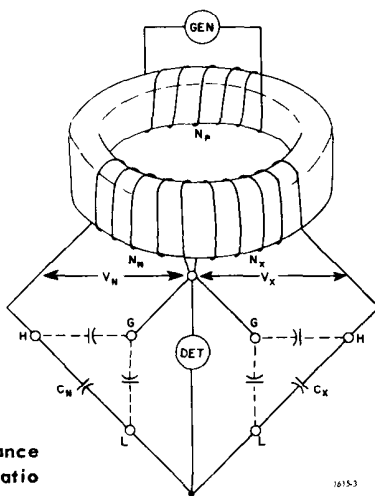

Figure 5-6. A capacitance bridge with transformer ratio arms.

Figure 5-6 also explains the exceptional ability of the transformer bridge to make three-terminal measurements without the use of a guard circuit or auxiliary balance. Capacitances from the H terminals appear across the low-impedance transformer winding, while those from the L terminals are across the detector, where they do not enter the balance expression. These capacitances are thus excluded from the measurement of direct capacitance, C_x , between H and L terminals. Because this type of bridge can tolerate relatively large capacitances from both sides of the unknown to the guard point, long cables with guard shields can be used for remote measurement, and circuit capacitances can often be measured *in situ*.

Conventional bridges can also be adapted for three-terminal measurements (although they generally cannot tolerate as low an impedance to guard). On the GR Types 1650 and 1608 Impedance Bridges, any stray capacitance is in parallel with a standard capacitor of at least $0.1 \mu F$ and usually has negligible effect. A Wagner-type guard circuit (GR Type 716-P4) is available for use with the GR Type 716 Capacitance Bridge. On the Type 1605 Impedance Comparator an electronic amplifier provides a guard point.

5.1.7 LIMIT BRIDGES AND COMPARATORS.

In limit bridges, the unbalance voltage of the bridge actuates a meter, which indicates the degree of deviation of one impedance from another. The GR Type 1652 Resistance Limit Bridge, which includes an adjustable standard resistor, can limit-test resistors over a wide range. The Type 1605 Impedance Comparator indicates the magnitude and phase differences between the unknown and an external standard. On this instrument, the availability of several sensitive ranges enables the user to measure small differences very accurately. For instance, the nominal $\pm 3\%$ accuracy of the comparator is translated into an actual measurement accuracy of $\pm 0.009\%$ on the $\pm 0.3\%$ full-scale range if suitable standards are used.

5.1.8 THE AUTOMATIC BRIDGE.

The ultimate in convenience is a bridge that balances itself. The GR Type 1680 Automatic Capacitance Bridge fully automates the balance procedure — selecting range, balancing, and indicating both capacitance and loss in digital in-line form.

The implications of such automatic measurement are far-reaching. The conversion of bridge-measured data into digital and binary-coded form (the Type 1680 has a binary-coded decimal output) gives the bridge access to the whole modern arsenal of data-processing equipment — printers, tape-punchers, sorters, etc. Speed is one obvious byproduct of automatic equip-

ment: GR's automatic bridge takes about one-half second to achieve balance.

5.1.9 COAXIAL-LINE INSTRUMENTS.

The Slotted Line

The upper-frequency limit of conventional bridge circuits using lumped-parameter elements depends on the magnitude of the residual impedances of the elements and leads. The corrections for these usually become unmanageable at frequencies above a few hundred megahertz, and circuits based on coaxial-line techniques are more satisfactory.

One of the basic methods of measuring the impedance of a coaxial device is the measurement of the standing-wave ratio it introduces in a uniform line. The measurement is best made by a slotted line, an instrument consisting of a length of coaxial air line with a longitudinal slot in its outer conductor and an electrostatic probe, which enters the line through the slot. The probe is moved along the length of the line, sampling the field inside. Thus are the magnitudes and positions of voltage maxima and minima determined and, from this information, the impedance of an unknown connected to the line. In this instrument the impedance standard is the line itself, and its accuracy depends primarily on its physical dimensions.

General Radio offers two slotted lines: the Type 874-LBB, for general impedance measurements, and the highly accurate Type 900-LB, the most advanced slotted line available commercially.

The Admittance Meter

The GR Type 1602 UHF Admittance Meter uses adjustable loops to sample the currents flowing in three coaxial lines fed from a common source and terminated, respectively, in the unknown, a standard conductance, and a standard susceptance. The loops are adjusted so that the combined output from them is zero (a null balance). Scales associated with the three loops give the value of the unknown directly, in terms of admittance.

The Transfer-Function and Imittance Bridge

The GR Type 1607 Transfer-Function and Imittance Bridge is similar to the Admittance Meter described above but also permits four-terminal measurements, such as those of forward and reverse transconductance and transsusceptance, transimpedance, and input-output voltage and current ratios. This bridge is widely used to evaluate the transfer characteristics of transistors and tubes in the vhf and uhf ranges.

5.1.10 GENERATORS AND DETECTORS.

Several GR bridges include both generator and detector. Some others – the Types 1615, 716-C, and

716-CS1 Capacitance Bridges and the Types 1632 and 1633 Inductance Bridges – are available as complete measuring assemblies, with generator, detector, interconnecting cables, relay rack, and other accessories. Unless one obtains such a complete system, he must carefully choose generator and detector to ensure satisfactory measurement results. (Even with a complete system, the user may at times wish to connect a different generator or detector to the bridge, and almost all GR bridges include panel connectors for such use.)

The chief generator requirements are good frequency stability, adequate power output, and low harmonic content. A wide choice of GR oscillators is available, covering the frequency range from audio to microwave.

Desirable detector characteristics are;

1. High sensitivity, preferably the ability to detect a few microvolts.
2. High selectivity, to reject harmonics, noise, and other interfering signals. This is particularly important in measurements on iron-core coils and other nonlinear elements.
3. Logarithmic or nearly logarithmic response, to minimize gain adjustment during the balancing procedure.
4. Good shielding, to prevent errors from extraneous pickup.

At audio frequencies, GR's Type 1232 Tuned Amplifier and Null Detector is recommended for its high sensitivity and for its general versatility in the lab. The Type 1212 Unit Null Detector is useful up to several megahertz. Crystal mixers are available for both the detectors, extending their frequency ranges to about 60 MHz. At these and higher frequencies, the heterodyne type of detector is preferred, because of its wide frequency range and excellent shielding. The GR Type 1241 Detectors operate from 70 kHz to 2000 MHz.

One of the most popular generator-detector combinations, the Type 1311 Audio Oscillator (50 Hz to 10 kHz) with the Type 1232 Tuned Amplifier and Null Detector, is available in a single assembly as the Type 1240 Generator-Detector Assembly.

5.1.11 CONNECTIONS – SHIELDING.

Adequate ground connection and shielded generator and detector leads are always important, but they are particularly so at high frequencies. At audio and low radio frequencies, electrostatic shielding of leads is usually enough; above a few megahertz, coaxial leads, securely grounded to the detector, generator, and bridge shields, are necessary. GR's patch cords and cables (Table 1-1) are recommended for bridge connections.

5.2 1650 BRIDGE.

This section discusses some details of the construction and frequency compensation of the 1650 Bridge.

The variable bridge components are General Radio precision wire-wound rheostats. The CGRL rheostat uses a mechanical justifying mechanism for high accuracy, and the DQ rheostat has a 54-dB logarithmic range. The standard capacitor is a General Radio Precision Polystyrene Capacitor and the resistors are 0.1%, low temperature coefficient, metal-film resistors except for the 1-ohm ratio arm that uses a 1/4% precision General Radio wire-wound card.

5.2.1 BRIDGE SWITCHING.

The CGRL MULTIPLIER switch (S101) selects the bridge range by switching in various ratio-arm resistors. Clockwise rotation of this two-rotor switch increases the multiplier value for the G, R, L, and C bridges. Both ends of the range resistor are switched out so that the unused resistors can be grounded to reduce capacitance across this arm. Double, solid-silver contacts ensure low switch resistance and long switch life.

The CGRL PARAMETER switch (S102) selects the bridge circuits. The actions of this switch are such that it (1) selects the correct rotors of S101 and grounds one of the unused rotors, (2) selects the correct standard arm, and (3) reverses the bottom two arms of the bridge to form the L and R or C and G bridges.

The function switch sets up the correct internal source and detector circuits for the desired operation. When this switch is in either of the two external positions, the EXT GEN terminals, used for externally applied ac or dc, are connected in as the bridge source.

5.2.2 COMPENSATION TECHNIQUES.

To achieve the required D-Q accuracy over such wide ranges, several compensating schemes are used. The components used for this purpose are listed below, with brief description of their functions. Component designations refer to the schematic wiring diagrams (Figures 6-6 and 6-9).

C2: This capacitor corrects for the phase shift caused by stray capacitance across the CGRL rheostat (R_N). This capacitor forms a three-terminal T-network with the two parts of the rheostat to produce an effective inductance to balance out the stray capacitance.

C3: This capacitor compensates for the inductance of the 1- Ω ratio arm (R_5).

C4: This capacitor compensates for the inductance of the 10- Ω ratio arm (R_6).

C7 and C8: These capacitors correct the phase angle of the DQ potentiometer (R_T) to compensate for

the inductance of the winding. Without compensation, this inductance would cause an error in C_s and L_p at high frequencies, and in C_p and L_s when the unknown has a very low Q or high D.

C9: A sixth compensating capacitor consisting of two turns of grounded wire about the 1-M Ω resistor R13 compensates for the stray capacitance across R13.

5.2.3 BRIDGE SOURCES AND DETECTORS.

The dc bridge supply is taken from the four internal D cells, which supply about 6 V limited by a 100- Ω resistor to a maximum of 60 mA. The dc indicator on the panel has a sensitivity of 2 μ A/mm near zero, a resistance of 75- Ω , and a shaped characteristic.

The ac source is a 1-kHz transistor RC Wien-bridge oscillator. The output voltage is about 1 V at the secondary of the 4-to-1 step-down transformer. The OSC LEVEL control adjusts output voltage by adjusting the voltage across the transformer primary.

The ac detector is a four-transistor, variable-gain amplifier, which uses a twin-T RC filter to obtain selectivity when on the AC INTERNAL 1 kHz position. This amplifier drives the panel meter to provide a visual ac null indication, and the output from the amplifier is supplied to the side panel DET phone jack.

The ac oscillator and detector combined draw approximately 10 mA from the internal 6-V battery.

5.2.4 ORTHONULL.

Orthonull is a mechanical device that improves the bridge balance convergence when low Q inductors or high D capacitors are measured. Ordinarily, balances with such components are tedious and often impossible due to the "sliding null" resulting from the interdependence of the two adjustments. Rapid balances are possible with Orthonull, which does not affect electrical balance but which does help avoid false nulls, improving bridge accuracy for low Q measurements.

The bridge output voltage for the L_s (Maxwell) bridge can be expressed, as in the equation of Figure 5-7.

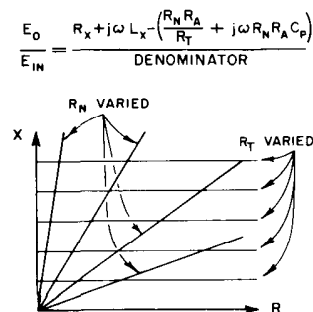
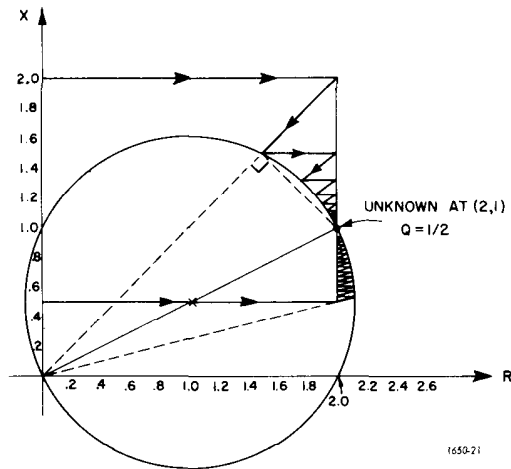

Figure 5-7. Loci of R_N and R_T adjustments on Z plane.



IDEALIZED BALANCING LOCI $Q = 1/2$

Figure 5-8. Loci of "sliding null" balance.

We will assume that the denominator is more or less constant in the region of the null. The numerator is the difference between the unknown impedance $R_x + j\omega L_x$ and what can be called the "bridge impedance." The bridge output is proportional to this difference, which is the distance between them on the complex plane. To balance the bridge, the bridge impedance is varied by adjustment of R_N (the CGRL dial) and R_T (the DQ dial) until it equals the unknown impedance. An adjustment of R_T varies only the real part of the bridge impedance, whereas an adjustment of R_N varies both parts, and is therefore a multiplier of the bridge impedance. Thus, adjustment of R_T moves the bridge impedance horizontally on the complex plane, while

adjustment of R_N moves it radially (Figure 5-7). Each control is adjusted for a minimum voltage.

When $X \gg R$ (i.e., Q is high) these two adjustments are almost orthogonal, and rapid convergence is possible. When Q is low, however, the adjustment becomes more parallel and convergence is slow, causing a "sliding null", as shown in Figure 5-8, where $Q = 1/2$. With smaller Q 's, convergence is even slower.

The Orthonull device makes the two adjustments orthogonal by nonreciprocally ganging R_N and R_T . From the equation it is apparent that if R_N/R_T remained constant as R_N was varied, only the imaginary part of the bridge impedance would change. But when R_T is adjusted, R_N must not move to vary only the real part. The solution is a simple mechanism to permit nonreciprocal action. Both the inherent difference in friction of the two rheostats and the pulley ratio favor torque transmission in the desired direction.

The ratio R_N/R_T must be constant for variation in R_N for any initial settings of R_N and R_T , since R_T may be moved independently of R_N . This requires rheostats with exponential characteristics (and logarithmic dials). The DQ rheostat is a 54-dB exponential potentiometer with the correct initial resistance (R_3) added when the L_s and C_p bridges are used. The CGRL rheostat is exponential in the dial range from 1 to 11, and linear below 1. Thus, for correct Orthonull action, the CGRL dial must be in the range above 1.

The Orthonull mechanism is shown in Figure 6-2. The clutch action is between the wire and the free pulley driven by the wire belt. The clutch is disengaged by the switch on the panel so that normal operation is possible for high- Q (low- D) components.

Section 6—Service and Maintenance

6.1 WARRANTY.

We warrant that each new instrument manufactured and sold by us is free from defects in material and workmanship and that, properly used, it will perform in full accordance with applicable specifications for a period of two years after original shipment. Any instrument or component that is found within the two-year period not to meet these standards after examination by our factory, District Office, or authorized repair agency personnel will be repaired or, at our option, replaced without charge, except for tubes or batteries that have given normal service.

6.2 SERVICE.

The two-year warranty stated above attests the quality of materials and workmanship in our products. When difficulties do occur, our service engineers will assist in any way possible. If the difficulties cannot be eliminated by use of the following service instructions, please write or phone our Service Department (see rear cover), giving full information of the trouble and of steps taken to remedy it. Be sure to mention the type and serial numbers of the instrument.

Before returning an instrument to General Radio for service, please write to our Service Department or nearest District Office, requesting a Returned Material Tag. Use of this tag will ensure proper handling and identification. For instruments not covered by the warranty, a purchase order should be forwarded to avoid unnecessary delay.

6.3 MINIMUM PERFORMANCE STANDARDS.

The eighteen checks listed in Table 6-1 are given so that it can be determined that the instrument is in proper working condition (1) on receipt of a new bridge, (2) after a period of non-use, or (3) after repairs have been made to the bridge. If any specifications (READ column) are not met, refer to paragraph 6.4. Table 6-2 lists the recommended test equipment for these checks plus the equipment needed for the calibration procedures given later. Figure 6-1 shows the equipment connected in a block diagram form.

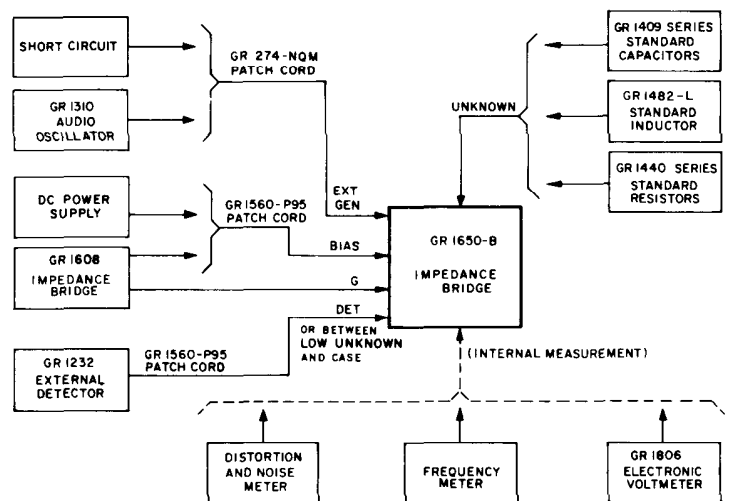

Figure 6-1. Test setup for service and maintenance of 1650-B.

TABLE 6-1
ACCURACY AND OPERATIONAL CHECKS

EXTERNAL STANDARD		CGRL SEL	Function Switch	CGRL MULT	Read	Bridge Components in Circuit		
GR Cat. No.	Value					R _A	R _B or R _T , C _T	R _N
1440-9601	1 Ω	R	INT 1 kHz	100 mΩ	R = 10, ±1 div	R5, C3	R4	CGRL
1440-9601	1 Ω	R	INT 1 kHz	1 Ω	R = 1, ±1/2 div	R6, C4	R4	CGRL
1440-9111	10 Ω	R	INT 1 kHz	10 Ω	R = 1, ±1/2 div	R7	R4	CGRL
1440-9621	100 Ω	R	INT 1 kHz	100 Ω	R = 1, ±1/2 div	R8	R4	CGRL
1440-9631	1 kΩ	R	INT 6 V	1 kΩ	R = 1, ±1/2 div	R10	R4	CGRL
1440-9641	10 kΩ	R	INT 6 V	10 kΩ	R = 1, ±1/2 div	R11	R4	CGRL
1440-9651	100 kΩ	R	*EXT 200 V	100 kΩ	R = 1, ±1/2 div	R13, C9	R4	CGRL
1440-9631	1 kΩ	G	INT 1 kHz	1 mΩ	G = 1, ±1/2 div	R7	R4	CGRL
1440-9661	1 MΩ	C _S	INT 1 kHz	100 pF	C = 10.3, ±1/2 div D = note reading (about 0.159)	R13, C9	DQ, C1	CGRL
1409-9706	.001 μF							
1440-9661	1 MΩ	C _S	INT 1 kHz	1 nF	C = 1.03, ±1/2 div D = must be within 1/3 div of reading above	R11	DQ, C1	CGRL
1409-9706	.001 μF							
1409-9706	.001 μF	C _S	**EXT 1 kHz	100 pF	C = 10, ±1 div	R13, C9	DQ, C1	CGRL
1409-9706	.001 μF	C _S	**EXT 1 kHz	1 nF	C = 1, ±1/2 div	R11	DQ, C1	CGRL
1409-9712	.01 μF	C _S	**EXT 1 kHz	10 nF	C = 1, ±1/2 div	R10	DQ, C1	CGRL
1409-9720	.1 μF	C _S	**EXT 1 kHz	100 nF	C = 1, ±1/2 div	R9	DQ, C1	CGRL
1409-9720	.1 μF	C _S	**EXT 4 kHz	100 nF	C = 1, ±1 div D = 0.251, ±3/4 div	R9	DQ, C1	CGRL
1440-9621	100 Ω							
1409-9720	.1 μF	C _p	**EXT 4 kHz	100 nF	C = 1, ±1 div D = 3.98, ±3/4 div	R9	R3, DQ, C1	CGRL
1440-9621	100 Ω							
1482-9712	100 mH	L _S	INT 1 kHz	100 mH	L = 1, ±1/2 div	R8	R3, DQ, C1	CGRL
1482-9712	100 mH	L _p	INT 1 kHz	100 mH	L = 1, ±1/2 div	R8	DQ, C1	CGRL

* From external power supply.
** From external signal source.

TABLE 6-3
TROUBLE-ANALYSIS GUIDE

CIRCUIT	DETAILED SERVICE INFORMATION (Paragraph)	FUNCTION SWITCH SETTING			
		AC EXTERNAL	AC INTERNAL 1 kHz	DC INTERNAL 6 V	DC EXTERNAL
Oscillator	6.6.6.	out (use external signal source)	in	out	out (use external power supply)
Detector	6.6.7	in	in	out	out (use external power supply)
Batteries	6.5.1	in	in	in	out (use external power supply)
Meter	6.4.3	in (external indicator may be used)	in	in	in
Bridge	6.4.5, 6.6.4 (DQ dial), 6.6.5 (CGRL dial), 6.6.8	in	in	in	in

Note that an equivalent, external circuit can be substituted for all of the major circuits, except the bridge circuit.

6.4 TROUBLE ANALYSIS.

6.4.1 PRELIMINARY CHECKS.

If satisfactory measurements are difficult or impossible to obtain, make the following external checks first:

1. Is the unknown component connected correctly?
2. Is the unknown what it is thought to be?

Large inductors can look like capacitors at 1 kHz.

3. Are all the panel switches set properly?
4. Are the BIAS and EXT DQ jack switches closed? Insert a plug and short the plug to check.
5. Is the D so high (Q so low) that Orthonull should be used?
6. Is OSC LEVEL control on?
7. Is DET SENS control on?
8. Are the batteries correctly in place?

6.4.2 TROUBLE-ANALYSIS GUIDE.

The Type 1650 Impedance Bridge incorporates five major circuits, one or more of which can be

switched out by means of the function switch as detailed in Table 6-3.

6.4.3 NO METER INDICATION.

No meter indication, or a low meter indication, may be due to weak or dead batteries, low oscillator output, poor detector sensitivity, or a faulty meter. If the trouble persists in the DC INTERNAL 6 V position of the function switch (where the oscillator and detector are switched out), the fault is in either the batteries or the meter circuit.

The batteries can be checked either by replacement or by substitution of an external dc power supply. In the latter case, set the bridge function switch to DC EXTERNAL. If the trouble persists, the meter is faulty.

The meter can be checked by connection of an external indicator (earphones, ac meter, oscilloscope, etc) to the DET jack.

TABLE 6-4
MEASUREMENTS FOR CALIBRATION CHECK

MEASUREMENT	STANDARD	GENERAL RADIO CAT. NO.	BRIDGE CIRCUIT	RANGE MULTIPLIER SETTING	FAULTY COMPONENT
A	1Ω	1440-9601	RAC	100 mΩ	R5
B	1Ω	1440-9601	RAC	1 Ω	R6
C	100Ω	1440-9621	RAC	10Ω	R7
D	100Ω	1440-9621	RAC	100Ω	R8
E	10 kΩ	1440-9641	RAC	1 kΩ	R10
F	10 kΩ	1440-9641	RAC	10 kΩ	R11
G	1 MΩ	1440-9661	RAC	100 kΩ	R13
H	0.1 μF	1409-9720	CS	100 nF	(both C1 and R9)
I	0.1 μF	1409-9720	CS	1 μF	R9

6.4.4 NOISY OR ERRATIC BALANCES.

Noisy or erratic balances may be due to surface contamination of the wire-wound CGRL and DQ control rheostats. Contamination can form if the 1650 Impedance Bridge is idle for an extended period and can be remedied by rotation of the controls several times.

6.4.5 MEASUREMENT ERRORS.

Measurement errors are due to faulty bridge-circuit components, which can be located with the series of measurements listed in Table 6-4. Four standard resistors and one standard capacitor are needed for these measurements.

1. When any one measurement is in error, the faulty component is listed in Table 6-4.

2. When all resistance measurements are in error, R4 is out of tolerance.

3. When both capacitance measurements are in error, C1 is out of tolerance.

4. When all measurements are in error, the CGRL rheostat is in error.

5. When all measurements at either 1 or 10 on the CGRL dial are in error, the CGRL rheostat is in error at either 1 or 10.

6. When all measurements are within tolerance, all the fixed components of the bridge are within tolerance, and the CGRL rheostat is correct at the 1 and 10 settings; the CGRL rheostat still may be incorrect between 1 and 10.

6.5 REPAIR NOTES.

6.5.1 BATTERY REPLACEMENT.

The 1650-B Impedance Bridge is powered by four D cells, which will last for over 500 hours' operation with normal use. The instrument can operate with somewhat reduced battery voltage, but the detector sensitivity will decrease, and the oscillator level will decrease and have increased distortion.

For a quick check of the battery, use the BAT CHECK position of the GENERATOR switch. If the meter reads low, replace the batteries.

To replace the battery cells:

a. Unscrew the two No. 10-32 screws from each side of the case (Figure 1-4).

b. Remove the instrument from the case.

c. Remove the old battery cells from the black fiber tube (refer to instructions on tube).

d. Observe the polarity markings on the fiber tube and insert the new battery cells.

e. Replace the tube between the contacts.

f. Reinstall the instrument in the case.

g. Tighten the four No. 10-32 screws.

6.5.2 ETCHED CIRCUIT REMOVAL.

For access to the etched circuit shown in Figure 6-2, remove the two screws holding the top of the board in place and loosen the two screws at the bottom of the board one turn. Tilt the board out as in Figure 6-2.

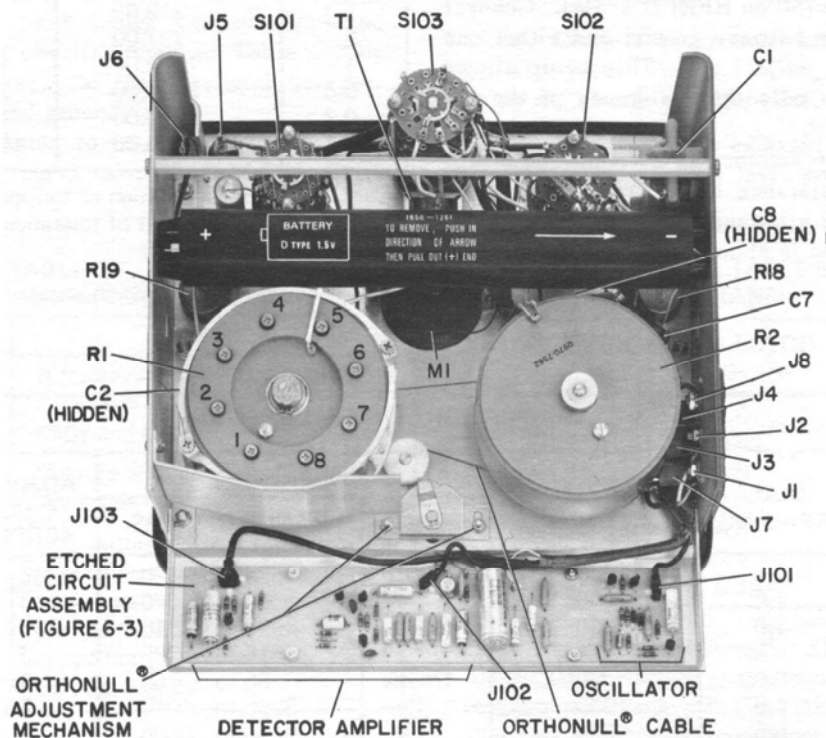

Figure 6 - 2. Interior view of 1650-B Bridge.

6.6 CALIBRATION PROCEDURE.

6.6.1 GENERAL.

The few internal adjustments are factory set and normally do not require readjustment. Procedures for readjustment are included here, but should be used only when the operator is reasonably certain that readjustment is necessary.

6.6.2 EQUIPMENT REQUIRED.

The equipment necessary to perform the following calibration procedures is listed in Table 6-2.

6.6.3 ORTHONULL OPERATION.

With the switch in the OUT position, the CGRL and DQ dials must operate independently of each other.

With the lever in the ORTHONULL position, the CGRL dial must move the DQ dial but the DQ dial must not move the CGRL dial; if performance is different and DQ dial moves the CGRL dial or the CGRL dial doesn't move the DQ dial, the ORTHONULL wire tension is incorrect. Adjust tension by repositioning the metal bracket under the ORTHONULL switch (Figure 6-2).

6.6.4 DQ DIAL.

Set the function switch to POWER OFF, the CGRL PARAMETER switch to C_p , and the DQ dial fully counterclockwise (50 on HIGH D scale). Connect a dc resistance bridge between ground and either one of the BIAS terminals at jack J4. This setup allows the bridge to measure only the resistance of the DQ rheostat in series with R3. With the DQ dial fully counterclockwise, its resistance is zero and the bridge measures only the resistance of R3, which should be $31.90 \Omega \pm 0.96 \Omega$, after allowance for bridge lead resistance. If the indication is abnormal and:

1. Resistance is too high – R3 is open or its value is too high.
2. Resistance is too low – R3 value is too low or C1 is leaky.

Set the DQ dial to 20 on HIGH D scale. The resistance should be 79.70Ω . If necessary, reposition the DQ dial on its shaft until the resistance is 79.70Ω at a setting of 20. Then check the DQ dial calibration as given in Table 6-5. To reposition the dial, remove the knob and loosen the two set screws on the bushing. Turn the dial to the new position and re-install the parts.

6.6.5 CGRL DIAL CHECK.

Keep the function switch set to POWER OFF, but change the CGRL PARAMETER switch to L_p . This connects the CGRL PARAMETER rheostat between ground and the BIAS terminals. The resistance measured should equal the setting of the CGRL dial in kilohms, as in Table 6-6.

TABLE 6-5
DQ DIAL CALIBRATION

DQ DIAL (HIGH D)	RESISTANCE (OHMS)	TOLERANCE ($\pm 3\%$) (OHMS)
50	31.90*	30.94 to 32.86
20	79.70	slip DQ dial for exact reading
10	159.20	154.40 to 163.98
5	319.00	309.43 to 328.57
2	797.00	773.09 to 820.91
1	1592.00	1544.24 to 1639.76
0.5	3190.00	3094.30 to 3285.70
0.2	7970.00	7730.90 to 8209.10
0.1	15920.00	15442.40 to 16397.60

Resistance is either too high or too low:

- (1) DQ rheostat is out of tolerance.
- (2) C7 or C8 is leaky.

*Some units have 32.4Ω ; bridge accuracy unaffected.

TABLE 6-6
CGRL DIAL CALIBRATION ADJUSTMENTS

DIAL READING	RESISTANCE IN OHMS	TOLERANCE		ADJUST CAM SCREW
		\pm	RANGE IN OHMS	
2.6	2600	1%	2574 to 2626	5
1.6	1600	1%	1584 to 1616	4
1.0	1000	1%	990 to 1010	3
0.52	520	1/4 div	515 to 525	2
0.06	60	1/4 div	55 to 65	1
4.0	4000	1%	3960 to 4040	6
6.5	6500	1%	6435 to 6565	7
10.0	10000	1%	9900 to 10100	8

If the resistances are within tolerance and the dials operate properly, disconnect the resistance bridge and proceed to paragraph 6.6.6.

CGRL justifying mechanism. If the readings are abnormal, the CGRL rheostat mechanical justifying mechanism must be readjusted. The CGRL rheostat mechanical justifying mechanism consists of eight cam screws located on the rear of the CGRL rheostat (Figure 6-2), numbered from 1 to 8 in a clockwise direction as indicated in the figure. To adjust, set them for the proper resistances as indicated in Table 6-6.

Vernier drive. The CGRL dial has a vernier planetary drive with a 7:1 reduction over a 90-degree knob rotation. It consists of two solid gears and one spring gear in a triangular configuration centered in a combination of three outside rings (gear, cork, and solid metal). When a coarse setting is made, the cork ring slides inside the metal ring. When the vernier is used, the cork ring is similar to an engaged clutch and stops the rotation of the outside rings, leaving the internal reduction gears to rotate. It will not be necessary to disassemble these gears in any of the service procedures described in this instruction manual.

6.6.6 OSCILLATOR.

Set the function switch to AC INTERNAL 1 kHz and the OSC LEVEL control to its full cw position. Use the C_s bridge with nothing connected to the UNKNOWN terminals. The CGRL control should be full cw. Perform the checks listed in Table 6-7 by measurement of the output of the oscillator between the collector of Q103 and ground.

If operation is found to be abnormal, perform a stage-by-stage voltage check of the transistors (refer

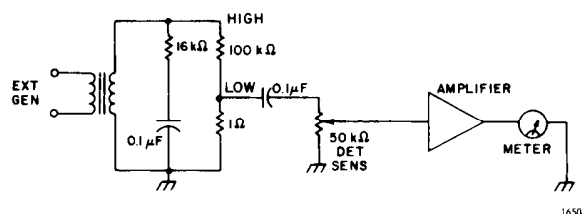

Figure 6 - 3. Schematic for checking the detector circuit.

to Table 6-8). Check the battery voltage with the panel meter (BAT CHECK position) before reading transistor voltages.

6.6.7 DETECTOR.

To check the detector, set the controls as follows:

PARAMETER	C_s
GENERATOR	AC EXTERNAL
CGRL	Full ccw
DQ	Full ccw
MULTIPLIER	100 μ F
DET SENS	Full cw

Continue with the following procedure:

a. Connect a 100-k Ω resistor between the UNKNOWN terminals.

b. Short out the EXT GEN terminals with a shorting plug. The null meter should deflect less than $\frac{1}{2}$ division due to noise. Remove the shorting plug.

c. Connect an external oscillator (1 kHz) to the EXT GEN jack. Turn the CGRL control full cw. This sets up the circuit of Figure 6-3.

d. Use a 1-KHz external oscillator and adjust the external oscillator's level control so there is 3 V

TABLE 6-7

OSCILLATOR PERFORMANCE CHECK	
MEASUREMENT	REMARKS
Frequency: 1000 Hz, ± 20 Hz	If frequency is incorrect, check the values of R101, R102, R103, C102 and C103.
Output voltage: at least 2.7 volts rms	Measure with OSC LEVEL fully clockwise.
Distortion: less than 2.5%	Low output or excessive distortion may be due to weak batteries (refer to paragraph 6.5.1). If the batteries are normal, R107 or R108 may be clipped out to increase the OSC LEVEL slightly.

TABLE 6-8

NOMINAL TRANSISTOR VOLTAGES*			
TRANSISTOR	COLLECTOR (VOLTS)	BASE (VOLTS)	EMITTER (VOLTS)
Q151	4.6	2.2	1.6
Q152	0.52	0.52	0.0
Q153	5.0	0.52	0.0
Q154	2.7	5.2	5.9
Q101	0.6	4.3	5.0
Q102	3.3	0.6	0.0
Q103	0.13	4.6	5.4

*Measurement Conditions: DET SENS full ccw, OSC LEVEL full cw, GENERATOR switch at AC INTERNAL 1kHz; measurements made with GR Type 1806 ELECTRONIC VOLTMETER between component and ground; all voltages are positive. Voltages may vary $\pm 10\%$.

rms between the HIGH terminal and the case of the bridge. This puts 30 μV rms into the amplifier, which should cause at least a 2-division meter deflection.

e. Turn to AC INTERNAL 1 kHz and adjust the OSC LEVEL for 0.5 V rms between the HIGH terminal and the case of the bridge. This puts 5 μV rms into the amplifier and should cause at least a 1-division deflection. If it doesn't, it can be that the oscillator frequency and the peak amplifier response don't coincide.

If the detector amplifier oscillates in the AC INTERNAL 1 kHz position, it could be that the feedback is too great. R155 should be increased to perhaps 20 k Ω . The green and brown amplifier output wires at S103 should be routed away from the amplifier input wire, which is the shielded cable with the brown plastic band. If they are too close, the amplifier may oscillate. If the amplifier is inoperative, a stage-by-stage voltage check should be made (Table 6-8).

6.6.8 INTERNAL GENERATOR.

Use the setup of Figure 6-3 and measure the rms voltage between the HIGH terminal and the case. With the oscillator level full cw it should be within the range of 0.9 V to 1.1 V.

6.6.9 FINAL ACCURACY/OPERATIONAL CHECK.

The measurements given in Table 6-1 are designed to:

1. Check the accuracy of the ratio resistors, R4 to R14.
2. Check the continuity and proper operation of the CGRL PARAMETER, function, and CGRL MULTIPLIER switches and the EXT GEN and UNKNOWN terminals.
3. Recheck the accuracy of the DQ and CGRL dials.

Trouble-shooting notes:

1. Since the DQ and CGRL dials have been checked, incorrect readings on any range will ordinarily be caused by the ratio resistor, R_A, for that range (R4 to R14).
2. If R DC INTERNAL 6 V readings are incorrect, be sure the NULL meter is zeroed.

6.7 KNOB REMOVAL.

If it should be necessary to remove the knob on a front-panel control, either to replace one that has been damaged or to replace the associated control, proceed as follows:

- a. Grasp the knob firmly with the fingers, close into the panel (or the indicator dial, if applicable), and pull the knob straight away from the panel.

CAUTION

Do not pull on the dial to remove a dial/knob assembly. Always remove the knob first. To avoid damage to the knob and other parts of the control, do not pry the knob loose with a screwdriver or similar flat tool, and do not attempt to twist the knob from the dial.

b. Observe the position of the setscrew in the bushing, with respect to any panel markings (or at the full ccw position of a continuous control).

c. Release the setscrew and pull the bushing off the shaft. Use a No. 10 Allen wrench for the CGRL PARAMETER and MULTIPLIER bushings and a No. $\frac{1}{4}$ for the DQ bushings.

d. Remove and retain the black nylon thrust washer, behind the dial/knob assembly, as appropriate.

NOTE

To separate the bushing from the knob, if for any reason they should be combined off the instrument, drive a machine tap a turn or two into the bushing for a sufficient grip for easy separation.

6.8 KNOB INSTALLATION.

To install a knob assembly on the control shaft:

- a. Place the black nylon thrust washer over the the control shaft, if appropriate.
- b. Mount the bushing on the shaft, using a small slotted piece of wrapping paper as a shim for adequate panel clearance.
- c. Orient the setscrew on the bushing with respect to the panel-marking index and lock the setscrew with the appropriate hex-socket key wrench (paragraph 6.7c).

NOTE

Make sure that the end of the shaft does not protrude through the bushing or the knob won't bottom properly.

- d. Place the knob on the bushing with the retention spring opposite the setscrew.
- e. Push the knob in until it bottoms and pull it slightly to check that the retention spring is seated in the groove in the bushing.

NOTE

If the retention spring in the knob comes loose, reinstall it in the interior notch that has the thin slit in the side wall. It will not mount in the other notch.

FEDERAL MANUFACTURERS CODE

From Federal Supply Code for Manufacturers Cataloging Handbooks H4-1
(Name to Code) and H4-2 (Code to Name) as supplemented through June, 1967.

Code	Manufacturers Name and Address	Code	Manufacturers Name and Address	Code	Manufacturers Name and Address
00192	Jones Mfg. Co., Chicago, Illinois	53021	Sangamo Electric Co., Springfield, Ill. 62705	80583	Hammarlund Co. Inc., New York, N. Y.
00194	Walsco Electronics Corp., Los Angeles, Calif.	54294	Shalcross Mfg. Co., Selma, N. C.	80740	Beckman Instruments, Inc., Fullerton, Calif.
00656	Aerovox Corp., New Bedford, Mass.	54715	Shure Brothers, Inc., Evanston, Ill.	81073	Grayhill Inc., LaGrange, Ill. 60525
01009	Alden Products Co., Brockton, Mass.	56289	Sprague Electric Co., N. Adams, Mass.	81143	Isolanite Mfg. Corp., Stirling, N. J. 07980
01121	Allen-Bradley, Co., Milwaukee, Wisc.	59730	Thomas and Betts Co., Elizabeth, N. J. 07207	81349	Military Specifications
01295	Texas Instruments, Inc., Dallas, Texas	59875	TRW Inc. (Accessories Div), Cleveland, Ohio	81350	Joint Army-Navy Specifications
02114	Ferroxcube Corp. of America, Saugerties, N. Y. 12477	60399	Torrington Mfg. Co., Torrington, Conn.	81751	Columbus Electronics Corp., Yonkers, N. Y.
02606	Fenwal Lab. Inc., Morton Grove, Ill.	61637	Union Carbide Corp., New York, N. Y. 10017	81831	Filton Co., Flushing, L. I., N. Y.
02600	Amphenol Electronics Corp., Broadview, Ill.	61864	United-Carr Fastener Corp., Boston, Mass.	81860	Barry Controls Div. of Barry Wright Corp., Watertown, Mass.
02768	Fastex Division of Ill. Tool Works, Des Plaines, Ill. 60016	63060	Victoreen Instrument Co., Inc., Cleveland, Ohio	82219	Sylvania Electric Products, Inc. (Electronic Tube Div.), Emporium, Penn.
03508	G. E. Semiconductor Products Dept., Syracuse, N. Y. 13201	63743	Ward Leonard Electric Co., Mt. Vernon, N. Y.	82273	Indiana Pattern and Model Works, LaPort, Ind.
03636	Grayburne, Yonkers, N. Y. 10701	65083	Westinghouse (Lamp Div), Bloomfield, N. J.	82389	Switchcraft Inc., Chicago, Ill. 60630
03888	Pyrofilm Resistor Co., Cedar Knolls, N. J.	65092	Weston Instruments, Weston-Newark, Newark, N. J.	82647	Metals and Controls Inc., Attleboro, Mass.
03911	Clairtex Corp., New York, N. Y. 10001	70485	Atlantic-India Rubber Works, Inc., Chicago, Ill. 60607	82807	Milwaukee Resistor Co., Milwaukee, Wisc.
04009	Arrow, Hart and Hegeman Electric Co., Hartford, Conn. 06106	70563	Amperite Co., Union City, N. J. 07087	83058	Carr Fastener Co., Cambridge, Mass.
04713	Motorola Semi-Conduct Product, Phoenix, Ariz. 85008	70903	Belden Mfg. Co., Chicago, Ill. 60644	83186	Victory Engineering Corp (VECO), Springfield, N. J. 07081
05170	Engineered Electronics Co., Inc., Santa Ana, Calif. 92702	71126	Bronson, Homer D., Co., Beacon Falls, Conn.	83361	Bearing Specialty Co., San Francisco, Calif.
05624	Barber-Colman Co., Rockford, Ill. 61101	71294	Canfield, H. O. Co., Clifton Forge, Va. 24422	83587	Solar Electric Corp., Warren, Penn.
05820	Wakefield Eng., Inc., Wakefield, Mass. 01880	71400	Bussman Mfg. Div. of McGraw Edison Co., St. Louis, Mo.	83740	Union Carbide Corp., New York, N. Y. 10017
07127	Eagle Signal Div. of E. W. Bliss Co., Baraboo, Wisc.	71590	Centralab, Inc., Milwaukee, Wisc. 53212	84411	TRW Capacitor Div., Ogallala, Nebr.
07261	Avnet Corp., Culver City, Calif. 90230	71666	Continental Carbon Co., Inc., New York, N. Y.	84835	Lehigh Metal Products Corp., Cambridge, Mass. 02140
07263	Fairchild Camera and Instrument Corp., Mountain View, Calif.	71707	Coto Coil Co. Inc., Providence, R. I.	84971	TA Mfg. Corp., Los Angeles, Calif.
07387	Birtcher Corp., No. Los Angeles, Calif.	71744	Chicago Miniature Lamp Works, Chicago, Ill.	86577	Precision Metal Products of Malden Inc., Stoneham, Mass. 02180
07595	American Semiconductor Corp., Arlington Heights, Ill. 60004	71785	Cinch Mfg. Co. and Howard B. Jones Div., Chicago, Ill. 60624	86684	RCA (Electrical Component and Devices) Harrison, N. J.
07828	Bodine Corp., Bridgeport, Conn. 06605	71823	Darnell Corp., Ltd., Downey, Calif. 90241	88140	Cutler-Hammer Inc., Lincoln, Ill.
07829	Bodine Electric Co., Chicago, Ill. 60618	72136	Electro Motive Mfg. Co., Wilmington, Conn.	88219	Gould Nat. Batteries Inc., Trenton, N. J.
07910	Continental Device Corp., Hawthorne, Calif.	72259	Nytronics Inc., Berkeley Heights, N. J. 07922	88419	Cornell Dubilier Electric Corp., Fuquay-Varina, N. C.
07983	State Labs Inc., N. Y., N. Y. 10003	72619	Dialight Co., Brooklyn, N. Y. 11237	88627	K and G Mfg. Co., New York, N. Y.
07999	Amphenol Corp., Borg Inst. Div., Delavan, Wisc. 53115	72699	General Instrument Corp., Capacitor Div., Newark, N. J. 07104	89482	Holtzer Cabot Corp., Boston, Mass.
08730	Vemaline Prod. Co., Franklin Lakes, N. J.	72765	Drake Mfg. Co., Chicago, Ill. 60656	89665	United Transformer Co., Chicago, Ill.
09213	General Electric Semiconductor, Buffalo, N. Y.	72825	Hugh H. Eby, Inc., Philadelphia, Penn. 19144	90201	Mallory Capacitor Co., Indianapolis, Ind.
09823	Burgess Battery Co., Freeport, Ill.	72962	Elastic Stop Nut Corp., Union, N. J. 07083	90750	Westinghouse Electric Corp., Boston, Mass.
09922	Burdy Corp., Norwalk, Conn. 06852	72982	Erie Technological Products Inc., Erie, Penn.	90952	Hardware Products Co., Reading, Penn. 19602
11599	Chandler Evans Corp., W. Hartford, Conn.	73445	Amperex Electronics Co., Hillsville, N. Y.	91032	Continental Wire Corp., York, Penn. 17405
12498	Teledyn Inc., Crystalonics Div., Cambridge, Mass. 02140	73559	Elco Electric Co., New York, N. Y.	91146	ITT Cannon Electric Inc., Salem, Mass.
12672	RCA Commercial Receiving Tube and Semi- conductor Div., Woodridge, N.J.	73690	J. F. D. Electronics Corp., Brooklyn, N. Y.	91293	Johanson Mfg. Co., Boonton, N. J. 07005
12697	Clarostat Mfg. Co. Inc., Dover, N. H. 03820	73899	Heinemann Electric Co., Trenton, N. J.	91598	Chandler Co., Wethersfield, Conn. 06109
12954	Dickson Electronics Corp., Scottsdale, Ariz.	74193	Industrial Conductor Corp., Chicago, Ill.	91637	Dale Electronics Inc., Columbus, Nebr.
13327	Solitron Devices, Tappan, N. Y. 10983	74790	E. F. Johnson Co., Waseca, Minn. 56093	91662	Elco Corp., Willow Grove, Penn.
14433	ITT Semiconductors, W. Palm Beach, Florida	75042	IRC Inc., Philadelphia, Penn. 19108	91719	General Instruments, Inc., Dallas, Texas
14655	Cornell Dubilier Electric Co., Newark, N. J.	75382	Kulka Electric Corp., Mt. Vernon, N. Y.	91929	Honeywell Inc., Freeport, Ill.
14674	Corning Glass Works, Corning, N. Y.	75608	Linden and Co., Providence, R. I.	92519	Electra Insulation Corp., Woodside, Long Island, N. Y.
14936	General Instrument Corp., Hicksville, N. Y.	75915	Littelfuse, Inc., Des Plaines, Ill. 60016	92678	Edgerton, Germeshausen and Grier, Boston, Mass.
15238	ITT, Semiconductor Div. of Int. T. and T., Lawrence, Mass.	76005	Lord Mfg. Co., Erie, Penn. 16512	93332	Sylvania Electric Products, Inc., Woburn, Mass.
15605	Cutler-Hammer Inc., Milwaukee, Wisc. 53233	76487	James Millen Mfg. Co., Malden, Mass. 02148	93916	Cramer Products Co., New York, N. Y. 10013
16037	Spruce Pine Mica Co., Spruce Pine, N. C.	76545	Mueller Electric Co., Cleveland, Ohio 44114	94144	Raytheon Co. Components Div., Quincy, Mass.
19701	Electra Mfg. Co., Independence, Kansas 67301	76684	National Tube Co., Pittsburg, Penn.	94154	Tung Sol Electric Inc., Newark, N. J.
21335	Fafnir Bearing Co., New Briton, Conn.	76854	Oak Mfg. Co., Crystal Lake, Ill.	95076	Garde Mfg. Co., Cumberland, R. I.
24446	G. E. Schenectady, N. Y. 12305	77147	Patton MacGyver Co., Providence, R. I.	95146	Alco Electronics Mfg. Co., Lawrence, Mass.
24454	G. E., Electronic Comp., Syracuse, N. Y.	77166	Pass-Seymour, Syracuse, N. Y.	95238	Continental Connector Corp., Woodside, N. Y.
24455	G. E. (Lamp Div), Nela Park, Cleveland, Ohio	77263	Pierce Roberts Rubber Co., Trenton, N. J.	95275	Vitramon, Inc., Bridgeport, Conn.
24655	General Radio Co., W. Concord, Mass 01781	77339	Positive Lockwasher Co., Newark, N. J.	95354	Methode Mfg. Co., Chicago, Ill.
26806	American Zettler Inc., Costa Mesa, Calif.	77542	Ray-O-Vac Co., Madison, Wisc.	95412	General Electric Co., Schenectady, N. Y.
28520	Hayman Mfg. Co., Kenilworth, N. J.	77630	TRW, Electronic Component Div., Camden, N. J. 08103	95794	Ansonda American Brass Co., Torrington, Conn.
28959	Hoffman Electronics Corp., El Monte, Calif.	77638	General Instruments Corp., Brooklyn, N. Y.	96095	Hi-Q Div. of Aerovox Corp., Orlean, N. Y.
30874	International Business Machines, Armonk, N.Y.	78189	Shakeproof Div. of Ill. Tool Works, Elgin, Ill. 60120	96214	Texas Instruments Inc., Dallas, Texas 75209
32001	Jensen Mfg. Co., Chicago, Ill. 60636	78277	Sigma Instruments Inc., S. Braintree, Mass.	96256	Thordarson-Meissner Div. of McGuire, Mt. Carmel, Ill.
35929	Constanta Co. of Canada Limited, Montreal 19, Quebec	78488	Stackpole Carbon Co., St. Marys, Penn.	96341	Microwave Associates Inc., Burlington, Mass.
37942	P. R. Mallory and Co. Inc., Indianapolis, Ind.	78553	Tinnerman Products, Inc., Cleveland, Ohio	96906	Military Standards
38443	Marlin-Rockwell Corp., Jamestown, N. Y.	79089	RCA, Commercial Receiving Tube and Semi- conductor Div., Harrison, N. J.	97966	CBS Electronics Div. of Columbia Broadcast- ing Systems, Danvers, Mass.
40931	Honeywell Inc., Minneapolis, Minn. 55408	79725	Wiremold Co., Hartford, Conn. 06110	98291	Sealco Corp., Mamaroneck, N. Y. 10544
42190	Miter Co., Chicago, Ill. 60638	79963	Zierick Mfg. Co., New Rochelle, N. Y.	98821	North Hills Electronics Inc., Glen Cove, N. Y.
42498	National Co. Inc., Melrose, Mass. 02176	80030	Prestole Fastener Div. Bishop and Babcock Corp., Toledo, Ohio	99180	Transitron Electronics Corp., Melrose, Mass.
43991	Norma-Hoffman Bearings Corp., Stanford, Conn. 06904	80048	Vickers Inc. Electric Prod. Div., St. Louis, Mo.	99378	Atlee Corp., Winchester, Mass. 01890
49671	RCA, New York, N. Y.	80131	Electronic Industries Assoc., Washington, D.C.	99800	Delevan Electronics Corp., E. Aurora, N. Y.
49956	Raytheon Mfg. Co., Waltham, Mass. 02154	80211	Motorola Inc., Franklin Park, Ill. 60131	83033	Meissner Mfg., Div. of Maguire Industries, Inc., Mount Carmel, Illinois
		80258	Standard Oil Co., Lafayette, Ind.		LRC Electronics, Horseheads, New York
		80294	Bourns Inc., Riverside, Calif. 92506		
		80431	Air Filter Corp., Milwaukee, Wisc. 53218	80183	Sprague Products Co., N. Adams, Mass.

Parts Lists and Diagrams

ELECTRICAL PARTS LIST

Ref. No.	Description	Part No.	Fed. Mfg. Code	Mfg. Part No.	Fed. Stock No.
CAPACITORS					
C1	Plastic, 0.1 μ F \pm 1/4%	4872-1040	24655	4872-1040	
C2	Mica, 150pF \pm 5% 500 V	4640-0600	72136	CM15, 150pF \pm 5%	
C3	Wax, 0.47 μ F \pm 10% 200 V	5020-1200	80183	109P47492	
C4	Ceramic, .001 μ F \pm 10% 500 V	4406-2108	72982	811, .001 μ F \pm 10%	5910-928-1476
C6	Oil, 0.1 μ F \pm 10% 600 V	4510-4500	56289	73P10496	5910-928-1485
C7	Plastic, .0068 μ F \pm 10% 400 V	4863-2689	56289	194P68294	
C8	Plastic, .047 μ F \pm 10% 200 V	4860-7869	84411	663 μ W 0.047 μ F \pm 10%	
C101	Electrolytic, 200 μ F +100-10% 12 V	4450-0400	37942	97679	5910-799-9281
C102	Plastic, 0.01 μ F \pm 1% 100 V	4860-7752	84411	663 μ W, 0.01 μ F \pm 1%	
C103	Plastic, 0.01 μ F \pm 1% 100 V	4860-7752	84411	663 μ W, 0.01 μ F \pm 1%	
C104	Electrolytic, 3.3 μ F \pm 20% 15 V	4450-4600	56289	150D335X0015A2	5910-837-9325
C105	Plastic, 0.1 μ F \pm 10% 100 V	4860-8250	84411	663 μ W, 0.1 μ F \pm 10%	
C151	Electrolytic, 5 μ F +100-10% 50 V	4450-3900	37942	204059539C10X3	5910-448-5527
C152	Electrolytic, 15 μ F +100-10% 15 V	4450-3700	37942	TT, 15 μ F +100-10%	
C153	Electrolytic, 200 μ F +100-10% 6 V	4450-2610	37942	TT, 200 μ F +100-10%	
C154	Electrolytic, 10 μ F +100-10% 25 V	4450-3800	56289	30D106G025BB4M1	5910-952-8658
C155	Ceramic, 68pF \pm 5% 500 V	4404-0685	72982	831, 68pF \pm 5%	
C156	Plastic, .01 μ F \pm 1% 100 V	4860-7752	84411	663 μ W, 0.01 μ F \pm 1%	
C157	Plastic, .01 μ F \pm 1% 100 V	4860-7752	84411	663 μ W, 0.01 μ F \pm 1%	
C158	Plastic, .02 μ F \pm 1% 100 V	4860-7852	84411	663 μ W, 0.02 μ F \pm 1%	
C159	Ceramic, 10pF \pm 10% 500 V	4400-2999	72982	315N, 10pF \pm 10%	
C160	Electrolytic, 5 μ F +100-10% 50 V	4450-3900	37942	2040595S9C10X3	5910-448-5527
C161	Plastic, .02 μ F +80-20% 50 V	4402-3200	01121	36-203W, 0.02 μ F +80-20%	5910-952-8659
C162	Ceramic, 100pF \pm 5% 500 V	4404-1105	72982	831, 100pF \pm 5%	
DIODES					
CR3	Type 1N965B	6083-1015	07910	1N965B	5960-877-6192
CR1	Type 1N4009	6082-1012	24446	1N4009	
CR2	Type 1N4009	6082-1012	24446	1N4009	
CR101	Type 1N4009	6082-1012	24446	1N4009	
CR102	Type 1N4009	6082-1012	24446	1N4009	
RESISTORS					
R1	Potentiometer, 11.2k Ω	0977-4110	24655	0977-4110	
R2	Potentiometer, 16.2k Ω	0977-4021	24655	0977-4021	
R3	Film, 32.4 Ω \pm 3% 1/2 W	6450-9324	75042	CEC-T0, 32.4 Ω \pm 1%	
R4	Film, 10k Ω \pm 0.1% 1/2 W	6188-2100	75042	MEC-T2, 10k Ω \pm 0.1%	
R5	Potentiometer, 0.980 Ω \pm 0.1%	0510-4000	24655	0510-4000	
R6	Film, 10 Ω \pm 1/4% 1/2 W	6452-0100	75042	CEC-T0, 10 Ω \pm 1/4%	
R7	Film, 100 Ω \pm 0.1% 1/2 W	6188-0100	75042	MEC-T2, 100 Ω \pm 0.1%	
R8	Film, 1k Ω \pm 0.1% 1/2 W	6188-1100	75042	MEC-T2, 1k Ω \pm 0.1%	
R9	Film, 1k Ω \pm 0.1% 1/2 W	6188-1100	75042	MEC-T2, 1k Ω \pm 0.1%	
R10	Film, 10k Ω \pm 0.1% 1/2 W	6188-2100	75042	MEC-T2, 10k Ω \pm 0.1%	
R11	Film, 100k Ω \pm 0.1% 1/2 W	6188-3100	75042	MEC-T2, 100k Ω \pm 0.1%	
R13	Film, 1M Ω \pm 0.1% 1/2 W	6188-4100	75042	MEC-T2, 1M Ω \pm 0.1%	
R14	Composition, 3.9k Ω \pm 5% 1/2 W	6100-2395	01121	RC20GF392J	5905-279-3505
R15	Composition, 100 Ω \pm 5% 1/2 W	6100-1105	01121	RC20GF101J	5905-190-8889
R16	Composition, 750 Ω \pm 5% 1/2 W	6100-1755	01121	RC20GF751J	5905-195-9481
R17	Composition, 164k Ω \pm 5% 1/2 W	6350-3164	75042	CEB, 164k Ω \pm 5%	5905-192-0667
R18	Potentiometer, Variable, 2.5k Ω \pm 10%	6000-0400	12697	53MS, 2.5k Ω \pm 10%	5905-034-5378
R19	Potentiometer, Variable, 50k Ω \pm 10%	6020-0600	01121	JA, 50k Ω \pm 10%	5905-539-4900
R101	Film, 15.8k Ω \pm 1/2% 1/2 W	6451-2158	75042	CEC-T0, 15.8k Ω \pm 1/2%	
R102	Film, 21.5k Ω \pm 1/2% 1/2 W	6451-2215	75042	CEC-T0, 21.5k Ω \pm 1/2%	
R103	Film, 59k Ω \pm 1% 1/2 W	6450-2590	75042	CEC, 59k Ω \pm 1%	
R104	Film, 2.74k Ω \pm 1% 1/2 W	6450-1274	75042	CEC, 2.74k Ω \pm 1%	
R105	Composition, 10k Ω \pm 10% 1/4 W	6099-3109			
R106	Film 6.49k Ω \pm 1% 1/2 W	6450-1649	75042	CEC, 6.49k Ω \pm 1%	
R107	Composition, 150k Ω \pm 10% 1/4 W	6099-4159	75042	BTS, 150k Ω \pm 10%	
R108	Composition, 300k Ω \pm 10% 1/4 W	6099-4309	75042	BTS, 300k Ω \pm 10%	
R109	Composition, 3.6k Ω \pm 10% 1/4 W	6099-2369	75042	BTS, 3.6k Ω \pm 10%	
R110	Composition, 2k Ω \pm 5% 1/4 W	6099-2205	75042	BTS, 2k Ω \pm 5%	5905-279-4629
R111	Composition, 2k Ω \pm 5% 1/4 W	6099-2205	75042	BTS, 2k Ω \pm 5%	5095-279-4629
R112	Composition, 100 Ω \pm 5% 1/4 W	6099-1105	75042	BTS, 100 Ω \pm 5%	
R151	Composition, 200k Ω \pm 5% 1/4 W	6099-4205	75042	BTS, 200k Ω \pm 5%	

ELECTRICAL PARTS LIST (cont)

Ref. No.	Description	Part No.	Fed. Mfg. Code	Mfg. Part No.	Fed. Stock No.
RESISTORS (Cont)					
R152	Composition, 200k Ω \pm 5% 1/4 W	6099-4205	75042	BTS, 200k Ω \pm 5%	
R153	Composition, 10k Ω \pm 5% 1/4 W	6099-3105	75042	BTS, 10k Ω \pm 5%	
R154	Composition, 1k Ω \pm 5% 1/4 W	6099-2105	75042	BTS, 1k Ω \pm 5%	
R155	Composition, 15k Ω \pm 10% 1/4 W	6099-3159	75042	BTS, 15k Ω \pm 10%	
R156	Composition, 1M Ω \pm 10% 1/4 W	6099-5109	75042	BTS, 1M Ω \pm 10%	
R157	Film, 16.9k Ω \pm 1% 1/2 W	6450-2169	75042	CEC-T0, 16.9k Ω \pm 1%	
R158	Film, 16.9k Ω \pm 1% 1/2 W	6450-2169	75042	CEC-T0, 16.9k Ω \pm 1%	
R159	Film, 6.65k Ω \pm 1% 1/2 W	6450-1665	75042	CEC, 6.65k Ω \pm 1%	5905-581-4975
R160	Composition, 39k Ω \pm 10% 1/4 W	6099-3399	75042	BTS, 39k Ω \pm 10%	
R161	Composition, 4.7k Ω \pm 10% 1/4 W	6099-2479	75042	BTS, 4.7k Ω \pm 10%	
R163	Composition, 4.7k Ω \pm 10% 1/4 W	6099-2479	75042	BTS, 4.7k Ω \pm 10%	
R164	Composition, 10k Ω \pm 10% 1/4 W	6099-3109	75042	BTS, 10k Ω \pm 10%	
R165	Composition, 2k Ω \pm 5% 1/4 W	6099-2205	75042	BTS, 2k Ω \pm 5%	5905-279-4629
R166	Composition, 680 Ω \pm 5% 1/4 W	6099-1685	75042	BTS, 680 Ω \pm 5%	
R167	Composition, 1k Ω \pm 10% 1/4 W	6099-2109	75042	BTS, 1k Ω \pm 10%	
TRANSISTORS					
Q101	Type 2N3905	8210-1114	04713	2N3905	
Q102	Type 2N3416	8210-1047	24446	2N3416	5961-989-2749
Q103	Type 2N3905	8210-1114	04713	2N3905	
Q151	Type 2N3416	8210-1047	24446	2N3416	5961-989-2749
Q152	Type 2N3416	8210-1047	24446	2N3416	5961-989-2749
Q153	Type 2N3391A	8210-1092	24454	2N3391A	5961-989-2749
Q154	Type 2N3905	8210-1114	04713	2N3905	
Q155	Type 2N1302	8210-1018	96214	2N1302	5960-086-0039
MISCELLANEOUS					
B1	Battery, 1.5 V	8410-0200(4)	77542	2LP	
J1	Jack	4150-3200	24655	4150-3200	
J2	Jack	4150-3200	24655	4150-3200	
J3	Jack	4260-1030	82389	#111	
J4	Jack	4260-1041	82389	N112A	
J5	Jack	0938-3000	24655	0938-3000	
J6	Jack	0938-3000	24655	0938-3000	
J7	Jack	4260-1041	82389	N112A	
J8	Jack	4150-3200	24655	4150-3200	
J101	Jack	Built In			
J102	Jack	Built In			
J103	Jack	Built In			
M1	Meter	5730-1431	91929	ME-3T	
PL101	Plug	Part of Z2WIS-18L			
PL102	Plug	Part of Z2WIS-18L			
PL103	Plug	Part of Z2WIS-21D			
S101	Switch, Rotary	7890-4680	24655	7890-4680	
S102	Switch, Rotary	7890-4690	24655	7890-4690	
S103	Switch, Rotary	7890-4700	24655	7890-4700	
T1	Transformer	0746-4020	24655	0746-4020	

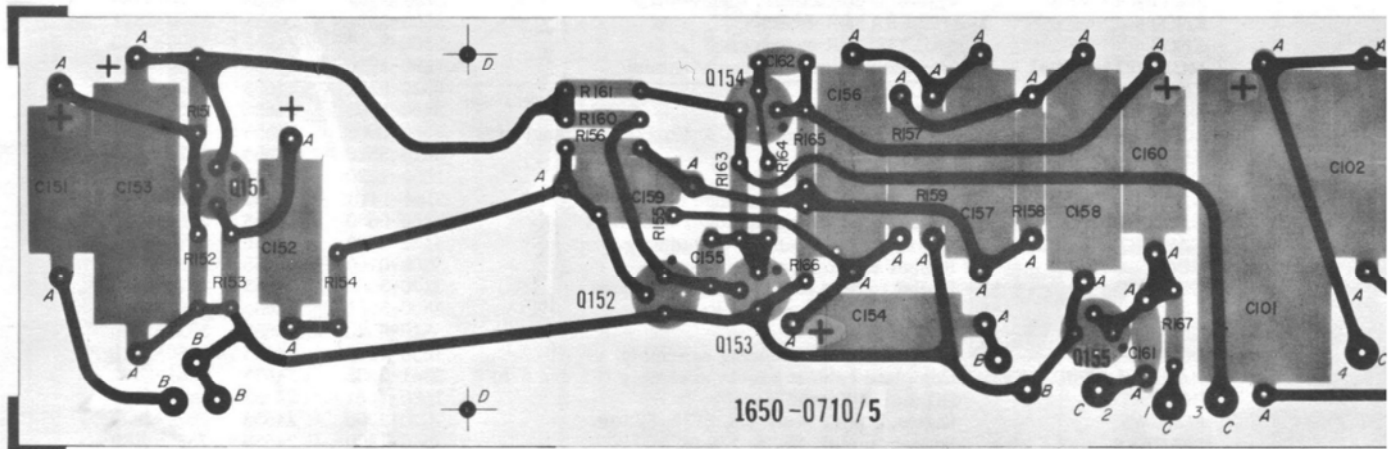
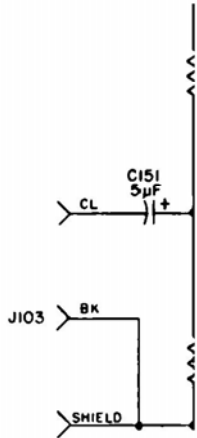

Figure 6 - 4. Etched circuit assembly (P/N 1650-2710).

t)

Mfg. Part No.	Fed. Stock No.
00kΩ ±5%	
0kΩ ±5%	
kΩ ±5%	
5kΩ ±10%	
MΩ ±10%	
10, 16.9kΩ ±1%	
10, 16.9kΩ ±1%	
6.65kΩ ±1%	5905-581-4975
9kΩ ±10%	
.7kΩ ±10%	
.7kΩ ±10%	
0kΩ ±10%	
kΩ ±5%	5905-279-4629
80Ω ±5%	
kΩ ±10%	
5	
4	5961-989-2749
5	
4	5961-989-2749
4	5961-989-2749
1A	5961-989-2749
5	
2	5960-086-0039



- 1200
- 1200
- 1000
- 1000
- 1200

r

- 680
- 690
- 700
- 1020

NOTE: The number appearing on the foil side is not the part number. The dot on the foil at the transistor socket indicates the collector lead.

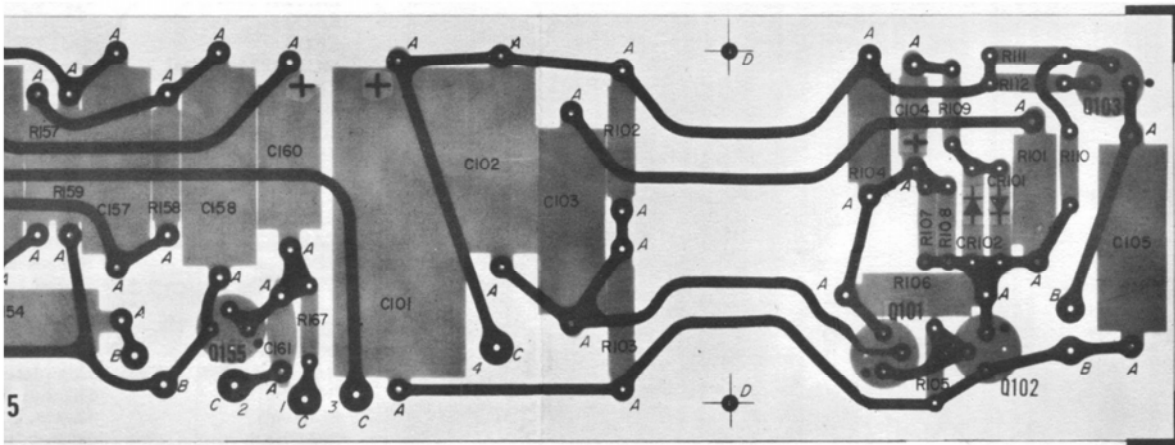

50-2710).

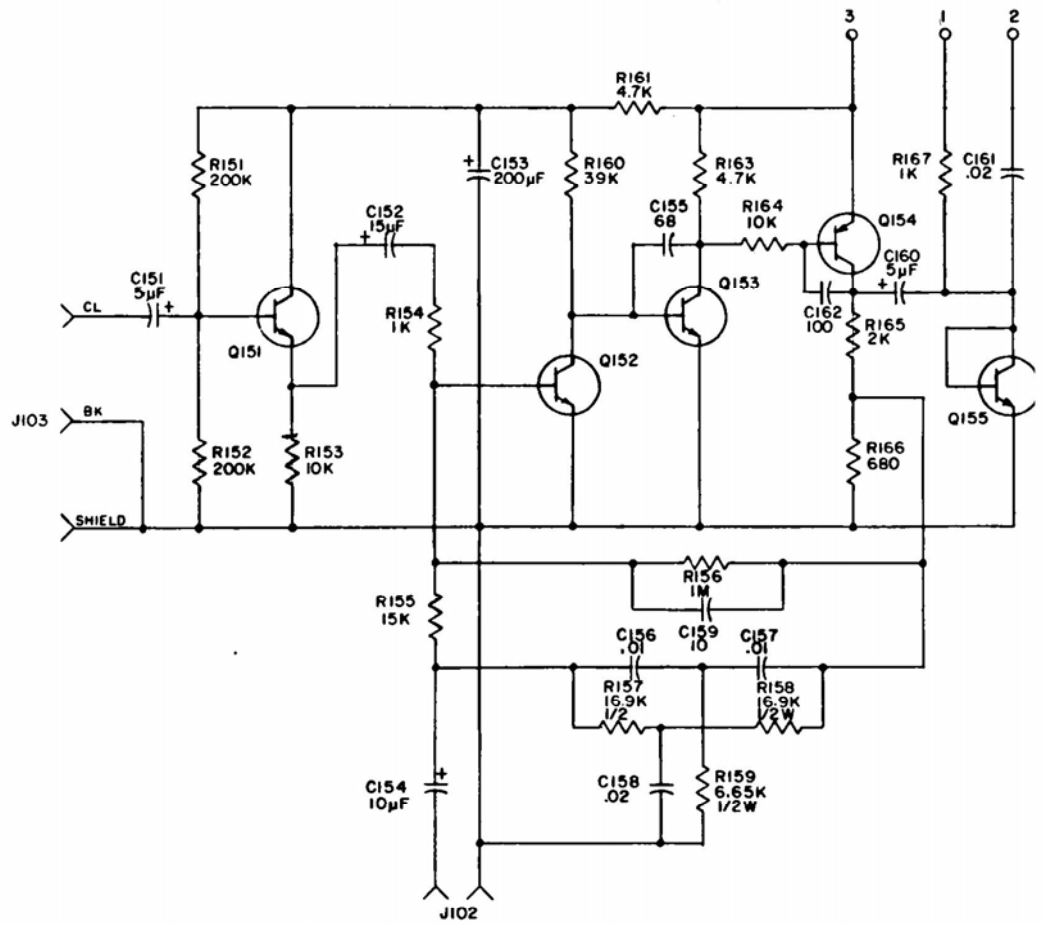

DETECTOR

the foil side is not the part number.
 the socket indicates the collector lead.

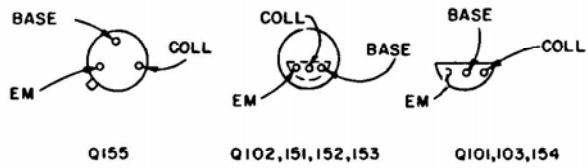
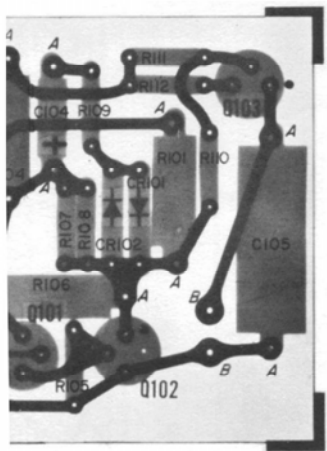

BOTTOM VIEW OF TRANSISTORS

Figure

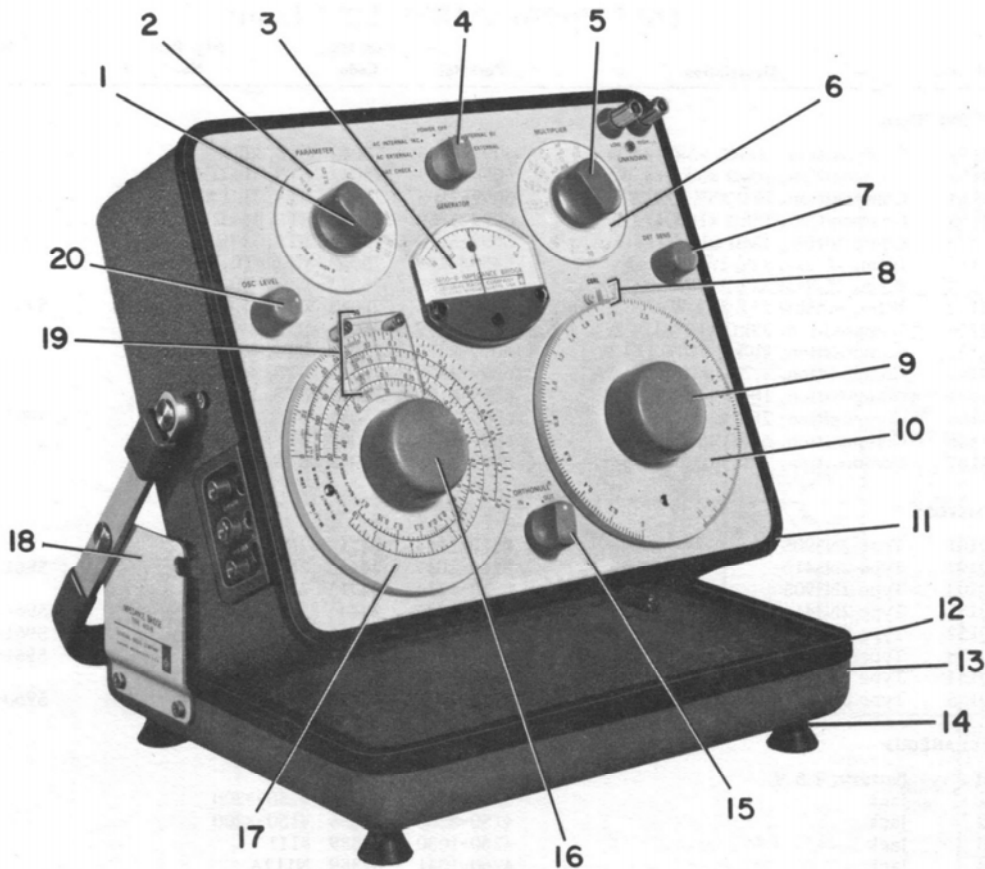

Figure 6 - 5. Replaceable mechanical parts.

MECHANICAL PARTS LIST

Figure 6-5 Reference	Name	Description	Part No.	Fed. Mfg. Code	Mfg. Part No.	Fed. Stock No.
1	KNOB	PARAMETER switch knob	5500-5420	24655	5500-5420	
2	PARAMETER dial	Marked dial and bushing assembly	1650-1240	24655	1650-1240	
3	METER COVER	Plastic meter cover, Honeywell	5720-3713	24655	5720-3713	
4	KNOB	GENERATOR switch	5500-5321	24655	5500-5321	
5	KNOB	MULTIPLIER switch knob	5500-5420	24655	5500-5420	
6	MULTIPLIER dial	Marked dial and bushing assembly	1650-1250	24655	1650-1250	
7	KNOB	DET SENS knob	5520-5221	24655	5520-5221	
8	INDICATOR	CGRL dial indicator	5460-1303	24655	5460-1303	
-	SCREWS	Screw, binder head, No. 4-40, 1/4 in., panel gray	7060-0902	24655	7060-0902	
9	KNOB	CGRL dial knob	5520-5520	24655	5520-5520	
10	CGRL dial	Marked dial assembly	1650-1520	24655	1650-1520	
11	GASKET	Rubber gasket around edge of panel	5168-1410	24655	5168-1410	
12	GASKET	Rubber gasket around cover assembly	5168-0680	24655	5168-0680	
13	CABINET ASSEMBLY	Entire flip-tilt cabinet including gasket	4182-2002	24655	4182-2002	
14	FOOT	Rubber foot for cover assembly	5260-0760	24655	5260-0760	
-	EYELET	Eyelet to hold foot to cover assembly	5170-5030	24655	5170-5030	
15	KNOB	ORTHONULL® control knob	5500-5321	24655	5500-5321	
16	KNOB	DQ Dial knob	5520-5520	24655	5520-5520	
17	DQ dial	Marked dial and bushing assembly	1650-1510	24655	1650-1510	
18	HANDLE ASSEMBLY	Complete cabinet handle assembly (Figure 6-6)	5361-2002	24655	5361-2002	
19	INDICATOR	DQ dial indicator	1650-7161	24655	1650-7161	
-	SCREWS	Screw, binder head, No. 6-32, 5/8 in.	7070-2900	24655	7070-2900	5305-938-9109
-	SPACERS	Spacer, metal, No. 6, 3/8 in.	7650-1300	24655	7650-1300	
20	KNOB	OSC LEVEL knob	5520-5221	24655	5520-5221	
	BINDING POST	Binding post, J5, UNKNOWN LOW;				
	INSULATOR	J6, UNKNOWN HIGH	0938-3000	24655	0938-3000	5940-075-9617
		Insulator for J5 and J6	0938-7130	24655	0938-7130	

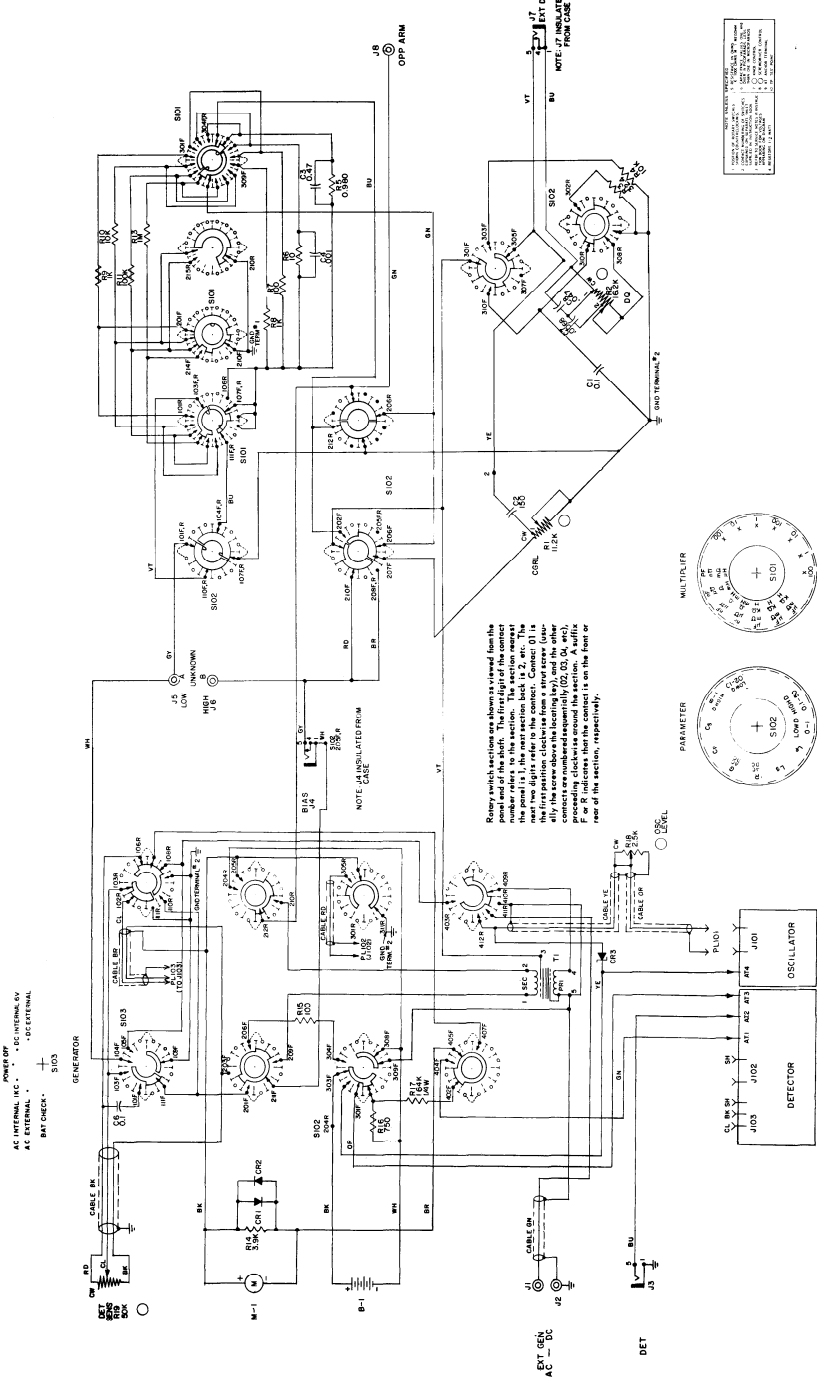

Figure 6-9. Schematic diagram of 1650-B Impedance Bridge.

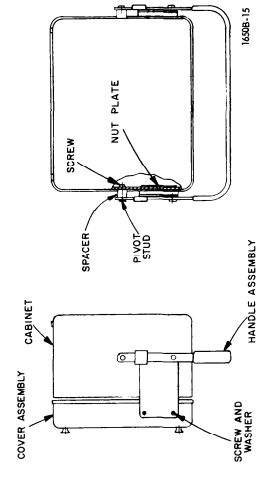

Figure 6-1. Complete cabinet assembly (P/N 4182-2002).

Name	QTY	Part No.	QTY	Name	Part No.
Cabinet	1	4182-2002	1	Mounting Plate	7894-2002
Spacer	1	4170-2005	1	(Name Plate)	8140-0105
Screw Stud	1	7036-0005	1	Slide Washer	4170-3030
Handle Assembly	1	5981-2002	1	Slide Washer	4170-3030
				Slide Washer	1556B-0105

**Slide mounting plate to pins 152, 153, 154 (top), both sides.

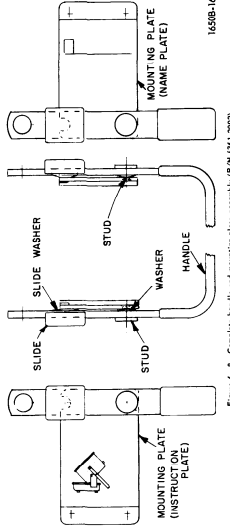

Figure 6-2. Complete handle and mounting plate assembly (P/N 1541-2002).

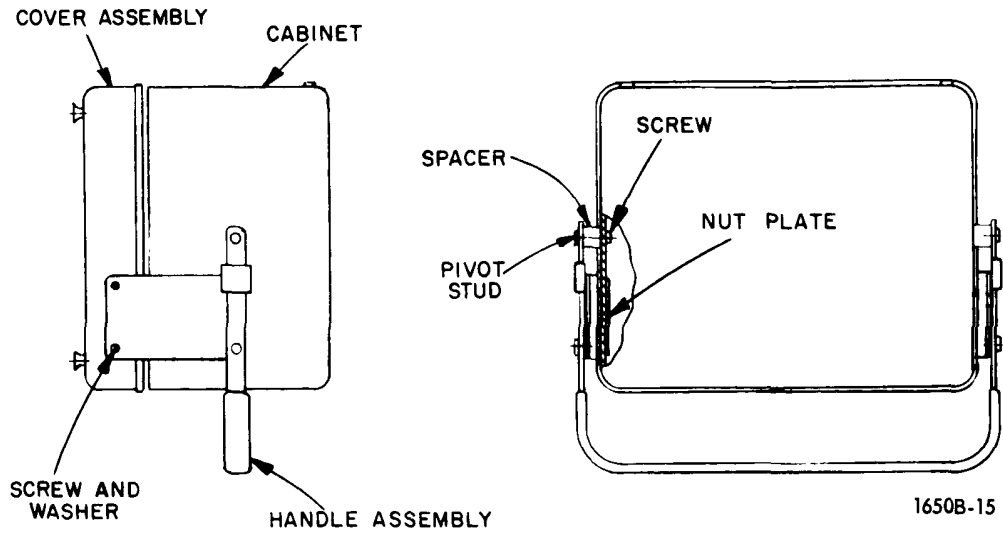

Figure 6 - 7. Complete cabinet assembly (P/N 4182-2002).

Name	GR Part No.	Name	GR Part No.
Cabinet	4182-8210	Cover Assembly	4170-2066
Spacer	4170-0700	Nut Plate	4170-1305
Pivot Stud	4170-1000	Screw	7080-1000
Screw*	7090-0075	Washer	8040-2400
Handle Assembly	5361-2002		

Name	GR Part No.	Name	GR Part No.
Mounting Plate (Instruction Plate)	7860-5770	Mounting Plate (Name Plate)	7864-8200
Stud	4170-1100	Washer	8140-0105
Slide	4170-1270	Slide Washer	4170-7030
Handle	5360-1013		

*Tighten 1/4 - 28 screws to 45-55 in. lbs torque.
 **Bend mounting plate to give 1/32 to 1/16 spacing, both sides.

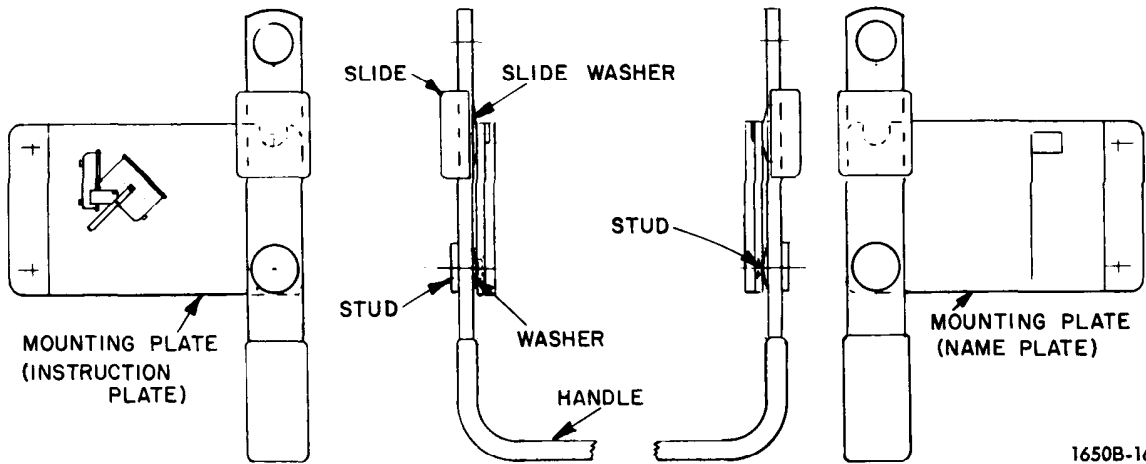
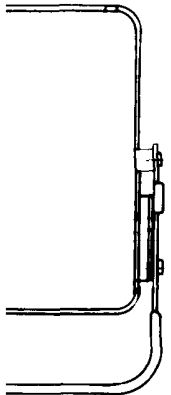

Figure 6 - 8. Complete handle and mounting plate assembly (P/N 5361-2002).

EXT
AC -

D



1650B-15

Name	GR Part No.
Mounting Plate (Name Plate)	7864-8200
asher	8140-0105
le Washer	4170-7030

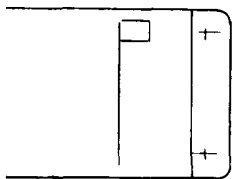

MOUNTING PLATE (NAME PLATE)

1650B-16

POWER OFF
 AC INTERNAL IKC • • DC INTERNAL 6V
 AC EXTERNAL • • DC EXTERNAL
 BAT CHECK • +
 S103

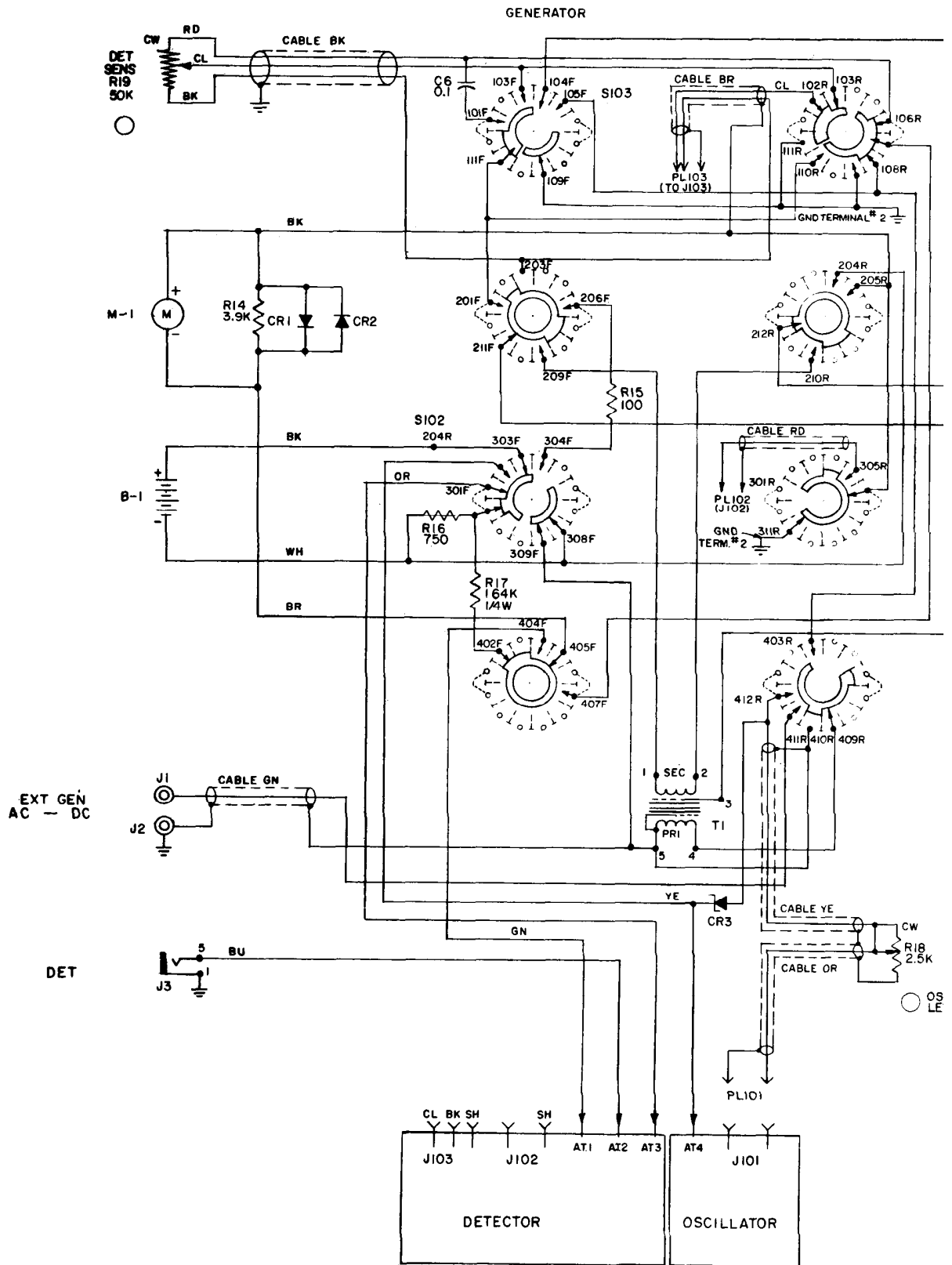

INTERNAL 6V
C EXTERNAL

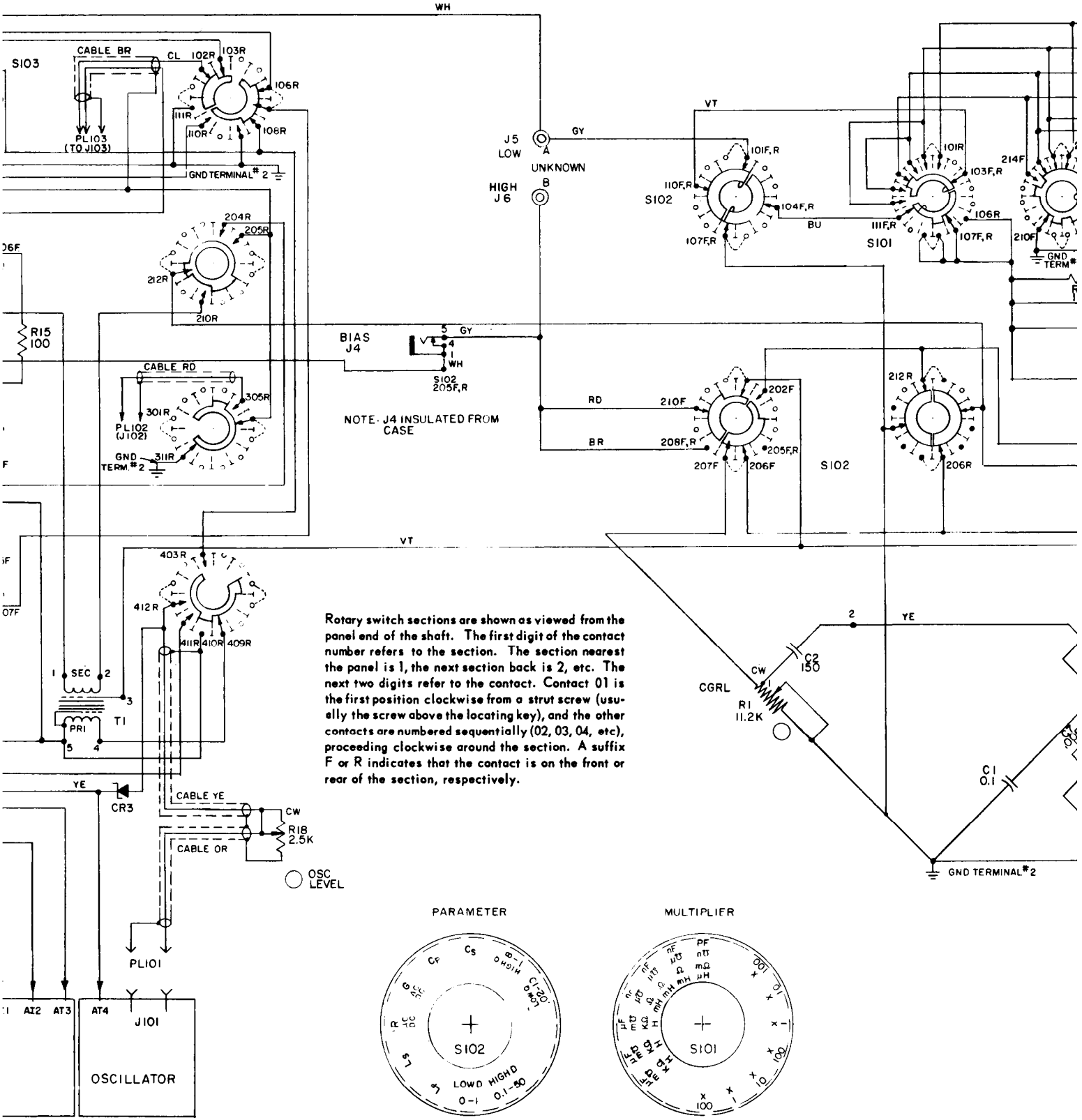
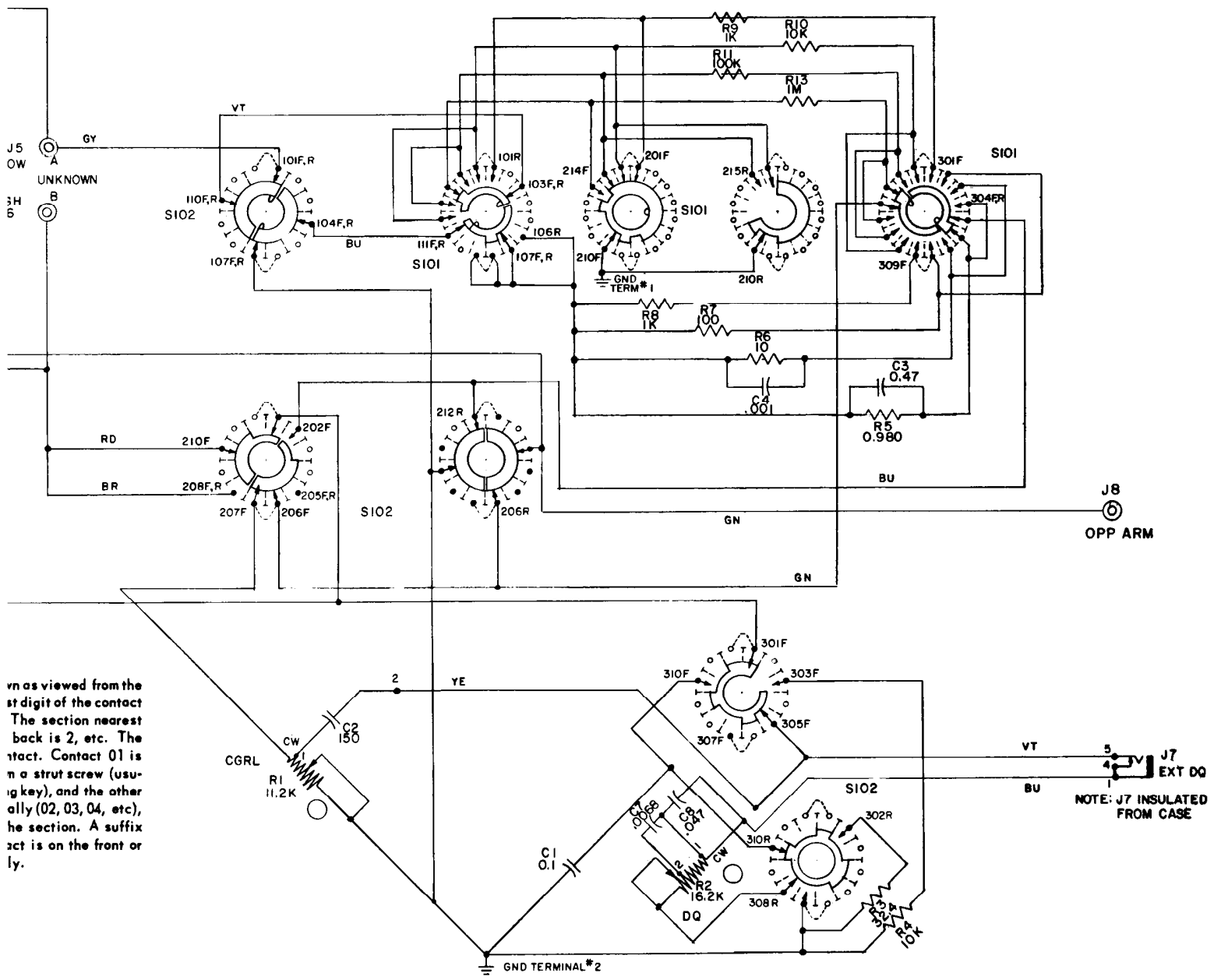
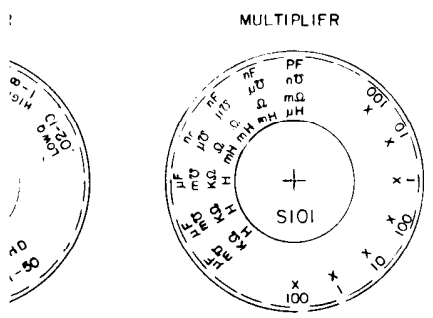

Figure 6 - 9. Schematic diagram of



as viewed from the
 st digit of the contact
 The section nearest
 back is 2, etc. The
 fact. Contact 01 is
 a strut screw (usu-
 g key), and the other
 ally (02, 03, 04, etc),
 he section. A suffix
 act is on the front or
 ly.



- NOTE UNLESS SPECIFIED
- 1 POSITION OF ROTARY SWITCHES SHOWN COUNTERCLOCKWISE
 - 2 CONTACT NUMBERING OF SWITCHES EXPLAINED ON SEPARATE SHEET SUPPLIED IN INSTRUCTION BOOK
 - 3 REFER TO SERVICE NOTES IN INSTRUCTION BOOK FOR VOLTAGES APPEARING ON DIAGRAM
 - 4 RESISTORS 1/2 WATT
 - 5 RESISTANCE IN OHMS X 1000 OHMS M T MEGOHMS OVER IN PICO FARADS LESS THAN ONE IN MICROFARADS
 - 6 CAPACITANCE VALUES ONE AND OVER IN PICO FARADS LESS THAN ONE IN MICROFARADS
 - 7 KNOB CONTROL
 - 8 SCREWDRIVER CONTROL
 - 9 AT ANCHOR TERMINAL
 - 10 TP TEST POINT

Figure 6 - 9. Schematic diagram of 1650-B Impedance Bridge.

NOMOGRAPH FOR CONVERSION OF C, L, D AND Q AT 1 kHz

The nomograph below greatly simplifies the process of converting from series to parallel value (or vice versa) of inductance and capacitance, for values of dissipation factor up to 10 (Q down to 0.1). To illustrate use of the nomograph, assume a parallel capacitance of $2\ \mu\text{F}$, and a D of 7. A straight line connecting these two points is seen to cross the center (C_S) bar at 100. Therefore, the equivalent series capacitance is $100\ \mu\text{F}$.

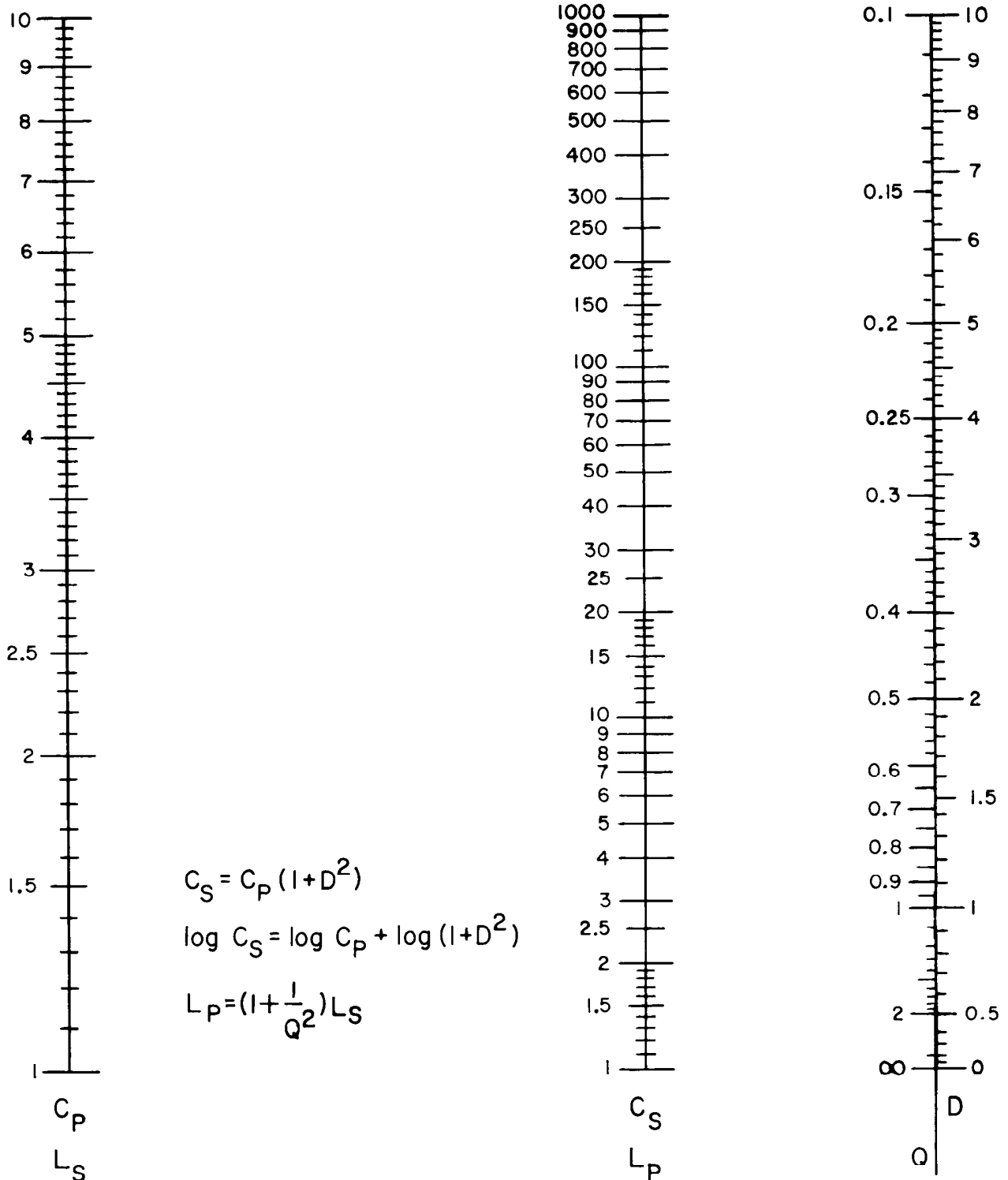

Appendix

The instruments on the following pages are useful accessories in certain applications of the bridge. Table A lists some of the instruments and their primary use with the bridge.

ACCESSORY*	APPLICATION
Type 1560-P95 Adaptor Cable	Connections to: External bias. Detector output. External DQ potentiometer.
Type 1650-P1 Test Jig	Incoming inspection. (Rapid checking of single components.)
Type 1412-BC Decade Capacitor	RAC and GAC reactive balances.
Type 1350 Generator-Recorder Assembly	Transducer Analysis. (Investigating sharp resonances in mechanical transducers.)
Type 1232 Tuned Amplifier and Null Detector	External detector.
Types 1309, 1310, 1311, and 1313 Oscillators	External generators.
Type 1900 Wave Analyzer	High frequency (>20 kHz) tuned null detector. Tracking generator.
Type 1191 Counter	Checking frequency of external ac generator.

*GR instruments. For a detailed description see the General Radio Catalog.

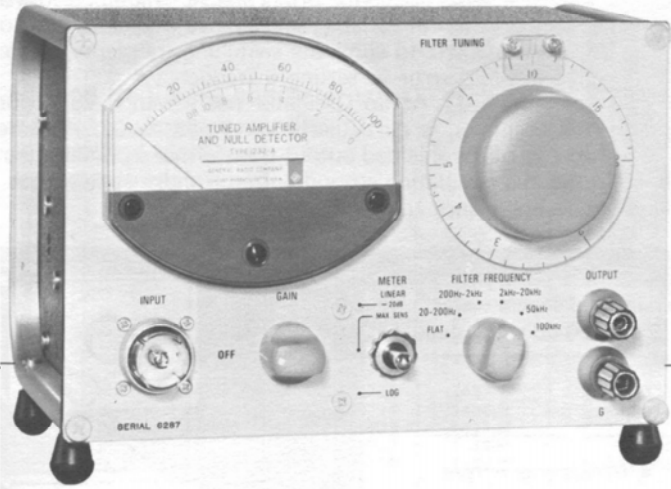

TUNED AMPLIFIER AND NULL DETECTOR

Type 1232-A

- 20 Hz to 20 kHz, 50 and 100 kHz
- 0.1- μ V sensitivity
- bandwidth approx 5%
- 120-dB gain

The Type 1232 Detector is a sensitive, general-purpose, metered audio amplifier. Intrinsically broadband (± 3 dB from 20 Hz to 20 kHz), it has optional filtering that can be tuned continuously over the audio-frequency range or at spots up to 100 kHz.

Its utility as a null detector is enhanced by high gain, long-life battery power, and the optional logarithmic response characteristic. The output is adequate to drive headphones.

Catalog Number	Description
1232-9701	1232-A Tuned Amplifier and Null Detector
0480-9837	480-P317, for 1232-AP (with pre-amp) and companion 8-in. instrument

GENERATOR-RECORDER ASSEMBLY

Type 1350

- automatic frequency-response plotting
- 20 Hz to 20 kHz
- combines 1304-B with 1521 Graphic Level Recorder

This automatic, audio-frequency measuring system combines the Type 1304-B Beat-Frequency Audio Generator and Type 1521-B Graphic Level Recorder in a single assembly for the automatic plotting of frequency-response data. The recorder is a fully transistorized, single-channel, servo-type with a 40-dB, dynamic range plug-in potentiometer (20-dB, 80-dB, and linear potentiometer are also available).

The complete assembly includes the following:

1304-B Beat-Frequency Audio Generator with accessories, end frames and rack supports.

1521-B Graphic Level Recorder with accessories (including a 40-dB potentiometer), 1521-P19 motor, end frames and rack supports.

1521-9427 Chart Paper, 10 rolls

274-NP Patch Cord

1521-P10B Drive Unit

1521-P15 Link Unit

1521-P16 Sprocket Kit

1560-P95 Adaptor Cable

1304-P1 Muting Switch

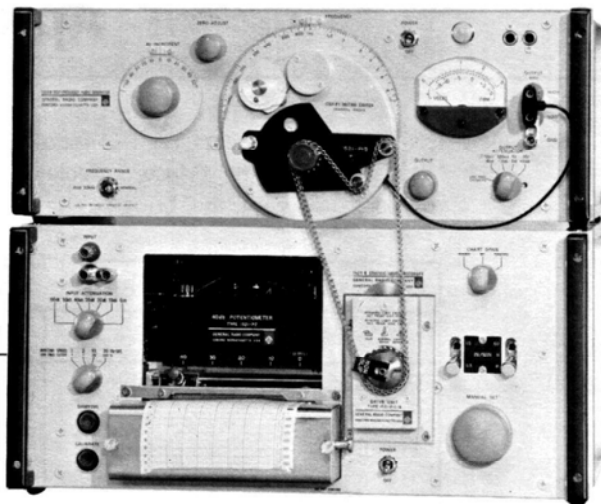

Constant generator output and uniform recorder response make this an excellent assembly for measuring the response of filters, attenuators, networks, loud-speakers, amplifiers, microphones, transducers, and complete acoustic systems.

The blank parts on the chart paper correspond to the length of the blank portion on the generator dial so that many charts can be recorded with complete synchronization of the chart and the dial frequency.

Catalog Number	Description
	Generator-Recorder Assembly
1350-9701	1350-A, for 60-Hz supply
1350-9494	1350-AQ1, for 50-Hz supply

EXTERNAL GENERATORS

General Radio manufactures several oscillators that can be used as external generators for a measurement bridge. Three oscillators in this group are the variable frequency type and the fourth is a fixed frequency generator.

The 1309 Oscillator has a variable range of 10 Hz to 100 kHz. Distortion, noise, and hum are exceptionally low in this instrument, and the output is flat over the entire frequency range.

The 1310 Oscillator offers constant output over a variable range from 2 Hz to 2 MHz with low distortion, high dial reso-

lution, and exceptional amplitude and frequency stability.

The 1313 Oscillator offers similar over-all performance to the 1309 but with variable, single-range frequency control from 10 Hz to 50 kHz to eliminate switching transients and to minimize possible error in setting a frequency.

The 1311 Audio Oscillator has eleven fixed frequencies. This oscillator is particularly suited for bridge measurements because of the shielded output-transformer secondary that minimizes the circulating ground currents and matches loads over a wide impedance range.

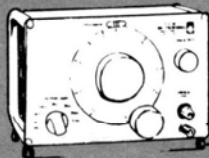
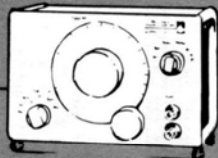
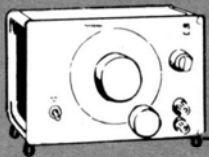
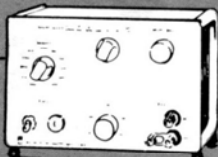
	GR 1310-A	<ul style="list-style-type: none"> ■ 0.05% distortion ■ 10 Hz to 100 kHz ■ 5 V ■ 60-dB step attenuator 	GR 1309-A	
	GR 1313-A	<ul style="list-style-type: none"> ■ 2 Hz to 2 MHz ■ 20 V ■ 0.25% distortion 		
		<ul style="list-style-type: none"> ■ 1 W ■ 100 V or 4 A ■ transformer output ■ 50 Hz to 10 kHz ■ discrete frequencies 	GR 1311-A	
		<ul style="list-style-type: none"> ■ 10 Hz to 50 kHz in one range ■ sine and square waves 		

DECADE CAPACITORS, RESISTORS, and INDUCTORS

The GR decade capacitors, resistors and inductors can be used to support the bridge externally. The 1412-BC Decade Capacitor is especially useful for ac resistive and conductive reactive balances. Consult the General Radio Catalog for details of each decade.

DECADE CAPACITOR

Type 1412-BC

- 50 pF to 1.11115 μ F
- better than 1-pF resolution
- accuracy $\pm(1\% + 5 \text{ pF})$
- low loss, leakage, dielectric absorption

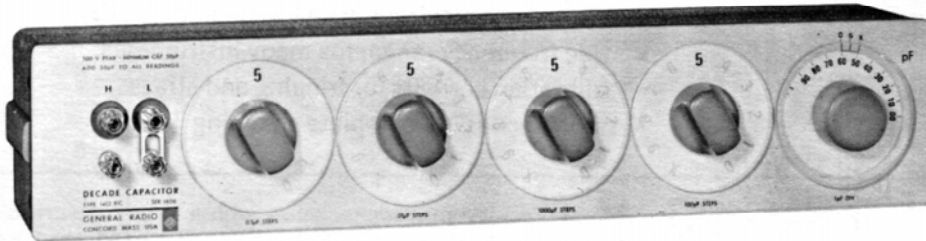

Catalog Number	Description
1412-9410	1412-BC Decade Capacitor

DECADE RESISTOR

Type 1434

- $\pm 0.05\%$ accuracy
- 5-, 6-, or 7-dial settability
- excellent stability, low cost

Catalog Number	Description	Total Resistance (Ω)	Resistance Per Step	Number of Decades
Decade Resistor				
1434-9714	1434-N	11,111	0.1 Ω	5
1434-9713	1434-M	111,110	1.0 Ω	5
1434-9716	1434-P	1,111,100	10 Ω	5
1434-9576	1434-QC	1,111,105	1 Ω /div	4 + rheostat
1434-9702	1434-B	1,111,100	1.0 Ω	6
1434-9724	1434-X	111,111	0.1 Ω	6
1434-9707	1434-G	1,111,111	0.1 Ω	7

DECADE RESISTOR

Type 1433

- $\pm 0.02\%$ accuracy
- good frequency characteristics
- low temperature coefficient
- excellent stability
- low zero resistance

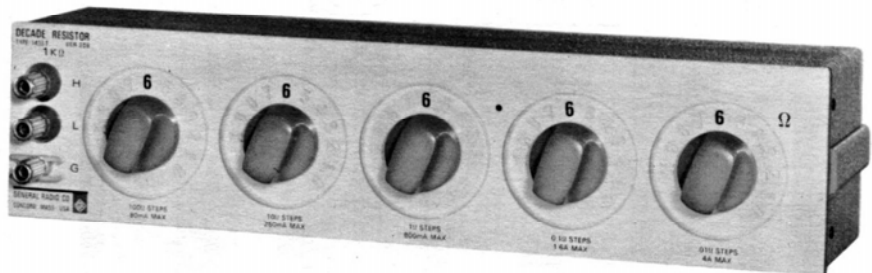

Catalog Number		Type	Total Ohms	Ohms per Step	No. of Dials	Type 510 Decades Used
Bench	Rack					
1433-9700	1433-9701	1433-U	111.1	0.01	4	AA, A, B, C
1433-9702	1433-9703	1433-K	1111	0.1	4	A, B, C, D
1433-9704	1433-9705	1433-J	11,110	1	4	B, C, D, E
1433-9706	1433-9707	1433-L	111,100	10	4	C, D, E, F
1433-9708	1433-9709	1433-Q	1,111,000	100	4	D, E, F, G
1433-9710	1433-9711	1433-T	1111.1	0.01	5	AA, A, B, C, D
1433-9712	1433-9713	1433-N	11,111	0.1	5	A, B, C, D, E
1433-9714	1433-9715	1433-M	111,110	1	5	B, C, D, E, F
1433-9716	1433-9717	1433-P	1,111,100	10	5	C, D, E, F, G
1433-9718	1433-9719	1433-Y	11,111,000	100	5	D, E, F, G, H
1433-9720	1433-9721	1433-W	11,111.1	0.01	6	AA, A, B, C, D, E
1433-9722	1433-9723	1433-X	111,111	0.1	6	A, B, C, D, E, F
1433-9724	1433-9725	1433-B	1,111,110	1	6	B, C, D, E, F, G
1433-9726	1433-9728	1433-Z	11,111,100	10	6	C, D, E, F, G, H
1433-9729	1433-9730	1433-F	111,111.1	0.01	7	AA, A, B, C, D, E, F
1433-9731	1433-9732	1433-G	1,111,111	0.1	7	A, B, C, D, E, F, G
1433-9733	1433-9734	1433-H	11,111,110	1	7	B, C, D, E, F, G, H

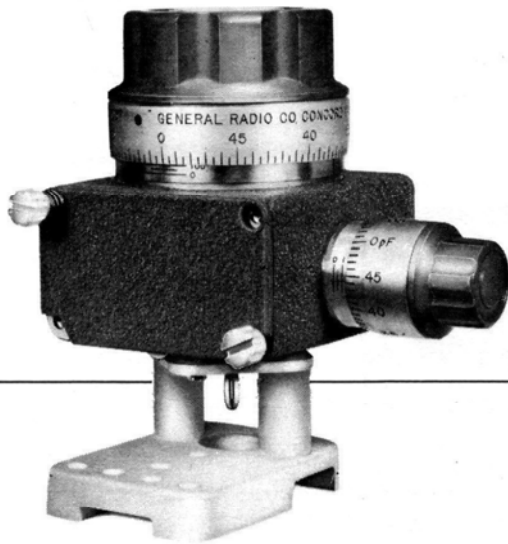

DIELECTRIC SAMPLE HOLDER

Type 1690-A

- micrometer-electrode-type for dielectric disks
- wide frequency range; fits many instruments
- calibration corrects for fringing and strays
- stable mounting, complete shielding

The 1690-A is a sample holder of the Hartshorn and Ward type,* used for the measurement of dielectric constant, dissipation factor, and volume resistivity of 2-inch-diameter, or less, disks of dielectric material in accordance with ASTM test method D-150. It is suitable for any flat sample whose largest diameter is not over 2 inches and whose thickness is not over 0.3 inch.

It can be used with resonant circuits for susceptance-variation or frequency-variation measurements, with the Types 1615-A and 716-C Capacitance Bridges, the 874-LBB and 900-LB Slotted Lines, the 1602-B and 1609 immittance meters, the 1644-A Megohm Bridge, and the 1650-B Impedance Bridge.

* L. Hartshorn and W. H. Ward, Proceedings of the Institution of Electrical Engineers, Vol. 79, pp. 597-609 (1936).

A precision micrometer screw with a large knob drives a movable grounded electrode with respect to a fixed, insulated electrode. An accurately divided drum indicates the electrode spacing. The micrometer screw is electrically shunted by a metal bellows to assure a positive, low resistance-connection. A release mechanism automatically disengages the drive to prevent damage when the electrodes are in contact. The movable electrode adjusts itself to the plane of the specimen surface.

The vernier capacitor with the micrometer screw is for use in the susceptance-variation method of measurement, and for precise C balance with low-loss samples.

The assembly is mounted in a rugged aluminum casting which shields it on four sides. Two removable cover plates, which permit access to the electrodes, complete the shielding. The holder can be mounted on either horizontal or vertical panels.

Catalog Number	Description
1690-9701	1690-A Dielectric Sample Holder
1690-9602	1690-P2 Adaptor Assembly (for connecting to GR874 coaxial equipment)

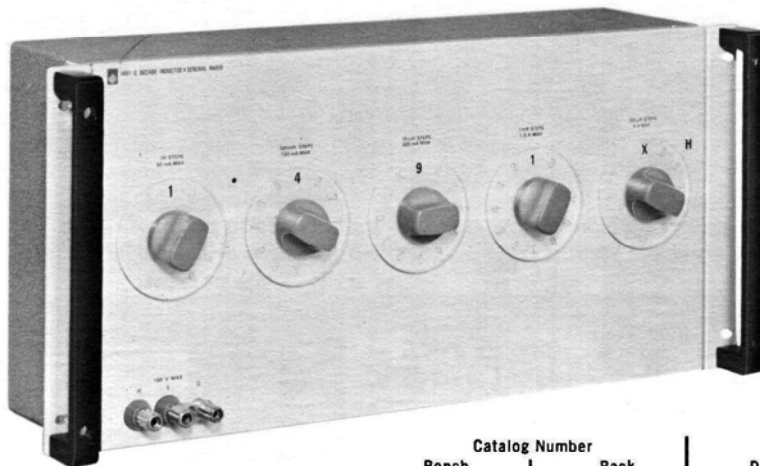

DECADE INDUCTOR

Type 1491

- high-Q
- shielded toroidal cores for small mutual inductance little effect from external fields
- sealed against moisture

Catalog Number		Description	Inductance		940's Included
Bench	Rack		Total	Steps	
Decade Inductor					
1491-9701	1491-9711	1491-A	0.111 H	0.0001 H	DD, E, F
1491-9706	1491-9716	1491-F	1.111 H	0.0001 H	DD, E, F, G
1491-9703	1491-9713	1491-C	1.11 H	0.001 H	E, F, G
1491-9707	1491-9717	1491-G	11.111 H	0.0001 H	DD, E, F, G, H
1491-9704	1491-9714	1491-D	11.11 H	0.001 H	E, F, G, H
1491-9702	1491-9712	1491-B	11.1 H	0.01 H	F, G, H

REACTANCE CHART

Always use corresponding scales

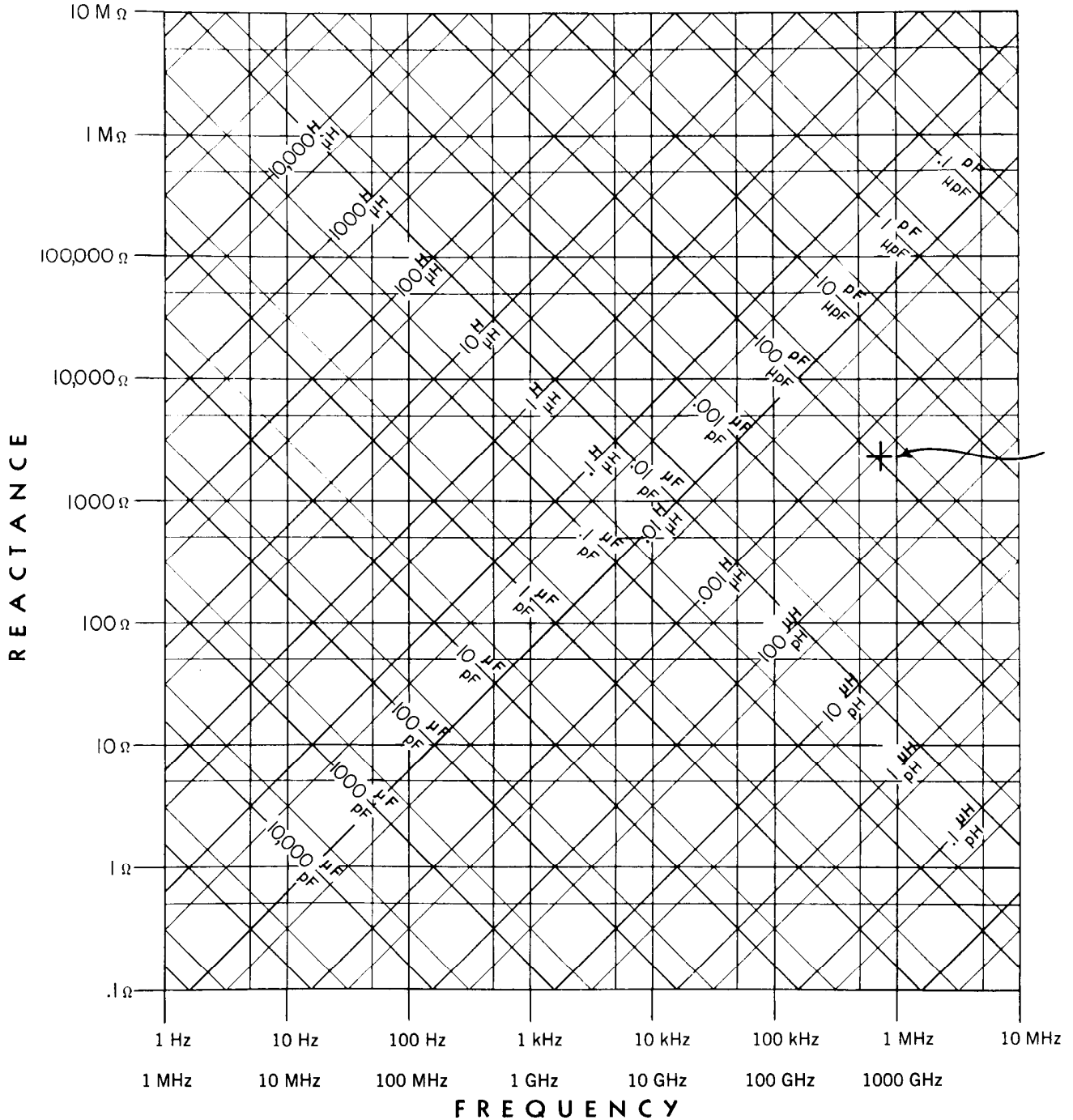

FIGURE 1

Figure 1 is the complete chart, used for rough calculations. Figure 2, which is a single decade of Figure 1 enlarged approximately 7 times, is used where two or three significant figures are to be determined.

TO FIND REACTANCE

Enter the charts vertically from the bottom (frequency) and along the lines slanting upward to the left (capacitance) or to the right (inductance). Corresponding scales

(red or black) must be used throughout. Project horizontally to the left from the intersection and read reactance.

TO FIND RESONANT FREQUENCY

Enter the slanting lines for the given inductance and capacitance. Project downward and read resonant frequency from the bottom scale. **Corresponding scales (red or black) must be used throughout.**

REACTANCE CHART

Always obtain approximate value from Figure 1 before using Figure 2

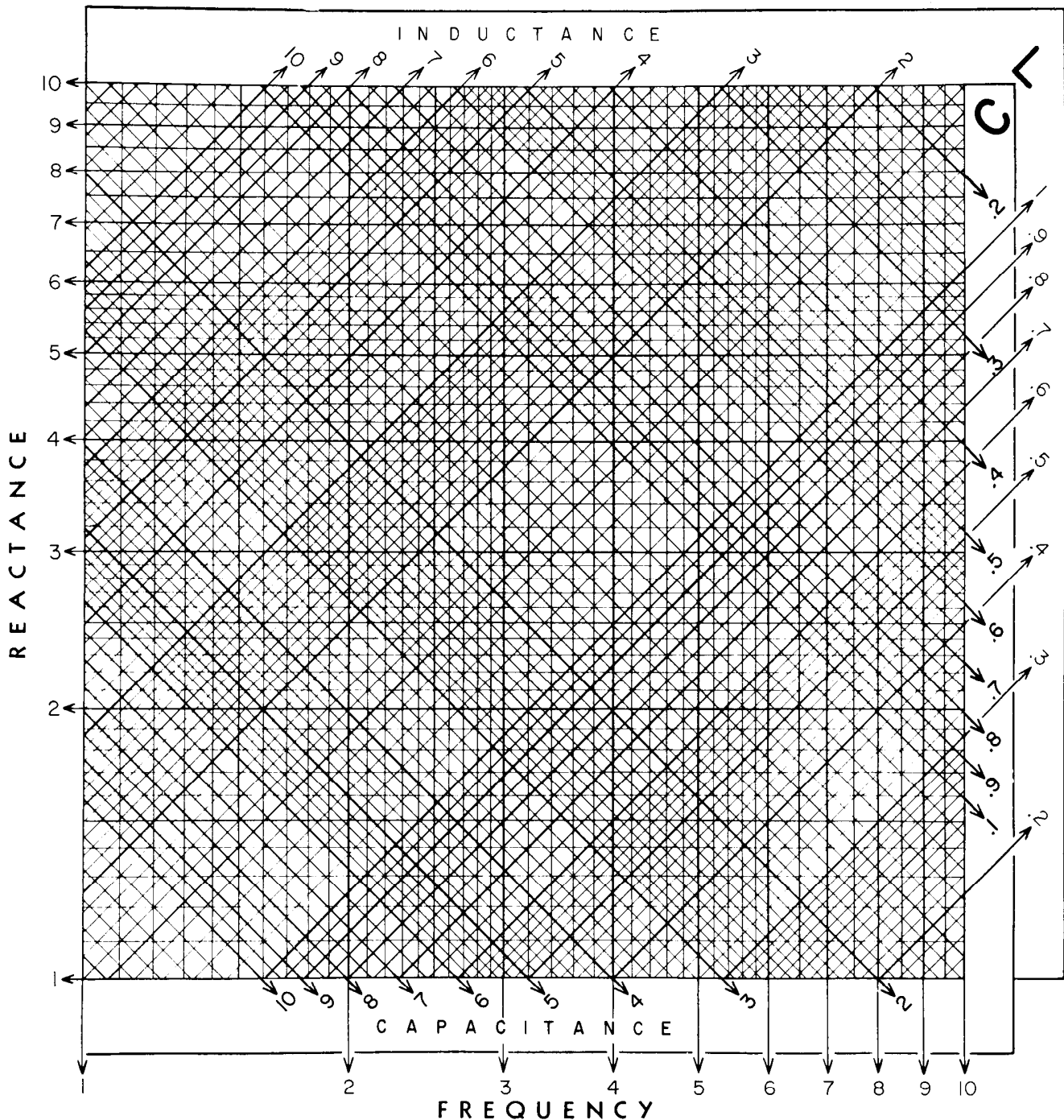

FIGURE 2

Example: The point indicated in Figure 1 corresponds to a frequency of about 700 kHz and an inductance of 500 μ H, or a capacitance of 100 pF, giving in either case a reactance of about 2000 ohms. The resonant frequency of a circuit containing these values of inductance and capacitance is, of course, 700 kHz, approximately.

USE OF FIGURE 2

Figure 2 gives additional precision but does not place the decimal point, which must be located from a preliminary

entry on Figure 1. Since the chart necessarily requires two logarithmic decades for inductance and capacitance for every single decade of frequency and reactance, unless the correct decade for L and C is chosen, the calculated values of reactance and frequency will be in error by a factor of 3.16. In Figure 2, the capacitance scale is red; inductance scale is black.

Example: (Continued) The reactance corresponding to 500 μ H or 100 pF is 2230 ohms at 712 kHz, their resonant frequency.

GENERAL RADIO

WEST CONCORD, MASSACHUSETTS 01781
617 369-4400

SALES AND SERVICE

ALBUQUERQUE	505 265-1097	DAYTON	513 434-6979	*LOS ANGELES	714 540-9830
ANCHORAGE	907 279-5741	DENVER	303 447-9225	*NEW YORK (NY)	212 964-2722
ATLANTA	404 633-6183	DETROIT	313 261-1750	(NJ)	201 943-3140
BOLTON	617 779-5562	GREENSBORO	919 288-4316	PHILADELPHIA	215 646-8030
BOSTON	617 646-0550	GROTON	203 445-8445	ROCHESTER	315 454-9323
BRIDGEPORT	203 377-0165	HARTFORD	203 658-2496	SAN DIEGO	714 540-9830
BURBANK	714 540-9830	HOUSTON	713 464-5112	*SAN FRANCISCO	415 948-8233
*CHICAGO	312 992-0800	HUNTSVILLE	800 241-5122	SEATTLE	206 747-9190
*CLEVELAND	216 886-0150	INDIANAPOLIS	317 636-3907	SYRACUSE	315 454-9323
COCOA BEACH	800 241-5122	LONG ISLAND	201 934-3140	*WASHINGTON,	
*DALLAS	214 637-2240			BALTIMORE	301 881-5333

INTERNATIONAL DIVISION

WEST CONCORD, MASSACHUSETTS 01781, USA

*ARGENTINE and PARAGUAY Coasin S.A. Buenos Aires	HONG KONG and MACAU Gilman & Co., Ltd. Hong Kong, B.C.C.	PERU Importaciones y Representaciones Electronicas S.A. Lima	*GENERAL RADIO COMPANY (OVERSEAS) P.O. Box 124, CH-8034, Zürich, Switzerland		
*AUSTRALIA Warburton Franki Industries Pty. Ltd. Sydney, Melbourne, Brisbane, Adelaide	INDIA Motwane Private Limited Bombay, Calcutta, Lucknow, Kanpur, New Delhi, Bangalore, Madras	PHILIPPINES T. J. Wolff & Company Makati, Rizal	AUSTRIA Dipl. Ing. Peter Marchetti Wien	*FRANCE General Radio France Paris, Lyon	REPUBLIC OF SOUTH AFRICA G. H. Langier & Co., Ltd. Johannesburg
*BRAZIL Ambriex S.A. Rio de Janeiro São Paulo	*JAPAN Midoriya Electric Co., Ltd. Tokyo	SINGAPORE Vanguard Company Singapore	BELGIUM Groenpol-Belgique S. A. Bruxelles	*GERMANY General Radio GmbH München, Hamburg	SPAIN Hispano Electronica S.A. Madrid
*CANADA - General Radio Canada Limited Toronto, Montreal, Ottawa	KOREA M-C International San Francisco, Seoul	TAIWAN Heighten Trading Co., Ltd. Taipei	DEMOCRATIC REPUBLIC OF THE CONGO Desco de Schuffness Zürich	GREECE Marios Dalleggio Representations Athens	SWEDEN Firma Johan Lagercrantz KB Solna
CHILE Coasin Chile Ltda. Santiago	MALAYSIA Vanguard Company Kuala Lumpur	THAILAND G. Simon Radio Company Ltd. Bangkok	DENMARK SEMCO Semler & Co. København	ISRAEL Eastronics Ltd. Tel Aviv	SWITZERLAND Seyffer & Co. A.G. Zürich
COLOMBIA Manuel Trujillo Venegas e Hijo, Ltda. Bogota 2, D. E.	*MEXICO Electronica Fredin S.A. Mexico, 10 D.F.	URUGUAY Coasin Uruguay S.A. Montevideo	EASTERN EUROPE General Radio Company (Overseas)	*ITALY General Radio Italia S.p.A. Milano	TURKEY Mevag Engineering, Trading and Industrial Corporation Istanbul
ECUADOR Suministros Technicos Ltda. Guayaquil	*NEW ZEALAND W. & K. McLean Limited Auckland, Wellington	VENEZUELA Coasin C. A. Caracas	EIRE General Radio Company (Overseas) General Radio Company (U.K.) Limited	NETHERLANDS Groenpol Industriële Verkoop N.V. Amsterdam	*UNITED KINGDOM General Radio Company (U.K.) Limited Bourne End, Buckinghamshire
	PAKISTAN Pak Land Corporation Karachi		FINLAND Into O/Y Helsinki	NORWAY Gustav A. Ring A/S Oslo	YUGOSLAVIA General Radio Company (Overseas)
				PORTUGAL Casa Serras Lisboa	

*Repair services are available at these offices.

PRINTED IN U.S.A.

GENERAL RADIO
WEST CONCORD, MASSACHUSETTS 01781