User's Reference

Publication number 16500-97023
August 1997

For Safety information, Warranties, and Regulatory
information, see the pages behind the Index.

© Copyright Hewlett-Packard Company 1987, 1990, 1993, 1994, 1996, 1997
All Rights Reserved

HP 16500C/16501A Logic Analysis System

Welcome to the Hewlett-Packard Logic Analysis System! The HP 16500C Logic Analysis System is designed to be the easiest system to use, ever. Its modular design allows you to configure it with just the measurement modules you need now, yet add other modules later.

This reference explains the operation of the System and Intermodule menus.

Part 1: HP 16500C Mainframe

This part contains mainframe reference information.

What is in the HP 16500C User's Reference?

- Chapter 1 introduces the HP 16500C by summarizing its features.
- Chapter 2 describes the System menus and how to access them.
- Chapter 3 describes the communication interfaces.
- Chapter 4 describes the flexible disk and hard disk operations, and the file system.
- Chapter 5 describes the customization options for the real-time clock, touch calibration, and screen colors.
- Chapter 6 explains how to make intermodule measurements.
- Chapter 7 guides you through connecting to the LAN the first time.
- Chapter 8 lists the instrument specifications and characteristics.
- Chapter 9 explains the general instrument maintenance and repacking information. Also included is a description of the self-test that is performed when the instrument is turned on.
- Chapter 10 describes all system and disk error messages.

Part 2: System Options

This part contains information on the optional keyboard, the HP 16501A Expansion Frame, and the HP 16505A Prototype Analyzer.

What is in the System Options?

- Chapter 11 explains the keyboard options.
- Chapter 12 describes the HP 16501A Expansion Frame option.
- Chapter 13 describes the HP 16505A Prototype Analyzer option.

Even though you may not have purchased these options yet, keep this information for possible future use.

Part 3: Common Module Operations

This part contains information common to most modules: installing modules, using symbols, and assigning labels.

What is in the Common Module Operations?

- Chapter 14 describes assigning labels.
- Chapter 15 describes using symbols.
- Chapter 16 explains the general installation of modules.

MS-DOS® is a U.S. registered trademark of Microsoft Corp.

Pentium® is a U.S. registered trademark of Intel Corporation.

PostScript™ is a trademark of Adobe Systems Incorporated which may be registered in certain jurisdictions.

UNIX® is a registered trademark in the U.S. and other countries, licensed exclusively through X/Open Company Limited.

Windows and MS Windows are U.S. registered trademarks of Microsoft Corp.

Part 1 HP 16500C Mainframe

1 What Is the HP 16500C Logic Analysis System?

| | |
|------------------------|----|
| Overview | 16 |
| Key Features | 17 |
| Optional Features | 17 |
| User Interfaces | 18 |
| Default Configurations | 18 |
| Accessories | 19 |

| | |
|---|----|
| HP 16500C Demonstrations | 20 |
| Demonstration of Cross-Domain Analysis | 21 |
| Demonstration of HP 16522 Pattern Generator | 23 |

2 Using the Menus

| | |
|---|----|
| Layout of the System Configuration Menu | 26 |
|---|----|

| | |
|-------------------------|----|
| Accessing the Menus | 27 |
| Menu Naming Conventions | 27 |
| Getting to the Menus | 28 |
| Common Menus | 29 |

| | |
|---------------------------|----|
| System Menu Functions | 30 |
| System Configuration Menu | 30 |
| System Hard Disk Menu | 31 |
| System Flexible Disk Menu | 32 |
| System Utilities Menu | 33 |
| System Test Menu | 34 |
| Intermodule Menu | 35 |

3 Configuring Communications

Protocol Settings 40

Configuring the HP-IB Interface 40

Configuring the RS-232-C Interface 41

Configuring the LAN Interface 43

Configuring the Target Control Interface 45

Configuring the 16505A Interface 45

Equipment Settings 46

Supported Printers 46

Connecting HP-IB Printers 47

Connecting RS-232-C Printers 49

Connecting Parallel Printers 51

Connecting to Other Hewlett-Packard Printers 51

Printing the Display 53

Connecting a Controller by HP-IB, RS-232-C, or HP 16505A 55

Connecting a Controller by LAN or X Window 56

Setting Up Target Control 59

4 Working with Files

Installing a Flexible Disk 66

Installing Software Upgrades 66

Selecting a Disk Operation 67

Loading a File 68

Formatting a Disk 70

Storing Files on a Disk 72

Renaming a File 74

Autoloading a File 75

Deleting a File 77

Copying a File 78

Packing a Disk (LIF only) 79

Duplicating a Disk 80

Making a Directory (DOS only) 81

Changing the Directory 82

Creating a System Flexible Disk 83

| | |
|----------------------------------|----|
| Transferring Files Using the LAN | 84 |
| Transferring Files Using NFS | 85 |
| Transferring Files Using ftp | 86 |
| The HP 16500C File System | 87 |
| Dynamic Files | 92 |

5 Customizing the Interface

| | |
|---|-----|
| The Touch, Clock, and Sound Fields | 95 |
| Touch Calibration | 95 |
| Setting the Real-time Clock | 97 |
| Turning the Sound On/Off | 98 |
| Display Color Selection | 99 |
| Setting the Color, Hue, Saturation, and Luminosity Fields | 101 |
| Returning to the Default Colors | 101 |
| Selecting Colors | 102 |

6 Correlating Measurements

| | |
|---|-----|
| Configuring a Group Run | 106 |
| Configuring Port In/Out | 108 |
| The Group Run/Stop Field | 111 |
| The Modules List | 112 |
| Status Indicators and Time Correlation Bars | 113 |
| Adjusting Skew | 114 |
| What Are Some Typical Intermodule Measurements? | 115 |
| Displaying Multiple Module Data on One Screen | 119 |
| Helpful Hints | 122 |

7 Installing the HP 16500C on your LAN

Requirements 125
Characteristics 125

Connecting and Configuring 127

Connect to your network 128
Configure the network addresses 128
Verify connectivity with the ping utility 130
Mount the Logic Analysis System 131

Troubleshooting 133

Assess the problem 134
Troubleshoot in a workstation environment 136
Troubleshoot in an MS-DOS environment 139
Troubleshoot in an MS-Windows environment 142
Verify the HP 16500C performance 145
Status Number 148
Network Status Information 151

8 General Characteristics

Characteristics 154

9 Maintaining the HP 16500C

Cleaning Requirements 160
Preparing For Use 160
Inspecting the Logic Analysis System 161
Applying Power 162
Setting the Line Voltage 162
Degaussing 163
Service and Calibration 163
The System Test Menu 164
Repackaging for Storage or Shipment 166

10 Error Messages

- Disk Error Messages 171
- Disk Warning Messages 173
- Other System Warning Messages 174
- Powerup Self-Test Documentation 175
- Fail Codes 176
- Critical Errors 177
- Non-Critical Errors 177

Part 2 System Operations**11 Using the Optional Keyboard**

- Moving the Cursor 183
- Entering Data into a Menu 184
- Using the Keyboard Overlays 186
- Defining Time Units 188
- Defining Voltage Units 188
- Assigning Edge Triggers 189
- Closing a Menu 189

12 The Optional HP 16501A Expansion Frame

- Component Details 193
- System Configuration 193
- System Power-Up 194
- System Arming and Triggering 195
- Connecting the HP 16501A Expansion Frame 197

13 The Optional HP 16505A Prototype Analyzer

- Component Details 201
- Initial System Power-Up 202

Part 3 Common Module Operations

14 Label Assignment

Label Assignment Fields 207

Rolling Labels and Pods 209

15 Symbols Assignment

Symbols Field 213

16 Installing and Removing Cards

General Installation Procedure 219

Multi-Card Module Considerations 223

Index

Part 1

The HP 16500C is the mainframe of the Hewlett-Packard Logic Analysis System. It offers a modular structure for plug-in cards with a wide range of state, timing, oscilloscope, and pattern generator capabilities. This allows you to configure the HP 16500C using only the modules you need, while giving you the flexibility to change or update later.

The HP 16500C Mainframe part of the User's Reference describes the mainframe, its menus, communication interfaces, disk drives, and customization options.

| | | |
|-----------|---|--|
| 1 | What is the HP 16500C Logic Analysis System? | |
| 2 | Using the Menus | |
| 3 | Configuring Communications | |
| 4 | Working with Files | |
| 5 | Customizing the Interface | |
| 6 | Correlating Measurements | |
| 7 | Installing the HP 16500C on your LAN | |
| 8 | General Characteristics | |
| 9 | Maintaining the HP 16500C | |
| 10 | Error Messages | |

HP 16500C Mainframe



What Is the HP 16500C Logic Analysis System?

The HP 16500C Logic Analysis System

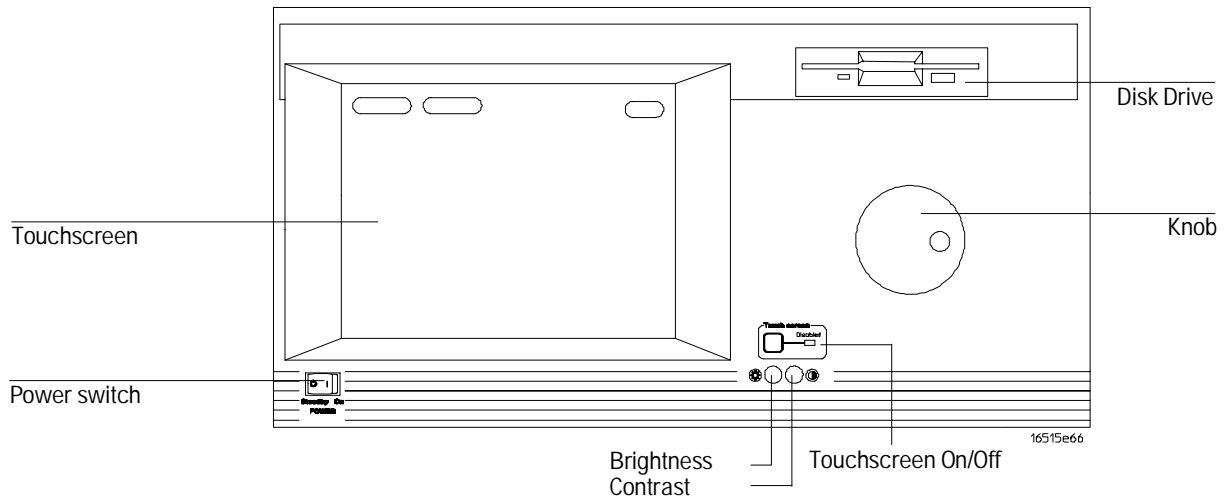

Power Switch For your convenience, there is a power switch on the front panel as well as the line switch on the rear. Both switches need to be on to operate the Logic Analysis System.

Touchscreen The dark blue fields on the screen are selectable with just a touch. To activate them, touch the field then move your finger away from the screen keeping your finger above the field.

Touchscreen On/Off This button disables the touchscreen. You can still select fields using a mouse or keyboard.

Knob Use the knob to scroll through displays or to change the values of some field.

Disk Drive The flexible disk drive accepts standard high-density or double-density disks in either LIF or DOS format.

Brightness and Contrast The brightness and contrast knobs let you adjust the screen to your liking. The left knob is brightness and the right knob is contrast.

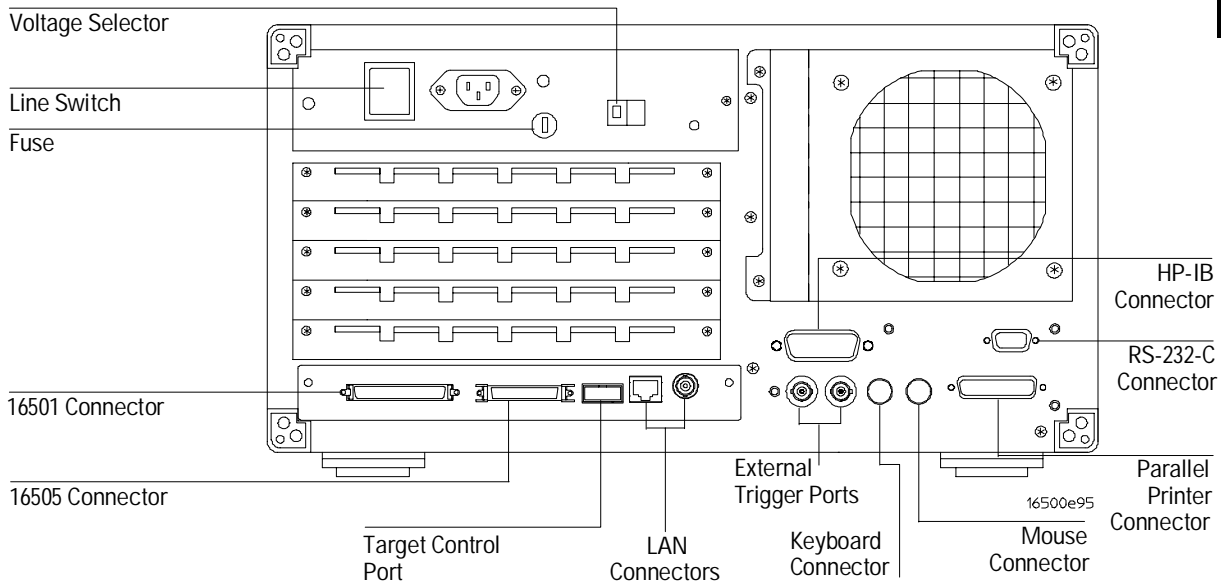

Line Power Module Voltage selector which permits selection of 110-120 or 220-240 Vac, the fuse module which contains the fuses for each of these voltage ranges, and the main power (line) switch.

HP-IB Connector Standard HP-IB connector for connecting an HP-IB printer or controller.

RS-232-C Connector Standard DB-9 type connector for connecting an RS-232-C printer or controller.

Parallel Printer Connector Standard Centronics connector for connecting a parallel printer.

LAN Connectors BNC connector for 10Base2 ("ThinLAN") and UTP connector for 10Base-T ("Ethertwist") for connecting to your local Ethernet network.

Target Control Port Lets you send signals to your device from the system and monitor activity.

HP 16505 and HP 16501 Connectors Connectors for the HP 16505 Prototype Analyzer and the HP 16501 Expansion Frame.

Overview

The HP 16500C is the mainframe of the Hewlett-Packard Logic Analysis System. It offers a modular structure for plug-in cards with a wide range of state, timing, oscilloscope, and pattern generator capabilities. This allows you to configure the HP 16500C using only the modules you need, while giving you the flexibility to change or update later.

With the intermodule capabilities of the Logic Analysis System, you can make interactive measurements between modules. This allows you to configure modules to interact with each other using the triggering capabilities of one module and the acquisition capabilities of another.

The LAN interface provides direct connection to computers located on an Ethernet local area network (LAN). The LAN interface enables you to upload measurement data for post-processing and easy access to data files.

System Options

The HP 16501 is the add-on mainframe for expanding the module capacity of the HP 16500C. When the HP 16501 is connected to the HP 16500C, they function as a single ten-module system which is turned on and controlled by the HP 16500C. The HP 16501 forms a tightly coupled system with the HP 16500C, permitting each of the two mainframes to arm or trigger any module from any other module.

The HP 16505 Prototype Analyzer acts as an analysis and display processor for the system. It works in concert with the measurement modules to provide a complete analysis environment, and allows you to set up measurements by manipulating icons. Its windowed environment also lets you see your setup and data simultaneously.

Key Features

The key features of the HP 16500C are:

- Modular mainframe with five module slots.
- 9-inch color screen.
- Touchscreen with on/off control.
- Battery-backed real-time clock.
- Programmable PORT IN and PORT OUT voltage level and edge selection.
- 3.5-inch flexible disk drive with DOS and LIF format support.
- 540 Mbyte hard disk drive with DOS format support.
- Intermodule triggering and 2-nanosecond time correlation of acquired data.
- HP-IB, RS-232-C, parallel printer, LAN, and HP 16505 interfaces.
- Target control.

Optional Features

The optional features of the HP 16500C are:

- HP 16501 Expansion Frame.
- HP 16505 Prototype Analyzer.
- Keyboard.
- Expandable system memory up to 16 Mbytes.
- Service Guide.
- Programmer's Guide.

See Also

Part 2, "System Options," for more information on available system hardware options.

User Interfaces

The HP 16500C has four user interface devices: the knob on the front panel, the touchscreen, the mouse, and the optional keyboard.

The knob on the front panel is used to move the cursor on certain menus, increment or decrement numeric fields, and to roll the display.

The touchscreen fields can be selected by touch or with the mouse or keyboard. To activate a field by touch, press a dark blue field on the display with your finger until the field changes color and then move your finger away from the screen to activate the selection. You can disable the touchscreen with the front-panel Touch On/Off button.

You can also operate the Logic Analysis System through an X Window interface. This interface acts like the front panel interface, and accepts input from your computer's mouse or keyboard.

See Also

Chapter 3, "Configuring Communications," for how to set up an X Window. Part 2, "System Options," for more information on using the optional keyboard.

Default Configurations

When the Logic Analysis System is turned on, predetermined values are automatically assigned to the different fields of the menus to configure the system for basic measurements. This allows you to make a measurement by turning on the instrument, connecting the probes, and touching the Run field. Often, only minor changes are needed for more complex measurements.

Storing Default Configurations

The default configurations may be saved on a disk for later use or restored by cycling the power. Storing default configurations on a disk is a convenient way to return to the default values without cycling the power. Default values for each module can be stored separately or together in one file.

See Also

Chapter 4, "Working with Files," for more information on the Store, Load, and Autoload operations.

Accessories

The following list of accessories is supplied with the HP 16500C Logic Analysis System. If any accessory is missing, contact your local Hewlett-Packard Sales Office.

| Accessories Supplied | Qty. |
|---|-------------|
| Training kit | 1 |
| <i>User's Guide</i> | 1 |
| <i>Setting Up the System</i> | 1 |
| Power cord | 1 |
| Disk pouch containing composite software | 1 |
| HP E2450 Symbol Download Utility software | 1 |
| Mouse | 1 |
| Filler Panels | * |

* Quantity depends on how many modules are ordered with the HP 16500C/16501A

Other accessories available for the HP 16500C/16501A Logic Analysis System are listed in the *Accessories for HP Logic Analyzers* brochure, available from your HP Sales Office.

HP 16500C Demonstrations

Your HP 16500C Logic Analysis System comes with two demonstrations available on the hard drive. These demonstrations show you some of the measurements you can accomplish with your Logic Analysis System.

The first demonstration shows a correlated measurement using an oscilloscope and a logic analyzer. It requires an HP 16534A 2-channel 2 GSa/s, 32 K Oscilloscope and an HP 16550A 100-MHz State/500-MHz Timing Logic Analyzer. This demonstration will not work with other logic analyzer modules.

The second demonstration highlights the HP 16522 200M Vector/s Pattern Generator. It requires a TTL data pod, the Training Kit board, and an HP 16550, 16554, 16555, or 16556 logic analyzer.

To run the demonstrations, the logic analyzer module should be in slot E, the pattern generator module in slot D, and the oscilloscope module in slot C.

Demonstration of Cross-Domain Analysis

This demonstration shows a typical set-up for characterizing signals on a MC68332 target system. The logic analyzer shows acquired waveforms for AS, R/_W, DS, CS, DSACK0, and DSACK1 signals so that they can be compared to the electrical specifications outlined in the MC68332 User's Manual. The Mixed Display menu focuses on the AS and R/_W signals, using markers to precisely measure the time delay between the two signals.

- 1 Make sure you have an HP 16550 Logic Analyzer in slot E and an HP 16534 Oscilloscope in slot C.**

This demonstration will not work with other models of logic analyzers or oscilloscopes.

- 2 Select the System Hard Disk menu.**

If you are unfamiliar with selecting menus, see chapter 2, "Using the Menus."

- 3 In the top directory level, highlight DEMO and touch Change Dir.**

- 4 Load DEMO_1 . _ _ into ALL.**

If you are not familiar with the Disk Drive operations, see chapter 4, "Working with Files." Because this demonstration uses the Intermodule menu, it will not work if you do not have the logic analyzer in slot E and the oscilloscope in slot C.

5 Select the 100/500 MHz LA Mixed Display menu.

The Mixed Display menu looks like the one below. To see how this measurement was set up, look at the other module menus and the Intermodule menu.

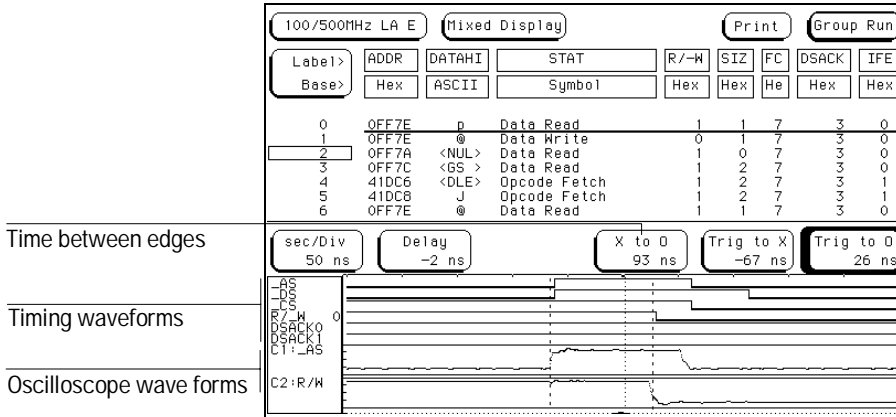

Measuring time between edges

Notice how the logic analyzer and oscilloscope waveforms are correlated with the state listing. To do this for your own measurements, turn on Count Time in the state analyzer's Trigger menu and have the logic analyzer module arm the oscilloscope module, as shown in the Intermodule menu.

Demonstration of HP 16522 Pattern Generator

This demonstration creates a 40-channel stimulus pattern which operates at clock speeds of up to 100 MHz. The stimulus pattern uses one bit as a clock signal.

- 1** Make sure you have a logic analyzer in slot E and an HP 16522 Pattern Generator in slot D.
- 2** Select the System Hard Disk menu.
If you are unfamiliar with selecting menus, see chapter 2, "Using the Menus."
- 3** In the top directory level, highlight **DEMO** and touch **Change Dir.**
- 4** Load `DEMO_2._D` into **ALL**.
If you are not familiar with the disk drive operations, see chapter 4, "Working with Files." If you have the modules in slots different than those specified in step 1, load `DEMO_2._D` into the pattern generator and `DEMO_2._E` into the logic analyzer.
- 5** If you just want to view the set up, look at the analyzer and pattern generator menus. If you want to proceed as you might for an actual measurement, continue with this procedure.

- 6** Using a TTL data pod, connect Pod 3 of the HP 16522 Pattern Generator to J4 of the Training Kit board.

You can also use ECL data pods, but you will need to change the logic analyzer to detect ECL levels.

- 7** On the Training Kit board, set the CLK1 jumper to PG.

This generates the clock signal from bit 7 of the pattern generator.

- 8** Connect Pod 1 of the logic analyzer to J1 on the Training Kit board.

- 9** Load `full_ch.txt` into **200M Patt Gen**.

- 10** In the logic analyzer menu, touch **Run Single**.

The message "MACHINE 1 — Slow or missing clock" appears since the pattern generator isn't running yet. If you don't get this message, go back to step 4 and load the configuration files.

- 11** In the pattern generator menu, touch **Run Repetitive**.

- 12** Go to the logic analyzer menu and view the listing and waveforms.

- 13** Go to the 200M Patt Gen Sequence menu, and set Pod 3's base to Binary. Notice how bit 7 changes every time, but the other bits do not change more frequently than every two times. This is because bit 7 is acting as the logic analyzer clock.



Using the Menus

The System Configuration Menu

The System Configuration menu is the first menu you see after the initial power-up of the instrument. This menu lists the modules and software options that your system is configured with and shows whether there are five module slots (the HP 16500C alone) or ten module slots (the HP 16500C with the optional HP 16501A attached) available. It also shows if the mouse or keyboard is connected. Finally, the system configuration menu gives you access to the various interfaces.

Layout of the System Configuration Menu

The figure below shows the layout of the System Configuration menu for the HP 16500C. The figure is labeled with the major features and functions of the menu.

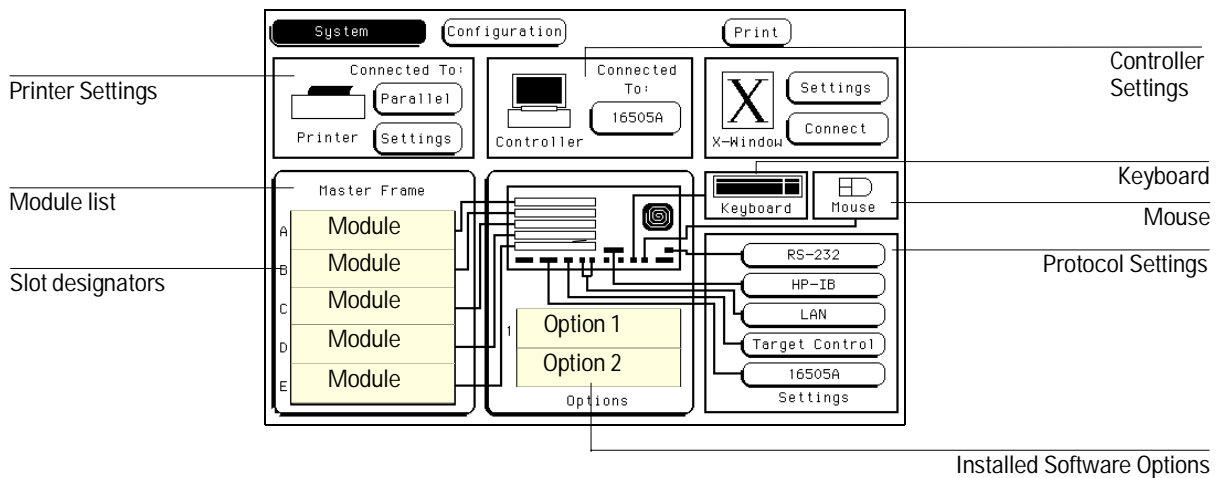

System Configuration Menu

Accessing the Menus

This section explains how the menus are named, and how you can get to any menu that the manual references based upon its name.

Menu Naming Conventions

When you turn on the Logic Analysis System, the first screen that appears after the system tests is the System Configuration menu. Menus are identified by two fields in the upper left corner. The leftmost field shows System. This field is sometimes referred to as the "module field" because it controls which module's menus you can access. The second field, just to the right of the module field, accesses specific module menus and so is called the "menu field". Menus are referred to by the titles that appear in the module and menu fields, for example, System Configuration.

The figure below shows the top of the first screen. The module field displays "System". The menu field displays "Configuration". Because menus are identified by the titles in these two fields, this menu is called the System Configuration menu. When there is no risk of confusion, the menu is sometimes just referred to by the title in the menu field, for example, the Configuration menu.

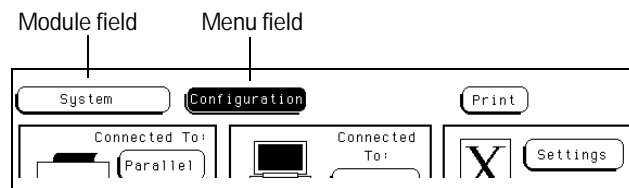

Module and Menu Fields

Getting to the Menus

HP documentation follows the convention of referring to menus by the words that appear in the module field and menu field, for example, the System Configuration menu.

To access a particular menu, follow these steps:

1 Select the module field.

A pop-up menu appears listing System, Intermodule, and the available modules.

2 Select the one you want.

The HP 16500 screen displays the last menu of this module that you accessed.

3 Select the menu field.

A pop-up menu appears listing all choices for that module.

There is no menu field in the Intermodule menu.

4 Select the one you want.

Common Menus

The following table shows common menu types for the HP 16500 modules. Not all modules of a certain type will have all the menus.

Table 2-1

Common Module Menus

| Logic Analyzer | Oscilloscope | Pattern Generator |
|-----------------------|---------------------|--------------------------|
| Configuration | Channel | Format |
| Format | Trigger | Sequence |
| Trigger | Display | Listing |
| Listing | Auto-Measure | User Macros |
| Waveform | Marker | |
| Mixed Display | Calibration | |
| Compare | | |
| Chart | | |

System Menu Functions

This section briefly describes what each System menu is used for. It shows a picture, and tells you what functions the menu performs. For a detailed description, see the chapter mentioned in the "See Also."

System Configuration Menu

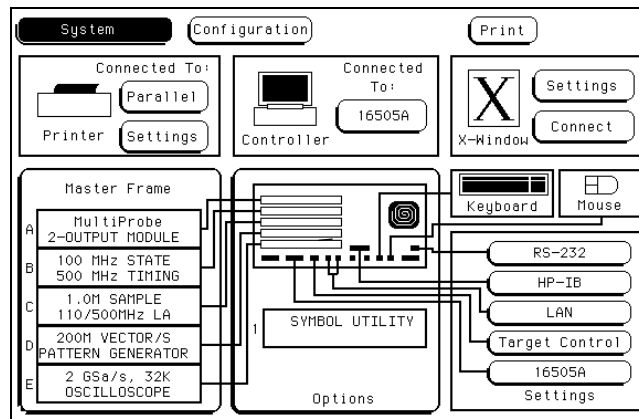

System Configuration Menu

The System Configuration menu appears when you turn on the instrument. The picture provides a quick visual check that all installed modules and peripherals are functioning. A missing icon, such as no module listed for a slot or no mouse icon, means no device was detected at that connection. A module labeled "Unrecognized Card" means that a module was detected but the Logic Analysis System could not locate the proper software or that the card is not seated properly.

The System Configuration menu is also used to configure the Logic Analysis System to work with your particular communication protocols and to set up the Target Control Port. From the System Configuration window, you can also initiate an X Windows session.

See Also

Chapter 3, "Configuring Communications," for information on setting up the communication protocols.

System Hard Disk Menu

| | | | | | |
|---|--|--------------------------|--|----------------------|--|
| System | | Hard Disk | | Print | |
| Store | | System | | to file: BACKUP .___ | |
| file description: | | SYSTEM BACKUP SETTINGS | | | |
| Change Dir. | | file type: 16500B_system | | Execute | |
| DOS Filename Date Time Bytes File Description | | | | | |
| .. 12Sep90 0:00:40 0 DIRECTORY | | | | | |
| PVTEST_ 90ct90 17:39:50 270336 HP16500C System Test Prog V01.za | | | | | |
| SYSTEM 90ct90 17:39:32 685312 HP16500C System Software V01.za | | | | | |
| SYS_004 90ct90 18:33:24 471040 4 GHz Timing/1 GHz State V01.za | | | | | |
| SYS_014 7May96 14:34:02 404736 32K Deep, G5a/s Scope V01.za | | | | | |
| SYS_025 90ct90 18:36:00 395520 200MHz Pattern Generator V01.za | | | | | |
| SYS_034 7May96 14:36:42 1060608 1M SAMPLE LA V01.za | | | | | |
| TMP_025 90ct90 18:30:12 0 DIRECTORY | | | | | |
| PWD: \SYSTEM | | | | | |
| DOS Disk Space(bytes) - Total: 544,997,376 Free: 541,310,976 | | | | | |

System Hard Disk Menu

The System Hard Disk menu allows you to do file operations on the hard disk. The logic analyzer provides the same file management capabilities you would expect on a computer.

When you receive your logic analyzer, your hard drive is already formatted in standard DOS format and contains two directories, SYSTEM and DEMO. The SYSTEM directory contains all the logic analyzer software and should never be deleted. For your own safety, make a copy of the SYSTEM directory on flexible disks. The DEMO directory contains sample configuration and data files to show you some of the capabilities of your Logic Analysis System.

See Also

Chapter 4, "Working with Files," for instructions on how to work with files, including how to load demo files.

System Flexible Disk Menu

| System | | Flexible Disk | | Print | |
|---|----------|---------------|----------|------------------|----------------------------------|
| Load | | All | | from file ICPU32 | |
| file type: inverse_assem | | | | Execute | |
| LIF | Filename | Date | Time | Blocks | File Description |
| CH03 | | 24Jun93 | 10:46:06 | 99 | Compare Exercises |
| CH05 | | 24Jun93 | 10:46:06 | 98 | Patl. Gen. Exercises (ST config) |
| CH06 | | 24Jun93 | 10:46:06 | 99 | Mixed Mode Exercises |
| CH08A | | 24Jun93 | 10:46:06 | 99 | IMB Exercises(State/Time config) |
| CH08B | | 24Jun93 | 10:46:06 | 269 | IMB Exercises(1 G5a Scope CFG) |
| CH09 | | 24Jun93 | 10:46:06 | 99 | Multi-level State Triggering Ex. |
| I80960 | | 24Jun93 | 10:46:07 | 722 | i80960 Waveform/Symbols |
| ICPU32 | | 24Jun93 | 10:46:07 | 54 | CPU32 Disassembler 2.0 |
| MOTOROLA | | 24Jun93 | 10:46:07 | 720 | 68332 Disassembled Data |
| POW_UP0 | | 24Jun93 | 10:46:07 | 5 | Power Up Configuration, System |
| POW_UP1 | | 24Jun93 | 10:46:08 | 98 | Power Up Configuration, Sta/time |
| POW_UP2 | | 24Jun93 | 10:46:08 | 51 | Power Up Configuration, 4 GHz |
| POW_UP3 | | 24Jun93 | 10:46:08 | 11 | Power Up Configuration, Pat Gen |
| POW_UP5 | | 24Jun93 | 10:46:08 | 269 | Power Up Configuration, 16Sa Osc |
| LIF Disk Space(blocks) - Total: 3060 Free: 269 Largest: 269 | | | | | |

System Flexible Disk Menu

The System Flexible Disk menu allows you to do file operations on a flexible disk. It supports the same operations as the System Hard Disk menu, and also allows you to duplicate disks.

When you select the Flexible Disk menu, the logic analyzer attempts to read the flexible disk drive. If there is no disk in the drive, the screen displays NO DISK in large letters. To get the logic analyzer to read the flexible disk after you have entered the menu, spin the knob or make a menu selection.

See Also

Chapter 4, "Working with Files," for instructions on how to work with files.

System Utilities Menu

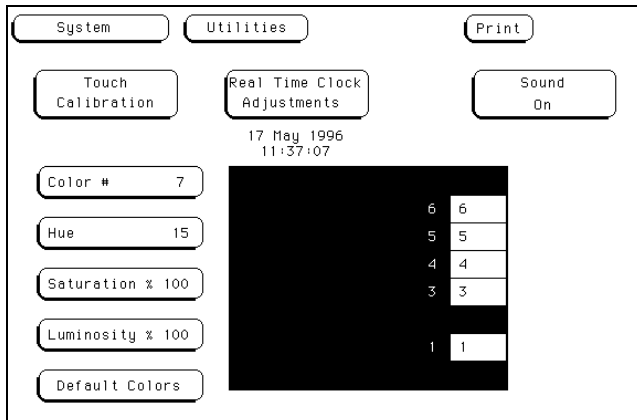

System Utilities Menu

The System Utilities menu is used for turning the sound on and off, calibrating the touchscreen, setting the clock, and changing the instrument's default colors.

See Also

Chapter 5, "Customizing the Interface" for instructions on how to adjust the various aspects.

System Test Menu

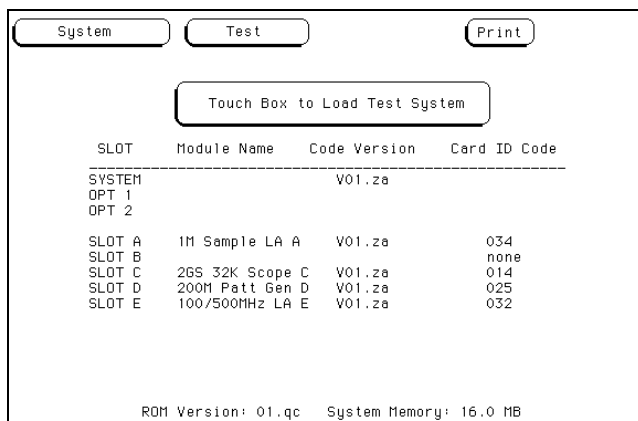

System Test Menu

The System Test menu has two uses. First, it is a quick way to see what version of the system software each part of the Logic Analysis System is using. This can be important when using software options.

Second, the System Test menu loads the Performance Verification tests. These tests run simple checks on the Logic Analysis System's hardware.

See Also

Chapter 9, "Maintaining the HP 16500C" for more information on running Performance Verification tests.

Intermodule Menu

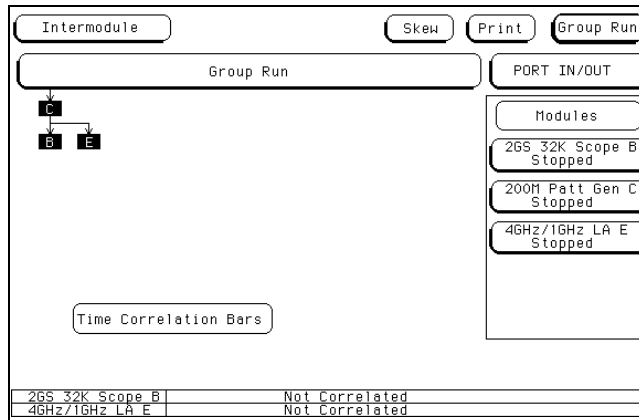

Intermodule Menu

The Intermodule menu is used to set up correlated measurements between different modules in the Logic Analysis System. When modules are correlated in the Intermodule menu, you can display their measurements at the same time on a single screen. This screen also shows the current status (Running, Waiting, or Stopped) of all modules.

The basic functions of the Intermodule menu are:

- Set up modules to run simultaneously or in a specified sequence.
- Synchronize the Logic Analysis System with external equipment.
- Adjust skew between modules.

See Also

Chapter 6, "Correlating Measurements" for how to set up correlated measurements.



Configuring Communications

The Communications Interfaces

This chapter describes the communications interfaces and their configurations. It describes the settings for each protocol, and how to set up a printer, controller, X Window, and the target control port.

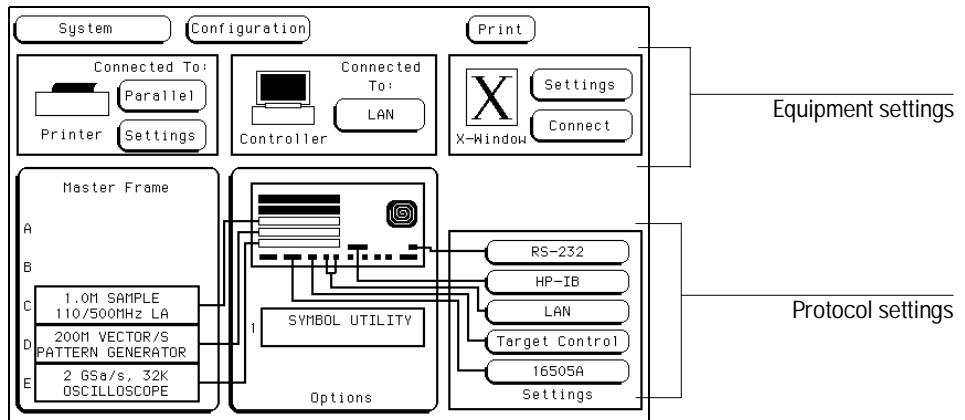

Settings of the System Configuration Menu

The Controller Interface

The controller interface gives you remote access for running measurements, for uploading and downloading configurations and data, and more. The HP 16500C can be controlled from a standard RS-232-C, HP-IB, or Ethernet connection, or by means of an HP 16505 Prototype Analyzer. The controller interface is explained in more detail in the *HP 16500C/16501A Programmer's Guide*. This chapter provides information on settings.

The Printer Interface

The HP 16500C Logic Analysis System can output its screen display directly to printers supporting HP PCL (Printer Control Language) or Epson standard command set. You can connect your printer to the Logic Analysis System using HP-IB, RS-232-C, or the parallel printer port. The HP 16500C can only print to printers directly connected to it. It cannot print to a networked printer.

The X-Window Interface

The X-Window interface allows you to connect to a computer supporting the X Window System. To use this interface, you must have the HP 16500C on your local network. Once the X Window is connected, you can control the Logic Analysis System through the X Window.

The Target Control Interface

The target control port allows you to send signals to the device under test and to detect activity on the target's control lines. Outgoing signals are set up in the target control interface. Target control is not intended to function like a pattern generator, but more like a control switch on the device.

Protocol Settings

The protocol settings are generally configured independently of the equipment. The HP 16500C Logic Analysis System supports four protocols: RS-232-C, HP-IB, Ethernet LAN, and a special protocol for the HP 16505A Prototype Analyzer.

Configuring the HP-IB Interface

The Hewlett-Packard Interface Bus (HP-IB) is Hewlett-Packard's implementation of IEEE Standard 488-1978, "Standard Digital Interface for Programmable Instrumentation." HP-IB is a carefully defined interface that simplifies the integration of various instruments and computers into systems. It uses an addressing technique to ensure that each device on the bus (interconnected by HP-IB cables) receives only the data intended for it. To accomplish this, each device is set to a different address and this address is used to communicate with other devices on the bus.

Setting an HP-IB Address

The HP-IB address can be set to 31 different HP-IB addresses, from 0 to 30. Simply choose an address that is compatible with your device or software. The default is 7.

- 1** Select the **HP-IB** field in the **Settings** group.
- 2** Enter an HP-IB address in the field directly under "HP-IB Address."
- 3** When you are finished configuring the HP-IB Address, select **Done**.

Configuring the RS-232-C Interface

The RS-232-C interface is Hewlett-Packard's implementation of EIA Recommended Standard RS-232-C, "Interface Between Data Terminal Equipment and Data Communications Equipment Employing Serial Binary Data Interchange." This interface sends data one bit at a time, and characters are not synchronized with preceding or subsequent data characters. Each character is sent as a complete entity without relationship to other events.

Baud Rate

The baud rate is the rate at which bits are transferred between the interface and the peripheral. The baud rate must be set to transmit and receive at the same rate at both ends, or data cannot be successfully transferred. The default value is 9600 baud.

Stop Bits

Stop bits are used to identify the end of a character. The number of stop bits must be the same at both ends. The default value is 1.

Parity

The parity bit detects errors as incoming characters are received. If the parity bit does not match the expected value, the character is assumed to be incorrectly received. The action taken when an error is detected depends on how the interface and the device program are configured.

Parity is determined by the requirements of the system. The parity bit may be included or omitted from each character by enabling or disabling the parity function. The default value is None, or no parity checking.

Protocol

Protocol governs the flow of data between the instrument and the external device. The Logic Analysis System supports None and Xon/Xoff.

With less than a 5-wire interface, selecting **None** does not allow the sending or receiving device to control how fast the data is being sent. No control over the data flow increases the possibility of missing data or transferring incomplete data. With a full 5-wire interface, selecting **None** allows a hardware handshake to occur. With a hardware handshake, hardware signals control data flow. The HP 24542G cable allows the HP 16500C to support hardware handshake.

Xon/Xoff stands for Transmit On/Transmit Off. With this mode, the receiver controls the data flow and can request that the sender stop data flow at any time. Xon/Xoff is the default value.

Data Bits

Data bits are the number of bits sent and received per character that represent the binary code of that character. The HP 16500C supports the 8-bit binary code.

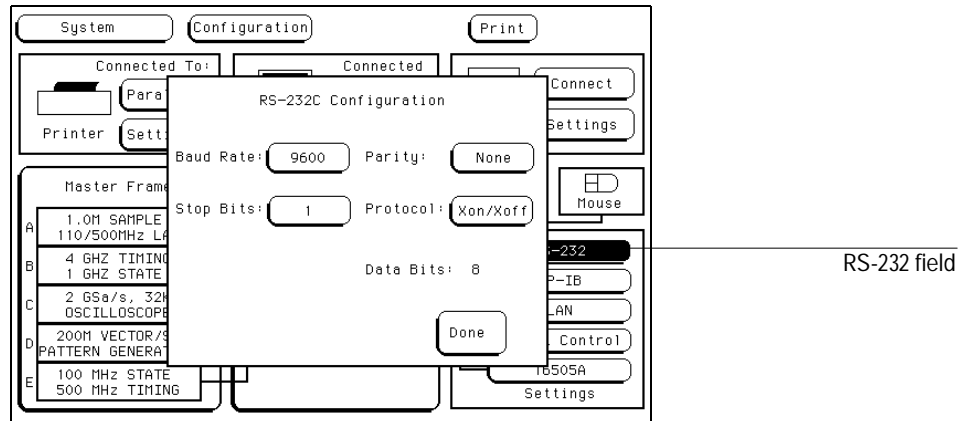

RS-232-C Settings Menu

- 1 Select the **RS-232** field in the Settings group.
- 2 When the pop-up menu appears, select the appropriate field.
- 3 When the list appears, select the value you want from the list displayed in the pop-up.
See the descriptions on the preceding page for what the values mean.
- 4 Select **Done**.

Configuring the LAN Interface

The LAN interface is Hewlett-Packard's implementation of IEEE standard 802.3 (ISO 8802-3), "Carrier Sense Multiple Access with Collision Detection (CSMA/CD) Access Method and Physical Layer Specifications." This network protocol is commonly referred to as Ethernet. To use the HP 16500C on a LAN, you must set several values.

Lan Port

There are two ports for connecting the Logic Analysis System to a LAN. **LAN TP** is for a twisted pair network, sometimes known as ethertwist or 10Base-T. **LAN BNC** is for a coaxial cable network, sometimes known as thinlan or 10Base2. The LAN Port field toggles between these two ports. Select the field that matches your LAN network and the connector you are using.

Analyzer IP Address

This is the IP address that the Logic Analysis System will respond to, and must be unique on the network. If you need to create an IP address, contact your system administrator. Enter the address for the HP 16500C in this field.

Gateway IP Address

The gateway IP address is only necessary if the host computer and HP 16500C are on different subnets. Use the address of the gateway nearest the logic analyzer between the analyzer and the host. Your system administrator should be able to provide this information.

File Timeout

The file timeout is the amount of time the Logic Analysis System will keep a file in memory. If you are transferring 1 M of data, the file timeout must be larger than if you are transferring 4 K of data. The file timeout can also affect the network timeout. Generally, 1.5 seconds is a good value.

Analyzer name

You can assign a name to the Logic Analysis System. It does not have to be the same as the IP alias, although you could set it to that. This name shows up in the X Window title bar and in ASCII files created by the system.

Help with . . .

These buttons provide additional information on the LAN settings screen, hosts table, and PC settings.

Show LAN Connections

This button pops up a list of all connections to the HP 16500C, and some information as to the type of connection. An IP address followed by "0.0" is an X Window connection. A line beginning with FTP is an ftp connection. PARSER SOCKET is a telnet connection. A straight IP address or computer name is an NFS client.

Ethernet Statistics

This button pops up a display showing the system's Ethernet address, the subnet mask, and transmit and receive statistics on the current session, which may be helpful for troubleshooting. These fields are not configurable. To bring up the Lan Settings menu, select the **LAN** field in the Settings group.

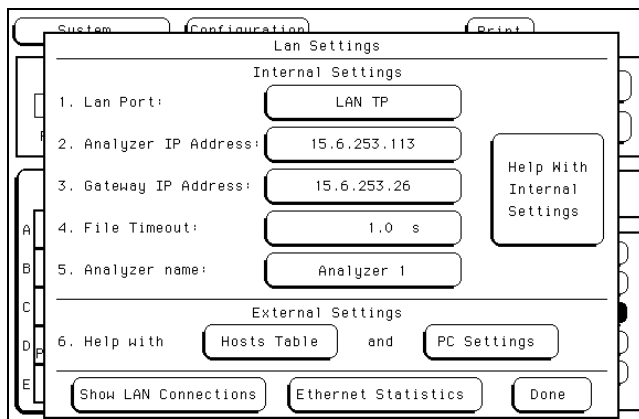

LAN Settings menu

See Also

Chapter 7, "Installing the HP 16500C on Your LAN" for detailed instructions, and "Connecting a Controller by LAN or X Window" later in this chapter for how to control the Logic Analysis System via LAN.

Configuring the Target Control Interface

The Target Control Interface is the same as the signal settings. Because most of the time you set up the signals as part of using target control, the signal settings are covered in "Setting up Target Control" later in this chapter.

To access the Target Control Signal Settings menu,

- 1 Select the **Target Control** field in the Settings group.
- 2 Select the signal you want to configure.
- 3 Select **Modify Signal**.

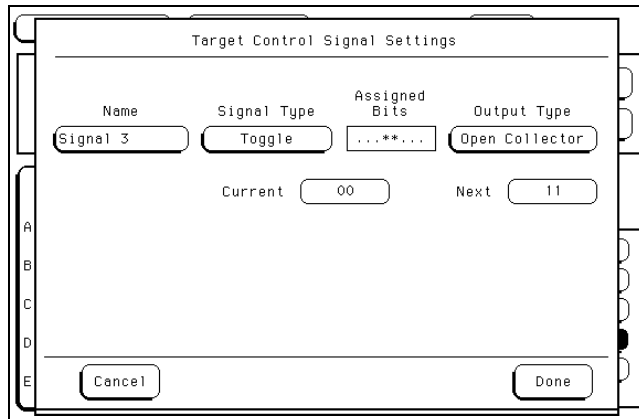

Target Control Signal Settings Menu

Configuring the 16505A Interface

The 16505A address can be set to any value between 0 and 5. The 16505A address should be 5 if you're using a preprocessor. When only a single HP 16500 system is being used with an HP 16505 Prototype Analyzer, the value of the 16505 address does not matter.

- 1 Select the **16505A** field in the Settings group.
- 2 Enter an address in the field directly under "16505A Address."
- 3 When you are finished configuring the address, select **Done**.

Equipment Settings

The equipment settings are settings specific to the type of peripheral you are connecting to. Some peripherals, such as the HP 16501A Expansion Frame, do not require any additional settings.

The HP 16500C can output its screen display to various HP-IB and RS-232-C graphics printers. Configured menus, waveforms, and other data can be printed for complete measurement documentation. It cannot print to a network printer.

The HP 16500C can also be controlled remotely from a computer or an HP 16505 Prototype Analyzer.

Supported Printers

Hewlett-Packard has tested the HP 16500 with the printers below. If a printer does not appear in this list, it means it was not tested.

| | |
|---------------------------|-----------------------------|
| DeskJet Plus | LaserJet 2D |
| DeskJet 500C ¹ | LaserJet 3 ² |
| DeskJet 520 | LaserJet 4 |
| DeskJet 560C | LaserJet 4L |
| DeskJet 660C | LaserJet 4 Plus |
| DeskJet 850C | LaserJet 4MV |
| DeskJet 855C | LaserJet 4Si |
| DeskJet 1200C | LaserJet 5L |
| DeskJet 1600CM | C LaserJet ³ |
| QuietJet | PaintJet |
| ThinkJet | PaintJet XL300 ¹ |

¹ Some color distortion occurs.

² The HP LaserJet 3D does not work with the HP 16500.

³ Prints as black and white, not color.

Connecting HP-IB Printers

The HP 16500C interfaces directly with HP PCL printers supporting the printer command language or with Epson printers supporting the Epson standard command set. These printers must also support HP-IB and Listen Always modes. Printers currently available from Hewlett-Packard with these features include:

- HP ThinkJet.
- HP QuietJet.
- HP LaserJet.
- HP PaintJet.
- HP DeskJet.
- HP DeskJetC.

The printer must be in Listen Always mode when HP-IB is the printer interface. In addition, the HP 16500C HP-IB port does not respond to service requests (SRQ) when controlling a printer. The SRQ enable setting for the HP-IB printer has no effect on HP 16500C printer operation.

HP-IB Printer Setup

- 1 Turn off the HP 16500C and the printer, and connect an HP-IB cable from the printer to the HP-IB connector on the rear panel of the 16500C.**
- 2 Make sure the printer is in the Listen Always (or Listen Only) mode.**

For example, the figure at the top of the next page shows the configuration switches for an HP-IB ThinkJet printer. For the **Listen Always** mode, move the second switch from the left to the "1" position. Because the HP 16500C doesn't respond to SRQ EN (Service Request Enable), the position of the first switch doesn't matter.

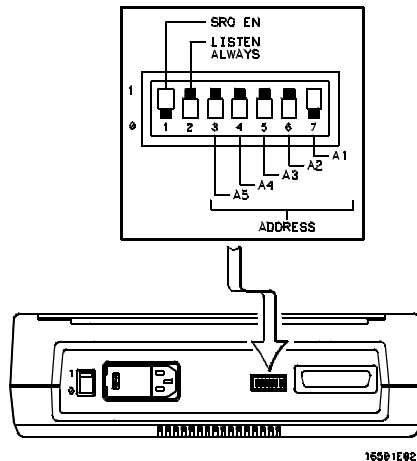

Configuration Switches for the HP ThinkJet Printer

- 3 Turn on the HP 16500C and the printer.
- 4 From the System Configuration menu, configure the HP 16500's printer settings.
 - a If the printer is not already set to HP-IB, select the field under "Connected To:" in the Printer box and choose **HP-IB** from the menu.
 - b Select the **Settings** field to the right of "Printer".
 - c When the pop-up appears, select the printer that you're using (such as ThinkJet or QuietJet). If you're using an Epson graphics printer or an Epson-compatible printer, select **Alternate**.
 - d Select the field to the right of "Print Width" and depending on your application, toggle the width to either **80** or **132**.

Print width tells the printer that you are sending up to 80 or 132 characters per line (when you Print All) and is totally independent of the printer itself.

- If you select 132 characters per line when using other than the QuietJet selection, the listings are printed in a compressed mode. Compressed mode uses smaller characters to allow the printer to print more characters within a given area.
- If you select 132 characters per line for the QuietJet selection it can print a full 132 characters per line without going to compressed mode, but the printer must have wider paper.

- If you select 80 characters per line for any printer, a maximum of 80 characters are printed per line.
- e Select the field to the right of **Page Length**. Depending on your application, toggle it to either **11** or **12**.
Page length tells the printer the page length for the type of paper you are using.
- f Select **Done** when you are finished.

Connecting RS-232-C Printers

The HP 16500C interfaces directly with RS-232-C printers, including the HP ThinkJet, HP QuietJet, HP LaserJet, HP PaintJet, HP DeskJet and HP DeskJetC printers.

- 1 Turn off the HP 16500C and the printer, and connect an RS-232-C cable (HP 24542G) from the printer to the RS-232-C connector on the rear panel of the Logic Analysis System mainframe.

If you use an HP 24542G RS-232 cable, the default settings will work. We cannot guarantee other cables.

- 2 Before turning on the printer, set the mode switches as follows:

- The HP QuietJet series printers have two banks of mode function switches inside the front cover. Push all the switches down to the "0" position as shown in the figure below.

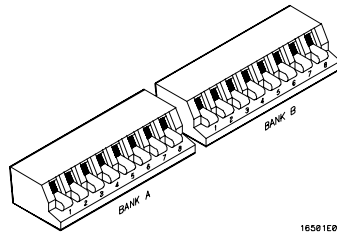

Switch Configuration for HP QuietJet Printers

- For the HP LaserJet printer, the switch settings can remain in the factory default settings.

- For the HP 2225D (RS-232 HP ThinkJet) printer, the mode switches are on the rear panel of the printer. Push all the switches down to the "0" position as in the figure at the top of the next page.

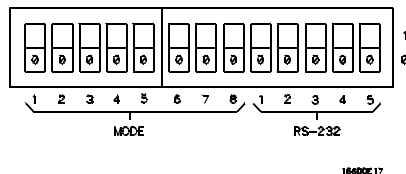

Switch Configuration for HP ThinkJet Printers

- 3 Turn on the HP 16500C and the printer.
- 4 From the System Configuration menu, configure the HP 16500's printer settings.
 - a If the printer is not already set to RS-232, select the field under "Connected To:" in the Printer box and choose **RS-232** from the menu.
 - b Select the **Settings** field to the right of "Printer".
 - c When the pop-up appears, select the printer that you're using (such as ThinkJet or QuietJet). If you're using an Epson graphics printer or an Epson-compatible printer, select **Alternate**.
 - d Select the field to the right of "Print Width" and depending on your application, toggle the width to either **80** or **132**.

Print width tells the printer that you are sending up to 80 or 132 characters per line (when you Print All) and is totally independent of the printer itself.
 - e Select the field to the right of "Page Length". Depending on your application, toggle it to either **11** or **12**.

Page length tells the printer the page length for the type of paper you are using.
 - f Select **Done** when you finished.
- 5 Select the **RS-232** field in the Settings group and check that the current settings are compatible with your printer.

See Also

For complete information on these RS-232-C interface parameters see "Configuring the RS-232-C Interface" earlier in this chapter.

Connecting Parallel Printers

There are no settings specific to the parallel printer connector.

- 1 Turn off the HP 16500C and the printer, and connect a parallel printer cable from the printer to the parallel printer connector on the rear panel of the Logic Analysis System mainframe.
- 2 Before turning on the printer, configure the printer for parallel operation.

The printer's documentation will tell you what switches or menus need to be configured.

- 3 Turn on the HP 16500C and printer.
- 4 From the System Configuration menu, configure the system's printer settings.
 - a If the printer is not already set to Parallel, select the field under "Connected To:" in the Printer box and choose **Parallel** from the menu.
 - b Select the **Settings** field to the right of "Printer".
 - c In the top field of the pop-up menu, select the type of printer you are using. If you are using an Epson graphics printer or an Epson-compatible printer, select **Alternate**.
 - d If the default print width and page length are not what you want, select the fields to toggle them.

If you select 132 characters per line when using a printer other than QuietJet, the listings are printed in a compressed mode. QuietJet printers can print 132 characters per line without going to compressed mode, but require wider paper.

- e Press Done.

Connecting to Other Hewlett-Packard Printers

The HP 16500C can also be used with other Hewlett-Packard graphics printers. Simply connect the printer to the HP 16500C using the appropriate cable (HP-IB or RS-232-C) and configure the HP 16500C as shown in the following table. The HP 16500C cannot print to printers on the local area network.

Table 3-1

HP Printer Selection

| For this HP Printer | Select this Printer from the pop-up menu |
|-------------------------|--|
| HP 2631G | QuietJet |
| HP 2671G | ThinkJet |
| HP 2673A | ThinkJet |
| HP 9876A | ThinkJet |
| HP 2932/34 (option 046) | QuietJet |

HP-IB printers must support Listen Always to work with the HP 16500C. The HP 82906A graphics printer is not supported because it does not support Listen Always on HP-IB.

The HP 2932A or HP 2934A option 046 printer is configured from the front panel of the printer, instead of with switches on the rear panel. The correct configuration for the HP 16500C is shown in the figure below.

See Also

Refer to the *HP 16500C Programmer's Guide* for information on setting up an external controller to activate the printer.

```

*****  SETTINGS  *****
*****  LIST *****  *****  MODIFY *****
PRINTER  INTERFACE  PRINTER  INTERFACE

*****  LIST INTERFACE  *****

                                HP-IB

SECONDARY COMMANDS  LISTEN ALWAYS  SERVICE REQUEST  ADDRESS  SET DEFAULTS
                   off                on                off                1

*****  END OF SETTINGS  *****
    
```

16501B01

Configuration for the HP 2932/34 Option 046

Printing the Display

Each menu has a Print field in the upper right corner. Select the Print field and a pop-up menu appears, displaying current choices. Depending on the module and menu you are printing, only some of the following choices will appear.

- **Cancel** stops the print.
- **Print Screen** prints everything shown on the screen through the connection specified in the Printer box.
- **Print All** prints all of the information listed for that display, including any listings that do not appear on the screen. These listings can be 80 or 132 characters wide, depending on the print width setting.
- **Print Partial** prints a partial range.
- **Print Line** prints lines between a designated start and end line.
- **Print Record** prints records between a designated start and end record.
- **Print Disk** prints everything shown on a single screen, or all data from the listing buffer, to either the flexible or hard disk.

Configuring a Print to Disk

When you select the **Print Disk** option, a Print to Disk configuration menu appears as shown below.

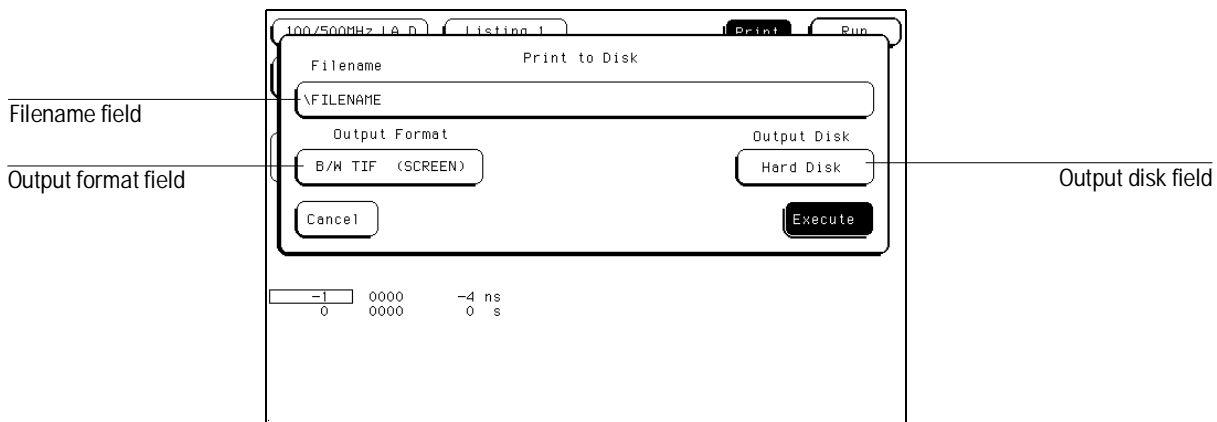

Print to Disk Menu

- 1 Select the **Filename** field, then enter a filename (**LIF**), or the path and filename (**DOS**).

If the file is stored to a DOS disk, the filename can contain a maximum of 8 characters plus a 3-character extension. If the file is stored on a LIF disk, a maximum of 10 characters can be used for the filename, and no extension is required. The filename plus any path may contain a maximum of 64 characters.

- 2 Select the **Output Format** field, then select one of the following formats:

ASCII (All) All data in listing buffer in ASCII form.

B/W TIF (Screen) The current screen in black and white with TIF format.

Color TIF (Screen) The current screen in color with TIF format.

PCX (Screen) The current screen in color with PCX format.

EPS (Screen) The current screen in black and white with Encapsulated PostScript format.

When storing to DOS disk, if you forget to add the extension, it will be added automatically according to the format type.

- 3 Select the **Output Disk** field, then select the destination disk.
- 4 Select **Execute**.

Connecting a Controller by HP-IB, RS-232-C, or HP 16505A

You can control the HP 16500C Logic Analysis System with another instrument, such as a computer running a program with embedded analyzer commands or an HP 16505 Prototype Analyzer. The steps below outline the general procedure for connecting to a controller.

- 1 Turn off both instruments, and connect the cable.**
If you are using RS-232-C, we recommend the HP 24542G RS-232 cable.
- 2 Turn on the logic analyzer and then the controller.**
- 3 In the System Configuration menu, select the field under Connected To: in the Controller box and set it appropriately.**
The figure below is for HP-IB.
- 4 If necessary, select the appropriate field in the Settings group and configure the values to be compatible with the controller.**

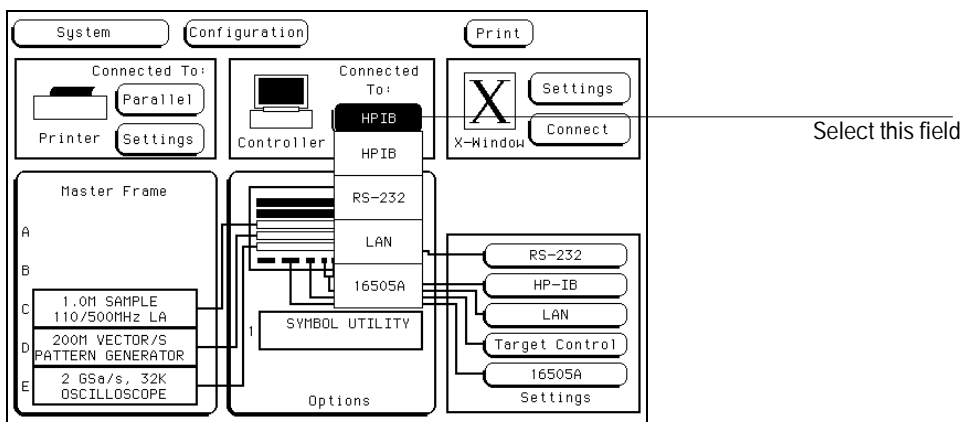

Selecting a Controller

See Also

The appropriate topics under "Protocol Settings" in this chapter for information on settings, and the *HP 16500C Programmer's Guide* for information on writing programs to control the Logic Analysis System.

Connecting a Controller by LAN or X Window

These instructions are only a general guide for controlling a Logic Analysis System that is already on your LAN. Each type of LAN is slightly different. For information on connecting to your specific LAN, see the section "Configuring the LAN Interface" earlier in this chapter, or chapter 7, "Installing the HP 16500C on Your LAN."

- 1 In the System Configuration menu, check that the LAN settings are correct and set the field under "Connected To:" in the Controller box to LAN.**

LAN settings are described in "Configuring the LAN Interface" earlier in this chapter.

- 2 Start your preferred means of communication.**

- X Window: After enabling client-initiated windows, select **Connect** in the X-Window box.
- NFS: Contact your network administrator.
- Telnet or ftp: Initiate a session from your controlling computer. If you are using telnet, be sure to specify socket 5025. If you are using ftp, log in as control.

- 3 Control the Logic Analysis System as appropriate to your connection type.**

- X Window: Use the mouse and keyboard with the X Window display to control the Logic Analysis System as though from the front panel.
- Telnet: Type programming commands in directly.
- NFS or ftp: Prepare a file containing commands, and copy it to the logic analyzer's `\system\program` file. The analyzer must be connected as control.

To load the custom fonts

- 1 From the computer running your X server software, access the HP 16500C's file system.**

Refer to the "Working with Files" chapter.

- 2 Copy the SM165.BDF and LG165.BDF files from the HP 16500C's \system\disk\hard\system directory to a directory on your computer.

These font files may also be copied from the HP 16500C Operating System media.

- 3 Set up the X server so that it can read these fonts.

Refer to your X Windows server documentation for instructions on loading and using custom fonts. Generally, the steps you will take are:

- a Compile the .BDF files into the proper format.
- b Build the font directory (FONTS.DIR) file.
- c If the font directory is not in the current font path, add the new directory to the font path.

The custom fonts make the HP 16500C's X Window interface look identical to the instrument's display. If the custom fonts are not loaded, you will see odd characters in place of arrow symbols and may see out-of-bounds text in the X Window image.

Example

Suppose the computer running your X server software is also running the UNIX operating system.

Change to the directory where you want to install the custom font files.

```
cd /users/guest/165fonts
```

As the data user, access, via FTP, the file system of the HP 16500C named lp16500c. Then, copy the SM165.BDF and LG165.BDF files from the HP 16500C's \system\disk\hard\system directory to your computer.

```
ftp lp16500c
220 HP16500B V01.00 FUSION FTP server (Version 3.3) ready.
Name (lp16500c:guest): data
230 User DATA logged in.
ftp> cd /system/disk/hard/system
200 Remote Directory changed to "/system/disk/hard/system".
ftp> get lg165.bdf
200 PORT command ok.
150 Opening data connection for lg165.bdf (15.6.253.146,1121)
(20494 bytes).
226 Transfer complete.
23338 bytes received in 0.69 seconds (32.82 Kbytes/s)
ftp> get sm165.bdf
200 PORT command ok.
```

```
150 Opening data connection for lg165.bdf (15.6.253.146,1122)
(19595 bytes).
226 Transfer complete.
22311 bytes received in 0.32 seconds (68.04 Kbytes/s)
ftp> quit
```

To create a `fonts.dir` file in the current directory:

```
mkfontdir
```

To prepend the current directory to the font path:

```
xset +fp /users/guest/165fonts
```

To reset the font path to its current value:

```
xset fp rehash
```

Close the HP 16500C's X Window interface and re-start it. You should now see the same fonts that are used on the HP 16500C's front panel display.

The `xset` commands must be repeated each time that X11 is restarted. To overcome this, simply install the fonts in the default X11 font directory, typically found in `/usr/lib/X11/fonts/misc`; this directory is usually protected, so your system administrator may have to perform the installation.

Remember to disconnect your LAN session before turning off the Logic Analysis System.

See Also

The *HP 16500C Programmer's Reference* for more information on programming commands.

Setting Up Target Control

The target control is an 8-bit input/output TTL port that allows you to control and monitor signals on the target system. The target control is intended to function like a remote control to switches on your device. It is not a miniature pattern generator. As such, signals are only sent when you select the action field.

The Current Status indicator shows the signal being put out on each line. The asterisks in the Bits column indicate which bits are assigned to which signal. Each bit can only be assigned to one signal at a time.

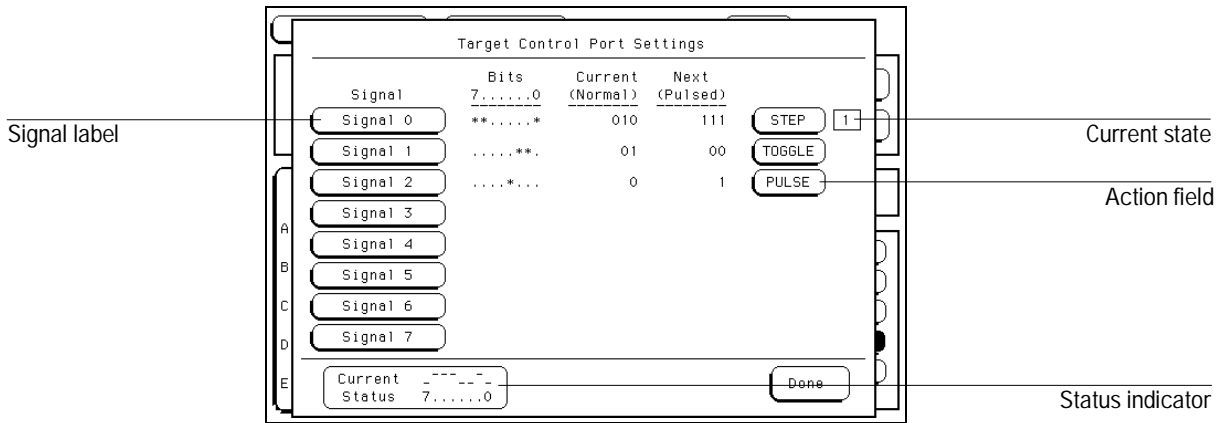

Target Control Settings Menu

Sending a Signal

- 1 In the System Configuration menu, select the **Target Control** field. A menu like the one above appears.
- 2 Select the action field in line with the signal you want to send.

The Current Status indicator changes, and the value that was in the **Next** column is now in the **Current** column, except for pulsed signals. If the action was **STEP**, the current state indicator also increments.

Modifying a Signal

The HP 16500C Logic Analysis System has eight default signals, one for each line. If you turn on all signals, you will have eight discrete toggles. This may not be suitable for all your needs, however.

To get a Target Control Signal Settings menu, select the signal you want to modify, and select **Modify Signal**. The Target Control Signal Settings menu pops up.

Each signal has five main attributes you can set. These are name, signal type, assigned bits, output type, and states. The name works like labels in a logic analyzer. Touch the field under **Name**, and type in your preferred name.

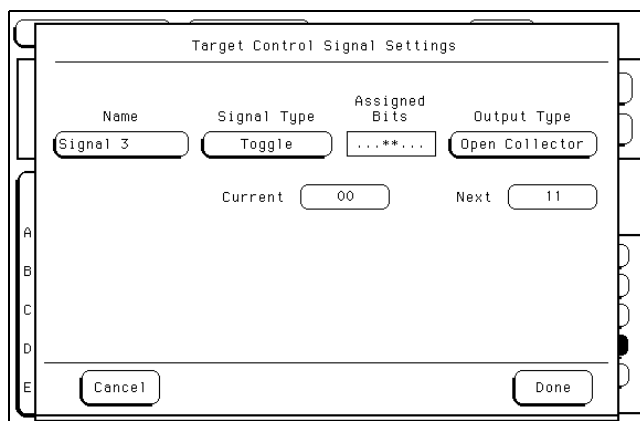

Target Control Signal Menu

Signal Type Three types of signals can be sent.

- **Toggle:** The signal toggles between two patterns when you select the action field, labeled **TOGGLE**, in the Target Control menu.
- **Pulse:** The signal sends the pattern in the **Next (Pulsed)** column for about 17 milliseconds when you select the action field, labeled **PULSE**, in the Target Control menu.
- **Sequence:** The signal steps through a sequence of up to eight states when you select the button labeled **STEP**. The current state field shows the current state. Only one step is taken per button press.

Assigned Bits You can assign any number of individual bits to a signal. (Each bit may be assigned to only one signal at a time, because it

corresponds to one physical wire.) Assigning a bit removes it from any signal it was originally assigned to. If no bits are assigned to a signal, it is automatically turned off. A "." means the bit is not assigned to this signal; an "*" means the bit is assigned.

Output Type Each signal can be configured as **Normal** (standard TTL output) or **Open Collector** (0 sinks a current of 64 milliamps and 1 is high impedance).

States The labels of the state fields depend upon the signal type. For Toggle signals, the states are **Current** and **Next**. For Pulsed signals, the states are labeled **Normal** and **Pulsed**. For Sequence signals, the states are labeled **State 0** through **State 7**. For Sequences, the **Last State** field specifies the last state to step through before starting over at State 0.

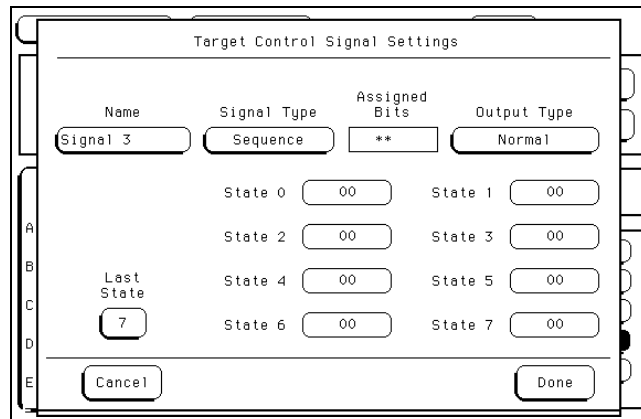

Target Control Signal Menu for a Sequence-type Signal

- 1 From the Target Control Port Settings menu, select the label of the signal you want to change.

A pop-up menu appears.

- 2 Select the appropriate field.

If you select **Modify Signal**, a Target Control Signal Settings menu appears. If you select **Turn Signal On**, the signal information appears as it was last configured. If you select **Turn Signal Off**, the signal information disappears.

You cannot turn on a signal if it does not have any bits available to it. If you try to turn on a signal that has no bits assigned to it, the Target Control Signal menu pops up.

3 In the Target Control Signal menu, change the settings as required.

If you decide not to keep the changes you have made, you can exit the menu by selecting **Cancel**. When you cancel, the changes are not saved.

4 Select Done.

When you make changes and select **Done** the signal reverts to its first state. For example, if you select **Modify Signal** for a sequence-type signal that happens to be at state 2, if you select **Done** the signal will go back to state 0. If you select **Cancel** or did not make changes but selected **Done**, the signal will remain at state 2.

Connecting Target Control

The target control cable is color-coded to help you identify lines. The black and the white lines are both ground. The line controlled by bit 0 in the Target Control menu is brown, bit 1 is red, bit 2 is orange, and so on up to bit 7 (grey).

The target control cable is also keyed, so it can be inserted only one way. Plug it in to the Target Control port on the back of the Logic Analysis System mainframe with the key up, and the cable hanging down as in the illustration below.

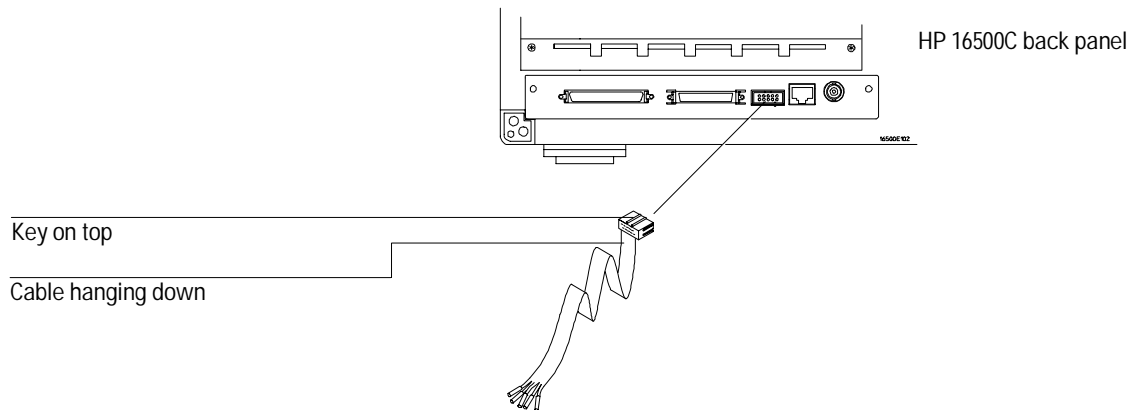

Connecting the Target Control Cable

When connecting the cable to your device, remember that open collector output requires pull-up resistors, and sinks 64 milliamps of current.



Working with Files

Using the Disk Drive Menus

The Logic Analysis System has both a 3.5-inch, double-sided, high-density or double-density, flexible disk drive and a 540-Mbyte hard disk drive built in. The flexible disk drive can read both LIF (Logical Interchange Format) and DOS (Disk Operating System) formats. The hard disk drive is formatted for a DOS file system.

This chapter describes the disk operations available in both the System Hard Disk and System Flexible Disk menus, and how to use them. It is organized into separate "How to" examples demonstrating the use of the disk menus and all the disk operations.

The Disk Operations

- Autoload

Designates a set of configuration files to be loaded automatically the next time the analyzer is turned on.

- Copy

Any file can be copied from one disk to another or to the same disk.

- Duplicate Disk

All volume labels, directories, and file positions from one disk are copied exactly to another disk. The new disk is formatted to match the source disk if it is required. All files on the destination disk will be destroyed with this operation. The hard drive cannot be duplicated. Flexible disks must be the same size.

- Format Disk

Any double-sided, double-density or high-density, 3.5-inch flexible disk can be formatted in either LIF or DOS format. The hard disk can be formatted in DOS format. The directory and all files on the disk will be destroyed with this operation. Formatting a flexible disk on the HP 16500C mainframe makes future HP 16500C disk accesses faster.

- Load

System configurations, analyzer measurement setups (including measurement data), and inverse assembler files for the analyzer can be loaded from the disk drive.

- Pack Disk

This function packs files on a LIF disk. Packing removes all empty or unused sectors between files on a disk so that more space is available for files at the end of the disk.

- Purge

Any file on a disk can be purged (deleted) from the disk.

- Rename

Any filename on a disk can be changed to another name.

- Store

Instrument system configurations and analyzer measurement setups including measurement data can be stored (saved) to either disk drive.

- Change Directory

The present working directory can be changed to any other directory on either the hard disk or flexible disk drives.

- Make Directory

New directories can be created on both the hard disk and flexible disk.

Disk Operation Safeguards

If there is a problem or additional information is needed to execute an operation, an advisory appears displaying an error message or a prompt for more information. If executing any disk operation could destroy or damage a file, a warning appears before you select Execute.

Disk Operations using the LAN

Disk operations using the LAN interface are restricted to DOS formatted disks. For more information refer to "Transferring Files using the LAN" later in this chapter.



Installing a Flexible Disk

- 1** Hold the disk so the disk label is on top and the metal auto-shutter is away from you.
- 2** Push the disk gently, but firmly, into the disk drive until it clicks into place.

You can use double-sided, double-density and double-sided, high-density disks. To display all files on any disk, insert the disk into the drive, then turn the knob.

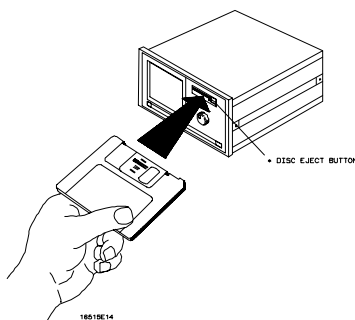

Installing a Disk

Installing Software Upgrades

- 1** In the System Hard Disk menu, copy all the files in your \SYSTEM directory to flexible disks.
See "Copying a File" in this chapter for detailed instructions on copying files.
 - 2** Insert the flexible disk containing the upgrades into the disk drive.
 - 3** In the System Flexible Disk menu, set the copy menu to copy all files to \SYSTEM on Hard Disk.
 - 4** Select **Execute**.
 - 5** Repeat steps 3 and 4 for all disks.
 - 6** Turn off the HP 16500, and then turn it on again to run the new software.
-

If you cannot run the new software, insert the flexible disk copy of the old software into the disk drive and repeat step 5.

Selecting a Disk Operation

Although some default parameters are provided, a disk operation may require new information be entered. This information is entered in the appropriate parameter fields within each disk operation menu.

- 1 Select the **Disk Operation** field.
- 2 From the pop-up menu that appears, select the desired disk operation.

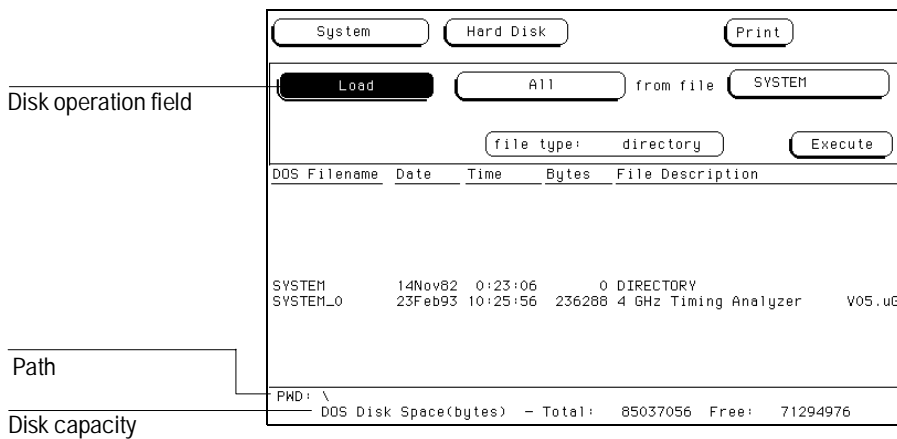

Common Fields of a Disk Operation Menu

When performing disk operations, the path and disk capacity information located at the bottom of the menu will be helpful.

DOS Formats

PWD: is the present working directory and contains the files shown.

Total: is the total memory capacity (bytes) of the flexible or hard disk.

Free: is the total memory capacity (bytes) remaining.

LIF Formats

Total: is the total memory capacity (blocks) of the flexible disk.

Free: is the total memory capacity (blocks) remaining.

Largest: is the size of the largest block remaining.

Loading a File

The Load operation allows you to load data and configuration files into the Logic Analysis System. Use this operation when you want to quickly restore the system or a module to a configuration used in a previous measurement.

- 1 Insert the source disk into the disk drive.
- 2 Select the **Load** operation.

When Load is selected, the analyzer reads the disk directory and displays a list of all files on the disk.

- 3 Select the **File type** field.

The screenshot shows a menu with the following options: System, Flexible Disk, Print, Load, 200M Patt Gen C, from file, JEFF_PRG._C, Change Dir., file type: 16522.config, and Execute. Below the menu is a table of files on the disk:

| DOS Filename | Date | Time | Bytes | File Description |
|--------------|------|------------------|--------|-------------------------|
| DEFAULT | ._A | | 58368 | DEFAULT CONFIGURATIONS |
| JEFF_PRG | ._B | 29Apr96 13:26:56 | 13568 | TEST PROGRAM |
| JEFF_PRG | ._C | 29Apr96 13:27:14 | 226816 | TEST PROGRAM |
| JEFF_PRG | ._D | 29Apr96 13:27:30 | 270848 | TEST PROGRAM |
| JEFF_PRG | ._E | 29Apr96 13:27:46 | 217600 | TEST PROGRAM |
| JEFF_PRG | ._ | 29Apr96 13:26:54 | 1792 | TEST PROGRAM |
| LABS_PG | ._A | 21Mar96 9:37:30 | 3328 | PAT GEN SETUP FOR LAB 5 |
| TEST_1 | ._A | | 87552 | TEST_1 CONFIGURATIONS |
| TEST_1 | ._ | | 1792 | TEST_1 CONFIGURATIONS |

At the bottom of the screen, it shows: PWD: \ DOS Disk Space(bytes) - Total: 1,474,560 Free: 574,976

File type field

File Type Parameter Field

4 From the pop-up menu that appears, select the desired file type.

System loads things like interface and intermodule configurations, and defaults from the Utilities menu.

The Module choices load measurement module configurations and data.

All loads both System and module configurations and data files.

5 Select the desired file name from the list by rotating the knob, or using the mouse or keyboard to type a name. As the knob is rotated, the file names are rolled into the Filename field.

The two lines (_) after the filename designates that this file is for the system. One line and a letter (for example, "_A") after the filename designates that the file is for the measurement module in that slot.

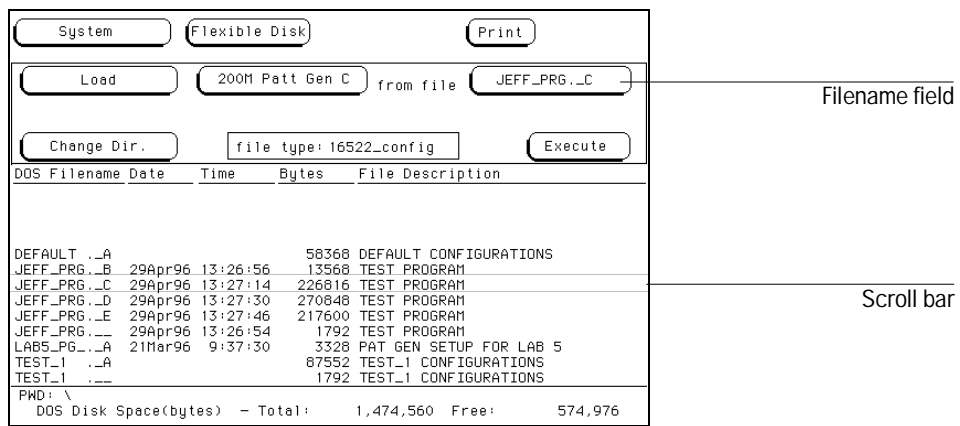

Filename Selection

6 Select the Execute field.

The disk drive indicator light illuminates as the file is being loaded.

Formatting a Disk

The Format operation initializes new flexible disks for use in the analyzer as well as reformats the hard drive. The analyzer will format double-sided, double density or high density flexible disks in both LIF and DOS formats. The analyzer does not support single-sided formats.

Formatting a DOS disk in the logic analyzer instead of in a personal computer makes accesses on that disk faster because the logic analyzer optimizes the format for its data.

The logic analyzer does not support track sparing during formatting. If a bad track is found, the disk is considered bad. If a disk has been formatted elsewhere with track sparing, it will be read successfully.

To format a flexible disk, perform the following steps:

- 1 Insert the flexible disk to format into the disk drive.**
- 2 Select Format Disk.**

When Format is selected, the disk directory is displayed. UNSUPPORTED FORMAT appears if the disk is a new, unformatted disk. This is normal; continue the format operation.

- 3 Select the Format type field, and select either LIF or DOS.**

The analyzer recognizes a variety of sector sizes for LIF disks. However, when formatting LIF disks, the analyzer only creates 1024-byte sectors. When formatting DOS disks, the analyzer creates 512-byte sectors.

- 4 Select the Size field and choose the appropriate size.**

Use **720 KByte** for double density disks, and **1.44 MByte** for high density disks. If you choose the wrong one, the disk will be badly formatted and the message UNSUPPORTED FORMAT appears when the disk directory is read.

Double-density disks have only a write protect tab. High-density disks have a write protect tab and a hole on the opposite edge of the disk.

System Flexible Disk Print

Format Disk DOS Format 1.44 MByte

Change Dir. file type: 16500C_system Execute

| DOS Filename | Date | Time | Bytes | File Description |
|--------------|---------|----------|--------|---------------------------------|
| SYSTEM | 19Jun96 | 13:26:34 | 684544 | HP16500C System Software V01.za |
| SYS_12B | 13May96 | 11:10:34 | 685824 | HP16500C System Software V01.zb |

PWD: \
DOS Disk Space(bytes) - Total: 1,474,560 Free: 87,040

Format type field

Size field

Format Selections

CAUTION

BEFORE YOU CONTINUE, be sure you are in the **FLEXIBLE DISK** menu. Because you can format both the flexible and hard disks, you always should be sure which disk menu you are in.

CAUTION

Once the format operation is executed, all files are permanently erased from the disk being formatted. This includes the **HARD DISK**. There is no way to retrieve the original information from a formatted disk.

- 5 Select the **Execute** field, then select **Continue**.

Storing Files on a Disk

The Store operation allows you to store instrument configurations and measurement data. Use this operation when you want to save the present analyzer setup for recalling at a later time. When configurations are stored to disk, you are given the option to store System only, module only, or All (System and module).

- 1 If you are storing to a flexible disk, insert the destination disk into the flexible disk drive.

- 2 Select the Store operation.

When Store is selected, the analyzer reads the disk directory and displays a list of all files on the disk.

- 3 Select the File type field.

The screenshot shows a terminal window with the following elements:

- Buttons: System, Flexible Disk, Print
- Store operation selected
- File type field: All
- to file field: SYSTEM_001
- file description field: 1 GHz Timing Analyzer V05.01
- file type: 001@16500A
- Execute button

| LIF Filename | Date | Time | Blocks | File Description |
|--------------|---------|----------|--------|----------------------------------|
| AUTOLOAD | 24Feb93 | 14:59:45 | 1 | status: ENABLED file: YYJJLOAD_? |
| SYSTEM_001 | 24Apr92 | 10:06:29 | 200 | 1 GHz Timing Analyzer V05.01 |
| SYSTEM_032 | 24Apr92 | 10:06:21 | 1696 | 100MHz State/500MHz Time V05.01 |
| YYJJLOAD_B | | | 268 | status: ENABLED file: BOOT_? |

LIF Disk Space(blocks) - Total: 3060 Free: 895 Largest: 778

Annotations on the right side of the image:

- File type field
- to file field
- file description field

Parameter Fields

- 4 From the pop-up menu that appears, select the desired file type.

System stores mainframe settings like interface and intermodule configurations, and settings from the Utilities menu.

The Module choices store module configurations and data.

All stores both System and module configurations and data files.

5 If you are storing to a new name, select the **to file field and type in the new name.**

The filename must start with a letter and may contain a maximum of eight characters. It can be any combination of letters and numbers, but there can be no blank spaces between any of the characters.

If you are storing to an existing file name, simply turn the knob to scroll existing file names through the field.

When performing disk operations, the path and disk capacity information located at the bottom of the menu will be helpful.

DOS Formats

PWD: is the present working directory and contains the files shown.

Total: is the total memory capacity (bytes) of the flexible or hard disk.

Free: is the total memory capacity (bytes) remaining.

LIF Formats

Total: is the total memory capacity (blocks) of the flexible disk.

Free: is the total memory capacity (blocks) remaining.

Largest: is the size of the largest block remaining.

6 Select the **file description field and using the pop-up keypad, type in a description of the file.**

A file description can contain up to 32 characters, but also can be left blank. This field is for your convenience to make it easier for identifying the type of data in each file.



Renaming a File

The Rename operation allows you to give a new name to a previously stored file. The only restriction is that you cannot rename a file to an existing filename.

- 1 Select the **Rename** operation.
- 2 Turn the knob until the file name you want to rename is scrolled into the **File** field.

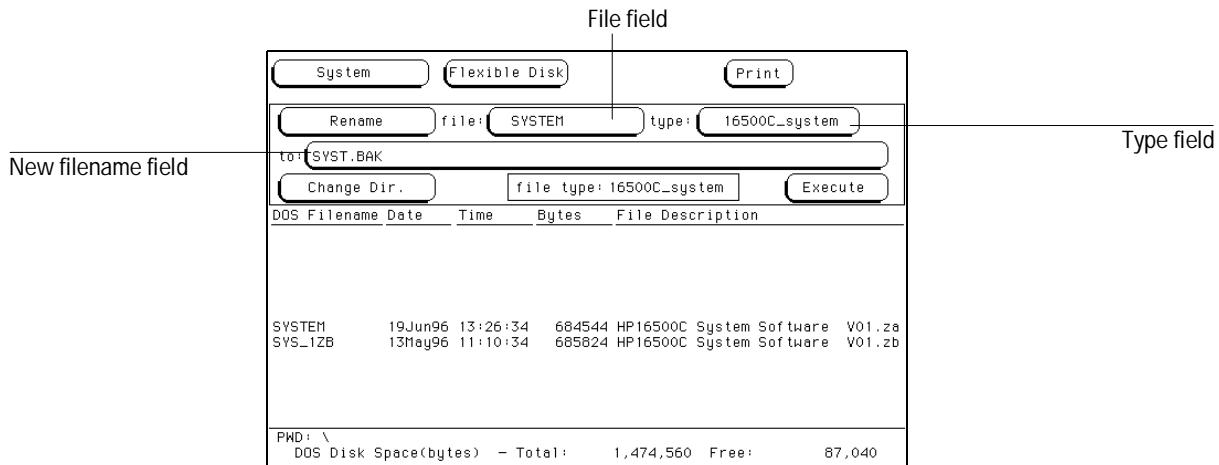

Parameter Fields for Rename Operation

- 3 Select the **Type** field. From the pop-up menu that appears, select the desired type selection.
The **All** selection allows you to rename all files with the same base name.
The **Module** selection allows only the module file type to be renamed.
- 4 Select the **New filename** field.
- 5 Using the pop-up keypad, type in the new filename, then select **Done**.

Autoloading a File

The Autoload operation allows you to designate a set of configuration files to be loaded automatically the next time the instrument is turned on. This allows you to change the default configuration of certain menus to a configuration that better fits your needs.

- 1 Select the **Autoload** operation.
- 2 Select the **Enable/Disable** field then select **Enable**.



| DOS Filename | Date | Time | Bytes | File Description |
|--------------|---------|----------|--------|------------------------------|
| SYSTEM | 14Nov82 | 0:23:06 | 0 | DIRECTORY |
| SYSTEM_0 | 23Feb93 | 10:25:56 | 236288 | 4 GHz Timing Analyzer V05.u6 |

Enable/Disable field

Autoload Enable Field

- 3 Turn the knob until the file name you want to autoload is scrolled into the file name parameter field.
- 4 Select the **Execute** field.

An autoload file is created and placed in the list of files. The file description contains the file name to be autoloaded and indicates whether or not the Autoload operation is enabled.

The screenshot shows a control panel for Autoload. At the top, there are buttons for 'System', 'Flexible Disk', and 'Print'. Below these are 'Autoload' and 'Enable' buttons, with 'File : AUTOLOAD' displayed next to them. A label 'Filename field' points to this area. The status shows 'Current AUTOLOAD status : ENABLED' and 'Current AUTOLOAD file : YYJJLOAD_?'. Below this is a 'file type: autoload_file' field and an 'Execute' button. A table lists files with columns for LIF, Filename, Date, Time, Blocks, and File Description. A label 'Autoload file' points to the table. At the bottom, it shows 'LIF Disk Space(blocks) - Total: 3060 Free: 895 Largest: 778'.

| LIF | Filename | Date | Time | Blocks | File Description |
|------------|----------|---------|----------|--------|----------------------------------|
| AUTOLOAD | | 24Feb93 | 14:59:45 | 1 | status: ENABLED file: YYJJLOAD_? |
| SYSTEM_001 | | 24Apr92 | 10:06:29 | 200 | 1 GHz Timing Analyzer V05.01 |
| SYSTEM_032 | | 24Apr92 | 10:06:21 | 1696 | 100MHz State/500MHz Time V05.01 |
| YYJJLOAD_B | | | | 268 | status: ENABLED file: BOOT_? |

Autoload Filename Field

The Autoload operation loads all files for a given file name. If you want to load only the file for a single type, rename that file to separate it from the other files and enable it as the current Autoload file.

As long as Autoload is enabled before the instrument is shut off, Autoload will remain enabled when you turn on the instrument and load the configuration files.

Deleting a File

The Purge operation allows you to delete a file from the list of file names.
The file type can be either Module or All.

- 1 Select the **Purge** operation.
- 2 Turn the knob to scroll the file name to be purged into the **file** field.

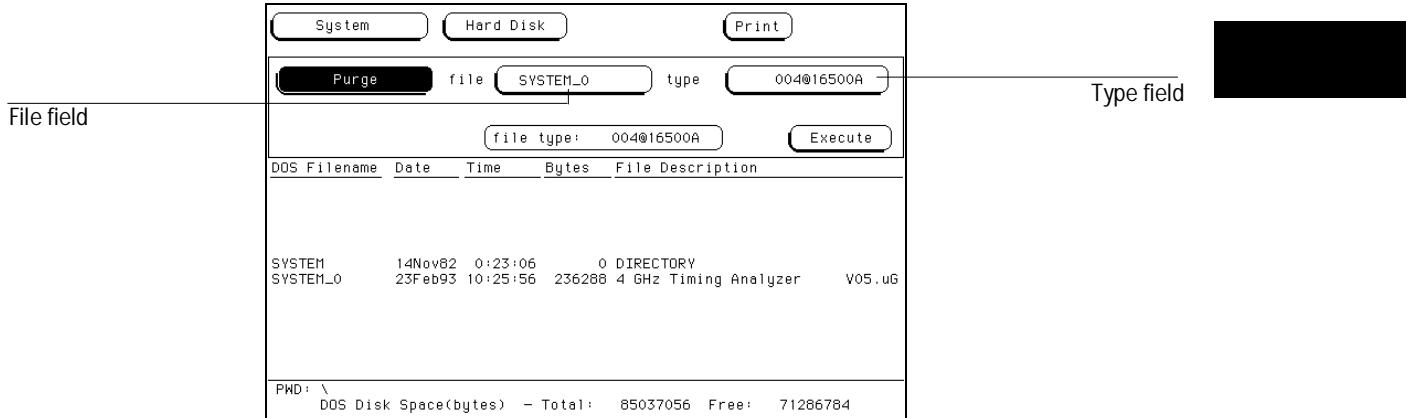

File Field and Type Field

- 3 Select the **type** field, then select the file type to purge.
The **All** selection allows you to purge both the system and module types.
The **Module** selection allows only the module type to be purged.
- 4 Select the **Execute** field, then select **Continue**.

Copying a File

The Copy operation allows you to make a duplicate copy of an existing file on the same disk or a different disk. If you copy the file to the same disk, the only restriction is that you must give the copied file a new name. You can specify to copy **All** types or just the Module part of a file.

- 1 Select the **Copy** operation.
- 2 Turn the knob until the file name you want to copy is scrolled into the **file field**.

System Hard Disk Print

Copy file: T02500C .FNC type: DOS

to: FONTS

on: Flexible Disk file type: DOS Execute

| DOS Filename | Date | Time | Bytes | File Description |
|--------------|---------|----------|-------|------------------|
| .. | 90ct90 | 18:30:12 | 0 | DIRECTORY |
| T02500C .FNC | 20May96 | 10:04:02 | 18480 | DOS FILE |
| T025MPC .DAT | 20May96 | 10:04:26 | 73760 | DOS FILE |

PWD: \SYSTEM\TMP_025
DOS Disk Space(bytes) - Total: 544,997,376 Free: 541,310,976

File field
Type field
New filename field

Copy Filename Parameter Field

- 3 Select the **Type** field, then select the desired file type.
The **All** selection copies both the system and module parts.
The other selection copies only the specified part.
- 4 Select the **New filename** field, then enter the new filename.
 - If you want to keep the old name, select **CLEAR**, then **DONE**. The old name is transferred automatically.
 - If you want a new name, type in the new name, then select **DONE**.
- 5 Select the **Execute** field.

Packing a Disk (LIF only)

By purging files from the disk and adding other files, you may end up with blank areas between files that are too small for the new files you are creating. On LIF disks, the Pack Disk operation packs the current files together, removing unused areas from between the files so that more space is available for files at the end of the disk.

If you try to use Pack Disk on a DOS-formatted disk, the disk is unaffected.

- 1 Select the **Pack Disk** operation.
- 2 Select the **Execute** field, then select **Continue**.

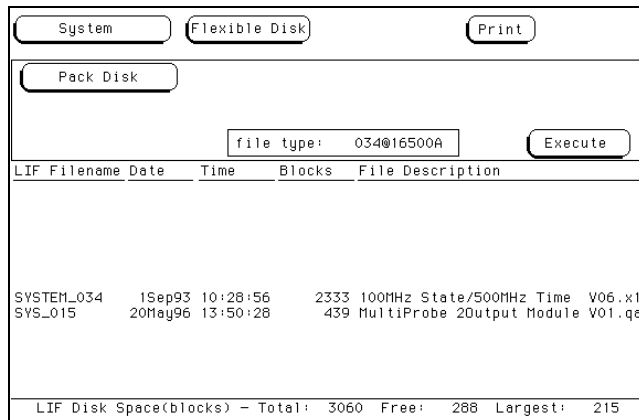

The screenshot shows a terminal window with the following elements:

- Buttons at the top: **System**, **Flexible Disk**, and **Print**.
- A **Pack Disk** button.
- A text field labeled "file type:" containing "034@16500A" and an **Execute** button.
- A table with columns: LIF, Filename, Date, Time, Blocks, File Description.
- Table content:

| LIF | Filename | Date | Time | Blocks | File Description |
|------------|----------|---------|----------|--------|----------------------------------|
| SYSTEM_034 | | 1Sep93 | 10:28:56 | 2333 | 100MHz State/500MHz Time V06.x1 |
| SYS_015 | | 20May96 | 13:50:28 | 439 | MultiProbe 2Output Module V01.qa |
- Footer text: LIF Disk Space(blocks) - Total: 3060 Free: 288 Largest: 215

Pack Disk Operation

Duplicating a Disk

The Duplicate Disk operation copies the volume labels and directories from one disk to another. If the new disk is not formatted, this operation also formats the disk. This operation allows you to make a backup copy of your important disks so you won't lose important data in the event that a disk wears out, is damaged, or a file is accidentally deleted.

CAUTION

The original directory and files on the destination disk are destroyed by the **Duplicate Disk** operation.

- 1 Select the **Duplicate Disk** operation.
- 2 Select the **Execute** field, then select **Continue**.

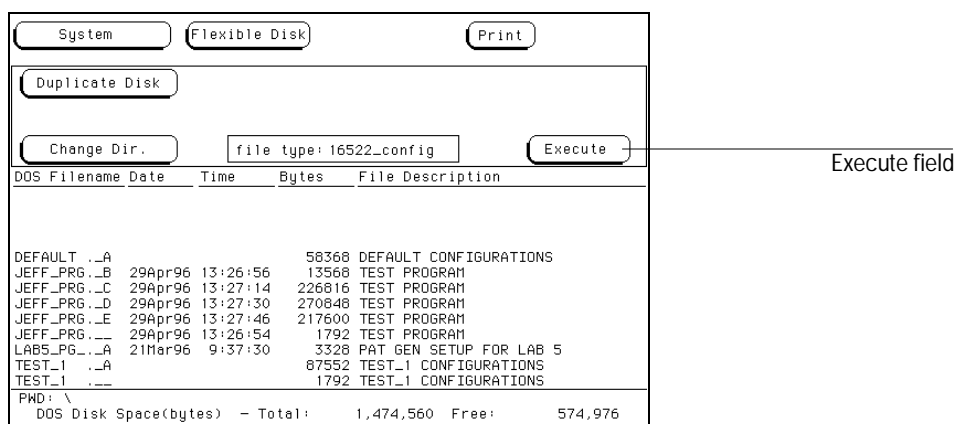

Duplicate Disk Operation

- 3 When "Insert DESTINATION disk" appears, insert the destination disk into the disk drive.
- 4 When "Insert SOURCE disk" appears, remove the destination disk and reinstall the source disk.

The number of times you need to change the disks depends on whether you have a double-density or high-density disk. Simply follow the instructions on the display and select **Continue** to continue.

Making a Directory (DOS only)

- 1 Select the **Make Directory** operation.
- 2 Select the **New directory name** field and type in the new directory name.
- 3 Select **Execute**, then select **Continue**.

If you try to use Make Directory on a LIF disk, the disk is unaffected.

| DOS Filename | Date | Time | Bytes | File Description |
|--------------|---------|---------|-------|------------------|
| SYSTEM | 12Sep90 | 0:00:40 | 0 | DIRECTORY |

New directory name field

Make Directory Operation

Changing the Directory

- 1 Select the **Change Directory** operation.
- 2 Select the **Directory name** field. Using the knob, the pop-up keypad, or the keyboard, enter the new directory name.
- 3 Select **Execute**.

Two Change Directory options:

Operation

Quick key

| | | | | | |
|--------------------------------|---------|----------------------|-----------|-------------------------|---------|
| System | | Flexible Disk | | Print | |
| Change Directory | | directory name: TEMP | | | |
| Change Dir. | | file type: directory | | Execute | |
| DOS Filename | Date | Time | Bytes | File Description | |
| JEFF_PRG._B | 29Apr96 | 13:26:56 | 13568 | TEST PROGRAM | |
| JEFF_PRG._C | 29Apr96 | 13:27:14 | 226816 | TEST PROGRAM | |
| JEFF_PRG._D | 29Apr96 | 13:27:30 | 270848 | TEST PROGRAM | |
| JEFF_PRG._E | 29Apr96 | 13:27:46 | 217600 | TEST PROGRAM | |
| JEFF_PRG._F | 29Apr96 | 13:26:54 | 1792 | TEST PROGRAM | |
| LABS_PG._A | 21Mar96 | 9:37:30 | 3328 | PAT GEN SETUP FOR LAB 5 | |
| TEMP | 21May96 | 12:28:42 | 0 | DIRECTORY | |
| TEST_1 .A | | | 87552 | TEST_1 CONFIGURATIONS | |
| TEST_1 .F | | | 1792 | TEST_1 CONFIGURATIONS | |
| PWD: \ | | | | | |
| DOS Disk Space(bytes) - Total: | | | 1,474,560 | Free: | 574,464 |

Change Directory Operation

Most of the disk operation menus have a Change Directory quick key. Selecting the quick key causes the HP 16500C to change directory to the currently highlighted file. If that file is not a directory, the Logic Analysis System displays "Invalid file type for this operation."

Creating a System Flexible Disk

Location of the System Files

When the Logic Analysis System is configured at Hewlett-Packard with the appropriate modules, the system files for the mainframe and individual modules were loaded onto the hard disk drive in the subdirectory called "SYSTEM". It is recommended that if new modules are added or any system file revisions occur, they be loaded onto the hard disk drive in this subdirectory.

However, if you want system files on a flexible disk, use the appropriate disk operations, such as store or copy, to store all required system files on a flexible disk.

What Files are Required on a System Disk?

A system disk consists of the software required to operate the mainframe and each module in the system. For the mainframe, this is the file SYSTEM of the file type 16500C_system. For the individual modules, it is the file SYS_XXX of the file type XXXXXX@16500C. The three characters (XXX) in the file name represent the identification code for each individual module. The six characters (XXXXXX) in the file type represent the product model number for each module. Some older modules use the identification code in the file type.

What is a System Performance Verification Disk?

A system performance verification disk is a disk that contains all the performance verification software required to run the performance verification tests for the HP 16500C Logic Analysis System and the corresponding modules configured in the system. This composite disk is found in each software pouch. For more information on the performance verification tests, refer to chapter 9, "Maintaining the HP 16500C."

All system performance verification files are stored on the hard disk in the \SYSTEM subdirectory. The performance verification files have names beginning "PV."

Transferring Files Using the LAN

The HP 16500C Logic Analysis System mainframe comes equipped with a LAN interface. You can transfer information from the Logic Analysis System to a computer for processing or storage over the LAN without ever copying a file to disk.

Because there are so many different network software packages, this section does not attempt to explain how to put your Logic Analysis System on the local network or how to establish a network connection. Those topics are covered in detail in Chapter 7, "Installing the HP 16500C on your LAN."

There are four basic types of connection you can establish between a computer and a Logic Analysis System over an Ethernet LAN: NFS, ftp, telnet, and X Window. NFS programs use the Network File System protocol to share file systems, effectively making the Logic Analysis System a part of your computer. File Transfer Protocol (ftp) is a common UNIX® program for copying files between two computers. It is also available on many personal computers. A telnet or X Window connection is better for controlling the HP 16500C, but cannot transfer files.

See Also

Chapter 7, "Installing the HP 16500C on your LAN" for information on setting up network connections and chapter 3, "Configuring Communications" for LAN settings.

Transferring Files Using NFS

- 1 Check that your network software supports NFS, and connect your Logic Analysis System to the network.**

See chapter 7, "Installing the HP 16500C on your LAN," for instructions on connecting to a network.

- 2 Mount the Logic Analysis System.**

Different NFS packages have different commands for mounting. See chapter 7 or your local network documentation. You may require a network administrator to mount the logic analyzer on the server.

- 3 Copy files from the Logic Analysis System to wherever you need them on your computer using your computer's commands.**

The various files you see in the HP 16500C's file system are explained in "The File System" later in this chapter.

If your computer is a SUN workstation, you may have trouble with certain types of files. If you find you are receiving only 1 byte of a file, try using the `dd` command for copying. These files are dynamic files, and the file size is computed after they are built. The unknown file size confuses some utilities.

- 4 Be sure to unmount the Logic Analysis System before turning it off.**

If you do not unmount the Logic Analysis System before turning it off, you may have trouble remounting it later.

See Also

"The File System" and "Dynamic Files" later in this chapter for more details.

Transferring Files Using ftp

- 1 Check that your network package includes ftp, and connect your Logic Analysis System to the LAN.**
See chapter 7, "Installing the HP 16500C on your LAN," for instructions on connecting to a network.
- 2 From the computer you want to transfer files to or from, establish an ftp connection.**
- 3 At the login prompt, log in as data or control.**
If you want to load files to control the Logic Analysis System, log in as control. Otherwise, log in as data.
- 4 If you will be transferring screen images or configuration files, set type to BIN.**
- 5 Locate the file you want, and transfer it.**
"The File System" later in this chapter explains the different types of files in the file system. Most ftp software lets you use your regular computer commands for moving around the remote file system and listing files. To copy files, most ftp software uses "get" and "put".

See Also

"The File System" later in this chapter for a description of files and chapter 7, "Installing the HP 16500C on your LAN," for how to establish an ftp connection.

The HP 16500C File System

The HP 16500C Logic Analysis System directory structure is shown below. From the front panel, only the files under `\system\disk` are accessible.

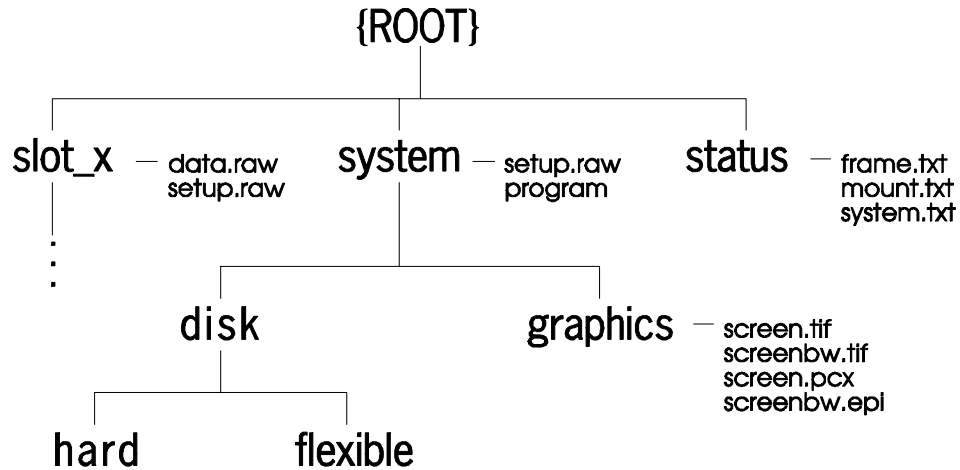

HP 16500C Directory Structure

\slot_x Subdirectories for HP 16500C modules.

\slot_x\data.raw Binary measurement data files. You can save and restore measurement data by copying these files.

setup.raw (Both `\system` and `\slot_x`) Binary configuration files. You can save and restore configurations by copying these files.

\system\program Port for sending programming commands to the command parser.

\system\disk\hard Same as HP 16500C System Hard Disk.

\system\disk\flexible Same as HP 16500C System Flexible Disk.

\system\graphics Image files for the current screen in TIFF, PCX, and Encapsulated PostScript formats.

\status Status information.

The directory structure of the HP 16500C is fixed. You cannot create or delete directories or files except under the local hard and flexible disk directories.

HP 16550, 16554, 16555 and 16556 Logic Analyzer Subdirectories and Files

If you are using an HP 16550, 16554, 16555 or 16556 logic analyzer, the `slot_x` directory contains a subdirectory called `data.asc` that contains ASCII measurement data.

There are two subdirectories attached to the `data.asc` directory, one for each of the two analyzers (if they are turned on in the Configuration menu) in the logic analyzer module. The default names of these subdirectories are `machine1` and `machine2`, but they will change whenever the analyzer names are changed in the Configuration Menu.

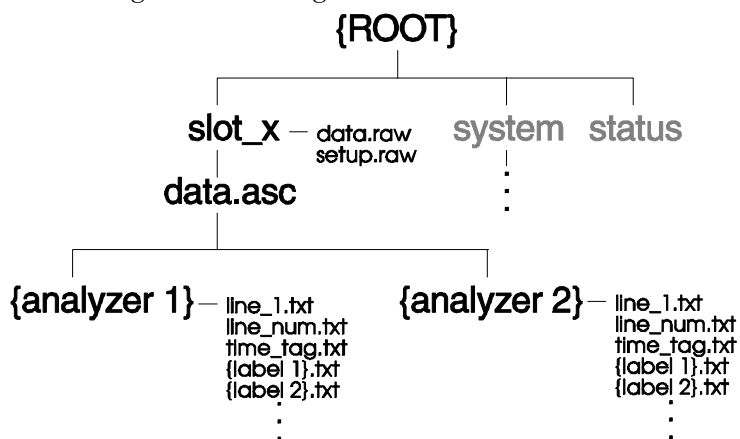

HP 16550/54/55/56 Logic Analyzer Directory Structure

Label Data Files: `\slot_x\data.asc\{analyzer name}\{label name}.txt`

Both analyzer subdirectories contain files corresponding to the labels you have set up in that analyzer's Format Menu. These files contain the current measurement data for the channels assigned to each label.

Both state and timing data are available, and both kinds of data are represented as a column of values. The numeric base — hex, binary, etc. — in these files is the same as the base that is currently set in the Listing Menu.

The 1st_line.txt File The `1st_line.txt` file lists the number of the first line of the most recent data acquisition.

This file shows the number of states that occur before the trigger state, which is always state zero (at line number 0). You can use this information to align data from different measurements.

Time Tag and State Tag Data If time tags have been turned on, the `time_abs.txt` file contains a column of time values for the most current state or timing measurement.

If state tags have been turned on, the `state_abs.txt` file contains a column of state count values for the most current state measurement.

Line Numbers The `line_num.txt` file contains line numbers corresponding to the lines of data in a state listing.



HP 16542A State Analyzer Subdirectories and Files

If you are using an HP 16542A 2-Mbyte State Analyzer, the `slot_x` directory contains a subdirectory called `data.asc` that contains ASCII measurement data.

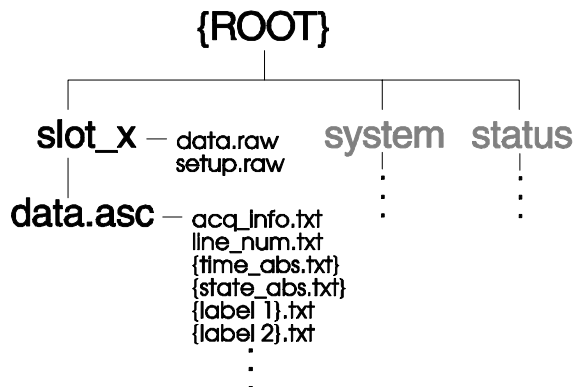

HP 16542A State Analyzer Directory Structure

Label Data Files: `\slot_x\data.asc\{label name}.txt` The `data.asc` subdirectory contains files corresponding to the labels you have set up in the HP 16542A Format menu. The files contain the current measurement data for the channels assigned to each label. The numeric base — hex, binary, etc. — of the data in these files is the same as the base that is currently set in the Listing Menu.

The `acq_info.txt` File The `data.asc` subdirectory contains a file called `acq_info.txt`. This is an ASCII file that gives you information about the most recent data acquisition.

The contents of the `acq_info.txt` file vary depending on the mode of the acquisition. If the analyzer is in state mode and record mode is not being used, the file will list the line number of the first line of the acquisition and the number of lines in the acquisition:

```
Beginning_line    0
Number_lines     523776
```

If the data was acquired in record mode, the `acq_info.txt` file lists the number of records in the acquisition and the record length:

```
Number_records    255
Record_length     4096
```

If the analyzer is in timing mode, the `acq_info.txt` file lists the line number of the first line and the number of lines, as well as the relative time of the first sample in the acquisition and the sample period:

```
Beginning_line    0
Number_lines      523776
Beginning_time    -3.14e-6
Sample_period     10e-9
```

See Also

The *HP 16542A User's Reference* for more information about data acquisition modes.

Time Tag and State Tag Data If time count feature is turned on, the `time_abs.txt` file contains a column of time values for the most current state or timing measurement.

If state tags have been turned on, the `state_abs.txt` file contains a column of state count values for the most current state measurement.

Line Numbers The `line_num.txt` file contains line numbers corresponding to the lines of data in a state listing.

Inverse-Assembled Data Inverse assembled data is not available through the ASCII data files for the HP 16542A.

Dynamic Files

The HP 16500C's file system uses dynamic files for configuration information and data. This means that some applications, such as File Manager or a spreadsheet, cannot determine the size of the files until they are retrieved.

When you view the file statistics for these files in the HP 16500C's file system, you will see file sizes of "0" bytes or "1" byte. The "0" file size indicates that the file is empty. The 1-byte size indicates that there is information in the file. If you transfer the file of interest to your PC or workstation, you will be able to see the actual file size.

Known Incompatibilities

Some operating systems and applications may exhibit unexpected behavior when working with the dynamic files from the HP 16500C. The "% complete" display may appear incorrect during file transfers. This does not affect the transfer or the contents of the file. Once you have saved the file in your local environment, the correct "% complete" will be displayed during future retrievals.

Your applications might only retrieve one or two characters from a file that you believe has many more characters in it. To work around this problem, copy the file that you want to work with from the HP 16500C system to your local computer. Use the local copy as your working copy.

SUN Operating Systems

The file copy commands in the SUN workstation and Solaris operating systems will not work with the dynamic files like those used in the HP 16500C system. You can use the `dd` command instead of using the `cp` or `cat` commands.



Customizing the Interface

The System Utilities Menu

The System Utilities menu is one of the menus within the System module. The menu is used for turning the sound on and off, recalibrating the touchscreen, setting the clock, and changing the default instrument colors.

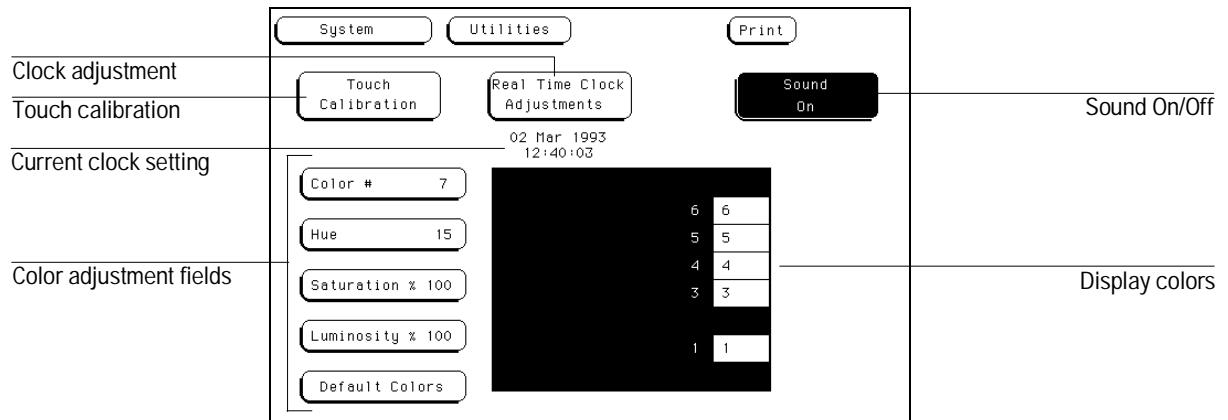

System Utilities Menu

The Touch, Clock, and Sound Fields

This section covers the Touch, Real Time Clock, and Sound fields of the System Utilities menu. These fields allow you to recalibrate the touchscreen for better line-of-sight use and turn on and off the sound of the instrument.

Touch Calibration

Touch calibration allows you to reset the touchscreen to your needs and compensate for parallax from different viewing angles. It is unnecessary to periodically calibrate the touchscreen if the power remains on.

The Touch Calibration field in the upper left corner of the display brings up the pop-up for adjusting the touchscreen calibration to your own line of sight and to the angle at which you touch the screen.

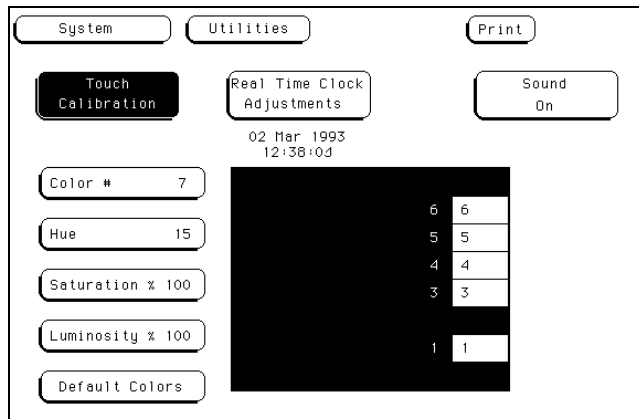

Touch Calibration

At power-up, the touchscreen returns to the default calibration unless a customized system configuration file is loaded as part of an autoload sequence.

The default calibration is acceptable for most uses, but to change the calibration do the following:

1 Select the Touch Calibration field.

The Touch Calibration pop-up menu appears.

2 Select the A field, touching the A as accurately as possible.

3 Select the B field, touching the B as accurately as possible.

Recalibration is done immediately after you touch A or B. The point at which you remove your finger from A or B determines where you place your finger to activate subsequent fields.

4 Select Done when you are finished.

To return to the default Touch calibration, select the **Touch Calibration** field and when the pop-up menu appears, select the **Default** field. This returns the instrument to its default touchscreen calibration. Select **Done** when you are finished. Turning the instrument off and on also resets the screen.

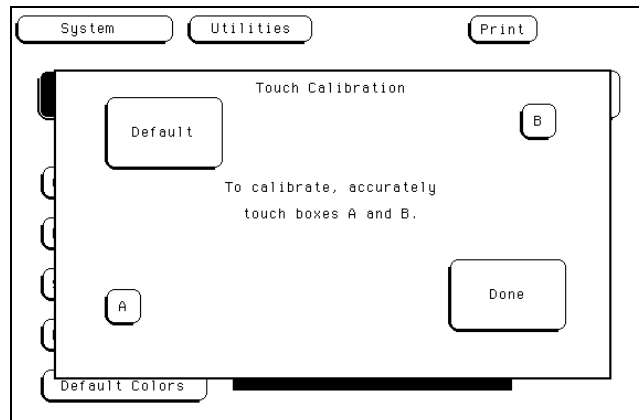

Touch Calibration Pop-up Menu

Touch On/Off

To turn the Touch function on or off, press the **Touch Screen** button on the front panel. A light under **Disabled** indicates the touch screen is turned off.

Setting the Real-time Clock

For documentation purposes, a real-time clock readout appears in the display menus. This time is also stamped on files. To adjust the real-time clock, simply select the **Real Time Clock Adjustments** field, then select the date or time element desired from the pop-up menu shown below. Use the knob to set numbers and the keyboard or the touch screen to select the correct month. When you are finished, select **Done**.

The **Time Zone** field is used in calculating the apparent time when the file system is mounted over NFS. The Time Zone value should match the time zone setting of your computer system.

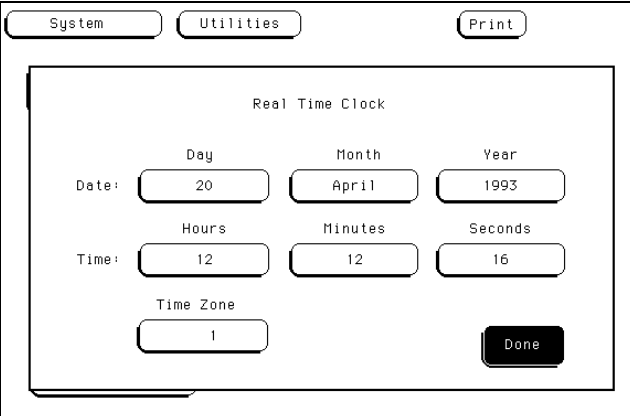

The image shows a graphical user interface for setting the real-time clock. At the top, there are three buttons: "System", "Utilities", and "Print". Below these is a large rectangular frame containing the "Real Time Clock" settings. The settings are organized into two main sections: "Date" and "Time".

| | Day | Month | Year |
|-----------|-------|---------|---------|
| Date: | 20 | April | 1993 |
| | Hours | Minutes | Seconds |
| Time: | 12 | 12 | 16 |
| Time Zone | 1 | | |

A "Done" button is located at the bottom right of the "Real Time Clock" frame.

Real-time Clock Pop-up Menu

Turning the Sound On/Off

The sound field in the upper right corner is used to turn the instrument's sound on and off. These include the clicks you hear when you select fields on the menus and the beeps you hear on error messages.

To turn off the sound, select **Sound On** and it changes to **Sound Off**, shutting off the sound. To turn the sound on again, select **Sound Off** and it changes back to **Sound On**.

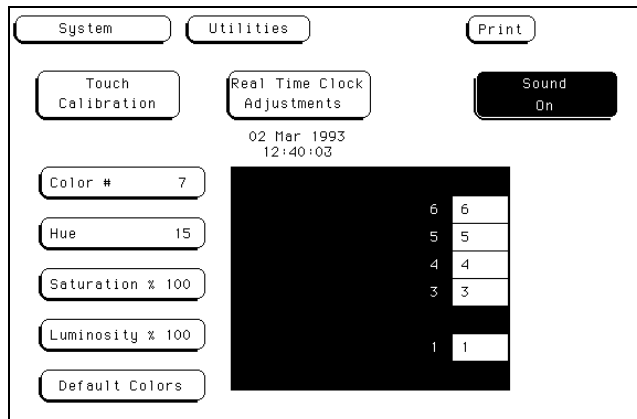

Sound On Field

Display Color Selection

In the HP 16500C, color saves time and prevents errors by clarifying the display, making it easier to distinguish one major area from another.

The color selection feature of the HP 16500C allows you to customize display colors, which improves contrast and lessens eye fatigue caused by your operating environment. If you are color-blind to certain colors, are operating in a difficult light environment, or don't like the default colors, you can quickly and easily change them.

The colors used by an X Window are always the default colors, and cannot be changed.

The Color Model: Hue, Saturation, and Luminosity

The HP 16500C uses the HSL color model (Hue, Saturation, and Luminosity). This model is very effective for interactive color selection. Similar in concept to the method used by artists for mixing paints, pure hues are selected, and then white and black are mixed to dilute the color or darken it.

- Hue is the pure color. 0 is red, 33 green, and 67 blue. The selection ranges from 0 to 100.
- Saturation is the ratio of the pure color mixed with white (0 to 100%).
- Luminosity is the brightness per unit area (0 to 100%).

The figure on the next page shows a cylindrical representation of the HSL model (Hue, Saturation, and Luminosity). Hue is the angular coordinate, Saturation is the radial coordinate, and Luminosity is the altitude above the polar coordinate plane.

The cylinder rests on a black plane (Luminosity = 0%) and extends upward. As you increase in altitude, you increase luminosity, which represents an increase in brightness. Whenever luminosity is zero, the values of saturation and hue do not matter. Zero luminosity is black, and 100% luminosity gives you the pure color.

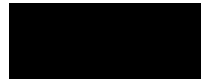

White is the center of the top of the cylinder (Luminosity = 100%, Saturation = 0%). The center line of the cylinder (Saturation = 0%) is a line which connects the center of the black plane (Luminosity = 0%, Saturation = 0%) with white (Luminosity = 100%, Saturation = 0%) through a series of gray steps (Luminosity from 0% to 100%, Saturation = 0%). Whenever saturation is 0%, the value of hue does not matter. Zero saturation is white, and 100% saturation gives you the pure color. The outer edge of the cylinder (Saturation = 100%) represents the fully saturated color.

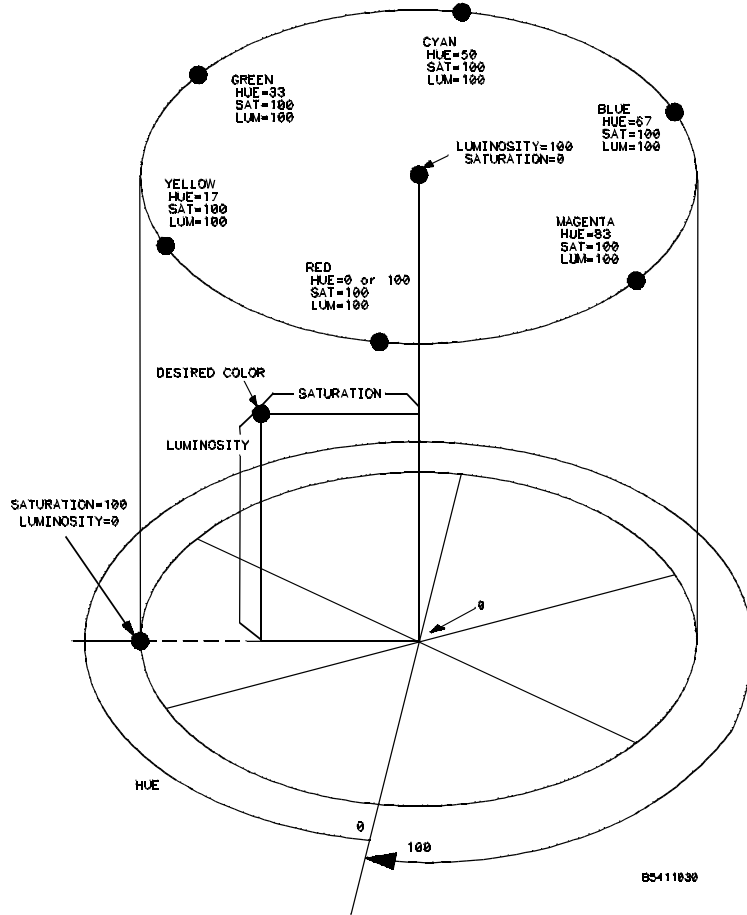

The Color Model

Setting the Color, Hue, Saturation, and Luminosity Fields

To set the Color, Hue, Saturation, or Luminosity fields, see if the field you want has a different background than the other fields (light blue if using default colors). If it already has a different background, rotate the knob to change the value in that field. Otherwise, select the field once and its background will change color, indicating that it has been selected. Then rotate the knob to change the value. If you look at the large field in the center of the display, you can see how the knob affects the color.

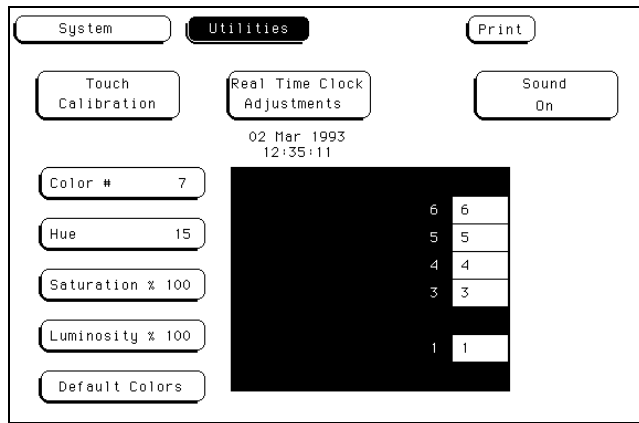

Color Selection

Returning to the Default Colors

The Default Colors field, below the Luminosity field, allows you to return to the default colors simply by selecting that field. These default colors are listed in the table on the previous page.

Selecting Colors

Once the Color field has been selected, you can select any one of seven variable display colors by rotating the knob on the front panel. The Color field displays your choice (1 through 7). The large field to the right of the Color field displays the color you are working with, and the small numbered fields within this large field display the other colors available.

The screen may be turned off when using an external controller by setting the Luminosity of each color to zero.

Table 5-1

HP 16500C Display Colors

| Color | Default Color | Hue | Saturation | Luminosity | Uses |
|-------|---------------|-----|------------|------------|---|
| 1 | Tan | 13 | 43% | 76% | Main background color for the display |
| 2 | White | 0 | 0% | 100% | Light text and timing waveforms on certain modules |
| 3 | Dark Blue | 60 | 100% | 60% | For touch items (touch-sensitive fields) |
| 4 | Light Blue | 60 | 45% | 90% | For selected items, items that the knob is assigned to, limited background use, and certain display channels on the oscilloscope module |
| 5 | Green | 33 | 100% | 75% | For the Run field, advisory fields, the X marker on certain modules, certain display channels for the oscilloscope module, and miscellaneous other uses |
| 6 | Red | 0 | 100% | 100 | For the Stop field, error fields, the Cancel Print field, the trigger point, and certain display channels on the oscilloscope module |
| 7 | Yellow | 15 | 100% | 100% | For warning or advisory fields, the O marker on certain modules, certain display channels on the oscilloscope module, and miscellaneous other uses |
| 0* | Black | — | — | 0% | For dark text, background, and waveform areas |

* Color "0" is a non-variable color.



Correlating Measurements

Intermodule Measurements

The HP 16500C can be configured with several different modules inside the instrument at one time. The Intermodule menu allows you to make interactive measurements between these modules. As an example, you would use the acquisition capabilities of one module to look at a signal, while using the triggering capabilities of another module to properly trigger the measurement.

When modules are configured in the Intermodule menu, you also have the capability to display the resulting waveforms and state listings from several modules together in the same display menu.

The basic functions of the Intermodule menu are:

- Configure modules to run simultaneously or in a specified sequence between modules.
- Synchronize with external equipment.
- Adjust skew between modules.

When there are no modules installed in the mainframe, intermodule measurements are not possible so the Intermodule menu is not available.

Configuring Arming Sequences

You select modules to run either independently or within an intermodule configuration. As you make module selections, a configuration tree begins to form. In addition, an arming order is created dependent on the order in which you select the modules.

Within the configuration tree, modules that are connected directly to the large **Group Run** field are armed immediately after a **Group Run** is executed. Modules that appear connected below other modules are armed when the preceding module finds its trigger.

Synchronizing with External Equipment

Once a module is added to the configuration tree, the PORT OUT signal can be added beneath that module or any other module, which sends the module's arming signal out to a BNC connector on the rear panel. You can define the PORT OUT signal in several ways. The signal can be routed straight from the module to the BNC connector, latched to produce a continuous signal, or pulsed. The signal polarity and output type are also configurable.

The PORT IN signal can be selected to arm the intermodule configuration in conjunction with the Group Run/Stop field. You can qualify the PORT IN signal by defining level and edge criteria.

Adjusting Skew between Modules

You can modify the skew or timing deviation between the modules within the intermodule measurement. This allows you to compensate for any known delay of the system under test or compare two signals by removing any displayed skew between the signals.

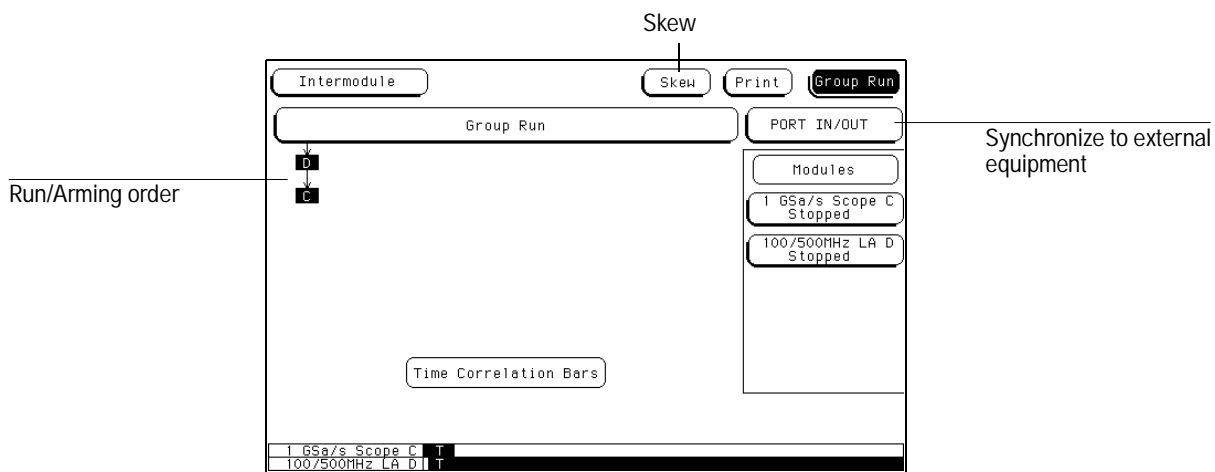

The Intermodule Menu

Configuring a Group Run

The **Group Run** field offers three choices which set how the intermodule measurement is armed. You can run the group in Single or Repetitive acquisition mode, as with independent measurements. In Repetitive acquisition mode, all modules must finish before the next run begins.

When you have an intermodule measurement configured, the Run field changes to Group Run for all modules running as part of the group run. Any module set to run separately will still show Run.

Group Run This selection starts the intermodule measurement when you select the Group Run field in any of the menus.

Group Run Armed from PORT IN This selection starts the run when you select the Group Run field but is not armed until an external signal is seen at the PORT IN BNC connector on the rear panel.

Group Run with OR TRIGGER This selection starts the run when you select the Group Run field. However, if you have one or more Deep Memory Logic Analyzer modules (models HP 16554, 16555, and 16556) running as the first level of a Group Run tree, the modules plus PORT IN and PORT OUT form an OR TRIGGER group. The first module in the group that finds its trigger triggers the other analyzers in the group and sends a signal through PORT OUT. The other analyzers, remain at their current sequence level. Modules not in the OR TRIGGER group behave as they normally would for a Group Run.

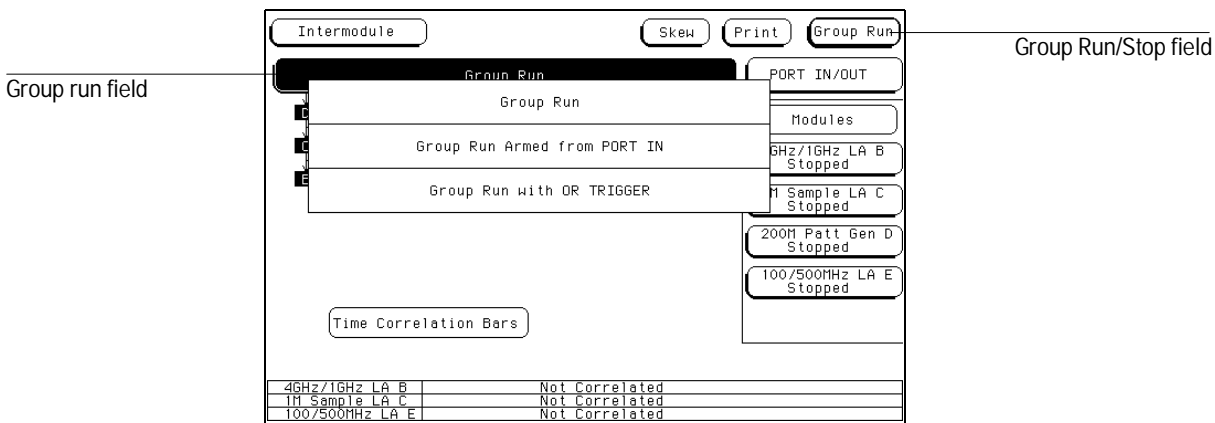

Group Run Field

Example

The following example illustrates what happens when you execute a Group Run. For this example we use the intermodule configuration shown in the figure below.

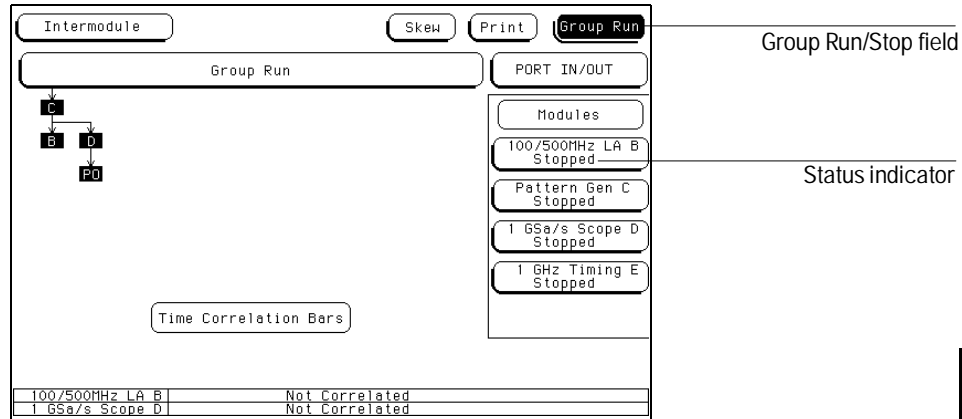

When you select the **Group Run** field in the above setup, events occur in this order:

- 1 The status indicator of each module involved changes from **Stopped** to **Running**.
- 2 The prestore and trigger qualification status of module B (analyzer) and module D (oscilloscope) is checked.
- 3 When prestore and trigger qualification of modules B and D are met, module C is armed and its appropriate measurement is run.
- 4 Module C triggers, and simultaneously arms modules B and D.
- 5 Module D triggers, and sends a signal to an external device through "PO" (PORT OUT).
- 6 The status of each module changes to **Stopped** when the module finishes its operations. After all the modules are finished, the data is displayed in the individual display menus of the modules.

If the modules are time correlated, the time correlation bars at the bottom of the menu display the start and stop acquisition window of each module relative to the other modules.

Configuring Port In/Out

The PORT IN/OUT field accesses a configuration menu which is used to configure which module sends an external arming signal (PORT OUT) and what the signal is. Also from this menu you define voltage level and edge criteria that must be matched by any incoming arming signal (PORT IN) before the intermodule measurement can be armed. The PORT IN/OUT field is shown below.

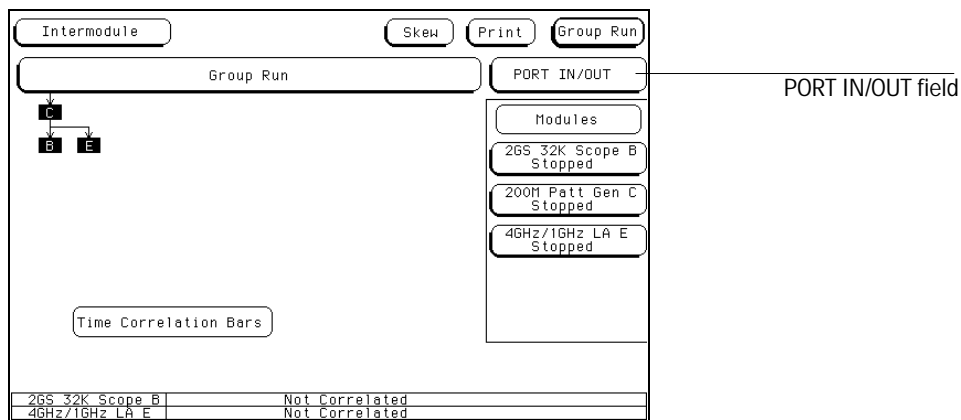

PORT IN/OUT Field

PORT IN

When using PORT IN, an external device must be connected to the PORT IN BNC on the rear panel. If an external device isn't connected, or is accidentally disconnected, the instrument will not arm.

Only the HP 16500C mainframe has a PORT IN BNC. However, the PORT IN signal is available to modules in both the HP 16500C and HP 16501A frames.

By using a trigger signal connected to the PORT IN BNC on the rear panel, the intermodule measurement can be armed when preset voltage and edge criteria are met. To configure a PORT IN signal, do the following:

- 1 Select the **PORT IN/OUT** field above the module field.
- 2 Select the **PORT IN Level** field and set the level to TTL, ECL, or a user-defined level between +5 V and -4 V.
- 3 Select the **PORT IN Edge** field and toggle the edge type to either Rising or Falling.

4 Select Done.

After the PORT IN voltage level and edge criteria are set, select the **Group Run** field. The analyzer will wait until the proper signal is seen at the PORT IN BNC before the measurement arms.

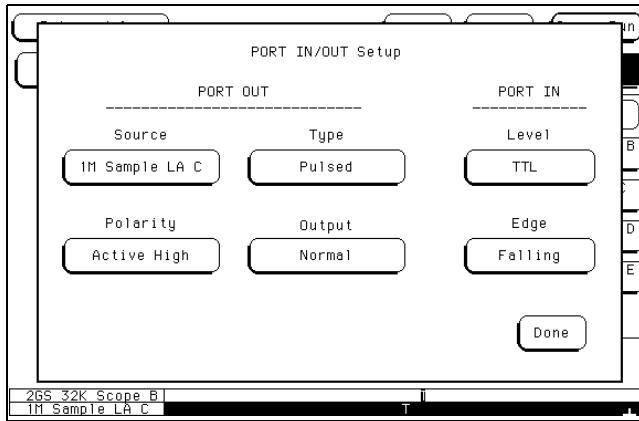

PORT IN/OUT Setup Menu

PORT OUT

PORT OUT is used to send a signal to an external device from a module in the intermodule configuration tree. The port may be terminated by a 50-Ω load to reduce ringing, however, a TTL (Normal) signal will then be less than or equal to 0.4 V when low and at least 2.0 V when high. To configure a PORT OUT signal, do the following:

- 1** Select the **PORT IN/OUT** field above the module field.
- 2** Select the **Source** field and choose the module you want the signal to come from.

If the Group Run field is **Group Run with OR TRIGGER**, the PORT OUT signal is automatically assigned to the OR TRIGGER group and cannot be assigned to a specific module.

If a module in the HP 16500C is armed by a module in the HP 16501A Expander, then Port Out cannot be armed by any other module in the HP 16501A other than the one arming the module in the HP 16500C.

The selection list will contain the names of all the modules configured in the group run. A "PO" indicator will appear in the configuration tree originating from the module you select.

3 Toggle the Polarity field to either **Active High** or **Active Low**.

4 Toggle the Output field to **Normal** or **Open Collector**.

Normal sends out a standard TTL signal. **Open Collector** sinks 128 milliamps of current in its low state.

5 Select the Type field and choose your preferred signal type from the menu.

PORT OUT can send three different types of signals.

Feedthrough lets the source module drive the PORT OUT line directly. Most modules latch the line and stay latched until the next run, but the timing varies depending on the module that is driving it. Feedthrough is provided for backward compatibility with old measurements.

In **Latched**, the HP 16500C latches the signal to Port Out when the source module triggers. The Port Out signal is held until the Group Run stops.

A **Pulsed** signal is held between 40 and 80 nanoseconds. Pulse width is not adjustable.

6 Select Done.

The Group Run/Stop Field

When a module is added to the intermodule configuration tree, that module's Run/Stop field changes to the Group Run/Stop field. When an acquisition is started in the intermodule menu, you can monitor the results with the Running/Stopped status indicators and time-correlation bars.

When you select the **Group Run/Stop** field, a pop-up menu appears with two choices for acquiring data.

- **Single** allows you to run the measurement once.
- **Repetitive** allows you to run the measurement as many times as you want to collect data for statistical measurements, etc. Press **Stop** when you want to stop a repetitive run.

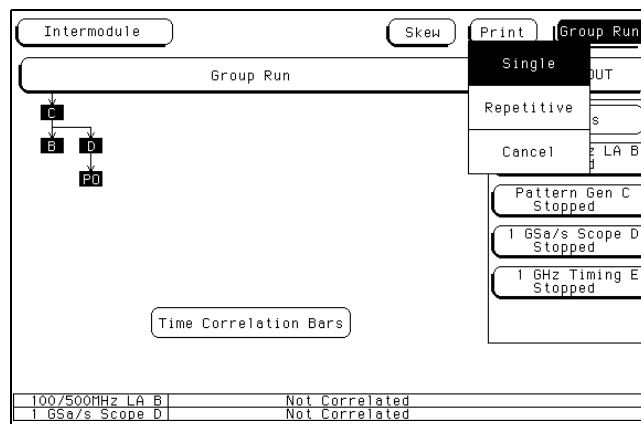

Group Run/Stop Field

- **Cancel** closes the menu without running any measurements.

While a measurement is running, you can move between menus without halting the measurement. Changing any parameters in the measurement modules that are running will halt the measurement, however.

If you run the measurements in repetitive mode, all modules in a single configuration tree finish acquiring data before the measurement is run again.

The default measurement mode is whichever mode was used last time. If this measurement is the first one after the HP 16500C was turned on, the default is single.

The Modules List

On the right side of the screen are fields listing the different modules that can be configured in the Intermodule menu. When you select one of the module fields, a pop-up menu appears displaying the possible locations of the module in the intermodule configuration tree.

- **Independent** allows the module to run independently of the other modules and removes it from the intermodule configuration tree.
- **Group Run** places the module directly below the large Group Run Configuration field. This module is started immediately after the Group Run/Stop field is touched.
- The other fields in the pop-up menu list the name of the modules that are already part of the intermodule configuration tree, and can be used to arm this module. Selecting one of these fields places the current module below the module indicated by the field you selected. The current module is then armed when the preceding module finds its trigger.

After you make your selection, a box appears in the intermodule configuration tree with the module's slot location (A through E for the HP 16500C alone, or A through J for the HP 16500C with the HP 16501A attached), representing the location of the module in the tree.

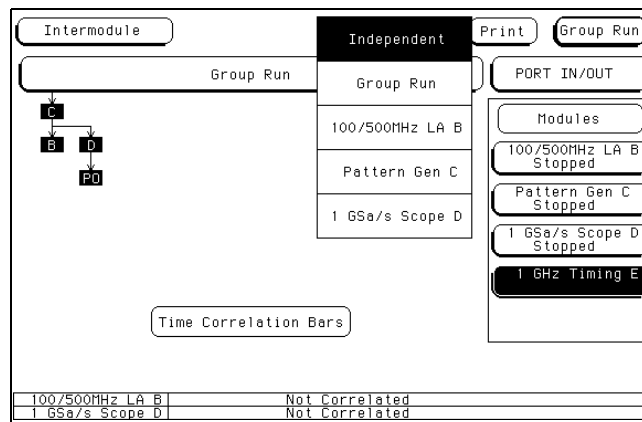

The Module Pop-up Menu

Status Indicators and Time Correlation Bars

The message "Running" or "Stopped" appears below the names of the individual modules that are listed on the right side of the Intermodule menu. This indicates the current status for each module and can be used to monitor the intermodule measurement. If there is a problem with the measurement, a quick check of these status indicators can show you which modules have completed their operations (Stopped) and which ones are still running. Generally:

- If a module was running and is stopped now, you can assume it received its arming signal and triggered properly.
- If a module located below a stopped module on the intermodule configuration tree is running, it is still looking to satisfy its trigger specification.
- If a module below a running module on the intermodule configuration tree has not received its arming signal, it will not begin running.

The time correlation bars at the bottom of the menu display the start and stop time of each module relative to the other modules.

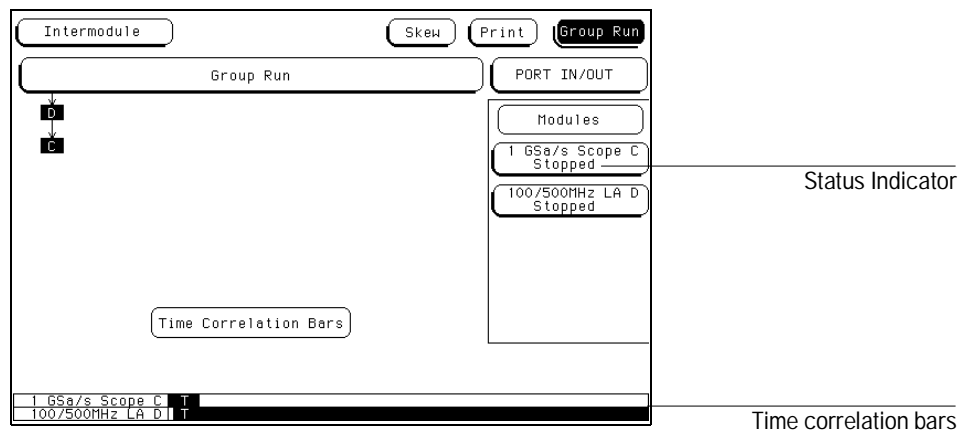

Status Indicators/Time Correlation Bars

Adjusting Skew

Selecting the **Skew** field brings up the Intermodule Skew menu.

The Intermodule Skew menu is used to skew waveforms or state listings between modules on the display. This allows for display adjustment to within 2 nanoseconds between modules. The major purpose of this adjustment is to compensate for variances in internal probing delays across modules.

To adjust the skew of the module, select the individual module within the Skew menu and add or subtract a known time value. This value may be calculated with the markers by measuring the skew between some common signal sampled by both modules.

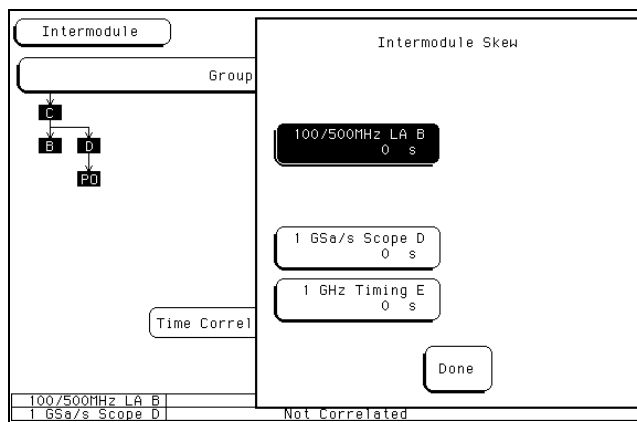

Skew Pop-up Menu

What Are Some Typical Intermodule Measurements?

Intermodule measurements may be as simple as starting several modules at once, or very complex with multiple arming sequences between modules and external equipment.

Example

Analyzing a Glitch

A glitch is defined as two or more transitions between the samples of a timing analyzer that cross the logic threshold. A timing analyzer can trigger on a glitch and capture it, but doesn't have the voltage or timing resolution to look at the glitch in detail. On the other hand, an oscilloscope can acquire waveforms with a great deal of resolution, but it can't trigger on glitches, combinations of glitches, or patterns.

To analyze a glitch, use a timing analyzer and an oscilloscope interactively. Set up the timing analyzer to trigger on a glitch and when the timing analyzer triggers, capture the glitch with the oscilloscope. Then use the oscilloscope to look at the waveform parameters of the glitch, including its width, shape, and amplitude.

For this intermodule measurement, you are using the triggering capabilities of the timing analyzer and the acquisition capabilities of the oscilloscope.

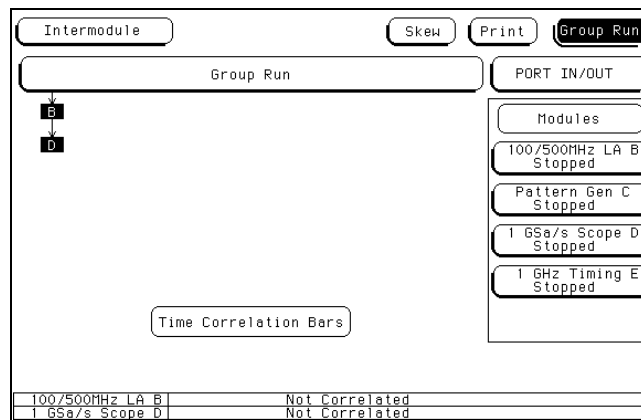

Glitch Example

Example

Analyzing Interrupt Handling in a CPU System

Most microprocessor programs can be interrupted by an asynchronous hardware signal. Software designers are interested in the processor's real-time response to interrupts. In particular, you need to answer these kinds of questions:

- Does the processor branch to the proper interrupt handling routine?
- Are registers and status information saved properly?
- How long does it take to service the interrupt?
- Is the interrupt acknowledged properly?
- After the interrupt is serviced, does the processor restore registers and status information and continue with the previous routine as expected?

Usually, software designers want to look at the program flow of the microprocessor system around an asynchronous event.

A state analyzer, coupled with a preprocessor and an inverse assembler, is useful for tracing the flow of a microprocessor program. A timing analyzer or an oscilloscope is designed to trigger on asynchronous events like edges.

In this example, use an oscilloscope with a sample rate faster than the microprocessor clock to trigger on the asynchronous event and to arm the state analyzer. Then use the state analyzer to check the address of the interrupt routine. You may also use the state analyzer to see if the microprocessor is properly servicing interrupts and returning to the correct address after each interrupt routine.

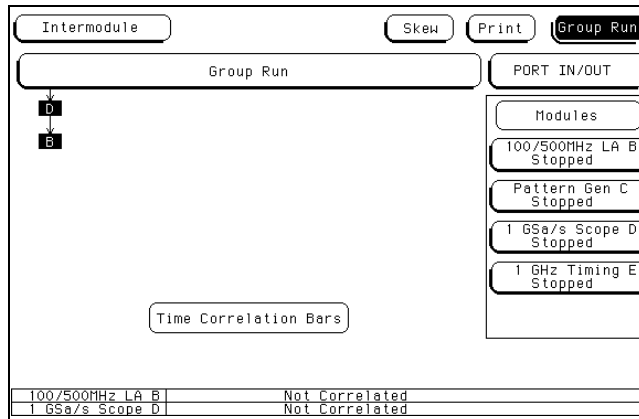

Interrupt Handling Example

Set up the oscilloscope to trigger on the asynchronous interrupt line. This is usually an edge-sensitive line on which the oscilloscope can trigger.

The state analyzer should be armed by the oscilloscope. Set the state analyzer to trigger on all "don't cares" and it will capture the interrupt service routine when the arm signal is received. For this intermodule measurement, arming the state analyzer with the oscilloscope allows a software designer to track the flow of a microprocessor program around a hardware interrupt.

Example

A Simple Stimulus/Response System

During system development, designers are often faced with verifying a part of a design when the input signals for that part are unavailable. Here are some common examples of this problem:

- Verifying hardware operation when a part of the hardware is unavailable to drive the circuit.
- Testing a PC board without a board test system.

The traditional solution is to use word generators to emulate the missing part of the design, and to use logic analyzers and oscilloscopes to capture the system response.

Unfortunately, designers are often faced with an awkward solution of stacking several boxes on top of each other, with a maze of cables tying them together, and a different interface for each instrument.

The pattern generator in the HP 16500C can act as the stack of word generators in this problem. State, timing, and analog modules can all be used to capture the response of the system.

The pattern generator is loaded with the proper patterns and when it starts sending patterns, it sends an arm signal over the intermodule bus.

The acquisition modules are armed from the pattern generator module and set to trigger on the appropriate event in the system.

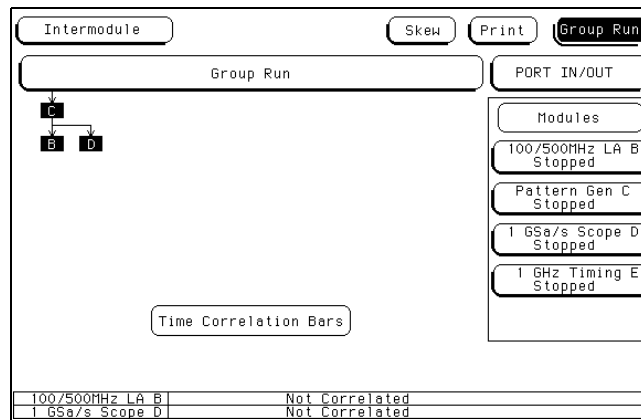

Stimulus/Response Example

Displaying Multiple Module Data on One Screen

When you are making intermodule measurements, you can display the resulting waveforms or state listings for several modules together on one screen. For example, to display waveform data for both an oscilloscope and a timing analyzer on an oscilloscope menu, follow the procedure below. You may not have the exact same configuration of modules but the procedure steps will be similar.

- 1 Select the module field in the upper-left corner of the screen.
- 2 When the pop-up appears, select the **Oscilloscope** module.
- 3 When the oscilloscope menu appears, select the menu in which you want to view the data (for this example, **Auto-Measure**).
- 4 Select the **Channel label** field to the left of the waveform display once to scroll the waveforms. Select this field again to access the display parameters.

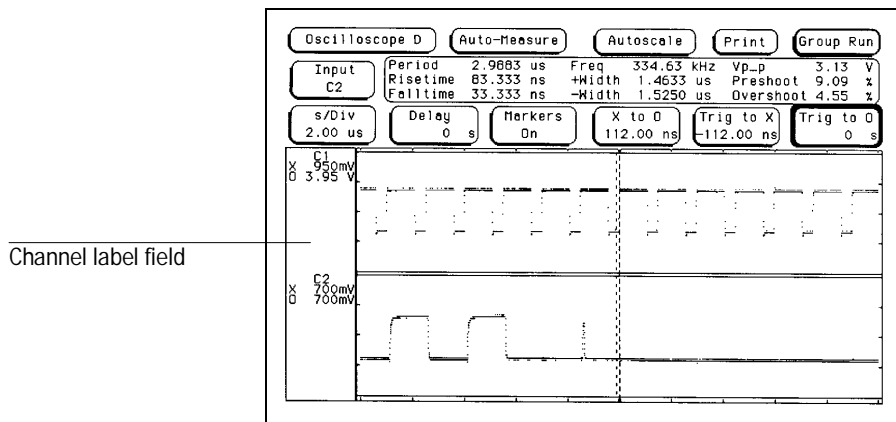

Selecting the Channel Label Field

- 5 In the **Waveform Selection** pop-up, select the **Module Oscilloscope** field. Another pop-up menu appears listing all correlated measurement modules.
- 6 Select **State/Timing**. After the pop-up disappears, the appropriate labels for the channels of the HP 16550A State/Timing Analyzer will be listed under the **State/Timing** field.

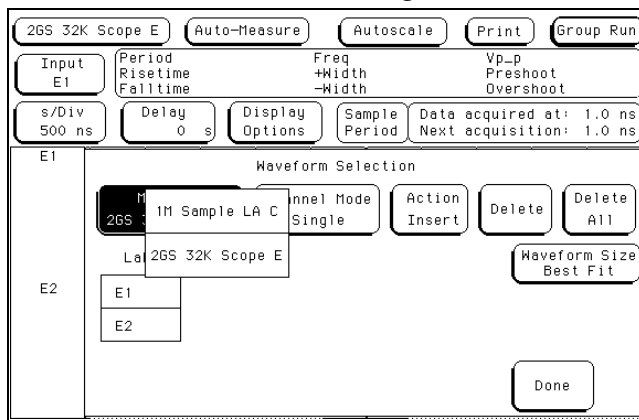

Selecting the Analyzer

- 7 Select the labels for the channels that you want displayed.

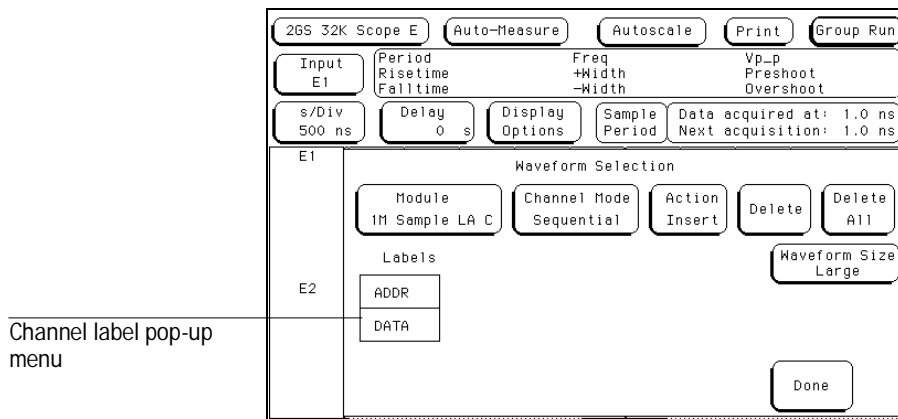

Selecting Analyzer Channels

8 Select Done.

The Waveform Selection pop-up menu disappears, returning you to the waveform display.

As shown in the figure below, the five timing analyzer channels (OUT_4) are now displayed with the oscilloscope channels C1 and C2 on the Oscilloscope D Auto-Measure menu.

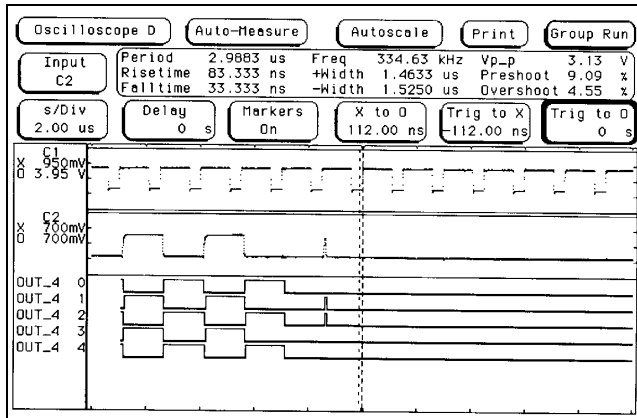

Displaying Multiple Module Data on One Screen

Helpful Hints

- When setting up measurements, start with simple setups and work up to more complex ones. For example, set up the module that will trigger first and take a measurement with only this module. Once you've verified that this first trigger works properly, start adding additional modules to be armed by this trigger.
- Before starting the measurement, set up a simple trigger condition, then set all modules to store data while they search for the trigger condition. This way you can see information on both sides of the trigger condition as you fine-tune the measurement.
- For complex triggering between modules, initially set the modules that are armed from the intermodule bus to trigger on all "don't cares" or to "trigger immediately." Then increase the triggering requirements in stages by starting with the first modules that are armed and working from the top to the bottom of the intermodule configuration tree.



Installing the HP 16500C on your LAN

In This Chapter

This chapter is about connecting the HP 16500C Logic Analysis System to your local area network (LAN). It covers the necessary steps for installing the Logic Analysis System on your network. The information in this chapter only needs to be referenced the first time you make a connection to your LAN. After the first time, all configurations should be in place. This chapter also covers troubleshooting the LAN connection.

To use this chapter effectively, you need to be familiar with:

- System administration tasks.
- Network administration.
- Your network setup and operation.

Also, you need system administration access to your system, and your network and the host system need to be fully operational.

Requirements

- HP 16500C Logic Analysis System mainframe
- NFS or FTP capabilities on your TCP/IP Ethernet LAN

Characteristics

Physical Connection

RJ-45 connector for direct connection to 10Base-T ("EtherTwist") networks

BNC connector for direct connection to 10Base2 ("ThinLan") networks

Supports

IEEE 802.3 type 10Base-T networks and StarLan 10 networks.

IEEE 802.3 type ThinLan (10Base2) networks.

Supported Protocols

Transmission Control Protocol/Internet Protocol (TCP/IP)

Network File System (NFS)

File Transfer Protocol (FTP)

X Window System version 11, release 5 (X11R5)

Program Interfaces

Instrument settings and operating modes may be remotely programmed through data files transmitted via NFS or FTP.

Data Files

ASCII formatted data is available from popular measurement modules.

Binary file format data is available from all measurement modules.

Screen images are available in TIFF, PCX, and EPS file formats.

Refer to the table on the next page.

File Structures

File structures for binary ASCII data are documented in The File System, in chapter 4, "Working with Files."

Dynamic Files

The size of dynamic files is not known until you actually try to retrieve them. Because file sizes vary, the HP 16500C creates a dynamic file when you request a file copy. Refer to Dynamic Files in chapter 4, "Working with Files," for more information.

Network Management

The HP 16500C supports the Simple Network Management Protocol (SNMP) and is MIB II compliant. Community name: public.

Table 7-1

HP 16500C Networked File System Support Matrix

| Features | Modules | |
|---------------------------|--|---|
| | HP 16517A, 16518A, 16522, 16534A, 16550A, 16554A, 16555A/D, 16556A/D, 16542A, 16532A | Other HP 16500-series measurement modules |
| X Window Interface | Yes | Not Available |
| ASCII Data Files | State per label, Timing per label, Digitized Analog Data (HP 16532A) | Not Available |
| Binary Data | Yes | Yes |
| Status Files | Yes | Yes |
| Program Files | Yes | Yes |
| Screen Image Files | All menus: TIFF (BW, color); PCX (color), EPS (BW) | |

Connecting and Configuring

In order to use your HP 16500C's network capabilities, you need to connect it to your network. Then, you need to configure the HP 16500C to work with your network.

The following chart shows an overview of the process.

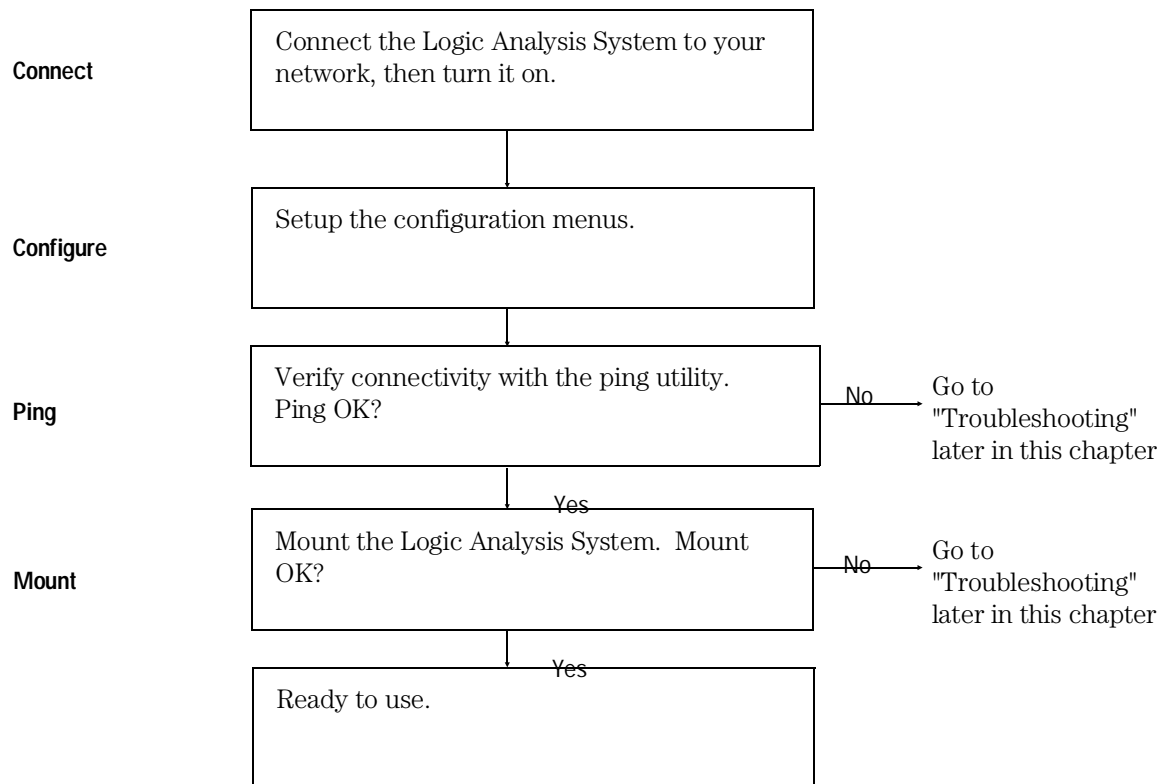

Connect to your network

- 1 Remove power from the HP 16500C mainframe.
- 2 Connect the Logic Analysis System to your network using either the RJ-45 or the BNC connector.

If you are not using a 10Base-T or 10Base2 physical connection you may need a cable converter. The LAN ports on the back of the mainframe are labeled LAN-TP and LAN-BNC.

- 3 Turn on the HP 16500C Logic Analysis System.

Configure the network addresses

You can configure the HP 16500C to work with your network from the front-panel touchscreen.

Information entered in the configuration menus will be stored in nonvolatile memory.

- 1 Access the LAN Settings menu.
 - a Turn on the HP 16500C mainframe and wait until the power-up tests are complete.
 - b In the System Configuration menu, select the LAN box in the Settings group.

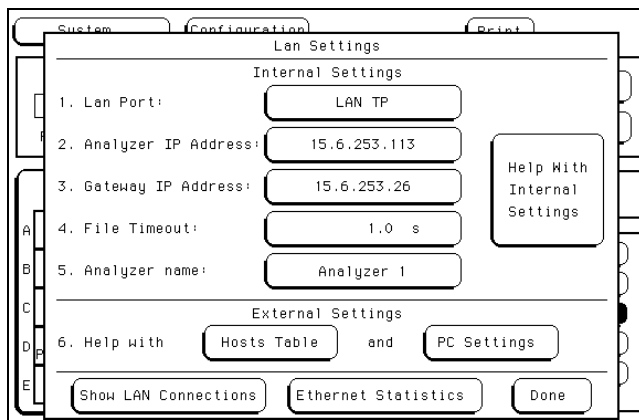

LAN Settings Menu

2 Set up the LAN Settings menu.

| | |
|------------------------------|--|
| LAN Port | The LAN Port field toggles between LAN TP and LAN BNC. Select the one that matches the connector you are using. |
| Internet Address (IP) | The TCP/IP protocol uses the Internet Protocol Address (IP) for communication between network nodes, and requires this entry. The value entered is in integer dot notation. The HP 16500C responds to messages sent to this IP address. |
| Gateway Address | To make connections between the HP 16500C and other networks or subnets, this address must be set to the address of the gateway machine. The value entered is in integer dot notation. The address 0.0.0.0 disables the gateway function. Use the gateway closest to the HP 16500C on the subnet. |
| File Timeout | <p>The File Timeout, ranging from 500 ms to 1 ks, is used by the HP 16500C to determine whether a file should be considered complete. The recommended value (and the default value) is 1.5 seconds. 1.5 seconds is enough time for an average packet to go from source to destination. If your packet has a long destination or your network has a lot of gateways, you may need to increase the time.</p> <p>A guideline for setting the File Timeout is to set the timeout to 150% of the average time for packets to go from source to destination.</p> |
| Analyzer Name | The Analyzer Name is entered as 20 characters. This name is for user reference only and appears in the status files of the HP 16500C. It can be used by a remote user to confirm that the correct HP 16500C has been mounted. |

File Timeout Caution

Set the File Timeout for the minimum time for packets to go from source to destination. File Timeouts can affect file transfer time. If the File Timeout is set too long, the HP 16500C will not respond soon enough.

3 Exit the LAN Settings menu.

Verify connectivity with the ping utility

Use the **ping** utility to verify that the HP 16500C system is on your network. Refer to your network documentation for the exact syntax.

- **UNIX**

```
ping [IP address|symbolic name]
```

- **MS-DOS**

```
ping [IP address|symbolic name]
```

- **MS-Windows**

For a Windows environment, select the **ping** icon in your network menu. Refer to your network documentation for more information about using the **ping** utility.

Mount the Logic Analysis System

Before Mounting

You need to wait at least 15 seconds after the System Configuration menu is displayed before attempting to mount. If you try to mount too soon, you will receive an error message.

You can mount the HP 16500C Logic Analysis System on your network for two different levels of use: control or data. The HP 16500C system accommodates one controller and multiple data users. Control allows users to read and write files to and from the HP 16500C system, while data only allows users to read the files from the system. Data users can also write files to the disk drives of the HP 16500C.

For problem solving, refer to "Troubleshooting" later in this chapter.

For the exact syntax of the mount command for mount, refer to your network documentation.

Mounting and Unmounting

You must unmount the HP 16500C before removing power. Then, you can mount the HP 16500C 15 seconds after the System Configuration menu is displayed when powering up the instrument. You can write a network script that executes an unmount and mount procedure.

- **UNIX**

For UNIX, use your network **mount** command for an NFS mount.

For example:

```
[mount][computername:]/[control|data][mount point]
```

Some UNIX workstations will not accept an IP address. You must add an aliased name of the HP 16500C Logic Analysis System to the host file, usually named /etc/hosts, then use that name in your mount command.

Refer to your network documentation for more information.

- **MS-DOS**

For a PC using MS-DOS and running PC-NFS, use your **net use** command.

For example:

```
net use [drive specifier][IP address or a named alias]\  
[control|data]
```

Refer to your PC-based NFS documentation for more information.

- **MS-Windows**

For an MS-Windows environment, refer to your MS-Windows based NFS documentation and MS-Windows File Manager documentation for mounting instructions.

Troubleshooting

This section provides troubleshooting information for the HP 16500C LAN interface.

The following chart shows an overview of the process.

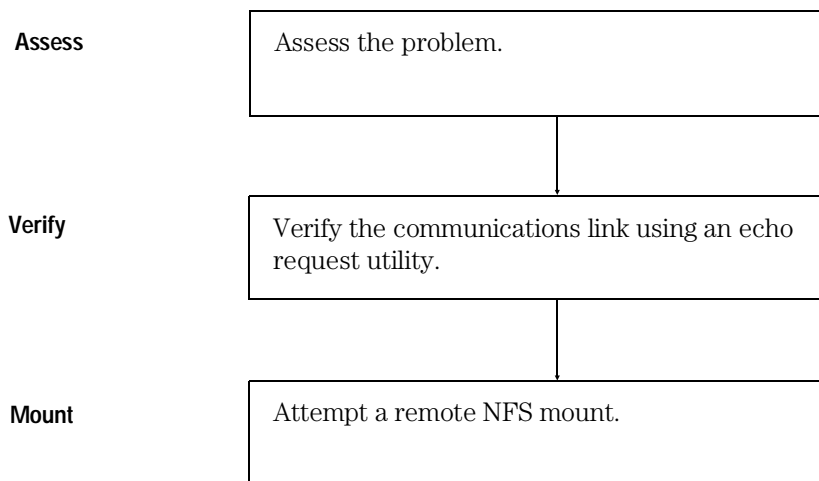

Assess the problem

No utilities or proprietary driver software are needed to connect the HP 16500C System to your network. The HP 16500C operating system was designed to operate with common network utilities and drivers.

Either a hardware problem or a software problem can prevent the HP 16500C remote file server from communicating over the LAN.

Single server/single client network

You can connect the HP 16500C to a single server/single client network. In this configuration, the client is running an NFS application program. In case of difficulties, the troubleshooting procedures included with the documentation for both the NFS application program and the communications controller should be attempted first. If the NFS application program is running in an MS-Windows environment, then the MS-Windows documentation should be consulted.

- **Timeout errors**

Error messages such as "Device Timeout," "File Timeout," "Operation Timeout," or other similar messages from workstations or PCs indicate timeout problems with the workstation or PC. To increase your timeout period, refer to your local workstation or PC documentation for instructions.

- **Problems transferring or copying files**

Copying files out of the HP 16500C

If you have problems copying files out of the HP 16500C, you might be having timeout problems. Refer to the paragraph above for timeout problems.

If you only receive 1 byte back when copying files, refer to the section Dynamic Files in chapter 4, "Working with Files."

Copying files into the HP 16500C

If you have problems copying files into the HP 16500C, such as copying setup or data to change a configuration, then check the File Timeout setting in the LAN Settings menu. Refer to "Configure the Network Addresses" earlier in this chapter.

- **Packets routinely lost**

If packets are routinely lost, proceed to the troubleshooting section relating to your network in this chapter.

- **Communications not established**

If you have just installed and configured the HP 16500C and you have not yet been able to read the remote file server directory, go directly to the troubleshooting section relating to your network in this chapter.

If you have been able to read the HP 16500C remote file server directory and now cannot do so, check the following:

Has any hardware been added or moved on your network? This includes adding or removing any workstations or peripherals, or changing any cabling.

Have software applications been added to the network?

Have any configuration files been modified?

Have any of the following files been deleted or overwritten?

UNIX:

`/etc/hosts`

`/etc/inetd.conf`

`/etc/services`

PCs:

dependent network files

If you know or suspect that something has changed on your network, check the changes and adjust the configuration for the HP 16500C LAN interface using the procedures earlier in this chapter. Otherwise, proceed to the troubleshooting section relating to your network.

- **Problems with the HP 16500C measurement modules or the HP 16500C mainframe**

If you are having trouble accessing one of the HP 16500C measurement modules, go to the Service Guide for that module. If you suspect a problem with the HP 16500C mainframe, go to the Service Guide for the mainframe. You can order the Service Guides through your HP Sales Office.

Troubleshoot in a workstation environment

1 Verify the communications link.

Verify the communications link between the client and the HP 16500C remote file server using the **ping** utility.

```
ping [hostname|IP Address] 64 10
```

Hostname is the name assigned to the HP 16500C remote file server in the node names database (*/etc/hosts*). Most workstation platforms permit an IP address to be used in place of hostname. Packet size will be 64 and 10 packets will be transmitted.

To aid in troubleshooting, enter the Ethernet Statistics menu on the HP 16500C. You can view Transmit and Receive activity on this menu. The Ethernet Statistics menu is accessed through the LAN Settings menu. If needed, refer to "Network Status Information" in this chapter for more information about the Ethernet Statistics menu.

- Normal Response

A normal response to the **ping** will be a total of 9, 10, or possibly 11 packets received with a minimal average of round-trip time. The minimal average will be different from network to network. LAN traffic will cause the round-trip time to vary widely.

Because the number of packets received depends on your network traffic and integrity, the normal number might be different for your network.

For every packet transmitted and received by a **ping** command, the Transmit Successful and Receive Successful fields in the HP 16500C Ethernet Statistics menu increments by 1.

Go to step 2, "Attempt a remote NFS mount."

- Error Messages

If error messages appear, check the command syntax before continuing with the troubleshooting. If the syntax is correct, resolve the error messages using your network documentation.

If an **unknown host** error message appears, check the node names database (*/etc/hosts*) to see that the hostname and IP address are correctly entered.

- No response

No packets received indicates no response from a **ping**.

If there is no response, type in the IP address with the **ping** command. Check that the typed address matches the IP address assigned in the HP 16500C LAN Settings menu, then check the other addresses in the menu.

Check that the hostname and IP address are correctly entered in the node names database on your workstation (*/etc/hosts*).

Ping each node along the route between client and the HP 16500C remote file server starting with the client (your workstation). **Ping** each gateway, then attempt a **ping** of the remote file server.

If the HP 16500C remote file server still does not respond to **ping**, then suspect a hardware problem with the LAN interface. To verify the performance of the hardware, refer to "Verify the HP 16500C performance " in this chapter.

- Intermittent Response

A problem with the network is indicated if 1-8 packets were received. Because the number of packets received depends on your network traffic and integrity, the number might be different for your network.

Use a LAN analyzer or LAN management software to monitor activity and determine where bottlenecks or other problems are occurring.

The HP 16500C remote file server will still function; however communications over the LAN will be slower.



2 Attempt a remote NFS mount.

Attempt a remote NFS mount of the HP 16500C remote file server using command syntax that is specific for NFS mounts. Refer to your computer reference documentation for the specific command syntax. The command usually includes the remote NFS directory (hostname and either the /control or /data directory) and the mount point (the directory the remote file server will be attached to).

For example:

```
mount logic4:/control/nfs/logic4
```

- Normal Response

The UNIX command line prompt reappears. To verify that the remote NFS mount was successful, type **\$ mount** to view the mount table (/etc/mnttab). The remote file server should appear on the table of mounted devices.

- Error Messages

If error messages appear, check the command syntax before continuing with the troubleshooting. If the syntax is correct, resolve the error messages using your network documentation.

Verify that all of the mounting rules are being followed. Refer to the documentation of your network platform for the mounting rules.

A Device Busy error message appears when you try to mount for control if someone else has already mounted for control. Also, the Device Busy error message appears when an unmount is attempted and a user's pwd (present work directory) is a directory on the remote file server. If the Device Busy message appears, then recycle power on the HP 16500C and reattempt the remote NFS mount.

An error message is also received if you try to mount too soon after power-up. You need to wait at least 15 seconds after the System Configuration menu is displayed before attempting to mount.

Troubleshoot in an MS-DOS environment

1 Verify the communications link.

Verify the communications link between the client and the HP 16500C remote file server using the **ping** utility or other similar echo request utility.

To aid in troubleshooting, enter the Ethernet Statistics menu on the HP 16500C. You can view Transmit and Receive activity on this menu. The Ethernet Statistics menu is accessed from the LAN Settings menu. If needed, refer to "Network Status Information" in this chapter for more information about the Ethernet Statistics menu.

If the **ping** utility is not available on the PC, this is an indication that the PC-based NFS software is not properly installed. Reinstall the PC-based NFS software and attempt to verify the communications link.

The syntax of the **ping** command varies with the PC-based NFS software used. Usually, the command requires at least the IP address. If the syntax permits a specified number of echo requests, specify 10 as the number of echo requests. Refer to the PC-based NFS software documentation for more information.

```
ping [IP address] 10
```

- Normal Response

A normal response to the **ping** will be a total of 9, 10, or possibly 11 packets received if 10 echo requests were specified. Because the number of packets received depends on your network traffic and integrity, the normal number might be different for your network.

For every packet transmitted and received by a **ping** command, the Transmit Successful and Receive Successful fields in the HP 16500C Ethernet Statistics menu will increment by 1.

Go to step 2, "Attempt a remote NFS mount."

- Error Messages

If error messages appear, check the command syntax before continuing with the troubleshooting. If the syntax is correct, resolve the error messages using your NFS documentation.

Certain PC-based NFS software packages permit the use of hostname in place of the IP address. In this case, if an **unknown host** error message appears, check the node names database to see that the hostname and IP address are correctly entered.

Refer to the documentation of the PC-based NFS software for specific information on any error messages.

- No response

No packets received indicates no response from a **ping**.

If there is no response, type in the IP address with the **ping** command. Check that the typed address matches the IP address assigned in the HP 16500C LAN Settings menu, then check the other addresses in the menu.

Check that the hostname and IP address are correctly entered in the node names database and that the IP address matches the IP address assigned in the HP 16500C LAN Settings menu.

If the HP 16500C remote file server still does not respond to **ping**, suspect a hardware problem with the LAN interface. To verify the performance of the HP 16500C, refer to "Verify the HP 16500C performance" in this chapter.

- Intermittent Response

On a multi-client network, a problem with the network is indicated if 1 to 8 packets were received. Because the number of packets received depends on your network traffic and integrity, the number might be different for your network.

Use a LAN analyzer or LAN management software to monitor activity and determine where bottlenecks or other problems are occurring. The HP 16500C remote file server will still function; however communications over the LAN will be slower.

On a single-client/single-server network, the most likely cause of intermittent response to an echo request is a hardware problem with the LAN module installed in the client, the cable, or the HP 16500C. To verify the performance of the hardware, refer to "Verify the HP 16500C performance" in this chapter.

2 Attempt a remote NFS mount.

Attempt a remote NFS mount of the HP 16500C remote file server using command syntax that is specific for NFS mounts. Refer to the PC-based NFS software documentation for the specific command syntax. The command usually includes the remote NFS directory (hostname and either the /control or /data directory) and a disk drive designation.

- Normal Response

The DOS command line prompt should reappear. To verify that the remote NFS mount was successful, type **net use** to view the mounted drives.

- Error Messages

If error messages appear, check the command syntax before continuing with the troubleshooting. If the syntax is correct, resolve the error messages using your network documentation.

Verify that all of the mounting rules are being followed. Refer to the documentation of your network platform for the mounting rules.

A Device Busy error message appears when you try to mount for control if someone else has already mounted for control.

Also, if a Device Busy (or similar) error message appears, check the CONFIG.SYS file for the LASTDRIVE= command. The LASTDRIVE= command should be set to a drive letter that would make a disk drive designation available to use as a drive for the remote file server while still allowing the last three disk drive designations to be available for printers. For more information, refer to the documentation for MS-DOS.

An error message is also received if you try to mount too soon after power-up. You need to wait at least 15 seconds after the System Configuration menu is displayed before attempting to mount.



Troubleshoot in an MS-Windows environment

1 Verify the communications link.

Verify the communications link between the client and the HP 16500C remote file server using the **ping** utility or other similar echo request utility.

To aid in troubleshooting, enter the Ethernet Statistics menu on the HP 16500C. You can view Transmit and Receive activity on this menu. The Ethernet Statistics menu is accessed from the LAN Settings menu. If needed, refer to "Network Status Information" in this chapter for more information about the Ethernet Statistics menu.

If the **ping** utility is not available on the PC (the icon does not appear), this is an indication that the MS-Windows-based NFS software is not properly installed. Reinstall the MS-Windows-based NFS software and attempt to verify the communications link.

The execution of the **ping** command depends on the MS-Windows-based NFS software used. Usually, the command requires at least the IP address. If a specified number of echo requests can be sent, specify 10 as the number of echo requests. Refer to the MS-Windows-based NFS software documentation for more information.

- Normal Response

A normal response to the **ping** will be a total of 9, 10, or possibly 11 packets received if 10 echo requests were specified. Because the number of packets received depends on your network traffic and integrity, the normal number might be different for your network.

For every packet transmitted and received by a **ping** command, the Transmit Successful and Receive Successful fields in the HP 16500C Ethernet Statistics menu increments by 1.

Go to step 2, "Attempt a remote NFS mount."

- Error Messages

If error messages appear, check the command syntax before continuing with the troubleshooting. If the syntax is correct, resolve the error messages using your NFS documentation.

Check that all fields are correctly filled.

Certain MS-Windows-based NFS software packages permit the use of hostname in place of the IP address. In this case, if an **unknown host**

error message appears, check the node names database to see that the hostname and IP address are correctly entered.

Refer to the documentation of the MS-Windows-based NFS software for specific information on any error messages.

- No response

No packets received indicates no response from a **ping**.

If there is no response, type in the IP address with the **ping** command. Check that the typed address matches the IP address assigned in the HP 16500C LAN Settings menu, then check the other addresses in the menu.

Check that the hostname and IP address are correctly entered in the node names database.

If the HP 16500C remote file server still does not respond to **ping**, then suspect a hardware problem. To verify the performance of the HP 16500C, refer to "Verify the HP 16500C performance" in this chapter.

- Intermittent Response

On a multi-client network, a problem with the network is indicated if 1 to 8 packets were received. Because the number of packets received depends on your network traffic and integrity, the number might be different for your network.

Use a LAN analyzer or LAN management software to monitor activity and determine where bottlenecks or other problems are occurring. The HP 16500C remote file server will still function, however communications over the LAN will be slower.

On a single-client/single-server network, the most likely cause of intermittent response to an echo request is a hardware problem with the LAN module installed in the client, the cable, or the HP 16500C. To verify the performance of the HP 16500C, refer to "Verify the HP 16500C performance" in this chapter.



2 Attempt a remote NFS mount.

Attempt a remote NFS mount of the HP 16500C remote file server using MS-Windows File Manager. In the Disk menu of File Manager, the Network Connections field should appear. If this field does not appear, this indicates that the MS-Windows-based NFS software was not properly installed.

Select a Drive Letter under New Connection. If a drive letter does not appear, then check the LASTDRIVE= command in the CONFIG.SYS file. The LASTDRIVE= command should be set to a drive letter that would make a disk drive designation available to use as a drive for the remote file server while still allowing the last three disk drive designations to be available for printers. For more information about the CONFIG.SYS file, refer to the documentation for MS-DOS.

- Normal Response

When Connect is selected, the drive letter and the mounted remote file server should appear under the Network Drive Connections window.

- Error Messages

If error messages appear, resolve the error messages using your NFS documentation.

Check to make sure all of the appropriate fields in the Network Connections menu have the correct information. If all of the fields have correct information, refer to the documentation for the MS-Windows-based NFS software and for MS-Windows File Manager for more information.

A Device Busy error message appears when you try to mount for control if someone else has already mounted for control.

An error message is also received if you try to mount too soon after power-up. You need to wait at least 15 seconds after the System Configuration menu is displayed before attempting to mount.

Verify the HP 16500C performance

The HP 16500C LAN performance verification (self-test) is divided into two sections. The first section tests the physical connection, for example, the cable and termination. The second section tests the internal functions of the LAN IC on the HP 16500C LAN interface. When both sections of the self-test have completed, a status reporting message appears in the Mainframe Test menu. The status reporting message indicates whether the tests pass, if a failure occurs, and which section failed.

The first section, the physical connection, is tested depending on the LAN topology used. If ThinLAN is used, a test transmission signal is transmitted over the LAN. If a reply is received, the physical connection is considered good. If EtherTwist (10Base-T) is used, the HP 16500C will listen for the heartbeat signal from the LAN. If a heartbeat is received, the physical connection is considered good.

The second section is tested using internal loopback features of the LAN IC. Transmitted packets are looped back to the receive circuit of the LAN IC. When the looped back packets are received, they are processed like a packet received from a remote client or server. If the looped back packet is recognized and processed, then the LAN IC and the LAN function are considered good.

Perform the following check before beginning the procedure.

- Check all network cables and connectors. Verify that all cables are properly connected.

Procedure

This procedure verifies the performance of the HP 16500C interface module. To verify performance of the overall HP 16500C Logic Analysis System or the optional modules, refer to the Service Guides for those products.

- 1** Go to the System Configuration menu.
- 2** Verify that LAN available in the Controller box on the HP 16500C System Configuration screen and that the LAN box is present in the Settings group.

If the LAN selections appear in the Communications box, go to the next step.

If LAN does not appear, the LAN interface is not recognized by the HP 16500C operating system. If the screen is completely blank, cables might be defective, disconnected, or not properly seated.

To check the hardware problems, perform the following steps.

- a Remove power from the HP 16500C, disconnect the power cable, then remove the top cover.
- b Ensure that all cables are connected and properly seated.
- c Install the top cover of the HP 16500C mainframe, connect the power cable, and reapply power.

If Ethernet still does not appear, suspect a defective CPU board.

Contact an HP Service Center to replace the CPU board.

- 3 Touch **Configuration**, then touch **Test**. When the test menu appears, touch the blue field to load the performance verification test system.
- 4 Touch **Test System**, then select **Mainframe Test** in the pop-up menu. The screen will display the Mainframe Test menu.

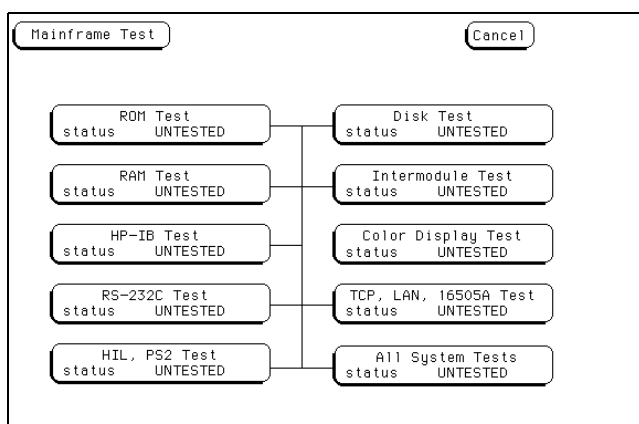

Mainframe Test Menu

5 Select TCP, LAN, 16505A Test, then select Run.

6 Verify that the tests pass.

If all of the tests pass, go to the next step.

If any of the tests fail, LAN hardware or the HP 16500C interface hardware is suspect.

The status number in the TCP, LAN, 16505A Test menu indicates whether the LAN hardware or the HP 16500C interface hardware caused the failures.

- To troubleshoot the failure using the status number, note the number, then compare it with the status number descriptions and perform the recommended action. Refer to "Status Number" on the next few pages for status number descriptions and recommended actions.
- To verify the LAN hardware, check that the LAN cable is good and that all signal lines in the cable have electrical integrity.

7 Exit the Test System.

a Touch the Module field, then touch Test System.

b Touch the Menu field, then touch Exit Test.

c Touch the field near the center of the screen to exit the test system and to load the operating system.



Status Number

When you run the TCP, LAN, 16505A Test, the test menu reports a status number. The following figure shows the bit positions of the hexadecimal status reporting word.

A "1" in a bit position signifies that the bit is set and the test failed.

A "0" in a bit position signifies that the bit is not set and the test passed.

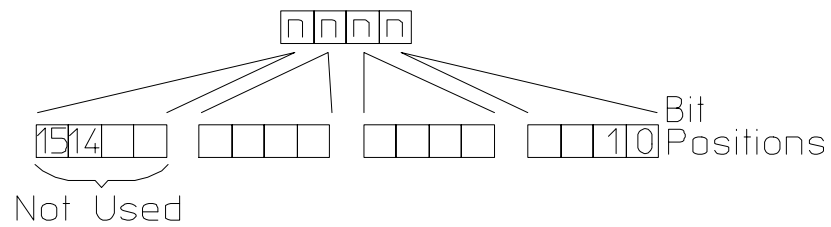

16500m05

Status Reporting Message

The following table describes each bit in the status number.

Table 7-2

Status Bits

| | |
|-------|---|
| Bit 0 | The internal registers of the LAN IC are loaded with known test values and then are read. If this bit is not set, it implies that the LAN IC is operating properly and that the microprocessor can communicate with the LAN IC. If this bit is set, the LAN module is not operational and must be replaced. |
| Bit 1 | The CAM (Content Addressable Memory) bit reports whether the LAN address can be written from the LAN module Static RAM (SRAM) to the internal memory of the LAN IC. Also, the CAM bit reports whether the LAN address can be written to SRAM from the LAN IC. If this bit is not set, it implies that both the SRAM and the LAN IC internal memory are able to recognize and store the LAN address. If this bit is set, the LAN module is not operational and must be replaced. |
| Bit 2 | If this bit is not set, the self-test has detected that the LAN cable is properly connected to the LAN module. If this bit is set, the physical connection of the LAN cable must be checked. |
| Bit 3 | If the Termination bit is set, the self-test has detected an excessive number of collisions. The most probable cause of excessive collisions is an improperly terminated LAN cable. Provide a proper termination of the LAN cable according to the LAN topology being used. |
| Bit 4 | The MAC (Media Access Control) bit indicates whether the Media Access Control unit on the LAN IC is functioning. If this bit is not set, it implies that both the transmit functions and receive functions of the LAN IC are operating properly. If this bit is set, the LAN module is not able to properly transmit and receive packets, and must be replaced. |
| Bit 5 | The ENDEC (Encoder/Decoder) bit indicates whether the encoder/decoder internal to the LAN IC is functioning. The encoder/decoder is the interface between the MAC and the Ethernet transceiver. If this bit is set, the ENDEC is not operating properly and the LAN module must be replaced. |

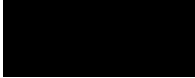

Status Bits (continued)

| | |
|------------|---|
| Bit 6 | The TRANS (Transceiver, such as Ethernet transceiver) bit indicates whether the circuitry between the LAN IC and the LAN cable is functioning. If this bit is not set, the path between the LAN cable and the LAN IC is operating properly. If this bit is set, then the LAN module must be replaced. |
| Bit 7 | If the Timeout bit is set, bits 4, 5, or 6 will also be set. Refer to the appropriate bit for a suggested course of action. |
| Bit 8 | The Tx bit indicates whether the transmission portion of the MAC, ENDEC, or TRANS test failed. Therefore, the Tx bit is used in conjunction with bits 4, 5, and 6. Refer to the appropriate bit for the suggested course of action. |
| Bit 9 | The Rx bit indicates whether the receive portion of the MAC, ENDEC, or TRANS test failed. The Rx bit is used in conjunction with bits 4, 5, and 6. Refer to the appropriate bit for the suggested course of action. |
| Bit 10 | The Parameters bit indicates the integrity of the LAN module self-test parameters. If this bit is not set, the parameters sent to the self-test routine are correct. If this bit is set, contact your nearest HP Sales and Service Office. |
| Bit 11 | The EPROM that is used to hold the Ethernet address, IP address, and gateway address has been corrupted. If this bit is set, the LAN module must be replaced. |
| Bits 12–15 | Not Used |

Network Status Information

The Ethernet Statistics menu supports network troubleshooting through the front-panel.

- To access the statistics menu, select LAN in the Settings group. In the LAN Settings menu, select Ethernet Statistics from the bottom of the pop-up menu.

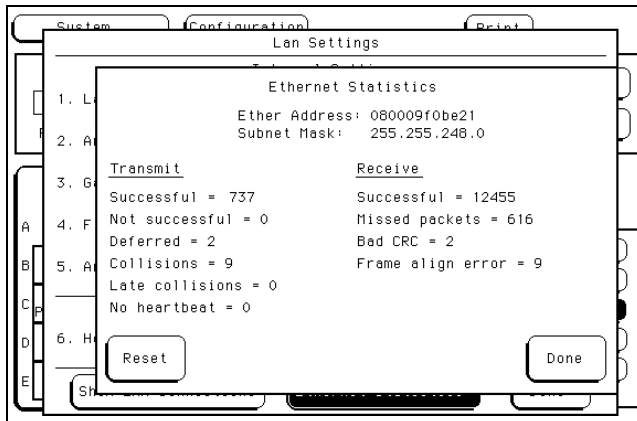

Ethernet Statistics Menu

Table 7-3

Information on the Ethernet Statistics menu

| | |
|----------------------|---|
| Ether Address | The Ether Address is a 12-character hex address. This address is configured in each HP 16500C shipped from HP. You cannot enter or change the Ether Address. |
| Subnet Mask | The HP 16500C automatically gets the subnet mask by sending a broadcast ICMP query over the network. The broadcast ICMP query is transmitted approximately 10 seconds after power is applied to the HP 16500C and approximately 2 seconds after the IP address is changed. When the query is answered by another network device, the HP 16500C stores the subnet mask information in internal memory. |
| Transmit | |
| Successful | Number of successfully transmitted packets |
| Not successful | Number of packets not transmitted due to errors. The transmit not successful field is tied primarily to transmit deferrals and possible hardware problems. If a packet is deferred (but not because of a collision), the packet is given a delay and retransmission is attempted. After 15 deferrals, the not successful field is incremented. |
| Deferred | Number of packets deferred due to network traffic. After 15 deferrals, the not successful field is incremented. |
| Collisions | Number of packets that had to be retransmitted due to network traffic. |
| Late collisions | Number of illegal collisions that have occurred after 51.2 μ s from either the first bit of preamble or from SFD (Start of Frame Delimiter). |
| No heartbeat | Number of packets where the transceiver fails to provide a collision pulse. |
| Receive | |
| Successful | Number of successfully received packets. |
| Missed packets | Number of packets that were dropped for lack of resources in the HP 16500C. |
| Bad CRC | Number of corrupt packets. |
| Frame align error | Number of packets with frame alignment error. |



General Characteristics

General Characteristics

This chapter describes the general characteristics of the HP 16500C/16501A Logic Analysis System, including hardcopy capability, the input/output BNCs, and information about making interactive measurements. This chapter also includes the weight and dimensions of the HP 16500C/16501A, and information about the operating environment necessary to ensure optimum equipment performance.

Characteristics

These characteristics are not specifications, but are included as additional information. The following characteristics are typical for the HP 16500C/16501A Logic Analysis System.

| | |
|----------------------------|---|
| Hard Disk Drive | Capacity 540 Mbyte, DOS format. IDE Interface Bus. |
| Flexible Disk Drive | Capacity 1.44 Mbyte formatted, DOS and LIF formats. |
| Programmability | Instrument settings and operating modes, including automatic measurements, may be remotely programmed via RS-232-C, HP-IB (IEEE-488), or Ethernet. |
| Hardcopy Output | Printers Supported HP ThinkJet, HP QuietJet, HP LaserJet, HP PaintJet, HP Deskjet, Epson and Epson-compatible (for example Epson FX-80) via RS-232-C, HP-IB, or Parallel. RS-232-C Configurations Protocols: XON/XOFF, None; Data bits: 8; Stop bits: 1, 1 1/2, 2; Parity: none, odd, or even; Baud rates: 110, 300, 600, 1200, 2400, 4800, 9600, 19200. HP-IB Interface Functions SH1, AH1, T5, TE0, L3, LE0, SR1, RL1, PP1, DC1, DT1, C0 and E2. |

Input/Output

Port-in BNC User selectable: TTL, ECL or user defined; $Z_{in} = 4 \text{ k}\Omega$;
 $V_{in} = -6.0 \text{ V}$ at 1.5 mA to +6 V at 1.6 mA, CAT 1.

Port-out BNC Selectable active high or low, 3 V TTL-compatible
output level, high $> 2 \text{ V}$ into 50Ω , low $< 0.4 \text{ V}$ into 50Ω .

LAN IEEE 802.3 (ISO 8802-3) CSMA/CD, selectable between 10Base-T
(Ethertwist) or 10Base2 (ThinLan).

PS/2 Mouse and optional keyboard interface.

Centronics standard parallel-printer interface.

Target Control Port Used with logic analyzer accessories specifically
designed to provide run control of a target system.

Input: TTL input, 7.0 V max, CAT 1

Output: 3 V TTL-compatible output level, high $> 2 \text{ V}$ into 50Ω , low $< 0.4 \text{ V}$ into 50Ω .

Intermodule Bus (IMB) Characteristics

Run Control Oscilloscope, timing, state, and pattern generation can be
armed by Group Run. Modules can run concurrently or be armed in
series. Each module can arm one or more modules.

Mixed Display Mode Any timing or oscilloscope waveform displays
can be mixed. State listings can be included with waveforms in the
State/Timing Mixed Mode display.

Acquiring Data for Mixed Displays To obtain a mixed display,
multiple modules must be armed through the IMB. To include state
listings in mixed mode displays, state time tagging must be on.

Time Interval Accuracy Between Modules Equals the sum of the
channel-to-channel time interval accuracies of each module used in the
measurement, for a de-skewed measurement.

Time Correlation Resolution 2 ns (500 MHz)

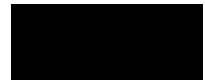

Operating Environment

Temperature

Instrument 0 °C to 50 °C (32 °F to 122 °F).

Disk Media 10 °C to 40 °C (50 °F to 104 °F).

Probes and Cables 0 °C to 65 °C (32 °F to 149 °F).

Humidity

Instrument up to 95% relative humidity at 40 °C (104 °F).

Disk media and hard drive 8% to 80% relative humidity at 40 °C (104 °F).

Altitude Up to 4600 m (15 000 ft). Hard drive to 300 m (10 000 ft).

Vibration

Operating Random vibration 5-500 Hz, 10 minutes per axis, 2.41 g (rms).

Nonoperating Random vibration 5-500Hz, 10 minutes per axis, ~ 2.4 g (rms); and swept sine resonant search, 5-500Hz, 0.75g (0-peak), 5-minute dwell at 4 resonances per axis.

Power 115 V/230 V, 48 to 66 Hz, 475 W max. CAT 1

Weight

HP 16500C

Net 18.1 kg (40 lbs) + (0.7 kg (1.6 lbs) × number of optional cards installed).

Shipping 25.9 kg (57 lbs) + (3.6 kg (8 lbs) × number of optional cards installed).

HP 16501A

Net 12.2 kg (27 lbs) + (0.7 kg (1.6 lbs) × number of optional cards installed).

Power Requirements

HP 16500C 115 V/230 V, 48 to 66 Hz, 475 W max. CAT 1

HP 16501A 115 V/230 V, 48 to 66 Hz, 420 W max. CAT 1

Dimensions

Refer to the following figure for dimensional detail.

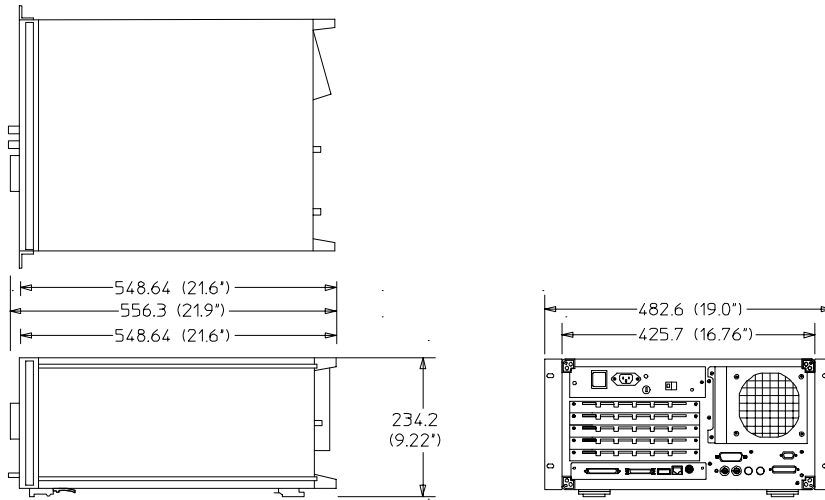

HP 16500C

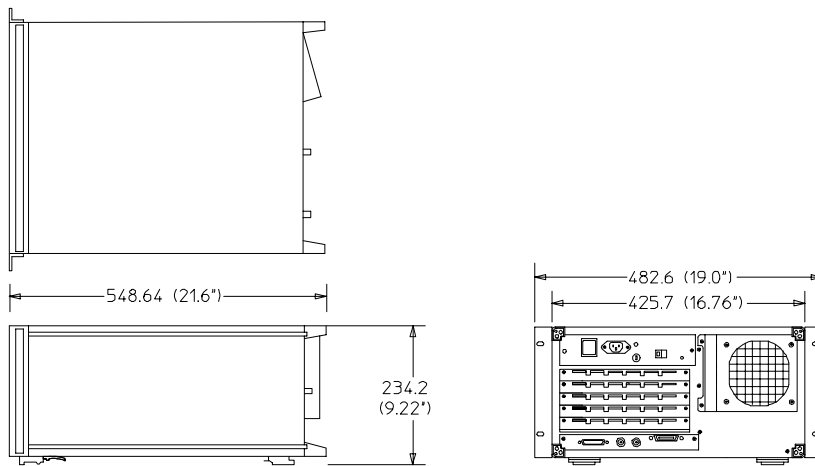

HP 16501A

16500e94

Dimensional Detail



Maintaining the HP 16500C

Maintaining the HP 16500C

This chapter describes the maintenance requirements for the HP 16500C Logic Analysis System. It explains cleaning requirements and degaussing procedures, and tells you where to look for information when the instrument needs service or recalibration. It also explains how the System Test menu is used.

Cleaning Requirements

When cleaning the HP 16500C, USE MILD SOAP AND WATER only. A harsh soap or solvent may damage the water-base paint finish.

Clean the CRT display and surrounding area regularly. DO NOT place tape or other foreign material on the screen.

Vacuum the ventilation slots on the sides of the instrument and the fan on the rear panel whenever there is a visible amount of dust on them.

Preparing For Use

Power Requirements

HP 16500C The Logic Analysis System Mainframe requires a power source of either 115 Vac or 230 Vac, -22 % to +10 %, single phase, 48 to 66 Hz, 475 W maximum power.

HP 16501A The Logic Analysis System Expansion Frame requires a power source of either 115 Vac or 230 Vac, -22 % to +10 %, single phase, 48 to 66 Hz, 420 W maximum power.

Operating Environment

The operating environment is listed in chapter 8. Note the noncondensing humidity limitation. Condensation within the instrument can cause poor operation or malfunction. Provide protection against internal condensation.

The Logic Analysis System will operate at all specifications within the temperature and humidity range given in chapter 8. However, reliability is enhanced when operating it within the following ranges:

- Temperature: +20 °C to +35 °C (+68 °F to +95 °F)
- Humidity: 20% to 80% noncondensing

Storage

Store or ship the logic analysis system in environments within the following limits:

- Temperature: -40 °C to + 75 °C
- Humidity: Up to 90% at 65 °C
- Altitude: Up to 15,300 meters (50,000 feet)

Protect the system from temperature extremes which cause condensation on the instrument.

Inspecting the Logic Analysis System

1 Inspect the shipping container for damage.

If the shipping container or cushioning material is damaged, keep them until you have checked the contents of the shipment and checked the instrument mechanically and electrically.

WARNING

Hazardous voltages exist in this instrument. To avoid electrical shock, do not apply power to a damaged instrument.

2 Check the supplied accessories.

Accessories supplied with the logic analysis system are listed in "Accessories Supplied" in chapter 1.

3 Inspect the product for physical damage.

Check the logic analysis system and the supplied accessories for obvious physical or mechanical defects. If you find any defects, contact your nearest Hewlett-Packard Sales Office. Arrangements for repair or replacement are made, at Hewlett-Packard's option, without waiting for a claim settlement.

Applying Power

- 1 Check that the line voltage selector, located on the rear panel, is on the correct setting and the correct fuse is installed.**

See also, "Setting the Line Voltage" in this chapter.

- 2 Connect the power cord to the instrument and to the power source.**

This instrument is equipped with a three-wire power cable. When connected to an appropriate ac power outlet, this cable grounds the instrument cabinet. The type of power cable plug shipped with the instrument depends on the country of destination.

- 3 Turn on the instrument line switch located on the rear panel, then turn on the power standby switch located on the front panel.**
-

Setting the Line Voltage

When shipped from HP, the line voltage selector is set and an appropriate fuse is installed for operating the instrument in the country of destination. To operate the instrument from a power source other than the one set, perform the following steps.

- 1 Turn the front panel power switch to the **Standby** position, then turn the rear panel power switch to the **Off** position. Remove the power cord from the instrument.**
- 2 Replace the main fuse with a 5 A/250 V fuse for 230 V operation, or a 10 A/125 V fuse for 115 V operation.**
- 3 Set the rear panel line select switch for the desired voltage.**
- 4 Reconnect the power cord, turn on the rear panel power switch, then continue normal operation.**
- 5 If your system includes an HP 16501A Expansion Frame, repeat this procedure for it.**

The expansion frame has only one power switch, and that switch is located on the rear panel.

Degaussing

After you have used the instrument for a while, the CRT may become magnetized and start to distort the colors on the screen or other display data. To remedy this problem, degauss the CRT by pressing and releasing the button on the rear panel marked DEGAUSS. If the screen is in particularly bad condition, repeat this procedure several times until the screen clears up.

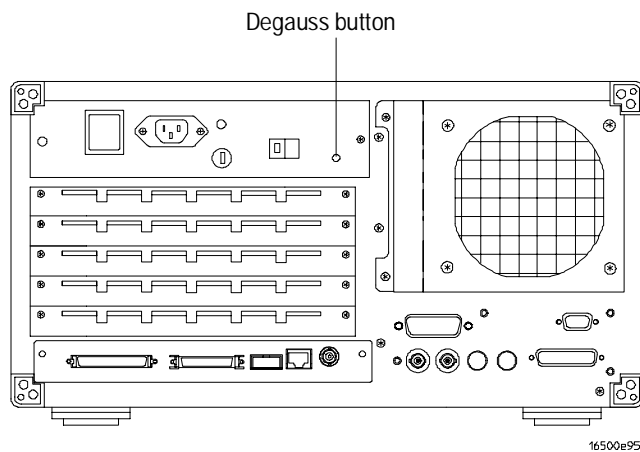

The Degaussing Button

Service and Calibration

If at any time the instrument fails to operate properly or needs to be adjusted, refer to the *HP 16500C Service Guide*. The Service Guide can be ordered through your HP Sales Office.

The HP 16500C Logic Analysis System mainframe does not require calibration. However, some modules of the Logic Analysis System require periodic calibration. For more information, refer to the Service Guide of your HP 16500-series module.

The System Test Menu

The System Test menu is used to test portions of the microprocessor board including the system peripheral interfaces and the disk drives. It also allows you to check the color module for color purity.

For more information on this menu, refer to the *HP 16500C Service Guide*, available from your HP Sales Office.

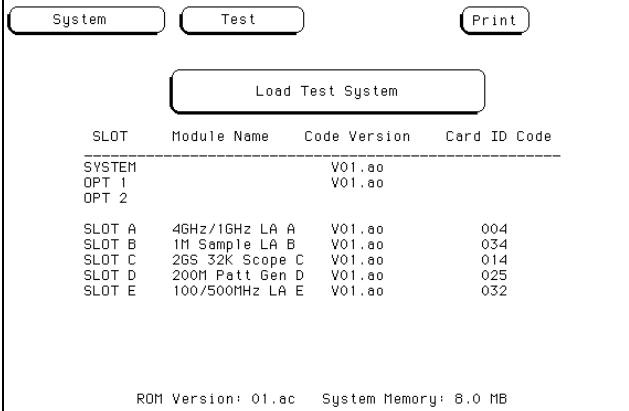

The screenshot shows a menu interface with three buttons at the top: "System", "Test", and "Print". Below them is a "Load Test System" button. A table lists hardware components with columns for Slot, Module Name, Code Version, and Card ID Code. At the bottom, it displays "ROM Version: 01.ac" and "System Memory: 8.0 MB".

| SLOT | Module Name | Code Version | Card ID Code |
|--------|-----------------|--------------|--------------|
| SYSTEM | | V01.00 | |
| OPT 1 | | V01.00 | |
| OPT 2 | | | |
| SLOT A | 46Hz/1GHz LA A | V01.00 | 004 |
| SLOT B | 1M Sample LA B | V01.00 | 034 |
| SLOT C | 26S 32K Scope C | V01.00 | 014 |
| SLOT D | 200M Patt Gen D | V01.00 | 025 |
| SLOT E | 100/500MHz LA E | V01.00 | 032 |

ROM Version: 01.ac System Memory: 8.0 MB

Loading the Test System Software

To perform the self-tests

The self-tests verify the correct operation of the logic analysis system. Self-tests can be performed all at once or one at a time. While testing the performance of the logic analysis system, run the self-tests all at once.

1 If you just did the power-up self-tests, go to step 2.

If you did not just do the power-up self-tests, disconnect all inputs, then turn on the power switch. Wait until the power-up tests are complete.

2 Go to the System Test menu.

3 Select the box labeled Load Test System.

4 Select Test System, then select Mainframe Test from the pop-up menu.

5 Install a formatted disk that is not write protected into the flexible disk drive.

6 Select All System Tests.

You can run all tests at one time by running All System Tests. To see more details about each test, you can run each test individually. This step shows how to run all tests at once.

The status of the tests will change from Untested to Passed or Failed. If a test fails, refer to the optional Service Guide.

The Color Display Test is not normally needed. The screens are primarily used when the color display assembly requires adjusting. For the adjustment procedure, refer to the optional Service Guide.

7 Exit the mainframe tests.

a In the Mainframe Test menu, select **Mainframe Test**, then select **Test System**.

b Select **Configuration**, then select **Test** in the pop-up menu.

c Select the box labeled **Exit Test System** to exit the test system and to load the mainframe operating system.

After the operating system is loaded, the System Configuration menu is displayed.

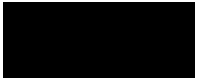

Repackaging for Storage or Shipment

Proper repackaging is necessary to prevent damage to the HP 16500C. The instrument may be stored or shipped in environments within these limits:

Temperature

40 °C to 70 °C (–40 ° F to +158 °F)

Humidity

Up to 90% relative humidity at 65 °C
(149 °F)

Altitude

Up to 15,300 m (50,000 ft)

The instrument should also be protected from temperature extremes which could cause condensation within the instrument. Condensation within the instrument may cause it to malfunction.

Tagging the Instrument for Service

If the instrument is to be shipped to a Hewlett-Packard office for service or repair, attach a tag with the owner's name and address, the model number, the complete serial number, and a description of the service required. In any correspondence, refer to the instrument by model number and serial number. The model number is on the front of the instrument. The serial number is on the side of the rear fan housing.

Repacking the Instrument

Before repacking the instrument, insert a shipping disk into the flexible disk drive. The shipping disk helps protect the disk drive from damage during shipping.

If the original packing material is unavailable or unserviceable, material identical to factory packaging is available through Hewlett-Packard offices. Always mark the container **FRAGILE** to ensure careful handling.

If you use other packaging, follow these general instructions:

- 1** Wrap the instrument in heavy paper or plastic.
- 2** Use a strong shipping container. A double-wall carton made of 350-lb test material is adequate.
- 3** Protect the control panel with a piece of cardboard.
- 4** Put a layer of shock-absorbing material 70- to 100-mm (3- to 4-in.) thick around the instrument to firmly cushion it and prevent any movement inside the container.
- 5** Seal the shipping container securely.
- 6** Mark the container **FRAGILE** to ensure careful handling.





Error Messages

Error Messages

This chapter lists the disk error messages and disk warning messages you may receive while operating the disk menus in the HP 16500C/16501A Logic Analysis System. In addition, there is information on the powerup self-tests errors.

Disk Error Messages

The following is a list and description of error messages that may be displayed in the disk menus.

Configuration not loadable This module or option does not have the ability to load a configuration.

Configuration not storable This module or option does not have the ability to store a configuration.

Destination disk has different capacity The disk drive only permits the duplicate disk operation between flexible diskettes with the same capacity (double density or high density) and format (LIF or DOS).

Directory contains files You cannot purge a directory that contains files. Delete all files within the directory first, then purge the directory.

Directories not supported on LIF disk Directory operations may not be performed on LIF disks.

Disk CRC error Cyclical Redundancy Check (CRC) failed on this disk. If this appears during a Format operation, you may have selected the wrong disk size. Otherwise, try to recover any needed files and reformat the disk. Formatting the disk may not correct the current problem. If it doesn't correct the problem, discard the disk.

Disk data lost Unable to read the disk. Try re-installing the disk or cycling the power.

Disk is write-protected The current disk is write-protected. Disengage the write-protect tab on the disk.

Disk record not found The disk format has been damaged. Recover any needed files and reformat the disk. Formatting the disk may not correct the current problem. If it doesn't correct the problem, discard the disk.

Disk timeout The disk drive may not be working properly or the disk was removed while being accessed.

Duplicate filename A file with the same name already exists on the current disk. Select a different destination name.

End of file encountered Trying to read data beyond the end of the file. The file was generated improperly or its contents have been altered.

File is being used You cannot purge a file or directory that is being used by another operation. Operations may be initiated using the touch screen, controller, or Ethernet. Finish the other operation and try your operation again.

File not found The specified file is not on the disk. Also, when copying a file, the directory that contains the destination file may not exist.

Filename already exists A file with the same name already exists on the current disk. Select a different destination name.

Insufficient memory There is not enough memory to perform the selected operation at this time. Reduce the number of operations being performed on the logic analyzer (using the touch screen, controller, or Ethernet) and try the operation again.

Invalid configuration file The contents of this file are incorrect.

Invalid file name The file name is invalid for any of the following reasons: the name contains invalid characters for the disk format (LIF or DOS), the name is too long, or the file name has spaces embedded in the wrong places.

Invalid file type for this operation The current operation may not be performed with a file of the current type.

No destination disk No disk is currently installed in the destination disk drive.

No disk No disk is installed in the flexible disk drive.

No room in directory The directory on the disk is full. Purge any files no longer needed.

No room on disk The disk is full and the currently written file does not fit. Deleting unneeded files and/or packing the disk may correct the problem.

Permission for this operation denied The logic analyzer does not permit certain operations: duplicating the hard disk, formatting the hard disk in LIF format, or writing or purging a file that has its read-only attribute set (flexible disk only).

Selected file is incompatible The file being loaded is incompatible for this module or option.

Too many files open The logic analyzer's maximum number of simultaneously open files has been exceeded. File operations may be initiated from the touch screen, the controller, or the Ethernet. Reduce the number of file operations and try again.

Unsupported format The disk in the disk drive is unformatted or formatted on a non-compatible system. If the contents of the disk are NOT needed, format it.

Wrong format on high density diskette A high-density (two holes) diskette has been formatted with a double-density format. The logic analyzer cannot read this diskette.

Disk Warning Messages

Disk warning messages are displayed when the contents of a file or a disk are in danger of being destroyed by an operation.

Duplicate Disk destroys contents of destination A warning that the duplicate disk command does not append the source files to the destination. It overwrites any files on the destination disk in a packed form.

Filenames must begin with a capital letter This warning indicates that the disk will not accept the filename as it has been entered. Retype the filename with a capital letter at the beginning.

Embedded blanks not allowed in filename This warning indicates that the disk will not accept the filename as it has been entered. Remove the blank spaces or replace them with underscore characters.

Please verify disk is the correct density type and is not write protected or damaged An error in formatting a flexible disk. If the disk is not write-protected, attempt formatting the disk again using a different disk size setting.

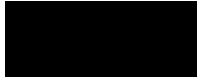

Other System Warning Messages

ORed Triggering

No modules in the group run support Or'd triggering! Either Group Run with OR TRIGGER was active and you have removed the last ORable module from the top level of Group Run, or you have a Group Run set up and attempted to change it to Group Run with OR TRIGGER when no ORable modules were assigned. Selecting the Group Run field will still start the measurement, but no modules will be triggered by the triggers of other modules.

Attempted configuration is illegal; restoring original The Group Run configuration that you set up is beyond the capabilities of the Logic Analysis System. The illegal configuration is replaced with the original Group Run configuration.

Target Control

All bits are assigned to other signals This warning appears when you attempt to turn on a signal, but all bits are already assigned. To use the signal, select **Modify Signal** from the pop-up menu and assign bits. Because all bits are already assigned, modifying the signal means you will be changing the bit assignment of at least one other signal. When you close the Target Control Signal Settings menu, the warning "You have reassigned a bit from another signal to the current signal" appears.

One or more bits have been reassigned to another signal This warning appears when you attempt to turn on a signal that was turned off when its bits were reassigned. The Target Control Signal Settings menu shows the state of the signal before it was turned off. You can restore the signal's former state by selecting **Done**. This reassigns bits away from the other signal and back to the current signal. The message "You have reassigned a bit from another signal to the current signal" appears.

There are no bits assigned to this signal This warning appears when you turn on or modify a signal which has no bits assigned to it. Assign bits, and then set the state.

You have reassigned a bit from another signal to the current signal The assigned bit from another signal to the current signal has been assigned to other signals which may now be inactive or altered.

Powerup Self-Test Documentation

When you turn on the HP 16500C, it initiates a set of self-tests to check the basic condition of the instrument and the operating system. This is a limited set of tests that checks whether or not the CPU board is working well enough to boot the rest of the software from disk.

If a test fails, consult the *HP 16500C Service Guide* (available from your HP Sales Office) or run the Performance Verification tests as described in chapter 9, "Maintaining the HP 16500C."

No self-test routines are performed for any modules at power-up. The following is a list of self-tests performed.

- ROM test
- RAM test
- Interrupt test
- Display test
- HIL Devices test
- Touchscreen test
- PS2 Controller test
- Correlator test
- Hard Disk test
- Flexible Disk test



Fail Codes

The type of fail codes you might encounter are:

Disk Test passed
 failed
 no disk

The flexible disk test returns no disk when there is no disk in the drive. If there is a disk in the flexible disk drive and this error is returned, re-insert the current disk. If you still get this error, your HP 16500C requires service.

Touchscreen passed
 impaired
 failed

Impaired means there is not a complete touchscreen, but the HP 16500C can still be operated; or the touch failed, but a mouse was detected on the interface loop. To correct an incomplete touchscreen, try wiping the bezel on the display and cleaning the CRT. Make sure no objects are blocking the screen on power-up.

Failed means there is not enough touchscreen to operate the HP 16500C through the touchscreen. You can still operate it with the mouse, however.

All Others passed or failed

Critical Errors

Critical errors are system load errors detected at power-up. When one of these is detected, it is displayed on the screen in yellow and the self-test routine is stopped IMMEDIATELY. These include:

SYSTEM FILE NOT FOUND Indicates the last drive searched for a system file had a disk, but no system file was found on the disk.

SYSTEM DISK NOT FOUND Indicates the last drive checked had no disk on it.

SYSTEM FILE READ ERROR Indicates an error was detected during all three attempts to load the system file.

SYSTEM DISK ERROR Indicates the drive that the system file was on failed during load.

Non-Critical Errors

Non-critical errors occur in the power-up self-tests. Non-critical errors allow sequences to continue and won't stop the power-up routine. Some non-critical errors are "touchscreen impaired" and "no disk."



Part 2

The HP 16500C Logic Analysis System is a modular design. There are many test and measurement modules available that fit into the mainframe. In addition, as your system expands, you may accumulate many system options.

The System Options part of the User's Reference is where you find the information for the keyboard, HP 16501A Expansion Frame, and HP 16505A Prototype Analyzer. Even though you may not have purchased these options yet, keep this information for possible future use.

What is in the System Options?

- Chapter 11 explains the keyboard options.
- Chapter 12 describes the HP 16501A Expansion Frame option.
- Chapter 13 describes the HP 16505A Prototype Analyzer.

| | | |
|-----------|---|--|
| 11 | Using the Optional Keyboard | |
| 12 | The Optional HP 16501A Expansion Frame | |
| 13 | The Optional HP 16505A Prototype Analyzer | |

System Operations



Using the Optional Keyboard

The Keyboard

This chapter explains how to use the optional keyboard interface. The keyboard and mouse can be used interchangeably with the knob and touchscreen for all menu applications. The keyboard functions fall into the two basic categories of cursor movement and data entry.

The keyboard connects to the keyboard connector on the back panel. When the keyboard and mouse are connected, a graphic is included in the System Configuration menu to represent the interface options being used.

Moving the Cursor

The keyboard cursor is the location on the screen highlighted in inverse video. To move the cursor, follow one of the methods described below.

Keyboard Cursor Movement

There are four cursor keys marked with arrows on the keyboard. These keys perform the following movements:

- Up-pointing arrow moves the cursor up.
- Down-pointing arrow moves the cursor down.
- Right-pointing arrow moves the cursor to the right.
- Left-pointing arrow moves the cursor to the left.

The cursor keys do not wrap. This means that pressing the right-pointing arrow when the cursor is already at the rightmost point in a menu will have no effect. The cursor keys do repeat, so holding the key down is the fastest way to continue keyboard cursor movement in a given direction.

You can also use the cursor keys to duplicate the function of the knob on the front panel of the HP 16500C. To simulate rotating the knob clockwise, simultaneously press the **Shift** key and either the up-pointing arrow key or the right-pointing arrow key. To simulate rotating the knob counter-clockwise, simultaneously press the **Shift** key and either the down-pointing arrow key or the left-pointing arrow key.

Home Key If you want to move the cursor to the first item in a menu, press the **Home** key. If you want to move the cursor to the last item in a menu, press the **Home** and **Shift** keys simultaneously.

Page Up and Page Down Keys The Page Up and Page Down keys are used for paging through listings. The Page Up key will display the next page of data, if one exists. The Page Down key will display the previous page of data, if one exists. These functions work only for the logic analyzer modules.

Selecting a Menu Item To select a menu item using the optional keyboard, position the cursor on the desired menu item using one of the methods described in the section "Moving the Cursor" and press either the **Return** or the **Enter** key.

Entering Data into a Menu

When the cursor is over the desired field, and either the Return key or the Select key is pressed, the cursor is displayed over the leftmost digit of the particular item. When you enter a number, it is displayed in the cursor position, and the cursor is advanced. Cursor keys move the cursor within the field. Pressing either the **Return** key or the **Enter** key will terminate data entry for that item.

If you want to erase the data entry, press the **Delete** key.

Autoroll

When entering pattern generator data, you can move through each line horizontally, filling in each data field in the line before going to the next line, or you may want to fill in all the data in a column before moving on to the next column. The Autoroll feature makes moving from one data entry field to another easier than selecting each in succession.

When you select a data field and the pop-up menu appears, notice that a field labeled Autoroll also appears at the left side of the screen. To use the Autoroll feature, place the cursor over the desired data field, then press either the Return key or the Enter key. When the cursor is at the left margin of the data, press the left-pointing arrow key. The cursor will disappear from the data and reappear in the Autoroll field.

When you select the Autoroll field, another pop-up menu appears. This menu presents you with three choices:

- Off.
- A field containing a right-pointing arrow and a down-pointing arrow.
- A field containing a down-pointing arrow.

If you want to move through your data line by line, from left to right, select the field marked with the right-pointing arrow and the down-pointing arrow. Once this field is activated, the pop-up menu will close and autoroll through the data fields from left to right. When you finish entering data into the last field in a line, the pattern generator will automatically move to the first field in the next line. This process continues until the pattern generator reaches the end of the program or until you turn Autoroll off.

If you want to move through your data column by column, select the pop-up field marked with the down-pointing arrow. When this field is selected, the pattern generator moves down each column of data, and, when data entry in the column is complete, automatically moves to the top of the next column. This process continues until the end of the program is reached or until you turn Autoroll off.

Autoroll is automatically turned off when data entry to all the available fields is complete. If you want to turn off Autoroll before data has been entered into all the data fields, press the left-pointing arrow key when the cursor is at the left margin of a data field. When the Autoroll pop-up menu appears, select Off.



Using the Keyboard Overlays

The function keys above the number pad have been redefined to work with the HP 16500C/16501A keypad. A keyboard overlay is included in the HP E2427B Keyboard Kit. The overlay shows the redefined function keys. These function keys are listed below.

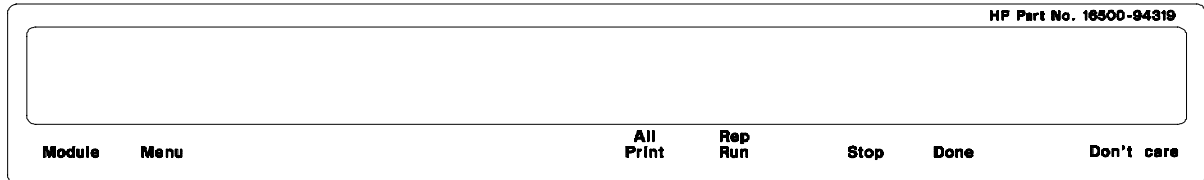

Keyboard Overlays

Table 1-1

Units and Hex Keys

| Key | Real-Time Keypad | Voltage Keypad | Hex Keypad |
|-----|------------------|----------------|------------|
| F9 | Seconds | Volts | D |
| F10 | Milliseconds | Millivolts | E |
| F11 | Microseconds | - | F |
| F12 | Nanoseconds | - | - |
| * | - | - | A |
| / | - | - | B |
| + | - | - | C |



Don't Care Key

Tab is the "Don't Care" key. The value of this key is determined by the currently displayed keypad. It is "X" in the hex keypad and double quotation marks (" ") in the stimulus hex keypad.

Table 1-2

| Don't Care Key | | |
|-----------------------|---------------------|------------|
| Key | Stimulus Hex Keypad | Hex Keypad |
| Tab ("Don't Care") | Double Quotes (" ") | X |

Function Keys

Several function keys have been provided to simplify frequently used keystrokes. The function-to-key mapping is shown below.

F1, F2, F7, and F8 only work when there are no submenus popped up.

Table 1-3

| Function Keys | |
|---------------|---|
| Key | Function |
| F1 | Selects and pops up the module field. |
| F2 | Selects and pops up the menu field. |
| F7 | Selects and pops up the print field. |
| F8 | Invokes the run key for its current setting. If the run key is set to repetitive, pressing F8 will invoke repetitive running. If the run key is set to single run, pressing F8 will invoke a single run. If the module is running, F8 will stop the module. |

Defining Time Units

In addition to the function keys which are mapped to the HP 16500C/16501A real-time keypad, other keys on the keyboard invoke the units keys. The time unit keys are listed below.

Table 1-4

Time Units Keys

| Key | Time Units |
|------------|---------------------------------|
| S | Selects the seconds units. |
| M | Selects the milliseconds units. |
| U | Selects the microseconds units. |
| N | Selects the nanoseconds units. |

Defining Voltage Units

Besides the function keys which are mapped to the HP 16500C/16501A real-time keypad and the time units keys, other keys on the keyboard invoke the voltage units keys. The voltage unit keys are listed below.

Table 1-5

Voltage Units Keys

| Key | Voltage Units |
|------------|----------------------|
| V | Selects volts. |
| M | Selects millivolts. |



Assigning Edge Triggers

Several keys map to edge assignments. These keys and their functions are listed below.

Table 1-6

Edge Trigger Keys

| Key | Edge Trigger Assignment |
|---------------------|--|
| U | Selects the up or rising edge. |
| D | Selects the down or falling edge. |
| R | Selects the rising edge. |
| F | Selects the falling edge. |
| B | Selects either the rising or falling edge. |
| Up-Pointing Arrow | Selects the rising edge. |
| Down-Pointing Arrow | Selects the falling edge. |

Closing a Menu

To exit a menu, press either the Done or Enter key. The Enter key is mapped to the Done key, so pressing either key closes the menu.



The Optional HP 16501A
Expansion Frame

The HP 16501A Expansion Frame

The HP 16501A Expansion Frame has been developed to extend the HP 16500C Logic Analysis System beyond its five-card limit, and meet the anticipated need for systems requiring more than five slots.

This chapter explains the components and system configuration of the HP 16501A. There are sections explaining and illustrating module-to-module system arming and triggering, as well as an inter-frame arming/triggering block diagram. In addition, this chapter contains information on how to connect the HP 16501A to the HP 16500C.

Adding the HP 16501A to the HP 16500C creates a tightly-coupled, two-frame, ten-card system, fully controlled by the HP 16500C. A single power switch (located on the HP 16500C front panel) turns on both frames.

The HP 16501A offers inter-frame module arming/triggering capabilities with a 2-nanosecond time correlation between modules.

Component Details

The HP 16501A Expansion Frame is very similar to the mainframe. It consists of a card cage, rear panel, power supply, and fans.

The interface is a buffering scheme to pass signals between the mainframe and the HP 16501A backplane. It contains circuitry which controls external arming selection and enables an HP 16501A card to drive an output dedicated to triggering other instruments.

System Configuration

The expansion frame interface board is connected to the mainframe interface board through a 68-pin flat cable as shown below. In addition to the HP 16500C rear panel signals, the cable incorporates control signals which allow the CPU to communicate with and control the expansion frame interface board. Ground lines separate signal lines within the cable to prevent cross-coupling or soft failures. The cable is externally shielded to reduce RFI emissions.

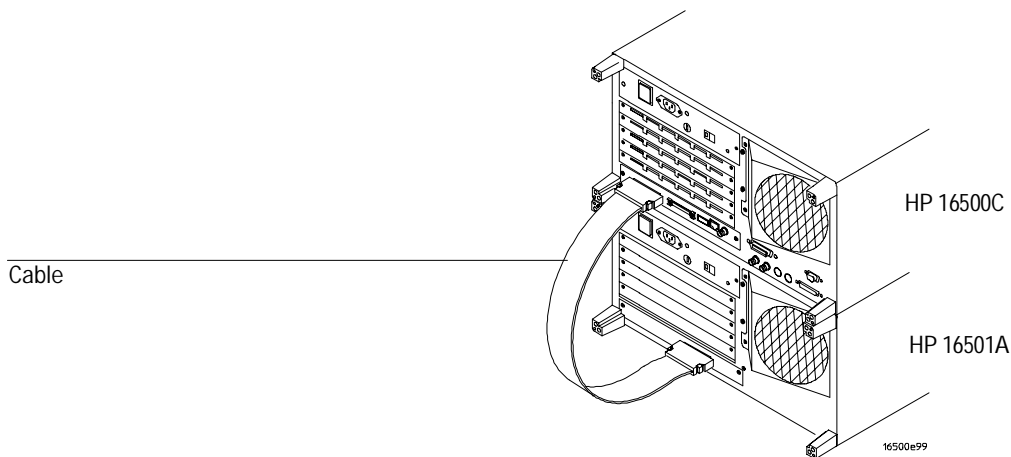

Connecting Cable

System Power-Up

The HP 16501 Expansion Frame's power supply is controlled by the HP 16500 mainframe. Because the power is controlled from another instrument, the HP 16501's power switch must be on before the HP 16500 is turned on or the Expansion Frame will not be recognized by the Logic Analysis System software.

- 1** Connect the cable from the HP 16500 to the HP 16501.
- 2** Turn on the rear power supply of the HP 16500 mainframe.
- 3** Turn on the power breaker of the HP 16501 Expansion Frame.
- 4** Turn on the front panel power of the HP 16500 mainframe.

System Arming and Triggering

Module-to-module arming within the HP 16501A follows the arming specifications for the HP 16500C in that any module may arm any other module. The maximum intermodule arming level is five.

When the HP 16501A is attached to the HP 16500C, the resulting HP 16500C/16501A system operates as a single frame. The HP 16500C and HP 16501A may receive only one external arming signal from the other frame. The figure below shows how module-to-module arming is selected.

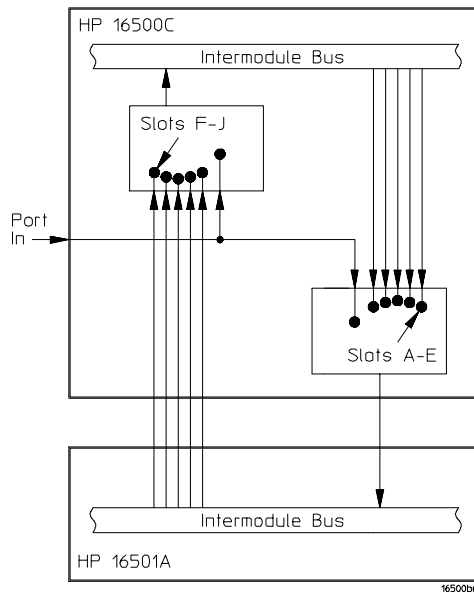

Module-to-Module Arming

The HP 16500C mainframe may use only two external arming signals — any module in the HP 16501A expansion mainframe or the rear-panel BNC. The arming signal can come from three sources:

- Any module in the HP 16500C mainframe.
- Any module in the HP 16501A expansion mainframe.
- From the rear-panel PORT IN BNC.

The arming signal from the HP 16501A overlays with the PORT IN signal. If a measurement requires that modules in the 16500C receive arming signals from both PORT-IN and the HP 16501A, the modules should be reconfigured. Arrange the modules such that PORT IN arms the module in the HP 16500C and the module in the HP 16500C arms the module in the HP 16501A.

Any card in the HP 16500C mainframe can be armed from its external inputs or from one of the other four cards in the HP 16500C mainframe.

The HP 16501A Expansion Frame may use only one external arming signal. The arming signal for any module can come from two sources:

- Any module in the HP 16501A Expansion Frame.
- From a single module or the PORT IN BNC in the HP 16500C mainframe.

Any module in the HP 16501A Expansion Frame may be armed from a single HP 16500C module or from one of the other four modules in the HP16501A Expansion Frame.

To summarize, the arming triggers available for output from the HP 16500C/16501A are:

HP 16500C

- Module A through Module E.
- PORT IN BNC.

HP 16501A

- Module F through Module J.

It should be noted that only the HP 16500C has a PORT OUT BNC. There is no PORT OUT BNC on the HP 16501A. The PORT OUT signals from module F through module J use the PORT OUT BNC on the HP 16500C.

See Also

The "Correlating Measurements" chapter found earlier in this User's Reference for more information on intermodule measurements using the HP 16500C/16501A.

Connecting the HP 16501A Expansion Frame

The optional HP 16501A Expansion Frame has two components:

- The expansion frame.
- A flat, bi-directional cable 2 meters long with a 68-pin "D" connector at each end.

Connect the HP 16501A to the HP 16500C as illustrated below.

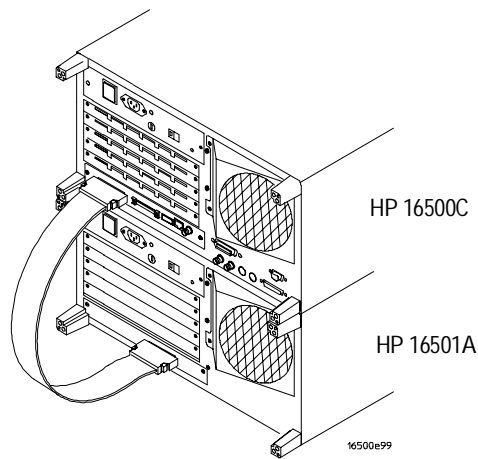

Connecting the Optional Expansion Frame

Make sure the connector is properly seated into the port by pulling the connector without pressing the release tabs. If the connector is properly seated, it will remain connected to the port.

At power-up, the HP 16500C CPU board checks for an expansion frame connection. If found, the CPU establishes a "link" between the rear panels of the two frames. The interface link is graphically displayed by the System Configuration menu.



The Optional HP 16505A
Prototype Analyzer

The HP 16505A Prototype Analyzer

The HP 16505A Prototype Analyzer creates a new visual analysis environment for digital design teams doing prototype integration, verification, debug, and root-cause analysis. The Prototype Analyzer works as an analysis and display processor for the Logic Analysis System.

This chapter explains the components of the HP 16505A. In addition, this chapter contains information on how to connect the HP 16505A to the HP 16500C.

Adding the HP 16505A to the HP 16500C creates a complete prototype analysis environment that allows you to see multiple views of your data simultaneously.

Component Details

The HP 16505A Prototype Analyzer is a new logic analysis interface designed to help your design team quickly progress through the prototyping stage of product development. Using the HP 16500 Logic Analysis System mainframe and modules as the acquisition front end, the Prototype Analyzer reduces the user interface to drag-and-drop icons. The HP 16505A Prototype Analyzer also has more computational power than the HP 16500 mainframe.

The HP16505A Prototype Analyzer includes the following features:

- 60-MHz PA-RISC compute engine.
- 32-Mbyte base system memory.
- 3.5-inch (90-mm) flexible disk drive.
- keyboard and mouse.
- optional extra memory
- optional 1-Mbyte VRAM

The Prototype Analyzer requires but does not include an SVGA monitor.

Initial System Power-Up

These instructions are valid only for an HP 16505A Prototype Analyzer and an HP 16500C Logic Analysis Systems. Other combinations may require additional hardware.

- 1** Connect the monitor, mouse, and keyboard to the HP 16505A.
- 2** Connect the High Speed Interface Cable to the port labeled "16505" on the rear of the HP 16500C and to the port labeled "High Speed Port" on the HP 16505A.
- 3** (Optional) Connect an HP 16501 Expansion Frame.
- 4** Connect power cables and position the instruments so that they have about 2 inches (5 cm) around the sides for cooling.
- 5** Turn on the system power.
 - a** Turn on the HP 16500C main power switch on the rear.
 - b** Turn on the power break of the optional HP 16501A Expansion Frame.
 - c** Turn on the HP 16500C standby power switch on the front.
 - d** Wait for the HP 16500C to fully boot.
 - e** Turn on the monitor's power switch.
 - f** Turn on the HP 16505A Prototype Analyzer's main power switch on the front panel.
- 6** Configure your system to support your monitor.

Cycle the power on the HP 16505 and immediately press the Tab key on the keyboard about ten times. The display will change the screen every few seconds as the system cycles through the monitor choices. The cycle of choices will repeat until you press the enter key to make a selection, then confirm.

When the system has been properly booted, the Session Manager window will appear.

See Also

HP 16505A Prototype Analyzer Installation Guide for more information on setting up the system.

HP 16505A Online Help for information on setting up measurements.

Part 3

The HP 16500C Logic Analysis System is designed to be modular in both a hardware and software respect. For each test and measurement module there are some operations that are common. For example, the process of assigning labels to data channel groups is the same for all logic analyzers.

The Common Module Operations part of the User's Reference contains the information which is common to most of the modules.

The installation chapter does not cover information about inter-card connections specific to modules. That information is covered in the module's User's Reference.

| | | |
|-----------|--------------------------------------|--|
| 14 | Label Assignment | |
| 15 | Symbols Assignment | |
| 16 | Installing and Removing Cards | |

Common Module Operations



Label Assignment

Labels

Hewlett-Packard logic analyzers give you the ability to separate or group data channels and label them with names that are meaningful to your measurement. The information in this chapter is applicable to all analyzers.

Labels are assigned only in the Format menu. Once assigned, the labels are displayed in all display menus. Use labels when you want to group data channels by function with a name that has meaning to that function.

The default label names are Lab1 through Lab126. However, you can modify the names to any six-character string. The figure below gives you an example of label use.

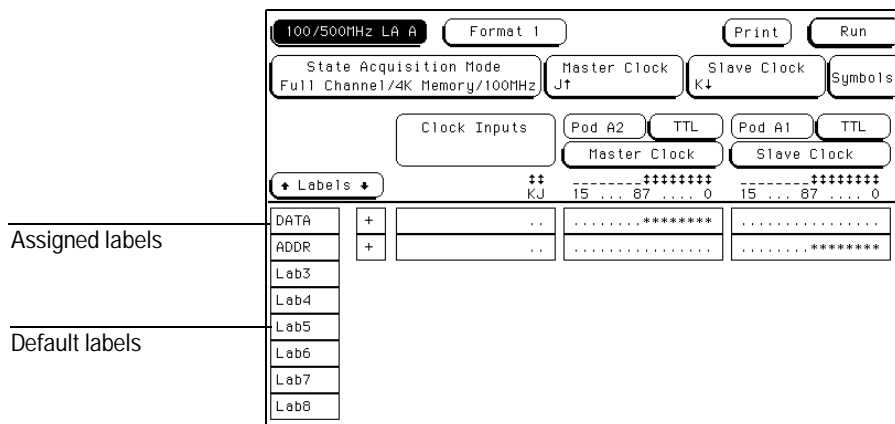

Labels in the Format Menu

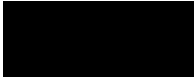

Label Assignment Fields

The label assignment fields found in the Format menu display the user-defined label names. Use custom label names when there are different types of data to be tracked. The labels you assign in the Format menu appear in all other display menus. Labels can be shown in or removed from display menus, but not assigned. Label assignment can only be done in the Format menu.

The label column contains 126 label fields that you can define. The analyzer displays only 8 labels at any time.

When any label field is selected, a pop-up menu appears which is used to modify the label list.

Label assignment field

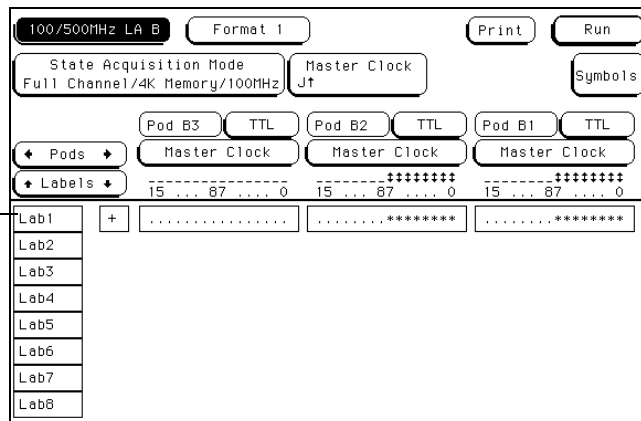

Label Fields

Turn Label On

The Turn Label On selection is used to activate a label and its accompanying bit assignment field. Once a label field is activated, you can assign a custom name. If a custom name is not assigned, the default name assigned by the analyzer will remain the label. In addition, if no channels are turned on in the bit assignment fields, the label is turned off when the Format menu is exited.

Turn Label Off

The Turn Label Off option turns off the label. When a label is turned off, the label name and the bit assignments are saved by the logic analyzer. This gives you the option of turning the label back on and still having the bit assignments and name if you need them. With labels off, the label names remain displayed for identification and searching purposes.

Modify Label

If you want to change the name of a label, or want to turn on a label and give it a specific name, select the **Modify Label** option. When selected, an alpha-numeric entry pop-up menu appears for you to enter a label name. A label name can be a maximum of six characters.

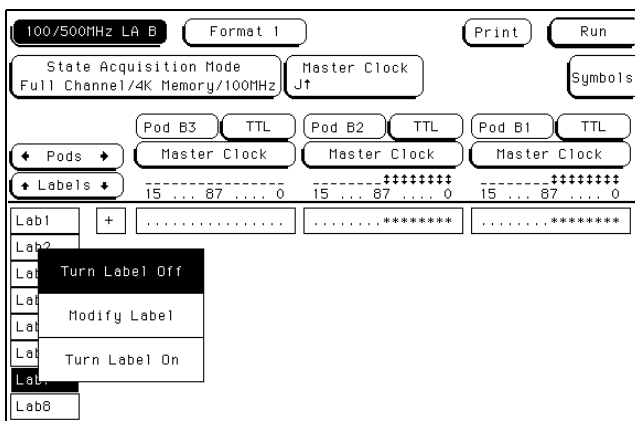

Modify Label Selection Pop-up Menu



Rolling Labels and Pods

The Labels roll field allows you to view offscreen labels.

To view offscreen labels, select the Labels roll field to ensure it is active, then rotate the knob. The labels scroll up and down.

The Pods roll field allows you to view offscreen pods.

To view offscreen pods, select the Pods roll field to ensure it is active, then rotate the knob. Pods are positioned with the lowest numbered pod on the right.

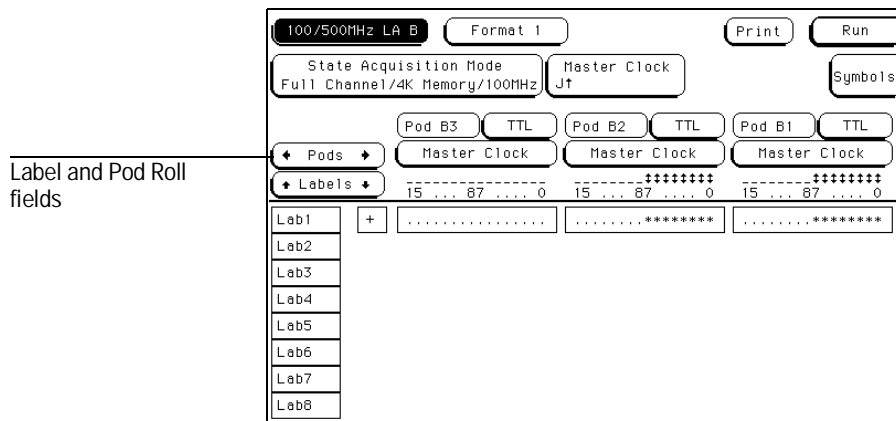

Labels and Pods Roll Fields



Symbols Assignment

Symbols

State listings can display acquired data in a variety of numeric formats. However, one of the most useful forms of display is not a numeric form, but a symbolic form.

When symbols are defined and the base type set to Symbols, the custom mnemonic you create is placed in the data listing where the bit pattern would normally be displayed. This makes the data listing easy to read or scan for specific values.

You can specify up to 1000 symbols within an analyzer module. If your analyzer module can be configured into two analyzer types (state and timing), you can use all 1000 symbols in one analyzer type or divide them between both.

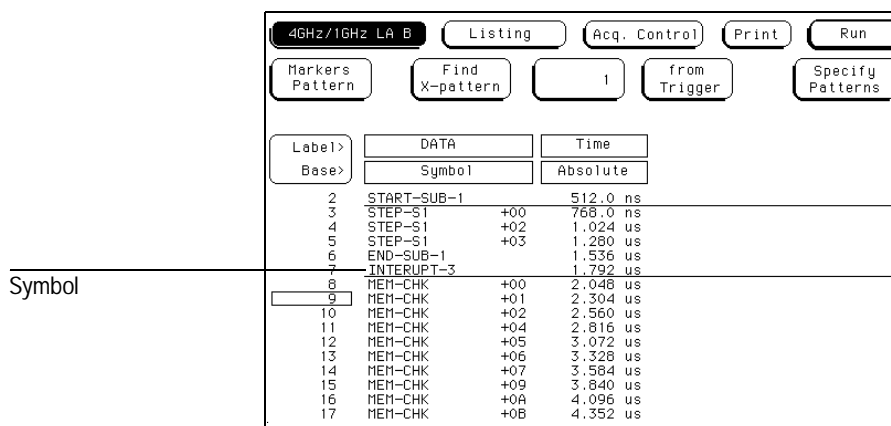

The screenshot shows a software interface for an analyzer. At the top, there are buttons for '4GHz/1GHz LA B', 'Listing', 'Acq. Control', 'Print', and 'Run'. Below these are buttons for 'Markers Pattern', 'Find X-pattern', a text input field containing '1', 'from Trigger', and 'Specify Patterns'. The main display area is a table with columns for 'Label>', 'DATA', and 'Time'. Below the table, there are sub-columns for 'Base>', 'Symbol', and 'Absolute'. The table contains 17 rows of data. A line labeled 'Symbol' points to the 'Symbol' column header.

| Label> | DATA | Time |
|--------|-------------|----------|
| Base> | Symbol | Absolute |
| 2 | START-SUB-1 | 512.0 ns |
| 3 | STEP-S1 +00 | 768.0 ns |
| 4 | STEP-S1 +02 | 1.024 us |
| 5 | STEP-S1 +03 | 1.280 us |
| 6 | END-SUB-1 | 1.536 us |
| 7 | INTERUPT-3 | 1.792 us |
| 8 | MEM-CHK +00 | 2.048 us |
| 9 | MEM-CHK +01 | 2.304 us |
| 10 | MEM-CHK +02 | 2.560 us |
| 11 | MEM-CHK +04 | 2.816 us |
| 12 | MEM-CHK +05 | 3.072 us |
| 13 | MEM-CHK +06 | 3.328 us |
| 14 | MEM-CHK +07 | 3.584 us |
| 15 | MEM-CHK +09 | 3.840 us |
| 16 | MEM-CHK +0A | 4.096 us |
| 17 | MEM-CHK +0B | 4.352 us |

Example of Symbols in a Data Listing

Symbols Field

The Symbols field is located in the Format menu and is used to access the symbol table. The symbol table is where symbols are created and maintained. The figure below shows the Symbols field in a state analyzer's Format menu.

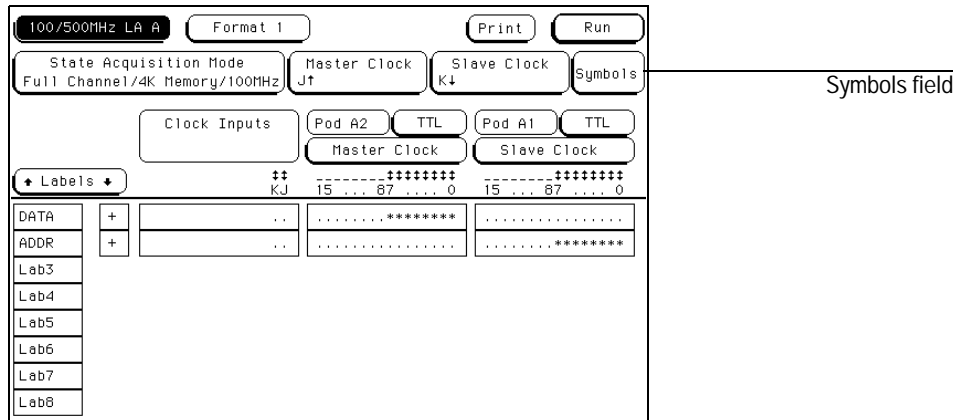

Symbols Field in the Format Menu

Symbols can also be loaded using the HP E2450A Symbol Download Utility included with the HP 16500C Logic Analysis System. See the User's Guide included with HP E2450A.

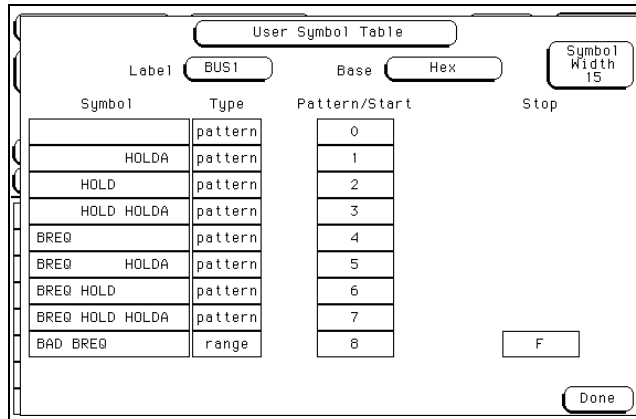

Symbol Table Pop-up Menu

Label Field

The Label field identifies the label for which you are specifying symbols. When you select this field, a selection menu appears that lists all the labels turned on for that analyzer. Each label has a separate symbol table so you can give the same name to symbols defined under different labels. From the label selection menu, select the label for which you want to specify symbols.

Base Field

The Base field is used to select the numeric base in which the pattern in the symbols menu is displayed. If more than 20 channels are assigned to a label, the Binary option is not offered. When a symbol is specified as a range, there is only enough room for 20 bits to be displayed on the screen. Decide which base you want to work in and choose that option from the numeric base pop-up menu.

If you choose the ASCII option, you can see the ASCII characters represented by the patterns and ranges defined by your symbols. ASCII characters represented by the decimal numbers 0 to 127 (hex 00 to 7F) are offered on your logic analyzer.

You cannot specify a pattern or range when the base is ASCII. First define the pattern or range in one of the other bases, then switch to ASCII to see the ASCII characters.

Symbol Width Field

The Symbol Width field is used to specify how many characters of the symbol name will be displayed when the symbol is referenced in the Trigger, Waveform, and Listing menus.

Select the Symbol Width field and set the number of characters in the symbol. You can have the logic analyzer display from 3 to 16 of the characters in the symbol name.

Symbol Name Field

When you first access the symbol table, there are no symbols specified. The symbol name field reads **New symbol**. Select this field and enter the name of your symbol. A maximum of 16 characters can be used in a symbol name.

When a symbol name is assigned, the symbol Type field becomes active. The symbol Type field is used to define the symbol type as either a pattern or a range. When you select this field, it toggles between pattern and range.

Pattern Type Field

When the symbol is defined as a pattern, a Pattern/Start field appears to the right of the Type field. Use this field to specify the pattern. Select the Pattern/Start field and enter the desired pattern.

Range Type Field

If the symbol is defined as a range, a Pattern/Start field and a Stop field appears. Use these fields to specify the upper and lower boundaries of the range.

Select both fields and specify the boundaries of the range. You can also specify ranges that overlap or are nested within each other.



To add, delete, or modify symbols in the symbol table, select any field displaying a defined symbol name. A pop-up menu appears with the following choices.

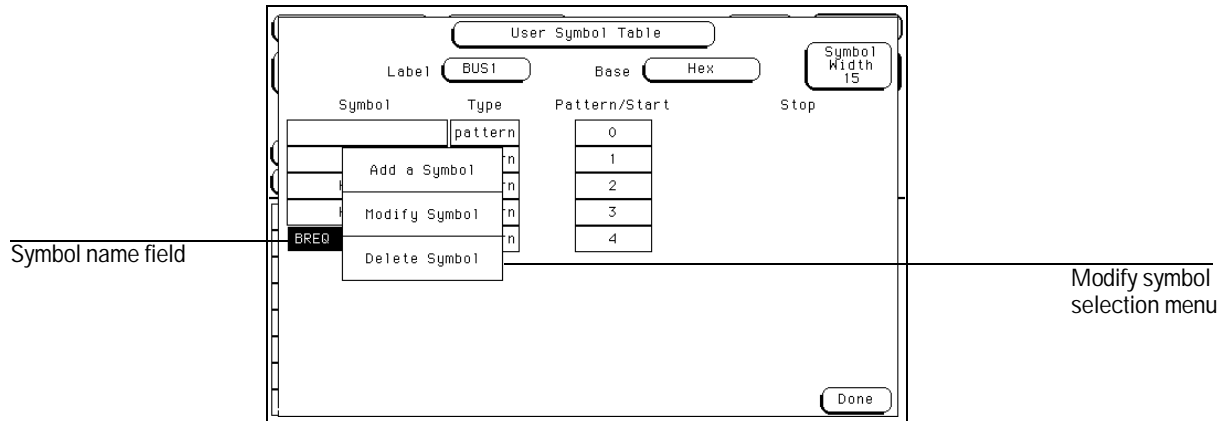

Modify Symbol Selection Menu

Modify Symbol

Select this option to change the name of the symbol.

Add a Symbol

When you select this option, you must enter a new symbol name. When you select **Done**, your new symbol will appear in the symbol table directly below the original symbol name.

Delete Symbol

If you select this option, the highlighted symbol will be deleted from the symbol table.

When you have specified all your symbols, you can leave the symbol table menu by selecting the **Done** field.



Installing and Removing Cards

Installing and Removing Cards

This chapter is organized into two types of information. First, there is a general installation section which contains the procedure to install and remove modules from the mainframe. If there are no specific cabling considerations for a single-card module, this section is all that is required for installation information.

Following the general installation information is a section which contains inter-card cable information for multi-module configurations. You should first refer to this section and the installation section of the specific module's User's Reference to make sure any cables are connected properly, then install the module into the mainframe.

Because of the modular design of the Logic Analysis System, you can move modules within and between the HP 16500C and the HP 16501A frames. Be sure you check each specific model's calibration considerations for any unique calibration concerns.

General Installation Considerations

- When modules have both a master card and an expansion card, both cards must be installed in the same frame. For example, an HP 16520A master card must be installed in the same frame as the HP 16521A expansion card.
- Do not install, remove, or replace cards unless the instrument is shut off and the power cord is disconnected.
- Filler panels must be installed in all unused card slots to ensure correct air circulation.
- Save all unused cables and filler panels for future configurations

General Installation Procedure

Where Do Cards Mount?

Turn off the instrument and unplug it. Then turn the frame around so the rear panel is facing you.

Each frame contains five slots in which to insert the cards. Each slot has a label to its right. The top slot on the HP 16500C is A, the next one down is B, then C, D, and E. The CPU board of the frame is located beneath slot E.

The top slot on the HP 16501A is labeled F, the next one down is G, then H, I, and J.

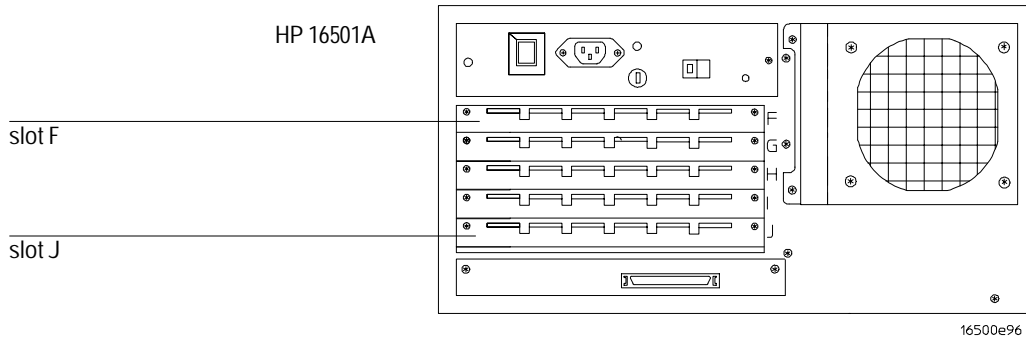
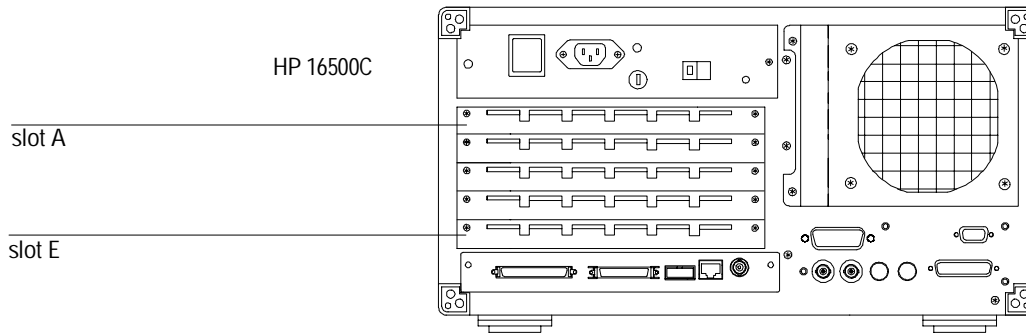

16500e96

The HP 16500/16501 Card Cages

Installing Cards in the HP 16500C/16501A

CAUTION

The effects of ELECTROSTATIC DISCHARGE can damage electronic components. Grounded wriststraps and mats should be used when you perform any kind of service to the mainframe or the cards in it.

- 1 Starting from the top of the card cage, loosen the thumb screws on the filler panel(s) and pull them out of the frame.

Because the endplates of the cards overlap, you must start with the top slot of the frame you want to change and work down when removing cards. To install cards, start with the first open slot at the bottom of the card cage and work up.

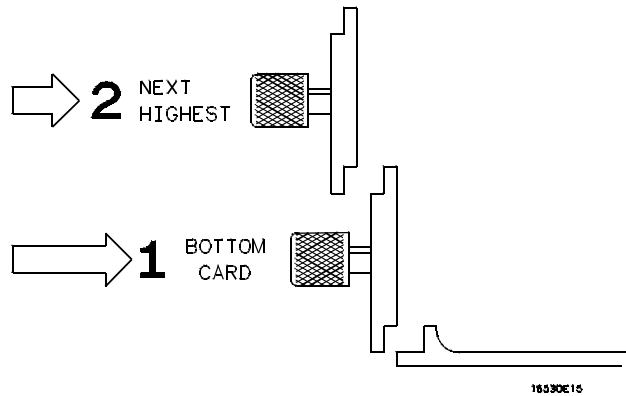

Endplate Overhang

- 2 Hold the card (or set of cards) so that the components are facing upward and the main connector is pointing away from you.
- 3 Align the card (or set of cards) with an appropriate set of slots on the rear panel, filling the slots closest to the bottom first. Gently slide the card in until the connector on the card touches the connector on the frame.

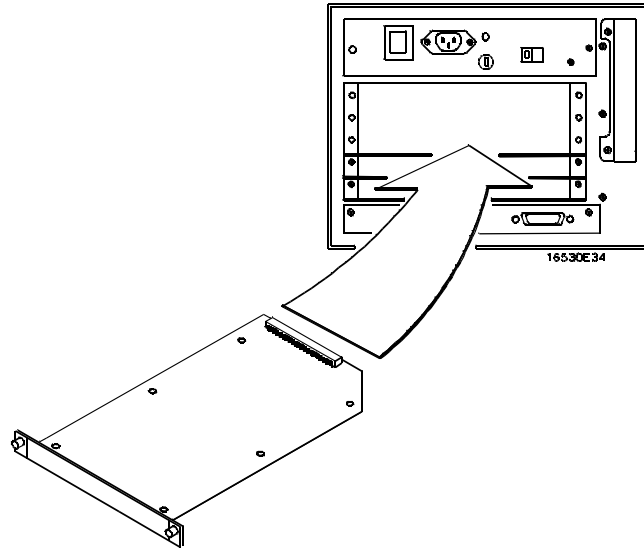

Installing Cards

- 4 Gently, but firmly, push the card in until the endplate on the card is flush with the rear panel.
- 5 While applying pressure to the center of the card endplate, tighten down the thumb screws on either side of the endplate.
- 6 After you are finished installing cards, install filler panels in all unused slots.

Removing Cards from the HP 16500C/16501A

To remove cards from the frame, you must start with the card in the top slot (slot A in the HP 16500C or slot F in the HP 16501A). Remove the next card down. Proceed in this manner until you get to the card you need. To remove the cards from their slots:

- 1 Loosen the thumb screws on either side of the endplate of the card until the thumb screws are free from the frame.**

Removing Connected Cards

If two cards need to be removed together, loosen the screws from both cards before trying to remove the cards.

- 2 Gently, but firmly, pull on the heads of the thumb screws and slide the cards out.**

Multi-Card Module Considerations

Multi-card modules must be configured such that the cards are installed adjacent to one another, with no empty slots between them and no other test and measurement modules between them. For some modules, card order determines which card is the master card. See the User's Reference for the specific module to see if order determines which card controls the module.

Calibration

After an oscilloscope module has been installed, it is recommended that each oscilloscope card contained in the multi-card module be calibrated. This is not necessary for multi-card logic analyzer modules. In some cases all of the modules in the mainframe must be calibrated. Refer to the applicable manual for any other modules that may require calibration.

General Rules

There are several rules that you must understand and follow to configure multiple oscilloscope modules as a single multi-channel oscilloscope.

- Most multi-card configurations are determined at system power up. Changes (adding or removing interconnect cables) to the configuration will not be recognized by the system unless you cycle power.
- The letter of the master card slot is used to identify a multi-card module in mainframe operations such as intermodule measurements.
- The cards making up a multi-card module must be located in adjacent card slots.
- A multi-card module must reside entirely within the cardcage of either the HP 16500C Mainframe or the HP 16501A Expansion Frame.

Multimodule Installation Procedure

- 1 Turn instrument power switch off, unplug power cord and disconnect any input connections.
- 2 Insert or remove other measurement modules as needed to position the multi-card module in desired card slots. Use the procedures given in the section titled "General Installation Procedure" given earlier in this chapter.

Some modules require you to install the interconnecting cables before inserting the module into the mainframe. Check the module's User's Reference for more information.

- 3 Install any external interconnecting cable, or cables, between the cards.

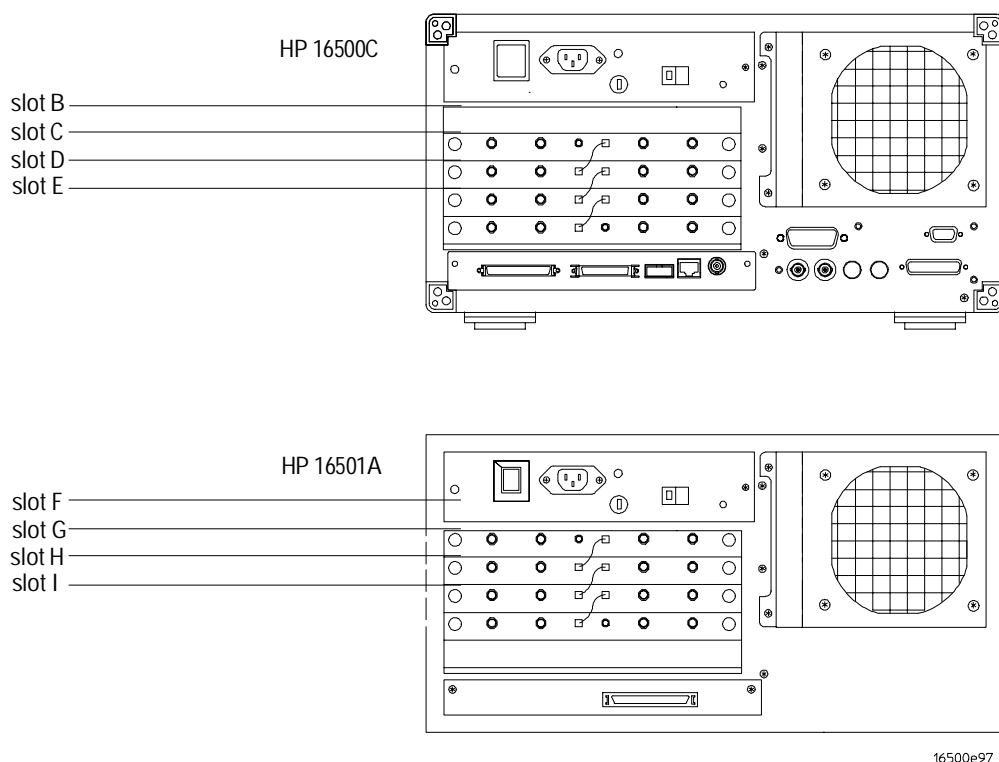

16500e97

Example of a Multi-card Oscilloscope

I

0-byte file size,92
1-byte file size,92
10Base-T,125
10Base2,125
1st_line.txt file,89
2-Mbyte state analyzer ,90

A

accessories,19
accuracy intermodule,155
acq_info.txt file,90
address
 See also network addresses
addresses
 selecting,40
altitude,156
analyzer name field,129
analyzer problems
 file timeout,43
arming
 between modules,112, 155
arming signal
 sources for HP 16500C,195
 sources for HP 16501A,196
arming triggers,196
autoload,64
 enabling,75
autoroll
 defined,184
 turning off,185
 using,184

B

baud rate,41
bits
 See status bits
boards
 installing,219

C

calibration,163
callouts,14
CAM (Contents Addressable Memory)
bit,149
card cage,219
card slots,219
cards
 installing,219 to 220

 removing,222
Centronics
 See parallel printer
characteristics,154 to 157
 LAN connection,125 to 126
cleaning instructions,160
clock,97
color
 default values,102
 for display,102
 returning to defaults,101
 selecting,101
 X Window,99
color model,99
communications link
 verifying in MS-DOS,139
 verifying in MS-Windows,142
 verifying in workstations,136
communications not established,135
 See also troubleshooting LAN
community name
 network management,126
configuration tree,119
connecting,15
 target control,62
controller,55
 interface,39
 LAN,56 to 58
 network,56 to 58
copy,64, 78, 134
 and SUN computers,85
correlated measurement,20, 35, 115 to
 121, 155
cp command on SUN operating systems,92
CRC error,171
cross-domain analysis,21
cursor
 moving with cursor keys,183
 moving with home key,183
 moving with next and previous keys,183
 selecting an item,183
cursor keys,183
 duplicating knob motion,183
custom fonts for X Window interface,
 loading,56

D

data
 binary,126
 data files,125
 HP16542A,90
 HP16550A,88
data bits
 defined,42
 supported,42
data.asc subdirectory,88, 90
default configuration
 defined,18
 storing,18
degaussing,163
deleting files
 See purge
demo files,20
 demo_1,21
 demo_2,23
 directory,31
description of analyzer,16
Device Busy message
 in MS-DOS,141
 in MS-Windows,144
 in workstations,138
Device Timeout message,134
dimensions,157
directory structure
 HP 16500 file system,87 to 91
disk drive
 autoload a file,75 to 76
 capacity,154
 characteristics,154
 copy a file,78
 duplicate a disk,80
 error messages,171
 pack a disk,79
 purge a file,77
 select an operation,67
 store a file,72 to 73
disk operations,64
 autoload,64, 75 to 76
 change directory,82
 copy,64, 78
 default values,68, 70
 duplicate disk,64, 80
 forbidden,172
 format disk,64, 70 to 71
 load,65, 68 to 69

-
- make directory,81
 - pack disk,65, 79
 - purge,65, 77
 - rename,65, 74
 - selecting,67
 - store,65, 72 to 73
 - disks
 - creating system,83
 - duplicating,80
 - formatting,70
 - packing,79
 - storing files on,72
 - display
 - cleaning,160
 - default colors,102
 - impaired,176
 - multiple module data on one screen,119
 - printing,53
 - selecting color for,102
 - don't care key,187
 - done key,189
 - duplicate disk,64, 80
 - dynamic files,85, 92, 126
 - problems with SUN operating systems,92
 - E**
 - edge trigger assignment keys,189
 - ENDEC (Encoder/Decoder) bit,149
 - endplates,220
 - enter key,184, 189
 - environment
 - storage,166
 - Epson printers,47
 - error messages,170
 - Device Busy message,138, 141, 144
 - Device Timeout,134
 - File Timeout,134
 - in MS-DOS,139, 141
 - in MS-Windows,142, 144
 - in workstations,136, 138
 - Operation Timeout,134
 - unknown host message,136, 139, 142
 - error messages from mount
 - in MS-DOS,141
 - in MS-Windows,144
 - in workstations,138
 - error messages from ping
 - in MS-DOS,139
 - in MS-Windows,142
 - in workstations,136
 - Ether address,152
 - Ethernet
 - See LAN
 - not in Communications menu,134
 - Ethernet statistics,151
 - Ethernet Statistics menu,151
 - examples,20, 115 to 118
 - expansion frame
 - See HP 16501
 - expansion frame interface,193
 - external trigger,105
 - F**
 - faulty cable
 - performance verification,145
 - feedthrough,110
 - file identification code,83
 - file management,43
 - file structures,126
 - file system
 - directory structure,87 to 91
 - file timeout,129
 - File Timeout message,134
 - file types,74
 - filenames
 - invalid,172
 - files
 - available,125 to 126
 - copying,78, 126, 134
 - identification code,83
 - loading,68
 - purging,77
 - reading,131
 - receiving 1 byte,134
 - renaming,74
 - size,92, 126
 - storing,72
 - transferring,134
 - writing,131
 - filler panels,221
 - first line of acquisition,89 to 90
 - flexible disk drive,154, 167
 - floppy drive
 - See flexible disk drive
 - flowcharts
 - connecting and configuring,127
 - troubleshooting LAN,133
 - fonts for X Window interface, loading,56
 - format disk,64, 70 to 71
 - Format menu
 - label assignment fields,207 to 208
 - labels,207 to 208
 - symbol field,213 to 216
 - frame align error,152
 - ftp,56, 86
 - function keys,186 to 187
 - G**
 - gateway IP address,43, 129
 - glitch,115
 - Group Run/Stop,106
 - repetitive,106, 111
 - using,111
 - H**
 - hard disk drive,154
 - home key,183
 - hostname
 - in MS-DOS,139
 - in MS-Windows,142
 - in workstations,136
 - HP 16500
 - characteristics,154 to 157
 - defined,14
 - file system,87 to 91
 - grounding,162
 - key features,17
 - optional features,17
 - power requirements,160
 - repacking,167
 - HP 16500A
 - tagging for service,166
 - HP 16500B X Window interface
 - loading custom fonts,56
 - HP 16500C
 - arming specifications,195
 - card cage,219
 - verifying it is on the network,130
 - HP 16501,15 to 16
 - characteristics,156
 - port out,109
 - power requirements,160
 - HP 16501A
 - arming specifications,195
-

card cage,219
 components,193, 197
 features,192
 system configuration,193
 HP 16505,15 to 16
 HP 16505A
 components,201
 setting up,202
 HP 16542A
 acquisition information,90
 data files,90
 inverse-assembled data,91
 labels,90
 line numbers,91
 subdirectories and files,90
 time tags,91
 HP 16550A
 data files,88
 labels,88
 line numbers,89
 HP-IB interface
 defined,40
 selecting an address,40
 HP-IB printers
 configuration,48
 Listen Always,47
 setup,47
 supported,47
 hue
 defined,99
 selecting,101
 humidity,156, 160 to 161

I
 impaired display,176
 installation,219
 multi-card,223
 installing expansion frame,197
 installing prototype analyzer,202
 installing software,66
 interface
 controller,55 to 58
 HP 16505,45
 HP-IB,40
 LAN,43
 printer,154
 printers,51 to 52
 printers (HP-IB),47 to 48

printers (parallel),51
 printers (RS-232),49 to 50
 RS-232-C,41 to 42
 target control,45, 59 to 62
 interfaces
 programmatic,125, 154
 intermittent response from ping
 in MS-DOS,140
 in MS-Windows,143
 in workstations,137
 Intermodule measurements
 accessing,119
 analyzing a glitch,115
 analyzing interrupt handling,116
 helpful hints,122
 simple stimulus/response,117
 Intermodule menu,35, 104
 configuring,119
 Internet Address (IP),129
 interrupt handling,116
 IP
 See Internet Address
 IP address,43

K
 key features,17
 keyboard
 cursor,183
 cursor keys,183
 Don't Care key,187
 done key,189
 edge trigger assignment keys,189
 enter key,184, 189
 function keys,186 to 187
 functions,182
 home key,183
 next and previous keys,183
 overlays,186
 return key,183
 select key,183
 Tab key,187
 time unit keys,188
 voltage unit keys,188
 keyboard overlays
 function keys,186
 using,186
 knob,18
 duplicating motion with cursor keys,183

L
 label assignment fields,207 to 208
 label names,88, 90
 labels,207 to 208
 symbol table,214
 LAN,84, 124
 connections,44
 See also network
 settings,43
 status,44
 troubleshooting,44
 LAN Port,129
 LAN Settings menu,128 to 129
 LAN test
 running,147
 last line of acquisition,90
 latched,110
 line numbers of an acquisition,89, 91
 line_num.txt file,89, 91
 Listen Always,47
 Listing menu
 symbols,215
 load,65, 68
 Logic Analysis System
 defined,16
 maintenance,160
 luminosity
 defined,99
 selecting,101

M
 MAC (Media Access Control) bit,149
 Mainframe Test menu,146
 maintenance
 calibration,163
 cleaning requirements,160
 degaussing,163
 measurement modules
 HP 16542A,90
 menu
 closing,189
 entering data into,184
 menus
 accessing,27
 common names,29
 generic module,29
 naming,28
 system menus,30

-
- mixed display,155
 - example,21
 - module-to-module arming,195
 - modules
 - adjusting skew,114
 - displaying data on screen,119
 - LAN support,126
 - locations in configuration tree,112
 - multiple,155
 - status of,113
 - mount
 - error message,131
 - for control,131
 - for data,131
 - in MS-DOS,131, 141
 - in MS-Windows,131, 144
 - in UNIX,131
 - in workstations,138
 - mounting and unmounting,131
 - mouse,18
 - MS-DOS
 - Device Busy message,141
 - error messages,139, 141
 - error messages from mount,141
 - error messages from ping,139
 - hostname,139
 - intermittent response from ping,140
 - mount,132, 141
 - no response from ping,140
 - normal response from mount,141
 - normal response from ping,139
 - ping,130, 139
 - unknown host message,139
 - MS-Windows
 - Device Busy message,144
 - error messages,142, 144
 - error messages from mount,144
 - error messages from ping,142
 - hostname,142
 - intermittent response from ping,143
 - mount,132, 144
 - no response from ping,143
 - normal response from mount,144
 - normal response from ping,142
 - ping,130, 142
 - unknown host message,142
 - N**
 - network,124
 - configuring the HP 16500C,128 to 129
 - connecting,128
 - management,126
 - mounting,131
 - single-server/single-client,134
 - statistics,151
 - supported,125
 - network addresses
 - accessing,128
 - configuring,128, 152
 - Ether address,152
 - gateway address,129
 - IP address,129
 - network problems
 - See troubleshooting LAN
 - next key,183
 - NFS,56, 85, 97
 - NFS mount
 - See mount
 - no heartbeat,152
 - no response from ping
 - in MS-DOS,140
 - in MS-Windows,143
 - in workstations,137
 - normal output type,61
 - normal response from mount
 - in MS-DOS,141
 - in MS-Windows,144
 - in workstations,138
 - normal response from ping
 - in MS-DOS,139
 - in MS-Windows,142
 - in workstations,136
 - O**
 - open collector,61 to 62
 - operating environment,160
 - operating requirements,156
 - LAN,125
 - Operation Timeout message,134
 - optional features,17
 - P**
 - pack disk,65, 79
 - packets
 - corrupt,152
 - receive,152
 - transmit,152
 - packing material,167
 - parallel printer,15
 - parallel printers,51
 - parameters bit,150
 - parity
 - defined,41
 - selecting,42
 - performance verification,165
 - during troubleshooting,145
 - failures,147
 - self-test description,145
 - software,83
 - ping
 - in MS-DOS,130, 139
 - in MS-Windows,130, 142
 - in UNIX,130
 - in workstations,136
 - not available in MS-DOS,139
 - not available in MS-Windows,142
 - PO
 - See port out
 - port in
 - characteristics,155
 - voltage range,108
 - port out
 - and OR TRIGGER,109
 - BNC connection,108
 - characteristics,155
 - HP 16501,109
 - use of,119
 - power,15
 - power requirements,156
 - powerup self-tests,175
 - previous key,183
 - print all,53
 - print disk,53
 - print line,53
 - print partial,53
 - print record,53
 - print screen,53
 - printer interface
 - defined,39
 - printers
 - alternate,48, 50
 - Centronics,51
 - Epson,47
 - HP-IB,47
-

other HP,51
 parallel,51
 RS-232-C,49
 supported,46, 154
 printing the display,53 to 54
 protocol
 RS-232,41
 supported LAN,125
 prototype analyzer,199, 201 to 202
 See HP 16505
 pulsed
 target control,60
 pulsed (Port Out),110
 purge,65, 77

R

reading files,131
 reading statistics,151
 receive packets,152
 remote mount
 See mount
 rename,65, 74
 repetitive run,111
 requirements,125
 LAN,125
 return key,183
 RS-232-C interface,41
 RS-232-C printers
 configuration,50
 mode configuration switches,49
 supported,49
 running a measurement,111
 running measurement,155
 Rx bit,150

S

saturation
 defined,99
 selecting,101
 saving files
 See storing files
 screen brightness,14
 screen contrast,14
 select key,183
 self-test,165
 self-tests,175 to 176
 service,163
 settings

LAN,44
 printer,51
 shipping,167
 shipping environment,161
 signal,59
 size of files,92
 skew
 adjusting,114
 Skew menu
 accessing,114
 use of,114
 software
 version,34
 sound,98
 state listings,155
 state tags
 HP 16542A,91
 HP 16550A,89
 status bits,149
 status indicators,113
 status number
 description,148
 status reporting message
 See status number
 stop bits,41
 storage environment,161, 166
 store,65, 72
 storing files,72 to 73
 subnet mask,152
 SUN workstations,92
 symbol field,213 to 216
 symbols
 add,216
 base field,214
 delete,216
 label field,214
 modify name,216
 name field,215
 pattern and range fields,215
 width field,215
 System Configuration menu,26, 30
 SYSTEM directory,31
 System Flexible Disk menu,32
 System Hard Disk menu,31
 system options,16
 system software
 version,34

System Test menu,34, 164
 System Utilities menu,33, 94
 sound,98
 touch calibration,95

T

tab key,187
 target control
 cable,62
 output,61
 setting up,59 to 62
 telnet,56
 temperature,156, 161
 termination bit,149
 test,165
 testing,175
 text files containing data,88, 90
 thumb screws,220
 time correlation,155
 time correlation bars,113
 time tags
 HP 16542A,91
 HP 16550A,89
 time unit keys,188
 time_abs.txt file,89, 91
 timeout bit,150
 timeout errors,134
 touch calibration,95
 Touch On/Off button,18
 touchscreen
 calibrating,95
 impaired,176
 on/off,96
 use of,18
 TRANS (Transceiver) bit,150
 transferring files,134
 transmit packets,152
 Trigger menu
 symbol,215
 troubleshooting,165, 169, 171 to 177
 troubleshooting LAN
 in MS-DOS,139 to 141
 in MS-Windows,142 to 144
 in workstations,136 to 138
 troubleshooting modules

See module Service Guides
troubleshooting the mainframe
See HP 16500C Service Guide
Tx bit,150

U

UNIX

mount,131
ping,130
See also workstations
unknown host message
in MS-DOS,139
in MS-Windows,142
in workstations,136
unmount,131
upgrading software,66
user interface,14, 18
knob,18
mouse,18
touchscreen,18
user interfaces
keyboard,182
prototype analyzer,201

V

version
software,34
vibration,156
voltage,15, 162
voltage unit keys,188

W

Waveform menu
symbols,215
waveforms
display,155
selecting,120
weight,156
windows
See MS-Windows
workstations
Device Busy message,138
error messages,136, 138
error messages from mount,138
error messages from ping,136
hostname,136
intermittent response from ping,137
mount,138

no response from ping,137
normal response from mount,138
normal response from ping,136
ping,136
troubleshooting in,136 to 138
See also UNIX
unknown host message,136
writing files,131

X

X Window,56, 126
color,99
X Window interface (HP 16500B)
loading custom fonts,56

© Copyright Hewlett-Packard Company 1987, 1990, 1993, 1994, 1996, 1997
All Rights Reserved.

Reproduction, adaptation, or translation without prior written permission is prohibited, except as allowed under the copyright laws.

Document Warranty

The information contained in this document is subject to change without notice.

Hewlett-Packard makes no warranty of any kind with regard to this material, including, but not limited to, the implied warranties or merchantability and fitness for a particular purpose.

Hewlett-Packard shall not be liable for errors contained herein or for incidental or consequential damages in connection with the furnishing, performance, or use of this material.

Complete product warranty information is given on the last page of this guide.

Safety

This apparatus has been designed and tested in accordance with IEC Publication 348, Safety Requirements for Measuring Apparatus, and has been supplied in a safe condition. This is a Safety Class I instrument (provided with terminal for protective earthing). Before applying power, verify that the correct safety precautions are taken (see the following warnings). In addition, note the external markings on the instrument that are described under "Safety Symbols."

Warning

- Before turning on the instrument, you must connect the protective earth terminal of the instrument to the protective conductor of the (mains) power cord. The mains plug shall only be inserted in a socket outlet provided with a protective earth contact. You must not negate the protective action by using an extension cord (power cable) without a protective conductor (grounding). Grounding one conductor of a two-conductor outlet is not sufficient protection.
- Only fuses with the required rated current, voltage, and specified type (normal blow, time delay, etc.) should be used. Do not use repaired fuses or short-circuited fuseholders. To do so could cause a shock of fire hazard.

- Service instructions are for trained service personnel. To avoid dangerous electric shock, do not perform any service unless qualified to do so. Do not attempt internal service or adjustment unless another person, capable of rendering first aid and resuscitation, is present.
- If you energize this instrument by an auto transformer (for voltage reduction), make sure the common terminal is connected to the earth terminal of the power source.
- Whenever it is likely that the ground protection is impaired, you must make the instrument inoperative and secure it against any unintended operation.
- Do not operate the instrument in the presence of flammable gasses or fumes. Operation of any electrical instrument in such an environment constitutes a definite safety hazard.
- Do not install substitute parts or perform any unauthorized modification to the instrument.
- Capacitors inside the instrument may retain a charge even if the instrument is disconnected from its source of supply.
- Use caution when exposing or handling the CRT. Handling or replacing the CRT shall be done only by qualified maintenance personnel.

Safety Symbols



Instruction manual symbol: the product is marked with this symbol when it is necessary for you to refer to the instruction manual in order to protect against damage to the product.



Hazardous voltage symbol.



Earth terminal symbol: Used to indicate a circuit common connected to grounded chassis.

WARNING

The Warning sign denotes a hazard. It calls attention to a procedure, practice, or the like, which, if not correctly performed or adhered to, could result in personal injury. Do not proceed beyond a Warning sign until the indicated conditions are fully understood and met.

CAUTION

The Caution sign denotes a hazard. It calls attention to an operating procedure, practice, or the like, which, if not correctly performed or adhered to, could result in damage to or destruction of part or all of the product. Do not proceed beyond a Caution symbol until the indicated conditions are fully understood or met.

Product Warranty

This Hewlett-Packard product has a warranty against defects in material and workmanship for a period of one year from date of shipment. During the warranty period, Hewlett-Packard Company will, at its option, either repair or replace products that prove to be defective. For warranty service or repair, this product must be returned to a service facility designated by Hewlett-Packard.

For products returned to Hewlett-Packard for warranty service, the Buyer shall prepay shipping charges to Hewlett-Packard and Hewlett-Packard shall pay shipping charges to return the product to the Buyer. However, the Buyer shall pay all shipping charges, duties, and taxes for products returned to Hewlett-Packard from another country.

Hewlett-Packard warrants that its software and firmware designated by Hewlett-Packard for use with an instrument will execute its programming instructions when properly installed on that instrument.

Hewlett-Packard does not warrant that the operation of the instrument software, or firmware will be uninterrupted or error free.

Limitation of Warranty

The foregoing warranty shall not apply to defects resulting from improper or inadequate maintenance by the Buyer, Buyer-supplied software or interfacing, unauthorized modification or misuse, operation outside of the environmental specifications for the product, or improper site preparation or maintenance.

No other warranty is expressed or implied. Hewlett-Packard specifically

disclaims the implied warranties or merchantability and fitness for a particular purpose.

Exclusive Remedies

The remedies provided herein are the buyer's sole and exclusive remedies.

Hewlett-Packard shall not be liable for any direct, indirect, special, incidental, or consequential damages, whether based on contract, tort, or any other legal theory.

Assistance

Product maintenance agreements and other customer assistance agreements are available for Hewlett-Packard products.

For any assistance, contact your nearest Hewlett-Packard Sales Office.

Certification

Hewlett-Packard Company certifies that this product met its published specifications at the time of shipment from the factory. Hewlett-Packard further certifies that its calibration measurements are traceable to the United States National Institute of Standards and Technology, to the extent allowed by the Institute's calibration facility, and to the calibration facilities of other International Standards Organization members.

About this edition

This is the *HP 16500C Logic Analysis System User's Reference*

Publication number
16500-97023, August 1997
Printed in USA.

Print history is as follows:
16500-97017, August 1996

New editions are complete revisions of the manual. Many product updates do not require manual changes and manual corrections may be done without accompanying product changes. Therefore, do not expect a one-to-one correspondence between product updates and manual updates.

DECLARATION OF CONFORMITY

according to ISO/IEC Guide 22 and EN 45014

Manufacturer's Name: Hewlett-Packard Company

Manufacturer's Address: Colorado Springs Division
1900 Garden of the Gods Road
Colorado Springs, CO 80907 USA

declares, that the product

Product Name: Logic Analyzer Mainframe

Model Number(s): HP 16500C

Product Option(s): All

conforms to the following Product Specifications:

Safety: IEC 348:1978 / HD 401 S1:1981
UL 1244
CSA-C22.2 No. 231 (Series M-89)

EMC: CISPR 11:1990 / EN 55011:1991 Group 1 Class A
IEC 555-2:1982 + A1:1985 / EN 60555-2:1987
IEC 555-3:1982 + A1:1990 / EN 60555-3:1987 + A1:1991
IEC 801-2:1991 / EN 50082-1:1992 4 kV CD, 8 kV AD
IEC 801-3:1984 / EN 50082-1:1992 3 V/m, {1kHz 80% AM, 27-1000 MHz}
IEC 801-4:1988 / EN 50082-1:1992 0.5 kV Sig. Lines, 1 kV Power Lines

Supplementary Information:

The product herewith complies with the requirements of the Low Voltage Directive 73/23/EEC and the EMC Directive 89/336/EEC and carries the CE marking accordingly.

This product was tested in a typical configuration with Hewlett-Packard test systems.

Colorado Springs, 4/24/96

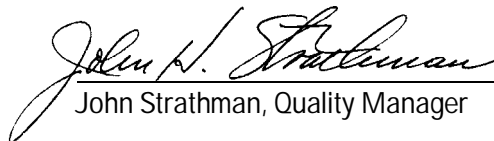
John Strathman, Quality Manager

European Contact: Your local Hewlett-Packard Sales and Service Office or Hewlett-Packard GmbH, Department ZQ / Standards Europe, Herrenberger Strasse 130, D-71034 Böblingen Germany (FAX: +49-7031-14-3143)

Product Regulations

Safety IEC 1010-1: 1990+A1 / EN 61010-1: 1993
UL 3111
CSA-C22.2 No.1010.1:1993

EMC This Product meets the requirement of the European Communities (EC)
EMC Directive 89/336/EEC.



Emissions EN55011/CISPR 11 (ISM, Group 1, Class A equipment)

| Immunity | EN50082-1 | Code ¹ | Notes ² |
|-----------------|-------------------------|-------------------|--------------------|
| | IEC 555-2 | 1 | |
| | IEC 555-3 | 1 | |
| | IEC 801-2 (ESD) 8 kV AD | 1 | A |
| | IEC 801-3 (Rad.) 3 V/m | 1 | A |
| | IEC 801-4 (EFT) 1 kV | 1 | B |

¹ Performance Codes:

- 1 PASS - Normal operation, no effect.
- 2 PASS - Temporary degradation, self recoverable.
- 3 PASS - Temporary degradation, operator intervention required.
- 4 FAIL - Not recoverable, component damage.

² Notes:

- A TTL logic threshold with all cables disconnected
- B TTL logic threshold with HP-IB cable connected

Sound Pressure Level Less than 60 dBA