



# **OPERATORS GUIDE**

## **MODEL 1740A OSCILLOSCOPE**

HEWLETT-PACKARD COMPANY/COLORADO SPRINGS DIVISION  
1900 GARDEN OF THE GODS ROAD, COLORADO SPRINGS, COLORADO, U.S.A.

Manual Part Number 01740-90911

**PRINTED: AUGUST 1976**

## **SAFETY SUMMARY**

*The following general safety precautions must be observed during operation of this instrument. Failure to comply with these precautions or with specific warnings elsewhere in this manual violates safety standards of design, manufacture, and intended use of the instrument. Hewlett-Packard Company assumes no liability for the customer's failure to comply with these requirements.*

### **GROUND THE INSTRUMENT.**

*To minimize shock hazard, the instrument chassis and cabinet must be connected to an electrical ground. The instrument is equipped with a three-conductor ac power cable. The power cable must either be plugged into an approved three-contact outlet or used with a three-contact to two-contact adapter with the grounding wire (green) firmly connected to an electrical ground (safety ground) at the power outlet. The power jack and mating plug of the power cable meet International Electrotechnical Commission (IEC) safety standards.*

### **DO NOT OPERATE IN AN EXPLOSIVE ATMOSPHERE.**

*Do not operate the instrument in the presence of flammable gases or fumes. Operation of any electrical instrument in such an environment constitutes a definite safety hazard.*

### **DO NOT REMOVE INSTRUMENT COVERS.**

*Operating personnel must not remove instrument covers. Component replacement and internal adjustments must be made by qualified maintenance personnel. Service instructions for this instrument are provided in a separate Operating and Service Manual.*

### **DANGEROUS PROCEDURE WARNINGS.**

*Warnings such as the example below, precede potentially dangerous procedures throughout this manual! Instructions contained in the warnings must be followed.*

### **WARNING**

*Dangerous voltages, capable of causing death, are present in this instrument.  
Use extreme caution when handling, installing or operating.*

**TABLE OF CONTENTS**

	Page		Page
OPERATING INSTRUCTIONS.....	1	Mixed Sweep Display .....	22
General Information .....	1	X-Y Display.....	22
Description .....	1	APPLICATIONS .....	24
Accessories Furnished .....	1	Introduction .....	24
Accessories and Options Available .....	8	Voltage Measurements .....	24
Preparation For Use .....	9	Absolute Voltage Measurements.....	25
Power Cord .....	9	Voltage Difference Measurements .....	26
Power Requirements .....	9	Average Voltage Measurements .....	26
Controls and Connectors .....	10	Amplitude Comparison Measurements .....	26
Turn-on Procedure .....	17	Common Mode Rejection .....	28
Operators Calibration .....	18	Time Measurements.....	29
Trace Alignment.....	18	Time Duration .....	29
Astigmatism and Focus .....	18	Period Measurements .....	30
Probe Compensation .....	19	Repetition Rate or Frequency	
Vertical Accuracy Check .....	19	Measurements .....	31
Timing Accuracy .....	19	Rise-time Measurements .....	31
Trigger Selection Table .....	20	Delayed Sweep .....	33
OBTAINING BASIC DISPLAYS.....	20	Delayed Sweep Time Interval	
Normal Sweep Display .....	20	Measurements .....	33
Magnified Sweep Display .....	20	Pulse Jitter Measurements .....	36
Delayed Sweep Display .....	22	Eliminating Jitter.....	37
		Viewing Pulses With Variable Time	
		Duration.....	37

**TABLE OF CONTENTS (Cont'd)**

	Page		Page
Measuring Phase Difference by Time Delay .....	38	Triggering .....	41
A VS B Phase Measurements .....	39	Trigger View.....	41
		Eliminating Multiple Triggering on Complex Waveforms .....	42
		Option 101 - Logic State Display .....	42

## MODEL 1740A OPERATORS GUIDE

### OPERATING INSTRUCTIONS

#### GENERAL INFORMATION.

This Operators Guide will acquaint you with the Model 1740A features, capabilities, accessories, power requirements, and controls. To aid in operating the oscilloscope, initial turn-on and calibration procedures and a performance check are provided. In the Applications Section are detailed explanations showing how you can use the varied capabilities of the Model 1740A to best advantage in a variety of electrical measurements. Model 1740A specifications and general characteristics are listed in tables 1 and 2. Service information is available in a separate service manual.

#### DESCRIPTION.

The Hewlett-Packard Model 1740A is a dual-channel, 100-MHz, delayed-sweep oscilloscope designed for general-purpose bench or field use. The dual-channel dc to 100 MHz vertical deflection system has 12 calibrated deflection factors from 5 mV/div to 20 V/div. A maximum sensitivity of 1 mV/div to 40 MHz is provided on both channels by means of a 5X vertical

magnification. Selectable input impedance of either 50 ohms or 1 megohm permits you to select the impedance that best meets your measurement application. The horizontal deflection system has calibrated sweep rates from 2 s/div to 0.05  $\mu$ s/div and delayed-sweep rates from 20 ms/div to 0.05  $\mu$ s/div. A 10X magnifier expands all sweeps by a factor of 10 and extends the fastest sweep to 5 ns/div. In alternate or chop modes, a trigger-view control will display three signals: the channel A signal, the channel B signal, and the trigger signal. This allows you to correlate the time between the trigger signal and the channel A and channel B signals. In trigger-view operation, center screen represents the trigger threshold point, allowing you to see the triggering level location. With the A VS B control, an X-Y mode of operation is possible. The channel A input (Y-axis) is plotted versus the channel B input (X-axis). The CRT has 8- by 10-cm major divisions on an internal graticule.

#### ACCESSORIES FURNISHED.

A blue light filter (HP Part Number 01740-02701), front-panel cover, power cord, vinyl accessory storage

Table 1. Specifications

### VERTICAL DEFLECTION (Two Channels)

**RISE TIME:**  $\leq 3.5$  ns (measured from 10% to 90% points of 6-division input step).

**\*BANDWIDTH:** dc to 100 MHz.

\*Measured 3-dB down from 8-div reference. Bandwidth may be limited to approximately 20 MHz by BW LIMIT switch.

**Lower 3-dB Limit, ac Coupling:**  $\sim 10$  Hz.\*\*

\*\*  $\sim 1$  Hz with 10:1 probe.

### DEFLECTION FACTOR

**Ranges:** 5 mV/div to 20 V/div in 12 calibrated positions.†

†1, 2, 5 sequence, accurate within 3%. With vernier uncalibrated, continuously variable between ranges and to at least 50 V/div.

### INPUT RC (SELECTABLE)

**AC and DC:** 1 megohm  $\pm 2\%$  shunted by approximately 20 pF.

**50 Ohm:** 50 ohms  $\pm 3\%$ , VSWR  $< 1.4:1$  at 100 MHz on all ranges.

### MAXIMUM INPUT VOLTAGE

**AC and DC:** 250 V (dc + peak ac) or 500 V p-p ac at 1 kHz or less.

**50 Ohm:** 5 Vrms.

### A + B OPERATION

**Differential (A — B) Common Mode:** CMRR is at least 20 dB from dc to 20 MHz. Common mode signal amplitude equivalent to 8 div with one vernier adjusted for optimum rejection.

### VERTICAL MAGNIFICATION (X5)

**Bandwidth:** 3 dB down from 8-division reference signal.

**Dc-coupled:** dc to  $\sim 40$  MHz (ac-coupled;  $\sim 10$  Hz to 40 MHz).

**Rise Time:**  $\leq 9$  ns (measured from 10% to 90% points of 8-division input step).

**Deflection Factor:** increases sensitivity of each deflection factor setting by a factor of five with a maximum sensitivity of 1 mV on channels A and B.

Table 1. Specifications (Cont'd)

MAIN AND DELAYED SWEEP			CALIBRATED SWEEP DELAY																	
<p><b>RANGES</b></p> <p><b>Main:</b> 50 ns/div to 2 s/div (24 ranges) in 1, 2, 5 sequence.</p> <p><b>Delayed:</b> 50 ns/div to 20 ms/div (18 ranges) in 1, 2, 5 sequence.</p>			<p><b>DELAY TIME RANGE:</b> 0.5 to 10 x MAIN TIME/DIV setting; 100 ns to 2 s (minimum delay 150 ns).</p>																	
<p><b>ACCURACY</b></p> <table border="1"> <thead> <tr> <th>Sweep Time/Division</th> <th>*Accuracy X1 X10</th> <th>Temperature Range</th> </tr> </thead> <tbody> <tr> <td rowspan="3">50 ns to 20 ms</td> <td>±3% ±4%</td> <td>0°C to 15°C</td> </tr> <tr> <td>±2% ±3%</td> <td>15°C to 35°C</td> </tr> <tr> <td>±3% ±4%</td> <td>35°C to 55°C</td> </tr> </tbody> </table> <p>*50 ms to 2 s add 1%</p>			Sweep Time/Division	*Accuracy X1 X10	Temperature Range	50 ns to 20 ms	±3% ±4%	0°C to 15°C	±2% ±3%	15°C to 35°C	±3% ±4%	35°C to 55°C	<p><b>DIFFERENTIAL TIME MEASUREMENT ACCURACY</b></p> <table border="1"> <thead> <tr> <th>Main Time Base Setting</th> <th>*Accuracy (+15°C to +35°C)</th> </tr> </thead> <tbody> <tr> <td>100 ns/div to 20 ms/div</td> <td>±(0.5% +0.1% of full scale)</td> </tr> <tr> <td>50 ms/div to 2 s/div</td> <td>±(1% +0.1% of full scale)</td> </tr> </tbody> </table> <p>*Add 1% for temperatures from 0°C to +15°C and +35°C to +55°C</p>		Main Time Base Setting	*Accuracy (+15°C to +35°C)	100 ns/div to 20 ms/div	±(0.5% +0.1% of full scale)	50 ms/div to 2 s/div	±(1% +0.1% of full scale)
Sweep Time/Division	*Accuracy X1 X10	Temperature Range																		
50 ns to 20 ms	±3% ±4%	0°C to 15°C																		
	±2% ±3%	15°C to 35°C																		
	±3% ±4%	35°C to 55°C																		
Main Time Base Setting	*Accuracy (+15°C to +35°C)																			
100 ns/div to 20 ms/div	±(0.5% +0.1% of full scale)																			
50 ms/div to 2 s/div	±(1% +0.1% of full scale)																			
<p><b>Sweep Vernier (Main Only):</b> continuously variable between all ranges and extends slowest sweep to at least 5 s/div. Front panel UNCAL light indicates when vernier is not in CAL position.</p> <p><b>X10 Magnifier:</b> expands all sweeps by a factor of 10 and extends fastest sweep to 5 ns/div.</p>			<p><b>Delay Jitter:</b> &lt;0.002% (1 part in 50 000) of maximum delay in each step from +15°C to +35°C; &lt;0.005% (1 part in 20 000) from 0°C to +15°C and +35°C to +55°C.</p>																	
<p><b>TRIGGERING</b></p> <p><b>INTERNAL:</b> dc to 25 MHz on signals causing 0.3 division or more vertical deflection, increasing</p>																				

Table 1. Specifications (Cont'd)

to 1 division of vertical deflection at 100 MHz in all display modes.

Increase signal level by 2 when in CHOP and by 5 when MAG X5 is used.

**EXTERNAL.** dc to 50 MHz on signals of 50 mV p-p or more increasing to 100 mV p-p at 100 MHz.

Increase signal level by 2 when in CHOP.

#### LEVEL AND SLOPE

**Internal:** at any point on the positive or negative slope of the displayed waveform.

**External:** continuously variable through  $\pm 1.5$  V on either slope of the trigger signal;  $\pm 15$  V in  $\times 10$ .

#### MAXIMUM INPUT VOLTAGE

**AC and DC:** 250 V (dc + peak ac) or 500 V p-p ac at 1 kHz or less.

#### TRIGGER VIEW

Displays the internal or external trigger signal. In alternate or Chop mode (dual channel) channel A, channel B, and the trigger signal are dis-

played. In channel A or B mode (single channel), trigger view overrides that channel and displays the trigger signal. Displayed amplitude of the internal trigger signal is approximately the same as the on-screen vertical signal. Deflection factor of the external trigger signal is 100 mV/div or 1 V/div in EXT  $\div$  mode. Trigger point of the main sweep is approximately at the point that the displayed trigger signal crosses center screen. With identically timed signals applied to a vertical channel and the external trigger input, the trigger signal is delayed by 2.5 ns  $\pm 1$  ns.

#### A VS B OPERATION

##### BANDWIDTH

**A (Y-axis):** same as channel A.

**B (X-axis):** dc to 5 MHz.

**DEFLECTION FACTOR:** 5 mV/div to 20 V/div (12 calibrated positions) in 1, 2, 5 sequence.

**PHASE DIFFERENCE BETWEEN CHANNELS:**  $< 3^\circ$  dc to 100 kHz.



Table 1. Specifications (Cont'd)

<p><b>CATHODE-RAY TUBE AND CONTROLS</b></p> <p><b>Z-AXIS INPUT:</b> +4 V, &gt;50-ns width pulse blanks trace of any intensity, useable to &lt;10 MHz for normal intensity. Input R, 1 kilohm <math>\pm 10\%</math>. Maximum input <math>\pm 20</math> V (dc + peak ac).</p>	<p><b>GENERAL CALIBRATOR</b></p> <p><b>Type:</b> approximately 1.4-kHz square wave, &lt;0.1 <math>\mu</math>s rise time.</p> <p><b>Voltage:</b> 1 V p-p into <math>\geq 1</math> megohm; 0.1 V p-p into 50 ohms.</p> <p><b>Accuracy:</b> <math>\pm 1\%</math>.</p> <p><b>REAR PANEL OUTPUTS:</b> Main and delayed gates, 0 V to <math>&gt; +2.5</math> V.</p>
---	---

Table 2. General Characteristics

<p><b>VERTICAL DEFLECTION (Two Channels)</b></p> <p><b>DISPLAY MODES:</b> channel A; channel B (Normal or Invert); Alternate; chopped (approximately 250 kHz rate); A + B; and Trigger View.</p> <p><b>INPUT COUPLING:</b> selectable for AC or DC, 50 ohms (dc), or ground. Ground position disconnects input connector and grounds amplifier input.</p> <p><b>SIGNAL DELAY:</b> input signals are delayed sufficiently to view leading edge of input pulse without advanced trigger.</p>	<p><b>HORIZONTAL DEFLECTION</b></p> <p><b>DISPLAY MODES:</b> main, main intensified, mixed, delayed, MAG X10, and A vs B.</p> <p><b>TRIGGERING</b></p> <p><b>MAIN SWEEP</b></p> <p><b>Normal:</b> sweep is triggered by internal or external signal.</p> <p><b>Automatic:</b> bright baseline displayed in absence of input signal. Triggering is same as normal above 40 Hz.</p>
--	---

Table 2. General Characteristics (Cont'd)

**Single:** sweep occurs once with same triggering as normal; reset pushbutton arms sweep and lights indicator.

#### DELAYED SWEEP

**Auto:** delayed sweep automatically starts at end of delay period.

**Trig:** delayed sweep is armed and triggerable at end of delay period from selected sources.

#### TRIGGER SOURCE

Selectable from channel A, channel B, composite, or line frequency (composite triggering on displayed signal except in chop; in chop, channel A is trigger source).

**External Input RC:** approximately 1 megohm shunted by approximately 20 pF.

**Coupling:** AC, DC, LF REJ, or HF REJ.

AC: attenuates signals below approximately 20 Hz.

LF REJ: (main sweep only) attenuates signals below approximately 4 kHz.

HF REJ: (main sweep only) attenuates signals above approximately 4 kHz.

TRIGGER HOLDOFF: (main sweep only) increases sweep holdoff time in all ranges.

#### CATHODE-RAY TUBE AND CONTROLS

**TYPE:** post accelerator, approximately 15 kV accelerating potential; aluminized P31 phosphor.

**GRATICULE:** 8- by 10-div internal graticule; 0.2-div subdivisions on major horizontal and vertical axes. 1 div = 1 cm. Internal flood gun graticule illumination.

**BEAM FINDER:** returns trace to CRT screen regardless of setting on horizontal, vertical, or intensity controls.

**REAR PANEL CONTROLS:** astigmatism and trace align.

Table 2. General Characteristics (Cont'd)

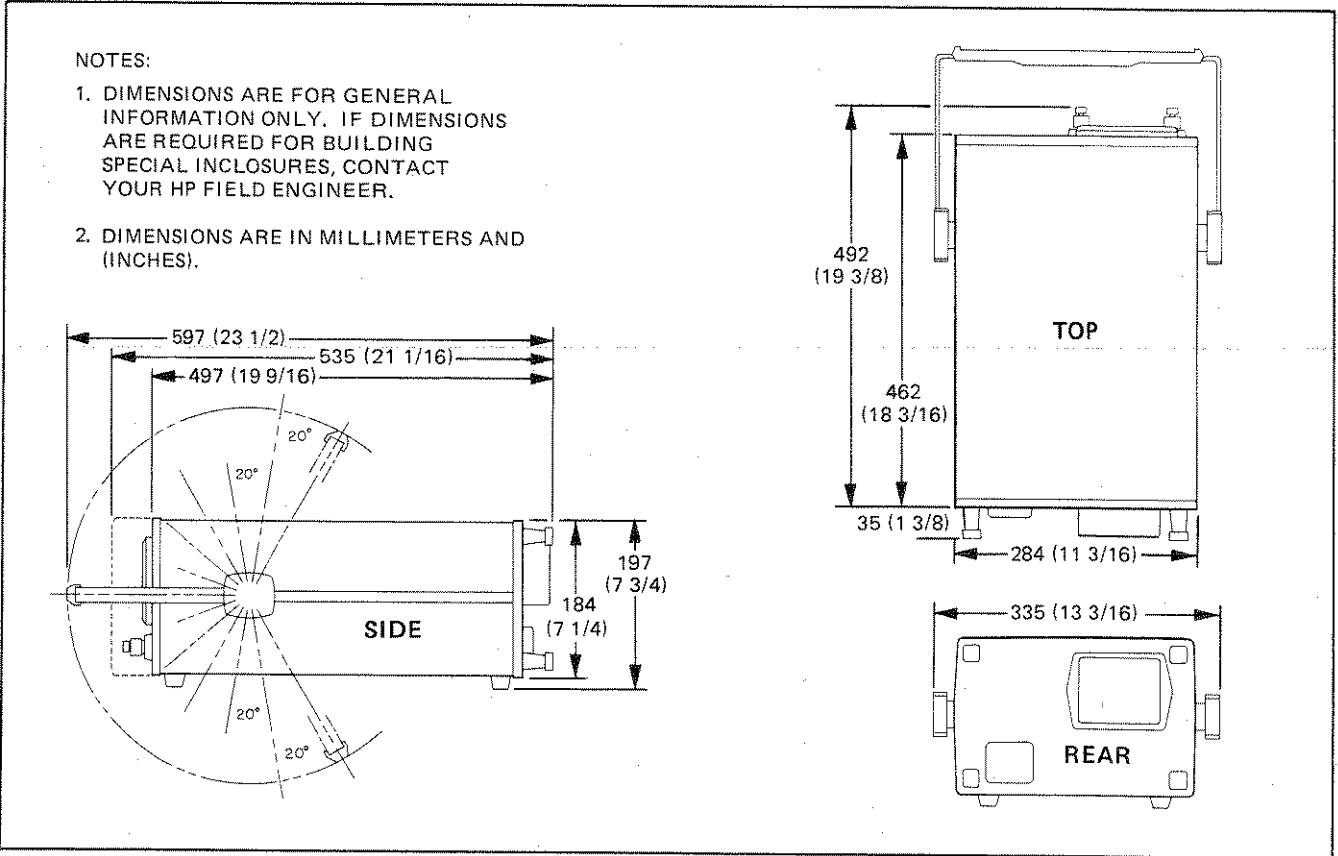

Table 2. General Characteristics (Cont'd)

GENERAL	OPERATING ENVIRONMENT
<p><b>POWER:</b> 100, 120, 220, 240 Vac, <math>\pm 10\%</math>, 48 to 440 Hz, 100 VA maximum.</p> <p><b>WEIGHT:</b> (with accessories) net, 13 kg (28.6 lb); shipping, 15.7 kg (34.6 lb).</p> <p><b>DIMENSIONS:</b> see outline drawing.</p>	<p><b>Temperature:</b> 0°C to 55°C.</p> <p><b>Humidity:</b> up to 95% relative humidity at 40°C.</p> <p><b>Altitude:</b> to 4600 m (15 000 ft).</p> <p><b>Vibration:</b> vibrated in three planes for 15 minutes each with 0.254 mm (0.010 in.) excursion 10 to 55 Hz.</p>

pouch, and two Model 10006D 10:1 divider probes approximately 2 m (6 ft) long.

### ACCESSORIES AND OPTIONS AVAILABLE.

Several divider probes are available with various voltage division ratios and lengths.

Model 10002A: 50:1, approximately 1.5 m (5 ft) long.

Model 10004D: 10:1, approximately 1.1 m (3.5 ft) long.

Model 10007B: 1:1, approximately 1.1 m (3.5 ft) long.

Model 10020A resistive divider probe kit has a probe length of approximately 1.2 m (4 ft) and division ratios of 1:1, 5:1, 10:1, 20:1, 50:1, and 100:1.

Option 090 deletes the two Model 10006D divider probes normally supplied. You may specify other probes listed that are more suited to your requirements.

A metal mesh contrast screen (HP Part Number 01741-07101) improves display contrast and serves as an RFI filter.

Model 10140A collapsible viewing hood aids in viewing low duty-cycle signals that are hard to see in high ambient light. With a Model 10376A adapter, the Model 197A camera can be utilized.

Models 1001A, 1002A, and 1114A testmobiles all accept the Model 1740A and provide convenient, mobile stands for the oscilloscope.

Option 101 is designed for optimum performance with the HP Model 1607A Logic State Analyzer to provide

both logical state and electrical analysis. The X-Y mode of operation is deleted.

### PREPARATION FOR USE.

#### WARNING

Read the Safety Summary at the front of this guide before installing or operating the instrument.

#### POWER CORD.

The power cord required depends on the ac input voltage and the country in which the instrument is to be used. Figure 1 illustrates standard power receptacle (wall outlet) configurations. The HP part number shown above each receptacle drawing specifies the power cord equipped with the appropriate mating plug for that receptacle. If the appropriate power cord is not included with your instrument, notify the nearest HP Sales/Service Office and a replacement cord will be provided.

#### POWER REQUIREMENTS.

The oscilloscope requires a power source of either 100, 120, 220, or 240 volts ac  $\pm 10\%$ , single phase, 48 to 440 Hz that can deliver 100 VA (maximum). The instrument is normally set at the factory for 120-volt operation.

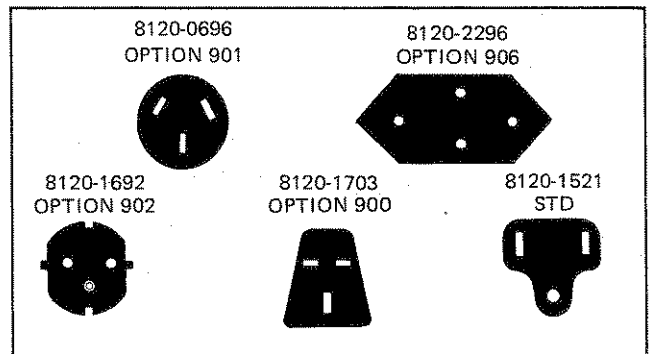

Figure 1. Power Receptacles

#### CAUTION

Instrument damage may result if the line voltage selection switch is not correctly set for the proper input power source.

To operate the instrument from any other ac power source, proceed as follows:

1. Disconnect the power cable from the power source.
2. Stand instrument on rear-panel legs and use a blade-type screwdriver to position power selector switches through opening in bottom cover. Figure 2 shows switched set for 120-V operation.

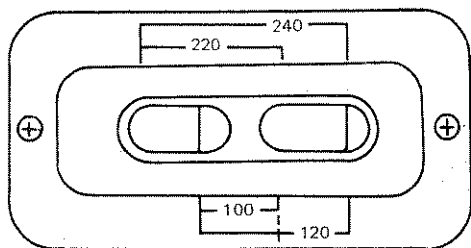

1740A-001-08-76

Figure 2. Line Voltage Selection Switch Settings

3. For 220-V or 240-V inputs, replace fuse F1 with the 0.5 ampere slow-blow fuse supplied with your instrument (see figure 3).

4. Connect the input power cable to the power source.

### CONTROLS AND CONNECTORS.

Front- and rear-panel photographs (see figures 27 and 28) are located at the rear of this guide on a fold-out page for easy reference while you are reading any section. Control and connector descriptions have

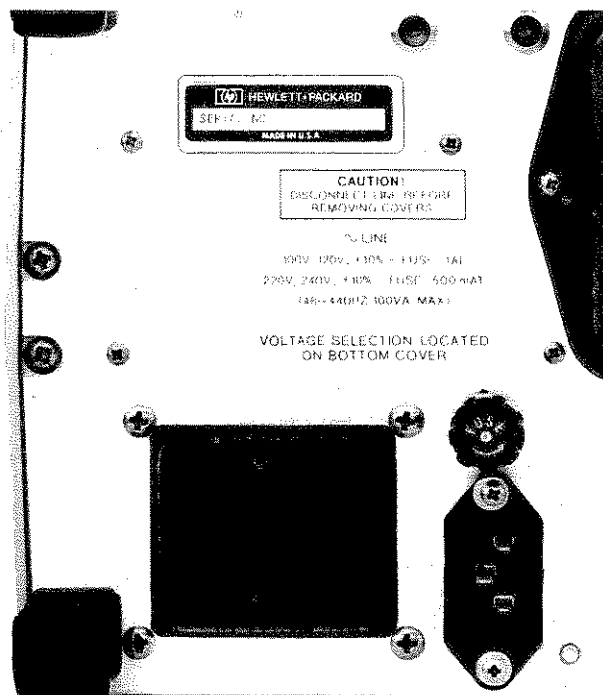

1740A-002-08-76

Figure 3. Fuse Replacement

index numbers that are keyed to the panel photographs. The following paragraphs provide detailed descriptions of the control and connector functions. See the Applications Section for information on using the Model 1740A when you are making measurements.

- ① **LINE** - Switch turns instrument power on and off.
- ② **LINE INDICATOR** - Indicator lights when the instrument power is on.
- ③ **BEAM FIND** - Pressing this pushbutton increases the intensity and compresses the display within the viewing area. This enables you to locate the beam and determine the action necessary to center a display (for example, reduce input signal amplitude, adjust deflection factor or position controls, or increase intensity).
- ④ **BEAM INTENSITY** - Controls the brightness of the CRT display.
- ⑤ **FOCUS** - Adjusts the writing beam for the sharpest trace. Always keep this display focused to prevent damaging the CRT internally.
- ⑥ **SCALE ILLUM** - Adjusts the CRT background illumination for good contrast between the background and the graticule. Useful to illuminate the graticule when viewing in a dark area, photographing - if camera has no light source, or prefogging film.
- ⑦ **ALT** - Channel A and B signals are displayed alternately on consecutive sweeps.
- ⑧ **Channel A** - Displays the channel A input signal.
- ⑨ **Channel B** - Displays the channel B input signal.
- ⑧ & ⑨ **A + B** - Pressing both channel A ⑧ and channel B ⑨ displays the algebraic sum of the channel A and channel B input signals. If the channel B display is inverted (press CH B INVT ⑭), an A minus B display results.
- ⑩ **CHOP** - Channel A and B signals are displayed simultaneously by switching between channels at 250-kHz rate.

11 **TRIG VIEW** - Displays the selected internal or external trigger signal at a fixed sensitivity of approximately 100 mV/div or 1 V/div with EXT +10 45. TRIGGER LEVEL 39 positions the display vertically. Center screen indicates the trigger threshold level with respect to the trigger signal. If ALT 7 or CHOP 10 is selected, three signals are displayed: channel A, the selected trigger signal (at center screen), and channel B. If an external trigger signal is selected, you can correlate the time between the trigger signal and the channel and channel B signals. If you select a single channel, trigger view overrides that channel to display the selected trigger signal.

12 **MAG X5** - Magnifies the vertical presentation five times, and increases the maximum sensitivity to 1 mV/div. The bandwidth is decreased to 40 MHz. Recommended on 5 mV/div and 10 mV/div ranges only.

13 **BW LIMIT** - Reduces the bandwidth of channel A and channel B to approximately 20 MHz.

14 **CH B INVT** - Inverts the polarity of the channel B signal. In A + B 8 & 9 mode, pressing

CH B INVT 14 results in an A minus B display.

15 **TRIGGER A** - Selects a sample of the channel A signal as the trigger signal when INT/EXT 44 is in INT.

16 **TRIGGER B** - When in INT, a sample of the channel B signal is selected as the trigger signal.

15 & 16 **COMP** - When the display mode is set to channel A, channel B, ALT, or A + B, the sweep is triggered by the displayed signal. When in CHOP, the sweep is triggered by the channel A signal only.

#### NOTE

In the following descriptions for controls 17 through 22, only channel A controls and connectors are discussed. Channel B controls and connectors are identical in function.

17 **AC** - Selects the input coupling and impedance for the vertical amplifiers. In the AC position



the dc component of the input signal is blocked. The lower 3-dB limit is approximately 10 Hz.

**GND** - The input signal is disconnected from the amplifier, and the amplifier input is grounded.

**DC** - All elements of the input signal are passed to the vertical amplifier. The input impedance is approximately 1 megohm shunted by 20 pF.

**50  $\Omega$**  - The input signal is dc coupled, and the input impedance is 50  $\Omega$ . Pull the lever forward and down to select this position. Do not apply more than 5 Vrms to the input connector.

- ⑩ **VOLTS/DIV** - Selects the vertical deflection factor in a 1, 2, 5 sequence from 0.005 V/div to 20 V/div, accurate within 3% with vernier ⑬ in the CAL position.
- ⑬ **Vernier** - Provides continuous control of the deflection factor between calibrated VOLTS/DIV ranges. Vernier range is at least 2.5 to 1.

- ⑳ **UNCAL** - Lights when the vernier control is out of detent position to indicate VOLTS/DIV is uncalibrated.
- ㉑ **INPUT** - BNC connector to apply external signals to the channel A (Y) and channel B (X) amplifier. Impedance and coupling are selectable by ⑰. Do not apply more than 250 V (dc + peak ac) or more than 500 V p-p ac at 1 kHz or less.
- ㉒ **POSN** - Controls the vertical position of the display.
- ㉓ **CAL 1 V** - Provides a 1-V peak-to-peak (within 1%) square-wave voltage signal recurring at an approximate rate of 1.4 kHz (100 mV peak-to-peak when terminated in 50  $\Omega$ ).
- ㉔ **GROUND POST** - Convenient chassis ground connector. Useful to ensure a common ground with equipment under test.
- ㉕ & ㉖ **POSITION** - Coarse ㉕ and FINE ㉖ adjustments position the display horizontally.

27 **AUTO/NORM** - AUTO sweep mode (pushbutton out). A free-running sweep provides a bright display in the absence of a trigger signal. A trigger signal input (internal or external) of 40 Hz or more overrides AUTO operation and sweep triggering is the same as in the NORM mode.

NORM sweep mode (pushbutton in) requires an internal or external signal to generate a sweep and must be used if the input frequency is less than 40 Hz.

28 **SINGLE** - Sweep occurs once with the same triggering as in NORM. After each sweep, the trigger circuit must be manually RESET 29

29 **RESET** - Momentary pushbutton that arms the trigger circuit in the single-sweep mode. After RESET 29, the sweep can be triggered by an internal or external trigger signal or by rotating the TRIGGER LEVEL control 39 through zero.

30 **Reset Lamp** - When lit, indicates the trigger circuit is armed. Lamp goes off at the end of the sweep and remains off until the trigger

circuit is again armed by pressing the reset button.

31 **MAIN** - Selects main sweep for horizontal display. Sweep rate and triggering are selected by the main-sweep controls 25 - 34, and 36 - 38.

32 **A VS B** - Selects an X-Y mode of operation with channel A input (Y-axis) plotted versus channel B input (X-axis). Vertical positioning is adjusted by channel A POSN 22, and horizontal positioning is adjusted by POSITION 25 and FINE 26.

**OPTION 101** - Deletes the A VS B function and adds logic state display. When the Model 1740A is connected to a HP Model 1607A Logic State Analyzer, pressing STATE DSPL 32 displays a 16-word table of 16-bit words. See the Applications Section for details.

33 **MAG X10** - Magnifies the horizontal display 10 times, and expands the fastest sweep time to 5 ns/div, maintaining a sweep accuracy within 3% at room temperature.

- 34 **MAIN TIME/DIV** - The inner knob controls the main-sweep rate, which is indicated by the numbers displayed in the knob skirt opening. Sweep accuracy is within 2% (unmagnified) at room temperatures.
- 35 **DLY'D TIME/DIV** - The outer rotating section selects the delayed-sweep rate, which is indicated by the marker on the outer knob. Sweep accuracy is the same as with MAIN TIME/DIV. An interlock is incorporated so the delayed sweep is always faster than the main sweep. When rotated out of the off position in the MAIN mode 31, a portion of the main sweep is intensified indicating the length and delay position of the delayed sweep with respect to the main sweep.
- 36 **SWEEP VERNIER** - Provides continuous adjustment of main sweep TIME/DIV between calibrated positions, extending the slowest sweep to 5 s/div.
- 37 **UNCAL** - Lights when SWEEP VERNIER 36 is out of the CAL detent position, and indicates that the sweep is not calibrated.
- 38 **TRIGGER HOLDOFF** - Increases the time between sweeps and aids triggering on complex displays such as digital words.
- 39 & 51 **TRIGGER LEVEL** - Selects the voltage level on the input trigger signal where the sweep is triggered. With external trigger signals, the trigger level is continuously variable from +1.5 V to -1.5 V on either slope of the input trigger signal; +15 V to -15 V in EXT +10 45 mode. With internal trigger signals, the trigger level selects any point on the vertical waveform displayed.
- 40 & 52 **POS/NEG** - Two-position pushbutton switch that selects the slope of the (EXT 44 or INT 44) trigger signal used to start the sweep.
- 41 **LF REJ** - Attenuates internal or external trigger signals below approximately 4 kHz. This is useful to condition high-frequency signals for best synchronization by eliminating unwanted low-frequency signals such as power line interference.

- 42 **HF REJ** - Attenuates internal or external trigger signals above approximately 4 kHz. This is useful to condition low-frequency signals for best synchronization by eliminating unwanted high-frequency signals such as RF.
- 41 & 42 **LINE** - Selecting both LF REJ 41 and HF REJ 42 removes all EXT 44 input or INT 44 displayed signals from the trigger circuit and applies a power-line frequency signal for triggering.
- 43 & 53 **AC/DC** - Selects ac or dc coupling of the input (EXT 44 or 54) or displayed (INT 44 or 54) signal to the trigger circuit. The DC position must be selected for signals below approximately 20 Hz.
- 44 & 54 **INT/EXT** - INT Selects a sample of the internal vertical signal chosen by the TRIGGER source 15 or 16, while EXT selects the signal at the EXT TRIGGER 46 or 56 input for application to the main trigger circuit. Internal signals from dc to 25 MHz displaying 0.3-div amplitude or more are sufficient for stable triggering, increasing to 1 div of amplitude at 100 MHz. Externally applied signals 50 mV p-p from dc to 50 MHz, increasing to 100 mV p-p at 100 MHz are sufficient for stable triggering.
- 45 & 55 **EXT +10** - Attenuates EXT TRIGGER 46 or 56 input signal by a factor of 10.
- 46 & 56 **EXT TRIGGER** - BNC connector for external trigger input. Input impedance is approximately one megohm shunted by approximately 20 pF. Do not apply more than 250 V (dc + peak ac) or 500 V p-p ac at 1 kHz or less.
- 47 **DELAY** - The DELAY control provides a variable delay time from 0.5 to 10 X the MAIN TIME/DIV settings of 100 ns to 2 s. See the Applications Section for more information.
- 48 **DLY'D** - Selects delayed sweep for horizontal display.
- 49 **MIXED** - Selects main and delayed sweeps for the horizontal display. The first portion of the sweep is at the main-sweep rate, and the second portion of the sweep (starting point chosen by DELAY 47) is at the delayed-sweep rate. See Mixed Sweep Display under Obtaining Basic Displays for more information.
- 50 **SWEEP AFTER DELAY AUTO/TRIG** - Selects the method of starting the delayed-sweep when in main intensified, delayed, or mixed mode operation. In AUTO, delayed sweep

starts immediately after the delay interval, which is the product of the DELAY 47 dial reading (div) and the main TIME/DIV 34 reading. In TRIG, the delayed-trigger circuit is armed after the delay interval and delayed sweep must be triggered by either an internal or external trigger signal. See Pulse Jitter in the Applications Section for more information.

- 57 **Z-AXIS INPUT** - BNC connector for intensity modulation of the CRT display. A +4-volt,  $\geq 50$ -ns width pulse blanks a trace of any intensity. Do not apply more than  $\pm 20$  V (dc + peak ac).
- 58 **TRACE ALIGN** - Screwdriver adjustment to align the horizontal trace with the graticule.
- 59 **ASTIGMATISM** - Screwdriver adjustment used in conjunction with FOCUS 5 to achieve a clean, sharp spot or trace. Adjustment is easier with a stationary spot.
- 60 **LINE INPUT** - Connector for the power cord.
- 61 **MAIN GATE OUTPUT** - Provides a rectangular output of approximately +2.5 V coincident with the main gate.

62 **DLY'D GATE OUTPUT** - Provides a rectangular output of approximately +2.5 V coincident with the delayed gate.

63 - 65 **1607A INPUTS** - Option 101 only.

63 **HORIZ** - X-axis input from HP Model 1607A.

64 **VERT** - Y-axis input from HP Model 1607A.

65 **Z-AXIS** - Intensity input from HP Model 1607A.

66 **FUSE** - 1A 250 V slow-blow for 100-V or 120-V operation. 0.5A 250 V slow-blow for 220-V or 240-V operation.

#### TURN-ON PROCEDURE.

Before turning on the oscilloscope, please read and follow the instructions in the safety summary (at the front of this guide) and in the power cord and power requirements paragraphs. You should also become familiar with the controls and their functions by reading the Controls and Connectors Section and by referring to figures 27 and 28 at the back of this guide.

To turn on the Model 1740A, perform the following steps:

1. Turn all control knobs to the 12 o'clock position except verniers ①⑨ and SWEEP VERNIER ③⑥ which should be in the CAL position; TRIGGER HOLDOFF ③⑧ should be on MIN. The MAIN TIME/DIV ③④ control should be fully clockwise.

2. All pushbuttons should be out except A ⑧, A ①⑤, and MAIN ③①.

3. Press the LINE switch ①; the LINE indicator ② should light. After CRT warm up, a free-running trace should be observed near the center of the screen.

4. Increase (or decrease) BEAM INTENSITY ④ to a comfortable viewing level, and adjust FOCUS ⑤ as necessary for the sharpest trace.

### OPERATORS CALIBRATION.

A few checks and adjustments will ensure that Model 1740A is operating properly. If the oscilloscope is moved from one electromagnetic environment to another, the trace alignment control may need adjustment to align the horizontal trace with the graticule. Astigmatism and focus controls may need adjust-

ment to obtain the sharpest display. Probe compensation may be required because the total input resistance and capacitance varies slightly from one oscilloscope to another.

### TRACE ALIGNMENT.

1. Obtain a display as described in the turn-on procedure.

2. With the vertical POSN control ②②, align the trace with the center graticule line.

3. With a screwdriver, adjust TRACE ALIGN ③⑧ (on rear panel) for best trace alignment with the graticule line.

### ASTIGMATISM AND FOCUS.

1. Select A VS B ③② and lower BEAM INTENSITY ④ to a low level.

2. Position the spot near the center of the CRT with POSN ②② and POSITION ②⑤ controls.

3. Adjust FOCUS ⑤ and ASTIGMATISM ⑤⑤ (on rear panel) for the smallest round spot.

**PROBE COMPENSATION.**

1. Connect the probe to be compensated to the appropriate vertical channel INPUT connector **(21)** and the CAL 1 V output **(23)**

2. Set VOLTS/DIV **(18)** to 0.1, MAIN TIME/DIV **(34)** to 0.2 mSEC, and input coupling **(17)** to DC.

3. Adjust the main TRIGGER LEVEL **(35)** for a stable display of the calibrator square-wave voltage. The display should have flat tops. Any distortion in the presentation is caused by incorrect probe compensation.

4. If overshoot or undershoot is present, turn the screwdriver adjustment in the probe for a flat-top presentation (see figure 4).

**VERTICAL ACCURACY CHECK.**

1. Set the controls to the positions indicated in the turn-on procedure.

2. Apply the CAL 1 V **(23)** signal to the channel A INPUT **(21)** connector using a BNC to banana plug adapter and a test lead with alligator clips.

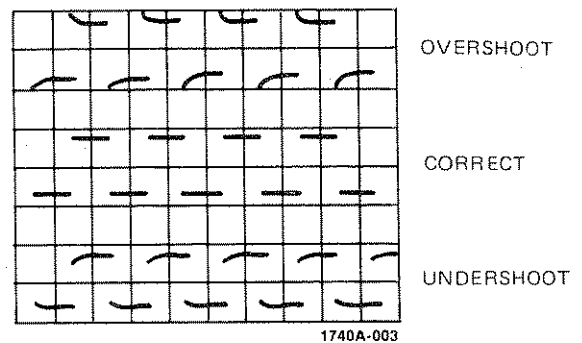

Figure 4. Probe Compensation

3. Adjust the channel A VOLTS/DIV **(18)** control to 0.2 V/div and the MAIN TIME/DIV **(34)** control to 0.2 mSEC/div. The square-wave amplitude should be five major divisions within 4%. For a complete calibration check refer to the service manual.

**TIMING ACCURACY.**

1. Apply an accurate calibration signal (such as from a HP Model 226A Time Mark Generator) to the channel A INPUT **(21)** connector.

2. Set the controls to the positions indicated in the turn-on procedure except for MAIN TIME/DIV which you should adjust to 0.5  $\mu$ SEC/div.

3. Set a marker on the graticule line at the far left with the horizontal position control. Markers should line up approximately with each graticule line across the CRT. The marker on the far right-hand side should be within 2 mm of the graticule line.

### TRIGGER SELECTION TABLE.

Table 3 will help you in determining whether a trigger mode is unuseable, useable, good, or the best mode for various signal conditions.

### OBTAINING BASIC DISPLAYS.

These procedures will help you become familiar with the operation of the Model 1740A so you can obtain commonly used displays. Before performing the procedures, complete the turn-on procedure and adjust the following controls:

Channel A TRIGGER.....	A	15
Channel A coupling.....	DC	17
Channel A VOLTS/DIV	18	0.05
MAIN TIME/DIV	34	0.5 mSEC
DELAY	17	fully CCW

### NORMAL SWEEP DISPLAY.

1. Connect your Model 10006D probe to the channel A INPUT 21 connector, the CAL 1 V 23 output, and the ground post 24

2. Adjust the POSN 22 control to align the base of the square wave on the center graticule line and the TRIGGER LEVEL 39 control for a stable display. You will see a square wave with an amplitude of two divisions and approximately five to nine positive-going pulses.

### MAGNIFIED SWEEP DISPLAY.

1. Follow steps 1 and 2 to obtain a Normal Sweep Display.

2. Adjust the horizontal POSITION 25 control to place the waveform portion you want to magnify on the CRT center graticule (see figure 5a).

3. Press MAG X10 33 and adjust the horizontal FINE 26 control for precise placement of the magnified display (see figure 5b).



Table 3. Display and Trigger Selection Table

SIGNAL CONDITIONS	DISPLAY MODE	TRIGGER SELECTION				
		A	B	COMP	EXT	
I. Single Signals Applied to Channel A or B	A or B	OK	or	OK	OK	OK <sup>1</sup>
	ALT <sup>5</sup> or CHOP <sup>5</sup>	OK	or	OK	NG	OK <sup>1</sup>
II. Time Related Signals Applied to Channels A & B	ALT	<input type="checkbox"/> OK <sup>2</sup>		<input type="checkbox"/> OK <sup>2</sup>	NG <sup>3</sup>	<input type="checkbox"/> OK <sup>2</sup>
	CHOP	<input type="checkbox"/> OK <sup>2</sup>		<input type="checkbox"/> OK <sup>2</sup>	NG <sup>4</sup>	<input type="checkbox"/> OK <sup>2</sup>
	A+B (A-B)	OK		OK	<input type="radio"/> OK <sup>6</sup>	OK
III. Nontime Related Signals Applied to Channels A & B	ALT	NG		NG	<input type="radio"/> OK	NG

<sup>1</sup> Assume time related signal applied.

<sup>2</sup> Time relation displayed.

<sup>3</sup> No time relation displayed.

<sup>4</sup> If COMP is selected in CHOP, switching overrides and selects A.

<sup>5</sup> Signal is only displayed on one channel.

<sup>6</sup> Triggers on algebraic sum or difference of signals.

OK Useable trigger mode.

OK Good trigger mode.

OK Best trigger mode.

NG Unuseable trigger mode.

**DELAYED SWEEP DISPLAY.**

1. Follow steps 1 and 2 to obtain a Normal Sweep Display.

2. Adjust the delayed TIME/DIV **35** control for 50  $\mu$ SEC/DIV, and observe the portion of the square wave that is intensified. Set the BEAM INTENSITY **4** control to comfortable viewing level.

3. Set SWEEP AFTER DELAY to AUTO and turn the DELAY **47** control clockwise until the intensified portion of the trace is over the trace area you wish to investigate. This is demonstrated in figure 6a.

4. Press DLY'D **46** and note the intensified portion of the trace is now displayed across the entire CRT (see figure 6b).

5. You may turn the DELAY **47** control to view other pulses in the pulse train.

For a more complete description of delayed sweep, including TRIG operation, refer to the Applications Section.

**MIXED SWEEP DISPLAY.**

1. Follow steps 1 and 2 to obtain a Normal Sweep Display.

2. Adjust the delayed TIME/DIV **35** control for 50  $\mu$ SEC and note the portion of the square wave that is intensified. Set the BEAM INTENSITY **4** control to a comfortable viewing level.

3. Turn the DELAY **47** clockwise until part of the waveform in the second half of the CRT is intensified (see figure 7a).

4. Press MIXED **49** and notice the first portion of the display is at the main TIME/DIV **34** sweep rate and the second portion is at the delayed TIME/DIV **35** sweep rate (see figure 7b). You can vary the transition point from main sweep to delayed sweep by adjusting the DELAY **47** control.

**X-Y DISPLAY.**

1. Press A VS B **32**. BEAM INTENSITY **4** may need to be decreased. Apply the vertical (Y-axis) signal to the channel A INPUT **21** connector and

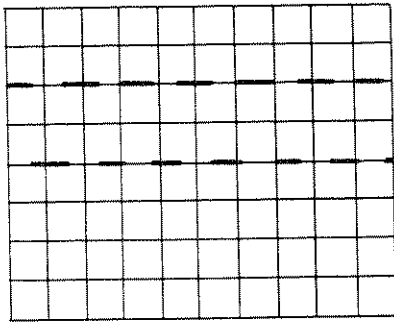

Figure 5a. Normal Display

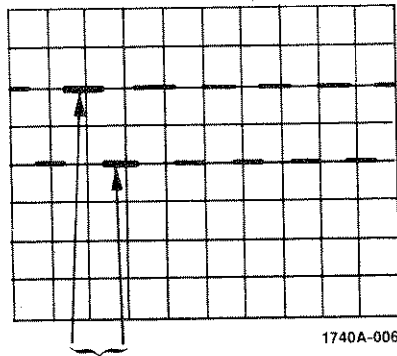

Figure 6a. Normal Display With Intensified Area

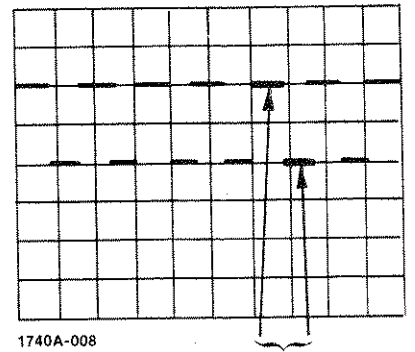

Figure 7a. Normal Display With Intensified Area

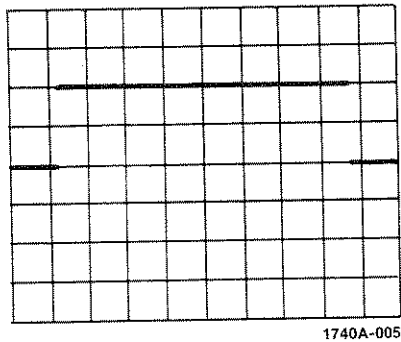

Figure 5b. Magnified Display

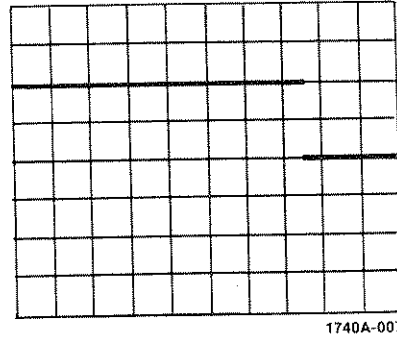

Figure 6b. Delayed Sweep Display

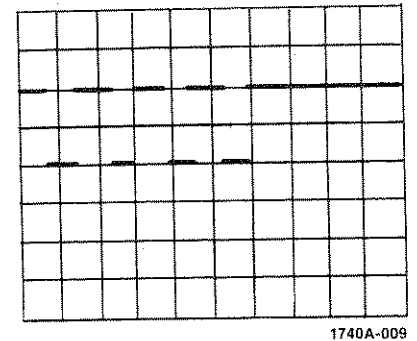

Figure 7b. Mixed Sweep Display

the horizontal (X-axis) signal to the channel B INPUT connector. The channel A POSN ⑳ control will adjust vertical positioning, and the horizontal POSITION ㉕ control will adjust horizontal positioning. Adjust channel A and B VOLTS/DIV ㉑ controls as required.

2. If the display is not visible, press BEAM FIND ③ and adjust the channel A and B VOLTS/DIV controls until the display is compressed vertically. Next, center the compressed display with POSN ㉑ and POSITION ㉕ controls. Release BEAM FIND, and adjust FOCUS ⑤ for a sharp display.

## APPLICATIONS

### INTRODUCTION.

This section will assist you in using the Model 1740A oscilloscope for various measurement applications. In many cases, illustrations and examples are provided for clarity. We do not attempt to cover every possible application. If you have difficulty with any procedures or you have questions about an application not described here, please feel free to call on your HP Sales/Service representative for assistance. A list of HP

Sales/Service Offices is included at the back of this guide. When measurements are made by scaling or interpolating on the CRT graticule, you should use five or more major divisions of display between measurement points. Most observers will agree, when adequate care is used, that most measurements can be kept within  $\pm 1/20$  of a major division. This amounts to a scaling error of  $\pm 1\%$  for five divisions of separation.

### VOLTAGE MEASUREMENTS.

Voltage measurements can be made between a point on a waveform and a zero-volt reference (absolute voltage, see figure 8) or between any two points on a waveform (voltage difference, see figure 8).

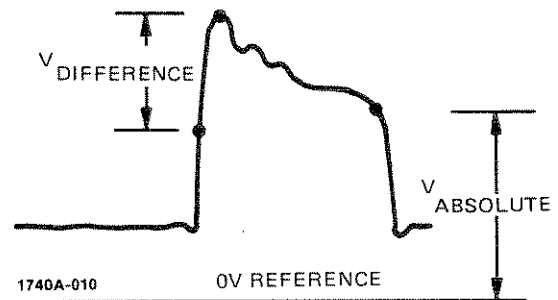

Figure 8. Absolute Voltage and Voltage Difference Measurements

The Model 1740A vertical deflection system has 12 calibrated positions from 5 mV/div to 20 V/div that allow you to make voltage measurements which are accurate within 3%.

#### ABSOLUTE VOLTAGE MEASUREMENTS.

The following procedure is used to make absolute voltage measurements, which are made with respect to a zero-volt reference.

1. Connect your signal to the channel A or B INPUT connector, and select channel A or B DISPLAY and TRIGGER.
2. Adjust the appropriate VOLTS/DIV control for six to seven divisions of display. The vernier should be in the CAL detent position.
3. Set input coupling to GND and AUTO/NORM to AUTO.
4. With the appropriate POSN control, set the trace on a graticule line to establish a zero-volts reference. Don't move the POSN control after the zero reference is set.
5. Set the input coupling to DC, and adjust TRIGGER LEVEL for a stable display. Adjust the MAIN TIME/DIV control as required.

6. Measure the distance in divisions between the reference line and the level on the waveform you want to measure. An example is shown in figure 9.

7. You can determine the polarity of the signal by comparing it to the reference line. If it is above the reference line, the voltage is positive; below the line it is negative.

8. Multiply the number of divisions in step 6 by the VOLTS/DIV setting. Include the attenuation factor if you are using a probe.

**Example:** Assume the vertical distance is 7 div, the waveform is above the reference line, and the VOLTS/DIV setting is 1 (see figure 9).

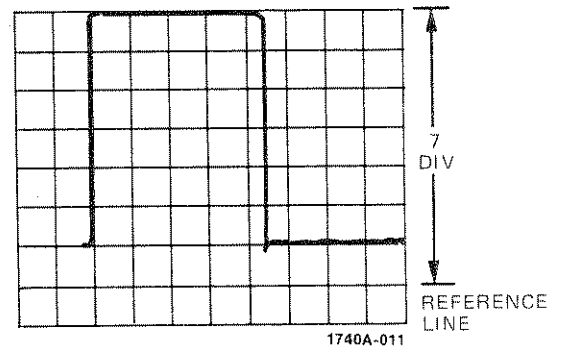

Figure 9. Absolute Voltage Measurement

Voltage =  $7 \times 1 = +7$  volts.

The waveform is above the reference line and so the voltage is positive.

#### VOLTAGE DIFFERENCE MEASUREMENTS.

The procedure used in making voltage difference measurements is similar to the absolute voltage procedure. However, the vertical distance is measured between two points on the waveform, not between a zero-volt reference line and the waveform. An example of a voltage difference measurement is peak-to-peak voltage, which is shown in figure 10.

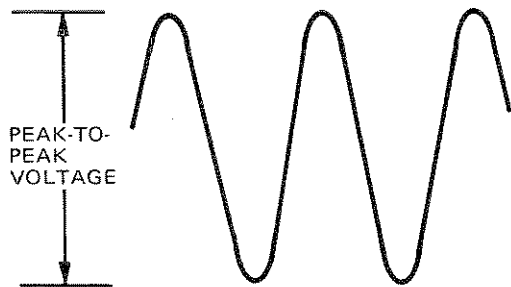

1740A-012

Figure 10. Peak-to-peak Voltage

#### AVERAGE VOLTAGE MEASUREMENTS.

To measure average voltage, a zero-volt reference line is determined by setting the input coupling to GND. Next, switch the input coupling to DC and measure the absolute voltage to the point of interest on the waveform (see figure 11a). Switch input coupling to AC and measure the absolute voltage to the same point on the waveform (see figure 11b). The difference between the first and second voltage is the average voltage.

#### AMPLITUDE COMPARISON MEASUREMENTS.

When you are comparing an unknown signal to a known (reference) amplitude, it may be helpful to use deflection factors not calibrated on the VOLTS/DIV control. With this method, a particular amplitude can be displayed by an exact number of divisions of deflection. This would be desirable when you are calibrating an instrument. You can also increase the accuracy of your measurements with the comparison method; the accuracy of your measurement depends on the reference signal accuracy, not on the oscilloscope accuracy.

1. Apply the reference voltage to the channel A INPUT connector, and set DISPLAY and TRIGGER to channel A.

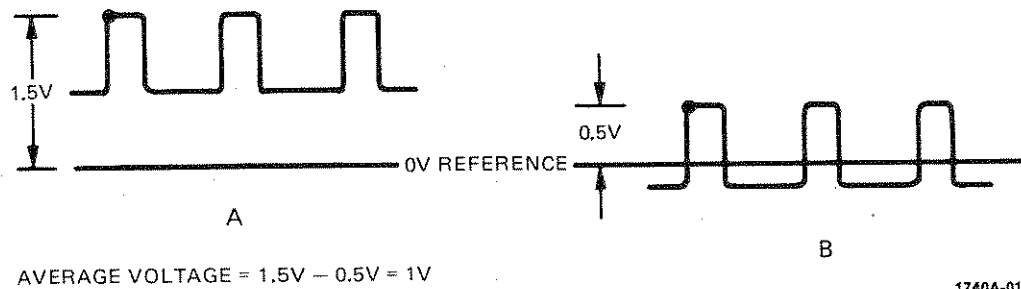

Figure 11. Average Voltage

2. Adjust MAIN TIME/DIV control for several cycles of display and TRIGGER LEVEL for a stable display.

3. Set the appropriate VOLTS/DIV, vernier, and POSN controls for exactly six, seven, or eight divisions of amplitude. Don't readjust the vernier after this step.

4. You should now calculate a scale factor (sf) so the amplitude of a known signal can be verified or the amplitude of an unknown signal can be determined.

Use the following formula:

$$sf = \frac{\text{Reference Signal Amplitude (volts)}}{\text{Display Amplitude in Div (Step 3) X VOLTS/DIV Setting}}$$

5. Disconnect the reference signal and connect the signal to be measured. Adjust the VOLTS/DIV control for enough amplitude to make an accurate measurement. Note this display amplitude. Don't readjust the vernier control.

6. Use the following formula to calculate the amplitude of the signal being measured:

$$\text{Amplitude} = \text{VOLTS/DIV Setting (Step 5) X sf (Step 4) X Display Amplitude in Div (Step 5)}$$

**Example:** Assume a reference signal amplitude of 40 Volts, a VOLTS/DIV setting of 5, and a display amplitude of six divisions.

Substituting in the formula from Step 4:

$$sf = \frac{40}{6 \times 5} = 1.3$$

Now, if the signal to be measured has a display amplitude of five divisions with a VOLTS/DIV setting of 2, determine the amplitude from the formula in Step 6.

Amplitude = 2 VOLTS/DIV X 1.3 X 5 DIV = 13 volts.

You can also calculate an unknown signal as a percentage of a known signal.

**Example:** Assume the reference signal has a deflection of eight divisions. Therefore, each division represents 12.5%. If the unknown signal has a deflection of 6.2 divisions, the amplitude of the unknown signal is:

UNKNOWN SIGNAL AMPLITUDE = 6.2 DIV X 12.5% / DIV = 77.5% of the reference signal amplitude.

### COMMON MODE REJECTION.

Frequently, signals of interest are modulated by an undesired dc or low-frequency ac component that prevents you from using a vertical range sensitive enough to make adequate measurements. You can often cancel the unwanted signal components by applying a signal similar to the unwanted components on the opposite channel and selecting A + B display mode and pressing the CH B INVT switch. The result is A minus B and only the desired signal is displayed. With this procedure, you can subtract unwanted components that are much larger in amplitude than the desired signal.

1. Apply the desired signal with unwanted components to the channel A INPUT connector and a signal similar to the unwanted components to the channel B INPUT connector.
2. Set input coupling as required, and select ALT. Adjust the VOLTS/DIV and vernier controls so the unwanted components on the channel A and B signals are approximately equal in amplitude.
3. Select TRIGGER A, CH B INVT, and DISPLAY A + B. With either channel A or channel B vernier control, adjust for minimum deflection of the common mode signal.



4. The resultant display will either subtract all the unwanted components in the desired signal or display the desired signal larger than the common mode signal.

**Example:** In figures 12a and 12b the common mode rejection method is illustrated.

**TIME MEASUREMENT.**

**TIME DURATION.**

Time duration measurements are made between two points on the same or different waveforms (see figure 13). Alternate should be selected for displaying high frequency signals and chop for low frequency signals. You must select channel A or B trigger when using alternate or chop. For fast, single-shot or low repetition rate signals, use the A + B display mode.

The following procedures illustrate period and repetition rate or frequency measurements. Pulse width and time difference measurements are very similar. Pulse width is the time duration of the pulse measured between the 50% amplitude point on the leading edge to the 50% amplitude point on the trailing edge of the waveform. On waveforms with variable transitions, we recommend measuring pulse width from the start of the leading edge to the start of the trailing

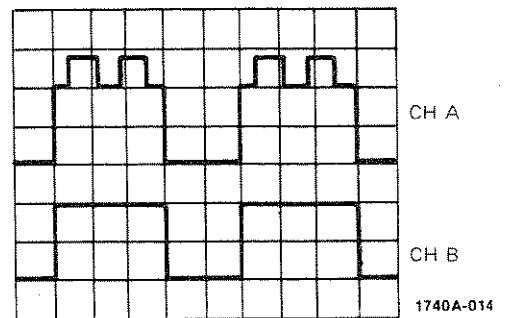

Figure 12a. Channel A With Desired Signal and Unwanted Components. Channel B With Only Unwanted Components.

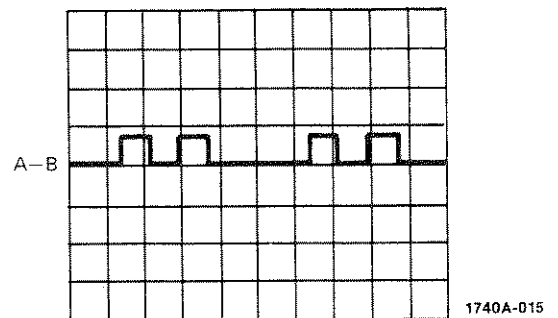

Figure 12b. Resultant Display

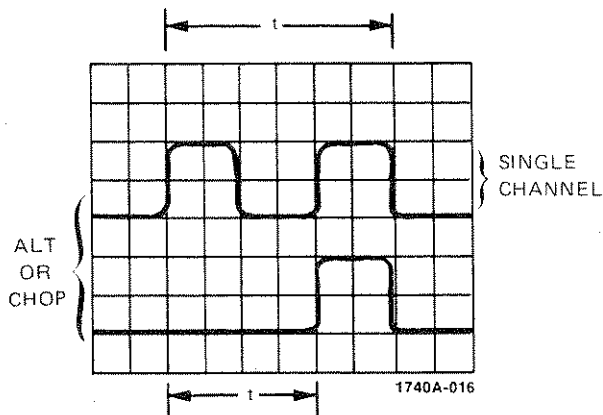

Figure 13. Examples of Time Duration Measurements

edge. If these points are not well defined, use the 10% rise and fall points. In time difference measurements, both channels of the oscilloscope are used and the horizontal distance measured is from the start of a reference waveform to the start of the waveform being compared to the reference.

The time base accuracy is within 2% at room temperature. Refer to table 1 for complete specifications.

#### Period Measurements.

1. Apply your signal to the channel A or B INPUT connector, and select A or B DISPLAY and TRIGGER.

2. Adjust the appropriate VOLTS/DIV control for six to seven divisions of display, if possible, and set the MAIN TIME/DIV control to the fastest sweep speed that will display at least one cycle within the 10 available divisions on the CRT.

3. Using the appropriate POSN control and the horizontal POSITION control center the display.

4. Measure the horizontal distance for one cycle in divisions. The SWEEP VERNIER should be in CAL detent.

5. Multiply the horizontal distance in step 4 times the MAIN TIME/DIV setting. If you are using the MAG X10 switch divide the product by 10.

Use the following formula:

$$\text{Period} = \text{Horizontal Distance For One Cycle in Div} \\ \times (\text{Step 4}) \times \text{MAIN TIME/DIV Setting (Step 2)} \\ \div \text{Magnifier}$$

**Example:** Assume one cycle of the waveform occurs in four divisions, the MAIN TIME/DIV setting is 0.2 mSEC, and the MAG X10 switch is off (see figure 14).

Substituting in the formula:

Period = 4 Div X 0.2 ms/Div = 0.8 ms  $\pm 2\%$  at room temperature

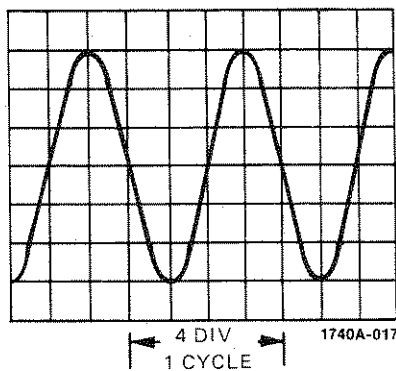

Figure 14. Period Measurement

#### Repetition Rate or Frequency Measurements.

1. The repetition rate or frequency of a waveform is the reciprocal of the period.

2. Use the procedure for period measurements to calculate the period of your signal and take the reciprocal to determine the repetition rate or frequency.

**Example:** Using the period from the previous example of 0.8 ms, take the reciprocal to find the repetition rate or frequency.

$$\begin{aligned} \text{Repetition Rate or Frequency} &= \frac{1}{\text{Period}} = \frac{1 \text{ cycle}}{0.8 \text{ ms}} \\ &= \frac{1 \text{ cycle}}{8 \times 10^{-4} \text{ s}} = 0.125 \times 10^4 \frac{\text{cycle}}{\text{s}} = 1.25 \text{ kHz } \pm 2\% \end{aligned}$$

#### RISE TIME MEASUREMENTS.

Rise time measurements are made between the 10% and 90% points of the waveform transition. Rise time is measured on the leading edge of the waveform and fall time is measured on the trailing edge of the waveform. The Model 1740A CRT has 10% and 90% points conveniently marked by dotted lines for both a six- and an eight-division reference. The dots are also spaced identically to the minor division markings on the major axis to assist you in interpolation.

1. Apply the pulse to the channel A or B INPUT connector, and select A or B DISPLAY and TRIGGER.

2. Adjust the appropriate VOLTS/DIV control and vernier for six or eight divisions of amplitude and the MAIN TIME/DIV control to display enough pulse top and baseline for measurement. Spread the 10% and 90% points as far apart as possible.

3. Turn the horizontal POSITION control until the 10% point on the waveform intersects a 10% marking and a vertical graticule line. The display should be centered in the viewing area.

4. Count the number of divisions until the pulse rise crosses the 90% markings. The SWEEP VERNIER should be in CAL detent.

5. Multiply the number of divisions in step 4 times the MAIN TIME/DIV setting. This is the rise time ( $R_T$ ) you use the MAG X10 switch, divide the product by 10.

**Example:** Assume the number of divisions between the 10% and 90% points is four and the MAIN TIME/DIV setting is 2  $\mu$ SEC (see figure 15).

$$R_T = 4 \times 2 \mu s = 8 \mu s$$

If you use the oscilloscope to measure a rise time near the Model 1740A rise time ( $\leq 3.5$  ns), error correction may be required. For accurate results, error correction

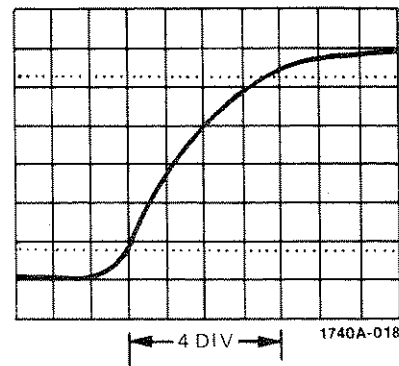

Figure 15. Rise Time Measurement

should be used when the pulse rise time is four times the oscilloscope rise time or faster.

Use the following formula:

$$R_T (\text{pulse}) = \sqrt{R_T^2 (\text{observed}) - R_T^2 (\text{oscilloscope})}$$

**Example:** Assume the 10% to 90% observed rise time is 7.5 ns and the oscilloscope rise time is 3.5 ns.

Substituting in the formula:

$$R_T (\text{pulse}) = \sqrt{7.5^2 - 3.5^2} = 6.6 \text{ ns}$$

**DELAYED SWEEP.**

For many time-interval measurements, delayed sweep will provide increased accuracy and resolution. In this guide we discuss three procedures using delayed sweep: magnification of a portion of a complex waveform for closer investigation, measuring the time interval between two pulses, and measuring pulse jitter.

The first procedure is discussed in the section: Obtaining Basic Displays. The remaining two procedures are explained in the following paragraphs.

**Delayed Sweep Time Interval Measurements.**

The delayed sweep mode can be used to increase the accuracy of your timing measurements. The following measurement determines the time interval between two pulses displayed on the same trace. The procedure may also be used to measure the time interval between pulses from two different channels or to make time duration measurements on a single pulse. To demonstrate the increase in accuracy, a measurement will first be made using only the main time base, and then the delayed time base will be used to make the same measurement.

1. Apply your signal to the channel A INPUT connector, and set TRIGGER and DISPLAY to channel A.

2. Set input coupling as desired, and adjust VOLTS/DIV for approximately four divisions of amplitude.

3. Select INT main trigger, and MAIN sweep.

4. Adjust the MAIN TIME/DIV control to display six to eight divisions between pulses, and adjust main TRIGGER LEVEL for a stable display.

5. Using horizontal POSITION, place the 50% point of the first pulse on a convenient graticule line and count the number of divisions to the 50% point of the second pulse (see figure 16).

6. To calculate the time interval (t), use the following formula:

$$t = (\text{Divisions between pulses} \times \text{MAIN TIME/DIV})$$

**Example:** Assume 6.2 divisions between pulses, and a MAIN TIME/DIV setting of 0.5 mSEC.

Substituting in the formula:

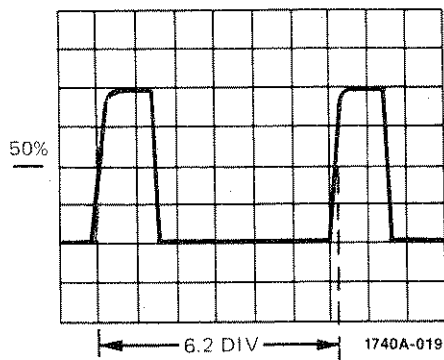

Figure 16. Time Interval Measurement  
Using Main Time Base

$$t = (6.2 \text{ DIV} \times 0.5 \frac{\text{ms}}{\text{DIV}}) \pm 2\% \text{ at room temperature}$$

$$t = 3.1 \text{ ms} \pm 0.062 \text{ ms}$$

Now we will use delayed sweep to make the same measurement.

1. Perform steps 1 through 4 of the previous procedure and select AUTO SWEEP AFTER DELAY.

2. Set the DLY'D TIME/DIV control as required, and turn the DELAY control to place the intensified portion on the first pulse (see figure 17a).

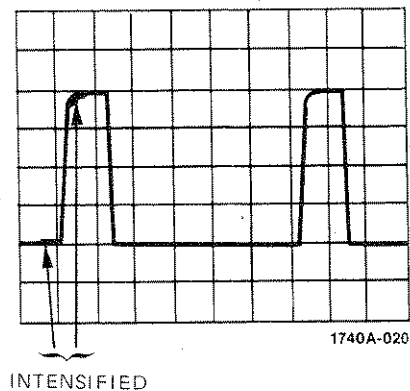
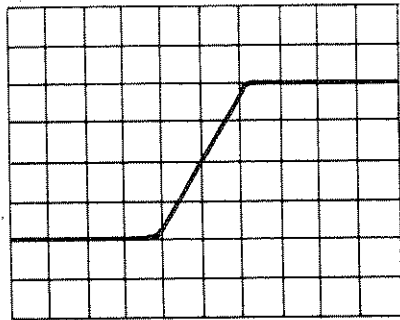

Figure 17a. Intensified Area On First Pulse

3. Select DLY'D sweep and adjust the DELAY control so the 50% amplitude point of the first pulse is on the center vertical graticule line (see figure 17b). Note the DELAY control reading.

4. Rotate the DELAY control clockwise until the second pulse is positioned on the same point of the center vertical graticule line (see figure 17c). You can verify this is the correct pulse by returning to MAIN sweep and observing the intensified portion. Again note the DELAY control reading.

5. To calculate the time interval ( $t$ ), use the following formula:



PULSE 1 1740A-021

Figure 17b. Time Interval Measurement Using Delayed Time Base - Pulse 1

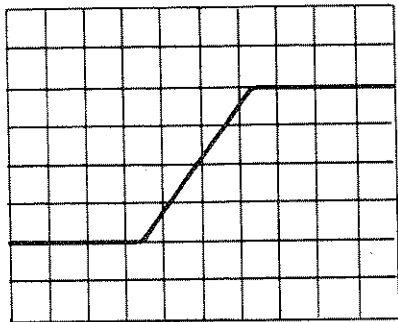

PULSE 2 1740A-022

Figure 17c. Time Interval Measurement Using Delayed Time Base - Pulse 2

$$t = \frac{\text{(Second DELAY reading)} - \text{First DELAY reading}}{\text{X MAIN TIME/DIV} \pm \text{error}}$$

**Example:** Assume the first DELAY control reading is 1.31 and the second DELAY control reading is 7.58 with the MAIN TIME/DIV control set to 0.5 ms and the DLY'D TIME/DIV control set to 0.05 ms (see figure 17d).

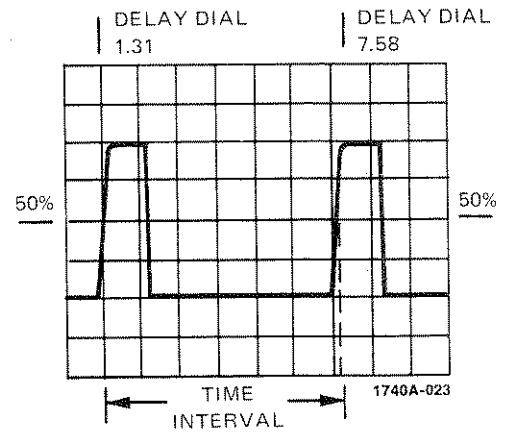

1740A-023

Figure 17d. Time Interval Measurement Using Delayed Time Base - Delay Dial Readings

Substituting in the formula:

$$t = (7.58 - 1.31) \times 0.5 \frac{\text{ms}}{\text{DIV}} \pm \text{error}$$

$$t = 3.14 \text{ ms} \pm \text{error}$$

The error is  $\pm [(0.5\% \times t) + (0.1\% \times \text{maximum delay period})]$ . The maximum delay period is the main sweep rate times the total length of the display (10 div in the 1740A).

Therefore,

$$\text{error} = \pm [(0.5\% \times 3.14) + (0.1\% \times 5)] = \pm 0.021 \text{ ms.}$$

And,

$t = 3.14 \text{ ms} \pm 0.021 \text{ ms}$ , an accuracy of  $<0.7\%$ . For greatest accuracy, use the fastest possible main sweep rate you can. This reduces the maximum delay period.

#### Pulse Jitter Measurements.

Jitter is a time uncertainty in the waveform caused by random noise, or spurious or periodic signals. To measure jitter use the following procedure.

1. Apply the signal to the channel A or B INPUT connector, and select A or B DISPLAY and TRIGGER.

2. Adjust the appropriate VOLTS/DIV control for five or more divisions of vertical deflection, and set the MAIN TIME/DIV control to show the complete waveform.

3. Adjust TRIGGER LEVEL until the display is as stable as possible.

4. Set the DLY'D TIME/DIV control as required, and turn the DELAY control to place the intensified display on the portion of the pulse showing jitter. The SWEEP VERNIER control should be in the CAL detent position.

5. Select the DLY'D mode and AUTO SWEEP AFTER DELAY. The horizontal movement of the pulse is the pulse jitter. There is some inherent jitter in any delayed sweep time base and should be included in the measurement (jitter in Model 1740A 1:50,000, which is insignificant in most measurements). Using the horizontal POSITION control, place the leading edge of the pulse on the center vertical graticule line. With the POSN control center the display.

6. Measure the horizontal displacement on the center horizontal graticule line as shown in figure 18. This displacement times the DLY'D TIME/DIV setting is the pulse jitter in time.



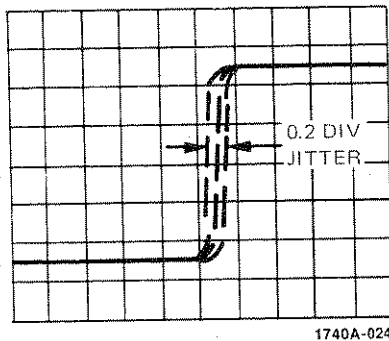

Figure 18. Pulse Jitter Measurement

**Example:** Assume the DLY'D TIME/DIV setting is 0.1 mSEC and the horizontal displacement is 0.2 DIV (see figure 18).

$$\text{Pulse Jitter} = 0.2 \text{ DIV} \times 0.1 \text{ ms/DIV} = 0.02 \text{ ms.}$$

#### Eliminating Jitter.

You can eliminate jitter from the display by using the TRIG SWEEP AFTER DELAY control. In this mode, the delayed sweep is triggered on the jittering pulse after the delay interval. So by triggering the delayed sweep after the delay period, the effect of

jitter on the display is eliminated, and you can measure pulse parameters. Remember, in this mode the DELAY dial is uncalibrated (see figure 19).

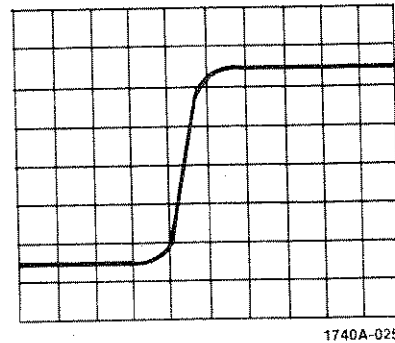

Figure 19. Pulse Jitter Eliminated

#### Viewing Pulses With Variable Time Durations.

When the time duration between the end of one pulse and the start of another pulse is variable, you can use the TRIG SWEEP AFTER DELAY control and the DELAY dial to arm the delayed-trigger circuit after the last known pulse. The delayed sweep will now be triggered by the pulse with variable time duration and its parameters can be measured (see figure 20).

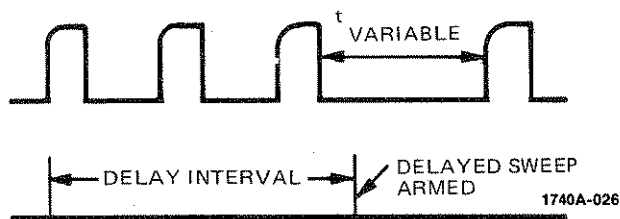

Figure 20. Pulse With Variable Time Duration

#### MEASURING PHASE DIFFERENCE BY TIME DELAY.

The phase difference between two signals of the same frequency can be determined up to the frequency limitation of the vertical amplifier. Use the following procedure:

1. Select ALT, channel A TRIGGER, and main POS.
2. Apply the input signal to the channel A INPUT connector and the output signal to the channel B INPUT connector. The cables or probes used must either have the same electrical length or the delay differences must be accounted for to prevent measurement error.

3. Select AC input coupling for both channels, and adjust channels A and B VOLTS/DIV and vernier controls for an equal amplitude on both channels.

4. Adjust the MAIN TIME/DIV and SWEEP VERNIER controls so a complete cycle for each waveform is displayed within 10 horizontal divisions.

5. Using the POSN controls center both waveforms vertically.

6. Readjust SWEEP VERNIER for one complete cycle of the input signal in an exact number of major divisions. Six or eight divisions is suggested, which would equal  $60^\circ/\text{Div}$  and  $45^\circ/\text{Div}$  respectively. You can obtain additional resolution by using the MAG X10 switch. In this case, six divisions would equal  $6^\circ/\text{Div}$  and eight divisions would equal  $4.5^\circ/\text{Div}$ .

7. Count the number of major plus minor divisions between the reference signal and the output signal at the point where they both cross the center horizontal graticule line. Convert divisions to degrees and this is the phase difference.

**Example:** Assume one cycle of the input signal occurs in six divisions and there are three minor divisions between the input and output waveforms (see figure 21).

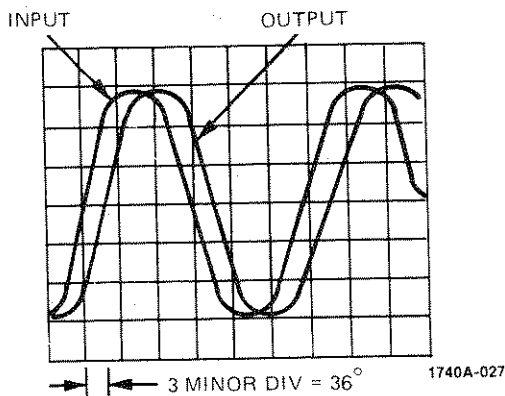

Figure 21. Phase Difference Measurement

Since one major division equals  $60^\circ$ , one minor division equals  $12^\circ$ . Phase Difference =  $3 \times 12 = 36^\circ$ ; the output lags the input by  $36^\circ$ .

**A VS B PHASE MEASUREMENTS.**

The A VS B mode will allow you to measure the phase differences between two signals of the same frequency up to 100 kHz. The channel A input signal provides deflection along the Y-axis, and the channel B input signal provides deflection along the X-axis. The phase difference can be measured from the resulting lissajous pattern using the following procedure.

1. Connect one signal to the channel A and the other to the channel B INPUT connector.

2. Select A VS B, and adjust the channel A VOLTS/DIV control for six to seven divisions of vertical deflection (Y-axis) and the channel B VOLTS/DIV control for eight to nine divisions of horizontal deflection (X-axis).

3. Using the channel A POSN control for vertical positioning and the horizontal POSITION control for horizontal positioning, center the display on the CRT.

4. Measure distances A and B as shown in figure 22a. A is the distance intersected by the trace on the

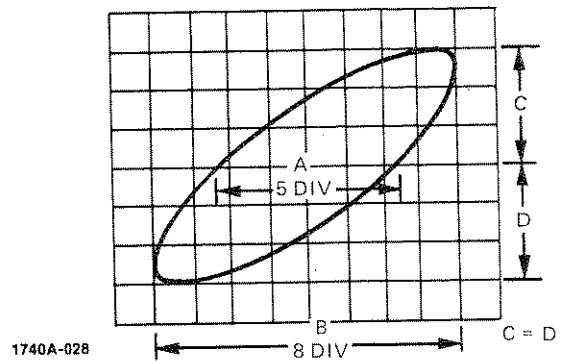

Figure 22a. A VS B Phase Measurement

center horizontal graticule line, and B is the total horizontal deflection of the trace.

5. The sine of the phase angle between the two signals is A/B. Figures 22b, 22c, and 22d show signals in phase, 90° out of phase, and 180° out of phase respectively. If the trace is rotating, the signals are not at the same frequency.

**Example:** In figure 22a, A equals five divisions and B equals eight divisions. Distance C is equal to distance D. The sine of the phase difference ( $\theta$ ) is A/B, which is 0.625.

Therefore: (using HP 21 calculator).

Phase Angle ( $\theta$ ) = arc sine of 0.625 = 38.7°.

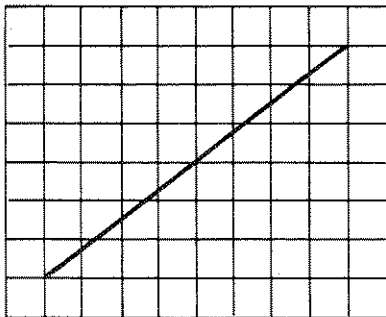

1740A-029

Figure 22b. Signals In Phase

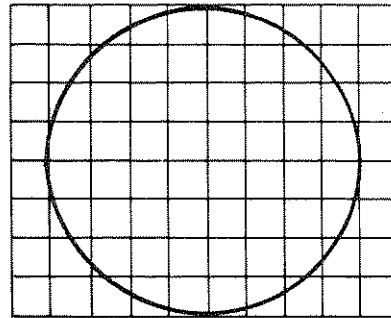

1740A-030

Figure 22c. Signals 90° Out Of Phase

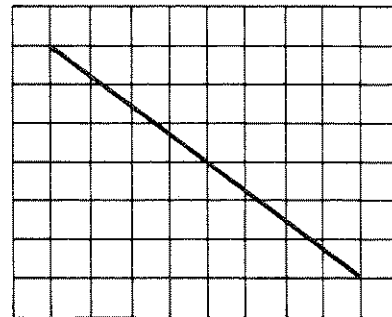

1740A-031

Figure 22d. Signals 180° Out Of Phase

## TRIGGERING.

### TRIGGER VIEW.

The TRIG VIEW control replaces the channel A or B trace with the trigger signal if channel A or B is selected as the display mode. In the ALT or CHOP display mode, three signals are displayed: channel A, the selected trigger signal, and channel B. In TRIG VIEW, the center horizontal graticule line represents the trigger threshold level with respect to the trigger signal (see figure 23).

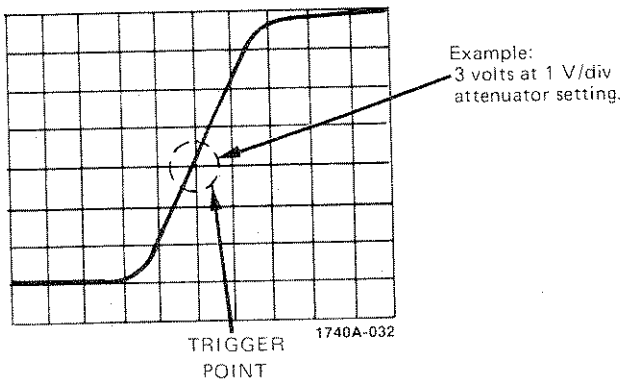

Figure 23. Trigger Point Location

It is frequently helpful to observe the trigger signal being applied to the external trigger input. When you use trigger view in conjunction with CHOP or ALT, both vertical channels plus the external trigger signal can be viewed simultaneously. This is useful in setting triggering and observing time correlation between the external trigger signal and the channel A and B signals. The deflection factor is approximately 100 mV/div.

**Example:** We will now use trigger view to determine the triggering level location.

1. Connect the trigger signal to the main EXT TRIGGER input connector, and select main EXT TRIGGER.
2. Select TRIG VIEW; the trigger signal will be displayed near center screen. The point where the trigger signal crosses the center horizontal graticule is the trigger point.

By adjusting the TRIGGER LEVEL control you can move the trigger level location. The center horizontal graticule indicates the trigger point. When you use the POS position of the POS/NEG switch, the trigger circuit triggers on the positive-going portion of the trigger signal; In NEG it triggers on the negative-going portion of the trigger signal.

### ELIMINATING MULTIPLE TRIGGERING ON COMPLEX WAVEFORMS.

Figure 24a shows an example of multiple triggering. To have a stable display, the period between sweeps must match the period of the waveform being displayed. In the example, the first sweep displays three bits of a four-bit word. The next sweep displays the remaining bit in the word. So on consecutive sweeps we see different portions of the same word causing the instability in figure 24a.

To eliminate the instability, the TRIGGER HOLDOFF control can be adjusted to vary the time between the

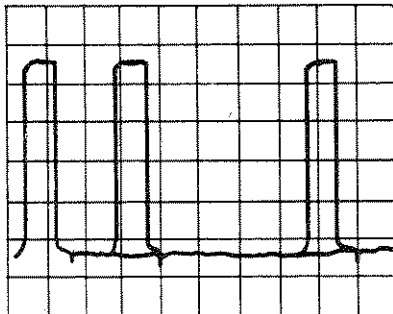

1740A-033

Figure 24a. Multiple Triggering With Display Instability

end of one sweep and the beginning of the next. This is the holdoff period. In the example, if you increase the holdoff period long enough, the trigger from the fourth bit is held off, which eliminates the additional sweep that caused the display instability (see figure 24b).

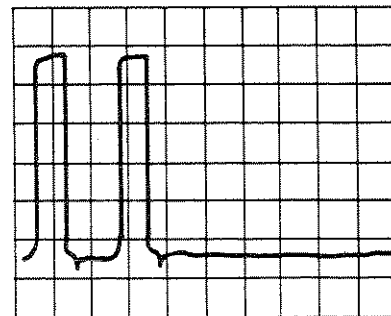

1740A-034

Figure 24b. Multiple Triggering Eliminated With Trigger Holdoff Control

### OPTION 101 - LOGIC STATE DISPLAY

This option allows you to use the Model 1740A with the HP Model 1607A Logic State Analyzer to aid in your analysis of digital systems that depend on sequences of logic states to control their operation.

Horizontal, vertical, and Z-axis signals from the Model 1607A convert the Model 1740A into a 16-channel logic state analyzer. You can switch from logical state to electrical analysis by pressing one pushbutton - a real convenience.

To connect the Model 1740A to the Model 1607A, place the Model 1740A on top of the Model 1607A and using three Model 10502A cables, connect the Model 1607A rear-panel outputs: HORIZ, VERT, and Z-AXIS to the corresponding Model 1740A rear-panel inputs.

You may check Model 1740A operation with the Model 1607A by the following procedure:

**NOTE**

Clock and data probes don't have to be connected to the Model 1607A for this procedure.

1. Press STATE DSPL on the Model 1740A.
2. Set the Model 1607A controls as follows:

POWER ..... OFF  
 OFF/WORD ..... WORD  
 Sample Mode ..... SINGLE

COLUMN BLANKING ..... fully CCW  
 Z-AXIS ..... ON  
 All other pushbuttons ..... disengaged

3. Apply power to the Model 1740A and the Model 1607A, and adjust the 1740A FOCUS control for the sharpest display. A focused 16-word table of one's and zero's will be displayed. If the table is not displayed, you may have to press the Model 1607A power switch on and off to cause the Model 1607A to start up in a display mode.

**NOTE**

The following adjustments apply to the Model 1607A.

4. Adjust the HORIZ SIZE control for a six-division wide display and the VERT SIZE control for an eight-division high display. You may have to adjust the HORIZ and VERT POSN controls to center the display.
5. Set BYTE to 3 BIT and notice that the display format changes from four-bit bytes to three-bit bytes.
6. Set LOGIC to NEG and note that all zeros change to ones and all ones change to zeros.

7. Rotate the COLUMN BLANKING control clockwise and observe that the vertical columns are blanked, starting with the most significant bit.

8. Rotate the COLUMN BLANKING control fully clockwise and note that the least significant bit column remains on the CRT.

9. Rotate the COLUMN BLANKING control fully counterclockwise.

10. Set trigger mode to START DSPL and observe that the first word is intensified.

11. Set trigger mode to END DSPL and note that the last word is intensified.

12. Set DELAY ON/OFF to ON. Setting the DELAY thumbwheels from 0 to 15 will move the intensified word on the display. For delays greater than 15, the intensified word will not be displayed.

In the following example, we will show how you can use Option 101 in logic state and electrical analysis to find the location of a fault in digital program flow.

Since a fault in an algorithmic state machine will cause an erroneous state to exist in the program flow, it is desirable to start troubleshooting using program

flow. When you find the fault location, you can more easily find the specific cause using conventional time analysis techniques. With Option 101, the Model 1740A and Model 1607A provide logic state and timing analysis displays.

Assume our algorithmic state machine is a 60-second timer that is terminating its count prematurely. By observing the logic state flow with the Model 1740A and Model 1607A, the premature termination point can easily be found. In this example, the malfunction is at count 25 (see figure 25). In this case we triggered on word 20. Notice the timer proceeded normally until word 24, when it reset to zero.

The Model 1607A supplied an external trigger to the Model 1740A, triggering the time display on the word we selected (word 20). A probe was connected from channel A on the Model 1740A to the least significant bit channel on the timer. Another probe was connected from channel B to the reset line on the timer. By switching the Model 1740A STATE DSPL pushbutton to the off position, we obtained a time display starting with word 20 (see figure 26).

You will notice on channel A the pulses are normal until after word 24. The pulse at word 25 started to go high, but was not completed. Instead, the timer reset and started again at zero. Looking at the reset line on channel B, we see a "glitch" at word 25.



Model 1740A

	Least Significant Bit	Word	
0010	0000	20	← TRIGGER WORD
0010	0001	21	
0010	0010	22	
0010	0011	23	
0010	0100	24	
0000	0000	0	← ERROR
0000	0001	1	
0000	0010	2	
0000	0011	3	
0000	0100	4	
0000	0101	5	
0000	0110	6	
0000	0111	7	
0000	1000	8	
0000	1001	9	
<u>0001</u>	<u>0000</u>	10	
BCD	BCD		
"10's"	"1's"		
Column	Column		

Figure 25. Logic State Display

In this example, you can see the advantage of being able to switch from logic state to electrical analysis and interrogate inputs, outputs, and control lines for transients and glitches.

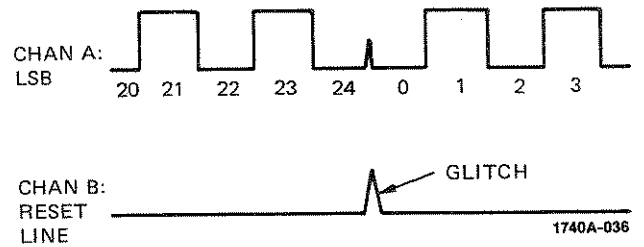

Figure 26. Glitch on Timer Reset Line Causing Timer to Reset Prematurely



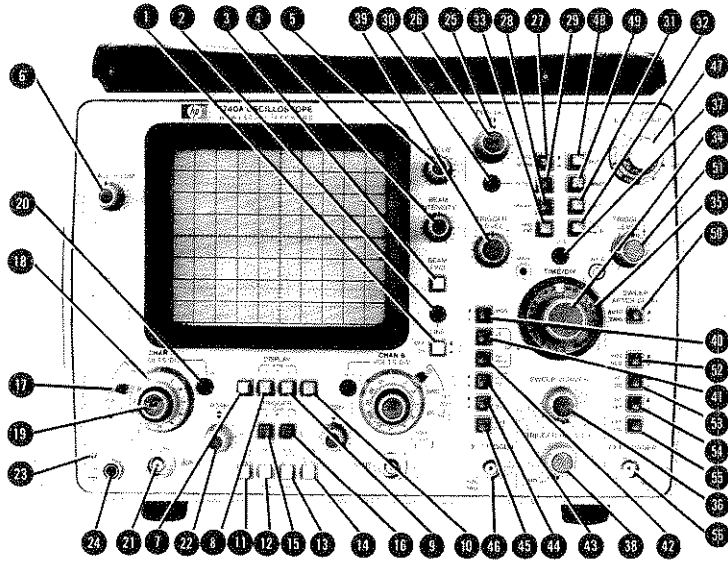

Figure 27. Front-panel Controls

1740A-03T

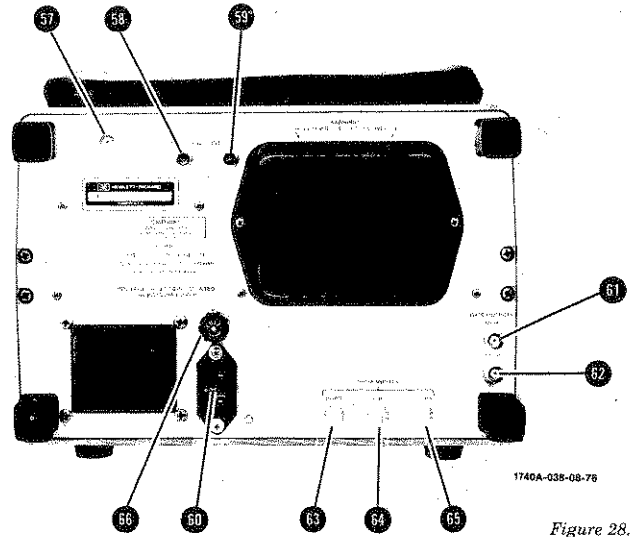

Figure 28. Rear-panel Controls



# HEWLETT PACKARD SALES & SERVICE OFFICES (Cont'd)

## EUROPE

**AUSTRIA**  
Hewlett-Packard Ges. m. b. H.  
Hoselstraße 52/3  
P. O. Box 7  
A-1025 Vienna  
Tel: (0222) 33 66 06 to 09  
Cable: HEWPAK vienna  
Telex: 75923 newpak a

**BELGIUM**  
Hewlett-Packard Benelux  
S.A. N.V.  
Avenue de Col-Vert 1  
(Groenendaaglan)  
B-1170 Brussels  
Tel: (02) 672 22 40  
Cable: PALOEN Brussels  
Telex: 23 494 aaloben brlx

**DENMARK**  
Hewlett-Packard A/S  
Datavej 57  
DK-3480 Birkerød  
Tel: (01) 81 65 40  
Cable: HEWPAK AS  
Telex: 166 40 hp as  
Hewlett-Packard A/S  
Navnvejs 1  
DK-8600 Silkeborg  
Tel: (06) 92 71 66  
Telex: 166 40 hp as  
Cable: HEWPAK AS

**FINLAND**  
Hewlett-Packard Oy  
Nankkahousenkatu 5  
P. O. Box 6  
SF-00211 Helsinki 21  
Tel: 692031  
Cable: HEWPAK OY Helsinki  
Telex: 12-15363

**FRANCE**  
Hewlett-Packard France  
Quartier de Courcouronnes  
Boite Postale No. 6  
F-91401 Orsay  
Tel: (1) 907 78 25  
Cable: HEWPAK Orsay  
Telex: 60048

Hewlett-Packard France  
Agence Régionale  
Chemin des Moutiers  
Boite Postale No. 12  
F-68130 Ecully  
Tel: (70) 33 61 25  
Cable: HEWPAK Ecully  
Telex: 31 617  
Hewlett-Packard France  
Agence Régionale  
Zone Aéronautique  
Avenue Citronnier Ader  
F-31770 Colomiers  
Tel: (61) 78 11 35  
Telex: 51557

Hewlett-Packard France  
Agence Régionale  
Centre d'aviation générale  
F-13721 Aéroport de  
Marseille  
Tel: 691 86 92 36  
TWX 41770 F

Hewlett-Packard France  
Agence Régionale  
F-35000 Rennes  
Tel: 749127  
Telex: 74 912 F

Hewlett-Packard France  
Agence Régionale  
74 Avenue de la Robertsau  
F-67000 Strasbourg  
Tel: (86) 15 23 26 71  
Telex: 69141  
Cable: HEWPAK STRSG  
Mental Calculator Only  
Hewlett-Packard France  
Agence Régionale  
Centre Vauban  
201, rue Colbert  
Enferme Az  
F-59000 Lille  
Tel: (20) 51 44 14

**GERMAN FEDERAL REPUBLIC**  
Hewlett-Packard GmbH  
Viertelstraße Frankfurt  
Bernerstrasse 11  
Postfach 560 140  
D-6000 Frankfurt 56  
Tel: (069) 50 04 1  
Cable: HEWPAKSA Frankfurt  
Telex: 41 32 49 112

Hewlett-Packard GmbH  
Technisches Büro Boblingen  
Herrenbergstrasse 110  
D-7030 Boblingen Württemberg  
Tel: (07031) 66 72 67  
Cable: HEWPAK Boblingen  
Telex: 72 65 739 dbn

Hewlett-Packard GmbH  
Technisches Büro Düsseldorf  
Vogelsanger Weg 38  
D-4000 Düsseldorf  
Tel: (0211) 63 80 31 5  
Telex: 85-86 533 hpod d  
Hewlett-Packard GmbH  
Technisches Büro Hamburg  
Wendensstrasse 23  
D-2000 Hamburg 1  
Tel: (040) 24 13 93  
Cable: HEWPAKSA Hamburg  
Telex: 21 63 032 hpnh d

Hewlett-Packard GmbH  
Technisches Büro Hannover  
Meliendorfer Strasse 3  
D-3000 Hannover-Kirchfeld  
Tel: (0511) 55 60 46  
Telex: 092 3256

Hewlett-Packard GmbH  
Technisches Büro Nürnberg  
Harsbrunnstrasse 42  
D-8500 Nürnberg  
Tel: (0911) 57 10 66  
Telex: 623 800

Hewlett-Packard GmbH  
Technisches Büro München  
Unterhachinger Strasse 28  
ISAR Center  
D-8012 Otobrunn  
Tel: (089) 801 30 61 7  
Telex: 52 49 85  
Cable: HEWPAKSA München  
**(West Berlin)**  
Hewlett-Packard GmbH  
Technisches Büro Berlin  
Kottb Strasse 2-4  
D-1000 Berlin 30  
Tel: (030) 24 90 86  
Telex: 18 34 05 hpbn d

**GREECE**  
Kostas Mikoyannis  
18, Ermou Street  
GR-Athens 126  
Tel: 3236-303 Sales SVC  
3239-305 Adm. Order Proc.  
Cable: RAKAR Athens  
Telex: 21 99 62 rkar gr  
Hewlett-Packard S.A.  
Mediterranean & Middle East  
Operations  
35 Kolokotroni Street  
Plata Metallou  
Gr-Athens Athens  
Tel: 8080337, 8080359  
8080429, 8019693  
Telex: 21 0668  
Cable: HEWPAKSA Athens  
Analytical Only  
"INTECO" G. Papathanassiou & Co  
Mariti 17  
GR - Athens 103  
Tel: 521 915  
Cable: INTEKNIKA  
Telex: 21 5329 INTE GR

Medical Only  
Technomed Hellas Ltd  
52, Skoufa Street  
GR - Athens 135  
Tel: 626 372  
Cable: ETALAK Athens  
Telex: 21-4693 ETAL GR

**IRELAND**  
Hewlett-Packard Ltd.  
King Street Lane  
Wexford, Wexford  
GB-Berkshire RG11 5AR  
Tel: Wokingham 784774  
Telex: 847 776 846179

Hewlett-Packard Ltd  
The Grangers  
Stamford New Road  
GB-Aittricham Cheshire  
Tel: (061) 928-9021  
Telex: 568068

**ITALY**  
Hewlett-Packard Italiana S.p.A.  
Via Antonio Vesputci 2  
I-20124 Milan  
Tel: (2) 6251-110 lines  
Cable: HEWPAK I Milan  
Telex: 32046  
Hewlett-Packard Italiana S.p.A.  
Via Pietro Naroncelli 40  
I-35100 Padova  
Tel: 66 40 62 65 31 88  
Telex: 32046 via Milan  
Medical Only  
Hewlett-Packard Italiana S.p.A.  
Via Medaglie d'Oro 2  
I-56100 Pisa  
Tel: (050) 2 32 04  
Telex: 32046 via Milan  
Hewlett-Packard S.p.A.  
Via G. Arimondi 10  
I-00143 Rome-Eur  
Tel: (6) 5912944-5  
Telex: 61514  
Cable: HEWPAK I Rome  
Hewlett-Packard Italiana S.p.A.  
Via San Quintino 46  
I-10121 Turin  
Tel: 53 82 64 54 84 68  
Telex: 32046 via Milan  
Medical Calculators Only  
Hewlett-Packard Italiana S.p.A.  
Via Principe Nicola 43 G.C.  
I-95126 Catania  
Tel: (095) 370505

**LUXEMBURG**  
Hewlett-Packard Benelux  
S.A. N.V.  
Avenue de Col-Vert. 1.  
(Groenendaaglan)  
B-1170 Brussels  
Tel: (02) 672 22 40  
Cable: PALOEN Bruxelles  
Telex: 23 494

**NETHERLANDS**  
Hewlett-Packard Benelux N.V.  
Weerbesten 117  
P. O. Box 7625  
NL-Amsterdam 1031  
Tel: (020) 6411522  
Cable: PALOEN Amsterdam  
Telex: 13 216 nepa nl

**NORWAY**  
Hewlett-Packard Norge A.S.  
Nesveien 13  
Box 149  
N-1344 Haslum  
Tel: (02) 53 83 60  
Telex: 16621 npnas n

**POLAND**  
Analytical Medical Only  
Hewlett-Packard  
Warsaw Technical Office  
Szpitalna 1  
00-170 Warsaw  
Tel: 768031  
Telex: 812452

**PORTUGAL**  
Telecota-Empresa Técnica de  
Equipamentos Eléctricos S. a r.l  
Rua Rodrigo da Fonseca 103  
P. O. Box 2531  
P-Lisbon 1  
Tel: (1) 98 60 72  
Cable: TELECTRA Lisbon  
Telex: 12558  
Mundiatec  
Intercomércio Mundial de Comércio  
Sarl Avenida Antonio Augusto  
de Aguiar 136  
P. O. Box 2761  
P - Lisbon  
Tel: (1) 53 21 31 7  
Cable: INTERCAMBIO Lisbon

**SPAIN**  
Hewlett-Packard Española. S.A.  
Jerez No. 3  
E-Madrid 16  
Tel: (1) 458 26 00 (10 lines)  
Telex: 23515 hpe  
Hewlett-Packard Española. S.A.  
Milanesado 21-23  
E-Barcelona 17  
Tel: (3) 203 6200 (5 lines)  
Telex: 52603 hpde e  
Hewlett-Packard Española. S.A.  
Av Ramón y Cajal, 1  
Edificio Sevilla I, planta 5  
E-Seville  
Tel: 64 44 54 58

Hewlett-Packard Española S.A.  
Edificio Albia II 7 E  
E-Bilbao  
Tel: 23 85 06 23 82 06  
Calculators Only  
Hewlett-Packard Española S.A.  
Alvaro Bazan 12  
E-Jordico Luz  
E-Valencia - 10  
Tel: 66 42 00

**SWEDEN**  
Hewlett-Packard Sverige AB  
Engelströms 1-3  
Fax  
S-161 20 Bromma 70  
Tel: (08) 730 05 50  
Cable: HEWPAK SWEDEN  
Stockholm  
Telex: 18221  
Hewlett-Packard Sverige AB  
Hagaregatan 3C  
S-451 21 Mölndal  
Tel: (031) 27 68 08 01  
Telex: Via Bromma

**SWITZERLAND**  
Hewlett-Packard (Schweiz) AG  
Zürcherstrasse 20  
P. O. Box 64  
CH-8500 Schlieren Zurich  
Tel: (01) 96 18 21  
Cable: HPAC CH  
Telex: 50333 hpag  
Hewlett-Packard (Schweiz) AG  
9, chemin Louis-Petit  
CH-1214 Vernier Geneva  
Tel: (022) 41 49 50  
Cable: HEWPAKSA Geneva  
Telex: 27 333 hpss ch

**TURKEY**  
Telekom Engineering Bureau  
Saglik Sok No. 15 F  
Ayaspaşa-Beyoğlu  
P. O. Box 457 Beyoğlu  
TR-Istanbul  
Tel: 49 46 40  
Cable: TELEMATIOM Istanbul

**UNITED KINGDOM**  
Hewlett-Packard Ltd  
King Street Lane  
Wokingham, Wokingham  
GB-Berkshire RG11 5AR  
Tel: Wokingham 784774  
Telex: 847 776 846179  
Hewlett-Packard Ltd.  
The Grangers  
Stamford New Road  
GB-Aittricham Cheshire  
Tel: (061) 928-9021  
Telex: 568068

Hewlett-Packard Ltd  
c/o Makro  
South Service Wholesale Centre  
Ames Way  
Halesowen Industrial Estate  
GB-Halesowen, Worcs  
Tel: Birmingham 7860  
Hewlett-Packard Ltd  
4th Floor  
Wedge House  
799, London Road  
GB-Thornion Heath CR4 6XL  
Surrey  
Tel: (01) 684 0105  
Telex: 946825

Hewlett-Packard Ltd  
c/o Makro  
South Service Wholesale Centre  
Wear Industrial Estate  
Washington  
GB-New Town County Durham  
Tel: Washington 464001 ext 57 58  
Hewlett-Packard Ltd is registered  
address for V.A.T. purposes  
only.

70, Hmsbury Pavement  
London, EC2A 1SX  
Registered No. 690597

**USSR**  
Hewlett-Packard USSR  
c/o Commercial Office  
American Embassy (Box M)  
A-1091 Vienna, Austria  
Tel: 221-25-71  
Telex: 7825 newpak SU  
**YUGOSLAVIA**  
Iskra-Standard Hewlett-Packard  
Topska 58/3  
61006 Ljubljana  
Tel: 315-875321-674  
Telex: 31300

**SOCIALIST COUNTRIES  
PLEASE CONTACT:**  
Hewlett-Packard S.A.  
7, rue du Bois-de-Lan  
P. O. Box 349  
CH-1217 Meyrin 1 Geneva  
Switzerland  
Tel: (022) 41 54 00  
Cable: HEWPAKSA Geneva  
Telex: 2 24 86

## HEWLETT PACKARD SALES & SERVICE OFFICES (Cont'd)

### UNITED STATES

**ALABAMA**  
8290 Whitesburg Dr., S.E.  
P.O. Box 4267  
Huntsville 35893  
Tel: (205) 861-4561  
Medical Only  
228 W. Valley Ave.,  
Room 220  
Birmingham 35206  
Tel: (205) 942-2061

**ARIZONA**  
2336 E. Magnolia St.  
Phoenix 85034  
Tel: (602) 244-1361  
2424 East Aragon Rd.  
Tucson 85706  
Tel: (602) 294-3148

**ARKANSAS**  
Medical Service Only  
P.O. Box 5646  
Brady Station  
Little Rock 72205  
Tel: (501) 664-8773

**CALIFORNIA**  
1430 East Grangethorpe Ave.  
Fullerton 92631  
Tel: (714) 670-1000  
3939 Lankershem Boulevard  
North Hollywood 91604  
Tel: (213) 877-1262  
TWX: 910-499-2170  
6305 Arizona Place  
Los Angeles 90045  
Tel: (213) 849-2511  
TWX: 910-528-6147

**Los Angeles**  
Tel: (213) 776-7500  
3003 Scott Boulevard  
Santa Clara 95050  
Tel: (408) 249-7000  
TWX: 910-338-0518

**HAWAII**  
2075 So. King Street  
Honolulu 96814  
Tel: (808) 955-4455

**Ridgcrest**  
Tel: (714) 446-6166  
2220 Watt Ave.  
Sacramento 95825  
Tel: (916) 482-1463  
9606 Acra Drive  
P.O. Box 23333  
San Diego 92123  
Tel: (714) 279-3260

**COLORADO**  
9500 South Ulster Parkway  
Englewood 80112  
Tel: (303) 771-3455  
**CONNECTICUT**  
12 Lunar Drive  
New Haven 06525  
Tel: (203) 389-5551  
TWX: 710-465-2026

**FLORIDA**  
P.O. Box 24210  
2806 W. Oakland Park Blvd.  
Ft. Lauderdale 33307  
Tel: (305) 731-2020

**Jacksonville**  
Medical Service Only  
Tel: (904) 725-6333  
P.O. Box 13810  
6177 Lake Elanor Dr.  
Orlando 32805  
Tel: (305) 859-2900  
P.O. Box 12826  
Pensacola 32575  
Tel: (904) 434-3681

**GEORGIA**  
P.O. Box 105005  
Atlanta 30348  
Tel: (404) 955-1500  
TWX: 810-766-4890  
Medical Service Only  
Augusta 30903  
Tel: (404) 736-0592

**INDIANA**  
7301 North Shadeland Ave.  
Indianapolis 46250  
Tel: (317) 842-1000  
TWX: 810-260-1796

**ILLINOIS**  
5500 Howard Street  
Skokie 60076  
Tel: (312) 677-0400  
TWX: 910-223-3613  
Effective Nov. 1, 1976  
35201 Tollview Dr.  
Rolling Meadows 60008  
Tel: (312) 255-9800  
Tel: (714) 279-3260

**INDIANA**  
7301 North Shadeland Ave.  
Indianapolis 46250  
Tel: (317) 842-1000  
TWX: 810-260-1796

**IOWA**  
1952 Stradway  
Iowa City 52240  
Tel: (319) 338-9466  
Night: (319) 338-9467

**KENTUCKY**  
Medical Only  
Atkinson Square  
2901 Atkinson Dr.,  
Suite 207  
Louisville 40218  
Tel: (502) 456-1573

**LOUISIANA**  
P.O. Box 840  
3239 Williams Boulevard  
Kenner 70062  
Tel: (504) 721-6201

**MARYLAND**  
6701 Whitestone Road  
Baltimore 21207  
Tel: (301) 944-5400  
TWX: 710-862-8157  
2 Choke Cherry Road  
Rockville 20850  
Tel: (301) 948-8170  
TWX: 710-828-9684

**MASSACHUSETTS**  
32 Harwell Ave.  
Lexington 02175  
Tel: (617) 851-9868  
TWX: 710-526-6904

**MICHIGAN**  
23855 Research Drive  
Farmington Hills 48024  
Tel: (313) 476-6466  
TWX: 910-742-2900

**MINNESOTA**  
2400 N. Pirost Ave.  
Roseville 55113  
Tel: (612) 636-0700  
TWX: 910-569-3734

**MISSISSIPPI**  
"Jackson"  
Medical Service Only  
Tel: (601) 982-9383

**MISSOURI**  
11131 Colorado Ave.  
Kansas City 64137  
Tel: (816) 765-8000  
TWX: 910-771-2067

148 Weldon Parkway  
Maryland Heights 63043  
Tel: (314) 567-1455  
TWX: 910-764-0630

**NEBRASKA**  
Medical Only  
7071 Mercy Road  
Suite 10  
Omaha 68106  
Tel: (402) 392-0948

**NEW JERSEY**  
W. 120 Century Rd.  
Paramus 07652  
Tel: (201) 265-5000  
TWX: 710-990-4951

**NEW MEXICO**  
P.O. Box 11634  
Station E  
11300 Lomas Blvd., N.E.  
Albuquerque 87123  
Tel: (505) 292-1330  
TWX: 910-966-1185

**NEW YORK**  
6 Automaton Lane  
Computer Park  
Albany 12205  
Tel: (518) 456-1550  
TWX: 710-441-8270  
201 South Avenue  
Poughkeepsie 12601  
Tel: (914) 434-7330  
TWX: 510-248-0012

39 Sapsinaw Drive  
Rochester 14623  
Tel: (716) 473-8600  
TWX: 510-253-5961

5858 East Molloy Road  
Syracuse 13211  
Tel: (315) 454-2466  
TWX: 710-541-0482

1 Crossways Park West  
Woodbury 11797  
Tel: (516) 921-0300  
TWX: 710-890-4951

**NORTH CAROLINA**  
P.O. Box 5188  
1923 North Main Street  
High Point 27262  
Tel: (919) 865-8101

**OHIO**  
16500 Sprague Road  
Cleveland 44130  
Tel: (216) 243-7300  
TWX: 810-423-9431  
330 Progress Rd.  
Dayton 45449  
Tel: (513) 859-8202  
1041 Kingsmill Parkway  
Columbus 43229  
Tel: (614) 436-1041

**OKLAHOMA**  
P.O. Box 32008  
Oklahoma City 73132  
Tel: (405) 721-0200

**OREGON**  
17890 SW Lower Boones  
Ferry Road  
Tualatin 97062  
Tel: (503) 620-3350

**PENNSYLVANIA**  
111 Zets Drive  
Pittsburgh 15238  
Tel: (412) 782-0400  
TWX: 710-795-3124  
1021 8th Avenue  
King of Prussia Industrial Park  
King of Prussia 19406  
Tel: (215) 265-7000  
TWX: 510-650-2670

**SOUTH CAROLINA**  
6941-O N. Trentholm Road  
Columbia 29260  
Tel: (803) 782-6493

**TENNESSEE**  
"Knoxville"  
Medical Services only  
Tel: (615) 523-5022

**"Nashville"**  
Medical Service Only  
Tel: (615) 244-5448

**TEXAS**  
P.O. Box 1270  
201 E. Arapaho Rd.  
Richardson 75080  
Tel: (214) 231-6101  
P.O. Box 27409  
6300 Westpark Drive  
Suite 100  
Houston 77027  
Tel: (713) 761-6000  
205 Billy Mitchell Road  
San Antonio 78226  
Tel: (512) 434-8241

**UTAH**  
2160 South 3270 West Street  
Salt Lake City 84119  
Tel: (801) 487-0715

**VIRGINIA**  
Medical Only  
P.O. Box 12778  
No. 7 Koger Exec. Center  
Suite 212  
Norfolk 23502  
Tel: (804) 497-1026/7  
P.O. Box 9854  
2014 Hungry Springs Road  
Richmond 23228  
Tel: (804) 285-3431

**WASHINGTON**  
Bellefield Office Pk.  
1203-114th Ave. S.E.  
Bellevue 98004  
Tel: (206) 454-3971  
TWX: 910-443-2446

**"WEST VIRGINIA"**  
Medical/Analytical Only  
Charleston  
Tel: (504) 345-1640

**WISCONSIN**  
9034 West Lincoln Ave.  
West Allis 53227  
Tel: (414) 541-0550

**FOR U.S. AREAS NOT LISTED:**  
Contact the regional office  
nearest you: Atlanta, Georgia,  
North Hollywood, California,  
Rockville, Maryland...Rolling Meadows,  
Illinois. Their complete  
addresses are listed above.

**\*Service Only**