

HP Archive

This vintage Hewlett Packard document was preserved
and distributed by

[www. hparchive.com](http://www.hparchive.com)

Please visit us on the web !

On-line curator: Georg zur Horst-Meyer

OPERATORS GUIDE

1744A OSCILLOSCOPE



HEWLETT  PACKARD

SAFETY SUMMARY

The following general safety precautions must be observed during operation of this instrument. Failure to comply with these precautions or with specific warnings elsewhere in this manual violates safety standards of design, manufacture, and intended use of the instrument. Hewlett-Packard Company assumes no liability for the customer's failure to comply with these requirements.

GROUND THE INSTRUMENT.

To minimize shock hazard, the instrument chassis and cabinet must be connected to an electrical ground. The instrument is equipped with a three-conductor ac power cable. The power cable must either be plugged into an approved three-contact outlet or used with a three-contact to two-contact adapter with the grounding wire (green) firmly connected to an electrical ground (safety ground) at the power outlet. The power jack and mating plug of the power cable meet International Electrotechnical Commission (IEC) safety standards.

DO NOT OPERATE IN AN EXPLOSIVE ATMOSPHERE.

Do not operate the instrument in the presence of flammable gases or fumes. Operation of any electrical instrument in such an environment constitutes a definite safety hazard.

DO NOT REMOVE INSTRUMENT COVERS.

Operating personnel must not remove instrument covers. Component replacement and internal adjustments must be made by qualified maintenance personnel. Service instructions for this instrument are provided in a separate Operating and Service Manual.

DANGEROUS PROCEDURE WARNINGS.

Warnings such as the example below, precede potentially dangerous procedures throughout this manual! Instructions contained in the warnings must be followed.

WARNING

*Dangerous voltages, capable of causing death, are present in this instrument.
Use extreme caution when handling, installing or operating.*



OPERATORS GUIDE

MODEL 1744A OSCILLOSCOPE

© COPYRIGHT HEWLETT-PACKARD COMPANY/COLORADO SPRINGS DIVISION 1978
1900 GARDEN OF THE GODS ROAD, COLORADO SPRINGS, COLORADO, U.S.A.

ALL RIGHTS RESERVED

Operators Guide Part Number 01744-90902
Microfiche Part Number 01744-90802

PRINTED: AUGUST 1978

TABLE OF CONTENTS

	Page		Page
General Information	1	Eliminating Flicker	29
Description	1	Storing a Trace	30
Accessories Furnished	8	Display Brightness Control	30
Accessories and Options Available	8	Measurement Techniques	31
Preparation for Use	8	Introduction	31
Power Cord	8	Voltage Measurements	31
Power Requirements	9	Absolute Voltage Measurements	32
Controls and Connectors	10	Peak-to-peak Voltage Measurements	33
Turn-on Procedure	18	Average Voltage Measurements	34
Checking Instrument Performance	19	Amplitude Comparison Measurements	35
Trace Alignment	19	Method 1	35
Astigmatism and Focus	20	Method 2	36
Probe Compensation	20	Common Mode Rejection	36
Vertical Accuracy Check	21	Time-interval Measurements	38
Sweep Time Accuracy	21	Period Measurements	38
Trigger Selection Table	21	Repetition Rate or Frequency Measurements	38
Obtaining Basic Displays	21	Transition Time Measurements	39
Normal Sweep Display	21	Delayed Sweep	40
Magnified Sweep Display	23	Measuring Phase Difference by Time Delay	43
Delayed Sweep Display	24	A vs B Phase Measurements	45
Mixed Sweep Display	25	Triggering	46
X-Y Display	25	Trigger View	46
Variable Persistence - Storage Operation	26	Eliminating Multiple Triggering on	
Auto Erase	26	Complex Waveforms	47
Auto Store Mode	26	Measuring CRT Writing Speed	48
Continuous Scan	28		

MODEL 1744A OPERATORS GUIDE

OPERATING INSTRUCTIONS

GENERAL INFORMATION.

This Operators Guide will acquaint you with the Model 1744A features, capabilities, accessories, power requirements, and controls. To aid in operating the oscilloscope, initial turn-on instructions, calibration procedures, and a performance check are provided. Detailed explanations in the Applications Section show how you can use varied capabilities of the 1744A to best advantage in a variety of electrical measurements. Specifications and general characteristics for the 1744A are listed in tables 1 and 2. Service information is available in a separate service manual.

DESCRIPTION.

The Hewlett-Packard Model 1744A is a dual-channel, 100-MHz, delayed-sweep variable persistence storage oscilloscope designed for single-shot transients and low duty cycle waveform analysis in the bench or field environment. The writing speed specification of 1800 cm/ μ s permits full screen capture of transients at the maximum slew rate of the vertical amplifier system. The

dual-channel dc to 100 MHz vertical deflection system has 12 calibrated deflection factors from 5 mV/div to 20 V/div. A maximum sensitivity of 1 mV/div to 30 MHz is provided on both channels by means of a 5X vertical magnification feature. Selectable input impedance of 50 ohms or 1 megohm permits selection of that impedance which best meets measurement requirements. The horizontal deflection system has calibrated sweep rates from 2 s/div to 0.05 μ s/div and delayed sweep rates from 20 ms/div to 0.05 μ s/div. A 10X magnifier expands all sweeps by a factor of 10 and extends the fastest sweep to 5 ns/div. In alternate or chop modes, a trigger-view control will display three signals: the channel A signal, the channel B signal, and the trigger signal. This allows you to correlate time between the trigger signal and the channel A and channel B signals. In trigger-view operation, center screen represents the trigger threshold point, allowing you to see the triggering level location. With the A VS B control, an X-Y mode of operation is possible. The channel A input (Y-axis) is plotted versus the channel B input (X-axis).

A trigger-view control provides capability for observing the channel A signal, channel B signal, and an external

Table 1. Specifications

VERTICAL AMPLIFIERS (2)

Bandwidth and Rise Time at all deflection factors from 0°C to +55°C.

BANDWIDTH: 3 dB down from 6 div reference signal.

DC-Coupled: dc to 100 MHz in both 50Ω and 1 MΩ input modes.

AC-Coupled: approx 10 Hz to 100 MHz; 1 Hz with 10:1 divider probes.

BANDWIDTH LIMIT: limits upper bandwidth to approx 20 MHz.

RISE TIME: <3.5 ns, measured from 10% to 90% points of a 5 div input step.

DEFLECTION FACTOR

Ranges: 5 mV/div to 20 V/div (12 calibrated positions) in 1, 2, 5 sequence, accurate within 3%.

Vernier: continuously variable between all ranges, extends maximum deflection factor to at least 50 V/div. UNCAL light indicates when vernier is not in CAL position.

POLARITY: channel B may be inverted, front panel pushbutton.

INPUT RC (selectable)

AC or DC: 1 MΩ ±2% shunted by approx 20 pF.

50 Ohm: 50Ω ±3%.

MAXIMUM INPUT

AC or DC: 250 V (dc + peak ac at 1 kHz or less) or 500 V (p-p ac at 1 kHz or less).

50 Ohms: 5 V rms.

A+B OPERATION

Amplifier: bandwidth and deflection factors are unchanged; channel B may be inverted for A-B operation.

Differential (A-B) Common Mode: CMRR is at least 20 dB from dc to 20 MHz. Common mode signal amplitude equivalent to 6 divisions with one vernier adjusted for optimum rejection.

VERTICAL MAGNIFICATION (X5)

BANDWIDTH: 3 dB down from 6 div reference signal.

DC-Coupled: dc to approx 30 MHz.

AC-Coupled: approx 10 Hz to 30 MHz.

RISE TIME: ≤12 ns (measured from 10% to 90% points of 5 div input step).

DEFLECTION FACTOR: increases sensitivity of the 5 and 10 mV/div deflection factor settings by a factor of 5 for a maximum sensitivity of 1 mV on channels A and B.

TRIGGER SOURCE

Selectable from channel A, channel B, composite, or line frequency.

CHANNEL A: all display modes triggered by channel A signal.

Table 1. Specifications (Cont'd)

<p>CHANNEL B: all display modes triggered by channel B signal.</p> <p>COMPOSITE: all display modes triggered by displayed signal except in Chop. In Chop mode, trigger signal is derived from channel A.</p> <p>LINE FREQUENCY: trigger signal is derived from power line frequency.</p> <p>TRIGGER VIEW</p> <p>Displays internal or external trigger signal. In Alternate or Chop mode, channel A, channel B, and the trigger signals are displayed. In Channel A or B mode, Trigger View overrides that channel. Internal trigger signal amplitude approximates vertical signal amplitude. External trigger signal deflection factor is approx 100 mV/div or 1 V/div in EXT $\div 10$. Triggering point is approx center screen. With identically timed signals to a vertical input and the external trigger input, trigger signal delay is ≤ 3.5 ns.</p> <p>MAIN AND DELAYED TIME BASES</p> <p>RANGES</p> <p>Main: 50 ns/div to 2 s/div (24 ranges) in 1, 2, 5 sequence.</p> <p>Delayed: 50 ns/div to 20 ms/div (18 ranges) in 1, 2 5 sequence.</p>	Accuracy: (over center 8 div)			
	Sweep Time/Div	*Accuracy		Temp Range
		X1	X10	
	50 ns to 20 ms	$\pm 3\%$ $\pm 2\%$ $\pm 3\%$	$\pm 4\%$ $\pm 3\%$ $\pm 4\%$	0°C to +15°C +15°C to +35°C +35°C to +55°C
*Add 1% for 50 ms to 2 s ranges.				
<p>MAIN SWEEP VERNIER: continuously variable between all ranges, extends slowest sweep to at least 5 s/div. UNCAL light indicates when vernier is not in CAL position.</p> <p>MAGNIFIER (X10): expands all sweeps by a factor of 10, extends fastest sweep to 5 ns/div.</p> <p>CALIBRATED SWEEP DELAY</p> <p>DELAY TIME RANGE: 0.5 to 10 X Main Time/Div settings of 100 ns to 2 s (minimum delay 150 ns).</p> <p>DIFFERENTIAL TIME MEASUREMENT ACCURACY:</p>				
Main Time Base Setting		*Accuracy (+15°C to +35°C)		
100 ns/div to 20 ms/div 50 ms/div to 2 s/div		$\pm(0.5\% + 0.1\%$ of full scale) $\pm(1\% + 0.1\%$ of full scale)		
*Add 1% from 0°C to +15°C and +35°C to +55°C.				

Table 1. Specifications (Cont'd)

DELAY JITTER: <0.002% (1 part in 50 000) of maximum delay in each step from +15°C to +35°C; <0.005% (1 part in 20 000) from 0°C to +15°C and +35°C to +55°C.

TRIGGERING

INTERNAL: dc to 25 MHz on signals causing 0.3 division or more vertical deflection, increasing to 1 division of vertical deflection at 100 MHz in all display modes (required signal level is increased by 2 when in Chop mode and by 5 when X5 vertical magnifier is used). Triggering on Line frequency is also selectable.

EXTERNAL: dc to 50 MHz on signals of 50 mV p-p or more increasing to 100 mV p-p at 100 MHz (required signal level is increased by 2 when in Chop mode).

EXTERNAL INPUT RC: approx 1 M Ω shunted by approx 20 pF.

MAXIMUM EXTERNAL INPUT: 250 V (dc + peak ac at 1 kHz or less) or 500 V (p-p ac at 1 kHz or less).

LEVEL and SLOPE

Internal: at any point on the positive or negative slope of the displayed waveform.

External: continuously variable from +1 V to -1 V on either slope of the trigger signal, +10 V to -10 V in divide by 10 mode ($\div 10$).

COUPLING: AC, DC, LF REJ, or HF REJ.

AC: attenuates signals below approx 20 Hz.

LF Reject (Main Sweep): attenuates signals below approx 4 kHz.

HF Reject (Main Sweep): attenuates signals above approx 4 kHz.

CALIBRATED MIXED TIME BASE

Dual time base in which the main time base drives the first portion of sweep and the delayed time base completes the sweep at the faster delayed sweep. Also operates in single sweep mode. Accuracy, add 2% to main time base accuracy.

A vs B OPERATION

BANDWIDTH

Channel A (Y-AXIS): same as channel A.

Channel B (X-AXIS): dc to 5 MHz.

DEFLECTION FACTOR: 5 mV/div to 20 V/div (12 calibrated positions) in 1, 2, 5 sequence.

PHASE DIFFERENCE BETWEEN CHANNELS: <3°, dc to 100 kHz.

CATHODE-RAY TUBE AND CONTROLS

Z-AXIS INPUT (INTENSITY MODULATIONS): +4 V, ≥ 50 ns width pulse blanks trace of any intensity usable to 10 MHz for normal intensity. Input R, 1 k Ω $\pm 10\%$. Maximum input ± 20 V (dc \pm peak ac).

Table 1. Specifications (Cont'd)

<p>PERSISTENCE Variable: approx 100 ms to 1 minute. STORAGE WRITING SPEED: ≥ 1800 cm/μs over center 6 x 8 div (with viewing hood).</p> <p>STORAGE TIME Display Mode: at least 10 s at 22°C. Store Mode: at least 30 s at 22°C. Wait Time: at least 60 s at 22°C. ERASE TIME: approx 300 ms.</p> <p>GENERAL</p> <p>REAR PANEL OUTPUTS: main and delayed gates, +0.8 V to $>+2.5$ V capable of supplying approx 5 mA.</p>	AMPLITUDE CALIBRATOR (0°C to +55°C)		
	Output Voltage	1 V p-p into ≤ 1 M Ω 0.1 V p-p into 50 Ω	$\pm 1\%$
	Rise Time	≤ 0.1 μ s	
	Frequency	approx 1.4 kHz	
	<p>POWER: 100, 120, 220, 240 Vac, $\pm 10\%$, 48 to 440 Hz; 100 VA max. WEIGHT: net, 13.8 kg (30.4 lb); shipping, 16.6 kg (36.6 lb).</p> <p>OPERATING ENVIRONMENT Temperature: 0°C to +55°C. Humidity: to 95% relative humidity at +40°C. Altitude: to 4600 m (15 000 ft). Vibration: vibrated in three planes for 15 min. each with 0.254 mm (0.010 in.) excursion, 10 to 55 Hz.</p>		

Table 2. General Characteristics

VERTICAL DEFLECTION**VERTICAL DISPLAY MODES**

Channel A; channel B; channels A and B displayed alternately on successive sweeps (ALT); channels A and B displayed by switching between channels at an approximate 250 kHz rate with blanking during switching (CHOP); channel A plus channel B (algebraic addition); and trigger view.

DELAY LINE: input signals are delayed sufficiently to view leading edge of input pulse without advanced trigger.

INPUT COUPLING: selectable AC or DC, 50 Ω (dc), or ground. Ground position disconnects input connector and grounds amplifier input.

HORIZONTAL DISPLAY MODES

Main, main intensified, mixed, delayed, mag X10, and A vs B.

TRIGGERING**MAIN SWEEP**

Normal: sweep is triggered by internal or external signal.

Automatic: bright baseline displayed in absence of input signal. Above 45 Hz, triggering is same as normal. For stable triggering at approx 45 Hz and below, use Normal triggering.

Single: automatically switches triggering to Normal and the sweep occurs once with same triggering as Normal, reset pushbutton arms sweep and lights indicator. Single sweep is also initiated with Erase pushbutton, sweep is armed after the erase cycle.

DELAYED SWEEP (SWEEP AFTER DELAY)

Auto: delayed sweep automatically starts at end of delay.

Trig: delayed sweep is armed and triggerable at end of delay period.

TRIGGER HOLDOFF (Main Sweep): increases sweep holdoff time in all ranges.

CATHODE-RAY TUBE AND CONTROLS

TYPE: Hewlett-Packard, 12.7 cm (5 in.) rectangular CRT, post accelerator, approx 7.5 kV accelerating potential, aluminized P31 phosphor.

GRATICULE: 8 x 10 div (1 div = 0.72 cm) internal, nonparallax graticule, 0.2 subdivision marking on major horizontal and vertical axes, with markings for rise time measurements. Graticule illumination is achieved with Persistence control set to minimum.

BEAM FINDER: returns trace to CRT screen regardless of setting of horizontal and vertical controls.

OPERATING MODES: write, store, display, auto store, and auto erase.

REAR PANEL CONTROLS: astigmatism, trace align, and display brightness.

DIMENSIONS: see outline drawing.

Table 2. General Characteristics (Cont'd)

NOTES:

1. DIMENSIONS ARE FOR GENERAL INFORMATION ONLY. IF DIMENSIONS ARE REQUIRED FOR BUILDING SPECIAL ENCLOSURES, CONTACT YOUR HP FIELD ENGINEER.
2. DIMENSIONS ARE IN MILLIMETRES AND (INCHES).

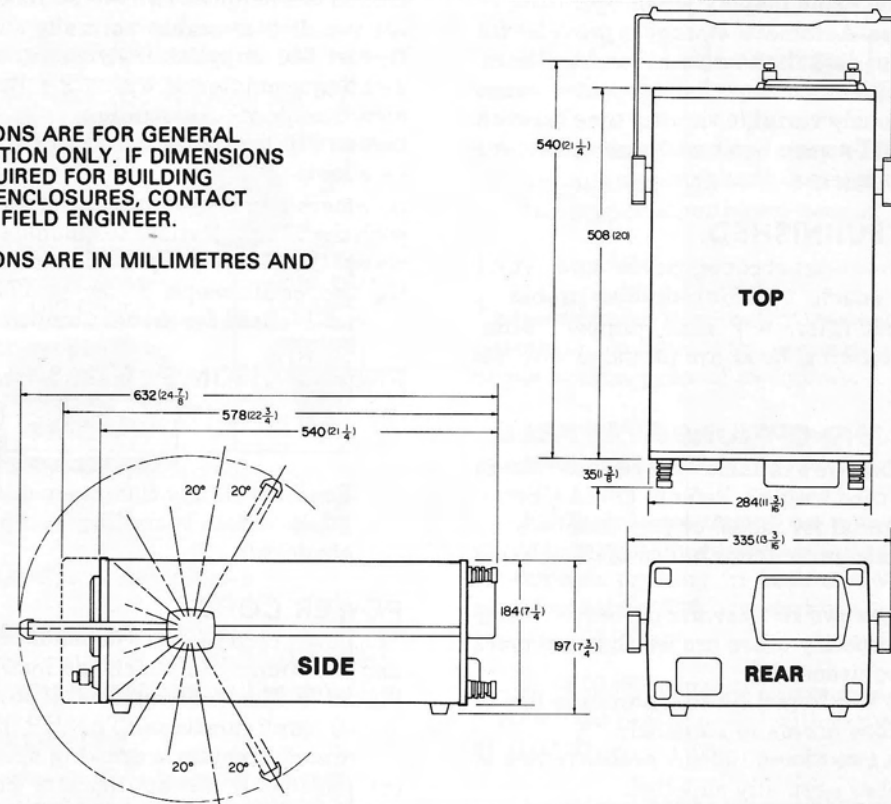

trigger signal on the same display when operating in ALT or CHOP modes. Automatic storage is provided for capturing single-shot data that occurs at random times. Automatic erase allows continuously repeated erase cycles with continuously variable viewing time between erase cycles. The CRT screen has 8 x 10 major divisions (0.72 cm/div) on an internal graticule.

ACCESSORIES FURNISHED.

A blue light filter, front-panel cover, power cord, vinyl accessory storage pouch, two 10:1 divider probes, a metal mesh contrast filter, a B-scan jumper filter, and a collapsible viewing hood are provided with the 1744A.

ACCESSORIES AND OPTIONS AVAILABLE.

Several divider probes are available with various voltage division ratios and cord lengths. Refer to 1744A Operating and Service Manual for model or part numbers.

Option 001 has a fixed power cord in lieu of detachable power cord.

Option 090 deletes the two 10:1 divider probes normally supplied. You may specify other probes that are more suitable for your requirements.

Option 091 supplies two Model 10042A probes in lieu of the two divider probes normally supplied.

Option 092 supplies two Model 10040A probes in lieu of the two divider probes normally supplied.

Option 096 supplies two Model 10006D probes in lieu of the two divider probes normally supplied.

Option 580 supplies instrument with CSA label indicating compliance with CSA Bulletin 556B. (Canadian Standards Association)

Option 910 furnishes two Operating and Service Manuals instead of one.

A camera adapter permits use of an oscilloscope camera with the 1744A. Various testmobiles are available which accept the 1744A and provide convenient, mobile stands for the oscilloscope. Refer to 1744A Operating and Service Manual for model numbers.

PREPARATION FOR USE.

WARNING

Read the Safety Summary at the front of this guide before installing or operating the instrument.

POWER CORD.

The power cord required depends on the ac input voltage and the country in which the instrument is to be used. Figure 1 illustrates standard power receptacle (wall outlet) configurations. The HP part number shown above each receptacle drawing specifies the power cord equipped with the appropriate mating plug for that





HP POWER CABLE PART NUMBERS		
8120-1692 OPTION 902	8120-1369 OPTION 901	
		
8120-1703 OPTION 900	8120-2296 OPTION 906	8120-1521 STANDARD
		
INPUT POWER RECEPTACLE TYPES		

Figure 1. Power Receptacles

receptacle. If the appropriate power cord is not included with your instrument, notify the nearest HP Sales/Service Office and a replacement cord will be provided.

POWER REQUIREMENTS.

The oscilloscope requires a power source of 100, 120, 220, or 240 volts ac $\pm 10\%$, single phase 48 to 440 Hz that can deliver at least 100 VA.

CAUTION

Instrument damage may result if the line voltage selection switch is not correctly set for the proper input power source.

The instrument is normally set at the factory for 120 V operation. To operate the instrument from any other ac power source, proceed as follows:

- Verify that 1744A power cable is not connected to a power source.
- Stand instrument on rear-panel legs and use blade-type screwdriver to position power selector switches through opening in bottom cover (figure 2 shows switches set for 120 V operation).
- For 220 V -240 V inputs, replace fuse F1 with 0.5 A slow-blow fuse supplied with instrument (HP Part No. 2110-0202).
- Connect 1744A input power cable to input power source.

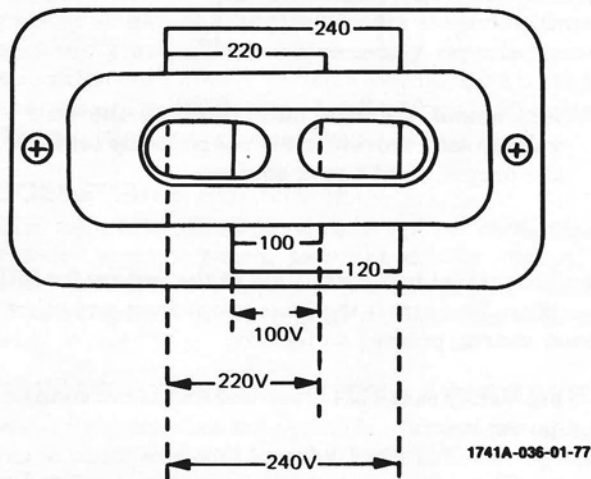

Figure 2. Line Voltage Selection Switch Settings

CONTROLS AND CONNECTORS.

Front- and rear-panel photographs (see figure 32) are located at the rear of this guide on a fold-out page for easy reference while you are reading any section. Control and connector descriptions have index numbers that are keyed to the panel photographs. The following paragraphs provide detailed descriptions of control and connector functions. Refer to the Applications Section for information on using the Model 1744A.

CRT CONTROLS

- 1 **LINE OFF/ON.** Switch turns power on and off. Indicator lights when power is ON.
- 2 **BEAM FIND.** Restricts the display to the viewing area regardless of control settings. Permits the operator to determine what action is necessary to return the beam to the viewing area (reduce input signal amplitude, change deflection factor, increase intensity, change position controls, etc.).
- 3 **BEAM INTENSITY.** Determines intensity of the electron beam as it writes on the storage mesh.
- 4 **FOCUS.** Adjusts the writing beam for sharp, well-defined trace. Keep FOCUS adjusted to avoid internal CRT damage.
- 5 **AUTO ERASE/AUTO STORE.** Two-function push-button to select either AUTO STORE or AUTO ERASE mode of operation. Respective lamps light to indicate which mode is selected. The AUTO ERASE lamp is green.
AUTO ERASE. In auto erase, the 1744A operates in a repetitive single-shot mode, even when a continuous signal is available. This mode is

also helpful during setup for capture of single-shot events by making it easier to obtain optimum focus and intensity for a particular signal. In addition, if you are viewing more than one trace, such as two or three channels, the 1744A will wait for the required number of sweeps to be displayed before automatically erasing the display. Operating at high drive levels in variable persistence and storage modes may cause the storage mesh to retain residual images. These residual images may appear as a cluttered display when BRIGHTNESS **8** is at or near maximum. Residual traces are conveniently removed by operating the 1744A in the auto erase mode for a few minutes with INTENSITY **3** fully ccw.

NOTE

Pressing ERASE **7** terminates the AUTO ERASE cycle allowing the operator to vary the cycle time at slower rates.

AUTO STORE. Used to set up the 1744A for applications requiring capture of random single-shot events. AUTO STORE is selected by

pressing SINGLE **4**, AUTO STORE **5**, and WRITE **9** to prevent self-triggering. When the random event occurs, the 1744A automatically triggers, sweeps and switches from WRITE mode to STORE mode. To capture another event, press write **9** and RESET **41** or ERASE **7** to arm trigger circuit. AUTO STORE allows the operator to capture high-speed, single-shot, random transients. After triggering occurs the 1744A switches to store. At slower writing rates, the time the operator can view the image before it fades will increase. Therefore, it is to the operator's advantage to use the lowest BRIGHTNESS setting in viewing and storing traces.

- 6 PERSISTENCE/VIEW TIME.** Two-function potentiometer to vary persistence or viewing time of signal, depending on operating mode selected.

PERSISTENCE. Variable persistence allows you to adjust the trace retention for optimum display when viewing low repetition rate, fast rise time signals. By adjusting persistence to match the sweep rate, you can cause the trace to refresh and provide a continuous display of hard-to-view signals such as low duty-cycle pulse trains.

VIEW TIME. In AUTO ERASE **5** mode, the VIEW TIME control establishes the time that the trace is retained on the display before another erase cycle is initiated.

- 7 ERASE.** Pushbutton which initiates the erase cycle to remove stored traces from the CRT storage mesh. Inoperative when STORE/DISPLAY indicators are on to prevent accidental erasure of the stored signal. In auto store mode, ERASE may be pressed to arm the trigger circuit.
- 8 BRIGHTNESS.** Adjusts brightness of stored images. Store time is inversely proportional to BRIGHTNESS setting, BRIGHTNESS is also used in the WRITE **9** mode to vary the writing rate.
- 9 WRITE.** Conditions the 1744A to write applied signals on the display in storage and variable persistence operation. WRITE lamp lights when WRITE is selected.
- 10 STORE/DISPLAY.** Engaging this pushbutton when the 1744A is operating in the WRITE **9** mode stores the trace being written, and lights the STORE lamp. Pressing the pushbutton

again causes both STORE and DISPLAY lamps to light and displays the stored trace on screen. Brightness of the display is increased by rotating the BRIGHTNESS **8** control cw. After the trace has been examined, press the pushbutton again to enter STORE mode to achieve longest store time.

VERTICAL AMPLIFIER CONTROLS

- 11 CAL 1 V.** Provides a 1 V peak-to-peak ($\pm 1\%$) square-wave signal with a frequency of approximately 1.4 kHz (100 mV p-p when terminated in 50 ohms).
- 12** . Provides convenient front-panel chassis ground.
- 13 CHAN A (B) VOLTS/DIV.** Selects the vertical deflection factor in a 1, 2, 5 sequence from 0.005 V/div to 20 V/div, accurate within 3% with vernier **14** in CAL detent.
- 14 Vernier.** Provides continuous control of the deflection factor between calibrated ranges. Vernier range is at least 2.5:1.

- 15 UNCAL.** Lights when Vernier (either CHAN A or CHAN B) is out of CAL detent. Indicates that VOLTS/DIV setting is uncalibrated.
- 16 Coupling.** Selects the input coupling and impedance for the vertical amplifiers. In the AC position, the dc component of the input signal is blocked. The lower 3-dB limit is approximately 10 Hz.
GND. The input signal is disconnected from the amplifier, and the amplifier input is grounded.
DC. All elements of the input signal are passed to the vertical amplifier. The input impedance is approximately 1 megohm shunted by 20 pF.
50Ω. The input signal is dc coupled, and the input impedance is 50Ω. Pull the lever forward and down to select this position. Do not apply more than 5 V rms to the input connector.
- 17 INPUT.** BNC connector to apply external signals to the channel A (Y) or channel B (X) amplifier. Impedance and coupling are selectable by **16**. Do not apply more than 250 V (dc + peak ac at 1 kHz or less) or more than 500 V (p-p ac at 1 kHz or less).
- 18 POSN** . Controls the vertical position of the display.
- 19 ALT.** Channel A and B signals are displayed alternately on consecutive sweeps.
- 20 Channel A.** Displays the channel A input signal.
- 21 Channel B.** Displays the channel B input signal.
A + B. Pressing both channel A **20** and channel B **21** displays the algebraic sum of the channel A and channel B input signals. If the channel B display is inverted (press CH B INVT **28**), an A minus B display results.
- 22 CHOP.** Channel A and B signals are displayed simultaneously by switching between channels at 250-kHz rate.
- 23 TRIGGER A.** Selects a sample of the channel A signal as the trigger signal when INT/EXT **36** is INT.
- 24 TRIGGER B.** When in INT **36**, a sample of the channel B signal is selected as the trigger signal.
COMP. When display mode is set for channel A, channel B, A + B, or ALT, and both **23** and **24** are pressed, the sweep is triggered by the displayed signal. When display is set to CHOP, sweep is triggered by channel A signal only.



25 TRIG VIEW. Displays the selected internal trigger signal with approximately the same sensitivity indicated on the corresponding channel VOLTS/DIV **13** control. A selected external trigger signal is displayed with a fixed sensitivity of approximately 100 mV/div with INT/EXT **36** set to EXT (1 V/div if EXT \div 10 **37** engaged). TRIGGER LEVEL **31** positions the trigger signal vertically about the center horizontal graticule line. Center screen indicates the trigger threshold level with respect to the trigger signal. In ALT **19** or CHOP **22** modes, three signals appear on the same display: channel A, the selected trigger signal (at center screen), and channel B, with no need for erasing between each display. This is extremely useful in applications such as digital circuits where it is necessary to use external trigger sources to maintain proper timing relationships and to know the time relationship of the trigger signal to the displayed events. TRIG VIEW is also helpful in establishing discrete trigger levels.

26 MAG X5. Magnifies the vertical presentation five times, and increases the maximum sensitivity to 1 mV/div. The bandwidth is decreased to 30 MHz.

27 BW LIMIT. Reduces the bandwidth of channel A and channel B to approximately 20 MHz.

28 CH B INVT. Inverts the polarity of the channel B signal. In A + B **20** & **21** mode, pressing CH B INVT **28** results in an A minus B display.

MAIN TIME BASE CONTROLS

29 & **30 POSITION**  . Coarse **29** and FINE **30** adjustments position the trace horizontally.

31 MAIN TRIGGER LEVEL. Selects the voltage level on the input trigger signal where the main sweep is triggered. With external trigger signals, the trigger level is continuously variable from +1.0 V to -1.0 V on either slope of the input trigger signal; +10 V to -10 V in EXT \div 10 **59** mode. With internal trigger signals, the trigger level control selects any point on the displayed vertical waveform.

32 POS/NEG. Two-position pushbutton used to select either the positive or negative slope of the trigger signal as the starting point for the sweep.

33 LF REJ. Attenuates internal or external trigger signals below approximately 4 kHz. This is

useful to condition high-frequency signals for best synchronization by eliminating unwanted low-frequency signals such as power line interference.

- 34 HF REJ.** Attenuates internal or external trigger signals above approximately 4 kHz. This is useful to condition low-frequency signals for best synchronization by eliminating unwanted high-frequency signals such as RF.

LINE. Selecting both LF REJ **33** and HF REJ **34** removes all EXT **36** input or INT **36** displayed signals from the trigger circuit and applies a power line frequency signal for triggering.

- 35 AC/DC.** Selects ac or dc coupling of the signal applied to the trigger circuit. The DC position must be selected for signals below approximately 20 Hz.

- 36 INT/EXT.** INT selects a sample of the internal vertical signal chosen by the TRIGGER source **23** or **24** while EXT selects the signal at the EXT TRIGGER **38** input for application to the main trigger circuit. Internal signals from dc to 25 MHz displaying 0.3-div amplitude or more are sufficient for stable triggering, increasing

to 1 div of amplitude at 100 MHz. Externally applied signals 50 mV p-p from dc to 50 MHz, increasing to 100 mV p-p at 100 MHz are sufficient for stable triggering.

- 37 EXT ÷ 10.** Attenuates EXT TRIGGER **38** input signal by a factor of 10.

- 38 EXT TRIGGER.** BNC connector for external trigger input. Input impedance is approximately one megohm shunted by approximately 20 pF. Do not apply more than 250 V (dc + peak ac at 1 kHz or less) or 500 V (p-p ac at 1 kHz or less).

- 39 AUTO/NORM.** AUTO sweep mode (pushbutton out). A free-running sweep provides a bright display in the absence of a trigger signal. A trigger signal input (internal or external) of 45 Hz or more overrides AUTO operation and sweep triggering is the same as in the NORM mode.

- 40 RESET.** Momentary pushbutton that arms the trigger circuit in the single-sweep mode. After RESET, the sweep can be triggered by an internal trigger signal or by rotating the TRIGGER LEVEL control **31** through zero. RESET lamp lights to indicate circuit is armed for next

trigger signal. Pressing ERASE **7** will also reset the sweep.

- 41 SINGLE.** Sweep occurs once with the same triggering as in NORM. After each sweep, the trigger circuit must be manually RESET **40**. SINGLE must also be pressed in conjunction with WRITE **9** and AUTO STORE **5** to condition the 1744A for AUTO STORE operation.
- 42 MAG X10.** Magnifies the horizontal display 10 times, and expands the fastest sweep time to 5 ns/div, maintaining a sweep accuracy within 3% at room temperature.
- 43 UNCAL.** Lights when SWEEP VERNIER **45** is out of the CAL detent, and indicates that the sweep is not calibrated.
- 44 MAIN TIME/DIV.** The inner knob controls the main sweep rate, which is indicated by the numbers displayed in the knob skirt opening. Sweep accuracy is within 2% (unmagnified) at room temperatures.
- 45 SWEEP VERNIER.** Provides continuous adjustment of main sweep TIME/DIV between calibrated positions, extending the slowest sweep to 5 s/div.

- 46 TRIGGER HOLDOFF.** Increases the time between sweeps and aid triggering on complex displays such as digital words.
- 47 MAIN.** Selects main sweep for horizontal display. Sweep rate and triggering are selected by the main-sweep controls **29** - **45**.
- 48 A VS B.** Selects an X-Y mode of operation with channel A input (Y-axis) plotted versus channel B input (X-axis). Vertical positioning is adjusted by channel A POSN **18**, and horizontal positioning is adjusted by POSITION **29** and FINE **30**.

DELAYED TIME BASE CONTROLS

- 49 DLY'D.** Selects delayed sweep for horizontal display.
- 50 MIXED.** Selects main and delayed sweeps for the horizontal display. The first portion of the sweep is at the main sweep rate, and the second portion of the sweep (starting point chosen by DELAY **52**) is at the delayed-sweep rate. See Mixed Sweep Display under Obtaining Basic Displays for more information.

- 51 DLY'D TIME/DIV.** The outer rotating ring selects the delayed sweep rate, which is indicated by the marker on the ring. Sweep accuracy is the same as with MAIN TIME/DIV **44**. An interlock is incorporated so the delayed sweep is always faster than the main sweep. When rotated from the OFF position in the MAIN **47** mode, a portion of the main sweep is intensified in brightness indicating the length and delayed position of the delayed sweep with respect to the main sweep.
- 52 DELAY.** The DELAY control provides a variable delay time from 0.5 to 10 X the MAIN TIME/DIV **44** settings of 100 ns to 2 s. See the Application Section for more information.
- 53 DELAYED TRIGGER LEVEL.** Selects the voltage level on the input trigger signal where the delayed sweep is triggered. With external trigger signals, the trigger level is continuously variable from +1.0V to -1.0V on either slope of the input trigger signal; +10 V to -10 V in EXT \div 10 **58** mode. With internal trigger signals, the trigger level selects any point on the displayed vertical waveform.
- 54 SWEEP AFTER DELAY AUTO/TRIG.** Selects the method of starting the delayed sweep when in main intensified, delayed, or mixed mode operation. In AUTO (pushbutton released), delayed sweep starts immediately after the delay interval, which is the product of the DELAY **52** dial reading (div) and the MAIN TIME/DIV **44** reading. In TRIG (pushbutton pressed), the delayed trigger circuit is armed after the delay interval and delayed sweep must be triggered by either an internal or external trigger signal. See pulse jitter in the Application Section for more information.
- 55 POS/NEG.** Refer to POS/NEG **32**.
- 56 AC/DC.** Refer to AC/DC **35**.
- 57 INT/EXT.** Refer to INT/EXT **36**.
- 58 EXT \div 10.** Refer to EXT \div 10 **37**.
- 59 EXT TRIGGER.** Refer to EXT TRIGGER **38**.

REAR PANEL CONTROLS

- 60 DISPLAY BRIGHTNESS.** When switch is in NORMAL position, the CRT floodgun is pulsed on and off. In MAX position, the CRT floodgun is always on.
- 61 Z-AXIS INPUT.** A BNC connector allowing input of a signal to modulate CRT beam intensity.
- 62 TRACE ALIGN.** Aligns horizontal trace parallel to the horizontal graticule lines.
- 63 ASTIGMATISM.** Controls roundness of displayed spot. (Interacts with FOCUS **4**.)
- 64 Line Input.** Power cord connector.
- 65 MAIN GATE OUTPUT.** Provides a rectangular output of approximately +2.5 V coincident with the main gate.
- 66 DLY'D GATE OUTPUT.** Provides a rectangular output of approximately +2.5 V coincident with the delayed gate.
- 67 LINE FUSE.** AC power-input fuse.

TURN-ON PROCEDURE

WARNING

Before you turn on the oscilloscope:

- 1) Read safety summary at front of this guide;
- 2) Observe all safety precautions;
- 3) Be sure power selector switches are set properly for power source you are using to avoid instrument damage;
- 4) Familiarize yourself with controls and connectors by reading Controls and Connectors section and referring to panel illustrations at back of this guide.

To turn on the Model 1744A, follow these steps to avoid CRT damage and achieve a useful display.

1. Turn all control knobs to 12 o'clock position except: PERSISTENCE/VIEW TIME **6**, BEAM INTENSITY **3**, and BRIGHTNESS **8** fully ccw, all VERNIERS **14**, **45** to CAL (detent) position, TRIGGER HOLDOFF **46** to MIN, and MAIN TIME/DIV fully cw.
2. All pushbuttons should be disengaged except DISPLAY A **20**, TRIGGER A **23**, and MAIN **47**.

3. Engage LINE **1** switch; LINE indicator lamp should light.
4. Press WRITE **9** pushbutton; WRITE indicator lamp should light.
5. Press ERASE **7** pushbutton.
6. After CRT warmup, increase BEAM INTENSITY **3** to comfortable viewing level; adjust FOCUS **4** for sharpest trace.

NOTE

The 1744A is equipped with a high performance CRT using an expansion storage technique. Because of this technique and under certain operating conditions a secondary trace will appear on screen. This secondary trace is called "write through" and is a normal characteristic of the expansion storage technique. To minimize write through, reduce beam intensity.

CHECKING INSTRUMENT PERFORMANCE.

CAUTION

The CRT is capable of very high writing speed.

When operating at high intensity setting, write gun electrons may start charging the storage mesh faster than floodgun electrons can discharge it. If this happens, a slow-moving trace or spot may become extremely bright, outlined by a dark area. Should you observe this condition, immediately turn BEAM INTENSITY fully ccw and press AUTO ERASE **5**. Allow the instrument to operate in this mode for 5 minutes to remove the residual trace. Otherwise, the CRT may be permanently damaged.

You can make a few checks and simple adjustments to ensure that the Model 1744A is operating properly. If the oscilloscope is moved from one electromagnetic environment to another, the trace alignment control may need adjustment to align the horizontal trace with the graticule. Astigmatism and focus controls may need adjustment to obtain the sharpest display. Probe compensation may be required because the total input resistance and capacitance varies slightly from one oscilloscope to another.

TRACE ALIGNMENT.

1. Obtain trace as described in initial turn-on procedure.

2. With vertical POSN **13**, align trace with center graticule line.

3. Using nonmetallic alignment tool, adjust TRACE ALIGN **62** (on rear panel) until trace aligns with horizontal graticule line.

ASTIGMATISM AND FOCUS.

1. Select A VS B **43** and set BEAM INTENSITY **3** to low level.

2. Position spot near center of CRT with POSN **18** and POSITION **29** controls.

3. Adjust FOCUS **4** and ASTIGMATISM **63** (on rear panel) for smallest, round spot.

PROBE COMPENSATION.

1. Perform initial turn-on procedure.
2. Connect divider probe cable to channel A INPUT **17** connector.
3. Connect probe tip to CAL 1 V **11** output.
4. Set channel A input coupling **16** to DC position.

5. Set main TIME/DIV **44** for horizontal display of at least two full square waves.

6. Set channel A VOLTS/DIV **13** for square-wave display with two or three divisions of vertical deflection.

7. Adjust TRIGGER LEVEL **31** for stable display.

8. Adjust divider probe compensation for correct display (see figure 3).

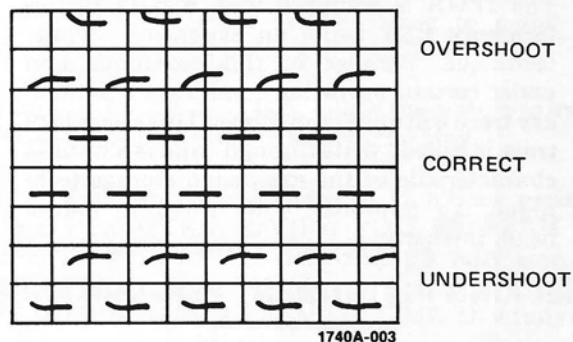

Figure 3. Probe Compensation

VERTICAL ACCURACY CHECK.

1. Accomplish initial turn-on procedure.
2. Connect CAL 1 V **11** output to channel A INPUT **17** using BNC to banana plug adapter and test lead with alligator clip.
3. Set channel A input coupling **16** to DC position.
4. Set channel A VOLTS/DIV **13** to 0.2 V/DIV position.
5. Set main TIME/DIV **44** to 0.2 mSEC position.
6. Square-wave amplitude of displayed waveform should be five major divisions ($\pm 4\%$).

SWEEP TIME ACCURACY.

1. Accomplish initial turn-on procedure.
2. Apply an accurate 0.5 μ SEC time mark signal to channel A INPUT **17** connector.
3. Set main TIME/DIV **44** to 0.5 μ SEC position.
4. Using horizontal POSITION **29**, **30** controls, set one marker on second left vertical graticule line.

5. Time markers should line up approximately with each vertical graticule line across CRT.

6. Marker on tenth graticule (second from right side of CRT) of CRT should be within 0.16 division.

TRIGGER SELECTION TABLE.

Table 3 will help you in determining whether a trigger mode is unusable, usable, good, or the best mode for various signal conditions.

OBTAINING BASIC DISPLAYS.

To familiarize yourself with the 1744A, you may wish to use the following procedures for producing some basic displays. Start by referring to the turn-on procedure and control settings. In addition, set controls as follows:

13 Channel A VOLTS/DIV	0.05
14 Channel A Vernier	CAL
16 Channel A Coupling	DC
44 MAIN TIME/DIV	0.5 mSEC
52 DELAY	fully ccw

NORMAL SWEEP DISPLAY.

1. Connect 10:1 divider probe (provided with 1744A) between channel A INPUT **17** and CAL 1 V **11** output.

Table 3. Display and Trigger Selection Table

SIGNAL CONDITIONS	DISPLAY MODE	TRIGGER SELECTION				
		A	B	COMP	EXT	
I. Single Signals Applied to Channel A or B	A or B	OK	or	OK	OK	OK ¹
	ALT ⁵ or CHOP ⁵	OK	or	OK	NG	OK ¹
II. Time Related Signals Applied to Channels A & B	ALT	OK ²		OK ²	NG ³	OK ²
	CHOP	OK ²		OK ²	NG ⁴	OK ²
	A+B (A-B)	OK		OK	OK ⁶	OK
III. Nontime Related Signals Applied to Channels A & B	ALT	NG		NG	OK	NG
¹ Assume time related signal applied.				⁶ Triggers on algebraic sum or difference of signals.		
² Time relation displayed.		OK		Usable trigger mode.		
³ No time relation displayed.		OK		Good trigger mode.		
⁴ If COMP is selected in CHOP, switching overrides and selects A.		OK		Best trigger mode.		
⁵ Signal is only displayed on one channel.		NG		Unusable trigger mode.		

2. Connect divider probe grounding strap to ground post **12**.
3. Adjust main TRIGGER LEVEL **31** for stable display.
4. Adjust channel A POSN **13** to align base of square wave on center graticule line.
5. Observe square-wave display of five to nine positive going pulses with amplitude of two divisions (see figure 4).

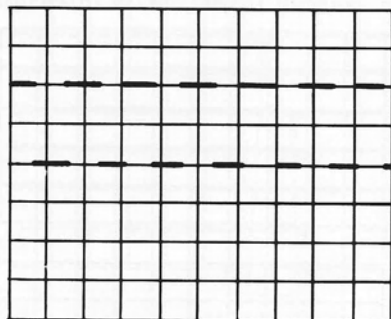

1740A-004

*Figure 4. Normal Display***MAGNIFIED SWEEP DISPLAY.**

1. Accomplish normal sweep display procedure.
2. Using horizontal POSITION **29**, place waveform to be magnified on center graticule line.
3. Engage MAG X10 **42** pushbutton.
4. Adjust horizontal POSITION **30** for precise placement of magnified display (see figure 5).

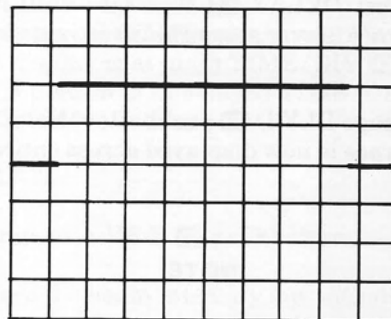

1740A-005

Figure 5. Magnified Display

DELAYED SWEEP DISPLAY.

1. Accomplish normal sweep display procedure.
2. Set delayed TIME/DIV **51** to 50 μ SEC position. Observe portion of square wave that is intensified.
3. Adjust BEAM INTENSITY **3** for comfortable viewing level.
4. Ensure SWEEP AFTER DELAY **54** is in AUTO position.
5. Adjust DELAY **52** clockwise until intensified portion of trace is over area to be investigated (see figure 6).
6. Engage DLY'D **49** pushbutton. Note intensified portion of trace is now displayed across entire CRT (see figure 7).

NOTE

Other pulses in the pulse train may be observed by varying the position of the DELAY control **52**.

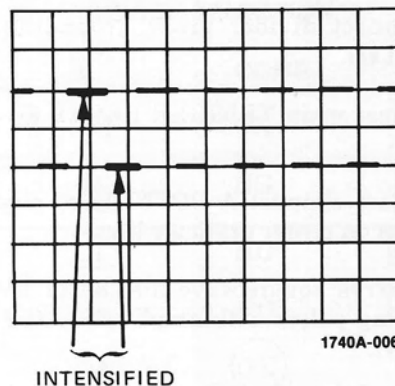

Figure 6. Normal Display With Intensified Area

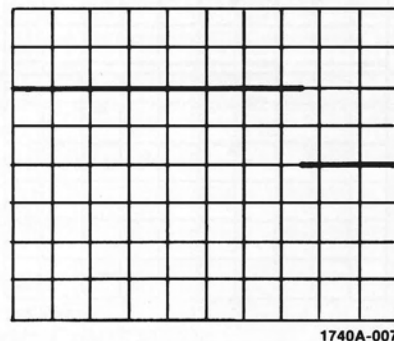
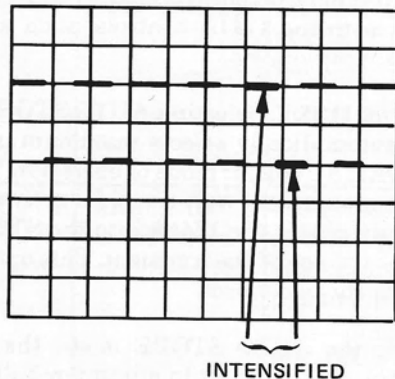

Figure 7. Delayed Sweep Display

MIXED SWEEP DISPLAY.

1. Accomplish normal sweep display procedure.
2. Set delayed TIME/DIV **51** to 50 μ SEC position.
3. Adjust BEAM INTENSITY **3** for comfortable viewing level.
4. Adjust DELAY **52** clockwise until intensified portion of waveform is in second half of CRT (see figure 8).



1740A-008

Figure 8. Normal Display With Intensified Area

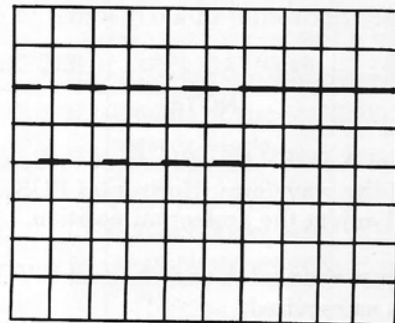

1740A-009

Figure 9. Mixed Sweep Display

5. Engage MIXED **50** pushbutton. Verify that first portion of display is at main TIME/DIV **44** sweep rate and second portion is at delayed TIME/DIV **51** sweep rate (see figure 9).

X-Y DISPLAY.

1. Engage A VS B **48** pushbutton.
2. Keep the beam intensity low with no deflection.
3. Apply vertical (Y-axis) signal to channel A INPUT **17**.

4. Apply horizontal (X-axis) signal to channel B INPUT **17**.

NOTE

Channel A POSN **18** will adjust vertical position of the waveform. Horizontal POSITION **29** will adjust the horizontal position.

5. Adjust channel A and channel B VOLTS/DIV **13** controls as required.

6. If display is not visible, engage BEAM FIND **2** to locate display. Make necessary control adjustments to center display on CRT.

VARIABLE PERSISTENCE-STORAGE OPERATION.

The 1744A variable persistence and storage capabilities may be used through three different modes: AUTO ERASE, AUTO STORE, and continuous scan. (See table 4 for summary of operation.)

AUTO ERASE. Selecting the AUTO ERASE mode of operation automatically sets the persistence to maximum, insuring maximum writing speed. The 1744A waits for a trigger signal, sweeps once, displays the waveform for

up to 15 seconds, automatically erases, resets the sweep, then repeats the cycle. The display time is adjustable from 600 ms to 15 s by the VIEW TIME control. To store a waveform, engage the STORE pushbutton.

The AUTO ERASE mode is useful for applications where very fast writing speeds are required and the operator needs an updated display every few seconds. Since the screen is erased automatically prior to each display cycle, the waveform and its background are presented in a high quality display. The short update cycle (600 ms) is very helpful when immediate feedback is desired after making adjustments to either the circuit under test, or to the 1744A controls, such as INTENSITY, focus, position, etc.

AUTO STORE MODE. Selecting AUTO STORE mode of operation automatically selects maximum persistence and the NORMAL trigger mode of operation. This mode permits the maximum "wait time" for a transient and automatically places the 1744A into the STORE mode after the occurrence of the transient. This optimizes the store time of the waveform.

When using the AUTO STORE mode, the BRIGHTNESS control should be set to minimum (fully counterclockwise) to ensure maximum "wait time". To view a stored signal, select DISPLAY mode and rotate the

Table 4. Summary of Modes of Operation

MODE	PERSISTENCE	VIEW TIME	STORE TIME	TRIGGER	APPLICATIONS	MAXIMUM WRITING SPEED
AUTO ERASE	Automatically set to maximum	Selectable PERSISTENCE control.	30 seconds if STORE mode selected immediately after sweep.	NORMAL OR AUTO	Update of successive single-sweep events. Always a clean display. Easy set-up of single sweep event.	1800 cm/ μ s
AUTO STORE	Automatically set to maximum	10 seconds after selection of DISPLAY mode.	30 seconds, after up to 60 seconds "wait time".	NORMAL (Automatically Selected)	Maximizes "wait" time" for transient; then switches into maximum store time mode (30 seconds minimum).	1800 cm/ μ s
CONTINUOUS SCAN	variable-100 ms minimum	Continuous-down to 10 seconds depending on PERSISTENCE and BRIGHTNESS control settings.	30 seconds minimum after selection of store mode.	NORMAL OR AUTO	For bright display of low repetition rate signals. For capture of non-periodic glitches.	1800 cm/ μ s

BRIGHTNESS control slowly clockwise until the stored trace is visible. As the BRIGHTNESS control is rotated clockwise, the operator trades viewing time for brightness. A step-by-step procedure to accomplish the AUTO STORE mode is as follows:

1. Repeat setup used in storing a trace and turn BRIGHTNESS **8** and PERSISTENCE **6** fully ccw.
2. Press AUTO ERASE **5** and adjust BEAM INTENSITY **3** and FOCUS **4** for optimum display.
3. Engage CHOP **22** pushbutton for multitrace, single-shot capture.
4. Press AUTO STORE **5** and WRITE **9** push-buttons.
5. Engage SINGLE **41** pushbutton. Model 1744A now set up for AUTO STORE operation.
6. Turn main TRIGGER LEVEL **32** fully ccw.
7. Trigger circuit can be armed either by pressing RESET **40** or ERASE **7**. Note that RESET lamp comes on to indicate that circuit is armed. It is good practice to arm by pressing ERASE **7**, since erase cycle is initiated and ensures that previously stored traces are erased.

8. Rotate main TRIGGER LEVEL **31** cw until RESET lamp goes out. Note that STORE lamp is on to show that trace has been captured and stored.

9. Press STORE **10** and note that DISPLAY lamp also lights. Turn BRIGHTNESS **8** slowly cw to view trace.

CONTINUOUS SCAN. The 1744A is in the continuous scan mode when the WRITE mode is selected and AUTO ERASE/AUTO STORE modes are not selected. In this mode, the operator may select either AUTO or NORMAL triggering and has the full range of persistence via the PERSISTENCE control. The BRIGHTNESS control may be used to enhance the writing speed. When the PERSISTENCE and BRIGHTNESS controls are fully counter-clockwise, the 1744A will never require erasure to eliminate blooming and it will operate with minimum persistence (100 ms). It is possible to store any display that occurs during the continuous scan mode by selecting the STORE mode. Writing speed is maximized by using maximum persistence along with some clockwise rotation of the BRIGHTNESS control.

The continuous scan mode is useful for a variety of applications. For slow sweep speeds, the use of persistence helps eliminate flicker and provides a continuous display. For fast sweep applications the PER-

SISTENCE and BRIGHTNESS controls permit the viewing of glitches which occur randomly. The continuous scan mode maximizes the time that the 1744A acquires information, therefore, optimizing the probability of capture of events which do not occur on every sweep. To obtain a variable persistence display, proceed as follows:

1. Accomplish initial turn-on procedure.
2. Apply fast transition, low repetition rate signal to channel A INPUT **17** connector.
3. Note waveform transition give very faint trace (see figure 10).
4. Turn PERSISTENCE **6** slowly clockwise. Observe transition portion of waveform gradually integrates up to bright, easily observed trace (see figure 11).

ELIMINATING FLICKER. A trace will "flicker" when viewed at sweep speeds of approximately 2 ms/div or slower, or whenever the trigger frequency is below approximately 30 Hz. This flicker can be eliminated by adjusting persistence so that one trace is just disappearing as the next trace is written.

1. Turn PERSISTENCE control **8** fully ccw. Adjust MAIN TIME/DIV **44** to 5 mSEC/DIV and press MAG X10 **42**.

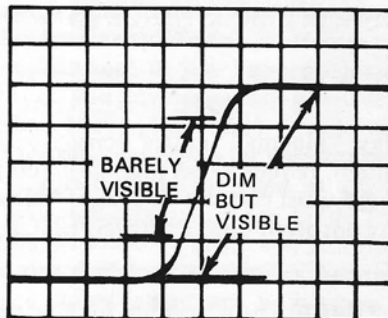

Figure 10. Fast Rise Time, Low Repetition Rate Signal (Normal)

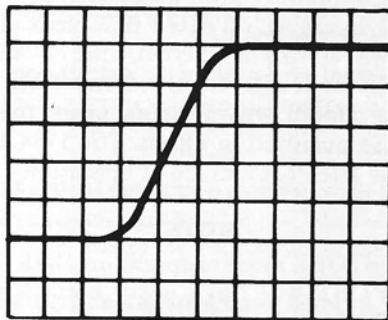

Figure 11. Fast Rise Time, Low Rep Rate Signal "Integrated Up" with PERSISTENCE Control

2. Slowly turn PERSISTENCE **6** cw until flicker ceases.

NOTE

If display "blooms" (entire screen becomes illuminated), reduce beam intensity and press ERASE **7** until display no longer "blooms." This may not occur until PERSISTENCE is set to MAX.

STORING A TRACE. The procedure for storing a trace is to press the STORE/DISPLAY **10** pushbutton. The STORE indicator will light, signifying that the display has been stored. The 1744A will switch to the STORE mode of operation only after all sweeps are completed. For example, in the ALT-TRIG VIEW mode of operation (with three waveforms displayed), the 1744A will switch to the STORE mode after the third waveform is written. To view the stored waveform(s), press the STORE/DISPLAY **10** pushbutton again. The 1744A will then switch to the DISPLAY mode of operation.

NOTE

In the STORE mode of operation, the left side of the CRT will flash every second or so. This flashing is normal for the expansion-storage CRT used and has no adverse effect on the STORE mode of operation.

DISPLAY BRIGHTNESS CONTROL. Brightness of the CRT display can be increased by a rear-panel switch (DISPLAY BRIGHTNESS **60**). Typically, the instrument is operated with the DISPLAY BRIGHTNESS **60** switch set to NORMAL. In this mode of operation, the CRT floodgun is pulsed on and off. Dim displays can be brightened by placing the DISPLAY BRIGHTNESS **60** switch to its MAX position. In this mode of operation, the CRT floodgun is always on. This enhances the display with a corresponding decrease in view time.

B-SCAN. When images have been deeply written on the CRT storage mesh due to too high INTENSITY setting, long exposure to repetitive signals, etc., it is best to remove these images while in B-SCAN mode of operation. To accomplish B-SCAN, proceed as follows:

1. Set 1744A controls as follows:

BEAM INTENSITY **3** fully ccw
 PERSISTENCE/VIEW TIME **6** ... fully ccw
 BRIGHTNESS **8** fully ccw
 TRIGGER HOLDOFF minimum
 MAIN TIME/DIV **44** 0.2 s/div
 DELAYED TIME/DIV **5** OFF
 All Verniers **14 45** CAL detent
 DISPLAY A **20** Engaged
 All others Disengaged or midrange

2. Using filter accessory (HP Part No. 01744-62101) furnished with 1744A, connect output from 1744A calibrator **11** to channel A input connector **17**.
3. Adjust BEAM INTENSITY **3** for medium intensity (approximately eleven o'clock position).
4. Adjust channel A VOLTS/DIV **13** control and channel A Vernier **14** so that vertical deflection is slightly greater than full screen.
5. Allow oscilloscope to operate in this mode (B-SCAN) for one hour, checking in display mode for removal of deeply written image.
6. After removal of deeply written images, disconnect filter (HP Part No. 01744-62101) from channel A input connector **17**.

NOTE

Some deeply written images may require longer than one hour of B-SCAN operation to be removed.

MEASUREMENT TECHNIQUES

INTRODUCTION. This section will assist you in using the Model 1744A Oscilloscope for various measurement

applications. In many cases, illustrations and examples are provided for clarity. We do not attempt to cover every possible application; if you have difficulty with any procedures or if you have questions about an application not described here, please feel free to call your HP Sales/Service representative for assistance. A list of HP Sales/Service Offices is included at the rear of this Guide. When measurements are made by scaling or interpolating on the CRT graticule, you should use five or more major divisions of display between measurement points. Most observers will agree, that when adequate care is used, most measurements can be kept within $\pm 1/20$ of a major division. This amounts to a scaling error of $\pm 1\%$ for five divisions of separation.

VOLTAGE MEASUREMENTS. Voltage measurements can be made between a point on a waveform and a zero-volt reference (absolute voltage) or between any two points on a waveform (voltage difference). These voltage measurements are illustrated in figure 12.

The 1744A vertical deflection system, with 12 calibrated positions from 5 mV/div to 20 V div, allows you to make voltage measurements which are accurate within 3%.

ABSOLUTE VOLTAGE MEASUREMENTS. The following procedure is used to make absolute voltage measurements with respect to a zero-volt reference.

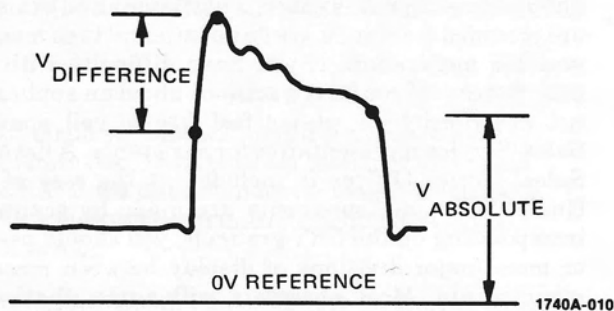

Figure 12. Absolute Voltage and Voltage Difference Measurements

1. Connect input signal to channel A or B INPUT connector, and select channel A or B DISPLAY and TRIGGER.
2. Adjust the appropriate VOLTS/DIV control for six to seven divisions of display. The vernier should be in the CAL detent position.
3. Set input coupling to GND and AUTO/NORM to AUTO.
4. With the appropriate POSN control, set the trace on a graticule line to establish a zero-volt reference. Do not move POSN control after the zero reference is set.

5. Set the input coupling to DC, and adjust TRIGGER LEVEL for a stable display. Adjust the main TIME/DIV control as required.

6. Measure the distance in divisions between the reference line and the level on the waveform you want to measure. An example is shown in figure 13.

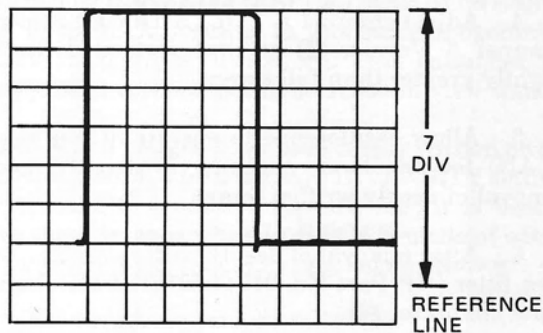

Figure 13. Absolute Voltage Measurement

7. You can determine the polarity of the signal by comparing it to the reference line. If it is above the reference line, the voltage is positive; below the line it is negative.
8. Multiply the number of divisions in step 6 by the VOLTS/DIV setting. Include the attenuation factor if you are using a probe.

$$\begin{aligned}\text{Voltage} &= 7 \times 0.5 \\ &= +3.5 \text{ volts}\end{aligned}$$

Example: Assume the vertical distance is 7 div, the waveform is above the reference line, and the VOLTS/DIV setting is 0.5 V/div (see figure 13).

The waveform is above the reference line, so the voltage is positive.

PEAK-TO-PEAK VOLTAGE MEASUREMENTS. Oscilloscope displays of ac voltages contain errors in amplitude due to the frequency response of the instrument. With low-signal frequencies, there is less amplitude error. With increasing signal frequencies, the amplitude error increases. To obtain displays with less than 10% amplitude error, the frequency of the signal being measured must be less than half of the specified bandwidth of the oscilloscope. A frequency equal to the specified bandwidth of the oscilloscope will display a voltage amplitude on the CRT that is somewhat less than the actual amplitude of the applied signal. The frequency rolloff of the instrument must be considered when making voltage measurements with an oscilloscope. To measure the peak-to-peak voltage of an input signal, proceed as follows:

1. Connect the signal to the channel A or B INPUT connector.

2. Set input coupling to AC and adjust main TRIGGER LEVEL for a stable display.

3. Adjust vertical POSN, VOLTS/DIV, and main TIME/DIV for a centered display of at least three cycles duration and at least three divisions of amplitude. Make sure that the VOLTS/DIV vernier is in the CAL detent.

4. Using the vertical POSN control, place the negative peaks of the input signal on a horizontal graticule line near the bottom of the graticule.

5. Using the horizontal POSITION control, place one positive peak of the signal on the center vertical graticule line.

6. Count the number of vertical divisions from the most negative to the most positive portions of the waveform (estimate to nearest tenth of division). (See figure 14.)

7. Multiply the number of divisions noted in step 6 by the setting of the VOLTS/DIV switch. If the signal is derived through a divider probe multiply the result of this step by the attenuation factor of probe. Remember to consider the amplitude attenuation caused by the frequency rolloff of the oscilloscope.

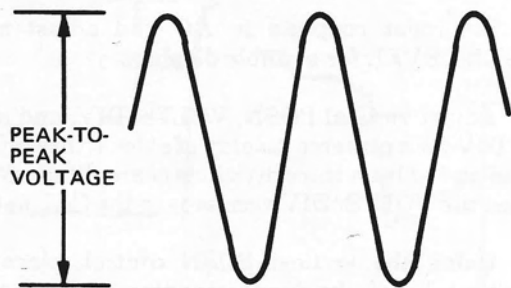

1740A-012

Figure 14. Peak-to-peak Voltage Measurement

AVERAGE VOLTAGE MEASUREMENTS. To measure average voltage using the oscilloscope alone, proceed as follows:

1. Connect the signal to the channel A or B INPUT connector.
2. Set input coupling to GND and AUTO/NORM to AUTO. The trace level is zero volt.
3. Switch input coupling to DC and measure the absolute voltage at the point of interest on the waveform. (See figure 15A.)

4. Switch coupling to AC and measure the absolute voltage to the same point on the waveform. (See figure 15B.)
5. The difference between the first and second voltage measurements is the average voltage.

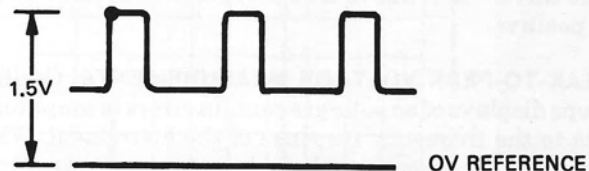

A

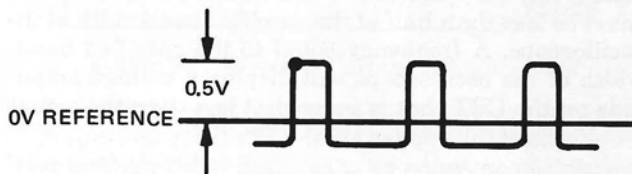

B

1740A-013

$$\text{AVERAGE VOLTAGE} = 1.5\text{V} - 0.5\text{V} = 1\text{V}$$

Figure 15. Average Voltage

AMPLITUDE COMPARISON MEASUREMENTS.

METHOD NO. 1. When you are comparing an unknown signal to a known (reference) amplitude, it may be helpful to use deflection factors not calibrated on the VOLTS/DIV control. With this method, a particular amplitude can be displayed by an exact number of divisions of deflection. This would be desirable when you are calibrating an instrument. You can also increase the accuracy of your measurements with the comparison method; the accuracy of your measurement depends on the reference signal accuracy, not on the oscilloscope accuracy.

1. Apply the reference voltage to the channel A INPUT connector, and set DISPLAY and TRIGGER to channel A.

2. Adjust main TIME/DIV control for several cycles of display and TRIGGER LEVEL for a stable display.

3. Set the appropriate VOLTS/DIV, vernier, and POSN controls for exactly six, seven, or eight divisions of amplitude. Do not readjust the vernier after this step.

4. You should now calculate a scale factor (sf) so the amplitude of a known signal can be verified or the amplitude of an unknown signal can be determined.

Use the following formula:

$$sf = \frac{\text{Reference Signal Amplitude (volts)}}{\text{Display Amplitude in Div (Step 3)} \times \text{VOLTS/DIV Setting}}$$

5. Disconnect the reference signal and connect the signal to be measured. Adjust the VOLTS/DIV control for enough amplitude to make an accurate measurement. Note this display amplitude. Do not readjust the vernier control.

6. Use the following formula to calculate the amplitude of the signal being measured:

$$\text{Amplitude} = \text{VOLTS/DIV Setting (Step 5)} \times sf \text{ (Step 4)} \times \text{Display Amplitude in Div (Step 5)}$$

Example: Assume a reference signal amplitude of 40 Volts, a VOLTS/DIV setting of 5, and a display amplitude of six divisions.

Substituting in the formula from Step 4:

$$sf = \frac{40}{6 \times 5} = 1.3$$

Now, if the signal to be measured has a display amplitude of five divisions with a VOLTS/DIV setting of 2, determine the amplitude from the formula in Step 6.

$\text{Amplitude} = 2 \text{ VOLTS/DIV} \times 1.3 \times 5 \text{ DIV} = 13 \text{ volts.}$

You can also calculate an unknown signal as a percentage of a known signal.

Example: Assume the reference signal has a deflection of eight divisions. Therefore, each division represents 12.5%. If the unknown signal has a deflection of 6.2 divisions, the amplitude of the unknown signal is: $\text{UNKNOWN SIGNAL AMPLITUDE} = 6.2 \text{ DIV} \times 12.5\% / \text{DIV} = 77.5\%$ of the reference signal amplitude.

METHOD NO. 2. Storage operation provides another simple method of amplitude comparison between two waveforms.

1. Apply the two signals of interest to the channel A and channel B INPUT connectors.

2. Select DISPLAY A and TRIGGER A, and set channel A V/DIV as desired. Use MAIN sweep and set main TIME/DIV as required.

3. Use channel A POSN to locate trace in top half of the display area.

4. When desired trace is obtained in WRITE mode, press STORE pushbutton.

5. Repeat steps 1 through 4 using channel B. Position trace in bottom half of graticule using channel B POSN, with WRITE pushbutton pressed.

6. Again press STORE.

7. Pressing STORE a second time and turning BRIGHTNESS cw will display both signals and retain them for comparison.

COMMON MODE REJECTION. Frequently, signals of interest are offset by undesired dc or low-frequency ac components that prevent use of vertical ranges sensitive enough to make good measurements. Often a signal similar to the unwanted component can be connected to the opposite channel, inverted, and added algebraically to the signal of interest to cancel the unwanted component.

True dc components can usually be eliminated by selecting ac input coupling. The ability of an oscilloscope to cancel ac common-mode signals varies with the amplitude and frequency of the signals. Very high common-mode amplitudes may not be completely cancelled. Good common-mode rejection should be achieved

with common-mode signal amplitudes of up to two screen diameters (16 CRT divisions). With high-frequency, common-mode signals, minor components may be impossible to eliminate from the display. The lower the frequency of the common-mode signal, the better will be the common-mode rejection in the oscilloscope.

To use the common-mode rejection technique, proceed as follows:

1. Apply the desired signal with unwanted components to the channel A INPUT connector and a signal similar to the unwanted components to the channel B INPUT connector.

2. Set input coupling as required, and select ALT. Adjust the VOLTS/DIV and vernier controls so the unwanted components on the channel A and B signals are approximately equal in amplitude.

3. Select TRIGGER A, CH B INVT, and DISPLAY A+B. With either channel A or channel B vernier control, adjust for minimum deflection of the common mode signal.

4. The resultant display will either subtract all the unwanted components in the desired signal or display the desired signal larger than the common mode signal.

Example: In figures 16 and 17 the common mode rejection method is illustrated.

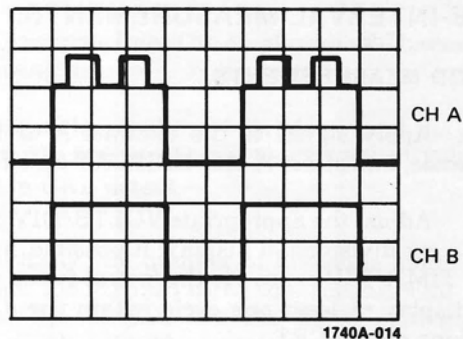

Figure 16. Channel A with Desired Signal and Unwanted Components. Channel B with Only Unwanted Components

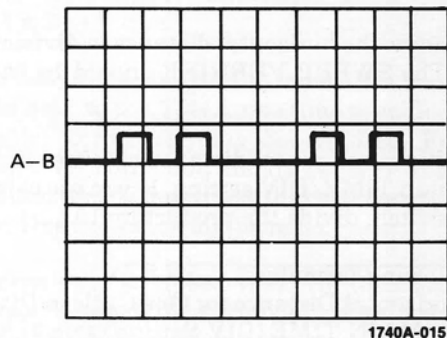

Figure 17. Resultant Display

TIME-INTERVAL MEASUREMENTS.

PERIOD MEASUREMENTS.

1. Apply signal to the channel A or B INPUT connector, and select A or B DISPLAY and TRIGGER.

2. Adjust the appropriate VOLTS/DIV control for five to six divisions of display, if possible, and set the main TIME/DIV control to the fastest sweep speed that will display at least one cycle within the 8 available divisions on the CRT.

3. Use appropriate vertical POSN control and horizontal POSITION control to center the display.

4. Measure the horizontal distance in divisions for one cycle. The SWEEP VERNIER should be in CAL detent.

5. Multiply horizontal distance obtained in step 4 times the main TIME/DIV setting. If you are using the MAG X10 switch, divide the product by 10.

Use the following formula:

Period = Horizontal Distance for One Cycle in Div (step 4) x MAIN TIME/DIV Setting (step 2) ÷ Mag nifier (if used).

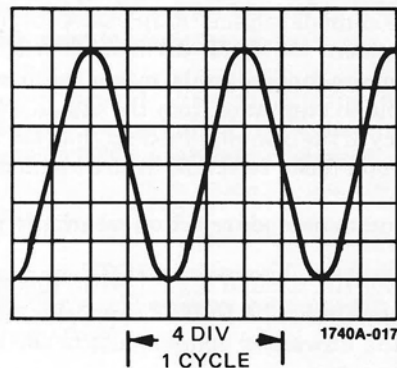

Figure 18. Waveform Period Measurement

Example: Assume one cycle of the waveform occurs in four divisions, the MAIN TIME/DIV setting is 0.2 mSEC, and the MAG X10 switch is off (see figure 18). Substituting in the formula:

Period = 4 div x 0.2 ms/div = 0.8 ms \pm 2% at room temperature.

REPETITION RATE OR FREQUENCY MEASUREMENTS.

1. The repetition rate or frequency of a waveform is the reciprocal of the period.

2. Use the procedure for period measurements to calculate the period of your signal and take the reciprocal to determine repetition rate or frequency.

Example: Using the period from the previous example of 0.8 ms, take the reciprocal to find the repetition rate or frequency.

$$\text{Repetition Rate or Frequency} = \frac{1}{\text{Period}} = \frac{1 \text{ cycle}}{0.8 \text{ ms}}$$

$$\frac{1 \text{ cycle}}{8 \times 10^{-4} \text{ s}} = 0.125 \times 10^4 \frac{\text{cycle}}{\text{s}} = 1.25 \text{ kHz} \pm 2\%$$

TRANSITION TIME MEASUREMENTS. Transition measurements are normally made between the 10% and 90% points on the leading or trailing edge of the waveform. The 1744A has 10/90% and 20/80% points conveniently marked by lines for a five-division reference. The dots are also spaced identically to the minor division markings on the major axis to assist you in interpolation.

1. Apply the pulse to the channel A or B INPUT connector, and select A or B DISPLAY and TRIGGER.

2. Adjust the appropriate VOLTS/DIV control and vernier for at least five divisions of amplitude and the MAIN TIME/DIV control to display enough pulse top and baseline for measurement. Spread the 10% and 90% points as far apart as possible.

3. Turn the horizontal POSITION control until the 10% point on the waveform intersects a 10% marking on

a vertical graticule line. The display should be centered in the viewing area.

4. Count the number of divisions until the pulse-rise crosses the 90% markings. The SWEEP VERNIER should be in CAL detent.

5. Multiply the number of divisions obtained in Step 4 times the MAIN TIME/DIV setting. This is the rise time (R_T). If you use the MAG X10 switch, divide the produce by 10.

Example: Assume the number of divisions between the 10% and 90% points is four and the MAIN TIME/DIV setting is 2 μSEC (see figure 19).

$$R_T = 4 \times 2 \mu\text{s} = 8 \mu\text{s}$$

If you use the oscilloscope to measure a transition time that is near to the 1744A rise time specifications (≤ 3.5 ns), error correction may be required. For accurate results, error correction should be used when the pulse transition time is four times the oscilloscope rise time or faster. Use the following formula:

$$R_T (\text{pulse}) = \sqrt{R_T^2 (\text{observed}) - R_T^2 (\text{oscilloscope})}$$

Example: Assume the 10% to 90% observed rise time is 7.5 ns and the oscilloscope rise time is 3.5 ns.

Substituting in the formula:

$$R_T (\text{pulse}) = \sqrt{7.5^2 - 3.5^2} = 6.6 \text{ ns}$$

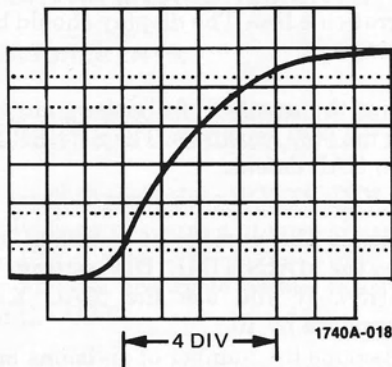

Figure 19. Rise Time Measurement

DELAYED SWEEP. For many time-interval measurements, delayed sweep will provide increased accuracy and resolution. In this guide, we discuss three procedures using delayed sweep: magnification of a portion of a complex waveform for closer investigation, measuring the time interval between two pulses, and measuring pulse jitter.

The first procedure is discussed in the section: Obtaining Basic Displays. The remaining two procedures are explained in the following paragraphs.

Delayed Sweep Time Interval Measurements. The delayed sweep mode can be used to increase the accuracy

of your timing measurements. The following measurement determines the time interval between two pulses displayed on the same trace. The procedure may also be used to measure the time interval between pulses from two different channels or to make time duration measurements on a single pulse. To demonstrate the increase in accuracy, a measurement will first be made using only the main time base, and then the delayed time base will be used to make the same measurement.

1. Apply your signal to the channel A INPUT connector, and set TRIGGER and DISPLAY to channel A.
2. Set input coupling as desired, and adjust VOLTS/DIV for approximately four divisions of amplitude.
3. Select INT main trigger, and MAIN sweep.
4. Adjust the main TIME/DIV control to display six to eight divisions between pulses, and adjust main TRIGGER LEVEL for a stable display.
5. Using horizontal POSITION, place the 50% point of the first pulse on a convenient graticule line and count the number of divisions to the 50% point of the second pulse (see figure 20).

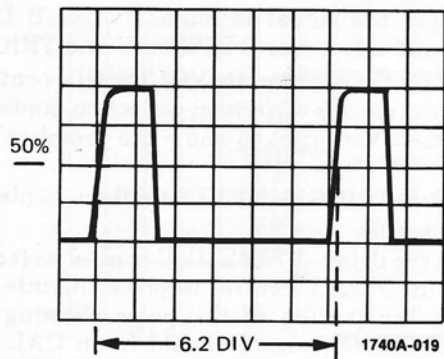

Figure 20. Time Interval Measurement Using Main Time Base

6. To calculate time interval (t), use the following formula:

$$t = (\text{Divisions between pulses} \times \text{main TIME/DIV})$$

Example: Assume 6.2 divisions between pulses, and a main TIME/DIV setting of 0.5 mSEC.

Substituting in the formula:

$$t = (6.2 \text{ div} \times 0.5 \text{ ms/div}) \pm 2\% \text{ at room temperature}$$

$$t = 3.1 \text{ ms} \pm 0.062 \text{ ms}$$

Now we will use delayed sweep to make the same measurement.

1. Perform steps 1 through 4 of the previous procedure and select AUTO SWEEP AFTER DELAY.

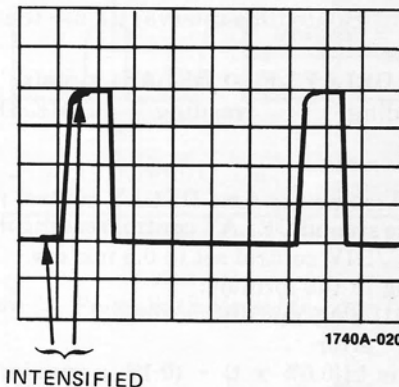

Figure 21. Intensified Area on First Pulse

2. Set the delayed TIME/DIV control as required, and turn the DELAY control to place the intensified portion on the first pulse (see figure 21).

3. Select DLY'D sweep and adjust the DELAY control so the 50% amplitude point of the first pulse is on the center vertical graticule line. Note the DELAY control reading.

4. Turn DELAY control clockwise until the second pulse is positioned on the same point of the center vertical graticule line. You can verify this is the correct pulse by returning to MAIN sweep and observing the intensified portion. Again note the DELAY control reading.

5. To calculate time interval (t), use the following formula:

$$t = \left(\frac{\text{Second DELAY reading} - \text{First DELAY reading}}{\text{TIME/DIV}} \right) \times \text{main} \pm \text{error}$$

Example: Assume the first DELAY control reading is 1.31 and the second DELAY control reading is 7.58 with main TIME/DIV control set to 0.5 ms/div.

Substituting in the formula:

$$t = (7.58 - 1.31) \times 0.5 \text{ ms/div} \pm \text{error}$$

$$t = 3.14 \text{ ms} \pm \text{error}$$

The error is $\pm[(0.5\% \times t) + (0.1\% \times \text{maximum delay period})]$. The maximum delay period is the main sweep rate times the total length of the display (10 div in the 1744A).

Therefore,

$$\text{error} = \pm[(0.5\% \times 3.14) + (0.1\% \times 5)] = \pm 0.021 \text{ ms.}$$

And,

$t = 3.14 \text{ ms} \pm 0.021 \text{ ms}$, an accuracy of $<0.7\%$. For greatest accuracy, use the fastest main sweep rate possible. This reduces the maximum delay period.

Pulse Jitter Measurements. (Also see section on Obtaining Basic Displays.) Jitter is a time uncertainty in the waveform caused by random noise, or spurious, non-periodic signals. To measure jitter use the following procedure.

1. Apply the signal to channel A or B INPUT connector, and select A or B DISPLAY and TRIGGER.

2. Adjust the appropriate VOLTS/DIV control for five or more divisions of vertical deflection, and set the main TIME/DIV control to show the complete waveform.

3. Adjust TRIGGER LEVEL until the display is as stable as possible.

4. Set the delayed TIME/DIV control as required, and turn the DELAY control to place the intensified display on the portion of the pulse showing jitter. SWEEP VERNIER control should be in CAL detent position.

5. Select the DLY'D mode and AUTO SWEEP AFTER DELAY. The horizontal movement of the pulse is the pulse jitter. There is some inherent jitter in any delayed sweep time base, and it should be included in the measurement (jitter in the 1744A is 1:50 000, which is insignificant in most measurements). Using the horizontal POSITION control, place the leading edge of the pulse on the center vertical graticule line; with the vertical POSN control center the display.

6. Measure horizontal displacement on the center horizontal graticule line as shown in figure 22. This displacement times the delayed TIME/DIV setting is the pulse jitter in time.

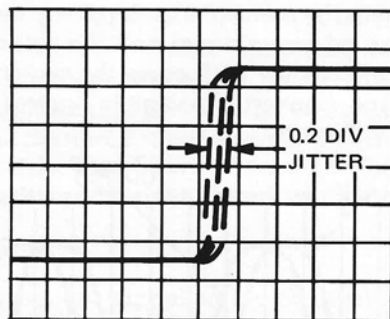

1740A-024

Figure 22. Pulse Jitter Measurement

Example: Assume the delayed TIME/DIV setting is 0.1 mSEC and the horizontal displacement is 0.2 div (see figure 22).

Pulse Jitter = 0.2 div x 0.1 ms/div = 0.02 ms.

Eliminating Jitter. You can eliminate jitter from the display by using the TRIG-SWEEP AFTER DELAY control. In this mode, the delayed sweep is triggered on the jittering pulse after the delay interval. So by triggering the delayed sweep after the delay period, the effect of jitter on the display is eliminated, and you can measure pulse parameters. Remember, in this mode the DELAY dial is uncalibrated.

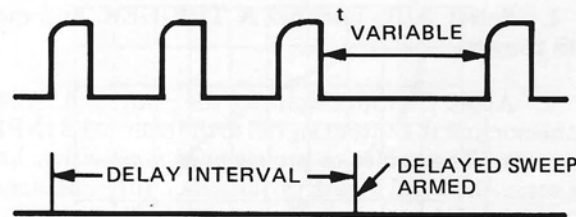

1740A-026

Figure 23. Pulse With Variable Time Duration

Viewing Pulses With Variable Time Duration. When the time duration between the end of one pulse and the start of another pulse is variable, you can use the TRIG-SWEEP AFTER DELAY control and the DELAY dial to arm the delayed-trigger circuit after the last known pulse. The delayed sweep will now be triggered by the pulse with variable time duration and its parameters can be measured (see figure 23).

MEASURING PHASE DIFFERENCE BY TIME DELAY. The phase difference between two signals of the same frequency can be determined up to the frequency limitation of the vertical amplifier. Use the following procedure:

1. Select ALT, channel A TRIGGER, and main POS trigger.

2. Apply the input signal to the channel A INPUT connector and the output signal to the channel B INPUT connector. The cables or probes used must either have the same electrical length or the delay differences must be accounted for to prevent measurement error.

3. Select AC input coupling for both channels, and adjust channels A and B VOLTS/DIV and vernier controls for an equal amplitude on both channels.

4. Adjust the main TIME/DIV and SWEEP VERNIER controls so a complete cycle for each waveform is displayed within 8 horizontal divisions.

5. Using the POSN controls center both waveforms vertically.

6. Readjust SWEEP VERNIER for one complete cycle of the input signal in an exact number of major divisions. Six or eight divisions is suggested, which would equal $60^\circ/\text{Div}$ and $45^\circ/\text{Div}$ respectively. You can obtain additional resolution by using the MAG X10 switch. In this case, six divisions would equal $6^\circ/\text{Div}$ and eight divisions would equal $4.5^\circ/\text{Div}$.

7. Count the number of major plus minor divisions between the reference signal and the output signal at the point where they both cross the center horizontal graticule line. Convert divisions to degrees and this is the phase difference.

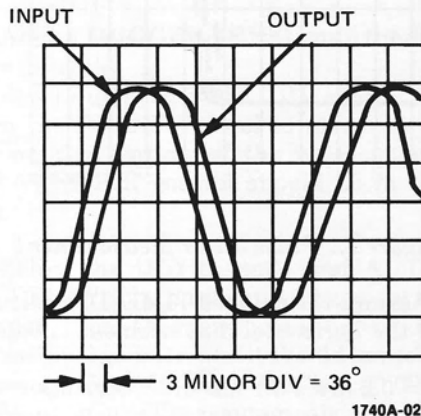

Figure 24. Phase Difference Measurement

Example: Assume one cycle of the input signal occurs in six divisions and there are three minor divisions between the input and output waveforms (see figure 24). Since one major division equals 60° , one minor division equals 12° . Phase Difference = $3 \times 12 = 36^\circ$; the output lags the input by 36° .

A VS B PHASE MEASUREMENTS. The A VS B mode will allow you to measure the phase difference between two signals of the same frequency up to 100 kHz. The channel A input signal provides deflection along the Y-axis, and the channel B input signal provides deflection along the X-axis. The phase difference can be measured from the resulting Lissajous pattern using the following procedure:

1. Connect one signal to the channel A and the other to the channel B INPUT connectors.

2. Select A VS B, and adjust the channel A VOLTS/DIV control for five to six divisions of vertical deflection (Y-axis) and the channel B VOLTS/DIV control for seven to eight divisions of horizontal deflection (X-axis).

3. Use the channel A POSN control and the horizontal POSITION control to center the display.

4. Measure distances A and B as shown in figure 25. A is the distance intersected by the trace on the center horizontal graticule line, and B is the total horizontal deflection of the trace.

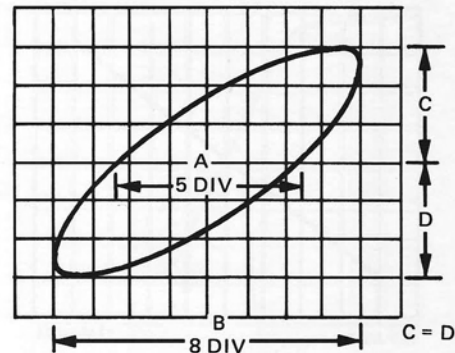

1740A-028

Figure 25. A VS B Phase Measurement

5. The sine of the phase angle between the two signals is A/B. Figures 26, 27, and 28 show signals in phase, 90° out of phase, and 180° out of phase respectively. If the trace is rotating, the signals are not at the same frequency.

Example: In figure 25, A equals five divisions and B equals eight divisions. Distance C is equal to distance D. The sine of the phase difference (Φ) is A/B which is 0.625. Therefore: Phase Angle (Φ) = arc sine of 0.625=38.7°.

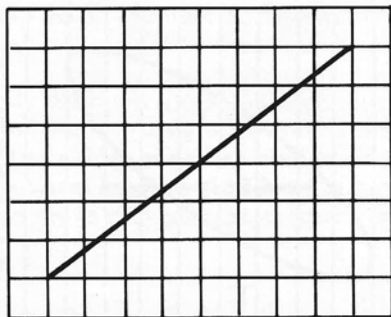

1740A-029

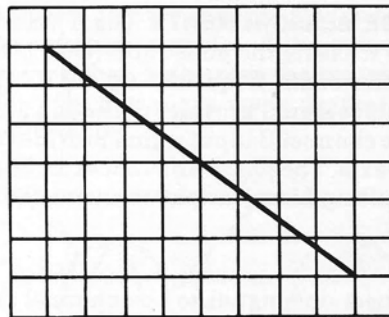
Figure 26. Signals in Phase

1740A-031

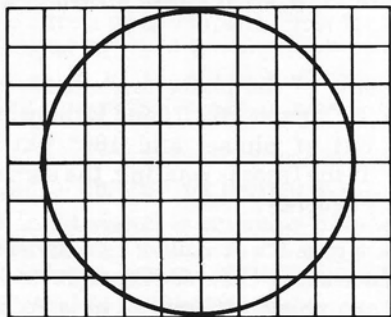
Figure 28. Signals 180° Out of Phase

1740A-030

Figure 27. Signals 90° Out of Phase

TRIGGERING.

TRIGGER VIEW. The TRIG VIEW control replaces the channel A or B trace with the trigger signal if channel A or B is selected as the display mode. In this type of operation, the trigger sensitivity is approximately equal to the VOLTS/DIV setting. In the ALT or CHOP display mode, three signals are displayed: channel A, the selected main trigger signal, and channel B. In TRIG VIEW, the center horizontal graticule line represents the trigger threshold level with respect to the trigger signal.

It is frequently helpful to observe the trigger signal being applied to the external trigger input. When you use trigger view in conjunction with CHOP or ALT, both vertical channels plus the external main trigger signal can be viewed simultaneously. This is useful in setting triggering and observing time correlation between the external trigger signal and the channel A and B signals. The deflection factor is approximately 100 mV/div. Delayed trigger cannot be viewed by TRIG VIEW control.

Example: We will now use trigger view to determine the triggering level location.

1. Connect the trigger signal to the main EXT TRIGGER input connector and select main EXT TRIGGER.

2. Select TRIG VIEW. The trigger signal will be displayed near center screen. The point where the trigger signal crosses the center horizontal graticule is the trigger point (see figure 29).

By adjusting the TRIGGER LEVEL control, you can move the trigger level location. The center horizontal graticule line indicates the trigger point. When you use the POS position of the POS/NEG switch, the trigger circuit triggers on the positive-going portion of the trigger signal; in NEG, it triggers on the negative-going portion of the trigger signal.

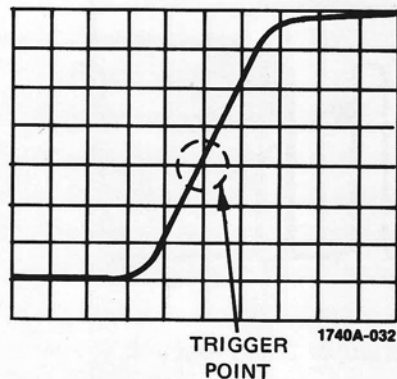

Figure 29. Trigger Point Location

ELIMINATING MULTIPLE TRIGGERING ON COMPLEX WAVEFORMS. Figure 30 shows an example of multiple triggering. To have a stable display, the period between sweeps must match the period of the waveform being displayed. In the example, the first sweep displays three bits of a four-bit word. The next sweep displays the remaining bit in the word. So on consecutive sweeps we see different portions of the same word causing the instability in figure 30.

To eliminate the instability, the TRIGGER HOLDOFF control can be adjusted to vary the time between the end

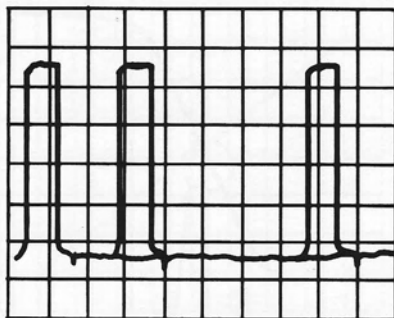

Figure 30. Multiple Triggering with Display Instability

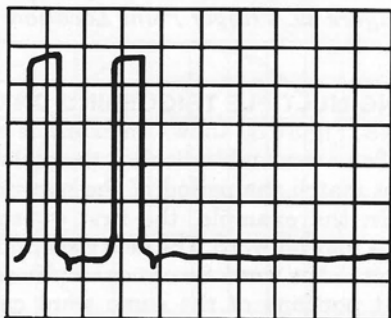

Figure 31. Multiple Triggering Eliminated with Trigger Holdoff Control

of one sweep and the beginning of the next. This is the holdoff period. In the example, if you increase the holdoff period long enough, the trigger from the fourth bit is held off, which eliminates the additional sweep that caused the display instability (see figure 31).

MEASURING CRT WRITING SPEED.

Writing speed is a rate that defines how far the electron beam can be deflected per unit of time and still provide a stored signal for display. The writing speed of the 1744A is specified at $1800 \text{ cm}/\mu\text{s}$, making it possible to capture a 100 MHz, single-shot, sine wave with an amplitude of eight major divisions. Single-shot pulses eight major divisions in amplitude with transition times as fast as 3.5 ns may also be captured. Although the 1744A must be overdriven to obtain an 8-division display at maximum bandwidth, a fully specified trace is captured and displayed within the quality area of the CRT.

With a specified writing speed of $1800 \text{ cm}/\mu\text{s}$, the maximum cw frequency that can be captured with an amplitude of eight major division can be calculated as follows:

$$\text{Writing Speed} = \pi A f \text{ centimeters}/\mu\text{s}$$

Where: f = frequency in megahertz.

A = peak-to-peak amplitude in centimeters.

Model 1744A

Therefore: $1800 \text{ cm}/\mu\text{s} = (3.1416)(8 \text{ div})(0.72 \text{ cm}/\text{div}) f$

$$f = \frac{1800}{(3.1416)(8)(0.72)(10^{-6})} = 99.47 \text{ MHz}$$

To determine the writing speed necessary to capture an 8-division amplitude pulse with an observed transition time of 3.5 ns, use the following procedure:

$$\text{Writing Speed} = \frac{0.8A}{t_r}$$

$$\text{Therefore: Writing Speed} = \frac{0.8(\text{div})(0.72 \text{ cm}/\text{div})}{3.5 \times 10^{-9} \text{ s}} = 1317 \text{ cm}/\mu\text{s}$$

In the above example, it will be noted that the specified writing rate of the 1744A (1800 cm/ μ s) is more than adequate to capture pulses that approach the specified vertical deflection limits of the 1744A.

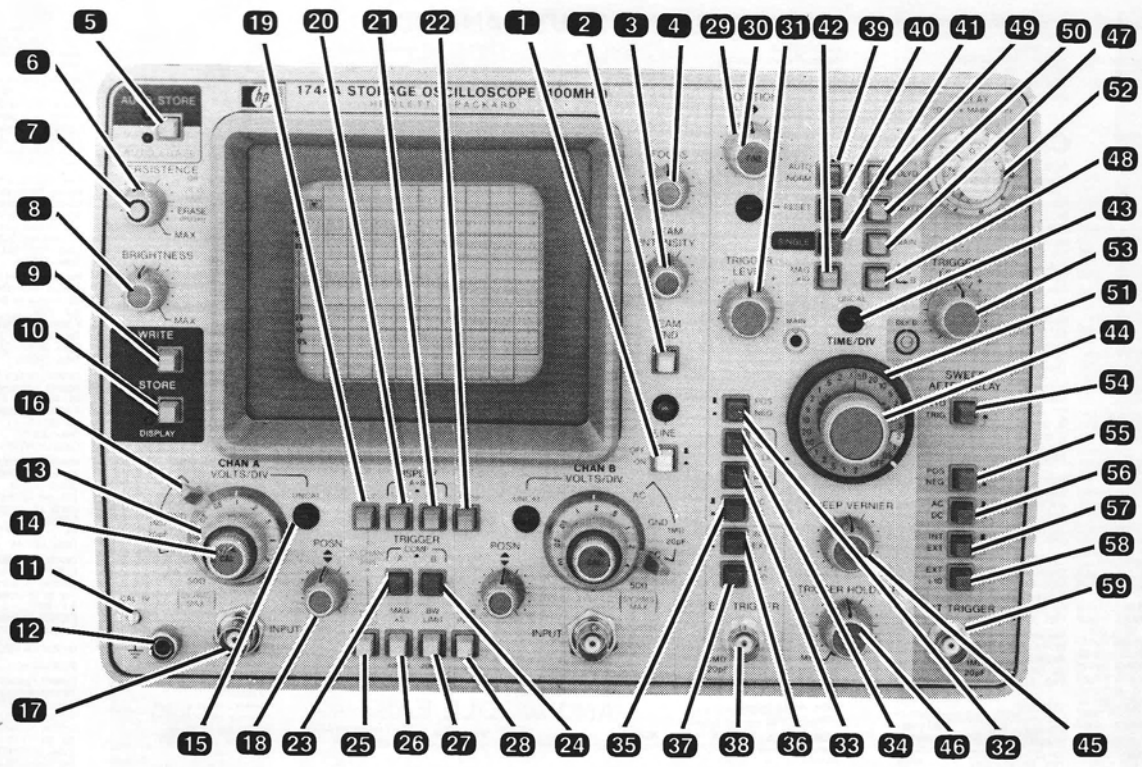

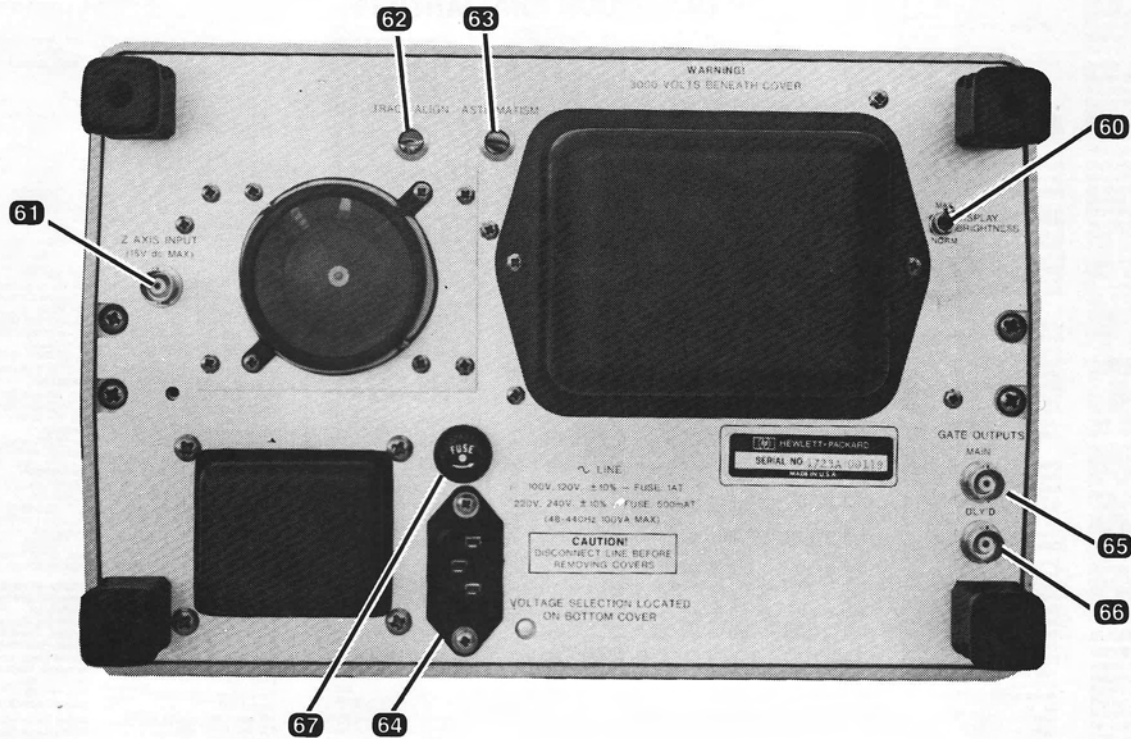

Figure 32.
Front and Rear-panel Controls and Connectors

AFRICA, ASIA, AUSTRALIA

ANGOLA

Telectra
Empresa Técnica de Equipamentos
Eléctricos, S.A. R.L.
R. Barbosa Rodrigues, 42-I DT
Caixa Postal, 6487
Luanda
Tel: 359156
Cable: TELECTRA Luanda

AUSTRALIA

Hewlett-Packard Australia Pty. Ltd.
31-41 Joseph Street
Blackburn, Victoria 3130
P.O. Box 36
Doncaster East, Victoria 3109
Tel: 89-6351
Telex: 31-024
Cable: HEWPARD Melbourne
Hewlett-Packard Australia Pty. Ltd.
31 Bridge Street
Pymble
New South Wales, 2073
Tel: 449-6566
Telex: 21561
Cable: HEWPARD Sydney
Hewlett-Packard Australia Pty. Ltd.
153 Greenhill Road
Parkside, S.A. 5063
Tel: 272-5911
Telex: 82536 ADEL
Cable: HEWPARD ADELAID
Hewlett-Packard Australia Pty. Ltd.
141 Stirling Highway
Nedlands, W.A. 6009
Tel: 86-5455
Telex: 83859 PERTH
Cable: HEWPARD PERTH
Hewlett-Packard Australia Pty. Ltd.
121 Wollongong Street
Fyshwick, A.C.T. 2609
Tel: 95-2733
Telex: 62650 CAMBERA
Cable: HEWPARD CANBERRA
Hewlett-Packard Australia Pty. Ltd.
5th Floor
Teachers Union Building
495-499 Boundary Street

Spring Hill 4000 Queensland
Tel: 534770 & 535166
Cable: HEWPARD Brisbane

GUAM

Medical Pocket Calculators Only
Guam Medical Supply, Inc.
Jay Ease Building, Room 210
P.O. Box 8947
Tamuning 96911
Tel: 646-4513
Cable: EARMED Guam

HONG KONG

Schmidt & Co (Hong Kong) Ltd
Tel: 654-430
Cable: BLUESTAR
Blue Star Ltd
Meaaks* Mandiran
xxx 167a Mahatma Gandhi Rd
Cochin 582 016
Tel: 32069 32161 32282
Telex: 0885-514
Cable: BLUESTAR
Blue Star Ltd
1-1-117-1
Saroini Devi Road
Secunderabad 500 003
Tel: 70126-70127
Cable: BLUEFROST
Telex: 015-459
Blue Star Ltd
2-34 Kodambakkam High Road
Madras 600034
Tel: 82056
Telex: 041-379
Cable: BLUESTAR

INDIA

Blue Star Ltd
Kasturi Buildings
Jamshedji Tata Rd
Bombay 400 020
Pty. Ltd.
Tel: 29 50 21
Telex: 001-2156
Cable: BLUEFROST
Blue Star Ltd
Sahar
414-2 Vir Savarkar Marg
Prabhadevi
Bombay 400 025
Tel: 45 78 87
Telex: 011-4093
Cable: FROSTBLUE
Blue Star Ltd
Band Box House
Prabhadevi
Bombay 400 025
Tel: 45 73 01
Telex: 011-3751
Cable: BLUESTAR
Blue Star Ltd
7 Hare Street
P.O. Box 506
Calcutta 700 001
Tel: 23-0131
Telex: 021-7655
Cable: BLUESTAR

Blue Star Ltd
7th & 8th Floor
Bhandari House
Tel: 33569
Cable: BASTEL Tel-Aviv
New Delhi 110024
Tel: 631-2463
Cable: BLUESTAR
Blue Star Ltd
Blue Star House
Tel: 232-2024 YHP MARKET
Bangalore 560 025
Tel: 55668
Telex: 043-430
Cable: BLUESTAR
Blue Star Ltd
Meaaks* Mandiran
xxx 167a Mahatma Gandhi Rd
Cochin 582 016
Tel: 32069 32161 32282
Telex: 0885-514
Cable: BLUESTAR
Blue Star Ltd
1-1-117-1
Saroini Devi Road
Secunderabad 500 003
Tel: 70126-70127
Cable: BLUEFROST
Telex: 015-459
Blue Star Ltd
2-34 Kodambakkam High Road
Madras 600034
Tel: 82056
Telex: 041-379
Cable: BLUESTAR

INDONESIA

BERCA Indonesia P.T.
P.O. Box 496-Jkt
Jl. NeAbdul Muhs 62
Jakarta
Tel: 40369 49886.49255.35608
JKT 42895
Cable: BERACON
BERCA Indonesia P.T.
63 J.L. Raya Gubeng
Surabaya
Tel: 44309
ISRAEL
Electronics & Engineering Div.
of Motorola Israel Ltd
17, Kremenetski Street
P.O. Box 25016

Tel-Aviv

Tel: 38973
Tel: 33569
Cable: BASTEL Tel-Aviv
JAPAN
Yokogawa-Hewlett-Packard Ltd
Odashi Building
59-1 Yoyogi 1-Chome
Shibuya-ku, Tokyo 151
Tel: 03-370-2281/92
Telex: 232-2024 YHP MARKET
Tokyo 23724
Cable: YHPMARKET

Yokogawa-Hewlett-Packard Ltd
Chuo Bldg. 4th Floor
4-20, Nishinakajima 5-chome
Yodogawa-ku, Osaka-shi
Osaka 532
Tel: 06-304-6021
Yokogawa-Hewlett-Packard Ltd
Nakano Building
24 Kam Sasayama-cho
Nakamura-ku, Nagoya 450
Tel: (052) 571-5171
Yokogawa-Hewlett-Packard Ltd
Tanigawa Building
2-24-1 Tsuruya-cho
Kanagawa-ku
Yokohama 221
Tel: 045-312-1252
Telex: 382-3204 YHP YOK
Yokogawa-Hewlett-Packard Ltd
Mito Mitsui Building
105, Chome-1 San-no-maru
Mito, Ibaragi 310
Tel: 0292-25-7470
Yokogawa-Hewlett-Packard Ltd
Inoue Building
1349-3, Asahi-cho, 1-chome
Atsugi, Kanagawa 243
Tel: 0462-24-0452
Yokogawa-Hewlett-Packard Ltd
Kumagaya Asahi
Hachijuni Building
4th Floor
3-4, Tsukuba
Kumagaya, Saitama 360
Tel: 0485-24-6563

KENYA

Technical Engineering
Services I.E.A. Ltd.
P.O. Box 18311

Nairobi

Tel: 55726556762
Cable: PROTON
Medical Only
International Aeradio (E.A.) Ltd.
P.O. Box 19012
Nairobi Airport
Nairobi
Tel: 336055/56
Telex: 22201/22301
Cable: INTAERIO Nairobi
KOREA
Samsung Electronics Co. Ltd.
20th Fl. Dongbang Bldg. 250, 2-KA
C.P.O. Box 2775
Taepyeong-Ro, Chung-Ku
Seoul
Tel: (23) 6811
Telex: 22575
Cable: ELEKSTAR Seoul
MALAYSIA
Teknik Mutu Sdn. Bhd.
2 Lorong 136A
Section 13
Petaling Jaya Selangor
Tel: 54994/5496
Telex: MA 37605
Protel Engineering
P.O. Box 1917
Lot 259, Sarok Road
Kuching, Sarawak
Tel: 2400
Cable: PROTEL ENG

MOZAMBIQUE

A.N. Goncalves, Lta
162, 1 Apt. 14 Av. D. Luis
Caixa Postal 107
Lourenco Marques
Tel: 27991, 27114
Telex: 6-203 NEGON Mo
Cable: NEGON

NEW ZEALAND

Hewlett-Packard (N.Z.) Ltd.
P.O. Box 9443
Courtney Place
Wellington
Tel: 871-199
Cable: HEWPACK Wellington
Hewlett-Packard (N.Z.) Ltd.
Pakuranga Professional Centre
267 Pakuranga Highway
Box 51092

Pakuranga

Tel: 55726556762
Cable: HEWPACK Auckland
Analytical/Medical Only
Medical Supplies N.Z. Ltd.
Scientific Division
79 Carlton Gore Rd., Newmarket
P.O. Box 1234
Auckland
Tel: 75-289
Cable: DENTAL Auckland
Analytical/Medical Only
Medical Supplies N.Z. Ltd.
147-161 Tony St.
Wellington
Tel: 850-799
Telex: 3858
Cable: DENTAL Wellington
Analytical/Medical Only
Medical Supplies N.Z. Ltd.
P.O. Box 309
239 Stannmore Road
Christchurch
Tel: 892-019
Cable: DENTAL Christchurch
Analytical/Medical Only
Medical Supplies N.Z. Ltd.
303 Great King Street
P.O. Box 233
Dunedin
Tel: 88-817
Cable: DENTAL Dunedin
Cable: PROTEL ENG

NIGERIA

The Electronics
Instrumentations Ltd
N6B-770 Dyo Road
Ouseun House
P.M.B. 5402
Ibadan
Tel: 61577
Telex: 31231 TEL Nigeria
Cable: THETEL Ibadan
The Electronics Instrumentations Ltd
144 Agge Motor Road, Mushin
P.O. Box 6645
Lagos
Cable: THETEL Lagos

PAKISTAN

Mushko & Company, Ltd.
Gosman Chambers
Abdullah Haroon Road

Karachi-3

Tel: 511027, 512927
Telex: 2894
Cable: COOPERATOR Karachi
Mushko & Company, Ltd.
388, Satteli Town
Rawalpindi
Tel: 41924
Cable: FEMUS Rawalpindi
PHILIPPINES
The United Advanced
Systems Corporation
Rico House
Amsoro cor Herrera Str.
Legaspi Village, Makati
Metro Manila
Tel: 85-35-81, 85-34-91
Telex: 3274 ONLINE
RHODESIA
Field Technical Sales
45 Kelvin Road North
P.O. Box 3458
Salisbury
Tel: 705251 (5 lines)
Telex: RH 4122

SINGAPORE

Hewlett-Packard Singapore
(Pte.) Ltd.
1150 Depot Road
Alexandra P.O. Box 58
Singapore 4
Tel: 270-2355
Telex: HPSG RS 21486
Cable: HEWPACK Singapore

SOUTH AFRICA

Hewlett-Packard South Africa
(Pty.) Ltd.
Private Bag Wendywood
Sandton, Transvaal 2144
Hewlett-Packard Centre
Daphne Street, Wendywood,
Sandton, Transvaal 2144
Tel: 802-10408
Telex: 8-4782
Cable: HEWPACK JOHANNESBURG
Service Department
Hewlett-Packard South Africa
(Pty.) Ltd.
P.O. Box 39325
Grahamley, Sandton, 2018
451 Wynberg Extension 3,
Sandton, 2001
Tel: 636-8188/9
Telex: 8-2391

Hewlett-Packard South Africa
(Pty.) Ltd.
P.O. Box 120
Howard Place, Cape Province, 7450
Pine Park Centre, Forest Drive,
Pinefields, Cape Province, 7405
Tel: 53-7955 thu 9
Telex: 57-0006
Service Department
Hewlett-Packard South Africa
(Pty.) Ltd.
P.O. Box 37099
Overport, Durban 4067
Braby House
641 Ridge Road
Durban, 4001
Tel: 88-7478
Telex: 610-831-2431
Cable: HEWPACK PAO ALTO

TAIWAN
Hewlett-Packard Far East Ltd.,
Taiwan Branch
39 Chung Hsiao West Road
Sec. 1, 7th Floor
Taipei
Tel: 3819160-4
Cable: HEWPACK TAIPEI
Hewlett-Packard Far East Ltd.
Taiwan Branch
68-2, Chung Cheng 3rd Road
Kaohsiung
Tel: (07) 242318-Kaohsiung
Analytical Only
San Kwang Instruments Co., Ltd.,
No. 20, Yung Sui Road
Taipei
Tel: 3715071-4 (5 lines)
Telex: 22894 SANKWANG
Cable: SANKWANG TAIPEI

TANZANIA
Medical Only
International Aeradio (E.A.), Ltd.
P.O. Box 861
Dar es Salaam
Tel: 21251 Ext. 265
Telex: 41030

THAILAND
UNIMESA Co., Ltd.
Eicom Research Building
2538 Sukumvit Ave.
Bangkok
Tel: 3932387, 3930338
Cable: UNIMESA BANGKOK

UGANDA
Medical Only
International Aeradio (E.A.), Ltd.,
P.O. Box 2577
Kampala
Tel: 54388
Cable: INTAERIO Kampala

ZAMBIA
R.J. Tibury (Zambia) Ltd.
P.O. Box 2792
Lusaka
Tel: 27393
Cable: ARJAYTEE, Lusaka

OTHER AREAS NOT LISTED, CONTACT:

Hewlett-Packard Intercontinental
3200 Hillview Ave.
Palo Alto, California 94304
Tel: (415) 493-1501
TWX: 919-212-1267
Cable: HEWPACK PAO ALTO

CANADA

ALBERTA
Hewlett-Packard (Canada) Ltd
11820A - 168th Street
Edmonton T5M 3T9
Tel: (403) 452-3670
TWX: 610-831-2431
Hewlett-Packard (Canada) Ltd
210 7220 Fisher St. S.E.
Calgary T2H 2H8
Tel: (403) 253-2713
Twx: 610-831-2431

BRITISH COLUMBIA
Hewlett-Packard (Canada) Ltd
837 E. Cordova Street
Vancouver V6A 3R2
Tel: (604) 254-0331
TWX: 610-922-5059

MANITOBA
Hewlett-Packard (Canada) Ltd
513 Century St.
St. James
Winnipeg R3H 0L8
Tel: (204) 786-7581
TWX: 610-671-3531

NOVA SCOTIA
Hewlett-Packard (Canada) Ltd.
800 Windmill Road
Dartmouth B3B 1L1
Tel: (902) 469-7820
TWX: 610-271-4482 HFX

ONTARIO
Hewlett-Packard (Canada) Ltd
1020 Morrison Dr.
Ottawa K2H 8K7
Tel: (613) 820-6483
TWX: 610-563-1636
Hewlett-Packard (Canada) Ltd
6877 Goreway Drive
Mississauga L4V 1M8
Tel: (416) 678-9430
TWX: 610-492-4246

QUEBEC
Hewlett-Packard (Canada) Ltd
275 Hymus Blvd
Pointe Claire H9R 1G7
Tel: (514) 691-4232
TWX: 610-422-3022
TLX: 05-821521 HPLC

FOR CANADIAN AREAS NOT LISTED:
Contact Hewlett-Packard (Canada)
Ltd. in Mississauga

CENTRAL AND SOUTH AMERICA

ARGENTINA
Hewlett-Packard Argentina
S.A.
Av. Leandro N. Alem 822 - 12
1900 - Buenos Aires
Tel: 31-4963-4 S.B. and 7
Telex: 122443 AR CIGY
Cable: HEWPACK ARG

BOLIVIA
Casa Karin S.A.
Calle Potosi 1130
P.O. Box 500
La Paz
Tel: 41330-53221
Telex: OWC BA 5298 IIT 356006Z
Cable: KAVLIN

BRAZIL
Hewlett-Packard do Brasil
I.E. C. Ltda.
Avenida Rio Negro 980
Alphaville
06400-Barueri SP
Tel: 429-3222
Hewlett-Packard do Brasil
I.E. C. Ltda.
Rua Padre Chagas, 35
90000-Porto Alegre-RS
Tel: (0512) 22-2998, 22-5621
Cable: HEWPACK Porto Alegre
Hewlett-Packard do Brasil
I.E. C. Ltda.
Rua Siqueira Campos, 53
Copacabana
20000-Rio de Janeiro
Tel: 257-80-94-DDD (021)
Telex: 398-212-9605 HEWP-BR
Cable: HEWPACK
Rio de Janeiro

CHILE
Calcagni y Metcalfe Ltda.
Alameda 580-01 807
Casilla 2118
Santiago 1
Tel: 398813
Telex: 3520001 CALMET
Cable: CALMET Santiago

COLUMBIA
Instrumentación
Henrik A. Langebaek & Kier S.A.
Carrera 7 No. 48-75
Apartado Aéreo 6287
Bogotá, D.E.
Tel: 69-88-77
Cable: AARIS Bogotá
Telex: 044-400

COSTA RICA
Centífica Costarricense S.A.
Avenida 2, Calle 5
San Pedro de Montes de Oca
Apartado 10159
San José
Tel: 24-38-20, 24-08-09
Telex: 2367 GALGR BR
Cable: GALGUR

ECUADOR
Calculators Only
Computadoras y Equipos
Electrónicos
P.O. Box 8423 CCI
Eloy Alfaro #1824-3 Piso
Quito
Tel: 453482
Telex: 02-2113 Sagita Ed
Cable: HEWPACK ECU

EL SALVADOR
Instrumentación y Procesamiento
Electrónico de el Salvador
Bulevar de los Heroes 11-48
San Salvador
Tel: 252787

GUATEMALA
IPESA
Avenida La Reforma 3-48,
Zona 9
Guatemala City
Tel: 63627, 64786
Tel: 4192 Teletro Gu
Hewlett-Packard Mexico
S.A. de C.V.
Av. Periferico Sur No. 6501
Teseapan, Xochimilco
Mexico 23, D.F.
Tel: 905-676-4600
Hewlett-Packard Mexicana,
S.A. de C.V.
Ave. Constitución No. 2184
Monterrey, N.L.
Tel: 48-71-32, 48-71-84
Telex: 038-410

MEXICO
Hewlett-Packard Mexico
S.A. de C.V.
Av. Periferico Sur No. 6501
Teseapan, Xochimilco
Mexico 23, D.F.
Tel: 905-676-4600
Hewlett-Packard Mexicana,
S.A. de C.V.
Ave. Constitución No. 2184
Monterrey, N.L.
Tel: 48-71-32, 48-71-84
Telex: 038-410

NICARAGUA
Roberto Terán G.
Apartado Postal 689
Edificio Terán
Managua
Tel: 25114, 23412, 23454
Cable: ROTERAN Managua

PANAMA
Electrónico Balboa, S.A.
P.O. Box 4929
Calle Samuel Lewis
Ciudad de Panama
Tel: 64-2700

PERU
Compañía Electro Médica S.A.
Los Flamencos 145
San Isidro Casilla 1030
Lima 1
Tel: 41-4325
Cable: ELMED Lima

PUERTO RICO
Hewlett-Packard Inter-Americas
Puerto Rico Branch Office
Jeffers 6
No. 203 Urb. Country Club
Carolina 00924
Tel: (809) 762-7255
Telex: 345 0514

URUGUAY
Pablo Ferrando S.A.
Comercial e Industrial
Avenida Italia 2877
Cable de Correo 370
Montevideo
Tel: 40-3102
Cable: RADIUM Montevideo

Telex: 3483103 Curunda,
Canal Zone
Cable: ELECTRON Panama

VENEZUELA
Hewlett-Packard de Venezuela
C.A.
P.O. Box 50933
Caracas 105
Los Ruices Norte
3a Transversal
Edificio Segre
Caracas 107
Tel: 35-00-11 (20 lines)
Tel: 25146 HEWPACK
Cable: HEWPACK Caracas

VENEZUELA
Hewlett-Packard de Venezuela
C.A.
P.O. Box 50933
Caracas 105
Los Ruices Norte
3a Transversal
Edificio Segre
Caracas 107
Tel: 35-00-11 (20 lines)
Tel: 25146 HEWPACK
Cable: HEWPACK Caracas

FOR AREAS NOT LISTED, CONTACT:
Hewlett-Packard
Inter-Americas
3200 Hillview Ave.
Palo Alto, California 94304
Tel: (415) 493-1501
TWX: 910-373-1260
Cable: HEWPACK PAO ALTO
Tel: 034-6300, 034-8493

ARGENTINA
Hewlett-Packard Argentina
S.A.
Av. Leandro N. Alem 822 - 12
1900 - Buenos Aires
Tel: 31-4963-4 S.B. and 7
Telex: 122443 AR CIGY
Cable: HEWPACK ARG

BOLIVIA
Casa Karin S.A.
Calle Potosi 1130
P.O. Box 500
La Paz
Tel: 41330-53221
Telex: OWC BA 5298 IIT 356006Z
Cable: KAVLIN

BRAZIL
Hewlett-Packard do Brasil
I.E. C. Ltda.
Avenida Rio Negro 980
Alphaville
06400-Barueri SP
Tel: 429-3222
Hewlett-Packard do Brasil
I.E. C. Ltda.
Rua Padre Chagas, 35
90000-Porto Alegre-RS
Tel: (0512) 22-2998, 22-5621
Cable: HEWPACK Porto Alegre
Hewlett-Packard do Brasil
I.E. C. Ltda.
Rua Siqueira Campos, 53
Copacabana
20000-Rio de Janeiro
Tel: 257-80-94-DDD (021)
Telex: 398-212-9605 HEWP-BR
Cable: HEWPACK
Rio de Janeiro

CHILE
Calcagni y Metcalfe Ltda.
Alameda 580-01 807
Casilla 2118
Santiago 1
Tel: 398813
Telex: 3520001 CALMET
Cable: CALMET Santiago

COLUMBIA
Instrumentación
Henrik A. Langebaek & Kier S.A.
Carrera 7 No. 48-75
Apartado Aéreo 6287
Bogotá, D.E.
Tel: 69-88-77
Cable: AARIS Bogotá
Telex: 044-400

COSTA RICA
Centífica Costarricense S.A.
Avenida 2, Calle 5
San Pedro de Montes de Oca
Apartado 10159
San José
Tel: 24-38-20, 24-08-09
Telex: 2367 GALGR BR
Cable: GALGUR

CYPRUS
Kypricos
15 Gregorios & Xenopoulos Rd.
P.O. Box 1152
CY-Nicosia
Tel: 4502879
Cable: KYPRONICS PANDEHIS
Telex: 3018

CZECHOSLOVAKIA
Vývojova a Provozní Závádna
Výzkumný Ústav v Bechovicích
CSSR-25097 Bechovice v Prahy
Tel: 89 33 41
Telex: 121333
Institute of Medical Biokinetics
Výzkumný Ústav Lekarské Bioniky
Jedlůva 6
CS-68346 Bratislava-Kramare
Tel: (91) 89 12 36
Cable: HEWPACK MARGN
Telex: 410770

DDR
Entwicklungsabtor der TU Dresden
Forschungsinstitut Meinsberg
DDR-7305
Waldheim/Meinsberg
Tel: 37 667
Telex: 112145
Export Contact AG Zuerich
Guenther Forger
Schlegelstrasse 15
1040 Berlin
Tel: 42-74-12
Telex: 111889

DENMARK
Hewlett-Packard A/S
Datavej 52
DK-3460 Birkerød
Tel: (02) 81 86 40
Cable: HEWPACK AS
Tel: 37409 hps dk
Hewlett-Packard A/S
Nærvæjg
DK-8500 Silkeborg
Tel: (06) 82 71 66
Telex: 37409 hps dk
Cable: HEWPACK AS

FINLAND
Hewlett-Packard OY
Nahkahuusitie 5
P.O. Box 6
SF-00211 Helsinki 21
Tel: (90) 6923031
Cable: HEWPACKOY Helsinki
Telex: 12-1563 HEWPA SF

FRANCE
Hewlett-Packard France
Quartier de Courtaouef
Boite Postale No. 6
F-91401 Orsay Cédex
Tel: (1) 907 78 25
Cable: HEWPACKSA Orsay
Telex: 600648
Hewlett-Packard France
Agence Régionale
Le Saquin
Chemin des Mouilles

GERMAN FEDERAL REPUBLIC
Hewlett-Packard GmbH
Vertriebszentrale Frankfurt
Bernerstrasse 117
Postfach 560 140
D-8000 Frankfurt 56
Tel: (0611) 50 04-1
Cable: HEWPACKSA Frankfurt
Tel: (0611) 50 04-1
Cable: HEWPACKSA Frankfurt
Tel: 04 13249 hpfmd
Hewlett-Packard GmbH
Technisches Buero Böblingen
Herrenbergerstrasse 110

GERMAN FEDERAL REPUBLIC
Hewlett-Packard GmbH
Vertriebszentrale Frankfurt
Bernerstrasse 117
Postfach 560 140
D-8000 Frankfurt 56
Tel: (0611) 50 04-1
Cable: HEWPACKSA Frankfurt
Tel: (0611) 50 04-1
Cable: HEWPACKSA Frankfurt
Tel: 04 13249 hpfmd
Hewlett-Packard GmbH
Technisches Buero Böblingen
Herrenbergerstrasse 110

GERMAN FEDERAL REPUBLIC
Hewlett-Packard GmbH
Vertriebszentrale Frankfurt
Bernerstrasse 117
Postfach 560 140
D-8000 Frankfurt 56
Tel: (0611) 50 04-1
Cable: HEWPACKSA Frankfurt
Tel: (0611) 50 04-1
Cable: HEWPACKSA Frankfurt
Tel: 04 13249 hpfmd
Hewlett-Packard GmbH
Technisches Buero Böblingen
Herrenbergerstrasse 110

GERMAN FEDERAL REPUBLIC
Hewlett-Packard GmbH
Vertriebszentrale Frankfurt
Bernerstrasse 117
Postfach 560 140
D-8000 Frankfurt 56
Tel: (0611) 50 04-1
Cable: HEWPACKSA Frankfurt
Tel: (0611) 50 04-1
Cable: HEWPACKSA Frankfurt
Tel: 04 13249 hpfmd
Hewlett-Packard GmbH
Technisches Buero Böblingen
Herrenbergerstrasse 110

GERMAN FEDERAL REPUBLIC
Hewlett-Packard GmbH
Vertriebszentrale Frankfurt
Bernerstrasse 117
Postfach 560 140
D-8000 Frankfurt 56
Tel: (0611) 50 04-1
Cable: HEWPACKSA Frankfurt
Tel: (0611) 50 04-1
Cable: HEWPACKSA Frankfurt
Tel: 04 13249 hpfmd
Hewlett-Packard GmbH
Technisches Buero Böblingen
Herrenbergerstrasse 110

GERMAN FEDERAL REPUBLIC
Hewlett-Packard GmbH
Vertriebszentrale Frankfurt
Bernerstrasse 117
Postfach 560 140
D-8000 Frankfurt 56
Tel: (0611) 50 04-1
Cable: HEWPACKSA Frankfurt
Tel: (0611) 50 04-1
Cable: HEWPACKSA Frankfurt
Tel: 04 13249 hpfmd
Hewlett-Packard GmbH
Technisches Buero Böblingen
Herrenbergerstrasse 110

GERMAN FEDERAL REPUBLIC
Hewlett-Packard GmbH
Vertriebszentrale Frankfurt
Bernerstrasse 117
Postfach 560 140
D-8000 Frankfurt 56
Tel: (0611) 50 04-1
Cable: HEWPACKSA Frankfurt
Tel: (0611) 50 04-1
Cable: HEWPACKSA Frankfurt
Tel: 04 13249 hpfmd
Hewlett-Packard GmbH
Technisches Buero Böblingen
Herrenbergerstrasse 110

GERMAN FEDERAL REPUBLIC
Hewlett-Packard GmbH
Vertriebszentrale Frankfurt
Bernerstrasse 117
Postfach 560 140
D-8000 Frankfurt 56
Tel: (0611) 50 04-1
Cable: HEWPACKSA Frankfurt
Tel: (0611) 50 04-1
Cable: HEWPACKSA Frankfurt
Tel: 04 13249 hpfmd
Hewlett-Packard GmbH
Technisches Buero Böblingen
Herrenbergerstrasse 110

GERMAN FEDERAL REPUBLIC
Hewlett-Packard GmbH
Vertriebszentrale Frankfurt
Bernerstrasse 117
Postfach 560 140
D-8000 Frankfurt 56
Tel: (0611) 50 04-1
Cable: HEWPACKSA Frankfurt
Tel: (0611) 50 04-1
Cable: HEWPACKSA Frankfurt
Tel: 04 13249 hpfmd
Hewlett-Packard GmbH
Technisches Buero Böblingen
Herrenbergerstrasse 110

GERMAN FEDERAL REPUBLIC
Hewlett-Packard GmbH
Vertriebszentrale Frankfurt
Bernerstrasse 117
Postfach 560 140
D-8000 Frankfurt 56
Tel: (0611) 50 04-1
Cable: HEWPACKSA Frankfurt
Tel: (0611) 50 04-1
Cable: HEWPACKSA Frankfurt
Tel: 04 13249 hpfmd
Hewlett-Packard GmbH
Technisches Buero Böblingen
Herrenbergerstrasse 110

GERMAN FEDERAL REPUBLIC
Hewlett-Packard GmbH
Vertriebszentrale Frankfurt
Bernerstrasse 117
Postfach 560 140
D-8000 Frankfurt 56
Tel: (0611) 50 04-1
Cable: HEWPACKSA Frankfurt
Tel: (0611) 50 04-1
Cable: HEWPACKSA Frankfurt
Tel: 04 13249 hpfmd
Hewlett-Packard GmbH
Technisches Buero Böblingen
Herrenbergerstrasse 110

GERMAN FEDERAL REPUBLIC
Hewlett-Packard GmbH
Vertriebszentrale Frankfurt
Bernerstrasse 117
Postfach 560 140
D-8000 Frankfurt 56
Tel: (0611) 50 04-1
Cable: HEWPACKSA Frankfurt
Tel: (0611) 50 04-1
Cable: HEWPACKSA Frankfurt
Tel: 04 13249 hpfmd
Hewlett-Packard GmbH
Technisches Buero Böblingen
Herrenbergerstrasse 110

GERMAN FEDERAL REPUBLIC
Hewlett-Packard GmbH
Vertriebszentrale Frankfurt
Bernerstrasse 117
Postfach 560 140
D-8000 Frankfurt 56
Tel: (0611) 50 04-1
Cable: HEWPACKSA Frankfurt
Tel: (0611) 50 04-1
Cable: HEWPACKSA Frankfurt
Tel: 04 13249 hpfmd
Hewlett-Packard GmbH
Technisches Buero Böblingen
Herrenbergerstrasse 110

GERMAN FEDERAL REPUBLIC
Hewlett-Packard GmbH
Vertriebszentrale Frankfurt
Bernerstrasse 117
Postfach 560 140
D-8000 Frankfurt 56
Tel: (0611) 50 04-1
Cable: HEWPACKSA Frankfurt
Tel: (0611) 50 04-1
Cable: HEWPACKSA Frankfurt
Tel: 04 13249 hpfmd
Hewlett-Packard GmbH
Technisches Buero Böblingen
Herrenbergerstrasse 110

D-7030 Böblingen, Württemberg
Tel: (0731) 667-1
Cable: HEPAK Böblingen
Telex: 07265739 bbn

Hewlett-Packard GmbH
Technisches Büro Düsseldorf
Emanuel-Leitz-Str. 1 (Seestern)
D-4000 Düsseldorf 11
Tel: (0211) 59711
Telex: 085/6 533 hppd d

Hewlett-Packard GmbH
Technisches Büro Hamburg
Wendenstrasse 23
D-2000 Hamburg 1
Tel: (040) 24 13 83
Cable: HEWPACKSA Hamburg
Telex: 21 6332 hpph d

Hewlett-Packard GmbH
Technisches Büro Hannover
Am Grossmarkt 5
D-3000 Hannover 91
Tel: (0511) 46 80 01
Telex: 092 3259

Hewlett-Packard GmbH
Werk Göttingen
Ohmstrasse 6
D-7500 Karlsruhe 41
Tel: (0721) 69 40 06
Telex: 07-825707

Hewlett-Packard GmbH
Technisches Büro Nürnberg
Neumeyer Str. 90
D-8500 Nürnberg
Tel: (0911) 56 30 83/85
Telex: 0623 860

Hewlett-Packard GmbH
Technisches Büro München
Unterhachinger Strasse 28
ISAR Center
D-8012 Ottobrunn
Tel: (089) 601 30 61/7
Cable: HEWPACKSA München
Telex: 0524985

Hewlett-Packard GmbH
Technisches Büro Berlin
Keith Strasse 2-4
D-1000 Berlin 30
Tel: (030) 24 90 86
Telex: 18 3405 hpbm d

GREECE
Kostas Karayannis
8B, Omirou Street
GR-Athens 133
Tel: 3237731
Cable: RAKAR Athens
Telex: 21 59 62 rxar gr

Medical only
"INTECO" G. Papathanassiou & Co.
Marni 17
GR - Athens 103
Tel: 522 1915
Cable: INTEKNIKA Athens
Telex: 21 5329 INTE GR

Medical only
Technomed Hellas Ltd.
52, Skoufa Street

GR - Athens 135
Tel: 362 622, 353 3830
Cable: ETALAK Athens
Telex: 21-4693 ETAL GR

HUNGARY
Műszaki
Műszaki Ügyi és Mérési Technikai
Szolgálat
Lenin Krt. 67
1391 Budapest XV
Tel: 42 03 38
Telex: 22 51 14

ICELAND
Medical only
Elding Trading Company Inc.
Hafnarvegur - Tryggvatoru
IS-Reykjavik
Tel: 58 20
Cable: ELDING Reykjavik

IRAN
Hewlett-Packard Iran Ltd.
No. 13, Fourteenth St.
Miramad Avenue
P.O. Box 41/2419
IR-Tehran
Tel: 851082-7
Telex: 21 25 74 khm ir

IRAQ
Hewlett-Packard Trading Co.
4/1/8 Mansour City
Baghdad
Tel: 5517827
Telex: 2455 hppairaq iq
Cable: HEWPACDAD, Baghdad Iraq

IRELAND
Hewlett-Packard Ltd.
King Street Lane
GB-Winnerah, Wokingham
Berks. RG11 5AR
Tel: (0734) 78 47 74
Telex: 847178/848179

ITALY
Hewlett-Packard Italiana S.p.A.
Via Amerigo Vesputici 2
Caseggi postale 3645
I-20100 Milano
Tel: (2) 6251 (10 lines)
Cable: HEWPACKIT Milano
Telex: 32046

Hewlett-Packard Italiana S.p.A.
Via Pietro Maroncelli 40
(ang. Via Visentini)
I-35100 Padova
Tel: (49) 56 48 88
Telex: 41912 HWpack

Medical only
Hewlett-Packard Italiana S.p.A.
Via G. Agnardi, 7
I-56100 Pisa
Tel: (050) 2 32 04
Telex: 32046 via Milano

Hewlett-Packard Italiana S.p.A.
Via G. Armetini 10
I-00143 Roma

Tel: (06) 54 69 61
Telex: 61 24 53 hepa pi
Cable: HEWPACKIT Roma

Hewlett-Packard Italiana S.p.A.
Corso Giovanni Lanza
I-1031 Torino
Tel: (011) 58245/589308
Telex: 36190

Medical/Calculators only
Hewlett-Packard Italiana S.p.A.
Via Principe Nicola 43 G/C
I-05126 Catania
Tel: (095) 37 05 04

Hewlett-Packard Italiana S.p.A.
Via Amerigo Vesputici, 9
I-80142 Napoli
Tel: (081) 53 77 11

Hewlett-Packard Italiana S.p.A.
Via E. Masi, 9/B
I-40137 Bologna
Tel: (051) 30 78 87

KUWAIT
Al-Khalidya Trading &
Contracting Co.
P.O. Box 830-Saft
Kuwait
Tel: 424910-411726
Telex: 2481 arsep kt
Cable: VISCONT

LUXEMBURG
Hewlett-Packard Benelux
S.A./N.V.
Avenue du Col-Vert, 1.
(Greenkaaglan)
B-1170 Brussels
Tel: (02) 672 22 40
Cable: PALOGEN Brussels
Telex: 23 494

MOROCCO
Gerep
190, Blvd. Brahim Roudani
Casablanca
Tel: 25-18-7625-90-99
Cable: Gerep-Casa
Telex: 23739

NETHERLANDS
Hewlett-Packard Benelux N.V.
Van Heuven Goedhartlaan 121
P.O. Box 667
NL-1134 Amstelveen
Tel: (020) 47 20 21
Cable: PALOGEN Amsterdam
Telex: 13 216 hpa nl

NORWAY
Hewlett-Packard Norge A/S
Nesveien 13
Box 149
N-1344 Haslum
Tel: (02) 53 83 60
Telex: 16621 hpnas n

POLAND
Biuro Informacji Technicznej
Hewlett-Packard
Ul. Slawek 2, 6P
00-950 Warszawa

Tel: 395962/395187
Telex: 61 24 53 hepa pi
UNIPAN
Zaklad Doswiadczalny
Budowy Aparatury Naukowej
Ul. Krajowej Rady Narodowej 51/55
00-800 Warszawa
Tel: 36190

Telex: 81 46 48
Zaklady Naprawcze Sprzetu
Medycznego
Plac Komuny Paryskiej 6
90-007 Lodz
Tel: 334 41, 337-83

PORTUGAL
Teletra-Empresa Técnica de
Equipamentos Eléctricos S.a.r.l.
Rua Rodrigo de Fonseca 103
P.O. Box 2531
P-Lisbon
Tel: (1) 98 60 72
Cable: TELETRA Lisbon
Telex: 12598

Medical only
Mundinter
Intercomercio Mundial de Comercio
S.a.r.l.
Av. A. A. de Aguiar 138
P.O. Box 2781
P-Lisbon
Tel: (1) 53 21 31/7
Cable: INTERCAMBIO Lisbon

RUMANIA
Hewlett-Packard Reprezentanta
Bd. N. Balcescu 16
Bucharest
Tel: IS8023/138885
Telex: 10440

I.I.R.U.C.
Intreprinderia Pentru
Intretinerea
Si Reparatia Utilajelor de Calcul
B-dul prof. Dimitrie Pompei 6
Bucharest-Sectorul 2
Tel: 12 64 30
Telex: 11716

SAUDI ARABIA
Modern Electronic Establishment
King Abdul Aziz str. (Head office)
P.O. Box 1228
Jeddah
Tel: 31173-33220
Cable: ELECTRA 2
P.O. Box 2728 (Service center)

Riyadh
Tel: 62596-66232
Cable: RAUDFOC

SPAIN
Hewlett-Packard Española S.A.
Genova, Calle 3
E-Madrid 16
Tel: (1) 458 26 00 (10 lines)
Telex: 23515 hpe

Hewlett-Packard Española S.A.
Mianesedo 21-23

E-Barcelona 17
Tel: Adex. 01 203 6200 (5 lines)
Telex: 52603 hpe e

Hewlett-Packard Española S.A.
Av. Ramón y Cajal, 1
Edificio Valencia, planta 9.
E-Sevilla 5
Tel: 64 44 54/58

Hewlett-Packard Española S.A.
Edificio Albia II 7° B
E-Bilbao-1
TR-Ankara
Tel: 23 83 06/23 82 06

Calculators Only
Hewlett-Packard Española S.A.
Gran Via Fernando El Católico, 67
E-Valencia-8
Tel: 308 67 28/326 85 55

SWEDEN
Hewlett-Packard Sverige AB
Enighetsvägen 1-3
Fack
S-161 20 Bromma 20
Tel: (08) 730 05 50
Cable: MEASUREMENTS
Stockholm

Telex: 10721
Hewlett-Packard Sverige AB
Ostra Vintergatan 22
S-702 40 Örebro
Tel: (019) 14 07 20

Hewlett-Packard Sverige AB
Fridslipgatan 30
S-421 32 Västra Frölunda
Tel: (031) 49 09 50
Telex: 10721 Via Bromma Office

SWITZERLAND
Hewlett-Packard (Schweiz) AG
Zürcherstrasse 20
P.O. Box 307
CH-8052 Schlieren-Zürich
Tel: (01) 732 52 40/730 18 21
Cable: HPAG CH
Telex: 53933 hpaag ch

Hewlett-Packard (schweiz) AG
Château Bloc 19
CH-1219 Le Lignon-Geneva
Tel: (022) 96 03 22
Cable: HEWPACKAG Geneva
Telex: 277 333 hpaag ch

SYRIA
Medical/Calculator only
Sawah & Co
Place Azmé
B-P 2308
SYR-Damascus
Tel: 16367, 19697, 14268
Cable: RAOUFOS

TURKEY
Telekom Engineering Bureau
P.O. Box 437
Beysoglu
TR-Istanbul
Tel: 49 40 40
Cable: TELEMATIOM Istanbul
Telex: 23699

Medical only
E. Adex. 01 203 6200 (5 lines)
Muhendislik Kolektif Sirketi
Adakale Sokak 41/6
TR-Ankara
Tel: 175622

Analytical only
Yilmaz Özyurek
Milli Müdafaa Cad. No. 16/6
Kizilay
TR-Ankara
Tel: 25 03 09
Telex: 42576 ozek tr

UNITED KINGDOM
Hewlett-Packard Ltd.
King Street Lane
GB-Winnerah, Wokingham
Berks. RG11 5AR
Tel: (0734) 78 47 74
Cable: HEWPAC UK
Telex: 847178/9

Hewlett-Packard Ltd.
Trafalgar House
Navigation Road
Atrincham
Chesham WA14 1NU
Tel: (0561) 928 6422
Telex: 668086

Hewlett-Packard Ltd.
Lyon Court
Hereward Rise
Dudley Road
Halesowen
West Midlands B62 8SD
Tel: (021) 550 9911
Telex: 339105

Hewlett-Packard Ltd.
Wedge House
799, London Road
GB-Thornthorpe Heath
Surrey CR4 0XL
Tel: (01) 864 0103/8
Telex: 946825

Hewlett-Packard Ltd.
c/o Makro
South Service wholesale Centre
Wear Industrial Estate
Washington
GB-New Town, County Durham
Tel: Washington 464001 ext. 57/58

Hewlett-Packard Ltd.
10, Wesley St
GB-Castletford
West Yorkshire WF10 1AE
Tel: (09775) 50402
Telex: 557355

Hewlett-Packard Ltd.
1, Wallace Way
GB-Hitchin
Herts
Tel: (0462) 52824/56704
Telex: 825981

Hewlett-Packard Ltd
25, Adex. 01 203 6200 (5 lines)
Muhendislik Kolektif Sirketi
Adakale Sokak 41/6
TR-Ankara
Tel: 175622

USSR
Hewlett-Packard
Representative Office USSR
Pokrovsky Boulevard 4/17-KW 12
Moscow, 101000
Tel: 31 58 79/32 16 74
Telex: 31583

YUGOSLAVIA
Iskra-standard/Hewlett-Packard
Miklosiceva 38/VI
61000 Ljubljana
Tel: 31 58 79/32 16 74
Telex: 31583

SOCIALIST COUNTRIES
NOT SHOWN PLEASE CONTACT:
Hewlett-Packard Ges. m. b. H.
P.O. Box
A-1205 Vienna, Austria
Tel: (0222) 35 16 21 to 27
Cable: HEWPAC Vienna
Telex: 75923 hewpak a

MEDITERRANEAN AND
MIDDLE EAST COUNTRIES
NOT SHOWN PLEASE CONTACT:
Hewlett-Packard S.A.
Mediterranean and Middle
East Operations
35, Kolokotroni Street
Plata Kefalariou
GR-Kifissia-Athens, Greece
Tel: 808337/359429
Telex: 21-6588
Cable: HEWPACKSA Athens

FOR OTHER AREAS
NOT LISTED CONTACT
Hewlett-Packard S.A.
7, rue du Bois-du-Lan
P.O. Box
CH-1217 Meyrin 2 - Geneva
Switzerland
Tel: (022) 82 70 00
Cable: HEWPACKSA Geneva
Telex: 2 24 86

UNITED STATES

ALABAMA

6296 Wheelburg Dr., S.E.
P.O. Box 4207

Montevalle 25802
Tel: (205) 961-4961

Medical Only
228 W. Valley Ave.

Room 220
Birmingham 35209
Tel: (205) 942-2081/2

ARIZONA

2336 E. Magnolia St.
Phoenix 85034

Tel: (602) 244-1361

2424 East Aragon Rd
Tucson 85706

Tel: (602) 294-3148

*ARKANSAS

Medical Service Only
P.O. Box 5646

Brady Station
Little Rock 72215

Tel: (501) 376-1844

CALIFORNIA

1430 East Orangethorpe Ave.
Fullerton 92631

Tel: (714) 870-1000

3939 Lankershim Boulevard
North Hollywood 91604

Tel: (213) 877-1282
TWX: 910-499-2671

5400 West Rosecrans Blvd.
P.O. Box 92105

World Way Postal Center
Los Angeles 90009

Tel: (213) 978-7500

*Los Angeles
Tel: (213) 776-7500

3003 Scott Boulevard
Santa Clara 95050

Tel: (408) 249-7000
TWX: 910-338-0518

*Ridgcrest
Tel: (714) 446-6165

644 W. North Market Blvd
Sacramento 95834

Tel: (916) 929-7222

9606 Aero Drive
P.O. Box 23333

San Diego 92123
Tel: (714) 278-3200

COLORADO
5600 South Ulster Parkway
Englewood 80110

Tel: (303) 771-3455

CONNECTICUT

12 Lunar Drive
New Haven 06525

Tel: (203) 389-6551
TWX: 710-465-2029

FLORIDA

P.O. Box 24210
2806 W. Oakland Park Blvd.

Ft. Lauderdale 33311

Tel: (305) 731-2020

*Jacksonville
Medical Service only
Tel: (904) 398-0663

Fullerton 92631
P.O. Box 13910

6177 Lake Ellenor Dr.
Orlando 32809

Tel: (305) 859-2900

P.O. Box 12826
Pensacola 32575

Tel: (904) 476-8422

GEORGIA

P.O. Box 105005
Atlanta 30348

Tel: (404) 955-1500
TWX: 810-766-4890

Medical Service Only
*Augusta 30903

Tel: (404) 736-0592

P.O. Box 2103
Warner Robins 31098

Tel: (912) 922-0449

HAWAII

7875 So. King Street
Honolulu 96814

Tel: (808) 955-4455

Telex: 723-705

ILLINOIS

5251 Tolview Dr.
Rolling meadows 60008

Tel: (312) 255-9800
TWX: 910-687-2260

INDIANA

7301 North Shadeland Ave.
Indianapolis 46250

Tel: (317) 842-1000
TWX: 810-260-1797

IOWA

2415 Heinz Road
Iowa City 52240

Tel: (319) 338-9466

KENTUCKY

Medical Only
Atkinson Square

3901 Atkinson Dr.
Suite 407 Atkinson Square

Louisville 40218
Tel: (502) 456-1573

LOUISIANA

P.O. Box 840
3229-39 Williams Boulevard

Kenner 70063
Tel: (504) 443-6201

MARYLAND

6707 Whiteside Road
Baltimore 21207

Tel: (301) 944-5400
TWX: 710-862-9157

2 Choke Cherry Road
Rockville 20850

Tel: (301) 948-6370
TWX: 710-828-9684

MASSACHUSETTS

32 Hartwell Ave.

Lexington 02173
Tel: (617) 861-8960

TWX: 710-326-6904

MICHIGAN

23855 Research Drive
Farmington Hills 48024

Tel: (313) 476-5400

724 West Centre Ave.
Kalamazoo 49002

Tel: (606) 323-8362

MINNESOTA

2400 N. Prior Ave.
St. Paul 55113

Tel: (612) 636-0700

MISSISSIPPI

*Jackson
Medical Service only
Tel: (601) 982-9363

MISSOURI

11131 Colorado Ave.
Kansas City 64137

Tel: (816) 763-8000
TWX: 910-771-2087

1024 Executive Parkway
St. Louis 63141

Tel: (314) 878-0200

NEBRASKA

Medical Only
7171 Mercy Road
Suite III

Omaha 68106
Tel: (402) 392-0948

NEW JERSEY

W 120 Century Rd.
Paramus 07652

Tel: (201) 265-5000
TWX: 710-990-4951

Crystal Brook Professional
Building
Eatontown 07724

Tel: (201) 542-1384

NEW MEXICO

P.O. Box 11634

Station E
1300 Lomas Blvd. N.E.

Albuquerque 87123
Tel: (505) 292-1330

TWX: 910-989-1185

156 Wyatt Drive
Las Cruces 88001

Tel: (505) 526-2484
TWX: 910-9983-0550

NEW YORK

6 Automation Lane
Computer Park

Albany 12205
Tel: (518) 458-1550

201 South Avenue
Poughkeepsie 12601

Tel: (914) 454-7330
TWX: 510-253-5981

650 Perinton Hill Office Park
Fairport 14450

Tel: (716) 223-9950

5858 East Molloy Road
Syracuse 13211

Tel: (315) 454-2486
TWX: 710-541-0482

1 Crossways Park West
Woodbury 11797

Tel: (516) 521-0300
TWX: 710-990-4951

NORTH CAROLINA

P.O. Box 5188
1923 North Main Street

High Point 27262
Tel: (919) 885-8101

OHIO

15600 Sprague Road
Cleveland 44130

Tel: (216) 243-7300
TWX: 810-423-9430

330 Progress Rd
Dayton 45449

Tel: (513) 859-8202

1041 Kingsmill Parkway
Houston 77036

Tel: (713) 776-6400

205 Billy Mitchell Road
San Antonio 78226

Tel: (512) 434-8241

OKLAHOMA

P.O. Box 32008
Oklahoma City 73132

Tel: (405) 721-0200

OREGON

17890 SW Lower Boones
Ferry Road

Tualatin 97062
Tel: (503) 620-3350

111 Zeta Drive
PENNSYLVANIA

Tel: (412) 782-0400

1021 8th Avenue
King of Prussia Industrial Park

King of Prussia 19406
Tel: (215) 265-7000

TWX: 510-660-2670

SOUTH CAROLINA

6941-D N. Trenholm Road
Columbia 29260

Tel: (803) 782-6493

TENNESSEE

*Knoxville
Medical Service only
Tel: (615) 523-5022

3027 Vanguard Dr.
Director's Plaza

Memphis 38131
Tel: (901) 346-8370

Nashville
Medical Service only
Tel: (615) 244-5448

TEXAS
P.O. Box 1270
201 E. Arapaho Rd

Richardson 75080
Tel: (214) 231-6101

10535 Harwin Dr.
Houston 77036

Tel: (713) 776-6400

205 Billy Mitchell Road
San Antonio 78226

Tel: (512) 434-8241

UTAH

2160 South 3270 West Street
Salt Lake City 84119

Tel: (801) 972-4711

VIRGINIA

P.O. Box 12778
No. 7 Koger Exec. Center

Suite 212
Norfolk 23502

Tel: (804) 461-4025/6

P.O. Box 9669
2914 Hungary Springs Road

Richmond 23228
Tel: (804) 285-3431

TWX: 910-443-2446

WASHINGTON

Bellevue Office Pk.
1203 14th Ave. S.E.

Bellevue 98004
Tel: (206) 454-3971

TWX: 910-443-2446

*WEST VIRGINIA

Medical-Analytical Only
Charleston

Tel: (304) 345-1640

WISCONSIN

9004 West Lincoln Ave.
West Allis 53227

Tel: (414) 541-0550

FOR U.S. AREAS NOT LISTED:

Contact the regional office
nearest you: Atlanta, Georgia...

North Hollywood, California
Rockville, Maryland... Rolling Meadows,
Illinois. Their complete
addresses are listed above

*Service Only



01744-90902

PRINTED IN U.S.A.